

THE MARCONI REVIEW

No. 43.

July-August, 1933.

Editor: H. M. DOWSETT, M.I.E.E., F.Inst.P., M.Inst.R.E.

EXPERIMENTAL AND THEORETICAL STUDY OF THE POLAR DISTRIBUTION OF ENERGY IN A BEAM AT GREAT DISTANCE FROM THE SENDER

The following article discusses the question of the difference between theoretical and observed values of energy concentration from a beam aerial array as revealed by recent experiments made by the Marconi Company in conjunction with the British Post Office on the transmission from the Marconi Beam Station at Klipheuwel, South Africa.

A LARGE number of measurements of beam performances, particularly comparisons of the gain of a beam over a broadcast aerial with a given power, show that this gain does not always attain its theoretical value.

Results of an extended number of measurements are given by Bruce, I.R.E. Proc.,* in which the percentage of the time for which the gain is equal to or greater than a specified amount is plotted. Thus, for example, for 37 per cent. of the total time the gain is equal to or greater than half the maximum theoretical gain, but it is for only about 5 per cent. of the total working time that the beam gain approaches to within 10 per cent. of its maximum value. These observations were taken at New Jersey on the 16.39m. station at Rugby, i.e., GBS.

Many other observations also show this falling off from optimum performances. The explanation of these results requires a complete and exhaustive knowledge of transmission phenomena.

As a preliminary we may consider in what manner the gain may deviate from its theoretical optimum value. It is perhaps easiest to discuss this from the point of view of reception, remembering that the function of the beam (as far as energy considerations and gains are concerned) is the same in reception as in transmission.

To obtain the optimum gain, the rays received (or transmitted) must be in the direction of optimum reception (or transmission), and this condition must obtain over the whole face of the beam.

* Developments in S.W. Directive Antennas. Proc. I.R.E., Vol. 19, August, 1931, No. 8, pp. 1406-1432.

This may be alternatively expressed as the condition that the equiphase surfaces of the incoming signals must be plane and parallel to the surface of the beam array. This condition certainly does not obtain in the majority of cases of short wave transmission, for in the first place, we know quite definitely, from facsimile measurements, that the energy is transmitted along a number of rays of different angles of elevation.

To the first approximation the diversity in direction in the vertical plane does not matter in the case where the gain of a beam array over one of the elements of the beam is required, i.e., the horizontal directivity. But, of course, it is a factor in reducing the beam performance below its optimum value. Deviation of the rays in the horizontal plane are of greater importance. Evidence of such effects have been obtained from time to time on the Marconi-Adcock Directional Receiver, where deviations as great as 5° to 10° have been found. Some examples of such effects are given in the writer's "Investigation of Short Waves," Journal I.E.E., Vol. 67, No. 392, August, 1929, p. 1,013, and have been attributed to horizontal gradients of density in the Heaviside layer. These directional measurements taken with an Adcock aerial may be open to a certain amount of doubt.

Any residual reception of horizontally polarised rays may introduce errors and the interpretation of the bearing variation as due to a real shift of the beam may, therefore, be doubtful. Observations of the field intensity over a wide range of distance in front of a beam are not subject to this uncertainty. Theoretically, beams should give maximum intensity along a defined great circle perpendicular to the beam array, and should fall off in a known manner at other positions at the side of this great circle. The investigation of the field intensity over the front of a beam at great distances is therefore of great value in this connection and supplies answers to such questions as (A) Does the beam maintain its polar diagram over a long distance of transmission? (B) Does it deviate from the true great circle direction at any time or times? (C) What are the causes of the deviation from the ideal performance of a beam? Experiments of this nature were carried out by the Marconi Company in October, 1930, and by the British Post Office in conjunction with the Marconi Company in November, 1931. The transmitting station used was the 16.08m. Marconi Beam Station at Klipheval, South Africa.

If the beam behaves according to its theoretical expectation, then there should be a large variation of intensity over an arc between the extreme west and east of England.

A series of simultaneous field intensity measurements at various places on such an arc should give the horizontal intensity distribution and horizontal polar diagram of the beam measured at great distances (approximately 10,000 k.m.). The first experiments were on a more moderate scale. Simultaneous measurements were made at Somerton, a few miles from Bridgwater, in Somerset, England (on which the beam is directed), and at Broomfield, near Chelmsford, Essex, England, some 2.2 degrees off the optimum direction.

The second experiment was done on a more comprehensive scale. Four simultaneous measurements were made at places nearly equally spaced on the arc between Poldhu in Cornwall, nearly at the extreme west of England, and Clacton, Essex, at the extreme east of England. The locations were, Poldhu, Cornwall; Bridgwater, Somerset; Baldock, Herts; and Clacton, Essex. The angles subtended

by these at Klipheval, South Africa, were respectively: Poldhu, Bridgwater, $1^{\circ} 41'$, Bridgwater, Baldock, $1^{\circ} 56'$, and between Baldock and Clacton, $0.45'$. The extreme angle by these stations was therefore $4^{\circ} 24'$.

In the original experiment the angle subtended by the Somerton - Chelmsford arc was $2^{\circ} 12'$. In this test, the observations were made throughout four consecutive days, October 20th to October 23rd, 1930.

The measurements were made at Broomfield with the Type 205 semi-portable field measuring set, already described in THE MARCONI REVIEW.

A more portable set on the same lines of design was constructed and a comparative test at Chelmsford showed that the two agreed within the errors of measurement. This was set up in a hut at Somerton in sufficiently open ground to ensure normal results.

The results of the four days' tests are shown on the accompanying Curves (Figs. 1 and 2). Watch was kept only throughout the daylight hours on the 16.08m. transmission. A few observations were obtained on the 32m. night transmission, but these do not provide sufficient material for any deductions.

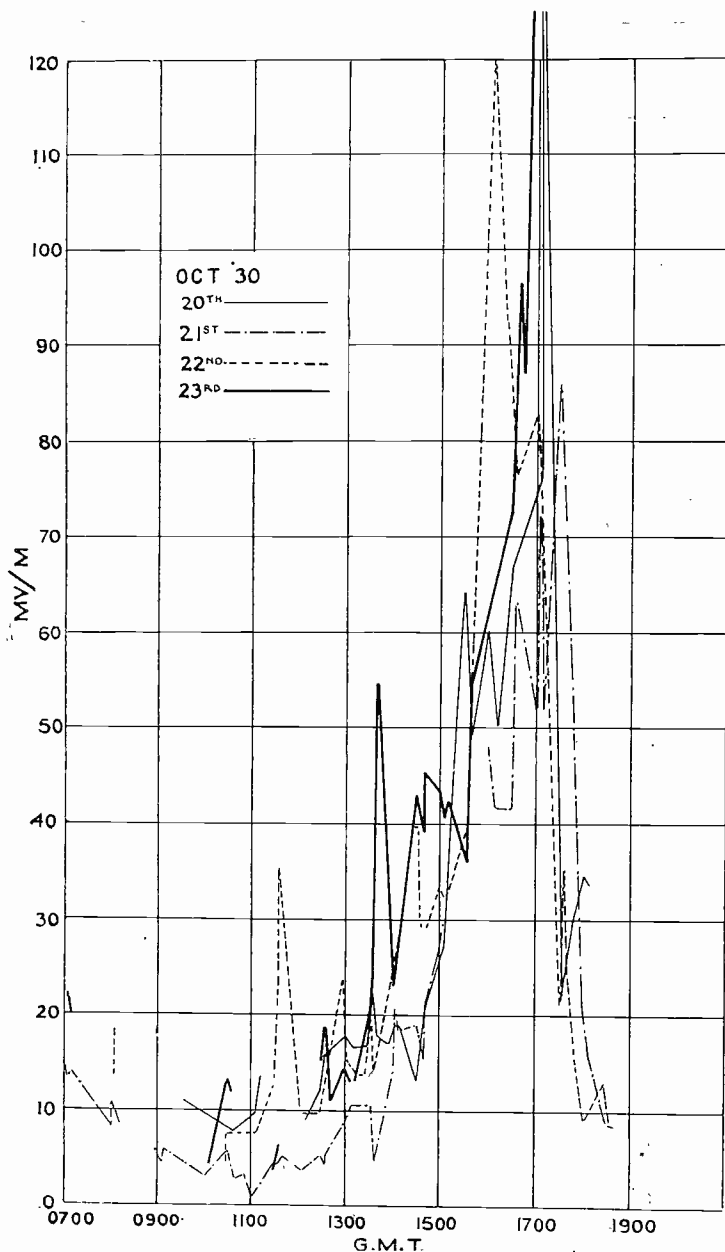

FIG. 1.

A glance at the Figs. 1 and 2 shows immediately that there is no very striking difference between the two, except in the sunset period (about 1630), when, contrary to expectations, the Chelmsford signals are considerably stronger than the Somerton ones.

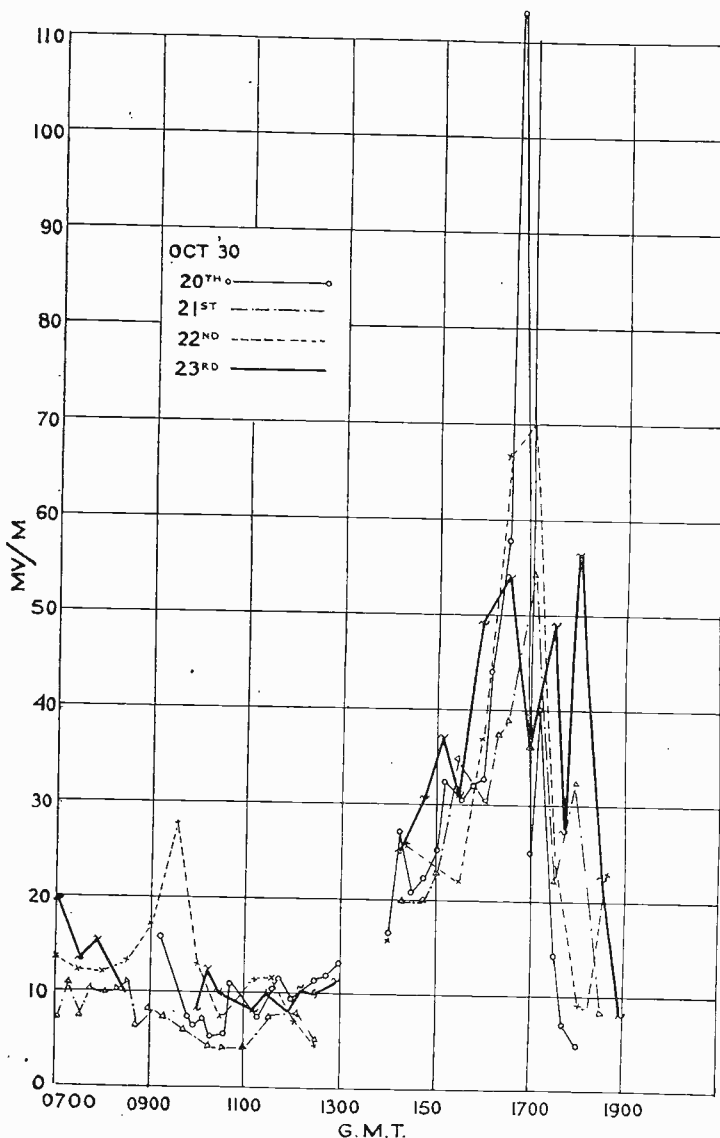

FIG. 2.

at Chelmsford. If the signals at the two places were always equal, the points in the diagram would cluster round a straight line at 45° to either axis. It will be seen that this is approximately the case for the weak signals which occur about midday. The points for the stronger signals, which occur near the sunset peaks at

On averaging the field strengths during the daylight hours, 0800 to 1300, a definite difference of 2.6 decibels appears in favour of Somerton. This is, however, very much less than the theoretically expected difference, which should be between 5.6 and 13 db. for the angular separation of the two receiving stations. The first figure is obtained on the assumption that the beam aperture is 20λ and the second 15λ aperture.

The Fig. 3 gives an alternative method of exhibiting the results.

In this method a simultaneous measurement at Chelmsford and Somerton (the measurements were arranged so as to obtain practically simultaneous observations every quarter hour) is represented by a single point in the diagram, the ordinate being the field strength at Somerton and the abscissa the simultaneous field strength

(1700 G.M.T.), Figs. 1 and 2, lie chiefly in the sector between the horizontal axis and the 45° line, showing that the signals at this time were actually much stronger at Chelmsford than at Somerton. Take, for example, the strongest signal recorded; it is 135.5 μ.v./m. at Chelmsford, but only 36 at Somerton, that is, only approximately quarter the strength. To account for this fact we must suppose that at the sunset

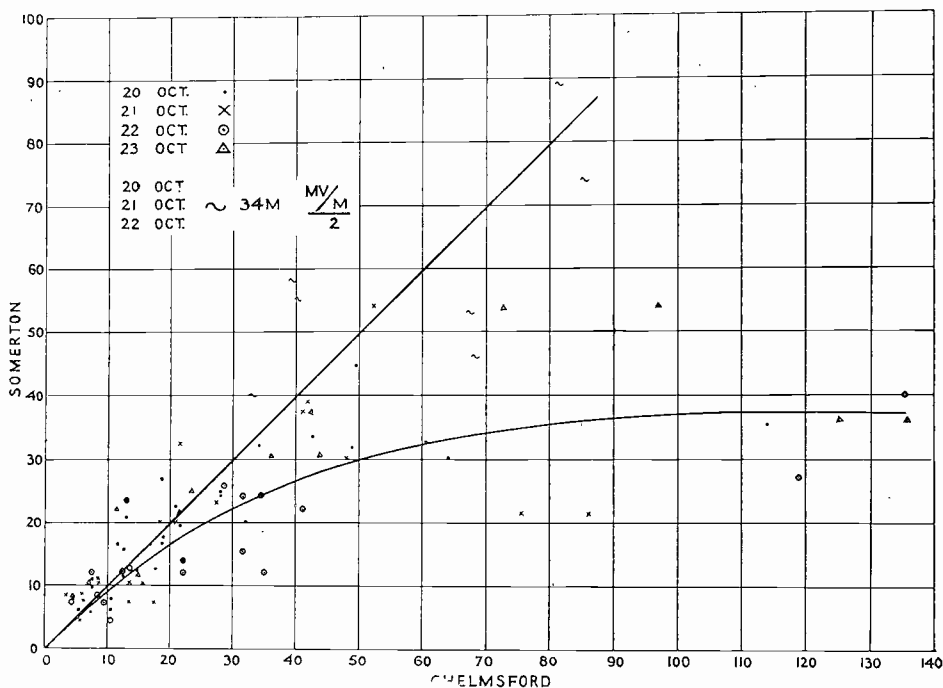

FIG. 3.

peak the beam is laterally deviated towards Chelmsford, so that the energy is showered on this spot rather than on Somerton. Such a lateral deviation in the beam is probably due to the marked horizontal gradient in ionic content across the ray direction which occurs at this time. An examination of a shadow chart, which gives the contours of maximum ionic density (both empirically and theoretically) shows that at this time the shadow band or the line dividing the light from the dark regions passes very nearly through Klipheval and Chelmsford simultaneously.

Sunset actually occurs slightly earlier at Chelmsford than at Klipheval; South Africa. We may represent this in a crude way diagrammatically as in Fig. 4, in which the shadow condition just after sunset, Chelmsford, and just before sunset, Klipheval, is represented. Regions to the right of the line are in shadow and to the left in light. The ionic density in the former region is less than in the latter, and consequently the phase velocity will be less in the region S than in the region L. This results in a refraction of the rays as shown in the figure towards the dark region and will therefore bend the beam from its true objective, Bridgwater, towards the east, where Chelmsford gets the full benefit. A more exact specification in terms of the shadow charts shows that there is no absolute discontinuity in the ionic density at the shadow band, but that the gradient of density from W to E

is greatest at this time, resulting in a gradual bending to the east of the beam rather than a sudden bend at O, the fictitious surface of separation.

To check this hypothesis, a watch was kept at Broomfield, Chelmsford, for the deviation in bearing which should accompany this change. Bearings were taken on the Marconi-Adcock aerial through the period 1200 to 1800 G.M.T. on 26th October, 1930. Fig. 5 shows the results obtained, in which there is a well marked deviation towards the east at 1730, with a recovery at about 1800. The observations described here certainly suggest that there may be considerable lateral bending of the beam on occasions when there is a horizontal gradient of ionic density perpendicular to the direction of the ray.

The results obtained at midday when ionic conditions are uniform, suggest that the beam is not so sharp as it theoretically should be, that indeed there is some spreading of the beam, or else that the beam is not correctly centred on Bridgwater, or what is practically the same thing, Somerton. This conclusion must be taken with some reserve, because later results taken in conjunction with the Post Office show a gain at Bridgwater compared with values at Baldock, Poldhu and Clacton consistent with the theoretical sharpness of the beam.

In this respect the results of the first test and the second are not consistent, for the latter shows a gain of about 9 db. of Bridgwater over Chelmsford (interpolated), whereas the former shows only 2.6 db.

In this connection it must be remembered that the choice of sites may exercise a considerable influence, especially with such short waves where the elevation angle is small.

Recent results obtained by Potter and Friis, Proc. I.R.E.* show that an average gain of about 5—9 db. may be obtained by choosing a site for the receiver on the brow of a hill facing the transmitter, over and above the field at a situation some 1,000 feet back from the brow of the hill. At the time that our observations were made, the influence of the site was not so clearly realised and the sites not so carefully chosen as they might have been in the light of Potter and Friis' experiments.

Further Experiments.

These were made with the object of measuring the energy distribution over the front of the beam and determining the loss suffered at a receiving site at Baldock in comparison with Bridgwater, on which the beam is directed.

Measurements were made simultaneously at Poldhu, Cornwall; Bridgwater, Somerset; Baldock, Herts, and Clacton, Essex.

Post Office measuring instruments were situated at Bridgwater, Baldock and Clacton and Marconi measuring sets at Poldhu and Baldock. The sets were all carefully compared at Baldock before the tests and allowance made for the difference in calibration of the two sets.

The overlapping measurements at Baldock with the Post Office and Marconi set allowed the difference Baldock-Poldhu and Baldock-Clacton to be made without any reference to the difference in calibration of the two types of set. It was, however, found that the differences in calibration of the Post Office and Marconi set remained constant on the average over the whole period.

The test was carried out over a period of approximately a fortnight, November 2nd to November 13th, 1931.

* Short Wave Reception. Proc. I.R.E., Vol. 20, April, 1932, No. 4, p. 699.

The tests comprised measurements of field intensity, every quarter hour in the period 0900 to 1700 G.M.T. daily with the exception of Sundays.

The average run of the diurnal field strengths at Poldhu, Bridgwater, Baldock and Clacton shows that the contrast between peak and minimum was not so great as in the previous year, but this may be partly due to the fact that the two sets of

observations were not taken quite at the same season. The latter observations taken in November should not show such extreme peak values as those taken in October, when the transmission along the shadow band at sunset is particularly good.

The general distribution of energy over the arc is best exhibited in Fig. 6, in which the hourly means of the db. above 1 μ .v./m. is plotted against the angular deviation from the centre line of the beam. Although individual results may differ by considerable amounts from time to time, it will be seen that the means are extraordinarily consistent.

The curves show the distribution of field intensity over the arc Poldhu-Clacton, for different hours of the day. These hourly means are taken because a casual glance at the curves for the different situations shows at once that there is a real alteration of distribution throughout the day which appears very definitely when the means are taken.

On examining these closely we observe that for most of the diurnal period, i.e., 1200 to 1600 G.M.T., the signal intensity shows a marked peak at

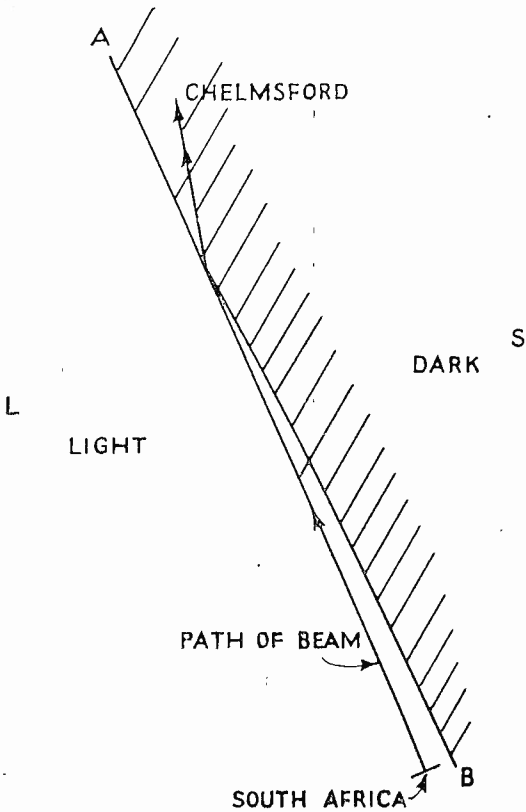

FIG. 4.

Bridgwater and falls away towards Poldhu and Baldock almost in accordance with the theoretical curve for an 18λ aperture. The theoretical fallings away between Baldock and Clacton is not maintained where the signals are some db. too high.

A striking feature of the results is that between 0900 and 1000 the signals are actually strongest at Poldhu and fall away uniformly to the east and that between 1000 and 1200 the maximum appears to be displaced to the west. There is no doubt about the significance of these results since the differences are large compared with their probable errors. We have here again evidence of a lateral shift of the beam, in this case to the west instead of the east; the amount of lateral shifts may be as much as 2° or 3° west.

There is an apparent slight lateral shift to the west slightly after the shadow peak at about 1700 (Curve Fig. 6). This is, I think, due to the slight difference in local time between the east and west of England; signals drop out rapidly after local sunset and therefore fall to a low value first at stations to the east and progressively later at more western situations.

Thus when the signal has dropped out at Clacton (it being well after sunset), it still remains stronger at Poldhu, where night is not so far advanced. There is, therefore, at a given time, a bias in favour of the western station. It is rather remarkable that there is no eastward bending as in the previous case, but this may probably be attributed to the fact that the ionic distribution is not so favourable for this as earlier in the year when the shadow band passes over the sender and receiver almost simultaneously.

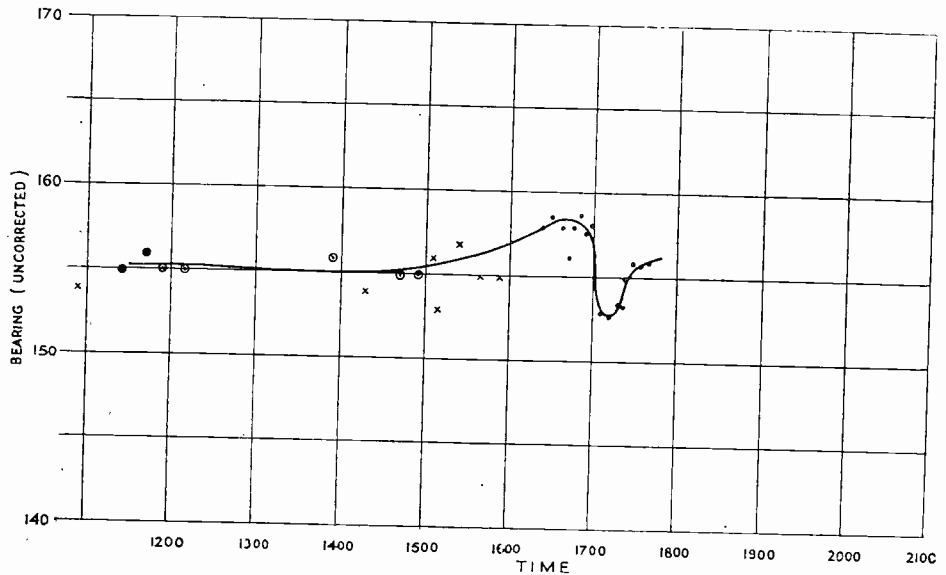

FIG. 5.

The deviation to the west at 0900 can again be explained with reference to the shadow chart. At this time there is quite a considerable ionic gradient towards the west, causing a bending in this direction. A point that is worth emphasising is that when the beam is bent to the west the gradient of intensity over the arc from Poldhu to Clacton is very much less than might be expected if the beam were bent bodily as much as 2° towards the west as it appears to be. It seems as if the beam were not only bent but also spread, some of the rays—for example, the high angle ones—being largely bent, and others, say, the low angle ones, being hardly bent at all.

On examining the theory given in the next section, it appears that such an effect would follow on the assumption that the rays are bent both by a vertical and by a horizontal gradient of ionic density.

A further example of the effects of lateral bending has been afforded by the behaviour of the 34m. beam transmission from India to England. This exhibited itself originally on many occasions as a very puzzling fade out of signals between the hours 1800 and 2000 in the winter months, November, December, January, 1930, 1931. On examining the shadow charts there appeared no obvious reason why such a fade should occur. The electron density on the route was sufficient, and according to our past experience, the attenuation should have been small. That the electron density was sufficient was clearly indicated by the fact that the signal intensity recovered after 2000 G.M.T., although the route was in more intense or later darkness.

It was noted that at the time of the fade the route India-Chelmsford ran parallel to the contour lines of constant density and that there was a rapid fall off in density at right angles to the path in a northerly direction. The effects were therefore attributed to the northward bending and spreading of the beam.

When the signals were observed on the Adcock D.F. at this time, a flattening

of the bearing and tendency to a southward deviation were noted. No doubt other anomalies of the same type can be explained on similar lines now that our eyes are opened to the possibilities of such an effect.

To settle the matter more definitely an analysis of the transmission of wireless waves through a layer graded both horizontally and vertically is required.

The shadow charts give a fairly good measure of the horizontal gradients that occur in various cases and an analysis should show whether the actual gradients are sufficient to produce the effects observed or whether they must be attributed to some other cause.

Transmission of Waves in an Ionised Gas in which there is a Horizontal as well as Vertical Gradient.

This problem offers considerably greater difficulties than the usual one where the gradient of ionic content is purely vertical, for in this case the rays in general are tortuous and not plane curves.

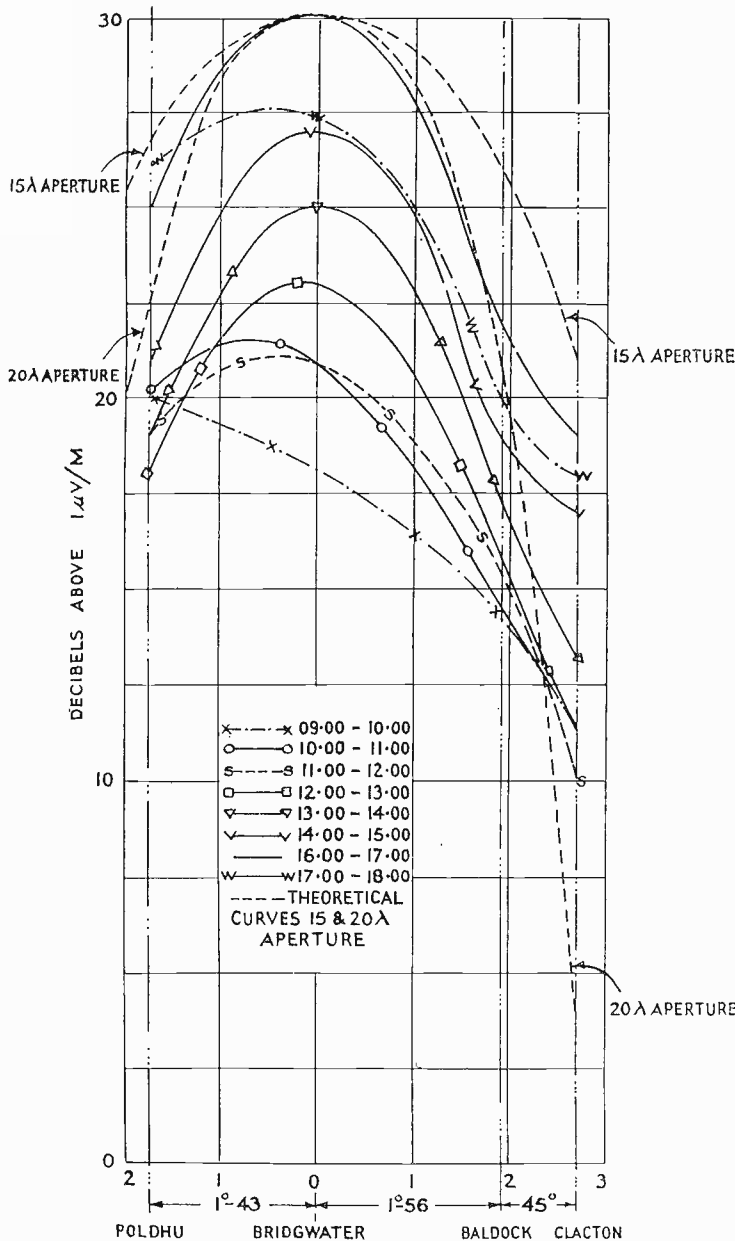
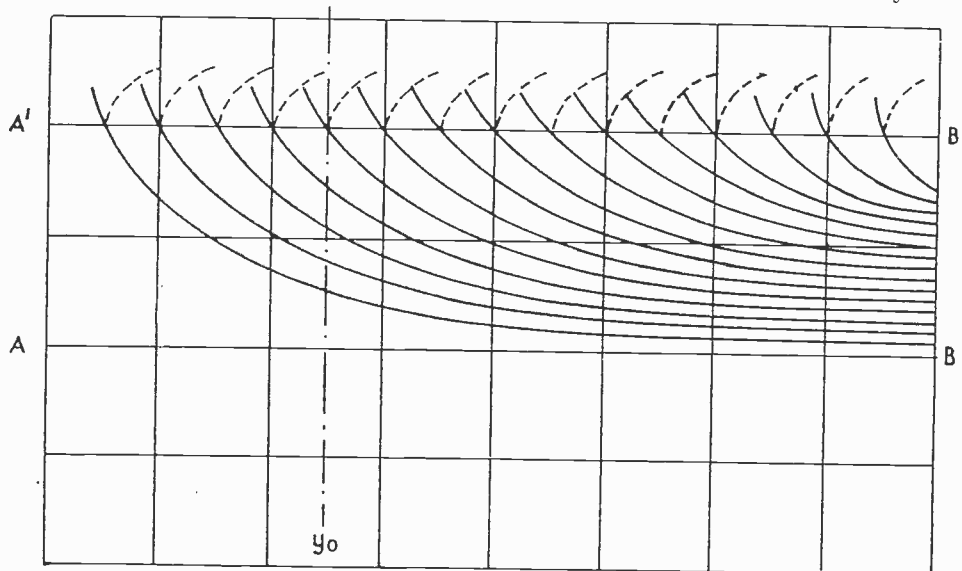

FIG. 6.

Rays and Phase Surfaces.

There are in general two more or less equivalent methods of considering such problems. We may either focus our attention on the rays or the constant phase surfaces perpendicular to these rays. The latter aspect appears to me to have more physical significance. An isolated ray has little physical significance: a group of rays is required to give coherence. Such a group defines a constant phase surface perpendicular to it, or alternatively we may consider a constant phase surface (part of a plane wave and directly observable) as defining the rays. In the present problem the phase surface method is employed and used to define the rays.



CONTOUR LINES OF EQUAL DENSITY

FIG. 7.

The complete analysis is rather long and complex and only the results will be given.

Let x be the direction of propagation and z vertical. Then we will assume the density in the layer to be a function of y and z only.

Thus we assume

$$N \propto (y + y_0) z$$

where z is the height above the lower surface of the layer, in fact we put

$$\frac{Ne^2c^2}{\pi mf^2} = \frac{(y+y_0)z}{z_0^2}$$

The vertical gradient $\frac{\partial N}{\partial z}$ is proportional to $\frac{y+y_0}{z_0^2}$, and for a given value of y is a uniform one, but the steepness of the gradient increases in proportion to $y + y_0$. Similarly the horizontal gradient $\frac{\partial N}{\partial y}$ is proportional to $\frac{z}{z_0^2}$, and for a given value of z is a uniform one.

This distribution of density is exhibited in Fig. 7 as a series of contour lines

of equal density. This will give a better picture of the electron distribution to be investigated than the algebraic relations.

A B represents the lower surface of the layer. At the B end where $y + y_0$ is large, the contour lines are closely spaced and the vertical gradient is large.

According to the formula the density increases, both upwards and towards the right without limit. Actually, of course, the density comes to a maximum at a height z , say, represented by A' B' in the figure, and then dies away. We may represent this by the dotted contours in the figure which breaks off to the right from the hyperbolas at a height z_1 .

In the region below z_1 with which we are concerned, since we are dealing with the rays which do not escape, the algebraically formulated contours represent the density distribution with some exactitude.

The path of the rays calculated for this case are no longer plane curves; a ray initially sent out in the x direction is bent both downwards at the layer and to the left.

The ray path can be specified by expressing the co-ordinates y and z of the path as a function of x , or more conveniently $\theta = \frac{x}{\sqrt{2z_0 l}}$.

Thus

$$y = \sqrt{2}nz_0\theta - n \frac{z_0\sqrt{2}\theta^3}{6} + \frac{y_0\theta^4}{24} \quad \text{approx.}$$

$$z = \sqrt{2}nz_0\theta - m \frac{z_0\sqrt{2}\theta^3}{6} - \frac{Y}{2} \cdot \theta^2$$

where l, m, n are the direction cosines of the ray on entering the layer.

The ray traverses the route in a series of hops. At each hop the horizontal gradient in the layer deviates the ray from its straight path.

The amount of deviation in the y direction, y_r , after r hops, can be calculated from the formula

$$y_r = r^2 \delta m \left[\frac{h}{m} + \frac{2nz_0}{k} \right]$$

$$\text{where } \delta m = -\frac{4}{3} \frac{n^3}{k^2}$$

$$k = \frac{y_0}{z_0}$$

and h is the height of the lower surface of the layer above the earth.

It will be seen that the deviation is proportional to the square of the number of hops. The trace of the ray on the ground is then a parabola.

Also the amount of deviation increases rapidly with n the angle of elevation, so that the high angle rays are more deviated than the low angle ones and the beam is fanned out.

The observed results suggest that such a process does actually occur.

The deviation likely to be produced with known horizontal gradients in the layer can be calculated and they are found to be of the right order. It seems therefore probable that the explanation offered of the results observed is substantially correct.

A LONG WAVE SINGLE SIDEBAND TELEPHONY RECEIVER FOR TRANS-ATLANTIC WORKING

By C. J. W. HILL and H. PAGE

The following is the concluding part of a paper delivered by the above authors before the Institution of Electrical Engineers Students' Section on January 31st, 1933.

The paper deals with the receiver recently constructed by the Marconi Company for the Post Office and installed at Baldock.

The first part of the paper was published in THE MARCONI REVIEW, No. 42.

Description of the Antennae.

THE loop itself consists of four turns of silicon-bronze wire, connected in series, and supported by two lattice steel towers, on concrete foundations, spaced 200 yards apart. The vertical antenna consists of a single horizontal portion 130 feet high, stretching between the towers, with a down lead at the centre of the system.

The loop and vertical are both tuned to the signal mid-band frequency, and are combined in a small hut situated near the loop. The combined output is connected, through a screened transformer, to an open wire, transposed, balanced transmission line, to the receiver. The length of line from the two forward loops is artificially lengthened to be one quarter of a wavelength longer than those from the backward loops, and thus the 90 degrees phase lag of the forward loops, necessary for the production of the correct polar diagram, is obtained.

Thus, without the use of any phase shifters, all the loops are approximately in phase for combination as they enter the receiver building. This is not assumed to be the case, however, as the polar diagram of the system is finally adjusted at the receiver itself, by means of the antenna combining equipment.

Antenna Combining Equipment.

This combining equipment comprises three types of network, namely, Delay Networks, Attenuators and Hybrid Networks.

A delay network is one which produces a change in phase of the output current, relative to the input current, without reduction of the amplitude. The two forms shown in Fig. 25 are used, both being lattice structures. The simpler form is used for small values of angular delay, and the more complex type for larger values of angular delay.

By the use of fixed and variable delays in tandem, it is possible to vary the phase of any part of the circuit relative to any other.

Attenuators, on the other hand are networks which attenuate the output current relative to the input current, without causing any phase change; they are used to adjust the amplitude of the current in any circuit. The lattice type of

structure is again used, as illustrated in Fig. 25, and by employing a number of these sections, each of which can be keyed separately, it is possible to obtain an attenuator continuously variable in 0.1 decibel steps.

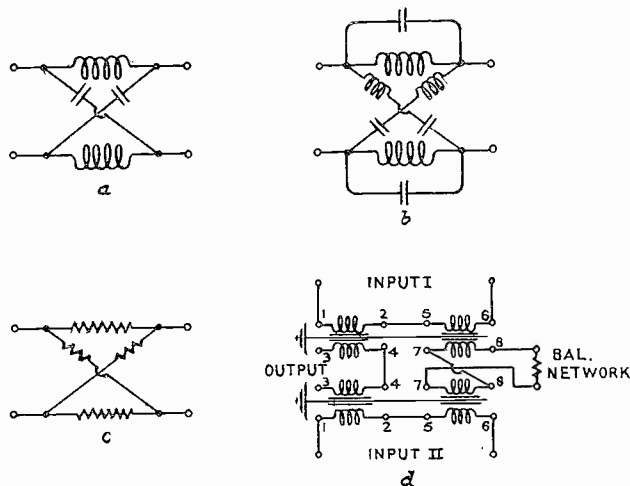

FIG. 25.

The hybrid network is an essential part of the combining equipment, inasmuch as this is the network in which the actual combination of the outputs of two circuits occurs. It is illustrated in Fig. 25, and consists of two transformers, with primaries and secondaries wound in two equal halves. The two input circuits are connected as shown, to terminals 1.6 of each transformer, and the combined output is taken from terminals 3.3.

If the output impedance is equal to the balancing network impedance, over the frequency band, then an E.M.F. injected into terminals 1.6 of transformer I causes no current to flow in the primary of transformer II, and *vice versa*. An E.M.F. injected into either primary, however, causes an output current to flow from terminals 3.3. Hence we are enabled to combine the two separate inputs, without any interaction of one circuit on the other.

We shall now consider how these networks are used in the combination of the antennae outputs.

Combination of the Antennae Outputs.

As previously described, the four outputs reach the receiver approximately in the correct phase for the production of the polar diagram, and require only small adjustments.

A schematic, showing the general layout of the combining equipment is shown in Fig. 26, and from this we can follow through the input circuits to the receiver proper. Each incoming input is terminated in a transformer, consisting of a toroidal core of iron dust, wound with silk-covered copper wire, the primary and secondary being electrostatically screened from each other by means of an earthed copper screen. From the transformer, each circuit passes through its associated delays and attenuators, and at this stage the two forward loops, 1A and 2A are combined in hybrid A, and the two backward loops, 1B and 2B in hybrid B.

Chain B then passes through further delays and attenuators, and is finally combined with chain A in the main input hybrid, the output of which is taken to the antenna filter of the receiver.

By this arrangement it is possible to vary the amplitude and phase of any loop output, and the method of adjusting these will be obvious if we consider one typical combination, for example that of 1A and 2A. These are the two forward loops, and the outputs should be identical in amplitude and phase. To examine if

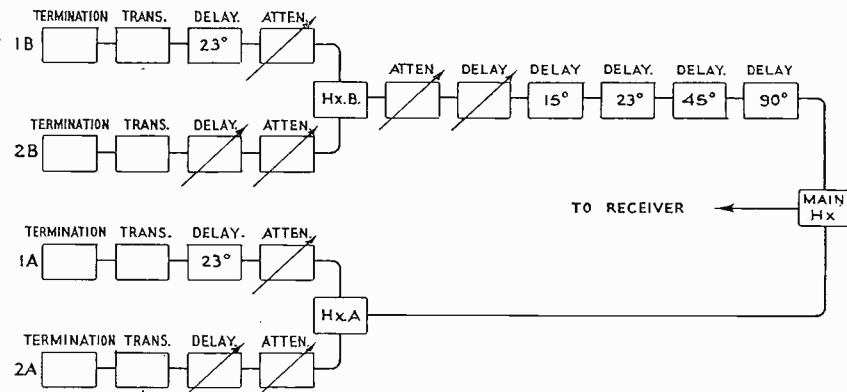

FIG. 26.

this is the case, we reverse the output from 1A when a signal is being transmitted from New York; thus we should get no output from the combination, and we actually adjust the delay networks and attenuators until we reach minimum output. On removing our reversal from 1A we know that the two forward loops are correctly adjusted; this we repeat for the backward loops. Now for a signal from the direction of the transmitter, the forward and backward loops should be in phase, and of the same amplitude, so that we make the final adjustment in chain B in a similar manner, by first reversing one chain.

All the circuits are then set for the production of the correct polar diagram.

5. Supply Equipment.

In accordance with modern practice, the receiver is worked from two sources of E.M.F., a 24 volt battery being used to supply the filament circuits, and a 130 volt battery for the plate circuits. The positive side of the filament battery, and the negative side of the plate battery are commoned to the receiver earth. Thus in every filament circuit there is a potential of -24 volts available, and this is utilised by inserting resistances in the negative end of the circuit, from which tappings can be taken for grid bias. Thus no separate grid biasing potential is required.

Each battery supply passes via isolating switches, and fuses, to a main smoothing circuit, and thence to the main bus bar. From this, each circuit passes via a separate fuse, and thenceforward each circuitual supply is a separate entity, until it reaches its associated apparatus. This applies to both filament and plate supplies.

Considering a typical filament circuit, this first leaves the bus bar via a fuse, and thence to a rheostat, which controls the current passing through the valve

A Long Wave Single Sideband Telephony Receiver for Transatlantic Working.

from this we pass to a key, which, when depressed, places an ammeter in circuit, thus giving an indication of the current ; from the key the circuit passes direct to the unit to be supplied.

The plate circuit, on the other hand, is slightly more complicated ; as before, we pass from the main bus bar, via a separate fuse, to a meter key, by means of which the plate current of the valve may be read, and to a plate relay, which, with normal plate current flowing, is energised. If, however, for any reason the plate

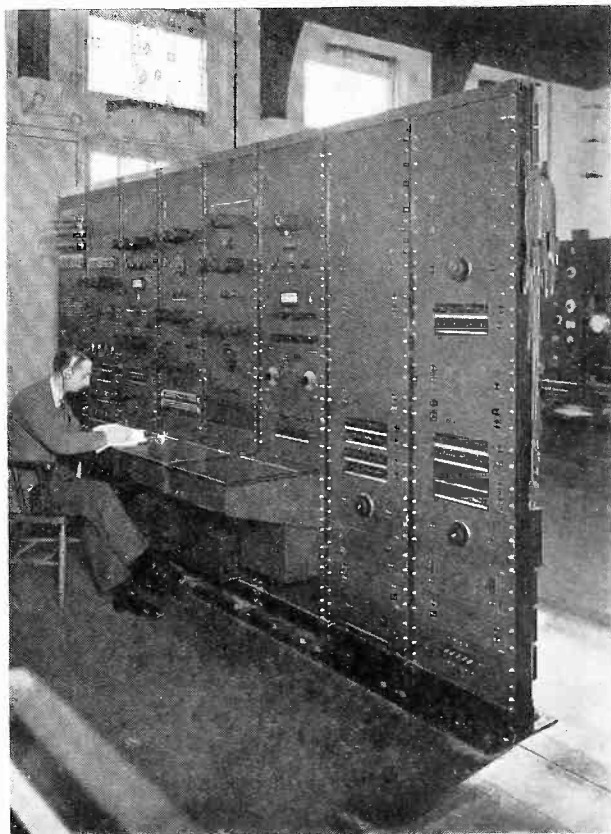

FIG. 27.

current falls to zero, the relay is not energised, and an alarm lamp indicates failure of the plate supply. These alarm lamps make the location of faults a very simple matter.

From the plate relay we pass to a protecting lamp, of 200 ohms resistance, which prevents an excessive load being taken from the battery should a short circuit occur, and thence to its associated valve. In addition to alarm lamps indicating the failure of plate supplies, an additional alarm lamp is mounted on each fuse panel ; when any fuse blows, a spring contact is made between the bus bar and the alarm bar, thus lighting the alarm lamp, and at the same time operating an alarm

bell, which thus gives audible indication of a fault, a necessary precaution in cases where the receiver is operated from a remote position.

In addition meters are provided to read the filament and plate supply voltages, whilst pilot lamps give visible indication when the supplies are switched on to the receiver.

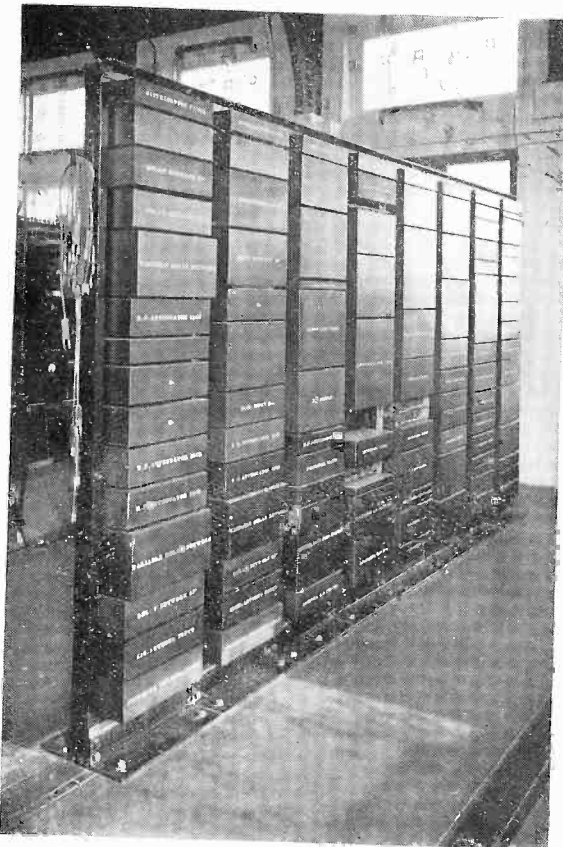

FIG. 28.

6. General Layout of Receiver.

The receiver is built up of component units, mounted on eight standard racks, 19 in. wide, and 7 ft. 6 in. high. A photograph of the front of the receiver is shown in Fig. 27.

The antennæ inputs enter the receiver at the bottom of the two racks on the extreme right, these two racks comprising combining equipment only.

The next four racks include the receiver proper, and also the test apparatus necessary on a receiver of this type. The output from the receiver, and also monitoring positions, are connected through to the main jack field, which is in close proximity

to the operating position. On this jack field the outgoing lines, and spare trunks are located, whilst provision is also made for extension of the volume indicator detector plate current by means of jacks for remote operation.

The two racks on the extreme left carry the supply apparatus, this being mounted so that all controls, meters, etc., are readily accessible. All valves are mounted in front of the panels, and are protected by metal covers ; thus it is a simple matter to change a valve, should any prove faulty.

A rear view of the receiver is shown in Fig. 28, and the manner in which each panel is fitted with its own dust cover is readily seen. It is difficult to see the external wiring on this photograph, but it actually comprises a cableform on each rack, each wire being separately screened by copper braiding, and the screens bonded to earth ; all wiring passes to the top of the rack, and thence to the source of supply via tag blocks. The whole is thus very accessible and flexible in nature.

7. Conclusion.

The single sideband system, as previously stated, has only been used on one circuit commercially up to the present, namely, that from New York to London.

It is anticipated, however, that another Transatlantic circuit will be opened shortly, utilising a further portion of the band 50 to 75 kc.

Attempts have also been made to apply the system to short wave working, but obvious difficulties present themselves, inasmuch as the frequency difference between suppressed and re-supplied carrier must be limited to a maximum of 20 cycles, and this represents a percentage frequency variation of one ten thousandth of one per cent. at a wavelength of 15.0 metres—obviously a condition difficult to obtain in practice. A development of this has recently been seen, whereby, although the carrier is suppressed, a pilot wave of small amplitude is transmitted, and this used to control the frequency of the re-supplied oscillator, but the method has not been used commercially. It is a matter of conjecture, of course, as to how far the single sideband system will be applied in the future.

In conclusion, the authors wish to express their thanks to Marconi's Wireless Telegraph Company and to the Engineer-in-Chief of the British Post Office for permission to present this paper ; and also to Mr. W. P. Wilson and Mr. F. M. G. Murphy, for their valuable suggestions towards its compilation.

NOISE AS A LIMITING FACTOR IN AMPLIFIER DESIGN

Experimental work which was undertaken to provide data for the design of wide frequency spectrum amplifiers used for television reception and transmission brought out very clearly the fact that as the band width is increased, more noise is admitted. From this arises the fact, the practical implications of which perhaps have not been clearly realised, that better results for weak signal inputs as regards signal to noise ratio can always be obtained by using an amplifier which is efficient only over the frequencies actually required. Moreover, with present day photo cells which are relatively insensitive to light, the outputs of which need considerable amplification, a frequency spectrum limit is soon reached which it is desirable not to exceed if a reasonable signal to noise ratio is to be preserved.

THE special case of a combined photo cell and amplifier will be considered in relation to noise. The following will contribute towards the total noise:—

- (1) Shot effect in photo-cell.
- (2) Thermal effect in photo-cell load.
- (3) Shot effect across first anode load.
- (4) Thermal effect in first anode load.
- (5) Photo electric effect in valves.
- (6) Flicker effect.

The first four of these must always exist owing to their fundamental nature, but Nos. 5 and 6 can by careful valve design be reduced to negligible proportions. Each cause will be discussed below.

(1) In present day photo cells, shot effect is negligible owing to the extremely small currents passed. When photo cells are made capable of yielding large currents, or if direct scanning is employed in place of indirect, this effect must be taken into consideration.

(2) Thermal effect in the photo cell load is the largest component of total noise under existing conditions.

(3) Shot effect in the amplifier need only be considered in relation to the first valve load.

(4) Thermal effect in first valve load is small in comparison with shot effect (3) and may be neglected.

(5) Photo electric effect in valves is of such a small order that it can be neglected. It is too small to be observed on the Standard Amplifier.

(6) With existing indirectly heated valves, Flicker effect disappears within a few minutes of switching on.

Thermal effect in photo cell load and shot effect in the first valve of the amplifier are the only sources of noise that need be considered at the present stage of development. As a result of measurements on the Standard Amplifier, the following formulæ have been confirmed:—

Output noise due to thermal effect in photo cell load

$$E_T^2 = 0.016 R M^2 (f_1 - f_0) 10^{-18} \text{ (volts)}^2 \quad \dots \quad (1)$$

where E_T = output voltage, R = photo cell load

M = amplification of whole amplifier

$(f_1 - f_0)$ = frequency spectrum (overall).

Output noise due to shot effect in first valve circuit

$$E_S^2 = 3.18 R^2 M^2 I (f_1 - f_0) 10^{-19} \text{ (volts)}^2 \quad \dots \quad (2)$$

where E_S = output voltage

R = first anode load impedance

M = amplification of amplifier excluding first stage

I = anode current in first valve (amp.)

$(f_1 - f_0)$ = frequency spectrum of amplifier excluding first stage.

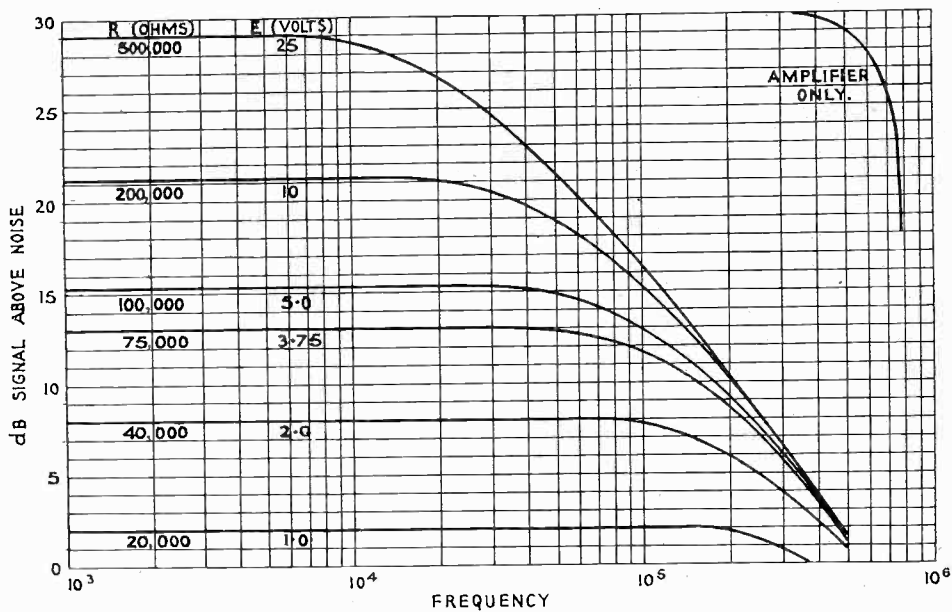

FIG. 1.

Then total noise at output E_N

$$E_N = \sqrt{E_T^2 + E_S^2}$$

The formulæ (1) and (2) are only strictly true when provision is made for sharp cut-off of unwanted frequencies, but where provision is not made for this the formulæ must be modified. (See Appendices A and B.) As a result of the measurements taken on the amplifier the curves of Fig. 1 have been plotted. They show overall frequency characteristics for photo cell and Standard Amplifier for various values of photo cell load R , and show the signal to noise ratio for the various values of load together with the output voltage that will be produced when a current of 10^{-9} amp. flows through the photo cell. This value of current has been chosen as it is of the same order as that which is obtained in practice. For currents other than 10^{-9} amp. the corresponding levels shown in Fig 2. must be added to the signal to noise levels in Fig. 1. For instance, Fig. 1 shows signal to noise ratio (at

10 k.c.) as 15.2 dB. for $R = 100,000_\infty$ for a current of 10^{-9} amp. In Fig. 2, for a current of 4×10^{-9} amp. the level shown is +12 dB., so that with the Standard Amplifier working with a photo cell current of 4×10^{-9} amp., the signal to noise ratio will be 27.2 dB.

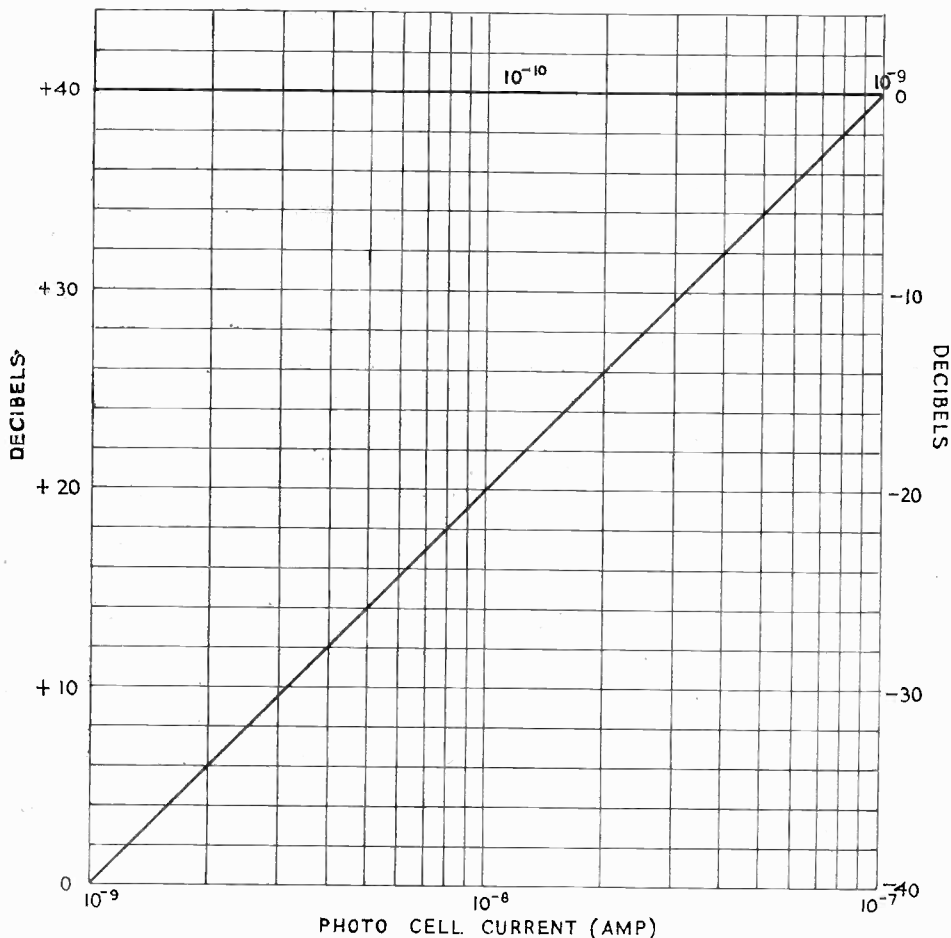

FIG. 2.

We will now consider the ideal case of a combined photo cell and amplifier possessing a sharp cut-off beyond the maximum frequency desired and possessing a flat overall frequency characteristic, i.e., any loss in photo cell circuit to be made up in amplifier. Fig. 3 shows maximum signal to noise ratios that can be obtained for such a case where the cut-off frequency is 100 k.c. and the photo cell current 10^{-9} amp. (For currents other than this, add levels shown in Fig. 2.) A comparison between Figs. 1 and 3 is of interest. For $R = 20,000$ the reduced ratio in Fig. 1 shows clearly the undesirability of making the amplifier unnecessarily "good"; the curve for $R = 500,000$ also shows an apparent gain in ratio of 4 dB. over the ideal case, but this is clearly obtained at the expense of linearity of frequency characteristic, the characteristic of Fig. 1 being 2 dB. down at 17 k.C.

Fig. 4 shows the variation of signal to noise ratio with frequency spectrum for various photo cell loads, the frequency characteristic being assumed to cut off sharply at the particular frequency under consideration as in Fig. 3. Used in conjunction with Fig. 2, Fig. 4 will provide all information with regard to signal to noise ratio for any photo cell load or any photo cell current over any frequency spectrum provided photo cell is followed by a standard M.S.4B stage and shot effect in photo cell is negligible.

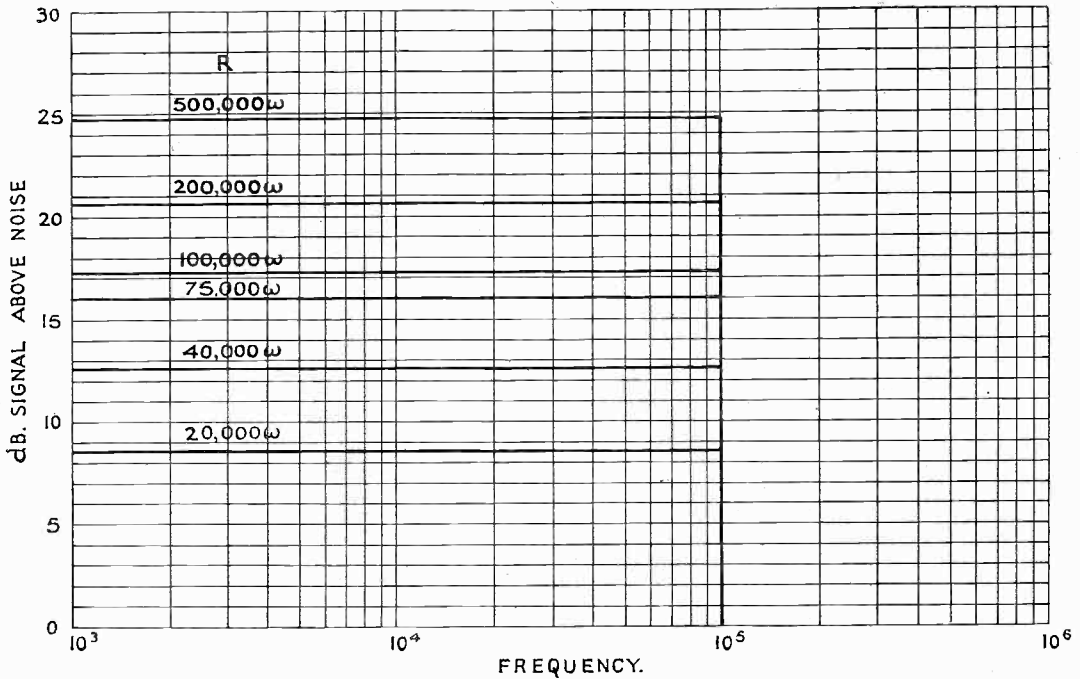

FIG. 3.

The following example will give some indication of the limitations imposed by noise. Three scanning systems will be compared, viz., 50, 100 line, 200 line. The photo cell load is taken as 100,000 Ω and the overall frequency characteristic is flat up to the maximum frequency, beyond which sharp cut off is provided. Discs are used to provide the scan and the same high power arc used as a light source in each case.

TABLE A.

Lines.	Max. frequency K.C.	Screen spot light intensity for given source.	Assumed current.	Signal to Noise.
50	18.75	1	4×10^{-9}	36.5 dB.
100	75	1/4	1×10^{-9}	18.5 dB.
200	300	1/16	$.25 \times 10^{-9}$.5 dB.

It should be noted that for "broadcast" quality a minimum signal to noise ration of 40 dB. is required.

If now the light be increased in proportion as the lines are increased so as to provide the same screen spot intensity (i.e., light increased as the square of the number of lines), then the photo cell current will be constant for any number of lines. A good vacuum photo cell should give 10 microamps per lumen so that 10^{-9} amp. corresponds to 10^{-4} lumen. In the following table, signal to noise ratios for constant screen spot light are shown, photo cell and amplifier conditions being as above.

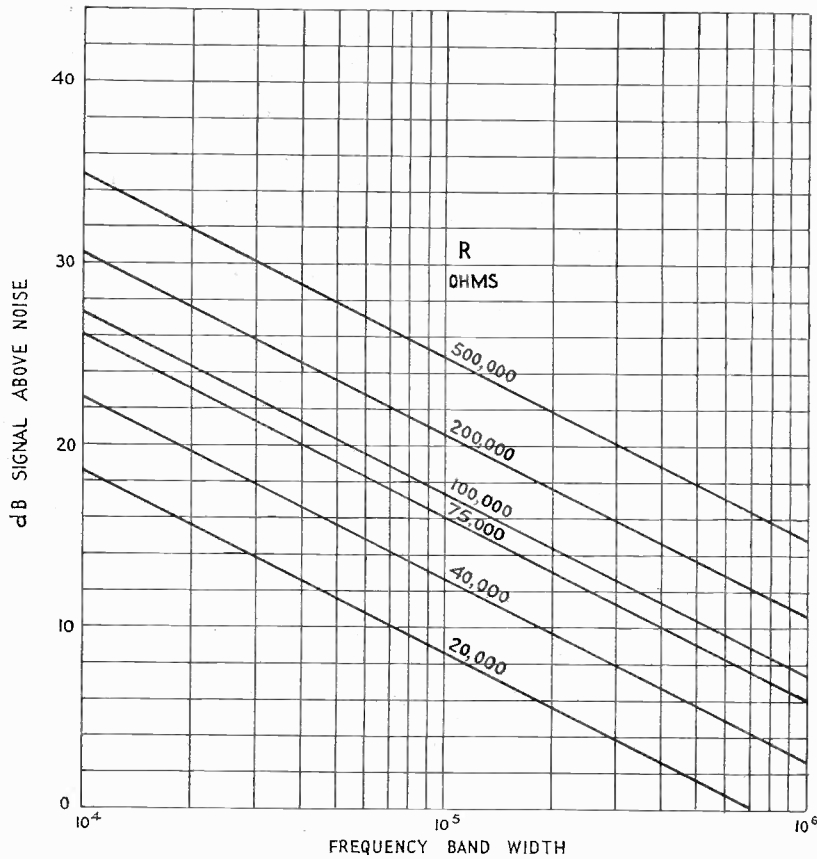

FIG. 4.

TABLE B.

Signal to noise ratio for constant screen spot intensity.

Lines.	10^{-4}	2×10^{-4}	4×10^{-4}	lumen
	10^{-9}	2×10^{-9}	4×10^{-9}	amp.
50	24.5	30.5	36.5	
100	18.5	24.5	30.5	
200	12.5	18.5	24.5	

In both Tables A and B disc scanning systems have been considered, and since a practical limit is soon reached as to size of arc projector, it is clear that if other systems are capable of producing greater light intensity, they are to be preferred.

Conclusion.

In order to preserve a reasonable signal to noise ratio in a television transmission (it is suggested that 30 dB. should be aimed at in the present state of development) the following requirements should be met.

- (1) Maximum light on screen.
- (2) Photo cells in reflectors, this arrangement also assisting to increase wanted to unwanted light ratio by virtue of the directional effect.
- (3) Amplifiers cutting off sharply at the maximum frequency. Should it be desired to include the third harmonic of the maximum frequency then there will be a decrease of 4.8 dB. in the signal to noise ratios shown in the Tables above.

The greatest limitation is the first named and until improved lighting or improved photo cell performance is available, any question of the inclusion of the third harmonic is premature.

It is of interest to note the advantage to be gained by direct scanning (such as in a film system) for assuming a current of only 10^{-7} amp., which is likely to be well below that which could be obtained, then signal to noise ratio for 200 line scan would be 52 dB. as against 18 dB. for a current of 2×10^{-9} in an indirect scanning system, this current being of the order of that obtained in practice.

Literature.—T. C. Fry, Journ. Franklin Inst., Feb., 1925, p. 203. Von F. v. Orban, Zeit. f. Tech. Phys., 1932, No. 9, p. 420. L. B. Turner, Journ. I.E.E., Jan., 1933, p. 10.

APPENDIX "A"

Thermal Agitation of Electrons in Conductors.

(1.) The formula developed by Johnson and Nyquist states that the mean square of the voltage E developed in a frequency interval $\delta\nu$ is product of a constant 4π , the resistance in which the agitation is occurring, the absolute temperature, the Boltzmann constant, and the frequency interval,

$$\text{i.e., } \overline{E^2} \delta\nu = 4\pi KTR\delta\nu \quad \dots \quad (1)$$

For average room temperature (293° K) and using micro volt, megohm, second units

$$\overline{E^2} \delta\nu = .0161 R\delta\nu \quad \dots \quad (2)$$

In order to avoid confusion of units in what follows, it is proposed to specify the voltage unit used and other units will be in terms of ohms, farads and seconds, also the frequency interval $\delta\nu$ will be represented by $(f_1 - f_0)$.

Hence, re-writing equation (2)

$$\overline{E^2} = .0161 R (f_1 - f_0) 10^{-6} (\mu \text{ volts})^2 \quad \dots \quad (3)$$

If now the thermal effect is produced at the input of an amplifier giving an overall amplification of M , then the output voltage will be

$$E_T = M E \times 10^{-6} \text{ volts} \quad \dots \quad (4)$$

Substituting (4) in (3) we have

$$E_T^2 = .0161 R (f_1 - f_0) M^2 10^{-18} (\text{volts})^2 \quad \dots \quad (5)$$

Where a narrow band of frequencies is concerned, this equation will be found most useful. As an example, suppose the resistance R to be the grid leak of the first stage of an amplifier and to have a value of 100,000 Ω , let the band width ($f_1 - f_0$) be 10 k.c., and the overall voltage amplification be 100,000 or 100 dB. Then the voltage E_T at the output of the amplifier due to thermal effect will therefore be

$$E_T = \sqrt{0.0161 \cdot 10^5 \cdot 10^4 \cdot 10^{10} \cdot 10^{-18}} \text{ volts} \\ = .4 \text{ volt.}$$

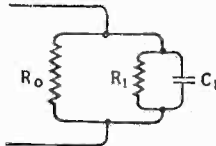

FIG. 5.

In the case of amplifiers capable of handling a wide frequency spectrum, the formula must be modified as neither R nor M remain constant over the whole spectrum

(II.) We will now consider these modifications and evolve a new formula to cover this, the general case.

(A) The resistance R is assumed to be connected between the grid-cathode of the first valve which has a grid-cathode capacity C_1 and grid-cathode resistance R_1 .

The input circuit will then be of the form shown in the network of Fig. 5. The impedance Z of this network is of the form $Z = R + jX$; the resistance with which we are concerned is defined as the real term (R) in this expression and has the value

$$R = \frac{R_0 \left(1 + \frac{R_0}{R_1} \right)}{\left(1 + \frac{R_0}{R_1} \right)^2 + \left(\omega C_1 R_0 \right)^2} \quad \dots \quad (6)$$

Since R_1 is in general high compared with R_0 we can for such cases write

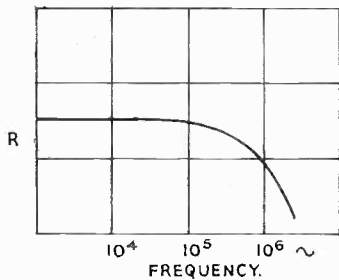

FIG. 6.

$$R = \frac{R_0}{1 + (2\pi f C_1 R_0)^2} \\ = R_0 \cdot \frac{1}{1 + a^2 f^2} \quad \dots \quad (7)$$

where $a = 2\pi C_1 R_0$

This indicates that the effective resistance of the input circuit decreases with increasing frequency due to presence of grid-cathode capacity. The relation between R and f is shown diagrammatically in Fig. 6, f being plotted on a logarithmic scale.

(B) It is convenient to express the amplification-frequency characteristic of an amplifier in a simple form and it has been found that for an uncorrected resistance amplifier the amplification M will vary with frequency in the same way as the impedance Z of a parallel resistance-capacity network varies.

This is not strictly true at the low frequency end of the scale, but the error introduced by neglecting the falling off of amplification at very low frequencies is too small to be of any account.

$$\text{In Fig. 7 } Z = \frac{I}{\frac{I}{R_2} + j\omega C_2} = \frac{R_2}{1 + j\omega C_2 R_2} = R_2 \frac{I}{\sqrt{1 + (2\pi f C_2 R_2)^2}}$$

Note.— $Z=R_2$ over the flat portion of the curve, Fig. 8.

If now we put $M_0=R_2$ and give C_2 a suitable value so as to reproduce the frequency characteristic of the amplifier (Fig. 8) then

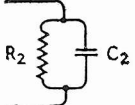

$$M = M_0 \frac{I}{\sqrt{1 + (2\pi f C_2 M_0)^2}}$$

$$\text{or } M = M_0 \frac{I}{\sqrt{1 + b^2 f^2}} \quad (\text{where } b=2\pi C_2 M_0) \quad \dots \quad (8)$$

FIG. 7.

Using the results of equations (7) and (8) we can rewrite equation (5) thus

$$E_T^2 = .0161 R \frac{I}{1 + a^2 f^2} (f_1 - f_0) M_0^2 \frac{I}{1 + b^2 f^2} 10^{-18} \text{ volts}^2$$

$$\text{i.e., } E_T^2 = .0161 10^{-18} R_0 M_0^2 (f_1 - f_0) \frac{I}{1 + a^2 f^2} \cdot \frac{I}{1 + b^2 f^2} \text{ (volts)}^2$$

where $(f_1 - f_0)$ is small f should be taken as $\frac{f_1 + f_0}{2}$

Where $(f_1 - f_0)$ is large, however, R and M may vary considerably over the range, in which case

$$|E_T^2|_{f_0}^{f_1} = .0161 10^{-18} R_0 M_0^2 \int_{f_0}^{f_1} \frac{I}{1 + a^2 f^2} \cdot \frac{I}{1 + b^2 f^2} df$$

Now $\int_{f_0}^{f_1} \frac{I}{1 + a^2 f^2} \cdot \frac{I}{1 + b^2 f^2} df = \left| -\frac{a}{b^2 - a^2} \tan^{-1} af + \frac{b}{b^2 - a^2} \tan^{-1} bf \right|_{f_0}^{f_1}$

(See Appendix A 1.)

$$\text{Whence } |E_T^2|_{f_0}^{f_1} = .0161 10^{-18} R_0 M_0^2 \left| \frac{-a}{b^2 - a^2} \tan^{-1} af + \frac{b}{b^2 - a^2} \tan^{-1} bf \right|_{f_0}^{f_1} \dots (9)$$

This is the general formula.

It should be noted that, unless a filter is incorporated in the amplifier or measuring instrument, the amplification M will tend to approach zero as f is increased but will not reach zero until $f = \infty$, hence the integration limits are $f_1 = \infty$ $f_0 = 0$. Substituting these limits in equation (9) we have

$$|E_T^2|_0^\infty = .0161 10^{-18} R_0 M_0^2 \left(\frac{-a}{b^2 - a^2} \cdot \frac{\pi}{2} + \frac{b}{b^2 - a^2} \cdot \frac{\pi}{2} \right)$$

$$\therefore |E_T^2|_0^\infty = .0161 10^{-18} R_0 M_0^2 \frac{\pi}{2(a+b)} \dots \dots \dots (10)$$

$$\text{or } |E_0^2|_0^\infty = .0161 10^{-18} R_0 M_0^2 \frac{I}{4(C_2 M_0 + C_1 R_0)}$$

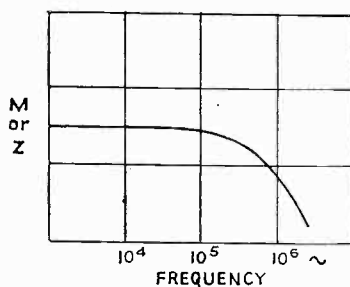

FIG. 8.

A graphical representation of the steps involved is shown diagrammatically in Figs. 9 and 10.

Fig. 9 shows variation with frequency of R , M^2 , and RM^2 frequency being on a logarithmic scale, while in Fig. 10, frequency is plotted on a linear scale and the expressions R , M^2 , and RM^2 are divided by R_0 , M_0^2 and $R_0M_0^2$ respectively, so that each has a maximum value of unity. The process of integration determines the area bounded by the curve C and the axes, and the area obtained divided by unity will therefore give a frequency f representing the average value for the amplifier, measuring instrument and input circuit for the condition that R and M are assumed to remain constant at their normal values of R_0 and M_0 , i.e., the area between curve C and the dotted lines above it is equal to the area below curve C from f to ∞ . This value of f appears as the term $\frac{\pi}{2(a+b)}$ in equation 10, and is therefore the effective frequency spectrum of the whole circuit.

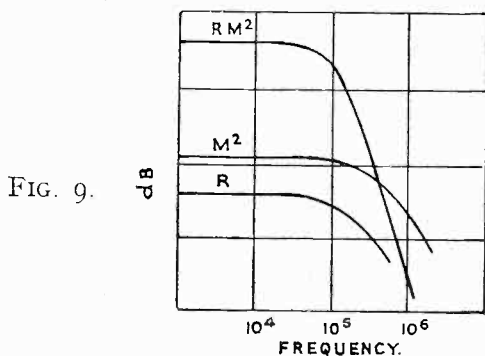

FIG. 9.

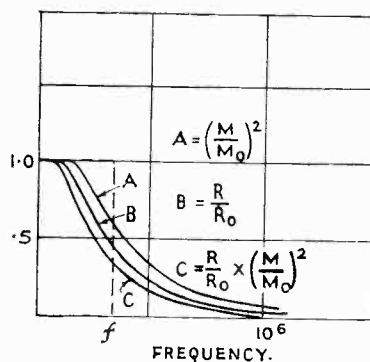

FIG. 10.

The case defined by Johnson and Nyquist's equation (equations 1 and 2) is obtained from the general formula by making a and b (equation 9) very small or af and bf very small.

In that case $\tan^{-1} af = af$ and the frequency term in equation 9 becomes

$$\left| -\frac{a}{b^2-a^2} \cdot af + \frac{b}{b^2-a^2} \cdot bf \right| \frac{f_1}{f_0} = \left| f \right| \frac{f_1}{f_0} = (f_1 - f_0)$$

This, as pointed out before, assumes that R and M remain constant over the frequency range $(f_1 - f_0)$ and that f_1 and f_0 are sharply defined as would be the case if a band pass filter were included in the circuit.

O. E. KEALL.

(To be continued.)

BOOK REVIEWS

"SHORT WAVE WIRELESS COMMUNICATION"—By A. W. LADNER
AND C. R. STONER.

(LONDON: Chapman & Hall, Ltd. pp. vi. and 348). Price 15s. net.

This work is one of the very few which deal essentially with short wave transmission, propagation and reception, and as such fulfils an obvious demand, as the branch of wireless technique which employs short waves (i.e., waves from 100 metres downwards) is rapidly becoming of paramount importance.

Although the authors assume an adequate knowledge of the general principles of wireless communication, they also, as stated in the preface, have attempted to make the book as self-contained as possible.

The work may be roughly divided into five sections :—

- (1) Historical development of short waves as carriers of intelligence.
- (2) Theory and Propagation of Electro Magnetic Waves.
- (3) Design and operation of short wave transmitters.
- (4) Short Wave Aerial Systems.
- (5) Reception of Short Waves.

The authors' special recommendation is that they are well qualified to discuss the development of short waves from their association with the Marconi Company, the pioneers of much of the work which has been done in this direction. On the other hand, development is even now progressing at such a rapid rate that it is not surprising to find many parts of the book which could be bettered by being brought up to date. In future editions, for instance, due stress no doubt will be laid on the improvements which have been made by Imperial & International Communications, Ltd., and by the Post Office in their short wave traffic systems.

Chapter 3 on "Notes on Electro Magnetic Waves" is, if anything, too condensed in its treatment of wave motion, and of the production of Electro Magnetic Waves from a radiator. A line must be drawn somewhere in discussing such matters, but it might be considered that more space should have been devoted to what is, after all, a most important subject.

The Chapter dealing with the propagation of short waves is carefully treated in a non-mathematical manner. Such remarks as "the ultra short waves (below 10 metres) are suitable for only strictly visual ranges" require modification, as recent experiments made by the Marchese Marconi with waves of the order of 60 cms. have been received far beyond the limits of visual range. Transmission on a wavelength of 8 metres has also been received from Poldhu in New York and Australia. The truth is that the theory of propagation of such waves is only partially understood, and that future work in this direction may open up fresh avenues for their exploitation.

The principles of modulation and the theory covering the design of transmitters are treated in Chapters V—X.

Chapters XI and XII, dealing with high frequency feeders and aerials, cover as much ground as is permitted by the nature of the book and avoid detailed mathematical analysis, whilst still presenting the main facts in a clear fashion.

The discussion of polar diagrams of short wave aerial arrays presents a novel view of a very important subject, and serves well as an introduction to those who may desire to follow this form of research work.

The last part of the book deals with commercial receivers and transmitters, and concludes with a chapter on ultra short waves, in which, perhaps, too definite opinions are voiced and concerning which, as has been mentioned, comparatively little is known. Two appendices dealing with valve and feeder theory are given.

Taken as a whole the book should appeal to any who are desirous of learning the present state of short wave research, and should form a thoroughly good basis for more extensive and specialised reading on the subject.

H.M.D.

“ WIRELESS OVER THIRTY YEARS ”—By R. N. VYVYAN.

(LONDON: George Routledge & Sons, Limited. pp. 256, with 16 Plates and 12 Diagrams.
Price 8s. 6d. net.

The author has been associated with high power radio engineering for well over 30 years and in the present volume tells the fascinating story of his own career and the parallel progress of the art of radio communications up to the date of his retirement recently from the post of Engineer-in-Chief to the Marconi Company.

The book may be divided into seven sections :—

- (1) History of the Development of Wireless Communication from the times of Clerk-Maxwell, Hertz, etc., to the erection of the Clifden-Glace Bay service. pp. 1-54.
- (2) The development of commercial wireless. Imperial Communication on long waves—beam development, and the present day commercial network of radio stations in England. pp. 55-108; 185-198.
- (3) Wireless in War on land, sea and air. pp. 109-141.
- (4) Wireless for distress calls and for ordinary marine and air communication. pp. 142-168.
- (5) The influence of the British Post Office on Wireless Telegraph Communication. pp. 169-184.
- (6) Broadcasting.
- (7) The technical side of Radio Research and Manufacture.

This book is a very pleasing addition to the literature of wireless. It is well written, and whether the author is discussing Marconi's early transatlantic tests in which he participated, the history of beam development, the erection of the beam stations for the design of which he was responsible, the radio activities of the Post Office, developments in the mercantile marine, the use of wireless in aviation or other matters, the story reads as a connected narrative and holds one's attention to the last page.

This volume can be heartily recommended.

H.M.D.

MARCONI NEWS AND NOTES

A TRIBUTE FROM ARGENTINA.

MARCHESE MARCONI'S broadcast to Argentine listeners on June 29th—reported in the last issue of *THE MARCONI REVIEW*—had an interesting sequel two days later, when Mr. A. B. Dougall, of Radio Excelsior, Buenos Aires, broadcast through that station a warm tribute to Marchese Marconi and the Marconi Company.

“I wish to place on record,” said Mr. Dougall, “how much I appreciate the immense goodwill shown to us by the Marconi Company, which has complied amply and generously with all its undertakings towards Radio Excelsior.

“It is evident that it has wished that this British transmitter, the first of its model in South America, should demonstrate the excellence of its fine qualities on this occasion of entering into friendly rivalry with its worthy and respected competitors.

“To Marchese Marconi, the creative genius of wireless telephony, who has agreed to become the godfather of Radio Excelsior, I wish also to record my profound gratitude.”

A Marconi Trophy.

A NEW trophy has been presented by the Marconi Company for competition among the wireless students of Air Service Training, Limited, at “Britain's

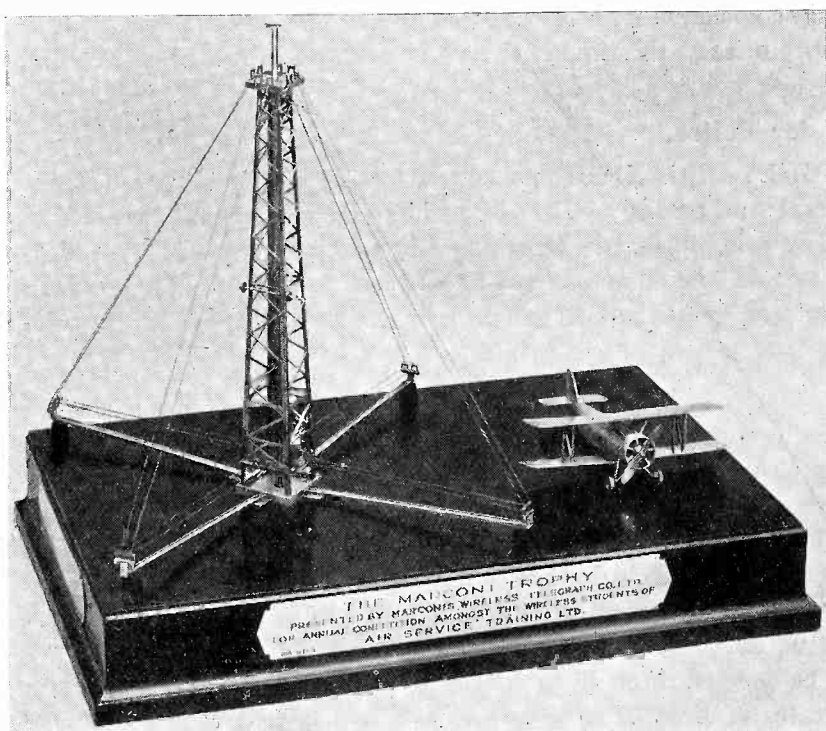

Air University" at Hamble, Southampton. The trophy, which was designed and modelled by Messrs. Mappin & Webb, represents in facsimile the mast and aerial system of a Marconi wireless direction finding station of the type installed at the London Air Port, Croydon, and at many of the world's principal aerodromes. Alongside is a model of a typical "tutor" biplane.

The trophy is a symbol of the close co-operation that has been maintained from the outset between the Marconi Company and the authorities at Hamble, who use Marconi equipment for instructional purposes in their aircraft, their ground station, and their workshops. Hamble is the only civilian establishment in Great Britain where facilities are afforded for students studying for the Postmaster-General's wireless telegraph air operator's licence to gain air experience before sitting for the Air Ministry's examination at Croydon.

Marconi Television.

A DEMONSTRATION of the latest developments in Marconi television was given to a large party of members of the Television Society who visited the Marconi Works at Chelmsford recently. Displays of television transmission and reception by the Marconi system, including the projection of a received picture on a screen 4 ft. square, were watched with great interest. Research and development activities in connection with Marconi television were proceeding in the normal way in the laboratories at the time of the visit which added to the general interest.

Wireless for Police.

A HIGHLY-ORGANISED police wireless service has been instituted by the Federal authorities of Brazil for inter-communication between the central police station in Rio de Janeiro and provincial police stations and motor-cycle patrols, and also for communication between the Rio de Janeiro marine police station and vessels in the harbour or at sea.

The principal wireless station in the organisation is that at the police headquarters in Rio de Janeiro, which is equipped with two Marconi transmitters—for medium wave and short wave working—and two receivers. Both transmitters are suitable for either telephonic or telegraphic operation, and the medium wave station is to be used for a "broadcasting" service as well as for police communications. The broadcasting service will comprise a "police hour," during which will be radiated at a convenient time each day police news and notices of value and interest to the public, such as information regarding persons and goods lost or found, special traffic instructions, and new regulations. Reliable communication for these purposes can be effected throughout the territory of the Federal District and the neighbouring States of Brazil.

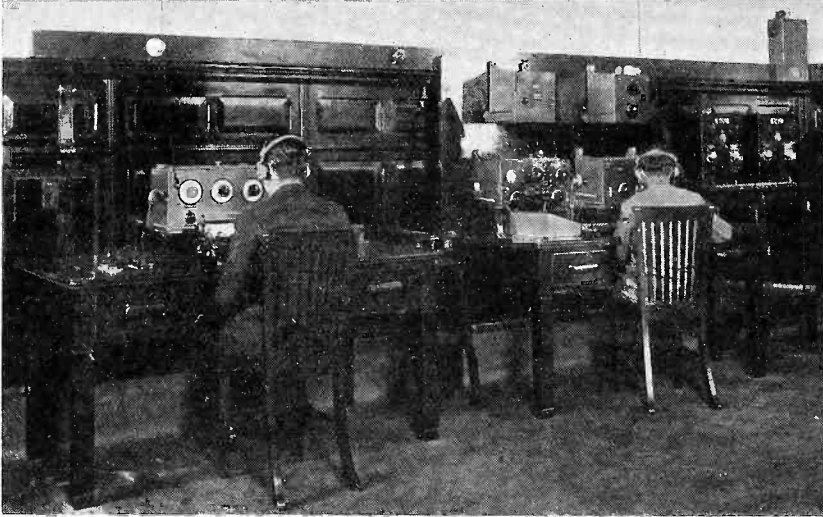

Wireless control and reception room at the central police headquarters, Rio de Janeiro.

The short wave station also carries out a number of valuable auxiliary services in addition to its routine duties of internal police communications. It is capable of communication with all the Brazilian States and a large number of foreign countries, and by its means a daily radio-telegraph service has been inaugurated for the transmission of a regular bulletin of police and general news. During tests of this station, messages were exchanged with the s.s. "Orontes," while that ship was near England, and also with Bergen Radio, Norway.

Seven Short Wave Stations.

In addition to this central wireless station, no fewer than seven short wave transmitting and receiving stations are being installed—one at the headquarters of the Rio de Janeiro marine police, four at strategic points for police operation in the Federal District, and two in police launches—providing a complete network of wireless communications throughout the area.

The road-patrol service consists of six motor-cycles and side-cars equipped with Marconi transmitting and receiving sets. These patrols are in constant touch by wireless with the police stations, and the efficiency of their communications was recently tested with striking success when the head of the Government made a journey by road from a sanatorium at Petropolis to Rio de Janeiro, a distance of 30 miles. The motor-cars in which rode the head of the Government with his family and suite were accompanied throughout the journey by the motor-cycle police, who were able by wireless to maintain continuous contact with the authorities at the Presidential Palace.

“Homing” by Wireless.

THE utility of the Marconi “Homing” Device as an aid to air navigation has been further demonstrated by the experience of Mr. John Grierson, the well-known British aviator.

Early in August, Mr. Grierson began a survey flight of the Northern Transatlantic route from Great Britain to North America by way of Iceland and Greenland, using a British light aeroplane fitted with Marconi “Homing” equipment. His aeroplane was wrecked by heavy seas at Reykjavik, Iceland, and the survey was performed abandoned for the time being, but in the course of his flight from England to Iceland he had a sufficient indication of the utility of this method of wireless navigation. He reported that he flew through clouds over “magnetic” mountains guided solely by the “Homing” device, and in a message to the *London Times* of August 22nd, he wrote:

“The advantages offered by ‘Homing’ wireless have decided me to employ this method on all future long-distance flights.”

Mr. Grierson is one of the most experienced private aircraft owners in the world, having flown from India to England and from England to Samarkand and back alone in his own light aeroplane, and his comment provides convincing testimony to the Marconi “Homing” method of navigation by wireless.

Marconi Company's New Offices.

THE Marconi Company's head offices and London research laboratories have been transferred from Marconi House, Strand, London, to the new Electra House, Victoria Embankment, from Monday, September 4th.

The new postal address is: Marconi's Wireless Telegraph Company, Ltd., Electra House, Victoria Embankment, London, W.C. 2. The telephone number and telegraphic address remain unchanged as Temple Bar 4321 and “Expanse, Estrand, London,” respectively.

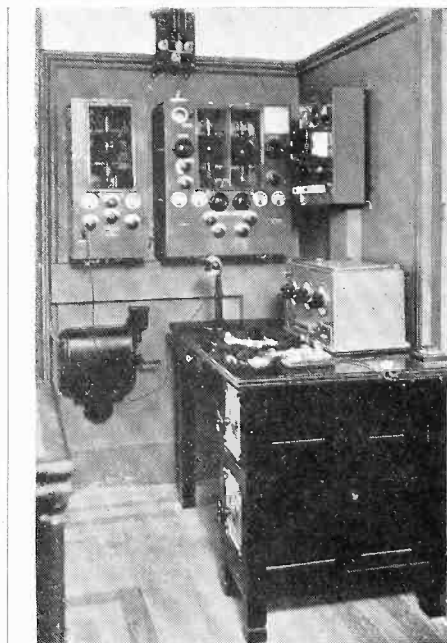

Marconi short-wave equipment as installed in Brazilian police stations. (See pages 30 and 31.)