

THE MARCONI REVIEW

No. 37.

July-August, 1932

Editor: H. M. DOWSETT, M.I.E.E., F.Inst.P., M.Inst.R.E.

THE QUARTZ OSCILLATOR.

A few years ago after the publication of certain information by Cady (1) Pierce (2) and others (3), on the use of Quartz as a stabiliser for Radio Frequency Circuits, it seemed possible that Quartz would offer a very cheap and easy way of solving the problem of keeping a radio transmitter at its correct frequency to within a very few parts in a million.

Exaggerated claims have been made regarding stability, and these have caused those interested in radio communication to consider the advisability of investigating the problem. In spite of all the work which has been done on the subject, however, engineers and others are often met, who are still under the impression that a simple piece of quartz suitably cut, and connected to a valve system, will give a constant frequency under the most varying conditions.

The Marconi Company, in an extensive research on this subject, have overcome many of the difficulties associated with it, but there are still many points on which knowledge is to be gained. The following article is written by an engineer who has specialised for some years on the utilisation of Quartz as a constant frequency oscillator.

Occurrence of Quartz Crystals.

IT may be as well to describe briefly the natural quartz crystal. The crystal occurs in many parts of the world, and when found complete, is generally an hexagonal prism terminated at each end in a pyramid. Such crystals are rather unusual, and the crystal purchased is more often a short prism, broken at one end, and capped by the pyramid; in fact, a portion of the complete crystal. In some crystals, facets occur at the position where the prism meets the pyramid, and, depending on the direction of slope of these facets, so the crystal may be right or left-handed, i.e., a section of the crystal cut at right angles to the vertical, optic, or Z axis of the natural crystal has the power of rotating the plane of polarised light transmitted in the direction of the optic axis in a right or left-hand direction.

Besides being either right or left-handed, some crystals are "twinned." Twinned crystals are of little use in radio engineering. Fig. 1 gives an idea of the appearance of natural quartz crystals as generally obtained.

The appearance of a crystal is the only guide in selecting raw material. If the facets indicate a uni-axial crystal, and the body is free from flaws, clouds, colours, etc., the lines on the sides of the prism should be looked to. Where the lines are

parallel, straight, and unbroken, the crystal will generally be found to be of more use than one in which the sides are broken into a collection of irregular figures.

Quartz may be of many colours, from water clear to deepest blues, but although coloured crystals have yielded results, it has been found best to avoid such and work only on the clear crystal. The colours are generally due to the presence of salts in the body. The chemical formula of quartz is Si O_2 , it has a density of 2.65 at 0°C , and is 7 in Mohs' scale of mineral hardness.

Supplies are obtained mainly from Brazil and Madagascar. Opticians appear to be unanimous in favour of Brazilian quartz, but it is very doubtful if a definite statement can be made as to the relative qualities of the material from the two sources when judged from the standpoint of the radio engineer.

Quartz has three sets of axes: an optic axis (Z), three electrical axes (X), and three mechanical axes (Y). The directions of these are shown in Fig. 2.

Method of Cutting Crystals.

If a section is cut at right angles to the optic axis as shown by AB. CD. it should be found that opposite sides are parallel, and adjacent sides should include an angle of 120° . Adjacent sides need not be, and rarely are of equal length.

Having cut such a section, a test can be applied which decides at once whether further work should be done on the particular specimen.

The section having been ground, and the cut faces brought parallel to one another and at right angles to the optic axis, the faces should be sufficiently polished to give a fair transparency through the section.

A pair of Nicol prisms crossed to extinction should now be mounted together with a light source and suitable optical arrangements for viewing. If now the prepared section is passed between the Nicols it will generally be found that certain parts of the specimen exhibit a uniform colour under the influence of the polarised light, but other parts, usually near the edges of the crystal are broken up into a series of very beautiful multi-coloured triangles. The uniform colour indicates crystal growth of one axis, the other medley of colours is indicative of other crystals growing into the main body. The text books on light explain this interesting spectacle, and it is not necessary to go into a detailed explanation here, all that need be said is that the portions of uniform light and colour are generally useful, but it is a waste of time to attempt to produce a satisfactory crystal from the variegated portion.

Fig. 3 shows a photograph of a crystal section as seen with the Polariscope. The triangular ingrowths are useless.

Owing to this lack of homogeneity in a crystal, it will be appreciated that there is quite a lot of waste in the production of the quartz plate. Perhaps 5 per cent. of the total amount of raw material is worth working on after the polarised light selection, but there are still other difficulties and faults which will be found, which again lower the total percentage of useful material.

The cutting of the quartz, to produce an active sample, is generally done in one of two directions. These directions are shown in Fig. 2 where one plate is shown cut with its long edge parallel to a Y axis, and another plate is shown with its long

edge parallel to an X axis. The electrodes of the crystal are placed in the first case against the faces whose edges are in the direction of the Y and Z axes, and in the second case against those faces whose edges are in the X and Z directions. Other directions of cutting have been tried by certain investigators, but these cuts are unusual, and not often met with in practice.

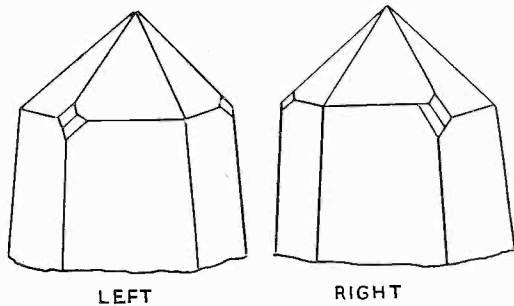

FIG. 1.

To these two directions of cutting and the plates resulting therefrom, a number of names have been applied (4). That shown in Fig. 2 in the direction of the Y axis, is known as the "X," "zero degree," "face perpendicular," "curie," or "long wave" cut, the other is known as the "Y," "30 degree," "face parallel," or "short wave" cut. For simplicity it will be best to refer to these as long and short wave crystals respectively.

The edges of all crystals when cut as rectangular plates are usually parallel to the axes of the crystal. Sometimes plates are cut as discs, when in the case of "long wave" crystals, the diameter is in the direction of the Y axis, and in "short wave" crystals in the direction of the X axis, the Z axis becomes a diameter of the disc in either case.

In the case of any crystal so prepared, it is possible to cause this crystal to generate or respond to a frequency, the value of this frequency being largely determined by the dimensions of the X or Y axis. The Z axis is inactive in itself, but it does contribute to some extent to the final frequency of the plate.

A long wave crystal will usually give two very distinct frequencies, one depending largely upon the length of the Y axis, and the other upon the length of the X axis.

In the earlier days of piezo-electric practice, the expression "metres per millimetre" was much in use, and it indicated that a given length of crystal in millimetres, say along the Y axis, multiplied by a factor, gave the wavelength in metres, of the crystal, or λ metres = F (Y millimetres). In the case of the long wave crystal generating a long wave, experience has shown that F may vary from 102 to 118, with a general value of about 110 for thin crystals. This factor also holds generally for the shorter wave generated by a "long wave" cut crystal where λ metres = F (X millimetres). If crystals are "short wave," then the "metres per millimetre" are of the order of 145, and have been known to vary from 120 to 175 in various samples.

Accepting the approximate values obtained by experience with thin plates, the equations given here are a useful guide for the lengths or thicknesses of crystals.

Long wave crystal as long wave oscillator—

$$\lambda = 110 Y. \text{ or } f = 2730/Y \text{ K.C.}$$

Long wave crystal as short wave oscillator—

$$\lambda = 110 X. \text{ or } f = 2730/X \text{ K.C.}$$

Short wave crystal as short wave oscillator—

$$\lambda = 145 Y. \text{ or } f = 2070/Y \text{ K.C.}$$

Where all dimensions are in millimetres λ is in metres and f in kilocycles.

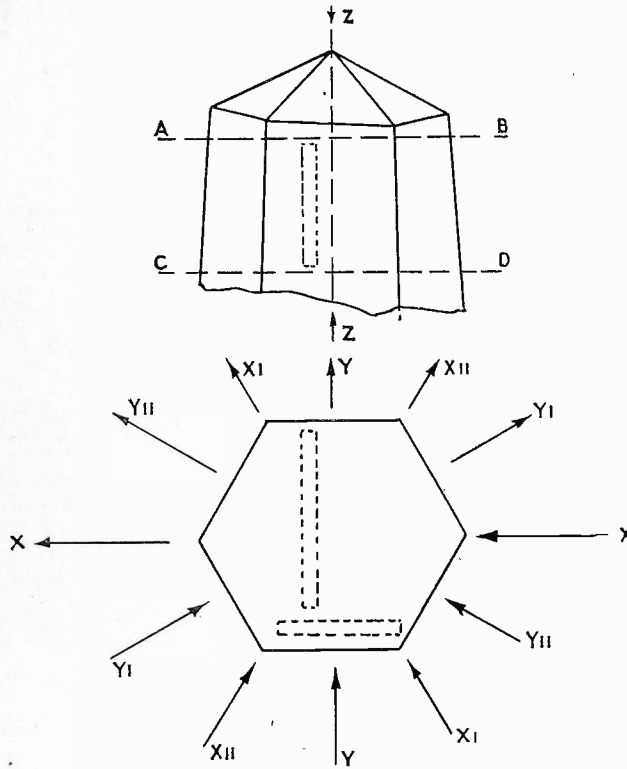

FIG. 2.

Use of Crystals.

Quartz plates can be used in a variety of ways, but the three chief uses in radio practice are:—

- (1) As a means of producing high frequency oscillations when associated with a valve system which of itself is incapable of generating such oscillations.
- (2) As a means of stabilising the frequency of any of the well known fundamental high frequency oscillations.
- (3) As a means whereby a frequency equal to that of the quartz plate can be detected and indication given.

Generation of Oscillations.

Considering (1): Pierce, by means of a simple circuit shown in Fig. 4, produced oscillations. In this circuit the grid leak is not essential, but sometimes if it is not used, oscillations build up to a maximum and collapse and continue in this cyclic manner. The anode circuit may be a resistance or an inductance, but if an inductance, the natural frequency of the inductance must be less than the crystal frequency, for the circuit shown. The crystal can alternatively be connected between grid and filament, and if this is done and an inductance used in the anode circuit, the frequency of the crystal should be less than that of the anode inductance. Greater output can be obtained if choke or resistance of Pierce's anode circuit is replaced by a tuned LC circuit, when, if the crystal is grid anode connected, it will be found that as the tuning condenser is decreased from a large value (i.e., a frequency below the resonant point) towards the resonant point, the position is reached where oscillations start very weakly, increase in amplitude as the resonant point is approached, to decrease slightly and finally collapse when a point is reached in the

L.C. circuit where the frequency of the circuit is slightly inferior to that of the quartz.

If the crystal is grid filament connected, the condenser is tuned from a low value towards resonance, and the collapse occurs again just before resonance point is reached.

The collapse in each case is accompanied by continuous change of frequency which can be heard in a telephone connected in a detector circuit as a rapidly changing note.

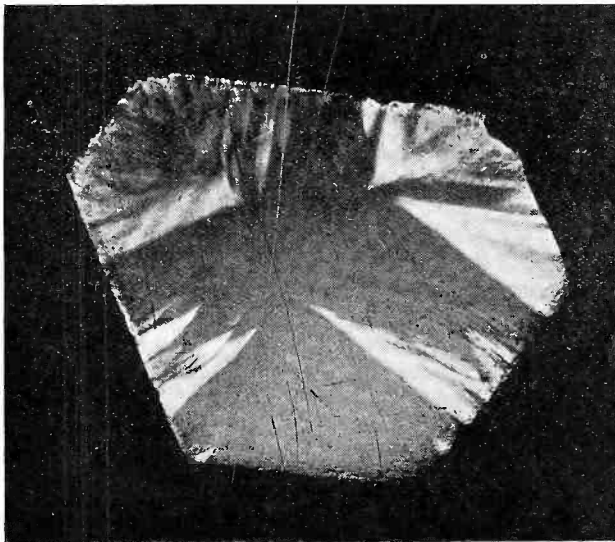

FIG. 3.

Miller and Crossley⁽⁵⁾ have modified the Pierce circuit in one case by tapping the inductance of the anode circuit so that valve impedance can be matched to circuit impedance, and in another case by substituting a choke and grid negative battery for the grid leak, and by using a choke feed to the anode of the valve thereby isolating the D.C. circuit from the H.F. circuit.

Frequency Stabilisation.

Such circuits as these are generally used in Quartz oscillators, but in some cases the Quartz controlled self oscillator is used. This type of oscillator will generally give much greater power than the Pierce type of circuit, but there is a definite objection to its use unless suitable precautions are taken.

In any fundamental oscillator the frequency will fall in a regular manner as the tuning condenser is continuously increased, but if an active quartz plate is connected across the oscillator circuit, or a part of it, the characteristic of the circuit can no longer be represented as a smooth curve but appears as the diagram shown in Fig. 5.

As can be seen, there are two frequencies which can be controlled by the quartz crystal, neither of which is the correct frequency of the quartz. Where the frequency

of the self oscillator starts higher than the natural frequency of the quartz, the resultant controlled frequency will be superior to the quartz, and if the self oscillator frequency is raised from a low value, the controlled frequency will be inferior to the quartz. This difficulty can be overcome by making the frequency of the oscillator of a fixed value, but the system does not recommend itself where great precision and stability is required. All quartz controlled oscillators of variable frequency display this ambiguity in a greater or lesser degree.

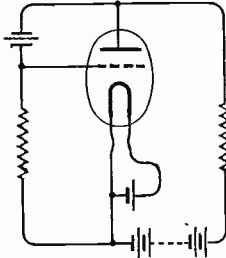

FIG. 4.

It has also been found to be present in combined circuits such as Master Oscillators for Broadcast Transmitters, where a single valve has been used for either a "spot wave" crystal oscillator or a wide range L.C. circuit, the valve being switched from one system to another.

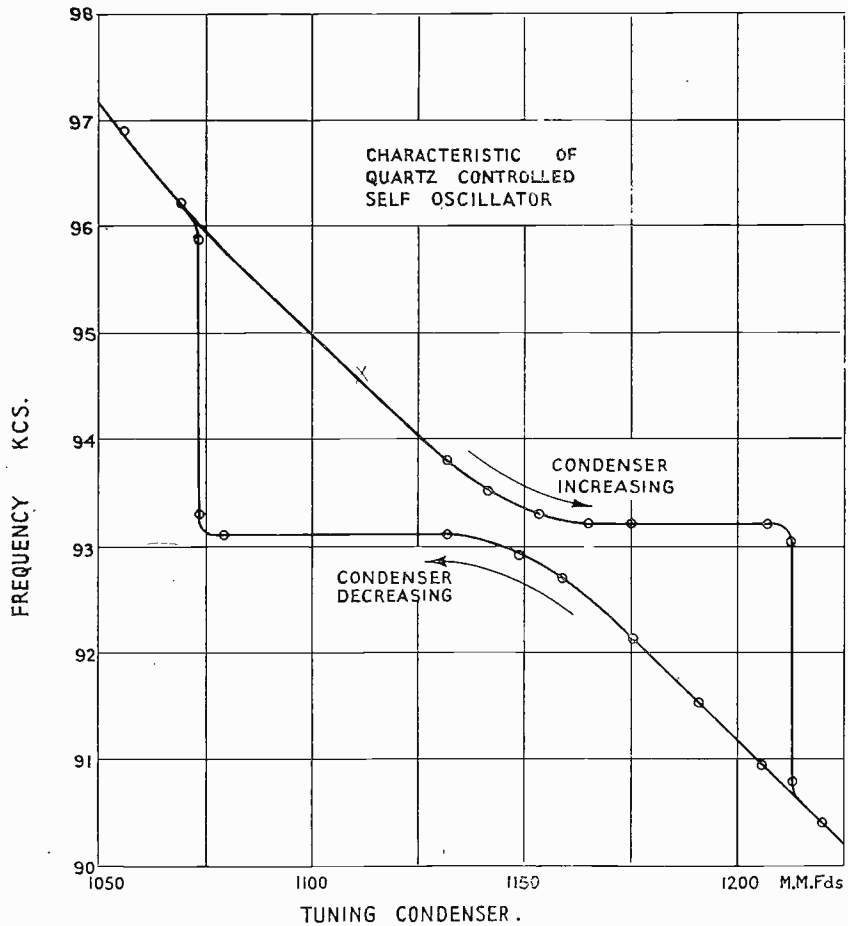

FIG. 5.

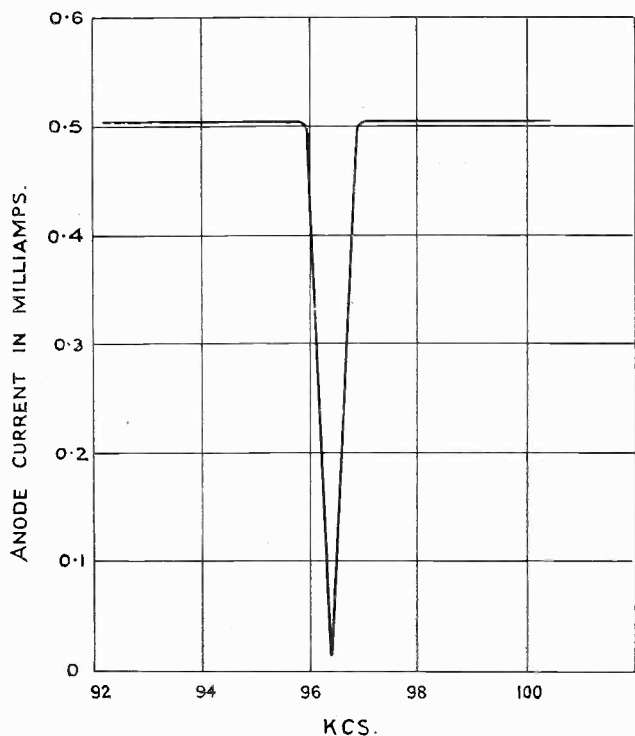

FIG. 6.

Frequency Indication.

The use of quartz as an indicator has not progressed very far.

If an alternating E.M.F. of correct frequency is applied to a quartz plate, then that plate behaves as an extremely low impedance for that frequency.

This can be shown very simply by arranging a simple valve oscillator and a detector circuit.

Over a short range of frequency, the power delivered by the generator will be substantially constant, and the E.M.F. rising on the tuned circuit of the detector will again be very nearly constant, hence the deflection of the galvanometer G will be practically the same over the whole short range when the detector circuit is tuned to the oscillator.

If, however, a crystal is connected across the tuned circuit of the detector, then the galvanometer deflection remains constant until the frequency of the generator to which the detector is tuned is almost that of the crystal, when a sharp decrease

In this case it was found that although the crystal was disconnected from the valve and L.C. circuit when the latter was in use, yet the crystal could be influenced by the L.C. oscillator and react upon it in such a manner that frequencies of ± 1 part in 5,000 of the crystal frequency, could not be generated by the L.C. oscillator, as control by the crystal was sufficient to hold the circuit steady over this band.

The use of quartz controlled oscillators is not to be recommended except in such stations as portable sets where the greatest power, fewest controls, and smallest size are of greatest importance and where a departure of 0.1 per cent. from specified frequency is not important.

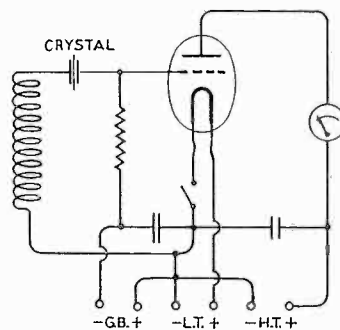

FIG. 7.

in anode current practically to zero occurs, and remains so until the frequency has passed the critical part. It illustrates the extremely low impedance of the quartz crystal at its proper frequency. It is one method of indicating a frequency, but requires great skill and care in handling. The coupling between the circuits must be weak, for if too strong, the crystal will be overloaded and may burst into small pieces, generally accompanied by a loud report. Fig. 6 shows the characteristic. Giebe and Scheibe (6) have produced a luminous resonator which glows in a peculiar manner when excited by an E.M.F. of the correct frequency. The resonator consists

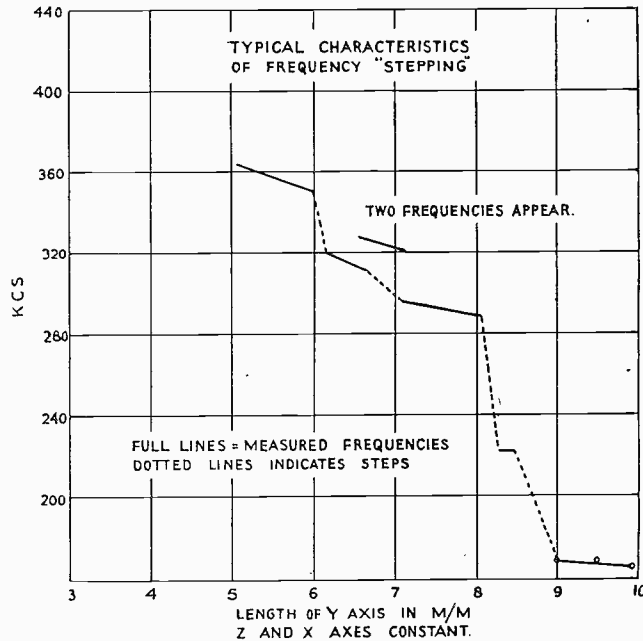

FIG. 8.

of a piece of quartz of definite size suitably mounted and contained in a glass vessel whose atmosphere is of neon at a pressure of a few centimetres of mercury. Connections from the electrodes of the quartz are brought out through a cap to pins in much the same manner as on a valve. Associated with this resonator is an aperiodic pick up coil. When the frequency of the generator is correct, the quartz exhibits a glow which is entirely different to, and not to be confused with the usual neon tube glow.

The usual neon glow can generally be caused to appear in the tube at any frequency if the E.M.F. induced into the pick up circuit is sufficient, but the E.M.F. required to glow the quartz is very much less than that required for neon. About 40 volts is sufficient to bring the quartz to the luminous state, and of course the weaker the coupling, the greater the discrimination of the device.

As a rule, more than one luminous resonator is used associated with the pick up coil. If three are used, then one is correct, and of the others, one is of lesser

frequency and one of greater frequency. Thus, if the oscillator frequency under observation swings, one can observe the swing by watching the glowing of the resonators.

The Marconi Company have produced a simple instrument as a quartz "spot wave" indicator. It consists of a valve circuit as shown in Fig. 7. The anode is brought to zero current when at rest by the use of a grid bias battery. When the transmitter is of correct frequency, the crystal is of practically zero impedance, and an E.M.F. appears on the grid of the valve, causing a rise in anode current. It is to be pointed out that at least two indications may be obtained, one, that due to the quartz, and another, that due to the natural frequency of the pick up coil, but the quartz indication is sharp, whereas the resonance curve of the pick up is very wide, and there is no doubt as to the correct indication. Further, the frequency of the coil can be far removed from that of the quartz and so lessen the chance of error.

The main trouble with any of these indicators is that they are far too exact and constant for the average transmitting station.

The foregoing has very briefly touched upon the more common application of quartz in Radio Engineering. There now arise many points which cannot be treated quite so generally, and owing to the limitation of space available, these must be condensed as much as possible.

Defects of Quartz Crystals.

One of the most serious difficulties encountered in the manufacture of quartz plates is what is known as "stepping." This is particularly troublesome in the case of plates of high frequency where the plates are thin. Up to about 2,500 k/cs. the trouble is present, but not too tiresome, at higher frequencies than this, "stepping" becomes a very great nuisance.

Imagine a plate of quartz, carefully selected in the manner outlined in the earlier part of this paper, and accurately worked. A frequency is obtained and found to be too low, hence further grinding is necessary. The smallest amount of grinding may cause the crystal to become inactive, or it may cause a sudden jump which takes the frequency too far on the other side of the required value.

If the crystal ceases to oscillate, it may be caused by further grinding, to again oscillate, but by this time the frequency may be too high.

Another trouble which may occur is the generation of two frequencies. This occurs very often. Still another trouble is the "jumping" of frequency due to change of temperature. A crystal may behave quite normally over a certain range of temperature and then change frequency very suddenly. A mechanical or electrical shock will often change a frequency.

These difficulties are all well known, and it has been the practice of the Marconi Company to scrap such crystals at the first sign of "stepping" or "jumping," for experience has shown that once these troubles have started with a specimen cut as

indicated, there is little chance of cure. Other cuts and shapes have been tried with a view to curing the "stepping," but none of these up to the time of writing have proved to be a complete cure.

In some cases an improvement can be produced by making the dimensions of the X and Y axes of certain proportions. This, of course, means that every crystal must be treated as an individual subject, and it is doubtful if this is an economic measure. News is to hand that investigators in Germany have succeeded in overcoming the trouble, but no experimental evidence is available at the moment.

Fig. 8 shows "stepping" as thickness is reduced.

A very simple and interesting experiment can be performed which will give an idea of the number of frequencies to which a quartz plate can be made to respond. If a variable frequency oscillator is set up and a crystal used as a coupling condenser to a detector circuit, then by continuously changing the frequency of the oscillator and observing the deflections of the detector anode galvanometer one can form some idea of the response to various frequencies by the quartz plate.

In one case which was tested out with a crystal 25 m/m square, ground "short wave" to a natural frequency of 655 k/cs., it was found that the crystal responded to no less than 52 distinct frequencies. Some of these responses were multiples and sub-multiples of the fundamental frequency, but a large number bore no simple relation to the fundamental frequency and had to be regarded as parasitic.

As has been stated, many efforts to overcome these irregularities have been made. One of the most interesting was to bore a hole in the centre of the plate. This invariably caused the crystal to oscillate at a lower frequency when the hole was small and gave a slight increase in power, but as the hole was enlarged, the frequency increased and the power decayed. These experiments gave no very conclusive results, but it seems possible that the piercing of a crystal plate may be useful in the adjustment of frequency to a very fine degree.

In connection with the search for the perfect crystal, it may be as well to describe an experiment which was made with a number of crystals of the "short wave" cut.

A simple Pierce oscillator was connected and a crystal placed with its optic axis vertical between a pair of parallel electrodes. The crystal was then gently and regularly propelled through the electrodes, and definite changes of anode feed current observed. This was done moving the crystal from right to left and left to right. The crystal was then turned so that the optic axis was horizontal and the experiment repeated. It was found that every violent change of feed current represented a definite abrupt change of frequency, and by careful measurement, a map of the crystal face could be constructed showing those portions of the crystal where the abrupt changes of frequency occurred. Due allowance had to be made for the portion of the crystal uncovered by the electrodes, as this would cause a gentle departure from the normal frequency, but quite distinct from the other changes. This mapping showed that patches of the crystal were of a different frequency to the other portion, and they were removed, but in the very great majority of cases the crystal became inactive after the doubtful portions were taken away.

The Quartz Oscillator.

This experiment strengthened the idea that a crystal plate was not an oscillator of single frequency, but that the frequency obtained was the result of a number of independent oscillators each attempting to deliver its own peculiar frequency, but being held to a common frequency by the predominant parts.

This unpleasant characteristic of "stepping" is more noticeable in crystals of high frequency than in those of lower frequency. It is also more general in crystals cut near the edge of the natural body than in those taken from a plane nearer the centre.

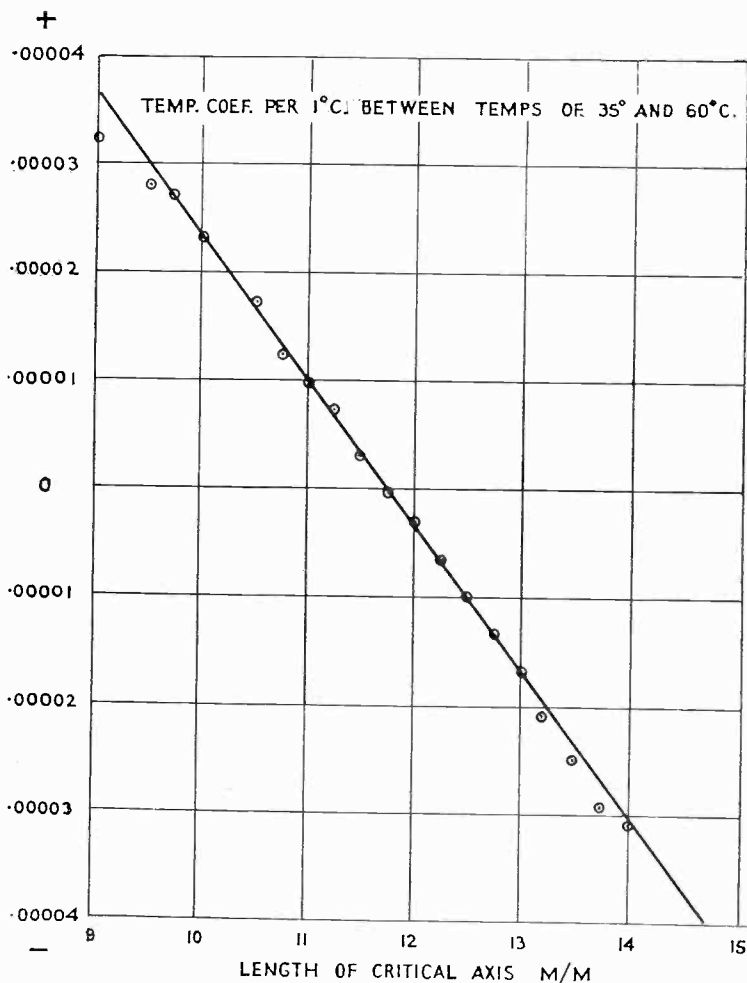

FIG. 9.

This trouble raises the question as to whether it is more economical to start with a fairly low frequency crystal and multiply the frequency by a chain of valve circuits, or whether it is desirable to cut many shorter wave crystals in the hope of eventually finding one that is satisfactory.

This question is one of first importance and cannot be easily answered, but for those who wish to debate the point, it may be of interest to them to know that the Marconi Company have successfully produced oscillating crystals ranging from 30 to 8,000 metres (10,000 to 37.5 k/cs.), but on occasions it has been necessary to cut a number of crystals to produce a few which would satisfy the standard of frequency accuracy and power output.

There is much to be said in favour of starting with a low frequency crystal. The crystal is easier to produce, it has fewer "stepping points," it can be made to have a better temperature coefficient, and of course, it can be made to deliver quite a number of multiple frequencies. Against this must be set the extra values and circuits required, which are somewhat costly in manufacture and maintenance.

Power Output.

Power output is another point which requires much consideration.

If a crystal is driven hard, it will be found that even if there is no tendency to spark, the crystal will show signs of tiring, and the stability will be of a lower order than that of a more gently used crystal, but it is to be noted that if a number of crystals are cut from the same body, all brought to a given frequency, the dimensions, other than the active one, equal in all cases, and the same drive system used, then the voltage arising from any one specimen may be and, invariably is, very different to that delivered by any of the other samples.

Ignoring the samples which refuse to oscillate and considering those that do, it has been found that a voltage ratio of 2/1 between specimens from the same material body is not uncommon.

The only way of overcoming this trouble is to cater for a low value and dissipate the extra power from the better samples, whilst keeping the valves in the system to a reasonable number.

The questions of "stepping" and power, are points which are still ignored by a number of manufacturers.

From time to time, advertisements have appeared which offer quartz crystals at very low prices. A number of these have been tried, and whilst most of them have been beautifully made plates, none of those tested have come up to the requirements. Most of the faults are X frequencies, low power, poor mountings in no way to be compared with the crystal itself, and inexact frequency.

Temperature Coefficient.

The temperature coefficient of crystal oscillators is a matter upon which a great deal of work has been done by various experimenters. Morrison⁽⁷⁾, Heising⁽⁸⁾, and Lack⁽⁹⁾, in America have devoted much care and attention to this matter.

Morrison's work on the ring crystal is of extraordinary value, but any attempt to give an abstract from his paper would require more space than is available here.

Heising and Lack have analysed the problem and regard a crystal as being a system of coupled circuits, and from this standpoint have given information which

The Quartz Oscillator.

indicate the dimensional ratios of the crystal to produce a frequency at a given temperature coefficient.

The Marconi Company have also investigated the problem of producing crystals of substantially zero temperature coefficient, and have been able by the selection

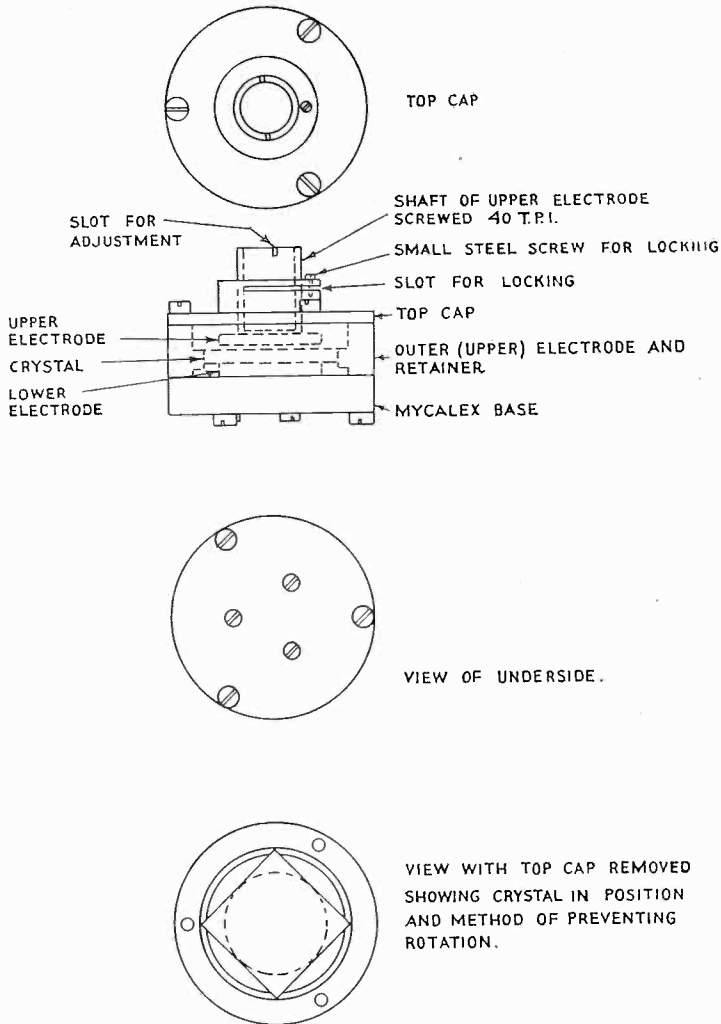

FIG. 10.

of correct dimensions of the three axes to produce crystals whose temperature coefficient is of a very low order.

These crystals can only be those cut and used in the short wave manner, and this agrees with the expectation of Lack, who states "that it would be impossible to obtain zero temperature coefficient crystals with this orientation" (i.e., the long wave cut).

The frequency range over which the zero temperature coefficient crystal is at present produceable is somewhat restricted, as in the case of crystals of frequencies below about 375 k/cs. the size of the crystal is becoming somewhat small and in consequence difficult to handle with the care which is necessary, whilst a lower frequency limit is reached where the crystal becomes too heavy.

It has been found that with a short wave crystal a positive or negative temperature coefficient can be produced by the simple readjustment of the axial lengths.

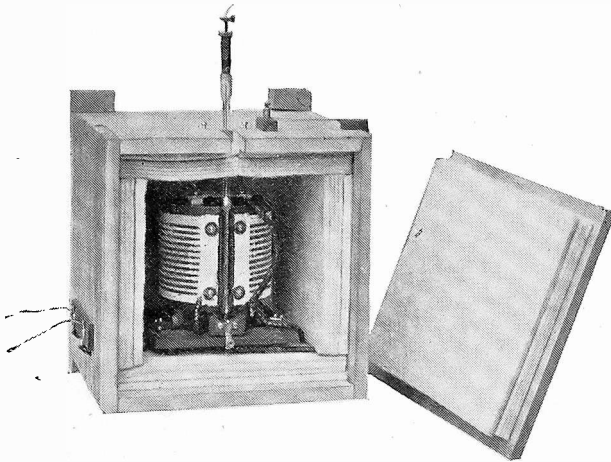

FIG. II.

Fig. 9 shows the results of measurements of temperature coefficients of a certain crystal after various adjustments of axes.

It has been found in these experiments that all the axes had some bearing on the frequency, but the length of one axis was critical for the temperature coefficient. To produce a crystal of required frequency and temperature coefficient requires calculation concerning the three axes, and it is interesting to note that the formulæ given in a previous portion of this article

no longer hold for the approximate frequency of the crystal. These low temperature coefficient crystals are thicker than those in general use and for a certain case the formula $\lambda = K. H. \cos \alpha$ was found to hold over a fairly wide range, where the mechanical axial length was kept unaltered, and the optical and electrical axial lengths were reduced but kept in the same ratio one to the other.

λ = Wavelength in metres

$H = \sqrt{X^2 + Y^2}$ (X and Y in millimetres)

α = Angle between H and the adjacent Y axis

K = 103.1 for the particular case

from which one can calculate the frequency. Other crystals have been made on these lines and in every case it has been found that by making the axial lengths of the correct order, a very low temperature coefficient can be obtained.

A great amount of work has been done by certain experimenters on crystal holders. That of Morrison is undoubtedly practically ideal, but from experiments made, it does seem that the holder itself, if well made, rigid and of good materials, has not so much bearing upon the temperature coefficient of the system as the crystal itself. To test this out, a pair of crystal holders were made, one being of brass electrodes on mycalex, and the other of Invar steel on fused silica, and the same crystal tested in both holders. It would be difficult to state with assurance which of these holders gave the lesser overall frequency change due to temperature.

One of the latest types of crystal holder used by the Marconi Company is quite a simple affair and is shown in Fig. 10.

The crystal lies flat on one face on the lower electrode, it is prevented from

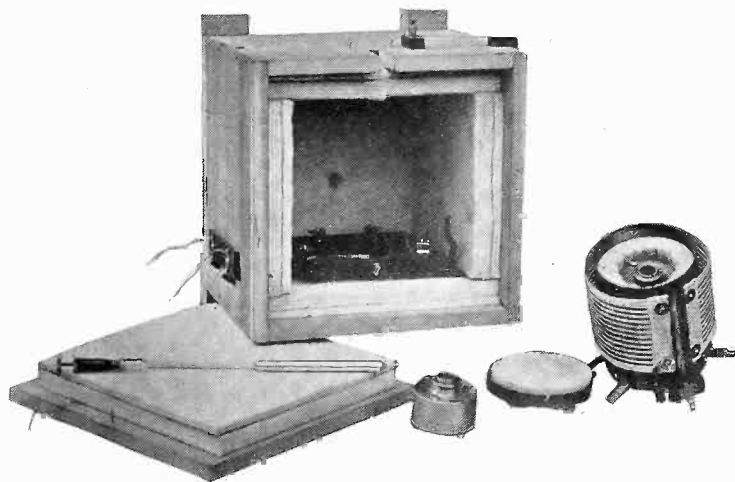

FIG. 12.

turning by the retainer, and adjustment can be made by the upper electrode after the whole is finally assembled. It also has the advantage that the expansions of the electrodes are to some extent compensated, and the only portion liable to serious change is a small section rather thicker than the crystal itself.

In every case, if at all possible, a quartz crystal should be thermally controlled. It is often inconvenient to run a costly stirred thermal chamber and the Marconi Company has produced a small chamber and controller. This is shown in Figs. 11 and 12. In Fig 11 is shown the complete assembly with front removed, and in Fig. 12 the individual parts with a spare crystal holder.

The thermostat is a mercury thermometer capable of fine adjustment, and the inner smoothing chamber is of copper, heavily lagged with dry felt, in which the crystal holder is held.

A test on such a chamber gave the following results. The crystal in use was quite an ordinary one and not of the low temperature coefficient variety, and the test was made in a room in a corrugated iron building in November. The room is approximately 50 feet by 16 feet, has 5 doors, is heated by a small coke stove, and the crystal chamber was near 2 doors and 30 feet from the stove.

Nov. 23	G.M.T.	1005	Freq.	1301.802	Nov. 25	G.M.T.	1520	Freq.	1301.805
		1120		1301.802			1630		1301.805
		1220		1301.805			1735		1301.807
		1305		1301.808	Nov. 26		1005		1301.800
		1740		1301.805			1200		1301.800
Nov. 24		1020		1301.805			1300		1301.802
		1120		1301.807			1420		1301.800
		1235		1301.805			1520		1301.805
		1420		1301.807			1630		1301.805
		1520		1301.805			1740		1301.805
		1620		1301.805	Nov. 27		1030		1301.802
		1740		1301.805			1130		1301.802
Nov. 25		1000		1301.800			1300		1301.805
		1110		1301.800			1420		1301.805
		1210		1301.802			1530		1301.807
		1300		1301.805			1630		1301.805
		1420		1301.805			1740		1301.802

The Quartz Oscillator.

Voltage changes on a crystal oscillator give rise to very small changes in frequency. Tests made of various crystals have shown that variation of the supply voltages by ± 10 per cent. of either L.T. or H.T. or both together do not give a change of frequency of more than 3 parts in 10^6 from normal. This voltage change is greater than is to be expected under ordinary circumstances in practice and the frequency change can, except for very special work, be disregarded.

It has been the usual practice up to the present to use 3 electrode valves as the crystal oscillator valve, but now the tendency is to use the 4 electrode valve. This matter is being steadily investigated by the Marconi Company, and it seems that in the future these valves will at least be used on certain types of apparatus. The various advantages of the 4 electrode over the 3 electrode valve all appeal to the crystal manufacturer and user. Oscillation with a 4 electrode valve is easier, output is greater, and heavier crystals can be used, but unwanted capacities must be kept to the utmost minimum.

Nothing has been mentioned in this article of the alteration of frequency due to barometric changes. That air pressure will cause a frequency change is quite well known. Its importance from a transmitting standpoint at the moment is not of high order, but within the next few years, it is very likely this matter will have to be seriously investigated if the radio channels increase in number as they have done in recent years, and quartz driven circuits are used.

T. D. PARKIN.

REFERENCES :

- (1) The Piezo-electric resonator, W. G. Cady, Proc. Inst. Rad. Eng., Vol. 10, No. 2, April, 1922. W. G. Cady. An International comparison of Radio wavelength Standards by means of Piezo-electric resonators. Proc. Inst. Rad. Eng., Vol. 12, No. 6, Dec., 1924, and W. G. Cady, Piezo-electric standards of high frequency. Optical Soc. America, Vol. 10, No. 4, April, 1925.
- (2) G. W. Pierce, Piezo-electric Resonators, etc. Proc. Amer. Ac. of Arts and Sciences, Vol. 59, No. 4, Oct., 1923.
- (3) E. Mallet and J. J. Terry. The quartz oscillator. "Wireless World," No. 306, Vol. 16, No. 20, June 24th, 1925.
- (4) Summary of Piezo-electric Crystal Conference held by U.S. Navy Department, Dec. 3 and 4, 1929. Proc. Inst. Rad. Eng., Vol. 18, No. 12, Dec., 1930, and W. G. Cady. Piezo-electric Terminology. Proc. Inst. Rad. Eng., Vol. 18, No. 12, Dec., 1930.
- (5) Piezo-electric Crystal Controlled Transmitter by A. Crossley. Proc. Inst. Rad. Eng., Vol. 15, No. 1, Jan., 1927.
- (6) Vibrations in Quartz Crystals by H. Kronkš. "Wireless World," 23/12/25, and Brit. Pat. Spec. 252,170. Complete accepted Nov. 14, 1927.
- (7) High Precision Standard of Frequency. W. A. Morison. Proc. Inst. Rad. Eng., Vol. 17, No. 7, July, 1929.
- (8) Improvements in or relating to Piezo-electric Crystals. Brit. Pat. Spec. 351,940. Complete accepted June 30, 1926, Elec. Research Products and R. A. Heising.
- (9) Vibration and Temperature of crystal plates by F. R. Lack. Proc. Inst. Rad. Eng., Vol. 17 No. 7, July, 1929.

PROPERTY OF
CANADIAN MARCONI CO.

THE PERFORMANCE OF THE MARCONI-ADCOCK DIRECTION FINDER

Previous articles on the Marconi-Adcock direction finder, published in THE MARCONI REVIEW, No. 21 and No. 31, have indicated the theoretical basis of this system of direction finding and have described the practical construction of an instrument of this type.

Curves given have also demonstrated that one of the chief sources of error in any direction finder, so called "night effect," is reduced to a minimum in the Marconi-Adcock system.

Prolonged experiments have furnished further information, and the results of a large number of observations are given and analysed in the following article.

ACCURATE direction finding under conditions of night effect depends upon the direction finder being entirely immune from the influence of the abnormal polarised component. Under these conditions the instrument would continually select only the normally polarised signal component and the sharpness or quality of the bearing would depend on the strength of such component. Under conditions of severe night effect the quality of the bearings would be continually varying and would deteriorate as the level of the normal component approached general noise level and finally a condition when no bearing could be taken would occur when the normal component of the signal dropped below noise level or became zero.

In actual practice these variations of signal strength would be occurring with such rapidity that the effective bearing would be generally of good quality, but the point is that a direction finder entirely immune from the abnormal component of the signal will, on occasions, be inoperative under conditions of night effect.

The Marconi-Adcock direction finder up to the present represents the nearest approach to the ideal instrument cited above and when erected under favourable conditions is largely free from reception of the abnormal signal component. With this instrument high accuracy may be obtained under severe night effect conditions and the writer has made an analysis of data which has accumulated during tests with the view of providing a more accurate picture of performance and of formulating a general figure of merit for the instrument.

Observations taken at Writtle, Chelmsford, on four transmitting stations are set out in the graphs shown in Figs. 1 to 4.

The Performance of the Marconi-Adcock Direction Finder.

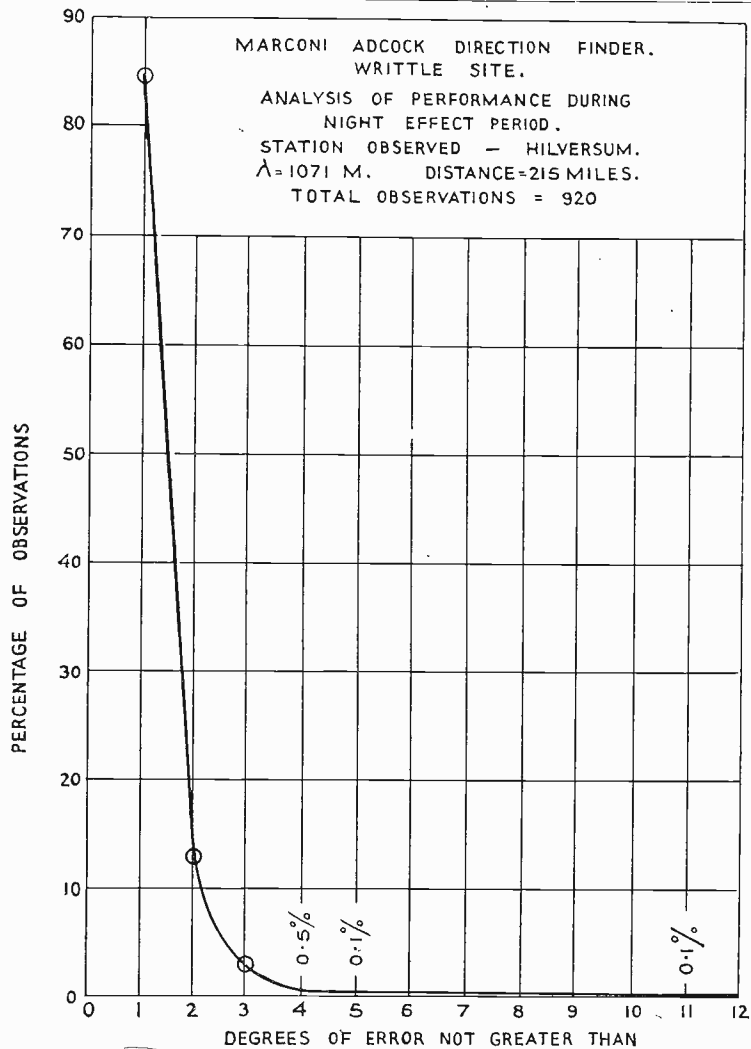

The results may be summarised as follows :—

FIG. I.

Marconi Adcock Direction Finder.

Station Observed.	W/L Metres.	Distance (Miles).	% of bearings with error not greater than 1°.	% of bearings with error not greater than 3°.	% of bearings with error greater than 3°.	% of observations "no bearing possible."	Total of observations.
Brussels ..	509	210	77	98.76	1.2	—	421
Hilversum ..	1071	215	84.5	99.2	0.76	—	920
Warsaw ..	1411	873	78.6	96.8	3.2	—	421
Kalundborg	1153	510	70.25	92.07	7.67	0.26	1146

The Performance of the Marconi-Adcock Direction Finder.

Simultaneously with the above observations on the Brussels transmitter with the Marconi-Adcock direction finder, bearings were taken on the Bellini-Tosi direction finder and comparative analysis is of interest in showing the much higher performance of the Marconi-Adcock system.

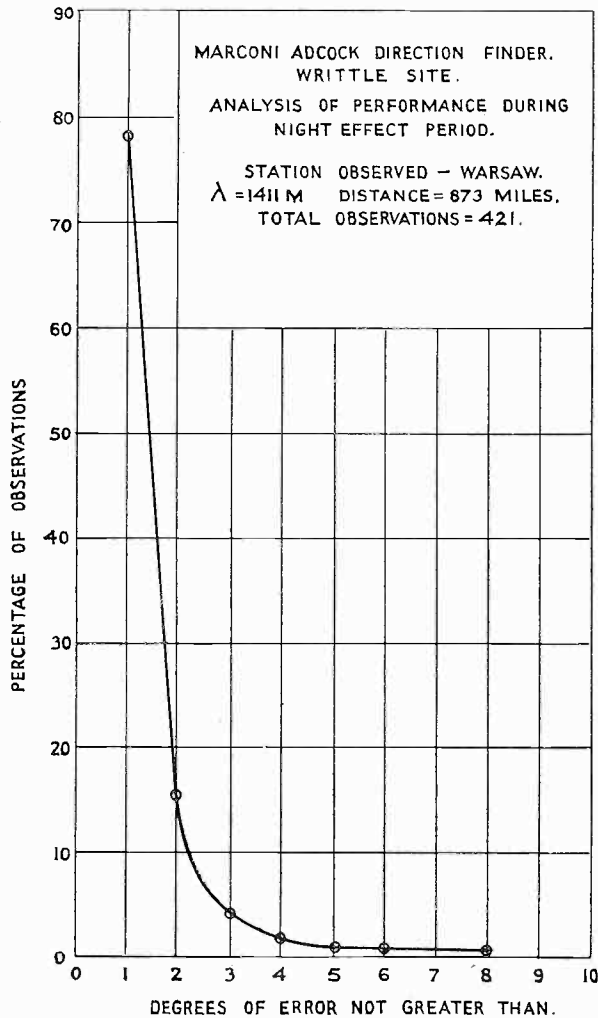

FIG. 2.

Bellini Tosi Direction Finder.

Brussels ..	509	210	%	%	%	%	451
			11.5	36.2	63.8	—	

With the Marconi-Adcock system the mean percentage of bearing on these four stations giving an error greater than 3° is 3.2 per cent. and the result is of

The Performance of the Marconi-Adcock Direction Finder.

special interest as the transmissions under observation were chosen as subject to considerable variation under night condition.

The explanation of the deviations from the true bearing is that the normally polarised component of the signal has become very weak and comparable with residual pick-up of the abnormally polarised component. In a direction finder

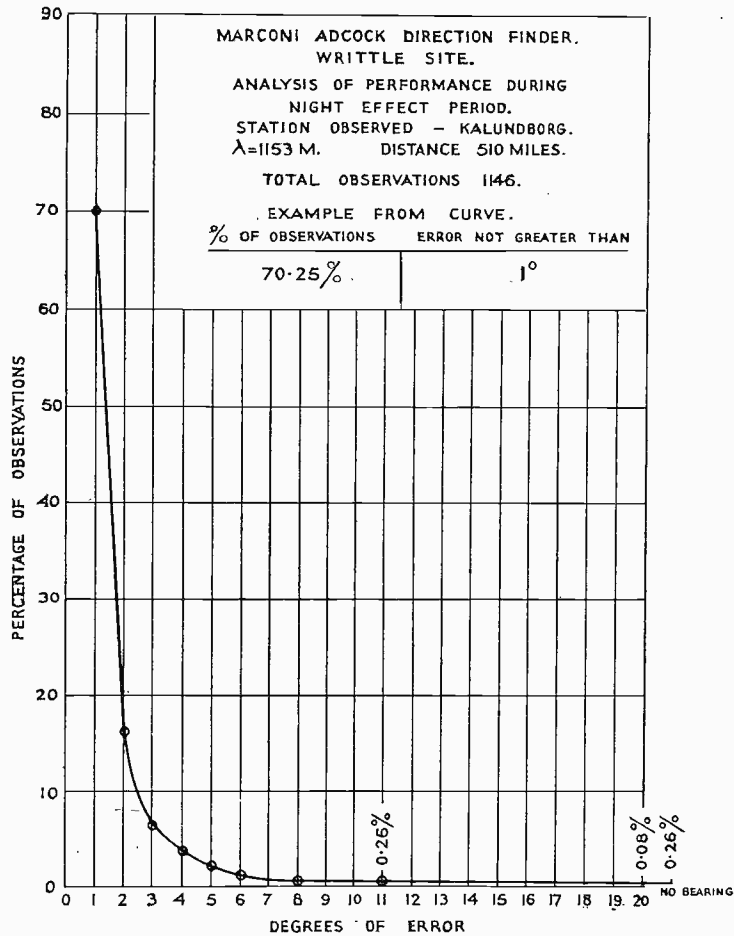

FIG. 3.

entirely immune from the abnormal component the condition represents one in which no bearing would be possible owing to the necessary wide swings and indefinite zone of zero signal. In the practical instrument slight residual pick-up of the abnormal signal component tends to swing and slightly sharpen the zero zone but this still remains flat and indefinite and the period is easily recognisable as impracticable for direction finding. Experience shows that such periods are generally of very

The Performance of the Marconi-Adcock Direction Finder.

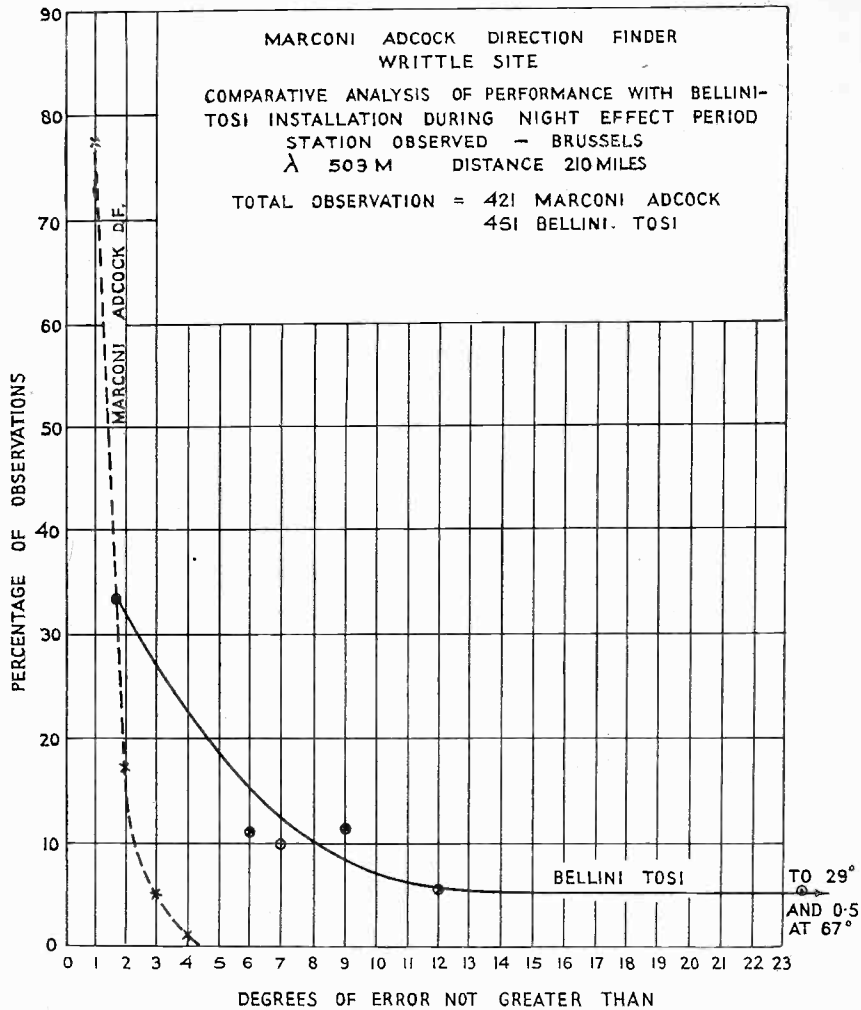

FIG. 4.

brief duration and in practical direction finding do not in any way prejudice the utility of the instrument. They usually concur with sunset at the transmitter or at the direction finding station and appear to be most severe on transmissions from a distance of 400 to 600 miles in the medium wavelength band.

N. E. DAVIS.

MARCONI DIRECTION FINDER

TYPE D.F.G.9B

This type of Direction Finder has been developed for Naval Purposes and is intended for use with the small type of shielded frame aerial.

The Type D.F.G.9a Direction Finder, of which the D.F.G.9b is a modification has been previously described in the MARCONI REVIEW, No. 35.

THE Type D.F.G.9b Direction Finder is similar in general construction and performance to the D.F.G.9a, but has the greater waverange of 130—4,000 metres, the amplifier and direction finder circuits being covered by 5 and 4 ranges respectively.

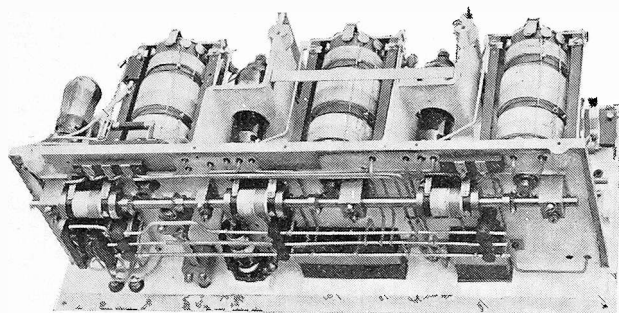

FIG. 1. *Amplifier Section of D.F.G.9b.*

The high frequency transformers for wavelengths covered by range 1 are accommodated on the transformer drive spindle and are mechanically brought into circuit by the wavechange handle in the range 1 position. In this way these small transformers are conveniently screened from the active parts of the amplifier and the arrangement is clearly shown in Fig. 1.

Although there is little call at present for actual direction finding at the lower end of this waverange, the instrument is of considerable practical value at shore stations for the directional reception of trawler telephony and spark signals on the 130—300 metre band.

The inclusion of this lower tuning scale, however, calls for special precaution in the loop circuits in order to maintain reasonable accuracy when D.F. bearings are required on these wavelengths. With aperiodic fixed loop direction finders it is necessary to ensure that the natural frequency of either loop circuit comprising aerial, connecting cable and goniometer field coil, shall be outside the normal tuning range of the instrument. In any case it is not desirable that the ratio of the natural wavelength of either loop to that of the received wave shall fall closer than as 4 : 5 or its reciprocal.

With the extended waverange of the present instrument, however, it is not practicable to keep loop resonance outside the tuning scale. Therefore, artificial capacities are employed in such a manner that when working on range 1 for

Marconi Direction Finder.

example, loop resonance is transferred to a wavelength nominally covered by range 2. This device is controlled by a switch on the goniometer panel.

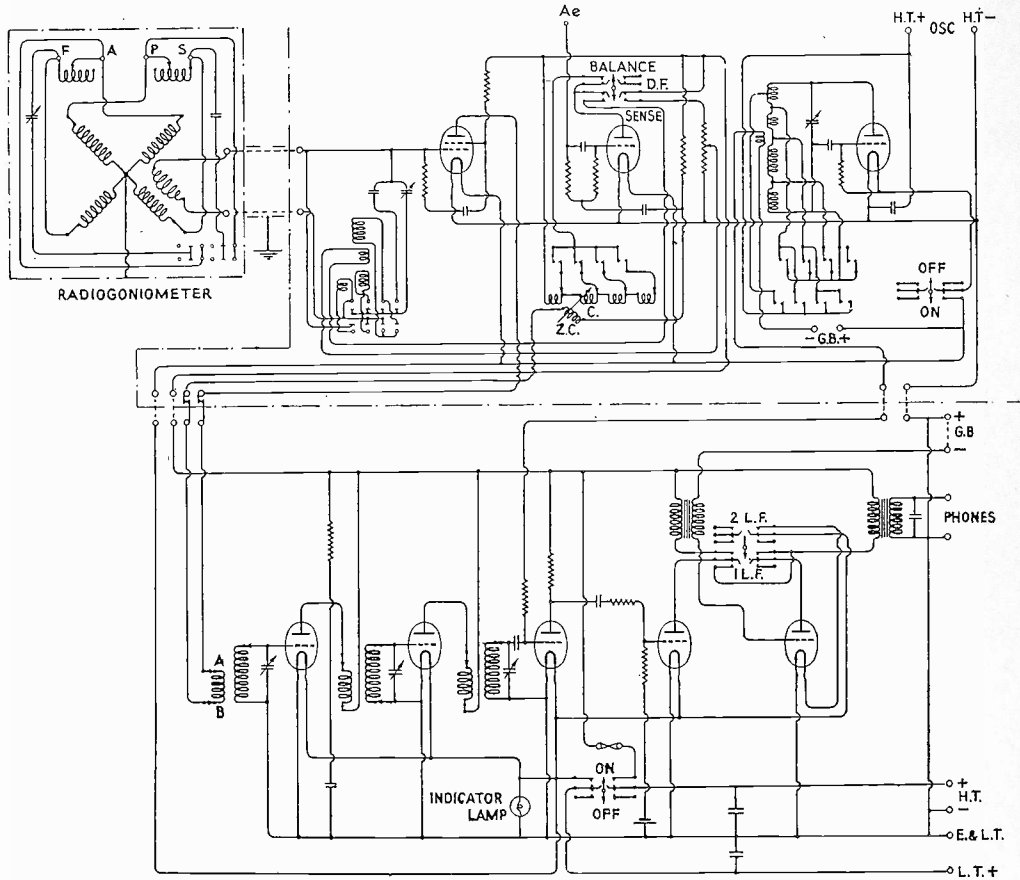

FIG. 2.

Two complications result from this procedure :—

- (1) When working on range 1 loop resonance occurs above that of the received wave, whilst on the higher ranges this condition is reversed. Accordingly "sense" will be reversed by merely changing wave-range. This difficulty, however, is overcome by reversing the "sense" coupling for the range 1 position.
- (2) Since artificial capacities are introduced into the aerial circuit on range 1, the receptive balance between the two aerial loops is interfered with and calibration will be affected. For this reason

one loading capacity is fixed and the other variable. Therefore, it is necessary first of all to calibrate the instrument on one of the higher ranges and then to compensate range 1 by means of the variable condenser in order that the calibration for all ranges shall be identical.

The search coil circuit is tuned over the complete waverange which results in very uniform reception efficiency.

The complete electrical arrangement is given in Fig. 2.

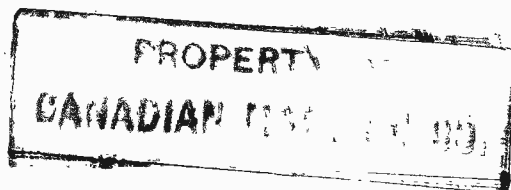

NEW TECHNICAL JOURNAL.

We have received from the Associazione Elettrotecnica Italiana, Milano (2/2) —Via San Paolo, N.10, a copy of the first number of a newly published quarterly magazine entitled "Alta Frequenza." This Journal deals primarily with radio communication, and secondarily with radio technique, telephony and applied acoustics. It is published under the patronage of the National Council for Research, the Italian Electrotechnical Association and the Italian Physical Society, and has for President of the Committee of Management, His Excellency, Marchese Marconi. The magazine is issued under the direction of Professor G. Vallauri and contains interesting articles on the detection of ultra short waves, electrical methods for the measurement of pressures and displacements, a study of an amplifier for very low frequencies or continuous current, and experimental research on the projection of an electromagnetic wave in an ionised medium in a magnetic field, in addition to abstracts of articles which have appeared in other journals, and of patent specifications. The Journal also contains reviews of various publications and the first number contains 160 pages. The magazine is well printed and illustrated and the quality of the articles throughout is excellent.

We wish the new magazine every success. It is obtainable from the publishers mentioned above, and the price per single copy is 12 lire, or for annual subscription 30 lire.

THE MARCONI SYSTEM FOR DISTANT CONTROL BY WIRELESS OF FOG SIGNALS

In an article published in THE MARCONI REVIEW, No. 32, entitled Coastal and Harbour Wireless Services, attention was drawn to the many services which wireless communication offers to Coastal and Harbour authorities for the protection of life and property in congested and dangerous waters.

The purpose of this article is to describe a system of fog signal control by means of wireless which has been evolved by the Marconi Company for the Honourable Corporation of Trinity House, and which has been in successful experimental operation for many months between two Light Vessels a distance of 8 miles apart in the Thames Estuary.

FOR the purpose of this description the equipment can be divided into two portions, namely (A) the wireless control transmitter with its code sender ; (B) the fog signalling apparatus and the wireless control receiver.

When fog is observed the transmitting installation is put into operation and sends out an interrupted continuous wave at the rate of 60 impulses per minute. These impulses are intercepted by the wireless receiver at the fog signal station and by means of a special oscillating balance wheel operate the fog signalling mechanism. When the fog lifts the wireless transmitter sends out another train of impulses at the rate of 46 impulses per minute. These impulses operate a second oscillating balance wheel which stops the signal sounding.

The special precautions taken in the design of the receiver and of the oscillating balance wheels ensure that the fog signal operates only under the following conditions :—

- (1) When the receiver is tuned to the wavelength of the transmitter.
- (2) When the transmissions are effected at the correct impulse frequency.

It will thus be seen that the apparatus is sufficiently immune from atmospheric and interference from other wireless transmitters.

The Transmitter.

The transmitting equipment used by Trinity House for sending out the control signal consists of the standard Marconi Type Y.B.1 100-watt set, but any transmitter which incorporates the interrupted continuous wave method of signalling can be used. The additional apparatus required at the transmitting end consists of a spring driven code sender provided with two code discs and a motor driven interrupted disc. Either of these discs, one known as the " Start " disc and the other as the " Stop " disc can be connected in series with the interrupter disc by means of a small change-over switch.

The Marconi System for Distant Control by Wireless of Fog Signals.

For starting the fog signalling plant, the "start" code disc causes a series of 12 I.C.W. impulses followed by a dash to be transmitted at the rate of 60 impulses per minute while, for stopping it the second or "stop" disc is used which causes a series of 12 I.C.W. impulses at the rate of 46 impulses per minute to be transmitted.

A simplified diagram of connections of the transmitting end is shown below, Fig. 1.

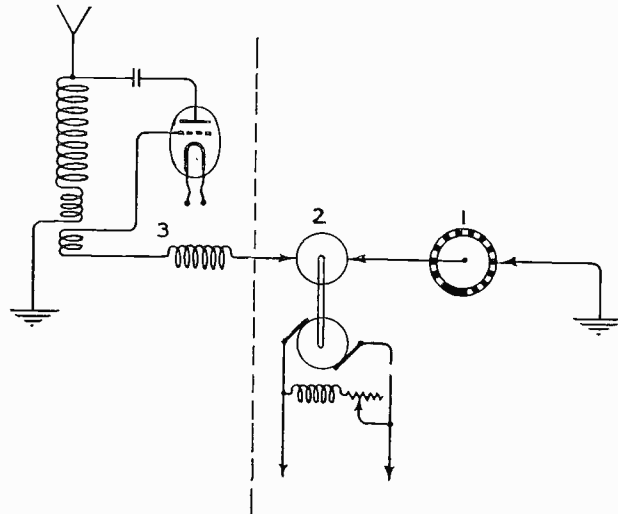

FIG. 1.

The code sender (1) consists of a high quality gramophone motor which drives the "start" and "stop" discs. The starting and stopping of the motor is controlled by a press button and after being started the code sender will transmit one complete set of signals and then automatically stop. A three-way switch enables either code disc to be switched into circuit or the switching out of both. The motor of the code sender is operated by means of a small press button.

The interrupter disc (2) is driven by a small motor connected to a 24 volt battery and is connected to the grid circuit (3) of the wireless transmitter. A two-way switch is provided for changing from normal working on the wireless transmitter to code sending for operating the distant controlled fog signal apparatus.

When this switch is in the fog position the interrupter disc is automatically started, and either the "start" or "stop" signal is transmitted according to the code disc selected, by merely pressing the starting button of the code sender.

The Receiver.

The receiver associated with the fog signalling plant consists essentially of a high frequency amplifying valve, a detector valve and two low frequency magnifying valves with the necessary tuning circuits.

A simplified diagram of connections of this receiving set is shown below, Fig. 2.

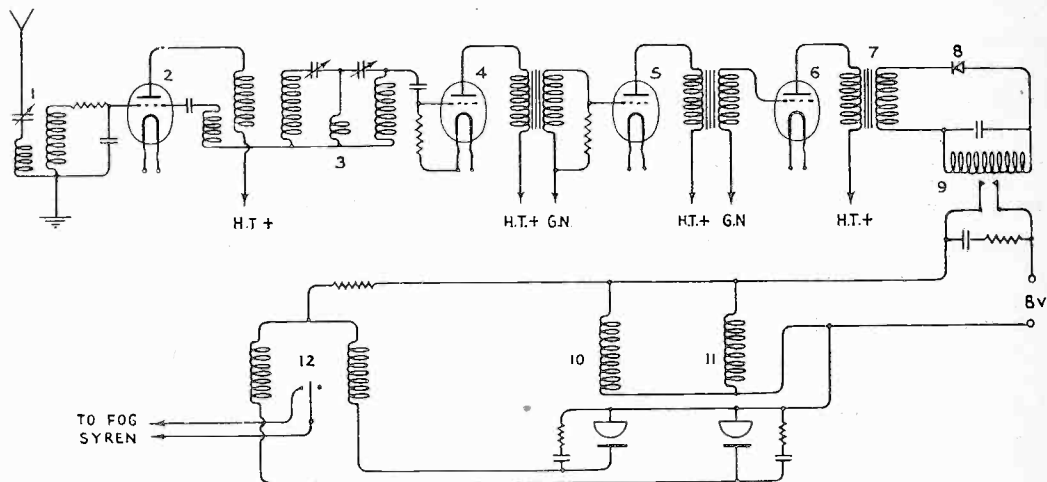

FIG. 2.

In the anode circuit of the second low frequency magnifying valve (6) is included the primary winding of a stepdown transformer (7). The second winding is connected to a copper oxide rectifier (8) and the field winding of a Weston relay (9). The contacts of the relay are in series with the field windings of two oscillating balance wheels (10) and (11) and an 8 volt battery.

Each balance wheel is fitted with a make and break contact which is connected to the field winding of another relay (12) which in turn is connected to the mechanism for operating the fog signal. One of the balance wheels has a natural period of oscillation of 60 per minute and the other of 46 oscillations per minute. Each wheel will, therefore, be set in oscillation only when impulses of the correct frequency pass through the field windings.

The alternating current output of the low frequency magnifying valve (7) is rectified by means of the metal rectifier (8) and the first impulse received will close the contacts of the relay (9). If now a sufficient number of impulses at 60 per minute are received, the "60" oscillating wheel will oscillate with an increasing swing until the contacts make thus closing the relay (12) which operates the fog signal mechanism. If the "stop" signal namely, 46 impulses per minute is transmitted, then the "46" wheel will make contact and open the relay (12) thereby stopping the plant.

The Marconi System for Distant Control by Wireless of Fog Signals.

The component parts of the receiver together with the oscillating wheels are housed in a substantially constructed containing case. The oscillating wheels are mounted in gimbals to minimise the effect of the ship's motion when installed on lightships, etc.

Type H.2 valves are used in all four stages of the receiver, the total filament consumption being less than 1 watt, and the total anode feed about 3.5 milliampere at 80 volts.

Range.

A series of tests carried out by the Marconi Company in conjunction with the Honourable Corporation of Trinity House shows that the actual range of the equipment is much greater than the figure quoted above, reliable operation under ordinary working conditions over a range of 15 miles having been obtained.

MARCONI NEWS AND NOTES

THE KING OF ITALY VISITS "ELETTRA"

THE King of Italy visited Marchese Marconi's famous yacht *Elettra* in the Gulf of Genoa on July 14th, and witnessed a demonstration of short wave wireless telephony.

During his tour of inspection of the *Elettra*, which is used by Marchese Marconi as a mobile laboratory for his researches, the King examined the new experimental equipment for working on "quasi-optical" wavelengths of about half a metre and less. Marchese Marconi intends to carry out a fresh series of experiments with this apparatus during the summer.

New Marconi Beam Services.

NEW Marconi transmitting and receiving stations are to be erected near Shanghai to the order of the Chinese Government for the operation of short wave Beam services between China and Europe and the United States of America.

The equipment of the new stations will include two Beam transmitters and four sets of receiving apparatus, and a unique feature of the installation will be the inclusion of auxiliary Marconi apparatus enabling the transmitters to be utilised for broadcasting services when they are not in use for telegraphic communications.

While the two new transmitters will follow standard practice in the principal features of their design, arrangements have been made for them to operate on increased power and the consistently reliable service given by the present Marconi Beam stations in all parts of the world indicates that this provision of additional power will give the Shanghai station a wide safety margin for good communication under all conditions.

The auxiliary apparatus for broadcasting consists of a modulating equipment which can be connected to either of the telegraph transmitters, when not in use for normal service, to provide telephone signals of broadcasting quality. A complete set of Marconi studio equipment is also to be supplied to enable this auxiliary service to be conducted in accordance with the most modern practice.

Beam and Omni-directional Aerials.

The aerial system of the transmitting station is of particular interest. For the commercial telegraph services to Europe, two bays of Beam aerials, accurately oriented to concentrate their signals on the receiving stations, are to be erected, one being tuned to the wavelength of 17 metres and the other to 26 metres, the wavelengths allotted to these circuits. A third Beam aerial array will be directed on San Francisco for the American service.

In addition, there will be four omni-directional aerials, one of which will be used for broadcasting. The others are provided to afford the station the maximum flexibility in the range and extent of its telegraphic services, enabling the equipment to be used if required for short wave communications over comparatively small distances, for which the special qualities of Beam transmission are not necessary.

At the receiving station four high-speed commercial service receivers of the Marconi Beam type are to be installed, with two Beam aerial systems directed on Europe and two on San Francisco for the reception of the European and American services respectively. Four omni-directional receiving aerials are also to be supplied for the reception of short wave signals from other countries with which Beam services are not required.

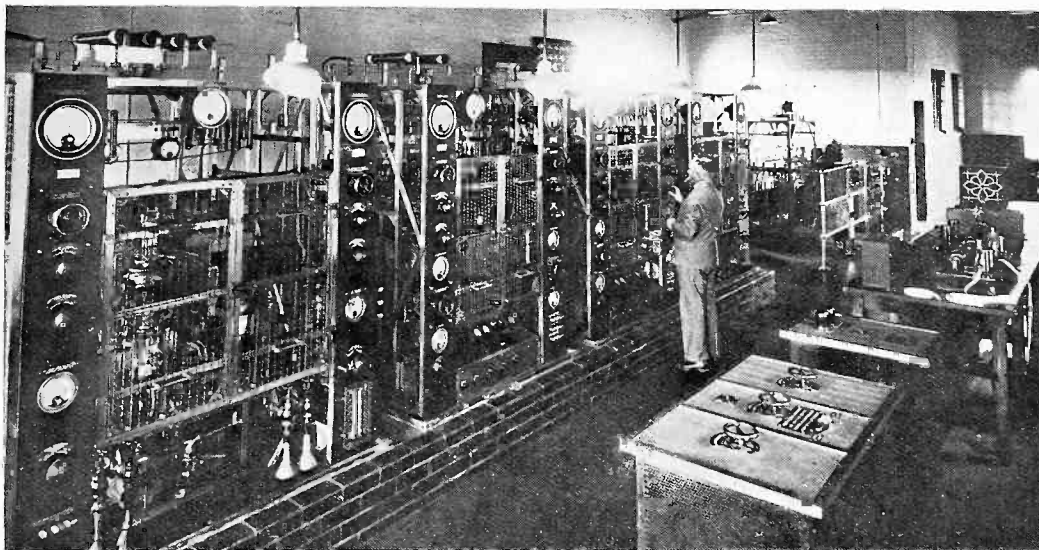

Interior of the Marconi Beam Station at Salisbury, Southern Rhodesia, showing the transmitter, main rectifier, and control tables.

Salisbury (Rhodesia) Beam Station.

THE order from the Chinese Government for Marconi Beam transmitting and receiving stations followed closely upon the opening of the new Marconi Beam Station at Salisbury, Southern Rhodesia, which forms an important new link in the chain of British Empire communications. The Salisbury Beam Station is operated by Imperial and International Communications, Limited, for high speed wireless telegraph services with Great Britain.

An interesting feature of the installation is the concentration of the transmitting and receiving equipment on the same site instead of building separate

transmitting and receiving stations at a distance of some miles in accordance with the usual practice. This innovation, which has considerable advantages from the point of view of economy, has proved entirely satisfactory from the technical standpoint.

In addition to the Beam telegraph service between Great Britain and Northern and Southern Rhodesia and Nyasaland, which was inaugurated on May 23rd by the exchange of congratulatory telegrams, the Salisbury Station is capable of utilisation in the near future for overseas telephone services and also for a re-broadcasting service.

Irish Broadcasting Achievement.

THE successful broadcasting of the opening of the Eucharistic Congress on June 22nd by the Marconi high-power station near Athlone, was the culmination of three months' work in station-building unique in the history of broadcasting.

The decision to attempt to complete the Irish Free State's own high-power broadcasting station in time for the Congress was only made in April, when the Minister for Posts and Telegraphs announced that by careful organisation and the fullest co-operation of all concerned he intended to endeavour in three months to do what was scheduled to take six months.

When this decision was made the foundations of the building were not completed, but by intensive efforts made by the Chief Engineer of the Irish Posts and Telegraphs and his assistants, the work of erecting the masts, buildings, and the installation of the transmitting plant were carried out simultaneously.

The installation was completed in record time, and on the night of June 21st, after the Dublin station had closed down, the new high-power broadcast transmitter transmitted a short test in readiness for the opening of the Eucharistic Congress the following day.

The broadcasting of the historic ceremony of the opening of the Eucharistic Congress was the first official programme of any kind radiated by the new station, which afterwards broadcast successfully all the principal functions of the Congress week in Dublin, and was then closed down for final adjustment and formal re-opening in the autumn.

The transmitter, which has been allotted the wavelength of 413 metres, is situated at the geographical centre of Ireland.



Senor Alcala Zamora, President of the Spanish Republic, inaugurates the new South American broadcasting studio of Transradio Espanola, S.A., Madrid. Special programmes of interest to Latin-American listeners are now being transmitted from this studio through the Marconi short-wave station EAQ, at Aranjuez, near Madrid.

Ultra-Short-Wave Broadcasting.

IN collaboration with the Marconi Company, the British Broadcasting Corporation is undertaking investigations into the suitability of ultra-short waves for broadcasting and a Marconi transmitter covering a wave band of $6\frac{1}{2}$ to 8 metres has been installed at Broadcasting House, the new London headquarters of the B.B.C.

The transmitter, which is a standard Marconi short wave telephone installation, with the exception of the special inductance introduced to reduce the wavelength, has been fitted in a room at the top of the building, and utilises a Franklin uniform aerial fixed to a small mast on the roof.

The wavelength used in the experiments now beginning is 7.75 metres, and the energy of the transmitter is 400 watts in the aerial.

The object of the tests is to determine whether ultra-short wavelengths of this order may be capable of giving an intensive broadcasting service over a restricted area, such as a town or industrial district, without causing any appreciable interference outside a comparatively limited range. This would enable a number of local broadcasting services to be carried out on a common wavelength without mutual interference, a development of great importance and utility.