

# THE MARCONI REVIEW

No. 16.

January, 1930.

Technical Editor: H. M. DOWSETT, M.I.E.E., F.Inst.P., M.Inst.R.E.

General Editor: W. G. RICHARDS.

## A PORTABLE PRECISION FREQUENCY METER

*The continued increase in the number of short wave radio stations has made it imperative that a frequency meter, capable of fine discrimination should be produced.*

*During the last few years, great efforts have been made by experimentalists to produce apparatus, transmitters in particular, which can be set to work at a certain frequency and relied upon to remain at that frequency with a very small percentage variation over long periods of time. Some engineers have applied themselves to the development of the piezo-electric oscillator, others to tuning forks and frequency doublers, and still others to the perfection of the condenser-inductance circuit. It is not the present purpose to discuss here the merits of the various systems but rather to consider what has been done to meet the resultant demand for apparatus capable of measuring the constancy of frequency of stations which use any of the well known systems of master oscillator, frequency multipliers, amplifiers, and power output apparatus.*

*There exist various Laboratory Standards for the measurement of frequency (such as the Alternator method of measurement of frequency, described in THE MARCONI REVIEW, of April, 1929), which on account of their precision and structure, cannot be moved from place to place, or effectively handled except by experts. There also exist frequency meters of such great discrimination that they can only be regarded as second to fundamental standards, and which in consequence suffer some of the disadvantages of the fundamental standard.*

THE Marconi Company have realised the urgent need of a portable frequency meter of high accuracy, small temperature co-efficient, great mechanical rigidity, and good shielding, and have investigated the problem with a view to producing such an instrument.

The instrument which has been designed and made is shewn in Fig. 1, and the scheme of connections is shown in Fig. 2.

Referring to Figs. 1 and 2 it will be seen that the apparatus consists of a main condenser-inductance circuit, which can be coupled to a transmitting circuit by means of the aperiodic coupling coil and the two small feeder condensers. Coupled inductivity to the main condenser inductance circuit is a second aperiodic circuit which is connected to the detector valve. The schedule of items accompanying Fig. 2 is sufficiently explanatory, and the only unusual items are the small air condenser G.G., and the tapper key and switch H. The functions of these parts will be dealt with later. It was decided at the commencement of work on this subject that the normal range of the complete instrument should be from 30,000,000 cycles to

## A Portable Precision Frequency Meter.

3,000,000 cycles, *i.e.*, 10 to 100 metres but it was found later that this could be extended; that the instrument should be fitted with a finely engraved scale of 100 useful divisions with a vernier pointer and that at the highest frequency one vernier division should represent a change of frequency of the order of 5,000 cycles.

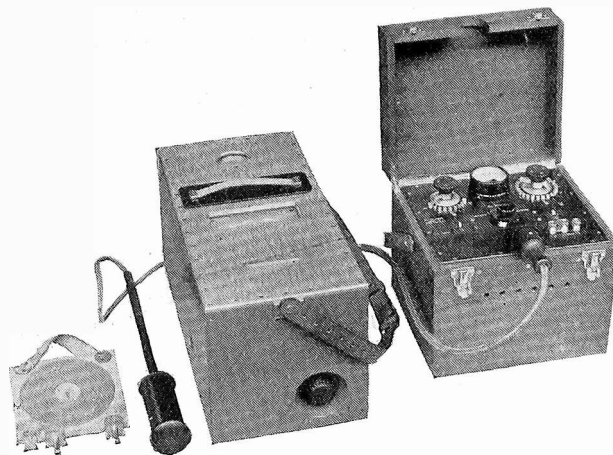

FIG. 1.

The general requirements of the instrument have been enumerated in the foregoing paragraphs, and the consideration of these points considerably influenced the design of the instrument.

The problem of solid insulators demanded serious attention. Although solid insulators of what might be termed second order have been used in parts of the instrument, these have not been employed at any point where their use would affect the stability or accuracy of the final apparatus. Wherever any doubt has arisen the material Mycalex has been employed. The reason for the use of Mycalex is that although ebonite is a good high frequency insulator it is well known that it has both fluid and acid qualities. Under the influence of quite ordinary temperatures, and very small strains, Ebonite will measurably change its shape, and also when exposed to the combined action of sunlight and damp the material will exude acid. The result of this is that in the first case an instrument, such as a condenser or inductance using Ebonite as an insulator can never be regarded as stable, and in the second case the surface leakage of the Ebonite will vary from time to time, and in consequence the power factor of the circuit will change, seriously affecting the accuracy of the instrument. Bakelite is not such a good high frequency insulator, it is chemically inert, but it has a large temperature coefficient. Glasses of various kinds and porcelain are excellent high frequency insulators and of low temperature coefficient, but the difficulty of working these materials rather precludes their use for an instrument of this type, and their brittleness is against hard usage. Mycalex is a good high frequency insulator, has a low temperature coefficient and can be worked with a fair amount of ease and exactitude.

It will be as well to describe in some detail the more important parts of the instrument. In the base of a cast aluminium case  $18\frac{1}{2}$  ins. long by 9 ins. high by 9 ins. wide, fitted with a sheet aluminium cover is securely fixed on six cast pillars a sheet of Mycalex 15 ins. long by 6 ins. wide by  $\frac{3}{8}$  in. thick, and upon this base is

*A Portable Precision Frequency Meter.*

built the essential portions of the instrument. A reference to Fig. 2 and noting those items, excluding J contained within the dotted rectangle R, will indicate the permanent fixed details of the system. The condenser E is of the variable series air dielectric type. It consists of two banks of fixed vanes of brass, mounted opposite to each other on solid brass supports which are secured to the Mycalex base, and one bank of double ended brass vanes which interleave with the two fixed banks mounted on a central spindle, whose lower end is fitted with a worm which engages with a worm giving a ratio of 1/100. Beneath the worm wheel, the central spindle is brought

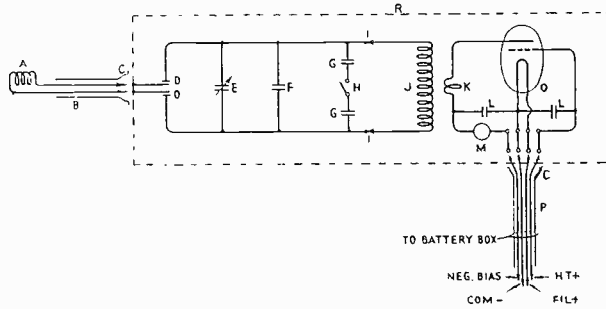

FIG. 2.

- |  |   |
|--|---|
| <p>A. Search Coil.<br/>         B. Twin core Armoured Cable H.F. Feeder.<br/>         C.C. Screwed glands covering plug connections.<br/>         D.D. Small Feeder Condensers.<br/>         E. Variable Air Condenser.<br/>         F. Fixed Air Condenser.<br/>         G.G. Small Air Condensers for Balancing.<br/>         H. Tapper Key and switch.<br/>         I.I. Sockets.</p> | <p>J. Inductance with plugs for connection to I.I.<br/>         K. Aperiodic Coil for coupling between tuned circuit and Detector Valve.<br/>         L.L. Mica Condensers shunting battery supplies.<br/>         M. Galvanometer.<br/>         O. Detector Valve.<br/>         P. 4-core Armoured Cable for battery supplies.<br/>         R. Aluminium Screening Case.</p> |
|--|---|

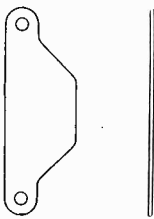

FIG. 3

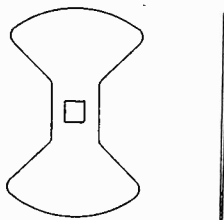

FIG. 4

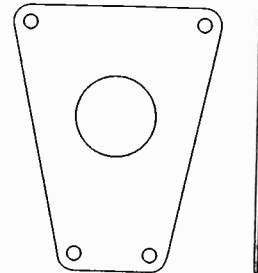

FIG. 5

through a suitable bearing in the Mycalex base, and on the underside of the base it is secured with the requisite degree of freedom by two nuts screwed on to the spindle. The driving shaft of the worm gear is brought out with its axis parallel to the base to the end of the aluminium case where in a cavity in the case the driving handle is secured to the shaft. This handle is shown in Fig. 1.

The shape of the fixed and variable vanes of the variable condenser are shown in Figs. 3 and 4 respectively. Above the variable condenser is built the fixed condenser F. This again consists of brass vanes and air dielectric. The shape of these plates is shown in Fig. 5. At two points in each plate they are secured to the same brass pillars which support the fixed vanes of the variable portion, and two other pairs of stout brass pillars are supplied and fixed in the Mycalex base to support the other extremities of the vanes of the fixed condenser. These last two pairs of supports are larger than the first two pairs and are carried up through a second Mycalex plate which forms the top securing insulating plate of the condenser. Through a large central hole in each of the fixed vanes is brought the upper end of the shaft of the variable condenser and this shaft passes through a bushed central hole in the top Mycalex plate where it is secured by means of a bush screwed to the shaft. On the top Mycalex plate is the scale of the instrument, and on the shaft bush is the pointer.

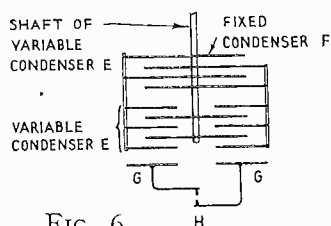

FIG. 6.

The scale is of silver plated brass. It is engraved with 110 divisions, of which 100 divisions subtend an angle of  $90^\circ$ . The pointer has 10 divisions which equal 9 divisions of the scale. One hundred divisions of the scale are active and represent the full angular travel of the condenser, the remaining 10 permanent vernier observations to be taken when an angle of more than 91 divisions of scale is exceeded.

The terminals of the complete condenser system are those of the fixed condenser which are connected to the fixed vanes of the variable condenser. The moving vanes are free of all connection, and in this way the troubles due to brush gear or flexible connection is entirely avoided.

Beneath the fixed vanes of the variable condenser and insulated by air from them are placed two small plates of brass. These are connected to the contacts of a small key whose insulated head protrudes through the left hand side of the case. These form the small balancing condensers and taper key shown in Fig. 2. The contacts of this key are of 22ct. gold. This metal was adopted after repeated tests were made with various metals. A good contact at this point is imperative and gold proved to be superior for the purpose to all other metals, including platinum. Fig. 6 gives a general idea of the arrangement of these balancing condensers. It will be seen that when the contacts H are closed a capacity variation occurs in the total condenser owing to G.G. being connected together and placed near to a pair of electrodes of opposite sign. Stiff, wide, thick, plates of copper are run from the terminals of the complete condenser, on the lower side of the Mycalex base. At a part on each plate, a stout brass bush is connected to the plate, brought through and secured to the Mycalex base. This gives the position for the inductance J which is not a permanent fixture to the base but can be withdrawn and replaced by another as required by the frequency to be measured. The copper plates are then carried on to almost the extremity of the Mycalex base and still beneath it, where at a suitable position they are air insulated from and overshadowed by another pair of copper plates. These two pairs of plates constitute the coupling condensers D.D. and they have each a capacity of about 1 cm. The second pair of

## *A Portable Precision Frequency Meter.*

---

plates are carried on to the end of the base where by suitable means they are secured to a porcelain insulator, which insulator passes freely through a bushed screwed hole in the aluminium case and terminates with its face flush with the outside of the case. This insulator is fitted with two brass sockets connected to the second pair of plates and these sockets serve as terminals for the aperiodic coupling coil and cable.

The other apparatus mounted on the Mycalex base is the valve detector circuit. This is shown in Fig. 2, contained within the dotted rectangle and at the right hand end of the sketch. The detector circuit consists of a small square copper frame supported upon the base with its plane parallel to the plane of the Inductance J when the inductance is in position. One terminal of the frame connects directly to the plate of a triode, the other terminal of the frame connects to one terminal of a moving coil galvanometer 0 to 100, which represents 0.5 milliamp full scale deflection. The other terminal of the galvanometer connects to a metal socket of a porcelain insulator. Two other metal sockets in this insulator connect to the filament terminals of the valve and a fourth socket in the insulator connects to the grid of the valve. Small mica condensers of .01 mfd. connect from the junction of the frame and galvanometer to the negative filament terminal and from the grid of the valve to the negative filament terminal. The porcelain insulator which is similar to that used for the feeder cable connection socket, is mounted upon the Mycalex base and passes through a similar screwed bush to that used for the feeder cable and terminates with its face flush with the surface of the aluminium case. The valve which is mounted in a holder on suitable copper supports lies with axis parallel to the centre line of the base and above it. In the end of the case a large hand hole is bored, so that the valve can be easily withdrawn when required, and into this hole is screwed a large metal dome to protect the valve from damage. The whole is mounted in the aluminium case, which is closed by an aluminium lid in which are cut 4 windows. It will have been noted that in the case are 5 apertures, 2 for connection purposes, one for tuning handle, one for balancing key and one for the valve protecting dome. The surfaces of all these holes and the top surface of the case have been very accurately machined so that when the top plate of the instrument and the appropriate fittings are screwed into position the screening of the apparatus is as perfect as the use of the instrument will permit.

The four windows cut in the lid cannot very well be closed by metal screens for the following reasons. One window is provided for the indicating galvanometer, one for an aperture to permit the withdrawal and refitting of the various inductances, one for scale and pointer, and one for the thermometer, which is secured in a perforated metal tube to the lid of the instrument. The aperture for the inductance removal is closed by a Bakelite cover plate which is fitted with two ball catches clipping into two sockets on the lid. This can be seen in Fig. 1. The reason for using an insulator and not a conductor for closing this slot is that if a metal plate were used, the screening and consequent accuracy of the instrument would depend upon the care with which an observer fitted the cover plate into position. As the total resistance of the screen would be changed with every removal of the protecting plate, it was considered advisable not to use metal, but to use an insulator so that this variable screening difficulty could be eliminated. In spite of the 4 apertures in the lid of the instrument the total screening of the apparatus is of a very high order.

The aperiodic search coil and cable is shown in Fig. 7. It consists of a Bakelite former screw cut and wound with copper wire. A protecting tube and two end caps enclose this coil. No metal, other than the winding and cable is permitted in the construction of this coil and feeder, so that the chances of brushing are reduced to the minimum. A protecting insulating tube for use as a handle fits

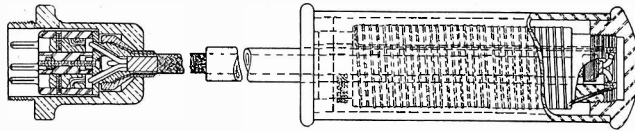

FIG. 7.

into the coil former and its covering and through this is passed a two core armoured cable, the ends of the conductors of which are soldered to the coil terminals.

To the other ends of this cable are secured two metal pins which are held in a porcelain insulator. Also to this insulator is fastened a metal cone terminating in a male thread. Over this cone fits the armouring of the cable and it is secured in position by an internal cone with a female thread at the base, which screws on to the male thread of the previous cone. A solid metal cover, as shown in Fig. 8, envelops cones, insulator and plugs, and when the plugs are inserted into the sockets provided in the instrument and the cover screwed home, connection is made for the feeder cable, the armouring is earthed to the case, and the screening of the case at that point completed.

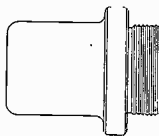

FIG. 8.

The same arrangement is used with the four core battery cable. This is not so long as the feeder cable, and its free end terminates in another porcelain insulator fitted with 4 metal sockets which connect to a 4-pin plug in the battery box. This insulator is covered with a Bakelite handle for ease in removal from the battery box. It is shown in Fig. 9 and can be seen in position in Fig. 1.

The battery box is a simple affair and is provided with all the necessary batteries for working the instrument. It is also provided with a series resistance for the

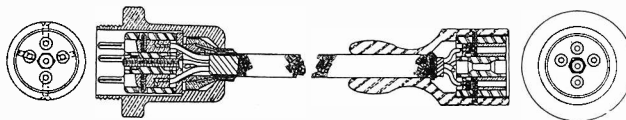

FIG. 9.

filament of the valve, a milliammeter-voltmeter with a range switch and a main switch. The diagram of connections of the battery box are shown in Fig. 10.

The battery in the box consists of dry cells, an extra cell being provided with a link for connection should the L.T. battery run down. The application of negative to the valve is arranged by switch. The whole is very simple in construction, and the battery box is copper shielded.

The only part of the complete instrument now to be described are the standard inductances of the measuring circuit. Whilst it was fairly easy to build a robust condenser with a small temperature coefficient, it was a more serious problem to construct a really sound inductance. Had a total disregard of weight and size been possible, the problem would not have been quite so difficult as it ultimately proved to be, where small dimensions were imperative. The relative advantages of the

## A Portable Precision Frequency Meter.

cylindrical coil and flat spiral having been considered it was decided that the flat spiral had advantages in compactness over the more common cylindrical coil for the purpose in hand. Tests showed that Ebonite as a base upon which to build the

spiral inductance had considerable advantages over Bakelite from a sensitivity view point, but tests on the variation of inductance with temperature definitely proved that both of these materials were quite useless for the work in hand.

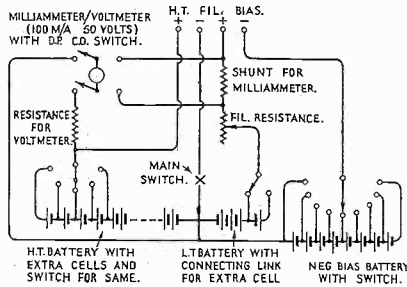

FIG. 10.

of a Mycalex sheet upon which the metal spiral is fastened at a number of points. Each Mycalex plate is fitted with two stout spring plugs and a third plain faced foot. The plugs are the terminals of the inductances and the plain foot is insulated.

There are four distinct models of this inductance. One, Type A, which is a plain wide single turn of copper, which is used for the highest frequencies, the second.

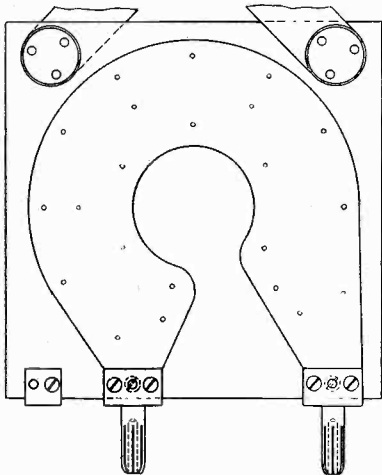

FIG. 11.



Type B, is a flat spiral of  $\frac{1}{4}$ -in. pitch, which can be adjusted for frequencies rather lower than the first type, a third, Type C, consists of two plates, each similar in structure to the second type, mounted back to back with centre points connected and the outer ends of each coils brought to the terminals of the complete unit, and the fourth, Type D, is similar to the third but employs a spiral of  $\frac{3}{16}$ -in. pitch.

Each inductance is cut from a plain copper sheet, for it was known that any attempt to bend strip into a spiral would set up unequal stresses and strains in the metal and very probably considerably affect the temperature coefficient of the unit. The inductance in conjunction with its condenser can be adjusted to a frequency with considerable accuracy, and when once adjusted the copper is not removed from the Mycalex, but is left secured, the whole finely sand blasted and cold lacquered. The bases of the plug connections are engraved with the approximate frequencies at 10 and 90 divisions of scale, when the inductance

*A Portable Precision Frequency Meter.*

is used with its specified instrument. The instrument number is engraved upon a brass plate and fixed in an upper corner of the Mycalex plate, and the range number engraved upon a similar plate fixed to the opposite corner. The

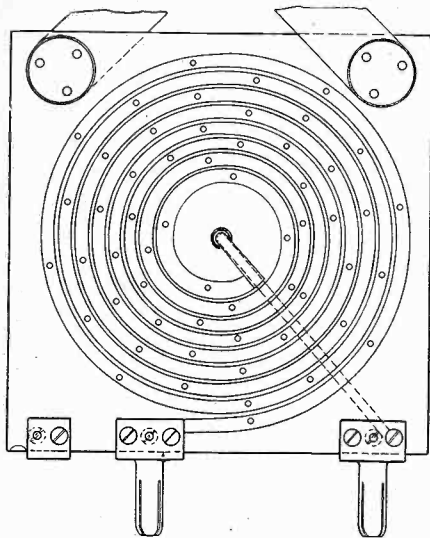
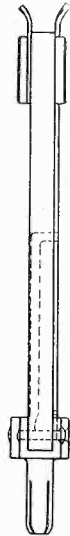

FIG. 12.



two brass plates also secure a leather strap to the Mycalex plate which assists in the removal of the inductance from the body of the instrument.

Mention has been made of a plain foot affixed to the Mycalex plate. The reason for this is as follows. In the Mycalex base of the complete instrument are fixed two heavy brass sockets into which the plugs of the inductance fit. These sockets are purposely not situated symmetrically about the centre line of the instrument in order that no error can occur in fitting the inductance to the main body.

It was found that a certain amount of misplacement of the inductance could occur on account of the plate being rocked about the plug nearest to the centre line of the

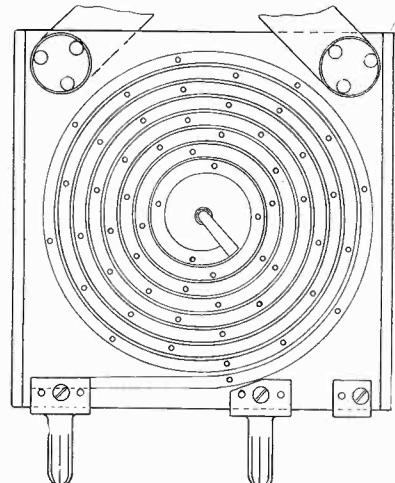
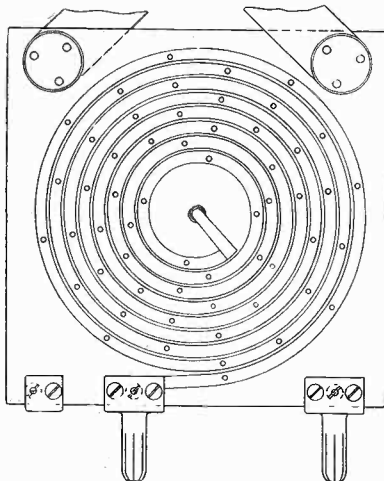

FIG. 13.

plate. Therefore in the Mycalex base of the main body a small brass plug was fixed and this and the face of the two sockets carefully reduced to a common level, and



*A Portable Precision Frequency Meter.*

on the inductance Mycalex edge a plain brass foot was fitted, which with the faces from which the plugs stand was also brought to a dead level. The result is that the plugs of the inductance fit into sockets provided for them and the metal projections on the edge of the inductance plate engage at 3 points with 3 points on the main base. Tests, on the withdrawal and refitting of an inductance from and to the main

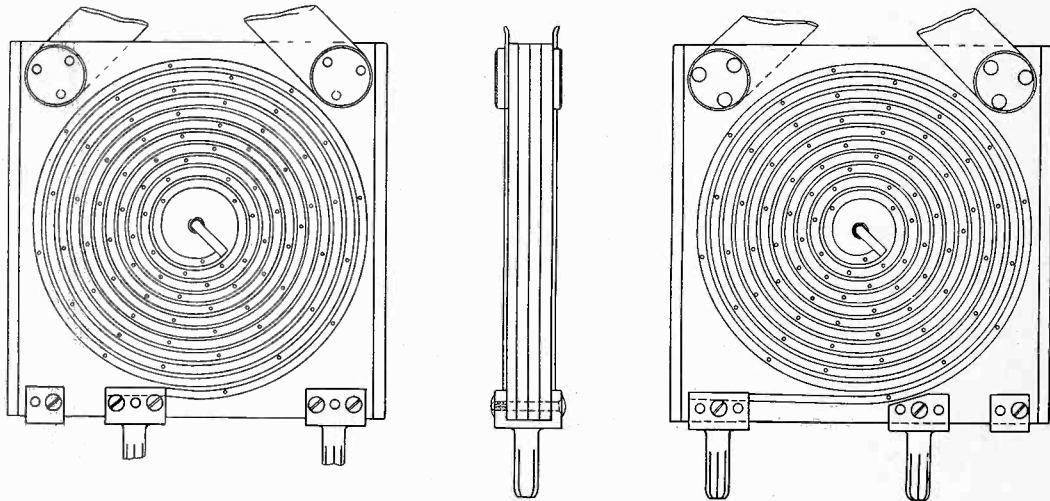

FIG. 14.

body, have shown that an error of 1 in 25,000 is of the order of inaccuracy to be expected, and as this figure is without the appreciation of the instrument it can be neglected. It should be mentioned here that in the aluminium case of the instrument are fitted two channelled Bakelite guides into which the inductance plate slides. The plate is definitely a very loose fit in the channels and is not intended in any way to grip or support the plate, for it has been found that if the plate is subject to any restraining influence, then great errors can be introduced by these influences. The plate must stand free of everything except the two plugs and their feet and the third plain foot. The object of the channels is for ease in locating the inductance plate with respect to the base and to prevent damage in removal. The foregoing describes in some necessary detail the items comprising the complete instrument, and sufficient has been stated to give general reasons for the lines upon which development has taken place. It is now necessary to give some idea of the performance of the instrument. As the term wavelength conveys little information to anyone in present day radio work and as frequency means a great deal more, it was therefore decided to calibrate the instrument in frequency and not in wavelength. Further, as the frequency varies inversely as  $\sqrt{C}$ , the pointer of the condenser is fixed in such a position that the lowest scale indication is also the lowest frequency of any particular range. The instrument was originally intended to cover a frequency band of 3,000 kc. to 30,000 kc. and to have a difference of 5 kc. per vernier division at the highest frequency. Overlaps between ranges had to be considered, and therefore if a useful scale length of 750 vernier division per range was allowed the number of ranges to cover the total band would not be too great, and each pair of adjacent ranges would not be separated by a gap. Now if the assumption is made that

*A Portable Precision Frequency Meter.*

---

characteristic of the instrument is a straight line over 750 vernier divisions of scale, and if U is the upper and L the lower limit of the total band of frequency to be measured in kilocycles, and the discrimination is 5 kc. per vernier division on the highest range, the

$$U = L \left( \frac{U}{U - 750 \times 5} \right)^N$$

where N is the number of ranges of the complete instrument.

$$30,000 = 3,000 \times \left( \frac{30000}{26250} \right)^N$$

N = 17.24 and the factor  $\frac{30,000}{26250} = 1.1428$  is the range factor per scale of the instrument assuming that the self capacity of all inductances used are equal one to the other and are small enough to be neglected. The assumption that the frequency increases uniformly per vernier division is of course incorrect, and in any case it is unsatisfactory, for if at the highest frequency of the highest range the discrimination is 5 in 30,000, *i.e.*, 1 in 6,000, then at the lower limit it becomes 5 in 26,250 or 1 in 5,250.

Assuming that the value of the condenser increases equally from point to point and that the range of frequency remains the same then the discrimination varies from 1 in 4,900 at the highest value of frequency to 1 in 6,500 at the lowest value of frequency in a range.

This second arrangement is also rather unsatisfactory for the accuracy of discrimination per vernier division is not equal throughout the range. The ideal arrangement is the one in which  $\frac{d_2 - d_1}{d_1}$  is a constant for the whole range where  $d_1$  is the frequency at a certain vernier scale position and  $d_2$  is the frequency at the vernier division adjacent and superior to  $d_1$ .

If  $\frac{d_2 - d}{d} = \frac{1}{6000}$  30,000 kc. is the highest frequency to be measured and 750 vernier division is the useful width of a scale we get as the lower limit of that scale.

$\left( \frac{5999}{6000} \right) 750 \times 30,000 = 26,492$  kc. and the fraction  $\frac{30000}{26492} = 1.1324$  becomes the new range factor. The use of this factor, of course increases the number of ranges to 19 as a minimum to cover the total band from 30,000 kc. to 3000 kc.

Such is the ideal case, but in actual practice there is one factor which definitely prevents the ideal from being obtained over more than one range, unless very elaborate precautions are taken. The factor is the self capacity of the inductance and as this cannot easily be maintained identical in all inductances the characteristic of the various ranges of the instrument must vary somewhat. In spite of this it has been thought desirable to modify the variable portion of the tuning condenser so that the frequency characteristic of the final instrument approaches the ideal. The alteration is simple and merely affects the shape of one plate of each fixed bank of the variable condenser.

## *A Portable Precision Frequency Meter.*

In practice it will generally be found that the discrimination of the instrument is of a higher order than the figure of 1 in 6000, for the self capacity of the inductance shortens the frequency band per range and so gives a higher accuracy. This is however an advantage in the majority of cases.

The temperature coefficient of the instrument has been touched upon, but it may be of interest to give a few figures relating to the 4 types of inductance used.

	Approximate frequency band.	Temp. Coeff.
Type A.	30000—18750 kc. . .	$\pm 1$ in 25,300 per $\mp 1$ deg. cent.
Type B.	18750— 5580 kc. . .	$\pm 1$ in 27,400 per $\mp 1$ deg. cent.
Type C.	5580— 2955 kc. . .	$\pm 1$ in 24,000 per $\mp 1$ deg. cent.
Type D.	2955— 2239 kc. . .	$\pm 1$ in 20,000 per $\mp 1$ deg. cent.

The foregoing figures indicate the order of the temperature coefficient, but these will vary with different instruments on account of the slight inherent differences in the materials used. As the instrument is calibrated at a definite temperature, after standing at that temperature for not less than twelve hours, and is checked at another temperature after being kept at this second temperature for a period of twelve hours; and as the temperature coefficient is stated upon the frequency chart, the observer need have no fear in using the instrument and applying the temperature correction.

The calibration of the instrument is done under almost ideal conditions, and every care is taken to ensure the accuracy of the results.

In a previous paper the fundamental Marconi method of determination of frequencies has been described. Since the date of that paper further developments have taken place, and in some cases a tuning fork now replaces the alternator as the standard of frequency. Although the greatest precautions are taken in maintaining the tuning fork constant in temperature to 0.01 deg. cent. and the electric supplies to the driving valves are kept to a very high order of constancy, it is not to be supposed that the frequency of the fork is blindly accepted as constant for the purpose in hand. The tuning fork frequency is referred to the alternator at least twice per day when in use so that any change of the order of 1 in 100,000 can be determined. This is costly, but certainly worth while.

It has been stated that the instrument is kept at constant temperature during calibration. To do this it has been necessary to build a calibration tank. A large outer steel tank contains a smaller steel tank and the inside of the smaller steel tank is heavily lagged with thick felt and wood. Between the two tanks water circulates. Two thermostats, one for high and the other for low temperature, are fitted in the inner tank. Electric heaters are contained in the inner tank which are operated by the thermostat in use via a relay. A fan driven by a motor external to the tanks keeps the air in circulation in the inner tank. The whole is closed by a heavy wooden top lagged internally. In this top are two close fitting glazed doors which are normally locked and through which the instrument to be tested can be lowered into the tank. Various small handles protrude through glands in the tank for the tuning of the instrument under test. In calibration the instrument is placed in the tank with the aperiodic coil and its cable protruding through its appropriate gland.

Calibration is done by coupling the search coil of the frequency meter to the output inductance of a screened oscillator and powerful double magnifier circuit.

## A Portable Precision Frequency Meter.

Each stage of this system is effectively screened from all other stages, and the result is that the application of the search coil to the output circuit does not in any way affect the frequency of the oscillator. The actual measurement of the frequency

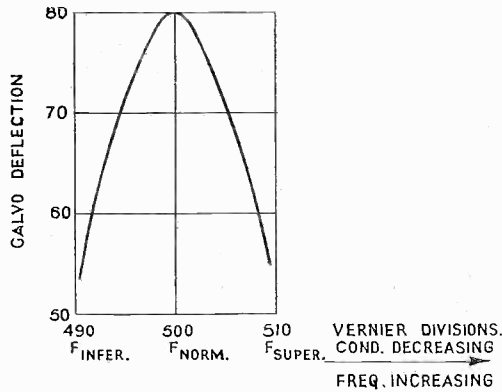

FIG. 15.

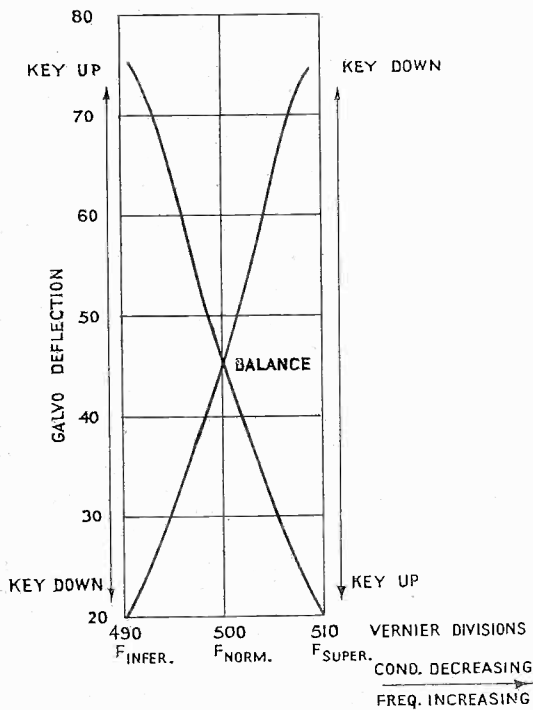

FIG. 16.

is made by the methods described in the previous paper, using an electrically maintained fork instead of the alternator. The instrument is brought into resonance with the oscillator by simple tuning by means of the main tuning handle of the condenser. This is rotated until the galvanometer indicates the maximum deflection. The key at the left hand side of the instrument is now depressed, and as this action introduces a small condenser to the tuning circuit of the frequency meter, the galvanometer deflection is reduced. Tuning by the main driving handle and detuning by the balancing key continues until the deflection of the galvanometer with the key depressed is equal to the deflection of the galvanometer with the key released. The pointer of the instrument now indicating a certain scale value this is taken as being the indication of the known frequency of the oscillator.

The explanation of this tuning and detuning condenser is simple. In Fig. 15 is shown an actual characteristic of condenser value in scale division against galvanometer current, keeping the frequency constant and varying the instrument. It will be seen that this curve is rather flat topped. When the instrument is in tune with the oscillator and the detuning condenser is introduced the galvanometer current is lessened owing to the circuit being out of resonance with the oscillator. If now the main tuning condenser is decreased a point will be found where the addition of the detuning condenser places the main tuned circuit slightly out of tune with the oscillator on

the one side and the removal of the detuning condenser again places the tuned circuit slightly out of tune but on the other side of the resonance point of the circuit. When these two out of tune positions are equally placed about

## *A Portable Precision Frequency Meter.*

the point of resonance, the rectified currents in the valve circuit are equal and the balance points are symmetrically disposed about the point of resonance. This is the condition of balance and the foregoing explains the use of the tapper key and balancing condensers. The reason for the use of this detuning and balancing system is as follows. Fig. 15 shows the characteristic of galvanometer indication against condenser setting in the ordinary manner. It will be seen from this that misplacing the condenser by one vernier division at maximum deflection gives a

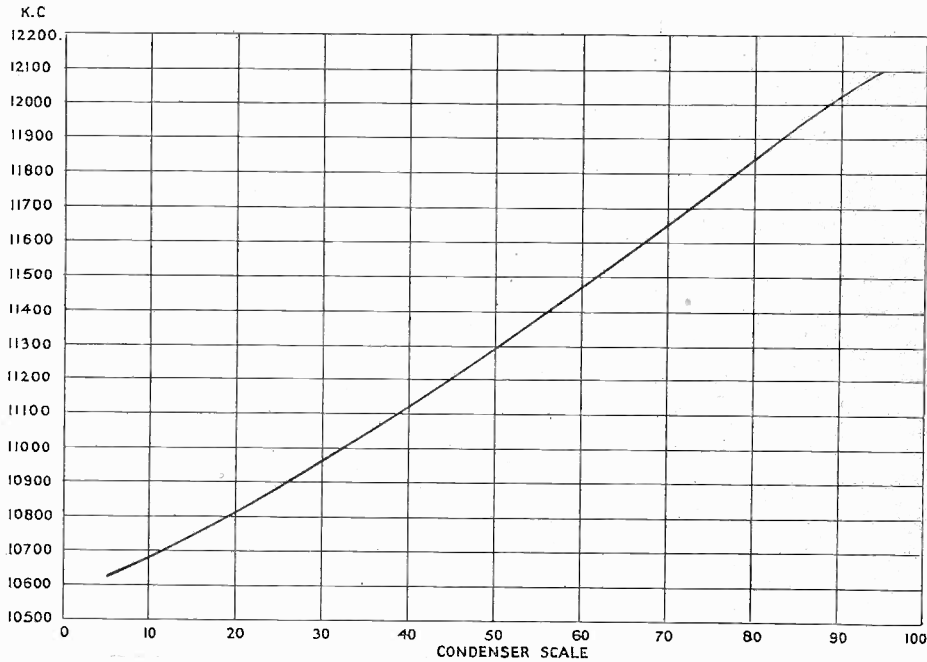

FIG. 17.

change of galvanometer current of about .5 of a scale division, but Fig. 16 shows the case where the detuning and balancing condenser is used, and from this it will be seen that a misplacement of 1 vernier division of the condenser upsets the galvanometer indication by no less than 3 divisions about the point of balance, and in consequence, in spite of the fact that the galvanometer deflection is not so great as in the more simple case, the accuracy of the complete instrument is made considerably greater by the use of the detuning and balancing system.

The balancing system is not at all difficult to use. The method of using the instrument is as follows. The correct range coil being fitted, with the search coil in position and the battery connected and switched, the search coil is presented to the circuit to be measured and the instrument tuned to full galvanometer deflection. Balancing then proceeds until the down and up positions of the detuning key give the same galvanometer deflection. The scale and pointer is now read off and referred to the chart of the instrument from which the frequency can be abstracted. Correction for temperature can also be made. As the instrument is of a portable type it was thought that a curve might be inconvenient to the user, therefore charts similar

## *A Portable Precision Frequency Meter.*

to the well known logarithm table are supplied. These charts give main division and tenth of division from 5 to 95 divisions of scale and the frequency for each  $1/10$  division is printed in the chart. Curves if required are of course available, and such a curve on a very much reduced scale is shown in Fig. 17.

Fig. 18 shows the calibration of the tuning condenser of the instrument. This is measured when the condenser is in its case, as the metal body of the case, of course, has some effect upon the capacity of the instrument.

Tests have been made to find to what extent the proximity of large masses of metal influence the instrument. As the instrument is calibrated in a metal tank it can be taken that this is an extreme condition. A calibration was made in the

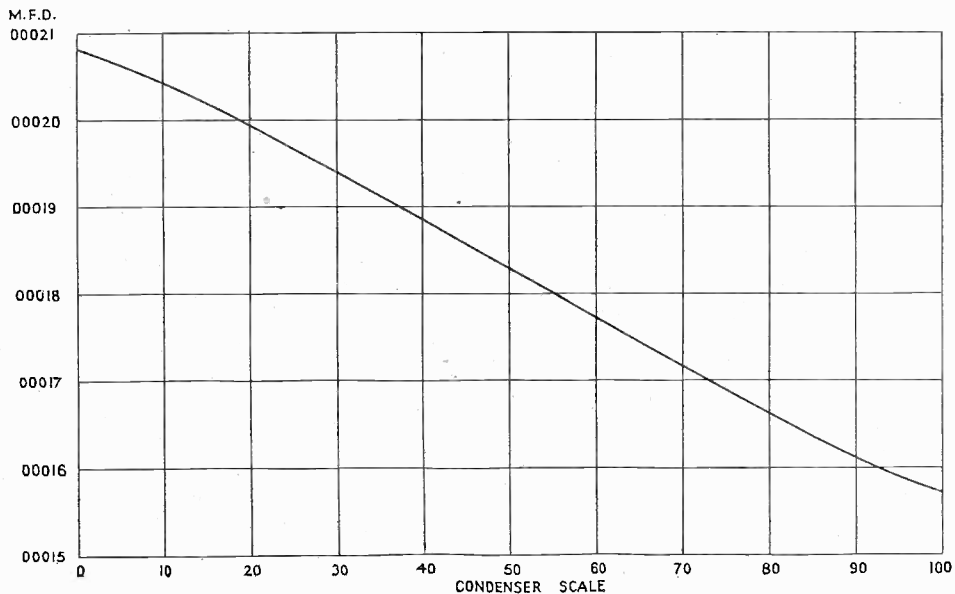

FIG. 18.

tank at a given temperature. The instrument was then removed to a position remote from metal bodies and returned and recalibrated by alternator, and the temperature correction applied.

The result of this test showed that no difference of any magnitude appreciable by the instrument existed after temperature correction was made.

As a further test the instrument was taken to the well known B.B.C. station 5 SW and the frequency of that station measured by the instrument. At the same time 5 SW on an unmodulated dash was measured at the laboratory by alternator. The results showed an error of 1 in 25,500, which is without the appreciation of the instrument. This test was of further interest. It was expected that sufficient stray field from the transmitter to indicate on the instrument would be present and the instrument was set with full negative bias to prevent damage to the galvanometer, but it was actually found that with this bias the search coil of the instrument had to be presented to the closed circuit of the last stage of the main amplifier before the

*A Portable Precision Frequency Meter.*

instrument was sufficiently operated. This gives an idea of the screening of the instrument.

The valve used as a detector is the Marconi D.E.3. This valve is very suitable for such an instrument as the one described, for its filament current is only 60 m/amps. at 2.8 volts, and its characteristic when connected as shown in Fig 2 is steep enough to give a sharp rise in plate current for small impressed voltages. By using this valve a dry cell battery can supply all the necessary voltages, and this removes the troubles of charging and acid creeping which are always found with secondary batteries.

Changes of voltage on the valve do not make any detectable change in the accuracy of the instrument, although, of course, the galvanometer current varies with the voltages applied to the valve.

Changes of valves of the same type do not impair the accuracy of the instrument, although, here again, the galvanometer current will vary with different valves.

It has been stated in the earlier portion of this article that the discrimination of 1 in 6,000 was the desired figure. This figure has been somewhat exceeded in certain cases, owing to the capacity of the inductance and a typical case may be quoted where, in the instrument for which Fig. 17 is the characteristic the discrimination between 100 and 850 vernier divisions can be obtained from the following table. For the purpose of allowing for overlaps between ranges the band between 100 and 850 vernier divisions is taken as the useful portion of the scale.

Division.	Frequency.	$\frac{d_2 - d_1}{d_1}$	Discrimination per Vernier Division
100 ( $d_1$ )	10,680	$\frac{1.2}{10680}$	1 in 8900
101 ( $d_2$ )	10,681.2		
200 ( $d_1$ )	10,815	$\frac{1.4}{10815}$	1 in 7725
201 ( $d_2$ )	10,816.4		
300 ( $d_1$ )	10,963	$\frac{1.5}{10963}$	1 in 7308
301 ( $d_2$ )	10,964.5		
400 ( $d_1$ )	11,121	$\frac{1.6}{11121}$	1 in 6950
401 ( $d_2$ )	11,122.6		
500 ( $d_1$ )	11,288	$\frac{1.7}{11288}$	1 in 6640
501 ( $d_2$ )	11,289.7		
600 ( $d_1$ )	11,466	$\frac{1.8}{11466}$	1 in 6370
601 ( $d_2$ )	11,467.8		
700 ( $d_1$ )	11,648.5	$\frac{1.9}{11648.5}$	1 in 6131
701 ( $d_2$ )	11,650.4		
800 ( $d_1$ )	11,835	$\frac{1.9}{11835}$	1 in 6223
801 ( $d_2$ )	11,836.9		
849 ( $d_1$ )	11,928.1	$\frac{1.9}{11928.1}$	1 in 6288
850 ( $d_2$ )	11,930		

*A Portable Precision Frequency Meter.*

---

Here may be given another Table, from which ranges per type of inductance, whether A, B, C or D, can be derived for an instrument covering the entire band of frequencies.

TYPE A.

Range Factor, 1.134 approx.  
Total Range, 30,000 to 18,750 kc. approx.  
No. of ranges, 4 approx.

TYPE B.

Range Factor, 1.12 approx.  
Total Range, 18,750—5588 kc. approx.  
No. of ranges, 12 approx.

TYPE C.

Range Factor, 1.108 approx.  
Total Range, 5588 to 2955 kc. approx.  
No. of ranges, 6 approx.

TYPE D.

Range Factor, 1.106 approx.  
Total Range, 2955—2239 kc. approx.  
No. of ranges, 3 approx.

This Table should not be taken as inflexible, as it is merely the result of measurements taken and cases will occur where it will be more convenient to depart from the Table than adhere to it, and variation can, of course, be made to suit individual requirements.

It will be noted that Type B inductance is fitted to more ranges than any other type. This is simply a matter of convenience as Type B is easier to adjust than Type A and simpler to construct than Types C or D.

The weight of the instrument with one inductance, aperiodic coil and battery load is 56 lbs. 8 ozs. The weight of the battery box is 31 lbs. 8 ozs., and the weights of the inductances vary with type between 2 lbs. 9 ozs. and 4 lbs. 9 ozs.

The foregoing is a brief description of the Company's Precision Frequency meter, the use of which it is thought will assist in keeping the present day high frequency transmitters to their respective channels.

T. D. PARKIN.



# WIRELESS TELEPHONY AND DIRECTION FINDING IN THE FAR SOUTH

## PART II.

*The first part of this article, which was published in THE MARCONI REVIEW, No. 15, dealt with the general conditions of service that wireless apparatus for use in the Whaling Industry has to meet.*

*This discussion is continued below, and the article concludes with an account of the advantages attending the use of direction finders on Whaling Vessels.*

THE majority of whale-catchers are built in either England or Norway, and most of them have to proceed without an escort from the builders' yard to the fishing grounds in the Antarctic, a distance of from 7,000 to 8,000 miles. During this long and lonely voyage these very small boats are liable to get into very tight corners due to adverse weather conditions causing a shortage of bunkers, stores, water, etc., and as the wavelength of their standard wireless telephone installation is fixed at a spot wavelength between 300 and 400 metres, they would in the event of emergency be unable to communicate with shipping, which normally employ a wavelength of 600 metres. In order to provide for such an emergency, the Marconi Company have introduced into their 1930 "Whaler" Telephone Sets an additional spot wavelength of 600 metres which can be brought into immediate operation by means of a single switch, so that in the event of a whaler being in difficulties during the voyage from Europe to the Antarctic, the Master of the vessel can immediately get into touch with neighbouring shipping or a commercial coast station and thereby secure assistance.

It is the general rule for whale-catchers to return to Europe every two or three years for overhaul and Lloyd's Survey, and during this homeward voyage and the subsequent outward voyage the 600 metre wavelength can again be employed.

Another advantage of this addition is that it gives the gunner an alternative wavelength for inter-ship telephonic communication when on the fishing grounds so that if interference is experienced on the lower wavelength a change can be made to the 600 metre wave and the communication maintained.

Reports received from the whaling fleets show that considerable difficulty is sometimes experienced on the fishing grounds due to the interference caused by the transmissions of a number of whaleboats which have been fitted with wireless telephone and telegraph installations manufactured by other wireless companies. Investigation proves that this interference is due to the fact that these transmitters use direct coupled aerials, with the result that their tuning is extremely flat. It is

worthy of note that not a single complaint has been received that the Marconi telephone sets cause interference to receivers not tuned exactly to the transmitting wavelength. This is undoubtedly due to the fact that the Marconi "Whaler" transmitters have loosely coupled aerials, which result in the tuning being extremely sharp.

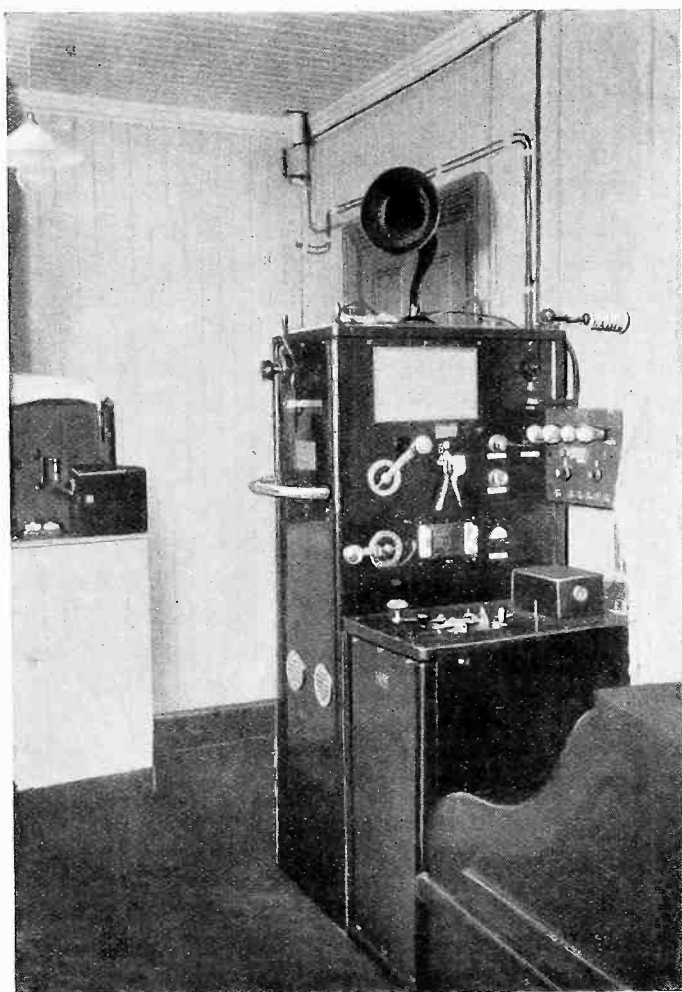

*Marconi 500 Watt Telegraph-Telephone Set with Adaptor for 600 m. wave installed at Prince Olaf Harbour.*

was installed in a radio station on the Humber, which is now available for telephonic communication with any vessel working on a wavelength of 220 metres. Reports received show that this station is capable of communicating with trawlers up to a distance of 300 miles and this range is frequently exceeded.

In 1927 tests were carried out with the co-operation of the British Post Office, with a view to ascertaining what range could be obtained between a trawler fitted with a Marconi  $\frac{1}{4}$  kw. Telephone Set (X.M.D. 1), and a British commercial wireless coast station. During these tests, which were carried out in summer time during daylight, reliable telephonic communication was maintained with the General Post Office coast station at Grimsby up to a distance of 250 miles, and at this distance messages were transmitted to the owners of the trawler.

A few months after these successful tests a Marconi type X.M.C. 1 telephone set

## *Wireless Telephony and Direction Finding in the Far South.*

---

In passing it is of interest to note that the National Lifeboat Institution have recently equipped a number of their lifeboats with Marconi "Whaler" telephone sets of the X.M.B. 1 type, so that the coxswains of the lifeboats can keep in touch with the various lightships and coastguard stations around the British coast, which were fitted some years ago with Marconi telephone apparatus.

Various Governments have also purchased a number of X.M.C. 1, X.M.D. 1 and X.M.B. 1 telephone sets for point to point telephonic communication and these transmitters are giving a service equal to and in many cases superior to the land line service previously employed, which, owing to the nature of the country, or damage to the under-sea cable, had frequently been subject to interruption.

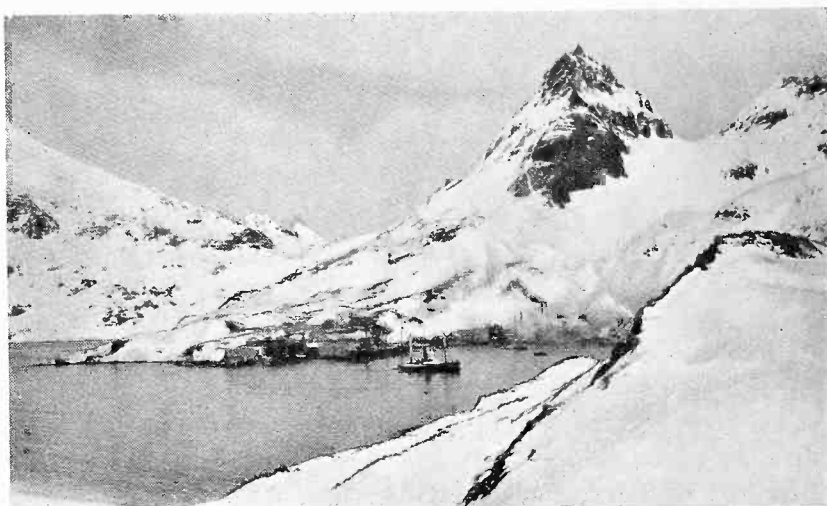

*Prince Olaf Harbour, South Georgia.*

With the introduction of wireless telephony into the whaling industry, it was not long before the whaling crews realised the possibilities of wireless direction finding as a valuable aid to the industry, and in 1926 a number of important whaling companies requested the Marconi Company to fit their catchers with direction finding apparatus. The Marconi Company developed a special direction finder suitable for installation on small whale-boats, where it would be subject to very rough handling and severe climatic conditions.

From the experience gained during the installation of the wireless telephone sets during the previous year, it was evident that a direction finder which was complicated in operation would be of no value to the whaling fleets, and would

## *Wireless Telephony and Direction Finding in the Far South.*

---

in fact be a menace, owing to the possibilities of the whaling crews making faulty adjustments which would result in very inaccurate bearings being taken.

To enable the reader to thoroughly appreciate the value of the direction finder to whaling fleets it is necessary for one moment to study the method employed in whale chasing.

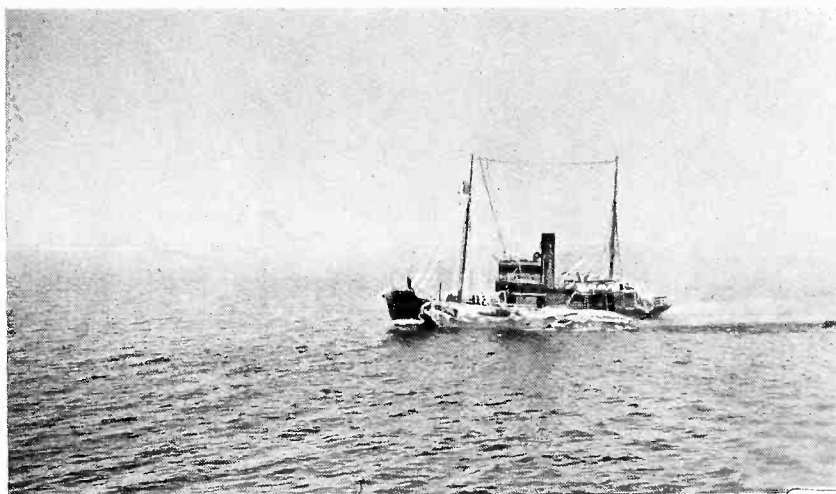

*Whale Catcher with whale lashed alongside.*

A steam trawler leaves her base and proceeds in search of whales. Immediately the "blow" of a whale is sighted, the vessel is steered in that direction, and the speed increased to approximately 14 knots. Before the vessel has gone very far on this course the whale will have sounded, and will eventually appear in a totally different direction, with the result that the course of the vessel has to be again changed. During a long chase the whale will sound twenty or thirty times, each time coming up in a different position, with the result that in order to get close enough to the whale to shoot, the course of the whale-catcher will have to be changed probably twenty to thirty times. During the excitement of the chase no records are ever kept of these alterations in course, with the result that when the whale is eventually captured the gunner is very uncertain as to the actual position of his vessel. Before the introduction of the wireless telephone and direction finder, if the gunner found that the whale was drawing him too far away from his base, he had to give up the chase owing to the difficulty he would experience in finding his way back. All of this has now been altered, as when the gunner desires to return he immediately gets into communication with his base by means of the wireless telephone, and requests them to transmit for one or two minutes in order that he can obtain a bearing with the aid of his direction finder, and thereby ascertain the exact course to steer to return to his base.

With the aid of the direction finder it is always possible for the catchers to find their way back to their base, even in very foggy weather.

An example of the enormous value the wireless direction finder has already proved to the Antarctic whaling fleets is the sinking of the whaling mother-ship, "Southern Queen," on the 24th February, 1928. This vessel at the time was cruising some distance from the South Orkneys in the Antarctic, and on the morning of February 24th had despatched her whale-catchers in search of whales. Some time after the catchers had left and were out of sight, the mother-ship "Southern Queen" struck an iceberg, and immediately began to sink. The Marconi wireless telephone set with which she was fitted was immediately put into use, and calls transmitted to the catchers recalling them to her assistance. These distress calls were immediately picked up by the catchers, who forsook their whales, and immediately started back at full speed to the assistance of their mothership. Unfortunately, visibility was very poor about this time, and in order to assist their return the catchers requested the operator of the mothership to keep transmitting so that they could use their direction finders and find their way back without delay. This the operator of the mothership did until ten minutes before his ship sank, when, together with the other members of the crew, he was compelled to take to the lifeboats. A quarter of an hour after the sinking of the "Southern Queen" the catchers arrived on the scene, and picked up the lifeboats, thereby saving the whole crew.

The valuable aid which the wireless telephone and direction finder had proved during this unfortunate episode demonstrated to all the whaling companies the great advantage of wireless, with the result that it has been universally adopted among the whaling fleets of the world.

In the polar regions, owing to varying magnetic influences, the ordinary magnetic compasses are often very unreliable, and subject to large errors. The use of the wireless direction finder overcomes this difficulty, as courses and positions can be repeatedly checked by means of the wireless direction finder, which is not influenced in any way by magnetic variations.

During recent years wireless direction finders have been fitted on a large number of British and foreign fishing trawlers, where they have proved of enormous value in assisting trawlers to find their way back to port during adverse weather conditions, and also in locating the position of other trawlers fishing in productive areas.

## THE UNIFORM SHORT WAVE AERIAL

*The subject of phased short wave aerials, both for broadcast and beam transmission, is, in certain respects, still capable of further development. The uniform type of aerial to be described below has so many undoubted advantages over the older types, that the latter are being replaced by the uniform type of aerial throughout all the Marconi beam stations.*

*A large increase in signal to noise ratio from stations changing over to the use of uniform aerials has been almost universally noted, and other considerations enumerated in the following article indicate that this aerial represents a notable advance in short wave aerial design.*

IN the design of aerials for short wave communication, it is very important to consider the way in which the aerial under consideration distributes its radiated energy in the vertical plane. It has been proposed to use aerials which radiate their energy upwards in order to take advantage of the reflection from the Heaviside layer, and it is essential that we should know in what directions aerials of various types radiate their maximum power.

If we assume that the power source or excitation point of the aerial is at the base of the aerial, the energy beam may be taken as diverging from this point. The analysis of the distribution of this energy near the aerial itself is of little importance compared with the distribution at points far removed from the aerial. This region may be taken to mean that zone in which the electric and magnetic intensities are in phase and equal, and has been termed the "Wave Zone."

The intensity of the energy beam can be calculated and plotted as a function of the polar angle and is called a "distribution diagram" to distinguish it from the "polar diagram," which is the distribution diagram at points near the aerial.

The angle that the direction of maximum radiation makes with the earth varies, of course, with the value of  $l/\lambda$ , where  $l$  is the length of the vertical aerial, and  $\lambda$  is the operating wavelength.

If we take the case of a simple vertical half wave aerial, and if we assume the earth to possess perfect conductivity, we shall see that the polar diagram of such an aerial has a maximum value in a plane which is at right angles to the aerial and which passes through the centre of the aerial. Hence we should expect the vertical polar diagram of such an aerial to be as shown in\* Fig. 1. If we take into account the fact that the earth is not perfectly conducting, the absorption by the earth of the rays propagated horizontally is so great that all these lower rays are more or less

---

\* "Short Wave Wireless Telegraphy." T. L. Eckersley. Journal I.E.E. Vol. 65, No. 366. June, 1927.

completely absorbed and we are left with a diagram of the form shown in Fig. 2, in which the dotted curve represents the effective radiation.

We know that in long wave working the waves can be considered as travelling in a plane horizontal to the earth's surface at any point, and hence in long waves we should require to concentrate the energy in a horizontal plane. But with short waves, owing to the very high earth losses, the horizontal part of the wave known as the direct ray is quickly attenuated to a negligible amount, as pointed out above,

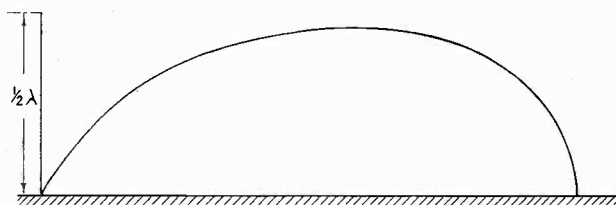

FIG. 1.

and cannot therefore be used for long distance communication as is the case with long waves. It is most probable that for nearly all long distance work, *i.e.*, over 2,000 miles, the most useful radiated energy is that which leaves the transmitting aerial system at a

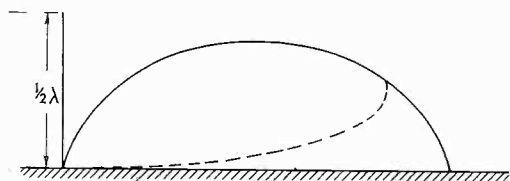

FIG. 2.

zenithal angle of between  $5^\circ$  and  $15^\circ$ , the angle increasing for shorter distance work until it becomes so large that the ray, instead of being reflected or retracted by the Heaviside layer and so returning to earth, penetrates the layer and is lost. For very short distances, therefore, we have to rely on the direct ray for communication. Thus, for long distance communication we require an aerial system which projects most of its energy at a zenithal angle of something between  $5^\circ$  and  $15^\circ$  from the horizontal. The approximate distribution diagrams of different type aerials on short wavelengths are shown in Fig. 3. These are actually drawn for Franklin aerials in which the radiation from alternate half wavelengths is suppressed, but we shall see later that they are applicable to the uniform aerial.

The following inferences can be made :—

- (1) A short vertical aerial with loading to give a node of potential at the earth gives a maximum radiation in a plane inclined at an angle which increases as the distance from the transmitting aerial increases, and finally attains some constant value at great distances. This angle is reduced when the aerial becomes a half wave aerial with its lower end near earth.
- (2) If the length is increased to multiples of half a wave length without phasing devices, thus forming what is known as an harmonic

aerial, the radiation produced is all high angle, because each successive half wavelength oscillates in anti-phase and the effective radiation at shallow angles is very greatly reduced.

- (3) If one adds a series of half wave aerials vertically so as to oscillate in phase, the zenithal angle of maximum radiation is reduced, and such a system gives a concentration of energy in directions which are more efficient for short wave working.

In beam aerials used prior to the uniform aerial, the radiation from alternate half wavelengths was wholly, or in part, suppressed, to ensure that the resultant radiation at a point far removed from the aerial should be the sum of the fields of

radiation due to currents in the same direction, and hence that the radiation from the adjacent parts of the aerial should be additive and should not tend to cancel each other.

The uniform aerial, however, has for its principal object the attainment of strongly marked directional qualities without any substantial suppression of radiation. In this aerial, which is long relative to the wavelength employed, the currents are mechanically reversed in direction at alternate half wavelengths, the arrangement being such that the radiation from these sections of the aerial is added to that of the remaining half wavelengths.

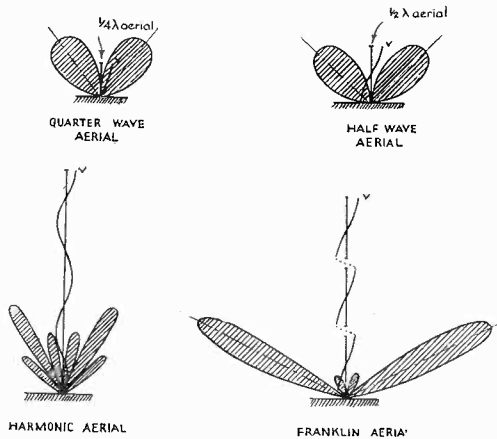

FIG. 3.

In one form of construction, a vertical aerial is formed with its first or lowest half wavelength as a simple vertical wire. The second half wavelength proceeds for a distance equal to  $\cdot 1$  of a wavelength as a prolongation of the first half wavelength, after which it turns through a right-angle and proceeds in a perpendicular direction for  $\cdot 05$  of a wavelength. It is then bent through a second right-angle and extends down through  $\cdot 2$  of a wavelength, after which it turns from a third right-angle proceeding in a direction perpendicularly away from the first half wavelength through a further  $\cdot 05$  of a wavelength. Finally, it is bent again through a right-angle and proceeds upward through its final  $\cdot 1$  of a wavelength. The third half wavelength is formed as a vertical prolongation of the last portion of the second half wavelength. The fourth half wavelength is formed in a similar manner to the second, except that it proceeds towards the vertical line in which the first half



## The Uniform Short Wave Aerial.

wavelength lies, instead of away from it. This construction is continued as is shown in the diagram.

By making the length of the wire between centres of adjacent sections of the aerial greater or smaller than half a wavelength, a progressive change of phase between sections may be obtained. Maximum radiation may thus be obtained in directions substantially different from the direction at right angles to the aerial.

The aerials designed on the above basis are illustrated in Fig. 4, in which (a) represents an aerial in which alternate half wavelengths are suppressed, and (b), (c), (d), (e) and (f) represent modifications to the uniform type of aerial.

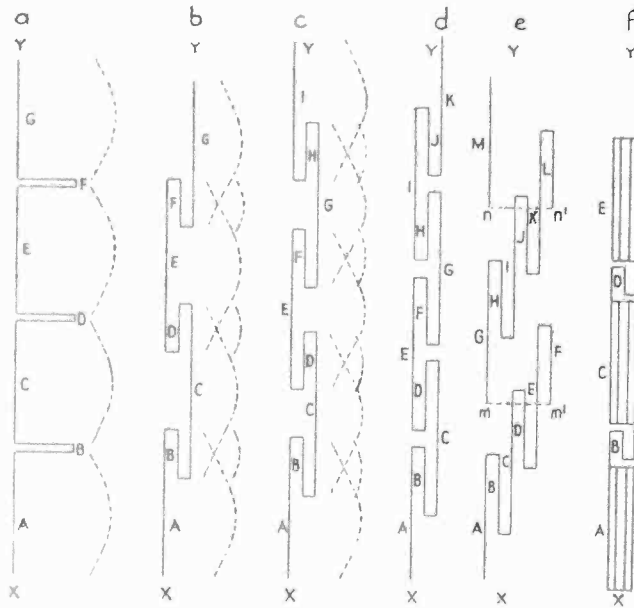

FIG. 4.

The simplest form is given in (b) where the sections B, D, F are caused to radiate, and owing to the reversal of the direction of the wire, assist the radiation from the sections A, C, E and G.

If equal currents are induced in (a) and (b), (b) will give approximately  $\frac{5.2}{4}$  times the field strength given by (a).

The advantages of the uniform type of aerial over the previous types employed may be stated as follows:—

- (1) Substantially the whole length of each vertical unit is employed to produce radiation, instead of alternate half wavelengths as previously used.

- (2) For the same height the radiation per unit current of the aerial is very much increased, which means that for equal radiation, smaller voltages and smaller currents are required in the new uniform type.
- (3) The radiation from the aerial is substantially uniform throughout the whole vertical extension instead of being more or less concentrated at points about half a wavelength apart. The result is that the new uniform type has far less tendency to produce large loops of radiation in undesired directions in the vertical plane.
- (4) By adjusting the lengths of the folded back portions of the aerial, the angle of the beam in the vertical plane can be easily controlled, and the aerial can be specified for any definite angle in the vertical plane which may be desired.
- (5) The radiation of the aerial can be made substantially uniform throughout the whole linear extension or can be made to follow any desired law, and this again has marked effect on the size of the loops of radiation in undesired directions in the vertical plane.
- (6) The practical construction presents a more uniform surface to the wind, as in the older type concentrated masses appeared about every half wavelength.

**Comparison of results obtained with standard multisectional and uniform type aerials.**

Comparative tests between the two types of aerials were carried out in the period between February 26th, 1929, and April 18th, 1929, on the normal programmes radiated from G5SW, the short wave experimental broadcast station developed and erected at Chelmsford by Marconi's Wireless Telegraph Company for the B.B.C.

In analysing the results given below, two points should be borne in mind. The first is that the majority of the reports were sent in by amateurs, and possess, therefore, varying amounts of statistical reliability, and the second is the fact that the two aerials were not in absolutely identical positions as regards surrounding metallic objects, etc., although particular care was taken to ensure that differences in radiation due to this cause were reduced to a minimum.

The uniform aerial was supported from a triatic wire at a height of 250 ft. from the aerial feeder box, and the multisectional aerial was supported from the same triatic at a height of 350 ft.

Both aerials hung vertically and were connected to the transmitter by similar beam copper tube feeders.

*The Uniform Short Wave Aerial.*

The tests covered the whole daily programme time, 12.30 to 13.30 G.M.T., and 19.00 to 24.00 G.M.T., thereby ensuring various conditions of light and darkness. The change from one to the other aerial being made at each half hour and occupying not more than 30 seconds.

ANALYSIS OF REPORT.

LOCALITY.	FAVOURABLE TO UNIFORM AERIAL.	FAVOURABLE TO STANDARD MULTISECTIONAL TYPE AERIAL.
U.S.A. }	69%	31%
Canada } .. .. .		
Australia }	80%	20%
New Zealand } .. .. .		
Europe .. .. .	90%	10%
South Africa .. .. .	75%	25%
India .. .. .	50%	50%
Egypt }	100%	—
Sudan } .. .. .		
Malta .. .. .	100%	—
East Africa .. .. .	100%	—
British Guiana .. .. .	100%	—
China }	85%	15%
Hong Kong }		

The quick change-over lessened the chance of reports being affected by any appreciable alteration in conditions.

In view of the definite superiority of the uniform aerial the programmes radiated from G5SW since April 30th, 1929, have been carried out entirely on the uniform aerial.

## MARCONI VETERANS' SECOND ANNUAL REUNION DINNER

*At the inaugural dinner held on the 29th November, 1928, Marchese Marconi was the host, and his guests were men of "The Old Brigade," who had served with the Marconi group of companies for 25 years or more.*

*On the present occasion the old brigade—who had in the meantime adopted the name of "Marconi Veterans"—acted as host to Marchese Marconi.*

THE Dinner was held at The Royal Adelaide Galleries, Strand, W.C. 2, on Saturday, December 14th, 1929, with Col. H. Jameson-Davis, the Founder in 1897 of the Wireless Telegraph and Signal Co.—the original Marconi Company—in the Chair.

Sir Ambrose Fleming and 48 other veterans attended, and telegrams expressing good wishes and regretting their inability to be present were received from Mr. H. W. Allen on the S.S. "Naldera," in the Indian Ocean, Mr. Hayburn, Brussels, and Marquis Solari, Paris.

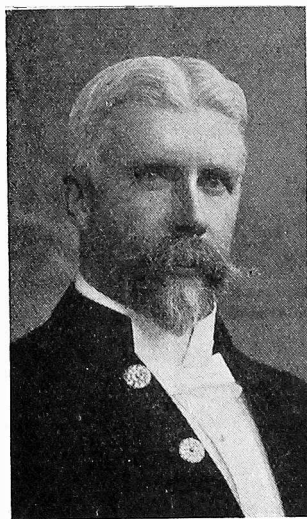

*Col. H. Jameson-Davis.*

The Chairman, Col. H. Jameson-Davis, said that he was very pleased to propose the health of their honoured guest, Marchese Marconi, his very distinguished relative, who was not only the inventor of wireless communication which had proved its utility over land and sea, but had so often helped the Marconi Company through difficult periods by some timely new discovery, such as the beam system, and now we were informed that at no long distance of time power may be transmitted without wires as messages are now sent by telegraph and telephone.

He referred to the work done by the veterans in the early days, and mentioned Sir Ambrose Fleming and Mr. G. S. Kemp, and expressed sorrow at the loss during the year of their old friend Mr. Holloway.

It was with much regret that he had heard the news of the death that day of Admiral of the Fleet, Sir Henry Jackson, an old personal friend, and one of the early believers in the Marconi system, who worked wireless successfully on his own ship.

*Marconi Veterans' Second Annual Reunion Dinner.*

---

Marchese Marconi in his reply said :—

“ I wish to thank Col. Jameson-Davis for the very kind things he has said about me and my work, and the achievements of us all—I particularly appreciate them coming from him, for as we all very well know, Col. Jameson-Davis was the founder of the Marconi Company. Had it not been for his faith in wireless, and in me, there might have been no Wireless Company formed in 1897 ; and although I believe that wireless was nevertheless bound to come, its development might have been very seriously prejudiced and delayed, and the lead which this country gained, and, as I believe, still retains over all others in wireless communication, might well have been lost.



*The Marchese Marconi,  
G.C.V.O., LL.D., D.Sc.*

“ Our Company, which was the first ever to be formed for working wireless, is also, I may say, a very rare example of a pioneer Company not only successfully surviving, but also remaining a pioneer Company.

“ There are those of us here who represent what have been, and still are, the leaders of this Company, especially on its technical side, and if we have also been able to prove to the world more and more as time went on that radio communication to the more distant parts of the earth was no mere idle dream, but a reality, not only serviceable and practicable, and in some cases, essential, but also commercially profitable—that, I submit, has been no mean achievement.

“ Gentlemen, it is a very great pleasure for me to be able to see so many of you here to-night—so many who have survived the trials, the vicissitudes, and the turmoils, not only of this mortal life, but also of the Marconi Company. I think it can justly be said—and even with all due modesty—that had it not been for you who are now present, and all who have worked with us, including those who, alas ! are no more—this Company would never have been able to realise what has constituted an undreamed of extension, I may say a beneficent revolution of the means of communication between human beings.

“ With the comparatively recent development and practical application of the Beam system, we have once more proved that our initiative and our vitality are undiminished.

“ Gentlemen, I wish to thank you with all my heart, not merely for your hospitality in asking me to partake of this very excellent dinner, but above all for

giving me the still greater pleasure of again meeting here to-night so many of my friends, and so many of those who, for over a quarter of a century, have loyally co-operated with me in the carrying out of what is surely a great work."

Marchese Marconi then paid a tribute to the late Mr. Holloway, and also took the opportunity of this occasion to say that he would always gratefully remember the kindness and assistance he received from Admiral Sir Henry Jackson when demonstrating his invention to the Admiralty on his first arrival in this country, and later, on ships under the command of Sir Henry.



Sir Ambrose Fleming,  
M.A., D.Sc., F.R.S.

Sir Ambrose Fleming on being called upon to speak, remarked on the pleasure it gave him to be present at the second of these Marconi Veterans Dinners, and said that probably not all present were aware of the interesting electrical history connected with the building in which they were then assembled. It was originally built in 1830 as a place for stimulating an interest in popular science and called after the Consort of King William IV. "The Adelaide Gallery of Practical Science." Model steam engines, oxy-hydrogen, microscopes, and other scientific novelties of that day were exhibited for public instruction and entertainment. Amongst other things it possessed a sample of a live electric eel or *gymnotus* and the visitors amused themselves by getting shocks from it. Faraday was desirous of discovering whether its electricity was identical with that furnished by the Voltaic pile and electrical machine, and by permission carried out many experiments here

with it, which are detailed in the Second Volume of his *Experimental Researches*.

He caused the shock of the animal to deflect a galvanometer, and used it to magnetise a sewing needle. He also employed it to decompose iodide of potassium and even obtained from it an electric spark, thus proving that its discharge was a genuine current of electricity and not any spurious imitation of it.

Here also in this Adelaide Gallery, Sir Charles Wheatstone made his classical experiments in the velocity of electricity in wires and showed them to many people. William Sturgeon, the inventor of the electromagnet was a frequenter of the gallery, and having heard here from a Mr. Peaboddy of Joseph Henry's experiments in the United States on the self induction of wires, was led to experiment on the subject himself, and so made an induction coil which provided one of the essential elements for the early progress of wireless.

*Marconi Veterans' Second Annual Reunion Dinner.*

1895

Marchese G. Marconi



1896

G. S. Kemp

1897

Col. H. Jameson Davis, H. W. Allen, J. Cave,

1898

P. W. Paget, C. E. Rickard, R. F. Cave,

1899

W. Densham, Andrew Gray, H. M. Dowsett, R. T. Munson,

F. S. Stacey, F. Woodhouse, C. S. Franklin, P. J. Woodward,

1900

R. N. Vyvyan, A. J. Clark, F. Archer, J. Harvie Clark,

Sir Ambrose Fleming, A. H. Atkinson, E. E. Triggs,

1901

W. S. Entwistle, W. J. Willey, G. H. Green, H. W. Corby, A. Eve,

Capt. C. V. Daly, G. Pells, E. G. Tyler, F. E. D. Pereira, F. K. May, A. H. Girman,

1902

E. Berry, W. F. Thomas, R. D. Bangay, F. E. Burrowes, W. Davies, Capt. H. J. Round,

H. A. Ewen, R. G. Kindersley, A. A. Kift, J. Lewis, A. B. Blinkhorn, F. J. Leathers,

1903

D. W. Tullock, J. R. Stapleton, F. Jones, J. Harvey,

A. J. Huff, H. T. Worrall, E. T. Hills,

1904

H. J. Tattersall, A. J. Irvine, T. Iddon, W. A. Taylor, W. I. McGhee,

F. L. Dennis, J. R. Robinson, H. F. White, W. Platt, W. J. Collop,

W. N. Ball, F. S. Hayburn, P. L. Rowland, A. Cappelaere,

H. Cornwall—1904

*Marconi Veterans' Scroll, 1929, on the reverse of the Reunion Programmes.*

*Marconi Veterans' Second Annual Reunion Dinner.*

---

Later on, when an indifferent public failed to give it sufficient support as a home for popular science, the Adelaide Gallery was converted into a dancing saloon and devoted to the worship of the goddess of the twinkling feet. Finally when that failed, it was acquired by Messrs. Gatti, and became this noted restaurant. Hence it would hardly have been possible for the Committee to select a place for the dinner in honour of the inventor of wireless telegraphy, the Marchese Marconi, more appropriate than the Royal Adelaide Galleries, made notable by its association with the work of Faraday, Wheatstone and Sturgeon.

It might even be appropriate, said Sir Ambrose, if the Marconi Veterans Dinner were always held in this restaurant.

In conclusion he begged permission to wish them all a pleasant Christmas and a very happy and successful New Year.

Other speeches by Mr. G. S. Kemp, Mr. G. H. Green, and the Joint Secretaries, Mr. H. M. Dowsett and Mr. C. E. Rickard followed, and after a musical programme, the proceedings terminated.