

AUDIO · COMPUTERS · RADIO · CONTROL SYSTEMS

No. 71



ELECTRONICS

The Maplin Magazine

Britain's Best Selling Electronics Magazine

NOVEMBER 1993 £1.95

Printed in the United Kingdom

FULL SOR

Superb Digital Train Control System For You To Build -

Allows 14 Trains to be controlled on a single layout! See inside for full details...

New Series by Graham Dixey Starting This issue...

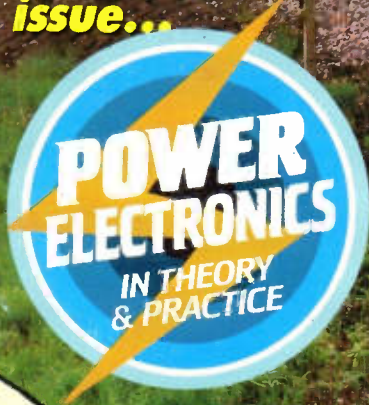

- How to...**
- Use valves
 - Control appliances without touching them!
 - Measure temperature using a computer
 - Check light levels with an exposure meter
 - Build a graphic equaliser
 - Ensure impedance matching
- Plus, Lots, Lots More...**

7 PROJECTS FOR YOU TO BUILD!



COMING SOON TO A FRONT ROOM NEAR YOU...

THE
NEW
MILLENNIUM
4-20
AMPLIFIER



IT'S NOT A
DINOSAUR!

**FOR TIMELESS
QUALITY VALVE SOUND —
AT AN AFFORDABLE PRICE!**

**Look out for the January and February 1994
issues of *Electronics — The Maplin Magazine*
for detailed instructions of how to build this
superb amplifier yourself!**

January and February 1994 issues of *Electronics — The Maplin Magazine* are on general release at outlets near you from 3rd December 1993 and 7th January 1994

Electronics — The Maplin Magazine is available on subscription (see coupon in this issue), from Maplin's regional stores, **WHSMITH**, **Martin the newsagent**, **R S McColl** and other leading news stockists.



PROJECTS FOR YOU TO BUILD!

DIGITAL MODEL TRAIN CONTROLLER 4
This versatile, track-side project allows you to control up to fourteen locomotives on a single layout, with up to four locomotives being driven at any one time.

INFRA-RED SWITCH 21
Look, no hands! Imagine being able to operate electrical or electronic equipment without touching it! This ingenious and versatile project uses active infra-red sensing techniques to achieve its objective.

USING TEMPERATURE MODULES 28
How to put temperature sensing modules to use in practical applications. This project shows simple relay switching through to computer data logging techniques.

PHOTOGRAPHIC LIGHT METER 41
Left in the dark as to the correct exposure? Let this project remove some of the guesswork when making enlargements in the dark-room.

DIGITAL TRAIN RECEIVER 44
The latest microcontroller technology is put to work in the other half of this issue's Digital Train Controller project.

300W + 300W STEREO MOSFET AMPLIFIER 52
This superb stereo amplifier sounds great and looks good too! Bridged operation is possible which transforms the unit into a 600W mono amplifier.

10-BAND GRAPHIC EQUALISER 61
Tweak those frequency bands with this easy to build project. Single PCB construction means that interwiring is kept to an absolute minimum.



FEATURES ESSENTIAL READING!

THE BBC WORLD SERVICE - THE INSIDE STORY 12
Ian Poole takes a look at Britain's flagship radio service that is renowned the world over.

A PRACTICAL GUIDE TO IMPEDANCE MATCHING & MISMATCHING 37
Interconnecting electronic equipment is not all that it would first seem to be. Bob Pearson gives some first rate advice, and points out some common pitfalls and misconceptions.

THE HISTORY OF COMPUTERS 50
Greg Grant introduces us to ENIAC, the world's first general purpose programmable electronic computer.

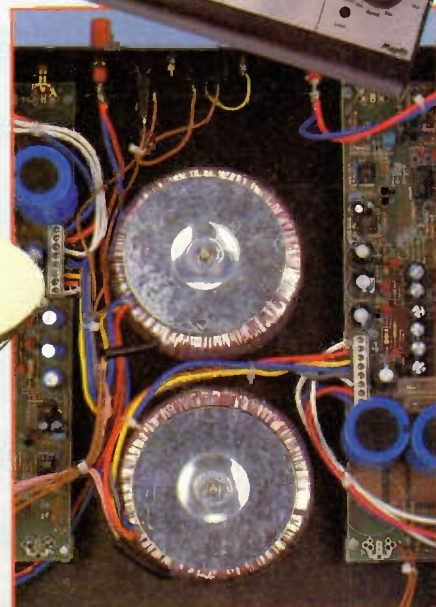
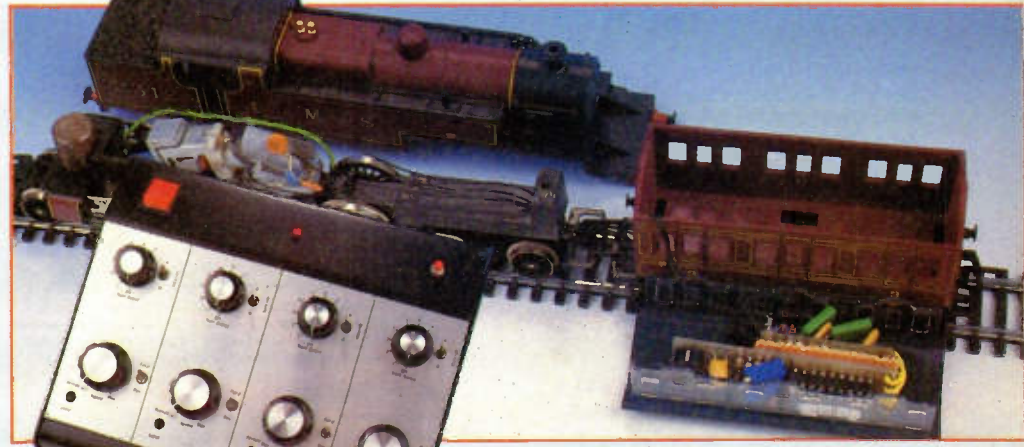

POWER ELECTRONICS - IN THEORY & IN PRACTICE New Series! Graham Dixey, explains operation and applications of devices from this heavy-weight branch of electronics. 56

A PRACTICAL GUIDE TO USING VALVE TECHNOLOGY 66
This month, practical use of the pentode is described. A design for a pentode amplifier is presented, which can be built and tested using the power supply and development chassis described earlier in this series.

UNDERSTANDING AND USING PROFESSIONAL AUDIO EQUIPMENT 70
Tim Wilkinson deals with the operation of analogue audio tape recording equipment.

REGULARS NOT TO BE MISSED!

ABOUT THIS ISSUE..	2	ORDER COUPON	19	NEXT ISSUE & TOP 20 KITS	51
TECHNOLOGY WATCH	3	HOW TO SUBSCRIBE	20	COMPETITION WINNERS	65
NEWS REPORT	16	CLASSIFIED ADVERTS	26	TOP 20 BOOKS	IBC
STRAY SIGNALS	18	AIR YOUR VIEWS	27		

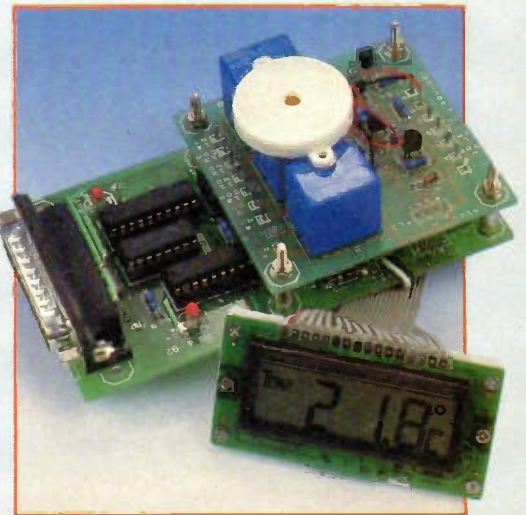

ABOUT THIS ISSUE...

Hello and welcome to this month's issue of *Electronics*!

The response to the readership survey in last month's issue has been massive; so a big thank you to everyone who took the time to fill in the questionnaires and send them back! The results of the survey will be published shortly, as will a list of all the prize winners – you never know, you might be the fortunate winner of a superb oscilloscope or one of the other sixty special prizes! The results of the survey will allow me to closely steer the editorial content of *Electronics* and give you what you want to see in these pages.

Two projects that have provoked a lot of letters are the E510 MIDI Keyboard Scanning Module and the Digital Train Control System. A great many readers would like to see a MIDI master keyboard and a pedal board, as well as several other MIDI projects. The back-room boys have already got their thinking caps on, so watch this space!

The Digital Train Control System project appears in this issue, it comprises a track-side master control unit and receiver units which fit inside the locomotives. Fourteen trains can be controlled on the same layout, with up to four trains being driven simultaneously. The controller is basically the same design as was published in the March-May 1982 issue of *Electronics*, with a few minor changes. However, the receiver has been completely re-designed using state-of-the-art microcontroller technology (the original receivers used ICs that are now no-longer manufactured). The result of this is that the new receiver is smaller than the original receivers (there were several different

shaped receivers) so will be easier to fit into locomotives. Another plus point is that the receiver is completely compatible with the original controller and can be used alongside the old receivers if you have any. For the benefit of all new readers that we have gained since 1982, rewritten and updated constructional details for the controller are included in this issue as well. If you've been reading the magazine since 1982 congratulations on being a longstanding reader, and I hope that you won't mind too much seeing the controller half of the project again!

I am sure that many of you will have a copy of the new 1994 Maplin Full Colour Catalogue; I would be very interested to hear what you think of it. Just a couple of years ago, the very thought of producing a colour catalogue, as well as a colour magazine, struck fear into the hearts of the editorial and production teams here! Certainly, it was a mammoth task; every single picture had to be re-photographed in colour and scanned, many existing hand drawn illustrations re-drawn on computer, and every single line of text transferred onto the new computer desk top publishing equipment. Plus, all of the pictures, drawings and text for all the new items making their first appearance! This required a massive amount of data storage; in excess of nine giga bytes of data for one 800 page catalogue in fact. The data is held on optical disks – not surprisingly we've got a few back-up copies too! We hope you like the new catalogue and find it easier to see exactly what you need to build your projects. So until next month, all that remains for me to say is I hope that you enjoy reading this issue as much as the 'team' and I have enjoyed putting it together for you!

CORRIGENDA FOR ISSUE 70 (October)

We have to apologise for a few mistakes affecting the previous October issue. In page order, the errors are as follows:

Page 11 (PC Weather Station) The lefthand column of Table 1 (containing numbers 0 to 17) should have a sub-title at the top reading 'Beaufort Scale', while column 2 should be titled simply 'Knots' (without the 'per hour').

Page 12 (PC Weather Station) In the circuit of Figure 5, IC10 should be a 74HC4020, not a 4020BE. In the accompanying Parts List on page 22, IC7 has been missed out and an extra line should read 'IC7, 74HC4040, 1 (UF02C)'.

Page 26 (Loop Alarm) The captions for Figures 2 and 3 have been transposed. What is shown as Figure 2 should be the box drilling, while the other smaller drawing is the assembly.

Page 39 (Satellite TV continued) The bottom three lines of the middle column have been transposed. The last two sentences, going over to column three, should read 'At over £100, it may appear expensive, but it has no equal. There is also a Eurostat-modified SR-50 available, which may kill two birds with one stone...' etc.

Pages 42-43 (Professional Audio) The drawings for Figures 2 and 4 are transposed. Similarly the photo on page 42 and the Figure (bottom right) on page 43 are transposed. In all cases the captions are positioned correctly.



R. Ball

ABC
ADVERTISING & COMMUNICATIONS
CONSUMER PRESS

Front cover picture:
© Copyright 1993
Pictor International Ltd.
The Golden Age of Steam –
West Highlander by
Poinish, Lochailort,
Scottish Highlands.

EDITORIAL

Editor Robert Ball AMPRE
Technical Authors Mike Holmes
Print Co-ordinator John Craddock
News Editor Stephen Waddington BEng (Hons)
Technical Illustrators Ross Nisbet,
Lesley Foster, Paul Evans, Nicola Hull
Project Development Tony Bricknell
Chris Barlow, Dennis Butcher,
Alan Williamson, Nigel Skeels

PRODUCTION

Art Director Peter Blackmore
Designer Jim Bowler
Published by Maplin Electronics PLC.,
P.O. Box 3, Rayleigh, Essex, SS6 8LR.
Tel: (0702) 554155. Fax: (0702) 553935.
Lithographic Reproduction by
Stirling Graphics Ltd., 16-22 West Street,
Southend-on-Sea, Essex, SS2 6HJ.
Printed in the United Kingdom by
St. Ives (Caerphilly) Ltd.,
Mid-Glamorgan, CF8 3SU.

MANAGEMENT

Publications Manager Roy Smith
Development Manager David Goodman
Drawing Office Manager John Dudley
Marketing Manager Vic Sutton

ADVERTISING

Jackson-Rudd & Associates Ltd.,
2 Luke Street, London, EC21 4NT.
Tel: (071) 613 0717. Fax: (071) 613 1108.
Advertisement Director Colin Pegley
Advertisement Manager Eric Richardson

UK NEWSTRADE DISTRIBUTION

United Magazine Distribution Ltd.,
Castle House, 37-45 Paul Street,
London, EC2A 4PB.
Tel: (071) 490 2020. Fax: (071) 490 1239.

* Copyright 1993 Maplin Electronics PLC.

Copyright. All material is subject to worldwide copyright protection, and reproduction or imitation in whole or part is expressly forbidden. Permission to reproduce printed circuit board layouts commercially or marketing of kits must be sought from the publisher.

Advertisements: Whilst every reasonable precaution is undertaken to protect the interests of readers by ensuring, as far as possible, that advertisements appearing in the current issue of *Electronics* are bona fide, the publisher and staff of the magazine cannot give any undertakings in respect of statements or claims made by advertisers, whether on printed page or on loose insert. Readers who have reasonable grounds to believe that they have been misled are advised to contact their local Trading Standards Office.

Editorial: The views of individual contributors/authors are not necessarily those of either the publisher or the editor. Where errors occur corrections will be published as soon as possible afterwards.

Publisher's Statement: Maplin Electronics PLC., take all reasonable care to prevent injury, loss or damage of any kind being caused by any matter published in *Electronics*. Save insofar as prohibited by English law, liability of every kind including negligence is disclaimed as regards any person in respect thereof.

Project Ratings

Projects presented in this issue are rated on a 1 to 5 for ease or difficulty of construction to help you decide whether it is within your construction capabilities before you undertake the project. The ratings are as follows:

- Simple to build and understand and suitable for absolute beginners. Basic of tools required (e.g., soldering iron, side cutters, pliers, wire strippers and screwdriver). Test gear not required and no setting-up needed.
- Easy to build, but not suitable for absolute beginners. Some test gear (e.g., multimeter) may be required, and may also need setting-up or testing.
- Average. Some skill in construction or more extensive setting-up required.
- Advanced. Fairly high level of skill in construction, specialised test gear or setting-up may be required.
- Complex. High level of skill in construction, specialised test gear may be required. Construction may involve complex wiring. Recommended for skilled constructors only.

Ordering Information

Kits, components and products stocked by Maplin can be easily obtained in a number of ways:

Visit your local Maplin store, where you will find a wide range of electronic products. If you do not know where your nearest store is, refer to the advert in this issue or Tel: (0702) 552911. To avoid disappointment when intending to purchase products from a Maplin store, customers are advised to check availability before travelling any distance.

Write your order on the form printed in this issue and send it to Maplin Electronics, P.O. Box 3, Rayleigh, Essex, SS6 8LR. Payment can be made using Cheque, Postal Order, or Credit Card.

Telephone your order, call the Maplin Electronics Credit Card Hotline on (0702) 554161.

If you have a personal computer equipped with a MODEM, dial up Maplin's 24-hour on-line database and ordering service. CashTel, CashTel supports 300-, 1200- and 2400-baud MODEMs using CITT tones. The format is 8 data bits, 1 stop bit, no parity, full duplex with Xon/Xoff handshaking. All existing customers with a Maplin customer can access the system by simply dialling (0702) 552941. If you do not have a customer number Tel: (0702) 552911 and

we will happily issue you with one. Payment can be made by credit card.

If you have a tone dial (DTMF) telephone or a pocket tone dialler, you can access our computer system and place orders directly onto the Maplin computer 24-hours a day by simply dialling (0702) 556751. You will need a Maplin customer number and a personal identification number (PIN) to access the system. If you do not have a customer number or a PIN number Tel: (0702) 552911 and we will happily issue you with one.

Full details of all of the methods of ordering from Maplin can be found in the current Maplin Catalogue.

Prices

Prices of products and services available from Maplin, shown in this issue, include VAT at 17.5% (except items marked NV which are rated at 0%) and are valid between 1st October 1993 and 28th February 1994. Prices shown do not include mail order postage and handling charges, which are levied at the current rates indicated on the Order Coupon in this issue.

Technical Enquiries

If you have a technical enquiry relating to Maplin projects, components and products featured in *Electronics*, the Customer Technical Services Department may be able to help. You can obtain help in several ways; over the phone, Tel: (0702) 556001 between 2pm and 4pm Monday to Friday, except public holidays; by sending a facsimile, Fax: (0702) 553935; or by writing to: Customer Technical Services, Maplin Electronics PLC., P.O. Box 3, Rayleigh, Essex, SS6 8LR. Don't forget to include a stamped self-addressed envelope if you want a written reply! Customer Technical Services are unable to answer enquiries relating to third-party products or components which are not stocked by Maplin.

'Get You Working' Service

If you get completely stuck with your project and you are unable to get it working, take advantage of the Maplin 'Get You Working' Service. This service is available for all Maplin kits and projects with the exception of: Data Files; projects not built on Maplin ready etched PCBs; projects built with the majority of components not supplied by Maplin; Circuit Maker ideas; Mini Circuits or other similar 'building block' and application circuits. To take advantage of the service, return the complete kit to: Returns Department, Maplin Electronics PLC., P.O. Box 3, Rayleigh, Essex, SS6 8LR. Enclose a cheque or Postal Order based on the price of the kit as shown in the table below (minimum £17). If the fault is due to any error on our part, the project will be repaired free of charge. If the fault is due any error on your part, you will be charged the standard servicing cost plus parts.

Kit Retail Price	Standard Servicing Cost
up to £24.99	£17
£25 to £39.99	£24
£40 to £59.99	£30
£60 to £79.99	£40
£80 to £99.99	£50
£100 to £149.99	£60
Over £150	£60 minimum

Readers Letters

We very much regret that the editorial team are unable to answer technical queries of any kind, however, we are very pleased to receive your comments about *Electronics* and suggestions for projects, features, series, etc. Due to the sheer volume of letters received, we are unfortunately unable to reply to every letter; however, every letter is read – your time and opinion is greatly appreciated. Letters of particular interest and significance may be published at the Editors' discretion. Any correspondence not intended for publication must be clearly marked as such.

TECHNOLOGY WATCH!

with Keith Brindley

Expansion in peripheral items for home entertainment systems has generated several new devices, aimed at users, which might not necessarily be legal. These, in general, are convenience items which use radio signals to communicate. Three examples which appear from time to time in advertisements in the pages of home entertainment magazines covering, Hi-Fi, satellite television and electronics fields are:

- ★ Remote control links – These allow your television or Hi-Fi remote control handset to be used in any room in the house. The link re-transmits your controller's infra-red commands as a radio signal to a receiver positioned close to your telly or stereo system, then converts them back to infra-red. So you can be watching your favourite satellite programme in bed, decide it's time for bye-byes, press the off button and everything powers down.
- ★ Videosenders – To allow you to watch your favourite programme in bed means either hard-wiring your house with interconnecting cables, or using a videosender. Such a device takes the video signal from your satellite receiver or VCR and re-transmits it as a UHF radio signal which your bedroom television picks up directly. There are several videosenders around, but as they are strictly banned from use, are rarely now advertised.
- ★ Audiosenders – These do the same for an audio signal as the videosender does for a video signal; taken either from your main Hi-Fi unit, or from a satellite receiver – re-transmitting the stereo signal at a frequency which a tranny radio can pick up. Thus you can re-transmit your favourite album or any of the blossoming radio channels now available alongside satellite television channels, whilst you're working out in the garden. To my knowledge there is only one available audiosender as yet (this'll probably fill my mailbox with unsolicited letters to the contrary – Ed.), supplied by BPD Marketing (Tel: 0800 626040) more of which later, although now the concept has been broached, others are bound to follow.

These are all examples of devices which users appear to want. They must be – or the companies manufacturing and supplying them wouldn't stay in business. After all, it seems like a good idea to me, when I'm mowing my lawn for example, I can put on my personal stereo cassette/radio and pick up Virgin Radio in glorious high-quality stereo. It's usually on 121.5kHz AM of course, but it's also now broadcast as a stereo signal on the back of the satellite channel Sky News. By using an audiosender, re-transmitting on the VHF FM band, I can have my Virgin whenever and wherever I want – and in stereo at that.

There are other aspects to consider, mind you. What happens, say, if a videosender is used to re-transmit pornographic video material and it is intercepted by the child next door? What happens if two neighbours have similar devices each re-transmitting on an identical frequency? But whatever the moral issues, technically these devices might not always be as they seem. The problem is, they use the radio spectrum to re-transmit their signals. And the radio spectrum – or its use, that is – in the UK is quite closely controlled by the Radiocommunications Agency of the Department of Trade and Industry. In the case of videosenders, transmission has to be in the UHF band (otherwise other televisions can't pick up the signal), while in the case of audiosenders, transmission must be in the VHF band for radios to pick up the signal. Remote control links aren't

quite, I suppose, in the same category, as they can legally use deregulated frequencies not specifically allocated, such as 49MHz or 418MHz.

By transmitting in the UHF or VHF bands devices are, of course, strictly *illegal*. Illegal to use, and illegal to supply. Not that illegality has ever stopped market forces in the past. Take Citizens' Band radio as an example. Take early cordless telephones as another. What happened in both those cases was that users wanted them, suppliers supplied them, users used them, and eventually the Government got the message. Frequencies were allocated and legal devices became the norm. Convenience devices like these here need the same consideration now.

To date, the Radiocommunications Agency doesn't appear to have accepted this with this new batch of radio-using devices, instead enforcing legality by prosecuting suppliers of videosenders – with penalties of nearly £8,000 in one instance. Surely the best application of the DTI's (and the legal system's) time and money, however, is to recognise the requirement, allocate frequencies, generate specifications and an approvals procedure for these devices, to allow for good quality and performance, *legally*.

BPD Marketing's audiosender (known as the StereoSender) is claimed to cut through the legality aspect via two 'loopholes':

First, 107MHz in the VHF FM band is a frequency set aside specifically for test broadcasts. As such it is rarely used and no home receivers will be tuned to it. If a properly manufactured and *approved* sender uses that frequency, then theoretically it is not illegal.

Second, to keep interference (already low because of the use of the 107MHz test frequency) even lower, radiating power should be extremely small. Small enough in the StereoSender (less than 15µW) to allow it to be classed as an emission rather than as a transmission. A subtle, but technical, difference.

With this two-pronged approach BPD Marketing hopes to crack the illegality aspect, and hopes to gain approval from the Radiocommunications Agency. Of course, the Radiocommunications Agency being what it is, an executive agency of the Department of Trade and Industry, approval may take some time, if they get approval at all.

There may be another hurdle yet to come; radio and television programmes, videos, tapes, CDs and records (remember them?) are all covered by copyright. Using a video or audiosender to transmit them (or re-transmit them in the case of radio and TV) to your bedroom telly or personal stereo might be construed as *broadcasting* – others, as well as you, could receive the transmissions. According to the law, unless you have an agreement with the copyright holder, it's illegal to broadcast copyrighted material. Radio and TV stations have to pay royalties every time they broadcast copyrighted material, so their argument will be, so should you. That's impractical you may say, but pressure could be brought to bear on the home office to impose a levy on video and audiosenders (that's if they are ever made legal), just as the record industry still wants on blank tapes.

Killing Joke

Talking of intransigent bureaucracies, CENELEC, the European standards-making body for electrical products and installations is attempting to prepare a standard which will effectively impose a Europe-wide plug and socket arrangement for mains installations and appliances. Sounds fair,

you might say, after all we're in the European market so let's have a uniform mains system at least.

On the other hand, there are a few important implications for us here in the UK. First, there are a number of physical differences between UK and continental hardware. For a start, we use adaptable ring circuits in our homes, protected by 30A or 32A overcurrent devices at the distribution panel, together with fused 13A plugs at each socket. Our plugs now have insulated sections of the live and neutral pins which eradicate the possibility of anyone getting an electric shock when fitting or removing the plug to or from a socket by touching uninsulated sections of pins. Continental systems vary, but generally comprise radially wired (that is, non-ring) circuits protected by 20A overcurrent devices at the distribution panel. To be safe, the number of sockets fitted on a radial circuit has to be limited (to eight, for example, in France). They also have unfused plugs rated at 16A, with no insulated sections to prevent shock. Our sockets (known as type B) are of two-piece construction with a back-box and front panel with integral switch. Continental sockets (type A) are three-piece with back-box, front panel and separate switch. While the use of two- or three-piece sockets, and ring- or radially-wired circuits is largely an academic issue, the safety features of our fused and insulated plugs is surely not. If we resort to a continental unfused and uninsulated plug, deaths by electric shock or electrical fires will result.

Second, UK voltages are different to the rest of the continent. Our home system for a start is 240V, whilst their's is 220V. Not so hard to get around I guess, we could probably live with that and drop ours to 220V with few difficulties – our light bulbs would be a bit dimmer (but they'll last longer!) and some old appliances might not function properly. Or perhaps we could all meet in the middle, at say 230V! – I'm not joking, it's been discussed at international level. However, the continental system of using the same voltage (220V, or whatever) in portable industrial applications (building sites and the like) is more of a bitter pill. Our portable industrial systems use a transformed 110V supply, in which the maximum voltage to earth is a safe 55V. If forced to adopt a 220V supply for portable industrial applications, even if we're allowed to transform it to 110V, the only tangible result can be deaths by electric shock.

You may ask, why the changes? Well, it all comes down to one reason, to remove trade barriers; basically the idea is that any EC made product should be able to be sold anywhere else in the EC without modification. Standards and specifications are all going through a harmonisation process; in which all related standards are put in the melting pot and the best (or worst) bits of them are pulled out to form a new standard, once everyone agrees it then has to be adopted by all EC member states. Naturally, the UK being the only EC member to have fused and insulated plugs and 110V portable industrial circuits, it'll most likely be us who will have to change (it'll cost the EC as a whole, less to bring us into line with the rest of Europe than the other way around!). I'm all in favour of standardisation, generally. Personally though, on this particular issue, I'd much rather have a safer plug and a safer building site.

If you agree, perhaps you'd like to make your point by writing to your MP, your MEP, the PM, the EC, the DTI, the Home Office, or CENELEC. Maybe even write to them all.

THESE days model railway enthusiasts expect realism. Having cast aside rheostat and single slider voltage controllers years ago, the demand is now for control systems which enable trains to be driven as if the enthusiast were actually in the cab of the locomotive. This demands not only control of the speed and direction of the locomotive, but also the ability to move trains anywhere on a layout without the need for track isolating or switching. Companies

were not slow to respond to this need, producing systems able to control a multitude of trains at varying speeds on the same track layout. Maplin was one such company, who more than ten years ago produced a multi-train controller project – see Reference 1 – capable of controlling up to fourteen locomotives on a layout. Unlike other companies the cost was not prohibitive and the kit was – and still is – very popular.

The design of the Maplin controller is

split essentially into two distinct sections: The transmitter unit supplies a DC voltage and control data to the track. While the receiver modules, when fitted inside the locomotives, interpret the modulated data from the track and produce appropriate power signals for the locomotive motor.

The controller essentially provides a constant 18V DC supply to the track, onto which digital information is superimposed. Each train has a unique address and so the controller

4
PROJECT
RATING

DIGITAL

CONTROLLER



Below: The complete Digital Train Controller. Please note that the case is not included in the kit.

KITS AVAILABLE
TRAIN COMMON/PSU (LW61R)
PRICE £39.95 ca
TRAIN CONTROL (LW62S)
PRICE £9.95

FEATURES

- ★ 14 Locomotives individually controlled on the same track
- ★ Up to 4 locomotives controlled simultaneously
- ★ Supply always present for carriage lighting
- ★ Low-cost, two wire system
- ★ Automatic short-circuit protection
- ★ Modern microcontroller based receiver

Updated by Tony Bricknell
 Original Design by Robert Kirsch
 Text by Tony Bricknell and
 Stephen Waddington BEng(Hons.),
 M.I.E.E.E., A.I.E.E., A.I.T.S.C.

can modulate address data relating to an individual locomotive. This is followed by control information relating to the desired direction and power – or speed – level required for the locomotive addressed. Up to fourteen trains can be controlled on a layout at anyone time, with a possible four trains running consecutively.

During the last decade, while railway enthusiasts have been happy to tinker with track layouts under the management of the Maplin controller, the electronics industry has moved on. Consequently one of the components at the heart of the receiver module is no longer available, prompting us to redesign the system. This new project uses the original transmitter design with innovative receiver circuitry. Fear not if you have old receivers, the new receiver circuit boards are entirely compatible and will happily work alongside existing receiver circuits.

For purposes of simplicity we have split the project into two parts; this section concentrates on the construction of the transmitter unit whilst the second section – for those who already have a Maplin system – details the construction of the new receiver units.

THEORY

The transmitter sends out a series of forty data packets in a single time-slot; a data packet is allocated sequentially to each of the four possible locomotives that may be powered at any one time. Data transmitted in a typical time-slot – relating to locomotives numbered from 1 to 4 – follows the sequence 1, 2, 3, 4, 1, 2, 3, 4, continuing so that within a single time-slot, each of the four locomotives is serviced ten times. An individual data packet contains address data, uniquely identifying a locomotive, and a motor control pulse. As such, the motor is only ever turned on or off; discrete speed levels are achieved by varying the number of *on* and *off* periods within a single time-slot, in a manner similar to a 'burst fire' control system. Each locomotive can have its speed set on a scale of zero to

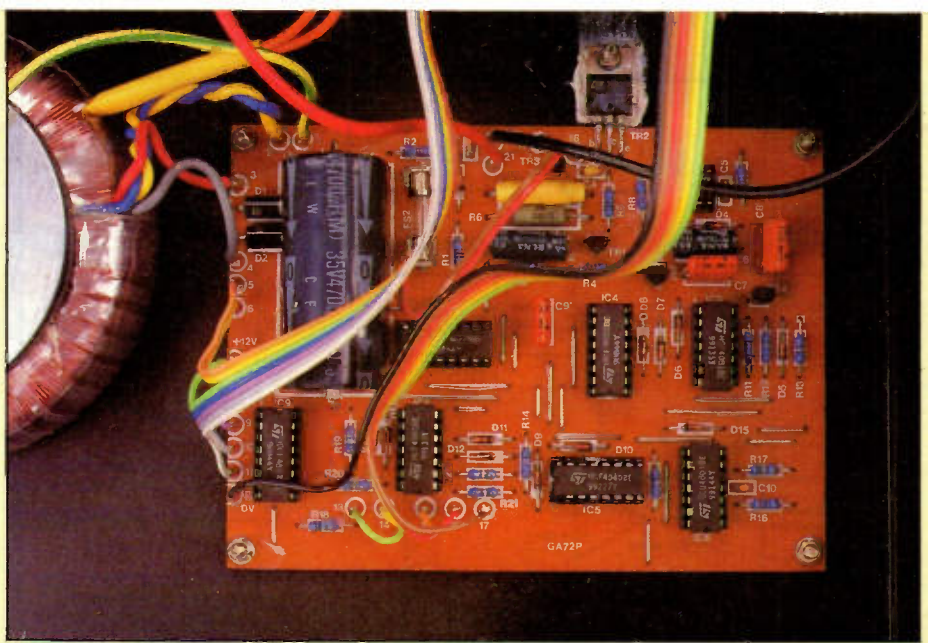

Wiring to the Common/PSU PCB.

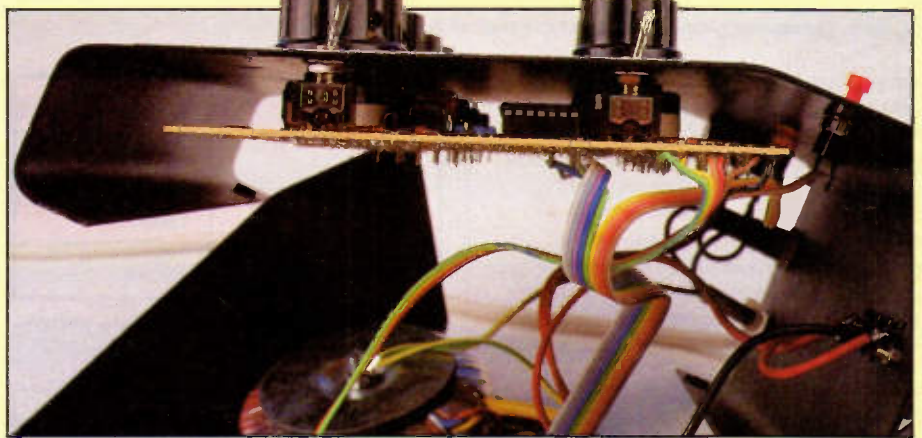

Side view showing switch and PCB mounting arrangements.

ten – zero corresponds to stop, while ten corresponds to full-speed.

Theory aside, let's consider a practical example which demonstrates how the system works – if locomotive 1 is to be run at full-speed then it will have a motor control pulse sent out the full ten times within a single time-slot. If locomotive 2 is to be run at half speed then its control

code will be sent out for the first 5 sequences, the remainder being coded zero. If locomotive 3 is to be run at minimum speed – speed 1 – then its code will be sent out for the first sequence only, the following nine being coded zero. Assuming only three trains are to be run on the track, then the code for the possible fourth locomotive will be coded

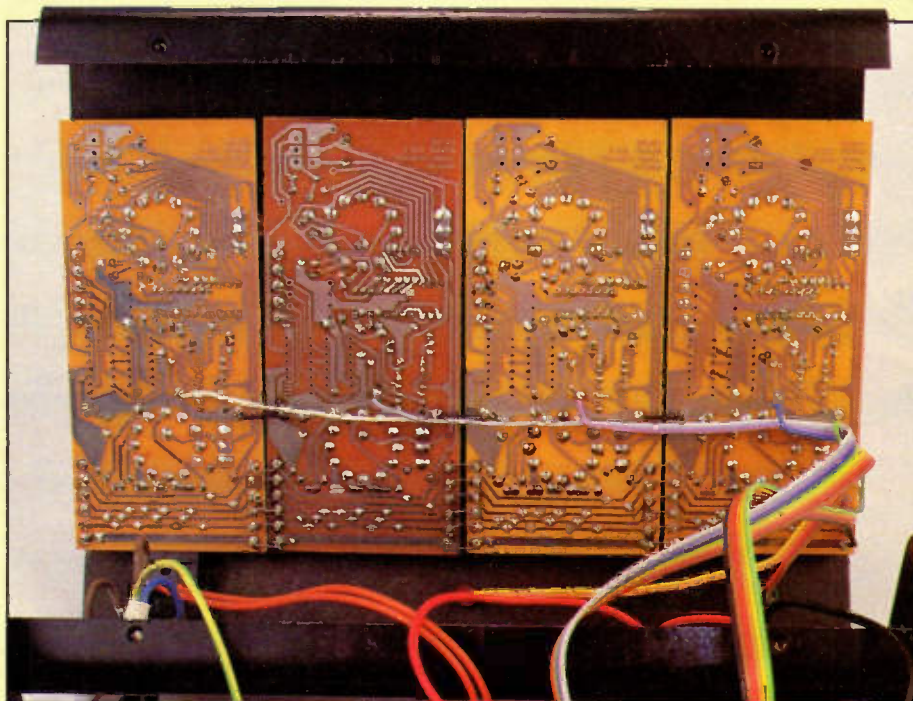

Wiring to the four Control PCBs.

Bit	Description
1	Group
2	Direction
3	Train Identity
4	Train Identity
5	Train Identity
6	Train Identity

Table 1. The six bits contained within a data packet.

zero throughout the time-slot. Using our hypothetical example, the motor control code transmitted to the track will follow the sequence 1, 2, 3, 0, 0, 1, 2, 0, 0, 1, 2, 0, 0, 1, 2, 0, 0, 1, 2, 0, 0, 1, 0, 0, 0 continuing for a full time-slot.

Each data packet contains seven data bits, as detailed in Table 1. A receiver module must receive two identical packets containing its locomotive address before it will latch the motor on. Thus when servicing a train, the transmitter

CIRCUIT DESCRIPTION

A functional block diagram of the transmitter unit is shown in Figure 1. The transmitter is split into two discrete sections each of which is built on separate PCBs. The common board contains the power and processing components whilst the control board supplies user-selected information relating to a locomotive address, speed and direction, to the common board. A control board is required for each of the four possible trains that may be controlled at any one time. Anyone wishing to run two or three trains consecutively instead of the maximum four, need only construct the appropriate number of control boards. The circuit diagrams for both the common/PSU and control boards are shown in Figures 2 and 3 respectively.

The data packet mentioned earlier, is produced by resetting IC4 – a divide by 8-counter – after 2, 3, or 6 clock pulses, depending on whether the data to be transmitted is a one, a zero, or an inter-packet gap. Transmission of the five bits in their correct sequence is achieved by IC8 – a divide by 8 counter – configured in this instance to divide by 6. During the first five clock cycles, the device is used to scan the five AND gates of IC7 so extracting the user-selected information relating to the desired speed, direction and locomotive address. The sixth count triggers the inter-data packet gap, and at the same time resets the counter.

Central to the common board design is IC6, configured to produce a square-wave. The clock frequency is further reduced by IC5, a 12-stage binary counter, configured here to divide by 192. The resultant signal has a pulse width of $850\mu\text{s}$. Each frame of data takes about $380\mu\text{s}$, so two complete frames can be sent in one pulse width. The trigger signal (TS) is used to clock the counter IC9 and produce four separate consecutive output pulses, TS1 to TS4, each approximately $850\mu\text{s}$ long.

Each of the four TS pulses is used to sequence the counter IC1 on the control board. The counter steps from one to ten before resetting itself for the next count-sequence. The first output from the counter sets the latch formed from IC2b and IC2c; this is subsequently reset when the counter reaches the user-selected number on the speed control. During the latched period, TS pulses are fed to the diode encoder formed from diodes D1 to D12. The pulses are connected onto one or more of the three data lines depending on the code of the receiver being addressed. If the reverse switch is operated or Group 2 is selected as opposed to Group 1 the TS pulse is also switched onto the appropriate data lines.

The DC supply fed to the track is stabilised by IC1 – on the control board – at 18V. Transistor TR4 modulates data signals upon it and also controls Darlington transistor TR2 that is used here to regulate the current supply to the rails. In order to protect the controller from damage due to the accidental short circuiting of the track, the current flowing through R6 is monitored by TR1. When the current exceeds the preset limit the transistor conducts and fires the Silicon Controlled Rectifier (SCR) TR2, thus

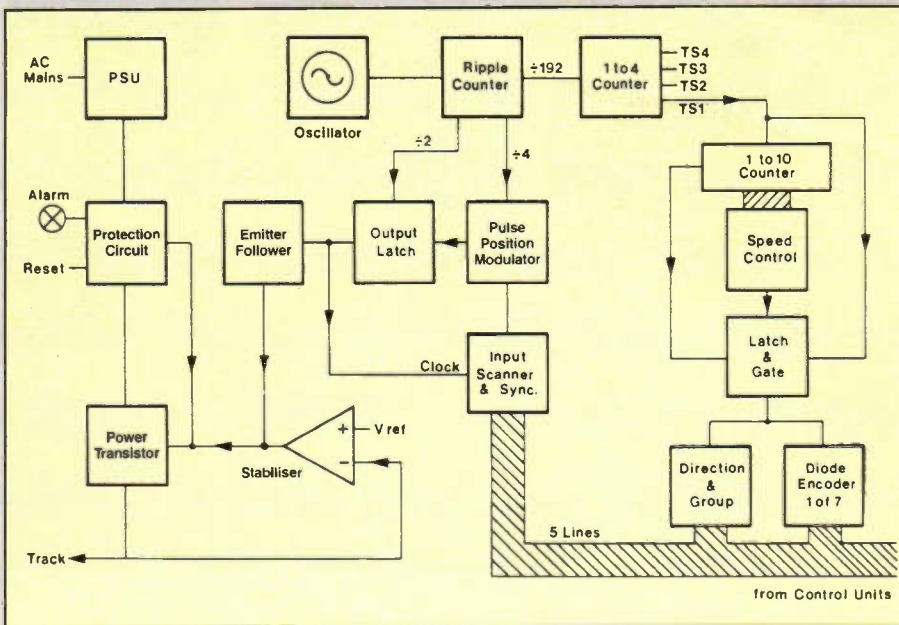
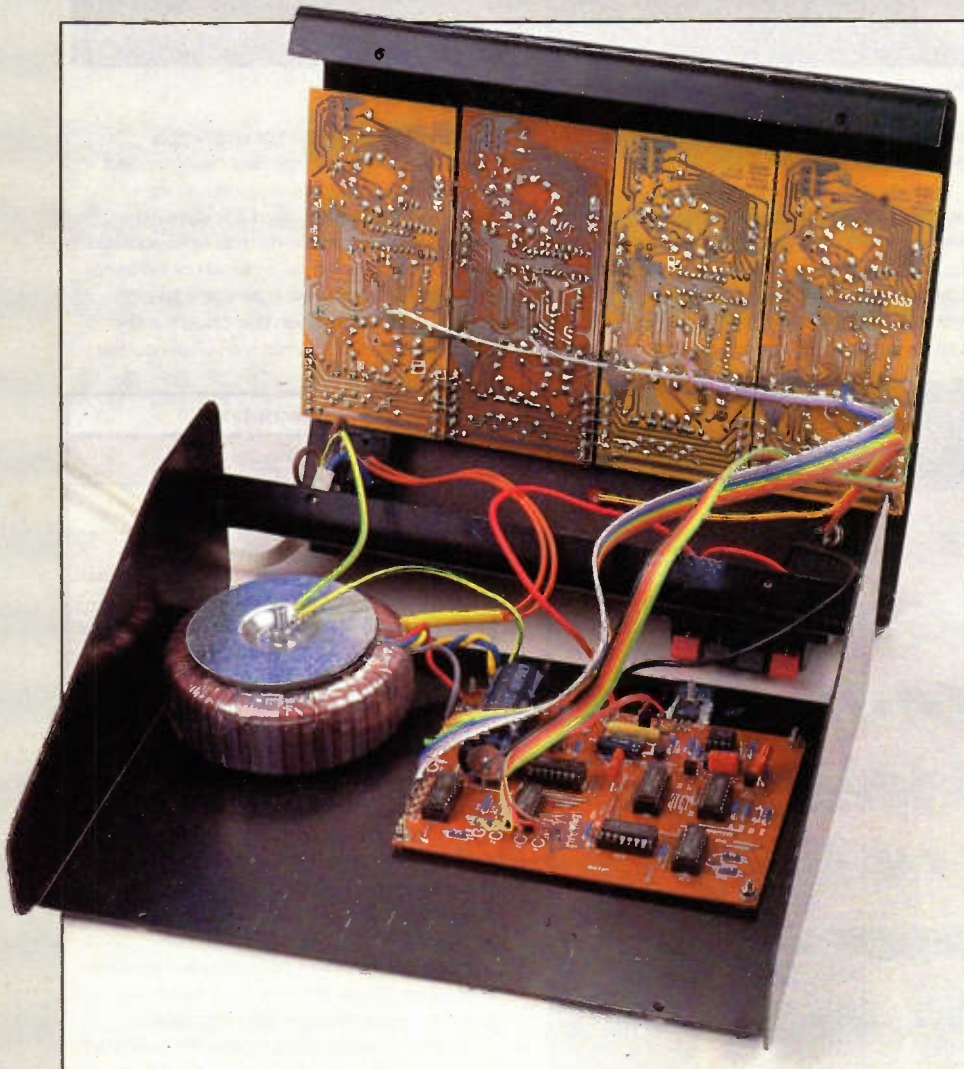

Figure 1. Functional block diagram of the Digital Train Controller.

generates two duplicate data packets before moving onto the next train address in any given time-slot. Utilising pulse position modulation (PPM), timing periods vary depending on whether the data transmitted is a one, a zero, or an inter-data packet gap. Table 2 details individual timing periods under the PPM scheme, while precise details of receiver decoding and motor control are discussed in the second part of this project.

Description	Timing Period
Logic 0	$34\mu\text{s}$
Logic 1	$15\mu\text{s}$
Inter-packet Gap	$102\mu\text{s}$

Table 2. Timing sequence for data within a data packet.



Inside the complete Digital Train Controller.

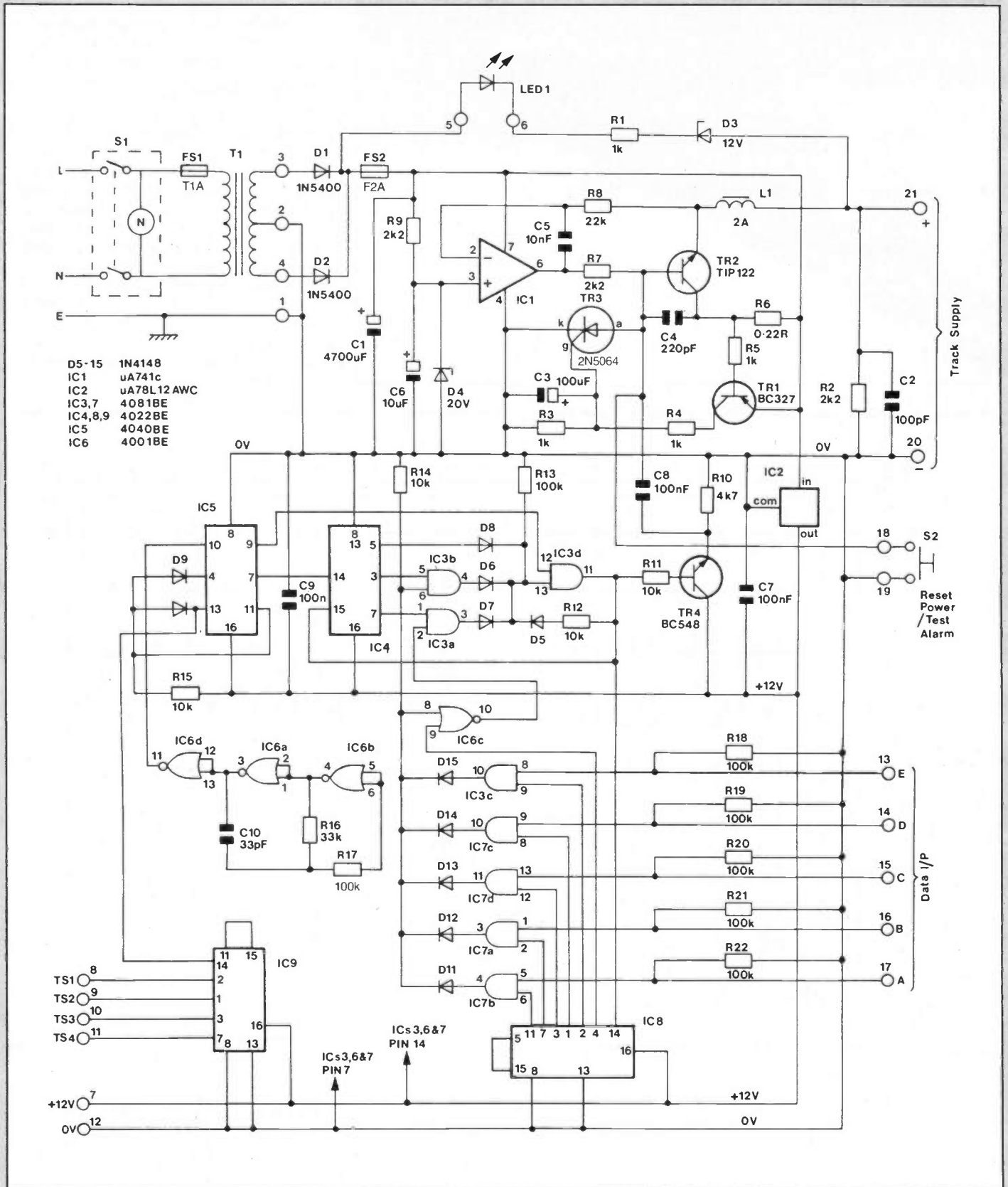
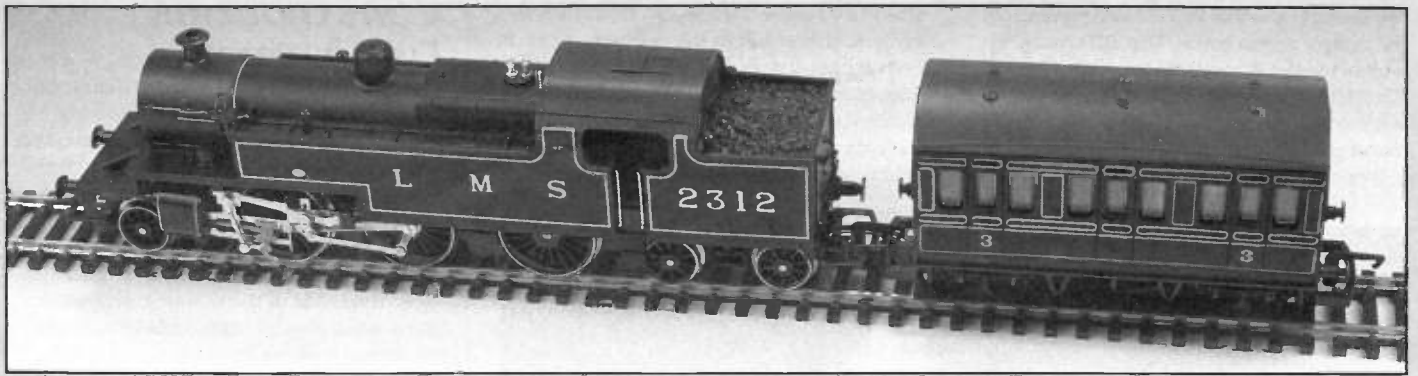

Figure 2. Common/PSU circuit diagram.

removing the signal to TR2 and turning off the supply to the track. The SCR remains latched until it is reset by shorting it with S2. If the fault is still present the circuit will trip again immediately and cause no damage.

When the track supply falls more

than 12V below the power unit's nominal output, either due to the protection circuit being tripped or due to a fuse failure, the indicator LED1 will light. Provision is also made for a buzzer to be fitted if an audible indication of track supply failure is required under these circumstances.

CONSTRUCTION

Common Board

Referring to the PCB legend in Figure 4, insert and solder the resistors, diodes, PCB pins, fuseholders, capacitors and the choke. Ensure the electrolytic capacitors and diodes are all fitted with the correct polarity. Insert and solder the two plastic transistors, the voltage regulator and the SCR into their correct positions. Carefully bend the leads of the power transistor to allow a suitable mounting position on the controller case as illustrated in Figure 5. Clamp the device lightly in a vice or pair of pliers before making the two bends, each through 90°. Finally insert and solder all ICs, observe CMOS precautions. Make sure that all devices are the correct way round.

Control Board

The track layout and component overlay for the Control Boards are shown in Figure 6. If you have an Issue 2 PCB, a modification must be made on the track side as illustrated in Figure 7; this problem has been alleviated on Issue 3 PCBs.

Insert and solder the resistors, diodes, PCB pins and capacitors. In this instance, fit all PCB pins from the component side of the PCB. This will ease the wiring required when the boards are fitted to the front panel. Note that the rotary switch, without the click stops, is mounted next to IC1, intended for use as the speed controller.

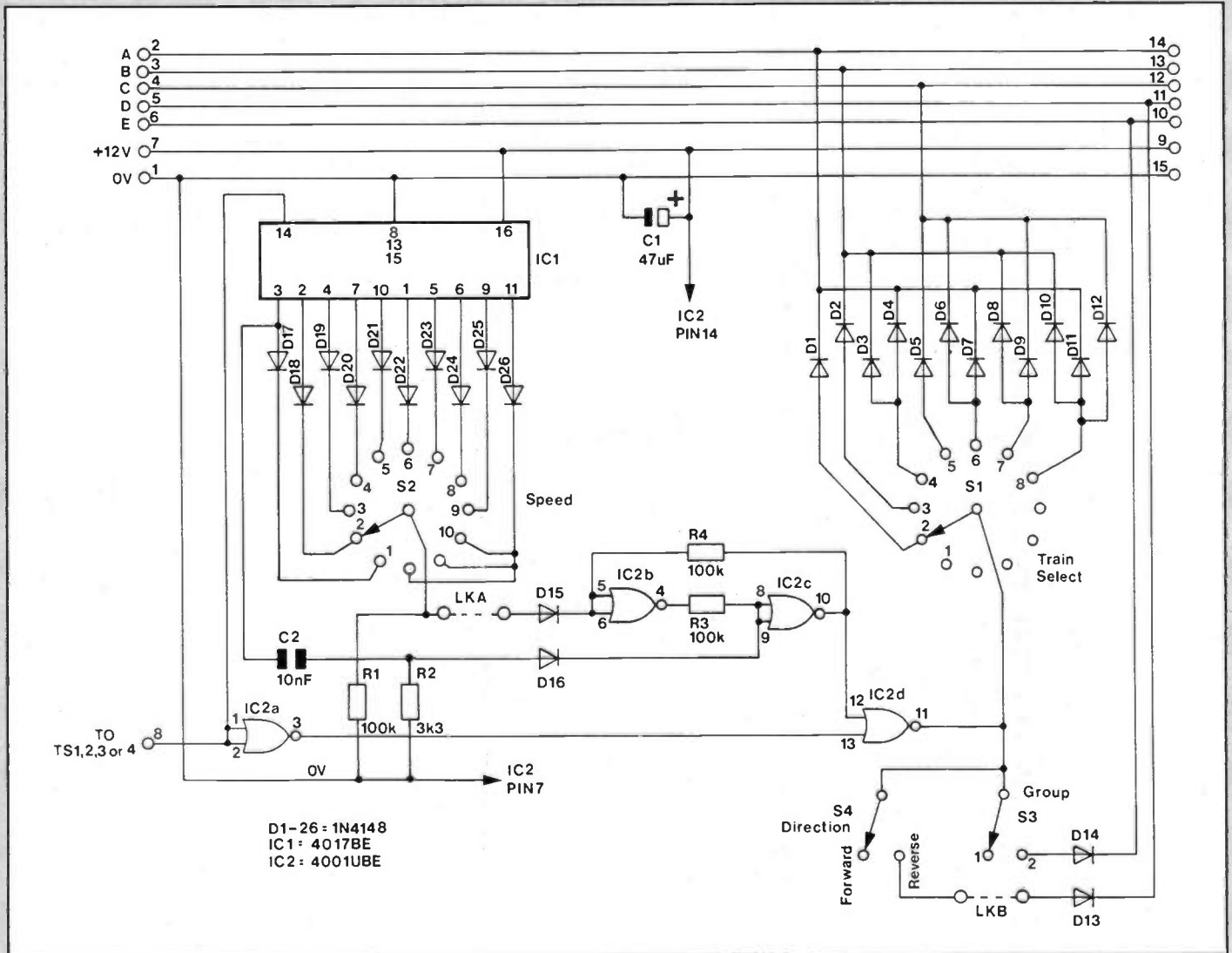

Figure 3. Control Module circuit diagram.

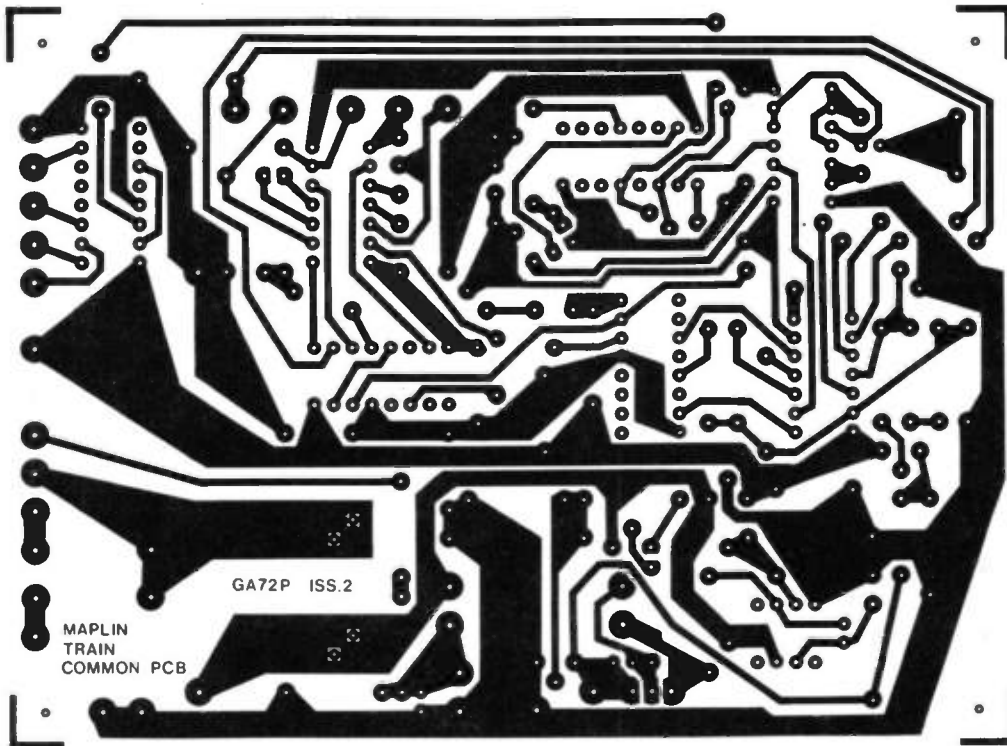
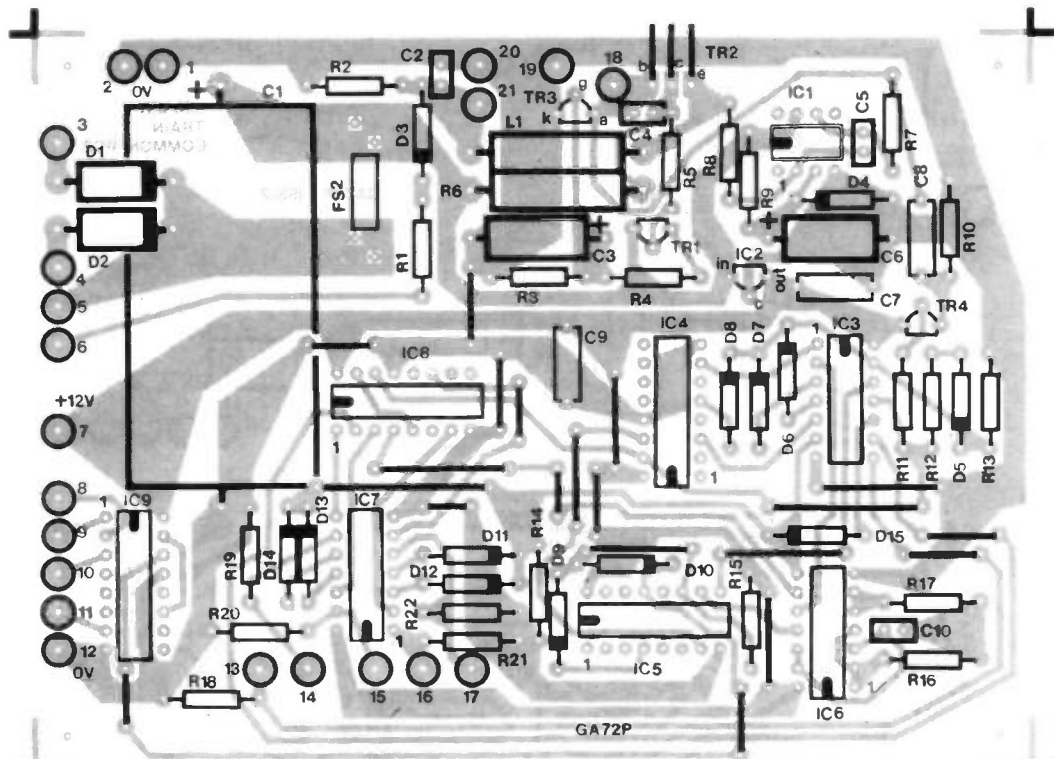

Figure 4. Common/PSU PCB legend and track.

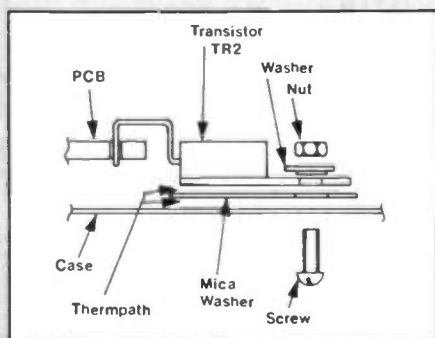

Figure 5. Power transistor mounting.



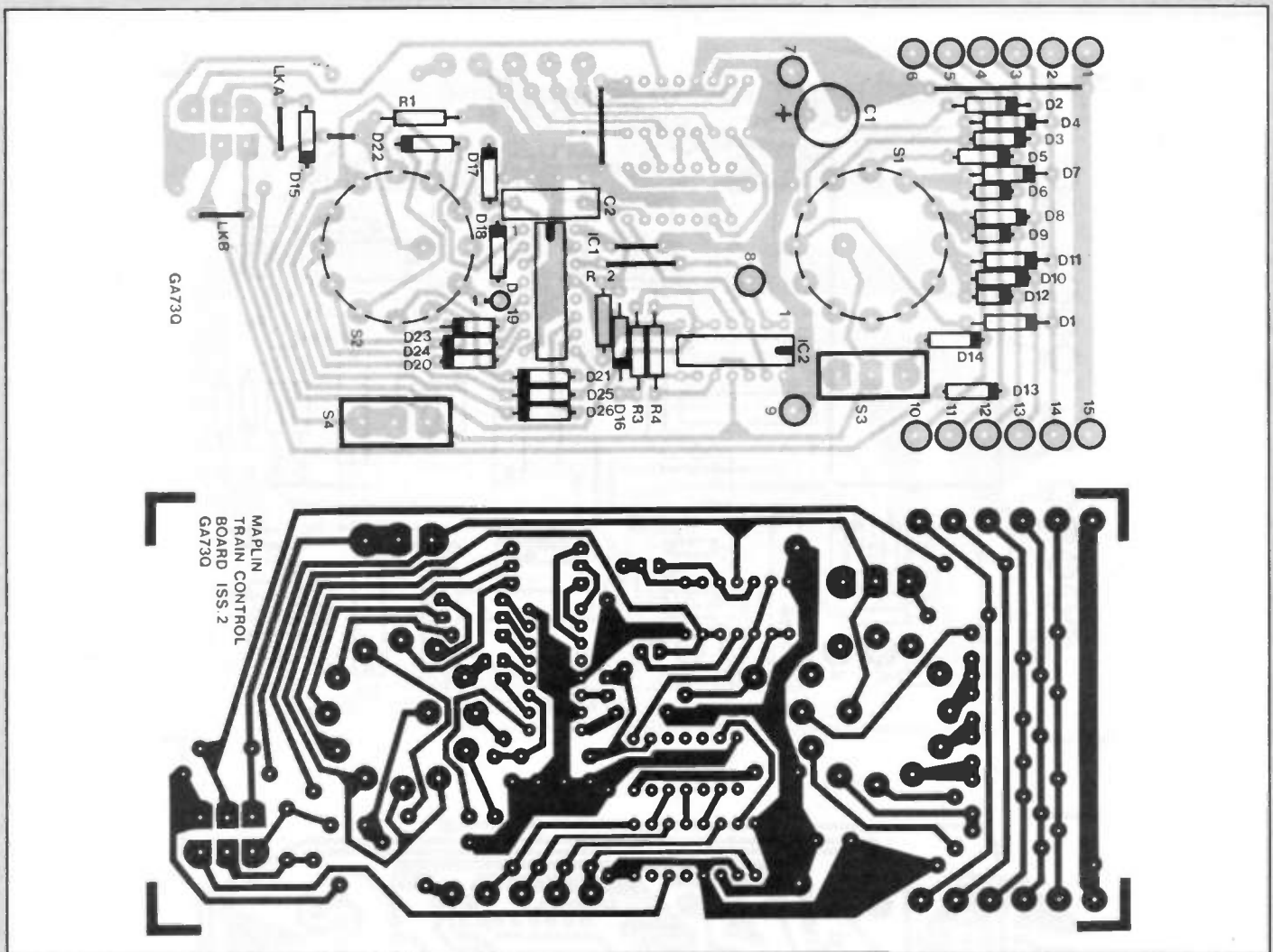

Figure 6. Control board PCB legend and track.

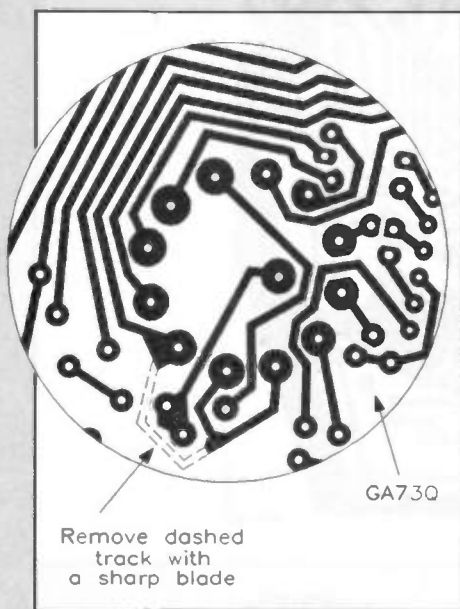

Figure 7. Modification required to Control Module PCB (Issue 2 only).

MECHANICAL ASSEMBLY

Mount the transformer, mains switch, fuseholder, LED, push-button and terminals in the case. Fit the common board and control boards. Note that only one control board need be fitted initially. The self-adhesive panel legend may be used as a template for drilling the front panel or the ready drilled case XG09K may be used – this is not included in the

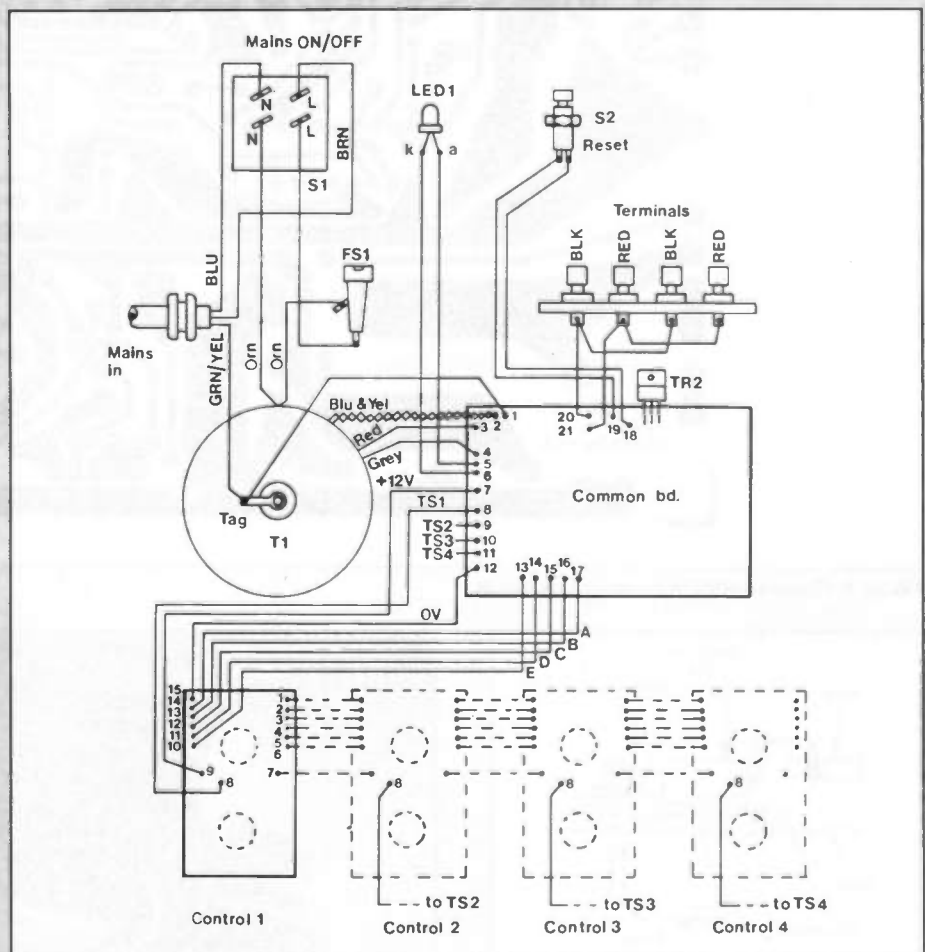

Figure 8. Wiring diagram for the Digital Train Controller.

kit. Connect all boards and components together as shown in Figure 8. Insert the fuses noting that the 1A anti-surge fuse is fitted in the panel fuseholder.

TESTING PROCEDURE

Switch on power with nothing connected to the output terminals. The neon indicator in the mains switch should

now be illuminated. Using a meter set to a 20V DC or higher range, check that there is approximately 18V at the output terminals. Press the reset button; the Track Supply Fail LED should light and extinguish when the button is released. If this test is satisfactory, short circuit the output terminals and the LED should again light brightly while the short circuit

is present, and dimly when the short circuit is removed. Press the reset button, the LED should extinguish and the 18V supply restored to output terminals.

REFERENCE

1. Digital Multi-Train Controller, Robert Kirsch, *Electronics – The Maplin Magazine*, March 1982.

TRAIN CONTROL MODULE PARTS LIST

RESISTORS – All 0.6W 1% Metal Film

R1,3,4	100k	3	(M100K)
R2	3k3	1	(M3K3)

CAPACITORS

C1	47µF 25V Radial Electrolytic	1	(FF08J)
C2	10nF Polyester	1	(BX70M)

SEMICONDUCTORS

D1-26	1N4148	26	(QL80B)
IC1	4017BE	1	(QX09K)
IC2	4001UBE	1	(QL03D)

MISCELLANEOUS

S1	Rotary Switch 1-pole 12-way	1	(FF73Q)
S2	Non Click Stop Rotary Switch 1-pole 12-way	1	(XX45Y)
S3,4	SPDT Sub-miniature Toggle Switch	2	(FH00A)

Veropin 2141	1 Pkt (FL21X)
Knob K7B	1 (YX02C)
Knob K7C	1 (YY03D)
PCB	1 (GA73Q)
Instruction Leaflet	1 (XK83E)
Constructors' Guide	1 (XH79L)

The Maplin 'Get You Working' Service is available for this project, see Constructors' Guide or current Maplin Catalogue for details.

The above items are available as a kit, which offers a saving over buying the parts separately.

Order As LW62S (Train Control Kit) Price £9.95.

Please Note: Where 'package' quantities are stated in the Parts List (e.g., packet, strip, reel, etc.), the exact quantity required to build the project will be supplied in the kit.

TRAIN COMMON/PSU PARTS LIST

RESISTORS – All 0.6W 1% Metal Film (Unless specified)

R1,3-5	1k	4	(M1K)
R2,7,9	2k2	3	(M2K2)
R6	0Ω 22 3W Wire-wound	1	
R8	22k	1	(M22K)
R10	4k7	1	(M4K7)
R11,12,14,15	10k	4	(M10K)
R13,17-22	100k	7	(M100K)
R16	33k	1	(M33K)

CAPACITORS

C1	4,700µF 35V Axial Electrolytic	1	(FB96E)
C2	100pF Ceramic	1	(WX56L)
C3	100µF 10V Axial Electrolytic	1	(FB48C)
C4	220pF Ceramic	1	(WX60Q)
C5	10nF Ceramic	1	(WX77J)
C6	10µF 25V Axial Electrolytic	1	(FB22Y)
C7,8,9	100nF Polyester	3	(BX76H)
C10	33pF Ceramic	1	(WX50E)

SEMICONDUCTORS

D1,2	1N5400	2	(QL81C)
D3	BZX61C12	1	(QF55K)
D4	BZY88C20	1	(QH21X)
D5-15	1N4148	11	(QL80B)
TR1	BC327	1	(WQ73Q)
TR2	TIP122	1	(WQ73Q)
TR3	2N5064	1	
TR4	BC548	1	(QB73Q)
IC1	741	1	(QL22Y)
IC2	78L12	1	(WQ77J)
IC3,7	4081BE	2	(QW48C)
IC4,8,9	4022BE	3	(QW19V)
IC5	4040BE	1	(QW27E)
IC6	4001BE	1	(QX01B)

MISCELLANEOUS

L1	2A RF Suppressor Choke	1	(HW05F)
T1	Toroidal Transformer 80VA 18V	1	(YK17T)
LED1	5mm Red LED	1	(WL27E)

FS1	T1A 20mm Fuse	1	(WR19V)
FS2	F2A 20mm Fuse	1	(WR05F)
S1	DPST Neon Rocker Switch	1	(YR70M)
S2	Push Switch	1	(FH59P)
	20mm Fuseholder	1	(RX96E)
	Fuse Clip	2	(WH49D)
	Strain Relief Grommet	1	(LR49D)
	Veropin 2141	1 Pkt (FL21X)	
	5mm LED Clip	1	(YY40T)
	Push to Release Terminal	1	(BW71N)
	White 6A Mains Cable	3m (XR04E)	
	10-way Ribbon Cable	1m (XR06G)	
	Black 6A Stranded Wire	1m (XR32K)	
	Red 6A Stranded Wire	1m (XR36P)	
	Mica Washer and Bush	1 (WR23A)	
	Silicone Grease	1 (HQ00A)	
	6BA X 1/2in. Bolt	1 Pkt (BF06G)	
	6BA Washer	1 Pkt (BF22Y)	
	6BA X 1/8in. Spacer	1 Pkt (FW33L)	
	6BA Nut	1 Pkt (BF18U)	
	2BA Solder Tag	1 Pkt (BF27E)	
	Front Panel	1 (XX47B)	
	Stick-on Feet	1 Pkt (FW38R)	
	Train Common PCB	1 (GA72P)	
	Instruction Leaflet	1 (XK83E)	
	Constructors' Guide	1 (XH79L)	

The Maplin 'Get You Working' Service is available for this project, see Constructors' Guide or current Maplin Catalogue for details.

The above items are available as a kit, which offers a saving over buying the parts separately.

Order As LW61R (Train Common/PSU Kit) Price £39.95 c.a.

Please Note: Where 'package' quantities are stated in the Parts List (e.g., packet, strip, reel, etc.), the exact quantity required to build the project will be supplied in the kit.

The following item (which is not included in the kit) is available.

Train Controller Case **Order As XG09K Price £24.95.**



Probably the best international broadcasting station in the World! This is how many people would describe the BBC World Service. Over the years it has built up an enviable reputation for reliable news reporting and quality programming. This has led to it attaining the largest international radio audience in the world.

DESPITE this, most people in the UK know little about the World Service. They mainly hear about it on TV news programmes during times of crisis. This happened recently during the Gulf War, and also in connection with Terry Waite, when his brother was seen on the television news sending messages to him via the World Service.

Even though the World Service is not well-known in the UK, it has a very good reputation worldwide. People will often

listen to it in preference to their own country's broadcasts. This reputation has not been easy to build up: it has taken 60 years since the service was first started.

Based at Bush House in Central London, the World Service broadcasts 24 hours a day to places all over the world. Whilst it is part of the BBC, it is an organisation in its own right funded by the Foreign and Commonwealth Office. It has its own news service and makes its own programmes. However, it has very strong links with the rest of the BBC, particularly the domestic radio services based at Broadcasting House.

Birth

The World Service was born out of the need for Britain to broadcast to its Empire. Initially, some experimental broadcasts were started in November 1927 from the station 5SW located at Chelmsford. However, it was not until December 1932 that the first regular service was launched from Daventry. The aim was that all countries of the

Empire would be able to hear at least one broadcast from London each day.

The service continued in this manner for a few years. However, towards the end of the 1930s, the political situation became very unstable. Italy invaded Ethiopia, and soon started to use short wave broadcasts in Arabic to help threaten the British interests in the area. As a defence, the BBC launched an Arabic service in 1938.

Germany was also beginning to realise the power of short wave broadcasting. She actively started to use this medium as part of her foreign policy. Again, the BBC needed to match these threats and more language services were added. In fact, by the outbreak of the Second World War, the BBC was broadcasting in a total of eight languages. During the course of the war this number was increased and, five years later, the total had risen to 45.

Above: Bush House – the home of the BBC World Service.

After the war the role of the service changed again. No longer was Germany the enemy, but a new threat rose with the onset of the cold war. The need turned to giving accurate and unbiased news to those closed societies behind the Iron Curtain, and later the Bamboo Curtain. Some different languages were broadcast and the emphasis was changed.

Now, in the 1990s, the political situation has changed yet again. The communist barriers have come down, but the need for the World Service is as great as ever. This is borne out by the fact that listening figures are rising rapidly, because people the world over know the BBC.

The Newsroom

Much of the reputation of the World Service has risen out of its reliable unbiased news reports. During the Gulf War, the US battleship *Wisconsin* had the World Service piped through the ship 24 hours a day. Admiral J. D. Williams, of the US aircraft carrier *Saratoga*, said that his main source of news was the BBC.

To maintain this high standard of reporting is not easy. In Bush House, the newsroom is a hive of activity 24 hours a day, taking reports from a wide variety of sources. It has its own correspondents around the world, and it also uses those from the domestic radio services, as well as a number of freelance workers. Apart from the correspondents, there are a host of other news sources including the BBC monitoring service at Caversham, near Reading. Here, the transmissions of broadcast stations from around the world are monitored, giving political views and comments from all manner of countries.

To help the Bush House newsroom process all of the incoming information and prepare the broadcasts, a system called EDiT is used. It derives its name from the words Editing Distribution and Translation, and is a highly specialised and developed news and multilingual word processing package. Says Chris Harrison, Senior Project Engineer for EDiT: "It is very much a news-based system". EDiT is used for editing and distributing the news around Bush House. However, it is being used for far more than just this – electronic mail and general word processing also feature. In fact, as Chris Harrison says: "It has been a victim of its own success – demand from users has been so high."

EDiT has, at its core, a £3.2 million Basys computer system which can operate in a wide variety of languages. It can even cater for non-standard alphabets including Greek and Cyrillic. When the system was installed, over 100 kilometres of cabling was used – this is hardly surprising as there are over 1,000 terminals; these can be either VT420s, or PCs running emulation software. In addition to this, there are over 300 laser printers and a potential of 2,800 users, although only 600 can be 'logged in' at any instant.

Although the system is based in Bush

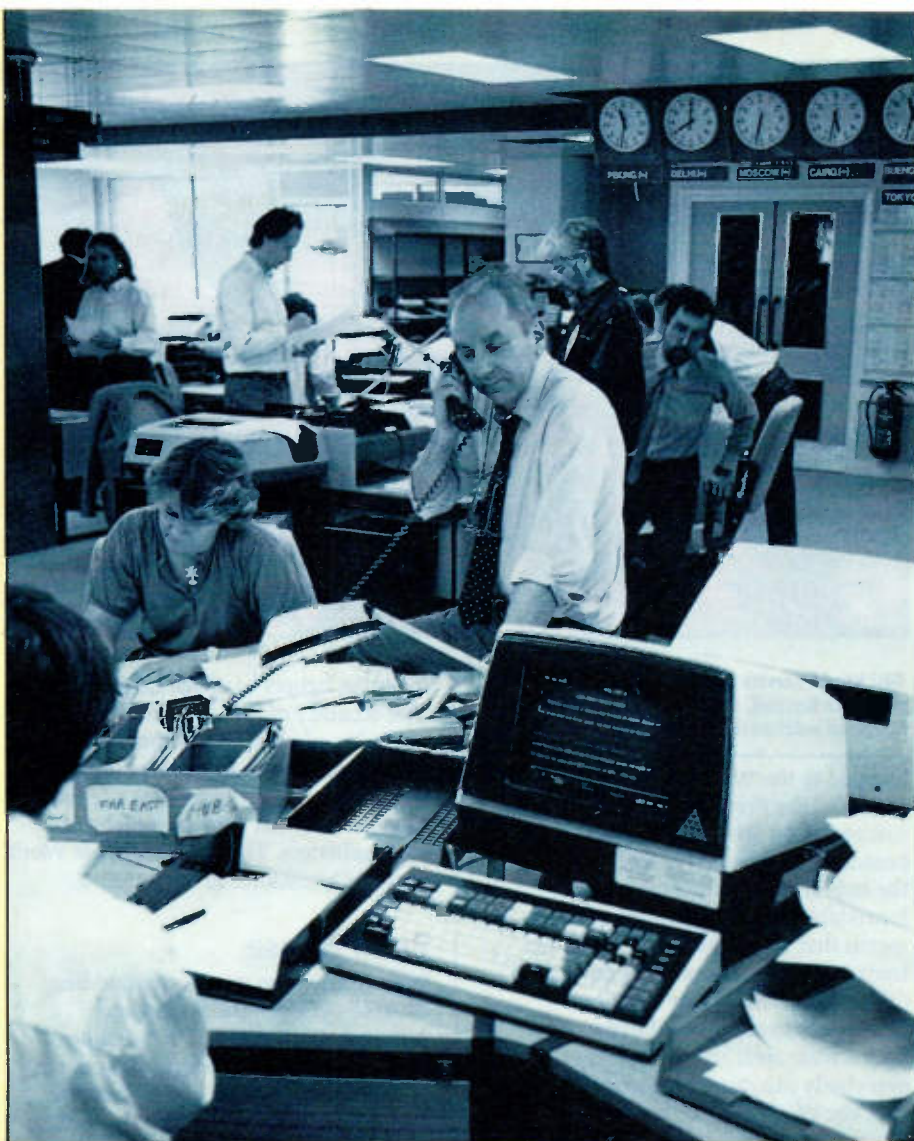

At the centre of World Service operations – the 24-hour newsroom.

House, it is linked to the monitoring service at Caversham, as well as Broadcasting House, the Television Centre and the other BBC regional centres. In this way, news can be gathered and disseminated – rapidly and efficiently.

Other Programmes

Whilst news and comment programmes are a major feature of the World Service output, there is much else besides – the overall aim is to cater for all interests.

Of the other types of programme, sport is very important. Programmes are broadcast at various times of the day and night so that people all over the world have a chance to hear them. On Saturdays the coverage is even greater, and during the winter months our football matches are given a very high profile.

Music programmes are also very popular, catering both for the lovers of pop and classical music.

Science-related topics also feature well. One programme, 'Waveguide', prides itself in being able to describe quite complicated topics in a manner that listeners can understand. It covers a wide range of topics associated with radio, as well as giving a number of equipment reviews.

Who Listens?

The World Service has some phenomenal listening figures – about 120 million people listen to it around the globe. These figures may seem large, but they are conservative estimates because they do not include figures for areas like China, where no audience research is possible. As a result, the actual listenership may be much larger. The World Service is known to have audiences 50% larger than those of the Voice of America (VoA), which has more transmitters, and broadcasts in more languages. It also has ten times as many listeners as Radio Moscow, which used to dominate the short wave bands with its many transmissions. Whilst many stations are seeing their listening figures diminish, the World Service estimates that its own have grown by about 60% over the last 12 years.

The English language service is the largest, with an audience of over 25 million. Most of these people are young professionals who have English as their second language, but many speak it as their first.

Recent surveys have shown some very interesting results. For example, in Nigeria over 10% of the population regularly listen to the BBC. The Caribbean has shown a similar rate of penetration, with figures of around 6%. In Jamaica, however, it was discovered that about three quarters of the population regularly



BBC World Service newsdesk employee Jonathan Birchall, seen here interviewing Egyptian soldiers during the Gulf War.

listened to the World Service.

Whilst the English service is very successful, 36 other languages are broadcast. Of these, the Arabic service is the largest and has one of the most formidable tasks. Transmitting to a region that stretches over 3,000 miles from one end to the other, it covers 18 different nations. There are great differences in culture and dialect over such a wide area, and so catering for everybody can cause problems. Despite this, the World Service has been able to achieve some phenomenal successes. During the Gulf conflict, the audience figures far exceeded those for any other station. In Amman, for example, it was found that 1 in 4 adults listened to the World Service; in Riyadh, meanwhile, the figure was about 50%. This made it more popular than some local stations, let alone other short wave broadcasters!

Other language services have seen similar successes. Russian is the most popular, after Arabic and English. It, too, has seen a remarkable amount of growth, especially during the coup attempt of August 1991.

To achieve the enormous growth in

listening figures has been no mean feat. The accuracy of the news, and the quality of the broadcasts, are obviously very important. However, they are only part of the picture. The programmes need to be broadcast so that they can reach their vast audiences. The story begins at World Service Operations, in Bush House.

Bush House

Bush House is an impressive building situated between the Strand and Aldwych, in central London. Built in 1923, the World Service moved here in 1940 when they were bombed out of Broadcasting House. Behind this rather grand exterior there is a highly sophisticated organisation that uses the latest technology.

Within Bush House, there are 54 studios which can 'go live', or have their output recorded for transmission at a later date. This number includes a suite of continuity studios which are designed specifically for live broadcasts, including news presentation and inter-programme announcements. These have been completed recently and they employ the latest technology to give tremendous flexibility.

Listening intently in a devastated Somalia.

On the Air

The programmes for transmission leave Bush House, and are carried to the various transmitting sites located around the world. For the sites within the UK, British Telecom land lines are used. For overseas sites and relay stations, satellites are used. These ensure that the programmes arriving at the relays are of the highest quality. For example, the BBC World Service can be found on the 7.38MHz subcarrier on Superchannel's Eutelsat II-F1 (13°E) transponder, and on the 7.56MHz, 7.74MHz and 7.92MHz subcarriers on SSVc's Intelsat VI-F1 (27.5°W) transponder. World Service listeners equipped with a satellite dish will find that the satellite-delivered BBC World Service offers much better sound quality – and no fading – compared to its short wave counterpart. In addition to these two established services, World Service can now be found on Astra – the 7.38MHz subcarrier on UK Gold's transponder, to be precise. This provides a significant proportion of Europe with reliable reception of the World Service. Out of interest, adjacent subcarriers provide Radios 1, 4 and 5 – introducing these services to a completely new audience.

At any given time, the World Service may be simultaneously transmitting a number of different services, each in a different language. To co-ordinate all the different services, ensuring that the correct programme reaches the correct transmitter, is no easy task. A new £6.5m control room, located in Bush House, is used for this. Linking all the studios, it only became operative in 1991; in fact, pressure was placed on the engineers completing it as the changeover took place. At the time, the Gulf land war broke out, and extra studios were needed rapidly. Despite the enormous task, the changeover was amazingly smooth. "It was a credit to those who planned it", said one of the engineers.

Transmitters

Once the programmes leave Bush House, they travel to transmitting sites around the world. In the UK, there are a total of three short wave sites. They are at Rampisham in Dorset, Skelton in Cumbria, and Wooferton in Shropshire. Each of these sites has around ten transmitters, or 'senders' as they are called. The most powerful can deliver 500kW to the aerial, while the others can provide 100kW or 250kW.

The fourth site in the UK is located at Orfordness in Suffolk. This site carries the medium wave BBC for Europe on 648kHz, which can be heard quite well in many areas of southern England. There is a second medium wave transmitter which carries the 1296kHz service to Central Europe.

In addition to these sites, the World Service has a total of seven overseas relay stations in such diverse places as Singapore and Ascension Island. On top of these sites, there are stations in





The HF transmitters (also known as 'senders') at Rampisham, in Dorset.

Lesotho, and an FM station in Berlin. To complete the line-up, there are a number of exchange facilities in the USA and Canada.

The BBC is continuing to improve its facilities. One of the most recent additions has come about with the end of the Cold War, and an improvement in relations with Russia. A new agreement has been reached, allowing the use of transmitters in Russia itself and Tashkent (Uzbekistan). This is particularly useful because it enables programmes to be broadcast into China, where there are some of the largest potential audiences in the world.

In all, the BBC operates over 80 transmitters and some 300 aerials at its own sites. Despite this, the BBC is not the most powerful station. However, it is certainly the most effective, claiming far more listeners per watt of transmitted power than any other station.

Recently, the World Service has undergone a massive improvement programme. This was sorely needed – the last of the old wartime transmitters were in use up until 1990. The newest transmitters are not only able to deliver more power, but can also realign themselves automatically if alternative frequencies have to be used, enabling them to be used far more effectively.

Many improvements have been made in signal processing. Various parts of the audio spectrum can be compressed so that the signal sounds louder and brighter. This requires more energy, and so to help reduce running costs other processing techniques are used. These reduce the effective transmitter power during periods of high modulation, when a lower signal-to-interference ratio can be tolerated.

Aerials are just as important as the transmitters, and have also been improved over the years. New designs, that are much better at delivering the power where it is needed, are now being used. Many of these antennas can be used on four different frequencies – this

is a great advantage, because many transmitters have to change frequency up to twelve times a day, to ensure that the correct language services are beamed to the right part of the world; in addition, the daily changes in propagation have to be taken into account. If single band antennas were used, they would remain idle for large portions of the day.

For the Future

The World Service is committed to improvement and development. Aware that many other broadcasters are planning large investments, the BBC is naturally looking to the future. As part of the continuing improvements, the relay station in the Gulf of Oman is to be updated. This will enable signals to Soviet Central Asia and the Indian sub-continent to be improved considerably. In addition to this, an eighth relay station is planned for Thailand – this station will also improve reception in India – and extra coverage will be provided in China, which is currently served only by the two transmitters in Hong Kong.

The BBC is not only looking to the short wave bands to improve its coverage. Satellites are now being used more widely, and the BBC will be drawing its attention to the Astra, Eutelsat and Intelsat radio services, which are available to anybody with a domestic satellite system capable of receiving the television channels on these satellites, and equipped with tunable audio facilities.

Currently, the cable companies can re-broadcast the World Service or local radio stations, or transmit selected programmes. This idea has been very successful, particularly in Europe, North and South America, and the West Indies.

The BBC took the satellite connection a stage further by launching a subscription-funded commercial service – World Service Television (WSTV), operated by BBC World Service Television Ltd, a wholly-owned subsidiary of the BBC – in 1991. This is a 24-hour news, information and entertainment station that evolved from the original (1988) SAVE-encrypted

Intelsat-delivered 'BBC TV Europe' channel, and it is still expanding. Broadcasting many programmes familiar to UK licence-payers, WSTV is watched by many people in Europe – mostly expatriates. A recent collaboration with Hutchvision has enabled it to be broadcast in Asia via two 'C' band transponders (providing 'north' and 'south' beams) aboard AsiaSat (105.5°E), where there is a colossal audience to be reached – this is particularly true since, unlike the European service, it is transmitted 'in the clear'.

In Europe, WSTV originates from a Ku-band transponder aboard the Intelsat VI-F1 satellite, where it is broadcast in D2MAC. The scrambling system used is Eurocrypt (refer to 'Europe Sans Frontières', in *'Electronics'* Issue 62 (February 1993), and a smart card is required. Interestingly, the D2MAC system has multichannel sound capability (with or without NICAM) as part of the basic specification, and so WSTV subscribers will get high-quality stereo sound with their BBC programmes before many areas in the UK! Come to think of it, they will be able to receive the BBC television programmes themselves somewhat more reliably than some areas in the UK. C'est la vie! There is also a 'C' band service from the same satellite; this is primarily intended to serve Africa as part of the M-Net subscription package. Again, encryption is used.

The continuing expansion of WSTV, together with the steady improvement of World Service Radio, is an indication of the BBC's intention to stay in with the leaders of the field, if not ahead of them. With this attitude to growth, the World Service will continue to be a major force in international broadcasting.

Acknowledgments

Thanks are due to the BBC World Service engineering and publicity departments for their help in the preparation of this article. Photographs © Copyright 1993 BBC World Service, used with permission.

NEWS Report

FIST Trading System Goes Japanese

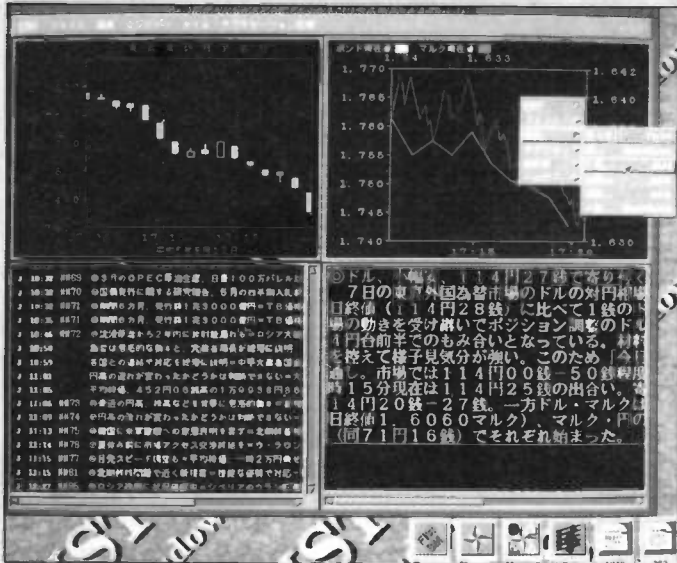

FIST, an advanced trading system from Kapiti of Slough, is now believed to be the only trading system available to incorporate multi-lingual capabilities. A new facility allows FIST to operate in almost any language, with the ability to customise all screen displays in the language of the user or trading room, as well as handling data feeds in different languages and character sets.

The first implementation using these new features of FIST has recently gone live at a leading Japanese bank in Tokyo, where the system is handling

English language datafeeds, together with specialised local feeds, which are transmitted in the mixture of character sets required for Japanese.

Japanese is in fact notoriously difficult to write, with three different alphabets in everyday use. A further complication is that any normal Japanese text may contain a mixture of character sets, with some characters requiring two bytes of data storage, as opposed to the one byte necessary for English characters used in most European languages.

BT Make a Noise

BT can always be trusted to keep our mail bag full; the telecommunications company seems to chuck out a ream of press releases almost daily. That said, however, a couple of interesting snippets have caught our attention this month.

Following the recent IRA bombings in the City of London, BT has launched 'Citysure', a disaster recovery service aimed at customers' private circuits. Under Citysure, BT guarantees to restore private circuits within an hour of the incident being reported between 7.30am in the morning and 6.00pm in the evening. At any other time, BT guarantees to restore services within four hours.

For the workaholic business person away from home, BT's new M-Sat mobile satellite phone service has voice, fax and data links all packed up in a briefcase with an antenna in the lid. For a mere £15,750, you could work – as BT suggest – from a desert island. Simply open your case, point the antenna towards the nearest Inmarsat satellite and dial. Convenient, but, with airtime costing £3.25 a minute, we're sure this is one luxury Robinson Crusoe, or Sue Lawley for that matter, would leave behind.

The Growth of 0898

Premium rate telephone services were, until recently, associated in many people's minds with chat-lines and 'adult' services. According to research recently carried out for the London-based Eurodata foundation, though, they are now being seen as an acceptable means of accessing a wide range of business and leisure services.

The research involved an extensive user survey, consisting of 1,400 interviews with consumers and business organisations across 12 countries, to investigate potential user requirements for telephone-based information services – and to find out whether they would expect to pay freephone, standard or premium rate telephone tariffs.

20% of UK business people surveyed had used a premium rate service, compared with 10% of all consumers. This compares favourably (for the service providers, at least!) with the average across Europe – where 12% of business people surveyed had used a premium rate service.

The research found that UK business people were keen to explore the opportunity of providing more information to its customers via premium rate services. However, when asked if they would be prepared to pay premium

rates to access telephone-based services, only 14% of those business respondents interested in 'financial information' services said that they would be prepared to pay a premium rate to access them; only 27% said that they would make a premium rate call to make a purchase. On the other hand, 29% of those business respondents who were interested in accessing 'services/advice' stated that they would be prepared to pay for them.

36% of consumer respondents stated that they were interested in accessing telephone-based 'adult' services, and 44% of these stated that they were interested in accessing telephone-based 'Government/public' information services. 30% of these stated that they would be prepared to pay a premium rate for them (But only if they keep taxes down! – Ed).

Summing up, Jane Dinwiddy of the Eurodata foundation said, "to achieve premium rate service and information providers will need to focus on three main areas". These are: (1) the introduction of efficient, concise information services that do not involve excessively long calls (lots of superfluous but expensive waffle... this is a premium rate call – oh, really? – and advertisements for other services could be cut out for a start; a future OFTEL requirement, perhaps? – Ed); (2) promoting a greater public awareness of the added value provided by premium services; (3) the introduction of services which address callers of a 'high priority requirement', for example those which are not adequately addressed by current methods of information provision.

The report comes in the month that WordPerfect joined the ranks of companies like Amstrad, having transferred their technical lines over to premium-rate numbers. It seems a shame that after paying several hundred pounds for a product, users are forced to pay through the nose for basic support and advice to which they should be freely entitled (Perhaps they should all make their manuals more user-friendly in the first place, but then again they would lose a lucrative source of revenue! – Ed).

Not to be left out, Eurodata are demanding that people interested in receiving a copy of their full report, should ring a 'fax-back' number – (0891) 300454; what a surprise, it's a premium-rate number!

Light-to-Voltage Conversion

A family of highly integrated devices that convert light-intensity into voltage signals are now available from Texas Instruments. The devices combine a large-area silicon photodiode, an operational amplifier and the feedback components for this function on a single chip.

Designed for use in light intensity measurement applications in a variety of electronic equipment, potential applications include lighting control, infra-red remote control, gas and oil flame monitoring and proximity detection.

Each single-chip device in the TSL250/1/2 family of light-to-voltage converters provides a linear voltage output over a wide range of visible light levels. The TSL250, TSL251 and TSL252 meet high, medium and low sensitivity requirements respectively.

The devices' output is a linear signal that ranges from near ground potential to within 1.5V of the positive supply rail. Near rail-to-rail output swing can be achieved through the addition of a pull-up resistor. Thus the TSL250/1/2 can be easily interfaced to comparators and analog-to-digital converters.

The integration of an amplifier and a photodiode on the same chip not only simplifies designs, but also enhances the noise immunity of the devices because the sensitive amplifier input node is inside the package.

Contact: Texas Instruments (0234) 223252.

Offer Given With One Hand...

All twelve regional electricity companies have accepted a new set of price controls from Offer, the Industry regulator. The new regime requires the companies to make efficiency gains, and pass benefits on to customers.

What's in it for the average householder? Well, Offer have limited future domestic price rises. At present the electricity companies can raise charges in line with inflation; from April 1994, this will be reduced to inflation minus 2%. A big help, especially when the government intends to put VAT at 17.5% on all fuel bills in the same month! Offer is, of course, a government department.

Car Radio Gongs



Clarion have won the equivalent of an Oscar in the world of automotive entertainment. Renowned for innovation, the company has received numerous awards for developments that they have brought to the world of in-car entertainment.

More recently, Clarion has been awarded two commendations from the journal 'Car Stereo & Security'. Judges were impressed by the ergonomic and 'thief-proof' design employed within their CMX270CD in-dash Radio and Compact Disc Player.

For those with lengthy excursions to work, the radio-CD is able to switch between six compact discs during any one journey. But the best is yet to come. The 'anti-theft design' relies on the owner removing the unit from the dashboard and stowing it away in the glove compartment – isn't that what most people do anyway these days?

At Maplin we're thinking of introducing a series of awards for dubious design achievements and incredulous claims.

Contact: Clarion (0793) 870400.

Energy Metering System



The National Grid Company – one of the new electrical distribution companies – has launched an energy metering system to enable up to 80,000 individual electrical appliances to be monitored remotely. Using a central personal computer (PC), the 'Point of Use Energy Metering' system (POEM) provides energy managers (?) of large organisations with the information necessary to implement energy saving measures.

The POEM system measures, collects and analyses the electricity demand of individual appliances remotely (receiving the data from each device), either in specific locations or throughout the organisation. To make this possible each appliance is fitted with an in-line meter using standard plugs and sockets, or a clip-on current transformer. Electricity demand data is transmitted either by radio or mains-

borne signals. Installation is quick and simple with no need to break cables.

Each appliance is connected to the mains supply via an in-line POEM meter which regularly transmits the demand by short range radio or mains-borne signal to a Local Collector Unit (LCU). Each LCU converts the data into half-hourly demand information, and transmits it to the Central Collector Unit (CCU), a standard personal computer running POEM analysis software.

The CCU can gather data from as little as a single LCU via a direct link, or from up to 5,000 LCUs via public telephone lines. The National Grid Company makes a leap of faith here, claiming all system configuration can be carried out via a CCU. We await the result of initial site acceptance tests to see if these claims are justified.

Contact: The National Grid Company (0322) 295000.

Something New From Sharp



Following other big name electronics companies, Sharp are set to launch a pen-based, hand-held computer. The Sharp PI-7000 Expert-Pad was jointly developed with Apple Computer of the United States.

An LCD-applied product based on computer technology, the Expert-Pad combines Apple Computer's Newton Intelligent software technology with Sharp's LCD, semiconductor, pen operating hardware and high-density mounting technology.

The PI-7000 features pen-based operation and communication capability. Users can send faxes or receive E-Mail directly via fax modem. Infra-red communication is possible with other

PI-7000's and with printers via an operational interface. Link software which enables the user to communicate with a Macintosh or IBM PC will also be available.

The Expert-Pad's electronic pen and paper concept approaches the ease of use of conventional pen and paper, but offers the data-processing powers of a personal computer, with its capability to be used anytime, anywhere and by anyone. Sharp reckon it is destined to become an indispensable tool in business, research, education and other fields. We'll wait until we've seen a device for review before we pass comment.

Contact: Sharp (061) 205 4255.

Motts Use CFD For CrossRail

Mott MacDonald has won the ventilation contract for the underground section of CrossRail, the strategic new railway for London and the South East. This appointment, by the London Underground Network South East joint venture, involves conceptual redevelopment, detailed design and performance specification for ventilating the scheme's 9.5km long, twin-bore tunnel and five underground stations in Central London.

CrossRail is being designed to accommodate 12 car trains of Class 341 rolling stock, travelling at speeds of up to 100kph (62mph) between stations in the underground section. Mott MacDonald's brief is to design a ventilation system that will control train velocities and pressure transients within levels which remain comfortable for passengers during normal operations. A more important demand, however, is to maintain temperatures to closely specified limits and achieve smoke control in the event of a fire.

To this end, the consultant will conduct an extensive program of physical modelling, full-size testing and mathematical modelling involving both one-dimensional analysis and Computational Fluid Dynamics (CFD). CFD will be used in several areas of the design, including the investigation of various fire scenarios to ensure that the ventilation system establishes and maintains smoke-free exit routes for passenger evacuation.

Thermistors Target Automotive Market

With the increased use of electronics in today's cars, thermistors have become key components of both fuel injection and alarm systems.

To help meet these applications, specialised manufacturers Vishay now offer a range of standard and special discrete NTC thermistors and thermistor assemblies to meet the harsh environment conditions found in automotive applications.

Vishay's thermistors and assemblies use highly reliable ceramic materials with resistance ranges from 50Ω to 40MΩ, and tolerances down to ±0.2° centigrade at critical operating temperatures.

Vishay's thermistor products are manufactured to the highest standards. Contact: Vishay (091) 514 4155.

Radio Networks Spread

NCR has just announced that the NEC Corporation is selling wireless systems in Japan with NCR WaveLAN components. NEC joins the Digital Equipment Corporation and the Solectek Corporation as an original equipment manufacturer (OEM) for WaveLAN.

Launched in the UK in May this year, NCR WaveLAN uses intrinsically secure radio waves instead of cables to link PCs or retail terminals. NEC's C7C-NET Radio 8100, which incorporates the WaveLAN spread spectrum radio, digital signal processor and antenna, provides wireless connectivity for workstations, PCs, and other computers in Japan.

The demand for wireless Local Area Networks is increasing throughout the globe. NCR's family of wireless WaveLAN products include: systems for desktop computers; WavePOINT, which is an access point for bridging WaveLAN to wired networks such as Ethernet, Token Ring and StarLAN; and credit card-sized WaveLAN/PCMCIA for portable computers and other devices.

Contact NCR on (071) 725 8248.

Hi-Fi Quality from Virgin 1215!

Readers of Keith Brindley's 'Technology Watch' will recall him saying, in a recent edition, that Virgin 1215 was 'his kind of radio station'. He wasn't that happy about the fact that the station is broadcasting in crackly old medium-wave, a format which hardly does justice to the music. There is now a Hi-Fi alternative, though. Owners of a satellite receiver system capable of receiving Astra will now find Richard Branson's foray into radio broadcasting on Sky News' transponder (11.377GHz), on the 7.38 and 7.56MHz subcarriers. And it's in stereo! With Sky about to extract yet more money out of us for watching its TV channels, there has to be a good reason for investing in a dish. And here it is! Interestingly, Virgin 1215 used satellite broadcasting (a mono sub-carrier on MTV's transponder) during its test period; it disappeared when the MW service began, much to the chagrin of those used to the FM subcarrier. Looking to the future, Virgin 1215 is considering moving into Digital Audio Broadcasting, once that system becomes finalised.

Events Listings

September 29 to 30. Highways Roadshow. Sandown Exhibition Centre, Sandown Park, Esher, Surrey KT10 9AJ. Tel: (081) 684 4082.

October 2. All Formats Computer Fair. Sandown Exhibition Centre, Sandown Park, Esher, Surrey KT10 9AJ. Tel: (0608) 662212.

October 5 to 7. Electronics Manufacturing Technology Show and Electronic Design Show. Wembley Exhibition Centre. Tel: (081) 336 1282.

October 5 to 7. Euro-EMC. Sandown Exhibition Centre, Sandown Park, Esher, Surrey KT10 9AJ. Tel: (0892) 544027.

October 16. Crystal Palace & District Radio Club Quiz Night. 7.30pm, All Saints Parish Church Rooms, Beulah Hill, Upper Norwood, London, SE19. Contact (081) 699 5732.

November 16 to 18. Electronic Information Display. Sandown

Exhibition Centre, Sandown Park, Esher, Surrey KT10 9AJ. Tel: (0882) 614 671.

November 20. All Formats Computer Fair. Sandown Exhibition Centre, Sandown Park, Esher, Surrey KT10 9AJ. Tel: (0608) 662212.

November 20. Crystal Palace & District Radio Club Surplus Sale. 7.30pm, All Saints Parish Church Rooms, Beulah Hill, Upper Norwood, London, SE19. Contact (081) 699 5732.

November 29. Crystal Palace & District Radio Club Surplus Equipment Sale. 7.30pm, All Saints Parish Church Rooms, Beulah Hill, Upper Norwood, London, SE19. Contact (081) 699 5732.

Please send details of events for inclusion in 'Diary Dates' to: The News Editor, 'Electronics' – The Maplin Magazine, P.O. Box 3, Rayleigh, Essex SS6 8LR.

Stray Signals

by Point Contact

Point Contact receives no end of electronics magazines, mostly of the sort with no cover price, being supported entirely by advertising, and known to your average professional engineer as 'freebies'. Some of these contain 100% of advertisements, and are consequently too boring to read in any detail, although it is necessary for the serious practitioner of electronics to scan through them quickly, to pick up information on the latest, best and fastest ICs and other components. Others include a proportion of editorial material, sometimes written or compiled by staff writers, sometimes by manufacturers – in which case it is usually based on one of their own Application Reports. With these magazines appearing monthly, fortnightly or even in some cases weekly, the pressure on deadlines must be severe, leading to odd misprints or more systematic errors where the reporter has got hold of the wrong end of the stick. For example, Analog Devices have recently brought out a new op amp, the OP-467, aimed at applications in high-speed instrumentation, signal conditioning circuits and test equipment and featuring a settling time to within 0.01% of the steady state value following a step change of input, of only 200ns. As you can imagine, this means it must be a fairly fast part, but the news item in an American magazine headlines its slew rate as $170\mu\text{V/s}$, which will hardly please the manufacturer. The magazine's staff reporter has got it consistently wrong throughout the piece, but compared to the correct figure of $170\text{V}/\mu\text{s}$ it is only out by a factor of a million million – this is of course an 'old English billion', before the billion got devalued to a thousand million, following American terminology.

Green minded readers will have been as concerned as the Nuclear Installations Inspectorate to hear about a leak of several kilograms of radioactive material from the Sellafield reprocessing plant, which remained undetected until spotted visually. The incident rated level three on the seven point scale of nuclear events, used by the International Atomic Energy Agency. The future of BNFL's nearby THORP nuclear reprocessing facility is in doubt, due to the costs involved. Not so far away, in the Lake district where they get plenty of wind, some Texan wind turbines are being installed. These have lightweight two bladed rotors mounted atop 50m towers,



towers, against the more common height of 25 to 30m. The electricity produced by these machines is both non-polluting and from a renewable resource; it is a great pity that it is not currently competitive with electrical energy from other sources, so it won't help to bring down – or even halt the rise in – the price of electricity. Indeed, the Regulatory Policy Institute of Oxford has issued a report claiming that electricity prices in GB are now 25% higher than they would have been under the monopolistic pre-privatisation structure of the industry, extrapolating from pre-privatisation trends. So it may be comforting to know that the European Commission has given its support to no less than 145 energy-saving projects concerned with renewable energy, solid fuels and hydrocarbons, rational use of energy etc. Let's hope that the 100 million ECUs to be spent under the 'Thermie' programme will be wisely spent, and result in less global warming due to mankind's profligate use of energy.

Talking blithely as he does of ECUs, metres, kilograms etc., one might think that by now, PC was 100% at home with metric units, but alas, not so. In

electronics, yes, but in other fields he still tends to use Imperial units. For instance, when doing carpentry, working out the exact centre of a piece of wood goes something like, "Ah, yes; seven and a quarter and a sixteenth and a little bit from this end". Such a distance, as some of you will have recognised, is in fact not much short of a link. What, you don't know what a link is? – shame on you. Surely everybody knows that a cricket pitch is one chain in length, namely 22 yards or one tenth of an eighth of a mile. And a chain is a real, physical measure, not unlike a giant tape-measure, being made up of 100 links. Since 22 yards equals 66 feet or 792 inches, obviously a link is exactly 7.92in. in length – what could be more logical? Whatever you may make of hogsheads, ells, firkins etc., you must admit that, however impractical, the Imperial system was at least more *interesting* than boring old metric with its monotonously uniform powers of ten.

Yours sincerely,

Point Contact

The opinions expressed by the author are not necessarily those of the publisher or the editor.

INFRARED SWITCH



Completed PCB – track side, showing how LD1, IR1 and PD1 are mounted.

Design by Alan Williamson
Text by Martin Pipe
and Alan Williamson

Have you ever wondered how the hot-air hand driers in public conveniences work? You place your wet hands under the drier and it starts up – withdraw them and it stops. It's magic – or is it? In fact, what you are experiencing is yet another application of infra-red energy. Radiation from an infra-red source (generally an LED) is reflected off your wet hands and is picked up by a sensor, which subsequently operates the drier.

**KIT
AVAILABLE
(LT38R)
PRICE
£9.95**

FEATURES

* Low-cost * High sensitivity * High immunity to spurious triggering * Changeover relay output * Flexible power supply requirement

APPLICATIONS

* Alarm Systems * Production Lines * Home Automation

Specification

Quiescent current:	12mA
Operating current:	46mA
Supply voltage:	12V DC, 9V AC or 9V-0-9V AC
PCB size:	65 x 50mm

THE infra-red switch presented here has more uses than operating a hand drier. There are three possible modes of operation – toggle, momentary, and only when infra-red energy is being detected. Applications include operating light switches (with the aid of the LP55K opto switch) or solenoid water valves in scrub rooms, turning on a shower when you step in it, an automatic door bell, part of a production run counter on assembly lines, or even a reversing parking radar. The number of applications is endless, and is only limited by your imagination.

Circuit Description

(i) Overview

The basic operation of an infra-red proximity switch is quite simple. The energy produced by an infra-red source is reflected, by the object to be detected, to a sensor. The output from the sensor is amplified, filtered and used to drive an external circuit. Now what could be easier than that? However, as we all know to our cost, the real world is never as simple as that. Many natural and everyday objects emit infra-red radiation, and if the detector circuit was a 'straight' one, spurious triggering from these sources would result – hardly ideal if the circuit is part of an alarm system, for example. However, this circuit (shown as a block diagram in Figure 1) overcomes this problem by relying on a 5kHz stream of infra-red pulses (thankfully rare in nature!), rather than the continuous presence of radiation. The 5kHz pulse train is generated by a LM567 tone decoder (a form of phase-locked loop – PLL for short), and is used to drive the infra-red LED, IR1. The 5kHz infra-red pulse train, when reflected by an object, is received by infra-red photodiode PD1, before being amplified and filtered. The processed pulse train is

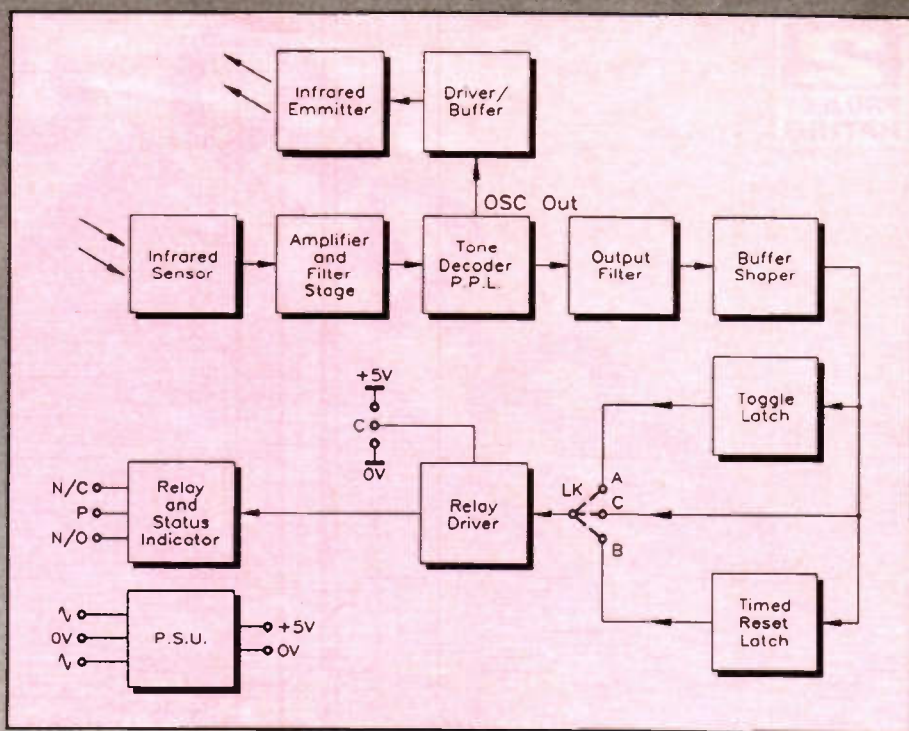

Figure 1. Block diagram.

then fed back into the tone decoder, which senses that they are of the same frequency as those it is generating, and flags an output to that effect. This output is used, with additional circuitry, in one of three different ways, to switch the relay.

(ii) The Works

The circuit diagram of the Infra-Red Switch is shown in Figure 2. At the heart of its circuit is the tone decoder/PLL IC2, which is a NE567 device. R9 and C11 set the PLL's internal oscillator to free-run at approximately 5kHz, its output is tapped off via R11 to the Darlington transistor TR1, which is used to modulate the infra-red emitting diode, IR1. R12 limits the current flowing through IR1 to 3mA.

Any reflected infra-red energy from IR1 will be detected by the infra-red receiver diode PD1, which is then AC-coupled to IC1d. IC1d, which is a NAND gate, is configured here as a linear amplifier.

Resistors R2, R5, R8 and RV1 determine the gain of each stage; capacitors C1 to C7, combined with resistors R2 to R7, provide band-pass filtering, reducing the possibility of overloading the PLL's input with wideband noise. The output of the PLL, meanwhile, is filtered by C12, which works in conjunction with load resistor R10. IC1c squares up the output of the PLL, providing a clean edge to trigger the D-type flip-flops IC3a and b.

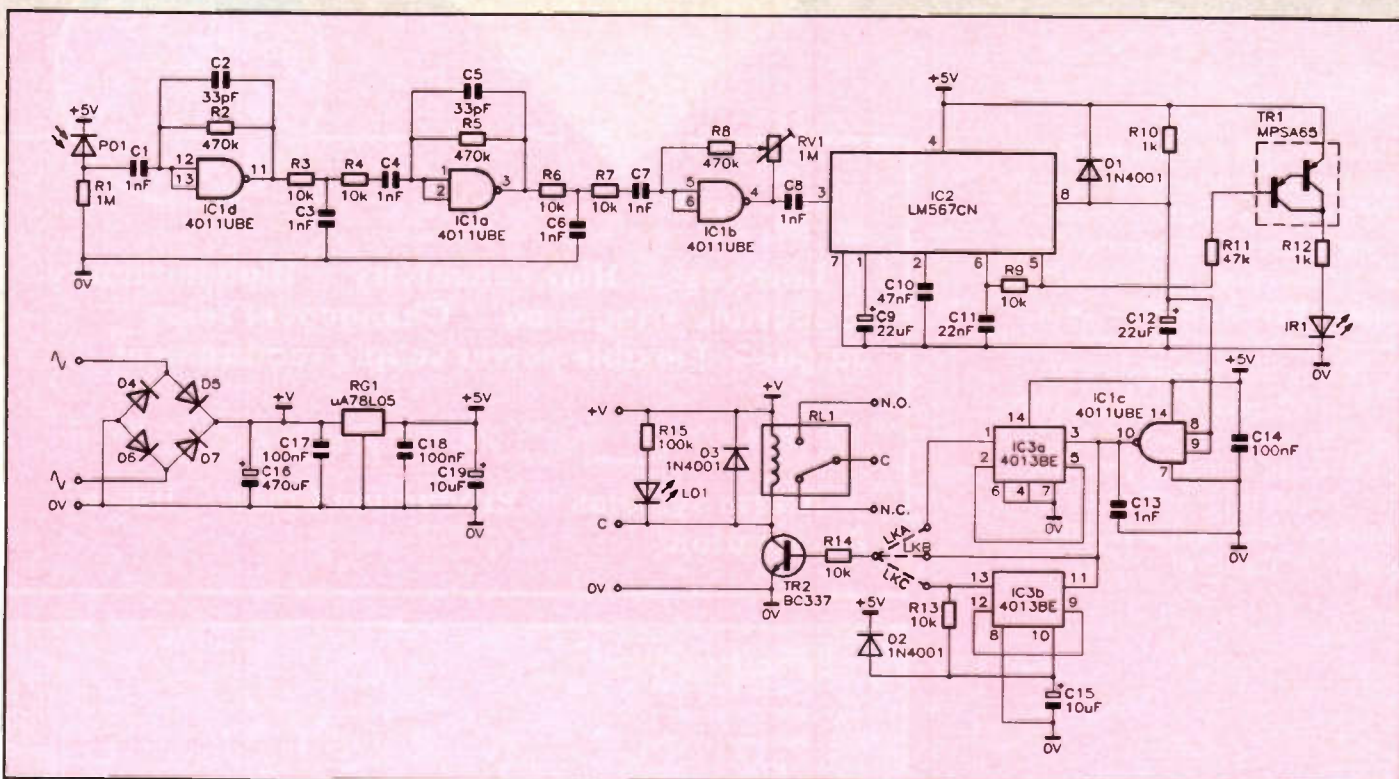

Figure 2. Circuit diagram.

IC3a is configured as a T (toggle) type flip-flop. Once triggered, the output will remain high until triggered again, at which point it will go low – or vice versa. IC3b is configured as a monostable; the Q output is connected to the D input to form a T-type flip-flop. However, R13 and C15 will reset IC3b after approximately half a second. The value of R13 could be increased to provide a longer time constant, or the value of C15 could be reduced to obtain a shorter one. Note that if the time constant chosen is too short, the relay (RL1) may not have time to operate.

Transistor TR2 is used to drive the relay RL1. An LED is fitted in parallel with the relay, to serve as a status indicator.

Fitting the link to position 'a' will operate the relay in toggle mode, since IC3a is switched into circuit. Position 'b' will operate the relay as long as the 5kHz stream of reflected infra-red energy is received, because IC3a and IC3b are both bypassed. The final position, 'c', will cause the relay to operate momentarily, since the monostable (IC3b) then becomes part of the circuit.

Connection to the normally open (N/O), common pole (P), and normally closed (N/C) contacts of the relay are via PCB pins. The use of a relay provides totally isolated switching contacts, but for applications that don't require isolation, you may wish to connect directly to the driver transistor. Provision for this has also been allowed for, via the PCB pin marked 'C'.

The power supply is a standard full-wave bridge rectifier, capacitors C16 and C17 provide low and high frequency decoupling, VR1 regulates the voltage to the ICs and capacitors C18 and C19 provide output decoupling of the regulator. Note that a 12V DC power supply can also be used; in this case, the rectifier diodes provide reverse-polarity protection.

Construction

Begin by deciding which option you desire; if the toggle or momentary options are not required, then the components D2, R13, C15, IC3 and IC3's socket need not be fitted.

Construction is fairly straightforward, and inexperienced readers are directed to the Constructors' Guide supplied with the kit. The PCB legend and track layouts are reproduced for your convenience, in Figure 3. First, fit the PCB pins and resistors – after soldering the components in position, trim off the excess leads; these can now be used for the four links (do not fit LK1 at this stage). Note that R1, R2, R4 to R9 and R11 are vertically-mounted, to preserve board area. Fit the diodes; D1 and D2 are 1N4148 signal diodes, while D3 to D7 (vertically mounted) are of the slightly larger black-bodied 1N4001 type. In each case, polarity is important, and the band on the diode should be lined up with that shown on the PCB legend. It is also important to align the three IC sockets correctly – there are two 16-pin types (IC1, IC3), and one 8-pin type (IC2). In each case, the notch should be aligned

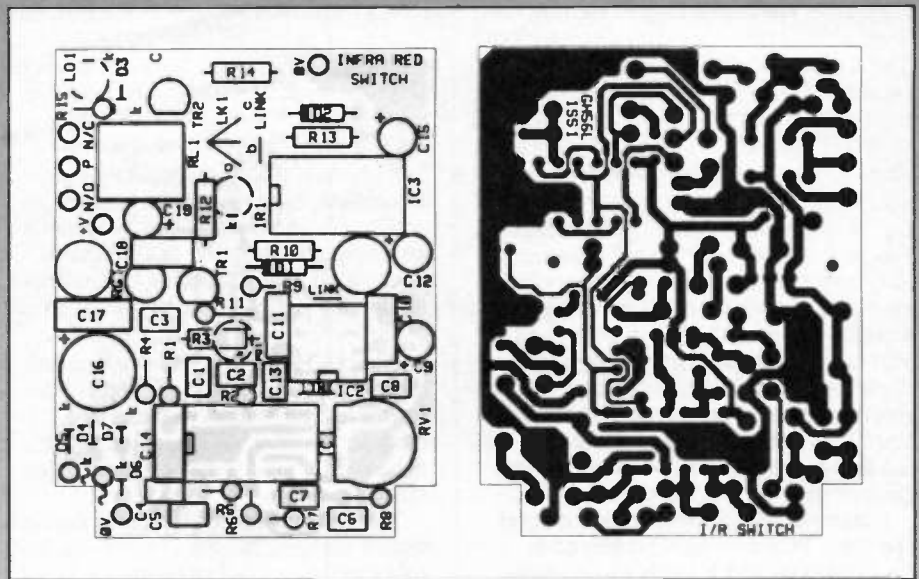

Figure 3. PCB legend/track.

with the corresponding one on the PCB legend – do not fit the ICs at this stage.

We can now proceed with the capacitors. C9, C12, C15, C16 and C19 are all electrolytic types – it is essential to insert these the correct way round. The negative symbol embossed on each capacitor must face away from the '+' symbol on the PCB legend. The other

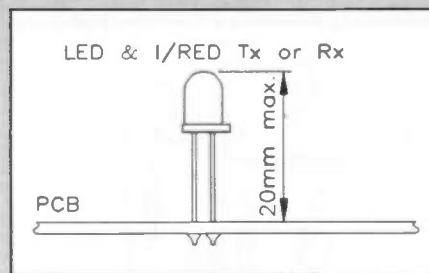

Figure 4. Mounting the infra-red devices.

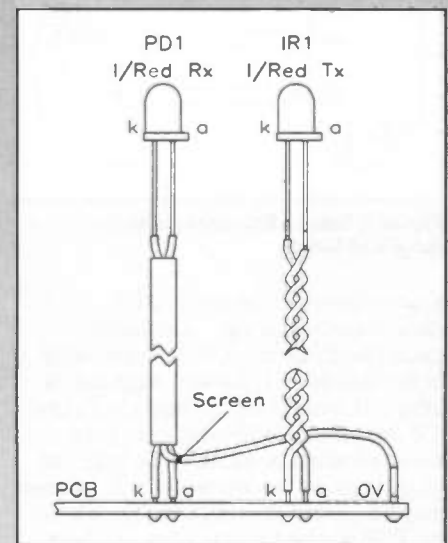
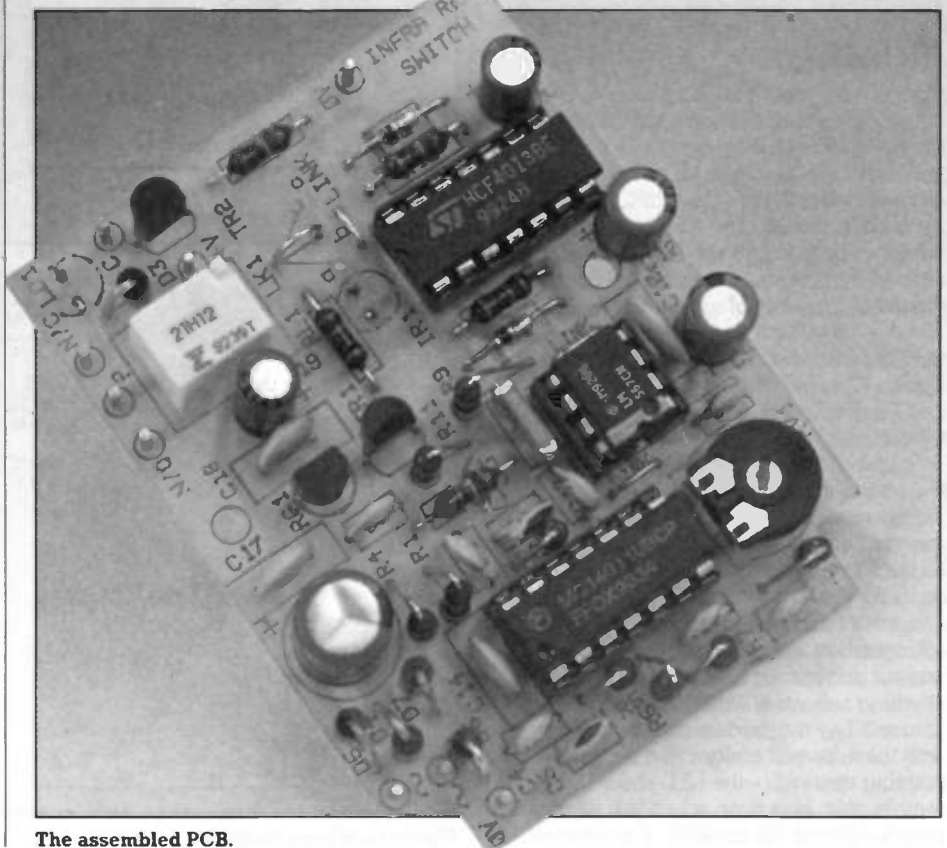

Figure 5. Remote wiring of I/R devices.



The assembled PCB.

capacitors are non-polarised and can be fitted either way round. The transistors – TR1 (MPSA65) and TR2 (BC337) – and regulator (RG1) can now be fitted; their outlines should correspond with those on the PCB legend – it is important to fit these devices the correct way round.

LD1, IR1 and PD1 should be fitted on the track side of the board, as shown in Figure 4. IR1 and PD1 are very similar in appearance, but fear not – they can be distinguished apart! IR1 normally has a green spot near its lead-in wires, and PD1 can be identified by its larger chip, as viewed from the top of the device. Apart from the operation mode-setting link LK1 (which will be fitted shortly), the final components to be soldered into position are relay RL1, and preset RV1.

If desired, IR1 and PD1 could be fitted remotely, PCB pins being soldered in the 'a' (anode) and 'k' (cathode) positions,

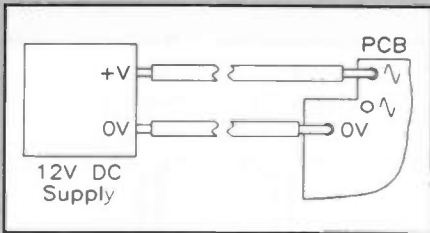

Figure 6. Using a DC supply with the Infra-Red Switch.

to accommodate the two pairs of interconnecting wires – screened cable should be used, most importantly in the case of PD1. Remote wiring of the infra-red transducers is shown in Figure 5. If this option is followed, care must be taken when co-locating the infra-red transmitter and receiver. Remote location may be desirable in applications where the PCB will be too obtrusive, or where an extended range is required (refer to 'Increasing the Range' section).

Testing

Connect the module to a suitable power supply. If you are following the 12V DC supply option, power and ground can be connected to one of the ac pins and the 0V pin (respectively). If a transformer is to be used, it should have a 9V secondary winding (both single winding and centre-tapped transformers are suitable), and should be capable of sourcing at least 50mA – YN15R is ideal. Power supply wiring is shown in Figure 6 (DC supply), Figure 7 (single winding transformer), and Figure 8 (centre-tapped transformer).

Solder the link LK1 in position 'b', as shown in Figure 9, and turn RV1 fully clockwise. The three ICs can now be inserted into their sockets – the notch on each one should line up with the notch on its socket. Power up the module, and adjust RV1 anti-clockwise until the LED extinguishes, ensuring that the infra-red emitter and sensor are not pointing at anything reflective – this includes yourself! Lay the module on a flat surface, with the infra-red emitter and sensor pointing upwards – the LED should remain unlit. However, when you pass your hand over the module, at a distance

of approximately 100mm, the LED should illuminate, returning to its unlit state when your hand is removed. Note that when the LED operates, you should also hear the relay click.

Disconnect the power and move the link LK1 to position 'a' (toggle mode); Reconnect the power to the module, and move your hand across the module as before; this time, the LED will stay illuminated until you pass your hand over the module again, at which point it should go out.

Remove the power again, and fit the link into position 'c'; when you reapply power and pass your hand over the module, the LED will illuminate briefly, even if your hand remains in front of the module.

The infra-red switch has now been fully tested; remove the power and fit the link LK1 into the desired position.

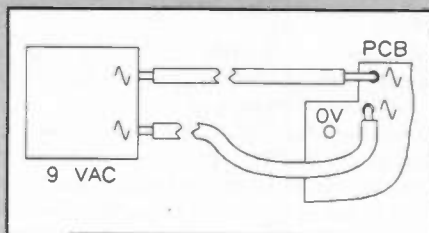

Figure 7. Using a 9V transformer with a single secondary winding.

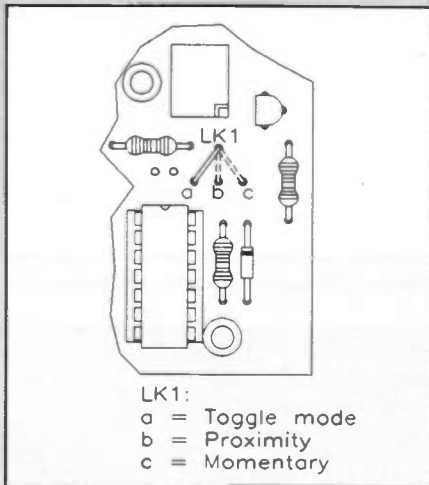

Figure 9. Link selection.

Module Usage

The module should be wired up as shown in Figure 10. Note that the maximum load that can be switched by the relay is 28V DC at 1A, or 50V AC at 500mA. If a higher voltage or current is to be switched than the relay will allow, an off-board relay could be connected between the collector of TR2 (pin marked with a 'C') and +V, as shown in Figure 11. Please note, however, that TR2 can only switch a maximum of 100mA (including RL1 & LD1 current); its maximum power dissipation is 500mW. As an alternative to a relay, the Mains Opto Switch module (LP55K) could be used where the switching of mains loads (max. 250W resistive) is anticipated. The use of a Mains Opto Switch is shown in Figure 12.

The sensor and emitter are now pointed at where the triggering event is

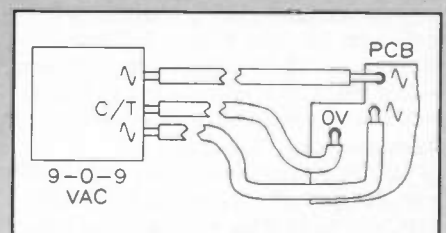

Figure 8. Using a 9V centre-tapped transformer.

likely to happen – a door or window in the case of a security system, or a conveyor belt in the case of a production line counter. A few trial runs should determine whether the sensitivity has been correctly set; further adjustment of RV1 may be required.

Increasing the Range – Some Ideas

The range of the Infra-Red Switch can be increased by remotely wiring the infra-red emitter and sensor further apart (refer to the 'Construction' section) to reduce the amount of stray infra-red energy picked up from the emitter by the sensor; although these two devices feature lenses which focus their energy (or sensitivity) towards the top of the

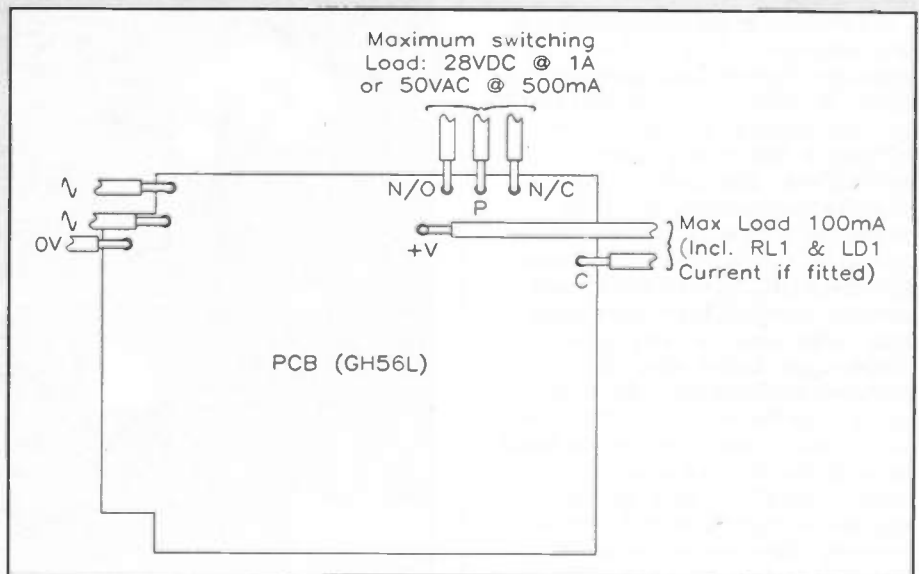

Figure 10. Wiring diagram.

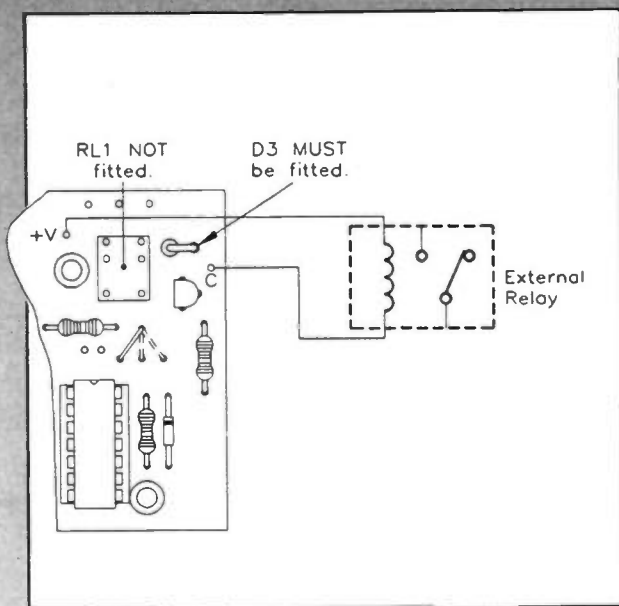

Figure 11. Using an optional external relay I/R Switch.

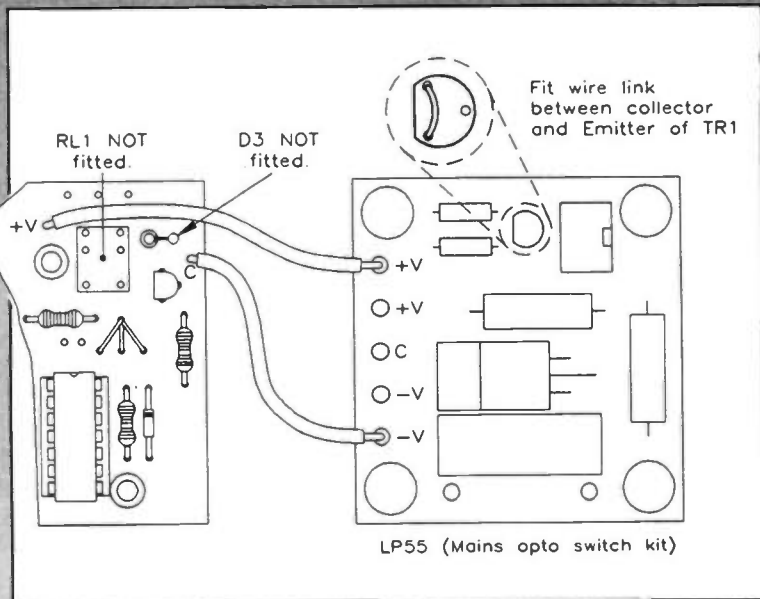

Figure 12. Connecting an optional Mains Opto Switch.

package, there will always be some activity, corresponding to the side of the devices. As an alternative, 4.8mm heatshrink sleeving (BF89W) could be placed over the body of the device, leaving a clearance of 1mm from the tip, so that the lens is uncovered; note that heat should only be applied around the base of the device, where its diameter is larger. RV1 can then be readjusted to give maximum sensitivity.

Another method of improving the sensitivity is to change the infra-red emitter and sensor for the high power emitter (YH70M) and photodiode (YH71N), which have a better spectral match. As another suggestion, reducing the value of R12 would increase the current through the infra-red emitter, yielding a higher output and consequently an improved range. R12 should have a minimum value of 56Ω for the emitter supplied in the kit, or 33Ω for the YH70M device.

Housing the Module

The PCB was designed to be used primarily with two cases – the MB1

box (ZB75S), or a 29mm single surface-mounting pattress with blanking plate (YB15R and HL86T). In either case (yet another awful pun! – Ed), 20mm insulated spacers (FS38R) should be used to mount the module.

(i) Pattress

The use of a pattress is recommended for permanent installations; note that in most of these instances, it is likely that IR1 and PD1 will be mounted remotely. Depending on your exact requirements, a surface-mounting or a flush-mounting pattress could be used – each has its advantages. A double pattress provides sufficient room for the receiver module and the power supply transformer. If the Mains Opto Switch is to be used, this could be mounted, together with the mains transformer, in the double pattress – the Infra-Red Switch module could then be mounted in a single pattress. This has the safety advantage of keeping the high-voltage mains supply isolated from the low-voltage electronics. *Please note that if the any items working at mains voltages (i.e. mains transformer, Mains Opto Switch) are installed in a metal case (e.g.,*

flush-mounting pattress), the case MUST be earthed!

Decide where you are going to install the module, and prepare the mounting surface (e.g., drill and install wallplugs). Obviously, it is advisable to choose somewhere near a power socket, unless you want to 'chase' the wiring. Mount the receiver into a single pattress, using epoxy glue to hold it in place. Note that a surface-mounted pattress is used for ease of construction; if a metal flush-mounted type is used, then the use of spacers is particularly important, to avoid the possibility of short-circuits. Don't forget to allow for the sensor and emitter wires!

(ii) MB1 Box

Another option is to use an MB1 box, with holes drilled for the emitter, sensor and LED – this would be ideal for experimental or temporary installations. Drilling details for the MB1 box are given in Figure 13. In this situation, it is advisable to use a DC power unit – for example, XX09K. A 2.5mm power socket (JK10L) should be mounted on the case to accommodate the trailing lead from the power unit.

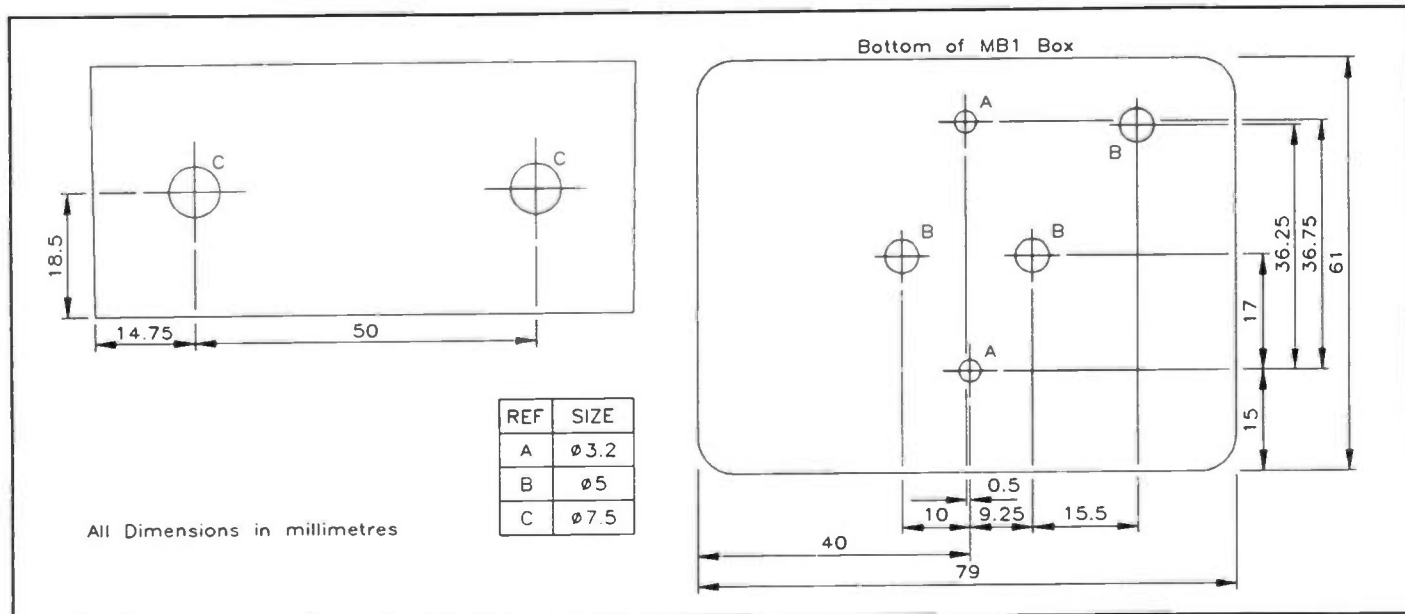

Figure 13. MB1 box drilling.

INFRA RED SWITCH PARTS LIST

RESISTORS: All 0.6W 1% Metal film

(Unless specified)

R1	1M	1	(M1M)
R2,5	470k	2	(M470K)
R3,4,6-9,			
13,14	10k	8	(M10K)
R10,12	1k	2	(M1K)
R11	47k	1	(M47K)
R15	100k	1	(M100K)
RV1	Hor Encl Preset 1M	1	(UH09K)

CAPACITORS

C1,3,4,			
6-8,13	Ceramic 1nF	7	(WX68Y)
C2,5	Ceramic 33pF	2	(WX50E)
C9,12	PC Elect 22µF 25V	2	(FF06G)
C10	Minidisc 47nF 16V	1	(YR74R)
C11	Ceramic 22nF	1	(WX78K)
C14,17,18	Minidisc 100nF 16V	3	(YR75S)
C15,19	PC Elect 10µF 50V	2	(FF04E)
C16	PC Elect 470µF 16V	1	(FF15R)

SEMICONDUCTORS

IC1	4011UBE	1	(QL04E)
IC2	LM567CN	1	(QH69A)
IC3	4013BE	1	(QX07H)
TR1	MPSA65	1	(QH61R)
TR2	BC337	1	(QB68Y)
D1-7	1N4148	7	(QL80B)
RG1	78L05	1	(QL26D)

MISCELLANEOUS

PD1	Infra-Red Photodiode	1	(YH71N)
IR1	Infra-Red LED	1	(YH70M)
LD1	5mm Red LED	1	(WL27E)
RL1	Low Power 12V 1A Relay	1	(DCS2G)
	Veropin 2145	1 Pkt	(FL24B)
	8-pin DIL Socket	1	(BL17T)
	14-pin DIL Socket	2	(BL18U)

PCB	1	(GH56L)
Instruction Leaflet	1	(XU39N)
Constructors' Guide	1	(XH79L)

OPTIONAL (Not in Kit)

ABS Box type MB1	1	(LH20W)
35mm Flush Metal Wall Box	1	(ZB75S)
40mm Surface Pattress	1	(ZB40T)
Blanking Plate	1	(HL86T)
M3 x 10mm Insulated Spacer	2	(FS36P)
Miniature Screened Cable	As Req	(XR15R)
2.4mm Heat Shrink Sleeve	As Req	(BF87U)
6.4mm Heat Shrink Sleeve	As Req	(BF90X)
Epoxy Resin Sachet	1	(FL45Y)
9V 250mA Transformer	1	(YN15R)
20mm Fuseholder	1	(KU33L)
20mm Fusholder	1	(RX96E)
Fuseholder Insulating Boot	1	(FT35Q)
T50mA Fuse	1	(UJ90X)
Unregulated 300mA AC/DC PSU	1	(XX09K)
2.5mm Panel Power Socket	1	(JK10L)

The Maplin 'Get-You-Working' Service is available for this project, see Constructors' Guide or current Maplin Catalogue for details.

The above items (excluding Optional) are available as a kit, which offers a saving over buying the parts separately.

Order As LT38R (Infra Red Switch Kit) Price £9.95

Please Note: Where 'package' quantities are stated in the Parts List (e.g., packet strip, reel, etc.) the exact quantity required to build the project will be supplied in the kit. The following new item (which is included in the kit) is also available separately.

Infra Red Switch PCB Order As GH56L Price £2.95

VARIOUS

2732 (4K) EPROMS used once; £1.50 each. 5V relays DTD, fit 16 pin DIL socket. £1 each. 25 pin R/A 'D' plugs 4 for £1. V21/23 Modem, auto answer/dial Hayes compatible, offers! Mel 0533-419742.

UNUSED (still boxed) 1.2m spun aluminium, prime focus dish, reflector and tripod arms, only needs mount and stand. Bargain at £50, buyer collects (Southend area). Tel: Martin on (0702) 603557.

'ELECTRONICS' - The Maplin Magazine, issues 1-68, in mint condition, offers please. Telephone 061-654 8012.

FOR SALE Maplin TY1000; £50 ono; also telequipment oscilloscope SS1E - offers. Tel: Basildon (0268) 414481.

NEW COMPONENTS, plus free pack of 100 resistors, assorted resistors, capacitors, diodes, ICs, etc. £10 per bag inclusive of postage and packing. Mr D. J. Brown, 2 Gwentworth Avenue, Whitmore Park, Coventry, West Midlands CV6 2HW.

TELEQUIPMENT type 43 scopes, 1 working, 1 for repair or spares with complete set of extra plug-in units (different amp, etc); £65 the lot. For information telephone Pete 0508-70432 (Norfolk).

MAPLIN 50W amplifier and PSU, 12in 80W speaker, horn tweeter; £35 the lot. 2 x 49 note keyboards; £30 the pair. Tel: Chelmsford (0245) 450050 (home).

DIGITAL SPEECH RECORD and playback module - assembled and working; £25 o.n.o. Tel: John on 0379-890267.

GIANT CLEAR-OUT! Long list of unused components including ICs, books, resistors, some in large quantities, all at bargain prices. Send S.A.E. for list. M. J. Dean, Blenheim, Walton Lane, Bosham, Chichester, West Sussex PO18 9CF.

COMPLETE MULTI-SATELLITE TV SYSTEM FOR SALE. 1.2m offset dish with ground stand, actuator, Polar Mount, Polariser and 1.2dB LNB. Salora XLE Receiver; 144 channels, fully tunable stereo sound, 2 decoder loops, built-in amplifiers, etc.; £250 the lot. Also Ferguson 3V43 VCR with NICAM Retrofit LP/SP, Dolby linear and Hi-Fi stereo sound, insert assemble edit, etc.; £200. Have both items for bargain price of £400. Tel: Martin (0702) 603557.

CLASSIFIED

Placing an advertisement in this section of 'Electronics' is your chance to tell the readers of Britain's Best Selling Electronics Magazine what you want to buy or sell, or tell them about your club's activities - Absolutely Free of Charge! We will publish as many advertisements as we have space for. To give a fair share of the limited space, we will print 30 words free, and thereafter the charge is 10p per word. Placing an advertisement is easy! Simply write your advertisement clearly, in capital letters, on a post-card or sealed-down envelope. Then send it, with any necessary payment, to: Classifieds, 'Electronics - The Maplin Magazine',

P.O. Box 3, Rayleigh, Essex SS6 8LR. Advertisements will be published as soon as possible, space allowing. No responsibility is accepted for delayed publication or non-inclusion of advertisements.

Private individuals only are permitted to advertise in this section; commercial or trade advertising of any kind is strictly prohibited by law. Advertisements are only accepted by the Publisher on this proviso. Readers who have reasonable grounds to believe that they have been misled as to the nature of an advertisement are advised to contact the Publisher and their local Trading Standards Office.

CUSTOM INTEL BOARDS made up. At silly prices. Please ring for more information. 0268 524968 (Basildon).

MASTER 128, 2 x 5.25in. drives, VDU, Star dpi, software, MER 6800D2 IC evaluation unit, CTL EPROM programmer - £300, and Z88 128K RAM/EPROM, Eraser, mags. £150. Tel: John (evenings) 0322 226822 (Dartford).

WANTED

RECEIVER. HF general coverage such as 9R.

59DS Prefer valves! Later on, my old, working HR0 will become available. Godfrey, C4GLM. 081-958 5113. Edgware. I often visit Aylesbury, etc.

Z80 stuff, trainers like Microprofessor, Maplin Z80, etc. Also books, boards, electronic test gear. W.H.Y. buy or photo gear to swap. Mel 0533-419742.

90V HT BATTERY for Vidor portable radio, would consider battery eliminator unit. D. Ibbertson, Cawtress Almshouses, 87 Cemetery Road, Wath-on-Deane, Rotherham, Yorks S63 6HY.

MUSICAL

KEYBOARD, 61-note high quality (Maplin code XB/6S), bought for uncompleted organ project, never used, still boxed; £30 and postage. Tel: Pete (0865) 371730 (Oxford) after 6 p.m.

COMPUTERS

SPECTRUM 128K, monitor, printer, recorder, joystick, Magnum, WAF, organmaster, Interface 2, Multiface, Multiprint, plus more, 80 programmes, some serious, 20 Spectrum books; £200 ono. Tel: Oxford (0865) 248411 (evenings).

FOR SALE: Maplin PC expansion (LP/2N), A-D converter and speech synthesiser, all working with software, connectors and circuits; also 10 new 3.5 DS disks; £55 ono. Tel: Andrew (0453) 886466 (Glos.).

ACNET - Circuit Analysis Program for IBM PC, active and passive components. Provides gain, phase, impedances, graphplots; £10. S.A.E. for details. P. Montgomery, Downings, Bells Hill, Stoke Poges, Slough SL2 4EC.

structures, conditional tests, string handling, I/O, integer maths, etc. in 65XX machine code. Original package runs on C64; IBM PC version also available to help program 6502 microcontroller cards, etc. or other machines. Compiler and assembler source listings can be made available if required. Expandable routine library. C64 disk has lots of demos, PC disk has lots of extra utilities. Send largish, e.g. C5 S.A.E. for more details to: Level 3, Aurora, Church Road, Laindon, Basildon, Essex, SS15 5SL.

CLUB CORNER

WIRRAL AMATEUR RADIO SOCIETY meets at the Ivy Farm, Arrowe Park Road, Birkenhead every Tuesday evening, and formally on the 1st and 3rd Wednesdays of every month. Details: A. Seed (G3FOO), 31 Withern Avenue, Bebington, Wirral, L63 5NE.

CRYSTAL PALACE & DISTRICT RADIO CLUB. Meets on the third Saturday of each month at All Saints Church Parish Rooms, Beulah Hill, London SE19. Details from Wilf Taylor, G3DSC. Tel: (081) 699 5732.

ELECTRONIC ORGAN CONSTRUCTORS SOCIETY. For details of meetings. Tel: (081) 902 3390 or write 87 Oakington Manor Drive, Wembley, Middlesex, HA9 6LX.

TESUG (The European Satellite User Group) for all satellite TV enthusiasts! Totally independent, TESUG provides the most up-to-date news available (through its monthly 'Footprint' newsletter, and a teletext service on the pan-European Super Channel!). It also provides a wide variety of help and information for its members. For further information, contact: Eric W. Wiltsher, TESUG, Rio House, Stafford Close, Ashford, Kent, TN23 2TT, England.

THE BRITISH AMATEUR ELECTRONICS CLUB (founded in 1966), for all interested in electronics. Four newsletters a year, help for members and more! UK subscription £8 a year (Junior members £4, overseas members £13 50). For further details send S.A.E. to: The Secretary, Mr. J. S. Hind, 7 Carlyle Road, West Brdford, Nottingham, NG2 7NS.

**A readers forum for your views and comments.
If you want to contribute, write to:**

**The Editor, 'Electronics – The Maplin Magazine'
P.O. Box 3, Rayleigh, Essex, SS6 8LR.**

Poor Value Velleman?

Dear Sir,
Firstly, may I thank you for your excellent magazine 'Electronics', to which I have been a subscriber for several years. Over the past year or two, you have featured a series of articles describing the range of Velleman kits which are available through your catalogue. A good number of these are useful projects, and your series of articles covers and describes them well, but they all suffer one serious drawback – the cost of the kit. In an issue of 'Electronics' a few months ago, I read that the projects in the magazine are aimed mainly at hobbyists. This in fact is what we are, school pupils, students and amateurs who are learning about electronics as a hobby or as an educational pursuit.

I have calculated that the cost of Velleman kits is between three and four times overpriced for the components they contain even allowing for making up the kit. Perhaps in Belgium, where they are made, the prices are more realistic – I don't know. If the cost of the kits were reduced to a reasonable amount, I am certain you would sell more of them. I know that Maplin pricing policy is not the responsibility of the magazine Editor, but hopefully this letter will be read by whoever is responsible for pricing. Now a suggestion on another topic.

It is becoming more common amongst Hi-Fi enthusiasts that the sound of valve amplifiers is preferred to that of the solid-state variety. This is borne out by the fact that you actually have valves in your catalogue. Please will you obtain some stocks of suitable mains transformers, some 16 μ F or 32 μ F capacitors rated at 500V and output transformers to suit EL84 and EL34 valves in push-pull so that we can build our own amplifiers. Thank you again for a very interesting and informative magazine.

A. W. Fisher, Cambridgeshire.

Dave Goodman

(Development Manager) replies:
We at Maplin are very much aware of the cost of projects and kits, especially to students. In fact, it is with this in mind that we keep our costs as low as we possibly can!

Our own kits offer substantial savings over buying the parts separately, and we try to reflect this in the pricing of kits that we market for any other kit manufacturers as well.

I must disagree with your figures for Velleman kits being between 'three and four times over-priced'. We purchase kits directly from them – and distribute through other outlets in the UK – so compared with our own manufactured kits they will cost more. Foreign exchange rates definitely feature in the pricing equation – witness the events over the past year – you will see the benefits of this through lower prices in the new 1994 Maplin Catalogue.

Mike Holmes replies:

As a result of the forthcoming Maplin Valve Amplifier project (scheduled for Issues 73 and 74) there will be, as you suggest, components available as stock items for such purposes, namely a high power mains transformer, a push-pull output transformer for powers up to 20W rms and a 68 μ F 500V capacitor. Actually finding the capacitor was a real headache; 500V electrolytics are simply not made any more as regular lines! The popular manufacturers now only go up to 450V, presumably because this correlates to the rectified 240V mains level, plus a safety margin, for switched mode power supplies in modern electronic equipment. As for the old values of 8 μ F, 16 μ F, etc., no chance!

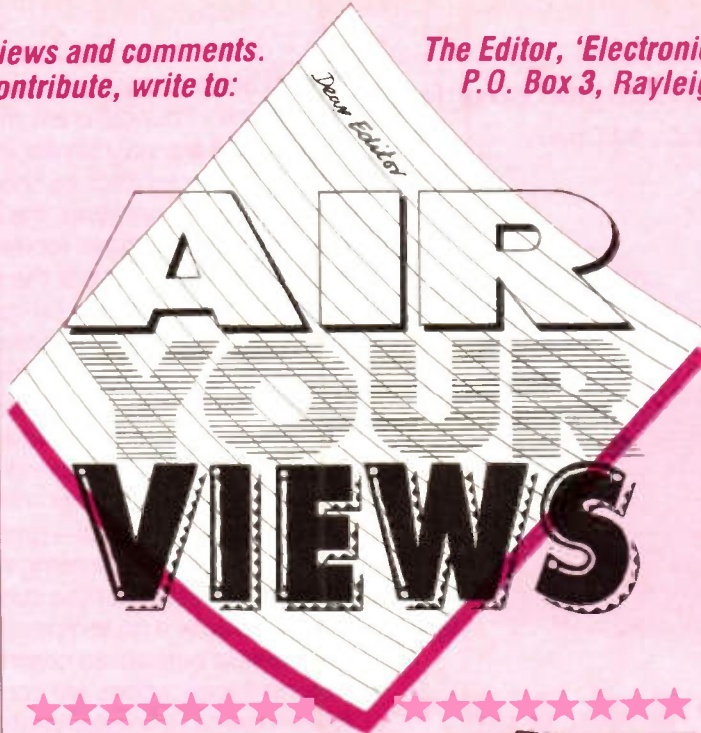

STAR LETTER

This issue, Mr M. Adams, from Alwoodley in Leeds, receives the Star Letter Award of a £5 Maplin Gift Token for his MIDI-related project ideas.



Re: Midi Scanner Project

Dear Sir,

Yes please. Let's have more MIDI gear. Possibly a modular keyboard system so that people can pick and choose the complexity of their systems. I myself use two Cheetah 5 octave keyboards. One is very simple to use, but only has velocity sensitivity on attack, pitch and modulation wheels and two fixed pedal sockets. The other (Master Series) has attack and release velocity, pitchbend, two assignable wheels, two assignable pedal sockets, and everything but the kitchen sink, all memorisable, with an A4 manual as thick as two Maplin magazines. Too much!

Most useful would be a MIDI pedal board, as most players use a 5 octave keyboard and transposing them isn't always convenient. Ideally it should have velocity on/off, channel select, pitch wheel (? remote?), pitch +/-, octave +/-, and perhaps most important (at least for me) is a MIDI merge Input, so that it can be placed in line with a keyboard. (The Roland MIDI controller is only 4 octaves!).

Other MIDI gear:

1. A Channel Changer – especially useful for the scanner – as it only transmits on Channel 1 and 2.
2. A MIDI foot volume pedal (continuous controller 1 and 2).
3. MIDI/CV box. There are many monosynths out there (especially DIY) whose sounds could be controlled via MIDI and thus by computer/sequencer. I for one could then 'saw off' the keyboard of my old Powertran 'Transcendent 2000' and save a LOT of space.
4. Some kind of MIDI controlled synth module (using the chips from the catalogue?). I know there are lots of

these available, but few, if any, include a white noise source, the most useful source of effects.

5. Velocity sensitive drum pads MIDI box. Each pad or Input could have a channel/note selectors.

The most important and probably the most commercial are the pedal board (I believe only one company ever made one) and the MIDI/CV box, as only one DIY attempt has been made. If these are all you produce I will still construct them, even if my Maplin organ bass pedals become redundant.

Mr. M. Adams, Leeds.

Joe Fuller replies:

Thanks for your comments in response to the footnote at the end of the E510 Data File, you (and others) have confirmed that my own ideas for MIDI projects would be popular. Some of the projects you suggest will require a processor to do the number crunching, so will need some software development as well as hardware development. It'll be the software side of things that'll take the time – I'll just have to persuade my wife that designing projects and writing assembly code is more important than re-decorating the hall and the other DIY jobs that need doing! Perhaps you ought to write to her instead! That aside I'll give some serious thought to producing a few designs.

A great many other letters on the same subject have also been received, but due to space constraints have not been included here. Thank you to everyone who has taken the trouble to write in on the subject of MIDI. More designs for MIDI projects will be forthcoming – Ed.

(Unless you want to pay a fortune for specials.) Instead you only have 10 μ F and 47 μ F (and 1 μ F axial) at 450V from the current Maplin range. The imminent 68 μ F 500V item is a high quality can electrolytic (made in Britain) and is used

in the valve amp PSU kit as the reservoir. The only suitable non-electrolytics in the Maplin range which are safe to use at up to 500V would be the polypropylene types (especially the audio-grade ones), and the HV ceramic discs.

Customer Suggestions

Dear Sir,

I suspect you welcome comments from your customers. Whilst I am not your most regular or biggest customer, and realise there is a limit to what you can stock, I would like to comment on your range of products.

First, may I say how happy I am with your sections of Boxes, Projects and Modules, Velleman and Heathkit kits, Capacitors, Speakers and Sounders, PCB equipment, Books, Connectors, Semiconductors and Test Gear (perhaps you could concentrate on discounting the best multimeters instead of stocking them all though!).

However, when recently looking for a good alphanumeric LCD, such as the one used in Casio pocket calculators, I found people such as RS stock them and you do not. Unfortunately, RS do not sell direct to the public. I was also hoping to buy a solar cell of say the same size as an A5 piece of paper. Maplin offer only a few roughly broken offcuts of solar cells mounted in plastic cases. I was also disappointed not to find a centre off momentary action double pole rocker switch, but then maybe nobody makes them. As a last example, your range of knobs seems to revolve around a common design. Where are the ones so commonly used as tuning dials on good communications receivers, or for tape control on video editing machines? They are typically about 5cm in diameter and have an offset finger indent for rapid turning. Of course, you would have to stock the associated switch mechanism.

May I suggest you scrap the sections on Computers, Entertainment and Protection, and discontinue cameras, clocks and torches. I cannot help feeling they clog the catalogue of valuable space and invariably contain items readily available in either high streets or more specialist magazines read by those likely to make such a purchase. To me, at least, in view of the fact you do not offer to undercut other suppliers' prices, it would make more sense to sell the things not obtainable elsewhere, by expanding your range of novel or specialist items such as tuning capacitors, vibration sensors, semiconductors, robotics and ancillary components such as motors and gears, joysticks as components in their own right and not as additions to a computer game, optoelectronic components, and pressure sensors.

A. Tonkin, Uckfield, E. Sussex.

Doug Simmons

(Marketing Director) replies:

I am pleased to tell you that there is a new range of alphanumeric LCD displays in the 1994 Maplin Catalogue. With regard to the solar cells, the fact that they are broken makes no electrical difference, you still get an output relative to the total surface area and they are much, much cheaper than unbroken ones.

Also these cells are much better quality than the amorphous types, which look better, but actually have a much shorter working life – again see the new catalogue.

Centre-off momentary action dp rocker switches are manufactured, but our opinion is that sales would be too small to justify stocking them. And we hold a similar opinion of the large knob you mention.

The items you would like to see scrapped do overall make a substantial contribution to the company's turnover and therefore help to spread overheads. You then benefit from this in that we are able to keep the prices of specialist components lower than otherwise.



by Alan Williamson and
 Stephen Waddington BEng(Hons.),
 M.I.E.E.E., A.I.E.E., A.I.T.S.C.

Previous articles in *Electronics* have described the specification and use of temperature modules available from Maplin. Four different modules are available and although all are very similar in appearance, each has unique characteristics as shown in Table 1. Apart from measuring temperature, the devices can provide a variety of information suitable for interfacing to other electrical/electronic equipment. In the simplest sense, this may involve connection to a Relay Board enabling switch contacts to be made or broken when programmable temperature points – set points – have been reached. More ambitious work enables one of the modules – FE33L – to be interfaced to a Personal Computer, leading to a more versatile temperature sensing system. The facilities of the computer – including data recording, monitoring and control – greatly further the potential of the temperature sensing module; the predominant advantage being that the computer can make intelligent decisions based on temperature readings and provide appropriate outputs as commanded by software. Potential applications are consequently endless ranging from modest domestic central heating controllers to more complex systems for controlling heaters, cooling fans and window mechanisms throughout a greenhouse complex.

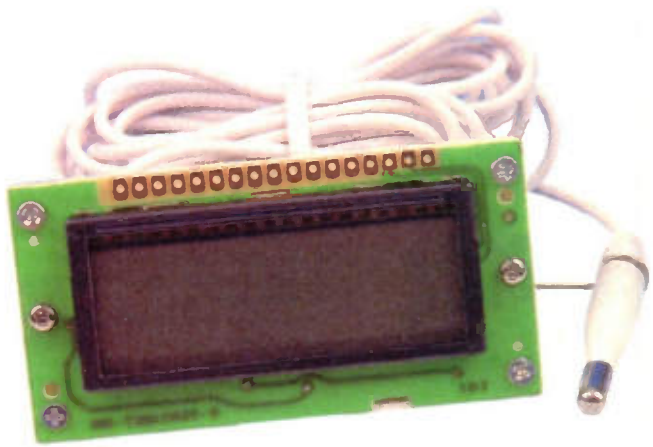

USING

TEMPERATURE MODULES

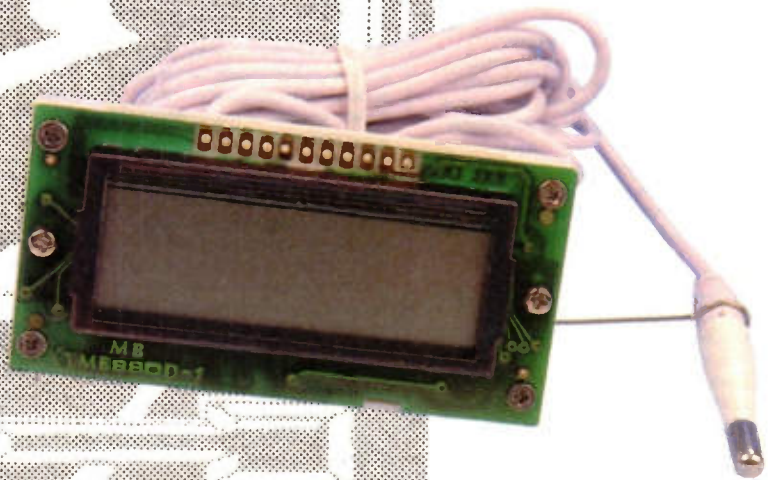
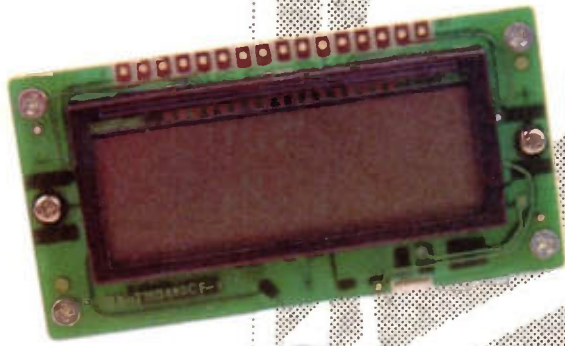

KITS
 AVAILABLE

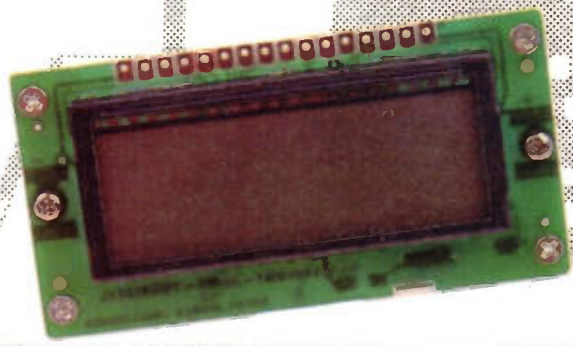

THE necessary hardware required to expand the temperature sensing modules is all available from Maplin in kit form. Basic expansion in the form of a Relay Card, with a simple alarm amplifier, suitable for all four temperature modules is available in the form of LM375. Computer interfacing however, is only suitable for temperature module FE33L and requires the use of a Serial to Parallel Converter and a PC I/O card. This article demonstrates how to interconnect the various kits and illustrate some of the potential applications for the equipment. Each of the articles detailed within the References at the end of this feature discusses the construction and basic operation of each of the kits. Fabrication details throughout this article have consequently been kept minimal, concentrating instead on the practicalities of operating the temperature modules and interfacing techniques.

Relay Card Connection

The outputs available from each of the temperature sensing modules are detailed in Figure 1. As Table 1 testifies, each provides sufficient data to enable connection to the Relay Board, although in the case of the YU00A only a basic alarm signal is available. Figure 2 shows the circuit diagram of the Relay Card; the essence of the circuit is relatively simple, consisting of a series of four transistor common emitter amplifiers. Relay RL1 operates when the high set point on the temperature module becomes active; similarly RL2 operates when the low set point is active. RL3 responds to a Hi/Low signal, active when either of the high or low set point is reached; the output signal necessary to operate this function is provided only by FE33L and YT99H, consequently RL3 is redundant when the Relay Module is used with any of the other modules. TR4 is pulsed from the alarm signal output at either 2kHz or 4kHz depending upon which temperature modules is being used. The amplified signal is used to drive a piezo electric transducer in the form of B21.

Electrical connection between the temperature sensing modules FE33L and FP64U and the Relay Card are shown in Figure 3a. The pin connections required for the other sensing modules are detailed in Table 2; note that only two wires are used for module YU00A – as illustrated in Figure 3b – since, as previously mentioned, this provides only a basic alarm signal. The relay contacts on the interfacing board are dry change over types rated at 3A 24V DC. In all instances, the moving contact is common, with the normally closed and normally open positions labelled NC and NO respectively.

Good quality colour coded IDC ribbon cable should be used to link the temperature and the Relay Modules; be extremely careful when soldering to the edge of a temperature module since the edge connectors are easily damaged.

Testing and Using the Relay Board

With wiring between the two modules complete, connect a 9 to 12V DC power supply to PL1, with positive to pin 4 and ground (OV) to pin 3. Before switching on

Module	Order Code	Temperature Range		Units	Sampling Rate	Serial Output	Internal Clock	Features		External Probe	Expansion
		Internal Probe	External Probe					Alarm Outputs	Memory Facility		
Temperature Module	FE33L	-19°C to +50°C	-19°C to 69.8°C	°C, °F	1, 10 seconds programmable	Yes	Yes	Outputs on High/Low Set Points 4kHz Signal on High/Low Set Points	None	FE34M	Relay Board Serial/Parallel Board PC I/O Board
Min/Max Temperature Module	FP64U	-5°C to +50°C	Low Probe -40°C to +50°C High Probe +20°C to 110°C	°C, °F	1, 15 seconds programmable	No	No	Outputs on High/Low Set Points 2kHz Signal on High/Low Set Points	Recall Min. and Max. Temps Since Last Reset	High Probe FP66W Low Probe FP65V	Relay Board
Wide Range Min/Max Module	YT99H	External Probe Only	-10°C to +110°	°C, °F	1, 10 seconds programmable	No	Yes	Outputs on High/Low Set Points 4kHz Signal on High/Low Set Points	Recall Min. and Max. Temps Since Last Reset	Supplied with External Probe	Relay board
Min/Max Dual Display Temperature Module	YU00A	-5°C to +50°C	-40°C to +50°C	°C	15 seconds	No	No	2kHz Signal High/Low Set Points	Recall Min. and Max. Temps Since Last Reset	Supplied with External Probe	Relay Board

Table 1. Characteristics of individual Temperature Modules.

the power supply, have available a canister of freezer spray and also a soldering iron as they greatly simplify the testing procedure enabling the far extremes of the temperature scale to be negotiated. Set up the temperature set points as necessary and place the hot soldering iron close to – but not on – the sensor and as the temperature reaches the high set point, RL1 and – where appropriate – RL3 will operate and BZ1 will beep. Spraying the freezer spray onto the sensor will drop the temperature to the lower set point, so energising RL2 and again RL3 where appropriate. The relays and the alarm signal do not latch permanently, but release according to the individual temperature module – precise details can be gleaned from individual instruction leaflets.

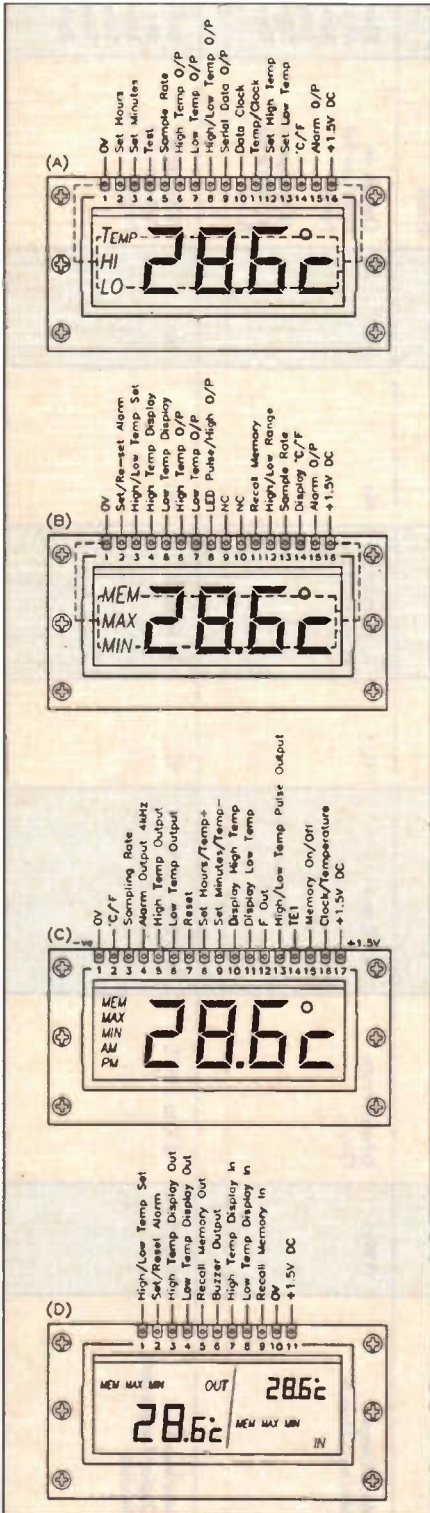

Figure 1. Pin out of Temperature Modules: (A) FE33L; (B) FP64U; (C) YT99H; (D) YU00A.

Customising your Expansion

It is possible for additional information from the temperature modules to be utilized. A method of extracting data in this way is illustrated in Figure 3c. Here temperature

module YT99H is connected to the Converter Board. A transistor is additionally connected to pin 13 on the temperature module, with power taken from the Relay Board, so providing an LED output whenever this pin becomes active; in this instance the LED will pulse when either

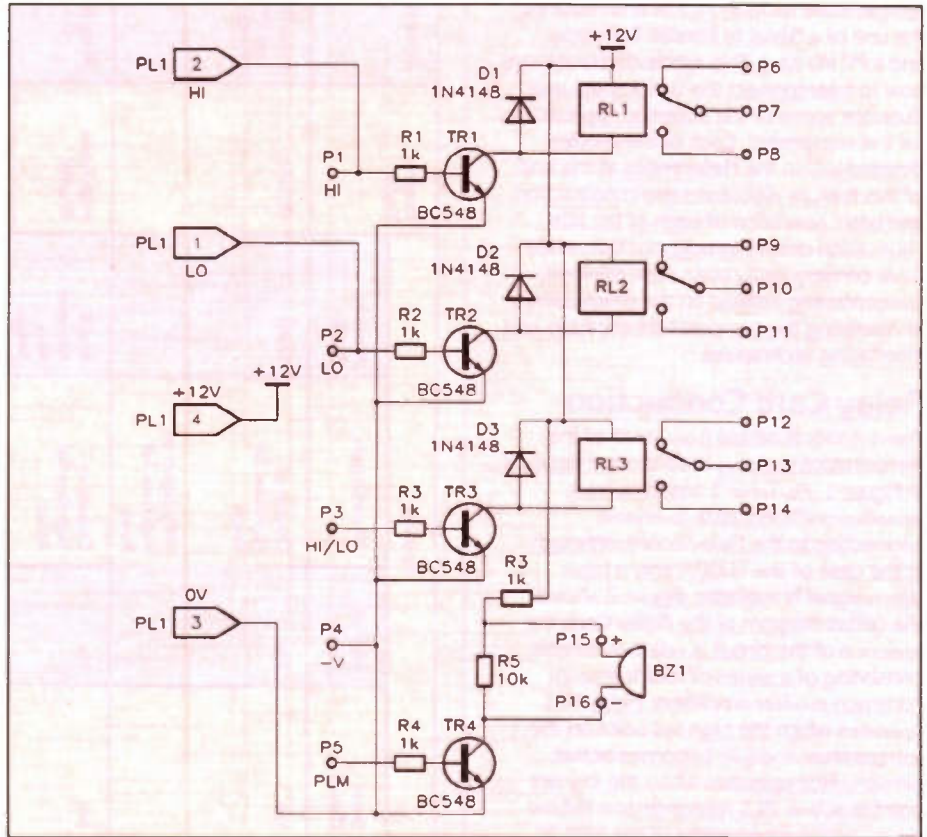

Figure 2. Relay Card Circuit (LM375).

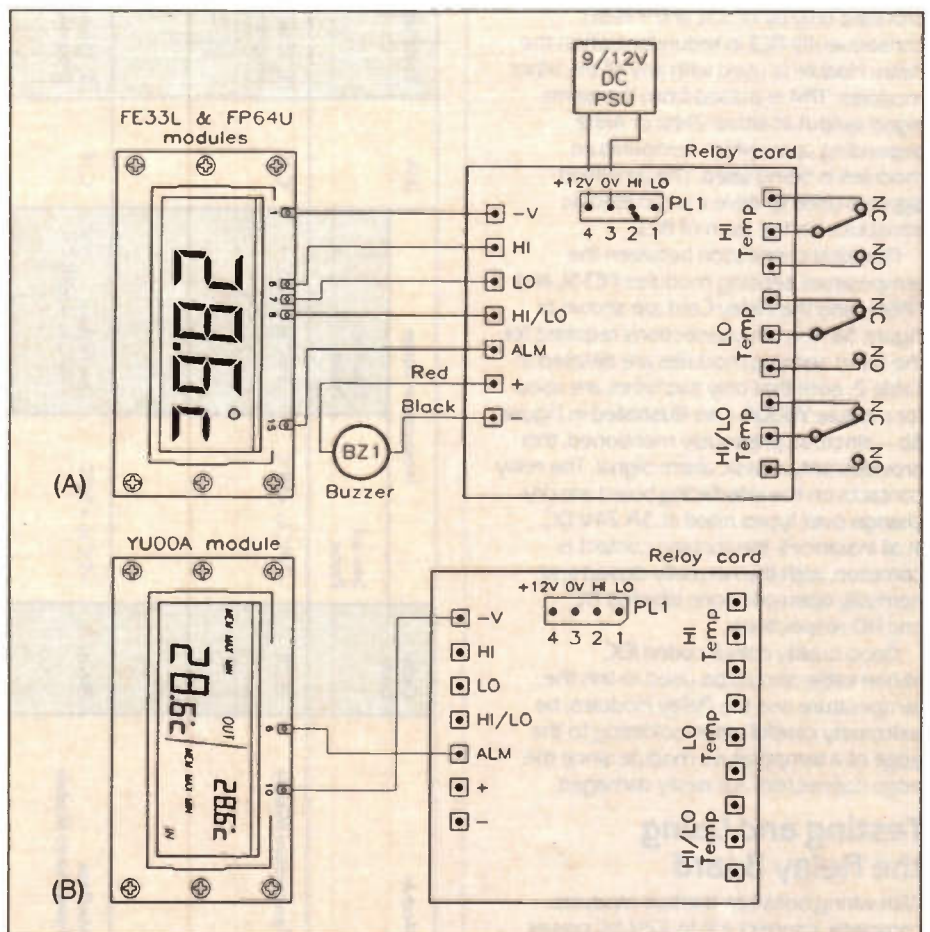

Figure 3. (A) Connections to Relay Card for Modules FE33L and FP64U; (B) Connection to Relay Card for Module YU00A.

Relay Board Signal	Temperature Module			
	FE33L	FP64U	YT99H	YU00A
-V _e	1	1	1	10
Hi	6	6	4	-
Low	7	7	5	-
Hi/Low	8	-	-	-
ALM	15	15	4	6

Table 2. Output capabilities of individual Temperature Modules.

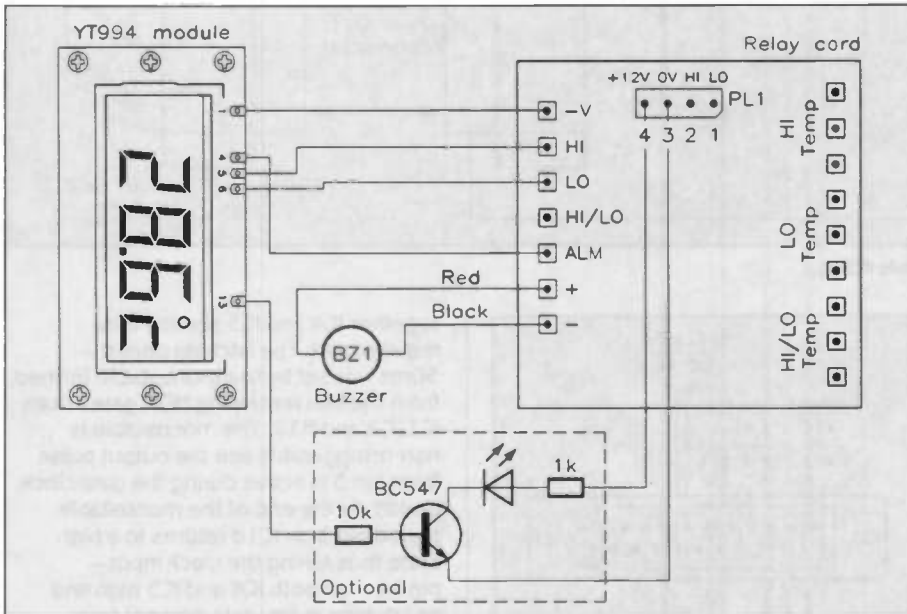

Figure 3C. Connections to Relay Card for Module YT99H.

of the Hi/Low set points is reached. Similar circuits could be used for other outputs from the temperature modules.

The various functions on the temperature modules can be realised by connecting the appropriate pin to +1.5V DC – precise details relating to the set points and the clock are detailed within individual instruction leaflets. The sampling rate is one of the temperature module variables which may be changed. On

modules FE33L, FP64U and YT99H, the sample rate may be changed from ten or fifteen seconds to one second by making a link between supply +V and the sample rate pin on the module; see Figure 1 for module connections.

A Simple Control System

The ability to control relay switches from a temperature module is worthwhile;

such an arrangement allows the designer to construct simple closed loop heating systems. One such example might be a central heating system, with RL1 triggering a boiler and RL2 operating a series of cooling fans. Possibilities are limited only by the fact that the system provides only three pieces of information – the temperature being monitored is either too hot, too cold or within desirable tolerances. Although the set points can be varied within the range of each of the individual temperature modules, this provides little compensation to a system where the designer needs to know by how much a set point has been exceeded; such information would allow a more controlled response to a temperature error signal. In our central heating example, if the set temperature was exceeded by a matter of a few degrees, then a fan might perhaps be operated at half or quarter speed, reducing the temperature gradually to the desirable level. Using the Relay Board would trigger the fan at full-speed quickly reducing the temperature, but in doing so, would probably exceed the lower limit requiring the boiler to be operated again. The system might then become unstable, oscillating sporadically between the higher and lower set points.

The most desirable design allows a calculated response to a change in temperature. A response which – to continue our central heating example – would specify the level to which a boiler or cooling fan is triggered. Obviously such a scheme demands more detailed information from the temperature sensor and the use of a processing element to produce the measured response. In the context of the temperature modules, the FE33L is able to provide serial data relating to the measured temperature. The processing element might take the form of a microcontroller, a dedicated microprocessor or as we shall consider later, an IBM compatible Personal Computer (PC).

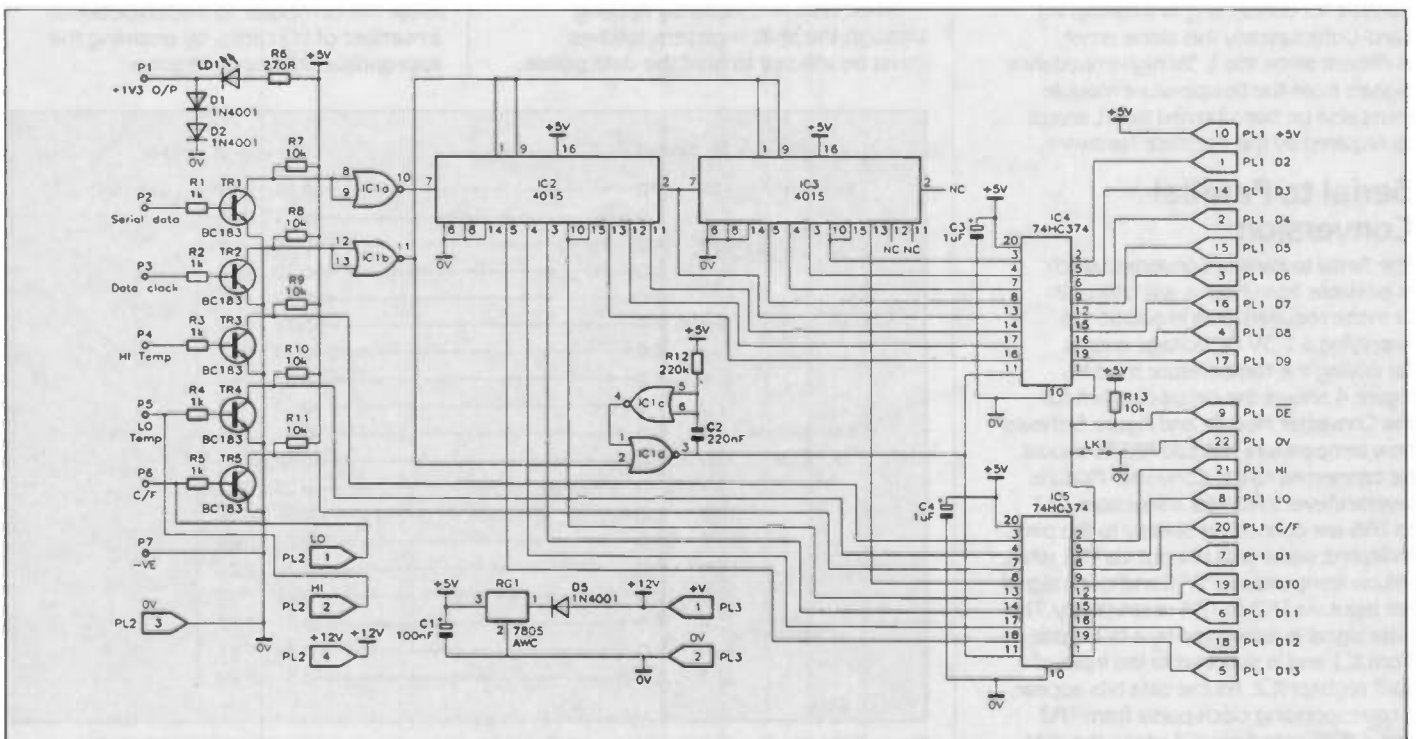

Figure 4. Serial to Parallel Converter Circuit (LM36P).

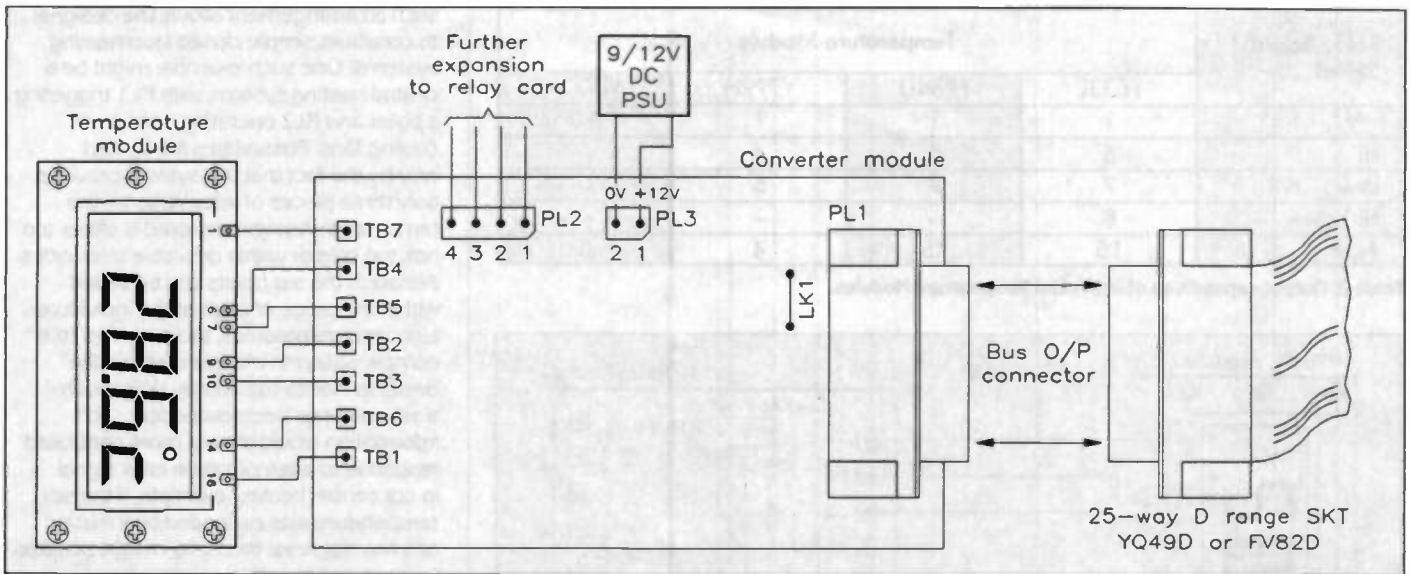

Figure 5. Connecting Serial to Parallel Converter to Module FE33L

Serial Output from Temperature Module

The serial data supplied by temperature module FE33L is in the form of a thirteen-bit pulse train. The numerical data is coded in BCD format, with a single bit for the sign and four BCD bits each, for units, tens and tenths; precise details relating to the format of the data is considered in Reference 1. Although most PCs are equipped with a serial port, the format of the serial data from the temperature module does not conform to a proprietary serial standard. To overcome the problem two possibilities exist; either use the computer's serial port and convert the data to a standard format with software, or convert the data into a parallel format using hardware and a Parallel I/O Card to input data to the computer. The later option is the simplest since it requires relatively simple hardware and minimal software to interpret the temperature data. The data from the temperature module must therefore be converted to a parallel format suitable for connecting to a Parallel I/O Card. Unfortunately this alone is not sufficient since the 1.5V high impedance signals from the temperature module must also be transformed to TTL levels, as required by the interface hardware.

Serial to Parallel Conversion

The Serial to Parallel Converter, which is available from Maplin, will fulfil both of these requirements in addition to supplying a 1.3V DC voltage output for driving the temperature module. Figure 4 shows the circuit diagram for the Converter Module and Figure 5 shows how temperature module FE33L should be connected to the Converter Module. Inverter/level translator transistors TR1 to TR5 are connected directly to the pins indicated; serial data is input via TR1 while Hi/Low temperature, °F/°C and clock signal are input via TR2 to TR4 respectively. The Data signal is reinverted by a NOR gate from IC1 and is supplied to the input of shift register IC2. As the data bits appear, a corresponding clock-pulse from TR2 and a NOR gate from IC1 steps the data through the register. A decoding stage is

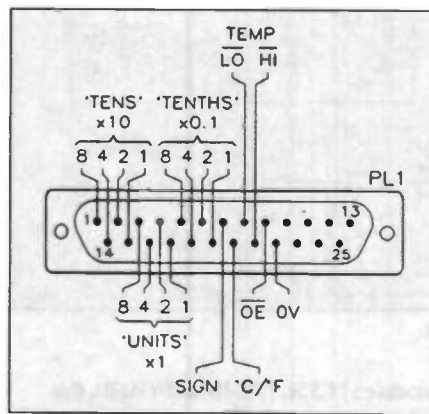

Figure 6. Connections to parallel output 25-way D-type connector.

required for each of the thirteen bits in the temperature module pulse train and thus two eight stage shift registers are used in the form of IC2 and IC3. Eight of the thirteen registers necessary for the design are contained within IC2 whilst the remaining five are within IC3.

Since data is constantly rippling through the shift registers, latches must be utilised to hold the data stable;

together IC4 and IC5 service this requirement. The latching period – 30ms – is set by the monostable formed from the two remaining NOR gates from IC1, IC2 and R12. The monostable is non-retriggerable and the output pulse from pin 3 is active during the data clock period. At the end of the monostable period pin 3 on IC1d returns to a high state thus taking the clock input – pin 11 – on both IC4 and IC5 high and so latching in any data present from the serial registers. This cycle is then repeated at the programmable sampling rate.

To assist in the direct connection to a PC I/O card, the outputs from IC4 and IC5 have their output pins brought out on a male 25-way D-type connector PL1. All data output lines are high impedance unless the Output Enable (OE) pin is held low (OV), allowing control to be dictated by the computer. If such control is required, then *do not* fit PCB link LK1 since doing so will permanently place data on the output. The OE pin exists to allow the computer to switch between a number of I/O cards, by enabling the appropriate OE line as required.

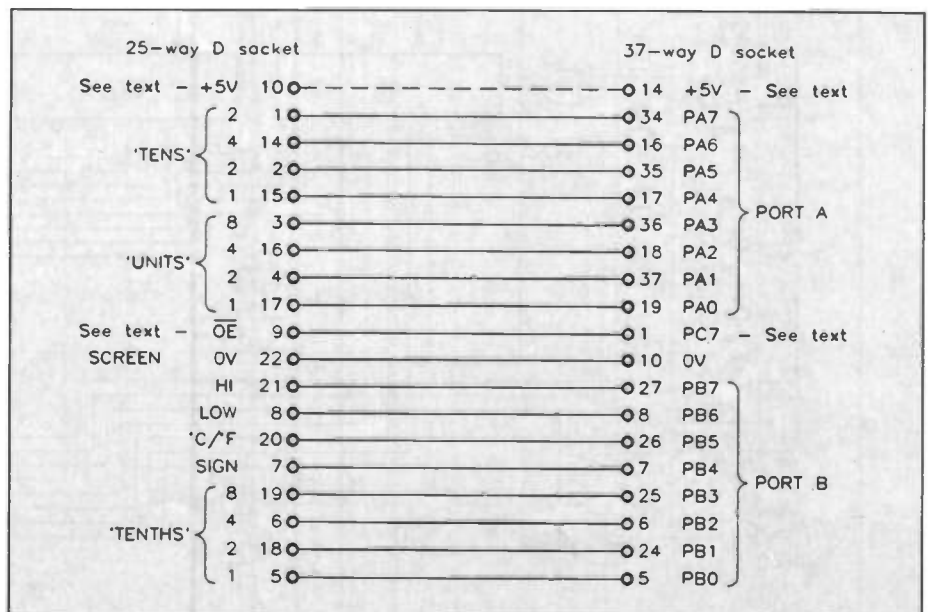

Figure 7. Wiring diagram showing interface cable connections between PC I/O Card (LP12N) and Serial to Parallel Converter (LM36P).

Parallel Bus Output Connector

The pin connections on the 25-way D-type connector are detailed in Figure 6 and Table 3. The connector wiring is arranged so that the first eight pins need only be used if integer values are required – this would allow connection to a computer equipped with only eight parallel I/O lines or with the addition of the necessary address decoding circuitry directly to the processor data bus of an 8-bit microprocessor. Should the full decimal reading be required then the tenths digit bits must also be included. For temperature readings above 100°F or below 0°C, the SIGN bit on pin 7 is required, thus 13 bits must now be used. Three additional bits have been included to expand the module's potential. These include, pin 20 which is high when the Centigrade scale is selected and low for the Fahrenheit; pin 8, when low indicates that the lower set point is reached and similarly pin 21 when low indicates that the upper set point has been reached. Connection to a PC I/O card is now relatively

Pin	Bit	Description
1	D2	8 Tens ($\times 10$) BCD
14	D3	4
2	D4	2
15	D5	1
3	D6	8 Units ($\times 1$) BCD
16	D7	4
4	D8	2
17	D9	1
19	D13	8 Tenths ($\times 0.1$)
6	D12	4
18	D11	2
5	D10	1
7	D1	Hundreds (°F)/Sign (°C)
20	°C/°F	High for °C
8	High	Temperature Set Points Reached (Active Low)
21	Low	
9	OE	Output Bus Enable
22	OV	Ground Return

Table 3. 25-way D-type connector pin functions.

straightforward. We have used the Maplin LP12N – see Reference 2. for full details.

Connecting to a Parallel I/O Port

Electrical connection between the Converter and the Maplin 24-line PC I/O Card is made using a custom 25 D-type socket to 37 D-type socket lead as shown in Figure 7. Two important lines to note between the Converter and the I/O card are pin 9 to pin 1 and pin 10 to pin 14. The former is the Output Enable (\overline{OE}) for the Converter – if this is to be used then the link must be included as shown. The latter connection should be included if the Converter Board is to be powered from the computer. This is possible since the Converter requires a 5V power supply. When using an external supply, diode D3 and regulator RG1 reduce the 12V supply to 5V. If opting for the computer supply, then both D1 and RG1 must be removed. Alternatively if using a separate power supply, connect 12V DC to PL3, either directly to the PCB or via a two-way

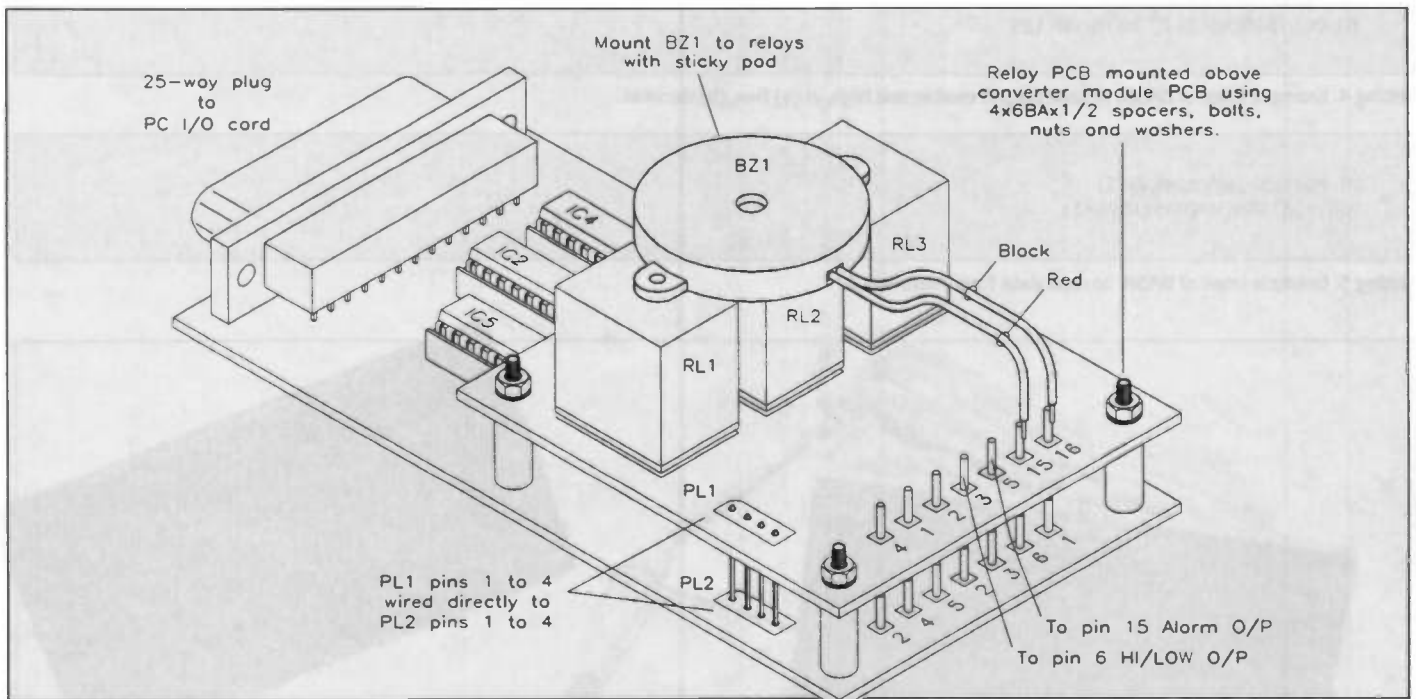
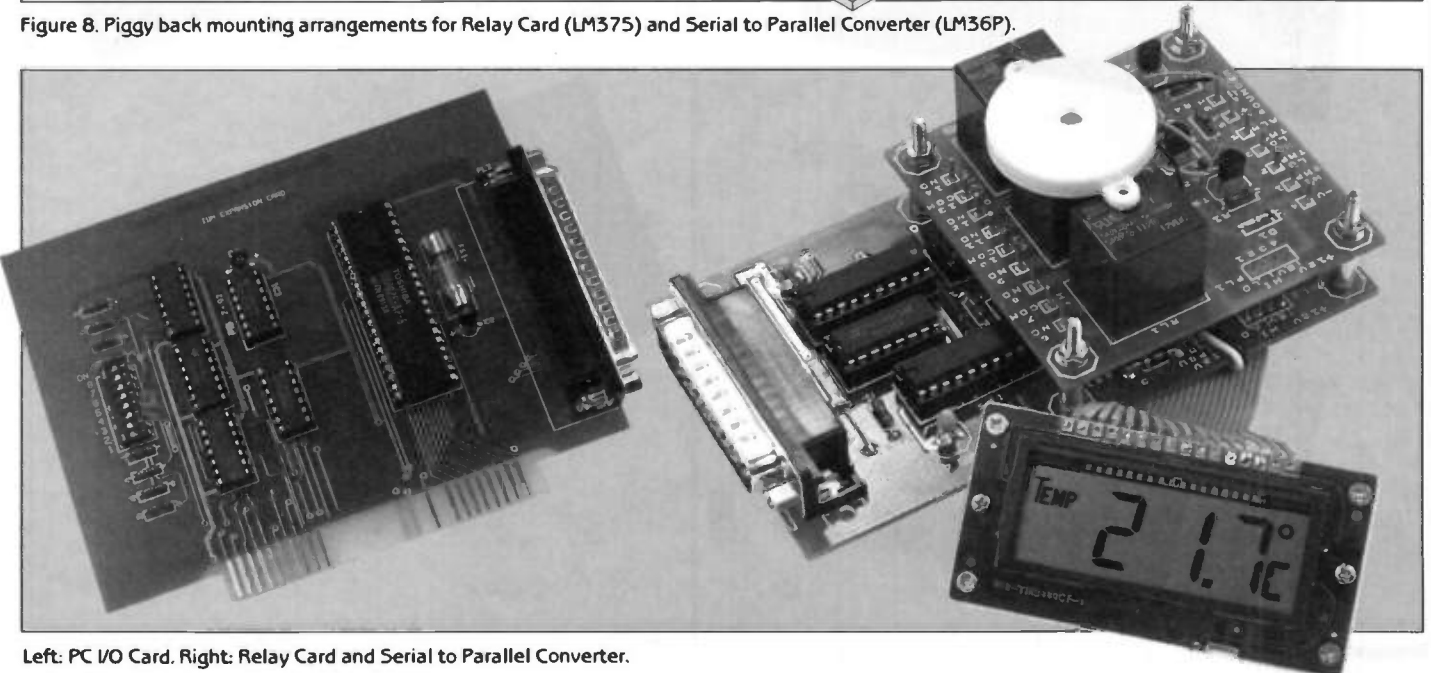

Figure 8. Piggy back mounting arrangements for Relay Card (LM375) and Serial to Parallel Converter (LM36P).



Left: PC I/O Card. Right: Relay Card and Serial to Parallel Converter.

```

10 BASEADD%=&H300
10 BASEADD%=768

```

Listing 1. Example lines of BASIC to define base address of I/O Card, in (a) hex, (b) decimal.

```

20 OUT BASEADD%+3, &H93
20 OUT BASEADD%+3, 147

```

Listing 2. Example lines of BASIC to configure ports A, B & C (lower) to input and Port C (upper) to output, in (a) hex, (b) decimal.

```

50 DAT%=INP(BASEADD%+2)
60 OUT BASEADD%+2, DAT% AND &H7F

50 DAT%=INP(BASEADD%+2)
60 OUT BASEADD%+2, DAT% AND 127

```

Listing 3. Example lines of BASIC to take output enable line low, in (a) hex, (b) decimal.

```

70 DAT%=INP(BASEADD%+2)
80 OUT BASEADD%+2, DAT% OR &H80

70 DAT%=INP(BASEADD%+2)
80 OUT BASEADD%+2, DAT% OR 128

```

Listing 4. Example lines of BASIC to take output enable line high, in (a) hex, (b) decimal.

```

90 PORTA%=INP(BASEADD%)
100 PORTB%=INP(BASEADD%+1)

```

Listing 5. Example lines of BASIC to read data from Ports A & B.

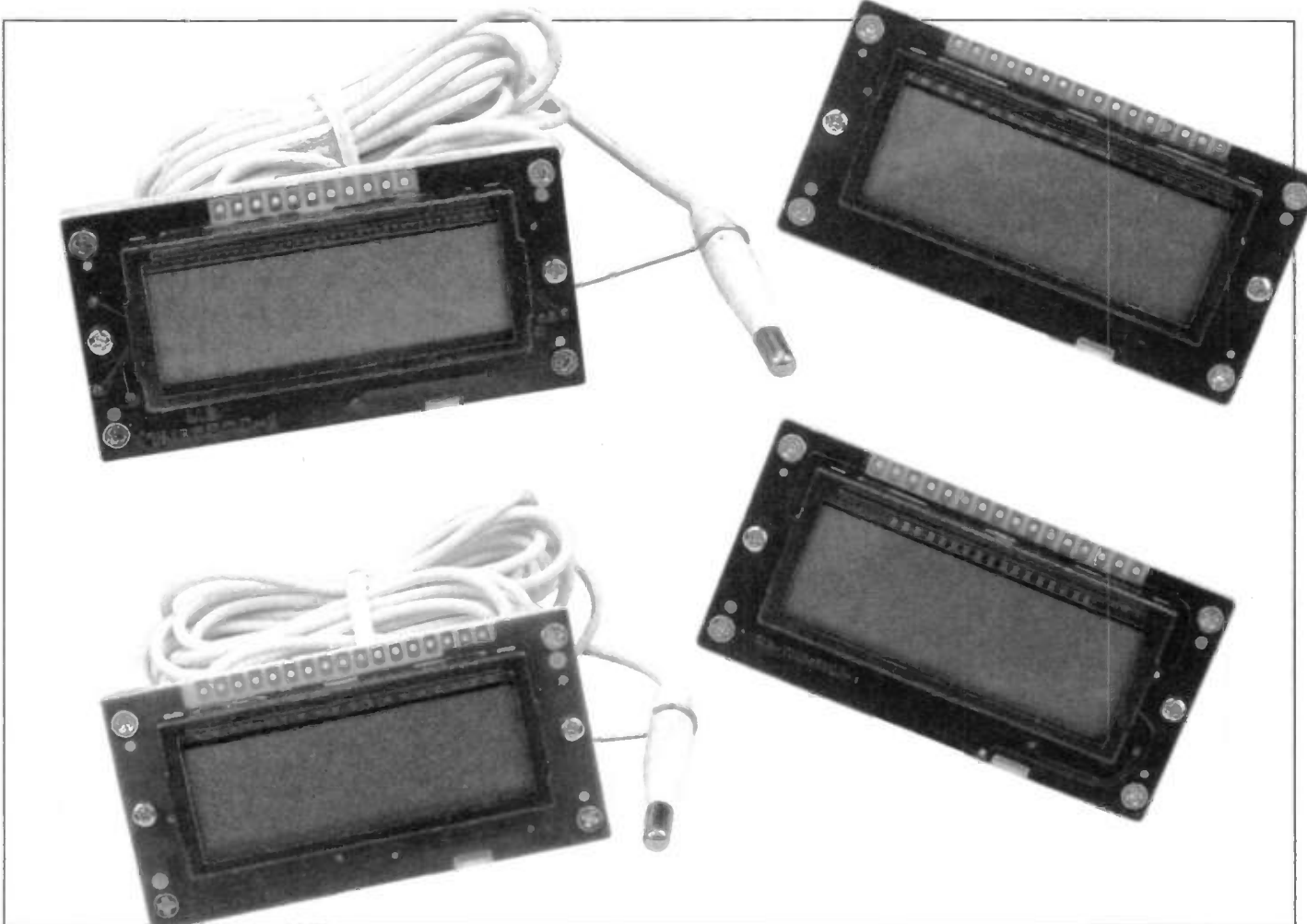

Temperature Modules.

```

1 REM SIMPLE GW-BASIC PROGRAM TO DISPLAY TEMPERATURE DATA ON IBM PC OR CLONE
2 REM REQUIRES 24-LINE PC I/O CARD & SERIAL/PARALLEL CONVERTER & TEMPERATURE MODULE
3 REM PROGRAM WRITTEN BY ROBERT BALL
4 REM COPYRIGHT (c) 1993 MAPLIN ELECTRONICS, ALL RIGHTS RESERVED
5 REM
6 REM WHEN TYPING IN PROGRAM, LINES CONTAINING REM STATEMENTS CAN BE OMITTED
7 REM PROGRAM CAN BE TERMINATED BY PRESSING 'E' KEY OR 'CTRL-BREAK'
8 REM
9 REM SET TEMPORARY VARIABLES
10 HILAST%=1: LOLAST%=1
20 CLS
25 REM DEFINE BASE ADDRESS OF PC IO CARD
30 BASEADD%=&H300
35 REM CONFIGURE PORTS A, B & C (LOWER) TO INPUT, PORT C (UPPER) TO OUTPUT
40 OUT BASEADD%+3,&H93
45 REM READ DATA FROM PORT C
50 DAT%=INP(BASEADD%+2)
55 REM MASK OFF D0-D6, RESET D7 AND WRITE DATA TO PORT C
60 OUT BASEADD%+2, DAT% AND &H7F
65 REM READ DATA FROM PORT A (UNITS AND TENS)
70 PORTA%=INP(BASEADD%)
75 REM READ DATA FROM PORT B (TENTHS AND STATUS BITS)
80 PORTB%=INP(BASEADD%+1)
85 REM SET SIGN FLAG
90 SIGN%=(PORTB% AND 16)/16
95 REM SET SCALE FLAG
100 SCALE%=(PORTB% AND 32)/32
105 REM SET HUNDREDS VARIABLE
110 IF SCALE%=0 AND SIGN%=1 THEN HUNDREDS%=1 ELSE HUNDREDS%=0
115 REM SET TENS VARIABLE
120 TENS%=(PORTA% AND 240)/16
125 REM SET UNITS VARIABLE
130 UNITS%=PORTA% AND 15
135 REM SET TENTHS VARIABLE
140 TENTHS%=PORTB% AND 15
145 REM SET LOW TEMPERATURE FLAG
150 LO%=(PORTB% AND 64)/64
155 REM SET HIGH TEMPERATURE FLAG
160 HI%=(PORTB% AND 128)/128
165 REM CALCULATE TEMPERATURE
170 TEMP=(HUNDREDS%*100)+(TENS%*10)+UNITS%+(TENTHS%/10)
175 REM ADD SIGN TO TEMPERATURE STRING
180 IF SCALE%=1 AND SIGN%=1 THEN TEMP$="-" ELSE TEMP$="+"
185 REM ADD TEMPERATURE TO TEMPERATURE STRING
190 TEMP$=TEMP$+STR$(TEMP)
195 REM ADD SCALE TO TEMPERATURE STRING
200 IF SCALE%=1 THEN TEMP$=TEMP$+"°C" ELSE TEMP$=TEMP$+"°F"
205 REM DISPLAY TEMPERATURE
210 LOCATE 1,1: PRINT TEMP$;" "
215 REM TEST HIGH AND LOW TEMPERATURE FLAGS
220 IF HI%<HILAST% OR LO%<LOLAST% THEN BEEP
230 HILAST%=HI%: LOLAST%=LO%
235 REM TEST HIGH TEMPERATURE FLAG AND DISPLAY/CLEAR MESSAGE
240 LOCATE 2,1
250 IF HI%=0 THEN PRINT "HI TEMPERATURE SET POINT REACHED" ELSE PRINT " "
255 REM TEST LOW TEMPERATURE FLAG AND DISPLAY/CLEAR MESSAGE
260 LOCATE 3,1
270 IF LO%=0 THEN PRINT "LO TEMPERATURE SET POINT REACHED" ELSE PRINT " "
275 REM TEST FOR PROGRAM TERMINATION KEY 'E'
280 IF INKEY$="E" OR INKEY$="e" THEN END
285 REM START AGAIN
290 GOTO 70

```

Listing 6. Simple BASIC program to display temperature data.

miniature connector. If intending to use the 1.5V DC supply output to drive the temperature module, then LD1 must be linked or fitted; this also serves as a power on indicator. Remove the AA cell from the battery module, but please note that all previously stored information will be lost when power is removed.

Mechanical Assembly of the Converter Board and Relay Board

Figure 8 shows the Relay Board mounted on top of the Serial to Parallel Converter. This situation is not essential since either

module can operate alone, however, Figure 8 presents a neat way of mounting and connecting the two circuit boards if both have been constructed. The Relay Card is mounted above the Converter using four 6BA nuts, bolts, washers and threaded spacers. In this instance only two connections are required from the temperature module to the Relay Card – pin 8 to pin 3 (Hi/Low Output) and pin 15 to pin 5 (ALM) of the temperature module. The other signals including the power (0V and +12V) and Hi and Low temperature output lines are extended through both cards via PL1 on the Relay Card and PL2 on the Serial to Parallel Converter. If 4-way

miniature-connectors have been fitted to either circuit board then remove them and wire directly from one board to the other. Note that the +5V output from the computer is insufficient to drive the Relay Board. In this instance it is essential to opt for a separate power supply.

Interfacing to a PC

After completing the hardware construction and establishing electrical connection between the Converter and the PC I/O Card, the next problem is to make use of the data. To do this we have opted to use BASIC, a language familiar to many readers. Although the programs

detailed have been written in GW-BASIC, conversion to other BASIC dialects should not prove too difficult.

The first task which must be undertaken before using a computer I/O card – whatever the intended task – is to define a base address within the memory of the machine for the card; this is readily achieved as demonstrated in Listing 1. Note the port parameters must be configured – this sets the various ports on the card for input or output operation, as shown in Listing 2.

Three further short listings are detailed, which demonstrate how to toggle the output enable line – Listings 3 and 4 – and then read for the I/O Card – Listing 5. The output enable function would allow the computer to control a series of cards simultaneously, polling each for data as required. Remember that if such control is required, *do not* fit PCB link LK1 on the serial to parallel converter card. Listing 5 illustrates how the data bits are extracted from the I/O Card.

Listing 6 is a complete program, enabling an IBM PC or clone to display temperature data. To this end, Listings 1, 2 and 5 are incorporated within it, although the output enable function has been omitted since a single temperature module is used. After completing configuration, the program obtains the Tens, Units, Tenths and Status bit data by scanning Ports A and B. The temperature data is then converted to a decimal number by a series of mathematical calculations and is displayed on screen. Further tests establish whether the module is set in Fahrenheit or

Centigrade mode and establish the sign of the measured temperature. Should the set points be exceeded at any time, then an appropriate message is displayed, accompanied by an audible alarm. The program is designed to continually loop, stopping only when the user presses 'E' or 'CTRL-BREAK'.

References

1. Temperature Module Expansion, *Electronics – The Maplin Magazine*, December 1987.
2. 24-Line Programmable I/O Card for IBM PC and Compatibles, *Electronics – The Maplin Magazine*, April 1991.

Ordering Information

Temperature Modules and Accessories

Temperature Module	FE33L	Price £8.95
Minimum/Maximum Temperature Module	FP64U	Price £9.95
Wide Range Temperature Module	YT99H	Price £12.95
Minimum/Maximum Dual Display Temperature Module	YU00A	Price £10.95
Plastic Mounting Bezel for Temperature Modules	FE35Q	Price 25p
Extension Probe for FE33L	FE34M	Price £2.75
Low Temperature Probe for FP64U	FP65V	Price £2.75
High Temperature Probe for FP64U	FP66W	Price £2.75

Note: Full details of modules and accessories may be found in the current Maplin Catalogue.

Interfacing Kits

Relay Interface Card Kit	LM375	Price £12.45
Serial/Parallel Converter Kit	LM36P	Price £14.95
24-line PC I/O Card	LP12N	Price £21.95

Note: Full reprints of the relevant articles are supplied with each kit.

Connectors

25-way D-type Socket	YQ49D	Price £1.20
25-way D-type Cover	FP29G	Price 86p
37-way D-type Socket	FV72P	Price £1.36
37-way D-type Cover	JB66W	Price 98p
20-core Screened Data Cable	XS21X	Price £1.45

PCB DESIGN SOFTWARE

LOW COST

RANGER 1 XT/AT PC Circuit — PCB

From Circuit Design
Through to Artwork
In One Package!

£100

Fully Integrated
AutoRouter

£50

Exchange your easy PC
For a free AutoRouter

NEW

RANGER 2 XT/AT + 386 PC

It has all the features you will ever need
at an outstanding price. But now with a new 2
layer 386 Ripup & Retry AutoRouter

£599

Option Pack 100% Router
Simultaneous 6 layer Ripup & Retry
AutoRouter with via Minimisation.
Autocad DXF in & out. GERBER in.

£350



Call us for details & demo disk on 0705 591037

SEETRAX
CAE



Seetrax CAE, Hinton Daubnay House, Broadway Lane, Lovedean, Hants. PO8 0SG

Tel: 0705 591037 Fax 0705 599036

A PRACTICAL GUIDE TO

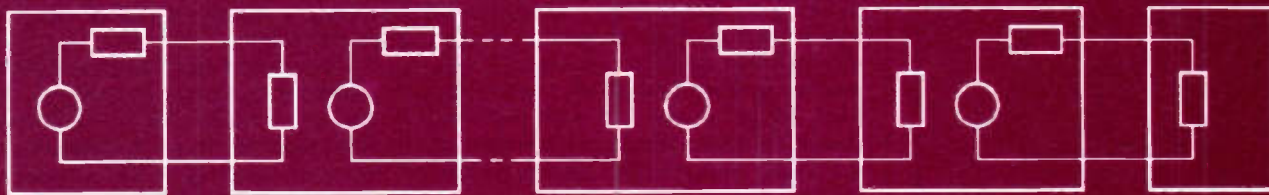

IMPEDANCE MATCHING AND MISMATCHING

by R. H. Pearson

BSc(Eng.), CEng., M.I.E.E.

Audio, radio and many other electronic systems consist largely of chains of modules, through which signals pass from one end to the other. At every interface between modules, impedances need to be suitably matched to ensure correct operation. But the word 'matched' can be ambiguous and can easily lead one astray. In some situations modules fit well together when impedances are equal but in many others it is necessary to have a considerable impedance mismatch.

BUYERS of ready made equipment and many kit builders do not want or need to get involved with all the subtleties that a circuit designer has to master; but they do need sufficient grasp of the subject to avoid anxiety or being misled.

Advertisers do not always help and in the face of intense competition, may even feel obliged to follow the crowd and choose incorrect terminology because that is what potential customers are used to seeing elsewhere. The classic case that has been repeated for at least 40 years is in the specification of domestic Hi-Fi systems. Even the most reputable firms have yielded to a quite absurd format such as 'Output Impedance 4Ω, Output Power 50W rms'.

Usually this really means that the Output Impedance is much less than 4Ω, that the most suitable impedance of the load to be attached is 4Ω and that the Output Power, when the signal is sinusoidal in waveform, can be at least 50W average. Incidentally, there is in fact no such unit as 'Watts rms' –

it is merely a mistake that springs from the relationship;

$$P_{AV} = V_{RMS} \times I_{RMS} \times \cos(\Theta)$$

When selecting modules to work together there are of course other factors to consider for compatibility, such as signal levels, noise levels and frequency response, but impedance matching seems to cause most confusion. The following attempts to ease problems and is a simplified account of the main principles and applications of *Impedance Matching*.

IMPEDANCE

Although simple 'resistance' will serve the present purposes, the more general term 'impedance' is widely used to embrace it and so deserves just a mention.

Resistance (*R*), Reactance (*X*) and Impedance (*Z*) all have the same form. In every case the magnitude is simply the ratio V/I – the voltage divided by the current. Impedance implies that the voltage and current may be out of phase with each other. When this is important the phase angle becomes involved in calculations. Reactance differs from Impedance only in that the phase angle is specifically plus 90° (inductive) or minus 90° (capacitive). Resistance differs only in that the phase angle is specifically zero. It is often convenient to regard impedance as a series combination of resistance and reactance.

SOURCES AND LOADS

The choice or design of modules in an analogue system is greatly simplified if each is regarded as a source of signal or

power, loaded by the input impedance of the following module. The first item in the chain is often a transducer that produces an electrical signal proportional to some physical quantity such as air pressure or velocity – as in the case of a microphone – and the very last, a transducer working the other way round, such as a loudspeaker. All modules in between will have some 'Input Impedance (Z_{in})' that loads the previous one in the chain. Also each will have an 'Output emf (E_o)' in series with an 'Output Impedance (Z_o)' as shown in Figure 1.

E_o is sometimes called the 'Source emf' or the 'Open Circuit Voltage'. Z_o may be called the 'Source Impedance' or 'Internal Impedance'. Equally, Figure 1 is not the only type of 'equivalent circuit' or 'circuit model', nor is it necessarily derived from the physics of any practical device but it does give a reasonable representation of many operating conditions.

It saves a lot of bother to remember that many types of equivalent circuit are entirely man-made and chosen to simplify the ensuing mathematics rather than to offer a close fit to practical characteristics. For the present purpose there is no need to get involved in any advanced mathematics at all. For nearly all interfaces at less than radio frequencies, it is practicable to work in terms of input and output resistance R_{in} and R_o rather than the more general term impedance.

CHOOSING A LOAD RESISTANCE

A simple DC source such as a battery might have a load characteristic like that in Figure 2, which also shows a simple equivalent

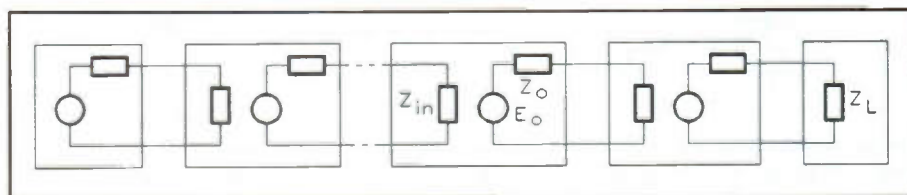

Figure 1. A typical electronic system as a chain of sources and loads.

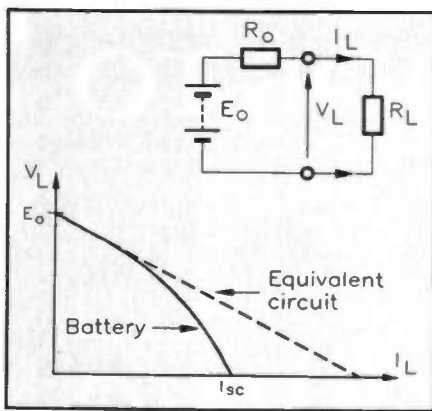

Figure 2. Battery load characteristic and simple equivalent circuit.

circuit that serves well enough for moderate load currents during normal operation, but which would not correctly predict the short circuit current.

What would be a sensible resistance R_L to connect to such a battery? To help our choice we can plot out what happens when we vary the load resistance as shown in Figure 3. The horizontal axis can be applied to any practical case because it is given as a ratio R_L/R_0 . The output power is greatest when R_L is equal to R_0 , and so this may be thought the most attractive condition. It is indeed confirmed by a formal proof in many text books and is the main part of the so called 'Maximum Power Transfer Theorem'.

But is it always relevant? Before answering, look at the power efficiency curve. This shows the proportion of the total power that reaches the load. At the $R_L/R_0 = 1$ condition the power efficiency is only 50%. In many practical circumstances even that may not be the worst feature.

Imagine a large power station supplying a nearby town with electricity. If the load

imposed by the town were chosen to equal the effective internal resistance of the generators, the generators themselves would get as hot as all the lamps, heaters and other appliances in the whole town! So as well as a staggering fuel cost, the power station cooling would present an intolerable problem. As if that were not enough, another problem would also arise. The load voltage would vary with the load current. If all the customers switched off the supply voltage would double; no joke for the lamps of the early risers!

In fact the load voltage varies with the load resistance in exactly the same way as the efficiency in Figure 3. So for all these reasons it is very unusual indeed to choose

matching – or equal – resistances, source and load, when considering a power system. A more usual condition is to make the load resistance at least 10 or 20 times the source resistance so that the load voltage is always reasonably close to the source emf.

This is one of many cases in which a very deliberate mismatch is required. It can lead to a really silly misunderstanding when one party to a conversation is using the word 'matched' in the everyday sense of 'these items of equipment are well matched' and the other person is wondering if impedances need to be equal or different.

TRANSFORMERS

There are several ways in which impedances can be transformed from an existing figure to a more convenient one. Wound transformers, on a magnetic core, are excellent for power and audio frequencies, but they are usually rather expensive for high quality audio usage. Radio frequency transformers are generally much cheaper and very widely used in receivers and transmitters.

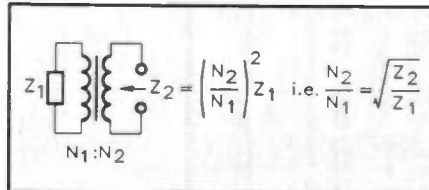

Figure 4. Using a transformer to change an effective impedance.

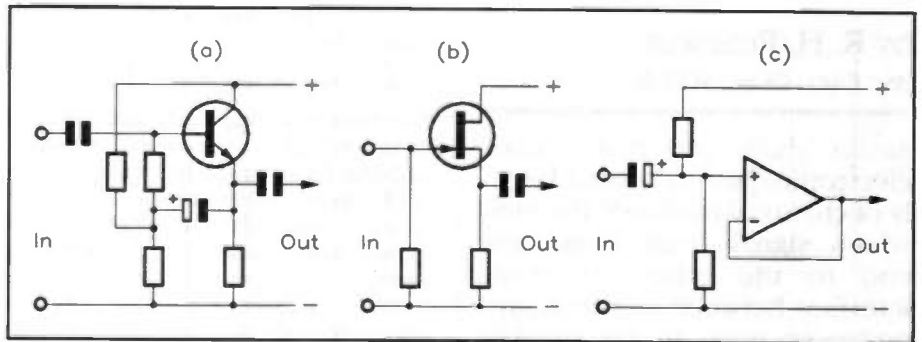

Figure 5. Voltage Follower circuits with a high input resistance and a low output resistance: 5(a). Emitter Follower; 5(b). Source Follower; 5(c). Integrated Circuit amplifier connected for unity voltage gain.

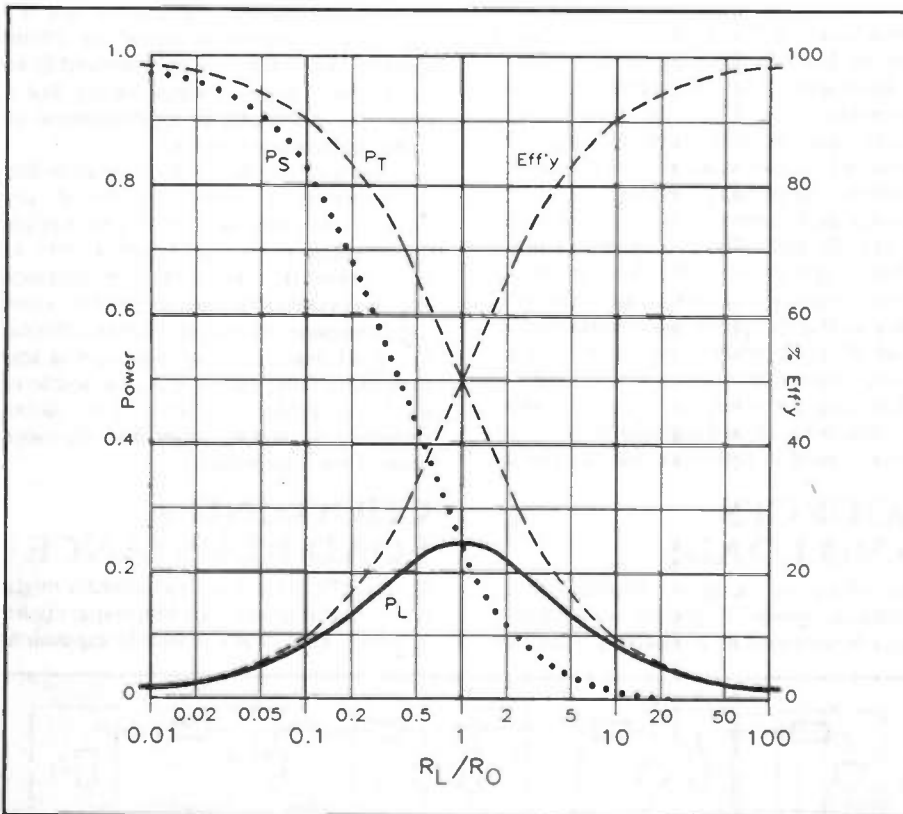

Figure 3. Power and Power Efficiency and how they vary with the load/source resistance ratio; P_L = Power reaching the load; P_S = Power wasted in source; P_T = Total power generated; Power Efficiency = $(P_L/P_T) \times 100\%$.

In addition, combinations of inductance and capacitance can be used over a very limited frequency range to transform an impedance and, especially, to 'tune out' an unwanted reactance. At very high frequencies it also becomes practical to use transmission lines such as coaxial cables as impedance transformers.

It is easy to calculate the required turns ratio n of a wound transformer, see Figure 4, the impedance ratio is proportional to the square of the turns ratio.

There are also many ways of connecting feedback amplifier circuits to produce required input and output impedances. The most common circuits are 'voltage followers' which have near to unity voltage gain, a high input resistance and a low output resistance. A single bipolar transistor connected as an 'emitter follower' or a single field effect transistor connected as a 'source follower' can be used in this role, as can a single integrated circuit amplifier; for examples of each see Figure 5.

POWER OUTPUT STAGES IN ELECTRONIC SYSTEMS

Besides sometimes being irrelevant there are often reasons why the 'Maximum Power Theorem' may not apply in practice

because its proof and validity assume no limits of current, voltage or power. In real life this is never the case. Electronic amplifiers contain active devices that can only operate safely within certain limits of current, voltage and power. Besides safety limits there are also tighter restrictions of satisfactory operation in respect of non-linearity and consequent production of distortion to signal waveforms. Overriding even these limitations is the fact that an electronic amplifier does not actually generate power, it only controls what is available from its power supply and that is necessarily limited in one or more aspects.

For example, a car radio running from a 13V DC supply and not using an output transformer or bridge configuration output staged can only provide the loudspeaker with 13V Pk-to-Pk even using ideal transistors. This limits the possible output power to 2.64W with an 8Ω loudspeaker or 5.28W with a 4Ω one.

CONNECTING LOUDSPEAKERS

The electromechanical moving parts of a loudspeaker interact with the amplifier that drives it. For best operation of the loudspeaker, the amplifier output impedance should be much less than the loudspeaker impedance. Although the nominal loudspeaker impedance may typically be 4, 8 or 15Ω, there is normally a considerable variation of loudspeaker impedance over the audio frequency range, rising a lot at high frequency and rising suddenly to one or more peaks at low frequency, with many smaller variations in between. The lowest loudspeaker impedance specified as suitable for a particular amplifier really should be regarded as an absolute minimum, otherwise excessive current output may damage or overheat the amplifier – or inconveniently blow a fuse or trip a cut-out. It is normally quite safe to use a higher than specified loudspeaker impedance as long as the consequent reduction in output power is acceptable. An 8Ω speaker will limit the output power of an amplifier specified for 4Ω to only half the rated power – a difference of 3dB, which the human ear would be barely able to detect.

One exception to this concept occurs with the relatively rare audio amplifiers that employ an output transformer – as all thermionic valve amplifiers used to do before the transistor era. In this case it may not be safe to leave the speakers disconnected while the amplifier is working, owing to the unusually high voltage that may arise at the transformer primary.

CONNECTING HEADPHONES

For the most critical listener using very expensive headphones it is, as with loudspeakers, important to use an amplifier with a low output impedance. In fact, many headphone output sockets on ready made Hi-Fi assemblies and similar equipment do not make this provision. The reason is that a resistive attenuator is usually needed to prevent the headphones being wrecked by the full power of the main amplifier. The cheapest solution is to

use a pair of resistors as a potential divider and usually with a much higher resistance than the amplifier output resistance. This is usually adequate for most listeners. If you wish to fit such an attenuator then try 10 or 12Ω across the headphones and 100 or 220Ω series feed from the amplifier.

CONNECTING ANTENNAS TO TRANSMITTERS

Most amateur radio transmitters use a transformer or an LC tuned circuit to raise the optimum load resistance from an ohm or so up to about 50 or 75Ω. This enables standard cables to be used, going either directly to an antenna or, via a separate antenna impedance matching unit. Radio frequency power amplifiers deliver their rated power to resistive loads not too different from the specified resistance. Although they usually contain protection circuits that automatically reduce the power when the resistance of the load is too high or too low, it is not wise to operate for long periods with loads of more than about twice or less than half the specified figure.

A quick and popular method of impedance measurement is usually one made indirectly using a reflectometer, operated to give an indications of Standing Wave Ratio (SWR). The load for which the meter is designed results in the lowest possible reading and corresponds to an SWR of 1.0. Higher or lower loads will result in a Higher SWR indication. For example a 25Ω or a 100Ω load will each produce a reading of SWR=2 on a 50Ω reflectometer.

TRANSISTOR INPUT AND OUTPUT RESISTANCES

In all but the power output stages of most equipment, signal amplitudes are small compared with the supply and bias voltages so that characteristics of transistors have fairly constant slopes. They can therefore be modelled with simple equivalent circuits, using constant resistances. The most common approximations for R_{in} and R_{out} are shown in Figure 6, in which all extraneous bias and coupling circuits have been removed. For bipolar transistors, the key quantities you need to know are the small signal current gain h_{fe} and the direct emitter current I_e , expressed in milliamps. For this purpose the emitter and collector currents can be taken as nearly enough equal.

The emitter current determines a crucial and very useful transistor parameter, the resistance $r_e = 25/I_e$ which is used in Figure 6. The resistor labelled R_e using a capital R, refers to any unbypassed impedance in the emitter circuit. The input resistance shown will of course be shunted by any bias resistances across the input circuit. In many cases these will have a significant effect, but there are crafty ways to get round the difficulty when seeking a high input resistance. One appears in Figure 5a where the lower end of the resistor connected to transistor base is forced to echo the voltage follower output. Since the output voltage is only very slightly less than the input voltage, the potential difference across the base resistor is much less than either input or output voltage. The current

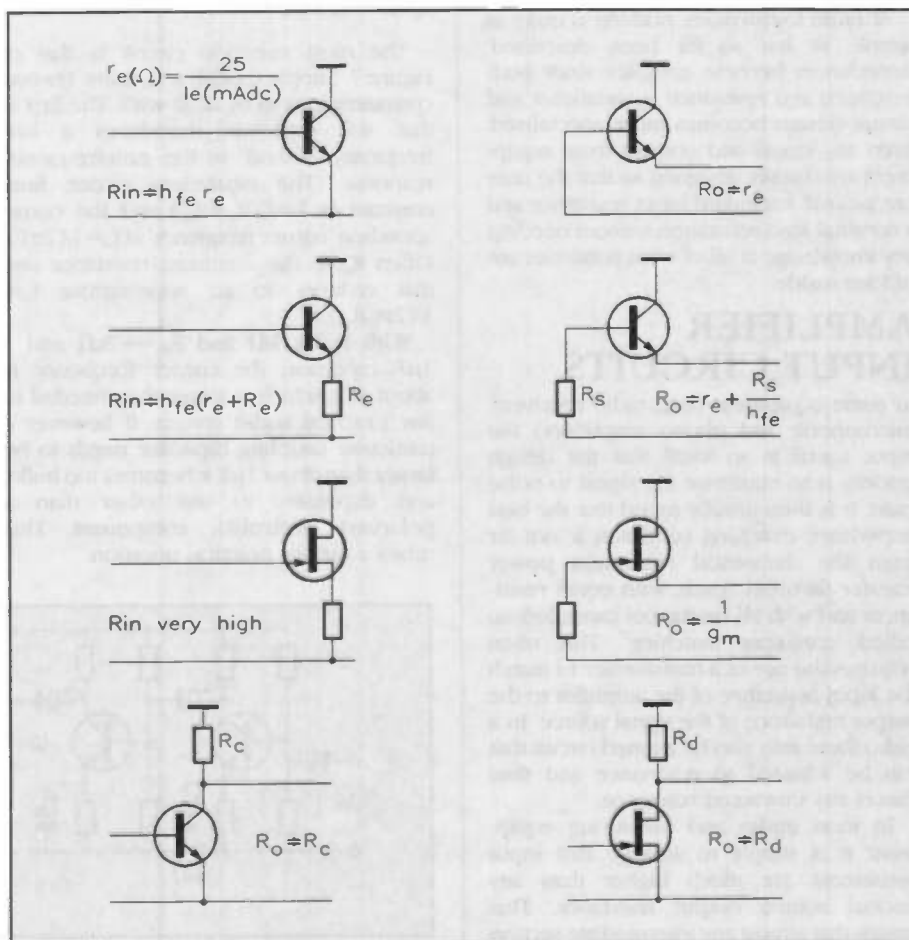

Figure 6. Estimating Input and Output Resistances for typical Bipolar and Field Effect Transistor amplifier stages.

is therefore much less than if the resistor had been placed directly across the input and the effective input resistance is correspondingly higher. The same principle applies to the internal input resistance of the transistor itself.

The output resistance at an emitter or source electrode is not just that of any resistor connected there, but appears in parallel with what is usually a much lower resistance as shown in Figure 6. This is often overlooked when choosing an emitter or source bypass capacitor. However, do not make the error of assuming that a transistor biased to a few milliamps of standing current will be able to supply vastly more, just because the output resistance calculated from small signal theory predicts a very low output resistance. This error is one of the most commonly seen, even in equipment from respectable sources!

Field effect devices have input resistances high enough to be treated as almost infinite, except in specialised measuring and timing circuits. For a FET, the output resistance at the source electrode depends upon the mutual conductance g_m (also called transconductance or y_{fs}) of the device. For small signal devices this is usually quoted in mS (millisiemens) or mA/V which amounts to the same thing; the reciprocal $1/g_m$ or $1/y_{fs}$ is thus a value in kilohms.

When the output is taken from the collector of a bipolar transistor – or the drain of an FET – it is likely that the output resistance of the device used will be too high to be of importance when in parallel with the resistance of any load connected to it. An exception may occur when the load is a tuned circuit.

At radio frequencies, nothing is quite as simple as has so far been described. Impedances become complex since both reactance and resistance is significant and circuit design becomes more specialised. Even so, inputs and outputs from equipment are usually designed so that the user can assume a standard input resistance and a nominal load resistance, without needing any knowledge at all of what subtleties are hidden inside.

AMPLIFIER INPUT CIRCUITS

In some equipment (e.g., radio receivers, microphone and phono amplifiers) the input signal is so small that the design priority is to maximise the signal to noise ratio. It is then usually found that the best impedance matching condition is not far from the theoretical maximum power transfer theorem result, with equal resistances and with all reactances cancelled; so called 'conjugate matching'. This often requires the use of a transformer to match the input resistance of the amplifier to the output resistance of the signal source. In a radio there may also be a tuned circuit that can be adjusted to resonance and thus cancel any unwanted reactance.

In most audio and measuring equipment it is simple to arrange that input resistances are much higher than any normal source output resistance. This means that almost any intermediate section of a Hi-Fi system can be connected to the next without worrying about impedance

matching. Other factors may of course be relevant.

A widely used standard for domestic audio equipment has been 47k Ω for input resistance and 4.7k Ω for output resistance. This is achieved by deliberately shunting inputs with a parallel resistor inside and adding series resistance to all but power output stages so that short circuits can do no damage to intermediate stages.

AC COUPLING AND LOW FREQUENCY RESPONSE

In some medical and industrial instruments it is necessary to directly (DC) couple each stage of a system to the next. This requires some sophistication in the design to minimise DC offsets early in amplifier chains. In most domestic applications these problems can be avoided by AC coupling using capacitors or transformers.

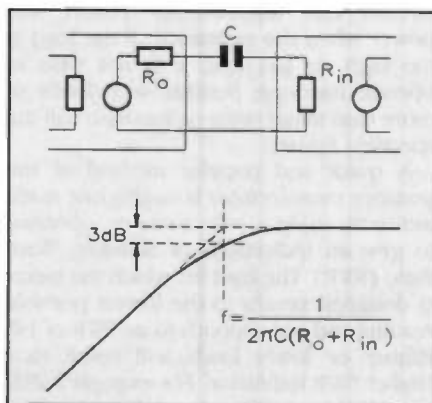

Figure 7. Estimating the effect of an AC coupling capacitor upon overall frequency response.

The most common circuit is that of Figure 7. Simple though it is, there are two considerations to be dealt with. The first is that the capacitor introduces a low frequency 'roll-off' in the gain-frequency response. The equivalent circuit time constant is $T=C(R_o+R_{in})$ and the corresponding 'corner frequency' is $f_c=1/(2\pi T)$. Often R_{in} is the dominant resistance and this reduces to an approximate $f_c=1/(2\pi CR_{in})$.

With $R_o=4.7k\Omega$ and $R_{in}=4.7k\Omega$ and a $1\mu F$ capacitor, the corner frequency is about 3Hz which is lower than needed in any practical audio system. If however a particular coupling capacitor needs to be larger than about $1\mu F$ it becomes too bulky and expensive to use other than a polarised electrolytic component. This raises a further practical question.

WHICH WAY ROUND TO CONNECT THE COUPLING CAPACITOR?

There is more in this than meets the eye; yet it has become common practice always to show one particular way even though it may be quite wrong in some applications. An input circuit commonly seen in hobby magazines is that of Figure 8a. It is rarely mentioned that the capacitor will only be correctly polarised if there is no positive direct component of the input signal greater than the base bias voltage of the input transistor. If the input signal comes from a previous transistor stage output directly, the voltage there is quite likely to exceed the base bias voltage. In that case the capacitor will need its negative terminal connected to the base of the input transistor.

While on this subject, it is worth mentioning the error that is sometimes made in connecting an emitter bypass capacitor when using truly split power supplies, one positive and one negative with respect to the common rail. This supply scheme simplifies transistor biasing but it may be forgotten that with an NPN transistor, the base is biased more positive than the emitter so that, if the base is set at the common rail potential, the emitter will be at a negative potential. The correct polarity for an emitter capacitor between emitter and the common rail is shown in Figure 8b – be warned, it may seem surprising at first glance.

CONNECTING A MICROPHONE

A microphone, like a loudspeaker, is an electromechanical transducer and there is interaction between its motion and the electrical circuit to which it is connected. In the most critical applications it is therefore necessary to load it with a specified resistance. This can be accomplished by a transformer or often more cheaply, by an active electronic amplifier circuit.

Suppose a low impedance microphone generates about 1mV emf and has an internal resistance of 5 Ω . To connect it to an amplifier with an input resistance of 50k Ω one might use a transformer with a voltage step-up ratio of 1:100 as in Figure 9. The equivalent circuit is shown referred to the output side but it might equally well have been shown as it affects the input side

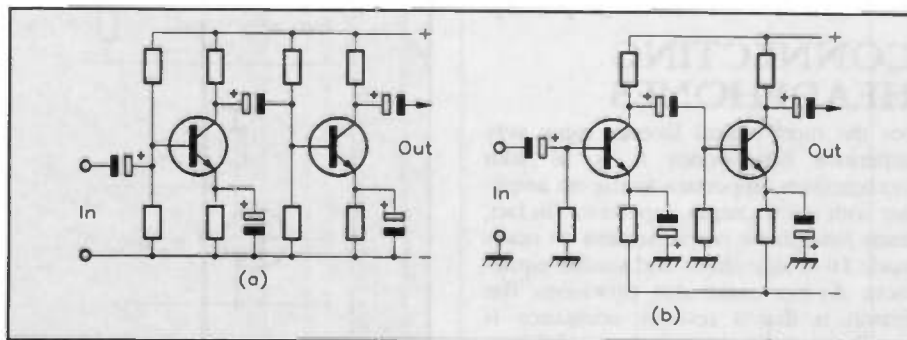

Figure 8. Typical AC coupled stages using polarised capacitors: 8(a). Single DC supply; 8(b). Dual DC supply.

Wide Range Lightmeter

by Ben Sullivan

RECENTLY I had to photograph some electronic apparatus, to illustrate a magazine article. The black and white 120 roll-film duly developed, it was time to unearth the enlarger from the dark recesses of the loft and produce a nice contrasty enlargement. In earlier times, when making enlargements, I had been in the habit of doing a test strip first, to get the exposure right. But this is rather a messy and time-consuming business, so the thought occurred that it would be nice to have a light meter to take some of the guesswork out of the process. My ancient Gossen photographic exposure meter covers a range of Light Values (LV) from LV 5 to 17 – when set for a film speed of ISO 100/21 – and its readings agree exactly with the Exposure Values (EV) read by the built-in light meter of my slightly less ancient Minolta 7S. Both meters proved far too insensitive for enlarging work. So an OC71 was unearthed from the drawer labelled 'odd transistors' and the paint scraped off, to convert it into an OCP71. I am told that this does not work nowadays,

as they changed the grade of muckite filling, but *my* OC71s are *very* old. Whilst it worked perfectly well as a photo-transistor in medium to bright light, being a germanium type there was an appreciable leakage current. That meant that as the light got dimmer, the current stopped falling, reaching an irreducible minimum at a level far higher than would be encountered in enlarging.

The circuit and information presented here must be considered as a basis for your own experimentation, no warranty is given for suitability in particular applications, reliability or circuit operation. Maplin cannot support, in any way, the information presented here. However, where possible, we will endeavour to check that information presented, is correct and that circuits will function as stated.

A more modern phototransistor was therefore needed, and the drawer labelled 'Opto' yielded a 2N5777 silicon photo-Darlington; this proved to have a collector leakage current of a nanoamp or less, even with the base open circuit. This permitted extremely low light levels to be measured, so low in fact that it was necessary to incorporate a small LED into the finished instrument, to illuminate the scale sufficiently so that it could be read! At the other extreme, the range can be extended to very bright light – even sunlight – by shorting the phototransistor's base to its emitter. This prevents the photocurrent being amplified by the gain of the transistor, reducing the sensitivity by typically two orders of magnitude or more. The current through the phototransistor – operating in the photoconductive mode – was made to flow through a load resistor, the resultant voltage drop being applied to an op amp which drives the meter. A choice of load resistors enables a wide range of light intensities to be covered.

Design Considerations

Since the current through the phototransistor at low light levels is only a matter of a few nanoamps, an op amp with a very high input impedance was needed. This is a requirement which is easily fulfilled by that old favourite, the CA3130, which also has the advantage of operating quite happily with an input voltage at or near the negative supply rail. The voltage applied to the phototransistor was stabilised to maintain accuracy as the battery voltage falls. A 9V PP3 battery powers the circuit and since only occasional operation is required, the ON/OFF switch is a push-button rather than the more conventional toggle switch; this prevents the unit being accidentally left ON. Obviously, at the higher light levels, the LED is not needed to illuminate the scale, so it was provided with an

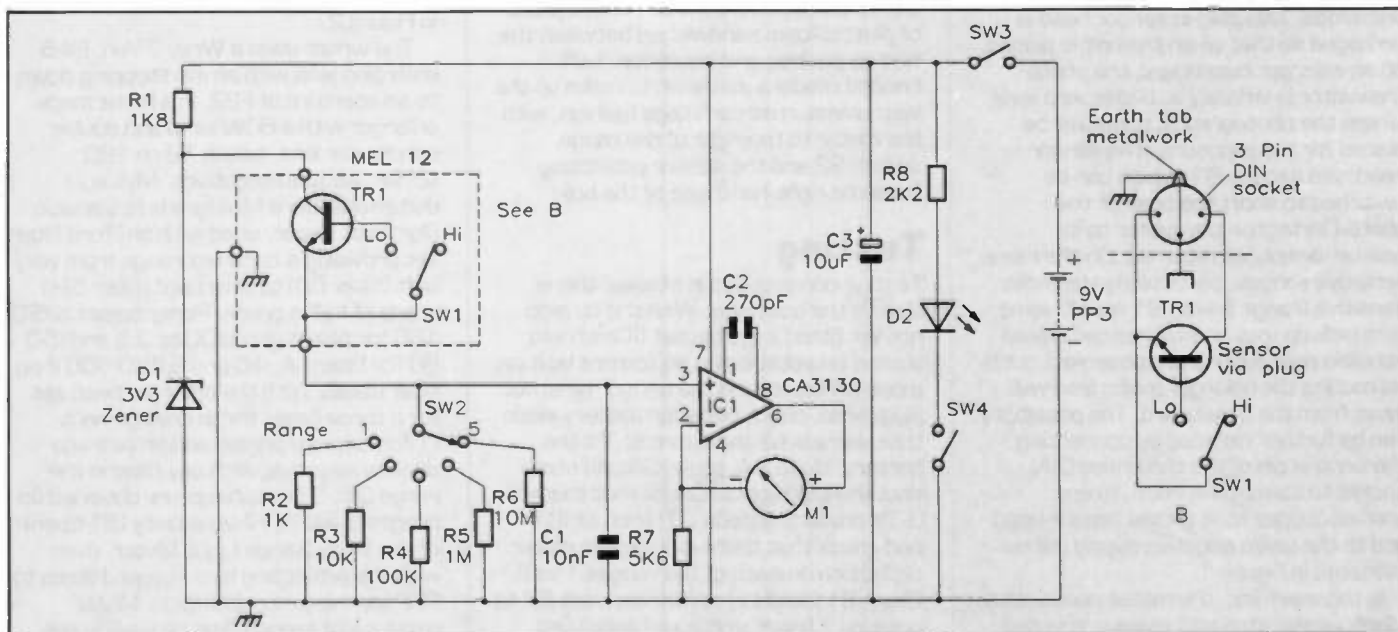

Figure 1. The circuit diagram of the Wide Range Lightmeter

ON/OFF switch, to conserve battery life. At a later stage it was discovered that the 2N5777 is now hard to find, so an MEL12 photo-Darlington was substituted; the performance of the two devices proved to be very similar.

How it Works

The circuit is shown in Figure 1. The 3.3V reference voltage provided by D1 is applied to the MEL12 NPN photo-Darlington transistor TR1 and the resultant current flows through a load resistor in the range 1kΩ to 10MΩ, as selected by the light range switch S2. The stated dark current of this device — base open circuit — is 100nA, which would make the most sensitive range unusable, but this must be a worst case figure, possibly at elevated temperature, since the measured leakage current was very similar to that of the 2N5777, around 1nA. The potential drop produced across the selected load resistor is applied to the non-inverting input of op amp IC1, which drives sufficient current through the meter M1 to cause the inverting input (pin 2) to rise virtually to exactly the same voltage as pin 3. The inclusion of C1 minimises the likelihood of problems due to hum pick-up, which might otherwise be experienced on the more sensitive ranges. C1 must be a low leakage type. Unlike many op amps such as the 741, the CA3130 is not internally compensated for gains down to unity, so stability is ensured by the 270pF capacitor between pins 1 and 8. C3 decouples the supply rail and light emitting diode D2 provides illumination of the meter scale if required, enabling it to be read when there would otherwise be insufficient ambient light.

Construction

The prototype was constructed in a Maplin Project Box model PX2 with the meter and switches S2 to S4 inclusive, mounted on the front panel. The phototransistor is mounted on a short length of copper strip board four holes wide, soldered to the pins of the inner portion of a 180° DIN plug, the rest of which is discarded. This plug-in sensor head is arranged so that when the unit is placed on an enlarger baseboard, the photo transistor is virtually at baseboard level, where the photographic paper will be placed for the exposure. The sensor head also carries S1, which can be switched to short the base of the photo-Darlington transistor to its emitter or not, as required. On the more sensitive ranges, particularly the most sensitive (range 5 with S1 open), some hum pick-up may be experienced unless sensible precautions are observed, such as routing the enlarger mains lead well away from the baseboard. The possibility can be further reduced by connecting the central pin of the three way DIN socket to its metal shroud, to any unused copper strip on the sensor head and to the unit's negative supply rail as indicated in Figure 1.

In the main unit, the meter used was a Maplin signal strength meter, mounted behind the panel using an adhesive, with

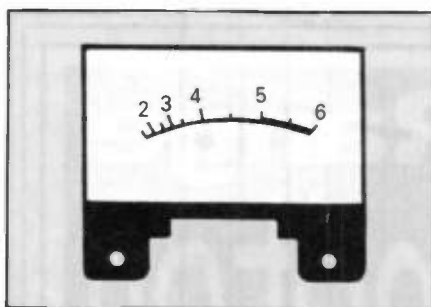

Figure 2. A suitable scale for use with the meter specified in the component list. It may be stuck over the existing scale, to provide relative LV (EV) readings. One scale division corresponds to one stop on the enlarger lens.

the scale area projecting through a 22 x 36mm cut-out; the ABS plastic of the box is fairly soft and hence very easily worked with simple tools. The scale shown in Figure 2 may be cut out and glued over the meter's existing scale, after removing the meter front cover — an easy task as it is only attached by a strip of adhesive tape. Take care to carry out this job in a scrupulously clean area; any trace of ferrous filings or ferrite dust can spoil your meter for ever! The modified meter provides a readout approximately in LV or EV — referred to an arbitrary datum. The circuitry in the prototype was constructed on a piece of stripboard about 45 x 55mm, which was mounted on the tags of S2, the range switch. The circuit board also carries the LED — which is placed to shine through the transparent meter case so as to illuminate the scale — together with all the components shown in Figure 1 except the meter, battery, switches, DIN socket and sensor head. On completion of construction, all wiring and joints on the circuit board should be examined with an eyeglass, to catch any dry joints, shorts between tracks or other potential sources of troubles, before mounting it on the tags of S2. Pieces of stripboard can be cut to fit into the vertical board guides of the case, so as to form a battery compartment for the PP3 battery. This sits underneath the meter, with a piece of plastic foam sandwiched between the two as packing and insulation. Left-handed readers may wish to make up the instrument in mirror image fashion, with the meter to the right of the range switch S2 and the sensor projecting from the right-hand side of the box.

Testing

Testing can proceed in stages; this is always the best way. With the op amp not yet fitted in its socket (ICs should always be socketed in equipment built on a one-off basis) and the sensor head not plugged in, check between battery leads that there is no short circuit. Fit the battery, close S4, press S3 and check that the LED lights. Check that there is 3.3V present across D1, then fit IC1 and check that there is negligible meter deflection on each of the ranges 1 to 5. Close S1 (sets LO sensitivity), set S2 to position 1 (least sensitive range) and plug in the sensor head. Full-scale

deflection should be obtained with the phototransistor sensor an inch or so from a 60W bulb (this corresponds approximately to direct weak sunlight). Check with steadily reducing light levels that indications are obtained down to near-complete darkness, increasing the sensitivity as necessary with S1 and S2.

The absolute sensitivity of the finished unit will depend upon the sensitivity of the particular phototransistor used, the MEL12 type shown in the components list proving to have the same sensitivity as the 2N5777 on the HI setting and about 2 LV units less sensitive on the LO, at least for the two samples tested. Variations between individual samples of the MEL12 should hopefully be minimal. Calibration against a commercial photographic light meter is in principle possible, but not satisfactory as the commercial item will have a very much narrower angle of light acceptance than the phototransistor used in this unit. This means that if the two are arranged to agree when looking at a point light source they will disagree when looking at a diffusely lit scene, and vice versa.

Using the Lightmeter

The primary use intended for this Wide-Range Light Meter was as an aid in enlarging work, for which use, the HI sensitivity ranges are required. In this connection, remember that each *increment* on the meter scale, e.g., 5 to 6, corresponds to a *doubling* of the brightness, requiring a one stop *narrower* aperture on the lens, e.g., F11 to F16, or to a *halving* of the exposure time, e.g., 10 to 5 seconds. One range change, e.g., range 4 to range 3, corresponds to a tenfold *decrease* in sensitivity, i.e. a tenfold *increase* in light intensity for a given scale reading. To obtain light values relative to the meter gradations on the most sensitive range, range 5, add 3.16 for each position of the range switch; e.g., a meter reading of 5 on range 3 becomes $(5 + (2 \times 3.16))$ or 11.3. If you are using one of the popular small VU meters in place of the meter in the component list, then 6dB corresponds to one division on the scale in Figure 2.

The writer uses a Wray 3 1/4in. F4.5 enlarging lens with an iris stopping down to an aperture of F22, in a home made enlarger with a 60W lamp and double condenser lens, taking 12 on 120 (2 1/4in. square) negatives. My usual material is Ilford Multigrade III Variable Contrast Paper, used with an Ilford filter set providing a contrast range from very soft (filter 00) to very hard (filter 5) in steps of half a grade. Paper speed is ISO 160 for filters grade 00 to 3.5 and ISO 80 for filters 4, 4.5 and 5 (ISO 400 if no filter used). With the enlarger head set for a three times linear enlargement (17cm square prints) and an average density negative, with any filter in the range 0 to 3.5, readings are obtained on ranges 3 and 4, HI sensitivity (S1 open) of the Wide-Range Light Meter, even with the projecting lens stopped down to F22 for maximum definition. Meter readings of around 3 on range 3 in the brighter areas (appearing as shadow

areas in the developed print) and around 4.5 on range 4 in the darker areas were obtained (these figures corresponded to a ten second exposure time). Adding 6.3 on range 3 and 3.2 on range 4, these correspond to light values referred to the most sensitive range, range 5, of 9.3 and 7.7 respectively. It is clear therefore that the Wide-Range Lightmeter has adequate sensitivity to cope with even the largest practical enlargements, bearing in mind that the light measurement can be made with the lens at a wider aperture and then stopped down for the exposure.

With its very wide range of sensitivity, much greater than a normal photographic exposure meter, many other uses will occur to the reader. One possibility I mean to explore is the

possibility of changing the unit's acceptance angle of light from very wide to something much narrower. This could be achieved by fitting a lens in front of the photo-transistor, or much more simply — at the expense of reduced sensitivity, which is not a problem as there is more than enough — by adding a short length of snug fitting internally blackened tube over the round body of the photo-transistor. For this application, a different sensor head with the photo-transistor looking away from the case, rather than at right-angles, would be more appropriate.

It should be realised that the sensitivity of the unit will vary somewhat with temperature, especially on the HI sensitivity ranges (S1 open). But the temperature is not likely to vary widely

during any particular enlarging session, and the unit provides a useful check on the required change in exposure or aperture needed when changing the size of enlargement being made. Another practical point that could puzzle you if it were not pointed out, is due to the high sensitivity of the meter circuit on range 5. The ABS case is an excellent insulator, and if rubbed will produce static electricity, particularly in hot, dry weather. This can cause the meter needle to wave around, apparently indicating a varying light intensity. Rapidly stroking the underside of the case from end to end can actually drive the needle off scale momentarily. However, the resultant charge soon leaks away, and in normal use the effect will not be observed at all.

WIDE-RANGE LIGHT METER PARTS LIST

RESISTORS: All 0.6W 1% Metal Film

R1	1k8	1	(M1K8)
R2	1k	1	(M1K)
R3	10k	1	(M10K)
R4	100k	1	(M100K)
R5	1M	1	(M1M)
R6	10M	1	(M10M)
R7	5k6	1	(M5K6)
R8	2k2	1	(M2K2)

CAPACITORS

C1	10nF Polystyrene	1	(BX92A)
C2	270pF 1% Polystyrene	1	(BX50E)
C3	10µF 63V Axial Electrolytic	1	(FB23A)

SEMICONDUCTORS

TR1	MEL12	1	(HQ61R)
IC1	CA3130E	1	(QH28F)
D1	BZY88C3V3	1	(QH02C)

D2 5mm Green LED 1 (WL28F)

MISCELLANEOUS

ABS Box PX2	1	(YU53H)
PP3 Battery Clip	1	(HF28F)
SPDT DIL Switch	1	(XX28F)
8-pin IC Socket	1	(BL17T)
Single Pole Slide Switch	1	(FF77J)
Single Pole 12-way Rotary Switch	1	(FH42V)
Small 250µA Meter	1	(LB80B)
Push Switch	1	(FH59P)
Stripboard	1	(JP49D)
Knob BK12	1	(RW75S)
Pins 2145	1	(FL24B)

The Maplin 'Get-You-Working' Service is not available for this project.

The above items are not available as a kit.

Impedance Matching continued from page 40.

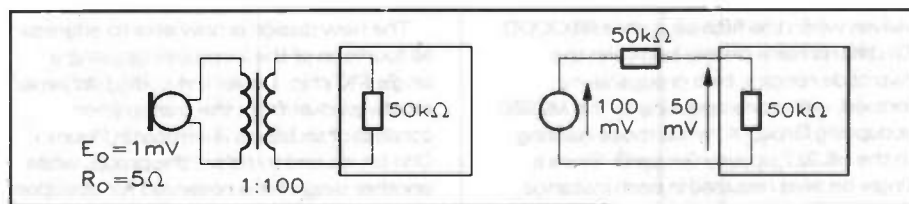

Figure 9. Using a microphone transformer.

where the primary voltage would be 0.5mV and the primary input resistance would be 5Ω. Transformer imperfections would of course slightly alter all these figures.

Electret microphones are very widely used because the essential parts can be purchased very cheaply indeed, yet the result obtained can be really excellent. They have high output resistance and are often made with a built-in FET impedance

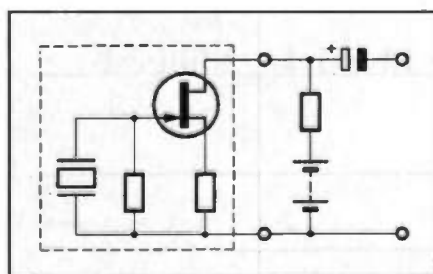

Figure 10. Connecting an Electret Microphone insert.

transforming stage. If a source follower is used, it needs three external connections; two for the DC supply and one for the output. If a common source circuit is employed as in Figure 10, only two connections are needed; the drain load resistor being fitted externally with the supply battery.

For on-stage and studio work, screened balanced pair connections are often used for microphones cables.

MATCHING FOR MEASUREMENT AND TO AVOID REFLECTIONS

After so much attention to those cases where deliberate mismatching of impedances is required, we should consider some important ones where considerable efforts are made to ensure closely matching impedances.

In measurements it is always preferable to make the overall accuracy dependent upon stable passive components as far as possible. So, for example, it is better to measure voltage gain and attenuation relying on resistive attenuators rather than upon voltmeters. To make precision attenuators conveniently usable, measurement systems confine themselves to one of the few standard output/input resistances. For audio work, 600Ω is one standard and, for radio frequencies 50Ω is the most common, with 75Ω a close second.

Another reason why so much radio frequency equipment is designed with a standard impedance at all interfaces, is the need to avoid reflections on transmission lines (this subject will be dealt with in greater depth in a forthcoming series entitled Pulses on a Line — Ed.). If a cable is terminated in a load equal to its 'Characteristic Impedance', the wavefront travels along the cable with minimum power loss and minimum electric stress on the insulation. Also, reflections of waves back from the load end are prevented. If matching is not exact at either end of a cable, a reflected wave can oscillate back and forth until absorbed by losses. When pulse waveforms are used, reflected pulses can cause havoc; producing ghost images on a TV picture and on a radar screen, or, producing data errors in a digital system.

As explained in the first section of this project, the receiver module for the Model Train Controller has been redesigned. The old receiver was based around a Plessey ML926 or ML927 IC and a 14-pin SSI logic IC. Since Plessey have long since discontinued both the ML926 and ML927 remote control receiver ICs, the previous design is obsolete; instead a new device from the PIC16C5X range of microcontrollers from Microchip Technology has been put to the task.



KIT AVAILABLE (LT29G) PRICE £12.95

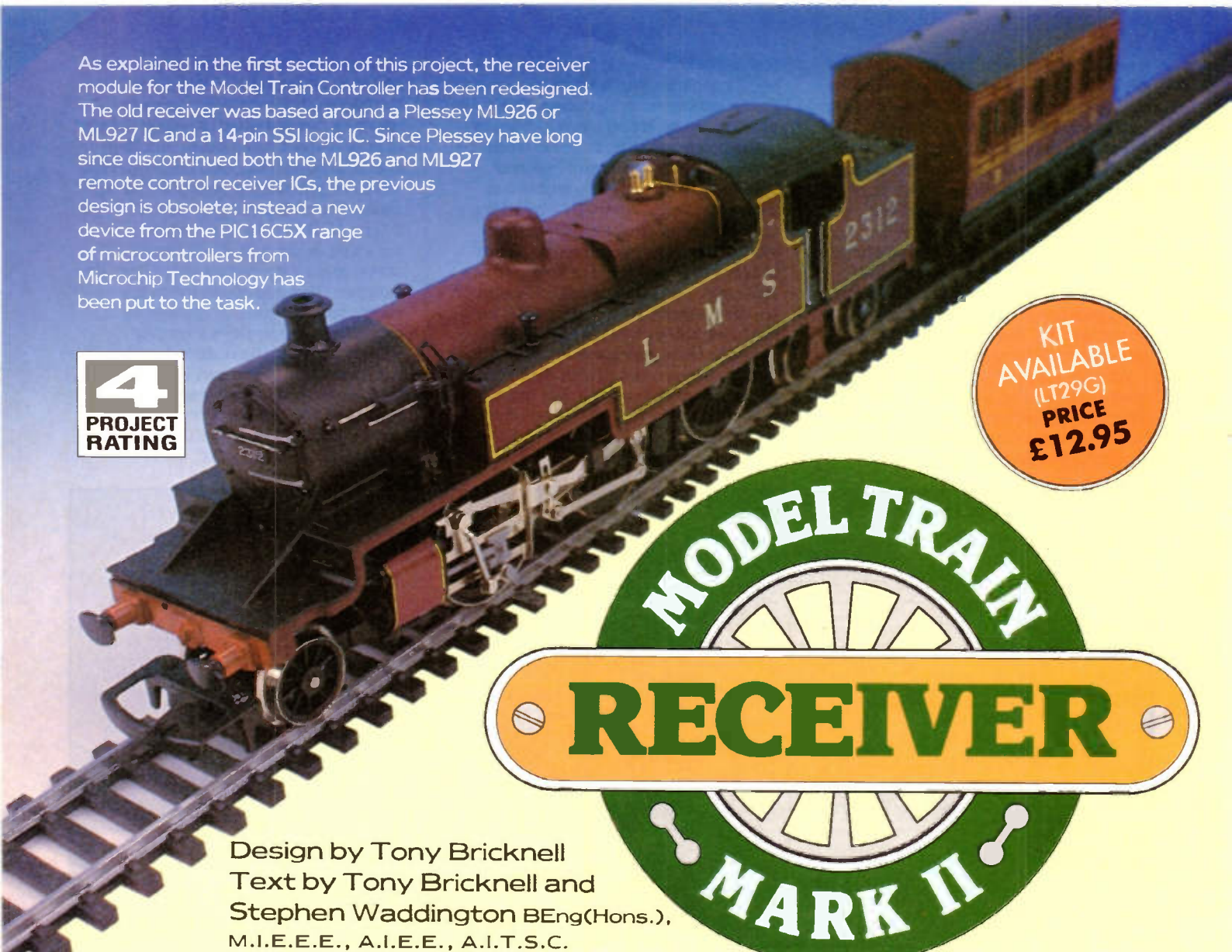

Design by Tony Bricknell
Text by Tony Bricknell and Stephen Waddington BEng(Hons.), M.I.E.E.E., A.I.E.E., A.I.T.S.C.

THE decoding circuitry is now considerably reduced since many of the functions performed by hardware have been incorporated into the software of the 8-bit microcontroller. A reduction in the number of components in the design is only one of the advantages in opting for a software controlled receiver; others include a compressed PCB design and the ability to make inexpensive software changes as new ideas and functions are conceived.

HOW IT WORKS

The Plessey ML926 or ML927 ICs are essentially the same; both being able to decode 5-bits of information. The ML926

decodes values, when the fifth bit is one (1XXXX); while the ML927 decodes values when the fifth bit is zero (0XXXX). To differentiate clearly between the two code ranges, two groups were formed, with codes relating to the ML926 occupying Group A, while those relating to the ML927 occupy Group B. Since a single bit was required in each instance for direction, three bits were left for addressing. This meant that the constructor could opt for a maximum of fourteen trains by using seven fitted with the ML926 – Group A module – and seven fitted with the ML927 – Group B module. In each case, the zero address was not used as a locomotive address, but was

reserved instead for use as a blank data-packet signifying a zero power level.

The new design is now able to address all fourteen of the locomotives using a single PIC chip. Under the coding scheme, a data-packet from the transmitter consists of six bits as illustrated in Figure 1. One bit is used to select the group, while another single bit is reserved for direction, leaving four bits for addressing. In reality the group bit can be considered as an additional address bit, extending the addressing range to 5-bits and thus the fourteen locomotives. The locomotive address for a particular receiver is set by bridging solder pads on the receiver PCB. The control data modulated onto the

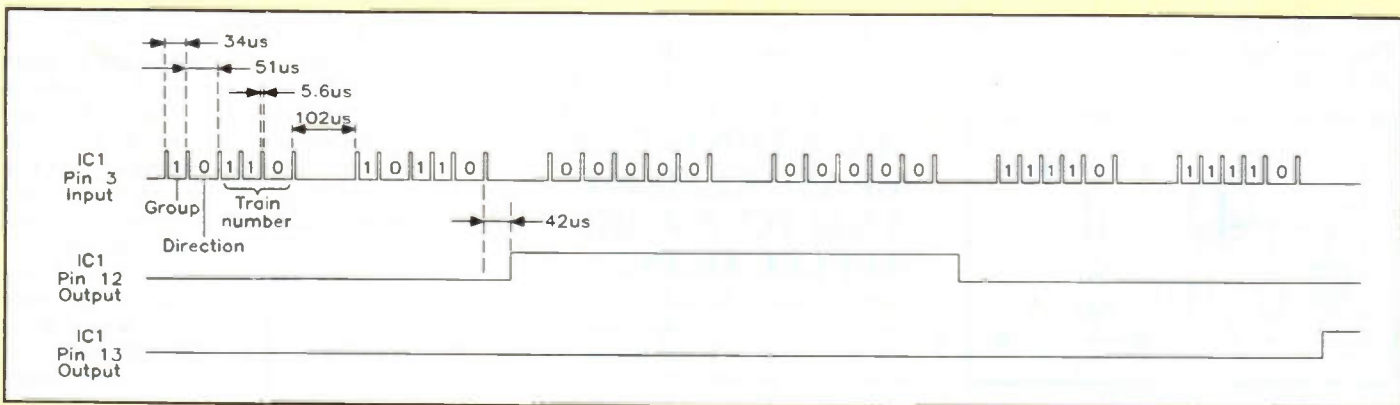
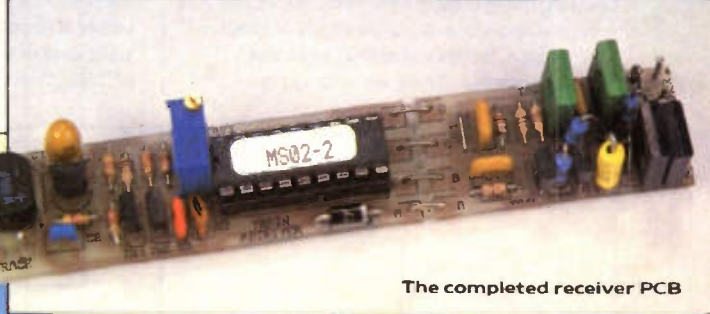
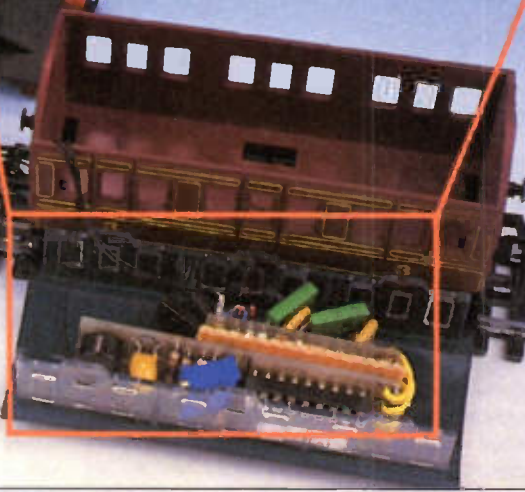
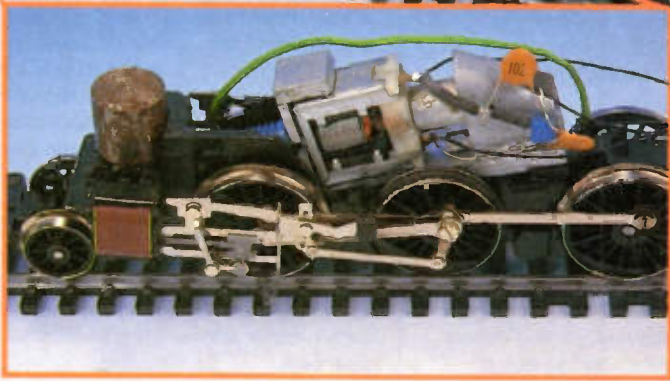
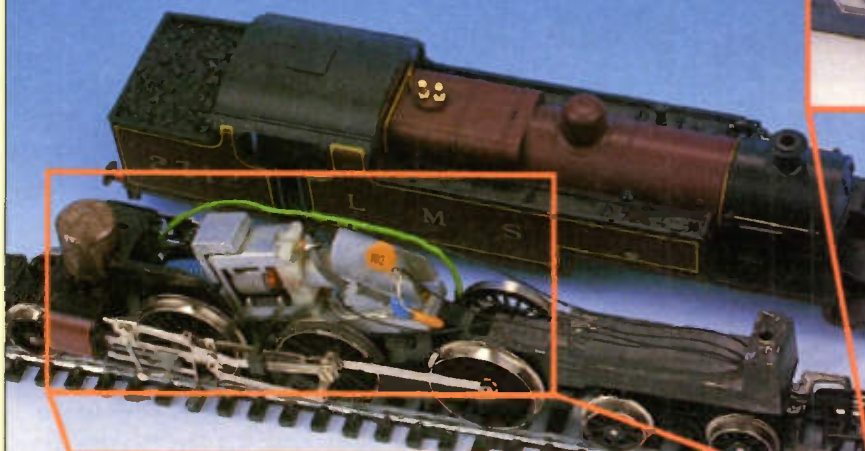
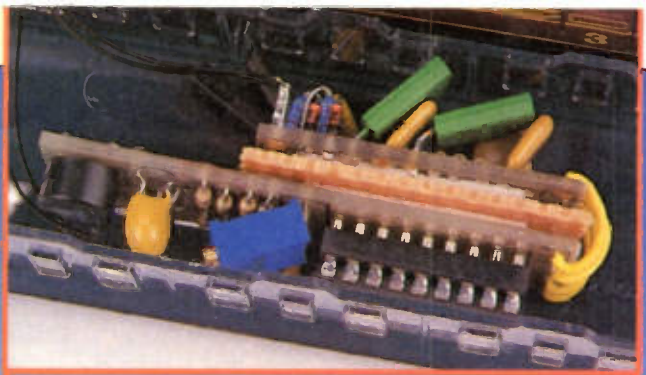
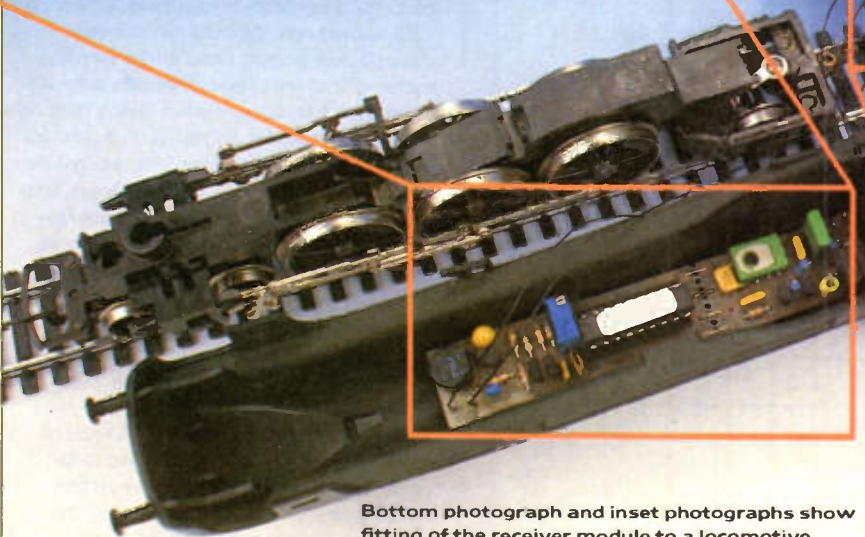

Figure 1. Receiver timing diagram.

Top photograph and inset photographs show fitting of the receiver module to a locomotive with a worm gear type motor.



The completed receiver PCB



Bottom photograph and inset photographs show fitting of the receiver module to a locomotive with a Ringfield type motor.



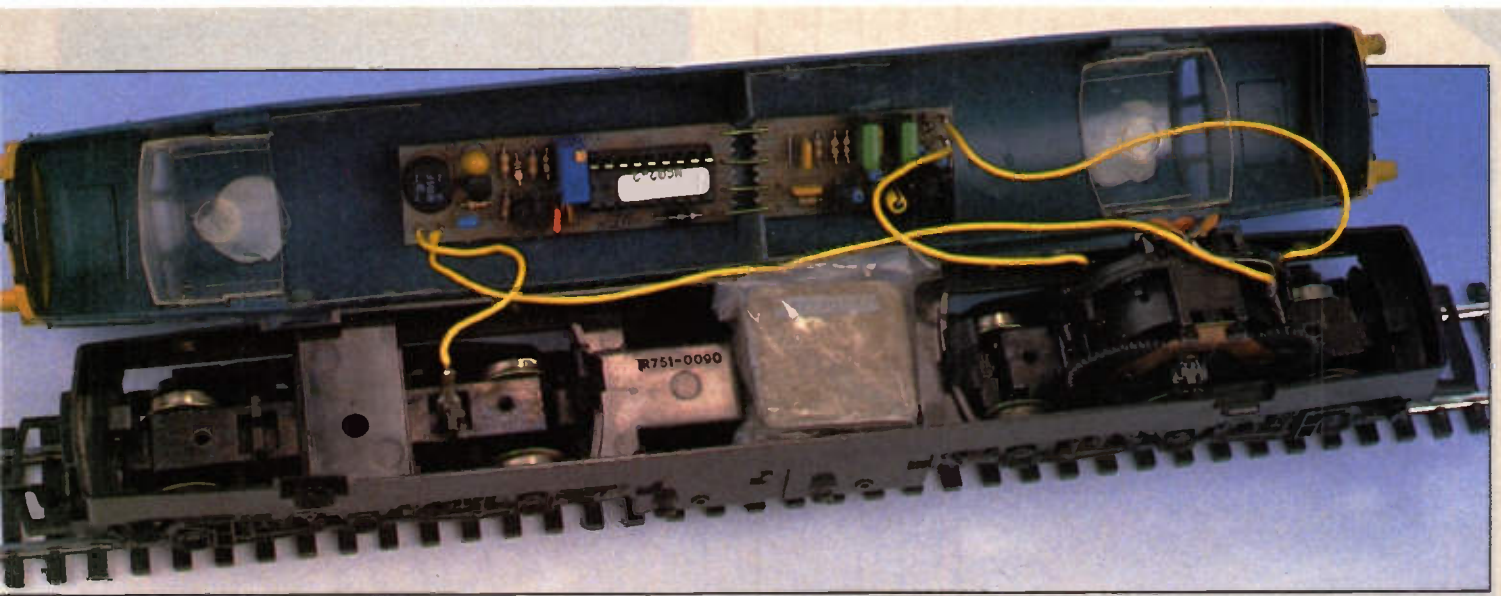

Fitting the receiver module to a 'diesel/electric' locomotive fitted with a Ringield type motor.

track by the transmitter is extracted by the receiver module. If a receiver identifies data corresponding to its address, then power is conveyed to the locomotive motor. The modulated data is decoded by the software of the PIC microcontroller – a flow diagram of the coded program is illustrated in Figure 2. The role of the receiver module is summarised in a block diagram in Figure 3. As the train can be placed on the rails either way around, it is necessary to ensure that both positive and negative supply rails are connected with correct polarity regardless of train orientation. To this end BR1 ensures correct polarity. The raw voltage is

regulated to 5V DC by RG1 and supplied (unregulated) to the H-type bridge allowing the train motor to be driven in either direction.

Consider the circuit diagram illustrated in Figure 4. Data signals superimposed on the track supply pass through C2, and are amplified and buffered by TR1 and TR2. An interesting arrangement here is the role that C3 plays; the signal from the track via the locomotive's wheels to the wheel brushes can be very noisy, and full of unwanted voltage spikes that can easily corrupt the data. C3 thus acts as a 'slug' and actually slows down the action of TR2, thereby effectively removing

any fast spikes or transients that would otherwise corrupt the data stream.

Each train receiver must be given a unique address. This is done by connecting pins 6, 7, 8 and 10 of IC1 to a combination of 5V or 0V as shown in Table 1. Only when two consecutive serial codes input on pin 3 of IC1 match that set on pins 6, 7, 8, and 10 is the data fully decoded and, depending on the state of the 'direction' bit, either TR3 or TR4 is turned on. These transistors, in turn, turn on either TR6 & TR7 or TR5 & TR8, applying power to the motor, making it turn in either the forward or reverse direction.

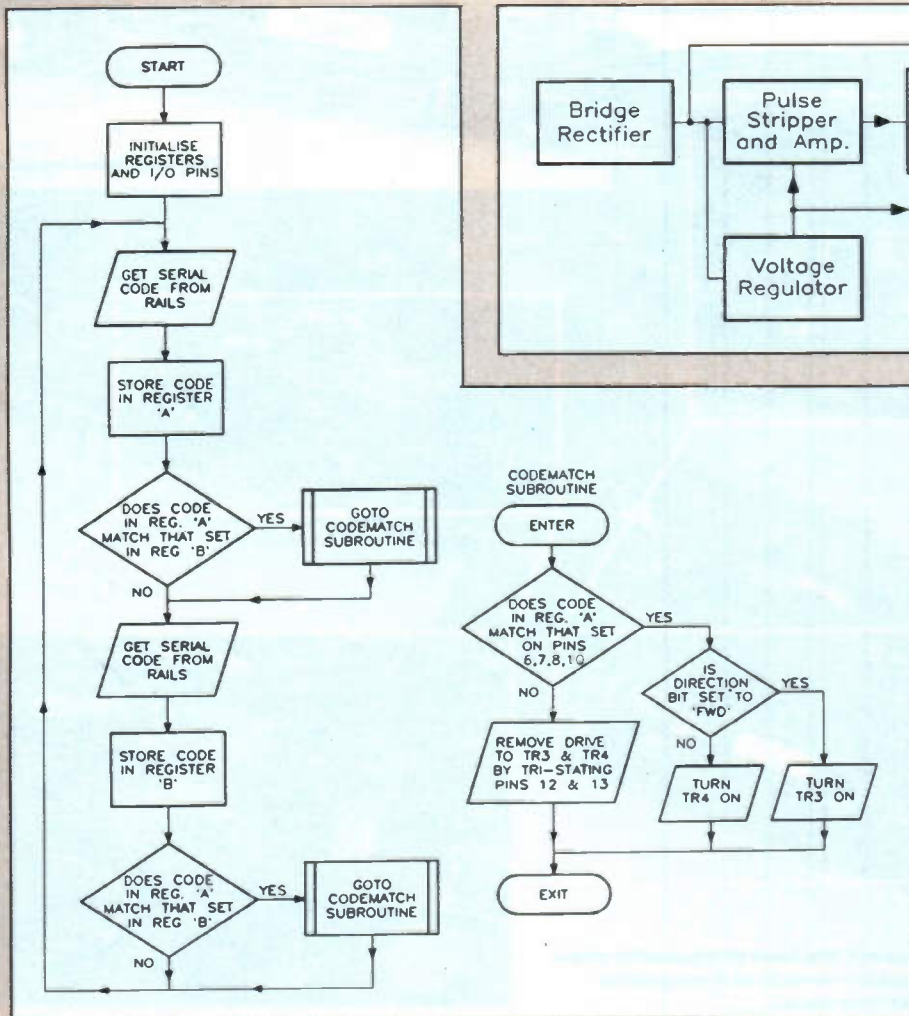

Figure 2. Flow chart of PIC microcontroller program.

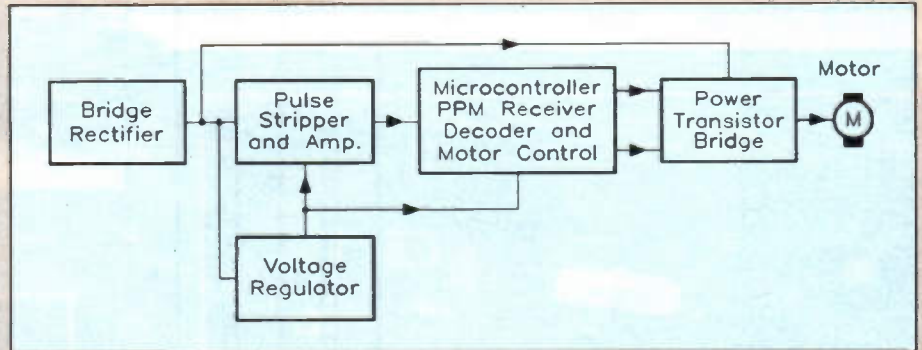

Figure 3. Block diagram of receiver.

As it is only possible to send the serial code for one receiver at a time, C4 keeps TR3 turned on until the next relevant data-packet comes around. To turn the motor off, all that has to happen is for IC1 to receive two consecutive codes that do not match that set on pins 6, 7, 8, and 10. Pins 12 and 13 then enter tri-state mode – as illustrated in Figure 1 – and allow C4 to discharge through TR3 and, after a few milliseconds, turn the motor off. Should the motor be running in the opposite direction then the operational components are TR4 and C5.

CONSTRUCTION

The receiver module PCB is shown in Figure 5. Depending upon what type of locomotive the board is destined to be used with, you may wish to break the PCB into two sections, separating the power and microcontroller sections. Ideally, you should do this before you commence construction of the PCB!

Group	Channel Number	Pin 6	Pin 7	Pin 8	Pin 10
A	1	5V	0V	0V	0V
A	2	0V	5V	0V	0V
A	3	5V	5V	0V	0V
A	4	0V	0V	5V	0V
A	5	5V	0V	5V	0V
A	6	0V	5V	5V	0V
A	7	5V	5V	5V	0V
B	1	5V	0V	0V	5V
B	2	0V	5V	0V	5V
B	3	5V	5V	0V	5V
B	4	0V	0V	5V	5V
B	5	5V	0V	5V	5V
B	6	0V	5V	5V	5V
B	7	5V	5V	5V	5V

Table 1. Channel selection code chart.

Fit and solder all components except IC1, starting with the four PCB pins and the IC socket. Next fit all resistors, capacitors, link LK1 and the inductor, noting that some components do not lie flat on the board. Fit all transistors and diodes, taking special care with the positioning of TR5, TR6, TR7, TR8 and D2, D3 and D4 as shown in Figure 6.

Decide which channel the receiver is to use and, using a small soldering iron bit, bridge the relevant solder pads as indicated in Table 1 and Figure 7. Using off cuts from component legs, link the four pairs of pads connecting the microcontroller section to the power section; link A to A, B to B, C to C, and D to D.

Now check your work very carefully, making sure that all the wires and solder joints are sound.

TESTING AND ADJUSTMENT

All DC tests are made using a multimeter. The readings taken from the prototype were made using a digital multimeter – some of the values you obtain may vary slightly depending upon the type of meter employed. The first test is to ensure that there are no shorts on the power rails. Set your meter to read $k\Omega$ on its $20k\Omega$ – or greater – resistance range, and connect the probes – either way round –

to the 'TRACK' pins on the PCB. A reading greater than $4k\Omega$ should be obtained. Next, connect the positive (+) probe to pin 14 of IC1 and the negative (-) probe to pin 5. Again, a reading greater than $4k\Omega$ should be obtained. If not, carefully check all solder joints and especially the code-setting solder islands for solder whiskers or bridges.

The lamp and diode arrangement should then be added to simulate the locomotive motor. Connect the 'TRACK' input on the receiver to the output of the control unit as shown in Figure 8. To set-up the receiver, the frequency of the RC oscillator, which is adjusted by RV1, must be set to 4MHz. There are two methods of doing this, the first uses only basic bench tools while the second requires the use of a frequency counter.

If opting for the first method, turn the

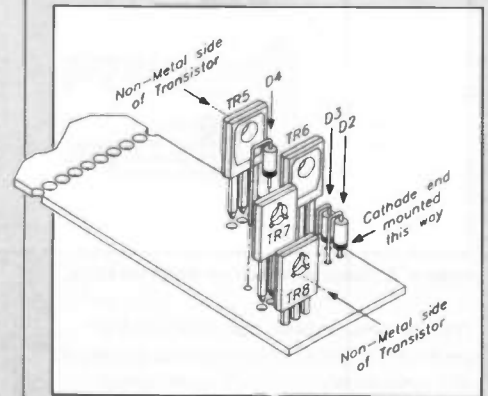

Figure 6. Diode and power transistor mounting.

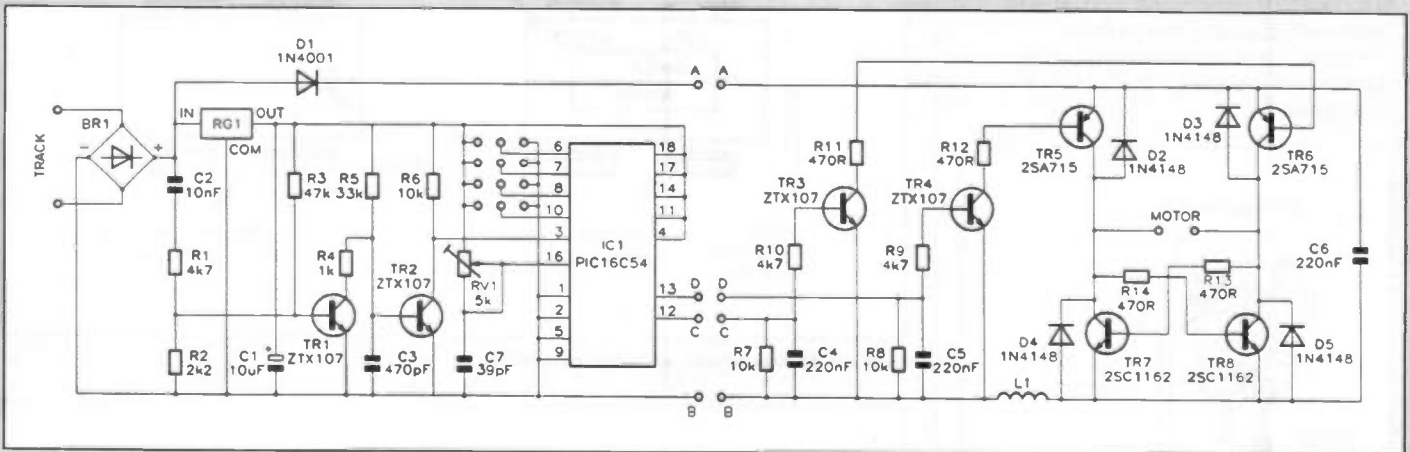

Figure 4. Receiver circuit diagram.

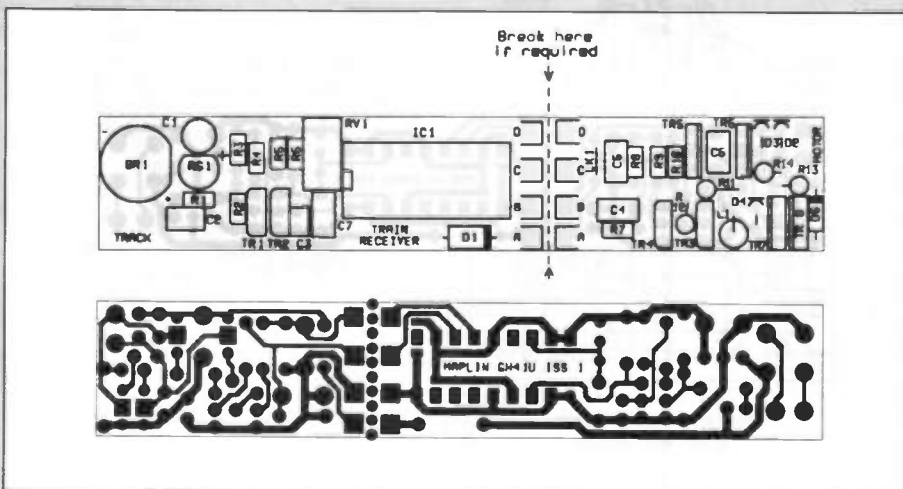

Figure 5. Receiver PCB legend and track.

22-turn preset RV1, 13 turns in from its anti-clockwise end-stop. Select the appropriate channel number and group of the receiver on the control unit and advance the speed control to maximum. Using a small screwdriver, turn RV1 until the lamp lights up constantly, with no flickering. Now slowly turn the speed control to minimum and then back up to maximum. The lamp should gradually dim to off and then brighten to full on. If the lamp fails to light or flickers unevenly, repeat the process with RV1.

Alternatively using a frequency counter capable of measuring at least 1MHz at TTL level, connect the input lead 0V to the negative (-) end of BR1 and the positive lead to pin 15 of IC1. Turn the 22-turn preset RV1 until a reading of $1MHz \pm 3kHz$ is read on the frequency counter. Select

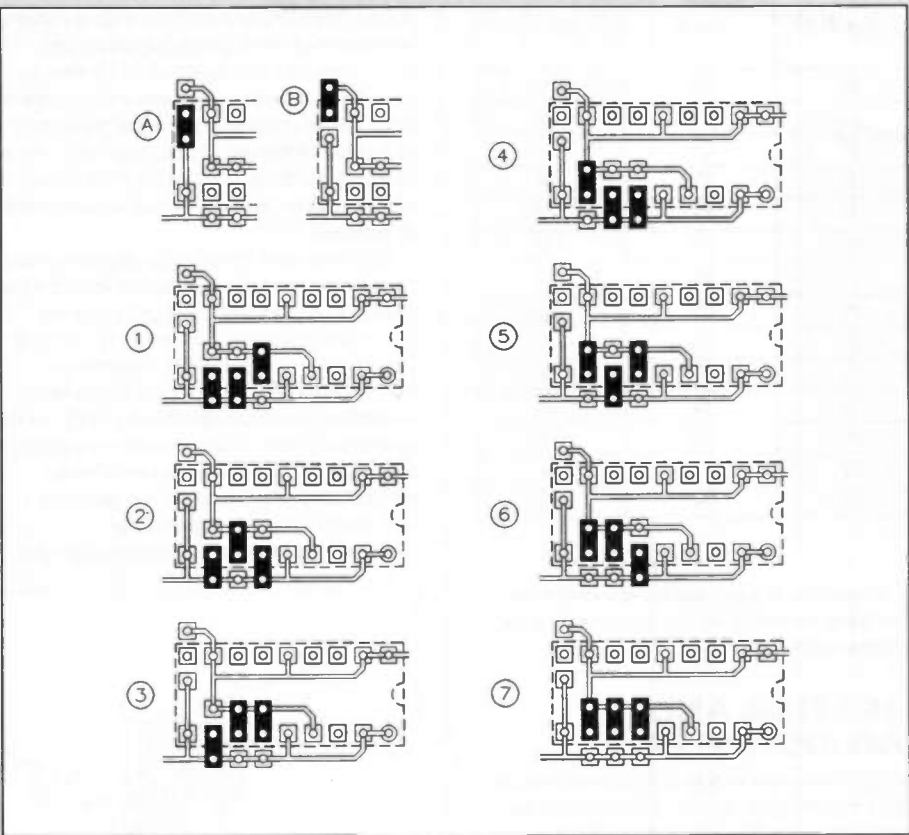

Figure 7. Channel selection pads on PCB.

the channel number and group of the receiver on the control unit and advance the speed control slowly to maximum. The lamp should slowly light up to maximum brightness with no flicker evident at maximum. As the speed control is turned to minimum and then back to maximum, the lamp should follow.

If these tests are satisfactory, the module is ready to be installed in the locomotive.

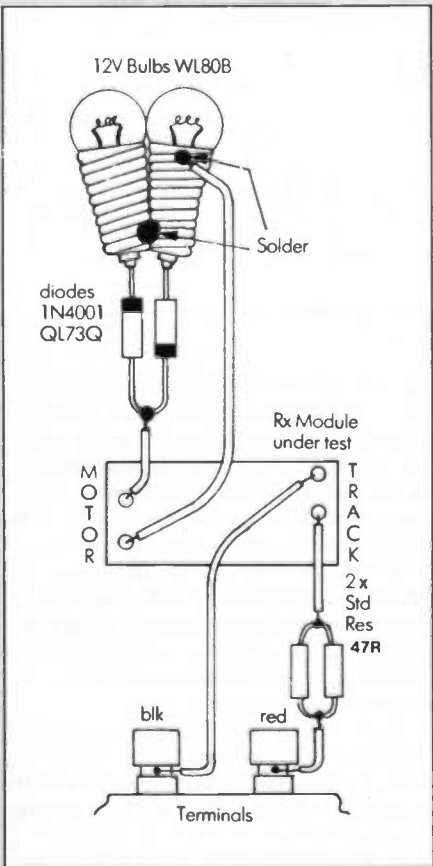

Figure 8. Testing and adjustment diagram.

INSTALLATION

All locomotives designed for use with conventional control systems have the two sides of the motor connected directly to the wheels on each side of the locomotive as shown in Figure 9. To install the receiver module, the motor must be completely isolated from the wheels. In many modern models this is accomplished by removing a wire link, but in some of the older models there is a permanent connection from one side of the motor to the chassis. In all cases by careful modification this connection can be removed. Some examples of this are shown in Figure 10. It is most important to ensure that the motor is completely isolated; it is worth checking this with a meter set to Ohms before installing the module.

Most locomotives are supplied with a single suppression capacitor strapped across the connections of the motor to reduce radio frequency interference. As the connection from one side of the motor to the chassis is being broken, two further capacitors are required to connect from each end of the motor, to the chassis as shown in Figure 11. Two 1nF capacitors are supplied in the kit for this purpose.

To install the receiver refer to Figure 12.

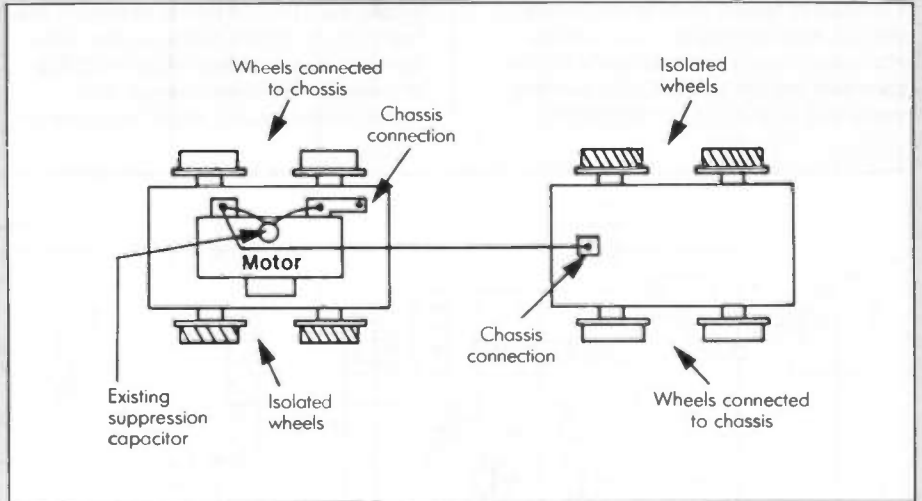

Figure 9. Wiring of conventional locomotive.

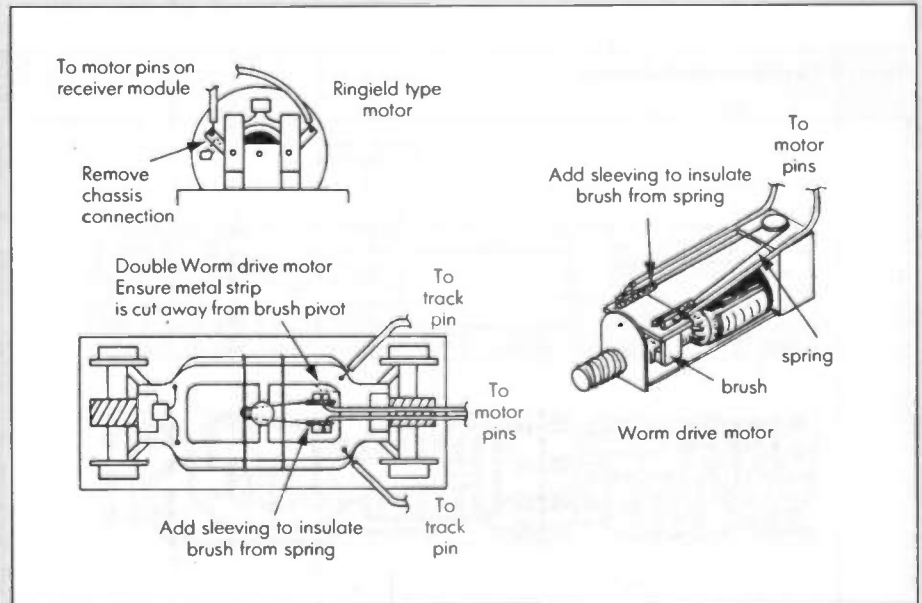

Figure 10. Modification wiring for various locomotive configurations.

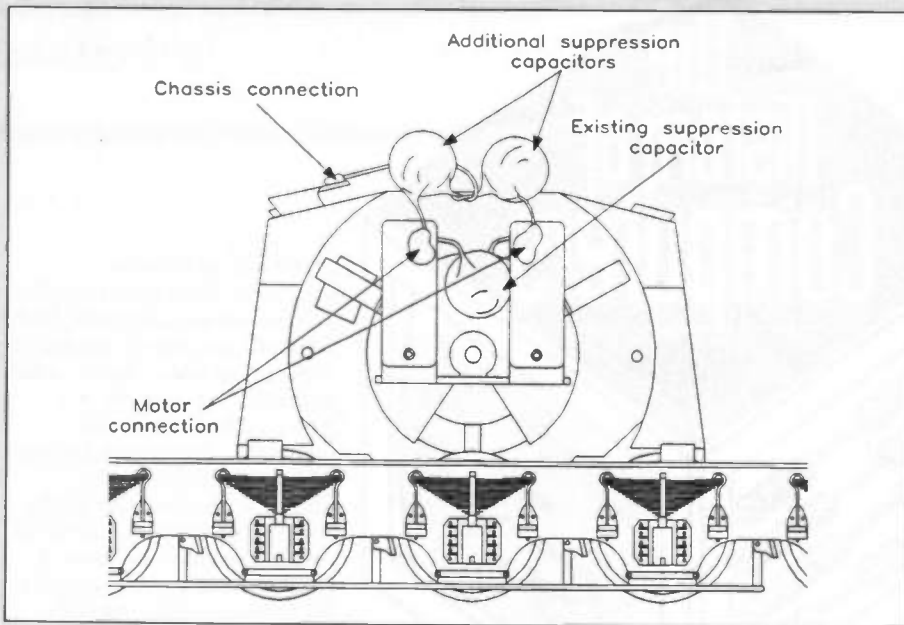

Figure 11. Fitting suppression capacitors to the motor.

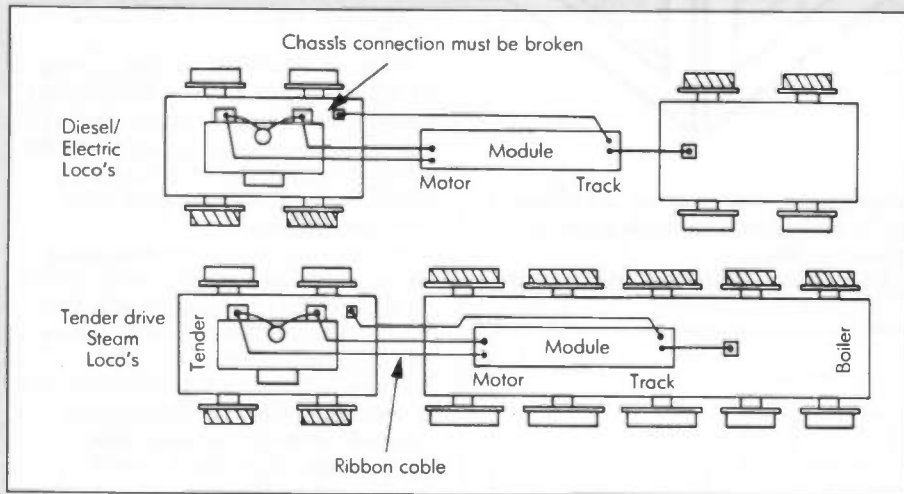

Figure 12. Receiver installation.

In most cases there will be a wire coming from one of the pickups, this is connected to one input of the receiver – labelled 'TRACK'. The other input is connected to the chassis at a suitable point. Connect the motor to the pins marked 'MOTOR'. If, after installation, it is found that the locomotive travels in the wrong direction in relation to the controller switch, the wires to the motor should be reversed.

With some, particularly noisy – RF wise – motors, it may be found that the train stops and starts. This is due to noise from the motor superimposing itself on the oscillator input of the microcontroller causing the processor to 'crash'. Fortunately, the watch-dog timer will re-start the processor after a maximum of 18ms. However, to overcome this problem, the motor will require additional suppression, usually in the form of a single 220nF capacitor connected across the motor terminals.

TIPS TO INCREASE RELIABILITY

To ensure reliable operation of this system, the locomotives should be in good condition, and it may be worth replacing brushes and cleaning wheels and pick ups before use. The track needs to be kept fairly clean, although the receiver will respond to signals as long as there is enough power to drive the motor. Steel is not a good material to use for track as a thin layer of oxidation can form on the surface within only a few days, reducing the contact reliability between the train and the track. By far the best track to use is Nickel-Silver, and if you are contemplating upgrading to such a track it is a most worthwhile investment, giving increased reliability and relatively little oxidation.

TRAIN CONTROL RECEIVER PARTS LIST

RESISTORS: All 1/4W 5% Carbon (Unless specified)

R1,9,10	4k7	3	(U4K7)
R2	2k2	1	(U2K2)
R3	47k	1	(U47K)
R4	1k	1	(U1K)
R5	33k	1	(U33K)
R6-8	10k	3	(U10K)
R11-14	470Ω Min Res	4	(M470R)
RV1	5k 22-Turn Cermet Preset	1	(UH24B)

CAPACITORS

C1	10μF 25V Tantalum	1	(WW69A)
C2	10nF Monores Cap	1	(RA44X)
C3	470pF Monores Cap	1	(RA38R)
C4-6	220nF Monores Cap	3	(RA50E)
C7	39pF Ceramic	1	(WX51F)
	1nF Ceramic	2	(WX68Y)

SEMICONDUCTORS

BR1	W005	1	(QL37S)
D1	1N4001	1	(QL73Q)
D2-5	1N4148	4	(QL80B)
RG1	μA78L05AWC	1	(QL26D)
IC1	PIC16C54RC-MS02	1	(DM59P)
TR1-4	ZTX107	4	(QL43W)
TR5-6	2SA715	2	(QR56L)
TR7-8	2SC1162	2	(QR59P)

MISCELLANEOUS

L1	Choke 2μ2H	1	(WH31J)
	18-Pin DIL Socket	1	(HQ76H)
	Pins 2145	1 Pkt	(FL24B)
	PCB	1	(GH41U)
	Instruction Leaflet	1	(XU40T)
	Constructors' Guide	1	(XH79L)

The Maplin 'Get You Working' Service is available for this project, see Constructors' Guide or current Maplin Catalogue for details.

The above items are available as a kit, which offer a saving over buying the parts separately.
Order as **LT29G (Digital Train Receiver Kit) Price £12.95.**

Please Note: Where 'package' quantities are stated in the Parts List (e.g., packet, strip, reel, etc.), the exact quantity required to build the project will be supplied in the kit.

The following new items (which are included in the kit) are also available separately.
Digital Train Receiver PCB Order As GH41U Price £1.95.
PIC 16C54RC-MS02 Order As DM59P Price £5.95

The History of Computers

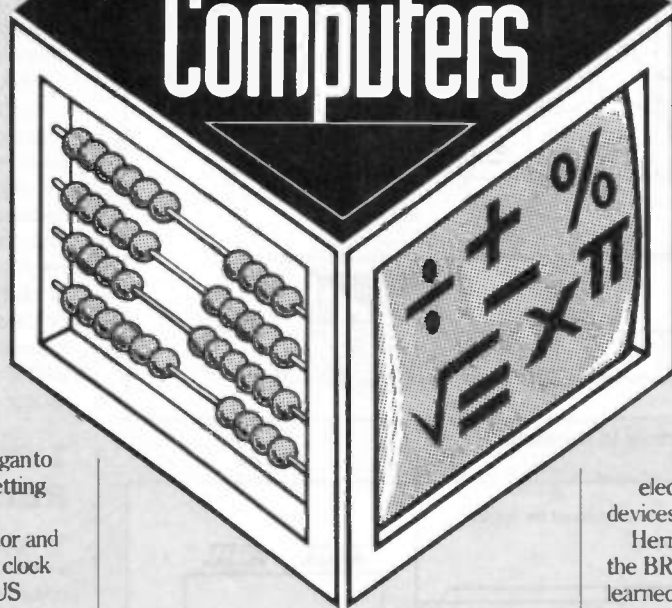

If Babbage's incomplete calculator was an icon of computing's hopes for the future, ENIAC became the first totem of computing's birth. Legends tend to become even more legendary in the re-telling and ENIAC was no exception. Writing after its press demonstration, one journalist declared that it was 'faster than (human) thought' – based on the calculation of 97,367 to the power of 5,000, which ENIAC performed in under half a second. This caught the public imagination and shortly all manner of superlatives began to be bandied around. So, let's start by getting the facts straight.

The Electronic Numerator, Integrator and Calculator to give it its full name, had a clock speed of 100kHz, cost some 400,000 US Dollars and weighed 30 tonnes. Taking up some 140 square metres of space its 6,000 switches, 10,000 capacitors, 18,000 valves and 70,000 resistors needed 150kW of power to carry out its 5,000 additions and subtractions every second. It also required a

considerable amount of cooling, but nothing like the horrendous amounts touted around by some people.

ENIAC was a child of war. The American

army's Ballistic Research Laboratory (BRL) had some 100 mathematics specialists using Bush differential analysers to calculate artillery firing tables. As the conflict progressed and weapons production began to increase enormously, the human calculators fell behind and by 1943, the situation had become critical. The army approached the University of Pennsylvania's Moore School of Engineering for a solution since, in the previous August, one of the School's assistant professors John

Mauchly had written a memo on using electronic valves as high-speed calculating devices.

Herman Goldstine, at that time in charge of the BRL's computing effort at the university learned of the memo. As a former professor of mathematics he saw that this could be the solution he was looking for. He asked the School to submit a viable proposal for an electronic calculator.

Mauchly, working with a brilliant young electronics graduate called J. Presper Eckert, wrote a proposal on the 2 April 1943. Two months later a contract was signed and the project was under way.

ENIAC, or Project PX as the army termed it, was a decimal device, carrying out its calculations in several sub-units called Accumulators, since it had no central processor. It didn't have a separate memory either and so stored its numbers in a card reader and large banks of numbered switches. Operations were synchronised by an electronic timer.

The design activity had begun with the accumulators, which were based on the Eccles-Jordan flip-flop. A year after the work had begun the first two accumulators were ready. Each one contained ten decade ring counters, one handling units, one tens, one hundreds and so on. One bonus became immediately apparent; the units proved to be twice as fast as their designer Eckert had predicted. This greatly impressed the army who decided to have 20 in the machine instead of the initially-specified four. There was – of course – a trade-off; the machine's construction took a lot longer.

By far the greatest problem was the valves. In fact many engineers reckoned that ENIAC would work for no more than about 10 minutes at the most, given the 'reliability' of the valves then in use. Eckert got round this by operating them well below their rated working voltages which not only increased their working life, but also considerably enhanced the equipment's power efficiency.

Overall, ENIAC took two and a half years to design and build, was around 1,000 times faster than the other relay-based calculators then in use, was both programmable and universal and could crack most mathematical problems if the instructions were specific.

Figure 1 gives some idea of how it was laid out and housed. It had nine basic units spread

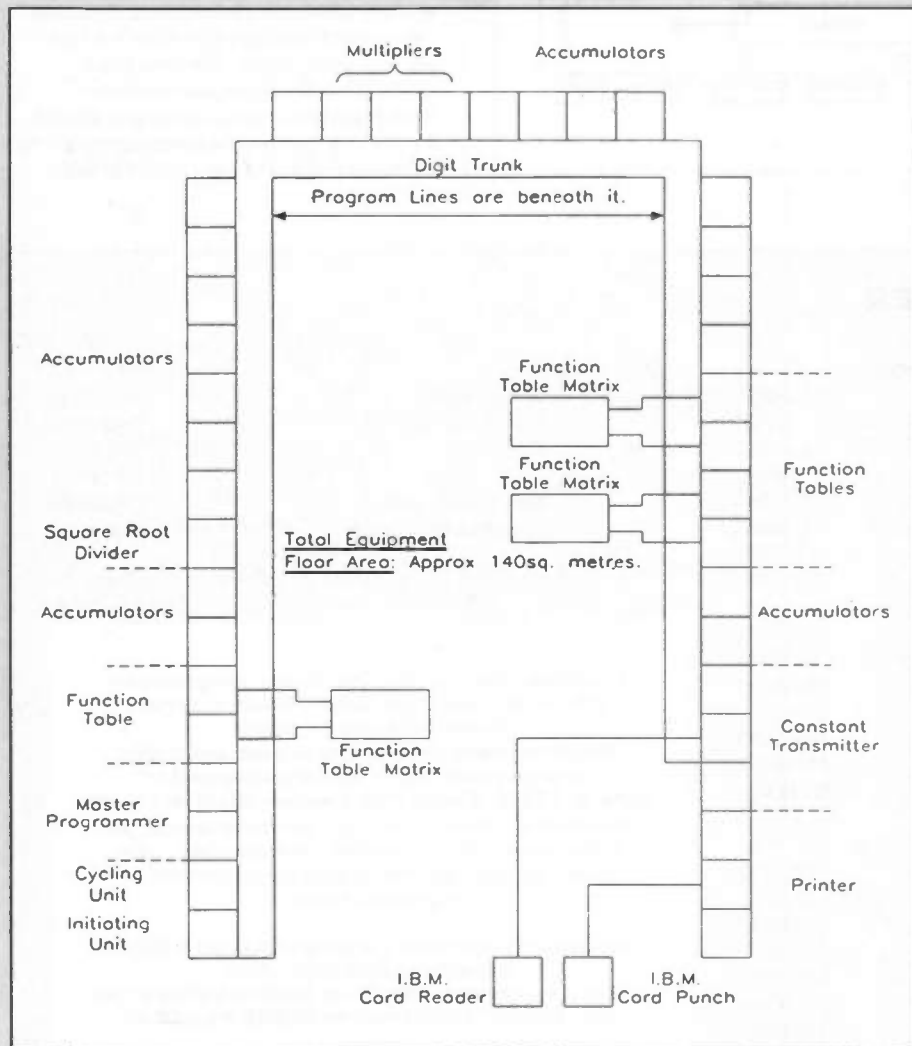

Figure 1. Equipment Layout of the Electronic Numerator, Integrator and Calculator (ENIAC), the first general-purpose electronic computer.

out over 40 panels arranged in a near-completed rectangle. Programming was literally a nightmare, a matter of setting up thousands of switches and connecting and unplugging hundreds of lines and cables. The execution of one program for example took two days of setting up. Still, where Bush's differential analyser worked out shell trajectories in 25 minutes, ENIAC took a mere 20 seconds. How did it do it?

Let's suppose we want to add the complex numbers 'a' and 'b'. To start with, we'd break the numbers up into what could be called machine-edible bites. 'a' and 'b' would then be read from the punched card input, 'a' going to one accumulator, 'b' to another. We'd then work out how the machine's panels are linked

and co-ordinated to work out our particular problem and then set up the equipment by plugging lines and cables in and out and resetting a large amount of switches on the front panel. The switches carried out specific instructions whilst the cables sorted the instructions out into the correct sequence. Lastly, we'd press the button on the initiating unit. This transmitted a pulse to the programmer which - in turn - pulsed the unit running the card reader.

The card reader control unit transmitted a program pulse to one of the accumulators which sent for quantity 'a'. Receipt was verified by the transmission of a received pulse back to the programmer. This unit then dealt with amount 'b', which would be handled

by a different accumulator. The final act was the summing of 'a' and 'b' on an output card.

Thus the entire sequence was controlled by the programmer and although speedy and accurate, was the major snag with ENIAC as it had all to be set up beforehand. The machine though, was every bit as influential as Bush's differential analyser had been and was even used in army recruiting posters!

Shortly however, another polymathic mind would propose a solution to the setting up problem; the stored-program machine. This idea remains the fundamental principle of current computing techniques and next month we'll look at the man, his idea and computing milestones of the last 40-odd years.



In next month's super issue of 'Electronics - The Maplin Magazine', there are some really great projects and features for you to get your teeth into! To whet your appetite, here's a taste of some of the goodies on offer:

AN INTRODUCTION TO MICROCHIP'S PIC

Tony Bricknell takes an in-depth look at the PIC (Peripheral Interface Controller) 16C5x range of microcontrollers from Microchip Technology. This family of low-cost, high performance, 8-bit, fully static, EPROM based microcontrollers are readily available from Maplin.

CONTINUITY TESTER FOR XMAS TREE LIGHTS

How many hours will you spend at Christmas trying to get your tree lights working properly? This simple, easy-to-construct Continuity Tester should relieve a lot of the hassle, and headaches, at Christmas when you plug in your tree lights and nothing happens!

FLICKERING CANDLE

The use of modern technology provides several advantages over the traditional wax variety. Firstly, it doesn't melt away; secondly, you won't burn yourself - because the flame has been replaced by a bulb; and thirdly, the flame won't be extinguished by the slightest breeze! Details are even given for building a safe, lantern style housing for the project. The project can be modified to drive more powerful light bulbs for greater effect - handy for Christmas tree lights, or the nativity scenes at the local church, or even to generate a more realistic 'coal burning' effect for electric fires.

PRIORITY QUIZ INDICATOR

Why is it that general knowledge quizzes get people so excited? It isn't

only the festive family events either, for it's quite likely that your local pub has a weekly quiz night. Our readers who were fed-up with the incessant argument over who was the first to answer a question at their local charity, domestic or pub quiz nights, asked us to design a priority quiz indicator. So we came up with this little project to put an end to all those feuds over 'who put their hand up first!' Up to eight contestants, or more if a second or third expansion PCB is connected, can use the quizzier. Each is equipped with a button and lamp to identify the first to the button.

Plus, of course, there's all the usual features for you to enjoy! 'ELECTRONICS - THE MAPLIN MAGAZINE', BRITAIN'S BEST SELLING ELECTRONICS MAGAZINE.

MAPLIN'S TOP TWENTY KITS

POSITION	DESCRIPTION OF KIT	ORDER AS	PRICE	DETAILS IN
1. (1)	L200 Data File	LP69A	£ 4.75	Magazine 46 (XA46A)
2. (2)	TDA7052 1W Amplifier	LP16S	£ 4.95	Magazine 37 (XA37S)
3. (3)	Live Wire Detector	LK63T	£ 4.75	Magazine 48 (XA48C)
4. (5)	MOSFET Amplifier	LP56L	£20.95	Magazine 41 (XA41U)
5. (4)	Remote Power Switch	LP07H	£ 5.25	Magazine 34 (XA34M)
6. (6)	1/300 Timer	LP30H	£ 4.95	Magazine 38 (XA38R)
7. (15)	LM386 Amplifier	LM76H	£ 4.60	Magazine 29 (XA29G)
8. (7)	Lights On Reminder	LP77J	£ 4.75	Magazine 50 (XA50E)
9. (9)	Electronic Ignition	VE00A	£12.95	Catalogue '94 (CA11M)
10. (10)	Car Battery Monitor	LK42V	£ 9.25	Magazine 37 (XA37S)
11. (8)	Stroboscope Kit	VE52G	£14.95	Catalogue '94 (CA11M)
12. (17)	LM383 8W Amplifier	LW36P	£ 7.95	Catalogue '94 (CA11M)
13. (11)	SL6270 AGC Mic Amplifier	LP98G	£ 8.75	Magazine 51 (XA51F)
14. (12)	IBM Expansion System	LP12N	£21.95	Magazine 43 (XA43W)
15. (16)	Mini Metal Detector	LM35Q	£ 7.25	Magazine 48 (XA48C)
16. (13)	Courtesy Light Extender	LP66W	£ 2.95	Magazine 44 (XA44X)
17. (14)	UA3730 Code Lock	LP92A	£11.45	Magazine 56 (XA56L)
18. (20)	8-bit I/O + RS232	LP85G	£19.95	Magazine 49 (XA49D)
19. (-)	1A Power Supply	VE58N	£ 8.95	Catalogue '94 (CA11M)
20. (-)	NEW ENTRY NEW ENTRY RS232/TTL Converter	LM75S	£10.75	Magazine 31 (XA31J)

Over 150 other kits also available. All kits supplied with instructions. The descriptions are necessarily short. Please ensure you know exactly what the kit is and what it comprises before ordering, by checking the appropriate project book, magazine or catalogue mentioned in the list above.

PCB and SCHEMATIC C.A.D.

EASY-PC

£98

+VAT & P+P

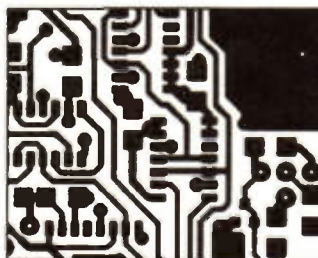
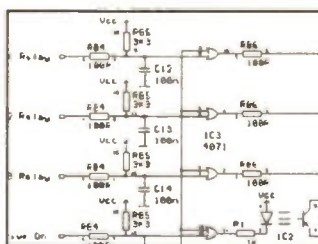

- Runs on PC/XT/AT/286/386 with Hercules CGA, EGA or VGA and many emulations.
- Design Single sided, Double sided and Multilayer boards.
- Use Surface Mount components.
- Standard output includes Dot Matrix / Laser / Inkjet printers, Pen Plotters, Photo-plotters and NC Drill.
- Award winning EASY-PC is in use in over 17,000 installations in 70 Countries World-Wide.
- Superbly Easy to use.

Options - 500 piece Surface Mount library - £48.00
1000 piece symbol library - £38.00. Gerber Import facility - £98.00

For full info' please phone, fax or write to:

Number One Systems Ltd.
Ref: MAP, Harding Way, Somersham Road,
St. Ives, Huntingdon, CAMBS, England, PE17 4WR
Telephone:- 0480 461778 (7 lines) Fax: 0480 494042
International:- +44 480 61778 Credit Cards Welcome



3
0
0
W
STEREO

Cast your mind back to the last issue, in which we showed you how to build a 300W mono MOSFET amplifier module, complete with power supply. Two of these modules can be combined into a stereo version, or a bridged 600W mono amplifier; a special kit, that contains two such amplifier kits together with the combination hardware, is available. If you don't have a copy of last month's magazine, and are interested in building this project, now's the time to order yourself a copy (and a subscription, while you're at it! — Ed).

MOSFET AMPLIFIER

KIT
AVAILABLE
(VF17T)
COMPLETE WITH TWO
300W AMPLIFIERS PLUS
ALL CASE PARTS
PRICE
£299.95
H29

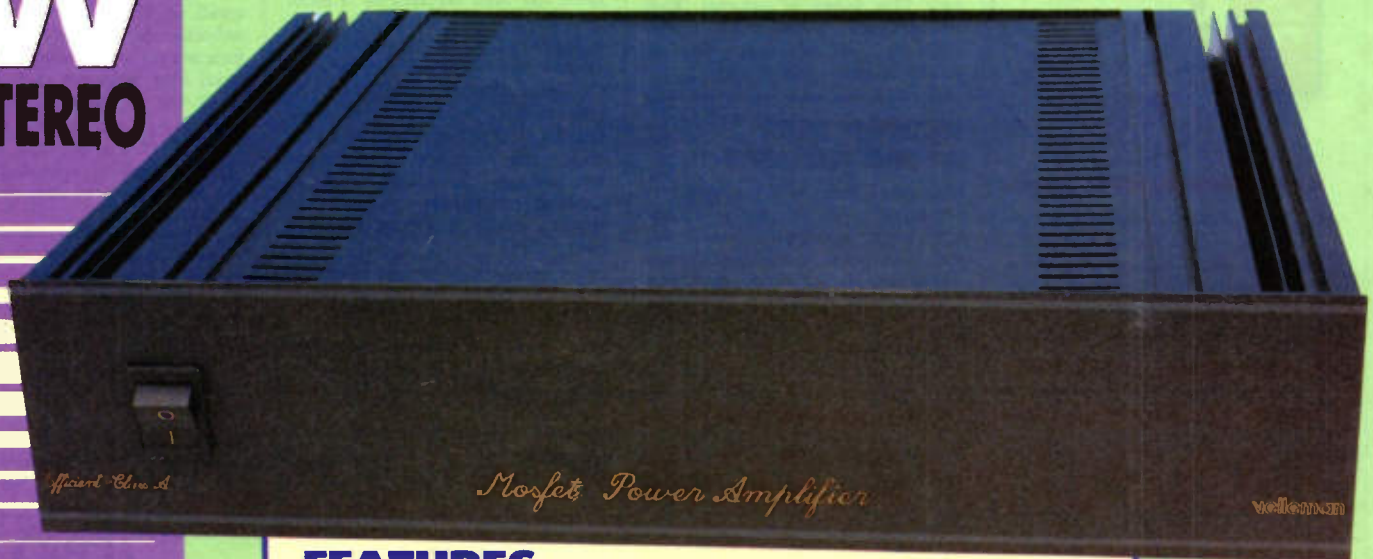

6
0
0
W
MONO

FEATURES

- * High power
- * Low distortion
- * Highly efficient
- * Comprehensive protection circuitry

APPLICATIONS

- * Hi-Fi systems
- * Disco applications
- * Laboratories
- * Studio monitoring

The complete
600W MOSFET
Amplifier.

Specification

Music power:	300W into 4 Ω , 200W into 8 Ω (600W bridged operation)
RMS power:	150W into 4 Ω , 100W into 8 Ω (300W bridged operation)
Harmonic distortion:	0.008% @ 1W 1kHz, 0.04% @ 90W 1kHz
Damping factor:	>300
Input impedance:	47k Ω
Input sensitivity:	1V RMS
Frequency response:	3Hz to 120kHz (-3dB)
Power bandwidth:	5Hz to 50kHz (-1dB)
Signal-to-noise ratio:	112dB (A weighted at full power)
Protection:	Thermal, DC and short circuit
Speaker switch-on delay:	2 seconds
Speaker DC protection trip voltage:	> \pm 1V
Thermal protection trip temperature:	90 $^{\circ}$ C
Efficiency:	>70%
Power consumption:	440W maximum
Dimensions W x H x D:	427 x 95 x 382mm (including connectors and feet)

Text by
Martin Pipe

4
PROJECT
RATING

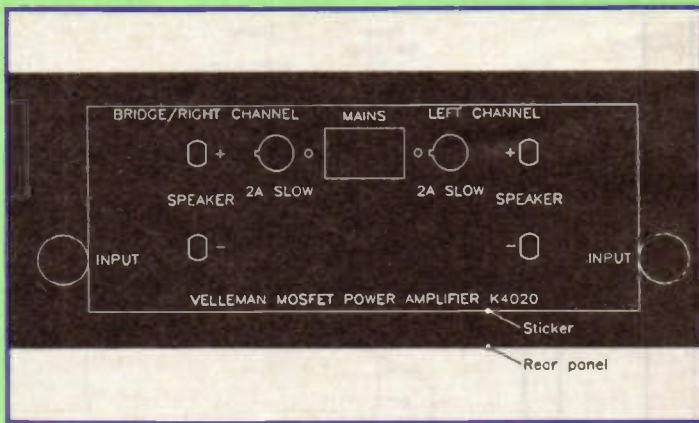

Figure 1. Rear panel assembly.



Rear panel wiring.

If you can remember, the final assembly details branched out in two slightly differing ways, giving rise to the 'left' and 'right' versions of the amplifier. The following article is concerned with such a pair of amplifiers.

One of the most noticeable features of the 300W mono amplifier is its huge heatsink. When a pair of these are combined, these heatsinks will form the side of the enclosure. What remains is the rear panel (with output binding posts, IEC mains connector and cut-outs for the PCB phono input sockets), the front panel (which will accommodate a pair of power meters; these will be covered in a future article), and the top and bottom covers.

Construction

Assuming that you have already built up a pair of amplifiers, we can proceed immediately to the assembly stage. The first step is to prepare the rear panel, which has been pre-prepared with a number of holes to accommodate the speaker terminals, fuseholder and mains connector. After giving

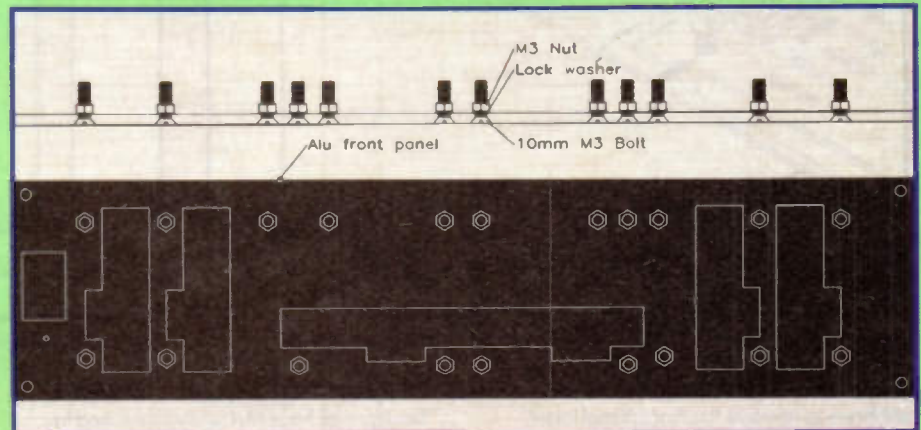

Figure 2. Front panel assembly.

it a good clean, the self-adhesive label can be applied. The label should be located centrally – horizontally (between the two holes reserved for the input socket), as well as vertically, see Figure 1. You may find it helpful to apply the label gradually, peeling the backing off as you proceed. When the label has been successfully transferred, please

do not succumb to temptation and start punching out holes corresponding to those in the panel! Only one of those relating to the fuseholder (that on the 'left channel' side) should be punched through; its 'right channel' counterpart should be left uncut. This is because only one fuseholder is required – at this stage, it is worth pointing out that the wiring diagram in the manual supplied with the kit does not conform to UK wiring standards, and should be ignored – revised instructions will follow shortly. Fuseholder apart, there's another consideration to be made before you unleash your scalpel on that label. If you are building a bridged mono amplifier, only one pair of speaker terminals needs to be catered for – the others can be left uncut.

The connectors and fuseholders can now be fitted to the rear panel, as shown in Figure 1. Note that the IEC mains connector is held in place by two 10mm countersunk M3 screws. Since these screws also clamp the earthing lug to the case, it is important to scrape away the anodisation from the corresponding area inside the case, so that there will be a reliable earth contact; in addition, a shakeproof washer should be sandwiched between the two surfaces. As with its other end, an M3 nut and shakeproof washer are used to secure the connector to the panel.

The 20mm fuseholder is a 'snap-in' type; it is inserted from the label side and simply pushed into place with a 'click'. In contrast, each of the speaker terminals is secured to the panel by a nut.

With the rear panel assembled, we can now turn our attention to the front panel. In a future issue of *Electronics*, we will be bringing you details of a power meter for use with this amplifier. If you do not require a power meter, you can skip this next section.

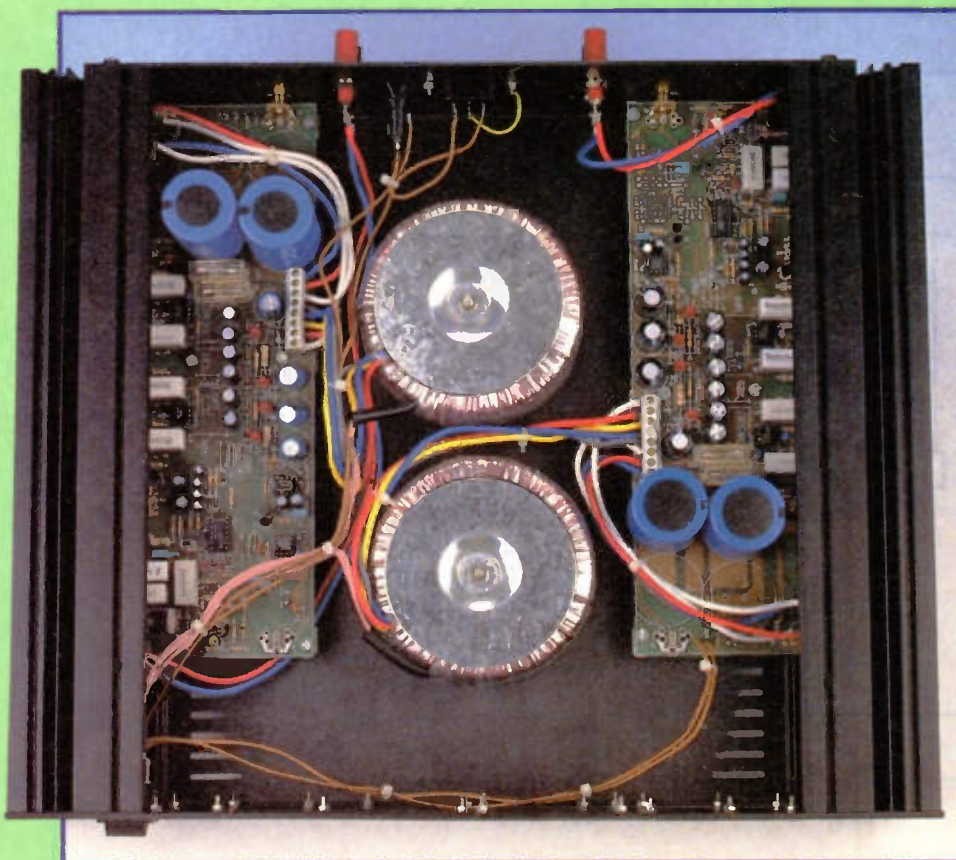

Inside the 600W MOSFET Amplifier.

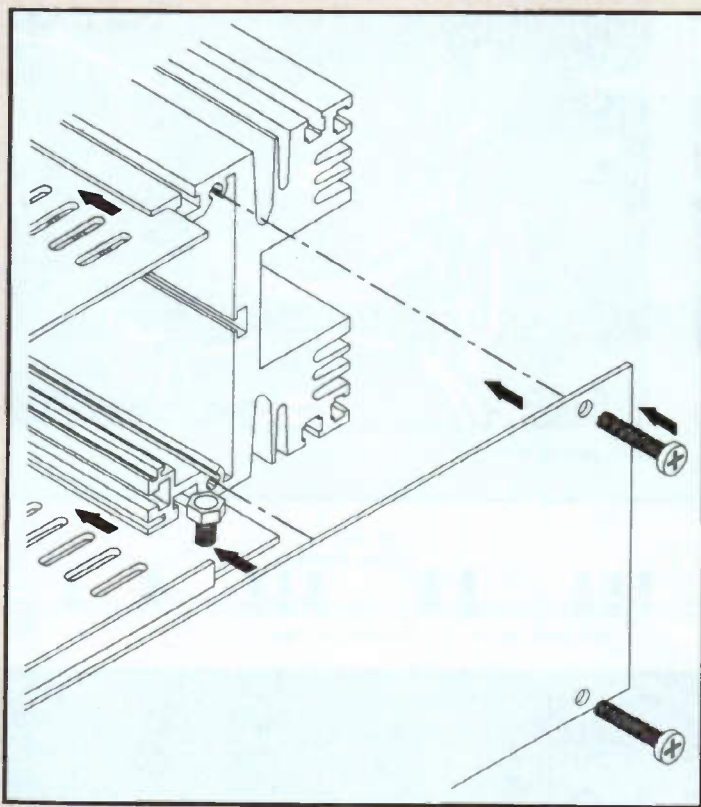

Figure 3. Case assembly.

But beware – if you change your mind, you will have to remove the front panel label, which is likely to damage it and make your amplifier look a mess!

If you intend to add a power meter to your amplifier at a later date, a number of 10mm countersunk M3 screws need to be mounted on the front panel, refer to Figure 2. This drawing also shows how the screws are mounted; note that a shakeproof washer is used in each instance. Once all the screws are in the correct place (refer back to Figure 2), their nuts can be tightened.

The heatsinks (which form the sides of the

case) need to be prepared, to accept the front panel. Four M4 screws are used to hold the front panel to the heatsinks – two for each, as shown in Figure 3. This drawing shows where the screws should go; please note that these holes are unthreaded and require tapping before the screws are finally fitted. This can be achieved by using a tap wrench and M4 tap – if you do not have such tools, a 25mm M4 screw is supplied for the job (thank heaven it's only aluminium we're tapping into! – Ed). Similar treatment must be administered to the four holes on the other side of each heatsink, which will

accommodate the screws that secure the back panel in place.

As you may remember from last month, the amplifier PCB bracket is held in place with three nuts, which are inserted into a channel in the side of the heatsink, and accept the bracket-securing screws. The base plate, which spans the two side-mounted heatsinks, is mounted in a similar way. In this case, the two screws on each heatsink (four in total) also hold the rubber feet in position. Each of the rubber feet is fitted with a 12mm M4 screw, and the assembly is loosely held to the plate with a M4 nut. Do not fit the feet on the

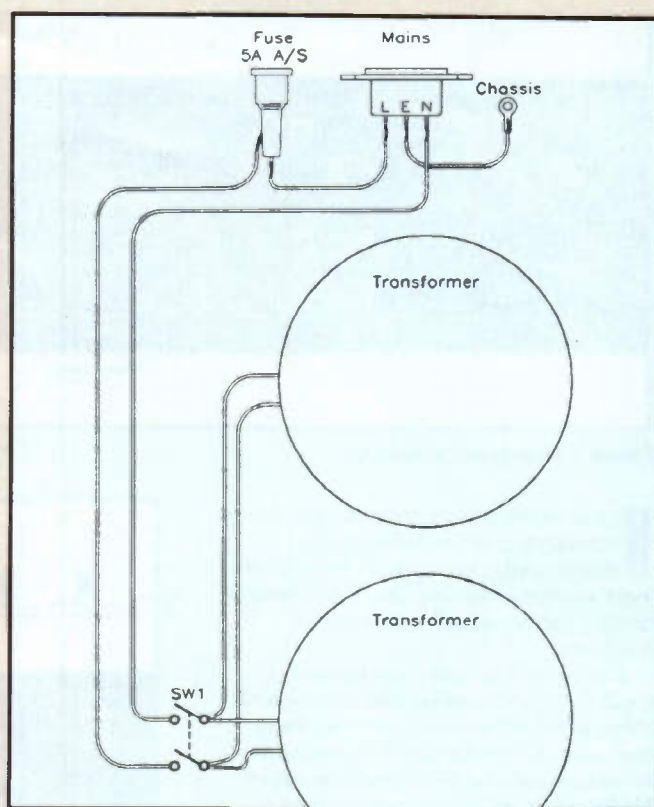

Figure 5. Mains wiring.

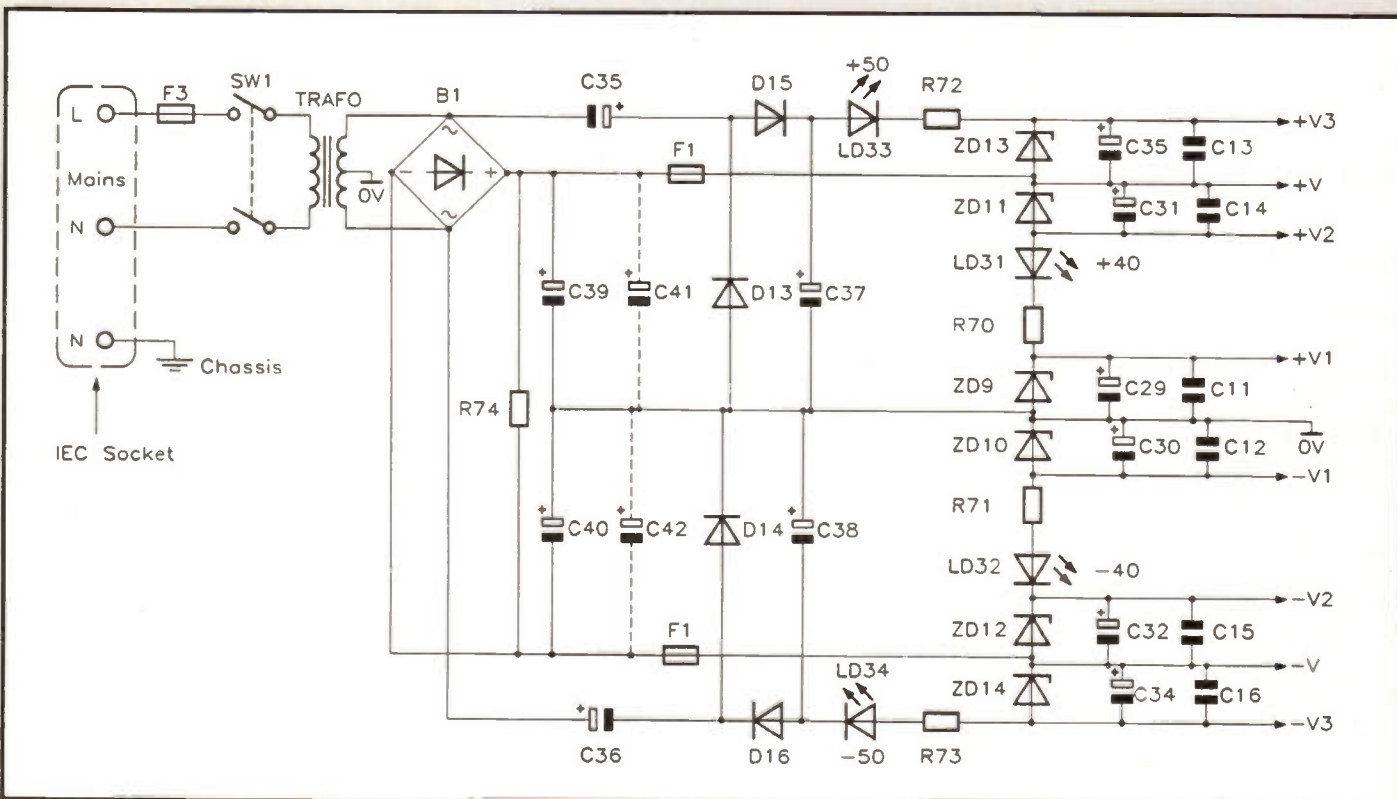

Figure 4. Revised power supply circuit.

same side of the plate that has the raised lip at each end!

When all four feet are in position, the amplifier can be turned 'upside down' and the plate slid into position, the nuts slotting into each heatsink's channel. Note that the raised lips of the plate should face the front and back of the amplifier respectively. The plate should be positioned so that its end lines up with those of each heatsink. The two transformers can now be bolted to the base plate — don't forget those rubber discs on top of, and underneath, each transformer.

The 300mm length of 'zip' (thin figure-of-8) wire should be soldered to the 'power on' LED's terminals; if required, heatshrink sleeving can be used to insulate the terminals — a quantity is supplied for this purpose. The LED can now be fitted to the front panel using a small amount of epoxy adhesive.

At this stage, we can bolt the front panel to the heatsinks, using the four countersunk 1.2mm M4 bolts — they should go in much easier, now that the holes have been threaded! To ensure that you've orientated the front panel correctly, its LED should appear in front of the left-channel amplifier; in addition, the panel's centrally-located horizontal slot should appear towards the top of the amplifier.

Now that the front panel is in position, it should be cleaned using methylated spirit or isopropyl alcohol. After leaving the panel to dry, its self-adhesive front panel label can be applied. Peel off the backing from one of the corners of the label, and apply it to the panel. Like the fuseholder, the mains switch is a 'snap-in' type, and should be fitted from the front of the amplifier. Unlike the rear panel label, which can be prepared in at least two different ways, the front panel label has been pre-cut to accommodate the switch.

Wiring

The physical construction virtually complete, we can now proceed with the wiring. The kit is supplied with a construction manual, but it is important that the mains wiring details contained therein are ignored — they do not meet UK standards. An alternative circuit diagram, reproduced in Figure 4, should be followed instead. Unlike the diagram supplied with the kit, the double-pole switch is used as such — switching both live and neutral mains lines for both amplifiers. In addition, earthing arrangements have been made, and the fuse protection provision is simplified. For your convenience, the wiring is also shown physically in Figure 5. A length of multi-strand cable has been provided for all mains connections with the exception of the earthing, for which a piece of green/yellow wire is supplied. The switch makes use of 'push fit' Lucar-style terminals, which are supplied in the kit for this purpose — it is imperative (for safety's sake) that you use the insulating boots. In addition, it is recommended that the exposed terminals of the fuseholder and mains connector are also covered up; there are special covers available for these items (refer to Optional Parts List).

The LED can now be wired up. It is connected to the '+V' (anode) and 'GND' (cathode) pins on one of the amplifier boards — refer to Figure 6. Note that a 3k Ω , 500mW resistor has been placed in series with the anode to limit the current; one lead of the resistor can be soldered to the PCB pin, and

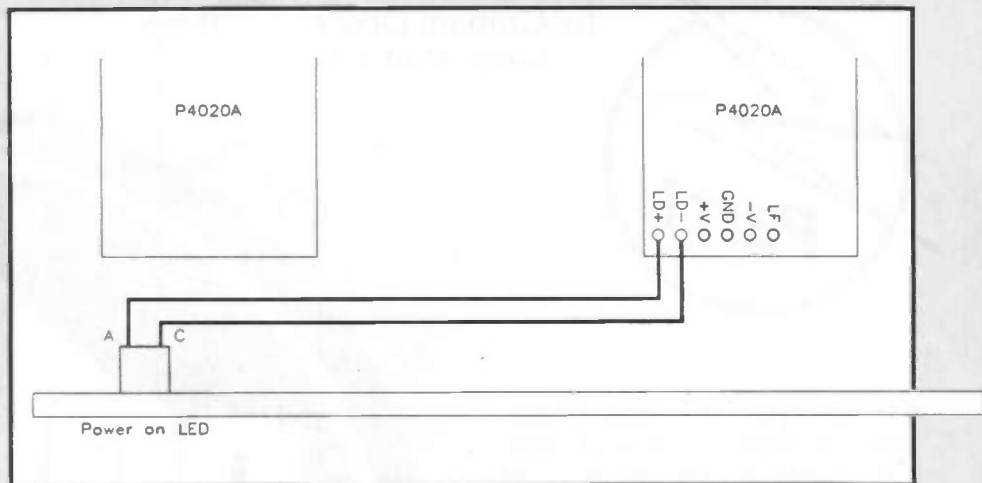

Figure 6. LED wiring.

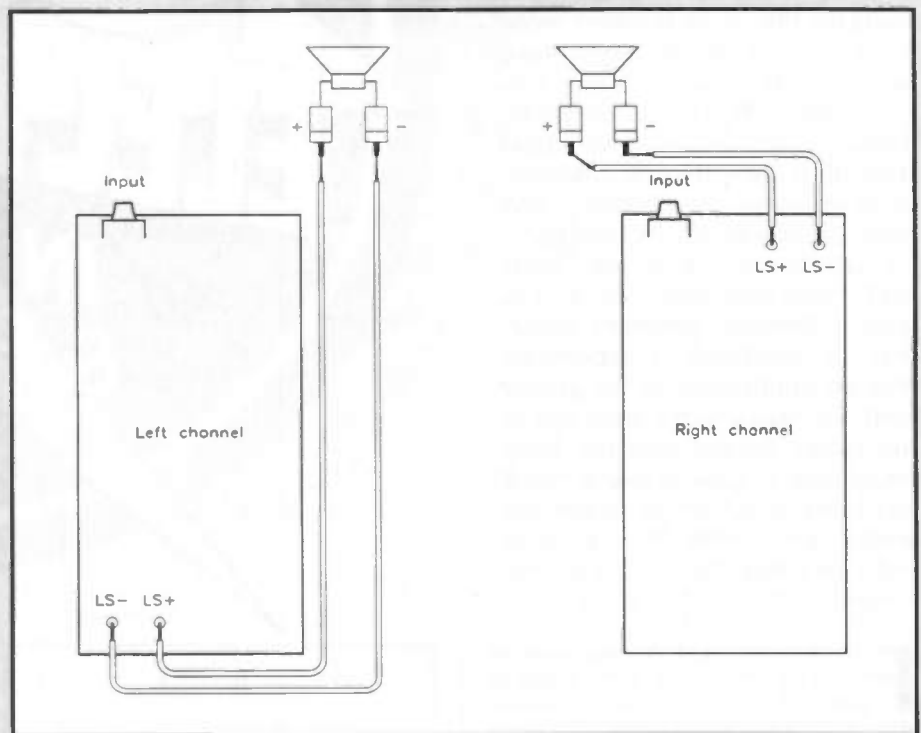

Figure 7. Signal wiring — stereo version.

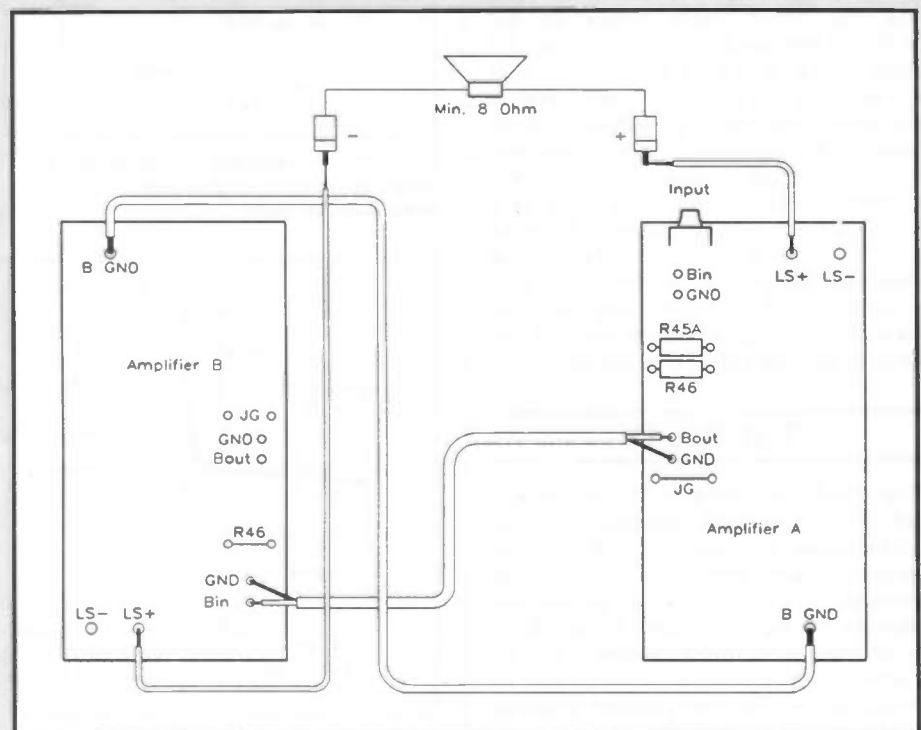

Figure 8. Signal wiring — mono bridge version.

Continued on page 60



by Graham Dixey
C. Eng., M.I.E.E.

POWER ELECTRONICS

IN THEORY & PRACTICE

For many years the words 'power' and 'electronics' occupied separate places in the hierarchy of electrical engineering. Students studying electrical engineering – using the title in the broadest sense – in breadth, would often have taken totally separate heavy current and light current subjects. Typically, the subject titles would have been something like *electrical technology* – for power – and *radio or electronic technology* – for electronics. There are, however, many semiconductor devices which, although generally classified as *electronic* components, find an application in the *power* field. For many years, their use in this heavy current area has been increasing, to such an extent that it has been necessary to merge the words *power* and *electronics* in order to create the relatively new subject of *Power Electronics*.

FOR those who wish to experiment in this area, there is a wide range of power devices available, at affordable prices. Thus, it is possible for anyone to investigate many of the principles of power electronics, with one concession, that the power levels themselves are scaled down to levels practical to the home work bench. Even so, practical circuits with applications in the home or the home workshop are feasible, giving some added incentive (if any is needed) for the amateur to have a go. In the coming months we shall be looking at a variety of devices and circuits, many of which will be described in detail so that they can be built up by the reader and evaluated. In this introductory part, we look at the principles behind some of the devices that we will use in the future.

THE DIODE

The diode is a two-electrode device which is commonly formed from the semiconductor material silicon. Its general characteristic is that it only permits the flow of a significant amount of current when its anode is made positive with respect to its cathode. This gives rise to a host of applications. In the present context however, the diode will be considered in its role as a rectifier, that is

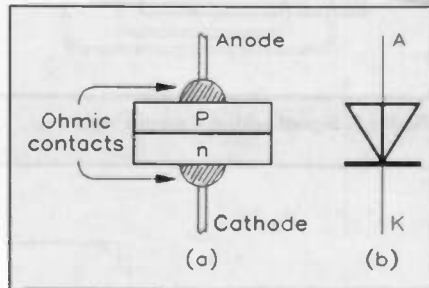

Figure 1(a). Construction of a silicon junction diode; 1(b). Circuit symbol for a semiconductor diode.

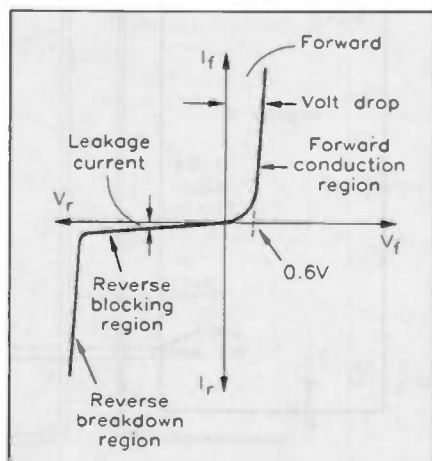

Figure 2. Characteristics for a silicon junction diode.

as a device that converts an alternating power input into a unidirectional power output. Thus, not only will we have to consider the voltage in/voltage out relationship but also the matter of current handling and power dissipation.

The diode shown in Figure 1a has been formed by the junction within a single crystal of p- and n-type materials. The basic physics of pn junctions, causes a *potential barrier* across the junction. This has a value of approximately 0.6V which has to be overcome by the forward potential between the anode and cathode before the device can be said to be conducting. The circuit symbol for a diode appears in Figure 1b.

The characteristics of a silicon diode are shown in Figure 2. In the first quadrant, forward voltage is plotted against forward current and it is seen that, once the initial 0.6V barrier has been overcome, the current rises very steeply for very little increase in forward voltage. The current in the device when conducting, is thus limited solely by the value of load. Consequently, the power dissipation will be equal to the product of forward voltage and forward current. The device current and power dissipation of the diode are thus limiting parameters, which



must be considered when selecting a device for a particular role. In practice, since the forward voltage of all diodes tends to remain the same, irrespective of their current ratings, it is usual only to specify the latter, the power rating then being implied. The forward current in rectifier diodes can be as high as hundreds of amperes, for the higher power devices.

The reverse characteristic of the diode appears in the third quadrant of Figure 2. This shows that, over a wide range of voltage, very little current flows through the diode. What current does flow is termed a leakage current and in rectifier diodes this current is of the order of a few micro-amperes. The range of voltage – termed the reverse blocking region – over which only a leakage current flows can vary between a few tens of volts and several thousand, depending upon the physical construction of the particular diode. After the reverse blocking region we enter the reverse breakdown region, in which the current rises very rapidly for virtually no change in the reverse voltage. This is similar to the forward characteristic – with one important difference – the power level involved! Consider an example:

Suppose that a particular diode has a power rating of 10W; this means that in the forward direction it could handle the combination of a forward voltage drop of 0.8V and a forward current of 12A approximately. Suppose that, for the same diode, the reverse breakdown occurs at 100V. Once breakdown has occurred, there is nothing to limit the diode current except perhaps the load itself. Thus, if the diode also attempts to pass 12A in the reverse direction, the power dissipated in the diode will be the product of the reverse breakdown voltage and the reverse current, namely 100V and 12A. This equates to a power level of 1200W. What chance does the diode stand under these circumstances? None at all. It is thus essential that breakdown in the reverse direction is prevented. This means that a further parameter required in selecting a diode for a particular job will be the *Reverse Breakdown Voltage or Peak Inverse Voltage* (PIV).

As a result of their very high forward – reverse current ratios, silicon diodes are capable of achieving rectification efficiencies up to about 99%. Couple this with the facts that, with correct handling, their life is virtually infinite; they are of small size; they are shockproof and are little affected by environmental conditions, and you begin to appreciate how superior they are to the thermionic devices that they have replaced.

As with all semiconductor devices, they are not totally unaffected by

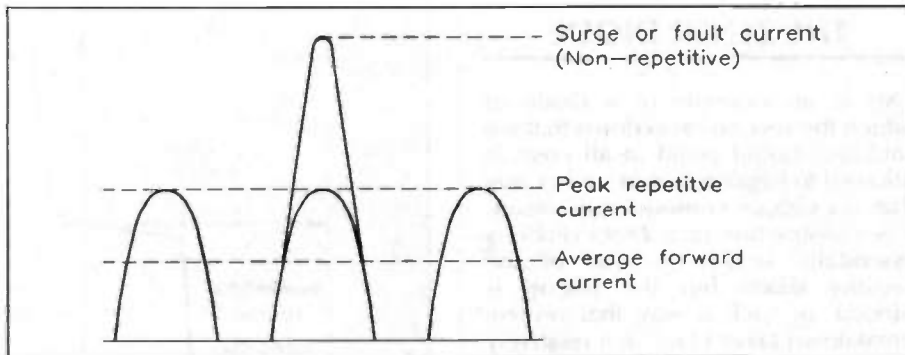

Figure 3. Currents in a diode rectifier.

temperature but what changes occur between sub-zero temperatures and about 200°C have limited significance. At 25°C, for example, the leakage current is typically 1µA and the forward voltage drop 1.5V @ 50A; at +150°C the leakage current has risen to 100µA accompanied by a forward volt drop at 50A of 0.6V. The higher leakage current at the elevated temperature is still only 0.1mA and compared with the forward current of 50A is insignificant; additionally, the reduced volt drop is actually an advantage.

DIODE RATINGS

The PIV, as a means of specifying diode performance has already been mentioned, as has the forward current. The latter, however, requires a little further explanation:

As the current flow in a rectifier is not usually DC, it is usual to give current ratings in terms of average, peak and RMS values; the latter of course implies the power rating of the diode. Published data for silicon rectifier diodes usually includes the ratings for both average and peak forward current. The *maximum average forward current* is the maximum average value of current which is allowed to flow in the forward direction during a full AC cycle, under specified temperature conditions. The *peak recurrent forward current* is the maximum repetitive instantaneous forward current permitted under given conditions. Another rating that is often provided is for the *non-repetitive surge current*, which may occur under normal conditions – such as when first switching on – or under momentary fault conditions. These three current ratings are illustrated in Figure 3.

IMPORTANCE OF JUNCTION TEMPERATURE

Silicon will melt if its temperature exceeds a maximum, which is normally considered to be about 180°C.

This will naturally cause an immediate failure of the device. The junction is heated above the ambient temperature by virtue of the power which it dissipates. The actual temperature that the junction reaches will be determined by the product of forward voltage and forward current and also by the junction's ability to dissipate heat. High power semiconductor devices are frequently mounted on metal heat sinks in order to allow heat to escape from them often considerably increasing their current rating. Many small diodes are, however, rated for use without heat sinks; it is only when we get into the realms of really high power operation that these extra precautions need to be taken.

SERIES AND PARALLEL OPERATION OF DIODES

It would seem obvious that we could connect several diodes together to obtain a higher rating. For example, series connection would cause the PIV rating to be increased by a factor equal to the number of series-connected diodes. The forward voltage drop would, of course, increase in the same proportion. We should have to ensure however, that the total reverse voltage applied to the combination was equally distributed between all diodes. If this were not so, one diode might be over-stressed, resulting in its eventual failure. The usual technique is to wire equal value resistors across each diode or, alternatively, equal value capacitors. Parallel resistors are generally used for steady state conditions and parallel capacitors are used where transients are expected. Sometimes both resistors and capacitors are included to cater for either eventuality.

Parallel operation of diodes would increase the current rating but, again equal sharing – this time of the total current – would have to be ensured. In practice, parallel operation is rarely used and hardly likely to be necessary since a wide range of diodes with high current ratings is available.



THE ZENER DIODE

This is an example of a diode in which the reverse breakdown that we said we should avoid at all costs is allowed to happen, but in such a way that no serious consequences result. The construction of a Zener diode is essentially similar to that of the rectifier diode but the silicon is 'doped' in such a way that reverse breakdown takes place at a relatively low voltage, certainly down to about 3V or so. The reason for doing this can be deduced from the reverse characteristic of Figure 2, from which we observe that, 'the current rises very rapidly for virtually no change in the reverse voltage'. In other words, the device is exhibiting a constant voltage characteristic in this region of its operation. This is precisely the function of the Zener diode, which is always used reverse-biased and in the state of breakdown, so as to obtain a constant voltage.

It is possible to buy Zener diodes which have breakdown voltages in the range 2.7 to 100V. The characteristic of a Zener diode is shown in Figure 4a, while its circuit symbol appears in Figure 4b.

Why is it that a rectifier diode will burn out when it breaks down while a Zener diode won't? The simple answer is that the power dissipated in a Zener diode is deliberately restricted so as to keep the power dissipation within the rating of the device. This is done by including a series resistor, sometimes called a 'ballast' resistor, which automatically limits the reverse current. The value of this resistor is determined by some simple calculations involving a knowledge of the circuit input voltage and the diode ratings. The characteristic ratings for a Zener diode include its *Zener voltage* – the maximum reverse voltage which it will tolerate – and power rating. The accuracy of the device parameters is presented as a percentage e.g., $\pm 5\%$.

THE SILICON CONTROLLED RECTIFIER (SCR)

Here we meet the first of a family of devices known under the generic heading of *thyristor*. This is a four-layer device, whose construction and circuit symbol is shown in Figures 5a and 5b respectively.

The SCR has three electrodes, the anode and cathode at the p- and n- ends of the silicon device, respectively, and the gate, whose terminal is connected to the p-region adjacent to the cathode. In use, the positive supply of the supply is connected to

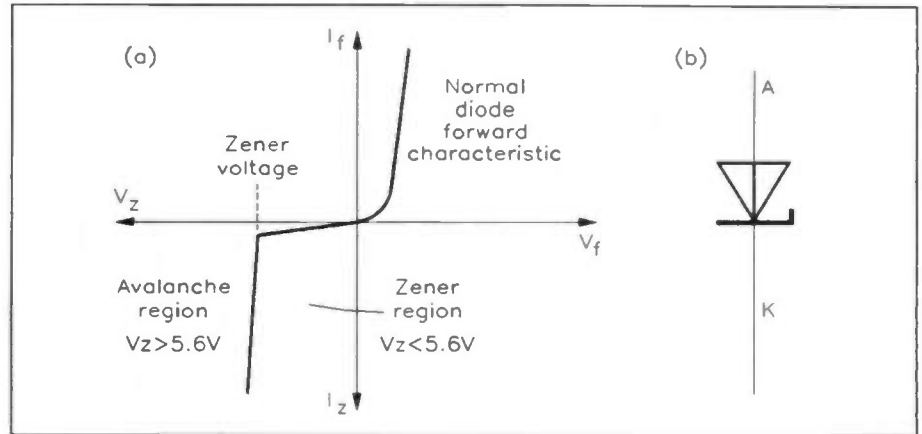

Figure 4(a). Zener diode characteristic; 4(b). Circuit symbol for Zener diode.

the anode and the negative supply terminal to the cathode. The gate is the input terminal of the device and in use is connected to a current source that is used to trigger the SCR on.

Figure 5c shows the characteristic relation between the anode-cathode voltage and the anode current for the SCR. The third quadrant shows a curve of the same form as that of a reverse-biased rectifier diode; the characteristic in the first quadrant is the one of particular interest. At first there is a forward blocking action until a high enough forward voltage is reached, when a large forward current suddenly flows. When this happens, the forward voltage drops to a very much lower value – in the order of 2V. Figure 5c actually shows three different forward characteristics, each for a different value of gate current I_G , including zero. The gate current is a current flowing in the gate circuit when a positive voltage is applied to the gate terminal. It can be

seen that the 'forward breakover voltage' depends upon the gate current. A high value of gate current means a low value of forward breakover voltage and vice versa. Put another way, if a moderately large forward voltage is applied between anode and cathode, with the gate current initially zero, then the application of a large enough gate current will cause the device to switch from being one that is virtually non-conducting to one that is conducting heavily.

There are a variety of ways in which the gate current can be used to trigger the SCR from the non-conducting state into a state of full conduction. Once the SCR is in the on state, the gate has no further control over it; reducing the gate current to zero has absolutely no effect. However, it is obviously going to be necessary on occasions to be able to turn the SCR off again, often at a quite specific point in time. Thus, in

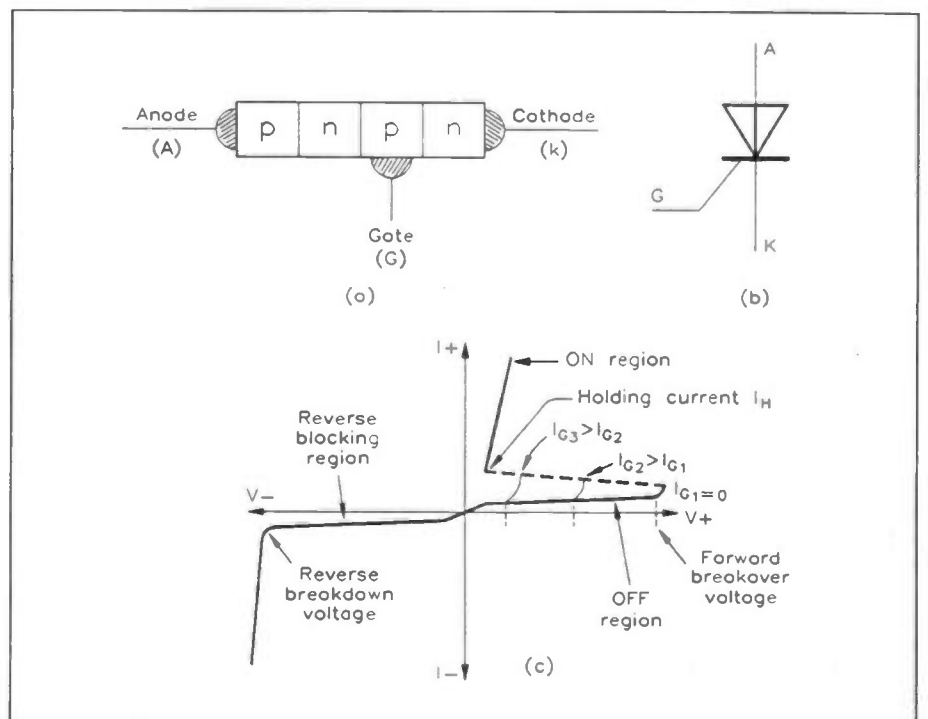

Figure 5(a). SCR construction; 5(b). SCR circuit symbol; 5(c). SCR characteristics.



investigating SCR circuits we shall have to consider various methods of turning the device on and off. It is surprising just how many ways there are to achieve these objectives.

The word 'rectifier' in the SCR's title implies that it can be used with an alternating input to produce a unidirectional output. This is true and Figure 6 shows the principal difference between this 'controlled' rectifier and the normal diode rectifier. Instead of always switching on near

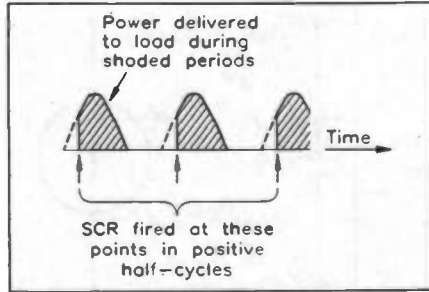

Figure 6. Output voltage from an SCR circuit where triggering is delayed.

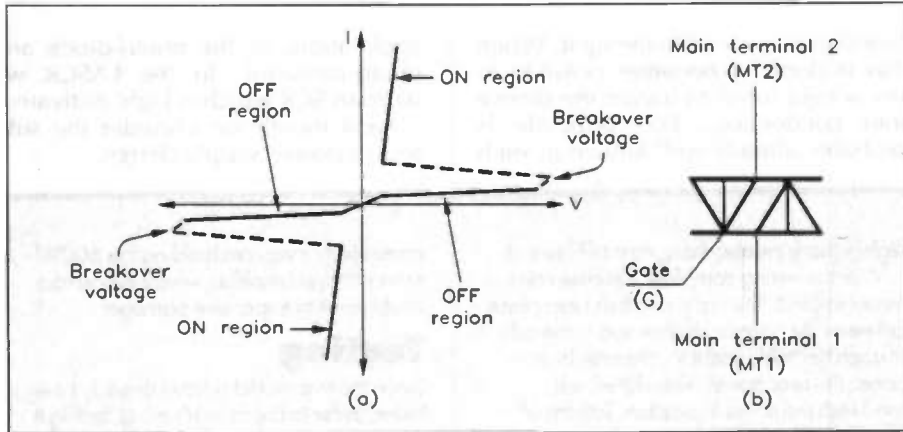

Figure 7(a). Triac characteristics; 7(b). Triac circuit symbol.

the beginning of each positive half-cycle, the triggering can be delayed until later. Thus, in Figure 6, the output from the rectifier consists of positive waveforms, each less than one half-cycle in duration. By controlling the actual triggering point from time to time, it becomes possible to control the power into the load.

THE TRIAC

The characteristics for a triac are shown in Figure 7a together with its circuit symbol in Figure 7b. The obvious difference between this device and the SCR is that its symbol comprises two 'back-to-back' diodes, which implies the ability to conduct bidirectionally, although there is still only one gate terminal. It can be triggered into conduction in just the same way as the SCR, by supplying enough gate current, provided that

the supply voltage between its two main terminals is large enough. Because the device is bidirectional, the polarity of the supply is unimportant. This obviously means that it can be operated with an alternating supply, and can be triggered into conduction on either half-cycle.

Figure 8 is the triac equivalent of Figure 6 and shows that triggering can be delayed on both positive and negative half-cycles, giving a controlled AC output voltage. Thus, we can expect that the triac will be a device to control AC power while the SCR will be used to control DC power.

THE DIAC

The characteristic for this device is shown in Figure 9a together with its circuit symbol in Figure 9b. It is also a four-layer device, is a member of the thyristor family, and is bidirectional.

However, it has no gate and can only be switched into the conducting state when the voltage across it reaches the required level. This is quite low, typically about 8V. It is used as a triggering device for higher power devices especially triacs. Since the diac switches at a predictable voltage, it becomes possible to improve the precision of triac triggering, by its use.

THE SILICON CONTROLLED SWITCH (SCS)

The circuit symbol for this device, also a thyristor, is shown in Figure 10a. This is a unidirectional device that has two gates, known as the *anode gate* and the *cathode gate*. It acts somewhat like an SCR but can be turned on by applying either a positive pulse to the cathode gate or a negative pulse to the anode. Once triggered into the on state, it can be turned off again by applying a negative pulse to the cathode gate or a positive pulse to the anode gate.

THE SILICON UNILATERAL SWITCH (SUS)

This device, whose circuit symbol appears in Figure 10b, is rather like an SCR but it has an anode gate instead of a cathode gate; there is also a built-in Zener diode between gate and cathode. In use, the gate is usually left open and triggering occurs when the voltage between anode and cathode reaches a value of about 8V. Thus, it behaves rather like a diac but is polarity sensitive.

THE SILICON BILATERAL SWITCH (SCS)

The circuit symbol for this device is shown in Figure 10c. It comprises two SUSs, wired back-to-back, in the same package. This allows it to trigger on either polarity of the supply voltage, exactly as for the diac.

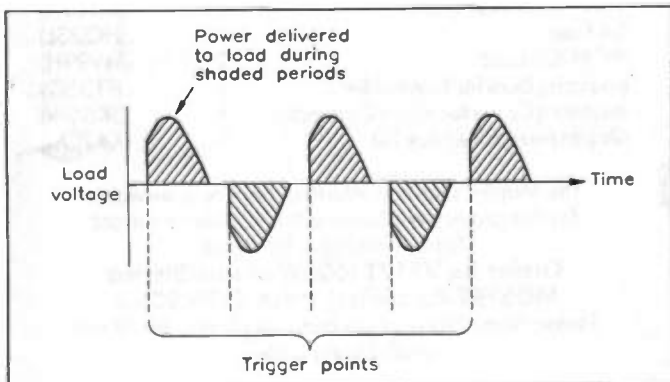

Figure 8. Controlled AC output from a Triac circuit.

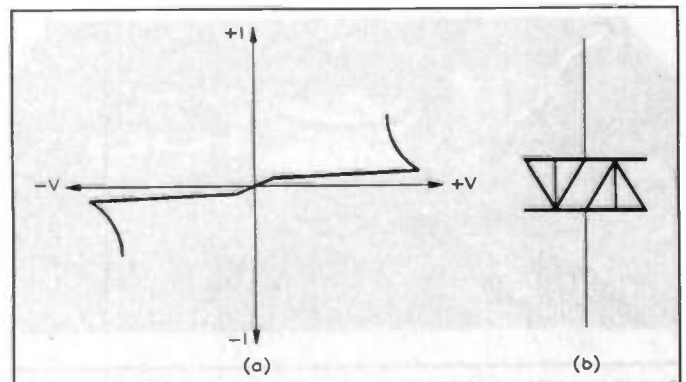

Figure 9(a). Diac characteristic; 9(b). Circuit symbol for Diac.



THE QUADRAC

It was mentioned earlier that the diac is often used as a trigger device for a triac. This being so, it makes sense to put one of each in a single package, this fact being reflected in the circuit symbol of Figure 10d – for the quadrac.

THE LIGHT ACTIVATED SCR (LASCR)

Semiconductors are light sensitive and it is possible to encapsulate semiconductor devices so that a

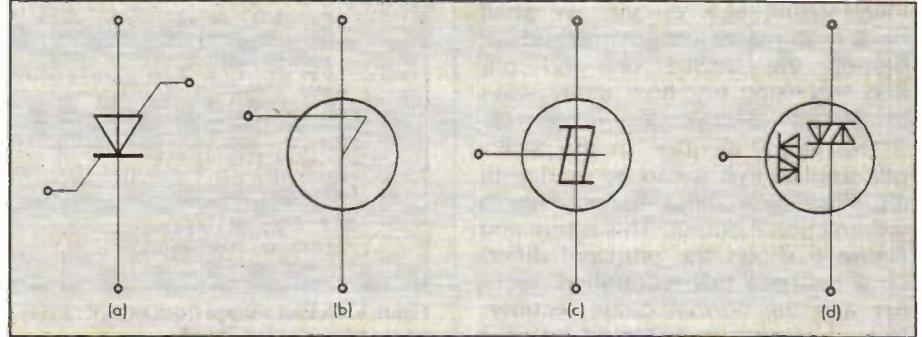

Figure 10. Circuit Symbols for; 10(a). SCS; 10(b). SUS; 10(c). SBS; 10(d). Quadrac.

junction is exposed to the light. When this is done, it becomes possible to use a light input to trigger the device into conduction. This principle is probably already well-known in such

applications as the photo-diode and photo-transistor. In the LASCR we have an SCR which is Light Activated.

Next month we consider the subject of power supply design.

600W Stereo Amplifier continued from page 55.

the anode's lead to the other end of the resistor. Heatshrink sleeving can be used to cover the resistor, if required.

How you continue with the wiring depends on your application. If you are building the 300W stereo amplifier, the wiring diagram of Figure 7 should be followed. If you are constructing the 600W bridge version, though, you should follow the

slightly more involved diagram of Figure 8.

With the wiring complete, the case can be assembled. The top cover is slid into place between the horizontal channels in the side of each heatsink, until it touches the front panel; the rear panel, when fitted, will sandwich the cover in position. Talking of which, the rear panel can now be screwed into position, using the remaining quartet of M4 bolts, and the 20mm 5A anti-surge fuse fitted in its holder. The amplifier is now complete, but you are advised to check thoroughly that everything is correct –

particularly if you are building the 600W mono bridge amplifier, where any errors could result in expensive damage!

Testing

Since the two modules have already been tested (refer to last month's issue), testing is simply a matter of installing the unit in its intended application. If you have built a 600W amplifier, the part of the back panel legend that refers to the unfitted pair of speaker terminals (left channel) can be 'inked in' with a PCB pen.

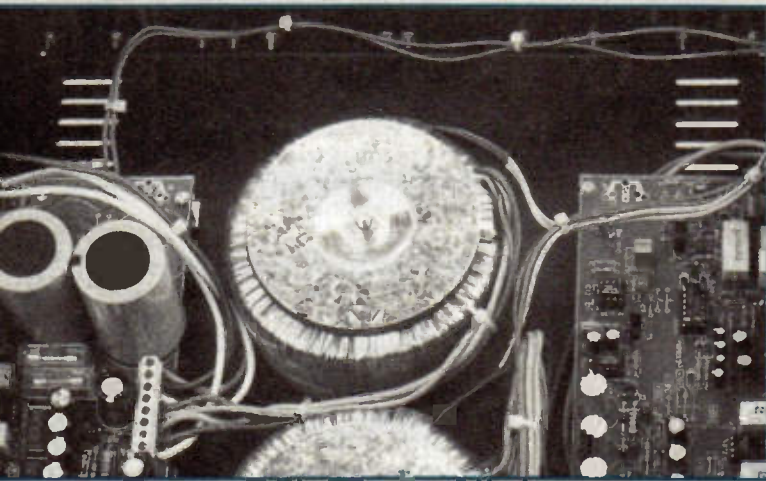

A view of the front panel, as seen from inside the amplifier.



Rear view of the amplifier. Note the positioning of the label, and the single fuseholder.

ADDITIONAL COMPONENT PARTS LIST FOR KIT

Zip Wire	30cm	(XR39N)*
M3 Solder Tag	1	(LR64U)*
Spade Terminal	4	(HF10L)*
Spade Terminal Cover	4	(FE65V)*
20mm 5A Fuse	1	(RA12N)
Heatshrink Sleeving CP32	5cm	(BF88V)*
32/0.2 Wire Green/Yellow	5cm	(XR38R)*
Double Bubble Epoxy Glue	1	(FL45Y)

Please Note: Items marked with a * are supplied in 'package' quantities (e.g., packet, strip, reel, etc.), see current Maplin Catalogue for full ordering information.

OPTIONAL PARTS LIST

(Not Included in Kit)

13A Nylon Mains Plug	1	(RW67X)
5A Fuse	1	(HQ33L)
IEC Mains Lead	1	(BW99H)
Insulating Boot for Fuseholder	1	(FT35Q)
Insulating Cover for Mains Connector	1	(JK66W)
Maplin Magazine Issue 70	1	(XA70M)

The Maplin 'Get-You-Working' Service is available for this project, see Constructors' Guide or current Maplin Catalogue for details.

Order As VF17T (600W Mono/Stereo MOSFET Amplifier) Price £299.95 H29.

Please Note: None of the items supplied in the kit are available separately.

2
PROJECT
RATING

Text by Martin Pipe

Last month we looked at the Audio Spectrum Analyser which, although usable in its own right, has been designed as part of the Modular Equaliser System. This comprises, Spectrum Analyser apart, a power supply and switching module, a 2U front panel – and, of course, the Graphic Equaliser itself, which is covered in this instalment.

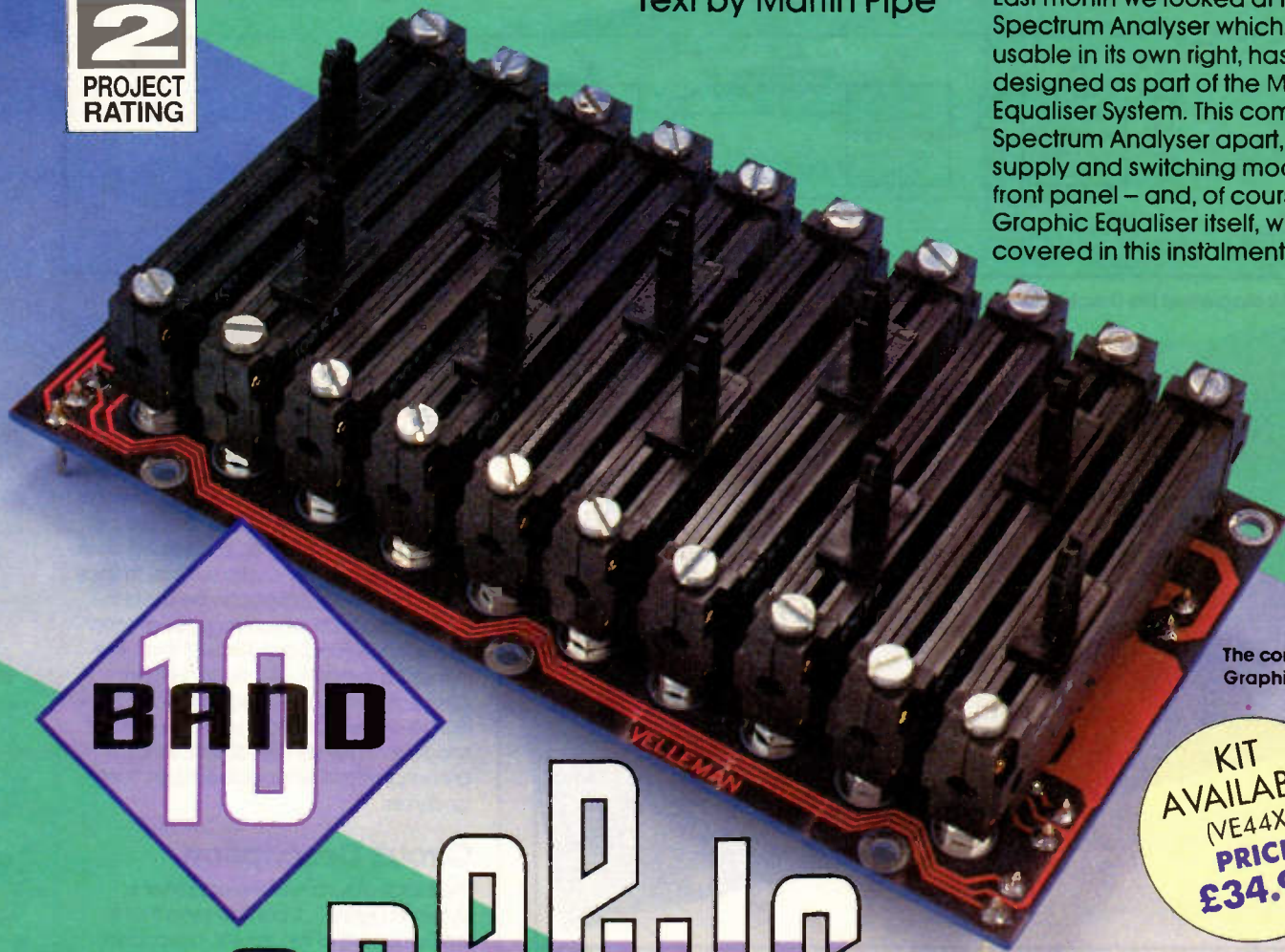

The completed Graphic Equaliser.

KIT
AVAILABLE
(VE44X)
PRICE
£34.95

10 BAND GRAPHIC EQUALISER MODULE

FEATURES

- * Compact size
- * Low distortion
- * Low-cost
- * 10dB of cut or boost across 10 frequency ranges
- * 5V to 12V DC single-rail power requirement

APPLICATIONS

- * Modular equaliser systems
- * Disco and PA equipment
- * Updating Hi-Fi equipment
- * In-Car applications
- * Home recording and electronic music

THE Graphic Equaliser presented here allows ten narrow (but overlapping) frequency bands across the audio range to be cut or boosted. These bands are arranged around centre frequencies of 32Hz, 64Hz, 125Hz, 250Hz, 500Hz, 1kHz, 2kHz, 4kHz, 8kHz and 16kHz, and are adjusted by moving the sliding variable resistors from the centre flat position to cut or boost at a specific frequency, or group of frequencies.

Well that's how one could be used. But why would you use one? A graphic equaliser allows room acoustics or speaker colouration problems to be brought under control, or allows the audio response to be tailored to personal preference – in other words what you think 'sounds good' (OK, a contradiction of the term 'high-fidelity', if you like!). In fact, many record producers do just that in the studio, so there's no reason why you can't, even if it's an attempt to negate their fiddling and come up with a 'neutral' sound (i.e. one that you believe resembles the original source). 'Hi-Fi snobs' may treat the graphic equaliser as if it has been blessed with a particularly contagious disease (other than 'Ye Olde Fyddler's Fyngers', of course), but the outcast does have its place! Perhaps the Hi-Fi snobs should refuse to buy records made in studios where tone controls (equalisation) have been used – their collections would take on a somewhat spartan appearance.

Hands up the old-timers who remember vinyl LPs! Well, most of you probably won't admit to owning any of

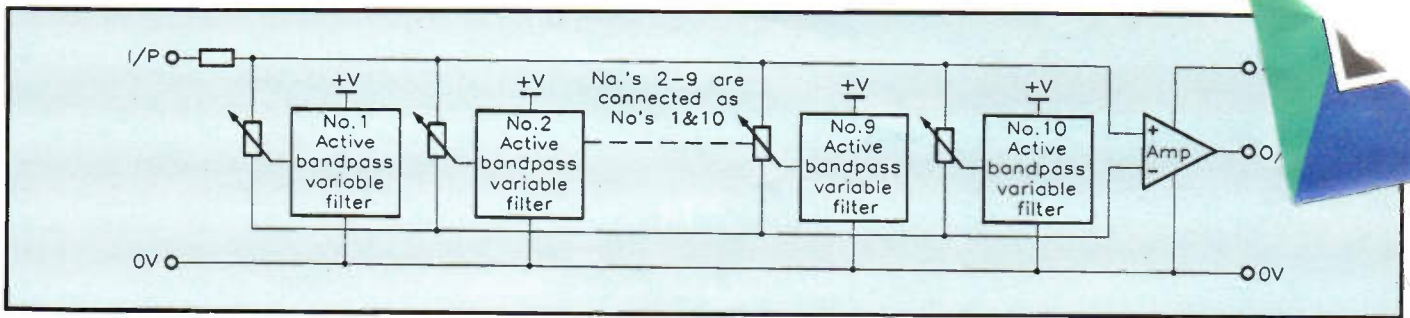
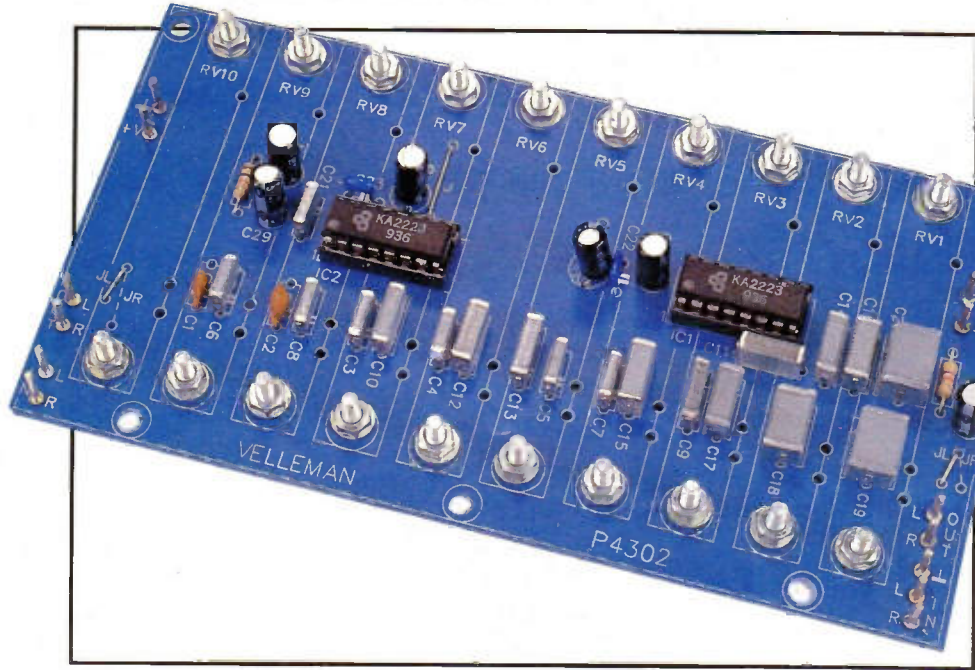

Figure 1. Block diagram of the Graphic Equaliser.



Component-side view of completed PCB.

those compilation LPs where 10 tracks are squeezed onto each side, simply so that the manufacturer can dispense with the requirement for a second record. Unfortunately, these records tend to lack dynamic range, and normally lack bass (being somewhat treble-orientated). The careful use of a graphic equaliser allows the problem to be redressed, particularly

so that tapes of the end result can be made. Talking of taping, the use of a graphic equaliser can help here as well, allowing the slight loss of top-end generally incurred during the home recording process to be countered with by a subtle tweak of the last two controls. The use of pre-equalisation during taping may also prove beneficial when

you are making tapes up for special applications; you may want a little bass lift for tapes destined for use in your car or personal stereo, for example.

Since the Graphic Equaliser design presented here can run off a regulated DC supply of between 5 and 12V, it can be used virtually anywhere. It could be installed in an amplifier, in a mixing desk, or even in your car audio system. In fact, the Graphic Equaliser can be used in any application which requires greater precision of tonal adjustment than the standard 'bass/treble' controls can afford. As we mentioned earlier, a future article will explain how you can use this module, together with others, to form a comprehensive equaliser/spectrum analyser.

Circuit Description

The block diagram of the equaliser is shown in Figure 1. It can be seen that it simply consists of ten, similar, cascaded stages.

Looking at Figure 2, it can be seen that the circuit centres around two KA2223 IC packages, which are specialised graphic equaliser amplifiers consisting of an op amp and five resonant circuits (filters), which are in its feedback loop. Each circuit equates to one of the five channels, and this explains why two ICs are required. For those that are interested, the internal workings of the KA2223 are shown in

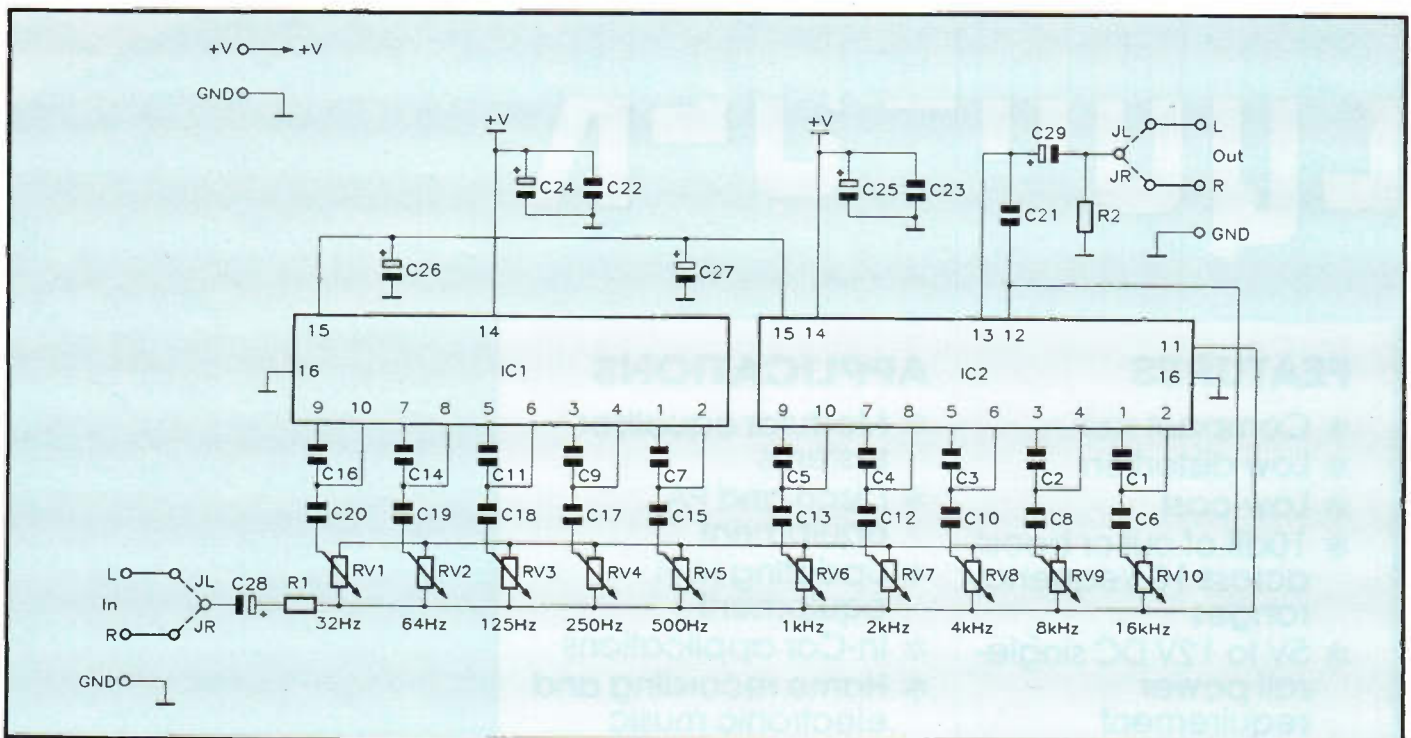

Figure 2. Circuit diagram of the Graphic Equaliser.

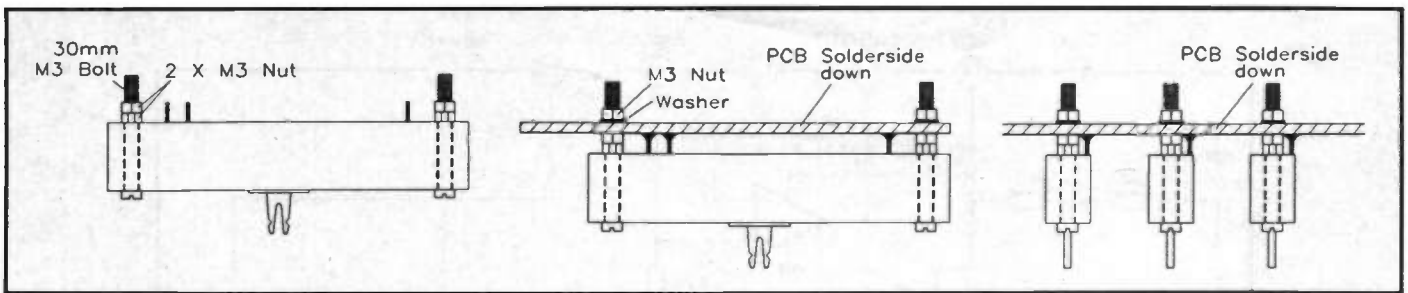

Figure 6. Fitting the potentiometers to the PCB.

if the equaliser you are building is to be used for the left ('JL' link fitted) or right ('JR' link fitted) channel.

Be sure to insert the electrolytic capacitors the correct way round; in addition, note that their leads will need preforming before they can fit neatly to the board prior to soldering. The orientation of the two ICs is also critical; note that the components are fitted in sockets. The sockets, rather than the ICs themselves, should be soldered in place – the ICs will be inserted just before testing.

Before the slider potentiometers can be fitted, they need to be prepared as shown in Figure 6. A 30mm M3 bolt is passed through the mounting hole in each end, from the slider end. Two M3 nuts are then threaded onto the screw, and are moderately tightened against the body of the potentiometer – don't use too much torque, or you may crack the plastic body. Each potentiometer prepared in this way can now be mounted on the track side of the PCB, as shown in Figure 6. Be careful to align the control correctly before screwing it to the board; its three pins should line up with the appropriate solder pads, which are identified clearly on the PCB legend printed on the other (component) side of the board. Once the potentiometer has been seated correctly, two M3 nuts and shakeproof washers, applied from the component side of the PCB, will clamp it to the board; these should be securely tightened. The device's leads can now be soldered to the pads. For ease of assembly

(at least when it comes to gaining access to the terminals for soldering), it is advisable to fit RV10 first.

After completing assembly, it is prudent to check your work – finding any incorrectly placed components could save considerable time and expense later on. Other gremlins to watch out for include solder bridges/whiskers and poor joints.

Testing and Installation

Before we can test the Graphic Equaliser, we need to procure a suitable DC power source. This should be regulated, and capable of supplying between 5 and 12V,

at a current of at least 10mA. A suitable power supply is shown in Figure 7. This should be connected to the '+V', and its companion 'A' (ground) pin. The ICs can now be inserted, aligning its identification notch with that of the socket; but not with the power supply switched on!

If you have a signal generator and an oscilloscope, the effectiveness of the equaliser can be evaluated. To do this connect the signal generator to the input of the equaliser ('IN L' or 'IN R'), and the equaliser output ('OUT L' or 'OUT R') to an oscilloscope. Screened cable (such as XR15R) should be used for all audio connections, to reduce the possibility of

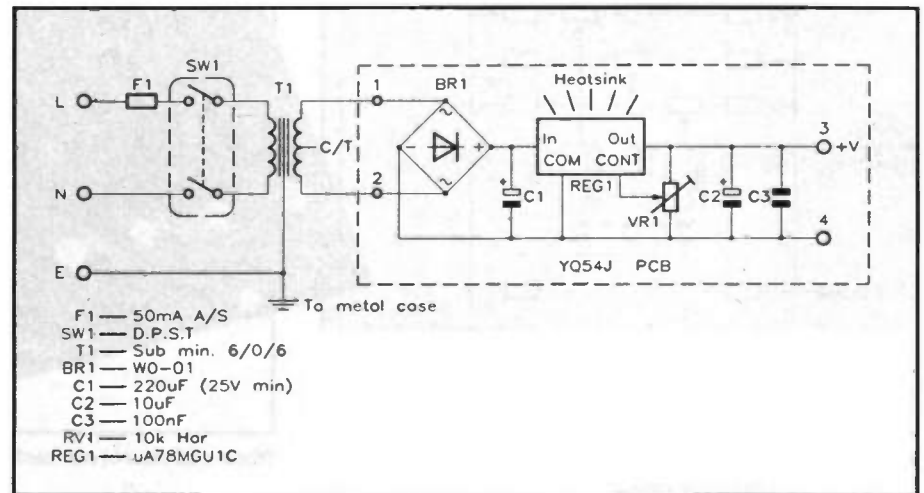

Figure 7. Suggested power supply circuit.

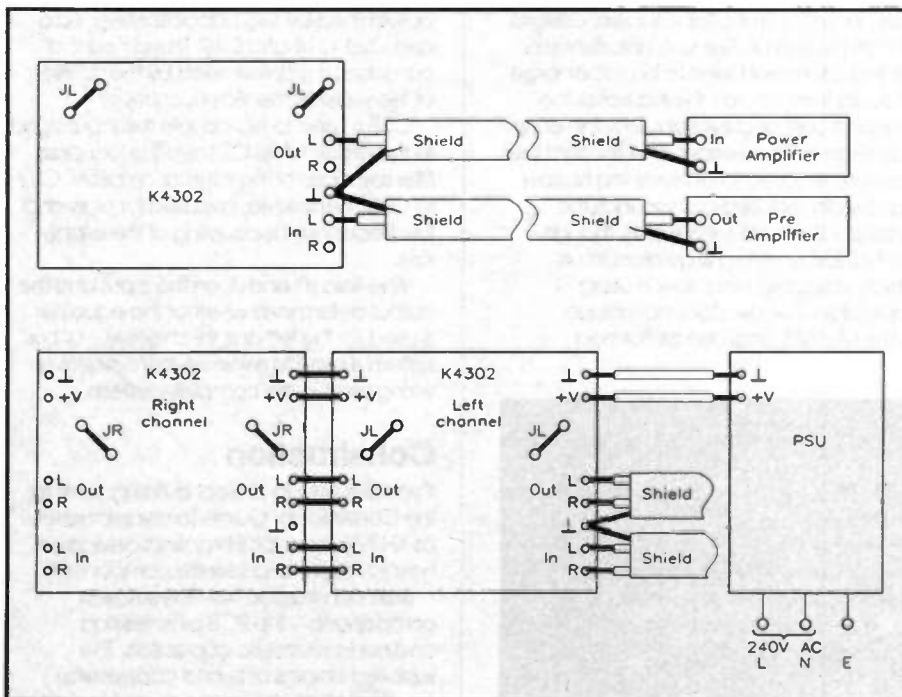

Figure 8. Wiring up the equaliser; both mono and stereo configurations are shown.

hum pick-up – there is a ground/common pin ('A') located between the inputs and outputs. The signal generator is now set to the first frequency band of the equaliser (32Hz) – all of the sliders are set to their central (flat) position. Apply power to the Graphic Equaliser, and raise the 32Hz slider to the top; the signal should be seen to increase in amplitude. Move the slider to the bottom of its travel; in this instance attenuation should be noted. The sliders lying directly next to the 32Hz will have some effect on the output because of overlap of the bands. As you try the controls further away, you should notice progressively less effect.

A similar procedure can be adopted with the other frequency bands. If an oscilloscope is not available, an amplifier and AC voltmeter may be used. A loudspeaker could be used, but this method is subjective and in any case results (particularly those at the frequency extremes) are likely to be affected by the speaker's frequency response limitations.

The best form of testing, though, is to use the Graphic Equaliser module in its intended application. The module should

be installed away from any strong mains fields (power transformers and the like), in a screened case. If the completed board is to form part of a modular equaliser system, it should be built into a decent metal case anyway! The next stage is to connect the equaliser between the audio source and the audio destination – as during testing, screened cable should be used. Figure 8 shows how a single mono equaliser can be wired between a preamplifier and power amplifier. If the

amplifier is an 'integrated' one, the Graphic Equaliser can be inserted between the preamplifier output and the power amplifier's input attenuator (the 'volume control') – a convenient point between the two can be broken, and the equaliser inserted into circuit as shown. Figure 8 also shows two equalisers configured as a stereo pair and linked together; in this case one is configured for the right channel and the other the left. This latter configuration is used if the Graphic Equaliser is to form part

of the modular system discussed earlier.

It is important to note that the slider knobs are special types with their own order code (refer to Optional Parts List) – due to the design of the slider shaft, no other Maplin knobs are suitable.

Figures 9 and 10 show simple bypass circuits, both of which allow the equaliser to be switched in or out of circuit as required. Figure 10 has the refinement that when power is removed, the equaliser is automatically bypassed.

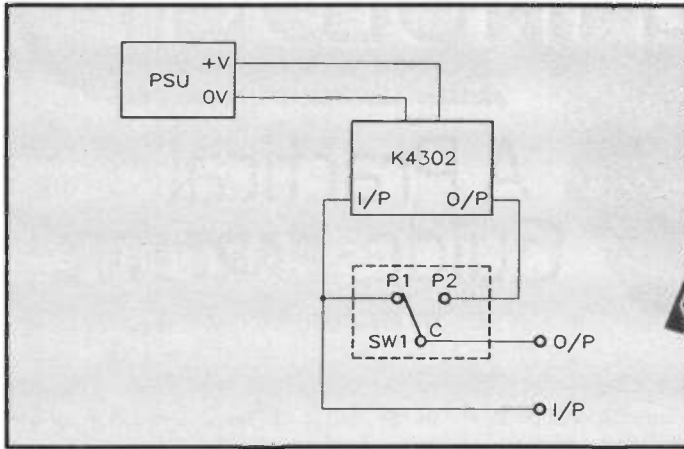

Figure 9. Switch bypass circuit.

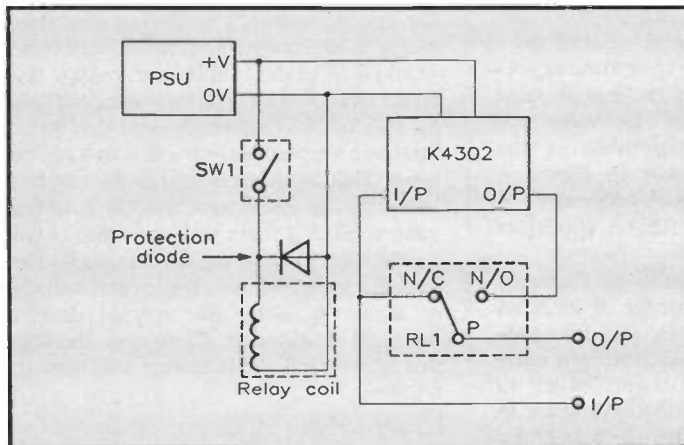

Figure 10. Relay bypass circuit.



Optional Parts List

(Not Included in Kit)

Slider Knobs	10 or 20	(VX18U)
Screened Cable	As required	(XR15R)
Constructors' Guide		(XH79L)

The Maplin 'Get-You-Working' Service is available for this project, see Constructors' Guide or current Maplin Catalogue for details.

Order As VE44X (Mono Graphic Equaliser Module) Price £34.95.

Please Note: Some parts, which are specific to this project (e.g., PCB, ICs) are not available separately. Slider knob Order As VX18U Price 48p.

COMPETITION WINNERS

CELLNET CONTEST

The questions and answers to the Cellnet Contest, which appeared in Issue 62 (February), were as follows:

1. What is the total number of telephones used worldwide? **(a) 820,000,000.**
2. The first public telephone exchange opened in London in 1912 with how many subscribers? **(b) 7.**
3. Spot the odd one out! **(d) Alan Sugar.**
4. When were Cellular phones first demonstrated in the UK? **(c) 1984.**

There were a total of nine prize winners; the first prize of a month's free use of a cellular phone and a visit to the Cellnet Network Management Centre goes to Mr. G. Wrath of Bedfordshire. Two second prizes of visits only to the Cellnet Network Management Centre were won by J. A. Emerson of Lancashire and Mr. T. Preston of Surrey. A further six runners-

up receive Cellnet T-shirts; these are: Chris Wellbelove, Derby; Mr. A. Wilson, Essex; D. Willcocks, West Lothian; C. Berwick, Middlesex; Robert McCormack, Northern Ireland; Peter Wright, Peterborough.

SKY NEWS CONTEST

The questions and answers to the Sky News Contest, which appeared in Issue 63 (March), were as follows:

1. Who would use an Autocue? **(b) A news-reader.**
2. Which broadcaster will be covering the Soccer Super League? **(a) BSkyB.**
3. Which of the following broadcasters does not have subscription only programmes? **(a) ITV.**
4. What area is covered by Astra transmissions? **(b) Europe.**

There were a total of seven prize winners, with the three first prizes, a tour of the Sky Studios in West London, going to: Steve Tucker, London; Mr. D. I. Wicker, Norfolk; Mr. D. Richards, West Midlands. A further four runners-up prizes of a Sky T-shirt each go to: Vince Buffin, Plymouth; Rupert Pilgrim, Bournemouth; Mr. D. M. Evans, Milton Keynes; M. Hylton, London.

BRANDS HATCH COMPETITION

Questions and answers to this Competition, which appeared in Issue 66 (June), were as follows:

1. Who was the 1992 Formula One World Champion? **(c) Nigel Mansell.**
2. What is the USA's equivalent to Formula One motor racing? **(b) Indy 500.**
3. Which commentator has a reputation for being a 'master of understatement'? **(b) Murray Walker.**
4. Which European city's roads are used as a Formula One race-track? **(b) Monaco.**

There was a total of six prizes for this competition, the first two being the chance to sit behind the wheel of a high performance single seat racing car and drive it around Brands Hatch (or optionally Oulton Park or Snetterton if these locations are more convenient for the winners), and receive a commemorative certificate of the occasion. Four runners-up each receive a super colour book on the world of Formula One. The joint First prize winners to be drawn from the editor's hat were Mr. D. Roberts from Aveley, and Mr. M. J. Chamberlain from Hereford. The 4 runners-up were Alan Dunnett of Edinburgh, Mark Barrett of Riddings, Richard Smith of Chesterfield and Philip Kent of Guildford.

DURING the first four parts of this series we have managed to introduce all of the most popular valve configurations and have provided an insight into their physical construction and development. We hope that some of the electrical theory, esoteric as it may at first appear, has not dissuaded anyone from experimenting with these devices. In practice it is usual for established circuit configurations to be applied to most types of valve, and reference to valve data literature usually reveals such circuits, thus making valve circuit building much easier. In the meantime we shall continue with the experimentation and discuss a practical pentode amplifier.

The term 'pentode amplifier' will be used here to embrace circuits which also employ beam tetrodes as well, since the design principles are essentially the same for both types of valve. However, when comparing the design approach of the above with that for triodes, some significant differences will be found, in addition to the obviously greater circuit complexity of the pentode arrangement. In Part Four of this series it was pointed out that one significant difference between the triode and the pentode is the fact that the latter has a very much higher value of r_a than the triode. It is this fact that changes the design approach.

The Pentode Amplifier Equivalent Circuit

Because of the very high value of r_a for pentodes, the equivalent circuit that is used is based on a constant current generator feeding into parallel resistors, the output from the circuit then being obtained from the product of a current and the effective load resistance. Thus, we start with so much available current which then divides between the parallel resistors, part of this current then being used to develop the output voltage. The idea is seen in Figure 1, which shows the simplest possible constant current equivalent circuit for a pentode.

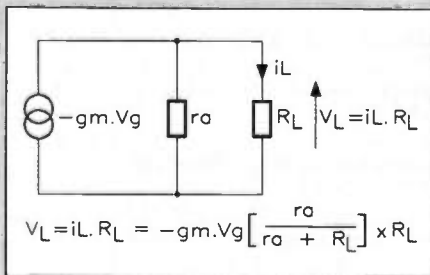
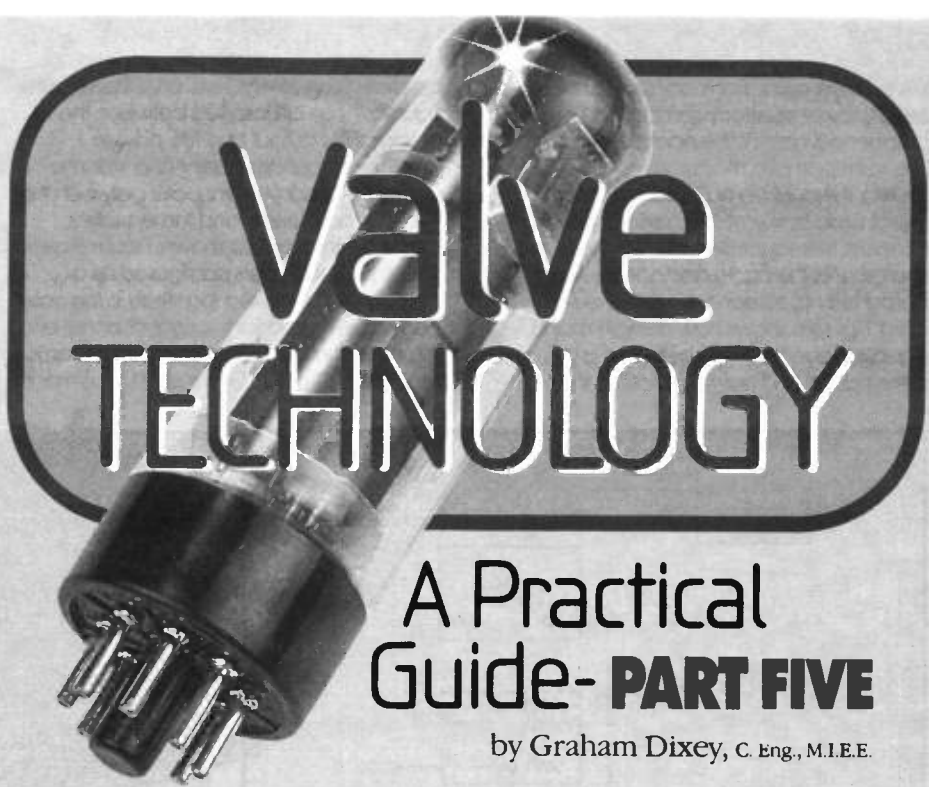

Figure 1. Constant current equivalent for a pentode valve.

This equivalent circuit consists of three elements. The first of these, with the 'figure of eight' symbol, is the constant current generator itself. This represents the amplifying action of the valve and is seen to consist of the mutual conductance g_m of the valve multiplied by the signal input voltage v_g ; to this has been attached a minus sign. Dealing with the latter first, this is merely a way of stating that the valve inverts the input signal. With the load in the anode circuit there is always a phase shift of 180° between the input signal and the output signal. This is exactly the same



situation as in transistor amplifiers of both the bipolar and field effect types – so there is nothing new here!

We know that $g_m = \delta i_a / \delta v_g$ (where δ means a small change of), so if we are multiplying this by v_g itself, we shall get a current as the answer. To put some figures to this, if the input signal had a peak value of 0.5V and the g_m of the valve was 1.85mA/V, then the magnitude of the constant current generator in Figure 1, namely $-g_m v_g$, will equal 1.85(mA/V) \times 0.5(V), which equals 0.925mA (peak) of anode current.

The two parallel resistors in Figure 1, into which this total current of 0.925mA feeds, are the r_a of the valve and the anode load resistor R_L itself. If we assume a value of r_a of 2.5M Ω , then it is merely left to assign a value to the anode load resistor in order to be able to calculate the gain of the stage and, hence, the value of the output voltage.

Determination of Anode Load

As for the triode, the voltage gain of the stage is directly proportional to the value of the anode load. However, there is always an upper limit to the value of anode load resistor that can be used, since the flow of direct anode current through this load causes a DC voltage drop. The maximum permitted voltage drop value depends upon the value of the DC supply available, and the required standing value of the anode voltage. For example, if the DC supply is +250V and the standing 'no signal' value is not to be less than 80V, then the DC voltage drop across the anode load resistor under no signal conditions cannot exceed 250V–80V, namely 170V. With a standing anode current of just 1mA, the value of the anode load obviously is limited to 170k Ω or less. Taking the first standard resistor value below this figure leads to a choice of 150k Ω for the anode load. This is quite small compared with the value of r_a quoted above, leading to the conclusion that most of the anode current

in the circuit of Figure 1 will flow in the anode load resistor R_L .

A Useful Simplification

We could obviously work out just how much of our constant current of 0.925mA would flow in the 150k Ω load resistor. We could employ the current divider principle for this, but it is not really necessary since there is a simple approximation that can be used. This is derived as follows, and is based on the assumption that the r_a of the valve is much greater than the value of the anode load resistor. Figure 1 includes the formula for calculating the output voltage v_L across R_L using the current divider principle mentioned above and the fact that $v_L = i_L \times R_L$. This is repeated here as follows:

Output voltage across

$$R_L = g_m \cdot v_g \times \left(\frac{r_a}{r_a + R_L} \right) \times R_L \quad (1)$$

If $r_a \gg R_L$, then the bracketed term ($r_a + R_L$) simplifies to just r_a . This allows r_a in both numerator and denominator to be cancelled, leaving us with the following expression for the output voltage.

Output voltage across

$$R_L = -g_m \cdot v_g \times R_L \quad (1a)$$

This in turn leads to a simple expression for voltage gain for pentode amplifiers; if we divide both sides by the input signal voltage, v_g :

$$\text{Voltage gain (VAF)} = -g_m \times R_L \quad (2)$$

We can now apply the above formulae to the specific case above, where we assigned values to the various parameters and circuit constants.

These were:

$$g_m = 1.85\text{mA/V}; v_g = 0.5\text{V peak}; R_L = 150\text{k}\Omega.$$

Thus:

$$\begin{aligned} \text{Output voltage} &= -1.85 \times 0.5 \times 150, \\ &= -138.75\text{V.} \\ &\quad \text{(using (1a) above)} \end{aligned}$$

$$\begin{aligned} \text{Voltage gain} &= -1.85 \times 150, \\ &= -277.5. \end{aligned}$$

(using (2) above)

The above calculations should make it clear that the voltage gain of a pentode amplifier can be much greater than that of a triode amplifier, because of its ability to employ very much higher values of anode load. One may also state that the superior amplifying ability of the pentode arises because of its very much higher value amplification factor μ . However, this is merely restating the above because $\mu = r_a \times g_m$ and it is the higher value of r_a that permits the higher value of R_L to be used.

Design of a Pentode Voltage Amplifier

The design of such an amplifier will have to take into account the supply voltage available. In the case of the power supply design offered in Part Two of this series, this is limited to about 150V. To be fair, this may seem a high voltage compared with the values that we associate with today's solid state circuits but, in terms of normal valve practice, it is actually quite low. Supply voltages of the order of 250 to 500V are more usual. Nonetheless, valves will work quite happily down to much lower voltages and the value of 150V, arrived at for our power supply design, was a result of considering the desirability of producing a stabilised supply of the simplest type. This led to the use of Zener diodes, the choice of these being dictated in turn by the types available, their power ratings, etc. A bit of a Catch 22 situation really.

If a higher, though unstabilised supply is required, it can be obtained from the reservoir capacitor, where the DC level will be of the order of 340V DC. In this event, most amplifier stages would have a series resistor and decoupling capacitor inserted into their supply rails to remove the supply ripple from the valve stage's actual HT supply, in effect an RC filter. Examination of commercial valve designs will show this approach to be very common. The design that follows should establish the basic principles, and other designs using different supply voltages should not be beyond the capabilities of the average experimenter.

The valve we are going to use for this experiment is the EF86, which, as with the ECC81 *et al*, comes in a B9A envelope and 9-pin base. It is a low noise, AF voltage amplifying pentode specifically for very small signal preamplifier applications. It features an all enclosing, outer screen or shield around all electrodes (connected to pins 2 and 7), special measures for extra mechanical stability against microphony, and a bifilar wound heater element to reduce hum injection to the absolute minimum.

It would be nice to have a full set of characteristics for the EF86 pentode as we had for the ECC81 double-triode. Unfortunately, these were not to hand at time of writing and I had to make do with the data in the Bernard's *Radio Valve Guide No. 2* which fortunately has survived. The relevant data from the book is shown in Table 1 (this has since been confirmed by a Mullard data book circa 1973/74 - Ed). What this gives us is a useful guide to the

possible DC conditions and also the typical values of two of the valve parameters. The third parameter, μ , should we wish to know it, can be derived from the product of the other two (the Mullard book tells you what it is in triode mode - Ed). Before we leave the table entirely, it ought to be mentioned that, as ever, the heater supply is 50Hz AC sinusoidal (from the mains transformer) and so of course the values quoted are RMS. A valve base connection diagram usually accompanies such data, as in Figure 2.

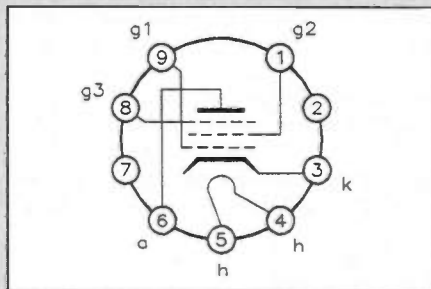

Figure 2. Pin-out diagram for the EF86 low-noise AF pentode valve (base viewed from below).

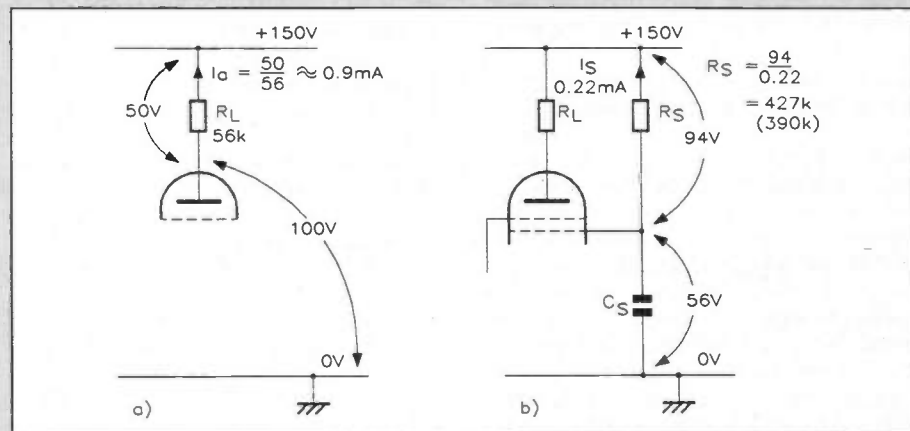

Figure 3. (a); calculating the value of R_L and the anode current I_a . (b); similar calculations for the screen dropper resistor.

Back to μ , though. Since $\mu = r_a \times g_m$; $\mu = 2,500 \times 1.85$; thus $\mu = 4,625$. The parameter r_a is in $k\Omega$ and g_m is in mA/V , so these two can be multiplied directly to give the correct result.

As a starting point, we shall simply scale down the anode and screen data in proportion to the value of supply voltage available. Since the supply voltage is only 150V to start off with, the anode voltage must be a good deal less than this.

Mentally, we say it could be about 100V; this leads to the thought that, if we do use this value, there will then be a drop of 50V across the anode load resistor. Another mental calculation follows based on the simple Ohm's law fact that:

$$\begin{aligned} \text{Voltage drop across anode load } R_L \\ = I_a \times R_L \end{aligned}$$

This leads to the rather obvious deduction that I_a and R_L are mutually dependent and choosing one - for whatever criteria - automatically determines the other. Which should we choose first? Voltage gain depends upon the value of R_L , so let us assume that we need to have a voltage gain somewhere in the range 80 to 100 times and work out the required value of R_L that would give such a gain. From this we can determine the corresponding value of anode current I_a and decide whether the value calculated is a practical one.

$$\begin{aligned} \text{Since } VAF &= g_m \times R_L, \\ \text{then } R_L &= VAF/g_m, \\ &= 100/1.85 \text{ (using the upper} \\ &\text{limit of VAF),} \\ &= 54k\Omega \text{ (or } 56k\Omega \text{ using nearest} \\ &\text{preferred value).} \end{aligned}$$

As already stated, the voltage drop across this load resistor is going to be about 50V. The anode current value that would produce such a voltage drop can be calculated using Ohm's law, as follows (see Figure 3a).

$$\begin{aligned} \text{Anode current} &= \text{voltage drop across} \\ &R_L / \text{value of } R_L, \\ &= 50V/56k\Omega, \\ &= 0.9mA \text{ (approx.).} \end{aligned}$$

Heater

V_h	6.3V
I_h	200mA

Heater volts
Heater current

Characteristics

V_a	250V
V_{g3}	0V
V_{g2}	140V
V_{g1}	-2V
I_a	3.0mA
I_{g2}	550 μ A (600 μ A*)
R_a	2,500k Ω
g_m	1.85mA/V (2mA/V*)
$\mu, g_1 - g_2$	38*

Anode volts
Suppressor grid
Screen grid
Control (signal) grid
Anode current
Screen grid current
Anode resistance

* = Mullard data book quoted figures

This is a perfectly reasonable value for I_a , so the design can proceed on this basis. We now need to calculate the component values for setting the screen voltage and current. What should these be?

Again, we shall simply scale down the values given in the table in the same proportions as we scaled down the anode voltage, that is 2.5:1. On this basis, if $V_s = 140V$ and $I_s = 0.55mA$, then these become $V_s = 56V$ and $I_s = 0.22mA$, obtained by dividing the original values of V_s and I_s by a factor of 2.5.

The screen voltage will be determined in the time honoured way by a resistor connecting the screen to supply HT+, with a decoupling capacitor from the screen down to 0V. The value of the screen dropper resistor is determined simply by using Ohm's law. Since the screen voltage (with respect to 0V) is 56V, then the voltage drop across this resistor is equal to $150V - 56V$, which equals 94V (see Figure 3b). With a screen current of 0.22mA, the value of the screen dropper resistor will be equal to $94V/0.22mA$, which equals 427k Ω .

The choice from the nearest preferred resistor values lies between 390k Ω and 470k Ω ; let us use the former as a starting point. We now have to determine the value for the decoupling capacitor from screen to 0V. This value will be determined by the signal performance required of the amplifier. The topic is covered in depth in the old time classic *Electronic and Radio Engineering* by F. E. Terman (McGraw-Hill), in which the author discusses the loss of gain that results, due to negative feedback, if the bypassing action of the screen to ground capacitance is not complete. It is not necessary to get into this discussion in depth; we can just pick the bones out of it and arrive at a rule of thumb approach for a practical solution.

On the basis that (according to Terman) screen bypassing will be complete if the impedance of the screen bypass capacitor is substantially less than the value of the total effective screen impedance, at the lowest frequency of interest, then we can derive the following simple rule.

At the lowest working frequency, the screen bypass capacitor should have a reactance whose value is not greater than one-tenth of the value of the screen dropper resistor.

The full derivation is too complex to include here and requires a knowledge of the dynamic resistance, r_s , of the screen, which is not available. Its value is, however, usually a good deal less than the value of the screen dropper resistance. On this basis, it seemed safe to use the factor of 'one-tenth' given above.

If we assume that the lowest frequency of interest is, say, 20Hz – a not unreasonable assumption for an audio-frequency amplifier – then we have to calculate a value of capacitance whose reactance is not greater than 390k $\Omega/10$ at this frequency.

$$\begin{aligned} \text{Since } X_C &= 1/(2.\pi.f.C), \\ \text{then } C &= 1/(2.\pi.f.X_C), \\ &= 1/(2.\pi.20.39.10^3), \\ &= 1/4.9 \mu\text{F}, \\ &= 0.2\mu\text{F (or } 0.22\mu\text{F, using} \\ &\quad \text{nearest preferred value).} \end{aligned}$$

Note that we have ended up with a

perfectly reasonable value for the screen bypass capacitor.

In the case of the EF86, the suppressor grid is not internally connected and, therefore, in this design we shall strap it externally to the cathode. Nine times out of ten it would be connected like this anyway.

We now come to the matter of the grid bias and here we are going to have to make an educated guess at the value of negative grid voltage required. All that we know is that, when the anode voltage is 250V, -2V on the grid gives an anode current of 3mA. Since the anode characteristics for a pentode are nearly horizontal over a wide range of anode voltage, then reducing the anode voltage from +250V to +100V should actually have very little effect on the anode current. However, we are also reducing the anode current requirement from 3mA to 0.9mA, an approximate 3:1 reduction and also reducing the screen voltage from +140V to +56V and this will have a significant effect on anode current. For a given grid bias voltage, reducing the screen voltage brings about a proportionate reduction in anode current. On this basis, we can probably safely leave the grid bias voltage at the value of -2V already given and assume that the lower screen voltage used will automatically give us the lower value of the anode current that we need. If it doesn't quite achieve this, we need only modify the test circuit accordingly. Let us see how this works out.

The value of the cathode bias resistor is obtained by using Ohm's law, as follows.

Cathode bias resistor = Grid bias voltage/total cathode current.

In the case of the triode the anode current and the cathode current are one and the same thing; in the case of the pentode they are not. For the pentode:

Total cathode current = anode current + screen current.

In this specific case, total cathode current = $0.9 + 0.22$ (mA),
= 1.12mA.

Since the required grid bias voltage, $V_g = 2V$, then the value of the cathode bias resistor is equal to $2V/1.12mA$, which equals 1.8k Ω (very nearly). This will need to be bypassed by a capacitor whose value is chosen in a similar manner to that of the

screen bypass capacitor, namely that its reactance at the lowest signal frequency (20Hz in this case) is not greater than one-tenth of the cathode bias resistor value. This can be expressed by the formula:

$$\begin{aligned} C &= 1/(2.\pi.20.180), \\ &= 44.2\mu\text{F (or } 47\mu\text{F, using nearest} \\ &\quad \text{preferred value).} \end{aligned}$$

The design is now essentially complete, the value for the grid leak resistor being the nominal 1M Ω that is usually chosen. The input coupling capacitor will, of course, influence the bandwidth by determining the low frequency cut-off point. If this capacitor has a reactance equal to the resistance of the grid leak at 20Hz, then 20Hz becomes the lower -3dB frequency. Thus, we have one final calculation for capacitance.

$$\begin{aligned} C &= 1/(2.\pi.20.10^5), \\ &= 1/4\pi \mu\text{F}, \\ &= 0.08\mu\text{F (or } 0.1\mu\text{F - } 100\text{nF -} \\ &\quad \text{using nearest preferred value).} \end{aligned}$$

The complete circuit for the pentode amplifier is shown in Figure 4.

Hooking Up the Amplifier

The same experimental chassis was used as previously and the under-chassis layout is shown in Figure 5. Only one valve base is required, of course. Because the valve base nearer to the terminal block end of the chassis had its heaters wired for the double-triodes, I left this alone for future use and used the other base for the pentode, the heater supply for this valve being wired to pins 4 and 5. A further twisted pair extended the heater wiring from the heater connections of the first valve.

Testing the Amplifier

The first tests consisted of measuring the DC potentials at the relevant electrodes, to see how they compared with the design values. I expected some discrepancy here because of a lack of exact knowledge of the grid bias voltage required. The results were as follows.

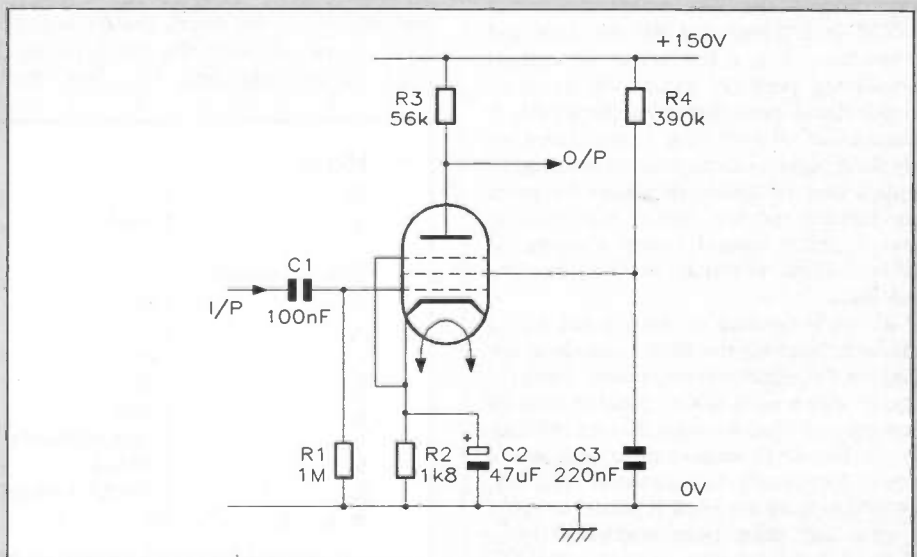

Figure 4. Circuit for the EF86 pentode amplifier designed in the text.

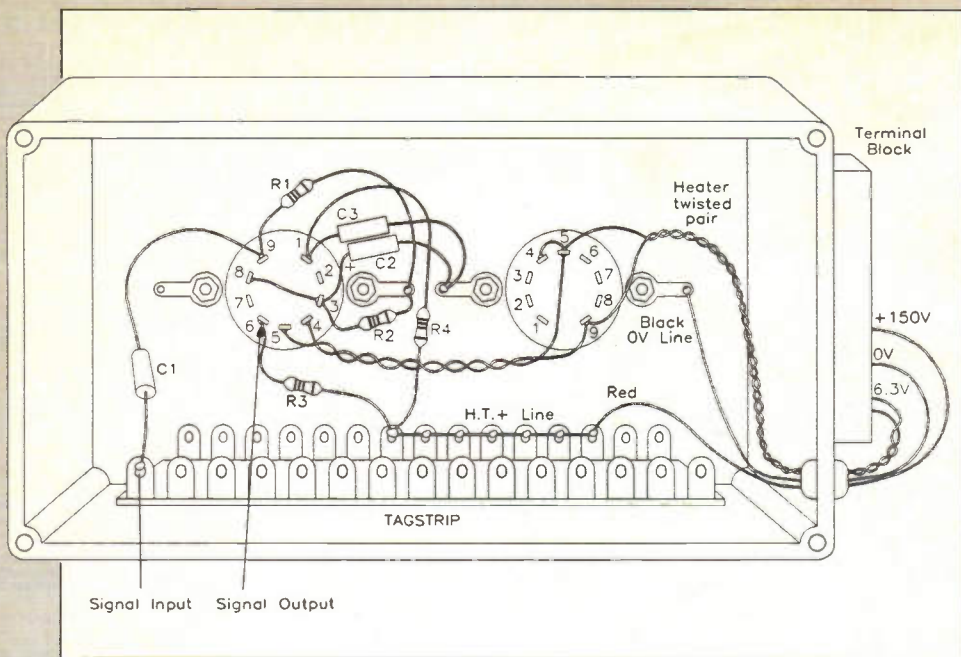

Figure 5. Under-chassis layout for the pentode amplifier.

Anode voltage $V_a = +108V$; Screen voltage $V_s = +94V$; Cathode voltage $V_k = +2.1V$.

From this it seemed that, even though the valve was probably taking about the right total space current, the screen current was too low, which accounted for the higher than required value of static screen voltage. However, it was not considered vital to make significant changes to the screen components in order to get the screen voltage closer to its design value; for the record, increasing the screen dropper resistor to $470k\Omega$ caused a reduction in V_s and an increase in V_a , with no effect on the dynamic performance of the amplifier.

With the DC values more or less acceptable, a signal input at $1kHz$ was connected to C1, the input coupling capacitor and the CRO used to monitor the input and output signal levels. It was found that the positive peak of the output signal began to round off noticeably at an output level of $62V$ Pk-to-Pk. This is due to non-linearity of valve characteristics and underlines the fact that the theoretical output swings, described in some text books, approaching supply voltage values are just that – theoretical! As it happens, this imposes no limitation at all on the use of this valve since its application area is as a preamplifier of relatively low level signals (where the Pk-to-Pk values are only a few volts) and not as an output stage.

Comparison of the amplitudes of input and output signals revealed something of a disappointment. With an output of $50V$ Pk-to-Pk, the input signal level was $0.8V$ Pk-to-Pk, giving a voltage gain of just about 63 ($36dB$), rather than the figure of 100 ($40dB$) hoped for. One can account for this by remembering that the values of g_m and r_a used in the calculations of gain made previously are subject to production spreads and, furthermore, were quoted in the data book at much higher levels of voltage and current (anode and screen). Working right down at the low end of the valve characteristics one can expect the slopes to be that much less and, consequently, the values of the parameters to be

that much lower than further up (but see 'Another Approach' below).

Measurement of Bandwidth

An electronic voltmeter with a decibel scale was used to monitor the output, which was adjusted so as to indicate at the $0dB$ mark, on a convenient range, at the mid-band frequency of $1kHz$. Naturally, the CRO was used to check that the signal level was well below that which would produce distortion. The frequency was then progressively reduced until the voltmeter reading fell by $3dB$; the frequency was noted as $11Hz$, this being an improvement on the design value of $20Hz$. The frequency was then similarly increased until again the output fell by $3dB$; the frequency at which this occurred was noted as $16kHz$, not exactly a startlingly high frequency performance. With more development, this could be improved, a figure of 20 to $30kHz$ being a more likely objective.

Summing Up

It is hoped that the procedure above has established a basic design approach to a single-stage pentode amplifier. The results, I think, justify statements made earlier concerning the superiority of the pentode as a voltage amplifier, certainly in terms of higher gain at least. The results would undoubtedly be even more impressive with a power supply capable of providing the higher voltages normally associated with such amplifiers in practice.

Another Approach – Using Mullard's Data

And now, after all this, reference to Mullard application data for the EF86 (which Mullard designed) supplied an archetypal circuit configuration for an EF86 pentode amplifier, for which, they say, only two sets of resistor values need be decided, and from which, advise Mullard, you should not deviate. Using Figure 4 again as a reference – this is, after all, the

At HT = $200V$ to $400V$:

Resistor	Scheme 1	Scheme 2
R1	$1M\Omega$	$1M\Omega$
R2	$1k2\Omega$	$2k2\Omega$
R3	$100k\Omega$	$220k\Omega$
R4	$390k\Omega$	$1M\Omega$

At HT = $150V$:

R2	$1k5\Omega$	$2k7\Omega$
R4	$470k\Omega$	$1M\Omega$

Table 2.

only circuit configuration that is practical for the EF86 (see Table 2).

No tedious calculations of any sort are required on the part of the designer, he just builds the circuit. Either scheme works well for all HT levels from $150V$ to $400V$. Scheme 1 is the commonest, and the stage is capable of signal gain exceeding $40dB$ (>100 times, depending on HT level – the higher the better), with noise down to $2\mu V$. Try it and compare it with the calculated model. As is usual in these cases, the manufacturer is right and his recommendations are practically impossible to improve on. It is for this reason that commercial valve circuits tend to resemble clones of each other; it is extremely difficult to be truly original when designing 'new' valve circuits, the valves themselves will not allow radical deviations. Scheme 2 is an extra-low noise, high gain configuration which might be used for very small signals, like tape playback head output. The actual value of R1 can be altered to match the impedance of the transducer – $47k\Omega$ for a magnetic pick-up cartridge, for example.

However, on choosing these values, you must not then expect to be able to precisely set the biased DC anode voltage wherever you like. In practice the anode voltage will be roughly two thirds that of the HT supply with the values shown in the table. From the point of view that the primary function of the circuit is that of an AC amplifier, its exact DC conditions are of secondary importance.

Application and other information on this and the other valves discussed in this series can be found in Maplin's Valve Data Booklet, Order Code XL52G.

Next month we shall be looking at a variety of audio-frequency applications for both triodes and pentodes before, in the following instalment, we proceed to consider valve power amplifiers.

DID YOU MISS US?

If you've ever wanted to lay your hands on an elusive issue of *Electronics – The Maplin Magazine*, then we can help! Many editions are still available, as back issues. Where issues are out of print, details of projects that are still current can be found in Maplin Projects Books and Best of Maplin Projects Books. Copies of back issues (subject to availability) can be obtained from Maplin Stores countrywide; by Mail Order, using the Order Coupon in this issue, or by calling the Credit Card Hotline on 0702 554161. If you are not sure which issue or projects book you require, call Customer Services on 0702 552911. Photocopies of out of print feature articles are available; a charge will be made, dependent on the length of the article to be copied – call Customer Services for details.

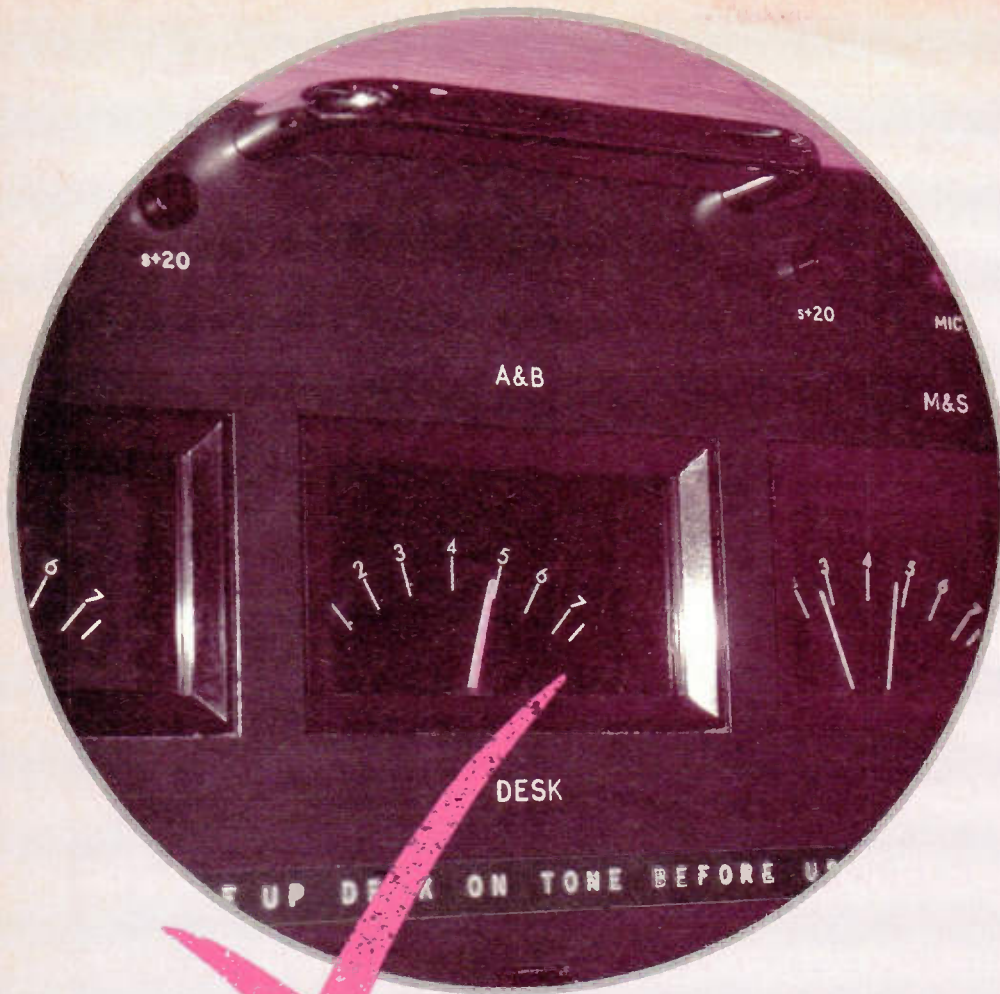

A GUIDE TO PROFESSIONAL AUDIO PART EIGHT

By T. A. Wilkinson

Last month, we examined some theoretical aspects of analogue recording, this month we can apply this in a practical way.

Firstly, we must in some way be able to relate the magnetic properties of tape to the amplitude of audio signals. All tape will have a specification of peak operating level in terms of magnetic flux. This is a measure of how much signal can be driven into the tape just prior to saturation and the onset of serious audible distortion.

TAPE peak operating level, *peak flux level* is measured in nWb/m, (nano Webers per metre); a typical figure for good quality tape may be say 1,500nWb/m. The difficulty is, how to relate this to audio signal amplitude. Fortunately, this relationship is quite logical and relatively easy to apply. If our tape is able to accept 1,500nWb/m, this simply means that at no time must the peak audio level produce magnetic flux greater than this figure. In practice it would be customary not to work the tape close to its limits but to allow something in hand (headroom) just in case there should be a very large and unexpected peak in the signal. A tape therefore with peak operating limit of 1,500nWb/m would perhaps be worked with peak audio producing a flux level (measured as 'short circuit flux' at the record head) of a 1,000nWb/m.

In a professional audio system the conventional line operating level would be based around the zero level (0dBu) convention. If this means nothing to you,

then do not pass go, do not collect £200 and go back to Part 1 of this series!

Okay, forgiven. To recap, on a meter used to measure audio signal levels, 0 level (zero level) corresponds to an rms voltage level of 775mV (0dBu) which gives an indication of 4 on a PPM meter. This can be thought of as the more or less standard line operating level. Peak audio, corresponding to the loudest peaks of audio, is normally considered as +8dB above this and corresponds to a reading of PPM6.

To relate peak audio of +8dBu (PPM6) to 1,000nWb/m of magnetic flux, we need the help of a reference standard. In order to get a recorder to produce a maximum of 1,000nWb/m with peak audio of +8dBu (PPM6), we must look at things from a definite datum and in this case we use the replay chain together with pre-recorded calibration tapes.

Calibration tapes come in all formats and sizes to suit all machines; there are tapes for all purposes such as checking frequency response, azimuth, speed and replay level alignment. In this case it is the latter of these - replay alignment (often called 'line up tape') which we must use to set up peak operating levels.

Logically, if we replay a line up tape recorded at 1,000nWb/m on a correctly calibrated machine with a peak operating level of 1,000nWb/m, this should give a reading of PPM6 or +8dBu on a PPM metering device - simple!

Well as usual this is not as straight forward as it may seem, just to confuse things, line up tape manufacturers rarely record tapes at this relatively high level, but at a somewhat lower flux level. Odd as this seems it actually allows a single line up tape to be used to line up a variety of machines with greatly differing operating references.

Typically, a line up tape may be recorded at 250nWb/m and of course if replayed on a machine with a peak level of 1,000nWb/m, the output of the tape will be several dB lower than peak level. But how much difference should there be? Well fortunately, there is a simple calculation that can be used to work out the difference.

$$\text{Difference ndB} = 20 \log \frac{\text{reference level}}{\text{peak operating level}}$$

Now lets assume the peak operating level of tape recorder x is 1,000nWb/m, and the line up tape from which we wish to establish a reference has been recorded at a level of 250nWb/m.

Putting these figures into the above expression will give us a difference in audio level of ndB.

$$\text{Difference ndB} = 20 \log \frac{250}{1,000} = -12\text{dB}$$

This tells us that the reference level will be replayed at +12dB below the peak operating level. Remembering that the peak operating level is +8dBu and should indicate 6 on a PPM meter (PPM6 = peak audio), since each division of a PPM is +4dB, +12dB below PPM6 is three divisions and thus indicates PPM3. So in summary, a 250nWb/m line up tape replayed on a machine with a peak operating level of 1,000nWb/m should cause a PPM

meter to indicate PPM3. If it doesn't then that machine's replay level trimmer pot must be adjusted so that it does! If the machine is a two track or multitrack type then the replay level has to be adjusted for each track.

There are other ways of establishing replay reference levels and some manufacturers state a 'nominal operating level', this equates to 0dBu of input signal producing mWb/m of flux, sufficient for good signal to noise ratios, but well below tape peak operating level. On the replay side of things, a nominal mWb/m of flux would produce an output of 0dBu. Commonly this nominal flux level mWb/m , is quoted as $320nWb/m$, thus a replay line-up tape recorded at this flux level should produce 0dBu of output signal and conversely 0dBu of input signal should produce $320nWb/m$ of magnetic flux. Again the calculation above would be used to work out any difference between the line-up tape reference level (say $250nWb/m$) and the recorder nominal operating level.

Difference ndB

$$= 20 \log \frac{250}{320} = -2.1dB$$

As can be seen, replaying a $250nWb/m$ line-up tape on a machine with a nominal operating level of $320nWb/m$, gives an output signal 2.1dB below 0dBu, say -2dBu - on a PPM this indicates PPM3.5.

Setting the replay level is only the thin end of the wedge and is the most basic of all of the recorders calibration procedures. It is, however, critically important to get this right, as already stated this operation sets a definite point of reference for the remainder of the calibration and an error in setting replay line up, means that the whole of the rest of the machine will be misaligned!

So having established a definite replay level reference, this is used as an aid in setting the record reference levels. Because we now know that a certain flux level coming off the calibration tape produces a certain amount of audio signal at the recorder output, applying a known audio signal level at the recorder input with the machine in record mode, should (as tape recorders usually have unity gain), produce the same signal level at the outputs via the replay head.

If this is not the case, and there is a smaller or larger output signal than expected, since we have already set up the replay levels, then almost certainly the record gain settings are incorrect. I say almost certainly because it is possible that some other area of the recorder alignment such as bias is not correctly adjusted, therefore affecting the overall system gain.

Studio Recorders

First let's decide just what is meant by a studio recorder and why some machines can call themselves this and others can't. Essentially, the requirements of a 'studio recorder' are much the same as those for any other domestic or semi-professional machine, these being the ability to capture and store 'the moment' whether it be Clinton's inauguration speech, an episode of the Archers', or that scoop of an interview with Lord Lucan down at the



Studer A807 professional recorder - note absence of any superfluous user controls.

local Tesco. Beyond this though, there is a world of difference.

Tape recorders have a long hard life in the studio and may be in more or less constant use for much of the day; they will of course be expected to perform faultlessly. Professional studio machines are by design quite capable of this and in real terms perform well for very many years. This is, in no small way, thanks to the engineers who maintain them but it must all start with the manufacturing quality. It is after all far nicer to maintain a well designed thoughtfully made piece of gear with solid components and easily accessible logical calibration procedures than it is to maintain something that is merely a collection of assembled components with no real concept.

Studer machines for example are superb feats of engineering design and construction. Under the covers the first thing that catches the eye is a beautiful cast alloy chassis which offers a truly rigid surface on which to mount the precision manufactured components. Everything has a real purpose with little in the way of gimmicky extras, these machines are designed with thought, all of this is reflected in their performance, reliability and price!

Of course all of this does not come cheaply, and a new Studer stereo mastering machine will set you back around £4,000. That said, there is little sense in paying £1,500 for an inferior (but claimed to be 'professional') recorder that may be worn out in a year, when for little more than twice the investment you get hold of a machine that should return 5 or 10 times the service.

The picture above illustrates a professional studio recorder - the Studer A807. Apart from the timer function controls and transport switches on the left, and the speed selector switches on the right, there are no other unnecessary user knobs, buttons and switches and thus no record and replay level controls accessible

to the user. Also notice the absence of any form of signal metering devices.

Clearly this sort of machinery is intended to be used in a controlled studio environment where a Standard Reference Level (known as SRL) is presented to, and expected from the recorder's inputs and outputs. In this way, setting of the recorder's record and replay levels by a user is not required, is not possible and will be taken care of at the mixer stage. The recorder will of course be accurately calibrated ('lined up') to a reference level at regular intervals by a maintenance engineer.

This way of operating has the advantage of removing from the audio chain a large amount of variables by denying the opportunity and temptation for itchy fingers to twiddle that knob just to see what happens! Yes I have to say that even in professional environments people simply have to twiddle, but that aside, removing unnecessary knobs and switches improves by simplicity the operation of these machines. This may be particularly desirable in a local radio station where many untrained, non-technical and infrequent freelance users come into contact with professional recorders.

Using such a machine is simplicity itself, to record an item, check and contain the audio peaks on the mixing desk/PPM meter, lace up the recorder with tape and press record. No messing with record levels and tape recorder VU meters, nice and easy with little room for error. Replaying a tape is similarly straightforward.

In practice this works very well providing everyone utilises the same operating standard, thus a tape recorded in Manchester last year can be replayed on a machine in Birmingham today without too much concern about the level at which the tape was recorded. In order to aid operational line-up however, it is customary to record say 20 seconds of 'line-up tone' at the front of a tape, historically this is at

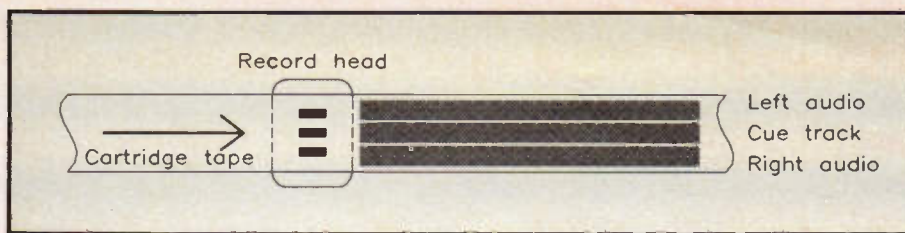

Figure 1. Typical layout of the three tracks used on a professional audio cartridge system.

1kHz, and will be recorded to your correct operating level. This can be subsequently used to establish an operating level by anyone who may come into contact with the tape.

In a recording studio environment where users might be more technically experienced than a casual radio presenter, the lack of the above facilities may prove a disadvantage, and generally flexibility is preferred to simplicity. Typically a recording engineer may wish to record onto only one track of a stereo tape for overdubbing purposes, and a recorder in a recording studio situation would need to be equipped in such a way as to allow this and other kinds of flexible facilities.

We examined some aspects of tape recorder mechanics last month, and top class studio machines will employ all of the systems mentioned to ensure ultimate tape transport with accurate speed and very low wow (slowly changing speed variations) and flutter (rapid speed variations). In fact many modern professional machines are so good in these areas that wow and flutter are almost a thing of the past.

Broadcast Cartridge

For many years now both radio and TV stations have been using broadcast cartridges and machines for playing short pieces of recorded audio in their programmes. Almost all of the jingles, station ID's sound effects, and short bits of music (such as those which can be heard in the background of say a radio traffic report), are recorded onto cart and subsequently replayed into the programme using dedicated machinery. Cart machine systems were born from the need to quickly access and play frequently used items such as those mentioned above.

The cartridge itself contains a pre-determined length of 1/4in. tape wound as an endless loop onto a centre hub. In actual fact the tape is not truly an endless loop but a length of tape with its ends stuck together with editing tape. Cartridge tapes are available in lengths ranging from 10 seconds or so to several minutes.

The tape contains three tracks arranged from top to bottom as left audio, cue track and right audio as shown in Figure 1. As can be seen, the record and replay heads of a stereo cartridge machine have provision for three separate tracks, these being Left audio, Cue track, and Right audio. The two audio tracks are self-explanatory but the cue track needs a little explanation. Basically, whatever audio is recorded on the cart it needs to be accompanied by a series of cue tones which are used as start, stop and fast spool instructions.

As some of these tones are within audible range, they must be recorded on a totally

separate cue track; the centre track of the tape is used exclusively for this purpose.

The cart system comprises of four elements these are, Eraser/splicefinder unit, replay or record/replay unit, record interface unit and the cartridge tape. As the cart contains a splice joint where the two ends of tape meet, it is important to avoid recording over this. The eraser/splicefinder operates in one of two modes. In splicefinder-only mode the unit simply cycles a cart and locates the splice, stopping immediately the splice has passed the sensor mechanism. In the other mode the unit erases any audio on the cart, finds the splice and does another complete cycle. This ensures the cart is completely blank from end to end.

Two types of audio units are available namely a replay only unit and a record/replay unit. As the bulk of work any cart machine has to contend with is replaying pre-recorded carts, it is not necessary for every machine to possess recording facilities and there is an obvious cost benefit in producing machines without the record head and associated electronics. The Replay only unit is fitted with a single replay head for replaying previously recorded carts. This unit also contains audio electronics and the necessary circuitry for decoding cue tones and can be cascaded with other replay units to offer sequential machine operation.

The record/replay unit is essentially a replay unit with the addition of a recording head, however, to realise full recording facilities, this must be used in conjunction with the record interface unit. Erase heads are not fitted to these units; any erasing will be done by the erase/splicefinder unit.

Operation

Having erased a cart and located the splice (carts are normally recycled many times), the cart is placed in the slot of a record unit and the record button pressed. This puts the unit into a ready mode. Material to be transferred to cart (say from 1/4in. tape) is cued up to the start of the audio. Next the start button on the originating machine is pressed simultaneously with the play button on the cart record unit. Firstly this puts a start tone at the beginning of the cart, i.e. just after the splice and the transfer of audio

proceeds. When the transfer is complete either the stop button or fast button is operated. Using the stop command stops the cart dead and also records a stop tone on the cue track. Alternatively if a fast command has been issued a fast tone is recorded onto the cue track and the cart fast winds forward onto the start tone, thus cuing up the cart ready for its next play.

Replaying a record cart is simple, push the cart into the slot and push start, the cart plays until it recognises a stop or fast cue tone and then acts accordingly.

Cart machines are often interfaced with mixing desk fader modules to allow the operator to start the replay process by opening the appropriate fader. A micro-switch built into the fader simply issues a start pulse.

Stereo Recorders

Straightforward two track, 1/4in. analogue stereo tape recorders are still the workhorse of the audio industry. This is probably because they have been around for so long that people feel comfortable working with them, they offer easy operational functions such as cut editing. In cost terms they represent considerable capital investment and to simply pension these off in favour of new technology equipment is a costly business.

The tape track allocation for stereo is shown in Figure 2, conventionally the Left audio track occupies the upper half of the tape with the Right audio track on the lower half. Commonly a 'guard band' (a narrow area of tape with no audio content) is used to separate the two tracks, its purpose being to minimise crosstalk between the tracks. Crosstalk would be most apparent if there was only a small misalignment of tape head height. The use of a guard band actually allows small errors of this type to be tolerated with no degradation of signal quality. Additionally, on some machines the extreme top and bottom edges of the tape may also contain no audio signal.

The size of audio tracks and guard bands may vary with manufacturers and is an inherent property of the chosen tape heads, however, it is sometimes possible when ordering a new recorder to specify a particular head with certain track and guard band widths.

1/2in. tape is also used for some stereo mastering work where no compromise quality is required. The additional tape surface area allows, better signal to noise ratios and thus superior quality recordings can be produced. The downside is that 1/2in. tape is almost twice the price of 1/4in. tape.

Next month we will look at the practical applications of the equipment described herewith and will consider both studio and outside broadcast recording.

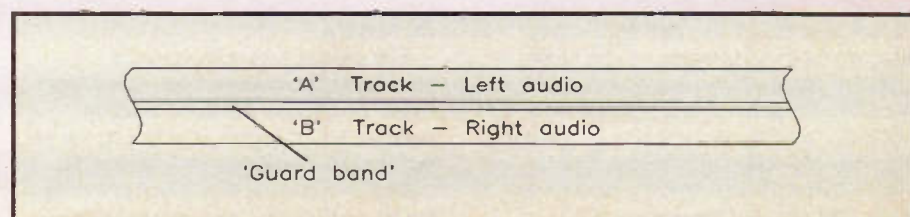

Figure 2. Conventional allocation of tape tracks for stereo work.

These are our top twenty best selling books based on mail order and shop sales during August '93. Our own magazines and publications are not included in the chart below.

20 best selling books

The Maplin order code of each book is shown together with page numbers for our 1994 catalogue. We stock over 250 different titles, covering a wide range of electronics and computing topics.

2



IC555 Projects, by E.A. Parr. (LY04E) Cat. P751. Previous Position: 3. Price £2.95.

3



Getting The Most From Your Multimeter, by R.A. Penfold. (WP94C) Cat. P746. Previous Position: 1. Price £2.95.

4



Home VCR Repair Illustrated, by Richard Wilkins & Cheryl Hubbard. (WZ32K) Cat. P755. Previous Position: 2. Price £13.95 A1.

5

NO CHANGE

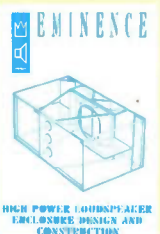

Loudspeaker Enclosure Design and Construction. (WM82D) Cat. P721. Previous Position: 5. Price £9.95.

6

NO CHANGE



An Introduction to Loudspeakers and Enclosure Design, by V. Capel. (WS31J) Cat. P720. Previous Position: 6. Price £2.95.

Number ONE

The VHF/UHF Scanning Frequency Guide

by B. Laver

A must for all amateur radio and scanning enthusiasts. (WT70M) Cat. P719. Previous Position: 4. Price £9.95.

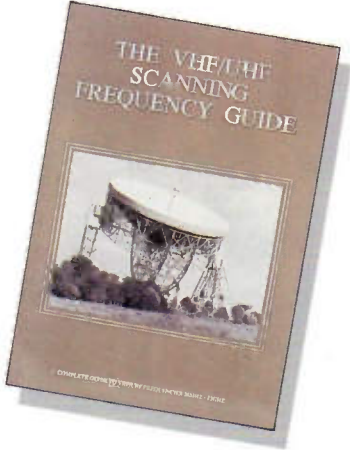

7



International Transistor Equivalents Guide, by Adrian Michaels. (WC30H) Cat. P745. Previous Position: 8. Price £3.95.

8



Power Supply Projects, by R.A. Penfold. (XW52G) Cat. P748. Previous Position: 7. Price £2.50.

9

NO CHANGE



How to Expand, Modify and Repair PCs and Compatibles, by R.A. Penfold. (WS95D) Cat. P729. Previous Position: 9. Price £4.95.

10

NO CHANGE



How to Use Oscilloscopes and Other Test Equipment, by R.A. Penfold. (WS65V) Cat. P746. Previous Position: 10. Price £3.50.

11

NO CHANGE



The Washing Machine Manual, by Graham Dixon. (WS98G) Cat. P755. Previous Position: 11. Price £12.95.

12



Scanners, by Peter Rouse. (WP47B) Cat. P719. Previous Position: 17. Price £8.95.

13

NEW ENTRY

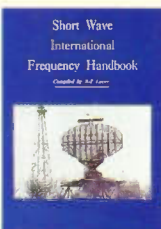

Short Wave International Frequency Handbook, by B. Laver. (WT73Q) Cat. P718. Previous Position: New-Entry. Price £9.95.

14



Remote Control Handbook, by Owen Bishop. (WS23A) Cat. P747. Previous Position: 18. Price £3.95.

15

NO CHANGE



Electronic Music Projects, by R.A. Penfold. (XW40T) Cat. P722. Previous Position: 15. Price £2.95.

16

NO CHANGE



Towers' International Transistor Selector by T.D. Towers. (RR39N) Cat. P745. Previous Position: 16. Price £19.95.

17

RE-ENTRY



Audio Amplifier Construction, by R.A. Penfold. (WM31J) Cat. P753. Previous Position: Re-Entry. Price £2.95.

18



Mastering C Programming, by W. Arthur Chapman. (WZ09K) Cat. P758. Previous Position: 20. Price £5.99.

19

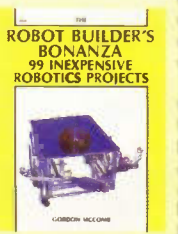

The Robot Builder's Bonanza, by G. McComb. (WT77J) Cat. P729. Previous Position: 14. Price £14.95 A1.

20

NEW ENTRY



VHF/UHF Manual, by G.R. Jessop. (WS14Q) Cat. P717. Previous Position: Re-Entry. Price £10.95 A2.

NEW

FULL COLOUR GUIDE TO ELECTRONIC PRODUCTS

Maplin



BS 5750
Part 2 1987

Level B:
Quality Assurance
RS12750



Order your copy of the New MAPLIN Catalogue on sale NOW!
Pick up a copy from any branch of WHSMITH, selected branches of RSM^{COLL} in Scotland ONLY, and Maplin stores nationwide for just £2.95, or post this coupon now to receive your copy for just £3.45, inc. p&p. If you live outside the U.K. send £6.80 or 18 IRC's for Airmail in Europe/£5.20 or 13 IRC's for surface mail outside Europe; or £11.50 or 30 IRC's for Airmail outside Europe.
I enclose £3.45/£6.80/£5.20/£11.50 (delete as applicable).

Name.....
Address.....
Post Code.....
Send to Maplin Electronics,
P.O. Box 3, Rayleigh,
Essex, England
SS6 8LR.
MMP4

Over 700 colour packed pages with hundreds of brand New Products at Super Low Prices, on sale now, only £2.95.

Available from all branches of WHSMITH, selected branches of RSM^{COLL} in Scotland ONLY, and Maplin stores nationwide. The Maplin Electronics 1994 Catalogue - **UNIQUELY DIFFERENT!**