

# INDUSTRIAL ELECTRONICS

APRIL 1967 5s

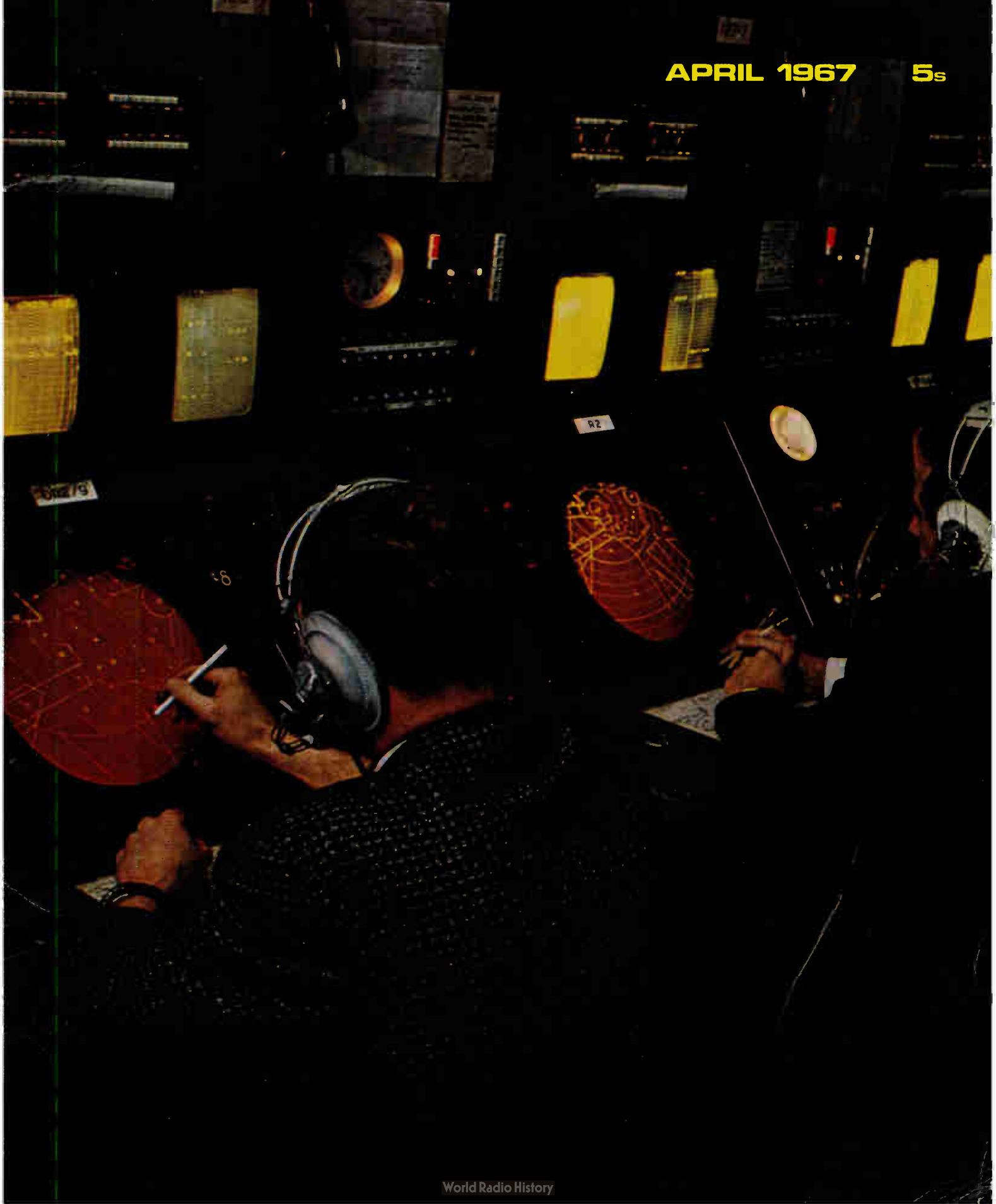

# eyes on the future feet on the ground

Constantly striving in the search for better methods and uses to which to put our range of products, we at IOCO are confident in the knowledge that we are fulfilling a service of which we are justly proud. Pushing the boundaries of technology forever forward, our research team is helping industry to set new standards of quality in plastics and rubber. For your next design problem in the electrical or rubber fields contact IOCO. IOCO leads the field, meeting tomorrow's demands, today!

#### **Electrical Insulation Products**

**Formapex** laminated sheets  
**Formapex** treated papers and cloths.  
**Silopex, Siloplast** cloths and tapes for class 'H' insulation.  
**Linapol** Polyurethane varnished Glass and Terylene.  
**Linapex** varnished cloth, nylon, terylene, glass, silk and paper.

#### **Rubber Products**

**Ocotex** sponge rubber, Roller covering, grinding and tank lining. Hospital bed sheeting, Specification proofing.  
**PVC Proofed Fabrics**  
**Plasoco**  
**Nyoco** (Nylon bound PVC coated material)  
Polyurethane Impregnated, double faced nylon.

**VICKERS LIMITED**  
**IOCO**

VICKERS LIMITED IOCO,  
Netherton Works, Glasgow, W.3.  
Tel. Scotstoun 5501/6. Telex 778117



For further information circle No. 200

---

# INDUSTRIAL ELECTRONICS

Incorporating **British Communications and Electronics**

---

COMMUNICATIONS AUTOMATION INSTRUMENTATION CONTROL

## Contents April 1967

---

Editor-in-Chief **W. T. COCKING, F.I.E.E.**

Editor **T. J. BURTON**

Editorial: **K. G. HOLMES**

**T. A. KELLY**

Production Manager **D. R. BRAY**

Drawing Office **H. J. COOKE**

Advertisement Controller

**G. H. GALLOWAY**

Advertisement Manager

**R. H. C. DOHERTY**

**145 Comment—Closed-Circuit Television in Industry**

**146 Selective Moving Target Indication**

*by R. N. Harrison*

Radar sets for air traffic control must be able to distinguish between returns from moving aircraft and the permanent echoes received from stationary objects. In the past, a facility called moving-target indication has been used to remove any unwanted signals, but in certain circumstances it cancelled out moving objects as well. Now, a development of the video-mapping technique has allowed a choice to be made between cancelled and uncancelled radar video, so that the operation of MTI can be limited to those areas where permanent echoes occur. Known as selective moving-target indication (SMTI), its operation and advantages are described in this article.

**149 Digital Data Transmission**

*by R. T. Shaw*

With the increasing use of teleprinters and remote input and output devices for centralized computers, the transmission of digitally-coded data has become an important function. It can be accomplished over ordinary telephone-type links and the public telephone network can be used. This article describes the equipment necessary, discusses its operation and indicates new and future developments.

**154 Vibrators in Industry—3**

*by B. Montandon*

The previous two articles in this series briefly dealt with the electromagnetic vibration exciter and also made some mention of other major components in a vibration test system. This article therefore deals with the vibrator drive amplifier and signal sources.

**158 C.C.T.V. in Industry and Commerce**

*by R. Foster*

During 1966, an independent survey was conducted by the author into the application of closed-circuit television throughout British industry, commerce and the public utilities. This article outlines the objectives of the survey, describes how it was undertaken and discloses what its principal findings were. It is briefly introduced by a description of the operating principles of c.c.t.v. and its associated equipment.

---

**VOLUME 5**

**NUMBER 4**

**continued overleaf**

---

© Iliffe Electrical Publications Ltd., 1967

Permission in writing from the Editor must first be obtained before letterpress or illustrations are reproduced from this journal. Brief abstracts or comments are allowed provided acknowledgment to the journal is given.

Published on the last Thursday of the preceding month by  
**Iliffe Electrical Publications Ltd., Dorset House, Stamford Street, London, S.E.1**  
Chairman: W. E. Miller, M.A., M.I.E.R.E. Managing Director: Kenneth Tett

Telephone: 01-928 3333 Telegrams/Telex: Electronics Iliffeprs 25137 London

**ANNUAL SUBSCRIPTION, HOME £3 0s. 0d. OVERSEAS £3 10s. 0d.  
CANADA and U.S.A. \$10.00**

---

---

# INDUSTRIAL ELECTRONICS

Incorporating **British Communications and Electronics**

---

COMMUNICATIONS AUTOMATION INSTRUMENTATION CONTROL

## Contents *continued*

---

### 167 Fluid Logic for Low-Cost Automation

Readers of *Industrial Electronics* will by now be familiar with the range of fluidic devices at present available for designing logic circuits. Several low-cost fluidic systems have already been developed for the automatic control of machine operations, and some of these applications are described in this article.

### 170 Applications and Techniques

C.C.T.V. for Tunnel-Traffic Control  
Glass/Semiconductor Bonding  
Computer Analysis of Production Costs  
T.V. Monitor for Cine Cameras  
Microfilm Documentation System

Oil Consumption Measured by Nuclear Method  
Automatic Flame Cutting  
XY Plotters in Hydraulics Research  
Electronic Stock Control  
Automatic Billet-Size Changing

### 175 New Apparatus

A regular feature of 12 pages giving, in this issue, details of 53 items of the latest equipment in electronics, communications, instrumentation, control, components and production aids.

### What's On and Where

A regular feature which lists forthcoming events. Professional meetings, symposia, conferences and exhibitions are included. **For easy reference this item is positioned facing the inside back cover.**

---

## Features

157 **Optical Character Recognition**  
163 **Automated Microcircuit Production**  
164 **Computer-Aided Patient Care**  
164 **Manufacturers' Literature**  
165 **Talkabout by Nexus**  
166 **Approaching Automation Advisory Centres**

173 **Design Notes: The Raysistor—A Photoelectric Switch and Variable Resistor**  
174 **Emett Goes Environmental for Industrial Electronics**  
187 **Industrial News**  
190 **Medea 67**  
192 **New Books**  
46 *Classified Advertisements*  
51 *Index to Advertisers*

---

## NEXT MONTH

The latest developments in microelectronics—how the limitations of early microcircuits are being reduced as production techniques improve—are discussed in one of next month's articles. The May issue will also include the fourth and last in the series 'Vibrators in Industry', which deals with sinewave and random-motion testing.



### OUR COVER

*This month's front-cover picture illustrates the operations room at the London Air Traffic Control Centre. Since last August, operational trials of radar video-mapping techniques to provide selective moving target indication have been carried out at the L.A.T.C.C., and the facility is to be applied to all radar installations at this centre. Elsewhere in this issue an article describes these techniques.*

---

## PRODUCT INFORMATION

For readers who require further information on specific items, a list of products, for which free brochures are available, is provided on the same sheet as the reader enquiry cards.



# UK3

Printed circuits for the solar cells of this first all-British satellite are based on Copper-clad BAKELITE Laminated

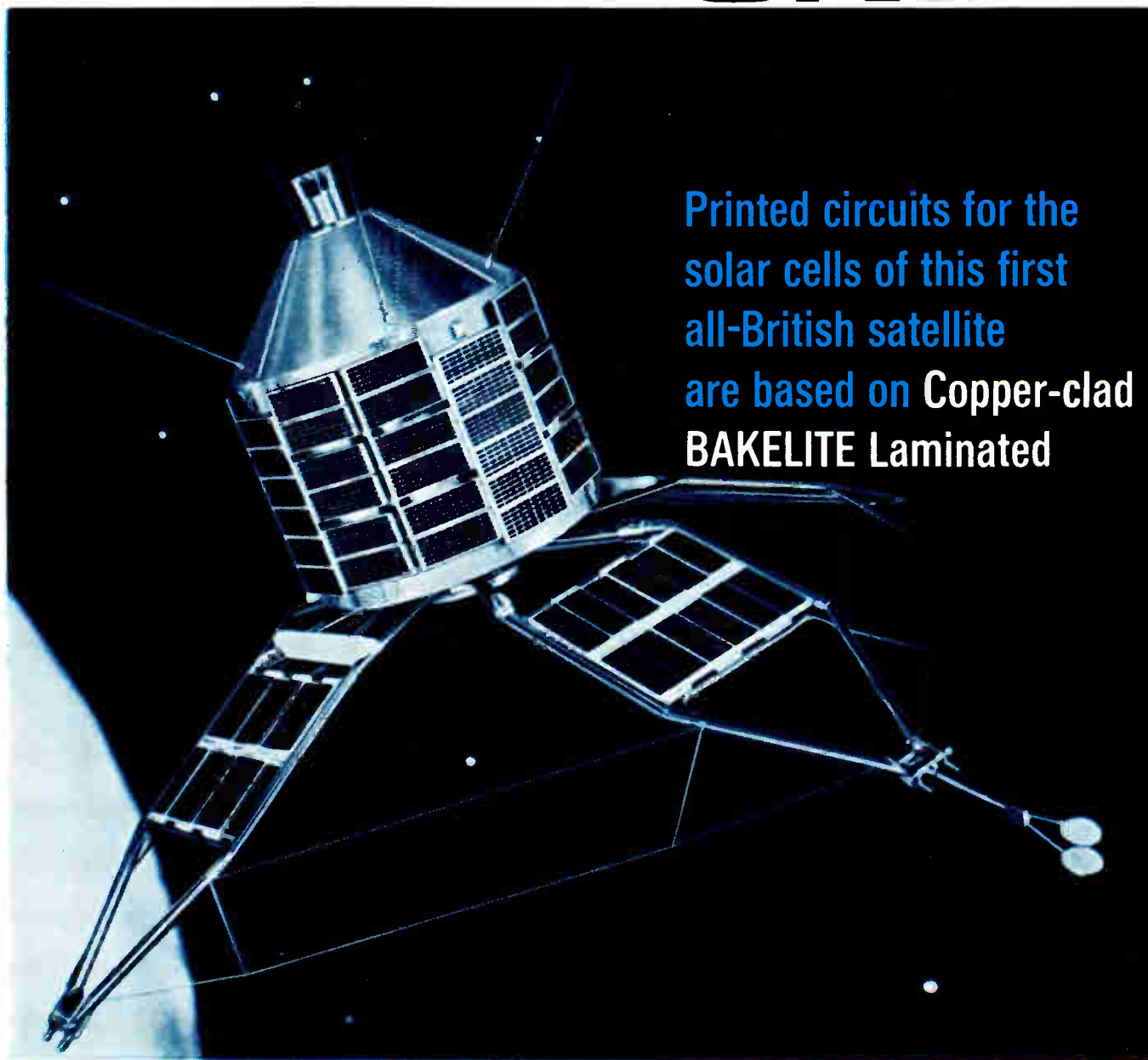

\* More than 6000 solar cells, made by Ferranti Limited, provide the power for the electronic circuits in this satellite, UK 3.

\* The printed circuits used in the assembly of these solar cells have been made by Ernest Turner Electrical Instruments Limited and are based on Copper-clad BAKELITE Laminated.

\* Copper-clad BAKELITE Laminated was chosen for the same reasons that it is used in computers, radio, television, telecommunications and all electronic fields—because of its outstanding mechanical and electrical properties and complete dependability of performance.

\* For more information on Copper-clad BAKELITE Laminated for printed circuits, send for a copy of our detailed booklet. Write to BXL Plastics Materials Group Limited, Dept. B7 12/18 Grosvenor Gardens, London SW1. Tel: SLOane 0898

**BXL**  
**BXL Plastics Materials Group Ltd**  
(FORMERLY BAKELITE LTD)

LP 34

For further information circle No. 203

## What do you want to control?



**The value of the £? Atomic fall-out?**

**Your boss's temper?**

*(Sorry about that).*

But if it's something more down to earth, like ...

a furnace

a press

a chemical process

a weighing system

a machine tool

a heating-ventilating  
system

a lift

a gas works

a sorting machine

a food preservation or  
bottling plant

a conveyor

a textile process

automatic inspection  
equipment

an automatic  
warehouse

... then EAC can solve your problem!

EAC, in addition to producing a fully comprehensive range of standard starters and accessories, have for many years been leaders in the development of special automatic controls. Our control engineers are always on hand to help in designing control systems that provide the maximum degree of reliability and safety.

### **solicon**

The SOLICON static (solid state) switching unit, providing long-term reliability and operating speeds impossible with conventional electro-mechanical devices.



*The Controls Division of*

# EAC

*The Electrical Apparatus Co Ltd  
St Albans · Herts*

**For further information circle No. 204**

**Data ready?  
Get it to the CP—  
Fast!**

Successful business depends on good communications. Particularly centralized data processing.

But distance (be it 5 miles or 5000) can still prove the greatest single obstacle to efficient centralized data processing. Which is why an STC data communication system makes such good sense. However many and however widely dispersed your locations, you're assured of fast, accurate transference of data to and from the processor.

An STC system can operate over virtually any telephone circuit and gives transmission speeds of up to 125 characters per second, **ON-LINE** or **OFF-LINE**.

Over 93% of time on-the-line is used

for actual data movement—less than 7% for its protection. The result: less rented time, the most significant cost factor in data communication.

Moreover, because of advanced error detection and correction facilities the chance of error is less than one in a hundred million!

Find out how an STC data communication system could increase your business efficiency, at lower cost, contact: Standard Telephones and Cables Limited, Integrated Electronic Systems Division, Burleigh House, Great Cambridge Road, Enfield, Middlesex. Telephone: ENField 5343. Telex: 21409.

*Photograph by arrangement with Ultronic Data Systems Limited.*



**STC**

Data Communications

**For further information circle No. 205**



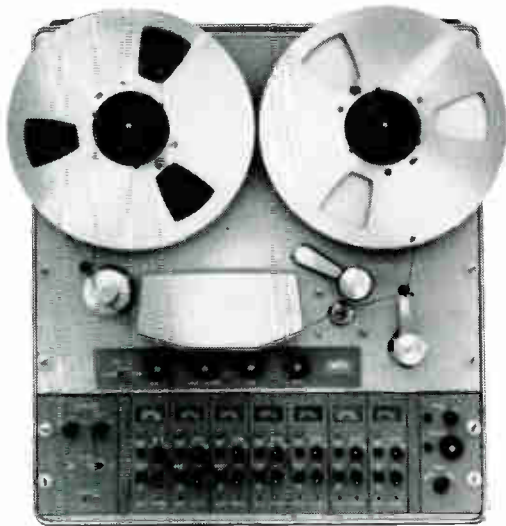

# Ampex make instrumentation recorders portable

—small in size, big in performance

## SP-300

The baby of the Ampex family. Combines the advanced technology of Ampex's larger, more complex instrumentation recorders with portability, compactness, economy, and ease of operation. Designed specifically for industry, medicine and education.

□ Records and reproduces any measurable phenomena □ reproduces data immediately after recording □ up to 7-channel capability □ simulates experimental parameters □ adapts to different analytical techniques □ permits time base expansion and contraction.

## FR-1300

The smallest portable instrumentation recorder with full 14-track capability with 300 KC on Direct, and 20 KC on FM. It took three years to develop and test the FR-1300 and it represents a simplification of proven design techniques from Ampex's accumulated experience in the field of instrumentation recording. FR-1300 does more—costs less.

□ Capstan servo drive for speed accuracy □ electrically switchable speed change □ full 14-track capability □ solid state electronics □ straight-line tape path for simplified threading □ tape lifters for increased head life □ controls interlocked to safeguard tape □ improved flutter □ available in rack-mounted version □ IRIG specifications □ many "extra performance" options available.

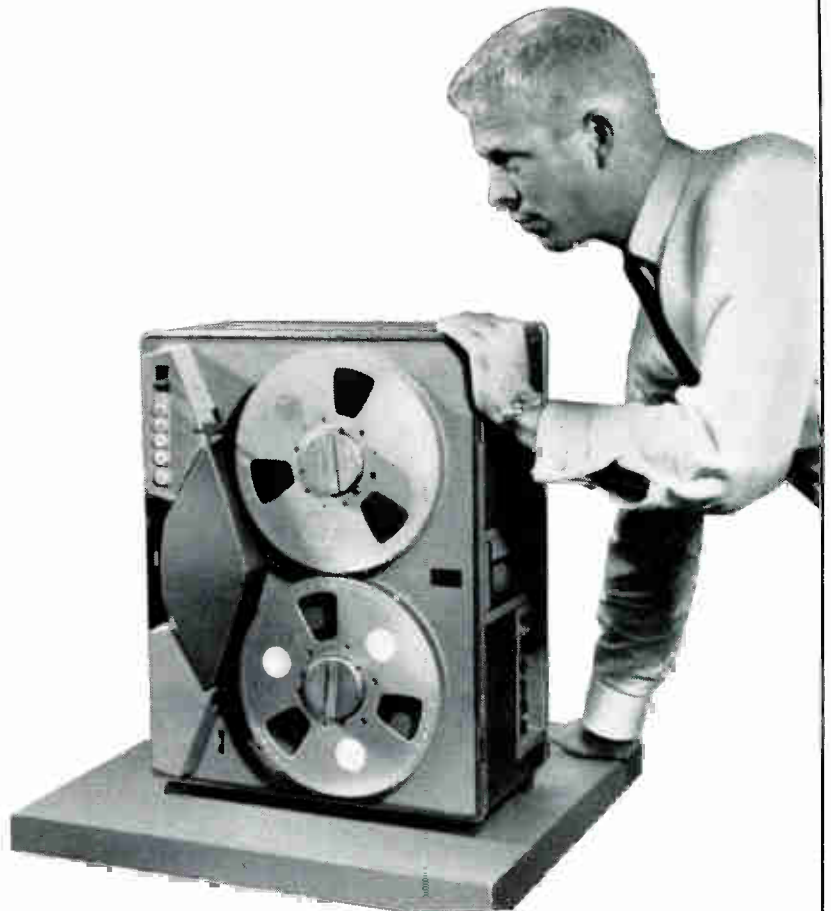

Ampex is the world's largest maker of magnetic tape recorders. Wherever there's a need for recording, one name stands supreme. Ampex. The name on the finest recording equipment.

# AMPEX

Ampex sales and service facilities are conveniently located throughout Europe and the Middle East. For more information write to: Ampex Great Britain Ltd., Acre Road, Reading, Berkshire, England. Telephone: Reading 84411. Ampex S.A., Via Berna 2, Lugano, Switzerland. Telephone: 091/3.81.12. Ampex Europa G.m.b.H., 6 Frankfurt/Main, Dusseldorfer Strasse 24, Germany. Telephone: 252001-5. Ampex, 41 Avenue Bosquet, Paris 7e, France. Telephone: 705.38.10.

For further information circle No. 206



2 to  
30,000 lb.

# THRUST

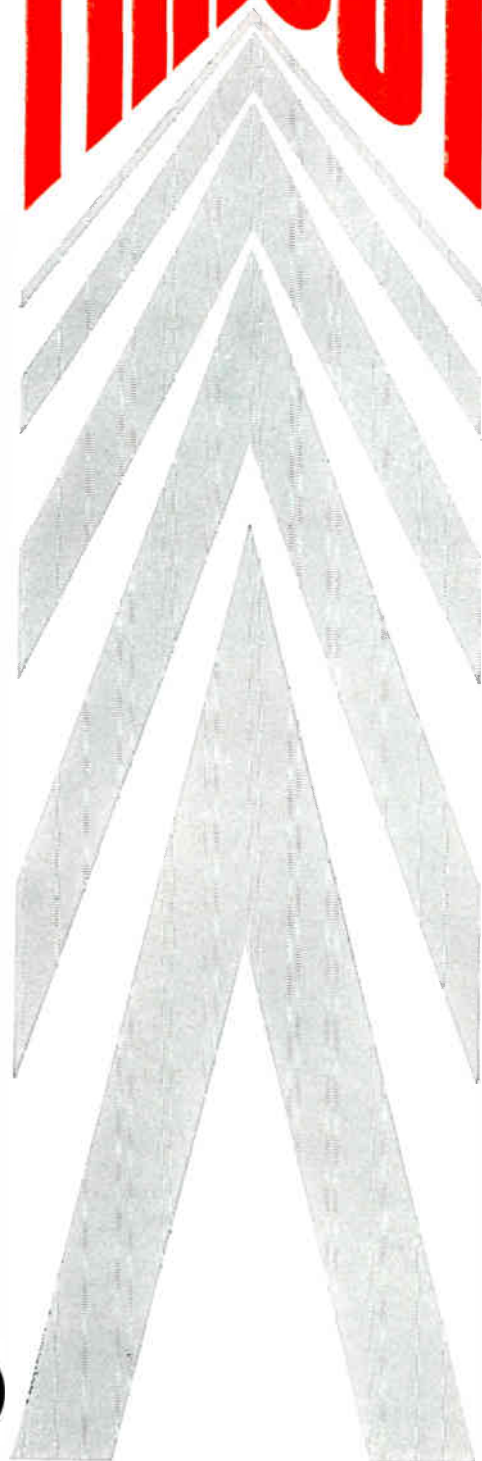

with **PYE-LING**

## vibration test equipment

Pye-Ling Vibration Testing Equipment is used extensively in many spheres of industry, its function being reflected in the reliability and advanced construction of many present-day products. Pye-Ling Ltd. have designed, engineered and commissioned several of the largest electro-dynamic vibration testing installations in Europe.

The Pye-Ling range includes:

**SHAKERS:** developing from 2 to 30,000 lb thrust.

**AMPLIFIERS:** providing from 0.25 to 210 kVA.

**CONTROL CONSOLES:** housing a wide variety of instrumentation suitable for the control and monitoring of any vibration test programme being undertaken.



**PYE-LING LIMITED**

HEATHWORKS · BALDOCK ROAD · ROYSTON · HERTS  
Tel: 2424 · Telex: 81174 (Pyeling Royston) · Telegrams: Vibration Royston

For further information circle No. 207



Please send me full details of  
Pye-Ling Vibration Test Equipment.

NAME .....

ADDRESS .....



**Everything  
you need for  
precision  
soldering  
from  
Enthoven**



4

2

3



5

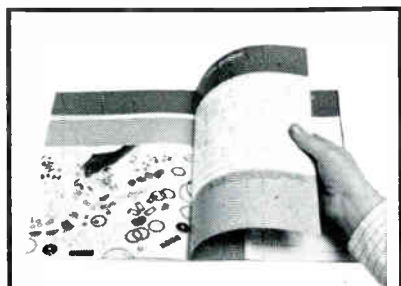

New free booklet describes the complete range of Enthoven Solder products. Ask now for your copy of 'Soldering with Enthoven'.

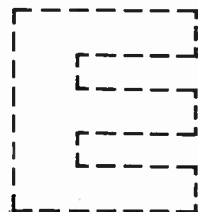

**ENTHOVEN  
SOLDERS LIMITED**

Sales Office & Works · Rotherhithe Street · London SE16 · Tel : 01-237 7156  
Head Office · Dominion Buildings · South Place · London EC2 · Monarch 0391

For further information circle No. 208



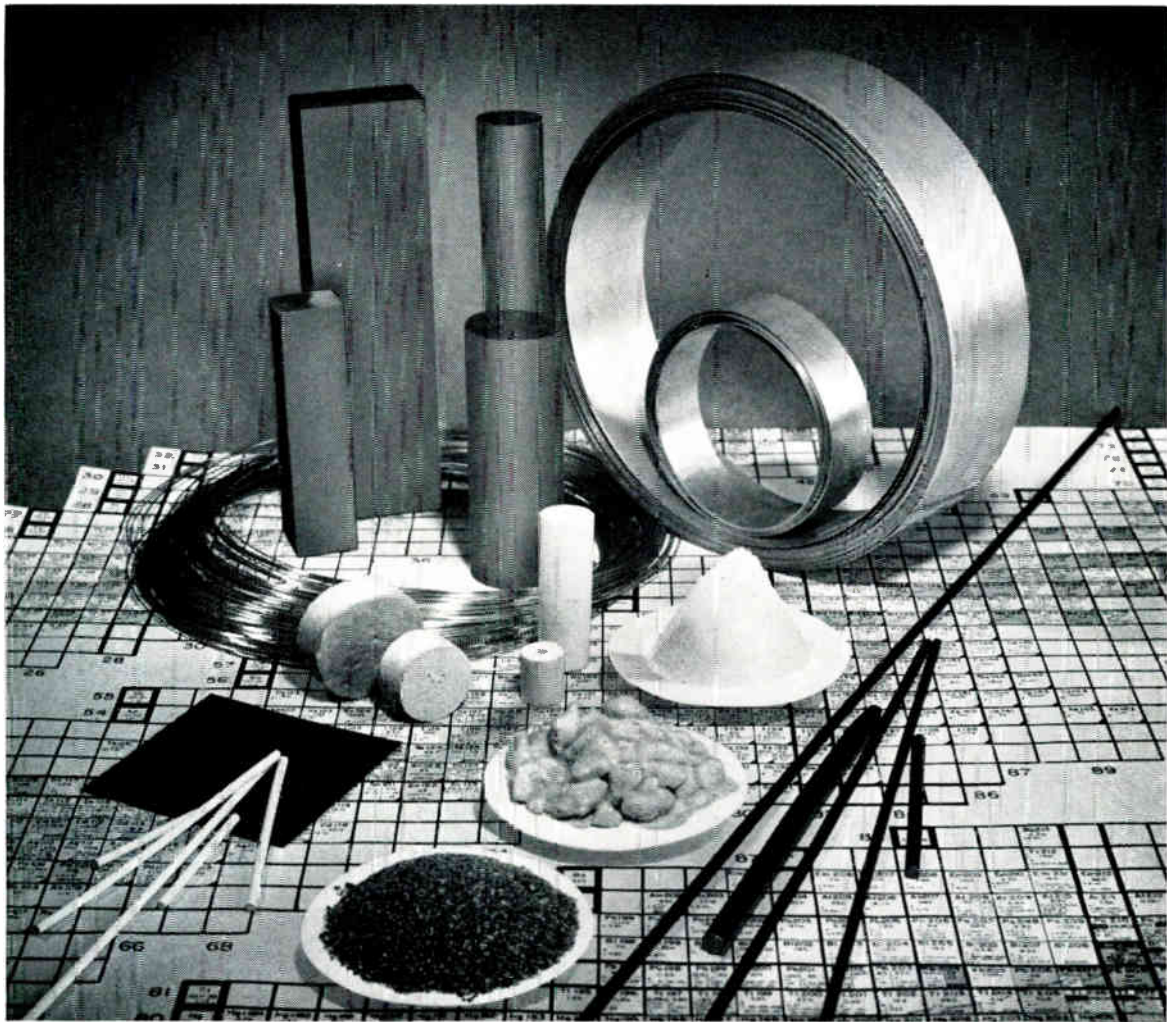

## These applications for rare earths are forcing a 100% increase in our plant capacity

**Nuclear**—Yttrium, a low neutron absorber, is used in fuel rod cladding. Samarium, gadolinium, europium, dysprosium, erbium, terbium and lutetium are high neutron absorbers, promising use for shielding purposes. The isotopes of thulium are being evaluated as a thermal heat source.

**Phosphors**—Yttrium and europium are widely used as phosphors in color TV tubes. Neodymium, samarium, thulium, terbium, gadolinium, lanthanum and dysprosium are being evaluated as potential phosphors.

**Metallurgy**—Rare earth metals, particularly yttrium, may find application as a new permanent magnet material. Yttrium in high chromium steel improves grain refinement, workability, oxidation, and crystallization resistance at high temperatures. Neodymium improves the strength and hardness of titanium, aluminum, and magnesium alloys. Erbium metal lowers hardness, improving workability of vanadium alloys.

**Electronics**—Yttrium and gadolinium con-

taining garnets are finding widespread use in microwave components.

**Lasers**—Yttrium crystals doped with neodymium and/or ytterbium are being used in laser systems. Gadolinium crystals doped with neodymium lase in the infra-red region.

**Ceramics**—The high melting point, stability, shock resistance, and low expansion of rare earth oxides indicate uses in ceramic and glass formulas, to serve as colorants, infra-red absorbers, neutron absorbers, and high-temperature stabilizers.

*These are some of the current applications. Others we cannot discuss. If you have either a research or commercial requirement, let us know how we can help you.*



RE-6673

### MICHIGAN CHEMICAL CORPORATION

2 North Riverside Plaza • Chicago, Ill. 60606 U.S.A. • Phone: 312-263-0580

Eastern Sales Office: 930 Stuyvesant Ave. • Union, New Jersey 07106 U.S.A. • Phone: 201-964-1262

© 1964, Michigan Chemical Corporation

Yttrium • Lutetium • Ytterbium • Thulium • Erbium • Holmium • Dysprosium • Terbium • Gadolinium • Europium • Samarium • Neodymium • Praseodymium • Lanthanum

**For further information circle No. 209**

# WESTINGHOUSE

## 1.5 Ampere Diffused Silicon Diode

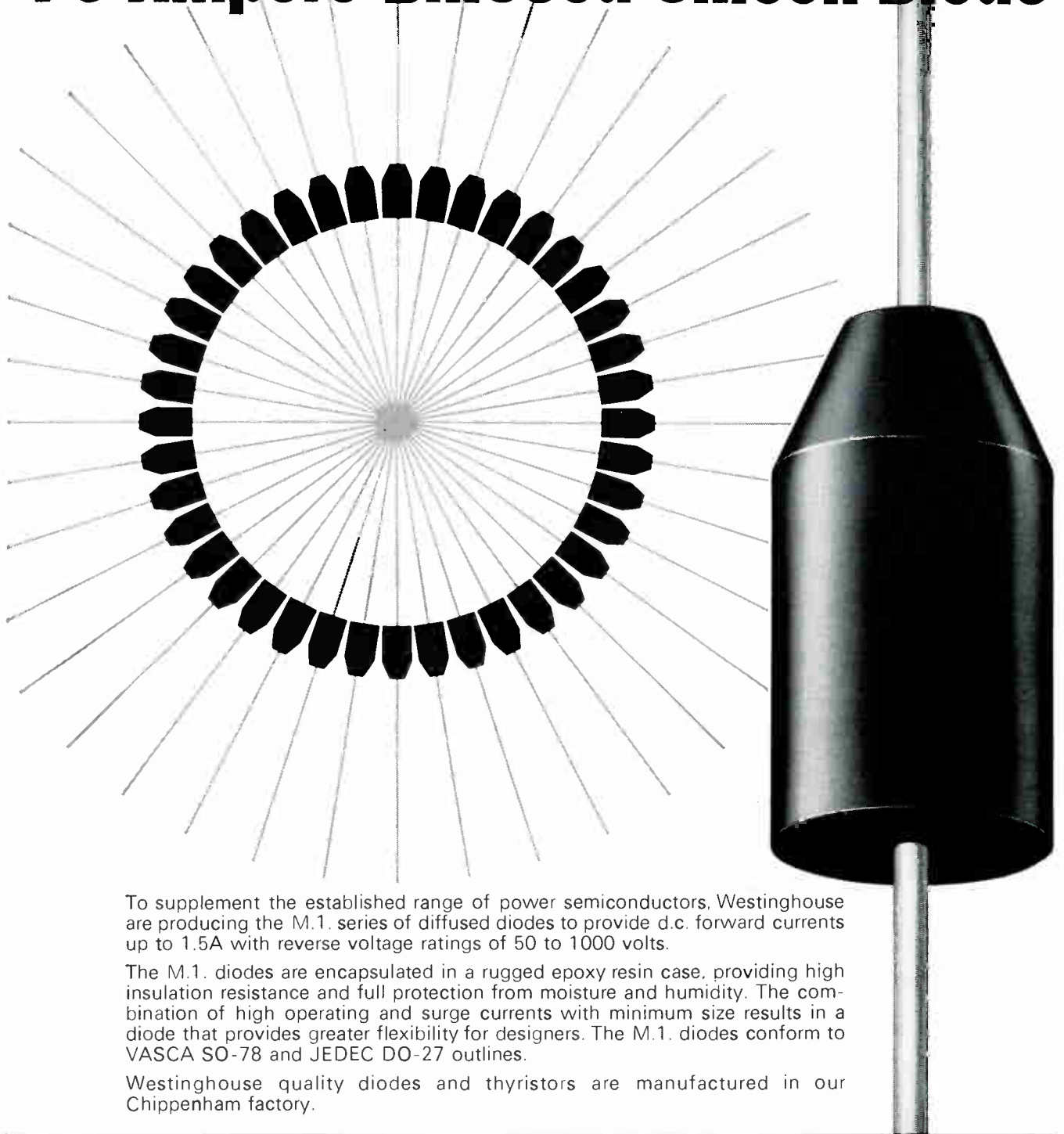

To supplement the established range of power semiconductors, Westinghouse are producing the M.1. series of diffused diodes to provide d.c. forward currents up to 1.5A with reverse voltage ratings of 50 to 1000 volts.

The M.1. diodes are encapsulated in a rugged epoxy resin case, providing high insulation resistance and full protection from moisture and humidity. The combination of high operating and surge currents with minimum size results in a diode that provides greater flexibility for designers. The M.1. diodes conform to VASCA SO-78 and JEDEC DO-27 outlines.

Westinghouse quality diodes and thyristors are manufactured in our Chippenham factory.



When it's a question of semiconductors  
**WESTINGHOUSE**  
 is the power behind them!

For further information write to: Dept. I.E. 4/67  
 SEMICONDUCTOR DIVISION  
**WESTINGHOUSE BRAKE AND  
 SIGNAL COMPANY LIMITED**  
 82 YORK WAY, KING'S CROSS  
 LONDON N.1.,  
 TERminus 6432, Telex 261629

For further information circle No. 210



**A NEW  
MULTIPLE  
POLE RELAY  
WITH  
WIPING  
CONTACTS**

**ARROW**

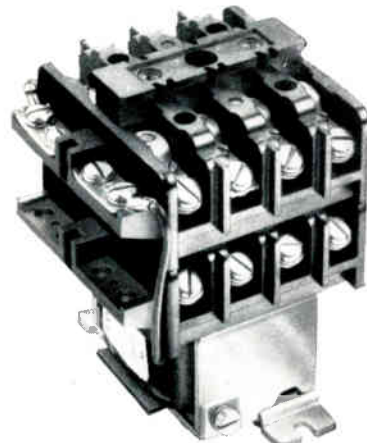

Available with up to eight poles, with a maximum of four normally closed poles, and supplied with coils for A.C. or D.C. operation

for switching  
low voltage  
A.C. & D.C. circuits  
at 24v and below!

**ARROW ELECTRIC SWITCHES LTD** BRENT ROAD • SOUTHALL • MIDDLESEX  
Telephone: SOUthall 2442 • Telex: 23332

A65

For further information circle No. 211



Model 885-235 D.C. Amplifiers  
 Gain Range : 3 to 3000  
 Input Resistance : 100 Megohms  
 Bandwidth : d.c. to 10 kc/s  
 Output : - 10 volts at  $\pm 100\text{mA}$   
 Drift :  $\pm 1\mu\text{V}$  for 40 hours  
 Temp Coeff :  $\pm 0.2\mu\text{V}/^\circ\text{F}$   
 Noise :  $2\mu\text{V rms}$

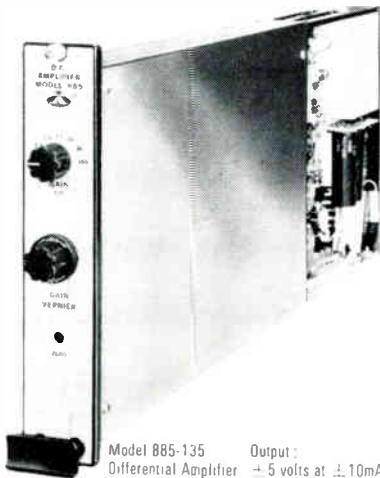

Model 885-135 Differential Amplifier  
 Gain Range : 1 to 3000  
 Input Resistance : 100 Megohms  
 Bandwidth : d.c. to 10 kc/s  
 Output :  $\pm 5$  volts at  $\pm 10\text{mA}$   
 Drift :  $\pm 1\mu\text{V}$  for 40 hours  
 Temp. Coeff :  $\pm 0.2\mu\text{V}/^\circ\text{F}$   
 Noise :  $2\mu\text{V rms}$



Model 887-115 Dual Output Differential Amplifier  
 Gain Range : 1 to 5000  
 Input Resistance : 25 Megohms  
 Drift :  $\pm 2\mu\text{V}$  for 40 hours  
 Temp Coeff :  $\pm 0.5\mu\text{V}/^\circ\text{F}$   
 Noise : 1 to  $7\mu\text{V rms}$  (depending on bandwidth)  
 Output A :  $\pm 10\text{V}$  @  $\pm 100\text{mA}$   
 Bandwidth A : d.c. to 60 kc/s  
 Output B :  $\pm 10\text{V}$  @  $\pm 10\text{mA}$   
 Bandwidth B : front panel selected  
 1  $\mu\text{C/s}$ , 100 c/s, 1000 c/s & 10,000 c/s

## Advanced solid-state **ASTRODATA** Amplifiers for instrumentation applications.

These quality High Gain amplifiers for low level wideband systems are completely transistorized and use field effect transistors (FET) in place of mechanical choppers to achieve a very low drift rate and freedom from microphonics combined with maximum reliability.

Two Differential Models—885-135 and 885-235 incorporate gain range selection facilities up to  $\times 3000$  combined with a continuously adjustable 10 turn vernier control as standard features. Amplifier outputs are  $\pm 10\text{mA}$  and  $\pm 100\text{mA}$  respectively from a low impedance source sufficient to drive long lines, A-D converters, multiplexers, galvanometer-recorders or tape recorders. Transfer characteristic is optimized to provide wide frequency response with minimum overshoot, fastest settling and overload times and minimum phase shift. Common mode rejection is greater than 120 db with up to  $\pm 300$  volts d.c. or peak a.c. common mode voltage.

The model 886-101 has similar characteristics to the 885 amplifiers but features a wider bandwidth and  $\pm 10\text{V}$  d.c. or peak a.c. common mode voltage.

These amplifiers have built-in power supplies, feature d.c. drift of less than  $4\mu\text{V rms}$  per 1000 hrs; wideband noise of less than  $4\mu\text{V}$ ; linearity better than 0.02%. They can be used either separately or in the same rack module with an Astrodata Model 1155 Universal Signal Conditioning Unit or Model 890 Electronic Filter to form complete, isolated, signal conditioning channels.

Model 887-115 d.c. Amplifier is the latest of the Astrodata Wideband d.c. Amplifier range and provides—*dual outputs*, which are mutually isolated, to drive simultaneously such devices as A-D converters, and galvanometer-recorders.

RAL's new Instrumentation Division has been set up to meet the fast-increasing demand for Astrodata products in the U.K. In addition to the Amplifiers illustrated, this proven range includes Telemetry Systems, Digital Data Acquisition and Timing Equipment.

For further information please contact John Gillman-Smith at:-

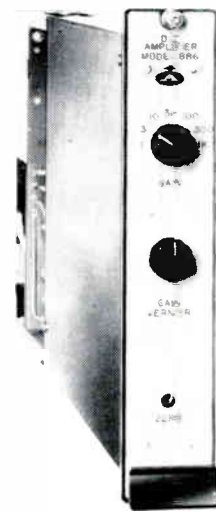

Model 886-101 D.C. Amplifiers  
 Gain Range : 1 to 3000  
 Input Resistance : 100 Megohms  
 Bandwidth : d.c. to 50 kc/s  
 Output :  $\pm 10$  volts at  $\pm 100\text{mA}$   
 Drift :  $\pm 1\mu\text{V}$  for 40 hours  
 Temp Coeff :  $\pm 0.2\mu\text{V}/^\circ\text{F}$   
 Noise :  $2\mu\text{V rms}$

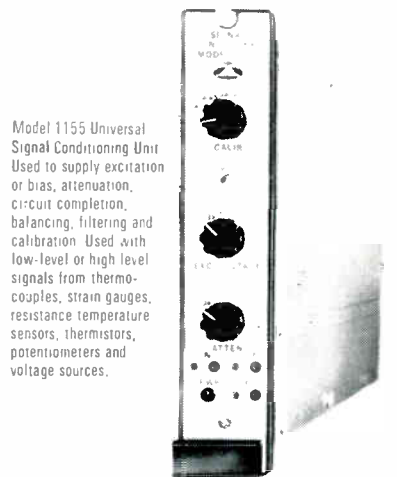

Model 1155 Universal Signal Conditioning Unit  
 Used to supply excitation or bias, attenuation, circuit completion, balancing, filtering and calibration. Used with low-level or high level signals from thermocouples, strain gauges, resistance temperature sensors, thermistors, potentiometers and voltage sources.



Model 120 Nanovolt Amplifier  
 Gain Range : 200 to 1,000,000  
 Bandwidth : d.c. to 100 c/s  
 Noise :  $0.05\mu\text{V rms}$   
 Input Resistance : 1 Megohm  
 Output Level : 0 to  $\pm 5$  volts at  $\pm 5\text{mA}$

**RAL**  
 THE HYBRID  
 COMPUTER SPECIALISTS

**REDIFON-ASTRODATA LTD**  
 Brookside Avenue Rustington Littlehampton Sussex Telephone Rustington 4166  
 A Member Company of the REDIFFUSION Group

For further information circle No. 212

**IF YOU NEED  
TO MEASURE  
VERY LOW  
FREQUENCY  
OPERATIONS—**

**YOU  
MUST  
HAVE  
THIS**

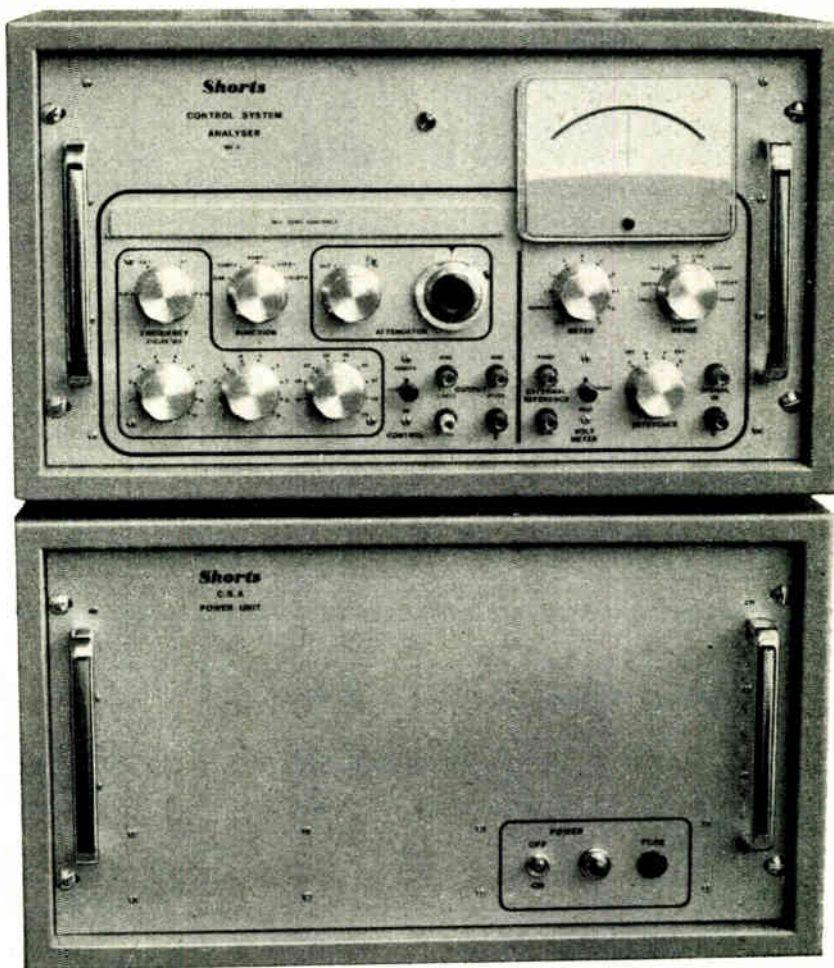

This is Shorts Control System Analyser Mk. 2.

It measures the performance of automatic control systems, with special emphasis on very low frequency operations.

The Control System Analyser is of particular value in the aircraft and missile industries, light and heavy electrical engineering, and chemical, nuclear and marine engineering. It has become standard equipment in the servo-mechanism and control laboratories of many research establishments and colleges.

These are its outstanding advantages:

- Ease of operation
- Low frequency operation
- Steady meter readings even at lowest frequency
- Oscillator starts from zero and decays exponentially, thus avoiding 'snatch'
- Very low DC level
- Competitive price.

**To: Short Brothers & Harland Ltd.,  
Gable House, Turnham Green Terrace,  
London W.4  
CHISWICK 6334**

*Please send me further details of the Shorts Control System Analyser Mk. 2.*

NAME ..... COMPANY .....

ADDRESS .....

..... POSITION..... IE2

**For further information circle No. 213**





# RCA 'overlay'

	TYPE	V <sub>CB</sub>	V <sub>CE</sub>	P <sub>OUT</sub> WATTS	P <sub>IN</sub>	MHZ	V <sub>CE</sub>
*	2N3553 (TO 39)	65	40	2.5 MIN	0.25	175	28
				2.5 TYP	0.5	260	28
*	2N3375	65	40	7.5 MIN	1	100	28
				3 MIN	1	400	28
*	2N3632	65	40	13.5 MIN	3.5	175	28
				10 TYP	3	260	28
	2N3733	65	40	14.5 TYP	4	260	28
				10 MIN	4	400	28
	2N4012	65	40	2.5 MIN	1	1000 (TRIPLER)	28
				3 TYP	1	800 (DOUBLER)	28

\*  
12 volt FM and  
28 volt AM versions  
also available

available from stock - on demand!

## plus NEW 2N4440 'overlay'

P<sub>out</sub>=5W (min.)  
@ 400 MHz;  
P<sub>in</sub>=1.7W

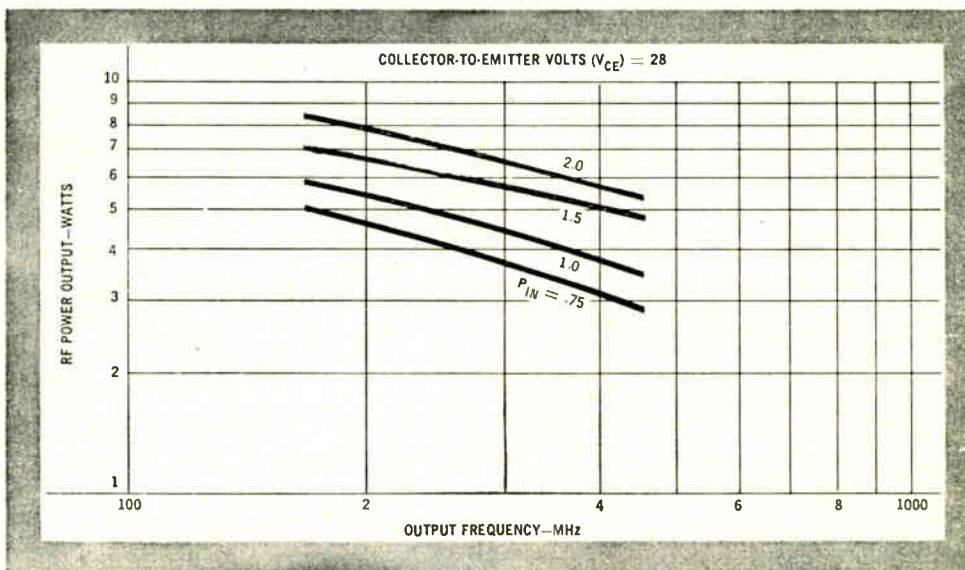

RCA now introduces 2N4440, a new high performance version of "overlay" type 2N3375—the industry's most famous rf-power device. Specified for Class A, B, and C service, this premium transistor extends solid-state performance for rf amplifier, multiplier, or oscillator service into the 175 to 400 MHz range.

The latest addition to RCA's extensive "overlay" family, 2N4440 offers:

P<sub>out</sub>=5W (min.) @ 400 MHz; P<sub>in</sub>=1.7W  
P<sub>out</sub>=6.5W (typ.) @ 225 MHz; P<sub>in</sub>=1.7W  
BV<sub>cev</sub>=65V (max.)

BV<sub>ceo</sub>=40V (max.)  
Typical gain bandwidth product  
500 MHz (@ 28V V<sub>ce</sub>, 150 max. I<sub>c</sub>)

Add to this performance the efficiency of an isolated-collector stud package (TO-60) and the increased reliability of 100% Power Rating Testing (each unit is tested at maximum power level for one second), and you have an important new design tool for VHF, UHF, and Microwave communications circuits.

For new low prices and full technical information, please write to Electronic Components and Devices Sales.



RCA Great Britain Limited

Electronic Components and Devices Sales, Lincoln Way, Windmill Road, Sunbury-on-Thames. Telephone: Sunbury 5511. STD (01-SM8-5511)

For further information circle No. 214

Reliability from RCA — within 24 hours

- \* Thyristors
- \* Photomultiplier Tubes
- \* Transistors
- \* Microwave Devices
- \* Power/Camera Tubes
- \* Magnetic Tape

For full technical information on all these RCA products write to the address at left.



# —AN IRON FOR EVERY PRECISION NEED!

## NEW—Complete Precision Soldering KIT

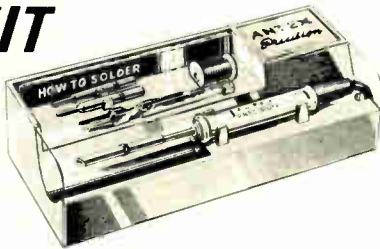

This kit—in a rigid plastic "tool-box"—contains everything you need for precision soldering.

- Model CN 15 watts miniature iron, fitted  $\frac{3}{16}$ " bit.
- Interchangeable spare bit,  $\frac{5}{32}$ "
- Interchangeable spare bit,  $\frac{3}{32}$ "
- Reel of resin-cored solder
- Felt cleaning pad
- Stand for soldering iron
- Space for stowage of lead and plug

PLUS 36-page booklet on "How-to-Solder"—a mine of information for amateur and professional.

**49/6d**

From Electrical and Radio Shops, or if unobtainable locally apply direct to ANTEX LTD.



Grosvenor House,  
Croydon, CR9 1QE  
Telephone 01-686 2774

**CN** 15 watts. Ideal for miniature and micro miniature soldering. Interchangeable spare bits available from .040" (1 mm) up to  $\frac{3}{16}$ ". For 240, 220, 110, 50 or 24 volts. **32/6**

**G** 18 watts. Ideal for miniature work on production lines. Interchangeable spare bits,  $\frac{3}{32}$ ",  $\frac{1}{8}$ ",  $\frac{3}{16}$ " and  $\frac{1}{4}$ ". For 240, 220 or 110 volts. **32/6**

**E** 20 watts. Fitted with  $\frac{1}{4}$ " bit. Interchangeable spare bits  $\frac{3}{32}$ ",  $\frac{1}{8}$ ",  $\frac{3}{16}$ ". For 240, 220, 110 or 24 volts. **35/-**

**ES** 25 watts. Fitted with  $\frac{1}{8}$ " bit. Interchangeable bits  $\frac{3}{16}$ ",  $\frac{3}{8}$ " and  $\frac{1}{4}$ ". Ideal for high speed production lines. For 240, 220, 110, 24 or 12 volts. **35/-**

**F** 40 watts. Fitted  $\frac{5}{16}$ " bit. Interchangeable bits  $\frac{1}{4}$ ",  $\frac{3}{16}$ ",  $\frac{1}{8}$ ",  $\frac{3}{32}$ ". Very high temperature iron. Available for 240, 220, 110, 24 or 20 volts. **42/6**

Spare bits and elements for all models and voltages immediately available from stock.

**Send for the 16-page ANTEX main catalogue**

## THE ANTEX DE-SOLDERING TOOL

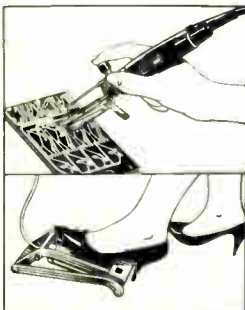

Soldered joints can now be easily, speedily and neatly unsoldered. A self-cleaning nozzle, exclusive to the ANTEX De-Soldering Irons, sucks up molten solder into stainless steel catcher. Operates by compressed air from airline or standard foot-pump. Type ESS (25W) for 240, 220, 110 or 24 volts. Type GSS (18W) for 240, 220 or 110 volts. Price £4. 4. 0d. De-Soldering Tool complete with foot-pump, as illustrated £4.19. 6d.

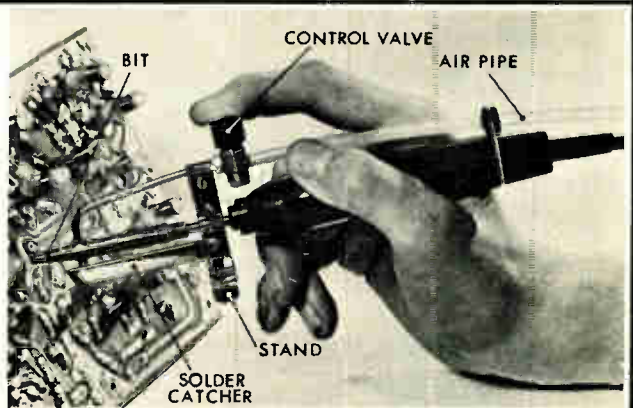

For further information circle No. 215



# OXIDE

is the reliable resistor that everyone's using  
electrosil glass-tin-oxide is the finest example

#### Here's why:-

##### continuous coating

The oxide film is applied to continuously drawn glass cane at red heat to achieve consistent film quality.

##### molecular bond

Film becomes integral with glass substrate.

##### extra film thickness

At least one order thicker than others. Consequently tougher.

##### matched thermal expansion

Glass and Film match within 1 part in 10 million for highest stability.

##### chemically inert, diamond hard

Film is unaffected by acids and alkalis and is impervious to moisture. Hardness of film resists mechanical damage.

##### withstands high temperatures

Will operate continuously at 400°C (twice that of carbon and metal films).

##### international availability

Three-source manufacture ensures continuity of supply, and favourable prices through large scale manufacture.

##### full approvals

Electrosil glass-tin-oxide resistors meet all U.K. and International Defence and Military specifications.

##### unequaled service

Electrosil 'ZIP' delivery means that all orders up to 500 pieces per value and tolerance will be despatched within 24 hours at no extra charge. Quick deliveries too on larger orders.



Electrosil Limited, P.O. Box 37, Pallion, Sunderland, Co. Durham. Phone Sunderland 71481 Telex 53273

For further information circle No. 216

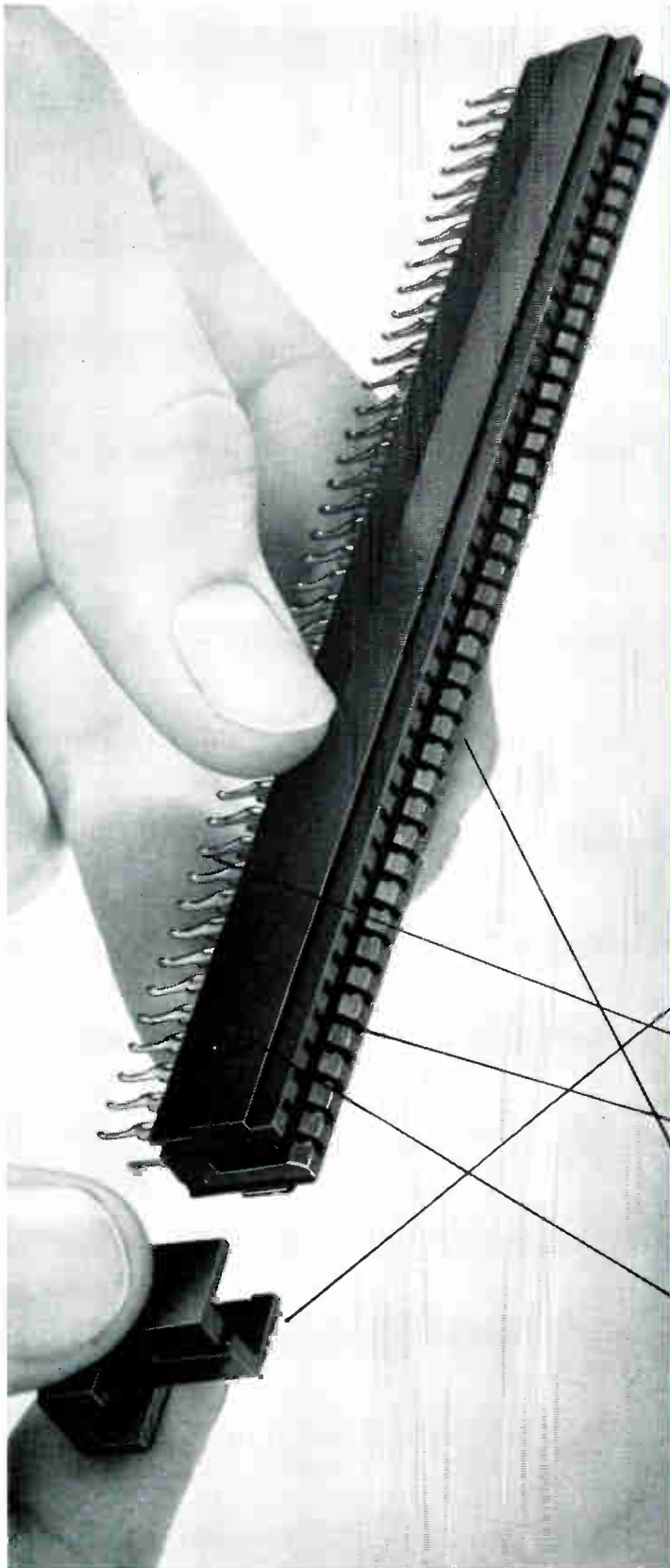

# **NEW**

## **Versatile modular Printed circuit edge connectors**

**custom built to suit your requirements**

- Available with 0.1", 0.15" and 0.20" spacings, in all number of ways from 4 to 60.
- Fixing lugs to suit all racking systems.
- Gold plated beryllium copper contacts for solder connections.
- Optimum contact performance with latitude for board printing tolerances.
- Suitable for single or double sided P.C. boards.
- Glass filled diallyl phthalate moulding.

For further details ring the Publicity Department, telephone no. 01-363 5393 ext. 15.

# **BELLING-LEE**

# **COMPONENTS**

***connecting research to industry***

**BELLING & LEE LIMITED, GREAT CAMBRIDGE ROAD, ENFIELD, MIDDLESEX**

Telephone: 01-363 5393 Telex: 263265

**For further information circle No. 217**



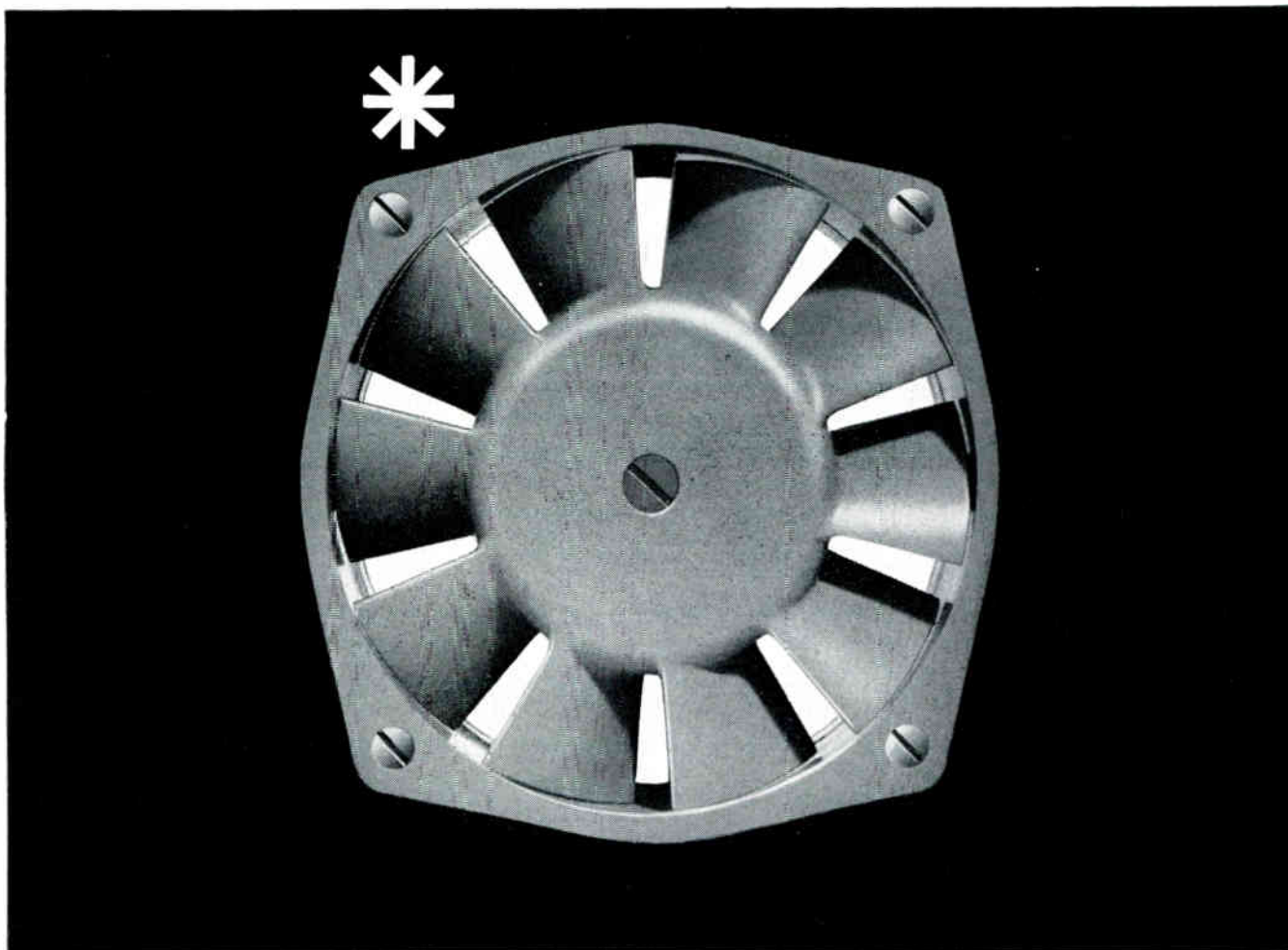

\* actual size

# New 3½" Plannette Blower

- \* Blows 25 c.f.m. free air
- \* Compact — only 1¾" deep
- \* Fitted with precision ball-bearings
- \* Plastic housing and impeller
- \* No capacitor required

The new 3½" Plannette has been developed especially for designers and manufacturers of electronic and electrical equipment — from computers to control gear and general instrumentation, in fact anywhere that hot-spot headaches need relieving!

The 3½" Plannette is the latest addition to a range of blowers extending up to a 12" model (3" deep) blowing 1000 c.f.m. free air. Because Plannettes are slim-line, designers can slip them — late in the design stage — into confined spaces where they will cool quietly and efficiently.

With Plannettes or one of our other 1000 purpose-built blowers, we solve temperature control problems throughout industry. Send for details now.



PLAN WITH PLANNAIR  
—specialists in aero-thermal control

**Plannair Limited**  
Kingston Road, Leatherhead, Surrey  
Telephone: Leatherhead 5341 (10 lines)

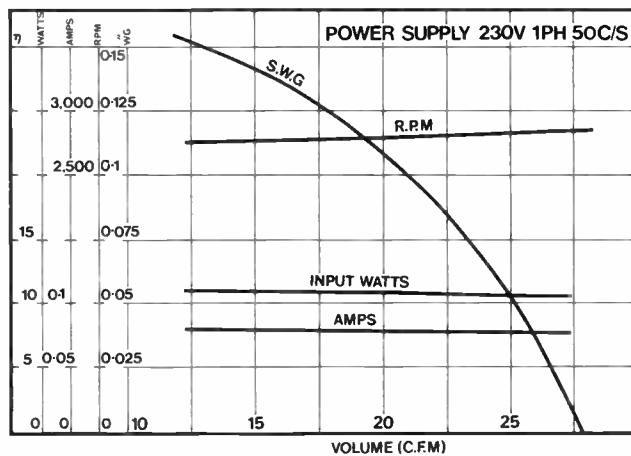

To: Plannair Limited

Please send me full details of the Plannette range of blowers

Please arrange for your representative to call (tick as appropriate)

Name \_\_\_\_\_

Position \_\_\_\_\_

Company \_\_\_\_\_

Address \_\_\_\_\_

For further information circle No. 218





## We're proud of the connections we've made with our miniature wires and cables

Many of the organisations we deal with are large. Important. With rigid standards.

Large industrial concerns; government bodies; public utilities; medical departments; manufacturers of electronic equipment; aeronautical authorities.

They come to us for one reason—the high quality of our miniature wires and cables.

There's the 98 ohm balanced twin cable, overall diameter .064 inch. High frequency coaxial cables, with overall diameters not exceeding .078 inch.

PTFE wires, cables and cable assemblies, made to withstand a constant temperature of 250°C, and, for short periods, 300°C.

Only the best materials are used in their construction: high tensile strength, silver-plated, copper clad steel wires; a dielectric of

polythene, irradiated polythene or polytetrafluoroethylene (PTFE); copper or silver-plated copper wire, fibre glass, nylon or PTFE sheathed.

That's what we mean by quality. Write, phone or telex for further details to: Standard Telephones and Cables Limited, Rubber and Plastic Cable Division, Corporation Road, Newport, Mon. Telephone: Newport 72281. Telex: 49368.

# STC

world-wide telecommunications and electronics

For further information circle No. 219

*\* in quality and reliability year-  
by HENGSTLER*

*Developed - Perfected and  
Manufactured in  
Great Britain*

*A NOTABLE ADVANCE IN  
ELECTRONIC HIGH SPEED  
COUNTING FOR INDUSTRIAL  
APPLICATION*



*unaffected by mains power  
failure or interference*

This new range of Electronic Pre-determining Counters has been specially developed to meet modern industrial requirements for a highly accurate counter with a maintenance-free life.

**3, 4, 5 or 6 figure capacity with display.**  
**A wide range of input and output facilities.**  
**Up to 100,000 counts per second.**  
**Silicon semi-conductors used throughout.**  
**Guaranteed to be unaffected by transient voltages on the main supply.**

These standard features, together with the services of our Applications/Design staff, make these counters readily adaptable to the majority of counting and control systems. You are invited to telephone or write for full technical specifications or a demonstration of these remarkable counters.



**FIRST IN ELECTRONIC COUNTERS FOR INDUSTRY**  
**J. HENGSTLER CO. GREAT BRITAIN LTD.**  
BROOKER RD., WALTHAM ABBEV, ESSEX PHONE: WALTHAM CROSS 26166-7-8

**For further information circle No. 220**

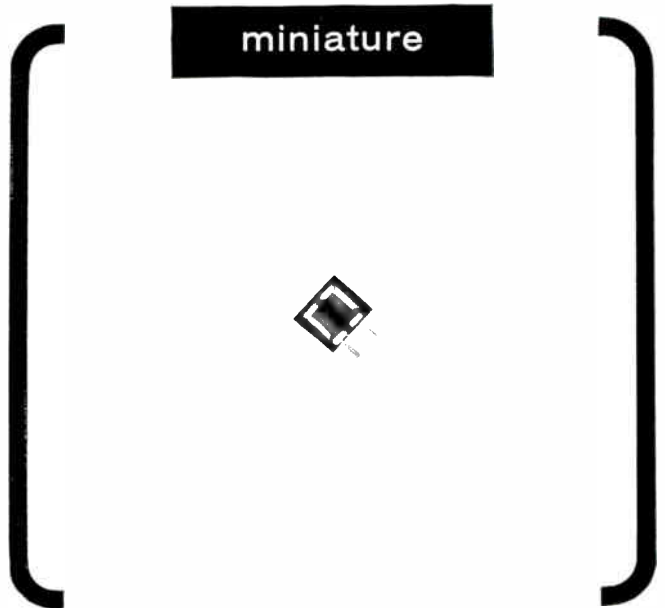

**Reduce your problems & equipment  
size to a minimum**

The Whiteley organisation has tackled and solved many big problems in the past and in the last decade have developed quite a technique for solving many miniaturisation problems.



Whiteley miniature components cover a very wide range, but we show as examples a transformer, a potentiometer mounting, a small iron cored choke and a mu-metal core encapsulated in epoxy resin. Modern research and development techniques are available to you by simply writing or telephoning us at Mansfield giving details of your particular big problem regarding small components.

**WHITELEY ELECTRICAL RADIO CO. LTD**

**MANSFIELD · NOTTS · ENGLAND** Tel: Mansfield 24762  
**London Office: 109 KINGSWAY, W.C.2** Tel: HOLborn 3074

**For further information circle No. 221**



says Rediffusion Reggie

## Rediffusion Industrial Services Ltd.

Astronaut House,  
Hounslow Road,  
Feltham, Middx.

Tel: 01-890 6325

### Calling all Industry . . .

Rediffusion Industrial Services Ltd. provides a range of products and services for communication in industry. The Company specialises in Public Address and Sound Communication Systems, Telephone and Intercommunication Networks, Closed Circuit Television for Industrial, Educational, Research and Commercial uses, Fire Alarm and Contact Schemes.

### Dealing with YOUR Problems

All types of communication and alarm systems can be supplied to deal with the specific problems and requirements of the buyer.

### All This and . . .

A free consultant and advisory service is available, which is backed by an unparalleled maintenance system from the many Rediffusion branches throughout the country. Find out exactly how we can solve your communication problems.

For further information circle No. 222





# TOROVOLT

*encapsulated  
variable transformers*

These new TOROVOLT variable transformers are of highest quality incorporating features that provide outstanding mechanical design and electrical performance at a low cost never before achieved. Write for leaflet G3/2.

**lowest prices ever !**

Input 240v. Output 0-240v.

Model	Rating	Price
33Y	0.9A	£3 . 12 . 6
34Y	1.4A	£4 . 4 . 0
36Y	1.7A	£4 . 12 . 6
38Y	2.5A	£6 . 17 . 0
40Y	4.0A	£9 . 8 . 0
42Y	6.0A	£10 . 15 . 0

Prices include knob and dial.

Quantity discounts available.

Enquiries invited.

**TOROVOLTS ARE BRITISH TO THE CORE.**



A member of the **expamet** Group

**THE CRESSALL MANUFACTURING COMPANY LIMITED**

CHESTON ROAD · BIRMINGHAM 7 · TELEPHONE · STD 021 EAST 3571

## ELECTRICAL PROPERTIES OF SEMICONDUCTOR SURFACES

O. R. Frankl,  
*Pennsylvania State University*

Professor Frankl discusses the dependence of the electrical properties of semiconductors on the nature, arrangement and surroundings of the outermost atomic layers of semiconductor samples. The book is intended to bring the reader up to date with existing theory and experiments, and to indicate where the most promising fields of future research and advancement may lie.

328 pages

84s./\$13.50

## MEDICAL ELECTRONIC LABORATORY EQUIPMENT, 1967/68

Edited by G. W. A. Dummer and J. M. Robertson,  
*Royal Radar Establishment, Malvern*

This new volume in the Pergamon Electronics Data Series describes the wide range of specialized medical equipment now available to members of the medical profession. The equipment, on which comprehensive data is given, includes lasers, monitoring systems, oscilloscopes, pupillography equipment, rate meters, stimulators, spiro meters, temperature controllers, thyroid function systems, X-ray actuators, etc.

1,050 pages

£10/\$30.00

## THEORY OF SEMICONDUCTOR JUNCTION DEVICES

A Textbook for Electrical and Electronic Engineers.  
J. H. Leck,  
*University of Liverpool*

This elementary text is suitable for third-year undergraduate students of electrical and electronic engineering and covers the applications of solid state theory and device operation. Topics of the book include:- The Application of Band Theory to the Special Case of Semiconductors; Electrical Properties of Semiconductors, Conductors, Hall Effect, p-n Junction Theory, Diodes, Multi-junction Elements, Injection and Field Effect Transistors, and the p-n-p-n Switch.

Approx. 160 pages

approx. 30s./\$4.50

## V.L.F. RADIO ENGINEERING

A. D. Watt,  
*Deco Engineers Inc., Boulder Colorado*

Provides a detailed coverage of the fields associated with V.L.F. radio engineering; a compendium of basic antenna, propagation and system information; and a guide for applying this information to the solution of practical problems. Although much of the interest in V.L.F. comes from the communications aspect, there are many other applications for the material presented here. They include:- navigation; basic ionospheric research; meteorology and thunderstorm study and tracking; standard frequency and time distribution; geological studies; and mineral exploration.

Approx. 600 pages

Approx. £7/\$21.00

**PERGAMON PRESS**  
Headington Hill Hall, Oxford.  
44-01 21st Street, Long Island City,  
New York 11101, U.S.A.

For further information circle No. 223

For further information circle No. 224



# Quality counts..



**TCeB series**  
(leaflets 212.32.3)

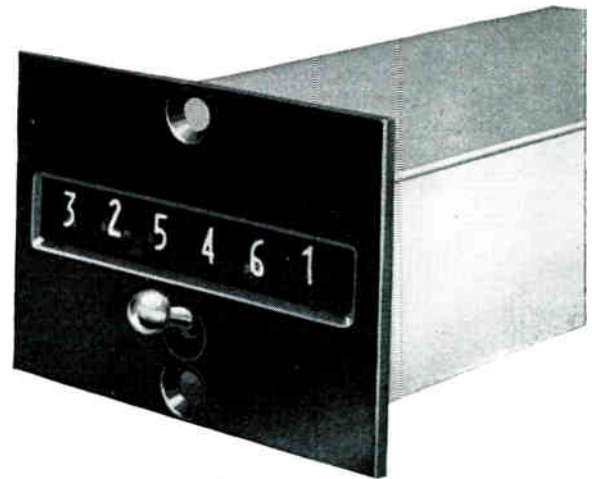

**TCe series**  
(leaflet 212.26.4)

TCeB series with optional mechanical push button reset, from 4 to 7 digits, low power consumption, AC version with built-in rectifier, flush or projecting fitting, counting speeds up to 25 i.p.s., with a guaranteed life expectancy of over 200 million operations.

TCe series electrical, mechanical (toggle switch) or without reset, from 3 to 8 digits, counting speeds up to 50 i.p.s., with a guaranteed life expectancy of over 200 million operations.

**Whatever your application, from simple totalising to sophisticated differential counting, you can't beat Sodeco.**



M & P L G C 9

## LANDIS & GYR LIMITED

Victoria Road · Acton · London W.3.  
Tel: Acorn 5311

**For further information circle No. 225**

## Planning your next move?

# ASK ABOUT "SELLOTAPE" ELECTRICAL TAPES

because you'll find the solution to many problems in the manufacture of electrical components in the versatile "Sellotape" electrical range—a range tailor-made for a wide variety of taping jobs—insulating, securing, protecting, holding, identifying (by printed tape) and many others. Whether the job calls for an extra-thin insulating material or for an extra-tough tape for heavy duty work . . . whether a component has to withstand freezing conditions or operate at very high temperatures you can be sure that "Sellotape" have a tape for it.

**1** "Sellotape" electrical tape is a neat, secure replacement for the usual metal lamination clamp on printed circuit components and in double-sided form it secures the component to a circuit board.

**2** "Sellotape" Polyester Thermosetting 1607 for security on stick-wound coils. **3** "Sellotape" electrical grade tape is an inexpensive, easy-to-apply insulating and protective medium for flexible printed wiring systems. **4** "Sellotape" electrical tapes wound on a mandrel adhesive outermost make inexpensive coil formers.

There is a team of "Sellotape" specialists constantly at work in this field. The benefit of their experience and advice is always freely at your disposal.

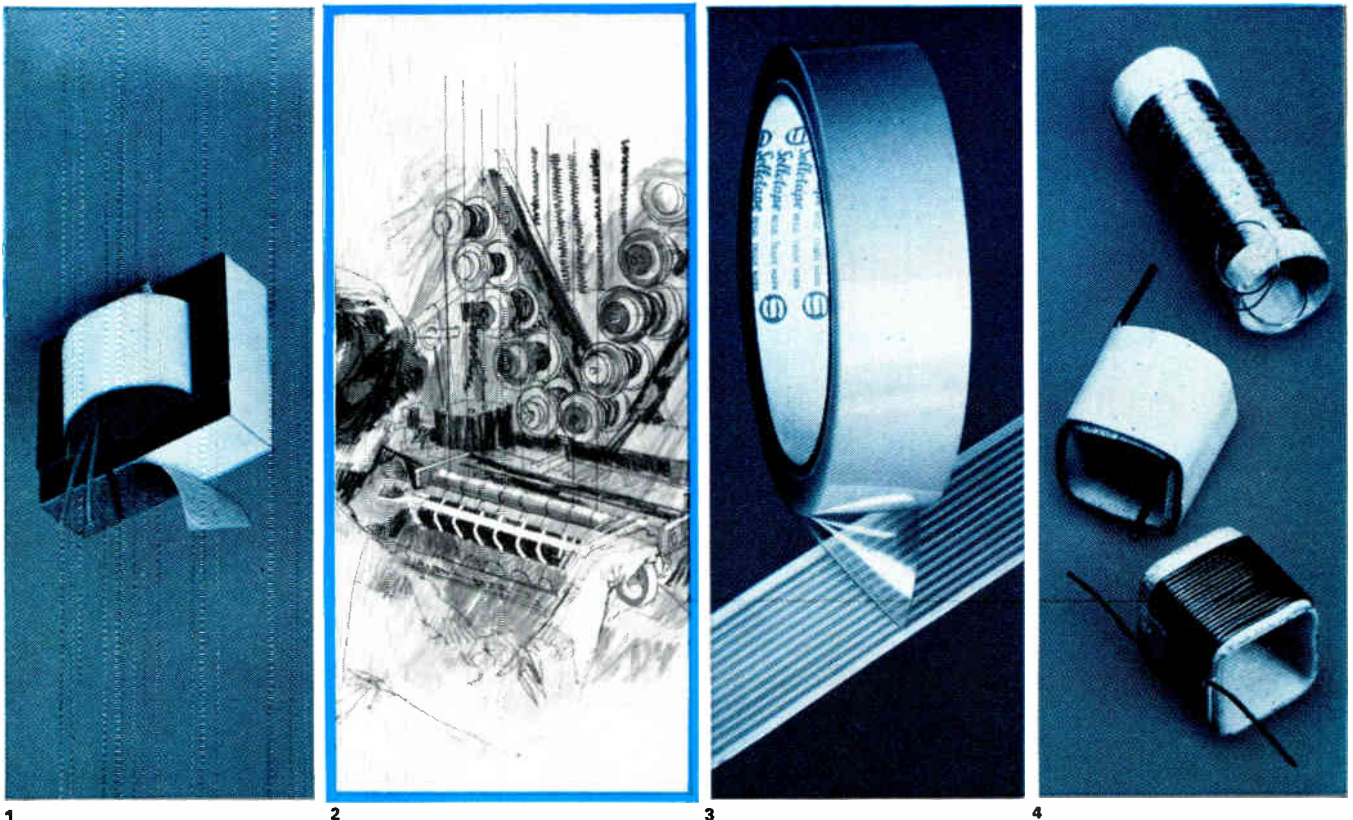

1 2 3 4



## Sellotape products—a plus on every production line

SELLOTAPE PRODUCTS LIMITED, INDUSTRIAL DIVISION, SELLOTAPE HOUSE  
54-58 HIGH STREET, EDGWARE, MIDDLESEX. Telephone: EDGware 2345. Telex: 262462  
GLASGOW OFFICE: 93 HOPE STREET, GLASGOW C2. Telephone: CENTral 6861. Telex: 77534  
DUBLIN OFFICE: 1/2 LOWER MOUNT STREET, DUBLIN 2. Telephone: 61108/9  
Associated Manufacturing Companies in Australia, Canada, Eire, New Zealand and South Africa

"SELLOTAPE" is the registered trade mark of Adhesive Tapes Limited

For further information circle No. 226



# INDUSTRIAL ELECTRONICS

## Closed-Circuit Television in Industry

Undoubtedly the most spectacular use of closed-circuit television has been the transmission back to earth of television pictures of the surface of Mars taken by an orbiting spacecraft. Such an accomplishment is a unique feat of engineering, but one may ask what impact does or should it have on industry—potentially the largest user of c.c.t.v. equipment?

The significance of the technical achievement lies principally in the high quality of the received pictures and the reliability of the remotely-controlled electronic equipment. Like all space-research equipment, it was specially developed at vast cost, but it has established the potential dependability of c.c.t.v. under the harshest and least predictable of environments and thus augurs well for more routine and down-to-earth applications.

Just how British industry has responded in the past to the exploitation of c.c.t.v. is indicated in one of this month's articles, which discusses the results of an independent survey into the uses of the medium throughout industry, commerce and the public sector. Its conclusions are drawn from the replies of a random sample of some 350 organizations, which the researcher had reason to believe were using c.c.t.v.

Perhaps the most impressive factor to emerge from the survey is the diversity of c.c.t.v. applications that industry (in particular the non-ferrous, iron and steel sections) has developed. Communication of information, remote observation and control, process monitoring and testing in hazardous or inaccessible locations, data handling, security and training are but a few of the proven uses of the technique.

It must not be assumed, however, that for each of these problems c.c.t.v. is the unique or most appropriate solution; too often, attempts have been made to apply c.c.t.v. in situations for which it is singularly ill suited. The essential task of thoroughly examining the motives for and consequences of introducing c.c.t.v. cannot be over emphasized.

That these consequences, which may range from a minor change in production practice to a relatively major reorganization, must be considered primarily from an economic point of view goes without saying. But the human factors involved are perhaps the most significant: consultation with staff and unions is an essential prerequisite and equipment operators must be properly trained (the survey indicates how little attention is paid to this area).

With the current availability of low-cost c.c.t.v. and the prospect of economic colour television and infra-red techniques, the future of c.c.t.v. from a technical standpoint seems assured. Whether industry will take advantage of these facilities depends very much on its appreciation of the state of the art. Although c.c.t.v. has been available for some ten years or more the number of installations in the U.K. are in the hundreds rather than thousands.

A valid case could be made for the establishment of an independent body which provides information on and evaluation of c.c.t.v. equipment and techniques.

Some of the energy and resources of one or two of the seemingly useless Mintech committees could well be channelled in this direction—perhaps through their Automation Centres.



Radar sets for air traffic control must be able to distinguish between returns from moving aircraft and the permanent echoes received from stationary objects. In the past, a facility called moving-target indication has been used to remove any unwanted signals, but in certain circumstances it cancelled out moving objects as well. Now, a development of the video-mapping technique has allowed a choice to be made between cancelled and uncanceled radar video, so that the operation of MTI can be limited to those areas where permanent echoes occur. Known as selective moving-target indication (SMTI), its operation and advantages are described in this article.

THE basic elements of a radar video map are a flying spot scanner, a map plate, an optical system, a photo-multiplier and a video amplifier. The principles of video mapping were worked out in the latter half of the 1940s, but the performance of the earlier equipments was greatly restricted by the limitations of the cathode-ray tubes available. The introduction of microspot c.r.t.s made it possible to achieve much higher standards, however, considerably enhancing the value of the map to the operator.

The design of video-mapping equipment and the achievement of accuracy and high resolution were discussed in two articles in *Industrial Electronics* in August and September 1965; since then there has

been a development in technique which allows the choice between cancelled and uncanceled radar video to be controlled by a video map. Developed by the Solartron Electronic Group in conjunction with the Ministry of Aviation, this new facility is called Selective Moving Target Indication (SMTI) and its function is to limit the operation of MTI to those areas in which permanent echoes occur, instead of gating it, as at present, at an arbitrary range.

The need for SMTI springs from the fact that the use of cancelled video (MTI) has some serious disadvantages, the most obvious of which is the fading which occurs when an object is moving tangentially to the radar line of shoot. To understand these disadvantages, it is necessary to understand how MTI works and what the requirements are that it is designed to meet.

### Moving Target Indication

An air-traffic controller is primarily concerned with radar returns from aircraft. In its basic form, a radar set accepts returns from anything that will reflect its transmissions, which means that houses, trees, hills, factory chimneys and the like will all appear on the screen as clutter. This clutter appears chiefly in the centre of the picture, extending to five, ten or even twenty miles out, depending on the terrain; beyond that range there are isolated patches of returns, which may be up to 40 or 50 miles out but which are probably limited to one or two narrow sectors.

As it is not possible to distinguish between aircraft returns and permanent echoes on the basis of signal strength (the strength of the return from permanent echoes is generally greater than that from an aircraft), a system of discrimination based on movement was devised, the signal returns from each pulse being stored and compared with those of the succeeding pulse. If there is no phase change, the circuit assumes that the object producing reflection is stationary and should not, therefore, be reproduced at the

display; instead this part of the signal is cancelled and not shown.

If there is a phase change, however, the object is assumed to be moving and is passed to the display for reproduction. Because responses from stationary objects have been deleted, the signal being fed from the MTI circuit to the display is called 'cancelled video'.

In order to achieve a phase change, there must be a radial component of movement. This means that an aircraft which is flying tangentially to the radar transmission is not recognized as a moving object, and its return

is not included in the cancelled-video signal fed to the display. There is a similar difficulty when the radial component of the speed of the object coincides with what is called the 'blind speed', i.e., that speed at which there is no phase

shift between the compared signals because the displacement is a precise number of cycles. The MTI circuit treats this effect as a return from a stationary object. The use of MTI is an expediency, and it is customary to gate its operation at the lowest range at which the majority of the permanent echoes are eliminated.

This means that there is a circular area at the centre of the picture in which cancelled video is used, while outside this area uncanceled video ('raw radar') is displayed. Permanent-echo patterns are usually far from circular, so the choice of a gating

range is a compromise between the elimination of all permanent echoes and the use of cancelled video over large areas covered by the system where there are no permanent echoes.

### Selective Moving Target Indication

The purpose of the selective MTI technique is to limit the operation of MTI to those areas where there are actually permanent echoes, and to use uncanceled video everywhere else. There is thus established a requirement to switch between cancelled and uncanceled video during each radial movement of the scan, such switching being either a single change or cycled several times, depending on the complexity of the permanent-echo pattern.

SMTI has as its basis a normal video map, or a single channel of a dual-optic video map, the video-map plate used being a photographic analogue of the permanent echoes occurring at the particular radar site. All echoes are of the same strength and are represented on the plate by clear emulsion, the rest of the plate being opaque. When the flying spot scans a permanent echo, light is transmitted to the photo-multiplier and induces an output voltage; as soon as the movement of the spot carries it beyond the permanent echo, the light is cut off and the output from the photomultiplier falls. Thus an output voltage from the photomultiplier corresponds to the occur-

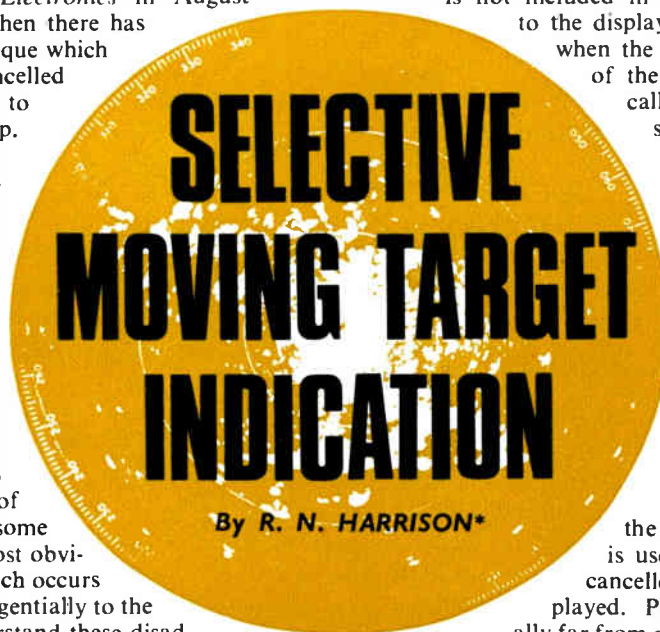

\* The Solartron Electronic Group Ltd.

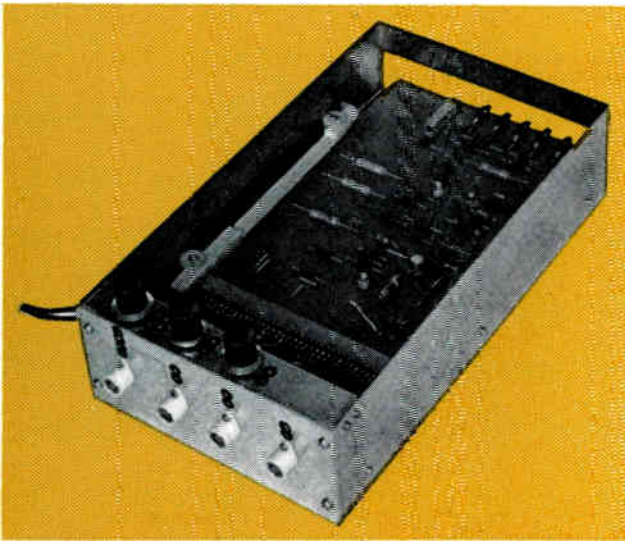

*Fig. 1. A prototype SMTI switching unit, built for trials at the London ATCC and still in use there*

rence of a permanent echo and indicates the need to use cancelled video; the absence of a voltage corresponds to an area without clutter, in which case uncanceled video can be used. The output from the photomultiplier is amplified and processed to produce a switching waveform, after which it is fed to a solid-state switching circuit.

A prototype switching unit, currently in operation at the London Air Traffic Control Centre, is shown in Fig. 1 and was used in the trials associated with the Marconi S.264 radar at Ash. The siting of this radar is such that traffic in Airways Red 1 and Blue 29 in the region of Clacton is flying tangentially, and tends to disappear at the time when it should be reporting. In Fig. 2, several aircraft in the vicinity of the Clacton reporting point (top left) are clearly visible with SMTI, but do not appear with normal MTI in operation.

Originally, permanent-echo plates for SMTI were produced empirically by scratching an exposed (and developed) photographic plate with a knife, and Fig. 3 shows a plate made in this way for the DASRI radar at Clee Hill. When video-map evaluation was being carried out by the Canadian Department of Transport at Carp, Ontario, it was decided that a more accurate method of producing the permanent-echo plates should be used. Three photographs were taken of the permanent-echo pattern, with a short time interval between each to show up movement; all moving returns were then eliminated, and the remainder were transferred to a scaled-up drawing prepared in the same way as a normal video-map drawing.

When this plate was used at Carp, it became apparent that insufficient allowance had been made for the variation which occurs between the maximum and minimum permanent-echo patterns. Under different weather conditions, the returns from objects on the ground varied considerably, and the photographs probably represented a minimum level of permanent-echo reflectivity rather than a maximum.

*Fig. 2. These two radar pictures of the Ash Marconi S264 were taken at the London ATCC. The first (a) was taken when normal MTI was in operation, while the second (b) was taken thirty seconds later during SMTI. The SMTI clearly shows a number of additional returns from aircraft which were not visible with MTI. The bottom diagram shows a and b superimposed. (Crown copyright photographs)*

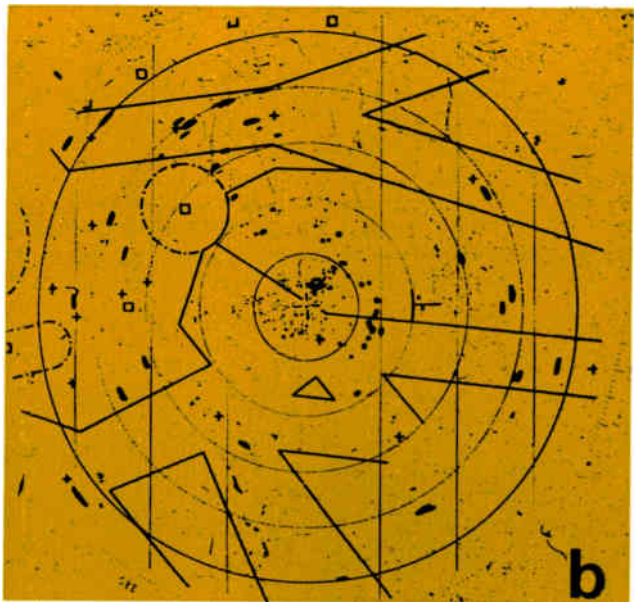
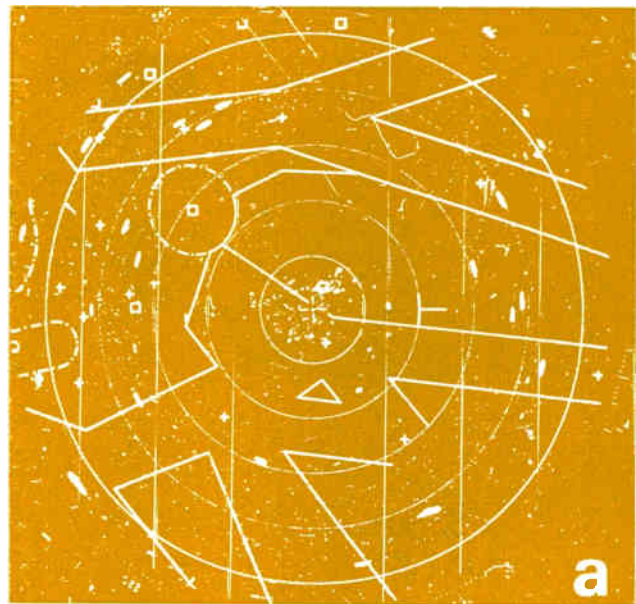



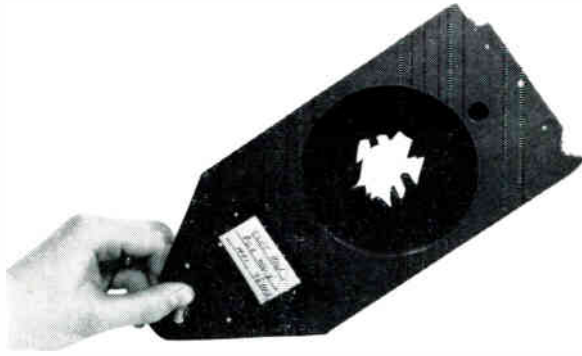

Fig. 3. A prototype permanent-echo plate (in its carrier), which was prepared manually by removing the emulsion from within the scribed outline of the permanent echoes that had been made on a fogged photographic plate. For operational plates, the production process will be entirely photographic

Another difficulty, which had been appreciated when making the permanent-echo drawing but had not been completely overcome, was the lack of circularity in the PPI (plan position indicator) sweep. This lack of circularity was apparent from the rangemarks, which could most fairly be described as 'somewhat oval' and although calculations had been made of the displacement of the permanent echoes thus induced, they had not been sufficiently accurate.

The permanent-echo plates now being produced represent the pattern of clutter, but they do not delineate individual permanent echoes unless these are well isolated from other returns. This ensures that seasonal variations in reflectivity

will not affect the picture, and the cost of preparing the plates is thus reduced.

Nowadays, provision is made for displaying to the controller the pattern of permanent echoes which is being used, showing him in what areas he may expect tangential-fade or blind-speed effects, and what areas will be free of them. To do this, the output from the head amplifier of the SMTI channel is repeated as a separate video signal and fed to the controller's display; there is a gain control associated with this circuit, and in using it the controller can bring up a background of fine-grain noise. As an alternative to this, it would be possible to display the permanent-echo area in outline, but the background method was chosen in order to avoid possible conflict with the use of contours for displaying weather information.

In the video-map equipment shown in Fig. 4, the switching unit is an integral part of the map and takes the form of printed-circuit boards. Where the gating of cancelled video takes place at the radar head, it is more convenient to switch between cancelled and uncanceled video at the receiver; in this case, a separate unit can be provided (complete with its own power supply), the switching action being triggered from the video map. The delay which occurs in this system can be compensated for by distorting the drawing of the permanent-echo plate; this avoids the difficulty that might otherwise occur if compensation was achieved by means of a pre-trigger in a dual-optic installation, the second channel of which was being used for normal video-mapping purposes.

SMTI has been used experimentally at the London Air Traffic Control Centre since August last year, and also during its evaluation trials in Canada. By the time this article appears, it is expected to be in operational use with the Plessey AR1 equipment (see Fig. 5) installed at London Airport.

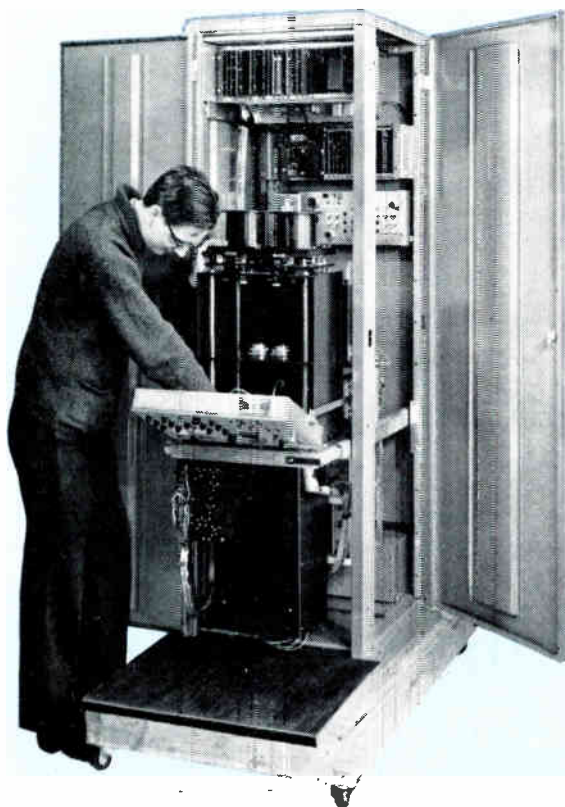
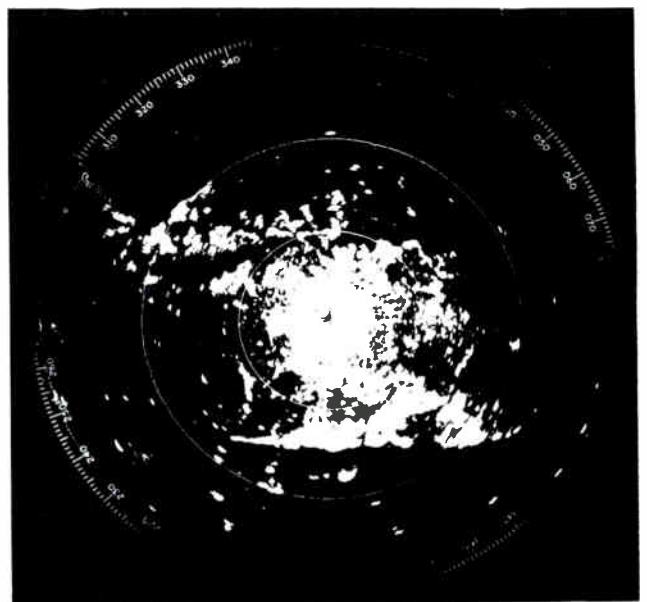

Fig. 4. The Solartron SY.2046 high-resolution video map, which incorporates the pre-production switching unit in the nest at the top of the cabinet

Fig. 5. Permanent echoes on the Plessey AR1 display at London (Heathrow) Airport, using uncanceled video; the range rings are at 10-mile intervals. (Crown copyright photograph)





# DIGITAL DATA TRANSMISSION

By R. T. SHAW\*

With the increasing use of teleprinters and remote input and output devices for centralized computers, the transmission of digitally-coded data has become an important function. It can be accomplished over ordinary telephone-type links and the public telephone network can be used. This article describes the equipment necessary, discusses its operation and indicates new and future developments.

THE term 'data transmission' could be interpreted quite generally to include radio and television, telemetry and other fields of telecommunications. However, it is not generally used in this wide sense to-day so that some restriction of the field covered in this article is desirable. It is concerned primarily with the transmission of alpha-numeric data in digital form from a point to one or more other points with a high order of accuracy, and in such a way as to allow precise control of the process.

## General Considerations in Digital Data Transmission

Telecommunication facilities already exist for transmitting information in the U.K. and many other countries, and these are the telephone and teleprinter (Telex) networks. Both networks can be used for transmitting data in digital form. The telephone network requires equipment to convert the digital data into voice-frequency signals, whereas the teleprinter operates directly in a digital form at the user's premises. Both, however, require means for the detection and correction of errors if a high order of accuracy is to be obtained.

## Existing G.P.O. Services

G.P.O. services for the transmission of data have been grouped under the general name of Datel Services. At present facilities are available in three speed ranges for which commercial equipment has been developed in response to user demands.

### Signalling at Low Speed

The signalling speed on the U.K. Telex network is limited to 50 bits (about seven five-element characters) per second but this speed can be increased to about 100 bits per second on some leased telegraph circuits; these facilities are provided in the Datel 100 Service. Another system of slow-speed data transmission can be provided by using voice-frequency telegraph equipment connected to a leased telephone connection. This system will allow a number of telegraph channels transmitting at a speed of 50-75 bits per second to be operated simultaneously

over the same telephone line. Each channel should preferably be terminated at the same geographical location. The number of channels available can be up to 18-24 (depending upon the frequency band available) assuming the telegraph speed to be 50-75 bits per second. Typical equipment is shown in Fig. 1.

### Signalling at Medium Speed

Medium-speed data transmission is possible over both the switched and leased telephone networks by using the Datel 600 Service. Equipment at present in use provides transfer rates ranging from about 50-150 eight-element characters per second. These transfer rates use line speeds

Fig. 1. An STC XTF9 24-channel voice-frequency telegraph equipment is shown here. This is a compact all-transistor design used and approved by the G.P.O.

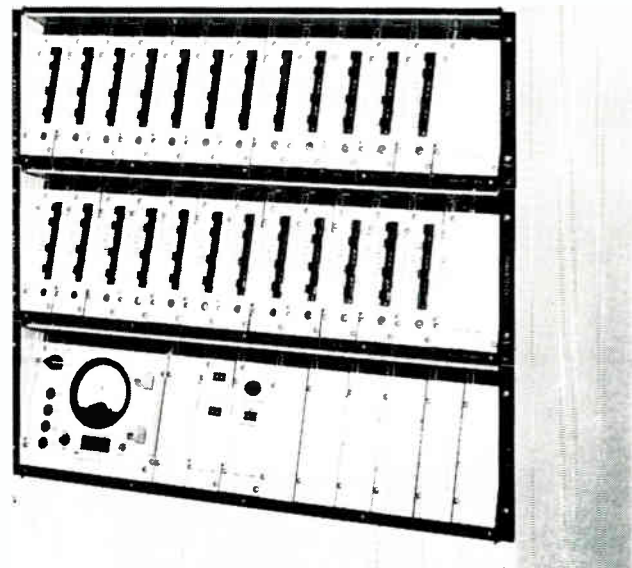

\* English Electric-Leo-Marconi Computers Ltd.

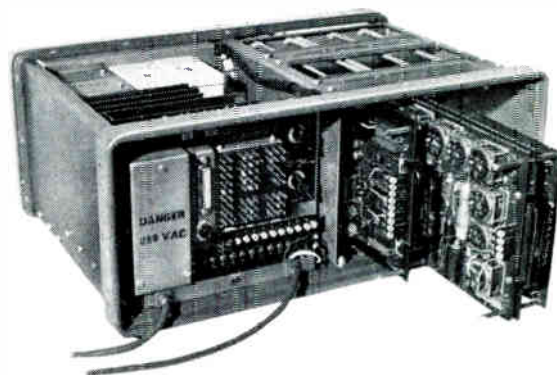
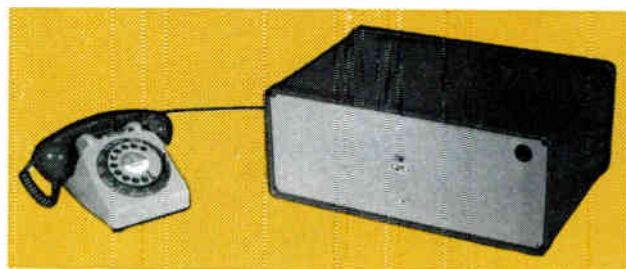

Fig. 2. In (a) a Datal Modem No. 1 is shown connected to a telephone which provides manual control of the unit. In (b) it can be seen with cover removed  
(Photos by courtesy of H.M. Postmaster General)

ranging from about 600–1,200 bits per second. The higher rate can usually be used continuously over a leased telephone circuit, but for the switched telephone network where exchange switching causes interference and the bandwidth is limited, it may be necessary to reduce the transmission rate to 600 bits per second. A modem meeting the CCITT recommendation V23 has been designed for this service and will facilitate international working. It is known as Datal Modem No. 1 and is shown in Fig. 2, a modem being a modulator/demodulator unit for sending and/or receiving digital data. The use of this modem is obligatory on the switched telephone network, but optional on leased circuits.

For private-circuit applications there is the Datal 2000 Service which provides the up-grading, if practical, of the transmission quality of existing point-to-point lines. Three parameters will be guaranteed to a minimum value and for each an additional rental charge of 12½% will be made. In some instances it will not be necessary, or possible, to upgrade all three parameters, in which case only those parameters upgraded will be charged for.

No guarantee will be given as to the signalling speed that these lines will transmit reliably, although with suitably designed modems it is expected to achieve a speed of up to 2,000 and possible 2,400 bits per second. Higher speeds of up to 3,600 bits per second may be achieved in some instances.

#### Signalling at High Speed

If it is required to transmit data at speeds very much faster than 150 eight-element characters per second, apart from using special modulation techniques not yet proved reliable on the G.P.O. network, it becomes necessary to use wideband point-to-point connections. These wideband connections are, in fact, a number of private telephone connections used together to form 'groups' (with a bandwidth of 48 kc/s), and 'super-groups' (with a bandwidth of 240 kc/s). By the use of suitable modulation equipment digital data can be transmitted over these channels at speeds ranging from about 5,000 eight-element characters per second to 25,000 eight-element characters per second. These connections have to be made to suitable junction positions in the telephone line equipment

and a special leased cable taken to the customer's premises. This is usually expensive and tends to limit the application of such connections. The actual speed obtained on any particular connection will depend upon the distortion present. This can be reduced by providing suitable equalizing and echo corrector circuits so that the best use can be made of the available bandwidth.

On practically all such 'group' circuits in the U.K. a pilot frequency is present at 84.08 kc/s in the 60–108 kc/s group which is used to control the gain of repeater circuits in the telephone network. This signal can be moved to the upper edge of the band at 104.8 kc/s by special arrangements with the G.P.O., thereby giving the full channel bandwidth for data signals.

#### Modulation Methods

When transmitting digital information over the telephone network it is necessary to convert, at the user's premises, the digital signals into voice-frequency tones. These tones are in effect sinewave carrier signals for the digital information. The carrier signal may be made to convey the digital information by varying its amplitude, frequency or phase (see Fig. 3).

In amplitude modulation the binary information '0' and '1' may be represented by having the carrier suppressed (modulated 100%) or unmodulated.

In frequency modulation, or frequency-shift keying as it is sometimes called, the information may be represented by having the choice of two tone carrier frequencies,  $f_1$  and  $f_2$ .

In one method of phase modulation the sinewave carrier for one signal element is shifted by 180° relative to that in the other. Where each signal element contains an exact multiple of one cycle of the carrier, the carrier in one signal element becomes inverted with respect to that in the other.

In modulation systems the carrier frequency is chosen so that the information energy is transferred from the lower frequencies to higher frequencies (inherent in the information) for transmission over the best part of the available frequency band. This ensures, among other things, minimum attenuation and distortion of the signal. Suitable demodulating circuits are required at the receiving points, and it is usual to refer to the modulating and demodulating equipment as modems.

#### Choice of Modulation

The choice of modulation will depend upon many factors and will inevitably be a compromise. In amplitude modu-



lation, which only needs simple terminating equipment, the effect of noise is more serious than with frequency or phase modulation. In double-sideband amplitude modulation the information carried in the upper and lower sidebands is the same, resulting in 50% redundant information in the two sidebands and, of course, the signal carrier itself carries no useful information.

Single-sideband suppressed-carrier transmission cannot generally be used for data transmission, however, as the energy in the modulating waveform is always concentrated towards the very low frequencies, down to d.c. It is, however, possible to remove a good part of one sideband, as in vestigial-sideband amplitude-modulation, where one sideband, the carrier and only a vestige of the other sideband is transmitted. The carrier itself could also be suppressed to give vestigial-sideband suppressed-carrier amplitude-modulated signals, but these are, in fact, the same as vestigial-sideband phase-modulated signals.

The ideal maximum signalling speed for a double-sideband amplitude-modulated system is one baud per cycle of the frequency band, although in practical systems a lower speed is used generally of about two-thirds of a baud per cycle.

With frequency modulation, it is convenient to regard the modulated signal as being formed by the addition of two separate amplitude-modulated signals, one with a carrier frequency of  $f_1$  and the other with a carrier frequency  $f_2$ . Both frequencies must be derived from the same oscillator for phase coherence. The frequency spectrum is therefore formed by the addition of the frequency spectra of the two separate modulated signals. In practice these spectra overlap and for maximum reliable signalling speed the frequency separation of the two carrier frequencies measured in cycles per second should have the same value as the signal element rate or the signalling speed in bauds. Practical frequency-modulation systems generally operate at speeds of not more than one-half baud per cycle.

The phase-modulated signal could be thought of as being formed by adding the unmodulated carrier to an amplitude-modulated signal whose amplitude is twice that of the carrier wave, whose frequency is the same as the carrier, but whose phase differs by  $180^\circ$ . This is equivalent to suppressing the carrier in the amplitude modulated signal without changing the level of the sidebands. As has been said, the carrier of an amplitude-modulated signal contains no useful information and, as regards tolerance to the additive type of noise, a phase-modulated signal is equivalent to an amplitude-modulated signal having twice the peak amplitude of the phase-modulated signal. This gives a 6-dB advantage of a phase-modulated signal over an amplitude-modulated signal of the same peak power level. It can be seen from the above remarks that either a phase-modulated or amplitude-modulated system enables a higher signalling speed to be obtained over a given bandwidth, compared with a frequency-modulation system.

It has been found, and is generally accepted, that so far as tolerance to impulsive noise is concerned, both phase-modulation and frequency-modulation systems have a distinct advantage over amplitude modulation. Phase modulation appears to have a small advantage over frequency modulation. In tolerance to amplitude-modulation noise, and sudden level changes, amplitude modulation is still at a disadvantage when compared with frequency and phase modulation, but in tolerance to frequency-modulation effects, amplitude modulation has an appreciable advantage over frequency-modulation systems. Frequency modulation has in turn an advantage over phase modulation. The lack of tolerance of a phase-modulation system to frequency-modulation effects is not very important when

the telephone circuits use audio links or when the frequency shift in the carrier telephone link is only 1 or 2 c/s. In the U.K. the frequency stability of carrier links is well controlled and a phase-modulation receiver can be designed to tolerate these small frequency drifts.

### Synchronization

When data is transmitted serially, bit by bit, in one channel using only a pair of connections it is necessary to establish timing information from the data transmitted. This can be achieved in two ways, either by start-stop or by synchronous means.

In start-stop systems, the timing is derived from a framing bit at the start of every character. The start framing bit initiates a series of timing pulses for strobing the presence of the remaining bits in the character. The additional bits framing each character reduce the useful transmission rate. A further disadvantage is that the system is more susceptible to noise and distortion. However, slow-speed serial systems usually employ this method of synchronization and so do some medium-speed systems, although these are usually isochronous systems (stop-start synchronous).

In synchronous systems, the timing information may be derived from the data transmitted. It is therefore necessary to establish synchronization at the commencement of transmission and to ensure throughout transmission that sufficient transitions occur between the two signalling levels to ensure correction against varying parameters that affect the timing. To do this any long strings of '1's or '0's in the information being transmitted must be broken by inserting a parity bit for each character or group of characters. Alternatively a separate timing channel can be used to maintain synchronism, and this facility is usually provided in the modem.

### Error-Control Techniques

Various factors tend to degrade the accuracy of data transmitted over telecommunication networks, so where a high degree of accuracy is required a system must incorporate a means for detecting and correcting errors in transmission. The error conditions vary considerably and on the average may be as bad as 1 in  $10^3$  bits. Detecting and correcting methods may reduce the undetected errors to 1 in  $10^7$  or  $10^8$  bits.

There are several methods of error detection and cor-

Fig. 3. The three types of modulation are illustrated in this diagram

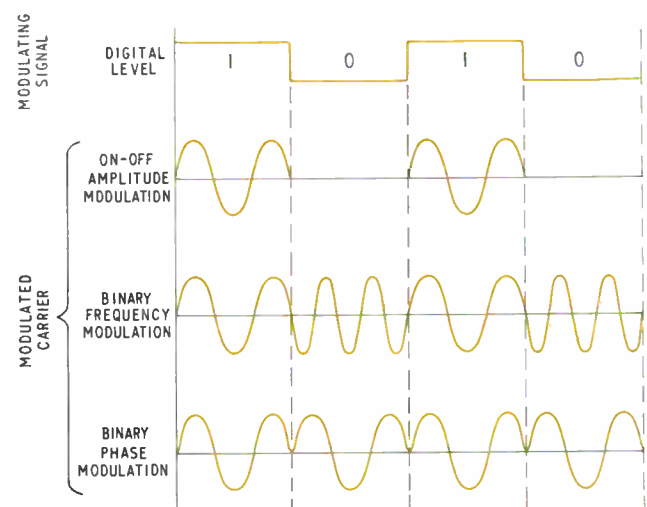



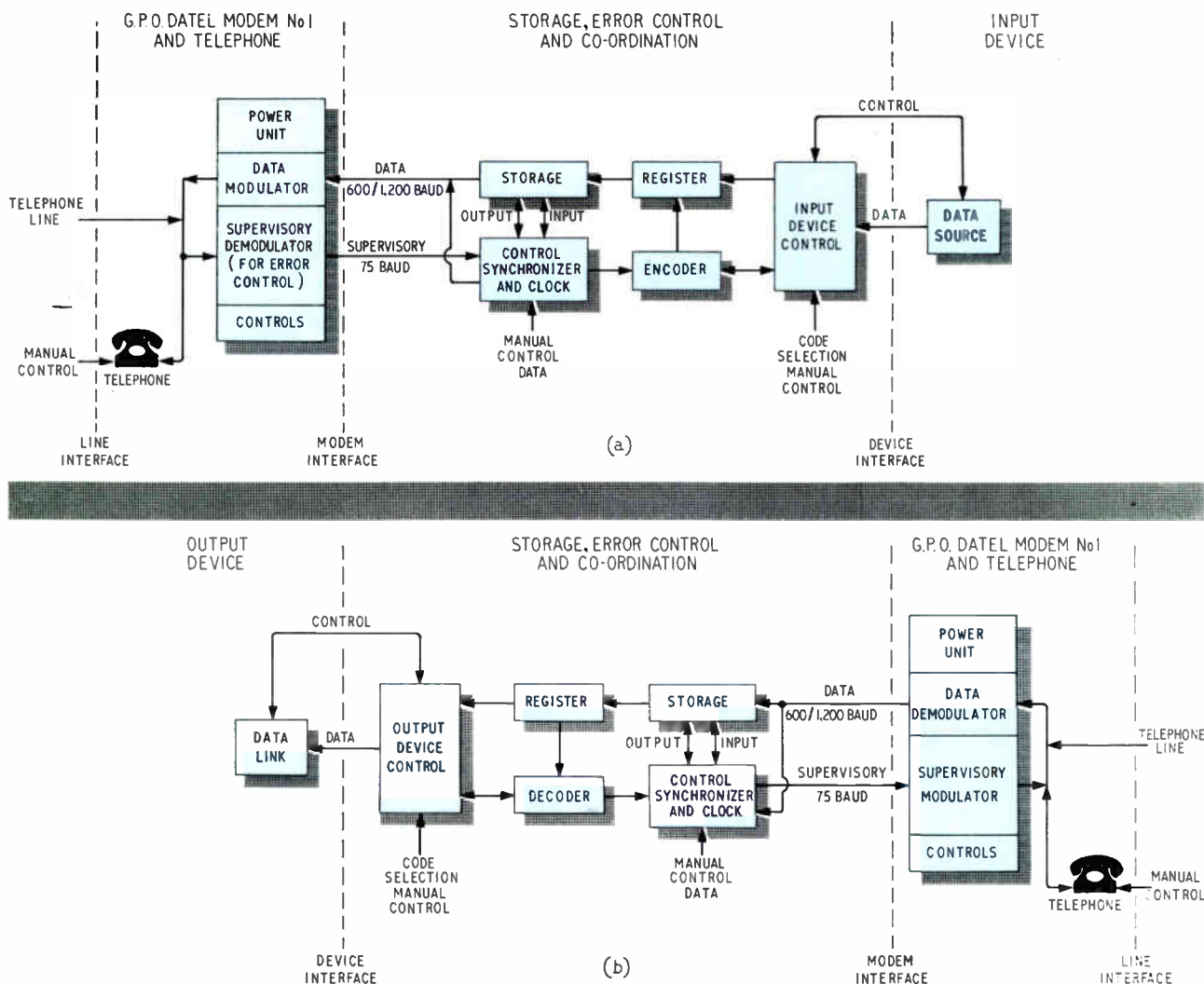

Fig. 4. The basic stages of a transmitting terminal are shown in (a) with a block diagram of the receiver in (b)

rection and they can be divided into two main classes: error detection and correction by re-transmission, and forward error correction. The first is the one that is most commonly used in digital data transmission systems today. At the transmitting terminal the digital data to be transmitted is first re-coded so that redundant information bits are added to the character or message. The information received by the receiving terminal is checked to the coding rules and if the checks indicate a failure then some information has been corrupted during the transmission. It is then necessary to request re-transmission of the appropriate information.

A request for re-transmission takes place by sending back to the transmitting terminal from the receiving terminal a failure indication on either an auxiliary narrow-band return channel or a return data channel. If the transmission of information in the forward direction is to be continuous, data storage will be required at the transmitting terminal to allow for the overall loop delay in connections likely to be encountered in practice. A typical system is illustrated in Fig. 4. Loop delay is the time delay incurred when signalling from the transmitter to the receiver and back

to the transmitter. A value of 150 msec loop delay has been recommended by CCITT as a design standard, but there are some long distance connections that are outside this limit figure, in particular satellite communication links. Some of the coding methods that can be employed to give protection to a message transmitted over telephone type channels are:—

- Character (or row) parity
- Block (or row and column) parity
- Cyclic group codes
- Convolutional codes
- Ratio codes (M out of N).

Another method of detecting errors is to use a return channel for sending the received information back to the transmitter, so that a comparison of the received and transmitted information can be made. Storage of data at the transmitter will be needed, the amount depending upon the loop delay and system parameters. In all methods using re-transmission for correction it is desirable to inhibit the release of data from the receive terminal until the character, group of characters or message (as the case

may be) has been checked by the coding rules or has been compared with the original and has passed the test. This will involve data storage at the receiving terminal if a reasonably constant flow of data is to be maintained with an output free from erroneous or overpunched information (clean output facility).

### **Some New Developments in Data Transmission**

Almost all of the developments in data transmission that can be foreseen at the present time arise from the expanding use of digital computers. It is inevitable that in this relatively new branch of telecommunications, development will proceed slowly. This is due to both users and designers of computing systems not being sure of their requirements, and to the transmission engineers having to follow agreed international recommendations that are slow to be formulated. Progress will therefore tend to take the form of advances in limited steps in each of the three mutually-dependent areas. A common factor, however, is the growing need for facilities whereby two or more computers can interchange information, or can receive and transmit data to and from distant peripheral equipments.

#### *Low-Speed Serial by Bit System*

This service, to be known as Datal 200, will provide a means of digital data transmission at speeds of up to 200 bits per second per channel on an ordinary telephone connection. There are two channels available on the telephone circuit thus permitting both forward and reverse operation simultaneously on the switched telephone network.

It is anticipated that the G.P.O. modems for this service will have a lower rental than those used for 600/1,200 bit per second applications. However, this will depend on the manufacturing costs. The main economy of this system will be derived from using inexpensive slow-speed peripherals and a simplified error-control technique. This modem will be designed to the CCITT recommendation V21 that will facilitate international working and will be known as the Datal Modem No. 2. As with Datal 600, the G.P.O. modem will be obligatory on the switched telephone network, but optional on leased circuits.

#### *Low-Speed Parallel by Bit and Serial by Character System*

This service is to be known as Datal 300 and is intended for data-collection schemes where a large number of inexpensive out-stations are required and are to be used by unskilled staff. The central equipment will be more expensive.

The G.P.O. envisage providing a punched-card system with a simple keyboard and a paper-tape system.

Rentals have not yet been announced but it is hoped that the annual rental for the complete out-station of both the card and tape systems will be about £100 per annum. It may also be possible to offer a 'keyboard-only' system at a corresponding lower rental. Printing facilities will not be provided at either the sending or receiving end. However, under certain circumstances private equipment may be connected to the standard G.P.O. modems instead of the G.P.O. terminal equipment.

A simple card reader is envisaged operating at a speed of about 20 characters per second for alpha-numeric working. It will have a simple keyboard of numerics 0-9, plus five undefined characters. Cards will be read giving fixed-field information and the keyboard can be used for insert-variable data.

A simple paper-tape reader (of up to eight tracks) operating at a speed of about 20 characters per second will be

provided. It may be possible, however, to operate at a speed of 40 characters per second when reading four tracks of the tape as, for example, in a numeric system. The G.P.O. does not intend to provide a keyboard.

#### *Modems for Transmission Speeds up to 3,600 Bits per Second*

To exploit effectively the upgraded point-to-point telephone lines provided by the Datal 2000 Service, it is necessary to connect to the telephone line a modem capable of operating at speeds above 1,200 bits per second.

The Datal Modem No. 1 has been designed to operate at a maximum speed of 1,200 bits per second, but it could be modified to operate at higher speeds. However, because this modem uses frequency modulation the extension will be restricted (on the majority of telephone lines) to about 1,800 bits per second. To achieve this speed of transmission with good error control it will be necessary to use special techniques such as duo-binary encoding (a form of three-level encoding). An alternative is to use a method of compensation for the grosser effects of characteristic distortion which will produce more efficient signal discrimination. This is known as characteristics distortion compensation (CDC).

Probably the best method of modulation for reliable transmission over the upgraded point-to-point telephone line is to use a phase-modulation system where four levels of phase displacement occur, such as in quaternary modulation.

A modem of this type usually operates at a fixed speed and provides a synchronous transmission signal; i.e., the signal transitions are always an integral multiple of unit time divisions.

The necessity to maintain synchronism between the transmitting and receiving units requires either a separate timing channel or sufficient transitions in the data stream from which the timing information can be obtained. The time intervals permitted in which no signal transitions occur will depend on the relative stability of the timing-clock frequencies at both ends of the transmission channel and the acceptable distortion that the decision circuit at the receiver can tolerate. A G.P.O. modem meeting these requirements is being developed.

#### *Automatic Answering and Dialling of Calls*

The next step in on-line data transmission is to provide facilities that will enable automatic calling and answering of both telex and telephone calls. This facility will be most valuable where a central computer is used either to collect or distribute data between many remote locations, or where a large number of short message transmissions are required between any two points. There are many problems in providing a facility on the public telephone network covering all the possible situations that might arise when telephone calls are being made. Human operators readily overcome these problems by taking human decisions; to implement these situations automatically makes the system very complex. The alternative is to use a simple 'time out circuit' which detects if the process has not been carried out successfully within a specified time. This is an economic solution, but leaves much to be desired as part of an automatic system.



# VIBRATORS IN INDUSTRY-3

By B. MONTANDON, M.Inst.M.S.M.\*

The previous two articles in this series briefly dealt with the electromagnetic vibration exciter and also made some mention of other major components in a vibration test system. This article therefore deals with the vibrator drive amplifier and signal sources.

ARTICLE No. 2 in this series indicated some of the requirements of the power amplifier; i.e., low distortion, low hum and low noise. In addition the drive amplifier must feed power to the vibration exciter over a wide frequency range, be capable of operating at full power for long periods, and be fully protected against mal-operation.

The vibration test engineer is much more concerned with the device under test on the vibrator than he is with the various electronic items which enable this test to be executed. Frequently, with large systems, the drive amplifier will be situated several feet from the vibrator and may even be in a separate room. Essential amplifier controls would then be in a control console near the test engineer. This arrangement could be applied to any size system but is usually favoured for systems in excess of 1,500-lb thrust or with a drive amplifier of 6 kVA output or more.

The drive amplifier will have interlocks on all doors so that in the event of a door being opened while the unit is in operation, dangerous voltages will be removed from the circuit. Meters showing output voltage and current, output valve currents and e.h.t. voltage will probably be fitted. At least one manufacturer also incorporates a comprehensive set of indicators which monitor every important amplifier interlock and sub-chassis. This facility is invaluable for rapid fault finding and considerably reduces the 'out of commission' time of the equipment. Interlocks linking the drive amplifier and vibrator are usually also built-in so that in the event of a fault outside the amplifier, power will be removed, thus preventing damage to the vibrator.

Additional interlocks will be incorporated according to the operational requirements or complexity of any particular system.

## Power Rating

Fig. 1 indicates the voltage and current requirements for a typical high performance electromagnetic vibration exciter in order that this vibration exciter shall deliver full rated thrust over a very wide frequency range. As will be seen from this curve the impedance of the shaker does not change very much and at approximately 40 c/s it is at its highest value. Below 40 c/s the voltage requirements will be seen to fall off and this is because the vibration exciter is only required to operate at a maximum displacement of 1 inch and therefore in the unloaded condition, or with only a fairly small load, the desired thrust from the shaker will of course fall. If however the load on the table is increased then the story is still quite similar as the impedance will not rise because the back e.m.f. generated by the motion of the moving coil is a function of the velocity of this coil and an increased mass on the table will limit the velocity at which the drive coil, or armature, can operate. Fig. 1, therefore, can be considered truly representative of this particular vibration exciter and indeed the voltage and current requirements will become less severe as the load on the shaker table is increased. The power drive amplifier must therefore feed the voltage and current requirements indicated by this curve into the vibration exciter.

It will be appreciated that this is a fairly flat curve and

\* Pye-Ling Ltd.



therefore the vibration exciter will be relatively efficient in terms of audio power requirements if one considers the size of amplifier required to give full thrust. If the curve were not so flat (i.e., if the voltage requirement at, for instance, 40 c/s were very much more than indicated in Fig. 1) then an amplifier of considerably greater power would be required in order to drive this particular vibration exciter to its full wideband thrust rating. The vibration exciter manufacturer will therefore endeavour to manufacture a vibration exciter with a relatively flat frequency response as he can then offer his customer a much more efficient system, and therefore possibly achieve a lower system cost compared with a less-efficient system. Although the vibration exciter will appear to have a requirement for a certain maximum voltage and a certain maximum current, this unfortunately is not the complete story. The curves in Fig. 1 do not indicate any phase relationship between the voltage and the current. These will not always be in phase and in fact the phase angle will vary very considerably. A vibration exciter drive amplifier must therefore be capable of feeding into the vibration exciter the necessary voltage and current even though the exciter is a load with a poor power factor. For this reason it is common for manufacturers to grade their amplifiers not only in terms of actual power output but also in terms of output valve anode dissipation. This is a very important guide to the customer in that it will indicate the true capabilities of the amplifier when matched to a vibration exciter. If the vibrator presents a poor power factor to the amplifier then a great deal of the amplifier output will be reflected back into itself and will have to be dissipated somewhere internally. This obviously will take place in the output valve anodes. If, however, the output valves and associated power supplies are not adequately rated either the system will not perform to specification or over heating of the amplifier components will result. A power



drive amplifier for a vibration exciter adequately sized for its job may well have a quoted power output of 20 kVA continuous rating. This rating is generally applied only for vibration exciter operation. If this amplifier were required for matched loads or perhaps for music requirements then its rating could well be in excess of 30 kVA. If one is, therefore, making a comparison between amplifiers it is particularly important to ensure that the true capabilities of the amplifiers are considered.

### Vibration Power Amplifier

Power ratings apply for sinusoidal testing, but for random-motion testing the required instantaneous volt-ampere levels will be much higher. For sine testing the vector value of thrust is used. This is the maximum thrust that the vibrator must deliver during each complete cycle of a sine wave. For random motion testing the r.m.s. thrust, integrated over a wide band of frequencies, is the operating level. Usually peak thrust levels of three times the r.m.s. thrust level must be provided for. From the drive amplifier view point it must deliver power to ensure a certain r.m.s. thrust from the vibrator and must also have sufficient reserves to ensure the vibrator provides the 'three-times' levels. In terms of power the amplifier must supply nine times the r.m.s. power (three times the current and three times the voltage). The e.h.t. power supply must have large reserves of power and must be capable of supplying the heavy power demands for very short periods without interfering with other supplies in the amplifier or introducing distortion.

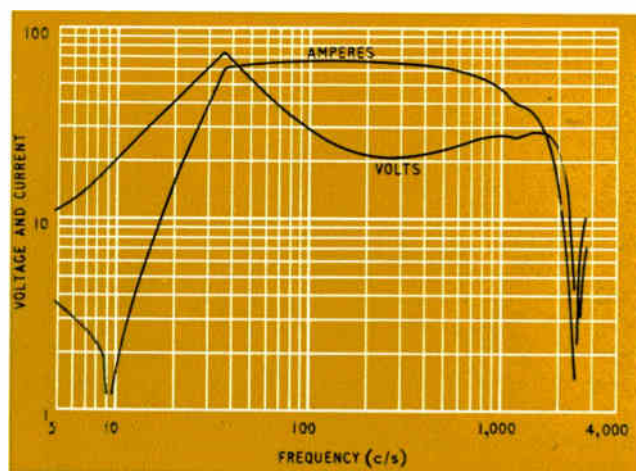

Fig. 1. Voltage and current plotted against frequency for an 8,000-lb thrust shaker with a payload of 49 lb and 1 in. peak-to-peak displacement

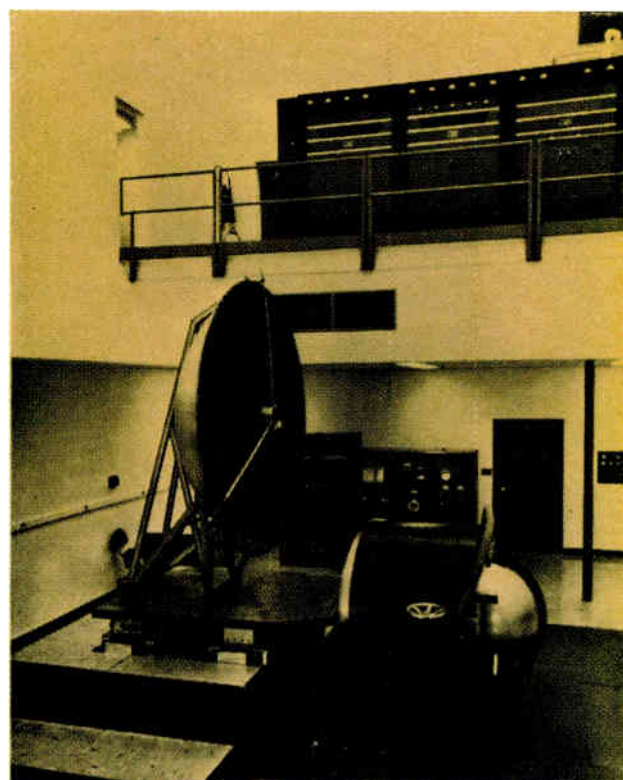
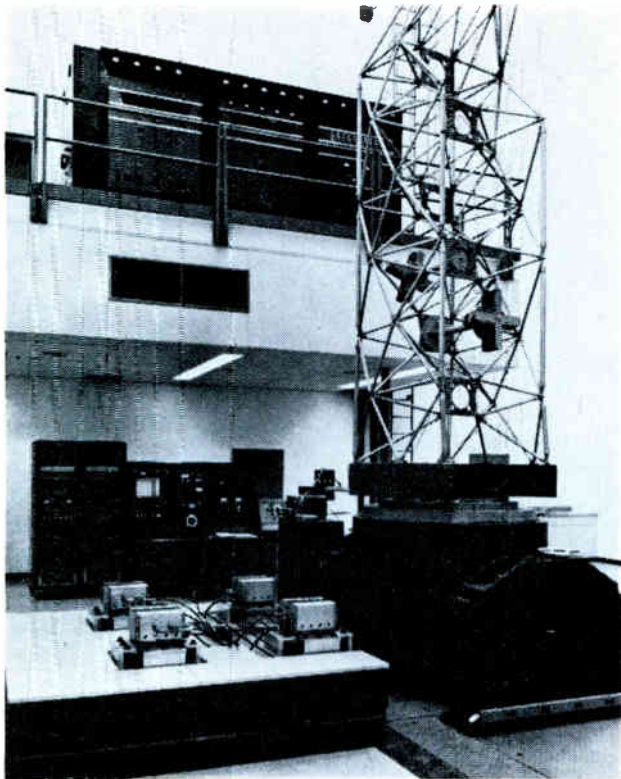

Fig. 2. This picture shows the testing of an aerial on a Ling 30,000 lb thrust vibrator using a slip table



*Fig. 3. Illustrated here is an aerial structure under test on a vibrator. The drive amplifiers can be seen in the gallery above the test area*

tion for a high-quality vibrator drive amplifier of 60 kVA output will probably be less than 1% over a 2-kc/s frequency band and at full output.

### Valves

The early amplifying stages are fairly conventional and cooling will be by convection. The output stages and output driver stages will be cooled in accordance with their power. Typically a 1-kVA output amplifier will have forced-air cooling of the output stages and a 12-kVA output amplifier will have water cooling of the output stages.

Amplifiers of this power will probably have automatic sequence control to ensure that h.t. and e.h.t. supplies are not applied to the valves until their correct operating conditions have been reached. With amplifiers having higher power outputs, water-vapour cooling of the output valves will frequently be employed.

Until recent years this technique has not been possible because suitable valves were not available. Valve manufacturers have devoted considerable research to this field and very reliable valves are now also available in Britain as well as in the U.S.A. An example of an amplifier using these valves is shown in Figs. 2 and 3. This amplifier is completely self-contained except for the secondary cooling system used to cool the water returned from the output-valve heat exchangers. It has a continuous-duty output rating of 120 kVA, an anode dissipation (output valves) of 150 kW, and will deliver full power within the frequency range 20 c/s to 5 kc/s.

To start the amplifier the start button is depressed and an automatic sequence switch then brings on supplies as required. In the event of a fault the sequence is automatically halted at the operation immediately prior to the faulty circuits. Once the fault is cleared the sequence will continue.

### Signal Source

Vibration testing may be carried out with any type of signal with electromagnetic vibrators, e.g., sinusoidal, random, pulse, etc. The most common input signals are, however, sinusoidal and random motion.

Two basic types of oscillators will be used by the vibration engineer for sine-wave testing—the decade and the sweep oscillator. The decade oscillator will cover the appropriate frequency range in decade steps and it is necessary to have some overlap of ranges. This is usually achieved by a continuously-variable sweep control which will cover slightly more than one decade. A high-quality oscillator of this nature is very useful for testing at fixed frequencies but wide-band sweep testing is very difficult.

### Sweep Oscillation

Two types are available to the vibration test engineer:

- A simple sweep unit covering a fairly wide frequency band in one or more ranges.
- A comprehensive instrument designed for vibration testing and having manual and motor-driven frequency sweeping, manual or servo-control of the output voltage, automatic control of velocity, displacement and acceleration, frequency-sweep-cycling, etc.

*Fig. 4. A vibration control sweep frequency oscillator covering the frequency range 5-10 kc/s in two bands*

### Distortion

For reasons quoted in the previous article, the drive amplifier must have very little harmonic distortion.

The demands placed upon the amplifier are severe as often it must deliver full current over the range 5 c/s to 5 kc/s.

The biggest cause of distortion will usually be the output transformer as the operating range is at least 1,000:1. Internal distortion in a high-quality amplifier will be very low, probably less than 0.1%, and very careful consideration is given to the output transformer design. Overall distortion

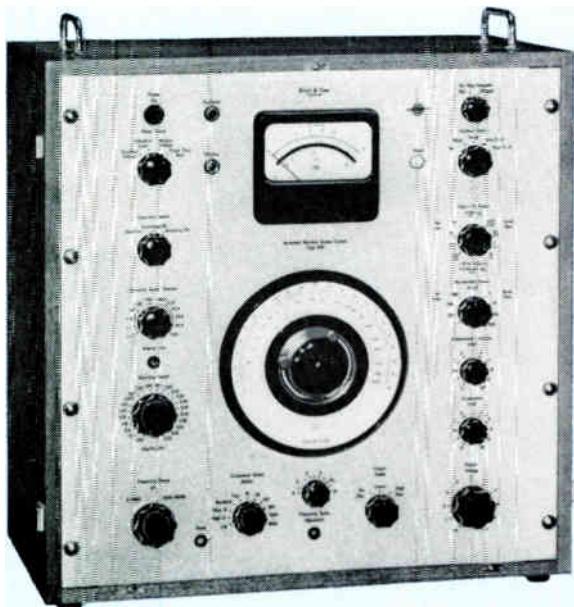

Type (b) is the oscillator which the environmental test engineer should have if at all possible so that all sinusoidal testing specifications can be accomplished with ease and confidence that the specification is being adhered to.

An example of a modern sweep oscillator is illustrated in Fig. 4. This instrument is a beat-frequency oscillator in principle and a frequency range of 5 c/s to 10 kc/s is covered in two ranges. Servo control of acceleration, velocity or displacement levels is possible and the feedback signal can be derived from a reference accelerometer on the vibrator table. If required this instrument will control the displacement of the vibrator table at low frequencies and at a pre-set frequency change from displacement control to control of the acceleration level over the remainder of the frequency range.

#### Conclusion

From the foregoing it will be appreciated that a power drive amplifier for an electromagnetic vibration exciter is a complex and carefully designed package of electronics with qualities which may not be realized at first sight. It

must be extremely reliable under adverse conditions and should therefore be designed without resorting to unnecessarily complex electronic or electromechanical circuits.

#### Reference

Society of Environmental Engineers. Proceedings 1959-60. 'The Electrical Characteristics of Moving Coil Vibrators', by P. H. Taylor.

#### Acknowledgements

The author wishes to thank: Pye-Ling Limited, Ling Electronics, U.S.A., Brüel & Kjaer A.G., Philco Western Development Laboratories, U.S.A.

Opinions expressed in this article are the author's own and are not necessarily supported by the above companies.

## Optical Character Recognition

Following their recent London conference on 'Character Recognition', the British Computer Society have now published a handbook on the subject\* which should serve as a valuable guide to the whole field of automatic document reading.

The design of character-reading machines has been based principally on two types of reading technique—magnetic ink character recognition (MICR) and optical character recognition (OCR). The B.C.S. handbook is comprehensive in its description of both. Besides giving details of actual character-recognition processes, it includes comments on paper and printing characteristics and the problems of document handling, transportation and scanning; proprietary equipment and services are also discussed, further sections dealing with cost comparisons and practical systems applications.

The handbook mentions that OCR may eventually replace MICR in many important application areas, and so not unnaturally gives a more detailed analysis of OCR—in

particular the range of suitable type fonts that have been suggested. The responsibility for recommending a standard OCR type font rests with the International Standards Organization (I.S.O.), but a considerable amount of controversy has already arisen on this issue. There are at present two contenders for adoption, the OCR-A font (favoured mainly by the U.S.A.) and the OCR-B font (developed and backed in Europe), and it is expected that both will now become standards approved by the I.S.O.

Examples of these two type fonts are given below, but it must be remembered that judgement of their relative merits will not be confined to legibility and aesthetic qualities alone; such factors as costs, character degradation and complexity of equipment and systems design must also be considered.

Should the compromise decision of adopting both be reached, the opportunity to establish a single type-font standard throughout the western world will have been lost; the difficulties of maintaining inter-machine compatibility will be aggravated, and different countries will once again develop their technologies to different specifications.

\* 'Character Recognition 1967'. Published by the British Computer Society, 23, Dorset Square, London, N.W.1. Price 22s. 6d.

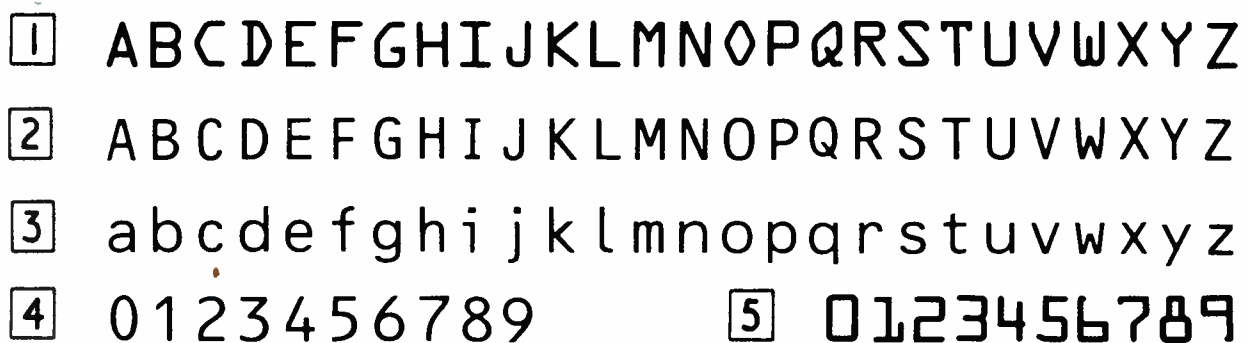

These examples of OCR type fonts show (lines 1 and 5) the alphabet and numerals of the Class-A font. Lines 2 and 3 show the alphabet of the Class-B font in both upper and lower cases, while line 4 shows the Class-B numerals



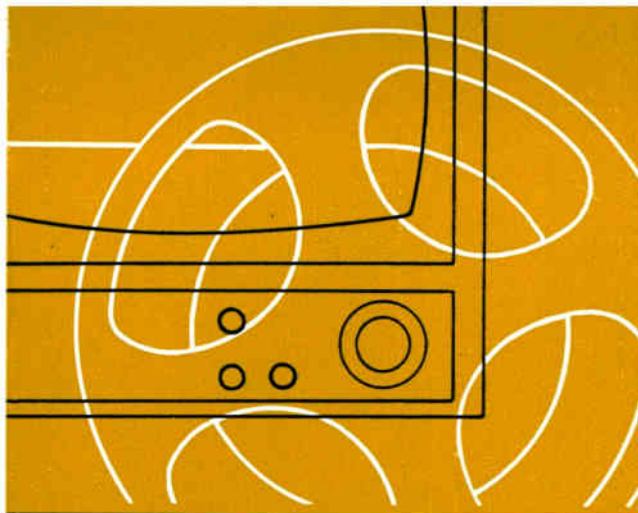

# C.C.T.V. IN INDUSTRY & COMMERCE

By R. FOSTER, M.B.K.S., A.M.B.I.M., M.I.S.M.\*

A SURVEY OF ITS  
PERFORMANCE AND  
APPLICATIONS

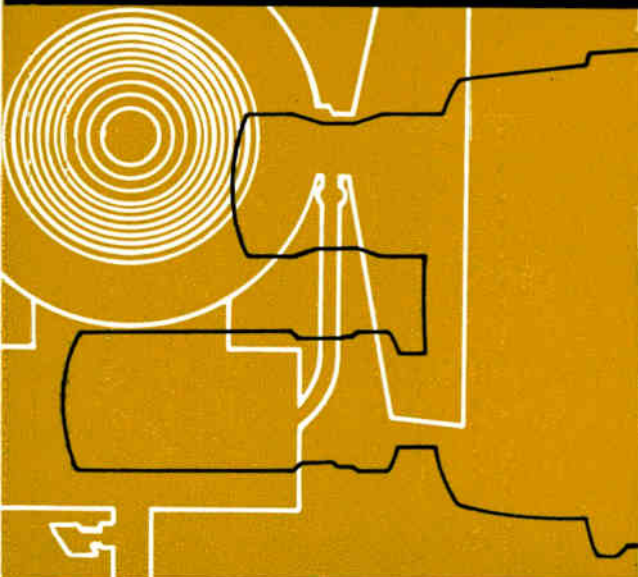

During 1966, an independent survey was conducted by the author into the application of closed-circuit television throughout British industry, commerce and the public utilities. This article outlines the objectives of the survey, describes how it was undertaken and discloses what its principal findings were. It is briefly introduced by a description of the operating principles of c.c.t.v. and its associated equipment.

**B**EFORE an account is given of the survey that forms the basis of this article, it is important not only to establish the distinction between broadcast (or 'open-circuit') television systems and closed-circuit television (c.c.t.v.), but also to describe briefly the equipment conventionally used in c.c.t.v. installations.

Broadly speaking, broadcast television is public television that can be received by domestic receivers and involves radiation of the television signal over a considerable reception area. C.C.T.V., on the other hand, is a system of private television that uses a highly-directional transmission link; this link is in the form either of a very narrow beam of radiation, which can only be received by means of a highly-directional receiving system, or of a coaxial cable linking the camera directly to the receiver.

The coaxial-cable method is called video distribution, and has the advantage that a low-power signal can be used; but it has two disadvantages: first, the system allows picture transmission for only about 1,000 yd. after which repeater amplifiers must be installed to boost the signal; and secondly, it is customary for a separate cable to be used for transmitting the sound that accompanies the picture.

## C.C.T.V. Equipment

### Cameras

The television camera is similar to the ordinary photographic camera in that light reflected from the scene to be televised is collected by a lens and focused on to a light-sensitive surface; but this surface consists of over two million photoelectric elements deposited on a sheet of insulating material, and so the optical image is transformed into millions of electrical signals, the potentials of which are proportional to the brilliance of each minute portion of the image.

All television cameras use straight-line scanning, by means of which the optical image is converted into electrical signals in a series of horizontal straight lines. For broadcasting purposes in this country, the image is broken up into either 405 or 625 lines; for colour television only 625 lines are used. It is usual to adopt the same 405 or 625-line standards for closed-circuit television, although it is not necessary to do so.

There are two main types of television camera—the image-orthicon and the vidicon—but a third (the plumbicon) has recently been introduced which current trends indicate may supersede them both. All are enclosed in high-vacuum tubes, but the image-orthicon is expensive to make and has only a relatively short life; it is commonly used by professional networks when high-quality images are necessary and fast movement is involved.

The vidicon, however, is a simpler and cheaper type of tube, though its drawbacks could include poorer results in contrast and shading. The plumbicon tubes now entering the market incorporate some of the advantages of both the image-orthicon and the vidicon, and are comparable in price to the vidicon.

\* Lecturer, Management Residential Centre, University of Strathclyde.

A television camera can be fitted with turret or zoom lenses; the former (which have three or four lenses of different focal length) are more generally used, but the introduction of zoom lenses, which allow focal-length variations of up to 20:1, is beginning to make them preferred. Microscope attachments, or close-up lenses that permit objects from 6 to 12 in. away to be focused, are also available, and to obtain maximum flexibility for the camera such additional items as pan-and-tilt heads, viewfinders, remote-control attachments, tripods and dollies may be used.

C.C.T.V. installations can vary in equipment range from a single camera and monitor to several of each, in which case they will require a control room for viewing and selecting (on a 'line' monitor) the picture to be transmitted. Editing must be undertaken electronically and can provide such effects as combining or superimposing images from different cameras; the equipment required to do this (and much else besides) is, however, very expensive at present.

### Recorders

Until a few years ago, recording television signals on magnetic tape by using a video tape recorder (v.t.r.) was prohibitively expensive for the small c.c.t.v. user. The broadcast-standard v.t.r. is very costly, but recently smaller and less expensive v.t.r. units have become available which, despite their technical limitations, are quite adequate for most requirements. Operating costs include not only the cost of the tape (which is nevertheless re-usable) but also the replacement of recording heads.

A more detailed discussion of the role of v.t.r.s in c.c.t.v. is given at the end of the article.

## The Survey

### Objectives

The objectives of the survey were to ascertain details of the practical situations in which c.c.t.v. was being applied in industry and commerce; to gauge the effectiveness of c.c.t.v. from the point of view of the user; and to assess the effect of using c.c.t.v. techniques in the fields of aids to management, training and management education.

Three methods of undertaking the survey were considered. The first was to circulate a draft copy of a questionnaire to manufacturers of television equipment, in order to seek their co-operation and approval of its form. They were then to be requested to forward subsequently printed questionnaires to their clients, or to provide a confidential list of their clients to enable direct distribution of the forms by the researcher. This method was abandoned, since only two organizations agreed to assist in the project. The remainder stated that their interest was only in educational television, or that the time was inopportune for their clients to be approached; some placed restrictions on the researcher, and two organizations did not reply at all.

The second method was to circulate the questionnaire to known users of c.c.t.v., but this was not pursued since the results would not have revealed which sections of British industry and commerce were using the technique.

The third method, which was eventually adopted, was to distribute questionnaires to a reasonably representative sample of industrial and commercial organizations selected at random from a reputable trades directory. The names of some 450 organizations were originally selected, but the list was subsequently reduced by almost 100 when it was found that random selection produced many companies known to be subsidiaries of major organizations already selected. National undertakings, industries and public utilities were, however, selected completely at random.

To respect the wishes of those organizations which might

not desire to disclose their names, each form was allocated a reference number from a master schedule and the organization's name appeared only on the envelope used to despatch the questionnaire.

### Questionnaire

The questionnaire not only explained the nature of the survey and requested assistance, but was designed in such a way that a logical presentation of the desired information could be achieved. It comprised six parts, in which the principal questions asked are summarized below.

- Part 1. General details of the organization and its activities: whether industrial or commercial; the number of its employees; why c.c.t.v. techniques were adopted; the areas or processes in which the techniques were used.
- Part 2. Details of the actual c.c.t.v. installation: its mobile or fixed nature; whether colour or monochrome, 405 or 625 lines; the number and types of cameras; the number of sizes of monitors; the trades or professions of the operators and whether they had had any formal training; what additional equipment (such as two-way sound or a v.t.r.) was being used.
- Part 3. This dealt with the 'human relations' aspects of the installation: what the reactions were to the proposed introduction of c.c.t.v.; how employees responded during and after its installation.
- Part 4. Financial and cost data: the initial cost of the equipment and its installation; any additional expenditure and operating costs.
- Part 5. Users' evaluation (in practical and monetary terms) of the installation: whether it had proved its worth; improved operators' performance; increased quantity or quality of output; assisted in operator training; failed to achieve its purpose.
- Part 6. If users were satisfied with their present installation, details of future plans were requested: what further applications were being considered; how much more money was to be invested in improvements and developments.

Fig. 1. A table showing the 28 categories of users of c.c.t.v. that were established for the survey

1	Agriculture, Horticulture and Fisheries
2	Building and Contracting
3	Chemicals and Allied Products
4	Clothing
5	Electrical and Electronics
6	Engineering and General Machinery
7	Metal Products
8	Food, Drink, Tobacco and Confectionery
9	Security Organizations
10	Iron, Steel and Non-ferrous
11	Leather Manufacture
12	Oil and Petroleum
13	Paper and Allied Products
14	Plastics
15	Printing, Publishing and Photography
16	Rubber
17	Scientific and Surgical Instruments
18	Textiles
19	Timber and Cork
20	Commerce
21	Mining, Quarrying, Clay and Glass Products
22	Nationalized Industries
23	National Transport
24	Wholesale Distribution
25	Retail Distribution
26	Public Utilities and Services
27	Entertainment
28	Miscellaneous



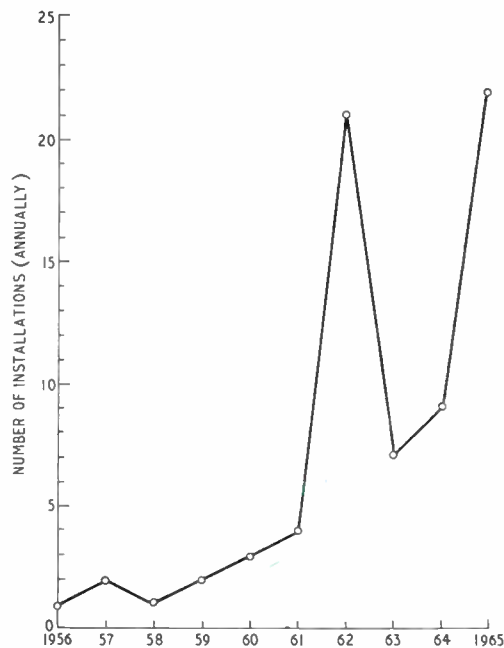

Fig. 2. These graphs show (solid line) the number of c.c.t.v. systems installed each year from 1956 to 1965, and (broken line) the cumulative totals over the same period. The 58 systems for which no dates of installation were given are not included

### Conclusions

Over 70% of the questionnaires were returned, and the replies to the survey were processed by first dividing up the organizations that were approached into 28 categories (see Fig. 1).

It was then found that the main users of c.c.t.v. were the nationalized industries (48 installations) with the iron, steel and non-ferrous group of industries (28 installations) lying second; third on the list were national transport undertakings (17 installations) and fourth the engineering and general machinery group (12 installations). There then followed those organizations in groups 5, 7, 8, 25 and 26, which each had either five or six installations, while groups 1, 4, 11, 14, 16, 17, 18, 19, 21, 24 and 27 had no installations to report; the remainder had either one or two installations.

In all, reports on 137 installations\* were received, of which 134 were monochrome, 90 being 625-line systems and 19 being 405-line. Some 77 of the 159 cameras in use were remotely controlled, whereas 63 were directly controlled; 98 installations were fixed, only 12 being mobile.

Graphs which indicate the growth of c.c.t.v. installations over the years 1956 to 1965 are given in Fig. 2. They exclude five installations that were declared 'installed over several years', and a further 53 for which no installation dates were given. The graphs show a steady rise up to 1962, and it is considered reasonable to assume that had the 58 installations mentioned above been dated (they represent about 42% of all installations reported), the growth rate up to 1962 would have been maintained.

Regarding the maintenance of the installations, over

\* Not all the returned questionnaires gave full details of the installations; the figures quoted here are not, therefore, complete.

85 (62%) were maintained by the user organization, 40 (29%) by the supplier or manufacturer of the equipment, and only three (2%) by local television dealers; no details were given for nine installations.

### Applications

The survey established that the principal reasons for using c.c.t.v. could be classified under the following headings: advertising, communications, inspection, management control, materials-handling control, quality control, safety, security, service to clients, training, and visual contact with production. Broken down into 12 of the 28 groups given in Fig. 1, the principal applications to which c.c.t.v. was being put were as follows:

#### Building and Contracting

Enabling tower-crane operators to see the three 'blind' sides of a building under construction

#### Electrical and Electronics

Car-park and military-area security

Radiation safety

Training

Ensuring that an operator could fully observe his machine, thus facilitating safe working conditions and production

#### Engineering and General Machinery

Job booking at a central office

Observation during icing tests

Studying re-heat characteristics

Viewing inside a furnace

Observing the blind side of a rolling mill

Inspecting the quality of bunker content

Improving operator control on difficult-access welding

Easing measurement under radiation conditions

Facilitating nuclear operation

#### Metal Products

Investigating boiler-tube corrosion

Scanning production areas during working hours for protection against larceny and fire

Coupling to optical equipment

#### Food, Drink, Tobacco and Confectionery

Assisting the operation of conveyor systems and the remote control of plants

Supervising the computer room from the computer manager's office

#### Iron, Steel and Non-Ferrous

Giving mill operatives a view of two important positions of a billet as it progressed through mill

Observing the position of slabs on the blind side of a plate mill and their ejection from a furnace

Observing the position of a moving carriage on a graduated scale during shearing

Facilitating process handling and inspection

Controlling a plant

Covering blind spots on rolls

Assisting the location of weld metal inside a tube

Enabling boiler operators to observe boiler-water levels

Transmitting written details of plant activity from a steel-plant to a rolling mill

#### Oil and Petroleum

Transferring data related to shipping movements

Remotely displaying flare conditions

#### Paper and Allied Products

Transmitting quality-control information

#### Printing, Publishing and Photography

Studying working conditions in darkrooms



### Nationalized Industries

Viewing reactors

Handling damaged components and viewing operations and mechanical motions in areas where there is radioactivity

Giving an operator the 'feel' of his machine which is being remotely controlled

Examining areas previously examined by intrascope

Reading instruments inside restricted areas

Viewing water levels

### Nationalized Transport

Providing information to the travelling public

Allowing signalmen to control remote level crossings

Improving communications systems

### Public Utilities and Services

Viewing hidden approaches to congested areas

Preventing and detecting crime

Improving municipal bus services

Displaying aircraft-movement information

### Comments

It is often assumed that numerous personal problems arise out of the introduction of c.c.t.v., and part 3 of the questionnaire was designed specifically to ascertain these; only a small number of replies to this section were received, however, (a mere 14 comments on 137 installations) and they indicated that no insurmountable problems had been met by either management or employees.

Operators of the equipment were predominantly male production or office staff, with no clear age group emerging. The surprising fact was that only two types of operators had had any formal training in c.c.t.v. techniques; these were clerks and cashiers in the Commerce category, who were trained by the installation supplier, and police personnel in the Public-Services category.

Comments on the question of human relations during the proposal, installation and operating stages of c.c.t.v. were on the whole enthusiastic, and employee co-operation was good after initial doubts had been dispelled. It is clear that when the motives for and implications of installing c.c.t.v. have been thoroughly explained to employees (who may feel that it tends to threaten their jobs or constitute a 'big brother' element) and when trades unions have been fully consulted, the problems are greatly reduced. Strict operating instructions must be laid down—to prevent

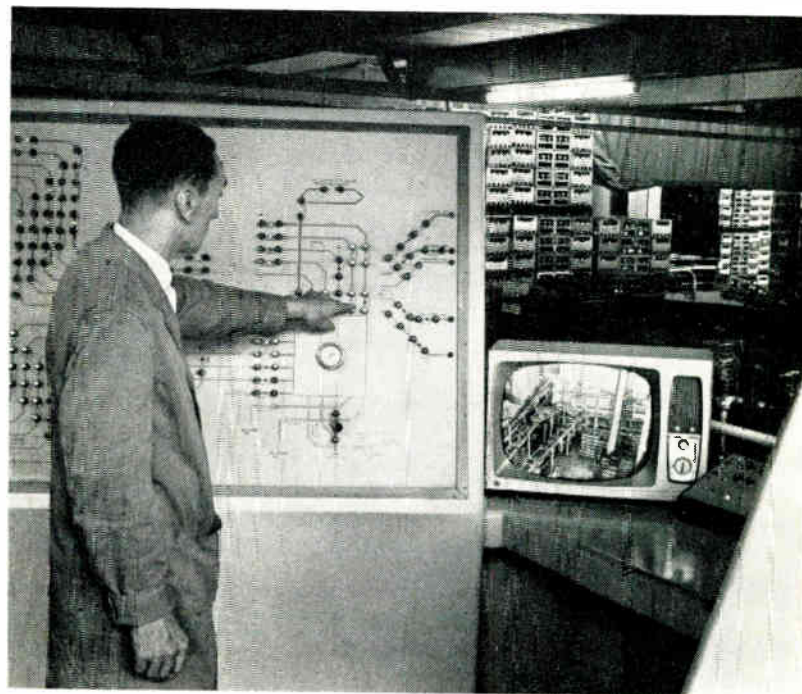

*The control of box conveyors at Ind Coope's Romford works is now being aided by c.c.t.v. The operator can watch two monitor screens, one of which is shown here, to verify the conditions of the conveyors as indicated by the signal lamps on the mimigram*

damage to the equipment by unauthorized adjustment of controls—and it must be clearly agreed that the system will not be used for disciplinary purposes.

Once an installation had been accepted and was operating successfully, it was found that in most cases it became an integral part of a more efficient system and that its presence was indispensable.

Few people welcome change, but the basic resistance to introducing c.c.t.v. appeared to come from its technical and social implications: an employee may have to acquire new knowledge or skills, and possibly change his pattern of work; furthermore, he may find his social or work status altered by the new equipment and its operation. Two of the most important aspects of human problems with c.c.t.v.

*A c.c.t.v. system is now operating at the U.K.A.E.A's Dounreay experimental reactor establishment. Shown here (left) is the reactor control room, in which is monitored the picture (right) transmitted by a camera installed to view part of the reactor*

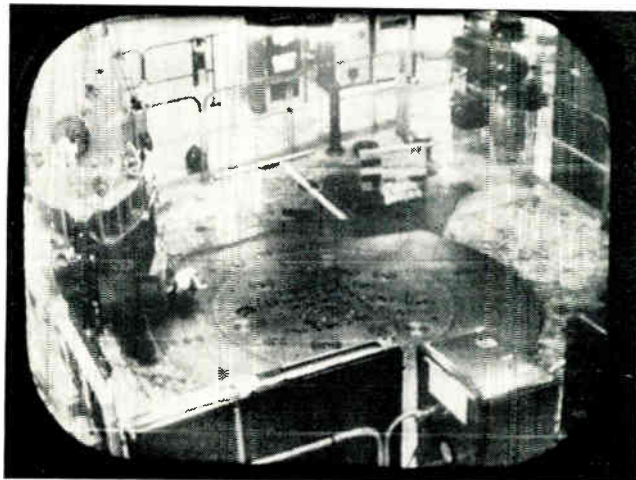
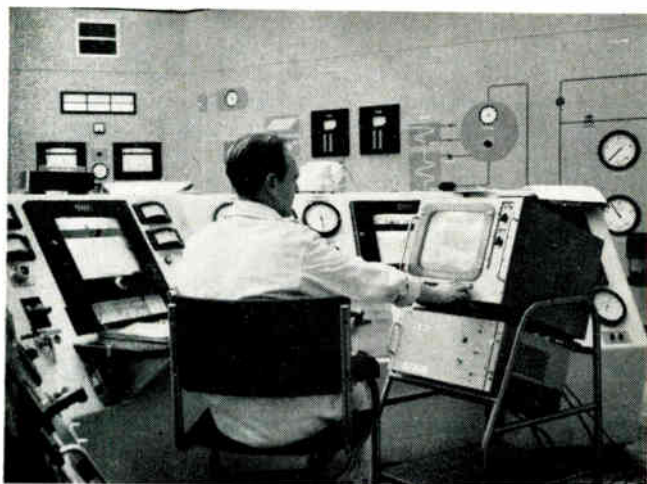

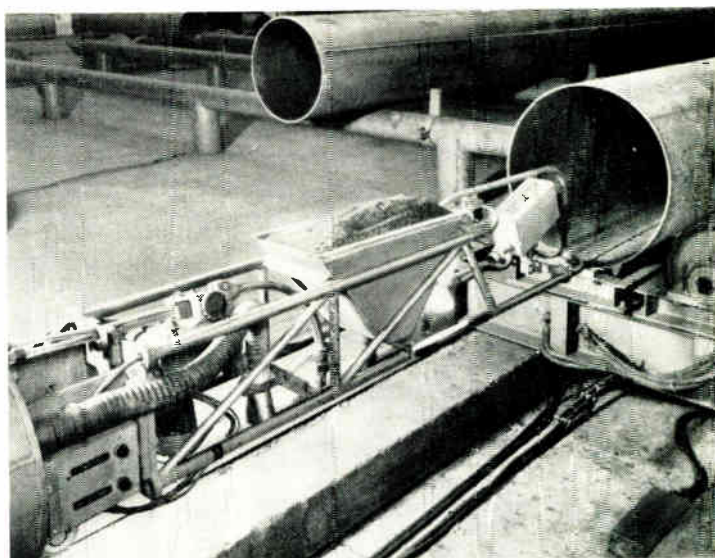

Stewarts and Lloyds' British Tube Works in Birmingham is using c.c.t.v. to assist the internal electric-fusion welding of large diameter pipes (left); the operator controls the welding by referring to the picture monitor on his control console. On the right, the cover from the head of a quasi-arc boom-welding machine has been removed showing the c.c.t.v. camera that is used for accurately guiding the welding electrodes

are perception and fatigue, for poor quality pictures can seriously affect operator response and efficiency.

User evaluations (part 5 of the questionnaire) established that the majority (96%) felt that their installations had proved their worth; only one stated that it had definitely not, while another described its success as 'only partial'. The performance of operators had been improved in 13 organizations, while only one claimed that an improvement was 'questionable'. An increase in the quality of output had been noticed by 86% of the organizations, and so taken as a whole the comments indicate that c.c.t.v. is undoubtedly assisting industry and commerce.

A financial evaluation of the installations was not possible since, in total, this amounted to only £4,000 from the returns of only two organizations; one of these credited £1,000 for an increase in operator performance, while the other credited £3,000 as an evaluation of improved quality in output, adding that this was a saving in salaries due to a reduction in the number of instructors required.

### Management, Training and Management Education

In assessing the effect of c.c.t.v. techniques in the fields of management, training and management education, a number of general conclusions can be drawn:

Industry, commerce and the public utilities are quite clearly very interested in c.c.t.v., and as a technique it is contributing greatly to the effectiveness of managers and personnel in their decision-making roles. The wide range of costs incurred and equipment installed indicated that each c.c.t.v. system must be designed for a particular application, and consideration must be given not only to equipment and maintenance costs, but also (and more important) to picture perception by the operator; furthermore, personnel problems are not created by using c.c.t.v. provided it is properly introduced.

Little additional equipment (such as microscope attach-

ments and v.t.r.s) is being used with installations, though this lack of v.t.r.s could be due to the high costs of such recorders in the past.

In the field of management education, there is a need to teach (preferably by demonstration) how, when, where and why c.c.t.v. can be used as an audio/visual control and communication medium; this became particularly clear when the draft report of the survey was circulated to practising managers in industry and commerce, as well as those in the radio industry. Statements such as 'I never knew I could use it that way' or 'I never thought of it' were frequently made.

### Video Tape Recorders

The survey revealed that no organizations were using v.t.r.s, although the introduction of  $\frac{1}{2}$ -in. tape equipment now presents management with an audio/visual tool of great flexibility and a wide range of applications.

Before the end of 1967, it has been predicted that many hundreds of v.t.r.s will be in use by management in this country; in the U.S.A. alone, one manufacturer sold approximately 2,000 machines last year, and another supplied over 5,000. One American manufacturer intends to produce some 24,000 units this year, and another forecasts that (with tapes and ancillary equipment) the market potential in the free world should be approximately \$400 million in four years' time.

The small v.t.r. in the price range £500 to £1,000 clearly has a great potential. One Japanese model now available is capable of recording from both open-circuit transmission and its own vidicon camera; it can be provided with a unit to enable picture selection from more than one camera, and has a power output sufficient to supply more than two 19-in. receivers.

Another Japanese model, which is shortly to be available, operates on 625 lines; it provides a 'hold' button to enable picture retention for up to ten sec and has editing facilities for recorded sound to be copied, erased or revised. Its colour adaptor offers colour-recording facilities from both B.B.C. transmissions and its supporting colour camera, although a separate monitor for receiving the colour transmission signals will be required. It is understood





from two of the three manufacturers of small v.t.r.s that they have overcome the problem of compatibility of recording heads, thereby facilitating the interchange of tapes between their own machines.†

The running costs of a small v.t.r. installation will include the replacement of recording heads, camera tube and recording tape, but the prepared tapes (with reasonable care and attention) should complete 1,000 passes before the signal is too weak to reproduce a picture.

The small v.t.r. has a number of specific advantages: play-back is immediate, its associated camera can take pictures at reasonable light levels (in black and white or colour), and the equipment is reasonably mobile. How, then, can management use these facilities?

### Managerial Applications

Visual and audio reports are now possible since (with the unit's mobility) management need not make decisions based on the written or verbal word alone, nor spend valuable time going to a site to view progress. Construction work to date can be shown visually, for example, at the same time that the site manager's report is presented; plant relocations can be viewed being undertaken and completed; and damage to buildings, plant and the like can be rapidly presented and assessed visually. Management must have all the facts available to assist their decision making, and in this field the small v.t.r. can be a dynamic aid.

Managers and potential managers can be trained by using a v.t.r. while they are in the plant and on the job; it enables them to learn from their own mistakes and to check their presentation prior to transmission. Sales staff can test possible advertising material prior to release, and communications in general can be improved in the area of human relations. Policy reports from management to employees could be recorded, for example, instead of being written, and the managers presenting the report could thus be seen by employees, creating an important visual impact. In the larger organizations, top management need no longer be names on correspondence but could be known by sight to all employees within the company.

In the training field particularly, v.t.r. has a host of applications. Induction training can now be supplemented by a television programme which introduces the employee to the general manager, the works manager and other functional heads; furthermore, programmes can be devised and produced for a company's individual requirements such as

† But now is surely the time when all manufacturers of v.t.r. equipment should be formulating standards of compatibility. Ed.

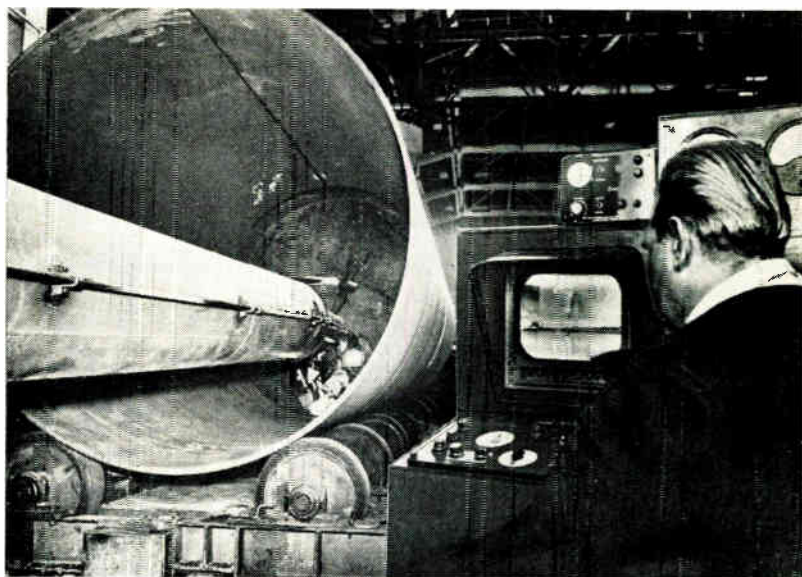

Submerged-arc welding equipment, installed in the Rotherham boiler-manufacturing plant of Robert Jenkins and Co., is shown here being remotely controlled and inspected with the use of c.c.t.v.

re-training the older employee, who might resist learning new methods or techniques because it would necessitate joining a group of younger people. The recording of programmes by specialists in the company would be of special value, and supporting programmes could be produced to assist the industrial training required under the Industrial Training Act, as recommended by the appropriate training board. Another important application is the possibility of transmitting programmes to canteens and classrooms on safety and health.

Prior to making any decision to purchase v.t.r. equipment, it is important that all its possible applications be assessed to ensure maximum equipment utilization and return on investment. Some of its principal industrial uses are apprentice and operator training; inspection and quality control (resulting in permanent visual and audio records of standards of production); the development and study of new methods; production control (to communicate more effectively to all employees the reasons for a system of planning and control); and making available to engineers programmes on specific subjects produced by universities and other research and development establishments.

## Automatic Microcircuit Production

The National Research Development Corporation has entered into an agreement with Welwyn Electric Ltd. (of Bedlington, Northumberland) to help establish an automated microcircuit manufacturing plant; the agreement is tantamount to an unsecured loan (of up to £¼ million), repayable over a number of years with interest.

Welwyn have spent some six years developing production methods of chemical-deposition and fired-on glazes (which are preferred to vacuum-deposition techniques due to their greater effectiveness, lower cost and ability to be accurately controlled), and production rates of up to 200,000 micro-assemblies per week are expected to be achieved once the plant is operating.

The micro-assemblies to be produced are thick and thin-

film products, consisting of alumina-ceramic substrates on which such passive components as resistors and capacitors are chemically deposited, printed or etched; active elements—the diodes and transistors that are also made by Welwyn—will also be attached to the films to make hybrid assemblies.

Film circuits offer a greater reliability and compactness than discrete-component assemblies, and can handle much higher powers and tolerate much higher temperatures than monolithic microcircuits; they thus have obvious advantages for communications and industrial control, for which they will initially be destined. The first off-the-shelf modules will operate at 12, 24 or 50 V.

For further information circle No. 82



# Computer-Aided Patient Care

Two Texas medical institutions—the Baylor University College of Medicine and the Texas Institute for Rehabilitation and Research (TIRR)—are to develop jointly a computer communications system to aid patient care in hospitals. An IBM computer system, recently installed at Baylor, will soon be linked with television-type display stations and typewriter keyboards in the wards of TIRR's hospital section, and when the system is in operation, medical personnel will be able to use these terminals to acquire, process and retrieve vital medical data about any patient's condition and responses to treatment and rehabilitation.

The new system will be expanded to include many other hospital activities, and it is envisaged that a single system will eventually be shared by individual doctors, nurses, and other professional personnel, and by laboratories and administrative offices throughout the hospital; as a by-product of recording patient data, the system could simultaneously support accounting operations, control hospital-service resources, and undertake statistical studies on the incidence and management of disability. The basic information needed for any application will come from a single, detailed and continuously-updated record of the patient's behaviour, treatment and response to treatment;

this will enable the hospital to estimate (perhaps more accurately than ever before) precise costs for individual patient care and for overall hospital operations.

Baylor and TIRR have already developed a variety of computer techniques for processing patient-care information and the new system will enable users to apply these techniques more efficiently since the computer will ultimately be time-shared; a user will get his results almost immediately because he will work at a remote terminal as if he alone were using the computer.

With the system, for example, a nurse will be able to report complete details of a patient's condition, medication, therapy and response to treatment almost as they happen; instead of filling out a handwritten report for submission hours later, she will type the information directly into a nearby display station, which will be linked via ordinary telephone lines to the central computer. The computer will compare the nurse's report with the patient's past records and other standards, will detect possible errors in entries and unusual changes in vital indications such as pulse rate or blood pressure, and then transmit them back to the display. Later, when the doctor makes his rounds, he can request from the display station an up-to-the-minute record of his patient's treatment and response.

## Manufacturers' Literature

**Silicon-Rectifier Equipments.** Design and construction details of G.E.C.'s industrial silicon-rectifier equipments are given in this 8-page publication (RCD300). Illustrated with photographs and diagrams, it describes the various circuit arrangements and methods of output-voltage control and overload protection, also detailing a system of diode cooling based on the use of liquid-filled natural-air-cooled busbars.

**For further information circle No. 54**

**Model 444 Teleprinter.** This 17-page brochure (041-033-IE) from Creed provides an introduction to their new model 444 heavy-duty teleprinter. Fully illustrated, it gives complete technical specifications for the machine, describing its capabilities, operation and maintenance requirements.

**For further information circle No. 55**

**Magnetizing of Permanent Magnets.** This 12-page technical vides information on the technique of magnetizing to ensure bulletin (No. 7) from the Permanent Magnet Association pro that the properties of permanent magnets are fully exploited. Methods of magnetizing and practical limits are given, and the text is supported by diagrams and tables.

**For further information circle No. 56**

**Sealectoboard.** Sealectro have now issued a 10-page illustrated technical brochure on their Sealectoboard programming and matrix system. This multiple pole and throw-switching device consists of an X-Y matrix with two or three contact decks in the Z plane; it thus provides interconnection flexibility for programming, equipment process control, breadboarding and input/output signal selection.

**For further information circle No. 57**

**The Transformer Ratio-Arm Bridge.** Monograph No. 1 from Wayne Kerr discusses in its 12 pages the theory of the transformer ratio-arm bridge and its various practical arrangements. The text is general, without any reference to commercial instruments, and the principles given apply equally to low a.f. and v.h.f.

**For further information circle No. 58**

**Pocket Guide to Field-Effect Transistors.** A comprehensive pocket-sized spiral-bound guide to field-effect transistors has been published by Texas Instruments Ltd. It is aimed at simplifying the circuit designer's choice of f.e.t.'s and the subjects covered include technology and construction notes, parameters and terminology, formulae, parameter measurement, summaries of linear and non-linear applications, and f.e.t. equivalents. Details of books, application notes and data sheets available from the company are also given.

**For further information circle No. 59**

**Absorption Spectroscopy.** The first of a new series of application reports on absorption spectroscopy from Hilger & Watts, this 6-page publication (BR.1800) describes a new method of measuring epitaxial-film thickness in semiconductor materials. The technique is based on the interference of reflected infra-red light from the surface and substrate of the material, and can be easily adapted to routine measurements.

**For further information circle No. 60**

**Kodak Seminar on Microminiaturization.** Papers presented at the Rochester (New York) symposium on microminiaturization, which was sponsored by the Eastman Kodak Co., have now been published in this 66-page booklet. They discuss the role of photo-resist technology in the electronics and microelectronics industries, treating in detail such fields as mesa transistor manufacture and the applications of photo-etching in the manufacture, interconnection and packaging of microcircuits.

**For further information circle No. 61**

**CUDOS.** The latest in the Elliott-Automation series, 'Automation in Action' is their illustrated 8-page booklet on continuously-updated dynamic optimizing systems. It first outlines the development of such control systems, which must be capable of adapting themselves to the behaviour of almost any industrial plant, and then describes an actual experiment carried out on a pilot-scale water gas shift reactor at the Mintech's Warren Spring laboratory.

**For further information circle No. 62**

# MARCONI TELEVISION

## Brings your problems into focus

Marconi special-purpose television systems have solved a wide variety of problems in industry, training, commerce and government service. Marconi systems are engineered and planned to ensure permanent reliable visual information links at the lowest cost, over the longest period of time. Marconi with nearly twenty years' experience in closed-circuit television has achieved a vital lead in the provision of the most economically engineered systems using the highest-quality equipment.

Marconi closed-circuit television systems are based on the V321 and V322 series of Vidicon cameras and a wide range of ancillary equipment. But, if the system demands it, special equipment is designed to meet specific requirements.

**Simple operation**  
**Long-term stability**  
**High reliability**

The Marconi Company Limited  
Closed-Circuit Television Division, Basildon, Essex, England  
Telephone: Basildon 22822 Telex: 99225

AN 'ENGLISH ELECTRIC' COMPANY

LTD/V58

V321



A compact automatic camera designed to withstand considerable mechanical shock and extreme climatic conditions.

V322A



A compact single unit camera ideal for general surveillance, telecine and microscopy applications.

V322B

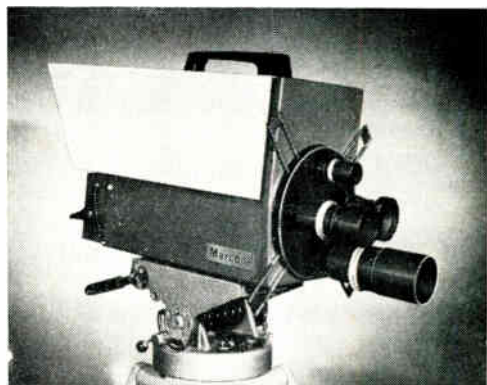

A compact single unit camera, incorporating a high-brightness electronic viewfinder, ideal for all educational and training purposes.

**For further information circle No. 227**

**Imagine a clutter-free combination of MTI and raw radar which also reduces fade.**

## Like SMTI.

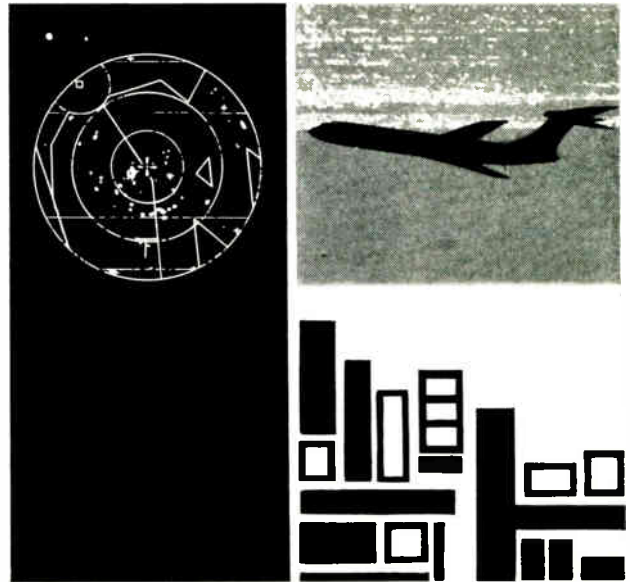
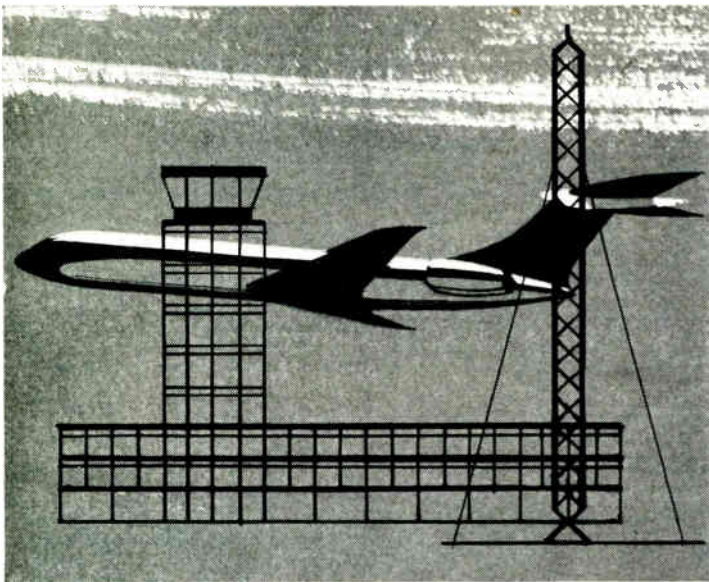

Selective Moving Target Indication—SMTI for short—is an important new radar development. It is important because it eliminates most tangential fade without increasing ground clutter.

It is, in fact, an entirely new function of the Solartron High Resolution Video Map System. It can be added to an existing system, and can be used with normal video mapping facilities.

In the SMTI mode the video map scans a plate depicting the permanent echo pattern of the radar site, and supplies an actuating voltage to a solid state switching circuit.

So, SMTI automatically switches to cancelled video (MTI) on the parts of the scan where permanent echoes occur and switches to uncanceled video (raw radar) for the rest. You get the best of both systems.

If you want full information and specifications for SMTI—and for the rest of Solartron Video Map systems—send us the coupon.

Meanwhile, reflect on the extra safety and reliability that comes from the reduction in tangential and blind speed fading—an Air Traffic Controller's dream come true.

Please send full information and specifications for Solartron Video Map systems, including SMTI.

### ASK SOLARTRON

Name

Company or department

Address

**SOLARTRON** 

THE SOLARTRON ELECTRONIC GROUP LIMITED  
Farnborough · Hampshire · England · Telephone: 44433  
A member of the Schlumberger Group M/IE/4

**For further information circle No. 228**





# TALK ABOUT

**Patriotic readers** of *New Scientist* were incensed that the journal had not only carried a large advertisement from an American recruiting agency but had actually offered to handle correspondence arising from it.

Dr. Donald Gould, the editor, sharply reminded his critics that the brain drain could not be stopped or even stemmed by employing censorship or similar dictatorial methods. 'The facts', he wrote, 'should be published, and published as widely and as forcibly as possible. Then, perhaps, we may be stirred into putting our own house in order'.

The Society of British Aerospace Companies conducted their own survey last year and concluded that 1,300 specialists were lost to their industry in 1966. Specialists, in this context, were defined as people with a university degree or specialist training. The bulk of those who sought employment overseas gave uncertainty as their principal motive.

Included in the S.B.A.C. total were 344 who went to foreign firms in the U.K. Comprehensive Designers International at Southall employ 750 designers, draughtsmen and engineers working for Lockheeds, but S.B.A.C. does not regard all of these as key people. Sir Richard Smeeton, director of S.B.A.C., confirmed that the figures reflected unrest caused by uncertainty.

The Parliamentary debate on the brain drain in February produced little heat. Mr. Quintin Hogg complained that America had been plundering the educational systems of Western Europe and predicted the drain would turn into a flood. Mr. Hogg's motion, regretting that the Government had pursued policies which had aggravated the loss to the U.K. of qualified and skilled manpower, was inevitably defeated by a rubber-stamp Government majority of 81.

Of course those of us who are ill-informed tend to get a little hot under the collar about these issues but the Men Who Know take a much calmer attitude. These in-people take a broad view, study the long term, have access to inside information, can call on scientific, economic and even psychiatric advice. There are new slogans and even technological devices which can be deployed at the right moment.

An example was leaked to the press in an *Observer* interview with a keen, penetrating, clean-shaven, pipe-smoking 41-year-old inventor and philo-

---

## By NEXUS

---

sopher. When questioned on the brain drain he stated, 'I'm not so worried about the brain drain as some people because this country will be an increasingly exciting place to work in. The electro-magnet is switched on'.

This statement has everything. It radiates an air of cool objectivity on the present, the promise of an ecstatic life in the future and has a fine technological flourish at the end. A masterpiece, you might say. But I fear that it will hardly discourage those ungrateful wretches who hawk their talents overseas for a paltry threefold increase in pay coupled with free access to finely equipped laboratories.

The young hopeful who was interviewed was none other than Mr. Anthony Wedgwood Benn, Minister of Technology. But to give Mr. Benn his due, he has at least taken some action. Yes, another committee. This has been set up to obtain statistics and recommend changes. The issue is now in abeyance for some months, if not years, while we wait for a report.

Meantime, American Defence Secretary McNamara, needled by Prime Minister Wilson on the subject, remarked, 'Brains, on the whole, are like hearts. They go where they are appreciated'. A neat remark with some basic truth which explains the constant brain drain from firm to firm within a country as well as between countries. Within our shores there is constant movement by engineers from small unimaginative companies to large imaginative ones, from large unimaginative firms to small imaginative ones, from the North to the South-east, from state-sponsored research into private industry and vice-versa. On the whole this is a good thing and it has been going on ever since the railways provided cheap mobility 100 years ago.

Wholesale movement in one direction is another matter, especially when it is out of the country. An improved status for engineers and scientists, less stop-go on aircraft and other major projects, and less taxation would provide more incentive to stay than more committees and any number of electro-magnets, switched on or otherwise.

**M. Maurice Ruby**, Chef du Service des Relations Exterieures de la Federation Nationale des Industries Electroniques, has already sent me an invitation to the Salon International des Composants Electroniques. Don't worry, Maurice, I'm on my way and shall report at the Porte de Versailles (Metro Ligne 12) sharp on April 5.

This year, I and 139,999 other visitors from the U.K. and 69 other countries (if last year's figures are maintained) are at last fully automated. In 1966 I seem to remember that we ticked off our nationality, occupation and other interesting facts by pencil on our IBM punched invitation cards.

This year we are asked to punch out the holes ourselves opposite the appropriate written description. Entry to the exhibition is by exchange of the IBM punched card for a permanent pass. By this simple expedient the organizers, with the aid of a card reader, can get an immediate analysis of attendance at any point of time during the show with a grand total in categories of visitor within minutes of closing the doors for the last time on April 10. And each visitor is only counted once instead of every time he enters, which is more than can be said for some exhibitions and their claimed attendance.

Every other year the organizers find the greatest difficulty in booking the halls for February and with profound regret have to postpone the event until

April. The show is well worth waiting for and Paris is even more pleasant in the spring. But by a strange coincidence postponement, however regrettable, is only found necessary in years when our own R.E.C.M.F. components show takes place in London in May.

Now, if I were a European mainland having spent three or four days in Paris seeing all the world's components including the best of the British I would, indeed, be an idiot to risk my life crossing the channel a month later to see an insular British show, the best exhibits of which I had already seen in Paris.

The majority of exhibitors at R.E.C.M.F. would like the show to be international as is the I.E.A. with which it alternates. The exhibition organizers would also like it to be international. But the show remains stubbornly national. There are obviously arguments for and against a change but while things remain as they are Paris is internationally regarded as the place to exhibit, the place to visit and the place to trade. London, by comparison, is an also-ran.

**It is just a year ago** that I mentioned in this column the skirmish between the advocates of thin and thick film hybrid and monolithic integrated circuits and finished up with the comment, 'Maybe there's room for all the conflicting technologies, each being best for a particular application'.

The piece of in-fighting to which I was referring came from Mr. D. Boswell of STC who had caustically observed, apropos integrated circuits, that only the most primitive natives still fashion canoes by chiselling out logs.

Now, a year later, another exponent of film circuits is revealed not as a debater but as a doer to the extent of plunging £750,000 into an automated production line. I refer to Welwyn Electric Ltd. who have been quietly developing their process over the past six years and are now ready to start production in a big way. Welwyn's own faith in their process and in the future of hybrids is matched by the National Research Development Corporation who have agreed to make a substantial contribution to the cost.

Welwyn, having tried everything, have finally settled on chemical deposition and fired-on glazes in preference to vacuum deposition. Production rates up to 200,000 micro-assemblies a week are expected if all goes well on production and marketing, and yields, believe it or not, have

been targeted at 80 per cent. Another development if all goes well, is the use of a computer for on-line testing.

Key points for industrial electronics users of thin and thick film hybrids are that they have higher power-handling capacity than monolithics, are less temperature sensitive, generally have better heat dissipation, and are less susceptible to noise interference. All these factors add up to something really worthwhile for the sort of environment which is the common lot of industrial control applications.

Off-the-shelf modules are the aim and the first components are to come in a range embracing 12, 24 and 50-V operation. But even for specials, tooling costs are comparatively low in the range of £100-150 for reasonable production quantities.

Congratulations to Welwyn Electric. And to Mintech for backing N.R.D.C. and N.R.D.C. for backing Welwyn. N.R.D.C. are proud to be an independent public Corporation. In putting their money (our money, really) into support of the Welwyn initiative they rightly deserve a handsome return on the profits. And I wouldn't mind betting they get it.

**Cryogenics became** an 'in' topic in electronics a few years ago before the laser ousted superconductivity as the marvel of the age. Now, cryogenics is in everyday use in a number of roles including space communications and infra-red mapping, metallurgy and the great natural-gas rush of the '60s which makes the old Klondyke gold-rush days look very small beer.

I often wonder if Robert Stirling, a minister of the Church of Scotland, rests peacefully in his grave. For it was he who, over 150 years ago, took out a patent covering a hot-air engine embodying principles which have provided one of the most potent cryogenerators available to-day.

Stirling, so the story goes, was more than a little perturbed by the dramatic explosions, many fatal to life, which were common with the steam engines of his day. His hot-air engine was a runner but it couldn't match steam in efficiency or power/weight ratio and therefore didn't catch on.

We know that by 1834 it had been discovered that the engine was 'reversible'. That is, if the heat source was removed from the cylinder head and the engine kept turning by external mechanical drive, then the cylinder head showed marked cooling. A Stirling refrigerator was used in the 1860s but again the machine was inefficient and dropped out of favour.

The original heat-engine concept was resurrected by a group of Philips' engineers in 1938 who had a requirement for a simple prime mover to power generators for field radio equipment and a one-horsepower engine was developed.

Again it was noticed that the engine was 'reversible' and in 1945 two Philips' engineers revamped the engine into a cryogenerator and obtained a temperature of 83 °K (-190 °C).

Intensive further development was necessary before commercial machines became available in 1954 and since then a whole range of equipment has been developed from large machines producing 20 kW of cold at 77 °K down to tiny units producing 1.5 W of cold at 25 °K for cooling airborne infra-red detectors and satellite communication amplifiers.

The Stirling Cycle cryogenerator is another example of an invention before its time. For years it remained a textbook curiosity. It has taken nearly 30 years since 1938 to bring it to a degree of perfection. But belief in the idea, application of modern analytical methods of design and the introduction of new materials and technology have kept the name Stirling alive.

The old boy could not have imagined how useful his engine was to become. On balance, I think he rests peacefully even though his original intention of extracting power from heat has been turned upside down to provide cryogenic temperatures from power.

---

## 'Approaching Automation' Advisory Centres

The first two Ministry of Technology 'Approaching Automation' advisory centres (see 'Comment', January 1967) have now been opened in Scotland—at the Paisley College of Technology and Heriot-Watt University, Edinburgh. They have been set up to provide Scottish industry with training and advice in low-cost automation techniques, and specialist staff are available to help firms to identify the methods and equipment best suited to their processes.

Both centres are equipped with a wide range of equipment for simulating and solving industrial control problems, the solutions being proved in the laboratory before they are offered for adoption on the shop floor, and short training courses will be run at frequent intervals. Firms interested in the facilities offered should contact the industrial liaison officer at each centre.

# some people still use this when all they need is this

Times have changed. Circuitry has changed too. Ambient temperatures are lower, so small carbon film resistors are doing bigger jobs.

Conventional ratings, however, lag behind. Still tied to outmoded valve circuitry with ambient temperatures around 70°C. Conventional ratings therefore can lead you to use resistors which are unnecessarily large and costly.

Today's designers are turning to RATIONALISED RATING to bring resistors back to earth. It enables them to match the resistor to the job—and choose an inexpensive low-wattage Mullard CR25 or CR16 type. Result? Long term stability and compact design at a very attractive price.

TO ASSIST DESIGNERS MULLARD HAVE PRODUCED A PERFORMANCE NOMOGRAM.

It enables designers to select a CR25 or CR16 resistor according to all the relevant factors:—power dissipation, ambient temperature, hot spot temperature and maximum resistance drift after 1000 hours of operation. It gives the required long term stability in a resistor of minimum dimensions and cost.

The Performance Nomogram is available, free on request. Let us send you one.

## **Mullard** Carbon Film Resistors

Mullard Limited, Industrial Markets Division, Mullard House, Torrington Place, London WC1. 01-580 6633



***Mullard  
silicon planar  
epitaxials  
BC107, BC108 and BC109  
have low  
saturation voltages  
and high gain  
at low currents***

**Mullard**

This range of transistors meets economically the requirements of a wide number of industrial applications. Low saturation voltages, high gain at low currents (100 at 10  $\mu$ A for the BC109), and TO-18 encapsulation are features of all three types — and they're available now.

**BC107** High voltage, high gain type with low bottoming characteristics; a general purpose device suitable for industrial amplifying and switching applications.

**BC108** High gain, 20V transistor, intended as a general purpose device for low level amplifier stages, industrial counting and switching.

**BC109** Provides exceptionally low noise and high gain. Low level input stages for industrial instrumentation and control, and professional sound recording and reproducing equipments and typical applications.

*Here are brief specifications. For full technical data, contact Mullard at the address below.*

	BC107	BC108	BC109
$V_{CE0} \text{ max } (I_B = 0)$ ...	45V	20V	20V
$I_{CM} \text{ max}$ ...	100mA	100mA	100mA
$P_{lot} \text{ max}$ ...	300mW	300mW	300mW
$T_j \text{ max}$ ...	175 C	175°C	175°C
$h_{FE}$ ...	125 — 500	125 — 500	240 — 900
$V_{CE (sat)} \text{ max}$ ... ( $I_C = 10\text{mA}, I_B = 1.0\text{mA}$ )	100mV	100mV	100mV
$f_T \text{ (min)}$ ...	150Mc/s	150Mc/s	150Mc/s
Noise figure (typical) ...	3dB	3dB	2dB

Mullard Limited · Industrial Markets Division  
Mullard House · Torrington Place  
London WC1 · LANGham 6633

# rd si



# planar

For further information circle No. 230





# FLUID LOGIC FOR LOW COST AUTOMATION

Logic is necessary to provide the decision-making elements in any automatic control system, and recently a number of systems using fluids (normally air) instead of electronics have been devised to achieve such logic.

Fluid logic (or fluidics) was developed initially to meet the requirements in aerospace applications that were environmentally unfavourable to electronic circuits—extreme temperatures, severe vibration and shock, etc. High reliability, coupled with the prospect of low cost, has since stimu-

lated wide interest from industry, and fluidics is now emerging as an ideal form of low-cost automation within the limits of its particular abilities.

A wide variety of fluidic devices is now coming on to the market, some containing moving parts and others being entirely solid-state. Although electronic devices are much faster than fluidic ones, the speed of the latter is adequate for many control functions that require decisions to be made only in fractions of a second rather than micro or nanoseconds.

## Fluidic Devices

Many of the solid-state components used in fluidic systems consist of arrangements of accurately-shaped recesses in various metal or plastic materials, each component carrying out a given logic function. At a recent fluidics conference at Cambridge, International Computers and Tabulators (63) presented several papers that discussed the work that they are undertaking on applications for such fluidic devices, in particular for the sequencing and control of mechanisms in computer input/output equipment; one of their devices is shown in Fig. 1.

The industrial and electronic components division of the Plessey Components Group (64) also produces a range of fluid-logic devices, and these can provide the essential elements for a control system. Plessey aim to put fluidics on to the shop floor and production line as soon as possible, and will initially be marketing four devices, together with associated accessories. Their bistable unit and basic 'universal' element—the two-input OR/NOR unit shown in Fig. 2 (a)—are designed along familiar lines, but have several special features: a modular planar form of construction is used (each component being moulded in epoxy resin) and so easy 'integrated-circuit' building is

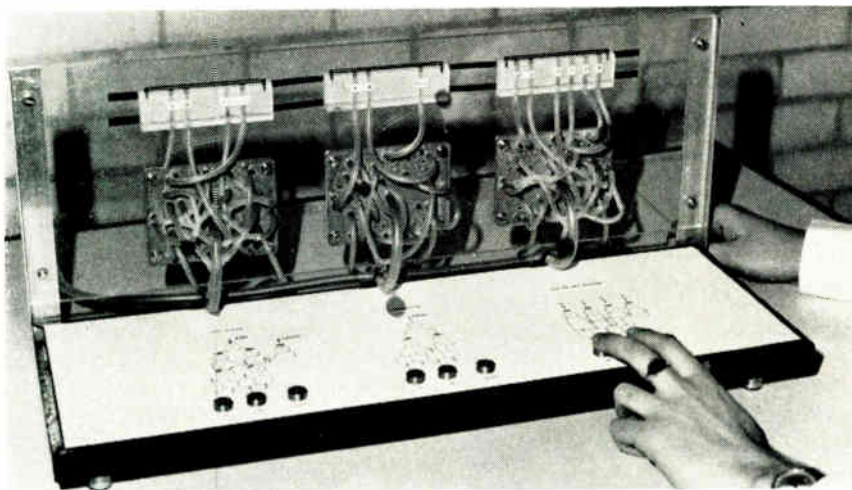

Fig. 1. (above) A general-purpose fluidic gate made by I.C.T. The device contains six 2-input OR/NOR gates and two 2-input bistable circuits, which can be connected externally to make up various logic circuits



Fig. 2. (a) (left) an OR/NOR fluid-logic element, one of four fluidic devices now being marketed by the Plessey Components Group; (b) (right) the Plessey shift register stage element, which can perform a number of operations besides counting



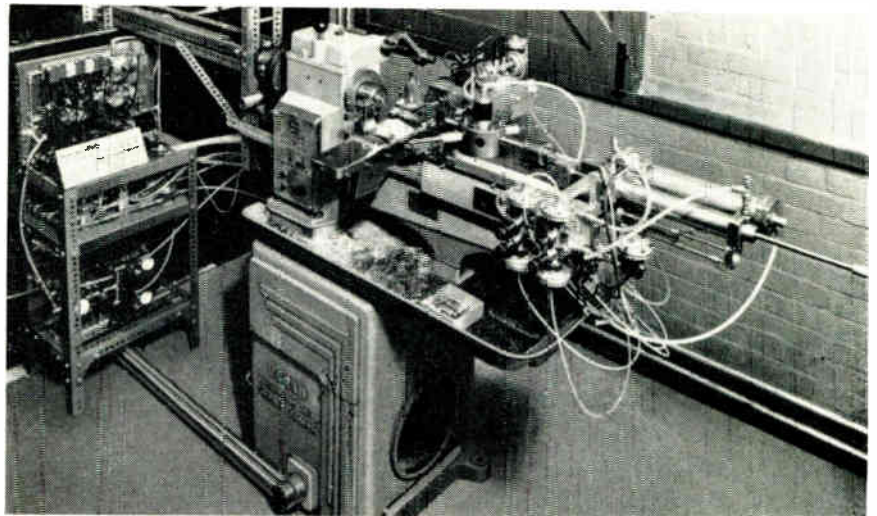
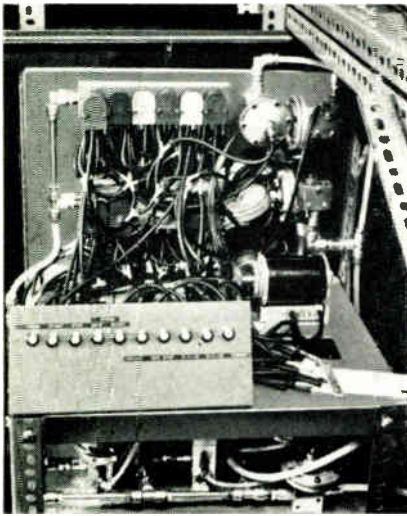

Fig. 3. The machine operations of the turret lathe (left) are automatically controlled by a fluid-logic system (right) made up of 'Technelog' units. Pneumatic pushbuttons are built into the system so that the machine can be controlled manually for setting up or adjusting tools

possible; also connecting tubes push into sockets in the device, these sockets remaining airtight at high pressures, which in fact improve the fit.

Plessey's pure-fluid digital amplifier incorporates in one 'integrated-circuit' device the high input sensitivity of a turbulence amplifier with the multi-output capability of wall-effect devices; it is similar in output to the single-input bistable (except that it can be set by extremely small input-pressure changes), and one of its functions is to drive logic devices from the low-pressure output of pneumatic sensing devices. Finally, their shift register stage—shown in Fig. 2 (b)—performs counting and memory func-

tions, its output taking up the state existing at the gate input when a shift signal is applied; a manifolding system is also available, into which twelve of these devices can be plugged for making up systems.

#### Numerically-Controlled Co-ordinate Table

Plessey Automation have devised a punched-tape-controlled co-ordinate table that uses pneumatic logic, position sensing and tape reading in conjunction with conventional air-piloted hydraulic control valves; a block tape reader is used, which senses 15 rows simultaneously, and its outputs are available for selecting the drill, drill

speed, depth stops and other functions. The table has a travel of 14 × 20 in. and is suitable for use with drilling machines of up to 1-in. capacity, a direct hydraulic drive (with integral power pack) being applied to each axis for speed, simplicity and reliability.

Binary-coded decimal (b.c.d.) signals for fine measurement up to 0.999 in. are used to select mechanical length-bars in each axis, while the b.c.d. signals for whole inches are converted in a pneumatic translator and used in a sensing system that causes the work table to move towards the selected position at maximum speed. As the desired position is approached, another pneumatic sensor changes the hydraulic system to the 'servo' mode and the table is hydraulically balanced on the selected notch on an accurate pitch bar; hydraulic table locks are applied during drilling, and air-gearing slide-ways are used throughout.

Fluidic devices from Corning Glass Works, Maxam Power and Techne (Cambridge) have already been described in past issues of *Industrial Electronics*, but details are now available of actual working control systems devised by these companies.

#### Automatic Turret-Lathe Control

Techne (65) have now developed a pneumatic system for the automatic control of the machine operations on a turret lathe (see Fig. 3). Such operations as opening and closing the collet, varying the spindle speed, selecting rapid or slow feed rates for the transverse movement of the cross slide and the longitudinal movements of the turret slide, indexing and clamping the turret, and operating the work-piece stop—all these are provided auto-

Fig. 4. The refrigerator-door punching equipment in operation; automatically controlled by a Maxalog system, the punching sequence is not carried out should any error be made by the operator

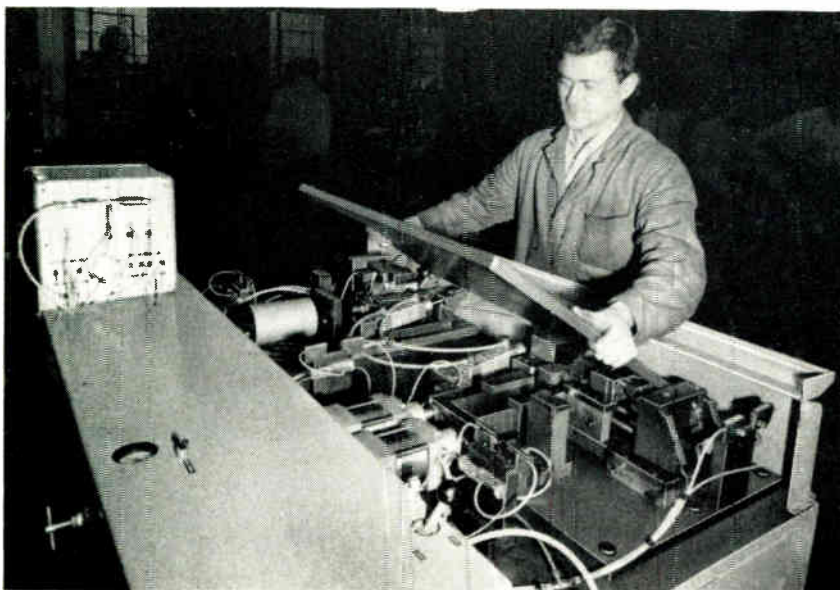



matically using their 'Technelog' moving-part fluid-logic devices.

Each step of the machine cycle is controlled by a pneumatic programmer according to the sequence of operations required; signals from the programmer switch NOR units, which operate diaphragm valves and cylinders to work the machine. Completion of each discrete step in the machine cycle is sensed by microswitches, the signals thus generated being employed to sequence the programmer on to the next step. The entire cycle is interlocked by fluid-logic devices, so that if any step is not completed, the sequence is stopped to eliminate damage to the machine, tool or work-piece.

One of the particular advantages of this equipment is the ease with which programs can be prepared—simply by punching holes in a plastic sheet; a non-destructible program is produced, which can be filed with the component drawing and re-used many times, thus reducing setting up time and the need for complicated plugboards and relay holding systems. Pneumatic push buttons are built into the system so that the machine can be controlled manually, and this enables movements of the slides and other machine functions to be selected, as required, during the setting up or adjusting of tools.

#### Metal-Punching Control

The 'Maxalog' solid-state fluid-logic devices from Maxam Power (66) are now being used by the Frigidaire division of General Motors in North London to provide sensing and control circuits for automating the punching of hinge holes in refrigerator doors. Fluidic rather than electronic control was chosen on account of its greater simplicity and reliability, the system evolved costing approximately one third that of a comparable electronic installation.

The hinge holes are punched after the door-forming operation, their position being varied according to whether the door is for left or right-hand hanging; it is essential to discriminate between left and right hand doors and to actuate the punch mechanism only when the correct door is inserted the right way round. Sensing is carried out using four air-stream detectors, in which a 1-p.s.i. air stream passes across a 3-in. gap and enters a collector tube. With the gap uninterrupted, the air stream switches off the air-stream detector; but placing a door in the gap immediately interrupts the air stream and allows the device to switch on.

At the start of an operating sequence, the machine is set to accept

*Fig. 5. The Corning fluidic circuit (inset) controls the vacuum pick-up and transfer device at the charge ends of two kilns. The system controls the movement of the transfer device on demand from the two kilns*

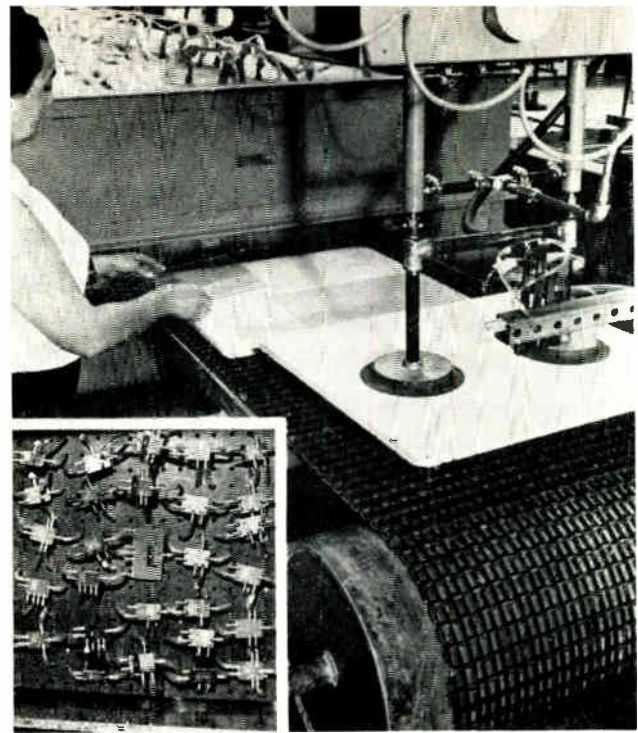

either left or right hand doors, and a door is then placed in position (see Fig. 4); a guard is then lowered, interrupting a second detector, and the two resulting outputs are fed as inputs to an AND gate. With both signals present at the gate, its output signal initiates the second stage of the cycle, which can consequently only take place if the door has been correctly positioned and the guard lowered. Two further air-stream detectors are located to sense the existing holes in the panel appropriate to either a left or right hand door, and the signal produced by the AND gate then operates a step-up relay valve; this supplies high-pressure air via a regulator to a left/right selector valve, which in turn supplies the air stream to either detector. Should the wrong door be loaded, or the correct door inserted upside down, the air stream at the detector selected will be interrupted and no further sequence can take place. Correct loading, however, allows the air stream to pass through a  $\frac{1}{4}$ -in. diameter hole in the door and actuate a simple logic circuit; this uses Maxalog turbulence amplifiers and operates a step-up relay which passes a high-pressure signal to initiate the clamping and punching sequence.

#### Pick-up/Transfer System

Finally, fluidic systems are now helping to produce fluidic systems at the Corning Glass Works in America (67). Three pallet-transfer devices, using vacuum pick-ups, are being controlled on demand from two kilns that are used in the manufacture of solid-state fluidic components.

One pallet transfer is located at the charge end of the heat-treatment kilns (see Fig. 5), the other two being at the

discharge ends of the kilns. At the charge end, the fluidic system consists of 28 standard devices (OR/NOR gates, flip-flops and a binary counter), and it instructs the pallet transfer when to pick up a ceramic pallet from a conveyor belt and to which kiln it should be delivered.

Sheets of photosensitive glass, which are used to make fluidic components, are then placed on the pallet by an operator; as the pallet moves through the kiln, the kiln's heat develops latent images of fluid channels in the glass, the developed images later being etched away to form channels, ports and chambers for fluidic elements. The control system is powered by compressed and filtered plant air, the power nozzles of the fluidic devices being supplied from one manifold of regulated air.

The sequential steps in the operation are triggered by three-way limit valves, which are connected to the fluidic-control circuitry by plastic tubing. If both kilns call for a pallet at approximately the same time, the transfer will respond to the kiln that called first; it will then return to the pallet conveyor belt, pick up another pallet, deposit it at the second kiln, and then return to the pallet conveyor belt.

The circuitry controlling the two pallet transfers at the discharge ends consists of 12 standard fluidic devices, two transfers being used because the kilns are of different lengths. This circuitry (similar but simpler than that at the charge ends of the kilns) is also activated by limit switches, but in this case the pick-up cylinders are controlled through a resistance-capacitance feedback.

For further information of specific items, circle the appropriate numbers



# APPLICATIONS & TECHNIQUES

## C.C.T.V. for Tunnel-Traffic Control

The Mersey tunnel closed-circuit television scheme—the largest for traffic control outside North America—has now become fully operational. Supplied and installed by EMI Electronics, the system enables trained police observers to keep a constant watch on the flow of traffic through the tunnel and into each of its four entrances, through which nearly 18 million vehicles passed last year.

With such a volume of traffic, any interruption in the flow through the tunnel (some ten breakdowns occur each day) results in serious disruption of the metropolitan traffic; the c.c.t.v. system will help the police to keep the traffic moving in several ways. First, accidents and breakdowns can be rapidly detected and a rescue vehicle despatched by radio immediately; secondly, congestion in the tunnel can be dealt with by notifying patrolling police, who can then take control of the situation on the spot; and thirdly, congestion at the entrances can be anticipated and a more flexible use of a tidal-flow system exercised on special occasions.

In the control room at the main Birkenhead entrance (see picture), the controller continuously monitors 14 television screens and has remote switching facilities to different cameras at the main entrances. He is in radio or direct-line telephone contact with the emergency

*18 EMI type-6 mini cameras are linked to the control room by over 45 miles of cable; ten of these cameras are sited unobtrusively at strategic points throughout the tunnel, the remaining eight being enclosed in weatherproof housings for viewing the approach roads*



services, police patrol cars, all entrances and the local police forces.

## Glass/Semiconductor Bonding

A new process that permits the hermetic bonding of inorganic insulating materials to various metals and semiconductor materials has been developed by P. R. Mallory & Co. Inc., Indianapolis. It could change present circuitry-packaging concepts for microelectronic devices by eliminating much of the hardware now needed to interconnect, package and encapsulate them.

Using the process, glass insulators could be bonded to such semiconductor materials as silicon, germanium and gallium arsenide, without affecting their electrical characteristics; active elements could thus be mounted and interconnected directly on a glass substrate, thereby eliminating many of the wiring and packaging steps that cause failure in conventional electronic circuitry. Potential applications of the process include a modified flip-chip approach to interconnecting, mounting and encapsulating silicon monolithic circuits in a single step, and hermetically sealing film circuits.

## Computer Analysis of Production Costs

English Electric-Leo-Marconi's Kidsgrove bureau is to be used to evaluate the production costs of all individual types of floor tiles manufactured by Daniel Platt and Sons. This is thought to be the first move in the industry to integrate detailed piece costs with financial accounts.

In addition to the production costs evaluation, the computer will automatically produce once every three weeks an evaluation of finished stock and work in progress together with an analysis of sales.

The manufacturing costs of each item, taking into account all factors such as labour, raw materials and equipment depreciation, will be evaluated and correlated with trading figures to determine the profit and loss on each item. The figures produced will provide an accurate basis on which to determine prices. They will also enable the manufacture of unprofitable product types to be controlled or discontinued before large stocks can accumulate and will allow a greater check on manufacturing expenses to be maintained.

The computer input data will be prepared by Daniel Platt and Sons on punched cards and the results of the computer analysis will be available within 24 hours.

## T.V. Monitor for Cine Cameras

An electronic system developed by Livingston Laboratories is providing cine film makers with television monitoring facilities in addition to normal optical viewfinding. Known as 'Add-a-Vision', it consists of a compact electronic conversion pack that is fitted to the side of the camera (see picture) to give the cameraman a



The Add-a-Vision is here shown mounted on a Mitchell BNC 35-mm camera. The picture on the 7-in. electronic viewfinder is repeated on the large screen monitor above the control console

picture of the actual shot he is taking when he is taking it.

Besides the camera attachment, a remote large-screen monitor enables other personnel to view the filming as it progresses; with a video tape recorder incorporated into the system, instant play-back is possible, thus eliminating delays in waiting for the film processing to be completed.

For further information circle No. 70

### Microfilm Documentation System

The exchange of technical drawings between the manufacturing centres of the Hoover organization in the U.K. and the U.S.A. is now being achieved by a 'Filmsort' microfilm aperture-card system supplied by the 3M Company.

On average, nearly 10,500 drawings of new products and developments are exchanged each year between the two centres and, in addition, there is an international demand for copies from Hoover's archives of 60,000 drawings. Such a large-scale exchange of drawings was causing mounting problems of storage, handling and transmission, but with the new system storage costs have been cut by as much as 75% and the savings in materials, handling and postal costs have been estimated at £1,500 p.a.

Each of the two centres has been equipped with a processor camera, copier and reader-printer. In 40 sec, the camera produces from drawings up to 30 x 40 in. in area complete microfilm aperture cards, from which the copier makes low-cost copy cards at the rate of 250 per hour; the reader-printer is then used to make 18 x 24 in. or 18 x 12 in. prints from the copy cards in 20 sec. The microfilming at the U.K. centre is linked through a data-processing system to an existing computerized documentation system, and this enables the copy-card files to be indexed quickly and accurately.

For further information circle No. 71

### Oil Consumption Measured by Nuclear Method

A nuclear technique developed by General Motors' research division is being used at the Buick plant in Michigan, U.S.A., to test the oil consumption of motor-car engines.

The new method enables engines to be tested before they are installed in the cars and the test can be completed within two hours of the engine leaving the production line. This was formerly impossible and allows defects causing excessive oil consumption to be detected and corrected before the cars are put on the road.

In this method, a small quantity of bromine-82, a radio-active substance, is added to engine oil which is then used to fill the engine under test. The engine is run for a certain period and the exhaust gases are collected. An analysis of the radioactivity of the gases gives a measure of the amount of bromine-82 present in the exhaust and enables the amount of oil consumed to be estimated.

One engine out of a batch is tested (it is planned to test one per cent of the total engine production) and if the tested engine shows excessive oil consumption the complete batch is inspected. Previous methods entailed running an engine on a dynamometer for several hours, or driving a finished car for a considerable mileage, and weighing the oil put into and drained from the sump before and after the test run. This took time and produced inaccurate results because of residual oil in the engine.

### Automatic Flame Cutting

Using two Messer Griesheim 'Statosec SK' automatic flame-cutting machines, a 25% increase in productivity and a reduction in scrap-metal wastage from 18 to 8% have been achieved by Thomas Smith and Sons at their

*The 'Statosec SK' can cut steel plate up to 10 in. thick, or up to 4 ft thick with a special torch; it will operate on acetylene, town gas or propane*

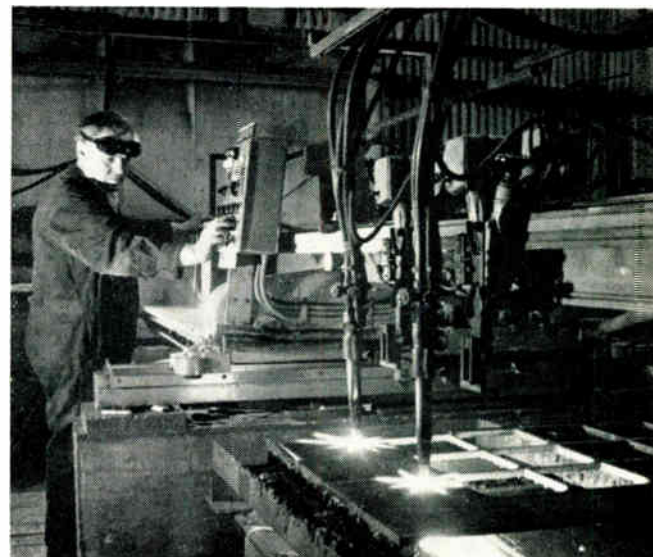



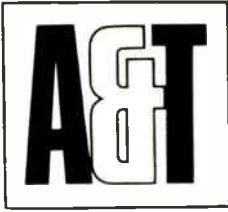

Rodley crane/excavator works. Each machine is operated by a photoelectric tracer head which follows a line drawing or template contour at any selected cutting speed up to 30 in. per min. An electric component analyser then transmits separate commands for the X and Y coordinates, and these are fed to the drive motors for both longitudinal and transverse motions, being amplified by a modulation system.

The speeds of the two drive motors are electronically governed by the component analyser in such a way that the cutting speed remains constant for all directions within the co-ordinate system. The motions of the cross carriage are transmitted directly (i.e., in the ratio 1:1) to the cutting torch, the machine's standard working length being 13 ft 2 in., but extendable by 6½ ft sections.

### XY Plotters in Hydraulics Research

The continuing modernization of harbours and ports, in order to keep pace with modern developments in shipping, cargo handling and dock-side industries, has led to an increasing need for hydraulics research. One organization that undertakes hydraulic-model studies and hydrographic surveys is George Wimpey and Co., at whose central laboratory Bryans series 2000 XY plotters are being extensively used.

One application of the equipment is in the making of estuary models, when it is set up to record tidal-level/tidal-time and tidal-velocity/tidal-time plots; if temperature distribution forms part of an investigation, additional plots of tidal-temperature/tidal-time can be made. Also, in harbour models (see picture), records of wave heights obtained inside and outside the harbour can provide a method of comparison that enables engineers to assess the effectiveness of various harbour layouts. In two-dimensional artificial-channel studies, the plotter can also be used to establish the

*Here, the XY plotter is being used to record tidal flow on a model harbour in a laboratory. The plotter can record on transparent sheets, from which direct prints can be made*

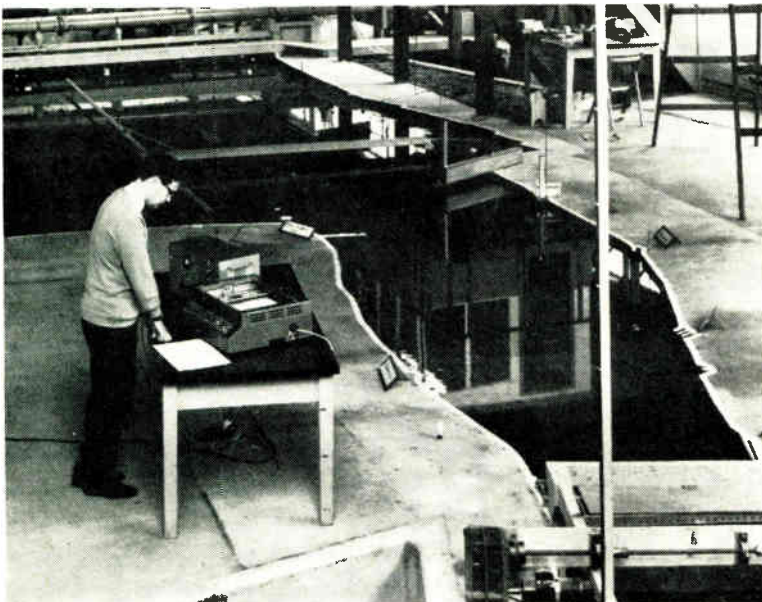

accuracy of the wave profile, while at the same time the existence of harmonics can be detected and their cause investigated.

**For further information circle No. 72**

### Electronic Stock Control

An electronic stock-control system has been installed at the new warehouse of Gallahers, the tobacco manufacturers. Designed by Lancashire Dynamo Electronic Products, it permits 85% of the available storage space to be used, in contrast to the 60-75% space utilization offered by other systems.

A central console equipped with a display system and a computer-type memory store is used to control ingoing and outgoing stock. Six fork-lift trucks are used to load and off load the storage racks and the operator at the central console communicates with the truck drivers by radio telephone.

With the use of thumbwheel switches, the operator can enter into the memory the type of product in each batch as it comes in, the lane and rack number into which that batch is loaded and the priority of the batch. Limit switches in the racks indicate to the system which racks are full or empty. When stock has to be taken out, the operator interrogates the memory and is able to instruct the truck drivers to take the batch from the rack which was the earliest to be filled with the required product. The system will also indicate the number of batches in stock and what is out of stock.

In this way any product can be stored anywhere in the warehouse; lanes of racks do not have to be allocated to one product type only as with former systems. The system also allows stock-taking to be performed in a third of the time that it took previously.

**For further information circle No. 73**

### Automatic Billet-Size Changing

A programmed automatic size-changing system has been installed by the English Electric Co. in the Rotherham continuous slab and billet mill of the Park Gate Iron and Steel Co. It is designed to set up roll gaps, mill-stand positions and rolling speeds in less than a third of the time required by manual change, without interrupting the rolling rate of the bloom mill that feeds the billet mill.

The new system is part of an integrated scheme that employs four E.E.L.M. computers, and utilizes a conventional computer-type core store to hold up to 100 programs for the mill set-up. When the selected program is scanned at high speed, the resulting set of position references is fed to a single time-shared digital position-control system, whose logic-circuit input and output gates are built from 'Norlog' static-switching elements. Each program involves 30 channels and controls, 18 of which cater for roll gap, stand shift and speed settings for the six stands; other channels feed mill displays, provide roll-wear compensation and give set-up information for the measuring roll, pinch roll and flying shear. The equipment will also accommodate the future expansion of the roughing train from two to four stands.



# The 'Raysistor'—A Photoelectric Switch and Variable Resistor

The 'Raysistor' (a trade name of the Raytheon Co.) consists of a photo-sensitive resistor and a light source, both of which are totally enclosed together in a single can. It is shown diagrammatically in Fig. 1.

The light source is either an incandescent-filament or an ionized-gas lamp. When a voltage is applied to the control (lamp) terminals to light the lamp, the incident illumination on the photo-resistor causes the resistor value to fall to a value determined by the intensity of the illumination. Typical values for low and high resistances are, respectively, 1 k $\Omega$  and 10 M $\Omega$  for the type CK1101, a gas-discharge light-source type, and 150  $\Omega$  and 1 M $\Omega$  for the type CK1103, a unit with an incandescent light source.

The Raysistor has several applications both as a switch and as a voltage-controlled variable resistor. Among its advantages when used as a switch are a long life, insensitivity to shock and vibration and freedom from contact bounce, jitter and deterioration. When used as a variable resistor it can introduce less noise than other circuitry or devices, provide isolation between a controlling voltage and a circuit being controlled and can simplify circuit design.

## A Low-Cost D.C. Regulator

An example of its use as a voltage-controlled variable resistor is shown in Fig. 2. This is a low-cost d.c. regulator incorporating a type CK1102 or CK1121 Raysistor, both of these being fast-acting filament-lamp types. A fast-acting Raysistor will respond quickly to variations in illumination

and to aid this the value of  $R_b$  is chosen so that sufficient filament current flows to keep the photo-resistor constantly illuminated. It then has to respond to variations about a mean illumination.

The action is as follows. The input voltage has a nominal value of 300 V and the output is stabilized at 100 V. If the input voltage should increase, the current through the valve and through  $R_i$  and  $R_x$  (the Raysistor resistance) will also increase. This will result in a higher grid potential for the valve as this is determined by the potential difference across  $R_x$ . A higher grid potential will further increase the current through the valve but the current through the Raysistor filament will also have increased. A higher intensity of illumination occurs thus reducing the value of  $R_x$ . The potential across  $R_x$  is reduced so that the grid potential falls to limit the valve current. As the valve current determines the output voltage, this will be kept at its required value.

Similarly, if the input should fall,  $R_x$  will increase to raise the valve current.

A mathematical analysis will show that the output impedance of the circuit for a fast-acting Raysistor tends towards  $1/g_m$  where  $g_m$  is the mutual conductance of the valve, a parameter unaffected by the input voltage.

A good regulation is achieved with an output of 100 V for an input variation of 200–400 V.

## Voltage-Controlled Oscillator

A further example of a Raysistor used as a variable resistor is the voltage-controlled variable oscillator shown

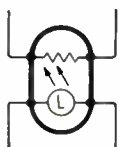

Fig. 1. The diagrammatical representation of a Raysistor is as shown here. The terminals connected to the lamp are known as the 'control' terminals while those connected to the photo-resistor are known as the 'signal' terminals

Fig. 2. This low-cost d.c. regulator is one example of the use of the Raysistor as a variable resistor

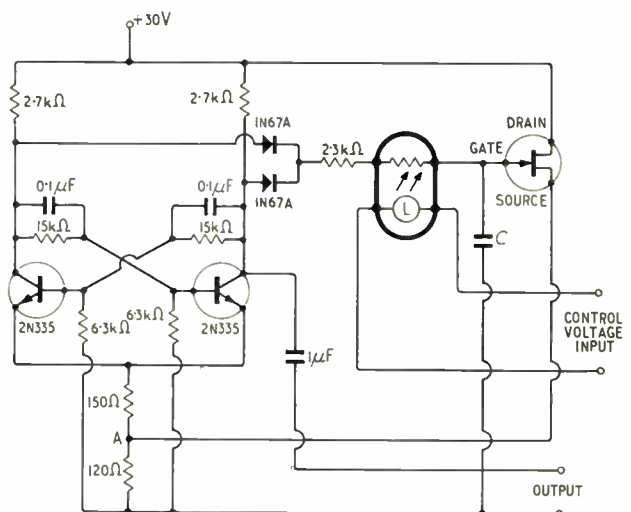
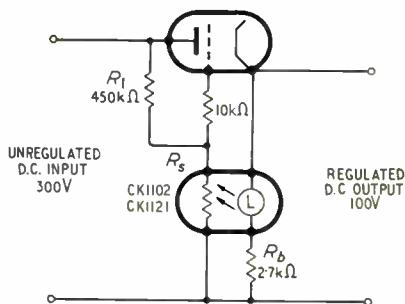

Fig. 3. Using a Raysistor with an incandescent-filament lamp, this voltage-controlled variable oscillator circuit also employs the variable-resistor mode of Raysistor action

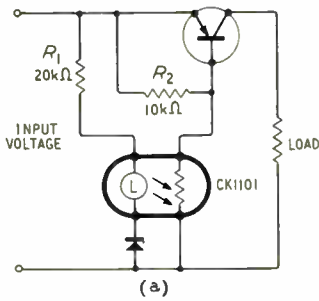

Fig. 4. (a) A gas-discharge light-source Raysistor is used as a switch in the under-voltage protection circuit depicted in this diagram

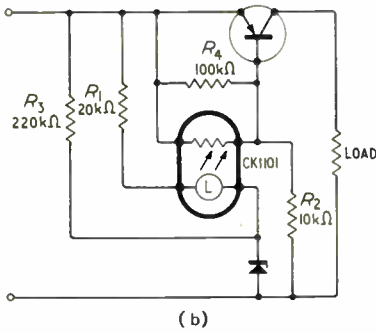

Fig. 4. (b) This over-voltage protection circuit uses a similar Raysistor to the one in the under-voltage circuit

in Fig. 3. In this circuit a bistable multivibrator is triggered by an n-channel field-effect transistor (f.e.t.).

In the n-channel f.e.t., current will pass from the drain to the source if the gate-to-source voltage,  $V_{gs}$ , is negative. As  $V_{gs}$  becomes less negative the drain-to-source current increases, and when  $V_{gs}$  becomes positive the gate-to-channel junction becomes forward-biased so that gate current flows.

In the circuit of Fig. 3, with one of the transistors of the multivibrator conducting, the capacitor  $C$  charges up. Initially the gate potential is lower than the source potential which is the potential at point A. As  $C$  charges up, the drain-to-source current will increase because of the increased voltage at the gate. The potential at point A will therefore rise until it is at such a value as to cut off the conducting transistor. When the voltage across  $C$  exceeds that at point A, gate current will flow to discharge  $C$ . The other transistor will now conduct and the action will be repeated.

The frequency is determined by the charging time-constant for  $C$ . The Raysistor resistance forms part of the charging circuit so that variation of the illumination will produce a variation in frequency. Using a type CK1103 Raysistor and a value for  $C$  of  $0.1 \mu\text{F}$ , a frequency variation of approximately 50–500 c/s can be obtained for a control voltage variation of about 0.3–0.8 V. A good linearity of frequency control is obtained and remote control is simplified because the control voltage is isolated from the oscillator circuit.

#### Under-Voltage Protection Circuit

The two previous circuits use an incandescent-filament lamp type of Raysistor. The next circuit, an under-voltage protection device, uses a gas-discharge light-source Raysistor, type CK1101. The circuit is shown in Fig. 4 (a).

When the voltage applied to the circuit is at the required level, the Raysistor lamp fires and the illumination keeps the Raysistor resistance to below  $1 \text{ k}\Omega$ . This resistance determines the bias on the base of the transistor and in this condition it is driven to saturation so that full current flows through the transistor to the load. If the supply voltage should fall below a level determined by the zener diode, the lamp is extinguished. The Raysistor resistance rises to a value greater than  $1 \text{ M}\Omega$  causing the transistor to be cut off so that no current flows through the transistor and load.

The load of this circuit could be a relay and one possible application is the provision of continuous operation for a unit or equipment in the event of a mains supply failure. The input could be taken from a power supply output and, should this output fall, the relay would switch in an auxiliary supply. Another use is with vacuum tubes, such as the klystron, where it is necessary to ensure that the reflector-plate voltage is at a certain level before the accelerator-grid voltage is applied.

An over-voltage protection circuit working on a similar principle is shown in Fig. 4 (b).

The Raysistor has several other applications and can be used in other ways. An example of this is its use as a chopper for producing a.c. from d.c. If the lamp filament is driven by an a.c. signal an a.c. voltage output can be obtained with a d.c. voltage applied to the Raysistor resistor. Raytheon produce a full range of Raysistors suitable for various applications and an application brochure giving various circuits can be obtained.

For further information circle No. 74

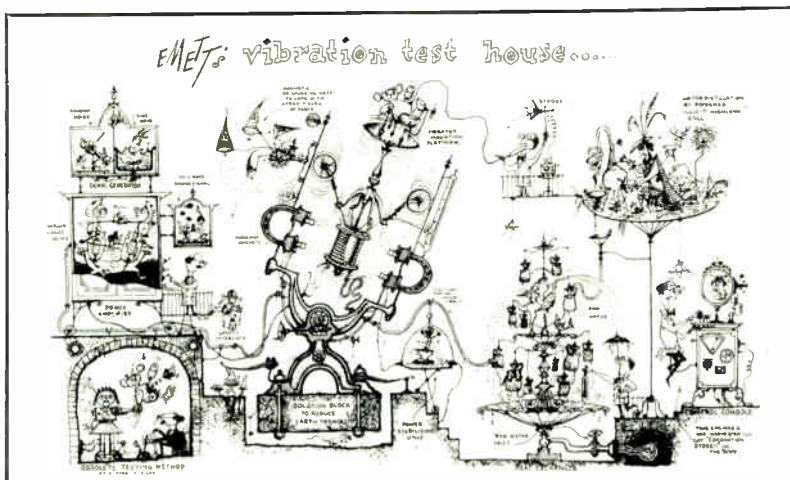

## Emett Goes Environmental for Industrial Electronics

Next month's issue of INDUSTRIAL ELECTRONICS features an exclusive design of remarkable engineering ingenuity by the distinguished artist Roland Emett. His inimitable interpretation of a vibration test house will appear in colour in a special two-page pull-out section, a small black and white reproduction of which is shown here.

# hothead



**...but he plays it cool!**

He's hot on connectors — multi-way low insertion force units, printed circuit edge, miniature screened, R.F., or high voltage types. And he gets all steamed-up when it comes to semiconductors; whether you are talking about high frequency transistors, integrated circuits, diodes, or anything else in the range.

Neither does he cool off when you switch him on to axial fans. But most of all he is a pretty cool customer when the subject of customer relationship is mentioned — he reckons he is the hottest of them all when it comes to this. He is right. That's why he's a Celdis Technical Sales Engineer. Get on the hot line and give him a call now.

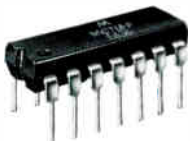

**SEMICONDUCTORS**

Digital I/C's—MECL MDTL MRTL MTTL in T.O. 5 & D.I.P. Linear I/C's — Operational, Differential & Sense Amplifiers. Transistors — Low-level to power (Ge & Si) including "Plastics" & F.E.T.'s Diodes—Rectifiers, Bridges, Zeners, Reference & Varacators

Motorola Semiconductor Products Inc.

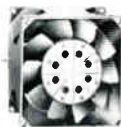

**FANS**

Range—3½" x 6" dia. C.F.M.—50 to 260 Supply —110 or 230V, 50 or 60 c/s. Constant speed, quiet in operation · Die-cast, warp free castings. High reliability—20,000 hrs without maintenance

Papst Motoren K. G.



**CONNECTORS**

Printed Circuit Connectors, Multipole Units · Multipole Coaxials · Low Insertion Units · Coaxial and Multipole Hybrids · Specials Service available.

S.O.G.I.E.



**R. F. CONNECTORS**

Matched impedance design. Heavy Gold plate for minimum resistance · Captive contacts · "Screw-on" · "Snap-on" mating engagements in both 50 and 75 Ω impedance.

Sealectro Limited



**HIGH VOLTAGE CONNECTORS**

Voltage—D.C. 70KV and 31KV A.C. 23KV and 15KV (r.m.s.) Insulation Res— > 10<sup>6</sup> M Ω Contact Res— < 2 x 10<sup>-3</sup> Ω Cable Pull-out — 220lbs and 110lbs respectively.

Constructions Electriques Jupiter



# CELDIS

**CELDIS LIMITED**

43/45 Milford Road, Reading, Berks. Tel: Reading 56256. Telex: 84370.

**For further information circle No. 232**





## Vosper static control components are designed to resist hot, humid, damp conditions

Somewhere in almost every power and control circuit there are extreme conditions that test ordinary electro-mechanical components to breakdown point. That's why Vosper have come up with a brand new range of static control switches and timers, *plus* servos. Encapsulated, they work with uninterrupted efficiency in any plane—resisting temperature extremes, vibration, humidity, dust and corrosion—because they have *no moving parts*. But they still give you versatility with multi-pole switching and flexible contact arrangement! So get the facts about this economic new concept in circuitry soon—and shut the damp, the heat, the *environment* out of your circuit with Vosper. *Vosper Electric—reliability in the extreme!*

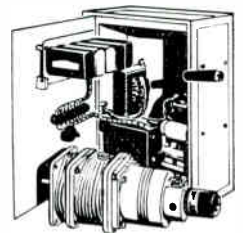

SERVO UNITS

# VOSPER ELECTRIC

INDUSTRIAL & MARINE CONTROLS DIVISION OF VOSPER LTD

STAND 23 OLYMPIA APRIL 25 — MAY 4  
INTERNATIONAL ENGINEERING EXHIBITION

Castle Trading Estate, Portchester, Fareham, Hampshire  
Telephone: Cosham 79481. Telex 86115.

VEC 1



A SUBSIDIARY OF THE DAVID BROWN CORPORATION LIMITED

For further information circle No. 233

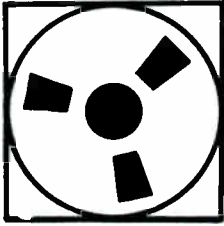

# NEW APPARATUS

ELECTRONICS COMMUNICATIONS INSTRUMENTATION CONTROL

## 1. Plastic 'Write-On' Sellotape

To provide a more suitable tape for a wider range of applications, Sellotape have now introduced a vinyl 'write-on' tape and labels. These ranges of waterproof tapes and labels now take the place of the former cellulose write-on tapes and labels, and have the advantages of better conformability, longer life, and resistance to abrasion and chemical corrosion. The plain, white surface is treated to make it accept legends written with pen, pencil or ball-point pen, and may be printed in four colours.

For further information circle No. 1

## 2. Computer-Peripheral Tester

An on-line tester has been announced by G.E.C. Computers and Automation that enables the peripheral devices of their S-range computers to be checked out while they are operating in real time; known as

the Model 7901 and to be available in mid-1967, it allows tests to be carried out without interrupting important programs and can detect and isolate interface problems. The equipment can also operate off-line for testing such elements as one-shots, Schmitt triggers, skew gates and photocells, and it will check such logical operations as parity generation, code conversion and error detection. Tests are arranged so that each portion of a peripheral device's operating cycle is under separate control, and if a problem is suspected at the interface between a peripheral device and its controller, the unit can be used to simulate the device and thus locate the fault in the controller.

For further information circle No. 2

## 3. Vehicle Detector

A compact solid-state system for detecting stationary or moving vehicles has been announced by RCA Great Britain Ltd. Their Ve-det

model can detect vehicles ranging in size from bicycles to articulated lorries, and is at present being used in the West London traffic experiment. The method of detection is based on the phase characteristic of a parallel resonant circuit, comprising the inductance of a wire loop set in the road and the tuning capacitor of the Ve-det; tuning is carried out at the time of installation and takes less than one minute. By driving the tuned circuit with an r.f. current that is constant in amplitude and phase, the voltage across the LC combination reflects the change in inductance of the loop as a vehicle enters it; the detector then uses this phase change to de-energize a relay in the sensor unit.

For further information circle No. 3

## 4. Gas Liquefier

The Hymatic Engineering Co. have introduced a miniature gas liquefier—the MAC216 minicooler—which is

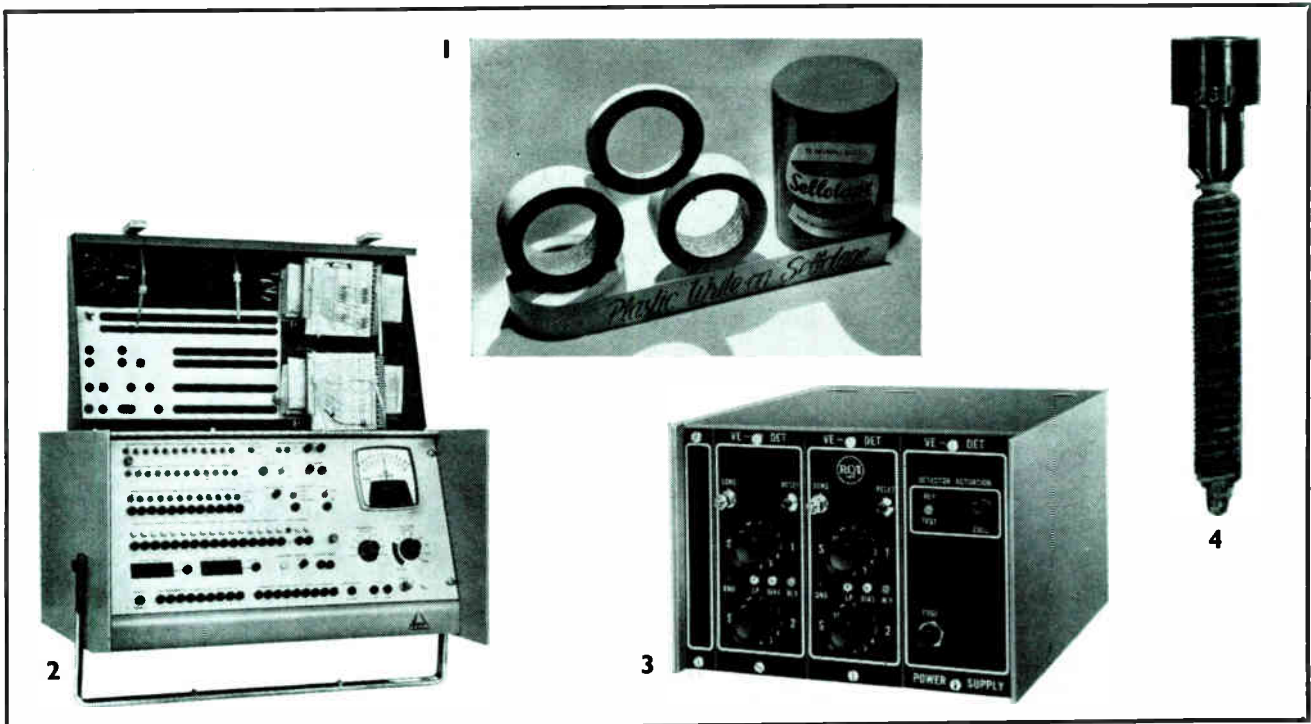



## ELECTRONICS

suitable for use in infra-red detector cells that are mounted on delicately-balanced mechanisms where minimal weight is of particular importance. Weighing less than 2 oz it measures 4.5 mm diameter by 47 mm long, although its dimensions can be varied to suit particular installations; utilizing the Joule-Thomson cooling effect and a counterflow heat exchanger, it will operate over an ambient temperature range of  $-40$  to  $+80$  °C, providing constant cryogenic temperatures from 200 to 77 °K and supplying up to 5 W of useful cooling.

For further information circle No. 4

### 5. Ultrasonic Wire Bonder

An ultrasonic wire bonder for use in the production of integrated circuits and transistors has been announced by the Vacwell Engineering Co. Its magazine facility allows each work-piece to be moved in two axes and rotated through 360° when under the bonding head, thus enabling completion rates in excess of 1,600 bonds per hr to be achieved. All normal device packages can be dealt with, including dual-in-line flat packs and TO5-type multi-lead headers; substrates of shapes and sizes to customers' specifications can also be accommodated. Aluminium or gold wires can be bonded to contacts of the same materials on silicon or silica bases, the wire feed and cut-off system being completely automatic and handling wires ranging from 10 to 75 microns in diameter. A fixed-magnification stereo microscope is also included with the bonder.

For further information circle No. 5

### 6. Ferrite-Core Memory Store

A.P.T. Electronic Industries have added to their 'Digitac' range of logic cards a ferrite-core memory store that is intended for applications in small computers, digital-data recorders and paper and magnetic-tape systems. The store module comprises a  $32 \times 32$ -bit matrix, address decoders, a read/write drive circuit and a sense amplifier, all mounted on a single printed-circuit card measuring  $11 \times 11\frac{1}{2} \times 5\frac{1}{8}$  in. Its input and output are controlled by selecting two 5-bit address codes, after which a read pulse is applied, followed by a short strobe pulse; the output (a 250-nsec logic pulse) then appears coincident with the strobe pulse and the sense amplifier output, the cycle time being 4-nsec minimum.

For further information circle No. 6

### 7. F.M. Telemetry

A frequency-modulated telemetry system which provides simultaneous monitoring of two parameters has been produced by Scientific Systems Ltd. It has been approved by the G.P.O. for use over private lines. The principle of operation is that two carrier signals of widely different frequencies are frequency modulated, one by a signal representing one parameter, and the other by a signal representing the other parameter. The higher carrier frequency is then amplitude modulated by the lower frequency at a fixed depth of modulation. The resultant modulated waveform can be transmitted over long distances without being affected by d.c. interference. The demodulated signals can be fed to meters and recorders.

For further information circle No. 7

### 8. S.H.F. Signal Generators

Rohde and Schwartz have replaced the s.h.f. (super high frequency) signal generators in the SMCK series with the types SMA1 (illustrated), SMBI and SMCI, all of which are available from Aveley Electric. The frequency range covered by each type is 0.5-1.8 Gc/s for the SMA1, 1.7-5 Gc/s for the SMBI and 4.8-12.6 Gc/s for the SMCI. A high frequency stability is featured and the digital readout of frequency is accurate to  $\pm 0.5\%$ . The frequency range of each unit is covered in one range without band-switching. Internal and external modulation can be applied and a variable attenuator, accurate to  $\pm 1.5\%$ , allows sensitivity and attenuation measurements to be made down to  $-130$  dBm.

For further information circle No. 8

### 9. A-to-D and D-to-A Converters

Analogue-to-digital and digital-to-analogue converters suitable for operation under severe environmental conditions are available from Epsilon Industries. The analogue-to-digital converter accepts input voltages between 0 and +6 V and produces a parallel 10-bit binary output. With a resolution of 1 part in 1,024 and an accuracy of  $\pm 0.1\%$  of full scale  $\pm$  half the least

significant digit, the unit has a maximum conversion rate of 10 kc/s. The digital-to-analogue converter accepts a pure binary parallel input with a 10-bit word length and produces an output between 0 and +5 V.

For further information circle No. 9

### 10. Shaft-Encoders

Vactric Control Equipment have introduced into the U.K. two further Norden size-23 shaft encoders produced by the United Aircraft Corp. of the U.S.A. One of these is a 360 counts-per-turn unit while the other is a 3,600-count 10-turn unit. Both encoders normally include micro-electronic driver circuits and output gates, but can also be supplied without the electronic circuits if desired. The encoders provide a non-ambiguous parallel binary-coded-decimal output with a range of 000-359 for the single-turn unit, and 0000 to 3599 for the multiturn unit. The logical levels at the output terminals of the encoders are +5 V for logical '1' and 0 V for logical '0'.

For further information circle No. 10

### 11. Signal Characterizer

Foxboro-Yoxall have announced a signal characterizer, the model 66N, which will accept a 10-50 mA input and produce a 10-50 mA d.c. output which is a non-linear function of the input. Screwdriver adjustments on the front panel allow eight different values of slope (i.e., rate of change of output for change of input) to be set at eight different values of input. This enables the output to be matched to complex curves. It is suitable for use in measurement and control systems where the transducers or other electronic stages have logarithmic or other non-linear laws.

For further information circle No. 11

### 12. Power Supply

The type 3-142-2 isolated mains power supply introduced by Consolidated Electrodynamics has been designed to provide a stable 10-V output to instrumentation systems with complete freedom from problems of earth loops and common mode voltages. The maximum output current of 320 mA at 10 V allows, for example, the excitation of 10 350- $\Omega$  strain-gauge transducers connected in parallel. The output voltage change is less than 0.2% for mains voltage changes from 200 to 260 V, or 100 to 130 V. An



# NEW

ELECTRONICS  
COMMUNICATIONS  
INSTRUMENTATION  
CONTROL

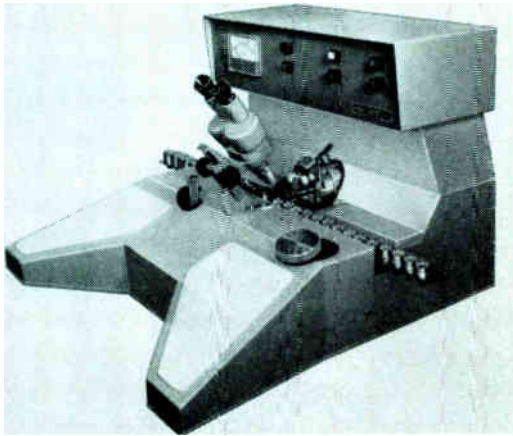

5

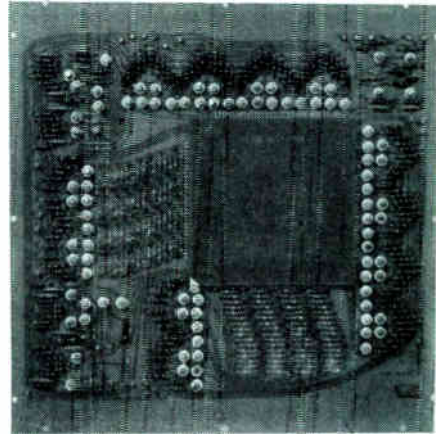

6

7

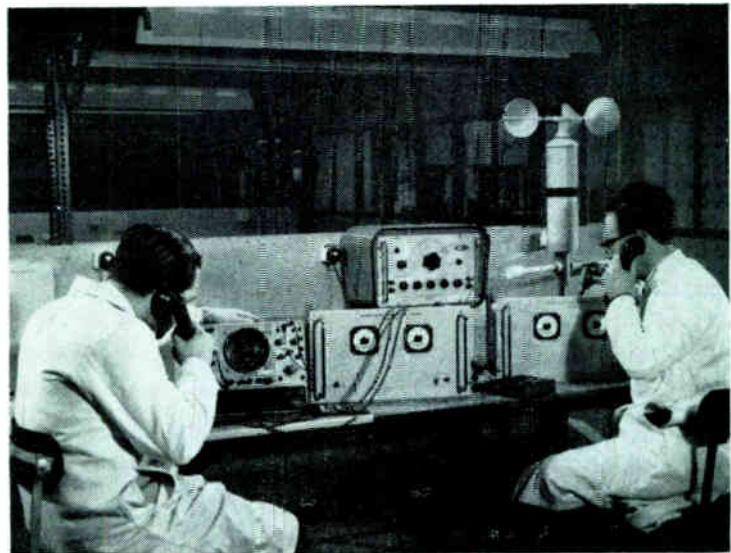

8

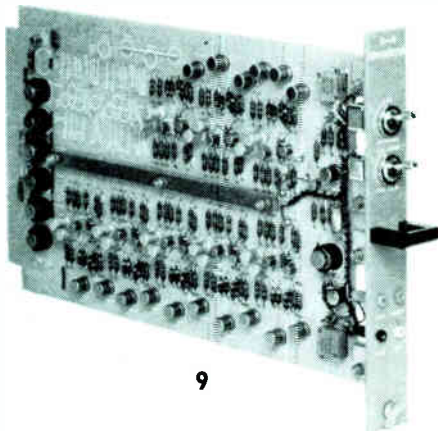

9

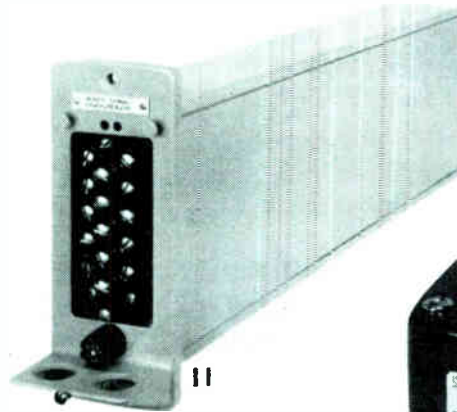

11



10



12



13



14

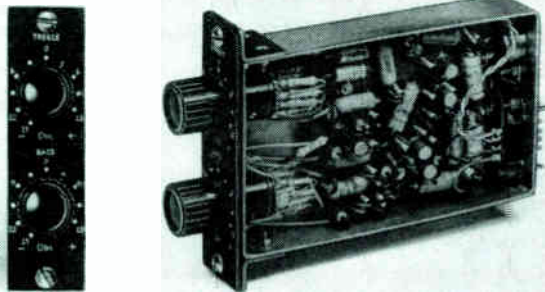

15

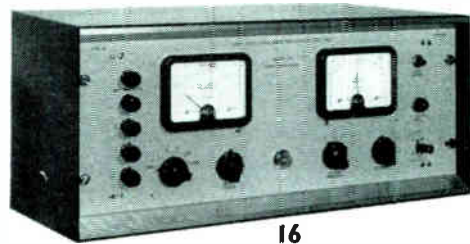

16

alternative version is available for output currents in the range 0–32 mA. For further information circle No. 12

### 13. Battery Charger

Specially designed for nickel-cadmium cells and batteries, the 'Volta-bloc CC' is a constant-current charger recently introduced by Cadmium Nickel Batteries Ltd. It is a compact and portable unit capable of charging up to 20 cells in series simultaneously. Three fully-transistorized models are available, with respective output ranges of 10–20 mA, 10–750 mA and 100 mA to 1 A. Each can be connected to an input of 90–130 V or 200–250 V, 50 or 60 c/s. The output is constant irrespective of input or load variations. A warning light illuminates if cells are wrongly connected to the charger or if there is a short circuit.

For further information circle No. 13

### 14. Data Processor

Control Data have introduced the 3150 data-processing system. Suitable for use in business, scientific and engineering applications, it can

be programmed in several of the common computer languages. Time sharing between two tasks is possible and the basic equipment can be expanded and modified as computing requirements alter. The basic processor includes a 16,000-word memory, disc storage, a card reader, a line printer and an input/output typewriter. Optionally available are an additional memory capacity and various other peripheral devices.

For further information circle No. 14

## COMMUNICATIONS

### 15. Audio Tone Unit

Elcom (Northampton) Ltd. have added the type EP 51 tone control unit to their range of audio modules. This tone control unit can be incorporated into almost any part of an audio circuit and gives a +12 to –15-dB range of tone compensation in both bass and treble functions. The circuit has been designed with a built-in transistorized amplifier to

give it a unity gain. It is constructed as a single channel unit with two rotary-switch type controls marked in 3 dB steps.

For further information circle No. 15

### 16. Cable Testing

A loop and unbalance resistance test meter has been designed by the Post Office and is being manufactured by Microtest Ltd. It allows unbalance between wires to be read directly off a meter and loop resistance to be measured by means of an external standard decade resistor. It consists, basically, of a Wheatstone bridge and a transistor chopper-type amplifier which feeds a centre-zero detector. A trigger circuit is incorporated and can be adjusted to operate if a pre-determined unbalance limit is exceeded. A manual reset facility and a detector short-circuit key having locking and non-locking positions are provided.

For further information circle No. 16

### 17. Telegraph Test Equipment

Plessey Automation have developed a distortion measuring unit, the



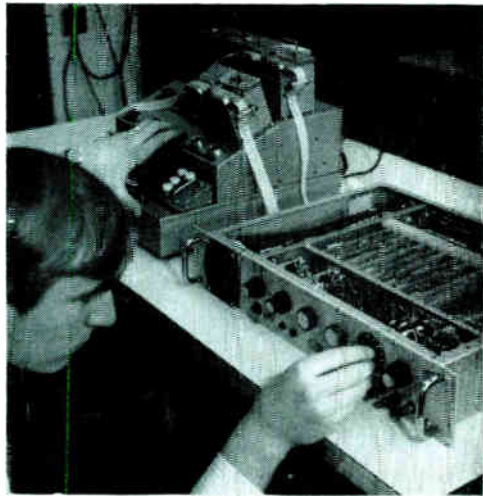

17

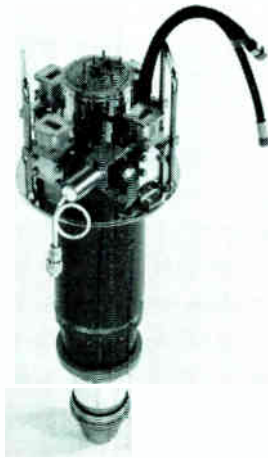

18

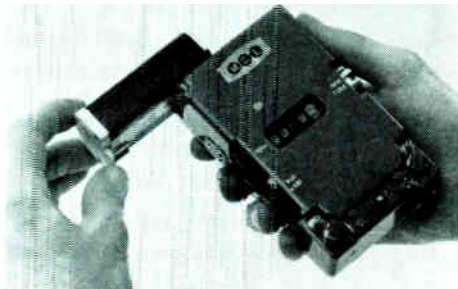

19

**NEW**

**ELECTRONICS  
COMMUNICATIONS  
INSTRUMENTATION  
CONTROL**



20

TDMS 70, and a telegraph signal generator, the TSG 10, for use in the testing of telegraph equipment. The TDMS 70 enables radio and line telegraph circuits and associated equipment to be tested in circuit without interruption to traffic. It is illustrated undergoing a test. Continuous coverage of telegraph speeds from 30-330 bauds is provided. The TSG 10 provides pulsed outputs at fixed speeds of 45.5, 50 or 75 bauds, 7-, 7½- or 8-unit code generation and continuous mark or continuous space outputs. It also generates a 100-character coded test message and enables variable degrees of distortion to be added to the output.

For further information circle No. 17

### 18. Travelling-Wave Tubes

The English Electric Valve Co. has developed two further travelling-wave tubes, the types N1061 and N1062. The N1061 (illustrated) is a broad-band pulsed t.w.t. intended for radar applications. Capable of peak output powers up to 1,000 kW, it has a gain at saturation of 25-35 dB and a duty cycle of 0.005. It can be supplied to work at various X-band frequencies.

The N1062 is a continuous-wave amplifier capable of a 3-5-kW output. Two associated tubes, the N1063 and N1064, are identical to the N1062 in all but operating frequency and the three tubes together cover the frequency range of 8.5-10 Gc/s.

For further information circle No. 18

### 19. Pocket Communications Receiver

Integrated and thin film circuits have enabled The M.E.L. Equipment Co. to produce a pocket-sized communications receiver measuring only  $6 \times 3\frac{1}{2} \times 1\frac{1}{2}$  in. This has a double superheterodyne circuit and covers the frequency range of 40 kc/s to 30 Mc/s, a digital readout displaying the tuned frequency. Although it is intended primarily for a.m. and c.w. reception, its stability is sufficient for s.s.b. working. Crystal control of the local oscillator maintains stability and a crystal-controlled b.f.o., which can be used for calibration as well as for the normal b.f.o. function, is included. It is powered by two easily-replaced mercury cells or by an external 9-V battery.

For further information circle No. 19

### 20. Telephone 'Scrambler'

A message-coding unit, or 'scrambler', for use with normal telephones has been developed by Hewlett-Packard. It provides telephone users with privacy of conversations and guards against telephone tapping. The battery-operated transistorized unit is held with the telephone handset in the manner shown in the illustration. No connection to the telephone is required. It receives the user's voice and distorts it to a special code before transmitting it to the mouthpiece of the telephone. The conversation can then be understood only by a person using an identically-coded scrambler which reconstitutes the message to an intelligible form.

For further information circle No. 20

### 21. Portable Public-Address System

A portable public-address system which can be used in lecture halls and similar locations where there is no permanent public-address installation is under production by Lustraphone. It is known as the 'Pelsa' and consists of a desk-type cabinet



housing a 3-W transistorized amplifier, a conveniently-positioned volume control and a loudspeaker. A ribbon microphone on a flexible positioning tube is available for use with the unit and in place of this a portable microphone or a radio-microphone receiver unit can be connected. Completely self-contained with a built-in power supply, the unit requires no external wiring or connections.

For further information circle No. 21

## 22. Broadcast Transmitter

Marconi have developed a 10-kW broadcast transmitter which has been tropicalized for use in extremes of temperature and humidity. The use of solid-state circuitry with the exception of a final output tetrode provides good reliability and stability and renders the equipment more compact than other comparable transmitters. Operation has been simplified and only three front-panel controls are used. Remote control

is also possible. Automatic limitation of the modulation depth to just over 100% for excessive audio input powers is featured as well as automatic isolation of the high-tension supplies in the event of a fault.

For further information circle No. 22

# INSTRUMENTATION

## 23. F.E.T. and M.O.S.T. Tester

The field-effect transistor tester manufactured by Comark Electronics is a battery-powered portable instrument for measuring the static and dynamic characteristics of field-effect transistors (f.e.t.s) and metal-oxide silicon transistors (m.o.s.t.s). It will measure drain current, pinch-off voltage and mutual conductance at various settings of drain and gate voltage or current. The drain and gate breakdown voltage may also be checked and the polarities of the drain and gate supplies are separately reversible. Overload protection has been built-in to reduce the risk of damage to the tester and tested component through misuse.

For further information circle No. 23

## 24. Timer Counter

The type TC7 timer counter has been added to the Advance Electronics range of digital instruments. This unit can measure frequencies from d.c. to 2 Mc/s, single periods of signals at frequencies from d.c. to 1 kc/s, and multiple periods of inputs at up to 100 kc/s. Random or regular pulses can be counted and, for time measurements, timing units of 10  $\mu$ sec, 1 msec and 100 msec can be selected. An internal crystal-controlled frequency standard of 100 kc/s has an accuracy of 1 part in  $10^5$  at room temperature and an external 1-Mc/s crystal-controlled standard can be used for an accuracy of 1 part in  $10^6$ .

For further information circle No. 24

## 25. Radioactivity Monitor

With the Nuclear Enterprises type NE 8423 environmental monitor, the radioactivity of iodine 131 can be measured even in the presence of strong gamma radiation from other iodine activities. It consists of a head unit and a transistorized control unit. The radiation detector in the head has a sensitivity which is sufficient

NEW

ELECTRONICS  
COMMUNICATIONS  
INSTRUMENTATION  
CONTROL

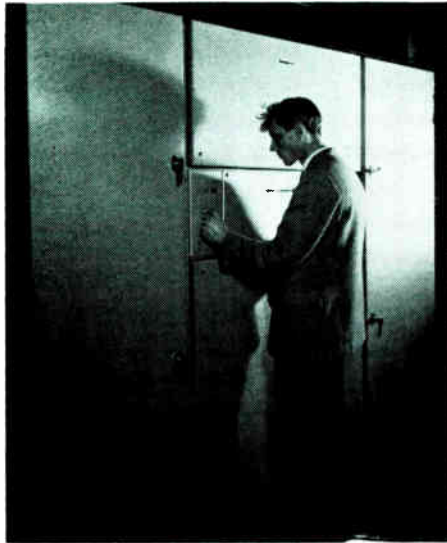

22

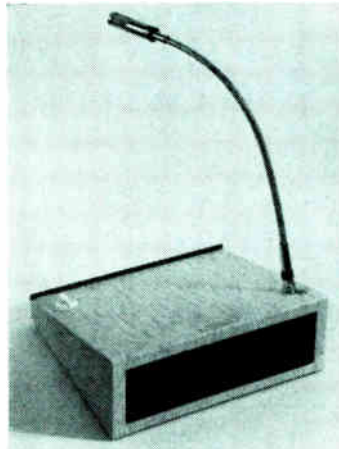

21



24



23

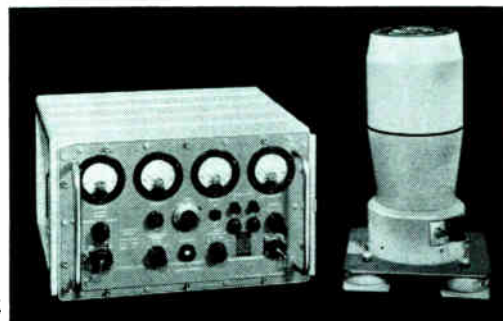

25



# it pays

## TO USE PICASTINGS

P.I. Castings case histories reveal savings often as high as 70% to 80% of the original manufacturing costs for small complex components in all grades of cast steel and many non-ferrous alloys.

Intricate design features are faithfully reproduced by this specialised investment casting technique to dimensional accuracies of  $\pm .005$  per inch or part of an inch. Qualified technical staff welcome the opportunity to advise at the design stage and to assist your value analysis investigations.



Send this coupon to:

**P.I. CASTINGS (ALTRINCHAM) LTD**

Specialist manufacturers of investment castings.

DAVENPORT LANE, ATLANTIC STREET, ALTRINCHAM

CHESHIRE Tel. ALTrincham 5811 Telex 66-105

NAME \_\_\_\_\_

ADDRESS \_\_\_\_\_

COMPANY \_\_\_\_\_

IE. 2

PI 26

For further information circle No. 234

# get a head start with

## PAPST FANS

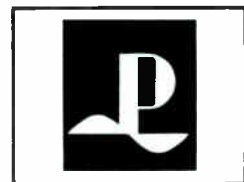
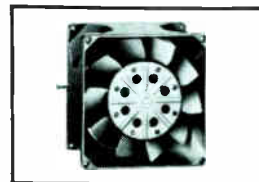

The expanding range of Papst Fans available from Celdis Limited include

Range	3½" x 6" dia.
C.F.M.	50 to 260
Supply	110 or 230V, 50 or 60 c/s
	Constant speed, quiet in operation
	Die-Cast, warp free castings
High reliability	20,000 hrs without maintenance

Write or telephone today,  
**Reading 56256**  
Celdis Technical Sales  
Division for complete  
information on Papst Fans.

# CELDIS

**CELDIS LIMITED**

43/45 Milford Road  
Reading, Berks  
Telex : 84370

C/P

For further information circle No. 235

EPSYLON TRANSISTORISED CLOSED CIRCUIT TELEVISION

# Vital tool for Industry

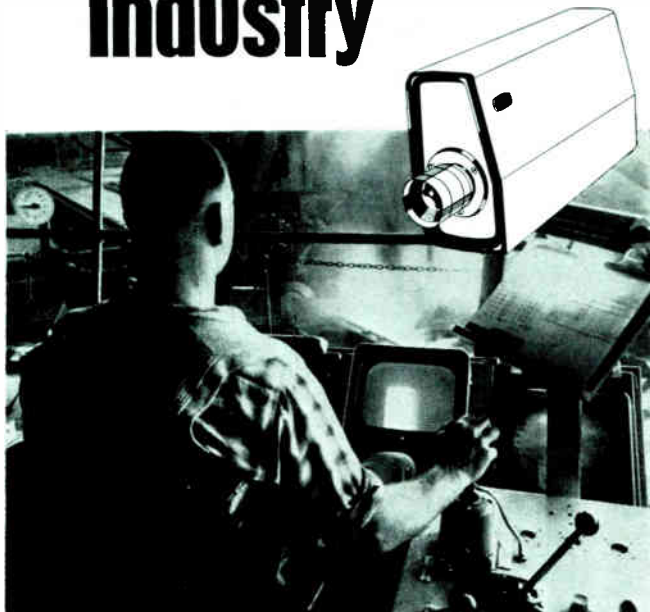

Transistorised industrial closed circuit television has proved a valuable and reliable link in the chain of production, especially where hazardous operations have to be observed and controlled remotely.

An Epsilon system will meet all your requirements efficiently and economically. It will comprise a camera, camera control unit, and one or more monitors, and can be left unattended to work 24 hours a day.

*Epsilon transistorised closed circuit television equipment offers:*

- HIGH DEFINITION AND CLARITY
- STABILITY OF PICTURE
- CAMERA TRANSISTORISED FOR RELIABILITY
- COMPACT, PORTABLE DESIGN
- RUGGED CONSTRUCTION
- LOW POWER CONSUMPTION

#### Users of EPSYLON systems include:

Rolls Royce Ltd.—Colvilles Ltd.—Ministry of Defence—Ministry of Aviation—National Coal Board—M.O.A., Woomera—N.W. Gas Board—G.P.O.—B.E.A. and B.O.A.C.—H.M. Dockyards.



A member of the Stone-Platt Group

## EPSYLON

INDUSTRIES LIMITED

Faggs Road, Feltham, Middlesex, England  
Telephone: FELtham 5091/5

For further information circle No. 236

# ADCOLA

ESTABLISHED 1919  
(Royal Trade Mark)

## SOLDERING EQUIPMENT

### SPECIALISING FOR THE SOLDERING JOINTING INDUSTRY

#### Illustrated

$\frac{3}{16}$ " BIT INSTRUMENT  
(LIST 64)  
IN  
PROTECTIVE SHIELD  
(LIST 700)

ALL VOLT RANGES  
FROM  
6/7 to 230/250V

BRITISH & FOREIGN PATS.  
& REG. DESIGNS, ETC.

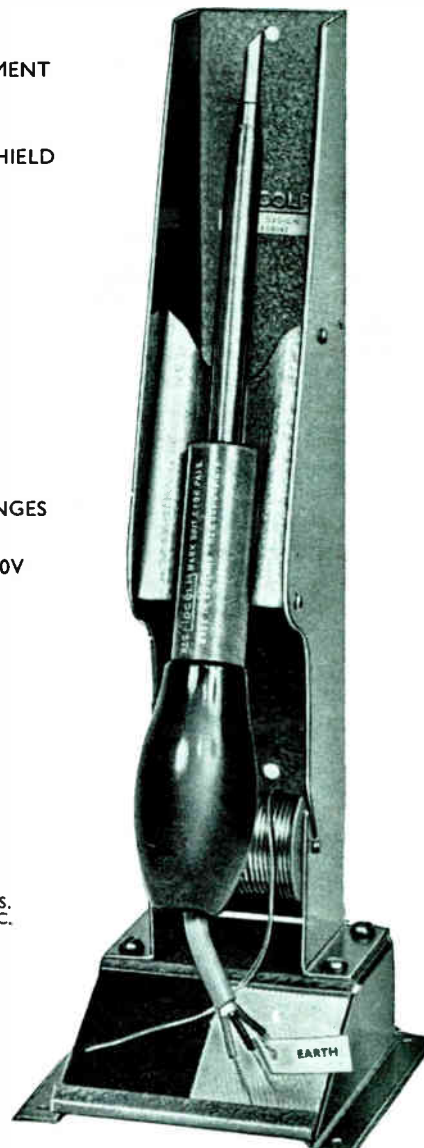

Apply Direct for Catalogues:

**ADCOLA PRODUCTS LTD.**

**ADCOLA HOUSE**

**GAUDEN ROAD**

**LONDON, S.W.4**

Telephones MACaulay 0291/3

Telegrams SOLJOINT LONDON S.W.4

For further information circle No. 237



for measurement in the range 0.007–0.65 microcuries of iodine-131 activity. This range corresponds to maximum permissible radiation levels in inhaled air. The monitor can also be used for industrial tracing, health physics and geological surveying.

For further information circle No. 25

### 26. Exposure Meter

A photographic exposure meter for measuring the light from an electronic flash unit has been developed by Bowens and is being manufactured by the Sifam Electrical Instrument Co. Using an industrial-type large-scale moving-coil meter as the indicating device, the unit measures the quantity of light falling on a subject from an electronic flash unit. It has a range of 50–5,000 joules for flash speeds from 0.5–20 msec. Exposure is indicated in *f* numbers on a scale which revolves for film-speed adjustment.

For further information circle No. 26

### 27. Resistance and Capacitance Boxes

The miniature resistance and capacitance boxes available from the Elliott Instrument Co. provide a clear and direct digital indication of resistance or capacitance to an accuracy of 1%. Three types of resistance boxes are available, with ranges of 1 Ω to 10 kΩ, 10 Ω to 100 kΩ and 100 Ω to 1 MΩ. They use high-stability cracked-carbon resistors for the low ranges with metal-oxide resistors for the higher ranges. The capacitance box covers the range 100 pF to 1 μF, silver mica capacitors being used on the low ranges and polyester film capacitors on the high ranges. The boxes are housed in well-screened cases with separate earth terminals.

For further information circle No. 27

### 28. Milliwatt Meter

A compact milliwatt test set (model 74311-A) intended primarily for field use has been developed by Standard Telephones and Cables. It operates at frequencies up to 30 Mc/s on 75-Ω circuits, and up to 300 Mc/s on 600-Ω circuits. It can also be adapted for 125-Ω and 140-Ω circuits. The meter is graduated from +1 dB to -1 dB in 0.25-dB steps. After internal calibration the measuring accuracy is ±0.25 dB at a meter reading of 0 dB and at 100 kc/s on 75-Ω circuits.

For further information circle No. 28

### 29. Expanded-Scale Thermometer

The model 390 expanded-scale direct-reading electrical thermometer manufactured in the U.S.A. by R.F.L. Industries Inc. is available in the U.K. from Wessex Electronics. This has two ranges: a 0 to 100 °C range with 1 °C increments and a centre-zero expanded scale of 1–0–1 °C range with 0.02 °C increments. When provided with two matched probes, this solid-state instrument may be used to measure temperature gradients or make differential temperature measurements. The resolution on the dial in the expanded-scale mode is about 0.01 °C and a recorder

output of approximately 0 to 45 mV at full scale is provided.

For further information circle No. 29

### 30. Microwave Measurements

A recently-introduced plug-in unit (model 5255A) for the Hewlett-Packard 50-Mc/s counters permits frequency measurements to be made between 3 and 12.4 Gc/s. It will also provide an automatic direct readout of frequencies between 1 and 200 Mc/s. It uses heterodyne conversion of the input frequency to a frequency within the frequency range of the counter instead of the previously-used technique of harmonic generation.

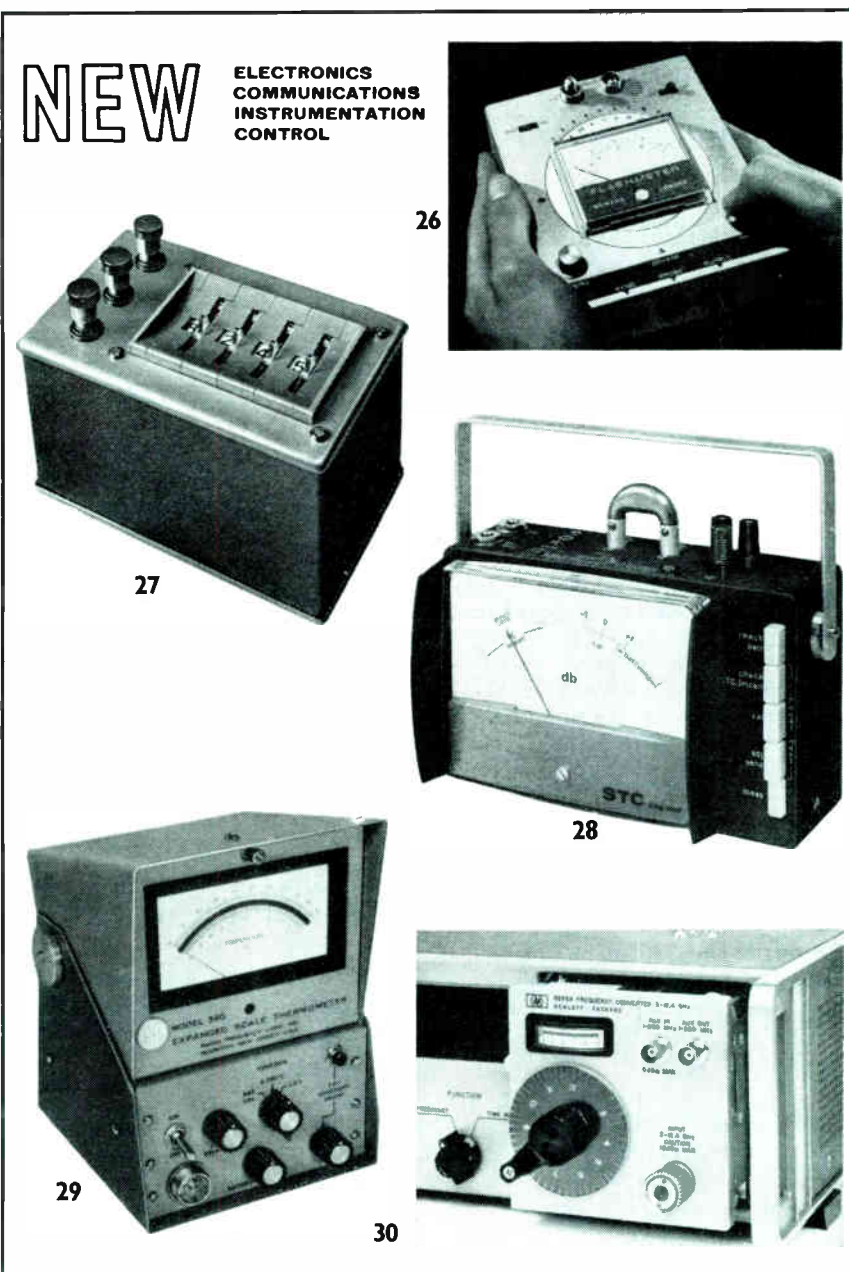

This enhances accuracy and simplicity of operation and enables a resolution of 1 c/s to be attained.

For further information circle No. 30

### 31. Chart Recorder

An electronic strip-chart recorder has been designed by Kent Industrial Instruments specifically for use in industrial, academic and medical laboratories. The recorder is a single-point instrument incorporating plug-in range-change units for ranges of  $-0.1$  to  $+1$  mV,  $-0.25$  to  $+2.5$  mV or  $-1$  to  $+10$  mV. Alternatively, the recorder can be equipped for 36 switch-selected ranges. A lift-out writing platform is featured. This supports the chart at a convenient angle for the making of notes etc. Three different chart speeds (6, 12 or 24 in. per hr) can be selected by a switch, and additional speeds are obtained by a simple change of gear-wheels.

For further information circle No. 31

## CONTROL

### 32. Conductivity Controller

The Elga conductivity controller type Y.1008 is the first of a series of liquid-purity monitors introduced by Elga Products; it consists essentially of a sensitive transistorized detector operating a control relay, and is initiated by variation in the conductivity of liquid media. This method of operation is dependent upon the fact that the electrical resistivity of a solution is proportional to the content of the electrolytes present, and the unit has a range of  $50 \Omega$  to  $10 M\Omega$ . Typical applications of the controller include rinse-water control in pathology and pharmacy, the maintenance of pre-determined purity in any electrolyte, quality control of deionized water and effluents, leakage warning systems for boiler feed, process control in chemical and pharmaceutical manufacture, and quality assessment in desalination and filtration.

For further information circle No. 32

### 33. Process Timer

The KOM-PAC/7 plug-in solid-state control instrument from KPE Controls provides accurate ( $\pm 1\%$ ) electronic time-delays in the range 10 msec to 30 sec; it consists of a

stable RC timing circuit and an accurate transistor voltage threshold detector, which switches when the voltage in the timing circuit reaches a definite value and fires an appropriate thyristor output circuit. For relay operation, a low-power thyristor is used to control a standard internal microswitch relay, while for solid-state control, the output pulse is used to fire the appropriate thyristor stack; its time delay is pre-set by means of a linear potentiometer, and the operating temperature range is  $0-60^\circ\text{C}$ . Typical applications include weld timing, motor starting, plastic injection moulding, conveyor-belt timing and industrial process timing.

For further information circle No. 33

### 34. A.C. Switching Semiconductor

Now available from Claude Lyons is the E.C.C. 'Quadrac', an integrated a.c. switching semiconductor equivalent to two thyristors connected in inverse parallel plus (optionally) a built-in bi-directional trigger diode. Current ratings of 3, 5, 10 and 15 A

are available, with voltage ratings of 200, 400 and 500 V, the units being passivated and completely protected from high voltage transients. Their cases are electrically insulated, breakdown resistance at  $80^\circ\text{C}$  case temperature being 1,500 V r.m.s. minimum for one min. 'Quadrac's are available either in swedge mounting (pressfit) versions or in TO3 transistor case designs, and they can be used in a variety of circuits for motor-speed controls, solid-state switches, static relays, temperature-modulation controls and industrial control equipment.

For further information circle No. 34

### 35. A.C. Solenoids

Varley a.c. solenoids made by Oliver Pell Control have now been updated, and performances have been improved by more than 100% in some cases; their AT2 L/S model, for example, had a pull of 2 lb-in., but this has now been increased to 5 lb-in. at a maximum stroke of  $\frac{1}{8}$  in. Their D and E ranges (the type E 9 is shown here) can also be updated if they are

NEW

ELECTRONICS  
COMMUNICATIONS  
INSTRUMENTATION  
CONTROL



31

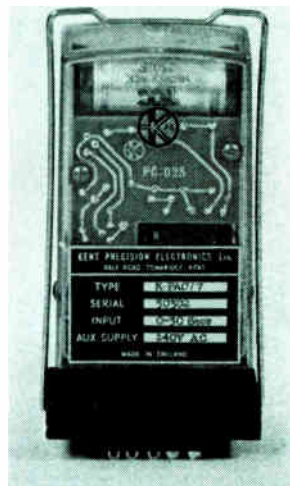
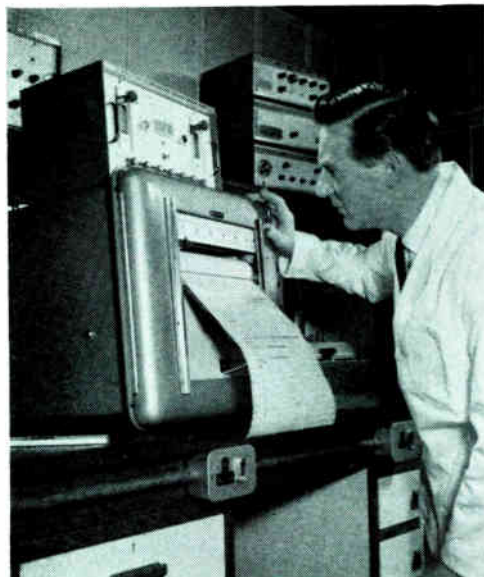



mounted on an efficient heat sink. The solenoids are used wherever push or pull mechanical action is required by remote control, such as in computers, machine tools, circuit breakers, process control, mechanical handling and automated production lines. Special designs can be supplied for high ambient-temperature operation.

For further information circle No. 35

### 36. Temperature Controller

Diamond H. Controls have introduced a solid-state temperature controller suitable for equipment used in the plastics industry, electric furnaces, laboratory ovens, etc. Working from a resistance-thermometer sensor, electrical loads of up to 15 A 250 V a.c. can be controlled at any temperature within the range of the resistance thermometer, proportional band and set-point adjustment being provided. The measuring bridge can be set to work at the optimum conditions for matching the load requirements, and zero-voltage switching is used in the thyristor circuitry to ensure interference-free

switching and avoid supply-waveform distortion.

For further information circle No. 36

### 37. Peak-Selector Memory System

The solid-state electronic peak-selector memory system introduced by Foxboro-Yoxall permits the use of non-continuous signals for closed-loop process control. It is designed primarily for chromatographic read-out, but may be used in rapid-rise industrial processes that require peak picking and electronic memory storage, a memory unit being required for each signal to be stored. The system senses the momentary peak value of a standard non-continuous 10 to 50-mA d.c. signal, locks on to the peak and then continuously transmits it to a receiving device. The maximum input value is held until the selector encounters a new peak with a positive slope, and the peaking time of the input signal may vary from 0.5 sec to 5 min; the storage loss of the locked signal is less than 0.25% per hr.

For further information circle No. 37

### 38. Stepper Servos

A range of electronic components manufactured by IMC Magnetics Corp. is now available in the U.K. from Computer Controls Ltd. Their stepper servos are of two basic types: four-phase permanent magnet (which provide magnetic detenting in each step-position), or three-phase variable reluctance (for smaller stepping angles and higher pulse rates); bi-directional response rates in excess of 1,000 pulses per sec, with response times lower than 1 msec, can be achieved. A typical unit (shown here) is the Mk. II Model 020-010, which is only 2½ in. long and weighs 26½ oz with its cooling flange; of the variable-reluctance 28-V d.c. type, it delivers a stall torque of 45 oz-in. for a power input of 78 W.

For further information circle No. 38

### 39. Static-Switching Modules

The M.E.L. Equipment Co. have introduced with their Norbit 2 range improved and cheaper versions of their Norbit static-switching modules for industrial control. Silicon transis-

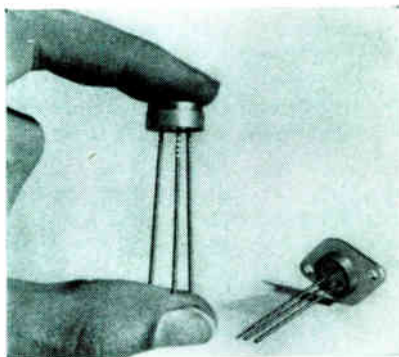

34

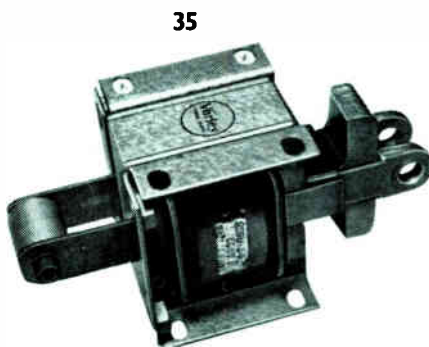

35



36



37

38

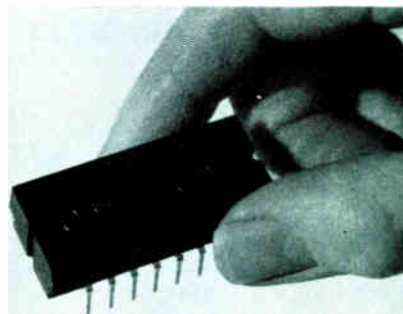
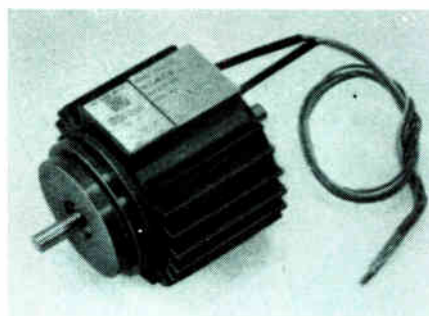

39



# NEW

ELECTRONICS  
COMMUNICATIONS  
INSTRUMENTATION  
CONTROL

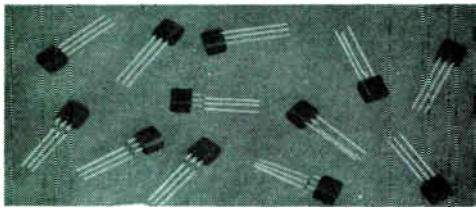

40

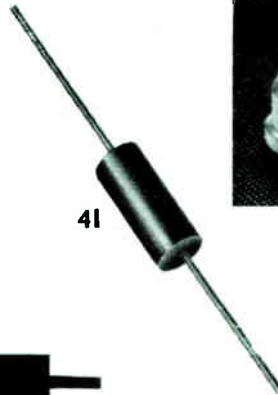

41

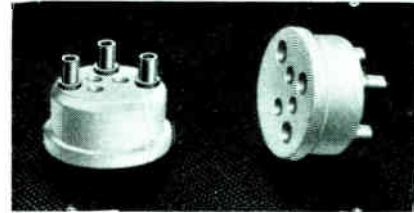

42

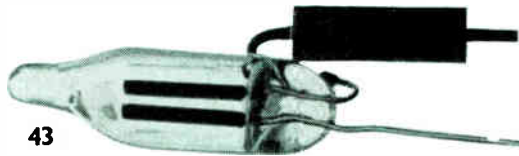

43



44

tors and diodes are used in their construction, and the range features the type 2NOR60 (illustrated) which provides two independent 4-input NOR circuits, an inverter amplifier, timer, switch filter, power amplifier and power-supply unit. The modules measure  $2 \times 1 \times \frac{1}{2}$  in. and from each of the longer sides protrude nine flat pins to which either wrapped wire or soldered connections can be made; being encapsulated, they are unaffected by dust and can be used with safety in hazardous atmospheres. The permissible working temperature range is  $-10$  to  $+85$  °C and no special power supplies are required. Operation is from a single-rail 24-V d.c. supply, which does not have to be stabilized, or via a mains supply unit, which is also part of the range.

For further information circle No. 39

## COMPONENTS

### 40. Epoxy Encapsulated Transistors

Ferranti have announced the availability of two ranges of epoxy encapsulated transistors. The ZTX300 series are general-purpose silicon n-p-n planar transistors which are intended for use in systems where a high degree of electrical and mechanical performance is required at low cost. The collector-emitter voltage ratings are from 20 to 45 V, the typical gain-bandwidth product

being 300 Mc/s and the typical output capacitance 4 pF. The ZTX310 series are silicon n-p-n planar switching transistors which are intended for high-speed low-current logic applications. They offer good performances with collector currents from 1–100 mA.

For further information circle No. 40

### 41. Voltage Variable Capacitors

Solitron Devices Inc. of the U.S.A. have introduced a range of voltage-variable capacitors. Available in capacitance values up to 150 pF and with  $Q$  values of 100 or greater, they can be used with voltages in excess of 100 V. A 500-mW power rating is quoted and the components are rugged and have stable performances. Matched pairs and quads are available with matching as close as 0.5%.

For further information circle No. 41

### 42. Transistor Holder

Sealectro Ltd. have produced a transistor holder which will accommodate either TO-5 or TO-18 cans having three leads. Designated the RTC-305 and forming part of the 'Press-Fit' line, the holder has three brass feed-through lugs which accept the leads of the TO-5 can. On a circumference inside that of the lugs are three holes through the Teflon bushing through which leads of the TO-18 holder are fed and wrapped around the lugs.

For further information circle No. 42

### 43. Neon Warning Lights

Neon/resistor assemblies consisting of a resistor welded to one lead of a neon indicator are available from West Hyde Developments. They can be soldered directly into circuits, particularly transistorized circuits where most terminals are at a low voltage, to provide a warning of the presence of high voltages such as on the primary terminals of a mains transformer. Operating at 160–260 V r.m.s. a.c., they produce high-intensity light while consuming a low power. An average life of 25,000 hours is quoted. Prices range from 1s. each for batches of 10 to 7d each for batches of 10,000.

For further information circle No. 43

### 44. Reed Relay

The type GB91 reed relay produced by Astralux Dynamics will withstand shock of 100  $g$  in all planes and operates over a temperature range of  $-60$  °C to  $+125$  °C. It has a life of  $10^8$  operations and an operating time of 1 msec. This microminiature reed relay is capable of switching currents of up to 3 A and voltages of up to 500 V.

For further information circle No. 44

### 45. Tin-Oxide Resistors

Corning Glass Works has achieved the full production of tin-oxide low-power resistors that will not burn when overloaded up to 100 times the rated power. These FP-style resistors will operate under overloads of

**precision control**

The most comprehensive range of servomotors tachogenerators and gearheads, together with electronic components of modular design.

Complete control systems can be tailored to suit your requirements.

**EVERSHED**

Evershed & Vignoles Ltd,  
F.H.P. Motors Division  
Devonshire Works, Dukes Ave,  
London, W4. Tel: 01-994 7801

*(Evershed Division of George Kent Ltd)*

TW2323

# get a head start with

## MOTOROLA Semiconductors

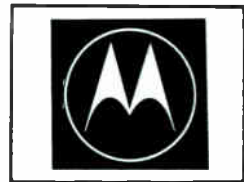
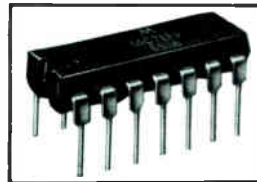

The expanding range of Motorola Semiconductor products available from Celdis Limited include

- Digital I/C's** MECL MDTL MRTL  
MTTL in T.O. 5  
and D.I.P.
- Linear I/C's** Operational, Differential  
and Sense Amplifiers
- Transistors** Low-level to power  
(Ge and Si) including  
"Plastics" and F.E.T's
- Diodes** Rectifiers, Bridges,  
Zeners, Reference  
and Varactors

Write or telephone today,  
**Reading 56256**  
Celdis Technical  
Sales Division  
for complete information  
on Motorola products.

**CELDIS**

**CELDIS LIMITED**  
43/45 Milford Road,  
Reading, Berks.  
Telex : 84370

C/MG

For further information circle No. 239

For further information circle No. 240

## AN IMAGE ORTHICON CAMERA AT UNDER £1,700 COMPLETE ??

**COMPACT AND PORTABLE** Fully transistorised, incorporating printed circuits throughout.

High quality reproduction, with exceptional reproduction in extremely low level light conditions, moonlight or normal street lighting.

Basic working unit comprises:

Camera for transmitting 625 or 875 lines, complete with lens, tube and all other normal functions; plus built-in pos./neg. modulation of output signal; horizontal and vertical image inversion and head-phone connections.

A vast range of ancillary equipment also available, including electronic view-finders; automatic or manual light controls; variations of rear camera controls for all lens functions etc. In fact, BOSCH can supply *all* equipment associated with closed-circuit television. All BOSCH cameras can be used in conjunction with the standard range of BOSCH precision studio monitors, available with screens from 8" to 23" for 625 or 875 lines.

Regular maintenance unnecessary.

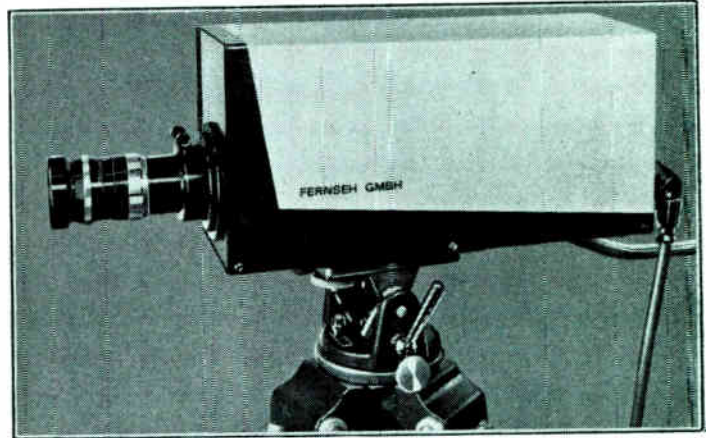

## YES!..BOSCH 3" IMAGE ORTHICON CAMERA!

Call on BOSCH to solve any of *your* closed-circuit TV problems.

**BOSCH LIMITED** - Audio & Visual Aids Division

205 GREAT PORTLAND STREET, LONDON, W.1. Tel. LAngham 2672-5.

# BOSCH

For further information circle No. 241



*Electronic Engineering demands*

# ASHLAM

INSULATION

*Synthetic Resin Bonded*

**LAMINATES**

*Paper, Fabric or Glass Fibre Base  
with all Resin Systems*

*Copper Clad Laminates and Films*

**ALL LAMINATES CONFORM TO  
RELEVANT B.S. AND SERVICE  
SPECIFICATIONS**

*Write for technical catalogue to*

**MICA & MICANITE SUPPLIES LTD.**

BARNBURY SQUARE :: LONDON, N.1.

Telephone: NORth 3032 (P.B.X.)

Telegrams: MICASULIM, LONDON, N.1.

For further information circle No. 242



# NEW

**ELECTRONICS  
COMMUNICATIONS  
INSTRUMENTATION  
CONTROL**

up to 10 times the rated power for up to 10 sec. Six types are included with power ratings of 2, 3, 4, 5, 7 and 10 W. A 200 p.p.m. temperature coefficient is specified for a temperature range of 55–150 °C, and the resistance change due to moisture is claimed not to exceed 2.0% when subjected to 90–95% relative humidity at 40 °C for 250 hours. The illustration shows an FP-style resistor and a normal low-power resistor both being overloaded, the FP resistor open-circuiting but not burning.

For further information circle No. 45

## 46. Thyristors

Four low-cost plastic-encapsulated thyristors, types TIC44, TIC45, TIC46 and TIC47, have been announced by Texas Instruments. They are rated at 30, 60, 100 and 200 V with a d.c. current rating of 600 mA. Typical applications include the control of lamps and small electric motors and use in relay circuits, ring counters, and interface circuitry for use with integrated circuitry. The peak anode surge current is rated at 6 A and the maximum gate-triggering current rating of 200  $\mu$ A eliminates the need to use extra desensitizing components to prevent false firing.

For further information circle No. 46

## PRODUCTION AIDS

## 47. Cooling Unit

The Lektrokit division of A.P.T. Electronic Industries has introduced a cooling unit type LKU.511, which has been designed for improving the efficiency of transistor heat sinks and for lowering the temperature level inside electronic assemblies. The housing measures 5 × 5 in. across the opening and it is 4½ in. deep; fixing holes are provided to enable the unit to be used as a replacement for the normal side plate of any Lektrokit assembly with the chassis rails bolted to it. In operation, the LKU.511 provides an air displacement of approximately 2,000 cu. ft per hr under conditions of reasonably-free air flow, the fan blades being driven by a fractional h.p. 200/250-V a.c. motor.

For further information circle No. 47

## 48. Event Recorder

Assisting process control and monitoring complex activities are two of the applications of the 'Stoptester' inkless event recorder now available from Barbie Engineering; twelve individual activities (or the operating conditions of up to twelve machines or stages of a process) can be recorded, as can production rates. The basic twelve-channel model gives either fine or thick lines on the chart, and another model has a non-resettable counter connected to each channel. This may be used to record the number of times (or the total length of time) a condition has occurred, or the quantity of pro-

duction in continuous or batch processes; an additional unit can also be incorporated in any channel to give clear indication of five distinct conditions.

For further information circle No. 48

## 49. Constant-Temperature Baths

As additions to its range of water-bath equipment, Techne (Cambridge) has introduced two new constant-temperature baths (models CTB 1 and 2), which incorporate 'Triac' electronic control; their operating range is -20 to +200 °C, with a sensitivity of  $\pm 0.05$  °C, and the

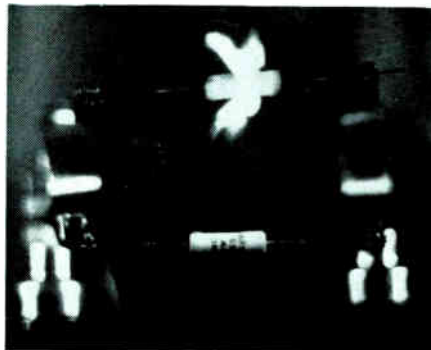

45



46

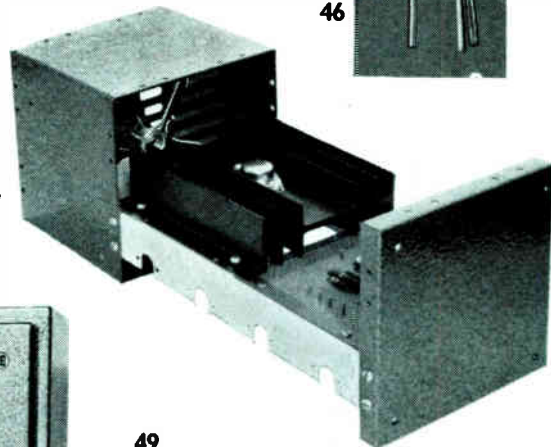

47

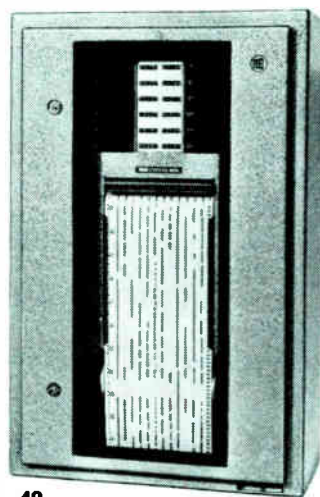

48

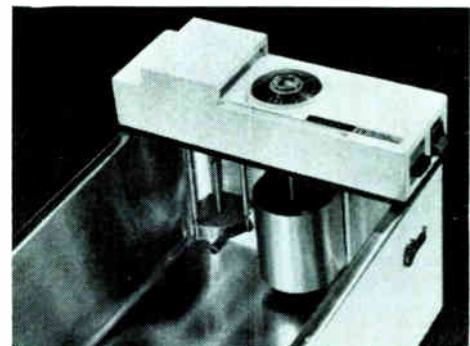

49

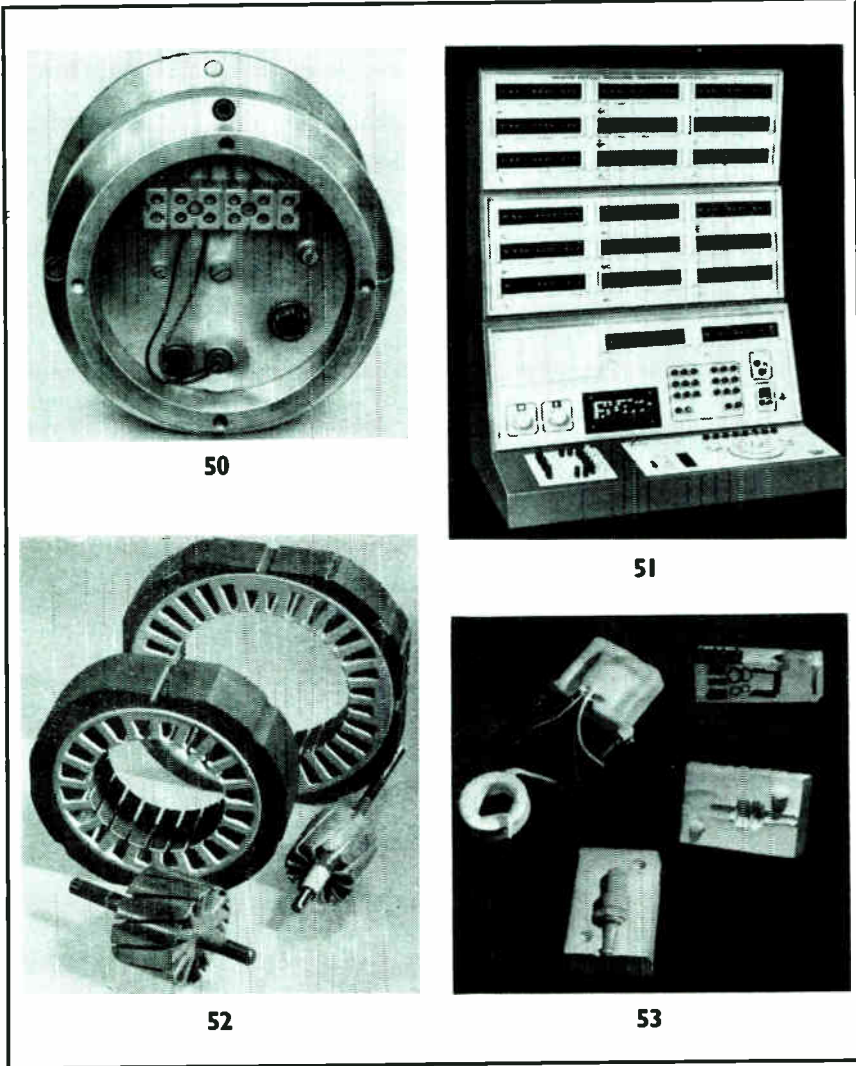

50

51

52

53

## NEW

### ELECTRONICS COMMUNICATIONS INSTRUMENTATION CONTROL

model CTB 2 with oil reaches 100 °C in 29 min. Other features include a high-capacity controllable circulating pump and a fail-safe device which cuts out overheating. The control units themselves may be obtained separately and used as portable constant-temperature circulators for converting any container into a constant-temperature bath.

For further information circle No. 49

### 50. Shaft-Rotation Fault Detector

A device that can detect faults on all kinds of rotating machinery has been introduced by Quinton-Crane Electronics; called the solid-state rotation switch, the device gives positive identification that a shaft is rotating faster or slower than desired. It can

be used for detecting under or over speeding of conveyors, or for identifying material breaks on other machines by monitoring the rollers over which the material passes; the thyristor circuit within the unit can be linked to a suitable warning system, the machine being stopped immediately a fault occurs. Its speed range is from 1 to 5,000 r.p.m., in four ranges, switching accuracy being better than 2% of set value. The unit is arranged to operate a d.c. relay, having a coil wound for 12-V operation and a maximum operating current of ½ A; switching accuracy is maintained over a temperature range of -20 to +50 °C.

For further information circle No. 50

### 51. Transistor Tester

The Teradyne T207, now available from Livingston Electronics, is an automatic high-speed go/no-go

instrument for production-line inspection, testing and classification of semiconductor devices. Standard industrial d.c. tests can be performed in only 35 msec, and an easy-to-program bin computer on the front panel assigns each device tested into one of four or more bins; with automatic handlers, the unit can test over 4,000 transistors per hr, manual operation testing 1,000 to 1,200. For complex classification and data-logging requirements, the T207 can be readily modified for control by a digital computer, the programming of all the conditions for each test being performed at a single position on the front panel; the programming switches and test circuits are so arranged that it is not possible to damage inadvertently the device under test or the test instrument.

For further information circle No. 51

### 52. Epoxy Powders

Hysol Sterling have announced an addition to their range of epoxy 'Dri-Kote' powders—the DK7 Green. Produced as a fast or no-post-cure material for integral insulation of armatures, stators and electronic components, it is suitable for both fluid-bed and spray application; smooth coatings have been obtained using preheat temperatures from as low as 130 °C up to 220 °C. Important safety features include the absence of a dust cloud over normal fluid beds, and the substantial elimination of any tendency for coatings to fume at elevated preheat temperatures; the photograph shows components coated in DK7.

For further information circle No. 52

### 53. Cold Cure Rubber

Midland Silicones have introduced their DP 2446 solvent-free pourable paste which, when mixed with its catalyst, vulcanizes at room temperature to give a high-strength silicone rubber; it has good flow characteristics and is recommended for mould making, potting and encapsulation (see picture). The paste is easy to use, is stable and inert from -50 to +250 °C, has good resistance to moisture, oxidation and weathering, and is an electrical insulant. It is tough (having a tensile strength of 700 lb per sq. in.) and its high-quality non-stick characteristics make it especially suitable for moulding synthetic resins and other materials.

For further information circle No. 53



**HELASHRINK TUBING**  
**HELASHRINK END CAPS**  
**HELASHRINK SLEEVES**  
**HELASHRINK MARKERS**

**AND NOW**

**HELASHRINK\* TAPE**

Heat shrinking, multi-purpose insulating tape provides inexpensive airtight and waterproof sealing.

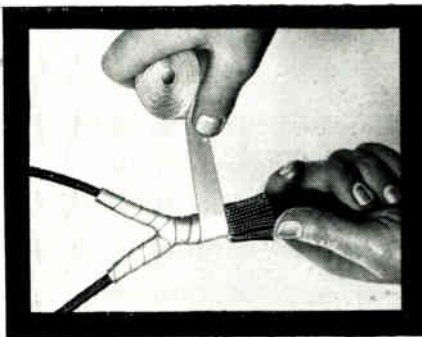

$\frac{3}{4}$ " wide tape in 108 ft. rolls (Part No. HTP x  $\frac{3}{4}$ "). Adhesive backing "holds" dual thickness tape prior to heating

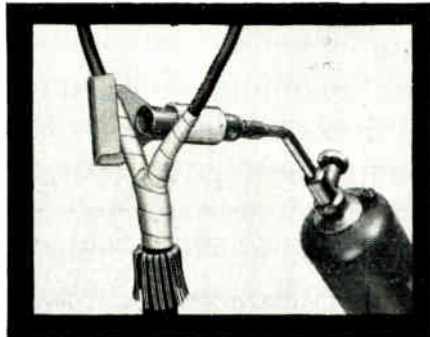

Heat for a few seconds with a Hellermann Heat Gun — the new Gas Gun is shown here — and the result is instant sealing

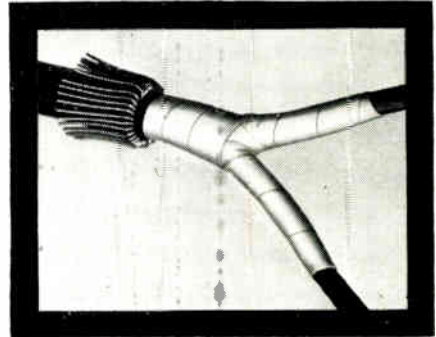

Helashrink Tape eliminates the need for expensive 'shapes'. There is now a Helashrink material to cover all applications

Write or phone for leaflet and samples

**HELLERMANN ELECTRIC LTD.**

World Leaders in Cable Accessories

\* Registered Trade Name



GATWICK ROAD · CRAWLEY · SUSSEX · TELEPHONE: 28888

A member of the Bowthorpe Holdings, Ltd. group of companies

For further information circle No. 243



# TD 700 LINE

## first practical tunnel diodes at exceptionally low prices!

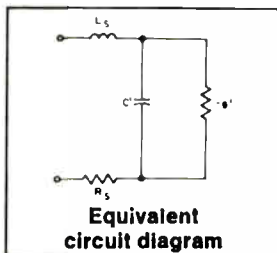
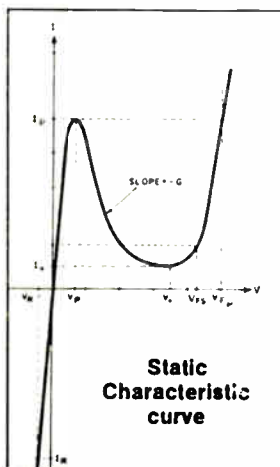

**General Electric Company of U.S.A.\* announces twenty new high-speed tunnel diodes, with ultra-low power consumption, that can save you up to 80% of the cost of alternative devices.**

These low-cost tunnel diodes will find particular use in the computer industry. Circuit designers will put them to use in critical areas such as level detection, frequency converters as well as mixer and logic applications. The high-speed and low power requirements of these diodes bring distinct advantages over alternative devices.

The new TD 700 Line of germanium tunnel diodes offers peak currents of .5, 1.0, 2.2, 4.7 and 10 mA. These devices, which make use of the quantum mechanical tunneling phenomenon, are designed for low-level switching and small signal applications at very high frequencies.

For fully detailed information and specifications of the new TD 700 Line of tunnel diodes, contact International General Electric Company of New York, Ltd., 296 High Holborn, London, W.C. 1, or *General Electric Company, Dept. EC-6701, 159 Madison Ave., New York, N.Y. 10016, U.S.A.*

\*General Electric Company, U.S.A., is not connected with the English company of a similar name.

**GENERAL ELECTRIC COMPANY OF U.S.A.**

**For further information circle No. 244**

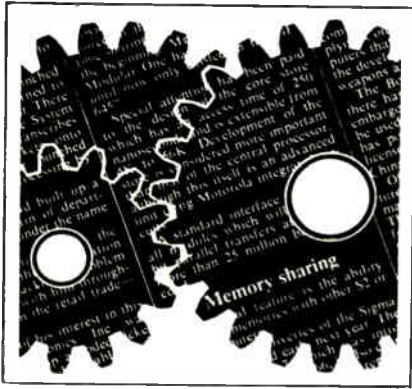

# INDUSTRIAL NEWS

## Computer Applications in Medicine

The formation of a new technical committee, to study computer techniques and applications in medical research and bio-medical practice, has been proposed by the International Federation of Information Processing. This will be the fourth technical committee to be set up by the IFIP—the other three being on computer terminology, programming languages and education—and one of the tasks suggested for it is the international codification of medical information.

## Further Satellite Station at Goonhilly

Goonhilly in Cornwall is to be the site for the G.P.O.'s largest yet satellite-communications earth station in the U.K. This station, Goonhilly 2, will establish telephone and television links over the Intelsat 3 satellite which is planned to be put into a synchronous orbit over the Atlantic in 1968. Communication to North and South America, the West Indies and Africa will be provided.

When Goonhilly 2 is completed it will take over the transatlantic telephone traffic from the existing station. Further equipment will be added to the present aerial to enable it to operate with a satellite to be placed over the Indian Ocean, providing communication to Australia, India, Pakistan, Ceylon, Japan and other Far East countries.

A 90-ft diameter parabolic aerial

will be used by the station. Ordered from Marconi together with receiving and transmitting equipment, it will be capable of handling 500 telephone channels and one television channel simultaneously. Duplicated transmitters will be used operating at a frequency of 6 Gc/s and with a bandwidth of 500 Mc/s. Duplicated receivers with the same bandwidth will be cryogenically cooled to  $-250^{\circ}\text{C}$  to produce the low-noise operation required for the reception of the very low-power signals from the satellite.

## Non-Destructive Testing and Ceramics Research Centres

The Ministry of Technology has announced that two further research centres, one dealing with non-destructive testing and the other with ceramics, are to be established at Harwell by the U.K. Atomic Energy Authority.

Both of these centres will receive support from the research associations, the universities and industry. Five-year research and development plans have been drawn up and the experience gained during the programmes will be made available to British Industry.

The ceramics centre will initially concentrate on providing assistance to those industries which are the main users of ceramic materials. These include the iron and steel, electronics, pottery and glass industries.

## Courses on Design Aids

Another series of one-day courses on techniques for improving drawing-office productivity has been arranged by the Ministry of Technology's National Engineering Laboratory. The courses cover functional draughting for the camera, the use of models and photographic techniques in design, and microfilm storage and retrieval; they will be held during April in Woolwich, Enfield, Slough and Coventry.

## Information Retrieval

A new company has been formed by Centre-file Ltd. to study the problems arising out of the 'technical information explosion' (see 'Comment', October 1966) and provide solutions through the application of computer techniques.

Named Indata Ltd., it will develop into practical systems the results of information-retrieval studies that have already been conducted by Centre-file, and an IBM 360/30 computer will be used to check out the operational programs.

## Computer Research Fellowships

NCR has granted three research fellowships to the University of Dundee, which will be formed in August of this year from Queen's College, Dundee. The research subjects to be pursued will be in the fields of numerical analysis and computational science.

The Fellows will be free to publish the results of their work. Any special equipment and apparatus that may be required will be supplied by NCR who will decide, with the University's professors of mathematics, the specific subjects to be followed. The subjects will include simulation, data processing and automation topics and mathematical problems in such areas as heat transfer, optics and fluid mechanics.

The fellowships will provide an opportunity for collaboration between industry and the university. Clear advantages will be gained from the combination of the special knowledge and research facilities of the university with the scientific resources of industry.

## S.R.C. Grant for Radio Telescope

A grant worth £45,000 has been made by the Science Research Council to Manchester University towards the cost of a design study for a radio telescope. This follows the Fleck Report 1965, the report of the Radio Astronomy Planning Committee, which recommended that a new large radio telescope should be provided for Professor Sir Bernard Lovell's team at Manchester.

The grant is without commitment to the construction of a telescope. No decision on construction will be made until the results of the design study and detailed cost estimates are available.

It is envisaged that the telescope will be a large steerable parabolic dish. Referred to as the Mk. V, it would be used individually and in conjunction with the Jodrell Bank telescope.

The U.K. Atomic Energy Authority will act as agents for the design study. They will be responsible for collecting data, for commissioning and assisting in the study, and for preparation of the cost estimates.

## Medical Engineering Conference in Montreal

The International Institute for Medical Electronics and Biological Engineering is to hold a 'guidelines' conference on medical engineering in Montreal during the Expo-67 World



In response to Mr. Alexei Kosygin's request that he see some of Britain's most advanced automation equipment during his visit last February, the Soviet Prime Minister was shown round the Borehamwood factory of Elliott-Automation Ltd. Accompanied by Sir Leon Bagrit, the company's chairman and managing director, he is seen here studying one of Elliott's ARCH on-line process-control computers, several of which are now operating in control of industrial plant in the Soviet Union

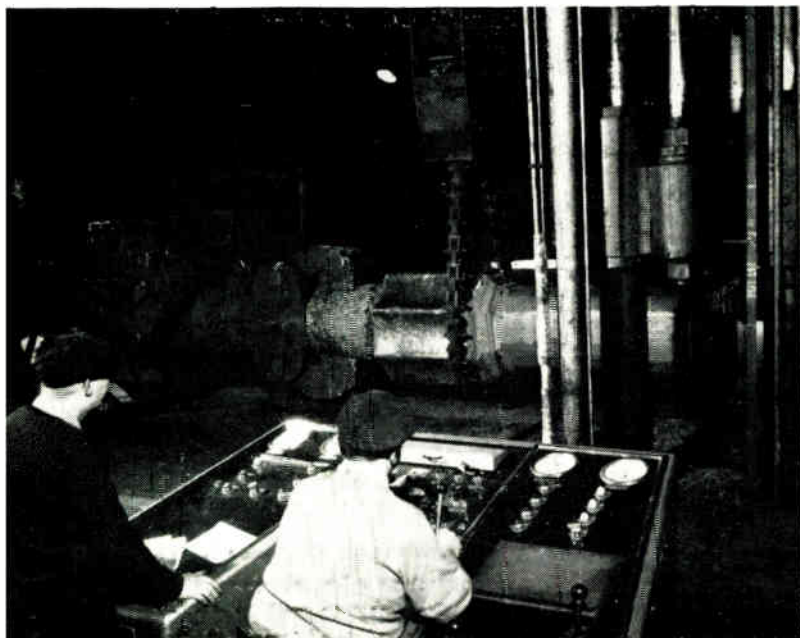

A complete mobile television unit, designed to show classroom techniques in teacher-training colleges, but having obvious applications in industrial training and communication as well, has been produced by Pelo Scott Ltd. Its console is a complete mixer/control unit (fitted for two live television channels, v.t.r. and sound) and its three main component parts can be carried by two men

For further information circle No. 75

Digital controls from Lancashire Dynamo Electronic Products, of Rugeley, have been installed in a 1,500-ton forging press at the Tipton (Staffs) plant of Wright's Forge and Engineering Co. Operations previously necessitating a crew of several men can now be carried out from a central control desk, and the picture shows an 18-ton ingot which has been removed from the furnace by a Wellman manipulator and taken to the press for cogging. Thickness is also controlled from the desk, its accuracy being within  $\pm 1/16$  in.

Fair. It will represent the first stage in a two-year study aimed at working out an international programme to 'upgrade medical care on a broad front by more effective medical technology and information processing'. Full details of the conference, which will be held during the third week in July, can be obtained from the Institute's headquarters at La Salpetriere, 47 Boulevard de L'Hopital, Paris 13<sup>e</sup>, France.

### Experimental Telephone Exchange

The Post Office is shortly to install the world's first pulse code modulation

(PCM) tandem system at their Empress exchange; when this experimental switching centre becomes operational at the end of the year, selected traffic from three other exchanges will be directed through it to test the technique that makes it possible for two ordinary telephone pairs to carry 24 simultaneous conversations.

P.C.M. had to wait for the development of the transistor before it became a practical and economic proposition. Eventually, the Post Office plans to install P.C.M. transmission equipment to the value of £6 million, and some has already been ordered from STC and G.E.C.; the remainder is being put to tender.

## PERSONAL NEWS

Marconi Instruments have announced that **Dr. C. S. Gaskell** is now chief engineer of the Sanders division. He has recently been engaged in research into solid-state microwave devices.

International Rectifier have promoted **S. Robertshaw** to the recently-created post of field sales manager. The product sales manager is now **A. M. Martin** and the distributor sales manager is **J. Butler**. Mr. Butler succeeds **H. C. Walford** who was recently promoted to general sales manager.



**A. T. Sharman, A.M.I.E.E., B.C.S.**, has received the appointment of managing director of Recognition Equipment Ltd. This company is the English subsidiary of Recognition Equipment Inc. of the U.S.A. which specialises in electronic reading machines.

**Graham Miller, B.Sc.**, is now the marketing director of Dynamco. He was recently sales director of Wayne Kerr after being general manager of their U.S. subsidiary.

The chairman of The Plessey Co. is now **Field Marshal Lord Harding**. He replaces the late **Lord Kilmuir**. **John Clark** has become deputy chairman and continues as the company's managing director and chief executive. It has also been announced that **T. C. Hudson**, a former managing director of IBM United Kingdom Ltd., has been appointed a director.

**F. S. Harris, C.Eng., M.I.E.E.**, has become group sales manager of Coubro and Scrutton Ltd. He has also been appointed a director of Precision Metal Spinnings Ltd. which recently became a wholly-owned subsidiary of the Coubro and Scrutton Group.

**C. A. R. Pearce, M.Sc.Eng., M.I.Mech.E., F.I.E.E.**, has been appointed acting general manager of the AEI Telecommunications Group. He succeeds **E. H. Ouston** who is leaving the company.

The automated systems division of Ultra Electronics is now headed by **D. S. Macintyre** who has become the general manager of the division on the resignation of **M. H. Meller**. The general sales manager for the division is now **M. S. Passingham**. A further recent appointment is that of **P. B. Williams** who has become chief engineer of the company following the resignation of **A. Sadler**.

The BBC has announced that **T. J. Allport**, formerly the engineer-in-charge, television outside broadcasts, has been appointed head of the equipment department. He succeeds **E. C. Drew, O.B.E., C.Eng., F.I.E.E.**, who has retired.

**J. A. Carswell, M.A.(Cantab)**, has joined the board of Edgcombe Peebles Ltd. He will continue to be manager of the control systems division of Bruce Peebles Ltd., both companies being members of the Bruce Peebles Industries Group.

The company quality assurance manager for STC is now **Dr. J. M. Grootcock, D.I.C., A.R.C.S., M.I.E.E.** In this post he will be responsible for quality control and the reliability of STC's products.

Two appointments have been announced by Emihus Microcomponents Ltd. **David Holmes** has become distributor sales manager for the U.K. and the continent, and **Dan Reid** is now the capacitor sales manager.

**Dennis Parry** has been elected a non-executive director of Eltromet Ltd. This company (a member of the George Kent Group) specializes in the design and manufacture of instrument and control panels.

## Obituary

**Mr. Frank W. Hollings**, Northern advertisement manager of *Electrical Review* and *Industrial Electronics* died on 12th March, following a heart attack.

Born in 1922, Mr. Hollings spent the whole of his working life on the staff of *Electrical Review* which he joined in 1936.

## COMPANY NEWS

AEI have combined **AEI Semiconductors** and **Domestic and Industrial Components** into a single components group. This group will enable AEI to expand its industrial control components activities as well as its domestic appliance control business.

**Telequipment Ltd.** have announced that, subject to Board of Trade and Treasury approval, an agreement has been reached whereby **Tektronix Inc.** of the U.S.A. will purchase the entire privately-owned share capital of Telequipment. Telequipment will become a wholly-owned subsidiary of Tektronix, but will continue to operate as a separate company with unchanged management.

**ML Industrial Products** have signed an agency agreement with **Elmwood Sensors Inc.** of the U.S.A. Elmwood manufacture a wide range of miniature thermostats and these will now be available throughout the U.K. from ML Industrial Products.

Negotiations have reached an advanced stage under which it is envisaged that **Elliott-Automation** will acquire from **G.E.C.** the business carried on by **G.E.C. Computers and Automation Ltd.** This business is to a large extent complementary to the process automation activities of Elliott-Automation.

A company known as **Computer Ancillaries Ltd.** has been formed by **Automatic Input Systems** in conjunction with **Intercontinental Systems Inc.**, which is the European subsidiary of the U.S. company, **Mohawk Data Sciences Corp.** The company will take over from Automatic Input Systems the exclusive U.K. sales of the data recorders produced by Mohawk Data Sciences.

The entire shares of **General Precision Systems**, a subsidiary of the **General Precision Equipment Corp.** of the U.S.A., have been acquired by **Redifon**. Both Redifon and General Precision Systems manufacture flight simulator equipment. The air-traffic management division of General Precision Systems is excluded from the transaction.

**Union Carbide Ltd.**, a subsidiary of the **Union Carbide Corp.** of the U.S.A., is now known as **Union Carbide U.K. Ltd.** The company is engaged in the manufacture and marketing of ferroalloys and superalloys, petrochemicals and silicones, electronic components, cryogenic and electric welding equipment, and non-woven fabrics.

A company known as **Strainstall Ltd.** has been formed to provide an installation service for strain gauges and associated measuring equipment. It is based at 90a High Street, Cowes, Isle of Wight.

**Dynamco** is to amalgamate its subsidiaries, **Dynamco Instruments**, **Dynamco Systems** and **Norbury Instruments** into one company trading as Dynamco Ltd. A factory has been leased at Chertsey and work has commenced on a factory at Dalkeith.

A semiconductor special assemblies service for equipment manufacturers has been formed by **SGS-Fairchild**. This service will make available encapsulated integrated circuits for particular applications.

The **Elco-Webster** range of miniature connectors are now being distributed in the U.K. by **Magnetic Devices Ltd.** The range comprises receptacles, plugs and terminations.



▲ The standard 'Mecolab' laboratory analysis system (76) shown by Joyce, Loebel and Co. was developed under the sponsorship of the Ministry of Health and consists of four automatic preparation units and an auto-colorimeter. Manually-transferred batches of up to 15 can be accommodated, four different types of estimation being possible and taking only 3 min each. The tests are monitored on the pen recorder and the results are presented either numerically or on punched-paper tape; the need for graphical analysis, computations or corrections is thus eliminated. The system can automate any manual chemical technique requiring a discrete method of analysis

▼ One of the more unusual instruments on display by C. J. Fox and Sons (Chemicals) was the 'Dormed' sleep inducer (77) developed by Robert Bosch Elektronik und Photokino. Shortly to undergo tests by British medical authorities, it works by feeding very low energy pulses into the patient's nervous system through electrodes that press lightly on the eyelids and parts of the skull immediately behind the ears; it generates square-wave pulses of up to 15 V in amplitude at from 12 to 200 pulses per sec. The treatment produces muscle relaxation, resulting in sleep, and it is hoped to use the equipment to combat the rising abuse of narcotics and barbiturates



► Patient-monitoring systems, with which such parameters as temperature, blood pressure and pulse, heart and respiratory rates can be continuously measured and recorded were very much in evidence at the exhibition. One such system was the 'Monitron' (78) which was developed jointly by the Medical Research Council and T.E.M. Instruments; it is modular in construction, allowing systems monitoring up to 20 patients to be constructed, and provision is made for up to 100 separate variables to be recorded and displayed. The equipment consists of input and indicator units, chart recorders and a sensor harness for fitting to the patient

# MEDEA 67



**I**N 1960, the first international medical electronics exhibition was staged at Earls Court, in conjunction with the third international conference on medical electronics. Since that time, enormous strides have been made by both the engineering and medical professions to integrate into medical practice the latest technological developments in automation and electronic equipment. Advanced techniques and apparatus are now becoming more familiar to hospital staff and doctors, for the electronics industry has met the challenge by acquainting itself with present-day medical requirements and satisfying them by developing special (or adapting existing) equipment.

The results of these activities were to be seen at Earls Court last month in Medea 67—the medical engineering and automation exhibition, which is now planned to be held every two years. Sponsored by the Electronic Engineering Association and the Scientific Instrument Manufacturers' Association, it was claimed to be the most comprehensive show of medical engineering yet presented, and did indeed indicate the wide scope of modern trends in this field.

Associated with the exhibition was the second European symposium on medical electronics (sponsored by *World Medical Electronics*), which provided an excellent opportunity for engineers and doctors to discuss the techniques and equipment that comprise the ever-expanding area of

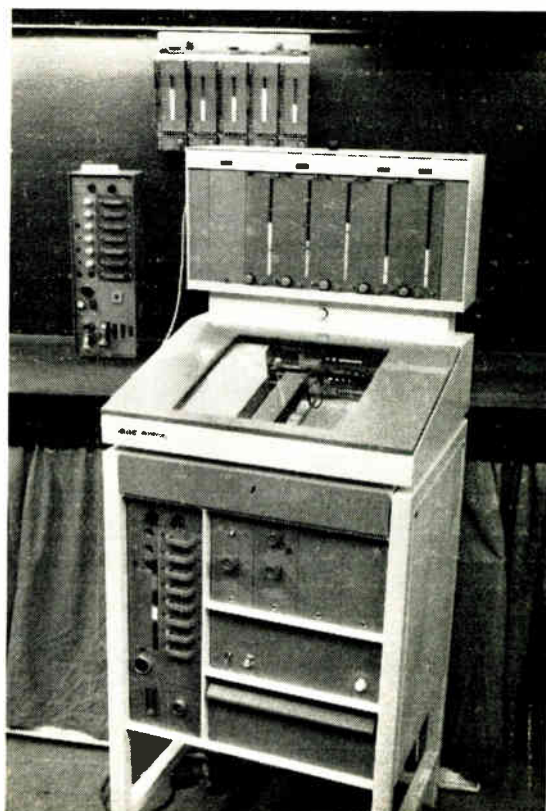



research and development that is common to their two professions. Such a forum for exchanging information and communicating ideas is essential if the technological revolution in medicine is to be achieved efficiently.

The exhibition's aim of demonstrating the ways that automation can be (or has been) adapted to medical practices, at the same time clarifying those aspects of medicine in which the latest electronic techniques can play a vital role, was wholly laudable; but too many of the exhibits were only to be seen in isolation on their stands, thus robbing their significance of much of its impact. What a pity, for example, that a mock-up of a hospital ward and/or operating theatre could not have been shown, in which the latest proven equipment and techniques for detection, diagnosis and treatment could have been demonstrated actually being operated.

No doubt such factors as cost, organization and availability of medical personnel rendered such a scheme impracticable, but even a modest attempt to relate the equipment on display to human beings, to 'animate' some of the stands, would have improved the overall impression for visitors considerably.

On the positive side, however, visitors were at least spared the insulting (and quite misleading) implications that permeate much uninformed comment on the part automation can play within the medical field. They were not invited to meet a computer doctor or undergo automatic diagnosis, nor was there any hint that equipment now being developed would in some way replace or degrade skilled medical personnel. Such concepts are so much nonsense, of course, though the belief still persists in many quarters that automation represents some kind of threat.

Automation is reducing much repetitive and boring work that was the inheritance of the industrial revolution; it now allows men to be retrained for more skilled, varied and responsible jobs, in which they can take a greater pride and enjoy a greater sense of achievement. Medical automation does not present a valid analogy to industrial automation, but some of the effects of its introduction will, it is hoped, be equally striking; in particular it should help to streamline our health and welfare services.

For further information circle appropriate numbers on Service Card

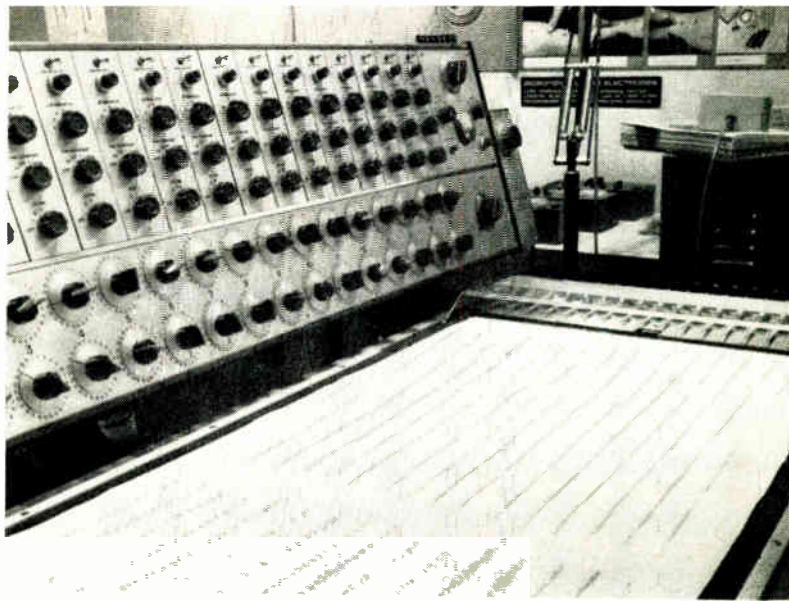
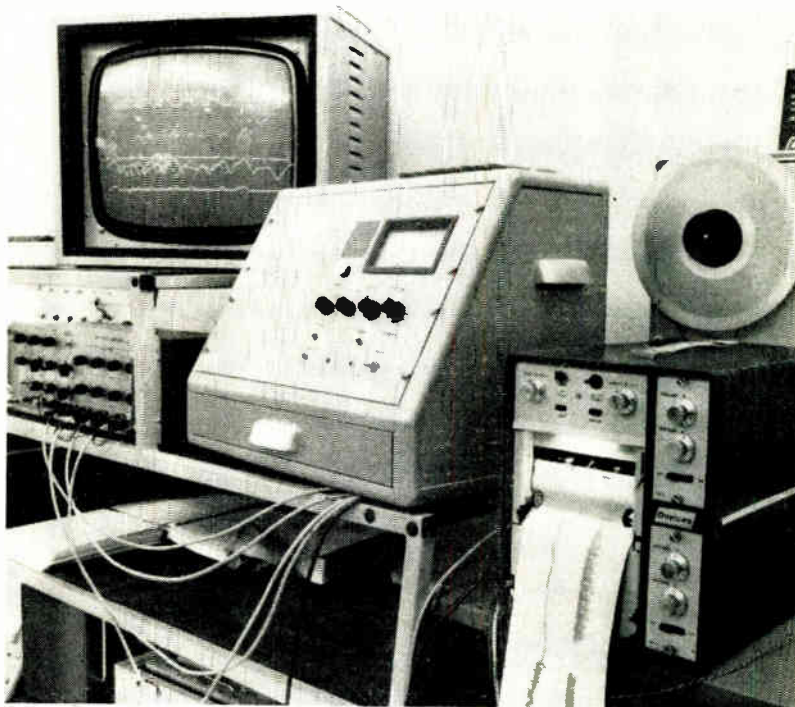

Chart recorders for the continuous measurement and display of electroencephalographs (recordings of brain activities) are an essential feature of modern diagnosis and clinical research. Of the many being demonstrated, the 'Galileo' model (exhibited by Specialised Laboratory Equipment and shown here) is an 18-channel device (79). It has one time and one stimulus-marker stylus for the signals coming from the photostimulator, and one time and one stimulus-marker stylus for every signal coming from other external apparatus; four chart-drive speeds are available

The data-handling capacity and calculating power of computers have already been put to effective use in hospitals in this country, and Lan-Electronics demonstrated their 'Pre-Arrester' computer (shown here in the centre) which has been specially programmed to give early-warning signals of impending heart attacks in patients connected up to it. The equipment (80), which was developed in association with cardiologists at Barnet General Hospital, continuously monitors a patient's heart action and detects when a crisis begins to build up 40 min before it might become fatal



Closed-circuit television applications in the medical field were demonstrated by Epsilon Industries, who showed how the quality required for interpreting X-ray plates could be maintained by using their high-definition c.c.t.v. cameras and monitors (81). In such areas as operating theatres, only small camera heads need be used, which can be equipped with remotely-controlled zoom lenses and closed-up attachments and then fitted to the theatre lamp. Their c.c.t.v. equipment can also be used with a wide range of endoscopes, as well as for ward surveillance and hospital communications





# NEW BOOKS



## **Avo International Transistor Data Manual**

Pp. 438 + vi. Avo Ltd., Avocet House, Archcliffe Road, Dover, Kent. Price £2 5s.

Avo (MI Group) has produced a new edition, the third, of its Transistor Data Manual.

This now well-established international reference book gives in-line data for more than 8,000 transistors including those of Russian manufacture. It provides a rapid and convenient guide for use not only with Avo instruments but also for wider application by laboratory and service engineers.

In addition to in-line data for every transistor, a comprehensive list of transistor equivalents is included, with commercial equivalents of Service transistors.

## **Magnetism in Solids**

By D. H. MARTIN, PH.D., F.INST.P. Pp. 452. Iliffe Books Ltd., Dorset House, Stamford Street, London, S.E.1. Price 120s.

This book is written primarily for advanced physics students of graduate level. It presents a broad account of the subject and takes the discussion of major topics to the points of current investigation.

The aim of this book is to show that the current basic problems in magnetism in solids can be appreciated, if not solved, within familiar theoretical formalisms.

## **Tristimulus Spot Colorimeter**

By H. A. S. PHILIPPART, A.M.I.E.R.E. Pp. 16. BBC Publications, 35 Marylebone High Street, London, W.1. Price 5s.

This B.B.C. report describes a photoelectric tristimulus spot colorimeter which measures the three stimuli X, Y and Z, as specified by the C.I.E. The instrument has been developed for making objective colour measurements on pictures displayed on a cathode-ray tube.

## **Electronics. From Theory into Practice**

By J. E. FISHER, C.ENG., A.M.I.E.E., A.M.I.E.R.E., and H. B. GATLAND, B.SC., DIP. ELECTRONICS. Pp. 411 + xv. Pergamon Press, Headington Hill Hall, Oxford. Price 35s.

This book introduces thermionic and semiconductor devices before explaining the common and basic electronic circuits. The concluding chapter deals with general design considerations for electronic circuitry.

## **Glossary of Terms Used in Telecommunication (Including Radio) and Electronics**

### **Supplement No. 3, Colour Television Terms**

Pp. 24. Supplement No. 3 (1966) to British Standard 204: 1960, produced by the British Standards Institution, British Standards House, 2 Park Street, London, W.1. Price 6s.

## **Weichlöten in der Elektronik**

By DR. GUNTHER LAUBMEYER and WOLFGANG KUPKE. Pp. 144. Schiele & Schön GmbH, 1 Berlin 61, Markgrafenstrasse 11, Germany. Price DM16.

## **Semiconductor Circuits: Worked Examples**

By J. R. ABRAHAMS, B.SC.(ENG.), M.SC., A.M.I.E.E., and G. J. PRIDHAM, B.SC.(ENG.), A.M.I.E.E., A.M.I.E.R.E. Pp. 208 + xii. Pergamon Press, Headington Hill Hall, Oxford. Price 21s.

The subjects covered by these worked examples encompass basic semiconductor physics, transistor characteristics, equivalent circuits, amplifiers, oscillators, pulse circuits and applications. Both mathematical and descriptive questions are included.

## **Mathematics for Radio and Electronics Technicians**

By DR.-ING. FRITZ BERGTOLD. Pp. 304 + xvi. George Newnes Ltd., Tower House, Southampton Street, London, W.C.2. Price 50s.

This book covers the branches of mathematics from simple algebra through to calculus. The author presents the material in a step-by-step manner and provides exercises and answers for the student.

The approach, although somewhat laborious to the initiated, is designed to teach students and for this purpose should prove very useful.

## **Crystals**

By P. KRATOCHVIL. Pp. 112. Physics Paperback No. 7 published by Iliffe Books Ltd., Dorset House, Stamford Street, London, S.E.1. Price 15s.

## **Electronic Automatic Control Devices**

By A. A. BULGAKOV. Pp. 549 + xxiv. Pergamon Press, Headington Hill Hall, Oxford. Price £6.

This is a translation from the second edition of the original Russian book.

## **Einführung in die Anwendung kontaktloser Schaltelemente**

By H. BUHLER. Pp. 162. Birkhäuser Verlag, 4000 Basel 10, Switzerland. Price sFr 32.

## **The Plane Wave Spectrum Representation of Electromagnetic Fields**

By P. C. CLEMMOW. Pp. 185 + vii. Pergamon Press, Headington Hill Hall, Oxford. Price 50s.

## **Methods For The Analysis of Nickel For Use In Electronic Tubes and Valves:**

**Part 1: Determination of Aluminium (Photometric Method)**  
B.S. 3727 : Part 1 : 1966. Pp. 7. British Standards Institution, 2 Park Street, London, W.1. Price 3s.

## **Static Inverters For Aircraft**

British Standard G196. Pp. 11. British Standards Institution, 2 Park Street, London, W.1. Price 8s.

## **Russian Books on Automation and Computers**

Compiled by E. GROS. Pp. 92. Scientific Information Consultants Ltd., 661 Finchley Road, London, N.W.2. Price £8.

# FROM THIS



# TO THIS



## WIREWOUND POTENTIOMETERS

COVERING A RANGE OF TYPES MORE EXTENSIVE THAN ANY OTHER MANUFACTURER. THESE INCLUDE:—

- \* STANDARD & MINIATURE
- \* TYPE APPROVED TO DEF 5121A
- \* HELICAL MULTI-TURN
- \* LINEAR & FUNCTIONAL

*Send us your specification. See your Electronic Engineering Index for full technical data.*

# COLVERN LIMITED

SPRING GARDENS, ROMFORD, ESSEX  
Telephone: ROMFORD 62222 Telex: 23984

# ELECTROLUBE\* MEANS EXTRA RELIABILITY

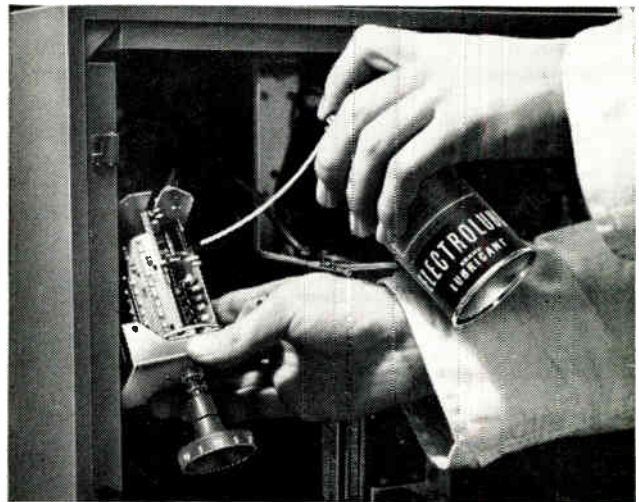

Electrolube 2A-X is the highly efficient and completely safe electrical and mechanical lubricant which improves contact performance and inhibits tarnish and sparking. Electrolube also improves the mechanical operation of plugs and sockets, rotary and sliding switches and all types of electro-mechanical device—giving an extra reliability factor to equipment and components wherever it is used.

## ONLY ELECTROLUBE 2A-X

Available—through wholesalers and agents all over the world—in the economical aerosol pack—compatible with all plastics, rubbers and paints.

For full technical details write to:—

U.K. Enquiries: Electrolube Ltd., Oxford Ave., Slough, Bucks  
Telephone: Slough 25574  
Telex: Electrolube Chamcom Slough 84314

Overseas Enquiries: Electrolube Ltd., 16 Berkeley Street,  
London W.1  
Telephone: MAYfair 7654



\* Registered Trade Mark

H For further information circle No. 245

For further information circle No. 246

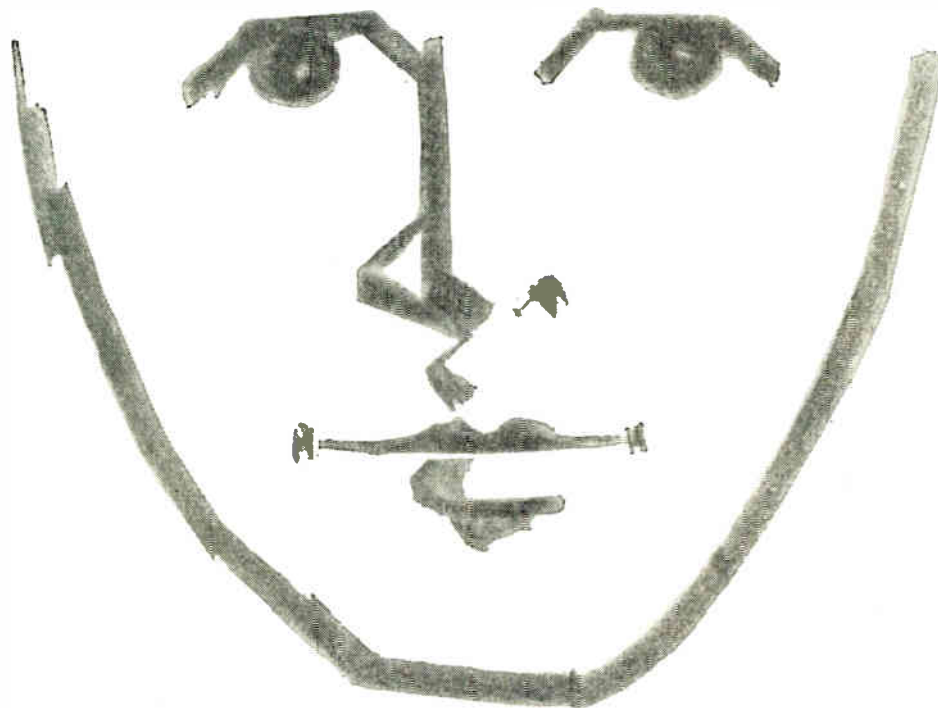
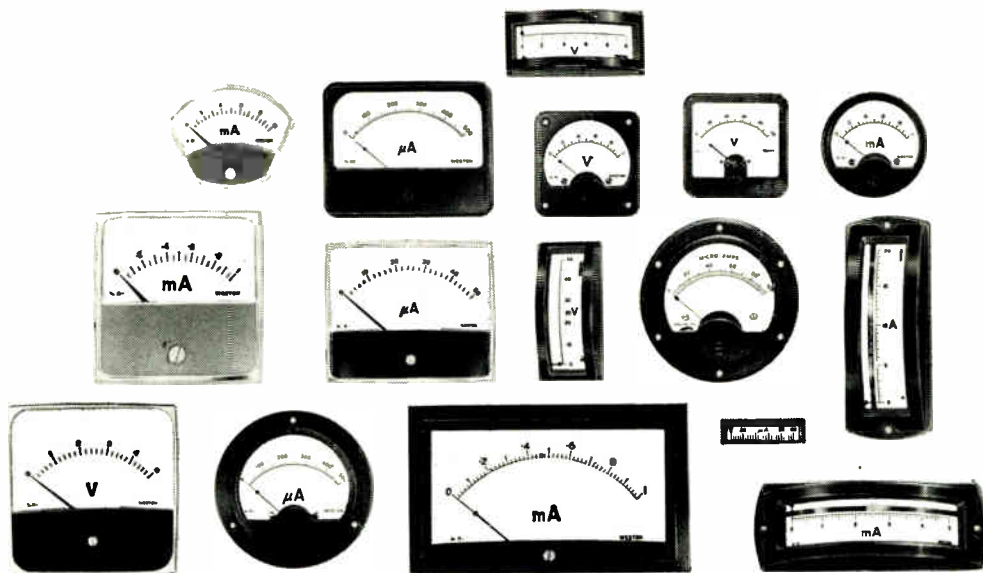

***Weston take a wait off your mind.  
Delivery of all panel instruments now  
possible within one to four weeks***

Send for our literature and let us quote for your needs. Better still, contact the Area Office nearest to you, and ask our representative to call . . . he will be delighted.

Enfield:  
C. Pozzi.  
01-366 1100.

London:  
W. Gray.  
01-242 4971.

Birmingham:  
J. C. Silverthorne.  
CENTral 0691.

Manchester:  
E. Axon.  
Denton 4411.

Southampton:  
L. C. Chapman.  
Southampton 23328.

Glasgow:  
L. H. Williams.  
Central 6208.



**SANGAMO WESTON LIMITED · ENFIELD : MIDDLESEX**  
Telephone: 01-366 1100 · Telegrams: Sanwest, Enfield : Telex: 24724

**For further information circle No. 247**



**vibration  
stops here**

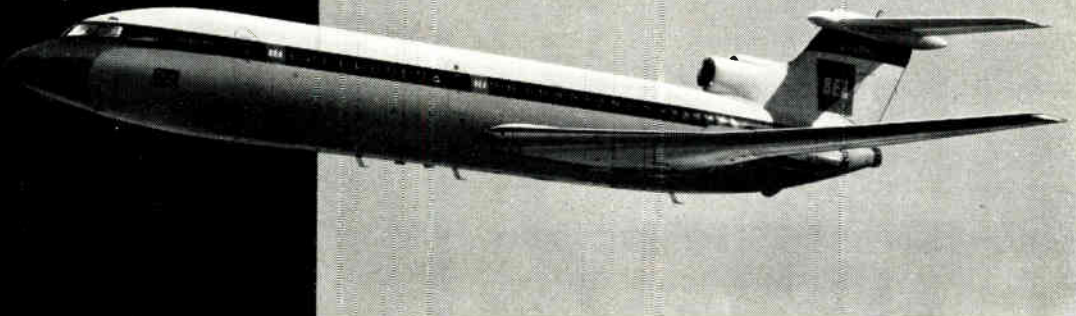

**for Hawker Siddeley and for Garrard**



Barrymount isolators are widely used in a divergent range of applications, all to the same purpose—to ensure that equipment is fully protected against shock and vibration and capable of its best performance irrespective of the operational environment. For example, electric motors in Garrard transcription automatic playing units are mounted on Type GB975 miniature isolators to prevent inherent vibration of the motor reaching the turntable.

In the Hawker-Siddeley Trident, vital communications and flight-control equipment is mounted on isolators specifically designed for the application; similar installations are being developed continuously and Muffelite isolators have been used in every British aircraft project during the last ten years.

Muffelite are the only company in the United Kingdom entirely concerned with the design, development and manufacture of shock and vibration isolation systems for a very wide range of applications.

There is a complete range of Barrymount shock and vibration isolators, meeting virtually every requirement. Comprehensive technical information, descriptive literature and details of Muffelite's Environmental Test Facilities are available on request.

**Cementation (Muffelite) Ltd.**

Hersham, Walton-on-Thames, Surrey. Tel: Walton-on-Thames 24122

*Barrymount Isolators are manufactured in England under licence from the Barry Wright Corporation, U.S.A.*

**EW CM1**

**For further information circle No. 248**

**CEMENTATION**  
**muffelite**

# PROPIMAX

400 CPS

*tubeaxial* **FANS**

## PROPIMAX 2



Specially designed for ground and air applications where weight and size must be kept to a minimum; with reliability essential where relatively high heat loads must be dissipated through air cooling.

- Size 3 x 1 1/2". Weighs only 6 1/2 oz.
- 60 - 120 CFM
- Reversible air flow. Servo mounting.
- High Altitude designs available.

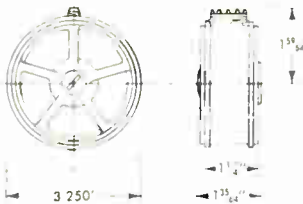

## PROPIMAX 3



The PROPIMAX 3 will supply large volumes of air against relatively high static pressures.

- 100 - 220 CFM at 22,000 RPM - 400 CPS
- Size 3 3/4 x 2"
- Reversible Air flow
- Built to MIL specifications

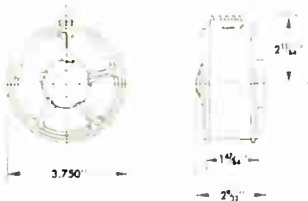

Write today for complete technical data

**Ad. AURIEMA LTD**

125, GUNNERSBURY LANE, LONDON, W.3. • Tele: ACOrn 8762

For further information circle No. 249

# PLASTIC MOULDINGS

THERMO-SETTING THERMO-PLASTIC

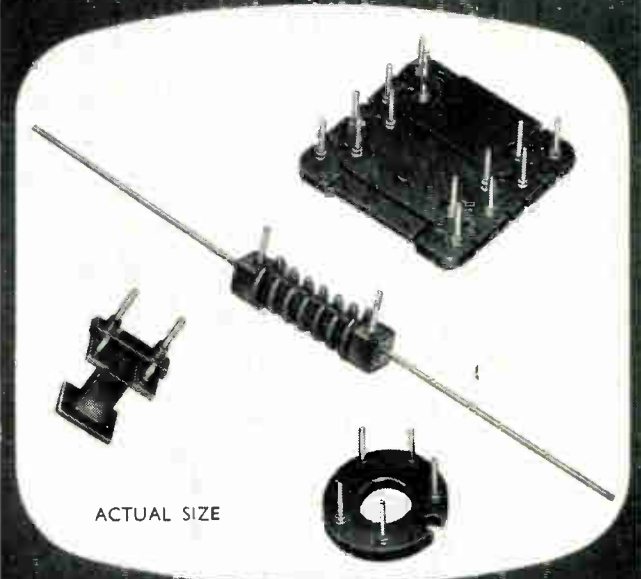

ACTUAL SIZE

**FREDERICK W. EVANS LTD.**  
Plastic Works, Long Acre, Birmingham 7.  
Telephone: STD. 021 EAST 3071 (4 Lines)

For further information circle No. 250

*"Invaluable for all radio and electronic engineers"*

By Dr. Ing. Fritz Bergtold

**MATHEMATICS FOR RADIO AND ELECTRONICS TECHNICIANS**

Begins with the most simple equations and the basic methods of calculations are reviewed and the compiling of diagrams is demonstrated. Later chapters deal with involution, evolution, curves, arrangement, transformation and solution of equations, the slide rule, logarithms, the treatment of trigonometrical functions, Fourier and other series, differentiation and integration, polar co-ordinates and the Gaussian plane, vectors and calculation with complex values.

**320 pages**  
**Line illustrations**

**50s.**

**FROM YOUR BOOKSELLER**  
*or in case of difficulty by post 52s. 6d. from*

**GEORGE NEWNES LTD., Tower House, Southampton St., W.C.2**

For further information circle No. 251



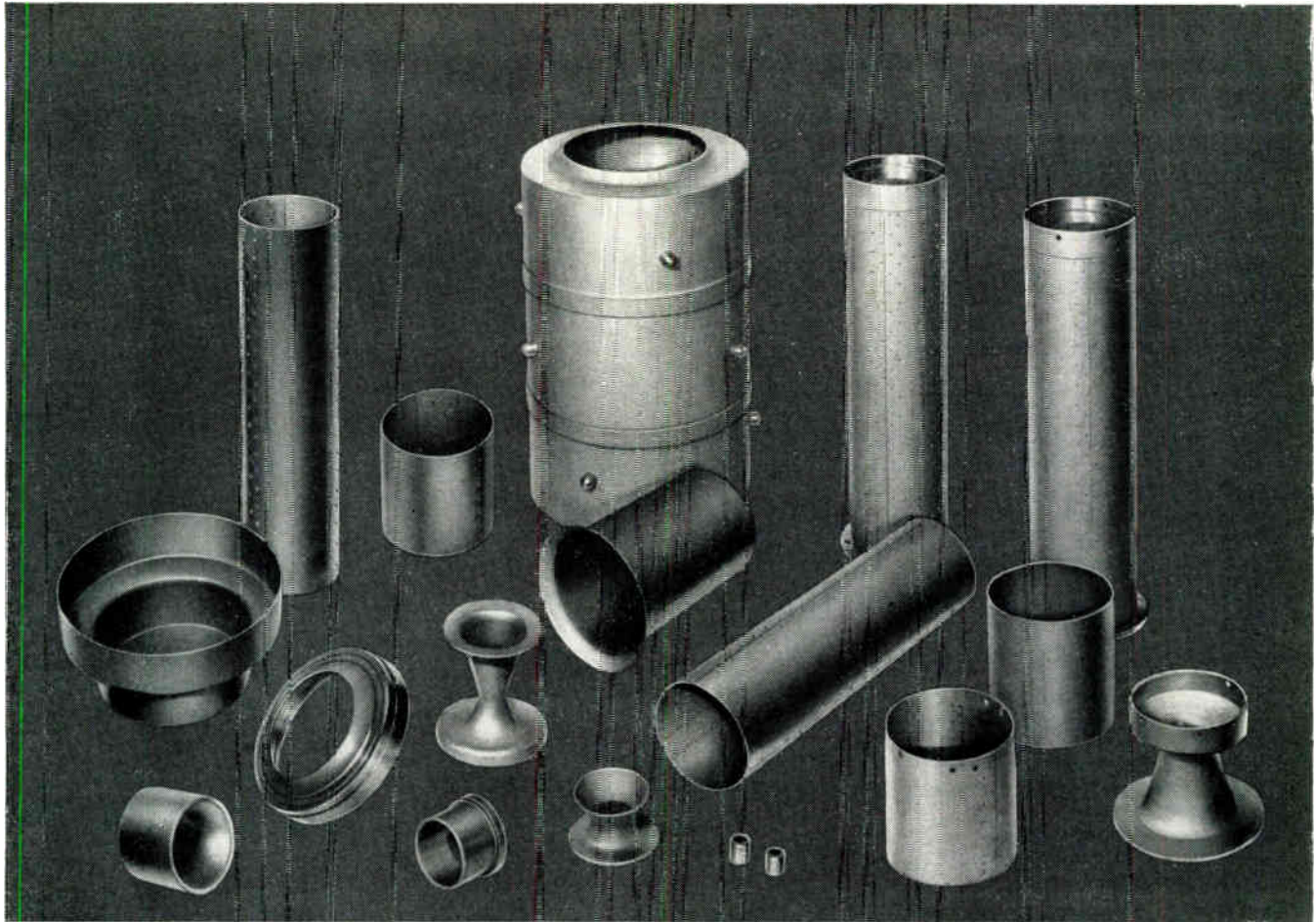

# TUNGSTEN, TANTALUM and MOLYBDENUM made and fabricated by Murex

The refractory metals—tungsten, tantalum, molybdenum and niobium are all made by Murex Ltd., and are available in the form of sheet, rod and wire. The company has excellent facilities for fabricating and forming these metals into a wide variety of components to suit customers' requirements. Corrosion resistant tantalum flanges, sleeves and plugs for the repair of glass and enamel vessels are standard Murex products. Plugs for damaged vessel walls are available from 1/2 in. diameter upwards and sleeves for the repair of damaged vessel ports from 1 in. to 12 in. diameter. Please write for full details.

★ Intricate shapes    ★ Wide range    ★ High quality

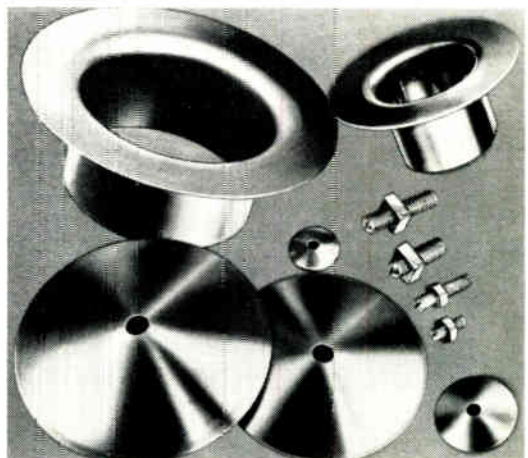

A few examples of Murex tantalum flanges, sleeves and repair plugs.



**MUREX LIMITED • RAINHAM • ESSEX**

*Powder Metallurgy Division*

Rainham, Essex 53322

Telex 28632:

Telegrams: Murex, Rainham-Dagenham Telex

P56

**For further information circle No. 252**



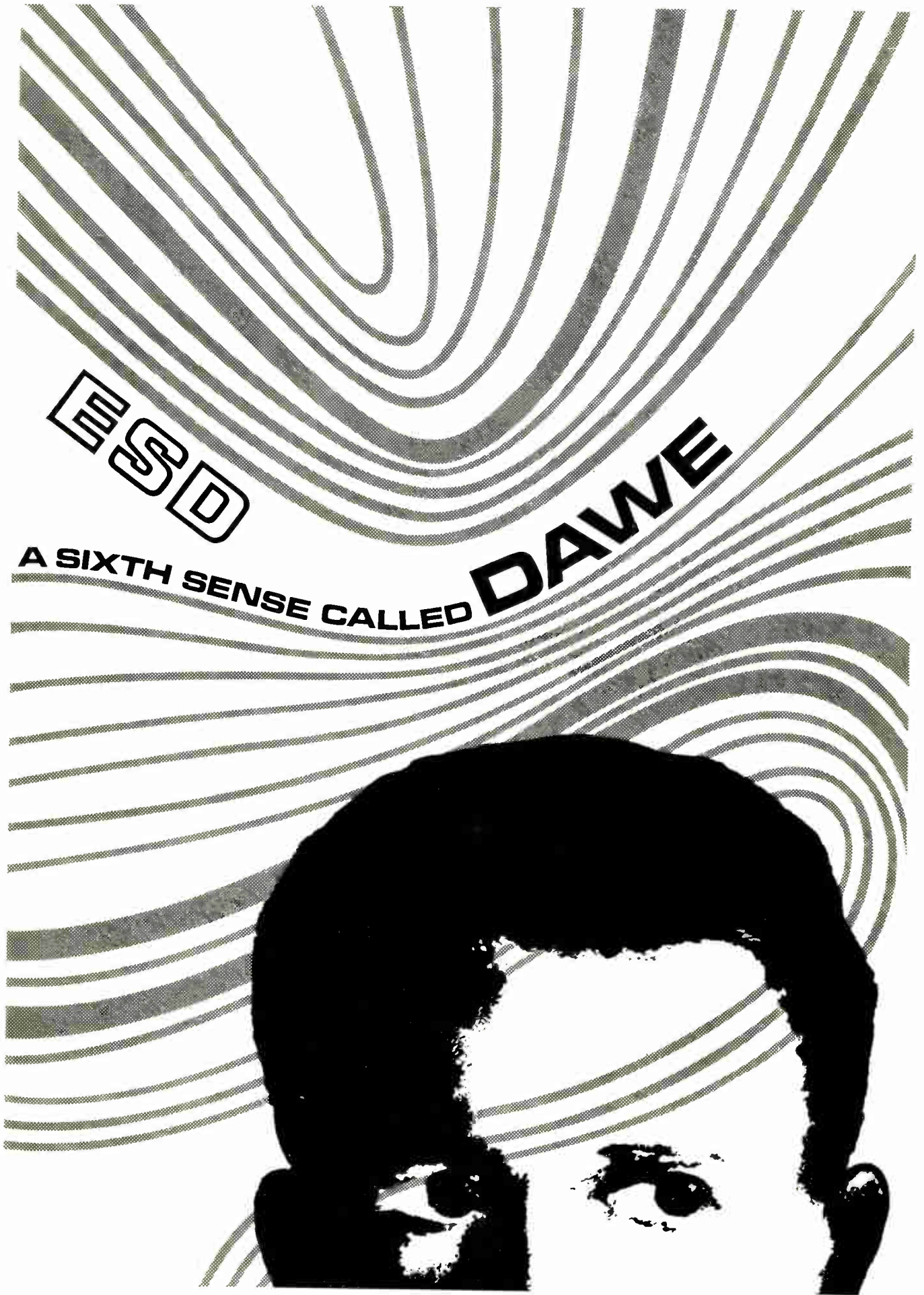

**ESD**

**A SIXTH SENSE CALLED**

**DAWE**

**For further information circle No. 253**

Extra Sensory Dawe instruments provide a sixth sense for industry. Accurate, reliable, robust instrumentation for measurement, study or detection of the apparently intangible; instrumentation designed and manufactured with care to advance industrial progress. And our para-normal powers don't end there. They can also be applied to production processes such as cleaning, welding and machining.

## EXTENDING YOUR RANGE OF MEASUREMENT DAWE 900 SERIES DIGITAL INSTRUMENTS

Counters, Timers, Tachometers, Ratio Meters, Frequency Meters and Multiple Function Units all of plug-in modular construction.

ALSO AVAILABLE AS INDIVIDUAL PLUG-IN MODULES



Digital Frequency Meter, Counter, Timer Type 901A/6. Frequency range: 1 MHz. Price: £154 (illustrated).  
Digital Frequency Meter, Counter, Timer Type 920A/4. Price: £113. Three, four or five digit models also available.



Digital Timer Type 960/6. Range: 10 $\mu$ s to 10<sup>4</sup> secs. (Nearly twelve days) with six digits. Price: £142. Three, four or five digit models also available.



Supply Frequency Monitor Type 728. For continuous monitoring of 50, 60 or 400 Hz supplies. Price: £69.

See the Dawe 900 Series Digital Instruments at the London International Engineering and Marine Exhibitions, Olympia, 25th April to 4th May, 1967, STAND NO. 46, Outer Row, Grand Hall, Gallery.

Write today for full technical details.

# DAWE

INSTRUMENTS LIMITED

CONCORD ROAD, WESTERN AVE., LONDON, W.3. TEL: 01-992 6751.

A member of the *Simms* group of companies

For further information circle No. 254

# CLASSIFIED ADVERTISEMENTS

**FULLY DISPLAYED:** £4 10s per inch (two-column page).

**SEMI-DISPLAYED:** £3 per inch (three-column page).

**RUN-ON:** 5/6 per line of approximately 7 words. Where an advertisement includes a Box Number 1s. extra.

**SERIES DISCOUNTS:** 12 insertions, 15%. Remittances payable to "Industrial Electronics".

Copy is required by 11th of the month for insertion in the following month's issue, by 6th of the month if proofs are required.

Address to:  
Classified Advertisement Dept.  
Industrial Electronics  
Dorset House, Stamford St., London, S.E.1.

## SITUATIONS VACANT

### BEXFORD LIMITED

*an associate Company of Ilford Limited and Bakelite Nylonite Limited, manufacturers of photographic and reprographic film base materials.*



### ELECTRONICS ENGINEER

The Company wishes to appoint a young engineer of H.N.C. standard with ability to develop, design and commission Electronic and Light current equipment used in a modern factory making Photographic Film Base.

The work also includes the evaluation of new products and incorporating them in the development of new Electronic equipment.

In this position ideas and initiative are most important, particularly to solving problems on automated production plant, and control systems.

Beaches, woodland, estuaries and yet within easy reach of London, plus a modern factory makes life in East Anglia very attractive. The Company operates a Contributory Pension Scheme with free Life Insurance.

*Please send full personal details to:*

**The Personnel Manager, Bexford Limited, Manningtree, Essex**

1690

## TELECOMMUNICATIONS ENGINEER

The Esso Petroleum Company Limited, anticipate a considerable increase in the use of telecommunications techniques over the next few years. A Telecommunications Engineer is to be appointed to ensure that the best use is made of the opportunities which the techniques provide. This is a specialist appointment and the successful applicant will be based at the Company Head Office in Victoria Street. He will be expected to research and study the needs most appropriate to the Company's requirements. He will be responsible for the design of a telecommunications network to cover the Company's operations in the U.K. and supervise pilot and proving installations. He may expect to lead a project team as the field develops.

The man we are seeking will be aged between 25-35, and be a graduate in electrical engineering with experience in telecommunications, and generally familiar with computers.

The salary will attract a man already earning up to £2,000 per annum. Applications giving details of age and present salary to



**J. G. C. Stainer (Ref. 25181E)**  
Esso Petroleum Company Limited  
Esso House, Victoria Street  
London, S.W.1.

1693

### ASSISTANT CONTROLLERS

#### POSTS AND TELECOMMUNICATIONS DEPARTMENT

#### SARAWAK

**DUTIES:** To undertake the installation and maintenance of all types of modern telecommunications equipment including multi-channel radio and automatic exchanges. A knowledge of associated line plant is desirable. To train staff in the practical aspects of their duties and be responsible for running a small zone centre.

Applicants, who should normally be nationals of the United Kingdom or the Republic of Ireland, must not be over 45 years and should possess Graduate or A.M.I.E.E. or equivalent qualifications.

Salary in scale £1,627-£2,905 p.a. plus approximately 25% terminal gratuity. 2-3 year contract. Free family passages and medical attention. Child and education allowances. Generous leave.

Please apply for further details giving your full name and age together with brief details of your qualifications and experience, and quoting RC 292/155/01,

Appointments Officer  
**MINISTRY OF OVERSEAS DEVELOPMENT**  
Room 301, Eland House  
Stag Place  
Victoria, London S.W.1

1691

### BUSINESS OPPORTUNITIES

Assembly and Wiring of Electronic, Electro/Mechanical equipment. Competent team with supervision and Inspection facilities available now to meet your immediate requirements.

**PERSHORE MOULDINGS LTD.**  
Trading Estate, Pershore, Worcs. [695]

### CHEMICAL MILLING

Large or small sizes or quantities, practically all metal.

**T. G. MARTIN & CO. LTD.**  
Gilmar Works, HYDE, Ches. Tel. 2123 [696]

### LOOKING FOR PROFITABLE NEW LINES?

#### OPPORTUNITIES - ONTARIO STYLE

Manufacturers from Ontario, Canada, wish to contact successful established sales organisation covering the U.K. Please send full particulars of your Company and product interest to:

Government of Ontario  
Trade and Industry Branch  
Ontario House, 13 Charles II Street  
London, S.W.1



## Situations Vacant (continued)

# ASSISTANT TELECOMMUNICATIONS ENGINEERS

Required by the GOVERNMENT OF KENYA, Police Department on contract for one tour of 24 months in the first instance. Gratuity 25% of total salary drawn. Free passages. Liberal leave on full salary. Accommodation provided at moderate rental. Generous education allowances. Outfit allowance.

## (a) Assistant Telecommunications Engineers, Grade I.

Candidates, up to 50 years of age, must have served an approved apprenticeship and possess the City and Guilds Telecommunications Technician's Certificate or equivalent. They must have had at least five years' experience in Telecommunications engineering including considerable practical experience with fixed, mobile and portable Telecommunications equipment operating in the H.F. (including S.S.B. and I.S.B.) and V.H.F. (AM and FM) bands and associated aerial and mast installation plus a knowledge of transistorized and mast equipment. A knowledge of V.F. Multiplex equipment is also essential. Commencing salary according to experience in scale rising to £2,202 gross per annum.

(M3D/61095/WF)

## (b) Assistant Telecommunications Engineers, Grade II.

Candidates, up to 50 years of age, must possess the City and Guilds Telecommunications Technician's Certificate and/or a Commercial Electronic Engineering background and have had at least four years' practical experience with fixed, mobile and portable Telecommunications equipment operating in the H.F. (D.S.B. and S.S.B.) and V.H.F. (AM and FM) bands and associated aerial and mast engineering. Experience in the maintenance, repair and calibration of modern Telecommunications test equipment and of V.H.F. multiplex carrier equipment is desirable. Commencing salary according to experience in scale rising to £1,878 gross per annum.

(M3D/61097/WF)

Apply to CROWN AGENTS, M. Dept., 4 Millbank, London, S.W.1, for application form and further particulars, stating name, age, brief details of qualifications and experience, and quoting the relevant reference.

### EXPERIMENTAL OFFICER

Queen Mary College  
(University of London)

AN Experimental Officer is required for work in connection with the University of London Intercollegiate Research Service for Chemistry and Related Sciences. He will be responsible for the running and maintenance of a Decca electron paramagnetic resonance spectrometer under the general supervision of Dr. K. D. Sales. Previous experience in this field is not essential, but applicants should either be graduates in Electrical/Electronic Engineering or possess equivalent qualifications or experience. Opportunities will also be available to develop the spectrometer and to take part in the research programme.

Initial salary according to age and experience on scale rising to £1,680 p.a.

Applications with relevant details to be sent to the Registrar, Queen Mary College, Mile End Road, London E.1, naming two referees.

[694]

SALES Engineer for Balancing Machines and allied equipment.  
Apply to Cole Electronics Limited,  
7-15 Lansdowne Road,  
Croydon, CR9 2HB.

[697]

### TUITION

## THE UNIVERSITY OF ASTON IN BIRMINGHAM DEPARTMENT OF ELECTRICAL ENGINEERING M.Sc. COURSE IN ELECTRICAL ENGINEERING

OCTOBER, 1967 to SEPTEMBER, 1968

A GRADUATE course leading to a Master's degree is being offered in electrical engineering. The course will be of one year's duration. It will consist of six months of lectures, tutorials and laboratory work, followed by six months of project work in a chosen specialist field. One third of the lecture work will cover mathematics and electrical engineering materials. The remaining time will be devoted to one specialist option selected from the following:—

1. Communication Systems.
2. Design of Pulse and Digital Circuits and Systems.
3. Control Systems.
4. Electrical Machines.
5. Electrical Power Systems.

Some S.R.C. Advanced Course Studentships will be available for this course.

Application forms and further particulars may be obtained from:

The Head of the Department of  
Electrical Engineering (ref. M.Sc/6)  
The University of Aston in Birmingham  
Gosta Green  
Birmingham 4

[692]

### ARTICLES FOR SALE

## POLYTHENE BAGS

POLYBAGS LTD.  
197 Ealing Road, Wembley, Middx.  
01-902 1100

[698]

### BOOKS

"TELEVISION Receiving Equipment." By W. T. Cocking, M.I.E.E. The fourth edition of one of the most important British books on television deals in a comprehensive manner with television receiver equipment and gives many practical details and much design data. The circuits of a television receiver are split into a number of sections and a separate chapter is devoted to each. Other chapters deal with general principles, the signal, superheterodyne interference problems, special circuits, the aerial, the complete receiver, faults and servicing. 30s net from all booksellers. By post 32s 4d from Iliffe Books Ltd., Dorset House, Stamford Street, S.E.1.

"ULTRASONIC Delay Lines." By C. F. Brockelsby, B.Sc., A.R.C.S., A.M.I.E.E., J. S. Palfreeman and B. W. Gibson, B.Sc.(Eng.), Grad.I.Mech.E. The authors are members of a team which has been working on ultrasonic delay lines, since the early days, at the Mullard Research Laboratories. This is the first book to be written specifically on the subject, which has important applications in radar, radio and television, electronic computers, pulse-forming networks, correlation techniques and multi-channel communication systems. The early chapters discuss basic principles and the various types of delay lines are then covered. The chapter on electronics for delay lines deals fully with design of broad-band amplifiers, oscillators, etc., either with transistors or valves. The last two chapters are devoted to delay line measurements and the many applications of delay lines. Among the five appendices there is one containing nearly 60 curves which give the characteristics of many delay line materials. The final appendix discusses one of the latest developments, ceramic transducers. 65s net. By post 66s 4d from Iliffe Books Ltd., Dorset House, Stamford Street, London, S.E.1.

# AVELEY ELECTRIC

## INTEGRATED INSTRUMENT BUYING -HIRING TOO

Take a few minutes—call us

RIFI - FREQUENCY SYNTHESISERS VIDEO/VHF/UHF or SWEEP  
FREQUENCY DISPLAY SYSTEMS PROGRAMMABLE  
REMOTE CONTROLLED ATTENUATORS MULTI CHANNEL  
PEN RECORDERS SPECTRUM ANALYSERS -MICROWAVE  
MEASURING AND TEST EQUIPMENT-TELEMETRY  
SYSTEMS -HIGH POWER SIGNAL GENERATORS PRECISION  
AUDIO STANDARDS -ANTENNA FIELD TEST EQUIPMENT  
CABLE FAULT LOCATION INSTRUMENTS.



The Kieler Pulse Echo Cable Fault Location Set "TELEFLEX"  
for locating faults in Power and Telephone lines and cables.

**AVELEY ELECTRIC LIMITED SOUTH OCKENDON ESSEX**  
TELEPHONE SOUTH OCKENDON 3444  
TELEX FOR CATALOGUES 24120 AVEL OCKENDON

Agents for ROHDE & SCHWARZ · SCHOMANDL · NARDA · FAIRCHILD INSTRUMENTATION · NORTH ATLANTIC · STODDART ELECTRO  
SYSTEMS · SCIENTIFIC ATLANTA · HOLT · KIELER HOWALDTSWERKE · DEFENSE ELECTRONICS · HOTTINGER BALDWIN · CALNE ELECTRONICS ·  
TEB HUBER · FAIRCHILD RECORDING · HDLMBERG · ESSEX ELECTRONICS · ELCOR INC · RICHARD JAHRE · DR. ING. KAMPHAUSEN

For further information circle No. 255

FSJ/T

This is the handy Elcometer thickness gauge



\*Actual Size

It measures paint, electro-plating, enamel, glassfibre, plastic, rubber, bitumen and other non-magnetic materials on a ferro-magnetic base. Measuring range from 0.2 thou to 0.2" thick with 44 different scales calibrated in English and Metric. Three basic models have contacts adapted to a variety of surfaces including bar material of only 1/4" diameter. Ferrite content in stainless steel can be measured between 4% and 29%. There are 78 scales with 3 model permutations.

A pointer locking device permits measurement in inaccessible places. Accuracy is guaranteed at  $\pm 5\%$  or 0.0001". \*Overall size is 3 1/2" x 2" x 1". Weight 6 oz.

**Price 15 gns.**

For details of this and our other measuring instruments contact:

**ELCOMETER INSTRUMENTS LTD**  
FAIRFIELD RD  
DROYLSDEN 11  
MANCHESTER  
Tel: DROylsden 2790



For further information circle No. 256

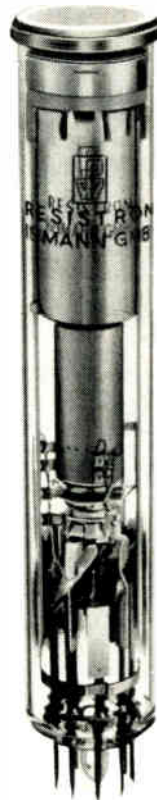

Whatever the job there's a PTW Resistron tube

These vidicon type TV pick-up tubes require low heater current and combine high sensitivity with small dimensions.

- + for industrial TV . . . . . model 2255 IND
- + for film scanners . . . . . model 2255 FIM
- + for X-ray television . . . model 2255 ROE
- + for infra-red applications model 2000 IR (wavelength: 350-1800 nanometers)

Also available:

- Infra-red image converter tubes
- image intensifier tubes
- electronic flash tubes

Manufactured by HEIMANN GmbH  
Postfach 13005  
62 Weisbaden - Dotzheim  
Western Germany



Write for full details to:  
**AEG (GT. BRITAIN) LTD.**  
27 Chancery Lane  
London WC2  
CHAncery 9944

For further information circle No. 257





# DESIGNED FOR TODAY

## TWO NEW MICROPHONES FROM AMPLIVOX



### THE NEW TELEMIKE

hand microphone for 2-way operation

- Transmits or receives on a single transducer
- High power performance
- Excellent speech quality
- Modern styling and attractive colour scheme
- Reliable switching

### THE NEW ELITE

high fidelity moving coil microphone

- High fidelity reproduction
- Full frequency coverage
- Rugged robust construction
- Modern appearance
- Available with single pole and double pole changeover switches

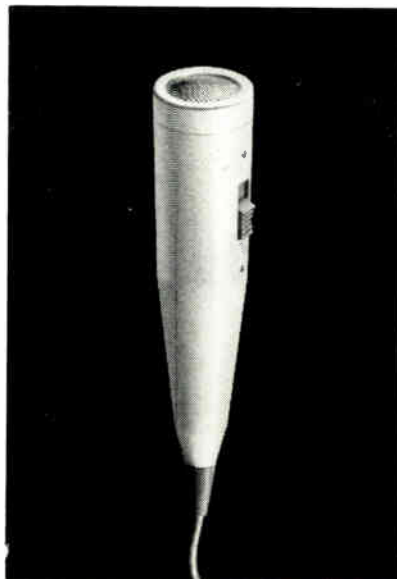

**AMPLIVOX**  
MAKE SOUND SENSE

Ideal for use with dictating machines; telephone answering systems; tape recorders; conferences; radio telephones and pocket sets.

**AMPLIVOX LIMITED • INDUSTRIAL DIVISION**

Beresford Avenue, Wembley, Middx. Phone: WEMbley 8991  
Grams and cables: Amplivox Wembley

For further information circle No. 259

# McGEOCH

## INDICATOR LIGHTS

MIMIC PANELS and DESKS designed and built to your specification



many standard patterns also 'specials' to requirements

**WILLIAM McGEOCH & CO. (BIRMINGHAM) LTD.**  
'phone 021 VIC 3371 (Telex: 338346 McGeoch B'ham)  
BORDESLEY, BIRMINGHAM 10

For further information circle No. 260

## ELECTRONICS PRINTED CIRCUITS

An extremely comprehensive service is available to industry which is unique in its scope and unprecedented in its quality of workmanship and speed of service while at the same time giving that all important individual attention and very competitive price terms that every buyer seeks.

The service consists of inclusive facilities for the design, development, and large scale production of all types of electronic equipment, instruments, etc., together with all processes involved in the design, development and production of printed circuit boards.

The unique location of T.E.S. Ltd., allows this first class service, which is to be found nowhere else, to be brought to your doorstep by an almost daily transportation service to 100 miles all for the price of a telephone call. Shanklin 3096.

Special attention will be given to very welcomed enquiries from customers outside the U.K.

**TRANSMETRIX ELECTRONIC SYSTEMS LTD.**  
Hyde Works, Shanklin, Isle of Wight, Hants

For further information circle No. 261

## TECHNICAL MOULDINGS

POLYSTYRENE-POLYTHENE  
POLYPROPYLENE  
CELLULOSE-ACETATE  
ABS-DELTRIN  
AND NYLON ETC.  
DESIGN TOOLMAKING  
HOT FOIL STAMPING  
MOULDING



**Henley Plastics Ltd.** HENLEY-ON-THAMES  
TELEPHONE 3861

For further information circle No. 262



# WHAT'S THE WORLD'S FASTEST 1/2" CAPACITY N/C DRILL? -THE MIDDLESEX NC100

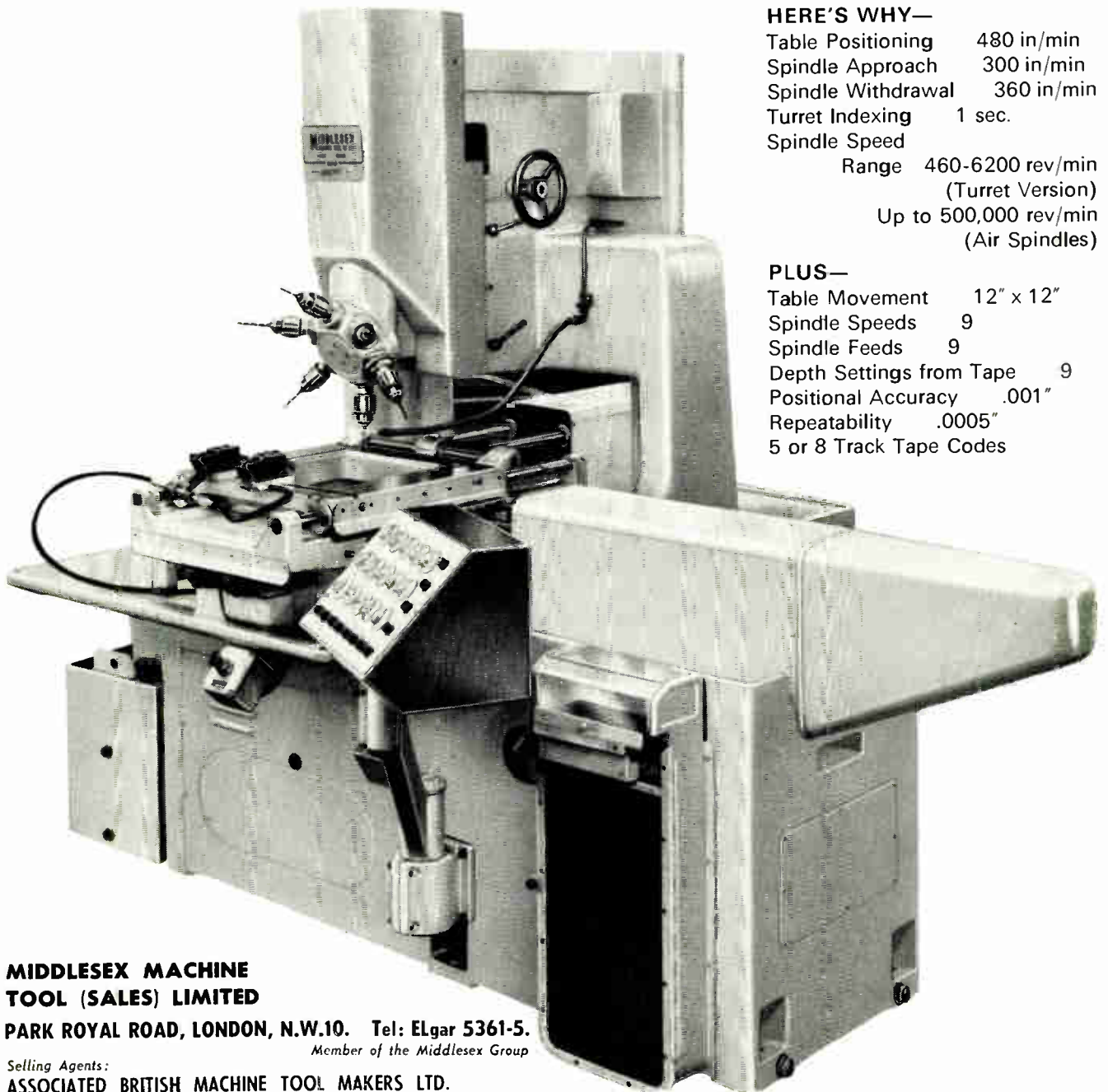

## HERE'S WHY—

Table Positioning	480 in/min
Spindle Approach	300 in/min
Spindle Withdrawal	360 in/min
Turret Indexing	1 sec.
Spindle Speed	
Range	460-6200 rev/min (Turret Version)
	Up to 500,000 rev/min (Air Spindles)

## PLUS—

Table Movement	12" x 12"
Spindle Speeds	9
Spindle Feeds	9
Depth Settings from Tape	9
Positional Accuracy	.001"
Repeatability	.0005"
	5 or 8 Track Tape Codes

## MIDDLESEX MACHINE TOOL (SALES) LIMITED

PARK ROYAL ROAD, LONDON, N.W.10. Tel: Elgar 5361-5.

*Member of the Middlesex Group*

*Selling Agents:*

ASSOCIATED BRITISH MACHINE TOOL MAKERS LTD.

17 Grosvenor Gardens, London, S.W.1. Tel: Tate Gallery 2384. Telex: 21611.

ALSO IN BIRMINGHAM, BRISTOL, LEEDS, MANCHESTER, NEWCASTLE-UPON-TYNE & PAISLEY.

**For further information circle No. 263**



# WHAT'S ON AND WHERE

## Meetings

### The Institution of Electronic and Radio Engineers

8-9 Bedford Square, London, W.C.1. (Phone: Museum 1901-3).

**10th April, 7.15 p.m.** Lecture on 'Parametric Amplifiers', to be given at the Lanchester College of Technology, Coventry.

**11th April, 5 p.m.** Lecture on 'Infra-red Detection', to be given at the School of Electronic Engineering, R.E.M.E., Arborfield, Berks.

**12th April, 6 p.m.** Lecture on 'Circuit Design using Digital Computers', to be given at Bedford Square.

**12th April, 6 p.m.** Lecture on 'Radio Astronomy', to be given at the Institute of Mining and Mechanical Engineers, Newcastle.

**18th April, 7 p.m.** Lecture on the 'Central Electricity Generating Board Communications System', to be given at the B.B.C. Club, Evesham.

**26th April, 7 p.m.** Lecture on 'Waveguides', to be given at Harlow Technical College.

**26th April, 7 p.m.** Lecture on 'Superconductivity', to be given at the University of Bristol.

### The Institution of Electrical Engineers

Savoy Place, London, W.C.2. (Phone: Covent Garden 1871).

All meetings are held at Savoy Place and begin at 5.30 p.m. (tea at 5 p.m.) unless otherwise stated.

**4th April.** Discussion meeting on 'Discharge Detection: Integrated or Resolved Response?'

**5th April.** Discussion meeting on 'Distribution System Control'.

**7th April.** Lecture on a 'Digital Computer Program for Design Synthesis of Large Squirrel-Cage Induction Motors'.

**7th April.** Lecture on the 'Development of Fluid-Damped Electrical Measuring Instruments'.

**12th April, 6 p.m.** Lecture on 'The Future Use of Solid-State Devices in the Microwave Field'.

**14th April.** Lecture on 'A Survey of Semiconductor Materials'.

**21st April.** Joint discussion meeting with the S.I.T. on 'The Dynamic Measurement of Stress using Strain Gauges'.

**25th April, 6 p.m.** Joint discussion meeting with the I.Mech.E. on 'In-Process Gauging', to be held at 1 Birdcage Walk, London, S.W.1.

**26th April.** Joint discussion meeting with the I.Mech.E. on 'The Reduction of Dynamical System Complexity'.

### Society of Electronic and Radio Technicians

33 Bedford Street, London, W.C.2. (Phone: Covent Garden 1152).

**5th April, 7.15 p.m.** Lecture on 'Transmission Techniques', to be given at the Charles Trevelyan Technical College, Newcastle-on-Tyne.

**6th April, 7 p.m.** Lecture on 'Recent Developments in Semiconductors', to be given at the London School of Hygiene and Tropical Medicine, London, W.C.1.

**12th April, 7.30 p.m.** Lecture on 'Medical Electronics', to be given at the Y.M.C.A. Club, Glasgow.

**20th April, 7.30 p.m.** Lecture on 'Hospital Broadcasting', to be given at the Southampton College of Technology.

**20th April, 7.30 p.m.** Lecture on 'U.H.F. Tuners', to be given at the Llandaff Technical College, Cardiff.

### The Institution of Electrical and Electronics Technician Engineers

26 Bloomsbury Square, London, W.C.1. (Phone: Langham 5927).

**6th April, 7.30 p.m.** Lecture on the 'Post Office Tower and its Place in the National Telecommunications Network', to be given at the Brighton College of Technology.

**10th April, 6 p.m.** Lecture on 'Electricity and Electronics in Aircraft', to be given at the I.E.E.

**12th April, 7 p.m.** Lecture on 'The Use of Closed-Circuit Television in Technical Courses', to be given at the Bolton College of Education (Technical).

**20th April, 7.30 p.m.** Lecture on 'Ultrasonic Sensing and Switching', to be given at the University of Leeds.

### Society of Instrument Technology

20 Peel Street, London, W.8. (Phone: Park 3755).

**5th April, 7 p.m.** Lecture on the 'Practical Uses of On-Line Computers with Chemical Plants and Analysis Instruments', to be given at the Cleveland Scientific Technical Institute, Middlesbrough.

**10th April, 6.45 p.m.** Lecture on the 'Instrumentation of Nuclear Power Stations', to be given at the Manchester Literary and Philosophy Society, Manchester 1.

**11th April, 7.15 p.m.** Lecture on the 'Latest Advances in Direct Digital Control of Plant Operation', to be given at the College of Further Education, Whitehaven, Cumberland.

# WHAT'S ON AND WHERE CONTINUED

**12th April, 7.15 p.m.** Lecture on 'Quality Control Instrumentation for Steel Strip and Tinplate Production', to be given at University College, Swansea.

**17th April, 7.30 p.m.** Lecture on 'Instrument Reliability', to be given at the Clarendon Hotel, Gravesend.

**19th April, 7.15 p.m.** Lecture on the 'Principles and Applications of Lasers', to be given at the Midland Hotel, Morecambe.

**25th April, 6 p.m.** Lectures on 'Computer Interface in Process Control', to be given at Manson House, Portland Place, London, W.1.

## Exhibitions

### 5th-10th April, Paris

International Exhibition of Electronic Components, to be held at the Porte de Versailles. Details from S.D.S.A.—Relations Exterieures, 16 rue de Presles, 75 Paris 15<sup>e</sup>.

### 11th-14th April, Manchester

Industrial Training Exhibition and Symposium, to be held at the Manchester College of Science and Technology. Organized by John Clarke Ltd., 11-13 Bridge Street West, Manchester 3.

### 14th-21st April, Paris

The Third 'Mesucora' Exhibition and Congress on Measurement, Testing, Control and Automation. To be held in the Palais de la Défense, and organized by Mesucora, 23 rue de Lubeck, 75 Paris 16<sup>e</sup>.

### 17th-20th April, London

The Physics Exhibition, to be held at Alexandra Palace. Organized by the Institute of Physics and The Physical Society. (Phone: Belgravia 6111).

### 29th April-7th May, Hanover

The 21st International Hanover Fair of industrial products. Further details from Schenkers Ltd., 13 Finsbury Square, London, E.C.2. (Phone: Metropolitan 9711).

### 22nd-26th May, London

Ninth International Instrument Show, to be held at Grosvenor House. Details and tickets from the Exhibition Officer, 9th International Instrument Show, Grosvenor House, London, W.1.

### 23rd-26th May, London

Radio and Electronic Component Exhibition, to be held in London. Details from the R.E.C.M.F., 21 Tothill Street, London, S.W.1. (Phone: Abbey 4226).

## Conferences, Symposia and Colloquia

**3rd-5th April.** Conference on the 'Resistive and Dielectric Properties of Thin Films', to be held in Nottingham. Organized by The Institute of Physics and The Physical Society, 47 Belgrave Square, London, S.W.1.

**3rd-7th April.** International Conference on 'Education for Scientific Information Work', to be held in London. Further details from ASLIB, 3 Belgrave Square, London, S.W.1.

**4th-5th April.** Symposium on 'Education for the Micro-circuit Era', to be held at the University of Southampton and co-sponsored by S.G.S. Fairchild. Further details from the conference secretary, Department of Electronics, University of Southampton.

**5th April.** Conference on 'Quality and Reliability and the Technician Engineer'. Organized by the I.E.E.T.E. (Phone: Langham 5927) and to be held at Queen Mary College, University of London, E.1.

**10th-14th April.** Conference on the 'P.A.L. Colour Television System', to be held at the University of Nottingham. Further details from the I.E.E. (Phone: Covent Garden 1871).

**10th-15th April.** International Conference on 'Electronics and Space', to be held in Paris. Further details from the Organizing Committee, 16 rue de Presles, Paris 15<sup>e</sup>, France.

**11th-12th April, 1967.** Conference on 'New Developments in Optics and their Applications in Industry'. Organized by the British Scientific Instrument Research Association, South Hill, Chislehurst, Kent. (Phone: Imperial 5555).

**11th-14th April, 1967.** Second U.K.A.C. Control Convention on 'Advances in Computer Control', to be held at the University of Bristol. Further details from the Convention Secretariat, The Institution of Electrical Engineers, Savoy Place, London, W.C.2. (Phone: Covent Garden 1871).

**13th-14th April.** Thirteenth Annual Standards Conference and Exhibition, to be held at Imperial College, London. Organized by the British Standards Institution, 2 Park Street, London, W.1. (Phone: Mayfair 9000).

**19th-20th April.** Symposium and exhibition on 'Preparing for Metrication', to be held at P.E.R.A., Melton Mowbray, Leicestershire.

**19th-22nd April, 1967.** Conference on 'Semiconductor Device Research', to be held in Bad Nauheim, West Germany. Further information from the German Section of the I.E.E.E., 6 Frankfurt-am-Main 70, Stresemann Allee 21, VDE-Haus.

**21st April, 2 p.m.** Colloquium on 'Electric Cars', organized by the I.E.E. and to be held in London.

**24th-26th April.** Conference on 'Image Detection and Processing', to be held at the Royal Radar Establishment, Great Malvern. Organized by the Institute of Physics and The Physical Society. (Phone: Belgravia 6111).

**25th-28th April, 1967.** Conference on 'Test Methods and Measurements of Semiconductor Devices', to be held in Budapest. Organized by The Scientific Society for Telecommunication, Technika Háza, Budapest V, Szabadság tér 17, Hungary.

**26th April, 2.30 p.m.** Symposium on 'Ultrasonic Methods in Non-Destructive Testing'. To be held at the London School of Hygiene and Tropical Medicine and organized by the I.E.R.E.

# BEST OF BOTH WORLDS

That's what you get with  
Delanco Melamine Impregnated  
Vulcanized Fibre Tubing



## 1. ELECTRICAL

Delanco V.F. Tubes laminated with Melamine Resin. This is a recent development which has been added to our range of Delanco laminated insulator tubes — thus giving the electrical designer yet another material whereby to meet the ever-growing demands in the field of electrical insulation. The tubes are distinguished by their excellent resistance to arcing and tracking in electrical applications. Contrary to general expectations they show a very low water absorption of some 5 to 7% compared with the usual 20 to 55% for vulcanized fibre tubes.

## 2. MECHANICAL

They have high mechanical strength, good machineability, excellent flame and heat resistance and good resistance to moderate concentrations of alkalis and most solvents. Thus they share the tough mechanical properties of vulcanized fibre but additionally show the good electrical properties of melamine resin. Temperature range up to 130°C but are capable to withstand short excursions up to 180°C. We may summarise above by stating the tubes easily meet B.S.S. 934 but also have the advantages of very low water absorption and outstanding resistance to arcing and tracking.

The manufacture of the tubes is carried out in our London factory, right from initial impregnation to the rolling and finishing stage.

We are thus able to keep a close control of the process and ensure continuity and constancy of properties.

Samples and prices on request from:—

**ANGLO-AMERICAN VULCANIZED FIBRE CO. LTD · CAYTON WORKS · 21/23 BATH STREET · LONDON E.C.1 · CLE 8484**

**For further information circle No. 201**





## Mawdsley's make a flowmeter for soap

or any other fluid -

milk, water, acid, honey, beer - including many that put up aggressive arguments against being metered at all. If you think *you* have a problem, let Mawdsley's show you how they would tackle it.

Mawdsley's flowmeters are more advanced, and less affected by turbulent flow, than any other comparable instruments.

Please write or 'phone if you have a flow measurement problem to solve.

**INSTRUMENT DIVISION**

**MAWDSLEY'S LTD**

DURSLEY · GLOUCESTERSHIRE · ENGLAND

Telephone: Dursley 2921    Telegrams: Zone Dursley    Telex: 43128

**ADVANCED FLOW MEASUREMENT**



For further information circle No. 202