

INDUSTRIAL ELECTRONICS

OCTOBER 1965 5s 0d

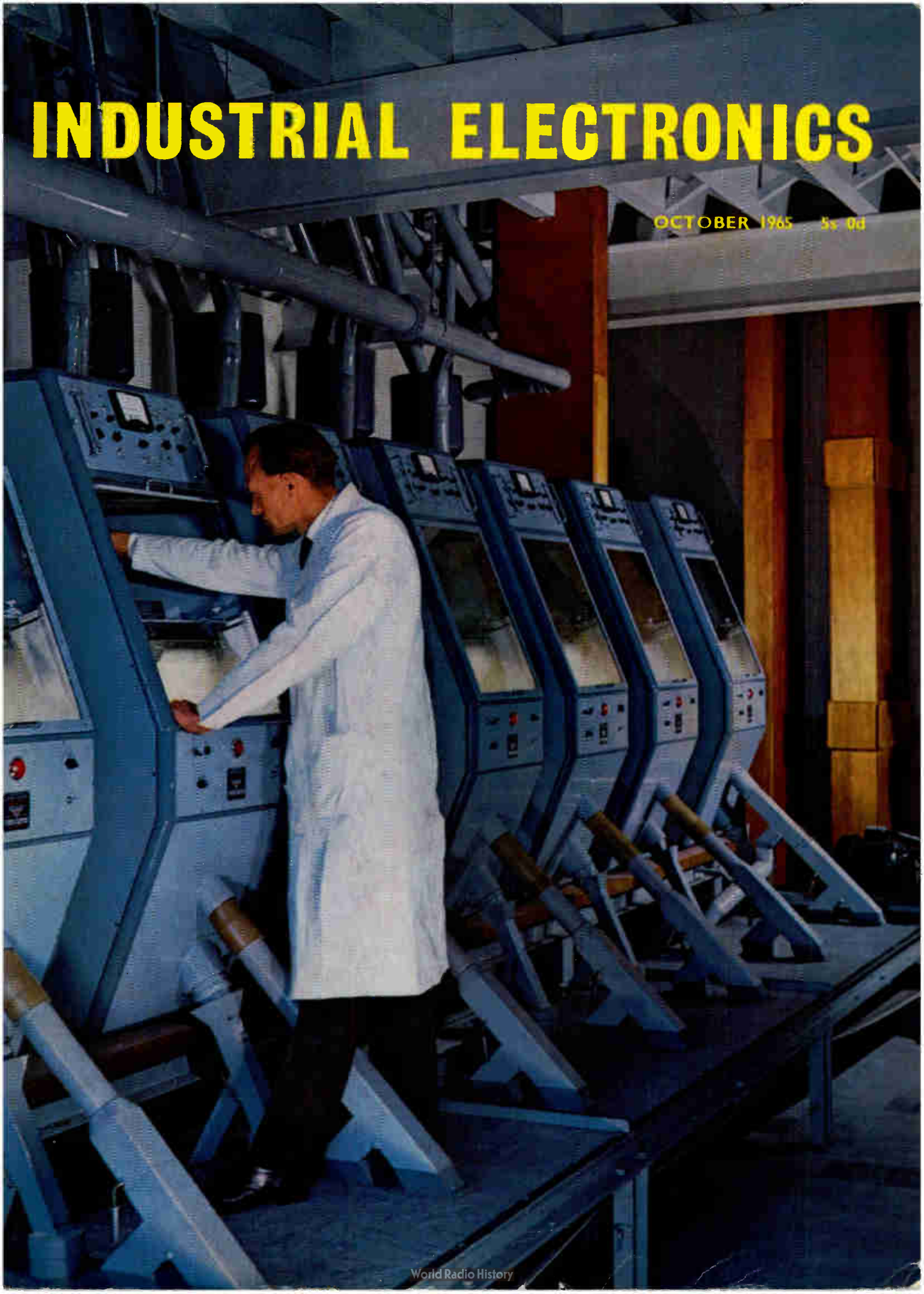

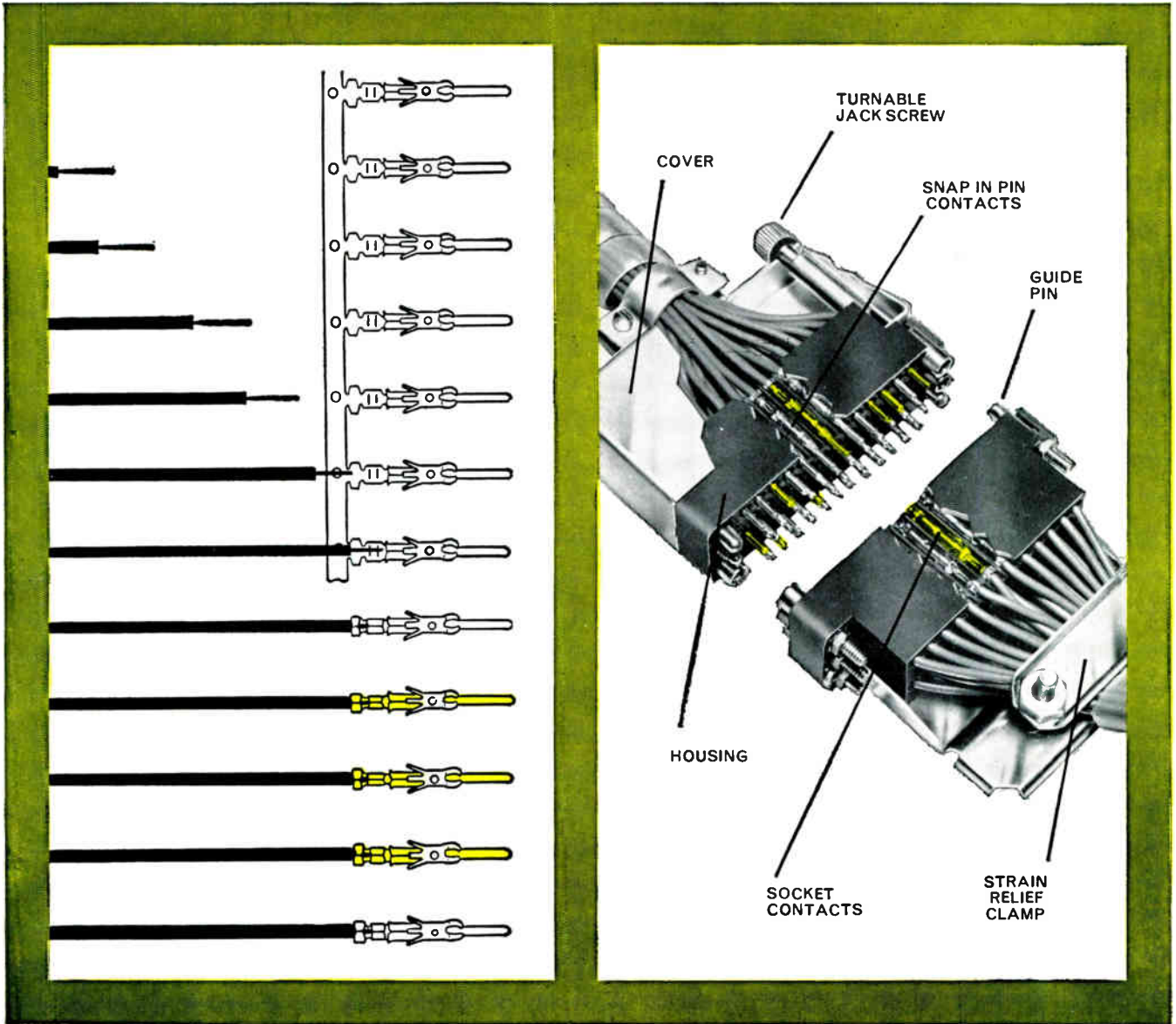

1600 perfect contacts per hour

Nothing can equal AMP matched crimp technique for low applied costs. For large scale production of AMP-INCERT Series M Connectors, contacts can be applied to wiring by A-MP automatic tooling at speeds up to 1600 terminations per hour. Every crimp is identical, mechanically and electrically perfect. AMP design offers advantages in assembly, too. Each pin or receptacle snaps instantly into its connector block and is firmly retained. Yet any

contact can be removed in a second for renewal or circuit variation. Gold contacts may be reserved for those circuits in which they are required. Pin and receptacle housing are supplied with 14, 20, 21, 26, 34, 41, 50, 75 and 104 positions.

For small and medium scale production there is A-MP hand and pneumatic tooling, giving the same controlled compression crimp which is the hallmark of all AMP terminations.

AMP-INCERT Series M Connectors

incorporating AMP controlled compression crimp for lowest applied cost.



AMP
AIRCRAFT-MARINE PRODUCTS
(GREAT BRITAIN) LIMITED

TERMINAL HOUSE, STANMDRE, MIDDX. STONEGROVE 6341
U.S.A. · AUSTRALIA · CANADA · FRANCE · GERMANY
HOLLAND · ITALY · JAPAN · MEXICO · PUERTO RICO · SPAIN

A-MP AND AMP-INCERT ARE TRADE MARKS OF AMP INC.

INDUSTRIAL ELECTRONICS

Incorporating British Communications and Electronics

Communications Automation Instrumentation Control

Contents October 1965

Editor-in-Chief **W. T. COCKING, M.I.E.E.**
Editor **T. J. BURTON**
Advertisement Controller **G. H. GALLOWAY**
Advertisement Manager **R. H. C. DOHERTY**
Production **D. R. BRAY**
Drawing Office **H. J. COOKE**

461 **Comment**

462 **Electronic Colour Sorting**

by Willy Schaub

In the food industry increasing use is being made of electronic sorting of commodities for quality selection. Almost any kind of seeds, nuts and similar products can be sorted by the wide range of machines employing the electronic colour separation techniques. Described here are the basic techniques involved, specific sorting machines and a typical application including the economics. Latest developments point to an adaptation of the same techniques to other industries.

466 **A Pulse Compression System for Radar, Pt. I**

by W. S. Mortley

A correlation system is described which enables a tapped delay line to be used as a decoding element in a radar system. This permits high discrimination to be obtained with radar pulses as long as ten microseconds.

471 **An Application of Photomultiplier Tubes in Temperature Measurement**

by J. Sharpe, B.Sc.

This article gives details of an approach to high temperature measurements using low-cost photomultiplier tubes. It shows that by operating a pyrometer at short wavelengths this technique can provide extreme sensitivity to small fluctuations in temperature.

478 **Electromagnetic Relays**

by D. A. Malden

Millions of relays are used in industry every year and of these the greatest proportion is electromechanical. However, there are many other basic types with particular characteristics and it is with these that this first article will deal, briefly describing their construction and operation and indicating their main features.

VOLUME 3

NUMBER 10

continued overleaf

© Iliffe Electrical Publications Ltd., 1965

Permission in writing from the Editor must first be obtained before letterpress or illustrations are reproduced from this journal. Brief abstracts or comments are allowed provided acknowledgment to the journal is given.

Published on the first Thursday after the 5th of each month by

Iliffe Electrical Publications Ltd., Dorset House, Stamford Street, London, S.E.1

Managing Director: W. E. Miller, M.A., M.I.E.R.E.

Telephone: Waterloo 3333. Telegrams/Telex: Electronics Iliffepres 25137 London

ANNUAL SUBSCRIPTION, HOME £3 0s. 0d. OVERSEAS £3 10s. 0d.
CANADA and U.S.A. \$10.00.

INDUSTRIAL ELECTRONICS

Incorporating British Communications and Electronics

Communications Automation Instrumentation Control

Contents *continued*

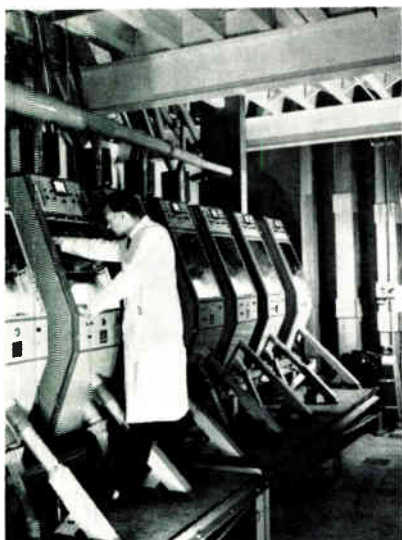

OUR COVER

This month's front cover picture shows a number of electronic colour sorting machines which are in operation at the Peterborough plant of Joseph Farrow and Co., Ltd. These machines are being used to separate discoloured and blemished peas from those which meet the standards required for packaging and canning. This is but one application of these machines. Other applications and the principles of operation are described in the article which starts on page 462.

● TO SAVE YOUR TIME

We will assist you to obtain further information on any products or processes described or advertised in this issue. Just use the enquiry cards included in this journal.

- 482 **Temperature Measurement by Ultrasonics** *by P. J. Robins*
From time to time there is some commercial 'fall-out' from large research and development projects. This article describes an interesting temperature-measuring technique using ultrasonics which has been developed for the 'Dragon' nuclear reactor project.
- 486 **INEL 65: 2nd International Exhibition of Industrial Electronics**
The 2nd International Exhibition of Industrial Electronics was held in Basle, Switzerland, last month. This report deals with some of the many interesting items shown at the exhibition.

What's On and Where?

A regular feature which lists forthcoming events. Professional meetings, symposia, conferences and exhibitions are included. For easy reference this item is positioned facing the inside back cover.

Features

- | | | | |
|-----|---|-----|--|
| 464 | Britain's First Computer-Controlled Port Traffic System | 484 | Comprehensive X-Ray Analysis Service |
| 465 | Electronic Speedometer for Railway Locomotives | 485 | Wire-Wrapping Machine |
| 470 | Electronic Control of Paper Stock | 485 | Direct Digital Control of Soaking Pits |
| 475 | Picture Transmission Over Telephone Lines | 492 | Computer-Wiring Test Equipment |
| 476 | Fucino Earth Station Transmits Live T.V. Signals to Early Bird | 492 | Ultrasonics Technical Service |
| 477 | Servo Controls for Materials Testing | 493 | New Apparatus |
| 481 | Alarm Scanner for Cargo Vessel | 505 | Computer Controlled Drawing Equipment |
| 482 | Proposed Changes in I.E.E. Membership Structure | 506 | Web Break and Edge Control by Ultrasonics |
| 483 | Floating Seastation Telecommunications System | 507 | Industrial News |
| | | 511 | New Books |
| | | 512 | Manufacturers' Literature |
| | | 94 | <i>Classified Advertisements</i> |
| | | 99 | <i>Index to Advertisers</i> |

Next Month

The November issue will contain an article dealing with automatic placement of components in circuit boards or panels. Among the other articles will be the concluding discussion of a pulse-compression system for radar.

For further information
circle 203 on Service Card

With over 20 years unique experience in the manufacture of Film Resistors—Welwyn now offer an **UNPARALLELED SERVICE IN THE FIELD OF THIN FILM INTEGRATED CIRCUITS**

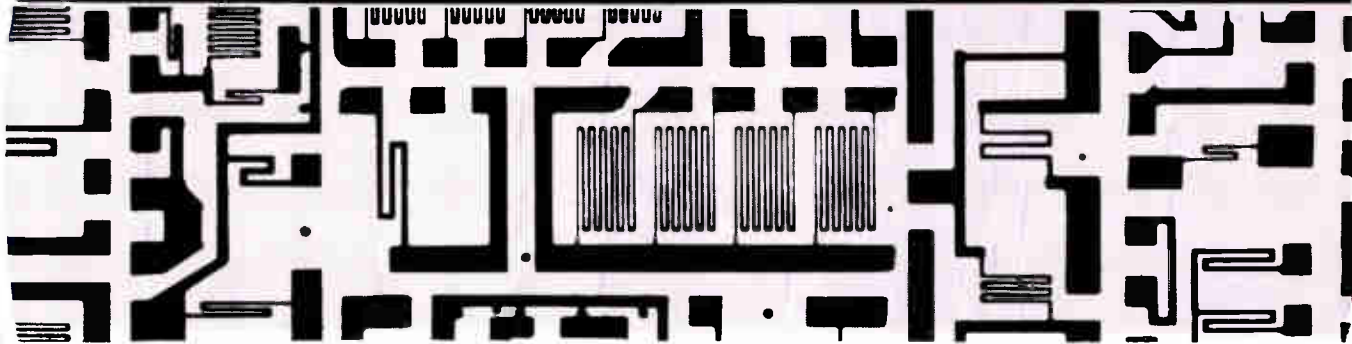

THIN FILM CIRCUITS from WELWYN

Leading the field in the latest production techniques—Welwyn offer

- Thin Film Integrated Circuits in volume production—NOW.
- Thin Film Integrated Circuits at PRICES MORE THAN ATTRACTIVE when compared with assemblies of high grade discrete components.
- Thin Film Integrated Circuits individually engineered to YOUR SPECIAL REQUIREMENTS.
- Essential Present Day reliability standards in every Welwyn Thin Film Circuit.

The new Welwyn brochure
"THIN FILM INTEGRATED CIRCUITS"
is now available—write for your copy.
Circuit Engineers are also requested to
submit their particular requirements for
evaluation in the Welwyn technique,
or to ask for general samples.



WELWYN ELECTRIC LIMITED

BEDLINGTON - NORTHUMBERLAND - ENGLAND

Telephone : Bedlington 2181-9 - Telegrams : Resistor' Bedlington.

FACTORIES IN AUSTRALIA AND CANADA

How big
do you expect
a good reliable
15A 2-contact
relay to be?

Try this for size

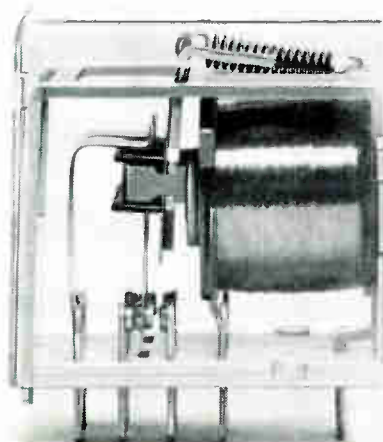

The Siemens & Halske Type 15 relay is designed specifically for domestic electrical appliances but its excellent specification makes it an ideal choice for many other uses:—

2 changeover contacts each capable of switching 15 amps (which can be used in parallel).
Coil and contact connections designed for $\frac{1}{4}$ " A.M.P. connectors.
AC or DC coils available, rated 3.4VA or 2.3 watts.
Silver or Silver/Nickel contacts.
Makrolon visible inspection dust cover.

Extremely compact, size only $2\frac{1}{4}$ " x $2\frac{1}{4}$ " x $1\frac{1}{4}$ ".
Very competitive price, especially for quantities.



Full details from
B & R Relays Ltd. Temple Fields,
Harlow, Essex
Harlow 25231. Cables Brelay-Harlow
Sole UK distributors of
Siemens & Halske Relays

B&R

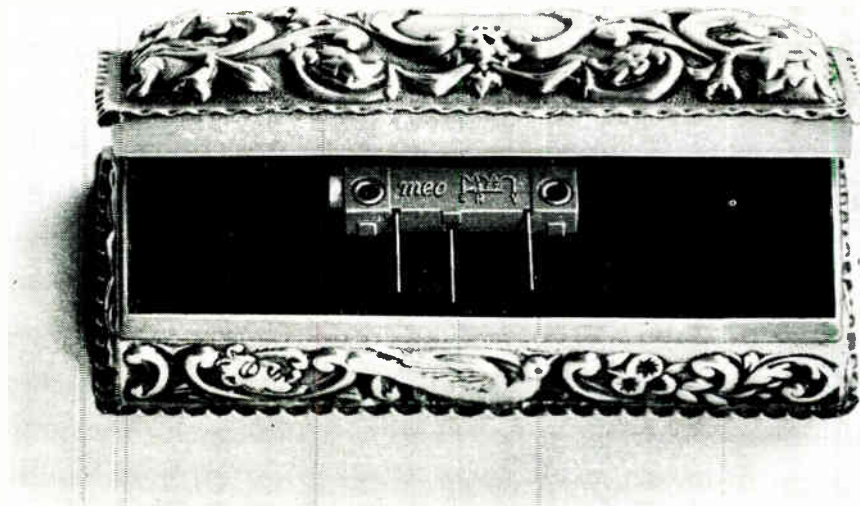
SIEMENS



A Mecpot is forever

Like a precious stone, the Mecpot once set retains its value But there the comparison ends for Mecpot trimmer potentiometers are inexpensive, versatile, easily adjusted, and with three connection types can fit any circuit Resistance values from 10 to 20,000 ohms Maximum rating 1 watt at 20°C. de-rating to $\frac{1}{4}$ watt at maximum temperature of 85°C. Three models: MP30  with solder tags for conventional chassis mounting; MP31  with L-shaped tags for insertion into printed circuits; MP32 illustrated above, actual size, with pins spaced along the body, for direct mounting on printed boards, no other fixing being necessary Write or phone for full specification and samples.

Miniature Electronic Components Ltd., St. John's, Woking, Surrey. Woking 5211.

m-e-c

For the first time

An active probe for digital counters

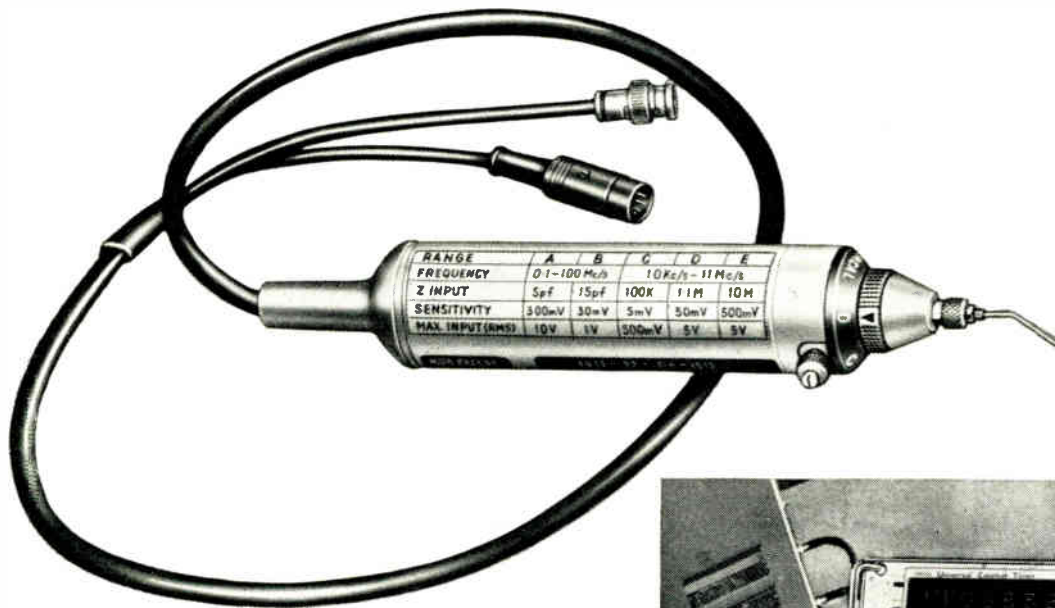

RACAL SA.544 ACTIVE PROBE

- All solid state
- Improves counter sensitivity, (typically to 5 mV)
- Wide frequency range—to 100 Mc/s
- Increases input impedance—to 10 MΩ
- U.K. Price—£55-0-0**

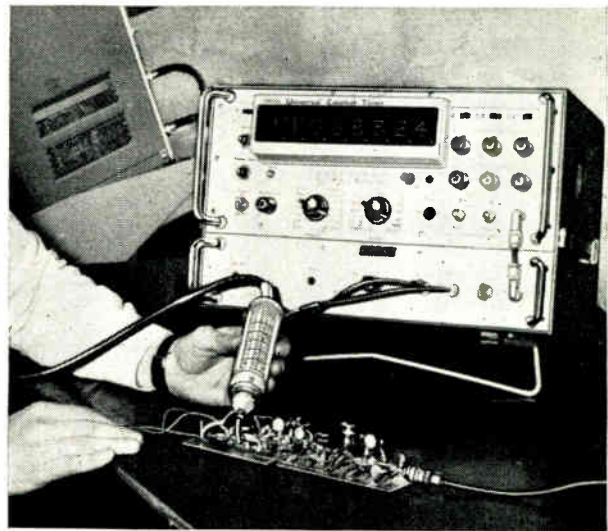

RACAL

Racal announce the first of a new range of Counter accessories. Digital counters can now be used for measuring much smaller inputs over a really wide frequency range without special external amplifiers and impedance-matching devices. The Racal SA.544 Active Probe is small, easy to use and designed to military standards (N.A.T.O. Code ref. 6625-99-519-1573). Simplify your difficult measurements with Racal equipment.

Racal Instruments Ltd.

Dukes Ride, Crowthorne, Berks. Telephone: Crowthorne 2272/3 & 3763
Telex 84166. Cables: Racal Bracknell

first
necessary
steps

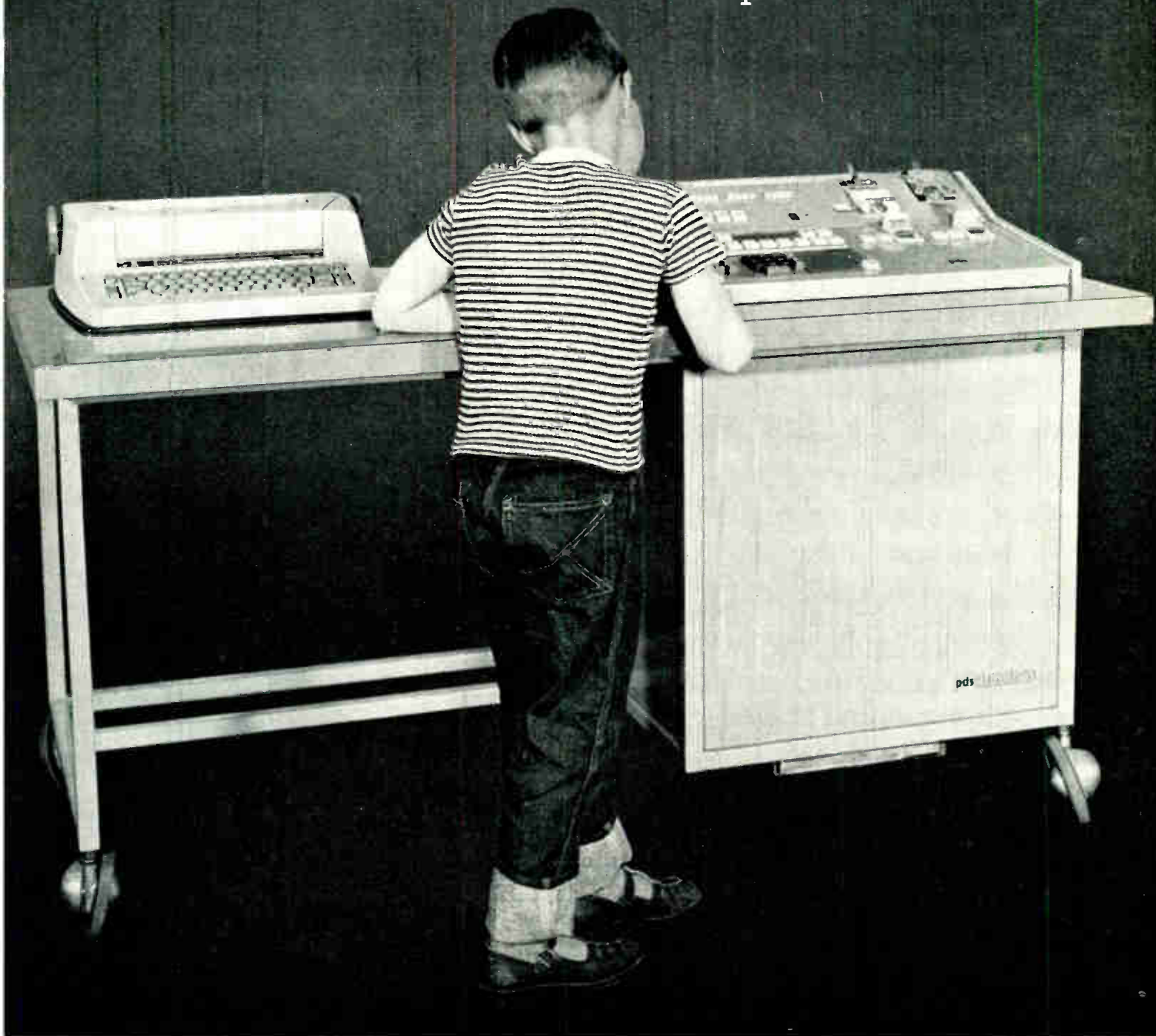

EAL

The PDS 1020 is not exactly child's play — but the first necessary steps in digital computation. Easy to learn — simple to operate, it provides a low cost 4096 word (16 bit) digital computer with no complicated programming procedure and only three sets of keys including special functions, (trigonometric values, exponentials etc.) arithmetic functions (add, subtract etc.) and numerical inputs.

ELECTRONIC ASSOCIATES LTD/BURGESS HILL/SUSSEX/TELEPHONE BURGESS HILL 5101

In liaison with EAI Long Branch, New Jersey, USA: ADVANCED SYSTEMS ANALYSIS AND COMPUTATION SERVICES □ ANALOGUE COMPUTERS □ HYBRID ANALOGUE-DIGITAL COMPUTATION EQUIPMENT □ DIGITAL COMPUTATION □ SCIENTIFIC AND LABORATORY INSTRUMENTS □ INDUSTRIAL PROCESS CONTROL SYSTEMS □ MILITARY AND INDUSTRIAL RESEARCH AND DEVELOPMENT SERVICES □ FIELD ENGINEERING AND EQUIPMENT MAINTENANCE SERVICES □ NUCLEONIC DEVICES FOR INDUSTRIAL CONTROL, EDUCATION/ RESEARCH AND GEOLOGICAL ANALYSIS □ SYSTEMS INSTRUMENTATION □ PRECISION ELECTRO-MECHANICAL COMPONENTS.

For further information circle 207 on Service Card

NOW

-200° to 1600°C

'BIKINI'

Regd. Trade Mark.

temperature instruments for use with thermocouples as well as resistance bulbs

- * Potentiometric accuracy
- * High impedance input circuit
- * Stable against varying supply voltages and ambient temperatures
- * Solid-state control switching to 0.2% differential. (No photo-cells)
- * Precision long-sweep slide wire with resolution of 0.1%

Many thousands of these low-cost, potentiometric, servo-operated, fully transistorised instruments have given maintenance-free service for over four years. They are the obvious choice for all temperature applications. Write for leaflets listed below.

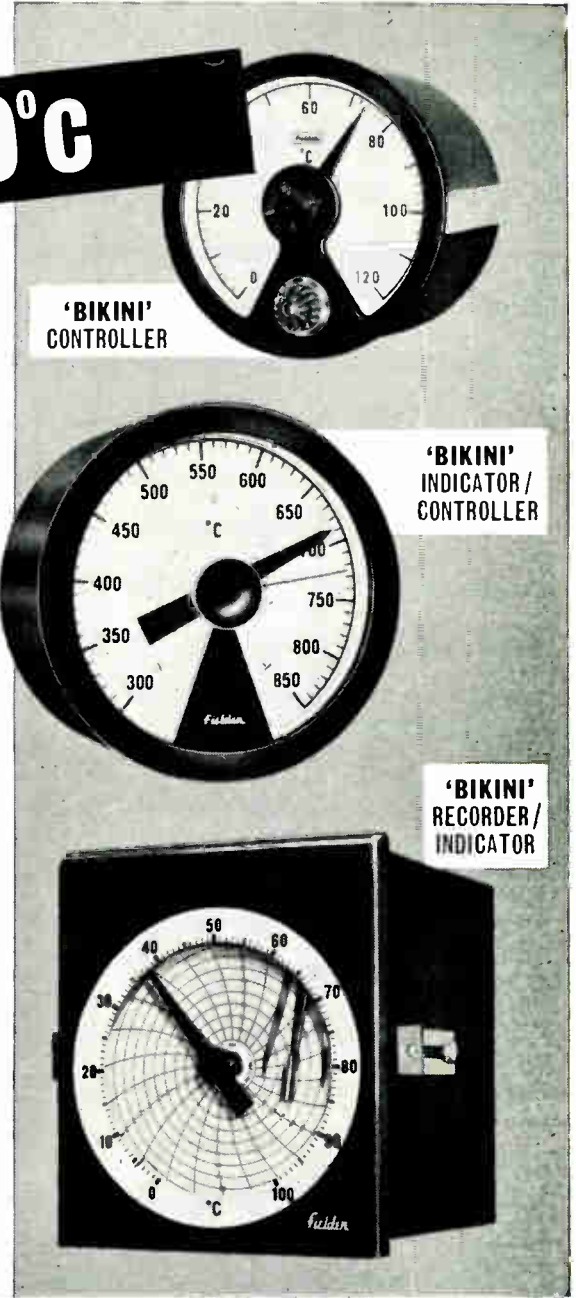

THERMOCOUPLE INSTRUMENTS

RESISTANCE BULB INSTRUMENTS

INSTRUMENT	SCALE LENGTH	CALIBRATION ACCURACY	MAX DISTANCE—MEASURING POINT TO INSTRUMENTS	APPROX. SIZE	WRITE FOR LEAFLETS	INSTRUMENT	SCALE LENGTH	CALIBRATION ACCURACY	MAX DISTANCE—MEASURING POINT TO INSTRUMENTS	APPROX. SIZE	WRITE FOR LEAFLETS
Indicator	12½"	± 0.5%	App. 1000 yds. (500 Ω)	6" dia.	BIK PT/2/1	Controller	9"	± 0.5%	300 feet	4½" dia.	BIK 1
Ind/Controller	12½"	± 0.5%	App. 1000 yds. (500 Ω)	6" dia.	BIK PT/2/1	Indicator	12½"	± 0.5%	300 feet	6" dia.	BIK 2/C
Recorder/Ind	13"	± 0.5%	App. 1000 yds. (500 Ω)	8½" x 7½"	BIK PT3/1	Ind/Controller	12½"	± 0.5%	300 feet	6" dia.	BIK 2/C
Rec/Ind/Cont	13"	± 0.5%	App. 1000 yds. (500 Ω)	8½" x 7½"	BIK PT3/1	Recorder/Ind	13"	± 0.5%	300 feet	8½" x 7½"	BIK 3
Rec/Ind/Prop.Cont	13"	± 0.5%	App. 1000 yds. (500 Ω)	8½" x 7½"	BIK PT3/1	Rec/Ind/Cont	13"	± 0.5%	300 feet	8½" x 7½"	BIK 3
						Rec/Ind/Prop.Cont	13"	± 0.5%	300 feet	8½" x 7½"	BIK 3 & EPC3

* 185 Standard temperature ranges — many available from stock

Whatever your instrumentation problem—consult Fielden on temperature, pressure, level, control systems.

Fielden

FIELDEN ELECTRONICS LIMITED · WYTHENSHAW · MANCHESTER

Telephone: Wythenshawe 3251 (6 lines) Telegrams: Humidity Manchester Telex: 66531
 Branch Offices: London, Walsall, Harrogate, and Scotland.
 Overseas Subsidiaries: AUSTRALIA: Fielden Electronics (Aust.) Pty. Ltd., 61 Betula Ave., Vermont, Victoria, and 107 Alexander Street, Crows Nest, New South Wales. ITALY: Fielden Electronics Italiana, Milan.
 Agents throughout the world.

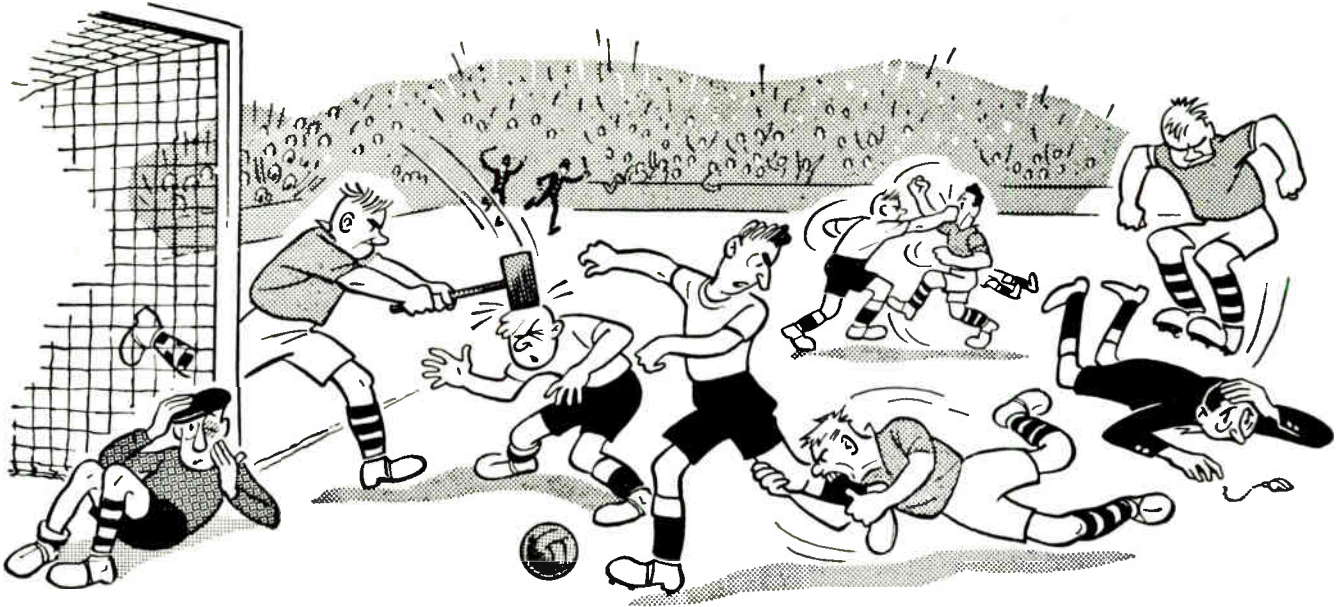

TOUGH AT THE TOP

When you're top of the league it's tough staying there. The Delanco organisation work as a team, think as a team, and sometimes argue among themselves, as most teams do, but with one aim, to keep Delanco Top of the League, for service and quality.

If your requirements are in the electrical insulation line, you'll find our team a very useful and helpful combination, and they know the game backwards.

If you can't get up to our ground,

(and you'll be very welcome if you can), all you have to do is drop us a line and we will set about answering your problems and in the meantime the full DELANCO technical catalogue will be sent to you.

Electrical Insulation materials, and machined parts. Vulcanised Fibre in sheet, Rod and Coil. S.R.B.P. and S.R.B.F. in sheet and machined parts, and strip. High heat materials. Mica. Moulded products. And many other products . . .

Delanco

TOP IN ELECTRICAL INSULATION

ANGLO-AMERICAN VULCANIZED FIBRE CO. LTD.

CAYTON WORKS BATH STREET LONDON EC1

CLE 8484 15 LINES

GRAMS 'PROMPSER' LONDON

pc

PLUG-IN RELAYS

MINIATURE

MINIATURE

MINIATURE

MINIATURE

MINIATURE

MINIATURE

MINIATURE

MINIATURE

light current and heavy duty types

FEATURES

Designed and manufactured by Perivale Controls over six years ago, the PC Miniature Plug-in Relay was first of its kind then—and it still leads. Built-in features of this wholly British relay include:

- ★ Complete interchangeability with most relays of foreign manufacture.
- ★ Operational accuracy derived from unique setting techniques.

★ High quality but competitive prices.

★ Speedy delivery even for specials.

SPECIALS

Flexibility of design is such that special derivatives seldom present a problem. Speedy delivery is offered as a service and enquiries for small or large quantities are invited.

STANDARDS

Over 100 different standard types for diverse applications. Designed for long term reliability and cost economy PC Miniature Plug-in Relays have standard operating voltages in the range 4 volts to 140 volts D.C. with a wide tolerance on nominal, and a myriad of contact configurations allowing for single or multiple operations in various combinations of make/break/changeover.

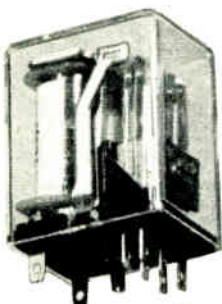

PC 2 Relay with Socket

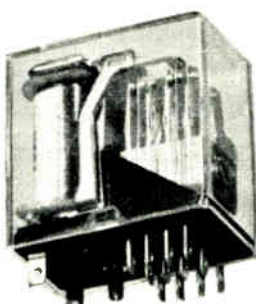

PC 4 Relay with Socket

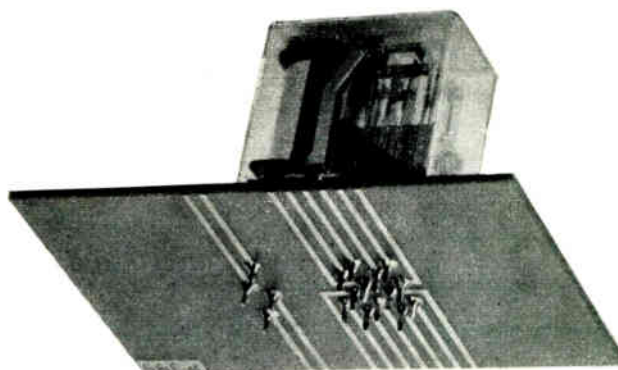

PC 4 Printed Circuit Relay Socket mounted on 1/8" board

PERIVALE CONTROLS COMPANY LIMITED

TELFORD WAY · EAST ACTON · W.3 TEL: SHEPHERDS BUSH 1015 (5 lines)

A **DAVALL** INSTRUMENTATION COMPANY OF THE BENTIMA GROUP

between

5pF and 250,000pF

your choice is easy...

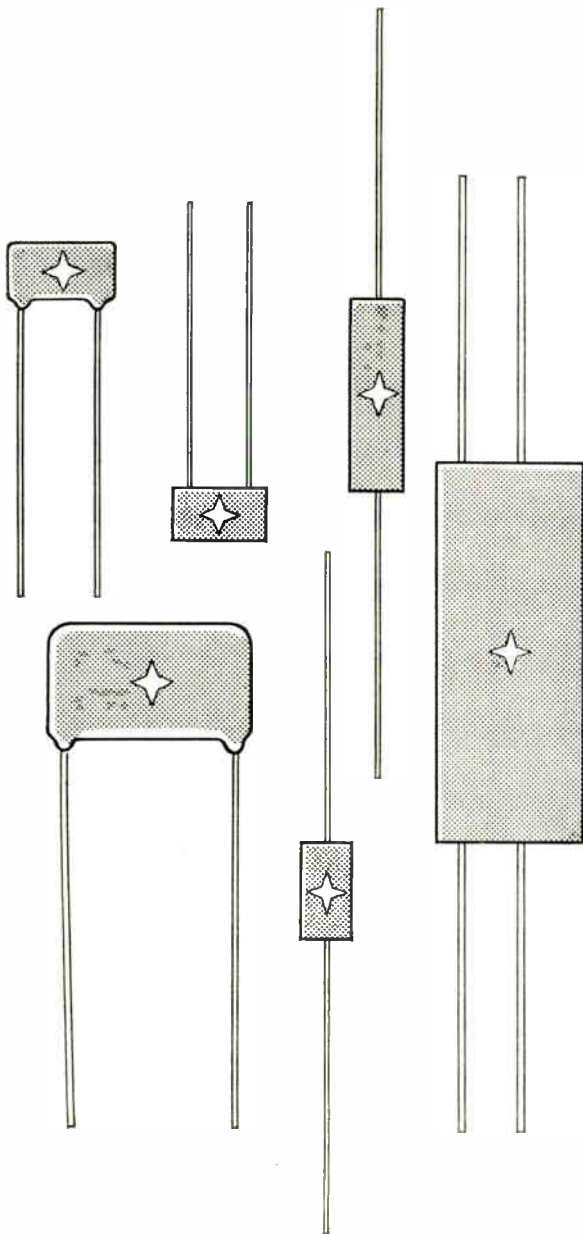

SILVER STAR CAPACITORS

cover all your needs

The standard range of Silver Star® capacitors contains a wide variety of sizes in encapsulated or dipped finishes. Your needs are covered, for any nominal capacitance value between 5 and 250,000 pF can be supplied—generally with a tolerance as close as $\pm 0.5\%$.

All Silver Star capacitors are of fired construction giving them unrivalled stability. A rigid system of process control throughout manufacture ensures that their outstanding electrical properties are consistently maintained.

In addition, every Silver Star capacitor is checked before we send it to you for four critical characteristics—capacitance, power factor, proof voltage and insulation resistance. Only components that meet the stringent Silver Star standards are supplied.



You can choose your requirements with these free data sheets. Just ask for them.

Johnson Matthey

JOHNSON, MATTHEY & CO., LIMITED
73-83 HATTON GARDEN, LONDON, E.C.1
Telephone: Holborn 6989 Telex: 21465
Vittoria Street, Birmingham, 1 Telephone: Central 8004
75-79 Eyre Street, Sheffield, 1 Telephone: 29212

GD 131

DOUBLE BEAM COSSORSCOPE 2300

Model 2300 is a compact, precision calibrated oscilloscope designed specifically for high-sensitivity, low-frequency applications in electrical engineering, servo analysis, electro-mechanical transducer displays, electro-myography and electro-cardiography. A double-gun cathode-ray tube is employed. Two identical amplifiers are provided with a choice of either single-ended or differential inputs.

The triggering system provides four modes of operation: Auto, A.C. Slow, A.C. Fast, and D.C., and the sweep may be triggered from any selected point on the positive or negative slope of the signal. Mechanical triggering is available, whereby an external contact closure, developed across the MECH and COMMON terminals of the oscilloscope by the apparatus under test, will trigger the time-base, an external voltage source being unnecessary. Single-stroke operation can be primed or triggered by a push-button.

- Frequency response d.c. to 200 kc/s (-3 dB)
- Identical Y amplifiers 1 mV/cm to 50 V/cm
- 19 calibrated timebase ranges 5 sec/cm to 5 μ sec/cm
- Voltage calibration $\pm 3\%$ and time calibration $\pm 3\%$
- Mechanical triggering Z modulation and equal X-Y facilities



COSSOR
A Member of the Raytheon International Group

COSSOR INSTRUMENTS LTD.
The Pinnacles, Elizabeth Way,
Harlow, Essex, England.
Tel: Harlow 26862 Cables: Cossor Harlow

T A K E S I X
to measure a megacycle



STOP PRESS

- * Variable sensitivity control on A.C. input.
- * Variable display timer (0.5-5 secs).
- * Period measurement over 1, 10 & 100 cycles
- * Provision for external ref.
- * Binary coded decimal output (optional extra).

Six big digits, clear and unambiguous, to measure frequency and time up to one megacycle and down to one microsecond—clearly, without flicker.

Six into one only just goes

Not much spare space on the panel of this instrument—the digits are big and the unit is small, compact, portable. Makes for convenience and easy reading, with an adjustable support that holds firm at any convenient angle.

Smaller and smaller!

Design of the Venner TSA 3436 Mark 2 is based on solid experience of applying transistorised digital techniques to measuring instruments. Small as it is, the TSA 3436 Mark 2 will give precise readings up to a megacycle and down to a microsecond.

ONLY £215 (Price applicable to U.K. only)

Laboratories and technical colleges welcome the compactness, strength and simplicity-in-use of the TSA 3436 Mark 2. In industry, its dependability, and the clarity of its display, make it uniquely suitable for inspection and quality control applications.

Full technical details will be sent on request.

VENNER TSA 3436 MARK 2 TIME/FREQUENCY METER

VENNER ELECTRONICS LIMITED

KINGSTON BY-PASS · NEW MALDEN · SURREY. MALDEN 2442

Overseas subsidiaries

VENNER A. G. BURGERNZIELWEG 16-3006 BERNE-SWITZERLAND-VENNER N. V. HELMSTRAAT 3-DEN HAAG-HOLLAND



a new concept
of integrated
circuit reliability
now available from

electrosil

UTILOGIC®

low cost
integrated circuits

Electrosil, who have made their name synonymous with component reliability, now introduce UTILOGIC integrated circuits to Britain. UTILOGIC is but one of the large ranges of devices made by the Signetics Corporation, a subsidiary of Corning Glass Works, whose glass-tin-oxide resistors have been so successfully manufactured and sold in the U.K. by Electrosil. UTILOGIC is a new force in micro-electronics for it has the high reliability consistent with products stemming from the Company which has been exclusively manufacturing integrated circuits longer than any other. U.K. production by Electrosil is now under active consideration.

Five reasons why UTILOGIC is the best buy in digital monolithic integrated circuits of up to 4 mc/s clock rate.

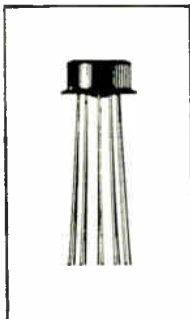

- 1 Very high noise immunity, worst case 0.8v.
- 2 High Fan-out — 17.
- 3 Capable of withstanding high capacitive loading.
- 4 Bistable element (J-K flip-flop) is not critical of rise-time and fall-time of clock waveform.
- 5 Very competitively priced.

LU UTILOGIC PRICE LIST

		1-24	25-99	100-999
LU 300K	Dual 3-Input Gate Expander	49/9	39/6	29/6
LU 305K	6-input AND Gate	54/-	43/-	31/3
LU 306K	Dual 3-Input AND Gate	54/-	43/-	31/3
LU 314K	7-Input NOR Gate	54/-	43/-	31/3
LU 315K	Dual 3-Input NOR Gate	54/-	43/-	31/3
LU 316K	Dual 2-input NOR Gate	54/-	43/-	31/3
LU 320K	J-K Binary Element	115/-	92/-	69/-
Temperature Range — +10°C to +55°C				
Encapsulation — 10 lead TO-5				

Elements on this list may be mixed on a single order to obtain the maximum applicable quantity discount.

* and an Electrosil exclusive — **AUGAT**

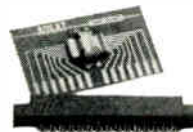

This unique equipment enables you to breadboard and test flat package or TO-5 encapsulated devices without soldering or damage to the leads. A simple clip holds the circuit in position and terminates the leads in plug sockets for jumper leads, or contacts for multi-sockets. Up to 50 devices can be accommodated on one board, and removal or replacement without damage is instantaneous. Send now for details.



ask Electrosil today for full details

MICRO-ELECTRONICS
DIVISION · LAKESIDE ESTATE
COLNBROOK · SLOUGH · BUCKS
TEL: COLNBROOK 2996 · 2196

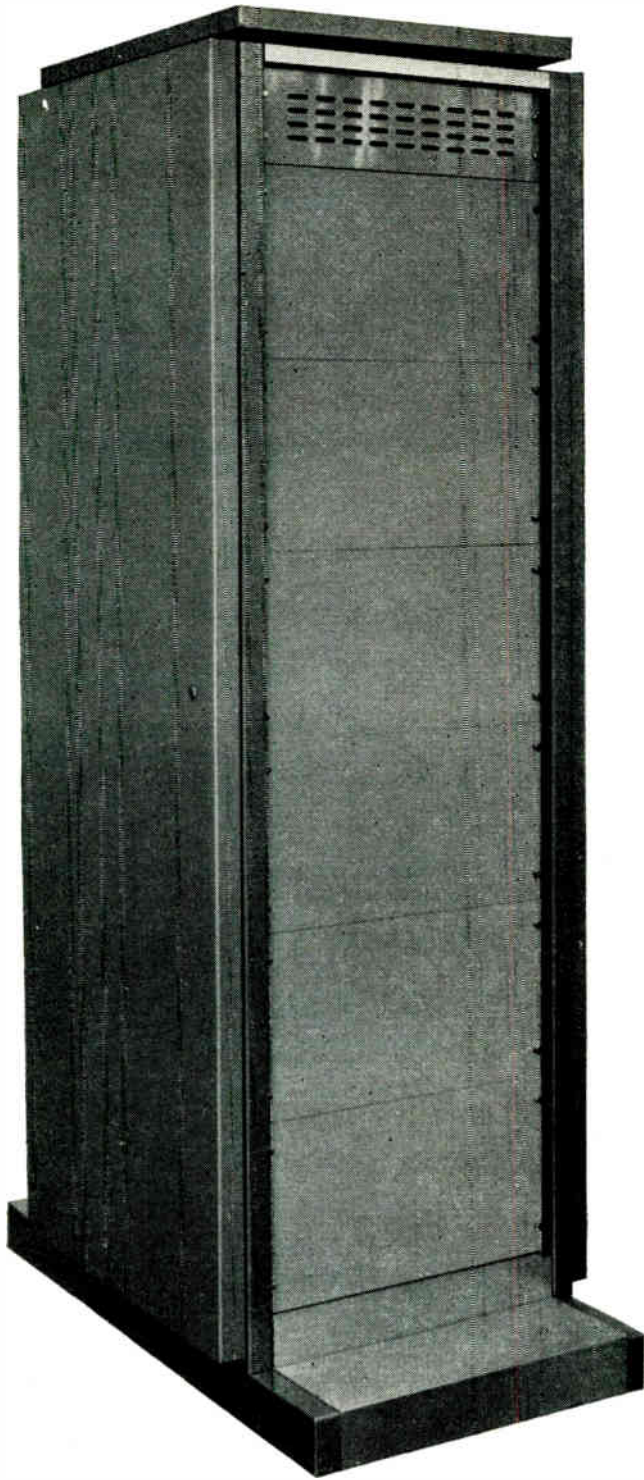

SQUARE FORM IMRAKS

at no extra cost

This new "square" form of styling is now available, as an optional alternative to the existing "radiused" design, on 95 models in the International Series of Imraks. These include all sizes of cubicle, enclosed, totally enclosed, induced ventilation and forced ventilation racks. When you buy any of these Imraks, you can choose the type of styling you prefer . . . at no extra cost!

On all but induced ventilation racks, these new square form racks have an attractive raised "mushroom" top to allow adequate ventilation (on induced ventilation racks the top is fitted in direct contact with the rack). These new style Imraks do, of course, still provide all the facilities offered by this versatile racking system, such as: choice of panel mountings, shortened doors, meter panel units, castors, lifting eyes, desk and drawer units, blowers, etc

A new range of low cost mobile bases and fixed plinths, designed to match the styling of the square form Imraks, has also been introduced with a model to suit each plan size of rack

Send today for full details and information on other new Imhof products

other new products include

new Imrak withdrawable desk units mounted on ball bearing telescopic slides, new small cases including carrying cases, new sizes of 600 series cases, new sizes of 1520 and 1550 cases, new induced ventilation fan units, new chassis runners, 18 new handles and paper protected aluminium panels

IMHOFS

Alfred Imhof Limited

Dept No. IE/10 Ashley Works
Cowley Mill Road Uxbridge Middlesex
Telephone Uxbridge 37123 Telex 24177
Telegrams IMCASE-UXBRIDGE-TELEX

Agents in Algeria Australia Belgium Brunei Canada Denmark Finland
France Germany Holland Iraq Israel Italy Lebanon
Mexico Morocco New Zealand Nicaragua Norway Portugal Singapore
Saudi Arabia South Africa Southern Rhodesia Sudan Switzerland
Syria Thailand Tunisia U.S.A. Zambia

**15 AMPS
IN ONLY
7³/₄" DIA
0-275 VOLTS**

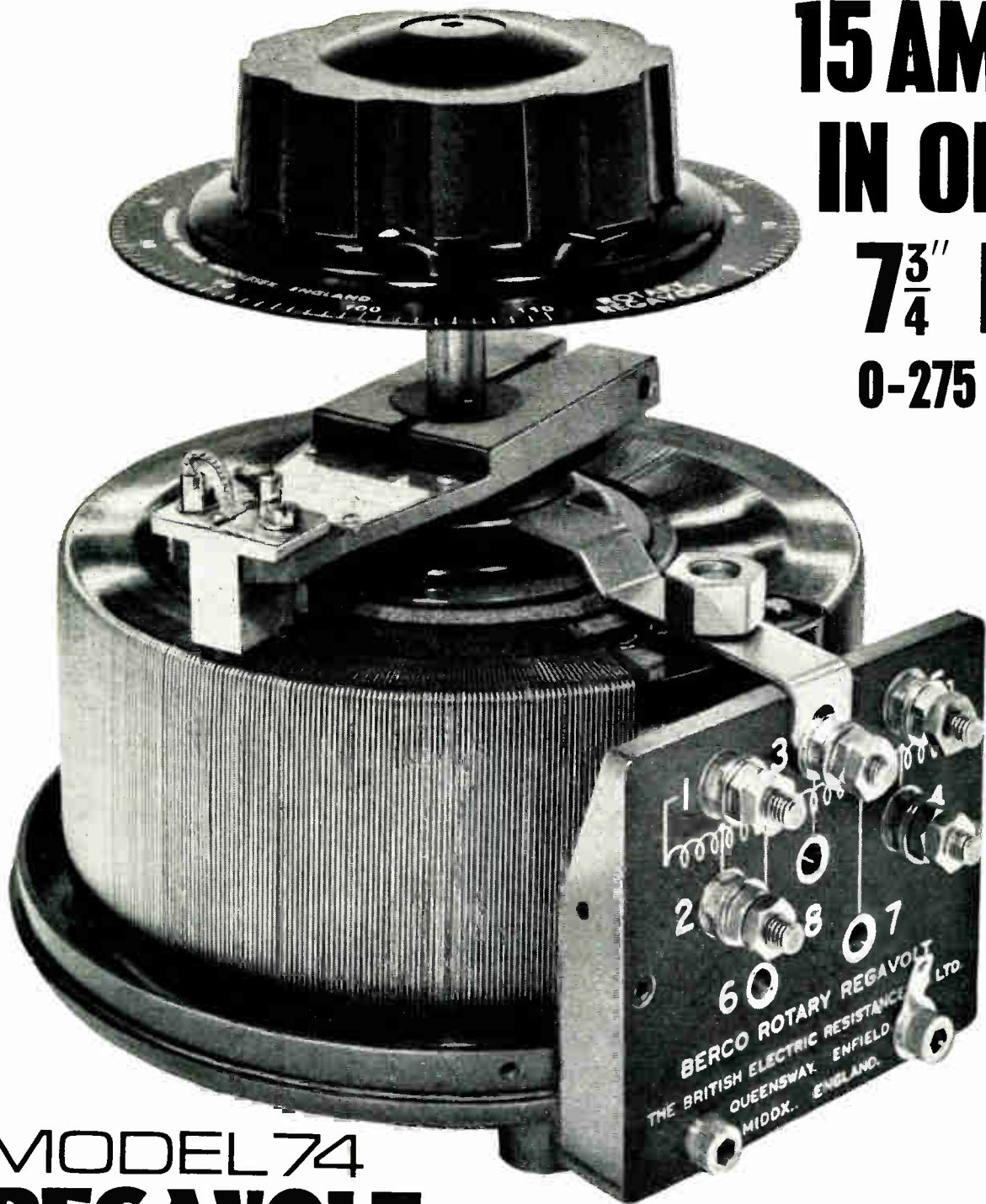

MODEL 74 REGAVOLT

variable transformer with trouble-free brush gear

Another winner for BERCO DESIGNERS . . .

Model 74 delivers twice as much KVA as any other variable transformer of equivalent size . . .

. . . only £25 · 15 · 0

. . . delivery from stock

Please phone Mr. Love, or write for List 625H/15 for full details.



THE BRITISH ELECTRIC RESISTANCE CO LIMITED
Queensway · Enfield · Middx · Tel: HOW 2411 · Grams: Vitrohm Enfield

The latest C.I. development —

**this self-service
Token Operated
Control for
Pumps or Meters**

Send for leaflet C.I.S.1

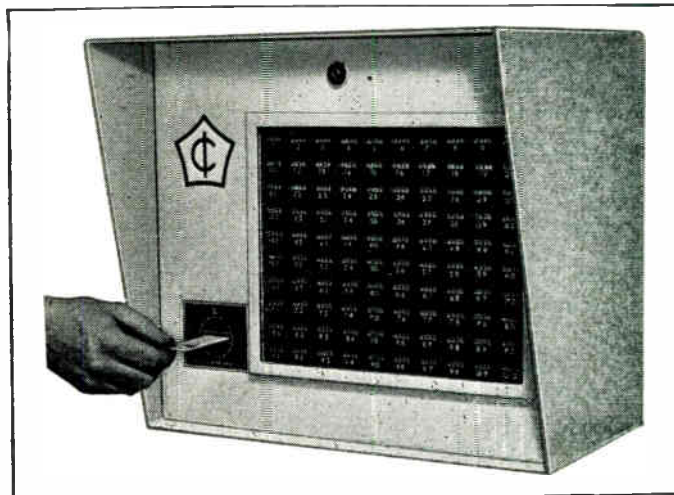

We have a large range of electro-magnetic counters which meet most applications, and to which we are continually adding.
—let us know your particular problem.



THIS IS SMALL AND FAST

Less than 1" deep this five or six figure counter operates at very high speeds.
Leaflet B8.

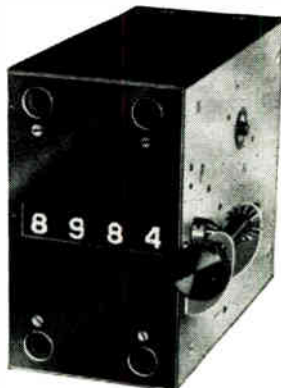

**THIS ONE ADDS OR
SUBTRACTS TO
CHOICE**

Separate and balanced mechanisms for add or subtract.
Leaflet B6.



**THIS IS LIGHT AND
TOUGH**

Very light weight. Maintains accuracy at 7G, 3 or 4 figures. Range includes presetting subtracting models
Leaflet B3/4.



**THIS IS FAST WITH
A QUICK RESET**

4 or 6 figures. Mechanical or Electric Reset High Speed Accuracy—Long Life.
Leaflet B1/2.



**THIS
SUBTRACTS
FROM A PRESET
NUMBER**

Returns to preset number when zero is reached. Mechanical or electrical reset.
Leaflet B7.



COUNTING INSTRUMENTS LIMITED

ELSTREE WAY · BOREHAM WOOD · HERTFORDSHIRE · Telephone: ELStree 4151

**'INTERCOM' (OCT 30th - NOV 7th 1965)
2nd International Fair of Communications
will feature the latest communications
by sea, river, lake, road, rail, air, radio,
post and cinema plus sections on new
materials, auxiliary equipment & services.**

OCTOBER 30th **GENOA** NOVEMBER 7th
BE THERE—SHOW THERE—SELL THERE

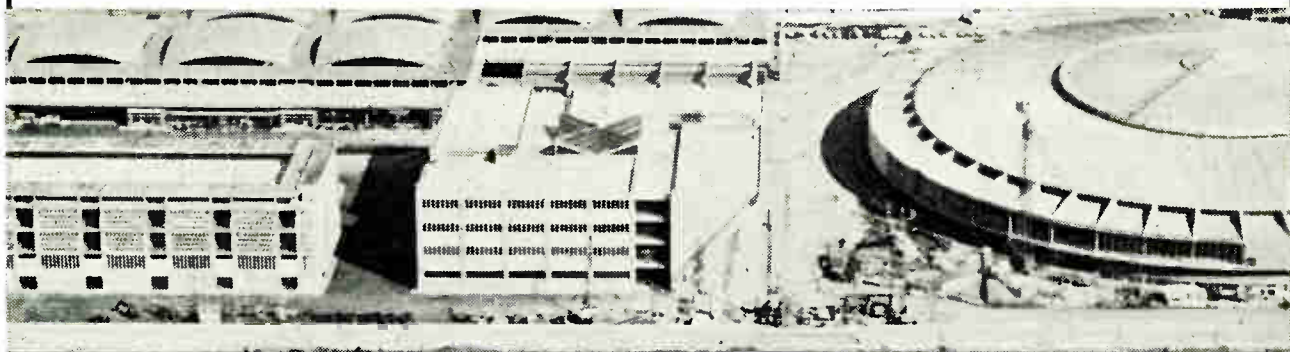

**2nd International Aeronautical Show will
feature aircraft & parts—airport installa-
tions & equipment—operational air
activity—organisation of air traffic.**

Full information can be obtained from:

EXHIBITION & TRADE FAIRS (OVERSEAS) LTD. · 10 CLIFFORD ST. · LONDON W.1 · (REgent 0511)

INSTANT NUMBERS*

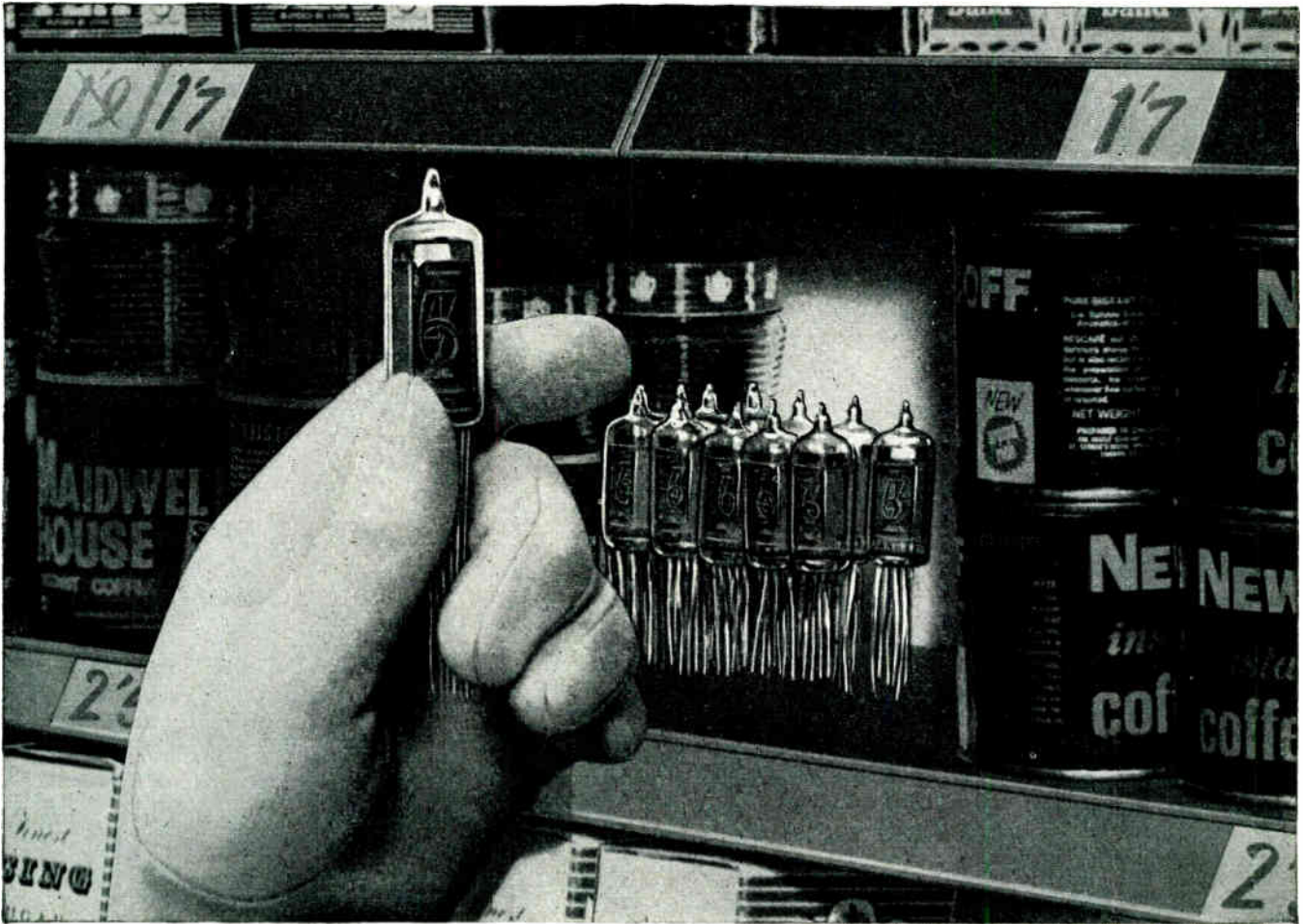

Hivac Numicators are *the* economic solution to digital display. Versatile, inexpensive, reliable, they are immediately available from stock in any quantity and offer the fullest range of symbols. Flying lead connections simplify component layout; low temperature, low current operation means long life.

Hivac will be pleased to consider manufacturing tubes with special symbols and to offer advice on integrating these versatile components with cold cathode tubes and other switching devices.

or, for that matter, letters and a wide range of symbols in* **numicators

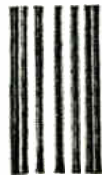

PLESSEY COMPONENTS GROUP

Hivac Limited

STONEFIELD WAY,
SOUTH RUISLIP,
MIDDLESEX.
Tel: Viking 1288



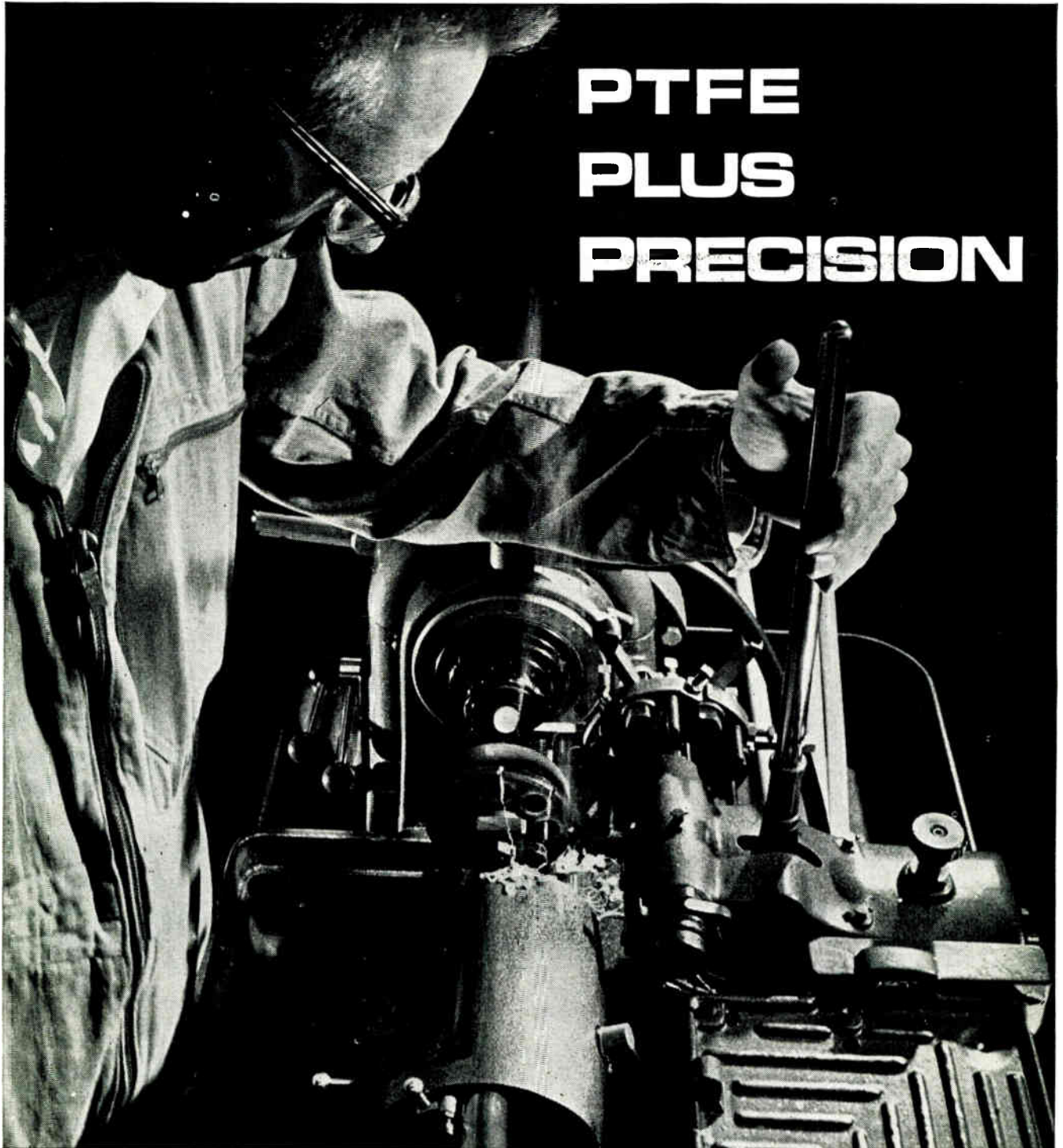

PTFE PLUS PRECISION

Photo by Walter Nurnberg

Extruded rod of correct uniform density, sintered under strict control and cured to relieve internal stresses. Finely honed cutters at exactly determined angles; machine speeds set to prevent temperature build-up... Some of the indispensable conditions for accurate, dimensionally stable components. PTFE plus precision. Klingerflon...

*Klingerflon, the trade-name for PTFE products of Richard Klinger Ltd.
For details of the Klingerflon range write to the address shown below.*



KLINGER

RICHARD KLINGER LIMITED · KLINGERIT WORKS · SIDCUP · KENT

Telephone FO0tscray 7777 Cables: Klingerit Sidcup Telex: London 28709

BRITISH DRIVER-HARRIS

DATA SHEET No. 2

Thermocouple Alloys

**'T1' and 'T2'
Special 'Advance'**

UNIFIED CONTROL OF QUALITY AT EVERY STAGE OF MANUFACTURE

In the field of temperature measurement and control, thermocouples are very important. The wires most widely used for thermocouples are base metal, and they vary in composition according to operating temperature requirements. We have specialised in the production of the base metal thermocouple wires in normal use, and we supply them to meet British Standard and Air Ministry Specifications. Data Sheet No. 2 (illustrated above) provides technical information. Copies will be supplied free of charge on request.

'T1' and 'T2' and 'Advance' are Registered Trade Marks
For further information circle 223 on Service Card

PLEASE SEND COPY/COPIES OF DATA SHEET No. 2
THERMOCOUPLE ALLOYS.

NAME

ADDRESS

IE 1065

**BRITISH DRIVER-HARRIS CO LTD
CHEADLE HEATH STOCKPORT CHESHIRE**

under £60



under £100



under £150



under £300



camera from £84 trolley from £15

SCOPE

more potentiality per pound

UNDER £60—from left to right

Amplifiers for S43, D43 and D43R 'scopes. Type A, General Purpose—£18. Type G, General Purpose Differential—£23. Type C, Ultra High Gain—£27. Type B, Differential—£32. Type D, Envelope Monitor—£35.

S51A—portable Serviscope* having all the advantages of a clear large screen display, extreme portability and lowest possible cost. Ideal for inspection, production control, monitoring and training. £55.

S51E—educational version of S51A Serviscope. Incorporates recommendations for simplified controls made by the Science Masters' Association and Nuffield Committee. Comprehensive instruction manual. £55.

UNDER £100—from left to right

S51T—special version of S51A Serviscope with d.c. X amplifier facility. Specially suited for use with a Transistor Curve Tracer to provide efficient, low cost transistor testing with cathode ray tube display. £60.

S32A—portable Serviscope capable of fast pulse work normally expected only of far more elaborate instruments. Weighing only 16 lb., this is truly the most portable measuring 'scope available today. £78.

S32AR—fulfils the need for an inexpensive ready-made instrument for building in as a permanent monitor, providing full measuring 'scope facilities. It occupies only 5" panel space in 19" rack. £90.

S43—portable laboratory 'scope with choice of five plug-in amplifiers. Capable of tackling a wide range of applications at a cost normally associated with 'scopes of limited potentiality. £98 with type A general purpose amplifier.

D52—for the first time a compact 5" double-beam Serviscope for less than £100. Suitable for laboratory applications, yet simple and robust enough for general and industrial purposes. £99.

UNDER £150—from left to right

S52—special purpose 5" Serviscope for applications involving phase comparison and measurement. Full 10 x 10 cms. display. Matched X and Y amplifiers and balanced attenuators. Also fulfils all the functions of a portable single-beam 'scope. £120.

D43R—a high performance and versatile 'scope system in standard 19" rack-mounting form, occupying only 7" of panel space. Choice of five plug-in amplifiers. £125 with type A general purpose amplifiers.

D43—has the brightest, finest trace yet in a portable double-beam laboratory 'scope. Accurate and versatile, with choice of five plug-in amplifiers, this 'scope is suitable for the widest range of applications. £125 with type A general purpose amplifiers.

CI Calibrator—basically an economical source of accurate and undistorted pulse and square waveforms in a wide selection of frequencies and repetition rates. Primarily intended to provide complete alignment facilities for Tequipment and other 'scopes. £120.

UNDER £300

D55A—double-beam laboratory 'scope with two wide-range calibrated time bases and a unique facility for the simultaneous magnified display on the upper beam of any part of the signal selected from the display on the lower beam. The D55A combines these features with large screen display and wide bandwidth. £275.

CAMERAS

Type A—comprehensive camera system. Choice of lenses, shutters and film backs—including 'Polaroid'. Parallax-free viewer. From £132.

Type E—an inexpensive and simple to operate 'scope camera with a 'Polaroid' back. Especially suitable for the smaller 'scope. From £84.

Trolley—one of a range suitable for Tequipment and other 'scopes. Two removable shelves. £15 6s 0d.

Further details and full technical specifications of the Tequipment range, or of an individual 'scope, will be sent on request.

**Serviscope is a registered trademark of Tequipment Limited.*

All prices quoted apply to the U.K. only.



Tequipment Limited · 313 Chase Road · Southgate · London N.14. Telephone: Fox Lane 1166
Scottish Office: 30 Castle Street · Edinburgh. Telephone: Balerno 3120

For further information circle 225 on Service Card

FERRANTI

MICRONOR

SOLID STATE DIGITAL CIRCUITS

Designed and manufactured in Britain for YOU

- **SHORT DELAY TIME** 15n Sec
Typical
- **GOOD NOISE IMMUNITY** 0.9v @ 25°C
0.5v @ 100°C
- **LARGE OUTPUT VOLTAGE SWING** 1.5v
- **AVAILABLE IN 8 LEAD TO-5 CASE OR 12 LEAD FLAT PACKAGE**

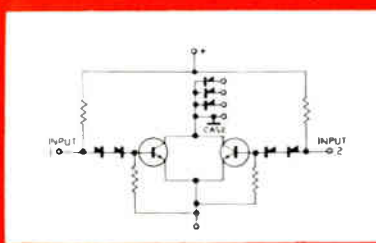

DOUBLE ENTRY NOR GATE
ZSS2B, ZSS32B

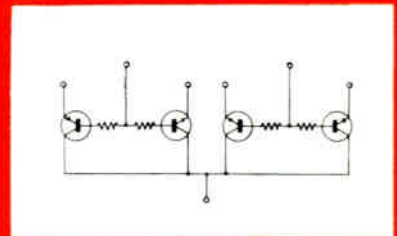

P.N.P. EMITTER FOLLOWER
ZSP6 (VX1717A), ZSP36

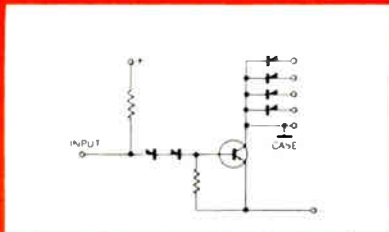

SINGLE ENTRY NOR GATE
ZSS1A (CN 7) ZSS31A

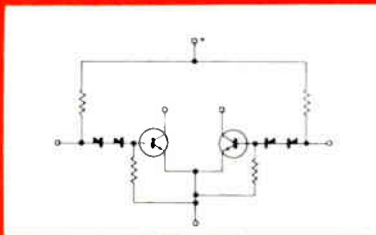

TWIN POWER DRIVER
ZST2 (CN 11) ZST32

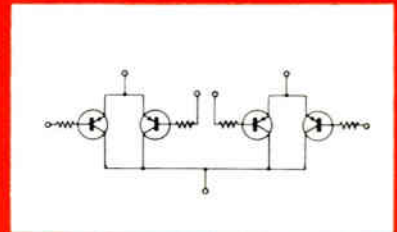

P.N.P. EMITTER FOLLOWER
ZSP7 (VX1717B), ZSP37

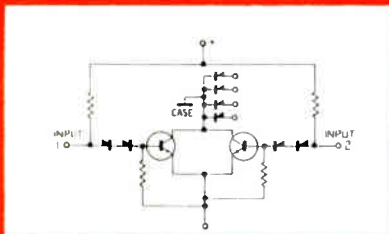

DOUBLE ENTRY NOR GATE
ZSS2A (CN 8) ZSS32A

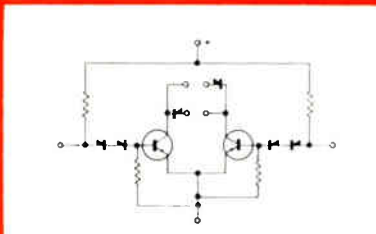

TWIN ENTRY NOR GATE
ZSS3B (CN 10) ZSS33B

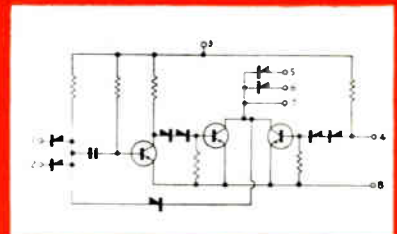

TRANSIENT MEMORY NOR GATE
ZSM1A (CN 12) ZSM31A



ACTUAL SIZE

TO-5

Flat Package

30 Series are in the Flat Package

WRITE NOW FOR MORE DETAILS :

FERRANTI LTD · GEM MILL · CHADDERTON · OLDHAM · LANCs · Telephone MAIn 6661

FERRANTI
First into the Future

Dawe digital voltmeter

Type 652

An inexpensive, multi-range voltmeter with millivolt sensitivity, and 4-digit display with automatic decimal point.

Main Features:

- ★ 0 to 1,000V d.c. in four ranges.
- ★ Available with 0.1% or 0.2% full scale accuracy.
- ★ Input impedance 2.2 megohms.
- ★ Measures floating or earthed sources with reversible terminal polarity.
- ★ Reading retention facility.
- ★ Compact, lightweight, portable.

Two models are available:

TYPE 652A with standard cell reference voltage, accuracy $\pm 0.2\%$ f.s.d., minimum measurement 2 mV;

TYPE 652AX with zener diode reference, accuracy $\pm 0.1\%$ f.s.d., minimum measurement down to 1 mV.

By using suitable transducer circuits other characteristics can be measured.

BRIEF SPECIFICATION

Range

0 to 1,000V d.c. in four ranges: 1,000V, 10,00V, 100,0V and 1,000V f.s.d. and 2% overspill on each range.

Overload Protection

Up to 500V on 1-V range and 1,500V on the other ranges.

A.C. Rejection

50 dB at 50 c/s.

Readout Time

For average readings, 2 seconds. Full scale, about 5 seconds.

Reading Retention

Reset may be operated externally by biased switch connected to jack socket in the rear panel.

Power Supply

110V and 200 to 250V, 50 to 60 c/s, A.C. mains 30 VA approximately.

Enclosure

Robust metal case with carrying handle. Finished blue, chrome bezels and light grey panels.

Dimensions

7½in x 6in x 1½in high, approximately.

Weight

9lb approximately.

U.K. List Price:

652A £98.

652AX £115.



Full technical data from:—

DAWE INSTRUMENTS LTD., WESTERN AVE., LONDON, W3 Tel: ACOm 6751

A member of the *Spang* group of companies

all in
one
piece

C I B A



Permal Ltd made this tap selector housing for the new 132 kV on-load tap changer designed and patented by AEI. It is a one-piece gravity casting in Permacast CRS-10, a mix based on Araldite epoxy resin. The strong adhesive properties of Araldite ensure that the metal inserts form an integral part of the unit.

Components cast in Araldite are purpose-designed to take advantage of the excellent electrical and mechanical properties of the resin. As shrinkage on curing is negligible, dimensions are accurate to very close limits. Components can be compact, saving cost and space. The castings are tough, strong and shock-resistant. In addition to their excellent insulating and anti-tracking qualities, Araldite castings provide protection against moisture, damage and vibration; they also ensure the permanent oil tightness required by designers of components such as this changer, and the good electrical discharge characteristics of the components.

Further information on Araldite resins for electrical purposes will be sent gladly on request.

ARALDITE EPOXY RESINS ARE USED:

- for casting large high-grade electrical insulators and insulation around equipment such as transformers, switchgear components etc.
- for impregnating, potting and sealing electrical windings and components.
- for constructing glasscloth laminates in electrical, nuclear, mechanical and aircraft engineering.
- for bonding metals, ceramics, glass, rubber, plastics, wood etc.
- for constructing tools for forming plastics or sheet metal, patterns for moulding foundry sand, jigs and fixtures for checking accuracy of assembly etc.
- for chemical resistant flooring and floor surfacing.
- for anti-corrosion protection of wood, concrete, metals etc.

Araldite

epoxy resins

Araldite is a registered trademark

CIBA (A.R.L) LIMITED, DUXFORD, CAMBRIDGE. TELEPHONE: SAWSTON 2121

SUBMINIATURE SWITCHES



The **ARROW**
RANGE OF
SUBMINIATURES
IS COMPLETE

SEND FOR FULL DETAILS TODAY

ARROW ELECTRIC SWITCHES LTD

BRENT ROAD · SOUTHALL · MIDDLESEX

Telephone: SOUthall 2442

A588

SPECIFY HUGHES DIODES

Hughes — originators of the world's first sub-miniature all-glass diode — manufacture at their Glenrothes, Scotland, factory an unequalled range of germanium and silicon devices for the most diverse diode applications. Add Hughes service and second-to-none product quality and solve your diode problems in the simplest way — SPECIFY HUGHES.

... diodes with superior performance and maximum reliability

GERMANIUM SWITCHING DIODES

HG1005 HG1006 HG1012	Point-Contact	PIV $I_F @ 1V$ $I_b @ 50V$ Capacitance	up to 100V > 5mA < 50 μ A 0.2pF	CV448 CV7041 CV7130
HG5003 HG5004 HG5008 HG5009	Gold-Bonded	PIV $I_F @ 0.8V$ $I_b @ 50V$ Capacitance Stored charge	up to 100V > 100mA < 25 μ A 0.4pF 400pC	CV7076 CV7127 CV7128
HD1810 HD1840 HD1841 HD1870 HD1872	Gold-Bonded	PIV $I_F @ 0.7V$ $I_b @ 10V$ Capacitance Stored charge	up to 50V > 100mA < 5 μ A 1.5pF 65pC	
HPS1670 HPS1672	Ultra-Fast Point-Contact	PIV $I_F @ 1V$ Reverse recovery time	up to 20V 10mA 0.8 nanosec	

SILICON SWITCHING DIODES

1N643 1N643A 1N806 1N809	High voltage diffused	PIV $I_F @ 1V$ Capacitance Stored charge	up to 200V 100mA 5pF 500pC	
1N914 1N914A 1N916 1N916A 1N3064 1N3067	Diffused Planar	PIV $I_E @ 1V$ $I_b @ 20V$ Capacitance Stored charge	up to 75V 20mA < 0.025 μ A 2pF 60pC	CV7367 CV7368
HD5000 HD5001 HD5004	Ultra Fast	PIV $I_F @ 1V$ $I_b @ 5V$ Capacitance Stored charge	up to 20V 5mA < 0.2 μ A 1pF negligible	

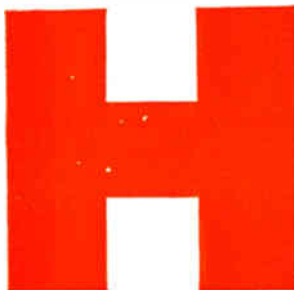

Write now for complete data on the full range of Hughes semiconductor products, which also includes:—Silicon sub-miniature power diodes/rectifiers, Voltage reference (zener) diodes, High voltage cartridge rectifiers, PNP and NPN Silicon Transistors.

HUGHES INTERNATIONAL (U.K.) LTD

GLENROTHES · FIFE · SCOTLAND

Sales office:
HEATHROW HOUSE, BATH ROAD, CRANFORD, HOUNSLOW, MIDDLESEX
TEL: 8KYport 9584/5 and 9961/2. TELEX: 23613.

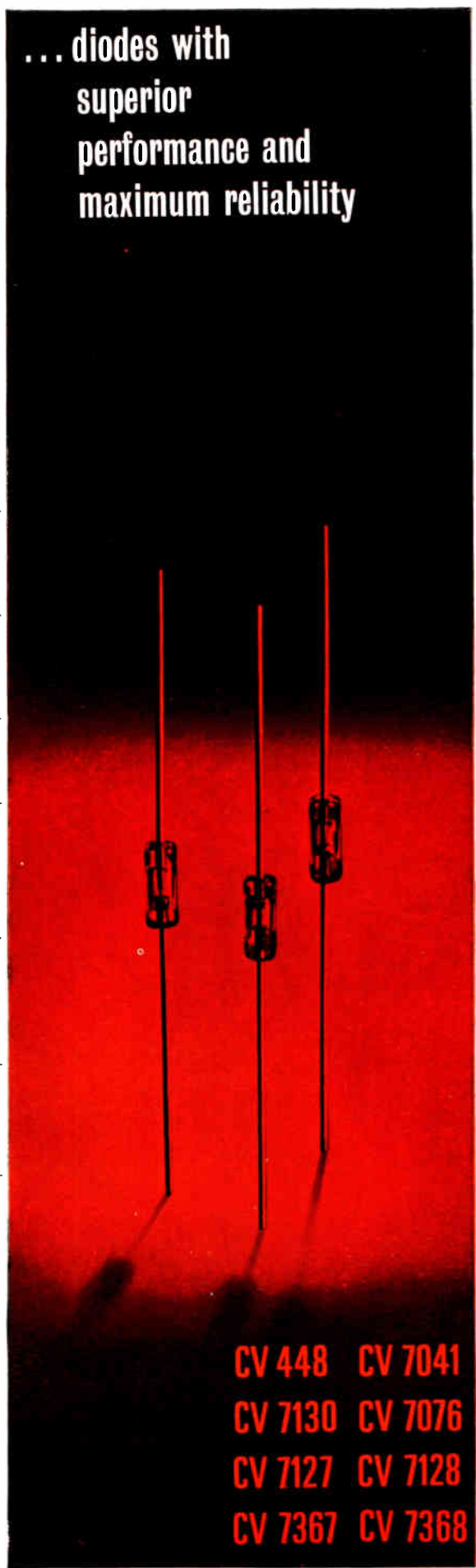

CV 448 CV 7041
CV 7130 CV 7076
CV 7127 CV 7128
CV 7367 CV 7368

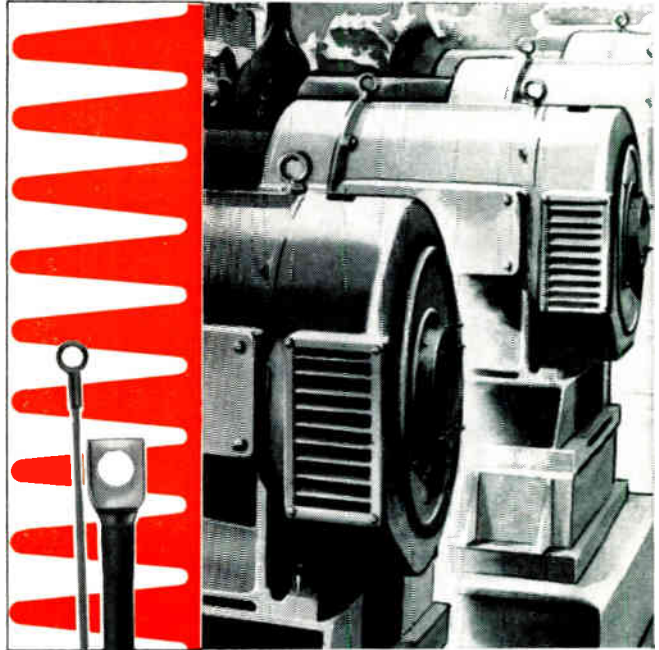

When it's a question of **SEMICONDUCTORS** **WESTINGHOUSE** *IS THE POWER BEHIND IT!*

Whatever your need—d.c. power or the control of a.c. or d.c. power—Westinghouse have the silicon diode or thyristor to meet your application. Special compression bonding techniques employed in the manufacture of Westinghouse semiconductors means greater reliability and improved performance. Add this to the fact that Westinghouse have had over 40 years experience in designing and making semiconductors, and you'll see why more and more industries are solving their current problems by specifying Westinghouse.

Our new SEMICONDUCTORS brochure showing the Westinghouse range of Silicon Diodes, Thyristors and Rectifier Assemblies will tell you a lot more. Why not write for a copy?

Dept. I.E. 10/65

WESTINGHOUSE BRAKE AND SIGNAL CO. LTD.
82 York Way, King's Cross, London N.1. Terminus 6432 Telex 2-3225

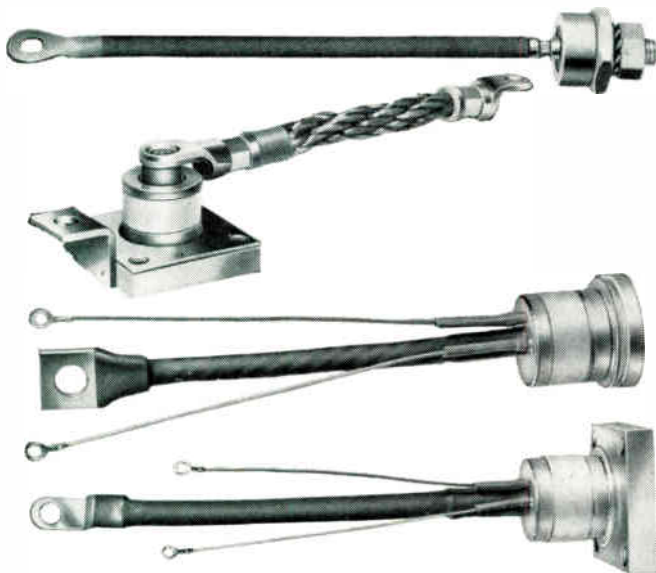

Typical examples of
Westinghouse Silicon Power Diodes and Thyristors

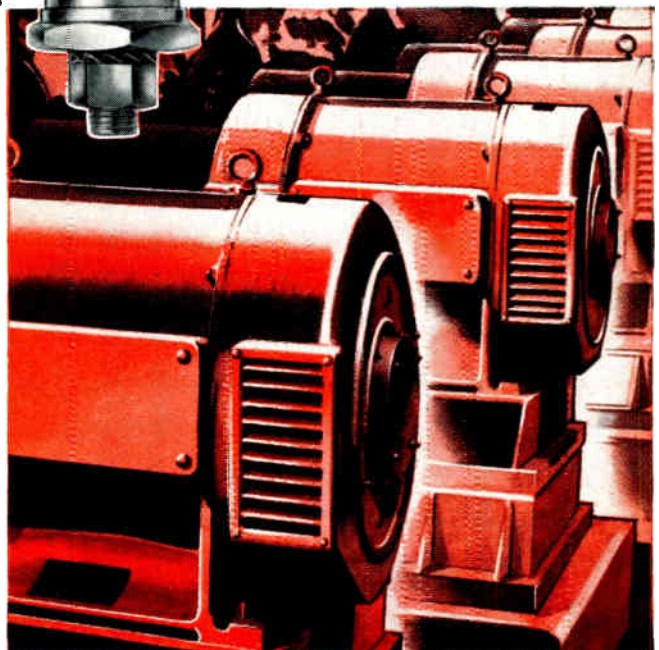

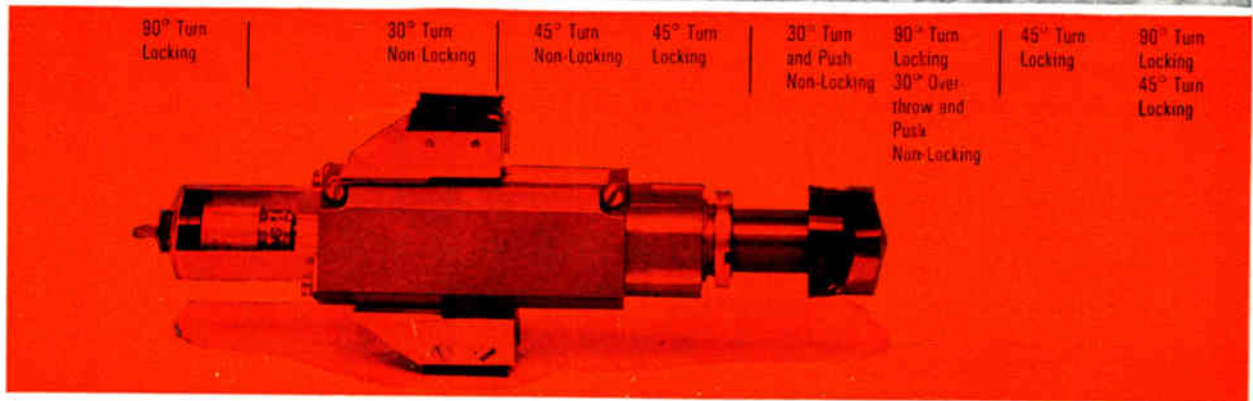
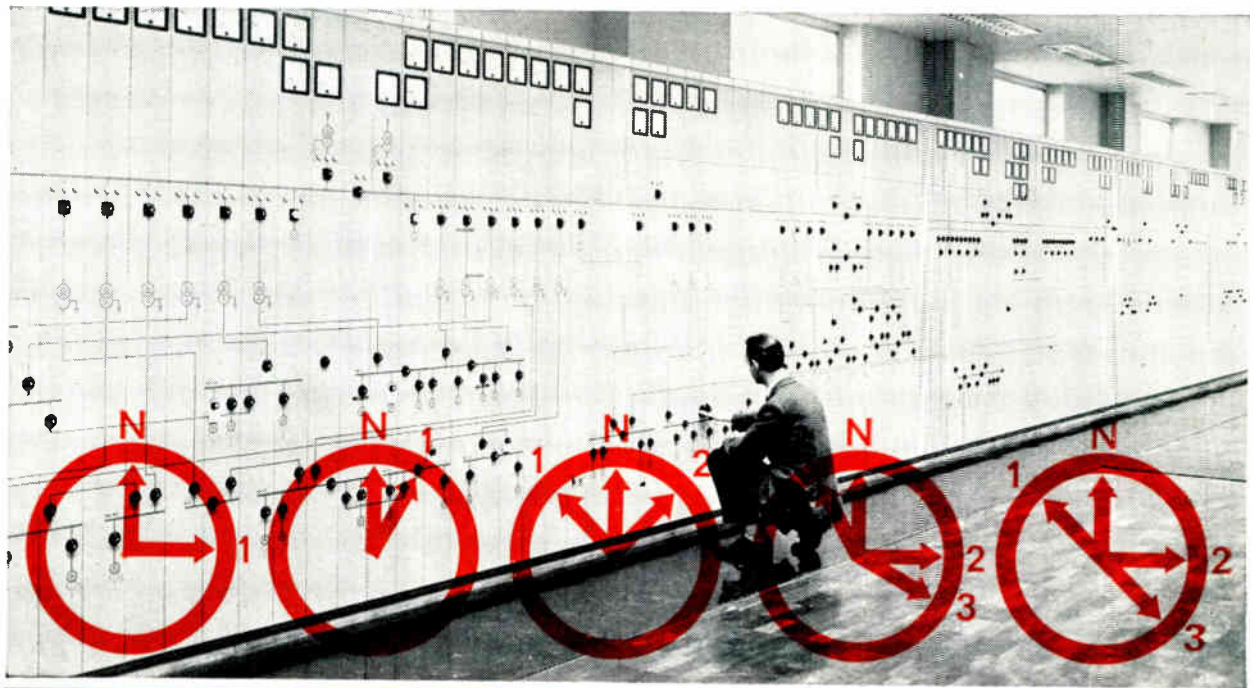

New STC miniature control switch type 871

The type 871 is an improved control switch which replaces the 4400 range of discrepancy keys. It has been specifically designed to meet the requirements of the CEGB and other major users. Totally enclosed and dustproof, this robust switch operates efficiently under severe climatic

conditions. The 871 has a wide variety of switching operations, locking and non-locking actions. A completely new range of knobs, conforming to CEGB requirements, has been designed. Although intended primarily for use in STC Mosaic Diagrams, it can be mounted equally well in metal or plastic panels. The switch is equipped for an MES pattern lamp which can be

replaced from the front of the control diagram. Alternatively, an STC three-colour lamp indicator can be fitted.

Details from Standard Telephones and Cables Limited, Integrated Electronic Systems Division, Burleigh House, Great Cambridge Road, Enfield, Middlesex. Telephone: ENField 5343. Telex: 21409.

world-wide telecommunications and electronics

STC

CAST WITH PRECISION

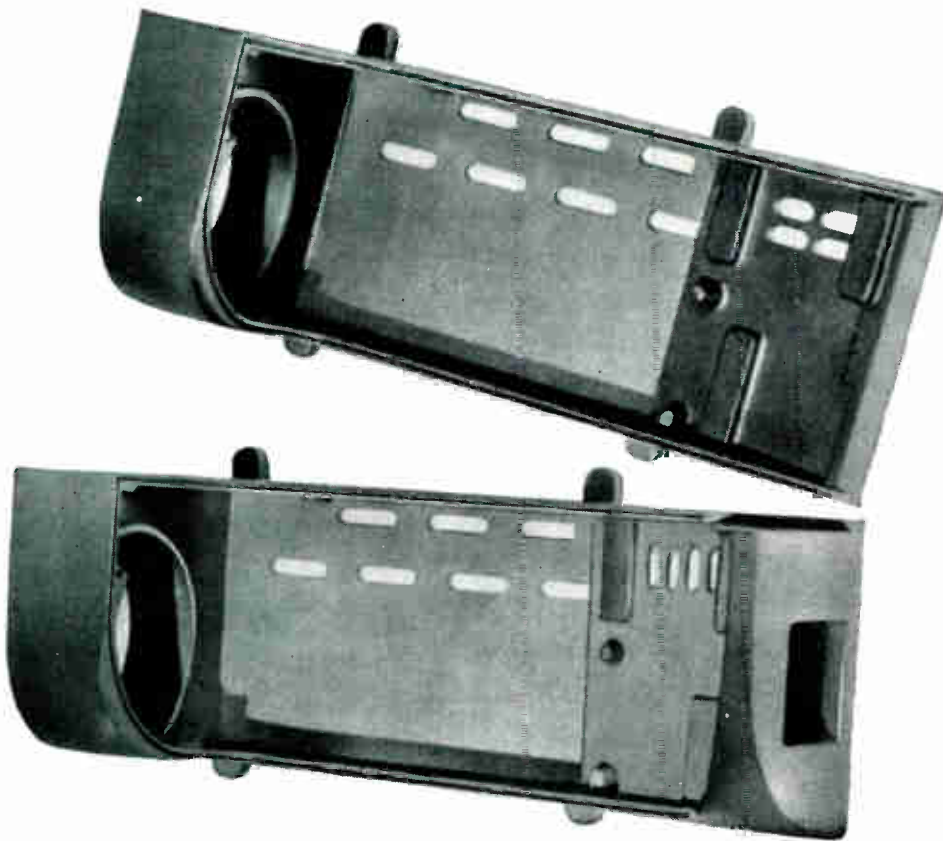

Cathode Ray Tube Housings.
Plaster moulded castings
in Aluminium alloy LM6M.
By courtesy of Ferranti Ltd.

- Aluminium and magnesium alloy castings by sand, die, shell and plaster mould processes.
- Engine blocks and cylinder heads in high duty iron.
- Castings of the highest quality at the required scheduled quantities.
- Over 50 years technical experience augmented by quality control of production.

STERLING METALS LIMITED

NUNEATON · ENGLAND · Phone Nuneaton 4221

SO MUCH MORE BEHIND A SOLARTRON INSTRUMENT

- * WILL MEASURE—
- * 2.5 microvolts—1000 Volts d.c.
- * 10 microvolts on top of 500 Volts peak common mode
- * 10 microvolts d.c. through 10 millivolts of noise
- * 1 millivolt d.c. from a 100 megohm source impedance



Integrating Digital Voltmeter LM 1420 2 measures d.c. voltages from 2.5 microvolts to 1000 Volts with an accuracy of 0.05% ± 1 digit, at a maximum rate of 33 readings per second. Maximum input resistance is > 5000 megohms, both terminals being fully guarded with isolation impedance of 10^9 megohms/25pf. Common mode rejection is thus 150dB d.c. and 120dB a.c. The integrating technique together with optional 30dB filter gives 60dB attenuation of input noise. Detailed information will be sent on request and Solartron Engineers are available to discuss applications.

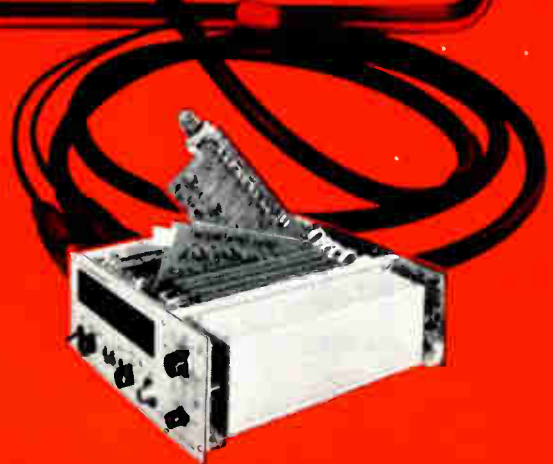

SOLARTRON
 For Data Systems · Transducers · Computers
 Military Systems · Electronic Instrumentation

THE SOLARTRON ELECTRONIC GROUP LIMITED
 Farnborough, Hants, England, Tel: Farnborough (Hants)
 44433 Telex: 85245 Solartron Farnborough
 Cables: Solartron Farnborough
 A MEMBER OF THE SCHLUMBERGER GROUP

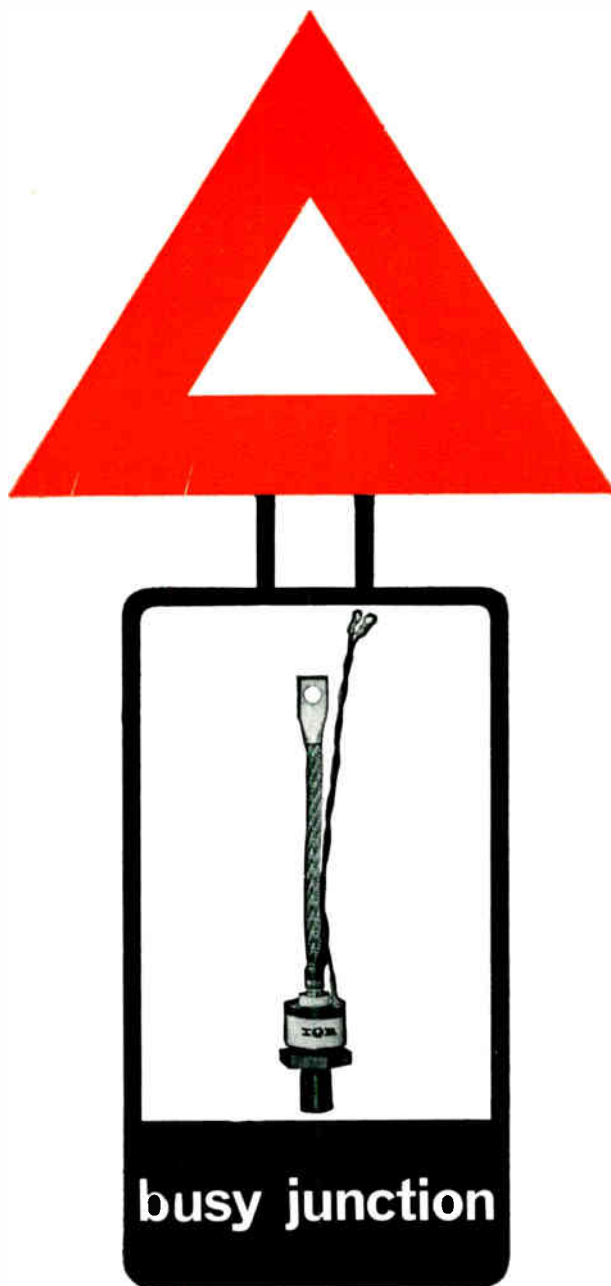

Heavy currents ahead. IR control them with new heavy duty epitaxial thyristors. Currents up to 150 A, PRV up to 1300. Give yourself new power over power; find out exactly what these new IR power thyristors can do.

IR INTERNATIONAL RECTIFIER

Immediate off-the-shelf delivery from IR distributors - phone

COLCHESTER 6173 · CRAWLEY 28700 · GLASGOW DOUGLAS 2711 · (LANCS) TODMORDEN 2601 · LEEDS 35111
LEICESTER 68561 · (LONDON S.E.27.) GIPSY HILL 6166 · (MIDDLESEX) SKYPORT 1314 · PORTSMOUTH 20465

INTERNATIONAL RECTIFIER CO. (GREAT BRITAIN) LTD · HURST GREEN · OXTED · SURREY · TELEPHONE OXTED 3215 · TELEX RECTIFIER OXTED 8819



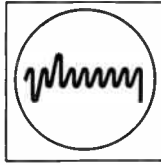

PLESSEY PROFESSIONAL COMPONENTS

Individual Requirement Specialists —A Unique Service

Each component range produced by Plessey Professional Components Division requires a high degree of specialisation and experience—the result of years of development and production. Products of this Division include miniature and sub-miniature relays, rotary solenoids, printed circuit switches, filters, individually built precision variable capacitors, crystal ovens, vibrators, trimmer capacitors and thermostats, and many more. These are products which require manufacture to exacting specifications, and call for an exceptionally high degree of skill. Plessey Professional Components Division occupies a modern, 125,000 sq. ft. plant at Titchfield, Hampshire, and offers unparalleled experience and 'know-how' in the field of high-precision components. In addition, the resources of the whole Plessey Company are available to give unique service to equipment designers and manufacturers. Nearly every component from the Professional Components Division has Qualification Approval or is approved to equivalent standard. The highest standards of quality control are ensured through the facilities of the Plessey Environmental Laboratory.

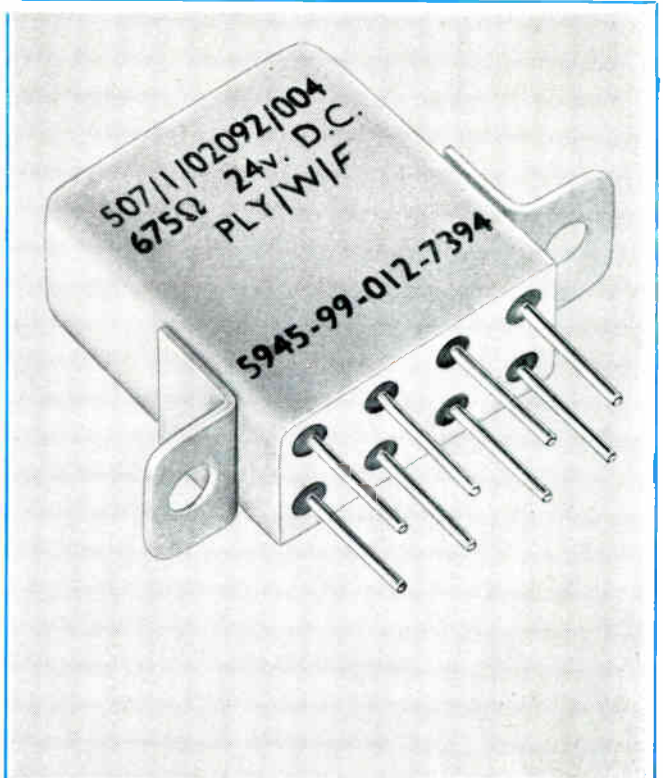

This relay works from -65°C to $+125^{\circ}\text{C}$

Relays: A typical item is the SUB-MINIATURE RELAY TYPE CF (NATO ref. 5945-99-012-7392 to 7396), approved to Ministry R.C.S.C. Specification DEF. 5165—SM5L. Fully sealed, and with a balanced armature and high contact pressures, it gives a particularly good performance under conditions of severe shock. Twin gold-plated contacts make it specially suitable for switching in low-level circuits.

Contact action: 2-pole changeover.

Contact rating: 3 Amps at 28 volts d.c. or 115 volts a.c. 400 c/s. 10^5 ops at 3 amps.

Standard coil values: 6, 12, 24, 48 and 110 volts d.c.

Voltage proof: 1000 volts r.m.s. a.c. at 50 c/s between terminals and case; 750 volts between open contacts.

Temperature range: -65° to $+125^{\circ}\text{C}$.

Shock: 100 g for 8 milliseconds.

Weight: 0.52 oz (14.8 gm) max.

For further information on how Plessey Professional Components Division can help you, write today.

PERFORMANCE FIRST

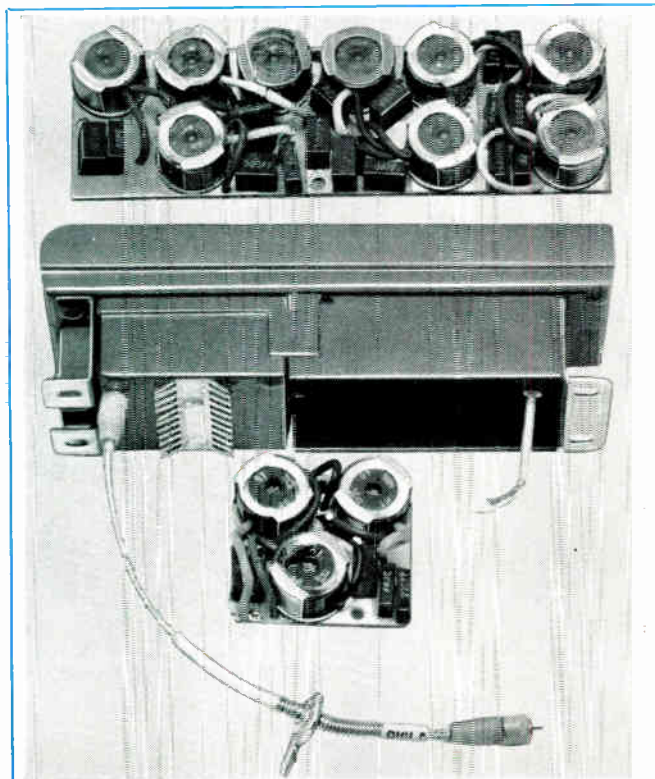

This filter works from -55°C to $+100^{\circ}\text{C}$

Filters: An example of a filter designed, engineered and manufactured to customer specification, is this 1st and 2nd I.F. Filter Unit (NATO ref. 5915-99-951-4140 and 5915-99-951-4141).

	1st I.F. Filter	2nd I.F. Filter
Centre Frequency	1.825 mc/s	500 kc/s
Pass Band	1.77-1.88 mc/s (1db)	477.5-522.5 Kc/s (6db)
Pass Band Loss Spread	1db	1db
Discrimination, Upper	55db @ 2.8 mc/s	60db @ 545 Kc/s
Discrimination, Lower	55db @ 1.3 mc/s	60db @ 455 Kc/s
Input Impedance	50 ohms u/bal	5000 ohms u/bal
Output Impedance	5000 ohms u/bal	5000 ohms u/bal
Temp. Range	-55° to 100°C	
Environmental Spec.	MIL-STD-202B	

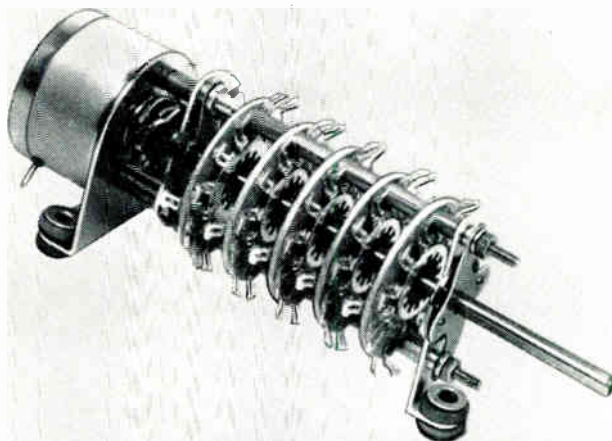

This solenoid works from -65°C to $+180^{\circ}\text{C}$

Switches and Allied Equipment: The Division offers an extensive service to equipment designers on switching problems, and it manufactures printed-circuit assemblies ranging from the 10- and 16-way edge switches to the miniature rotary type.

The Rotary Solenoid Size 14 is the first of a series in which torque is produced by a perfect magnetic couple, achieved by the rotation of a segmented armature in an annular gap. The absence of axial movement permits direct mechanical coupling to the load.

Low inertia of the armature makes for rapid cycling at a given power. It is shown here driving a 6 wafer switch, making a complete circuit selector.

Operating voltage range: from 2 volts to 440 volts d.c.

Power rating: 100 watts maximum, within duty-cycle limits; 12 watts continuous.

Temperature range: -65°C to $+180^{\circ}\text{C}$ (the latter on minimum duty cycle).

Repetition rate: 50 cycles per second typical.

Stroke angles: ranging between 15° and 80° .

PLESSEY
Components Group



The Plessey Company Limited
Professional Components Division
Abbey Works, Titchfield
Fareham, Hampshire
Telephone: Titchfield 3031
Telegrams: Plessey Fareham Telex

CHOOSING A TRANSFORMER?

Make it your business to know our business

Our business is *making* transformers — mains transformers to 10 kVA, audio transformers, voltage transformers, current transformers and pulse transformers as well as smoothing and swinging chokes and saturable core and A.C. linear reactors. It's a business that we know *all* the ins and outs of . . . which is why we can produce *exactly* the instrument you want at a really competitive price. It's a business that we've been perfecting for over 35 years — and in that time we've built up a reputation for a second-to-none advisory service that covers every aspect of design and application. It's a business that's good enough to get M.O.A. and A.R.B. approval as well as delegated Admiralty Inspection facilities. Yet it's a business that's not grown too large for close *personal* attention to all customers' needs. Our name is Redcliffe Industries Limited and next time you're choosing a transformer keep the name



right in the forefront of your mind

REDCLIFFE INDUSTRIES (BRISTOL) LIMITED
Emery Road, Brislington, Bristol 4 Tel: Bristol 77431-4

JACKSON

THE BIG NAME IN PRECISION COMPONENTS

Precision built radio components are an important contribution to the radio and communications industry. Be sure of the best and buy Jackson Precision Built Components.

MADE IN ENGLAND



TEFOTRIM TRIMMER CAPACITOR

P.T.F.E. Dielectric 3 start thread for smooth rapid adjustment. Locking device for permanent accuracy. Five types available in capacities $\frac{1}{4}$ -8 p.F. up to 2-30 p.F. Test voltages up to 3,500. Various temperature coefficients.

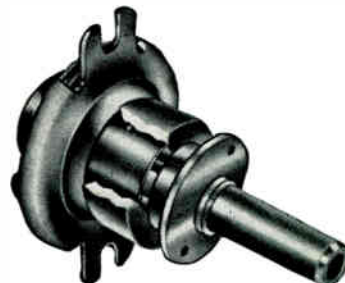

BALL DRIVES

Thousands of Jackson dual-ratio ball drives are in daily use in u.h.f. television tuners. Type 4511DR provides 6:1 fast ratio and 36:1 "reverse vernier" on one spindle. Type 4511DRF, with a flange for carrying a pointer, is ideal for use in receivers and measuring instruments as well. Other Jackson ball drives provide simple 6:1 reduction or combined 1:1 forward and 6:1 reverse vernier movements. Ask for details.

- ★ High torque
- ★ Take standard 0.25 in. spindles
- ★ Simple fixing
- ★ Low backlash
- ★ Utterly reliable—of course!

It's reliable if it's made by Jackson!

Write for literature



JACKSON BROS. (London) LTD.

Dept. IE, KINGSWAY-WADDON, CROYDON, SURREY.
Telephone: Croydon 2754-5. Telegrams: Walfilco, Souphone, London.
Canadian Distributors: Messrs. R. Mack & Co. Ltd., 1485, South West Marine Drive, Vancouver, 14, B.C., Canada.
American Distributors: Messrs. M. Swedgal Electronics, 258, Broadway, New York, 7, N.Y.

400V $V_{CE(sus)}$

5A $I_C(peak)$

10 Mc $f_T(min)$

For the first time
at Economy Prices

2N3583
 $V_{CE(sus)} min = 250 V$

2N3584
 $V_{CE(sus)} min = 300 V$

2N3585
 $V_{CE(sus)} min = 400 V$

40255
 $V_{CE(sus)} min = 350 V$
 $I_C max = 1 amp$
 $\theta_{j-c} = 15^\circ C/W$

40256
 $V_{CE(sus)} min = 250 V$
 $I_C max = 1 amp$
 $\theta_{j-c} = 15^\circ C/W$

2N3439
 $V_{CE(sus)} min = 350 V$
 $I_C max = 1 amp$
 $\theta_{j-c} = 30^\circ C/W$

2N3440
 $V_{CE(sus)} min = 250 V$
 $I_C max = 1 amp$
 $\theta_{j-c} = 30^\circ C/W$

RCA ADDS THREE NEW "SMALL TO-3" (TO-66) HIGH-CURRENT TRANSISTORS TO THE LOW-COST, HIGH-VOLTAGE SILICON LINE

For further information please write or telephone:—

		2N3583	2N3584	2N3585
η_{FE}	@ $I_C = 100 ma, V_{CE} = 10 V$	40 min	40 min	40 min
	@ $I_C = 1 amp, V_{CE} = 10 V$	10 min	25-100	25-100
$\eta_{fc} @ 5 Mc$	@ $I_C = 200 ma, V_{CE} = 10 V$	2 min	2 min	2 min
$I_{S'b}$	@ $V_{CE} = 100 V$	250 ma min	250 ma min	250 ma min
$V_{CE(sus)}$	@ $I_C = 200 ma$	175 V min	250 V min	300 V min
$V_{CE(sat)}$	@ $I_B = 125 ma, I_C = 1A$		0.75 V max	0.75 V max
I_C		5 amp peak 2 A continuous	5 amp peak 2 A continuous	5 amp peak 2 A continuous



THE MOST TRUSTED NAME IN ELECTRONICS

RCA GREAT BRITAIN LIMITED Sales Division, Lincoln Way, Windmill Road, Sunbury-on-Thames.
Associate Company of Radio Corporation of America. Telephone: Sunbury 5511.

For further information circle 241 on Service Card

microwave

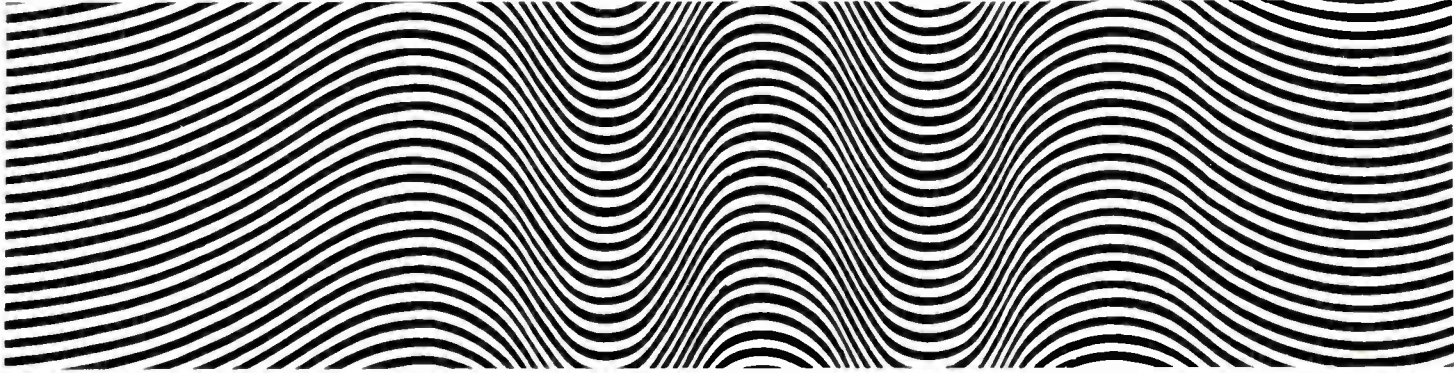

components

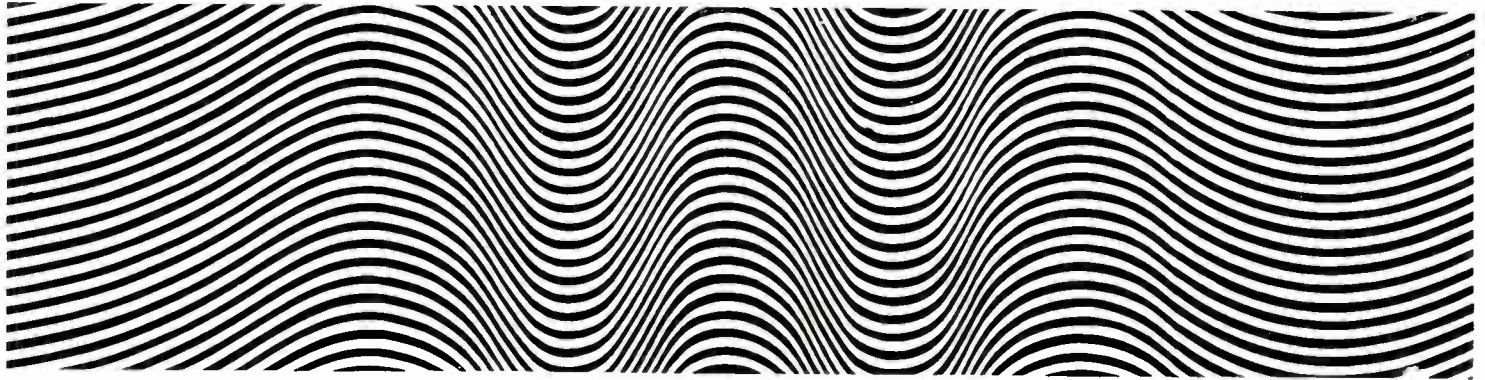

For industry's broadest line—from DC to 40 gc— look to General Electric Company of U.S.A.

CERAMIC gridded triodes and tetrodes, DC to 10 gc. Highest electronic performance: high power output (milliwatts to 50 KW peak), low noise (fractions of db at low frequency), high gain and wide bandwidth (gain-bandwidth products up to 5000 MC).

VTM'S in three groups. Low-power, low-noise voltage-tunable magnetrons (up to 1 watt) for use as local oscillators or in signal generators. Intermediate-power VTM's (1-10 watts) for altimetry, fusing, telemetry. High-power VTM's (10 watts to hundreds of watts) with high efficiencies (70 per cent) for use in countermeasures barrage jamming, broadband transmitters, other airborne applications.

TWT'S. Traveling-wave tubes range from P-band to Ku-band for applications in radar, communications and surveillance equipment. Low-noise preamplifiers, 10-watt-CW and 10-KW pulsed TWT's are included. All low-noise TWT's are available with solid-state power supplies for use with ac or dc sources. All TWT's from General Electric, U. S. A., are designed and manufactured for high reliability under severe environmental conditions.

KLYSTRONS. Latest General Electric developments have improved the efficiency of broad-band single-beam klystrons and have resulted in totally new multiple-beam devices: the Transverse-Wave Klystron for very wide bandwidths; the resonant Multiple-Beam Klystron, now in X-band for CW applications. Both multiple-beam devices facilitate the generation of very high power levels without need to parallel tubes.

FILTERS. A wide variety of bandpass and harmonic filters are available for high-power UHF and microwave transmitters. Applications include interference suppression, diplexer channeling, high-power breakdown protection and receiver protection. Complete field-installation kits can be provided to speed retrofit of transmitters already in service.

Complete data on any General Electric microwave component can be obtained from International General Electric Company of New York, Ltd., 296 High Holborn, London, W.C. 1 . . . or *General Electric Company, Dept. EC-65-05, 159 Madison Ave., New York, N. Y. 10016, U. S. A.*

GENERAL ELECTRIC COMPANY OF U.S.A.

For further information circle 243 on Service Card

Virtually every type and value of resistor available can be supplied immediately—ex stock—by the Radio Resistor Co., Ltd.

High stability, solid carbon, cracked carbon, wire-wound, precision metal oxide, epoxy resin resistors.

Miniature and sub-miniature potentiometers. All are described in the illustrated sample book.

WIDEST RANGE

LAB

TESTED

TYPES	WATTAGE RANGE	OHMIC RANGE	TOLERANCES AVAILABLE
1 To MIL-R-10509D Charac B	0.125w to 1w	10Ω to 5.11MΩ	±1%
2 Solid Carbon	0.1w to 2w	2.2Ω to 22MΩ	±5%, 10%, 20%
3 { Cracked Carbon Sub-miniature Carbon	0.125w to 2½w 0.03w	5Ω to 10MΩ 5Ω to 0.5Ω M	±5%, 10% ±0.5% to ±20%
4 Metal Oxide Precision & Power	0.125w to 6w	68Ω to 4.2MΩ	±1%, 2%, 5%
5 High Resistance Carbon	(8000v max.)	up to 10 ¹² Ω	±5%, 10%, 20%
6 { High Stability Carbon Instrument quality Carbon	0.05w to 3w 0.03w to 2w	1Ω to 50MΩ 1Ω to 10MΩ	±1%, 2%, 5% ±0.1% to ±1%
7 Epoxy Resin encapsulated Carbon	0.25w to 1w	10Ω to 4.7MΩ	±1%, 2%
8 Vitreous Enamel Cement & Wirewound	0.5w to 200w	0.1 to 150K	±1%, 2%, 5%

FASTEST SERVICE

Whatever your resistor query
get in touch with

RADIO RESISTOR CO LTD

PALMERSTON ROAD · WEALDSTONE · HARROW · MIDDX

Telephone: HARrow 6347

Telex: 25573

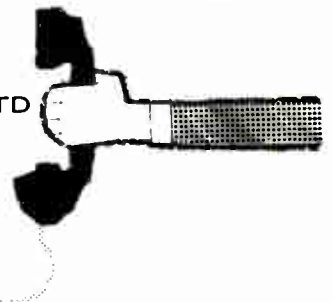

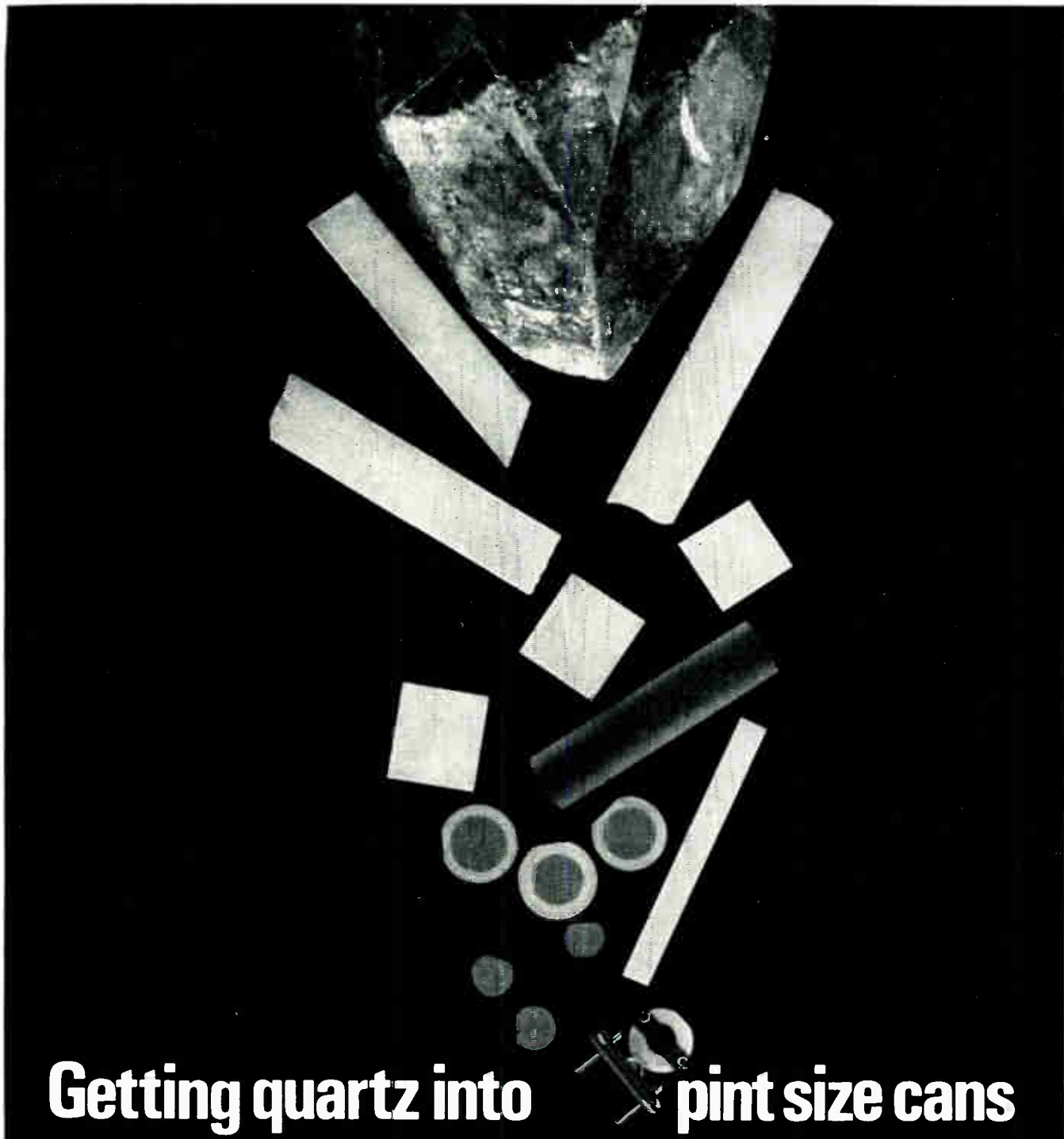

Getting quartz into pint size cans

SUB-MINIATURE HOLDERS SAVE SPACE

To meet the increasing demand for lightweight compact components in advanced equipment, Brush are now selling a range of sub-miniature styles. Styles Q12 and Q13 (covering the frequency range 4—100 Mc/s) permit a sixfold increase in packing density, with



no loss of stability. Other alternatives in metal and glass encapsulation are also available covering the frequency range 50 kc/s to 100 Mc/s. Crystals can be supplied to meet current British and American service specifications.



KEEP YOUR EYE ON BRUSH

BC BRUSH CLEVITE

BRUSH CLEVITE COMPANY LTD HYTHE SOUTHAMPTON

PHONE HYTHE 3031 GRAMS BRUDEV HYTHE SOUTHAMPTON TELEX 47687

Industrial Electronics October 1965

BY APPOINTMENT TO
H.R.H. THE DUKE OF EDINBURGH



SUPPLIERS OF MOBILE
RADIOTELEPHONE EQUIPMENT



'CAMBRIDGE' transistor Mobile Radiotelephone

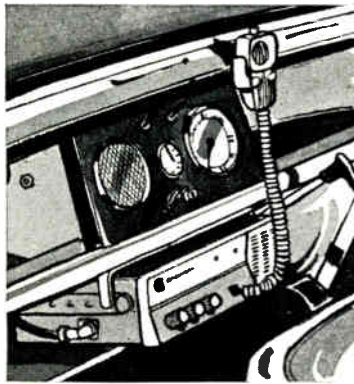

A new high standard in Mobile Radiotelephone design

- Fully transistorised receiver
- Printed circuit sub-assemblies
- Sealed I.F. block filters
- Dustproof and splashproof
- GPO approved and meeting American and European specifications
- 100 Milliamps receiver drain
- A.M. or F.M. versions
- 25 Kc/s or 50 Kc/s channelling
- Single or six channel

PYE TELECOMMUNICATIONS LIMITED

CAMBRIDGE • ENGLAND • TELEPHONE: TEVERSHAM (CAMBRIDGE) 3131 • TELEX No. 81166

and **Now-**
*a Fully Transistorised
Walkie-Talkie!*



Bantam
TWO-WAY RADIOTELEPHONE

*Once again in
the tradition of
the outstanding
Cambridge and
Vanguard Radio-
telephones, Pye
have produced the
Bantam, a brilliant
fully transistorised
Walkie-Talkie.*



- Fully transistorised Transmitter and Receiver
- Long endurance with Rechargeable or Dry Batteries
- Reliability and accessibility of components
- Lightweight 4 lbs. (1.82 kg.)
- Air Registration Board approved for light aircraft category III.
- Approved by G.P.O. to Spec. W6345.
- Crystal Filter selectivity
- Very high performance Receiver
- Frequency Band 25-174 Mc/s.
- Weatherproof

PYE TELECOMMUNICATIONS LTD. CAMBRIDGE ENGLAND • *TEL: TEVERSHAM 3131*
Telex No. 81166



we can't hide our power supplies under a bushel

The ETHER range of power supplies has been designed to provide stabilised D.C. power for the widest range of applications.

Stabilisation ratios as high as 5000:1, very low ripple and noise, fully transistorised printed circuitry—these, and competitive prices are some of the reasons for choosing ETHER D.C. power supplies. Enquiries for adaptations and units to special requirements are welcome.

- * Stabilisation Ratios up to 5000:1
- * Ripple and noise as low as 200 μ V
- * Modular construction
- * Quick delivery
- * Low cost

ETHER A.C. voltage regulators provide a clean regulated output with very low distortion. Valve and transistor types with outputs from 200VA to 5000VA for rack mounting or as cabinet units.

Write or telephone for comprehensive details to

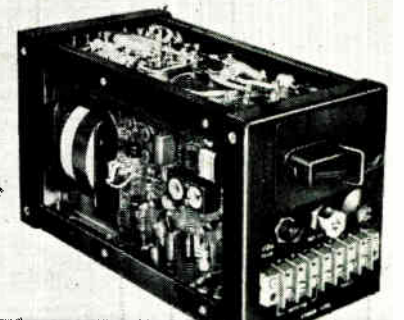
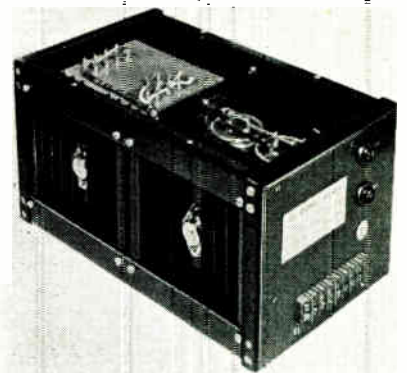

ETHER

ETHER LTD., CAXTON WAY,
STEVENAGE, HERTS.
Telephone: Stevenage 3040-55

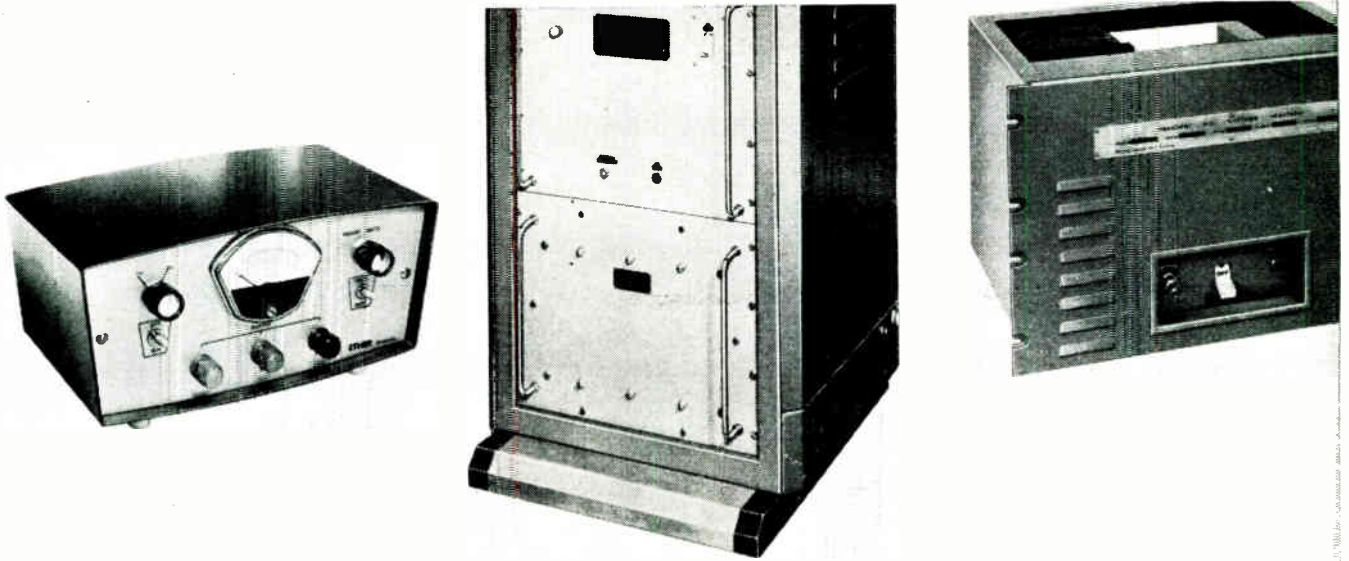

there are too many of them



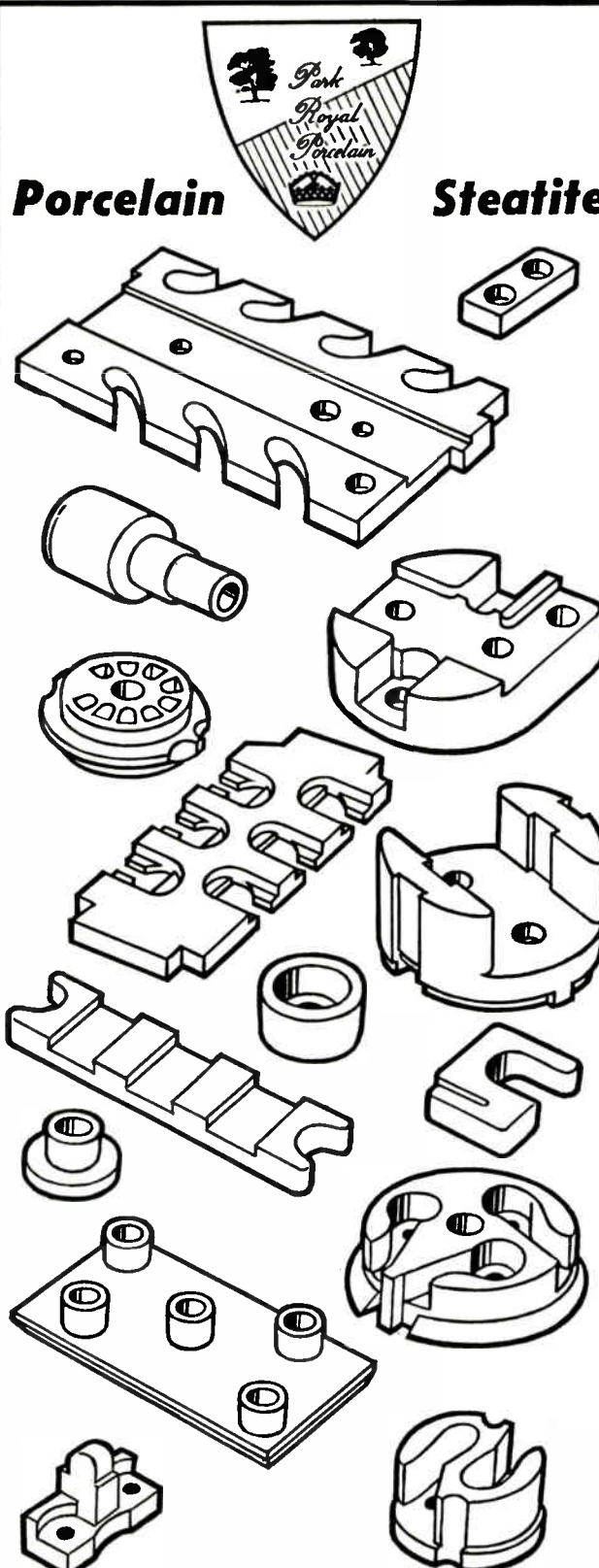

Porcelain **Steatite**

V. G. PORCELAIN CO LTD

GORST ROAD
PARK ROYAL
LONDON, N.W.10

Telephones:
ELGAR 1411/7
Telex:
London 25589

SILICON TUNNEL DIODES

Hoffman Electronics Corporation

Silicon tunnel diodes are designed primarily for *low level switching* applications.

FEATURES

Temperature stability, uniformity, reliability. Available with 2% tolerance on peak point current. Operating temperature: -65°C to $+150^{\circ}\text{C}$. Rugged.

TO18 and DO17 packages.

UNITUNNEL DIODES

or 'Backward Diodes'.

High conductance at low voltage levels. High forward/reverse impedance ratios.

WALMORE
ELECTRONICS LTD
11-15 BETTERTON ST., DRURY LANE, LONDON, WC2 Tel: TEMple Bar 0201-5

ROAR FOR TR

Electrosil triple rated glass-tin-oxide resistors receive qualification approval to DEF5115-1 multiple rated pattern RFG-5

In establishing a concept of multiple rating, R.C.S.C. have pointed the way to economy. This means that one type of resistor can perform three roles of operation, according to the stability required. These are equivalent to the semi-precision oxide of DEF 5114A, the grade one carbon of DEF 5112A, and the general purpose oxide of DEF 5114A. All three types can now be replaced by one resistor—Pattern RFG5 of DEF5115-1, stocks and expenditure are thus greatly reduced and the discrete component situation vastly simplified. DEF5115-1 also include Pattern RFG2, which covers general purpose metal oxide only. Needless to say the Electrosil TR range has also received approval to this Pattern.

Electrosil Type	DEF5115-1 Reference	Ratings (Watts 70°C)	Approved Range
TR4	RFG5-F	$\frac{1}{16}$, $\frac{1}{8}$, $\frac{1}{4}$	51 ohms-47K
TR5	RFG5-E	$\frac{1}{8}$, $\frac{1}{4}$, $\frac{1}{2}$	20 ohms-470K
TR6	RFG5-D	$\frac{1}{4}$, $\frac{1}{2}$, 1	20 ohms-1 meg

Pattern RFG5 includes 1%, 2% and 5% selection tolerances, and is therefore the only pattern in DEF 5115-1 available to 1% selection tolerances.

Industry too, can benefit from the Triple-rating concept. Ask Electrosil today for full details; a leaflet is being prepared listing the relevant Nato stock numbers



ELECTROSIL LIMITED
PALLION SUNDERLAND CO. DURHAM
Tel: Sunderland 71557 Telex 53273

Triple Rating means Triple Economy

For further information circle 252 on Service Card

NORMA VIENNA

★ 40 RANGES FOR—
D.C. CURRENT & VOLTAGE
A.C. CURRENT & VOLTAGE TO 30 kc/s
RESISTANCE TO 5 MEGOHMS
TEMPERATURE
OUTPUT

★ Sensitivity of
20,000 Ohms/volt D.C.
4,000 Ohms/volt A.C.

★ Accuracy of
2.5% D.C.
3.5% A.C. to 500 c/s

★ Robust Taut
Suspended Meter Movement

★ Price £9-18-0

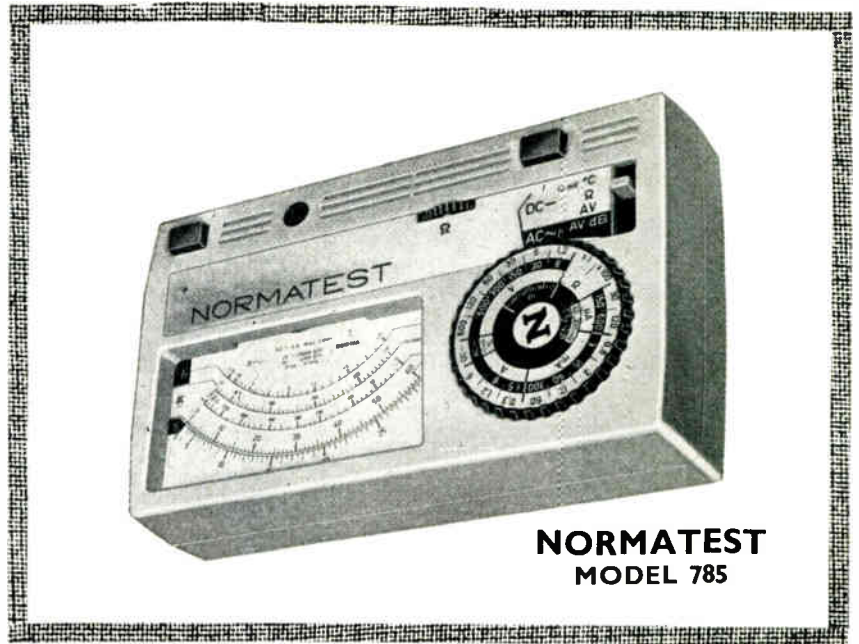

**NORMATEST
MODEL 785**

The newest small Multirange Meter obtainable with a specification comparable to standard-size multirange meters.

* Chosen at the Hanover Fair 1964 by a Panel of International Judges for "Good Industrial Design".

CROYDON PRECISION INSTRUMENT COMPANY

HAMPTON ROAD · CROYDON · SURREY Telephone THORNTON HEATH 4025 & 4094

For further information circle 253 on Service Card

PHASEMETERS

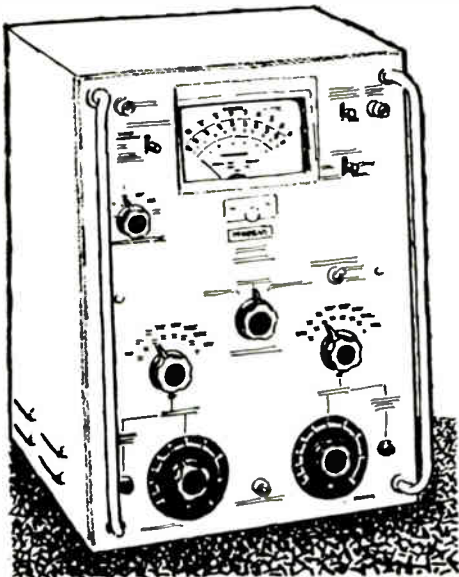

'TECHNIQUE'

A quarterly journal of instrument engineering is of interest to all designers and available on request.

Muirhead phasemeters are ideal for measuring the phase change and gain of amplifiers, and the input/output characteristics of passive and active networks. Why? Because there is no appreciable load imposed on the sources; furthermore, a direct reading is given of both phase angle and level difference.

Two models are available, the D-729-A (2c/s—100kc/s) and the D-729-B (0.25c/s—10kc/s). The latter instrument is of particular use to servo engineers and when used in conjunction with the D-925-B Tunable Filter enables measurements to be made on non-sinusoidal waveforms. Second harmonic rejection is 23dB and third harmonic rejection is 28dB.

We can tell you more about these instruments in Publications 110 and 111—send for them today.

MUIRHEAD

MUIRHEAD & CO. LIMITED, Beckenham, Kent, England.
Telephone: BECKENHAM 4888 Telex: 262710 (MUIRHEAD BECKNM)
MUIRHEAD INSTRUMENTS LIMITED, Stratford, Ontario, Canada. Telephone: Code 519, No. 271-3880.
MUIRHEAD INSTRUMENTS INC., 1101 Bristol Road, Mountainside, New Jersey, U.S.A. Telephone: Code 201, No. 233-6010.

710

DO IT YOURSELF PANEL METERS ?

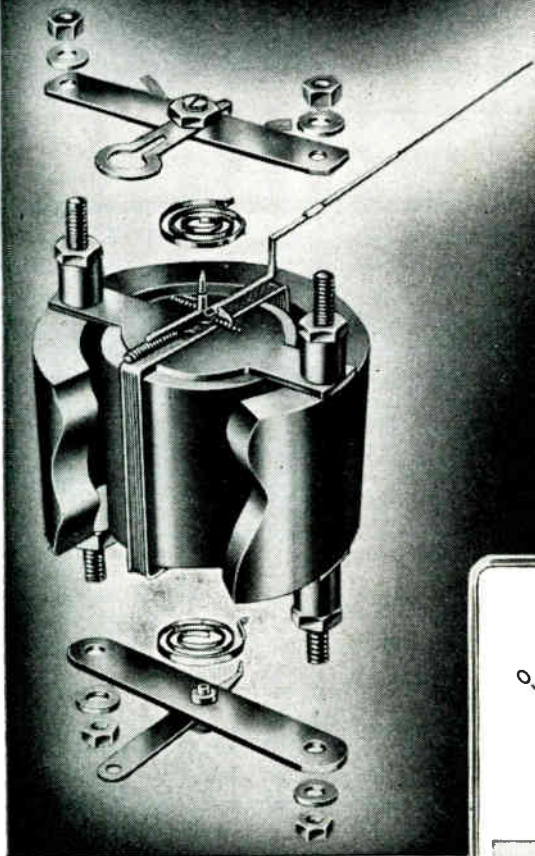

You can't draw experience. You can't give know-how a part number or put it on a shelf in the store. Without it, the components of even a Taylor Panel Meter would be just a do-it-yourself kit. But add Taylor know-how, experience and insistence on fastidious inspection and quality control. Now you have a meter built to uncompromising standards of craftsmanship, design and presentation, sold on a guaranteed delivery at a competitive price.

Taylor leadership in the features that really matter to the equipment designer and engineer is demonstrated in the Taylor Clarity Range. Clear, see-through fronts and wide, clean, open scales give shadowless readings and the overall styling that's right for contemporary equipment.

Recently added to the Clarity range—inserts in nine different colours. This new feature means that meters can be linked visually with controls by colour, an invaluable aid to accuracy in crowded instrument panels.

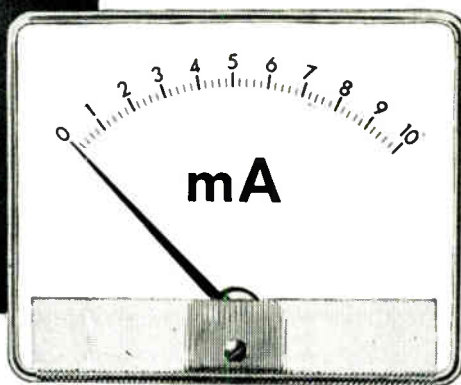

Taylor CLARITY

Models 32, 42 and 52 with scale lengths of 2 1/4", 3" and 4". Accuracies from $\pm 1\%$ f.s.d. on d.c. ranges, and from $\pm 2\%$ on a.c. ranges. Incorporate Taylor centre-pole movement, ensuring high sensitivities with practically friction-free operation and providing inherent magnetic shielding.

Catalogue M102 is a comprehensive reference and guide to the Taylor Panel Meterrange, with general dimensions of all models. Get a copy on your desk now.

IF IT'S **Taylor** MADE, IT'S CLEARLY BETTER



TAYLOR ELECTRICAL INSTRUMENTS LTD. Montrose Avenue, Slough, Bucks.

Phone: Slough 21381 • Grams: Taylins, Slough.

865/2

Industrial Electronics October 1965

49

minitest IS PROVING ITSELF EVERYWHERE



... IN THE FIELD



Small instrument... fits in the pocket... tip-top performance. It's the Salford Minitest, a highly sensitive test meter for the measurement of A.C. and D.C. volts, current and resistance. Wherever there's a measuring job to do — you can rely on the Minitest. The clarity of the scale is exceptional and the knife edge pointer ensures accurate reading. Housed in a tough Melamine cover, the movement is built into a pressed steel case which effectively screens it from external magnetic fields.



... IN THE LAB



... IN THE TROUBLE SHOOTER'S HANDS

MINITEST	D.C. Amps	D.C. Volts	A.C. Volts
Ohms	0 - 1 Amp.	0 - 1,000	0 - 1,000
	0 - 100 mA.	0 - 250	0 - 250
0 - 2,000	0 - 10 mA.	0 - 100	0 - 100
0 - 200,000	0 - 1 mA.	0 - 25	0 - 25
0 - 20 Megohms	0 - 50 uA.	0 - 10	0 - 10
		0 - 2.5	0 - 2.5

TRADE PRICE ONLY £7-17-6
(with leather case £8-12-6)

All ranges are selected by a single twelve-position rotary switch. A separate slide switch is provided to change over from A.C. to D.C. ranges.

At your finger-tips with the Minitest:-

- * D.C. sensitivity 20,000 ohms per volt
- * A.C. sensitivity 2,000 ohms per volt
- * D.C. accuracy $\pm 2\frac{1}{4}\%$ F.S.D.
- * A.C. accuracy $\pm 2\frac{3}{4}\%$ F.S.D.
- * A.C. accuracy maintained up to 20 kc/s
- * Additional decibel scale
- * Small size $5\frac{3}{4}'' \times 3\frac{1}{2}'' \times 2\frac{1}{8}''$
- * Weight 18 ozs. * 20 ranges.

SEI

Leaflet on request

S&C.

SALFORD ELECTRICAL INSTRUMENTS LIMITED
Peel Works · Silk Street · Salford 3 Tel: BLAckfriars 6688
London Sales Office: Brook Green · Hammersmith W6 Tel: RIVERSIDE 5245
A Subsidiary of THE GENERAL ELECTRIC COMPANY LTD OF ENGLAND

LUSTRAPHONE

knocks out the background noise



Lustraphone Noise Cancelling Microphones have been specially designed to withstand the most difficult ambient noise conditions wherever they may be encountered.

They are available as dynamic inserts with a standard impedance of 25 ohms or as electromagnetic microphones with impedance ratings up to 1,000 ohms.

LUSTRAPHONE

the foremost name in microphones

Lustraphone Ltd., St. George's Works
Regents Park Road, London, N.W.1
PRImrose 8844

PLASTIC MOULDINGS

FREDERICK W. EVANS LTD.
Plastic Works, Long Acre, Birmingham 7. Tel. East 3071-2-3



What's that?

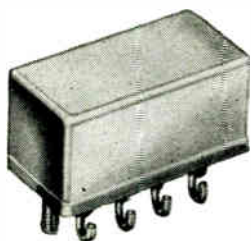

it's a new **SUB MINIATURE**, super sensitive, hermetically sealed, 2-changeover **RELAY** - and that's only half the story.

Designed to operate over the temperature range of -55°C - $+100^{\circ}\text{C}$, under severe environmental conditions, TMC's new relay has a balanced armature and two gold alloy changeover contacts. But what is unique, is the fact that it will do this on only 24 mW operate power. Yes, 24 mW, far less than any known competitor for the same volume—and still there's more to tell you, so write or telephone today for leaflet SMR101.



TELEPHONE MANUFACTURING COMPANY LIMITED

Components Division,
Roper Road, Canterbury, Kent. Telephone: 66577. Telex: 28115

TMC is a Registered Trade Mark

A MEMBER OF THE  GROUP OF COMPANIES

build them yourself with UNIFRAME KITS

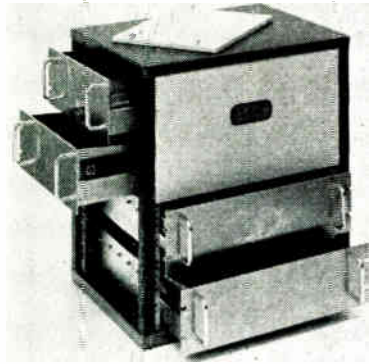

the economical do-it-yourself system which cuts shipping, storage and assembly costs.

Based on new and unique design features, extremely versatile and styled in a range of colours in the modern 'Stelvetite G' material, Uniframe Kits obviate the necessity of stocking a wide range of cases, cabinets and racks of different sizes. Standard Kits range from under £6 to £14 each and can be supplemented by a wide range of accessories. Two examples of assemblies built from the Uniframe range are illustrated, together with our Blower Unit BL 35 (bottom left). This was primarily intended for Uniframe, but in any 19" width system - an efficient unit costing only £16 complete.

Can we send you details of this cost-cutting range or of the Blower Unit?

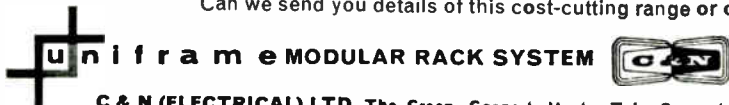

C & N (ELECTRICAL) LTD, The Green, Gosport, Hants. Tel.: Gosport 80221/8. Telex 86121.

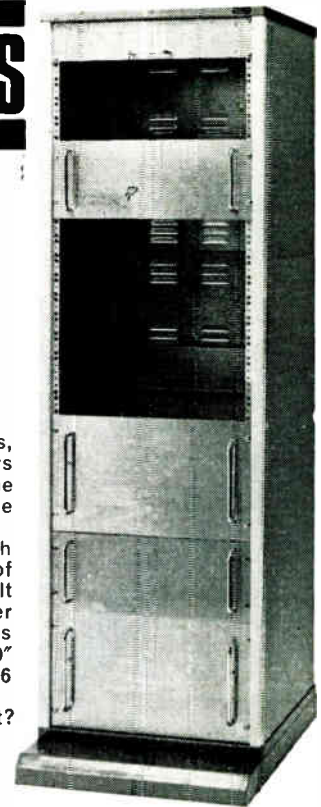

For further information circle 260 on Service Card

Touro Strob ELECTRO-OPTICAL TACHOMETER

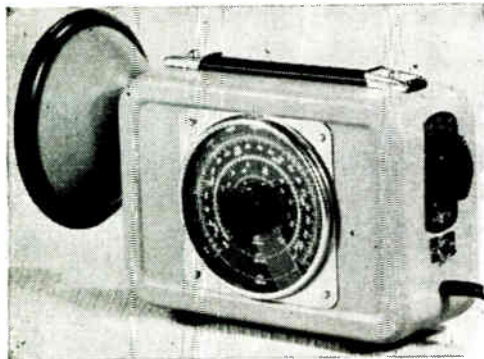

For measuring rotary speeds and cyclic movements

ADVANTAGES

Incurs no loss of power, as no mechanical coupling to the parts under examination required, and can be used in inaccessible places. Suitable for determining rate of movement of machines, cutting tools, shears, pistons, valves, pumps, etc.

RANGE between 200 and 15,000 r.p.m. in three stages. Stroboscope has a maximum flashing frequency of 250 c/s. Suitable for 200/240 volt, A.C. 40-60 c/s supply. Consumption approximately 25 watts. Accuracy within $\pm 1\%$.

Available in 5 models.

Either equipped with neon discharge tube producing a red light, easily seen in daylight, or with Xenon-Pyrex-Tube, with outstanding white light intensity of 1.4×10^6 lumens.

Model 030B (as illustrated above.) Price: £41. 10s. 0d.—weight: 4 lb.

PLEASE ASK FOR COMPLETE LITERATURE WITH PRICE LIST FOR ALL TYPES.

Also Importers of:—Vernier Caliper Gauges and Height Gauges · Trammels and Protractors · "Brightboy" Rubber-Cushioned Abrasives (Wheels and Hand Tablets)

ERIC H. BERNFELD LTD

282 KINGSLAND ROAD, LONDON, E.8

Telephone: CLIssold 4837

For further information circle 261 on Service Card

TOUGH RECORDING REQUIREMENTS

RUSTRAK IS THE ANSWER

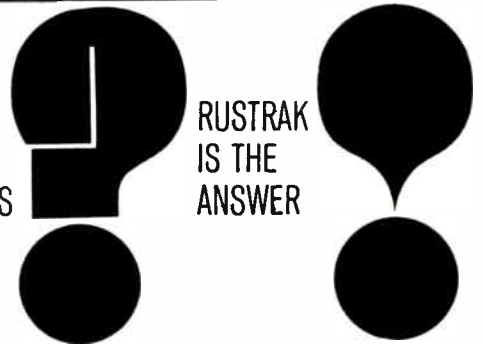

Because Rustrak recorders use pressure sensitive paper (no ink or heated stylus) they will operate with optimum accuracy from sub zero to 160°F.; from below sea level to 100,000 ft.—and under conditions of high humidity. The housing is made to match—a rugged die cast aluminium case. The motor drive mechanism, galvanometer and writing system will all give many years of faithful service under adverse conditions. Rustrak recorders are versatile, too. They are capable of gathering voluminous data at very slow chart speeds. With interchangeable gear trains and motors no less than 99 different speeds are available and information of a duration of 20 milliseconds is clearly visible. Rustrak recorders operate on AC or DC power or from rechargeable batteries. For full information about Rustrak recorders write to —

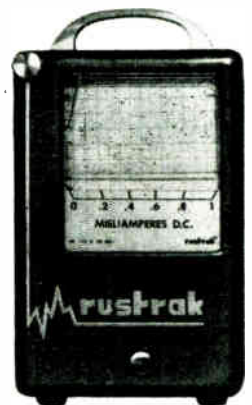

WEST Instrument Limited
A Division of
Gulton Industries (Britain) Limited
The Hyde · Brighton 7 · Sussex · England
Tel: Brighton 662711 · Telex: 871172

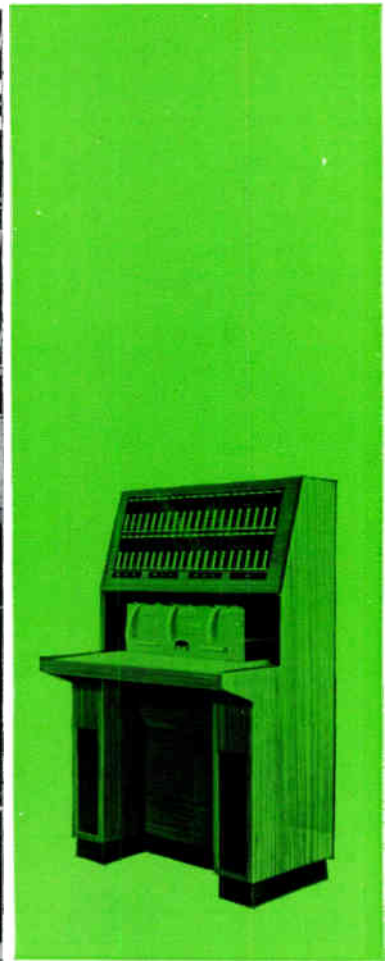
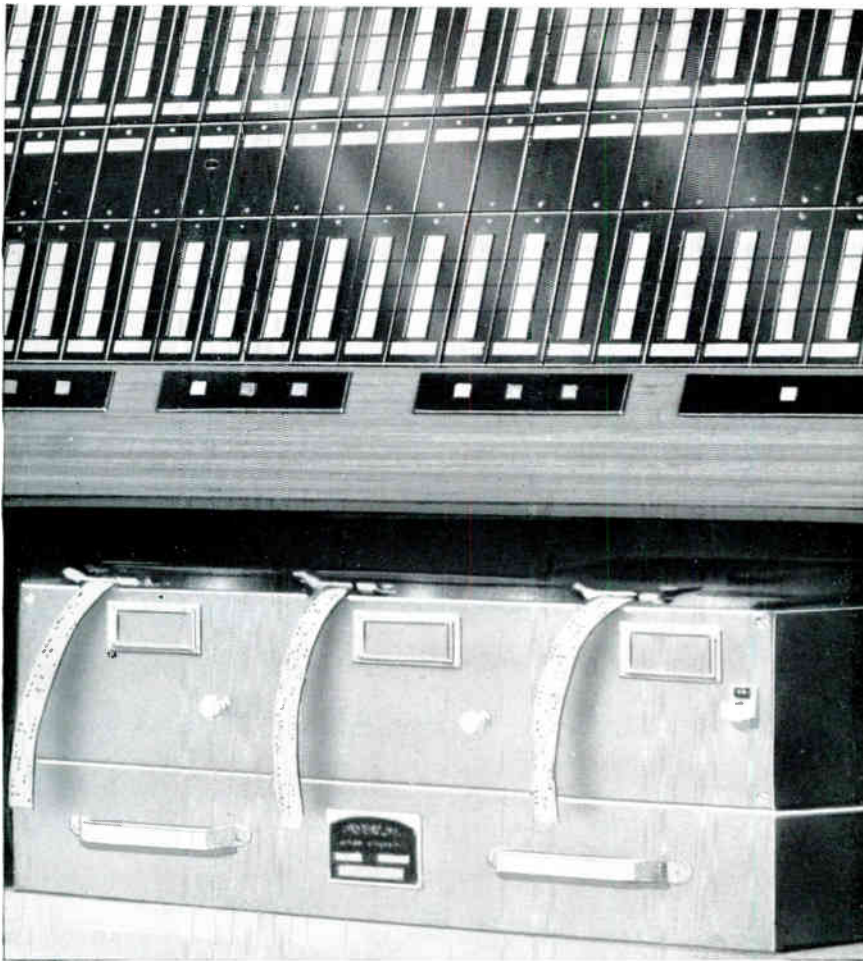

Semi-Automatic torn-tape relay telegraph system

For moderately loaded message switching systems, the use of complicated and expensive equipment is not economic. The STC Semi-Automatic Torn-Tape Relay Telegraph system provides a limited amount of automatic control and, compared with manual transfer systems, uses the services of operating personnel more efficiently. Amongst the facilities offered are:

1. Torn-Tape working with automatic selection of outgoing route (or routes) by push button operation.
2. Automatic insertion of a heading line including outgoing message serial number by semi-electronic means.

3. Rapid and efficient message handling, one operator routing up to 150 messages per hour.
4. Simultaneous transmission of up to three different messages from each operating position.
5. Single transmission for multi-address messages.
6. Two degrees of priority, ensuring that priority messages have precedence over normal messages.
7. Visual indication at the operating positions of engaged outgoing routes.
8. Display at operating position of serial number of outgoing transmission(s).
9. Simple equipment requiring the minimum of maintenance.
10. Employment of well proven telegraph machines and switching equipment approved by the British Post Office and other administrations.

11. Suitable lamp indication during selection of outgoing circuits.
 12. Cancellation of the selection in the event of a routing error.
 13. Switching circuitry ineffective until the transmitter head is loaded with tape.
 14. Release of connexion on completion of transmission i.e. when length of tape has passed through the transmitter head.
- Details from: Standard Telephones and Cables Limited, Telephone Switching Division, Oakleigh Road, New Southgate, London, N.11. Telephone: ENTerprise 1234. Telex: 21612.

STC

world-wide telecommunications and electronics

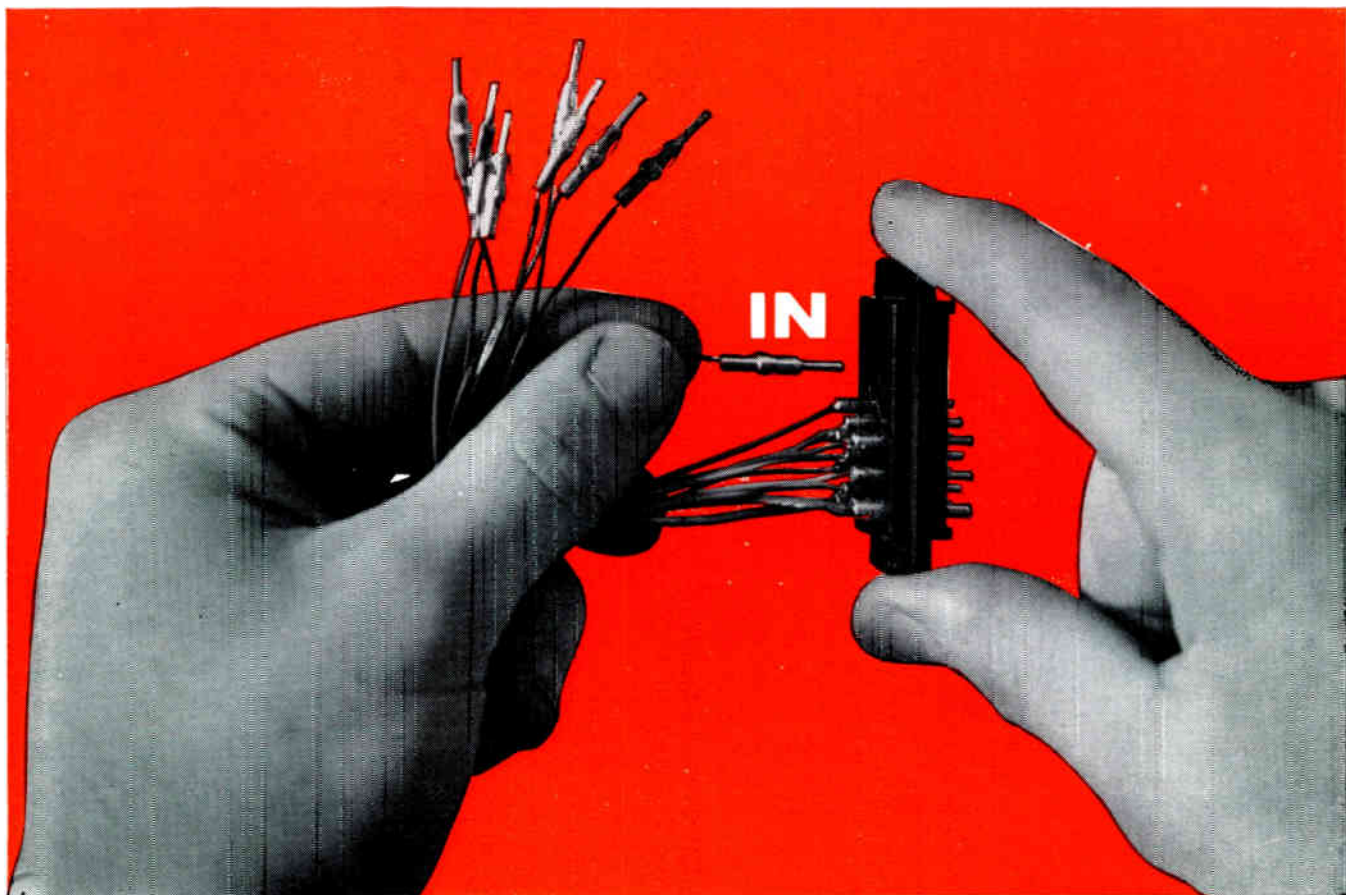

NEW PUSH-HOME UNITOR

developed from type 102

- Robust, slim, glass filled Diallyl-phthalate moulding
- Contacts simply soldered or crimped, then loaded into rear of moulding
- Contact inserts designed to international crimping standards—need little force to insert and withdraw
- Contact springs of beryllium-copper
- Closed-entry sockets
- Ambient temperature range -55°C to -200°C
- High current ratings, 10 and 20 amp
- Simple removal tool supplied with contacts

Write for leaflet P661—
or telephone Miss Woolgar at
Enfield 5393 Ext. 27.



BELLING-LEE

Belling & Lee Ltd · Great Cambridge Rd
Enfield · Middx. Telex: 263265

INDUSTRIAL ELECTRONICS

Incorporating British Communications and Electronics

Radio-Communications Record

Not very much has so far been published about Mariner IV, the American spacecraft which has now transmitted back to earth pictures of the surface of Mars. There are probably two reasons for this; first, the long time which it has taken the craft to reach Mars and, secondly, the unspectacular nature of the pictures themselves.

It seems to have gone unnoticed by most people that a new distance record for radio-communications has been made. It is one of over 134 million miles! With an effective radiated power of 10.5 watts, the received power was around 10^{-20} watt. To detect and utilize such a weak signal has required not only the use of high-gain receiving aerials on earth but the use of a very narrow bandwidth. What the bandwidth is has not been stated, but it took 8 hours 35 minutes of transmission time to convey one picture to earth. In normal television with a bandwidth of 3 Mc/s it takes 1/25 second! Instead of one picture, in this long time there would be 770,000 ordinary television pictures, so one may guess that the bandwidth is of the order of $30/7.7 \approx 4$ c/s. The transmission rate was only $8\frac{1}{2}$ bits per second.

The spacecraft was launched on 28th November 1964 and reached some 5,000–6,000 miles from Mars on 14th July 1965. In its 228-day passage it travelled 325 million miles. It weighs 575 lb and has a design life of 6,500 hours.

The pictures from the television camera tube were transformed into binary coded form, the signals being quantized into 64 levels, and recorded on magnetic tape. The Martian 'fly-past' occupied about 25 minutes during which time 21 still pictures were recorded.

The transmission to earth of the recorded information took place subsequently and, in fact, each picture was transmitted twice, to minimize the effects of noise and other errors.

Throughout its journey the craft has been sending back information on conditions in space and this is probably much more valuable than the actual pictures.

These do show, however, that the surface of Mars is covered with craters and is, in fact, much like that of the moon. No information at all about whether or not there is life on Mars has been gained. Pictures taken at 5,000 miles range would be very unlikely to show any artificial structure.

We are all inclined nowadays to take for granted scientific and engineering achievements. Only 10 years ago most of us thought this kind of thing a dream of science fiction and did not seriously consider it as a possibility of the near future. It can now most definitely be done, but it is very costly. Including the previous failure, Mariner IV has cost about \$120,000,000!

ELECTRONIC COLOUR SORTING

By WILLY SCHAUB*

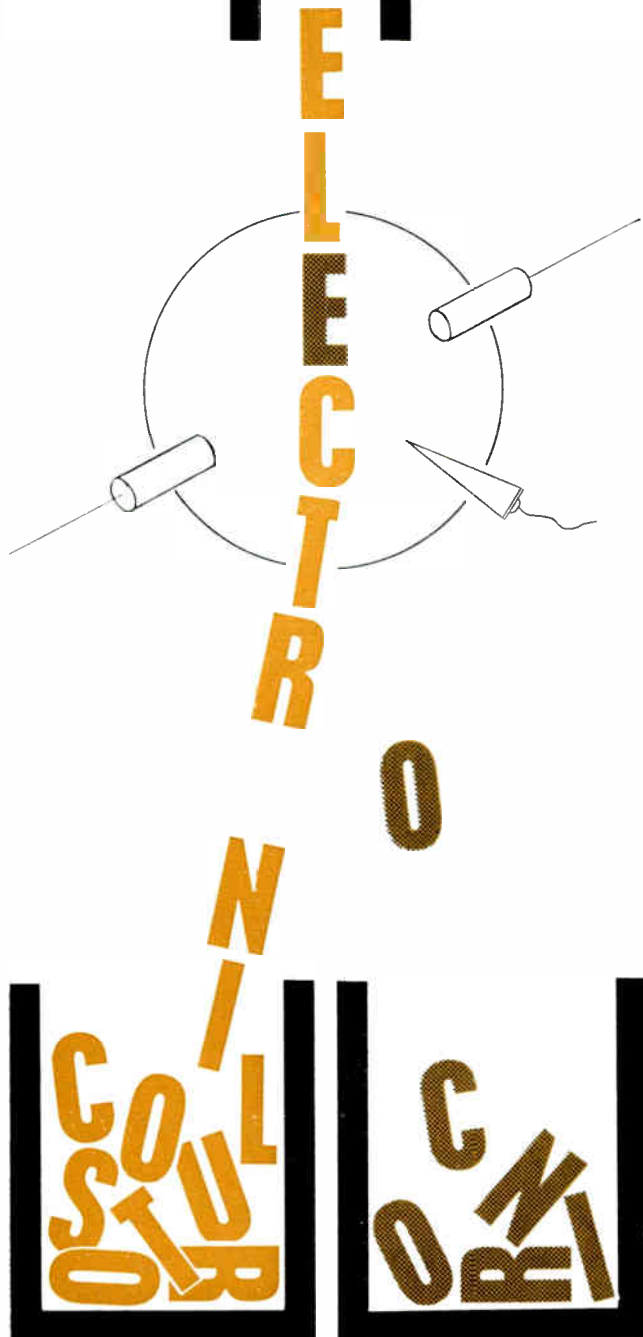

In the food industry increasing use is being made of electronic sorting of commodities for quality selection. Almost any kind of seeds, nuts and similar products can be sorted by the wide range of machines employing the electronic colour separation techniques. Described here are the basic techniques involved, specific sorting machines and a typical application including the economics. Latest developments point to an adaptation of the same techniques to other industries.

THE three methods of seed separation described in this article all use photocells as the selecting agent. One method is based on tone selection and is called monochromatic sorting. The second method, bichromatic sorting, is a more complicated process involving colour selection. The third method is also bichromatic but differs from the second in the ejection process. Here products like rice, small grains, ergot and so on, being too small to be ejected pneumatically, are sorted by electrostatic deflection. This third process is therefore called electrostatic sorting.

Monochromatic sorting involves the use of one photocell per viewing channel. It is the method used when the tone of a bad article is lighter or darker than a certain shade. Discoloured or blemished articles are detected and rejected because the light reflected from them will be lighter or darker than that reflected by the good articles.

Most agricultural commodities have a significant reflectivity over the whole of the visible spectrum. Their distinctive colour is often due to only a slight predominance in one or other portion of the spectrum.

For example a green pea may differ from a yellow pea in that the green pea's ratio of green to red reflectivity is greater. On the other hand the absolute value of reflectivity of the green pea may be always higher or lower than the yellow pea depending on whether it is pale green or dark green respectively.

Hence to separate yellowish peas from green peas ranging from very pale to very dark green, it is necessary to sort according to their green/red ratio of reflectivity; i.e. bichromatically.

Simultaneously light/dark sorting may be carried out to eliminate material which although not outside the green/red ratio limit is outside the absolute light/dark limit in either or both the red and the green.

On one version of the machine bichromatic and light/dark sorting is carried out independently from two diametrically opposite directions plus light/dark sorting from two further such directions at right angles.

Here the photocells must distinguish actual colours, and this means that both detection and measurement of the differences in colour tones require two photocells with colour filters employed for each viewing channel.

Fig. 1 shows the sorting process. The commodity to be sorted enters the machine through a hopper funnel and is fed by a vibratory feeder on to a moving V-shaped belt. From the feeding belt the articles of the commodity fall in a single stream through the optical chamber and are examined there by the photocells. There are two to four viewing channels depending on the type of machine. The photocells compare each article with reference to a background. The backgrounds are interchangeable and are chosen so that they have the same colour and brightness as the good product, according to the particular range of colour or brightness sensitivity of the photocell.

*Gunson's Sortex Ltd.

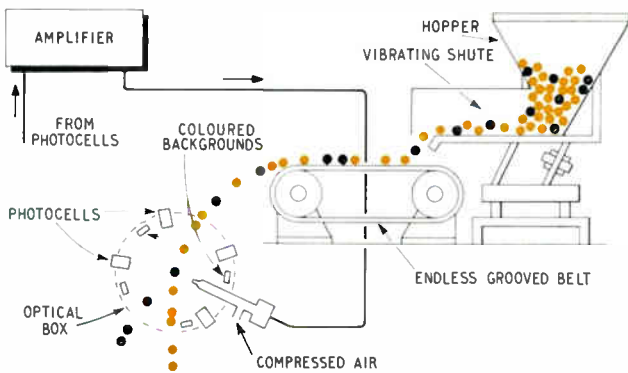

Fig. 1. Illustrated here is the bichromatic sorting process

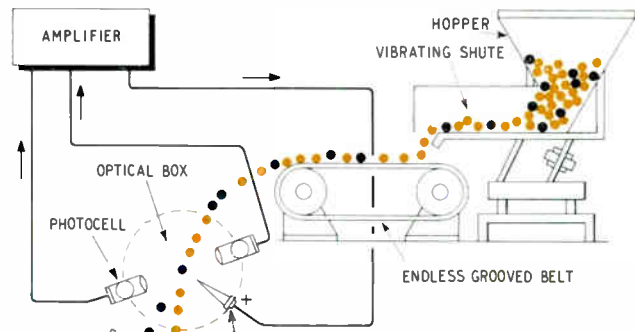

Fig. 2. (Right) This shows the monochromatic machine with electrostatic sorting

When an article of a different colour or brightness falls through the optical chamber, the photocell sees the difference against the background and sends out an electrical pulse. This pulse is passed through the amplifier to operate the ejector nozzle so that a jet of air is released and the reject article is blown out of the normal line of fall into a separate collection channel for the bad articles.

In the bichromatic machine the filters are fixed inside the optical box and can be changed easily by a technician. This is seldom required, because the controls of the amplifier can be set to give any standard of commodity separation by careful selection of backgrounds and filters. A red filter is always used in conjunction with a green or blue filter and often with both according to the commodity. Each colour has a light and dark selector and a sensitivity control which can be increased or decreased depending on the degree of sensitivity required. If the light and dark signals are too slight to work the ejector, the amplifying controls can be turned up.

The ejector consists of a nozzle joined to the air tube. In the air tube is a valve which is opened electromagnetically. When a signal is applied to the electromagnetic valve it is operated and the compressed air is released through the nozzle.

With the bichromatic machine the commodity stream is viewed from four sides, and this makes more efficient sorting possible.

Fig. 2 shows a schematic drawing of the monochromatic machine with electrostatic sorting. Commodities for sorting are fed from the hopper by means of a vibrating chute and align themselves on an endless grooved belt. They pass by free fall through an optical box where they are inspected in mid-air by photocell from two sides against coloured backgrounds. Unwanted discoloured items receive a positive charge at this point. Good and unwanted items continue to fall and pass through an electrostatic field formed by two plates. Due to a positive charge on one plate charged items are deflected to the reject side of the divider plate for separate collection.

Monochromatic machines can also be fitted with air-deflection sorting. With the help of the different electronic circuits, different filters and backgrounds, a very wide range

of sorting selections can be made. Even colour differences invisible to the human eye can be detected by the machine and sorted out. This machine can find the smallest insect damage, and worm holes.

The sorting capacity depends on the type of machine used, and on the quality and size of the commodity to be sorted. Some production figures are given below for comparison. The figures in brackets are the figures for the SORTEX types G423, G523, G526 and G22R which have a double feeding system and a double optical box in the one machine.

Peas, Beans	60-140 kg/h. (120-280)
Green Coffee	60- 90 kg/h. (120-180)
Peanuts, Hazelnuts and Almonds	100-200 kg/h. (200-400)
Rice	(50- 80)

Automatic cleaning systems are installed in Sortex electronic colour separators. Formerly an automatic blow-down system cleared the lenses and lamps every minute in order to prevent dust settling and thus lessening efficiency. Air was fed to symmetrical rings with outlet vents leading directly on to each lens and lamp face so that, when air was blown through, the sorting operation was completely undisturbed by its action.

Now increased efficiency of dust prevention has been achieved by providing the continuous air curtain in front of the lenses and bulbs.

As most of these separator machines are exported often to developing countries, Sortex have been most careful to ensure a simplicity of design and operation in the interests of reliability. An often claimed feature of the machines is the fact that they only have two moving parts (the drive-in belt on the motor and the pulleys on the feed belts). Also it has been found that only one operator is required to look



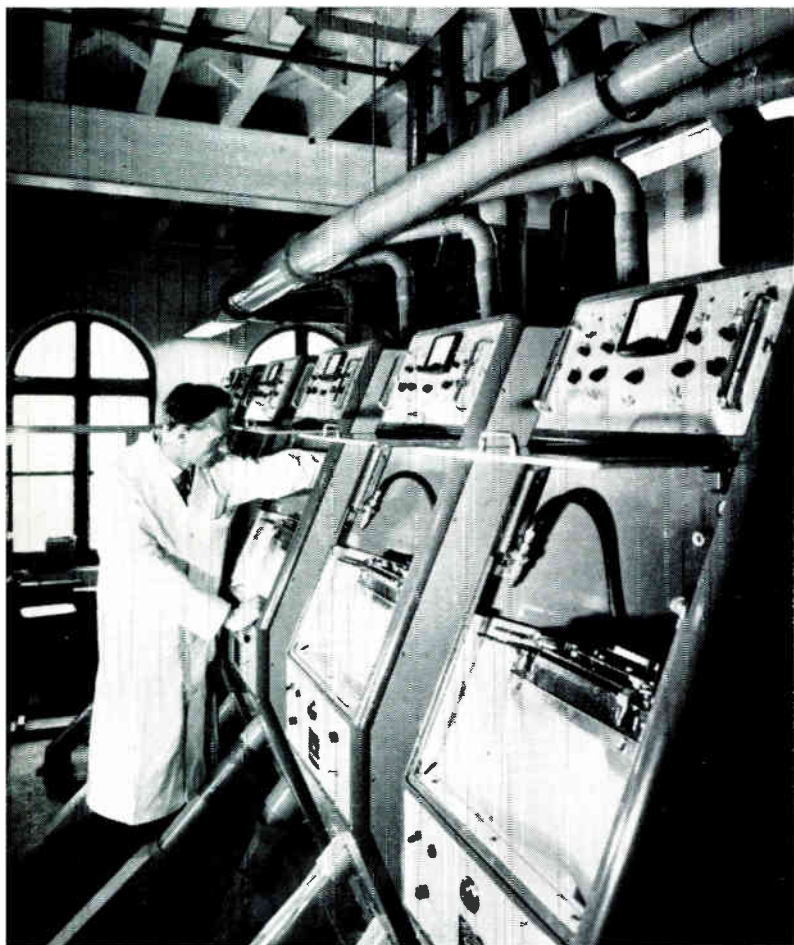

Some of the Gunson machines which are used for sorting peas at the Peterborough factory of J. Farrow Ltd.

after 50 machines, working day and night, week after week if necessary.

Installation and maintenance are extremely simple. All sub-assemblies are mounted on sliding chassis, and are accessible from either the front or the back so that a number of machines can be installed together side by side in a battery, occupying a small floor space.

Each machine being an independent unit can be staffed without affecting the operation of the other machines.

Electronic sorting is being increasingly used in the food industry to control the quality of commodities. Originally the machines were introduced by Gunson Sortex Limited to sort seeds. The demand for this type of sorting machine quickly increased and models were developed to sort other products as well as seeds. Now at least 25 different types of commodity can be electronically sorted. These range from peas, beans, seeds, grain to nuts, kernels, dried fruit and dried vegetables. Latest commodity developments include non-agricultural products such as plastic, bone, rock salt, minerals and industrial diamonds. Gunson Sortex are now perfecting processes of mineral sorting, following success of industrial diamond sorting machines ordered by Industrial Grit Distributors Ltd. of Ireland.

Before electronic sorting the only method of quality selection was the laborious process of hand sorting. It is therefore best to demonstrate the economies of the machines by showing costing calculations for both hand and machine sorting, and comparing them. The comparison between hand sorting and electronic sorting of Green Coffee in Addis Ababa is the most interesting for the fact that wages for manual work in Ethiopia are very low.

It was calculated that the daily expense of operating a hand sorting installation worked out at 905 Ethiopian dollars a day against a daily expense of operating an electronic sorting installation at 474 Ethiopian dollars a day (with a redemption time of five years for the cost of the whole installation taken into account).

tain F... Cont led rt Traffic Systc.

Early next year, the Port of Bristol will become the first port in Britain and, possibly, the first in Europe to operate an on-line traffic control system.

Between the Avonmouth Docks and the Port of Bristol Authority's head offices in Queen Square, Bristol, there is to be operated an automatic data-transmission link by which details of every ship's cargo arriving at Avonmouth and its subsequent discharge will be controlled on an NCR 315 computer equipped with random-access memory files.

At present, a large clerical staff is required at Avonmouth to maintain the numerous traffic ledgers in which are manually recorded details of all the many different kinds of cargo discharged from vessels, delivered to merchants ex-ship or stored at the Port. The new system will mean

that experienced personnel on the traffic staff can be released from routine clerical work to spend more time on controlling the increasing flow of traffic through the Port.

As soon as each vessel arrives at Avonmouth, details of the cargo are punched into paper tape which is then fed into a special transmitter unit. This transmits data over a G.P.O. line to the Port's computer centre in Queen Square, Bristol, where an identical tape is produced. The tape is then fed into the computer which stores the information on its random-access memory files. The computer will be programmed to take into account 'exceptional' factors, such as moisture allowance, damaged cargo and shortages in cargoes.

One of the major advantages of the new traffic system is a high-speed interrogation facility. When, for example, an urgent enquiry is received from a merchant the traffic clerk concerned has immediate access to the information stored in the computer's memory on that particular cargo. He has only to input an alpha-numeric code on the interrogation unit nearby and, within $\frac{1}{2}$ to 2 sec, the answer is received from the memory file and printed out in the office.



COMMUNICATIONS
CENTRE

ELECTRONIC SPEEDOMETER FOR RAILWAY LOCOMOTIVES

A PART from giving indications of speed and mileage covered, speedometer equipment on railway locomotives is now required to control the automatic field-weakening of the main traction motors on diesel-electric engines. Also, in the near future, control of low speed will be necessary for liner-trains and for the private railways such as those used in power stations.

The existing method for speedometers, consisting of an axle-driven generator and a voltmeter calibrated in m.p.h., cannot perform these functions and has the disadvantages of poor low-speed response and a tendency for pointer oscillation.

These disadvantages are eliminated and the new requirements met with the A.E.I. Type S electronic tachometer equipment which has recently been developed. This gives a good low-speed indication with accurate readings down to 0.2 m.p.h. and a complete absence of pointer flutter. Some of the Type 2 diesel-electric locomotives of British Rail are being fitted with the equipment and the Type 1 locomotives now on order are scheduled for installation.

A transmitting unit is fitted in place of the normal axle-box cover on one of the axles. This generates pulses by the action of a rotating toothed wheel attached to the axle and an electro-magnetic probe. The pulses are passed to a control box where they are amplified and the wave shape changed. The control unit is made up of completely transistorized plug-in modules and is powered by the 110 V d.c. supply of the locomotive.

The speed-indicating meters situated in the driver's cab are millimeters calibrated in m.p.h. The pulses fed to them are integrated by the moving-coil action of the meters and the figure indicated is equal to the mean current. All pulses are of the same amplitude and the mean current readings are directly proportional to the pulse repetition frequency, a linear scale of speed being obtained.

A calibrated shunt connected across the meter compensates for wheel-wear and adjustments can be made for wheel diameters between 36 and 48 in. When two meters are required, these are connected in series to avoid unequal current sharing.

Mileage is recorded by a capacitor-discharge circuit which actuates an electro-magnetic counter. Speed-sensitive relays are used for automatic field weakening and delay circuits prevent operation during wheel-slip.

Similar equipment to this is being used for recording the number of hours an engine has run. Any form of engine can be used to initiate pulses which are then fed, as above, through a control box to an electro-magnetic counter.

For further information circle 40 on Service Card

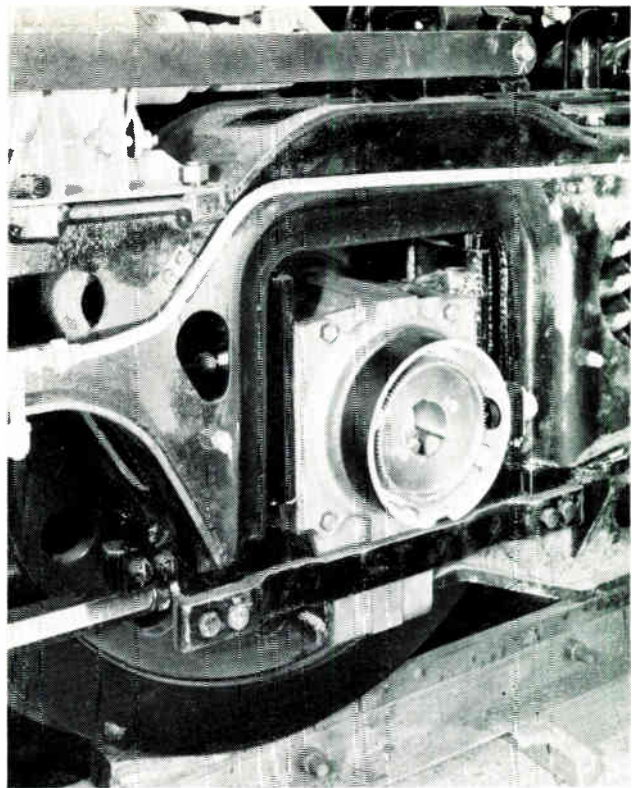

This shows the transmitter unit with the cover removed. The toothed wheel and the electro-magnetic probe can be seen

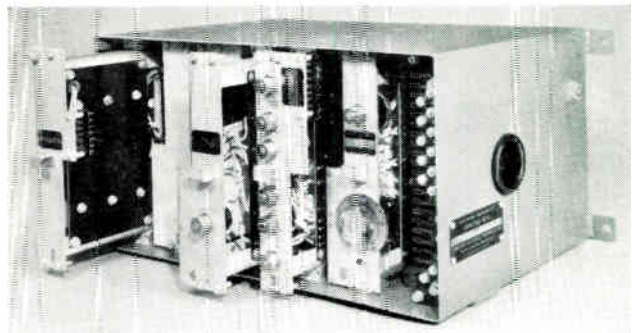

Here the control box is illustrated with some of the plug-in modules partially removed

In this picture the cab of a Type 2 British Rail diesel-electric locomotive is shown fitted with the A.E.I. electronic speedometer and mileage recorder

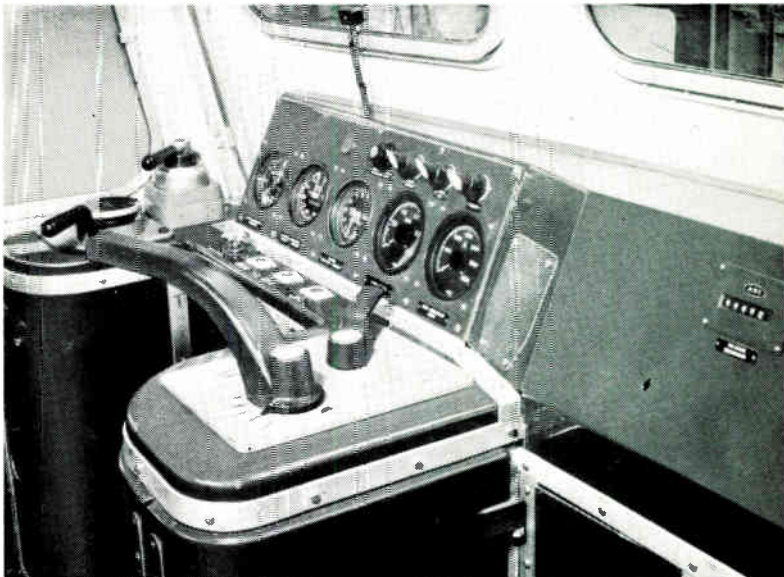

A PULSE COMPRESSION SYSTEM FOR RADAR

Part 1: The System

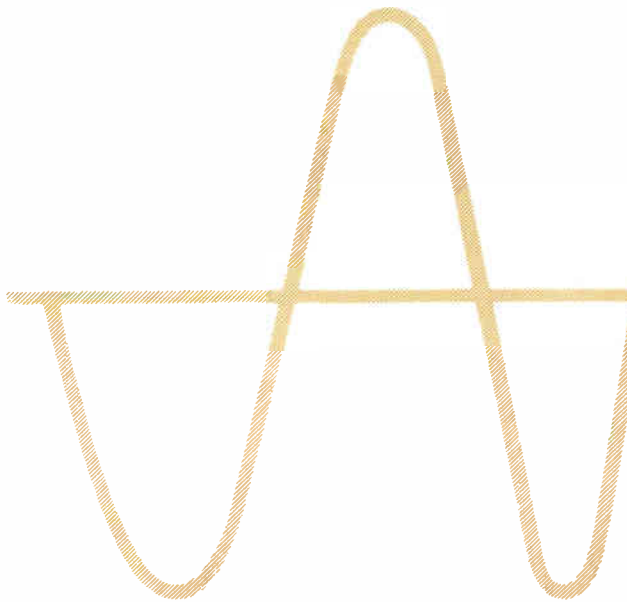

By W. S. MORTLEY, A.M.I.E.E.*

A correlation system is described which enables a tapped delay line to be used as a decoding element in a radar system. This permits high discrimination to be obtained with radar pulses as long as ten microseconds.

IN order to be able to discriminate between close targets at long range, it is necessary to widen the frequency bandwidth of a relatively-long transmitter pulse. The received echo pulses may then be shortened in the receiver by a process of phase decoding. There is more than one method of doing this but the best known is the 'Chirp' system of Bell Telephone Laboratories.¹ That system uses a dispersive delay line for phase decoding from a pulse with a linear frequency sweep. The operation is generally known as 'pulse compression'.

There are difficulties in making and adjusting dispersive networks for a high degree of 'compression' and these difficulties are increased considerably if accurate signal comparison between a number of receiver channels is required.

The correlation system described below avoids some of the difficulties by using a tapped uniform delay line as a decoding element which may be common to any number of channels.

Pulse Compression

There are two main reasons for requiring a short radar pulse. The more obvious is in discriminating between targets which are close together. The other is in discriminating between a target of small dimensions and a distributed clutter background (echoes from the ground, the sea or rain). The proportion of signal energy returned from the distributed clutter at a given range is proportional to the pulse length, whereas that from a target which is short compared with the equivalent pulse length in space is not affected by the pulse length. Therefore there are advantages in using a pulse which is spatially equivalent to a dimension of the same order as that of a typical target, say one-tenth of a microsecond. Pulse compression from ten microseconds (100 μ s) would give 100 times the spatial resolution and would increase aircraft target to clutter ratio by nearly 20 dB. These are typical attainable figures.

For many practical reasons there is a limit to the peak power which may be used economically and so for very small and distant targets the pulse energy can be increased only by lengthening the pulse. In order to obtain advantage from the lengthening, the received echo energy must be integrated over the duration of the pulse by being passed through a narrow-band filter. This produces a rounded pulse of maximum detectability but which is uncertain in position by an amount which is of the order of a pulse width, when near the limit of visibility. If there were two targets separated in range by less than this uncertainty they would be indistinguishable. The long pulse duration also has the effect of producing an unfavourable signal-to-clutter ratio in the presence of rain or other range-distributed interference.

The situation cannot be improved by differentiation or by any other trick that does not put more information into the pulse. Improvement entails increasing the bandwidth of its frequency spectrum.

It might appear to be an advantage to fill the available bandwidth as uniformly as possible (this being as far as one can get from the constant-frequency pulse). In fact this is not quite the case because interference effects result in the production of 'ghost' pulses before and after the main one, known as 'range side lobes'. In order to avoid these the spectrum must have a 'tapered off' energy density. However, it is generally most efficient, owing to the characteristics of microwave transmitting valves, to radiate a spectrum of uniform density and to shape it in the receiver.

A spectrum of approximately uniform power density is obtained most easily by a uniform rate of frequency sweep

* The Marconi Company Limited.

over the band, the 'sidebands' being spaced by the pulse repetition frequency (Fig. 1). Assume, for example, that the transmitter pulse is 10- μ sec long and that the frequency sweeps upwards at 1 Mc/s per μ sec so that the total sweep is 10 Mc/s. In the receiver the intermediate frequency might be arranged to sweep from, say 20 Mc/s to 30 Mc/s. If this signal is passed through a dispersive delay line so designed that 20 Mc/s elements are delayed 10 μ sec longer than 30 Mc/s elements and proportionally in between, then all elements of the signal arrive at the end of the line at the same time and produce a single narrow pulse envelope with the same frequency spectrum as the input. The phases between the component frequencies are different from the input, of course.

The output pulse is the Fourier transform of the input pulse and its half-power width is about equal to the inverse of the frequency sweep; one-tenth of a μ sec in this example. The product of the transmitter pulse length and the frequency sweep is called the 'dispersion factor' (=100 in this example). The 'compression ratio' is the name given to the ratio of the transmitter pulse length to the practical compressed pulse length and is reduced considerably below the dispersion factor in 'shaping' to suppress the 'range side lobe pattern'; e.g. to about 80.

The dispersive line system for pulse compression is known as a coherent system. all the frequency components being added, correctly phased, before detection. We may note here, in passing, that a non-coherent system can be produced in which a number of narrow-band receivers are tuned to all the frequency elements, the detected outputs being suitably delayed separately, and added. It turns out that in this system the optimum bandwidth for each receiver only gives a pulse compression ratio of \sqrt{D} ; ten in the present example.

The New Correlation System²

In its simplest form, this system also uses a linearly swept f.m. transmitter pulse and it is a coherent system. Its performance should be similar to that of a good dispersive line. Its main advantage is that it is more adaptable to a multi-channel receiver system and its main disadvantages are size and cost. Nevertheless, both cost and maintenance problems are minimized by the fact that so many elements are identical. Extensive use is made of printed boards.

A dispersion factor, D , with a pulse length, T , requires a sweep of $f_D = D/T$. So that diagrams do not become too unwieldy we will assume, at first, a very small dispersion factor of $D=4$ with a pulse length of $T=10 \mu$ sec. Then the frequency sweep f_D is 400 kc/s, and the rate of sweep is 40 kc/s per μ sec. We may assume a pulse repetition frequency of 250 c/s.

Referring to Fig. 2, if we cause the local oscillator to sweep in the same direction and at the same rate as the transmitter, there will be constant difference frequencies between the local oscillator and the target echoes. Two echoes are shown at about half a pulse length (i.e., 5 μ sec) apart. The constant difference frequencies are therefore 200 kc/s apart. For a pulse length of 10 μ sec a near optimum filter bandwidth is 100 kc/s, so these two echoes can be separated by being passed through separate filters.

It should be noted that the use of the swept local oscillator produces i.f. signals which are indistinguishable in character from those which would be produced by a normal c.w. pulse radar. The noise bandwidth is the 100-kc/s filter bandwidth, therefore, and not the transmitted bandwidth of more than 500 kc/s. (The transmitted bandwidth is made up of the sweep bandwidth and the pulse envelope bandwidth. The latter is often ignored if the compression ratio is large.)

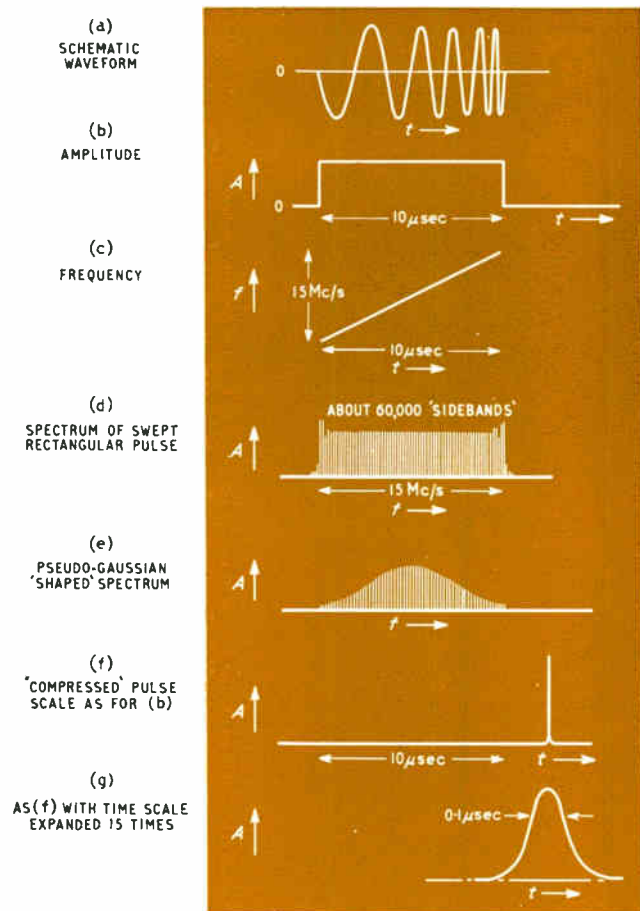
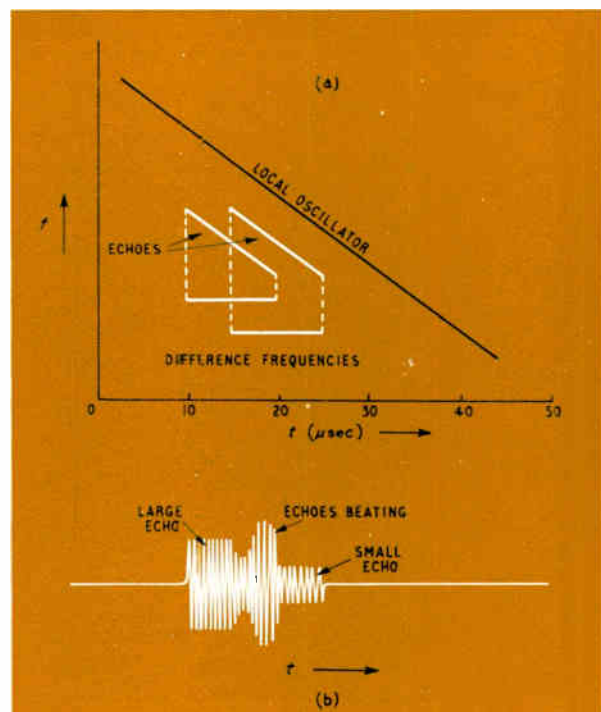

Fig. 1. Typical pulse compression waveforms

Fig. 2. Shows the constant difference frequencies between the swept local oscillator and the target echoes



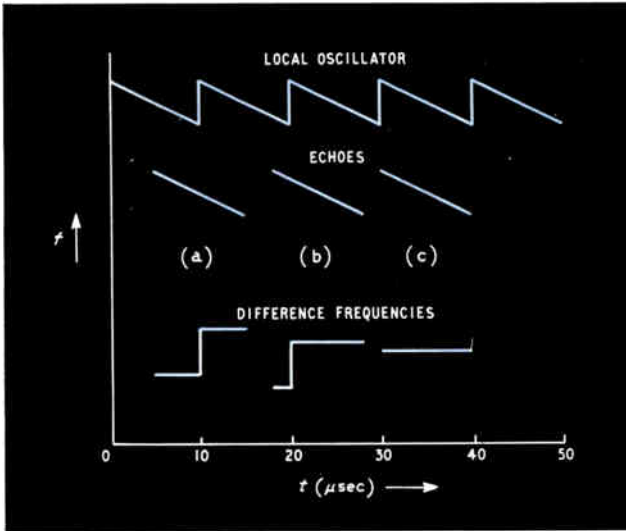
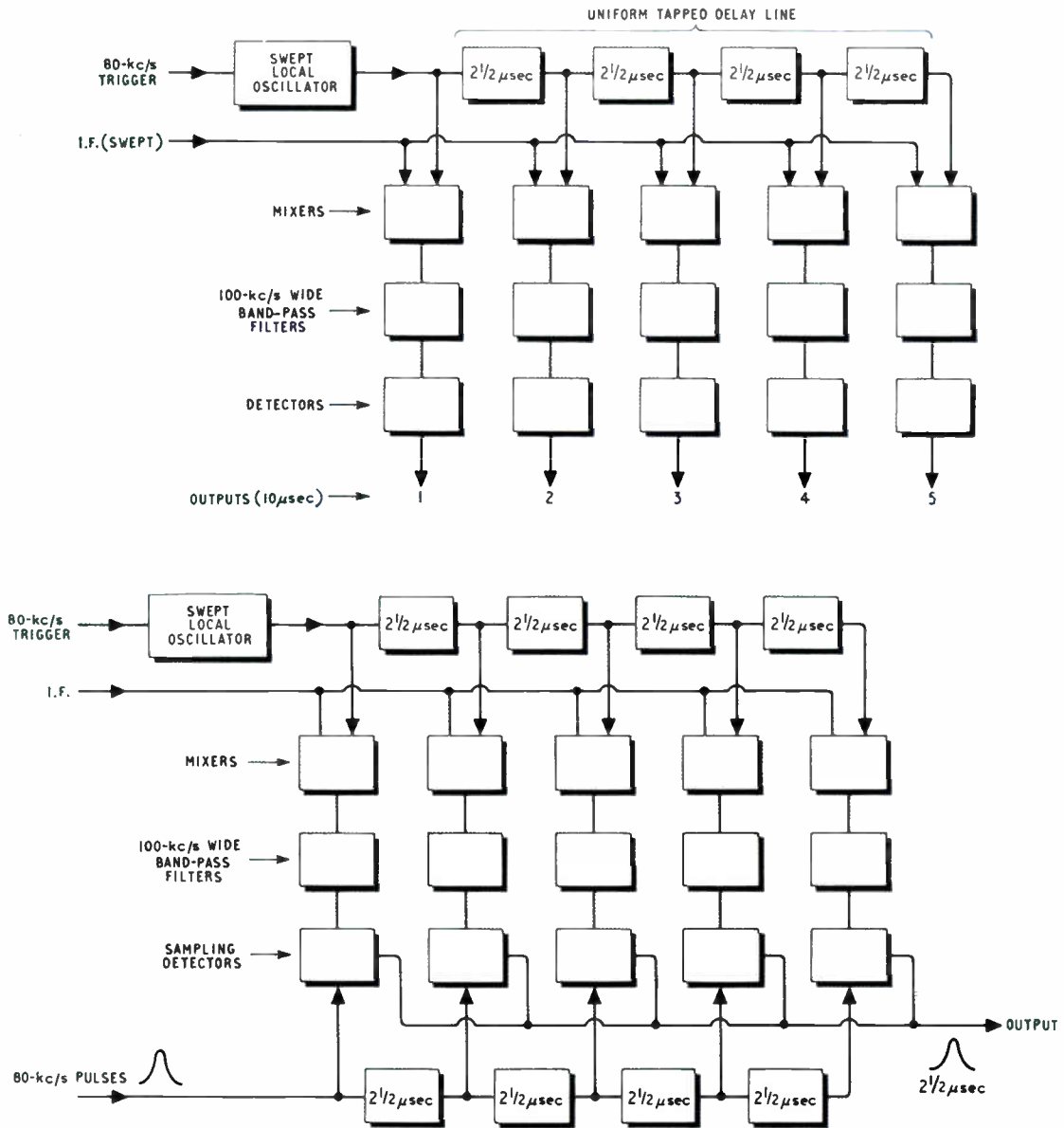

Fig. 3. (Top) This shows that by using a repetitively-swept oscillator and 10 filter frequencies echoes will usually appear unequally divided between two of these filters

Fig. 4. (Centre) Uniform delay line range discrimination scheme

Fig. 5. (Bottom) Sampled U.D.L. scheme



A radar using a constant rate of oscillator sweep throughout its range is impractical. In the case being considered it would require about 150 Mc/s sweep and 1,500 narrow-band filters over the same range. To avoid this difficulty we can sweep the oscillator repetitively; say every 12.5 μ sec in this example. Then there need be only ten filter frequencies but usually echoes will appear unequally divided between two of these filters as in Fig. 3. However, with this arrangement the resolution suffers when the pulse coming from the mixer is nearly equally divided between the two frequencies because the spectrum width centred on each frequency will approach double that obtained in the arrangement of Fig. 2. Moreover, there will be a 3-dB loss of signal-to-noise ratio under these conditions even if the bandwidths of the various filters are optimized for the pulse-lengths they will receive, because the available signal power will be divided between two channels containing uncorrelated noise.

The number of filter frequencies can be reduced to unity if there exist swept local-oscillator frequencies spaced in time at all multiples of the inverse of the frequency sweep, so that the filter always selects a single frequency for the whole pulse duration, as at Fig. 3 (c). In this example this is at every 2.5 μ sec corresponding to 100-kc/s frequency intervals at any instant. Six such sweeps are required in order to allow some time for 'flyback' as well as to allow for the signal to be half-way between two sweeps without being shortened, but for numerical convenience we will assume here that there are only five.

These five 'overlapping' frequency sweeps may be produced either by five oscillators or by one oscillator and a uniform tapped delay line. There are difficulties with both methods, but for ease of maintenance the latter method is much the superior. This arrangement is illustrated by Fig. 4, and it will be seen that there are five outputs, in any one of which an echo signal may appear. If one imagines receiving an echo from a 'target' moving radially away from the radar aerial, the signal would appear initially at output 1 and then move successively to 2, 3, 4 and 5, back to 1, 2, 3... and so on.

If the filter and intermediate frequencies are suitably related,† each of the outputs will be a pulse of at least 10 μ sec, so there is a difficulty in displaying the information obtained. Sometimes, however, if the outputs are to be fed into a computer, it is convenient for them to be

† See Appendix.

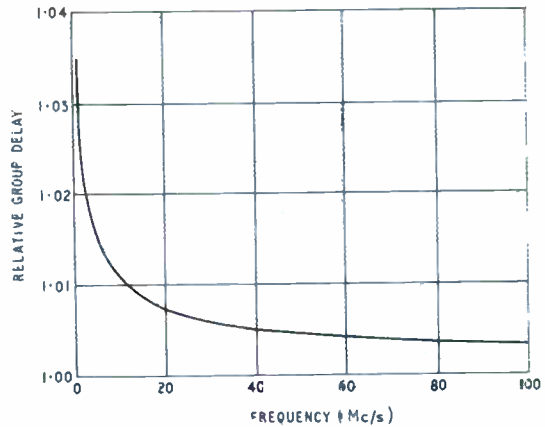
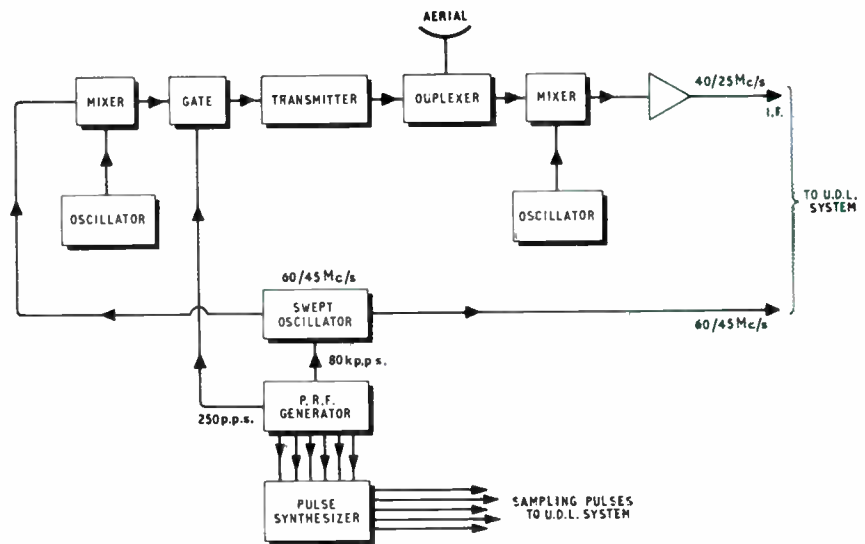

Fig. 6. Dispersion in small coaxial cable

already sub-divided into elements of range. When used in this way it is improper to speak of 'pulse compression' as the actual output pulses may be allowed to retain their original length. What has been achieved is improved resolution, so it is better to refer to a 'resolution ratio' which is the equivalent of 'compression ratio'. The display problem is resolved by sequentially sampling the 10- μ sec pulses by 2- μ sec pulses and adding them all together as in Fig 5. With suitably-shaped sampling pulses, the output samples 'fade into one another' as the target echo signal progresses from sampler to sampler. The overall process may now be described as 'pulse compression' and the 'pulse compression ratio' may be compared directly with other systems. Any normal type of radar display may be used, of course, provided that it has adequate bandwidth for the compressed pulse signals. In Fig. 5 the sampling pulses are obtained from an auxiliary delay line. This is convenient for illustration, but it is not as easy to do as it might appear. The chief difficulty is that it is impossible to make practical lines of this length without distortion (Fig. 6). For this reason we prefer to synthesize pulses from the frequencies available from a frequency-divider chain which also generates the 80-kc/s local-oscillator repeti-

Fig. 7. F.M. pulse radar scheme



tion frequency and the transmitter p.r.f. of 250 c/s. This results in all the pulses being identical and uniformly spaced and it also takes much less space than a tapped delay line.

In a low-resolution system such as we have described it might be convenient to use separate oscillators for transmitter and receiver. For high ratios this is rather inconvenient in that the rates of sweep, including departures from linearity, have to be matched. In this case it is better to use only one swept oscillator and to gate out one of its sweeps for transmission (Fig. 7). Then the errors of linearity tend to cancel. Errors of slope still have a second-order effect which will either widen the final output pulse (if the slope is too small) or will make it vary in amplitude with range if the slope is too great, because the system isolation then becomes too great in relation to the spacing in range of the separate channels. (Note that these effects will generally be greatly reduced if a spectrum-shaping filter is in use in the receiver before the mixers.)

Appendix

The filter passband characteristic required to give an optimum signal-to-noise ratio in this case is such that its convolution with the Fourier transform of the envelope of the local-oscillator signal is equal to the spectrum of the signal pulse emerging from the mixer.

The reason why the usual relation governing optimum

bandwidth does not apply is that the noise input to the filter is gated by the local-oscillator pulse, which thereby introduces a measure of correlation into its spectrum. When a filter is fed through a gate in this way, its response to a c.w. input signal is given by the convolution of the frequency response of the filter itself with the spectrum of the gating function, and this gives an alternative way by which to arrive at the optimum signal-to-noise criterion.

In the ideal case where there is no phase error between the local oscillator and the incoming signal, the spectrum of the signal as it emerges from the mixer will be the same as the Fourier transform of the envelope of the incoming signal, apart from a translation by the intermediate frequency. Thus, if the envelopes of the local oscillator and incoming signals are identical, which is a likely case, the criterion dictates a filter of infinitesimal bandwidth. Practical considerations in the realization of the filter prevent this from being achieved but fortunately the loss in performance is small as long as the filter does not exceed the width of the Fourier transform of the incoming signal envelope.

References

- ¹ Klauder, J. R., Price, A. C., Darlington, S., and Albersheim, W. J., 'The Theory and Design of Chirp Radars', *Bell Syst. Tech. J.*, 39, p. 745 (July 1960).
- ² British Patent No. 948763, U.S.A. Patent No. 3188637.

Electronic Control of Paper Stock

An electronic control scheme, which is the first of its kind in this country, has been designed and installed by George Kent Ltd., at the Thames Division of Bowaters U.K. Pulp and Paper Mills Limited. The scheme provides fully

automatic quality and quantity control of feedstock to the No. 1 papermaking machine.

Kent 'Veriflux' magnetic-flow detector heads measure the individual flows of all the constituents that make-up the final paper stock; i.e. groundwood stock, sulphite stock, alum, size, clay, and several dyes. These flow detectors provide the initial 'measured-value' signals which are transmitted via Kent 'Transdata' magnetic-flow converters to the controllers and presentation instrumentation.

Control is implemented by Kent 'Transdata 153' Series controllers, which are low-drift modular-constructed instruments based on plug-in circuit cards. The panel-mounting facia of each controller carries the ratio or 'desired-value' setting potentiometer, together with a deviation meter, output meter, and auto/manual switch. It is therefore quick and simple to adjust the stock constituent percentages for various grades of paper.

The flow-rate of the first constituent is used to govern the flow of the next constituent. This cycle is repeated for each subsequent additive and the sequential control thereby enables all flows to be blended in accurate proportions to each other, therefore ensuring consistently high product quality.

Thus, from the stock tanks to the machine head box, all variables are subjected to strict ratio control, the accuracy of which is automatically maintained regardless of changes in flow rate.

All controlling and presentation instruments are housed in one console situated in a central control room from which the operator controls the whole plant.



This shows the plant operator making adjustments to a 'Transdata' controller on the instrument console

An Application of Photomultiplier Tubes in Temperature Measurement

By J. SHARPE, B.Sc., M.I.E.E.*

This article gives details of an approach to high temperature measurements using low-cost photomultiplier tubes. It shows that by operating a pyrometer at short wavelengths this technique can provide extreme sensitivity to small fluctuations in temperature.

At a temperature of about 700 °C, a hot body will begin to glow visibly, a dull red colour being seen. As the temperature is increased, the apparent colour changes through yellow to a yellowish-white which we associate with incandescent lamps. The distribution of energy also changes with temperature, the wavelength at which maximum emission occurs moving toward the blue region of the spectrum, as the temperature rises.

Fig. 1 shows how the power, measured in watts per square centimetre over a wavelength range of one micron, varies with wavelength for black body radiators at various temperatures. A black body, or full radiator, is one for which the radiative (or absorptive) capability is not dependent on wavelengths and for which the power radiated follows the Planck relationship

$$B(\lambda T) = c_1 \lambda^{-5} [\exp.(c_2/\lambda T) - 1]^{-1} \text{ Wcm}^{-2}\mu^{-1} \dots (1)$$

Here, $B(\lambda T)$ is the power emitted at a given wavelength (λ) and absolute temperature, T °K (0 °C = 273 °K). The peak power emitted at a temperature T is

$$B_{\text{max}}(T) = 1.290 \times 10^{-15} T^5 \text{ Wcm}^{-2}\mu^{-1} \dots (2)$$

at a wavelength

$$\lambda_m = 2,898 T^{-1} \mu \dots (3)$$

The constant c_2 is equal to 14,380 μ °K and is approximately equal to

$$5\lambda_m T \dots (4)$$

The total radiated power to surroundings at 0 °K,

$$\int_0^{\infty} B d\lambda = 5.679 \times 10^{-12} T^4 \text{ Wcm}^{-2} \dots (5)$$

and when the surroundings are at T_0 °K, the excess power radiated is given by the Stefan Boltzmann function,

$$5.679 \times 10^{-12} (T^4 - T_0^4) \text{ Wcm}^{-2} \dots (6)$$

From the above equations it will be seen that an absolute measurement of the specific power emission from a black body at a known wavelength, through a filter transmitting over a fairly narrow bandwidth, enables the temperature to be determined. Fig. 2 shows the power which would be received at the focus of a quartz lens of diameter 2.5 cm (1 in.) mounted 100 cm from a black body of area 1 sq cm, at various wavelengths, through a filter passing a band of 300 Å (0.03 μ)

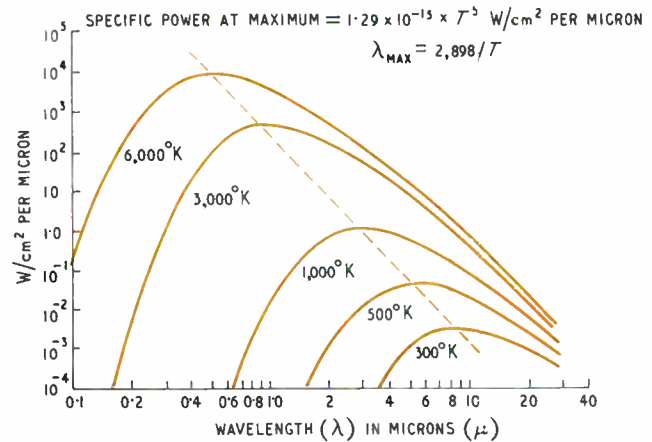
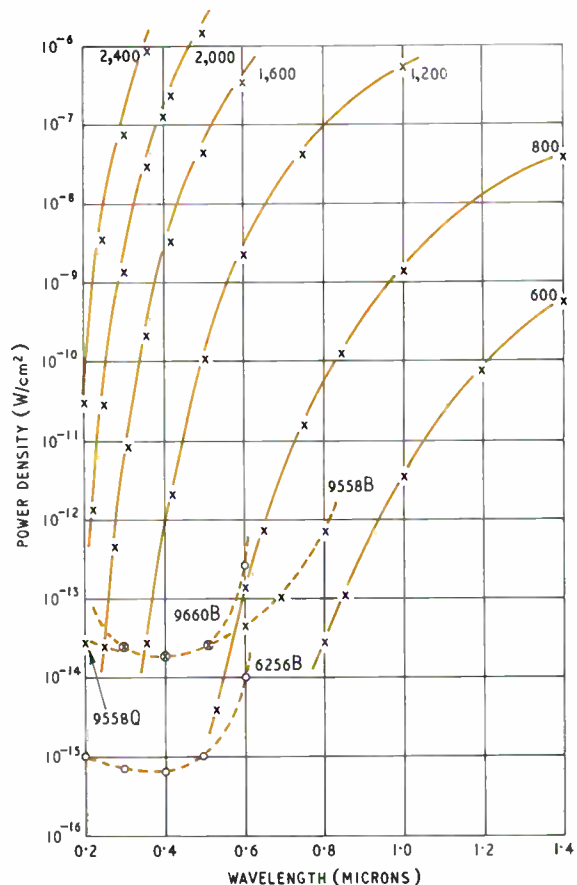

Fig. 1. Spectral distribution of radiation from hot black bodies ($1\mu = 10^4$ Angstrom units = 10^{-6} metre)

Fig. 2. Power versus wavelength for various temperatures



*EMI Electronics Ltd.

10^{-6} A respectively. Various feedback circuits, designed originally for wide range photometers, have been published to carry out the adjustment automatically.² (See appendix.)

In all of the above arrangements in which anode current is involved, the instrument calibration depends on the constancy of the tube gain characteristics. A change of e.h.t. voltage of 0.1% will give a tube gain change of 0.7% in a 9660, but a more serious problem is set by the temperature coefficient of gain, which is about $-\frac{1}{2}\%$ per °C, and by the fact that in almost all photomultiplier tubes the gain will change slowly with use, particularly if high anode currents are drawn. This suggests that, for very accurate work, a method of continuous calibration would be desirable, or alternatively that the photomultiplier tube should be used as a transfer detector from a variable temperature lamp filament, such as is used in an optical pyrometer. The temperature scale would then appear on the lamp current meter. Quite simple optical arrangements can be used to present the object field and a section of a standard lamp filament alternately to the input.

Advantages of Using Short Wavelengths

One important point comes out from Fig. 5, when we examine the rate of change of radiant power with temperature, at the wavelengths on the short side of peak power. In this region, the radiation formula for a black body can be simplified to Wien's form:

$$B(\lambda T) = c_1 \lambda^{-5} \exp. (-c_2/\lambda T) \dots \dots (7)$$

and it will be seen that the curves of Fig. 5 can be approximated by equations of the form $\log(B) = A - D/T$. For 0.4μ , $\log_{10}(B) = 0.72 - 15,264/T$, from which we can calculate that between 2 and 4% change in temperature gives a change of 2:1 in power over the range 1,000 to 2,000 °K. This means that the temperature scale is not nearly so dependent on the stability of the measuring gear as is the power scale. By the same token, a pyrometer using photomultiplier tubes is very sensitive to small changes in temperature of the surface observed.

Deviation from Black Body Conditions

Although the calculations above have assumed that the hot surface has the properties of a full radiator, in practice this is rarely the case, and the emissivity at a given wavelength, $\epsilon_{\lambda T}$, may fall very much below unity. Under these circumstances, the power radiated per cm^2 is $W(\lambda T) = \epsilon_{\lambda T} B(\lambda T)$, and if the instrument has been calibrated against a true black body it will give an apparent temperature, T_a , lower than the

true temperature, T . The instrument registers a power $B(\lambda T_a)$ equal to $\epsilon_{\lambda T} B(\lambda T)$ so that

$$\epsilon_{\lambda T} = \left[\frac{\exp. (c_2/\lambda T) - 1}{\exp. (c_2/\lambda T_a) - 1} \right] \dots \dots \dots (8)$$

and to a first approximation,

$$\log(\epsilon_{\lambda T}) = \frac{c_2}{\lambda} \left(\frac{1}{T} - \frac{1}{T_a} \right) \dots \dots \dots (9)$$

By making measurements at two wavelengths, λ_1 and λ_2 , where emissivities are ϵ_1 and ϵ_2 and the apparent temperatures are T_1 and T_2 , we have

$$\frac{\log \epsilon_1}{\log \epsilon_2} = \frac{\lambda_2 T_2}{\lambda_1 T_1} \left(\frac{T_1 - T}{T_2 - T} \right)$$

If the emissivities are not very different, so that $\epsilon_1 \sim \epsilon_2$ as is the case for a grey body, then

$$T = \frac{T_1 T_2 (\lambda_1 - \lambda_2)}{\lambda_1 T_1 - \lambda_2 T_2}$$

and for

$$\lambda_1 = 2\lambda_2, T = T_1 T_2 / (2T_1 - T_2)$$

Under these circumstances, the true temperature can be measured by observation of T_a at two wavelengths. Using a photomultiplier, with its high speed of response, the two wavelengths could be selected by rotating the two filters before the tube, with the tube output switched alternately from unknown to standard for each filter.

For less accurate measurements (on grey bodies) we may use the relationship

$$T = T_a \left(1 - \frac{\lambda T}{c_2} \log \epsilon \right)$$

which follows from Equ. (9).

Since

$$c_2 \sim 5\lambda_m T$$

(Equ. 4), we have

$$T = T_a \left(1 - \frac{\lambda \log \epsilon}{5\lambda_m} \right) \dots \dots \dots (10)$$

and if $(\lambda/5\lambda_m) \log \epsilon$ is much less than one, the error due to the greyness of the surface becomes small. (It will be seen that this is the mathematical basis of the discussion in section headed 'Advantages of Using Short Wavelengths' with power error in place of ϵ .)

Table 2

Power, P , collected by 2.5 cm lens, 100 cm from body of area 1 cm^2 . (Collection efficiency = 8×10^{-5}) through filter of bandwidth 0.03μ , at specified centre wavelength, and error, E , due to emissivity of 0.5

T (°K)	λ_m (μ)	$\lambda = 0.3 \mu$		$\lambda = 0.4 \mu$		$\lambda = 0.5 \mu$		$\lambda = 0.6 \mu$	
		P (Watts)	E (%)	P (Watts)	E (%)	P (Watts)	E (%)	P (Watts)	E (%)
700	4.2							2.1×10^{-15}	2
800	3.75					7×10^{-16}	1.8	1.3×10^{-13}	2.23
1,000	3.0			2.2×10^{-15}	1.9	9.4×10^{-13}	2.3	4.5×10^{-11}	2.8
1,200	2.5			10^{-12}	2.2	1.1×10^{-10}	2.8	2.5×10^9	3.35
1,300	2.3	3.5×10^{-15}	1.8						
1,400	2.14	6.7×10^{-14}	2	6.2×10^{-11}	2.6	3.5×10^{-9}	3.2	4.3×10^{-8}	3.9
1,600	1.88	3.6×10^{-12}	2.2	1.6×10^{-9}	2.9	4.5×10^{-8}	3.8	3.6×10^{-7}	4.5
1,800	1.65	10^{-10}	2.5	1.9×10^{-8}	3.3				
2,000	1.5	1.5×10^{-9}	2.8	1.4×10^{-7}	3.7				
2,200	1.35	1.3×10^{-8}	3.1						

Note: $E = \left(0.7 \frac{\lambda}{5\lambda_m} \right) \times 100\%$, for emissivity $\epsilon = 0.5$ ($\log \epsilon = -0.7$)

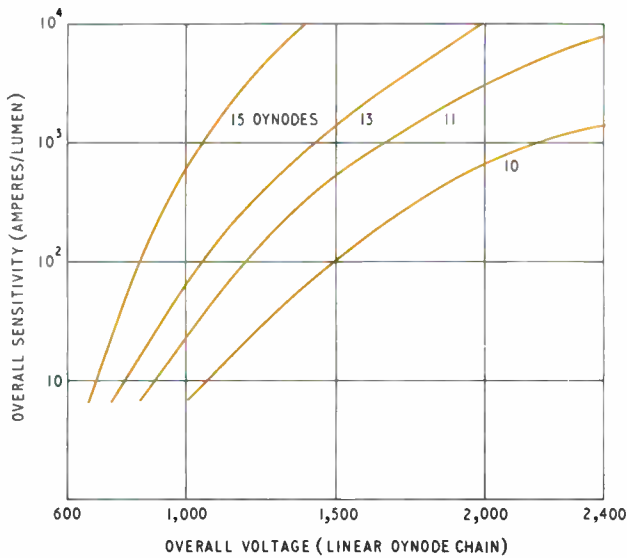
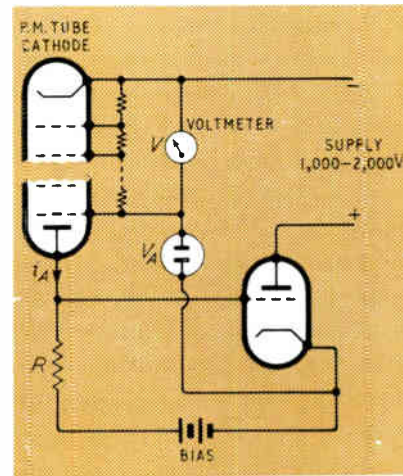

Fig. 6. (Left) Gain versus anode-cathode voltage

Fig. 7. (Below) A simplified 'Sweet' circuit



For $\epsilon = 0.5$, $\log \epsilon = -0.7$, and for $\lambda/5\lambda_m = 1/30$, the error is about 2%. For $\epsilon = 0.2$, the error is 5%, and the curves of Fig. 5 have lines of equal error for $\epsilon = 0.5$ superposed. The values are given in Table 2. (Since λ_m is approximately equal to $3,000 T^{-1}$, the operating wavelength $\sim 600 T^{-1}$.) In general ϵ is nearer to unity at short wavelengths.

Illumination of the hot body by stray light may be considered as a special deviation from black body conditions, but may affect the readings much more seriously than the effects so far considered, particularly at low temperatures. The only safe procedure would be to ensure that there was no stray light falling on the body, within the spectral ranges used in the instrument.

A further deviation from ideal conditions which may occur in practice is the interposition of absorbing material, such as fumes, between the hot body and the optical system of the power measuring instrument, and again special precautions would have to be adopted to prevent errors due to this cause. Atmospheric absorption would prevent the use of wavelengths below 0.2μ .

Conclusion

By operating a pyrometer at wavelengths shorter than about $600/T$ micron, adequate power to operate quite inexpensive photomultipliers in optical pyrometers can be obtained for temperatures above $1,000^\circ\text{K}$ (727°C) provided the area of the source multiplied by the geometrical collection efficiency of the optical system is equal to at least 8×10^{-5} and a filter bandwidth of not less than 300 \AA is used. Operation at short wavelengths minimizes errors due to inaccuracy of power measurement and to emissivity less than unity, and gives extreme sensitivity to small fluctuations in temperature.

Very accurate measurements are possible by using more expensive photomultiplier tubes and by the use of electron counting to record the power levels.

Acknowledgments

This paper is published by permission of the Directors of EMI Electronics Ltd.

Appendix

Logarithmic Photometer Circuit for Photomultiplier Tubes

The relationship between gain of a photomultiplier tube and the voltage applied between cathode and anode is very

approximately logarithmic, as shown in Fig. 6, being more nearly accurate as the number of dynodes increases. The 'Sweet' circuit utilises this relationship in a feedback circuit, Fig. 7, connected so that the anode circuit is kept constant at a value i_A depending on R , and the bias voltage. The voltmeter reads a value V approximately proportional to the logarithm of the light intensity at the photomultiplier cathode.

References

- ¹ J. Sharpe, *Electronic Technology*, June and July 1961. *Industrial Electronics*, Vol. 1, pp. 70 & 129, 1962.
- ² M. H. Sweet, *Electronics*, Vol. 18, No. 3, p. 102, 1945; Vol. 19, No. 11, p. 105, 1946; *J. Opt. Soc. Amer.*, Vol. 37, p. 432, 1947; *J. Soc. Mot. Pic. Engrs*, Vol. 54, p. 35, 1950. Hariharan & Bhalla, *J. Sci. Inst.*, Vol. 33, p. 69, 1956; *Rev. Sci. Inst.*, Vol. 27, p. 3, 1956.
- ³ L. H. Treiman, Private Communication.

Picture Transmission Over Telephone Lines

Standard Telephones and Cables Ltd. recently demonstrated their 'Videx' communications system for transmitting pictures over an ordinary telephone line.

The basic equipment consists of camera and camera control units at the transmission end and monitor display and monitor control units at the receiving end; these may be in either portable or table-top versions and various camera accessories are available.

After first establishing voice contact, the flat copy (documents, photographs, etc., or small objects not more than 2-in. thick) is placed in the camera enclosure and photographed electronically in $1/10$ th of a sec. It may then be removed while the unit uses a slow-scan technique to send the picture to the receiving monitor.

The monitor display screen is automatically and instantaneously cleared for reception and displays a picture for up to six minutes for visual comparison or photographic recording. Transmission-time speeds are from 10 to 60 sec, depending on the definition required, and for moving pictures, such as newsreels, a frame-by-frame transmission technique is used.

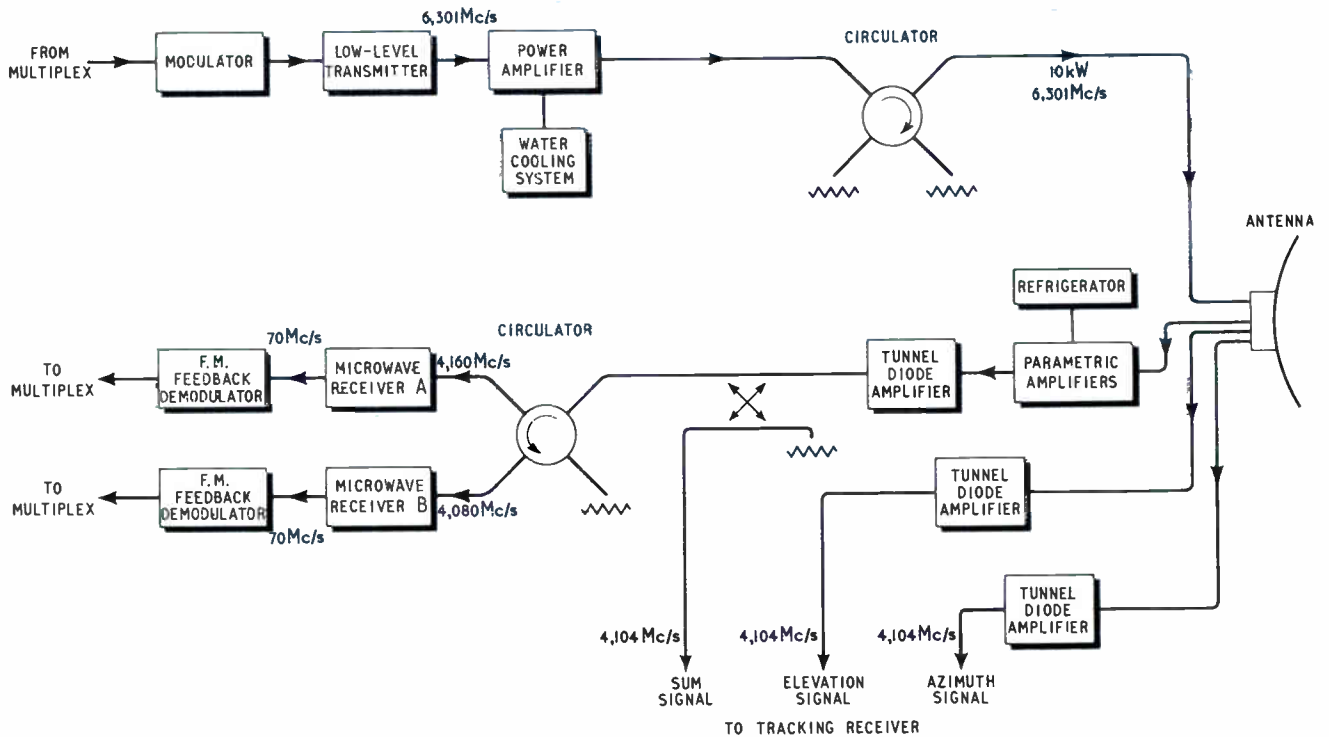

Block diagram of communications system at Fucino earth station

Fucino Earth Station Transmits Live T.V. Signals to Early Bird

The Early Bird communications satellite recently relayed the first live television broadcast from Russia to the U.S.A. via the Fucino earth station in Italy. The station embodies a solid-state microwave system developed by an Italian subsidiary of the General Telephone and Electronics Corporation.

The Soviet television system transmitted the programme by ground facilities from Moscow to Helsinki, whence the video signal was relayed, through Hamburg, to a control studio in Rome and the Fucino station. The Fucino station transmitted a powerful 10-kW television signal to the 'stationary' satellite, and the programme was re-transmitted in turn to the earth station in Andover, Maine, which is operated by the Communications Satellite Corporation.

Early Bird, the world's first commercial communications satellite, is in synchronous orbit over the equator and went into commercial operation at the end of June this year; a total of 46 nations have so far agreed to participate in this new world communications venture. The drum-shaped satellite is designed to provide service between North America and Europe and supplies circuits to relay 240 telephone conversations simultaneously, one TV channel, and telegraph, facsimile and data traffic.

In addition to Fucino, the locations of the other European stations participating in the Early Bird programme are at Goonhilly Downs in Cornwall, Pleumeur-Bodou in France, and Raisting in Germany.

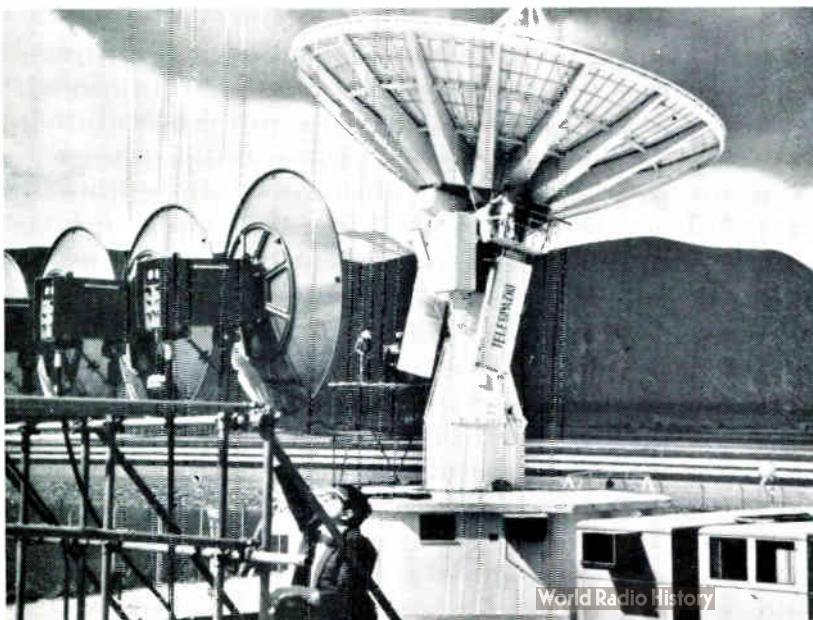

The transmitting and receiving system at the Fucino earth station. The 44-ft diameter parabolic antenna is mounted on a pedestal above an octagonal concrete blockhouse, and two adjoining 24-ft trailers house portions of the transmitter and receiver, as well as the control and support systems. In the foreground are the dish-type antenna and the two-hop 15-mile microwave radio link, which connects the ground station with Rome and the Italian and European communications networks

2N709 - 600 mc*
2N709A - 800 mc*
2N2784 - 1000 mc*
2N3633 - 1300 mc*

	2N3633	2N2784	2N709A	2N709
f_T (min)	1300 mc 1300 MHz	1000 mc 1000 MHz	800 mc 800 MHz	600 mc 600 MHz
$V_{CE(SAT)}$ (max)	0.21 v	0.26 v	0.3 v	0.3 v
h_{FE}	50-150	40-120	30-90	20-120
C_{OB} (max)	2.5 pf	3 pf	3 pf	3 pf
t_s (max)	5 ns	5 ns	6 ns	6 ns
h_{1B}	25-30	—	—	—
V_{CBO} (min)	15 v	15 v	15 v	15 v

* Minimum f_T * Minimale Beta-Eins-Frequenz

**a new generation of silicon
NPN high frequency
transistors**

**Une nouvelle famille
de transistors NPN silicium
haute fréquence**

**Eine neue Familie von
NPN-Silizium-Transistoren
für hohe Frequenzen**

Transitron now offers circuit designers the broadest range of high frequency transistors for use in switching or amplifier circuits.

The new planar epitaxial 2N 3633 delivers the highest guaranteed f_T in a commercially available high speed silicon switching transistor, and is ultrasonically bonded with aluminium wire to eliminate "purple plague" at the chip. Available in TO-18, TO-46 and TO-51 encapsulations also smaller packages for thin film applications.

The advanced design of the 2N 3633 makes it highly resistant to nuclear particle irradiation. Typically, h_{FE} is still considerably greater than 10 after an equivalent neutron dose of 10^{16} neutrons/cm².

TRANSITRON offre à l'Ingénieur d'étude la plus large gamme de transistors haute fréquence pour utilisation en amplification ou en commutation.

Le nouveau transistor 2N 3633, planar épitaxial, donne le produit gain-bande passant le plus élevé, dans la gamme des transistors de commutation disponibles sur le marché. Ses connexions internes par fils d'aluminium soudés aux ultra-sons éliminent le danger de "purple plague". Cet élément peut être livré en boîtier TO18, TO46, TO51, et en boîtiers micro-miniatures pour utilisation sur circuits à film mince.

La technologie avancée du 2N 3633 le rend particulièrement résistant aux rayonnements nucléaires. Le h_{FE} est largement supérieur à 10 après une exposition à une dose équivalente de 10^{15} neutrons/cm².

Wir stellen Ihnen hiermit eine Auswahl neuer Schalt- und Verstärkertransistoren vor. Der in Planar-Epitaxialtechnik ausgeführte 2N3633 weist die zur Zeit höchste Beta-Eins-Frequenz auf (garantiertes Minimum). Durch Ultraschallverfahren werden Kontaktierungsschwierigkeiten wie "purple plague" vermieden. Erhältlich im TO-18-, TO-46-, und TO-52- Gehäuse sowie in kleineren Ausführungen für Dünnfilmanordnungen.

Eine fortgeschrittene Fertigungstechnik macht diesen Transistor gegenüber herkömmlichen Typen relativ strahlungsunempfindlich. Nach einer Strahlendosis von 10^{15} Neutronen/cm² ist die Stromverstärkung noch wesentlich höher als 10.



Transitron Electronic.

29 avenue de l'Opera, Paris 1er—OPE.69.89. Telex: 21697
 Distributeur: E.T.I. 73 avenue de Neuilly, Neuilly-sur-Seine, Seine.

Transitron Electronic Limited

Cardner Road, Maidenhead, Berks.
 Tel: 26371. STO-OMA-8. Telex: 84335.

Transitron Electronic G.m.b.H.

8000 München 5, Corneliusstrasse 12.
 Tel: 24 12 74 u. 24 04 19. Telex: 05-22109.

Representatives in: Amsterdam · Copenhagen · Milan · Oslo · Stockholm · Vienna · West Berlin · Zurich

COLVERN

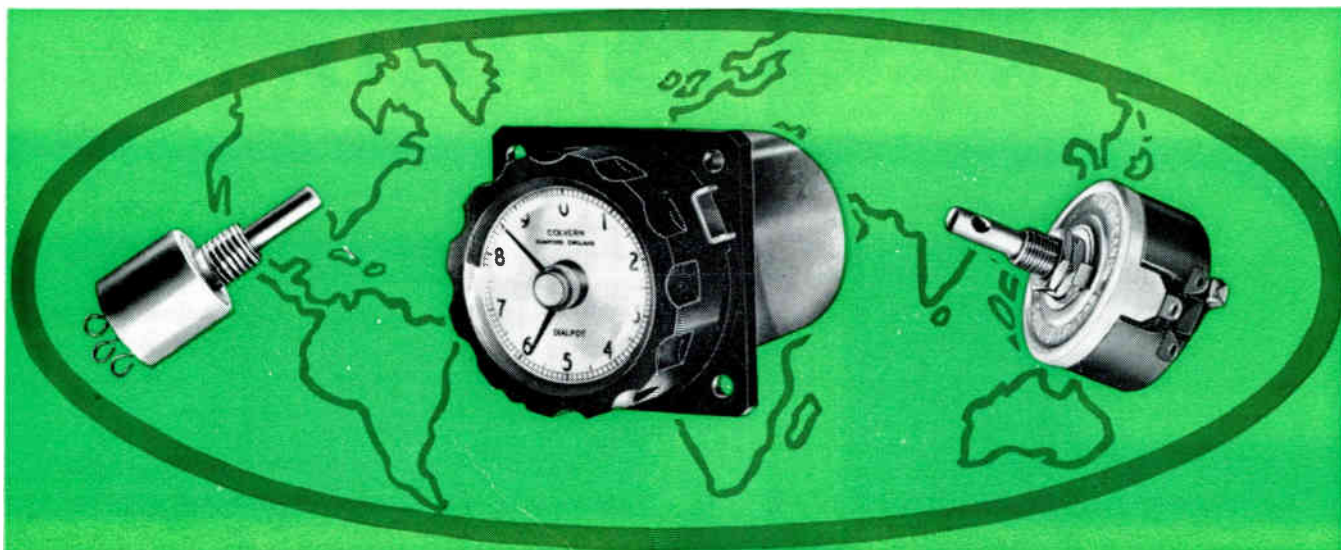

WORLD RENOUNDED

for wire wound **POTENTIOMETERS**

- ★ STANDARD TYPES 1-25 WATT.
- ★ SEALED TROPICAL TYPES.
- ★ HELICAL, STANDARD AND PRECISION.
- ★ PRECISION LINEAR AND FUNCTION.

With over 50 types in production. This comprehensive range covers most of the requirements of a wirewound potentiometer, but if you have a special problem contact our advisory engineering service. Literature also available.

COLVERN
L I M I T E D

Spring Gardens, Romford,
Essex, England
TEL. ROMFORD 62222 (PBX) TELEX 23984

This picture shows the testing machine on the left and the control console on the right

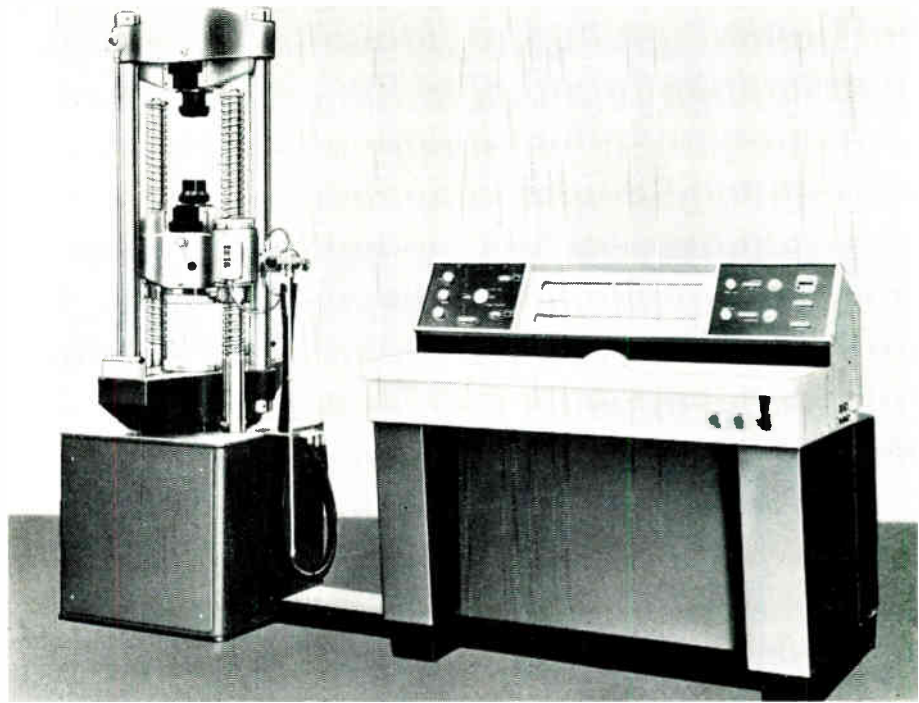

Servo Control for Materials Testing

A NEW approach to materials testing has been made by W. & T. Avery Ltd. with a servo-controlled testing machine Type 7113 CSB. Unlike previous systems this does not rely on the skill of the operator for accurate results.

Transistors are used throughout and, in place of the normal mechanical elements, load cells form the sensing elements in the straining unit. Stability under all conditions within the design parameters of the machine is offered and the equipment adjusts itself to a wide variation in materials and test conditions, it being highly responsive to control and to changes in the condition of the specimen under test. A demand cursor indicates when the specimen being tested or the machine is being overloaded. Built-in facilities allow for a test programme to be carried out automatically and changes in load and deflection can be accurately applied and maintained. Of 100,000 pounds force capacity, the machine is designed for tensile compression and transverse tests.

The straining unit consists of a hydraulically-operated ram in the form of a piston and cylinder assembly, a servo-controlled oil flow to either side of the piston ensuring precise control of the ram movement. A cross-head is attached to the ram and this is fitted with a compression plate and bending dogs. The top cross-head is supported by the lower cross-head on two smooth columns so that both the lower and the top cross-heads are directly attached to the ram and move with it. The intermediate cross-head is supported by two threaded columns which can be rotated to move the cross-head up and down. The lower ends of these columns are attached to frames supported between steel fixtures, and between the lower ends of these frames and the heavy steel plate holding the cylinder are the load cells.

For compression and transverse tests the test piece is placed between the lower compression plate and the intermediate cross-head and for tensile tests the specimen is suspended between the top and intermediate cross-heads. The required load is applied by moving the ram upwards and the movement is transmitted via the test piece and the intermediate cross-head and through the frames to exert a downward pressure on to the load cells.

The control circuitry, the indicating meters and the hydraulic pump are housed in a desk-shaped console. The two illuminated scales indicate the force applied and the deflection caused by it. Deflection is read as a vertical movement of the ram or a reading may be taken off an extensometer or strain-follower attached to the test piece. A hand-wheel provides control of the force or the deflection, and changes in load and deflection occur in response to the movements of the load cursor controlled by the handwheel. An automatic system is available whereby the control cursor traverses the scales at preselected speeds or it can be set to cycle between limits. Single-cycle or continuous operation is possible over a speed range of 5% to 100% of full speed and the number of cycles completed is indicated on a readout counter. The machine can be set so that it completes a number of cycles up to 999,999 and then stops. The straining speed is infinitely variable from 0 to 5 in. per minute and the controlled rate of loading may be preset between 60 and 1,200,000 pounds force per minute, the time taken to reach the full capacity loading at the maximum rate being 5 sec.

More complicated programmes may be devised and remote control of load or strain can be provided. Also available is a bi-directional recording unit for programming purposes.

For further information circle 41 on Service Card

Millions of relays are used in industry every year and of these the greatest proportion is electromechanical. However, there are many other basic types with particular characteristics and it is with these that this first article will deal, briefly describing their construction and operation and indicating their main features.

ELECTROMAGNETIC RELAYS

By D. A. MALDEN, Grad.I.E.R.E.*

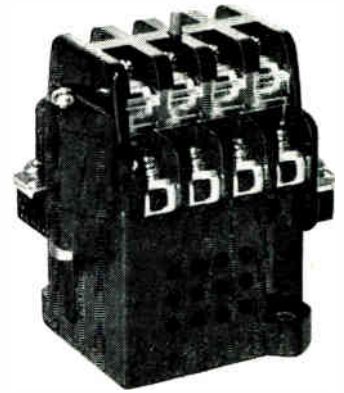

A typical solenoid-type relay (MA.415) which can switch four circuits each carrying a current up to 15 A

THE relay is a component used extensively in control circuits and automated equipment. It is found in every branch of electronic and electrical engineering, as well as general industry, and yet designers do not fully appreciate all the details of its application, design and potentialities. This is not surprising when academic courses touch on them only briefly, devoting a possible maximum of one complete lecture to a subject which has a vast amount of complex data associated with it. The article deals in broad outline with various types of relays.

Dry-Reed Relay

The dry-reed relay (illustrated in Fig. 1) is a simple but comparatively recent development, consisting of two flat soft nickel-iron reeds overlapping and sealed into a glass envelope. The envelope is evacuated and then either filled with an inert gas or left as a vacuum. Operation of the relay is achieved by subjecting the reeds (one or both being flexible) to a magnetic field which will induce opposite polarities into the reeds causing them to snap together to close 'a contact'. Such relays are characterized by a long life, low contact resistance and fast operation.

Moving-Coil Relay

A moving-coil relay works on the principle of the moving-coil meter known to all engineers. The coil, iron-cored and set between the pole faces of a permanent magnet, carries an arm which acts as one contact point (Fig. 2).

* Keyswitch Relays Ltd.

Current passing through the coil sets up a magnetic flux which reacts with the magnet to cause rotation of the arm. Sufficient movement results in the 'making' of the contact. A restoring force to return the contacts to 'normally open' is supplied by an helical spring. The main feature of these relays is the very low current, of the order of microamperes, that is needed to operate them. However, the light contact pressure enables only very small powers to be switched without the use of an interposing relay. An added advantage of this specialized relay is that it has a zero differential, which means that it will make and break its contact for the same figure of current or voltage.

Moving-Iron Relay

Moving-iron or rotary relays have a basic mechanical method of operation similar to the moving coil but work on a.c. and have a metal vane (specially shaped) moving inside a magnetic system of two coils wound in opposition to each other. The field set up by the current passing through the vane, which in the 'normally open' contact position is only just in the air gap, causes it to move into this space. This results in a rotary action, and thus 'closes' the contacts fixed to the main spindle (Fig. 3). This type of relay is characterized by its very low current requirement, of the order of microamperes, and is used in earth-fault protection circuits.

Induction-Type Relay

Induction-type relays only operable on a.c. have a wide application in earth-leakage detection and overcurrent pro-

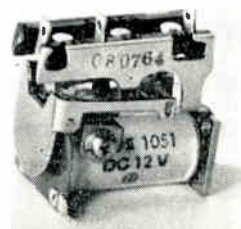
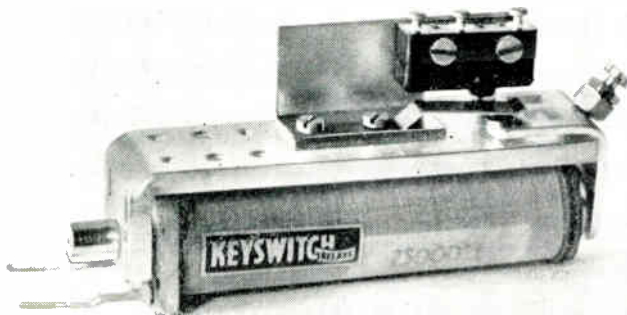

This shows two microswitch relays. On the left is the G.P.O. MSW.600 type which is fitted with an adjustable sensitivity control. The simpler one on the right is type 1051 which incorporates the microswitch in the relay mechanism

tection. The basic mechanical layout employed in these relays is that two iron-cored electromagnets are positioned near the edge of a metal disc, which is able to rotate on a spindle (Fig. 4). An helical spring retains the plate in a set position and a fixed contact can make with a second one when sufficient rotation of the disc has been achieved. The electrical principle is that the coils of two electromagnets supplied with a.c. so that there is a phase displacement between them, induce currents in the disc. These currents react against the magnetic field of one set of the electromagnets and set up a force causing rotation of the disc, and thus the making of the contacts.

Frequency-Responsive Relay

Frequency-responsive relays are those that are capable of registering the frequency of a particular a.c. voltage or current. Such relays work on a metal reed which is tuned to that of the frequency to be detected. One end of the reed is physically held and on the other is mounted a contact. The reed itself passes through a coil into which the incoming source will be fed. As the resonant frequency is approached the vibration of the reed will be such that the contact at its end makes with a second fixed contact (Fig. 5).

Solenoid Relay

Solenoid relays operating on either a.c. or d.c. are designed around a coil into which is attracted an iron core to act as an armature. With a suitable linkage attached to the core, contacts are operated by its movement in and out of the coil, as it is energized. Either gravity or a spring restores the core to the normally open position.

The accompanying sketch (Fig. 6) shows the principle employed and a particular relay made to this design, the MA.415, is illustrated; it has contacts which can switch four separate circuits at 15 A and operates on varying voltages of a.c.

Polarized Relay

Polarized relays employ some form of permanent magnet or spring device which biases the armature. In a particularly well-known form of this relay the armature also constitutes the lever contact and is balanced in a magnetic field. A coil-winding when energized causes unbalance and the armature moves sideways to make 'a contact'. These relays can be very sensitive, fast and need only a small power for operation, and find particular use in telegraph signalling detection equipment.

Microswitch Relay

Microswitch relays are basic electro-mechanical relays to which are fitted microswitches, singly or in banks. A particular Keyswitch Relay type has eight, the armature movement being used to actuate the switch mechanism either directly or through a mechanical linkage. Two illustrations show the G.P.O. MSW.600 type fitted with adjustable sensitivity control and a 5-A microswitch, and a very simple type, the 1051, where the microswitch is built into the relay mechanism. The transfer function of these relays, which is one of positive contact action for both slowly rising or falling energized power, has wide application in sensing circuits.

Mercury-Switch Relay

Mercury-switch relays are again basic relays fitted with mercury switches, the tilt required for their operation being obtained by linkage with a moving armature. In the case of solenoid-operated types, the mercury switches are fixed

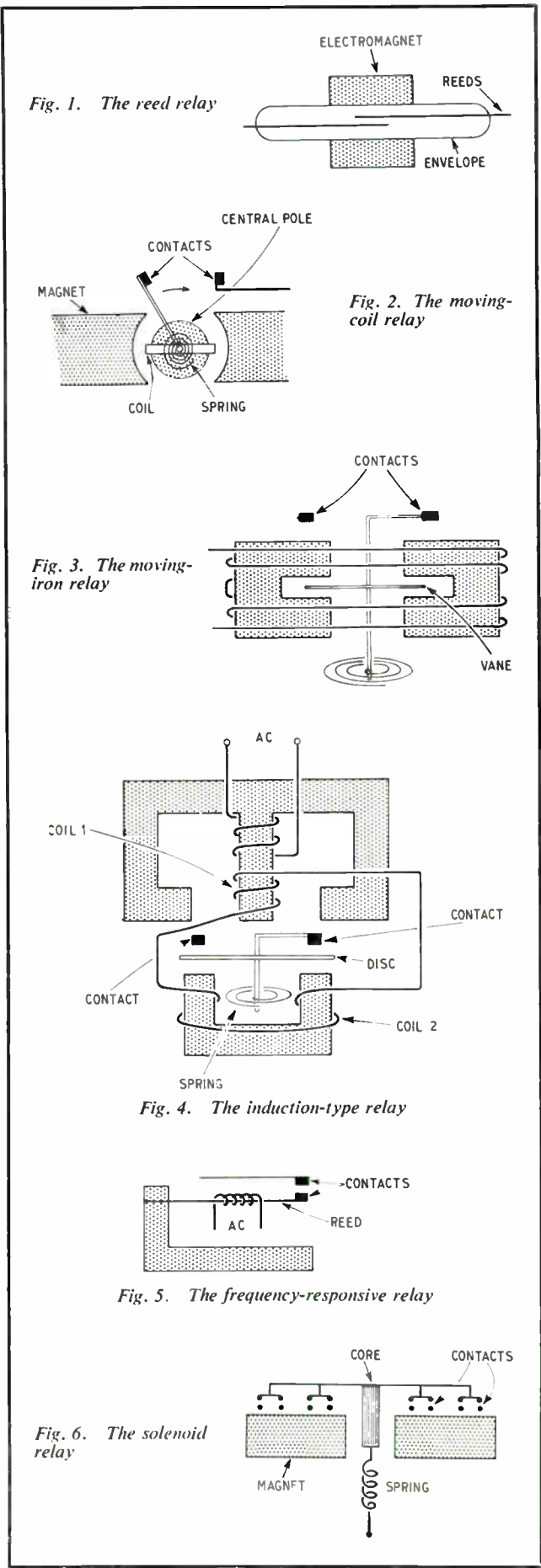



Illustrated here are three typical plug-in relays

There are three distinct types. The mechanical requires manual resetting by pressing a button. The electrical needs resetting by a second relay mechanically linked to the first. The remanent has a special core material making it a permanent magnet when energized and holding in the armature; release is obtained by cancelling the flux, either with a second coil, or the reversing of current to the single coil.

Plug-in Relay

Plug-in relays have become widely used to overcome the high cost of servicing, ease the problem of equipment manufacture, and avoid the possibility of having to shut down automated plant, power stations, and general control equipment for even a limited period due to component failure. Any relay which can be suitably mounted on to a plug and then fitted into a socket will be classified as plug-in. Examples of three representative types are shown in the accompanying illustration. First there is the B.P.O. 3000 type incorporated into a multiple 22-pin socket. The MK3P, a good general purpose relay, plugs into a standard 11-pin valve base. Thirdly, there is the subminiature type

to the moving core which is attracted into the coil as described earlier.

Latching Relay

Latching relays are those that once having been operated remain so after the energizing power has been removed.

<i>Operating Power</i>	<i>Contacts</i>	<i>Operating and Release Speed</i>	<i>Special Features and Applications</i>
DRY REED Very low D.C.	Enclosed. Low contact resistance. Limited power handling (VA)	Very fast, a few milliseconds on operate and a few hundred microseconds, on release	Very small in size. They are prone to contact bounce and have only one contact per tube. Enclosed contacts enable use in hazardous atmospheres, high temperatures and humidities
MOVING COIL D.C. Very low of the order of a few microamps (Adaptable for A.C. with rectifiers)	Without special provisions not to exceed 100 mA	Slow due to inertia of coil movement	Used to detect over or under current, over or under voltage or current reversal. Very small differential between operate and release voltage/current
MOVING IRON/ROTARY A.C. of the order of 5 mA and above	Low power handling due to low pressure	Slow due to inertia of movements	Used in earth-fault protection equipment, to detect leakage of any predetermined current figure
INDUCTION TYPE Low figure of A.C.	Low power handling due to low pressure	Slow due to inertia of movements	Main application in protective equipment associated with power transmission. Earth-leakage detection and overcurrent sensing. These types provide the basis for relays designed for several other special applications
FREQUENCY RESPONSIVE A.C. operated	Low power handling	Slow	Detecting over or under frequency thereby protecting generator output. Providing means of superimposing control signals on remote equipment
SOLENOID A.C./D.C.	High power ratings in excess of 20 kVA	Fast; of the order of 15 msec	They provide enclosed contacts of high power rating. Contacts can be replaced. High contact pressure, and double-break action obtained. Noisy in operation
POLARIZED D.C.	Not greatly in excess of 1 A	Can be very fast of the order of a few millisecs	Used in telephone/telegraph and protective circuits where high speed is essential
MICROSWITCH A.C./D.C. as low as 25 mW	From 5 A up to 25 A and greater for special switches	Fast; of the order of 10 msec	General purpose applications. An enclosed snap action contact. Sensing circuits where slow rising power would damage ordinary contacts. Multiple switches can be incorporated
MERCURY SWITCH A.C./D.C.	Up to as high as 200 A. Handle inductive switching	Dependent on number and type of switches	Totally enclosed contacts for explosive and inflammable atmospheres. Multiple switches can be incorporated in some designs. Heavy inductive switching
LATCHING A.C./D.C.	Generally up to 30 A	Fast; of the order of 10/15 msec	Protective equipment requiring the resetting by a secondary operation. Memory circuits, requiring no power to keep them energized

The contact ratings of relays are given as general figures and in no way are considered to be maximum.

of relay, MH4P, meeting the demand for space saving and an easily replaceable unit.

All the relays so far discussed have varying modes of operation, and the sketches are to show in the simplest form the basic principles of their operation; in practice the relays are more elaborate. This list is by no means exhaustive; there are many others that could be mentioned, such as the mercury-wetted relay, wire-contact and coaxial relay, to mention just a few.

The accompanying table outlines the main characteristics of the various types of relay discussed in the article. Because there are so many of them, the information in the table is necessarily limited to provide a general indication of the parameters of each type.

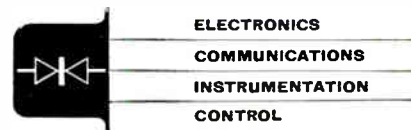

The British Post Office 3000 and 600 type relay operates on the principle which is truly electro-mechanical in that they have a coil wound on to a core, a yoke and some form of pivoting armature. The armature itself being used to move contacts by some form of linkage.

Since the greatest number of relays in use today are relays of this particular design, they will be discussed in greater detail in a subsequent article.

Alarm Scanner for Cargo Vessel

An alarm scanning system built by Honeywell Controls Ltd. is one of the latest electronic devices to be employed in modern ships. The system is installed in the 'Port Huon', a refrigerated cargo vessel.

Situated in the engine room, to the left of the main controls, the scanner makes a significant contribution to the overall engineering supervision of the vessel, making possible inspection of all temperatures and pressures associated with the main engine at a single control panel. Temperatures are continuously scanned and, should any exceed pre-set limits, an alarm system is automatically brought into operation; this rings an alarm bell and flashes a warning light (red for high temperature, green for low temperature). Pressures associated with tank levels, jacket

cooling water, piston cooling water and piston c.w. outlets are constantly monitored on the mimic diagram mounted on the front of the control panel, and eight fire points are also monitored and linked to an automatic fire alarm.

Additionally incorporated on the control panel is a precision temperature indicator, from which temperature measurements for any point represented on the mimic diagram can be read off by simply turning the appropriate key on a switchboard.

Thirty-two resistance bulbs form the basis of the scanning system, the scanners continuously selecting each bulb in turn, comparing it with a high limit and sending a signal to the control panel to indicate points in an alarm condition; the speed of scan is one point every 5 secs.

The Honeywell control panel (foreground) in the engine room of the 'Port Huon' refrigerated cargo vessel. The mimic diagram indicates points covered by the scanning system, and a precision temperature indicator, mounted horizontally on the right of the diagram, gives the temperature of any of these points when the appropriate switch on the mounting beneath it is pressed

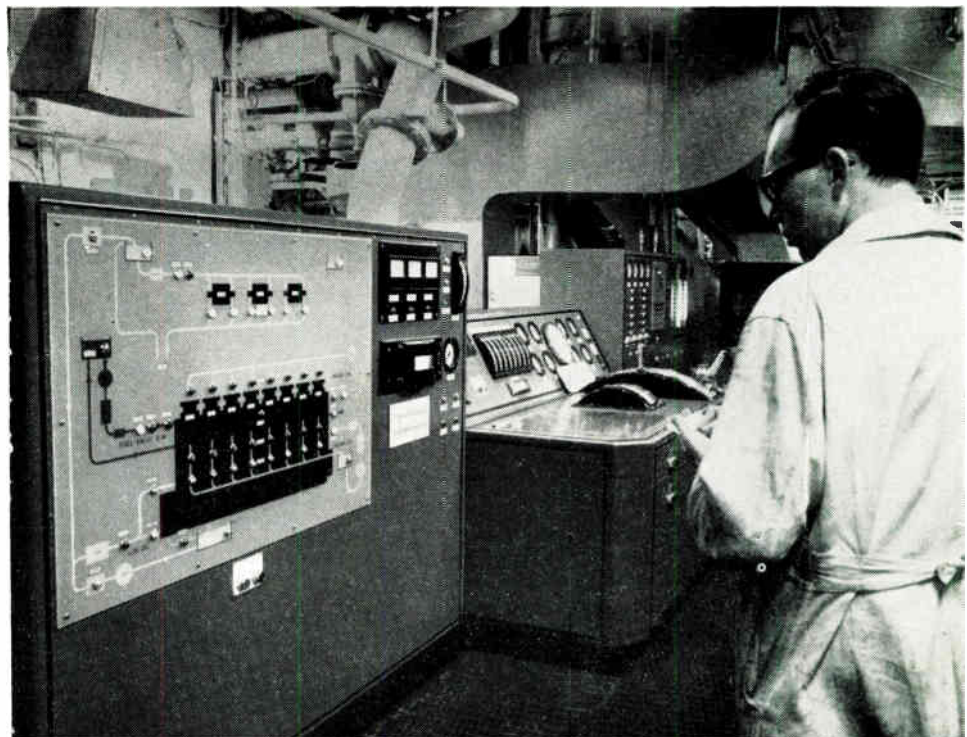

From time to time there is some commercial 'fall-out' from large research and development projects. This article describes an interesting temperature-measuring technique using ultrasonics which has been developed for the 'Dragon' nuclear reactor project.

TEMPERATURE MEASUREMENT BY ULTRASONICS

By P. J. ROBINS

A NOVEL method of temperature measurement which gives high accuracy, fast response to change and no drift has been developed by the research and development department of the 12-nation 'Dragon' nuclear reactor project at Winfrith, Dorset. Experimental work has confirmed that a characteristic of sound, which travels at speeds related to the temperature of its conducting medium, can be used to give reliable temperature indications.

At the Dragon experimental reactor, recordings from liquid nitrogen (-211°C) to white heat at the core centre (about $+1,500^{\circ}\text{C}$) can be taken by using ultrasonics.

The experimental rig (shown diagrammatically in Fig. 1) is made up of a bar of metal on which is machined a shoulder, at a convenient distance from one end, to form a bulb of known length—about 8 cm. This metal bar is attached to a nickel tube round which are wound two separate coils to form a transmitting transducer and a receiving transducer.

An ultrasonic pulse in the 150-kc/s to 250-kc/s range generated in the tube passes along the solid rod until reaching the discontinuity formed by the shoulder. The discontinuity causes some of the energy to be reflected as a pulse back along the bar. A second pulse is reflected back by the end of the bar. Both pulses of energy are picked up by the receiving transducer and presented on a cathode-ray tube.

An accurate measurement of the time taken by the pulses of energy to travel from the shoulder to the end of the bar and back is possible by transmitting at a fixed interval behind the first pulse, a second pulse. This is timed to reach the shoulder at almost the same moment as the pulse which is reflected from the end of the rod. On the c.r.t. screen this shows as a combined signal with two peaks.

To provide a form of vernier reading on the c.r.t., the

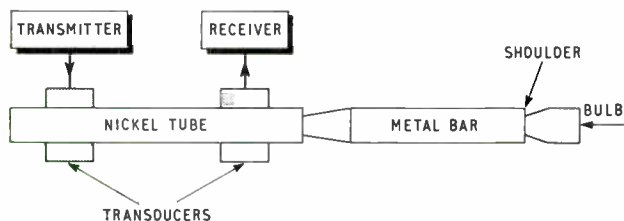

Fig. 1. A schematic diagram of the metal bar thermometer

timing of alternate pairs of pulses is locked to the preceding pair. The time interval of the first pair is slightly greater than the bulb traversing time and, by the same difference the time interval of the second pair is slightly less. This gives two combined signals on the display which when correctly adjusted to the temperature of the bulb will look alike. Any change of temperature or alteration of the time interval will produce a large change in one of the combined signals.

At Winfrith a number of materials which seemed to be promising had to be discarded for reasons directly connected with reactor material matching. However, a number of those rejected are known to be suitable for commercial application. Characteristics looked for were high melting points, no hysteresis between falling and rising temperatures and predictable curves of results under all conditions. The two best metals for non-reactor use were considered to be molybdenum and rhenium but for moderate industrial temperatures many other metals which meet the particular conditions without deterioration can be used.

A simple alternative to the solid machined rod is possible by using wire of about 2-mm diameter and kinking it at the first point of reflection (Fig. 2).

Another variation is available, which requires no frequency change. A probe-rod of constant section is used in which a number of pits are drilled. Each is filled with a fusible material of known melting point. When these

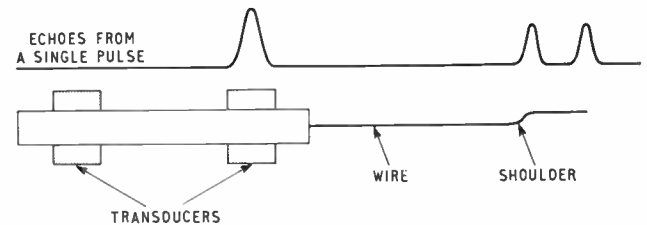

Fig. 2. This shows the kinked-wire version of the thermometer

materials are in a solid state no echo is received from them, but as the melting point is reached a strong signal is returned.

Ultrasonic temperature measurement is one example of research fall-out from the £25M Dragon project. Nearly half of the total budget has been spent on research and development alone.

Proposed Changes in I.E.E. Membership Structure

Corporate members of the Institution of Electrical Engineers—members and associate members—will become fellows and members respectively if a group of Council recommendations are endorsed at a special general meeting of corporate members (to be held during the 1965–66 season), and are approved by the Privy Council.

It is also proposed that the existing graduate and associate classes should be combined to form a new non-corporate class of associate members, admission being open only to those who have satisfied the examination requirements and having no upper age limit.

These proposals follow others announced last year that the recruitment to the class of associates should end and that a new class of non-corporate membership should be created for those interested only in the learned society activities of the I.E.E. and who do not qualify for other classes of membership.

FLOATING SEASTATION TELECOMMUNICATIONS SYSTEM

A NEW company called Seastation Telecommunications Ltd. has been formed initially to study and later to develop and supply trans-oceanic telecommunication systems to provide navigation and communication facilities for the rapidly increasing high-speed air traffic, especially on the North Atlantic routes. These facilities will consist of permanent floating seastations for carrying radio, radar and other aeronautical navigational equipment, interconnected with each other and with shore stations by a submarine cable communication system.

The new company, in collaboration with the Ministry of Aviation, is undertaking a design study of such a system.

Seastation Telecommunications Ltd. has been formed with equal shareholdings of Submarine Cables Ltd., of Greenwich (a company owned jointly by A.E.I. and B.I.C.C.), and Cammell Laird & Company (Shipbuilders & Engineers) Ltd. Cammell Laird is responsible for the seastation aspect of the study and Submarine Cables for the communication system.

Seastations and Submarine Cable Systems

Communication between an aircraft and a land-based station obviously requires a radio link and it is fortunate that with the cruising altitudes of modern aircraft a line-of-sight condition can easily be achieved over considerable distances. However, when the aircraft disappears below the radio horizon it is no longer possible to maintain communication of good standard.

At the present time when an aircraft is crossing the wider oceans it is out of range of first-class communication services. It cannot contact its land bases with the reliability and regularity which is desirable for a good control of air traffic and to achieve the highest standards of safety.

This picture could now be completely changed by the all-British seastation which is in the design-study stage.

A floating seastation has been designed which can be moored in mid-ocean in deep sea and which is suitable both for the termination of a submarine cable and also for the installation of radio equipment. Communications from aircraft in

the vicinity of the seastation can be passed to the distant shore by means of the submarine cable and reliable circuits of the very highest quality can be obtained from aircraft to land and vice-versa. The installation of seastations at intervals along the routes overflowed by aircraft crossing the oceans can provide entirely dependable communication with these aircraft at all times.

A seastation consists of a tubular structure typically about 400 ft in length and 16 ft in diameter, floating vertically in the sea with the greater part of its length immersed. The top end of the cylinder supports a superstructure well above the reach of waves and providing accommodation for equipment, for crew, for a helicopter landing deck and for aerial systems. The bottom end of the cylinder is moored by three cables to anchorages on the sea bottom. The submarine telephone cables leave the bottom of the seastation and fall in catenaries to the ocean bed. Power is supplied by diesel oil generators and fuel supplies and provisions for a considerable period are carried.

The motions of the sea decrease rapidly with distance below the sea surface and the configuration of the seastation described makes use of this fact to the maximum advantage, achieving remarkable stability in the roughest weather. Calculations, which have been confirmed by scale-model tank tests, indicate that for 95% of the time in the North Atlantic the half-amplitude pitch or roll will not exceed 0.5° and the vertical motion 0.5 ft. Even for extreme con-

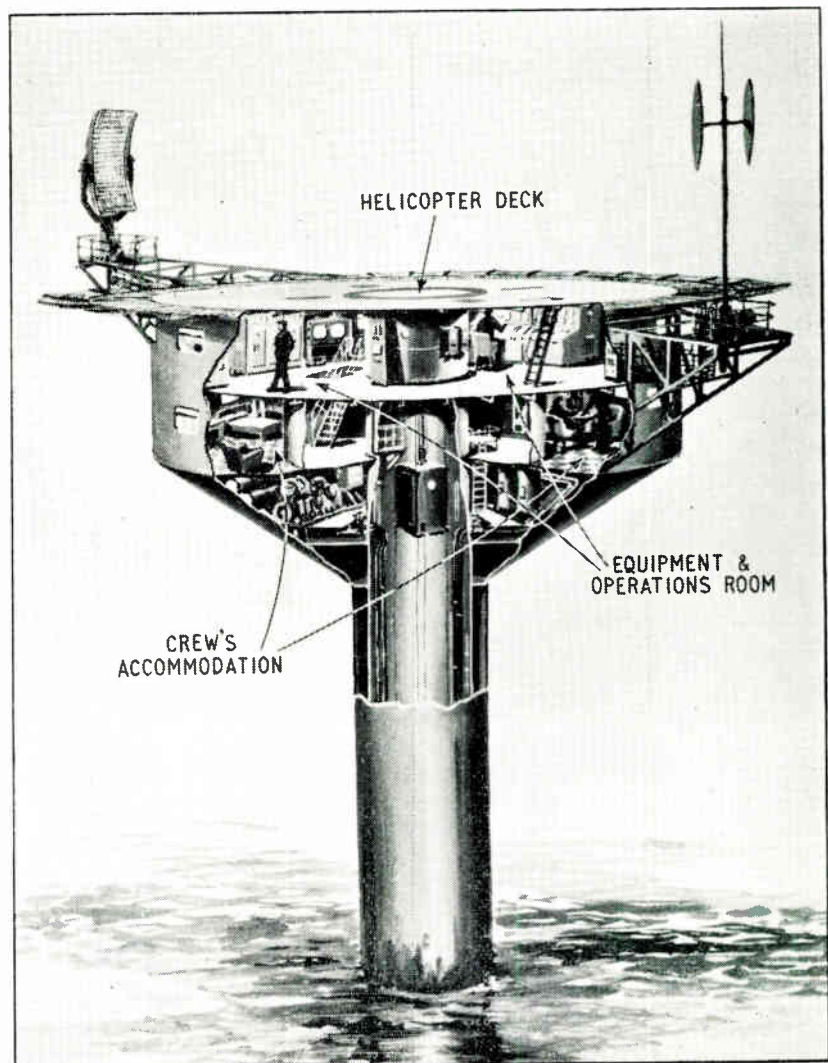

This is an artist's impression of operational and accommodation decks of seastation showing the lift connecting with engine room area. This part projects about 80ft out of the water; some 300 ft or more of the structure is below the water



A model seastation

ditions the performance meets in full the operational requirements.

The submarine cable with its installations on land and in the seastation follows well-proven practice and differs from previous cables only in respect of the catenary con-

nections which are specially engineered. The cable and the seastations remain at sea for the life of the system which is designed for a minimum of twenty years with only routine maintenance of equipment in the seastation.

The primary communication services provided from a seastation are intended to be radio in the v.h.f. and u.h.f. wavebands for air-traffic control, for airline company traffic and for passenger-to-shore conversations. But this is by no means the only use of seastations. A number of navigational services for aircraft can be accommodated and primary and secondary radar facilities can be added. Weather reporting and weather forecasting are other uses and all the services can be envisaged as applicable to ships as well as to aircraft. Broadly speaking a survey of the hydrospace surrounding the seastation as well as the airspace above them could be arranged and air and sea safety services could become important. Whatever the service, complete information relating to it can be passed immediately to the shore and the operation can be monitored or controlled from land if desired.

It is in fact the possibility of permanently stationing crews of trained men in safety and comfort at any desired positions over the oceans of the world, equipped with all facilities for observation, communication and assistance to craft in their vicinity as well as continuous reliable and private communication with the land which is created by the use of seastation and submarine cable in combination.

At this early stage it is anticipated that a chain of 3 or 4 seastations providing services for North Atlantic routes could be in operation in 2 to 3 years. Such a chain is estimated to cost about £10M to £15M.

Comprehensive X-Ray Analysis Service

What are claimed to be the most comprehensive X-ray analysis facilities in Europe are now available to British industry on a service basis from Elliott-Automation's Metals & Minerals Division at Blackwall Lane, Greenwich, London, S.E.10.

The service provides facilities for the simulated on-stream analysis of liquids, powders and slurries, in addition to normal laboratory scanning techniques. The availability of on-stream techniques means that the service is not limited to the analysis of small quantities of materials, but can undertake large-volume on-line analytical problems which necessitate the use of bulk-sampling methods using flow-cell techniques.

These developments have been made possible by the use of the Elliott multi-fixed-channel X-ray spectrometer type XZ 1070, the modular construction of which enables it to be used on-stream in a large variety of industries including minerals, cement making, oil processing and fertilizers. Its rugged simple construction ensures that it will operate reliably in the most rigorous environmental conditions, thus making it suitable for on-line use in mining and similar applications where conditions would be too difficult for conventional spectrometers to operate.

One of the main difficulties which had to be overcome was the abrasive effect of some slurries. With a Mylar window 6μ thick, abrasive slurries of the order of 55% solid material by weight can now be pumped through the cell for at least 20 hours before causing any appreciable wear. Thicker windows have a correspondingly longer

life. An advantage of using thin window techniques is that analysis does not have to be limited to the high atomic number elements such as copper, zinc and iron.

For further information circle 42 on Service Card

The Elliott XZ 1070 multi-fixed-channel X-ray spectrometer

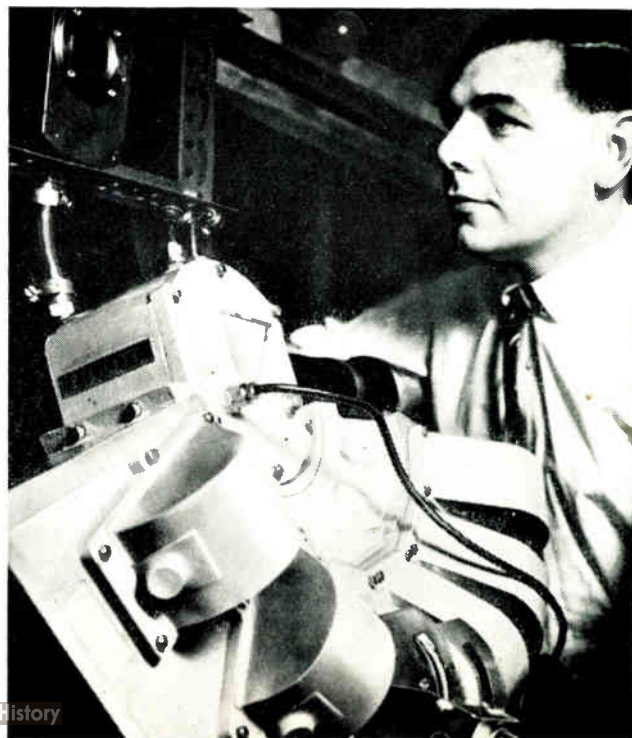

When
you go
shopping
for
tubes...

EMI ELECTRONICS ARE THE PEOPLE TO SERVE YOU!

EMI has been in the electron tube business for 30 years. This experience and capability combined with advanced manufacturing techniques ensure that high quality tubes are produced in quantity to precise electrical and mechanical limits.

Talented engineers are always ready to discuss your particular application or to work with you on special projects. For full details please return the reply card.

Reply Card

Please send data sheets and application information for the following:—

- Cathode Ray Tubes
- Photomultipliers
- Camera Tubes
- Microwave Tubes
- I would also like to receive regular information regarding new developments

NAME AND POSITION

(BLOCK LETTERS PLEASE)

COMPANY'S NAME

ADDRESS

TELEPHONE

EXT. NO.



CATHODE RAY TUBES

EMI pioneered the use of C.R. tubes in TV receivers

The EMI range of high quality, high precision cathode ray tubes includes all types of radar tubes from 2" airborne radar tubes giving extremely high definition to 21" metal coned tubes.

Oscilloscope tubes of various types are available, including designs with nanosecond time resolution.

EMI Electronics Ltd. has specialised in the development of high-resolution tubes with an extremely small spot size, and in the use of precision alignment techniques, which are particularly valuable in projection systems. A range of flying spot scanner tubes is available and EMI research is aimed at producing new phosphors for these and other tube types.



PHOTOMULTIPLIER TUBES AND PHOTOCONDUCTIVE DEVICES

EMI Electronics Ltd. is the largest producer of photomultiplier tubes in Europe

These tubes are designed to convert very low levels of illumination into usable values of electric current, and are extensively applied in television, astronomy, spectrophotometry, scintillation counting, gamma ray spectrometry, space research and other fields. All EMI photomultiplier tubes are tested repeatedly for consistency of performance and reliability, and carry a complete guarantee.

Photomultipliers can be supplied with various types of photocathode designed for specific applications, S cathode tubes, for instance, being particularly suitable for carbon 14 and tritium counting. EMI tubes are outstanding for the very low values of dark current obtainable, with high gain, photosensitivity and stability of operation.

EMI photomultipliers are used by many of the most important European and American companies manufacturing nuclear health equipment and scintillation counters.



CAMERA TUBES

Image Orthicons

EMI produced the 'Emitron', the original high-definition camera tube, in 1935, and has been actively engaged in development and production of camera tubes ever since. Today, EMI Electronics' 4" inch Image Orthicon has extremely good sensitivity, low microphony, and an excellent grey scale. It is widely used in broadcast studios throughout the world.

VIDICONS

Separate mesh electrode structure has been a standard feature of all EMI vidicons for the last two years.

Apart from the range of high definition low heater wattage 1" vidicon tubes, EMI leads with its superb 1/2" tube. Superior vidicons for colour cameras, rugged vidicons for special applications, UV tubes and IR tubes are all part of the EMI range.



MICROWAVE TUBES

Klystrons:

EMI was among the first industrial concerns to manufacture reflex klystrons.

A system of plug-in reflex klystrons operating with external cavities, having advantages in economy and versatility, has been exploited, now to give a series of wide range units, giving continuous frequency coverage in the 3,000 to 12,000 Mc/s (S to X) band. A recently developed J-band plug-in tube of advanced design is now available.

Integral cavity Q-band (8mm wavelength) klystron type R5146 and its descendants cover frequencies from 12.4 to 40 KMc/s. The specially designed tuner gives long-term stability and confers a generous tuning range. A klystron for O-band (70 KMc/s) is also available.

Medium-power EMI klystrons have been in use for many years as carrier sources in Eurorision and other EMI microwave links.

In the province of power amplifiers, EMI produces a 4-cavity, water-cooled klystron with a gain of 50 dB capable of handling peak powers in S-band of 100 kW, as well as higher power tubes. Applications are in radar systems and in particle accelerators.

Magnetrons:

EMI made the first commercial 8mm pulsed magnetrons for radar.

And now produces a range of magnetrons for high power pulse operation designed for use in J, Q and O bands.

Postage will be paid by Licensee

No Postage Stamp necessary if posted in Great Britain or Northern Ireland

BUSINESS REPLY CARD
Licence No. SOX 64

VALVE DIVISION · DEPT. EC5
EMI ELECTRONICS LTD.
HAYES · MIDDLESEX · ENGLAND

FOR FURTHER INFORMATION PLEASE
SEND THE REPLY PAID CARD TO EMI



EMI ELECTRONICS LTD
VALVE DIVISION, HAYES, MIDDLESEX
TELEPHONE: HAYES 3888 · EXT. 2165

This shows the machine which has been developed by STC. It automatically lays out wires on a board or panel to be wired up and makes wrapped joints at the terminals according to a programme on punched tape

WIRE-WRAPPING MACHINE

A machine capable of automatically laying out wires on a board and making wrapped joints at the terminals according to a programme on punched tape has been developed to an advanced prototype stage by engineers at Standard Telephones and Cables' Advanced Production Development Department.

A numerically-controlled co-ordinate positioning table carries in an horizontal plane the panel to be wired and a fixed work head and its associated hydraulically-actuated mechanism feeds out, strips, cuts, bends and wraps the wire. There are two inter-connected control systems, one of which controls the functions of the work head while the other provides positional information for the table. A commercially-available table has been employed in this instance. All the information required to operate the whole machine is provided from a single, eight-channel, punched tape.

The work head is equipped with a feed tube which directs the wire between rows of terminals in a plane parallel to the table, grippers to hold wire at a suitable point while bending or wrapping operations are being performed, a bending mechanism, and a wrapping bit that incorporates a wire stripping feature.

Wire laying is achieved by feeding out wire from a reel through the feed tube as the table moves from one position to the next, the feed rate being equal to the table velocity. Tachogenerators mounted on the table lead-screws provide synchronization by feeding current to the wire-feed drive motor. Bends at 90 degrees are provided during laying by stopping the table and activating the gripping and bending elements.

When the location of a terminal for wrapping is reached the table stops, the wire is cut to the appropriate length, stripped of its p.v.c. covering, and wrapped to the terminal post. A terminal post may be wrapped at either an upper or a lower vertical level. Consequently, having made a joint at the lower level a second joint at the upper level would enable a continuous electrical path to be made beyond the terminal. Alternatively the conductor could finish at the terminal in question and operations continued at some other co-ordinate position as determined by the programme.

The machine is able to deal with terminals on a 0.200-in. matrix and with the terminal spacings on STC's ISEP and other equipment practices. The total available X and Y co-ordinate motion is 20 × 15 in.

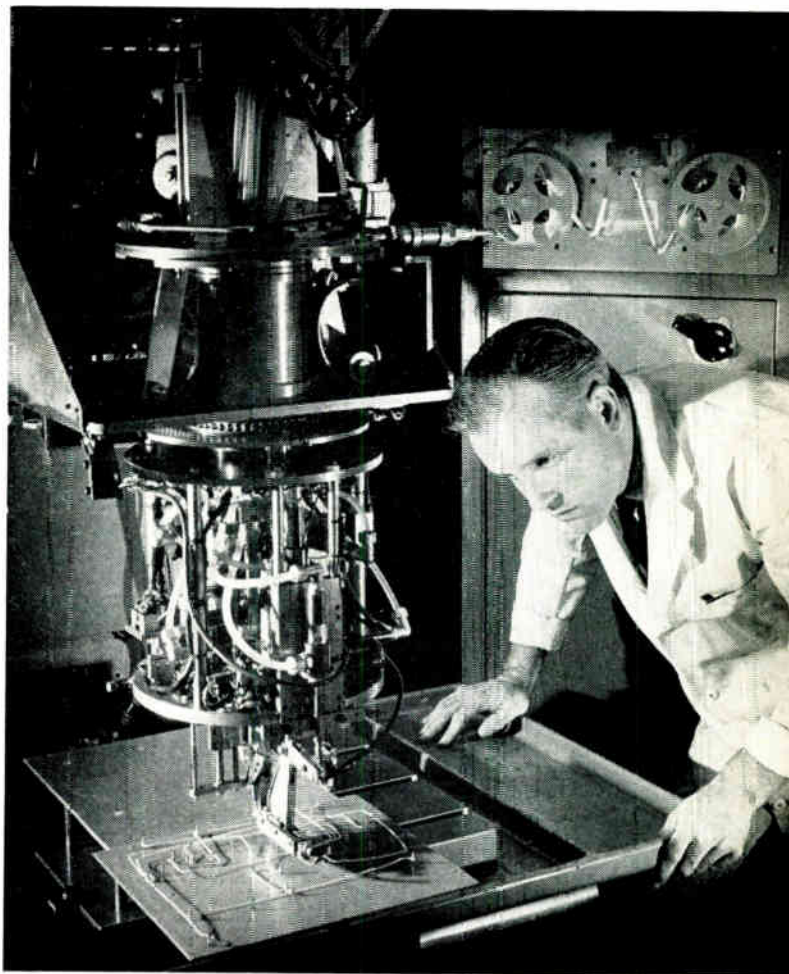

The control systems use semiconductor devices throughout, and to facilitate setting and fault finding a manual control panel is incorporated inside the work-head console. In conjunction with a patchboard plug system this enables any of the functions of the head to be manually operated.

Direct Digital Control of Soaking Pits

A Ferranti Argus 100 computer control system has been ordered by Richard Thomas and Baldwins Ltd., of Scunthorpe, to control a new soaking-pit installation. This is the first time in the world that a direct digital control computer has been used for this purpose.

The computer will be used in conjunction with instrumentation completely to replace the conventional three- and two-term controllers normally associated with soaking-pit control. A manual standby control method is included in the installation to operate any control loop in the event of computer or instrument failure.

The following functions will be under direct digital control: pit temperature, pit pressure and air and gas flows, air to gas ratio, excess oxygen in the flue gas, waste-gas outlet temperature, recuperator temperature and exhaust-fan inlet temperature.

In addition the computer will log thermocouples and other instruments in order to provide a basis for subsequent improvements in control procedures. It will also record all alarm conditions of critical parameters and operators' actions.

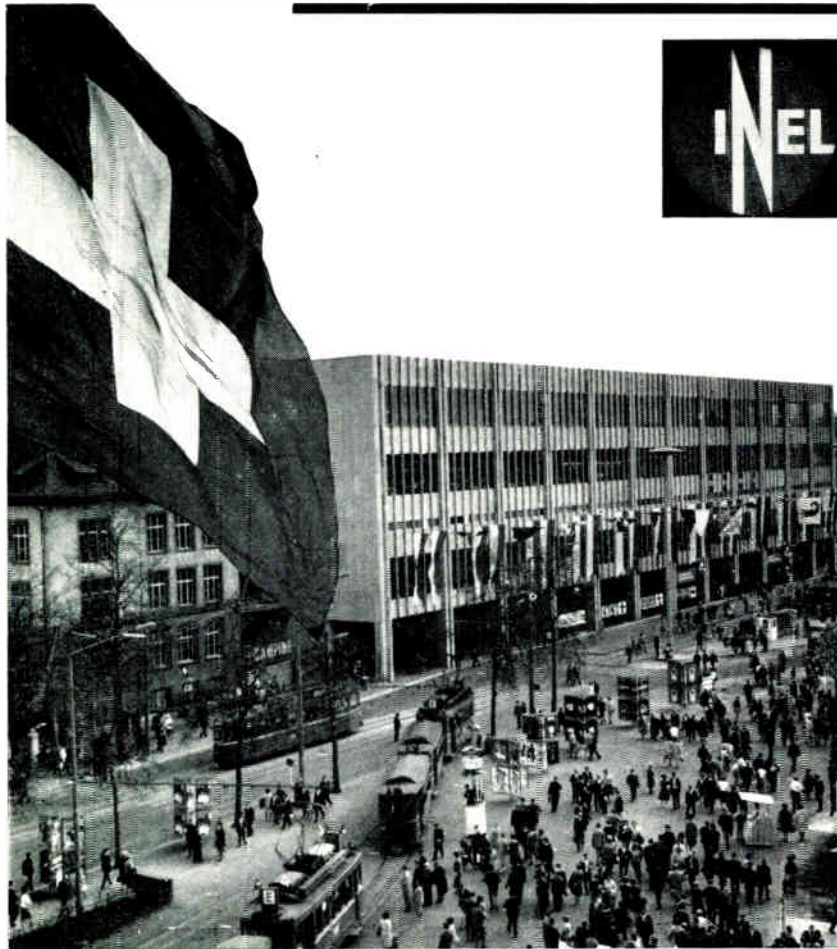

INEL 65

Basel, Schweiz 7-11 Sept

2nd International Exhibition
of Industrial Electronics

2^e Salon International de
l'Electronique Industrielle

2. Internationale Fachmesse Für
Industrielle Elektronik

MORE than 450 exhibitors, representing 12 countries and more than 600 manufacturers, took part in INEL 65. This is the second International Exhibition of Industrial Electronics which was held at Basle, Switzerland, from 7th to 11th September.

Although it was an interesting and successful exhibition it was a little disappointing to those solely concerned with the application of industrial electronics. Certainly industrial electronics equipment and devices were to be seen at the exhibition, but also there was a profusion of standard electronic equipment and components, thus giving the impression that this was a general electronics exhibition. In the five days of the show about 30,000 people passed through the doors and there was much to interest them. Some of the latest developments that were exhibited are described in this report.

Control and Data Handling Systems

The increasing size and complexity of industrial installations and public utility undertakings is leading to the

widespread use of electronics systems for remote control. Many of these systems use telemetry techniques for the transmission of signals from a remote point to a central control and monitoring console. G.E.C. Electronics, well known in this field, were displaying and demonstrating some of their telemetry systems including 'Teledata', 'Teleshift', 'Telecode', etc. The latest addition to this range of equipment was one of the main features of the G.E.C. Electronics stand. This is their 'Teleducer' quantitative signal-transmission system. It has been introduced to transmit analogue quantitative measurements over lines and radio channels where the added complication and cost of digital equipment is not justifiable. The system is completely transistorized and will provide an accuracy of better than $\pm 1\%$ full scale overall. The design is such that by using the Teleshift system up to 24 channels can be accommodated over a line having a 3,180-c/s upper frequency limit. It basically comprises an input coder, a pulse transmitter, a receiver and a decoder. The parameter to be

measured or monitored is fed to the coder as a voltage by an appropriate transducer. The coder triggers the transmitter which produces pulses at a rate proportional to the amplitude of the input voltage. At the receiving end the pulses are decoded and presented as an output signal.

For control of another kind, Fernsteuergerate of Berlin were demonstrating their integrator for the measurement of material quantity flow on a conveyor belt. In this a tachogenerator, connected to the drive for the belt, produces a d.c. signal which is proportional to the velocity of the conveyor. This signal is fed to the two fixed end contacts of a potentiometer. The moving arm of the potentiometer is mechanically coupled and moved by a weighing platform in contact with the conveyor belt. Thus the output voltage appearing between one end contact and the moving arm of the potentiometer is proportional to the product of the weight and velocity of the product on the conveyor belt. Continuous integration of this output voltage produces a signal which is an

accurate indication of the amount of material being transported. The system incorporates an arrangement whereby after a pre-set amount is transported a pulse is generated by the integrator and fed to a pulse counter to display the total material transported over any selected period. The counter provides an electrical output on command to operate a printer which can be used to record batch quantities.

Shown in Europe for the first time, the Ram cartridge-loaded random-access memory, made by Potter Instrument Co. Inc., U.S.A., is for use with medium and low cost digital computer systems. It is intended for use wherever rapid access to a volume of information is required and where the quantity of information is too large to be economically stored in ferrite core memories. Information is recorded in a multiplicity of tracks on loops of tape. The tape loop assembly is enclosed within a case and the whole unit is called a tape pack cartridge and typically it has a storage capacity of 25.1 million bits of information. Two of the main features claimed for Ram are: its low cost and its fast operation assisted by a unique check-read-after-write capability. It is claimed to cost about half that of a comparable unit, the average access time is 87.5 msec and it provides an immediate read-check facility after writing.

For the control of standard frequency oscillators Time and Frequency Inc., U.S.A., were displaying a range of robust tuning forks. Various models of tuning-fork standards are produced for fundamental frequencies from 800 c/s to 500 kc/s and associated frequency-divider circuits are available to provide frequency standards down to a fraction of a cycle. The tuning forks are of bi-metallic construction using two metals, one with a positive temperature coefficient and the other with a negative temperature coefficient. In the final testing and calibration grinding of one side or the other of each fork produces a near-zero temperature coefficient. This makes it unnecessary to use an oven for temperature compensation and stabilization. Excitation of the fork is by a barium-titanate element connected to one side of the base of the fork and the output or oscillator control signal is taken from a second barium-titanate element cemented to the other side of the fork. Typical stability of the 1 to 12-kc/s model is $\pm 0.005\%$ from -20°C to 85°C .

Vega of Wolfach, Germany, were demonstrating a range of material level control systems for silos and hoppers. New for the show was their Vegamet 312 which provides independent control

This contact simulator for logic system designers and students was introduced by Ebauches S.A. of Neuchatel. The device, type B1810, contains 21 transistor logic units which are interconnected in various ways by plugs and cords. The range of standard units available include AND, OR, memory, delay and double output amplifier units

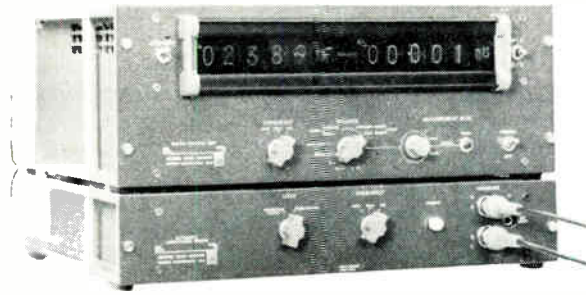
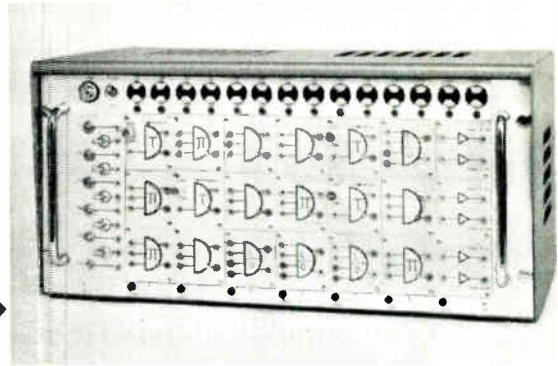

This automatic capacitance bridge type 1680-A is typical of the equipment being shown by General Radio. It automatically selects the range, makes the balance and displays the capacitor value in less than 1/2 sec. Additionally, the measured value is available in binary-coded decimal form. The measuring range is 0.01 pF to 1,000 μF and the accuracy is $\pm 0.1\%$ of reading

A low-cost source of relatively high peak power coherent light was featured by Semi-Elements Inc. of U.S.A. This semiconductor pulsed laser system model LDS-2, illustrated here, includes a dewar and diode holder which eliminate beam interference from liquid nitrogen bubbling. The unit is capable of supplying 0 to 40 A peak pulse current with a pulse width of 5 μsec . The pulse repetition rate is continuously variable from 100 to 10,000 c/s

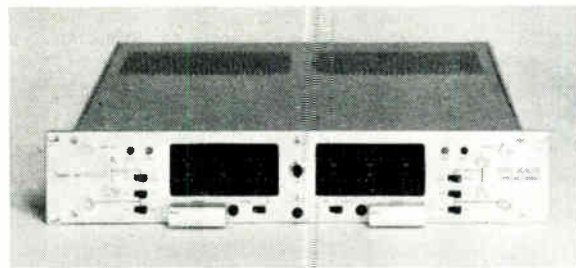
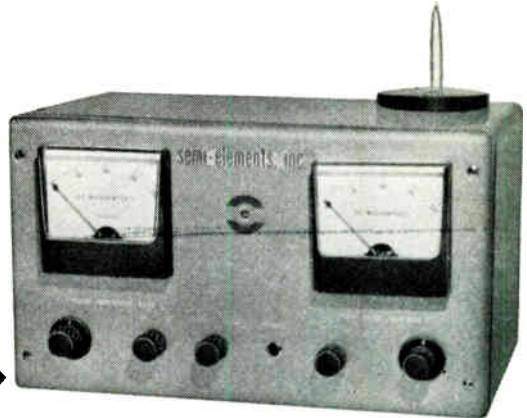

Introduced at the show by Borer & Co. of Solothurn, Switzerland, was a number of electronic scalers for direct counting up to 100 Mc/s. The range includes double scalers with 6 decades and binary display and double scalers with 8 decades, decimal display and a built-in discriminator. This picture shows the 50-Mc/s scaler type 612

The influence of the Swiss watchmaking techniques was to be seen in many small components. Typically, Reno SA were demonstrating 'Escap' micromotors. The three shown operate from 1.5 to 6 V and are available with or without integral governors. One unit, the AR 581 B has a body length of 30 mm and a diameter of 26 mm. It has a moment of inertia of 8 gm cm^2 and a torque of about 6 gm cm^2 at 2,000 r.p.m. when operating at 4.5 V d.c.

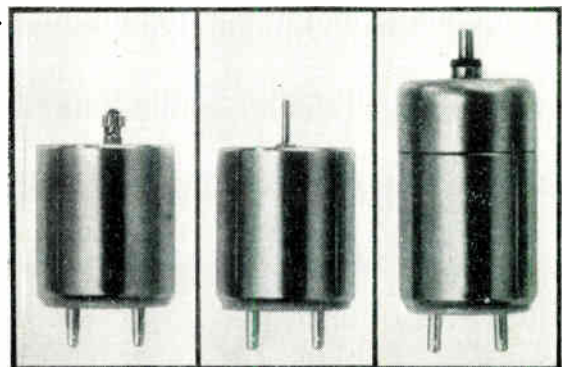

Many companies were showing and demonstrating thyristor-controlled speed drives for d.c. motors. This illustrates a typical unit shown by Oerlikon Engineering Co. of Zurich. Known as a 'Varikon' adjustable speed drive, the d.c. output range is 1 to 5 kW, the speed control range is 10:1 and the accuracy is $\pm 2 \times 10^{-2}$ of the maximum speed

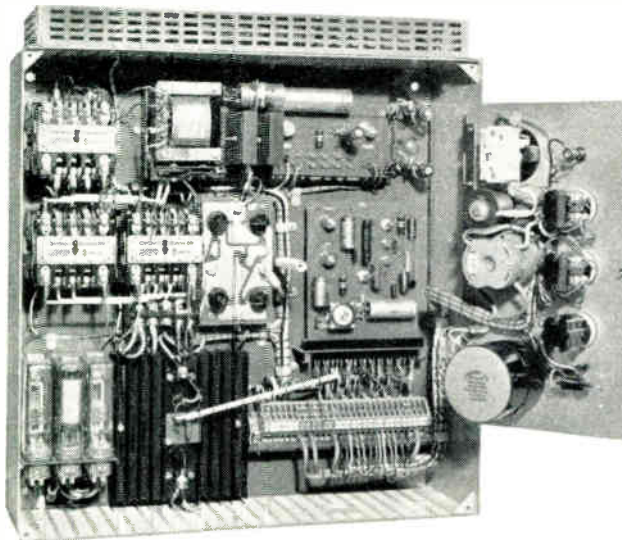

Dr. C. Schachenmann & Co. were showing this decade resistance box with digital readout of the set value. It covers the range 1 to 9999 kΩ with an accuracy of 1%



Bourns AG were featuring many trimmers and potentiometers and this exponential resistor. It is called the 'Quadratron' and it is made of modified silicon carbide. Unlike a normal resistor, the current through a Quadratron is equal to Ke^n . When used with high-gain operational d.c. amplifiers and established computer circuits it makes possible the generation of non-linear functions such as x^2 , \sqrt{x} , x^3 , $\sin x$, $\cos x$

The phenomenon of cavitation is used in industrial ultrasonic cleaning. In the immediate vicinity of an ultrasonic transmitting transducer in liquid, the agitation causes thousands of minute bubbles to build up and collapse. The energy released as they do so is a measure of the cavitation taking place and also an indication of the efficiency of the system. With any given equipment maximum cavitation is achieved with a particular input power and any increase in input power above this point does not increase cavitation significantly. Therefore a device which directly measures cavitation can be used to indicate the most efficient operating conditions of an ultrasonic system.

One such device, known as the cavitation meter type CVM-3a, was demonstrated by Macrosonics Corp., U.S.A. This basically comprises an ultrasonic probe microphone followed by an amplifier and a meter from which the intensity of cavitation is read. The device illustrated operates up to 600 kc/s

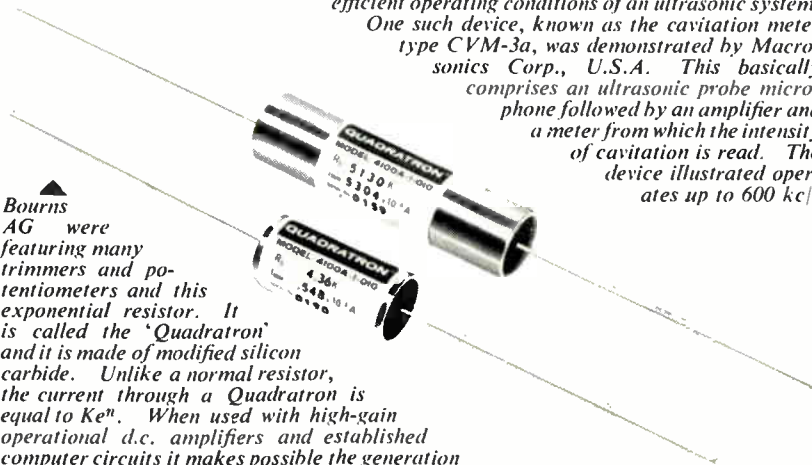

Special analytical balances were featured by Ainsworth of Denver, U.S.A. These are micro-balances with electronic indicating and recording in place of the usual mechanical or optical readout. They are intended for use wherever a continuous record of the weight changes occurring in a sample as a function of time is of interest. This recording vacuum balance type AV-AU-2K illustrated here makes it possible to study weight changes of materials over periods of time in a controlled environment. The analytical model, shown at Inel 65, is one of three versions, each with a particular weight capacity. This is the 'heavy-weight' model with a maximum capacity of 200 gm and a sensitivity of 1 mgm. The 'light-weight' model has a maximum capacity of 5 to 10 gm and a sensitivity of 0.01 mgm

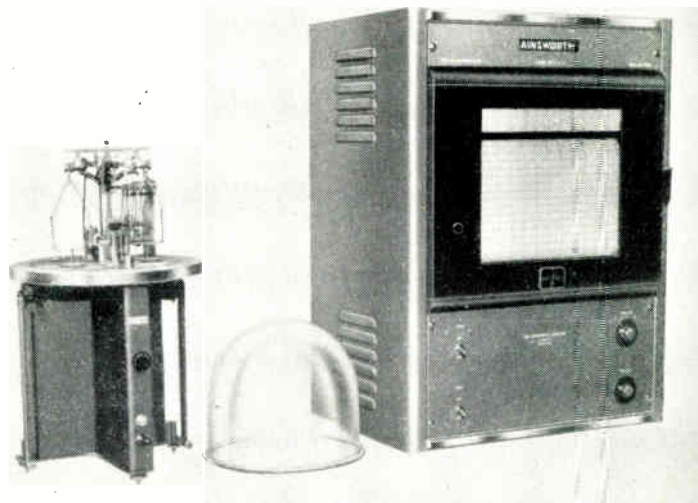

and monitoring facilities for up to five silos. The control and display unit, which may be situated almost any distance from the silos, contains two separate pre-set level controls for each of the five channels. One of the controls is for setting the required high level (usually maximum silo capacity) and the other is for the minimum content level. Any one of the five channels can be remotely monitored by pressing a switch on the display unit. The sensing probes which are suspended in the hoppers can be of any length and these can be made of metal rod or wire. Many variations of the basic system are possible. For example, if two or more hoppers are being used to feed material, it can be arranged for the first hopper to supply material until the minimum-content level is reached, then No. 2 hopper is opened to feed material until its minimum-content level is reached, and so on for any number of hoppers. While No. 2 hopper is emptying No. 1 hopper is being filled automatically, and so the cycle continues ad infinitum.

Other Production Aids

Most electronic devices can directly or indirectly aid some production process, but not all electronic devices are designed specifically for this purpose. At the Inel exhibition many companies were showing equipments which have been designed for production processes, but in the main these were of American origin. In this section we deal with some of the electronic production aids which are typical of those to be seen at the show.

For the continuous colour monitoring of on-line processes Intrade, Inc., were demonstrating the 'Chrom-O-Scope' which is made by Milletron, Inc., U.S.A. It observes processes and automatically detects deviations from a pre-set norm as they occur. Deviations are displayed on either or both of the two meters built in to the instrument. One indicates colour independent of intensity, while the other indicates intensity as a function of reflectivity or transmissibility. Thus, the instrument can provide information concerning process deviations involving gloss, sheen, texture, opacity, etc., which, with or without changes in pigmentation, are causes of colour deviations. In operation, the instrument uses a diffused light source to illuminate the object or process it is monitoring. The sample to be matched is placed in the field of view and the instrument's meter readings are noted and used as the standards. The field of view is adjustable and the operating distance is controlled by the lens on the 'camera'; the standard 3-in.

focal length lens will focus from 3 ft to infinity.

For temperature measurement and monitoring, without physical contact, H. Dauber Associates, Inc., of Munich, were displaying infrared thermometers which are produced by Barnes Engineering Co., U.S.A. Typical of these is the model IT-3. It basically comprises a sensing head with sights and a pistol grip and a compact case containing the electronic circuitry, controls and indicating meter. Standard models cover the temperature ranges of -50 to 150 °F, 150 to 400 °F, 10 to 110 °F and 50 to 150 °F. The absolute measuring accuracy depends on the temperature being measured and the model being used; for the four standard models accuracy ranges from 1.2 °C to 4 °C. Accurate measurement is achieved by a comparative method. Radiation from the selected target and from an internal controlled cavity is alternately sensed by a thermistor bolometer detector. Special versions of the IT-3 are also available for the measurement of the temperature of thin-film plastics.

In the production of semiconductor elements or wafers, for transistors and integrated circuits, a major problem is the handling and testing of very small wafers or chips which may only be a few-thousandths-of-an-inch square. Electroglas Inc. were demonstrating their Automatic Wafer-Die-Sort model 920 which can be used to test up to 2,000 semiconductor devices per hour. This is basically a jig in which the wafer, containing very many identical semiconductor elements, is placed. Around the jig are mounted up to 17 test probes and one inking probe. The operator selects and positions the appropriate test probes with the aid of the built-in microscope, sets up the sequence in which the probes make contact with the element and finally programmes the jig control unit which indexes the wafer in a step-by-step fashion under the test probes. Once the probes are positioned and the required jig X and Y movement selected the machine will automatically go through the required movements until all the elements of the wafer are checked. It is claimed that this machine, model 920, will operate with any semiconductor parameter tester that provides a go/no-go output signal. Should a measured parameter of the semiconductor fall outside the acceptable limits the resulting 'no-go' signals from the tester actuate the inking probe on the jig which marks the element being tested as a reject. The useful working area of the jig is 2×2 -in., each probe can be adjusted up to 0.3-in. in both the X and Y planes and the

pressure of each probe is adjustable between the range 7 to 17 gm.

An unusual instrument which will find many applications in production was demonstrated by Hewlett-Packard S.A., Geneva. Called the Ultraschall-Lecksucher-Ultrasonic Translator Detector, it is basically an ultrasonic microphone with an amplifier, detector and earphones. It is capable of detecting very small leaks from pneumatic, hydraulic and vacuum systems and when used with an ultrasonic probe, instead of the microphone, it can detect worn or damaged ball bearings in ball races, etc. As a leak detector it was demonstrated to be extremely effective. Leaks will generate whistle-like signals which are usually above the audibility of human hearing but an ultrasonic microphone can pick up these signals. When these are amplified, detected and fed to a pair of earphones as an audible sound it is possible to pinpoint the leak. Normal audible noise has no effect on the equipment. The same principle applies when using the ultrasonic probe for the detection of worn or damaged bearings.

For accurate and repeatable length measurement on lathes and machine tools Weltrawo A.G. of Worb, Switzerland, were demonstrating their Preciso-tester type C. This is a modified dial indicator length gauge. It is fitted to the machine in the normal way with the dial head attached to a moving part, such as the tool carriage of a lathe, and the free end of the spring-loaded tape is attached to a stationary part or bed of the machine. As the carriage moves the tape which is wound around a spring-loaded drum unwinds and in doing so drives the needle of a dial gauge to indicate the length of travel. The modification to this standard unit consists of attaching a toothed wheel to the spindle of the tape drum and mounting a lamp one side of the teeth and a photodiode on the opposite side of the teeth. As the toothed wheel rotates with the movement of the carriage the light beam is interrupted by the teeth and the photodiode produces pulses of current. By counting these pulses with an electronic counter a very accurate indication of length measurement is obtained. In addition, provision is made in the counter for pre-setting any required length. When this is reached a light on the machine is switched on.

Landis & Gyr, of Zong, were showing equipment for the continuous measurement and recording of the density of fluid or granular materials flowing through a tube without contact with the material. The equipment comprises a separate gamma source

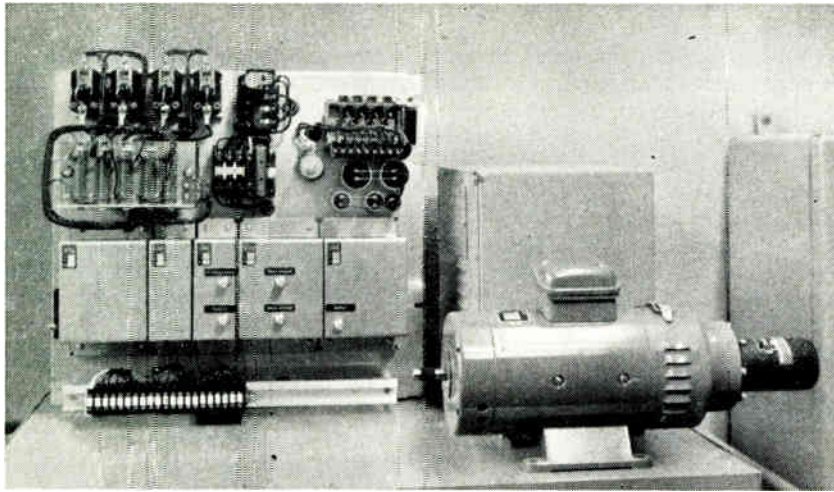

▲ Sprecher & Schuh AG of Aarau, Switzerland, demonstrated various control systems using static switching units, including one for a moulding press to control the whole cycle of events and another for the centring and counting of parcels on a conveyor belt. This picture shows another of their developments. This is a semiconductor speed control system for d.c. motors which is provided with a digital readout. Speed can be varied over a range of 100 : 1 and the unit maintains the set speed independent of supply voltage, temperature and load

and a gamma radiation detector and a recorder. In operation the gamma source is mounted one side of the tube through which the material flows. On the other side the gamma detector picks up the radiation from the source after it has passed through the tube. Measurement of the radiation signal strength before and while the material is flowing indicates the absorption of the gamma radiation by the material and therefore its density.

Instrumentation

This exhibition presented many instruments from all over the world for design, development and use in industry. British and American companies predominated this field.

Typically, Muirhead & Co. introduced on the Ministry of Aviation stand the K-134-A wave analyser. This is a portable instrument which can analyse most classes of vibration, noise and electrical waveforms in the frequency range 3 c/s to 31.6 kc/s. It is ideal for 'on-site' analyses as it incorporates rechargeable cells which can be used when no mains supply is available. The cells are connected automatically when the mains supply is removed. The frequency accuracy over the band 3 c/s to 10 kc/s is 0.5% and over the band 10 to 30 kc/s the accuracy is $\pm 1.5\%$. The bandwidth about the selected frequency is 2% or 10% and the voltage range is 1 mV to 300 V f.s.d.

To extend the frequency measurement range of the universal counter/timers type SA 535A/B Racal Instruments have developed and were displaying the 15-Mc/s decade divider

unit type SA 548. When used in conjunction with one of the counters type 535, measurements over the range d.c. to 15 Mc/s can be made without the need for tuning or interpolation and the counter accuracy of ± 1 count ± 1 part in 10^6 is retained over the operating temperature range 0 to 45 °C. The dynamic range of the input circuits is such that signals as low as 100 mV can be accommodated and the level-set controls enable the input trigger level to be off-set in six ranges up to ± 300 V. The decade divider 548 is made in the form of a plinth unit and it can be used to extend the frequency coverage of any 1-Mc/s counter to 10 Mc/s provided the counter has a sensitivity of better than 2 V r.m.s. over the measurement range.

Another counter which has many applications in industry, where counting, measuring, batching, regulating and time interval must be performed with high precision, was shown by Elesta AG Elektronik of Bad Ragaz, Switzerland. This instrument, universal electronic preselecting counter and precision digital timer type CPT.1, features an externally-controlled input gate and an integral 1-kc/s time base. It has a maximum count rate of 100 kc/s, has four decades and incorporates electronic and contact-operated reset. The counter includes a power supply for external photo-diodes and proximity detectors. Silicon planar transistors are used throughout.

For direct and accurate measurement of temperature, Hewlett-Packard featured their quartz thermometers. While the principle of quartz thermometry is not new, it is based on the

sensitivity of the resonant frequency of a quartz crystal to temperature change, it is claimed that a unique angle of cut of the crystals used in these thermometers exhibits a very linear and yet sensitive correspondence between the resonant frequency and temperature. The range of the Hewlett-Packard quartz thermometers DY-2800A/2801A is -40 to 230 °C. Over this range the linearity is $\pm 0.05\%$. Usable sensitivity is 0.0003 °C for absolute measurements and 0.0001 °C for differential measurements. These excellent sensing characteristics are supplemented by the advantages of direct digital readout (no bridge balancing, or reference to curves), immunity to noise and cable resistance effects, no reference junction and good interchangeability between sensing probes.

A new impulse recorder for the measurement and recording of impulse lengths, impulse ratios and time differences, such as those occurring in relay and similar circuits, was one of the main features of Hasler Ltd. of Berne. In operation, a waxed paper tape is driven by a synchronous motor at a known speed and the impulse to be recorded is fed through an amplifier to a recording stylus which scribes the impulse on to the waxed tape. The instrument has three separate input



▲ Shown here is one of the test chambers featured by Blue M Electric Co. Known as the 'Vapor-Temp', it is a controlled temperature and relative humidity chamber for testing electronic components and laboratory specimens under controlled conditions. The unit consists of a base section containing the controls, motor and blower, water reservoir, cooling coil and heating elements. The chamber is formed by an inverted Pyrex jar, 14-in. high \times 16-in. diameter

sockets, three amplifiers and three independent recording styli. The accuracy of the record trace is 1 msec and the upper cut-off frequency is 100 c/s. Input 1 is of high impedance (100 k Ω) with a sensitivity from 15 to 300 V. Input 2 is of low impedance (10 Ω) with a sensitivity from 0.15 to 300 mA. Input 3 is associated with an internal voltage supply for use with passive or unenergized low-rating (150 mA) contacts. Included in the instrument is a reference impulse generator and switched facilities are included to provide four tape speeds of 20, 10, 5 and 2.5 msec/mm.

Other Devices and Techniques

Many firms were showing novel components and devices which had been constructed using new techniques.

One sample of a new technique, claimed to be a 'first-in-the-world', was shown by Plessey Radar (Special Products Dept.). This was a cathode-ray tube on which a magnetic screen had been electroformed directly on to the glass envelope of the tube. This technique is still being developed but it is now possible to electroform magnetic alloys of nickel-iron on to glass and other materials. Because the alloy is grown with known and controllable stresses the magnetic characteristics of the electroformed layer of alloy approach those of mumetal. Other examples of electroforming shown by Plessey included copper-waveguide units which include brass components such as flanges, tuning sockets, etc., that are grown into the copper body of the unit and not brazed or soldered. This results in stepless low-loss joins and closer tolerances.

A family of magnetrons based on the type YJ1090 was the main feature of the Mullard section of the British stand. These are miniature tunable magnetrons for operation in X-band (9,000 to 10,000 Mc/s). The basic unit produces 50 W peak pulse power, but versions have been developed with outputs of up to 500 W peak pulse power. By using ring magnets the complete units are extremely small, rugged and stable, for example one of the versions of the YJ1090 measures 1.35-in. diameter \times 4.0-in. long, including the magnet assembly and a coaxial socket. A typical frequency temperature coefficient is 50 kc/s per $^{\circ}$ C.

An unusual range of high-output load cells for heavy industry was demonstrated by Asea of Vasteras, Sweden. Known as 'Pressductors', these rely on magneto-elastic principles for their operation. The Pressductor, which derives its name from pressure inductor, is based upon the fact that the permeability of a magnetic material

This large-screen oscilloscope type SGM43 with a useful screen area of 8.6 \times 11.8 in. is produced by Knott Elektronik of Munich and was exhibited by their Swiss representative Baerlocher AG.

It is designed for demonstrations and for the simultaneous measurement of up to eight low-frequency signals. A range of plug-in units makes this a versatile instrument for measurements in the frequency range 0 to 10 kc/s. In many cases the direct connection of transducers such as strain and pressure gauges or pick-ups is possible

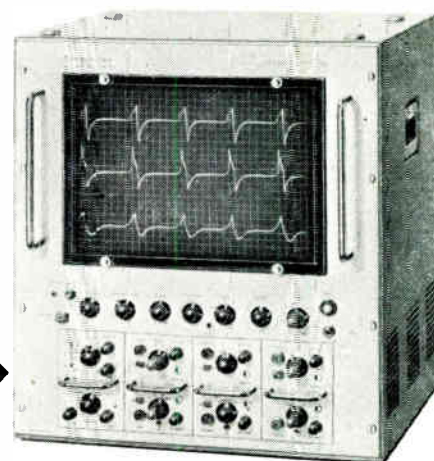

is influenced by mechanical stress. For a material with positive magnetostriction, compression decreases the permeability in the direction of stress, and increases it to a smaller degree at right angles to the stress; tension has the opposite effect. A basic Pressductor comprises a number of transformer-like square laminations, with four holes through each lamination located symmetrically on the diagonals. The laminations are cemented together and four channels are thus obtained in which two coils are wound, crossing each other at right angles. One coil acts as a primary or excitation winding and the other acts as a secondary or pick-off winding. When no compressive force is applied to the edges of the laminations the magnetic coupling between the two windings is virtually zero. When the Pressductor is subjected to compressive stress, with an a.c. signal applied to the primary winding, the permeability is reduced in the direction of stress and a signal is induced in the secondary winding which is proportional to the impressed force. From this basic construction stacks of lamination can be built up to almost unlimited size and many Pressductors can be assembled together to provide a load cell with a very large area. Also the output signal is only limited by the gauge of the wire used for the primary winding and the excitation current passed through it.

Elliott Brothers featured, on the M.o.A. stand, an altimeter using a laser. Using a near infra-red carrier frequency it has definite advantages over one using an r.f. carrier. The much shorter wavelength eliminates anomalies due to terrain 'skin effects' and enables a small beamwidth to be obtained thus giving higher accuracy. The experimental altimeter shown uses a transmitter, a gallium arsenide semiconductor laser and a p.i.n. photodiode detector. It is designed to operate to

an altitude of 1,000 metres with an accuracy of ± 1 metre or $\pm 1\%$.

An all-metal integrated circuit envelope set in a matching glass sheet with contacts coming through the metal case on to the glass sheet was featured by Hermetic Seal Corp., U.S.A. It is known as the 'Intimite' all-metal integrated circuit envelope and it is made of Kovar with matching glass. The height or thickness of the package is 0.075-in., but they can be made up to 0.156-in. high. Leads from the envelope are on a 0.050-in. grid. The design is such that it will withstand thermal shock of 5 cycles from -197° C (liquid nitrogen) to 360° C, without any loss in dielectric or vacuum tightness.

Although there were many power supply units to be seen at the exhibition none seems to provide such extensive facilities as the Power Supply Set exhibited by W. Bryan Seavage Ltd. It is a special unit designed for Service use and it provides three outputs. They are: 115 V r.m.s., single phase at 2.4 kc/s, 500 VA; 115 or 200 V r.m.s., three phase at 400 c/s, 225 VA; and 26 V d.c., 250 W. The a.c. supplies handle a wide range of loads with good regulation and low distortion. The 2.4-kc/s supply will feed non-linear loads and the 400-c/s supply will feed highly reactive loads. Both a.c. supply systems basically consist of stabilized oscillators and high-power amplifiers. In the case of the 400-c/s supply, the output is fed into phase-shifting networks which produce a three-phase output. Each phase is then amplified and ultimately combined in a star connection.

This report has dealt with some of the products which are typical of those shown at the Inel 65 exhibition. Most visitors and exhibitors seemed to be of the opinion that the exhibition was worthwhile and that they would again visit and support it.

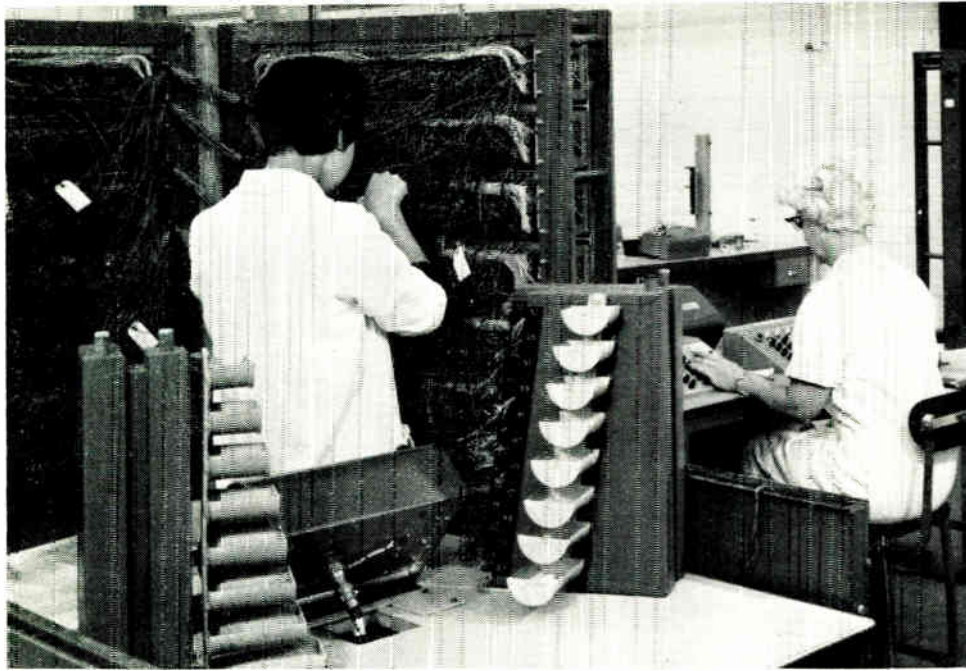

This shows a computer frame being wired and checked using the I.C.T. equipment

Computer-Wiring Test Equipment

Visual checks and manual continuity tests for the frame wiring in computers have now been eliminated by a semi-automatic mechanized method developed by I.C.T. and being used in their Computer Equipment department. This ensures that every wire is connected between the correct pins and its reliability is such that computers built by I.C.T. using this equipment undergo no other wiring tests apart from those performed on the data-processing system when manufacture is completed.

Two desk units are coupled to the frame being wired, one for the operator and the other for the checker. In the centre of each desk is a continuous scroll of paper on which the wiring instructions are printed and displayed through a narrow window, only one wiring instruction being visible at a time. The instructions are in the form of code groups specifying the pins to be connected and the length of wire to be used.

The checker sits in front of the frame being wired and plugs a unit into the edge-connectors on the frame thus connecting every pin into the checking circuit. The pins

to be wired are selected by means of two switches situated one either side of the checker's desk so that the relevant pair of pins is in circuit.

Signal lights on the display units are then illuminated and the operator reads the instruction, selects the correct length of pre-cut wire from a dispenser and connects it between the pins. When the wire is attached the check circuit is completed and after a 3-second delay, ensuring that the wire is secure, a control pulse advances the scrolls so that the next wiring instruction is displayed.

If a mistake has been made in the wiring the test circuit is not complete and the scroll is not advanced. The supervisor has to be called to check the wiring and the switch selection.

The total time for the checking of each wire is 4 seconds; 3 seconds delay and 1 second for the scroll advancement. The equipment can be used to check wiring modifications and the whole wiring procedure has been speeded-up and errors eliminated.

For further information circle 43 on Service Card

Ultrasonics Technical Service

A new technical service to industry is announced by Kelvin Electronics Company which will be of interest to users of ultrasonic equipment and others generally interested in the techniques of non-destructive testing. This service takes the form of a bound loose-leaf handbook which gives a full technical appraisal of the fundamentals, technicalities and the scope within the field of ultrasonic non-destructive testing.

To date, the handbook has seven completed sections dealing with the basic principles of ultrasonics; ultrasonic shadow testing; direct-echo testing; multiple-echo testing;

opacity testing; a guide to the correct probe selection and uses of a calibrated test block. The scope and contents of the handbook will be continuously reviewed and further parts or revised sections issued automatically to Registered Holders.

An initial registration fee of 5 guineas is made for this service, which covers the handbook, all amendments and additions, post free, which will be issued in the future.

Applications for registration should be made to: *Kelvin Electronics Co. Publicity Department (Ref. CHO/RG), Kelvin House, Wembley Park Drive, Wembley, Middlesex.*

NEW APPARATUS

ELECTRONICS
COMMUNICATIONS
INSTRUMENTATION
CONTROL

1. Flaw Detector

The Sonatest TE/6 is a low-cost ultrasonic flaw detector available in the U.K. from the M.E.L. Equipment Co. Ltd.

This is a compact battery-operated instrument with a 5-in. diameter cathode-ray tube. The frequency range is 2-6 Mc/s and this is covered by a broadband amplifier with a gain control calibrated from 0 to 100. The depth range is 0-20 ft in steel and is controlled by a six-position range selector switch and a range calibration control. Continuously variable delay is also provided.

Modifications offered include a higher-speed time-base, a switched attenuator and a calibrated delay. A variable dynamic range, which assists in defect-size evaluation, is also avail-

able.—*The M.E.L. Equipment Co. Ltd., 207 Kings Cross Road, London, W.C.1.*

For further information circle 1 on Service Card

2. Two-Pen X-Y₁-Y₂ Recorder

A bench-type two-pen X-Y₁-Y₂ recorder has been introduced by the Moseley Division of Hewlett-Packard. The recorder (Model 2FA) has two pens independently controlled in the vertical axis and integrally controlled in the horizontal axis, thus allowing simultaneous plotting of two dependent variables against a third. Horizontal separation of the pens is 0.1 in. and each axis has eleven calibrated d.c. input ranges, with sensitivities from 0.5 mV to 50 V per in. and input resistances of 1 MΩ at null.

A standard feature is a five-range time-base which operates on the X-axis only; this provides sweeps from 0.5 sec to 50 secs per division, corresponding to 7.5 to 750 secs for full-scale pen traverse. The time-base supplies a built-in independent variable for plotting two curves simultaneously.—*Hewlett-Packard, Dallas Road, Bedford.*

For further information circle 2 on Service Card

3. Dosimeter Reader

Nuclear Enterprises (G.B.) Ltd., of Edinburgh, are now marketing an accurate and dependable thermoluminescent dosimeter reader. The reader, Model TLD 1000, simplifies the techniques of the recording of the radiation dose on the finger-tips of

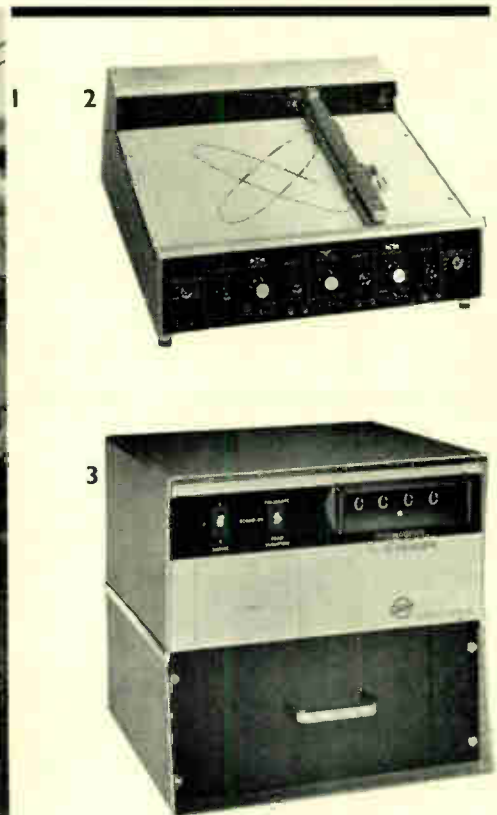

people handling radioactive materials by using the thermoluminescent properties of lithium fluoride. In this recently developed technique, small sachets of lithium fluoride powder are attached to the finger-tips and, after exposure, they are heated under controlled conditions. The light emitted from the powder gives an accurate dose measurement.

The unit has a wide dose range of 100 milliroentgens to 10,000 roentgens and a small sample size of 2 mg. The exposure in roentgens is displayed in digital form. As an optional feature, for recording and data processing, the readout information is available in binary-coded decimal form. The accuracy at full scale on each range is better than $\pm 5\%$, with reproducibility at 100 roentgens better than 3%. The equipment is simply operated by two switches and the plug-in modular transistorized units ensure easy maintenance. The reader has wide applications in environmental radiation-level measurements, particle-flux measurement, attenuation studies, source calibration, dose determination, whole-body irradiation, radiology, radiation sterilization, etc.—*Nuclear Enterprises (G.B.) Ltd., Sighthill, Edinburgh.*

For further information circle 3 on Service Card

4. Aspirated Soldering Iron

An aspirated soldering iron manufactured by Philips and coded HY.140.83 is available from Amalgamated Electric Services Ltd. It has been developed specifically to simplify the removal of components from printed panels during service work.

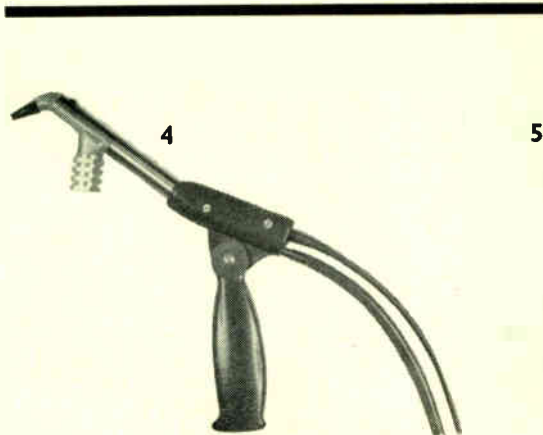

A hollow copper-beryllium bit is placed on the joint to be unsoldered and the solder is sucked away as it is melted. The suction pressure is applied by a connected footpump and the solder is stored in a receptacle in the barrel.

The iron is robustly constructed of aluminium alloy and stainless steel with an adjustable fibreglass handle. The handle, which is pistol-grip shaped, can be swivelled to the most comfortable position for any specific operation. A bench stand is supplied with the iron and it also carries spanners for the removal of the solder pot and bit. 230/250, 200/220 and 110/125 V versions are available.—*Amalgamated Electric Services Ltd., Waddon Factory Estate, Croydon, Surrey.*

For further information circle 4 on Service Card

5. Demand Recorder and Translator

Developed by the Westinghouse Meter Division, this magnetic-tape demand recording system (type WR-4) is a combination of recorders, translator and data-processing equipment.

It has up to four channels on $\frac{1}{4}$ -in. magnetic tape and recordings can be made of any device that emits pulses proportional to the quantity to be measured; electrical units such as kW, kW-hr, volts, amps and combinations of these units can all be recorded, automatically processed and translated into a form acceptable to the data-processing equipment.

The print-out can include other computed information such as power factor, impedance, load factor and transformer or generator efficiency.—*Westinghouse Electric International Co., 200 Park Avenue, New York, U.S.A.*

For further information circle 5 on Service Card

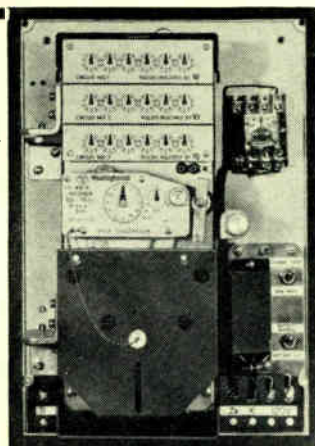

6. Real-Time Computers

Three general-purpose computers are being manufactured by Remington Rand. These form the Univac 490 series of modular real-time systems and are the Univac 491, the 492 and 494.

In this real-time data-processing system, information is transmitted to a central computer from several points and this information is processed, the results being obtained in time to influence the activities being monitored or controlled.

The 491 and 492 are medium-scale systems available in a choice of expandable internal memory systems and input/output channels. Both have a standard memory of 16,384 words expandable up to 65,536 words. The 491 has 8 input/output channels which can be increased to 14 and the 492 has 14 channels. The fastest and largest model is the 494. Twelve input/output channels are provided with this unit and these can be expanded in groups of four up to 24. The standard memory is 16,384 words as for the 491 and 492 and this can be increased to 131,072 words.

Among the accessories available for all three models are mass-storage systems, punched-card processors and a data-communications terminal and controller. The accompanying illustration shows the 494 model.—*Univac Division of Remington Rand Ltd., 65 Holborn Viaduct, London, E.C.1.*

For further information circle 6 on Service Card

7. Wave Analyser

Radiometer of Copenhagen have announced the introduction of a wave analyser, the model FRA3, which is suitable for measurements of frequency response, harmonic distortion, noise and vibration. The FRA3 tunes through a 10-c/s to 60-kc/s spectrum and measures both the amplitude and frequency of the various harmonic components comprising the input signal.

Voltage measurements cover 30 μ V to 300 V full scale, with an accuracy of $\pm 5\%$. Frequency measurements on a linear scale are accurate to $\pm 0.5\%$, with a resolution of 2 c/s.

Variable selectivity is a feature of the instrument and six switch-selected ranges of ± 3 , ± 6 , ± 12 , ± 25 , ± 50 and ± 100 c/s, each with a 1-dB bandwidth, are provided. Other features include a signal restorer out-

put, which is equal in frequency to the particular component tuned by the analyser, a recorder output, an incremental frequency scale and facilities for driving the analyser as a slave instrument. It is available in the U.K. from: *Livingston Laboratories Ltd., 31 Camden Road, London, N.W.1.*

For further information circle 7 on Service Card

8. Stabilized D.C. Power Unit

The Stabilized Power Unit Type D.P.S. 6-301 has been designed by Etronix Ltd. to meet the requirement for a compact stabilized power supply which may be incorporated into any system where unit packing density is a primary consideration. The compactness has been achieved by basing the mechanical construction on an 'Ashgrove' resin cast transformer on to which are mounted all the component parts. The unit can be mounted in any position using the four mounting bushes cast into the base of the transformer.

An electronic protection circuit ensures the safety of the unit in the event of overloading or a short circuit. Local heating of any part of the unit is avoided by the heat-sink and the general layout.

The output voltage can be set at 6, 12, 18, 24, or 30 V all at a maximum current of 1 A. The mains input required is 200-245 V at 50 c/s or 100-125 V at 50 or 60 c/s. For a $\pm 10\%$ mains variation the output variation is within 0.05%. Ripple voltage and noise is kept to 1 mV peak-to-peak. Variation of output with temperature is 0.05% per degree C. and the maximum allowable ambient temperature is 50 °C. Weighing 5 lb 2 oz, the power supply measures $6 \times 3\frac{1}{2} \times 4$ in. — *Etronix Ltd., 96 Amyand Park Road, Twickenham, Middx.*

For further information circle 8 on Service Card

9. Logarithmic Converter

A solid-state instrument from Hewlett-Packard accurately delivers logarithmic counterparts of d.c. or a.c. signals of frequencies up to 100 kc/s and provides two entirely separated channels.

This model 7560A facilitates semi-log or log-log plotting with the Moseley X-Y recorders. It can also act as the logarithmic converter in decibel systems or it will serve as a computing element to multiply and divide. Each channel has a 60 dB dynamic range. In a.c. applications either peak or average detection may be selected. Accuracy is 0.5 dB up to 50 kc/s and 1.0 dB from 50 to 100 kc/s. Input attenuators provide full-



6

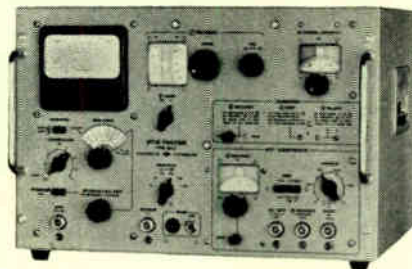

7

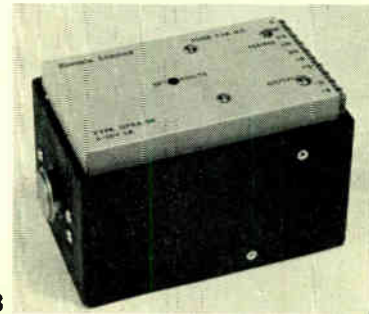

8



9

scale input ranges from 1 mV to 100 V on a.c. and 3-16 mV to 316 V d.c.

The equipment for both channels is housed in a rack-convertible module which is only 3½-in. high and contains a built-in power supply.—*Hewlett-Packard Ltd., Dallas Road, Bedford.*

For further information circle 9 on Service Card

10. Solid-State Wave Analyser

The Sierra Division of Philco have announced the 128A solid-state wave analyser covering the 10-kc/s to 15-Mc/s frequency spectrum. Direct indications of signal levels are given on 600, 135 or 75-Ω balanced or un-

NEW

ELECTRONICS
COMMUNICATIONS
INSTRUMENTATION
CONTROL

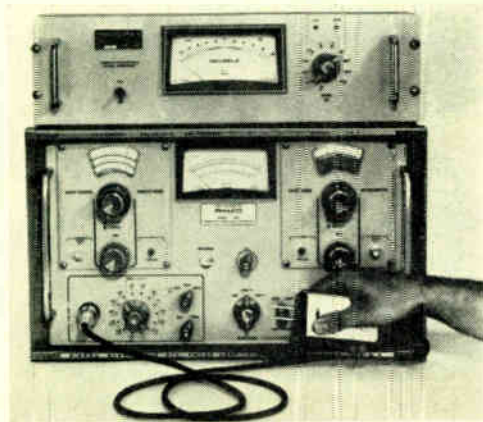

10

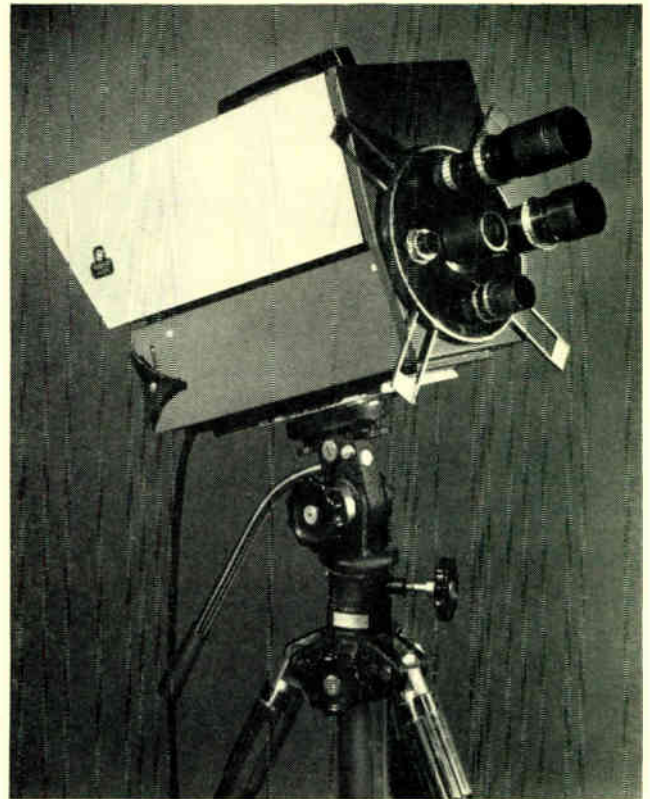

11



12

13

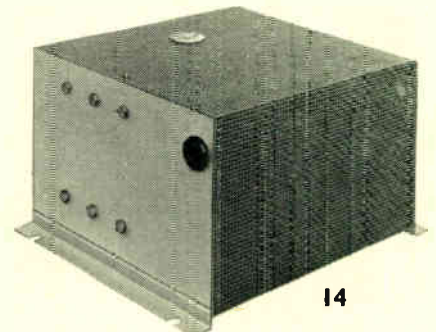
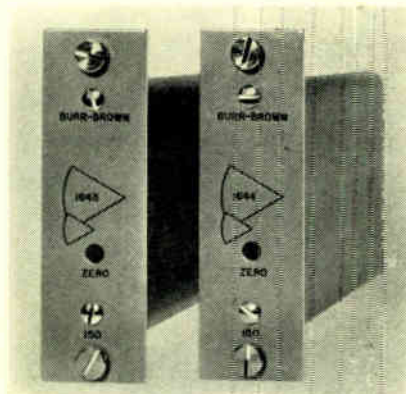

14

balanced systems from -110 to $+32$ dBm at any frequency within its range. In the $600\text{-}\Omega$ position, it also reads out in volts from $30\ \mu\text{V}$ to $30\ \text{V}$. Frequency accuracy of the order of $20\ \text{ppm} \pm 300\ \text{c/s}$ is assured by a system of controlled oscillators locked to crystal references at $100\ \text{kc/s}$. Dual selective bandwidths of $250\ \text{c/s}$ and $2.5\ \text{kc/s}$ permit either specific signal-level measurements or audio monitoring of a system under test. A major accessory to the Model 128A Voltmeter is an expanded scale meter mounted on a $5\frac{1}{4}$ -in. panel that makes possible readings as precise as $0.01\ \text{dB}$ on a $\pm 1.0\text{-dB}$ scale. The instrument

can also be used with a balance probe to measure voltage directly on unbalanced lines of any impedance.—*Wessex Electronics Ltd., Royal London Buildings, Baldwin Street, Bristol 1.*

For further information circle 10 on Service Card

COMMUNICATIONS

11. Solid-State Television Camera

The introduction of a single-unit, solid-state television camera, the V322A, has

been announced by the Marconi International Marine Co. Ltd. This camera offers stability with operational simplicity. Compactness and accessibility of components have been achieved in the design of the unit which measures only $15\frac{1}{4} \times 6\frac{3}{4} \times 4\frac{3}{4}$ in. With the side panels open, the two main printed boards can be inspected and removed.

Only two controls are provided, adjustment of lens iris and adjustment of the focus, which make operation simple. Resetting of the lens iris is rendered unnecessary by a circuit which automatically maintains a constant output regardless of changes in

subject illumination as great as 2,000 times. This circuit maintains the brightness of white picture information at a predetermined level by adjustment of the vidicon camera tube sensitivity. An automatic black-level control circuit maintains absolute black in the picture.

The model V322B (shown in the picture) is identical but has the added facility of a viewfinder.—*The Marconi International Marine Co. Ltd., Elettra House, Westway, Chelmsford, Essex.*

For further information circle 11 on Service Card

12. Vibration Exciters

Derritron Electronic Vibrators has released two small electro-magnetic vibration exciters types VP4 and VP4B. These utilize permanent magnets for the field and are designed for high-frequency testing of sub-assemblies and components.

A magnesium-alloy table is used and five specimen fixing points are provided. The VP4B is supplied with a blower to provide additional cooling of the drive coil and can therefore be used with a more powerful amplifier and will deliver more thrust than the VP4. A 24-lb thrust is obtained from the VP4 with a type 100WLF power amplifier having an output of 100 VA, and that provided by the VP4B with a type 250WLF amplifier, delivering 250 VA, is 34 lb. The frequencies over which full thrust can be applied are 5 c/s to 8.9 kc/s, the first major table resonance occurring at the latter frequency. The vibrator is useful up to 10 kc/s.

The units can be supplied with or without trunnion fixing and when supplied with a type T4 trunnion fixing they can be used in either the horizontal or the vertical or any position in between.—*Derritron Electronic Vibrators Ltd., 24 Upper Brook Street, Mayfair, London, W.1.*

For further information circle 12 on Service Card

13. Stabilized 100-V Amplifier

Two all-silicon operational amplifiers with 50 and 100-V outputs have been introduced by the Burr-Brown Research Corporation. Employing an electromechanical chopper to reduce voltage and current offset and drift, both models 1943 and 1644 feature 160-dB gain and 3 Mc/s bandwidth. Drifts are ± 0.01 nA and ± 1 μ V per $^{\circ}$ C. The operating range is -40 $^{\circ}$ C to $+85$ $^{\circ}$ C, silicon semiconductors being used throughout to permit operation over this range of ambient temperatures. Operating power is obtained from external d.c. power supplies.

These chopper-stabilized amplifiers are especially suited for use in integrating, differentiating, sample and hold, and as low level preamplifiers. A standard Burr-Brown $3\frac{1}{2} \times 19$ -in. relay rack adaptor will conveniently mount up to 16 amplifiers. Each amplifier measures $3\frac{1}{2} \times 1\frac{1}{4} \times 7$ in. and weighs 12 oz.—*General Test Instruments Ltd., Station Point, Wokingham, Berks.*

For further information circle 13 on Service Card

14. P.A.B.X. Power Supplies

The constant voltage d.c. power required for private automatic telephone exchanges is provided by a low-cost power supply unit available from the Westinghouse Brake and Signal Co. Ltd. The unit is for use in temperate or tropical climates up to average ambient temperatures of 45 $^{\circ}$ C.

The series transistor constant voltage rectifier units are designed to operate from single-phase 50–60 c/s mains supplies of the following ranges of voltages: 100–110 V, 115–127 V, 200–220 V and 230–250 V. The voltage output is 50 V and the limits of variation of output are 48–52 V. These limits are maintained against mains input variations of up to $\pm 6\%$. Normal mains frequency variations will not affect the output voltage regulation. Three models are produced which supply the maximum currents of 3 A, 6 A and 10 A respectively. The output voltage limits are also maintained for variations of load current from 0.5 A up to their maximum output currents. A high degree of

smoothing of the output is achieved by the high a.c. impedance of the transistor and the ripple voltage produces an output at the telephone receiver equivalent to that produced by an 800-c/s signal of 2 mV.

The dimensions of the models are: for the 3 A model, $9 \times 6 \times 9$ in.; for the 6 A model, $12 \times 8 \times 15$ in.; and for the 10 A model, $15 \times 10 \times 20$ in.—*The Westinghouse Brake and Signal Co. Ltd., 82 York Way, King's Cross, London, N.1.*

For further information circle 14 on Service Card

15. V.H.F. Facsimile Receiver

A specially developed v.h.f. weather satellite receiving system has been announced by Rohde & Schwarz, of Munich. Already in use by the Federal German Meteorological Office at Offenbach, the system is fully automatic and more than adequately caters for the low-rate transmissions of the A.P.T. system (Automatic Picture Transmission) now fitted into weather satellites.

The system incorporates a frequency and time standard which feeds a programme contactor with a standard frequency of 50 c/s. The programme contactor serves as a time switch, and is so adjusted that the system is switched into operation the very instant a weather satellite shows on the horizon. The six controller drums of the programme contactor permit the exact number of satellite revolutions to be programmed.

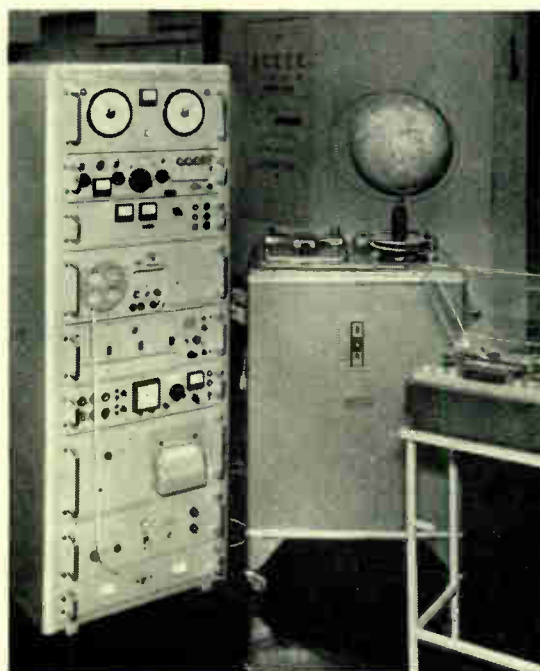

15

NEW

**ELECTRONICS
COMMUNICATIONS
INSTRUMENTATION
CONTROL**

The two-axis rotator carrying the helical receiving aerial is operated by means of a tape-programmed controller.

The signals picked up by the aerial pass through a low-noise preamplifier and are then applied to the crystal-controlled receiver. Frequency demodulation produces a sub-carrier output of 2,400 c/s of instantaneous amplitude corresponding to picture brightness.

A facsimile recorder produces the picture. This recorder combines the advantages of an electro-mechanical recorder with those of a photographic recorder, giving immediately a continuous series of high-quality pictures of cloud formations.

An aerial position indicator and tape puncher for programming aerial follow-up, completes the assembly. The system can be left unattended for 24-hr periods.

Full details of the system and supporting facilities are available from *Aveley Electric Limited, South Ockendon, Essex.*

For further information circle 15 on Service Card

16. Oscillator and Level-Measuring Set

The Testing Apparatus Division of Standard Telephones and Cables Ltd. has announced a complementary pair of portable battery-operated equipments for generating signals and measuring levels over the range 300 c/s to 300 kc/s.

The 74254-A oscillator has an output level variable in 1 dB steps from 0 to -49 dBm into 75, 125, 140 and 600- Ω circuits. The attenuator has two controls, 0 to -40 dB in 10-dB steps and 0 to -9 dB in 1-dB steps. A set-level control is incorporated in association with a meter calibrated ± 0.25 dBm. The output level accuracy is ± 0.1 dB at 0-dB output and at a temperature of 20 °C over the whole frequency range, although at other attenuator settings an extra 0.2-dB error may arise. Between 10 °C and 40 °C, changes in ambient

temperature will cause errors no greater than ± 0.2 dB. The harmonic content of the output will not exceed 1%. The frequency accuracy is $\pm 1\%$.

The 74255-A level-measuring set has been designed for use in conjunction with the 74254-A oscillator and has the same frequency range. The measuring range of the instrument is +21 dBm to -51 dBm and it can be used on 75, 125, 140 and 600- Ω balanced and unbalanced circuits. Both through and terminated levels can be measured, and an accuracy of ± 0.25 dB can be expected at the temperature of calibration. The use of negative feedback not only gives a flat response/frequency characteristic but also provides a high-impedance feed to the meter so that an almost linear shape is obtained across the 4½-in. scale. The meter is calibrated from +1 dB to -11 dB in 0.2-dB steps and works in conjunction with a switched control that enables an input-level range of 72 dB to be covered.

The level-measuring set weighs 12½ lb and measures 12¼ × 8 × 7¼-in. Like the oscillator, it uses eight 1.5-V dry cells and consumes about 40 mA. —*S.T.C. Testing Apparatus Division, Corporation Road, Newport, Mon.*

For further information circle 16 on Service Card

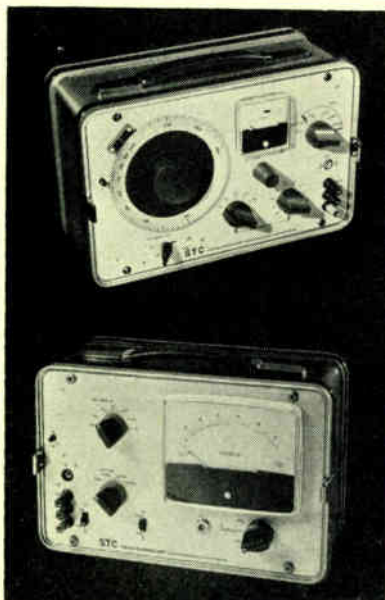

16

17



17. Two-Way Radio Intercom

The Motorola Overseas Corporation has announced the Transit 'Dispatcher', a two-way radio specially designed for use in railway trains and underground trains. The unit provides communication between the guard and the motorman and also allows communication to passengers over the train's public address system.

The transmitter-receiver is portable and can be plugged into a special mounting rack. It is fully transistorized and weighs less than 5.5 kg including microphone. Clear audibility under conditions of high ambient noise is provided by a 5-W audio output with less than 10% distortion. The unit operates on a 24-44 V d.c. external power supply and has an r.f. output of 8 W. All connections, including aerial, power supply and a foot-operated push-to-talk switch, are made through a single plug and the bottom of the radio.—*The Motorola Overseas Corporation, 9401 W. Grand Avenue, Franklin Park, Illinois, U.S.A.*

For further information circle 17 on Service Card

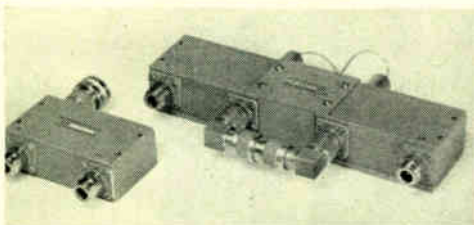

18

18. C-Band Tunnel Diode Amplifiers

A new range of tunnel-diode amplifiers has been developed for C-Band microwave link applications by Microwave Associates.

The frequency of operation of the amplifiers is 6.58-6.87 Gc/s with a

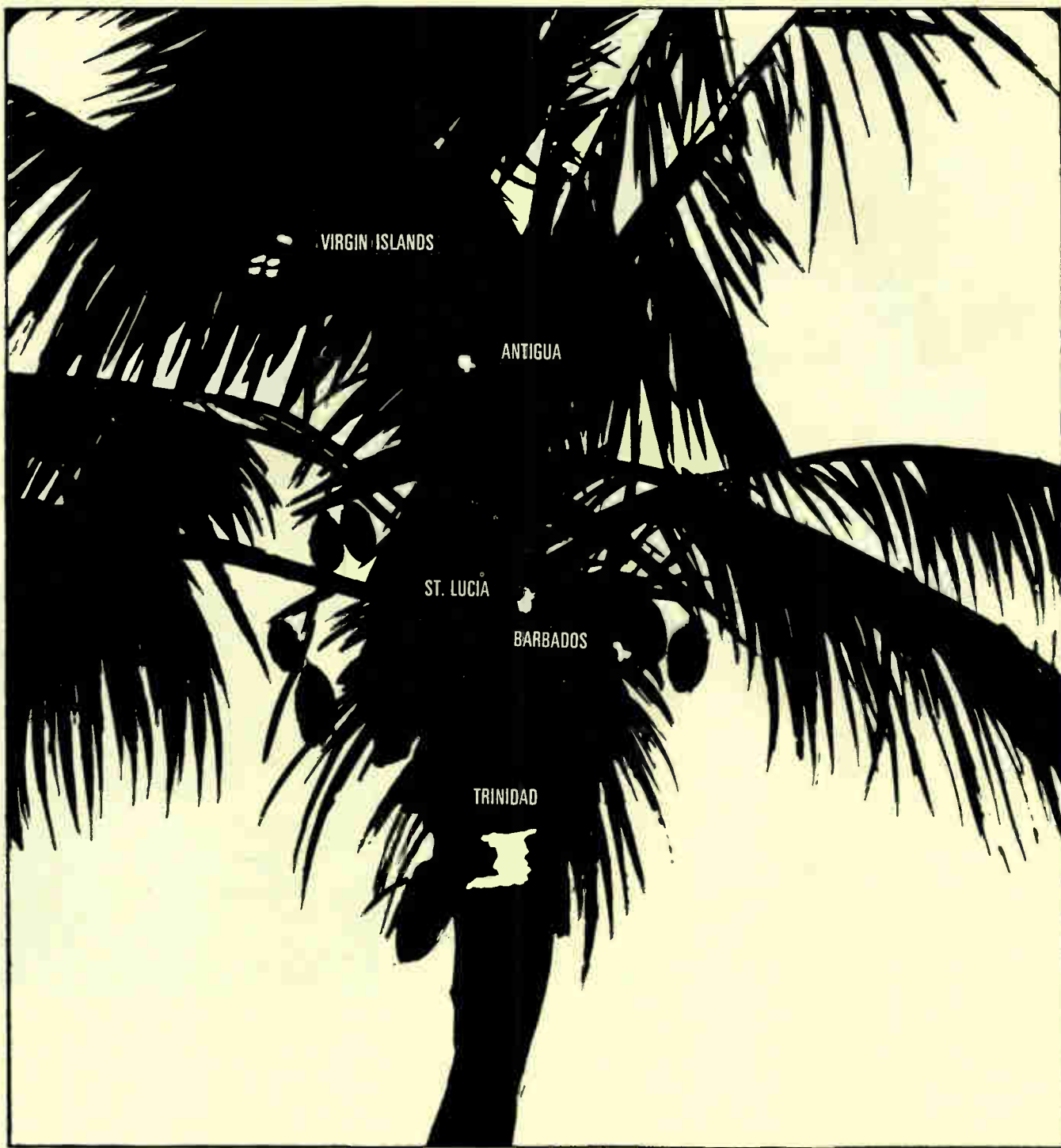

AEI GOES CARIBBEAN

New Communications Contract for AEI. From the shores of the Pacific to the South China Seas . . . from the bustling European seaboard to the waving palms of the West Indies, AEI experience spans the world.

Now, following their substantial contribution to the Commonwealth Submarine Cable System, and the new complex of transistorised multichannel undersea links between Britain, Scandinavia and the Low Countries, AEI are to supply Carrier Frequency Generating and Group Translating Equipment to the Marconi Company for the new Cable and Wireless multichannel radio telephone trunk network system in the Caribbean.

TA11971

This new contract is yet another instance of AEI's continuing participation and experience in important communications projects.

Where reliability matters, AEI equipment is used.

AEI
TELECOMMUNICATIONS

Associated Electrical Industries Ltd.
Telecommunications Division Transmission Department
Woolwich London S.E.18

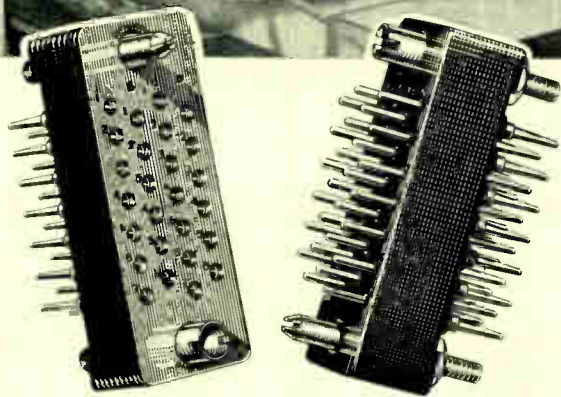
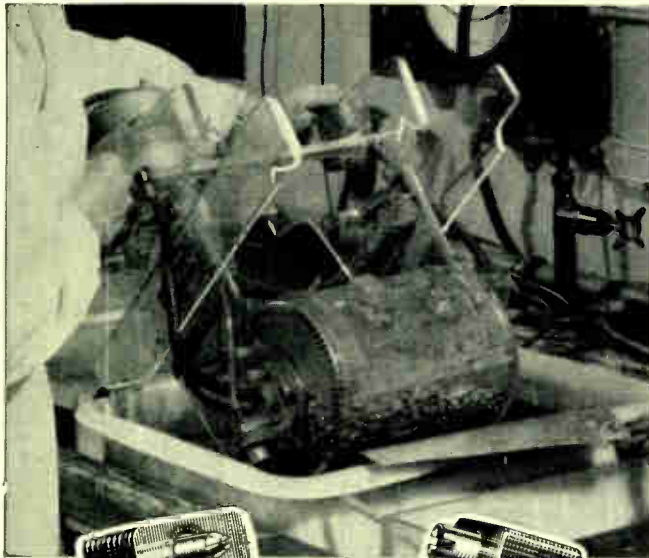

Standard Micronectors

A range of miniature plugs and sockets by **McMurdo** for rack panel and hire mounting. Gold plated contacts, Nylon P.F. or Melamine moulding. Solid drawn aluminium covers with top or side entry and rigid cable clamps.

9.14.18.26.37.41.50 ways
R.C.S.C. Quality approved

Can be supplied with taper tag terminations as illustrated for use with A.M.P. Series 37 receptacles



Gold Plating
Micronector contacts in an intermediary stage of gold plating

McMurdo

McMurdo Instrument Co. Ltd.

Rodney Rd., Portsmouth, Hants.
Tel. Portsmouth 35555. Telex 8612.

Contact our Sales Office for details of our full range

when quality counts... 

SODECO COUNTERS

for
**London
Airport
Car Park**



Photographs by courtesy of the Witton-Kramer division of GEC (Engineering) Ltd.

Sodeco counters were chosen by GEC for their photoelectric control equipment at London Airport multi-storey car park.

For administrative convenience two remote reading counter cabinets are installed, one at the car park entrance, the other in the superintendent's office.

These automatically record the progress of cars from floor to floor. With two entrances and exits on central floors it is necessary for the counters to be able to register simultaneous movement at four points on each floor. When only ten car spaces are left on any floor an automatic alarm is sounded and an indicator shows the floor concerned.

DR/SC/3A



PRODUCTS
MEASURE
COUNT CONTROL
PRECISELY

LANDIS & GYR LTD
VICTORIA ROAD
ACTON · LONDON W3
ACORN 5311

For further information circle 271 on Service Card

ADCOLA
PRODUCTS LIMITED
(Regd Trade Mark)

**SOLDERING
EQUIPMENT**

**SPECIALISING FOR THE
SOLDERING JOINTING INDUSTRY**

Illustrated

**$\frac{1}{4}$ " BIT INSTRUMENT
(LIST 64)
IN
PROTECTIVE SHIELD
(LIST 700)**

**ALL $\frac{1}{2}$ VOLT RANGES
FROM
6/7 TO 230/250 V**

**BRITISH & FOREIGN PATS.
& REG. DESIGNS, ETC.**

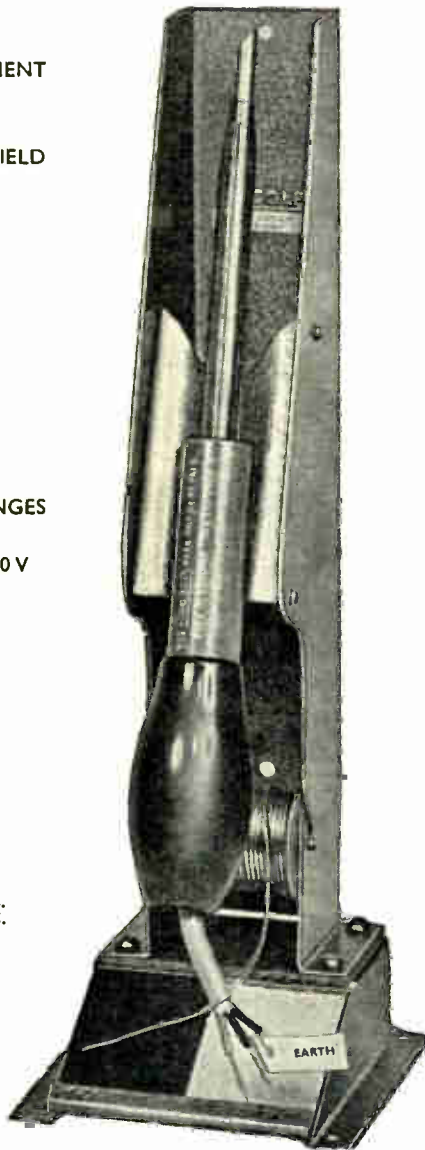

Apply Direct for Catalogues :

ADCOLA PRODUCTS LTD.

ADCOLA HOUSE

GAUDEN ROAD

LONDON, S.W.4

Telephones MACaulay 4272 and 3101

Telegrams SOLJOINT LONDON S.W.4

Industrial Electronics October 1965

G*

61

Let the

INDUSTRIAL ELECTRONICS

READER ENQUIRY SERVICE

help you to obtain more information

To obtain further details of any of the coded items mentioned in the Editorial or Advertisement pages of this issue, please complete one or more of the attached cards circling the appropriate reference number(s). Your enquiries will be passed on to the manufacturers concerned and you can expect to hear from them direct in due course. Cards posted from abroad require a stamp. These Service Cards are valid for six months from date of publication.

PLEASE USE CAPITAL LETTERS

Pour obtenir tous renseignements sur les produits codés mentionnés dans les articles ou dans les pages publicitaires de ce numéro, nous vous prions de remplir une ou plusieurs des cartes ci-jointes en encerclant le ou les numéros de référence appropriés. Vos demandes de renseignements seront transmises aux fabricants intéressés qui, en temps voulu, vous feront parvenir une réponse. Il est nécessaire d'affranchir les cartes postées de l'étranger. Ces cartes de service sont valides pendant six mois à partir de la date de publication.

PRIÈRE D'UTILISER DES CARACTÈRES D'IMPRIMERIE

Weitere Einzelheiten über irgendwelche Artikel, die auf redaktionellen oder Anzeigenseiten erscheinen, erhalten Sie, indem Sie eine oder mehrere der beigefügten Karten ausfüllen und die entsprechende(n) Kennnummer(n) einrahmen. Ihre Anfrage wird an den Hersteller weitergeleitet, und Sie werden dann direkt von ihm hören, Karten, die im Ausland aufgegeben werden, müssen frankiert werden. Diese Service-Karten sind für sechs Monate vom Ausgabebetrag gültig.

BITTE IN BLOCKSCHRIFT AUSFÜLLEN

Per ulteriori particolari in merito agli articoli menzionati nel testo o nelle pagine pubblicitarie di questo numero, Vi preghiamo di completare una o più delle schede allegate chiudendo in un cerchietto il numero o i numeri di riferimento. La Vostra richiesta sarà inoltrata ai fabbricanti interessati che Vi risponderanno direttamente. Le schede dall'estero devono essere regolarmente affrancate. Questo scontrino di servizio è valido per sei mesi dalle data di pubblicazione.

**SI PREGA DI COMPILARE LE SCHEDE A
TAMPATELLO**

Con objeto de obtener más detalles de cualquiera de los artículos mencionados en las páginas editoriales o de anuncios de este número, sírvase rellenar una o más de las unidas tarjetas poniendo un círculo al número o números de referencia. Sus consultas serán transmitidas a los fabricantes interesados de quienes tendrán noticias directamente a su debido tiempo. Las tarjetas enviadas desde el extranjero requieren franqueo. Estas tarjetas de servicio son válidas durante 6 meses a partir de la fecha de publicación.

SÍRVASE ESCRIBIR CON LETRAS MAYUSCULAS

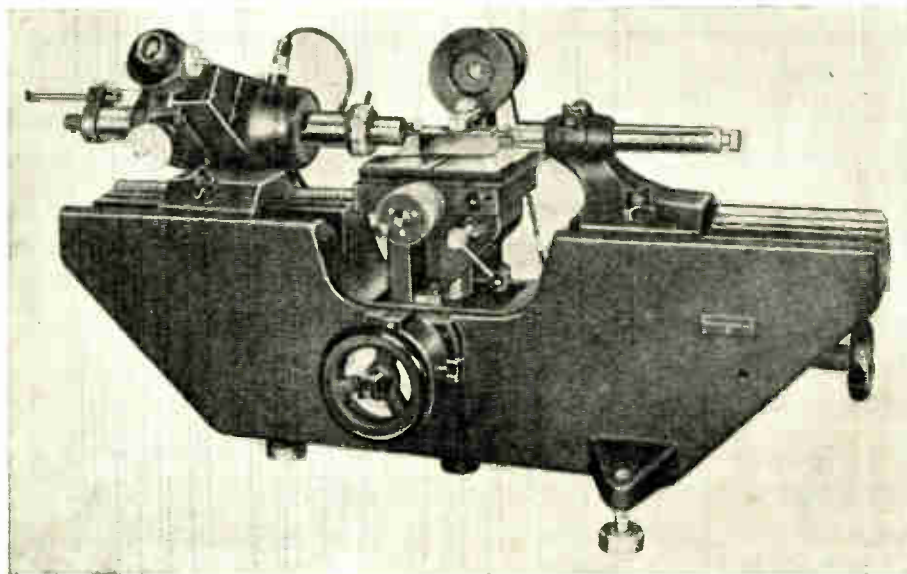

TOOL MAKERS' MICROSCOPES
 ABBE METROSCOPES
 UNIVERSAL HORIZONTAL METROSCOPES
 ANGLE DIVISION TESTERS
 UNIVERSAL MEASURING MICROSCOPES
 SMALL BORE MICROSCOPES

VEB Carl Zeiss JENA

Manufacturers of the world's finest scientific instruments for over a century

The Original Home of ZEISS

UNIVERSAL HORIZONTAL METROSCOPE

This entirely new instrument replaces the old optimizer and is extremely versatile. To be used for direct and differential measurement, for length measurement from

- 0-18" externally—Mechanical contact
- $\frac{3}{8}$ -7" internally—Mechanical contact
- 0-078-7" Electrical contact

This is also an excellent precision internal diameter measuring instrument. The "electronic eye" enables the stylus to contact the test piece without measuring pressure.

SPECIAL FEATURES:

- * **Extreme accuracy**
- * **A centering attachment for rapid centering or aligning the test piece for internal measurement.**
- * **Speed of work**
- * **Opto-mechanical indicating device for making rapid series measurements.**

For further information and details of the Carl Zeiss Jena range of Mechanical Instruments for length and Screw-Thread Measurements, Opto-Mechanical Instruments for Measuring lengths, Screw-Threads and Contours. Please write or phone:

C.Z. SCIENTIFIC INSTRUMENTS LTD.
 Zeiss England House, 93/97 New Cavendish Street, W.1
 Telephone: LANgham 0571/5

bandwidth of 110 Mc/s between the 0.25-dB points. The gain is 13.5 dB ± 1.0 dB and this varies by ± 0.9 dB over a temperature range of -20° to $+70^\circ$ C. A maximum noise figure of 5.0 dB is quoted and the amplifiers are claimed to be stable under all conditions of operation.

The units were designed with particular reference to the improvement of the performance of microwave relays where the distances between repeater stations are excessive.—*Microwave Associates Ltd., Crodock Road, Luton, Bedfordshire.*

For further information circle 18 on Service Card

NEW

**ELECTRONICS
COMMUNICATIONS
INSTRUMENTATION
CONTROL**

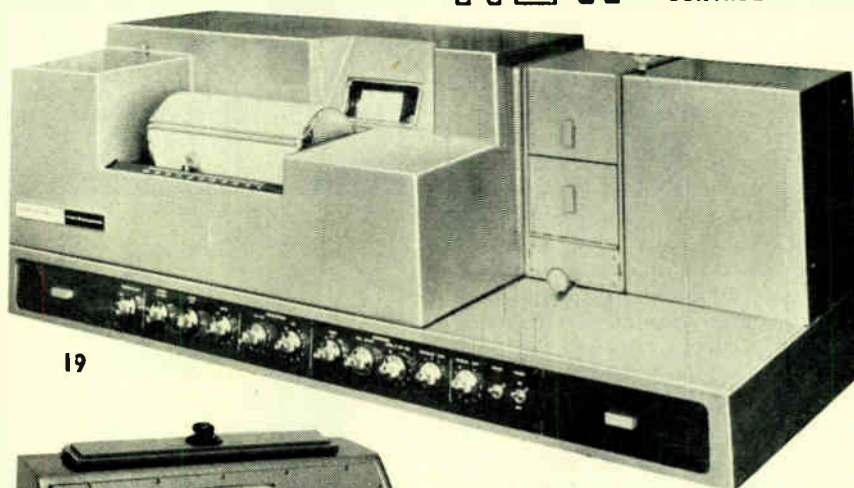

19

INSTRUMENTATION

19. Spectrophotometer

A high-performance recording spectrophotometer covering the ultraviolet, visible and near infrared spectrum from 165 millimicron to 2.7 micron has been produced by Perkin-Elmer Ltd. Its applications include qualitative and quantitative determinations of steroids and proteins, trace-gas analysis and classification of isolated double-bonds. The study of the spectral radiation of sources is assisted by the single-beam facility of the instrument.

The instrument is of the ratio-recording type and gives high resolution of 0.03 millimicron at 175 millimicron, and 0.1 millimicron at 250 millimicron. Also it has low levels of stray radiation of the order of 0.1% at 170 millimicron and 0.0002% at 210 millimicron. The energy level in the reference beam is kept constant and precise adjustments can be made to compensate for mismatched cells or aging of optical components.

The spectrum is recorded on pre-calibrated charts with linear absorbance or transmittance scales. Recordings can also be made at a single wavelength against time or a portion of the spectrum can be repeatedly recorded. Scale-expansion factors of up to 50 times normal are provided for the transmittance mode and a pen response control reduces the noise level.

A complete range of fused silica cells is available and the accessories enable the instrument to be converted for spectral fluorescent or optical rotatory dispersion measurements. Other accessories include units for diffuse reflectance, flame emission, microsampling and specular reflectance.—*Perkin-Elmer Ltd., Beaconsfield, Buckinghamshire.*

For further information circle 19 on Service Card



20

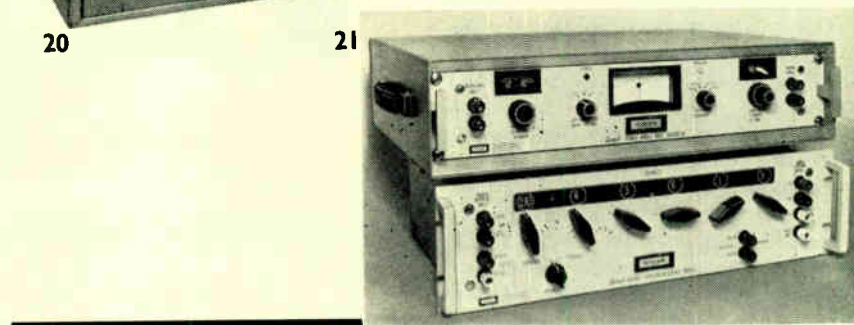

21

20. Precision Moisture Meter

A solid-state precision moisture meter is announced by Shaw Moisture Meters. This meter will test any fibre or textile for moisture content from absolute dryness to 25% regain.

Operation is simple; the material to be tested is inserted and a direct reading of percentage moisture content (regain) is displayed on the dial. Readings are not affected by hysteresis, power loss or any factor other than moisture content. The percentage regain is determined by means of measurement of the dielectric constant of the material being tested. A frequency of 20 Mc/s is used which ensures high accuracy. The accuracy is maintained by the use of a stabilized mains transformer.

The instrument is fully transistorized and the power consumption is 20 W. It is claimed to give at least 30,000

hours of trouble-free running and will test any type of natural or man-made fibre.—*Shaw Moisture Meters, Rawson Road, Westgate, Bradford.*

For further information circle 20 on Service Card

21. System Error Measurement

Now available from Wayne Kerr is a complete system-error bridge, comprising a decade synchro-resolver bridge (frequency range 200–800 c/s) and a phase-angle null indicator (full-scale ranges: 100 V to 10 mV).

The unit has been designed primarily for testing control transmitters, differentials (rotors) and torque transmitters or for simulation of an incremental control transformer in a servo loop. Because it has high resolution (0.001° steps) the unit can measure the output angle of synchros and resolvers, such as those used in radar aerials, inertial

NEW

ELECTRONICS
COMMUNICATIONS
INSTRUMENTATION
CONTROL

platforms, aircraft indicators and vertical and directional gyroscopes. Alternatively, the unit can simulate small errors in transmitters and generate accurately-known system inputs to autopilots and navigational computers. It can also determine sources of error in data transmission systems, attributable to cable loading, gearing dial readout, component angular accuracy, receiver or transmitter impedance, and voltage or frequency deviations.—*The Wayne Kerr Laboratories Ltd., Sycamore Grove, New Malden, Surrey.*

For further information circle 21 on Service Card

22. Synchro Position Analyser

The Muirhead K222A analyser will measure the angle represented by the three line-voltages from a synchro system to an accuracy of better than 0.3 minutes of arc, and has a resolution of 3.6 seconds of arc.

The instrument incorporates a resistive delta-bridge network, similar to the type used for synchro production testing, and may be set to any angle from 0 to 360 degrees. The output from the bridge is fed to a phase-sensitive detector (tuned to 400 c/s), which virtually rejects all harmonics and only measures the angle represented by the in-phase component of the line voltages. A phase shifter, covering the range 0 to 360 degrees and with a calibrated scale, is provided so that the reference voltage may be shifted through the same angle as the system phase-shift and measured.—*Muirhead & Co. Ltd., Beckenham, Kent.*

For further information circle 22 on Service Card

23. Gas Sample Counting System

Beckman Instruments have introduced a gas-sample counting system which enables sensitive measurements to be made of carbon-14 and tritium for age dating and tracer applications.

This product combines efficiency with low background noise for the detection, measurement and analysis of radioactive gases by the internal gas counting method. Designed for the measurement of low-energy beta emitters, the system can measure any beta or alpha-emitting sample which can be prepared in the form of a proportional or other counting gas. It will analyse carbon dioxide, methane and other hydrocarbons or gas mix-



22

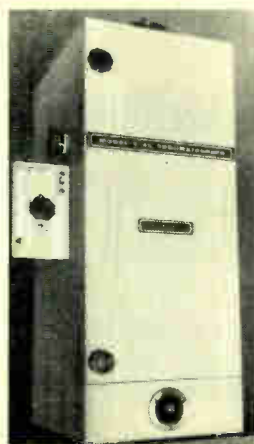

24

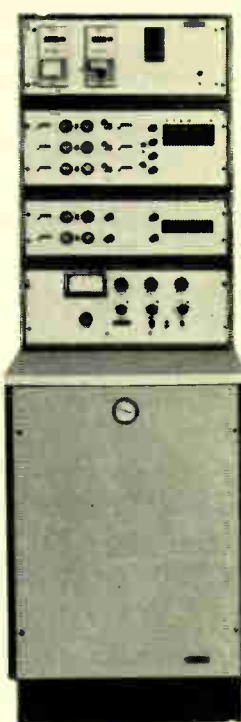

23

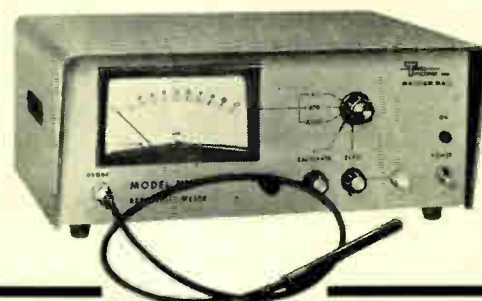

25

tures that provide a good proportional plateau below 10 kV.

A choice of four detector sizes is offered, 100, 250, 500 and 1,000 millilitres. The background noise generated by the 1,000-millilitre detector is less than 10 counts per minute. Using two detectors, seven counting modes are made available.—*Beckman Instruments Ltd., Glenrothes, Fife, Scotland.*

For further information circle 23 on Service Card

24. Valved Gas Chromatographs

Meter-Flow Ltd. are now marketing a gas chromatograph, the model C-40, under licence from Messrs. Instruments Incorporated, U.S.A. It is designed for general laboratory applications and can be used with flame detectors, thermistor detectors, thermo-couple or hot-wire detectors. Temperature control is standard.

The unit can be fitted with high-temperature sampling valves (internal to the chromatograph) and can also be

fitted with a gas-sampling system. Provisions are made for high-speed recording from the instrument.—*Meter-Flow Ltd., North Feltham Trading Estate, Feltham, Middlesex.*

For further information circle 24 on Service Card

25. Resistivity Meter

Teltronics are now producing a contactless resistivity meter for semiconductor materials. This unit, Model NNP, provides a measure of semiconductor resistivity through the use of eddy currents induced in the specimen. The measurement probe contains an inductor which forms part of the tuned circuit in a high-frequency oscillator. The lower the resistivity in the semiconductor material, the greater the amount of loading there will be and hence the lower the oscillation level.

The range of resistivity covered by the Model NNP is 0.001 Ω /cm to 5 Ω /cm. Accuracy in this range is $\pm 5\%$. The operating temperature

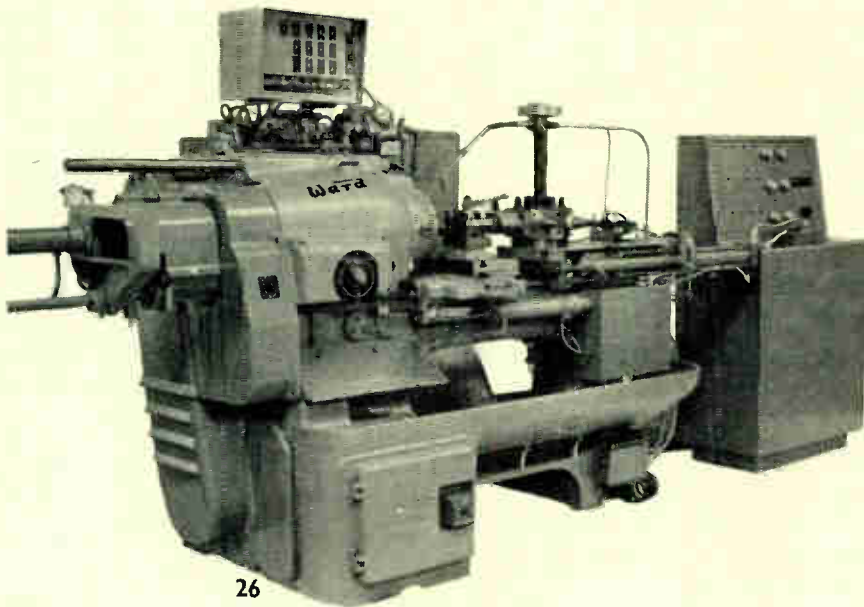

26



27



28

range of the probe is -50°C to $+100^{\circ}\text{C}$. The probe diameter is $\frac{3}{16}$ in. and the unit requires power from 115 V, 60 c/s mains. It is available in either a cabinet measuring $5\frac{1}{4} \times 13 \times 9$ in. or in a rack panel mount.—*EMEC. Inc., 160 Terminal Drive, Plainview, Long Island, N.Y. 11803.*

For further information circle 25 on Service Card

CONTROL

26. Tape Control for Capstan Lathe

Industrial Automation & Electronics Ltd. have produced a low-cost system for an automated tape-controlled capstan lathe.

This equipment uses a simple read-out mechanism which passes the information pulses from a punched-paper tape to mechanical memories. These hold the information until it is

cleared by further impulses from the tape and pass it on to discriminating circuits which actuate the pneumatic-hydraulic valves and power switches controlling the movement of the relevant parts of the lathe. The operations that are controlled by the tape include the movement of the turret, cross-slide and saddle to a fixed datum point, the movement of these simultaneously or separately at a selected rate during the machining cycle, the opening and closing of the chuck and the bar feed. Positional accuracy is within 0.002 in. and this is maintained by the use of linear transducers.

The tape used is 8-hole international and the positional information that can be recorded on it is in inches to three places of decimals. Tape programming is simple, the information being easily applied using the tape-punch provided. The control is suitable for single-cycle, manual or fully automatic operation with repeated machining

cycles using a continuous tape band. An overriding control is fitted to enable a supervisor to interrupt the automatic control. A built-in digital readout monitors the positional information.—*Industrial Automation & Electronics Ltd., Victorian Grove Works, Victorian Grove, Stoke Newington, London, N.16.*

For further information circle 23 on Service Card

27. Banjo Needle Valve

Sixplifix Couplings Ltd. have recently introduced a type of needle control valve which is arranged so that the needle is housed completely within the bolt of a banjo coupling. Adjustment of the needle is by means of a screw-driver slot, and the operating thread is external to the spindle seal which takes the form of an 'O' seal.

The bolt is of mild steel, zinc plated and passivated. The needle is high-duty bronze and the standard single or double banjo bodies with which the bolt can be used are manufactured from brass pressings. The maximum recommended working pressure for this valve is 500 p.s.i. and the maximum temperature is 100°C . This valve is suited for use in pneumatic or lubrication systems as a variable orifice and complete shut-off can readily be attained.—*Simplifix Couplings Limited, Hargrave Road, Maidenhead, Berkshire.*

For further information circle 27 on Service Card

28. Flame Failure Control

Photain Controls Ltd. are now marketing a plug-in photoconductive cell which can be used for many industrial applications including flame and smoke detection and control, automatic lighting control and conveyor control.

Designed for side-on illumination, the cell is primarily sensitive (over 220 sq. mm) in the red/yellow region of the spectrum, being insensitive to infra-red light, which forms the bulk of background radiations from hot brickwork. Suitable for operating from a 200/250 V a.c. supply, it has a rating of 1 W, a temperature range of -30 to $+70^{\circ}\text{C}$, and is capable of switching a relay direct without the need of an amplifier.—*Photain Controls Ltd., Randolph Road, Leatherhead, Surrey.*

For further information circle 28 on Service Card

29. Ambient-Temperature Compensator

A compensating device for cancelling the error introduced by changes in ambient temperature surrounding a thermocouple, which is calibrated to

NEW

**ELECTRONICS
COMMUNICATIONS
INSTRUMENTATION
CONTROL**

a specific reference temperature, is announced by the Moseley Division of Hewlett-Packard. The Model 17004A remote reference junction is a moisture-proof module which can be placed near a thermocouple to maintain the thermocouple e.m.f. output within $\pm 0.5^\circ$ in relation to the specific reference temperature, over an ambient range of $0-55^\circ\text{C}$.

Leakage resistance of the module from input to output is greater than $1,000\text{ M}\Omega$. The compensator connects between the thermocouple and a Moseley recorder and it consists of an independently-powered standard bridge circuit using a temperature-sensitive nickel resistor as the compensating element. Calibration and response

characteristics are adjusted for various commonly-used cold-junction thermocouples. The input of the device connects directly to the thermocouple, the output to a Moseley recorder.—*Hewlett-Packard, Dallas Road, Bedford.*

For further information circle 29 on Service Card

COMPONENTS

30. Miniature Relays

A range of inexpensive miniature relays for a.c. and d.c. is available from Magnetic Devices Ltd. The relays are enclosed in transparent covers and are mounted directly on the plug base, eliminating the need for independent mounting brackets. The

number of assembled parts has been kept low and the reduction in the number of connection points assists reliability.

The Series 120 (d.c.) and 125 (a.c.) models are two-pole change-over relays riveted to moulded 8-pin bases. Series 120 has a power rating of 3 VA and a maximum working voltage of 250 V and Series 125 has a power rating of 1.25 W with a working voltage of 125 V.

The Series 130 (a.c.) and 135 (d.c.) have three-pole change-over contacts and are mounted on 11-pin bases having anti-tracking barriers. The power rating of the 130 is 3.5 VA and the working voltage is 250 V while the Series 135 is rated at 1.5 W, the maximum working voltage being 125 V.

All the relays are rated at 6 A and have a coil resistance of 7.3 k Ω . The Series 125 and 135 operate in 10 msec and release in 6 msec. The maximum temperature that the relays can withstand is 40°C and they are available vacuum-impregnated for humid or tropical conditions. The components can be supplied with fine silver or elkonite contacts.—*Magnetic Devices Ltd., Exning Road, Newmarket, Suffolk.*

For further information circle 30 on Service Card

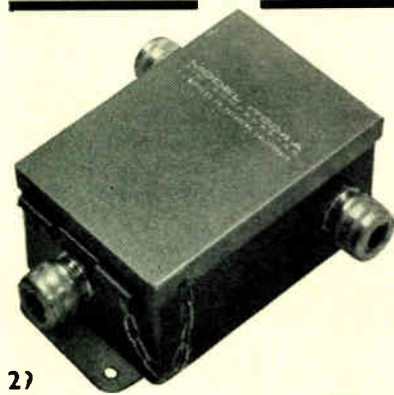

27

30

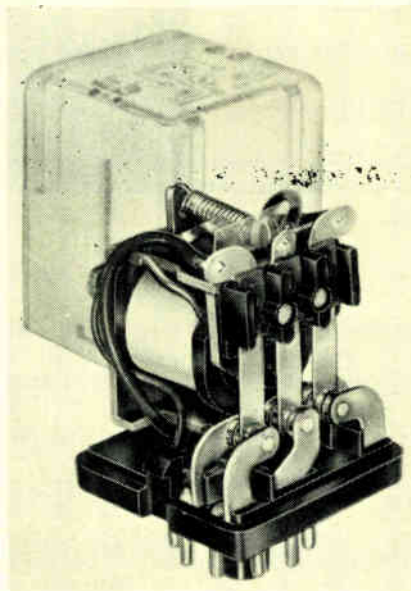

31. Industrial Heating Magnetron

A 25-kW magnetron, designed for industrial heating applications, has been introduced by Eitel-McCullough Inc. The EM15LS operates in the $915 \pm 15\text{ Mc/s}$ frequency band, and has a high d.c.-to-r.f. conversion rate giving 80% efficiency.

The water-cooled tube is designed to operate under widely varying load conditions and has a directly-heated tungsten spiral-cathode for use in severe industrial environments; it weighs about 25 lb, is 17 in. long by 7 in. in diameter and its ratings include 14 kV d.c. anode voltage, 3 A anode current, and 3 gal per min maximum water-flow cooling requirements.—*Walmore Electronics Ltd., 11-15 Betterton Street, Drury Lane, London, W.C.2.*

For further information circle 31 on Service Card



31

32

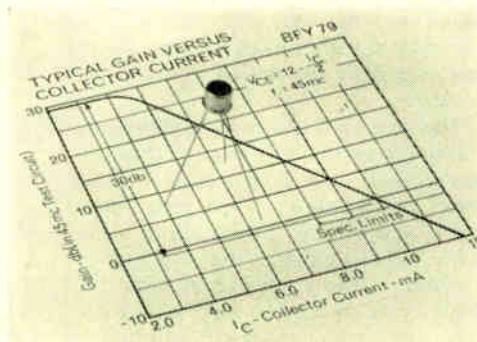

32. V.H.F. Transistor

The advantages of forward gain-control in i.f. and r.f. amplifiers have been increased by the introduction, by SGS-Fairchild Ltd., of a silicon v.h.f. transistor with guaranteed gain-control characteristics.

The new device, the BFY79, is an n-p-n silicon planar transistor, which has been designed for use within a

What is **RXE 11**?

An important new Shell development

A completely new resin casting system

A **liquid** resin system

Overcomes curing-agent problems

Easy to handle

Has outstanding crack resistance

Cuts casting costs

Provides a better-performance end product

RXE11 is the new EPIKOTE resin liquid casting system for the electrical industry

write for details now:

The Information Officer
Shell Chemical Company Limited
Shell Centre, Downstream Building, London, SE1
Please send me literature on the
RXE 11 EPIKOTE RESIN LIQUID CASTING SYSTEM

Name _____

Position _____

Company _____

Address _____

End-use requirement _____



Shell Chemical Company Limited
Shell Centre, Downstream Building, London, SE1

SHELL and *EPIKOTE* are trade marks

Increased protection cuts maintenance costs

The latest **A E I Protector-No. 16** provides an exceptionally high degree of protection for communication and instrument circuits.

It operates many times without attention and thus considerably reduces maintenance costs. The three-electrode construction enables it to replace two conventional protectors and, due to the tendency of both gaps to break down simultaneously, it minimises the excess voltages to which the apparatus is subjected.

The protector will withstand momentary peak currents of about 20,000 amps and many hundreds of 100 Joule discharges. Prompt delivery can be offered, because demand from many parts of the world has proved so high that production capacity has been greatly expanded.

The protector is available in three breakdown voltage ranges:—
150—350 d.c.
300—500 d.c.
500—900 d.c.

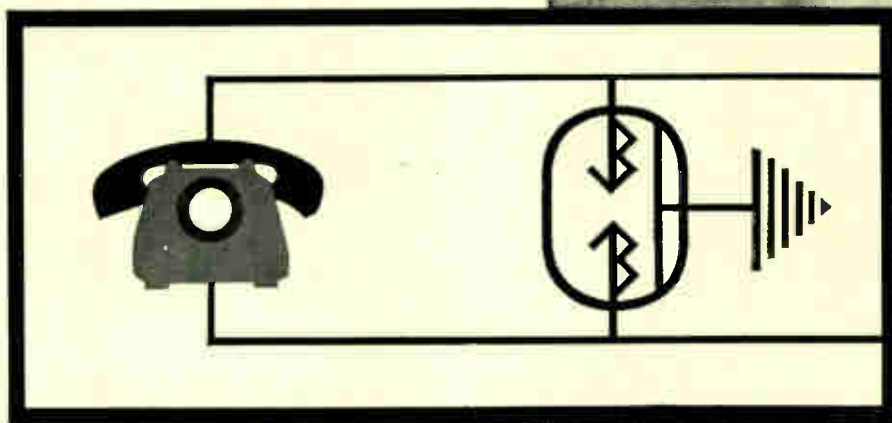

AEI

Associated Electrical Industries Limited
TELEPHONE APPARATUS DEPARTMENT
Telecommunications Division Woolwich London SE18

frequency range up to 250 Mc/s. It has a minimum power-gain guaranteed to be greater than 24 dB at 45 Mc/s, with a collector current of 4 mA.

The gain-control characteristic is specified to guarantee 30 dB gain reduction when the collector current is increased to between 8 and 12 mA in the specified circuit configuration. It can dissipate 300 mW in free air at 25 °C.—*SGS-Fairchild Limited, 23 Stonefield Way, Ruislip, Middlesex.*

For further information circle 32 on Service Card

33. Miniature Microswitch

The type 18 microswitch is now being manufactured by the Plessey Components Group under licence from the Licon Division, Illinois Tool Works Inc. This microswitch has been designed for applications where reliability in a small space is important.

The construction is of dual non-stressed beryllium copper blades and stainless-steel coil springs that ensure vibration and shock resistance and a mechanical life in excess of 10-million operations. Tests have shown no contact chatter at 25g between 10 c/s and 2 kc/s with the actuator depressed to within 0.0025-in. of trip. The type 18 is a double-break or two-circuit switch with a contact rating of 8 A at 250 V a.c. or 30 V d.c. The case and cover are moulded in diallyl phthalate to protect the gold-plated contacts against corrosion. The plunger movement is 0.050-in. pretravel and 0.10-in. overtravel. Excluding tags and plunger the dimensions are 0.51 × 0.2 × 0.35 in. — *Plessey-UK Ltd., New Lane, Havant, Hants.*

For further information circle 33 on Service Card

34. Plastic Conductivity Cells

Philips have produced a range of conductivity cells using 'Penton', an American chlorinated polyether. Penton is claimed to be corrosion-resistant to a wider range of fluids than any other existing plastics material. There are two main types of cell, one having a cell constant of 1 cm⁻¹, making measurements possible over the range 0.1 micromho to 300 millimho, the other having a cell constant of 0.02 cm⁻¹ with measurements from 0.002 micromho possible. Both cells have coated wire-wound electrodes, insulation resistance between electrodes being 1,000 MΩ; the maximum permissible operating temperature is from 70 to 130 °C according to the chemical components of the fluid being measured. Each cell is supplied with two interchangeable jackets, one for immersion and the other for reference measurements. The reference jacket is en-

closed at the bottom to form a reservoir for a small quantity of liquid, and is used for reference purposes in temperature-compensated measurements.—*The M.E.L. Equipment Co. Ltd., 207 King's Cross Road, London, W.C.1.*

For further information circle 31 on Service Card

35. Heat Sinks

A.P.T. Electronic Industries Ltd. have produced a series of heat sinks which are available in four models.

The heat sinks Nos. LK 1111 and LK 1121 are shaped to provide a variety of mounting arrangements, both singly and in groups. The slotting pattern permits free air circulation, allowing efficient cooling at any angle, and two heat sinks can be bolted back to back with one transistor to increase the dissipation. These two types of heat sink are manufactured from 18 gauge high conductivity aluminium in a folded and slotted form. They are ready pierced for power transistor mounting and are finished in black. Their thermal resistance in free air is approximately 3.5 °C/W.

Heat sinks Nos. LK 1131 and LK 1141 are manufactured from solid aluminium finned extrusions, drilled for transistor mounting, and are also finished in black. The thermal resistance of these is approximately 1.6 °C/W, mounted vertically, and 1.75 °C/W mounted horizontally in free air.

The LK 1111 and the LK 1131 models mount the standard TO-3 outline transistors while the LK 1121 and the LK 1141 models mount the TO-36 outline transistors as well as power zener diodes and rectifiers. — *A.P.T. Electronic Industries Ltd., Chertsey Road, Byfleet, Surrey.*

For further information circle 35 on Service Card

36. Kilowatt Transducer

For true and reactive power monitoring in many instrumentation and control schemes, A.E.I. have introduced a transducer which, when combined with a voltage transformer and a moving-coil meter, can replace the older combination of current transformer, voltage transformer and complex wattmeter.

The type FB32/A1 is a resin-encapsulated magnetic ring core which can be threaded on to a busbar or cable. When connected to a voltage transformer it gives an accurate d.c. output, with an amplitude proportional to the vector product of load current and load voltage. This output will be proportional to either kW or kVAR, according to the method of connec-

NEW

ELECTRONICS
COMMUNICATIONS
INSTRUMENTATION
CONTROL

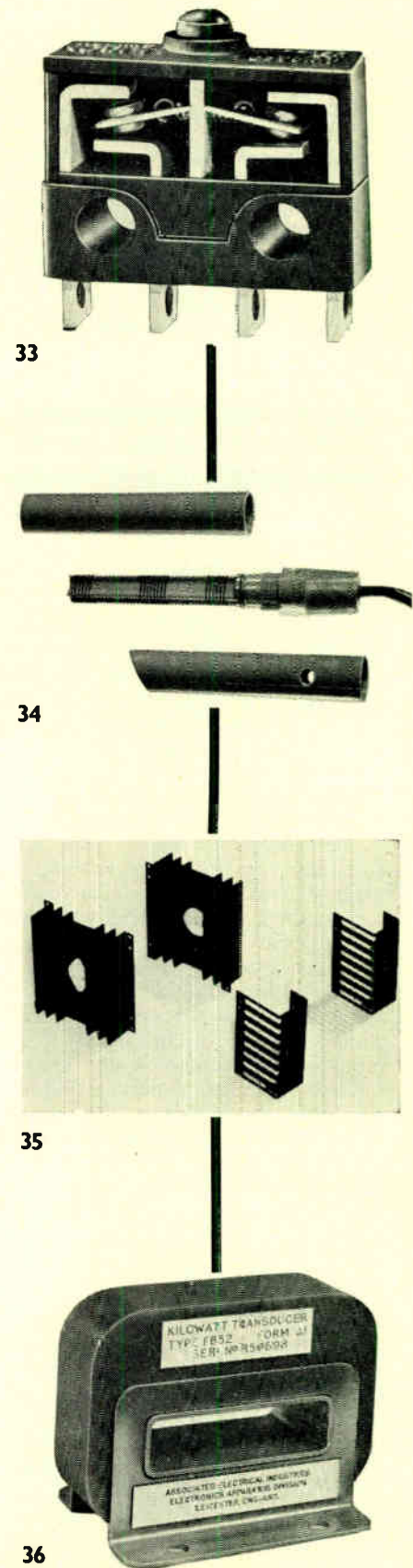

NEW

**ELECTRONICS
COMMUNICATIONS
INSTRUMENTATION
CONTROL**

tion, but an a.c. output with amplitude proportional to kVAr is also obtainable.

The transducer gives a high output voltage and low output impedance (5 to 20 Ω purely resistive), is small and has high linearity even at low power factors. Its frequency range is 35 to 65 c/s, and it may be used on single or three-phase supplies with balanced or unbalanced load.—*Associated Electrical Industries Ltd., Electronic Apparatus Division, New Parks, Leicester.*

For further information circle 36 on Service Card

PRODUCTION AIDS

37. Flaw Detection Equipment

C.N.S. Instruments Ltd. have announced that their eddy-current test equipment can now be supplied with magnetic saturation units enabling steel tube and rod of diameters 0.050–1.50 in. to be scanned for flaws and defects. The equipment, Type 720, comprises an eddy-current test unit, a power pack, a saturation unit, coils, a set of guides and a set of pole pieces.

The frequency range is 1–100 kc/s and time constants are variable between 5 and 100 msec. Five output sockets are provided, three of which are high-impedance outputs for oscilloscope display and two of which are low impedance for recording the outputs.

The saturation unit is fitted with two photocells to enable the signals to be suppressed at the end of the tube or rod being scanned, permitting continuous routine works testing. Automatic alarm circuits are optional extras.—*C.N.S. Instruments Ltd., 61 Holmes Road, London, N.W.5.*

For further information circle 37 on Service Card

38. Decade Counter

The Durant Unipulser is a high speed, single decade counter with visual and electrical readout manufactured by the Durant Manufacturing Co. who are represented in the U.K. by Perfection Parts Ltd. This electromechanical counter will count from transistorized circuitry, a photocell input or a standard contact closure. It also performs a control function of the counting recorded.

With the Unipulser, accumulated data is always retained even if power fails and the printed circuitry permits the handling of high electrical loads. Counting, controlling and readout are performed within the Unipulser and additional modules are not required for these functions. The count frequency is 40 pulses per second with a required pulse width between 12 and 500 msec and a pulse voltage between 15 and 150 V d.c. The reset voltage is 24–115 V a.c.

All electrical connections terminate on the printed circuit providing a plug-in arrangement so that a number of decades can be mounted together. This permits easy interchanging of decades. The normal life span of a single decade is 100 million counts.—*Perfection Parts Ltd., 59 Union Street, London, S.E.1.*

For further information circle 38 on Service Card

39. Anti-Corrosion Compound

Electrical and electronic equipment can be effectively proofed against failure due to moisture and corrosion with the Formula CRC-2.26 compound being distributed by Corrosion Abolition Ltd. This is a light, liquid

compound which has a low surface tension and will spread out over the treated equipment underneath any moisture that may be present. A protective film then forms to prevent moisture settling again. It also contains a light, non-drying, lubricant which will ensure the smooth action of any moving parts.

The liquid is sprayed on to the equipment to be treated using an aerosol spray and can be applied during manufacture, packaging and maintenance checks. Periodic application ensures protection against oxidation and any chemical or electrochemical action and there is no deterioration in the performance of equipment or lowering of insulation resistance values. Sometimes, equipment that has suffered from the effects of moisture can be restored to efficiency and resistance values improved by the removal of moisture with CRC-2.26.

The liquid is harmless and non-irritant to personnel and will not affect materials such as metals, plastics and rubber. It is supplied in aerosol cans or in drums for bulk orders.—*Corrosion Abolition Ltd., Camey House, Horton Road, West Drayton, Middlesex.*

For further information circle 39 on Service Card

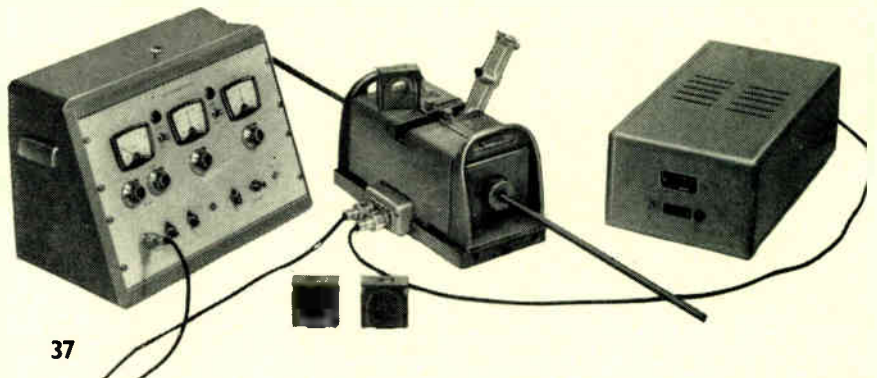

37



38

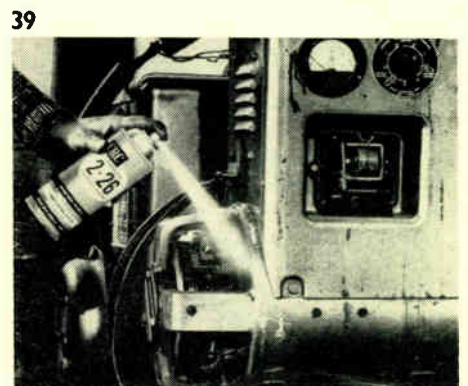

39

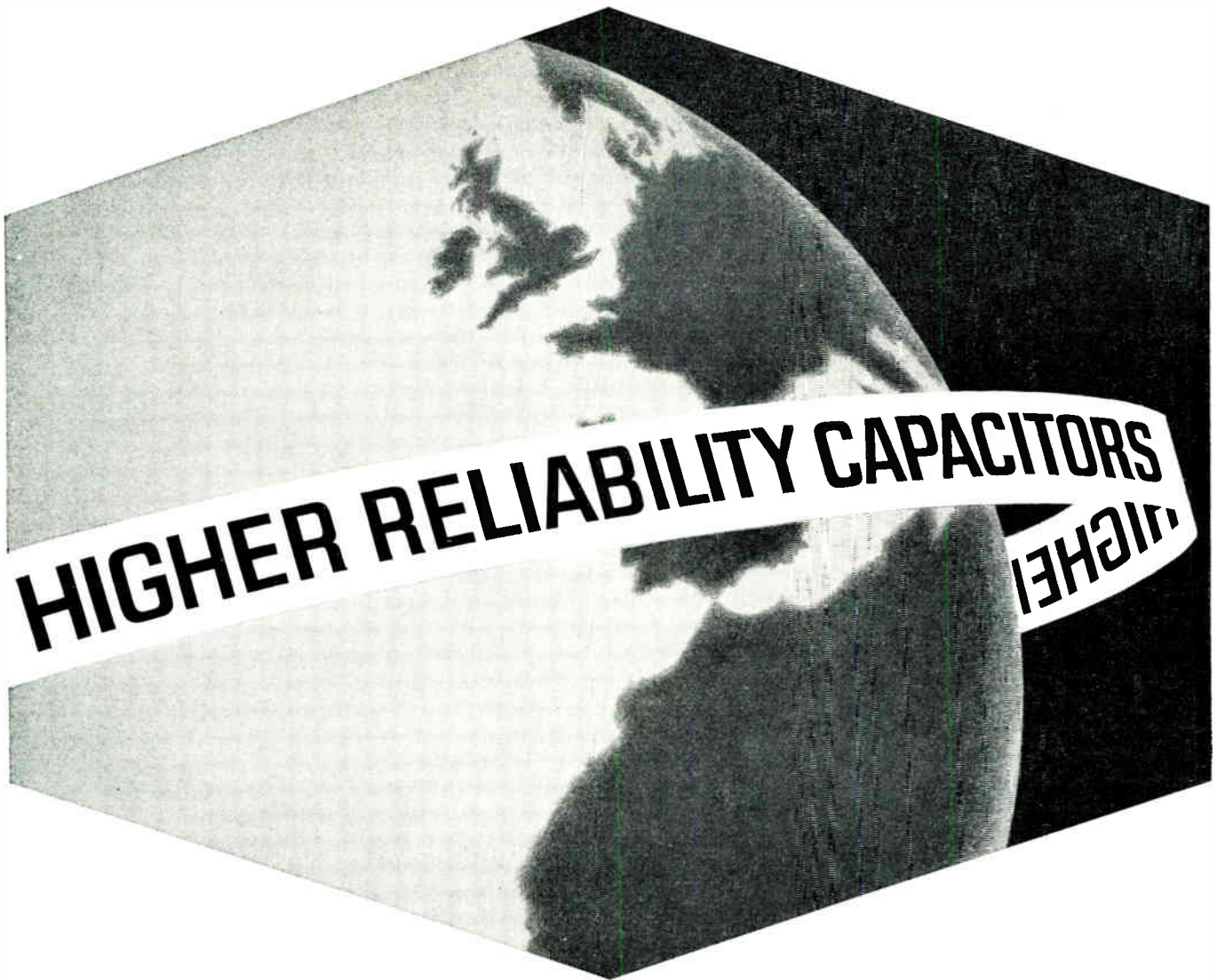

Union Carbide High Reliability GRJ-series— a new achievement in capacitors

Kemet GRJ-Series Solid Tantalum Capacitors are intended for use in critical applications where reliability must be known, and known precisely! This is why each and every batch of GRJ capacitors—no matter whether it be a quantity of ten or one thousand—is accompanied by a detailed summary of test results. And remember, these results refer not to a random

selection of components from the production line, but to the actual batch in question. For it is by 100% test and inspection of every batch that Union Carbide is able to guarantee a failure rate of less than 0.001% per 1000 hours. This makes GRJ-Series capacitors the obvious choice for the really important electronic circuits.

SOLID TANTALUM CAPACITORS ANOTHER PRACTICAL PRODUCT OF



**UNION CARBIDE LTD. Kemet Dept. Engineering Products Division, 8 Grafton St. London W.1.
Sales and Enquiries: Aycliffe Industrial Estate. Co. Durham. Aycliffe 2180.**

CHEMICALS • CRYOGENICS • DYNEL FIBRE • ELECTRONIC COMPONENTS • FERRO-ALLOYS • FLAME PLATING • PRESTONE ANTI-FREEZE • SILICONES • SUPERALLOYS • UCON LUBRICANTS

The terms Kemet, Dynei, Prestone, Ucon and Union Carbide are registered trade marks of Union Carbide Corporation.

WCW 65E

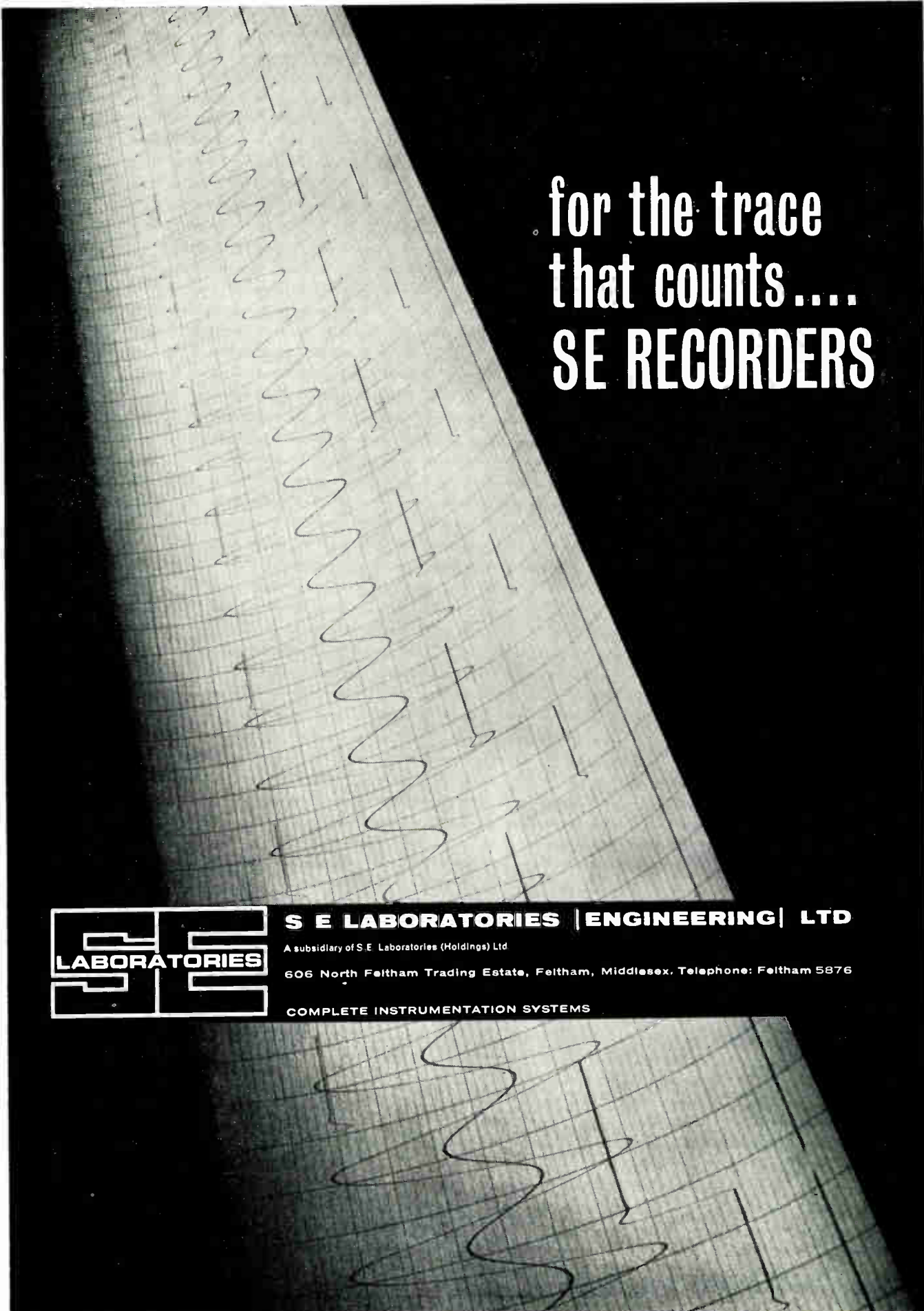

for the trace
that counts....
SE RECORDERS



S E LABORATORIES | ENGINEERING | LTD

A subsidiary of S E Laboratories (Holdings) Ltd

606 North Feltham Trading Estate, Feltham, Middlesex. Telephone: Feltham 5876

COMPLETE INSTRUMENTATION SYSTEMS

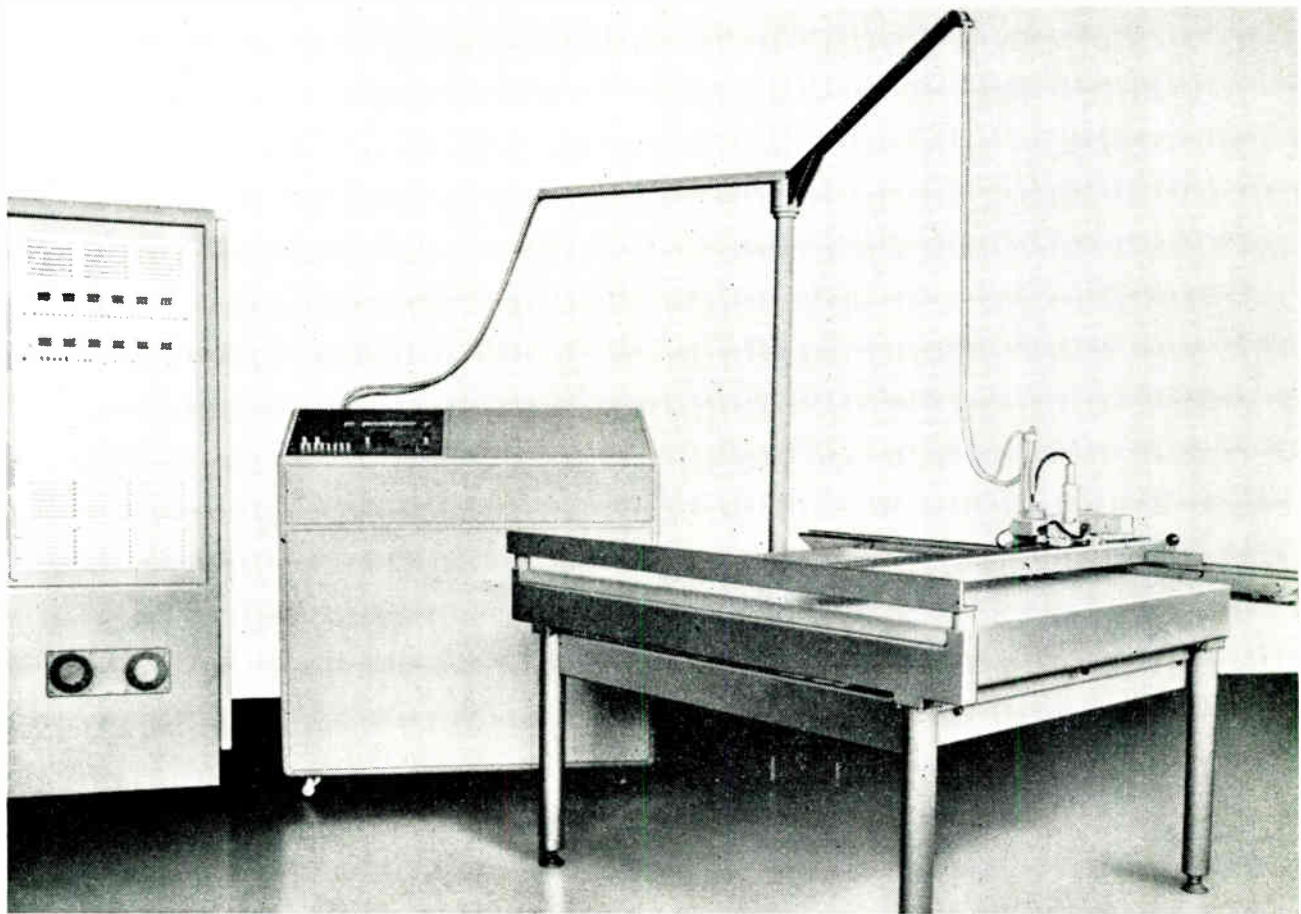

The complete co-ordinatograph showing the computer on the left, the control unit in the centre and the plotting table on the right

Computer Controlled Drawing Equipment

DATA processing, designing and machine-tool engineering can now be assisted by an accurate computerized drawing board known as the Co-ordinatograph. This has been produced by the Kynmore Engineering Co. and consists of a Haag-Streit plotting table driven by a Contraves control unit and a digital computer.

This equipment provides graphic representation of computer-derived structures and it will develop three-dimensional shapes, arranging the resultant two-dimensional shapes for maximum economy of manufacture. Curves, graphs and diagrams are drawn in response to instructions from the computer and data added to and inserted in the programme will show the effects of changes in parameters. Quantitative evaluation of optically-projected profiles of intricate components is possible so that signs of wear can be detected.

For machine-tool work the equipment can be used to test a machining cycle before the programme is applied to the machine-tool drives themselves.

The computer has a fixed word length of 24 bits, corresponding to 7 decimal places, and a memory capacity of 2,048 words. Information is fed in either by using a directly-coupled I.B.M. Selectric typewriter or via punched cards or paper tape. The input data is converted into binary form and passed on to the control unit. Index values for

co-ordinate plotting are computed 100 times a second and provisions for operations such as translation or rotation of axis are stored in the computer.

The control unit operates the servo-mechanism driving

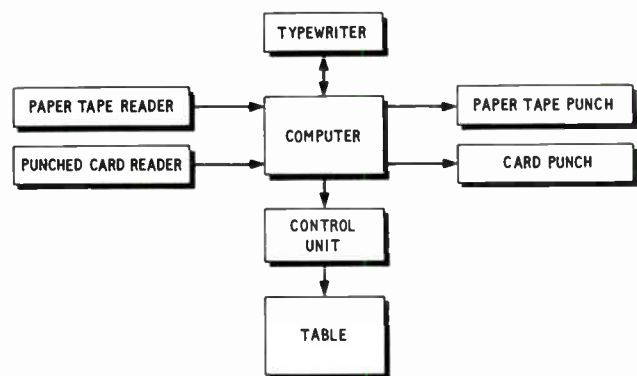

This block diagram shows the three inputs that can be applied and also how outputs can be taken to a Selectric typewriter or tape or card punches. It is possible to work backwards semi-automatically from an existing curve or profile to store data for the preparation of a programme

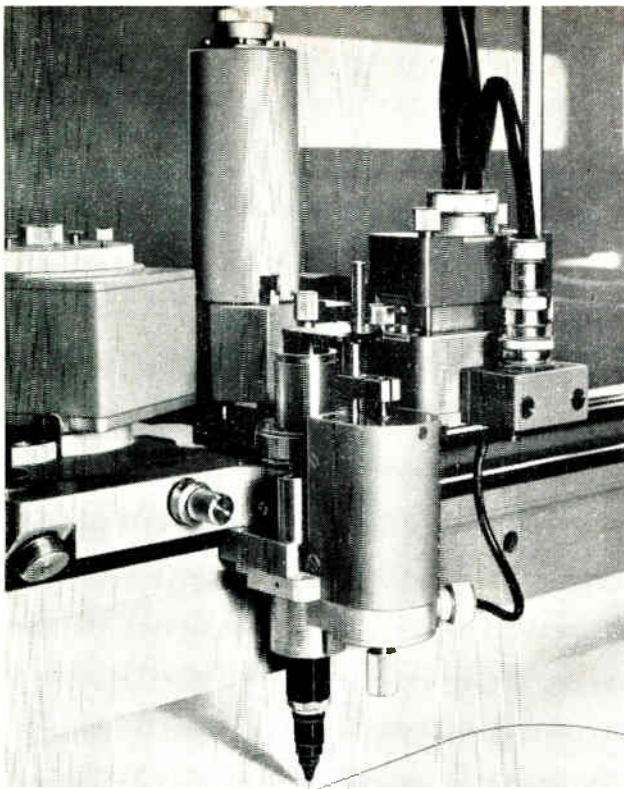

The plotting head shown fitted with a Rapidograph drawing pen

two carriages, one in the X direction and the other in the Y direction, which run on high precision racks. Separate measuring racks determine the position of the plotting head, which is attached to the carriages, and a calibrated dial provides a visual indication of the position. The plotting head is usually fitted with a Rapidograph drawing pen although other instruments can be used for fine-line and coloured work. Measuring signals are fed back to the control unit where they are compared with the signals from the computer, the difference signals being applied to the servo-mechanism for the plotting head-drive. This feedback system compensates for dynamic errors.

The maximum static positional error is ± 0.06 mm and the plotting head moves towards a specified co-ordinate position at a maximum rate of 80 mm/sec. A working area of 115×110 cm is provided by the plotting table and, as the X and Y co-ordinates are independently variable, the origin of axis can be set at any point on or off the drawing area.

For further information circle 44 on Service Card

Web Break and Edge Control by Ultrasonics

To provide an effective form of web-break detection and web-edge control for a recently-installed calendering machine John Galloway & Co. have fitted five sets of Sonac ultrasonic sensing and switching devices.

Two sets are mounted at one edge of the web (as shown in the photograph) with one acoustic beam path uninterrupted and the other broken by the passage of the web between the sensors. In the event of any lateral movement of the web, both beams will be either uninterrupted or broken (according to the direction of web movement). The

resulting output signals from the sensors are amplified and used to institute corrective action through clutch couplings. These are fitted to contra-rotating motors and their output shafts are coupled by a toothed belt to a reduction gearbox which mechanically moves the web when required.

The other three sensing units are located on either side of the web at critical points in the passage of the paper through the machine. If a break occurs the ultrasonic beam is allowed to pass between the two sensing heads and a signal is transmitted which is used to stop the machine.

This shows the two pairs of ultrasonic units which provide web-edge control

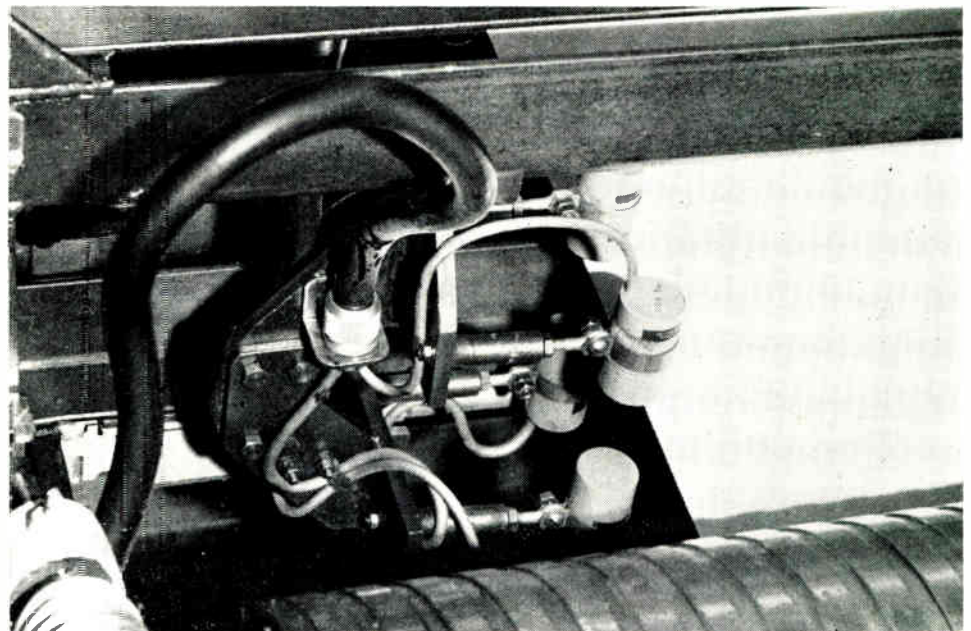

from AEI
the most
logical
switch of all

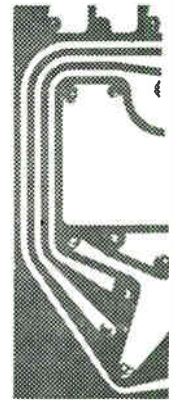
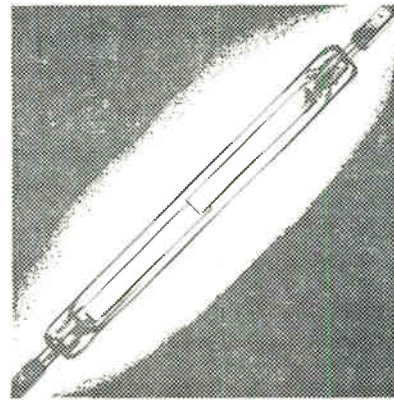
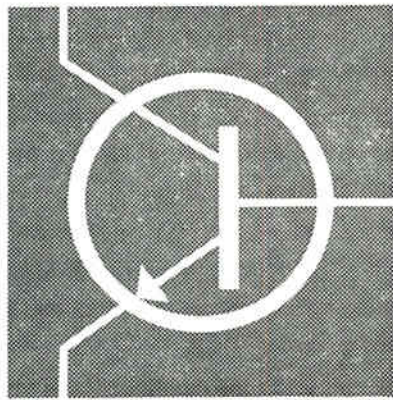
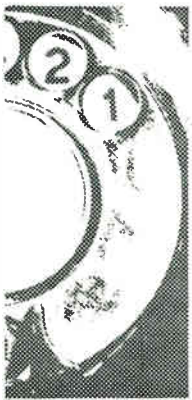

REX®

THE REED ELECTRONIC EXCHANGE

- Electronic common control spatial switching system
- Reed relay precious metal speech path
- Economic high speed operation
- Unlimited provision for future facilities
- Full system security
- Up to 70% saving of floor space
- Complete flexibility for extension and traffic growth
- Minimal and simple maintenance
- Universal compatibility

the most advanced factory produced telephone exchange system in the world

Developed in conjunction with the G.P.O. and other British manufacturers under the auspices of the Joint Electronic Research Committee

AEI
TELECOMMUNICATIONS

Please write for further information to

ASSOCIATED ELECTRICAL INDUSTRIES LIMITED • TELECOMMUNICATIONS GROUP • PUBLIC TELEPHONE SYSTEMS DEPARTMENT • WOOLWICH • LONDON S.E.18

TA2752

AMPLIVOX FOR COMMUNICATIONS

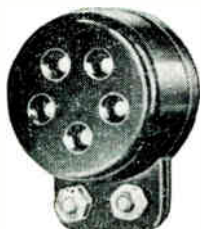
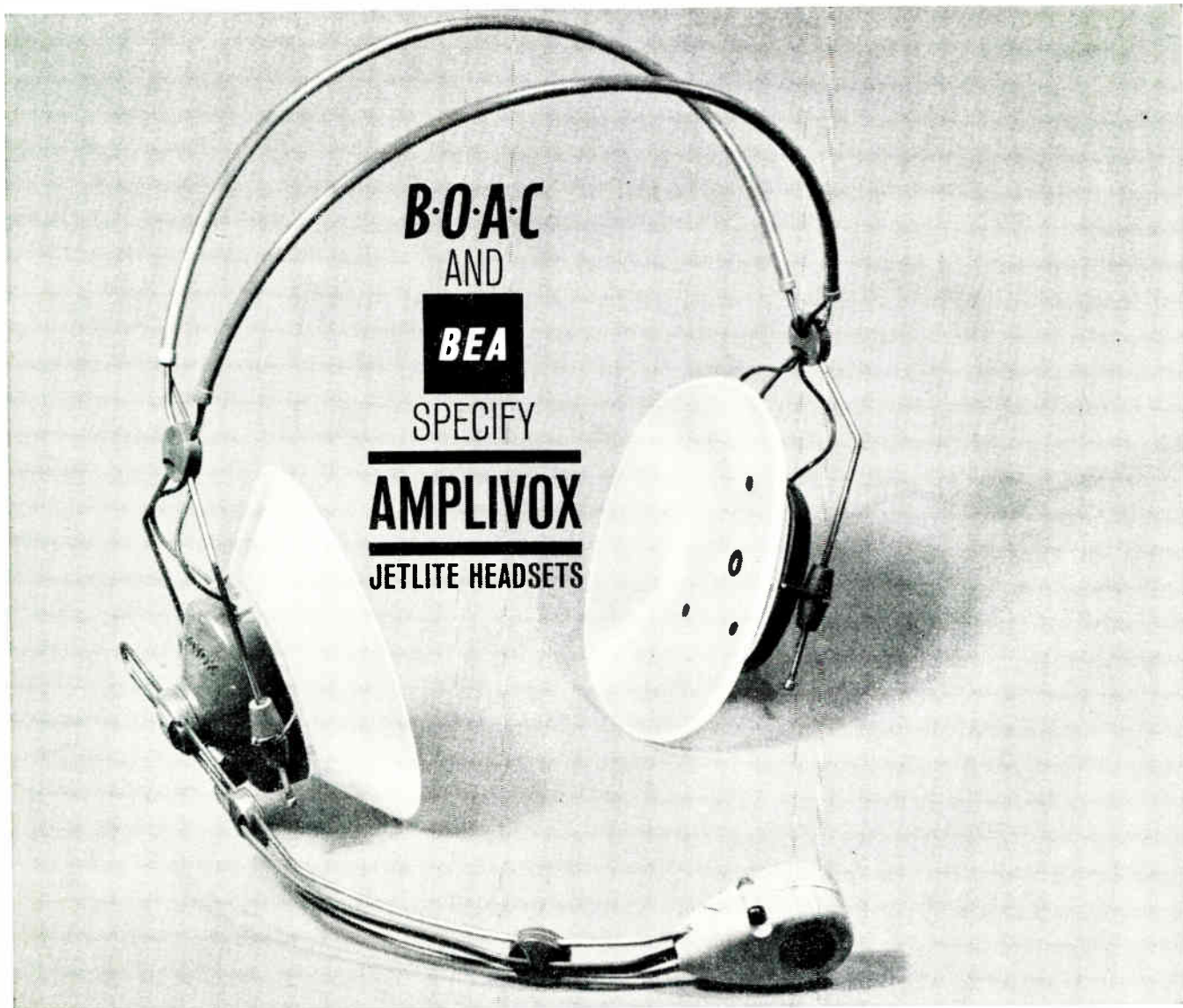

A range of tropicalised microphones and earphones



Ampligard: A range of noise excluding headsets



New Ear Defender Handset Type 16450



Noise cancelling hand microphone Type 15700



Ampliphone: Pocket size inter-communication system



New Throat Microphone Type 17600/1

Most products available for prompt delivery

AMPLIVOX

AMPLIVOX INDUSTRIAL DIVISION
BERESFORD AVE. WEMBLEY, MIDDLESEX.
Telephone: WEMBLEY 8991



Personal News

The new secretary of the National Electronics Research Council is **Lt. Col. J. P. A. Martindale, B.A., B.Sc., M.I.E.R.E., A.M.I.E.E., A.F.R.Ac.S., A.M.I.E.(Aust.)**. The Council is now occupying its own premises at 50 Bloomsbury Street, London, W.C.1.

R. A. Fisher has joined the Electro-mechanical Division of Standard Telephones & Cables Ltd. He will specialize on the sales of the division's acoustic products, covering mainly microphones, headsets and speakers.

John Stuart Pritchard, A.M.I.E.E., has been appointed head of sales for the Industrial Automation Division of Hawker Siddeley Dynamics Ltd. He has been associated with the sales of the company's electronic equipment for some time.

The Aviation Division of S. Smith & Sons (England) Ltd. have announced the appointments of **E. R. Sisson**, formerly director of technical services, as divisional manager, and **D. G. Johnson** as technical sales and services director. **Air Vice-Marshal M. E. M. Perkins, C.B., C.B.E., B.A., M.I.Mech.E., F.R.Ac.S.**, becomes a divisional director.

D. A. Higgs, A.M.I.Mech.E., A.F.R.Ac.S., A.B.I.M., has received the appointment of general manager of the Hymatic Engineering Co. Ltd. He succeeds **J. A. Hunt, M.B.E.**, who becomes executive director on the board of the Chloride Electrical Storage Co. Ltd.

Lord Erroll of Hale, M.I.E.E., M.I.Mech.E., has joined the board of Whessoe Ltd. Engineers. He will serve as a non-executive director.

Beckman Instruments Ltd. have announced the appointment of **W. A. Roberts** as product specialist (nuclear instrumentation). In this capacity he will be responsible for Beckman Sharp nucleonic equipment.

The Postmaster General has appointed **A. W. C. Ryland, C.B.**, a deputy director general of the Post Office in charge of telecommunications. He succeeds **W. A. Wolverson** who is retiring.

The Royal Commission on Trade Unions and Employers' Associations has appointed **Dr. W. E. J. McCarthy**, of Nuffield College, Oxford, as a research director. He will organise research into the methods of selection of shop stewards and will be considering questions such as the non-recognition of trades unions.

A. S. Fignis has become chief development engineer of Rank Pullin Controls. He will be chief of all research and development activities.

J. M. C. Dukes, M.A., D.I.C., A.M.I.E.E., has been appointed technical director for A. C. Cossor Ltd. Formerly he was with the Plessey Co. as a group chief engineer.

E. C. J. Jezierski has joined the Radio Communications Co. as chief engineer. He previously held the position of research director with Derritron Research and Development Ltd.

Harold Andrew Peterson has been appointed chief executive of the Plessey Co.'s South African Region. He will be responsible for all activities in that area.

R. H. L. Cooke, a director of the M.E.L. Equipment Co. Ltd., is the new president of the Scientific Instrument Manufacturers' Association. He is a member of the British Institute of Management and a founder member of the Society of Non-destructive Examination.

M. G. Guthrie has now become marketing manager of Westinghouse M.E. He has relinquished the post of publicity manager which is being taken over by **G. H. Stiles**.

W. Leslie Button, a director of Electronics Marketing Ltd., has been appointed marketing director of the Didcot Instrument Co. Ltd. He will be responsible for the marketing at home and abroad of all the company's products and services.



AIR TRAFFIC CONTROL RADAR FOR HEATHROW AIRPORT.—A Plessey AR-1 air surveillance radar system is to be installed at London's Heathrow Airport, and will be operational before the end of the year. The airport, one of the largest and busiest in the world, is already equipped with complex radar and navigational-aid systems, but is faced with the problems of ever-increasing traffic densities.

The system is being installed by the Ministry of Aviation to meet the exacting requirements of the terminal-approach and intermediate-range surveillance roles, and the equipment comprises a standard AR-1 radar system, with two transmitter/receivers in diversity and two autonomous displays.

The picture shows the approach control room of a similar installation at Guernsey Airport. On the left is the transistorized AR-1 display and control panel; on the right is the director's display (with a maximum display range of 25 miles); and at the centre is the talk-down display.

Wm. T. Starkey has been appointed managing director of Monroe International (UK) Ltd. and **C. C. Hill**, managing director of Royal McBee (UK) Ltd., joins the board of Monroe International and continues as secretary of both companies. Monroe International and Royal McBee are soon to become integrated.

D. G. Smee, M.B.E., Assoc.I.E.E., has become commercial director of the Marconi Co. He has been with the company since 1933, and has been assistant general manager for two years.

T. F. Gay, M.A., is now the secretary of the Domestic Appliances Division of the British Electrical and Allied Manufacturers' Association. He has been with the overseas division of B.E.A.M.A. since 1962.

Company News

Elliott Marine Automation Ltd., an Elliott-Automation subsidiary, has appointed **Walton Associates Inc.**, of Hoboken, New Jersey, as agents in the U.S.A. Walton Associates supply engineering cathodic protection systems and provide services in the areas of port facilities, drilling rigs, marine surveys and repairs at sea.

The Plessey Co. Ltd. have established the administrative headquarters of the new Electronics Group in London at Surrey House, Temple Place, Strand, W.C.2. The Plessey Electronics Group will be primarily concerned with the design, development and production of electronic equipment in the fields of radar, radio communications, radio telephones, transmission and marine systems.

Aveley Electric Ltd. have been appointed sole U.K. agents for **Holt Instrument Laboratories** of the U.S.A. The Holt equipment covers audio voltage standards, r.f. and a.c. voltage calibrators, thermal transfer voltmeters and audio oscillators.

Friden Ltd. has opened a new branch office covering London and the West of England. Named London West, the new branch office is at 98 Blackfriars Road, London, S.E.1. Its territory covers all West and North-West London postal districts and W.C.1, also Berkshire, Buckinghamshire, Middlesex and Oxfordshire. In addition, it will control the company's activities in Wiltshire, Somerset and part of Gloucestershire through an existing area sales office in Bristol, and Devon and Cornwall through another sales office in Plymouth. Manager of the new branch is Mr. Ian Skinner.

The Rediffusion Group has formed a new company, **Redifon-Astrodata Ltd.** This company will be concerned with the development, manufacture and marketing of analogue and hybrid computers.

A Management Sciences Division of C-E-I-R Ltd. has been established at 30-31 Newman Street, London, W.1. This aims to make the experience in management problems gained by the operational research groups more readily available to industry, commerce and government.

A distribution and manufacturing agreement between the **Plessey Co. Ltd.** and the **Bissett-Berman Corp.** of the U.S.A. has been announced that will extend the range of each company in the oceanographic and meteorological fields. Plessey will be the sole distributors for the Bissett-Berman products in the Commonwealth, South Africa, Holland, Norway and Sweden while Bissett-Berman will sell the Plessey equipment in America.

Three new overseas subsidiary companies have been formed by **Graviner (Colnbrook) Ltd.** to extend and develop its interests in Australasia and the Far East. These companies are Graviner (Australia) Pty. Ltd. in Melbourne, Graviner (Rolf Industries) Ltd. in Palmerston North, New Zealand, and Graviner (Hong Kong) Ltd. Their formation follows the acquisition by Graviner (Colnbrook) Ltd. of the issued share capital of Rolf Industries Ltd., of New Zealand, and its subsidiaries, Rolf Industries (H.K.) Ltd. and Rolf Industries (Aust.) Pty. Ltd.

MTE Control Gear Ltd., of Leigh-on-Sea, Essex, who manufacture components for electric motor starting and control and also build specialized control panels, have appointed **The Electrical Equipment Company (NI) Ltd.**, of Kelvin House, Adelaide Street, Belfast 2, as agents for Northern Ireland. The Belfast company will also act as authorized technical stockists, supplying components and, as an additional facility, control panels built from MTE components.

The sales division of **S. E. Laboratories (Engineering) Ltd.** have moved to larger premises at Astronaut House, Hounslow Road, Feltham, Middlesex (Phone: Feltham 2267 and 2395). They are also installing a permanent demonstration room. The rest of S.E. Laboratories (Engineering) and Meter Flow Ltd. will remain at the North Feltham Trading Estate.

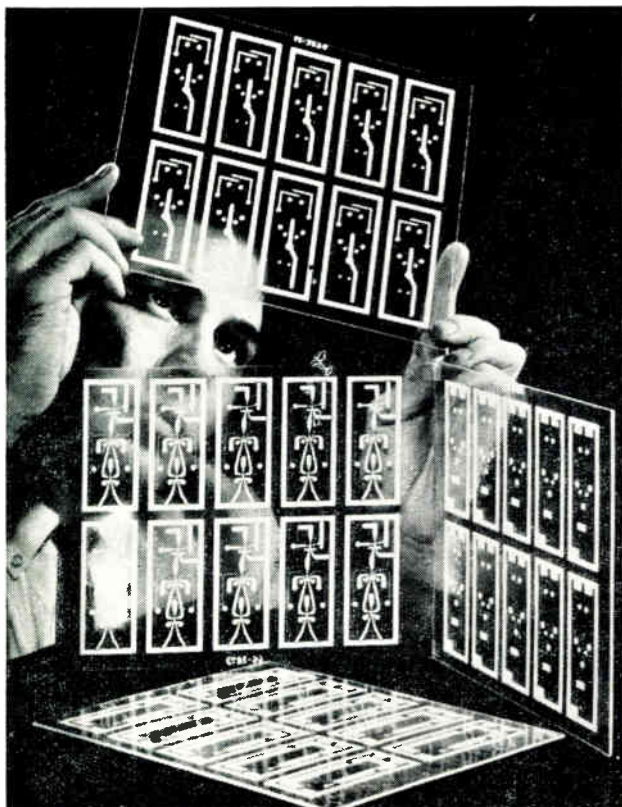

GLASS THAT 'TAKES PICTURES' is being used by the Corning Glass Works, of New York, to form devices called fluid amplifiers. In new kinds of control systems that run on air or liquids, fluid amplifiers are used to recognize instruction signals and for counting or switching.

To make the devices, a pattern is developed in photo-sensitive glass and the resulting paths are then partly etched away to form fluid channels. The four glass plates in the photo, when stacked and sealed, make up ten identical four-layered binary counters

Clarke, Chapman & Co. Ltd. now have a new electronics division which has been formed from a section of the research and development department. This division is concerned with the production of thyristor (s.c.r.) control units for motors and, although the original development work was directed towards marine winches and cargo-handling gear, the units available and being developed now are applicable to all types of lifting gear as well as the control of machine tool drives, conveyors, mixers and similar equipment employing motors of up to 500 h.p.

White-Rodgers Ltd. have announced the appointment of **Herwood Engineering Ltd.** as their distributors for Yorkshire and North-East England. Herwood Engineering Ltd. will stock the complete range of White-Rodgers thermostats, motorized valves, damper motors and controls for heating and ventilating.

A circuit design and advisory service has been set up by **J. Hengstler Company Great Britain Ltd.** at their Waltham Abbey works for the benefit of the spinning and machinery sector of the textile industry. The company will be directly responsible for negotiation with the textile machinery manufacturers. **J. Darbyshire & Co. Ltd.**, who have for many years been the textile agents for **J. Hengstler KG.**, will continue to operate as before, and be responsible for the winding machinery sector, direct sales to textile machinery users and for the servicing of mechanical textile counters.

Allied Industrial Designers have moved to 10 Rathbone Place, London, W.1. (Phone: Langham 8465). The group's services for the design of products, interiors, exhibitions, packaging, graphics and corporate identification will be housed in the new building, together with the newly-formed marketing consultancy company in which they have an interest.

International Rectifier, of Oxted, Surrey, has appointed **Harper Robertson Electronics**, of 97 St. George's Road, Glasgow, C.3 (Phone: Douglas 2711), as authorised industrial distributor for the whole of Scotland. International Rectifier is owned equally by the MI Group of London and International Rectifier Corporation of Los Angeles.

V. A. Howe & Co. Ltd. have been appointed sole U.K. agents for **Mat-Atlas; Mess-und Analysen Technik G.m.b.H.**, of Bremen. The company manufactures mass spectrometers and related equipment.

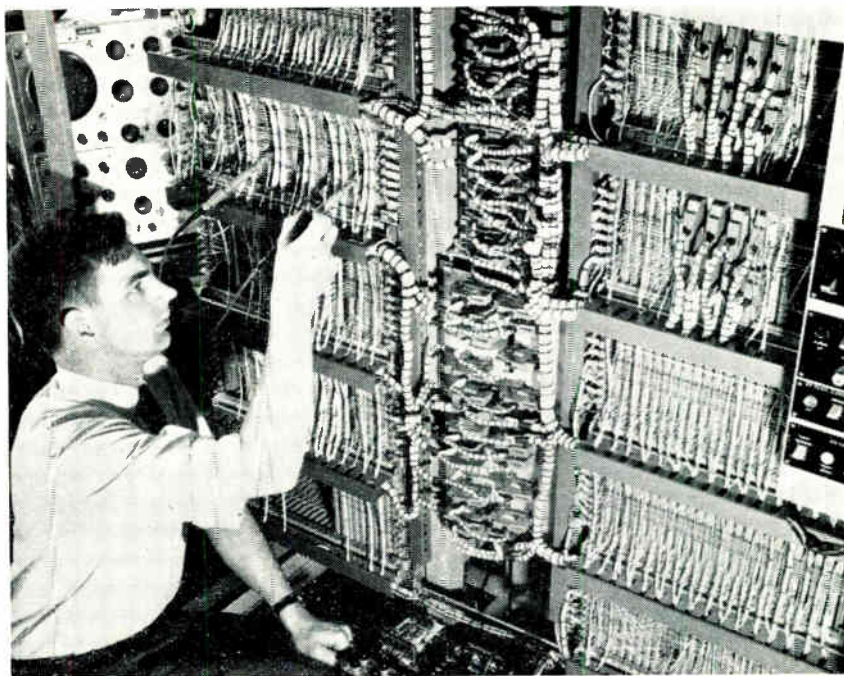

BRITISH COMPUTING SYSTEM.—A powerful new central processor, and a high-speed memory capable of storing more than a quarter of a million words, have been added to the **NCR-Elliott 4100** range of multi-purpose data-processing equipment introduced earlier this year.

The 4130 is fully compatible with the smaller 4120 unit, but is faster and more flexible, offering multi-programming facilities and incorporating high-speed floating-point arithmetic. Multi-access working with the processor will enable many different people, in offices remote from the computer installation, to use the machine at the same time.

The 4100 range uses standard interface connections for all units, enabling both the central processors and the peripheral equipment to be interchanged or expanded as required. All programmes written for the 4120 processor can also be used with the new 4130, without modification.

The picture shows the new processor being commissioned with a 2-microsecond core-store memory unit

Teddington Aircraft Controls Ltd. have been appointed as sole agents for the entire range of instruments and control components produced by **Giannini Controls Corp.** of America. This range includes gyros, aerodynamic probes and vanes and stepper motors.

Waycom Ltd. have announced their appointment as sole distributors in the U.K. for products manufactured by **Mial S.P.A., Milan, Italy.** Waycom will be offering all the Mial ranges of high grade professional polystyrene capacitors, in addition to a general purpose range for the entertainments industry.

Royal Charter for Council of Engineering Institutions

A Royal Charter has been granted to the Council of Engineering Institutions, formerly the Engineering Institutions Joint Council. His Royal Highness the Duke of Edinburgh will be the founder president for a period of five years.

The Council is a federation of thirteen chartered engineering institutions.

It was set up in 1962 to give expression to the views of the engineering profession, to provide joint action with the government and important national bodies and to establish common standards of professional competence.

Computers in the Chemical Industry

A detailed study of the application of a computer and advanced electronic equipment to the optimization of a complex industrial chemical process is being carried out jointly by the Distillers Co. Ltd. and Elliott-Automation. The experience gained by this study will enable the two companies to formulate computer techniques that can be applied to many aspects of the chemical industry.

The project is based at the reaction section of the Distillers Co.'s Industrial Solvents Division and the results will be applied to a larger plant which is to be completed in 1966. The computer has already been delivered and began operation in September.

Some entirely new ground will be

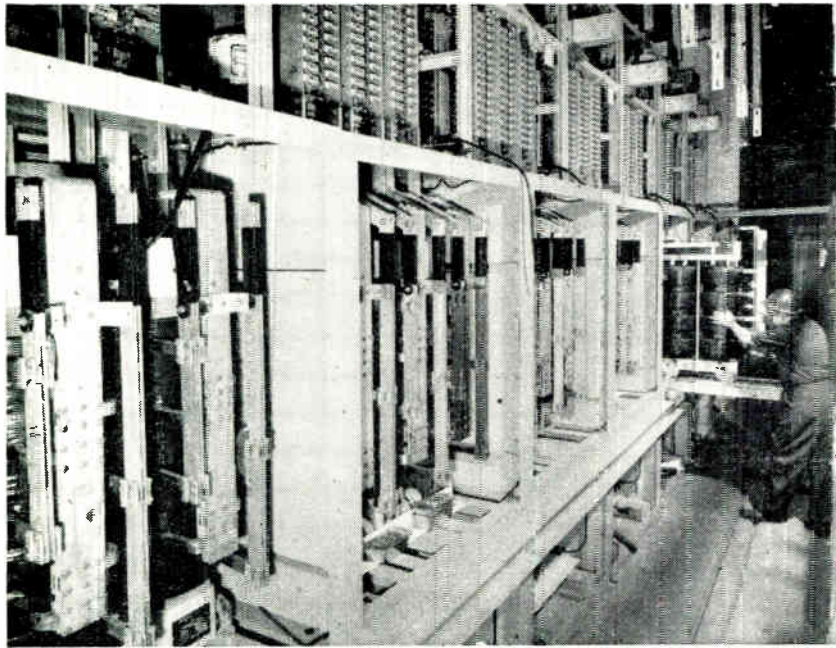

RECTIFIER EQUIPMENT FOR ELECTROTINNING.—The Westinghouse Brake and Signal Co. are installing rectifying equipment which will supply a plating current totaling 232,500 A to a continuous electroplating line at the Steel Company of Wales' Trostre Works.

To produce a tin deposit of the required accuracy the plating current is maintained linear with respect to the strip speed within $\pm 1\%$ at all speeds, the top speed being 1,500 feet per min. To facilitate accurate set-up for the width of the strip and the thickness of the tin required, a digital system is provided which accordingly attenuates the line speed signal and so controls the plating current

broken during the course of the study concerned in particular with the on-line analysis of complex chemical mixtures. A new knowledge and understanding of basic chemical reactions will be acquired to assist the company to obtain increased and more efficient production.

Cathodic Protection of Algerian Pipeline

A 500-mile oil pipeline owned by the Algerian Government Agency, Sonatrach, linking a reception tank farm at Haoud El Hamra and a coast terminal near Oran, is being fitted with cathodic protection equipment manufactured by S.T.C. Rectifier Equipment Division.

The equipment, installed by Corrosion Welding and Engineering Ltd., ensures permanent protection for the buried pipes against corrosion by means of a low-voltage d.c. current being passed through the protected metal to the ground. Various power outputs and different spacings are required for the units installed along the route depending upon the nature of the terrain and a survey has been carried out to obtain data on such factors as the resistivity of the ground.

Five of the units installed along the

pipeline provide 100 A and fourteen have outputs of 50 A at voltages between 7 and 48 V. Most of them will be situated along the mountainous northern third of the route and in the rainier areas, two-thirds of the route being in desert terrain. In regions where the new pipes run close by older pipes which also have cathodic protection, precautions have been taken to ensure that there is no electrical interference between the two, for this could result in serious corrosion.

Computer Automation for Cement Plant

A comprehensive computer control and centralized monitoring system is to be installed by Skanska Cementaktiebolaget—Sweden's largest cement producer—at its Limhamn plant near Malmo.

I.S.C. Ltd., of Wembley, an associate of G.E.C. Ltd., will provide the major part of the scheme by supplying the equipment for two central control rooms. One will control the cement production plant and the other the quarrying area and new raw-materials blending plant some 2 kilometres away from it.

Particular features of the scheme are

a computer control system for on-line regulation and optimization of the five wet-process kilns, and the control of the materials blending operation, which will incorporate on-line X-ray analysis.

The installations, which should be completed around mid-1968, will include a solid-state interlocking system (to provide automatic sequencing in the quarrying and blending process and in a large new cement kiln), remote manual control from both control rooms, and closed-circuit television monitoring of the kilns and quarrying.

Television Translator Equipment

Four television translator equipments are being produced for the B.B.C. which will improve the reception of B.B.C.2 programmes. These will be installed in areas where reception is poor due to local topography.

The equipment, built by the M.E.L. Equipment Co., receives the signals from a main transmitter, translates them to another channel, to avoid interference between received and transmitted signals, and, after amplification, re-transmits them. Both the video and audio signals are handled together as one broadband signal and retransmission is at a level of 1 kW. Except for the final klystron amplifier, the equipment is transistorized throughout.

Creative Analysis Service

Aircraft-Marine Products (GB) Ltd., whose range of electric-wiring components for industry includes 25,000 different terminals, connectors, printed-circuit components, programming systems and other equipment, have established a 'creative-analysis' service to assist design engineers and others employed in meeting the complexities of modern technology.

The free service is available, without obligation, to any manufacturer whose products include electric circuitry, and AMP technical advisers will study existing methods and prepare a report with recommendations for improving circuit reliability and lowering production costs. A complete analysis is made of the electric-wiring operation, from the design stage to a study of the most economical production method, and the latest techniques of manufacturing rationalization will be applied.

In the past, equipment design was often finalized before the production and economics of the wiring layout was considered. Now, a study of wiring at the earliest stage of planning has become imperative, and this new service should go some way towards meeting the need for a proper appreciation of its importance.

For further information circle 45 on Service Card

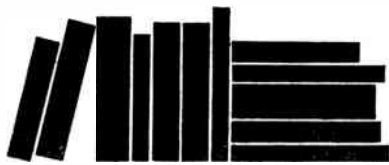

NEW BOOKS

Principles of Automation

By J. F. SCHUH. Pp. 380 + xii. Philips Technical Library, available in the U.K. from Cleaver-Hume Press Ltd., (Macmillan & Co. Ltd.), 10-15 St. Martin's Street, London, W.C.1. Price 72s.

Sub-titled 'What a Robot Can and Cannot Do', this book provides a detailed explanation of the basic mathematical and electronic principles of automation and computers. Commencing with a comparison between the human mind and nervous system and the workings of a computer, the author proceeds to outline basic ideas of signal theory, logic and logic circuits. The codes and languages used in computer programming are discussed with examples of how these are applied and the mathematics of computers is explained in easy stages. The text includes passages on Boolean algebra and Laplace transforms with an appendix on Fourier series.

Having dealt with the logical and mathematical ideas behind computation, the author then concerns himself with the electronic methods of how these are applied in practice. The principles of network and feedback theory are introduced and the text is concluded with remarks on analogue and digital signalling and a discussion on digital techniques.

This is not a book for the electronic engineer alone for it has been written with the interested layman in mind and in particular the student or engineer intending to enter this field.

Precision Electrical Measurements in Industry

Edited by J. R. THOMPSON, B.Sc.(Eng.), A.M.I.E.E. Pp. 123 + xiv. Butterworth & Co. (Publishers) Ltd., 88 Kingsway, London, W.C.2. Price 37s 6d.

Edited versions of the seven papers presented at a symposium held in 1963 on the procedures and practices in precision electrical measurements in industry form the subject matter for this volume. Summaries of the discussions that followed the reading of the papers are included.

The text commences with papers on the general principles of precise measurements and on the construction, qualities, care and maintenance of electrical standards. The papers following these are concerned with audio- and radio-frequency and precision frequency measurements and also with a method for checking precision decade bridges. General aspects of laboratory procedures and records are discussed in the concluding passages.

As a whole this book provides a useful and authoritative survey of some of the recent developments in the field of electrical measurement.

Topics in Communication Theory

By DAVID MIDDLETON. Pp. 126 + x. The McGraw-Hill Publishing Co. Ltd., Shoppenhangers Road, Maidenhead, Berkshire. Price 48s.

This book provides a concise introduction to the problems in communication theory of the detection of signals in and their extraction from noise, and optimum systems for these functions are discussed. Communication theory is regarded as a statistical process and the basic principles of statistical

decision theory are outlined in the first chapter. A basic knowledge on the part of the reader is required of such mathematical principles as the elements of probability theory, statistics, matrices, Fourier transforms, advanced calculus and the calculus of variations. Some new results in the development of a canonical theory of threshold detection and in detection and extraction theory are included although the exposition of these is not detailed.

The book is concluded with a critique of the general approach, and current areas of application and anticipated future developments are discussed. An appendix provides the mathematics needed for the examples that are used by way of illustration in the concluding passages.

Enamelled and Rayon-Covered Copper Conductors

British Specification 3902 : Part 1 : 1965. Pp. 18. The British Standards Institution, 2 Park Street, London, W.1. Price 6s.

This new British Standard specification replaces part of a standard published as B.S. 2479, which is being withdrawn since the rayon it specified as an alternative to natural silk is no longer available.

The rayon now in use requires an increase in the maximum overall diameter of the covered wire—but apart from this change, the technical requirements of the new publication are the same as those given in B.S. 2479. Requirements for silk-covered conductors are set out in B.S. 3685.

Part 1 of the new standard covers a range of bare diameters from 0.0016 to 0.064 in. inclusive, and gives requirements and dimensions for wire covered with oleo-resinous enamel and one or two layers of rayon yarn. The enamelled wire must comply with B.S. 156, Part 1.

Requirements for the chemical purity of the yarn, wire elongation and increase in diameter due to the rayon covering are included, together with methods of test.

English-French Dictionary of Electrical and Electronic Terms

By HENRY PIRAUX. Pp. 362 + xi. Editions Eyrolles, 61 Boulevard Saint-Germain, Paris, France. Price 38.90 F. including tax.

This edition numbers over 20,000 words or expressions. Several practical conversion tables between American, English and metric measures are included.

Quantum Electron Theory of Amorphous Conductors

By ALEKSANDR IVANOVICH GUBANOV, translated from the Russian by A. TYBULEWICZ. Pp. 277 + xv. Consultants Bureau Enterprises Inc., 227 W. 17th Street, New York, N.Y. 10011. Price \$17.50.

Published in Russia in 1963, the text has been revised and brought up to date for the English edition. It includes a critical review of experimental studies of the electrical properties and structure of liquid and glassy semiconductors, plus a separate chapter on the fundamentals of the quantum electron theory of solids.

Graded Problems for Electrical Engineers

By D. W. HINDE, B.Sc., M.I.E.E., M.I.E.R.E., and K. M. SMITH, A.M.I.E.E. Pp. 275 + ix. A Heywood book published by Temple Press Books Ltd., 42 Russell Square, London, W.C.1. Price 35s.

A complete range of problems is included with detailed solutions. Salient points in the theory precede each group of examples and they are followed by exercises. Answers to the exercises are given.

Ceramic Acoustic Detectors

By ALEVTINA ALEKSANDROVNA ANAN'EVA. Pp. 122 + viii. Consultants Bureau Enterprises Inc., 227 W. 17th Street, New York, N.Y. 10011. Price \$22.50.

Published in Russia in 1963, this book gives the results of investigations into the properties and possible methods of construction of piezoceramic transducers for various purposes, including acoustic and under-water acoustic detectors and transmitters used in measurement systems.

Amplifier and Memory Devices : with Films and Diodes

Edited by NOAH S. PRYWES, Ph.D. Pp. 456 + xv. McGraw-Hill Publishing Co. Ltd., Shoppenhangers Road, Maidenhead, Berks. Price £7.

This text by leading workers in the field seeks to train scientists for the creative development of new products and circuit techniques through comprehensive case histories. The devices chosen are the tunnel diode, magnetic films, parametric amplifiers and superconductive devices. Each device is described, starting with physical fundamentals and mathematical analysis and concluding with applications in devices and systems.

Penguin Survey of Business and Industry 1965

Edited by REX MALIK. Pp. 152. Penguin Books Ltd., Harmondsworth, Middlesex. Price 4s. 6d.

The subjects of the book include automation, management-worker relationships, future sources of power and a statistical picture of the U.K.

Manufacturers' Literature

Edwards Vacuum Measuring and Allied Instruments. A range of gauges, gauge control units, gauge heads and allied equipment for vacuum measurement and vacuum controlled switching is described and illustrated in the 6-page booklet, number 07676/1.

Edwards High Vacuum Ltd., Manor Royal, Crawley, Sussex.

For further information circle 46 on Service Card

Analog-Digital Converter Formatter for Tape Recording. Specifications and operational details for an analogue-digital converter are provided by this 6-page booklet which includes block-diagrams and a photograph of the unit.

Pastoriza Electronics Inc., 385 Elliot St., Newton Upper Falls, Massachusetts, U.S.A.

For further information circle 47 on Service Card

Television Sound Mixer. Two television sound mixer units are the subjects of the leaflets B/9001 and B/9003 Issue 1. Both of six pages, these publications describe the circuitry and construction of the units as well as the facilities offered. Data summaries and illustrations are included.

E.M.I. Electronics Ltd., Broadcast and Recording Equipment Division, Hayes, Middlesex.

For further information circle 48 on Service Card

Camlab Guide to Thin-layer Chromatography. The principles of thin-layer chromatography are outlined in this 80-page book which also discusses the basic equipment used in the technique. Operating instructions are provided together with details of the units and auxiliary equipment available. The illustrations are line-drawings and photographs and an index of published literature on chromatography is included.

Camlab (Glass) Ltd., Milton Road, Cambridge.

For further information circle 49 on Service Card

A Short Form Catalogue. This 5-page catalogue lists a range of ionization and corona detection equipment. The range includes discharge simulators, a dielectric loss analyser, display units and a step-wave generator as well as ancillary equipment manufactured by *F. C. Robinson and Partners Ltd., Southern Sales and Export, Davies House, 181 Arthur Road, Wimbledon, London, S.W.19.*

For further information circle 50 on Service Card

Transducers. This is a leaflet describing a number of hydrophones and pressure transducers. Each unit discussed is illustrated and specification figures are included.

Atlantic Research Corporation, Shirley Highway at Edsall Road, Alexandria, Virginia, U.S.A.

For further information circle 51 on Service Card

Precision Dynamic Weight/Time Liquid Calibrators. In this 7-page bulletin, number SP-9900, the models 9910 and 9900 dynamic weight/time liquid calibrators from Brooks Instruments are described. It is illustrated with line drawings and photographs and the operation and construction of the equipment are discussed.

Brooks Instrument N.V., Veenendaal, Holland.

For further information circle 52 on Service Card

Mono Stereo Recording Console. The Mono Stereo Recording Console Type 1404 produced by E.M.I. is described in the leaflet number B/SRC issue 2. Of six pages, this illustrated publication provides details of construction and circuitry as well as specification data.

E.M.I. Electronics Ltd., Hayes, Middlesex.

For further information circle 53 on Service Card

Electron Beam Evaporation Unit EVR 3. This 5-page illustrated leaflet gives the basic principles of and technical data for an electron beam evaporation unit. This unit is for the production of high purity thin films.

Balzars High Vacuum Ltd., Northbridge Road, Berkhamstead, Herts.

For further information circle 54 on Service Card

B.I.M.C.A.M. Handbook 1965/66. This 127-page booklet, published by the British Industrial Measuring and Control Apparatus Association, is a guide to the activities of B.I.M.C.A.M. and their members' products.

B.I.M.C.A.M., 23/24 Margaret Street, London, W.1.

For further information circle 55 on Service Card

Guide to Commercial DTL Integrated Circuits. A four-page quick reference guide 91-050 that presents schematic diagrams and complete model designations of 25 new DTL (diode transistor logic) integrated circuits for commercial computer applications is now available from Westinghouse.

The Westinghouse DTL circuit range includes a wide range of devices, such as NAND gates, flip flops, pulse binary counters, line drivers, level-detecting Schmitt triggers, and diode arrays. NAND circuits are available with one, two, three, four, and six gates having various combinations of multiple inputs, modes, and with or without collector resistors.

Westinghouse Electric International Company, P.O. Box 1133, Grand Central Station, New York, N.Y. 10017, U.S.A.

For further information circle 56 on Service Card



ENGLISH ELECTRIC

25kW
CW

FOR MICROWAVE HEATERS

The English C.W. Magnetron BM25L is designed specifically for industrial, scientific, medical and food processing applications in the authorised British and American 900 Mc/s band.

The BM25L Magnetron has a C.W. power output rating of 25kW at all phases of 2.5:1 v.s.w.r. This may be increased to 30kW, with an efficiency of 80%, when worked into a matched load.

ENGLISH ELECTRIC VALVE CO LTD CHELMSFORD ENGLAND
Telephone: Chelmsford 3491, Ex 262, Telex 99103 | AGENTS THROUGHOUT THE WORLD

EEV

DECADE OSCILLATOR

Available Now!

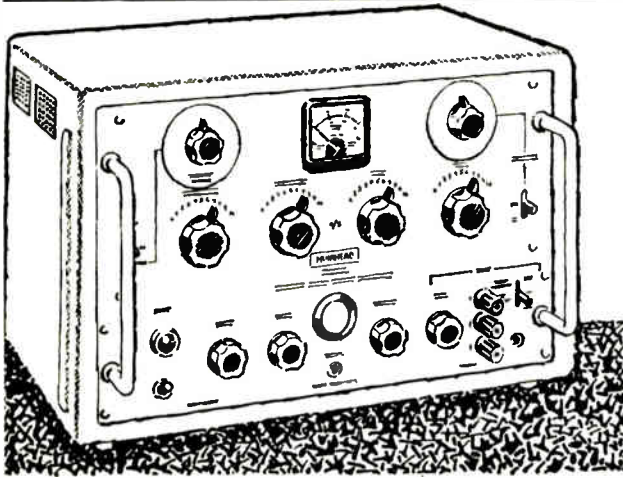

Accuracy—stability—reliability. All these features—and more—are provided by the Muirhead D-890-A Decade Oscillator. Frequency selection is by means of four decade switches, and a crystal check facility provides an instantaneous and accurate frequency standard. A one-inch c.r.t. on the front panel enables the oscillator frequency to be compared with the crystal frequency.

Brief specification :

Frequency Range 1/cs—111.1kc/s
Frequency Accuracy Using the crystal check facility, accuracies in the range $\pm 0.005\%$ to $\pm 0.1\%$ can be achieved.

Hourly Frequency Stability $\pm 0.02\%$

Maximum Output 126V into 8 kilohms (90V above 50kc/s)
25V into 600 ohms

We can tell you more about this instrument in Publication 136—send for it today.

'TECHNIQUE' A quarterly journal of instrument engineering—is of interest to all designers and available on request.

MUIRHEAD

MUIRHEAD & CO. LIMITED, Beckenham, Kent England.

Telephone : BECKENHAM, 4888 Telex : 262710 (MUIRHEAD BECKNM)

MUIRHEAD INSTRUMENTS INC., 1101 Bristol Road, Mountainside, New Jersey, U.S.A. Telephone Code 201 No 233-6010.

MUIRHEAD INSTRUMENTS LIMITED, Stratford, Ontario, Canada. Telephone : Code 519, No. 271-3880.

708

For further information circle 281 on Service Card

on reflection — **PRECISION METAL SPINNINGS**

On reflection think of deflection—and Precision Metal Spinnings. Illustrated from the range is a side shot passive reflector, 16 feet deep by 20 feet wide. Provided with a hurricane survival kit, it is obtainable in 20' x 24', 20' x 30' and 24' x 30'. On reflection, think of precision—and Precision Metal Spinnings. Most people do.

**PRECISION METAL SPINNINGS
(Stratford-on-Avon) LTD.**

Consultants in Metal Spinnings,
Microwave, Parabolic and Passive
Reflector designs.



Dept. IE, Masons Road, Stratford-on-Avon.
Tel. 3895

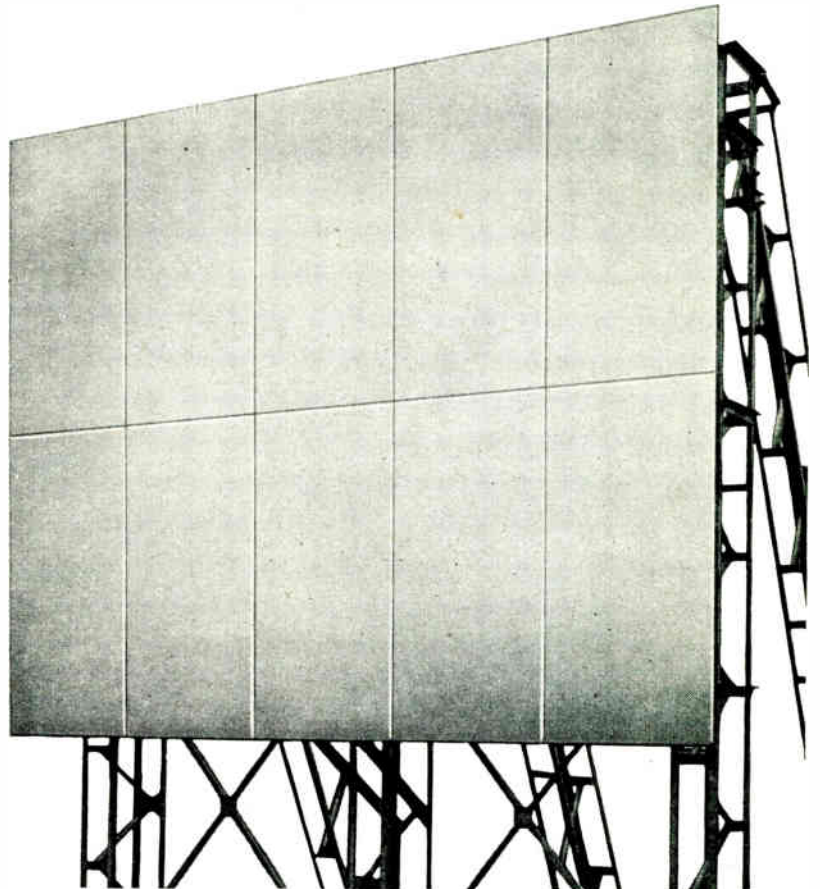

Sensitivity 40 μ V (1°C)

Multi-Million Operational life

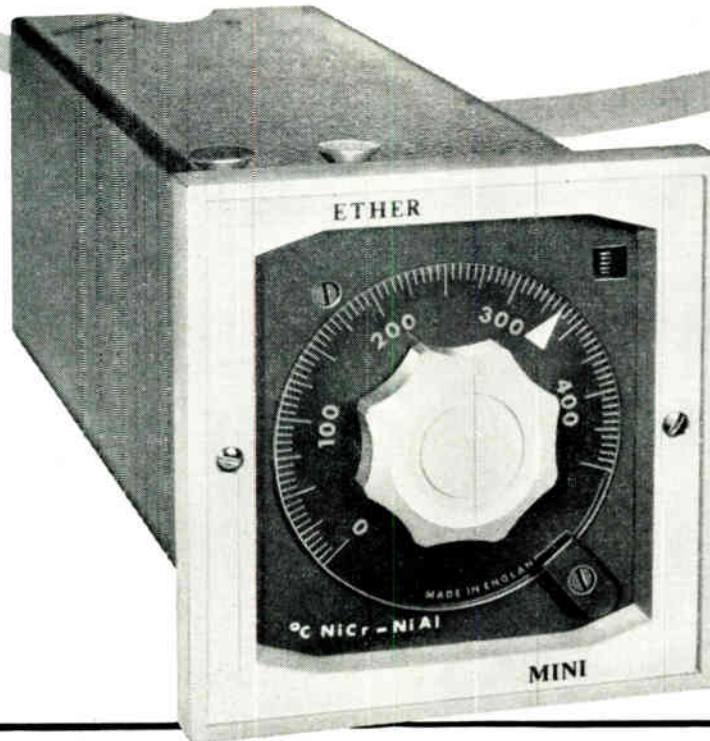

ETHER

TRANSISTORISED TEMPERATURE REGULATOR MINI TYPE 17-90

Accurate, Reliable Temperature Control up to 2000°C

The difference signal between the output of a thermocouple and an internal reference voltage is fed to a transistorised amplifier to operate a relay. The relay will operate on an input signal differential of less than 40 microvolts, equivalent to less than 1°C, with base metal thermocouples, and less than 2°C with precious metal types. Provision is made for increasing this differential by a factor of 10 where very close control is not required.

The relay has a life expectancy of several million operations at maximum load rating. Set point is adjusted by a precision potentiometer, and read by the position of an illuminated cursor on a calibrated scale. A signal lamp is provided to show the control condition. Standard ranges from £27-10-0.

ETHER
LIMITED

Send for full details to:—

CAXTON WAY, STEVENAGE, HERTFORDSHIRE
Telephone: Stevenage 3040-55



NEW transistorised
LEVEL equipment
...a Fielden low-cost,
reliable LEVEL CONTROLLER
for every application

TELSTOR 62
Continuous Level Indicator
A new approach to level equipment. Potted solid-state transmitting circuit can be in probe head—low cost, ideal for multi-point applications—simple to install—accurate, no moving parts—linear scale—alarm or control available.
Fully described on leaflet TEL62/1.

TEKTOR TT6
Level Controller
Complete transistor circuit in probe head—versatile and economic—single and multiple applications—extremely stable, no adjustment required.
See leaflet TT6/1.

PNEUMATIC LEVEL CONTROLLER PnL3
Provides pneumatic signal proportional to level of material—signal can be applied to a pressure gauge, existing pneumatic receiver/controller or diaphragm-operated control valve.
See leaflet PnL/3.

AQUATROL LEVEL CONTROLLER
For conducting liquids.
Ask for leaflet AQ/NF2.



FIELDEN ELECTRONICS LTD WYTHENSHAWE · MANCHESTER
Tel: Wythenshawe 3251 (6 lines) Grams: Humidity Manchester Telex 66531
Branch Offices: London, Walsall, Harrogate and Scotland
Overseas Subsidiaries: AUSTRALIA: Fielden Electronics (Aust.) Pty. Ltd., 61 Betula Ave., Vermont, Victoria and 107 Alexander Street, Crows Nest, New South Wales
ITALY: Fielden Electronics Italiana, Milan. Agents throughout the world

ROTAX
COMPONENTS &
TRANSDUCERS

ROTAX C.A.V. Transducer

401 Transducer

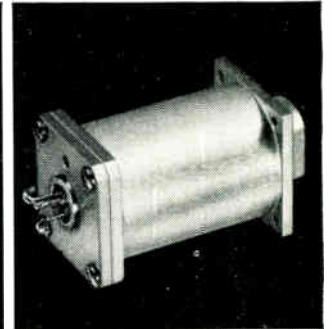
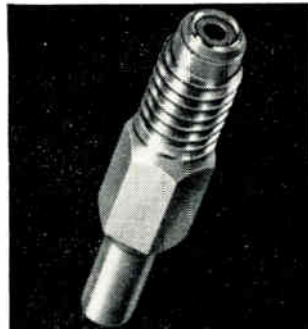

200 Series Encoder

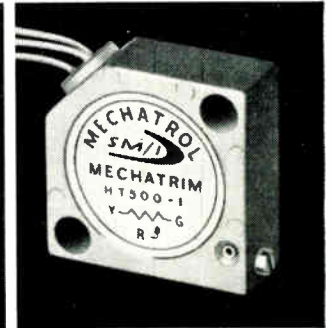

H.T. 500 Trimmer Potentiometer

Reliable instrumentation
to suit your needs exactly

Rotax produce a specialised range of equipment to very high standards of precision and reliability. Existing stocks provide for most normal needs. If your specification cannot be met exactly, Rotax will manufacture to your requirements.

Pressure transducers	potentiometric
Strain gauges	pressure transducer type
Digital shaft encoders	photo-electric
Trimmer potentiometers	miniature, metal-film

These instruments are designed to meet military environments. To find out more about Rotax Components and Transducers, ring Elgar 7777, Ext. 302 now, or write to:—



ROTAX LIMITED, INSTRUMENTATION DIVISION
WILLESDEN JUNCTION, LONDON, N.W.10. TELEPHONE: ELGAR 7777

Want to cut a few corners on your coil winding operation
—make better coils—and make more money?

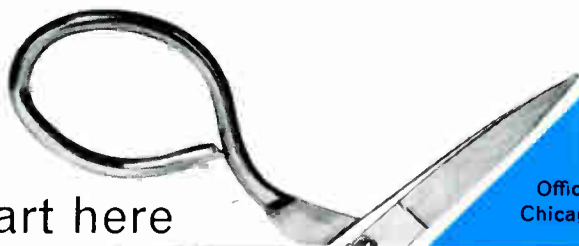

Start here

Coil winding is a fast developing industry. The picture will have changed in 1966. Leeson have already made sure of that. In the Leeson range there is a machine that can improve design, production and profitability on just about every coil winding operation. Get the facts. We are happy to be judged on them.

Leeson Limited

Heywood, Lancashire, England

Offices: Central Falls, Rhode Island, U.S.A. Philadelphia, Chicago, Los Angeles, Paris, France; Frankfurt, Germany.

Name : IF 1
Company :
Position in Company :

Build your own furniture

ENCAPSULATED ERGONOMICS

fix these



to these



with the aid of these

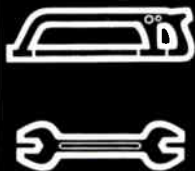

A hacksaw, spanner and the correct components are all that is necessary to construct either a simple or complicated cabinet. The Widney Dorlec system is based on the quick rigid central bolt, the feature that makes it superior. Widney Dorlec Telescopic Slides facilitate ease of access to equipment for maintenance purposes.

to make this

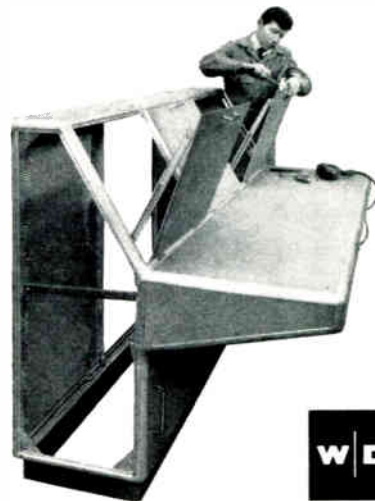

WIDNEY DORLEC

Write now for comprehensive illustrated literature.
HALLAM, SLEIGH & CHESTON LTD.
P.O. BOX 133, BAGOT ST., BIRMINGHAM 4.

W.D.59

For further information circle 284 on Service Card

£24

with advantageous trade and quantity discounts



UNIGOR

HIGH SENSITIVITY— MULTI-RANGE TEST METER FROM KELVIN

Measures AC/DC volts, amps, resistance, capacitance, decibels or temperature.

- Only one selector switch
- Automatic electrical cut-out guards against overload damage
- Shockproof ligament suspended movement
- High sensitivity
- Modern styling—two-tone grey plastic case
- Shadow-free scale—angled for legibility
- Carrying case and range of accessories available
- Three models with up to 48 ranges, giving large effective scale expansion:— Models 1S, 3S, 4S.

KELVIN

Please send me further details of the UNIGOR multi-range test meter

NAME POSITION

ADDRESS

KELVIN ELECTRONICS COMPANY, Kelvin House, Wembley Park Drive, Wembley, Middlesex. Tel: Wembley 8888

KEC/1521

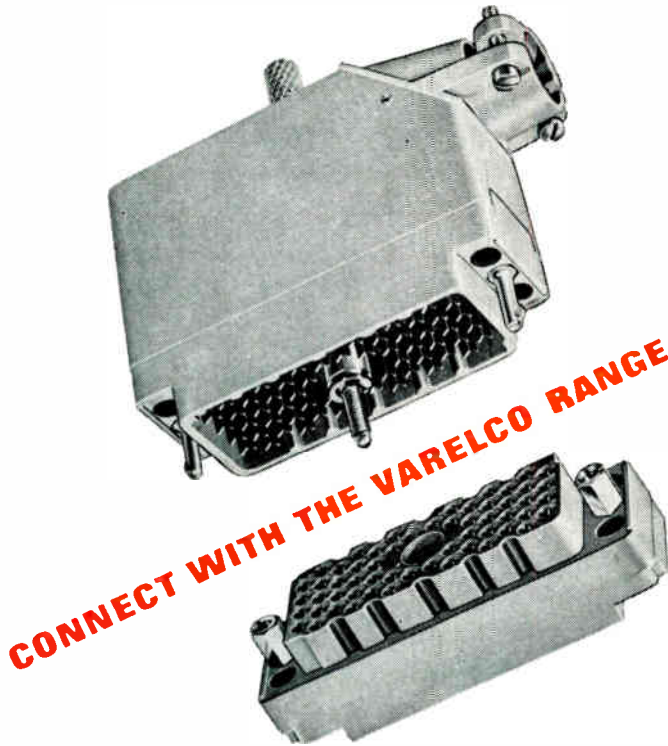

CONNECT WITH THE VARELCO RANGE OF MULTIWAY PLUGS AND SOCKETS

	<p><i>Series 8016</i> Multiway connector. Available as a 38 or 56 way connector with covers permitting side or top cable entry, also available without cover for panel mounting.</p> <p>Interchangeability of polarising guide pins and sockets provides 144 polarising positions. Contact resistance 5 milli-ohms. Contact rating 5 amps.</p>
--	--

The 8016 Connector illustrated above is one of a range of Multiway Plugs and Sockets utilising the Varicon* Contact. This unique fork shaped hermaphroditic contact has a very low contact resistance. The great reliability of the Varicon* Contact and its versatile design is the basis of a range of equipment including **Printed Circuit Connectors** and **Printed Circuit Board to Board Connectors**, as well as **Multiway Plugs and Sockets**.

Write today for the Varicon* catalogue which lists the full range of Multiway Plugs and Sockets, Printed Circuit Connectors and Board to Board Connectors.

*TRADE MARK

M.O.A.—A.R.R.E.—A.R.B. Approved Inspection. Can be supplied to meet P.O. Approval.



MAGNETIC DEVICES LTD.
 Newmarket, Suffolk
 Newmarket 3451 (10 lines) Telex 81245

VARELCO LIMITED
 Newmarket, Suffolk
 Newmarket 3451 (10 lines) Telex 81245

Under licence from the Elco Corporation, Willow Grove, Pennsylvania, U.S.A.

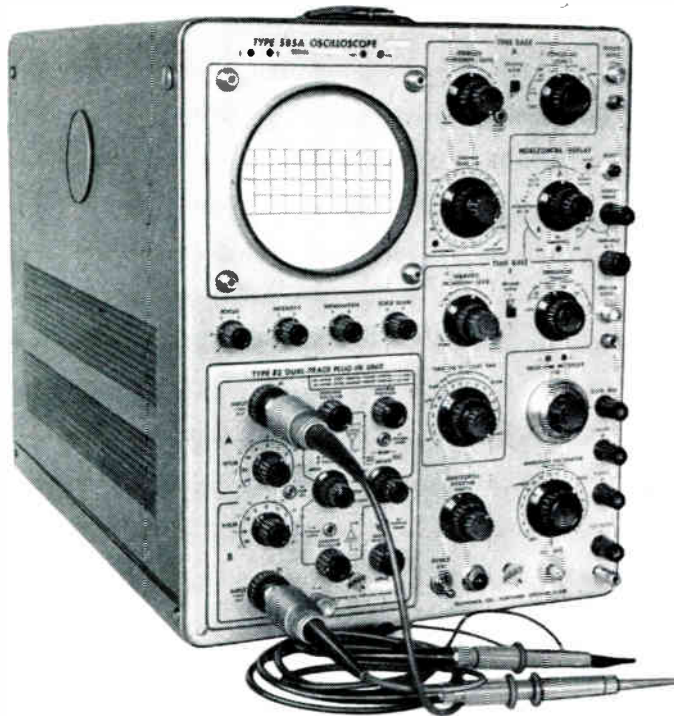

85 Mc/s

TEKTRONIX 585A

NEW MEASUREMENT CONVENIENCE FOR HIGH-SENSITIVITY, WIDE-BAND, DUAL-TRACE APPLICATIONS

DUAL-TRACE OPERATION with 4 operating modes and independent controls for each channel—for individual attenuation, positioning, inversion, and ac or dc coupling as desired.

PASSBAND typically DC-TO-85 Mc/s (3-db down) at 100 mv/cm (12-db down at 150 Mc/s), and typically DC-TO-80 Mc/s (3-db down) at 10 mv/cm.

CALIBRATED SENSITIVITY in 9 steps from 100 mv/cm to 50 v/cm, and in 10X Amplifier Mode, from 10 mv/cm to 5 v/cm, variable between steps.

INTERNAL AND EXTERNAL TRIGGERING to 150 Mc/s.

SWEEP RANGE from 10 nsec/cm to 2 sec/cm.

SINGLE SWEEP PHOTOGRAPHY at 10 nsec/cm.

BRIGHT, HIGH-RESOLUTION DISPLAY with small spot size.

CONVENTIONAL PASSIVE PROBES for convenience.

PLUS

COMPATIBILITY WITH 17 LETTER-SERIES PLUG-INS to permit differential, multi-trace, sampling, other laboratory applications—when used with Type 81 adaptor.

AVAILABLE BENCH MOUNTING 585A—£729 or RACK MOUNTING RM585A—£773

TYPE 82 DUAL-TRACE PLUG-IN UNIT—£270

Prices shown are free of duty subject to Treasury direction.



Tektronix U.K. Ltd. Beaverton House · Station Approach · Harpenden · Herts
Telephone: Harpenden 61251 · Telex: 25559

For overseas enquiries:—

TEKTRONIX Ltd, Albany House, St. Peter Port, Guernsey, C.I. · TEKTRONIX CANADA Ltd, Montreal, Quebec & Toronto (Willowdale), Ontario
TEKTRONIX AUSTRALIA PTY. Ltd, P.O. Box 488, Sydney, New South Wales
TEKTRONIX INTERNATIONAL A.G., P.O. Box 57, Zug, Switzerland · TEKTRONIX INC, P.O. Box 500, Beaverton, Oregon, USA

OCTOBER, 1965

STC components review

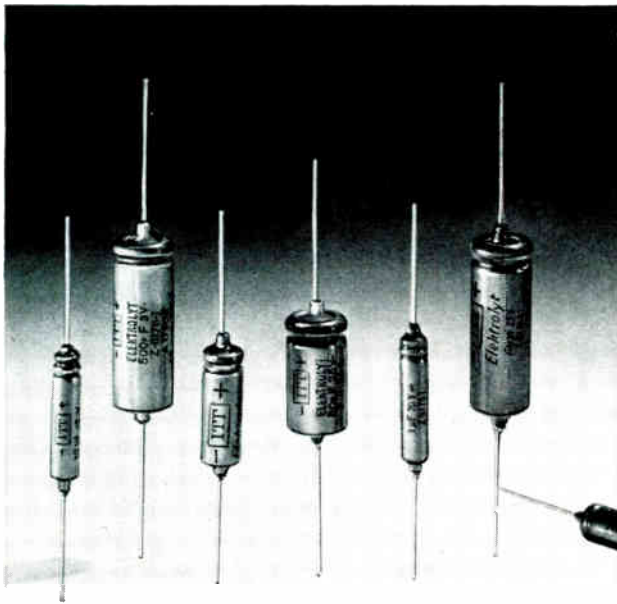

Miniature aluminium electrolytic capacitors

STC have introduced into the UK their Swiss associate's range of aluminium electrolytic capacitors. This means that there is now available a miniaturized, professional quality aluminium electrolytic type.

These capacitors have an established reliability acceptance in Europe. They are made with high purity materials and under full Quality Control. Cold welding techniques are used for anode and cathode connections, whilst the main case connection is made by ultra-sonic welding. This construction ensures a shelf life of at least two years without any reforming requirements. There is a transparent insulating sleeve over the case.

Performance and stability of this range of capacitors are to IEC 103 (1959) Class 564. They are suitable for operation at temperatures from -40°C to $+70^{\circ}\text{C}$. DC working voltages are 3, 6, 12, 25, 50 and 70V. Miniature aluminium electrolytic capacitors are ideal for use in telecommunications equipment, computers and professional electronic apparatus.

For data sheets, use Reader Service card or write, 'phone or telex STC Capacitor Division, Brixham Road, Paignton, Devon or London Sales Office, Footscray, Sidcup, Kent. Telephone: FOOTscray 3333. Telex: 21836.

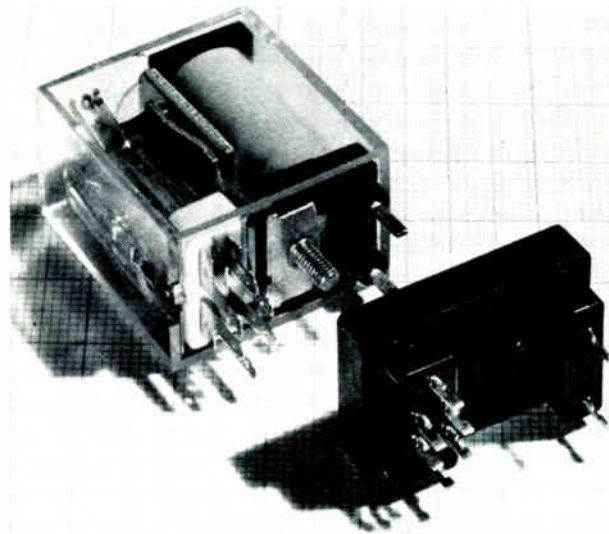

Low-cost midget industrial relays

STC have added to their relay ranges the Type 27—a low-cost version of the well-known 4189 Midget Relay. With two change-over contacts of twin silver, the Type 27 has a minimum life of 10^7 operations and functions in temperatures from -40°C to 85°C .

Average operating time is 7.5 milliseconds and release time 5 milliseconds. Maximum switched voltage is 300V a.c. or d.c. Typical contact ratings are: 24V d.c. at 1A (resistive); 48V d.c. at 0.25A (resistive), 240V a.c. at 0.5A. Standard coil voltages are 6V, 12V, 24V, and 48V. Other coil values are available to order.

The Type 27 is supplied with a transparent polycarbonate protective cover. The relay terminal pins can be wired directly into circuit or, for plug-in applications, they will fit a matching socket, also made by STC.

For data sheet, write, 'phone or telex STC Electro-mechanical Division, West Road, Harlow, Essex. Telephone: Harlow (STD code OBS96) 26811. Telex: 81184.

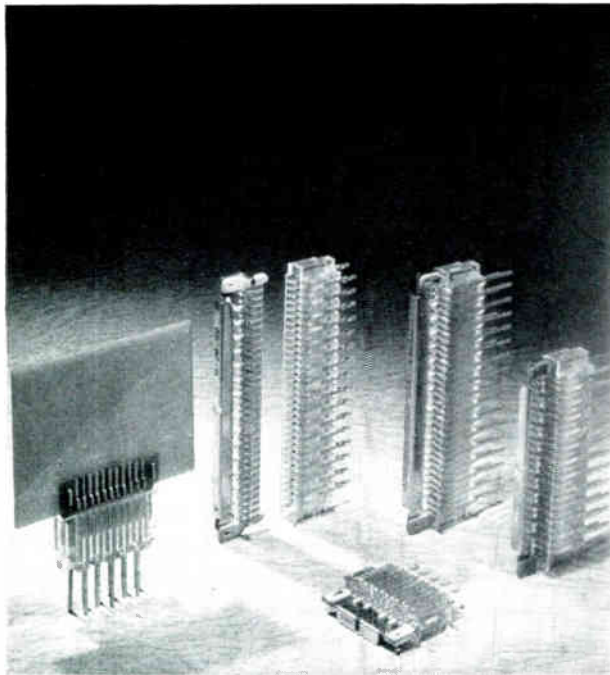

Printed circuit connectors

ISEP (International Standard Equipment Practice) edge connectors from STC have contacts with a pitch of only 0.1 in. (2.54 mm) between contact centres. The connectors are the answer to the equipment engineer's requirements for high density, multi-pole edge connectors for use on printed circuit boards carrying large numbers of miniature components.

Designed initially for connection between equipment wiring and plug-in boards within ISEP racking, these connectors are equally suited for use on other types of chassis or cabinets. Principal features of ISEP connectors are:

- Three sizes: 11, 25 and 33-way.
- 0.1 in. contact pitch conforms to latest international standards.
- Precious metal contacts rolled flat from wire to eliminate sharp edges.

- Available with wrap or solder tags.
- Plastic coding combs guarantee correct insertion.
- Fully integrates with ISEP racking system. Competitively priced.

Write, 'phone or telex for full details and prices to STC Electro-Mechanical Division, West Road, Harlow, Essex. Telephone: Harlow (STD code OBS96) 26811. Telex: 81184.

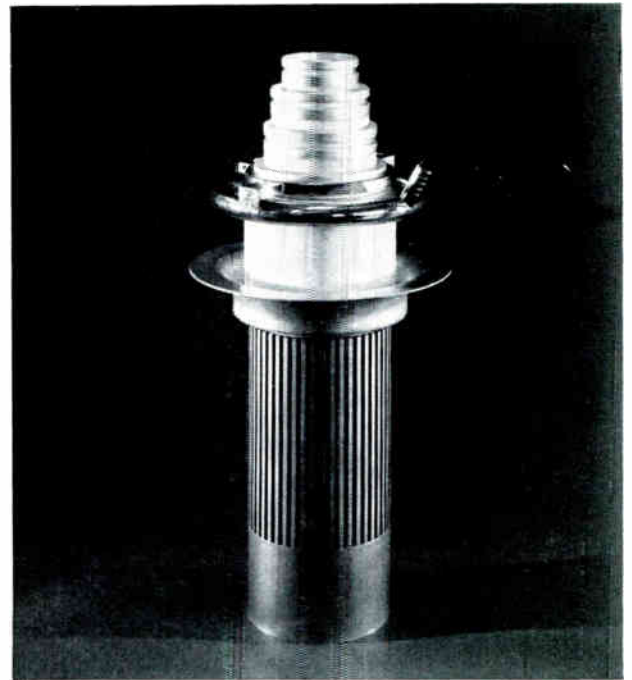

New 60 kW r.f. power tetrode

This tetrode has extremely linear characteristics and is designed to yield 60kW peak envelope power in Class AB₁ service. The maximum anode rating is 14kV at operating frequencies up to 30Mc/s.

The valve is available with two alternative forms of cooling. The forced-air-cooled version, type 4JC/300J will dissipate up to 30kW of power, and a vapour-cooled type 4ZC/300J (illustrated above) dissipates up to 40kW.

Maximum Ratings

	4JC/300J	4ZC/300J
V _a (kV)	14	14
p _a (kW)	30	40
p _{g2} (kW)	1.2	1.2
p _{g1} (kW)	1.0	1.0

Typical Power Output Performance

Class AB ₁ (P.E.P.)	60 kW	60 kW
Class C.Unmod./F.M.	71 kW	106 kW
Class C.Anode and Screen mod	42 kW	54 kW

Write, 'phone or telex for Data Sheets to STC Valve Division, Brixham Road, Paignton, Devon or London Sales Office, Footscray, Sidcup, Kent. Telephone: FOOTscray 3333. Telex: 21836.

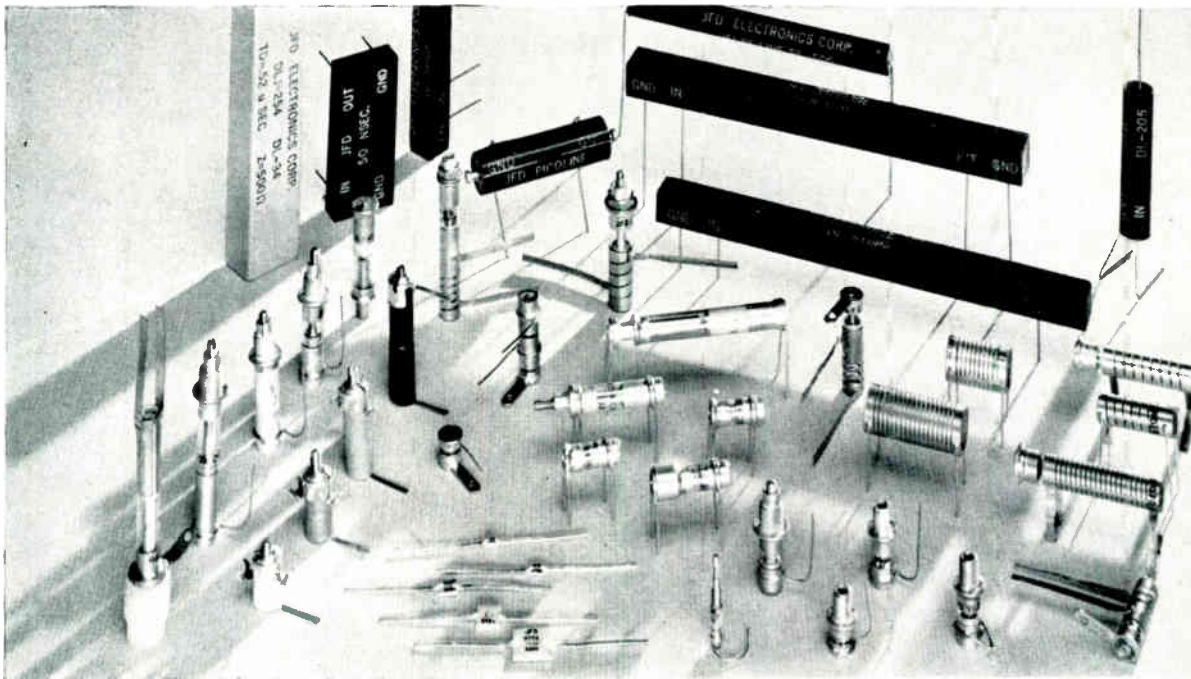

JFD precision products for the electronics industry

STC is sole UK agent for the JFD product line of precision devices which includes:—

Precision Piston Trimmers

The most comprehensive range of precision trimmers available. They are made for printed circuit or panel mounting and in five dielectrics of different characteristics.

Multi-gang Trimmers

These units, incorporating a number of single trimmers which may have different individual characteristics, give extremely fine ultra linear tuning over a wide range.

Stangard Trimmers

Low cost trimmer capacitors for commercial and industrial applications.

Metallized Inductors

The rugged construction of these devices results in extraordinary reliability under severe environmental conditions, especially those of shock, vibration, temperature and altitude.

LC Tuners

A single unit combining a precision variable piston trimmer capacitor with a precision fixed

metallized or air core inductor to provide a compact tunable LC circuit.

Unicerams

For a given capacitance and voltage rating, the smallest ceramic fixed capacitors ever offered. Also available are uniceram 'chips', for use on thin film and other totally encapsulated microminiature circuits.

Modutrim

Microminiature ceramic variable capacitors for micromodule and hybrid circuits. They give wide delta C's in extremely small and ultra stable units.

Delay Lines

A range of standard units for applications requiring short delay intervals backed by an engineering service offering quick delivery of custom-built delay lines.

For data sheets, use Reader Service Card or write, 'phone or telex STC Capacitor Division, Brixham Road, Paignton, Devon, or London Sales Office, Footscray, Sidcup, Kent. Telephone: FOOTscray 3333. Telex: 21836.

high-grade components by

STC

COMPONENTS GROUP

TELEPHONE CABLES

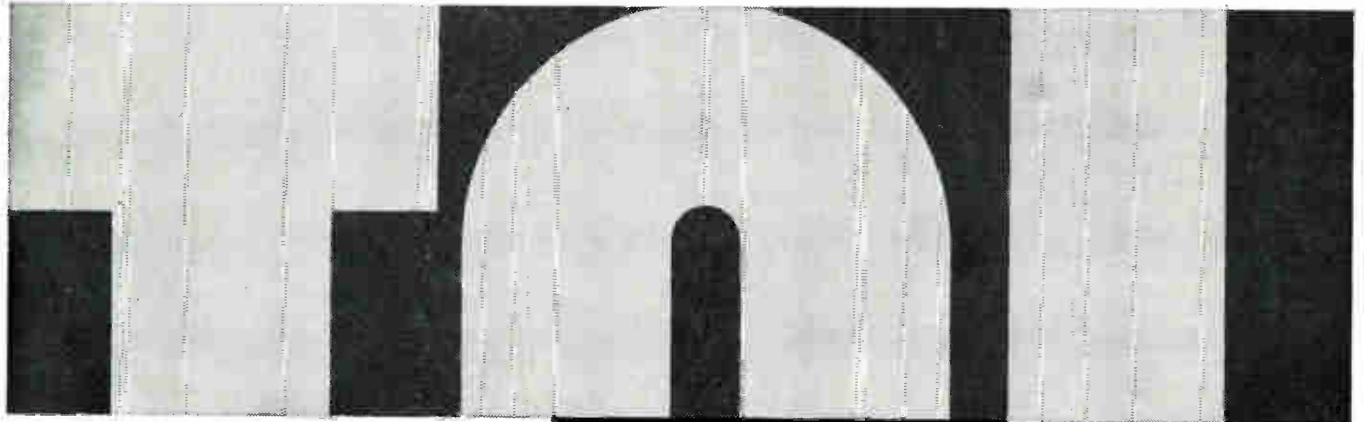

the makers with... **experience** 1837-1965

techniques

paper-polythene-moisture barrier-water block-coaxial

capacity

audio-1,500,000 pair miles a year
coaxial-5000 tube miles a year

current export orders exceed £7,000,000

CABLE • PLANNING • INSTALLATION

TELEPHONE CABLES LIMITED • DAGENHAM • ENGLAND

The Top People are at the bottom...



London's No. 1 landmark, the 620 ft. Post Office Tower, pinpoints the location of the No. 1 centre for all electronic components.

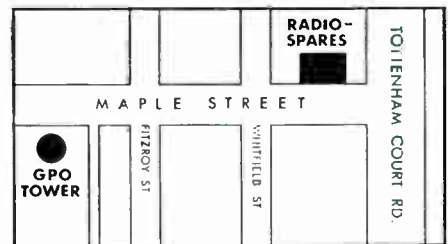

Radiospares Ltd.

4/8 MAPLE STREET, LONDON, W.1. ENGLAND · TELEPHONE: EUSTON 7232 (8 lines)
TELEGRAMS AND CABLES: RADOSPERS, LONDON, W.1.

RS 15

When a breakthrough is imminent

... you will find 'SELLOTAPE' Electrical Tapes contributing to the safety and reliability of heavily loaded, hard-worked components in motors, transformers, relays and coils. And in miniaturised components, particularly, where space for insulation is minimal, these specialised products carry out a host of essential jobs such as the insulation of windings during impregnation or baking, the securing of lead-out posts and the holding of parts during assembly and manufacture. 'SELLOTAPE' Electrical Tapes take this sort of thing in their stride, because they have been developed in close collaboration with electronic engineers to keep abreast of the constantly changing techniques of this fast growing Industry.

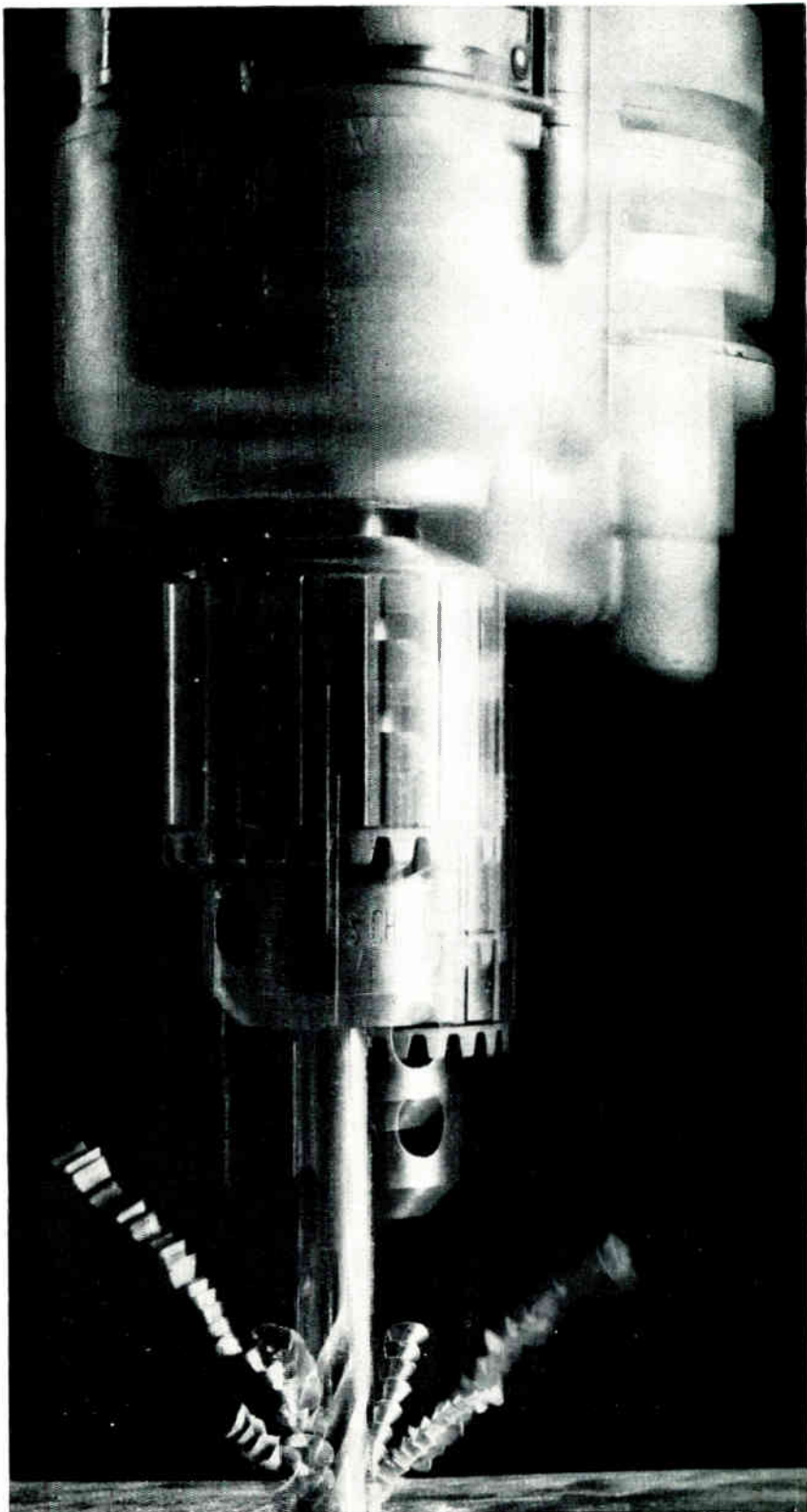

Sellotape

REGD. TRADE MARK

Sellotape

REGD. TRADE MARK

polyester thermosetting tapes

like it hot!

They have to because they have been developed for use in electronic components that are heat processed during manufacture or that operate at high temperatures. The tapes are based on various gauges of Polyester film, noted for its excellent volume resistivity and high dielectric and mechanical strength. The film is coated with thermosetting adhesive, which, on curing has increased bond strength and solvent resistance. The result is a range of electrical tapes designed to meet the stringent requirements of component manufacturers. 'SELLOTAPE' Extra-Thin Polyester Thermosetting Tape 1613—the thinnest in the range, specially developed for use in miniaturised components, and where maximum conformability is required.

'SELLOTAPE' Polyester Thermosetting Tape 1607—the most widely used in the range, shown in the drawing securing fine windings on a stick wound coil. The 0.001" based tape remains stable at 180°C for short periods and can be used continuously at 130°/155 C.

'SELLOTAPE' Heavy Duty Polyester Thermosetting Tape 1608—has that extra degree of toughness and insulation required on heavy coils etc. An ideal casing for capacitors.



Sellotape

REGD. TRADE MARK

electrical tapes

'SELLOTAPE' Double-Sided Polyester Thermosetting Tape 1609—simplifies many tricky securing and holding operations in coil manufacture. 0.001" thick film is coated on both sides with thermosetting adhesive, providing the ideal means of securing lead-out posts, starting off, insulating and securing primary windings and leads, and in holding interleaves.

'SELLOTAPE' High Strength Polyester Thermosetting Tape 1614—a 0.005" based tape for the extra tough jobs found in the production of large motors, turbines, switchgear and heavy duty heater pads. Also used for 'ground insulation' in domestic appliances and equipment.

... and a special paper-based thermosetting tape for low cost components—'SELLOTAPE' Creped Paper Thermosetting Tape 2701—will withstand processing temperatures of 180°C and continuous electrical operation at 105°C. Good insulation and moisture resistance properties make the tape an obvious choice for use in coils, transformers, relays etc. for holding, lead and slot liner binding, and finishing off.

Write for full details of the complete range of 'SELLOTAPE' Electrical Tapes or call in one of our technical representatives to ensure that you use the right tape for the job.

Sellotape Products Limited
Industrial Division, Sellotape House
54-58 High Street
Edgware, Middlesex
Telephone: Edgware 2345
Associated Manufacturing
Companies in Australia, Canada,
Eire, New Zealand and South Africa

electrical tapes

serve industry's pacemakers



'Sellotape' is the registered trade mark of Adhesive Tapes Ltd.

For further information circle 296 on Service Card

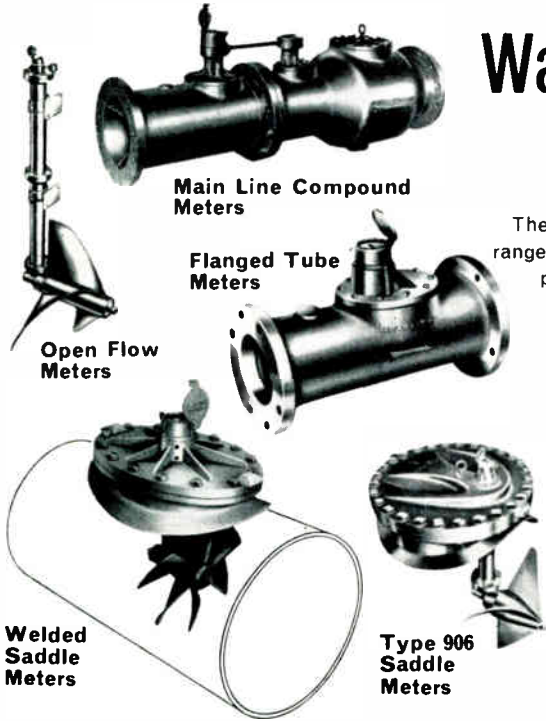

Water on your Brain?

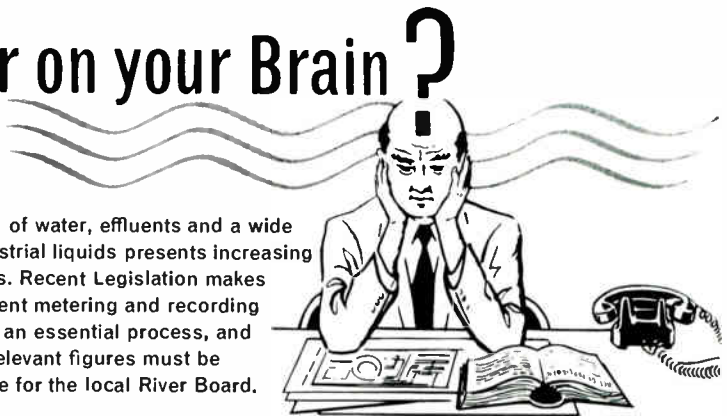

The control of water, effluents and a wide range of industrial liquids presents increasing problems. Recent Legislation makes an efficient metering and recording system an essential process, and all relevant figures must be available for the local River Board.

The most comprehensive range in the world...

These Main Line Propeller-type Meters for pipeline service are constructed in all sizes from 2" to 72" diameter, and provide accurate registration over very wide flow ranges. In Flanged Tube version for fitting directly in the line, or in Saddle-fitting version for mounting on to existing pipe, including asbestos-cement, rigid PVC and other non-metallic pipes.

Remote Integration, Indication and Chart Recording facilities are available, also a variety of automatic controls. A few meters are illustrated to show examples of their versatility and general application. We are always ready to assist you, whether in the design and construction of new installations or in the adaptation of existing systems. Send today to Dept. M.C. for details.



Hersey-Sparling Meter Company Ltd.

Water Meters and Recording Instruments

VICTORIA ROAD, BURGESS HILL, SUSSEX, ENGLAND. TELEPHONE: BURGESS HILL 2761/2

For further information circle 297 on Service Card

NEW! ELECTRONIC COMPONENTS

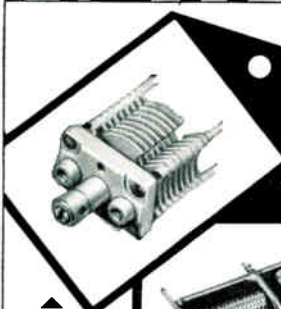

SMALL BUTTERFLY TYPE TRIMMER
C.952
Capacity 12-8 pF each side
·015" Gap.
Can be fitted with locking collar in which case type No. is C.953.



TUBULAR TRIMMER
S.56.12
P.T.F.E. Dielectric
30 pF mx.

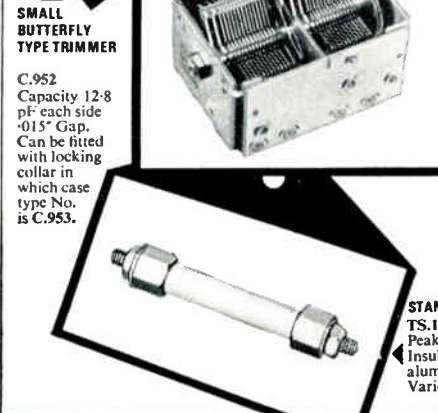

AM/FM GANG CAPACITOR
C.87.302
Fitted geared drive.
Capacity 392 x 15 pF.
AM only version available.
Air gap ·0125"
Capacity 326 pF each section.

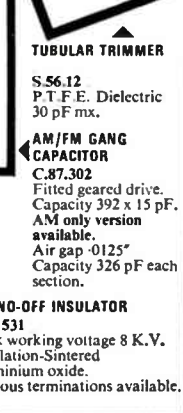

STAND-OFF INSULATOR
TS.1531
Peak working voltage 8 K.V.
Insulation-Sintered aluminium oxide.
Various terminations available.



WINGROVE & ROGERS LTD
DOMVILLE ROAD · LIVERPOOL 13
Telephone: Stoneycroft 2265
LONDON OFFICE: 75 Uxbridge Road · Ealing · W.5 · Tel: EALING 7046/7

For further information circle 298 on Service Card

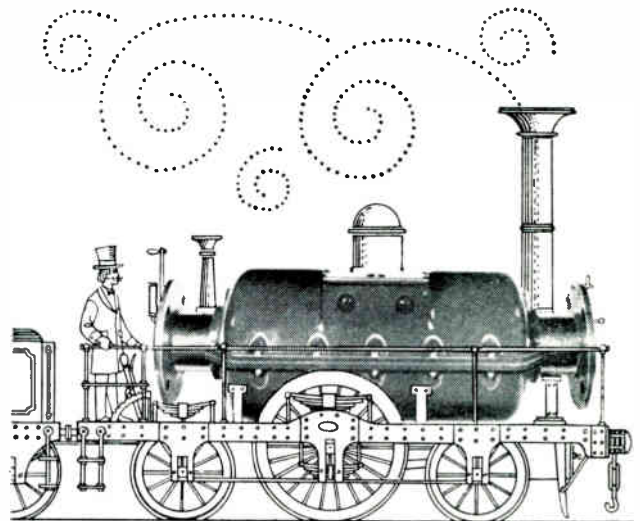

Not for travelling!

The EMFLUX is for measuring the flow of any conducting liquid

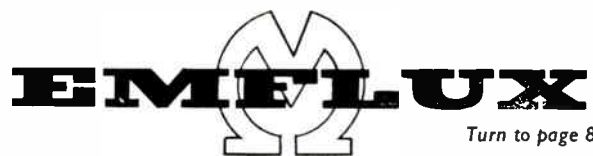

Turn to page 84

MAWDSLEY'S LTD Electronics & Instruments Division
DURSLEY · GLOS · ENGLAND

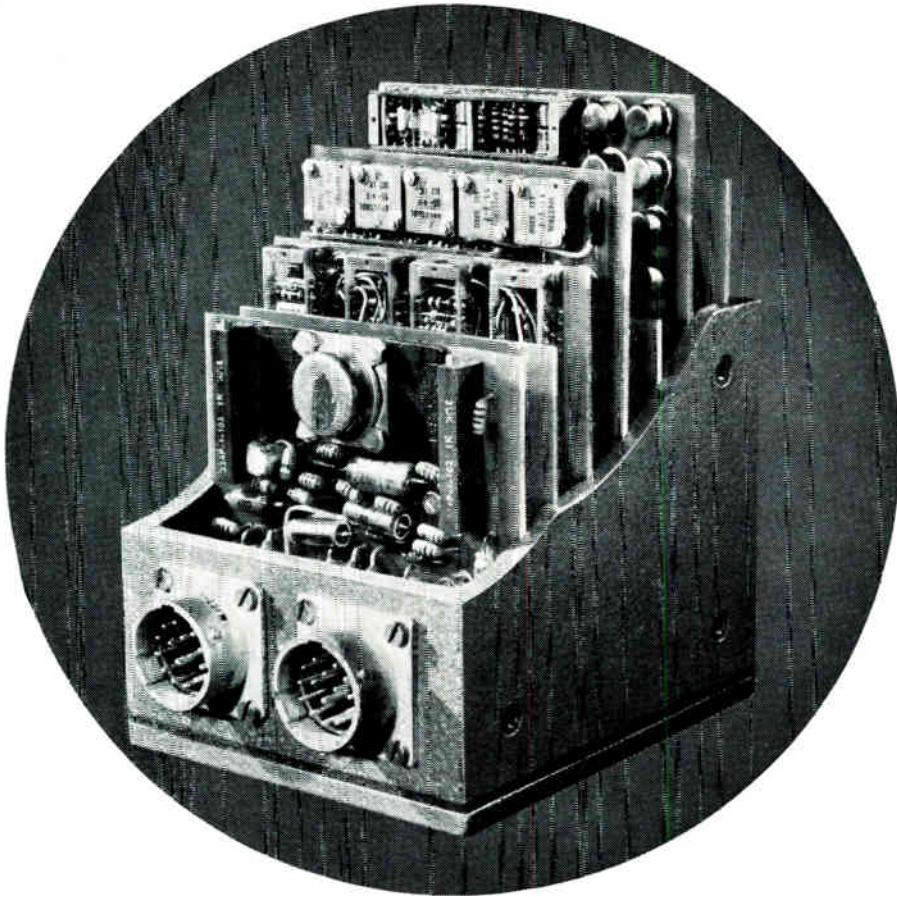

THE HEART OF A DATA HANDLING SYSTEM

The A/D Converter (type IL 6170/2) has been proved under operating conditions—in aerospace applications—as severe as any it will be expected to meet in industry.

High performance and long-term reliability are therefore assured when it is used for less demanding applications such as data logging, computer and general scientific systems.

Fast conversion rates make the A/D Converter especially suitable for computer and high-speed data acquisition work; its sealed unit and rugged construction for industrial use e.g. in steelworks and process control.

- * fast conversion rate
- * rugged sealed unit
- * increased production costs of the past two years have been absorbed: price unchanged at £795 ex. works
- * excellent delivery time: small quantities off the shelf
- * demonstrations arranged in customer's works

Input	Analogue range 0 to -6v d.c. Centre zero available on request Impedance 10 k.ohms Read Pulse A pulse going from earth to a positive level
Conversion	Minimum conversion time 140 micro-secs Maximum conversion rate 7000 words/sec Resolution 1 part in 1024 Accuracy $\pm 0.1\%$ full scale $\pm \frac{1}{2}$ least significant digit
Output	Pure binary 10 bit parallel words, stored until succeeding read command Digital representation '0' by 0 volts '1' by + 10 volts Impedance 5 k ohms for a logical '1' 1 k ohms for '0' Internal 100 Kc/s clock available for synchronising
Supplies	-12 v ± 0.25 v at 170 mA +12 v ± 0.25 v at 300 mA
Temperature range	-20°C to +55°C Full accuracy over range 0°C to 40°C
Size/weight	4 x 3½ x 3½ ins. approx. 2½ lbs.

BRITISH AIRCRAFT CORPORATION

GW DIVISION
BRISTOL WORKS FILTON BRISTOL
Telephone: 693831

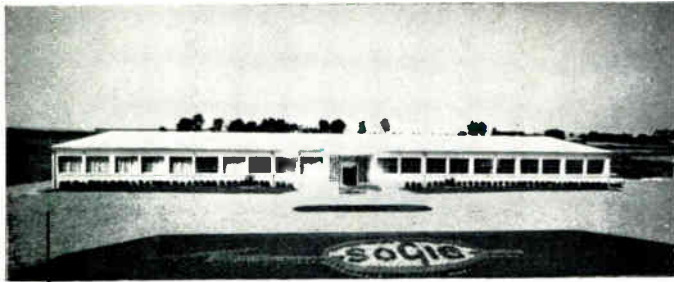

AN
ULTRA-MODERN
FACTORY PRODUCING
ELECTRICAL CONNECTORS
CUSTOM DESIGN WORK

● SOCIÉTÉ GÉNÉRALE
POUR L'INDUSTRIE
ÉLECTRONIQUE

305, RUE DE BELLEVILLE
PARIS
TÉL. : 205 25-61 — 205 41-48

PLANT LOCATED AT CHATEAU-RENAULT

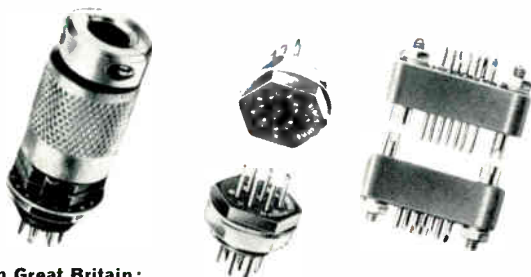

Agents in Great Britain:
CELDIS LTD.
4 TRAFFORD ROAD, RICHFIELD INDUSTRIAL ESTATE
READING, Berkshire

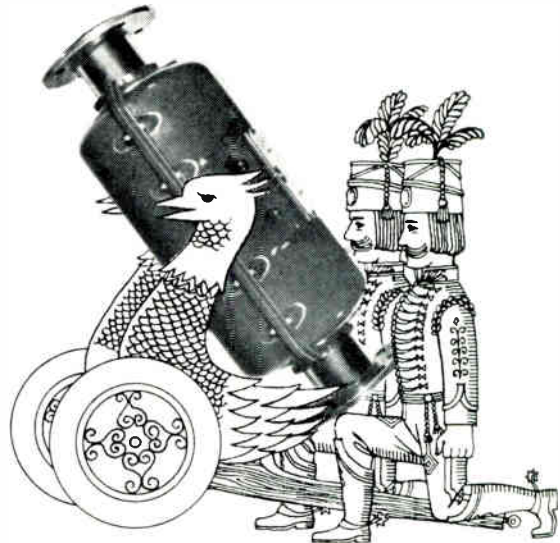

Not for firing!

The EMFLUX is for measuring
the flow of any conducting liquid



Turn to page 86

MAWDSLEY'S LTD Electronics & Instruments Division
DURSLEY · GLOS · ENGLAND

M^cGEOCH
INDICATOR LIGHTS
& MULTI-LIGHT UNITS
CONTROL & MIMIC PANELS

to
Customers'
requirements

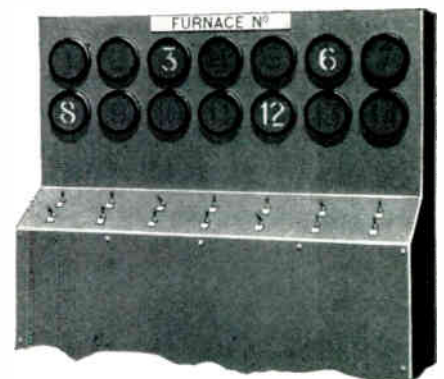

also

SWITCH and FUSE GEAR
WATERTIGHT SOCKETS and PLUGS
LIGHTING for all purposes

WM. McGEACH & CO. (BIRMINGHAM) LTD
(Dept. E.I.)
BORDESLEY, BIRMINGHAM 10
also at GLASGOW and LONDON

Associated Companies:
VERITYS (MAXLUME) LTD.

VERITYS (SWITCHGEAR) LTD.

minar

a NEW modular chassis system designed by the

BBC

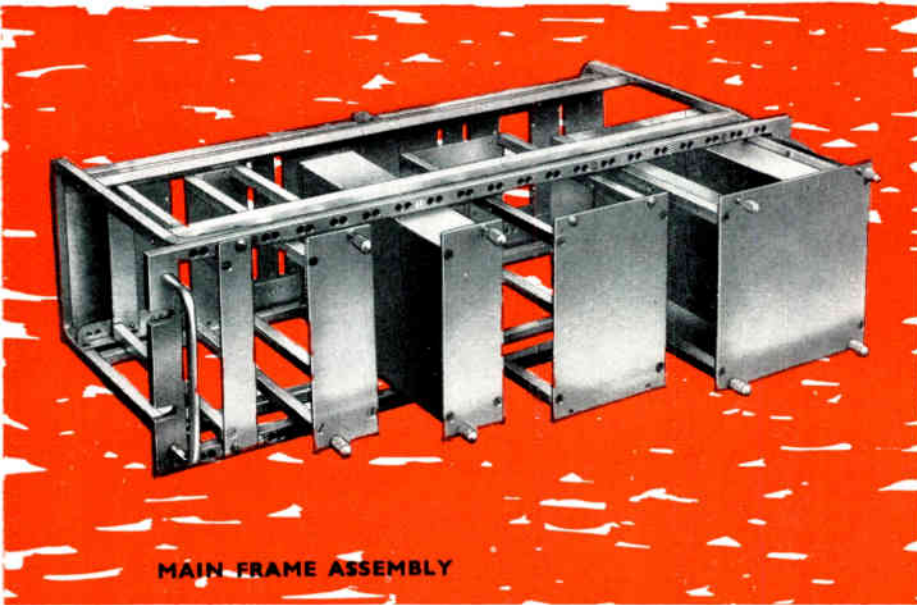

MAIN FRAME ASSEMBLY

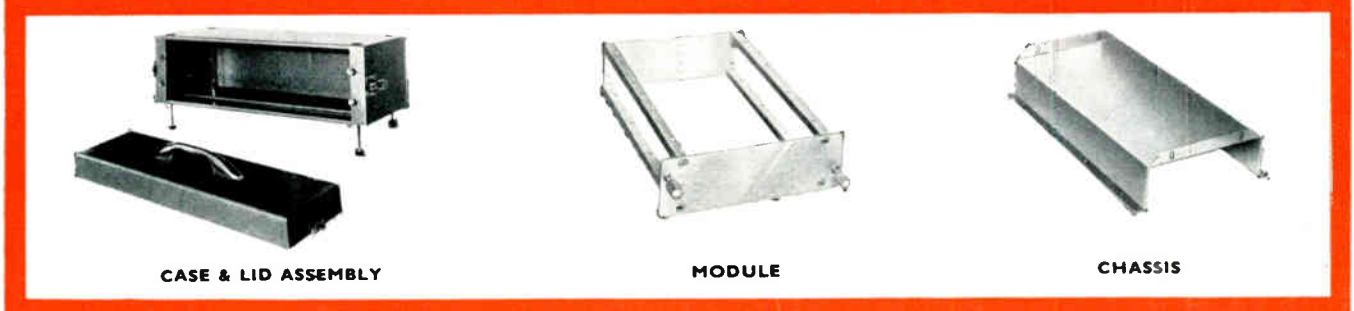
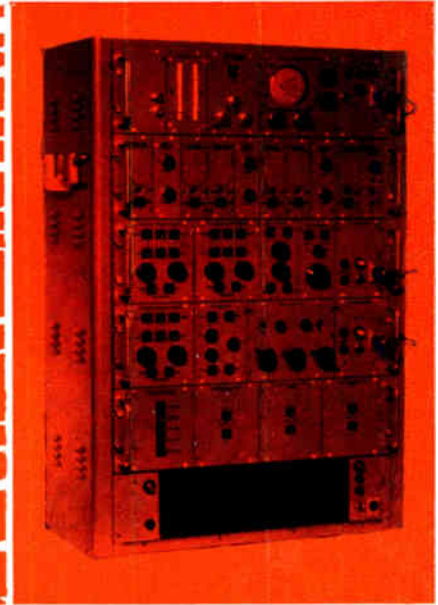

CASE & LID ASSEMBLY

MODULE

CHASSIS

Minar is based on a standard 19 inch x 5¼ inch panel in the form of a miniature rack into which units of various sizes may be inserted. The mechanical construction is straightforward and the overall assembly of units is capable of being used either in a standard 19 inch bay or in a portable carrying case. Space does not permit listing the numerous advantages this design affords when compared with similar systems. *We acknowledge our indebtedness to the British Broadcasting Corporation for permission to manufacture to their design.*

A.P.T **ELECTRONIC INDUSTRIES LIMITED**

CHERTSEY ROAD, BYFLEET, SURREY

Phone: Byfleet 41131/2/3/4 PABX Grams: APTRAN, BYFLEET

PLEASE SEND ME FULL INFORMATION ON THE MINAR SYSTEM

Name

Company

Address

.....

Position

IE2/LEE

Ten good reasons for choosing this Ward Brooke terminal block . . .

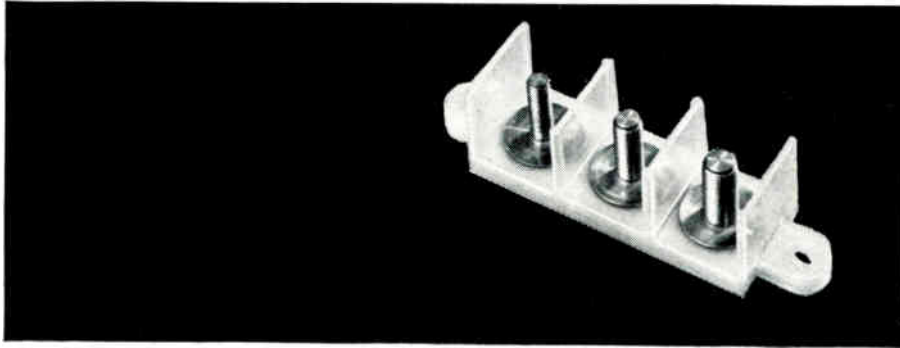

. . . or any other in the wide range of Ward Brooke blocks.

1. Blocks available up to 20 way, single or double row.
2. Light weight.
3. Non-corrodible studs.
4. Unbreakable plastic mouldings.
5. Up to 8 ring terminated conductors per stud.
6. Proofed against rotational shorting.
7. Inter-terminal linking strips.
8. BA or Unified threads.
9. Panel mounting, through or shrouded pattern.
10. Six colours and numbered terminals.

There is a very large range of Ward Brooke terminal blocks, fuse holders, conduits, helical wraps, 'LAYFLAT,' sleeving, ratchet and 'P' clips, lamp-holders, etc. These products are type approved. Every British aircraft being built today uses Ward Brooke parts throughout its electrical system. Why not write to the Sales Department for further details of the range?

WARD BROOKE *WB* & CO LTD

P.O. Box 34, High Wycombe, Bucks. Tel: High Wycombe 4531. Telex 83173

A member of the Southcros Group

For further information circle 305 on Service Card

Now for more information on the
EMFLUX system
of electromagnetic flow
measurement fill in the coupon
and get the complete handbook

To **MAWDSLEY'S LTD**
Electronics & Instruments Division, Dursley, Glos
Please send me your Emflux Electromagnetic Flowmeter Handbook

NAME

POSITION

COMPANY NAME AND ADDRESS

I. E.

For further information circle 306 on Service Card

VITALITY BULBS

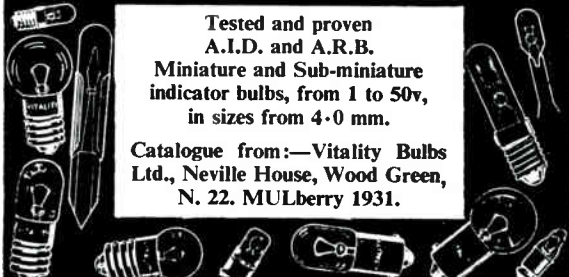

Tested and proven
A.I.D. and A.R.B.
Miniature and Sub-miniature
indicator bulbs, from 1 to 50v,
in sizes from 4.0 mm.

Catalogue from:—Vitality Bulbs
Ltd., Neville House, Wood Green,
N. 22. MULberry 1931.

For further information circle 307 on Service Card

ELECTRONICS PRINTED CIRCUITS

An extremely comprehensive service is available to industry which is unique in its scope and unprecedented in its quality of workmanship and speed of service while at the same time giving that all important individual attention and very competitive price terms that every buyer seeks.

The service consists of inclusive facilities for the design, development, and large scale production of all types of electronic equipment, instruments, etc., together with all processes involved in the design, development and production of printed circuit boards.

The unique location of T.E.S. Ltd., allows this first class service, which is to be found nowhere else, to be brought to your doorstep by an almost daily transportation service to 100 miles all for the price of a telephone call. Shanklin 3096.

Special attention will be given to very welcomed enquiries from customers outside the U.K.

TRANSMETRIX ELECTRONIC SYSTEMS LTD.
Hyde Works, Shanklin, Isle of Wight, Hants

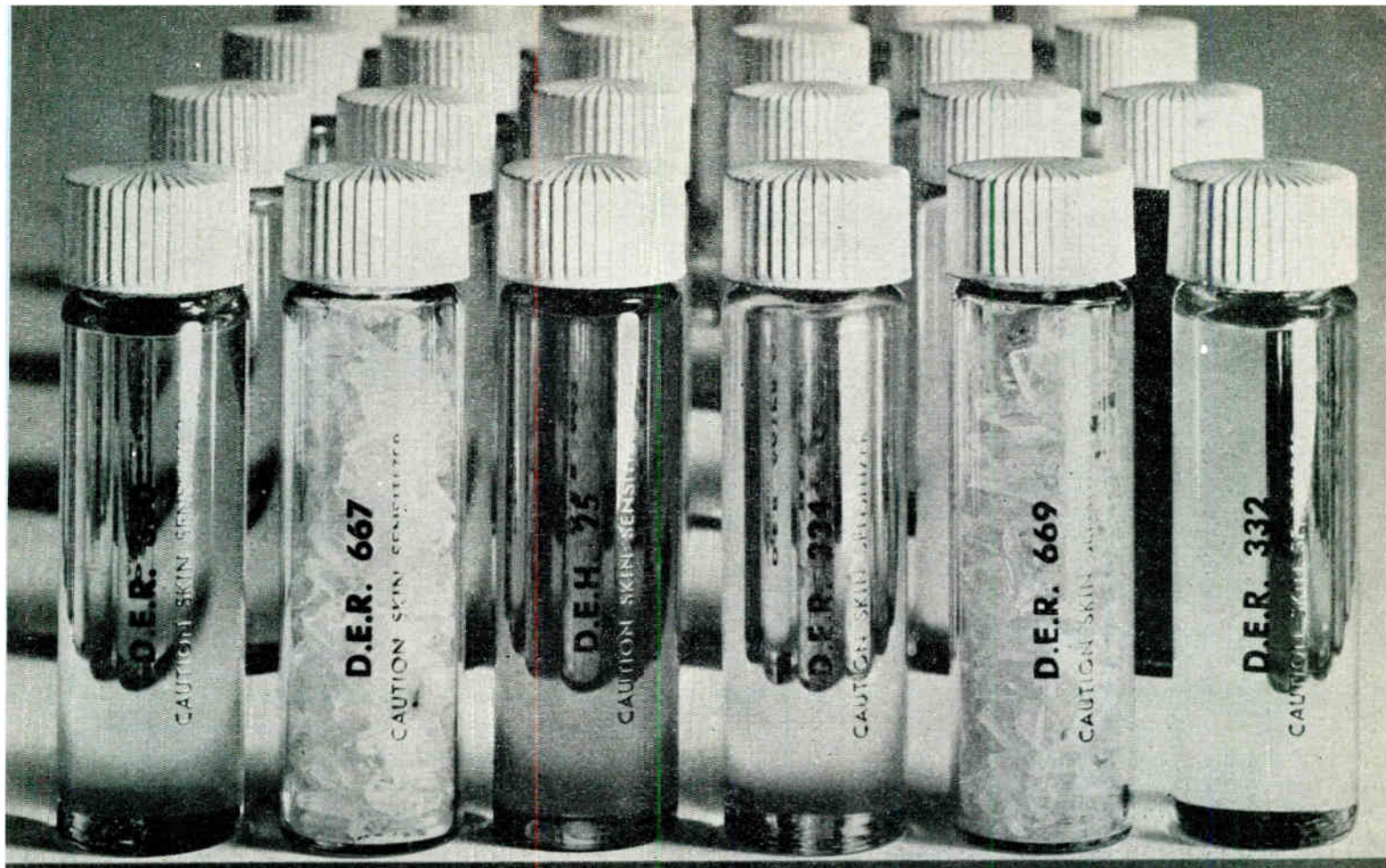

Any kind of epoxy resin you need, we've got.



Any kind of technical help you need
we'll give you.

Our line of epoxy resins is complete. For example, we make liquid systems for electrical applications, road coating, lacquers, laminating and adhesives; solid systems for paint coatings; novalac based resins for improvement of heat

stability, heat distortion temperatures, chemical resistance and gel time; flexible resins for elongation and flexibility; and flame retardant brominated resins. Should you desire technical assistance,

we will be happy to provide it. Dow Chemical Co. (U.K.) Ltd., 105, Wigmore Street, London, W.1. Tel: WELbeck4441 or St. Ann's House, Parsonage Green, Wilmslow, Cheshire. Tel: Wilmslow 2851

**Trademark of The Dow Chemical Company*



For further information circle 308 on Service Card

For further information circle 309 on Service Card

New facilities for electronic research

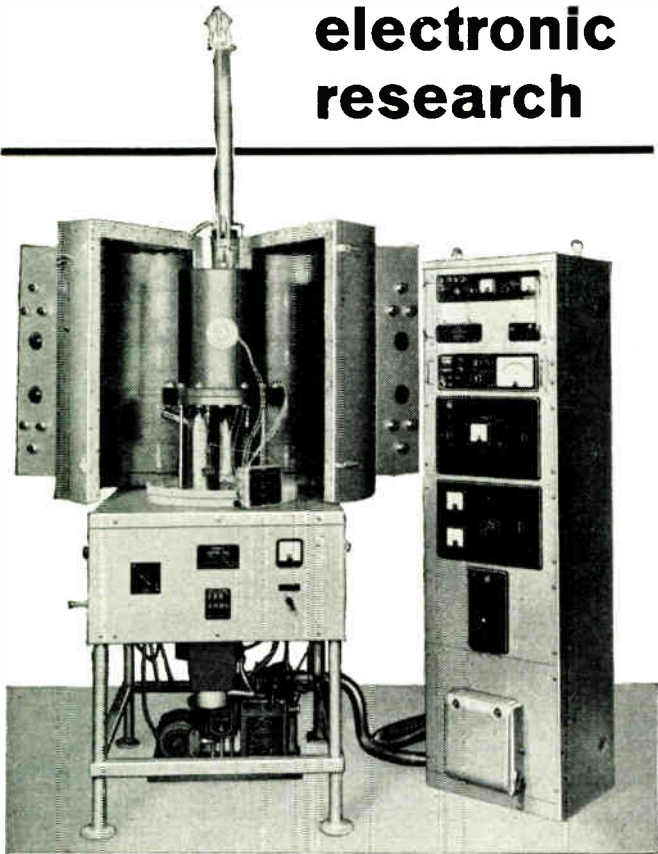

SUPER-PURE METALLIC FILMS FROM EDWARDS ULTRA HIGH VACUUM COATING UNIT

One advance leads to another. The progress made by Edwards in the field of metallising under ultra high vacuum conditions, as represented by the Edwards Model 12E8, is a direct aid to experimental electronics. This new equipment produces thin metallic films of unprecedented purity. They are already proving of vital importance in the production of high quality electronic components calling for super-conducting and magnetic films.

The Model 12E8 unit can be used in direct application for the experimental deposition of super-conducting tin and lead films used in the manufacture of Cryotrons; also the type of nickel/iron magnetic films which form an integral part of electronic memory instruments. If it is desired to examine surface properties of materials, for example semi-conductors, this can be carried out under very clean conditions. Highly efficient film monitoring accessories are available with this equipment.

PRODUCTION COATING: Edwards also manufacture production line equipment of any required capacity in the electronics industry.



EDWARDS HIGH VACUUM LIMITED

A member of Edwards International Group

MANOR ROYAL CRAWLEY SUSSEX ENGLAND

Telephone: Crawley 28844 Telex: 87123 Edhivac Crawley

GD307

For further information circle 310 on Service Card

NUMBER ONE IN ELECTRICAL CONNECTORS...



BATTERY SERIES

Heavy duty Aircraft and Commercial Battery Connectors. Contacts up to 600 Amps.

CANNON ELECTRIC (GREAT BRITAIN) LTD.
168 Old Street
London E.C. 1, England
Telephone: CLerkenwell 4954



For further information circle 311 on Service Card

One company in Britain makes ALL these types of capacitors

MICA
CERAMIC
POLYSTYRENE

LEMCO

The capacitor specialists

POLYESTER
ELECTROLYTIC

For further information write to:
LONDON ELECTRICAL MANUFACTURING COMPANY LIMITED

71 Bridges Place,
Parsons Green Lane,
London, S.W.6
Tele: Renown 7071

TAS/LEM.1

For further information circle 312 on Service Card

The earlier you come to Gabriel with your Waveguide problems the better. Gabriel Waveguides are, of course, themselves already flexible (not to mention twistable) but how much more flexible their use becomes when designed at the right time—it's easier for us—quicker and often more economical for you. Don't forget the advantages behind Gabriel flexibility either—long mechanical life; good VSWR and attenuation. And don't forget that in addition to producing a wide standard range of flexible Waveguides, Gabriel are also specialists in 'specials'.

GABRIEL

GABRIEL MANUFACTURING CO LTD · NEWTON RD · TORQUAY · DEVON

Telephone: Kingskerswell 3333 (2 lines)

A Member of the Tecalemit Group of Companies

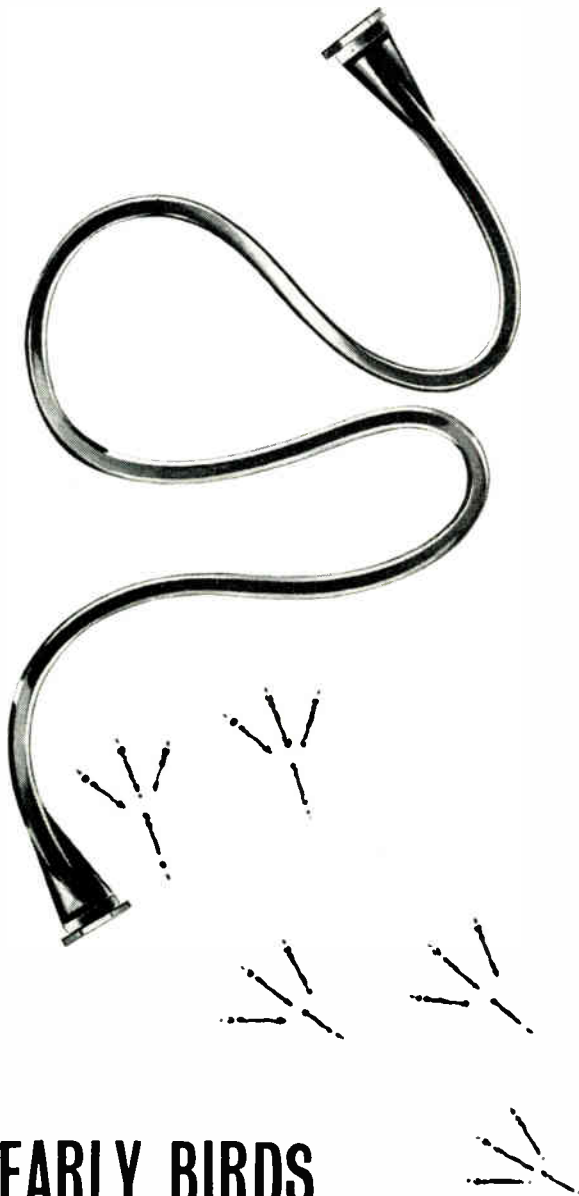

EARLY BIRDS
-catch Gabriel at their
most flexible

Industrial Electronics October 1965

For further information circle 314 on Service Card

Permacon edge connectors

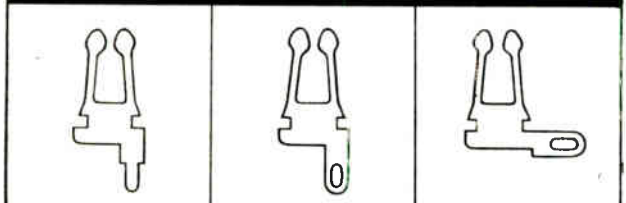

These inexpensive edge connectors feature polypropylene mouldings and brass or phosphor bronze contacts with a standard tinned finish. Silver plate, gold flash, or gold plate finishes are available to special order. .100" contact pitches provide a maximum of 40 positions whilst the .150" contact pitch range provides for a maximum of 26 positions. Contact tail variations (shown above) include solder slot tails projecting either vertically downwards or at 90° to the moulding, or tails for direct mounting to a "mother" printed circuit board. Mounting brackets provide "closed" or "open-ended" connectors or include contacts for direct earthing from the mating P.C. Board.

Electrical Ratings

Working voltage: 500 Volts D.C. or A.C. Peak (.150" pitch)

350 Volts D.C. or A.C. Peak (.100" pitch)

Current capacity: 5 amps max. per contact

CARR FASTENER CO LTD

the firm with the best connections

Stapleford, Nottingham. Telephone: Sandiacre 2661



Sales offices: Wembley and Sale.



For further information circle 315 on Service Card

CONTROLLED POWER CONTINUOUS POWER

SYSTEMS ENGINEERING

Pelapone automatic control systems cover all industries employing automatic production processes or requiring remote control and indication.

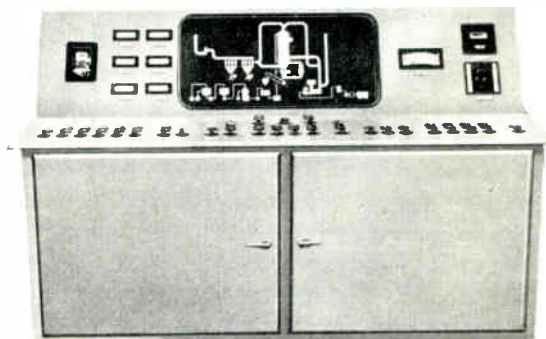

PELAPONE LIMITED

HEAD OFFICE AND WORKS: P.O. BOX No. 4, DERBY.

TEL: DERBY 45436. CABLES: PELAPONE, DERBY. TELEX: 37570

LONDON OFFICE: STEEL HOUSE, EASTCOTE, PINNER, MIDDLESEX. TEL: PINner 5881. CABLES: PELAPONE, LONDON. TELEX: 21619

For further information circle 316 on Service Card

Any type or make of
ENAMELLED WIRE
copper or resistance alloy
can be incorporated in our
**TEXTILE COVERED
WINDING WIRES**



STANDARD-BS 156
(oleo-resinous)

VINYL-ACETAL-BS 1844
(Synthetic)

Bicalex
Conymel
Polyanite
Lewmex
Simvar

POLYURETHANE-BS 3188
(Easy solder)

Bicelflux
Conysol
Polysol
Lewcosol
Sims Quick Solder

Also **POLYFLUX**
(Epoxy-resin, easy solder)

DIAMEL
(Epoxy-resin on resistance
wire only)

A complete and comprehensive range from one single source plus a service which it is our constant aim to maintain.

Textile covered wires in enamelled copper, plain copper, tinned copper or resistance alloys. Single, twisted pair, bifilar.

T.N.A. Wires for easy soldering and bonding.

Waxed bunched conductors.

Wave-winding Wires a speciality

If you have any development problem which involves winding wires remember that textiles are versatile and if a suitable wire does not exist we are always ready to elaborate new types.

FINE WIRES LIMITED

P.O. BOX 78, NOTTINGHAM
LONDON SALES OFFICE: 6/10

TELEPHONE: 44301
PORTLAND STREET, W.1

TELEGRAMS: STRENGTH, NOTTINGHAM
PHONE: LANGHAM 1071

leaders in their field

Newport—best-known name for electromagnets, magnet power supplies and magnetometers in laboratories all over the world. Because Newport specialisation gives superbly accurate, dependable equipment at economical prices.

See the full range in the Newport Catalogue ... send for your copy now



laboratory electromagnets

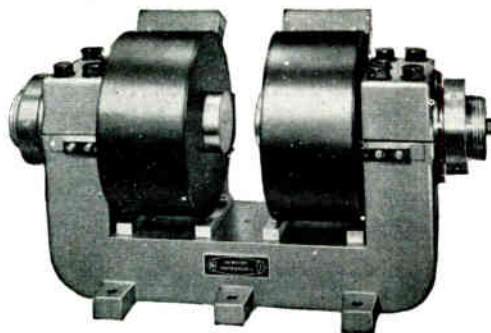

magnetometers



magnet power-supplies



Newport Instruments

NEWPORT INSTRUMENTS LTD.
Newport Pagnell, Bucks, England
Telephone: Newport Pagnell 401

ADJUSTABLE POLYSTYRENE CAPACITORS

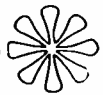

Plastic Capacitors Inc. supply a range of adjustable, hermetically sealed, polystyrene capacitors in bathtub cases. They are adjustable over a 2% range—allowing accurate frequency or tuning characteristics. Also it permits compensation for variation in the values of other components.



Brief details

Capacitance range: 0.001 to 2 μ F
Voltage range: 50 to 400 volts DC
Capacitance tolerance: from 10% to 0.1%

Temperature range: -90 to +85°C
High Stability: -1% to 0.1% change per year

Low dielectric absorption
(0.05% at 100V, 25°C)

Very high resistance (10¹² $\Omega\mu$ F)

Very low temperature coefficient (-80 to -100 PPM/°C)



APPLICATIONS

Tuned filters
LC tuned circuits
Integrating circuits
RC oscillators
Analogue computers
Decade capacitors
Standard capacitors

WALMORE ELECTRONICS LTD

11-15 BETTERTON ST., DRURY LANE, LONDON, WC2 Tel: TEMple Bar 0201-5

WHITELEY

cable test equipment
in the field

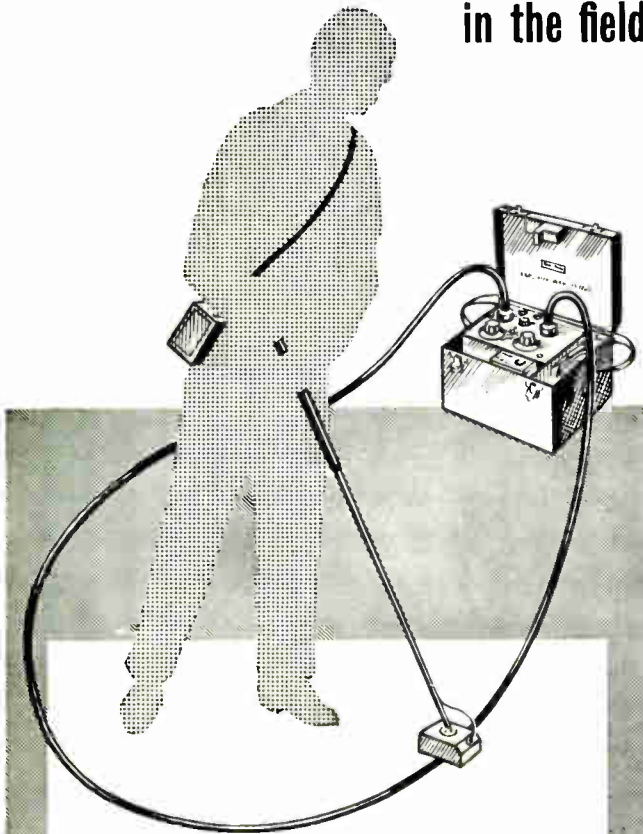

With Whiteley field equipment, both breaks and shorts in sheathed multiple conductor cables can be quickly located to within a fraction of an inch.

A capacitive probe run along the cable rapidly and accurately reveals the position of a broken conductor. To locate, with equal speed and accuracy, shorts between conductors, an inductive probe is used. For initial detection of a faulty conductor, a lamp type continuity tester is provided.

The equipment incorporates a battery-operated transistor oscillator, and a transistor amplifier. The oscillator frequency is 1000 c.p.s. $\pm 2\frac{1}{2}\%$ and can be continuous or interrupted according to the setting of the potentiometer.

Whiteley Field Cable Test Equipment is among the most efficient of its type, and because it is built to stand arduous working conditions, is completely reliable. For full technical details, please write to

WHITELEY ELECTRICAL RADIO CO LTD

MANSFIELD · NOTTS Tel: Mansfield 1762/5

WB169

a rendezvous you should not miss
from 3rd to 8th February 1966
in Paris, Porte de Versailles

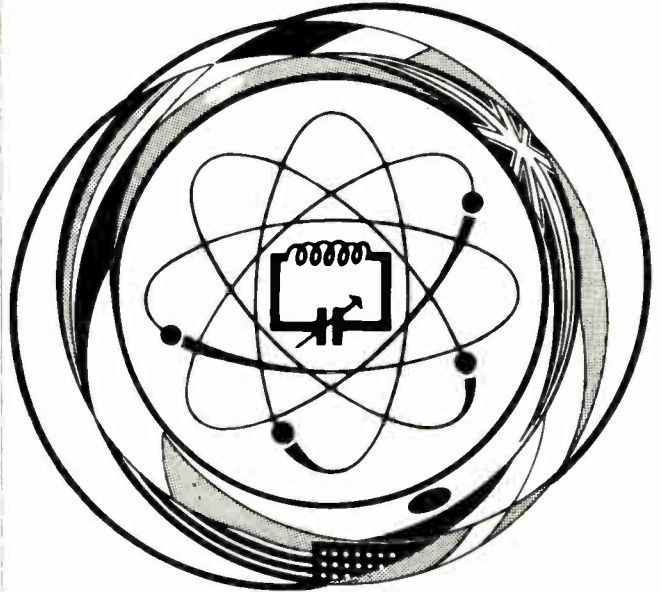

the foremost world-wide gathering of the year
at the international exhibition of

ELECTRONIC COMPONENTS

the most recent advances in the field of electronics:
all components, tubes and semi-conductors, measurement and control equipment, electro-acoustics...

for complete information please apply to:
S. D. S. A. 16, RUE DE PRESLES - PARIS 15^e - TEL. 273.24.70

PARIS 1966
PUBLICITY



Request for guest ticket
Please detach this coupon and
send it to:
S. D. S. A. Relations Extérieures
16, rue de Presles - Paris 15^e

NAME:

FIRM:

ADDRESS:

INTERNATIONAL EXHIBITION OF ELECTRONIC COMPONENTS

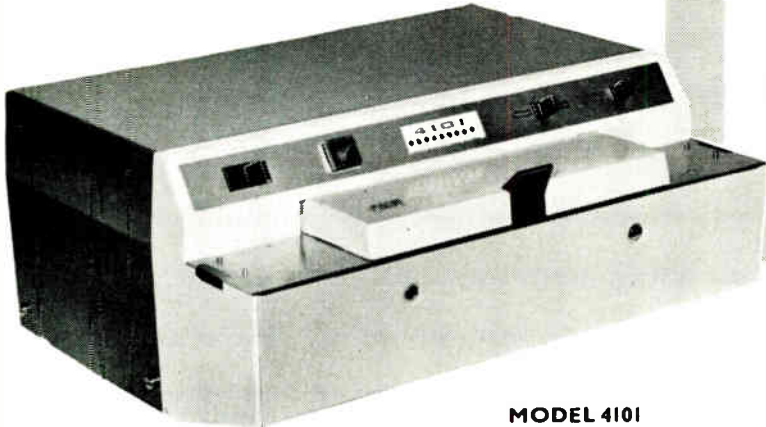

MODEL 4101

How fast can you read?

G.N.T Photo-electric tape reader

which is a read in unit for electronic digital computers and similar equipment requiring high speed operation, can read up to 1000 char/sec.

The Tape can be read at continuous operations from 250 char/sec to 1000 char/sec or intermittently (step by step) at a maximum 400 char/sec.
Forward and Backward Tape Feed. Extremely fast, start and stop of the tape is accomplished by powerful electro magnets and the special design of capstans and idling rollers.
Tape Guide instantly adjustable to 5-, 6-, 7-, or 8-channel tape. Olivetti tape with rectangular holes can be read when fitted with special circuitry.
Square Output Pulses with rise and fall times less than 2 μ s.
Alarm Circuits give information to the associated electronic equipment about open tape latch, tape out and manual control of the tape feed.
Special Input for the Control of Step-by-Step Operation requiring only a positive pulse to step the tape one character at any rate up to 400 characters per second.

Read Out Panel shows the combination of the characters over the reading station at all times.
The Electronic input and output specification makes this tape reader compatible with most transistorised electronic equipment.
Transistorised circuits mounted on gold plated printed circuit cards.
Start and Stop of Tape. Acceleration time (0-125 cm/sec) approx. 2-3 ms. Stopping time 250-0 cm/sec less than 0.8 ms.
Tape Width $\frac{3}{8}$ ", $\frac{7}{8}$ " or 1" Standard, 5-, 6-, 7-, or 8-channel plus sprocket channel.
Tape Bin. The tape reader is supplied with a tape bin capable of holding a 7 $\frac{1}{2}$ " roll of 8 channel tape. (Electronically controlled tape winding gear under development.)
Step by step control of tape by applying a 5-15v positive pulse to a separate input at any rate up to 400 times/sec.
Parity Check circuit cards can be supplied at an extra charge.
Mounting: Available on request as 19" standard rack mounted equipment.



GREAT NORTHERN TELEGRAPH WORKS

SYDHAVNS PLADS 4, COPENHAGEN SV, DENMARK
 LONDON OFFICE: 5 ST. HELEN'S PLACE, LONDON, E.C.3. Tel: LONDON Wall 4567

For further information circle 322 on Service Card

BRASS ACCESSORIES
 CABLE SOCKETS AND CONNECTORS, LOCKNUTS, BUSHES,
 PLUGS AND GLANDS IN NYLON AND METAL
 Ask for Catalogue No. ME1/62D/IE
METWAY · KEMP TOWN · BRIGHTON 7

For further information circle 323 on Service Card

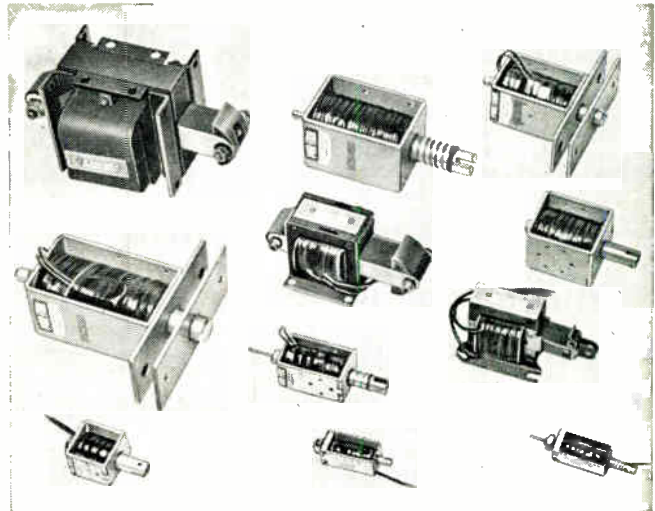

Phil-trol

For the Widest Range of Solenoids

Phil-trol Solenoids range from the small type 45, suitable for $\frac{3}{8}$ " spacing (i.e. for typewriters), to the AC type 83, 47 lbs over 1 $\frac{3}{8}$ " on impulse duty and also up to 650 lbs-ins for the DC type 96 with a complete range of AC and DC types between, push type, pull type, spring return and DC fitted with fully damped silicon rectifier circuits for AC supplies.

● For particulars ask for pamphlet 108a.

PHILLIPS CONTROL (G.B.) LTD

DEPT. K7 · FARNBOROUGH ROAD · FARNBOROUGH · HANTS.
 Telephone: Farnborough 41129 Grams and Cables: Philtrol, Farnborough, Hants.

CLASSIFIED ADVERTISEMENTS

FULLY DISPLAYED: 55/- per single column inch.
SEMI-DISPLAYED: 45/- per single column inch.
RUN-ON: 4/6 per line of approximately 7 words.
 Where an advertisement includes a Box Number Is. extra.
SERIES DISCOUNTS: 12 insertions, 15%.
 Remittances payable to "Industrial Electronics".

Copy is required by 18th of the month for insertion in the following month's issue, by 14th of the month if proofs are required.

Address to:
 Classified Advertisement Dept.
 Industrial Electronics
 Dorset House, Stamford St., London, S.E.1.

SITUATIONS VACANT



REAL TIME COMMUNICATIONS

OBJECTIVE

A major expansion of BOAC's world-wide communications network, covering both air to ground and ground to ground facilities.

REASONS

- a rapidly developing route structure plus heavy increases in traffic.
- the coming introduction of BOAC's "total" information system, based upon one of the largest real-time computer installations in the world.
- the need to keep up with the latest technological advances if the demands of the supersonic 70's are to be met.

PROJECTS *These will include work on*

- international telegraph systems, and the introduction of electronic message switching. Automatic switching has already been achieved for BOAC's London relay centre and plans are now afoot to extend it to New York, Sydney and Hong Kong.
- high speed data transmission facilities, to link BOAC's London Computer centre to cities all over Europe, N. America and the Caribbean. Later on this work may be extended to Africa and Asia.
- airport information systems, including video displays, audio and public address systems, and digital techniques of all kinds.
- flight communications for the Concord and other aircraft of the future.
- automatic telephone exchanges and network planning.

STAFF REQUIRED

A number of openings are available with starting salaries in the range £1,100 p.a. to £2,000 p.a. There are also a few senior appointments with starting salaries up to £3,000 p.a.

Applicants should preferably be aged 25 to 45, possess a degree or equivalent qualification, and have extensive experience in one or more branches of communications engineering, such as telegraphy, data transmission, video displays, real-time computer systems or auto-exchange design.

Applications, stating *concisely* experience and qualifications, to:

**Manager, Selection Services
 BOAC, Comet House, London Airport
 Hounslow, Middx.**

quoting ref. I.E.1

[477]

MECHANICAL AND ELECTRICAL/ELECTRONICS ENGINEERS

MINISTRY OF AVIATION

**Directorate of Air Technical Publications,
 Chessington, Surrey**

ELECTRONICS ENGINEER to assist initially in the planning of a series of Service publications relating to a guided missile system which will employ novel electronic techniques, and later to write on various aspects of the system and supervise the work of a team of authors engaged by the design contractor for the project. A sound theoretical knowledge and practical experience of electronics, in particular radar, television and servo systems, together with the ability to write clearly and concisely, is essential.

Technical Services Division, Aeroplane and Armament Experimental Establishment, Boscombe Down, Wilts

ELECTRICAL/ELECTRONICS ENGINEER to assess the needs of (a) first line aircraft radio servicing and (b) the process of diagnosing of complex faults in aircraft navigational/attack systems. The work involves critical examination of servicing techniques, test equipment, servicing schedules and the quality and training of craftsmen employed upon such servicing. The engineer will take direct charge of a team of twelve technicians engaged upon systems servicing and be technically responsible for a team of five technicians and about fifty craftsmen working at first line on aircraft radio. Experience of aircraft servicing is desirable either in the field of radio or instrument/electrical.

Royal Aircraft Establishment, Bedford

MECHANICAL or ELECTRICAL ENGINEER to take charge of all engineering aspects of the operation of and the maintenance of the plant for a large supersonic wind tunnel. Some experience with heavy rotating machinery and with supervision of personnel essential. Experience in some of the following fields desirable: E.H.T. switchgear (A.C. and D.C.), electro-mechanical servo systems, air compressors, refrigeration machinery.

QUALIFICATIONS: A.M.I. Mech. E., A.M.I.E.E., A.M.I.E.R.E. (September 1962 syllabus), or A.F.R.Ae.S., or satisfied the examination and training requirements for corporate membership.

SALARY (interim) £1,068 (at 25) to £1,633. (The post at Chessington carries an allowance of £50-£65.)

The posts are permanent and pensionable and carry prospects of promotion.

APPLICATION forms from Civil Service Commission, Savile Row, London W.1. Please quote S/85/MOA and state post in which interested. [478]

VARIAN ASSOCIATES LTD.

Require

Skilled Prototype Machinists for small batch work. Starting salary £1,200 per annum. Please write: **Varian Associates Ltd.** RUSSELL HOUSE, MOLESEY ROAD WATLON-ON-THAMES, SURREY Telephone: 28766 [484]

APPOINTMENTS FILLED

Dissatisfaction having so often been expressed that unsuccessful applicants are left in ignorance of the fact that the position applied for has been filled, may we suggest that Advertisers notify us to that effect when they have arrived at a decision? We will then insert a notice free of charge under this heading.



The Civil Service

Professional and Technical Appointments

The Civil Service offers an interesting and full career for professional engineers in government departments ranging from Cadetships which provide professional training for young graduates to Chief Engineer appointments with salaries of over £5,000. A booklet giving further details can be obtained from the Civil Service Commission at the address given below.

Current vacancies include the following:—

RADIO AND ELECTRONIC ENGINEERS MINISTRY OF AVIATION

Qualified engineers required as Assistant Signals Officers in the field of Civil Aviation for the provision and installation of advanced electronic equipment—including the latest type of radar, telecommunications, navigational aids, etc. **QUALIFICATIONS:** A.M.I.E.E., A.F.R.Ae.S., A.M.I.E.R.E. (September 1962 syllabus), 1st or 2nd class Honours Degree or Dip. Tech. in Electrical Engineering or Physics, or pass in (or exemption from) Institution Examinations, with some experience.

AGE: 23 and normally under 35 on 31/12/65 (extension for Forces and Overseas Civil Service).
SALARY: On the scale £930 to £1,772 depending on age and qualifications. Good prospects of promotion (Reference: S/85/ASO).

ASSISTANT PROFESSIONAL ENGINEERS MINISTRY OF AVIATION

Vacancies exist for Electronic, Mechanical and Aeronautical Engineers. The posts are suitable for young men and women (preferably under 26) who are qualified but lack post-graduate experience. The posts provide an excellent opportunity for obtaining such experience through doing professional work in accordance with a two-three year programme which is planned to meet individual needs.

QUALIFICATIONS: Applicants must have served an apprenticeship or had equivalent practical training, and must have passed or obtained exemption from examinations necessary for Grad. I.E.E. (or for I.E.R.E. to the September 1962 syllabus). Grad. I. Mech. E. or Grad. R.Ae.S.

Degree or Dip. Tech. an advantage.
SALARY: £980 (at 24)–£1,247 (under review) Very good prospects of promotion and established appointment.

Write or Telephone: Ministry of Aviation, S.M.(Eng.) 3, The Adelphi, John Adam Street, London W.C.2 (Temple Bar 1207, Ext. 1133)

TECHNICAL STAFF

MINISTRY OF PUBLIC BUILDING AND WORKS
Mechanical and Electrical Engineering vacancies in London, provinces and abroad.

QUALIFICATIONS: O.N.C. in Electrical or Mechanical Engineering or equivalent, together with an engineering apprenticeship followed by 3 years' practical experience in a responsible position.

DUTIES: Supervising the installation, maintenance and operation of electrical generating plant and H.T. and L.T. distribution services; also Heating, Ventilation and Air Condition systems, etc. including large boiler house and refrigeration plant. Appropriate experience in H.M. Forces can be considered in place of specified qualifications.

SALARY (Inner London): £1,084–£1,204.
AGE: At least 28 and under 53 on 1/1/65. Promotion prospects. Where appropriate time off for further technical study may be given (Reference: S/5775).

ENGINEER TECHNICIANS DIPLOMATIC WIRELESS SERVICE

The Diplomatic Wireless Service have vacancies for about 20 posts in (a) Grade II (b) Grade III.

This Department operates a world wide network of Radio Communication Stations which is in the process of being modernised and expanded and the most up-to-date techniques in radio teleprinter systems are being employed. The duties of Engineers in this field involve installation, modification, maintenance and operation of radio transmitters and receivers of the most modern types remotely tuned aerial systems teleprinter and voice frequency telegraph equipment. In addition several high powered broadcasting stations relaying programmes in both the H.F. and the M.F. bands. The Transmitters involved include some of the highest powers yet produced for this purpose. The duties in this field include the installation, modifications, maintenance and operation of these very high power transmitters, the most modern receiving equipment, tape recorders, diesel generating plants, etc. The Department's policy is to encourage versatility and to carry out as much installation and modification work as possible with its own staff. The initial appointments will be either to Crowborough Sussex or Hanslope Bucks. Liability for service overseas.

QUALIFICATIONS: O.N.C. in Electrical or Mechanical Engineering or a City and Guilds Telecommunications, Electrical, or Mechanical Engineering Technicians Certificate (Nos. 49, 57 or 293). Equivalent qualifications may be accepted. Higher qualifications will be an advantage.

SALARY (national interim): (a) £1,129–£1,288; (b) £796 (at age 21)–£1,099 (at 28 or over)–£1,129. Promotion prospects.
Closing date extended to 18th October, 1965. Candidates who have already applied need not do so again (Reference: S/6111/65).

EXECUTIVE ENGINEERS POST OFFICE

Seven posts in London and Provinces for mechanical, electrical and electronic engineers to develop and design communications systems and postal service equipment.

QUALIFICATIONS: Degree or Dip. Tech. in engineering or physics or exceptionally very high professional attainment. Final year students may apply.

SALARY (Inner London): £850–£1,748. Promotion prospects.
AGE: At least 21 and normally under 35 on 31/12/65. Some extensions for service in H.M. Forces or Overseas Civil Service (Reference: S/322).

MECHANICAL AND ELECTRICAL/ ELECTRONICS ENGINEERS MINISTRY OF AVIATION

Directorate of Air Technical Publications, Chessington, Surrey.
Electronics Engineer to assist initially in the planning of a series of Service publications relating to a guided missile system which will employ novel electronic techniques, and later to write on various aspects of the system and supervise the work of a team of authors engaged by the design contractor for the project. A sound theoretical knowledge and practical experience of electronics, in particular radar, television and servo systems, together with the ability to write clearly and concisely, is essential.

Technical Services Division, Aeroplane and Armament Experimental Establishment, Boscombe Down, Wilts.

Electrical/Electronics Engineer to assess the needs of (a) first line aircraft radio servicing and (b) the process of diagnosing of complex faults in aircraft navigational/attack systems. The work involves critical examination of servicing techniques, test equipment, servicing schedules and the quality and training of craftsmen employed upon such servicing. The engineer will take direct charge of a team of twelve technicians engaged upon systems servicing & be technically responsible for a team of five technicians and about fifty craftsmen working at first line on aircraft radio.

Experience of aircraft servicing is desirable either in the field of radio or instrument/electrical.

Royal Aircraft Establishment, Bedford.

Mechanical or Electrical Engineer to take charge of all engineering aspects of the operation and the maintenance of the plant for a large supersonic wind tunnel.

Some experience with heavy rotating machinery and with supervision of personnel essential. Experience in some of the following fields desirable: E.H.T. Switchgear—A.C. and D.C. Electro-mechanical Servo systems, Air Compressors, Refrigeration machinery.

QUALIFICATIONS: A.M.I.Mech.E., A.M.I.E.E., A.M.I.E.R.E. (September 1962 syllabus) or A.F.R.Ae.S., or satisfied the examination and training requirements for Corporate Membership.

SALARY (interim): £1,068 (at 25)–£1,633 (The post at Chessington carries an allowance of £50–£65). Promotion prospects.

Please quote S/85/MOA and state post in which interested.

There are also vacancies in the Scientific Civil Service as follows:—

BUILDING RESEARCH STATION

Garston, Watford, Herts.

ASSISTANT EXPERIMENTAL OFFICER/EXPERIMENTAL OFFICER (electrical or microwave engineer) to assist in the development of equipment for the application of high power microwaves to concrete breaking and to dry rot and woodworm eradication.

QUALIFICATIONS: Degree, Dip. Tech., H.N.C., or equivalent in appropriate subject. Under 22, minimum qualification is 2 G.C.E. A levels in Science and/or Maths subjects. Experience in design and measurement of waveguide components preferred.

SALARY: A.E.O. £549 (at 18)–£776 (at 22)–£983 (at 26 or over)–£1,201; E.O. (minimum age 26) £1,319–£1,675.
Prospects of permanent pensionable posts.

APPLICATION FORMS from the Director at the above address, quoting E/AF/172. Closing date 6th October 1965.

MINISTRY OF DEFENCE

(ARMY DEPARTMENT)

ORDNANCE BOARD

Kensington, W.14

ASSISTANT EXPERIMENTAL OFFICER/EXPERIMENTAL OFFICER required to examine the electrical safety of weapon systems; assess their behaviour under fault conditions or when exposed to electromagnetic fields; to co-ordinate the organisation and reporting of trials. Ability to chair meetings essential.

QUALIFICATIONS: Degree, Dip. Tech., H.N.C. or equivalent in appropriate subject. Under 22, minimum qualification is 2 G.C.E. A levels in Science and/or Maths subjects. A good knowledge of radio engineering would be an advantage.

SALARY: A.E.O. £614 (at 18)–£846 (at 22)–£1,053 (at 26 or over)–£1,276; E.O. (minimum age 26) £1,394–£1,760.

Opportunities for establishment.

APPLICATIONS: To Ministry of Defence, CE 2 (f) (AD), London W.C.2.

Except where otherwise stated all the above posts are pensionable, and APPLICATION FORMS may be obtained from Civil Service Commission, Savile Row, London, W.1. Please quote appropriate reference.

H.M. GOVERNMENT COMMUNICATIONS CENTRE

Hanslope Park, Near Wolverton, Bucks.

This Establishment is engaged in Research and Development covering an extensive range of communications projects. Graduate Scientists keen to work in this field are required. Areas of interest include:—

- Acoustics
- Magnetics
- Radio (VLF to microwave)
- Infra Red Optics
- Signal Analysis
- Computer programming

Qualifications: A university degree or Diploma in Technology with first or second class Honours. Exceptionally, evidence of high professional attainment would be accepted. All applicants and their parents must have been British subjects at all times since birth.

Salary Scales: Within the range £895 to £2,082 according to age and experience. These posts can lead to permanent and pensionable positions and carry good prospects of promotion to more senior posts.

The Establishment is situated in pleasant rural surroundings within easy reach of several residential areas.

Applications stating age, qualifications and experience, should be addressed to:—

The Personnel Officer,
H.M.G.C.C.,
Hanslope Park,
Hanslope,
Near Wolverton,
Bucks.

[476]

PRODUCT RESEARCH ENGINEER

MARCONI INSTRUMENTS LIMITED, ST. ALBANS

have a vacancy for an Electronics Engineer to work in a department largely concerned with the company's future products. The engineer would provide technical assistance to the sales and market research departments, and would be responsible for:—

1. Writing regular reports which evaluate the performance of the company's instruments compared with others on the market.
2. Preparing data which compares the published specifications of selected electronic instruments.
3. Obtaining and classifying information on electronic measuring equipments manufactured throughout the world.
4. Assisting in the evaluation of future products and answering questions on the competitive situation for particular instruments.

Applicants should have a qualification of at least H.N.D. standard or wide experience of electronic measuring instruments. Knowledge of telecommunications systems or electronic measuring techniques is essential and experience in technical writing would be an advantage.

Please apply in writing giving age, experience, qualifications and present salary to

The Personnel and Training Manager
MARCONI INSTRUMENTS LIMITED
c/o Group Personnel Services (B.C.2895A)
English Electric House, Strand, London W.C.2

[474]

DESIGN ENGINEERS REQUIRED

FOR INTERESTING WORK ON CONTROL GEAR

EXPERIENCED, ELECTRICALLY QUALIFIED MEN WITH A REAL INTEREST IN THE DESIGN OF MULTI-MOTOR CONTROL SYSTEMS SHOULD APPLY, GIVING DETAILS OF EXPERIENCE, ETC., IN FIRST INSTANCE TO:

PERSONNEL DEPT.
BROOK MOTORS LTD.
BARUGH GREEN WORKS
BARNSELY

[482]

IF YOU HAVE
STAFF PROBLEMS
WHY NOT LET US HELP
YOU?
BOOK NOW FOR
NOVEMBER

ENGINEER TECHNICIANS

Diplomatic Wireless Service

THE Diplomatic Wireless Service have vacancies for about 20 pensionable posts in (a) Grade II, (b) Grade III.

This Department operates a world-wide network of Radio Communication Stations which is in the process of being modernised and expanded and the most up-to-date techniques in radio teleprinter systems are being employed. The duties of engineers in this field involve installation, modification, maintenance and operation of radio transmitters and receivers of the most modern types, remotely tuned aerial systems, teleprinter and voice frequency telegraph equipment. In addition several high-powered broadcasting stations relaying programmes in both the H.F. and the M.F. bands. The transmitters involved include some of the highest powers yet produced for this purpose. The duties in this field include the installation, modifications, maintenance and operation of these very high power transmitters, the most modern receiving equipment, tape recorders, diesel generating plant, etc. The Department's policy is to encourage versatility and to carry out as much installation and modification work as possible with its own staff. The initial appointments will be either to Crowborough, Sussex, or Hanslope, Bucks. Liability for service overseas.

QUALIFICATIONS: O.N.C. in Electrical or Mechanical Engineering or a City and Guilds Telecommunications, Electrical, or Mechanical Engineering Technicians' Certificate (Nos. 49, 57 or 293). Equivalent qualifications may be accepted. Higher qualifications will be an advantage.

SALARY (national interim): (a) £1,129-£1,288; (b) £796 (at age 21) to £1,009 (at 28 or over) to £1,129. Promotion prospects.

WRITE (preferably by postcard) to Civil Service Commission, Savile Row, London W.1, for application form, quoting S/6111/65. (Closing date extended to 18th October, 1965. Candidates who have already applied need not do so again.) [473]

ASSISTANT PROFESSIONAL ENGINEERS

Ministry of Aviation

VACANCIES exist for Electronic, Mechanical and Aeronautical Engineers. The posts are suitable for young men and women (preferably under 26) who are qualified but lack postgraduate experience. The posts provide an excellent opportunity for obtaining such experience through doing professional work in accordance with a two-three-year programme which is planned to meet individual needs.

QUALIFICATIONS: Applicants must have served an apprenticeship or had equivalent practical training, and must have passed or obtained exemption from examinations necessary for Grad. I.E.E. (or for I.E.R.E. to the September 1962 syllabus), Grad. I.Mech.E. or Grad. R.Ae.S.

Degree or Dip. Tech. an advantage.

SALARY: £980 (at 24) to £1,247 (under review). Very good prospects of promotion and established appointment.

Write or telephone: Ministry of Aviation, S.M.(Eng.)3, The Adelphi, John Adam Street, London W.C.2 (Temple Bar 1207, Ext. 1133). (17) [472]



SITE ENGINEERS

Due to Company expansion, applications are invited from engineers for the commissioning and servicing of industrial electronic equipment manufactured by the Company.

Vacancies are available at all levels but our particular interest is for engineers who have experience in either of the following classes of equipment:—

- (a) Digital Equipment incorporating semi-conductors, particularly as applied to static switching.
- (b) Drive Systems incorporating electronic regulators for rotating machines and associated switchgear.

Applications for the above positions, stating age, qualifications and previous relevant experience, should be addressed to:—

Personnel Manager
LANCASHIRE DYNAMO ELECTRONIC PRODUCTS LTD.
RUGELEY, Staffs.

[485]

BUSINESS OPPORTUNITIES

STRATFORD JOHNS STUDIO
12, NEW QUEBEC STREET
MARBLE ARCH, LONDON W.1

TECHNICAL PHOTOGRAPHY

INTERIORS OR EXHIBITIONS, INDUSTRIAL OR TECHNICAL. PIECES OF SPECIFIED EQUIPMENT WHICH NEED TO BE CLEARLY MARKED AND REPRODUCED. TO BE USED FOR TRADE AND TECHNICAL PUBLICATIONS, NATIONAL OR PROVINCIAL PRESS OR GLOSSY MAGAZINE. EXECUTED TO VERY HIGH STANDARD.

MR. EDMUND HELLER, A.R.P.S.
will be pleased to give full information
AMBASSADOR 1818

[481]

QUALITY MANUFACTURED PRODUCTS FROM ONTARIO, CANADA

Looking for new lines to sell? Manufacturers from Ontario, Canada, are seeking established successful sales organisations covering the United Kingdom. Send full particulars of your company and product interest to:

Trade and Industry Department
Ontario House, 13 Charles II Street
London, S.W.1

[460]

CAPACITY AVAILABLE AIRTRONICS LTD.

for coil winding, assembly and wiring of electronic equipment, transistorised sub-units, sheet metal work. 3a, Walerand Road, London, S.E.13.

Telephone: LEE Green 1706.

[439]

ARTICLES FOR SALE

PHOTO-ELECTRIC CONTROLS

for industry

Quick delivery Send for Catalogues

Hird-Brown Limited

Flash Street, Bolton, Lancs.

Tel. 27311

[305]

ZVEI Electro Buyers' Guide, 1965. The directory of the German electrical industry. 1,200 pages. £1 each post free prepaid.—Magazine Subscriptions Ltd., 55 St. George's Square, London S.W.1. [475]

EDUCATIONAL

CRANFIELD

28th November to 10th December, 1965

POSTGRADUATE SHORT COURSE IN DIGITAL TECHNIQUES

A RESIDENTIAL course of instruction in theoretical and practical digital techniques. The coverage of the course will be broad, including components and circuits, combinational and sequential switching theory and applications to digital computers and to industrial instrumentation and control systems. Lectures will be supported by experimental work in well-equipped laboratories and by demonstrations.

FEES, including tuition and full board-residence, £54.

Further details and forms of enrolment from:—

The Registrar
The College of Aeronautics
Cranfield, Bedford

[479]

A.M.I.E.R.E., A.M.I.Mech.E., City & Guilds, G.C.E., etc. Become a Technician or Technologist for high pay and security. Thousands of passes. For details of Exams. and Courses in all branches of Electronics, Engineering, etc., write for 156 page Handbook—FREE. B.I.E.T. (Dept. 192), London, W.8. [380]

PATENTS

THE proprietors of British Patent No. 897245 relating to "A dynamo electric machine" desire commercial working of this patent in the United Kingdom by licence or otherwise.—Box 480.

Longlasting Precision...

is the essential attribute of the Oxley range of miniature electronic components designed to give enduring reliability in conditions which preclude regular servicing and manufactured to a fine degree of tolerance ensuring uncompromising performance

Write for technical details of Oxley products

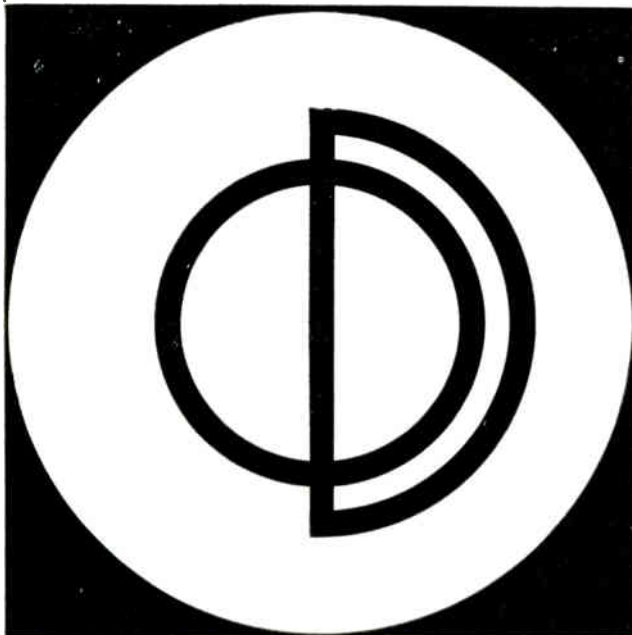

OXLEY

**DEVELOPMENTS
COMPANY LIMITED**

ULVERSTON, LANCASHIRE, ENGLAND
TELEPHONE: ULVERSTON 2567
CABLES: OXLEY ULVERSTON

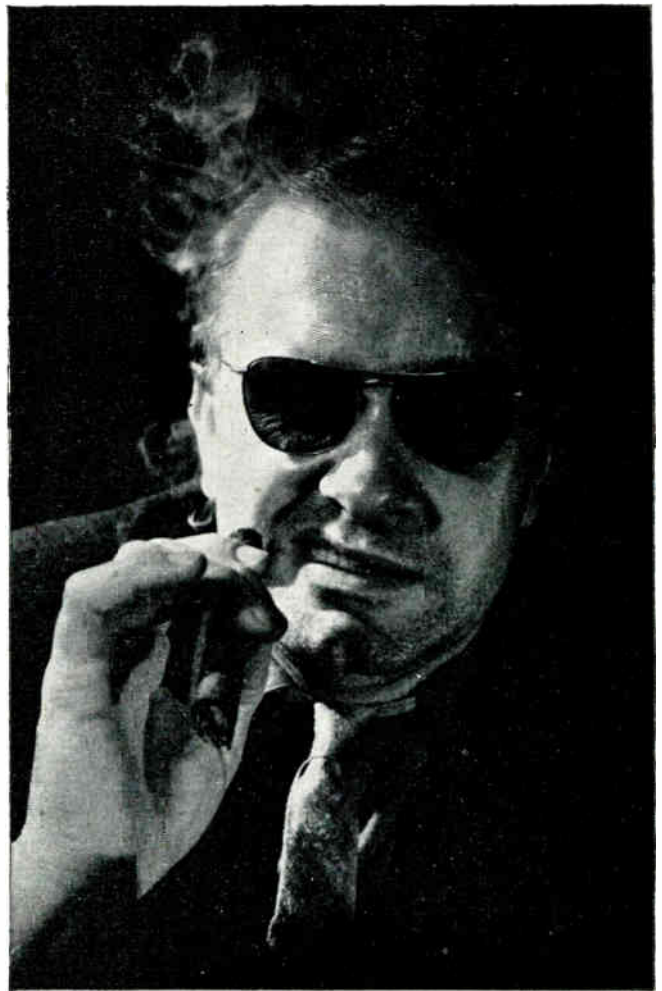

Buy our protection— or else.

Or else accidents. Because your product has a packaging problem. It's fragile. Delicate. Temperamental. Awkward. Big. Small. Expensive. Needs special protection. Hairlok protection. HAIRLOK take the rap for your product right down the line. They assess your product's exact needs. Design precision rubberised hair packs and outer containers. Make them. Test them. Ensure complete protection against all normal contingencies. For all the dope on the Hairlok mob, write to: *The BOSS, The Hairlok Company Limited, Power Road, Chiswick, London, W.4.*

Hairlok

THE HAIRLOK CO LTD • MAGNA WORKS • KATHIE RD • BEDFORD or write direct
to: HAIRLOK LABORATORIES • POWER RD • CHISWICK • LONDON • W4 CHI 6681-3

A.P.T. Electronic Industries Ltd.	85	Gabriel Mfg. Co. Ltd.	89	Painton & Co. Ltd. ...	<i>Cover iv</i>
Adcola Products Ltd.	61	General Electric Company of U.S.A.	38, 39	Pelapone Ltd.	90
Aircraft Marine Products (G.B.) Ltd.	<i>Cover ii</i>	General Precision Systems Ltd.	<i>Cover iii</i>	Perivale Controls Co. Ltd. ...	8
Amplivox Ltd.	68	Genoa Fair	18	Phillips Control (G.B.) Ltd. ...	93
Anglo-American Vulcanized Fibre Co. Ltd.	7	Great Northern Telegraph Works	93	Plessey U.K. Ltd.	34, 35
Appointments Vacant.....	94	Hairlok Co. Ltd.	98	Precision Metal Spinings (Stratford on Avon) Ltd. ...	70
Arrow Electric Switches Ltd....	27	Hallam, Sleigh & Cheston Ltd.	72	Pye Telecommunications Ltd.	42, 43
Associated Electrical Industries Ltd.	59, 64, 67	Hersey-Sparling Meter Co. Ltd.	82		
		Hivac Ltd.	19	RCA Great Britain Ltd.....	37
B & R Relays Ltd.	2	Hughes International (U.K.) Ltd.	28	Racal Instruments Ltd.	4
Belling & Lee Ltd.	54			Radio Resistor Co. Ltd.	40
Bernfeld, Eric H., Ltd.	52			Radiospares Ltd.	79
British Aircraft Corp. (Operating) Ltd.	83	Imhof, Alfred. Ltd.	15	Redcliffe Industries (Bristol) Ltd.	36
British Driver Harris Ltd.	21	Imperial Smelting Corp. (N.S.C.) Ltd.	100	Rotax Ltd.	70 <i>b</i>
British Electric Resistance Co.	16	International Rectifier Co. Ltd.	33		
Brookhirst Igranic Ltd.	11, 12			S.D.S.A.	92
Brush Cleviste Co. Ltd.	41	Jackson Bros. (London) Ltd.	36	S.E. Laboratories (Eng'g) Ltd.	66
		Johnson, Matthey & Co. Ltd.	9	S.O.G.I.E.	84
				Salford Electrical Instruments Ltd.	50
C & N (Electrical) Ltd.	52			Sellotape Products Ltd. ...	80, 81
C.Z. Scientific Instruments Ltd.	62	Kelvin Electronics Company... ..	72	Shell Chemical Co. Ltd.....	63
Cannon Electric (Gt. Britain) Ltd.	88	Klinger, Richard, Ltd.	20	Solartron Electronic Group Ltd.	32
Carr Fastener Co. Ltd.	89			Standard Telephones & Cables Ltd.	30, 53, 75, 76, 77
Ciba (A.R.L.) Ltd.	26	Landis & Gyr Ltd.	60	Sterling Metals Ltd.	31
Classified Advertisements	94	Leesona Ltd.	71		
Clerical & Medical Insurance Co. Ltd.	<i>Loose Inset</i>	London Electrical Mfg. Co. Ltd.	88	Taylor Electrical Instruments Ltd.	49
Colvern Ltd.	56	Lustraphone Ltd.	50	Tektronix U.K. Ltd.	74
Cossor Ltd.	10			Telephone Cables Ltd.	78
Counting Instruments Ltd.	17	McGeoch, William, & Co. (B'ham) Ltd.	84	Telephone Mfg. Co. Ltd.	51
Croydon Precision Instrument Co. Ltd.	48	McMurdo Instrument Co. Ltd.	60	Telequipment Ltd.	22, 23
		Magnetic (Elco) Ltd.	73	Transitron Electronics Ltd.	55
Dawe Instruments Ltd.	25	Mawdsleys Ltd.	82, 84, 86	Transmetrix Electronic Systems Ltd.	86
Dow Chemical Co. (U.K.) Ltd.	87	Metway Electrical Industries Ltd.	93		
		Miniature Electronic Components Ltd.....	3	Union Carbide Ltd.	65
		Muirhead & Co. Ltd.	48, 70		
				V.G. Porcelain Co. Ltd.....	46
E.M.I. Electronics Ltd.	57, 58	Newport Instruments Ltd. ...	91	Venner Electronics Ltd.	13
Edwards High Vacuum Ltd.	88			Vitality Bulbs Ltd.	86
Electrical Power Engineering Co. (B'ham) Ltd.....	100				
Electronic Associates Ltd.	5	Oxley Developments Co. Ltd.	98		
Electrosil Ltd.	14, 47			Walmore Electronics Ltd. ...	46, 91
English Electric Valve Co. Ltd.	69			Ward Brooke & Co. Ltd.	86
Ericsson Telephones Ltd.	19			Welwyn Electric Ltd.	1
Ether Ltd.....	44, 45, 70 <i>a</i>			West Instrument Ltd.	52
Evans, F. W., Ltd.	50			Westinghouse Brake and Signal Co. Ltd.	29
				Whiteley Electrical Radio Co. Ltd.	92
				Wingrove & Rogers Ltd.	82
Ferranti Ltd.	24				
Fielden Electronics Ltd.....	6, 70 <i>b</i>				
Fine Wires Ltd.	90				

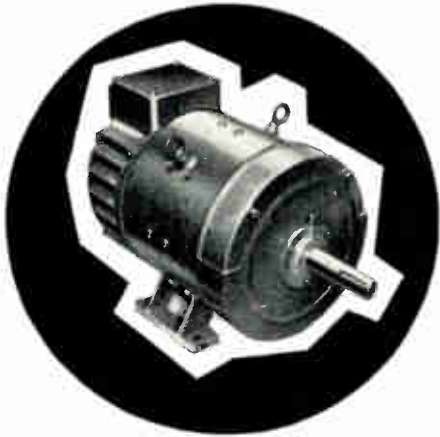

'X' type D.C. motors, $\frac{1}{2}$ - 40 h.p.

You can't say **DEPENDABLE**
without **EPE**



'Y' type D.C. motors, $\frac{1}{2}$ - 40 h.p.

D.C. Motors for electronic speed control



THE ELECTRICAL POWER ENGINEERING CO. (B'HAM) LTD.
EPE WORKS, BROMFORD LANE, BIRMINGHAM 8
Telephone: SEchford 2261
Grams: Torque Phone, Birmingham

WHAT DO YOU KNOW ABOUT BERYLLIA

Already well-known in the field of nuclear engineering, beryllia is beginning to play an important part in electrical and electronic applications. It offers a unique combination of properties :-

- High thermal conductivity — equal to that of aluminium
- High electrical resistivity
- Low dielectric loss

The special properties of beryllia enable it to solve problems of heat dissipation which often arise in the use of transistors, rectifiers, diodes and other semi-conductor devices. And beryllia is especially useful in the higher frequency regions, where capacitance effects caused by conventional insulators would otherwise be prohibitive. A range of standard base washers is available from stock—for full details write for illustrated brochure. A quick service is offered for parts machined to special requirements and quotations for small or large quantities will be gladly submitted on receipt of a sketch or drawing.

CONSOLIDATED BERYLLIUM LIMITED
— an associate company of



Enquiries to:
Imperial Smelting Corporation (N.S.C.) Ltd.
St. Andrew's Road, Avonmouth, Bristol.
Telephone: Avonmouth 3631



Meetings

The Institute of Physics and the Physical Society

47 Belgrave Square, London, S.W.1.

29th Oct. (postponed from 30th Sept.) at Queen Mary College, Mile End Road, London, E.1, 'Spectroscopic Studies of Vibrational Modes' (Phone: Belgravia 6111).

Society of Relay Engineers

Obelisk House, Finedon, Northants.

19th Oct. 2.30 p.m. at the Institution of Electrical Engineers, Savoy Place, London, W.C.2. 'Testing Methods and Equipment Applicable to V.H.F. and H.F. Wired Television Systems'. Tickets will be required.

Society of Environmental Engineers

Radnor House, London Road, Norbury, London, S.W.16 (Phone Pollards 0011).

14th Oct. 7 p.m. at the Royal College of Advanced Technology, Salford. Paper on the 'Testing of Cars for Quality and Reliability'.

20th Oct. 6 p.m. at Imperial College (Mechanical Engineering Department), Exhibition Road, London, S.W.7. Paper on 'Radio-Frequency Interference Control'.

16th Nov. 7 p.m. at the Royal College of Advanced Technology, Salford. Paper on 'Temperature-Testing Techniques and Instrumentation'.

15th Dec. 6 p.m. at Imperial College (Mechanical Engineering Department), Exhibition Road, London, S.W.7. Papers on the 'Economics of Humidity Control in Environmental Test Cabinets', and the 'Current Approach to "Mould Growth" Testing'.

The Institution of Mechanical Engineers

1 Birdcage Walk, Westminster, London, S.W.1 (Phone Whitehall 7476-9).

21st Oct. 6.15 p.m. in Birmingham. Discussion on 'Press Automation Equipment'.

26th Oct. 6 p.m. in London. Discussion on 'Machine-Loading Computer Programmes'.

28th Oct. in London. Conference on 'Automatic Warehousing'. Registration forms from U.K.A.C., Institution of Production Engineers, 10 Chesterfield Street, London, W.1.

16th Nov. 6 p.m. in London. Discussion on 'The Application of N.D.T. to Process-Plant Inspection'.

18th Nov. in London. Discussion on 'Computer Techniques in Stress Analysis'.

1st Dec. 4.30 p.m. in London. Papers on 'High-Reliability Servos', 'Automatic Flight-Control Systems', and 'Servo-Reliability in the "Sea-Cat" Missile'.

13th Dec. 6 p.m. in London. Discussion on the 'Application of Control Theory to Control of Surges'.

The Institution of Electronic & Radio Engineers

8-9 Bedford Square, London, W.C.1 (Phone Museum 1901-3).

13th Oct. 6 p.m. in the I.E.R.E. Lecture Room, Bedford Square. Paper on 'Signal Processing using Optical Techniques'. Tickets will be required.

20th Oct. 6 p.m. at the London School of Hygiene & Tropical Medicine, Keppel Street, Gower Street, London, W.C.1. Discussion on 'Computer/Instrument Interfaces'.

25th Oct. 6 p.m. At the Institution of Electrical Engineers, Savoy Place, London, W.C.2. Paper on 'Opto-Electronics'.

28th Oct. 6 p.m. at the Institution of Electrical Engineers, Savoy Place, London, W.C.2. Joint I.E.E.-I.E.R.E.-Television Society lecture on the 'P.A.L. Television System'.

Conferences, Symposia and Colloquia

14th Oct. One-day symposium on 'The Future Pattern of Research in Instrument Technology', to be held at Constantine College of Technology, Borough Road, Middlesbrough, Yorks, and organized by the Society of Instrument Technology. Details from G. F. Shute, 10 Mayberry Grove, Linthorpe, Middlesbrough.

2nd-3rd Nov. Conference on 'Automatic Control for Plastics Processing', to be held in London. Organized by the Plastics Institute, 6 Mandeville Place, London, W.1.

7th-13th Nov. International Conference of Electrical Engineers to be held in Berlin (East Germany) and organized by the Berlin Chamber of Technology. Information from Lex Hornsby & Partners Ltd., Wellington House, 125/130 Strand, London, W.C.2 (Phone: Temple Bar 3731).

15th-20th Nov. Industrial Conference on 'Productivity, Technology and Change', to be held in conjunction with the Industry '65 Exhibition at Earls Court. Registration forms from the British Productivity Council, Vintny House, Queen Street Place, London, E.C.4 (Phone: Central 9613).

18th-19th Nov. Conference on 'Computational Methods in Crystallography' to be held at the Institution of Electrical Engineers, London, and organized by the Institute of Physics and the Physical Society, 47 Belgrave Square, S.W.1 (Phone: Belgravia 6111).

18th-19th Nov. S.I.M.A. convention on 'Profit and Progress', to be held at the Grand Hotel, Eastbourne. Details from SIMA House, 20 Peel Street, London, W.8 (Phone: Park 2614).

22nd-23rd Nov. International Conference on U.H.F. Television, to be held at the I.E.E., Savoy Place, London, W.C.2. Sponsored by the I.E.R.E., the I.E.E. Electronics Division, the I.E.E.E. and the Television Society. Information from 9 Bedford Square, London, W.C.1 (Phone: Museum 1901). Note that this conference was to have been held from the 1st-2nd Sept.



WHAT'S ON AND WHERE

Continued

22nd–25th Nov. Conference on 'Control of Quality and Inspection in Engineering Manufacture', to be held at the Central Hall, Westminster, London, S.W.1. Organized by Business Publications (Conferences and Exhibitions) Ltd., 103–119 Waterloo Road, London, S.E.1 (Phone: Waterloo 3388).

4th–7th Jan., 1966. Conference on 'Solid-State Physics', to be held at the Manchester College of Science and Technology. Organized by the Institute of Physics and the Physical Society, 47 Belgrave Square, London, S.W.1 (Phone: Belgravia 6111).

20th–21st Jan., 1966. Symposium on 'The Accuracy of Electronic Measurements in I.C. Engine Development'. Organized by the Institute of Mechanical Engineers, 1 Birdcage Walk, London, S.W.1 (Phone: Whitehall 7476/9).

12th–15th April, 1966. Symposium on 'Electronics, Measurement and Control in Ships and Shipbuilding'. To be held at the University of Strathclyde and organized by the Institute of Electrical Engineers. Details from K. A. Murphy, 50 Holeburn Road, Newlands, Glasgow, S.3.

19th–22nd April, 1966. Colloquium on 'Microwave Communication', to be held in Budapest. Organized by the Hungarian Academy of Sciences and the Scientific Society of Telecommunication. Details from Valkó Péterné, Budapest V, Szabadság Tér 17, Hungary.

Exhibitions

2nd–10th Oct. Ljubljana, Yugoslavia
XIIth International Exhibition on Modern Electronics. Details from: Gospodarsko razstavisce (Ljubljana Fair), Ljubljana, Titova 50, Yugoslavia.

4th–13th Oct. London
Business Efficiency Exhibition, London (Olympia). Organized by Business Equipment Trade Association, 64 Cannon Street, London, E.C.4 (Phone: Central 7771).

13th–19th Oct. Dusseldorf
3rd International Congress and Exhibition of Measuring Instrumentation and Automation (Interkama), Dusseldorf, Germany. Represented by John E. Buck (Trade Fair Agencies) Ltd., 47 Brewer Street, Piccadilly, London, W.1 (Phone: Gerrard 7576).

26th Oct.–2nd Nov. Bucharest
SIMA Instrument Exhibition, organized by SIMA in conjunction with the Board of Trade. Full details from SIMA House, 20 Peel Street, London, W.8 (Phone: Park 2614).

26th Oct.–2nd Nov. Rumania
SIMA Exhibition on Instrumentation for Industry, Research & Education, to be held in Bucharest. Details from SIMA House, 20 Peel Street, London, W.8 (Phone: Park 2614).

27th–30th Oct. London
R.S.G.B. Radio Communications Show, Seymour Hall, London. Organized by P. A. Thorogood, 35 Gibbs Green, Edgware, Middlesex.

30th Oct.–7th Nov. Genoa
Second International Communications Fair, organized by the Genoa International Fair, Viale Brigate Partigiane, Genoa, Italy. To be held in conjunction with the Second International Aircraft Exhibition.

30th Oct.–7th Nov. Genoa
Second International Aircraft Exhibition, organized by the Genoa International Fair, Viale Brigate Partigiane, Genoa, Italy. To be held in conjunction with the Second International Communications Fair.

3rd–10th Nov. Oslo
Automatica 65—an exhibition of automatic control. Held in the Exhibition Hall, Skoyen, Oslo. Details from: Studiesel-skapet For Norsk Industri, Forskningsveien 1, Oslo 3.

15th–20th Nov. London
Industry '65 Exhibition—the International Industrial Equipment and Services Exhibition at Earls Court, London. Organized by the Industrial and Trade Fairs Ltd., Commonwealth House, 1-19 New Oxford Street, London, W.C.1 (Phone: Chancery 9011).

15th–20th Nov. London
Industrial Photographic and Television Exhibition at Earls Court. Sponsored by *The Financial Times* and organized by Industrial & Trade Fairs Ltd., 1-19 New Oxford Street, London, W.C.1 (Phone: Chancery 9011).

23rd–30th March, 1966. London
Electrical Engineers Exhibition, at Earls Court, London; organized by the Electrical Engineers (ASEE) Exhibition Ltd. Details from 6 Museum House, 25 Museum Street, London, W.C.1 (Phone: Museum 2706/7).

Courses

Non-Destructive Testing

Ilford Ltd. is to conduct three courses annually in non-destructive testing methods. The next four-week course will be held from 15th Nov. to 10th Dec. inclusive, at their N.D.T. Centre in London.

The course will train personnel in radiographic, ultrasonic and other N.D.T. methods, and is designed to meet the needs of those who have a limited practical or theoretical knowledge of them. Its aim is to provide students with an understanding of the factors involved in producing reliable high-quality results in all industrial techniques. Further information from Ilford Ltd., Tavistock House (North), Tavistock Square, London, W.C.1 (Phone: Euston 0631).

Integrated Electronics

A series of seven Tuesday-evening lectures is to be held at the Wandsworth Technical College, London, S.W.18 (Phone: Vandyke 2355), from 12th Oct. to 23rd Nov. The course has been organized by the College Electrical Engineering Department, in conjunction with E.M.I. Electronics, and will cover the broad spectrum of micro-electronics, with special emphasis being given to applications.

Computer Training

A comprehensive training programme in advanced management and computer techniques is announced by C-E-I-R Limited, 30/31 Newman Street, London, W.1, and will include courses designed for the specialist as well as the layman.

The programme covers the use of computers in management, the commercial applications of computers, critical path methods, and resource planning and scheduling methods. Programme booklet and further information from the Training Manager, C-E-I-R Ltd., Sanderson House, Berners Street, London, W.1.

Colour Television

A series of six special Tuesday evening lectures on Colour Television, starting on Tuesday, 12th October, and organized by the Norwood Technical College, Knight's Hill, London, S.E.27.

A knowledge of monochromatic television will be assumed and further particulars are available from the College Secretary.



INTRODUCE THE NEW

For use with computers and data handling equipment
Engineered to fulfil all industrial requirements for a fast versatile data printer

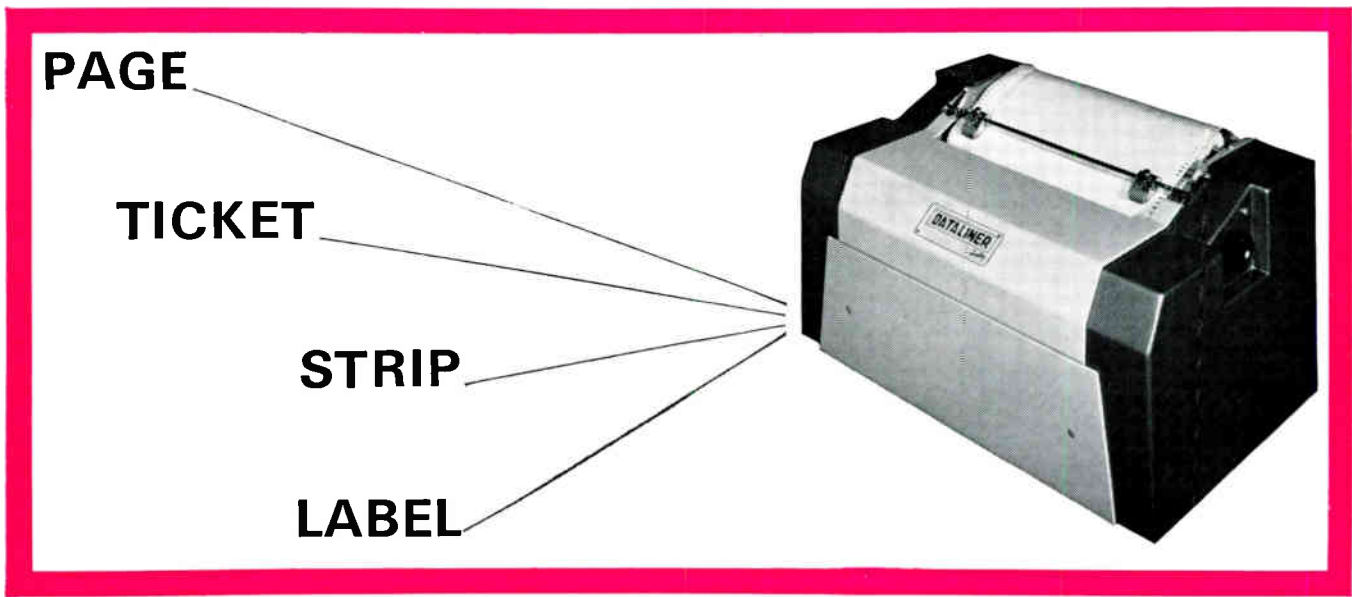

- ★ Used with industrial digital measuring equipment: Automatic Production Recorders, Data Loggers and Computers
- ★ Prints up to 70 characters simultaneously
- ★ Up to 150 lines per minute and any 13 characters per column
- ★ Information input on only 14 lines
- ★ Single shot operation
- ★ Modular construction
- ★ Drive circuits either electro-mechanical or semi conductor switches
- ★ Manufactured by GPS, famous for the Link Trainer, simulators and a wide range of industrial electronic equipment.

For detailed information or a demonstration please contact:



GENERAL PRECISION SYSTEMS LIMITED

INDUSTRIAL PRODUCTS DIVISION · AYLESBURY · BUCKS.
TELEPHONE: AYLESBURY 4611 TELEX: 83130

PAINTON RELIABILITY

at the right price for these

FIVE NEW CONNECTORS

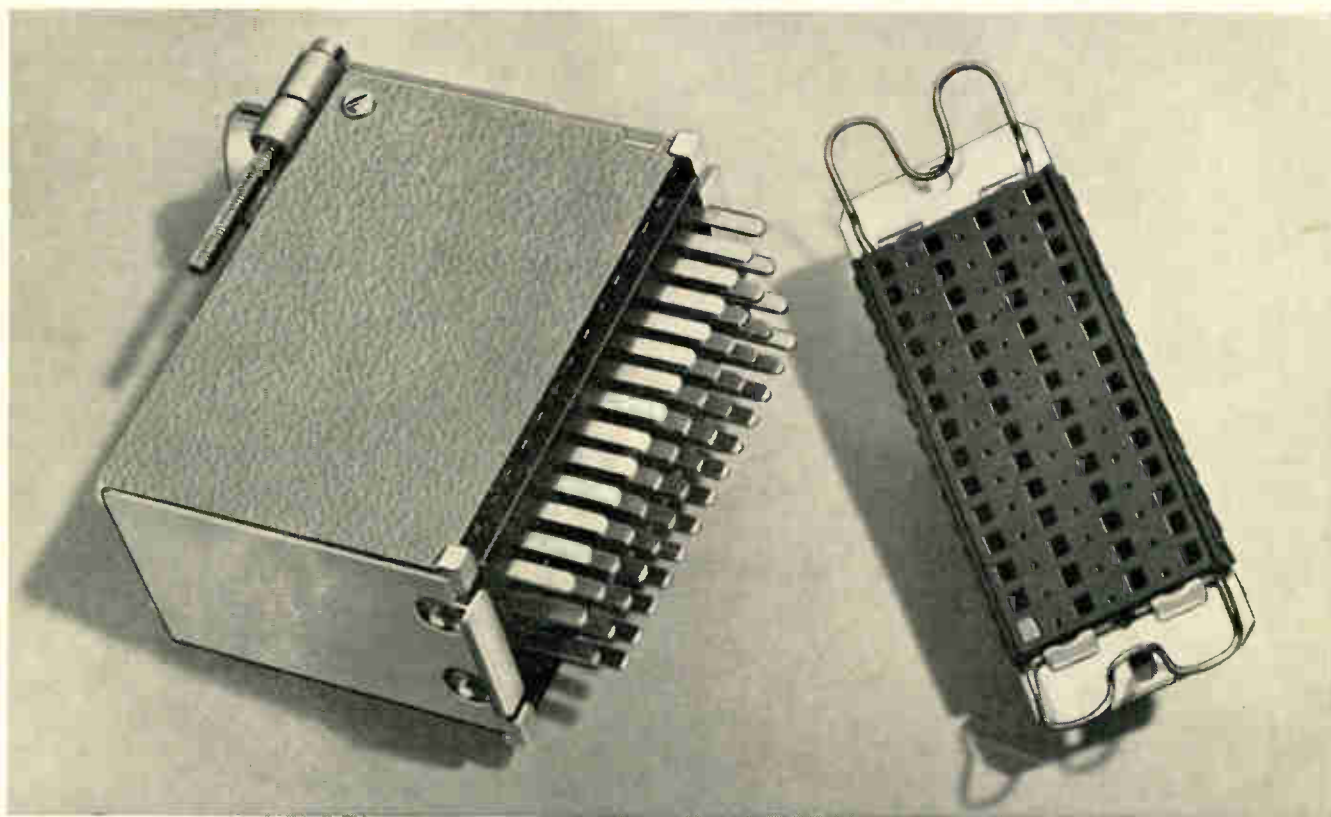

35 WAY

47 WAY

55 WAY

59 WAY

71 WAY

These new additions to the Painton **159 Series** Connectors embody the space-saving configuration and high standards of reliability already well established for this range of components, and are offered at sensible prices. Send for leaflet P.S.10

These Types specially developed for the G.P.O. & approved by them as PO203.

Painton
& CO LIMITED

KINGSTHORPE · NORTHAMPTON
Tel: 34251 (10 lines) · Grams: 'Ceil' Northampton · Telex 31576

Overseas Associated Companies **Australia** Painton Australia Pty. Ltd. · **Benelux** Painton S.A. · **Germany** Painton G.m.b.H. · **Italy** Painton Italiana · **Sweden** Svenska Painton A.B. · **U.S.A.** Painton Inc.