

INDUSTRIAL ELECTRONICS

JULY 1965 5s 0d

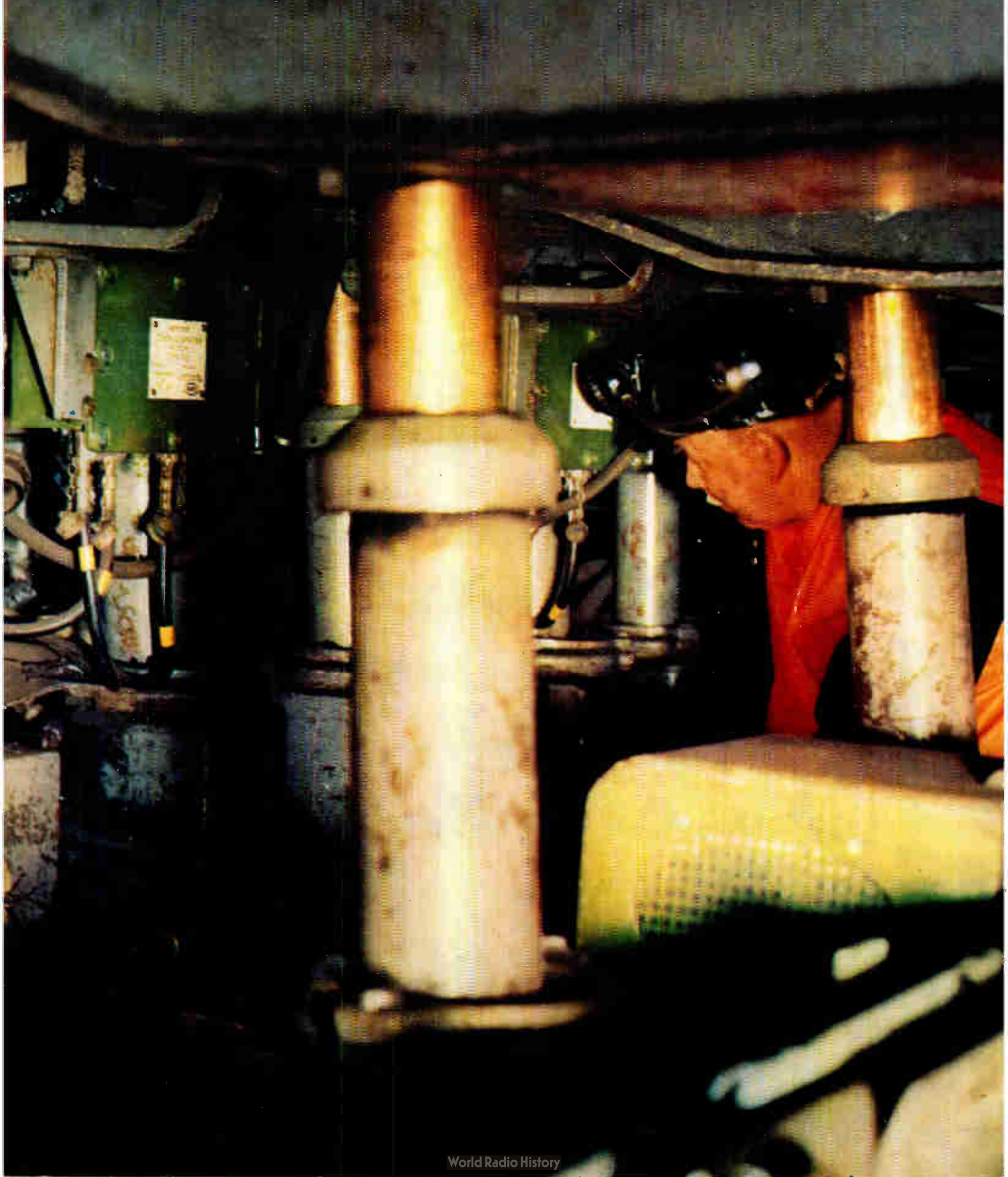

A NEW WAY OF MEASURING TORQUE

achieving accuracies within 0.25%

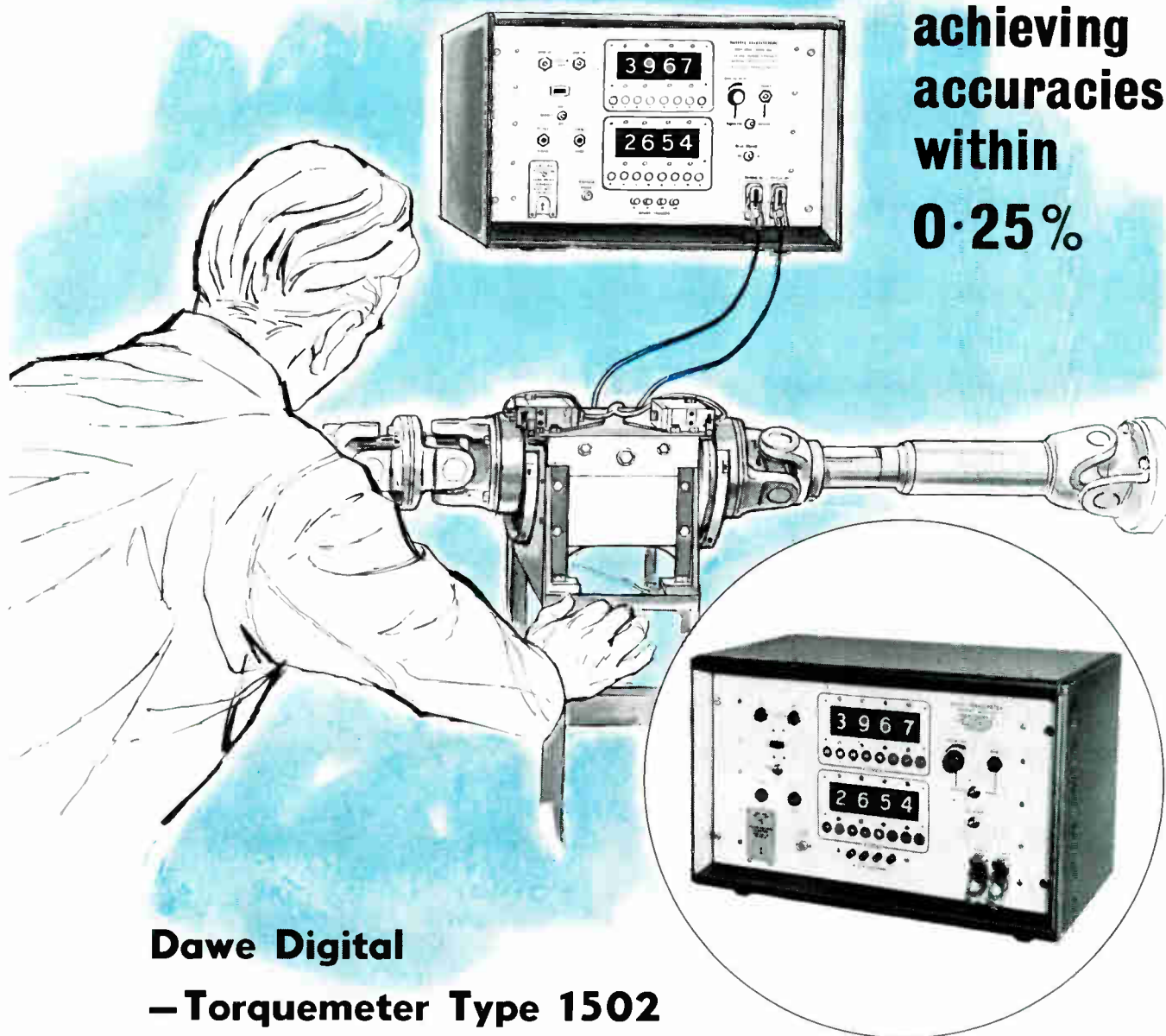

Dawe Digital —Torquemeter Type 1502

A MARKED ADVANCE ON EXISTING EQUIPMENT—

It takes 20 readings per shaft revolution and displays the average (obtained electronically). Under high-torque, low-speed conditions, it has distinct advantages over costly and bulky swinging dynamometer equipment.

- * Fully transistorised
- * Displays two 4-figure readings
- * Very high accuracy and resolution—typically 0.25% for a 3° twist at 500 r.p.m.
- * Simultaneous readings of speed and torque
- * Errors through torsional vibrations minimised by averaging techniques

- * Unique torque setting facility
- * Two instruments may be synchronised to give simultaneous readings

Send for leaflet of this latest contribution by DAWE to measuring techniques in the marine, automotive and aeronautical industries



Full technical data from:—

DAWE INSTRUMENTS LTD., WESTERN AVE., LONDON, W.3 Tel: ACO rn 6751

A member of the *Simms* group of companies

INDUSTRIAL ELECTRONICS

Automation Instrumentation Control

Volume 3

Number 7

July 1965

Contents

Editor-in-Chief **W. T. COCKING, M.I.E.E.**

Editor **T. J. BURTON**

Advertisement Controller **G. H. GALLOWAY**

Advertisement Manager **R. H. C. DOHERTY**

Production **D. R. BRAY**

Drawing Office **H. J. COOKE**

307 **Comment**

308 **Electronics in Coal Mining**

by P. J. Billing

More and more the coal mine is being mechanized. This in its turn demands remote control of the machinery and this makes it possible for miners to work further from the danger area. This article explains the control and communication systems now in use and shows how the special safety requirements of a coal mine are met.

314 **Hydraulic Handling of Fruit**

by P. G. Morgan

In the preparation of apricots for drying it is necessary to split each fruit into two halves and to remove the stone. This article describes a hydraulic system for handling the fruit and properly orientating it for the cutting operation.

318 **Continuous Weighing and Control in Heavy Industry**

by A. C. Elstow

This article describes a control system which has been installed in a Swedish steel mill. Both belt weighing for continuous operation and hopper weighing for batches are employed.

324 **A Practical Approach to Analogue Computers** *by D. S. Terrett, B.Sc.(Hons.)*

Continuing the discussion of analogue computers, this second half of the article discusses how they are used to solve equations and illustrates this by some simple examples. Multipliers and function generators are also discussed.

continued overleaf

© Iliffe Electrical Publications Ltd., 1965

Permission in writing from the Editor must first be obtained before letterpress or illustrations are reproduced from this journal. Brief abstracts or comments are allowed provided acknowledgment to the journal is given.

Published on the first Thursday after the 5th of each month by

Iliffe Electrical Publications Ltd., Dorset House, Stamford Street, London, S.E.1

Managing Director: W. E. Miller, M.A., M.I.E.E.E.

Telephone: Waterloo 3333. Telegrams/Telex: Electronics Iliffepres 25137 London

ANNUAL SUBSCRIPTION, HOME £3 0s. 0d. OVERSEAS £3 10s. 0d.
CANADA and U.S.A. \$10.00.

INDUSTRIAL ELECTRONICS

Automation

Instrumentation

Control

Contents *continued*

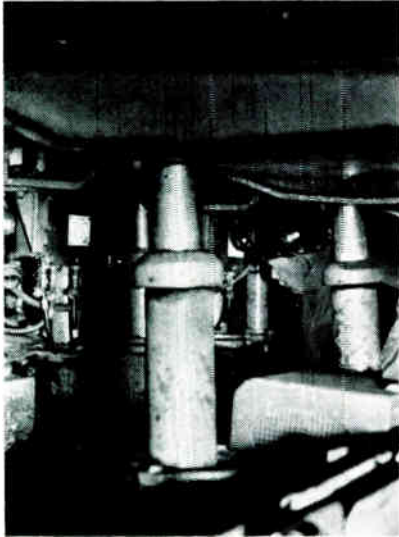

OUR COVER

This month's picture shows a maintenance man working on a remotely-operated roof support at Newstead Colliery. Elsewhere in this issue an article gives details on some of the electronic devices which are now being used in coalmining to increase efficiency and safety

● TO SAVE YOUR TIME

We will assist you to obtain further information on any products or processes described or advertised in this issue. Just use the enquiry cards included in this journal.

332 Digital Voltmeters

by J. B. Dance, M.Sc.

Digital voltmeters are now quite widely used. This article reviews their general principles of operation with particular reference to the methods employed for converting an analogue voltage into a digital display.

337 Control Design Data—Bridged-T Compensating Networks 2: Pole-Zero Methods

by N. G. Meadows, B.Sc.

What's On and Where?

A regular feature which lists forthcoming events. Professional meetings, symposia, conferences and exhibitions are included. For easy reference this item is positioned facing the inside back cover.

Features

313 Simulator Developed for Locomotive Driver Training

317 B.E.A.M.A. Annual Report

323 Automated Solid State Weighing

323 Longwall Face Roof Supports

329 New Developments in Ferrites

330 Illustrated News

339 New Apparatus

351 New Digital Teaching Machine

352 Industrial News

355 New Books

356 Manufacturers' Literature

48 Classified Advertisements

51 Index to Advertisers

Next Month

The control of a paper-making machine by a digital computer is described in next month's issue. Among other articles there will be one dealing with solid-state control instrumentation for industrial application.

For further information
circle 203 on Service Card

**With over 20 years unique
experience in the manufacture
of Film Resistors—Welwyn now offer an
UNPARALLELED SERVICE IN THE FIELD OF
THIN FILM INTEGRATED CIRCUITS**

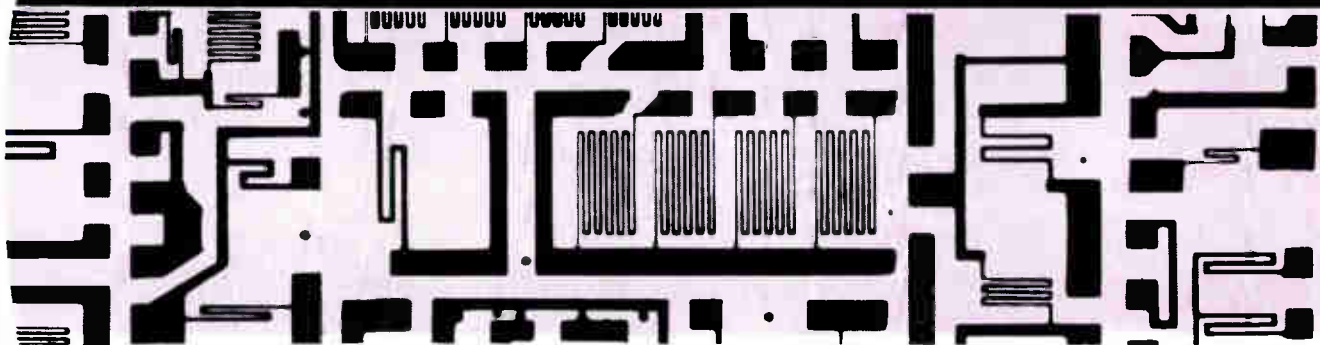

THIN FILM CIRCUITS from WELWYN

Leading the field in the latest production techniques—Welwyn offer

- Thin Film Integrated Circuits in volume production—NOW.
- Thin Film Integrated Circuits at PRICES MORE THAN ATTRACTIVE when compared with assemblies of high grade discrete components.
- Thin Film Integrated Circuits individually engineered to YOUR SPECIAL REQUIREMENTS.
- Essential Present Day reliability standards in every Welwyn Thin Film Circuit.

The new Welwyn brochure
“THIN FILM INTEGRATED CIRCUITS”
is now available—write for your copy.
Circuit Engineers are also requested to
submit their particular requirements for
evaluation in the Welwyn technique,
or to ask for general samples.



WELWYN ELECTRIC LIMITED

BEDLINGTON - NORTHUMBERLAND - ENGLAND

Telephone : Bedlington 2181-9 - Telegrams : Resistor' Bedlington.

FACTORIES IN AUSTRALIA AND CANADA

A low cost FULLY POTENTIOMETRIC INDICATING TEMPERATURE CONTROLLER

Eight control actions are available, including:—

- TWO-POSITION
- ANTICIPATORY
- PROPORTIONING*
- THREE-POSITION
- CONTINUOUSLY ACTING

*for thyristors or saturable reactors and motorised valves.

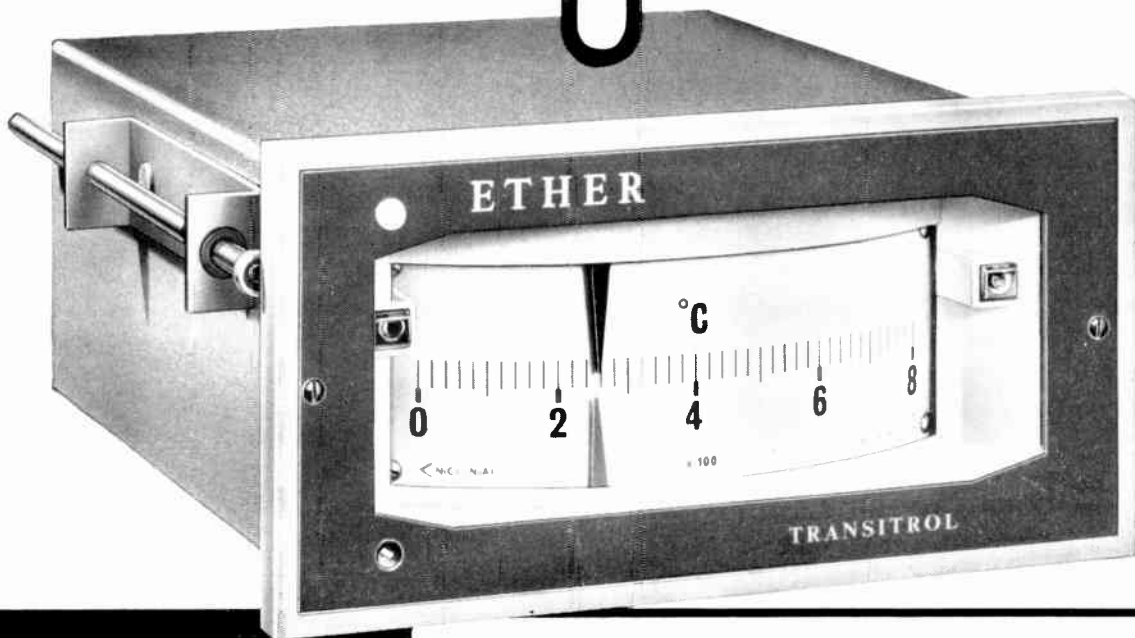

ETHER

TRANSITROL

SERIES 1290

Close accuracy, wide range, for Thermocouple Resistance Bulb or mV inputs.

Measurement is by the continuous comparison, via a slide wire, of the input signal against a stabilised internal reference voltage. The derived error signal is amplified to trigger a phase sensitive detector. This operates an actuator to drive both the indicator and the slide wire contact to eliminate the error.

Control is effected by two contacts on an auxiliary slide wire—one attached to the indi-

cating pointer and one in line with the control setting. The voltage difference is amplified and operates a suitable control relay. Thus both measuring *and* control actions are fully potentiometric—a unique feature giving TRANSITROL outstanding advantages over other temperature indicating controllers. The Transitrol is housed in an attractive, flush mounting, fully sealed case in two-tone grey finish, with easy-to-read vertical or horizontal scale.



Send for full details to:—

CAXTON WAY, STEVENAGE, HERTFORDSHIRE
Telephone: Stevenage 3040-55

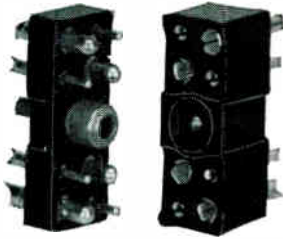

L1387 4+4 pole plug & socket

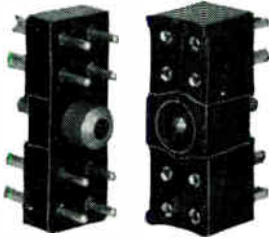

L1388 8 pole plug & socket

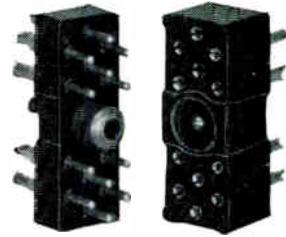

L1389 12 pole plug & socket



BELLING-LEE

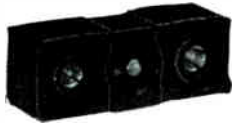

L1390 2 pole plug & socket



L1580 Twin co-axial plug & socket



miniature unitors that...



L1588/C Cover
L1588/R Retainer (not shown)



L1570 Co-axial shorting link

The Belling-Lee miniature unitor is based on a 1" x $\frac{3}{8}$ " module with up to 12 contacts, 5 and 10A rating, including r.f. and high-voltage connectors. Panel mounting or cable termination. Versatile. Compact. All units physically interchangeable. Polarising Earth Spigot, precision machining and controlled end-float of contacts ensure positive location.

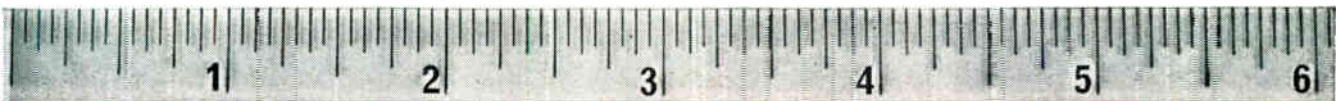

fit in with your designs

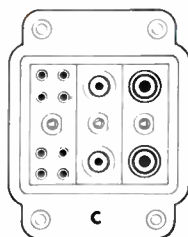
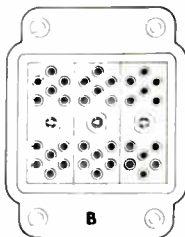
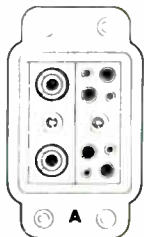

Example A shows an L1390 and L1387 side by side in a two unit shroud.
Example B shows three L1389 Miniature Unitors giving 36 poles in an area of only 1.32 sq. inches.
Example C shows an L1388, L1390 and L1580 side by side, in which supply voltages and r.f. or pulse signals can be grouped together in one unit. One of several thousand possible groupings.

Write now for full technical data.
Get down to detail with

BELLING-LEE

Most Belling-Lee products are covered by patents or registered designs or applications.

BELLING & LEE LIMITED · GREAT CAMBRIDGE ROAD · ENFIELD · MIDDLESEX · Tel: ENFIELD 5393



**it doesn't matter
which telephone
you use!**

... as long as you get through to HARrow 6347. Don't ask for a new telephone though - Radio Resistor are in business to sell you - resistors! Any sort of resistor you may require - any value, rating or tolerance and in any quantity. This is important - one day you may need one or a handful for a prototype - the next many thousands for your production line. HARrow 6347 is the number - try it and you'll be amazed how fast your request is met.

RADIO RESISTOR CO LTD

PALMERSTON ROAD · WEALDSTONE · HARROW · MIDDLESEX · TEL: HARrow 6347 · TELEX: 25572



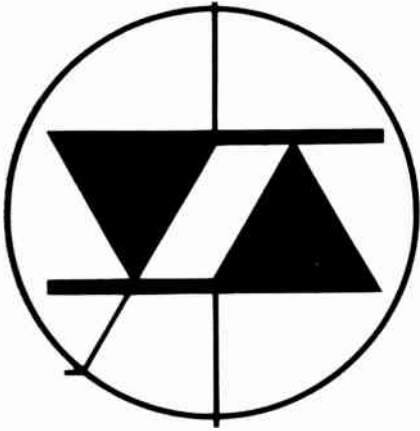

TRIAC

A NEW SEMICONDUCTOR SIMPLIFIES AC FULL-WAVE CONTROL CIRCUITS . . . REDUCES CIRCUIT SIZE AND COST

TRIAC is a new three-electrode AC semiconductor switch which is triggered into conduction in either direction by a gate signal.

It's actually a power "integrated" circuit, basically related to the Silicon Controlled Rectifier (SCR) and brought to you by the SCR pioneer, General Electric Company of U.S.A. The company's other technological advances include the Controlled Avalanche Rectifier and high-current silicon rectifiers.

TRIAC simplifies control of full-wave AC power by: 1. reducing the

number of power-handling components, 2. generally eliminating need for transient voltage suppression and 3. reducing size and complexity of gate-control circuits.

Compare the two circuits below. Both show a full-wave AC static switch. The one on the left—the more complex—uses multiple SCR's. The simpler circuit on the right uses a single TRIAC.

If you're interested in applications such as static power switching, temperature controls, lamp dimming or motor-speed controls,

you should look into TRIAC.

It's available in compact and rugged housings, stud or press-fit. And it comes in two voltage ratings: 200 V (SC40B) and 400 V (SC40D).

You'll also be interested in the new DIAC (diode AC switch), to trigger the TRIAC and SCR's.

For information, contact International General Electric Company of New York, Ltd., Lincoln House, 296 High Holborn, London, W.C.1 . . . or *General Electric Company, Dept. EC-65-02, 159 Madison Ave., New York, N.Y. 10016, U.S.A.*

This circuit can be simplified . . .

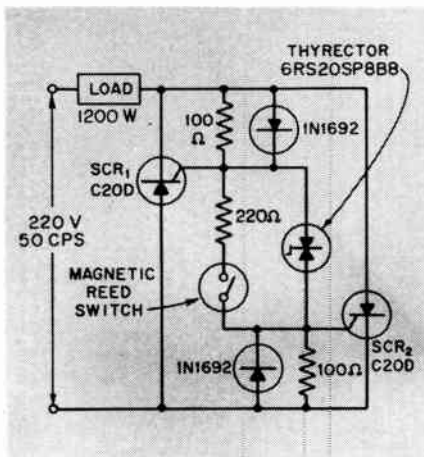

to this

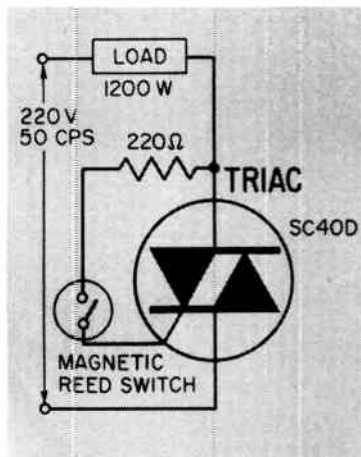

**GENERAL ELECTRIC
COMPANY OF U.S.A.**

'VSG' hydraulics

Hydraulic power has no equal for precise smooth and infinitely variable control of complex machine operations. 'VSG' Racine provides today's most advanced developments in hydraulic transmissions and pumps, with drives approaching 300 hp (maximum) and pumping pressures of up to 10,000 lb/in². In addition, the new Slipper

Pad 'VSG' range offers high performance units which are lighter and more compact than ever.

If you wish to know how 'VSG' or Racine hydraulic assemblies can benefit your production, please write or ring your nearest Hydraulics Division Office.

Left hand illustration shows the model SP 30 which delivers 100 gal/min at 2,800 lb/in² when driven at a speed of 960 rev/min. Right hand illustration shows model SP 3 which delivers 25 gal/min at 2,500 lb/in² when driven at a speed of 1,430 rev/min.

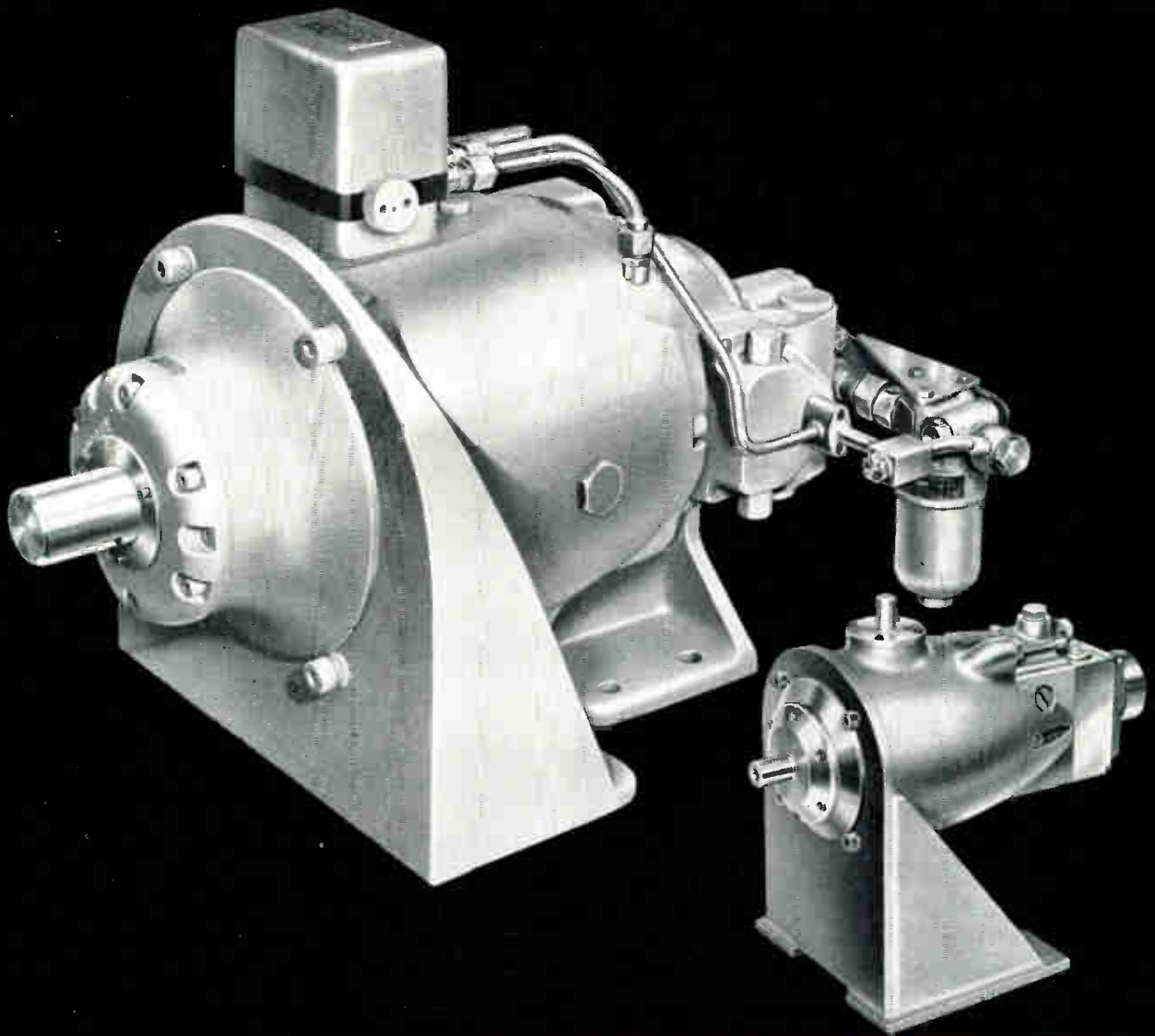

VICKERS LIMITED ENGINEERING GROUP HYDRAULICS DIVISION
VICKERS-ARMSTRONGS WEYMOUTH WORKS WEYMOUTH DORSET Tel: Weymouth 4
AREA SALES OFFICES BIRMINGHAM LIVERPOOL LONDON NEWCASTLE UPON TYNE WEYMOUTH

SPECIFY HUGHES DIODES

Hughes — originators of the world's first sub-miniature all-glass diode — manufacture at their Glenrothes, Scotland, factory an unequalled range of germanium and silicon devices for the most diverse diode applications. Add Hughes service and second-to-none product quality and solve your diode problems in the simplest way — SPECIFY HUGHES.

GERMANIUM SWITCHING DIODES

HG1005	Point-Contact	PIV	up to 100V	CV448
HG1006		$I_F @ 1V$	> 5mA	CV7041
HG1012		$I_b @ 50V$ Capacitance	< 50 μ A 0.2pF	CV7130
HG5003	Gold-Bonded	PIV	up to 100V	CV7076
HG5004		$I_F @ 0.8V$	> 100mA	CV7127
HG5008		$I_b @ 50V$	< 25 μ A	CV7128
HG5009		Capacitance Stored charge	0.4pF 400pC	
HD1810	Gold-Bonded	PIV	up to 50V	
HD1840		$I_F @ 0.7V$	> 100mA	
HD1841		$I_b @ 10V$	< 5 μ A	
HD1870		Capacitance	1.5pF	
HD1872		Stored charge	65pC	
HPS1670	Ultra-Fast Point-Contact	PIV	up to 20V	
HPS1672		$I_F @ 1V$ Reverse recovery time	10mA 0.8 nanosec	

SILICON SWITCHING DIODES

1N643	High voltage diffused	PIV	up to 200V	
1N643A		$I_F @ 1V$	100mA	
1N806		Capacitance	5pF	
1N809		Stored charge	500pC	
1N914	Diffused Planar	PIV	up to 75V	
1N914A		$I_E @ 1V$	20mA	CV7367
1N916		$I_b @ 20V$	< 0.025 μ A	CV7368
1N916A		Capacitance	2pF	
1N3064		Stored charge	60pC	
1N3067				
HD5000	Ultra Fast	PIV	up to 20V	
HD5001		$I_F @ 1V$	5mA	
HD5004		$I_b @ 5V$	< 0.2 μ A	
		Capacitance Stored charge	1pF negligible	

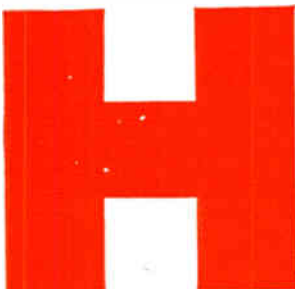

Write now for complete data on the full range of Hughes semiconductor products, which also includes:—Silicon sub-miniature power diodes/rectifiers, Voltage reference (zener) diodes, High voltage cartridge rectifiers, PNP and NPN Silicon Transistors.

HUGHES INTERNATIONAL (U.K.) LTD

GLENROTHES · FIFE · SCOTLAND

Sales office:
HEATHROW HOUSE, BATH ROAD, CRANFORD, HOUNSLOW, MIDDLESEX
TEL: 8KYport 9584/5 and 9961/2. TELEX: 23613.

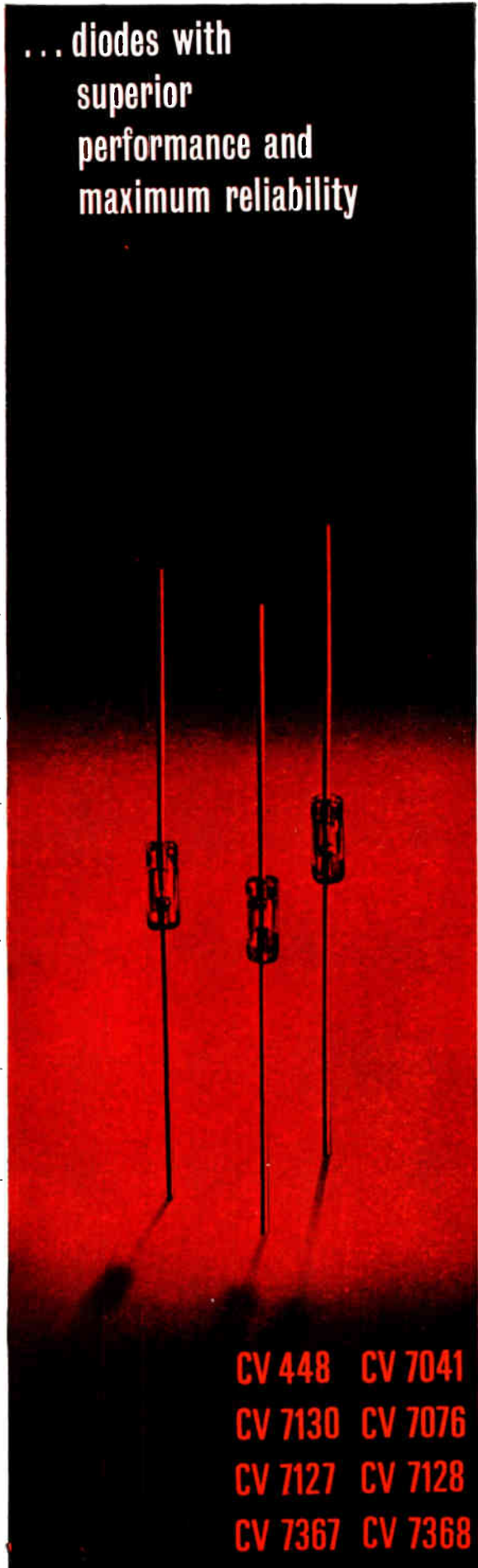

CV 448 CV 7041
CV 7130 CV 7076
CV 7127 CV 7128
CV 7367 CV 7368

no
shadow
of
doubt...

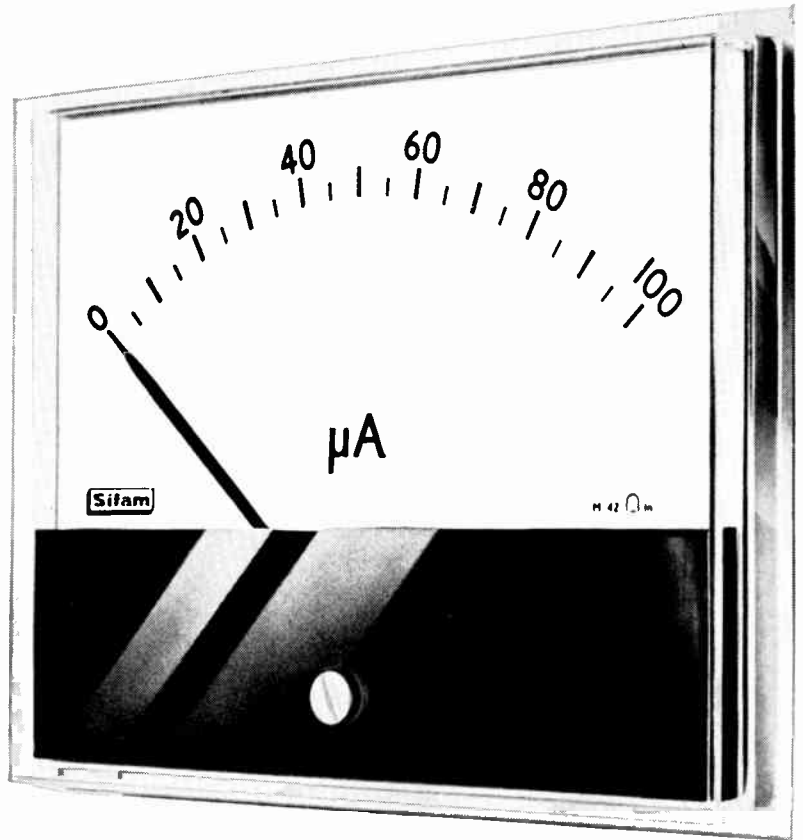

... why Sifam 'CLARITY' instruments
are specified, so often



The elimination of any solid surround to Sifam 'CLARITY' instruments eliminates top shadow, especially when instruments are mounted above eye level. This feature also provides greater readability, thereby minimising the risk of human error in recording readings.

The use of a completely transparent moulded front provides for a greater scale length for a given front area of instrument. Interchangeable masks are available in a choice of contemporary colours, to blend with customers' equipment. Designed with special reference to ergonomic considerations, Sifam 'CLARITY' instruments have a clean, modern appearance, combining contemporary styling with consistent accuracy.

Sifam 'CLARITY' instruments are normally supplied to meet the requirements of B.S.S.89 (1954) but other accuracies, i.e. the now obsolete B.S.S.89 (1937) can be supplied on request. Scale arcs, mountings and pointers can be supplied in accordance with the new B.S.S. 3693 Part 1, 1964, or to customers' requirements.

Please write for Data Sheets 106/C & 106/C1.



I N S T R U M E N T S

SIFAM ELECTRICAL INSTRUMENT CO. LTD.

Woodland Road, Torquay, Devon. Telephone: Torquay 63822/6

SI. 51

COLVERN

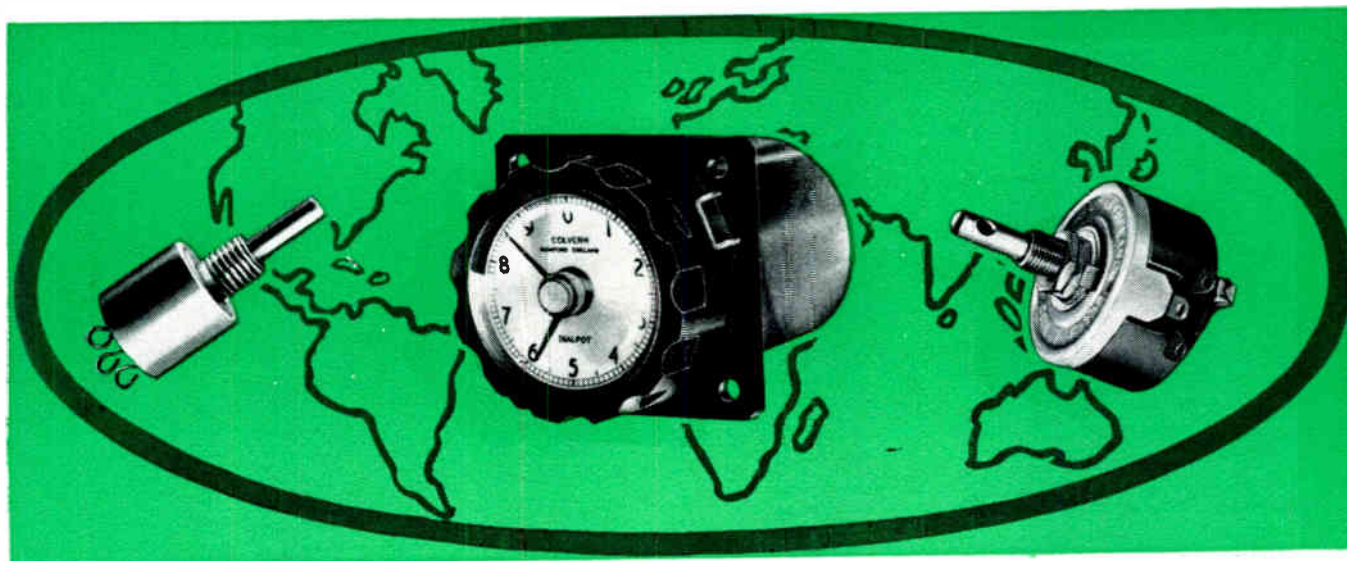

WORLD RENOWNED

for wire wound **POTENTIOMETERS**

- ★ STANDARD TYPES 1-25 WATT.
- ★ SEALED TROPICAL TYPES.
- ★ HELICAL, STANDARD AND PRECISION.
- ★ PRECISION LINEAR AND FUNCTION.

With over 50 types in production. This comprehensive range covers most of the requirements of a wirewound potentiometer, but if you have a special problem contact our advisory engineering service. Literature also available.

COLVERN
L I M I T E D

Spring Gardens, Romford,
Essex, England
TEL. ROMFORD 62222 (PBX) TELEX 23984

10⁻¹⁰ TORR

PUMPING SPEEDS INCREASED

NO EXTRA COST

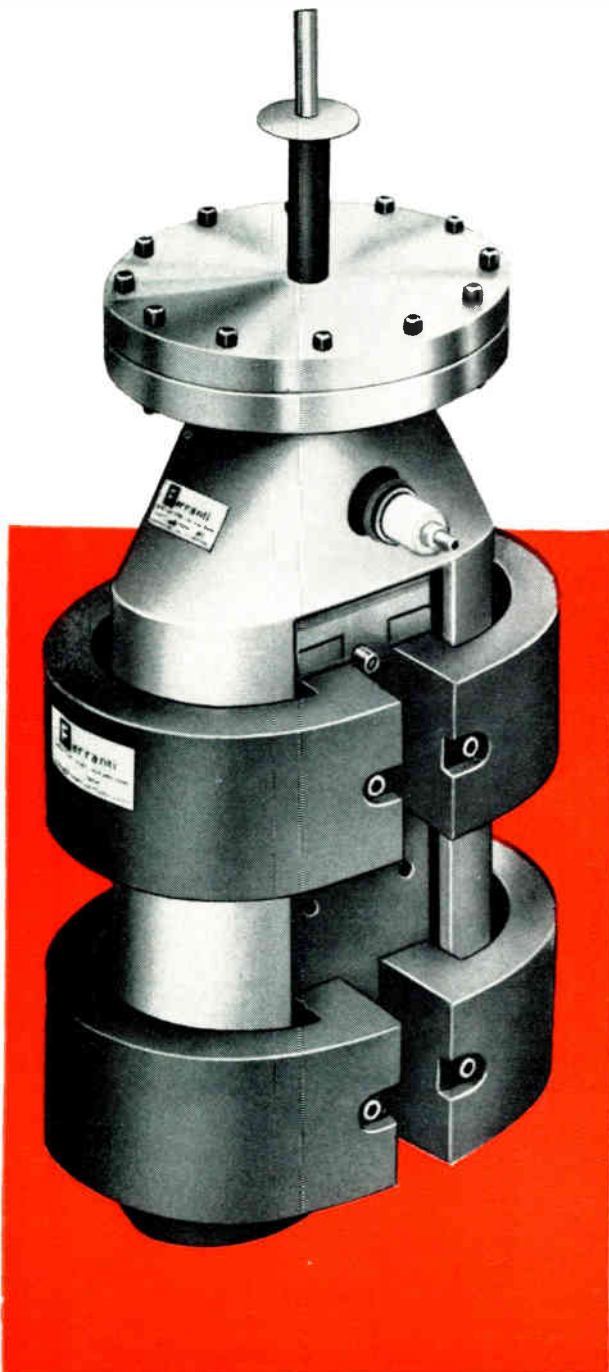

GETTER ION PUMPS

- Vacuum obtained electronically
- Pump current indicates degree of vacuum
- Uniform pumping speed
- Freedom from contamination
- Closed system ensures immunity from power failures
- No oil or other pumping fluid required
- Long life and very reliable
- Can be operated by remote control in any position
- Cold trap not necessary

Ferranti offer a series of Getter Ion Pumps with pumping speeds up to 500 litres per second. Higher speeds can be manufactured to customers' special requirements.

ABSORPTION PUMPS

The Ferranti Absorption Pump produces the initial vacuum for Getter Ion Pumps. It quickly produces a pressure of 10⁻² Torr from atmosphere by cooling a molecular sieve to liquid air temperature.

A full range of accessories such as Control Units, Flanges, Gaskets, T-pieces and High Vacuum Valves is available for use with these pumps.



FERRANTI

First into the Future

FERRANTI LTD GEM MILL
CHADDERTON, OLDHAM, LANCS. Tel: MAIn 6661

FE 255.2.

Industrial Electronics July 1965

JULY, 1965

STC components review

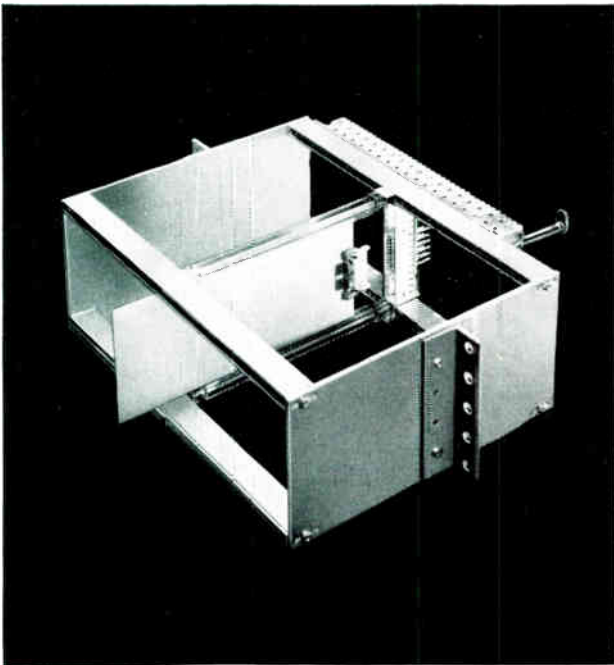

Equipment design and construction with ISEP

International Standard Equipment Practice covers a range of parts from connectors to cubicles. The system offers a rational solution to the problems inherent in the overall process of building electronic equipment.

The ISEP system is modular, but has enormous scope for dimensional variety. This gives the designer freedom of design ingenuity whilst keeping costs low through standardization of parts. All parts are available from STC "off the shelf". The mechanical work in producing dimensional variation is simple and minimal. No metal finishing is involved.

With ISEP hardware, the development prototype will be nearer to the production version than with other systems. In both instances assembly is fast and simple. No special tools are needed and no jigs are required. Standard parts either snap together or have built-in locations for screwing.

Write, 'phone or telex for full details to Electronic Services, STC, Edinburgh Way, Harlow, Essex. Telephone: Harlow (STD code OBS96) 26811. Telex: 81146.

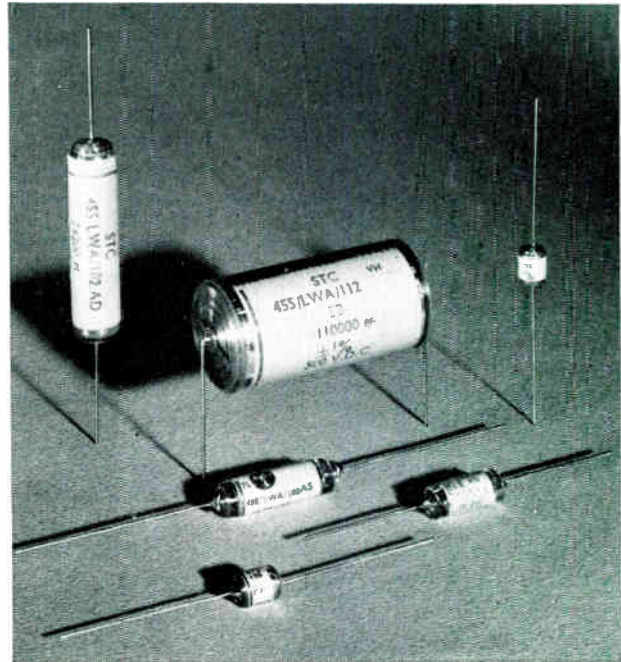

Polystyrene capacitors

STC polystyrene capacitors are non-polar. They have a low power factor, which is substantially independent of frequency; good capacitance stability and high insulation resistance.

STC polystyrene capacitors are made in three voltage ratings:—

125V with capacitance values from 10pF to 0.5 μ F
350 and 500V with capacitance values from 10pF to 0.2 μ F

The 500V range meets the requirements of classification H5 of draft British Standards 2137 over the temperature range -40°C to $+70^{\circ}\text{C}$.

All values are available to either high or low capacitance tolerances.

These capacitors are ideally suited for use in i.f. transformers, filters, oscillatory and computing circuits, for neutralizing and coupling.

Write, 'phone or telex for data sheet to STC Capacitor Division, Brixham Road, Paignton, Devon, or London Sales Office, Footscray, Sidcup, Kent. Telephone: FOOTscray 3333. Telex: 21836.

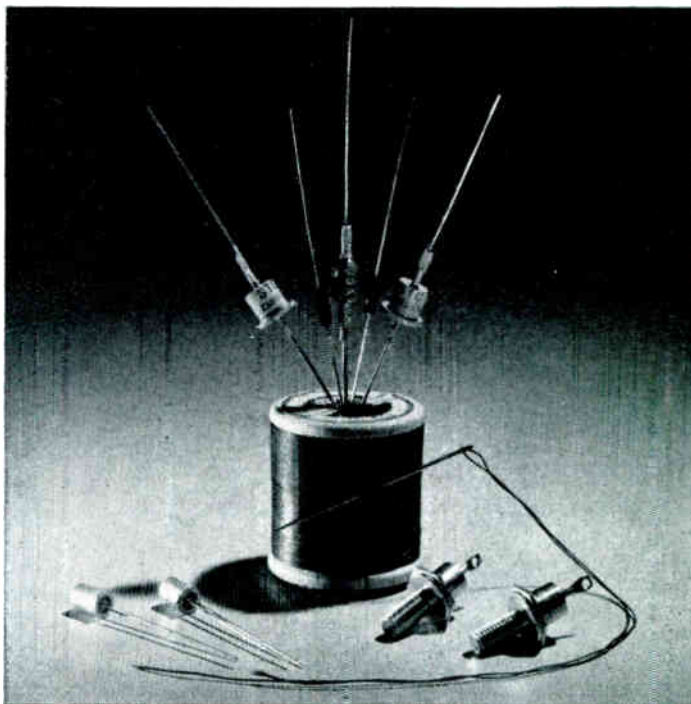
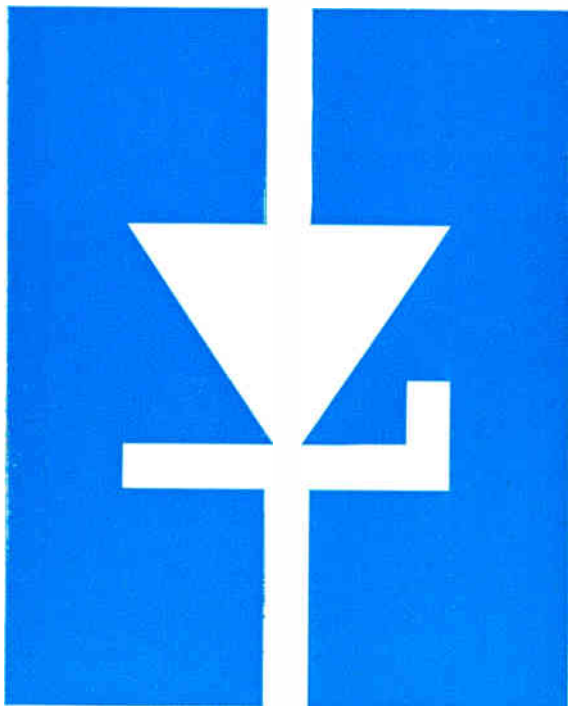

We have your Zener diode problem sewn up

Now added to the STC range of Zener diodes are those previously manufactured by Brush Clevite and the complete range from Intermetall. This means that Europe's biggest range of Zeners is now obtainable from STC. The combined ranges include Zeners of 10W, 1.5W, 1W, 400mW and 250mW dissipation available over many voltages at tolerances from 5% to 20%.

STC Zeners have sharp turn-over characteristics, low slope resistance and low leakage current. This makes the devices eminently suitable for d.c. voltage reference, regulation, clipping, limiting and surge protection.

Write, 'phone or telex for data sheets to STC Semiconductor Division (Rectifiers), Edinburgh Way, Harlow, Essex. Telephone: Harlow (STD code OBS96) 26811. Telex: 81146.

high-grade components by **STC**
COMPONENTS GROUP

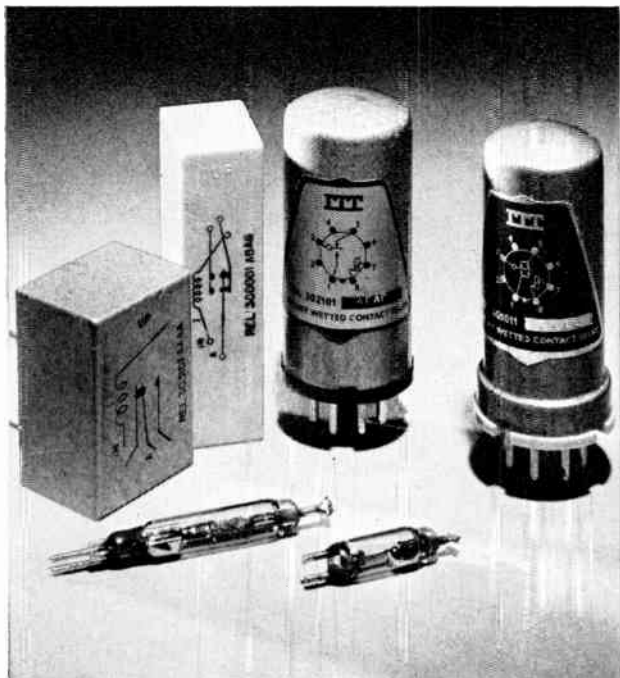

Mercury wetted relays

Individual STC mercury wetted relays have already performed 2,700 million operations without deterioration during routine tests. These tests have been conducted over several years whilst switching a 5 ampere non-inductive load. The switch contacts are permanently covered with a film of mercury and thus the contacts are renewed with each operation, because mercury feeds along the contact blades by capillary action from a small reservoir in the base of the relay.

The action of the new 'mercury-wetted' relays is basically different from that of the established tilting mercury switches used in many types of control equipment. Principal advantages of the new units are their superior contact rating for small size and very long life span with full reliability.

The switches are of the reed type, with contacts in thick-walled glass envelopes, filled with hydrogen and containing the mercury supply. Unlike conventional mercury switches, the new relays remain operational when tilted as much as 45°.

STC mercury-wetted relays can be obtained as basic switch units but are usually supplied complete with coils—the whole unit being potted ready for insertion in printed circuit boards or encased in steel cans and built on to standard octal plugs.

Full details of contact arrangements, ratings and sizes, are available from STC Electro-Mechanical Division, West Road, Harlow, Essex. Telephone: Harlow 21341. Telex: 81184.

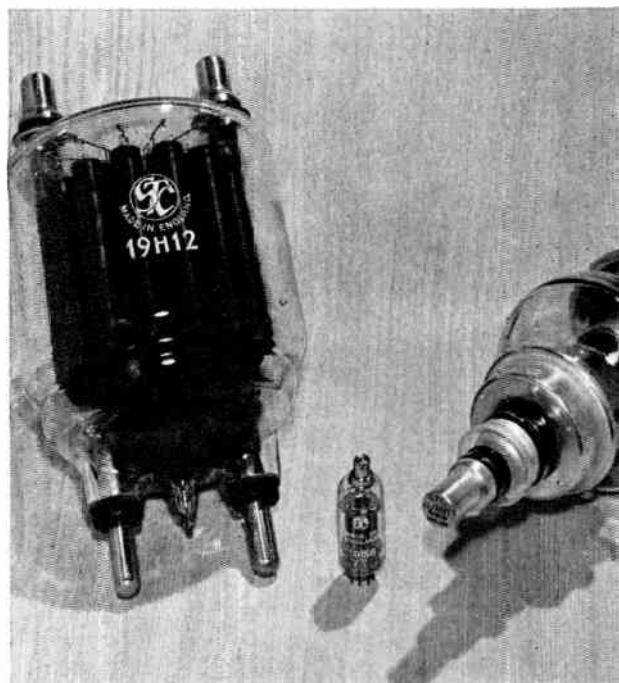

Vacuum rectifier valves

STC produce a comprehensive range of vacuum rectifier valves for applications which include high voltage power supplies, line charging and overswing damping. Notable features are the high power dissipation combined with compact structure of the forced-air-cooled type 2J/262E and the low pulse impedance of the type 19H12 (23Ω at 30A).

ABRIDGED DATA

Code	CV No.	Fil-Heater		Max. p.i.v. (kV)	Peak I _a (A)	Average I _a (A)	Max. P _a (W)
		(V) †	(A)				
19E2	265	4	2.1	4	12	—	—
19G6	371	4	0.5	6	0.18	0.03	—
S19G6*	4057	4	0.5	6	0.18	0.03	—
S19G6F*	4042	4	0.5	5	0.18	0.03	—
19G3	277	4	1.4	7	0.4	0.05	—
19H4	2180	2.5	1.7	20	0.18	0.03	—
19H5	490	4	4	20	0.35	0.125	—
19H12	—	4	12	25	30	—	50
705A	3587	5	5	30	0.4	—	60
ESU112	—	4	12	40	1.1	—	130
ESU77	2160	4	12	50	1.1	—	130
2J 262E	—	5	40	50	7.5	1.5	1500
LS945	—	5	12.5	100	4	0.75	100

*Special quality valves

Write, 'phone or telex for data sheets to STC Valve Division, Brixham Road, Paignton, Devon or London Sales Office, Footscray, Sidcup, Kent. Telephone: FOOTscray 3333. Telex: 21836.

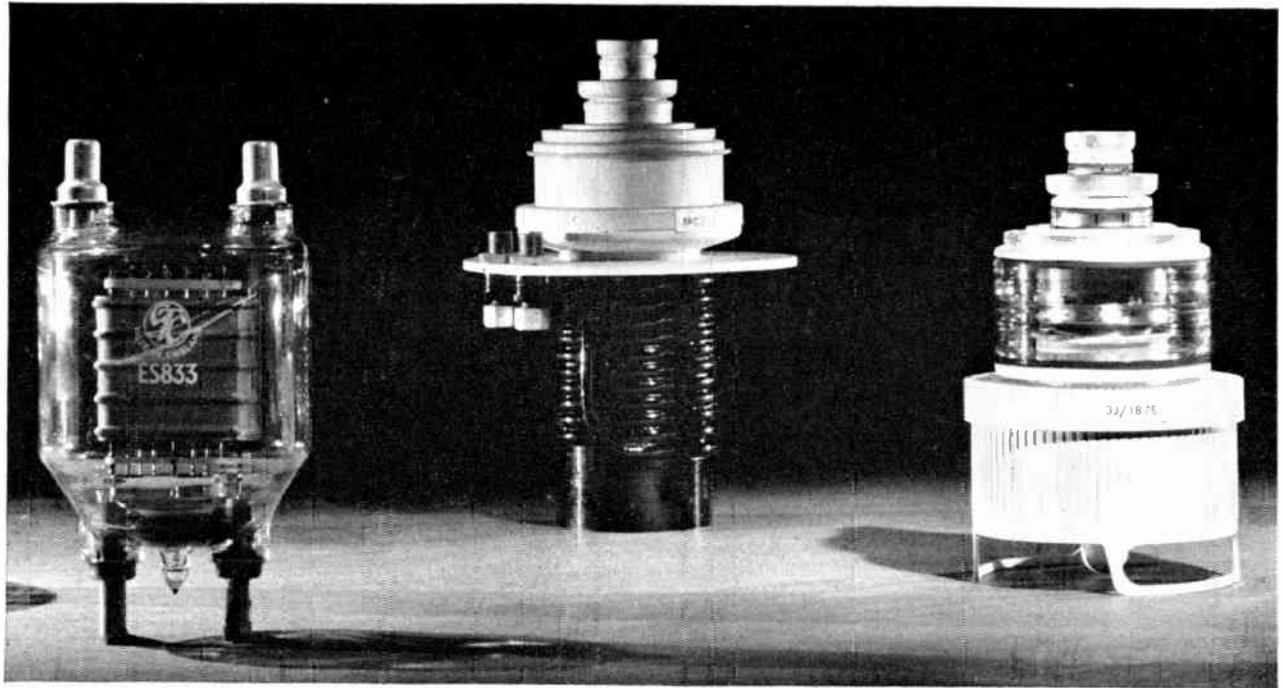

Power triodes for industrial RF heating

The STC range of industrial triodes is one of the most comprehensive in Europe. Important features of these valves are high safety factors on grid and anode dissipation and large reserves of peak cathode current emission.

Some valves from this range are available with a metal-ceramic envelope for use at high frequencies in dielectric heating; these are particularly suitable

for grounded grid operation since their drive power requirements are very low. Cheaper, glass-metal envelope versions are available for lower frequency operation. A number of valves in the range give customers a choice of anode cooling—forced-air, water and vapour cooled versions can be supplied.

ABRIDGED DATA (representative selection only)

Type	3C/150A	ES833	14D12	ES1001	3C 800E	3J 187E	3R/187E	3JC 1187E	ESA1500	16P12
Typical Output (kW)	0.3	1.4	1.5	2.0	2.7	5.0	5.0	5.1	6.0	6.0
i_{max} (Mc/s)	60	30	60	30	50	120	120	300	40	40
μ	18	15	21	40	22	12	12	12	24	24
ϕ_m (mA V)	5.0	9.0	3.3	8.0	5.0	22	22	22	7.5	7.5
V_a (kV)	2.0	4.0	6.0	5.0	6.0	5.5	5.5	5.5	6.0	8.0
P_a max (kW)	0.15	0.4	0.5	1.0	0.8	3.0	3.0	3.4	3.0	3.0
Cooling	Radiation	Radiation	Radiation	Radiation	Radiation	Forced Air	Water*	Forced Air	Forced Air	Water*

Type	3J 192E	3J 203E	3R 203E	3JC/203E	3J 223E	3R 223E	3JC/223E	3RC/223E	LS958A	3RC/262E
Typical Output (kW)	9.0	12	12	12	25	25	25	25	32	40
i_{max} (Mc/s)	22	50	50	220	50	50	100	100	30	80
μ	19	12	12	12	12	12	12	12	24	12
ϕ_m (mA V)	11	32	32	32	60	60	60	60	40	60
V_a (kV)	6.5	7.0	7.0	7.0	7.0	7.0	7.0	7.0	13	7.0
P_a max (kW)	4.2	6.0	6.0	6.0	10	12	10	12	30	24
Cooling	Forced Air	Forced Air	Water*	Forced Air	Forced Air	Water*	Forced Air	Water*	Water*	Water*

* Valves with an integral water jacket.

Write, 'phone or telex for full details to STC Valve Division, Brixham Road, Paignton, Devon or London Sales Office, Footscray, Sidcup, Kent. Telephone: FOOTscray 3333. Telex: 21836.

BASIC SYSTEM

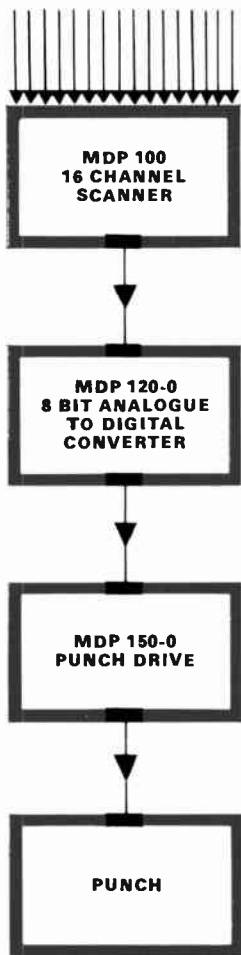

FULL SYSTEM

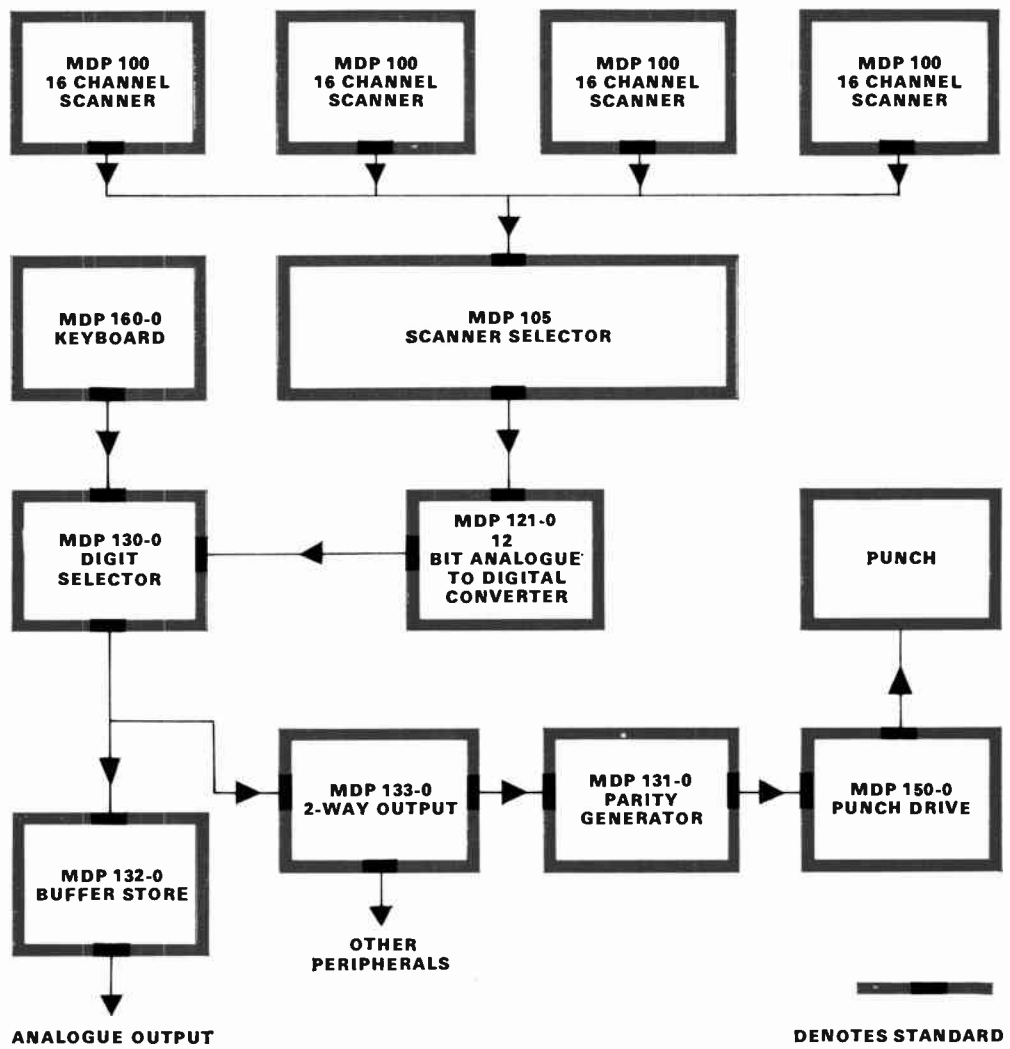

DENOTES STANDARD INTERFACE

There is little doubt about the need for great flexibility in the approach to data processing in the scientific field, the number and variety of projects to be undertaken by a single rigid data processing system. In fact it is fair to say that the reputation of the rigid system has been a limiting factor in the wider employment of data processing techniques simply because, having been used for the specific programmes around which it has been designed it thereafter becomes redundant. This clearly makes the employment of data processing systems a limited and expensive exercise. No electronics company in this country works more closely or exclusively to scientific requirements than Electronic Associates Limited and it is from their unique experience in the

field of scientific computation that a new high speed (up to 200 channels per second) Modular Data Processing System has been developed. At present 10 MDP modules are available, each of which represents a self-contained package interconnected to carry out a specific function. This is possible because the modules themselves are of compatible design and employ a Standard Interface which not only provides compatibilities of voltage levels but incorporates simple control logic. The minimum modular system uses three modules comprising a scanner, 8-bit analogue-digital Converter and a punch drive unit. This will scan 16 channels with 1/4% accuracy at up to 150 channels per second. The full system illustrated can scan 64 channels

with .025% accuracy at speeds up to 75 channels per second and has additional facilities such as a keyboard for manual insertion of data, a parity generator for producing computer codings and a drive unit for driving further peripheral equipment. There is also a buffer store for producing an analogue output. The 10 modules at present available include those designed to the specification of the National Physical Laboratory.

Further information is available in booklet form from

**Computer Division (MDP)
Electronic Associates Limited
Victoria Road
Burgess Hill · Sussex**

BURGESS HILL 5101

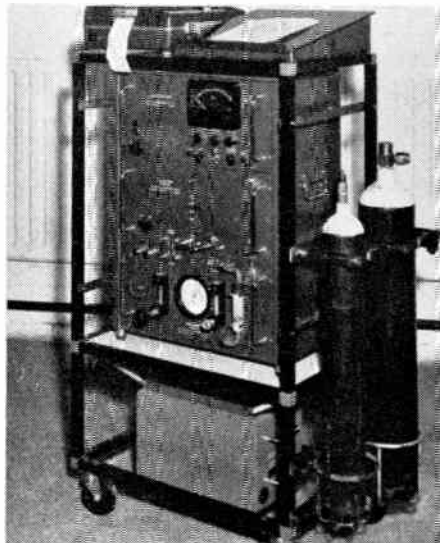
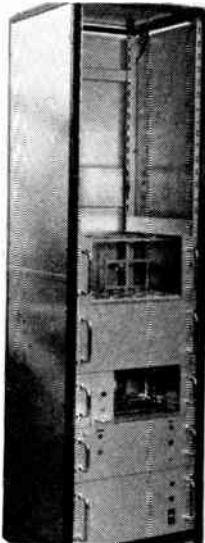

clean, simple—looks terrific

What's that? Dexion Speedframe.
What's it for? Test consoles and benches; trolleys, switchgear mountings, monitor stands; one-off prototypes or complete furnishing and equipment projects.
What's it do? Any-size, rigid frames in moments. Uses 1" or 3/4" square-tube. Tailor-made for every project, at far less cost than ready-made frames!
What's the catch? No catch. No welding, bolting, equipment, finishing or painting either.
What's it need? No skill. Little outlay. Unlimited ideas.

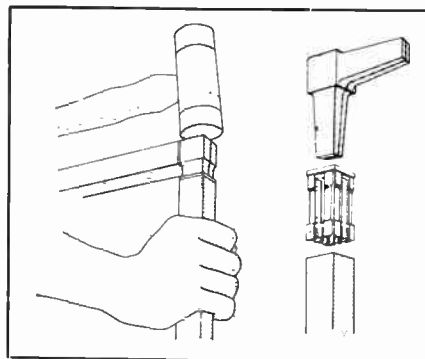

Here's the Speedframe tube-jointing idea:
Joint which, when hammered into the tube, is wedged by an **insert** which in turn jams tight inside the tube to keep the joint weld-firm.
You could do with Speedframe in your next project,
 We'll be delighted to send you material specifications, fresh ideas on Speedframe in electronics, further details of Dexion products. Send in the coupon now.

Please rush me full details and prices.

1" system 3/4" system Prices

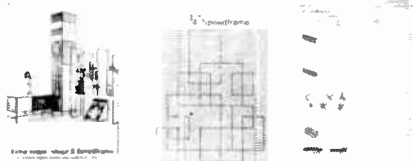

Name

Position

Company

Address

Phone

Dexion Ltd

Speedframe Division, Dexion House,
 Empire Way, Wembley, Middlesex.
 Tel: WEMbley 1281 B.247

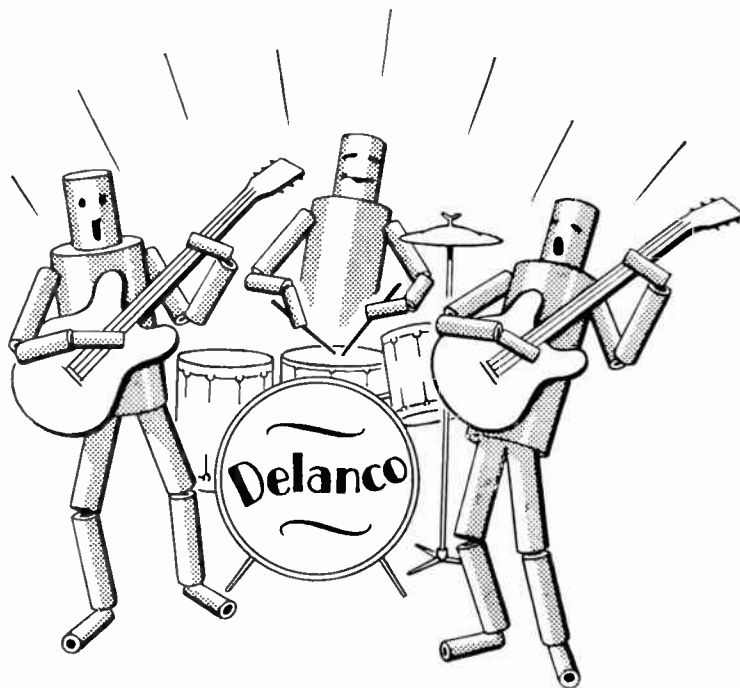

TOP OF THE TUBES

Delanco S.R.B.P., S.R.B.F Glass Laminates

for Electrical, Mechanical and High Heat application



Delanco Tubes are available in Paper, Fabric or Glass Based Laminates in round, square or rectangular form (even oval) over a vast range of dimensions from the very small to the very large. They can be manufactured to specified internal and external dimensions and they can be threaded, milled, turned, drilled and machined to almost any shape or requirement.

In fact, because of their lightness and strength, wearing and insulating qualities, economical price and in glass, heat resistance, LAMINATED TUBES are the ideal materials for all electrical, mechanical and high heat applications.

In addition, they are available—QUICKLY!
Consult our Technical Department for advice and suggestions.

ANGLO-AMERICAN VULCANIZED FIBRE CO. LTD.,

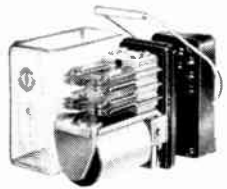
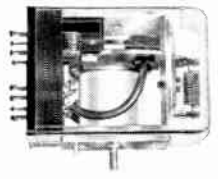
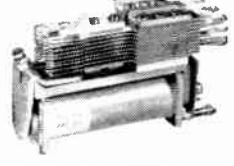
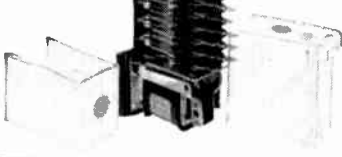
CAYTON WORKS · BATH STREET · LONDON E.C.1.
Cle 8489 15 lines Grams: "PROMPSERV" LONDON.

	RELAYS	SERIES 347 E RELAY
	RELAYS	SERIES 140 EP RELAY
	RELAYS	SERIES 355 REMANENT RELAY
	RELAYS	SERIES 250 HEAVY DUTY RELAY
	RELAYS	SERIES 325 RELAY
	RELAYS	SERIES 120 130 RELAY

General purpose relays, heavy duty relays, motor starting relays, interlocking relays, miniature relays, printed circuit relays, multi contact relays, dry reed relays, A/C relays, D/C relays, enclosed relays, sealed relays, Post Office type relays.

We are justifiably proud of our extensive range of relays, but if our basic range does not offer a solution to your problem then our Design or Applications Departments are at your service. If you require our Catalogue, a sample, a quotation—our help in any way, make contact with Magnetic Devices Now.



M.O.A.-A.R.R.E.-A.R.B. Approved Inspection

MAGNETIC DEVICES LIMITED
NEWMARKET · SUFFOLK · ENGLAND
TEL: NEWMARKET 3451 (10 LINES)

Grams: Magnetic Newmarket Telex 81245
MANUFACTURERS OF SOLENOIDS, CONNECTORS & TIMERS
 R.S.1004





INTEGRATED CIRCUITS

*comprehensive range of low cost
commercial types now available*

**WE HAVE THE SOLUTION TO YOUR PROBLEMS
AT OUR FINGERTIPS . . .**

- * high performance
- * low price level
- * now available



WESTINGHOUSE BRAKE AND SIGNAL CO. LTD. 82 YORK WAY, KING'S CROSS, LONDON N.1. TERminus 6432 Telex 2-3225

Wire wound potentiometers your business?

YOU KNOW YOU NEED SPECIAL WIRES

to achieve very high accuracy, linearity and resolution in your potentiometers, and so do we. That's why we have developed JMC Potentiometer Wires.

These wires are produced to the closest practicable limits on resistance per unit length, in some wires as close as $\pm 1.5\%$. Stringent production and inspection control ensures that they have perfect finish, absolute roundness and freedom from coil or twist. You use them in this condition for they are exactly wound on special reels.

All JMC Potentiometer Wires can have a coating of "Diamel" or "Trimel" controlled to close limits along the entire length.

special wires are our business!

Ask for free data sheet

JOHNSON, MATTHEY & CO., LIMITED
73-83 HATTON GARDEN, LONDON, E.C.1
Telephone: Holborn 6989 Telex: 21465
Vittoria Street, Birmingham, 1 Telephone: Central 8004
75-79 Eyre Street, Sheffield, 1 Telephone 29212



JMC POTENTIOMETER WIRES

2 NEW LOW PRICE ADDITIONS

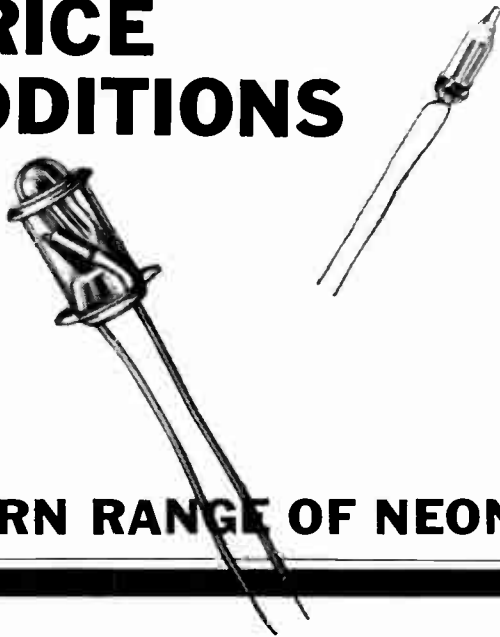

...TO THE THORN RANGE OF NEON SIGNAL LAMPS

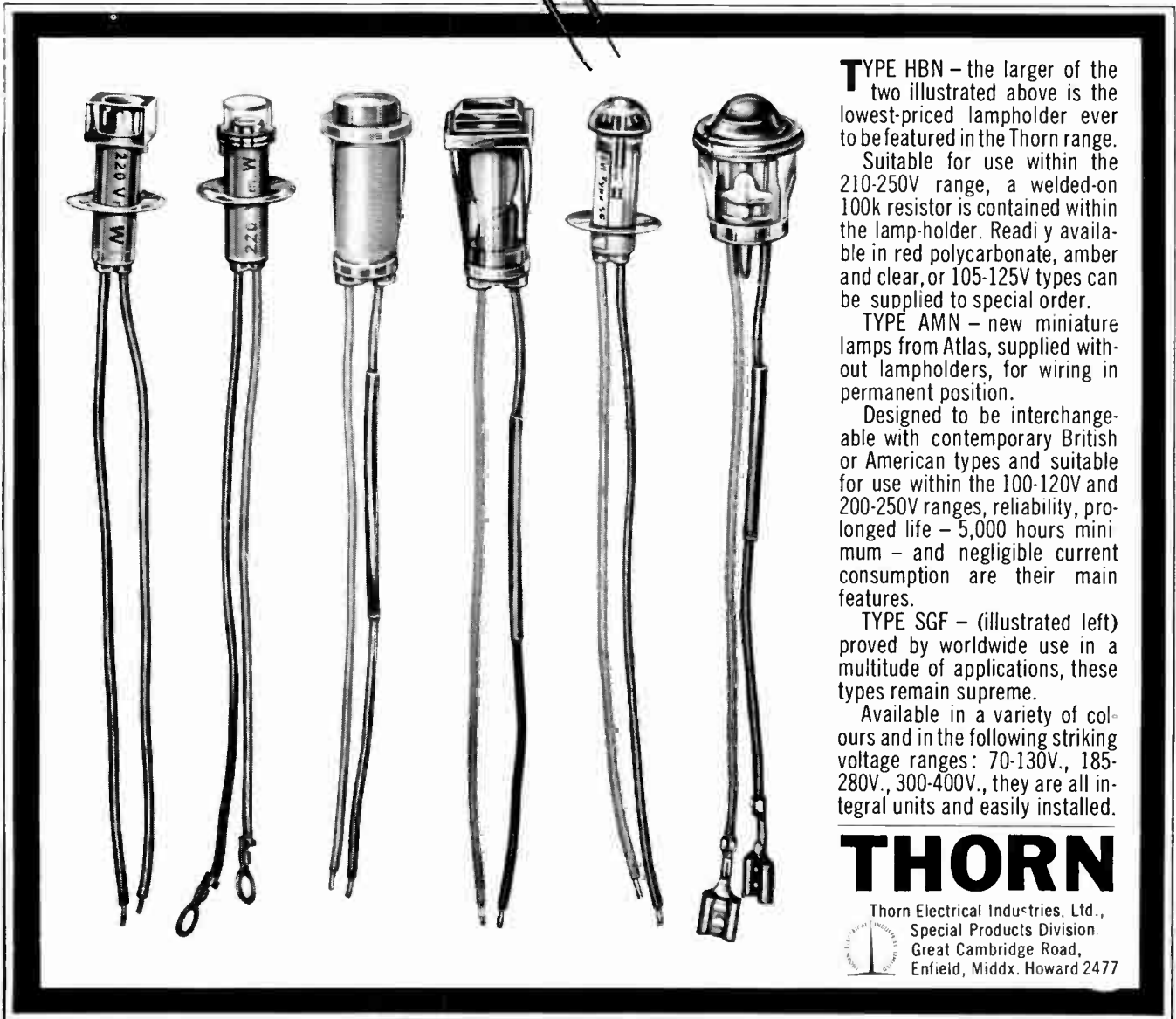

TYPE HBN – the larger of the two illustrated above is the lowest-priced lampholder ever to be featured in the Thorn range.

Suitable for use within the 210-250V range, a welded-on 100k resistor is contained within the lamp-holder. Readily available in red polycarbonate, amber and clear, or 105-125V types can be supplied to special order.

TYPE AMN – new miniature lamps from Atlas, supplied without lampholders, for wiring in permanent position.

Designed to be interchangeable with contemporary British or American types and suitable for use within the 100-120V and 200-250V ranges, reliability, prolonged life – 5,000 hours minimum – and negligible current consumption are their main features.

TYPE SGF – (illustrated left) proved by worldwide use in a multitude of applications, these types remain supreme.

Available in a variety of colours and in the following striking voltage ranges: 70-130V., 185-280V., 300-400V., they are all integral units and easily installed.

THORN

Thorn Electrical Industries, Ltd.,
Special Products Division,
Great Cambridge Road,
Enfield, Middx. Howard 2477



D1V/20



**SO MUCH
MORE BEHIND
A SOLARTRON
'SCOPE**

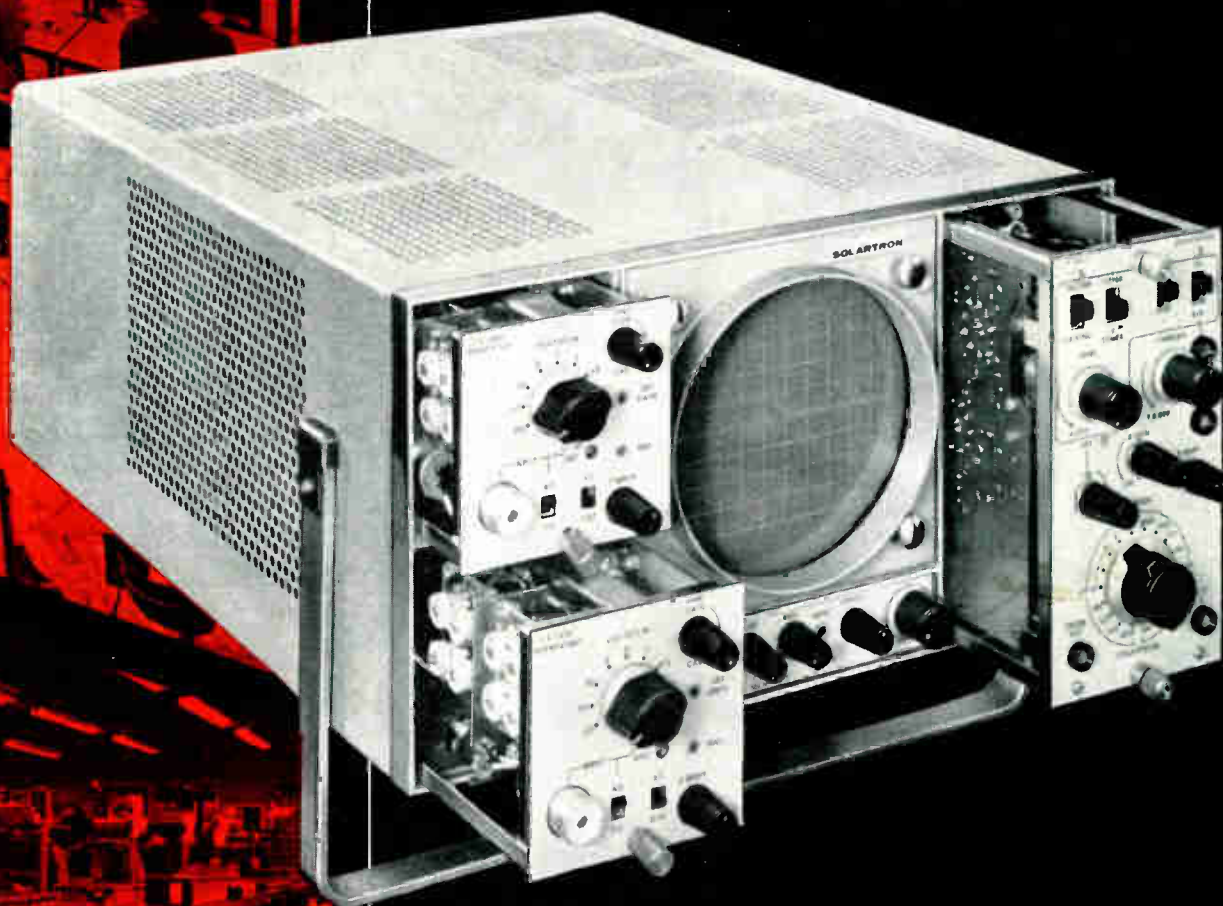

SOLARTRON

For Data Systems · Transducers · Computers
Military Systems · Electronic Instrumentation

Both X and Y units plug in, enabling the user to make a wide variety of measurements hitherto only possible with expensive instruments. To date, 2Y+2X operational plug-in amplifiers are available.

THE CD 1400 'SCOPE SYSTEM VERSATILE 5" PORTABLE DOUBLE BEAM

The CD 1400 from Solartron is a truly flexible low cost oscilloscope system – backed by the best in modern production techniques. The X and Y plug-in units currently available allow the instrument to be used for the widest range of applications and other plug-ins now under development will extend the system even further. A 5" double gun CRT operating at 4 kV provides bright, high resolution displays at all sweep speeds. Proprietary oscilloscope cameras can be attached, and trolleys are available for maximum mobility.

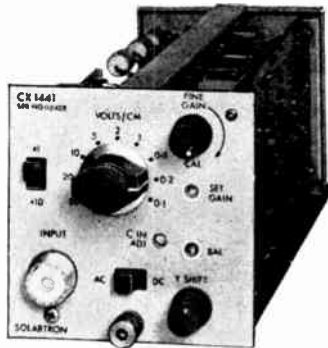

* CX 1441 DC – 15 Mc/s approximately, 100mV/cm, general purpose amplifier suitable for pulse work. Additional $\times 10$ provides 10mV/cm from DC – 750 Kc/s.



* CX 1442 1 mV/cm DC differential amplifier with a common mode rejection of 60dB. For use with transducers and servo systems etc. An AC $\times 10$ position gives a sensitivity of 100 μ V/cm for low level noise investigation.



* CX 1443 Basic time-base unit. 18 ranges from 0.5 μ sec/cm – 0.5sec/cm. Suitable for use with all Y units. "Normal", "Auto" and "HF sync".



* CX 1444 Time base and sweep delay generator. Performance similar to CX 1443. Delays up to 100m/sec. Suitable for digital computer and television waveform investigation.

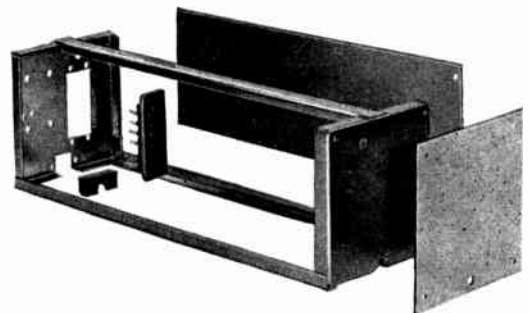

CX 1445-6 Blank X and Y plug-in units available enabling the customer to construct his own units to suit specialized applications.



* CX 1447 A rack-mounting case is available as an alternative for use in standard 19" racks. Side panel design permits simple signal connections from rear of instrument.

* Measurement Accuracy 5%

SOLARTRON

THE SOLARTRON ELECTRONIC GROUP LIMITED
Farnborough, Hants, England. Telephone: Farnborough (Hants) 44433
Telex: 85245 Solartron Fnbro. Cables: Solartron Farnborough.
A MEMBER OF THE SCHLUMBERGER GROUP

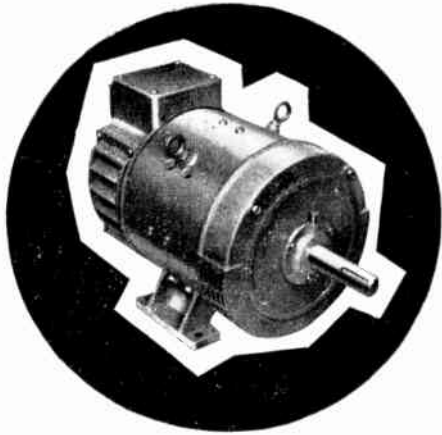

'X' type D.C. motors, $\frac{1}{4}$ - 40 h.p.

You can't say **DEPENDABLE**
without **EPE**

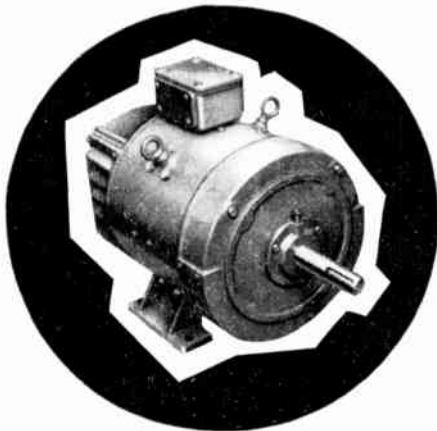

'Y' type D.C. motors, $\frac{1}{4}$ - 40 h.p.

D.C. Motors for electronic speed control



THE ELECTRICAL POWER ENGINEERING CO. (B'HAM) LTD.
EPE WORKS, BROMFORD LANE, BIRMINGHAM 8
Telephone: SEChford 2261
Grams: Torque Phone, Birmingham

Hendrey Spark Recorder Type 1487A

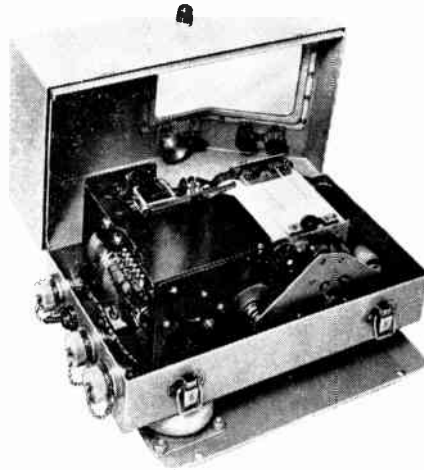

For full details and
specification ask for
Catalogue Sheet

A4



Compact and weatherproof, this single channel recorder is light in weight and easily portable. The perspex window gives a clear view of the heat sensitive chart for approximately 6 in. of its length.

The instrument can also be used mounted on bench, wall or panel and is supplied with mounting plate incorporating three anti-vibration mountings which render the instrument shock-proof and vibration-proof to service standards.

An electro-magnetically operated stylus, operated by a separate switch not supplied with the recorder, provides transverse markings near the edge of the chart. Provision is made for an external alarm circuit which can be pre-set to operate at any deflection from zero to full scale by means of a control on the case.

Sensitivity—50 micro-amps. Full scale. Supply—12 Volt, D.C.

Hendrey Relays

HENDREY RELAYS LIMITED
390-394 BATH ROAD, SLOUGH, BUCKS. Burnham 609/612

Telegrams: *Hendrelay, Slough*
MANUFACTURING ELECTRICAL ENGINEERS
CONTROL AND LABORATORY APPARATUS
A.R.B. & M.O.A. APPROVED DESIGN & INSPECTION

Industrial Electronics July 1965

Perivale Controls

range of
**MINIATURE
PLUG-IN
RELAYS**

Light Current and Heavy Duty Types

Features

Designed and manufactured by Perivale Controls over six years ago, the PC Miniature Plug-in Relay was first of its kind then—and it still leads. Built-in features of this wholly British relay include:

- ★ Complete interchangeability with most relays of foreign manufacture.
- ★ Operational accuracy derived from unique setting techniques.
- ★ High quality but competitive prices.
- ★ Speedy delivery even for specials.

Specials

Flexibility of design is such that special derivatives seldom present a problem. Speedy delivery is offered as a service and enquiries for small or large quantities are invited.

Standards

Over 100 different standard types for diverse applications. Designed for long term reliability and cost economy PC Miniature Plug-in Relays have standard operating voltages in the range 4 volts to 140 volts D.C. with a wide tolerance on nominal, and a myriad of contact configurations allowing for single or multiple operations in various combinations of make/break/changeover.

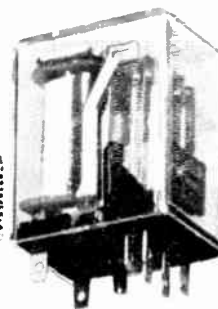

PC 2. Relay with Socket

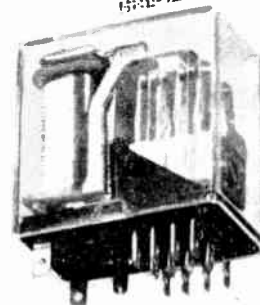

PC 4. Relay with Socket

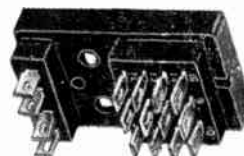

PC 4. Printed Circuit Relay Socket mounted on $\frac{1}{8}$ " board.

PERIVALE CONTROLS COMPANY, LIMITED

40 TELFORD WAY • EAST ACTON • W.3.

A **DAVALL** Instrumentation Company

SHEPHERDS BUSH 1015 (5 Lines)

Involuntary Isolationists may not have heard of

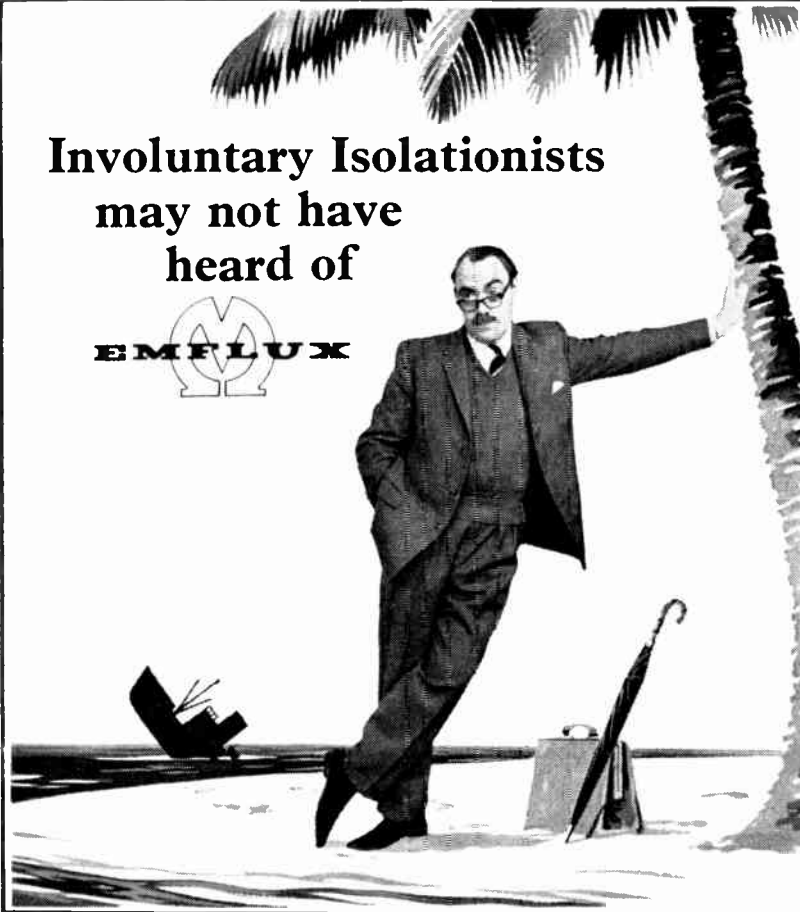

If you've been cut off from new developments in the flow measurement field, rescue is at hand in the shape of the Emflux Electromagnetic Flowmeter Handbook. Buoyant with information, it includes data on flowmeters, automatic range change units, liquid level monitors, reverse flow indicators and multi-point units, plus an invaluable section on materials of construction.

Write for your copy (posted by return) today. Or if you are on Rockall or Juan Fernandez, try a message in a bottle.

THE EMFLUX SYSTEM

Emflux provides the most versatile system for measuring the flow of any conducting liquid—from acids to coconut milk—without loss of head.

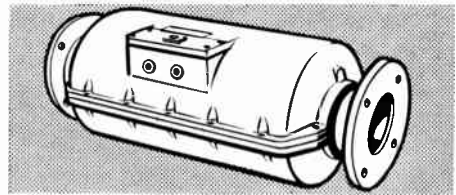

MAWDSLEY'S LTD

ELECTRONICS AND INSTRUMENTS DIVISION
DURSLEY · GLOUCESTERSHIRE · ENGLAND

for a
high quality
self-fluxing
enamelled
wire

Lewco
is the
unanimous
choice

Manufactured under strictly controlled conditions on newly developed plant, these wires will find immediate application where size, solderability, and a consistently high quality are essential requirements.

Write for pamphlet LB19

THE LONDON ELECTRIC WIRE COMPANY AND SMITHS LIMITED · LEYTON · LONDON · E.10.

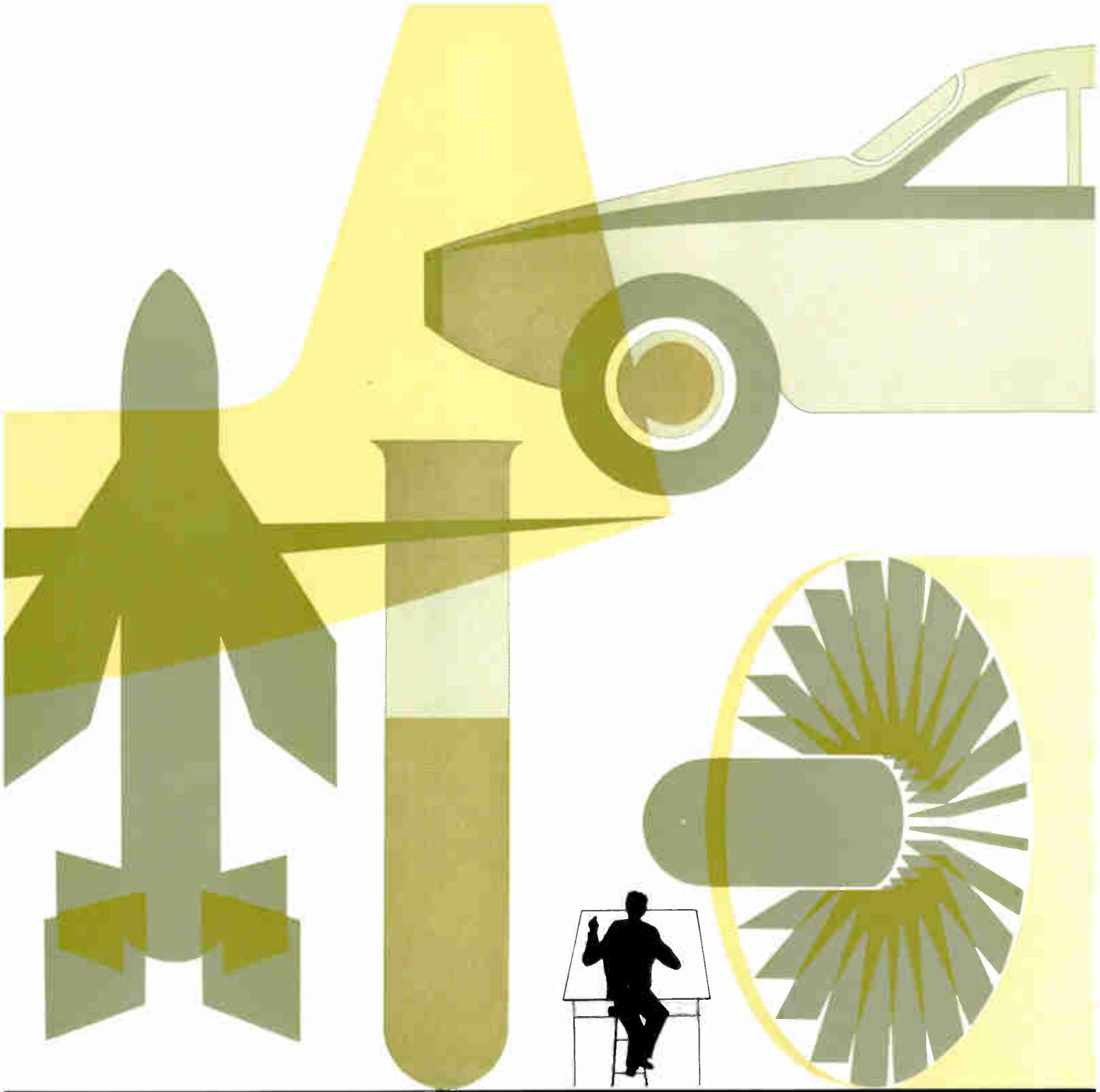

EMiac II the versatile low cost analogue computer

EMiac II is the most versatile analogue computer in its price range. The remarkable degree of versatility has been achieved in two ways; firstly, by adopting the principle of the smallest practical module, complete and self-contained, yet designed, like bricks, to build larger installations; secondly, by providing a selection of active computing elements which can be readily interchanged.

Thus the basic 18 amplifier module forms the ideal, low-cost installation for the small engineering group or technical institute, which can be extended as required.

At the other end of the scale, an installation of 20 or more modules with a control console, form a single computer capable of handling complex computations with extraordinary speed and simplicity.

For technical details and a closer study of the applications of EMiac II in various industries, please send the reply-paid card to us. We will gladly arrange a demonstration, if required.

Postage
will be
paid by
Licensee

No Postage
Stamp necessary
if posted in
Great Britain
or Northern
Ireland

BUSINESS REPLY CARD
Licence No. SOX 64

**AUTOMATION DIVISION
EMI ELECTRONICS LTD
HAYES · MIDDLESEX**

REPLY CARD

EMIac II IS VERSATILE IN CONTROL

Controls are grouped and identified to assist the operator to obtain optimum usage of the computer. The patchboard is an object in logical simplicity and clarity.

Within each module the problem may be broken down into three independently controlled parts and similarly on a multi-module basis each module may be switched out from central control to its individual control panel.

EMIac II IS VERSATILE IN LAYOUT

It is easy to change the computing function of any position within the module. This function is determined by the type of computer component box (C Box) which is plugged into that particular position. A full range of C Boxes now available includes integrators, summers, function generators, multipliers, electronic and quarter square, comparators, dead space unit and generalised integrators. Each may plug into any position. A further range is also available to be used in conjunction with the dual amplifiers which effectively double the module capacity.

EMIac II IS VERSATILE IN ACCESS

Problems which can be solved may be simple or complex, large or small. Built-in design enables the problems to be set up quickly or taken off and stored for future use. The patchboard is removable, enabling patching to be done off the machine and all C Boxes are also removable so that checked out patchboards and complex circuits may be stored, freeing the computer for other users.

Co-efficient panel containing 24 potentiometers. ①

Patch panel to which the active elements are connected. ②

Control and display panel for individual row control. ③

18 standard pigeon holes, contain the range of active computing elements which plug into the rear. 'C' Boxes are seen plugged into the front. ④

APPLICATIONS

Because of its flexibility, the applications of EMIac are practically limitless. They include:

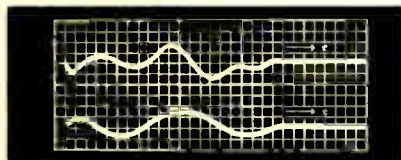

Aircraft and flight problems of every kind.

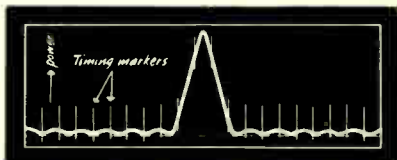

The optimization of electrical machine design.

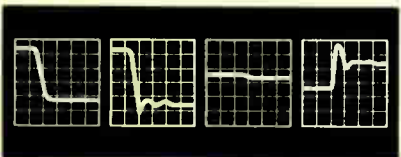

Simulation of complete chemical plant before it leaves the drawing board.

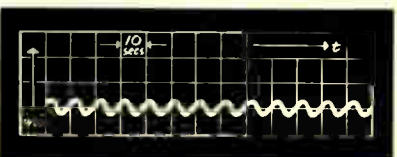

Automobile stability and suspension systems.

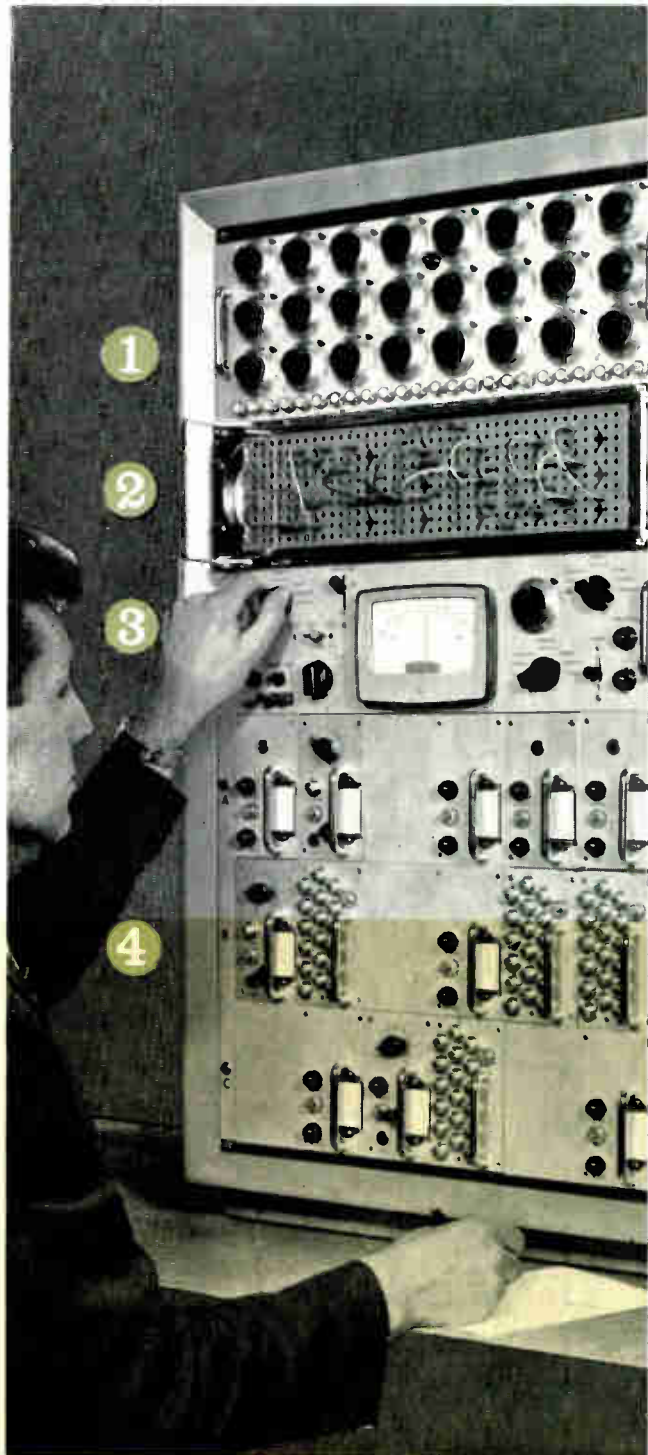

EMIac II

LOW PRICE, COMPLETE VERSATILITY

Reply card

- Please send me further details regarding the applications and operation of EMIac II Analogue Computer.
- Please contact me to arrange a demonstration.

NAME AND POSITION

COMPANY'S NAME

ADDRESS

TELEPHONE NUMBER - EXTN.



EMI ELECTRONICS LTD

AUTOMATION DIVISION · HAYES · MIDDLESEX
TELEPHONE: HAYES 3888 EXTENSION 2126

THIS MAN
HAD
A
PROBLEM

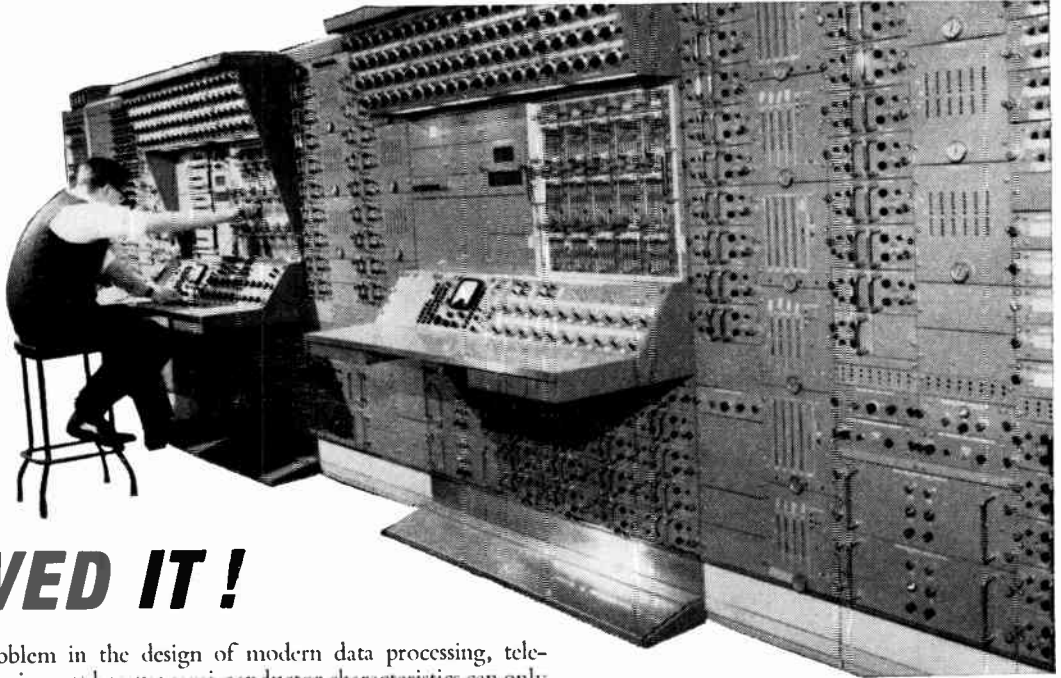

WE SOLVED IT!

Overheating is a major problem in the design of modern data processing, tele-communications and radar equipment because semi-conductor characteristics can only be specified over a narrow temperature range. This problem can be eliminated by installing a Normalair high efficiency cooling system which will maintain these critical components at their correct operating temperatures.

These purpose designed systems have been developed specifically for this application and are the outcome of an intensive research programme. The equipment is self-contained, electrically powered and designed to provide an adequate supply of ducted cold air. Normalair equipment can also be supplied for the overall conditioning of electronic laboratories or for the solution of any other temperature control problem of any size or complexity.

NORMALAIR LTD

Subsidiary of Westland Aircraft Limited

YEOVIL SOMERSET

TELEPHONE YEOVIL 5222

Europe's largest and most experienced producer of pressurization, air conditioning and oxygen breathing systems and components for aircraft.

NORMALAIR (Australia) Pty. Ltd. 26/32 Fraser St, Airport West, W.6, Victoria, Australia. NORMALAIR (Canada) Ltd. 1425 The Queensway, Toronto 18, Canada.

For further information circle 236 on Service Card

Build your own furniture

ENCAPSULATED ERGONOMICS

fix these



to these



with the aid of these

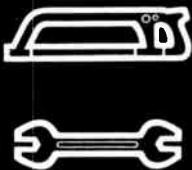

to make this

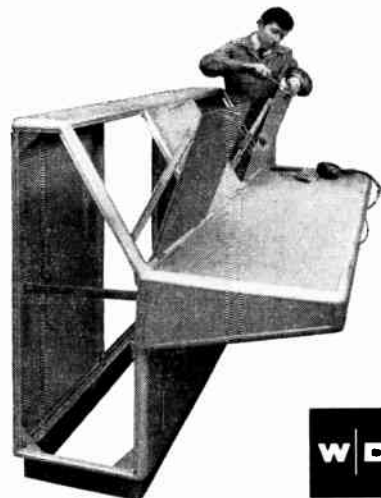

WIDNEY DORLEC

Write now for comprehensive illustrated literature.

HALLAM, SLEIGH & CHESTON LTD.
P.O. BOX 133, BAGOT ST., BIRMINGHAM 4.

W.D.59

SERVISCOPE* MEASURES HYDRAULIC PERFORMANCE

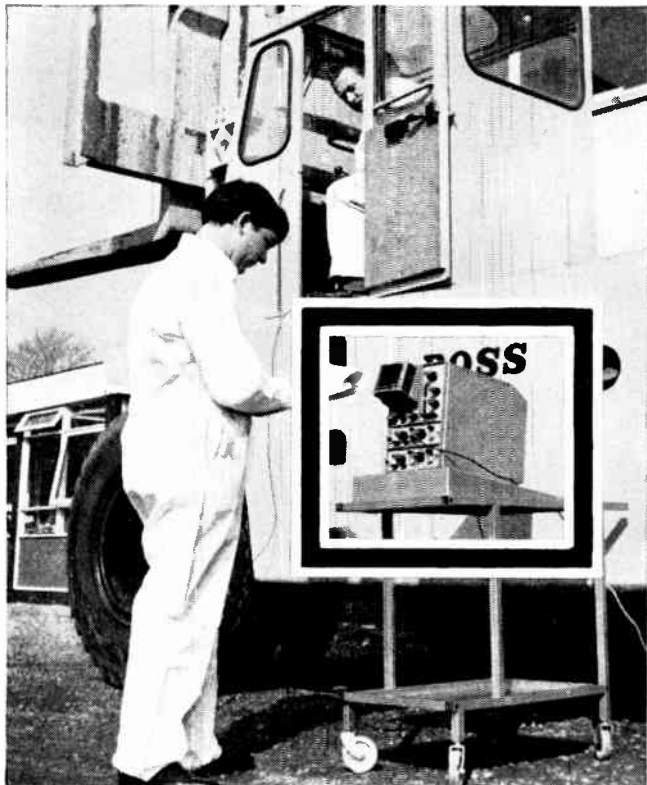

A Telequipment double-beam D43 Serviscope is used to assess pump and relief valve performance in the hydraulic system of a lift truck at the Leighton Buzzard plant of Boss Engineers Limited, a member of the Lancer-Boss Group. An oscilloscope is used for this procedure since no mechanical method is capable of representing the conditions inside the hydraulic system accurately enough. Serviscopes are playing an increasingly important part in the development and servicing of modern hydraulic systems.

All Telequipment Serviscopes are remarkably small in size, light in weight and low in cost, and both portable and rack mounting versions have gained a big reputation for consistent accuracy even under difficult operating conditions. The D43 double-beam 'scope costs £125; the trolley £15 6s. 0d.

A descriptive leaflet will be sent on request.

TELEQUIPMENT ... of course!

*Serviscope is a registered trade mark of Telequipment Limited, 313 Chase Road, Southgate, London, N.14. Fox Lane 1166
Scottish Office: 30 Castle Street, Edinburgh, Balerno 3120

AS 23



Porcelain
Steatite

V. G. PORCELAIN CO LTD

GORST ROAD
PARK ROYAL
LONDON, N.W.10

Telephones:
ELGAR 1411/7
Telex:
London 25589

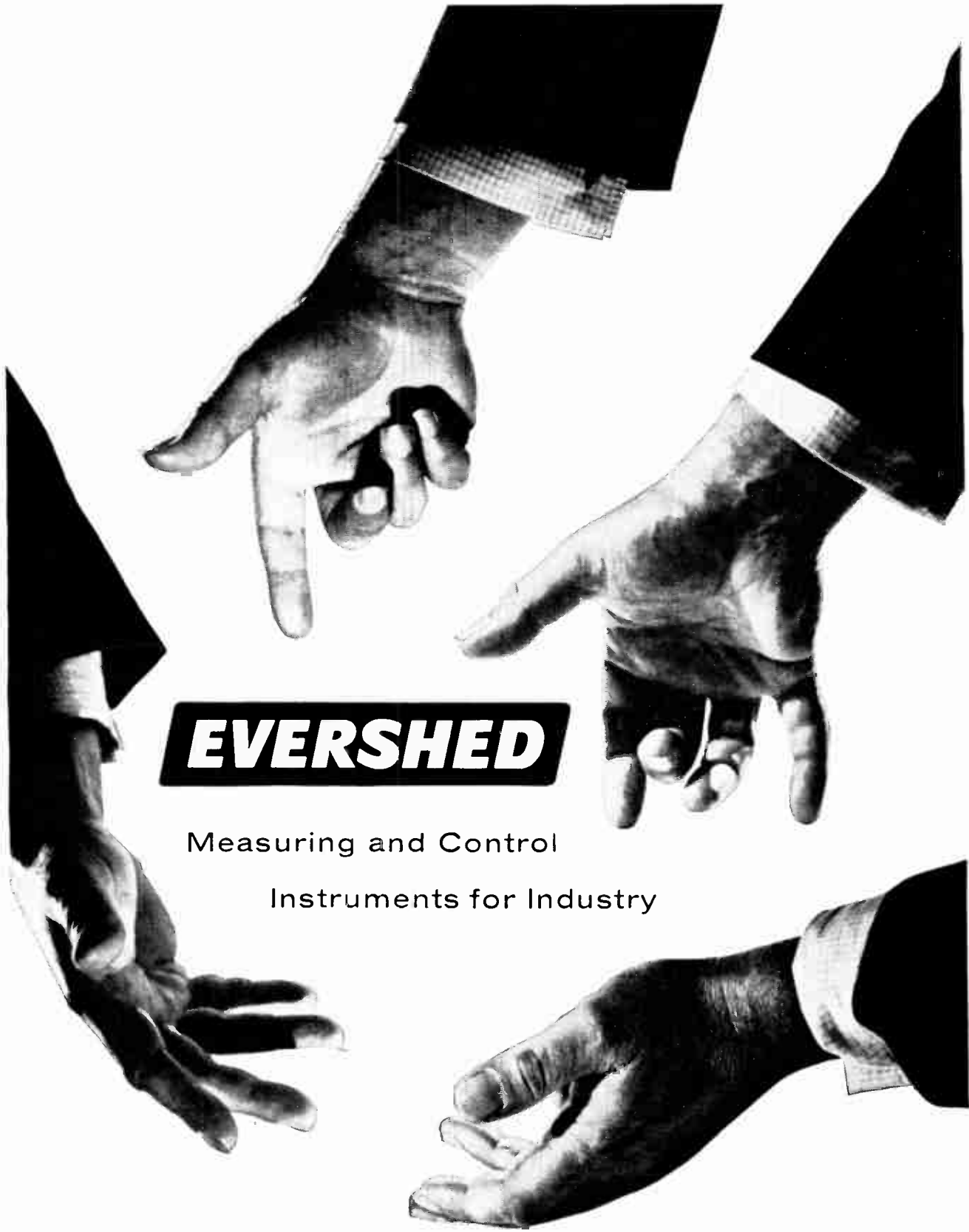

EVERSHED

Measuring and Control

Instruments for Industry

INSTRUMENTATION · MEASUREMENT · TESTING & CONTROL EQUIPMENT

F.H.P. SERVOMOTORS AND STEROMOTORS

Evershed & Vignoles Limited, Acton Lane Works, Chiswick, London, W.4. Telephone : CHiswick 3670 EV

A member of the Kent group of companies

A GLASS AND A HALF OF COMPONENTS GO INTO EVERY INTEGRATED CIRCUIT

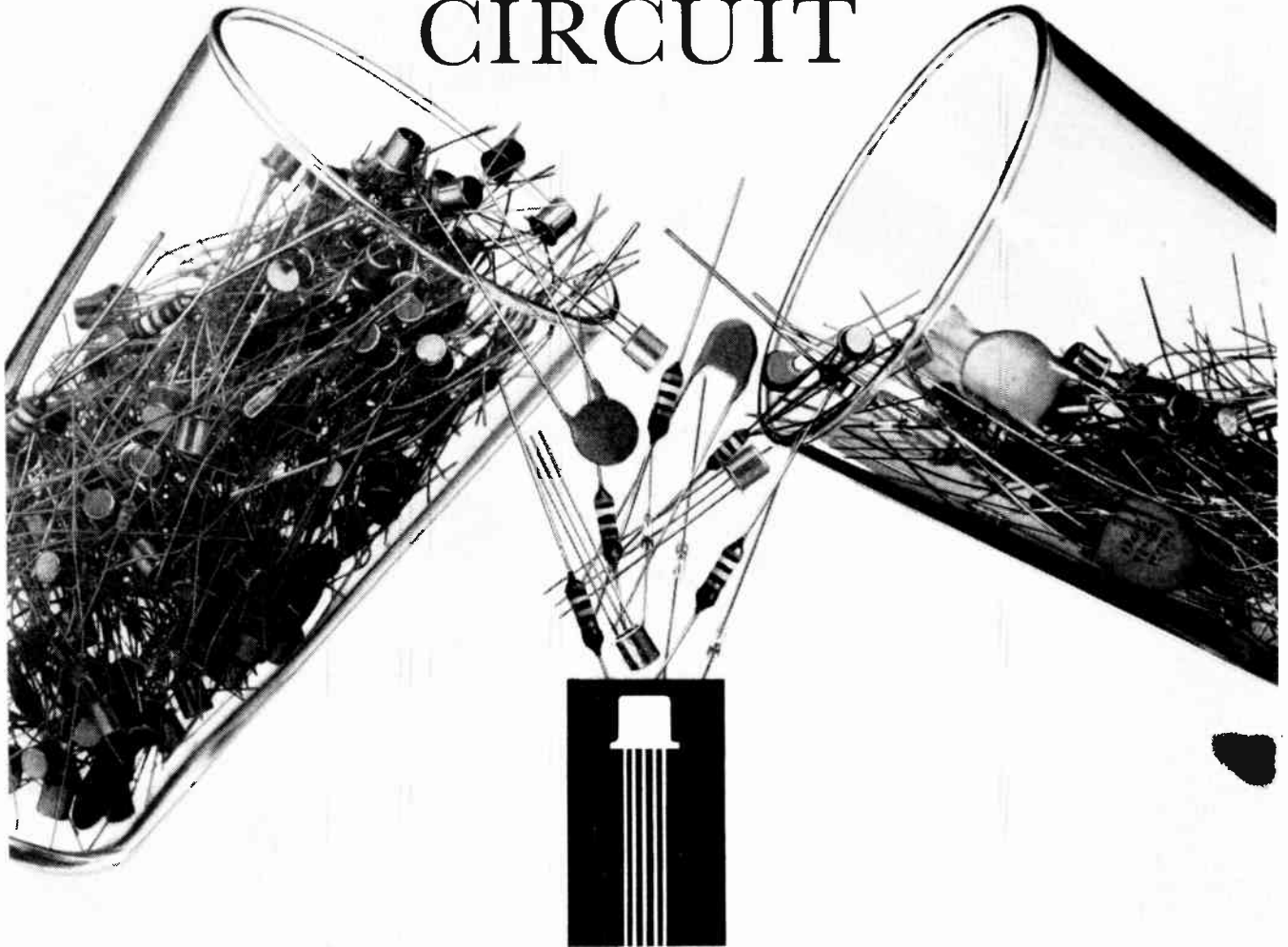

Roughly speaking. More precisely, Semiconductors Ltd. integrated circuits offer a range of sophisticated elements which by their versatility, compact form and low cost permit a completely new approach to many common requirements in circuit design.

The SL 700 Series, for example, are high-gain d.c. operational amplifiers, extremely tolerant of supply line

variations. Input d.c. offset voltage is typically 100mV and offset current 0.3 μ A. High gain versions have open loop gains of approximately 70dB, while alternative versions from the same basic chip enable gain to be traded for stability.

The SL 500 Series is a 100 Mc/s wideband amplifier, primarily intended for use in linear I.F. strips operating at centre frequencies between 10 and

60 Mc/s.

The amplifier gives a current gain of 26dB between 5 Mc/s and 100 Mc/s and the circuit incorporates AGC giving at least 40dB gain control range.

These are just two of the many advanced, monolithic, silicon integrated circuits available.

It will always pay you to check with Semiconductors Limited before initiating new equipment designs.

Semiconductors Limited

Cheney Manor, Swindon, Wilts. Tel: Swindon 6251



Electronic Telephone Exchanges

Last month the first electronic telephone exchange, of the type most likely to be chosen for general use by the G.P.O., went into operation at Peterborough. This marks an important stage in the development of electronic switching for the British telephone system and, in effect, represents the final trial of a series to determine the most suitable type of electronic equipment for the majority of the exchanges in our telephone system.

Developed under the auspices of the British Joint Electronic Research Committee, comprising the Post Office and the five principal manufacturers of telephone equipment, the Peterborough unit accommodates some 200 subscribers, but the design is suitable for exchanges serving up to ten times that number of subscribers.

Although initially the Peterborough electronic unit only forms part of the existing automatic exchange, the confidence shown in the design is such that the Post Office have already ordered a complete electronic exchange of the same type for installation at Ambergate, Derbyshire. The new Ambergate electronic exchange will have a capacity of about 800 lines and it is expected to come into operation in the summer of 1966.

What does this development mean to the average user? In the near future he will probably neither know nor care whether his exchange is electronic or not. However, in the future it may offer him extra facilities and this is the importance of the electronic exchange from the user point of view. The ability to have incoming calls temporarily transferred to another number merely by dialling an appropriate instruction number is a facility which can be provided much more easily with an electronic exchange than with other kinds. Then, again, it is possible to arrange for an abbreviated dialling code for a frequently-called number.

These things are possible. Whether they will be provided remains to be seen. It is unlikely that they will be until electronic exchanges are much more numerous than they are now. It will obviously be quite a long time before they are widespread, for it is uneconomic to replace existing exchanges before they wear out, and their life is quite long.

However much one would like these things, one must be realistic. The Post Office will certainly look very hard at the cost of providing them, for although it provides a public service, the public has to pay for it and will not be prepared to pay highly for extra frills which it does not really need. It seems to us likely, therefore, that, when a big enough electronic exchange is installed in a suitable area, the new possible facilities may be tried out experimentally to find out whether there is any real demand for them.

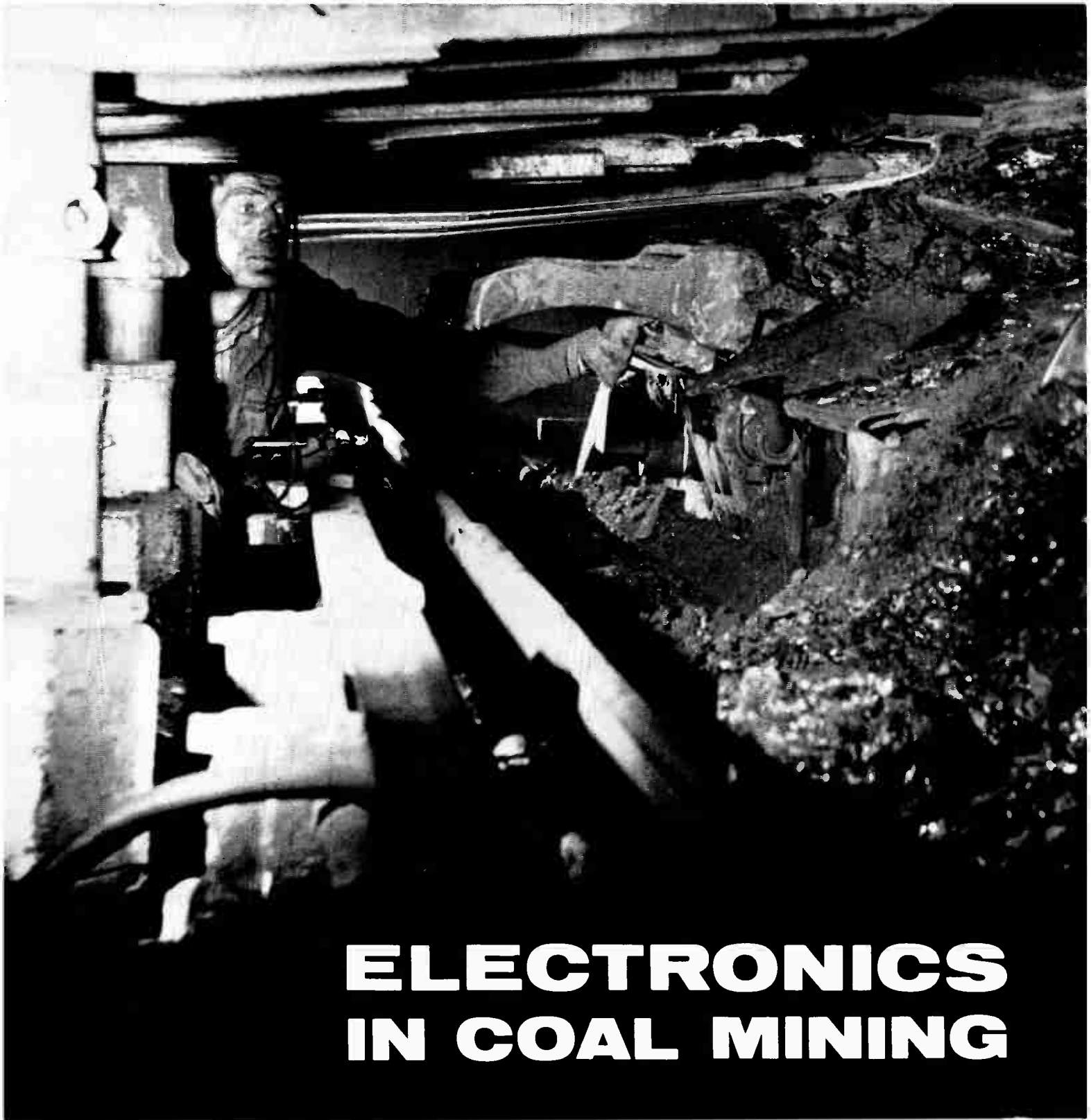

ELECTRONICS IN COAL MINING

LONGWALL face-mining involves driving two parallel tunnels or 'gates' and removing the coal lying between the gates as they are driven deeper into the coal seam. The two gates are kept open for the circulation of fresh air, removal of coal, and general access, while the roof between the gates is allowed to subside as the face advances. This system of mining lends itself to mechanization, including power-driven cutter-loaders which are hauled along the length of the face cutting a strip of coal and loading it on to a conveyor, and powered hydraulic

supports which hold up the roof near to the face and have horizontal rams for moving the support towards the face.

These mechanical aids are now highly developed, and it has been possible to take the next step, involving remote operation of the cutter and supports, so that men are removed from the vicinity of the face which is generally accepted as the area where risks are greatest.

Two of these ROLF (Remote Operated Longwall Face) equipments have now been put into service, at Newstead and Ormonde Collieries.



By P. J. BILLING*

The development of these systems has introduced requirements for various types of instrumentation to give the operators an appreciation of what is happening at the face, and the combination of remotely-operated equipment and instrumentation has set the stage for the introduction of more sophisticated systems.

A.E.I., which includes the former Metropolitan-Vickers and British Thomson-Houston companies, has for many years been closely associated with the mining industry,

* A.E.I. Electronics Group.

More and more the coal mine is being mechanized. This in its turn demands remote control of the machinery and this makes it possible for miners to work further from the danger area. This article explains the control and communication systems now in use and shows how the special safety requirements of a coal mine are met

providing motors, switchgear, winders, etc. This experience has placed the Company in an excellent position to extend its activities into the control and instrumentation fields arising from the new requirements. In this work, it has been found possible to employ many control techniques developed for use in heavy industrial and military applications, but the mining environment introduces problems which are not commonly experienced elsewhere, especially problems relating to the statutory requirements and regulations governing safety aspects. These relate particularly to the need to avoid igniting the methane/air mixture which may occur in coal mines.

Safety

Two basic methods of avoiding ignition are recognized, flameproof and intrinsically safe. Flameproof equipment is housed in enclosures which ensure that no matter what fault may arise the resulting arcing cannot ignite the mixture of methane and air surrounding the enclosure. Intrinsically-safe equipment uses power levels which are so low that no conceivable fault can produce a spark with sufficient energy to cause ignition. A comprehensive period of official testing is required before a certificate is given showing that equipment is safe and may be used in collieries. All mains-voltage equipment, transformers, contactor starters, filament lamps, etc., must be in flameproof housings. Certified intrinsically-safe signalling equipment may be housed in heavy-duty boxes and interconnected as desired within the terms of the certificate. Systems may also use a combination of the two classes of equipment. Fig. 1 shows an intrinsically-safe power-supply unit with cover removed.

The decision as to which class should be used is often difficult, the design, acceptance and manufacture of flameproof boxes being a costly business, as also is the design and acceptance of intrinsically-safe circuitry. The tendency today, however, is to use flameproof units powered from either 110 V, 230 V or 550 V to provide intrinsically-safe power supplies for electronic equipment. Such a unit then forms the heart of the system as its output, possibly 12 V d.c., will be carefully checked by the relevant authorities to ensure that any spark produced, if for instance when it is accidentally short-circuited, will not ignite methane. The circuit design of such a device is complicated by many factors and it is very difficult to obtain more than 2 to 3 amperes with safety. The reward for high output is great, however, for regulations forbid the use of two supplies in one equipment thus setting a definite limit to the complexity, and resulting current drain, that any single system may have. In the event of an equipment having to be split into two parts, each with its own power supply, then stringent precautions have to be taken to avoid any possibility of the two power supplies becoming interconnected.

Powered Roof Supports

During 1962 the National Coal Board initiated the work on remotely-operated powered roof supports by contracting with Gullick Ltd., Wigan, for manufacture of the ROLF I system. The control equipment was built by

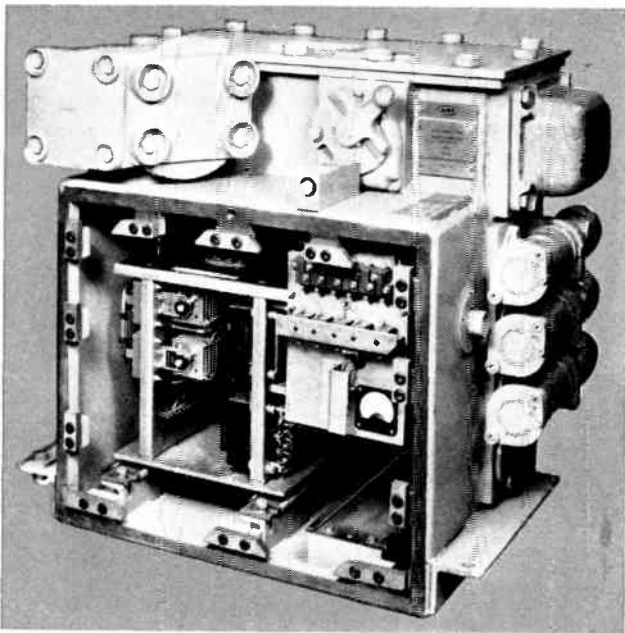

Fig. 1. Intrinsically-safe power-supply unit with cover removed

A.E.I. and was the first of a family of such equipments to be made. ROLF I was installed at Newstead Colliery, Nottinghamshire, the underground control console for which is shown in Fig. 2.

Considering the longwall system of mining, the roof supports must all be advanced towards the new face after each strip of coal has been removed. Only one support at a time may be released, and a selection system is required to pick out each support to be released and advanced. The system must operate over distances up to about 400 yards and must permit transmission of instructions to the unit, and the receipt of data from the unit. The choice of a selection scheme would not seem to be difficult but when it is appreciated that each one of 250 or more roof supports must be fitted with a receiver then its

cost must be carefully considered; it would be convenient if all receivers were identical. It was for these reasons that a sequential stepping system was adopted for the ROLF I system as against pulse-code or frequency-multiplex systems. The principle limitation of the stepping system is that direct access to any 'address' is not possible without moving through some preceding 'addresses'.

The Newstead step-by-step scheme controls 165 roof supports or 'chocks' which are arranged in sections of 20. Each section is selected by coincidence of signals on two out of five selection lines and each chock in a section selected by stepping on from number 1. The stepping signals are routed from a clock-pulse generator in the control console to a counter and lamp display, showing the chock selected, and to the chocks on the face. Each chock is fitted with a bistable circuit energizing a relay, which when operated allows the solenoid valves in the hydraulic circuits of the chock to initiate the chock movement towards the face. This movement is monitored by a potentiometric transducer and a pressure switch which transmits information to the console to ensure correct operation, before the sequence is continued. The power supply unit for this chock control system runs from the 110-V a.c. supply available, its outputs being nominally 22½ V d.c. A number of outlets are provided but as each is only intrinsically safe in itself there must be complete isolation of the various circuits supplied.

This scheme has proved satisfactory and has demonstrated in a convincing manner that manual labour can be replaced for this particular operation.

Instrumentation

For satisfactory control, the chock-control system required an instrumentation system to measure a number of variables in the coal-face area and transmit them to the control console and to a point above ground.

It was decided that the method of transmitting data would be by a 0-2-V d.c. analogue signal derived at the transmitting point from an amplifier with low output impedance and fed to an amplifier, at the receiving point, of high input impedance. It was appreciated that more

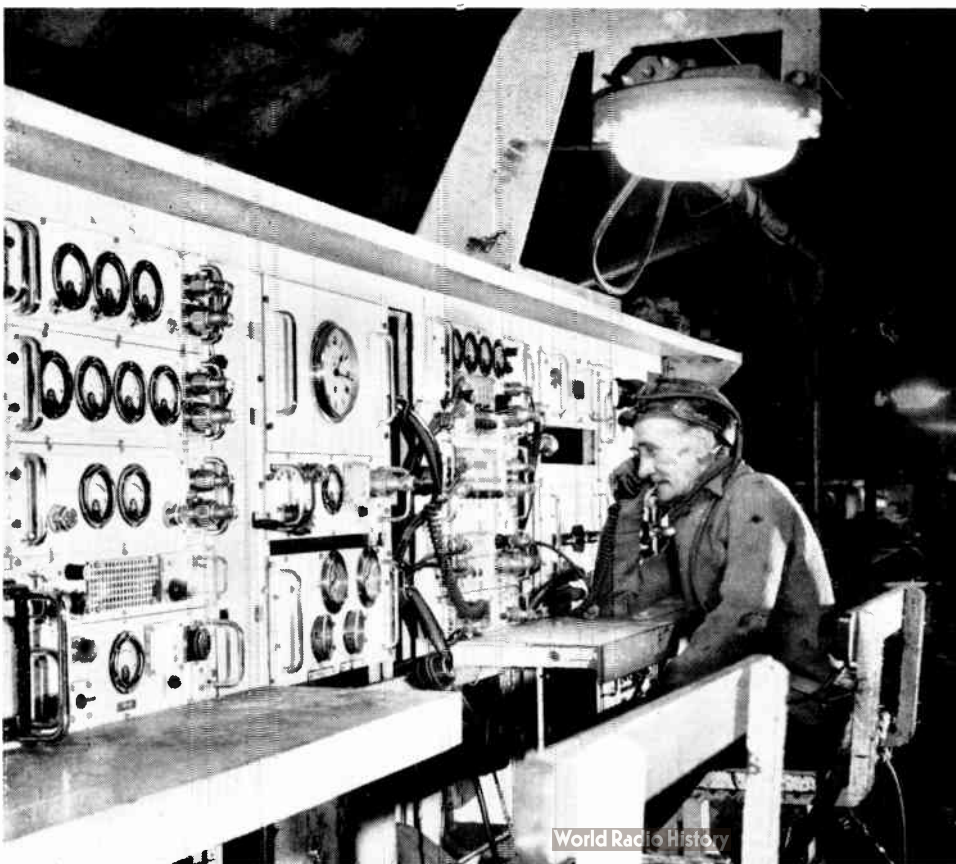

Fig. 2. Underground control console of ROLF I at Newstead Colliery

sophisticated schemes could be used but in the interests of economy and simplicity they were rejected. The system chosen was designed to minimize errors due to shunt losses in plugs and sockets in damp environments and series losses due to cable resistance. The whole of the underground part of this system is powered from a unit running from a 550-V 3-phase supply and capable of a maximum output, at 9-0-9 V, of 650 mA. It incorporates constant-voltage transformers and shunt stabilizers as aids to regulation under wide variations of input voltage.

Amplifiers

A range of standard plug-in electronic units was produced to cater for all needs, these being designed to have the lowest possible current consumption, correct operation from -5°C to 60°C , and linearity of better than $\pm\frac{1}{4}\%$.

They include:

- (a) Impedance Converter. Unity voltage gain. $R_{in} = 350\text{ k}\Omega$, $R_{out} = 1.0\ \Omega$.
- (b) Differential Input Amplifier. Voltage gain from 4 : 1 to 80 : 1. $R_{in} = 7\text{ M}\Omega$, $R_{out} = 1.0\ \Omega$. Common-mode rejection 80 dB.
- (c) Trip Unit. Operating levels: any +ve voltage and -ve voltage between 0.33 and 2.0 V (preset). Zero differential between pull in and drop out.
- (d) Chopper Amplifier. $R_{in} = 470\ \Omega$, $R_{out} = 1.5\text{ k}\Omega$. Voltage gain 150 : 1.
- (e) Methanometer Drive Unit. Bridge supply 2 V 300 mA. Amplifier output $\pm 2\text{ V}$.

Measured Variables

The variables to be measured were five hydraulic pressures, tension in the chain which hauls the coal cutting machine, methane content in the air near the machine, methane content in the ventilating air, power consumption of the coal cutter and measurement of the coal output from the face. The hydraulic pressures and haulage forces are measured using strain gauge transducers, the output being amplified to 2 V by 80 : 1 gain differential input amplifiers with single-ended output. The methane content in the air near the machine is measured using a hot-wire catalytic bridge. This bridge circuit relies on the principle outlined in Fig. 4, namely that the two heated elements, one of which has an active catalytic compound on it, attain different temperatures in the presence of methane, due to this catalytic action, thus upsetting the resistance balance of the bridge.

Referring to Fig. 4, it will be seen that the bridge is supplied with a 2-V peak square wave at 3 kc/s from a multi-vibrator-driven inverter. Resistors R_1 , R_2 and the elements EL_1 and EL_2 are set up so that the bridge output is zero at $1\frac{1}{4}\%$ methane. The output from the bridge is fed to a phase-sensitive amplifier which produces a d.c. output voltage varying from -0.8 V to $+1.2\text{ V}$ over the range 0% to 3% methane. The reason for arranging that the signal should be zero at $1\frac{1}{4}\%$ methane is that alarms, which sense zero signal, are set to operate at this point and inverter and amplifier failures are then picked up by the same alarm. A subsequent amplifier converts the signal to 0-2 V for meter operation.

The methane concentration in the ventilating air is measured using an instrument which burns butane in a modified version of the Davy lamp. A set of thermocouples is supported over the flame and when methane is burnt the temperature rises and the thermocouple voltage increases.

The voltage range is from 12 mV at 0% methane to 25 mV at 3% methane. The output from the lamp is amplified by a normal d.c. chopper-type amplifier to drive an alarm unit and meters.

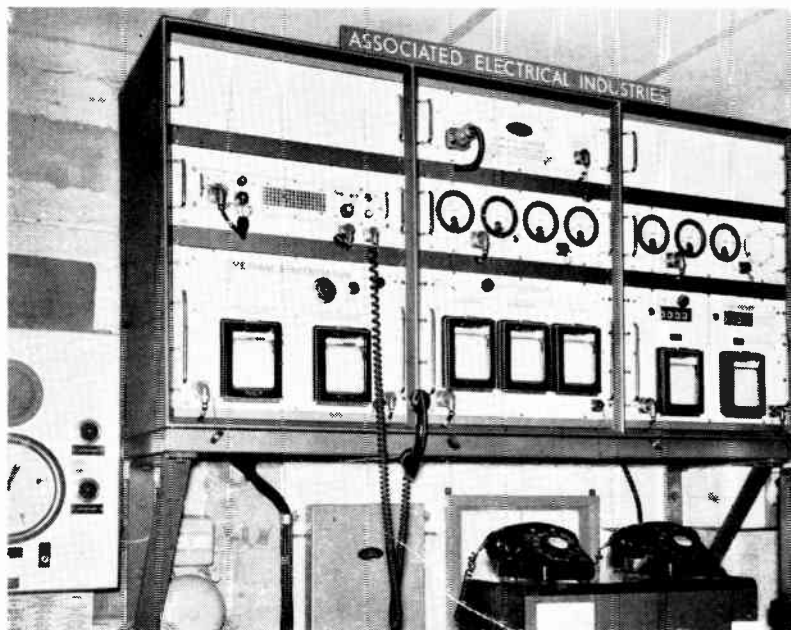

Fig. 3. Surface instrumentation console fitted in the telephone exchange at Newstead Colliery

Power consumption (i.e., kilowatts) is measured using a transducer, Fig. 5, incorporating a Hall effect device, which has been developed by A.E.I. This is a true multiplier and the d.c. component of the output signal is proportional to $VI \cos \phi$. The connections of the unit are shown in Fig. 6, this arrangement being for a 3-phase 3-wire balanced load. The line voltage is reduced to 15 V by the transformer shown and transducers are available for 5, 5+5, 200 and 400 A line current. The output voltage at full-load unity-power factor is 0.5 V. If an a.c. reading voltmeter is used the reading is proportional to volt-amps. An alternative connection enables reactive volt-amps to be measured.

Belt Weigher

A conveyor belt weigher has been developed which has been designed to be intrinsically safe and therefore when certified will be suitable for use underground. This is basically a high accuracy integrating device for producing a figure of total tons weighed. Differential transformers, which are supplied with a closely-stabilized primary current, are used to measure the deflection of a pair of cantilevers which support an idler roller set, over which the belt passes. The signals from these transformers are added, converted to d.c. then applied to a 'ramp type' analogue-to-digital converter. In operation this convertor assesses the load on the idler set, and converts this to an intermittent pulse train, the pulse frequency being determined by a crystal oscillator and the number of pulses being proportional to the idler deflec-

Fig. 4. Catalytic methanometer block diagram

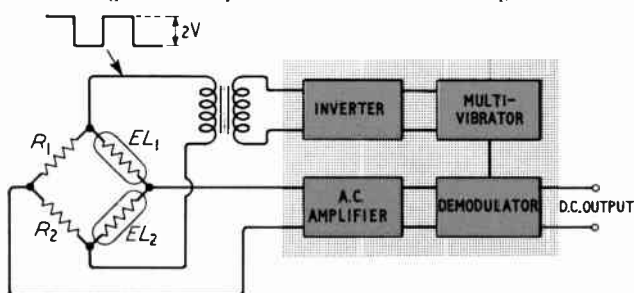
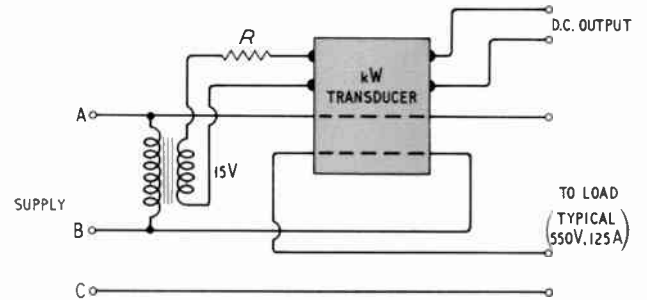



Fig. 5 (Left). Kilowatt transducer incorporating a Hall effect device

Fig. 6. Typical connection diagram for the kilowatt transducer



tion. This process is repeated for every 6 inches movement of the belt so that the resultant total number of pulses produced in a period is proportional to the amount of material carried. Using a binary divider the pulse rate is divided down to a level suitable to drive a counter calibrated in tons. A tons/hour signal is also extracted from the weigher.

Signalling Systems

The latest addition to the range of systems which A.E.I. are offering for data transmission in collieries is a 24-channel voice-frequency system with extra facilities for analogue and time-division multiplex channels. This system also has been designed in such a manner that it can be certified intrinsically safe and is being used for all data transmission at the new Bevercotes Colliery in Nottingham and in the

conveyor control and monitoring scheme now being introduced by A.E.I. Electronics Apparatus Division.

Referring to Fig. 7, which is a generalized arrangement, it will be seen that the transmitting and receiving points are linked by a twisted-pair cable, which may be one pair of a multipair telephone cable, with isolating transformers at each end of the cable. These transformers are essential to the intrinsic safety of the system as they form barriers between the power supply at each end, and the cable. Earthed-interwinding screens, windings of low inductance, and low leakage inductance, are also used as aids to safety. The sending amplifier has an output of 100 mV per channel, the loss in the cable being made good by the gain adjustment in the receiving amplifier. A total line loss of 30 dB may be tolerated without intermediate repeaters.

The four-channel oscillators form the basis of the trans-

Fig. 7. Typical arrangement of voice-frequency data-transmission system

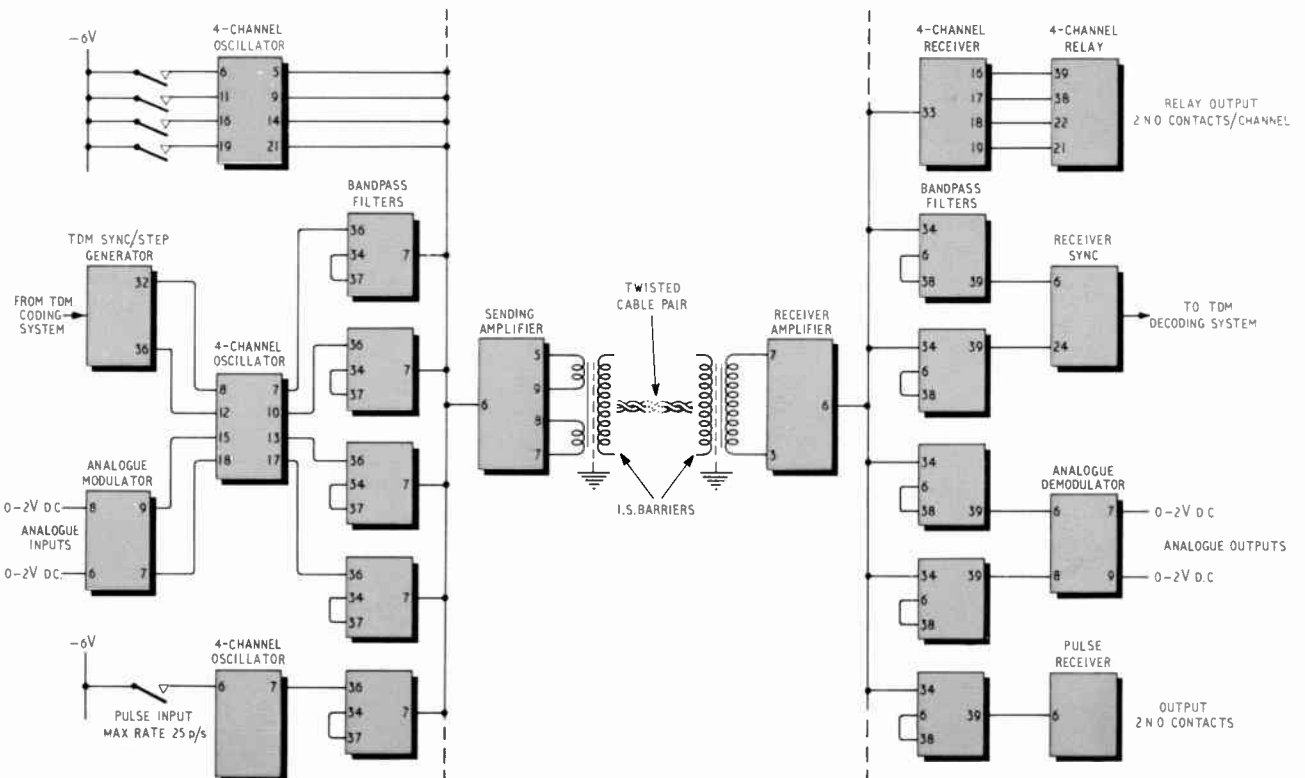

mitting system, the 24 channels ranging from 420 c/s to 3,180 c/s with spacings of 120 c/s as laid down by the international telegraphy agreement (C.C.I.T.). The oscillator uses an amplitude-stabilized LC circuit feeding through a buffer amplifier to a transistor switch. In use the oscillator runs continuously, the output being produced by operating this switch. For on-off signals external contacts may be used to switch the oscillators which in turn feed the sending amplifier. At the receiving end the four channel receivers use high-Q LC circuits preceded by four-channel bandpass filters. Each receiver is connected to a trigger circuit on a four-channel relay unit, the relays having 2 N/O contacts each.

If the on-off signal is at a rate greater than 2 per second then a bandpass filter and pulse receiver must be used at the receiving end with a maximum rate of 25 pulses per second. It will be noticed that a bandpass filter is included at the sending end to remove harmonic sidebands produced by square-wave switching of the oscillator.

If analogue transmission is needed then an analogue modulator is used to modulate the oscillators with a frequency corresponding to 5 c/s at zero input to 25 c/s at



2-V input. Again bandpass filters are used at each end, the receiving filter feeding the demodulator. This converts the signal back to 0-2 V d.c., the overall accuracy d.c. to d.c. being $\pm 2\%$.

A further facility (not shown in Fig. 7) is that of using any pair of the 24 channels to transmit a 64-point time-division multiplex scanning system which steps at 25 points per second.

A single cable pair may at any time transmit any combination of these signals up to the maximum of 24 channels.

The techniques described are the result of some years of individual development, and they and many other electronic systems are being put into operation at Bevercotes Colliery. Here new concepts of control and management are being employed which will depend largely on these modern electronic methods for their success.

Simulator Developed for Locomotive Driver Training

With the nearing completion of the 25-kV a.c. electrification scheme on the London Midland Region's main line between London and Manchester and Liverpool the training of drivers in the new form of traction is of paramount importance.

Theory can be taught anywhere but the practical 'over the road' training is difficult to provide on what is Britain's busiest main line.

Standard conversion driver training takes at present 26 days, half of which should be spent handling actual trains—both passenger and freight. While some of this time can be spent on service trains it nevertheless becomes necessary to run special trains solely for driver training.

In dense traffic areas it is only possible to provide actual moving training for about 3 hours per train per day. As two drivers are trained together this means that after one day's training each man has only had 1½ hours' experience at the controls.

Other training methods were sought and it was decided to develop a static electric locomotive trainer which would fully simulate a locomotive under actual driving conditions.

General Precision Systems were awarded the contract for a locomotive driver training simulator based on the 3,500 h.p. a.c. electric locomotive.

This simulator is the first of its kind in the world and is designed to produce realistic reaction to all controls and instruments and to simulate all the sounds and effects experienced by the driver of a locomotive. At the same time it incorporates a visual system, which includes fully operational signals, on a film which moves at a speed proportional to whatever train speed is being reproduced.

The film which covers some 16 miles of track was taken with a wide angle lens on a length of electrified line between Alderley Edge and Manchester, Piccadilly, and is in colour.

The camera was mounted in the same position relative to the track as the eye of a driver to obtain maximum realism

and was driven by a spindle attached to the axle of the vehicle used for filming.

The basic arrangement of the simulator consists of a very realistic 'mock up' of an electric locomotive driving cab with visual, motion and audio systems controlled from a computer.

With its aid static driver training can be undertaken in simulated 'over the road' conditions thus speeding up the training programme.

This shows the interior of the simulator with the driver at the controls



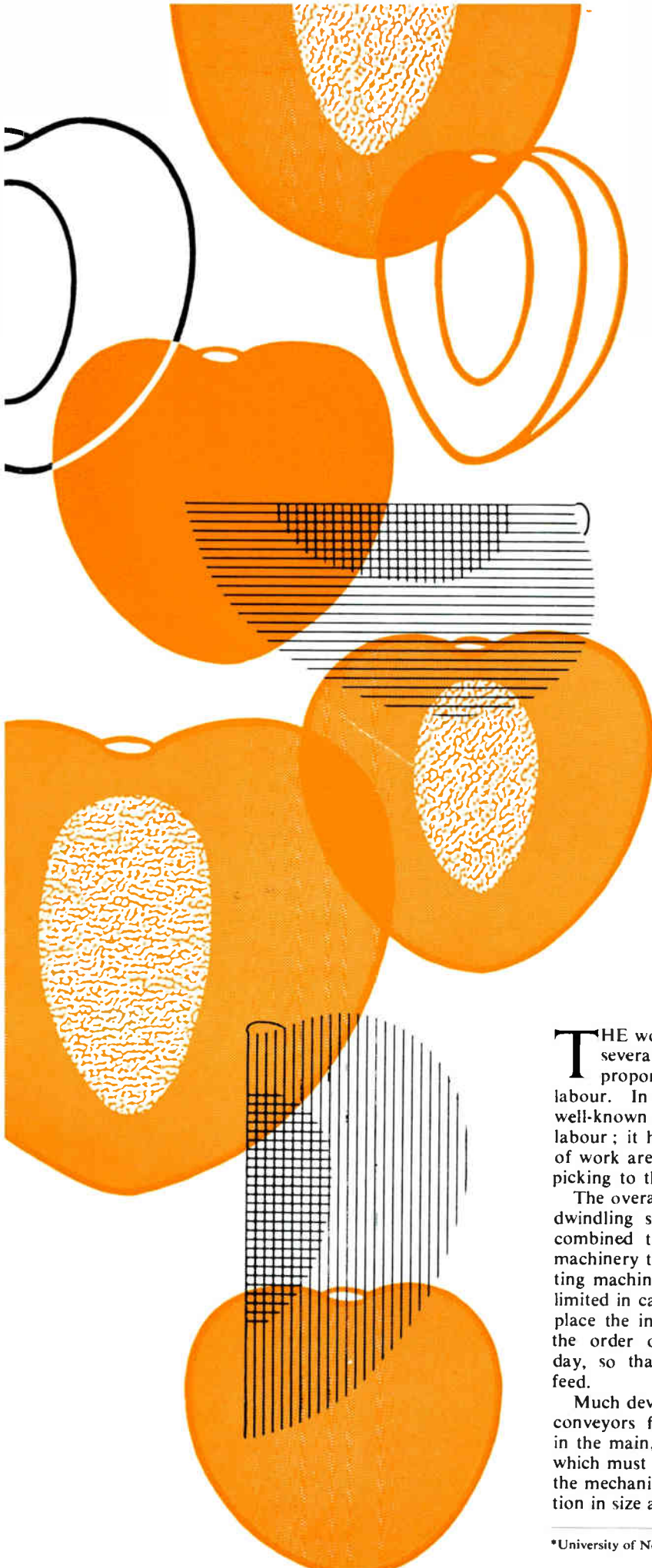

In the preparation of apricots for drying it is necessary to split each fruit into two halves and to remove the stone. This article describes a hydraulic system for handling the fruit and properly orientating it for the cutting operation.

hydraulic handling of fruit

By P. G. MORGAN*

THE world production of fruit is growing at a steady rate, with several million tons being processed each year. A fairly high proportion of this is dried, and most of it is processed by hand labour. In fact, many aspects of fruit production other than the well-known one, fruit picking, involve large amounts of seasonal labour; it has been estimated that approximately forty man-hours of work are required to process a ton of apricots from the original picking to the final preparation for drying or canning.

The overall increase in agricultural labour costs and the gradually dwindling supply of seasonal labour in an affluent society have combined to increase the effort devoted to the development of machinery to perform much of this work. For example, fruit cutting machines have been used for many years, but they have been limited in capacity by the rate at which the operator can accurately place the individual pieces of fruit in the machine; the rate is of the order of 60 pieces per minute or $1\frac{1}{2}$ tons in a ten-hour day, so that any increase in capacity necessitates an automatic feed.

Much development has been carried out on feeding machines and conveyors for machine tools and production-line processes, but, in the main, they deal with a series of identical components, all of which must be processed identically. Many problems are posed by the mechanization of fruit handling, especially in view of the variation in size and shape of the individual fruit, and also in view of the

*University of New South Wales.

limitations imposed by the properties of the fruit and their liability to damage. The equipment and techniques described below have been developed¹ with particular reference to the processing of Californian apricots, but there is ample evidence to show their application to a wide range of stone fruit, and it is possible that other branches of the mechanical-handling industry might be able to make use of the hydraulic manipulation methods which are discussed.

The number and type of operations which must be carried out include alignment, metering, orientating, cutting, stoning or pitting, the term depending on the type of fruit being processed, and spreading. The nature of the fruit is such that each one must be handled separately; there may be considerable variation in the consistency of the fruit in addition to the physical characteristics usually considered in processing equipment.

Alignment

The first operation mentioned above, alignment, involves a continuous single file of fruit, with the flow rate under complete control. Mechanical methods of dealing with soft fruit have their limitations, and these have led to the use of a fluid as the conveying and controlling medium. Fig. 1 shows a simple alignment unit with no moving parts. The receiving tank at the left-hand side has a capacity of some 120 lb of fruit. A bottom slope of some 15° towards the discharge side leads into the discharge channel, semi-circular in cross-section, which leads from the bottom of the receiving tank upwards at some 5° to the discharge point; the channel depth is some three-quarters of the average diameter of the fruit. The unit is completed by a triangular section adjacent to the discharge channel, as shown, with the bottom of this section level with the top of the channel. A water nozzle with a pressure of 5 lb/in.² gauge is mounted on a level slightly higher than the average fruit diameter, and is directed backward from the discharge end of the channel.

In operation, the water is maintained slightly above the level of the discharge point. The fruit is prevented from being damaged when it is dumped into the receiving tank by the cushioning effect of the water. The water flows along the channel to the discharge point with a velocity proportional to the hydraulic head, but maintains a finite depth established by the slope of the channel. The water jet flow rate and position are critical, and serve three purposes:

- to make up the water lost by flow from the channel;
- to maintain a circulation of water across the discharge section of the reservoir to carry fruit from the main mass into the channel entrance;
- to stop any fruit from moving up out of the channel by returning it to the entrance end of the channel.

The diameter of the discharge channel is equal to that of the largest fruit to be dealt with, and the simple arrangement described above is adequate for firm or ripe whole fruit. Soft fruit or crushed fruit tends to increase the frictional forces by presenting a larger surface of the fruit in contact with the channel wall, and this has been overcome by forming the channel wall of rubber and giving it a vertical agitation of some 0.2 in. at a frequency of some 1½ times the fruit delivery rate.

It has been found that a given channel will handle fruit size variation of up to 40% of the maximum fruit diameter, and, in general, the fruit from a given orchard will be within this range. To take account of seasonal variations or variations in type of fruit different channel inserts may be fitted. The density of the fruit is only slightly greater than that of water, so that practically any fruit is carried easily by the

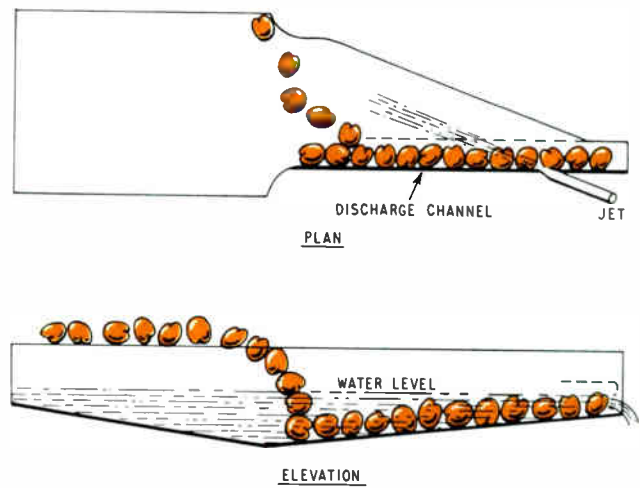

Fig. 1. Alignment unit for fruit

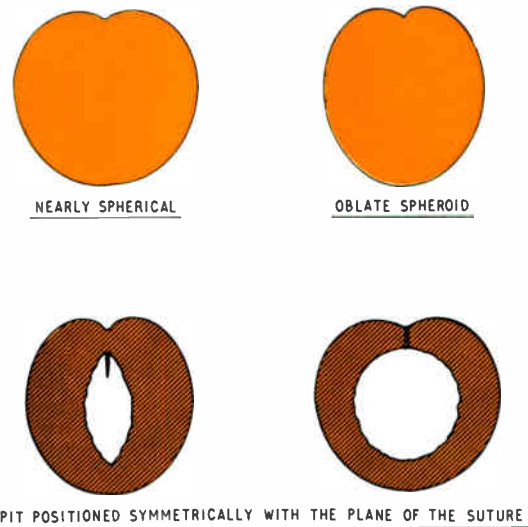
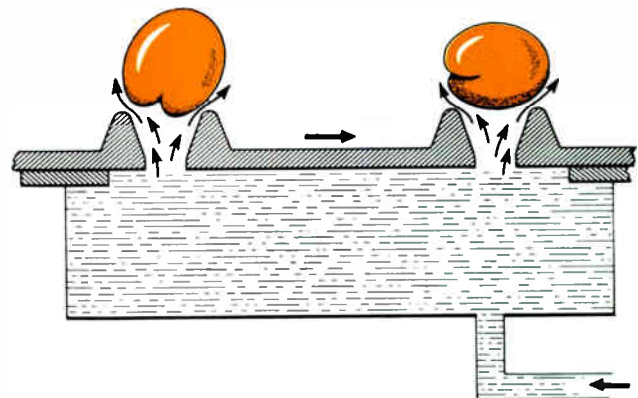

Fig. 2 General form of the apricot. The stone is best removed by cutting along the natural parting line

Fig. 3. Illustrating the method of orientating the apricot





flow of water in the channel with a minimum of contact of the fruit with the channel walls.

The above equipment enables a continuous supply of fruit to be obtained from an intermittent supply to the hopper, and it also allows the supply to be metered without much difficulty. Since the alignment, cutting and pitting require individual control of each fruit, it is necessary to meter its rate of flow at the discharge end of the channel. This is accomplished by a metering disc mounted at the end of the discharge channel and against which each fruit is held until it is dropped into a cup on the cutting machine belt. When the fruit is held stationary the fluid in the channel can flow past the fruit with 100% slip. The relative velocity between the fluid and the fruit is then a maximum, and provides a maximum force on the fruit in order to accelerate the line of fruit when the metering disc is rotated.

Orientation

Dealing now with a specific fruit, the apricot, one may consider the problems of orientation of the fruit for cutting. Apricots vary in shape from nearly spherical to an oblate spheroid. The pit (the name given to the stone for this fruit) is rather flat and is positioned symmetrically with the plane of the suture, or natural parting line, as shown in Fig. 2. Cutting the apricot on or near the suture results in a better dried product and makes removal of the pit easier, so that a requirement for the next stage in the processing is that the fruit should be orientated so that the sutures are in a single plane.

This operation can be accomplished also by means of a fluid system. The metering action previously described drops the fruit into cups spaced $5\frac{1}{2}$ in. apart on a narrow conveyor belt. These cups are annular in shape with sloping inner walls, allowing a small apricot to rest in a lower position than a larger one. A hole equal in diameter to the bottom of the cup penetrates the belt. From the metering point, the belt moves over a manifold, consisting of a tank with a smooth polished plate as the top. A tapered slot is cut along the centre-line of this plate for the length of this reservoir, and the belt is positioned to move over the manifold plate, so that the cup holes register with the tapered slot.

Water under a pressure of 10–15 lb/in.² gauge is supplied to the manifold, and the belt is held in contact with the top manifold plate by external pressure shoes. The principle of the orientating method is shown in Fig. 3. As a cup, holding a fruit in a random position, moves over the tapered slot water flows upward from the manifold, lifting the apricot and supporting it within the cup. The drag forces generated by the flow pattern of the fluid around the fruit are unbalanced, and develop a moment that rotates the fruit into a stable position. Classical hydrodynamics provides expressions for the forces and turning moments exerted by a moving fluid on an ellipsoid immersed in it. For the case of a flattened body of revolution (the apricot approximates to an oblate spheroid) the turning moment is such as to move the major axis into a plane perpendicular to the direction of the fluid stream. The suture of the apricot is in the plane of the largest diameter, so that the action of the fluid stream is to change the fruit from a random position to one with the suture in a hori-

zontal plane. The manifold slot width decreases in the direction of belt travel, gradually reducing the water flow and allowing the fruit to settle into the cup without disturbing its orientation.

An alternative method of fruit orientation has been developed, utilizing a fruit-holding cup of the pattern described but, in place of the axial hole through the cup and belt, the cup is hollow with four equally spaced slots on its inner wall, as shown in Fig. 4. The slots are so constructed that the water flows from them in a path tangential to the cup wall so that, under these conditions, the fruit is subjected to fluid drag forces which cause it to rotate within the cup. Due to the mass distribution of the fruit flesh and the pit, a couple is created which again causes the fruit to be aligned so that the suture plane is perpendicular to the cup axis.

Cutting and Pitting

After the orientation process, the belt and cups are carried forward and around a drum and returned to the metering point. Directly above the belt drum is a matching drum with cups set to synchronize with those on the belt.

The fruit is cut by two spring-loaded knives placed on the centre-line of the cup-supporting drums and in the horizontal plane midway between their centres. The contour of the cutting edge of each knife is such that, as the fruit is moved past it, the knife moves through the flesh to the pit at the leading edge, around the surface of the pit and out through the flesh at the rear, so that the two knives perform a complete cut along the suture of the fruit. The performance of the knives varies with the angle of the blades with reference to the axis of the machine, the blade shape and the loading-spring characteristics. Suitable choice of the spring constant and the initial tension provide sufficient force to cut into the firmest fruit with little increase in reaction as the knives move to their maximum separation.

As the fruit leaves the cutting assembly, a pair of stainless-steel splitters, shown in Fig. 5, directly behind the knives, feed into the knife cut and hold each half fruit in its cup through a certain angular displacement of the drums. During this range of rotation, a cam-actuated plunger containing five symmetrically spaced prongs moves through the base of the cup, pierces the fruit flesh and ejects the pit. The plungers must be duplicated in both the upper and lower cups, since the pit may cling to either half of the fruit. The holes caused by the pitting prongs are of no concern, since they do not affect the final dried product.

The above equipment, as it is described, deals with a uniform size of fruit. Apricots, as with most fruit, come in a range of sizes, and these need to be accommodated by the machine. The cup dimensions are determined so that the fruit diameter of the smallest apricot will be at the level of the edge of the cup, while that of the largest apricot is about $\frac{1}{2}$ in. above the cup edge. The drums must therefore be adjusted for each fruit so that the fruit diameter will

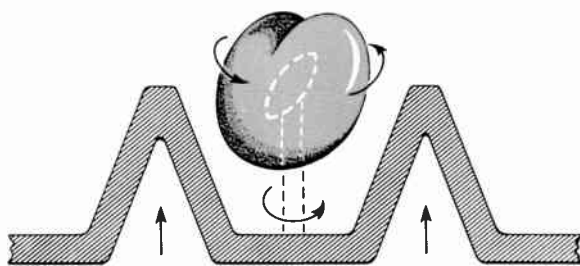

Fig. 4. An alternative way of orientating fruit

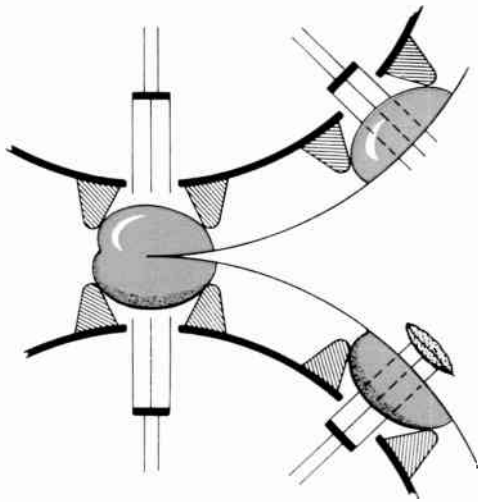

Fig. 5. Removing the stone from the apricot

always be in the plane of the knives. To allow for this adjustment, the drums are mounted on equal arms, spring-loaded to balance the drum weight. A lever system actuated by a hydraulic cylinder positions the drums symmetrically above and below the plane of the knives.

The hydraulic system consists of a reservoir, pump, accumulator, control valves and hydraulic cylinder. The cylinder is single-acting and the drums are held in position by the ram force acting against the spring load. In operation, the hydraulic fluid circulates from the reservoir through the valve and returns to the reservoir, the ram force being increased by restricting the return flow to the reservoir. The control valve of the rotary type needs to give free movement under maximum pressure, with long and narrow ports to provide adequate opening and to give control through a narrow angle of valve drum rotation.

Information is transferred from the fruit to the control valve by means of a light bale wire mounted adjacent to and associated with each cup on the upper drum. The bale traverses the cup diameter laterally and has an extension to one side long enough to engage the valve control lever. As the apricot rests in the lower cup and approaches the cutting section, the bale of the corresponding upper cup drops down and contacts the top surface of the fruit. The bale extension next engages the valve control lever and returns it to its proper position, so that the drums are set and the fruit is carried through the knives. A synchronized brake is applied just before the bale extension leaves the valve control lever to hold the new drum position. The brake is released at the instant of sensing the next fruit.

In order that the drums will change position only when there is a change in fruit size, a servo loop is built into the control system. A servo link, connecting the upper drum arm to the valve body determines the balance position of the drums for any particular condition. The drums thus maintain their setting for successive fruits of a given size and readjust only for a change in size. The maximum time must be allowed for cutting and pitting of the fruit; at a rate of 150 fruits per minute, 0.1 sec is allowed for sensing and 0.3 sec for cutting and pitting.

Final Orientation

The cut and pitted apricot halves leave the machine at two points (i.e., from the upper and lower drums) and drop in a random position on to a cross feeder belt located

above and at right angles to the moving trays on which the fruit pieces are to be deposited. A paddle blade sweeps across the belt at intervals, and from the belt the fruit falls by gravity down a seventeen-channel slide, set at an angle of 40° to the horizontal. These channels are V shaped, 2 in. wide and 2 in. deep. This slide realigns the fruit in general fashion, although it does not ensure uniform distribution of fruit among the channels; its principal function is to direct the apricot halves into the orientating section. This consists of a set of slides similar to those of the realigning slides but set at an angle of 5° to the horizontal, mounted in such a way as to permit the channels to be vibrated laterally with an amplitude of $\frac{1}{16}$ in. at a frequency of 2,600 cycles/min. An orientating lip is formed at the discharge end of each channel by cutting away its lower section along an experimentally determined contour. The action of the orientating channels, together with the uniquely designed lip, causes the fruit to progress at an even rate along the channels and to turn, cup up, on to the tray surface directly below the lip.

Conclusion

The above descriptions of novel handling techniques have applied particularly to apricots, but there is no doubt that they are applicable to the fruit-processing industry generally. Of particular interest is the application of the results of classical hydrodynamic analysis (i.e., the forces on an ellipsoid in a fluid stream) to practical problems; fluid-handling methods have wide application in the comparatively gentle handling of fruit.

It should be noted that much of the experience in the design of the equipment has been obtained experimentally, and it is suggested that there are a number of gaps in the knowledge of simple hydraulic problems, e.g. the fluid forces and flow rates of simple shapes in channels, the cushioning effect of layers of fluid, etc. Systematic experimental work on topics such as these should provide background information which would expedite the application of these techniques.

Reference

- ¹ Lorenzen, C., Lamouria, L. H. *Agricultural Engineering*, Vol. 45, p. 258 (1964).

B.E.A.M.A. Annual Report

The 1964-65 annual report of The British Electrical and Allied Manufacturers' Association is now published. This report, the fifty fourth to be produced, gives details of the activities of B.E.A.M.A., its various divisions and the electrical industry during 1964.

In the 'general review' it states that the output of British electrical and allied engineering products exceeded £2,000 million during the past year. Exports reached a new record of £363 million but this is only marginally up on 1963.

Necessarily the bulk of the report deals with the electrical industry but included is a mention of the work of the Electronics and other divisions of B.E.A.M.A.

While the setting up of nine divisions of B.E.A.M.A. was completed in 1963, it was only during 1964 that the work of the majority began to take shape and play an increasingly important part in the affairs of the Association.

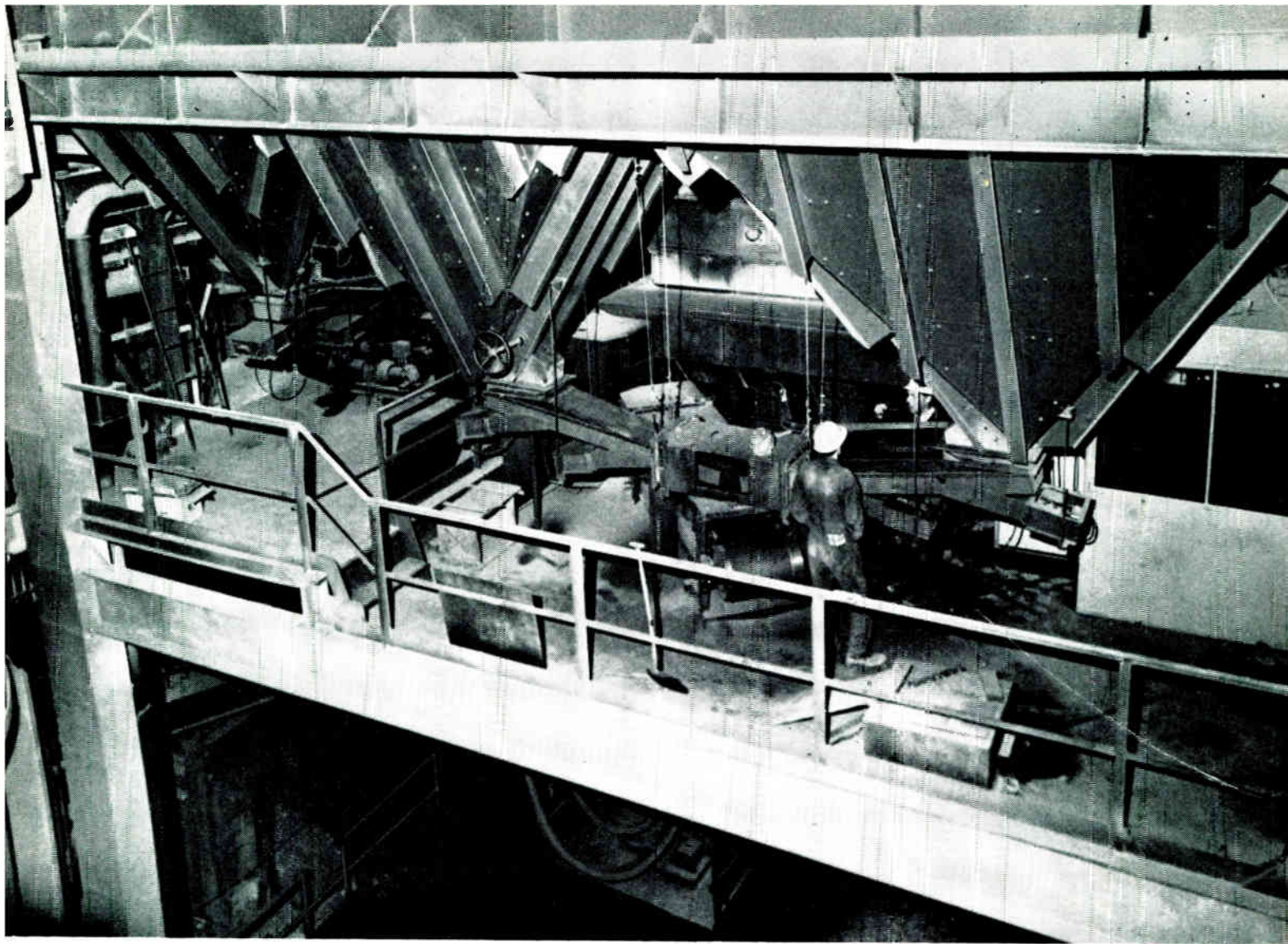

CONTINUOUS WEIGHING AND CONTROL IN HEAVY INDUSTRY

ELECTRONIC control equipment is being installed in more and more plant throughout Europe. Its importance grows steadily with the spread of automation and its flexibility, reliability, economy and potential for streamlining are becoming more apparent.

The variety of control systems developed by Rank-Bush-Murphy (Electronics) Ltd. gives ample evidence of the trend. An expanding list of installations has been carried out by

(Above) Short-weigh and vibro feeders, part of the Rank Electronic continuous weighing system installed at the Norrbottens Järnverk A.B. steel mill near Lulea in Sweden. Also seen are the G.E.C. vibrating equipment and, overhead, the bunkers containing ore slime and fine lime.

(Right) The Kaldo furnace in action during a 'blow' at the steel mill of Norrbottens Järnverk A.B. At the rear is the control room containing the Rank electronic continuous-weighing equipment.

the company in the United Kingdom, Italy and Sweden in steel, coal, chemical and other industries.

One of the latest installations, based on a belt-conveyor system, has just been completed in a Swedish steel mill, Norrbottens Järnverk A.B., near Lulea, close to the Arctic Circle. Here the system operates under the most arduous conditions in the industry—in the immediate vicinity of a 60–70 ton Kaldo furnace, where it is subject to very high plant temperatures, vibration and mechanical shocks of considerable magnitude.

A system was required to deliver small increments of solid materials into the furnace, and to allow an operator to set up desired batches from a platform adjacent to the furnace. Provision was made for recording individual and total deliveries of each of the materials—lumped lime, ore slime or mill scale, and fine lime. Several additions of all materials except the first of these are made during each production cycle.

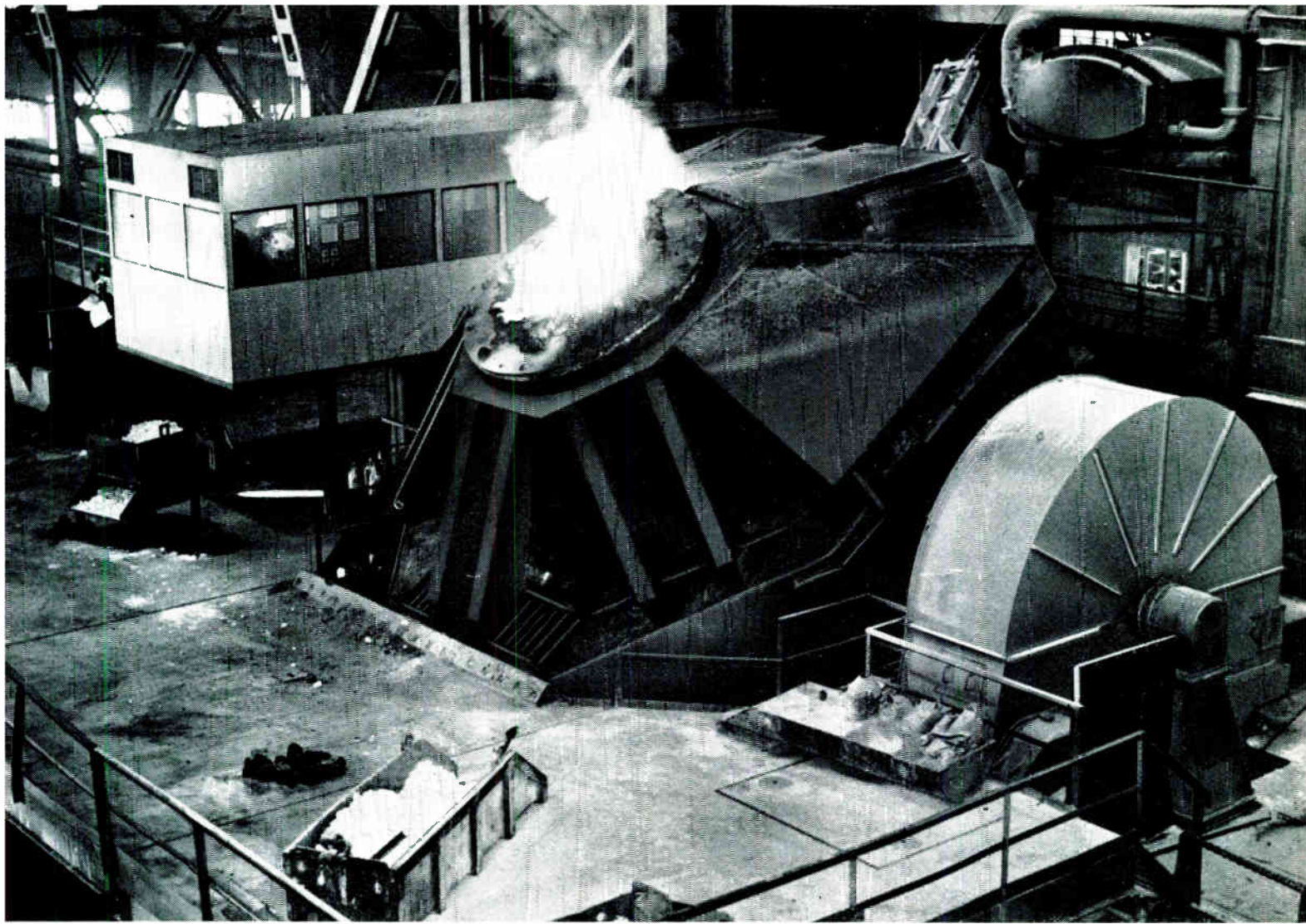

This article describes a control system which has been installed in a Swedish steel mill. Both belt weighing for continuous operation and hopper weighing for batches are employed.

By A. C. ELSTOW*

The Rank Flotronic belt weighing and control system, extremely compact equipment, was installed in the very limited space between the storage bunkers and the furnace. Two weighing systems are employed, one for batch-fed quantities over conveyor belts, where continuous weighing is effected, the other for material weighed in a hopper.

As the additions material exudes a fine metallic dust, the entire conveyor system from the hopper to the furnace delivery point has been enclosed in steel casing, and all the electronic equipment is hermetically sealed.

The advantages of the Flotronic system are considerable saving in operatives' time and the ability to make continuous additions of material without stopping the process, which results in more efficient control of quality in the steel produced, and it can be carried out from one central control desk.

* Rank-Bush-Murphy (Electronics) Ltd.

Ore mined in Malmberget, 211 miles away, is brought by rail, and coke comes by sea, to Lulea, a port from which the bulk of the finished steel is shipped out. Stock piles of the materials are fed by overhead crane to hoppers in which they are stored.

At the start of the process the crude steel is poured into the furnace and the lumped lime added in one single batch per cycle. This is weighed in a storage hopper and fed rapidly to the furnace by a retractable chute fitted with a pneumatic shovel.

Hopper Weighing

The lumped lime is stored in two large hoppers and extracted by means of two draglink conveyors working towards each other. Below the feed-end of the draglink conveyors is the weighing hopper, large enough to contain the required maximum of twelve and a half metric tons and supported by three 20,000-lb Baldwin load cells. A Rank Flotronic static-load indicator supplies three isolated voltages, one to each load cell, and the outputs from the load cells are connected in series to give a signal proportional to the weight of the hopper and its contents. A fourth isolated supply is used to cancel the voltage due to the weight of



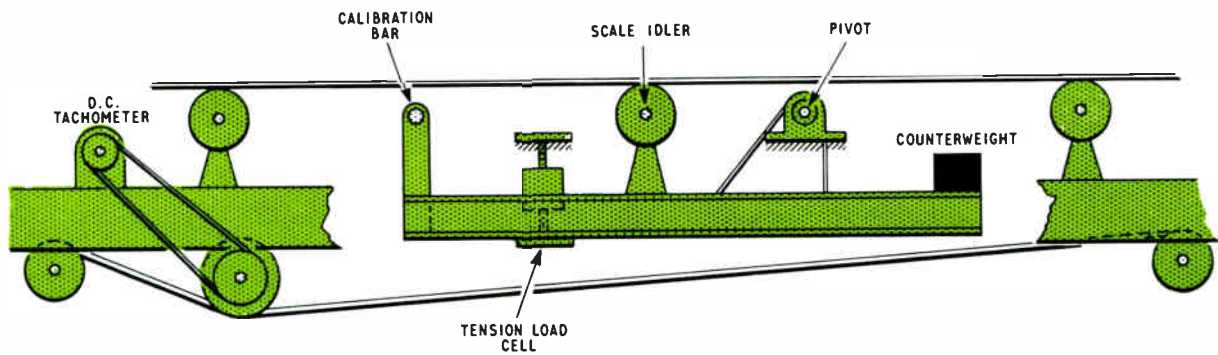

Fig. 1. The basic weigh scale

the hopper, reducing the effective output to zero when the hopper is empty. These supplies are stabilized to prevent changes in the calibration of the unit.

Due to the zeroing of the system the output signal is now proportional to the weight of material in the hopper and is amplified. An internal reference, calibrated in metric tons, is compared with the incoming signal which increases as the hopper fills. When the signal reaches the same magnitude as that of the reference a relay is operated. The action of this part of the equipment, therefore, is to compare the weight with the reference level by indicating the quantity of material on the static-load indicator and to initiate the start of the hopper filling by switching on the supply to the draglink conveyors. When the required level is reached the relay in the static-load indicator switches off the supply to the draglink conveyors and filling ceases.

Additional equipment is used for digital reading of the hopper batch. An analogue-to-digital converter is supplied from the amplifier output and on completion of the hopper filling an initiating signal is given to the converter unit. The digital information is stored, the sampling being carried out in a fraction of a second. The stored signal is then 'emptied'

at a rate of four pulses per second and for each pulse removed from the store a relay contact is opened and closed. This relay is used to drive an external counter so presenting the hopper weight in a digital form. The calibration of this hopper is made by placing a known weight of material in the hopper after zeroing.

Continuous Weighing and Batch Feeding Additions to the Kaldofurnace

The ore slime, mill scale and fine lime are supplied to the furnace via two short conveyors, and the Flotronic weighing equipment uses a counterbalance fitted to the conveyor, its movement being restrained by a load cell.

The distance between two of the conveyor rollers is accurately measured, the remainder of the belt being assembled in normal fashion. The two specially-positioned rollers are fixed to the side members of the conveyor and the weighing rollers on the counterbalance are set at equal intervals between them. This enables a fixed length of conveyor belt to be weighed. To counteract the weight of the weigh-rollers, steel plates are bolted to the other end of the counter-balance (Fig. 1).

Fig. 2. Block diagram of the batch-weighing system at Norrbottens Järnverk A.B.

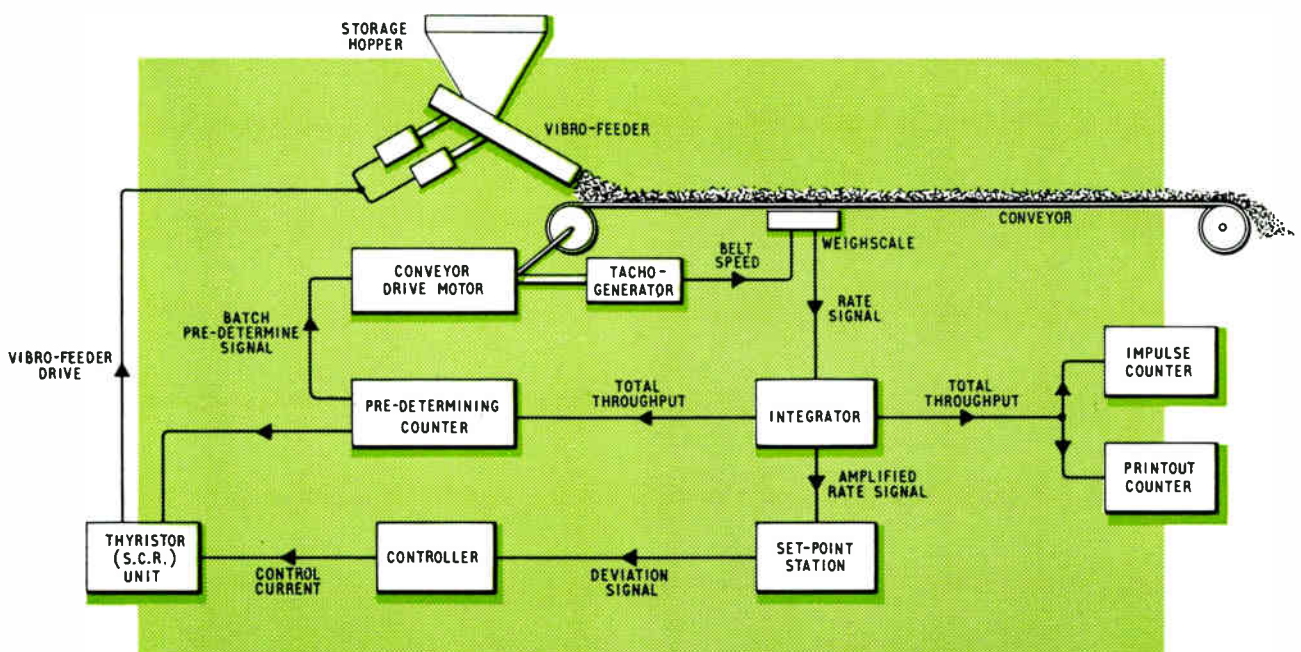

A d.c. generator is driven from the conveyor-belt motor, and the resultant voltage applied to the load cell. If variations in mains supply cause changes in the speed of the belt corresponding changes take place in the output voltage to the load cell. Material passing across the conveyor belt causes tension to be applied to the cell. This, too, changes the output voltage, which is thus dependent on both belt speed and weight of material. Consequently, the output voltage from the cell is proportional to the rate of material passing along the conveyor belt.

The output voltage from the load cell is fed to a Flotronic integrator, where it is amplified to about one thousand times its value. This amplified voltage, which still represents the rate at which material passes across the conveyor, is displayed in the front panel of the integrator, on a scale calibrated in metric tons per hour, so that the rate at which material is being fed to the furnace is always visible.

The rate voltage is changed to a digital quantity by integrating against a crystal-controlled clock and the pulses so produced are used to drive an internal impulse counter. This is also displayed on the front panel and gives the total amount of material which has passed over the conveyor. Each impulse to the counter represents one kilogramme and a decimal point is marked before the last three figures so that the counter shows the total number of metric tons which have been supplied by the conveyor. The integrator unit allows an operator to zero out the variation in belt weight over its complete length. By hanging a weight on the calibration bar, see Fig. 1, the total weight reading on the integrator can be adjusted to the correct figure for a finite number of belt revolutions.

The pulse which drives the counter also drives, via a relay, three external Landis & Gyr counters for totalizing, printout and predetermining (Fig. 2). The last has an upper scale which can be set to a required batch and a lower one set to zero. As impulses are received, the upper scale counts down and the lower scale counts up. When the amount set on the upper scale has been passed over and the reading is zero, a contact is switched in the counter, turning the con-

veyor off so that the supply of material stops, thus controlling the quantity of material fed to the furnace.

A set-point station is used to control the rate at which the material is supplied. The rate voltage fed to it is compared against another voltage set up by means of a potentiometer on the front panel. This voltage represents the required rate of feed. Both voltages are displayed on a double meter with a common scale. When the two pointers are coincident, the required rate of feed is being achieved. If the rate deviates from that required, a control current is produced which adjusts the power to a vibrofeeder transferring the material from the storage hopper to the conveyor.

The control current is derived from a G. Kent controller and control of the vibrating feeder is effected without the use of moving parts since a thyristor unit is used to provide power to vibrate the feeder trough.

The control current fed to the thyristor control unit is varied in the range 0-10 mA and in turn controls the voltage applied to the vibrator coils in the range 0-500 volts.

Another facility of the set-point station allows the material feed to be controlled manually by changing over a switch and adjusting the manual control knob on the front panel. The level of the control current to the vibrofeeder is shown on a third meter, which operates whether the drive is on manual or automatic. Briefly, the method of feeding a batch to the furnace is as follows:

The required batch is set on the predetermining counter and all external counters are set to zero. The set-point control is adjusted to the required rate of feed (if different from the previous batch rate). A series of interlocks ensures that the Kaldo furnace is in position and feeders and con-



Additions feed control desk, part of the Rank Flotronic continuous-weighing equipment in the Norrbottens steel mill. The picture shows controls for the batch-weighing and hopper-weighing systems installed, and the digital printouts for both



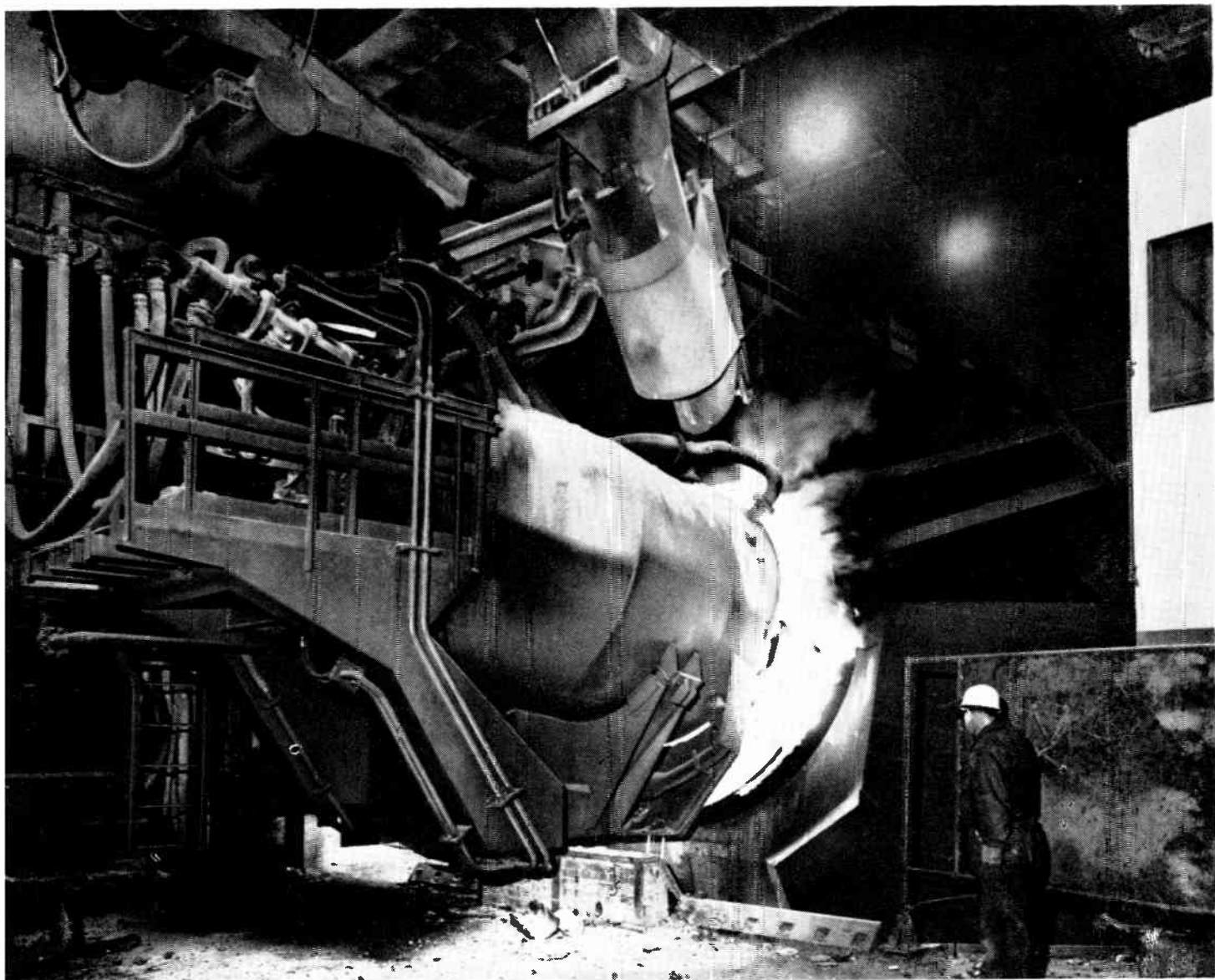

Charging the Kaldo furnace from the G.E.C. vibrofeeder in the Norbottens steel mill. The feeder is fed from above by the Rank Flotronic weigh belt

veyor are started in sequence. On pressing the start button, the mains supply is switched to the conveyor, setting it in motion. The vibrofeeder drive is increased and material is fed to the weighing conveyor and its weight totalized as described earlier.

After delivery of the required quantity, the contact on the predetermining counter causes interlocks to switch the system off in the required sequence. A printout record of the total amount supplied can then be taken and the next batch set ready. The impulse counter is zeroed only once per furnace cycle, so giving a total figure for all the batches supplied.

The ore slime and mill scale conveyor has a hopper and a feeder for each material and a selector switch on the

control desk selects the material required. Supply of these two materials is not simultaneous.

The fine lime conveyor has one hopper and one feeder. Both conveyors empty into a small surge hopper where another vibrofeeder transfers the materials to the additions inlet of the furnace. Fine lime and one of the other materials can be fed to the furnace at the same time.

In the future, it is anticipated that the weighing and control equipment should feed information to an analogue or digital computer for data-logging and control facilities.

The Flotronic systems used in the application described here are only two of the possible uses for the equipment. Both the integrator and the set-point station, which has two amplifying channels, can be scaled to accept inputs of any level from 10 millivolts upwards. The integrator, therefore, can be used as a device for measuring quantities other than total weight of material, and, in conjunction with the set-point station, for proportioning of two or more systems, so controlling the mixing of several materials, either by quality or quantity.



ELECTRONICS
INSTRUMENTATION
CONTROL

Automated Solid State Weighing

Computer Weighing S.A., the U.K. and European licencees of the 'Railweight' solid state system of weighing freight wagons while coupled and in motion, have been granted a number of additional certificates of approval from the Weights and Measures Division of the Board of Trade. Last August the B.O.T. granted the first approval for 'coupled and in-motion' weighing of freight trains for single destinations; in February this year an extension was made to cover a system of overhead hopper weighing. Each hopper is supported by four load cells and programme circuitry operates the complete weighing and discharging operations and also the movement of the train. When the material in the weighing hopper reaches a predetermined amount, the feed cut-off functions automatically and an accurate gross weight is taken, the weighing circuitry being fed by a continuous scanning arrangement. On completion, each hopper is weighed empty and the net weight of the load is automatically calculated. This process is repeated until the entire train is filled and the total net weight of the train is then printed out. At each weighing, the gross, tare and net weights are printed to the nearest 100th of a ton, together with the number of the train and

the time of day. A further certificate now allows the system to be used for weighing freight trains comprising wagons for different destinations and also permits the use of a closed-circuit television system. All the results may be permanently recorded on video recording tape, thus eliminating any necessity for manned control. Identification of wagons and trains can be linked to print-out units at locations far removed from the installations and the system can be linked to office data-processing equipment to give a further degree of automation.

When necessary the 'Railweight' system can be installed by adapting existing weighbridge pits—by retaining the conventional weighing machine lever mechanism and inserting a single strain-gauge load cell in the connecting rod. This means, however, that some mechanical parts must be retained, whereas a new installation with four load cells has no moving parts; furthermore a new installation can be sited at a point of maximum traffic thus rendering unnecessary detours to the weighbridge. Industrial Automation, a division of Hawker Siddeley Dynamics Ltd., is responsible for all of the engineering, installation and maintenance contracts both in the U.K. and Europe.

Longwall Face Roof Supports

This standard self-advancing powered roof support, being manually operated, is to be demonstrated by Electro-Hydraulics at the 1965 Mining Machinery Exhibition as an automatic and remote control system for longwall face mining. The standard support units are designed to provide a simple powered support operating on the same principle as the previous conventional prop and bar systems. Each unit comprises two support frames which stand in W formation, one frame of each unit standing one cut behind the other. When advancing the supports, this rear frame steps or leapfrogs past the other frame until it is standing one cut ahead.

The W support formation produces three lines of props, one close to the conveyor and two behind the travelling way to provide a safety track and to distribute the support more evenly over the area to be supported.

The 'leapfrog' advancing action ensures that a frame, once set immediately behind the conveyor, is not moved again until it reaches the waste edge. Frequent withdrawal and resetting of supports under the same area of roof is thereby avoided and, because only one frame of each double frame unit is moved for each web of coal cut, the new caving line is induced along a row of props which have already been set for a full cycle and have had an opportunity to achieve their full resistance.

The control valves are placed where they can be operated from a safe position with the operator under supported roof. Prop controls have a deadman's handle and the ram selectors are adaptable to various ram thrusts to suit ploughs as well as other power loaders.

The 30-ton props have maximum hydraulic travel to minimize the need for extension pieces and reduce the number of basic sizes. For example, the support designed for a 4 ft 3 in. maximum height can be used in a 3 ft 1 in. seam with 6 in. more hydraulic travel to accommodate convergence.

Four basic prop sizes cover a range of seam heights from 6 ft to 2 ft 8 in.

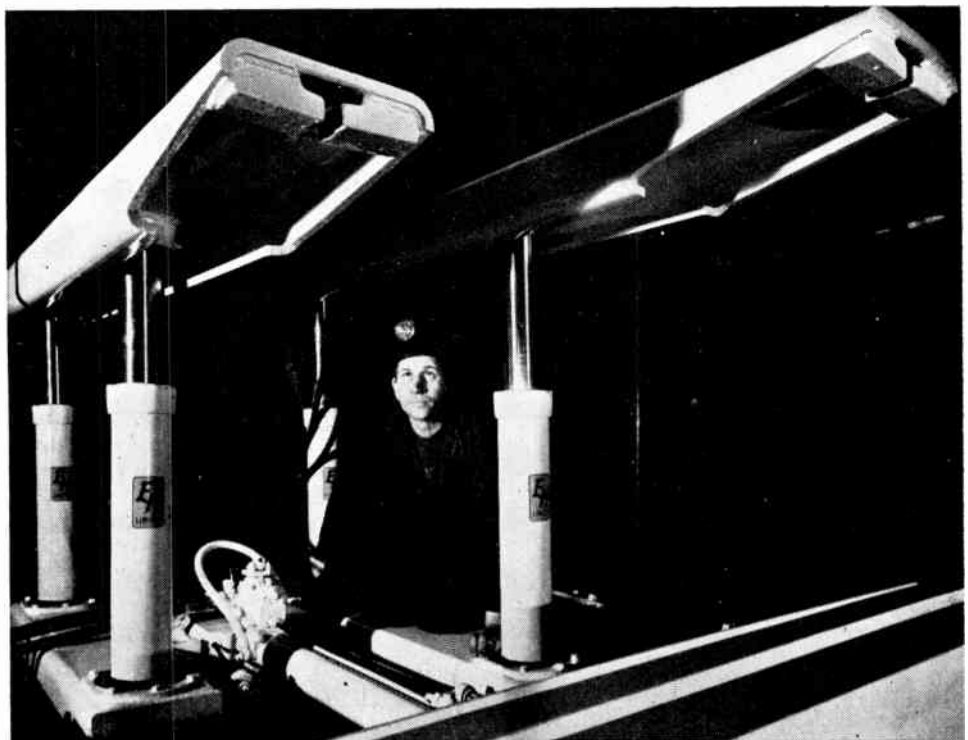

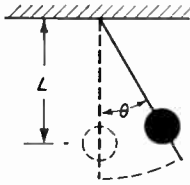

Fig. 13. Simple pendulum

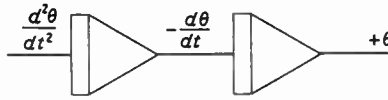

Fig. 14 (Left). If $d^2\theta/dt^2$ is available, one integration gives $-d\theta/dt$; another integration gives $+\theta$

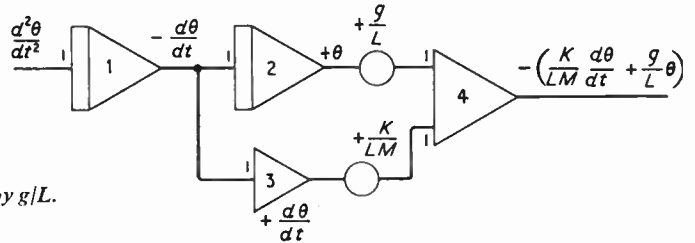

Fig. 15 (Right). Using pots to multiply $d\theta/dt$ by k/LM and θ by g/L . Adding these two terms gives $k/LM (d\theta/dt) + g/L (\theta)$

Continuing the discussion of analogue computers, this second half of the article discusses how they are used to solve equations and illustrates this by some simple examples. Multipliers and function generators are also discussed.

- (2) The air friction (damping) force = $K(d\theta/dt)$. Note that this force depends on velocity ($d\theta/dt$) and a friction constant K .

The equation of rotational motion is obtained by equating all torques about the pivot (including the rotational inertia term) to zero:

Torque 1 due to gravity = $MgL \sin \theta$
 Torque 2 due to friction $K = KL d\theta/dt$
 Rotational inertia of mass $M = ML^2$
 Rotational acceleration = $d^2\theta/dt^2$

\therefore Torque due to rotational acceleration = $ML^2 d^2\theta/dt^2$

Hence

$$ML^2 \frac{d^2\theta}{dt^2} + KL \frac{d\theta}{dt} + MgL \sin \theta = 0$$

The first step is to solve for the highest order derivative:

$$\frac{d^2\theta}{dt^2} = -\frac{K}{LM} \frac{d\theta}{dt} - \frac{g}{L} \sin \theta \quad \dots (6)$$

To simplify matters, we can assume that θ is always sufficiently small (less than 15°) so that we can approximate $\sin \theta$ by θ . This yields the equation:

$$\frac{d^2\theta}{dt^2} = -\frac{K}{LM} \frac{d\theta}{dt} - \frac{g}{L} \theta \quad \dots (7)$$

If we have a voltage proportional to $d^2\theta/dt^2$, then we can integrate once to find $d\theta/dt$ and again to find θ , as in Fig. 14.

We can multiply $d\theta/dt$ by K/LM and θ by g/L as shown in Fig. 15. If we add these two terms in a summer, we obtain the right-hand side of equation (7), as shown in Fig. 15. This sum must be $d^2\theta/dt^2$ according to equation (7). (Note the sign reversal every time an amplifier is used.)

Since amplifier 4 has the output $d^2\theta/dt^2$, we may use it for the input to amplifier 1, as shown in Fig. 16. This completes the circuit and satisfies equation (7).

Let us consider the case where the bob is given an initial displacement (θ_0) of $1/4$ radian and has an initial velocity of zero.

Since θ does not start at zero, the initial condition is imposed on θ by charging the feedback capacitor of integrator 2, which develops θ . This initial condition θ_0 is fed into an IC terminal on amplifier 2. The voltage at the output of amplifier 2 (θ) now satisfies the differential equation and the initial conditions $\theta = \theta_0$ and $d\theta/dt = 0$. The voltage

A PRACTICAL APPROACH TO ANALOGUE COMPUTERS

By D. S. TERRETT, B.Sc.(Hons.)*

(Concluded from p. 277, June issue)

THE three components described, summers, potentiometers and integrators, are sufficient to solve many basic differential equations that appear in physics and engineering. The simple pendulum problem is an example and this will now be considered.

The pendulum bob shown in Fig. 13 is acted on by two forces along its path, gravity and friction.

- (1) The tangential force due to gravity = $Mg \sin \theta$; it depends on the mass M , gravity g , and angular displacement θ .

* Electronic Associates Limited.

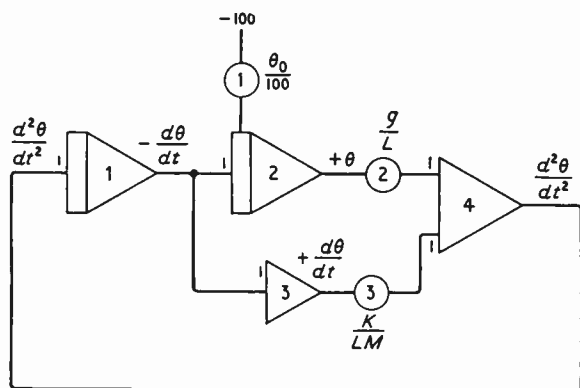
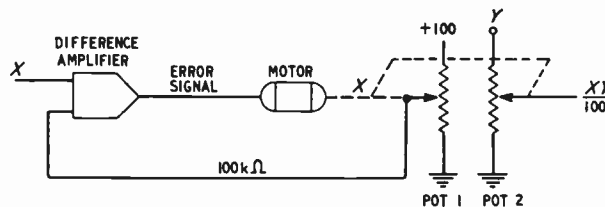

Fig. 16 (Left). Since output of summer-amplifier (4) is equal to the input of integrator (1), the circuit is completed as shown. Pot 1 is connected to the Initial Condition (IC) terminal of amplifier 2 to provide the proper initial condition θ_0 .

Fig. 17. Principle of multiplication of two variables. If top of pot is a variable Y , and setting is a variable X , then output is proportional to XY .



representing θ , therefore, will vary in the same manner as the angle θ in the original problem.

Multipliers

Equation (7) is so simple that an analytic solution is obtained easily and one normally would not use a computer to solve such an equation. In solving the pendulum problem, we made two assumptions—(1) that the damping was proportional to velocity and (2) that θ was so small that $\sin \theta$ could be replaced by θ without serious error. These assumptions had the effect of making the differential equation linear. Suppose, however, that the damping term is proportional to some power of the angular velocity, say $(d\theta/dt)^3$. Then equation (7) becomes:

$$\frac{d^2\theta}{dt^2} = -\frac{K}{LM} \left[\frac{d\theta}{dt} \right]^3 - \frac{g(\theta)}{L} \quad \dots (8)$$

Note that we are still assuming that θ is small.

Equation (8) is a non-linear differential equation. An analytic solution of (8) is difficult if not impossible. To solve it on the computer, we use a device that generates x^3 from x . This is done by using a device that multiplies variables so that x can be multiplied by x or y or x^2 or any other desired variable.

Servomultipliers

As we have seen (Fig. 6), a variable voltage (x) can be multiplied by a constant coefficient (K) by using a potentiometer. To multiply one varying quantity by another, we can use a potentiometer whose slider is automatically positioned by an electric motor to follow a second variable. This type of multiplier is known as a servomultiplier.

If we have two varying voltages (x and y in Fig. 17) and wish to produce a voltage proportional to xy , we use one potentiometer whose input is y and whose sliding setting is proportional to x . The output would be proportional to xy .

In practice, this is achieved by using two potentiometers which are ganged (i.e., mounted on a common shaft) and using a motor to turn this shaft (Fig. 17). One of the potentiometers is connected to a reference voltage (100 volts). Its arm is used as one of the inputs to a comparison network whose other input is x .

Potentiometer 1 in Fig. 17 has a wiper that is positioned by the motor, which receives a signal only when voltage on the wiper is not exactly equal to x . Thus the wipers on both

potentiometers follow every change in x , and the output from potentiometer 2 is proportional to xy . As shown in Fig. 17, the actual output is $xy/100$.

The output from potentiometer 2 is $xy/100$, and not xy as desired, because of the 100-volt supply used with pot 1. If a 1-volt reference had been used for potentiometer 1, the output from potentiometer 2 would be exactly xy . When a 100-volt supply is used on potentiometer 1, then x (output from potentiometer 1) = $100k$, where k is the fraction of potentiometer 1. Hence k (fraction of the potentiometer 1) is $x/100$. Since potentiometer 2 is ganged to potentiometer 1, its setting is also $x/100$, and its output must be $xy/100$.

The factor of 100 also can be appreciated by noting that x and y each can vary from 0 to 100 volts. Hence the maximum output of the product xy should be 100×100 , or 10,000 volts. However, the maximum voltage from potentiometer 2 is 100 volts. Hence the output from potentiometer 2 must be $xy/100$. Note that if potentiometer 1 had had a 1-volt supply, the output from potentiometer 2 would be exactly xy ; if potentiometer 1 had had a 10-volt supply, the output from potentiometer 2 would be $xy/10$, etc.

There is no reason to restrict ourselves to just two ganged potentiometers; the servomultipliers in the Electronic Associates PACE 231R analogue computer use six, labelled A to F (Fig. 18). The F potentiometer is connected to the reference voltage, and plays the role of potentiometer 1 in Fig. 17. If x is the variable positioning the servo, then all six potentiometers have the arm position $x/100$, and potentiometers A to E all are available for multiplication by x . This arrangement enables one to generate terms such as xy , xz , . . . etc., with only one servomultiplier. This feature is especially useful in generating polynomials. In particular, it allows us to generate the cubic term in equation (8) with just one servo, as shown in Fig. 19.

This scheme works only if x is a positive voltage because only positive voltages are available along the reference potentiometer winding. If it is to be both positive and negative, the arrangement in Fig. 20 is used. There is now no restriction on the sign of the voltage x . Note also that

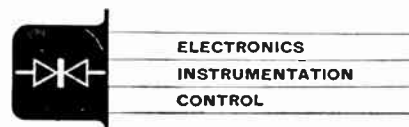

Fig. 18 (Below). Servomultiplier positions the taps on six ganged pots—one follower pot (F) and five multiplying pots (A-E)

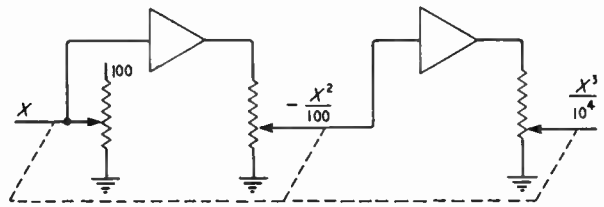
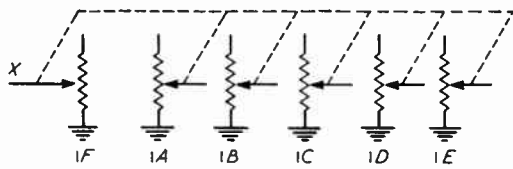

Fig. 19 (Above). Generating the cube of a variable with only one servo-multiplier

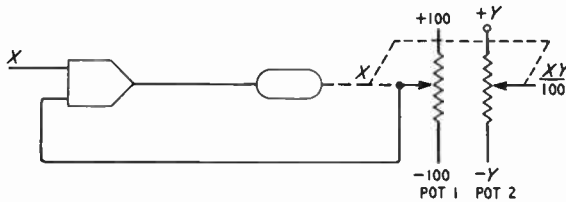

Fig. 20 (Left). Servomultiplier in which variable X can have any value between -100 and +100 volts. Note that both references (-100 and +100 V) are needed and also +X and -Y

Fig. 21 (Right). Symbols for a servomultiplier. Five pots (A-E) are ganged to the motor-driven pot (F) to permit X to be multiplied by five variables simultaneously

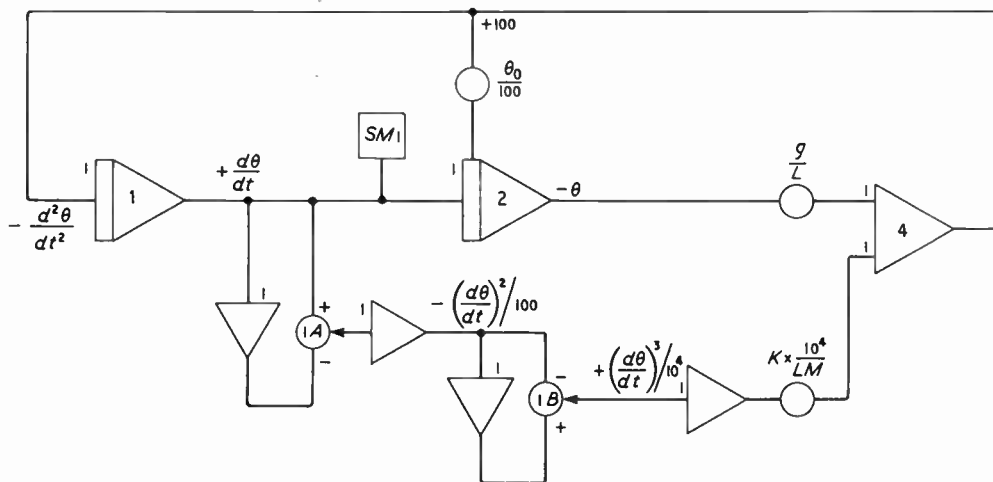
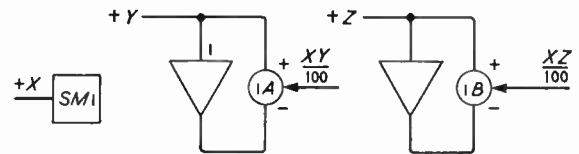

Fig. 22. Circuit for solving the pendulum problem with cubic damping term. Note that we can perform two multiplications by the factor $d\theta/dt$ to produce $(d\theta/dt)^3$ with only one servomultiplier

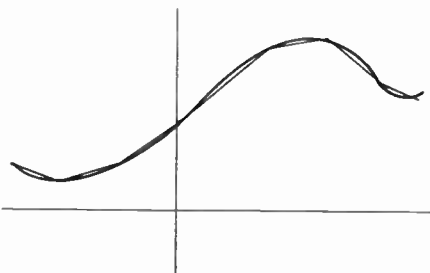
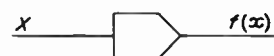

Fig. 23. Approximating a smooth curve by straight-line segments

Fig. 24. Symbol for a diode function generator



potentiometer 2 now has both xy and $-y$ voltages at its terminals. The variable $-y$ is obtained simply by using an inverter, as shown in Fig. 21, which also shows the symbol for a servomultiplier. Note in the symbol that one input goes to a box marked SM (number); the potentiometer that is ganged to the motor-driven potentiometer is identified by having the same number followed by a letter (1A), (1B), etc. All potentiometers that are ganged to one servomultiplier have the same number. Thus potentiometer 4C means the third potentiometer (C) ganged to the number 4 servomultiplier.

Fig. 22 shows how non-linear equation (8) is implemented and solved. Note that the computer solution for equation (8) is scarcely more complicated than that of equation (7), yet the analytic solution for equation (8) is much more difficult than that of (7).

The Quarter-Square Multiplier

Another widely used multiplying device is the quarter-square multiplier. This device uses the algebraic identity:

$$xy = \frac{1}{4}[(x + y)^2 - (x - y)^2]^*$$

To generate xy we need only perform addition ($x + y$), subtraction ($x - y$) and squaring of the two terms. Squaring turns out to be much simpler than multiplication because it involves only one variable. (This means of generating the square and other functions of a single variable will be discussed later.) As the quarter-square multiplier is all electronic, it has a much higher frequency response than the servomultiplier.

Function Generators

Equation (8) was simplified by the replacement of $\sin \theta$ by θ . If we are to remove this restriction we need a device which will accept an input voltage proportional to θ and produce a voltage proportional to $\sin \theta$. This can be done by a function generator.

Many types of function generators are available, but the variable diode function generator (DFG) is typical. It employs a network of resistors and diodes to approximate the given function by use of straight-line segments, as shown in Fig. 23. The slope and breakpoint of each segment can be individually adjusted to allow a best fit to the curve (function).

A fixed DFG consists of a printed-circuit card with specific components chosen to produce the desired function. Commonly used functions such as $\log x$, x^2 , x^4 , $\tan x$, $\sin x$, etc., are available. The symbol for either the fixed or variable type of DFG is given in Fig. 24.

The accuracy (closeness of fit to original function) of the DFG depends primarily on the number of segments used. Ten and twenty segment DFGs are available on the PACE 231-R computer and these are sufficient for most practical problems.

The pendulum problem can now be solved without any simplifying assumptions because we can use a DFG set up to give an output of $\sin \theta$ for an input θ . The computer programme for the non-linear pendulum is given in Fig. 25. (Other techniques can be employed to give a better approximation to $\sin \theta$, but this simple application illustrates the basic principles.)

Recording Devices

We have seen how to use a computer to obtain time-varying voltages that represent a solution to a mechanical problem. To observe and interpret these results we need measuring and recording devices.

* $xy = \frac{1}{4}[(x + y)^2 - (x - y)^2]$
 $= \frac{1}{4}(x^2 + 2xy + y^2 - x^2 + 2xy - y^2)$
 $= \frac{1}{4}(4xy) = xy$

One such unit, the strip-chart recorder employs a roll of paper drawn at a constant speed past a pen which is deflected proportional to the input voltage. The pen thus draws a graph of the computer voltage as a function of time. Typical models have parallel channels on a single strip of paper, allowing the operator to record several variables simultaneously. Fig. 26 shows the solution of equation (8) recorded on a strip-chart recorder. The three channels shown record the displacement (θ), velocity ($d\theta/dt$) and the velocity cubed term ($(d\theta/dt)^3$). In a more complex problem more channels might be needed.

Another recording device, the X-Y plotter, uses a moving pen and stationary paper. This device has two voltage inputs, enabling one to plot one varying voltage against another. The pen moves back and forth along a straight arm, its deflection being proportional to one voltage. The arm itself moves in a perpendicular direction positioned by the second voltage. On 10-in. \times 15-in. paper ruled in $\frac{1}{16}$ -in. squares, the resulting graph can be read with an accuracy of about 1 part in 1,000. Plotters for 11-in. \times 17-in. and 30-in. \times 30-in. graphs are popular; even larger sizes are available.

Problem Checking

Many tests have been devised to assure the operator that the problem has been programmed correctly and that all components are functioning properly. One of these, the static test, is a check on both the programme and the equipment.

The standard procedure consists of choosing an arbitrary set of initial conditions; that is, a set of values for the unknown variable and all its derivatives appearing in the problem, except the highest derivative. In the pendulum problem, this means choosing initial values for θ and $d\theta/dt$. The highest derivative (in this case $d^2\theta/dt^2$) then can be computed, and from this the voltage representing $d^2\theta/dt^2$ can be calculated. For example, suppose we are solving equation (7) for the case $k/LM = 0.5$ and $g/L = 0.8$. If we assume $\theta = 0.24$ radian (about 15°) and $d\theta/dt = 1$ rad/sec as initial conditions, we may solve equation (7) for the initial value of $d^2\theta/dt^2$:

$$\frac{d^2\theta}{dt^2} = -0.5(1) - 0.8(0.25) = -0.7 \text{ rad/sec}^2$$

The assigned initial values for $d\theta/dt$ and θ correspond on the computer diagram (Fig. 25) to scaled initial voltages of the outputs of integrators 1 and 2. Similarly, the calculated value for $d^2\theta/dt^2$ corresponds to a voltage output of the summing amplifier (No. 4). Since we know the initial outputs of the integrators, we can calculate the output of amplifier 4 from the circuit diagram. Comparing this scaled voltage to the calculated value for $d^2\theta/dt^2$, we have a check on the correctness of the diagram.

The final step in the static-check procedure is taken after the problem is put on the computer as follows:

Voltages proportional to the initial conditions (in this case $d\theta/dt = 1$ and $\theta = 0.25$) are established at the Initial Condition terminals of amplifiers 1 and 2, and the output of amplifier 4 is measured and compared with the calculated value. This check verifies the patching and the functioning of the computer components. Most errors, human or mechanical, are discovered and corrected during the static-test procedure.

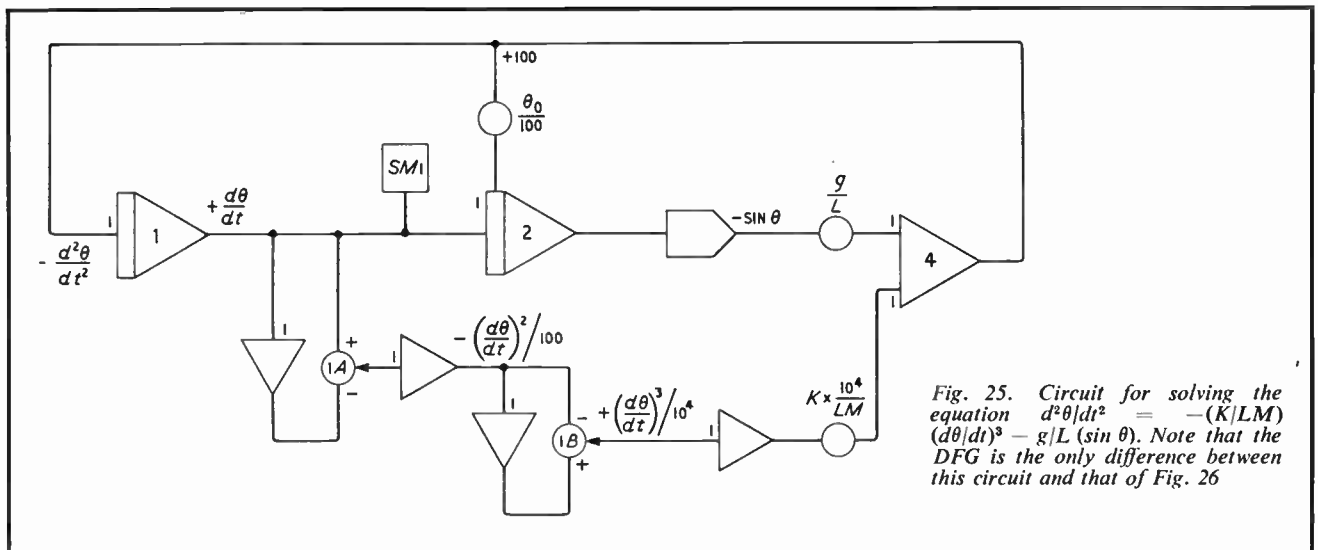

Automatic Set-up

As computers increase in size to allow the solution of more complex problems, there is a trend toward automatic devices to reduce set-up time and minimize the possibility of human error. The ADIOS (Automatic Digital Input-Output System) together with DAS (Digital Attenuator System) available on the 231-R is an example. Consisting of an electric typewriter, keyboard, paper-tape punch and tape reader, together with the necessary relays and switches, the ADIOS enables the operator to set up potentiometers and check programming from either the keyboard or tape. To set a coefficient potentiometer to a value 0.2317, the operator simply punches out on the keyboard an address code for the potentiometer desired and the digits 2317. A servomechanism in the computer automatically sets the potentiometer to the desired value. Both potentiometers and function generators can be

set up in this fashion, resulting in a much faster computer set-up and problem check. The combination of a paper tape and a removable patch panel allows for complete problem storage.

Repetitive Operation and Memory Logic Facilities

When the variation of many parameters is required in a design study, full advantage may be taken of the analogue computer's high speed by the addition of repetitive operation (rep-op), a feature available on many computers. In repetitive operation, the speed of solution is increased, generally, by changing the value of the feedback capacitors on all integrators, and using high-speed relays or preferably solid-state switching to reset repeatedly the initial conditions on these integrators, allow the solution to run, and then reset again. The resultant voltage output (viewed on an oscilloscope) appears as a continuous curve; a graph of the solution versus time. When the potentiometers (representing parameters) are varied, the result is an almost instantaneous change in the output graph. This visual display enables the operator to find the optimum parameters quickly.

The volume of simulation studies completed by computer laboratories throughout the world shows the potential of the analogue computer to be much greater than is at present realized. Perhaps overshadowed in its importance by the more glamorous and expensive digital computer, the analogue machine is in contrast the tool of the engineer, as opposed to the pure mathematician.

It can be seen that only by varying design parameters can the computer indicate comparative behaviour. This requirement on the part of the engineer to operate the computer, although clearly desirable, is not absolutely vital. Many industrialists rent analogue computer time on a contract basis at such centres as the U.K. Computation Centre, operated by E.A.L. at Burgess Hill.

All that is necessary for the Centre to run a problem is for the engineer to supply a set of equations relative to the design. These are then translated into analogue terms and a flow diagram is formed. The patch panel is then prepared and, after routine push-button check procedures, the computer is ready to start its work. This is where the engineer responsible for the design steps in and issues instructions on changes in variables according to the behaviour of the design. The subsequent performance data giving the design characteristics then enables the engineer to decide on any improvements before the prototype model is built.

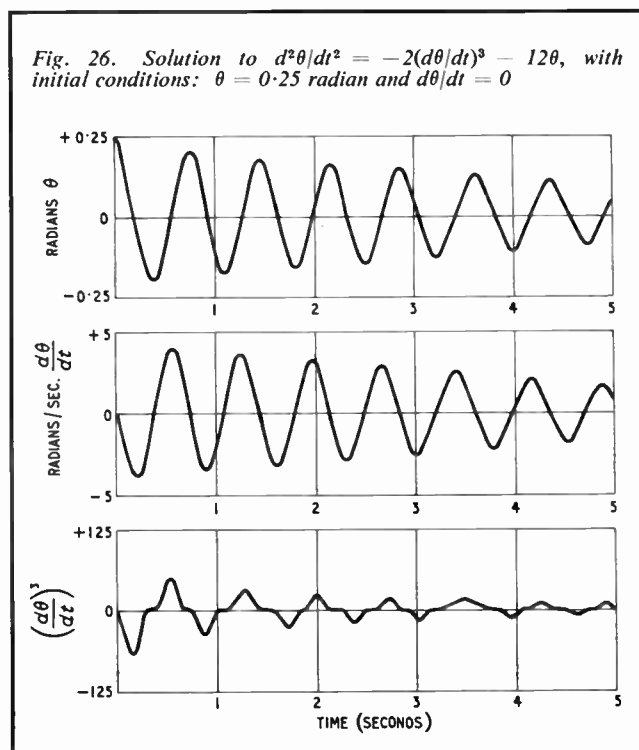

New Developments in Ferrites

A more versatile method of making ferrites, magnetic materials widely used throughout the electronic industry, is currently under study at the Research Laboratories of General Motors Corporation at Warren, Michigan, U.S.A.

The researchers call their new fabrication technique Ferriroll. The process makes practicable ferrites of virtually any shape or type.

Ferrites are hard brittle ceramic materials which are normally difficult to fabricate into small and intricate shapes. This is not so with the new General Motors 'cookie cutter' process. With Ferriroll, ferrite powders are first mixed with a plastic binder and rolled into flexible sheets of desired thickness.

The sheets can then be punched, sheared, or pressed into virtually any shape. Then controlled baking removes the plastic binder and transforms each part into a uniformly textured ceramic.

According to GM, the Ferriroll ceramic can have accurately controlled form and magnetic properties.

Engineers in the electronics-instrumentation department at GM's Research Laboratories have found the Ferriroll process particularly valuable for making multi-aperture devices. These devices are wafer-thin 'square-loop' ferrites used in computer memory cores and control circuits.

The ceramic ferrites offer advantages over metallic magnetic materials in many applications. For example, conventional magnetic metals, even when powdered and pressed into desired shapes, have large electrical losses at high frequencies when they are used as transformer cores or in other magnetic circuits. Eddy currents within the material generate heat and waste energy.

Ferrites, made of ceramic materials, are insulators and greatly reduce these electrical losses. In addition, ferrite properties can be controlled to give good permanent magnets where they are needed or, if preferred, to provide for easy change of magnetization.

At present Ferriroll ferrites are not commercially available. Development of the process and its applications is continuing as a joint effort of General Motors manufacturing divisions and the laboratories' electronics and instrumentation department.

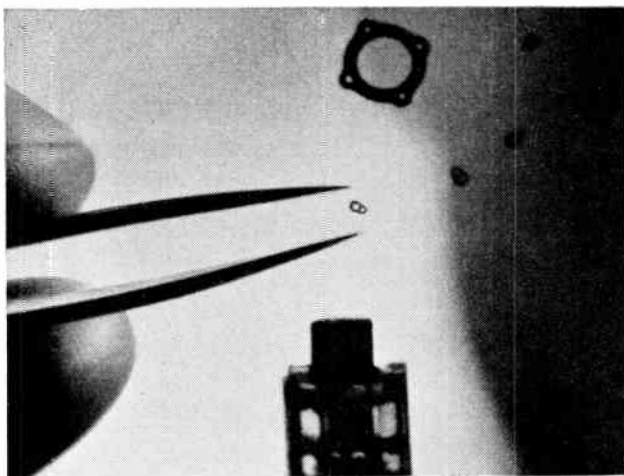

These pictures illustrate one of the advantages of the new ferrite material. The transistor circuit, containing 30 elements, overshadows an identical 3-element logic circuit (below tweezers) which uses ferrites. On the left an enlargement indicates more clearly the size of the ferrite components

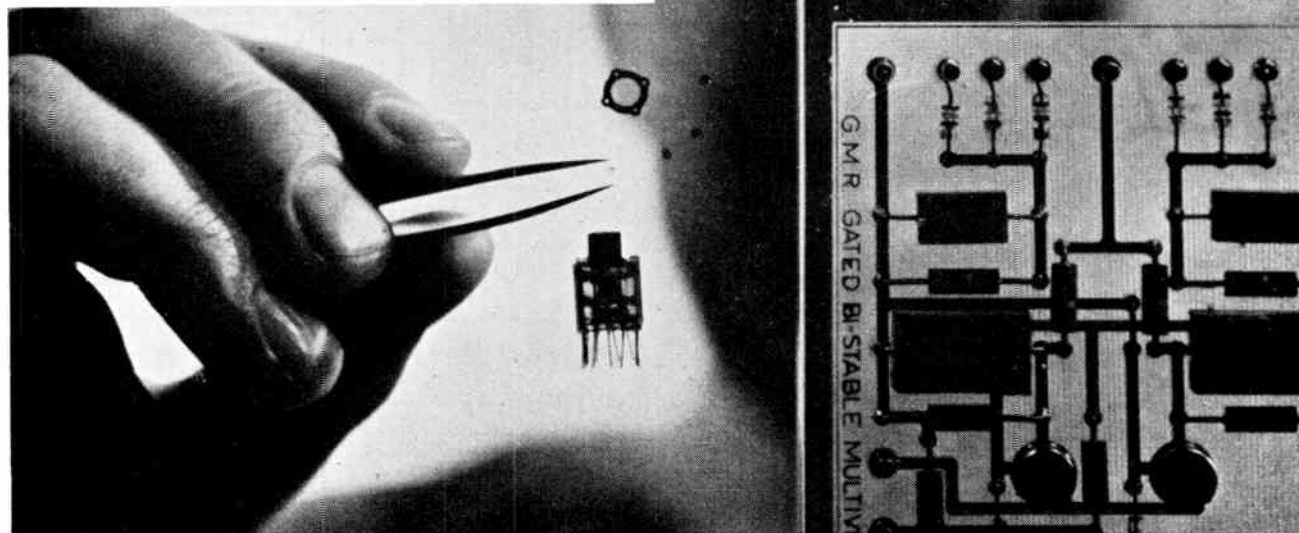



1



2

3



4

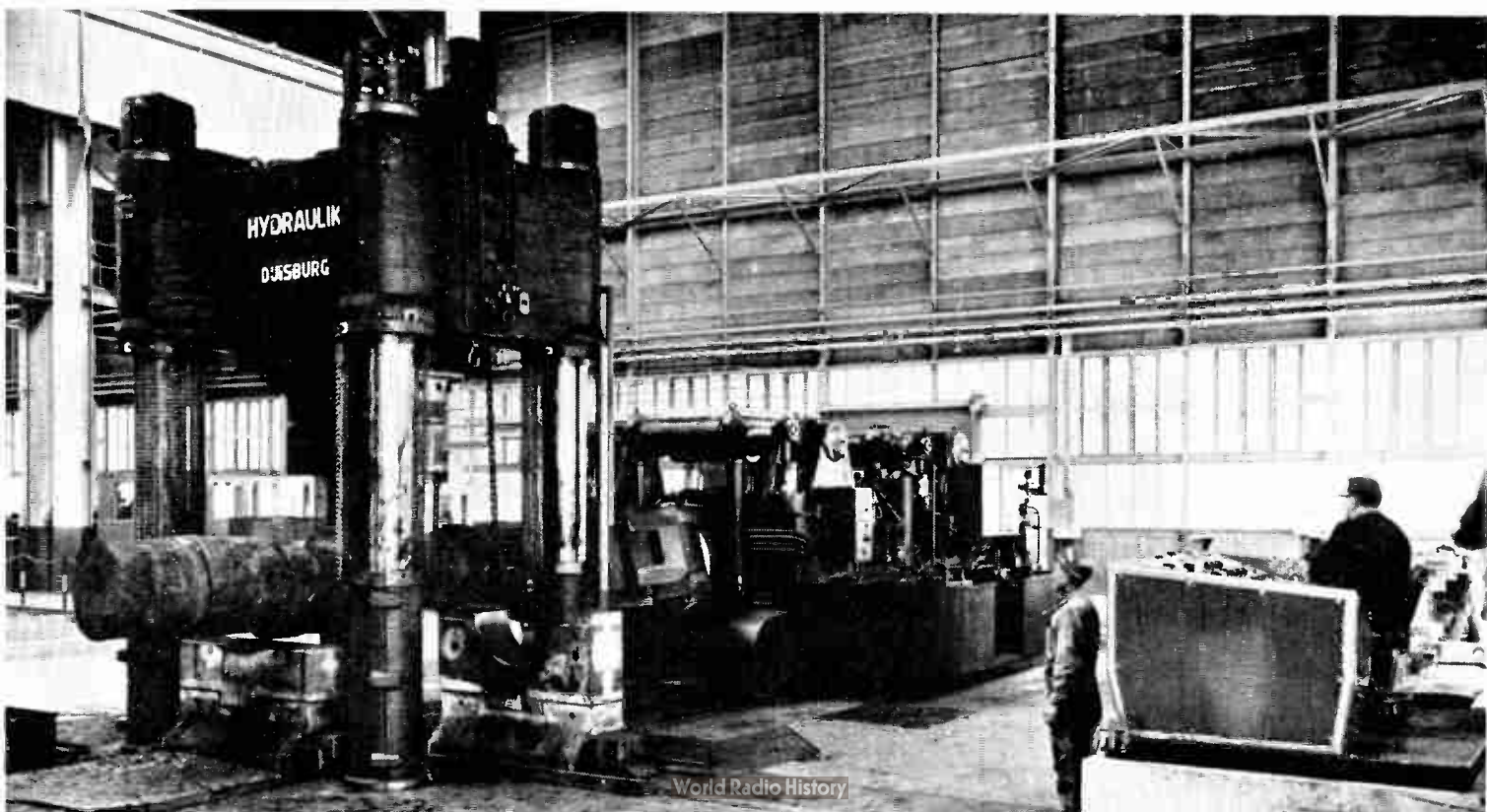

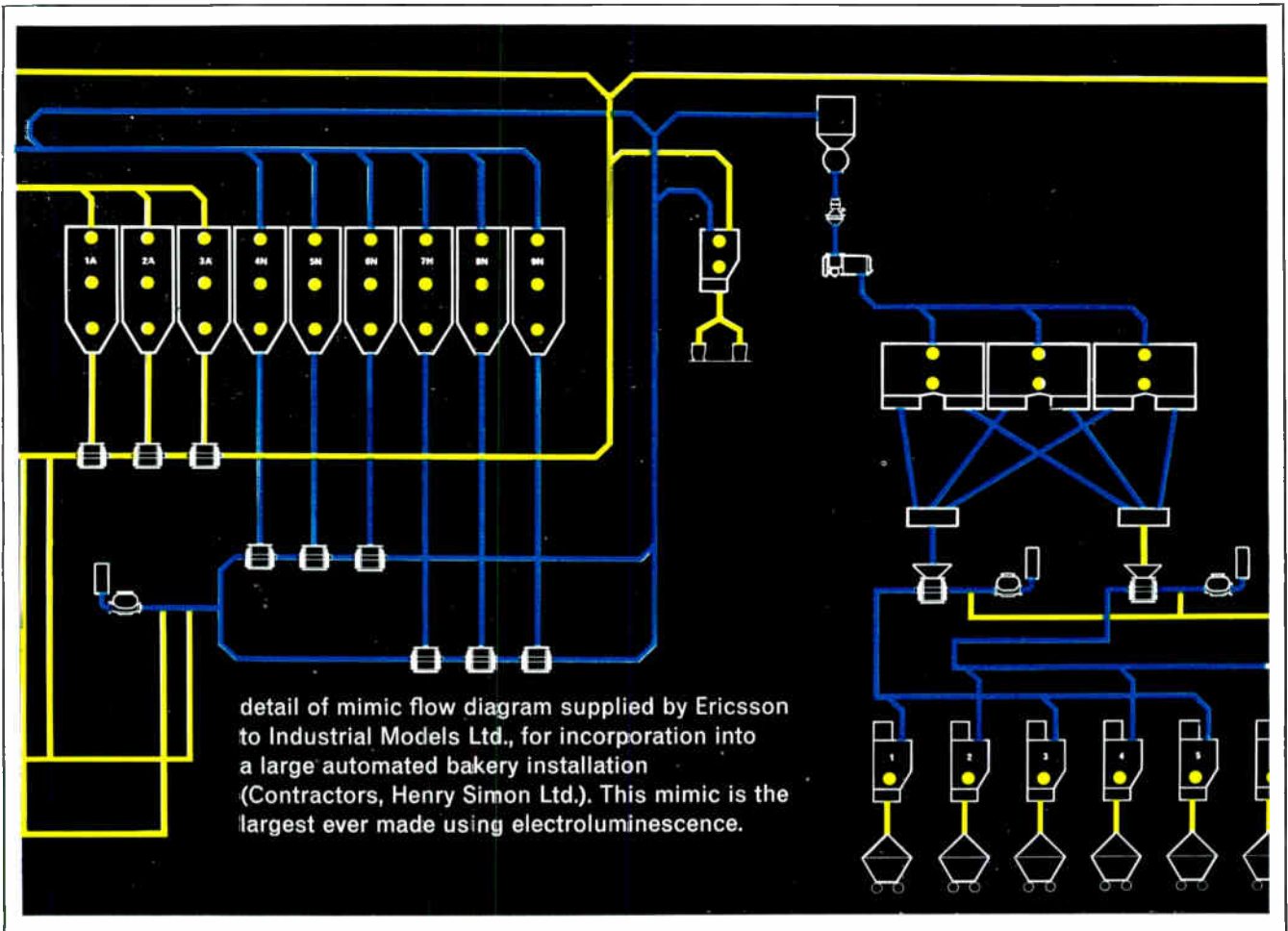

electroluminescence

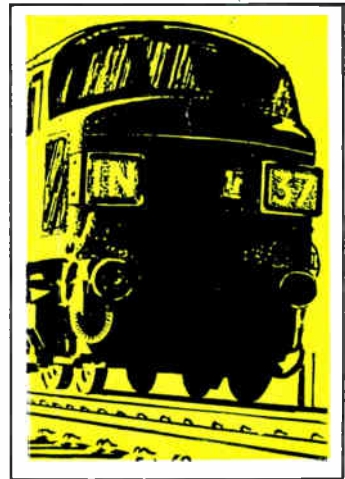
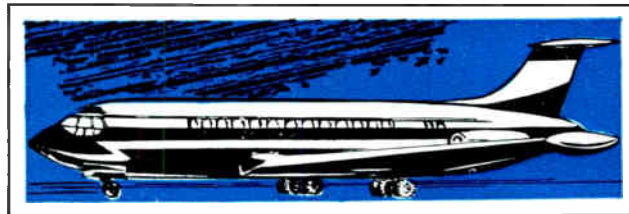
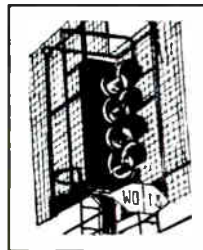
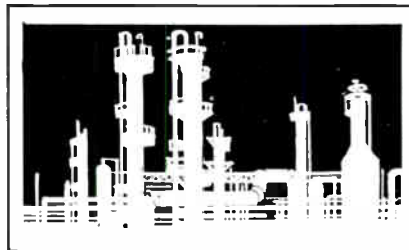
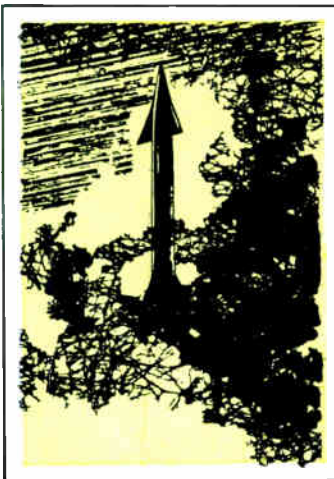

for mimic
control and
flow display

Electroluminescence offers a particularly flexible type of display, with a wide range of colours and the ability to display fine detail beyond the range of economically comparable systems. The Industrial and Educational applications are limitless and many industries are already taking advantage of its exceptional versatility. For further information please contact: Physics Division, Ericsson Telephones Ltd., Beeston, Nottingham.



ERICSSON TELEPHONES LTD • ETELCO LTD

A Principal Operating Company of the Plessey Group.

Registered Office: 22 Lincoln's Inn Fields, London, W.C.2. Tel: HOLborn 6936

Head Office and Main Works: Beeston, Nottingham. Tel: 254831. Telex: 37666

ER 107

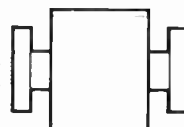
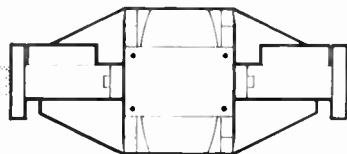

Look at M-O V's wide range of solid-state microwave components for Communication, Industrial and Defence Projects

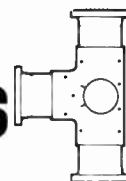

M-O V have now increased their range of microwave components with the addition of no less than *seventeen* devices. The commercial introduction of so many microwave products at one time is due to the vast experience of M-O V's 600 engineers, and their extensive R & D facilities devoted to microwave technology.

Modern quality-control methods ensure repeatability of characteristics over long and short production runs.

6 Waveguide-to-coaxial transitions: S-, C- and X-bands, side and rear entry; 2.5-4.1/4.1-7.0/7.0-11.5 Gc/s; VSWR 0.8; Waveguide connectors WG10/13/16; Coaxial connectors C or N (50 ohm).

3 Waveguide isolators: 5925-6425/5925-6175/6175-6425 Mc/s; Power handling capacity 10 W; Forward loss 0.35/0.5 dB; Reverse loss 25/35 dB; VSWR 1.02/1.06; Connectors WG14.

2 Coaxial isolators: 2500-4000/4000-7000 Mc/s; Power handling capacity 3 W; Forward loss 1-2 dB; Reverse loss 20-35 dB; VSWR 1.2-1.5; Connectors C (50 ohm).

2 High-performance hybrid mixers: Transmitter 5925-6425 Mc/s; R.F. power level 30-40 mW; Capacitance 20 pF (modulation input); Connector WG14. Receiver 5925-6425 Mc/s; R.F. power

level 1-2 mW; Capacitance 20 pF (I.F. output); Connector WG14.

1 X-band source: 7.0-12.4 Gc/s; Electronic tuning range 100 Mc/s at 7.0 Gc/s, 150 Mc/s at 12.4 Gc/s; Power output 30 mW at 7.0 Gc/s, 10 mW at 12.4 Gc/s. Input 30 V d.c. 250 mA; Connector WG16.

2 Fast X-band diode switches: Two-way 7.0-12.4 Gc/s; Insertion loss 2 dB; Isolation 20 dB; Switching time 1 ns; Connector WG16. One-way 7.0-12.4 Gc/s; Insertion loss 2.5 dB; Isolation 25 dB; Switching time 1 ns; Connector WG16.

1 X-band diode attenuator: 7.0-12.4 Gc/s; Insertion loss 1 dB; Attenuation 30 dB; VSWR 1.5 at minimum attenuation, 2.0 at maximum attenuation; Connector WG16.

NO OTHER EUROPEAN MANUFACTURER CAN MATCH THE CAPABILITY OF M-O V IN THE FIELD OF MICROWAVE TECHNOLOGY

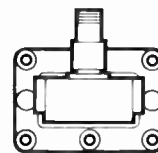
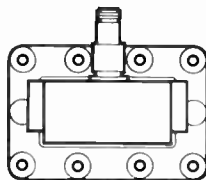

For full data and application sheets please write to, or telephone :

THE M-O VALVE CO LTD

Brook Green Works, Hammersmith, London W6

Telephone: RIVerside 3431 Telex: 23435



5

1 Honeywell instruments now monitor and control the variables throughout the heat treatment process at Ford's newly commissioned Halewood Transmission Plant, which serves gearbox needs for all Ford's car factories in Britain. Circular-chart recorders monitor and control temperatures ranging from 1,500 to 1,725 °F in the furnaces and a strip-chart recorder gives a continuous, permanent record of the carburizing temperatures. After carburizing and quenching the components must be washed and tempered for stress relieving, and further strip-chart recorders hold electric tempering furnaces to the required heat over a range of 300 to 500 °F. The picture shows a control panel being operated to insert batches of components for treatment.

2 For each international telephone call made from the United Kingdom, appropriate payment must be made to the overseas telephone administrations concerned for the use of their lines. With the increasing proportion of calls between the U.K. and Europe being connected automatically by the International Subscriber Trunk Dialling Service, the data required for accounting is now recorded electronically, using a digital system developed by British Telecommunications Research Ltd. The equipment contains magnetic drum stores and is designed to accept a large number of simultaneous data inputs in 'real time'. It can deal with information from over 2,000 sources and results are available on punched tape, which can be automatically printed in a page format. The picture shows one of the 378 circuit boards of the equipment installed in the International Telephone Exchange, Faraday House, London.

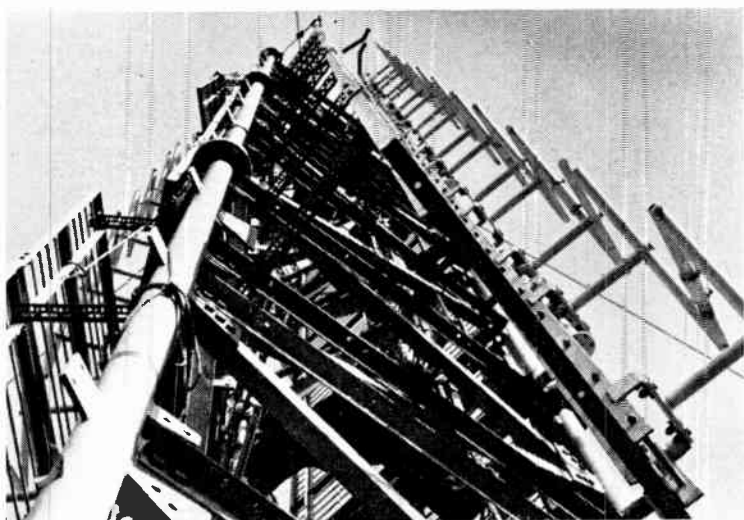

6

3 Details of an electron-beam system have been announced by National Research Corporation (a subsidiary of the Norton Co.) of Newton, Massachusetts. The system is used for welding, etching, annealing, refining and melting by bombarding material with a focused beam of electrons to produce intense local heat at the target point. Carried out in a vacuum, it is free from contamination and has pinpoint location. The gun is designed so that both filament and grid can be adjusted (by means of mechanically operated bellows) to move up, down and sideways and thus vary beam focus during operation.

4 Hydraulic equipment by Towler Brothers (M.I. Group) of Rodley, near Leeds, now provides the power and control for a large new forging press installed by Gebruder Sulzer Aktiengesellschaft in its works at Winterthur, near Zurich. The Towler equipment consists of a high-speed direct-oil system with semi-automatic electronic control and monitoring facilities. The electronics were provided by another M.I. company—Lancashire Dynamo Electronic Products, of Rugeley, Staffs—and the picture shows the forging press with the control desk on the right.

7

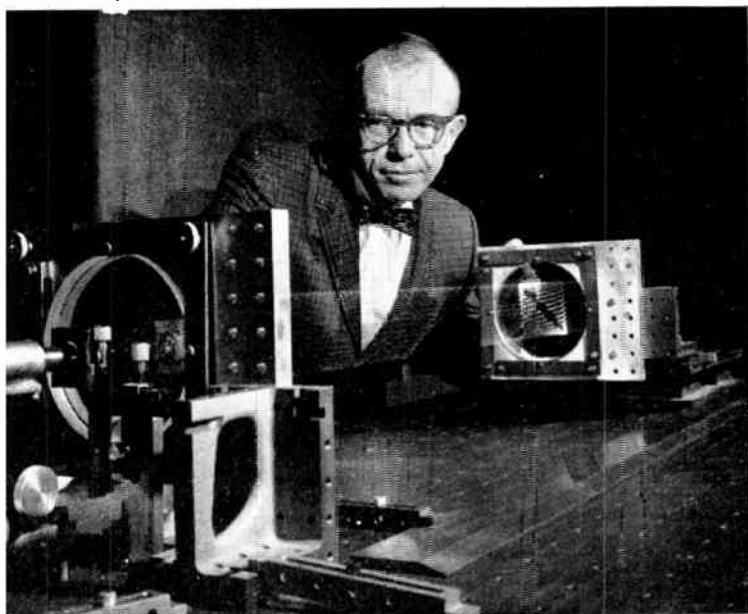

5 To celebrate the 500th sale of a Ferranti co-ordinate inspection machine, a hand-over ceremony of a size 2 model was carried out at the Rank Organization's Data Systems Division, Shepherds Bush. On this machine movement in the longitudinal and transverse directions is measured continuously, by diffraction gratings, and the amount and direction of the movement are recorded on co-ordinate digital counters. The machine is available in a range of sizes for different workpiece requirements and, in addition to inspecting and measuring, it can also be used for marking out and spot drilling.

6 Radiation and impedance tests have recently been completed on a new television aerial ordered by the Independent Television Authority from EMI Electronics. The aerial and feeder system are now being installed on a new mast erected at an I.T.A. transmitting station at Sandy Heath, Bedfordshire. Sub-contractor for the design, supply and erection of the 750 ft-high triangular lattice mast (see picture) was British Insulated Callender's Constructions. The aerial has a 96-ft aperture consisting of eight rings, each of three Mesney 12-ft panels; it is horizontally polarized and will transmit in Band III on Channel 6. Effective radiated power will be 28 kW in the northerly sector, with restriction to the east and south-west to avoid interference with other stations operating on the same channel. Two 3½-in. semi-flexible feeder cables—each of which will continue to operate if the other fails—will link the transmitter with the aerial.

7 At the Bell Telephone Laboratories, New York, a two-mile long laser beam has been 'folded' into a ten foot space by reflecting it over a thousand times between two mirrors; information can be modulated on to the light beam, stored, and retrieved 10 microseconds later. The experiment makes possible the use of optical delay lines as high speed, sequential computer memories: one such line could store 10,000 bits of information, which could be read out serially—one bit every nanosecond.



▲ The Digital Measurements Ltd. type DM2010 voltmeter. This instrument is understood to be the most accurate in current production anywhere in the world ($\pm 0.001\%$ of full-scale reading when measuring potentials of 11 V or less). The potentiometric technique is used with alternating voltages and an inductive potential divider. Voltages ranging from $10 \mu\text{V}$ to 1,100 V can be measured

▼ The Hewlett-Packard 3440 A digital voltmeter. A series of plug-in units make this instrument very versatile. D.C. voltages up to 1,000 V can be measured with an accuracy of $\pm 0.05\%$ of the actual reading (± 1 digit). One plug-in unit converts the instrument into a digital multimeter with voltage ranges of 0.1 to 1,000 V, current ranges of 100 mA to 1 A (accuracy $\pm 2\%$, ± 1 digit), resistance ranges of 1,000 Ω to 1 M Ω (accuracy $\pm 0.3\%$) and 1 M Ω to 10 M Ω ($\pm 1\%$). Another plug-in unit enables a.c. voltages from 1 mV to 300 V full-scale to be measured with an accuracy of 1% (50 c/s to 1 Mc/s) or 5% (10 c/s to 10 Mc/s). Some plug-in units incorporate automatic range selection

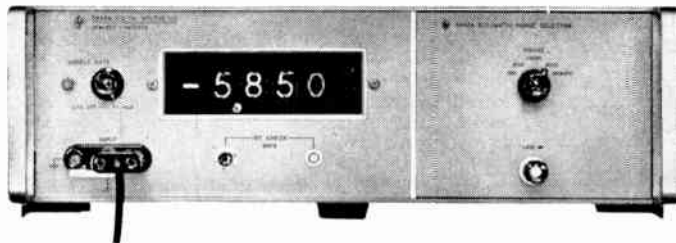

▼ A low-cost manually-balanced digital potentiometer manufactured by Scientific Furnishings Ltd. The accuracy is $\pm 0.15\%$ and the sensitivity $10 \mu\text{V}$. The internal ranges are 0-50 and 0-500 mV, but a plug-in adaptor is available to cover voltage ranges up to 500 V and current ranges of 0.5 and 5 mA



▼ The United Systems Corporation Digitec voltmeter for which Wayne-Kerr are British representatives. This is an economical instrument employing a potentiometric technique in which a servo motor drives a precision potentiometer which is coupled to a mechanical counter. The accuracy is $\pm 0.1\%$. The final reading is shown after about 2 to 4 seconds. An adaptor can be used for current measurement in the range 10^{-8} A to 2 A



DIGITAL

By J. B. DANCE, M.Sc.



▲ The Bendix Electronics digital voltmeter type 399. This instrument uses the voltage to frequency conversion technique and has ranges varying from 0.1 to 1,000 V (accuracy $\pm 0.1\%$ of the full-scale reading). The conversion time is about 0.5 second and the readout can be automatically cycled each five seconds. Readout is by projection type indicators

The Gloster Equipment B.I.E. 2123 Digimeter which uses the stepped ramp principle for a.c./d.c. voltage measurements. The accuracy is $\pm 0.2\%$ or ± 1 digit (whichever is the greater) on d.c. ranges, $\pm 0.5\%$ ± 1 digit with a.c. inputs of 30 c/s to 10 kc/s and $\pm 1.5\%$ with a.c. inputs of 20 c/s to 500 kc/s. The conversion time is about 0.3 second and the automatic sampling rate one reading per 2 seconds

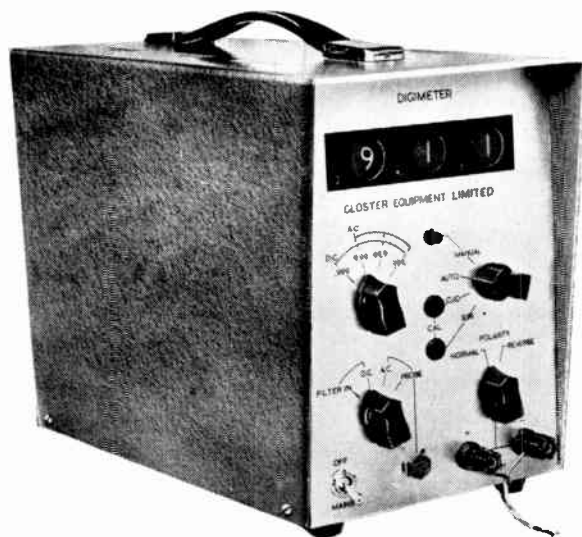

VOLTMETERS

Basic Principles of Operation

The Solartron voltage-to-frequency conversion LM 1420 voltmeter. This has ranges of 20 mV to 2,000 V and an accuracy of $\pm 0.05\%$ of the full-scale reading ± 1 digit. The maximum sensitivity is $2.5 \mu V$. The instrument can automatically sample the input signal at 33 c/s. Readout is by means of cold-cathode digital-indicator tubes. The reading can be increased by a factor of two or four if this will improve the accuracy



Digital voltmeters are now quite widely used. This article reviews their general principles of operation with particular reference to the methods employed for converting an analogue voltage into a digital display.

VOLTMETERS of the digital type provide a much higher degree of accuracy and are much more convenient to read than the normal type of moving-pointer instrument. Most commercial digital voltmeters have an accuracy falling within the range 0.3% to 0.001%. The number of digits indicated varies between three and seven, depending on the price of the instrument and its accuracy. The more expensive instruments usually measure voltages of either polarity and indicate this polarity, but the unknown voltage must be applied with the correct polarity to some of the cheaper instruments. Some instruments have automatic range-changing facilities, but in others the range-changing operation must be performed manually; in either case the decimal point is automatically inserted at the correct place. Alternating potentials can be measured by some instruments, but an additional a.c./d.c. converter unit is often required for this purpose. Electrical readout is normally provided for the operation of an automatic typewriter which makes a permanent record of voltages measured; the same output signal can be used to operate electrical printers.

Each measurement made by a digital voltmeter takes a short time. The voltage to be measured is sampled at a predetermined frequency and any changes are automatically indicated. Digital voltmeters are ideal for measuring any small changes in the input potential, e.g. a change of 500 microvolts in 1 volt. Facilities are often provided which enable an instrument to measure the input voltage at any chosen time and to display this voltage as a constant reading for any length of time thereafter.

Principles of Operation

A digital voltmeter converts the unknown input voltage (an analogue quantity) into a digital quantity and displays the latter as actual digits. The display itself may be effected by the use of cold-cathode numerical-indicator tubes, electroluminescent indicator panels or by one of the types of numerical indicators which employ one or more lamps.

There are three main ways by which the analogue-to-digital conversion may be carried out in a digital voltmeter. These are (i) the successive approximation or potentiometric method, (ii) the 'ramp' or voltage-to-time conversion technique and (iii) the voltage-to-frequency or integrator method. Numerous variations on these basic techniques are possible. Most manufacturers gain experience with one particular method of analogue-to-digital conversion and employ this method in all their instruments, but a few manufacturers produce a number of instruments which do not all employ the same basic method of analogue to digital conversion.

The Successive Approximation Method

The successive approximation technique is essentially a form of the well-known laboratory potentiometer in which the voltage-balancing process is carried out automatically and the result is displayed in digits. The basic



ELECTRONICS
INSTRUMENTATION
CONTROL

principles of operation of a three-digit voltmeter of this type may be illustrated by means of the block diagram of Fig. 1.¹ Initially the bistable control circuit marked 1 passes a pulse to the corresponding switching circuit (marked 1); this connects the line B to the upper end of the resistor R . The voltage V_2 is stabilized and a negligible current passes along the line A to the reference voltage source. Thus the voltage across R' is

$$V_1 = \frac{V_2 R'}{R}$$

The input voltage and V_1 are fed to a voltage comparator which usually consists of a d.c. chopper-type difference amplifier. If V_1 is larger than the unknown input voltage, a signal is fed from the voltage comparator along line C to the bistable control circuits. This results in the first control circuit being returned to its zero state and the current passing through R becomes zero as the first switching circuit opens. If, however, the input voltage is larger than V_1 , no pulse is fed from the voltage comparator to the control circuits and current continues to flow through R and R' ; this current is additional to any further current

which flows through R' as a result of later switching operations.

The switching unit marked 2 now receives a pulse from the second control unit and connects the line B to the resistor $2R$. The current flowing through this resistor is half of that which flows through R . The input voltage is again compared with V_1 ; if (and only if) V_1 is larger than the input voltage, the resistor $2R$ is switched out of circuit. Each of the resistors is tried in turn, the final step (the $800R$ resistor) causing the smallest change in V_1 . Thus at the end of the approximation operation the voltage V_1 differs from the input voltage by an amount which is less than the smallest increment of V_1 .

It should be noted that the resistor values are in a binary-coded decimal form ($R, 2R, 4R, 8R, 10R, 20R, 40R, 80R, 100R, 200R, 400R$ and $800R$). Further steps may be added to achieve greater accuracy, but a more accurate reference voltage and a more sensitive voltage comparator are then also required. The state of the bistable control circuits supplies the value of the voltage being measured in binary-coded decimal form to the display unit. The latter converts

Fig. 1. A three-digit voltmeter employing the successive approximation technique

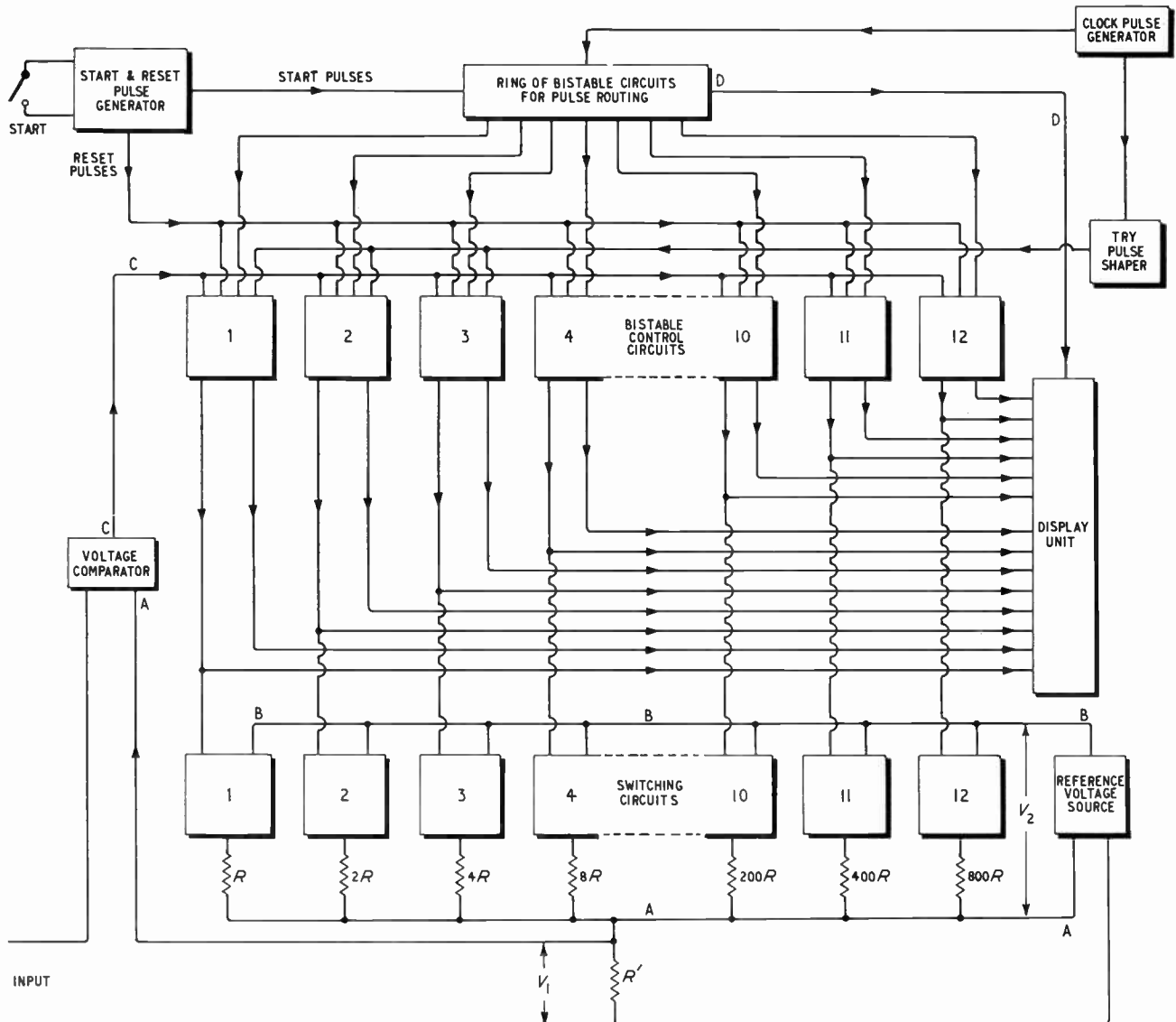

the information into decimal form (e.g., by means of a diode matrix) and displays it as digits.

The timing of the approximation operation is controlled by an astable clock-pulse generator. This feeds signals to a ring of bistable circuits which route pulses to each of the bistable control circuits in turn. Diode gates ensure that pulses from the 'try' pulse shaper can operate only the one bistable control circuit which is receiving a suitable potential from the ring counter at that instant. When the last resistor ($800R$) has been tried, a final bistable circuit in the ring circuit produces an 'operation completed' pulse which is fed to the display unit.

If a high operating speed is not required, relays may be employed as the switching units. Very high speeds of operation (a few microseconds) are possible if transistor bistable circuits are used as the switching units, since the whole operation merely requires that four resistors per decade shall be tried in sequence and the appropriate ones selected. The transistors are used in an 'inverted' state (that is, the collectors are earthed), since the voltage drop between collector and emitter can then be made less than one millivolt.

The reference voltage may be derived from some type of standard cell. Alternatively a zener diode may be employed to provide the reference voltage. Zener diodes with drift rates of less than 0.01% per thousand hours and temperature coefficients of less than 0.0005% per °C are now available.²

Precision reference resistors graded in value according to one of the binary decimal scales are required in this type of instrument. The overall accuracy of the instrument depends on the accuracy of these resistors and their cost is quite appreciable. The accuracy also depends on the stability of the reference voltage. The successive approximation technique is most useful when a very accurate instrument or a very high speed of operation is required. If an instrument employing this technique is used to measure a voltage which is changing, it may be impossible to obtain a clear indication.

In a recently developed digital voltmeter of very high accuracy close tolerance inductors are used instead of a resistive potential divider. It is claimed that this system is inherently more accurate than the usual resistive circuits, since the ratio of the potential divider system depends on the number of turns on a coil.

Simplified types of cheap digital voltmeters are now available in which the balancing process is carried out manually. In another type of relatively cheap instrument a servo motor drives a precision potentiometer which is coupled to a mechanical digital indicator.

The Ramp Method

The operation of another type of digital voltmeter involves the generation of a ramp voltage which rises linearly with time. A gate is opened when the ramp voltage passes through zero and a counting circuit commences to count the pulses from a stable oscillator. The gate is closed when the input voltage and the ramp voltage become equal. The counting time is thus proportional to the voltage being measured. If the rate of rise of the ramp waveform and the oscillator frequency are suitably chosen, the number of counts can be made equal to the input voltage when a decimal point is inserted in the correct position. Thus the number of counts recorded during the time the gate was open is displayed.

A crystal-controlled oscillator is normally employed in this type of circuit, the frequency being, perhaps, 1 Mc/s. A high speed counting circuit is therefore required. The ramp-voltage generator consists of an integrating circuit;

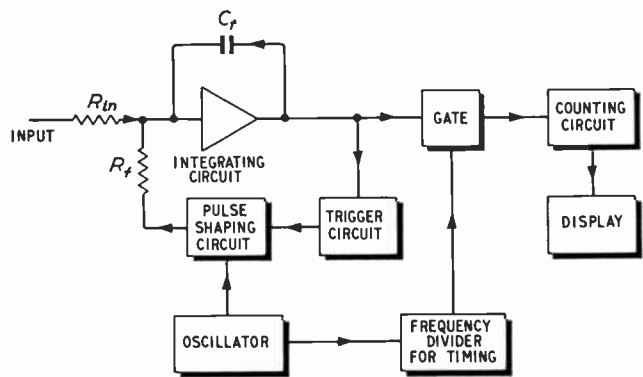

Fig. 2. Block diagram of one type of digital voltmeter employing the voltage-to-frequency conversion technique

that is, an amplifier with capacitive feedback. The gain of the amplifier must be large so that the ramp is linear; a non-linear ramp will, of course, cause errors in the indicated voltages. It may be necessary to place the integrating capacitor and its associated resistor in a temperature controlling oven³, but the instrument will then suffer from the disadvantage that a warming up time of about ten minutes will be required before the instrument attains its maximum accuracy.

Two voltage comparators are used in this type of instrument. One operates a gate when the ramp passes through zero, while the other operates the gate when the ramp and input voltages become equal. In sensitive instruments amplifiers are used to amplify the difference signal before the latter is fed to the comparator. In some instruments the ramp voltage passes from full-scale negative through zero to full-scale positive. The polarity is indicated by a signal derived from the comparator which operates first.^{3, 4}

Accurate instruments employing the ramp principle are usually fairly complicated. They always produce a reading in the presence of hum or noise, but this reading is the input voltage at the instant of time at which the ramp and the input voltages become equal.

The Staircase Waveform Technique

A modification of the ramp technique has recently been described⁵ which enables relatively inexpensive instruments to be constructed using cold-cathode counting tubes. The accuracy is, of course, somewhat inferior to the more expensive instruments.

The ramp waveform is replaced by a staircase waveform or stepped ramp which is generated by a diode pump circuit. Each step of this waveform is of an accurately defined ten millivolts amplitude. The cost of the linear ramp generator employing a high gain amplifier is thus eliminated. The high-frequency crystal-controlled oscillator is replaced by a 4-kc/s oscillator so that the counting can be carried out by Ericsson multiple anode Dekatrons which can drive digital-indicator tubes directly. This type of counting circuit is one of the most economical of those providing a digital display.⁵

The principle of operation is similar to that of a normal ramp type of instrument. Each step of the waveform occurs in one cycle of the 4-kc/s oscillator. A voltage comparator

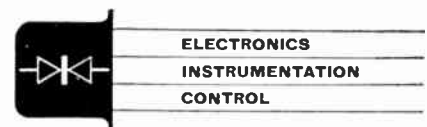

compares the amplified input voltage with the amplitude of the staircase waveform and stops the counting process when these voltages become equal. The accuracy of the instrument is not dependent on the time of counting, but only on the accuracy of the ten-millivolt steps of the waveform. A simple astable circuit can therefore be used to generate the 4-kc/s pulses. The amplitudes of the steps of the staircase waveform are limited by a zener diode.

Voltage-to-Frequency Conversion Technique

The operation of the third type of digital voltmeter involves the use of an integrating circuit to generate a frequency which is accurately proportional to the amplitude of the input voltage. An automatically-operated gate allows this frequency to pass to a counting circuit for an accurately defined time and the number of counts is displayed as the required voltage.

The basic circuit of one type of digital voltmeter which employs the voltage-to-frequency conversion technique is shown in Fig. 2. The input voltage is applied to an integrating circuit which consists of a voltage amplifier with capacitive feedback. The current flowing in the input resistor, R_{in} , causes the output of the integrating circuit to rise with a ramp waveform. When the output voltage from the integrating circuit reaches a predetermined level, it operates a voltage-sensitive trigger circuit. This causes a unit of charge to be fed back to the input of the integrating circuit and results in the output potential falling rapidly. The ramp rises again until the triggering process re-occurs and a further charge is fed back to the input. A sawtooth waveform is thus produced. The total charge flowing through the precision input resistor, R_{in} , must be equal to the total charge flowing through the precision feedback resistor, R_f , if the mean potential of the sawtooth output waveform is to remain constant. Thus if care is taken to ensure that each current pulse fed back through R_f carries a constant charge, the frequency of the sawtooth wave will be accurately proportional to the magnitude of the input current and hence to the magnitude of the input voltage.

The amplitude and duration of the pulses fed back through R_f must be accurately controlled to ensure that each pulse conveys a constant charge. The duration of the pulses may be controlled by employing a bistable circuit which is triggered from an oscillator. The resulting pulses may be used to trigger another bistable circuit which switches a reference voltage so that rectangular pulses of defined amplitude and duration are produced. The oscillator which determines the duration of the fed-back pulses can also be used to determine the counting time by means of suitable frequency-dividing circuits. Any variation of the oscillator frequency will then alter the duration of the fed-back pulses and the counting time in the same proportion so that the number of counts recorded is unaffected.⁶ The oscillator need not, therefore, be a particularly stable one.

It is not necessary for the rising parts of the sawtooth waveform to be linear and a very simple low-gain amplifier can thus be used in the integrator circuit.

The polarity of the sawtooth waveform at the output of the integrating circuit will depend on the polarity of the input voltage. Instruments which operate with inputs of either polarity may automatically switch the input to the polarity required by the trigger circuit or alternatively two separate trigger circuits may be employed.⁷ In the latter case sawtooth waveforms of a certain polarity are detected

by the appropriate trigger circuit and the polarity of the fed-back current pulses is such that they always oppose the input current.

Instruments operating on the voltage-to-frequency conversion principle can easily be designed so that they have a very low sensitivity to noise and hum. More than 140 dB rejection of common-mode noise has been obtained in voltmeters of this type.⁷ The voltage indicated by instruments employing the voltage-to-frequency conversion technique is proportional to the integral of the unknown input voltage with respect to time; that is, it is the average input voltage during the counting time. Any positive or negative peaks due to noise or hum thus tend to cancel one another. The counting period is normally one or more complete cycles of the mains frequency, since this helps to ensure that hum voltages do not affect the final reading.

Conclusion

Digital voltmeters of high accuracy can be designed by employing any one of the three principles discussed above. Each system has certain advantages and may be especially suitable in certain circumstances; for example, instruments employing the voltage-to-frequency conversion technique incorporate a frequency meter and this may enable one instrument to serve two purposes. The particular principle of operation chosen for an instrument is likely to be determined by economical considerations and by the particular preferences and the experience of the manufacturer concerned.

It must be stressed that only the basic principles of operation have been discussed in this article. Every manufacturer of digital voltmeters includes various special features in his instruments, since innumerable variations on the basic principles are possible.

Until very recently digital voltmeters have been regarded as very expensive instruments, but considerable efforts are now being made to design instruments which are much cheaper but which nevertheless have a reasonably good performance. They are quite suitable for use in applications where neither the highest accuracy nor high operating speeds are required. In addition the performance of the more expensive instruments has been considerably improved during the last few years.

Acknowledgment

The writer is indebted to those manufacturers who have provided photographs of their instruments. In addition he would like to thank Digital Measurements Ltd., Gloucester Equipment Ltd., Hewlett-Packard Ltd., Marconi Instruments Ltd. and the Solartron Electronic Group for reprints of technical papers or other information about digital voltmeter circuitry.

References

- ¹ R. I. Ostler, 'The Marconi Digitiser Type TF 1325', *Marconi Instrumentation*, Vol. 7, No. 6, p. 177 (June 1960).
- ² 'The Design and Application of Digital Voltmeters'. Published by Digital Measurements Ltd. (Oct. 1962).
- ³ H. Fuchs, B. D. Lazenby and D. Wheable, 'A Transistorized Five Digit Digital Voltmeter', *Electronic Engineering*, Vol. 34, p. 222 (April 1962).
- ⁴ 'A New Multi-purpose Digital Voltmeter', *The Hewlett-Packard Journal*, Vol. 15, No. 3 (Nov. 1963).
- ⁵ P. Gleghorn, 'An Inexpensive Digital Voltmeter Using Multiple Anode Dekatrons'. I.E.R.E. Symposium, Cambridge, March 1964.
- ⁶ E. Metcalfe, 'Methods of Digitisation'. Published by the Solartron Electronic Group (1964).
- ⁷ 'A New Digital Voltmeter Having High Rejection of Hum and Noise', *The Hewlett-Packard Journal*, Vol. 13, No. 6 (Feb. 1962).

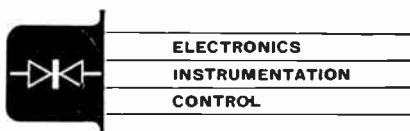

Bridged-T Compensating Networks 2: Pole-Zero Methods

By N. G. MEADOWS, B.Sc., A.M.I.E.E.*

THE pole-zero variations for bridged-T compensating networks are considered, with particular reference to the effects of pole-zero cancellation compensation methods. Conditions are given relating to the compensation of systems with real and complex open-loop poles.

Pole and Zero Variations

As shown in Part 1 the transfer function of the RC bridged-T networks of Figs. 1 and 2 is

$$\frac{e_0}{e_1} = \frac{s^2 + \frac{1+k^2}{T}s + \frac{1}{T^2}}{s^2 + \frac{2+k^2}{T}s + \frac{1}{T^2}} \quad \dots (11)$$

Writing $a = 1/T$ this becomes

$$\frac{e_0}{e_1} = \frac{s^2 + (1+k^2)as + a^2}{s^2 + (2+k^2)as + a^2} \quad \dots (12)$$

For the zeros $s^2 + (1+k^2)as + a^2 = 0$. Real zeros are located at

$$s = -\frac{a}{2} \left[(1+k^2) \pm \sqrt{(k^2+3)(k^2-1)} \right] \quad \dots (13)$$

providing $k > 1$

*Battersea College of Technology.

For $k = 1$ a double zero occurs at $s = -a \quad \dots (14)$

For $k < 1$ zeros are complex with values

$$s = -\frac{a}{2} \left[(1+k^2) \pm j\sqrt{(3+k^2)(1-k^2)} \right] \quad \dots (15)$$

In the s -plane, with $s = \sigma + j\omega \quad \dots (16)$

on equating real and imaginary parts of eqns. (15) and (16) and eliminating k , we have $\sigma^2 + \omega^2 = a^2$ as the locus of the network zeros, for k varying. This gives a semicircle of radius a , in the L.H.S. of the s -plane, providing $k < 1$. For $k > 1$ one zero is to the left of the double zero at $s = -a$, the other to the right.

For $k = 0$, $s^2 + as + a^2 = 0$ and

$$s = -\frac{a}{2} \pm j\frac{\sqrt{3a}}{2}$$

This shows that complex open-loop zeros are restricted to a 120° arc, as shown in Fig. 3. This restriction can be lifted if $T_1 \neq T_2$, giving

$$s^2 + \frac{T_2+T_3}{T_1T_2}s + \frac{1}{T_1T_2} = 0 \quad \dots (17)$$

for the zeros, which are complex when

$$s = -\frac{1}{2T_1T_2} \left\{ (T_2+T_3) \pm j[4T_1T_2 - (T_2+T_3)^2]^{1/2} \right\} \quad \dots (18)$$

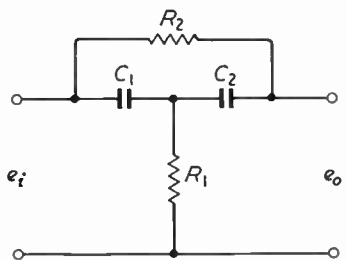

Fig. 1. Servo compensating network

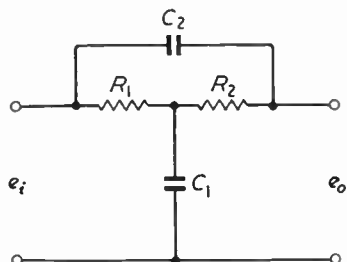

Fig. 2. Alternative form

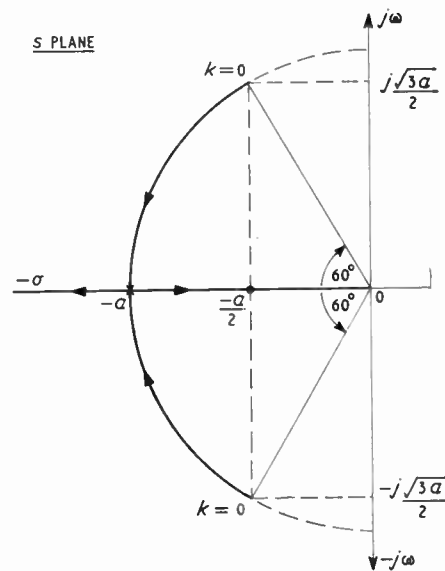

Fig. 3. Pole-zero locations, k variable (arrows denote directions for k increasing)

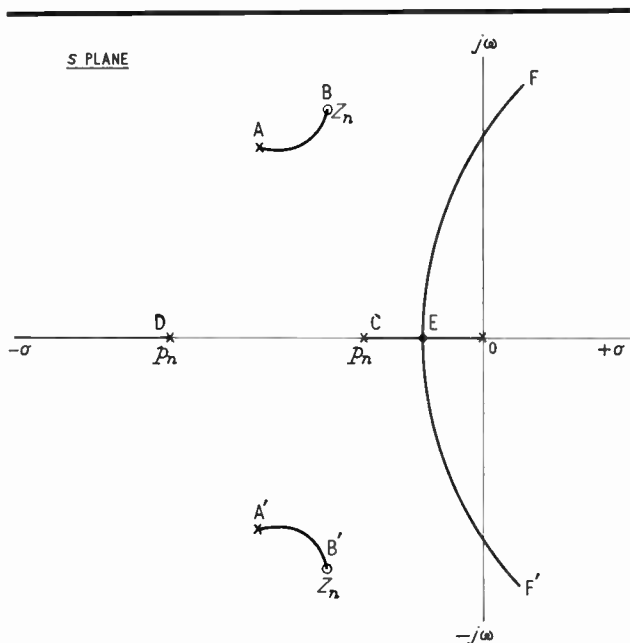

Fig. 4. Root locus for incomplete pole-zero cancellation

The limiting complex zero angle ϕ is given by

$$\tan \phi = \frac{[4T_1T_2 - (T_2 + T_3)^2]^{\frac{1}{2}}}{T_2 + T_3} \dots (19)$$

and can exceed 60° . For pole-zero cancellation procedures with open-loop poles of damping factor $\zeta < 0.5$ the unbalanced network must be used. This is discussed in a later section.

Pole-Zero Cancellation Compensation

For a system of open-loop transfer function

$$U(s) = \frac{KG(s)}{s^2 + 2\zeta\omega_n s + \omega_n^2} \dots (20)$$

$KG(s)$ is to remain unchanged and the denominator quadratic is to be cancelled by the network zeros. The compensated transfer function for series compensation is

$$C(s) = \frac{KG(s)}{s^2 + 2\zeta\omega_n s + \omega_n^2} \frac{s^2 + (1 + k^2)as + a^2}{s^2 + (2 + k^2)as + a^2} \dots (21)$$

For cancellation, $a = \omega_n$ and $(1 + k^2)a = 2\zeta\omega_n$.

$$\therefore T = 1/a = 1/\omega_n \dots (22)$$

$$\text{and} \quad k^2 = 2\zeta - 1 \dots (23)$$

specify the network transfer function. Eqn. (23) is valid for $\zeta > 0.5$ only so that the network in this form cannot cancel complex poles if $\zeta \leq 0.5$: here the unbalanced form must be used.

The network substitutes new poles given by

$$s^2 + (2 + k^2)as + a^2 = 0 \text{ or } s^2 + (1 + 2\zeta)\omega_n s + \omega_n^2 = 0 \dots (24)$$

The damping factor of the open-loop poles is increased from ζ to $1 + \zeta$, with ω_n unchanged. This usually results in a higher gain k in eqn. (21), consistent with closed-loop stability.

For the complex poles of $U(s)$,

$$s = -\omega_n[\zeta \pm j\sqrt{1 - \zeta^2}] \dots (25)$$

The substituted poles are, from eqn. (24),

$$s = -\omega_n[(\frac{1}{2} + \zeta) \pm \sqrt{(\zeta + \frac{3}{2})(\zeta - \frac{1}{2})}] \quad (26)$$

The difference of the real part s_r of the complex poles and the smaller, and therefore dominant, real pole is $|s_r - s_1| = \omega_n[\sqrt{(\zeta + \frac{3}{2})(\zeta - \frac{1}{2})} - \frac{1}{2}]$ and is always positive if $\zeta > 0.618$. Then the substituted pole $s_1 = -\omega_n[(\frac{1}{2} + \zeta) - \sqrt{(\zeta + \frac{3}{2})(\zeta - \frac{1}{2})}]$ is always nearer the $j\omega$ axis of the s -plane than the real part of the cancelled complex pole. This introduces a longer time constant as the penalty for achieving higher open-loop gain.

Use of the Unbalanced Network

For the unbalanced network,

$$N(s) = \frac{s^2 + \frac{T_2 + T_3}{T_1T_2}s + \frac{1}{T_1T_2}}{s^2 + \frac{T_1 + T_2 + T_3}{T_1T_2}s + \frac{1}{T_1T_2}} \dots (27)$$

If $T_3 = k^2T_2$, $a = 1/T_1$ and $b = 1/T_2$,

$$N(s) = \frac{s^2 + (1 + k^2)as + ab}{s^2 + [(1 + k^2)a + b]s + ab} \dots (28)$$

For cancellation of poles as in eqn. (25),

$$ab = \omega_n^2 \dots (29)$$

and

$$(1 + k^2)a = 2\zeta\omega_n \dots (30)$$

$$\therefore T_2 = \frac{2\zeta}{(1 + k^2)\omega_n} \dots (31)$$

$$T_1 = \frac{1 + k^2}{2\zeta\omega_n} \dots (32)$$

with

$$T_3 = k^2T_2 \dots (33)$$

Example

For $U(s) = \frac{KG(s)}{s^2 + 1.2s + 4}$, for the poles $\omega_n = 2$ and $\zeta = 0.3$. An unbalanced network is required as $\zeta < 0.5$.

Eqns. (31) and (32) give $T_2 = \frac{0.15}{1 + k^2}$ and $T_1 = \frac{1 + k^2}{2.4}$.

For k small T_2 is relatively large and T_1 small.

Typical values are

$$(a) \quad k^2 = 0.2 \quad T_1 = 1 \quad T_2 = 0.25 \quad T_3 = 0.05 \quad \zeta = 1.3$$

$$(b) \quad k^2 = 0.5 \quad T_1 = 1.25 \quad T_2 = 0.2 \quad T_3 = 0.1 \quad \zeta = 1.55$$

The larger value of ζ disposes towards higher gain values for closed-loop stability, but the larger time constant T_1 appears. A final choice of k must be a compromise between acceptable steady-state errors and transient response.

Effects of Incomplete Cancellation Compensation

In practice network zeros will not exactly cancel system poles and a dipole is left (Fig. 4). Z_n denotes a network zero, p_n a pole; other poles are system poles. The Z_n s may lie to the left or right of the complex system poles.

A typical root locus is shown. For k low complex closed-loop poles exist on sections A-B and A'-B' with two real poles between 0 and C and a further real pole to the left of D. At a certain k value two real poles coalesce at E and that from D moves farther to the left, while complex poles move towards A and A'. For a further increase of k closed-loop poles move up sections EF and EF'. An oscillatory response is obtained for all $k > 0$: this will include a small amplitude oscillatory term contributed by the dipole if the poles and zeros are closely matched. For exact cancellation of complex poles a non-oscillatory response region is obtained for the low-gain condition, but in practice precise cancellation cannot usually be maintained.

The network may be deliberately designed to produce zeros displaced from the network poles, giving a locus similar to that of Fig. 4.

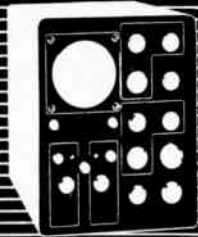

NEW APPARATUS

ELECTRONICS
INSTRUMENTATION
CONTROL

1. Stainless Steel Variable Area Meters

Meter-Flow have introduced a range of stainless-steel variable-area meters, with magnetic coupled indicators. This type of meter overcomes the limitations of the glass-type variable-area meter in applications where a high pressure or high temperature is encountered. With this type of meter it is no longer necessary to see the float position, consequently accurate measurements can now be taken on opaque liquids.

The H series meters have the advantage of external calibration adjustment which facilitates changing the scale reading pro rata to changes of density and/or viscosity. Each of the units have an accuracy of $\pm 1\%$ f.s.d. and all cones/tubes can be interchanged to give a wide variety of flow ranges. All meters have a 10:1 flow range and cover the following ranges: 125 to 1.25 g.p.h. ($\frac{1}{8}$ -in. bore), 350 to 3,500 g.p.h. (2-in. bore) and 2,500 to 25,000 g.p.h. (6-in. bore).—*Meter-Flow Ltd., North Feltham Trading Estate, Feltham, Middlesex.*

For further information circle 1 on Service Card

2. Overload Protection Device

In servo-mechanism applications there is often a need for a simple, robust, yet positive actuating device which responds instantly to excessive torque generated at a driven shaft. The device may be required to carry out, via microswitches, a number of actions, such as: stopping the motor driving the shaft, operating an 'overload' alarm, etc., and then, following a manual resetting, to continue to drive in the original direction.

To meet this need, Flight Refuelling Ltd.'s Industrial Electronics Division has produced an 'Overload Protection Device', which has already been applied to servo-gearboxes, where the requirement was for an immediate change of direction at each limit stop and where it was necessary to safeguard the drive motor against overload.

The unit, $1\frac{1}{8}$ in. diameter, and $\frac{1}{4}$ in. wide, is capable of being fitted to shafts up to $\frac{1}{2}$ -in. diameter and can be fitted to any type of drive incorporating a slipping clutch.—*The Industrial Electronics Division, Flight Refuelling Ltd., Wimborne, Dorset.*

For further information circle 2 on Service Card

3. Pocket Optical Micrometer

A pocket optical micrometer is now being marketed in the U.K. by Proops Bros. This uses optical components of the highest quality and consists of a cemented three-element $\times 7$ magnifying lens on a clear plastic mounting

cell fitted with a precise measuring reticle. The lens construction is such that field of view is flat over the whole of the reticle area, and a clear mounting tube provides all-round light admission. Reticles are optically-flat glass plates on which comprehensive sets of reference scales, angles, circles, radii, etc., have been etched. Measurements can be made instantly simply by placing the reticle face against the object and reading off directly through the magnifier.

One of the reticle scales available, to give an example, covers all the following measurements: 1–10 mm in 0.2-mm divisions; 0–0.5 in. in 0.005-in. divisions; angles from 0° to 90° in 5°

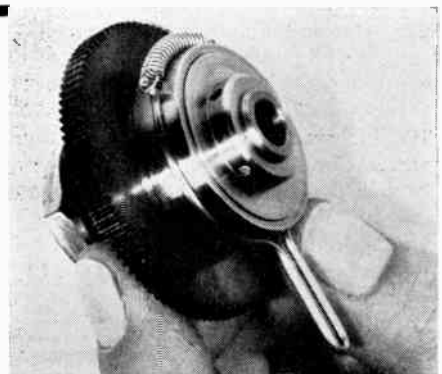
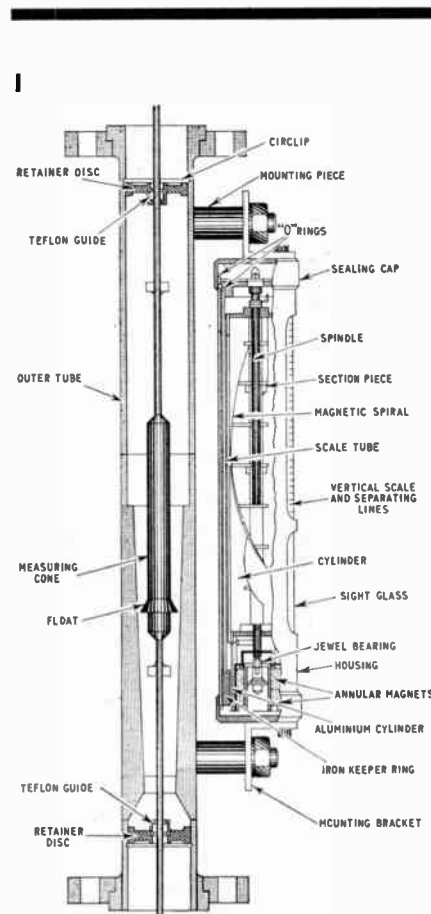

2

3



steps; radii from $\frac{1}{8}$ in. to $\frac{3}{8}$ in. in increments of $\frac{1}{32}$ in.; circles of $\frac{1}{4}$ in. to $1\frac{1}{4}$ in. dia. in increments of $\frac{1}{8}$ in.; thickness widths from $\frac{1}{8}$ in. to $\frac{1}{4}$ in. in $\frac{1}{8}$ in. and $\frac{1}{32}$ in. steps; and circles in decimal diameters from 0.005 in. to 0.050 in.

Other interchangeable reticles available are: large and small particle measuring grids, radii and angle scales, and widths and thickness gauge.

The size of the instrument is 2 in. \times 1 $\frac{1}{4}$ in. dia. overall. Supplied complete with leather carrying case, and one reticle.—*Proops Bros. Ltd., 52 Tottenham Court Road, London, W.1.*

For further information circle 3 on Service Card

4. Curve Analyser

The Europa Engineering Co. announce the introduction of their Atlas curve analyser and integrator for both the evaluation of curve function (determination of the ordinate values) and the measurement of areas. It has fully automatic read-off, with paper tape or punched card output, and may be used for such purposes as planimetry, gas chromatography, spectrography, statistics and data supply for electronic computers. The instrument accepts a sheet size 20-in. square and has a 19.2-in. square maximum evaluation area. Simple to operate, with clear keyboard programming for setting to individual tasks, it can be fitted with an additional device for statistical

evaluation. Output data appears immediately after scanning, which takes from 1 to 15 sec per cm length of the diagram, according to the drum speed and reader advance. With 0.5 mm reader advance per drum revolution the accuracy is generally better than 0.5%, and because of the automatic measuring from line centre to line centre no errors can be made by different widths of curve lines, even with steep curves.—*Europa Engineering Co. Ltd., 12a, Golden Square, London, W.1.*

For further information circle 4 on Service Card

5. High-Speed Card Reader and Punches

Now available from Scientific Furnishings the Card Reader reads 1,200 cards per min column by column thus reducing the complexity of the store and register electronics; high reliability is achieved by using a vacuum capstan which permits handling of cards which are damaged, crumpled or conditioned to high humidity. Several error checking features include dual read, photocell and amplifier failure check and 'fail to feed' detection. The vibrating feed tray and receiving tray both have capacities of 4,000 cards with a 240 card reject bin. The entire card path is accessible by means of quick-latch removal assemblies thus facilitating cleaning and maintenance. The Row Punch operates at 250 cards per min and has a capacity of 1,200 cards in the input hopper and 1,500 cards in the output stacker.—*Scientific Furnishings Ltd., Electronics Division, Poynton, Cheshire.*

For further information circle 5 on Service Card

6. Mass Memory Files

Honeywell has developed a range of fast, high-density, mass memory file units for use with the Series 200 computers.

The files were developed primarily for use with Honeywell's Series 200 computer family. Any of the five Series 200 processors can be equipped with the random memory units. In addition, combinations of the files and magnetic tape drives can also be attached to the Series 200 processors for a more flexible applications approach.

The basic storage medium for the mass memory files is a magnetic tape strip. A single cartridge contains 512 magnetic tape strips and weighs less than 5 lb.

In the smallest file, model 251, a single cartridge has a storage capacity of 15-million six-bit characters. Record access time is 95 msec.

In the larger files, models 252 and 253, each cartridge has a capacity of 60-million six-bit characters, accessible at speeds of 150- and 225-msec respectively.

The model 252 file permits a maximum of one cartridge on-line at one time; however, model 253 allows up to five cartridges to operate simultaneously for a maximum on-line storage capacity of 300 million characters. In addition up to eight files can be attached to a single control unit,



4



5

thereby increasing the maximum effective storage capacity of model 243 to 2,000 million characters.—*Honeywell Controls Ltd., Honeywell House, Great West Road, Brentford, Middx.*

For further information circle 6 on Service Card

7. Data Logging/Recording Equipment

The system is designed for marine, industrial and scientific applications and may be used as a simple recorder or extended into an extensive logging control system with on-line computing facilities. High or low level analogue signals up to 1,000 in number can be sampled at 20 inputs per sec. The equipment operates continuously within the accuracy limits for at least six months without calibration, self-calibration occurring each cycle, and independent limits may be set for each input. Printed output information in various formats and an edited punched tape are simultaneously provided as well as visual displays of input signal values and identities, alarm conditions and time.—*Hawker Siddeley Dynamics Ltd., Whitley Works, Coventry, Warwickshire.*

For further information circle 7 on Service Card



6

7

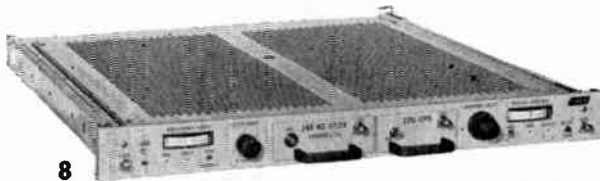
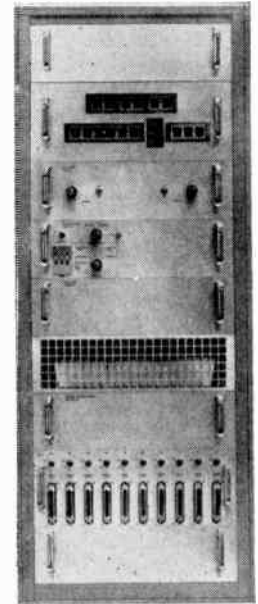

8

8. Pulse-Averaging Subcarrier Discriminator

The Sarasota Division of Electro-Mechanical Research, Inc., U.S.A., announces a low-cost precision subcarrier discriminator for recovering f.m./f.m. telemetry data. Designated the Model 287, it operates at subcarrier frequencies from 300 c/s to 500 kc/s, at data cut-off frequencies between 1 c/s and 85 kc/s, and with subcarrier deviations from 2.5% to 50%. Specific operating frequencies are determined by the channel selector and output filter, each of which can be plugged into the front panel independently.

Some features of the Model 287 include: 60-dB rejection of an adjacent-channel signal 40 dB greater than the desired signal with no degradation of time-delay characteristics; output filters with switchable characteristic 36 dB/octave roll-off at all frequencies; and linearity of $\pm 0.1\%$ of bandwidth.

For easy maintenance the discriminator employs plug-in printed-circuit boards which are removable from the top providing access to virtually all components in the main chassis.—*Electro-Mechanical Research, Inc., Sarasota, Florida, U.S.A.*

For further information circle 8 on Service Card

9

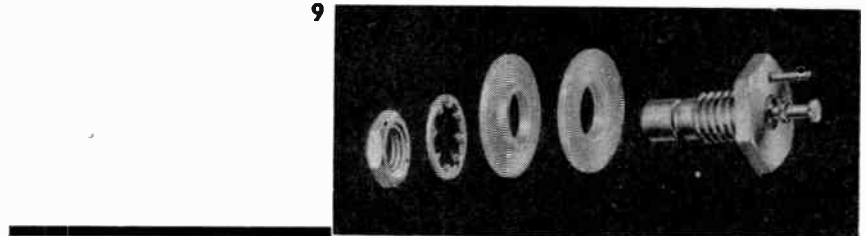

9. Subminiature Coaxial Connector

A special insulated bulkhead receptacle is now offered by the Conhex Division of Sealectro. This connector, the 51-043-0029, is provided with a special insulating bushing which effectively isolates the ground circuit from equipment chassis. A connecting stud is incorporated on the connector body for the isolated ground-lead termination in addition to the standard signal lead termination.

This connector is available in 50- and 75- Ω impedances and in snap-on, slide-on, and screw-on mating engagements. Captive contacts, 0.0001 in.

gold plating, and p.t.f.e. insulation provide maximum performance, and reliability.—*Sealectro Ltd., Hersham Trading Estate, Walton-on-Thames, Surrey.*

For further information circle 9 on Service Card

10. Synchroscope

Manufactured in Czechoslovakia by Telsa (Kovo), this oscilloscope is designed for the observation of high speed electrical phenomena such as short pulses, very high frequency oscillations and other such signals. Input impedance is 75 Ω and frequency response is from 0 to 1,000 Mc/s, with

a sensitivity drop of 6 dB and a maximum standing wave ratio of 2. A triggered time base gives durations of 10, 30, 100, 300, or 1,000 nsec. When the observed voltage is connected directly across the deflection plates the frequency response is flat from 0 to 250 Mc/s and rises up to 300 Mc/s. The instrument consists of an indicator and a power supply unit (220 V, 50 c/s) mounted above each other in a common cabinet, which measures 675 by 350 by 450 mm and weighs approximately 100 lb. — *Kandem Electrical Ltd., 711 and 715 Fulham Road, London, S.W.6.*

For further information circle 10 on Service Card

11. Static Voltage Regulator

AEI has recently introduced for traction service a static voltage regulator incorporating silicon semiconductor rectifiers.

The regulator has a quick response and high accuracy of regulation and, having no moving parts, requires only the minimum of maintenance.

The maximum current output of the new static voltage regulator is 8 A, and it was developed for use with generators having a nominal output voltage of 74 and 110 V. Regulators for other voltages can, however, be supplied to order. The range of adjustment of the single-setting potentiometer allows the regulator to be used with generators with nominal voltages $\pm 10\%$ of the regulator nominal working voltage.

Silicon semiconductors are used throughout, and this ensures that the regulator is suitable for use in locations where the ambient temperatures are high, its range of operation being from -20°C to $+50^\circ\text{C}$. Its response time is so short that in service the overall response time of the equipment depends on the response of the generator rather than that of the regulator.

The regulator is small in size, approximately 11 in. \times 5 in. \times 6 in., it has low heat dissipation and, being relatively insensitive to vibration and humidity, is ideal for traction service. It needs virtually no regular maintenance, apart from ensuring that excessive dust is not allowed to accumulate in the case.

The circuit consists of a voltage comparator which controls the mark/space ratio of a multivibrator firing circuit which, in turn, varies the on/off ratio of the silicon controlled rectifiers

controlling the current flowing in the generator field.—*Associated Electrical Industries Ltd., Trafford Park, Manchester.*

For further information circle 11 on Service Card

12. Digital Voltmeter

An all solid-state digital voltmeter which offers a combination of high accuracy, noise immunity, high and constant impedance and high speed is announced by Hewlett-Packard. The instrument provides a five-digit read-out, with a sixth digit for over-ranging. The maximum resolution on the lowest range is $10\ \mu\text{V}$ and the input impedance is a constant $10\ \text{M}\Omega$ on all ranges. Full accuracy ($\pm 0.005\%$ of reading, ± 2 counts, in environments from $+10$ to $+40^\circ\text{C}$) is maintained up to the instrument's highest operating speed of 15 readings per sec.

Relatively immune from normal-mode noise, common-mode rejection

(with $1,000\ \Omega$ unbalance) is 140 dB at all frequencies. Any one of four ranges, or autoranging, may be selected by push-button and, because the model has 20% over-ranging on all ranges, it will measure up to 1,200 V d.c., the highest voltage being presented with full accuracy on the six-digit display. Reversible counters are used for integration of signals varying around zero.—*Hewlett-Packard, Dallas Road, Bedford.*

For further information circle 12 on Service Card

13. D.C. Reference Source

Honeywell's high voltage d.c. reference unit (0–3,000 V) is designed for laboratory applications such as photomultiplier sources, ion chambers, klystrons, mass spectrometry and instrument calibration, and can supply a current of 20 mA. Accuracy is within 0.25% from 10 V up and ripple is 5 mV r.m.s. maximum. The robust instrument is



10

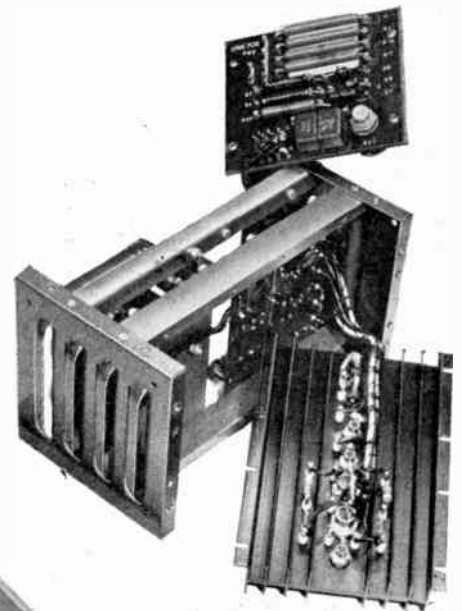

11

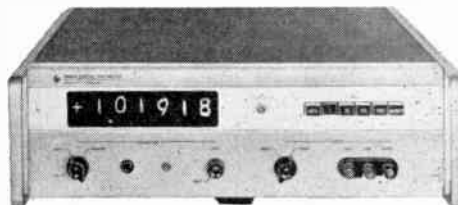

12



13

housed in a well ventilated steel cabinet, with rear and front output connections, and is suitable for bench or rack mounting.—*Honeywell Controls Ltd., Brentford, Middlesex.*

For further information circle 13 on Service Card

INSTRUMENTATION

14. Large-Area Floor Monitors

Equipment for the rapid monitoring of laboratory floors and processing areas for radioactive contamination is now available from EMI Electronics Ltd. Two types of floor monitors detect either alpha or beta contamination. Each monitor comprises a large area scintillation probe which has a cast aluminium reflector, the whole being mounted on three wheels. The rear is a castor to give maximum manoeuvrability and a hinged handle facilitates mobility. Both monitors can be connected via a suitable coaxial lead to most mains or battery-operated ratemeters or contamination monitors and are designed so that the EMI ratemeter type RM2 can be mounted directly on to them for easy reading.—*EMI Electronics Ltd., Hayes, Middlesex.*

For further information circle 14 on Service Card

15. Miniature Recorders

A range of miniature recorders, the Miniscribe range, is announced by Kelvin Electronics. These recorders have either a moving-coil or bi-metal movement and are inkless, using a chopper bar to record on pressure-sensitive waxed paper.

Miniscribe D is a moving-coil instrument with a robust ligament suspended movement. Versions are available for measuring and recording direct current from 0–10 μ A up to 10 A; voltages from 0–6 mV up to 600 V, d.c.; a.c. from 0–250 μ A up to 10 A, and voltages from 0–6 V up to 600 V a.c. Centre-zero or suppressed-zero models are also offered for recording d.c. or a.c. voltages. The overall accuracy is 1½%.

The Miniscribe B will find many applications in cases where, over fixed periods, the average of a current value has to be recorded. The instrument incorporates a bi-metal movement with a full-scale deflection time of 15 min. Versions are available for alternating current with a scale 0 to

120% (5 A = 100%) with or without saturable transformers, or for a.c. voltage with a scale 0 to 120% (220 V = 100%). The overall accuracy is 3%.

The Miniscribe Z has been arranged to record events where these can be indicated by the opening or closing of switches. Any events such as occur on machine tools, industrial installations, switch-on times for furnaces, etc., can be recorded. Each of the 10 event channels consists of a change-over relay which actuates a writing pen. The relays are available with voltage ratings from 6 to 110 V d.c. and 12 to 240 V a.c. The recording is continuous for each event channel, no chopper being used.

For all recorders in the Miniscribe range the chart width is 65 mm with a recording width of 59 mm and a chart roll length of 15.5 m. The chart drive is by synchronous motor with built-in gear change for two chart drive speeds with a ratio of 1 : 6. Five

exchangeable gear boxes are available with chart speeds of 10 and 60 mm/hr; up to 100 and 500 mm/hr. — *Kelvin Electronics Co., Wembley Park Drive, Wembley, Middlesex.*

For further information circle 15 on Service Card

16. Plug-in Function Generator

Extending the plug-in idea to function generators, Hewlett-Packard's Model 3300A is a compact, convenient, multi-purpose source of test waveforms. It provides two simultaneous outputs which may be any two of three waveforms. These are of common frequency and constant amplitude. Frequency is controllable either by a front panel dial or by an external voltage to a rear terminal connector, useful for controlled sweeps or programmed frequency. The basic instrument produces sine, square, or triangular waves ranging from 0.01 c/s to 100 kc/s.

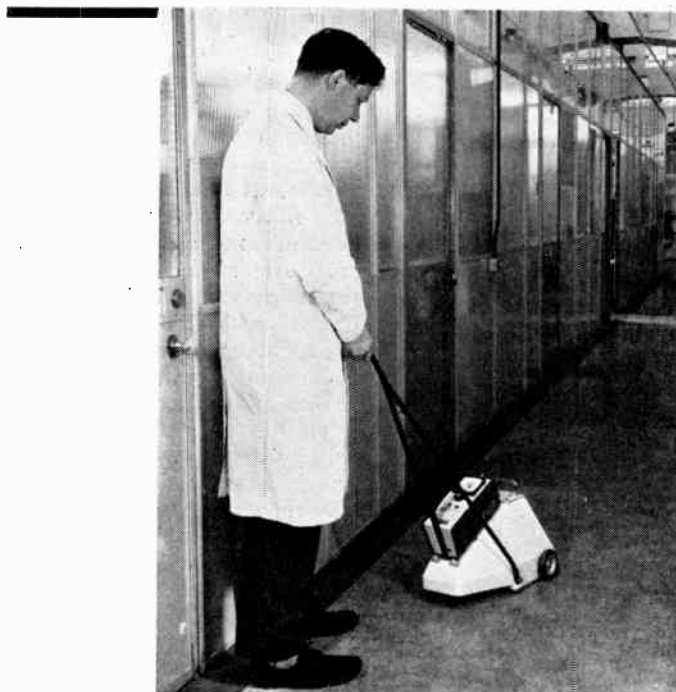

14

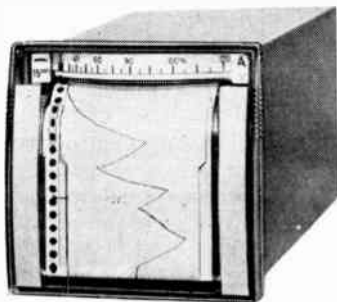

15



16

NEW ELECTRONICS INSTRUMENTATION CONTROL

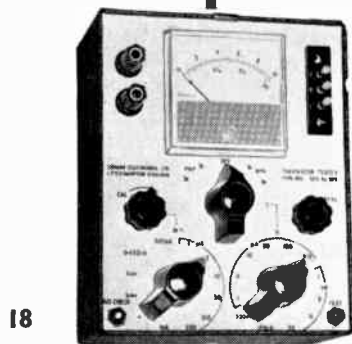
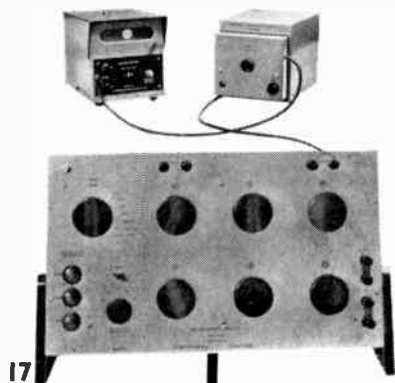

With the Model 3302 plug-in unit, the generator will deliver a single cycle on demand, in known phase with an outside signal, or multiple cycle on demand, in known phase with an outside signal, or multiple cycle operation with variable start/stop phase. A phase-lock loop makes it possible to synchronize the 3300A to any periodic signal with a frequency from 10 c/s to 100 kc/s. A front panel meter positively displays achievement of lock. The loop also provides 360° of phase variability.

Two output amplifiers are integral; either may be balanced or single-ended, and floating. Each will deliver 36 V peak-to-peak open circuit (4 V p-to-p into 50 Ω). The output system is d.c. coupled and fully floating with respect to the power line earth. — *Hewlett-Packard, Dallas Road, Bedford.*

For further information circle 16 on Service Card

17. High Precision Resistance Bridge

Having a measuring range of 0.0001 Ω to 100 MΩ, with corresponding bridge voltages of 2 to 60 V, this instrument eliminates switching errors usually associated with conventional Wheatstone bridge types. The variable arm incorporated in it is constructed of conductance elements, built up in binary increments, and covers a million steps. Six coils only are used, on each of six decades, and accumulated contact errors are avoided by having all the contacts in parallel. The instrument operates with a limit of error no greater than 0.01% within the lower extreme and 0.1% within the upper extreme measuring ranges; such a high degree of resolution can only be achieved by using a very sensitive d.c. detector in conjunction with an externally-connected secondary indicating galvanometer, both of which are available. — *H. Tinsley & Co. Ltd., Werndee Hall, South Norwood, S.E.25.*

For further information circle 17 on Service Card

18. Transistor Tester

Incorporating a nano-ammeter, this tester enables leakage and d.c. gain of both n-p-n and p-n-p transistors to be measured at currents from 10 nA up to 30 mA; leakage of 1 nA can be detected. Collector current is measured directly with a transistor-chopper d.c. amplifier and current divider with a maximum sensitivity of 100 nA f.s.d.; the collector test voltage is 4 V. Base current is continuously variable from zero to 1 mA in nine ranges and is

measured directly, with auto-ranging for ease of use. In addition nine pre-set base currents give direct-reading gain scales of 0-30, 0-100 and 0-300, and leakage may be backed off to zero. The instrument is powered by long-life mercury batteries and measures 6.25 in. by 5 in. by 3.5 in. — *Comark Electronics Ltd., Gloucester Road, Littlehampton, Sussex.*

For further information circle 18 on Service Card

19. Portable L.F. Generator

This Philips transistorized generator announced recently by M.E.L. covers the range 10 c/s to 100 kc/s. It weighs 5½ lb and is suitable for general purpose use in the workshop and field, internal batteries providing power for 200 hours' operation. In addition to the absence of mains hum there is negligible warm-up drift. There are four frequency ranges and sine-wave and square-wave outputs are available having maximum amplitudes of 2 V r.m.s. and -4 V peak respectively. Sine-wave distortion is 0.5% from 200 c/s to 20 kc/s, and 1% over the remainder of the range. — *The M.E.L. Equipment Co. Ltd., 207 King's Cross Road, London, W.C.1.*

For further information circle 19 on Service Card

20. Telephone Cable Tester

A portable, self-contained telephone cable test set has been announced by Standard Telephones and Cables.

Known as the 74226, the unit can rapidly measure mutual capacitance, capacitance unbalance and percentage resistance unbalance. Measurements may therefore be made of the various combinations of capacitance unbalance encountered in separate cable sections having quadded or paired construction, so that optimum section-jointing configurations may be employed to minimize crosstalk and interference.

The measuring ranges are as follows. Capacitance unbalance: range 1, 280-0-280 pF; and range 2, 1,100-0-1,100 pF, both with an accuracy of ± (1% + 2 pF). Mutual capacitance of up to 0.1121 μF can be dealt with at an accuracy of ± 50 pF, and for resistance unbalance ± 0.5% of conductor loop resistance may be measured to an accuracy of 0.01%.

The bridge circuit works in conjunction with a transistorized oscillator and amplifier and two versions are available having operating frequencies of 800 and 1,000 c/s respectively. Power is supplied internally from two 4.5 V dry batteries.

┌ circuit reliability starts with resistors

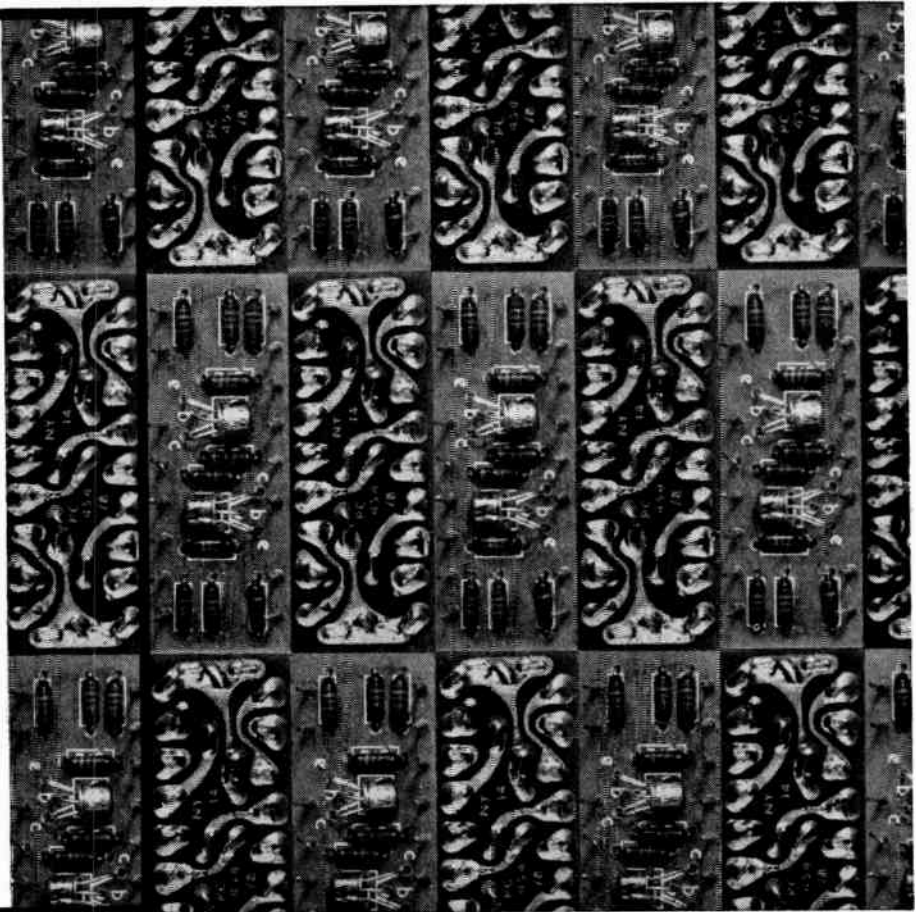
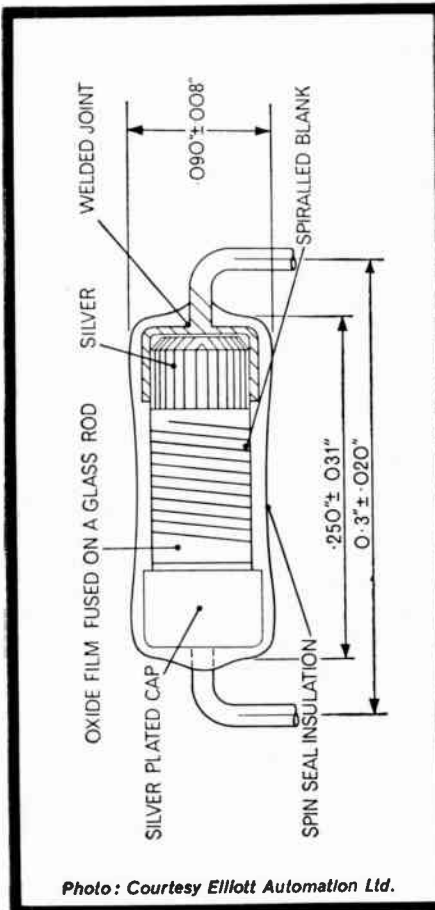

only Electrosil TR4 glass-tin-oxide resistors contribute so much to printed circuit reliability

The Electrosil TR4 is a triple rated glass-tin-oxide resistor which can be used at SEMI-PRECISION rating ($\frac{1}{10}W-70^{\circ}C$), HIGH STABILITY ($\frac{1}{2}W-70^{\circ}C$), GENERAL PURPOSE ($\frac{1}{4}W-70^{\circ}C$). Advance approval to DEF 5115 (Category RFG 2).

- Leads will not part at soldering temperatures, because they are welded to the end caps—no solder is used in construction
- Solvent-proof high temperature coating and colour bands are unaffected by flow soldering temperatures and defluxing baths.
- Copper leads* have extra thick coating of 60/40 solder for rapid and consistent soldering
- Ideal for 0.1" circuit board module—can be supplied to 0.3" lead centres
- The only metal oxide film resistor which will meet 0.3" centres
- Can be supplied preformed to any configuration (*Nickel leads can be supplied for all-welded forms of construction.)

get glass-tin-oxide reliability with



Write today for full details

ELECTROSIL LIMITED
 PALLION, SUNDERLAND, CO. DURHAM
 Tel: Sunderland 71557. Telex 53273

ES/AS2

when quality counts... 

SODECO COUNTERS

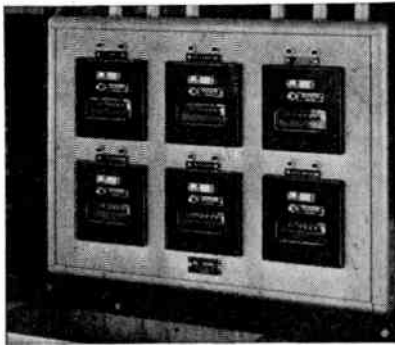

for
London
Airport
Car Park



Photographs by courtesy of the Witton-Kramer division of GEC (Engineering) Ltd.

Sodeco counters were chosen by GEC for their photoelectric control equipment at London Airport multi-storey car park.

For administrative convenience two remote reading counter cabinets are installed, one at the car park entrance, the other in the superintendent's office.

These automatically record the progress of cars from floor to floor. With two entrances and exits on central floors it is necessary for the counters to be able to register simultaneous movement at four points on each floor. When only ten car spaces are left on any floor an automatic alarm is sounded and an indicator shows the floor concerned.

DR/SC/3A



PRODUCTS
MEASURE
COUNT CONTROL
PRECISELY

LANDIS & GYR LTD
VICTORIA ROAD
ACTON · LONDON W3
ACORN 5311

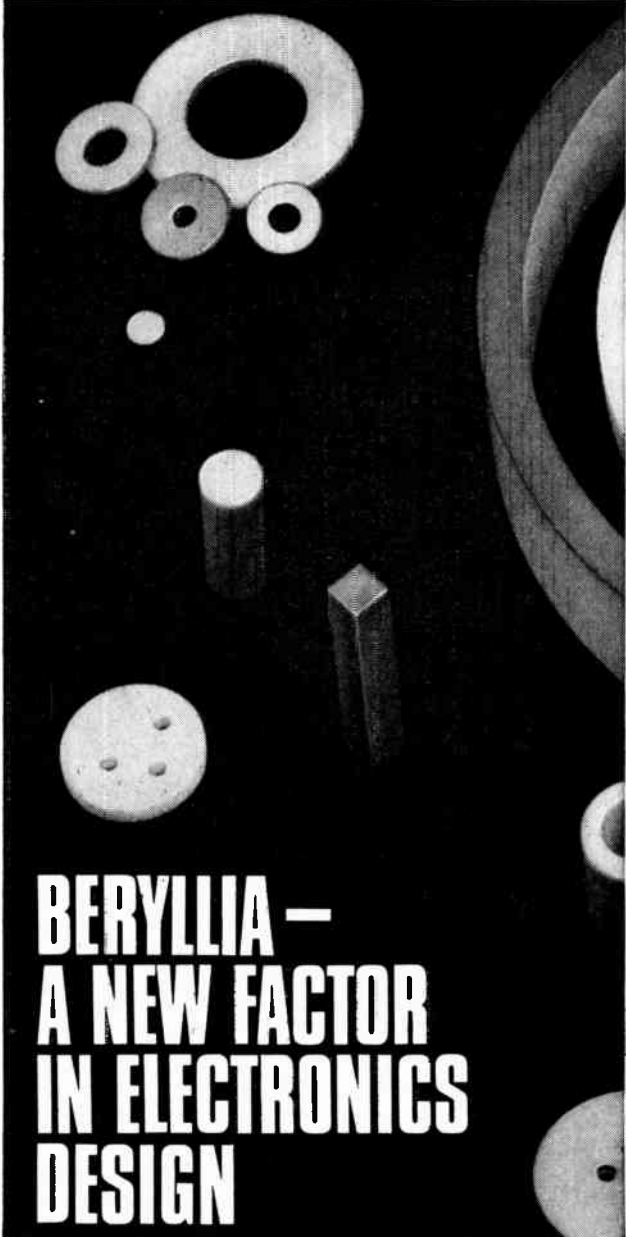

BERYLLIA — A NEW FACTOR IN ELECTRONICS DESIGN

Already well-known in the field of nuclear engineering, BERYLLIA is beginning to play an important part in electrical and electronic applications. It offers a unique combination of properties:—

- High thermal conductivity — equal to that of aluminium
- High electrical resistivity
- Low dielectric loss

The special properties of BERYLLIA enable it to solve problems of heat dissipation which often arise in the use of transistors, rectifiers, diodes and other semi-conductor devices. And BERYLLIA is especially useful in the higher frequency regions, where capacitance effects caused by conventional insulators would otherwise be prohibitive. A range of standard base washers is available from stock—for full details write for illustrated brochure. A quick service is offered for parts machined to special requirements and quotations for small or large quantities will be gladly submitted on receipt of a sketch or drawing.

CONSOLIDATED BERYLLIUM LIMITED
—an associate company of



Enquiries to: Imperial Smelting Corporation (N.S.C.) Limited, St. Andrew's Road, Avonmouth, Bristol. Tel: Avonmouth 3631

For further information circle 246 on Service Card

ADCOLA
PRODUCTS LIMITED
(Regd Trade Mark)

**HIGH EFFICIENCY
SOLDERING INSTRUMENTS
FOR
BENCH LINE PRODUCTION**

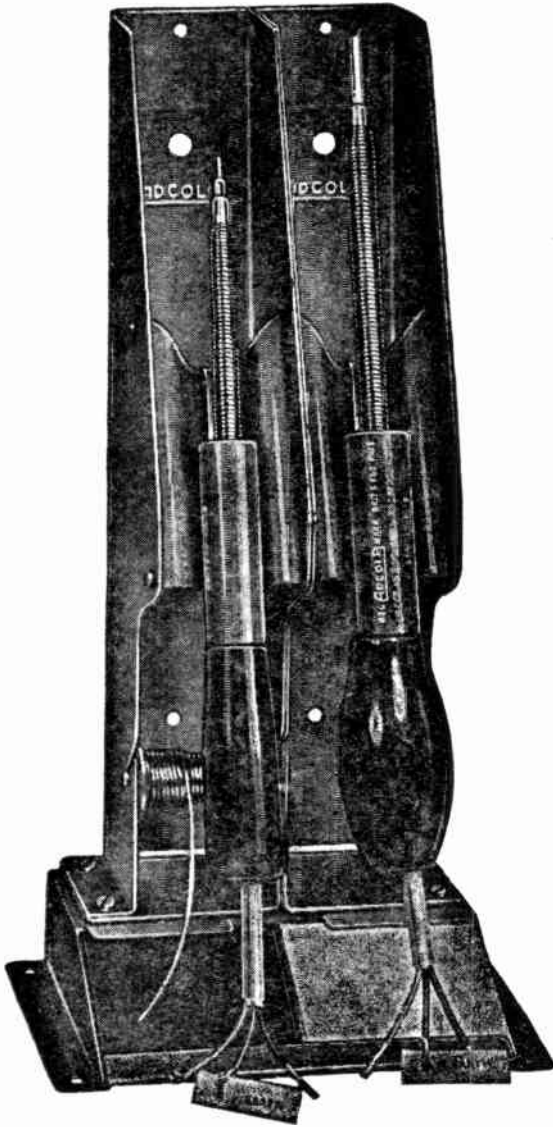

Apply direct to
Head Office Sales and Service

**ADCOLA PRODUCTS LTD.
ADCOLA HOUSE
GAUDEN ROAD
LONDON S.W.4**

Telephones
MACaulay
4272
and
3101

Telegrams
SOLJOINT, LONDON S.W.4

Industrial Electronics July 1965

F*

37

Let the

**INDUSTRIAL
ELECTRONICS**

**READER ENQUIRY
SERVICE**

help you to
obtain more
information

To obtain further details of any of the coded items mentioned in the Editorial or Advertisement pages of this issue, please complete one or more of the attached cards circling the appropriate reference number(s). Your enquiries will be passed on to the manufacturers concerned and you can expect to hear from them direct in due course. Cards posted from abroad require a stamp.

PLEASE USE CAPITAL LETTERS

Pour obtenir tous a renseignements sur les produits codés mentionnés dans les articles ou dans les pages publicitaires de ce numéro, nous vous prions de remplir une ou plusieurs des cartes ci-jointes en encerclant le ou les numéros de référence appropriés. Vos demandes de renseignement seront transmises aux fabricants intéressés qui, en temps voulu, vous feront parvenir une réponse. Il est nécessaire d'affranchir les cartes postées de l'étranger.

PRIÈRE D'UTILISER DES CARACTÈRES D'IMPRIMERIE

Weitere Einzelheiten über irgendwelche Artikel, die auf redaktionellen oder Anzeigenseiten erscheinen, erhalten Sie, indem Sie eine oder mehrere der beigefügten Karten ausfüllen und die entsprechende(n) Kennnummer(n) einrahmen. Ihre Anfrage wird an den Hersteller weitergeleitet, und Sie werden dann direkt von ihm hören, Karten, die im Ausland aufgegeben werden, müssen frankiert werden.

BITTE IN BLOCKSCHRIFT AUSFÜLLEN

Per ulteriori particolari in merito agli articoli menzionati nel testo o nelle pagine pubblicitarie di questo numero, Vi preghiamo di completare una o più delle schede allegate chiudendo in un cerchietto il numero o i numeri di riferimento. La Vostra richiesta sarà inoltrata ai fabbricanti interessati che Vi risponderanno direttamente. Le schede dall'estero devono essere regolarmente affrancate.

SI PREGA DI COMPILARE LE SCHEDE A
TAMPATELLO

Con objeto de obtener más detalles de cualquiera de los artículos mencionados en las páginas editoriales o de anuncios de este número, sírvase rellenar una o más de las unidas tarjetas poniendo un círculo al número o números de referencia. Sus consultas serán transmitidas a los fabricantes interesados de quienes tendrán noticias directamente a su debido tiempo. Las tarjetas enviadas desde el extranjero requieren franqueo.

SÍRVASE ESCRIBIR CON LETRAS MAYUSCULAS

For the Electronics Engineer ...

2 essential instruments

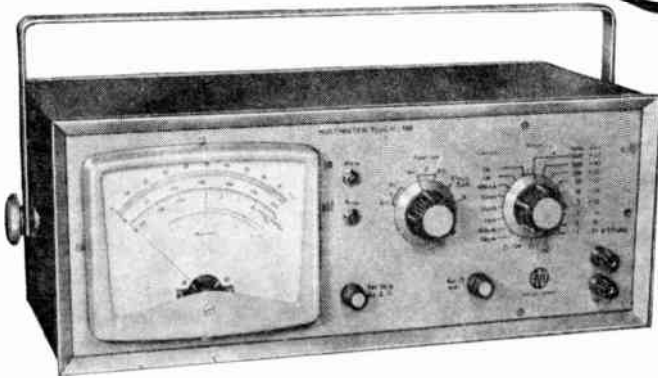

AVO MULTIMETER Type HI 108

A self-contained, battery operated, multi-range instrument for measuring a.c./d.c. voltage, a.c./d.c. current, resistance and decibels, with provision for measuring r.f. voltage using an external probe. Two transistorised amplifiers, one a.c., one d.c. form the basis of the multimeter. The d.c. amplifier, used for d.c. measurements, is a differential long tailed pair, stabilised by heavy negative feedback against supply voltage and temperature variations.

A dual input transistor reduces zero drift with temperature to a negligible value of the order of $24\mu\text{V}/^\circ\text{C}$, thus minimising operation of the set d.c. zero control.

A separate a.c. amplifier, used for a.c. measurements, is also stabilised by a high degree of negative feedback which also ensures the linearity of the a.c. scales. By using a probe, measurements up to 250 Mc/s can be made.

ACCURACY: d.c. $\pm 3\%$ f.s.d. a.c. $\pm 4\%$ f.s.d.

INPUT RESISTANCE: 1 M Ω /V to 30V, thereafter constant 30M Ω .
(a.c. & d.c. volts)

RANGES: Voltage a.c./d.c. 100mV to 1000 Volt in 9 ranges.
Current a.c./d.c. 30 μA to 3A in 8 ranges.
Resistance 0 to 20 M Ω in 3 ranges.

VOLTAGE DROP: The nominal potential drop as measured at the terminals at f.s.d. is 30mV on all a.c./d.c. current ranges.

STABILITY: Zero drift with temperature does not exceed 24 $\mu\text{V}/^\circ\text{C}$.

FREQUENCY RESPONSE: a.c. voltage/current r.m.s. 25 c/s to 50 kc/s,
r.f. voltage with probe up to 250 Mc/s.

Size: 16 x 7 $\frac{1}{2}$ x 6 $\frac{1}{2}$ in. approx.

Weight: 10 $\frac{1}{2}$ lb.

... Portable ... Battery operated

AVO In-Circuit Transistor Tester Type TT 162

A portable battery operated Transistor Tester for the "In-Circuit" testing of signal or medium power p.n.p. or n.p.n. transistors. Carefully designed circuits balance out the shunting effect of components around the transistor under test. A d.c. bridge circuit balances out the in-circuit components connected to the transistor collector and enables the collector current and voltage to be set to the required value. An a.c. bridge circuit balances out the in-circuit components connected to the base of the transistor under test and enables beta to be measured at the a.c. bridge frequency of approximately 1,000 c/s.

A battery check facility ensures that the supply voltages do not fall below the limit required for satisfactory operation. Overload protection is provided internally.

Size: 16 x 7 $\frac{1}{2}$ x 6 $\frac{1}{2}$ in. approx.

Weight: 10 $\frac{1}{2}$ lb.

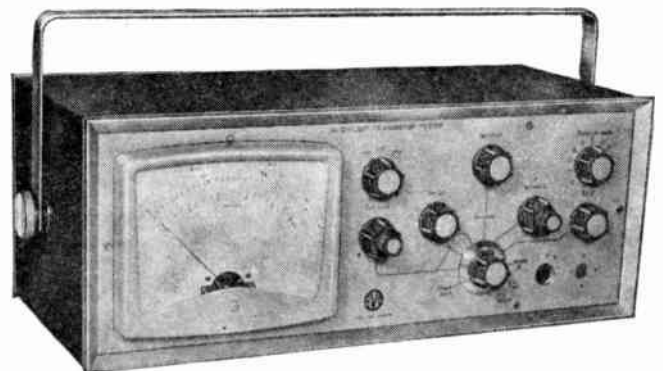

COLLECTOR VOLTAGE: (In-Circuit and Out-of-Circuit)
0-10V continuously variable.

COLLECTOR CURRENT: (In-Circuit and Out-of-Circuit)
0-10mA continuously variable, and additive steps of 10mA up to approximately 30mA.

CURRENT GAIN (Beta): (In-Circuit and Out-of-Circuit)
0-150 and 0-300 $\pm 5\%$ between $\frac{1}{2}$ f.s.d. and f.s.d. where external base loading is above 400 Ω .

LEAKAGE CURRENT I_{co}: (Out-of-Circuit only)
0-100 μA and 0-1mA.

● Ask for illustrated brochures giving full details of these and other Avo Instruments.

AVO LTD AVOCET HOUSE · 92-96 VAUXHALL BRIDGE ROAD · LONDON S.W.1

Telephone: VICtoria 3404 (12 lines)



The set is housed in a wooden box having carrying handles and a detachable lid. The overall dimensions are 17 x 12 x 10 in. and the weight is 43 lb. — *STC Testing Apparatus Division, Corporation Road, Newport, Monmouthshire.*

For further information circle 20 on Service Card

CONTROL

21. Water Circulation Controller

Baird & Tatlock have introduced a thermostatically-controlled water circulating unit which can be fitted to a variety of vessels to enable accurate temperature control to be maintained. Water can also be circulated around water-jacketed equipment by using an adaptor. The B.T.L. Circon unit has, therefore, many applications in research, development and control laboratories.

Temperature control is effected by means of a liquid-filled bellows system, situated within the spiral heater, which operates a high-capacity micro-switch. Water circulation is achieved by a centrifugal impeller, providing rapid dilution of heated water and a high rate of discharge. The temperature range that can be covered is from 10 to 90 °C.

The main advantages of the unit are reliability of the components, heaters, mechanical parts and electrical parts, all having been chosen for long life; the extreme lightness, the whole unit only weighing 5½ lb.; adaptability in that a depth of water as small as 2¼ in. can be circulated; high circulation rate; a thermostat which avoids the interference of external temperature variations.—*Baird & Tatlock (London) Ltd., 14-17 St. Cross Street, Hatton Garden, London, E.C.1.*

For further information circle 21 on Service Card

22. Metering Valves

The valves are rated for service from vacuum to 3,000 p.s.i. and it takes twenty turns of the handle to move the standard eight degree included-angle needle from the closed to the fully-open position. A special vernier handle is fitted for visual control and reference settings. For even finer metering characteristics, a one-degree spring-loaded spindle is available for valves with 1/8-in. orifice.

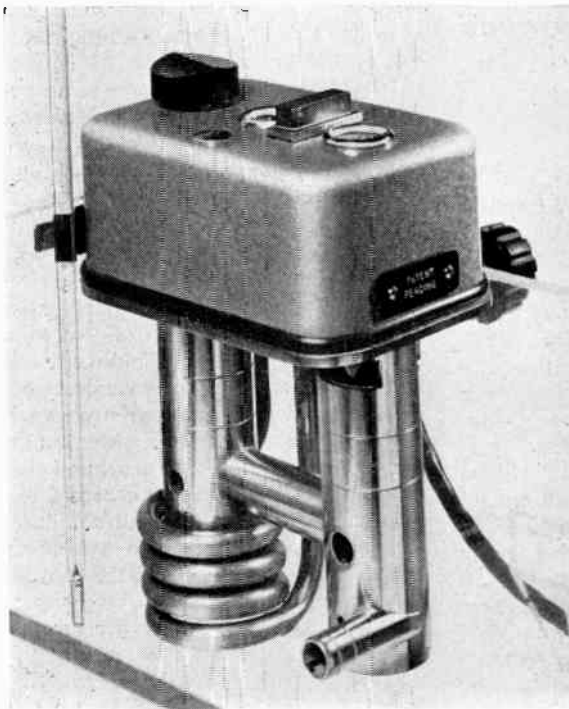

21

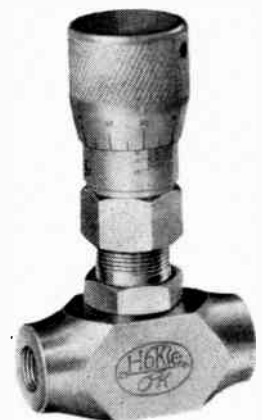

22

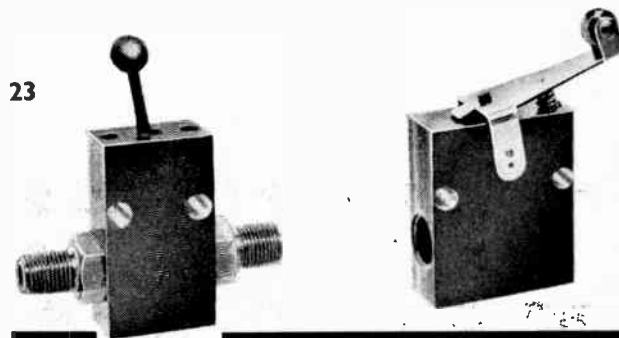

23

Operating temperature ranges are -40 to 200 °F for a brass model and -60 to 250 °F for a stainless steel one. The latter features a spring-loaded needle—to prevent galling and the possible enlargement of the orifice due to excessive tightening—which seats on a special stem insert for added protection. Globe and Angle patterns are also available with 1/4 or 1/2-in. connections.—*George Meller Ltd., 26 Hallam Street, London, W.1.*

For further information circle 22 on Service Card

23. Micro Valves

Meter-Flow Ltd. have introduced a range of toggle-acting micro-valves for general application in industry. All

valves are three-way two-position and use a snap action movement for positive seal; no sliding seals, packing or tight-fitting parts are used in the construction.

The valves are designed for continuous use over several million cycles of operation and are suitable for use with pressure up to 100 p.s.i. for a port size of 1/8 in., increasing to 250 p.s.i. for port size of 3/8 in. The standard equipment is manufactured with aluminium bodies and can be supplied with BSP, AN, NPT or metric threads. For applications in vacuum service, models can be supplied with special seals.—*Meter-Flow Ltd., North Feltham Trading Estate, Feltham, Middlesex.*

For further information circle 23 on Service Card

24. Electronic Events Timer

Timing events in minutes and seconds, and the facility to start timing at any pre-set value before or after zero, are the main advantages offered by the recently-introduced Fairey electronic events timer. Developed for industrial use, it records events up to a maximum of 100-min duration, after which it continues recording but recommencing from zero. The pre-setting allowance enables known delays, e.g., in starting mechanisms, to be catered for automatically. The starting and stopping of the timing sequence can be initiated by an external switch or photo-cell. These initiating signals can, alternatively, start the timer only, a separate mechanism being used to indicate the finish of the operation. A 100-c/s mains-driven oscillator is incorporated for general purposes, and for checking the equipment, but mains or battery operation in vehicles or remote locations is possible by using an external oscillator. The timer can be powered by 24 V or 12 V batteries.

The unit is fully transistorized, using

plug-in printed circuits, and can be linked to a camera to give a time print out on the film at intervals of 1/100, 1/50, 1/20 and 1/10 sec. — *Fairey Surveys Ltd., Reform Road, Maidenhead, Berks.*

For further information circle 24 on Service Card

25. Air Control Components

A wide range of miniature pneumatic control components is offered by Kuhnke Ltd., covering bidirectional and unidirectional air cylinders of $\frac{1}{8}$ -in. bore with maximum strokes of 5 in. and 2 in. respectively. Maximum operating pressure is 125 p.s.i. and the output force is claimed to exceed 6 lb. Miniature 3-way, 4-way and ancillary air control valves are also available, the basic dimensions of the 4-way valve being 1 in. by $\frac{1}{2}$ in. by $1\frac{1}{2}$ in.; their maximum operating pressure is 170 p.s.i. and the air flow rate at 85 p.s.i. is 5 c.f.m.—*H. Kuhnke Ltd., 163 Stanwell Road, Ashford, Middlesex.*

For further information circle 25 on Service Card

26. Press Mis-Feed Control

The unit is designed to protect expensive tools on high-speed presses but it can be used to detect an interruption

in any regular flow of parts. As each pressed part is ejected from the tool of the press a detector causes a pulse to be registered. A train of pulses is thus obtained, each one causing a relay to be held energized for an adjustable delay period. This delay is so arranged that it just holds the relay from one pulse to the next, the relay dropping out and stopping the press if a pulse fails. The press can only be started when the relay in the control unit is held energized, so a push-button box is supplied which contains 'start' and 'emergency stop' buttons, together with a pilot light. The control unit is housed in a metal case (10 in. \times 6 $\frac{1}{2}$ in. \times 5 in.) and contains power supply, transistor circuitry and output relay. Operation is on 230-250 V a.c. single phase, but other voltages can be supplied to order.—*Contronics Ltd., Garth Works, Deepcut Bridge Road, Blackdown, Nr. Aldershot, Hants.*

For further information circle 26 on Service Card

COMPONENTS

27. Low Series Resistance Capacitors

A range of miniature electrolytic capacitors with very low series resistance is announced by Plessey-U.K. Ltd. By using highly-conductive electrolytes, internal resistance has been reduced to a fraction of its usual value—a figure as low as 0.05 Ω has been confirmed on some samples, using a pulse measurement technique. The capacitors cover a range from 1 to 1,000 μ F, at working voltages up to 150 V; the operating temperature range is -30°C to $+40^{\circ}\text{C}$ or $+50^{\circ}\text{C}$, according to type. They are available in plain or etched foil type, with or without an insulating sleeve, and have a range of sizes.—*Plessey-U.K. Ltd., Kembrey Street, Swindon, Wilts.*

For further information circle 27 on Service Card

28. Resistance Transducer

A diaphragm-actuated transducer, the DR 10, has been designed to meet industrial requirements for gaseous and liquid measurements by K. D. G. Instruments. A range of pressure bands is available from zero to 50-in. WG to zero to 30 p.s.i., the diaphragm deflection being converted into an electrical signal via a potentiometer with a resolution of 1%. Each transducer

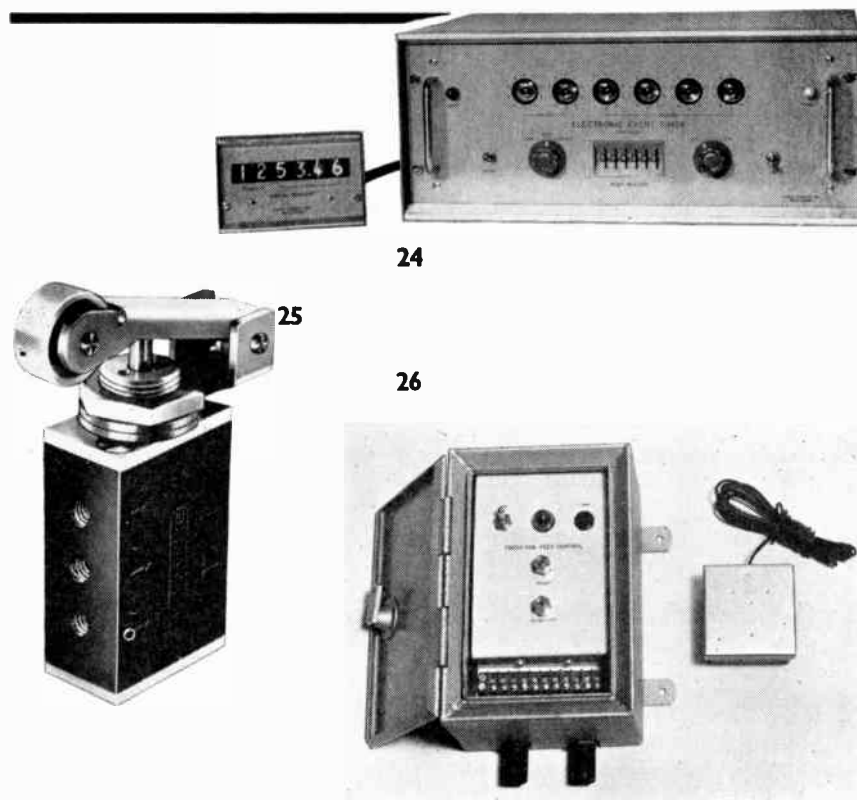

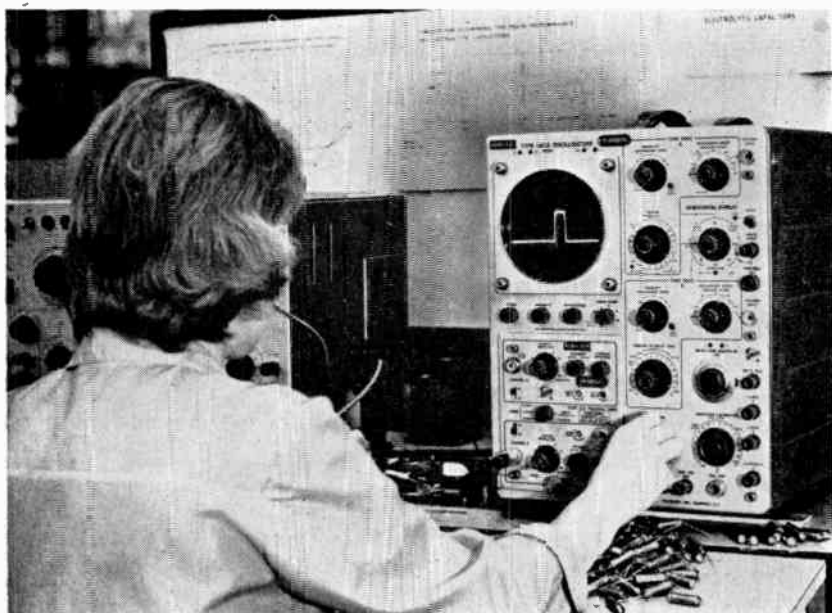

27



28

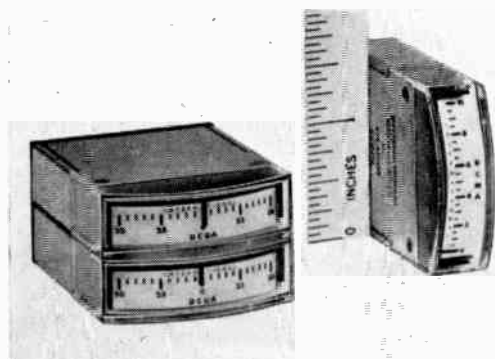

29

30

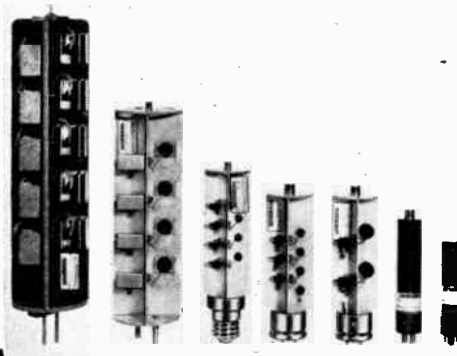

is supplied with a calibration curve and has an accuracy of $\pm 1\%$ over a range extending between 10% and 90% of the resistance value. The transducers can withstand up to 100% overload without rupture and barometric changes do not affect its accuracy. Between 80°C and -40°C there is a variation of 0.04% per degree from nominal temperature of 20°C and a standard 100 g shock test gives no change in calibration. — *K. D. G. Instruments Ltd., Manor Royal, Crawley, Sussex.*

For further information circle 28 on Service Card

29. Miniature Panel Meter

Developed in America, the instrument uses a single air gap moving-coil system which eliminates pivot misalignment problems and gives a high torque output. It measures 1.6-in. wide, 2.35-in. deep and 0.515-in. high

and weighs only 4 oz. It is available in 27 standard ranges, with sensitivities from $100\ \mu\text{A}$ or 50 mV f.s.d., with various zero positions and special scale arrangements. Initial accuracy is $\pm 2\%$ of full-scale value for d.c. ($\pm 3\%$ for a.c.) and its response time is 2.5 sec maximum.—*Leland Leroux Ltd., 145 Grosvenor Road, London, S.W.1.*

For further information circle 29 on Service Card

30. Silicon Avalanche Rectifiers

Introduced by Semikron Rectifiers and Electronics is a range of plug-in silicon avalanche rectifier assemblies designed to replace particular conventional valve rectifiers. Designed for high reliability and economy of operation, the range includes replacements for English and American types from 5R4GY to 857B.

The ratings for the type SKA4GY (replacement for the 5R4GY) are: peak inverse voltage 3,000 V, peak

surge current 90 A for 10 msec, and mean forward current 0.9 A.

A typical replacement for the 857B is type SKA 857/9600, consisting of series-connected 6-A avalanche diodes giving 10,000 V d.c. at 18 A from a three-phase bridge feeding into a choke-input filter. With forced-air cooling, the output of this assembly may be increased to 28 A average. All rectifiers are rated for operation at ambient temperatures of 50°C .—*Semikron Rectifiers and Electronics Ltd., 77 Gloucester Road, Croydon, Surrey.*

For further information circle 30 on Service Card

31. Microswitch Relays

A range of microswitch relays, based on the BPO 3000 and 600 standard types, and particularly designed for temperature control and sensing circuit uses, has been introduced by Key-switch Relays. Features include high

NEW ELECTRONICS INSTRUMENTATION CONTROL

contact ratings, low actuating forces, and a high (snap action) switching rate. Operating contacts are fully enclosed for suitability in hazardous atmospheres, and currents of up to 20 A at 480 V a.c. can be switched.

The three basic types available are BPO 3000 (multiple and single switch), and a BPO 600 type single switch. Working voltage (3000 types) is from less than 1 V d.c. to 300 V d.c., and up to 440 V a.c. with added components; on the 600 type it is from less than 1 V d.c. to 175 V d.c., and up to 440 V a.c.

D.C. resistance is from less than 1 Ω to 50,000 Ω for the 3000 types, and from less than 1 Ω to 10,000 Ω for the BPO 600.

Available variations on the standard range include double armatures on the BPO 3000 types, to allow for independent operation of the micro-switches.

Adjustable operating bias can be fitted to the 3000 single switch and 600 types, and manual-reset latching to

both the 3000 units. Coils can be tropicalized if required, and either screw or solder switch connections can be supplied.—*Keyswitch Relays Ltd., 120-132 Cricklewood Lane, London, N.W.2.*

For further information circle 31 on Service Card

32. Gated Symmetrical Switch

A gated symmetrical switch for full-wave proportional switching applications has been introduced by Texas Instruments.

By permitting full 0–360° control of a.c. power with one device, the new symmetrical switch replaces the functions of two silicon-controlled rectifiers and eliminates much of the associated circuitry. Offering direct full-wave control of a.c. mains power the new n-p-n-p-n semiconductor is ideal for such proportional control applications as light dimmers, appliance heating controls and universal motor controls. Because it is operated by a gate signal rather than a voltage pulse, the new TI gated device eliminates radio frequency interference and operates in inductive as well as resistive loads.

Typed TIC20-TIC23, the new TI device is available in both the auto-

motive press-fit package and a ¼-in. press-fit stud.

Electrical characteristics include high voltage capability—up to 300 V—for added protection against transient surges, conduction current of 5 A at or below 80 °C, and the power capability to control 600 W, 1,500 W peak.—*Texas Instruments, Inc., Semiconductor Building, 13500 North Central Expressway, Dallas, Texas, U.S.A.*

For further information circle 32 on Service Card

33. Spring-Connection Feed-Through Terminal

Sealectro has added another feed-through to its line of 'Press-Fit' terminals, this one with an inserted spring connection for the above chassis contact.

The FT-SM-901 TUR has a silver-plated turreted lug protruding from the minor diameter of the p.t.f.e. bushing. At the top termination there is a 0.128 in. hole into which a spring is inserted for electrical connection. A special tool, B-22-X-3, is available for rapid, positive installation. The bushing is of 100% p.t.f.e. available in any of the ten standard EIA colours.—*Sealectro Ltd., Hershaw Trading Estate, Walton-on-Thames, Surrey.*

For further information circle 33 on Service Card

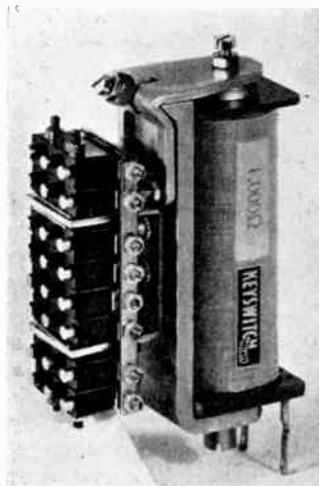

31

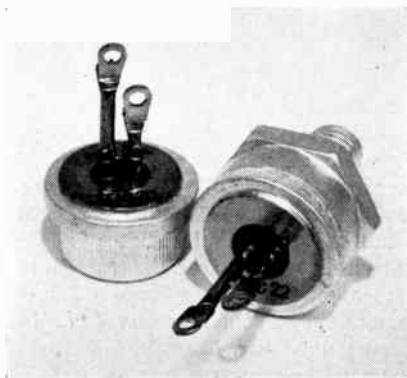

32

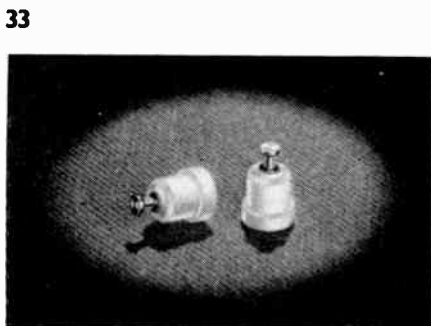

33



34

34. Pneumatic Counter

Veeder-Root Ltd. have introduced a general-purpose 6-figure pneumatic counter for use in pneumatic equipment where no mechanical coupling is possible, and where an electrical supply is inconvenient or impracticable.

The unit (3.5 by 1.26 by 1.25 in.) will count up to 600 c.p.m., has a recommended operational pressure of 60–80 p.s.i. and contains a re-set knob.—*Veeder-Root Ltd., New Addington, Surrey.*

For further information circle 34 on Service Card

35. Variable Capacitor

Designed for a.m. and f.m. tuning, with a wrapped-round steel chassis construction, capacitances available are 392 pF in the a.m. sections and 15 pF in the f.m. sections; a centre screen is provided to protect the front and rear sections. The f.m. sections employ a wide air-gap of 0.018 in. and a heavy-gauge vane material which ensure a high degree of rigidity and electrical stability. Gear and pinion drive is mounted internally to provide a 3 to 1 reduction and the capacitor,



TWO WATT PHOTOCELL

THE '5M' SERIES—
NEWEST ADDITION TO THE
CLAIREX RANGE OF
PHOTOCELLS

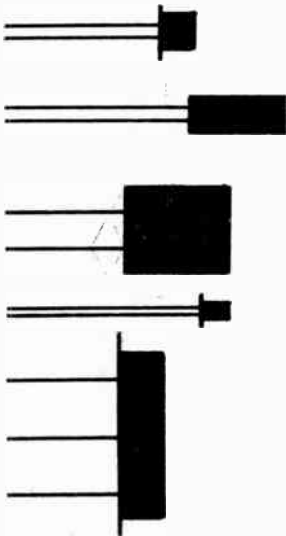
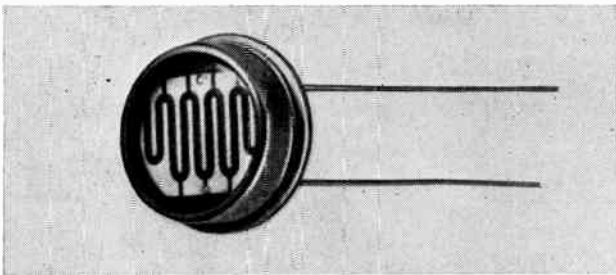

OVER 50 STANDARD
TYPES

6 PACKAGE TYPES

6 STANDARD
SENSITIVE
—MATERIALS
CdS and CdSe

SOME INTERESTING FEATURES

Type 3C material (CdSe) developed specifically for photo-choppers:— rise time <0.4 msec, fall time <3.0 msec.

CL 703 series—dual element types.

Type 5 material matches response of the human eye.

Small size series—T018 transistor can.

Send for copy of 16 page catalogue

WALMORE

ELECTRONICS LTD

11-15 BETTERTON ST., DRURY LANE, LONDON, WC2 Tel: TEMple Bar 0201-5



LOW VOLTAGE D.C. POWER SUPPLY SUB-UNITS



SINGLE OUTPUT (PRESET)

MSA	0-25V @ 1A or 0-30V @ ½A	£28
MSB	0-25V @ 2A or 0-30V @ 1A	£34

TWIN OUTPUT (PRESET)

MTA	2 x 0-25V @ ½A or 0-30V @ ½A	£39
MTB	2 x 0-25V @ 1A or 0-30V @ ½A	£46

GENERAL DESCRIPTION

The output is factory preset to the customer's requirement but an adjustment of approximately plus or minus 1 V can be effected by an internal trimmer potentiometer.

A different output voltage can be achieved by the alteration of three resistors on the circuit board and adjustment of the transformer tapplings. The units can also be operated in series or parallel.

Overload protection is given by current limiting circuitry which reduces the output current on short circuit but resets automatically on removal of the overload condition.

The units are compact and have four fixing bushes at the top and bottom for ease of mounting. As cooling is by convection provision must be made for free air flow, and stand off bushes are supplied should it be necessary to mount the unit on a plane chassis.



FARNELL INSTRUMENTS LIMITED

SANDBECK WAY · WETHERBY · YORKS · Phone 26912/3/4

Sales Engineers in London area and all parts of the U.K.

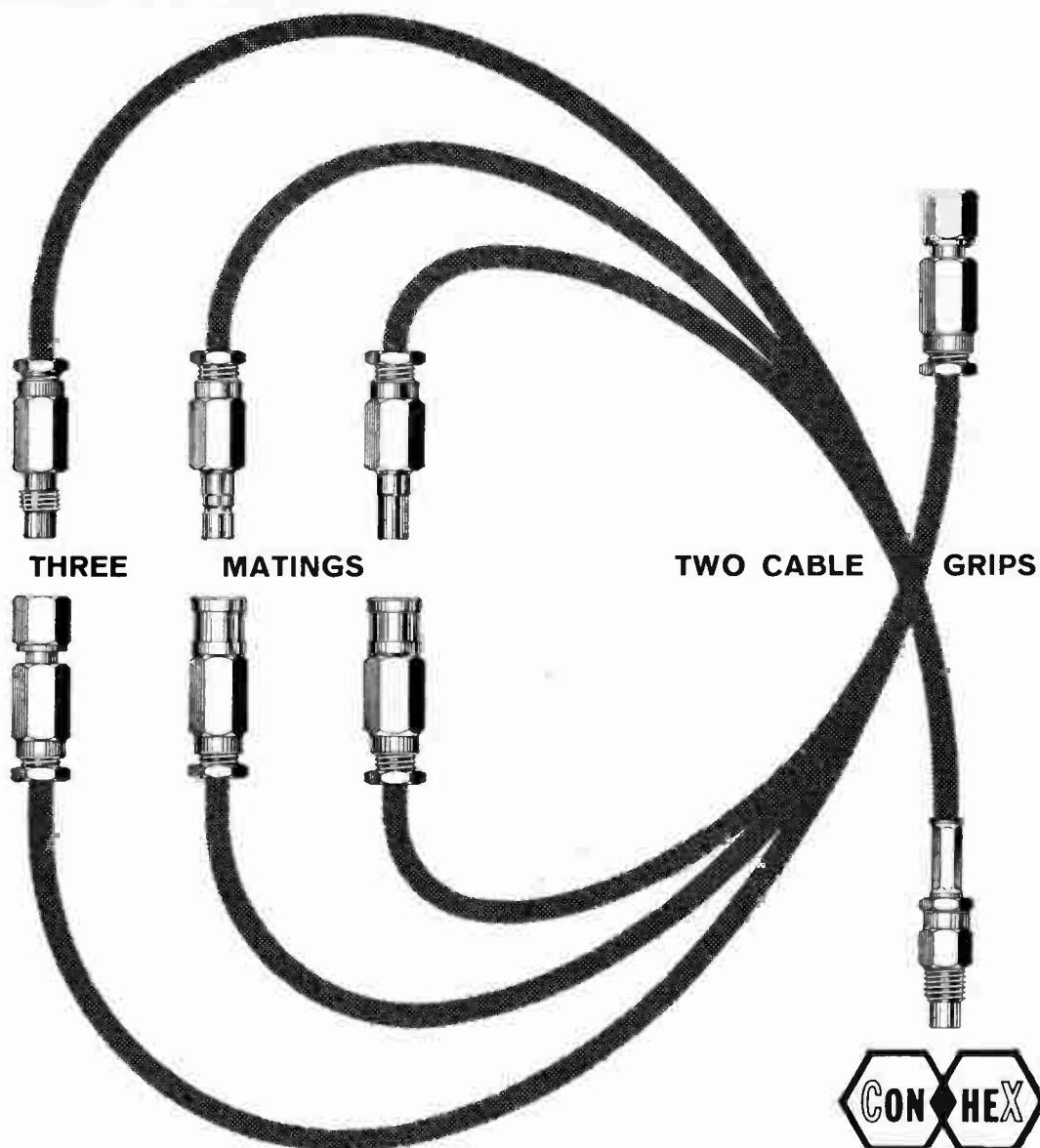

SUBMINIATURE R.F. CONNECTORS

Three matings—screw-on for positive mechanical engagement—snap-on for positive mechanical engagement when space precludes the use of spanners—slide-on for a light yet really reliable electrical and mechanical engagement.

Two cable grips—clamp type—for easy assembly in the field without the use of special tools—crimp type—for high production rates of assembly. Both types grip the cable with a strength in excess of the cable's breaking strain.

Over 300 functional configurations—straight or angled—cable end or chassis mounting—50 and 75 ohm impedance—full range of adapters to BNC, TNC etc.—Flexible or Semi-rigid cables.

Heavily gold-plated for minimum resistance and maximum protection—matched impedance for top performance. Produced to MIL-C-22557 and shortly to DEF 5322A (Prov.).

SEAELECTRO LIMITED

WALTON ROAD, FARLINGTON, PORTSMOUTH, HANTS. TEL: COSHAM 70323

which measures 2.4 in. by 1.9 in. by 1.3 in., can be mounted on any of the four faces of the chassis.—*Wingrove and Rogers Ltd., Paramount House, Ealing, W.5.*

For further information circle 35 on Service Card

36. X-Band Travelling-Wave Tube

This low-noise travelling-wave tube is packaged in a single-reversal, permanent-magnet mount and has a typical noise factor of only 9 dB. It is designed to work from a 1,200-V d.c. supply and to provide a gain of over 35 dB in the frequency range 7 to 11.5 Gc/s, the maximum output being in the range 2 to 15 mW. The unit is fitted with tapered waveguide transitions to WG 16 and alternative versions can be provided with coaxial connectors.

Tube positioning can be adjusted, in manufacture, to give an optimum noise factor within the particular narrow frequency band specified by the customer; low-noise travelling-wave tubes are also available for operation in S-band.—*Standard Telephones & Cables Ltd., Valve Division, Brixham Road, Paignton, Devon.*

For further information circle 36 on Service Card

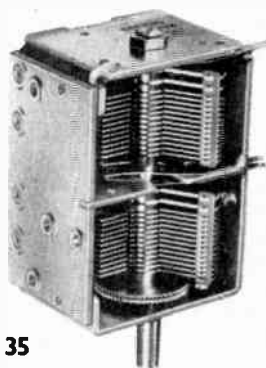

35

NEW ELECTRONICS INSTRUMENTATION CONTROL

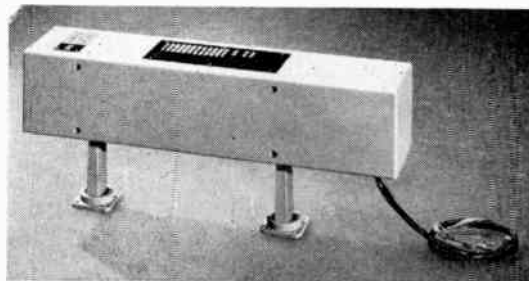

36



37

PRODUCTION AIDS

37. Plastic Gaskets

Loctite Plastic Gasket is a polymer material which can be applied directly from its bottle, through a ribbon nozzle, to a flange or housing face. Its principle is that it will flow freely over the flange surface, filling any low areas, and when the joint is made it will flow equally freely on to the other face; the joint is then tightened and metal to metal contact is achieved between the flanges, any cracks being filled. It cures, without shrinking, into a tough impervious solid, and will do so in the absence of air and in contact with most metals. The temperature limitation of the material precludes its use on steam lines and it is not recommended for normal use above 300 °F.—*Douglas Kane (Sealants) Ltd., Swallowfields, Welwyn Garden City, Herts.*

For further information circle 37 on Service Card

38. Timer/Batch Counter

This industrial counter has a maximum counting speed of 5,000 per sec and

uses a combination of transistorized circuitry and cold-cathode counting tubes. The instrument has four decades and will batch any quantity up to 9999, or it can be used for programme control or cycle timing up to 99.99 sec in units of 0.01 sec; an adjustable pre-batch or pre-time signal provides a warning signal or control function. A multipoint programme

plug is fitted on the rear panel and the input, output and reset arrangements can be varied to meet most requirements. Standard or special programme plugs can be supplied or can be wired by customers from the instructions provided.—*Advance Controls Ltd., Imperial Lane, Cheltenham, Glos.*

For further information circle 38 on Service Card

38



39. Magnet Charger

For the manufacture of very large magnets a 2-kV 2,400-watt-sec charger has been developed with fixtures capable of developing up to twenty million amp. turns. The equipment takes only 7 A from a 240-V single-phase supply during the recharge period and is capable of giving a pulse every 6 sec, the controls being devised so that the operator cannot discharge the charger until the pre-set voltage has been reached.—*Hirst Electronic Ltd., Gatwick Road, Crawley, Sussex.*

For further information circle 39 on Service Card

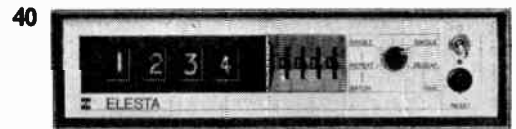
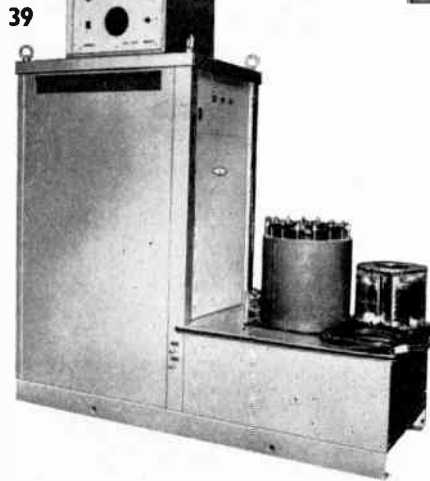

40. Industrial Electronic Counters

Elesta Electronics are introducing a range of batching and timer-counters with pre-selection facilities to cover a maximum counting rate of 100 kc/s.

The range includes a miniature pre-selection counter with 3 and 4 decades, universal pre-selection counter/timers (with double pre-selection if required) with 4 and 5 decades and a measuring counter with 4 and 5 decades. A number of ancillary items is also available.—*Elesta Electronics Ltd., 34 Cambridge Park, Wanstead, E.11.*

For further information circle 40 on Service Card



41. Portable Metal Marking Kit

Designed for the permanent electrolytic marking of metals, the kit consists of a power unit, electrolytes, cleaners, a selection of markers and stencil papers. A choice of two power units is available to give either manual or automatic timing, either of which is capable of marking metal in a matter of seconds. Two general-purpose electrolytes are provided in squeeze bottles, one being suitable for ferrous and the other for non-ferrous metals. Similarly, two cleaners are also supplied. Both 1-in. dia. and 1-in. x 1/2-in. rectangular reservoir type cartridge markers are included, together with three hand markers measuring 1 in. x 1/2 in.; 1 1/2 in. x 3/8 in.; and 1 1/2 in. x 3/4 in. to cover any requirements. A box of die-impression stencil paper is also provided to enable users to prepare their own stencils with the aid of a typewriter or ball-point pen.—*Lectroetch (Gt. Britain) Ltd., Spur Road, North Feltham Trading Estate, Feltham, Middlesex.*

For further information circle 41 on Service Card

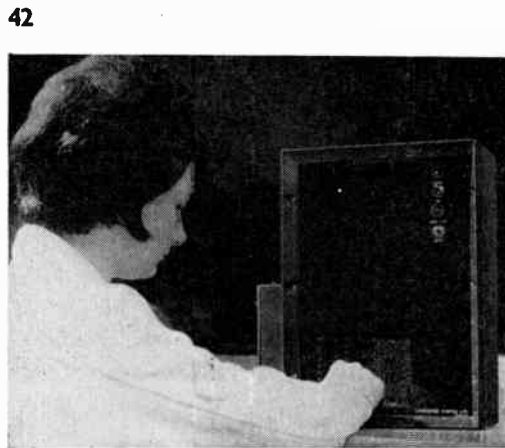

42. High-Speed Batcher

A high-speed batcher capable of counting 1,200 components or completed products a minute, from ball bearings to biscuits, and batching them at a rate of up to five times a second, has been developed by Livingston Control.

The latest addition to the company's range of solid-state control systems, the LC501 fast batching counter has been designed to help speed-up packaging processes. It is specially suited for fast automatic-batching operations into individual packs or containers.

One of the features of the unit is its built-in logic circuitry which enables a main and secondary batching pro-

gramme to be handled. When a pre-determined number of batches has been counted, the sub-programme can be brought into action to re-route production flow or actuate another process.

The batcher employs a digital read-out and can be used in conjunction with photo-electric, inductive or capacitive sensors. A batch-totalling counter can be included in the equipment if required. The batcher employs all-transistor circuitry and uses a solid-state output power switch.—*Livingston Control Ltd., 31 Camden Road, London, N.W.1.*

For further information circle 42 on Service Card

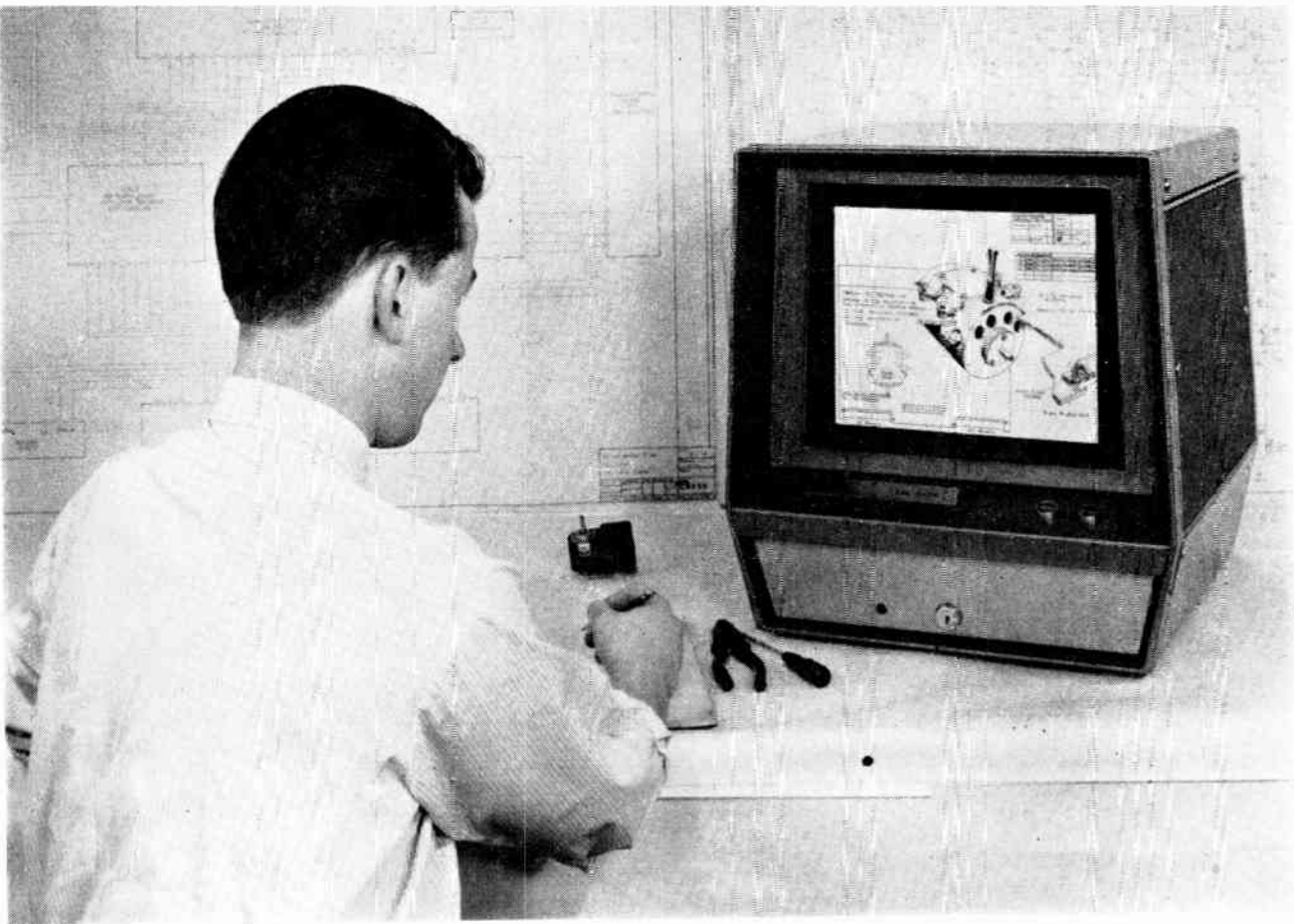

This shows an apprentice using a tm 1024 to study the basic construction and principles of an electric motor and its various applications. As practical diagrams are included in this programme a small electric motor is used by the apprentice to test his observation

New Digital Teaching Machine

LDEP of Rugeley has manufactured on behalf of Educational Systems a new teaching machine called the tm 1024.

The tm 1024 is a fully-transistorized machine based upon digital techniques and uses a 35-mm back-projection system. It is the only machine of its kind: all programme movements irrelevant to the learning process have been eliminated. The tm 1024 has only two control buttons for the student to operate, a 'yes' button and a 'no' button.

The film is loaded on to two spools mounted on a retractable tray in the lower part of the machine. This tray also contains the spool motors, pinch-roll drive, light source and optical lens assembly.

The film transport and mechanism system has been kept as simple as possible. Mechanical brakes and clutches have been avoided. The two spool motors are permanently energized to drive in opposite directions thus holding the film in tension and preventing spillage. The film movement is achieved by means of a pinch-roll drive from a reversible d.c. motor through a worm and pinion. This motor has dynamic braking and can stop the film within ± 0.02 in. thus achieving the required positional accuracy.

The light source is a 100-W quartz iodine lamp which ensures good viewing under high ambient light conditions.

The 'yes' and 'no' buttons select the next phase of the programme to be viewed as follows:

Down both the vertical edges of each frame is a binary code consisting of clear and opaque areas which indicate the number of frames to the next frame to be viewed and the direction of travel. Thus if the 'yes' button is pressed the code on the right edge of the frame is stored in the

register. On releasing the button the pinch-roll drive is energized in the required direction of travel and as each frame passes a photocell it is counted and subtracted from the contents in the register. If the film is more than one frame away from the required position, the drive is energized 'fast', that is six frames per second; when it is one frame away the speed is reduced to half a frame per second, thus when the register is at zero the new frame has been reached and the drive motor is de-energized.

Pressing the 'no' button causes a code on the left-hand edge of the frame to be transferred into the register and a similar action then takes place. The coded information is read by two groups of ten photocells positioned on each side of, and behind, a screen. Nine of these photocells detect the code and the tenth determines the direction of travel. A further cell is used for counting the film frames.

To avoid eye strain and distraction due to the flickering effect caused by the fast movement of the film a shutter is brought into operation under automatic control.

The electronic circuitry is fully-transistorized and is mounted on plug-in printed-circuit boards, as used in industrial control systems, which ensures the high degree of reliability required by industry.

The original research work on the tm 1024 was carried out by The National Physical Laboratory. The tm 1024 has been developed and is manufactured by LDEP for Educational Systems Ltd. of Ruislip.

The machine is fully covered by patent number 968601.

The price of the machine in the United Kingdom will be less than £300.

For further information circle 43 on Service Card



Personal News

John D. Clare, M.Sc., A.M.I.E.E., managing director of Standard Telecommunication Laboratories for the last 2½ years, has been appointed technical director of I.T.T. Europe Inc. **G. K. Duddridge, B.Sc.**, has been appointed general manager of the submarine cable division of S.T.C., having been manager of the division since its formation in 1955.

J. Milton has been appointed marketing director of G.E.C. (Electronics) Ltd. and will be based at the company's East Lane, Wembley headquarters. He will be responsible for marketing and sales activities for the company's group of nine divisions located at Wembley, Coventry, Portsmouth and Stanmore.

Michael F. Briggs, B.A., director of Rotork Engineering Co. Ltd., Bath, has been appointed joint managing director of the company with Mr. Jeremy Fry, founder of the firm.

Brian Arbib has been appointed a director of Multicore Solders Limited. Mr. Arbib, who has been with Multicore Solders since 1954, is now responsible for advertising and purchasing.

Victor D. Fenton, director and general manager of International Rectifier Company (Great Britain), has been appointed managing director. The company is owned jointly and equally by the M.I. Group and International Rectifier Corporation, Los Angeles.

On the retirement of **C. R. Jeffries**, the sales director of London Electrical Manufacturing Co. Ltd., **J. D. Dale-Lace, D.F.H., A.M.I.E.E.**, has been appointed to succeed him.

Following further expansion in the United Kingdom, Electronic Associates Limited, of Burgess Hill, Sussex, have appointed **C. R. Peter** managing director, with an overall company responsibility. **S. A. Lacey** retains overall control of the instrumentation division in the new position of alternate director and deputy to the managing director.

David R. Mallett has become contracts manager of Ultra Electronics Limited. He was formerly an executive sales engineer with the telecommunications division.

Honeywell have announced the appointment of **L. R. Price** as managing director of Honeywell Controls Ltd. and regional manager of the company's Scandinavian operations.

G. A. King has been appointed sales manager of the Plessey Industrial Electronic Components Division at Ilford. Mr. King joined Plessey last October from G.E.C. Electronics Limited (North Wembley).

R. D. Haxby, director of the military systems and simulation division of the Solartron Electronic Group Ltd. has now assumed the additional responsibilities of director, computing and data systems division.

J. P. A. Grant has been appointed field sales manager of Morganite Resistors Ltd. He will be responsible for the supervision and training of all salesmen in the U.K.

The Board of I.C.T. have announced that **Peter D. Hall, B.Sc.**, has been appointed an executive director of the Company.

Two new appointments within the E.D.P. Division of Honeywell Controls Ltd., have been made. **William Billis** is now the commercial manager and **Brian Long** is the manager of customer services within the U.K.

J. E. Gill has joined EMI Electronics Ltd. as assistant to **Roy Smith**, manager of commercial division's northern office at 30 Cannon Street, Manchester.

A. S. Pudner, M.B.E., M.I.E.E., has been appointed engineer-in-chief of Cable and Wireless Ltd. and associated companies. He will take over from **Donald Scott**, who will retire at the end of September.

S. R. Jarvis, formerly sales manager of Advance Controls at Cheltenham, and **P. G. Moore, A.C.A.**, secretary of Advance Electronics at Hainault, have been appointed directors on the board of Advance Controls—one of the Advance Electronics group.

Birthday Honours

Knighthood

B. A. Williams, C.B.E. (Former Chairman of Westool Ltd.).

K.C.B.

Sir R. E. German, C.M.G. (Director-General, General Post Office).

C.B.

G. G. Macfarlane (Director, Royal Radar Establishment, Ministry of Aviation).

J. A. Ratcliffe, C.B.E. (Director, Radio and Space Research Station, Science Research Council).

ONE MILLION AVOS.—*Avo—a member of the Metal Industries Group—has just produced its millionth multimeter. The Swedish Ambassador to the U.K. is here shown (right) presenting it, on behalf of the Company, to a representative of the Royal Swedish Air Force. Mr Stig von Melsted (left), Avo's representative in Sweden, was also at the ceremony, which took place at a luncheon at Olympia*



K.B.E.

W. Cawood, C.B., C.B.E. (Chief Scientist, Ministry of Aviation).
F. C. Wright (Director, Standard Telephones and Cables Ltd.).

O.B.E.

T. H. Bridgewater (Chief Engineer, Television, British Broadcasting Corporation).
D. Scott (Engineer-in-Chief, Cable and Wireless Ltd.).

M.B.E.

E. A. Thorogood (Chief Telecommunications Superintendent, North Area, London, General Post Office).

B.E.M.

L. C. Ware (Production Supervisor, Mullard Radio Valve Co.).
S. C. Dell (Rank Pullin Controls).

Company News

Two of the biggest manufacturers of hydraulic equipment in the U.S.A. have joined forces to launch a manufacturing subsidiary in Britain. The new Company is named **Tektro-Webster Ltd.**, and its shares are owned jointly by the Applied Power Industries group, Milwaukee, and the Webster Electric Company of Racine, Wisconsin. The object of the new Company is to manufacture Webster equipment for the British and Continental markets. The address of Tektro-Webster Ltd. is: Turnell's Mill Lane, Wellingborough, Northants.

Honeywell Controls Ltd. have opened new offices of their Electronic Data Processing Division, at Faulkner House, Faulkner Street, Manchester 1. The full range of Honeywell's EDP supporting services, including customers' programming and systems advice, maintenance service and training facilities, will be provided for the North-England area from these offices.

The Leeds Meter Company Ltd. announce that their London Office and the registered office of their subsidiary Reginald Christie & Dickinson Ltd., is now at Kingsway House, Kingsway, London, W.C.2. Telephone No. Holborn 3561.

Hawker Siddeley Dynamics have announced the formation of a separate division to expand their aerospace knowledge and techniques into general industry. This division, known as Industrial Automation, will be marketing digital recorders, two-way data-transmission links for measurement and control, and a range of instruments and logic elements.



EUROPE'S LARGEST C.C.T.V. SYSTEM.—The largest closed-circuit television system in Europe is now in operation in the Ministry of Defence building in Whitehall. The network has been designed to use 32 camera channels, feeding 70 different locations with up to 100 screens; the whole system is remotely controlled—from one main control room in the heart of the Ministry building—by an operator who sits at a console where requests for vision links are received and where he can monitor any of the sound or vision connections.

The network was designed and installed to Ministry requirements by Peto Scott Electrical Instruments Ltd., of Weybridge, using Hi Q cameras and studio monitors. Both mobile and static cameras are used in the system, which will speed up and clarify the transmission of information within the Ministry and provide additional security. The switching matrix for the nerve centre of the network is a solid-state unit and crosstalk figures are better than 48 dB.

The picture gives a general view of the Control Room. There are 32 pre-view picture monitor screens and all the cameras are remotely controlled by the engineers at the panels beneath the monitor screens.

Anthony Pratt & Co. Ltd., of New Malden, Surrey, announce the opening of a Midland Office at Victoria Works, Vittoria Street, Birmingham 1. Norman Ferris, previously of Rubery Owen & Co. Ltd. (Mechanair Division), has been appointed Midland manager.

The National Research Development Corporation has moved to new offices in Kingsgate House, Victoria Street, S.W.1.

Rohde & Schwarz and Schomandl, both of Munich, West Germany, have concluded an agreement covering the development, manufacture and sales of frequency synthesizers. Rohde and Schwarz have taken over all sales of Schomandl equipment on a world-wide basis, and a series of transistorized synthesizers of modular design has already been added to the established lines of both companies.

Electronic Machine Group have transferred their headquarters from Bromley to the existing offices and works of their subsidiary company, Vaewell Engineering, at Willow Lane, Mitcham, Surrey, telephone, Mitcham 7080. The sales and administration departments of another subsidiary, Electronic Machine Control, are now also operating from this address.

Digital Measurements Ltd., part of the Dynamco Group, has been renamed **Dynamco Instruments Ltd.** The company's existing and planned range of digital voltmeters will, however, continue to be marketed under the Digital Measurements' trade mark and name. Dynamco Instruments will concentrate on expansion in other fields of instrumentation.

The Cressall Manufacturing Co. Ltd., Cheston Road, Birmingham 7, the electrical engineering subsidiary of The Expanded Metal Co. Ltd., announce the acquisition of S.C.E.E. Ltd., Sutton Coldfield, manufacturers of printed circuits and electronic equipment.

Thomas Mercer Limited, of St. Albans, Herts., have formed an entirely new Company to specialise in consultancy, design and the supply of pneumatic, electronic and mechanical gauging systems.

Cooper Compressors Ltd., Letchworth, Herts., have changed the name of the company to Bell & Gossett Ltd. Cooper's, an American-owned subsidiary, produce a range of rotary pumps and exhausters and **Bell & Gossett** are known for their oil-free reciprocating compressors.



BRITISH RAIL REMOTE-CONTROL SYSTEM.—Sixty feet long and faced with over 50,000 mosaic tiles, this mimic diagram is being constructed at British Rail's new Willesden electric control centre. When it is finished, engineers will be able to monitor and control the distribution of electric traction power over the final section of the London to Manchester and Liverpool electrification scheme.

The diagram is part of a remote-control system supplied by Automatic Telephone and Electric Co. Ltd., and by having the controls, indicators and diagram elements contained in the one-inch plastic tiles, future modifications to the power network can be simply effected by re-arrangement or replacement.

Besides controlling the 25,000 V a.c. overhead supply already mentioned (represented by the left-hand panel), the equipment will also control the existing 650 V d.c. four-rail system between Watford and Euston (right-hand panel)

G.E.C. is developing its activities in the computer field. Following the company's acquisition of the Bunker-Ramo shareholding in International Systems Control Ltd., a range of digital computers for industrial control applications is to be manufactured.

SGS-Fairchild Ltd., Ruislip, is to build a second plant in the United Kingdom. The new factory will concentrate on the production of silicon planar integrated microcircuits and semiconductor devices for the total planar consumer range. The Ruislip plant will expand production of transistors, diodes and special products and remains the sales, administrative and applications research headquarters in the United Kingdom.

Electronic Aid to Agriculture

An electronic instrument, which accurately measures the amount of sunlight falling on any crop, is now being developed by British Telecommunications Research Ltd., of Taplow.

Known as an integrating solarimeter, it not only indicates when a crop needs watering but also calculates exactly how much it requires, thus allowing optimum growing conditions to be maintained.

The instrument consists of a panel of series-connected silicon photovoltaic diodes, which convert light energy into electrical energy. Their output produces a voltage proportional to the light input and provides the necessary power to operate a transistorized circuit. This, in turn, operates an electromagnetic numerical counter, which is calibrated in the standard meteorological units of milliwatt-hours per square centimetre.

COMPUTER TYPE-SETTING.—The first "Computerset", a computer type-setting system, is shown here undergoing commissioning tests at Elliott-Automation's Borehamwood factory. Soon to go into service with the Thomson paper, the Reading Evening Post, it is built around an Elliott 803 and is expected to increase productivity by 30%. The one computer serves twelve compositors who each have a keyboard, printer and associated tape punch. The 803 memorizes the whole of the required layout and prepares the copy (fed to it by the compositors) in the form of punched paper tape for the control of type-setting machines

Electronic Nurse-Call System

An electronic nurse-call system is to be installed at St. Albans City Hospital, St. Albans, Hertfordshire. The luminous system incorporates two-way speech facilities between patient and nurse which are superimposed by means of a patient-operated telephone handset.

A privacy relay in the circuit ensures that conversations between patient and nurse cannot be overheard, and, if required, two adjoining wards can be linked through the nurses' station.

The system is being supplied by the television and educational equipment department of G.E.C. Electronics' Industrial Division, Wembley, Middx.

Automated Drip Feed System Introduced

Decca Radar Ltd., have entered the field of medical electronics and automation. An automated transfusion unit, based on the Decca Mastercount photo-electric technique, has been exhibited which is capable of administering and controlling a transfusion without supervision.

A Practical Approach to Analogue Computers

The illustration on p. 277 of the June issue was reproduced by permission of the General Electric Co. Ltd. and shows the installation at Erith, Kent.





NEW BOOKS

British Instruments Directory and Data Handbook

Produced in co-operation with The Scientific Instrument Manufacturers' Association (S.I.M.A.). Pp. 594. United Science Press Ltd., 9 Gough Square, London, E.C.4. Price £8 8s.

This fifth edition of the 'British Instruments Directory and Data Handbook' features a completely new section. This is entitled 'Measuring Instruments Survey' and it consists of 118 pages of data sheets giving technical details of instrument systems for measuring fundamental physical conditions.

The directory has thus become a comprehensive handbook and its title has been changed to indicate its new scope. Formerly it was known as the British Instrument Directory and Buyers' Guide.

The 118 pages of data sheets in this section of the directory give details of instrument systems for measuring temperature; pressure; flowrate; weight; strain; linear displacement; angular displacement; linear acceleration; angular acceleration and angular velocity.

In addition to the new section this latest edition of the directory lists over 1,700 British manufacturers of instruments and components, together with foreign agents. Nearly 3,000 classified headings are included in the classified section with 100 new headings for instruments and components. The specification section has been amplified by the inclusion of RCS, RCL and DEF specifications (issued by the Radio Components Standardization Committee of the Ministry of Aviation and the Ministry of Defence) relating to instrument components. There is also a glossary of terms in five languages.

Brimar Valve and Cathode Ray Tube Manual No. 10

Pp. 415. Published by Thorn-AEI Radio Valves and Tubes Ltd., 155 Charing Cross Road, London, W.C.2. Price 7s. 6d.

This Manual gives data on 629 types of Brimar valves and tubes. Industrial cathode-ray tubes and industrial switching transistors have been added for the first time. Adequate design data with curves is given for 'Current Equipment' types, full data without curves for 'Maintenance' types, and abridged data for all the 'Obsolescent' and 'Obsolete' types back to the beginnings of Brimar.

In addition to valve and tube data, the Manual contains other useful reference material, such as designers' selection tables both by valve construction and by application, operational recommendations for designers, new Brimar circuits, an up to date list of British sound and T.V. broadcasting stations' channels and frequencies, radio formulae, component colour codes and Brimar's largest ever equivalents list containing over 1,200 commercial and C.V. types.

The book is arranged in a new self-indexing manner so that all valves may be looked up directly by type number without knowing the valves' classification. A Continuing Index at the foot of the main data pages gives the cross reference to data given under alternative nomenclatures and to abridged data for 'Obsolete' types. Equivalent and C.V. type numbers are given on each main data page, in

addition to the separate equivalents list. The introduction, explaining the self-indexing system, is given in English, French, German and Spanish.

The book is intended primarily for the designer of industrial electronic equipment, but it will also prove a valuable reference for maintenance and service engineers.

National Physical Laboratory Report for 1964

Pp. 277 + viii. Published by the Ministry of Technology and available from Her Majesty's Stationery Office, York House, Kingsway, London, W.C.2. Price 20s.

Glossary of Terms Used in Telecommunications (Including Radio) and Electronics : Supplement No. 2

Supplement No. 2 (1965) to B.S. 204:1960. Pp. 19. British Standards Institution, 2 Park Street, London, W.1. Price 5s.

Rapid developments in the terminology relating to semiconductors and semiconductor devices have made it necessary to supplement B.S. 204, although this was fully revised in 1960.

In this supplement No. 2 it has been found possible to include very many terms which have been agreed internationally since 1960.

The supplement supersedes subsection 22 of B.S. 204.

Precision Sound Level Meters

I.E.C. Publication 179. Pp. 26. Available from British Standards Institution, 2 Park Street, London, W.1. Price 25s.

Published by the International Electrotechnical Commission, this applies to sound level meters for high precision apparatus for laboratory use, or for accurate measurements in which stable, high fidelity and high quality apparatus is required. A sound level meter is, generally, a combination of a microphone, an amplifier, certain weighting networks, an attenuator and an indicating instrument having certain dynamic characteristics.

The object of this publication is to specify the characteristics of an apparatus for measuring accurately certain weighted sound pressure levels. The weighting applied to each sinusoidal component of the sound pressure is given as a function of frequency by three standard reference curves called A, B and C.

Electronic Transformers

By HAROLD M. NORDENBERG. Pp. 298 + x. Chapman & Hall Ltd., 11 New Fetter Lane, London, E.C.4. Price 108s.

A complete guide to the design, construction and application of electronic transformers.

The Dimensions of Punched Paper-Tape for Data Processing

British Standard 3880 : 1965. Pp. 11. British Standards Institution, 2 Park Street, London, W.1. Price 5s.

As part of an intensive standardization programme for the data-processing and computer industry, work has been in hand for some time now within a BSI technical committee on two related specifications for punched paper tape.

The first of these, dealing with tape dimensions and with the size and position of the punched holes, has now been published as B.S. 3880.

The second related British Standard, which will cover the material and properties of punched paper tape, has not yet been completed because of the more complex technical difficulties involved; it is expected to be available by the end of the year.

Digital Computers in Action

By A. D. BOOTH, D.Sc., Ph.D. Pp. 146 + vii. Pergamon Press Ltd., Headington Hill Hall, Oxford. Price 10s.

Providing an introduction to the structure and programming of digital computers, this book is written at the level of the senior form student or educated layman and discusses many recent developments and applications.

Inertial Guidance Sensors

By J. M. SLATER. Pp. 221 + x. Chapman & Hall Ltd., 11 New Fetter Lane, London, E.C.4. Price 88s.

An introduction to gyros and accelerometers, this book covers the entire field of inertial guidance sensors and may be readily understood by the interested non-specialist.

Variational Techniques in Electromagnetism

By LAURENT CAIRO and THEO KAHAN. Translation from the French by PROFESSOR G. D. SIMS, M.Sc., Ph.D. Pp. 152 + xv. Blackie & Son Ltd., 5 Fitzhardinge St., London, W.1. Price 27s 6d.

This monograph discusses the application of variational methods to electromagnetic wave propagation, particularly at conducting surfaces and in waveguides.

Microwave Filters, Impedance-Matching Networks and Coupling Structures

By GEORGE L. MATTHAEI, LEO YOUNG and E. M. T. JONES. Pp. 1,096 + xv. McGraw-Hill Publishing Co. Ltd., Shoppenhangers Road, Maidenhead, Berks. Price £9.

Manufacturers' Literature

Cathode Ray Tubes. A 12-page brochure which describes the characteristics of the E.M.I. range of c.r.t.s. Details include ratings and operational values in tabular form and outline drawings of the tubes, with their dimensions.

E.M.I. Electronics Ltd., Hayes, Middlesex.

For further information circle 44 on Service Card

Filters and Networks. This 16-page pamphlet, illustrated with response curves and photographs of filters available, outlines the characteristics and applications of basic filter systems in industry, communications and research.

Barr and Stroud Ltd., Kinnaird House, 1 Pall Mall East, London, S.W.1.

For further information circle 45 on Service Card

Signal Generators and Other Signal Sources. A comprehensive publication, from Rohde & Schwarz, which deals with the theory, design and use of modern signal generators. In 72-pages, illustrated with block diagrams and graphs and containing technical specifications, a thorough treatment of the subject is given.

Aveley Electric Ltd., South Ockendon, Essex.

For further information circle 46 on Service Card

Digital Memory Oscilloscopes. Two brochures are offered which describe the modes of operation and applications of the entire range of D.M.Os. manufactured by Northern Scientific Inc. of Wisconsin, U.S.A. Separate specification sheets may be obtained and a technical leaflet on the general subject of signal averaging is also available.

High Volt Linear Ltd., 1 Cardiff Road, Luton, Beds.

For further information circle 47 on Service Card

Photocells. Contained in this 36-page booklet are nine pages of circuit diagrams (with component values) which detail over two dozen separate applications to which photocells may be put. It also gives concise, tabulated data on the available range of R.C.A. cadmium-sulphide photoconductive cells, germanium p-n alloy photojunction cells and silicon N on P photovoltaic cells.

Accompanying the data are dimensional outlines, d.c. resistance curves and actual-size photographs, together with a section on photoelectric measurements of both visible and radiant energy.

R.C.A. Great Britain Ltd., Lincoln Way, Windmill Road, Sunbury-on-Thames, Middlesex.

For further information circle 48 on Service Card

Precise Angular Position Repeaters. A 28-page illustrated American publication describing the applications, specifications and operational theory of some new angle-repeating instruments. Angular position displays and recordings are produced using three basic techniques: absolute encoders, servo-mechanisms and system error bridges.

Theta Instrument Corporation, Saddle Brook, New Jersey, U.S.A.

For further information circle 49 on Service Card

Elgastat Deionizer. An English/German/French illustrated catalogue listing units available to obtain pure water instantaneously on the basis of passing ordinary tap water through ion-exchange resins. The larger models can supply 50-250 litres hourly.

Elga Products Ltd., Lane End, Bucks.

For further information circle 50 on Service Card

Semiconductors. The latest catalogue on semiconductors manufactured by Siemens & Halske A.G. contains a complete list of standard and industrial types available with ratings and characteristics tabulated. It also includes outline drawings, with dimensions, and photographic reproductions of each type. Available from:

R. H. Cole Electronics Ltd., 7-15 Lansdowne Road, Croydon, Surrey.

For further information circle 51 on Service Card

Signal Generators and Receiver Measurements. A publication discussing the applications of signal generators to simulate the action of aerials when testing a.m. receivers (below 100 Mc/s). Theoretical and practical treatments on source impedance, coupling to loop aerials, sensitivity, automatic gain control, receiver bandwidth, selectivity and spurious responses are complemented by clear block diagrams to present a useful 26-page reference booklet.

Marconi Instruments Ltd., St. Albans, Herts.

For further information circle 52 on Service Card

Series 901 Imlok Structures Manual. This is Imhof's 1965, 56-page guide to their well known cabinet and rack construction system. Larger and stronger units may now be designed, though a 4½ in. cube unit can still be produced. Fully illustrated with photographs and dimensional drawings of all component parts, the manual has a clear guide to structure design and construction.

Alfred Imhof Ltd., Ashley Works, Cowley Mill Road, Uxbridge, Middlesex.

For further information circle 53 on Service Card

PAINTON METLOHM[®] NEW METAL FILM RESISTORS

out-date and out-perform
conventional resistors

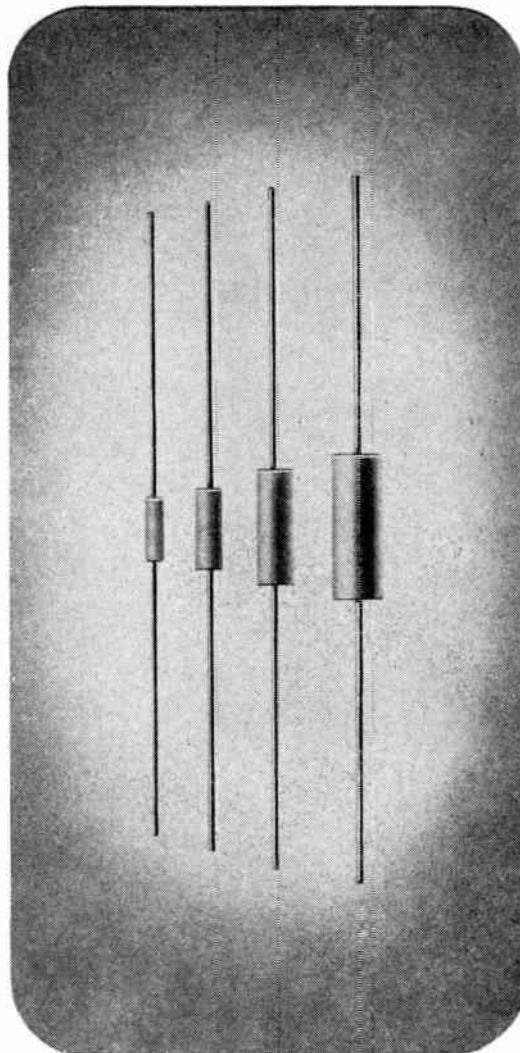

Painton introduce Metlohm — the fourth generation of film resistors. This metal film resistor possesses exceptional stability coupled with a full temperature coefficient range down to 25 p.p.m. or better, thus enabling today's engineers to work to closer limits than ever before. Capable of replacing existing film resistors with advantage, Metlohm provides the electronic and electrical industries with a quality resistor having higher resistance values than previously possible within such a confined envelope.

PAINTON RELIABILITY

to which are added
FAST DELIVERY & KEEN PRICES
Send for your evaluation pack of the
4 standard types now in production.



PAINTON **Painton**
& CO. LIMITED

KINGSTHORPE · NORTHAMPTON
Telephone: 34251 Telex 31576 Grams: Ceil, Northampton

Overseas Associated Companies Australia Painton Australia Pty. Ltd. Benelux Painton S.A. Germany Painton G.m.b.h. Italy Painton Italiana Sweden Svenska Painton A.B. U.S.A. Painton Inc.



SINTERED IRON POLE PIECES of High Permeability

Powder Metallurgy again contributes to lower costs by enabling complex shapes of high permeability to be manufactured for magnetic applications.

Some of the benefits obtained from sintered iron are:-

- Controlled density.
- Excellent tensile strength.
- Close tolerances maintained without additional machining.
- Consistent magnetic properties.
- Complicated shapes accurately reproduced.
- Density 7 g/cc.
- Maximum permeability $\mu = 1500$ when $H = 6$ Oersteds and $B = 9000$ gauss.

Murex sintered soft iron results from experience gained over many years in the manufacture of composite assemblies of magnet material and soft iron pole pieces by the 'Sincomax' Technique. Inevitably, there were applications which could not efficiently utilise the unique properties of this process. Therefore, separate iron parts of high permeability were developed to fulfil this requirement.

Technical personnel are always available to assist in design problems, and advise on the applications of soft iron and all magnetic materials offered by Murex Limited

M34

MUREX LTD · RAINHAM · ESSEX
(Powder Metallurgy Division)

Telephone: Rainham, Essex 53322 • Telex 28632 • Telegrams: Murex, Rainham-Dagenham Telex

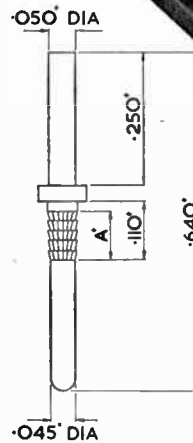
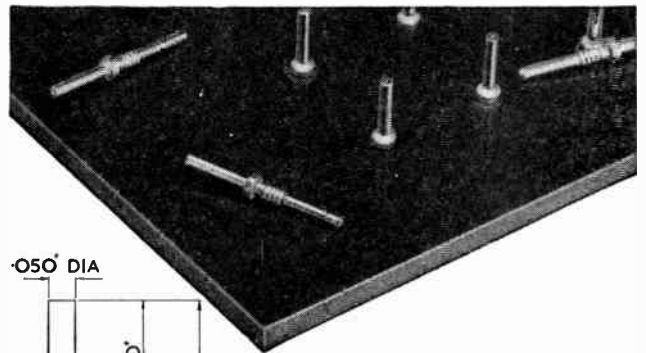

THE OXLEY SNALE PRINTED CIRCUIT LEAD-THROUGH FOR .05" dia HOLES

1. TAPERED for ease assembly into inaccurate holes.
2. SPLINED to inhibit rotation and avoid chipping the printed circuit board.
3. BARBED in order to attain high extraction force.

By ingenious design (Patents applied for) the Oxley "Snales" (P.C. nail) includes the features indicated. Oxley "Snales" are supplied heavily gold plated in sealed containers of 1,000. Write for technical details of these and other Oxley products.

OXLEY DEVELOPMENTS CO. LTD.
ULVERSTON, LANCASHIRE Telephone: Ulverston 2567

ELECTRONICS PRINTED CIRCUITS

An extremely comprehensive service is available to industry which is unique in its scope and unprecedented in its quality of workmanship and speed of service while at the same time giving that all important individual attention and very competitive price terms that every buyer seeks.

The service consists of inclusive facilities for the design, development, and large scale production of all types of electronic equipment, instruments, etc., together with all processes involved in the design, development and production of printed circuit boards.

The unique location of T.E.S. Ltd., allows this first class service, which is to be found nowhere else, to be brought to your doorstep by an almost daily transportation service to 100 miles all for the price of a telephone call. Shanklin 3096.

Special attention will be given to very welcomed enquiries from customers outside the U.K.

TRANSMETRIX ELECTRONIC SYSTEMS LTD.
Hyde Works, Shanklin, Isle of Wight, Hants

ELECTRICAL REVIEW

THE ELECTRICAL INDUSTRY'S PREMIER JOURNAL

CIRCULATION **14,696** (ABC)

A recent survey shows that each home copy is seen by an average of 12.5 readers and each overseas copy by an average of 5.9 readers.

CLASSIFIED ADVERTISEMENTS IN 1964
AVERAGED 13½ PAGES PER WEEK

For a specimen copy, write — ELECTRICAL REVIEW (Ref. 220),
ILIFFE ELECTRICAL PUBLICATIONS LTD., DORSET HOUSE,
STAMFORD ST., LONDON, S.E.1, or phone WATERLOO 3333 (Ex. 201)

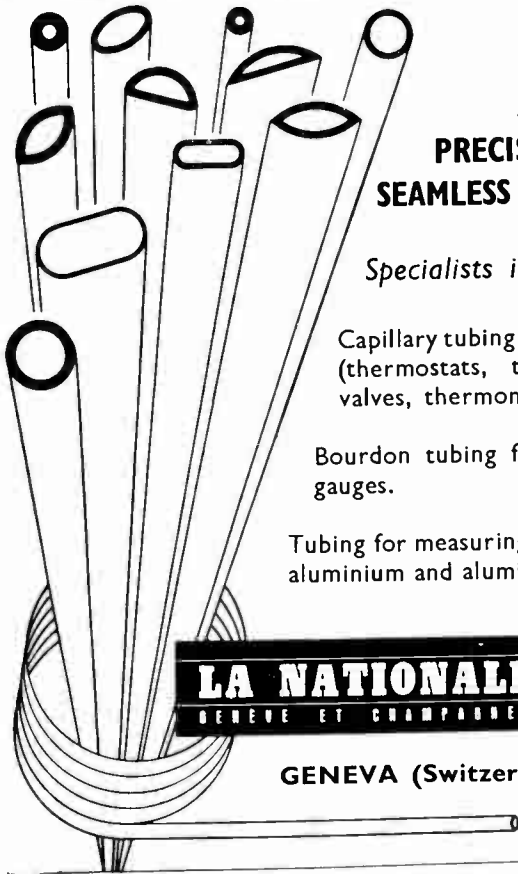

PRECISION SEAMLESS TUBING

Specialists in :

Capillary tubing for controls (thermostats, thermostatic valves, thermometers, etc.)

Bourdon tubing for pressure gauges.

Tubing for measuring pointers in aluminium and aluminium alloys.

LA NATIONALE S.A.
GENEVE ET CHAMPAgne SUISSE

GENEVA (Switzerland)

For further information circle 256 on Service Card

METWAY PRODUCTS
RUBBER ACCESSORIES

- CABLE CONNECTORS
- CONDUIT BUSHES
- MOULDED BUSHES
- GROMMETS
- BUFFERS
- PLUGS

METWAY, Kemp Town, Brighton 7, England
Phone: Brighton 4422 (9 lines) Gram: (Mersey) Phone Brighton
Lit. No. MEI 62 C

● **RUBBER ACCESSORIES**
Ask for Cat. No. MEI/62C/IE
METWAY • KEMP TOWN • BRIGHTON 7



DIGITAL VOLTMETERS



The DM 2010 is the most accurate Digital Voltmeter in the World. It is part of the wide range of DM Digital Voltmeters.

Please write for further information to:

DYNAMCO INSTRUMENTS LIMITED

Incorporating

DIGITAL MEASUREMENTS LIMITED

SALISBURY GROVE MYTCHETT ALDERSHOT HANTS

TEL.: FARNBOROUGH 44422

A MEMBER OF THE DYNAMCO GROUP OF COMPANIES



**two important new books for scientists,
technologists and electronic engineers**

THE ELECTRON IN ELECTRONICS

Modern scientific concepts for electronic engineers

M. G. SCROGGIE, B.Sc., M.I.E.E.

An introduction to a difficult subject, written in a manner that every electronic engineer will readily grasp. The author, himself an electronic engineer, appreciated the difficulties and has related the modern concepts to the things a student of electronics is likely to know already, and expresses them in familiar terms and symbols. The standard of mathematics and general physics assumed is at the most G.C.E. "A" level. Particular attention has been given to questions and difficulties that may arise; a feature that will be appreciated by home students.

ELECTRONIC EQUIPMENT IN INDUSTRY

W. D. GILMOUR, B.A. (Oxon.), A.M.I.E.E.

Electronic instrumentation and control equipment is finding increasing application throughout industry. To manage it well demands a broad, up-to-date understanding of the techniques and principles involved. This is what this book achieves. All aspects of the subject are examined clearly, concisely and in logical order, and to illustrate the text with specific examples, a large number of typical circuits and applications have been included.

This book does not replace standard textbooks, but offers a basis on which more formal treatments can be better understood and can be recommended to every scientist and technologist who needs a sound general picture of electronic control techniques and how to apply them.

obtainable from leading booksellers

ILIFFE Books Ltd.

DORSET HOUSE STAMFORD STREET LONDON S.E.1

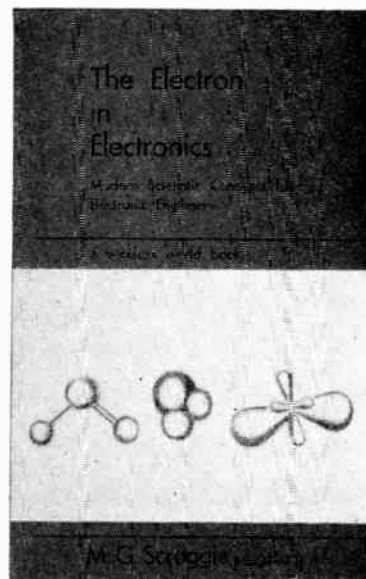

45s net by post 42s 2d
8½" x 5½" 270 pages 132 illust.

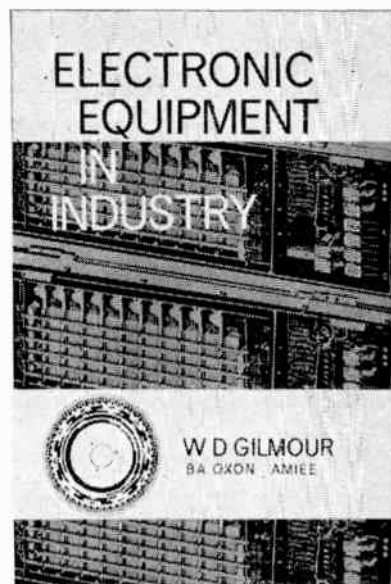

50s net by post 51s 3d
8½" x 5½" 265 pages
101 diagrams 6pp art plates

Variac

REGD

the original
and best
variable
transformers



THE VARIAC* variable transformer is the most useful and versatile device ever developed for the control of a.c. voltage, or of current, power, heat, light, speed. It provides smooth continuous adjustment of output voltage from zero to line voltage and above, either hand-operated or motor-driven.

There are over 600 Variac models and assemblies to suit virtually every possible requirement, ranging from small units for laboratory or instrument use to large ganged assemblies for high power 3-phase operation. The range includes low-voltage, high-frequency, dual-output and narrow-range types, open, covered, portable, metalclad and oil-immersed constructions, plus many special models. This is the largest range of variable transformers available today.

The technical superiority and dependability of Variac are the result of over 30 years of development and refinement since the introduction of the first Variac models—the *original* variable transformers.

*Variac is a registered trade mark

Variacs are made in England by The Zenith Electric Co. Ltd., London, and exclusively distributed in the U.K., Eire and British Colonies by Claude Lyons Ltd

Write for comprehensive catalogue to Publicity Department, Hoddesdon

CLAUDE LYONS LTD

Valley Works, Hoddesdon, Herts. Hoddesdon 4541 Telex 22724
76 Old Hall Street, Liverpool 3. MARitime 1761 Telex 62181

CS2

Industrial Electronics July 1965

ROTAX MINIATURE RELAYS

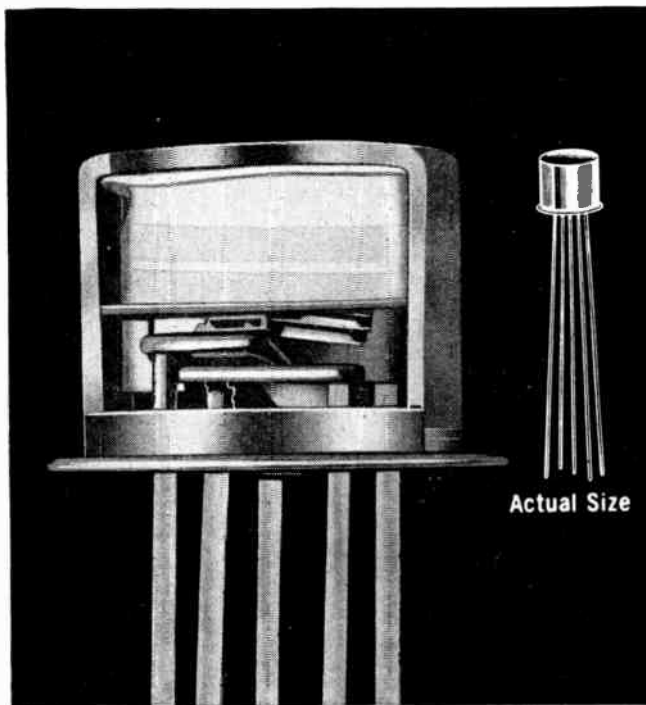

T0-5 size... robust...
and gold-plated for dry circuitry

Rotax miniature relays are now available in a full range including specially sensitive and magnetic latching types. Of all-welded construction, these relays will withstand high shock and vibration, and meet or exceed DEF 5124. They are hermetically sealed and gas-filled.

The three types—standard, magnetic latching, and sensitive—have SPDT contact arrangement, with DPDT also available on the standard range. All Rotax miniature relays are continuously rated to 1,000,000 operations at 0.5 amps, 28V d.c., resistive load at 125°C. or 100,000 operations at 1.0 amp. There is a choice of 25 different Rotax miniature relays covering d.c. coil voltages from 4.5 V to 75 V.

Rotax miniature relays could help solve your miniaturisation problems. Interested? Then ring Elgar 7777, Ext. 302—now.

ROTAX INSTRUMENTATION DIVISION

ROTAX INSTRUMENTATION DIVISION
WILLESDEN JUNCTION, LONDON, N.W.10. TELEPHONE ELGAR 7777

For further information circle 272 on Service Card

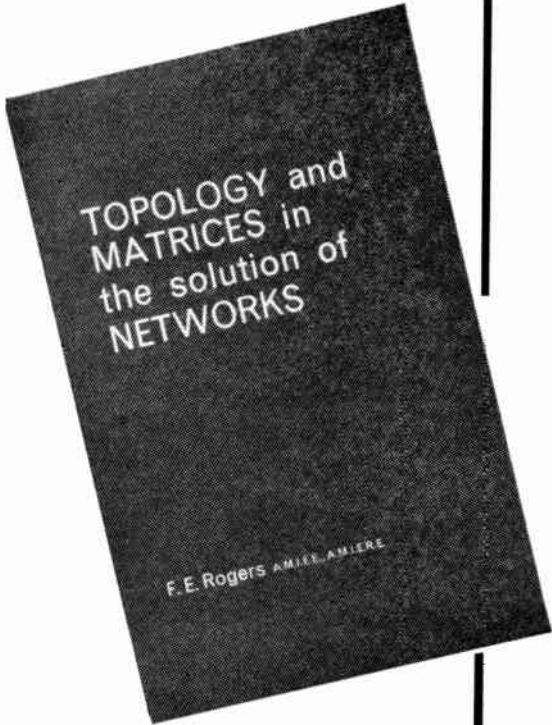

explains simply and clearly the principles of systematic methods for solving linear networks

TOPOLOGY AND MATRICES IN THE SOLUTION OF NETWORKS

F. E. ROGERS, A.M.I.E.E., A.M.I.E.R.E.

An important new book which explains, with liberal numerical illustrations, the principles of systematic methods for solving linear networks. It shows simply and clearly how topology and matrices have a natural place in orderly, economical approaches to the solution of networks, and how to apply such approaches in practice. The essential principles are contained in the text, where they are evolved smoothly in a practical perspective, in order to crystallise their significance. Fully worked out and annotated illustrated examples at the end of each chapter clarify practical interpretation and procedures, and are generally based on realistic circuits.

An invaluable book for students following university or comparable Diploma and Professional courses in Electrical and Electronic Engineering, and also to post-graduate or otherwise professionally trained engineers working in these fields.

45s net by post 46s 1d. 204 pp. 100 illustrations.

ILIFFE Books Ltd.

DORSET HOUSE, STAMFORD STREET, LONDON, S.E.1

obtainable from leading booksellers

For further information circle 273 on Service Card

Unified Circuit Theory in Electronics and Engineering Analysis

A new approach to solving non-steady state problems

J. W. HEAD, M.A.(Cantab.), F.Inst.P., A.M.I.E.E., F.I.M.A.
C. G. MAYO, M.A., B.Sc., M.I.E.E.

This important new book shows how the output, or response, of a linear system may be formulated, whatever the nature of the input may be. Steady-state conditions present no mathematical difficulties, but decidedly more advanced techniques are required when dealing with the non-steady state.

The authors advocate the use of operational calculus to solve these problems because the directness and simplicity of working makes it easy for practising engineers and students alike to appreciate the significance of each necessary process. The book is written in an easy style and shows that the basic ideas associated with operational calculus and the impedance concept are extremely easy to grasp—and once understood have a high 'resolving power'.

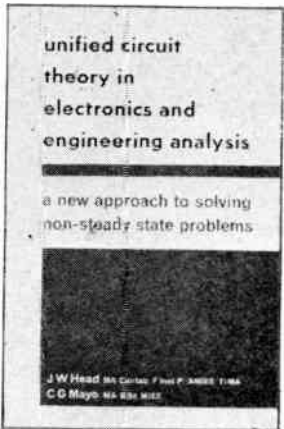

42s net by post 43s
174 pp. 20 illustrations

obtainable from leading booksellers

Published by **ILIFFE Books Ltd.**

DORSET HOUSE, STAMFORD STREET, LONDON, S.E.1

For further information circle 274 on Service Card



the world's guide to the British plastics industry

British Plastics YEAR BOOK 1965

The recognised guide to the plastics industry—its products, suppliers, materials, leading executives. Carefully revised for this 35th edition, it is complete, compact and fully up-to-date. It makes precise information on any aspect of the industry available to you at a moment's notice.

The information is contained under 11 sections: General: Materials: Manufactured Products: Services: Plant: Trade Names: U.K. Addresses: Overseas Addresses: Who's Who: Technical Data: Indexes.

50s net by post 53s 3d 9½ ins. × 6½ ins. 650 pp.

obtainable from leading booksellers

Published for British Plastics by **ILIFFE Books Ltd.**

DORSET HOUSE STAMFORD STREET LONDON S.E.1

WESTON—FOREMOST FOR MOVING COIL RELAYS

MODEL S 170 for control applications

The Model S 170, permanent magnet moving coil relay. Combines extreme sensitivity with high precision. It is eminently suitable for control applications when a relay operating within close tolerances is necessary. The minimum signal current is 5 mic A. d.c.; shunts and series resistors can be incorporated for currents and voltages up to 5 A and 250 V d.c.



MODELS S 124 a miniature alarm relay with "hold-on" contacts

The Model S 124 is of the permanent magnet moving coil type and can be supplied to operate on currents as low as 2 mic A. d.c. High contact pressure is ensured by magnetic attraction between the contacts; these will "hold-on" until reset manually or by remote electrical control. Front-of-panel and flush mounting relays are available.



MODEL S 115 a miniature switching relay

The Model S 115 functions as an "on-off" switching relay and is supplied for operating currents down to 50 mic A. d.c. Single and double coil windings are available. The relay can be mounted in any position and is magnetically self-shielding. The space occupied on the chassis is only 1 1/2 in. x 1/2 in.; weight, 1 1/2 oz.

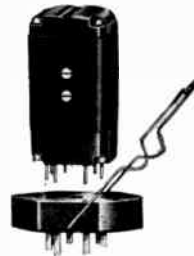

For full details of the Weston range of relays, please write to:—

SANGAMO WESTON LIMITED • ENFIELD • MIDDLESEX
Telephone: Keats 1100. Grams: Sanwest, Enfield. Telex: 24724

For further information circle 262 on Service Card

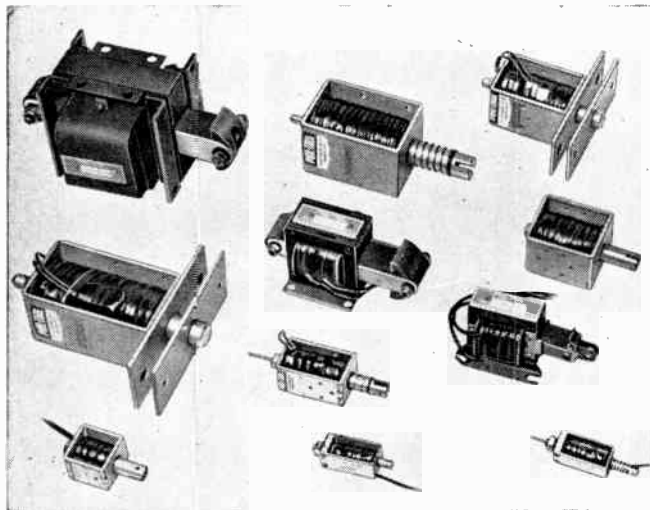

Phil-trol

For the Widest Range of Solenoids

Phil-trol Solenoids range from the small type 45, suitable for 3/8" spacing (i.e. for typewriters), to the AC type 83, 47 lbs over 1 1/2" on impulse duty and also up to 650 lbs-ins for the DC type 96, with a complete range of AC and DC types between, push type, pull type, spring return and DC fitted with fully damped silicon rectifier circuits for AC supplies.

● For particulars ask for pamphlet 108a.

PHILLIPS CONTROL (G.B.) LTD

DEPT. G7 • FARNBOROUGH ROAD • FARNBOROUGH • HANTS.
Telephone: Farnborough 41129 Grams and Cables: Philtrol, Farnborough, Hants.

For further information circle 263 on Service Card

NUMBER ONE IN ELECTRICAL CONNECTORS...



NATO TRAILER CONNECTORS

Rugged Steel/Neoprene Housings,
F.V.R.D.E. Approved. Up to 37 Contacts.

CANNON ELECTRIC (GREAT BRITAIN) LTD.

25-27 Bickerton Road, Upper
Holloway, London, N.19J

Telephone: ARChway 3088



CLASSIFIED ADVERTISEMENTS

FULLY DISPLAYED : 55/- per single column inch.
SEMI-DISPLAYED : 45/- per single column inch.
RUN-ON : 4/6 per line of approximately 7 words.
 Where an advertisement includes a Box Number Is. extra.
SERIES DISCOUNTS : 12 insertions, 15%.
 Remittances payable to "Industrial Electronics".

Copy is required by 23rd of the month for insertion in the following month's issue, by 17th of the month if proofs are required.

Address to:
 Classified Advertisement Dept.
 Industrial Electronics
 Dorset House, Stamford St., London, S.E.1.

SITUATIONS VACANT

EVERSHED

SENIOR DEVELOPMENT ENGINEERS

For New Projects in:
 DIGITAL CONTROL
 DATA TRANSMISSION
 HIGH SPEED RECORDING

We require Electronic Development Engineers with experience in one or more of the above fields of activity to take part in a major Development programme now being undertaken by this Division.

Salaries will be negotiated on individual merit.

Excellent working conditions in a modern Laboratory, with first class Pension, Canteen, Social and Sports Club facilities. Adjacent to Buses and Underground.

WRITE OR TELEPHONE TO :
 The Employment Officer
EVERSHED & VIGNOLES LIMITED
 Acton Lane Works, Chiswick, W.4.
 Tel. CHIswick 3670. Ext. 109.

[448]

ARTICLES FOR SALE

PHOTO-ELECTRIC CONTROLS

for industry
 Quick delivery Send for Catalogues

Hird-Brown Limited

Flash Street, Bolton, Lancs.
 Tel. 27311

[305]

CAPACITY AVAILABLE

AIRTRONICS LTD.

for coil winding, assembly and wiring of electronic equipment, transistorised sub-units, sheet metal work. 3a, Walerand Road, London, S.E.13. Telephone: LEE Green 1706.

[439]

DESIGN & PROTOTYPE CONSTRUCTION.—Somerset Electronics Ltd. Phone Shepton Mallet 2219.

[387]

EDUCATIONAL

A.M.I.E.R.E., A.M.I.Mech.E., City & Guilds, G.C.E., etc. Become a Technician or Technologist for high pay and security. Thousands of passes. For details of Exams. and Courses in all branches of Electronics, Engineering, etc., write for 156 page Handbook — FREE. B.I.E.T. (Dept. 192), London, W.8.

[380]



DO you have experience which will enable you to design Digital Computer Interface and Peripheral driving equipment?

ARE you conversant with solid state Digital 'Building Bricks'?

HAVE you a degree or H.N.C. in Electrical or Electronic Engineering?

IF SO, YOU are the man we want to become a Senior Engineer in an expanding team applying Digital Computers and Digital Techniques to our well known range of analytical instruments.

Please write in confidence to:

Personnel Officer (Technical), Hilger & Watts Ltd.
98, St. Pancras Way, Camden Road, London, N.W.1.

[445]

SEE PAGE 50

FOR A

SELECTION OF
COURSES

BEING HELD

This Autumn



Engineering Staff

The **INDEPENDENT TELEVISION AUTHORITY** has vacancies for **ENGINEERING STAFF** at its Transmitting Stations.

The work on the Stations consists of the operation and maintenance of television transmitters and ancillary equipment. This calls for a high degree of skill and knowledge of electronics, television techniques and high frequency engineering; these vacancies are for young men with good basic knowledge who can be given appropriate training. A Higher National Certificate in Electrical Engineering or similar qualification is required.

Conditions of service are excellent and include a contributory pension scheme. Shift working is involved to cover the period from 8 a.m. to midnight.

Starting salaries, depending on qualifications and experience, will be within the scale £875 to £1,145. Applications in writing, stating age and details of experience, and qualifications and quoting Reference Number WW/583 should be addressed to the:

**PERSONNEL OFFICER
INDEPENDENT TELEVISION AUTHORITY
70 BROMPTON ROAD, LONDON, S.W.3**

[447

SYSTEM PLANNING & MARKETING ENGINEERS



RANK-BUSH MURPHY LIMITED
A COMPANY WITHIN THE RANK ORGANISATION

requires two System Planning and Marketing Engineers for Multiplex Radio Links.

They should have some academic qualifications and practical experience in the planning and installation of vhf, uhf and microwave communications systems. Some Carrier, VF Telegraph or Telemetry experience would be an advantage. One of the engineers will be required to spend about three months of each year overseas.

Excellent salaries will be paid for these positions with pension, non-contributory life and accident cover and comprehensive fringe benefits. Some assistance with housing may be possible.

**PLEASE APPLY TO:-
THE PERSONNEL MANAGER,
RANK-BUSH MURPHY LIMITED,
BESSEMER ROAD,
WELWYN GARDEN CITY, HERTS.**

[449

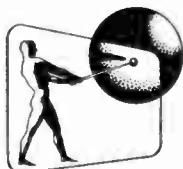

THE RANK ORGANISATION LIMITED

Technical Courses This Autumn

For further information circle 275 on Service Card

PORTSMOUTH COLLEGE OF TECHNOLOGY

(Southern Regional College)

Department of Electrical Engineering offers courses leading to:

B.Sc., B.Sc. (Eng.),

H.N.D., I.E.E. Pt. III.

Prospectuses of Full-time and Sandwich Courses from:

The Registrar
Portsmouth College of Technology
Portsmouth, Hampshire

[441]

For further information circle 276 on Service Card

UNIVERSITY COLLEGE OF NORTH WALES, BANGOR

School of Engineering Science

Honours Degree Courses

- (i) Electronics
- (ii) Electronics and Physics
- (iii) Electronics and Mathematics
- (iv) Physics and Materials Science

M.Sc. Courses

- (i) Electrical Materials Science
- (ii) Control Engineering and Instrumentation

Further particulars from the Registrar, University College of North Wales, Bangor.

[442]

For further information circle 277 on Service Card

MEDWAY COLLEGE OF TECHNOLOGY

Department of Electrical Engineering

A FULL-TIME COURSE

for the

Part III IEE Examination

Session: 1965/66

Next course, offering choice of both heavy or light current subjects, starts in September for examinations in June 1966. This course usually qualifies for a Major County Award.

Applications and further details from the Principal, Medway College of Technology, Horsted, Maidstone Road, Chatham, Kent.

[444]

For further information circle 278 on Service Card

PLYMOUTH COLLEGE OF TECHNOLOGY

Electrical Engineering Department

1. Part-time and Full-time Courses for I.E.E. and I.E.R.E. Examinations.

2. Special Courses arranged for Session 1965-66.

- Basic Microwave Theory
- Electronic Computers
- Electronics for Mechanical Engineers
- Logic and Switching Circuits
- Semiconductor Theory
- Electrical Installation Design
- Protective Systems for Power Networks
- T.V. Production Courses for Teachers
- T.V. Engineering
- Colour T.V.

3. One-day Courses.

- Medical Electronics
- Principles of Digital Computers
- The Generalised Machine
- Reliability

Full details on all courses may be obtained from:-
 The Head of Electrical Engineering Department,
 B.Sc.(Eng.), M.I.E.E., M.I.E.R.E., A.M.I.Mar.E. B. R. Webster, [450]

For further information circle 279 on Service Card

THE NORTHERN POLYTECHNIC

Holloway Road, London, N.7.

Principal:

J. LEICESTER, M.Sc., M.Sc.Tech., Ph.D., F.R.I.C.

Department of Electronics and Telecommunications

Head of Department:

J. C. G. GILBERT, M.I.E.R.E., Assoc. I.E.E., F.T.S.

Full-time 3-year course in preparation for the Northern Polytechnic Diploma in Electronics and Telecommunications. This course is recognised by the Institution of Electronic and Radio Engineers and gives full exemption from the Graduateship examination.

Part-time day release and evening courses for the external Graduateship examination of the Institution of Radio Engineers covering:-

Applied Electronics
 Computer Engineering
 Television Engineering
 Advanced Telecommunication Principles
 Communication Radio

Advanced Short Courses on:
 Colour Television Engineering
 Modern Network Theory
 Pulse Techniques
 Basic Microwave Techniques
 Transistor Engineering
 Audio Engineering Measurements

Full-time, 2-year course in Radio and Television Servicing in preparation for the City & Guilds of London Institute and the Radio Trades' Examination Board's Certificates. Part-time day release and Evening classes in Electronic Servicing for the Electronic Servicing Certificate of the City & Guilds of London Institute (Subject 47).

All the above courses include practical laboratory and workshop experience (where applicable). London fees: £36 per year, plus £3 10s. registration fee, for all full-time courses. (No fee for students under 18 years of age.)

Evening class fees range from 50s. to 90s. per session.

Enrolment for Day classes by appointment.

Enrolment for part-time day release and evening classes: 21st and 22nd September, 1965, between 5.30 and 7.30 p.m.

New session commences 27th September, 1965. Prospectus free on application to Secretary.

[443]

For further information circle 280 on Service Card

Postgraduate Courses at

CRANFIELD

Electronic
 and Control
 Engineering

The Department of Electrical and Control Engineering offers one-year and two-year residential postgraduate courses which provide for specialisation in any of the following subjects:

Electronics
Control Engineering
Flight Control
Aviation Electronics
Aircraft Power Systems

The courses emphasise the "systems engineering" concept and are specially designed to suit the graduate engineer or scientist in industry. Great importance is given to advanced experimental work and to design practice. Analogue and digital computing facilities are available.

Advice given on financial aid. Further information from:

The Registrar, The College of Aeronautics,
Cranfield, Bedford.

[446]

Adcola Products Ltd.	36	G.E.C. of U.S.A.	5	Phillips Control (GB) Ltd.	47
Anglo-American Vulcanized Fibre Co. Ltd.	17	Goring Kerr Ltd.	52	Radio Resistor Co. Ltd.	4
Appointments Vacant.	48	Hallam, Sleigh & Cheston Ltd.	29	Rotax Ltd.	45
Avo Ltd.	38	Hendrey Relays Ltd.	24	Sangamo Weston Ltd.	47
Belling & Lee Ltd.	3	Hughes International (U.K.) Ltd.	7	Sealectro Ltd.	40
Benson-Lehner Ltd.	<i>Cover 3</i>	Imperial Smelting Corporation (N.S.C.) Ltd.	36	Semiconductors Ltd.	32
British Plastics	46	Johnson, Matthey & Co. Ltd.	20	Sifam Electrical Instrument Co. Ltd.	8
Cannon Electric Ltd.	47	La Nationale S.A.	43	Solartron Electronic Group Ltd.	22, 23
Classified Advertisements	48	Landis & Gyr Ltd.	36	Standard Telephones & Cables Ltd.	11, 12, 13, 14
Colvern Ltd.	9	Leyland Leroux Ltd.	<i>Cover iv</i>	Telequipment Ltd.	30
Consolidated Beryllium Ltd. ...	36	London Electric Wire Co. & Smiths Ltd.	26	Thorn Electrical Industries Ltd.	21
Dawe Instruments Ltd. ...	<i>Cover 2</i>	Lyons, Claude, Ltd.	45	Topology & Matrices	46
Dexion Ltd.	16	M-O Valve Co. Ltd.	34	Transmetrix Electronic Systems Ltd.	42
Digital Measurements Ltd. ...	43	Magnetic Devices Ltd.	18	Unified Circuit Theory	46
Dynamco Instruments Ltd. ...	43	Mawdsley's Ltd.	26	V.G. Porcelain Co. Ltd.	30
EMI Electronics Ltd.	27, 28	Metway Electrical Industries Ltd.	43	Vickers Ltd.	6
EMI Sound Products Ltd.	52	Murex Ltd.	42	Walmore Electronics Ltd.	39
Elcometer Instruments Ltd. ...	52	Normalair Ltd.	29	Ward Brooke & Co. Ltd.	51
Electrical Power Engineering Co. (B'ham) Ltd.	24	Oxley Developments Co. Ltd.	42	Welwyn Electric Ltd.	1
Electronic Associates Ltd.	15	Painton & Co. Ltd.	41	Westinghouse Brake and Signal Co. Ltd.	19
Electronic Data Handbook ...	52	Perivale Controls Co. Ltd.	25		
Electronic Equipment in Industry	44				
Electrosil Ltd.	35				
Ericsson Telephones Ltd.	33				
Ether Ltd.	2				
Evershed & Vignoles Ltd.	31				
Farnell Instruments Ltd.	39				
Ferranti Ltd.	10				

For further information circle 267 on Service Card

Ten good reasons for choosing this Ward Brooke terminal block . . .

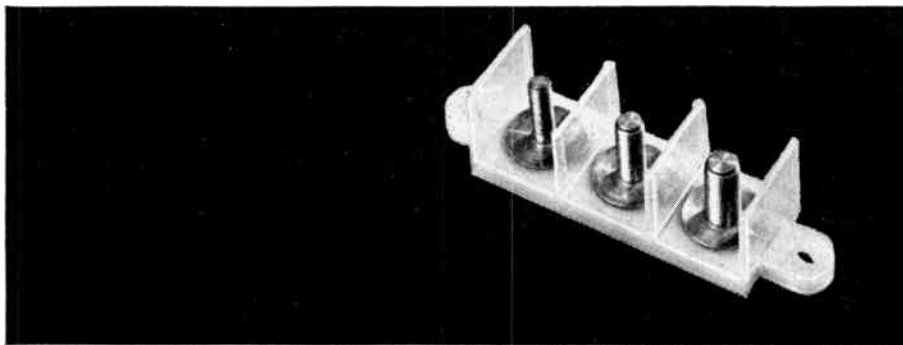

. . . or any other in the wide range of Ward Brooke blocks.

1. Blocks available up to 20 way, single or double row.
2. Light weight.
3. Non-corrodible studs.
4. Unbreakable plastic mouldings.
5. Up to 8 ring terminated conductors per stud.
6. Proofed against rotational shorting.
7. Inter-terminal linking strips.
8. BA or Unified threads.
9. Panel mounting, through or shrouded pattern.
10. Six colours and numbered terminals.

There is a very large range of Ward Brooke terminal blocks, fuse holders, conduits, helical wraps, 'LAYFLAT,' sleeving, ratchet and 'P' clips, lamp-holders, etc. These products are type approved. Every British aircraft being built today uses Ward Brooke parts throughout its electrical system.

Why not write to the Sales Department for further details of the range?

WARD BROOKE *WB* & CO LTD

P.O. Box 34, High Wycombe, Bucks. Tel: High Wycombe 4531. Telex 83173

A member of the Southcross Group

For further information circle 268 on Service Card

INEXPENSIVE & RELIABLE

Remember the name — EMI Shaded 2 Pole Motor Type Z. Consider the reliability — over 3,000 hours running without re-rolling — able to withstand continuous mechanical overload. Send for the Type Z data sheet.

■ Geared motor — approximate speeds 2,900 r.p.m. geared down to 16 r.p.m. ■ Low resistance rotor with copper bars and end plates. ■ Rotor has critically skewed bars for smooth running—dynamically balanced to special limits where required. ■ Sizes approx. $2\frac{1}{2}'' \times 3'' \times 1\frac{1}{2}''$. ■ Weight $17\frac{3}{4}$ oz. (standard), 21 oz. (Long Bearing A Motor). ■ Low mechanical noise — no electrical interference.

EMI SHADED 2 POLE AC MOTORS

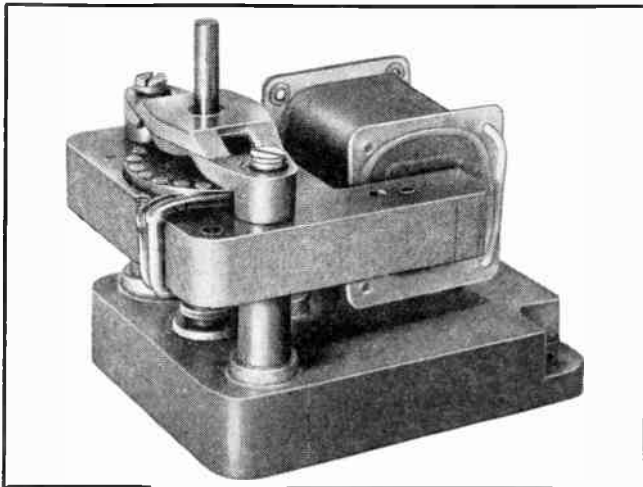

Full details from:
EMI SOUND PRODUCTS LIMITED, COMPONENTS DIVISION, HAYES
MIDDLESEX. TEL.: HAYES 3888 · EXT. 2515

For further information circle 269 on Service Card

HOW DEEP IS THE PLATING?
HOW THICK IS THE COATING?
HOW THIN IS THE FOIL?

YOU'LL KNOW AT A GLANCE

with the **POCKET**
elcometer

The depth of plating, paint or plastic on iron or steel . . . the thickness of non-ferrous coatings on iron or steel or non-ferrous foil . . . you can take these and many other measurements at a glance by means of the Elcometer. Completely non-destructive—like all our surface-metrology instruments—the Elcometer gives an accurate direct reading with fuss-free reliability, even in unskilled hands, even in the middle of a production run.

Choice of over
40 scales
ranging from
0-0.002"
to 0- $\frac{3}{32}$ "

13 GNS.

elcometer FAIRFIELD RD. DROYLSDEN 11 MANCHESTER
INSTRUMENTS LTD

Please send me free literature on the Elcometer and its companion instruments, the Elcotector and the Pin Hole Detector.

Name of Organisation.....

Address.....

For the attention of.....

For further information circle 270 on Service Card

A NEW CONCEPT
Compact Head Units
Virtually Indefinite Life
Proof Against Vibration
Fully Transistorised Circuit
Ignores All Extraneous Light
Fitted with Relay or Counter
Rugged Cast Aluminium Enclosure
Withstands High Degree of Lens Coating

GORING KERR PHOTO-ELECTRICS
IGNORE SUNLIGHT

Model GKP Photo-Electric Unit is Completely Independent Of Direct or Reflected Light From the Sun or From Any Other Source, Including Incandescent or Fluorescent Lamps. False Operation From Any External Cause is Completely Impossible.

Write For Full Details.

GORING KERR LTD.
HANOVER WAY, WINDSOR, BERKS.
TELEPHONE: 63211

For further information circle 271 on Service Card

NEW an invaluable work of constant reference

ELECTRONICS DATA HANDBOOK

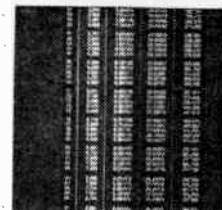

Electronics Data Handbook

Martin Clifford

The amount of data needed in the study of electronics today is very considerable, and the problem is to be able to find it readily. This handbook, by providing in one volume the formulae most frequently required, reduces the task of locating information. ELECTRONICS DATA HANDBOOK will be invaluable as a work of constant reference for students and technicians alike.

16s net by post 16s 10d
158pp illustrated

obtainable from
leading booksellers

Published for

ILIFFE Books Ltd.

DORSET HOUSE STAMFORD STREET LONDON S.E.1



Conferences, Symposia and Colloquia

9th–10th July at Cavendish Laboratory, Cambridge. Conference on 'Inelastic Scattering of Electrons by Solids'. Organized by The Institute of Physics and The Physical Society, 47 Belgrave Square, London, S.W.1 ('Phone: Belgravia 6111).

12th–17th July at the University of Exeter. XIIth International Spectroscopy Colloquium. Organized from 1 Lowther Gardens, Prince Consort Road, London, S.W.7.

15th–21st July. International Conference on the Education of Professional Physicists. Organized by the Institute of Physics and the Physical Society, 47 Belgrave Square, London, S.W.1 ('Phone: Belgravia 6111).

18th–21st July at Birmingham University. Conference on 'The State of the Art in Numerical Analysis'. Organized by The Institute of Mathematics and its Applications, 29 Gordon Square, London, W.C.1 ('Phone: Euston 6070).

6th–10th Sept. Convention on 'Machines for Materials and Environmental Testing'. Held at the Manchester College of Science and Technology, Manchester. Organized jointly by The Institution of Mechanical Engineers and The Society of Environmental Engineers from 1 Birdcage Walk, London, S.W.1 ('Phone: Whitehall 7476).

6th–10th Sept. 9th Conference of the European Organization for Quality Control. To be held in Rotterdam—details from the organization's Secretariat, Weena 700, Rotterdam 3, Netherlands.

8th–10th Sept. Symposium on 'Electronics in Industry'. Held at The University of Durham, Durham. Organized jointly by The Ministry of Technology and The Institution of Electronic and Radio Engineers from Wellbar House, Gallowgate, Newcastle-upon-Tyne, 1 ('Phone: Newcastle-upon-Tyne 27575).

13th–18th Sept. Engineering Materials and Design Conference. Held in conjunction with an exhibition at Olympia, London. Organized by Industrial & Trade Fairs Ltd., Commonwealth House, 1-19 New Oxford Street, London, W.C.1 ('Phone: Chancery 9011).

19th–25th Sept. International Conference on Elementary Particles, to be held in Oxford. Organized by the Rutherford Laboratory in collaboration with the Science Research Council. Details from The Rutherford Laboratory, Chilton, Didcot, Berks. ('Phone: Abingdon 1900, Ext. 438).

20th–25th Sept. International conference on 'Thermionic Electrical Power Generation'. Held at The Institution of Electrical Engineers, Savoy Place, London, W.C.2 ('Phone: Covent Garden 1871). Organized jointly by I.E.E. and O.E.C.D. European Nuclear Energy Agency.

21st–23rd Sept. Symposium on 'Applications of Microelectronics'. Held at Department of Electronics, The University, Southampton. Jointly organized by the I.E.E. and I.E.R.E. from The University of Southampton.

21st–24th Sept. First European Conference on Magnetism, Vienna. To be held at Technischen Hochschule, Vienna. Conference Secretariat: Verein Deutscher Eisenhüttenleute, 4 Dusseldorf, Breite Strasse 27.

23rd–24th Sept. Conference on 'Non-Metallic Thin Films'. To be held at Chelsea College of Science and Technology, London. Organized by The Institute of Physics and The Physical Society, 47 Belgrave Square, London, S.W.1 ('Phone: Belgravia 6111).

27th–30th Sept. Conference on 'Optics in Space'. Organized by the Institute of Physics and the Physical Society and to be held at the University of Southampton. For registration and details apply to I.P.P.S., 47 Belgrave Square, London, S.W.1 ('Phone: Belgravia 6111).

5th–6th Oct. Conference and Exhibition on 'Ultrasonics in Industry', to be held at St. Ermin's Hotel, St. James's, S.W.1. Applications to the organizers: *Ultrasonics*, Dorset House, Stamford Street, S.E.1 ('Phone: Waterloo 3333).

18th–19th Nov. Conference on 'Computational Methods in Crystallography' to be held at the Institution of Electrical Engineers, London, and organized by the Institute of Physics and the Physical Society, 47 Belgrave Square, S.W.1 ('Phone: Belgravia 6111).

22nd–23rd Nov. International Conference on U.H.F. Television, to be held at the I.E.E., Savoy Place, London, W.C.2. Sponsored by the I.E.R.E., the I.E.E. Electronics Division, the I.E.E.E. and the Television Society. Information from 9 Bedford Square, London, W.C.1 ('Phone: Museum 1901). Note that this conference was to have been held from the 1st–2nd Sept.

7th Dec. A one-day meeting on 'Semiconductor Junctions' arranged by the Institute of Physics and the Physical Society. To be held at the Royal Aeronautical Society, London. Details from the Meetings Officer, 47 Belgrave Square, London, S.W.1 ('Phone: Belgravia 6111).

Exhibitions

8th–17th July. London
Mining Machinery Exhibition, Olympia, London. Organized by Municipal and Industrial Exhibitions Ltd., 3 Clements Inn, London, W.C.2 ('Phone: Chancery 1200).

27th Aug.–5th Sept. Stuttgart
Deutsche Funkausstellung 1965—The German Radio and Television Exhibition. Held on the Killesberg in Stuttgart. Organized by Stuttgarter Ausstellungs-GmbH, 7 Stuttgart 1, Am Kochenhof 16.

7th–11th Sept. Basle
INEL 65 International Exhibition of Industrial Electronics, Basle, Switzerland. 61 Clarastrasse, 4000 Basle ('Phone: Basle (061) 323850).



WHAT'S ON AND WHERE

Continued

9th-19th Sept. Paris

Salon International de la Radio et de la Télévision, Paris.

13th-18th Sept. London

Engineering Materials and Design Exhibition. Held in conjunction with a conference at Olympia, London. Organized by Industrial & Trade Fairs Ltd., Commonwealth House, 1-19 New Oxford Street, London, W.C.1 (Phone: Chancery 9011).

14th-22nd Sept. Utrecht

HET Instrument 1965 Exhibition, Royal Dutch Industries Fair, Utrecht. Further details from: Cooperative Vereniging, 'HET Instrument' u.a., Sparrenlaan 2, Soest, Holland (Phone: Soest (02955) 3047).

28th Sept.-1st Oct. Brighton

Medical Electronic and Instrumentation Exhibition (in conjunction with The European Symposium on Medical Electronics) at Exhibition Hall, Brighton, Sussex. Organized by Events Promotions Ltd., Ashbourne House, Alberon Gardens, London, N.W.11 (Phone: Meadway 5555).

2nd-10th Oct. Ljubljana, Yugoslavia

XIIth International Exhibition on Modern Electronics. Details from: Gospodarsko razstavisce (Ljubljana Fair), Ljubljana, Titova 50, Yugoslavia.

4th-13th Oct. London

Business Efficiency Exhibition, London (Olympia). Organized by Business Equipment Trade Association, 64 Cannon Street, London, E.C.4 (Phone: Central 7771).

13th-19th Oct. Dusseldorf

3rd International Congress and Exhibition of Measuring Instrumentation and Automation (Interkama), Dusseldorf, Germany. Represented by John E. Buck (Trade Fair Agencies) Ltd., 47 Brewer Street, Piccadilly, London, W.1 (Phone: Gerrard 7576).

27th-30th Oct. London

R.S.G.B. Radio Communications Show, Seymour Hall, London. Organized by P. A. Thorogood, 35 Gibbs Green, Edgware, Middlesex.

30th Oct.-7th Nov. Genoa

Second International Communications Fair, organized by the Genoa International Fair, Viale Brigade Partigiane, Genoa, Italy. To be held in conjunction with the Second International Aircraft Exhibition.

30th Oct.-7th Nov. Genoa

Second International Aircraft Exhibition, organized by the Genoa International Fair, Viale Brigade Partigiane, Genoa, Italy. To be held in conjunction with the Second International Communications Fair.

Radio Show Cancelled

The organizers of The 1965 Radio Show have now announced that it is cancelled. The show was to have been held at Earls Court, London, from 25th Aug. to 4th Sept.

3rd-10th Nov. Oslo

Automatica 65—an exhibition of automatic control. Held in the Exhibition Hall, Skoyen, Oslo. Details from: Studieselskapet For Norsk Industri, Forskningsveien 1, Oslo 3.

15th-20th Nov. London

Industry '65 Exhibition—the International Industrial Equipment and Services Exhibition at Earls Court, London. Organized by the Industrial and Trade Fairs Ltd., Commonwealth House, 1-19 New Oxford Street, London, W.C.1 (Phone: Chancery 9011).

New Exhibitions

ALTEX the Automatic Laboratory Techniques Exhibition is to be held at the Royal Horticultural Hall, Westminster, London, S.W.1, from 1st to 3rd February 1966. Sponsored by Laboratory Equipment Digest it is believed that ALTEX will be the first exhibition of its kind in the world to be devoted exclusively to the application of the latest automatic, semi-automated and fully-automated apparatus. The exhibition is being organized by Southern Exhibitions Ltd., 11 Liverpool Terrace, Worthing, Sussex (Phone: Worthing 6584).

The International Medical Engineering and Automation Exhibition, 'MEDEA '67', will take place at Earls Court, London, from March 13th to 18th 1967. Organized by Industrial Exhibitions Limited, it is the successor to that company's International Medical Electronics Exhibition held in 1960. The new title indicates the trend of the exhibition which will cover all aspects of biological engineering, medical electronics and instrumentation, medical automation, hospital physics, electro-medical and X-ray equipment, and related techniques. It will be open to exhibitors from all countries and a special section will be offered to non-commercial organizations such as hospitals, research institutions and universities.

A national conference will be held during the exhibition and is now being discussed by an exploratory committee. Another committee, headed by L. A. Woodhead, a member of the Council of the Scientific Instrument Manufacturers Association, will deal with exhibition matters.

Courses

Value Analysis

20th-23rd July. 'Value Analysis'. I.Prod.E. Summer School 1965 at Loughborough College of Technology. Further details from: The Institution of Production Engineers, 10 Chesterfield Street, London, W.1 (Phone: Grosvenor 5254).

Radiation & Radiological Protection

Two postgraduate courses will be held at Battersea College of Technology during the session commencing in October. They are on 'The principles and practice of radiation protection' and 'Radiological protection'. Further details from the Director, Radiation Unit, Battersea College of Technology, London, S.W.11.

Non-Destructive Testing

Starting in September, the Croydon Technical College will be running a one-year evening course in non-destructive testing. The subjects to be offered include radiography, magnetic, eddy current and ultrasonic testing. It is intended to cover fundamental principles, testing techniques, and principles involved in the design of the instruments used.

The course is designed for students at about H.N.C. level and will include practical work. An examination will be set at the end, a college certificate being awarded to successful students.

Further details of the course can be obtained from the Head of the Science Department, Croydon Technical College, Fairfield, Croydon, Surrey (Phone: Croydon 9271).

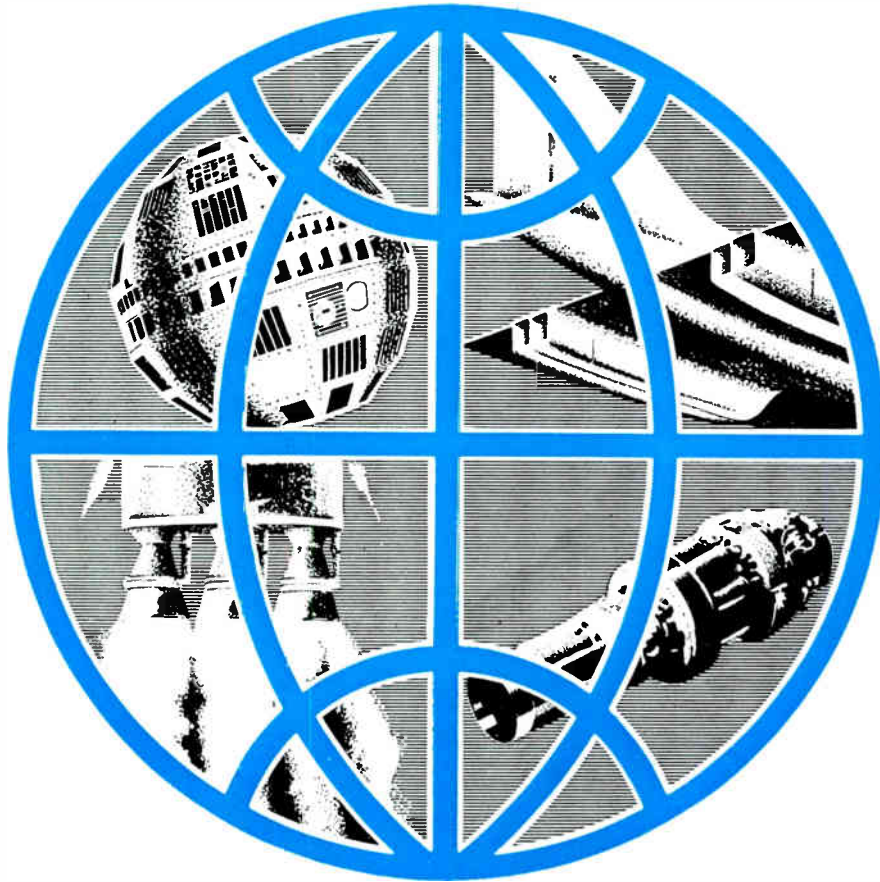

DEADLINE / **TODAY**

**In the data systems world of nanoseconds,
tomorrow is a century away.**

Benson-Lehner assist you in meeting your deadline today through their range of Redcor Amplifiers, which have long been recognised as the forerunners in the field of solid state circuitry, reliable under circumstances of continued performance. □ It is people, however, who will

ultimately be responsible for the success of your operation. □ The Benson-Lehner engineers form a dedicated group prepared to cope with any emergency, fully capable to assist you in meeting your deadline—today!

Redcor D.C. Differential Amplifiers are precision engineered for applications in varying strain gauge, thermocouple, resistive transducer and multiplexing operations. □ Individually numbered personal copies of our new Amplifier Applications Manual are available to members of research and engineering laboratories on request.

- Fast Recovery Time from 20 volt differential or common mode overload.
- High common mode rejection with wide bandwidth.
- High input impedance—1000 megohms.
- Line unbalance—0-1000 ohms either line.
- No guard shield—so no third wire.
- Variable gain—10-1000.
- Variable bandwidth unaffected by gain change.

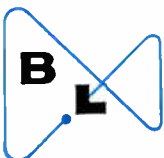
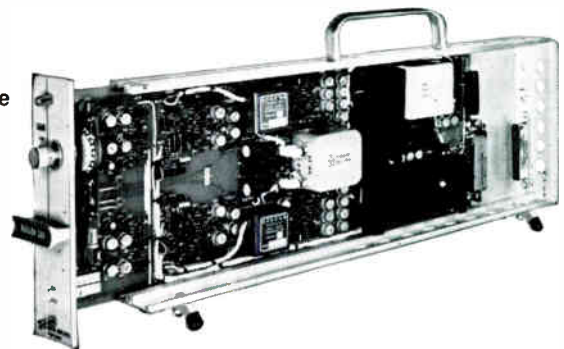

For full details of how BENSON-LEHNER can help you in the data systems field, telephone SOUTHAMPTON 27831, or write to: DIGITAL SYSTEMS DIVISION

benson-lehner

LTD / WEST QUAY ROAD / SOUTHAMPTON

For information on:—

D. C. AMPLIFIERS

/

A. D. CONVERTERS

/

MULTIPLEXERS

*Biotax
Precision
Micromotors*



*Biotax and Microtor
Precision D.C. Micromotors*

These miniature precision D.C. Motors, manufactured by BRION LEROUX & CIE of PARIS (under O.N.E.R.A. licence) are designed essentially for precision measurement and integration, for servo mechanisms, remote control and as tachometric generators. They are widely employed in automation systems.

*Automation and Communication Engineers
are invited to write for details to:*

- ★ Speed proportional to voltage as motor, or voltage proportional to speed as generator. Two independent windings can be employed in series or separately—one as motor one as generator.
- ★ Four models available: wound for 5, 20 or 50 volts on each winding at 3,000 r.p.m., tachometer model wound for 100 volts on motor winding, 9.5 volts from tacho winding at 3,000 r.p.m.
- ★ Very high efficiency, low inertia and time constant. Starting current as low as 1 to 2 milliwatts. Maximum power 3.6 watts.
- ★ Optional interchangeable reduction gearboxes of ratios 1:18, 1:50, 1:150, 1:2000 or 1:3000.
- ★ Smaller model MICROTOR with single winding for 5 or 10 volts has starting current from 100 microwatts. Maximum power 110 milliwatts. Reduction gearboxes of ratios 1:18, 1:50 or 1:150.

**LELAND
LEROUX LTD**

Precision Control & Meter Makers
TELEPHONE: VICTORIA 3243 (FIVE LINES)

145 GROSVENOR ROAD • WESTMINSTER • LONDON S.W.1