

INDUSTRIAL ELECTRONICS

MAY 1965 5s 0d

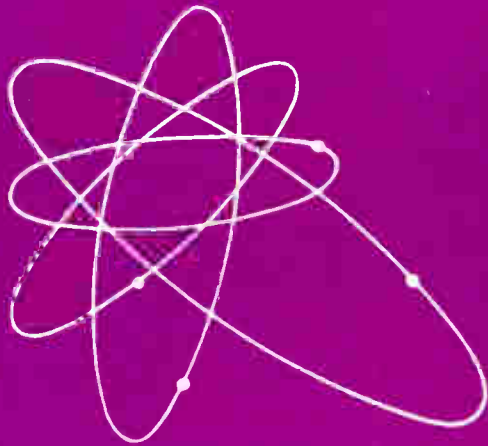

8th INTERNATIONAL INSTRUMENT SHOW



COMPLIMENTARY TICKETS AVAILABLE FROM

B & K LABORATORIES LTD., 4 TILNEY ST., PARK LANE, W.1

WHO WILL EXHIBIT A WIDE RANGE OF EQUIPMENT

SECOND
ENVIRONMENTAL
ENGINEERING
SYMPOSIUM

LONDON
MAY 17-21

ADVANCED
LABORATORY
AND INDUSTRIAL
INSTRUMENTATION

This exhibition has been timed to coincide with the Radio and Electronic Components Exhibition at Olympia so that both shows can be visited with the minimum travelling. Some of the World's leading Electronic Manufacturers will exhibit their latest instrumentation. Most of the equipment displayed will represent important design advancements and several entirely new instruments will be shown and demonstrated for the first time. The exhibition will be held at GROSVENOR HOUSE, within easy reach of Olympia, and tickets are available upon request.

Industrial Electronics May 1965

INDUSTRIAL ELECTRONICS

Automation Instrumentation Control

Volume 3

Number 5

May 1965

Contents

Editor **W. T. COCKING, M.I.E.E.**
Assistant Editor **T. J. BURTON**
Consulting Editor **T. E. IVALL**
Advertisement Controller **G. H. GALLOWAY**
Advertisement Manager **R. H. C. DOHERTY**
Production **D. R. BRAY**
Drawing Office **H. J. COOKE**

207 **Comment**

208 **Car Ferry Loading Control** *by N. Simpson*
This article describes a closed-circuit television system installed at Dover to facilitate control of the loading of cars on cross-Channel ferries. It is expected to reduce the turn-around time of a vessel from 90 minutes to 75 minutes.

211 **An Introduction to Torque Motors** *by J. B. F. Cartwright*
Torque motors are widely used for converting electrical signals into mechanical movement and so for positioning control valves, etc. This article describes their characteristics in elementary terms.

216 **Electronics in Textile Machines—3** *by R. Greenwood, B.Sc.*
In this concluding article of the series, a method of controlling a carding machine is described. This machine produces the sliver and the control system has enabled the coefficient of yarn variation to be reduced from 2.35% to 1.65%. This is considerable as a reduction of even 0.1% is significant.

224 **The Radio & Electronic Component Show 1965**
Every two years an exhibition of the latest radio and electronic components is held in London under the sponsorship of The Radio and Electronic Component Manufacturers' Federation. This year the show opens at Olympia on 18th May and closes on 21st May. This article is prepared as a guide to the exhibition. It includes a list of exhibitors and a plan of the exhibition area. Also, the article provides a preview of some of the products to be exhibited at the show. Where possible a guide is given to the trends being created by the component manufacturers.

continued overleaf

© Iliffe Electrical Publications Ltd., 1965

Permission in writing from the Editor must first be obtained before letterpress or illustrations are reproduced from this journal. Brief abstracts or comments are allowed provided acknowledgment to the journal is given.

Published on the first Thursday after the 5th of each month by
Iliffe Electrical Publications Ltd., Dorset House, Stamford Street, London, S.E.1
Managing Director: W. E. Miller, M.A., M.I.E.R.E.

Telephone: Waterloo 3333. Telegrams/Telex: Electronics Iliffepres 25137 London

ANNUAL SUBSCRIPTION, HOME £3 0s. 0d. OVERSEAS £3 10s. 0d.
CANADA and U.S.A. \$10.00.

INDUSTRIAL ELECTRONICS

Automation Instrumentation Control

Contents *continued*

- 232 **A Sonic Aid for Blind People** *by J. Lewis*
A device for detecting the presence and position of objects up to a range of approximately twenty feet, by means of auditory tones, is described in this article. It is intended as an aid for the blind and is now undergoing evaluation tests.
- 235 **Control Design Data—Third-Order Servomotor Systems—2**
by N. G. Meadows, B.Sc.
- 249 **The Physics Exhibition 1965**
Although the Physics Exhibition has long been renowned as a platform for fundamental research and development in physics, this year's show featured many products of a down-to-earth nature. Many new developments which have been designed with an ultimate application in mind are described in this review of the exhibition.

What's On and Where?

A regular feature which lists forthcoming events. Professional meetings, symposia, conferences and exhibitions are included. For easy reference this item is positioned facing the inside back cover.



OUR COVER

This month's front cover picture illustrates an interesting and efficient application of a closed-circuit television system. Here a number of cameras, each covering critical areas in the Dover Harbour Board's car ferry depot, provide instantaneous visual information about the density of traffic to a central control point. The article starting on page 208 gives more details of this installation.

● TO SAVE YOUR TIME

We will assist you to obtain further information on any products or processes described or advertised in this issue. Just use the enquiry cards included in this journal.

Features

- | | | | |
|-----|--|-----|---------------------------|
| 221 | Lincompex | 237 | New Apparatus |
| 222 | Feed-Monitor System for Jute Spreading | 252 | Industrial News |
| 223 | Automatic Asphalt Mixer | 255 | New Books |
| 231 | Traffic Automation in Munich | 256 | Manufacturers' Literature |
| 236 | High Speed Impact Counting | 74 | Classified Advertisements |
| | | 83 | Index to Advertisers |

Next Month

The electronic control of a machine for the automatic production of butter packs of constant weight will be described. Among the other articles will be one dealing with the modern analogue computer.

For further information
circle 203 on Service Card

WELWYN VITREOUS ENAMELLED WIRE WOUND RESISTORS "W" RANGE TO DEF 5115

WELWYN
W21

TYPE	DEF 5115 STYLE	DEF 5115 RATING at 70 C	ROOM TEMPERATURE RATING (20 C)
W21	RFH2-2.5	2.5 watts	3 watts
W22	RFH2-6	6 watts	7 watts
W23	RFH2-9	9 watts	10.5 watts
W24	RFH2-12	12 watts	14 watts

WELWYN
W23

SELECTION TOLERANCE: $\pm 1\%$, $\pm 2\%$ and $\pm 5\%$.

TEMPERATURE COEFFICIENT: For most resistors the temperature coefficient will be found to be in the region of 50 ppm and in no case will it exceed 100 ppm/ C.

STABILITY: After 2,000 hours D.C. cyclic load at 70 C the change in resistance will be less than 5% in accordance with DEF 5115.

AGEING: After three years storage change in resistance will not exceed 1%.

WRITE NOW FOR FULL DETAILS



WELWYN ELECTRIC LIMITED

BEDLINGTON - NORTHUMBERLAND - ENGLAND

Telephone : Bedlington 2181-9 - Telegrams : Resistor' Bedlington.

FACTORIES IN AUSTRALIA AND CANADA

TELFORD OSCILLOSCOPE CAMERAS

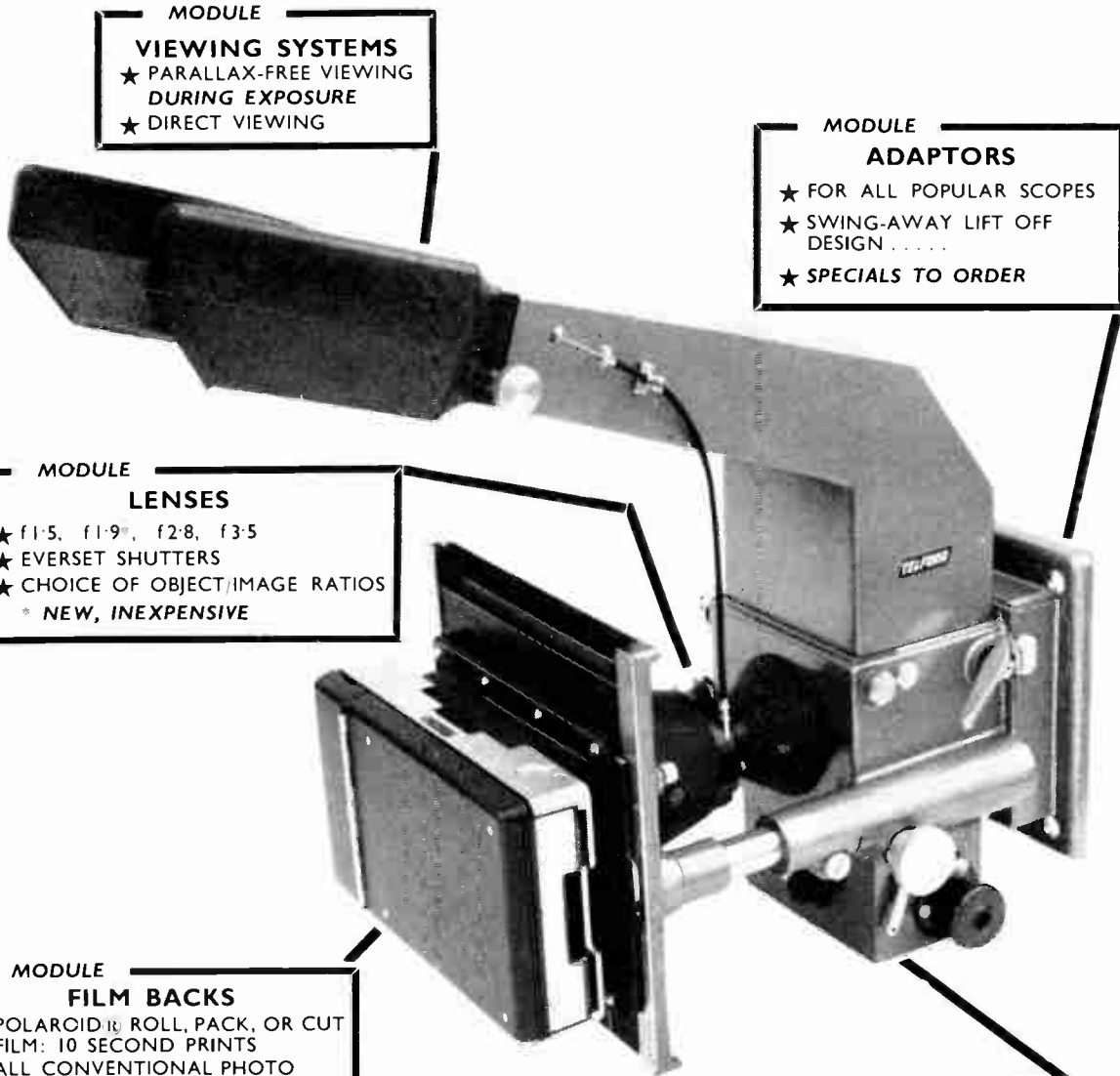

MODULE
VIEWING SYSTEMS
★ PARALLAX-FREE VIEWING DURING EXPOSURE
★ DIRECT VIEWING

MODULE
ADAPTORS
★ FOR ALL POPULAR SCOPES
★ SWING-AWAY LIFT OFF DESIGN
★ SPECIALS TO ORDER

MODULE
LENSES
★ f1.5, f1.9, f2.8, f3.5
★ EVERSET SHUTTERS
★ CHOICE OF OBJECT/IMAGE RATIOS
* NEW, INEXPENSIVE

MODULE
FILM BACKS
★ POLAROID® ROLL, PACK, OR CUT FILM: 10 SECOND PRINTS
★ ALL CONVENTIONAL PHOTO MATERIALS INCLUDING 35 MM.
★ FIXED OR RACKING

MODULE
ACCESSORIES
★ DATA RECORDING
★ SOLENOID OPERATION
★ UV LIGHT SOURCE*
★ PROJECTED GRATICULE
* NEW

® Registered trade mark of the Polaroid Corp.

MODULAR CONSTRUCTION – ADD MODULES TO BASIC CAMERA AS THE REQUIREMENT ARISES

TYPE A AS ILLUSTRATED; OTHER TYPES AVAILABLE; PRICES FROM **£84 TELEPHONE FOR FURTHER INFORMATION AND A DEMONSTRATION:—**

TELFORD PRODUCTS LIMITED Photographic Instrumentation Manufacturers

TELFORD WAY, E. ACTON, LONDON, W.3. TEL.: SHEPHERDS BUSH 1015 (5 LINES)

A **DAVALL** INSTRUMENTATION COMPANY

BRIDGES

modern variations of established ideas

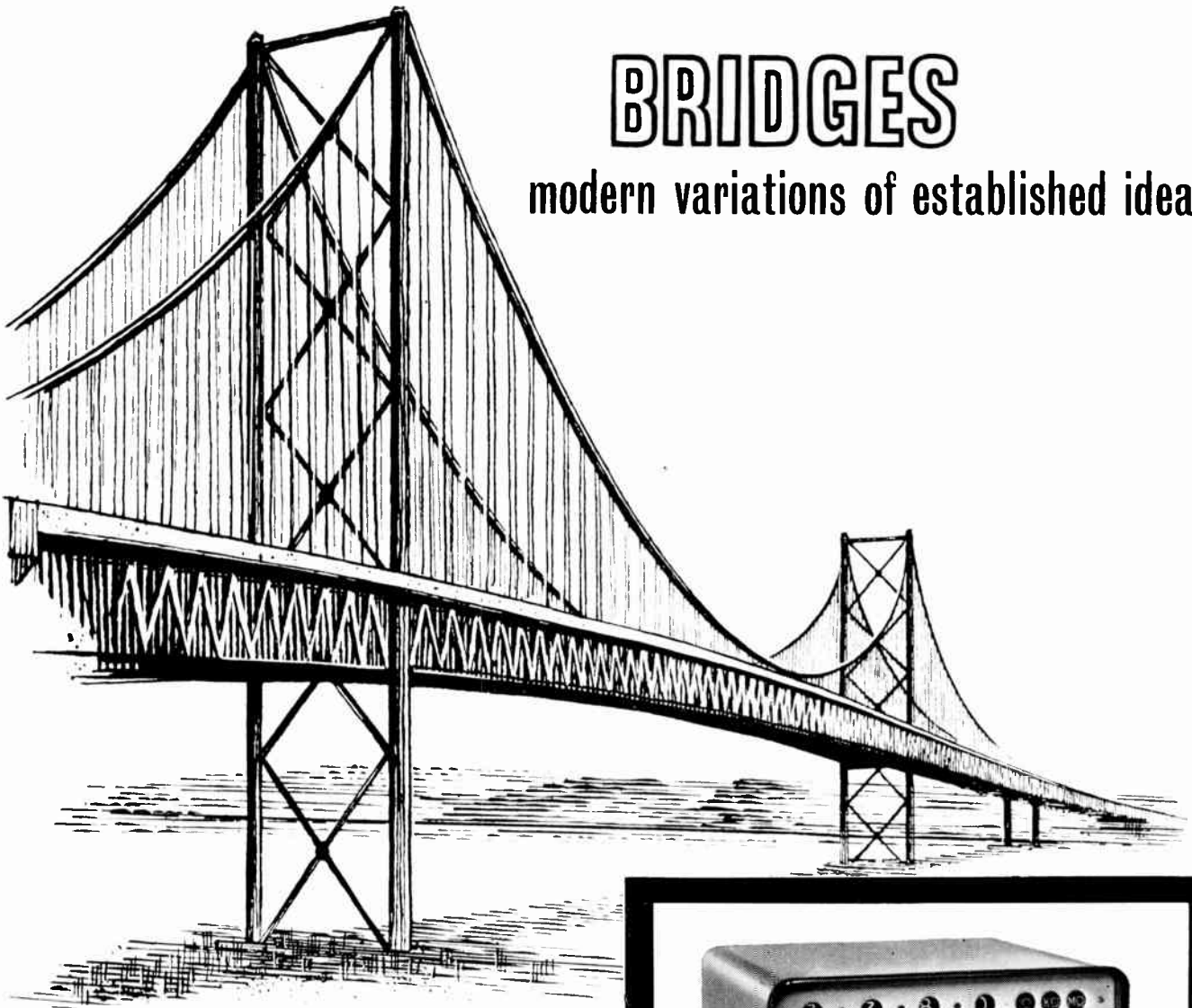

The new Forth Bridge
and the new

Digital Wheatstone Bridge

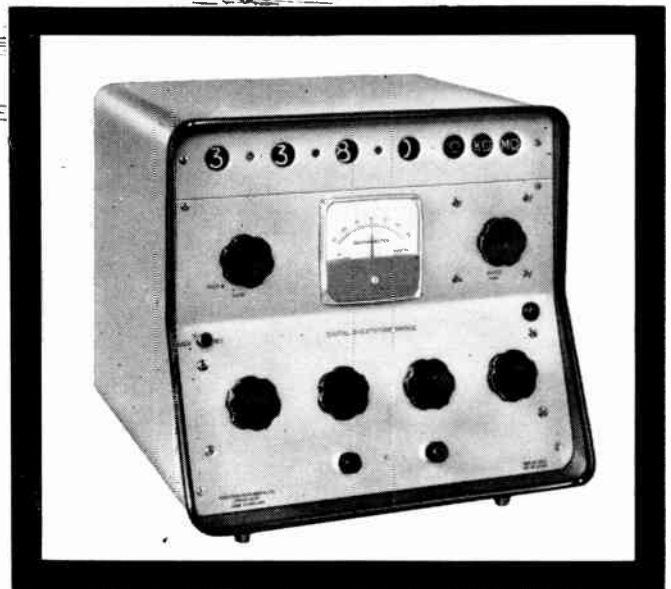

The old Forth Bridge is superseded. The same purpose is served but much more efficiently. This also applies to the modern version of the Digital Wheatstone Bridge. The high standard of accuracy and reliability is still there and the purpose is the same but there are many modern innovations. The illuminated display gives an instant and unambiguous digital readout of four figures, decimal point and the correct unit, i.e. Ohms, Kilohms or Megohms and there is therefore no need to work out the ratio in use. Resistance coils, wound in Constantan are adjusted to an accuracy of better than $\pm 0.1\%$. Test potentials of approximately 2.5 and 100 volts are obtained from supply mains and either 'Low' or 'High' can be preselected.



DERRITRON INSTRUMENTS LIMITED
24 UPPER BROOK STREET · LONDON W1
HYDE PARK 2291

1F/5/65

the same clear readout...



...and more in the box

TSA3334 MK111 Frequency Meter and Counter

- Blanking circuit now fitted, switching off display whilst count progresses
- Improved sensitivity — now 100mV
- Period measurement over 1, 10 and 100 cycles
- Count facility added, 1.2 Mc/s maximum
- Operates off one 12V battery or A.C. mains
- Price £135 (U.K. only)

Complete technical details on request from

VENNER

VENNER ELECTRONICS LIMITED
KINGSTON BY-PASS · NEW MALDEN · SURREY · MALDEN 2442

Overseas subsidiaries
VENNER A. G. BURGERNZIELWEG 16 · 3006 BERNE · SWITZERLAND
VENNER N. V. HELMSTRAAT 3 · DEN HAAG · HOLLAND

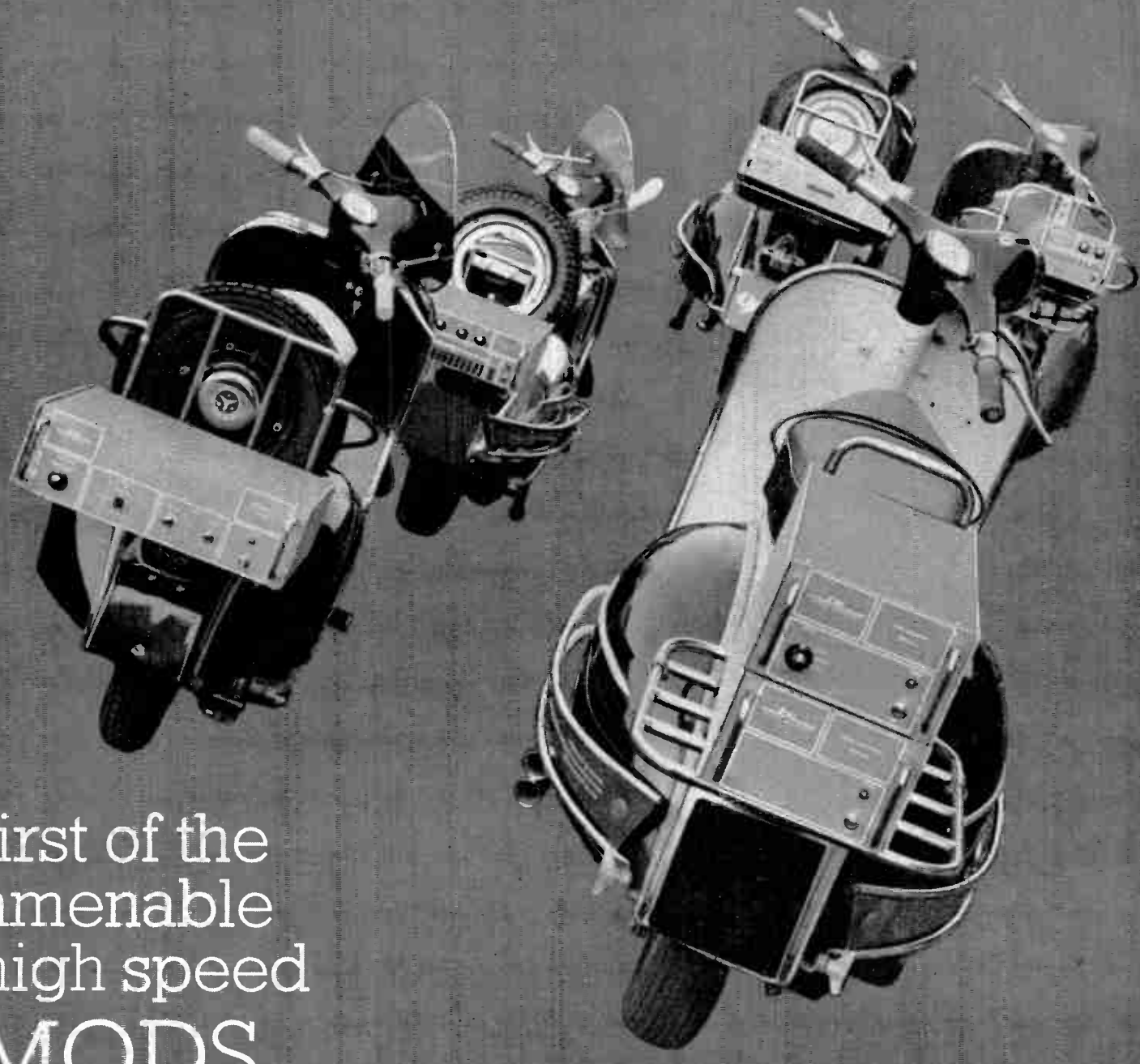

first of the
amenable
high speed
MODS

Modular data processing with **you** in mind

For further information circle 207 on Service Card

EAL

1965—and the leaders in scientific computation present a **new** kind of data processing capability—high-speed, modular—fast enough, flexible enough to meet day-to-day changes in individual scientific requirements. At present 10 modules with standard interface can be used in various combinations—later there will be more. This is a radical new look in data processing which is already saving time, money and space. Ask about it—and bear in mind EAL modular data processing systems include those recently developed to NPL specifications.

ELECTRONIC ASSOCIATES LTD · BURGESS HILL · SUSSEX · TELEPHONE BURGESS HILL 5101

In liaison with EAI Long Branch, New Jersey, USA: ADVANCED SYSTEMS ANALYSIS AND COMPUTATION SERVICES ANALOGUE COMPUTERS HYBRID ANALOGUE-DIGITAL COMPUTATION EQUIPMENT SIMULATION SYSTEMS SCIENTIFIC AND LABORATORY INSTRUMENTS INDUSTRIAL PROCESS CONTROL SYSTEMS PHOTOGRAMMETRIC EQUIPMENT RANGE INSTRUMENTATION SYSTEMS TEST AND CHECK-OUT SYSTEMS MILITARY AND INDUSTRIAL RESEARCH AND DEVELOPMENT SERVICES FIELD ENGINEERING AND EQUIPMENT MAINTENANCE SERVICES.



**miniature
blowers**

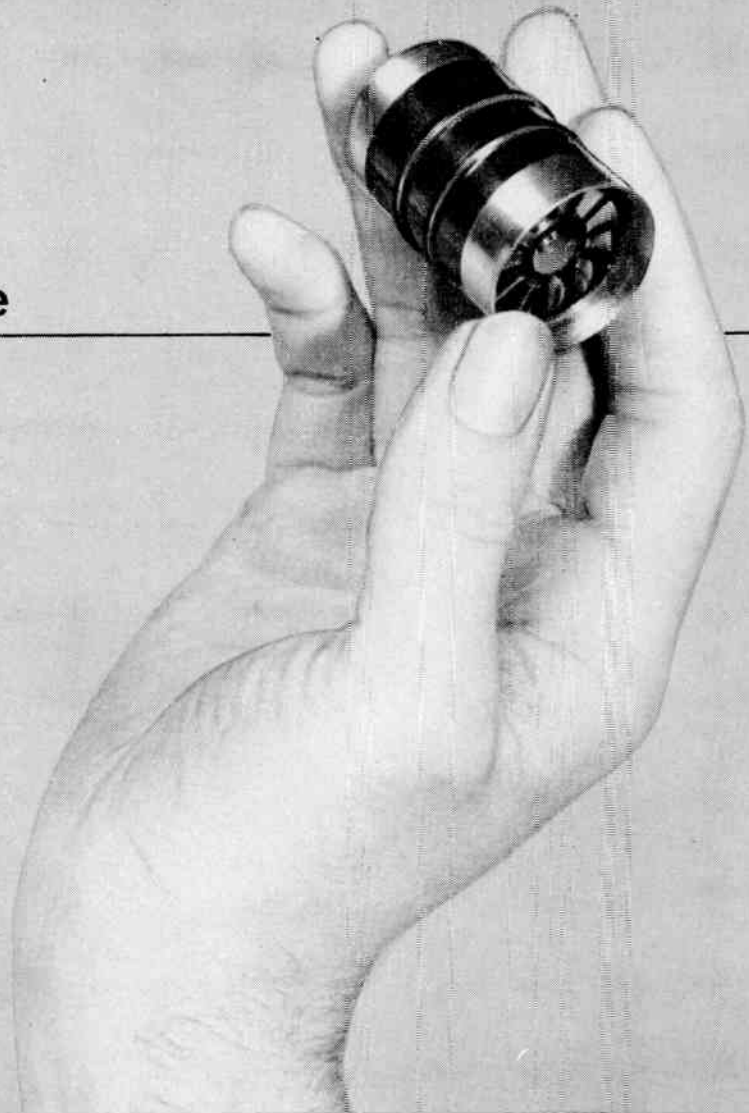

Designing new equipment? you'll need this guide to aero-thermal control

For further information
circle 208 on Service Card

With increasing miniaturisation, temperature control is becoming more and more critical. To meet this need Plannair has designed a whole range of miniature blowers offering the best combination of size, weight and performance. Sixteen of these blowers (including the tiny 2½ oz Thimble blower, which is only 1.85 in. long and 1.13 in. dia.)— out of a total range of over 1,000 designs — have been featured in a new publication, 'Plannair Miniature Blowers'. Full dimensions, and operating and performance data are given. Send for your copy by using the reader reply service or this coupon.

Note: Air movement and temperature control problems are often more than a matter of just fitting a blower. Plannair's aero-thermal control specialists will be pleased to come and discuss your specific problem with you right from the planning stage. Many manufacturers already take advantage of this service and PLAN WITH PLANNAIR.

To Plannair Ltd. Windfield House, Leatherhead, Surrey. Telephone: Leatherhead 5341-50

Please send me a copy of 'Plannair Miniature Blowers'

Name _____

Position _____

Company _____

Address _____



**specialists in
aero-thermal control**

PLA 15

Industrial Electronics May 1965

Continuous Frequency Coverage from 1.5 c/s to 150 kc/s in 5 Ranges at Decade Intervals

TRANSISTOR R.C. OSCILLATORS TYPES TG150, TG150M TG150D & TG150DM

SPECIFICATION:

FREQUENCY

1.5 c/s to 150 kc/s
±3% + 0.15 c/s.

STABILITY

< 0.05% drift after 30 seconds.
< 0.3% drift for 30% fall of supply voltage.
< 0.05% drift per °C at 1 kc/s.

DISTORTION

< 0.1% at 1 kc/s;
< 0.3% from 50 c/s to 15 kc/s;
< 1.5% below 50 c/s and above 15 kc/s.

SINE WAVE OUTPUT

Variable up to 2.5V into 600Ω
< 1% variation with frequency.
< 0.5% change for 30% fall of supply voltage.

SQUARE WAVE OUTPUT

Variable up to 2.5V
Rise time 1% of period + 0.2μs.

ATTENUATOR

20dB, 40dB and 60dB; 600Ω.

SUPPLY

Self-contained PP9 batteries, life 400 hours, or, 200/250V A.C. when Power Supply Unit is fitted.

SIZE

10" high × 6" wide × 4" deep.

WEIGHT

6 pounds.



SEE US ON
STAND No. 454
GRAND HALL GALLERY
RADIO & ELECTRONIC COMPONENT SHOW
OLYMPIA — 18th—21st MAY

TYPE	TG150	TG150M	TG150D	TG150DM
Output Waveforms:	Sine only	Sine only	Sine and Square	Sine and Square
Output Meter:	None	0-2.5V and dB	None	0-2.5V and dB
Price with batteries:	£32	£42	£35	£45

LEVELL
PORTABLE INSTRUMENTS

Mains Power Supply Unit **£7.10.0**

Leather carrying case **£3.10.0**

Fully detailed leaflets available on our complete range of portable instruments

LEVELL ELECTRONICS LIMITED

PARK ROAD, HIGH BARNET, HERTS — Telephone: BARnet 5028

A low cost FULLY POTENTIOMETRIC INDICATING TEMPERATURE CONTROLLER

Eight control actions are available, including :—

- TWO-POSITION
- ANTICIPATORY
- PROPORTIONING*
- THREE-POSITION
- CONTINUOUSLY ACTING

*for thyristors or saturable reactors and motorised valves.

See *ETHER* on
STAND AA655
at *INTERPLAS* Exhibition
OLYMPIA, June 16—26

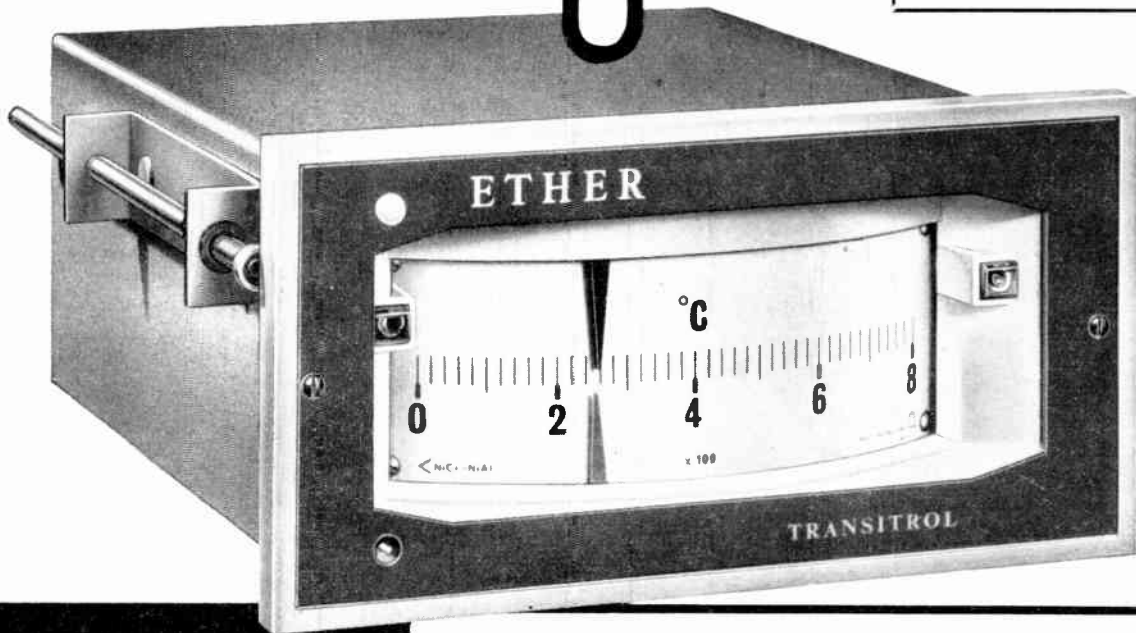

ETHER

TRANSITROL

SERIES 1290

Close accuracy, wide range, for Thermocouple Resistance Bulb or mV inputs.

Measurement is by the continuous comparison, via a slide wire, of the input signal against a stabilised internal reference voltage. The derived error signal is amplified to trigger a phase sensitive detector. This operates an actuator to drive both the indicator and the slide wire contact to eliminate the error.

Control is effected by two contacts on an auxiliary slide wire—one attached to the indi-

cating pointer and one in line with the control setting. The voltage difference is amplified and operates a suitable control relay. Thus both measuring *and* control actions are fully potentiometric—a unique feature giving TRANSITROL outstanding advantages over other temperature indicating controllers. The Transitrol is housed in an attractive, flush mounting, fully sealed case in two-tone grey finish, with easy-to-read vertical or horizontal scale.



Send for full details to :—

CAXTON WAY, STEVENAGE, HERTFORDSHIRE
Telephone : Stevenage 3040-55

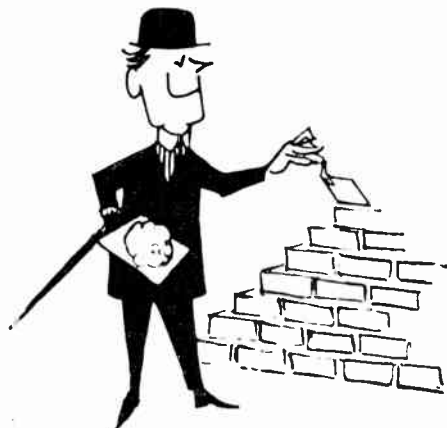

DO IT YOURSELF AUTOMATION

Brick by brick you can now build automation into your plant—for counting, routing or controlling production.

Livingston's new modular concept enables control systems to be tailor-made to meet your specific needs at a fraction of the cost of earlier systems. And because each of the electronic "bricks" used is interchangeable, systems can be extended as your needs grow.

Latest addition to the modular range is the LC 102 Inductive Switch—so versatile it can be used to maintain an accurate count of the smallest ball bearings or largest diesel locomotives. Rugged all-transistor construction ensures maximum reliability under the most severe conditions in ambient temperatures ranging from 0°—50°C.

See us on Stand 63 at PAKEX, Earls Court, May 19—27, and Stand 369 at the R.E.C. Show, Olympia May, 18—21.

LIVINGSTON CONTROL LTD

Greycaines House, Bushey Mill Lane
Watford, Herts.
Telephone: Watford 41291

<p>THE Livingston GROUP</p>	<p>To Livingston Control Ltd. Greycaines House, Bushey Mill Lane, Watford, Herts.</p>
<p>Please send me a copy of the "Modular Control for Industry" catalogue.</p>	
<p>NAME.....</p>	
<p>ADDRESS.....</p>	
<p>.....</p>	

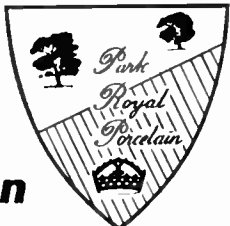

Porcelain
Steatite

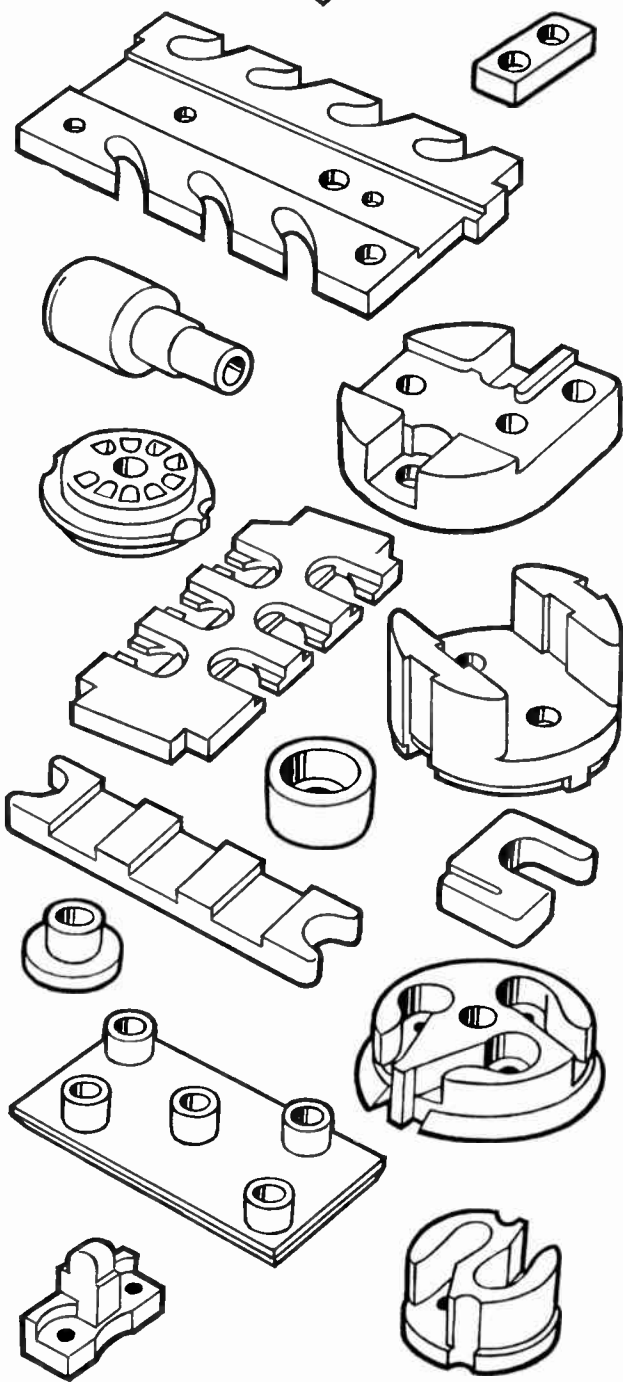

V. G. PORCELAIN CO LTD

GORST ROAD
PARK ROYAL
LONDON, N.W.10

Telephones:
ELGAR 1411/7
Telex:
London 25589

ROTAX COMPONENTS & TRANSDUCERS

ROTAX C.A.V. Transducer

401 Transducer

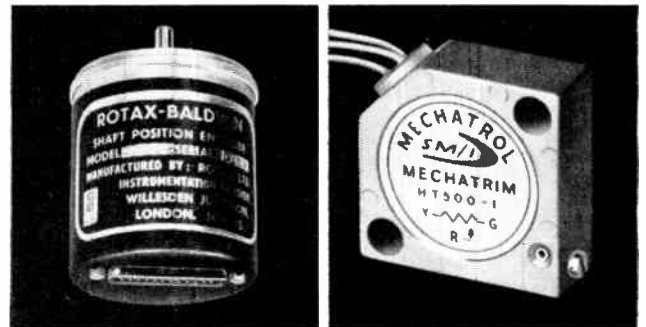
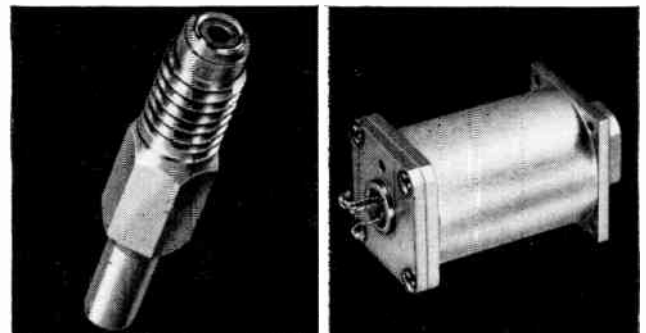

200 Series Encoder

H.T. 500 Trimmer Potentiometer

Reliable instrumentation
to suit your needs exactly

Rotax produce a specialised range of equipment to very high standards of precision and reliability. Existing stocks provide for most normal needs. If your specification cannot be met exactly, Rotax will manufacture to your requirements.

Pressure transducers	potentiometric
Strain gauges	pressure transducer type
Digital shaft encoders	photo-electric
Trimmer potentiometers	miniature, metal-film

These instruments are designed to meet military environments. To find out more about Rotax Components and Transducers, ring Elgar 7777, Ext. 302—now, or see us at the R.E.C.M.F. Exhibition, on stand no. 315.

ROTAX
INSTRUMENTATION DIVISION

ROTAX LIMITED, INSTRUMENTATION DIVISION
WILLESDEN JUNCTION, LONDON, N.W.10. TELEPHONE: ELGAR 7777

COLVERN

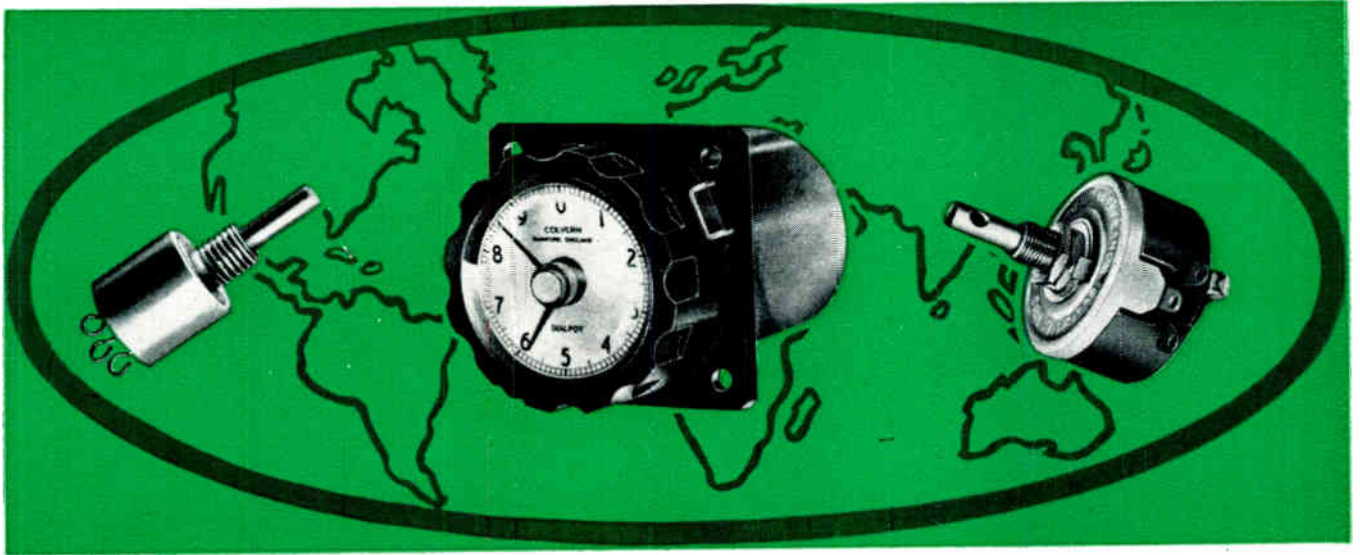

WORLD RENOWNED

for wire wound **POTENTIOMETERS**

- ★ STANDARD TYPES 1-25 WATT.
- ★ SEALED TROPICAL TYPES.
- ★ HELICAL, STANDARD AND PRECISION.
- ★ PRECISION LINEAR AND FUNCTION.

With over 50 types in production. This comprehensive range covers most of the requirements of a wirewound potentiometer, but if you have a special problem contact our advisory engineering service. Literature also available.



**SEE US ON STAND 253
RADIO & ELECTRONIC COMPONENT SHOW
OLYMPIA MAY 18-21**

COLVERN
LIMITED

Industrial Electronics May 1965

Spring Gardens, Romford,
Essex, England
TEL. ROMFORD 62222 (PBX) TELEX 23984

B*

11

MORE, precise..rugged..versatile

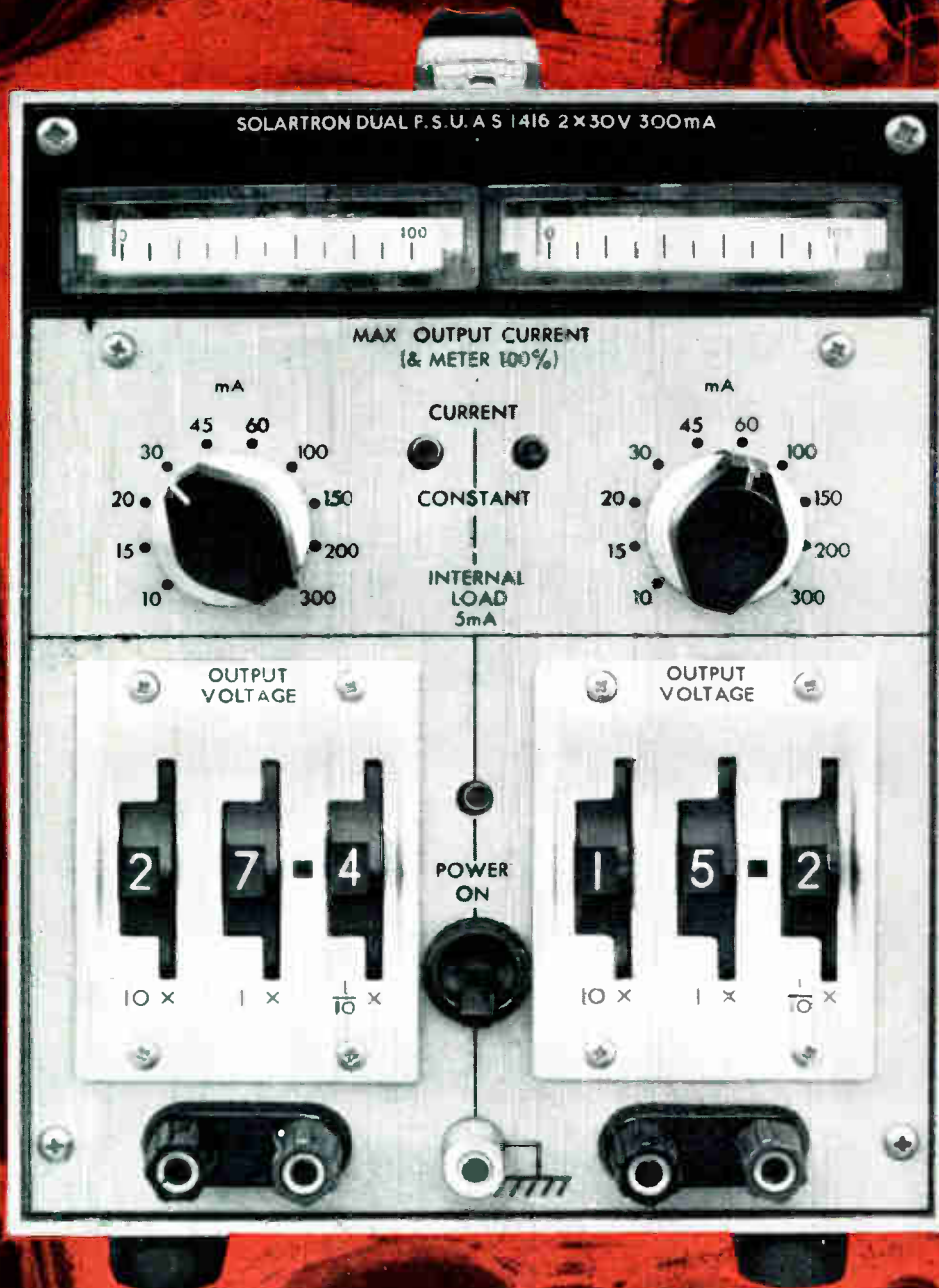

AS 1410
range of
Power Supplies
11 units
0-300mA to
0-5A

.. the standard of the future **NOW!**

What do you expect of a laboratory power supply?

The AS 1410 Range surpasses in all parameters the accepted standards of today — establishing the norm by which future designs will be judged. We state categorically they have no equal anywhere in the world.

Consider some of their performance features :

- * **Constant Voltage/Constant Current output characteristic with automatic changeover at any predetermined level.**
- * **0.25% typical decade voltage setting with supplementary smooth variable control.**
- * **10,000:1 Regulation against mains variation.**
- * **0.05% basic long term stability over 1000 hours and temperature coefficient of 0.01% per °C.**
- * **1 milliohm DC output resistance and 2 μsec response to full load transients.**

These alone justify our claims — there are additional benefits.

A novel method of meter ranging ensures that open scale readings are obtained at all current settings.

Specified ripple and noise are < 500 μV peak to peak but external modulation facilities allow low frequency signals to be superimposed at any desired level.

Long life and stability of parameters are guaranteed over an ambient temperature range 0–50 °C and even higher temperatures can be tolerated.

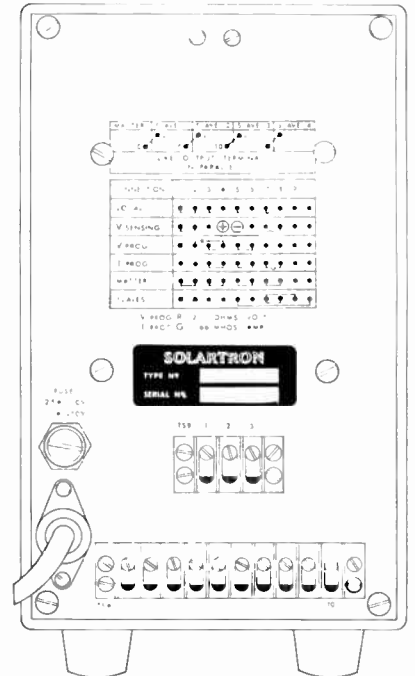

Full remote programme facilities for determining both voltage and current are combined with voltage sensing of remote loads and slaved parallel operation of multiple units.

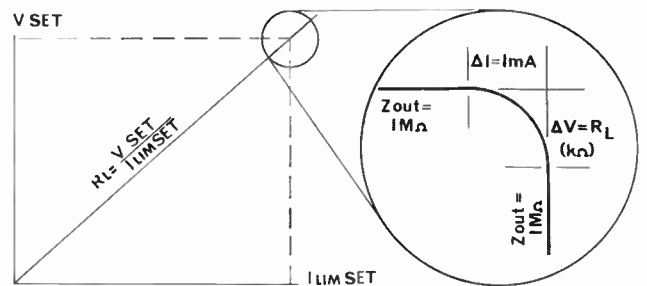

Automatic CV/CI changeover characteristic

SOLARTRON

For Data Systems · Transducers · Computers
Military Systems · **Electronic Instrumentation**

THE SOLARTRON ELECTRONIC GROUP LTD.

Victoria Road · Farnborough · Hants
Telephone · Farnborough · (Hants) · 3000
Telex · 85245 Solartron Fnbro
Cables · Solartron · Farnborough

A MEMBER OF THE SCHLUMBERGER GROUP

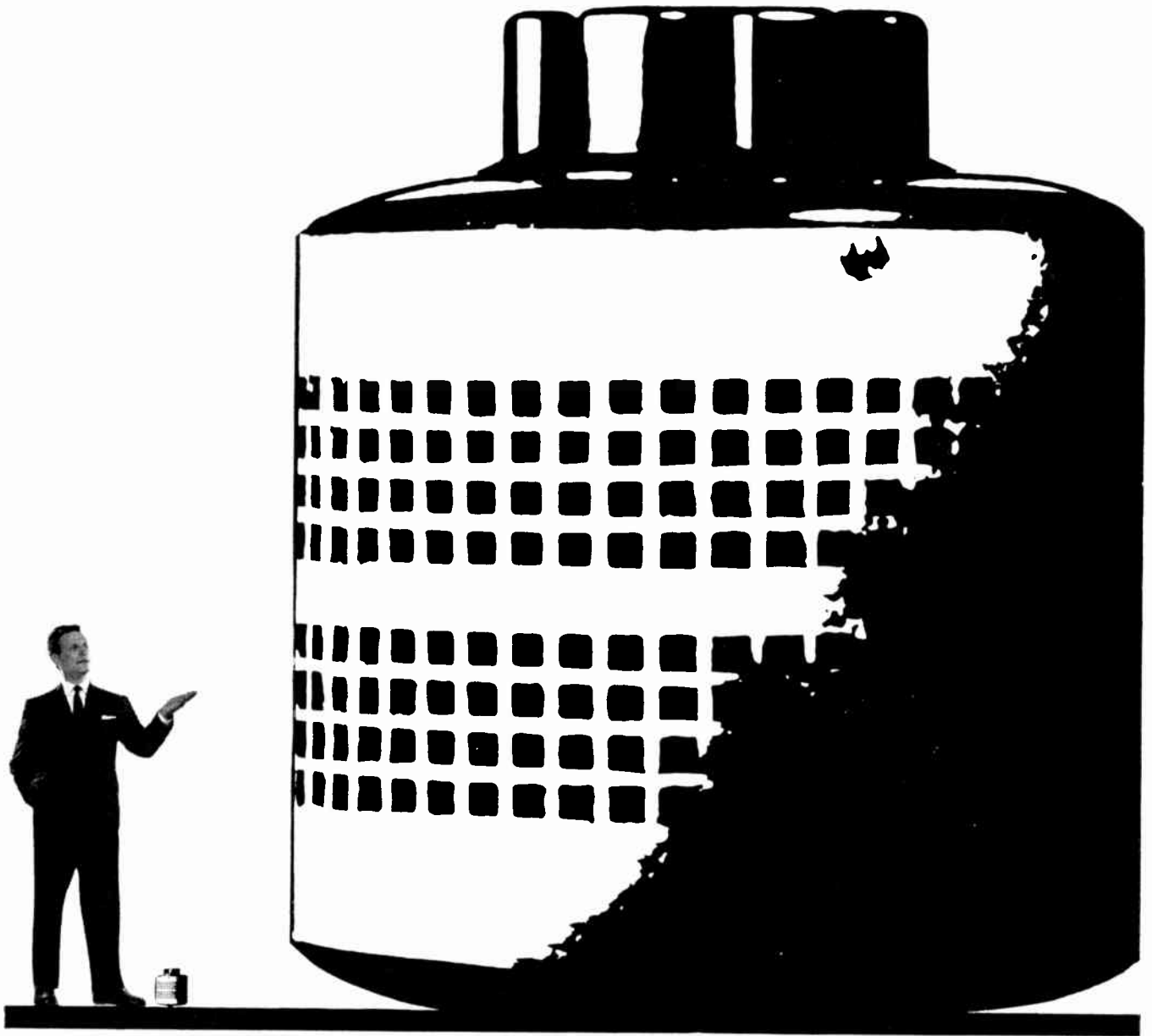

THE VARIAC* variable transformer is the most useful and versatile device ever developed for the control of a.c. voltage, or of current, power, heat, light, speed. It provides smooth continuous adjustment of output voltage from zero to line voltage and above, either hand-operated or motor-driven.

Only Variac has Duratrak* – a patented track surface giving longer life, increased overload and surge capacity and maximum economy in maintenance.

There are over 600 Variac models and assemblies to suit virtually every possible requirement, ranging from small units for laboratory or instrument use to large ganged assemblies for high power 3-phase operation. The range includes low-voltage, high-frequency, dual-output and narrow-range types, open, covered, portable, metalclad and oil-immersed constructions, plus many special models. This is the largest range of variable transformers available today.

The technical superiority and dependability of Variac are the result of over 30 years of development and refinement since the introduction of the first Variac models – the *original* variable transformers.

*'Variac' and 'Duratrak' are registered trade marks

Variac

REGD

the original and best
variable transformers

Variacs are made in England by The Zenith Electric Co. Ltd. London, and exclusively distributed in the U.K. Eire and British Colonies by Claude Lyons Ltd.

Write for comprehensive catalogue to Publicity Department, Hoddesdon

CLAUDE LYONS LTD

Valley Works, Hoddesdon, Herts Hoddesdon 4541 Telex 22724
76 Old Hall Street, Liverpool 3 MARitime 1761 Telex 62181

CL.45



INTEGRATED CIRCUITS

comprehensive range of low cost commercial types now available

WE HAVE THE SOLUTION TO YOUR PROBLEMS AT OUR FINGERTIPS . . .

- * high performance
- * low price level
- * now available



**SEE STAND
N° 317
RADIO AND
ELECTRONIC
COMPONENT
SHOW
18th-21st MAY
1965
OLYMPIA**

WESTINGHOUSE BRAKE AND SIGNAL CO. LTD. 82 YORK WAY, KING'S CROSS, LONDON N.1. TERminus 6432 Telex 2-3225

SPECIFY HUGHES DIODES

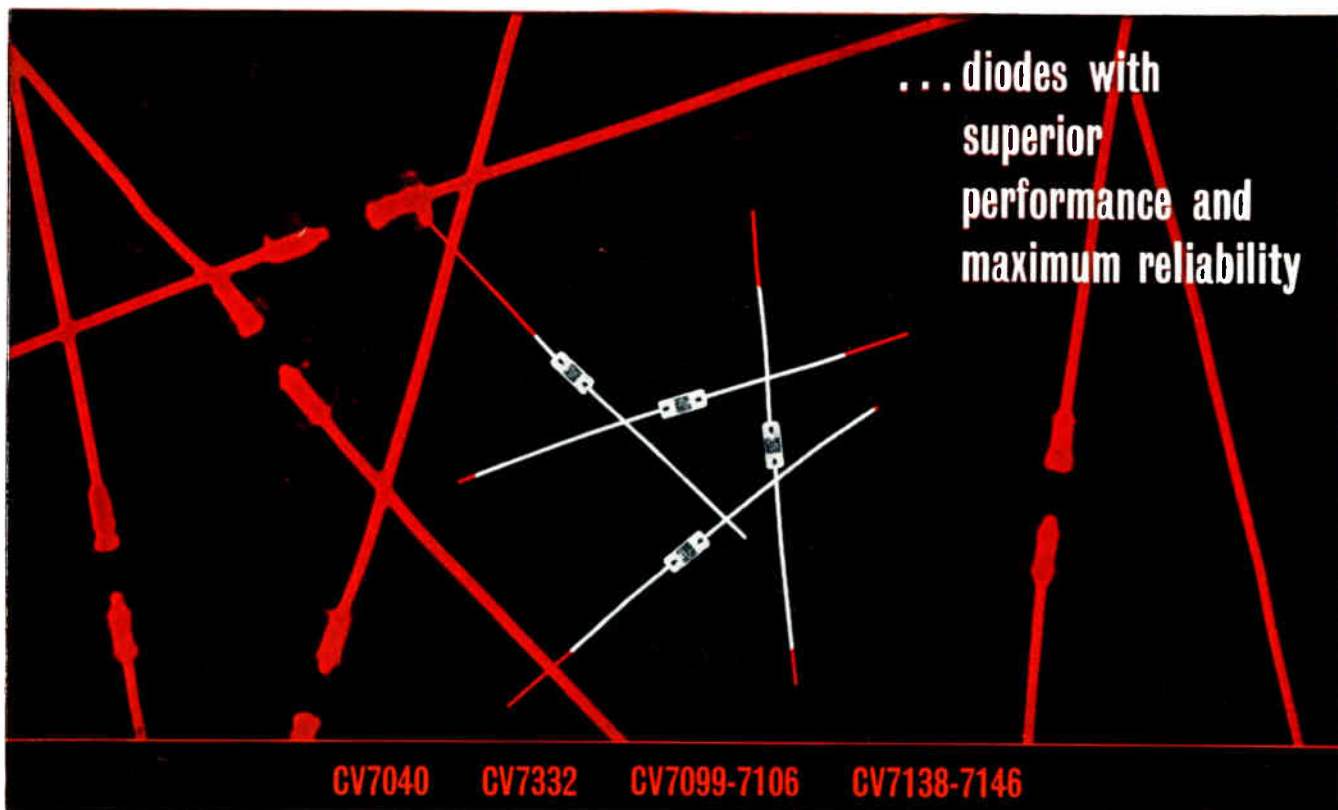

**SILICON SUB-MINIATURE POWER DIODES/RECTIFIERS ● ZENER DIODES
CARTRIDGE RECTIFIERS ● VOLTAGE VARIABLE CAPACITORS**

HS1020 HS1001 HS1004 HS1007 HS1010	General Purpose Diodes	PIV - - - - 50-200V Max. Avge. Rectified Current - - - 165mA I _b at PIV - <0.2μA CV 7040 CV 7332	HS2000 Series (250mW) HS 7000 Series (400mW)	Zener Diodes	Available in all preferred voltage values from 2.7—33V Low dynamic impedance High stability over wide temperature range CV7099-7106 CV7138-7146
HS3103 HS3104 HS3105 HS3106 HS3108 HS3110	200mA Power Diodes	PIV - - - - 300-1000V Max. Avge. Rectified Current - - - 165mA I _b at PIV - <0.2μA	HSC1 HSC2 HSC3 HSC4 HSC5 HSC6 ↑ HSC30	High Voltage Cartridge Rectifiers	PIV - - - - - 1-30kV Max. Avge. Rectified current - - 100mA Case size 0.55" dia. x approx. 0.25" per kV Welded assemblies of selected high voltage diodes, encapsulated in high grade epoxy resin
1N645 1N646 1N647 1N648 1N649	600mA Power Diode Rectifiers	PIV - - - - 225-600V Max. Avge. Rectified Current - - - 400mA I _b at PIV - <0.2μA	HC7001 HC7002 HC7004 HC7005 HC7006 HC7007 HC7008	Voltage Variable Capacitors	Capacitance range α -4V - - - - 35-100pF Peak voltage range - - 25-130V I _b @ max. voltage - - <1μA @ 25° C Standard Tolerance - - ± 20% (± 10% and ± 5% also available)

Hughes—originators of the world's first sub-miniature all-glass diode—manufacture at their Glenrothes, Scotland, factory an unequalled range of germanium and silicon devices for the most diverse diode applications. Add Hughes service and second-to-none product quality and solve your diode problems in the simplest way—SPECIFY HUGHES.



Write now for complete data on the full range of Hughes semiconductor products, which also includes:—Silicon and Germanium Signal and Switching diodes: PNP and NPN Silicon Transistors.

HUGHES INTERNATIONAL (U.K.) LTD

Sales office:

GLENROTHES · FIFE · SCOTLAND

HEATHROW HOUSE, BATH ROAD, CRANFORD, HOUNSLOW, MIDDLESEX. TEL: SKYpert 9584/5 and 9961/2. TELEX: 23613.

M & P HM23

'VSG' hydraulics

Hydraulic power has no equal for precise smooth and infinitely variable control of complex machine operations. 'VSG' Racine provides today's most advanced developments in hydraulic transmissions and pumps, with drives approaching 500 hp (maximum) and pumping pressures of up to 10,000 lb. in². In addition, the new Slipper

Pad 'VSG' range offers high performance units which are lighter and more compact than ever.

If you wish to know how 'VSG' or Racine hydraulic assemblies can benefit your production, please write or ring your nearest Hydraulics Division Office.

Left hand illustration shows the model SP-30 which delivers 100 gal/min at 1,500 lb/in² when driven at a speed of 900 rev/min. Right hand illustration shows model SP-5 which delivers 25 gal/min at 2,500 lb/in² when driven at a speed of 1,450 rev/min.

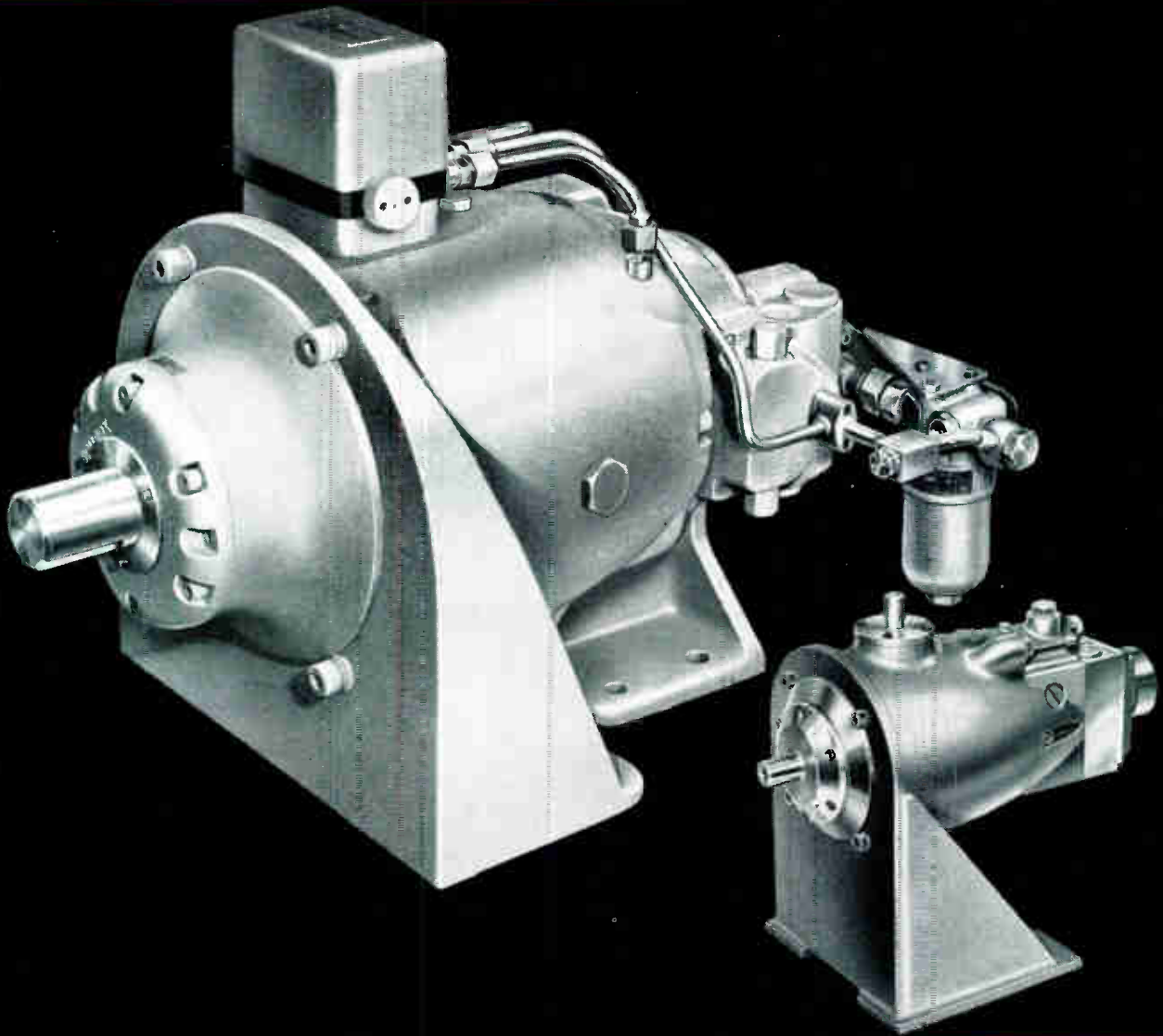

VICKERS LIMITED ENGINEERING GROUP HYDRAULICS DIVISION
VICKERS-ARMSTRONGS WEYMOUTH WORKS WEYMOUTH CORSBY Tel: Weymouth 4
AREA SALES OFFICES: BIRMINGHAM LIVERPOOL LONDON NEWCASTLE UPON TYNE WEYMOUTH

VR.7

Industrial Electronics May 1965

17

ISOLA-
base-materials:
for printed circuits for all purposes

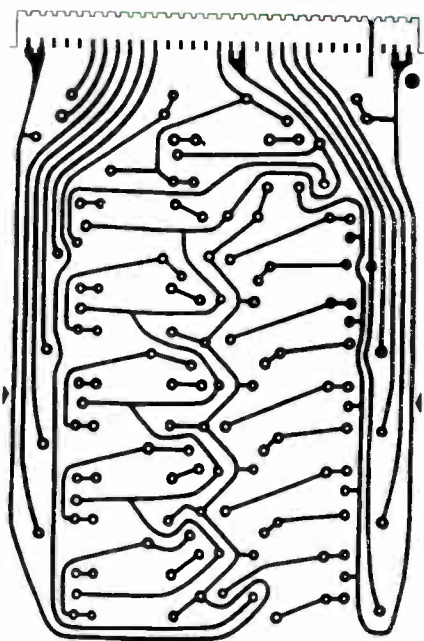

SUPRA-CARTA-Cu
quality 96

Supporting material: laminated paper on phenolic resin base, top quality for radio and television industries and for other commercial applications, corrosion-proof, non-burning according to ASTM D 635-56 T, cold-punchable

SUPRA-CARTA-E-Cu

Supporting material: laminated paper on epoxy resin base, low dielectric-loss factor for all frequencies, high resistance values, track resistant, good mechanical strength

VERRODUR-E-Cu

Supporting material: fire glass laminate on epoxy resin base with highest electrical and mechanical characteristics in extreme climates, quality 100 corresponding to NEMA-Part 10, G 10 quality 110 corresponding to NEMA-Part 10, G 11. Ask for our technical information bulletins and samples



Isola Werke A. G.
5160 Düren

Federal Republic of Germany
U. K. agent: J. M. Harding Assoc. J. E. E.
12 Offington Gardens, W. L. Thing, Sussex

**Heard about the major
breakthrough in transformer
design and manufacture?**

Lead slots designed for high speed winding

Bobbins can be reverse fitted

Positive isolation of windings

Integral tag boards on both bobbins

Illustration shows HINCHLEY size 13 being the first of a range to be tooled

Registered design No. 919201/2.

Hinchley
ENGINEERING COMPANY LIMITED
PANS LANE DEVIZES WILTSHIRE Tel: Devizes 573 15

**IT'S
THE NEW
DOUBLE
BOBBIN
METHOD**



For sheer quality and reliability there has never been anything like it. In place of the normal winding two entirely separate bobbins slot together to produce transformers with these outstanding advantages:

1. The inner winding is completely isolated—insulation breakdown between windings becomes virtually impossible.
2. Internal soldered joints are eliminated. Absolute reliability is guaranteed, and full visual inspection can be carried out at the final test stage.
3. Impregnation is unnecessary. The very high grade plastics used do not absorb moisture and the working life of this type of transformer exceeds that of expensive paper insulated types even under tropical conditions.

Substantial Price Reductions

The unique design of Double Bobbin Transformers permits the use of semi-automatic manufacturing processes virtually independent of operators' skill. Thus we can offer substantial price reductions.

LEADERS IN THE DESIGN AND MANUFACTURE OF IRON-CORED COMPONENTS

Industrial Electronics May 1965

SUBMINIATURE SWITCHES



The **ARROW**
RANGE OF
SUBMINIATURES
IS COMPLETE

*Make a point of seeing
our feature at the **RECMF***

STAND NO.490 GRAND HALL GALLERY

ARROW ELECTRIC SWITCHES LTD

BRENT ROAD · SOUTHALL · MIDDLESEX

Telephone: SOUthall 2442

A58

LABPak

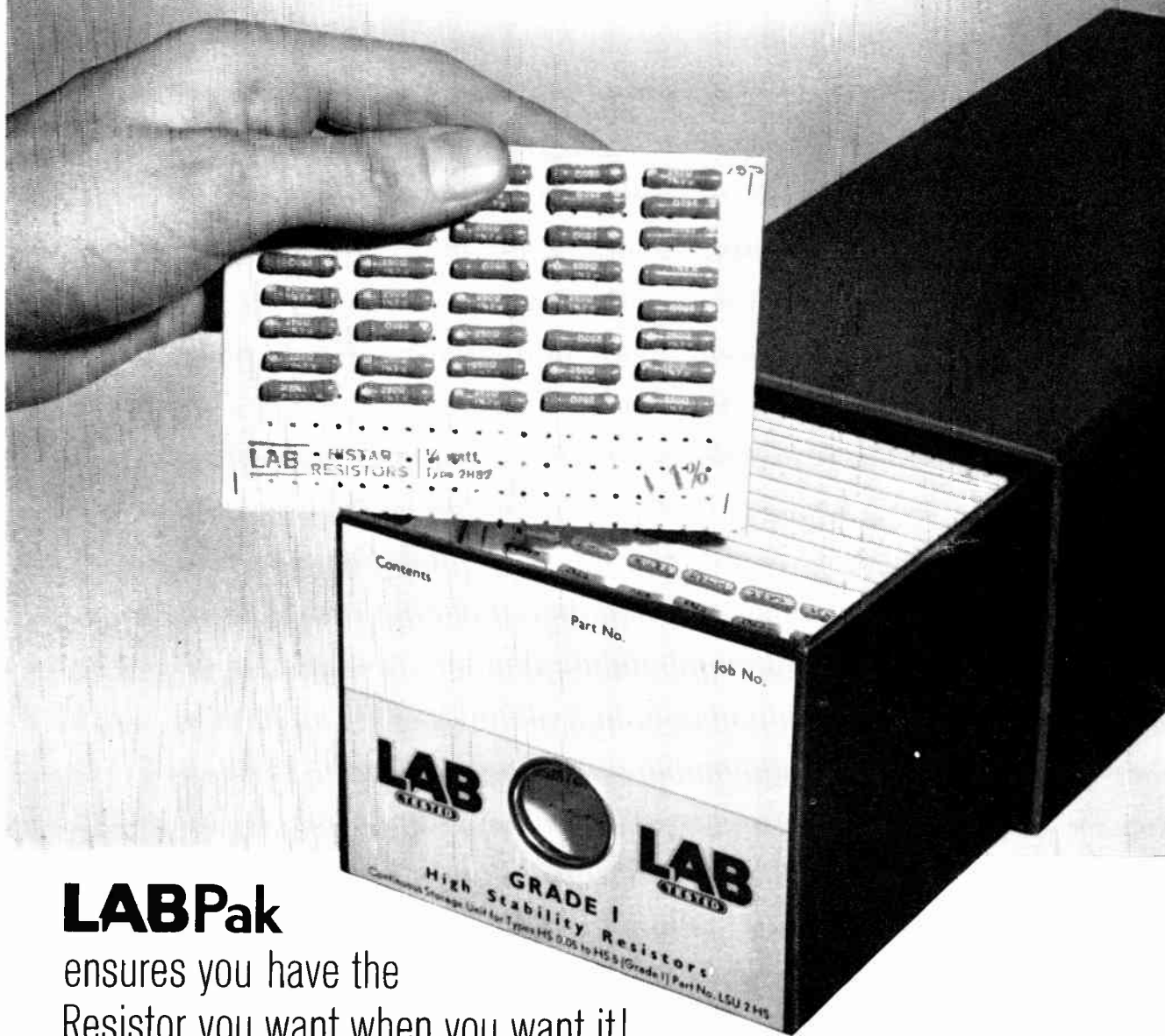

LABPak

ensures you have the Resistor you want when you want it!

At your fingertips you can now have:

ANY PREFERRED RANGE · ANY TOLERANCE

ANY QUANTITY OFF (SOLID CARBON · HIGH STABILITY METAL OXIDE · CRACKED CARBON · WIREWOUND RESISTORS)

Accessibly packed in free sleeve type continuous storage units.

First action is to send a card for brochure LSU464 which will tell you how to order precisely what you require by quoting a simple part number—and how much it will cost.

RADIO RESISTOR CO LTD

PALMERSTON RD · WEALDSTONE · HARROW · MIDDX · TEL: HARROW 6347 · TELEX: 25573



SOLDERABILITY TEST MACHINE

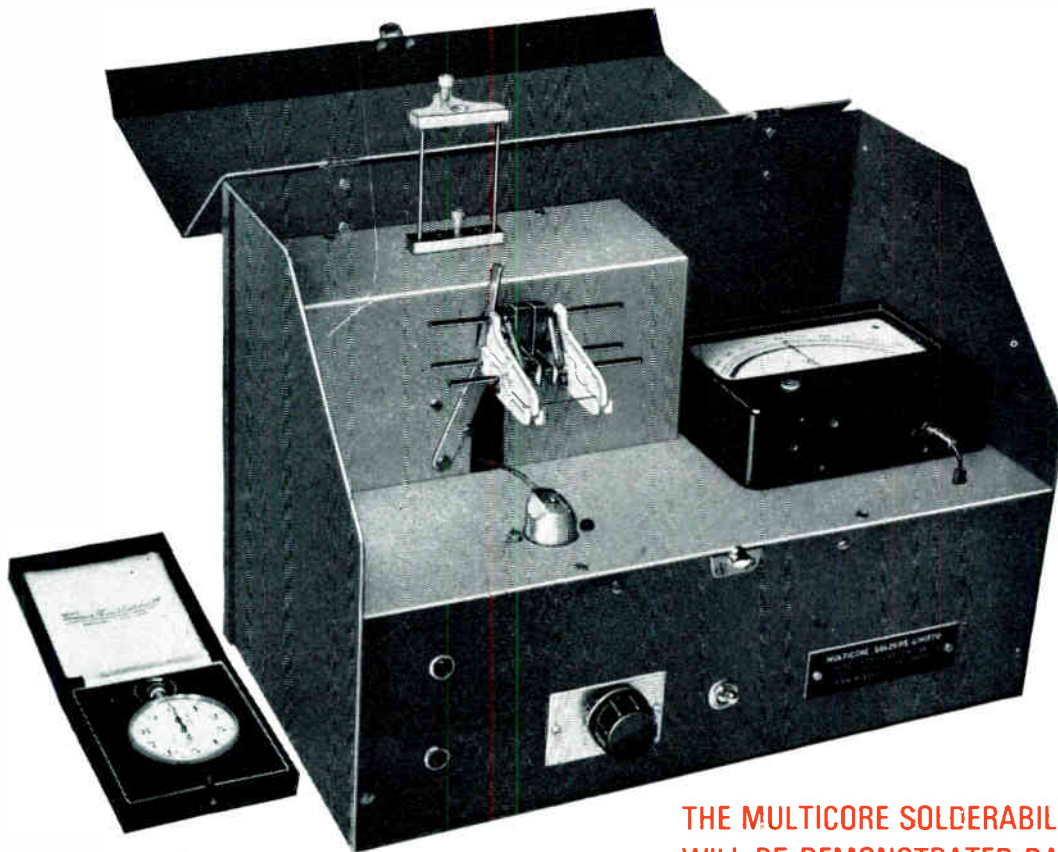

THE FIRST COMMERCIALY PRODUCED INSTRUMENT OF ITS KIND FOR ASSESSING THE SOLDERABILITY OF COMPONENT TERMINATION WIRES

Increasing production rates of electronic equipment, miniaturised components, mass production soldering methods, soldering machines, precision electronic instruments in prototype or in quantity, have in recent years created a need for a simple, accurate method of assessing the solderability of component termination wires.

Hitherto the suitability, reliability and standardisation within accurate limits of components used could be checked and assessed – but not the termination wires forming part of the components.

*Made as a service to industry
by the manufacturers of
the solder of the
utmost reliability*

MULTICORE SOLDERS LIMITED

Multicore Works Hemel Hempstead, Herts.
Telephone BOXMOOR 3636 (4 lines)

CHMS14

THE MULTICORE SOLDERABILITY TEST MACHINE WILL BE DEMONSTRATED DAILY ON STAND 168 MAIN HALL · RADIO COMPONENTS SHOW OLYMPIA · MAY 18–21 (incl)

A standard of solderability having been established in the laboratory, the use of these machines enables research, quality control departments and suppliers of components to ensure that all wire terminations of components meet the same standard.

Multicore Solderability Test Machine

Model Q 200-240 volts
Model R 100-110 volts



NOW

-200° to 1600°C

'BIKINI'

Regd Trade Mark

temperature instruments for use with *thermocouples* as well as resistance bulbs

- * Potentiometric accuracy
- * High impedance input circuit
- * Stable against varying supply voltages and ambient temperatures
- * Solid-state control switching to 0.2% differential. (No photo-cells)
- * Precision long-sweep slide wire with resolution of 0.1%

Many thousands of these low-cost, potentiometric, servo-operated, fully transistorised instruments have given maintenance-free service for over four years. They are the obvious choice for all temperature applications. Write for leaflets listed below.



'BIKINI' CONTROLLER



'BIKINI' INDICATOR / CONTROLLER

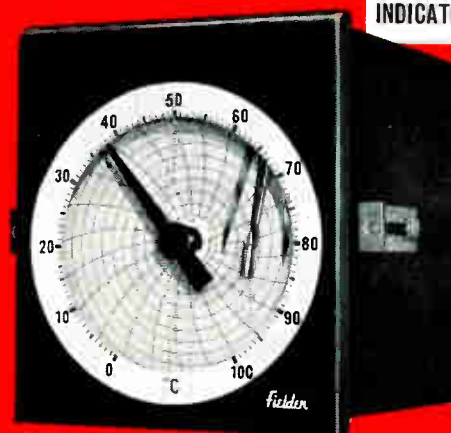

'BIKINI' RECORDER / INDICATOR

THERMOCOUPLE INSTRUMENTS

RESISTANCE BULB INSTRUMENTS

INSTRUMENT	SCALE LENGTH	CALIBRATION ACCURACY	MAX DISTANCE—MEASURING POINT TO INSTRUMENTS	APPROX. SIZE	WRITE FOR LEAFLETS	INSTRUMENT	SCALE LENGTH	CALIBRATION ACCURACY	MAX DISTANCE—MEASURING POINT TO INSTRUMENTS	APPROX. SIZE	WRITE FOR LEAFLETS
Indicator	12½"	± 0.5%	App. 1000 yds. (500 Ω)	6" dia.	BIK PT/2/1	Controller	9"	± 0.5%	300 feet	4½" dia.	BIK 1
Ind/Controller	12½"	± 0.5%	App. 1000 yds. (500 Ω)	6" dia.	BIK PT/2/1	Indicator	12½"	± 0.5%	300 feet	6" dia.	BIK 2/C
Recorder/Ind	13"	± 0.5%	App. 1000 yds. (500 Ω)	8½" x 7½"	BIK PT3/1	Ind/Controller	12½"	± 0.5%	300 feet	6" dia.	BIK 2/C
Rec/Ind/Cont	13"	± 0.5%	App. 1000 yds. (500 Ω)	8½" x 7½"	BIK PT3/1	Recorder/Ind	13"	± 0.5%	300 feet	8½" x 7½"	BIK 3
Rec/Ind/Prop.Cont	13"	± 0.5%	App. 1000 yds. (500 Ω)	8½" x 7½"	BIK PT3/1	Rec/Ind/Cont	13"	± 0.5%	300 feet	8½" x 7½"	BIK 3
						Rec/Ind/Prop.Cont	13"	± 0.5%	300 feet	8½" x 7½"	BIK 3 & EPC3

* 185 Standard temperature ranges — many available from stock

Whatever your instrumentation problem—consult Fielden on temperature, pressure, level, control systems.

Fielden

FIELDEN ELECTRONICS LIMITED · WYTHENSHAW · MANCHESTER

Telephone: Wythenshawe 3251 (6 lines) Telegrams: Humidity Manchester Telex: 66531
 Branch Offices: London, Walsall, Harrogate, and Scotland.
 Overseas Subsidiaries: AUSTRALIA: Fielden Electronics (Aust.) Pty. Ltd., 61 Betula Ave., Vermont, Victoria, and 107 Alexander Street, Crows Nest, New South Wales. ITALY: Fielden Electron.cs Italiana, Milan.
 Agents throughout the world.

Picture of a man saving £17,000 a year

Brodie-Kent meters are in use in the new bulk additive plant at Mobil's Birkenhead works. Brodie-Kent meters will make an important contribution to the saving of £17,000 a year which will be made every year by this plant.

Can Brodie-Kent help you increase your productivity? They will be very pleased to answer any inquiries.

GILBARCO LIMITED

Crompton Close, Basildon, Essex.
Telephone: Basildon 3090. Telex 1966.



(Photograph by courtesy of Mobil Oil Company Ltd)

SEND YOUR ORDER TO

AMPHENOL-BORG (ELECTRONICS) LTD
 BELLING-LEE LIMITED
 ELECTROSIL LIMITED
 ENGLISH ELECTRIC CO. LTD. (FUSEGEAR DIV)
 HUGHES INTERNATIONAL (U.K.) LTD



INTERNATIONAL RECTIFIER CO (G.B.) LTD
 PLESSEY-UK LIMITED
 S.T.C. TRANSISTOR DIVISION
 THORN ELECTRICAL INDUSTRIES LTD
 WELLER ELECTRIC CORPORATION

TOWNSEND-COATES LTD.
COLEMAN ROAD,
LEICESTER.



Phone: LEICESTER 68561 (5 lines)

FOR BY-RETURN POST SERVICE

M.O.A., W.O. and A.R.B. Approved • No minimum order charge

For further information circle 229 on Service Card

ADAPTABLE BOXES

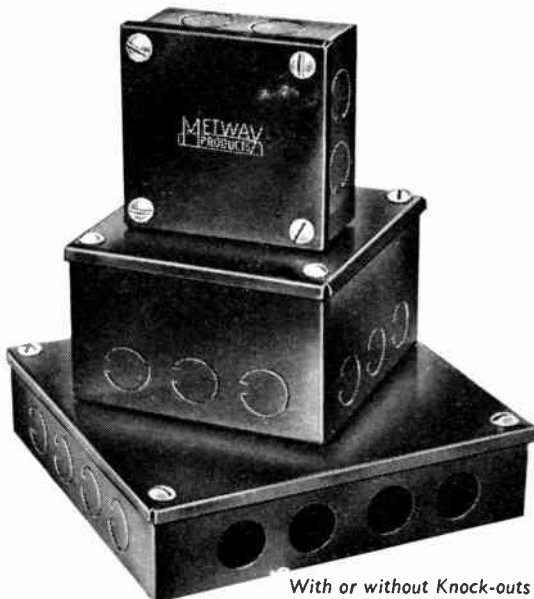

With or without Knock-outs

OVER 200 STANDARD SIZES

★ SPECIALS MADE TO CUSTOMERS' DRAWINGS

Ask for Catalogue No. 62E/IE

METWAY • KEMP TOWN • BRIGHTON 7

For further information circle 230 on Service Card

NEW! ELECTRONIC COMPONENTS

SMALL BUTTERFLY TYPE TRIMMER
 C.952
 Capacity 12.8 pF each side
 0.15" Gap.
 Can be fitted with locking collar in which case type No. is C.953.

TUBULAR TRIMMER
 S.56.12
 P.T.F.E. Dielectric
 30 pF mx.

AM/FM GANG CAPACITOR
 C.87.302
 Fitted geared drive
 Capacity 392 x 15 pF.
 AM only version available.
 Air gap 0.125"
 Capacity 326 pF each section.

STAND-OFF INSULATOR
 TS.1531
 Peak working voltage 8 K.V.
 Insulation-Sintered aluminium oxide.
 Various terminations available.



WINGROVE & ROGERS LTD

DOMVILLE ROAD · LIVERPOOL 13
 Telephone Stoneycroft 2265

LONDON OFFICE 75 Uxbridge Road Ealing W5 1EL FAX 0181 7

FERRANTI

MICRONOR

SOLID STATE DIGITAL CIRCUITS

Designed and manufactured in Britain for YOU

- **SHORT DELAY TIME** 15n Sec
Typical
- **GOOD NOISE IMMUNITY** 0.9v @ 25°C
0.5v @ 100°C
- **LARGE OUTPUT VOLTAGE SWING** 1.5v
- **AVAILABLE IN 8 LEAD TO-5 CASE OR 12 LEAD FLAT PACKAGE**

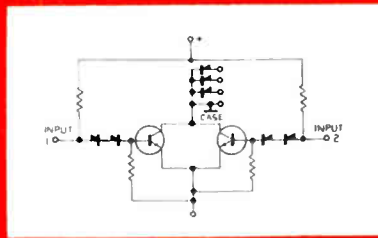

DOUBLE ENTRY NOR GATE
ZSS2B, ZSS32B

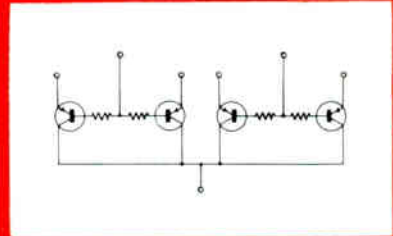

P.N.P. EMITTER FOLLOWER
ZSP6 (VX1717A), ZSP36

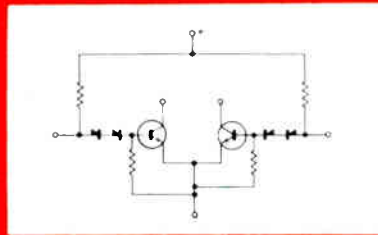

TWIN POWER DRIVER
ZST2 (CN 11) ZST32

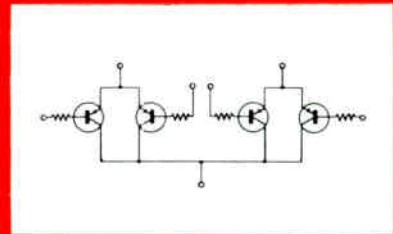

P.N.P. EMITTER FOLLOWER
ZSP7 (VX1717B), ZSP37

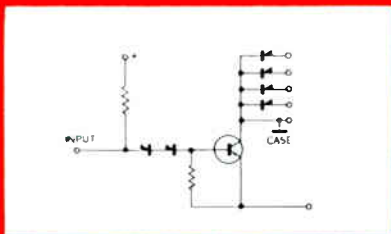

SINGLE ENTRY NOR GATE
ZSS1A (CN 7) ZSS31A

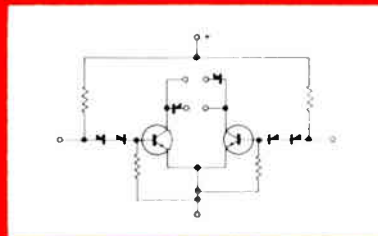

TWIN ENTRY NOR GATE
ZSS3B (CN 10) ZSS33B

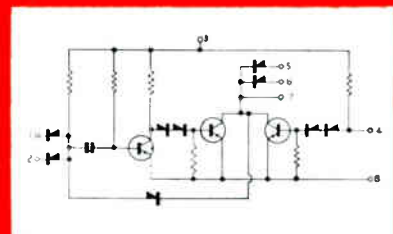

TRANSIENT MEMORY NOR GATE
ZSM1A (CN 12) ZSM31A

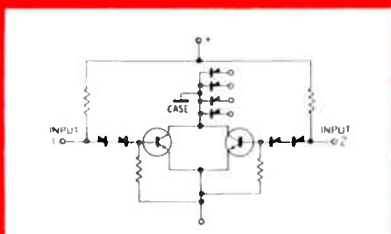

DOUBLE ENTRY NOR GATE
ZSS2A (CN 8) ZSS32A



TO-5



Flat Package

ACTUAL SIZE

30 Series are in the Flat Package

WRITE NOW FOR MORE DETAILS:

FERRANTI
First into the Future

FERRANTI LTD · GEM MILL · CHADDERTON · OLDHAM · LANCs · Telephone MAIn 6661

The International Plastics Exhibition in Europe for 1965 LONDON OLYMPIA 16-26 JUNE

interplas interplas

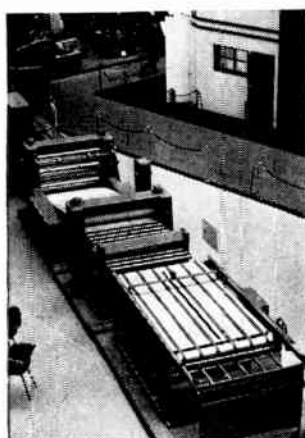

Typical of latest machinery—Prodex sheet plant incorporating a 4½" extruder and double shell cooling rolls embodying a built-in heat exchanger.



Many of the most brilliant achievements in plastics design in the International Design Display.



Information on all aspects of plastics and plastics trade—materials, markets, suppliers, customers, potential new applications.

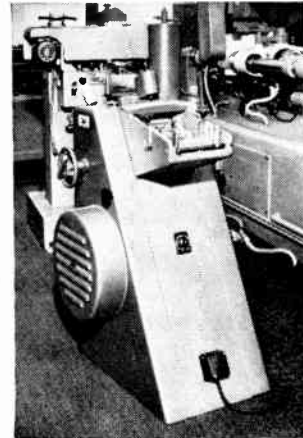

The latest equipment for plastics moulding, extrusion, vacuum forming, welding and printing—much of it in full operation.

an essential event for all concerned with plastics

This huge display—biggest ever held in Great Britain and unique in Europe in 1965—will present the latest achievements in plastics manufacture, design and technology. More than 500 firms from Great Britain, Germany, United States, France, Japan and other leading countries. Plant and machinery in action . . .

materials . . . processing equipment . . . finished and semi-finished plastics products . . . industrial and consumer goods ranging from boats to paper clips—more than 10,000 exhibits. An incomparable opportunity to gather new ideas for product improvement, cost reduction.

**SEE THE UNLIMITED
POTENTIAL OF
PLASTICS
TODAY
MAIL THIS NOW**

To: The Exhibition Manager, INTERPLAS 65, Dorset House, Stamford Street, London SE1

Please send full information and a free season ticket

NAME

FIRM

ADDRESS

DATE

47B

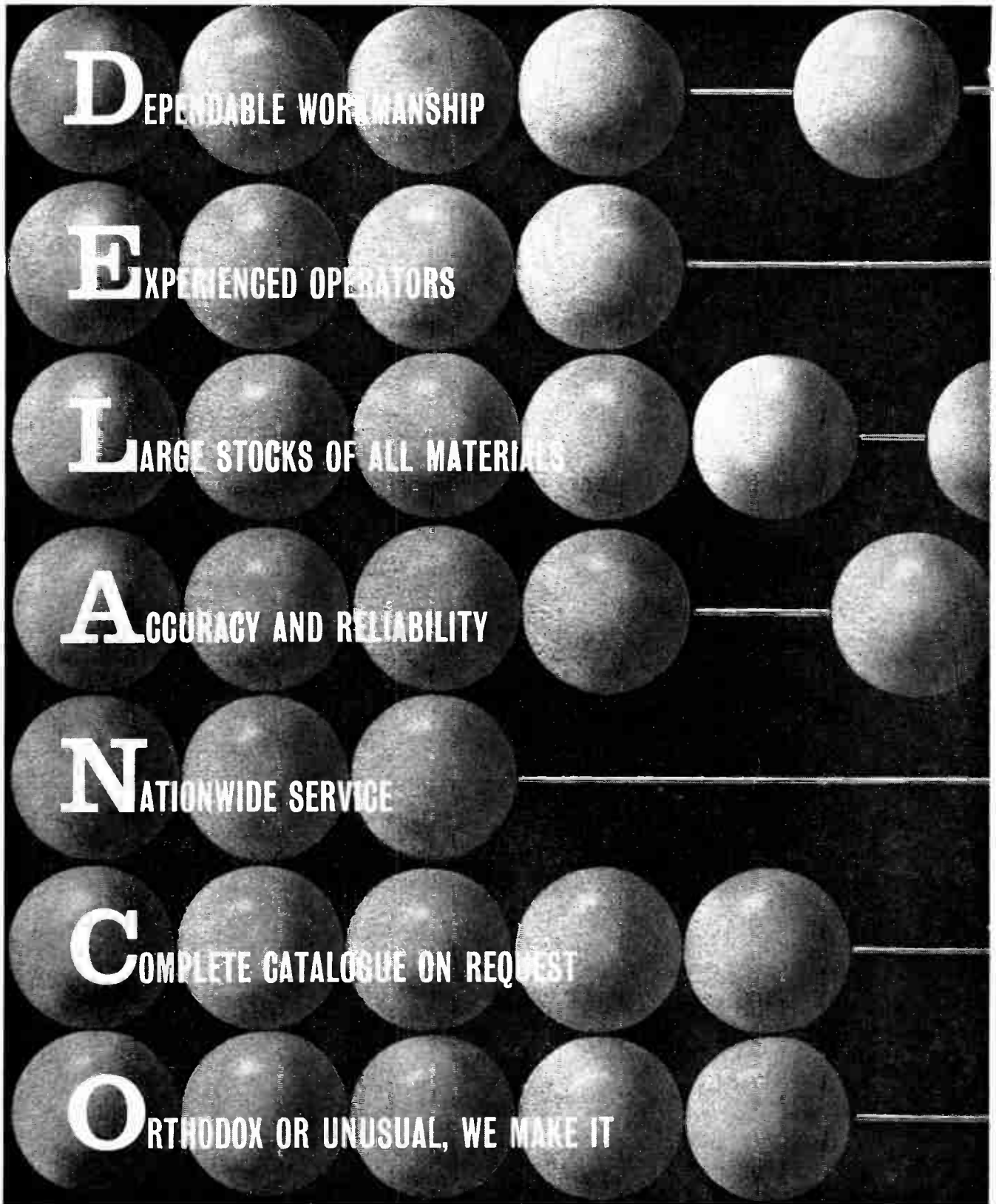

D E P E N D A B L E W O R K M A N S H I P

E X P E R I E N C E D O P E R A T O R S

L A R G E S T O C K S O F A L L M A T E R I A L S

A C C U R A C Y A N D R E L I A B I L I T Y

N A T I O N W I D E S E R V I C E

C O M P L E T E C A T A L O G U E O N R E Q U E S T

O R T H O D O X O R U N U S U A L, W E M A K E I T

IT ALL ADDS UP TO
Delanco

VULCANIZED FIBRE · LEATHEROID · PRESSPAHN · COMPOSITE
INSULATION · SILICONE & EPOXY BONDED GLASS FIBRE
BAKELITE SHEET, TUBE & ROD · COPPER CLAD LAMINATES
MICA AND MICANITE · AND PRECISION MACHINED
AND PRESSED PARTS IN ALL INSULATION MATERIALS

ANGLO-AMERICAN VULCANIZED FIBRE COMPANY LTD, CAYTON WORKS, BATH STREET, LONDON, E.C.1. CLE: 8484 (15 LINES)



NEW FROM THORN
low cost

**220-250 v
MAINS OPERATED
SIGNAL LAMPHOLDERS**



1



2



3



4



5



6



7



8

THORN SIGNAL BLINKER LAMP



A solid state device, unaffected by ambient temperature, giving instantaneous operation for critical installations where a flashing signal is vital. A.C. or D.C. Flash frequency can be regulated from 20 to 120 pulses per minute. Bayonet or screw cap versions available with lens colours of red, green, blue, amber, clear or opal.

THORN SUPPLY THE LAMPS TOO

Three lamps, available in Red or Green Neon, to fit the lampholders with the exception of type 0216



This filament lamp is specially designed for lampholder type 0216



THE BEST COST LESS FROM THORN

a brief description of types available

- 1** Type 0216. Large lampholder base, three alternative lenses, available with black, white or polished nickel bezel.
- 2** Type 0171. Long lampholder base with two alternative lenses.
- 3** Type 0172. Short version of type 0171 with three alternative lenses.
- 4** Type 0195. Medium sized lampholder, three alternative lenses.
- 5** Type 0228. Small lampholder with integral bezel and choice of two plastic lenses.
- 6** Type 0176. Large, flush-mounting lampholder with either black or white base and one type of lens only.
- 7** Type 0239. Short style lampholder with one high moulded plastic lens.
- 8** Type 0231. New style press switch. Second circuit is completed when illuminated cap is pressed.

**THORN ELECTRICAL INDUSTRIES LTD.,
SPECIAL PRODUCTS DIVISION,
105-109 Judd Street, London, W.C.1.**



Please send me full details of the Thorn (Mains operated) Signal Lampholders.

Name
Position
Company
Address

DTV/22

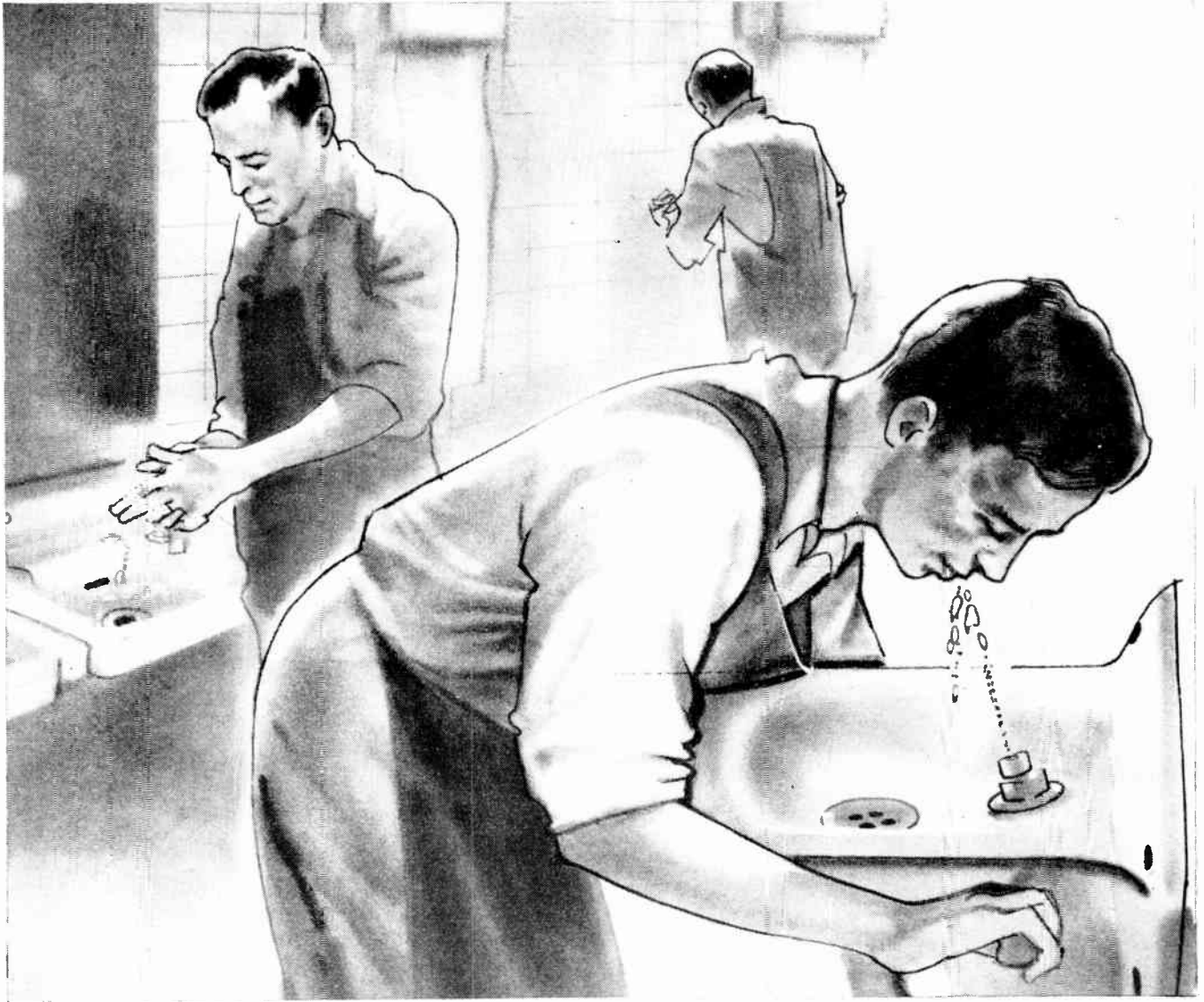

**WHEN
THE
PRESSURE
IS
ON...**

The pressure is on right now in the fight to conserve water. Birflo valves are being used increasingly to control water flow for industrial processes, the balancing of supplies in multi-storey buildings and washroom facilities, for example showers, drinking fountains, wash basins etc.

Wherever efficient economical control of water or air or light oils is essential—in factories, offices and homes—Birflo valves not only keep maintenance bills down to the very minimum, but they also help to reduce wastage and cut costs all round. If your firm needs valves, be sure that they are Birflo. Write now for full details of the Birflo range.

BIR FLO VALVES

for efficient economical control

Member of the



Birfield Group

Industrial Electronics May 1965

LAYCOCK ENGINEERING LIMITED

DEPT. IE/1, MILLHOUSES, SHEFFIELD 8 Telephone: SHEFFIELD 368221

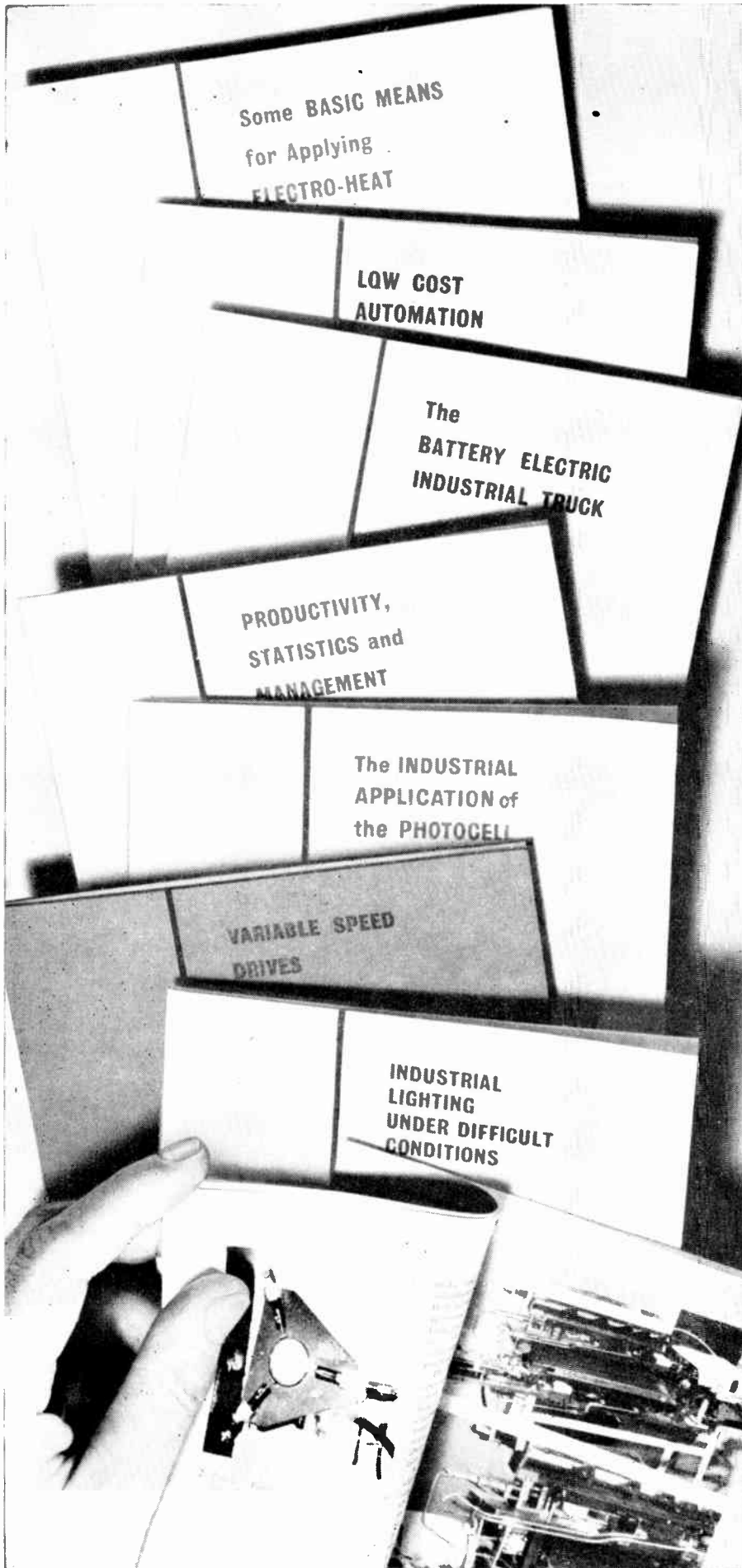

How to make a better profit

BY MAKING BETTER USE OF ELECTRICITY

These EDA monographs, written by experts, will help your company to benefit from the newest electrical techniques and equipment.

The Electrical Development Association exists to encourage the most efficient use of electricity. It is not a remote academic body. Its principal concern is with the *application* of electricity. It has assembled (and is frequently adding to) a mass of technical data based on particular industrial processes, on specific techniques, and on the latest fully-tested equipment.

The monographs shown here, and others, are available to you at 1/- each. For a full list of titles, fill in and post the coupon below.

You'll find it pays you handsomely to keep your senior technologists up to date with EDA monographs. And with all the other EDA publications in the catalogue.

To: Electrical Development Association (I/IE/2),
Trafalgar Buildings,
1 Charing Cross, London, S.W. 1

eda

Please send me a complete catalogue of all your Industrial Data Sheets, Monographs, Productivity Books and Films.

NAME

ADDRESS

.....

.....

it's easy to see...

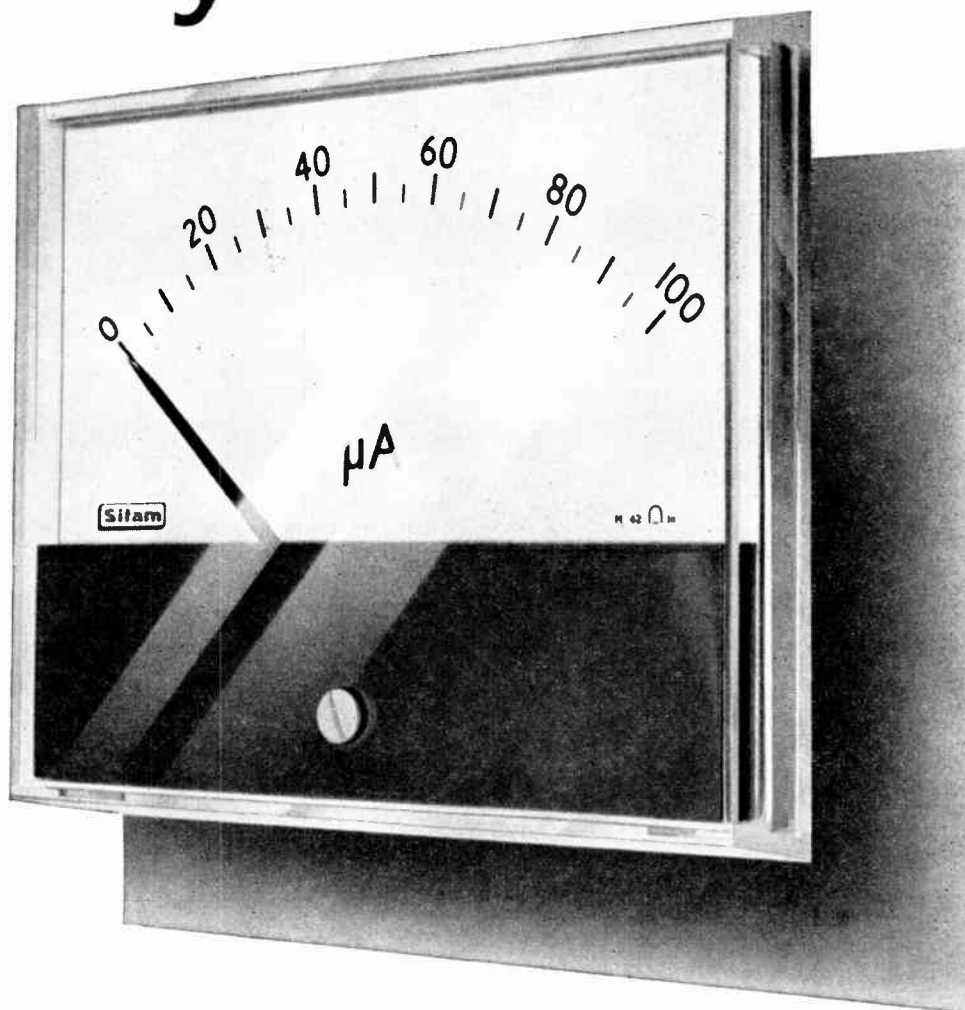

...why Sifam CLARITY instruments are specified, so often

Instruments that are consistently accurate *and* easy to read are essential in modern industrial equipment. Sifam 'Clarity' instruments—made to B.S.89 (1954) specifications—adequately meet these demands, having completely transparent fronts for maximum readability and providing a range which is outstanding in both visual presentation and workmanship. Scales and pointers are supplied to B.S.3693, Part 1, 1964, or to customers' requirements.

Our Technical Representative will be pleased to call.
Write for Data Sheets 106/C and 106/C1.

Sifam 'Clarity' instruments are part of a complete range of moving coil instruments.

See the Sifam range on Stand No. 461
R.E.C.M.F. Exhibition, Olympia, 18-21 May



I N S T R U M E N T S

SIFAM ELECTRICAL INSTRUMENT CO. LTD.

Woodland Road, Torquay, Devon
Telephone: Torquay 63822/3/4/5

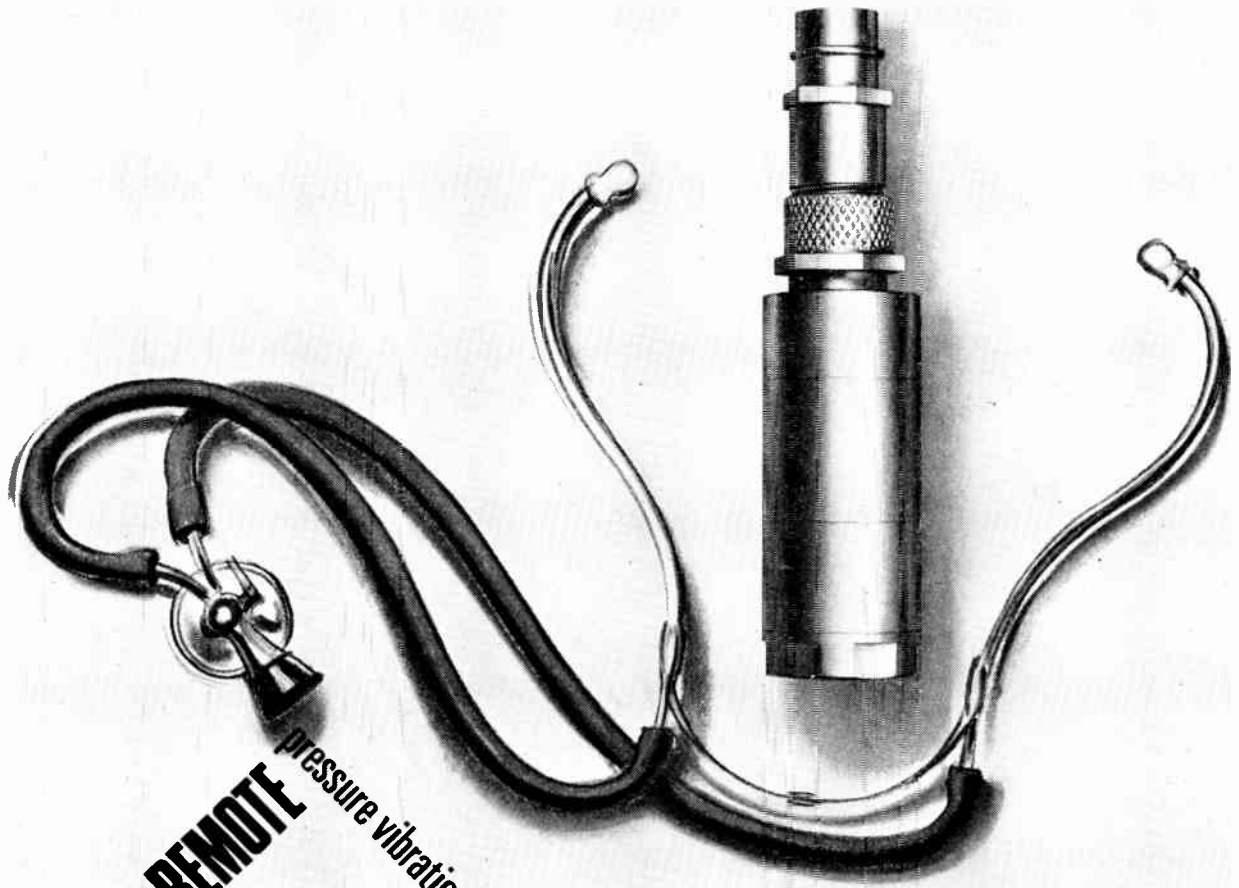

REMOTE pressure vibration torque transducer level temperature displacement **MEASUREMENT**

Let's examine the problem – measuring physical parameters and transmitting the information over long distances.

Solartron have been making transducers for many years and have accumulated a wealth of practical application experience.

Whether for recording data in plant or research establishments, for monitoring and controlling continuous process plant, or for transmitting precise information great distances, there is probably a Solartron Transducer to suit your requirements.

Typical applications include instrumentation of high speed aircraft and missiles, marine, nuclear, chemical and plastic plant monitoring and research.

If you feel you have a remote measurement transducer problem which might benefit by applying Solartron Transducers, our specialists, who have wide application experience, will be pleased to help you with your enquiries.

SOLARTRON

For—

Data Systems · Transducers · Computers
Military Systems · Electronic Instrumentation

THE SOLARTRON ELECTRONIC GROUP LIMITED
Victoria Road · Farnborough · Hants
Telephone · Farnborough · (Hants) 3000
Telex · 85245 Solartron Fnbro
Cables · Solartron · Farnborough
A MEMBER OF THE SCHLUMBERGER GROUP

M & P S184



In installations where control of pumps and water levels is critical, **NOFLOTE** control can take complete command. Simple and robust in construction and completely automatic in operation, **NOFLOTE** controls are currently saving manpower and worry in installations throughout the World. **NOFLOTE** is one of the many measuring and control instruments for industry made by Evershed & Vignoles Limited. For full details and specification of **NOFLOTE** control, write for leaflet No. SS.66/15

The term NOFLOTE is a trade mark of Evershed & Vignoles Ltd.

EVERSHED

Evershed and Vignoles Limited Acton Lane Works · Chiswick · London W4 · Telephone: Chiswick 3670 EVI

Ten good reasons for choosing this Ward Brooke terminal block . . .

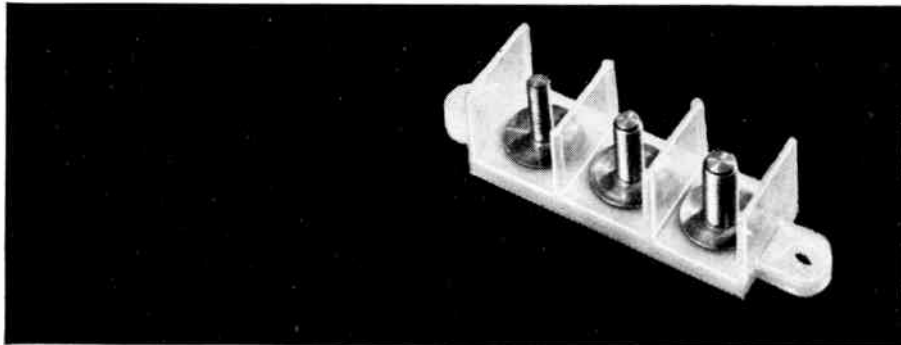

. . . or any other in the wide range of Ward Brooke blocks.

1. Blocks available up to 20 way, single or double row.
2. Light weight.
3. Non-corrodible studs.
4. Unbreakable plastic mouldings.
5. Up to 8 ring terminated conductors per stud.
6. Proofed against rotational shorting.
7. Inter-terminal linking strips.
8. BA or Unified threads.
9. Panel mounting, through or shrouded pattern.
10. Six colours and numbered terminals.

There is a very large range of Ward Brooke terminal blocks, fuse holders, conduits, helical wraps, 'LAYFLAT,' sleeving, ratchet and 'P' clips, lamp-holders, etc. These products are type approved. Every British aircraft being built today uses Ward Brooke parts throughout its electrical system. Why not write to the Sales Department for further details of the range?

WARD BROOKE *WB+* & CO LTD

P.O. Box 34, High Wycombe, Bucks. Tel: High Wycombe 4531. Telex 83173

A member of the Southcros Group

For further information circle 241 on Service Card

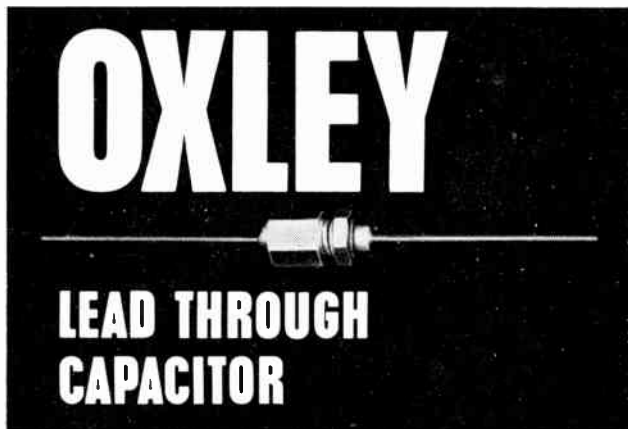

LEAD THROUGH CAPACITOR

This is a useful capacitor which takes up a minimum of space.

The body and nut have 2BA threads and are silver plated. The ceramic tube is sealed into the body with an appropriate resin material under vacuum to withstand arduous climatic conditions.

NOMINAL VALUES
LT 1000 - 1000 pF.
LT 470 - 470 pF.
LT 47 - 47 pF.

TOLERANCE
-10% + 80% or ± 20%
WORKING VOLTAGE
350 v. D.C.

Write for technical details of these or any other Oxley products

OXLEY DEVELOPMENTS CO. LTD.
ULVERSTON, LANCASHIRE. Tel: Ulverston 2567

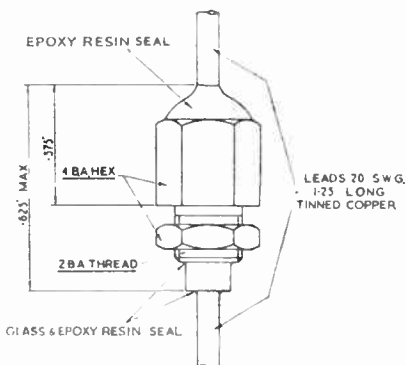

For further information circle 242 on Service Card

New! THE MINITOR THICKNESS GAUGE TRADE MARK

For measuring the thickness of paint, enamel, plastic, varnish and other non-conductive coatings on aluminium, brass, copper, Austenitic stainless steels, etc.

The Minitor meets the need for a stable and reliable lightweight instrument for the measurement of non-conductive coatings on non-ferrous bases. This pocket size precision instrument fully transistorised and with miniaturised printed circuit for lasting reliability, is designed to provide simplicity of operation. Setting procedure and calibration to a new base material are straightforward. Choice of five scales, from 0.5 thou. to 0.500 microns, built-in probe in base with contact tip capped with hard wearing compound. Three ball contact for general use; flat base model for measurements on flat surfaces or soft materials; V base model for measurements on round bar; separate probes for confined spaces.

£48 Complete with 60-hour stable voltage Mallory battery, scale to choice, calibration foils, hide leather case.

The Minitor can also be used to measure conductive coatings on non-conductive bases and to segregate ferrous metals and their alloys, etc.

elcometer

INSTRUMENTS LTD
FAIRFIELD ROAD
DROYLSDEN 11
MANCHESTER
Tel: DROYlsden 2790

Send this coupon now for full details of the Minitor Thickness Gauge

NAME.....
POSITION.....
COMPANY.....
ADDRESS.....

11

MAY, 1965

STC components review

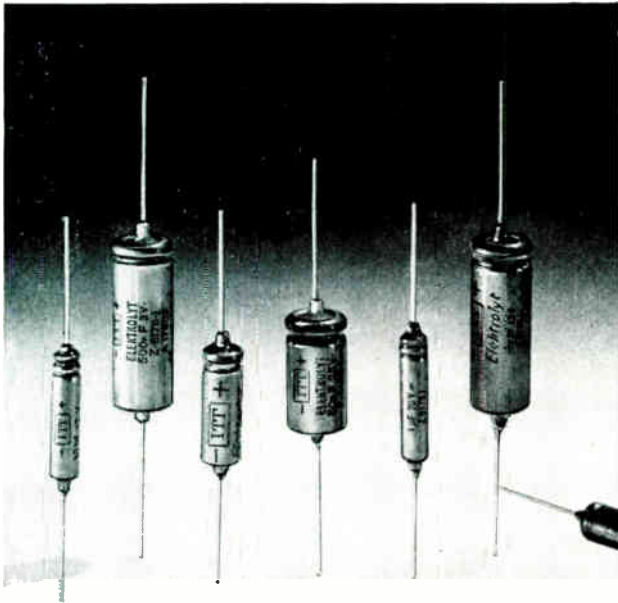

Miniature aluminium electrolytic capacitors

STC have introduced into the UK their Swiss associate's range of aluminium electrolytic capacitors. This means that there is now available a miniaturized, professional quality aluminium electrolytic type.

These capacitors have an established reliability acceptance in Europe. They are made with high purity materials and under full Quality Control. Cold welding techniques are used for anode and cathode connections, whilst the main case connection is made by ultra-sonic welding. This construction ensures a shelf life of at least two years without any reforming requirements. There is a transparent insulating sleeve over the case.

Performance and stability of this range of capacitors are to IEC 103 (1959) Class 564. They are suitable for operation at temperatures from -40°C to -70°C . DC working voltages are 3, 6, 12, 25, 50 and 70V. Miniature aluminium electrolytic capacitors are ideal for use in telecommunications equipment, computers and professional electronic apparatus.

For data sheets, use Reader Service card or write, 'phone or telex STC Capacitor Division, Brixham Road, Paignton, Devon or London Sales Office, Footscray, Sidcup, Kent. Telephone: FOotscray 3333. Telex: 21836.

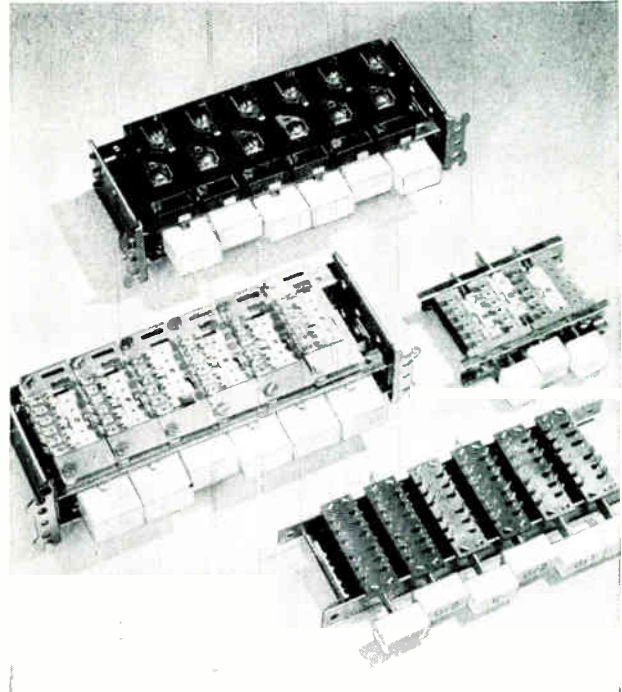

Mayr pushbutton units

The Mayr range of pushbutton assemblies from STC offers the control engineer a versatility of switching arrangements which is unique for this type of unit. The flexibility of the system gives multiple combinations of button hold and button release conditions. These include independent and mutual release assemblies with mutual release in groups, if required, or with common release.

As well as varying multiples of hold and release buttons, each, in turn, being able to perform a variety of switching functions, the Mayr assemblies can contain 'pulse' buttons in the same unit. The electrical and mechanical variations are infinite. Switch assemblies of differing construction (high and low power) can be supplied on the same switchbutton chassis. Each button can be made to perform a specified number of make, break or changeover operations. Most of the ranges are available with banks of 12 buttons. Construction allows for very close vertical and horizontal stacking of the banks. Buttons have removable transparent covers for the insertion of identification colour signals or written characters.

For full details of contact ratings and switching arrangements, use Reader Service card or write, 'phone or telex STC, Electro-Mechanical Division, West Road, Harlow, Essex. Telephone: Harlow 21341. Telex: 81184.



Logic system power units

STC Types 19GA and 19GB Modular Power Units are available as rack or bench mounting types for powering digital logic systems. The units offer economies in overall digital systems because sensitive circuits, such as analogue-digital converters, may be powered from the same two rails as the relatively insensitive circuits used in the system logic.

The rack-mounting version has a rugged yet light aluminium alloy construction with a satin aluminium front panel and dark grey enamelled side plates. It is designed to fit ISEP (International Standard Equipment Practice) rackings. Mains input is at the rear and d.c. output terminals are provided at front and rear. The bench mounting version is of the same construction and finish but has top, bottom and rear plates.

TYPES 19GA AND 19GB BRIEF SPECIFICATION

Input: 210-250V r.m.s., 50-60 c/s, 0.075 kVA (max). Permissible input voltage variation $\pm 25V$ r.m.s.

Output: Two simultaneous supplies, 1.0A at 20.6 to 27.6V on positive rail. 0.5A at 5.0 to 7.0V on negative rail.

Ripple: 1mV r.m.s. (max.) at full load.

Stability: Over full load range and for 20% input variation, long and short term conditions; better than 250mV on 24V rail and better than 60mV on 6V rail.

A semiconductor, current limiting circuit allows continuous short-circuit of the output without damage to the power units.

Size (nominal): 7.9 in. (201 mm) x 6.35 in. (161 mm) x 7.9 in. (201 mm).

For full specifications use Reader Service card or write, 'phone or telex Electronic Services-STC, Edinburgh Way, Harlow, Essex. Telephone: Harlow 26811. Telex: 81146.

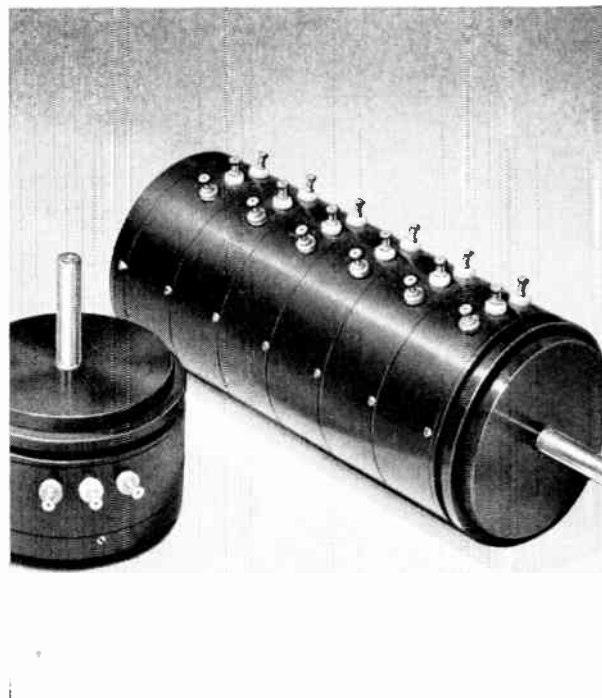

Multi-gang potentiometers

Now available from STC/P.X. Fox is a range of precision potentiometers with choices from multi-gang and multi-tap construction. Typical of the range is the S 11 International Frame Size, illustrated, which has a 1.062 in. (26.98 mm) outside diameter. This unit has a torque value of 1 g/cm per section and an operating life of 3 million cycles.

The S 11 range offers a linearity of 0.1% at 5k Ω and above. The potentiometers are available with up to 10 gangs per unit and with a maximum of 10 taps per gang. The unique Fox potentiometer contact, whilst giving extremely long life and low torque, achieves noise values as low as 10 Ω .

For data sheet with full details, use Reader Service card or write, 'phone or telex P.X. Fox General Controls, Standard Telephones and Cables Ltd., West Road, Harlow, Essex. Telephone: Harlow 21341. Telex: 81184.



Silicon diodes in all-glass encapsulation

STC silicon epitaxial planar diodes for high-speed switching are now available in an all-glass encapsulation. These will replace completely the earlier, resin moulded version. In addition, the range now includes the popular JEDEC types 1N914 and 1N916, also glass-encapsulated.

Of particular note is the BAY50 charge storage diode which has the following characteristics:—

Minority carrier storage at $I_F = 10\text{mA}$ 500 pC(min)
 Forward voltage at $I_F = 30\text{mA}$ 1 V (max)
 at $I_F = 20\mu\text{A}$ 0.5 V (min)

BRIEF DATA FOR STANDARD RANGE

Type	Maximum Forward Voltage (V)	Reverse Current (nA)	Maximum Reverse Recovery Time (ns)	Maximum Capacitance (pF)	P.I.V.
BAY31	1.0 at 30mA	20 at -15V (typ)	5 at 10mA, 10V	6	15
BA Y36(1N4147)	1.0 at 30mA	11 at -30V (typ)	5 at 10mA, 10V	6	30
BAY52	1.0 at 20mA	50 at -10V (max)	15 at 10mA, 6V	8	15
1N914	1.0 at 10mA	25 at -20V (max)	4 at 10mA, 6V	4	75
1N916	1.0 at 10mA	25 at -20V (max)	4 at 10mA, 6V	2	75

The case outline for the range remains in accordance with the VASCA SO-6 and JEDEC DO-7 specifications.

For data sheets, use Reader Service card or write, 'phone or telex STC Semiconductor Division (Transistors), Footscray, Sidcup, Kent. Telephone: FOOTscray 3333. Telex: 21836.

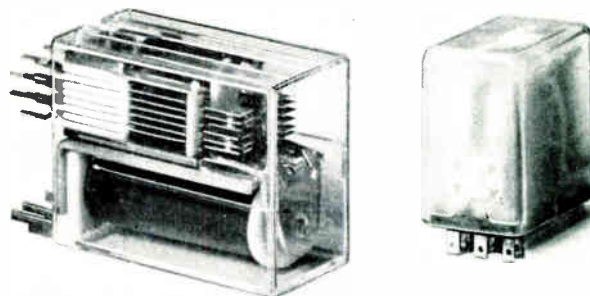

Miniature industrial relays

STC Types 24 and 25 miniature industrial relays are high precision, professional quality components. The original d.c. range has been augmented by the addition of a.c. types, and versions with magnetically latched (remanent) cores. In addition, the range is now available with gold alloy contacts to increase the scope of application in low-current circuitry.

Types 24 and 25 relays are plug-in components fitted with dustproof covers formed from a special non-gassing plastic. They are suitable for tropical use and are fully interchangeable in form, fit and function with many well-known continental types.

The type 200 relay on left is a miniature telephone relay of superior quality and performance. It can be provided with up to 6 changeover contacts or up to 8 makes or breaks. A dust cover is fitted as standard. Terminals are available for wire-wrap, soldering, printed circuit mounting, or for plug-in mounting to a special socket. Contacts are of palladium with silver and gold available as alternatives.

For full details of coil and contact ratings, use Reader Service card or write, 'phone or telex STC Electro-Mechanical Division, West Road, Harlow, Essex. Telephone: Harlow 21341. Telex: 81184.

RECMF

See us on Stand 162
 Grand Hall · Olympia
 May 18th - 21st.

high-grade components by

STC

COMPONENTS GROUP

A BENSON-LEHNER Incremental Plotter

Turns digits

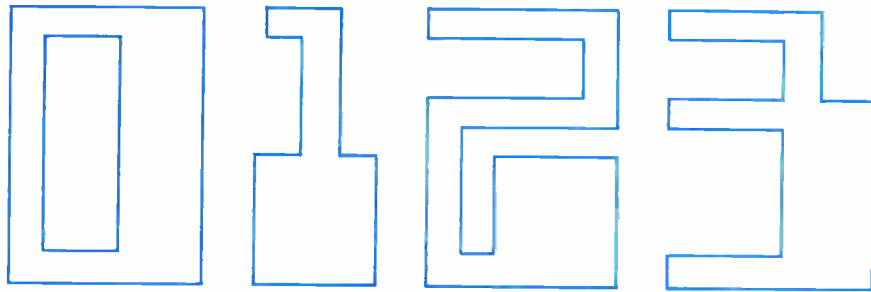

into graphs

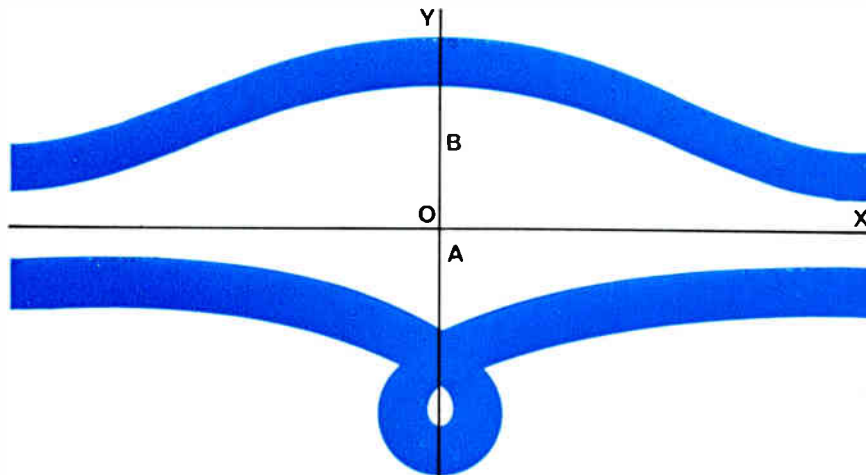

or charts and drawings of scientific, engineering, business and industrial process data.

The Benson-Lehner Incremental Plotter is capable of producing fully annotated plots under computer on-line control, or off-line from punched paper tape or magnetic tape. It operates from direct digital commands at a speed of 18,000 steps per min. with the high resolution of 0.1mm. or .005ins. Typical applications include automatic drafting, plotting of weather charts and critical path scheduling. Low cost makes the incremental plotter available for a much wider variety of uses, translating digital information of all types into clear, intelligible and easy to assimilate graphic form. You almost certainly need one now.

DEMONSTRATIONS:

Demonstrations of Benson-Lehner incremental plotting equipment will be arranged at your installation on request.

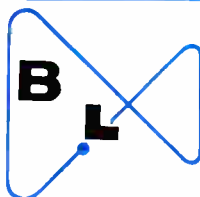
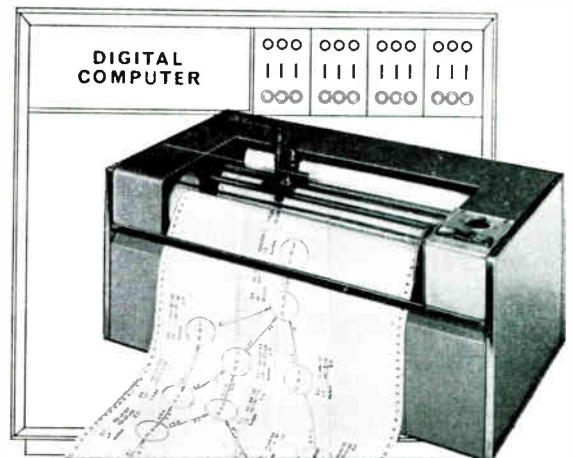

For full details of how BENSON-LEHNER can assist you in the data systems field, telephone SOUTHAMPTON 27831, or write to:—

benson-lehner LTD. / WEST QUAY ROAD / SOUTHAMPTON

For information on STRIP-CHART ASSESSORS / RECORD EDITORS / FILM ANALYSERS
D.C. AMPLIFIERS / A/D CONVERTERS / DIGITAL SYSTEMS

SOLENOIDS? RELAYS? TIMERS?



MAKE CONTACT WITH MAGNETIC DEVICES



M.O.A.—A.R.R.E.—A.R.B.
Approved Inspection

With justifiable pride we call your attention to our most extensive range of relays, solenoids and timers. If our wide basic range does not offer a solution to your problem then our Design or Application Departments are at your service. If you require our Catalogue, a sample, a quotation—our help in any way make contact with Magnetic Devices now.

MAGNETIC DEVICES LIMITED
NEWMARKET · SUFFOLK · ENGLAND · TEL: NEWMARKET 3451

Grams: Magnetic Newmarket Telex 81245

R.S.1003

When a breakthrough is imminent

. . . you will find 'SELLOTAPE' Electrical Tapes contributing to the safety and reliability of heavily loaded, hard-worked components in motors, transformers, relays and coils. And in miniaturised components, particularly, where space for insulation is minimal, these specialised products carry out a host of essential jobs such as the insulation of windings during impregnation or baking, the securing of lead-out posts and the holding of parts during assembly and manufacture. 'SELLOTAPE' Electrical Tapes take this sort of thing in their stride, because they have been developed in close collaboration with electronic engineers to keep abreast of the constantly changing techniques of this fast growing Industry.

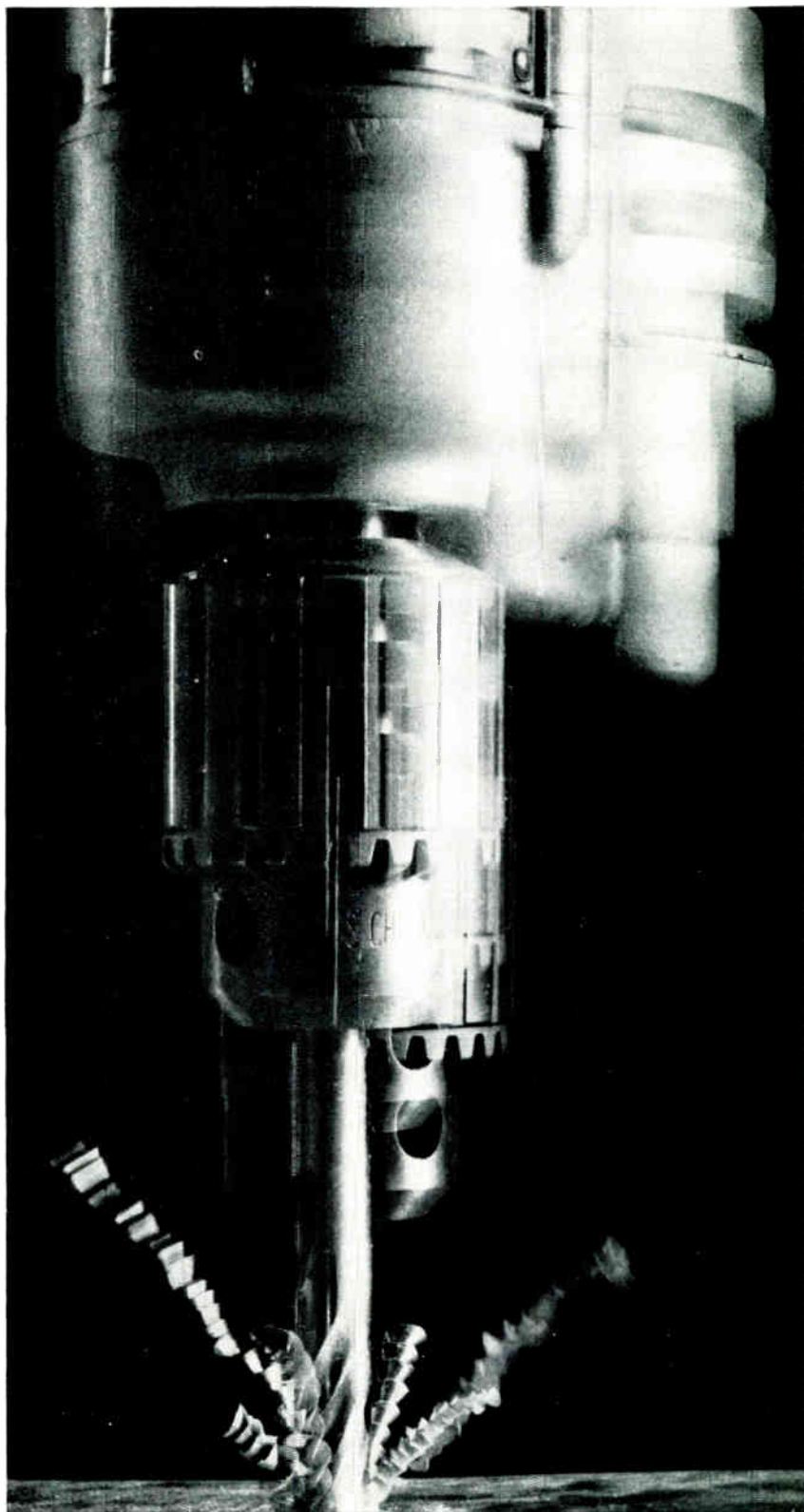

Sellotape

REGD. TRADE MARK

Sellotape

REGD. TRADE MARK

polyester thermosetting tapes like it hot!

They have to because they have been developed for use in electronic components that are heat processed during manufacture or that operate at high temperatures. The tapes are based on various gauges of Polyester film, noted for its excellent volume resistivity and high dielectric and mechanical strength. The film is coated with thermosetting adhesive, which, on curing has increased bond strength and solvent resistance. The result is a range of electrical tapes designed to meet the stringent requirements of component manufacturers.

'SELLOTAPE' Extra-Thin Polyester Thermosetting Tape 1613—the thinnest in the range, specially developed for use in miniaturised components, and where maximum conformability is required.

'SELLOTAPE' Polyester Thermosetting Tape 1607—the most widely used in the range, shown in the drawing securing fine windings on a stick wound coil. The 0.001" based tape remains stable at 180°C for short periods and can be used continuously at 130°/155°C.

'SELLOTAPE' Heavy Duty Polyester Thermosetting Tape 1608—has that extra degree of toughness and insulation required on heavy coils etc. An ideal casing for capacitors.

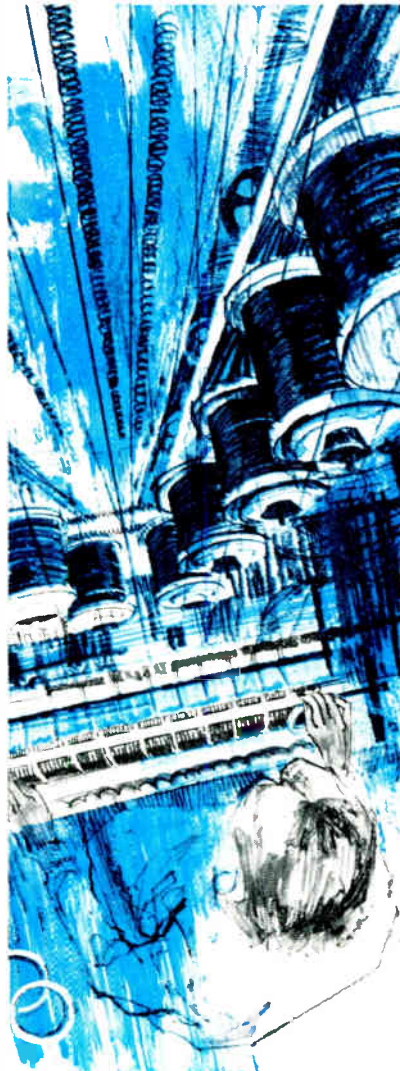

Sellotape

REGD. TRADE MARK

electrical tapes

'SELLOTAPE' Double-Sided Polyester Thermosetting Tape 1609—simplifies many tricky securing and holding operations in coil manufacture. 0.001" thick film is coated on both sides with thermosetting adhesive, providing the ideal means of securing lead-out posts, starting off, insulating and securing primary windings and leads, and in holding interleaves.

'SELLOTAPE' High Strength Polyester Thermosetting Tape 1614—a 0.005" based tape for the extra tough jobs found in the production of large motors, turbines, switchgear and heavy duty heater pads. Also used for 'ground insulation' in domestic appliances and equipment.

... and a special paper-based thermosetting tape for low cost components—'SELLOTAPE' Creped Paper Thermosetting Tape 2701—will withstand processing temperatures of 180°C and continuous electrical operation at 105°C. Good insulation and moisture resistance properties make the tape an obvious choice for use in coils, transformers, relays etc. for holding, lead and slot liner binding, and finishing off.

Write for full details of the complete range of 'SELLOTAPE' Electrical Tapes or call in one of our technical representatives to ensure that you use the right tape for the job.

Sellotape Products Limited
Industrial Division
Sellotape House
54-58 High Street
Edgware, Middlesex
Telephone: Edgware 2345

electrical tapes

serve industry's pacemakers



'Sellotape' is the registered trade mark of Adhesive Tapes Ltd.

NOW AVAILABLE FROM CANNON

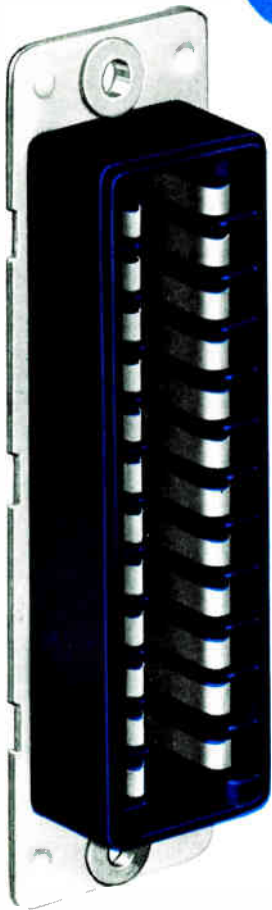

RC PLUGS WITH FLEX-LEAF SPRING CONTACTS

- Mates with similar lines
- For heavy duty rack/panel and cable-to-chassis use.
- Self-cleaning, tarnish-proof gold contacts.
- Low insertion and extraction force.
- Superior contact pressure.
- Flex-leaf contact principle used by cannon since 1940.



CANNON ELECTRIC (GREAT BRITAIN) LTD.

25-27 Bickerton Road, Upper Holloway, London N.19. Tel: ARChway 3088

PLANTS IN: LONDON • BORNEM, BELGIUM • PARIS • TOKYO • MELBOURNE • TORONTO
LOS ANGELES, SANTA ANA & ANAHEIM, CALIF. • PHOENIX, ARIZ. • SALEM, MASS.

Sales offices and representatives in principal cities of the world



© 1963 CANNON ELECTRIC COMPANY

European Enquiries: Cannon Electric International Inc., Bornem, Belgium. Telephone: (03) 77.06.14.

Scandinavian Enquiries: Sweden: Ab Gosta Backstrom, Box 12089 Stockholm 12. Denmark: Tage Schouboe, 7 Skyttegade, Copenhagen. Norway: Standard Telefon Og Kabelfabrik A/S, Postboks 60, Okern, Oslo 5, Norway Oslo 222050. Finland: ITT Myynti-Komponentit, Museokatu 8A, Helsinki, Finland Helsinki 440621

Exhibitions and Meetings

A glance at our 'What's On and Where' pages shows that with the coming of spring there is a change in the public activities in our field. The regular meetings of the professional institutions and societies are ceasing and being replaced by a spate of conferences, colloquia, conventions, symposia and seminars. In addition, the exhibition season is starting.

In this issue we report on two exhibitions, one past and one yet to come. The Radio and Electronic Component Show, which used to be known as the R.E.C.M.F. (Radio and Electronic Manufacturers' Federation) Exhibition, is being held towards the end of this month. We include a list of exhibitors and a plan of the stands, and there is also a forecast of some of the exhibits.

This exhibition is an important one in our field and those who are unfamiliar with its predecessors should not interpret its title too literally. Its coverage actually extends well beyond components and, in particular, instruments will be well represented. Materials will find a place and there is even likely to be some production machinery.

It is now held in alternate years, being interlaced with the I.E.A. Exhibition, and the interval of two years between exhibitions is an almost certain guarantee of many new exhibits.

The other exhibition to which we referred took place in early April and in Manchester. This was The Physics Exhibition. It used to be called the Exhibition of Scientific Instruments and Apparatus organized by the Institute of Physics and the Physical Society. The new name for it is certainly much less unwieldy.

For some time the organizers seem to have been trying to get the character of this exhibition back to what it was in the days when it was held in Imperial College. When it left there for the Horticultural Halls its character changed at once and many people felt that the change was not for the better.

Now in Manchester, it was held at the College of Technology and it certainly seems to have regained something of its old atmosphere. The exhibits are of research and development items and prototype models of new apparatus. True production models are banned and it is this which makes the exhibition so different from any other and is the reason why so many people enjoy visiting it. One gets there a foretaste of things to come.

Elsewhere in this issue we report briefly on some of the more interesting exhibits pertaining to our field.

This article describes a closed-circuit television system installed at Dover to facilitate control of the loading of cars on cross-Channel ferries. It is expected to reduce the turn-around time of a vessel from 90 minutes to 75 minutes.

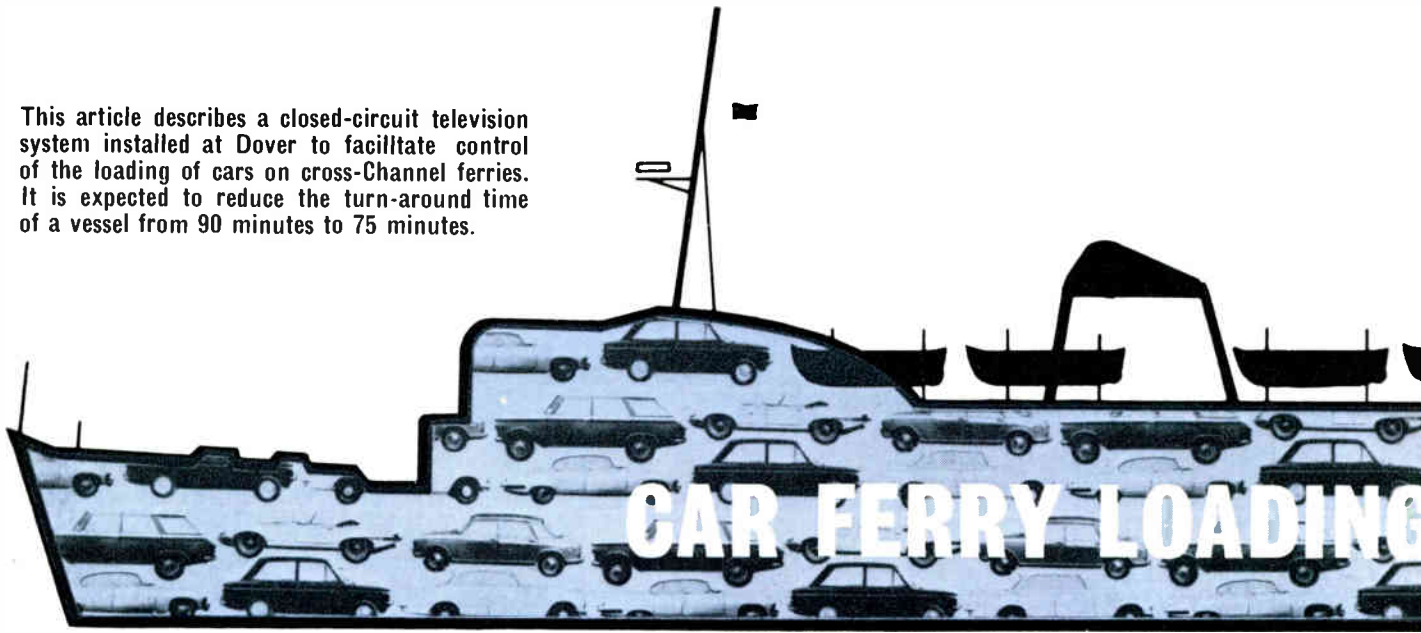

It was realized some time ago that although the combination of a simple closed-circuit television camera and monitor has many uses additional ancillaries could extend its usefulness considerably. With this fact in mind, manufacturers have each developed a standard range of equipment incorporating basic cameras and monitors which, with modifications, could be utilized in most of the present applications of closed-circuit television.

A typical example of this flexibility is the traffic control scheme installed by Pye at the Dover Car Ferry Centre in conjunction with Dover Harbour Board.

The turn-round time of each vessel in 1964 was 90 minutes but this year, with the new methods, it is hoped to reduce the time to less than 75 minutes. This improvement,

* Pye Telecommunications Ltd.

with the probability in the near future of two more loading berths and a larger car park and with the use of the closed-circuit television car guide, will make Dover the most up-to-date and efficient car-ferry point in the world.

After survey of the initial points to be covered by television, the question of camera siting had to be given primary consideration.

Six cameras were required and were positioned in such a way that they would not at any time look directly into the sun or its reflection on the water which, as any photographer knows, would give a poor quality picture lacking in essential detail. The time in which cameras were viewing (against the light) was thus kept to an absolute minimum.

The siting of the cameras viewing the terminal gates checkpoint and car park checkpoint was relatively easy.

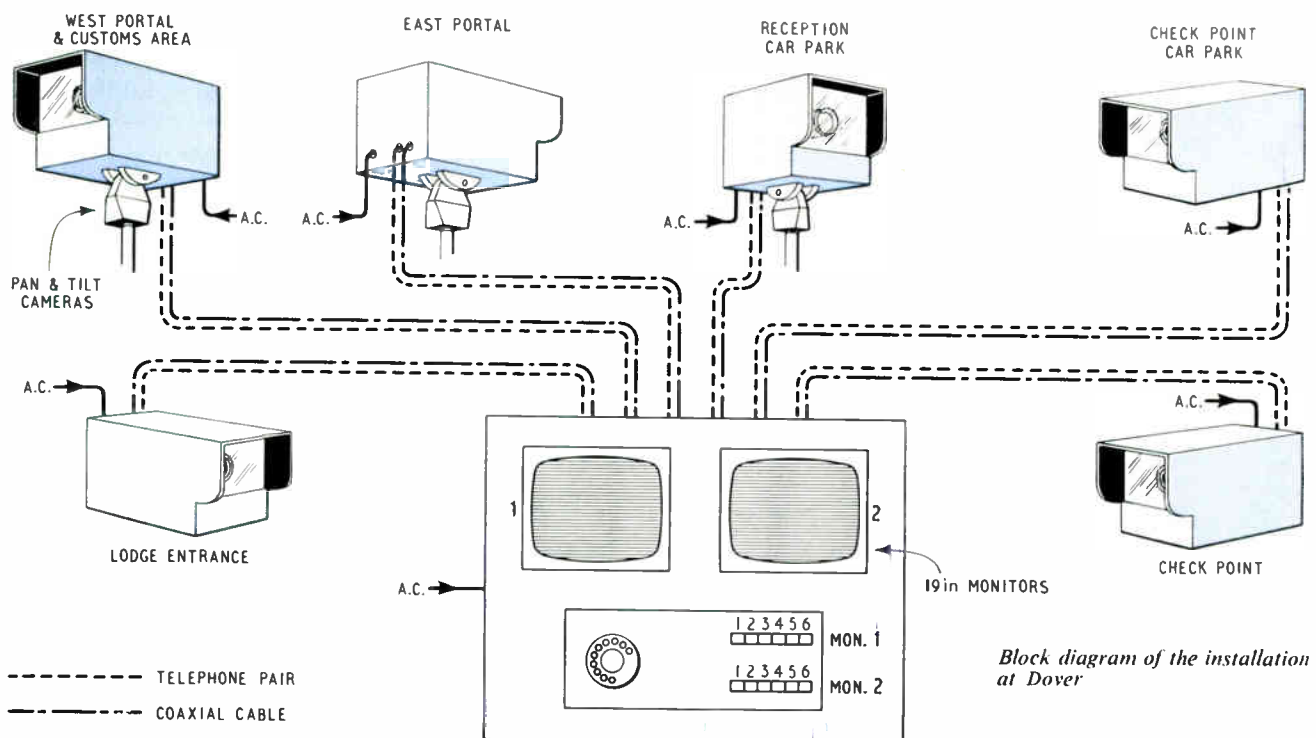

Block diagram of the installation at Dover

By N. SIMPSON



The camera on the floodlighting tower surveying the large reception car park was simply fitted with a shield to mask any glare from the mercury lamps at night and any possibility of seeing the sun by day. The two cameras on the ferry loading ramps had the stops on the pan and tilt units arranged in such a way that maximum coverage giving the best possible pictures was achieved.

The Pye Lynx camera was used in the units. This camera is lightweight and self-contained, using all solid-state components with a built-in power supply and synchronizing pulse generators. Operating on a voltage range from 90 V to 250 V with a composite video signal output of 1.4 V peak-to-peak and a power consumption of only 15 W, it is an extremely robust and versatile camera.

Although modern television cameras are stable in opera-

tion over long periods, it is always desirable to have some form of control over camera functions in order to compensate for deviations which fall outside the scope of the normal automatic camera functions.

There are several ways of achieving this. One is to provide local facilities which necessitates a video monitor adjacent to the camera for setting-up purposes. Such a method is cumbersome and time wasting and should not be considered unless the cameras are readily accessible.

The second method requires the use of expensive multi-core cables which have the added disadvantage of limited length over which control is possible owing to the voltage drop.

A third method has been developed using ordinary telephone lines which enables any camera to be controlled over an unlimited distance using only one telephone pair for control and one video line for picture return.

The units at the camera end utilize a standard telephone uniselector operating on voltages up to 50 V which are triggered by pulses from a G.P.O. telephone-type dial on the control panel, around which the required facilities are printed. This method enables up to ten functions to be controlled which in the case of the Dover Harbour Scheme are:

- | | |
|------------------------|------------------|
| 1. Pan and tilt | 6. Sensitivity |
| 2. Iris open and close | 7. Beam current |
| 3. Camera on-off | 8. Beam focus |
| 4. Wiper on-off | 9. Optical focus |
| 5. De-mist on-off | 10. Auxiliary |

The auxiliary function is useful in cases where a zoom lens is fitted but where night time working is required, a stop of $f/2.8$ (the usual numerical aperture of zoom lenses) can prove to be a disadvantage in terms of sensitivity. The lenses fitted to the cameras at Dover are one of two types, either 25 mm $f/0.98$ or 15 mm wide angle $f/1.4$, which ensure good results at low light levels.

Taking the sequence of events in detail, we start by selecting CAMERA ON-OFF and moving the dial to the stop. This first operation automatically resets the uni-selector which

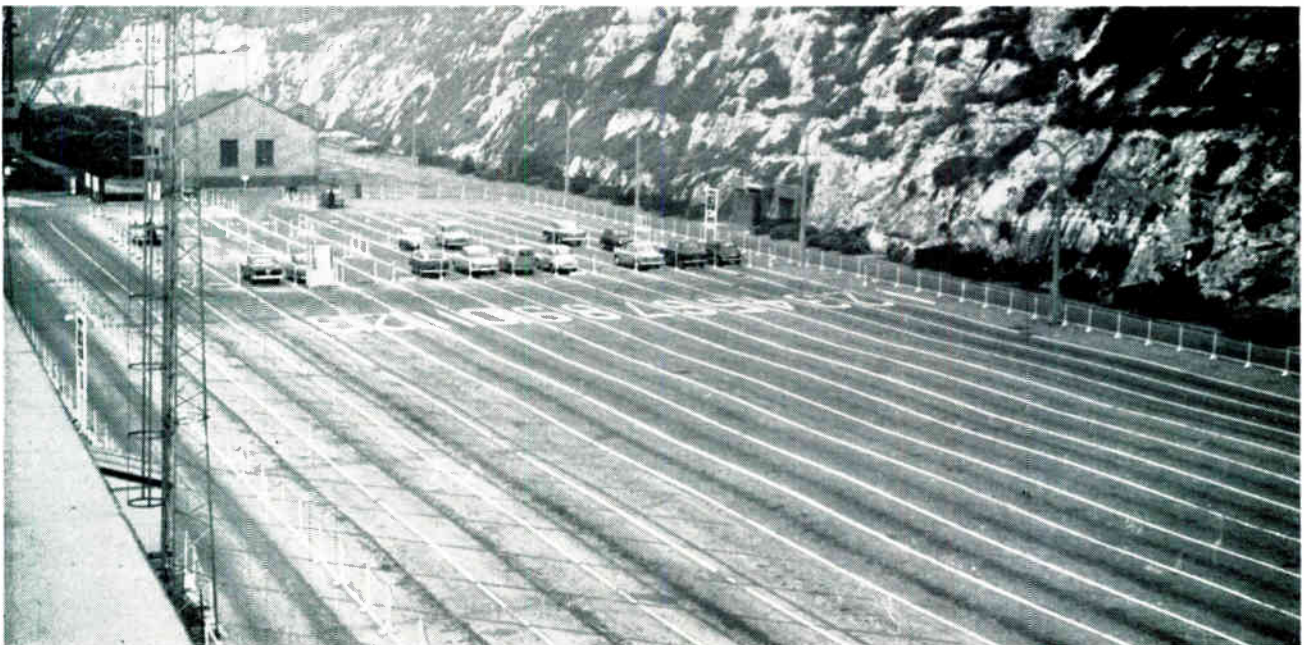

This picture shows a section of the enormous car park at Dover, on a very quiet day. Traffic is fed through here on its way to the ferry. The closed-circuit cameras keep watch, enabling officials to prevent jams, thus ensuring a smooth flow of traffic and speeding up the boarding of the vessels.

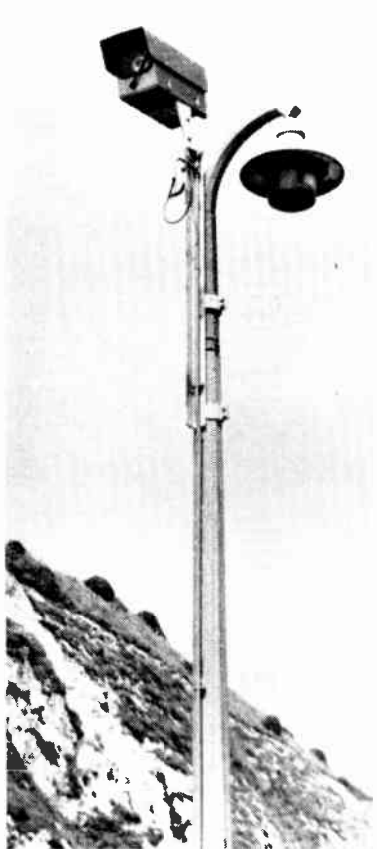

The picture on the left shows one of the cameras overlooking the entrance to the car-ferry terminal. Shown on the right is the control room where pictures from cameras installed by the ferry berths can be seen on the monitor screens. A telephone dialling system (shown below screens) enables the cameras to be controlled remotely so that focus, rotation and tilt can be adjusted

is controlled by a relay, thus conforming to G.P.O. regulations. On releasing the telephone-type dial, a series of pulses operate the uni-selector, via the relay, coming to rest at the selected function. The actual operation is carried out, at the control unit, by means of a toggle switch, moveable in two directions and suitably engraved INCREASE-DECREASE, for use when camera tube controls are selected, TILT-UP, TILT-DOWN, PAN-LEFT, PAN-RIGHT, when pan and tilt are selected, or ON-OFF when a.c. supplies are selected. A 24-V sealed relay completes the chain and carries information from the toggle switch to the selected function control. The ON-OFF circuits are controlled by means of latching relays, being mechanically locked in either ON or OFF position.

The camera tube controls are driven by three small motors, geared down and fitted with automatic disengaging clutches that ensure no override and give smooth control of beam focus, etc.

The control point is situated in the customs shed and consists of a standard dial unit and a video switcher which controls two 19-in. video monitors. The first row of switches selects each camera and in addition switches in the control unit to the camera selected. This means that each camera can be set up and switched on or off as required. The second row of switches selects only the required

picture from any one of the six cameras but offers no control.

Although the equipment at Dover was installed primarily for traffic control, other applications of closed-circuit television have proved equally successful. For example, installations currently in use in the City make use of cameras for the purpose of transmitting latest market prices from brokers' boxes at the London Stock Exchange to various London offices of both brokers and their clients.

One of the major uses of closed-circuit television equipment is currently proving to be in coal mining, both on the surface and underground, where Buxton approved flame-proof equipment can also be incorporated. This is an invaluable aid to increased production and improved safety.

The latest development by Pye Telecommunications Ltd. is the line equalizer which enables the picture quality to be maintained on monitors working at considerable distances by compensating for the distortion which occurs over long coaxial or telephone cables.

Closed-circuit television line equalizing equipment consists of a sender and receiver, both of which are transistorized wideband video amplifiers. Both have preset line-matching controls and the receiver has variable differential frequency characteristics. When 20-lb/mile telephone pairs are used, equalization is effective over 1-5 miles. Coaxial cable requires only a receiver for distances up to 2 miles, and one set of equipment will cover 2-4 miles. Greater distances require a receiver used as a repeater every 3-4 miles.

To compete industrially with other countries, we must make the fullest use of our available resources and the communications field is perhaps the most important factor in the modernization and expansion of our major industries.



ELECTRONICS
INFORMATION
CONTROL

IN aircraft and guided weapons it is often necessary to convert small electrical signals into equivalent limited mechanical motions or forces which in turn operate valves in hydraulic or pneumatic systems and ultimately operate the actual control surfaces or guidance system of the aircraft. A device used for this function of energy transfer is the torque motor and the purpose of this article is to describe such a torque motor, the basic principle of operation, and its adaptability for general applications in other branches of the engineering industry.

In view of the slightly specialized nature of design methods and production techniques associated with torque motors, there has in the past been a general tendency for designers to guard against the publication of any information which may be of use to competitive manufacturers. This tendency has led to a general shortage of technical information which in turn creates definite prejudices against the use of torque motors.

It is the intention of the author to break down these prejudices by explaining in simple terms the general terminology and systems of measurement, so that engineers will not only be better informed on the adaptability and typical applications, but also realize that the torque motor is a normal piece of engineering equipment which can be designed and produced by, and conversely used by, any competent engineering company.

It should be noted that, providing sufficient space is available, then there are no technical limitations to the torque output, and sizes in current production at Woden vary from a 1-in. cube to a 4½-in. cube, where torque outputs in excess of 100,000 gm-cm are available.

General Principle of Operation

A torque motor can be briefly described as a magnetic bridge circuit where two of the branches are formed by the static flux from permanent magnets, and the other two branches are formed by the fluxes generated in the control coils. The armature takes up a normal position which bridges the stator poles, thereby maintaining a state of magnetic balance in the four air gaps, see Fig. 1.

When a signal is applied to the control coils then a state of magnetic unbalance can be created, and the armature rotates to a new position in order to re-balance the magnetic bridge circuit.

The control coils can be fed from either a single-ended or differential source.

In single-ended applications the control coils are connected in series-aiding and the armature rotates in a direction determined by the direction of the current flow. In no-load applications the degree of rotation is directly related to the magnitude of the current flowing. Under loaded conditions the armature rotates to a position where the torque produced by the control current is equal and opposite to the applied torque load.

As the torque output is directly related to the current flowing then it can be seen that, by regulation of the control current, it is possible accurately to position a load anywhere within the angular deflection range of the torque motor.

Similarly in differential applications the torque output and deflection can be related to the differential between the currents flowing in each half of the control circuit.

Stiffness and its Effect on Other Parameters

Examination of Fig. 1 shows how the armature bridges the tips of the stator poles and takes up a natural centre position in order to maintain magnetic balance.

If the armature is deflected from the natural centre by means of an external load applied to the shaft, then the

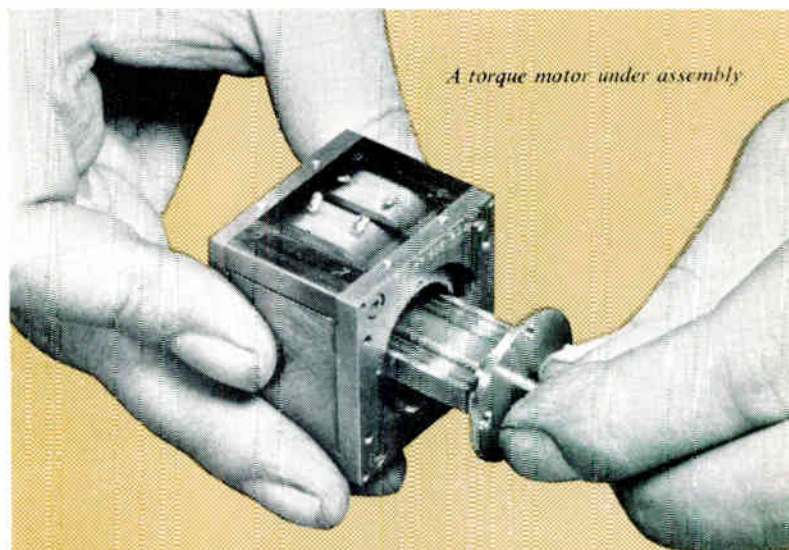

A torque motor under assembly

AN INTRODUCTION TO

TORQUE MOTORS

By J. B. F. CARTWRIGHT*

Torque motors are widely used for converting electrical signals into mechanical movement and so for positioning control valves, etc. This article describes their characteristics in elementary terms.

*Woden Transformer Co. Ltd.

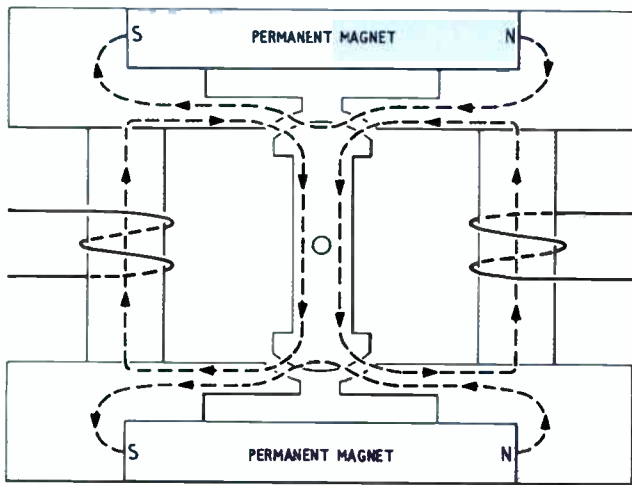

Fig. 1. Showing the basic magnetic circuit of a torque motor

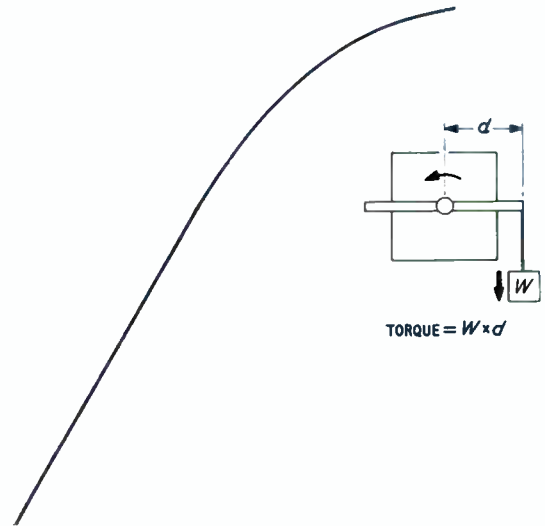

Fig. 2. Showing the torque/current characteristics at zero deflection

unbalanced static fluxes created will produce a force opposing the applied load in an attempt to restore the original state of magnetic balance. The armature will then take up a new position of balance which is dependent upon the magnetic restraining force and the applied load.

This magnetic restraining force is known as stiffness and is measured in terms of torque related to deflection; i.e., typically, 100 gm-cm/degree. This stiffness can be modified by adjusting the strength of the static fields produced by the permanent magnets.

The torque output from a torque motor is a direct function of the control current and this output can be measured at any point of armature deflection. It is usual to present this information either in terms of torque/deflection characteristics at a range of current levels, Fig. 3, or alternatively as the stall torque at zero deflection/current, Fig. 2.

Examination of Fig. 3 shows how the slope of the torque/deflection characteristics at different levels of excitation follow the same basic slope as the zero-current curve and as the zero-current curve is representative of the stiffness of the torque motor, then it will be seen that any modification to the stiffness will result in a corresponding modification to the slope of the torque/deflection characteristics when energized.

In order to determine the torque-motor stiffness required in any specific application numerous factors should be considered, the primary factor being the nature and magnitude of the load to be driven.

The stiffness of a torque motor should normally be such that the centralizing forces are sufficient to overcome the combined effects of valve stiffness, valve stiction, and valve reaction forces which may be encountered at any position of valve deflection.

It is, however, generally advantageous to have the torque motor stiffness as high as possible, compatible with the requirements of torque output at full deflection, as with a high stiffness unit the best dynamic characteristics and lowest hysteresis figures are obtained. This is discussed in the subsequent paragraphs. A general curve showing how the basic characteristics change with respect to stiffness is shown in Fig. 8.

For the purposes of overall guidance the change in performance characteristics can be related to a change in stiffness as indicated in Fig. 8. Other performance parameters can also be related to stiffness but this relationship is dependent upon specific design details of the unit under consideration and it would be misleading to over-generalize on these features.

Hysteresis

Hysteresis is a most important parameter of torque-motor performance and obviously must be considered in the early design stages of any project.

The term hysteresis is possibly misleading as this suggests that any measurements are purely a function of the B/H characteristics of the material in the iron circuit, and many engineers prefer to use the term dead sector. Personal preferences are, however, unimportant providing that the system of determination is clearly understood.

In order to measure hysteresis to the fine limits usually required Woden employ specialized optical equipment, and in some of the later units developed figures as low as 0.9 minutes (total) have been achieved.

The usual method of measuring hysteresis is to increase the control current slowly from zero to the full load current, then to reduce the current slowly back to zero and note the

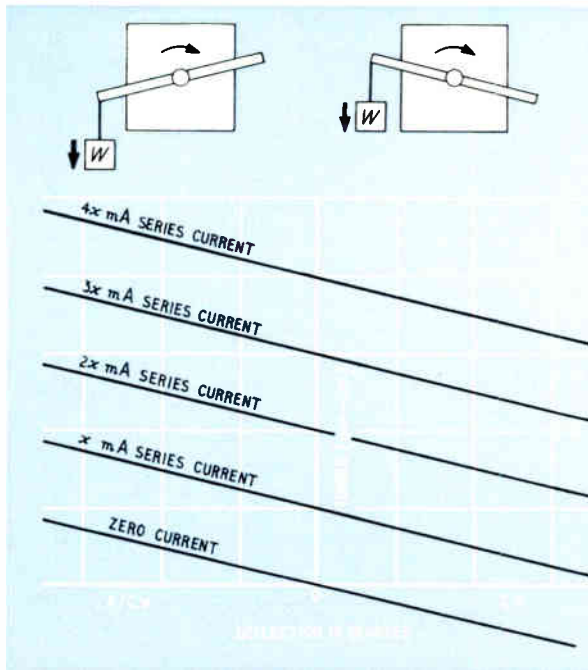

Fig. 3. Showing the torque deflection characteristics at various levels of excitation

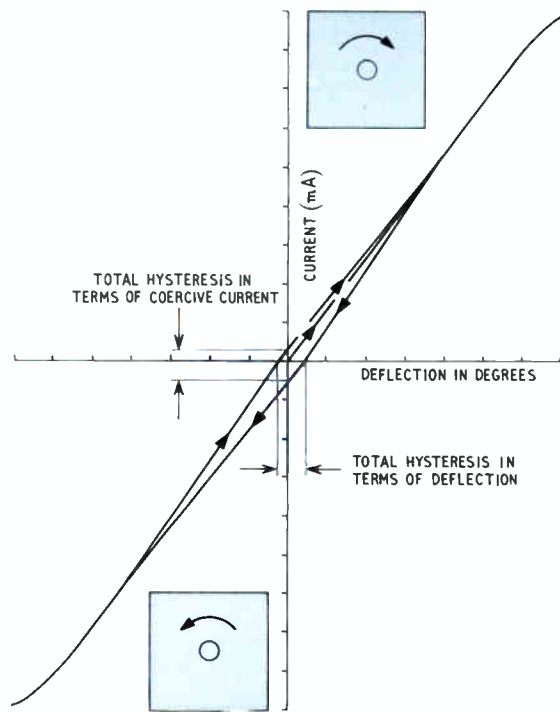

Fig. 4. Showing current/deflection sensitivity and hysteresis characteristics

rest position of the shaft. This cycle is then repeated with the current flowing in the opposite direction and again the rest position of the shaft is noted.

The total distance between the two rest positions is the hysteresis of the torque motor at zero deflection.

By recording intermediate points between zero and full current it is possible to plot a full hysteresis loop. This enables the hysteresis to be measured either in terms of deflection or coercive current at any level of current or deflection, as shown in Fig. 4.

The main factors which affect hysteresis are as follows:

1. The selection of material in the iron circuit.
2. The correct handling and treatment of the selected material during production processes.
3. The selection of suitable bearings.
4. The correct handling and fitting of the selected bearings.
5. The stator armature pole tip configuration in the electromagnetic design.

Fig. 8 shows the relation between hysteresis and stiffness.

Dynamic Characteristics

There is often some lack of clarity in the presentation and interpretation of dynamic characteristics and it is believed that the system now adopted by Woden is the most comprehensive and easily understood method.

A typical set of dynamic characteristics is detailed in Fig. 5 and the information provided allows users to read-off the gain in dB at any frequency level under constant-voltage or constant-current conditions of drive. The impedance/frequency curve is mainly of interest to the amplifier designers and enables the drive voltages and matching impedances to be determined.

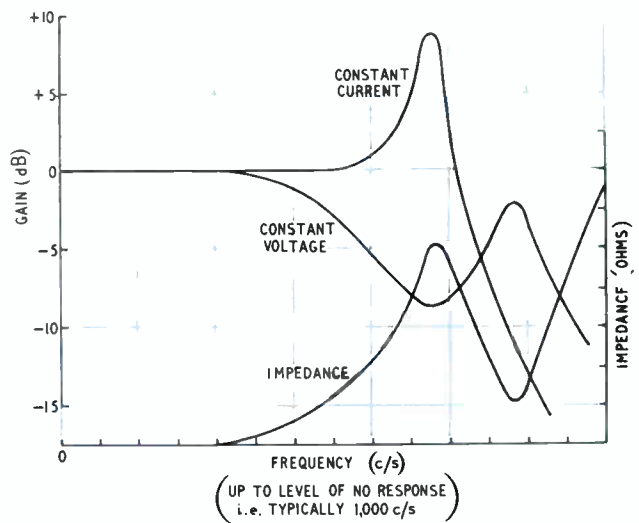
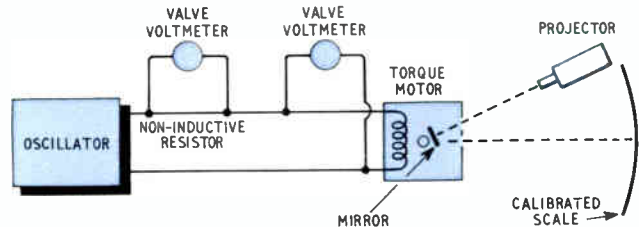

Fig. 5. Typical dynamic characteristics of a torque motor, taken under conditions of no load at a reference level of $\pm \frac{1}{2}$ amplitude

Fig. 6. Typical set up for the determination of dynamic characteristics



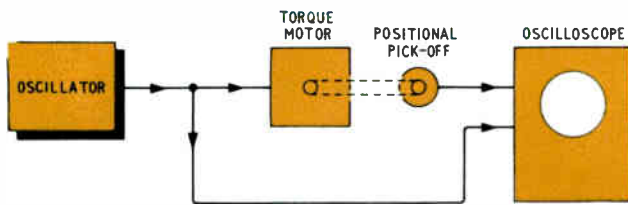
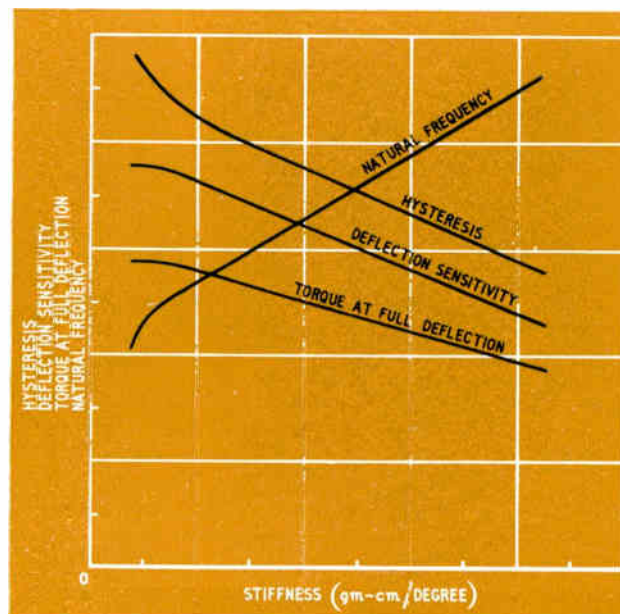

Fig. 7. Typical set up for the determination of phase lag

Fig. 8. Showing basic changes in parameters of performance related to changes in stiffness



The torque-motor shaft responds in accordance with the amplitude, frequency and waveform of the input signal. Three basic signals are referred to below; i.e., d.c., square-wave and sine-wave.

(1) *D.C.* The effects of d.c. excitation have been discussed in some detail in the preceding text.

(2) *Square-Wave.* A square-wave input will cause the shaft to switch between two positions of deflection, the amount of deflection being related to the amplitude of the input signal. When the amplitude ratio and the mark/space ratio are 1:1, then the mid position of deflection corresponds to the 'natural centre' of the torque motor.

If the amplitude ratio is varied by the application of a biasing signal, then the deflection amplitudes will become unbalanced about the natural centre. A simple example of this would occur when the input signal amplitude causes the shaft to deflect 2 degrees each side of the natural centre, and a biasing signal sufficient to cause a deflection of $\frac{1}{2}$ degree clockwise is applied. The resultant output from the shaft would then be $2\frac{1}{2}$ degrees clockwise and $1\frac{1}{2}$ degrees anticlockwise.

If the mark/space ratio is varied, then the shaft still follows the input signal and remains deflected in one direction for a greater period than in the other direction, depending upon the ratio of alternate pulse lengths. This system of control is now being subjected to a detailed examination in America, and is commonly referred to as p.l.m., pulse-length modulation.

(3) *Sine-Wave.* A sinusoidal input will cause the shaft to respond in a simple harmonic motion, where the instantaneous amplitude of deflection is related to the instantaneous value of the input signal; i.e., a sinusoidal output.



The system of measurement employed in the determination of dynamic characteristics is as follows.

A small mirror is fitted to the torque-motor shaft and the torque motor is driven by an RC oscillator.

The angular deflection of the shaft is measured by means of a hair-line image projected on to the mirror; this image is then reflected on to a rigidly mounted calibrated scale.

The current flowing is determined from measurements taken on a valve-voltmeter connected across a non-inductive precision grade resistor. The voltage measurements are taken from a valve-voltmeter connected directly across the torque-motor coils.

With the test equipment set up as in Fig. 6, the oscillator output is set at a level which causes a shaft deflection of half amplitude (peak-to-peak) and the frequency is progressively increased while the current level is maintained constant. The changes in amplitude of the shaft deflection are read off the light band projected on to the calibrated scale, and amplitude readings are recorded at 10-c/s increments until the point of no response is reached. These results are then plotted in terms of 'gain' in dB related to supply frequency.

The test is then repeated with the voltage across the torque-motor coils maintained at a constant level and the results are again plotted in terms of gain related to frequency, see Fig. 5.

The dynamic characteristics produced apply only to an unloaded torque motor and the overall characteristics of any complete electro-hydraulic combination, or other system, will obviously change in relationship to the stiffness and inertia of the system.

One feature of dynamic characteristics not yet discussed is the phase lag between the electrical input and the mechanical output, and it is obvious that as the input frequency increases then the lag in the positional response of the armature also increases.

There are various methods employed for the determination of phase shift and the system indicated in Fig. 7 is often used. Small errors can occur if the inertia of the

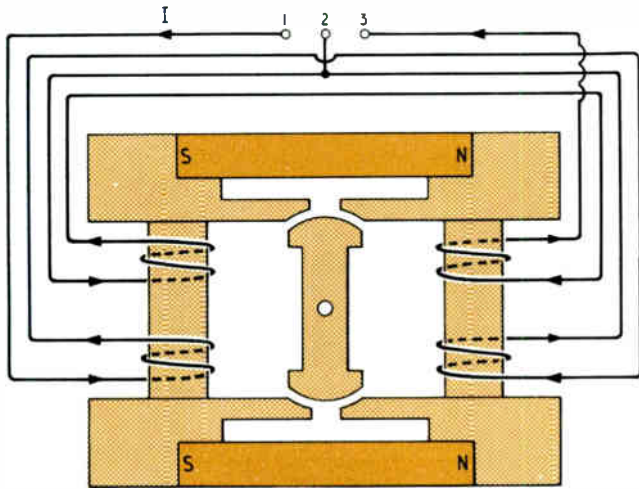

Fig. 9. This illustration shows the coil arrangement and interconnections which ensure even flux distribution

pick-off armature is high but in general sufficient compensation can be made at the commencement of testing by regulation of the X-shift on the oscilloscope.

Considerably more sophisticated circuitry is often employed in phase-shift measurements, but for the purpose of this article the principle outlined is satisfactory.

The phase lag will increase as the external loading increases and the change can be related to the nature and magnitude of the loads.

Coil Arrangement

The coils on a torque motor are usually arranged to ensure that the flux in each half of the control circuit is equal, whether the coils are fed from a differential or single-ended source.

This is achieved by having each coil split into two sections, then by correctly phasing the coils and interconnecting as shown in Fig. 9 the number of ampere-turns per unit length is evenly distributed between each half of the iron circuit.

For single-ended applications terminals 1 and 3 are used, and for differential applications terminal number 2 is used as the centre tap.

The d.c. resistance of the coils can be matched to the driving source, the most common levels being 20.0-20 ohms for use with transistorized amplifiers, 1,000.0-1,000 ohms for use with magnetic amplifiers and 10,000.0-10,000 ohms for use with valve amplifiers.

For applications where the control signal is derived from sources other than electronic amplifiers, then the coil resistance can be arranged to suit specific requirements.

Power Input

As the performance characteristics are a function of the control current then it follows that, within small limitations imposed by the increments in wire gauges available, the torque output can be related to the power input. For example, if a torque figure is obtained with 10 mA flowing through a total resistance of 20,000 ohms then the power input (I^2R)=2.0 watts.

Similarly, if the same torque output is required from a unit with a total resistance of 40 ohms, then the current required will be $I = \sqrt{W/R} = \sqrt{2/40} = 224$ mA.

Summary

In order to epitomize the preceding text it can be briefly stated that a torque motor is an electro-magnetic positional transducer where the output shaft reacts in a manner directly related to the applied signal.

The armature rotates and produces a torque in a direction determined by the direction and magnitude of the current flowing in the control coils.

With no current applied or, alternatively, where the differential signal is zero, then the armature maintains a central position, and will return to this position, after displacement due to any signal, when the current returns to zero or when any unbalance in the differential supply is removed.

In order to maintain the extreme consistency of performance required between units of a fixed design, very fine manufacturing tolerances are necessary and this requires extensive inspection at various stages of production.

As a result of continual experimental and development work conducted over recent years it has been decided that for best overall characteristics the iron circuit should be manufactured from a 50/50 nickel iron, and Radiometal 50* is used for this purpose. Other materials such as Mumetal*, Radiometal 36*, Permendur* and soft irons have also been used to obtain special performance characteristics.

Experiments using Super-Radiometal are now producing very promising results, and the development programme is arranged to experiment with new materials and components as and when they become available.

All units are designed to operate in adverse environments. A range of torque motors has been developed and type approved for use on military projects.

The applications for torque motors as positional devices in electro-hydraulic/pneumatic control systems are by now quite obvious, but less obvious applications are worthy of consideration.

When a torque motor is operated in reverse (i.e., by driving the shaft from an oscillating mechanism) then the torque motor becomes a tacho-generator.

A scheme for automated high speed weighing and recording has been devised where the load deflects the torque-motor shaft, and a high gain positional feedback signal returns the shaft to the original position. The current flowing is proportional to the applied load and is used to operate the recorder.

Torque motors can also be used in industrial pen-chart recorders where the pen is positioned in proportion to the current flowing. By adopting similar techniques it is possible for very small signals, as encountered in cardiographic measurements, to be recorded.

For extremely accurate current measurements it is possible to use a torque motor in a similar manner to a reflecting galvanometer. Such devices are often used at Woden for precise measurements where scale lengths of six feet, representing the normal full-scale deflection of a meter, have proved extremely useful.

Future Trends

There is no electro-mechanical positional device available at such an advanced state of development which can compare favourably with the torque motor as manufactured by Woden in reliability, consistency and robustness, and, as it is now possible to design to customers' requirements, then future trends will be largely determined by specific problems encountered by users.

* Materials manufactured by Telcon Metals Limited.

ELECTRONICS IN TEXTILE

3. Carding Machine Control

In this concluding article of the series, a method of controlling a carding machine is described. This machine produces the sliver and the control system has enabled the coefficient of yarn variation to be reduced from 2.35% to 1.65%. This is considerable as a reduction of even 0.1% is significant.

THIS, the third article in a series giving recent examples of the application of electronics to textile machines, describes how an experimental electronic servo-regulator has been applied to the textile processing machine known as a carding machine or more simply a 'card'. The name 'card' is derived from *carduus*, the Latin word for the teasle plant whose burrs were attached to wooden boards and used for the manual separation of raw fibres in the days of hand spinning.

The card uses a succession of revolving cylinders covered with fine wire teeth to separate a thick tangled sheet of raw fibres, remove the impurities and unwanted short fibres and then form a rope like sliver from the fine web of recombined fibres delivered in the output. A group of modern cards is shown in Fig. 1 and a sectional diagram of the machine operation in Fig. 2. As is shown, the separating and recombining action takes place continuously and the output sliver

is delivered at a linear speed approximately one hundred times faster than the input speed of the feed sheet; thus as far as mass per unit length is concerned the action is virtually a drawing out process and the output sliver is a stretched replica of the input feed sheet with the wavelength of input feed sheet variations increased by a factor of one hundred. Despite care in preparation, the feed sheet is usually far from regular in its mass per unit length structure and contains a series of marked medium-wave variations and long-term drifts as well as the very short wave variations from the statistical distribution of fibrous tufts in the feed sheet. A modern high speed card does little to smooth out these variations and can, in fact, add short-wave variations because of unavoidable slight eccentricity of its rotating cylinders.

Until recently the mass per unit length variations in the card output sliver have been accepted as unavoidable and been corrected to some extent by combining several slivers together in subsequent drawing processes to average out the variations. To make any significant correction of the medium-wave and long-term drift variations in this way it has been necessary to repeat the sliver combining and drawing process several times. Beyond a certain amount, repeated drawing is undesirable in modern textile processing and we have therefore studied methods of automatically correcting the mass per unit length of the card sliver as it

* T. M. M. (Research) Ltd.

Fig. 1. An installation of Platts cotton cards showing the roll of feed sheet at the input and the peeled off web condensed into a rope-like sliver at the output



MACHINES

By R. GREENWOOD, B.Sc.*

is produced. This article summarizes the problems involved in this task and describes an electronic control system designed for the card and successfully tested in a synthetic-fibre spinning mill. The object of the control system is to maintain automatically a desired output level of sliver mass per unit length and thus takes the name 'Autoleveller'.

Choice of Control System

The card can be simplified to a mechanical black box shown in Fig. 3 (a), where the input sheet is fed in at A by a feed roller running at a speed V_1 , the fibres pass through the box and after a process time lag t_1 , are delivered as sliver at B by output rollers running at V_2 where V_2 is much greater than V_1 . The passage of fibres through the card is not a simple acceleration effect and t_1 is considerably greater than $(t = s/v)$ the rotating surface distance (s) to average surface velocity (v) ratio time.

Considering Fig. 3 (a), at least five basic control systems can be applied to the machine.

1. Measure at A, Vary V_1 —Open loop.
2. Measure at A, Delay, Vary V_1 —Open loop.
3. Measure at B, Vary V_2 —Open loop.
4. Measure at C, Vary V_2 —Closed loop.
5. Measure at B or C, Vary V_1 —Closed loop.

It was found to be almost impossible to measure the

mass per unit length with sufficient accuracy at position A and any system that required a variation of V_2 was complicated by the fact that the sliver output rollers are connected to a complex mechanical system of high inertia for packing the sliver into containers. Also, while the open-loop systems gave the possibility of very short wave control they did not meet our preference for simplicity, reliability and, most important, self-compensation. The above points were the main factors in our final choice of system 5 and it was realized from the start that this system can only correct medium-wave variations and long-term drifts. We consider that there will always be a minimum of sliver-combining required for other textile technological reasons to take sufficient care of the very short wave effects.

The system chosen is illustrated in Fig. 3 (b) and is at first sight a straightforward closed-loop controller where the output sliver mass per unit length is compared against a reference to produce an error signal and this error signal is fed back to the input rollers to cause a corrective speed change with the loop closed by the passage of fibre through the card. Such a system could be electronic, hydraulic or mechanical but after careful analysis it was clear that only an electronic system would meet the high degree of measurement accuracy required with a severely low signal-to-noise ratio and be able to cope with the stability problems arising from the long process time lag at an economic power rating.

The Control System

The Basic Arrangement

The basic electro-mechanical arrangement is shown in Fig. 4. The output error against a reference setting is derived from a transducer measuring the output sliver and this signal is passed as a flip/flop (on-off-on) signal to a small servo motor. The output of the servo motor is taken through a very high ratio reduction gear box to change the setting of a mechanical variable-speed transmission unit inserted in the feed-roller drive shaft and thereby vary the rate of feed into the card to correct for the measured error. In this system the problems of output sliver measurement and the stability of the complete loop have a considerable bearing on the choice of electronic circuit and these two problems are discussed in detail before describing the final circuit.

Fig. 2. Fibres are struck out of the feed sheet by the first rotating toothed cylinder and combed against toothed strips. Fibre density is reduced by transfer between cylinders and peeled off as a web which is condensed to a sliver and packed into a container

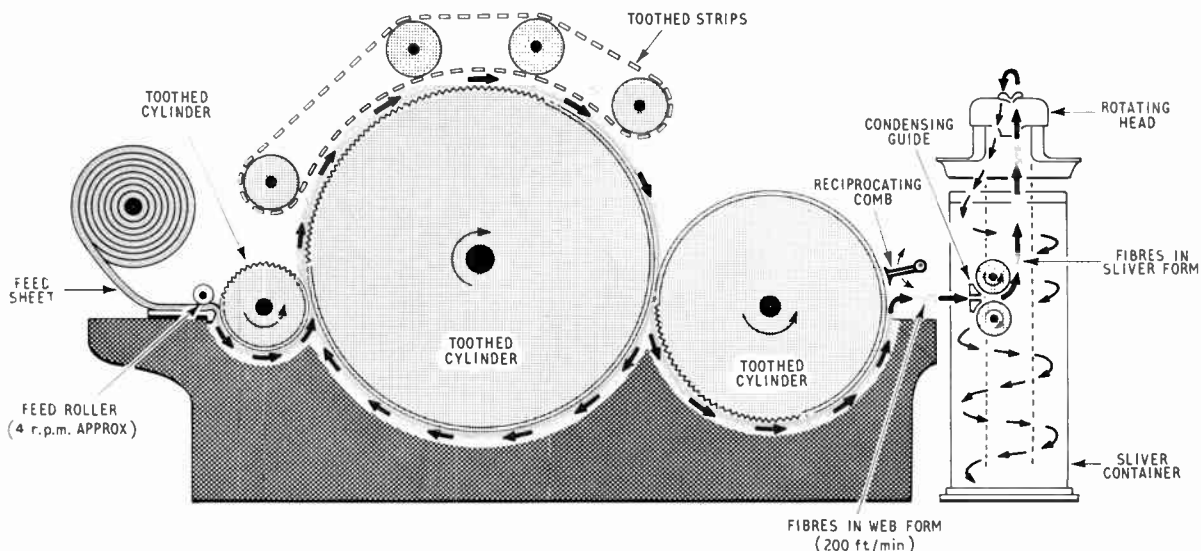

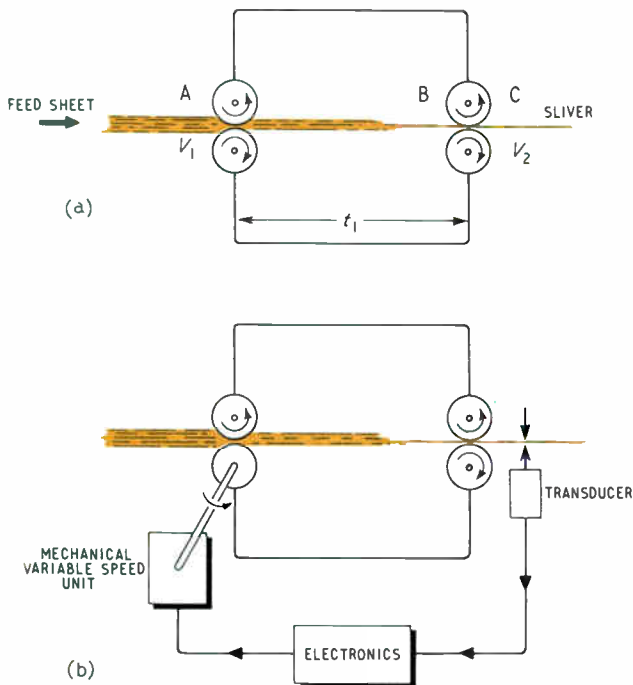

Fig. 3. The card as a mechanical black box (a) and the closed-loop control system (b)

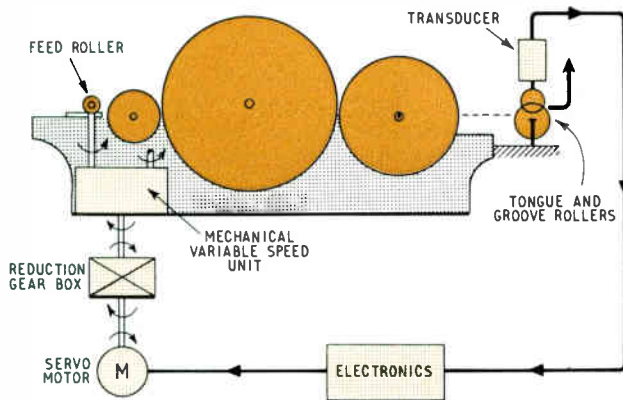
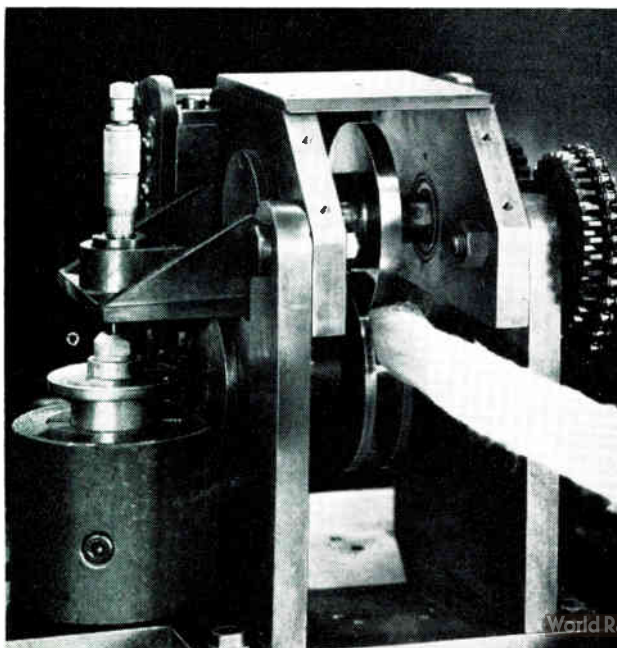

Fig. 4. General form of control system

Fig. 5. Measurement of sliver thickness



Measurement of the Output Sliver

The object of the system is to maintain the mass/unit length of the sliver within $\pm 1\%$ of a desired value measured over approximately 1,000-yard samples of sliver and to reduce medium-wave variations as much as possible. To make such a control action it is necessary to measure the output with significantly greater accuracy than the control limits and we usually adopt a factor of 10 for this purpose. Thus the device used to measure sliver mass per unit length is required to be accurate to within $\pm 0.1\%$ and to remain stable within these limits for a period of at least one week.

Direct weight measurement of the emergent sliver is virtually impossible because only about three feet (0.12 oz) of the sliver is exposed at any instant and the aerodynamic, friction and tension forces acting on the sliver are many times greater than gravitational forces. Three alternative techniques of sliver measurement were considered, nuclear, capacitive and thickness. Of these, thickness measurement was found to be the most reliable for this particular application. In its free state the card sliver has an ill-defined and weakly elastic cross-section of approximately 1 in. diameter and it is necessary to compress this section to a virtually solid state before thickness measurement becomes a reliable measure of mass per unit length. To keep the process time lag to a minimum the sliver thickness was measured immediately after the web had been condensed into a sliver and the required compression of the sliver was achieved by guiding it into a pair of tongue and groove rollers shown in Fig. 5. The lower grooved roller is fixed with the tongue roller riding on the sliver compressed in a $\frac{1}{2}$ -in. wide groove. Spring weighting is applied to the tongue roller and compresses the sliver into a ribbon approximately 0.050 in. thick. This thickness is measured by a 50-c/s L.D.T. transducer (see Appendix 1) acting on the tongue roller. It should be noted that this requires a measuring accuracy of 0.0001 in. The mean setting of the transducer is variable by a micrometer screw which can be used to set the desired thickness, thus making the L.D.T. electrical output an error signal related in phase and amplitude to the thickness error.

In order to determine the performance characteristics required from the servo system a tongue and groove roller with error transducer was applied to the output of a standard card. This arrangement was used to provide information on the wavelength and amplitude of the sliver variations requiring correction. A short length of a typical uncorrected error trace with very short wave noise filtered out is given in Fig. 6(a). When these records were first seen it seemed impossible to expect the control system to detect and correct the slow drift in mean level through such a severe short-wave background noise. For this reason care was taken to select a transducer that had an accurate null point without dead zone and was balanced for large amplitude signals to prevent positive or negative amplitude distortion being interpreted as a mean level drift. The Schaevitz type 03355-L L.D.T. was found to have the required characteristics and when fed by a 50-c/s supply enabled transistor circuits followed by magnetic amplifiers and a small 50-c/s servo motor to be used.

Control System Response and Stability

In order to maintain the desired sliver thickness the rate of feeding the fibrous sheet into the card is varied by changing the setting of the mechanical variable-speed unit by servo-motor action. When the feed roller speed is changed to make a correction, say speed reduced by 5%, it will take some time before a corresponding 5% reduction in sliver thickness is detected in the output sliver. This process time lag, depending on the running speed of the

card and on fibre storage and transfer effects within the machine, is about eight seconds for conventional cards.

Because of the process time lag, the change of feed roller speed must not be made so rapidly that hunting occurs or so slowly that no appreciable correction takes place. To meet this condition a high-ratio reduction gear box is used to connect the servo motor output shaft to the shift mechanism on the mechanical variable-speed unit, this making the speed change at the feed roller time-dependent and acting as a mechanical integrator, so that during correction the rate of feed to the card depends on the time that the servo motor has been running in a given direction. The reduction ratio is chosen to give the required rate of correction for response and stability and is adjustable for fine setting.

Another important stability factor is that a variable differential band must exist either in the measuring system or servo-motor operating range so that the servo motor does not respond to a very narrow band of sliver thickness signal each side of the zero error line. The optimum differential d (in.) is related to the process time lag t_1 (seconds) and also to the servo motor variable-speed unit rate of correction at the output R (in. sliver thickness/second). The general values of d and R related to t_1 are fixed by the fact that d must be less than the acceptable residual mean error and that for stability R must be less than d/t_1 . The specific choice of R and d also governs the rather differing effect the system will have on the medium-wave errors and on long-term drifts and a choice of the most worthwhile control action that can be applied requires decisions on the value of reducing the long-term drift residual to fractions of 1% at the expense of reducing the larger amplitude medium-wave variations to only, say, 25% of their amplitude.

To attempt to determine optimum values of R and d by process-control tests on a prototype controller applied to a card would have required months of expensive textile processing and statistical analysis. We were also keen to take advantage of the simplicity and reliability of a straight-forward flip-flop (i.e., on-off-on) control system, provided its response could be made to approach that of a more complex proportional system, but could not afford to attempt to make this decision by process testing. To resolve these selections we constructed an electronic analogue of the card and controller to derive performance curves of residual error for the full range of input wavelength and amplitude variations with different values of R , t_1 , and d , evaluating the effect of flip/flop and proportional control for each case.

Fig. 7. Typical simulator analysis with process time lag $t_1 = 8$ sec differential set to $d = 0.00025$ in. Equivalent servo motor reduction gearing = 10,000 : 1

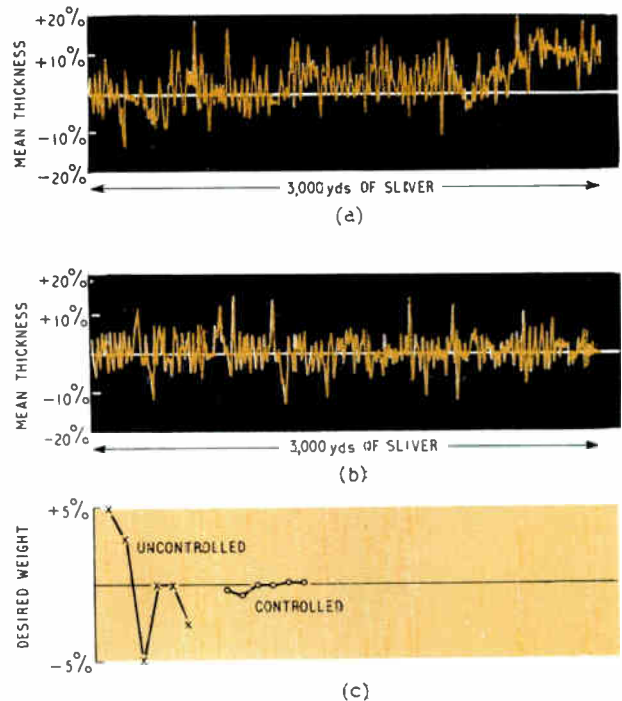
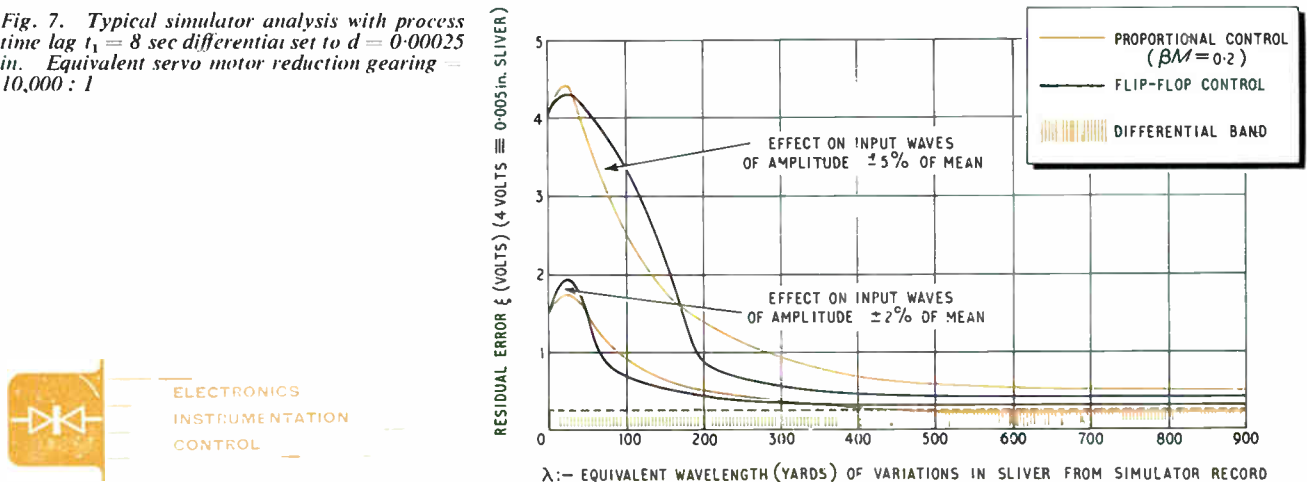

Fig. 6. Uncontrolled card (a), controlled card (b) and long term control (c) taken from the total weighings of 3,000-yard samples

A typical simulator analysis is shown in Fig. 7, and knowing the type of input variation we were likely to meet in a particular process we were able to use curves like this to determine settings for the card and to decide that in this case proportional control was not economical.

The Circuit Block Diagram

Having determined the basic control principles, the circuit was designed to take into account the important factors of reliability, simplicity and environmental conditions mentioned in the opening article. We were pleased to be able to achieve our aim of a simple on-off switch as an operative control action and the simplicity of the prototype transistorized equipment is shown in Fig. 8.

The circuit block diagram given in Fig. 9 starts with the transducer error signal, this signal is divided by a splitting circuit to give a control signal to the servo-motor amplifier

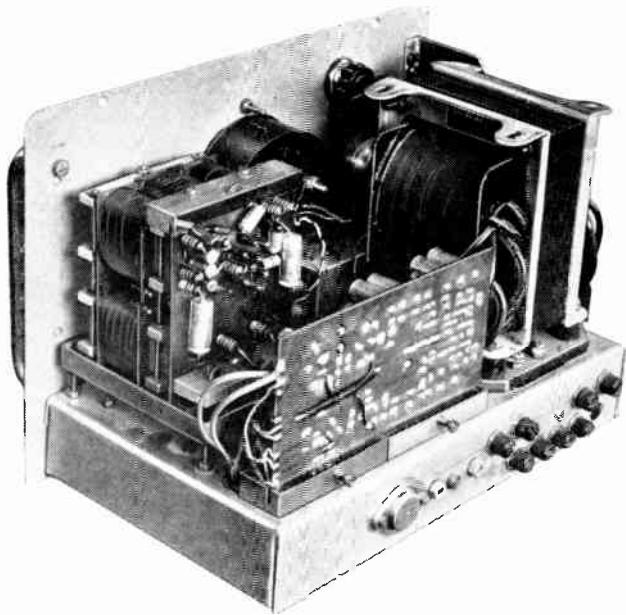

Fig. 8. Interior of prototype equipment

and a signal for an error-meter indicator and recorder.

The meter signal is amplified and fed to the error-indicating meter through a phase-sensitive rectifier and after integration is also fed to a high-resistance recorder to give records of the long-term control action.

The motor-control signal is amplified after a gain-control stage and the amplifier output taken to two phase-sensitive-rectifier circuits. Only one rectifier will give an output at any one time, depending on the sign of the transducer error signal, and the rectifiers are identified as forward or reverse according to the direction in which they drive the servo motor. These phase-sensitive rectifiers are set to give the differential band d by biasing them with a suitable reverse voltage, so that no output appears from the phase-sensitive rectifiers for small signals within the limits of the required differential band. This variable differential setting is more

convenient and reliable than transducer offset. It is possible for the reference signal to cause the servo motor to rotate within the differential band and, to prevent this, a signal is taken from each power amplifier to signal a braking circuit. This circuit applies d.c. to the servo-motor reference winding to ensure that the servo motor stops when a control signal is absent.

The power amplifiers are the last stage of the transistor network and their signals are fed to two magnetic amplifiers feeding direct into the servo-motor control winding. Limit switches in these lines prevent overtravel of the variable-speed unit and stop control action during a machine fault.

Mill Tests

An experimental version of the autoleveller described above has been tested in a synthetic fibre spinning mill and Fig. 6 (b) and (c) show its effect on output sliver regularity. Because of the high noise level it is difficult to assess the accuracy of long-term control from the error records: this is best measured by weighing each 3,000 yards of sliver produced as shown in Fig. 6 (c). As was expected from the start and confirmed by simulator tests these charts show that this autoleveller cannot completely remove all the medium-wave variations, but it is one of the interesting aspects of textile process control that if we had achieved any better sliver regulation at these wavelengths it would have been difficult to trace this additional improvement in the end product of the whole process. This end product is, of course, the yarn (fine thread) from the spinning frames, and the card sliver passes through several intermediate processes before being distributed to the various yarn spinning positions. The real test of the value of the autoleveller is the improvement it makes in the yarn spun from the controlled sliver, and to assess the improvement samples of controlled and uncontrolled sliver were processed side by side through the mill production line and a statistical comparison made of the yarn produced from these slivers. Comparing mass per unit length samples of yarn taken from 1,400 bobbins the prototype autoleveller reduced the coefficient of yarn variation from 2.35% to 1.65%. In textile processing a reduction of 0.1% is a significant improvement and there are practical limits to getting much below 1.5%.

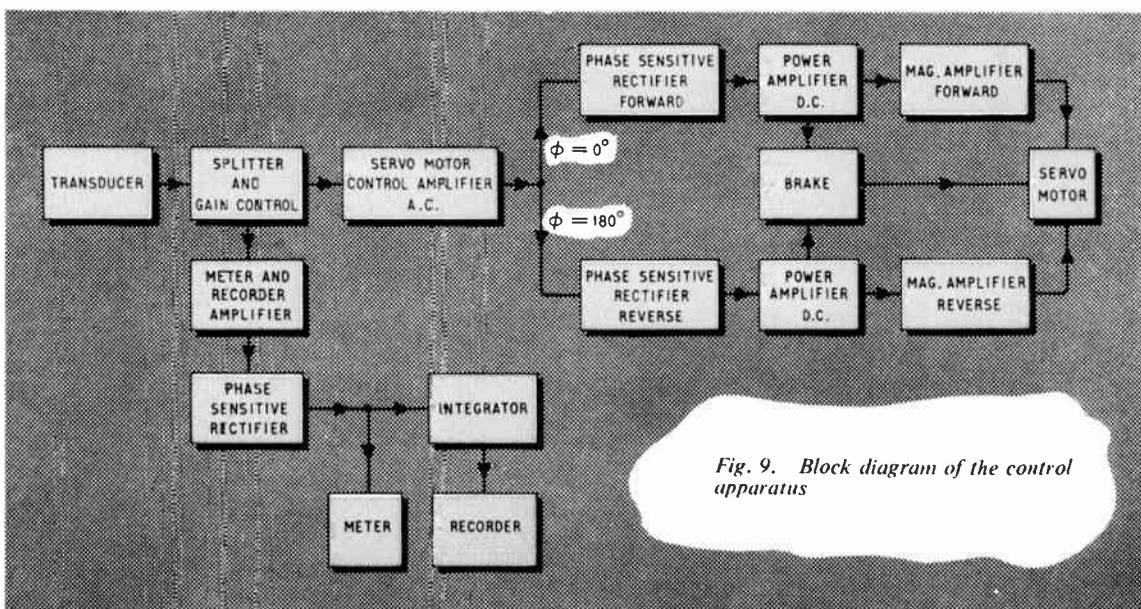

Fig. 9. Block diagram of the control apparatus

We believe that this electronic system is a worthwhile commercial proposition and are now engaged in wider application testing and production design, confident that the system will prove to be one of the most significant applications of electronics in existing textile spinning machinery, and also that a similar electronic system will become an essential part of future automation in textile machines.

APPENDIX 1

Linear Differential Transformer Transducer

This is an electro-mechanical device for converting a linear displacement into an appropriate electrical signal and is sometimes called a linear variable differential transformer. The basic construction is shown in Fig. 10 (a) and a wiring diagram in (b). This device produces an electrical output proportional to the displacement of a ferro-magnetic core and related in phase to the sign of this displacement from a central null point. The secondary output is zero for one central position of the core, but when the core is moved out from this null position the differential voltage output varies linearly with the changing core position and has a phase difference of 180 degrees between the two directions of movement.

APPENDIX 2

Measurement of Sliver Thickness by the Transducer

As is shown in Figs. 5 and 11, the sliver is passed between a pair of tongued and grooved rollers with the lower grooved roller fixed so that vertical displacement of the upper tongued roller is a measure of the sliver thickness. The vertical movement of this tongued roller is transferred to the L.D.T. via a micrometer screw so that this micrometer screw may be used to set the null point of the transducer for a required thickness. We have found this a convenient method of setting up the control system. With the control unit switched off, sliver is produced by the machine and the normal machine processing checks and alterations made to obtain the required sliver weight; this is checked by weighing samples of the emergent sliver. When a satisfactory output

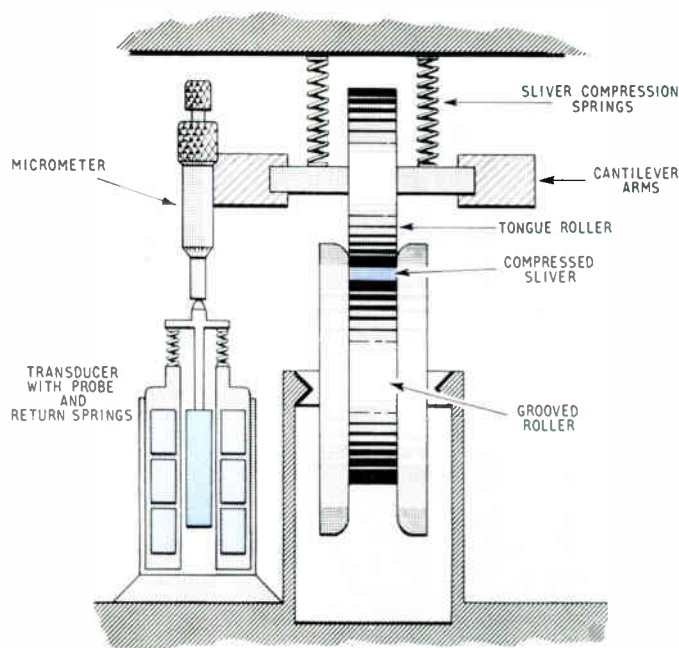

Fig. 11. Method of measuring sliver thickness

sliver weight has been obtained the control system is switched on and the transducer signal set to zero at this sliver thickness by adjusting the micrometer screw. The control system will then hold the sliver at this thickness regardless of processing variations.

If it is required to change the sliver weight from the set value this can be achieved by adjusting the micrometer screw to change the transducer setting and the control system will then increase or decrease the sliver weight in order to return the transducer to the null position.

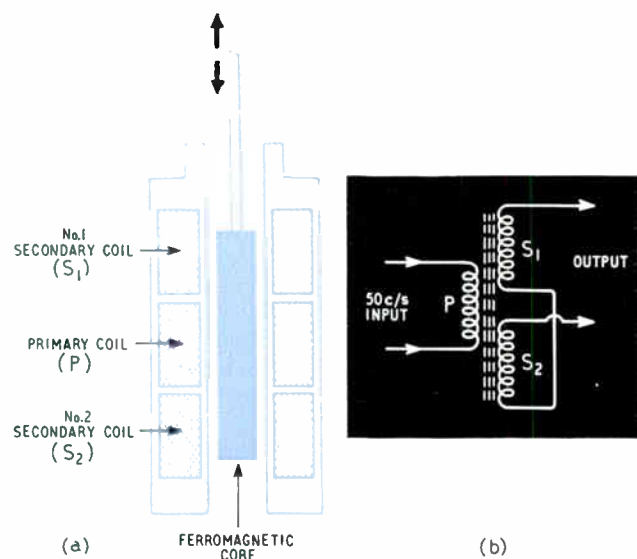

Fig. 10. General arrangement of linear differential transformer transducer

LINCOMPEX

This word comes from the name *linked compressor and expander* which is the designation of a new system undergoing trials on the radio-telephony circuit between London and New Delhi. At the sending end speech is applied to a compressor which gives a constant-level output, irrespective of the normal variations of speech level. The compressor also develops a control signal which is proportional to the incoming speech level. This is used to modulate in frequency a carrier signal with a deviation of about 100 c/s. The normal bandwidth of the speech is cut by about 400 c/s and the f.m. carrier is inserted in the gap so formed.

At the receiving end, the speech signal is applied to an expander the gain of which is controlled by the control signal. The original speech level variations are thus reproduced.

The system is claimed to be superior to the normal one in giving improved performance under poor signal-to-noise ratio conditions and so permitting acceptable communication for longer periods of time. In particular, the phenomenon known as lock-out does not occur, because the usual voice-operated anti-singing switches are not required.

Developed by the Post Office, some demonstration recordings from the trials were convincing evidence of the superiority of the system.

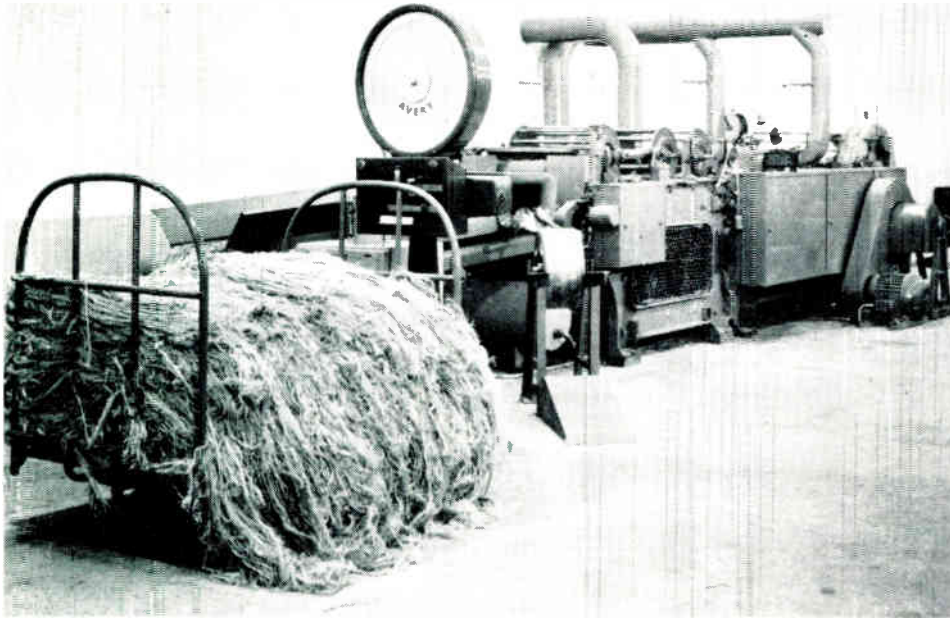

This is the machine built by James Mackie for spreading raw jute fibres. Avery have supplied the feed monitor system

FEED-MONITOR SYSTEM FOR JUTE SPREADING

IN part of the process of making ropes, sacks and matting it is important that operators should load jute fibres on to conveyor belts at a constant rate. To enable an unskilled operator to do this with maximum efficiency and to keep a check on the operator's performance for bonus calculations, a feed monitor system has been developed by W. & T. Avery, in conjunction with the British Jute Trade Research Association and James Mackie & Sons.

The feed-monitor consists of three basic parts: an Avery 4206 CLE weighing machine, a control unit and an indicating unit.

The weighing machine, which is separate from the spreader and can be sited as required, has a capacity of 1,000 lb graduated in 2-lb divisions and a platform 4 ft square. Tare bars are in a locked glass case and situated in the headwork is an electrical transducing unit.

Situated close to the spreader is the floor-mounted control unit which incorporates a gear box driven from the spreader itself. On the front is a shift switch and two or three pairs of production and bonus counters according to the number of shifts being worked. Under a locked cover are two calibrated knobs which preset the weight tolerance and the feed rate, which is adjustable from a minimum of 333 lb per 100 yards to a maximum of six times greater. In addition to the 'stop' and 'start' buttons there are two calibrated knobs to set the pre-determined feed rate and tolerance. Both knobs are contained within a lockable panel and cannot be altered once the cycle has started.

The indicating unit can be clearly seen from a distance of 3 or 4 yards. Having a vertical movement it has a red central zone marked 'correct' and a zone either side marked 'light' and 'heavy'. All the operator is required to do is to take the jute stricks off the truck at a rate which will keep the indicator pointer within the 'correct' zone. Previously the rate of feed, permissible tolerance and tare

weight of the truck has been set-in and the controls locked. As long as the indicator is in the 'correct' zone, two counts per yard of feed are registered on both counters. The bonus counter is cut off when the indicator is out of the 'correct' zone and the 'out of limits' lamp is lit. Comparison of the production counters and bonus counters makes it possible to judge the spreading efficiency of the operator.

At the end of the run the operator removes the truck from the weighing machine bringing into operation the resetting interlocks. The machine will only restart when the reset handle has been turned to bring the indicator back into the 'correct' zone and the reset button pressed. This releases the reset handle and prevents further resetting during the run.

Basically the feed-monitor system works as follows: An electrical signal, proportional to weight, is produced by the analogue generator in the weighing machine headwork. The spreader unit drives a multi-turn potentiometer via a reduction gearbox and slipping clutch housed in the control unit. This potentiometer produces an electrical signal proportional to the distance travelled by the feed belt. This signal is compared with that produced from the weighing machine in a transistorized amplifier and the resulting difference displayed on the indicator. In series with the meter is a moving-coil relay set to operate at the limits of the 'correct' zone of the indicator. When the relay operates it cuts out the six-figure bonus counter. Tolerance limits are varied by adjusting the gain of the amplifier which is very stable. Feed rate is adjusted by varying the voltage applied to the multi-turn potentiometer.

Incorporated in the machine is a 2 or 3 second delay device to overcome momentary deviations from the 'correct' rate due to the downward pull of the operator pulling stricks from the truck.

All the equipment is suitable for high ambient temperatures, high humidity and is dust proof.

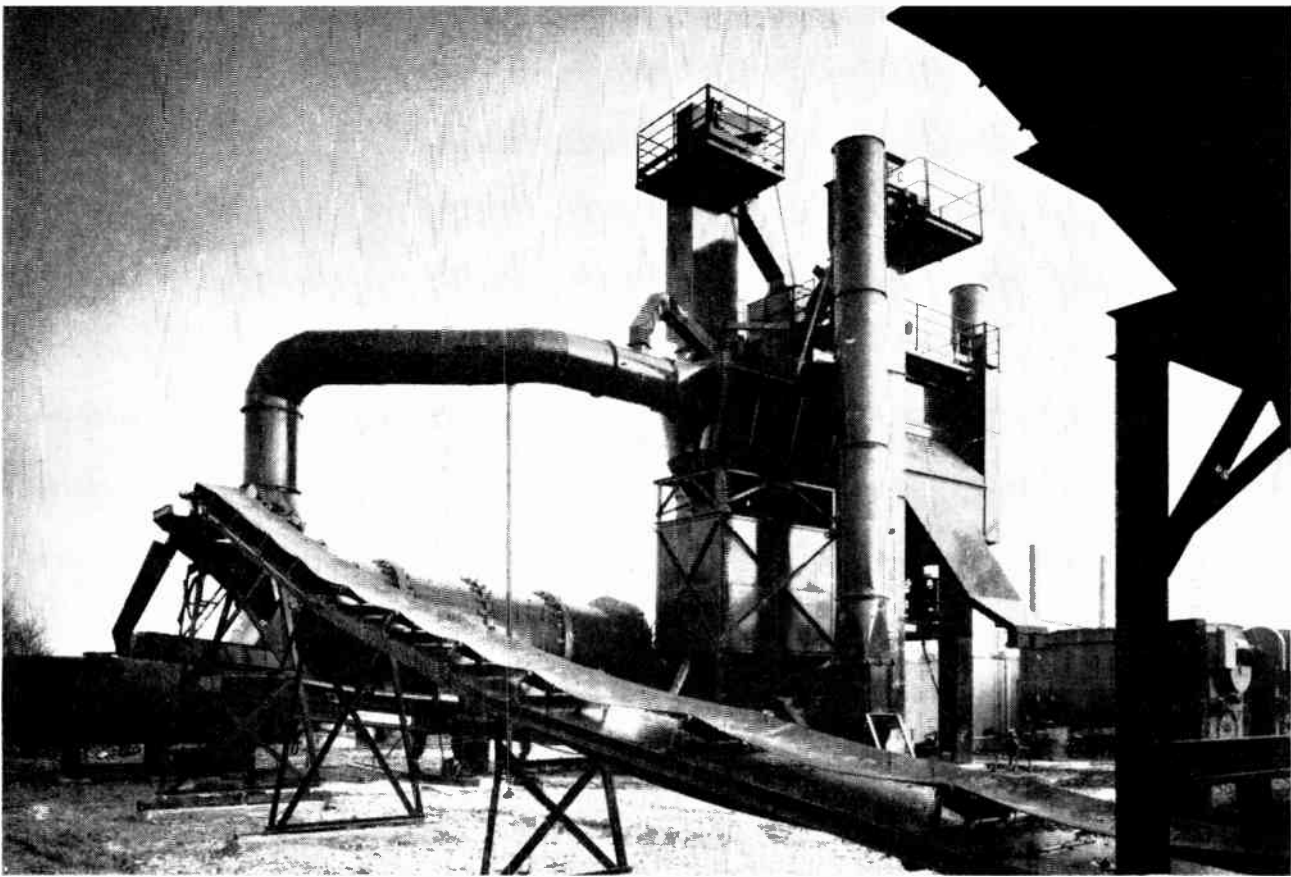

A 'Batchpac' automatic asphalt mixing plant

Automatic Asphalt Mixer

TO meet the growing demands of Europe's road and airport construction programme, Barber-Greene Olding & Co. Ltd., of Bury St. Edmunds, have recently introduced a new version of the American parent company's 'Batchpac' automatic asphalt mixing plant. Designed to be transported and re-erected wherever required, the three-storey high steel structure produces repetitive batches of up to 3,300 lb of asphalt of closely-controlled quality. Where it differs essentially from previous equipment of this type is the provision of semiconductor control devices to provide either flexible manual control or completely automatic pre-programmed operation.

The nerve centre of the machine is the control console, made by Simplex Electric Co. which incorporates, on the

left, a mimic diagram with illuminated signals showing the progress of the main ingredients (automatically-graded stone aggregate, binder, bitumen and flux) towards the pugmill where they are finally mixed. Dials show the constituent and total quantities and mixing times; batch numbers are recorded on a counter.

The centre section carries pushbutton switches and selectors for manual control of the operation, but for continuous operation the right-hand wing provides fully-automatic programming. Any required batch quantity, constituent proportions and mixing sequence can be selected by inserting a notched card in the slot at the left. Transistorized magnetic amplifiers control the gates, valves and weighers through hydraulic servos.

The control console



THE RADIO AND ELECTRONIC

A.B. Metal Products Ltd.	319	Concordia Electric Wire and Cable Co. Ltd.	104	Elliott-Automation Ltd.	160
A.K. Fans Ltd.	207	Connollys (Blackley) Ltd.	368	Elliott Brothers (London) Ltd.	160
Air Control Installations Ltd.	106	Cosmocord Ltd.	204	Enalon Plastics Ltd.	404
Aircraft-Marine Products (G.B.) Ltd.	313	Creators Ltd.	372	Enfield Phelps Dodge Ltd.	486
Aladdin Radio Industries Ltd.	57	Datum Division of Bedco Ltd.	484	Engineering Enterprises (London) Ltd.	359
Alberice Meters Ltd.	111	Davu Wire & Cables Ltd.	108	English Electric Valve Co. Ltd.	164
Alden Metal Products	452	J. Day & Co. (Derby Works) Ltd.	108	Enthoven Solders Ltd.	217
Allen Components Ltd.	234	Derritron Ltd.	493	Erg Industrial Corporation	269
Alma Components Ltd.	150	Dial Engineering Co. Ltd.	107	Erie Resistor Ltd.	228
Alston Capacitors Ltd.	150	Diamond H Controls Ltd.	213	Ether Ltd.	364
Amphenol-Borg (Electronics) Ltd.	277	Digital Measurements Ltd.	495	Ever Ready Co. (G.B.) Ltd.	256
Ancillary Developments Ltd.	476	Digitizer Techniques Ltd.	103	Evershed & Vignoles Ltd.	411
G. H. Anderson & Son Ltd.	57	Dubilier Condenser Co. (1925) Ltd.	273	Fane Acoustics Ltd.	351
Anglo-American Vulcanized Fibre Co. Ltd.	407	Duratube & Wire Ltd.	220	Fenbridge Products Ltd.	112
Antiference Ltd.	214	East Grinstead Electronic Components Ltd.	400	Ferranti Ltd.	311
Applied Developments Ltd.	501	Egen Electric Ltd.	258	J. P. Filhol Ltd.	52
Ariel Pressings Ltd.	323	Elcom (Northampton) Ltd.	483	Fine Wires Ltd.	502
Arrell Electrical Accessories Ltd.	206	The Electrical Apparatus Co. Ltd.	408	Firth Cleveland Fastenings Ltd.	216
Arrow Electric Switches Ltd.	490	Electrical Research Association	360	Flight Refuelling Ltd.	492
Ashburton Resistance Co. Ltd.	60	Electro Acoustic Industries Ltd.	255	Formica Ltd.	167
Associated Electrical Industries Ltd.	302	Electrolube	211	G.K.N. Screws & Fasteners Ltd.	219
Astralux Dynamics Ltd.	453	Electro Mechanisms Ltd.	54	Gardners Transformers Ltd.	478
Avel Products Ltd.	105	Electronic Machine Co. Ltd.	169	Garrard Engineering Ltd.	402
Ministry of Aviation	114	Electronic Machine Control Ltd.	169	The General Electric Co. Ltd.	312
Avo Ltd.	152	Electroprints Ltd.	409	Girdlestone Electronics Ltd.	363
B. & R. Relays Ltd.	170	Electrosil Ltd.	487	Goodmans Industries Ltd.	270
BICC-Burndy Ltd.	161	Electrothermal Engineering Ltd.	221	Greenpar Engineering Ltd.	50
BSR Ltd.	166			Gresham Transformers Ltd.	480
BTR Industries Ltd.	500				
Bakelite Ltd.	485				
Balfour & Darwins Ltd.	279				
Barlow-Whitney Ltd.	115				
Beckman Instruments Ltd.	266				
Bedco Ltd.	484				
The Belclere Co. Ltd.	466				
Belling & Lee Ltd.	308				
Sydney S. Bird & Sons Ltd.	200				
D. H. Bonnella & Son Ltd.	455				
G. & E. Bradley Ltd.	315				
C. Brandauer & Co. Ltd.	56				
Brayhead Ltd.	227				
Brayhead (Ascot) Ltd.	227				
Brayhead Electronic Components Ltd.	227				
British Electric Resistance Co. Ltd.	366				
British Insulated Callender's Cables Ltd.	161				
British Physical Laboratories	250				
Brush Clevite Co. Ltd.	479				
A. F. Bulgin & Co. Ltd.	155				
Burgess Products Co. Ltd.	305				
Burndep't Ltd.	361				
C.C.L. Ltd.	457				
The C.G.S. Resistance Co. Ltd.	352				
C. & N. (Electrical) Ltd.	318				
Cambion Electronic Products Ltd.	362				
Cannon Electric (G.B.) Ltd.	233				
R. E. Carder Ltd.	232				
Carr Fastener Co. Ltd.	263				
Cathodeon Crystals Ltd.	225				
Celestion Ltd.	223				
Chromeplas Ltd.	372				
Ciba (A.R.L.) Ltd.	203				
Circetch Ltd.	369				
Clare-Elliott Ltd.	160				
H. Clarke & Co. (Manchester) Ltd.	254				
Colvern Ltd.	253				

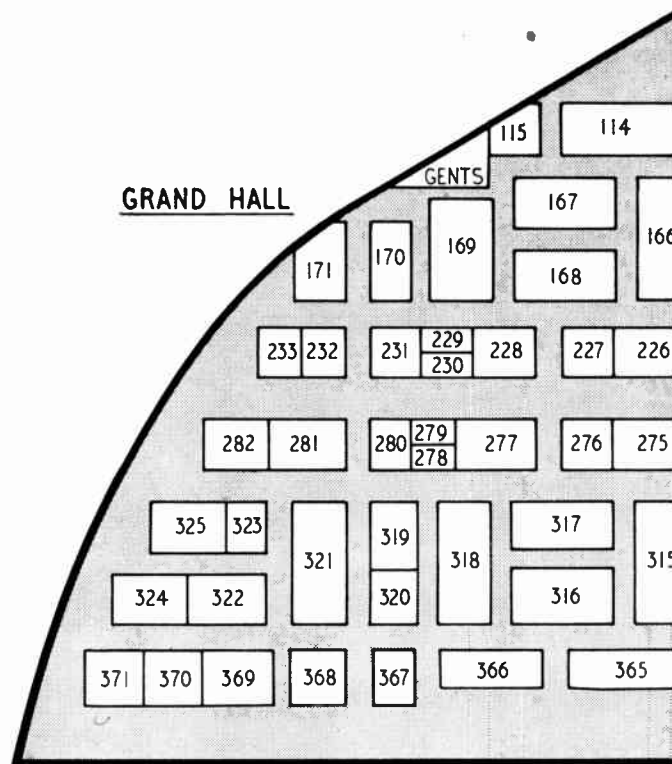

COMPONENTS SHOW 1965

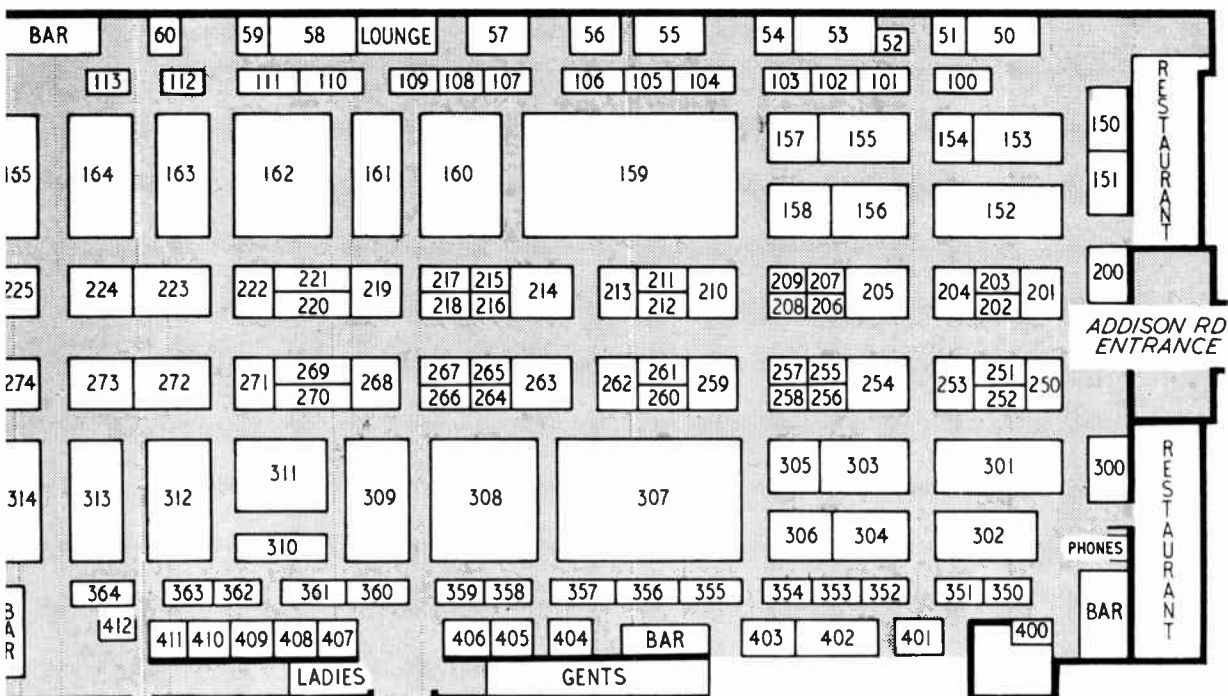
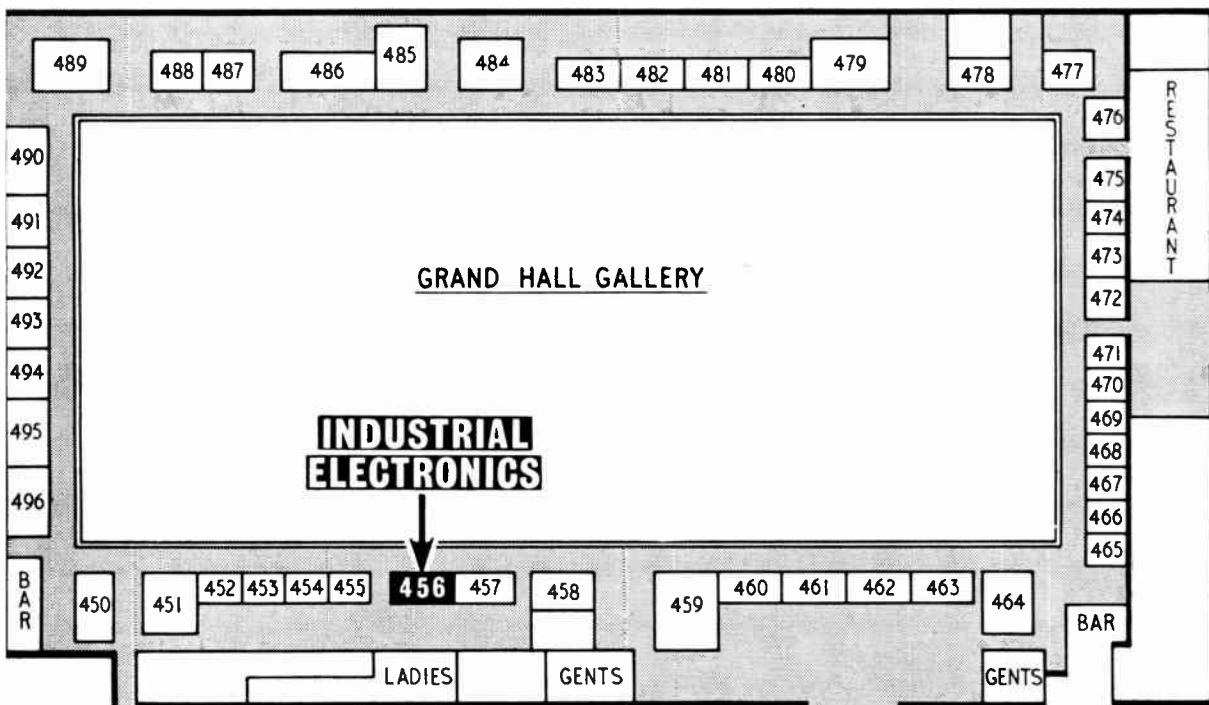

Thos. Haddon & Stokes Ltd.	219	Morganite Resistors Ltd.	301	Smart & Brown (Connectors) Ltd.	319
Hallam, Sleigh & Cheston Ltd.	205	Muirhead & Co. Ltd.	410	S. Smith & Sons (England) Ltd.	458
Harwin Engineers Ltd.	488	Mullard Ltd.	307	Smith Hobson Ltd.	55
Hatfield Instruments Ltd.	469	Multicore Solders Ltd.	168	The Solartron Electronic Group Ltd.	321
Hellermann Ltd.	316	Murex Ltd.	257	South London Electrical Equipment Co. Ltd.	320
Hendrey Relays Ltd.	503	N.S.F. Ltd.	222	Spear Engineering Co. Ltd.	264
Highland Electronics Ltd.	497	James Neill & Co. (Sheffield) Ltd.	261	Stability Capacitors Ltd.	252
Hinchley Engineering Co. Ltd.	280	Newmarket Transistors Ltd.	281	The Standard Insulator Co. Ltd.	229
Hivac Ltd.	159	Newport Instruments (Scientific & Mobile) Ltd.	109	Standard Telephones & Cables Ltd.	162
Hughes International (U.K.) Ltd.	324	Oliver Pell Control Ltd.	481	Steatite & Porcelain Products Ltd.	301
A. H. Hunt (Capacitors) Ltd.	303	Painton & Co. Ltd.	224	Stratton & Co. Ltd.	201
ICI Plastics Division	477	Palmer Aero Products Ltd.	500	Suffex Ltd.	210
Hiffe Electrical Publications Ltd.	456	Parmeko Ltd.	158	Surrey Steel Components Ltd.	353
Alfred Imhof Ltd.	304	Partridge Transformers Ltd.	259	Taylor Electrical Instruments Ltd.	152
Industrial Automation	51	Pelcomponents Ltd.	326	Technical Encapsulations Ltd.	103
Industrial Electronics	456	Permanoid Ltd.	206	Technograph & Telegraph Ltd.	464
Insulating Components & Materials Ltd.	460	Permark Service Ltd.	265	Tektronix U.K. Ltd.	365
Insuloid Manufacturing Co. Ltd.	278	G. V. Planer Ltd.	102	Telcon-Magnetic Cores Ltd.	156
International Electronics Ltd.	276	Plannair Ltd.	451	Telcon Metals Ltd.	156
International Nickel Ltd.	116	Plessey UK Ltd.	159	The Telegraph Condenser Co. Ltd.	272
JD Electronics (Birmingham) Ltd.	473	Plex (Engineering) Ltd.	497a	Telephone Manufacturing Co. Ltd.	153
Jackson Brothers (London) Ltd.	267	Precious Metal Depositors Ltd.	282	Tequipment Ltd.	231
Jermyn Industries	468	Precision Electronic Terminations Ltd.	361	Temco Ltd.	156
K.G.M. Electronics Ltd.	232	Pressac Ltd.	357	Texas Instruments Ltd.	53
Ketay Ltd.	159	Printed Circuits Ltd.	268	Thorn-AEI Radio Valves & Tubes Ltd.	325
Keyswitch Relays Ltd.	450	Pye Switches Ltd.	215	Thorn Electrical Industries Ltd.	309
Levell Electronics Ltd.	454	The Rank Organisation	171	Tilson Metal Fabrications Ltd.	103
The Lewis Spring Co. Ltd.	110	Rathdown Industries Ltd.	462	Geo. Tucker Eyelet Co. Ltd.	212
Linton & Hirst Ltd.	275	Reliance Controls Ltd.	151	20th Century Electronics Ltd.	467
Livingston Control Ltd.	369	Rendar Instruments Ltd.	350	Twickenham Automation Group	103
Livingston Laboratories Ltd.	369	Reproducers & Amplifiers Ltd.	260	Tygadure Ltd.	220
Londex Ltd.	160	Reslosound Ltd.	493	Ultra Electronics (Components) Ltd.	310
The London Electric Wire Co. & Smiths Ltd.	268	Richard Allan Radio Ltd.	355	Union Carbide Ltd.	401
London Electrical Co. Ltd.	262	Rivlin Instruments Ltd.	403	Vacwell Engineering Co. Ltd.	169
Joseph Lucas (Electrical) Ltd.	315	Rola Celestion Ltd.	223	Valradio Ltd.	113
Lustraphone Ltd.	209	Ross & Company (Foundry) Ltd.	472	Venner Electronics Ltd.	406
Claude Lyons Ltd.	371	Ross, Courtney & Co. Ltd.	482	Vero Electronics Ltd.	154
M.B. Metals Ltd.	113a	Rotax Ltd.	315	Vidor Ltd.	361
M.C.P. Electronics Ltd.	475	Royal Worcester Industrial Ceramics Ltd.	358	Vision Engineering Ltd.	470
The M-O Valve Co. Ltd.	312	Royston Industries Ltd.	361	Wego Condenser Co. Ltd.	208
The McMurdo Instrument Co. Ltd.	218	SASCO—Stewart Aeronautical Supply Co. Ltd.	494	Welded Modules Ltd.	412
Magnetic Devices Ltd.	314	SGS—Fairchild Ltd.	322	Welwyn Electric Ltd.	306
Magnetic & Electrical Alloys Ltd.	156	Salford Electrical Instruments Ltd.	312	Westinghouse Brake & Signal Co. Ltd.	317
Mallory Batteries Ltd.	100	George Salter & Co. Ltd.	405	Weymouth Radio Manufacturing Co. Ltd.	251
Mansol (Great Britain) Ltd.	274	Saunders-Roe & Nuclear Enterprises Ltd.	59	Whiteley Electrical Radio Co. Ltd.	163
The Marconi Company Ltd.	226	George L. Scott & Co. Ltd.	370	Wingrove & Rogers Ltd.	202
I. Markovits Ltd.	61	Sealectro Ltd.	157	Winston Electronics Ltd.	474
Marrison & Catherall Ltd.	472	Sellotape Products Ltd.	367	Wire Products & Machine Design Ltd.	356
Mec-Test Ltd.	300	Semiconductors Ltd.	159	Wireless World	456
Metway Electrical Industries Ltd.	471	Sifam Electrical Instrument Co. Ltd.	461	Woden Transformer Co. Ltd.	271
Microwave Associates Ltd.	498	Sintered Glass to Metal Seal Co. Ltd.	274	Wolsey Electronics Ltd.	101
Microwave Electronics Systems Ltd.	491	Slee Semiconductor Equipment Co. Ltd.	320	Work Study Equipment Ltd.	499
The Milton Ross Co. Ltd.	365a			The Zenith Electric Co. Ltd.	55
Miniature Electronic Components Ltd.	300				
Mining & Chemical Products Ltd.	475				
Minnesota Mining & Manufacturing Co. Ltd.	165				

PREVIEW OF EXHIBITS

For further information about specific items circle the appropriate number, shown in brackets in this review, on the Service Card

THE phenomenal growth-rate of the Radio and Electronic Component Show, one of Britain's most valuable technical 'shop windows', is indicated by the fact that some 300 exhibitors are participating this year. The exhibition will be 20 per cent larger than the last (1963) show and will be the most comprehensive yet staged.

The 1965 exhibition is the third of these shows to be presented at Olympia and the nineteenth of the RECMF series. In 1963, the show drew 50,000 visitors—it is expected that this record will be broken this year.

This report, based on advanced information obtained from the exhibitors, is intended to provide a

guide to the trends in the components industry. Where possible items have been selected to indicate these trends.

While microminiature circuits of the deposited thin-film and semiconductor variety are to be seen, there is also a positive trend toward packaged passive components designed for mounting on printed-circuit boards.

Many examples of packaged passive components can be seen around the exhibition. For example, Erie are showing their range of RC modules (47). In various shapes and sizes these are basically resistors and capacitors using thin-film techniques combined in package form. The type 821-1 measures $1 \times 0.35 \times 0.125$ in. and includes a $51\text{-}\Omega$ resistor, a $750\text{-}\Omega$ resistor and an $8,000\text{-pF}$ capacitor; connecting pins for 'plugging in' to printed-circuits are spaced 0.125 -in. apart.

Welwyn are also showing a range of metal-film resistors. These are given the name 'Vishay-Welwyn' resistors (48). By taking advantage of the inherent coefficient of expansion of both the metal film and substrate, the temperature coefficient of these resistors is extremely low—within ± 5 p.p.m. per $^{\circ}\text{C}$. Tolerances range from ± 0.1 to 0.5% and resistance values from $15\ \Omega$ to $100\ \text{k}\Omega$. Each resistor in the range is encapsulated in an epoxy shell. An indication of the size can be obtained from the dimensions of the type 4804; this measures $0.56 \times 0.51 \times 0.15$ in. and ranges in value from $30\ \Omega$ to $60\ \text{k}\Omega$.

Along with a range of resin-coated metal-film resistors, Morganite Resistors are displaying a miniature pre-set resistor for direct insertion into printed-circuit boards. This is type 62 which measures 12×9 mm and is rated at $0.2\ \text{W}$ at $40\ ^{\circ}\text{C}$. It is made in a range of values from $100\ \Omega$ to $1\ \text{M}\Omega$ (49).

Another range of components for plugging in to printed circuitry can be seen on the T.C.C. stand. Known as T.C.C. 'plug-in plastic-case electrolytics' (50) these capacitors range in value from $50\ \mu\text{F}$ ($50\ \text{V d.c.}$) to $5,000\ \mu\text{F}$ ($3\ \text{V d.c.}$).

Erg miniature relay modules (51) which are to be introduced at the show are also designed for mounting on printed-circuit boards. These are designated the M10 series and provide operational speeds of less than $1\ \text{msec}$. They are a range of packaged dry-reed relays with coil operating potentials from 6 to $24\ \text{V}$ and contact ratings from 150 to $1,110\ \text{mW}$. The pin terminations suit the 0.1 -in. grid system.

Another form of relay to be seen in abundance around the exhibition is the mercury-wetted type. The high-speed operation, high reliability and no-contact-bounce characteristics of this relay are rapidly establishing it as a first-class switching element. Flight Refuelling are showing the MRC-1 mercury-wetted reed switch (52) which is claimed to be the smallest available. The overall length, including the leads, is $1\frac{1}{2}$ in. and the glass envelope diameter is 0.13 in. Actuation time averages

This illustrates a new solderless connector system to be introduced at the show by Pressac. The female push-on connectors are supplied wound on to a reel. With the aid of a pneumatic press the connectors are separated and crimped to bared cable ends. Shown at A B & C are typical connector parts. D & E illustrate a plug-in lampholder and receptacle. (53)

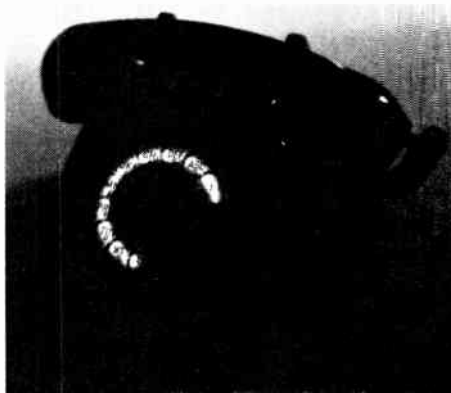
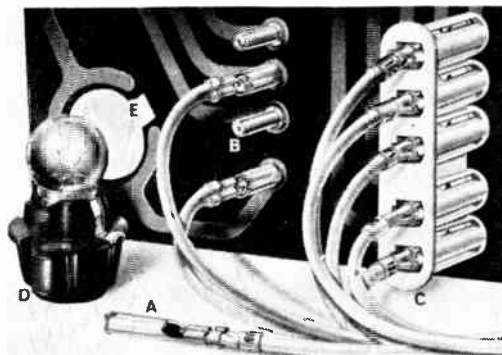

Saunders-Roe & Nuclear Enterprises are demonstrating 'Betalights' in all shapes and sizes. Betalights require no power supply and do not need to be exposed to daylight. They are self-powered and comprise basically a sealed glass tube coated internally and filled with tritium gas. (54)

Pye Switches are featuring many micro and limit switches including a 5-A unit. This has full Post Office approval and is now being fitted into the new P.O. telephones. (55)



Measuring $6\ \text{in.} \times 3\frac{3}{32}\ \text{in.}$ seated height, this new proportional control oven type B7 is being shown for the first time by Cathodeon Crystals. The internal chamber dimensions are $3\frac{1}{2}\ \text{in.} \times 1\frac{1}{2}\ \text{in.}$ diameter. The temperature setting range is from 50 to $80\ ^{\circ}\text{C}$ with long-term stability of $\pm 0.1\ ^{\circ}\text{C}$. (56)

Royal Worcester Industrial Ceramics are displaying a wide range of ceramic/metal terminals using ElectroX high alumina ceramic. Included is the range of standard sealed terminals which meet the Ministry of Defence Spec. DEF5331 and for which full qualification approval has been granted. (57)

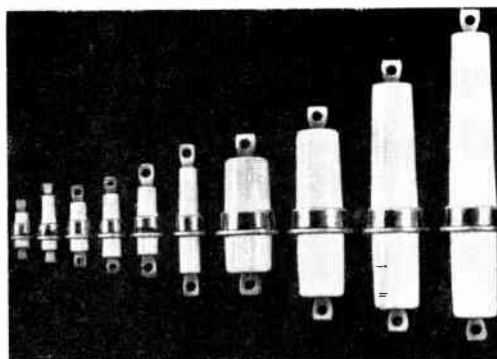

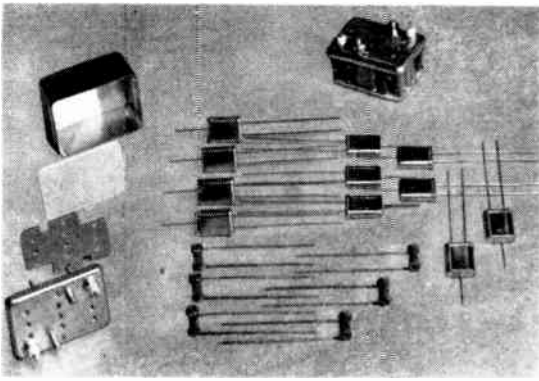

▲ At this year's R.E.C.S., STC Quartz Crystal Division is showing crystal oscillators covering the frequency spectrum from 1.5 kc/s to 100 Mc/s. Also, the Division will be featuring its ranges of h.f. crystal filter units of which over twenty types are available for close channel spacing in v.h.f. communications transceivers. This picture shows one of the filters opened to show its component parts. A 1½ in. × 1 in. × ¾ in. can may contain as many as six crystals, six transformers and a quantity of capacitors. (58)

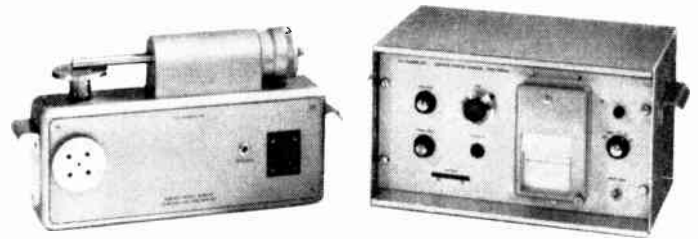
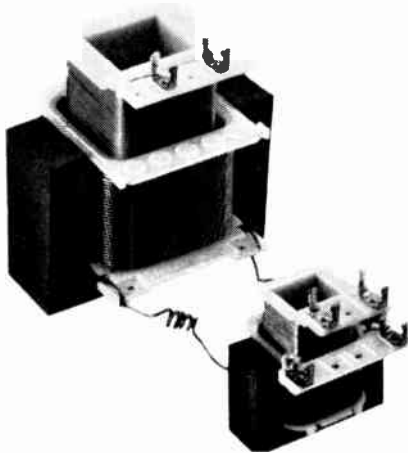

▲ This new surface profile monitor is being demonstrated by G. V. Planer Ltd. It is designed for measuring the thickness of evaporated thin films and the like. The movement of a stylus, made to traverse the surface of the film, is displayed on a chart recorder enabling thicknesses to be determined to better than 100 Å. (59)

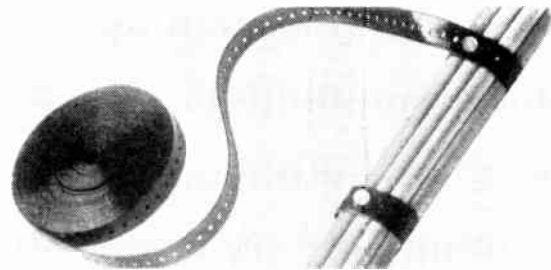

▲ This new cable-form strapping will probably solve many problems. It is simple to use and efficient. It is introduced by Merway Electrical Industries and is called 'Studway' cable strapping. (60)

◀ A special feature on the stand of Hinchley Engineering Co. will be a range of these unusual transformers, shown here partly assembled. The registered double-bobbin construction results in lower production cost and higher reliability. (61)

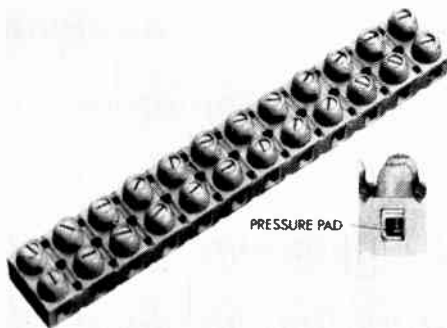

▲ It would seem that the very last snag has now been ironed out of terminal blocks. Like the earlier Belling-Lee flexible terminal blocks this new one features captive, vibration-proof screws, unbreakability, etc. In addition, it incorporates a stainless-steel pressure pad located between the end of the screw and the conductor. (63)

▶ Designed to carry 5 A at 250 V a.c. this model SD rotary switch is being featured by NSF. At 30 V d.c., the contacts will carry 10 A. This is a 12-position rotary switch with 30° or 60° indexing. (62)

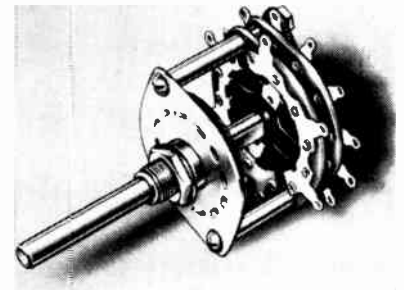

◀ This shows one of the four new product ranges introduced at the exhibition by Greenpar Engineering. These series ISA coaxial connectors are available in any combination of 50 Ω BNC, C, N and UHF plug and socket connections. For the first time in this country they are available in kit form. The kit provides for making up any four complete adaptors from a possible combination of twenty-eight different types. (64)

1 msec and minimum breakdown voltage is 500 V d.c. Contact rating is 75 W d.c. (3 A d.c. resistive maximum).

For use with process control valves for remote position indication, Zenith are introducing two 'Resistance Transducers' (65). One is suitable for a butterfly valve while the other has a linear movement. Both are based on toroidal rheostats, with the moving arm of the rheostat coupled to the valve shaft. When the rheostat is energized and connected as a potentiometer the valve position and/or flow can be read on a voltmeter connected to the rheostat.

Magnetic recording heads have improved in recent years and some of the latest developments are to be seen on the stand of Gresham Lion Electronics. One head provides 33 tracks (66) on one-inch tape. It is designed for digital applications and it is claimed to give the highest track-packing density commercially available in the U.K. It has an output of 1.5 mV peak-to-peak at 300 bits/sec at 15 in./sec.

Sealectro are introducing many products including 'Press-fit' transistor and micro-logic sockets or bases. A re-designed beryllium-copper socket, with a small 'end area' has enabled a closer spacing on pitch circles of 0.2 in. (TO-5) and 0.1 in. (TO-18). The features of this range of sockets or bases are one-piece p.t.f.e. bodies and single-hole press-fit mounting.

Ever Ready are displaying a range of improved batteries, known as their HP units (67). Typical of the range is the 1½-V type HP2 which is the same size as the popular U2, but has a useful life of six times as long as the standard U2. The HP batteries are still Leclanche cells but they have a paper separator which is much thinner than the electrolytic wall in the conventional paste version and a high-grade manganese dioxide which has excellent depolarizing properties.

A flexible copper-clad laminate based on polyethylene terephthalate (68) is being introduced by Bakelite. This will be shown along with a composite laminate (69) from which printed resistors can be made. The composite laminate consists of resistance metal foil bonded to a layer of epoxide resin-treated glass fibre which is in turn bonded to a sheet of aluminium.

Multicore Solders will be showing examples of more than 400 specifications of solders. In addition they are demonstrating for the first time at any British exhibition the new 'solderability test machine'. This machine has been developed by the Electronic Engineering Association in collaboration with the International Electrotechnical Commission with a view to establish-

ing it as a standard for testing the solderability of round wire and round-wire-ended components.

Avel Products will be showing a Gorman toroidal winding machine (70). This is claimed to be one of the fastest machines of its type and it is able to wind coils down to a minimum inside diameter of 0.055 in.

Aircraft-Marine Products (AMP) are to launch their 'Termi-Point' connector wiring programme (71) at the show. This is a complete wiring system incorporating connectors, service tools and test gauges. It is based on an XY co-ordinate machine and it is claimed to be the world's fastest automated wiring system. The machine is programmed by standard eight-track tape and the programme is facilitated by a single work-head, which moves in X or Y and diagonal directions.

A smaller but useful production-aid tool is being demonstrated for the first time by Hellermann Electric. This is their 'Universal sleeve fitting tool' (72). The main features of this tool are: interchangeable prongs which enables one tool to cover the whole range of cable sleeves, and a weight reduction.

Another first is being demonstrated by British Physical Laboratories. This is a precision capacitance bridge (73), using the Schering configuration, which is capable of measuring capacitances lower than 10 pF with an accuracy of $\pm 0.1\%$. The bridge is also capable of measuring power factor to a high degree of accuracy.

A new range of small electronically-controlled thermal chambers (74) are being displayed by Electrothermal. These are designed for environmental testing or for providing a stabilized elevated temperature chamber for components or small circuits. A bench model of 6 cubic inches is equipped with a hinged double-glazed door, removable shelves and facilities for 12-way connecting of items on test to outside monitoring circuits. It controls the internal temperature to within $\pm 0.3^\circ\text{C}$ up to 150°C .

Temperature control is also a feature of one of the new products being introduced at the show by Muirhead & Co. This is their 'controlled-temperature voltage standard' (75). By modifying a precision standard cell and housing it in a chamber whose temperature is kept at 37.5°C , it is possible to achieve a voltage stability of $\pm 5\ \mu\text{V}$ and a voltage accuracy of $\pm 20\ \mu\text{V}$, over a temperature range of 12 to 35°C . The cell is ideal as a self-contained voltage standard for bench and field use as batteries can be used to power the chamber. The unit measures $6\frac{1}{2}$ in. \times $4\frac{1}{2}$ in. diameter and consumes 100 mA at 11-15 V d.c.

The first public showing of 'Uniframe' (76) is to be made at the show by C. & N. (Electrical) Ltd. Uniframe is a versatile modular cabinet and rack system. With this system almost any popular-sized cabinet or rack can be built at relatively low cost. In addition, 'Stelvetite' (galvanized sheet steel coated with a closely bonded p.v.c. layer) is used to provide panels with an attractive and durable coloured finish.

Painton's new 62 range of connectors (77) typifies the latest trend in equipment connectors. Features of these connectors include easily removable plug blades and sockets permitting the user to utilize contacts only in the position where they are required. Plug blades and sockets are to 0.1 in. module and are 0.0002 in. gold plated; they are approved by the Post Office. The range comprises a 40-way plug and socket and composite audio and coaxial units having provision for 2, 4 or 6 coaxial connectors; mounting centres are 4.5 in.

Wego Condenser Co. introduce at the show for the first time a range of high voltage pulse generators (78) with very fast rise times. These new generators are simple, compact and safe in use since the output terminal remains at earth potential until the unit is triggered. Output voltages up to about 250 kV are possible with input voltages in the range 2 to 10 kV; rise times are typically a few tens of nanoseconds. One unit shown gives an output of 150 kV with a rise time of 100 nanoseconds. In operation, it is charged to 5.5 kV from a small power supply via two terminals A and B; these terminals are then short-circuited by means of a suitable switch and the high-voltage output is developed across another pair of terminals.

Many instruments are also being shown at the exhibition for the first time. Like the new Taylor Electrical Instruments model 45D valve tester (79), most are connected with the testing of components. This tester is capable of testing every known type of valve with up to 12 pins to a power dissipation of 25 W. With this tests can be carried out on over 7,000 types of valve; different bases are included to permit the testing of such latest valves as 'Nuvistors' and 'Compactrons'.

Prominent among the new devices shown by The M-O Valve Company will be an X-band solid state source type SSX1 (80). This is an electronically-tuned c.w. microwave source utilizing a varactor diode multiplier. The centre frequency may be anywhere in the band 7 to 12.4 Gc/s, the power output being between 10 and 30 mW.

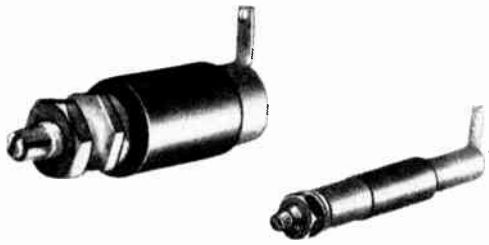

Two new 'Tefotrim's are to be displayed by Jackson Brothers. These are p.t.f.e. piston trimmers with facilities for accurate adjustment. The smaller of the two is style 518 which has a capacitance of 18 pF, while the larger is style 330 with a capacitance of 30 pF. (81)

Two new Veroboards from Vero Electronics. The first is made in fibreglass, which is stronger than conventional board and has a lower water absorption characteristic. The second has rolled tinned copper conductors for easier soldering. If tooling has been completed in time they will also show Veroboard with a 0.05-in. pitch for use with integrated circuits. (82)

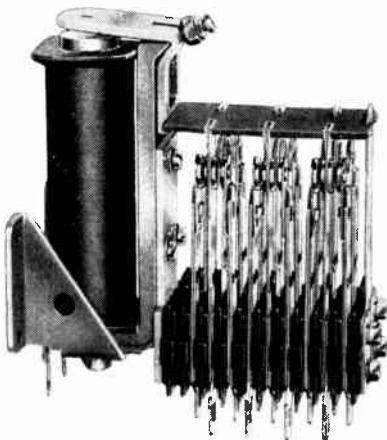
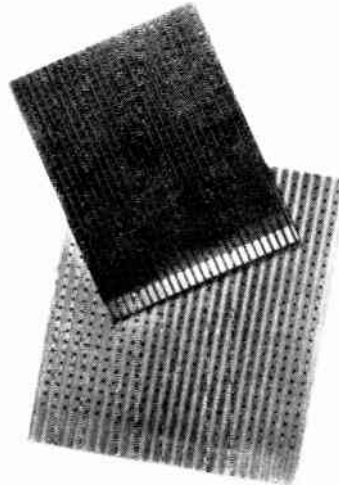

This illustrates one of the many new relays to be introduced by Magnetic Devices Ltd. It is a heavy-duty version of the Post Office type 3000 relay. (83)

Illustrated here are two units presented by Reliance Controls. These are 10-turn 1/2-in. diameter helical potentiometers type HEL 05-10 and are available in resistance values from 10 Ω to 100 k Ω with linearities from $\pm 1\%$. Rated at 1.5 W at 40 $^{\circ}$ C they operate over the temperature range -50 to 100 $^{\circ}$ C. (84)

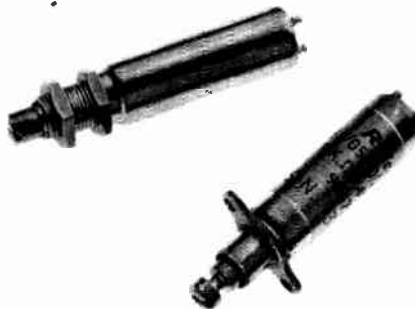

rising for the lower frequencies. An electronic tuning range of about 1.5% is given by a change of control voltage of less than 20 V, so it is readily adaptable for use in f.m. systems or as a local oscillator with a.f.c.

Another new introduction is the Londex 'Top' range of long-life relays (85). Both two- and three-pole change-over contact types are shown, with a transparent cover and in open form. The two- and three-pole relays are mounted on standard international octal and 11-pin bases, respectively. Features include an air-spaced arc shield to prevent tracking from contact sputter, a contact panel of high-insulation glass-filled nylon and sub-

stantial silver contacts. Coil voltages are up to 500 V a.c. and 240 V d.c. and contacts are rated at 6 A (240 V a.c.). The minimum mechanical life of the 'Top' relay is 20 million operations.

Using what are claimed to be new magnetic circuit techniques, Astralux Dynamics have produced a voltage stabilizing transformer (86) which, with an input variation from 168 V to 260 V (minus 30% to plus 10%), will hold the output steady to within $\pm 1\%$. It is the centre of their display at Olympia. The stabilizing transformers can be operated continuously at any load within their specification without affecting the stabilizing action.

Available from Digitizer Techniques and demonstrated on their stand are the 'Presin' digital print out units (87). These are modular print wheel positioning units. Each unit houses a 10- or 12-position print wheel with a solenoid-operated mechanism which sequentially advances the wheel on receipt of input pulses of either 12 or 24 V. Modules also include contacts which are operated by cams on the wheel for zero setting and carry pulses for serial operation. The module system includes chassis to house 9, 14 or 20 print-wheel assemblies. The chassis also houses a paper roll, type-writer ribbon and a print solenoid which, in addition to lifting the print platen, advances the paper and ribbon. A range of input control units is available with these modules including a transistorized reset oscillator and one for data lockout during print-out.

G.E.C. (Telecommunications) Ltd. are demonstrating that their new multi-cam ratchet relay (88) can provide a simple and efficient method of counting or absorbing pulses which is invaluable in the design of pulse-operated circuits. The relay has been developed from an earlier 2-cam version to provide a greater range of applications, particularly for decimal and binary coding in pulse-operated circuits. The demonstration will show the transmission of decimal information in a 2-out-of-5-code form which is widely used in modern data-transmission and data-handling techniques.

Four additions to the Newmarket Transistors range of packaged circuits (89) are making their debut at the show. The first, PC9, is a single-stage transistor amplifier which is designed to match high-impedance transducers, such as capacitor sensing elements, to the low impedance input of the standard Newmarket amplifiers. The other additions are three mains power packs, PC101, PC102 and PC106, which have been designed as d.c. power sources for packaged circuits.

Linton & Hirst will be showing among their products the Redpoint P-type transistor heat sink (90). This marks the entry of this company into large-dissipation heat sinks.

In this brief report we have dealt with some of the many new trend-making products at this year's Radio and Electronic Component Show. Certainly, those responsible have now proved that by holding the exhibition every two years, instead of every year, it makes the show more interesting. This year is no exception, there is lots to see and hear about that is new and interesting. The only problem to the visitor will be in trying to visit some 300 stands in the time available.

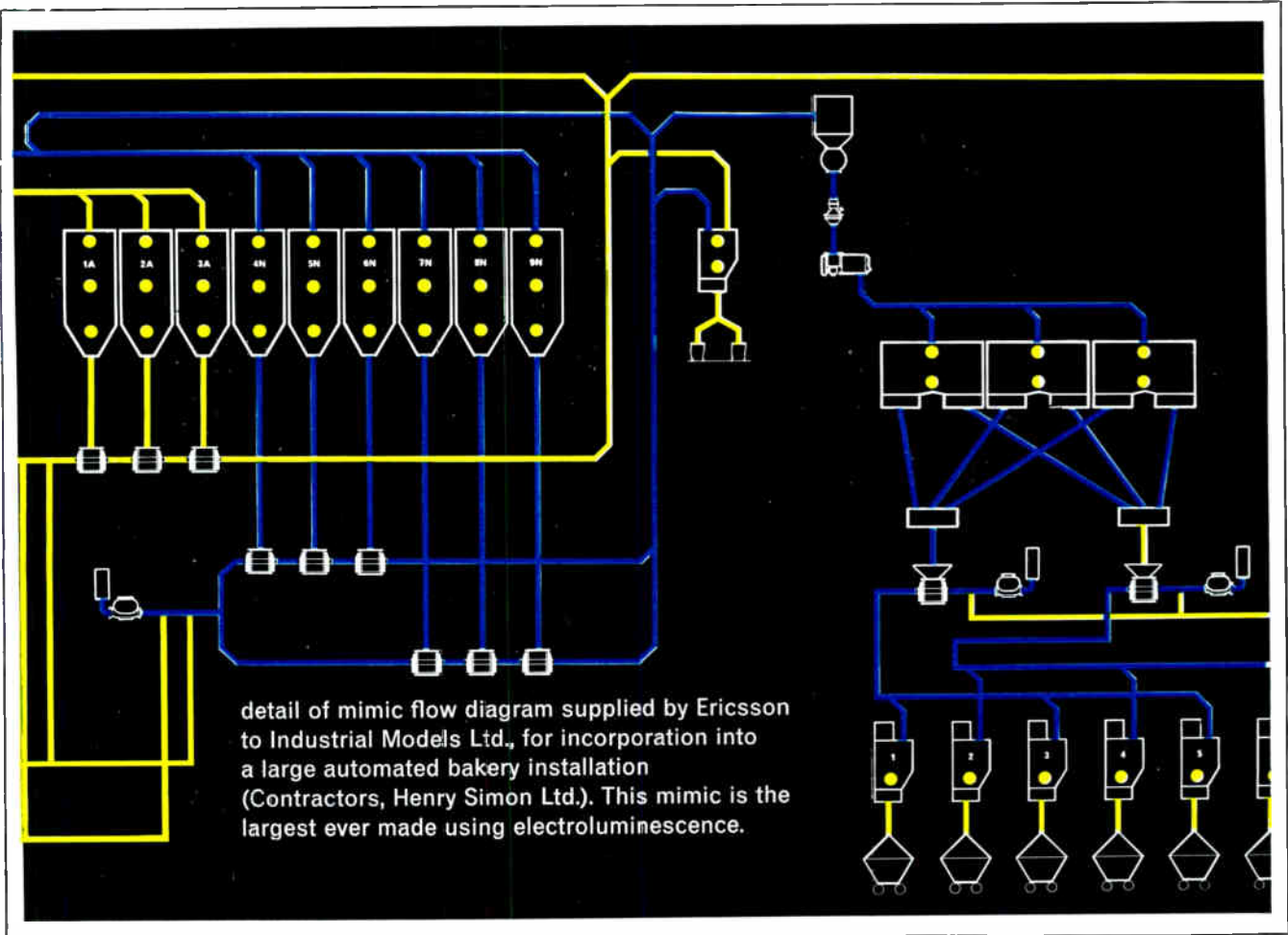

electroluminescence

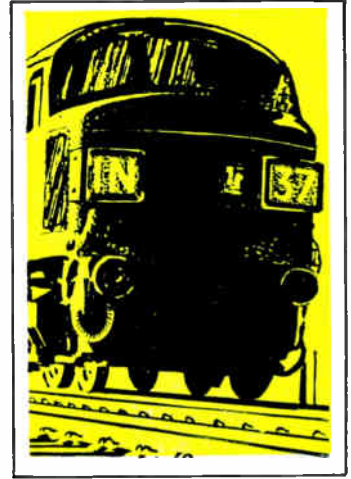
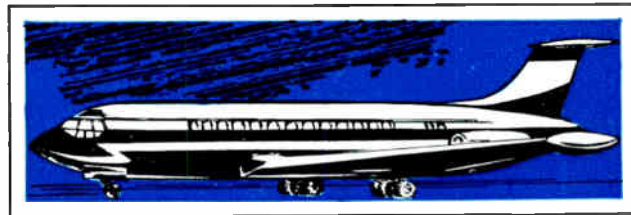
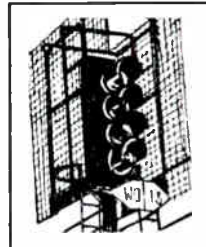
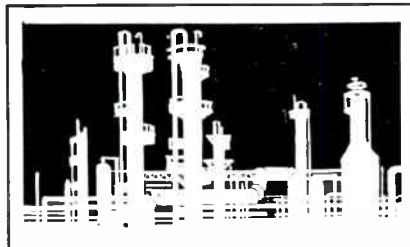
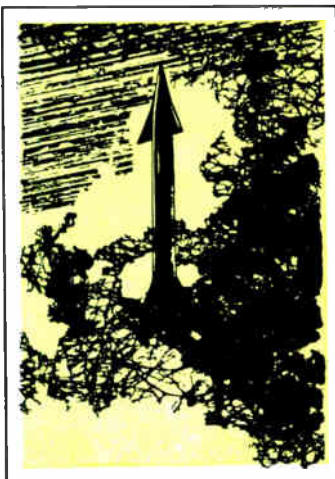

**for mimic
control and
flow display**

Electroluminescence offers a particularly flexible type of display, with a wide range of colours and the ability to display fine detail beyond the range of economically comparable systems. The Industrial and Educational applications are limitless and many industries are already taking advantage of its exceptional versatility. For further information please contact: Physics Division, Ericsson Telephones Ltd., Beeston, Nottingham.



ERICSSON TELEPHONES LTD • ETELCO LTD

A Principal Operating Company of the Plessey Group. Registered Office: 22 Lincoln's Inn Fields, London, W.C.2. Tel: HOLborn 6936
Head Office and Main Works: Beeston, Nottingham. Tel: 254831. Telex: 37666

ER 107



LOOK
AT IT
THIS
WAY

DAWE TRANSISTOR STROBOFLASH TYPE 1209A

Study rotary, reciprocatory and vibratory movements in slow motion with the DAWE Transistor Strobflash Type 1209A.

The high intensity, white light Xenon flash tube—a marked improvement over Neon flash tubes—transistor circuitry and Dawe's long experience in stroboscope design, make the Strobflash the perfect research instrument. The built-in Xenon flash tube ensures accurate colour rendering and excellent illumination of the subject even when the ambient lighting is of moderately high intensity. Transistor circuitry makes it possible to produce an instrument of remarkable compact proportions (7¼ in. × 7¼ × 8½ in.) and light weight (approximately 8 lb.)

Other outstanding features of the Strobflash are:

- Mean illuminations up to 100 lux at one metre distance.
- A range of 300 to 15000 flashes per minute.
- Three overlapping full-scale ranges of 1500, 5000 and 15000 flashes per minute.
- Speeds of up to 150000 per minute may be measured indirectly.
- Flash duration 5 to 10 microseconds.
- Accuracy ± 1% of f.s.d. when standardised.
- UK LIST PRICE £85

Also available: Strobosun, Type 1203B, similar to the Strobflash but with higher power Xenon flash tubes giving mean illumination up to 1000 lux at one metre distance.



Full technical data from:—

DAWE INSTRUMENTS LTD., WESTERN AVE., LONDON, W.3 Tel: ACOrn 6751

A member of the *Simms* group of companies

TRAFFIC AUTOMATION IN MUNICH



THE City of Munich is to install the most advanced traffic control system anywhere in the world. This will be based on the computer-controlled road-traffic system developed by Elliott Traffic Automation. The computer will monitor automatically the traffic situation at various points, calculate the signal settings required to obtain the optimum traffic flow and make the appropriate adjustment to the traffic lights, all within fractions of a second.

As the computer will receive a constant input of traffic values, it will be in continuous control of the entire traffic situation throughout the control area, counting vehicles entering through main or secondary roads.

This information will enable the computer to think ahead and to optimize the traffic flow under all conditions.

Vehicular traffic flows will be measured by means of lane detectors, threshold detectors and capacity detectors.

The computer will select the optimum traffic programme according to information that has been collected from the lane detectors. The final control of the traffic lights will be by means of the threshold detectors indicating the presence of vehicles in the various approach lanes, a few yards in advance of the intersection stop lines, and further, by means of the capacity detectors, which will be giving

continuous information on the traffic flow and density in the sections into which the traffic intends to enter.

The selection of the optimum traffic programme will also be influenced by tramway traffic and will be the result of a correlation of all the data from the entire area under the control of the computer.

To begin with, the system will select an optimum phase and time duration pattern from a possible combination of forty. As experience is gained, a fully functional, self-adaptive, programme will control the traffic lights, providing an infinite variety of programme combinations.

It is planned to extend the system to cover the control of the four neighbouring traffic centres. The control computer will optimize the traffic flow at these centres by constantly comparing a series of fixed programmes with the varying traffic density.

Surveillance officers will be in a position to interrupt the automatic control and carry out the functions manually in the event of accidents and other emergencies.

During the next few years, the basic principles of the system will be extended to cover the entire city area, which will be controlled from four or five traffic centres, similar to the one now being installed at the Stachus, Munich.

Shown here on the left is the Elliott MCS920 computer which is to be used for the Munich traffic control system. The rugged-looking equipment on the right is the 920 military computer from which the civil version was developed

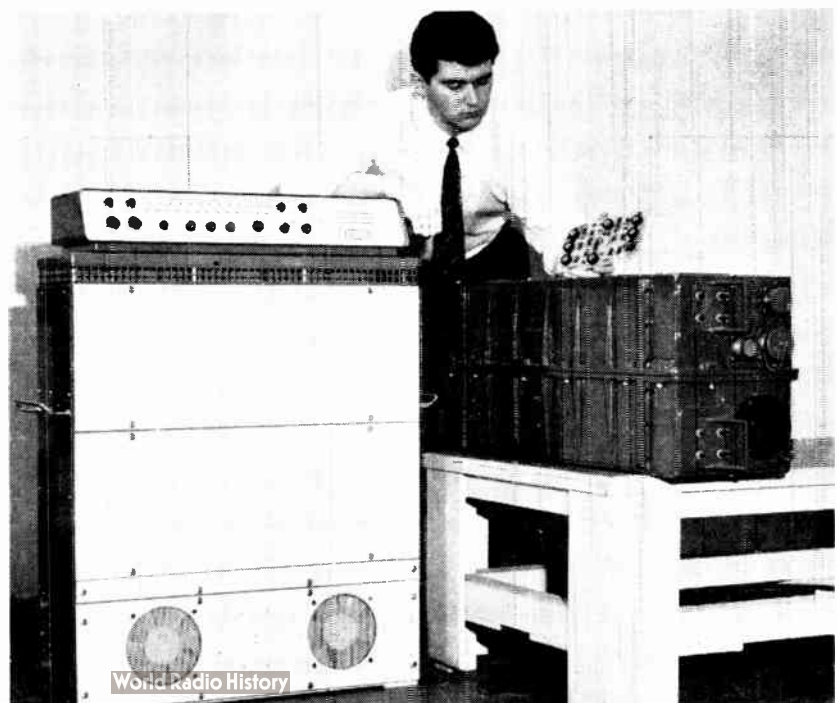



A SONIC AID FOR

By J. LEWIS*

A device for detecting the presence and position of objects up to a range of approximately twenty feet, by means of auditory tones, is described in this article. It is intended as an aid for the blind and is now undergoing evaluation tests.

THE equipment described has been developed by Ultra Electronics Ltd. and is based on a system originally conceived at Birmingham University by Dr. L. Kay.

Basic Description of the Aid

The physical form of the aid resembles to some extent an ordinary cylindrical electric torch, and is designed to be carried in the hand and be used by a blind person in a somewhat similar manner to that in which a torch would be used by a person with normal sight.

Instead of emitting a light beam, the aid transmits ultrasonic frequencies via a capacitance transducer with an active circular transmitting surface of approximately one-inch diameter. After reflection from objects within the path of the beam the ultrasonic frequencies are detected by a receiving transducer of similar design to the transmitter and positioned adjacent to it.

Principles of Operation

The operation of the aid depends on the time relationship between the rate of change of the transmitted frequency and the velocity of sound. The transmitted signal is caused to change linearly from a high ultrasonic frequency to a

lower ultrasonic frequency, followed by a rapid nonlinear recovery to the high frequency, to repeat the cycle of operations. The received reflected signal is heterodyned with the frequency currently transmitted and the difference in frequency amplified and delivered to an earphone of the hearing-aid type. The difference in frequency is therefore a function of the time taken for the transmitted sound to return to the aid, which is a measure of target distance. Thus, assuming the velocity of sound to be 1,100 ft/sec and the transmitted frequency to change at a rate of 150 cycles per millisecond, the difference note produced is 2.7 kc/s. A block diagram illustrating the operation of the device is shown in Fig. 1.

Circuit Design Considerations

The Transmitter

In order that the tone heard at the earpiece shall be constant throughout each frequency sweep for a reflecting surface at any one distance, the rate of change of the ultrasonic frequency must be of a high order of constancy, otherwise a marked change of audio frequency will occur during each sweep, resulting in a recurring tonal change, which may be best described as a 'sea-gull' effect.

To attain the high degree of frequency control over the wide frequency range required, an astable multivibrator oscillator is used, the frequency of operation of which is governed by a voltage sawtooth generator, which is applied to the bases of the multivibrator transistors via their base resistors.

A reasonably close approximation to the operation of the multivibrator circuit may be obtained if it is assumed that the transistors are merely switches operating at this

*Ultra Electronics Ltd.

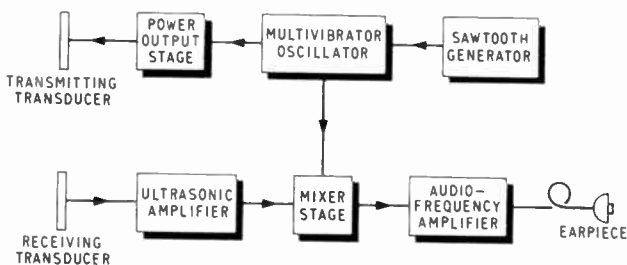
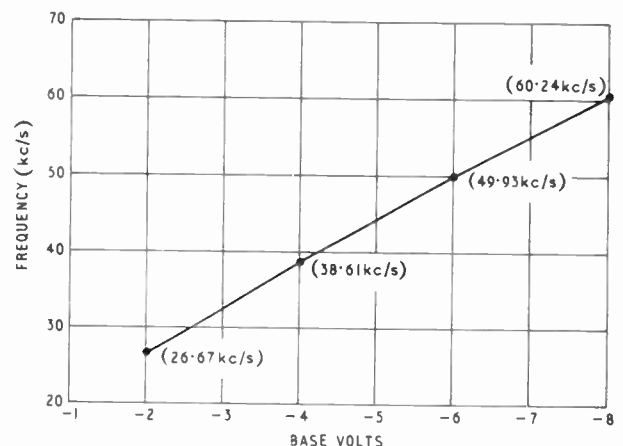

Fig. 1. Block diagram of apparatus

Fig. 2. (Right) Calculated multivibrator frequency for changes of base voltage



BLIND PEOPLE

emitter voltage level, which in this case is zero. For the conditions prescribed it can be easily deduced that the frequency of operation of the multivibrator is given by the expression:

$$\text{Frequency} = \frac{1}{2CR \log_e(1 + E_b/V)}$$

where E_b = supply voltage

V = voltage applied to bases due to the sawtooth generator

C = value of cross-coupling capacitors

R = value of base resistors

A graph has been plotted (Fig. 2) of oscillator frequency against base voltage calculated from the expression given.

The values chosen are: $C = 500 \text{ pF}$, $R = 22 \text{ k}\Omega$, $E_b = -9 \text{ volts}$, $V = -2 \text{ to } -8 \text{ volts}$. The signal at the multivibrator collectors is applied to the bases of a push-pull pair of power amplifying transistors, the output of which is transformer coupled to the transmitting transducer.

The design of the sawtooth generator controlling the multivibrator oscillator resembles a conventional timebase circuit, in which a capacitor is discharged in a linear manner via a constant-current transistor source and at a rate governed by the value of its base resistance. At a specified level of capacitor voltage a monostable multivibrator is triggered which allows for rapid recharging of the capacitor for a period governed by the multivibrator constants, after which the cycle of operations is repeated. A compensating circuit is also included to provide improved linearity of the sweep time—output frequency relationship.

The Receiver

The input signal from the receiver transducer is amplified by an emitter follower and two ultrasonic-frequency common-emitter stages. The signal is then heterodyned with the frequency being currently transmitted and the difference frequency, after two or three stages of a.f. amplification, is fed to a hearing-aid type of ear-phone.

The Transducer Assembly

As previously mentioned, capacitor transducers of similar design are used for both transmitting and receiving. This form of transducer is most suitable for use in the aid, because of its capability of working over a wide range of ultrasonic frequencies.

Basically each transducer comprises a plastic Melinex diaphragm having a deposit of aluminium on one side, and having the plastic side pressed against a metal circular disc of about 1-in. diameter. The surface of the disc is engraved to produce concentric rails and grooves, the dimensions of which are chosen in accordance with the required frequency response of the transducer.



Mr. Ernest Benham using the ultrasonic aid for the blind

The metal backplate and the metallic surface of the diaphragm, which is connected to the earthed shell of the transducer casing, provide the transducer electrical terminals.

The d.c. polarization of approximately 120 V required for this type of transducer is obtained from the rectified and voltage-multiplied transmitted signal, and fed via a resistance of several megohms.

The Flyback Period

Little mention has been made of the signal heard due to the frequency recovery or flyback period. The effect is most easily seen from a diagram as in Fig. 3 where graphs of (a) the transmitted frequency and the received frequency and (b) the difference frequency are plotted with reference to a common time scale.

It will be seen that the period when the beat tone is different from that of the main sweep is somewhat longer than the flyback period and depends on the target distance.

In the units produced the transmission is suppressed during the fly-back period to avoid ambiguity.

Frequency Change Due to Doppler Effect

At first sight it may seem that any change of the beat frequency due to Doppler effect would be too small to be significant. In fact, the change is considerable as is evident

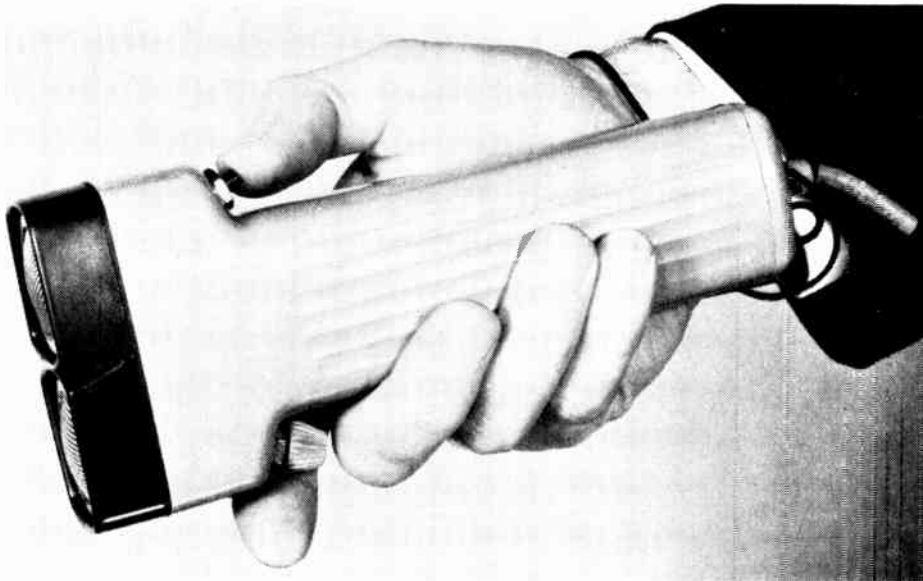

Ultrasonic aid for the blind showing the range switch at the top and the combined on/off switch and volume control at the bottom

when it is realized that the change of frequency is a function of the ultrasonic frequency and not the audio frequency. Thus, for example, the frequency change of the received ultrasonic signal at 60 kc/s for a target approaching at 5 m.p.h. is approximately 700 c/s whereas at 30 kc/s the frequency change is approximately 350 c/s.

The Doppler frequency change adds to the audio frequency due to distance alone for approaching targets and subtracts from it for receding targets.

The frequency change due to the Doppler effect is in a regular manner during each successive transmitting period, and a practised user should be able to detect this characteristic to provide a means of detecting movement.

Interpretation of the Signals

In general, the aid will not be directed towards plane surfaces at a normal angle of incidence and received signals will be due to a variety of various reflecting distances and

types of reflecting surface. The audio frequencies heard will generally therefore be somewhat complex, but with training the user should be able to interpret these tones to obtain considerable information regarding the immediate environment.

The Future

Recently 50 aids were delivered to St. Dunstan's, and it has already been purchased by approved blind organizations in nineteen countries. Both St. Dunstan's and Ultra have made it clear that the aid has reached a stage of development where extensive field trials are necessary.

No claims are being made that the aid is the complete answer to the mobility of the blind, nor that it is a replacement for any other form of assistance to mobility.

However, this is the first time that any aid of this kind has reached the field-trials stage. There is, therefore, reason for its future to be regarded optimistically.

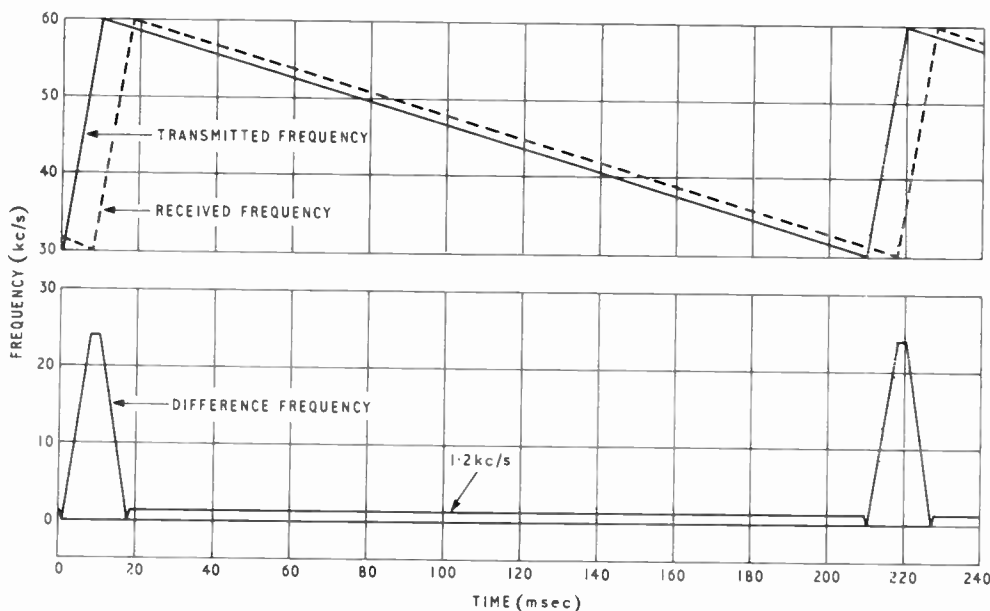

(a)

(b)

Fig. 3. Graph of transmitted and received frequencies (a) and the difference frequency (b) referred to a common time scale; rate of frequency change during main sweep = 3 kc/s in 20 msec; duration of main sweep = 200 msec; flyback period = 10 msec; echo delay = 8 msec (approx. distance 4 ft)

Third-Order Servomotor Systems-2

By N. G. MEADOWS, B.Sc., A.M.I.E.E.*

LAST month systems giving real open-loop poles were discussed. For this section systems which may give rise to complex poles are considered, with specific reference to split-field motor systems incorporating tachogenerator feedback and to armature controlled servos.

Split-Field Motor with Tachogenerator Feedback

The basic scheme for position control is shown in Fig. 1, with the switch S closed. The open-loop transfer function is:—

$$\frac{\theta_0}{\theta} = \frac{nkK_mAR_p/JL_fR}{s[s^2 + (F/J + R_f/L_f)s + (FR_f + n^2K_mK_tAR_p/R_t)/JL_f]} \dots 1$$

or

$$\frac{\theta_0}{\theta} = \frac{K}{s(s^2 + 2\zeta\omega_n s + \omega_n^2)} \dots 2$$

Comparison of equations (1) and (2) shows that $\zeta < 1$ is possible and complex open-loop poles may therefore occur. In equation (1), $R_p = RR_t/(2R_t + R)$ and K_t is the tachogenerator e.m.f. constant in volts/motor shaft radian per sec. Further symbols are as given last month and in Fig. 1.

If F is negligible and $F/J \ll R_f/L_f$ the transfer function becomes

$$\frac{\theta_0}{\theta} = \frac{K}{s(s^2 + sR_f/L_f + n^2K_mK_tAR_p/JL_fR_t)} \dots (3)$$

Complex poles occur for

$$R_f < 2n \left[\frac{K_mK_tARL_f}{(2R_t + R)J} \right]^{1/2} \dots (4)$$

If m.k.s. units are used, $K_m = K_t$ numerically. The effective moment of inertia referred to the load shaft is

$J = n^2J_m + J_L$. If the reflected inertia dominates the response then $J = n^2J_m$ approximately.

Complex poles then occur for

$$R_f < 2 \left[\frac{K_mK_tARL_f}{(2R_t + R)J_m} \right]^{1/2} \dots (5)$$

The gear ratio n does not then materially affect the open-loop pole locations.

Armature Controlled Servo

A position control system is shown in Fig. 2. The total armature resistance is R_a with L_a as the effective inductance. The open-loop transfer function is

$$\frac{\theta_0}{\theta} = \frac{AknK_T/2JL_a}{s[s^2 + s(R_a/L_a + F/J) + (FR_a + n^2K_gK_T)/JL_a]} \dots (6)$$

with $e = \theta k/2$. Here K_T is the motor shaft torque per unit armature current and K_g the generated e.m.f. per unit rad/sec motor shaft speed.

With $F = 0$,

$$\frac{\theta_0}{\theta} = \frac{AknK_T/2JL_a}{s[s^2 + sR_a/L_a + n^2K_gK_T/JL_a]} \dots (7)$$

This is similar in form to equation (2) with complex poles for

$$R_a < 2n \left[\frac{K_gK_TL_a}{J} \right]^{1/2} \dots (8)$$

Multi-Loop Representation

Equation (2) may be written as

$$\frac{\theta_0}{\theta} = \frac{K}{s^2(s + 2\zeta\omega_n)} = \frac{F(s)}{1 + H(s)F(s)} \dots (9)$$

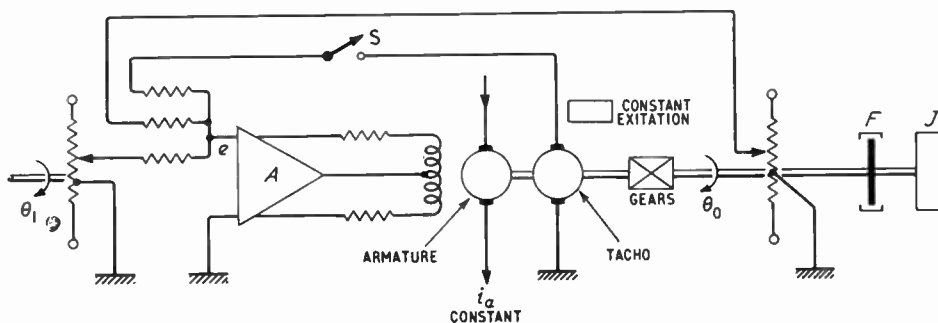

Fig. 1. Position control servo

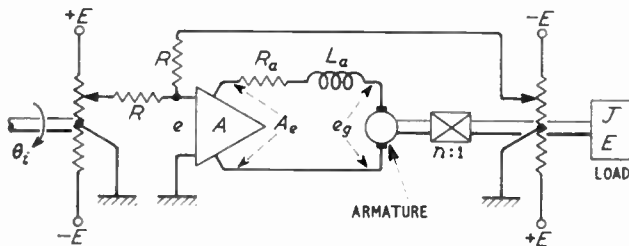

Fig. 2. Armature-controlled position servo

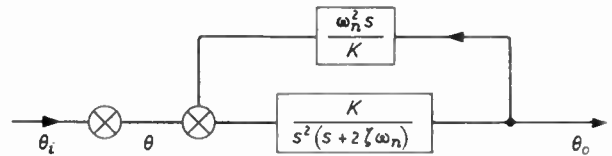

Fig. 3. Multi-loop representation

where

$$H(s) = \frac{\omega_n^2 s}{K}$$

and

$$F(s) = \frac{K}{s^2(s + 2\zeta\omega_n)}$$

The third-order system may therefore be reduced to a type two system with derivative feedback, as shown in Fig. 3.

For the split-field motor system, with $F = 0$,

$$\frac{\omega_n^2}{K} = \frac{nK_t R}{kR_t} \quad \dots (10)$$

For the armature-controlled system with $F = 0$,

$$\frac{\omega_n^2}{K} = \frac{2nK_g}{Ak} \quad \dots (11)$$

The overall closed-loop transfer function is

$$\frac{\theta_o}{\theta_i} = \frac{F(s)}{1 + F(s)[1 + H(s)]} \quad \dots (12)$$

Equations (9) and (12) lead to the block diagram given in Fig. 3.

High-Speed Impact Counting

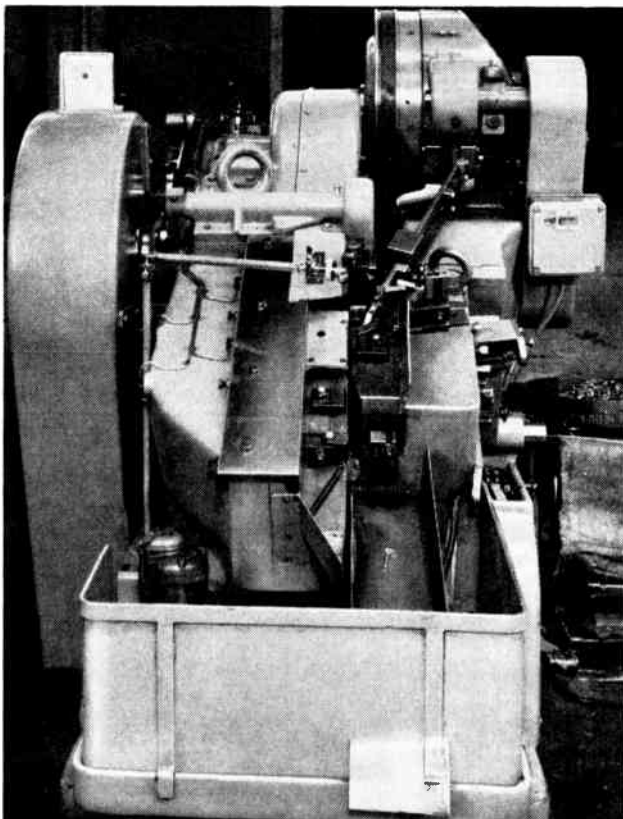

The immediate assessment of batch production presents many problems in industry, but at Normalised Bolts Ltd., of Darlaston, Staffordshire, these problems have been overcome by the installation of twenty-four impact counters, LDEP series IPC 1. The counters are being used for the high-speed counting of bolts as they are ejected from the thread-rolling machines.

The unthreaded bolts pass along a separation channel leading to the thread-rolling dies from the hopper, and each bolt is then sandwiched between two dies. It is then automatically rolled in a horizontal spiral movement by the dies rolling the length of thread required. On completion of this operation the bolt is ejected into the delivery chute, and the dies return to their original position for the next cycle. Fitted inside the delivery chute is the impact plate. As each bolt leaves the machine it strikes the plate and is registered on the numerical counting unit.

Approximately 11,000 bolts per hour are threaded by each machine. Before installing the impact counters, the bolts were collected in sacks from the delivery chute and weighed to give a general assessment of production. Now with the impact counters an accurate, economic and immediate assessment is provided of any type of bolt being produced.

For further information circle 91 on Service Card

LDEP impact counters being used at the Darlaston works of Normalised Bolts Ltd. to count bolts as they are ejected from the rolling machine. The counter unit is seen mounted on the right



SASCO SERVICE

Sasco service scores on three vital counts. **ONE—speed:** you place your order today and it's despatched today; you receive it tomorrow. **TWO—widest range:** we have over 30,000 different stock components on our shelves, the products of 33 leading manufacturers. Nowhere else will you find such a wide choice under one roof. **THREE—price:** when you deal with Sasco, you pay no more than if you'd bought direct from the manufacturer. Try hard but you won't beat Sasco service!

SEE US ON STAND 494 AT THE
RADIO & ELECTRICAL COMPONENTS EXHIBITION

Stewart Aeronautical Supply Co. Ltd.,
Box 20, Crawley, Sussex.
Tel: Crawley 28700 (10 lines) Telex: No. 87131

HERE TODAY — THERE TOMORROW!

SASCO

We extend a warm invitation to visit our stand during the R.E.C.M.F. Exhibition. Our products include:-

- ACCELEROMETERS
- BATTERY CHARGERS
- CAPACITORS
- ELECTRICAL INDICATING INSTRUMENTS
- LOADING COILS
- MAGNETIC MATERIALS
- METAL RECTIFIERS
- PRECISION POTENTIOMETERS
- QUARTZ CRYSTAL DEVICES
- SHEATHED WIRE ELEMENTS
- THERMOSTATS
- THERMOELECTRIC COOLING DEVICES

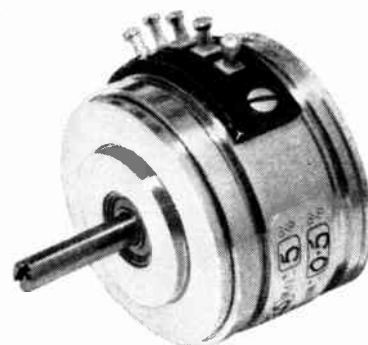
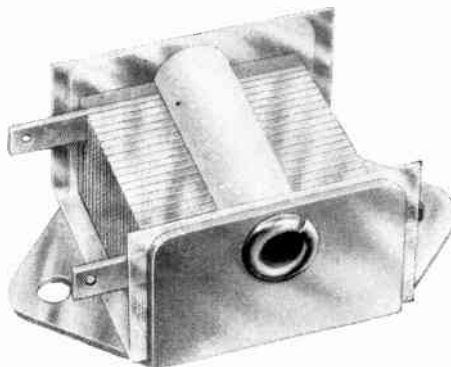

SALFORD ELECTRICAL INSTRUMENTS LIMITED
PEEL WORKS · SILK STREET · SALFORD 3 Tel: BLAckfriars 6688 Telex 66711
London Sales Office: Brook Green Hammersmith W.6. Tel: Riverside 5245
A SUBSIDIARY OF THE GENERAL ELECTRIC CO. LTD. OF ENGLAND



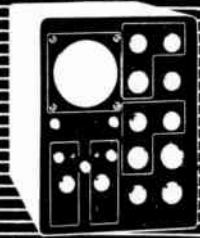

NEW APPARATUS

ELECTRONICS
INSTRUMENTATION
CONTROL

1. Micro-Image Viewer

One million documents can be stored on less than 400 transparencies, representing a stack of films less than 6 in. high, with the PCMI (photochromic micro-image) process and a micro-image viewer recently announced by N.C.R.

The viewer uses 3 × 5 in. film transparencies, each of which stores as much information as several large printed volumes. The PCMI process converts microfilm into micro-images on a photochromatic coating which has a very high resolution with no grain; this conversion achieves an area reduction of 40,000 to 1. The microscopic images can be erased and re-recorded if corrections are necessary. After

master film transparencies have been made on PCMI material and corrected, low-cost mass duplications can be made.—*The National Cash Register Co. Ltd., 206-216 Marylebone Road, London, N.W.1.*

For further information circle 1 on Service Card

2. Vibrating Table

Fulmar Engineering Co. announce the introduction of a table vibrator which is expected to have many applications in the food, chemical, and general industry for such uses as compacting cartons, bottles, sacks, etc., used with filling machines, de-aeration of powders, and for jogging and aligning components.

The unit is of substantial construction and smart appearance in green hammer finish. The top surface is 15 in. square, and the overall height is 5½ in. A 5-ft extension cable is supplied for the 230-V single-phase supply. A variable controller is fitted as standard so that the amplitude of vibration can be varied over a wide range. A switch and indication lamp are also included in the price of £28.—*Fulmar Engineering Co. Ltd., Chapel Street, Levenshulme, Manchester, 19.*

For further information circle 2 on Service Card

3. Paper-Tape Cassette

Jenkins Fidgeon have announced that their 'Crystal' 5 × 5 in. paper-tape

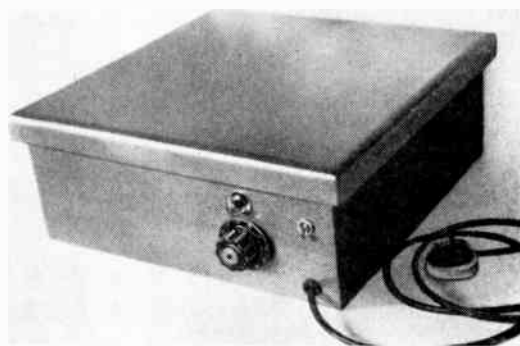

2

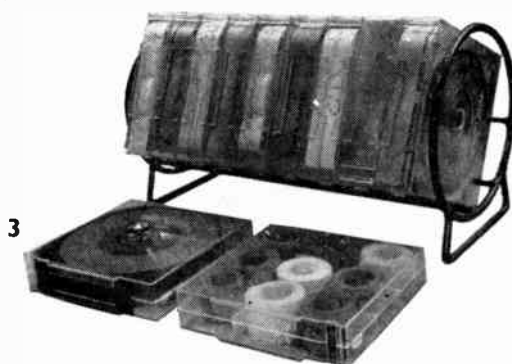

3

NEW ELECTRONICS INSTRUMENTATION CONTROL

cassette has been re-designed. Injection-moulded in clear polystyrene, it is suitable for all paper tapes up to 1 in. wide (8-channel) and is supplied in two alternative fittings.

The TC/A5 dispenser case features a 1 in. diameter core for spooled tapes up to 5 in. diameter. The TC/9 storage case is fitted with removable dividers to accommodate nine short lengths of tape; it is interchangeable with the TC/A5.—*Jenkins Fidgeon Ltd., Linley Road, Talke, Stoke-on-Trent, Staffs.*

For further information circle 3 on Service Card

4. Cable Ripper

A tool designed to solve the problem of removing the outer covering from underground feeder cable has been introduced by Holub Industries Inc. of Sycamore, Illinois, U.S.A. The tool is made of aluminium, has an overall length of 1 in., and weighs 4 oz.

The No. 245 ripper is shaped somewhat like the letter 'Z' and has a cutting slot with an adjustable blade at both ends. One slot is used when ripping the narrow side of cable; the other is a wide groove for ripping the flat surface of three-wire cable and two- or three-wire cable with earth lead. Blades can easily be sharpened or replaced, if necessary.

The ripper is gripped like a pistol and held against the cable, thumb pressure causing the cutting blade to pierce the insulation while a pull rips it. Once the two sides and face of the cable are ripped, the outer covering can be pulled away from the insulated conductors and cut off.—*Holub Industries, Inc., 468 DeKalb Avenue, Sycamore, Illinois, U.S.A.*

For further information circle 4 on Service Card

5. Air/Intercom Hose Reeling Units

Spemby Technical Products have announced a range of 'clean air' hose-and-reel units for use with air-line breathing or process air equipment.

The main feature of the units is the air hose fitted with completely internal cables and plug-and-socket end-connections. This enables both air and electrical power to be available at the end of a single long hose.

These units are now being used for air supply and intercommunication to pressure-suited operators in nuclear installations and are being developed to power hand-instruments as well.

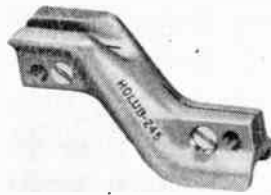

4

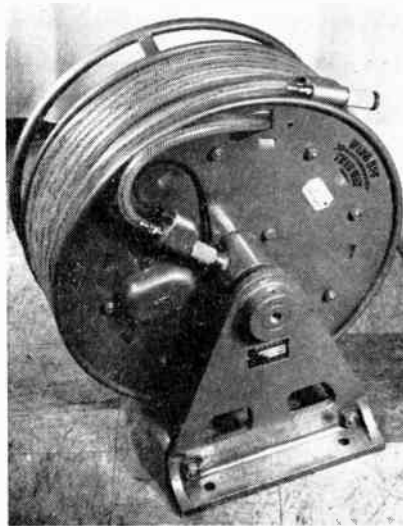

5



6



7



8

The illustration shows a standard 100-ft nylon-reinforced hose unit as supplied to a European nuclear establishment.—*Spemby Technical Products Ltd., New Road Avenue, Chatham, Kent.*

For further information circle 5 on Service Card

6. Liquid Nitrogen Storage Container

Spemby Technical Products have announced a liquid nitrogen container for laboratory and general use. This item is the first of a new range of liquefied gas containers.

The container has a capacity of 5 litres and is of all-stainless-steel construction with high-vacuum insulation. Alternative pouring spouts can be supplied making it ideal for filling traps, holding test samples and general purpose work.—*Spemby Technical Products Ltd., New Road Avenue, Chatham, Kent.*

For further information circle 6 on Service Card

ELECTRONICS

7. Electronic Viewfinder for Television Cameras

An electronic viewfinder which gives an exact reproduction on a 4 in. × 3 in. screen of the scene viewed by a television camera, even when fitted with a zoom lens or turret, is announced by E.M.I. Electronics.

This viewfinder can be quickly fitted to any closed-circuit television camera in the E.M.I. range, and can be just as easily detached. It is claimed to offer an operator the most inexpensive method of viewing the pictures during transmission.—*E.M.I. Electronics Ltd., Hayes, Middlesex.*

For further information circle 7 on Service Card

8. Digital Logic Modules

Plugging into a standard B9A valve-holder, Sidien digital logic modules are designed to provide a compact, inexpensive and versatile method of constructing digital computer and control systems. Each module has a diameter of $1\frac{3}{8}$ in. and a seated height of $1\frac{1}{8}$ in. and the different units are readily identified by their coloured plastic dust-covers. The removal of a plastic cover exposes the individual components which may be replaced in the event of accidental damage.

The modules can be supplied hermetically sealed in silicone rubber, beneath their dust covers, which may be broken if access to individual components becomes necessary. The hermetically-sealed units are suitable for soldering directly on to a printed-circuit board.

Six versions are at present available with maximum input frequencies ranging from 100 kc/s to 3 Mc/s. All switching circuits use diode catching thus providing a low output impedance for maximum fan-out (unless otherwise requested). A 10-Mc/s module is under development.—*Sidien Products Ltd. 11 Birchwood Court, Edgware, Middlesex.*

For further information circle 8 on Service Card

9. Ferrite Isolators

The M-O Valve Co. Ltd. has introduced a new range of ferrite isolators covering the frequency bands 5,925–6,425 Mc/s, 5,925–6,175 Mc/s and 6,175–6,425 Mc/s. The r.f. connections on all three devices are waveguide 14. These devices are particularly suitable for use in broadband radio communication systems.

The CIC4 (illustrated) is a field-displacement isolator with a maximum forward loss of 0.35 dB and a minimum reverse loss of 35 dB. The v.s.w.r. is 1.02:1. The CIC5 and CIC6 are resonance isolators with forward and

reverse loss of 0.5 dB and 25 dB respectively. Both have a v.s.w.r. of 1.06:1.—*The M-O Valve Co. Ltd., Brook Green Works, London, W.6.*

For further information circle 9 on Service Card

10. Airborne Data Converter

The Elliott phase-sensitive rectifier, type 81-SK-482, will convert 400-c/s a.c. signals into phase-sensitive d.c. signals. Its fast response time (6.5 msec) and high gain make it particularly suitable for converting a.c. data from synchros and pick-offs into the d.c. form required for recording the performance of aircraft and missile systems.

The data converter is compact (2.87 × 1.56 × 1.22 in.), lightweight, encapsulated and fully silicon-transistorized. Accuracy and high-speed response are obtained by the use of pulse circuit techniques, while pulse transformers ensure the complete isolation of input, output and reference supplies.—*Flight Instruments Division, Elliott Flight Automation Ltd., Airport Works, Rochester, Kent.*

For further information circle 10 on Service Card

11. Digital Print-Out Units

Now available from Digitizer Techniques, Presin digital print-out equipment offers an economical system of

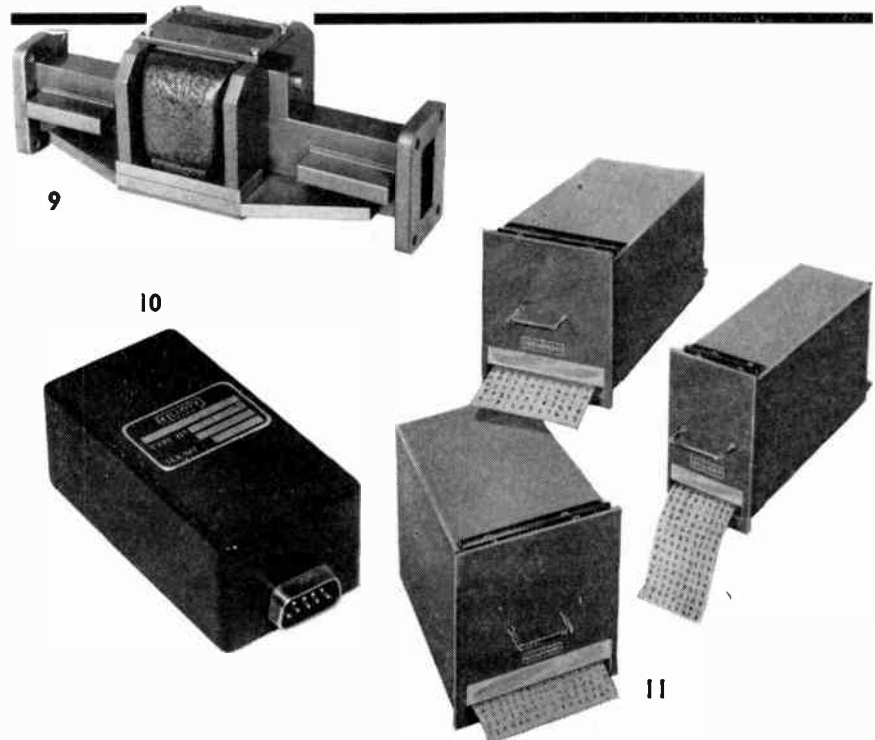

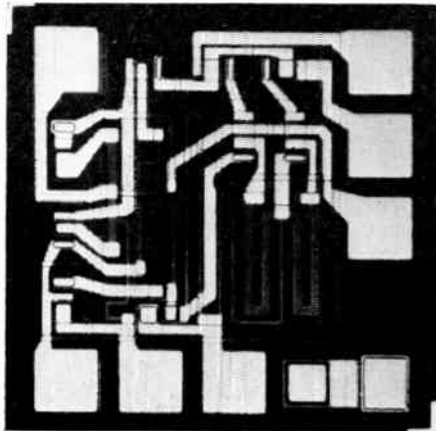

12



13

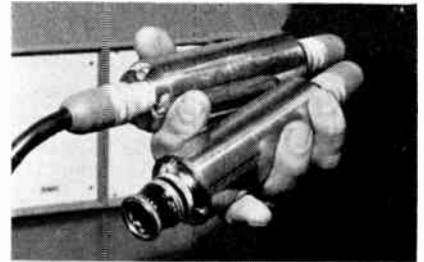

14



15

modular print-wheel positioning units. Each unit houses a 10- or 12-position wheel with a solenoid mechanism moulded in nylon which sequentially advances the wheel on receipt of input pulses. Solenoids are wound for 12 V or 24 V. The modules also include contacts operated by cams on the wheel for zero setting, and carry pulses for serial operation.

Printer chassis to house 9, 14 or 20 modules are available. The chassis also houses paper rolls 2½ in., 4 in. or 6 in. wide, typewriter ribbon, and a print solenoid which, in addition to lifting the print platen, advances the paper and ribbon. 12,000 impressions per roll are possible and the ribbon advance mechanism is self-reversing. A range of input controls can be supplied including transistorized reset oscillator and data lockout during print. All controls are housed within the printer chassis.—*Digitizer Techniques Ltd.*, 26 Sheen Road, Richmond, Surrey.

For further information circle 11 on Service Card

12. Integrated D.C. Amplifier

SGS-Fairchild have announced the availability in production quantities of the μ A702, a complete d.c. amplifier constructed on a single chip of silicon using the planar epitaxial process.

The μ A702 is a high-gain operational amplifier intended for use with

external feedback elements to determine operating characteristics. Significant features are low d.c. offset and drift, wide bandwidth, low power consumption, large output swing and operation over a wide range of supply voltages.

Peak output current is 10 mA and maximum power dissipation is 250 mW. Typical open-loop gain: 63 dB. Typical thermal drift: 5 μ V/°C. The amplifier is available in both μ A702 military (–55 °C to +125 °C) and μ A702C professional (–25 °C to +100 °C) versions. — *SGS-Fairchild Ltd.*, 23 Stonefield Way, Ruislip, Middlesex.

For further information circle 12 on Service Card

13. G-Switch Timer

The A. W. Haydon g-switch timer for missiles, space vehicles, aircraft and scientific equipment such as centrifuges or other applications involving gravity forces, is now available in the U.K. from Walmore Electronics.

A typical g-switch timer set for, say, 5 g, will operate only after experiencing this force continuously for ½ sec. The contacts then close after a delay which is adjustable from 10 to 30 sec, including the ½ sec required to initiate operation. The input voltage required is 28 V d.c. Units for various g responses and delay times can be furnished to user specifications.

The motion-sensing tolerance is ± 1 g with a pre-set delay of 0.6 sec (± 0.1 sec adjustable). The time delay accuracy is $\pm 2\%$ of setting. Contact rating: 5 A for 15 msec or 6 A for 10 msec. The following environmental tolerances apply: temperature range, –18 to +60 °C; altitude, 50,000 ft; shock, 100 g for 11 msec; acceleration, 100 g for 3 sec. Transient shock and vibration will not cause the units to operate.—*Walmore Electronics Ltd.*, 11-15 Betterton Street, Drury Lane, London, W.C.2.

For further information circle 13 on Service Card

14. Miniature Television Camera

A fully transistorized closed-circuit television camera only 4½ in. long has been developed by EMI Electronics. Despite its small size, the camera is extremely rugged and produces very high resolution pictures, so it is particularly useful in inaccessible locations where rough handling and poor illumination are expected. It can be operated on 405, 525 and 625 line standards, and can be changed from one standard to another merely by pressing a button.

Camera head-equipment is contained in two sealed stainless-steel cylinders, each 4½ in. long and 1.7 in. in diameter. The lens head unit, which weighs 1½ lb, contains an EMI ½-in. vidicon camera tube. It can easily be held in one hand,

leaving the other free to focus by rotating the lens, or it can be mounted in restricted locations.

Contained in the other cylinder is the amplifier head unit, weighing $\frac{1}{4}$ lb, which can be up to 100 ft away from the lens head and joined to it by cable. Camera control unit and other units comprising the camera channel can be up to 1,000 ft away.—*EMI Electronics Ltd., Hayes, Middlesex.*

For further information circle 14 on Service Card

15. Oscilloscope Probe Adaptor

A Conhex right-angle coaxial adaptor for most popular oscilloscope probes is now available from Seaelectro. This adaptor, the 55-005-0119, converts standard shielded probes to right-angle units and is particularly suitable for applications requiring multiple panel test-points for oscilloscope monitoring of internal equipment signals.

Conversion of standard probes simply consists of unscrewing the standard probe-tip and replacing it with the adaptor. The unit features 0.0001-in. gold plating and Teflon insulation.—*Seaelectro Ltd., Hersham Trading Estate, Walton-on-Thames, Surrey.*

For further information circle 15 on Service Card

INSTRUMENTATION

16. Precision Gas Laser

The Spectra-Physics model 115, now available from Claude Lyons, is a continuous-wave helium-neon gas laser for general research work and applications requiring substantial c.w. power. It has a 60-cm resonator length and a guaranteed output of 3 mW at 6,328 Å in the uniphase TEM₀₀ mode (6 mW multimode). Precision micrometer adjustments provide reflector alignment with 0.1 arc-sec accuracy. The hemispherical output is collimated to less than 0.3 milliradian (60 arc-sec) when using the supplied collimating reflector.

The model 200 r.f. exciter is a specially designed 40-Mc/s power source with facilities for up to 70% amplitude modulation of the laser output over the range 0 to 20 kc/s and up to 10% at 200 kc/s.

Applications include propagation studies, light scattering experiments, photo-elastic stress analysis, optical communications, long-path interferometry plasma diagnostics, optical testing and alignment, precision ranging

and velocity determinations, optical data processing, spectroscopy, and micro-heating.—*Claude Lyons Ltd., Instruments Division, Valley Works, Hoddesdon, Herts.*

For further information circle 16 on Service Card

17. V.I.F. Generator

The C.R.C. type GB64 v.l.f. generator, now available from Claude Lyons, provides five 10:1 ranges, calibrated in frequency and period, with an overall range of 0.005 c/s to 500 c/s. Alternative sine, square or triangular outputs are available with a balanced output variable up to 50 V peak-to-peak into 10 kΩ from an internal impedance of 100 Ω.

The sine-wave output has 2% maximum distortion, the square-wave output a rise-time of 25 μsec, and the triangular output a maximum slope error of 2%. Random noise level is 20 mV maximum. Frequency stability of 0.5% and level stability of 0.2 dB for ±10% mains variations are ensured by stabilized supplies.

Applications include the study and testing of servomechanisms, XY recorders, etc., biological studies, vibration generation, and applications in mechanics, geophysics and subsonics. A synchronization pulse output (25 V peak, 50 μsec), comprising alternative positive and negative pulses, is provided for such purposes as oscilloscope triggering.—*Claude Lyons Ltd., Valley Works, Hoddesdon, Herts.*

For further information circle 17 on Service Card

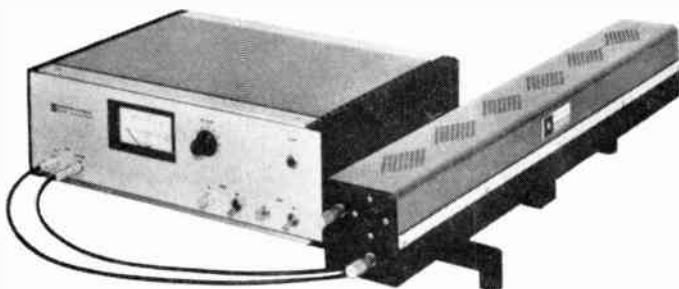

16



17



18

18. Klystron Power Supply

The Microtest 700 power supply is intended to meet the need for a compact portable bench supply capable of energizing a wide variety of low-power klystrons. It offers a fixed, well regulated 300-V resonator voltage, a zero to -300 V regulated and continuously-variable reflector supply, and a 6.3-V a.c. heater supply.

The reflector supply can be internally square-wave amplitude-modulated at frequencies between 900 c/s and 4 kc/s, or externally frequency-modulated by means of sawtooth waveforms or sine-waves. Transistorized circuits are used throughout the power supplies, while a valve circuit is used in the square-wave modulation generator. Cathode current and/or reflector voltage can be monitored on the internal 3½-in. meter and the output is via a standard six-pin connector.—*Microtest Ltd., 9 Old Bridge Street, Kingston-upon-Thames, Surrey.*

For further information circle 18 on Service Card



19

19. Frequency Divider

Advance Electronics have announced a 100-Mc/s divider unit, the TCD100, designed to extend the range of any electronic counter now commercially available from 1 Mc/s upwards to 100 Mc/s.

The instrument is transistorized and utilizes tunnel diodes. Measurement is achieved by a division factor of 100 or 20, controlled through a front-panel switch. Input and output parameters are sufficiently flexible to accommodate a wide range of input sources.

The TCD100 has an input sensitivity of 50 mV into 50 Ω, and output pulses at 3 V peak-to-peak are available from 10 kc/s to 1 Mc/s (÷ 100) and 50 kc/s to 5 Mc/s (÷ 20). The accuracy of the basic counter is unaffected by the divider unit. The dimensions are: 6½ in. high × 9½ in. wide × 8½ in. deep; weight, 8½ lb.—*Advance Electronics Ltd., Roebuck Road, Hainault, Ilford, Essex.*

For further information circle 19 on Service Card



20

20. Photoelectric Counters

A complete range of Visolux photoelectric counters is now available from Simmonds Relays. It covers a wide variety of counting duties including pre-selection of definite numbers of items, unit counting of items on conveyor belts, counting into definite batches in continuous flow, simultaneous counting of batches, and counting by weight. The range also covers electromagnetic and electronic counters to count at speeds of up to 10 kc/s.

Sensing heads can be provided to operate for distances of up to 30 ft between receiver and transmitter. Compressed-air fans can be provided for dusty atmospheres, so that the lenses of sensing heads can be kept clean; flameproof units are also available. Other means of initiating the counting operation are by galvanic contact, inductive transmitters, magnetic scanning heads and impulse generation. Illustrated is the EZZ 3 P pre-determining batch counter.—*Simmonds Relays Ltd., South Road, Harlow, Essex.*

For further information circle 20 on Service Card



21

21. Static Inverters

Industrial Instruments have announced a range of static inverters which employ semiconductor switching elements and are designed for d.c. inputs of 12, 24, 48, 110 and 220 V. The sinusoidal output is either 115 or 230 V r.m.s. and the frequency is 50 c/s. The power

22

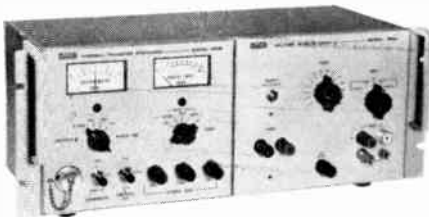

output varies according to model from 110 W to 6 kW. The units are protected against input-voltage polarity reversal and also incorporate electronic protection against overload and short circuits.

These inverters are tolerant of wide load power factor changes and models are available for energizing motors, such as are used in large recording machines, or portable electric tools, e.g. hand drills. Despite their comparatively small size, the inverters incorporate an automatic voltage regulator, which compensates for changes in load and d.c. input voltage. A frequency control unit is provided, capable of holding 50 c/s to better than 1%, regardless of d.c. input and load changes.—*Industrial Instruments Ltd., Stanley Road, Bromley, Kent.*

For further information circle 21 on Service Card

22. High-Accuracy Voltmeter

An instrument which uses thermal-transfer techniques for very accurate measurements of a.c. voltage and current is now being marketed in the U.K. by Livingston Laboratories. Developed primarily for use in laboratories where conventional voltmeters cannot give the degree of accuracy required, the Fluke model 540B will measure from 0.25 to 1,000 V r.m.s. in the frequency range 5 c/s to 50 kc/s with a transfer error of only ±0.01% to ±0.05%, depending upon range.

Thermal converters are available for use with the model 540B which enable voltages up to 50 V r.m.s. in the frequency range 5 c/s to 50 Mc/s to be measured with transfer accuracies as high as 0.01%. A.C. currents from 2.5 mA to 10 A (5 c/s to 100 kc/s) may be measured with transfer accuracy of ±0.03%, using the Fluke A40 series of current shunts.—*Livingston Laboratories Ltd., 31 Camden Road, London, N.W.1.*

For further information circle 22 on Service Card

CONTROL

23. Roll-Temperature Thermocouple

Now available from West Instrument is the Conax temperature thermocouple designed for accurate measurement and control of the surface temperature of rotating rolls, shafts and bearings. Among the features are fast response, ease of installation, resistance to wear, and no heat loss due to convection.

(continued on page 243)

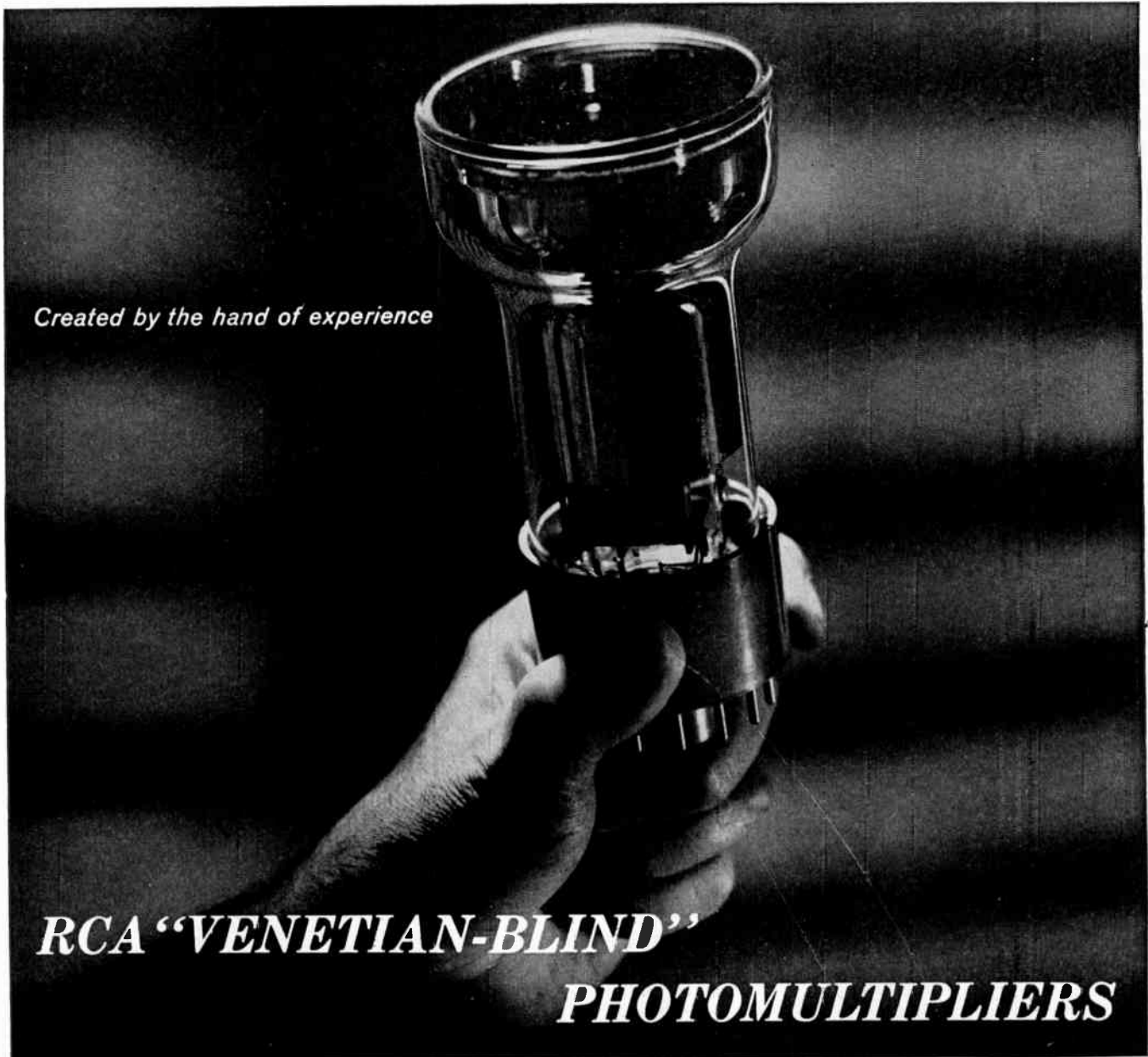

Created by the hand of experience

RCA 'VENETIAN-BLIND' PHOTOMULTIPLIERS

for pulse-counting applications

A typical pulse height resolution of less than 8% with a NaI (Tl) scintillator and the 662 KEV line of Cs^{137} . Outstanding performance in long-term gain drift at constant count rate. Typically less than 1% gain shift in sudden change of count rate from 1000 to 10,000 counts per second. Such characteristics as these make RCA photomultipliers particularly good choices for pulse-counting applications. All are head-on, flat-face types... employ venetian-blind dynode structure...and feature very-low dark current, uniform photocathode sensitivity, and excellent photoelectron collection from all parts of the photocathodes. These RCA 10-stage photomultipliers are relatively insensitive to the effects of extraneous magnetic fields. And the interstage voltages do not require critical adjustment for maximum anode current.

Type	Nom. Size	Spectral Response	Wave length of Max. Spectral Response. angstroms	Sensitivity	
				Radiant @ Wavelength of Peak Response. amp/watt	Luminous (2870°K) amp/lumen
4463	2"	S-20	4200	11000 [≠]	25 [≠]
4464	3"	S-20	4200	11000 [≠]	25 [≠]
4465	5"	S-20	4200	11000 [≠]	25 [≠]
8053	2"	S-11	4400	15000*	19*
8054	3"	S-11	4400	15000*	19*
8055	5"	S-11	4400	15000*	19*

[≠] At 1500 volts * At 2000 volts



THE MOST TRUSTED NAME IN ELECTRONICS

RCA GREAT BRITAIN LIMITED Sales Division, Lincoln Way, Windmill Road, Sunbury-on-Thames.
Associate Company of Radio Corporation of America. Telephone: Sunbury 5511.

• 25Q-43

LG SODECO COUNTERS



Sodecprint
1Tp3.

SODECO *print*

IMPULSE COUNTERS . . .

. . . give direct reading of results on an indicating counter as well as printing them on a paper tape. They provide three functions: counting; printing, and resetting to zero. These can be controlled remotely, or by an automatic operating cycle, or by the push button provided on the instrument.

- The 1Tp3 is a decimal counter with six digits.
 - The 1Tp4 is a time counter for hours, minutes, seconds and tenths of a second.
 - The 1Tp7 is fitted with independent monodecade counting elements.
 - The 1Tp8 is a date counter indicating either
 - days, months, hours, minutes
 - days, months, years, hours
 - days, hours, minutes.
- It is possible to combine two of these in a single instrument.

LANDIS & GYR

LANDIS & GYR LIMITED

Victoria Road . Acton . London W.3 . ACORN 5311

OVER LOAD CAPABILITY

Consolidated's new Type 4-353-0001 pressure transducer measures pressures in the low range of 0-1 p.s.i. absolute. This instrument is the smallest available in its class, combining light weight with accuracy and fast dynamic response. The Type 4-353 Pressure Transducer uses a radically new diaphragm design and a mechanical over-pressure stop permits **20X OVERPRESSURE WITHOUT DAMAGE**. This transducer incorporates many features which make it ideal for use in adverse environments.

Write for Bulletin 4353.



Consolidated Electrodynamics

A division of BELL & HOWELL LIMITED

14 Commercial Rd., Woking, Surrey. Tel: Woking 5633

For further information circle 263 on Service Card

ADCOLA
PRODUCTS LIMITED
(Regd Trade Mark)

**HIGH EFFICIENCY
SOLDERING INSTRUMENTS
FOR
BENCH LINE PRODUCTION**

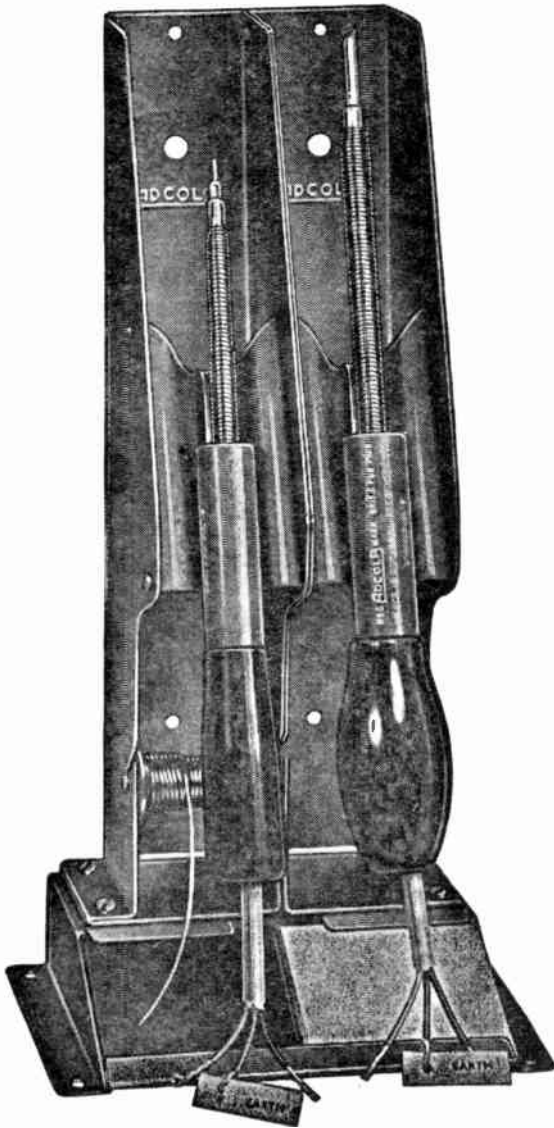

Apply direct to
Head Office Sales and Service

**ADCOLA PRODUCTS LTD.
ADCOLA HOUSE
GAUDEN ROAD
LONDON S.W.4**

Telephones
MACaulay
4272
and
3101

Telegrams
SOLJOINT, LONDON S.W.4

Industrial Electronics May 1965

F*

51

Let the

**INDUSTRIAL
ELECTRONICS**

**READER ENQUIRY
SERVICE**

help you to obtain more information

To obtain further details of any of the coded items mentioned in the Editorial or Advertisement pages of this Issue, please complete one or more of the attached cards circling the appropriate reference number(s). Your enquiries will be passed on to the manufacturers concerned and you can expect to hear from them direct in due course. Cards posted from abroad require a stamp.

PLEASE USE CAPITAL LETTERS

Pour obtenir tous renseignements sur les produits codés mentionnés dans les articles ou dans les pages publicitaires de ce numéro, nous vous prions de remplir une ou plusieurs des cartes ci-jointes en encerclant le ou les numéros de référence appropriés. Vos demandes de renseignements seront transmises aux fabricants intéressés qui, en temps voulu, vous feront parvenir une réponse. Il est nécessaire d'affranchir les cartes postées de l'étranger.

PRIÈRE D'UTILISER DES CARACTÈRES D'IMPRIMERIE

Weitere Einzelheiten über irgendwelche Artikel, die auf redaktionellen oder Anzeigenseiten erscheinen, erhalten Sie, indem Sie eine oder mehrere der beigefügten Karten ausfüllen und die entsprechende(n) Kennnummer(n) einrahmen. Ihre Anfrage wird an den Hersteller weitergeleitet, und Sie werden dann direkt von ihm hören, Karten, die im Ausland aufgegeben werden, müssen frankiert werden.

BITTE IN BLOCKSCHRIFT AUSFÜLLEN

Per ulteriori particolari in merito agli articoli menzionati nel testo o nelle pagine pubblicitarie di questo numero, Vi preghiamo di completare una o più delle schede allegate chiudendo in un cerchietto il numero o i numeri di riferimento. La Vostra richiesta sarà inoltrata ai fabbricanti interessati che Vi risponderanno direttamente. Le schede dall'estero devono essere regolarmente affrancate.

SI PREGA DI COMPILARE LE SCHEDE A
TAMPATELLO

Con objeto de obtener más detalles de cualquiera de los artículos mencionados en las páginas editoriales o de anuncios de este número, sírvase rellenar una o más de las unidas tarjetas poniendo un círculo al número o números de referencia. Sus consultas serán transmitidas a los fabricantes interesados de quienes tendrán noticias directamente a su debido tiempo. Las tarjetas enviadas desde el extranjero requieren franqueo.

SÍRVASE ESCRIBIR CON LETRAS MAYUSCULAS

**NEW FROM
U.S.A.**

**EUBANK
WIRE STRIPPER
AND BENDER
Model 821.**

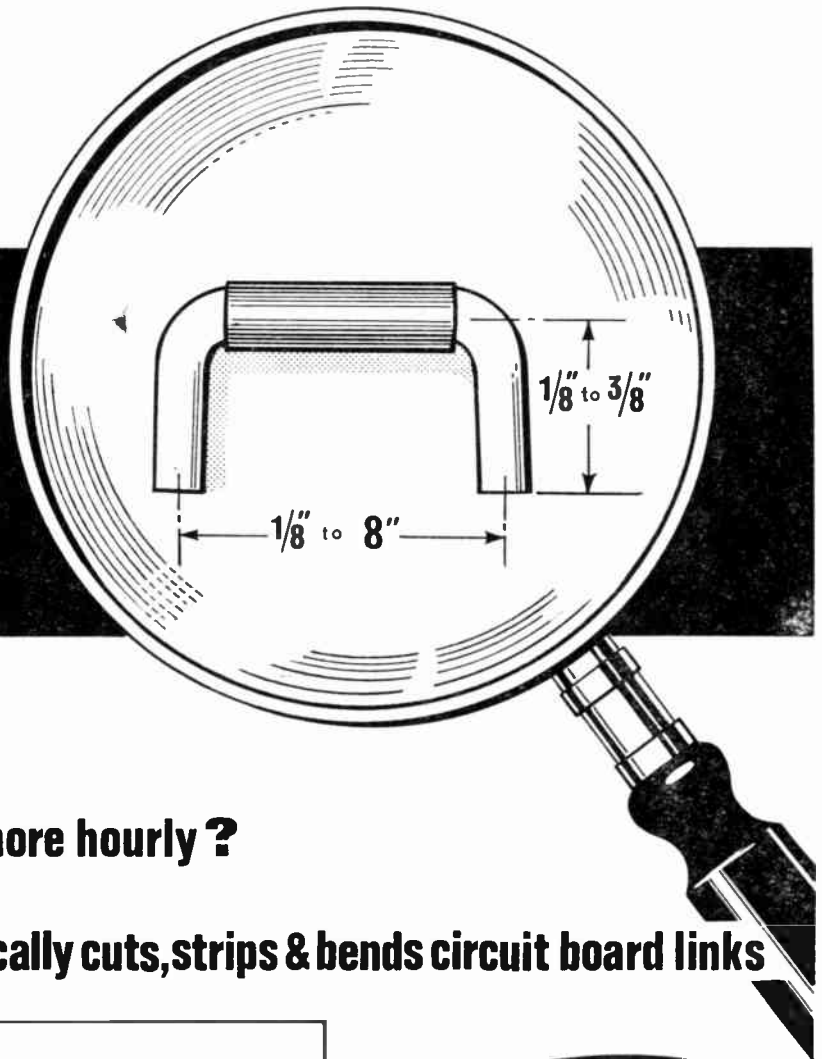

Do you hand make these ?

Could you produce 8000 or more hourly ?

EUBANKS model 821 automatically cuts, strips & bends circuit board links

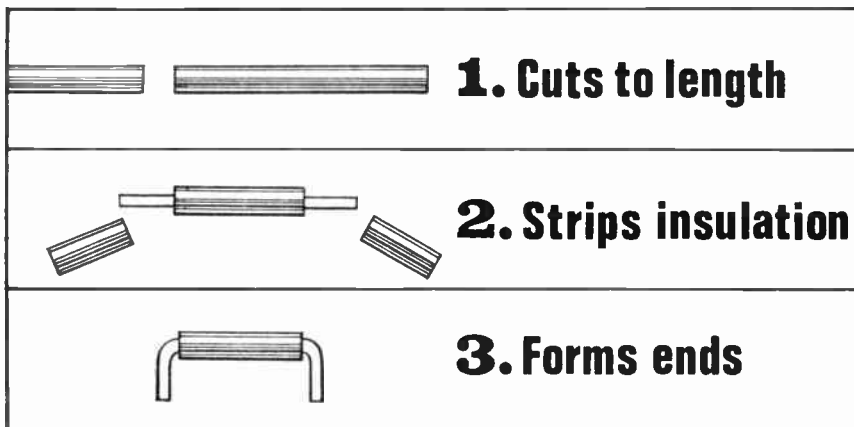

AUTOMATICALLY

The EUBANK Model 821 Wire Stripper/Bender automatically produces up to 8,500 insulated or bare wire links (Jumpers) hourly. The links are bent accurately to length, and the ends are stripped precisely, eliminating hand trimming. The strip is clean, and the conductor is neither scraped or nicked. Links from 1/4 inch to 8 inches centre to centre can be produced from solid wire in 18 to 30 S.W.G.

WRITE FOR ILLUSTRATED LEAFLET FROM:

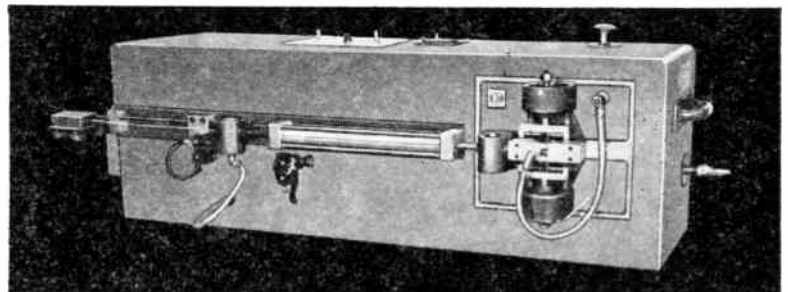

A member of the Marbaix Group of Companies

DEVONSHIRE HOUSE · VICARAGE CRESCENT · LONDON, S.W.11

Telephone: Battersea 5549

Telex 261269

Grams and Cables: Automashun, London

4905/A

NEW ELECTRONICS INSTRUMENTATION CONTROL

The temperature reading is unaffected by changes in roll velocity, and constant bearing pressure of the thermocouple is assured by an internal spring.

The sensing element is a brass plug which is flush-mounted in a spring-loaded Teflon plunger. This wear-resistant Teflon body bears against the roller forming a protective thermocouple shield from surrounding air. Natural lubricity of Teflon prevents build-up of friction heat and damage to roll.

Conax roll-temperature thermocouples are complete with bracket and Conax thermocouple head and are available with copper-constantan, iron-constantan or chromel-alumel thermocouple elements. — *West Instrument Ltd., The Hyde, Brighton 7, Sussex.*

For further information circle 23 on Service Card

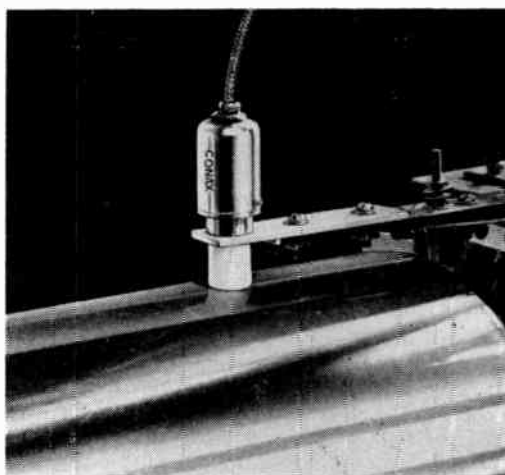

23



24

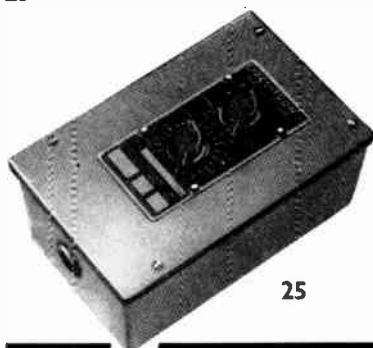

25



26

24. Electronic Process Timers

A range of plug-in electronic process timers has been produced by Photain Controls to meet the demand for stable time delays with high repetitive accuracy. They are suitable for use with a wide range of industrial process controls, and two or more timers can be connected together in tandem or ring formation to enable complex systems of industrial control to be built up.

There are four basic units in the range covering time periods 0-15, 0-30, 0-60, and 0-180 sec. They are each contained in a diecast zinc-alloy housing measuring $4\frac{1}{8} \times 3\frac{1}{8} \times 2\frac{1}{8}$ in. and are complete with an 11-pin plug and socket. The variable setting knob and scale are fitted to the lid, and inside is a printed-circuit chassis with all necessary components and an operational relay with two sets of change-over contacts each rated at 5 A 250 V a.c. resistive load.

The sequence of operation is that when an external contact is momentarily made the relay pulls in, changing over the switching contacts. When the set time period expires the relay drops out and the switching contacts revert to their normal condition. The external contact can be a push-button, microswitch or relay contact. No warming-up period is necessary and repetitive accuracy with a stable voltage supply is better than $\pm 1\%$. The unit can be mounted in any position, will operate in an ambient temperature from -20°C to $+60^\circ\text{C}$, and has a

life expectancy in excess of 10 million operations under normal operating conditions. — *Photain Controls Ltd., Randalls Road, Leatherhead, Surrey.*

For further information circle 24 on Service Card

25. Electronic Timer

A versatile electronic timer has been introduced by Circuitron for industrial and laboratory applications. Housed in a robust sheet-steel case, the standard model is offered with a range of adjustable delays from 1 sec up to 4 min, after which a P.O. type relay operates a set of change-over contacts which can switch circuits at up to 440 V a.c. Infinitely variable adjustment over the entire time range is given by two front-mounted controls.

The timer is designed to operate from 200, 250, 380 or 440 V, but other supplies can be accommodated. A feature of the design is that the printed-circuit base, carrying all components, can be removed on a 'plug-in' basis, making maintenance and servicing extremely easy.

A number of extra features are available to meet special requirements such as the fitting of stabilizers to deal with the wide fluctuations in the supply

voltage and, when the timing cycle is initiated by an impulse signal only, an additional maintaining relay can be incorporated. On the output side a variety of switching contacts is possible. — *Circuitron Ltd., 476 Coventry Road, Small Heath, Birmingham, 10.*

For further information circle 25 on Service Card

26. Pressure Controller

The Teddington Autocontrols KCK is an attractively styled, ruggedly constructed pressure controller featuring easy-to-read scales, rotary coin-slot adjusters, and screw-clamp terminals for quick and easy installation.

This is a dual-purpose instrument providing low-pressure control with a high-pressure cut-out. The plant will normally run under control of the low-pressure element, but when the high-pressure side rises to the pre-set safety limit, the switch opens, the low-pressure element is automatically overridden, and the electrical circuit broken.

The cut-in range of the low-pressure switch is 7.4-70 p.s.i., and the differential range is 5-30 p.s.i. The high-pressure cut-out range is 100-400 p.s.i., the differential being factory-set at 40 p.s.i.

NEW ELECTRONICS INSTRUMENTATION CONTROL

The KCK may also be used as a single-purpose instrument; both the high-pressure and the low-pressure sides are capable of operating independently. The switch rating is 15 A at 250 V a.c. (suitable for 240-V single-phase motors up to 1 h.p.).—*Teddington Autocontrols Ltd., Windmill Road, Sunbury-on-Thames, Middlesex.*

For further information circle 26 on Service Card

COMPONENTS

27. Resistor Kit

A comprehensive metal-oxide resistor kit primarily for use in electronics laboratories and experimental units has

been introduced by Electrosil. Containing thirty values of resistor, each with three ratings making it suitable for semi-precision, high-stability or general-purpose applications, the kit provides a compact stock with immediate availability.

The permanent solidly-constructed cabinet, measuring approximately 14 in. high × 12 in. wide × 5 in. deep, is either free-standing or wall-mounted, as required. The normal cabinet covers the E6 range of preferred values from 10 Ω to 1.4 MΩ, but special combinations of resistance values can be supplied to order.

The kit not only saves time and effort in stores requisitions and searching for required types and values, but the provision of a re-order card simplifies stock replenishment. Stability of all resistors is 0.5% at semi-precision rating, 1% at high-stability rating, and 2% at general-purpose rating. Standard tolerances are 5%, 2%, 1%.—*Electrosil Ltd., Pallion, Sunderland. Co. Durham.*

For further information circle 27 on Service Card

28. R.F. Coaxial Connector

Now available from Sealectro is the Conhex 5552 subminiature r.f. connector. Approximately ½ in. long overall, this 75-Ω minimum-projection feed-through connector terminates the coaxial cable shield at the mounting bulkhead and passes the cable core and centre conductor through for wiring to internal circuitry.

For maximum electrical efficiency, the entire connector features 0.0001-in. gold plating. Rigid torque-resistant 'D'-hole mounting reduces the possibility of cable damage due to twisting after installation.—*Sealectro Ltd., Hersham Trading Estate, Walton-on-Thames, Surrey.*

For further information circle 28 on Service Card

29. Latching Relays

Elremco have announced the introduction of the SBIK latching relay type 'StevOa', designed to obviate the need for additional circuitry to ensure that



27

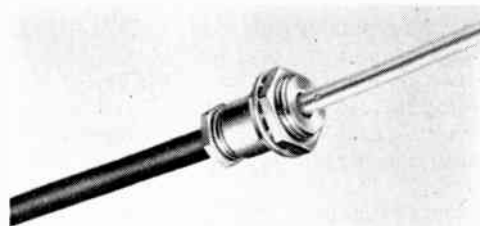

28

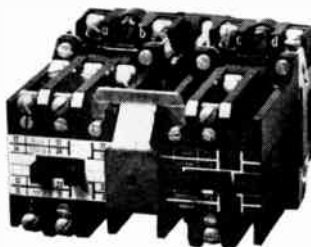

29

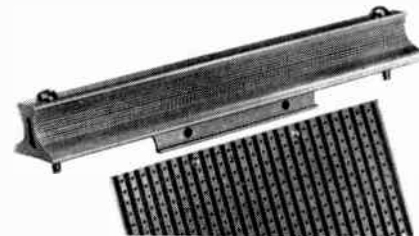

30

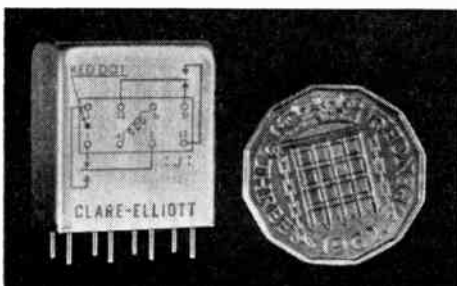

31

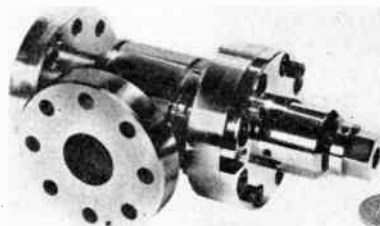

32

a process is continued at precisely the same point at which it was interrupted. On energization of the control relay, the moving contact block is latched mechanically in the energized position, and the latch is unlocked when the unlatching coil is energized.

These latching relays are available with combinations of five contacts, all rated for continuous use at 6 A. Both the control and latching relays can be operated manually if necessary. Alternatively the de-latch coil can be omitted; the unit then has electrical latch/mechanical de-latch characteristics.—*Electrical Remote Control Co. Ltd., The Fairway, Bush Fair, Harlow, Essex.*

For further information circle 2) on Service Card

30. P.C. Board Handle

Vero Electronics have added a series of plastic handles with locking screws to their range of printed-circuit board mounting facilities. The handles are

available in two widths, 0.6 and 1.0 in., and three standard lengths of 5½, 7 and 8½ in.

Two 6 BA screws are held captive in a grey plastic extrusion by means of special brass inserts. A tongue is provided at the back of the handle for the direct mounting of Veroboards or printed-circuit cards.—*Vero Electronics Ltd., 7 South Mill Road, Southampton.*

For further information circle 30 on Service Card

31. Sub-Miniature Industrial Relay

A sub-miniature two-pole changeover relay, the type CF, announced by Clare-Elliott, has been tested at speeds up to 30 c/s for 10 million operations without failure.

The CF relay, which is a commercial version of the Clare type F relay used in many advanced military applications, provides high sensitivity and reliability at low cost. It is intended for use in computing equipment and machine tool control applications and is of particular interest in the broad field of commercial communications equipment and systems.

Its brief specification is as follows: sensitivity, 300 mW; operate and release time, 5 msec maximum; contact resistance, 75 mΩ (maximum) or 25 mΩ (typically) at 6 V 100 mA. Contact rating: 3 A at 28 V d.c. resistive, 1 A at 115 V a.c. resistive, and 1 A at 88 V d.c. inductive.—*Clare-Elliott Ltd., 70 Dudden Hill Lane, London, N.W.10.*

For further information circle 31 on Service Card

32. Improved Vacuum Tap

Intended for use in one-inch metal ultra-high-vacuum systems, a bakeable metal tap, type VMT-25, now available from Mullard, has a number of advantages over previous designs. These include stainless-steel construction, low closing torque, high closed conductance, and all-demountable seals utilizing gold-wire gaskets and the positive-position flange system. Alternatively, it can be fitted with glass tubulations.

The seal on the tap seating incorporates a long-life knife edge, which will last for many thousands of openings and closings, and a copper pad. The copper, being the softer part of the seal, has a shorter life than the knife edge but can easily be replaced by the user without removing the pump body from the vacuum system. The same method of demounting the internal parts of the metal tap for cleaning can be used if contamination of the inner

surface (e.g., by zinc or cadmium) occurs during the vacuum process.—*Mullard Ltd., Mullard House, Torrington Place, London, W.C.1.*

For further information circle 32 on Service Card

33. Self-Powered Illuminated Signs

A self-powered illuminated exit sign for use in passenger carrying aircraft has been developed and produced by Saunders-Roe and Nuclear Enterprises.

This equipment has been specified as standard by American Airlines, Braniff Airways and Mohawk Airlines for their BAC One-Elevens.

Using tritium filled Betalights these signs meet all international requirements for emergency exit indication on civil and military aircraft. Constructed from light-weight corrosion-proof acrylic plastics and epoxy resins, SRNE aircraft signs require no external power supplies of any kind. The faces of all signs are smooth and free from discontinuity in frame or face line. Letters are white characters on a red background.

Any form of wording or style of lettering can be provided.—*Saunders-Roe & Nuclear Enterprises Ltd., North Hyde Road, Hayes, Middlesex.*

For further information circle 33 on Service Card

34. Miniature Trimmers

Oxley Developments Co. have recently introduced a range of solid-electrode miniature trimmers with mounting pins which permit side adjustment when mounted on layered printed-circuit boards.

The capacitance range of these components is between 2 and 16 pF, and they possess a temperature coefficient of capacitance of 50 parts per million per °C.—*Oxley Developments Co. Ltd., Priory Park, Ulverston, Lancs.*

For further information circle 34 on Service Card

35. Miniature Electrolytic Capacitors

STC have introduced into the U.K. their Swiss associate's range of aluminium electrolytic capacitors with axial leads and transparent insulating sleeve over the case.

Performance and stability of this range of capacitors are IEC 103 (1959) Class 564. They are suitable for operation at temperatures from -40 °C to +70 °C. D.C. working voltages are 3, 6, 12, 25, 50 and 70 V. Cold-welding techniques are used for anode and cathode connections, while the main case connection is made by ultrasonic welding. The construction ensures a



33

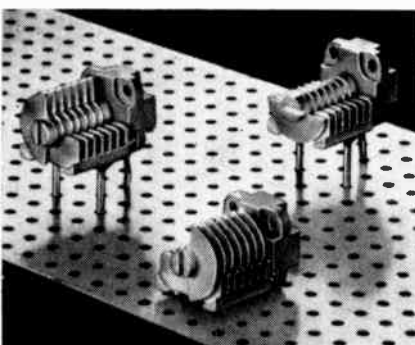

34



**electrosil put
a quart (and a pint)
into a pint pot**

triple rating means triple economy

Brilliant design and the use of metal oxide fused to a glass substrate, enables each Electrosil resistor to perform three roles:— Semi-precision, high stability and general purpose. Three applications for the price of one. Resistor stocks now need only be one-third the size. Powerful factors in industry are adopting this Electrosil concept — are saving space, effort and cash, getting more reliability in performance. TR resistors are approved to DEF.5114A and by the G.P.O. to D.2228A. Employ resistors the modern way — let Electrosil show you how.

	TR4	TR5	TR6	TR8	Stability
Semi-precision	$\frac{1}{10}W$	$\frac{1}{8}W$	$\frac{1}{4}W$	$\frac{1}{2}W$	0.5%
High stability	$\frac{1}{8}W$	$\frac{1}{4}W$	$\frac{1}{2}W$	1W	1%
General purpose	$\frac{1}{4}W$	$\frac{1}{2}W$	1W	2W	2%
Ohmic range	51Ω- 150K	10Ω- 470K	10Ω- 1M	100Ω- 1.4M	
Standard Tolerances (All types) 1% 2% 5%					

get glass-tin-oxide reliability with



Write today for full details

ELECTROSIL LIMITED

PALLION, SUNDERLAND, CO. DURHAM

Tel: Sunderland 71557. Telex 53273

ES/A55

The connector features heavy 0.0001-in. gold plating, Teflon insulation and captive contacts, and is also available with screw-on or slide-on mating engagements in addition to the snap-on type.—*Sealectro Ltd., Her-sham Trading Estate, Walton-on-Thames, Surrey.*

For further information circle 39 on Service Card

40. Miniature Magnetic Latching Relay

B & R Relays have now introduced to the British market the Siemens type P magnetic latching relay, which is available in two sizes. The smaller version has two changeover light-duty contacts; the larger has four changeover, six normally-open and six normally-closed contacts or two changeover heavy-duty contacts. Contacts are available in either silver or gold alloy for most versions. The type P cradle relay (reference number V23003) is designed to operate from a pulse.

The operation is such that when the relay is fitted with a single coil, it can be energized or pulsed and will then operate and stay in that state until the coil is excited in the opposite direction

Alternatively the relay can be fitted with two coils, when it can be energized by exciting one coil and de-energized by exciting the other.—*B & R Relays Ltd., Temple Fields, Harlow, Essex.*

For further information circle 40 on Service Card

41. Miniature Variable Capacitor

Oxley Developments have recently introduced a miniature tubular capacitor for printed-circuit mounting, which features a low temperature coefficient of capacitance and will withstand arduous climatic conditions.

The concentric design incorporates p.t.f.e. as the dielectric medium to ensure uniformly smooth adjustment and good coaxial alignment of the piston within the cylinder. The result is completely linear tuning with no reversals.—*Oxley Developments Co. Ltd., Priory Park, Ulverston, Lancs.*

For further information circle 41 on Service Card

42. Platinum Resistance Thermometers

A range of designs of stainless-steel-sheathed platinum resistance thermometers are now available from Research & Engineering Controls for steam temperature measurements in power stations and similar applications.

The designs are particular to the standard C.E.G.B. thermocouple pocket but can be easily adapted to suit most other thermowells or thermo-

couple pockets. The thermometer temperature sensing length is 1 in. and the sheath diameter over this sensing length is nominally $\frac{1}{8}$ in., enabling temperature changes to be monitored very rapidly, owing to the fast response time of the unit.

A resistance bridge system which has a standard output of 0–100 mV for all temperature spans, is available for use with the above range of thermometers and all other platinum resistance thermometers having an ice-point resistance of 100 Ω . The bridge output can be as high as 1 mV per degree and the overall system is capable of an accuracy of 0.1% of the temperature span.—*Research & Engineering Controls Ltd., Durban Road, Bognor Regis, Sussex.*

For further information circle 42 on Service Card

PRODUCTION AIDS

43. Improved Crystal Grower

An improved crystal-growing furnace with about double the production capacity of the earlier model has been announced by National Research Corporation. The NRC 2805, which is claimed to reduce labour costs by about 50%, may be used to grow



40

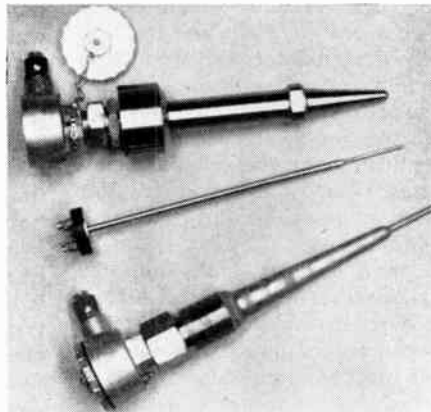

42

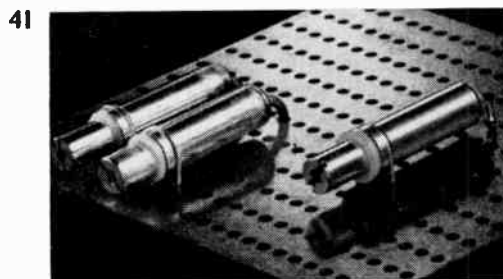

41



43

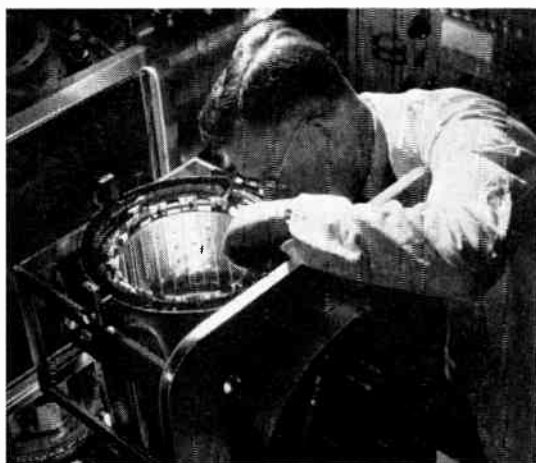

44

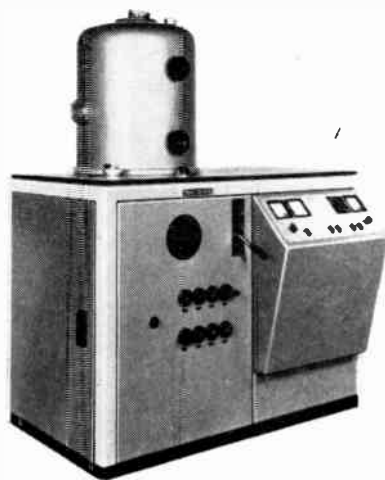

45



46

crystals of silicon, germanium and other materials used for transistors, diodes and as base material for micro-miniature circuits. Major applications are in the electronics, aerospace and chemical fields.

The capacity of the furnace is about 550 cu cm, sufficient to handle a 1,050-gm silicon charge. It will routinely 'pull' silicon and other materials up to 2 in. in diameter. The unit uses the Czochralski growing method and is resistance-heated; it operates under vacuum or an inert gas.—*National Research Corporation, 160 Charlemont Street, Newton, Massachusetts 02161, U.S.A.*

For further information circle 43 on Service Card

44. Modular Vacuum Unit

Torvac have introduced an 18-in. stainless-steel modular vacuum unit for furnaces and electron beam work. The one shown is equipped with one of several interchangeable furnace elements, some with fast cooling facilities, for research and pilot work.

The element, which is attached to one of the sliding end-plates, so it can be removed easily for cleaning and inspection, has a hot zone 8-in. in diameter by 12-in. high and is capable of temperatures up to 1,550 °C using 15 kVA. Refractory material is kept to a minimum, and an operating vacuum of 10^{-5} mm is practicable with an ultimate figure better than 10^{-6} mm.

In the version shown the hearth is loaded from below on a hydro-pneumatic ram so that delicate assemblies can be loaded into the furnace without vibration. Other elements for

high temperatures or larger hot zones are fitted in similar ways inside other sizes of modular units.

The wide variety of set-ups available to fit these modular units makes them particularly suitable for research organizations.

Four additional furnace elements and a full range of electron beam equipment for welding, melting and thin film work are also available.—*Torvac Ltd., Histon, Cambridge.*

For further information circle 44 on Service Card

45. High-Vacuum Coating Plant

Balzers High Vacuum have recently launched a coating plant, the BA 510, specially designed for the production of thin films for electronic applications. The plant is ideally suited for the manufacture of such components as semiconductors, magnetic films, metal-film resistors, and micro-circuits. For the latter, an 8-position substrate mask changer is available.

The mask-changer unit, built by Bendix-Balzers in the U.S.A., is designed so that each of the 8 substrates can be combined with any one of the 8 masks. Evaporation can thus be carried out from any of the three evaporation sources and the substrates can, if necessary, be heated up to a maximum of 400 °C. A wide range of ancillary equipment is available, including an electron-beam evaporation source.

The vacuum chamber of the BA 510 has a working capacity of 505 mm diameter \times 520 mm high. Ultimate pressures in the region of 10^{-7} torr are obtainable; with deep-cooling and Meissner trap, pressures as low as

5×10^{-8} are reached. The high pumping speed of the diffusion pump, 1,400 litres/sec, allows a pressure of 1×10^{-5} torr to be attained in the standard plant in approximately 6 min.—*Balzers High Vacuum Ltd., Northbridge Road, Berkhamsted, Herts.*

For further information circle 45 on Service Card

46. Self-Contained Ultrasonic Cleaner

An ultrasonic cleaner recently announced by the Sonics Division of Elliott-Automation is particularly suitable for the cleaning of delicate components in laboratories and precision industries, and in the jewellery and watch-making trades. The equipment is completely self-contained.

Both the 2-litre capacity tank (which measures $6 \times 4\frac{1}{2} \times 5$ in. internally) and the 60-W generator are housed in a strong case measuring $14 \times 8 \times 9\frac{1}{2}$ in. A pushbutton on/off switch is the only control necessary as tuning has been eliminated by the employment of transistorized circuits in conjunction with the Elliott-Acoustica 'Multipower' transducer. The maximum cleaning efficiency is always available irrespective of the contents of the tank or changes in temperature.

A drain cock is provided to facilitate emptying the tank, and a hose connection on the drain enables a recirculating pump and filter unit to be used if required. The equipment can be used by unskilled labour and the long-term stability of the power output enables cleaning times to be of standard duration.—*Sonics Division, Elliott-Automation Ltd., Bath Road, Beenham, Reading, Berks.*

For further information circle 46 on Service Card

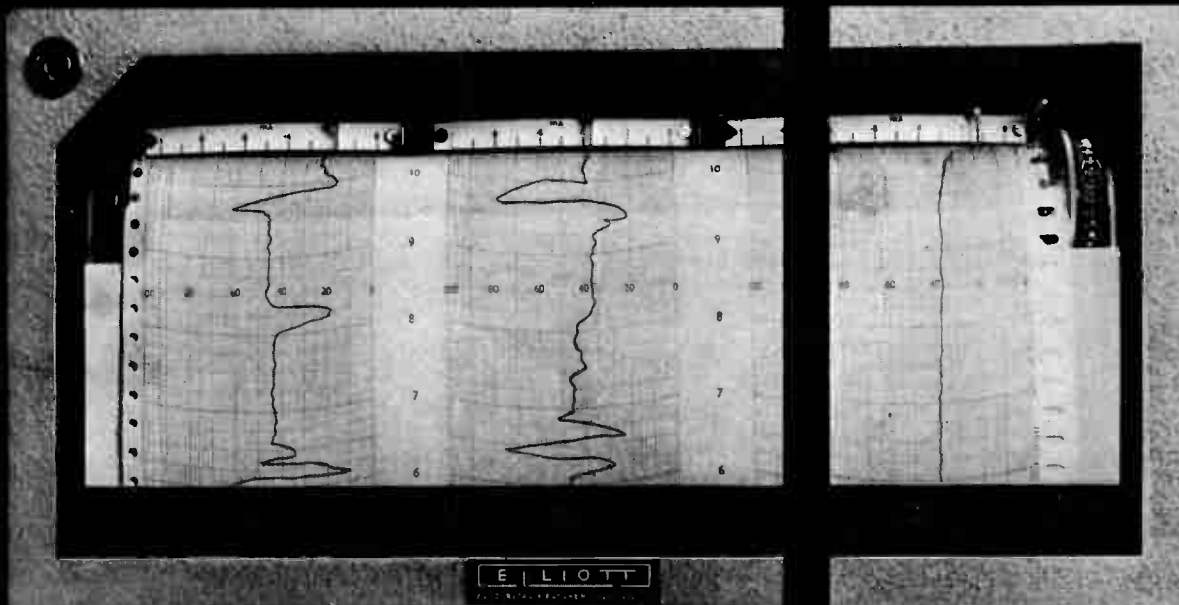

**Now that we've cut it down
to the perfect size...**

**we've
slashed
this much
off the price!**

By the full application of Value Engineering, Elliott have further improved the technical performance of the Emrec Recorder—and, just as important, have made big cuts in costs by new production methods. These benefits are passed on to you, the customer, by providing a compact 2-, 3-, 4- or 6-channel recorder, only 8½" high and

12" deep. Other features include * A new expendable cartridge inking system to give a clear high-definition trace * 3"-wide track * 5½ hours (at 1"/hour) visible at a glance * Self-contained strip lighting fitted as standard.

Other models are also available with * Electronic over-ride alarm and control

facilities * Dynamometer movements * Electrical suppression of ranges * Remote change of chart speeds.

With these improved performance facilities and a much reduced price, the Emrec MkII is a *must* for all those interested in direct writing recorders.

Write now for full information or, better still, ask for a demonstration



Electrical Measurement Division
ELLIOTT BROTHERS (LONDON) LIMITED
Century Works, Lewisham, London SE13. TIDeway 1271

 A Member of the Elliott-Automation Group

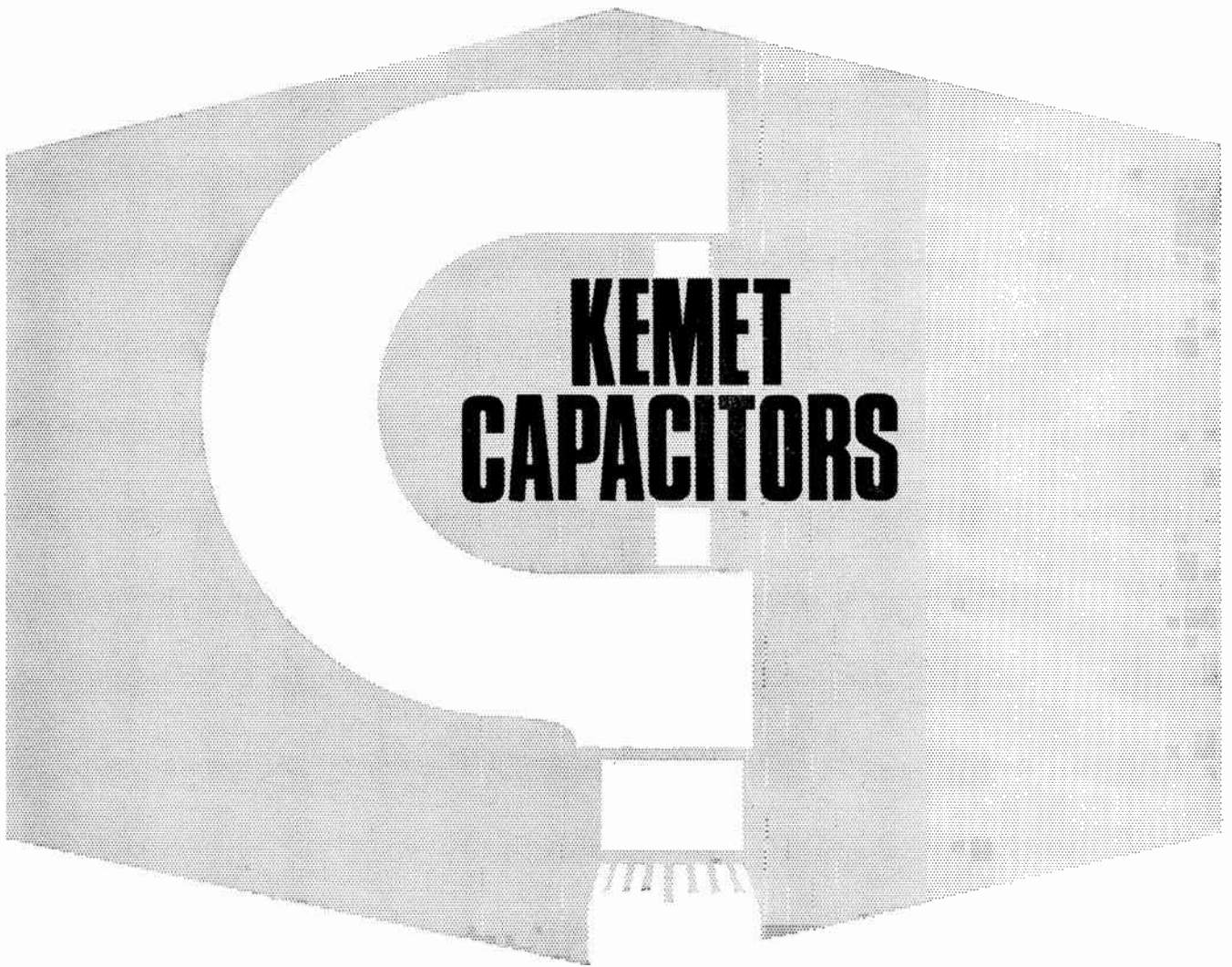

Every Union Carbide Kemet Capacitor is precision made to Aerospace standards

Kemet Solid Tantalum Capacitors go into aircraft and missiles, but they have many other less spectacular and equally important applications. In computers, for instance and many other electronic systems, Union Carbide Kemet capacitors are manufactured to the high standards demanded for Aerospace applications. This means that quality control must begin with the raw materials. The anode which forms the heart of Kemet capacitors is manufactured from Union Carbide's own tantalum powder – itself the subject of stringent quality control – this is sintered and pressed together to form the anode under carefully controlled conditions. Every subsequent operation is carried out with equal care, and the finished product is subjected to the exacting tests as laid down in

British and American Defence specifications. These include shock loading, vibration with accelerations of 15g and above, temperature cycling between -55°C and $+125^{\circ}\text{C}$, immersion cycling, moisture resistance and special tests for solderability and terminal strength.

There is, however, an important difference in the object of these tests as they are applied to Kemet capacitors. The reliability of Kemet capacitors is built-in, and testing is carried out as a service to the user who requires confirmation that the capacitors he buys are of the necessary quality level for his application, a quality level which has established Union Carbide Kemet as the foremost name in solid tantalum capacitor technology.

KEMET CAPACITORS ANOTHER PRACTICAL PRODUCT OF



Union Carbide Ltd., Engineering Products Division, 8 Grafton Street, London, W.1. MAYfair 8100

CHEMICALS • CRYOGENICS • DYNEL FIBRE • ELECTRONIC COMPONENTS • FERRO-ALLOYS • FLAME PLATING • PRESTONE CAR POLISH • SILICONES • SUPERALLOYS • UCON LUBRICANTS

SEE THEM AT OLYMPIA

The full range of Kemet Capacitors will be on display on stand No. 401 at the **RAOIO & ELECTRONIC COMPONENTS EXHIBITION** at Olympia, London, **MAY 18-21**. Union Carbide Barium Getters and Laser Crystals will also be on show.

The terms Kemet, Dynel, Prestone, Ucon and Union Carbide are registered trade marks of Union Carbide Corporation.

THE PHYSICS EXHIBITION 1965

THIS year the annual exhibition of The Institute of Physics and The Physical Society, the 49th in the series, was held in the Manchester College of Science and Technology at Manchester from 5th to 8th April. This is the first occasion on which it has been held outside London. Another change is in the title of the show to 'The Physics Exhibition'.

Here in this report we have selected some of the items which show promise for future application in all industries. It must be borne in mind that because of the character of the exhibition many of the items are research or prototype models which may not be available in production form for some time yet.

A typical prototype development was shown by Microwave Instruments in the form of their VX100 hygrometer. This is designed to measure humidity at temperatures between 100 and 300 °C to an accuracy of better than 1%. Its anticipated ultimate application will be in automatic measurement and control of continuous industrial processes. At the present time, conventional moisture-measuring techniques cannot operate accurately at temperatures of the order of 200 °C at atmospheric pressure. In principle the VX100 is simple. It comprises a microwave power generator, two waveguides and a microwave phase-comparator. The two waveguides, each shorted at the farthest end from the generator, are inserted into the chamber in which it is required to measure the humidity. One waveguide, known as the standard or reference, is sealed and filled with dry air or gas. The other waveguide is open to the atmosphere of the chamber. The microwave signal is switched alternately to each waveguide and the phase of the reflected signals of each guide is measured. The difference in phase between the two reflected signals is an accurate measure of the humidity of the chamber.

Sixty thousand million potatoes are grown annually in Britain and most of the crop is gathered by hand because fully automatic harvesting machines are not available. The main obstacle has always been the separation of stones and clods from potatoes. Quite a few aching backs may be relieved in the future by a development featured by the National Institute of Agricultural Engineering. This depends on the fact that X-rays pass through a potato much more easily than they do through a stone or clod. The principle can thus be used to distinguish stones and clods from potatoes and, with the appropriate mechanism, provide a

means of separating wanted and unwanted products. In the development model of the separator, potatoes, stones and clods fall from a conveyor belt through horizontal beams of X-rays. Each beam shines on its own detector, which can be set to provide an output signal only when stones or clods break the beam. If a detector senses a stone or clod it signals to a finger which moves out of the way and allows the unwanted product to fall straight down into a 'reject' bin. When a potato passes through an X-ray beam there is no signal; the finger stays in position and deflects the potato into a 'pass' bin. The full-scale experimental separator has 24 fingers, each able to operate at up to eight times per second, sufficient to allow the harvester to work at a rate of about 3 acres per day.

Another device that was demonstrated to have a practical application was the Sangamo Controls 'Specific Gravity Meter'. Designed for use in industrial processes, this instrument consists essentially of a probe containing a ferrous plummet, an electro-magnet or suspension solenoid and two search coils. In operation, the probe unit is placed in the process liquid so that the plummet is completely immersed. The search coils, fed with a 500-kc/s supply from the oscillator, sense the position of the plummet and are connected into the input circuit of the amplifier. The suspension solenoid is connected to the amplifier output terminals, forming a servo system which maintains the plummet at an exact position centrally between the search coils. The current flowing in the suspension solenoid, to maintain the plummet in this central position, varies inversely with the density of the process liquid and is an accurate measure of its specific gravity. The specific gravity range is 0.4 to 2 and accuracy of better than 0.0001 s.g. can be attained.

The National Engineering Laboratory demonstrated a flowmeter which is intended particularly for use in transient flow conditions. It is based on the principle that a plate or paddle in the pipeline on a flexible support is deflected by the drag force exerted on it by the fluid. If the deflection is measured it can be related to the rate of flow past the plate. In this design, which is somewhat like a variable-

This shows the probe, plummet and the box containing the power supply for the Sangamo Controls specific gravity meter

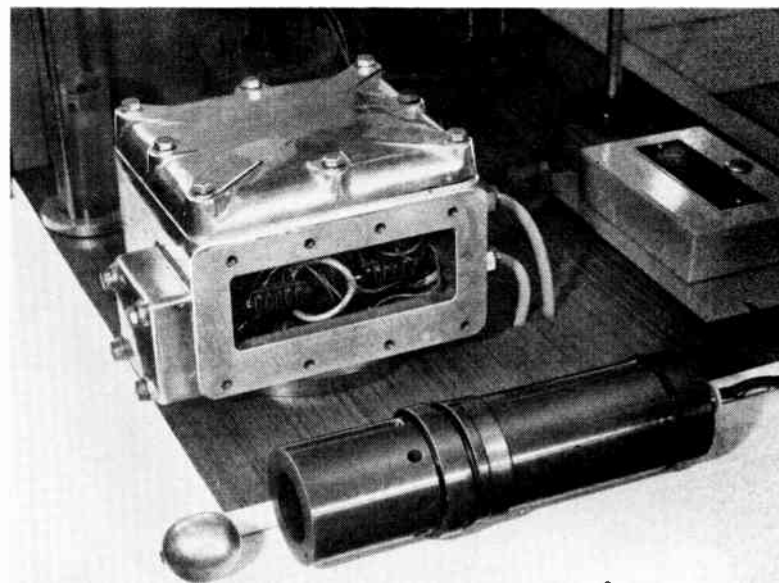



ELECTRONICS
INSTRUMENTATION
CONTROL



Launched at the show by Telequipment, this is claimed to be the first British ready-for-use oscilloscope for less than £25. It is intended for educational and general purposes. It uses a 2½ in. c.r.t., has a bandwidth of 30 kc/s and a sensitivity of 200 mV/cm

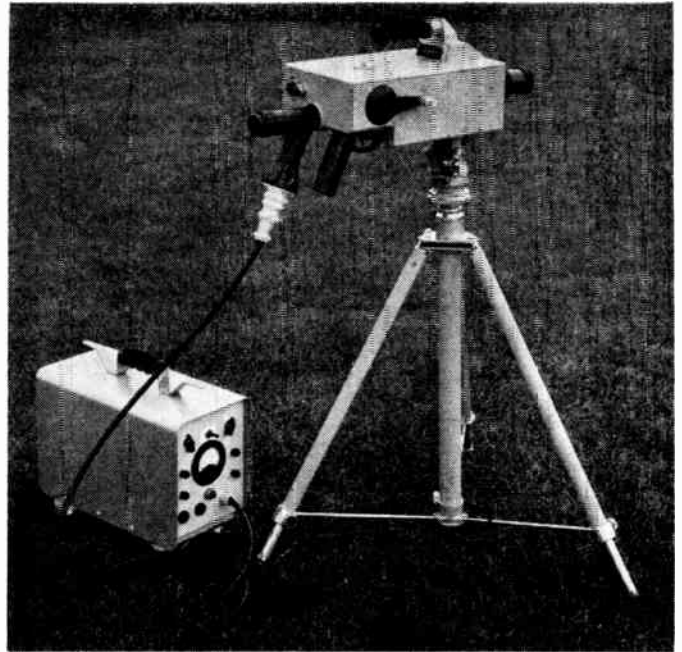

Barr & Stroud's laser rangefinder type L.F.1. Designed to be operated by one man, it gives fast and accurate ranging up to 10,000 metres. It has an accuracy of 10 metres and effective ranging can be achieved with target area equivalent to 0.5 milliradians beamwidth at maximum range. Minimum range is 300 metres

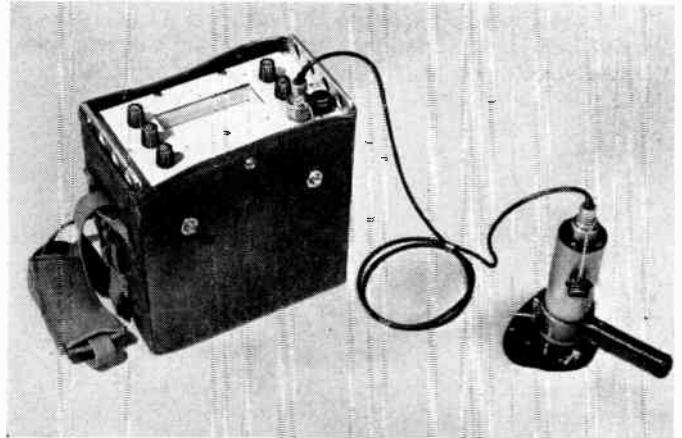

For the mining and mineral-processing industries A.E.R.E. and Hilger & Watts have developed this portable radioisotope X-ray fluorescence analyser. Shown for the first time at the exhibition it is designed to instantly detect metal in an ore sample. A radioactive source in the form of a 1 cm diameter disc is contained in the scanning head and is shielded by a safety shutter which can only open when the head is pressed against a sample. The source excites X-ray fluorescence in the specimen and the resultant secondary characteristic of the element sought is selected by filters and detected by a scintillation counter. Two specially prepared filters are used for each element and the difference in the count rate between them indicates the quantity of the element present

This new type of magnetic-film memory was demonstrated by Plessey. It will enable a low-cost, coincident-current, non-destructive readout store to be built with a capacity of several million bits. The required magnetic properties have been obtained in a novel way. The magnetic elements are electroplated into a mechanically stressed substrate, not in a magnetic field as is usual. After deposition the tensile stress is removed and the resulting compressive stress in the magnetic alloy induces the required magnetic properties



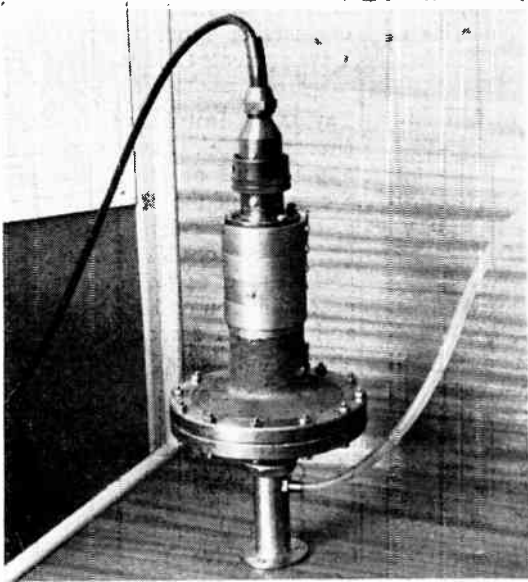

Illustrated here is one of Solartron's vibrating cylinder pressure transducers

reluctance pick-up, the plate is mounted on one end of a lever suspended on torsion hinges which also provide the restoring force. A magnetic armature is mounted on the other end of the lever and displacement of the armature changes the inductance ratio of two coils wound on a small E-type core which completes the magnetic circuit. By using a low mass plate and keeping the deflection small a fast response to flow changes can be obtained.

For liquid measurements of another kind Solartron were demonstrating their vibrating cylinder pressure transducer. With this the determination of the pressure caused by the head of liquid in a tank is measured and related to the mass content of the tank, the actual liquid level or volume. The pressure head is measured with a vibrating cylinder transducer by including a flexible separating diaphragm between the liquid itself and a volume of gas contained around the transducer. The liquid pressure is transmitted to the gas whose pressure is measured by the transducer. The vibrating cylinder comprises basically a hollow cylinder of a magnetic material with one end closed. Inside the cylinder are two magnetized pole pieces with a coil wound on each. One coil known as the drive coil is driven by a small amplifier, the input of which is from the other coil known as the pick-off. The system is then regenerative or self-oscillating at its natural frequency of resonance. Compared with conventional methods this system gives an output corresponding to liquid height or weight with good accuracy and very good long-term stability.

Yet another liquid-measuring device was demonstrated by Hird-Brown. This is what they call their optical dipstick. It consists of a photocell and a light source both mounted on one end of a Perspex rod. Light passes down the Perspex probe and is internally reflected at the tip and passes back up the probe to the photocell. When the probe contacts a liquid, internal reflection does not occur and prevents light reaching the photocell and a signal from the photocell operates a control relay. Two dipsticks with the relays connected appropriately could be used as a high and low-level control system. This dipstick arrangement is suitable for use with any transparent liquid.

The measurement of fluid velocities was demonstrated by the Hydraulics Research Station of The Ministry of Technology. With this, measurement of velocity was made by observing the movement of dust particles in a liquid as

they are illuminated by a strong light. The particles are viewed through a rotating glass cube with the aid of a telescope. The speed of rotation of the cube is adjusted to match that of the particles and they appear stationary. Rotational velocity of the cube is calibrated against a known standard and provides an accurate measure of liquid velocities. Where it is undesirable to introduce dust particles into the liquid air bubbles may be used instead.

An optical endoscope with ordinary and ultra-violet illumination was demonstrated with great enthusiasm by Optec. These endoscopes are optical probes with illumination for looking into small holes. They vary in diameter from 3 mm overall to $\frac{1}{4}$ -in and in length from a few inches to 6 ft. The light unit is fitted external to the viewing optics and therefore does not restrict the power of the bulb. Intense illumination is provided at the far end by transmission of light down the tube. It was shown that small cracks in metals can now be detected optically inside pipes and cavities. It is done with a dye which fluoresces under ultra-violet light. When a dye-treated work piece is illuminated and viewed with the u.v. endoscope, cracks and imperfections are obvious.

Techne (Cambridge) Ltd. demonstrated a novel valve for pneumatic and hydraulic control systems which is a simple stainless-steel helical spring blocked at one end. This is designed to overcome the disadvantages of the combination of a flapper and jet. In operation as long as the helix is straight it acts as a good seal; when deflected the air flows in between the turns to an extent proportional to deflection.

A very unusual demonstration using fluid logic devices was mounted by British Telecommunications Research. Logic devices using either jets of fluid or fluid in combination with simple moving parts, offer interesting possibilities for low-cost, reliable and rugged digital machines. The BTR demonstration showed a control unit for selectively operating one of several party-line teleprinters. While this is perhaps not a viable application for the technique, it is useful both as a means of showing some of the capabilities of fluid logic and a vehicle for investigating basic problems. The method of operation is broadly analogous to that of an electronic digital computer. Incoming telegraph signals are converted into pneumatic pulses by a transducer, sampled by pneumatic clock pulses and fed into a spool-valve shift register. The character in the register is then compared with pre-selected stored characters and if agreement is reached the teleprinter motor is switched on.

The Services Electronic Research Laboratory of Baldock featured a gallium arsenide laser rangefinder used as an aircraft altimeter. The instrument measures the time taken for the laser beam to reach the ground and return to the aircraft. The transmitter is a pulsed gallium arsenide laser operating at room temperature and the detector is a silicon p-i-n photodiode. The laser and its pulse generator are built into a compact transmitter (about the size and shape of a hand torch) which has a peak output power of about 10 W. The detector and pre-amplifier have a sensitivity of 0.1 μ W with a bandwidth of 100 Mc/s. Experimental flights have shown that heights up to 1,000 ft can be measured with an accuracy of about 5 ft. One result of particular interest is that double echoes are often obtained over wooded ground due to reflection from the tops of trees and the ground beneath. This enables the height of trees to be measured as well as the height of the aircraft.

The Physics Exhibition this year obviously showed that research and development establishments are really active in all facets of physics and in particular the electronics field. This brief report on some of the items being shown does indicate that much of the fundamental work going on is directed toward practical application in industry—long may it continue in this way.



Personal News

R. Telford of The Marconi Company Ltd. has been elected chairman of the Electronic Engineering Association. **R. J. Clayton** of G.E.C. (Electronics) Ltd. has been elected vice-chairman.

Welwyn Electric Ltd. announce the appointment of **R. H. W. Burkett** as managing director.

The B.B.C. has announced the appointment of **J. A. Fitzgerald, A.M.I.E.E.**, as head of engineering secretariat, to succeed **J. H. D. Ridley, M.B.E.**, who has retired.

Dr. David A. Jones has been appointed an assistant director of engineering of The English Electric Company Ltd.

W. R. Thomas, B.Sc., M.I.E.E., A.F.R.Ae.S., director of Elliott Space and Weapon Automation Ltd., has been appointed group chief scientist of Elliott-Automation Ltd.

David Ashworth has joined d-mac ltd. as applications engineer.

Edwin D. Birch has been appointed general manager of Ultra Electronics Ltd. He will have full responsibility for engineering, manufacturing and marketing for all the operating divisions of the company.

C. R. Wheeler, C.B.E., has been elected president of the B.E.A.M.A. The **Rt. Hon. Lord Nelson of Stafford** has been elected deputy president.

George Kent Ltd. announce that **B. D. Misselbrook**, a deputy chairman of the British American Tobacco Company Ltd., has been appointed to the board of directors. This move follows the recent proposed Kent acquisition of Evershed and Vignoles Ltd., in which B.A.T. hold a 91% controlling interest ; Mr. Misselbrook is chairman of Eversheds. He is also chairman of Mardon International Limited and a director of Wiggins Teape and Company Ltd., and British Sidac Ltd.

J. A. Hope has been appointed sales engineering manager of Oxley Developments Co. Ltd.

Taylor Instrument Companies (Europe) Ltd. have announced the appointment of **R. G. Robertson** to the board of the company as director of overseas sales. His duties will include responsibility for all agents and licensees as well as marketing and general liaison on behalf of the French and German associated companies.

R. G. Paterson, who was previously with the Ford Motor Company Ltd., has been appointed a director of G.E.C. (Telecommunications) Ltd.

C-E-I-R Ltd. announce the appointment of **Clive Wilkins** as publicity officer.

Keyswitch Relays Ltd. has appointed **S. D. Coombs** as chief development engineer.

N.S.F. Ltd. announce that **M. A. Hassid** has resigned his managing directorship but will continue as chairman. **K. G. Smith** and **P. C. D. Mace** have been appointed joint managing directors.

C.N.S. Instruments Ltd. announce the appointment of **K. H. Winchester** as their representative in London and the South East of England.

Hobson's Choice. *A large extension has recently been made to the analogue computing facilities of H. M. Hobson Ltd., the aircraft control system manufacturers, by the installation of six more EMIac II computer modules by EMI Electronics. Now consisting of ten modules, the system has been so arranged that several problems can be solved simultaneously on separate modules, or the complete installation can be controlled from one module when it is required to solve a single large problem. Typical of the wide range of problems on which the EMIac II computer is being used are control system simulation, power flying controls, and aircraft alternator drive systems. Recently introduced dual stabilized d.c. amplifiers and quarter-square multipliers give the complete installation an inherent capacity of between 300 and 400 computing units. These dual units are fully interchangeable with the single operational amplifiers, and the feature of not committing any space to a particular function has been retained while the capability of the complete system has been considerably extended*

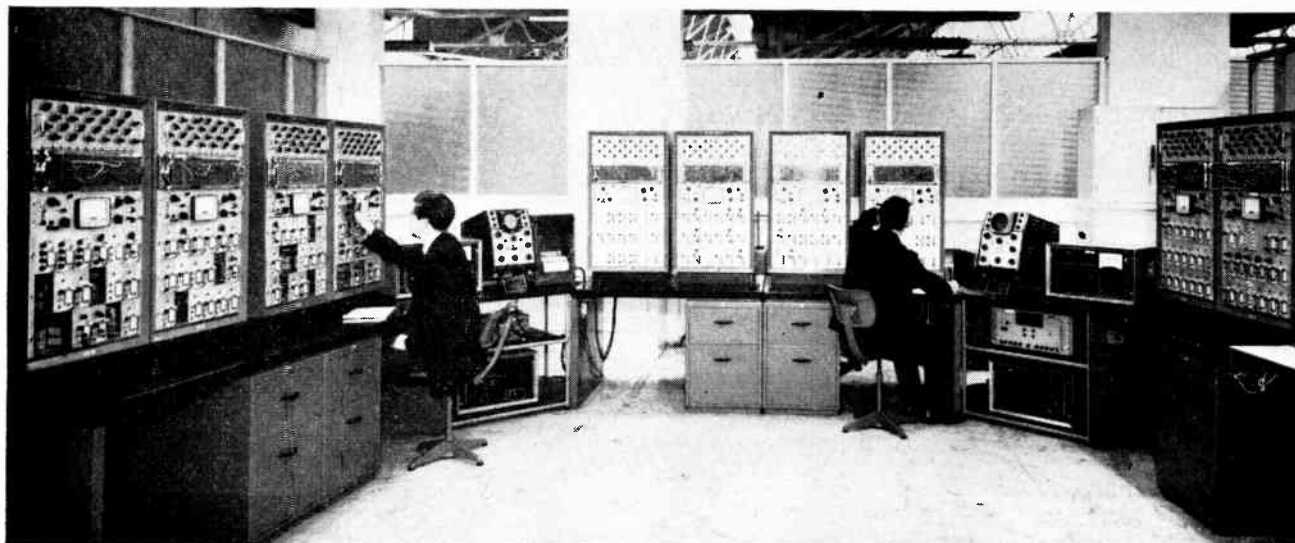



Masers at Goonhilly Amplify 'Early Bird' Signals. A close-up showing the top-plate assembly of one of a pair of masers built by scientists at the Mullard Research Laboratories for the G.P.O. Earth Station, Goonhilly Down, Cornwall. The masers are designed to amplify signals received from 'Early Bird' (HS303), the world's first commercial synchronous communications satellite, recently launched from Cape Kennedy. A superconducting magnet replaces the much larger permanent magnet used with the earlier (1962) maser installed at Goonhilly by the Laboratories for the Telstar programme. The new masers are believed to be the first in Europe operating with superconducting magnets. They operate at the temperature of liquid helium (-271°C) and are capable of amplifying signals of less than 10^{-13} W at frequencies of 4,160 Mc/s

Company News

The Commercial Division of **EMI Electronics Ltd.** has opened a branch office at Regent House, 30 Cannon Street, Manchester 4. (Telephone: Deansgate 6378/9). The newly-appointed manager is Mr. Roy Smith.

Electronic Services-STC is now the sales outlet for short runs of cable and wire manufactured by the STC Rubber and Plastic Cable Division. Many kinds of equipment wires and miniature coaxial cables are now available on 25, 50, 100 and 200-yard reels obtainable 'over-the-counter' or through same-day despatch. The address is Edinburgh Way, Harlow, Essex. Telephone: Harlow 26811. Telex: 81146.

Elliott-Automation Ltd. and **E. Leybold's Nachfolger K.G.** of Cologne announce that Elliott's holding in Leybold-Elliott Ltd. has been transferred to the Leybold Group. In view of the change of ownership, the name of the company has been changed to Leybold Vacuum Ltd., but its address and telephone number are unaltered.

In future, the operations of **The Plessey Co. Ltd.** in the U.K. will be re-aligned into five self-contained product groups under the single name Plessey: Plessey Automation, Plessey Components, Plessey Dynamics, Plessey Electronics and Plessey Telecommunications.

Hughes International (U.K.) Ltd. have moved their Sales Department from Kershaw House, Great West Road, Hounslow, to Heathrow House, Bath Road, Cranford, Middlesex.

The Automation Division of **The M.E.I. Equipment Co. Ltd.** has moved from Crawley to Stone Street, Waddon Factory Estate, Croydon, Surrey. Telephone: Municipal 4971. The change is temporary as the division is expected to return to Crawley at the end of 1965 when extensions to the company's main factory and offices will be completed.

Automatic Life-Testing of Transistors. Part of the equipment for the automatic life-testing of transistors at Associated Semiconductor Manufacturers Ltd., Southampton. Over 30,000 devices can be tested at any one time over periods of 1,000 or 10,000 hours; the results of the tests are fed to a computer which is programmed to produce the complete history of each sample

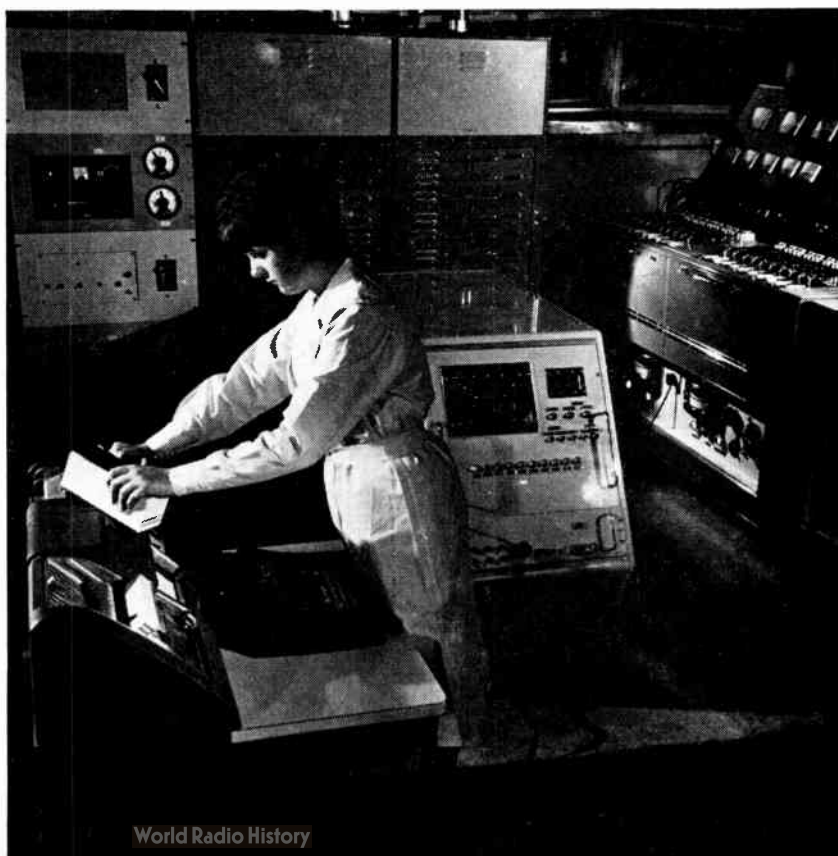

Sperry Gyroscope Co. Ltd. announce the appointment of a distributor in Nigeria for the products of their Data & Control and Components Groups: West African Associates Ltd., P.O. Box 38, Ikeja, Nigeria.

A company to be named **Dynamco Systems Ltd.** has been set up to manufacture and market data logging systems and associated instrumentation. It has been formed by the merging of the systems division of Digital Measurements Ltd. and Winston Electronics Ltd. The managing director will be Eric Rawlings.

Fisons Scientific Apparatus Ltd. have acquired the whole of the share capital of Gas Chromatography Ltd. and its wholly-owned subsidiary Scientific Industries International Inc. (U.K.) Ltd. W. A. Wiseman and H. Freedman, the respective founders of these two businesses, will continue in office as joint managing directors of Gas Chromatography Ltd. D. Sutton, managing director of Fisons Scientific Apparatus Ltd., and R. Allison, commercial director, have joined the board.

Litton Precision Products Ltd., the U.K. components division of Litton Industries Inc., have opened a London office at 503 Uxbridge Road, Hayes, Middlesex. Telephone: Hayes 8232.

The Medical Supply Association Group of Companies Ltd. have founded a new company, **Medical Electronics Ltd.**, under the joint managing directorship of Eric Ringwood and Peter Matthews, to undertake development projects of a medical nature and also to conduct research and manufacturing programmes for commerce and industry.

An agreement has been signed between **FieldTech Ltd.** and the Rockbestos Division of the Cerro Corporation of U.S.A. whereby FieldTech will market the products of the Rockbestos Wire and Cable Division in the United Kingdom.

Walker Crossweller & Co. Ltd. have announced a change in name of their wholly-owned subsidiary company, Arkon Manufacturing Co. Ltd. The company's new name will be **Arkon Instruments Ltd.** It now becomes a full trading concern, with responsibilities for marketing.

Townsend-Coates Ltd., Coleman Road, Leicester, have been appointed distributors of Weller Electric Corp. precision soldering equipment.

Painton & Co. Ltd. have acquired a majority shareholding in Electroprints Ltd., manufacturers of printed wiring. Painton's chairman, C. M. Benham, becomes chairman of Electroprints Ltd. and the other board members are: F. Salisbury, R. G. Kenwin, R. W. Addie and R. A. Aitken.

Vosper Ltd. have established a separate electrical division to offer comprehensive facilities for the design and manufacture of electrical and electronic control equipment for industry as well as for marine applications.

C. A. Norgren Ltd. and associate companies, Herbert Grange & Co. Ltd., Shipston Engineering Co. Ltd. and Sundstrand Sanders Ltd., have now moved their London office from 39 Eccleston Square, S.W.1, to 192-198 Vauxhall Bridge Road, S.W.1. The telephone number remains unchanged.

Firth Cleveland Expansion in Europe

Firth Cleveland Fastenings Limited are reorganizing and expanding their European manufacturing and marketing organizations.

For the E.F.T.A. countries, a new company has been formed, Firth Cleveland Fastenings Scandinavia A/B with its head office at Stockholm,

Sweden. Comprehensive stocks of Firth Cleveland's fastenings products are available at Stockholm to ensure that orders are promptly delivered.

The Common Market countries of Holland, Germany and Belgium will now be served by another new associated company, Firth Cleveland Fastenings Europa N.V. Its sales headquarters and manufacturing plant are at Naarden in Holland with additional warehousing facilities in Amsterdam. Branch sales offices and sales personnel will continue to be located at Mannheim in Germany and Brussels in Belgium.

Radio Interference Suppression Service Expands

Standard Telephone and Cables Ltd. has expanded its service for the measurement and suppression of radio

interference in industry. New screened rooms, extra staff, new equipment and facilities for on-site testing have been added to the service which covers aircraft, marine and industrial equipment and installations.

The STC interference suppression service is equipped and staffed to offer a comprehensive service to all relevant NATO and MIL specifications. The service is backed by the manufacture of separate ranges of suppression capacitors for aircraft, ships and general industry. In this way the equipment manufacturer and the user can obtain suppressors in the right price range for the job.

Details of the service are available from STC Capacitor Division, Brixham Road, Paignton, Devon, or from the London Sales Office at Footscray, Sidcup, Kent. (Telephone: Paignton 58685; Footscray 3333, Telex 21836.)

For further information circle 92 on Service Card

Seacat Missile Simulator. *This picture, taken inside a simulator for the Short Seacat guided missile, shows the aiming stand and the overhanging projection system. The Seacat simulator was originally built by Short's Precision Engineering Division for use by the guided-weapons design team during Seacat's development stage. The production version consists of a fully-equipped missile-aiming stand situated at the centre of a 30-ft diameter hemispherical dome. A moving image of an attacking aircraft is projected on to the inside surface of the dome, and the trainee aimer observes this image through his binoculars and guides a light spot, representing the missile in flight, to intercept it. Electronic computing equipment processes the control signals from the trainee's joystick and causes the missile image to respond in exactly the same way as would a real missile. The platform on which the aiming stand is mounted rocks about as would an actual ship, and realistic sound effects are provided. One of these simulators has already been supplied to the Royal Navy, and three more are on order*

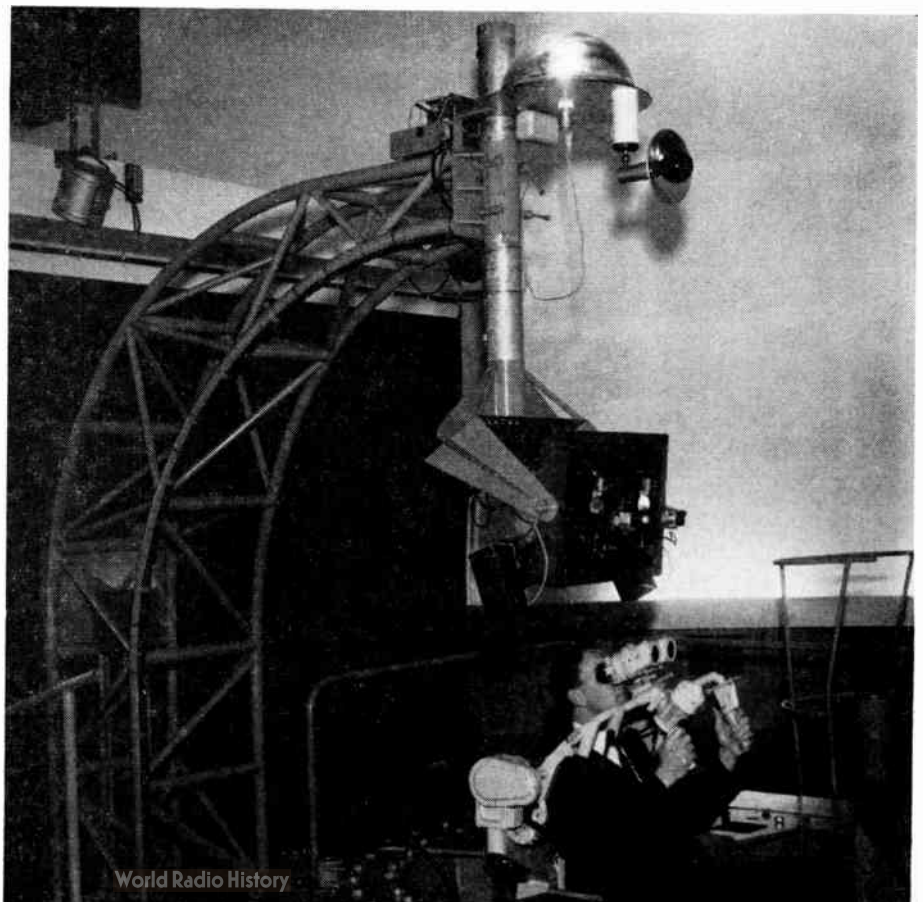

Ship Data-Loggers for Hire

Marine electronic data-loggers manufactured by English Electric-Leo-Marconi Computers are now also available to shipowners on rental maintenance terms from The Marconi International Marine Co. Ltd. Marconi Marine will also offer maintenance contracts for vessels with data logging supplied direct by the manufacturers.

In future the experience of English Electric-Leo-Marconi in data loggers and computers will be backed up, for marine purposes, by established Marconi Marine service depots in the United Kingdom and overseas as well as by those of certain of Marconi Marine's associated companies in other countries as training of technical personnel progresses.

To this end arrangements are already in hand to provide full training courses at the Kidsgrove works of English Electric for technicians of Marconi Marine and the selected associated

companies overseas to acquaint them with the techniques of data logging and the servicing that may be required. In addition, where rental-maintenance or maintenance contracts exist, Marconi Marine radio officers appointed to vessels fitted with English Electric-Leo-Marconi data logging installations will undergo training at Kidsgrove to enable them to carry out routine servicing work on the equipment at sea.

For further information circle 93 on Service Card

Gold Reclamation Service

In view of the exceptional demand for gold and its widespread use in the electronics and jewellery industries, P.M.D. Chemicals Ltd. of Coventry have set up a new service for the reclamation of gold from scrap transistors, diodes, plugs and sockets, printed circuits, watches and spent solutions.

P.M.D. have had many years of experience in applying precious-metal refining methods, and the general service which they are now offering is backed up by the most modern techniques. These include the use of special strippers for removing precious metal from any components, and the purification of precious metal solutions by the use of ion-exchange resins. A range of these are used including weak-base and strong-base exchange resins, either in the anionic or cationic form, which are capable of extracting precious metal from either acid or alkaline solutions.

The increase in price of precious metals over the last 12 months has highlighted the need for this new reclamation service, which, it is anticipated, will eventually be extended to include other precious metals such as rhodium, platinum, silver and palladium.

For further information circle 94 on Service Card

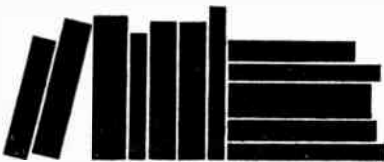

NEW BOOKS

The Design and Use of Electronic Analogue Computers

By C. P. GILBERT, M.Sc., A.M.I.E.E. Pp. 528 + xv. Chapman & Hall Ltd., 11 New Fetter Lane, London, E.C.4. Price 105s.

This book is divided into eight main sections, viz., introduction, the behaviour of operational computing circuits, computing amplifier design, the solution of differential equations, auxiliary computing equipment, computer construction, general techniques and applications. Each section is divided into a considerable number of sub-sections.

The reader is expected to have at least some familiarity with electronic circuitry and an elementary knowledge of the Laplace transform. Granted these things the reader should have little difficulty in understanding the book. The treatment is thorough and by no means highly mathematical; and it is well suited to the serious student. The emphasis is on small analogue computers.

The circuits treated are almost exclusively valve circuits. Some will no doubt consider that this dates the book, but since the emphasis is on small computers, the retention of the valve is not necessarily inappropriate.

An Introduction to Numerical Control of Machine Tools

By O. S. PUCKLE, M.B.E., M.I.E.E., and J. R. ARROWSMITH, B.Sc., A.M.I.E.E. Pp. 272 + xv. Chapman & Hall Ltd., 11 New Fetter Lane, London, E.C.4. Price 45s.

Since the subject is an exceedingly complex one, one cannot expect that in under 300 pages any complete and detailed treatment can be given. On the other hand, the book is much more than an elementary survey. It gives a

serious and factual treatment and should be exceedingly useful to thinking people to whom the subject is unfamiliar.

Only quite elementary mathematics is used and then only in the chapters dealing with data preparation.

List of U.K. Equipment CSA Approved: 5th Edition

Pp. 46. Published by BSI/CSA Agency and available from British Standards House, 2 Park Street, London, W.1. Price 6s.

Up-to-date information on U.K. electrical equipment approved for export to Canada is contained in this new edition (PD1870) of the list of U.K. equipment CSA approved which is issued by the British Standards Institution.

Since 1950, the BSI has operated an agency service in collaboration with the Canadian Standards Association to promote the acceptance of certain types of equipment exported from the U.K. to Canada. (To be accepted under Canadian law, all electrical equipment must receive CSA approval.) The BSI/CSA agency—situated at the BSI Hemel Hempstead test centre—carries out testing and inspection in this country and submits the required information to the Canadian Standards Association.

The fifth edition of the booklet now published provides a classified list of electrically-operated equipment manufactured in the U.K. and approved by the CSA, with names and addresses of the manufacturers holding approval. The publication is circulated to CSA agencies throughout the world and is made available to interested Canadian purchasers.

Cold Cathode Tube Circuit Design

By D. M. NEALE, B.Sc., A.M.I.E.E. Pp. 259 + viii. Chapman & Hall Ltd., 11 New Fetter Lane, London, E.C.4. Price 45s.

This is primarily a book for the designer of circuits in which cold-cathode tubes are to be used. It starts by describing the nature of a gas discharge and goes on to explain the various types of gas-discharge tubes. Diodes, stabilizers and reference tubes are then treated, followed by trigger tubes with their circuits and applications. Arc discharge, stepping, register and display tubes are covered.

The ordinary mathematics of circuit design is freely used and considerable attention is paid to the limiting values of components. The book is one which should be invaluable to the designer.

Methods for Measuring and Expressing the Performance of Audio-Frequency Amplifiers

B.S. 3860:1965. Pp. 20. British Standards Institution, 2 Park Street, London, W.1. Price 6s.

Monophonic and stereophonic audio-frequency amplifiers—suitable for domestic, public address and similar systems—are now covered by this British Standard. In B.S. 3860 methods are given for measuring and expressing the performance of these amplifiers, operating from d.c. or a.c. mains supply from a primary or secondary battery or from a combination of these.

The standard covers equipment employing valves, transistors or a combination of both for sound amplification, but excludes the signal generating source—for instance, a gramophone pick-up, microphone or tape deck—and loudspeakers. Separate methods are included where appropriate for measurements on pre-amplifiers, power amplifiers, and integrated amplifiers in which the pre-amplifier and power amplifier are constructed as one unit.

The contents include measurements of distortion, sensitivity, gain, frequency response, hum, noise and stability.

Excitation Control

By G. M. ULANOV. Pp. 100 + ix. Pergamon Press Ltd., Headington Hill Hall, Oxford. Price 30s.

This little book is a translation from the Russian and has only four chapters, introduction, principal types of automatic control systems and measuring devices operating on excitation, elements of the theory of automatic control system operating on excitation, and examples of calculations in respect of combined tracing systems and automatic control systems.

It is tough reading because the material is highly condensed and the exposition is far from clear. It is, of course, uncertain whether this is the fault of the original author or of the translator. It is, in fact, quite difficult to find out just what is meant by excitation control. The author states that 'The principle of compounding in electrical machines is one of the oldest examples of excitation compensation in electrically operated systems'. Most of the systems described appear to be based on combinations of open-loop and closed-loop control.

INFORMATION WANTED ?

If you require further details of products or processes described or advertised in INDUSTRIAL ELECTRONICS you will find it convenient to use the enquiry cards which will be found immediately preceding page 243. The sheet of cards can be folded out to enable you to make entries while studying the editorial and advertisement pages.

Manufacturers' Literature

ISEP. From S.T.C., this 12-page brochure (MG/104) gives a concise description of the ISEP (International Standard Equipment Practice) system of modular construction for electronic equipment housings. Diagrams and photographs explain the versatility of the ISEP system. These show how, with standardized parts, the user can build a multiplicity of sizes of racking, sub-assemblies, circuit boards, multi-pole connectors and cubicles.

Standard Telephones & Cables Ltd., Electronic Services Division, Edinburgh Way, Harlow, Essex.

For further information circle 95 on Service Card

Telcalloy & Telconstan Copper-Nickel Resistance Alloys. An 8-page publication No. TP15-165, giving technical data relating to Telcalloy 1, 1.5, 2, 3 and 4. Telconstan and Thermocouple Telconstan copper-nickel resistance wires, foil and strip, is available from

Telcon Metals Ltd., Manor Royal, Crawley, Sussex.

For further information circle 96 on Service Card

Silver Star Capacitors. This revised series of data sheets provides detailed information on the standard range of Silver Star capacitors. For the two qualification approved types, A22Q and A34Q, preferred and permissible values of capacitance are listed against the latest NATO stock numbers and joint service catalogue numbers.

Johnson, Matthey & Co. Ltd., 73-83 Hatton Garden, London, E.C.1.

For further information circle 97 on Service Card

Teleshift. A frequency-shift signalling system for transmitting control and supervisory signals over land lines, telephone lines, microwave and radio links, etc., is described in a 4-page folder IC/TT/2 available from

G.E.C. (Electronics) Ltd., East Lane, Wembley, Middlesex.

For further information circle 98 on Service Card

Cable Testing and Maintenance Service. This 16-page illustrated booklet, which includes a list of outside testing depots in the U.K. with the names of the engineers and their telephone numbers, describes the cable testing and maintenance service operated by

British Insulated Callender's Construction Co. Ltd., P.O. Box 108, 30 Leicester Square, London, W.C.2.

For further information circle 99 on Service Card

Guide to Brooksmeter Application. Basic information on Brooksmeter variable-area flowmeters and their applications is included in this 10-page technical bulletin 6311-T-001, which covers purge, general-purpose, armoured, straight-through flow and by-pass units. Information is also presented on viscosity effects and sizing for various applications and fluids.

Brooks Instrument N.V., Veenendaal, Holland.

For further information circle 100 on Service Card

Image Orthicon Television Camera. A 2-page pamphlet No. 1427a describes (in English, French, German and Italian) a fully-transistorized image orthicon television camera designed for use in unfavourable environments and in conditions of poor illumination. It is available from

Barr & Stroud Ltd., Kinnaird House, 1 Pall Mall East, London, S.W.1.

For further information circle 101 on Service Card

More Eccosorb Anechoic Chambers. Several high-performance anechoic chambers designed by Emerson & Cuming, Inc., are described in this 4-page illustrated brochure available from *Systems Engineering Services Ltd., 35-39 South Ealing Road, London, W.5.*

For further information circle 102 on Service Card

SEE THESE ON STAND 224 AT THE R.E.C.M.F.

PAINTON METAL OXIDE RESISTORS now available for quick delivery

Laboratory testing has reached

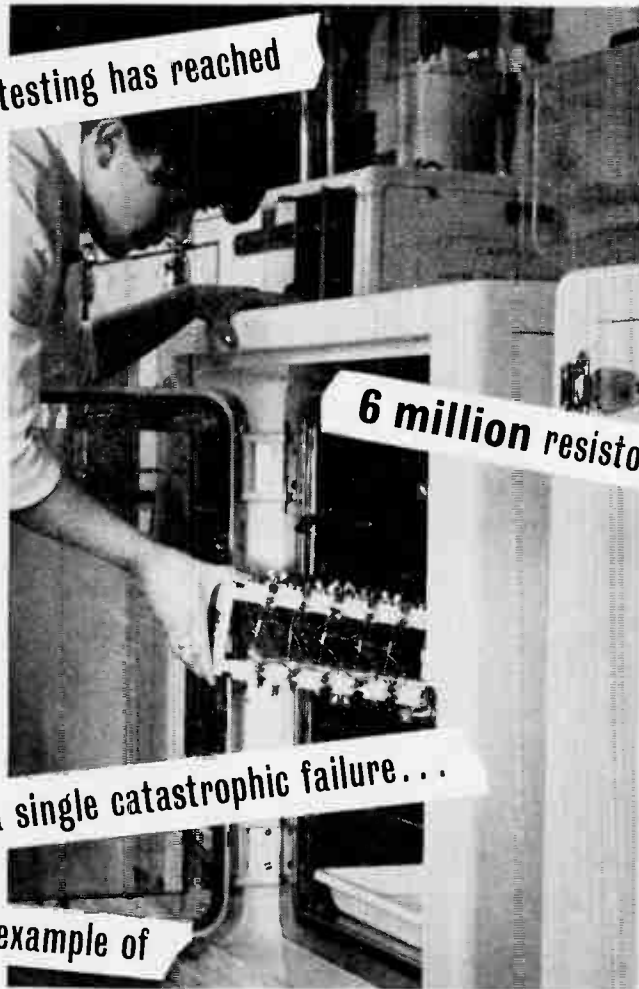

6 million resistor hours

without a single catastrophic failure...

another example of

PAINTON RELIABILITY

Write for leaflet MO/1

Painton

& CO. LIMITED

KINGSTHORPE · NORTHAMPTON

Tel: 34251 (10 lines) · Telex 31576 · Grams: 'Ceil' Northampton

Overseas Associated Companies Australia Painton Australia Pty. Ltd. · Benelux Painton S.A. · Germany Painton G.m.b.H.
Italy Painton Italiana · Sweden Svenska Painton A.B. · U.S.A. Painton Inc.

**RADIO
&
ELECTRONIC
COMPONENT
SHOW**

OLYMPIA LONDON 18-21 MAY

Sponsored by the
Radio & Electronic Component Manufacturers' Federation



BIG BUSINESS in small pieces

British radio and electronic equipment is world-famed. But it can never be better than the components that go into it.

Fresh techniques in the component industry, new materials, more sophisticated test instruments and smaller-than-ever micro-miniaturisation are all to be seen at the Radio and Electronic Component Show at Olympia — Britain's only major electronic show this year — from May 18th to 21st.

It is the biggest, widest-interest show of its kind. Three hundred exhibitors demonstrate the scientific and engineering progress which has rocketed our component exports 13 per cent this year.

A record 50,000 visitors from 70 countries saw the last component show. This year's exhibition, 20 per cent larger and even more comprehensive in scope, is the show that every buyer, engineer and scientist must see.

Exhibits include . . .

...components, accessories, valves, cathode-ray tubes, semi-conductors, instruments, test gear, materials, machinery and tools for:

- Professional & scientific electronic equipment
- Process control, industrial electronics & automation
- Nucleonic & atomic power control apparatus
- Civil & military ground & air equipment
- Medical & biological electronic & allied apparatus
- Radar & navigational aids
- Guided missile & spacecraft equipment
- Electronic computers & data handling equipment
- Telecommunications equipment
- Radio & television receivers
- Tape recorders, record reproducers, film equipment
- Amplifiers, tuners & "hi-fi"
- Measuring instruments & test gear

TIMES: 10 am - 6 pm DAILY

ADMISSION: 5/- or by ticket available only from exhibitors.
Foreign visitors free

AN **IEE** EXHIBITION

INDUSTRIAL EXHIBITIONS LIMITED 9 ARGYLL STREET LONDON W1

**Contactor
Type C.2839**
(Patent applied for)

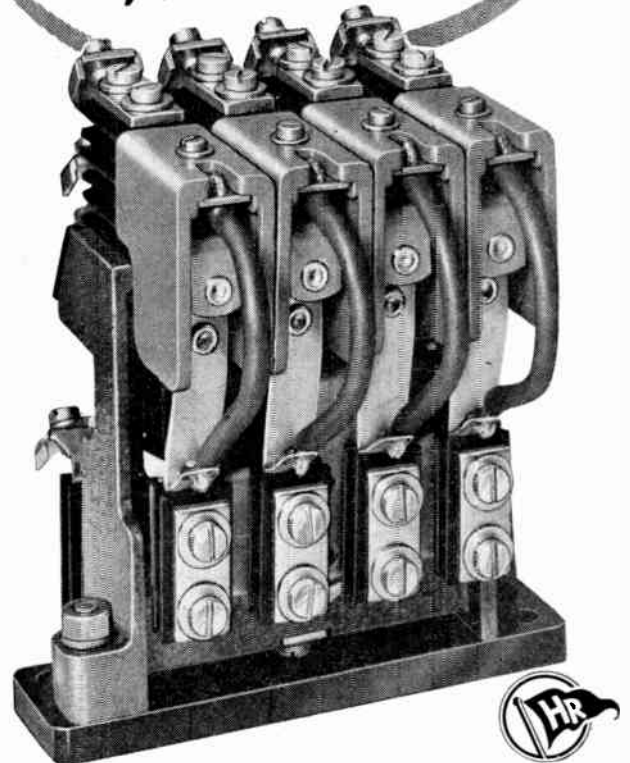

Produced with four important features in mind:

1. Maximum life and reliability
2. Low cost
3. Silent operation
4. Minimum overall size

Intended for use in applications where space is at a premium and for the control of medium power circuits up to 440v. A.C.

Hendrey Relays

See 'Hendrey' Relays and Instruments on Stand No. 503, at the R.E.C.S., Olympia, May 18th — 21st.

HENDREY RELAYS LIMITED
390-394 BATH ROAD, SLOUGH, BUCKS.

Tel.: Burnham 609/612

Telegrams: Hendrelay, Slough

MANUFACTURING ELECTRICAL ENGINEERS
CONTROL AND LABORATORY APPARATUS
A.R.B. and M.O.A. APPROVED DESIGN & INSPECTION

Perivale Controls

range of
**MINIATURE
PLUG-IN
RELAYS**

Light Current and Heavy Duty Types

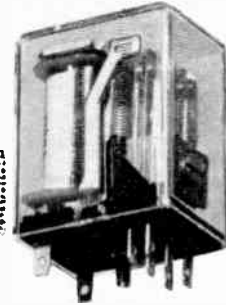

PC 2. Relay
with Socket

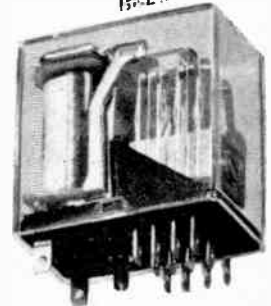
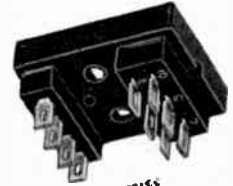

PC 4. Relay
with Socket

Features

PC Relays are superb in the applications for which they have been designed, including :

- ★ Complete interchangeability with most relays of foreign manufacture.
- ★ Operational accuracy derived from unique setting techniques.
- ★ High quality but competitive prices.
- ★ Speedy delivery even for specials.

Specials

Flexibility of design is such that special derivatives seldom present a problem. Speedy delivery is offered as a service and enquiries for small or large quantities are invited.

Standards

Over 100 different standard types for diverse applications. Designed for long term reliability and cost economy PC Miniature Plug-in Relays have standard operating voltages in the range 4 volts to 140 volts D.C. with a wide tolerance on nominal, and a myriad of contact configurations allowing for single or multiple operations in various combinations of make/break/changeover.

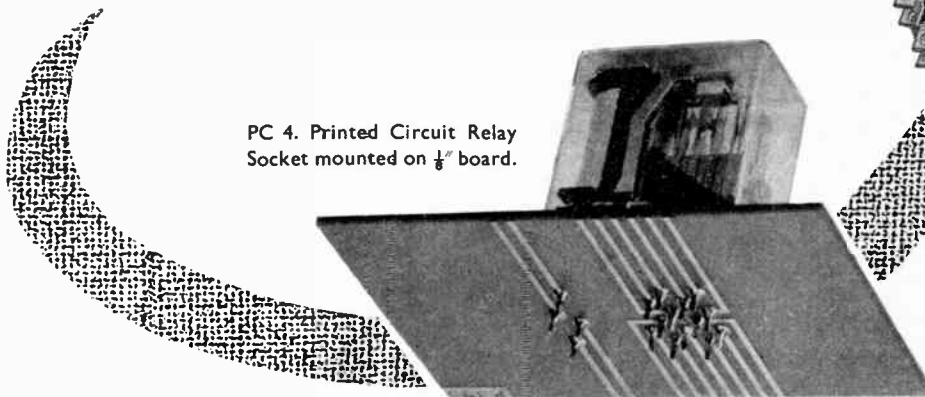

PC 4. Printed Circuit Relay
Socket mounted on $\frac{1}{8}$ " board.

PERIVALE CONTROLS COMPANY, LIMITED

40 TELFORD WAY · EAST ACTON · W. 3.

A **DAVALL** Instrumentation Company

SHEPHERDS BUSH 1015 (5 Lines)

NEW VALVE TESTER FROM TAYLORS MODEL 45D

This completely new valve tester from Taylor Electrical Instruments caters for every known type of electronic valve with up to 12 pins at a maximum power dissipation of 25 watts.

Ten valve holders are incorporated, including bases for the latest types such as 'Compatron' and 'Nuvistor.' A special B14E base is included to accept a range of Plug-in adaptors which will be made available to cover new or obsolete bases not incorporated. An adaptor can also be supplied to enable tests on most television tubes to be carried out without removing the tube.

The Model 45D offers an entirely new method of circuit selection, giving the advantage of being able to independently switch any of the valve pins to any electrode function.

The instrument is mounted in a smart metal case, finished with aluminium escutcheons, and is supplied complete with an instruction book and a valve data manual containing full testing data on over 7,000 valves and television tubes.

Write or phone today for leaflet.



TAYLOR ELECTRICAL INSTRUMENTS LIMITED

MONTROSE AVENUE, SLOUGH, BUCKS. TELEPHONE: SLOUGH 21381



For further information circle 274 on Service Card

INEXPENSIVE & RELIABLE

Remember the name — EMI Shaded 2 Pole Motor Type Z. Consider the reliability — over 3,000 hours running without re-oiling — able to withstand continuous mechanical overload. Send for the Type Z data sheet.

■ Geared motor — approximate speeds 2,900 r.p.m. geared down to 16 r.p.m. ■ Low resistance rotor with copper bars and end plates. ■ Rotor has critically skewed bars for smooth running — dynamically balanced to special limits where required. ■ Sizes approx. 2½" x 3" x 1½". ■ Weight 17½ oz. (standard), 21 oz. (Long Bearing A Motor). ■ Low mechanical noise — no electrical interference.

EMI SHADED 2 POLE AC MOTORS

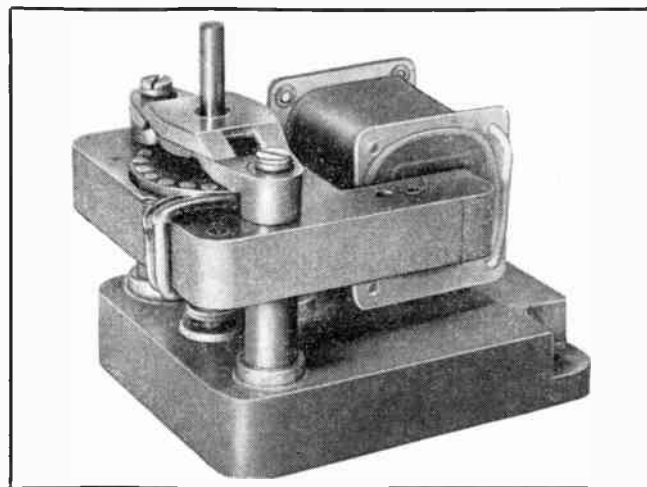

Full details from:—
EMI SOUND PRODUCTS LIMITED, COMPONENTS DIVISION, HAYES
MIDDLESEX. TEL.: HAYES 3888 · EXT. 2515

For further information circle 275 on Service Card



the world's guide
to the British
plastics industry

British Plastics YEAR BOOK 1965

The recognised guide to the plastics industry—its products, suppliers, materials, leading executives. Carefully revised for this 35th edition, it is complete, compact and fully up-to-date. It makes precise information on any aspect of the industry available to you at a moment's notice.

The information is contained under 11 sections: General: Materials: Manufactured Products: Services: Plant: Trade Names: U.K. Addresses: Overseas Addresses: Who's Who: Technical Data: Indexes.

50s net by post 52s 6d 9¼ ins. x 6¼ ins. 650 pp.

obtainable from leading booksellers

Published for British Plastics by
ILIFFE Books Ltd.
DORSET HOUSE STAMFORD STREET LONDON S.E.1

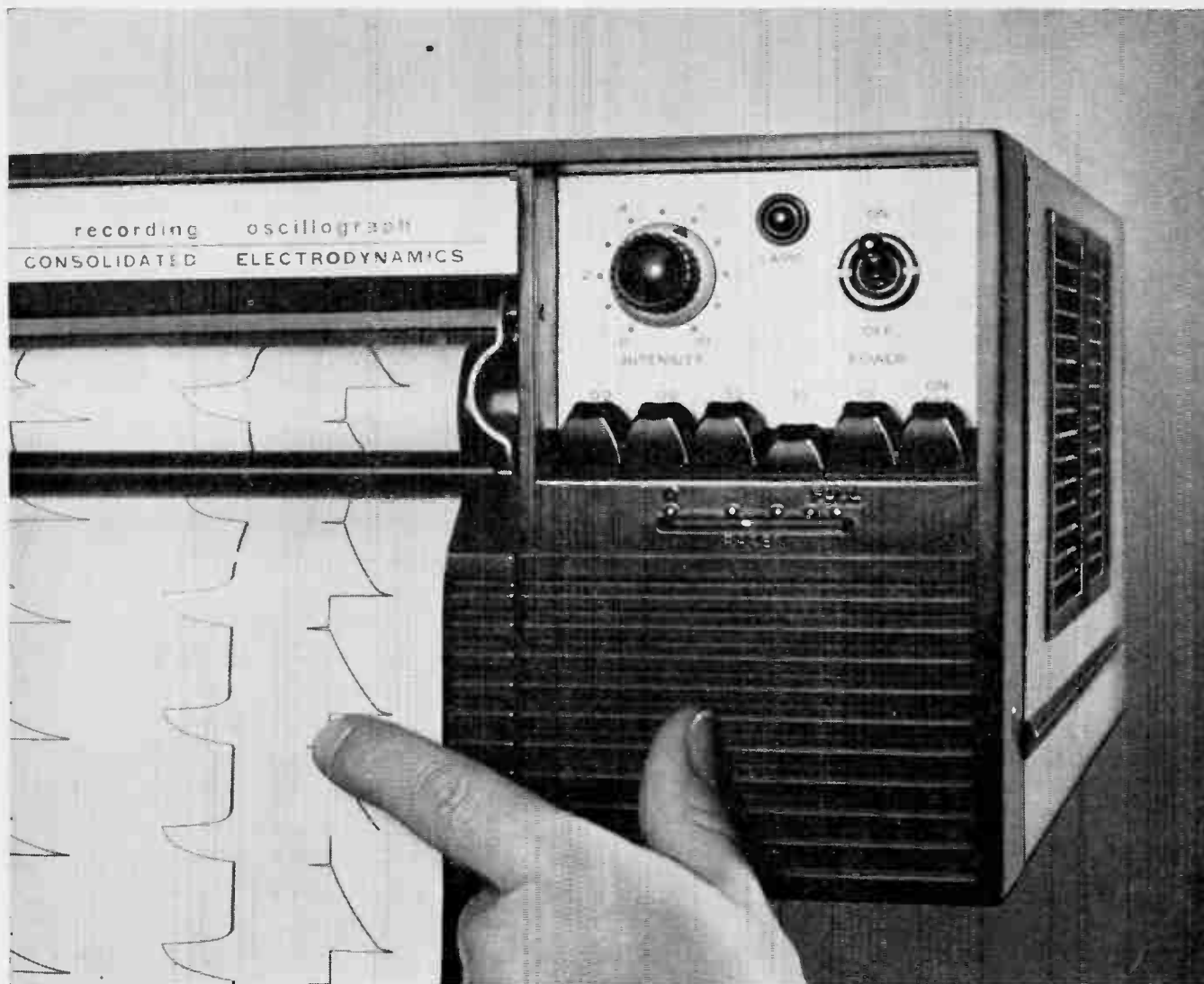

Big recorder capabilities in a package this small?

YES! Consolidated Electro Dynamics' 5-124 direct print U.V. oscillograph has a wide range of features which, coupled with its small size, make it a natural choice for environments where versatility and portability are important. The 5-124 measures just 7½" x 13" x 15¼" and weighs only 40 lbs. Yet, it can record data from d-c to 13,000 cps on 18 channels using standard Consolidated Electro Dynamics 7-300 series galvanometers . . . is capable of writing speeds up to 50,000 inches per second on 7-inch wide records . . . and has five record speeds instantly selected by pushbutton. Furthermore, it can

be loaded in just 10 seconds and is simple to operate. Simplicity of this recorder means reliability. It seldom needs maintenance.

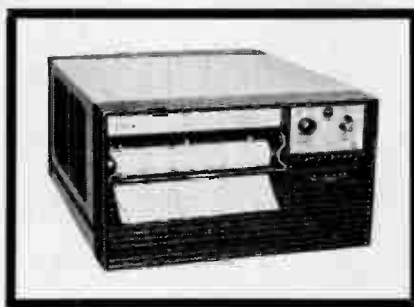

No record magazine is required, thereby eliminating spindles or the need for paper threading. Modular construction—all four basic modules being exposed by removal of the cover—for ease of inspection. Optional accessories include: Automatically exposed grid line system and trace interruption; trace numbering; a full-record-width electronic flash timing system; heated galvo block; special slow and higher record speeds; and record take-up unit.

For further information, write for Bulletin 5124. For rapid delivery, call Mr. R. T. Lancaster.

Consolidated Electro Dynamics

A division of BELL & HOWELL LIMITED

14 Commercial Road, Woking, Surrey. Telephone: Woking 5633

WESTON—FOREMOST FOR MOVING COIL RELAYS

MODEL S 170 for control applications

The Model S 170, permanent magnet moving coil relay. Combines extreme sensitivity with high precision. It is eminently suitable for control applications when a relay operating within close tolerances is necessary. The minimum signal current is 5 mic A. d.c.; shunts and series resistors can be incorporated for currents and voltages up to 5 A and 250 V d.c.



MODELS S 124 a miniature alarm relay with "hold-on" contacts

The Model S 124 is of the permanent magnet moving coil type and can be supplied to operate on currents as low as 2 mic A. d.c. High contact pressure is ensured by magnetic attraction between the contacts; these will "hold-on" until reset manually or by remote electrical control. Front-of-panel and flush mounting relays are available.



MODEL S 115 a miniature switching relay

The Model S 115 functions as an "on-off" switching relay and is supplied for operating currents down to 50 mic A. d.c. Single and double coil windings are available. The relay can be mounted in any position and is magnetically self-shielding. The space occupied on the chassis is only 1½ in. x ¾ in.; weight, 1¼ oz.

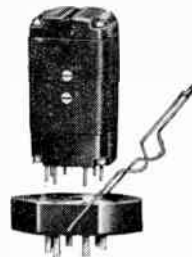

For full details of the Weston range of relays, please write to:—

SANGAMO WESTON LIMITED · ENFIELD · MIDDLESEX

Telephone: Enfield 3434 (6 lines) & 1242 (6 lines). Gram: Sanweat, Enfield

For further information circle 278 on Service Card



**ROTARY STUD SWITCHES
ATTENUATORS
PLUGS AND SOCKETS
P.C. COMPONENTS
RESISTORS
FADERS**

ELCOM

**COMPLETE SOUND EQUIPMENT
COMPENSATING AMPLIFIERS
MICROPHONE AMPLIFIERS**

**ELCOM (NORTHAMPTON) LTD.
WEEDON ROAD INDUSTRIAL ESTATE
NORTHAMPTON PHONE 51873-5**

**WRITE FOR SPECIFICATIONS
AND DETAILS OF
OUR COMPLETE RANGE**



between

5pF and 250,000pF

your choice is easy...

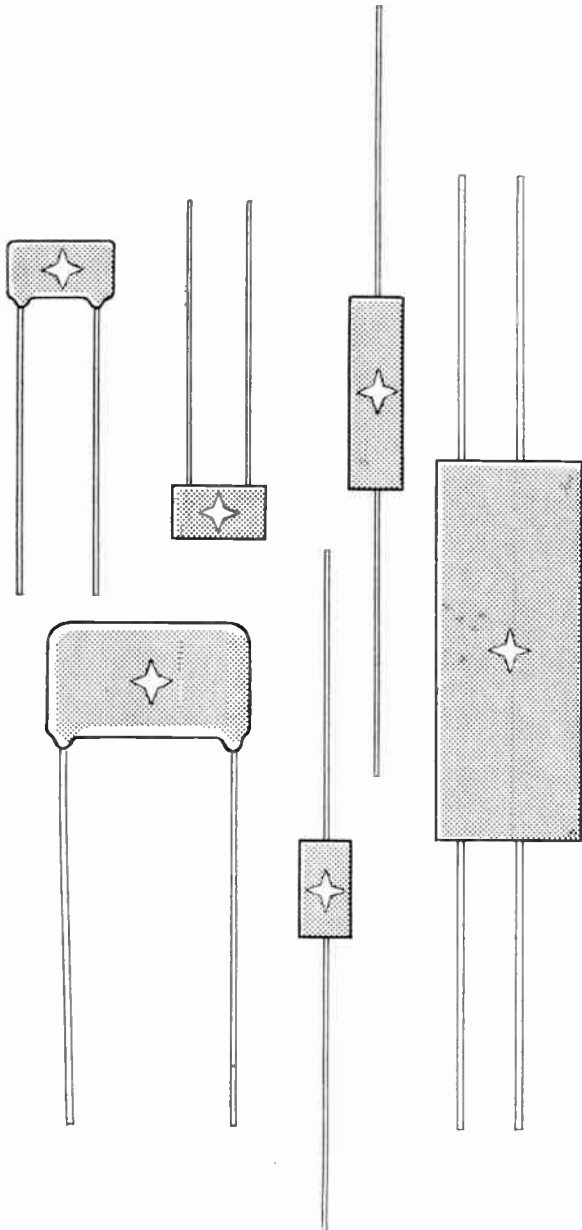

SILVER STAR CAPACITORS

cover all your needs

The standard range of Silver Star® capacitors contains a wide variety of sizes in encapsulated or dipped finishes. Your needs are covered, for any nominal capacitance value between 5 and 250,000 pF can be supplied—generally with a tolerance as close as $\pm 0.5\%$.

All Silver Star capacitors are of fired construction giving them unrivalled stability. A rigid system of process control throughout manufacture ensures that their outstanding electrical properties are consistently maintained.

In addition, every Silver Star capacitor is checked before we send it to you for four critical characteristics—capacitance, power factor, proof voltage and insulation resistance. Only components that meet the stringent Silver Star standards are supplied.



You can choose your requirements with these free data sheets. Just ask for them.

Johnson Matthey

JOHNSON, MATTHEY & CO., LIMITED
73-83 HATTON GARDEN, LONDON, E.C.1

Telephone: Holborn 6989

Telex: 21465

Vittoria Street, Birmingham, 1
75-79 Eyre Street, Sheffield, 1

Telephone: Central 8004
Telephone: 29212

GD 131

**MICRO-MINIATURE
ELAPSED
TIME AND
EVENTS
INDICATORS**

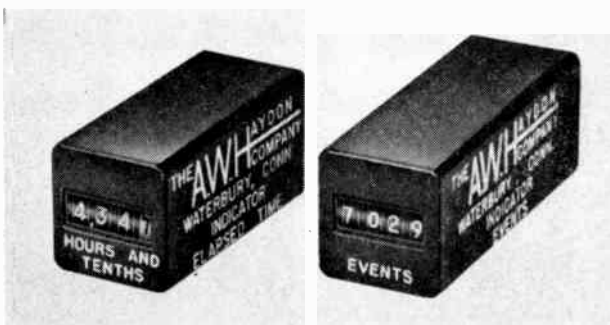

THE **A.W.H. AYDON COMPANY** elapsed time and events indicators are particularly intended for the aircraft and missile industry because of their small size and weight, ruggedness and wide operating temperature range.

Series	Elapsed Time Indicator		Events Indicator
	19200	19200 D	19500
Voltage	115v, 400cps	23-29v. D.C.	115v, 400cps or 23-29v. D.C.
Power Input	0.5W. max.	0.5W. max.	1.5W. max.
Weight	$\frac{3}{4}$ oz.	$\frac{3}{4}$ oz.	$\frac{3}{4}$ oz.
Size	$\frac{1}{2}$ " x $\frac{1}{2}$ " x $1\frac{1}{16}$ "		$\frac{1}{2}$ " x $\frac{1}{2}$ " x $1\frac{5}{16}$ "
High Temperature	85°C or 125°C		
Low Temperature	-54°C or -65°C		
Shock	200G, 2.5 m.secs.		
Vibration	20G, 10-2000 cps		
Acceleration	50G		10G

WALMORE
ELECTRONICS LTD

11-15 BETTERTON ST., DRURY LANE, LONDON, WC2 Tel: TEMple Bar 0201-5

**TSV
POWER SUPPLY UNITS**

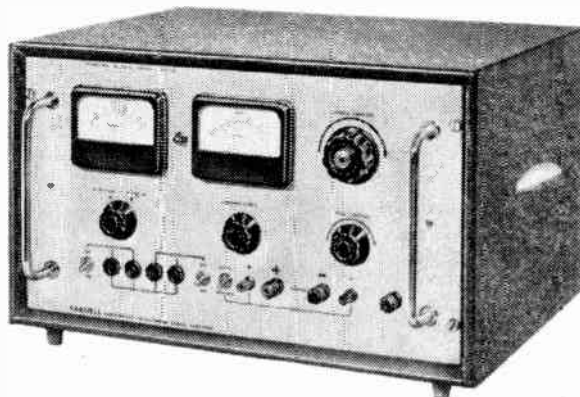

TSV 70

Highly stabilised voltage supply unit. Two ranges 0-70V at 5 amperes or 0-35V at 10 amperes.

Overload and short circuit proof. Remote sensing facilities. One control covering full voltage output on each range. Rack mounting version available.

U.K. PRICE £182

TSV 30/5CL

Output voltage continuously adjustable over the range 0-30 volts, maximum current 5 amp.

Current limiting overload protection automatically reset on removal of overload. Remote sensing facilities.

U.K. PRICE £100

TSV 30T/2CL

Compact twin power unit providing two highly stabilised D.C. voltage outputs. Each output 0-30 volts (adjustable), maximum current 2 amp.

Current limiting overload protection automatically reset on removal of overload. Simultaneous positive and negative supplies. Outputs can be series connected. Rack mounting version available.

U.K. PRICE £150

The ability and knowledge of highly trained electronic and mechanical engineers has produced this range of stabilised voltage supply units.

Sales engineers are based throughout the country, and will be pleased to call and discuss these instruments, and any other requirements in the power supply field.

For full detailed specifications write to:—

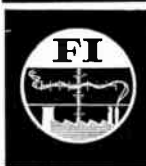

FARNELL INSTRUMENTS LIMITED

SANDBECK WAY · WETHERBY · YORKS.

Telephone 2691/2/3/4

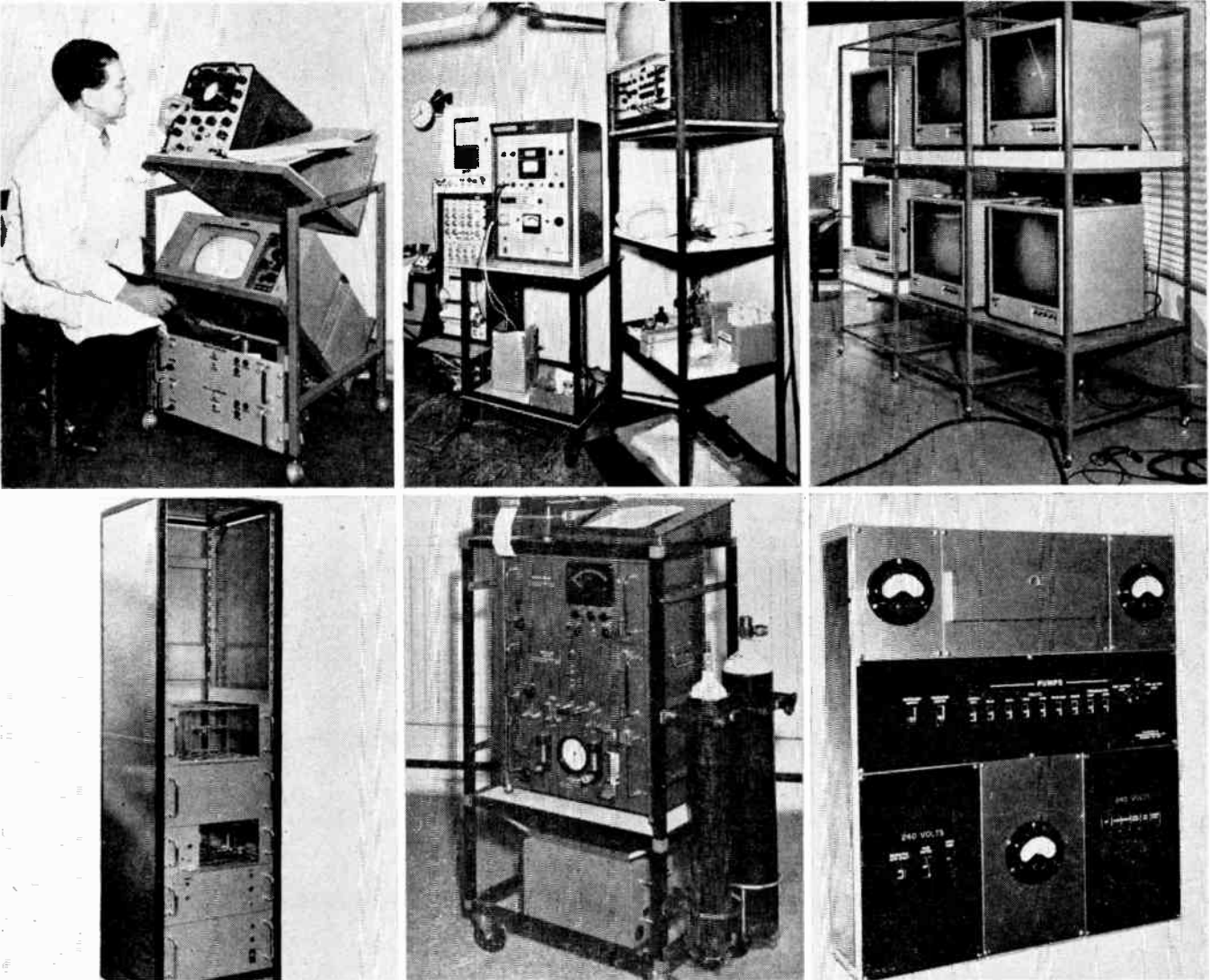

clean, simple – look terrific

What's that? Structures made with Dexion Speedframe system.

What's it for? Test consoles and benches; trolleys, switchgear mountings, monitor stands; one-off work units or complete furnishing and equipment projects.

What's it do? Gives any-size, rigid square-tube frames in moments (not confined to 90° angles). Tailor-made for every project, yet costs less than ready-made frames!

What's the catch?

No catch. No welding, bolting, finishing, painting or skill either.

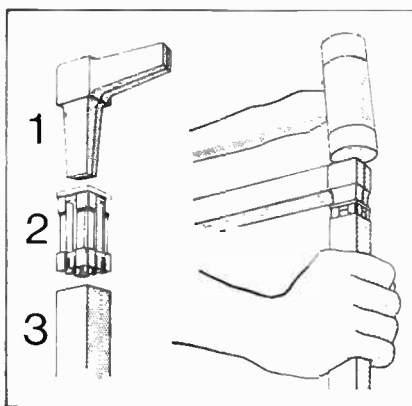

What's it need? Very little money to buy it. Perhaps a hack-saw to cut it. A mallet to knock it together.

The Speedframe joint:

Made up of three simple components
1. casting which, when hammered into the tube, is wedged by an
2. insert which in turn jams tight inside the
3. tube to keep the joint weld-firm.

You could do with Speedframe in your next project. We'll be delighted to send you material specifications, fresh ideas on Speedframe in electronics, further details of Dexion products. Send in the coupon now.

Please send me these booklets immediately.



Name

Position

Company

Address

Dexion Ltd.

B.214MY.

Phone

Speedframe Division,
 Dexion House, Empire Way,
 Wembley Park, Wembley, Middlesex.
 Tel: Wembley 1281

this SCANNING SYSTEM

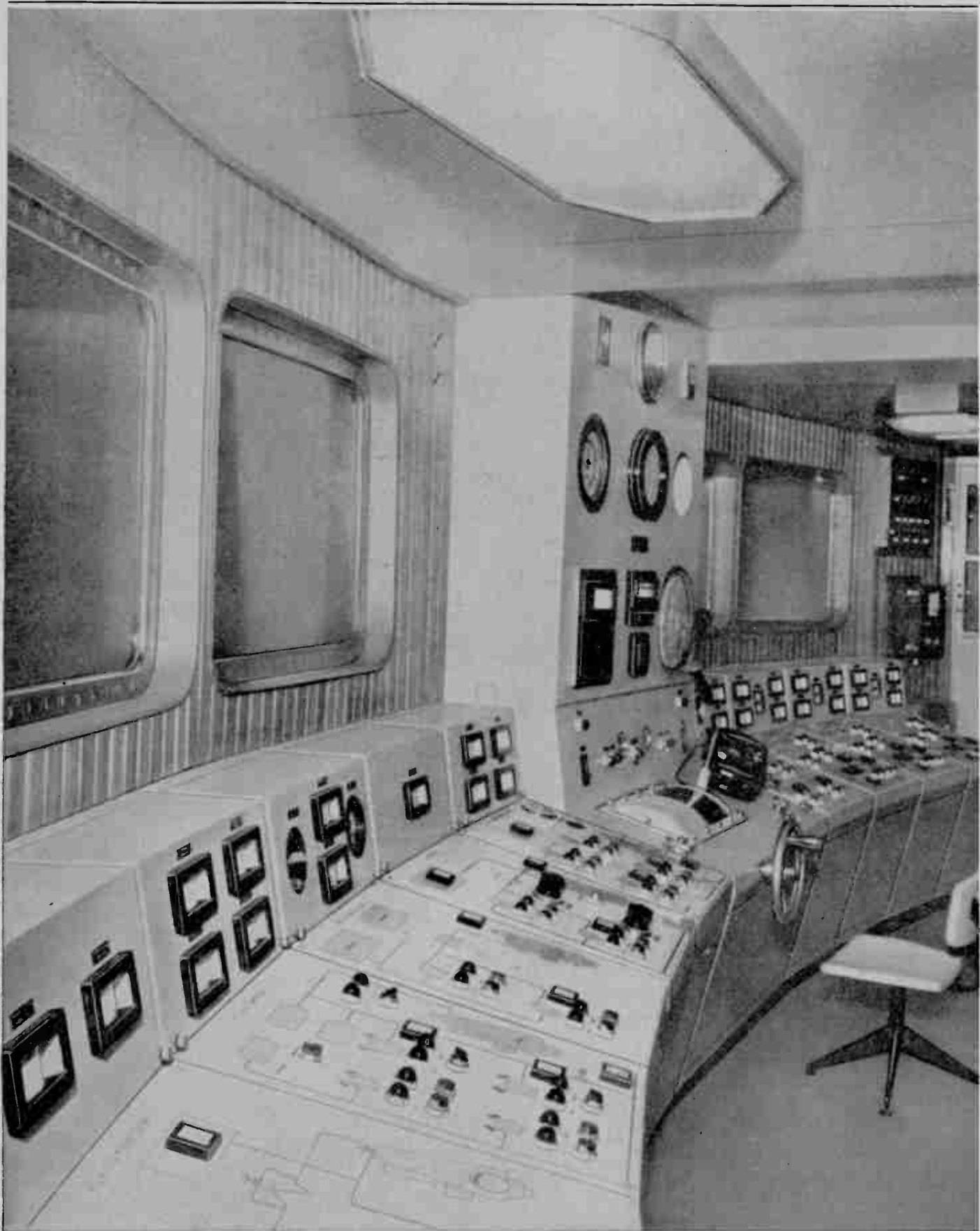

EXERCISES ITS OWN COOL JUDGEMENT



ON THE M.S. ESQUILINO HONEYWELL PLAYS WATCHDOG OVER 72 CRITICAL ENGINE-ROOM TEMPERATURES

Tailor-made by Honeywell for the M.S. Esquilino, the system records every deviation in temperature from normal safety limits. Records it complete with time checks and location—right under the eye of the Watch Engineer. Recording goes into action instantaneously, and continues through the off-limits period. Should over-heating in any of the 72 critical points reach a pre-set value, the system sets off visible and audible alarms.

MONITORED IN TWO MINUTES

In this installation, a monitoring system has been devised which could not have been accommodated by conventional instrumentation in the space available. Water, oil, bearings . . . in engine, generator and turbo-blowers . . . are monitored in a two-minute cycle.

The system can be used to monitor one specific danger point; or switched to record all variables without reference to off-limit conditions. The after-analysis of engine operating conditions is possible from the record or chart. All-in-all, this is a typical Honeywell assignment—to investigate and find the answer to a special problem. Call us in if we can be of similar help to you.

Honeywell

INDUSTRIAL PRODUCTS GROUP

HONEYWELL CONTROLS LIMITED, Brentford, Middlesex. ATLas 9191

HONEYWELL INTERNATIONAL: Sales and service offices in all principal cities of the world. Manufacturing in United Kingdom, U.S.A., Canada, Netherlands, Germany, France, Japan.

Eminent explorers may not have heard of **EMFLUX**



You may have been exploring other fields and missed the trail-blazing work done by Mawdsley's in flow measurement. It's all mapped out in the Emflux Electromagnetic Flowmeter Handbook—flowmeters, automatic range change units, liquid level monitors, reverse flow indicators and multi-point units, plus an invaluable section on materials of construction. Send for your copy today. If you *are* at the North Pole you may have to wait for the spring thaw, but otherwise you will have it by return.

THE EMFLUX SYSTEM

Emflux provides the most versatile system for measuring the flow of any conducting liquid—from acids to ice cream—without loss of head.

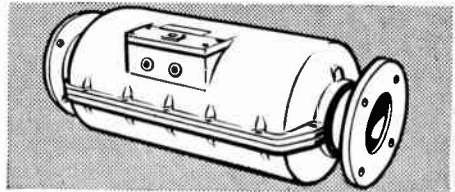

MAWDSLEY'S LTD

**ELECTRONICS AND INSTRUMENTS DIVISION
DURSLEY · GLOUCESTERSHIRE · ENGLAND**

For further information circle 286 on Service Card



LEWCOS ENAMELLED WIRES

The fine reputation in both oleoresinous and synthetic enamelled wires, of LEWCOS among manufacturers of electrical equipment justly reflects the high standards observed in their production. The most modern machinery and the latest techniques ensure the continued leadership of LEWCOS products.

THE
LONDON ELECTRIC WIRE
COMPANY & SMITHS LTD.

LEYTON, LONDON, E.10.

A member of the L.E.W. Group

encapsulated ergonomics

'HUMAN ENGINEERING IN A NUTSHELL'

add together...

this



this

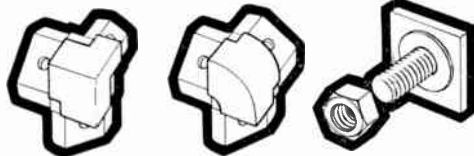

with this



and this



to make this

The Widney Dorlec prefabricated construction system is simple, quick and versatile. Assemble with the quick and rigid central bolt, the feature that makes this system superior. A simple or complicated cabinet is easy to construct. Just take a spanner, hacksaw, the correct components and construct your own technical furniture.

TELESCOPIC SLIDES. An indispensable aid to servicing and maintenance.

W/D

See complete range on **STAND 205**
Grand Hall, R.E.C. Show, Olympia

WIDNEY DORLEC

Write now for comprehensive illustrated literature

HALLAM, SLEIGH & CHESTON LIMITED
P.O. BOX 133 · BAGOT ST. · BIRMINGHAM 4

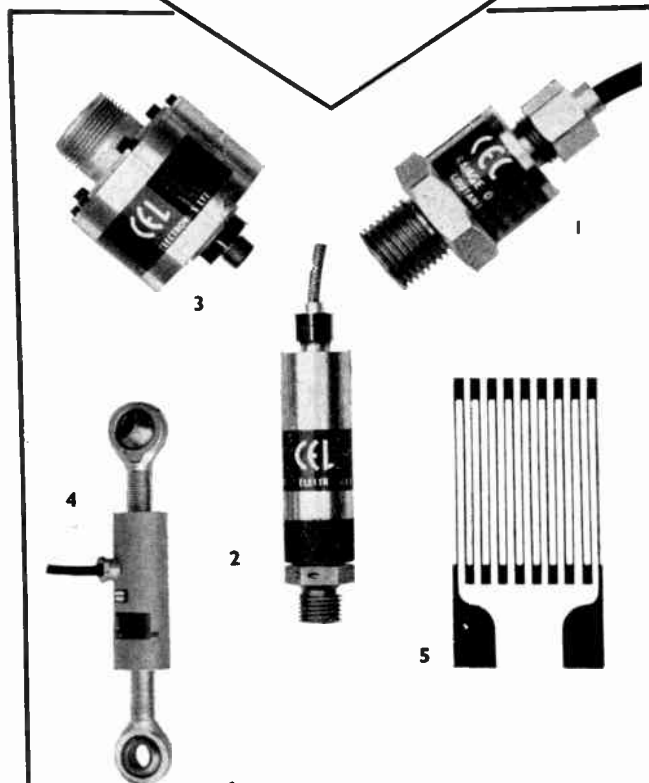
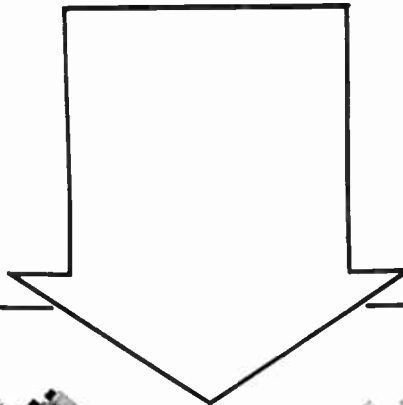
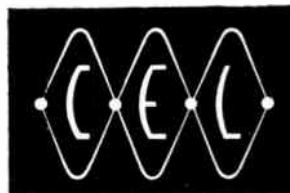

for pressure
and tension

TRANSDUCERS

1. CP types give up to 1.5V at max. pressure.
2. XT 33 is 0.25% accurate; ranges to 0-30,000 psi.
3. RV 22 measures down to 0-3 psi; 0.5% accuracy.
4. EM 50 checks tension; 0-500 lb. to 0-10,000 lb.
5. Precision die-cut strain gauges; $\frac{1}{8}$ in. to $\frac{1}{2}$ in.

WRITE OR PHONE FOR FULL DATA—

**COUTANT
ELECTRONICS
LIMITED**

Transducer Division
TRAFFORD ROAD
RICHFIELD INDUSTRIAL ESTATE
READING · BERKSHIRE
Telephone: Reading 55391

SMALL INTRICATE SHAPES
Consistent Magnetic Properties

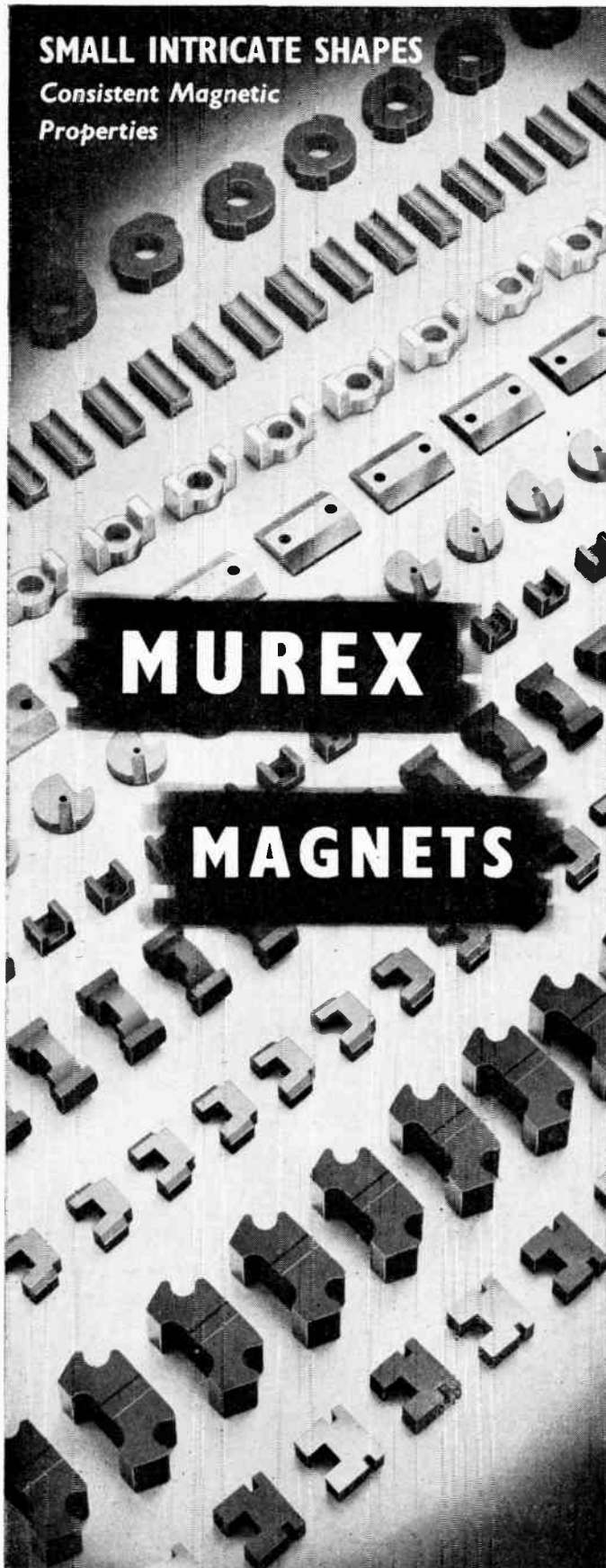

MUREX

MAGNETS

MUREX LTD · RAINHAM · ESSEX
 (Powder Metallurgy Division)
 Telephone: Rainham, Essex 53322 Telex 28632
 Telegrams: Murex, Rainham-Dagenham Telex

DM

**DATA
 LOGGING
 EQUIPMENT**

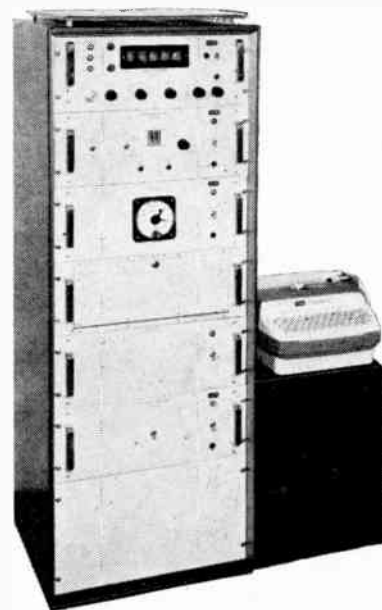

- * Up to 1000 channels
- * Resolution down to 1 μ V
- * Accuracies to 0.01%

Please write for further information to:
DIGITAL MEASUREMENTS LIMITED
 SALISBURY GROVE MYTCHETT ALDERSHOT HANTS
 TEL: FARNBOROUGH 3551

VISIT STAND 495 AT THE RECMF EXHIBITION

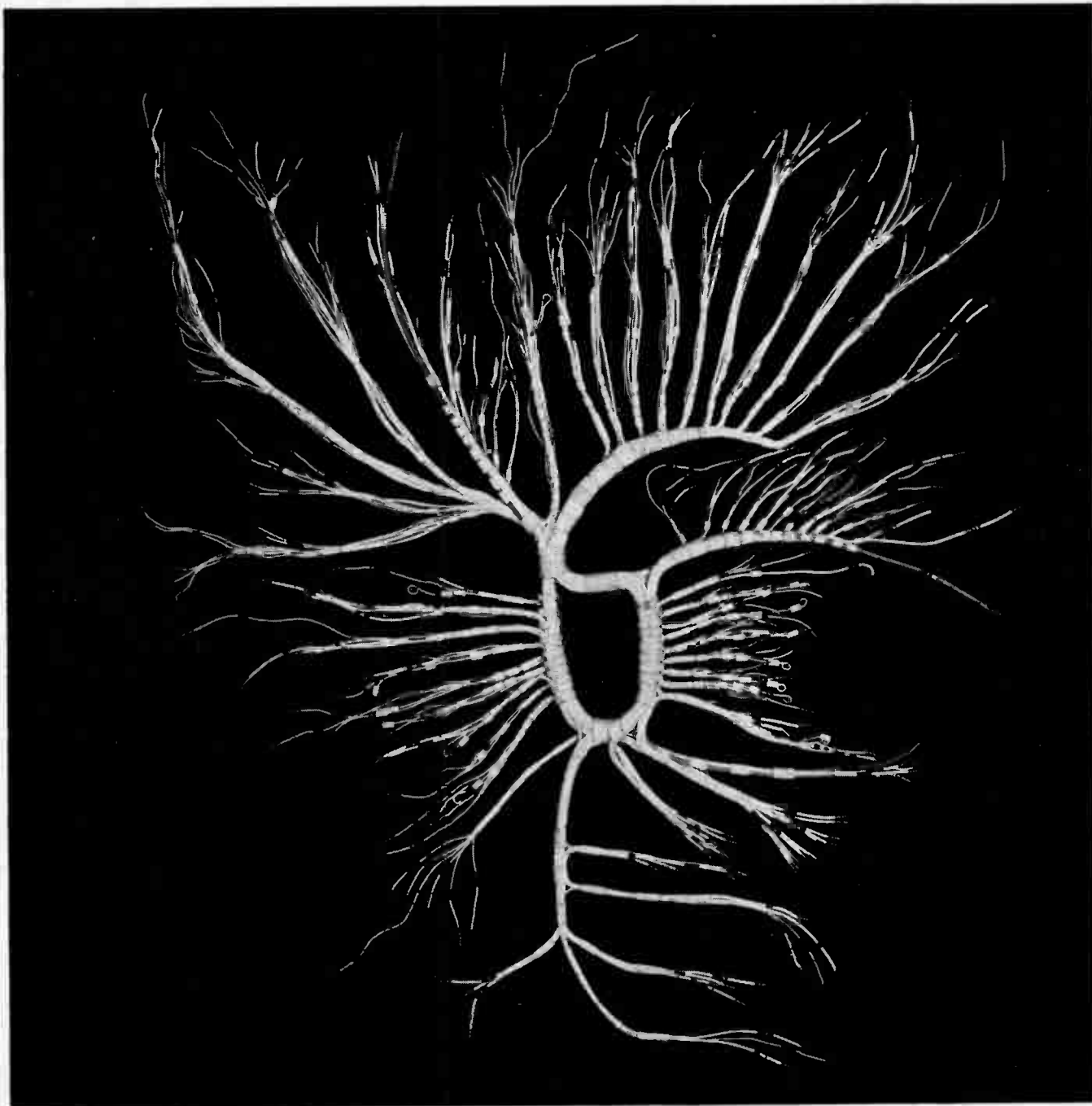

nerve system with superhuman reactions

This harness forms part of the fuel control system on the famous Bristol Siddeley 'Gnome' gas turbine engine. It connects the components of a data processing device. Here, complex variables from engines, gauges, meters, pumps and controls are detected and instantly adjusted to maintain correct rotor speed.

The harness was assembled by Hawker Siddeley Dynamics Limited from BICC P.T.F.E. equipment wires.

Miniature and sub-miniature wires from the extensive BICC range form vital links in many devices in all branches of electronics. The advice of specialist BICC engineers is always freely available to assist with your cabling problems.

BICC

*Cables &
Equipment Wires*

BRITISH INSULATED CALLENDER'S CABLES LIMITED 21 BLOOMSBURY STREET LONDON WC1

AD

SERVISCOPE* SERVES THE PRINTING INDUSTRY



W. R. Royle & Son Ltd., who are specialists in the production of fine colour printing, have recently installed two of the latest Vario Klischograph electronic colour engraving machines, both of which are equipped with Telequipment Oscilloscopes. These machines are designed to produce colour corrected separation positives of a very high standard, and have eliminated the laborious retouching hitherto necessary. In order to provide the operators with a precision monitor, Mr. Jeremy Royle, a director of the firm, has installed a Telequipment double-beam rack mounting oscilloscope in each machine. The oscilloscope, when connected to the output signals, provides each operator with a precision display of the actual picture signals as the scanning proceeds against a special graticule enabling them to see that various parts of the extremely complicated machines are functioning correctly. This unique application of the Telequipment double-beam rack mounting Serviscope demands very high standards of stability in the D.C. coupled vertical amplifiers and once again demonstrates the high standard of Telequipment instruments.

Double-beam rack mounting Serviscopes cost from £125; a descriptive leaflet will be sent on request.

TELEEQUIPMENT ... of course!

*Serviscope is a registered trade mark of Telequipment Limited, 313 Chase Road, Southgate, London, N.14. Fox Lane 1166
Scottish Office: 30 Castle Street, Edinburgh. Balerno 3120

AS20

See us at the
R.E.C.M.F.
on Stand No. 231

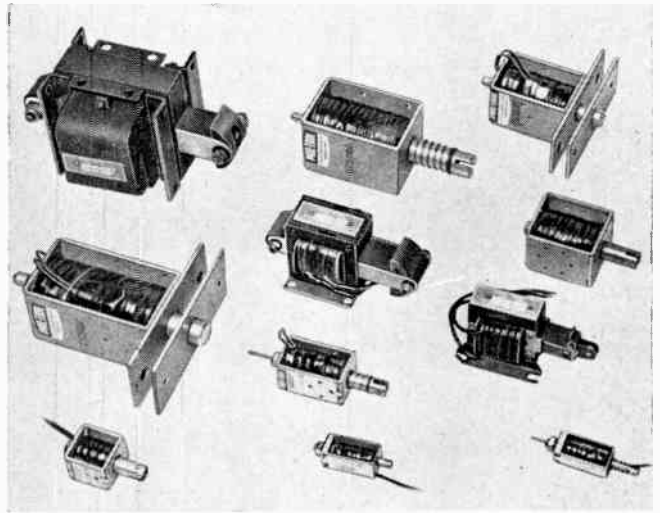

Phil-trol

For the Widest Range of Solenoids

Phil-trol Solenoids range from the small type 45, suitable for $\frac{3}{8}$ " spacing (i.e. for typewriters), to the AC type 83, 47 lbs over $1\frac{1}{2}$ " on impulse duty and also up to 650 lbs-ins for the DC type 96, with a complete range of AC and DC types between, push type, pull type, spring return and DC fitted with fully damped silicon rectifier circuits for AC supplies.

● For particulars ask for pamphlet 108a.

PHILLIPS CONTROL (G.B.) LTD

DEPT. G20 · FARNBOROUGH ROAD · FARNBOROUGH · HANTS.

Telephone: Farnborough 1120

Grams and Cables: Philtrol, Farnborough, Hants.

For further information circle 294 on Service Card

an invitation

IF YOU HAVE A PRINTING
PROBLEM... OF ANY SORT,
LETTERPRESS, GRAVURE,
WEB OR SHEET-FED LITHO,
BLOCKMAKING, BINDING,
you are invited to telephone
FLEet Street 0246 ext 2136



that's International Printers

ORBIT HOUSE, 9 NEW FETTER LANE, LONDON EC4

For further information circle 295 on Service Card

NEW—a portable intercom for noisy factories. The Transphone

The Transphone intercom is a completely portable system for providing telephone communication between a number of persons where high ambient noise level makes conventional systems difficult and sometimes impossible to use. The equipment consists of a telephone headset to which is attached a microphone on a swivel positioning boom. The transistorised amplifier is entirely self-contained with its own battery supply and fits into a jacket pocket. The only interconnection between the positions—which can be from two up to ten units—is a single circuit of bell flex with plug-in points wherever required. Write for details.

The **TRANSPHONE** portable noise-free intercom system by

LUSTRAPHONE

—the foremost name in sound equipment

Lustraphone Ltd., St. George's Works, Regents Park Rd.
London, N.W.1. PRImrose 8844

Radio Components Show, Olympia, Stand No. 209

For further information circle 296 on Service Card



GORING KERR PHOTO-ELECTRICS IGNORE SUNLIGHT

A NEW CONCEPT

- Compact Head Units
- Virtually Indefinite Life
- Proof Against Vibration
- Fully Transistorised Circuit
- Ignores All Extraneous Light
- Fitted with Relay or Counter
- Rugged with Aluminium Enclosure
- Withstands High Degree of Lens Coating

Model GKP Photo-Electric Unit is Completely Independent Of Direct or Reflected Light From the Sun or From Any Other Source, Including Incandescent or Fluorescent Lamps. False Operation From Any External Cause is Completely Impossible.

GORING KERR LTD.
HANOVER WAY, WINDSOR, BERKS.
TELEPHONE: 63211



For further information circle 297 on Service Card

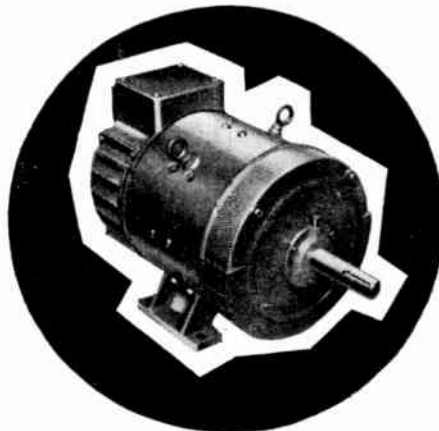

'X' type D.C. motors, $\frac{1}{2}$ - 40 h.p.

You can't say **DEPENDABLE**
without **EPE**

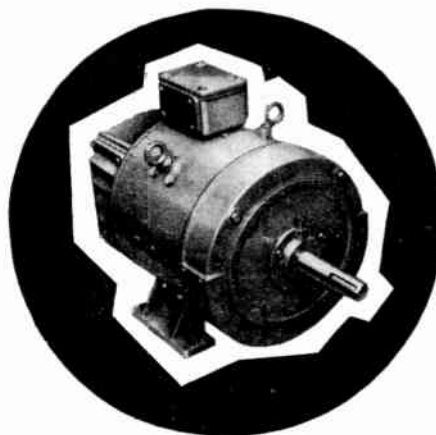

'Y' type D.C. motors, $\frac{1}{2}$ - 40 h.p.

D.C. Motors for electronic speed control



THE ELECTRICAL POWER ENGINEERING CO. (B'HAM) LTD.
EPE WORKS, BROMFORD LANE, BIRMINGHAM 8
Telephone: STEchford 2261
Grams: Torque Phone, Birmingham

VISIT THE COMPONENTS SHOW

A comprehensive range of AIRMAX Fans is exhibited which are widely used to provide forced air cooling in commercial and military electronics equipment including airborne applications.

Vaneaxial, tubeaxial and centrifugal fans are exhibited from 1" dia. upwards all of which have patented blade design for maximum air delivery with minimum size. Many types incorporate external rotor motors for minimum axial length.

Matching fan and heat sink assemblies are available to meet individual cooling requirements.

A. K. FANS LTD.
20 Upper Park Rd., N.W.3.
STAND 207

404

CATHODEON CRYSTALS LTD.
LINTON
CAMBRIDGE
STAND 225

408

ELECTRO ACOUSTIC INDUSTRIES LTD
Stamford Works, Broad Lane
Tottenham, London N.15
Tot: 0505 **STAND 255**

402

SPEAR ENGINEERING CO. LTD.
Titan Works
Limpsfield Road
Warlingham, Surrey
STAND 264

412

DURATUBE & WIRE LTD.
Rock Nook, Littleborough
Lancs
on **STAND 220**

420

INDUSTRIAL ELECTRONICS
◆◆◆
ELECTRICAL REVIEW
STAND 456

C. BRANDAUER & CO. LTD.
|
New John Street West
Birmingham 19
|
STAND 56

411

BELLING & LEE LTD.
GREAT CAMBRIDGE RD.
ENFIELD
MIDDLESEX
STAND 308

425

For the role of
Bakelite plastics in the
electronics industry

see

Bakelite Limited

on Stand No. 485

400

WELDED MODULES LIMITED
Bishopstoke Road, Eastleigh
are on **STAND 412**

422

ERIE RESISTOR LIMITED
South Denes, Gt. Yarmouth
Norfolk

Manufacturers of a wide range of
RESISTORS and CAPACITORS

VISIT OUR STAND 228
at the
RECMF EXHIBITION

424

WEYRAD (ELECTRONICS) LTD
School Street
Weymouth, Dorset
STAND 251

401

FINE WIRES LIMITED
P.O. BOX 78
GROVE RD., CASTLE BOULEVARD
NOTTINGHAM
STAND 502

421

TYGADURE LIMITED
ROCK NOOK, LITTLEBOROUGH
LANCASHIRE
STAND 220

423

WIRELESS & ELECTRICAL TRADER
◆◆◆
WIRELESS WORLD
STAND 456

for connectors
potentiometers
cable
cable assemblies

see Amphenol on Stand 277

On show: multiway, hermetic and r.f. connectors; helical potentiometers with digital dials, trimming potentiometers; r.f. cables, facilities in microelectronics.

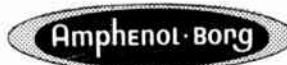

Amphenol-Borg (Electronics) Ltd

Thanet Way · Whitstable · Kent · Whitstable 4345

CLASSIFIED ADVERTISEMENTS

FULLY DISPLAYED: 55/- per single column inch.
SEMI-DISPLAYED: 45/- per single column inch.
RUN-ON: 4/6 per line of approximately 7 words.
Where an advertisement includes a Box Number 1s. extra.
SERIES DISCOUNTS: 12 insertions, 15%.
Remittances payable to "Industrial Electronics".

Copy is required by 23rd of the month for insertion in the following month's issue, by 17th of the month if proofs are required.

Address to:
Classified Advertisement Dept.
Industrial Electronics
Dorset House, Stamford St., London, S.E.1.

SITUATIONS VACANT

SMITHS

AVIATION DIVISION

SENIOR ELECTRONICS ENGINEERS FOR AIRCRAFT AND INDUSTRIAL PROJECTS

The work is very interesting and includes:

Low level analogue circuits using the latest components and packaging techniques.

Control systems using miniature electromechanical components.

Magnetic tape devices.

Automatic programming devices using digital techniques.

Applicants will preferably have a degree or H.N.C. in electrical/electronics engineering. They will have had some years' experience of original design work but not necessarily in the specified subjects.

Apply in writing, giving full particulars of experience, qualifications, age, present salary and salary envisaged to:

The Personnel Manager,
S. SMITH & SONS (ENGLAND) LTD.,
Aviation Division,
Bishops Cleeve,
Nr. Cheltenham.

[403]

TELEVISION ENGINEER (TRANSMITTER)

GOVERNMENT OF UGANDA

A Transmitter Engineer is required to take charge of the Marconi 5 kW vision transmitter and associated 1 kW sound transmitter at Kampala. The selected candidate will be in sole charge of the transmitting station under the Chief Engineer, will train and control a local staff of six, supervise the day to day running of the station, and prepare reports for the Chief Engineer. In addition he will maintain all sound and vision equipment and recommend on the maintenance of aerial towers etc.

Candidates must have a good educational background with the Higher National City and Guilds full Technological Certificate and extensive practical experience in the operation and maintenance of modern vision and associated sound transmitters, and in the use of transmitter test equipment including side band analysers, also the ability to test and maintain a modern high power vision transmitter.

Candidates should preferably have practical experience of T.V. aerials filter plexers and associated equipment.

The appointment will be on contract for one/two tours of 21-27 months with salary in the scale £1,725 to £1,956 per annum plus gratuity of 25% of total emoluments. Free family passages. Free medical attention and furnished quarters provided at moderate rentals. Generous leave and education allowances.

Applicants who must be natives of the United Kingdom or the Republic of Ireland should apply to the Ministry of Overseas Development, Room 301, Eland House, Stag Place, Victoria, London, S.W.1, giving qualifications, age, nationality and experience and quoting RC 237/183/02.

[415]

BOROUGH POLYTECHNIC

Borough Road, S.E.1

Department of Electrical and Electronic Engineering

ELECTRONIC TECHNICIANS

Applications are invited for the following laboratory posts:

Chief Technician—commencing salary £1,085 per annum, rising by annual increments to a maximum of £1,255 per annum.

Senior Technician—salary scale £835 per annum, rising by annual increments to a maximum of £1,035 (unqualified) or £1,105 (qualified) per annum. The commencing salary may be fixed above the minimum in certain circumstances.

Junior Technician—commencing salary on the scale £300 to £695 according to age and qualifications.

Experience of research, development and testing or servicing of electronic equipment is necessary for the senior posts.

Applications must be made in writing stating clearly the appointment which is sought. Candidates should give details of age, experience and qualifications and address their applications to the Secretary, Borough Polytechnic, Borough Road, London, S.E.1. [407]

UNIVERSITY OF NEWCASTLE UPON TYNE

Second Chair of Electrical Engineering

APPLICATIONS are invited for the newly created Second Chair of Electrical Engineering. Candidates should have a special interest in the field of light electrical engineering. The successful candidate will be required to take up duty at a date to be arranged as early as possible in the academic year 1965/66. Salary in accordance with the professorial scale (£3,400 x £125-£4,025 per annum) with membership of F.S.S.U.

Further particulars may be obtained from the undersigned with whom applications (15 copies), together with the names of not more than three persons to whom reference may be made, must be lodged not later than Tuesday, 8th June, 1965. (Applicants from outside the British Isles may submit one copy only.)

E. M. BETTENS
REGISTRAR
UNIVERSITY OF NEWCASTLE UPON TYNE
6 KENSINGTON TERRACE
NEWCASTLE UPON TYNE 2

[409]

QUEEN MARY COLLEGE (University of London),
Mile End Road, E.1.

Nuclear Engineering Department, Senior Technician
A Senior Technician is required to help in the development of electronic equipment for a variety of functions within the Nuclear Engineering Department. He will also be required to assist in the maintenance of existing electronic equipment.

The work of the department includes reactor technology, precision mechanical engineering and all aspects of nuclear and health physics instrumentation. Experience in electronics is an essential requirement. Pension Scheme; five-day week; four/five weeks annual leave.

Appointment according to ability etc. on scale £840 to £1,040 p.a., plus London Weighting up to £45 and possible £30 or £50 qualification supplement.

Letters only to the Registrar (NST) stating age and giving full details of experience and present work. [418]

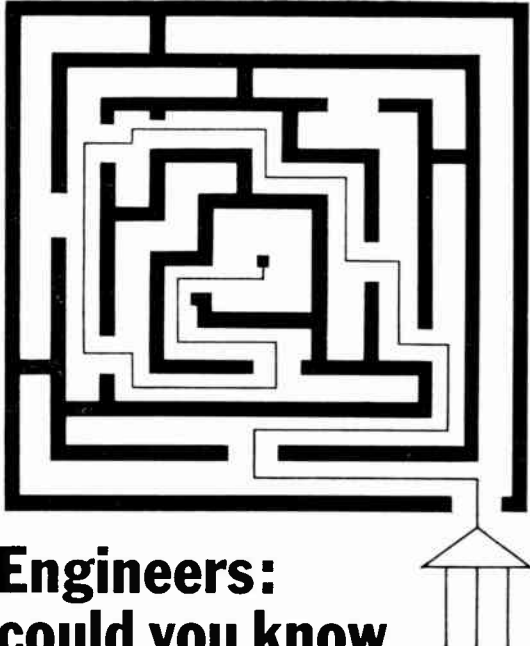

Engineers: could you know your way round a computer?

An IBM Data Processing Customer Engineer does. It's his job to keep data processing installations working smoothly. He works with his own customers in their offices, yet within daily reach of his home. His job is stimulating and rewarding; it is never dull. As well as maintaining a wide range of electronic and associated electro-mechanical machines, he applies his engineering knowledge and skill and develops a real understanding of his customers' needs. As customer management moves towards a more effective use of highly complex equipment, new problems may arise. The IBM Customer Engineer has the ability to produce new ideas and has confidence in his own judgement. He is a responsible man on whom all customer staff rely.

We provide a thorough training for a worthwhile career. You should be between 21 and 29 and have a basic knowledge of Electronics. An acceptable standard would be a Radar/Radio/Control Equipment Fitters Course, Telecommunications experience or ONC/HNC Electrical or Electronic.

Starting salaries are in the region of £1,000 a year, with more for men with special aptitude or specific experience. Increases are on individual merit. As a Customer Engineer you could be earning between £1,250 and £1,700 in three years. Promotion is also on merit and from within the company.

If you're not quite old enough to have reached the standards we've indicated we'd still like to hear from you. If you've just left school with 'A' level Maths and English or are studying for ONC Electrical Engineering, there could be a place for you.

There are immediate opportunities in the London area.

Please telephone Mr. W. E. Cross, Manager DP Workshop, VIKing 3341 or write briefly, summarising details of age, experience, training and background to Mr. I. F. Bush, IBM United Kingdom Limited, 101 Wigmore Street, London, W.1, quoting reference CE/1E/225.

IBM

You can grow with

[414]

Hydraulic, Electrical, Electronic Engineer/Writers Technical Authors

Required for permanent positions in our branch offices throughout England and Scotland.

Apply to:

A. W. PUBLICATIONS LTD.,
203, BLACKFRIARS ROAD,
LONDON, S.E.1

Some vacancies suitable for ex-service personnel with engineering experience and wishing to take up handbook writing. [396]

QUEEN MARY COLLEGE (University of London),
Mile End Road, E.1.

Senior Technician, Department of Zoology

An Electronics Technician is required in the Department of Zoology to be responsible for the design, construction and maintenance of electronic apparatus used in physiological research and teaching.

Possession of the National Certificate in Electrical Engineering or equivalent would be an advantage. Pension scheme; five-day week; four/five weeks annual leave.

Appointment according to ability etc. on scale £840 to £1,040 p.a., plus London Weighting up to £45 and possible £30 or £50 qualification supplement.

Letters only to the Registrar (ZST) stating age and giving full details of experience and present work. [417]

INDUSTRIAL STAFF LIMITED

offer you wide coverage of skilled labour to meet increased production requirements. I.S.L. service is complete, including wages, travelling expenses, P.A.Y.E., insurances, pension schemes and holidays. The simplest, most efficient method of meeting production peak problems. Ring MAL. 8728.

[391]

MEDICAL RESEARCH COUNCIL

PATIENT MONITORING

Technical Officer required for the further development of patient monitoring equipment designed in the Bioengineering Laboratory at the Medical Research Council Laboratories, Hampstead, London, N.W. 3. Duties will consist mainly of providing technical backing to research programmes concerned with assessing the place of monitoring in the hospital service. Some travelling and occasional short-term residence outside London may be involved. H.N.C., degree or equivalent qualifications, with considerable experience in electronics and light mechanisms are essential requirements. Salary £926 (age 26) to £1188 (age 31) rising annually to £1641.

Please apply to:
Personnel Officer, National Institute for
Medical Research, The Ridgeway, Mill
Hill, London, N.W. 7. [430]

CONTROL & INSTRUMENTATION ELECTRONICS ENGINEERS

Similar Vacancies in other divisions exist in the following fields.

H.F. & V.H.F. Telecommunications
Digital Computation
Integrated Circuit Research
Experimental Electronics Research

Full details of experience, qualifications and age should be submitted to the Personnel Officer.

ULTRA ELECTRONICS LTD.
Western Avenue, London, W.3

Exceptional opportunities occur at the North-West London headquarters of this well-established yet rapidly developing Company in the field of Control and Instrumentation.

The work demands engineers of high calibre to solve many novel problems associated with industrial control systems, supersonic engines and the control of VTOL aircraft.

Vacancies exist for the following:—

- (a) SENIOR ENGINEERS who have sufficient experience and initiative to accept project responsibility
- (b) ENGINEERS capable of running small groups of technical staff
- (c) JUNIOR ENGINEERS who wish to join design teams

A Degree, Dip. Tech. or H.N.C. qualification is desirable but candidates with O.N.C. will be considered for the junior positions. Experience in transistor or integrated circuit design, with a bias towards control system techniques would be an advantage.

[426]

EPSYLON INDUSTRIES LIMITED

requires

DEVELOPMENT ENGINEERS

Electronic and electro-mechanical

INTERMEDIATE and JUNIOR level, able to work with minimum supervision as members of lively project teams specializing in:—

DATA PROCESSING SYSTEMS

AVIONICS

PRECISION MAGNETIC RECORDING

INDUSTRIAL ELECTRONICS

CLOSED CIRCUIT TELEVISION

Epsilon is able to be selective in its choice of staff who carry the maximum of personal responsibility. The present requirement results from steady expansion in the demand for the Company's products.

Attractive salaries will be offered to those with appropriate qualifications

Please apply by letter or telephone to:—



Mr. G. Thompson, EPSYLON INDUSTRIES LIMITED
Faggs Road, Feltham, Middlesex. Telephone: Feltham 5091

(A Member of the Stone-Platt Group)

[427]

THE BRITISH DIVISION OF A PROGRESSIVE
AMERICAN COMPANY OF INTERNATIONAL
REPUTE IS SETTING UP A NEW

ELECTRONICS OPERATION

*in which there are vacancies
for enthusiastic, experienced*

TEST ENGINEERS

to work on tape controls for machine tools.

*This project offers an exceptional
opportunity for successful applicants
to join the team at an early stage.*

PERSONNEL OFFICER

CINCINNATI MILLING MACHINES LTD.

Dells Lane, Biggleswade, Beds.

[429]

d-mac Ltd. GLASGOW

Part of Thompson Holdings Ltd.

A subsidiary of the Thompson Organisation

During their expansion of activities in the data handling field there are good opportunities of interesting work for **TECHNICALLY QUALIFIED ENGINEERS** of many grades.

There is a particular requirement for **DEVELOPMENT AND TEST ENGINEERS** in Glasgow, and also for **SALES APPLICATION ENGINEERS** who will be stationed in the South.

A knowledge of digital transistor circuitry and/or Electro Mechanical Instrumentation is highly desirable.

Please reply to

**D-MAC LTD.
QUEEN ELIZABETH AVENUE
GLASGOW, S.W.2**

[431]

CANADA

A PROGRESSIVE ELECTRONICS COMPANY IN THE TORONTO AREA ENGAGED IN THE MANUFACTURE OF GYROSCOPES, STABLE PLATFORMS AND INERTIAL NAVIGATION SYSTEMS INVITES APPLICATIONS FROM:

Instrument Makers and Instrument Assemblers

who have five or more years' experience in the following fields: Gyros, Accelerometers, Inertial Guidance Systems, Airborne Precision Mechanical Equipment.

Engineering Technicians

who should have at least an Ordinary National Certificate in Electrical or Electronic Engineering, must have a practical knowledge of Transistorised Circuitry, be familiar with Electronic Instrumentation and Electronic Theory and Mathematics. All the above vacancies are in our Manufacturing Test Department and experience with Inertial Guidance Systems or Servo-mechanisms will be considered a definite asset.

Senior Production Engineers

who are qualified and capable of assuming the control of the production engineering aspects of a project. They must have a Higher National Certificate and at least five years' experience in a similar position in the manufacture and/or design of Gyros and Accelerometers, preferably the floated versions.

Engineers and Physicists

with a H.N.C. or Graduate Standing who are interested in contributing to the expansion of The Research and Development Division with one to ten years' experience in any of the following fields:

COMPUTERS GUIDANCE SYSTEMS NAVIGATIONAL SYSTEMS
AIRCRAFT ELECTRONIC SYSTEMS WEAPONS AIMING SYSTEMS DISPLAY SYSTEMS
ANTI SUBMARINE WARFARE EQUIPMENT INERTIAL INSTRUMENTS

all these positions are with a company which is part of a World Wide Organization. Top salaries, excellent working conditions with a wide range of company benefits - Life Assurance, Pension Plan and Medical Plan. After a probationary period, successful applicants will be reimbursed for passage up to a maximum of one month's Canadian salary.

Written applications, giving full details, should be addressed to:

**PERSONNEL MANAGER
LITTON SYSTEMS (CANADA) LTD.
25 CITY VIEW DRIVE,
TORONTO (REXDALE), ONTARIO,
CANADA.**

[413

PORTSMOUTH COLLEGE OF TECHNOLOGY

(The Southern Regional College)

Electrical Engineering Department

A full-time course of SIX MONTHS' duration in preparation for the

I.E.E. PART III EXAMINATION

will commence on

Tuesday, 2nd November, 1965

Forms of application may be obtained from:

The Registrar
Portsmouth College of Technology
Hampshire Terrace
Portsmouth
Telephone: Portsmouth 21371

[419]

CAPACITY AVAILABLE

AIRTRONICS LTD.

for coil winding assembly and wiring of electronic equipment, transistorised sub-units, sheet metal work. 4 Ashmead Road, London, S.E.8. Telephone: TIDeway 2249. [311]

TRANSFORMERS. 1VA to 10kVA single phase, 30kVA 3 phase, made to customers' requirements. Quick delivery. Electro-Stabilised Ltd., Queens Road, Ilford, Essex. ILFord 1578. [410]

DESIGN & PROTOTYPE CONSTRUCTION.—Somerset Electronics Ltd. Phone Shepton Mallet 2219. [387]

ARTICLES FOR SALE

PHOTO-ELECTRIC CONTROLS

for industry

Quick delivery Send for Catalogues

Hird-Brown Limited

Flash Street, Bolton, Lancs.
Tel. 27311

[305]

NOISE FIELD INTENSITY METER Model NF-105,

Mfg. Empire Devices Products Corporation

For details, write:

Joseph E. Bamberger, 7917D, Trappe Road,
Baltimore, Maryland 21222

[428]

PATENTS:

EXPLOITATION OF PATENTS

The Proprietors of British Patent Nos. 857,691, 859,431 and 859,432 relating to "Improvements in electrical weighing scales", "Improvements in electrical force measuring systems" and "Electrical weighing systems", desire commercial working of the patents in the United Kingdom by Licence or otherwise. Replies to Box I.E. 398.

"Patent No. 766,033" entitled "Improvements in or relating to Piezo-Electric Crystals" is for sale or licence. For details apply to CHATWIN & COMPANY, Chartered Patent Agents, 253, Gray's Inn Road, London, W.C.1. [406]

EDUCATIONAL

A.M.I.E.R.E. (A.M.Brit.I.R.E.), City & Guilds, G.C.E., etc., bring high pay and security. 'NO PASS—NO FEE' terms. Over 95% successes. For details of Exams and courses in all branches of Electronics Engineering, etc., write for 148 page Handbook—FREE. B.I.E.T. (Dept. 192), 20, Wright's Lane, London, W.8. [380]

BUSINESS OPPORTUNITIES

Electronic Engineer (capital available) seeks participation in or purchase of existing business. Box I.E. 399.

BOOKS

'RADIO Interference Suppression: As Applied to Radio and Television Reception.' By G. L. Stephens, A.M.I.E.E. 2nd Ed. An up-to-date guide to the various methods of suppressing electrical interference with radio and television reception. Many practical applications are given, particular attention being paid to the problem of interference at television frequencies. Other chapters deal with the design and choice of suppressor components, methods of locating the source of interference, and suppression at the receiver itself. 10s 6d net from all booksellers. By post 11s 2d from Hiffe Books Ltd., Dorset House, Stamford Street, London, S.E.1.

"SECOND Thoughts on Radio Theory." By Cathode Ray of WIRELESS WORLD. Forty-four articles reprinted from popular WIRELESS WORLD series, in which the author examines various aspects of elementary radio science, explains them clearly, and shows that there may be more behind them than is apparent from the usual text-book. This volume deals with basic ideas; circuit elements and techniques; circuit calculations; and some matters in lighter mood. An entertaining and helpful text-book for the student, refresher course for the engineer, and reference book for II, combined. 35s net from all booksellers. By post 36s 4d from Hiffe Books Ltd., Dorset House, Stamford Street, London, S.E.1.

"TRANSISTOR Inverters and Converters." By Thomas Roddam. The rapid development in recent years of portable transistor equipment such as radio receivers, tape recorders, record players, and scientific instruments including those incorporated in rockets and satellites, has brought in its train the need for a light and efficient means of providing both a.c. and d.c. voltages from low voltage d.c. sources. The transistor inverter and converter between them satisfy these requirements, the inverter which changes d.c. to a.c. being used either alone or as the heart of a converter which can supply as many d.c. voltages as may be needed. This is the first definitive book to be published on the subject and the author has produced a single theory to cover all the various types of transistor inverter circuits available. Earlier chapters deal with the large signal operation of transistors, and linear and saturable inductors. He then develops a unified circuit theory for transistor inverters from a consideration of the negative circuit impedance of oscillators which is followed by consideration in detail of various types of inverters such as push-pull, square wave, transistor bridge, sine-wave and driven. Containing many well tried designs as well as original designs by the author, this book will be invaluable to the electronic engineer with no previous experience of inverters and to the established designer who wishes to widen his knowledge of the subject. 42s net. By post 43s from Hiffe Books Ltd., Dorset House, Stamford Street, London, S.E.1.

"WIRELESS Servicing Manual." By W. T. Cocking, M.I.E.E. This is the tenth edition of a book which since 1936 has been known to radio servicemen everywhere as a reliable, thorough and comprehensive guide to solving most of the problems that arise in the repair, maintenance and adjustment of the modern radio receiver. In the present edition a major addition is a chapter devoted to transistors and transistor sets. The author of WIRELESS SERVICING MANUAL is well known to a wide circle of readers as former editor of *Electronic Technology* and now of *Industrial Electronics*. His crisp lucid style makes this hand-book of utmost value to the service man and amateur alike. 25s net. By post 26s from Hiffe Books Ltd., Dorset House, Stamford Street, London, S.E.1.



CLOSED CIRCUIT TELEVISION

An extensive range of closed circuit television cameras and monitors are manufactured for all types of industrial applications including flameproof equipment for underground mining installations.

Remote Control facilities enable cameras to be controlled from a central point up to 5 miles distant.

Pye closed circuit television installations similar to that used by the Dover Harbour Board for the observation and control of traffic, have remotely controlled cameras equipped with All Weather housings.

PYE H.D.T. LIMITED, COLDHAMS LANE, CAMBRIDGE. TEL : CAMBRIDGE 45115

For further information circle 299 on Service Card

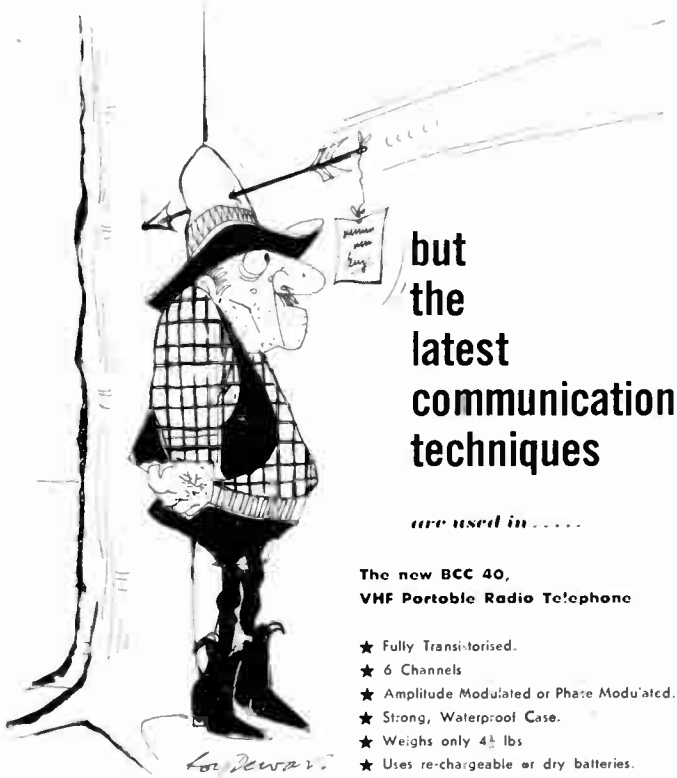

but
the
latest
communication
techniques

are used in.....

The new BCC 40,
VHF Portable Radio Telephone

- ★ Fully Transistorised.
- ★ 6 Channels
- ★ Amplitude Modulated or Phase Modulated.
- ★ Strong, Waterproof Case.
- ★ Weighs only 4½ lbs
- ★ Uses re-chargeable or dry batteries.



Further information from:—
BRITISH COMMUNICATIONS CORPORATION LTD.,

SOUTH WAY EXHIBITION GROUNDS, WEMBLEY, MIDDLESEX
Telephone: Wembley 1212. Telegrams: BEECEEE WEMBLEY

For further information circle 300 on Service Card

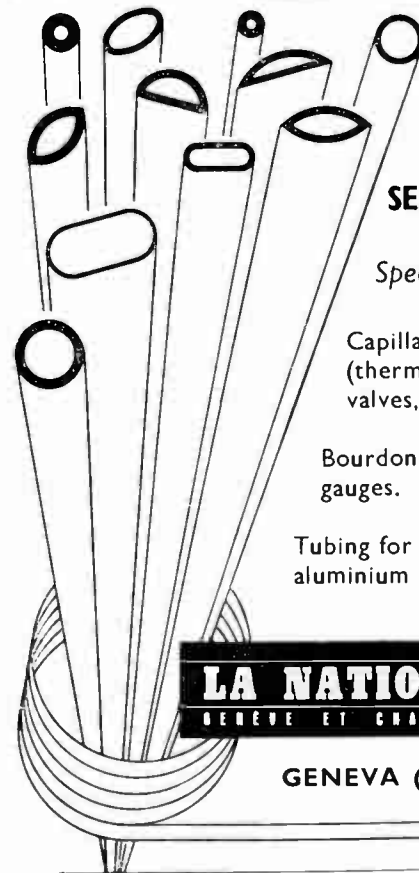

PRECISION SEAMLESS TUBING

Specialists in :

Capillary tubing for controls
(thermostats, thermostatic
valves, thermometers, etc.)

Bourdon tubing for pressure
gauges.

Tubing for measuring pointers in
aluminium and aluminium alloys.

LA NATIONALE S.A.

GENÈVE ET CHAMPAÑNE, SUISSE

GENEVA (Switzerland)

100 MΩ/V



- ★ 57 Ranges.
- ★ D.C. to 1,000 Mc/s.
- ★ All voltage and current readings on only two linear scales.
- ★ 5" scale length.
- ★ 2% accuracy on d.c.
- ★ Comprehensive d.c. standardising facilities to 0.5% short term.
- ★ Battery operated.

**robust as
the AvoMeter**

TRANSISTORISED MULTIMETER CT471A

RANGES

d.c. Voltage:
12mV to 1,200V f.s.d. in 11 ranges

d.c. Current:
12μA to 1.2A f.s.d. in 11 ranges

a.c. Voltage r.m.s.:
12mV to 1,200V f.s.d. in 11 ranges

a.c. Current r.m.s.:
12μA to 1.2A f.s.d. in 11 ranges

r.f. Voltage r.m.s.:
40mV to 4V f.s.d. in 5 ranges extending to 400V with capacitive divider

Resistance:
12Ω to 120MΩ f.s.d. in 8 ranges

A portable battery operated multi-range meter using semi-conductors throughout, of high stability and with an accuracy of $\pm 2\%$ on d.c. voltage.

Three basic scales cover all measurements. The two main scales, used for all voltage and current measurements, are linear and the third scale, used for resistance measurements, indicates increasing resistance towards full scale deflection.

Zero adjustment is effected on any d.c. range without disconnecting the meter from the circuit under test. Provision is made for centre zero operation on d.c. voltage. A

reversing facility enables both positive and negative d.c. voltages and current to be measured without reversing the connections.

Provision is made for checking the condition of the batteries and a d.c. standardising facility enables ranges up to 1.2V to be individually corrected to an accuracy of 0.5%. The battery supply is automatically disconnected when the cover is replaced on the instrument. Supplied with high impedance r.f. probe, capacitive divider (division ratio 100-1) and 50Ω and 75Ω terminating pads.

Ask AVO for Leaflet 376

AVO LTD AVOCET HOUSE · 92-96 VAUXHALL BRIDGE ROAD · LONDON S.W.1

Telephone: VICToria 3404 (12 lines)



TRANSMETRIX

For the highest quality and most rapid service in
DESIGN LAYOUT MANUFACTURE CAPACITY

PRINTED CIRCUITS

and

WIRING ASSEMBLY

The expert staff and unique facilities of T.E.S.
can save you **TIME AND MONEY.**

Phone: **SHANKLIN 3096**

TRANSMETRIX ELECTRONIC SYSTEMS LTD.
SHANKLIN · ISLE OF WIGHT · HAMPSHIRE

For further information circle 303 on Service Card

ELECTRONIC TIME DELAY SWITCH MODEL TT4

DELAY TIMES: 10 secs. to 10 mins.

CONTACTS: One or two changeover at 5 Amps 240 V. A.C.

SUPPLY: Mains 200-255 V. A.C. (Built in Stabilisation)

RESET TIME: 100 milliseconds

ADJUSTMENT: Only when box is open

DIMENSIONS: 3" × 5½" × 2¼"

PRICE: One changeover 81/6d.

Two changeover 89/-

Other models are available

R.M.S. INSTRUMENTS LTD.

21 London Street, Chertsey, Surrey

Telephone: Chertsey 3417

For further information circle 304 on Service Card

ELECTRICAL REVIEW

THE ELECTRICAL INDUSTRY'S PREMIER JOURNAL

CIRCULATION **14,696** (ABC)

A recent survey shows that each home copy is seen by an average of 12.5 readers and each overseas copy by an average of 5.9 readers.

CLASSIFIED ADVERTISEMENTS IN 1964
AVERAGED 13½ PAGES PER WEEK

For a specimen copy, write — **ELECTRICAL REVIEW (Ref. 220),**
ILIFFE ELECTRICAL PUBLICATIONS LTD., DORSET HOUSE,
STAMFORD ST., LONDON, S.E.1, or phone WATERLOO 3333 (Ex. 201)

A.K. Fans Ltd.	74	Johnson, Matthey & Co. Ltd.	63
Adcola Products (Electronics) Ltd.	51	La Nationale S.A.	81
Amphenol-Borg	74	Landis & Gyr Ltd.	50
Anglo-American Vulcanized Fibre Co. Ltd.	27	Laplace Transforms	83
Appointments Vacant 75, 76, 77, 78, 79	29	Laycock Engineering Ltd.	29
Arrow Electric Switches Ltd.	19	Levell Electronics Ltd.	7
Automation Ltd.	52	Livingston Control Ltd.	9
Avo Ltd.	82	London Electric Wire Co. & Smiths Ltd.	68
B & K Laboratories Ltd.	Cover ii	Lustraphone Ltd.	73
Bakelite Ltd.	74	Lyons, Claude, Ltd.	14
Bell & Howell Ltd.	50 & 61	Magnetic Devices Ltd.	39
Belling & Lee Ltd.	74	Mawdsley's Ltd.	68
Benson-Lehner Ltd.	38	Metway Electrical Industries Ltd.	24
Brandauer, C. & Co. Ltd.	74	Multicore Solders Ltd.	21
British Communications Corporation Ltd.	81	Murex Ltd.	70
British Insulated Callender's Cables Ltd.	71	Oxley Developments Co. Ltd.	34
British Plastics	60	Painton & Co. Ltd.	57
Cannon Electric (Great Britain) Ltd.	42	Parmeko Ltd.	Cover iv
Cathodeon Crystals Ltd.	74	Perivale Controls Co. Ltd.	59
Classified Advertisements 74, 75, 76, 77, 78, 79, 80	80	Phillips Control (G.B.) Ltd.	72
Colvern Ltd.	11	Plannair Ltd.	6
Coutant Electronics Ltd.	69	Pye H.D.T. Ltd.	81
Dawe Instruments Ltd.	46	RCA Great Britain Ltd.	49
Derritron Electronic Vibrators Ltd.	3	R.M.S. Instruments Ltd.	83
Dexion Ltd.	65	Radio Resistor Co. Ltd.	20
Digital Measurements Ltd.	70	Rotax Ltd.	10
Duratube & Wire Ltd.	74	Salford Electrical Instruments Ltd.	48
E.M.I. Sound Products Ltd.	60	Sangamo Weston Ltd.	62
Elcom (Northampton) Ltd.	62	Sealectro Ltd.	53
Elcometer Instruments Ltd.	34	Sellotape Industrial Ltd.	40, 41
Electrical Development Association Electrical Power Engineering Co. (B'ham) Ltd.	30 73	Sifam Electrical Instruments Co. Ltd.	31
Electrical Review	83	Solartron Electronic Group Ltd. 12, 13, 32	74
Electro Acoustic Industries Ltd.	74	Spear Engineering Co. Ltd.	32
Electronic Associates Ltd.	5	Standard Telephones & Cables Ltd. 35, 36, 37	74
Electrosil Ltd.	54	Stewart Aeronautical Supply Co. Ltd.	47
Elliott Bros. (London) Ltd.	55	Taylor Electrical Instruments Ltd.	60
Eriesson Telephones Ltd.	45	Telegraph Condenser Co. Ltd.	Cover iii
Ether Ltd.	8	Teleguide Ltd.	72
Erie Resistor Ltd.	74	Telford Products Ltd.	2
Evershed & Vignoles Ltd.	33	Thorn Electrical Industries Ltd.	28
Farnell Instruments Ltd.	64	Townsend-Coates Ltd.	24
Ferranti Ltd.	24	Transmetrix Electronic Systems Ltd.	83
Fielden Electronics Ltd.	22	Tygradure Ltd.	74
Fine Wires Ltd.	74	Union Carbide Ltd.	56
Gilbarco Ltd.	23	V.G. Porcelain Co. Ltd.	10
Goring Kerr Ltd.	73	Venner Electronics Ltd.	4
Hallam, Sleight & Cheston Ltd.	69	Vickers Ltd.	17
Hendrey Relays Ltd.	58	Walmore Electronics Ltd.	64
Hinchley Engineering Co. Ltd.	18	Ward Brooke & Co. Ltd.	34
Honeywell Controls Ltd.	66, 67	Welded Modules Ltd.	74
Hughes International (U.K.) Ltd.	16	Welwyn Electric Ltd.	1
IBM United Kingdom Ltd.	84	Westinghouse Brake and Signal Co. Ltd.	15
Industrial Exhibitions	58	Weyrad (Electronics) Ltd.	74
International Printers	72	Wingrove & Rogers Ltd.	24
Interplas	26		
Isola-Werke A.G.	18		

A valuable book for Electrical and Electronic Engineers

LAPLACE TRANSFORMS for ELECTRICAL ENGINEERS

By *B. J. Starkey, DIPL. ING., A.M.I.E.E.*

A presentation of the theory of Laplace transformation in which a physical vocabulary rather than a purely mathematical one is used as far as possible. This method of analysis has become of increasing importance to electrical engineers in many fields, and the work is designed to provide a thorough treatment of the subject in a language with which they will be familiar.

30s. net. BY POST 31s. 2d.

From booksellers. Published by:

ILIFFE BOOKS LTD DORSET HOUSE STAMFORD STREET LONDON SE1

IBM ANNOUNCES INDUSTRIAL PRODUCTS SALES

Mr. F. J. Brand,
Industrial Products,
IBM United Kingdom Limited,
101 Wigmore Street, London, W.1.
Tel: WELbeck 6600, Ext. 225

Please send further information on IBM Industrial Products. I am interested in the following:

1 2 3 4 5 6 7 8 9 10 11 12 13 14

(Circle those desired)

NAME.....

COMPANY.....

ADDRESS.....

DEPARTMENT.....

POSITION.....

IBM Industrial Products Sales market electronic components, scientific instruments and special systems. These products originally developed for IBM research, engineering and manufacturing, reflect the highest standards in quality and design available anywhere.

1 Wire Contact Relays: Fifteen years of field data ensure the highest performance at the lowest possible cost. 4, 6 or 12 pole relays. Contact material Eutectic-Silver or #1 Gold alloy. Reliability, 1 error per 400 million contact closures at 48 VDC. attainable. Operate time from 2.5 to 10 milliseconds. 4 or 6 pole mechanical latch relays also available. Coil voltages from 10 to 100 VDC.

2 Permissive-Make Relays: These relays feature high speed operation (2.0 to 3.2 milliseconds) with low contact bounce characteristics and long life. All relays are furnished with double coils, one pick up coil and one hold coil. Coil voltage from 12 to 48 VDC.

3 Reed Switch: Manufactured to closely held tolerances. Rhodium Gold contact material. All switches are dynamically adjusted, for operate time and air cap, and then tested for all electrical parameters.

4 Static Card Reader IE 206: A single card can be read respectively, as many times as desired, in either read station. Feeding hopper, two reading stations (electrical sensing) and stacking tray in one unit.

5 Card Reader: Cardfeed, hopper, two or three reading stations, and stacking tray in one unit. Maximum speed 150 cards per min. Reading while cards move from one station to the next station.

6 Control Panel Closure Mechanism: Available in four basic sizes, providing a range of total contact positions from 680 to 5120 contacts. Manufactured with phosphorbronze nickel plated contact pins (Gold plated pins are available). Adjustable cams enable precise horizontal and vertical pin, and spring alignment.

7 Component Testing System TE 601: High speed testing of electrical parameters (up to two diodes per second). Up to 35 separate test stations provide DC, AC and pulse test signals both at ambient and elevated temperatures... 252,000 tests an hour. Immediate analysis of results—the on-line computer compares each parameter tested, evaluates characteristics and prints reports.

8 Multiple Wire Connectors: Stationary connectors and cable connectors. 140, 160 or 180 phosphorbronze nickel plated contact pins. Used for interconnection between electronic machines, or as a programming device, to a desired machine logic.

9 Percussive Welder PW 200: Consists of integrated power supply and carrying case, an electrically inter-connected hand gun equipped with grippers for No. 26-28 and 30 awg. wire. Anvil may be machined to suit application. The storage is of a capacitor discharge type and the energy storage is 0.225 to 9.6 Watt-seconds.

10 Component Insertion Machine ME 501: Provides random selection of up to 24 different 1/4 Watt resistors for insertion into prepared printed circuit cards at a maximum rate of 4,500 insertions per hour. Operated by a punched paper tapereader which utilises standard 1 inch 8 channel tape.

11 Numeric Keyboard PE 707: 20 keys—10 inscribed with a digit and 10 with functions for controls. The electric output from the keyboard is in the form of contact closures. Power supply not included, and therefore must be supplied by unit to which it is connected.

12 Alpha Numeric Keyboard PE 708: 45 keys and a space bar, 18 keys inscribed with one alpha character only. 15 keys inscribed with one alpha and one numeric character and 12 keys inscribed with function or controls. The keyboard incorporates the best features of both a typewriter and numeric keyboard.

13 Coded Output Keyboard PE 709: 53 keys, not only for 88 different characters and symbols, but also controls for system operation. The 7 function keys could be for such use as space, back space, line feed, carriage return and line feed, tabulation, shift and shift lock.

14 Fly's Eye Camera SE 401: For making masks in the photoengraving type fabrication process of semiconductor devices. A wide range of magnification is possible. The use of stop masks enable multiple exposures to be made on the sample plate.



Meetings

Institution of Electronic and Radio Engineers

All meetings will be held at 6 p.m. at 9 Bedford Square, London, W.C.1, and tickets will be required, unless otherwise stated.

12th May. Joint I.E.R.E./I.E.E. meeting at the London School of Hygiene and Tropical Medicine, Keppel Street, Gower Street, London, W.C.1. 'Random Access Mass Stores'.

19th May. 'A Groove Control System for Phonograph Disc Cutting Equipments'.

26th May at the London School of Hygiene and Tropical Medicine, Keppel Street, Gower Street, London, W.C.1. 'The Impact of Electronics on the Army's Repair Organization'.

Institution of Electrical Engineers

All meetings will be held at 5.30 p.m. at Savoy Place, London, W.C.2, unless otherwise stated.

12th May, 6 p.m. at the London School of Hygiene and Tropical Medicine, Keppel Street, Gower Street, London, W.C.1. Joint I.E.R.E./I.E.E. meeting. 'Random Access Mass Stores'.

12th May. 'Television Recording'.

13th May. 'Effect of Weather on Performance of an 8 mm Radar'.

Society of Electronic and Radio Technicians

33 Bedford Street, London, W.C.2 ('Phone: Covent Garden 1152).

9th June, 7 p.m. at The Engineers Club, Albert Square, Manchester. 'Colour Television'.

16th June, 7.15 p.m. at The Branch Engineering College, Cookridge Street, Leeds. 'Dual-Standard Television'.

The Institute of Navigation

c/o The Royal Geographical Society, 1 Kensington Gore, London, S.W.7 ('Phone: Kensington 5466).

21st May, 5.30 p.m. at the Royal Institution of Naval Architects, 10 Upper Belgrave Street, London, S.W.1. 'A Satellite/Ground Station Navigational Aid'.

Conferences, Symposia and Colloquia

11th-13th May. Conference on 'Financial Management and Post Control'. Organized by the Production Engineering Research Association of Great Britain (PERA) and held at their headquarters at Melton Mowbray, Leicestershire ('Phone: Melton Mowbray 4133).

12th-14th May. Convention on 'Steam Plant Availability'. Held at Intercontinental Hotel, Pembroke Road, Ballsbridge, Dublin, Eire. Organized by The Institution of Mechanical Engineers.

13th-14th May. Conference on 'New Materials and Processes in Instrument Manufacture'. Held by British Scientific Instrument Research Association at Grand Hotel, Eastbourne. Applications for registrations to: SIRA, South Hill, Chislehurst, Kent ('Phone: Imperial 5555).

17th-18th May. Symposium on 'Acoustics in Engineering and Architecture'. Organized by and held at College of Technology, Broadway, Letchworth, Herts. ('Phone: Letchworth 3911).

17th-20th May at the I.E.E., Savoy Place, London, W.C.2. Joint I.E.E./I.E.R.E. international conference on 'Components and Materials used in Electronic Engineering'. Registration forms and further information from I.E.R.E., 9 Bedford Square, London, W.C.1.

18th-20th May. Conference on 'Design Engineering and Management'. Organized by the Production Engineering Research Association of Great Britain (PERA) and held at their headquarters at Melton Mowbray, Leicestershire ('Phone: Melton Mowbray 4133).

10th June. One-day symposium on 'Quantitative Aspects of Hearing'. Held at National Physical Laboratory, Teddington, Middlesex. Organized by The Institute of Physics and The Physical Society, 47 Belgrave Square, London, S.W.1 ('Phone: Belgravia 6111).

15th-18th June. Conference (in conjunction with exhibition) on 'Metal Heat Treatment'. Held at Bingley Hall, Birmingham. Sponsored by "Industrial & Process Heating", 103 Waterloo Road, London, S.E.1 ('Phone: Waterloo 3388).

30th June-2nd July at University College, London. Joint I.E.R.E./I.E.E. symposium on 'Microwave Applications of Semiconductors'. Papers and requests for further information should be sent to The Secretary, Joint Organizing Committee, Symposium on Microwave Applications of Semiconductors, The Institution of Electronic and Radio Engineers, 8-9 Bedford Square, London, W.C.1.

5th-6th July. Conference on 'Low Level Radioactivity Measurements—Limitations and New Techniques'. Held at The Imperial College of Science and Technology, London, by The Institute of Physics and The Physical Society. Applications for tickets to: I.P.P.S., 47 Belgrave Square, London, S.W.1 ('Phone: Belgravia 6111).

6th-10th Sept. Convention on 'Machines for Materials and Environmental Testing'. Held at the Manchester College of Science and Technology, Manchester. Organized jointly by The Institution of Mechanical Engineers and The Society of Environmental Engineers from 1 Birdcage Walk, London, S.W.1 ('Phone: Whitehall 7476).

8th-10th Sept. Symposium on 'Electronics in Industry'. Held at The University of Durham, Durham. Organized jointly by The Ministry of Technology and The Institution of Electronic and Radio Engineers from Wellbar House, Gallowgate, Newcastle-upon-Tyne, 1 ('Phone: Newcastle-upon-Tyne 27575).

13th-18th Sept. Engineering Materials and Design Conference. Held in conjunction with an exhibition at Olympia, London. Organized by Industrial & Trade Fairs Ltd., Commonwealth House, 1-19 New Oxford Street, London, W.C.1 ('Phone: Chancery 9011).



WHAT'S ON AND WHERE

Continued

20th–25th Sept. International conference on 'Thermionic Electrical Power Generation'. Held at The Institution of Electrical Engineers, Savoy Place, London, W.C.2 (Phone: Covent Garden 1871). Organized jointly by I.E.E. and O.E.C.I.D. European Nuclear Energy Agency.

21st–23rd Sept. Symposium on 'Applications of Microelectronics'. Held at Department of Electronics, The University, Southampton. Jointly organized by the I.E.E. and I.E.R.E. from The University of Southampton.

21st–24th Sept. First European Conference on Magnetism, Vienna. To be held at Technischen Hochschule, Vienna. Conference Secretariat: Verein Deutscher Eisenhüttenleute, 4 Dusseldorf, Breite Strasse 27.

Exhibitions

13th–19th May. London
International Photo-Cine Fair, Olympia, London. Arranged by British Organisers Ltd., 52 Grafton Way, London, W.1 (Phone: Euston 7930).

17th–21st May. London
8th International Instrument Show, Grosvenor House, Park Lane, London, W.1. Held by B & K Laboratories Ltd., 4 Tilney Street, London, W.1 (Phone: Grosvenor 4567).

17th–22nd May. Birmingham
Business Efficiency Exhibition, Birmingham (Bingley Hall). Organized by the Business Equipment Trade Association, 64 Cannon Street, London, E.C.4 (Phone: Central 7771).

18th–21st May. London
Radio and Electronic Component Show at Olympia, London. Organized by Industrial Exhibitions Ltd., 9 Argyll Street, London, W.1 (Phone: Gerrard 1622).

19th–25th May. Amsterdam
Electronic Exhibition, Amsterdam. Organized by Elvabé, Molenaaltee 63A, Wilp, Gld., Netherlands.

19th–27th May. London
Pakex 65—International Packaging Exhibition, Earls Court, London. Organized by Industrial & Trade Fairs Ltd. and F. W. Bridges & Sons Ltd., Commonwealth House, 1-19 New Oxford Street, London, W.C.1 (Chancery 9011).

25th–27th May. Dundee
'Electronics in Action' Exhibition, Marryat Hall, City Chambers, Dundee. Organized by the Scottish Section of the I.E.E. and I.E.R.E. from Electrical Engineering Dept., Queens College, Dundee (Phone: ODU2 23181).

15th–18th June. Birmingham
Industrial Process Heating Exhibition (concurrently with conference). Held at Bingley Hall, Birmingham. Organized by Business Publications, 103 Waterloo Road, London, S.E.1 (Phone: Waterloo 3388).

15th–19th June. London
1st Pumping Exhibition, Earls Court, London. Organized by Iliffe Exhibitions Ltd., Dorset House, Stamford Street, London, S.E.1 (Phone: Waterloo 3333).

15th–19th June. London
NAVREX—Noise and Vibration Reduction Exhibition, Earls Court, London. Organized by Iliffe Exhibitions Ltd., Dorset House, Stamford Street, London, S.E.1 (Phone: Waterloo 3333).

16th–26th June. London

Interplas 65—The International Plastics Exhibition in Europe for 1965, Olympia, London. Organized by Iliffe Exhibitions Ltd., Dorset House, Stamford Street, London, S.E.1 (Phone: Waterloo 3333).

8th–17th July. London

Mining Machinery Exhibition, Olympia, London. Organized by Municipal and Industrial Exhibitions Ltd., 3 Clements Inn, London, W.C.2 (Phone: Chancery 1200).

25th Aug.–4th Sept. London

Radio Show, Earls Court, London. Organized by Industrial and Trade Fairs, 1-19 New Oxford Street, London, W.C.1 (Phone: Chancery 9011).

27th Aug.–5th Sept. Stuttgart

Deutsche Funkausstellung 1965—The German Radio and Television Exhibition. Held on the Killesberg in Stuttgart. Organized by Stuttgarter Ausstellungen-GmbH, 7 Stuttgart 1, Am Kochenhof 16.

7th–11th Sept. Basle

INEL 65 International Exhibition of Industrial Electronics, Basle, Switzerland. 61 Clarastrasse, 4000 Basle (Phone: Basle (061) 323850).

9th–19th Sept. Paris

Salon International de la Radio et de la Télévision, Paris.

13th–18th Sept. London

Engineering Materials and Design Exhibition. Held in conjunction with a conference at Olympia, London. Organized by Industrial & Trade Fairs Ltd., Commonwealth House, 1-19 New Oxford Street, London, W.C.1 (Phone: Chancery 9011).

14th–22nd Sept. Utrecht

HET Instrument 1965 Exhibition, Royal Dutch Industries Fair, Utrecht. Further details from: Cooperative Vereniging, 'HET Instrument' u.a., Sparrenlaan 2, Soest, Holland (Phone: Soest (02955) 3047).

28th Sept.–1st Oct. Brighton

Medical Electronic and Instrumentation Exhibition (in conjunction with The European Symposium on Medical Electronics) at Exhibition Hall, Brighton, Sussex. Organized by Events Promotions Ltd., Ashbourne House, Alberon Gardens, London, N.W.11 (Phone: Meadway 5555).

2nd–10th Oct. Ljubljana, Yugoslavia

XIIth International Exhibition on Modern Electronics. Details from: Gospodarsko razstavisce (Ljubljana Fair), Ljubljana, Titova 50, Yugoslavia.

4th–13th Oct. London

Business Efficiency Exhibition, London (Olympia). Organized by Business Equipment Trade Association, 64 Cannon Street, London, E.C.4 (Phone: Central 7771).

13th–19th Oct. Dusseldorf

3rd International Congress and Exhibition of Measuring Instrumentation and Automation (Interkama), Dusseldorf, Germany. Represented by John E. Buck (Trade Fair Agencies) Ltd., 47 Brewer Street, Piccadilly, London, W.1 (Phone: Gerrard 7576).

3rd–10th Nov. Oslo

Automatica 65—an exhibition of automatic control. Held in the Exhibition Hall, Skoyen, Oslo. Details from: Studiesel-skapet For Norsk Industri, Forskningsveien 1, Oslo 3.

Courses

20th–23rd July. 'Valve Analysis'. I.Prod.E. Summer School 1965 at Loughborough College of Technology. Further details from: The Institution of Production Engineers, 10 Chesterfield Street, London, W.1 (Phone: Grosvenor 5254).

NEW +125° C

**ALUMINIUM FOIL
EXTENDED
TEMPERATURE RANGE
ELECTROLYTIC
CAPACITORS
TO MIL-C-39018 SIZES**

-55° C



Please send me a copy of your Bulletin No. 100 (Issue 2)

NAME.....

ADDRESS.....
.....

IES

NEW

T.C.C. E.T.R. capacitors are about one third the weight of corresponding tantalum foil capacitors, have a larger capacitance per unit volume and in many cases will match them in performance. Available in seven sizes and from 5-200 volts working at 125°C with a capacitance range of 3.3 µF to 1000 µF. These capacitors are a big step forward in Aluminium Foil Electrolytics and are the product of T.C.C.'s continued research and development based on many years of experience in the capacitor field. Send for the new T.C.C. Bulletin No. 100 (issue 2) by filling in and posting the coupon opposite, this new bulletin gives full details of the range with performance curves and complete specification.

THE TELEGRAPH CONDENSER CO. LTD.

(Electronics Division) North Acton, London W.3. Telephone: Acorn 0061 (16 lines) Telex: 261383

Also at **CHESSINGTON, SURREY** and **BATHGATE, SCOTLAND**



For further information circle 202 on Service Card

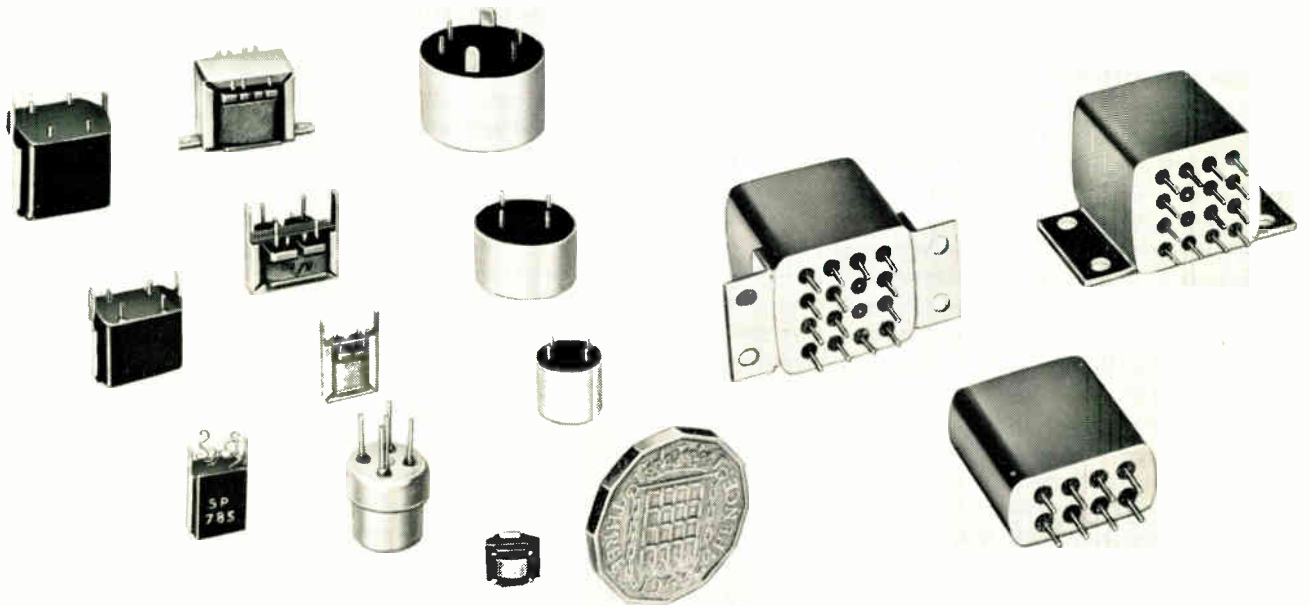

PARMEKO

Miniature Electronic Components

G.100 Series miniature relays

These 2-pole and 4-pole miniature relays were initially developed for use in guided weapon and airborne systems where high performance and reliability are essential. Balanced armature design enables them to withstand shock and vibration while the risk of contact contamination has been greatly reduced by sealing the coils and contacts in separate compartments. In addition, the contacts are in a gold alloy which also obviates the difficulties associated with plated contacts. Write for List 1100 which gives full technical specifications.

4000 Series miniature transformers, transducers, coils

This series is based on a progression of core sizes carefully selected as a result of many years specific research into the design of miniature components. The aim has been to ensure maximum utilisation of the space enclosed by their small overall dimensions. The comprehensive range of models available includes pulse, audio, power, and instrument transformers together with close tolerance inductors and coils. Please write for List 280 which gives full technical specifications.

PARMEKO LIMITED, PERCY ROAD, LEICESTER, ENGLAND

Telephone: Leicester 32287