

# INDUSTRIAL ELECTRONICS

FEBRUARY 1965 5s 0d

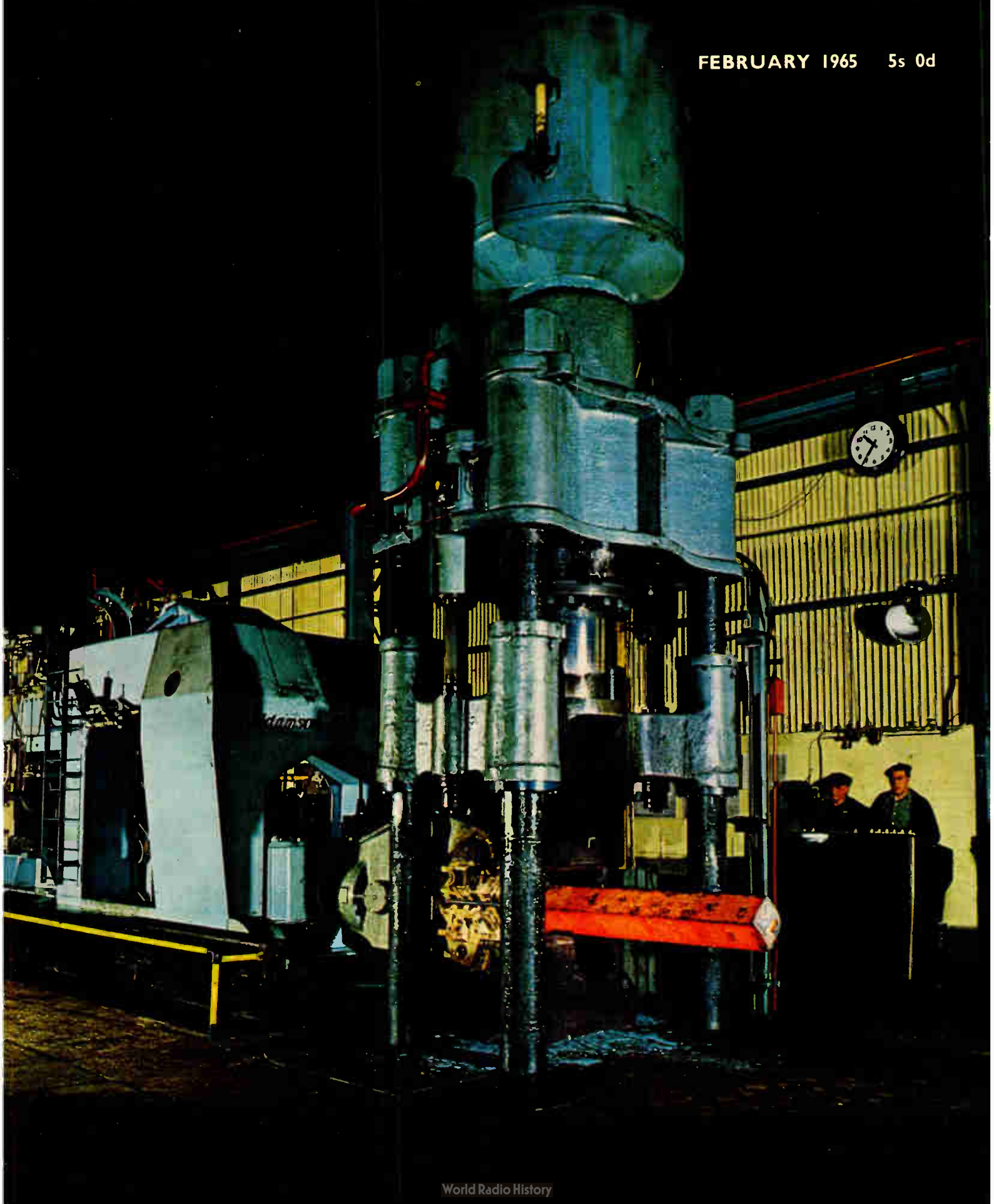

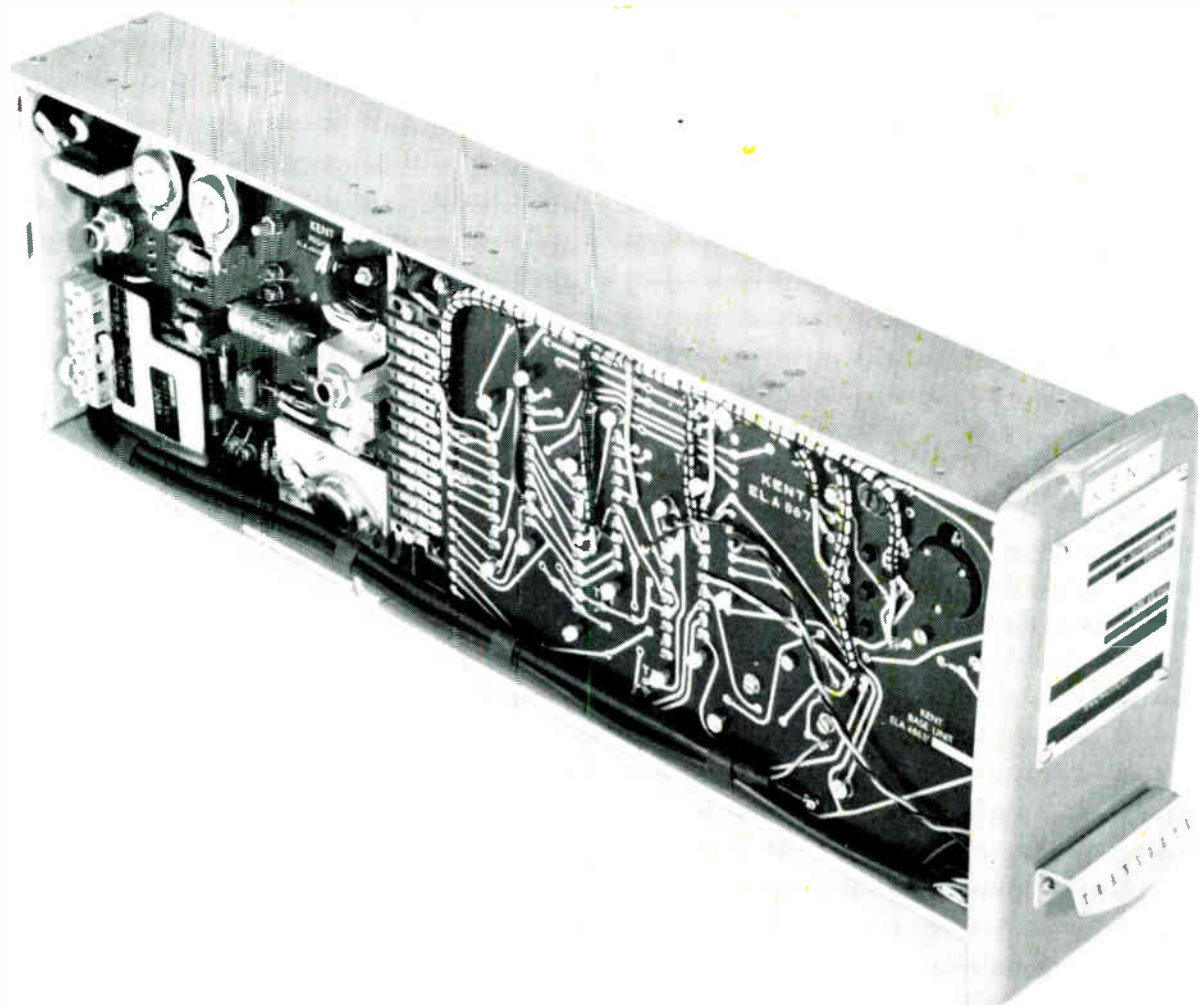

## TRANSDATA

One of the most flexible systems of process measurement and control. It consists entirely of single-purpose units related by a 0 to 10mA signal and incorporating the latest techniques in solid-state electronics. Custom-built integrated schemes, however simple or complex, are designed on the individual but economical basis of selecting from a comprehensive range those basic items needed to perform the necessary measurement, conversion or control functions.

Modular construction, printed circuitry and high-grade components are employed throughout to ensure flexibility, accuracy, reliability and ease of servicing.

May we send you further details of the Kent Transdata system?



For further information circle 200 on Service Card

# ....say yes to the **HONEYWELL SERVOTRONIK**-there's a type to meet your temperature control/indication requirements

CHECK THESE EVERY-MODEL FEATURES Null balance servo system \* Thermocouple, resistance thermometer or millivolt actuation \* Automatic cold junction compensation \* Calibrated accuracy— $\pm 1\%$  f.s.d. \* Suppressed zeroes available \* High impedance input \* No zeroing or adjustments for external resistance required \* Intrinsically safe models available \* 5-inch scale \* Broken sensor protection \* Robust, power driven indicator \* Vibration resistant—no pivots, no jewels, no springs \* Solid state construction \* Full range of thermocouples and resistance bulbs available \* Simple set-point adjustment \* Maximum economy of panel space — and money!

## VERTICAL SCALE

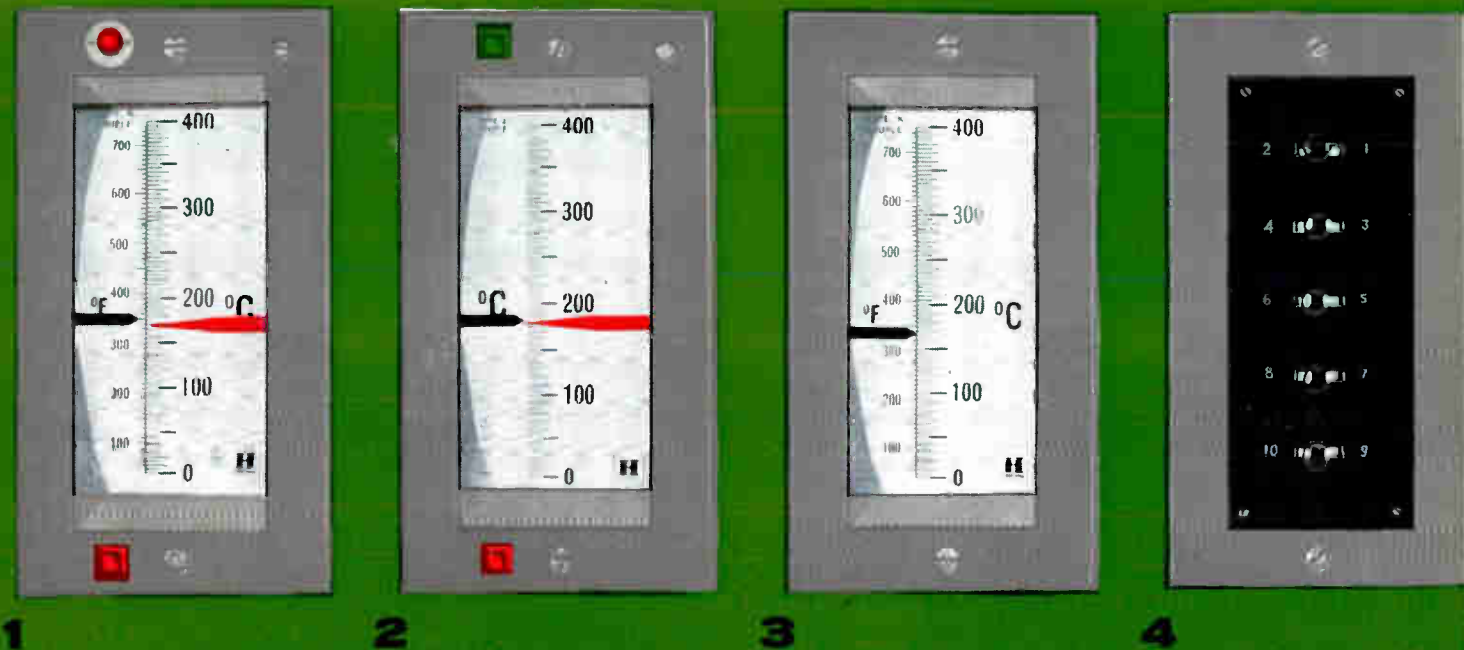

## HORIZONTAL SCALE

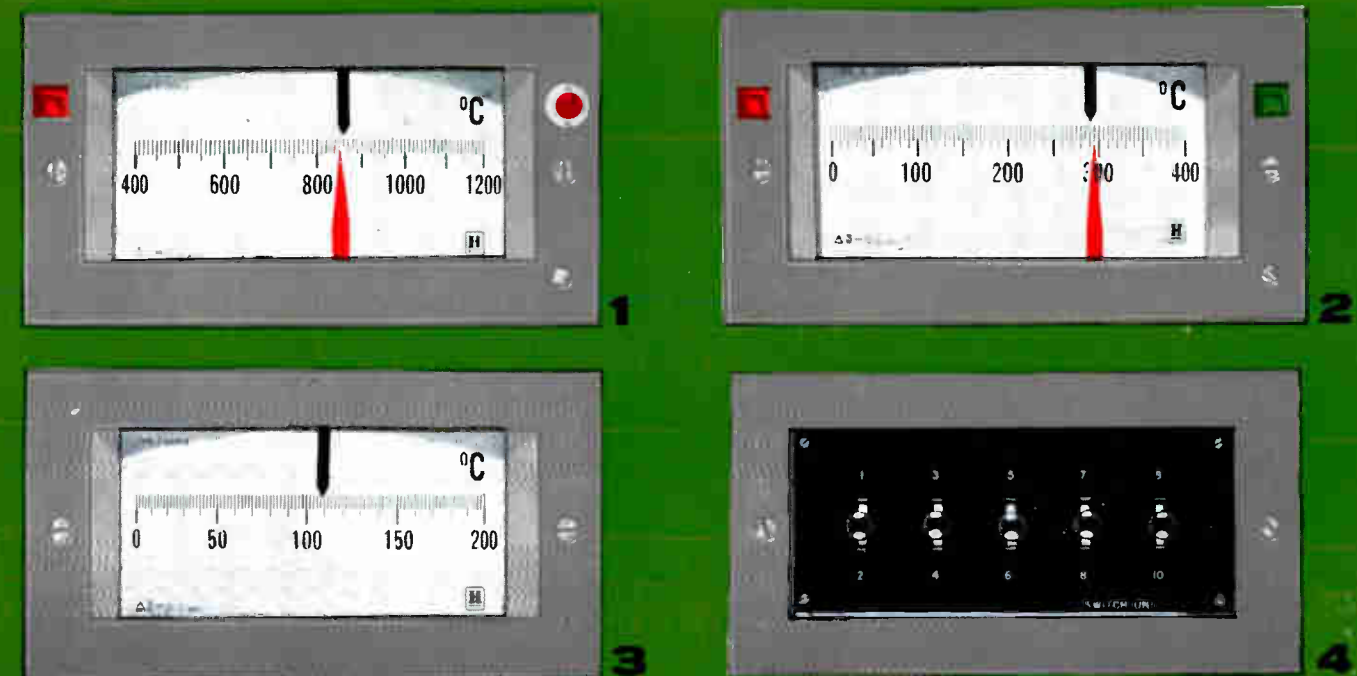

### TEMPERATURE CUT-OFF

**1**

Vertically and horizontally mounted ServotroniK instruments for excess temperature safety cut-off. These sentinel type instruments will shut off process power or fuel input should process temperatures exceed a pre-determined safe limit. Fitted with manual reset and alarm lamp. Control relay contacts rated at 5A, 250V non-inductive. Accurate set point adjustment over 5% to 95% scale length.

### TEMPERATURE INDICATION/CONTROL

**2**

Vertically and horizontally mounted ServotroniK instruments providing indication and on/off, three zone or anticipatory control action. For on/off or two position control one contact is made below set point, one above; differential 0.25% f.s.d. For three zone control, the centre zone is adjustable from 1% to 4% of full scale. Anticipatory control provides extremely accurate pulse proportional control by varying ratio of 'on time' according to deviation of variable from set point. Proportional band 1.5% f.s.d.

### TEMPERATURE INDICATION

**3**

Vertically and horizontally mounted ServotroniK instruments for temperature indication only.

**4**

Where up to six or ten points are to be monitored in turn, a matching six- or ten-points unit can be provided. Switching units for thermocouple or millivolt actuation include a filter circuit.

# Honeywell

**Honeywell ServotroniK** cuts out on-site calibration, combines ruggedness with accuracy, saves valuable panel space

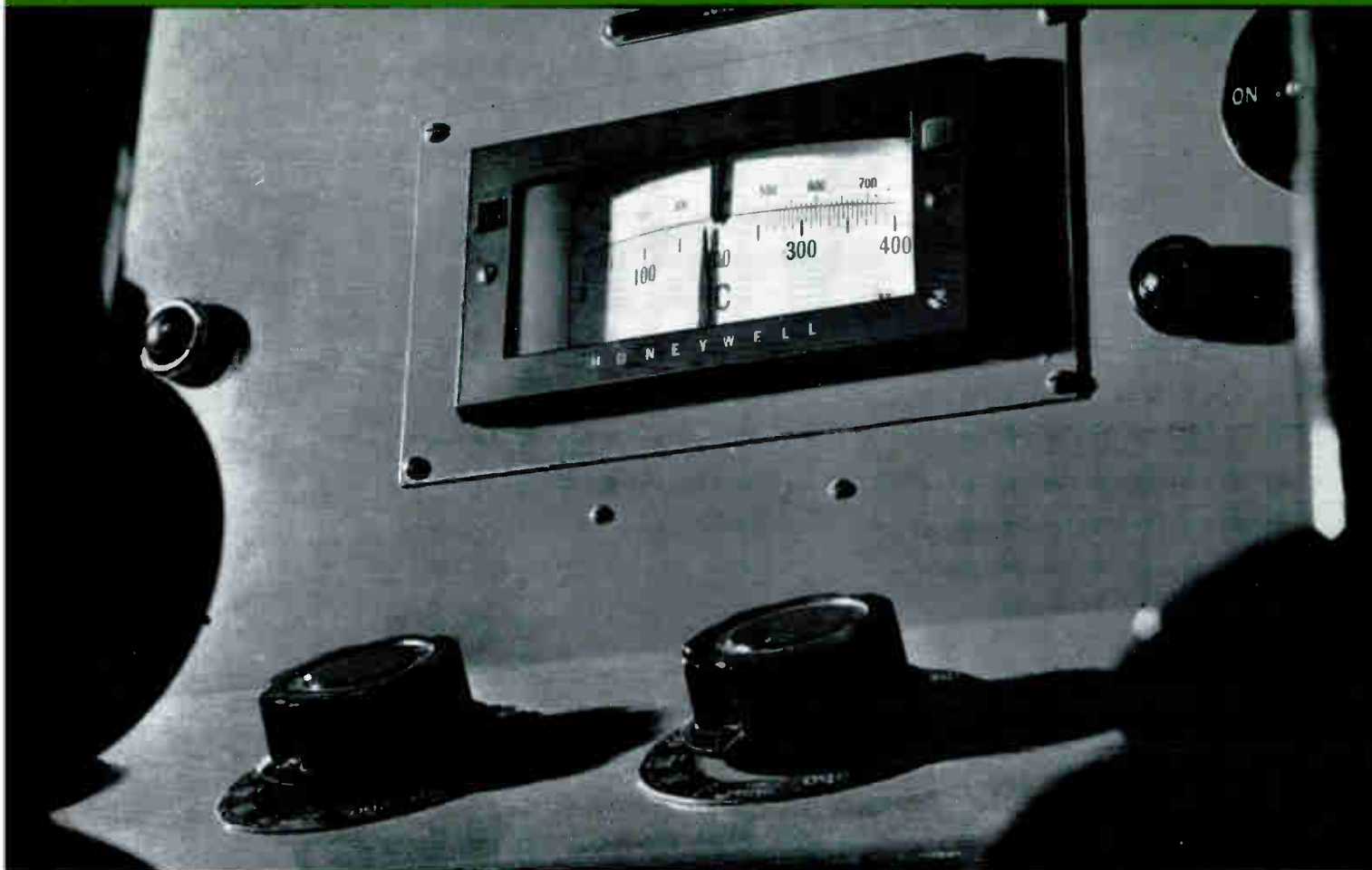

Contact your nearest Honeywell Branch Office for further details of the ServotroniK

<b>BELFAST</b>	Honeywell Controls Ltd., 296 Albert Bridge Road, Belfast, Northern Ireland. Belfast 58309
<b>BIRMINGHAM</b>	Honeywell Controls Ltd., Sutton New Road, Erdington, Birmingham 23. Warwicks. Erdington 6271
<b>CARDIFF</b>	Honeywell Controls Ltd., Room 19, Glamorgan Buildings, Frederick Street, Cardiff, Wales. Cardiff 26491-93
<b>REPUBLIC OF IRELAND</b>	Honeywell Controls Ltd., 38 Upper Mount Street, Dublin, Republic of Ireland. Dublin 65929
<b>MOTHERWELL</b>	Honeywell Controls Ltd., Newhouse Industrial Estate, Motherwell, Lanarkshire, Scotland. Motherwell 4145
<b>LEEDS</b>	Honeywell Controls Ltd., 5-7 New York Road, Leeds 2. Leeds 2-8535
<b>LONDON</b>	Honeywell Controls Ltd., Great West Road, Brentford, Middlesex. Atlas 9191
<b>MANCHESTER</b>	Honeywell Controls Ltd., Civic Centre, Wythenshawe, Manchester 22. Mercury 3214
<b>MIDDLESBROUGH</b>	Honeywell Controls Ltd., 59-61 Albert Road, Middlesbrough, Yorkshire. Middlesbrough 44331
<b>SHEFFIELD</b>	Honeywell Controls Ltd., Suffo'k House, Suffolk Road, Sheffield 2, Yorkshire. Sheffield 78981

**Honeywell**

**INDUSTRIAL PRODUCTS GROUP**

**HONEYWELL CONTROLS LIMITED**

Great West Road  
Brentford Middlesex Atlas 9191



**HONEYWELL INTERNATIONAL**  
Sales and Service offices in all principal cities of the world.  
Manufacturing in United Kingdom, U.S.A., Canada, Netherlands, Germany, France, Japan  
HCJ714/1164  
SAD18

World Radio History

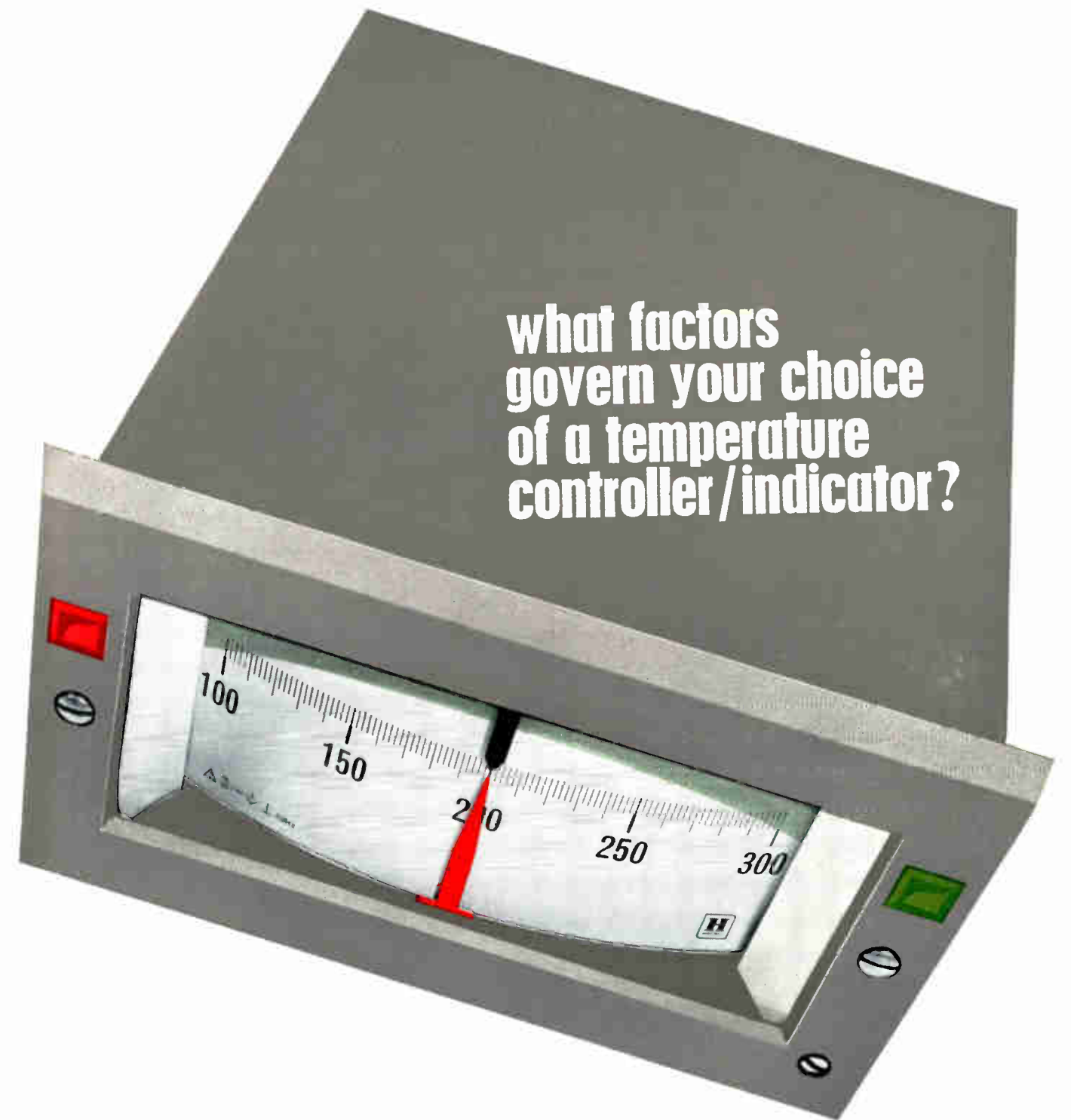

what factors govern your choice of a temperature controller/indicator?

- Low price?       Accuracy and reliability?       Minimal attention for operation and maintenance?
- Rugged ability to withstand vibration?       Easy-to-read scale covering only the required range?
- Vertical or horizontal mounting?       Ability to be shipped fitted to panels?       Quality materials and craftsmanship?       Speedy delivery?       Manufacturer's process control and application experience?

ONE 'YES' IS REASON ENOUGH TO INVESTIGATE THE

**HONEYWELL SERVOTRONIK**

---

# INDUSTRIAL ELECTRONICS

Automation      Instrumentation      Control

---

Volume 3

Number 2

February 1965

## Contents

Editor            **W. T. COCKING, M.I.E.E.**  
Assistant Editor        **T. J. BURTON**  
Consulting Editor        **T. E. IVALL**  
Advertisement Manager **G. H. GALLOWAY**  
Production                **D. R. BRAY**  
Drawing Office          **H. J. COOKE**

- 55    **Comment**
- 56    **High-Speed Forging Control** *by A. Hadfield*  
Forging requires a double control system, for the hot ingots of metal must be manipulated and the press controlled. This article describes a digital electronic control system which operates in conjunction with hydraulic actuation of the machinery.
- 62    **Programme Sequence Control** *by M. J. Williams*  
The equipment described in this article utilizes an entirely novel lamp, photocell and programme store arrangement to produce extremely complex process control sequences that can be changed in a moment.
- 66    **Microwave Moisture Measurement** *by H. B. Taylor*  
This article describes a method of measuring the water content of materials by determining the extent to which microwave power is absorbed. The method is in use in the fertilizer, toffee, marzipan, soap powder and nylon tow industries and is under investigation in the nitro-cellulose, foundry sand, coal, grain and soap industries. It is also being applied for research into wood pulp, roads and building.
- 72    **Land-Vehicle Navigation System** *by S. G. Spracklan*  
This article describes a navigational system which has been developed primarily for military purposes. Starting from a known position it provides continuous dead reckoning of position based on mileage and compass course.
- 77    **Communications System for Cranes**  
Multichannel transmission of digital data and speech information can be made with this new close-spaced loop communications system. Its improved performance offers many advantages over existing communication systems.

*continued overleaf*

---

© Iliffe Electrical Publications Ltd., 1965

Permission in writing from the Editor must first be obtained before letterpress or illustrations are reproduced from this journal. Brief abstracts or comments are allowed provided acknowledgment to the journal is given.

Published on the first Thursday after the 5th of each month by

Iliffe Electrical Publications Ltd., Dorset House, Stamford Street, London, S.E.1  
Managing Director: W. E. Miller, M.A., M.I.E.R.E.

Telephone: Waterloo 3333. Telegrams/Telex: Electronics Iliffepres 25137 London

ANNUAL SUBSCRIPTION, HOME £3 0s. 0d.    OVERSEAS £3 10s. 0d.  
CANADA and U.S.A. \$10.00.

---

# INDUSTRIAL ELECTRONICS

Automation      Instrumentation      Control

---

## Contents *continued*

- 78 **Measuring Alternating Voltages with Backward Diodes** *by B. Stuttard, M.Sc.*  
The use of backward diodes in measurement is discussed in this article. This diode is one which relies upon the tunnel effect for its operation.
- 82 **Fluid Flow Control Valves** *by J. C. McVeigh, M.A.(Cantab.), M.Sc., Ph.D.*  
For controlling the flow of fluid in a pipe line valves are needed. In this article the various forms of valve are described and their characteristics are indicated.
- 99 **Control Design Data—The Phase-Advance Network and Compensation Procedures**  
*by N. G. Meadows, B.Sc.*

### What's On and Where?

A new and regular feature which lists forthcoming events. Professional meetings, symposia, conferences and exhibitions are included. For easy reference this item is positioned facing the inside back cover.

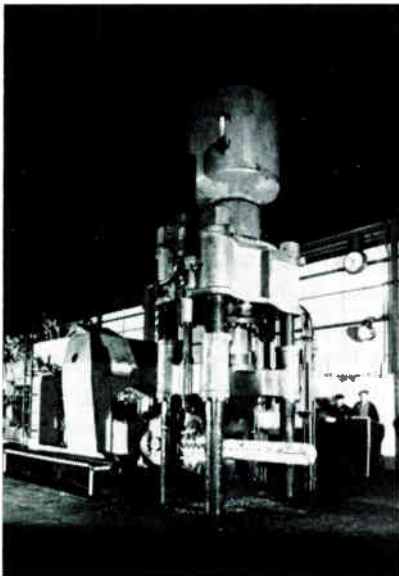

### OUR COVER

Shown on the front cover this month is a combined high-speed forging press and manipulator. This picture was taken at Parks Forge, Wigan. Electronic and hydraulic control systems have been incorporated in this equipment to utilize the potential high productivity of the machine. Starting on page 56 is an article which describes the system.

### ● TO SAVE YOUR TIME

We will assist you to obtain further information on any products or processes described or advertised in this issue. Just use the enquiry cards included in this journal.

## Features

- |    |   |     |                                      |
|----|---|-----|--------------------------------------|
| 61 | Self-Tuning Communications System                 | 101 | G.P.O. Tries P.C.M. Telephone System |
| 65 | City & Guilds Syllabuses 1964-65                  | 102 | Industrial News                      |
| 70 | Computer Typesetting                              | 105 | Correspondence                       |
| 71 | New TV/Phone Aerial                               | 105 | New Books                            |
| 76 | STC Form New Electronic Services Division         | 106 | Manufacturers' Literature            |
| 80 | Europe's Largest Aerial System (Illustrated News) | 56  | Classified Advertisements            |
| 87 | New Apparatus                                     | 61  | Index to Advertisers                 |

---

## Next Month

In the March issue there will be the first article of a short series dealing with the use of electronic control in the textile industry. Among the other articles will be one dealing with telemetry applied to measurement in a piston engine.

For further information  
circle 203 on Service Card

# WELWYN

## METAL FILM RESISTORS TO DEF 5115 STYLE RFG7

### RANGES AND RATINGS

WELWYN TYPE	DEF STYLE 5115 DRAFT	WATTS RATING at 70°C	MAXIMUM VOLTAGE	OHMIC RANGE AT $\pm 2\%$ , $\pm 1\%$ and $\pm 0.5\%$
M807	RFG7 - 0.125	0.125	200	100 $\Omega$ - 100K $\Omega$
M817	RFG7 - 0.25	0.25	250	100 $\Omega$ - 100K $\Omega$
M827	RFG7 - 0.5	0.5	350	100 $\Omega$ - 100K $\Omega$

These resistors have a long term, full load stability performance of better than 0.5%

TEMPERATURE COEFFICIENT: AVAILABLE AT  $\pm 50$  p.p.m./°C  
AND AT  $\pm 100$  p.p.m./°C

### DIMENSIONS

WELWYN TYPE	BODY LENGTH MAX.	BODY DIA. MAX.	LEAD LENGTH MAX.
M807	0.437"	0.165"	1.625"
M817	0.615"	0.210"	1.625"
M827	0.822"	0.275"	1.625"



WRITE NOW FOR FULL DETAILS



WELWYN ELECTRIC LIMITED

BEDDINGTON - NORTHUMBERLAND - ENGLAND

Telephone: Beddington 2104 - Telegrams: Resistor Beddington

FACTORIES IN AUSTRALIA AND CANADA

# IT ALL HAPPENS AT ONCE

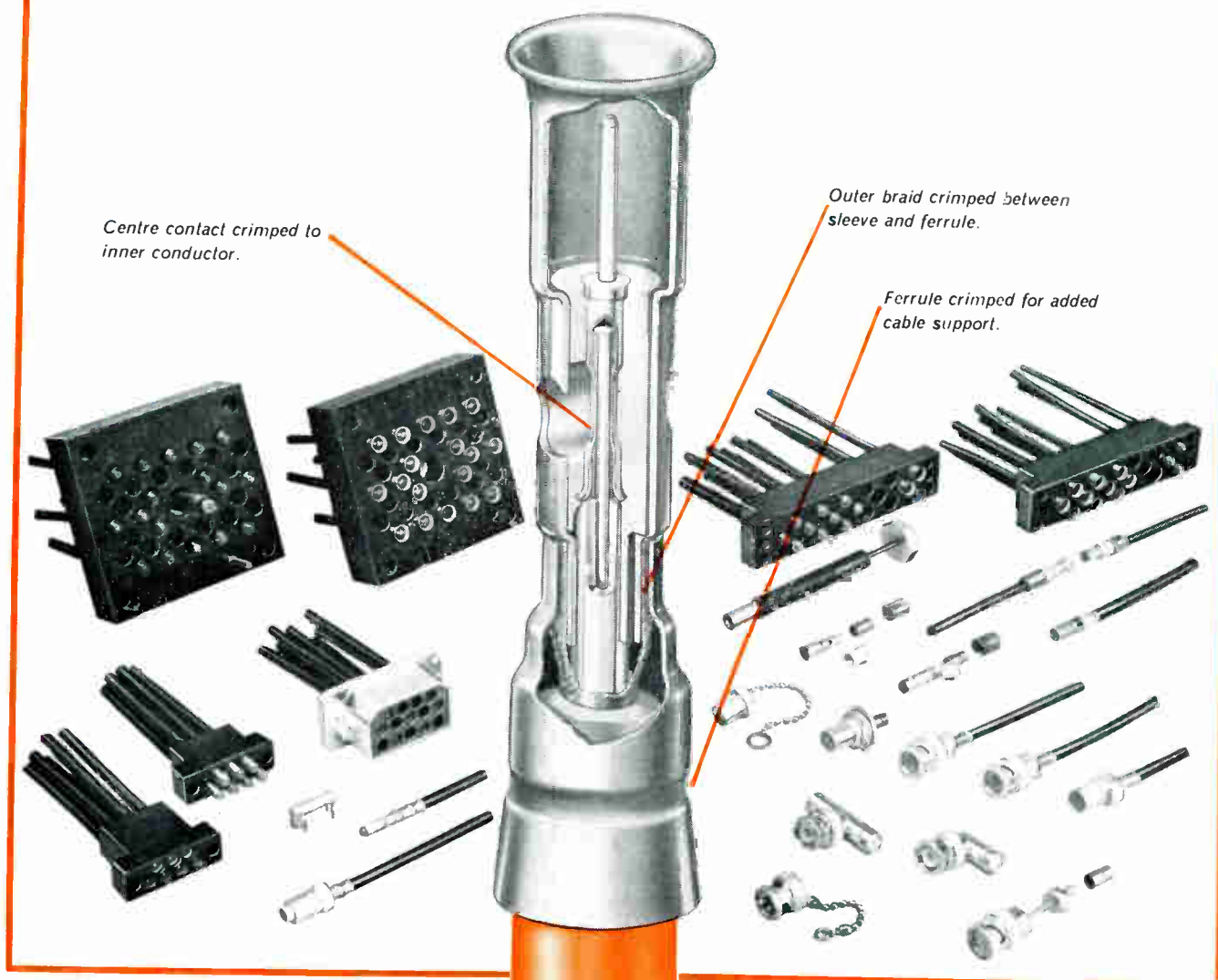

One controlled operation using a simple hand tool provides the perfect termination for coaxial cables. It crimps simultaneously the centre conductor and outer braid, and provides a positive cable grip. Damage to the cable is impossible; efficiency is high and consistent.

A-MP COAXICON Connectors are available in BNC, TNC, threaded, standard, twin standard, miniature and sub-miniature types. The standard, twin standard, miniature and sub-miniature ranges can be used for building up multiple connectors in which contacts snap-lock into position, but are removable at will.

*Please write for detailed data sheets*

## A-MP COAXICON connectors

incorporating AMP controlled compression crimp for lowest applied costs

# AMP

AIRCRAFT-MARINE  
PRODUCTS (G.B.) LTD



TERMINAL HOUSE, STANMORE, MIDDX. TEL: STOnegrove 6341

A-MP products and engineering assistance are available through associated companies in:  
U.S.A. · Australia · Canada · France · Germany · Holland · Italy · Japan · Mexico · Puerto Rico

A-MP AND COAXICON ARE TRADE MARKS OF AMP INC. AI\*292





**PLUG IN  
TO**

**AUTOMATIC  
BATCH COUNTING**

*FACTS THAT MATTER TO YOU*



No switches to be set up



Choice of 3 additional sub-programmes



Plug-in modules for any batch qty between 1 and 9,999



Batching rate 200 counts per second maximum

*A compact, rugged and reliable instrument designed for production-line applications*

For further information of the

**LC108 AUTOMATIC  
BATCHING COUNTER**



please contact

**LIVINGSTON CONTROL LIMITED**

Greycaines House · Bushey Mill Lane · North Watford · Herts

Telephone : Watford 41291

# G.E.C. MODULAR EVERY PROBLEM OF

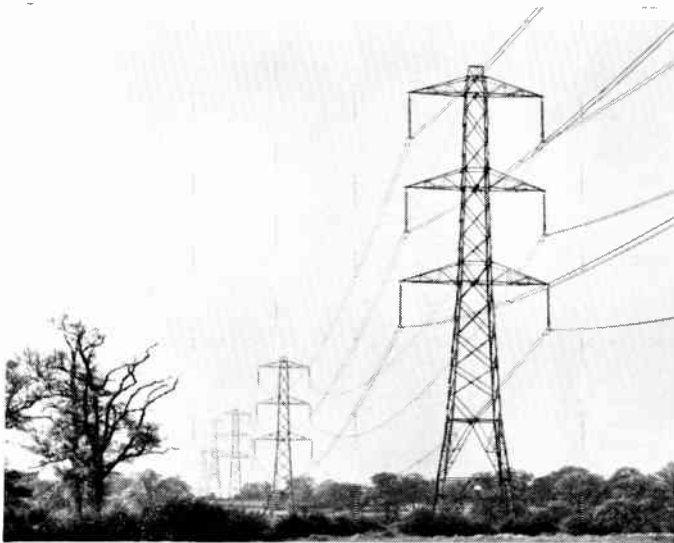

**Electricity Supply** G.E.C. equipment has been installed by many electricity supply undertakings for control and alarm purposes. A recent example has been for voltage control and monitoring at all distribution sub-stations by one of the largest area boards.

G.E.C. Electronics' modular systems provide the economic answer to any remote control problem. Whether the distance involved is one mile or hundreds of miles, G.E.C. (Electronics) Ltd. can build up from its comprehensive range of standard frequency and time division multiplex modules the ideal system for any application. This rational, modular approach gives fullest design flexibility and cuts costs by eliminating expensive special engineering. Simply by adding extra modules the systems can grow as the plant they control grows.

G.E.C. modular systems outmatch conventional methods on cost, on versatility and on reliability.

## These are some of the basic G.E.C. modular systems

- ★**Teledata**—data and control transmission equipment which operates between a number of points over a single pair of wires.
- ★**Comantel**—automatic answering unit for use with Teledata transmitters and receivers over the telephone system.
- ★**Teleshift**—transistorised frequency shift transmission equipment for faster signalling under adverse conditions.
- ★**Telecode**—scanning equipment which economically transmits digital control information over long distances.
- ★**Teleducer**—transistorised equipment for transmission of analogue quantitative measurements over line or radio circuits.



**Refineries and Pipelines** G.E.C. (Electronics) Ltd. has installed remote control systems for many different applications on behalf of major oil companies. A typical example is the use by Shell-Mex and B.P. Ltd. of G.E.C. equipment to operate motorised valves at isolated points on pipelines. Control in this instance is exercised over the G.P.O. telephone system.



**Airfields** G.E.C. equipment is extensively used on Airfields for centralised control of lighting, aircraft arrester barriers, fuel pumps and other airfield services.

# SYSTEMS SOLVE REMOTE CONTROL

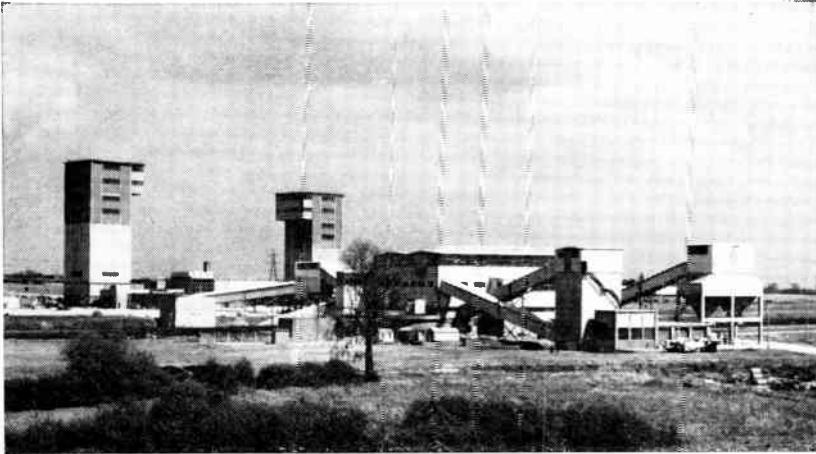

**Mining** G.E.C. equipment has received Certificates of Intrinsic Safety from the Ministry of Power and is therefore particularly suitable for use in coal mines, oil refineries and other hazardous areas. Systems have been provided for the N.C.B. for use with mining machinery, coal cutting machines, etc.



**Communications Control** Some miles from Goonhilly, aligned with Telstar's orbit, a static transmitter has been set up to simulate Telstar transmissions for testing the main receiving equipment. This transmitter is operated from Goonhilly by means of G.E.C. remote control equipment. Similar applications include the remote control of the master transmitter on the South Yorks Mobile Radio-phone scheme; and the operation from Prestwick Ground Control Station of radio transmitters at Stranraer.



**Railways** British Railways has commissioned large signal projects which make extensive use of G.E.C. modular equipment to provide electronic remote control of signals and points, and operations of train descriptors. It also gives indications back to the control point. As it is fully transistorised and can be relied upon to operate for long periods without attention, it is particularly suitable for railway use.



**modular  
remote control  
and telemetry**

INSTRUMENTATION & CONTROL DEPARTMENT, EAST LANE, WEMBLEY, MIDDLESEX.      ARNold 4353

**CONSULT G.E.C. ELECTRONICS NOW**

This coupon attached to your letterhead or a phone call to ARNold 4353 will put you in touch with the G.E.C. Electronics' team of systems engineers who will gladly help you solve your remote control problems.

NAME .....

POSITION .....

I.E.5

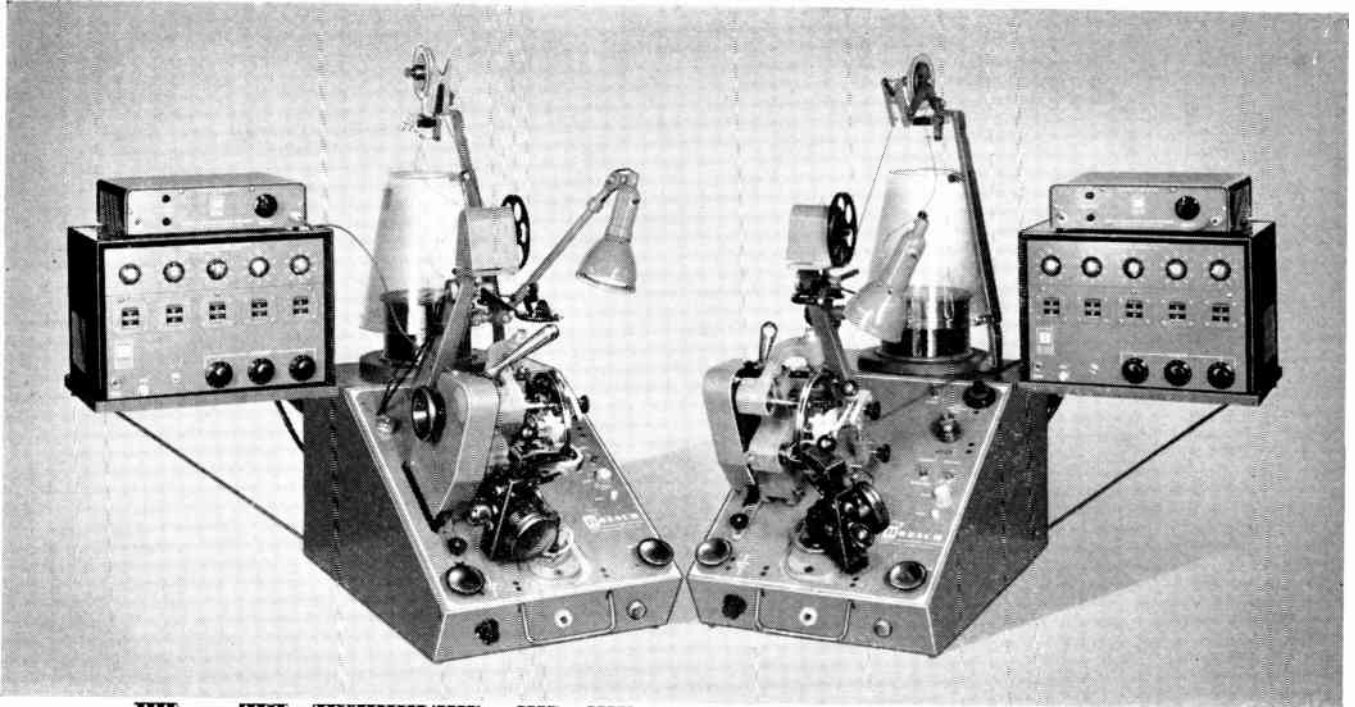

# NEW

# BOESCH TI00D

## *high production* TOROIDAL WINDING MACHINES

Outstanding features and versatility of operation make the new Boesch TI00D Series machines the most suited for high speed toroidal winding of coils in a wide latitude of wire sizes, with greater uniformity. Core sizes from .035 inches I.D. to 5 inches O.D.

Quick interchangeable shuttle heads for fast and flexible changes in set-up result in increased efficiency and economy in time and costs.

### *features include*

- dynamic braking
- built-in shuttle loader
- predeterminable footage counter
- predeterminable turns counter
- twin core positioning during operation

**Models to suit specific winding applications**

Send for further details :

**Automation Ltd.**

Devonshire House • Vicarage Crescent • London S.W.11

Telephone : Battersea 5549

Telex : 261269

Grams and Cables : Automashun, London

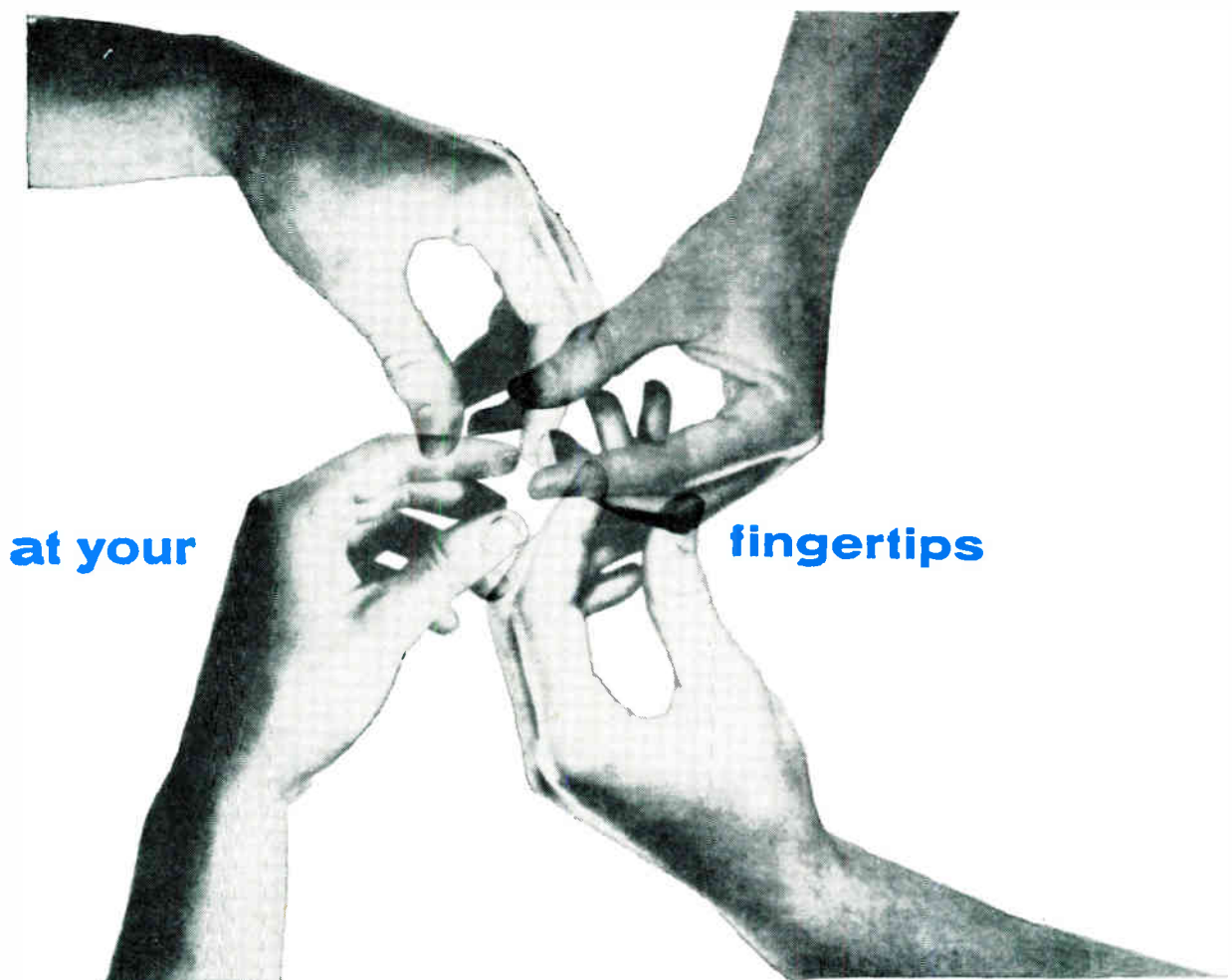

If, anywhere in your plant, accurate control of shaft speed is important, then LDEP can be of service to you. LDEP have developed five main types of variable speed drive, available in powers from  $\frac{1}{8}$  to 150 h.p., to meet any special set of circumstances. Many of their techniques are new, unmatched elsewhere for efficiency and reliability. Ask for details of LDEP drive control systems, and reprints of articles from technical journals.

**LDEP**

**DRIVES DIVISION**

LANCASHIRE DYNAMO ELECTRONIC PRODUCTS LIMITED • RUGELEY • STAFFS • PHONE RUGELEY 371 • TELEX 36135



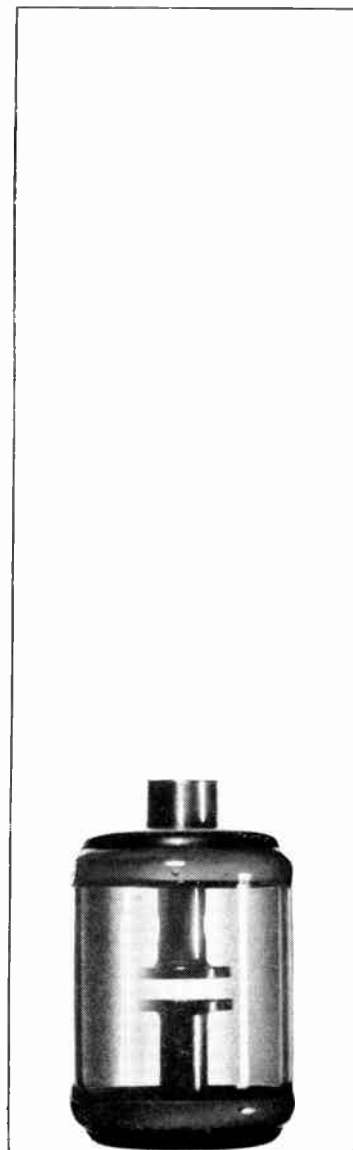
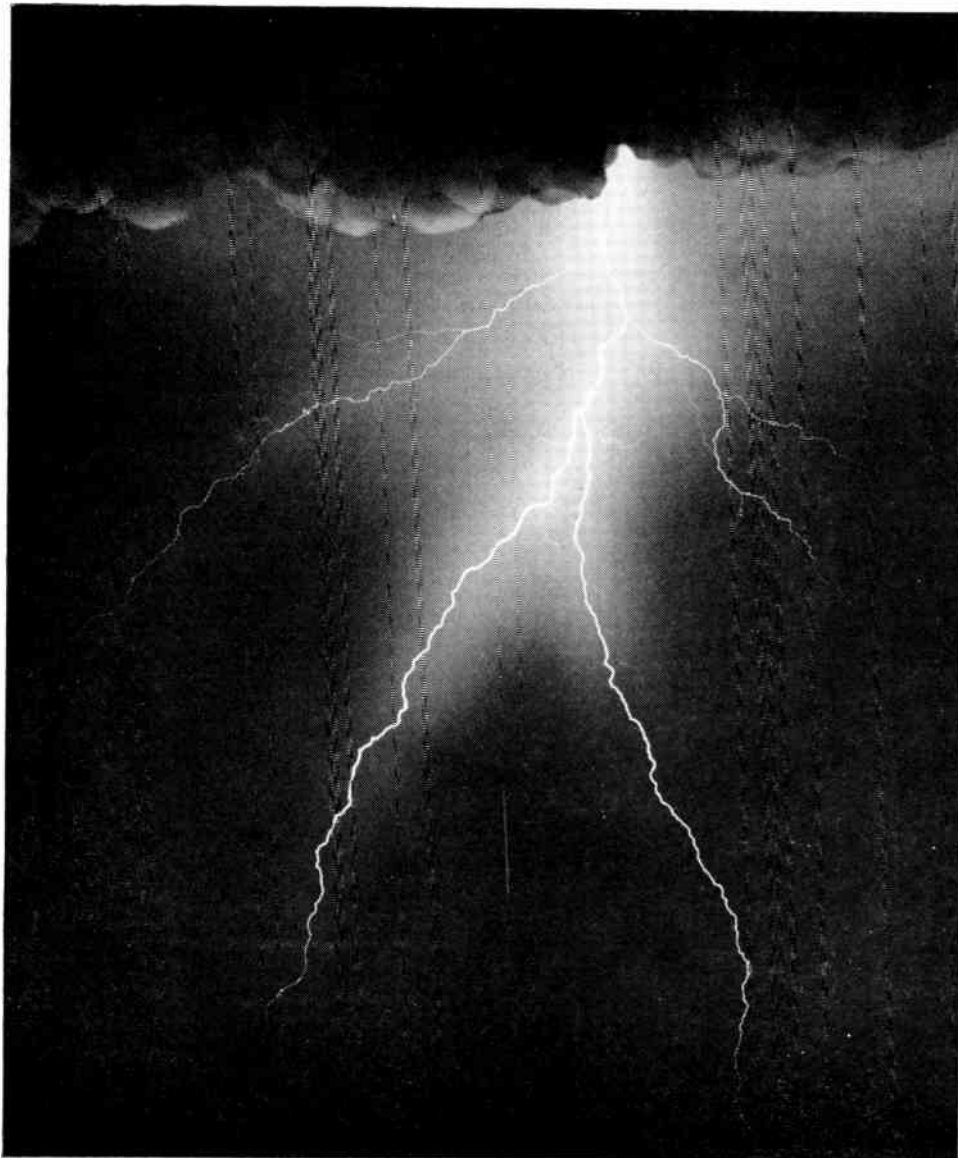

## spark gaps

We make the one on the right — less spectacular perhaps but more practical in its application. For example as you read this the chances are that somewhere equipment containing our spark gaps is helping to get another jet pay load safely airborne or maybe a New Zealand cattle farmer is making life a little easier for himself by using electrified fencing energised to the required level with the aid of spark gap tubes.

Your application may not be in these categories — you may be interested only in circuit protection or fuel ignition or just plain high voltage switching — if so we could have a diode or triggered spark gap to suit. Tubes are available with glass/metal or ceramic/metal seals. If you would like more information or care to talk about spark gap applications, write or telephone the Tube Division.

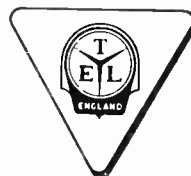

**ERICSSON TELEPHONES LTD • ETELCO LTD**

*A Principal Operating Company of the Plessey Group*

Head Office and Main Works: Beeston, Notts. Telephone: 254831. Telex: 37666  
Registered Office: 22 Lincoln's Inn Fields, W.C.2. Telephone: HOLborn 6936

ER 106

FEBRUARY, 1965

# STC components review

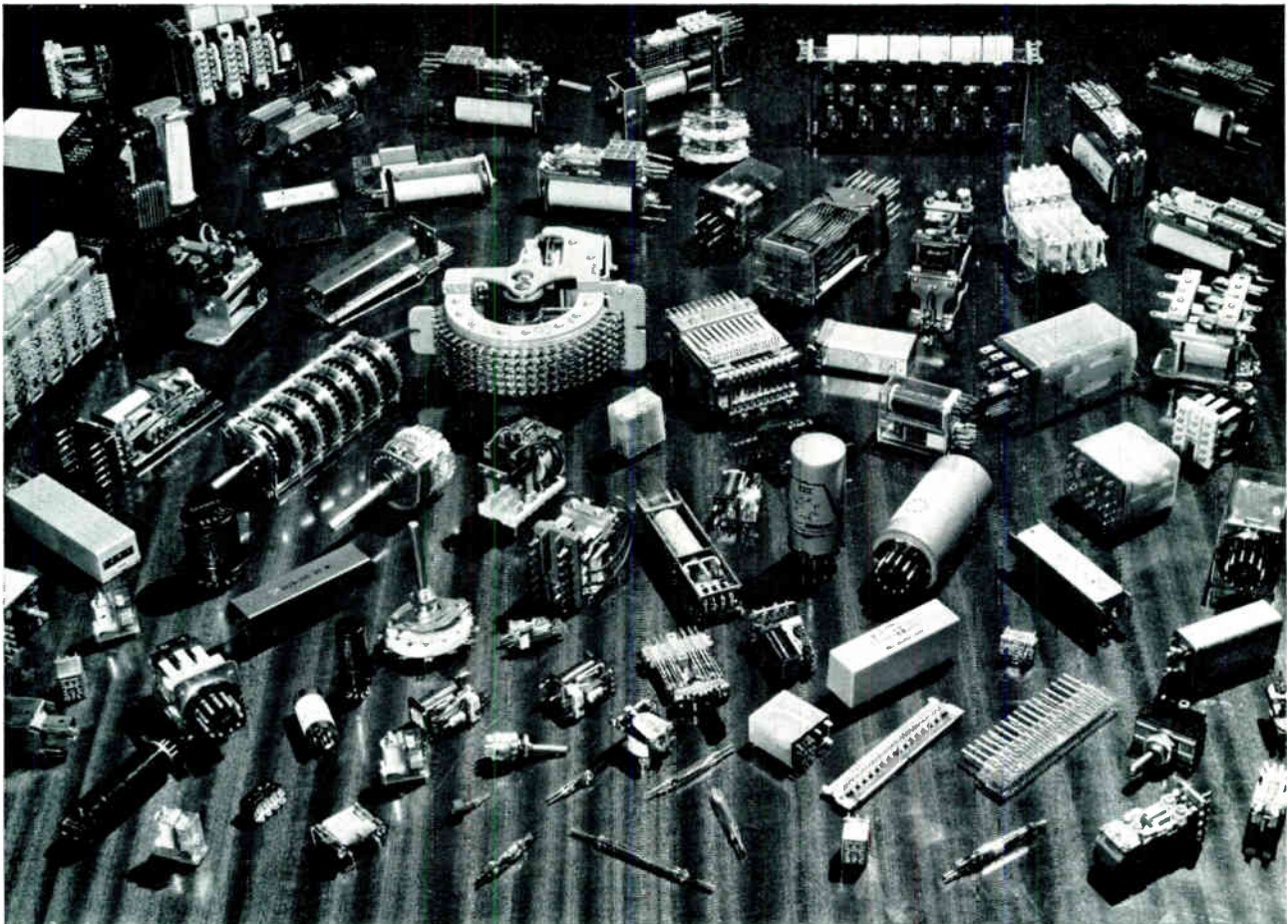

## World's greatest range of relays and switches

... and these are only a fraction of the STC electro-mechanical component range. This single supply source can offer you relays, switches and connectors covering all aspects of control engineering, from low cost industrial components to the most sophisticated

military and aerospace types. We have a Sales Engineer based near you, ready to help with any switching problem. Contact STC at the address below or use Reader Enquiry card. Ask for Relay Catalogue or specific data sheets.

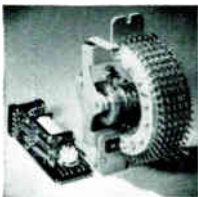

Counters and Uniselectors

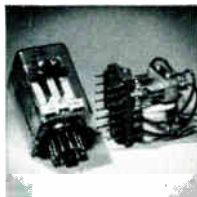

Industrial Relays



Midget Relays



Miniature Industrial Relays

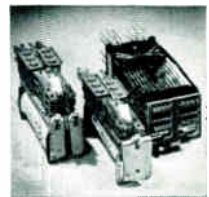

Telephone Types

STC Electro-mechanical Division, West Road, Harlow, Essex. Telephone Harlow 21341. Telex 81184.



### Piston trimmer capacitors

The Stangard, low cost, tubular glass piston trimmer range is now being marketed in the UK by STC Capacitor Division. The trimmers are ideal for use in such equipment as oscilloscopes, bridges, signal generators, frequency standards, calibrators, spectrum analysers, f.m. tuners and many applications previously limited to rotary ceramic discs, tubular ceramics and air variables.

Stangard trimmers are manufactured by JFD Electronics Corporation of New York and stocks are maintained by STC. The trimmers are ruggedly built and have a vinyl encapsulation which protects the glass dielectric against shock. Low cost is achieved through the use of solid electrode bands and automated production lines.

#### ABRIDGED DATA

Capacitance (pF)		DC Working Voltage (V)	Printed Circuit Model		Chassis Mounting Model		Body dia. Both Models (inches)
Min.	Max.		Code	Body Length (inches)	Code	Body Length (inches)	
0.5	3.0	1000	ST 851	3.32	ST 861	9/16	9/32
0.8	5.0	1000	ST 852	9/16	ST 862	23/32	9/32
1.0	8.0	1000	ST 853	7/8	ST 863	1-1/32	9/32
1.0	12.0	1000	ST 854	1-5/16	ST 864	1-7/16	9/32

Electrical characteristics include: Q better than 1000 at 1 Mc/s, insulation resistance  $10^6 M\Omega$  at 500 V d.c. and a dielectric that will withstand in excess of 2000 V. In addition, Stangard capacitors have a smooth adjustment torque and multiturn adjustment for sensitive tuning. These properties are fully retained through a temperature range of  $-55^{\circ}C$  to  $+125^{\circ}C$ .

Write, 'phone or Telex for Data Sheets to STC Capacitor Division, Brixham Road, Paignton, Devon or London Sales Office, Footscray, Kent. Telephone FOOTscray 3333. Telex 21836.

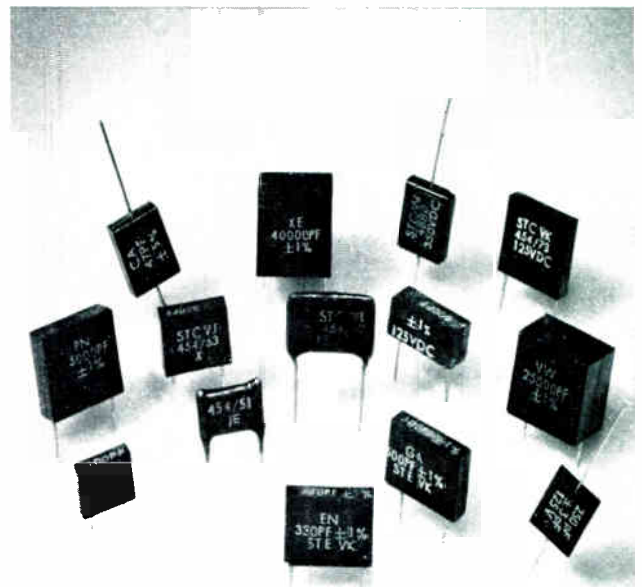

### Silvered mica capacitors Quality Assurance

STC has been awarded a Ministry of Aviation contract for the manufacture of special quality silvered mica capacitors under a long term evaluation programme to assess the performance and reliability of the product in various environmental conditions. This work is an extension of the quality control and assurance programmes developed for the STC range of silvered mica capacitors. The scheme provides an immediate feed-back of information, signals every trend and ensures that the inherent reliability of both design and materials is realized in full.

Part of the routine testing is the continuous checking and recording of capacitance, IR and loss angle on a statistically chosen percentage of the throughput. These are non-destructive tests and the capacitors used are then shipped. Sample batches are removed from production at intervals for shelf life, extended life and temperature coefficient tests. Batches are subjected to electrical endurance tests, mechanical, climatic and log term damp heat tests. The result of such intensive monitoring is a product with a high level of uniformity.

Write, 'phone or Telex for Data Sheets to STC Capacitor Division, Brixham Road, Paignton, Devon or London Sales Office, Footscray, Kent. Telephone FOOTscray 3333. Telex 21836.



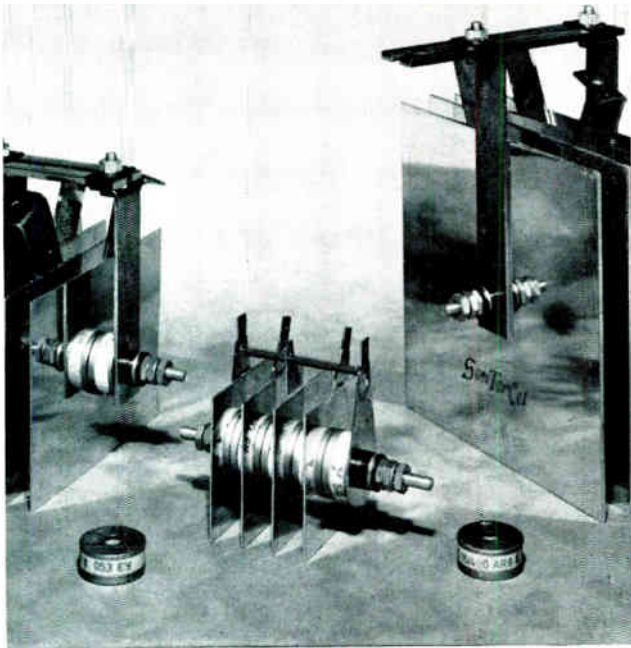

### Silrings • Silicon rectification using selenium stack practice

New in Britain, SILRING rectifier stacks from STC offer the circuit designer and equipment engineer a unique combination of compactness, simplicity and low cost. The SILRING stacks shown above have outputs of 4.2 kW, 2.1 kW and 9.45 kW. SILRING power diodes are rugged ceramic/metal case ring diodes with diffused silicon junctions. Their heavy gauge copper end-plates form the anode and cathode of the device and act as thermal conductors to the stack cooling fins. This arrangement provides maximum efficiency without overloading and consequent lowest price-per watt rectification. The simplicity of stack construction enables STC to offer quick delivery of SILRING diodes in the range 50-600 V<sub>RWM</sub>. When assembled into stacks these diodes give outputs from 5 to 232A.

For Data Sheets and prices write, 'phone or Telex STC Semiconductor Division (Rectifiers), Edinburgh Way, Harlow, Essex. Telephone Harlow 26811. Telex 81146.

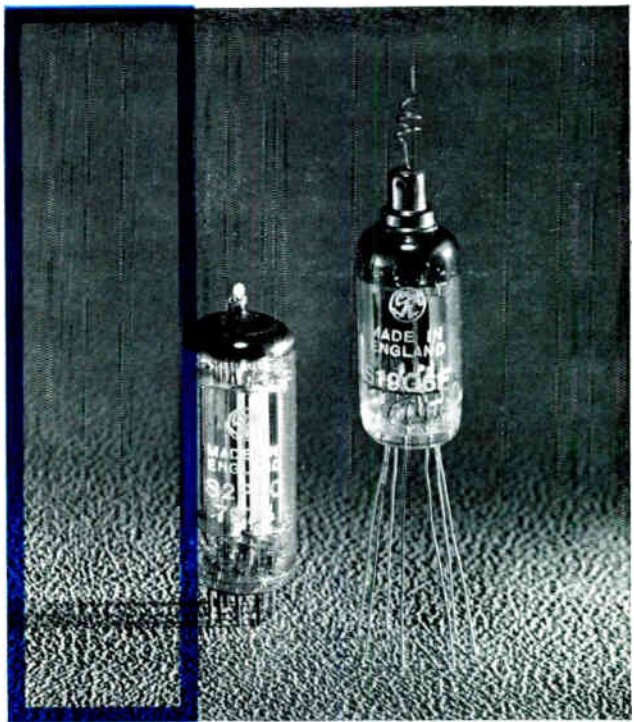

### Special quality valves

Valves are produced by STC for a variety of applications including those listed below. Special shock resistant constructions are employed and this feature, combined with stringent quality tests applied throughout manufacture, gives extreme robustness and a high degree of reliability and life expectancy. STC special quality valves available are:

Type	CV Number	Description
S2P20	4097	Quick heat, filamentary tetrode for transistor hybrid circuits.
S6F17	4040	Low impedance beam tetrodes for use as pulse or linear amplifiers.
S6F17F*	4041*	
S6F33	4064	Pentodes with short suppressor base for gate, transitron, and phantastron circuits.
—	4083*	
S11E12	4060	Beam tetrode for use as regulator valve.
S19G6	4057	High vacuum e.h.t. rectifiers.
S19G6F*	4042*	

\*Flying lead versions.

Write, 'phone or Telex for Data Sheets to STC Valve Division, Brixham Road, Paignton, Devon, or London Sales Office, Footscray, Sidcup, Kent. Telephone FOOTscray 3333. Telex 21836.

high-grade electronic components by

# STC

COMPONENTS GROUP

Sensitivity 40  $\mu\text{V}$  ( $1^\circ\text{C}$ )

Multi-Million Operational life

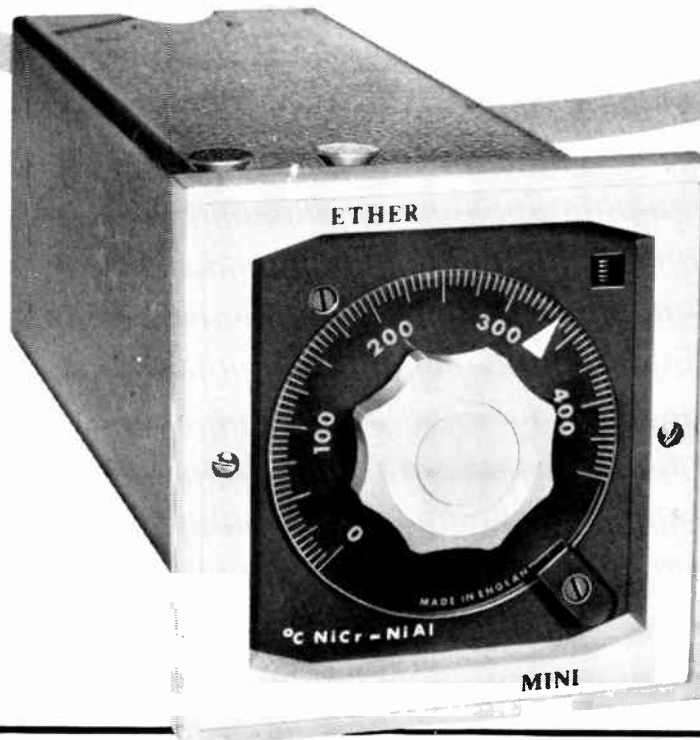

**ETHER**

## TRANSISTORISED TEMPERATURE REGULATOR MINI TYPE 17-90

### *Accurate, Reliable Temperature Control up to 2000°C*

The difference signal between the output of a thermocouple and an internal reference voltage is fed to a transistorised amplifier to operate a relay. The relay will operate on an input signal differential of less than 40 microvolts, equivalent to less than  $1^\circ\text{C}$ , with base metal thermocouples, and less than  $2^\circ\text{C}$  with precious metal types. Provision is made for increasing this differential by a factor of 10 where very close control is not required.

The relay has a life expectancy of several million operations at maximum load rating. Set point is adjusted by a precision potentiometer, and read by the position of an illuminated cursor on a calibrated scale. A signal lamp is provided to show the control condition. Standard ranges from £27-10-0.



Send for full details to:—

CAXTON WAY, STEVENAGE, HERTFORDSHIRE  
Telephone: Stevenage 3040-55

# GETTING THE MEASURE OF VIBRATION

A portable, battery-operated vibration meter for direct measurement of displacement, velocity, acceleration and jerk, using a lightweight pick-up.

Frequency Response	1.6c/s to 10Kc/s with standard accelerometer 1.6c/s to 1Kc/s with high sensitivity accelerometer. Choice of three L.F. cut-off frequencies, 1.6c/s, 16c/s and 160c/s.
Full-Scale Sensitivity	Displacement from 3µin. or 0.1in. Velocity from 0.003in/sec or 0.001in/sec. Acceleration from 3in/sec <sup>2</sup> or 0.1in/sec <sup>2</sup> . Jerk from 30in/sec <sup>3</sup> or 1in/sec <sup>3</sup> .
Meter Response	Average, r.m.s., peak +ve or peak -ve.
Power Supply	Self contained batteries. Battery life 100 hrs approx.
Weight	Standard Accelerometer 0.7 oz Sensitive Accelerometer 8 oz Cathode Follower 1 lb Electronic Unit 7 lb
Price	£190 (with standard accelerometer) complete with cathode follower probe and durable plastics dust-cover.

The Dawe range includes a complete series of instruments for measuring, analysing, and recording sound and vibration. Ask for details.

## DAWE Type 1433 VIBRATION METER



**DAWE**

Full technical data from:—

**DAWE INSTRUMENTS LTD., WESTERN AVE., LONDON, W.3 Tel: ACOrn 6751**

A member of the *Simons* group of companies



## Your best hands tied down in graphing?

Install a Bryans auto-plotter and you cut graph-drawing time to seconds. You speed up graph-production by 1000:1; and give your qualified staff more time for productive, satisfying work.

Bryans 20000 series plotters offer chart area 17" x 11", accuracy 0.1%, pen speed 37 in/sec, sensitivity 200  $\mu$ V/in; plus the reliability of solid state/printed circuit design. Optional facilities include symbol printer, digital/analogue data translator, keyboard point plotter, automatic chart feed.

Ask us for a demonstration, or send for our latest customer application list describing 66 time-saving jobs in widely different fields.

Bryans Ltd., Willow Lane, Mitcham, Surrey. Mitcham 5134.

# Bryans

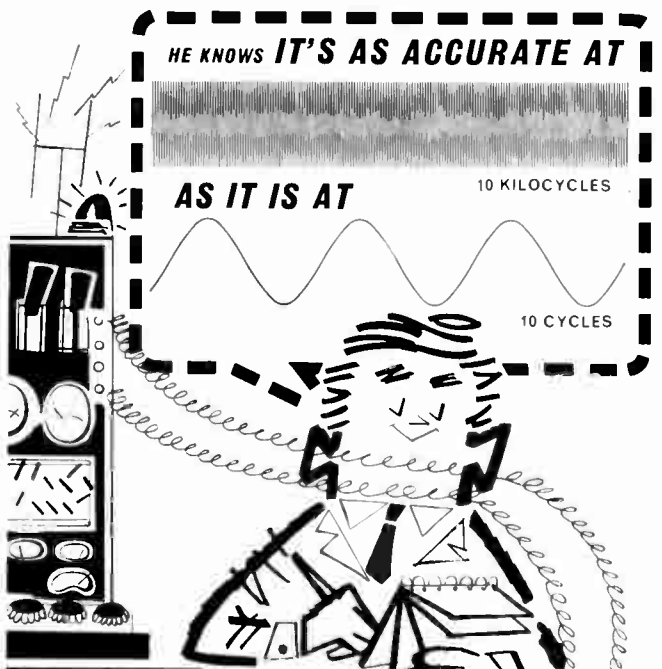
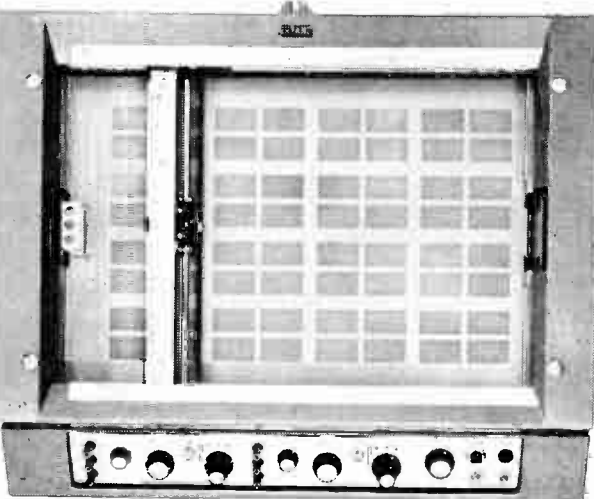

Would YOU like a multirange test set that is accurate over a wide frequency range?

### THEN YOU NEED A SELECTEST

Ranges are selected by two multi-position wafer switches capable of continuous rotation in either direction without mechanical interlock. Colour codings are used for easy identification of the voltage, current and resistance ranges.

There is a polarity reversing switch on the Super 50.

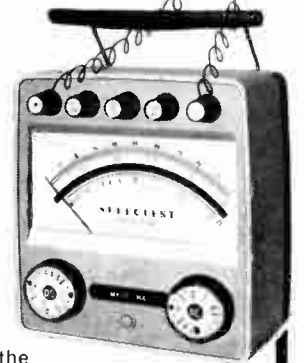

<b>SUPER K</b>	
39 self-contained ranges	0 to 5,000 ohms 0 to 1,500 volts A.C. & D.C. 0 to 15 amps A.C. & D.C.
External shunts and multirange transformer available to increase current ranges to 750 amps. D.C. and 300 amps. A.C.	
<b>TRADE PRICE £17.16.0 (Leather case extra)</b>	
<b>SUPER 50</b>	
32 self-contained ranges	0 to 20 megohms 0 to 2,500 volts A.C. & D.C. 0 to 10 amps A.C. & D.C.
External shunts and multirange transformer available to increase current ranges to 250 amps D.C. and A.C.	
<b>TRADE PRICE £20.18.0 (Leather case extra)</b>	

Automatic overload cut-out on both models. Accuracy complies with the latest British Standard Specification.

**IMMEDIATE DELIVERY** See our leaflet for full details.

**SEI** THE SALFORD **S&C**

# selectest

**SUPER K** **SUPER 50**

**SALFORD ELECTRICAL INSTRUMENTS LTD**  
PEEL WORKS SILK STREET SALFORD 3 Tel: BLAckfriars 6688  
London Sales Office: Brook Green Hammersmith W6. Tel: Riverside 5245  
A Subsidiary of THE GENERAL ELECTRIC CO. LTD. OF ENGLAND

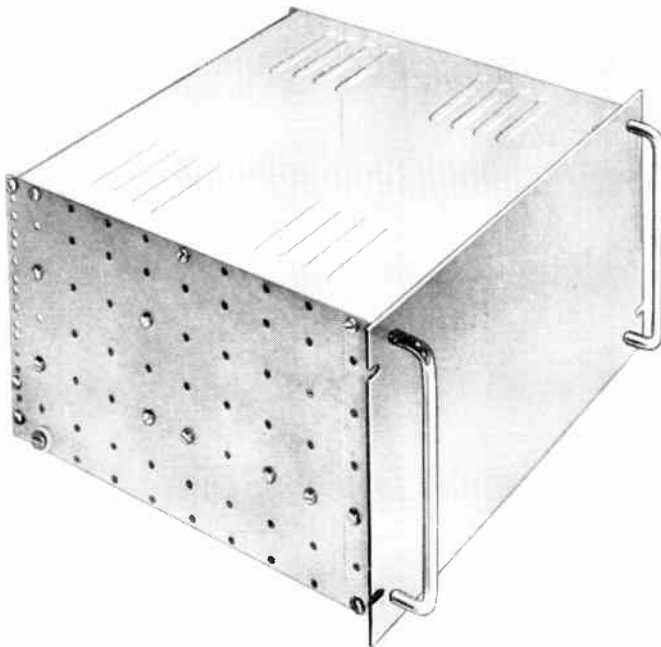

Front and rear views of typical Imkit assemblies. The rear beam when fitted as shown below provides a recessed mounting for plugs, jacks etc. Tie bars provide rigidity when dust covers are not used.

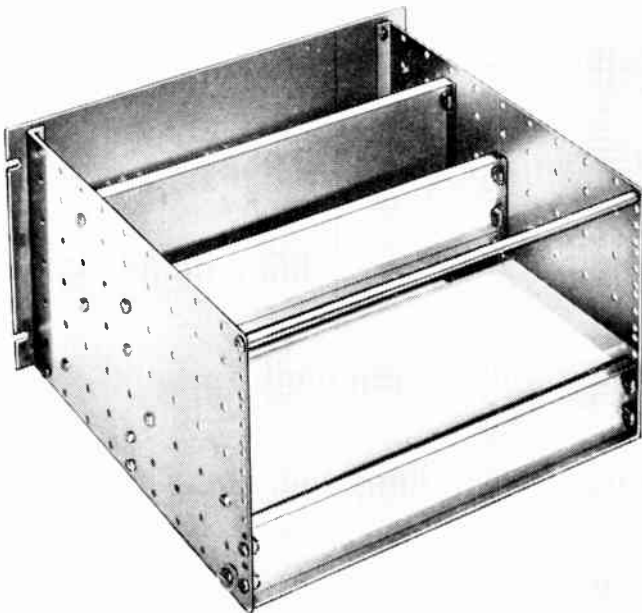

# NEW

## **IMKIT**

# SECTIONAL CHASSIS SYSTEM

Offers unsurpassed versatility of chassis design and layout at really economical prices

Chassis can be fitted horizontally or vertically (or both) allowing hundreds of different mounting arrangements

Eighteen sizes of side panels and eight chassis sizes allow components to be assembled to meet your exact requirements

All parts fitted with captive nuts or drilled and tapped to allow really quick and simple assembly

Special nylon rollers facilitate movement of loaded chassis

The internationally accepted 13 $\frac{3}{8}$ " module is used as a basis for all parts and Unified fixings are standard throughout

Send today for full details and prices

**ALFRED IMHOF LIMITED**  
Dept. IE/2, Ashley Works,  
Cowley Mill Road, Uxbridge, Middx.  
Telephone: Uxbridge 37123  
Telegrams: Imcase-Uxbridge-Telex  
Telex: 24177

### AGENTS IN

Algeria Australia Belgium Brunei Canada Denmark Finland France Germany Holland Iraq Israel Italy Jordan Kuwait Lebanon Malaysia Mexico Morocco  
New Zealand, Nicaragua Norway Portugal Saudi Arabia South Africa Southern Rhodesia Sudan Sweden Switzerland Syria Thailand Tunisia U.S.A. Zambia

# proved improved

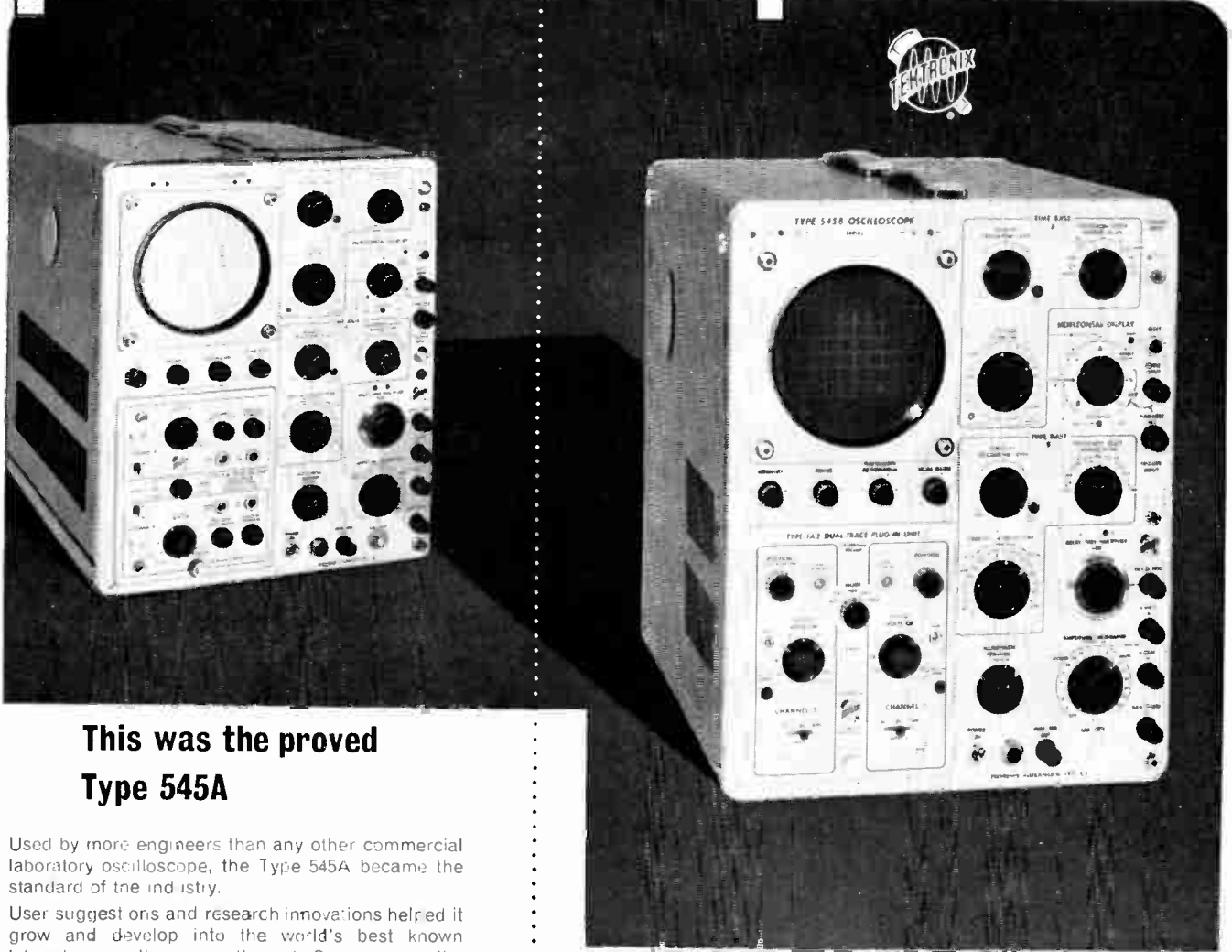

## This was the proved Type 545A

Used by more engineers than any other commercial laboratory oscilloscope, the Type 545A became the standard of the industry.

User suggestions and research innovations helped it grow and develop into the world's best known laboratory oscilloscope—through five years as the Type 545, another five years as the Type 545A.

Over the years, better circuit components and design techniques led to simpler operation and application, greater accuracy and reliability, easier maintenance and calibration.

Seventeen amplifier plug-in units were developed to provide quick adaptability for particular applications. Other features were added or improved to update performance specifications.

With the dual-trace unit, the Type 545A provided 50 mv/cm sensitivity for a wide range of dc-to-24 Mc/s applications.

Further updating of the "A" Model to implement additional improvements has resulted in a new "B" Model—as the "A" Model was developed from the early Type 545.

So, now, the Type 545A is superseded by the Type 545B. Replacement parts will continue to be available for the "A" Model, however for at least 10 years.

## Here is the improved Type 545B

Looks about like the Type 545A. But added capabilities and convenience further enhance its value.

New crt. Internal no-parallax illuminated graticule. Improved resolution, uniform focus over the full 6-cm by 10-cm (50% greater) display area. New hybrid vertical amplifier—greater stability and reliability. Fixed-tuned delay cable, prevents misadjustments. Triggering beyond 30 Mc/s. Sweep delay, single-sweep, other features and refinements that equal or excel those of the present "A" Model.

Use all your Tektronix Type A to Z Plug-In Units at equal or better frequency response, or the new Type 1A1 or 1A2 Dual-Trace Plug-In Units for 50 mv/cm at dc-to-33 Mc/s. The Type 1A1 also offers 5 mv/cm at dc-to-23 Mc/s dual-trace, and, by cascading the two amplifiers, 500  $\mu$ v/cm at 5-cps-to-10 Mc/s.

Full field-engineering services back up every instrument.

The 545B is yet another addition to the growing range of Tektronix Oscilloscopes produced in Guernsey, C.I.  
Price £634, including two probes.

**TEKTRONIX U.K. Ltd.** BEAVERTON HOUSE · STATION APPROACH · HARPENDEN · HERTS  
Telephone: Harpenden 61251 · Telex: 25559

For Overseas enquiries:—

TEKTRONIX CANADA Ltd. Montreal, Quebec & Toronto (Willowdale), Ontario

TEKTRONIX Ltd. Albany House, St. Peter Port, Guernsey, C.I.

TEKTRONIX INTERNATIONAL A.G. P.O. Box 57, Zug, Switzerland

TEKTRONIX AUSTRALIA PTY. Ltd. P.O. Box 488, Sydney, New South Wales · TEKTRONIX Inc. P.O. Box 500, Beaverton, Oregon, U.S.A.

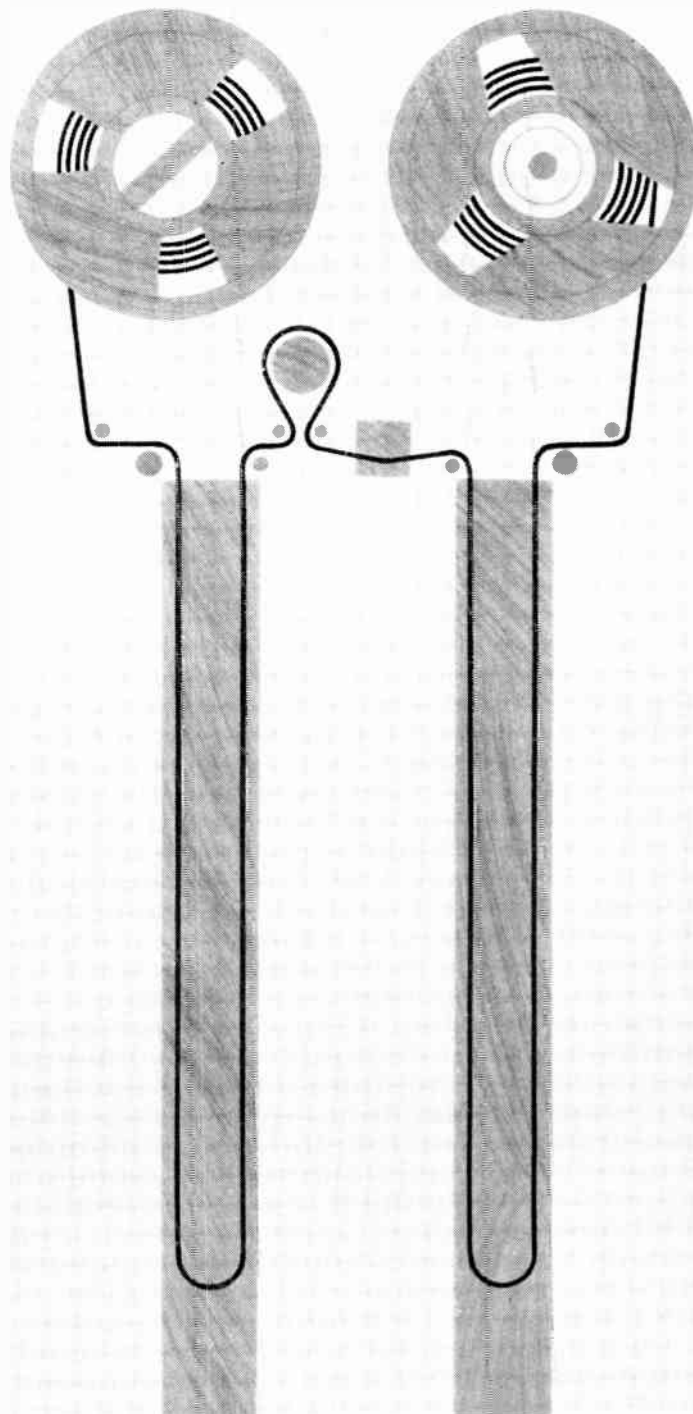

# NEW

## TM-11 tape transport can give 100,000 passes without a data error

The new Ampex TM-11 features a single-capstan drive, and eliminates roller guides, pinch rollers—every component that might pinch, rub, stretch, and damage tape. In this new Ampex tape drive system, all tape guides are air guides, which float the tape on a uniform film of air. Tape oxide touches only the head and the tape cleaner. Result: the TM-11 can deliver more than 100,000 passes without tape damage or data error—at speeds up to

120 ips, and densities of 200/556/800 bpi. The small number of moving parts sets a new standard in reliability. Result: MTBF is significantly higher than any other tape transport in use today. The TM-11 can meet all data formats. Plug-in 7 or 9 channel heads are



available (ASCII compatible with IBM 360). For more information write to: Ampex Great Britain Limited, Acre Road, Reading, Berkshire, England. Telephone Number: Reading 84411.

*Industrial Electronics February 1965*

17

# To 'read the pulse' of this giant turbo alternator, C. A. Parsons & Co. Ltd. used **KODAK LINAGRAPH DIRECT PRINT PAPER**

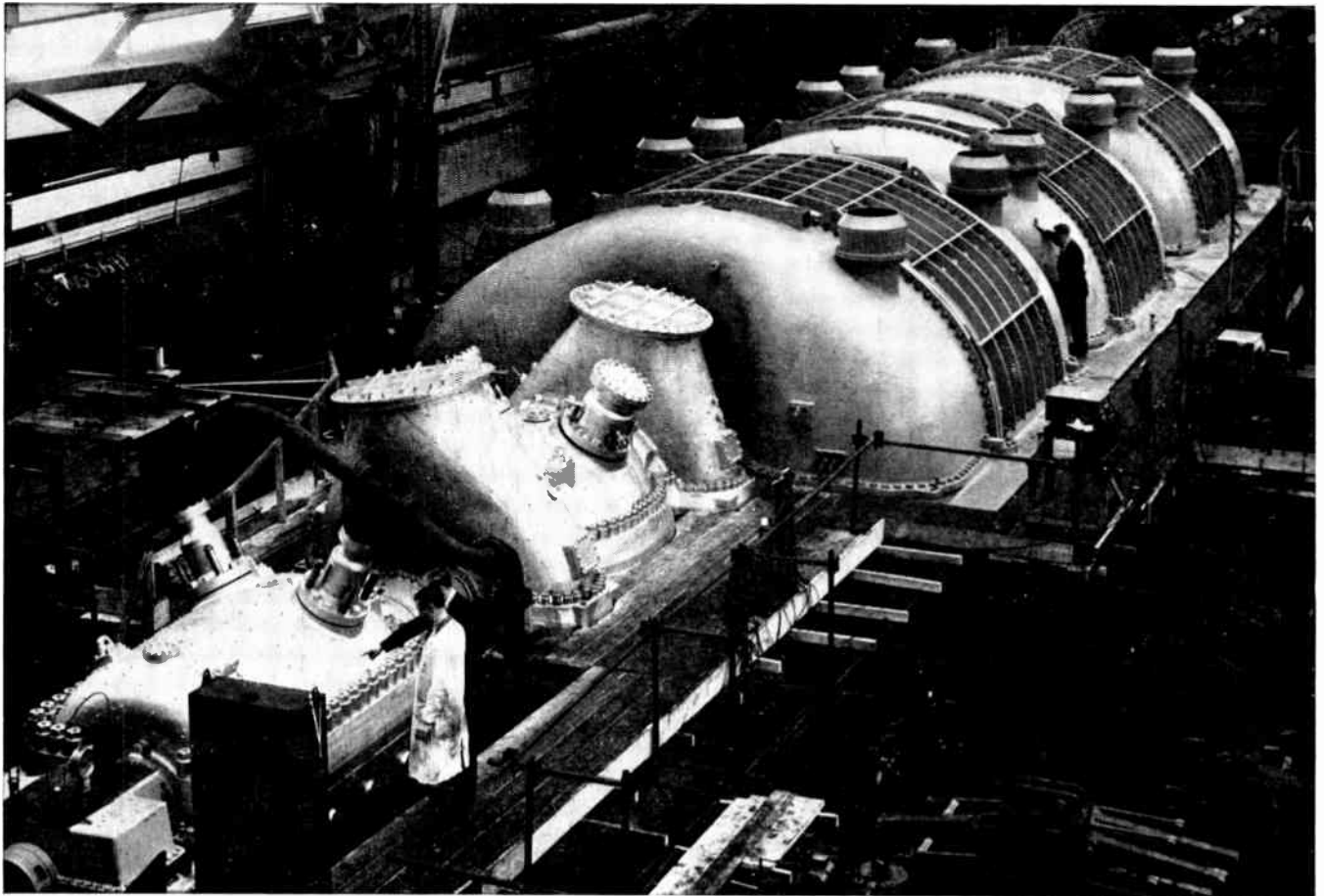

Our photograph shows final stage of construction of the 500 MW single line turbo alternator recently completed for the Central Electricity Generating Board 'C' Station at Ferrybridge, Yorks, by C. A. Parsons and Company Limited, leading manufacturers of turbo alternators.

Kodak 'Linagraph' Direct Print Paper was exclusively used in vitally important vibration tests on this giant, one of the largest single line turbo alternators ever built in this country. Parsons chose 'Linagraph' for this task because they find it unique in its ability to provide an instantly visible yet permanent record of the quality required.

'Linagraph' is also extensively used by Parsons in their electrical research laboratory and in the exhaustive 'on site' testing to which they subject all plant manufactured by them.

'Linagraph', says Mr. W. F. Ord, Electrical Research Engineer at Parsons, 'is a genuine boon to us. We find, in particular, that the speed and supreme reliability with which it enables records to be made affords a great saving in expensive running time on installations.'



'Linagraph' and 'Kodak' are registered trade-marks.

For full details of this new print-out paper, post this coupon today

NAME .....

ADDRESS .....

.....

Kodak Limited, Industrial/Professional Sales Division, Kingsway, London, W.C.2. 1E



*There's a black star on every packet of 'Linagraph'.*



# THINKING U-V?

**5-124**  **recording oscillograph**  
**CONSOLIDATED ELECTRODYNAMICS CORPORATION**

**RECORDER TYPE 5-124**

- 18 Active Data Channels
- 7-inch width Print-out Recording Paper
- 5 Push-button Speeds to 104 ins/sec
- Writing Speeds in excess of 50,000 ins/sec
- Electronic Flash Timing: 1, 1/10, 1/100 sec
- Coincident Grid line printing
- Trace Identification and numbering

**Write for Bulletin 5-124**

**Consolidated Electro Dynamics Division (BELL & HOWELL LTD)**

14 Commercial Road, Woking, Surrey  
Telephone: Woking 5633

For further information circle 225 on Service Card

## VISIBLY BETTER

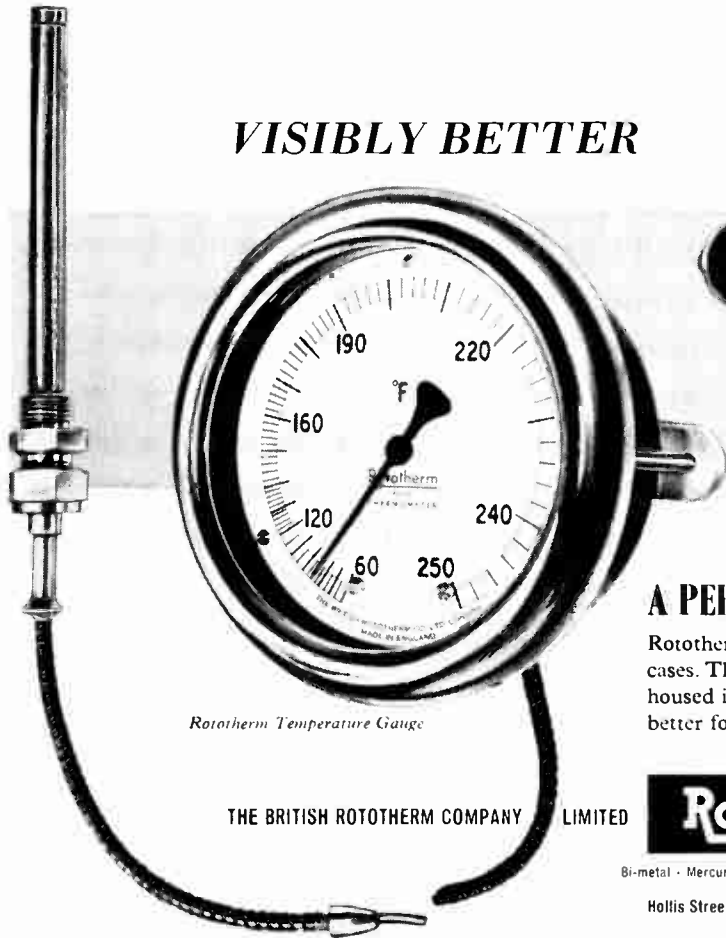

Rotothem Temperature Gauge

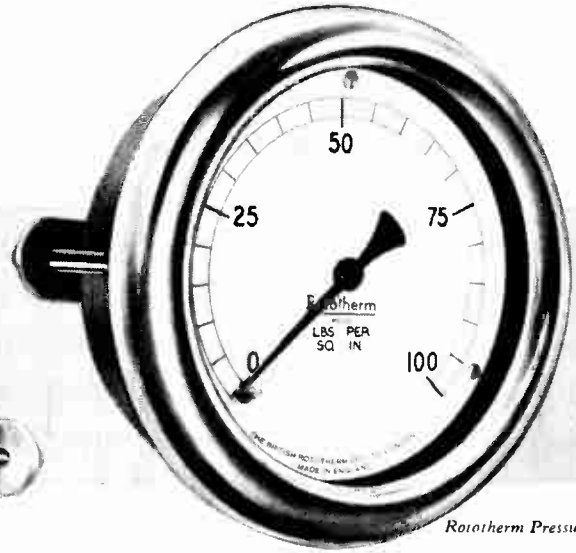

Rotothem Pressure Gauge

### A PERFECT CASE FOR ROTOTHEM

Rotothem realise that fine instruments deserve distinguished cases. That is why their superb instruments are obtainable housed in the finest quality matching cases, being visibly better for every instrument application.

THE BRITISH ROTOTHEM COMPANY LIMITED

**Rotothem**

Merton Abbey · London SW19 · LIB 7661

Bi-metal · Mercury-in-steel · Vapour pressure Thermometers

Hollis Street, New Basford, Nottingham and 87 St. Vincent Street, Glasgow G.2.

For further information circle 226 on Service Card

# MUREX MAGNETS are used in the

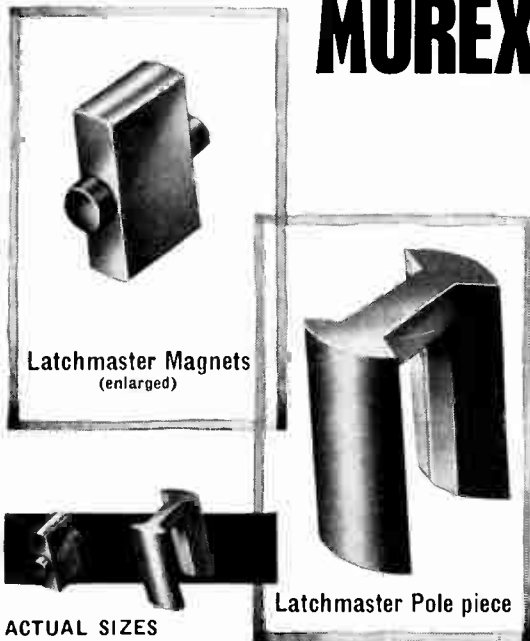

Latchmaster Magnets  
(enlarged)

Latchmaster Pole piece

ACTUAL SIZES

Technical personnel are available for immediate consultation upon the use and application of these materials.

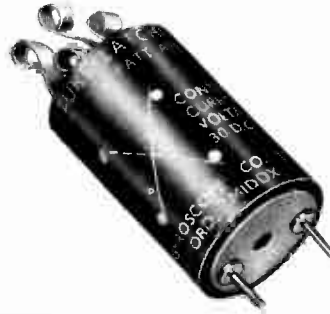

## SPERRY Latchmaster Relay

Murex magnets and iron pole pieces are used on the Sperry Latchmaster miniature Relay. Maintenance of limits down to  $\pm 0.0005$ " on the machined magnet and  $\pm 0.002$ " on the unmachined iron and consistent performance are absolutely essential for the successful operation of this Relay. The high standard set by Sperry is rigidly maintained by the Murex components. More detailed information on our materials, together with design data and a list of standard shapes and sizes currently available, can be provided on request.

**MUREX LTD · RAINHAM · ESSEX**  
(Powder Metallurgy Division)

London Sales Office: CENTRAL HOUSE · UPPER WOBURN PLACE · WCI

Telephone: Rainham, Essex 3322 Telex 28632

Telegrams: Murex, Rainham-Dagenham Telex

Telephone: EUSton 8265

# Integrating digital voltmeter LM 1420



- \* 2.5 Microvolts – 1000 volts DC
- \* 10 Microvolts on top of 500 volts Peak Common mode
- \* 10 Microvolts DC through 10 Millivolts of Noise
- \* 1 Millivolt DC from a 100 Megohm Source Impedance
- \* Frequency counts to 250 KC/S

Integrating Digital Voltmeter LM 1420 measures D.C. voltages from 2.5 microvolts to 1000 volts with an accuracy of 0.05% i.e. 1 digit, at a maximum rate of 33 readings per second. Maximum input resistance is > 5000 megohms both terminals being fully guarded with isolation impedance of  $10^5$  megohms/25 pf. to mains earth. Common mode rejection is thus 150 dB D.C. and 130 dB A.C. The integrating technique together with optional 30 dB filter gives 60 dB attenuation of input noise.

*Detailed information will be gladly sent on request and Solartron Engineers are available to discuss applications.*

## SOLARTRON

For – Data Systems · Transducers · Computers  
Military Systems · Electronic Instrumentation

THE SOLARTRON ELECTRONIC GROUP LIMITED  
Victoria Road · Farnborough · Hants.  
Telephone · Farnborough (Hants) 3000  
Telex · 85245 Solartron Fnbro.  
Cables · Solartron · Farnborough  
A MEMBER OF THE SCHLUMBERGER GROUP

# SPECIFY HUGHES DIODES

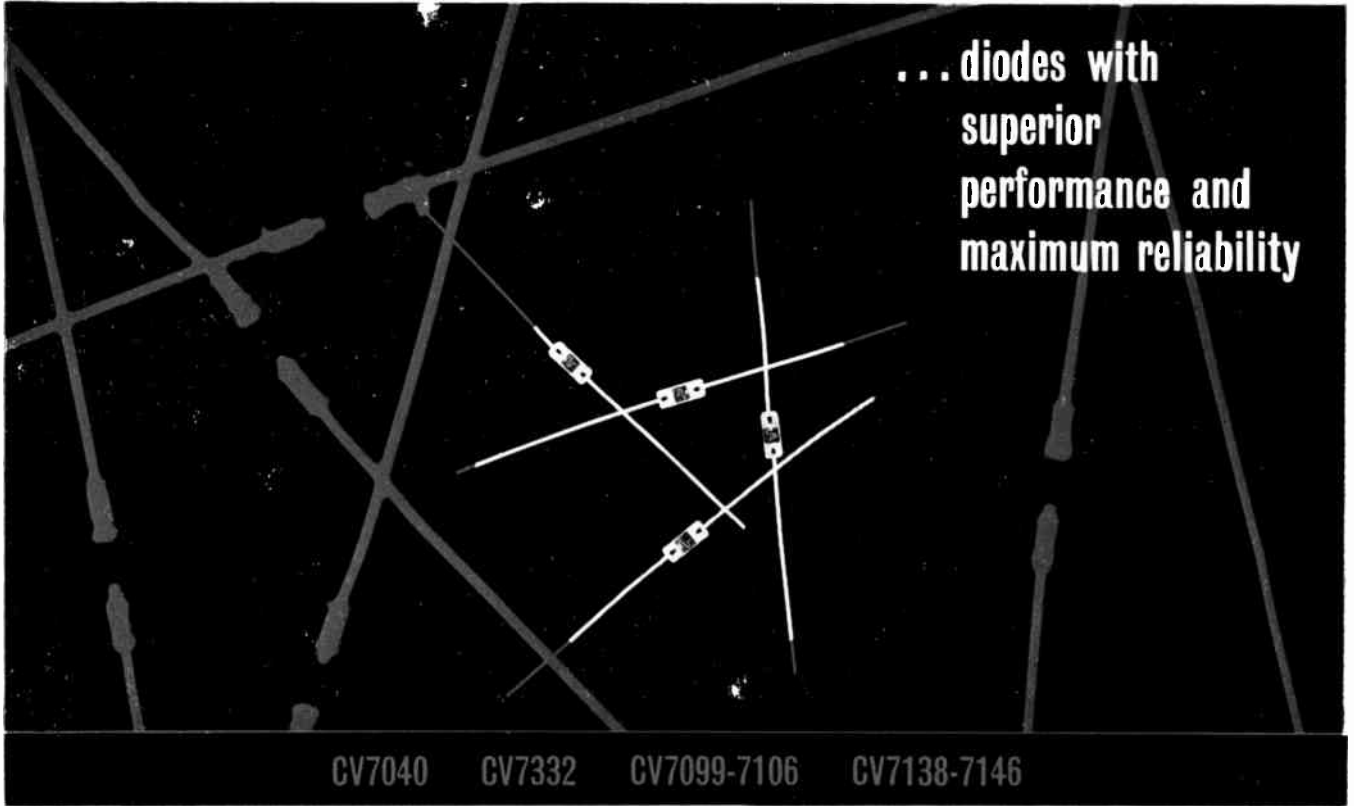

**SILICON SUB-MINIATURE POWER DIODES/RECTIFIERS ● ZENER DIODES  
CARTRIDGE RECTIFIERS ● VOLTAGE VARIABLE CAPACITORS**

HS1020 HS1001 HS1004 HS1007 HS1010	General Purpose Diodes	PIV - - - - 50-200V Max. Avge. Rectified Current - - - 165mA Ib at PIV - <0.2μA CV 7040 CV 7332	HS2000 Series (250mW) HS7000 Series (400mW)	Zener Diodes	Available in all preferred voltage values from 2.7—33V Low dynamic impedance High stability over wide temperature range CV7099-7106 CV7138-7146
HS3103 HS3104 HS3105 HS3106 HS3108 HS3110	200mA Power Diodes	PIV - - - 300-1000V Max. Avge. Rectified Current - - - 165mA Ib at PIV - <0.2μA	HSC1 HSC2 HSC3 HSC4 HSC5 HSC6 ↕ HSC30	High Voltage Cartridge Rectifiers	PIV - - - - 1-30kV Max. Avge. Rectified current - - 100mA Case size 0.55" dia. x approx. 0.25" per kV Welded assemblies of selected high voltage diodes, encapsulated in high grade epoxy resin
1N645 1N646 1N647 1N648 1N649	600mA Power Diode/Rectifiers	PIV - - - - 225-600V Max. Avge. Rectified Current - - - 400mA Ib at PIV - <0.2μA	HC7001 HC7002 HC7004 HC7005 HC7006 HC7007 HC7008	Voltage Variable Capacitors	Capacitance range @ -4V - - - 35-100pF Peak voltage range - - 25-130V Ib @ max. voltage - - <1μA @ 25° C Standard Tolerance - - ± 20% (± 10% and ± 5% also available)

Write now for complete data on the full range of Hughes semiconductor products, which also includes:—Silicon and Germanium Signal and Switching diodes: PNP and NPN Silicon Transistors.

**HUGHES INTERNATIONAL (U.K.) LTD**

GLENROTHES · FIFE · SCOTLAND

Sales Office:

KERSHAW HOUSE, GREAT WEST ROAD, HOUNSLow, MIDDLESEX. TEL: HOUNSLow 5222.

Hughes—originators of the world's first sub-miniature all-glass diode—manufacture at their Glenrothes, Scotland, factory an unequalled range of germanium and silicon devices for the most diverse diode applications. Add Hughes service and second-to-none product quality and solve your diode problems in the simplest way—SPECIFY HUGHES.

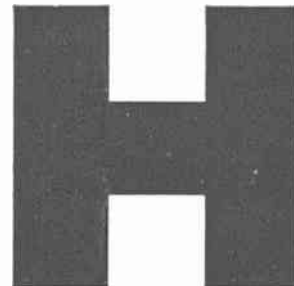

# "TOP END" ACCURACY

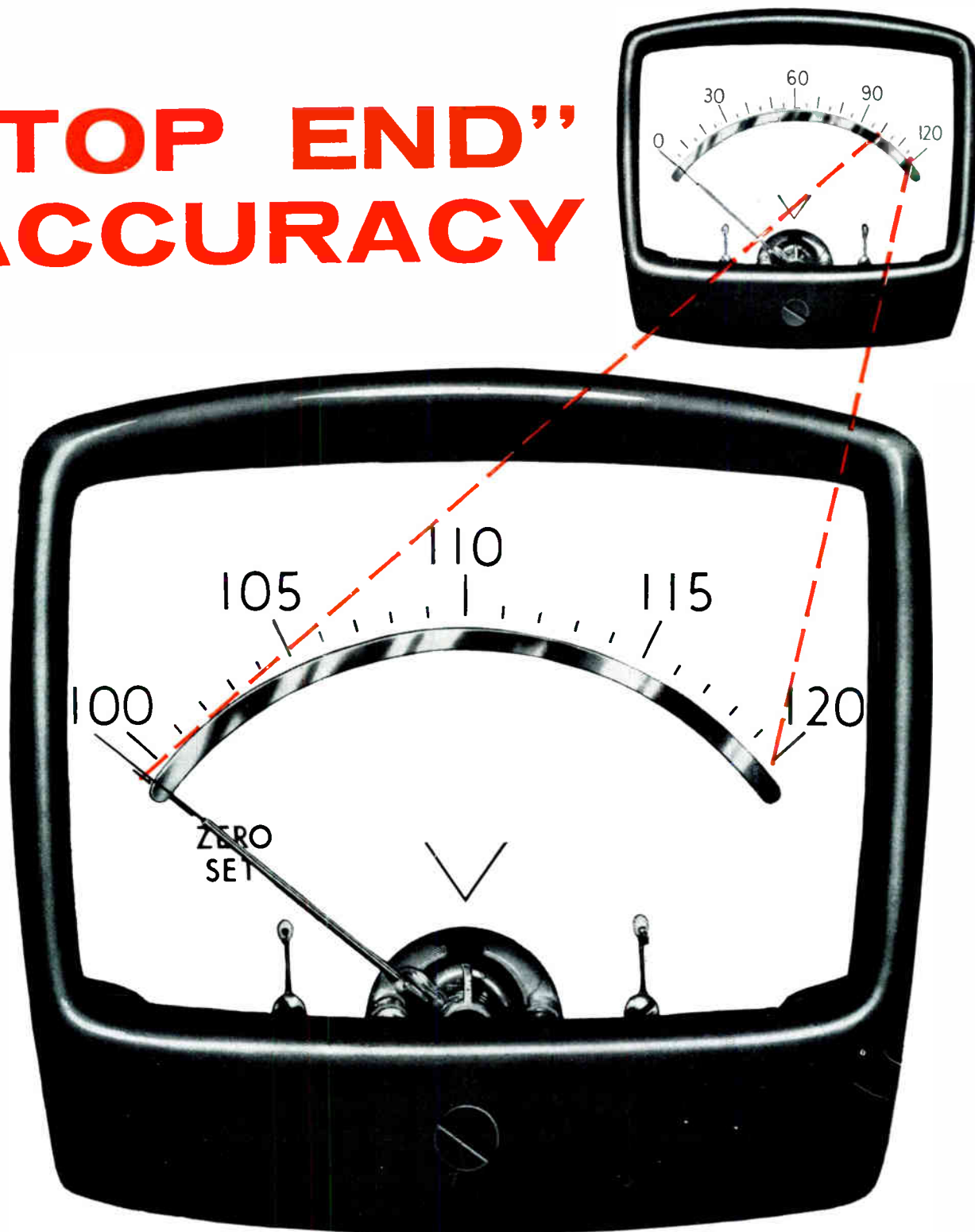

...WITH THE **NEW FERRANTI SHORT RANGE VOLTMETERS**

NOW AVAILABLE

- Accuracy within  $\pm 0.25\%$  of full scale reading.
- Available in 2", 2½", 3½", 4", 6" and 8" sizes.
- Supplied in Style A, Types NF, CF, RP, RF and Hermetically Sealed Cases.

**FERRANTI**  
*First into the Future*

FERRANTI LTD · MOSTON · MANCHESTER 10 Tel: FALLsworth 2071 · London Office: MILLBANK TOWER · MILLBANK, S.W.1 · Tel: VIctoria 6611

# POWER



## SEMICONDUCTOR DEVICES

### SILICON DIODE

#### TYPE FN 300

300 amperes up to 1500 volts P.I.V.

Fully hard soldered junction for optimum reliability.



### THYRISTOR

#### TYPE 71T

250 amperes 1200 volts forward and reverse voltage

Compression bonded junction eliminates thermal cycling problems.



**WESTINGHOUSE BRAKE AND SIGNAL COMPANY LIMITED**

82 YORK WAY, KING'S CROSS, LONDON, N1 TEL: TER 6432 Telex 2-3225

quality  
equipment  
needs  
quality  
batteries—  
**MALLORY**



Measuring only  $2\frac{1}{2}$  in. x  $1\frac{7}{8}$  in. x  $\frac{3}{8}$  in. this Multitone Talk-Back Transmitter for paging systems gets the power for 6 months normal use from a 5V Mallory Mercury Battery pack.



Precision-made Mallory batteries are built differently—inside and out—to give the powerful performance modern equipment demands. They last many times longer, deliver their energy uniformly without need for rest, retain their capacity while lying idle. And they're leakproof and corrosion resistant. Whether designing new products or using battery operated equipment, make Mallory batteries your choice for quality performance. Find out about *Mercury types* in miniature single and multivolt sizes, *Manganese types* in standard 1.5V sizes.

**MALLORY** *for new ideas in batteries*

**MALLORY BATTERIES LIMITED CRAWLEY SUSSEX Crawley 26041**

**DISTRIBUTORS TO THE ELECTRONICS INDUSTRY:**

A. C. Farnell Ltd, **LEEOS 2**; Wireless Electric Ltd, **BRISTOL 1**; Hawnt & Co. Ltd, **BIRMINGHAM 6**;  
Needham Engineering Co. Ltd, **SHEFFIELD 1**; Harper, Robertson Electronics Ltd, **GLASGOW C2**;  
Stewart Aeronautical Supply Co. Ltd, Crawley, **SUSSEX**; Scientific Furnishings Ltd, Poynton, **CHESHIRE**;  
Cables & Components Ltd, **LONDON, NW10**

**D**EPENDABLE WORKMANSHIP

**E**XPERIENCED OPERATORS

**L**ARGE STOCKS OF ALL MATERIALS

**A**CCURACY AND RELIABILITY

**N**ATIONWIDE SERVICE

**C**OMPLETE CATALOGUE ON REQUEST

**O**RTHODOX OR UNUSUAL, WE MAKE IT

VULCANIZED FIBRE · LEATHEROID · PRESSPAHN · COMPOSITE  
INSULATION · SILICONE & EPOXY BONDED GLASS FIBRE  
BAKELITE SHEET, TUBE & ROD · COPPER CLAD LAMINATES  
MICA AND MICANITE · AND PRECISION MACHINED  
AND PRESSED PARTS IN ALL INSULATION MATERIALS

ANGLO-AMERICAN VULCANIZED FIBRE COMPANY LTD, CAYTON WORKS, BATH STREET, LONDON, E.C.1. CLE: 8484 (15 LINES)



IT ALL ADDS UP TO  
***Delanco***



# Give it the works!

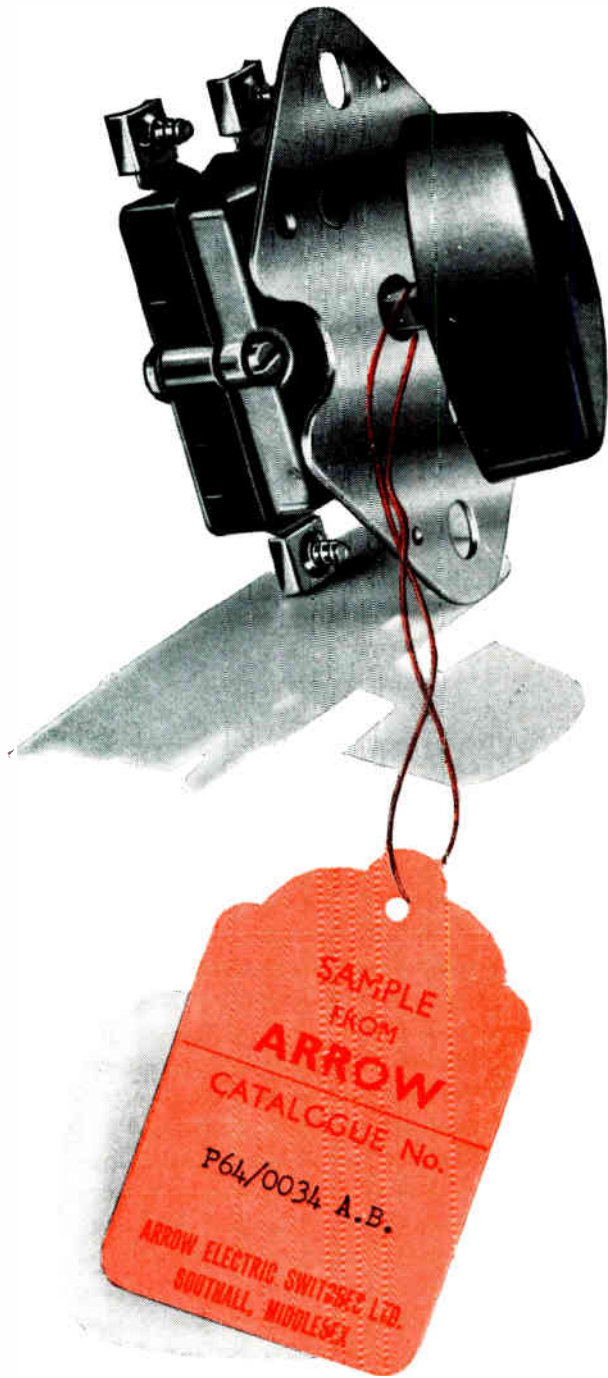

We, at ARROW, understand the responsibility which rests on any Engineer's shoulders whose job it is to specify switches. Therefore, knowing our products as we do, we welcome every opportunity to send samples to be given 'the works', as we are confident of the results. Illustrated is a very shallow and compact 4 position selector switch. This can be built-up to index in 5, 6, 7 or 8 positions as well. Why not 'give it the works'—you'll get good value for money!

## **ARROW ELECTRIC SWITCHES LTD**

**BRENT ROAD · SOUTHALL · MIDDX**

**Telephone: SOUthall 2442**

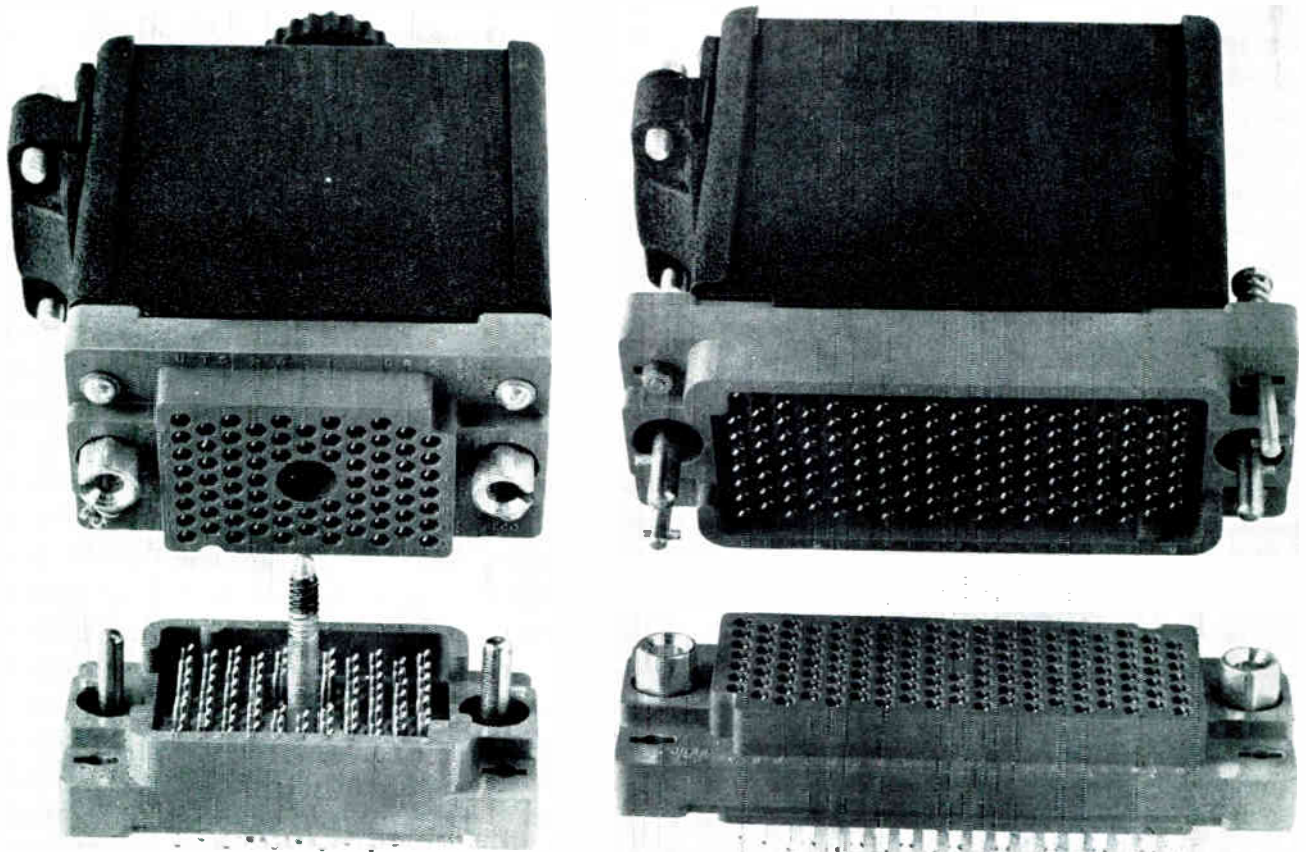

## Series 8017 and 8018 Multiway Plugs and Sockets

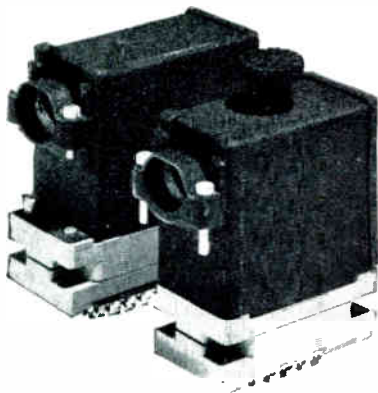

The Contacts are the well-known **VARICON\*** fork type Hermaphroditic contacts rated at 5 amps. They can have crimped connections and be removable from the moulding or be fixed contacts having solder terminations. The 8017 has 75, 100 or 130 ways and the two halves are secured by a screw arrangement. The 8018 has 80, 110 or 140 ways and is secured by bayonet clamps.

\* TRADE MARK

Can be supplied to meet P.O. approval

### MAGNETIC DEVICES LIMITED

Newmarket - England - Tel: Newmarket 3451 (10 lines)

Grans: Magnetic Newmarket

Telex: 81245

MANUFACTURERS OF RELAYS, SOLENOIDS, TIMERS

**Sole licensees in Great Britain of the Elco Corporation, Willow Grove, Penn., U.S.A.**

P.9623

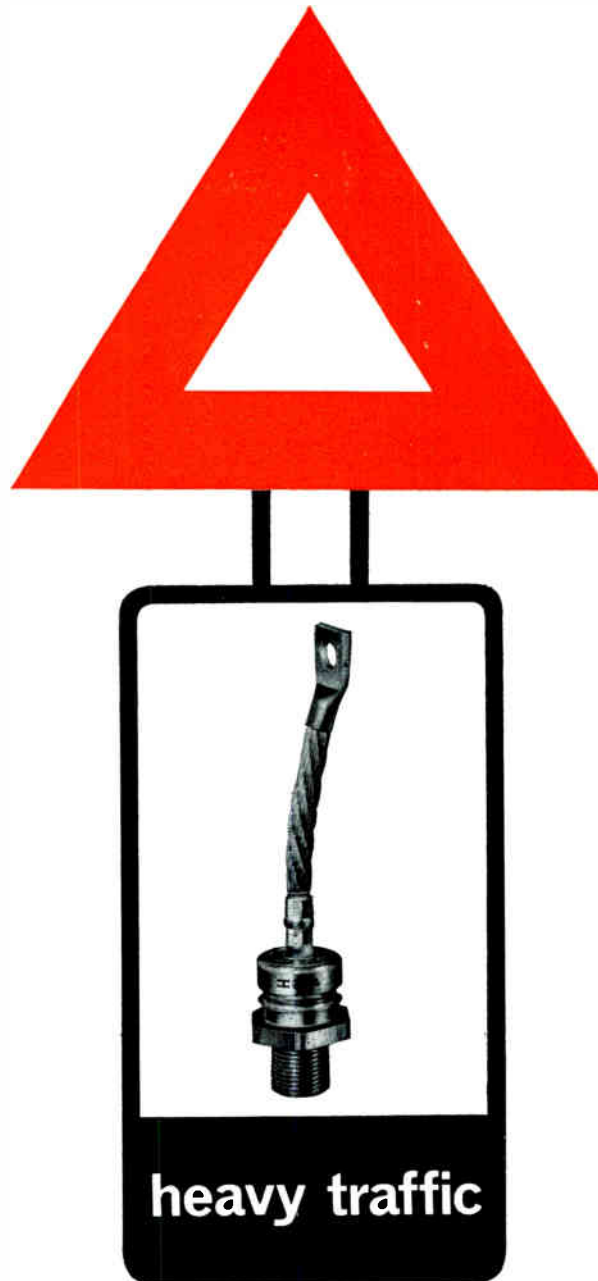

For heavy current up to 250 amp continuous, IR Type 70U diodes are a byword for operational reliability. Reliability proven by customers. With maximum thermal impedance of only 0.2° C/watt and voltage ratings up to 1400 P.T.R.V., there's no stopping their growing popularity.

To find out why, send for details.



## INTERNATIONAL RECTIFIER

Immediate off-the-shelf delivery from IR distributors—phone

COLCHESTER 6173 • CRAWLEY 28700 • GLASGOW DOUGLAS 8671 • (LANCS) TODMORDEN 602 • LEEDS 35111  
LEICESTER 68561 • (LONDON S.E.27.) GIPSY HILL 6166 • (MIDDLESEX) SKYPORT 1314 • PORTSMOUTH 20465

INTERNATIONAL RECTIFIER CO. (GREAT BRITAIN) LTD • HURST GREEN • OXTED • SURREY • TELEPHONE OXTED 3215 • TELEX RECTIFIER OXTED 8819



**NOW**

**-200° to 1600°C**

**'BIKINI'**

Regd. Trade Mark

**temperature instruments for use with *thermocouples* as well as resistance bulbs**

- \* Potentiometric accuracy
- \* High impedance input circuit
- \* Stable against varying supply voltages and ambient temperatures
- \* Solid-state control switching to 0.1% differential. (No photo-cells)
- \* Precision long-sweep slide wire gives resolution to 0.1%

Many thousands of these low-cost, potentiometric, servo-operated, fully transistorized instruments have given maintenance-free service for over four years. They are the obvious choice for all temperature applications. Write for leaflets listed below.



'BIKINI' CONTROLLER

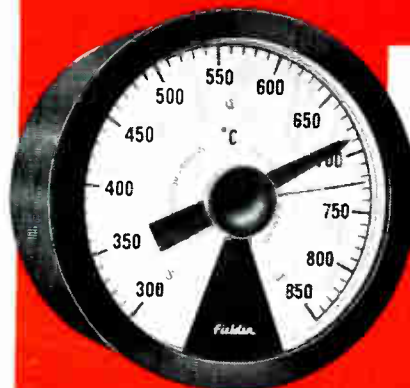

'BIKINI' INDICATOR / CONTROLLER



'BIKINI' RECORDER / INDICATOR

**THERMOCOUPLE INSTRUMENTS**

**RESISTANCE BULB INSTRUMENTS**

INSTRUMENT	SCALE LENGTH	CALIBRATION ACCURACY	MAX DISTANCE—MEASURING POINT TO INSTRUMENTS	APPROX. SIZE	WRITE FOR LEAFLETS	INSTRUMENT	SCALE LENGTH	CALIBRATION ACCURACY	MAX DISTANCE—MEASURING POINT TO INSTRUMENTS	APPROX. SIZE	WRITE FOR LEAFLETS
Indicator	12½"	± 0.5%	100's yards	6" dia.	BIK PT/2/1	Controller	9"	± 0.5%	300 feet	4½" dia.	BIK 1
Ind/Controller	12½"	± 0.5%	100's yards	6" dia.	BIK PT/2/1	Indicator	12½"	± 0.5%	300 feet	6" dia.	BIK 2/C
Recorder/Ind	13"	± 0.5%	100's yards	8½" x 7½"	BIK PT3/1	Ind/Controller	12½"	± 0.5%	300 feet	6" dia.	BIK 2/C
Rec/Ind/Cont	13"	± 0.5%	100's yards	8½" x 7½"	BIK PT3/1	Recorder/Ind	13"	± 0.5%	300 feet	8½" x 7½"	BIK 3
Rec/Ind/Prop.Cont	13"	± 0.5%	100's yards	8½" x 7½"	BIK PT3/1	Rec/Ind/Cont	13"	± 0.5%	300 feet	8½" x 7½"	BIK 3
						Rec/Ind/Prop.Cont	13"	± 0.5%	300 feet	8½" x 7½"	BIK 3 & EPC3

\* 85 Standard temperature ranges — many available from stock

Whatever your instrumentation problem—consult Fielden on temperature, pressure, level, control systems.

**Fielden**

**FIELDEN ELECTRONICS LIMITED · WYTHENSHAW · MANCHESTER**

Telephone: Wythenshawe 3251 (6 lines)      Telegrams: Humidity Manchester  
 Branch Offices: London, Walsall, Harrogate, and Scotland      Telex: 66531  
 Overseas Subsidiaries: AUSTRALIA: Fielden Electronics (Aust.) Pty. Ltd., 61 Betula Ave., Vermont, Victoria, and  
 107 Alexander Street, Crows Nest, New South Wales. ITALY: Fielden Electronics Italiana, Milan.  
 Agents throughout the world.

For matchless accuracy and rugged versatility  
 evaluate this proven digital voltmeter



**TYPE LM 1440 (autorange model LM 1480)**

High accuracy (0.005% of reading  $\pm 1$  digit) and variety of applications are the principal features of this new Voltmeter. Accuracy, resolution and long term accuracy-stability ( $\pm 0.006\%$  per annum) makes it the ideal instrument for the exacting requirements of the STANDARDS ROOM. Scale factor control, six operation modes input isolation and input filters (plus optional autoranging — LM 1480) provide the essentials for LABORATORY work. Simple operation, elimination of reading error and overload tolerance, enabling operatives to repeat highly accurate measurements without error make this instrument ideal for the PRODUCTION TEST. Add together all these facilities with the built-in Solartron "confidence factor" and you have an instrument eminently suitable for incorporation in DATA PROCESSING systems.

What's more — the applications of the LM 1440 can be further extended to  $\pm 0.08\%$  A.C. measurements by the use of the AC/DC converter (LM 1219). Accuracy 0.005% of reading  $\pm 1$  digit  $10\mu\text{V}$  to  $2\text{kV d.c.}$  with Automatic Polarity Indication  
 Resolution 1 part in 30,000  
 20,000  $\text{M}\Omega$  Input resistance  
 20 msec Conversion time  
 6 Operating modes  
 Low temperature coefficient  
 Long term accuracy stability  
 Optional Autorange Version

**SOLARTRON**

For—Data Systems · Transducers · Computers  
 Military Systems · Electronic Instrumentation

Write or telephone for a demonstration  
**THE SOLARTRON ELECTRONIC GROUP LIMITED**  
 Victoria Road · Farnborough · Hants.  
 Telephone · Farnborough (Hants) 3000  
 Telex · 85245 Solartron, Fnbro  
 Cables · Solartron · Farnborough  
**A MEMBER OF THE SCHLUMBERGER GROUP**

M & P 5194



'ENGLISH ELECTRIC'

# HIGH QUALITY Instrument Cathode Ray Tube

**T948** 5-inch P.D.A.  
Mesh Tube for Wide-band  
High-speed Oscilloscopes

- HIGH X and Y sensitivities of 9V/cm and 3V/cm respectively.
- EXCELLENT BRIGHTNESS giving high writing speeds and negligible distortion.
- GOOD SENSIBILITY with small spot size.
- UNIFORM DEFLECTION SENSITIVITY with changes of screen potential from 6.0 to 15kV.
- MINIMUM deflector plate inductance and interplate capacitance.
- VERY LOW background illumination.

The **English Electric** high quality instrument cathode ray tube, T948, has been designed for precision wide-band high speed oscilloscope applications. Its special post deflection accelerator mesh and advanced gun design provide the many features essential for modern transistorized oscilloscopes. The T948 has a flat clear glass faceplate and an aluminised screen. It is available with two phosphors; blue green (equivalent to P31) suffixed 'H' and yellowish/green (equivalent to P2) suffixed 'N'. Both phosphors have medium short persistence. Write for full information on the T948, 'H' and 'N' and other EEV instruments, projector, monitor and radar display tubes.

**ENGLISH ELECTRIC VALVE COMPANY LIMITED**

AGENTS THROUGHOUT THE WORLD

Chelmsford, England. Telephone: Chelmsford 3491

## Satellites

In recent years we have all grown rather blasé about satellites. We all know that there are quite a lot of them but few of us could say off hand just how many. Of those launched by NASA (National Aeronautics and Space Administration) there are now 45 in orbit round the earth and seven around the sun. These have all been launched between February 1959 (Vanguard II) and December 1964 (Explorer XXVI). Of all those launched the Telstars and Syncoms have been, and still are, of the most direct interest to us because they are providing the information upon which world-wide commercial communications are likely to be eventually based.

The three lunar probes have perhaps struck people's imagination more. They have, of course, been destroyed by impact with the moon, but have provided a great deal of information, including 4,316 television pictures of the moon taken during the last 17 minutes of the journey by Ranger VII.

The most ambitious project, of course, and the one which we all expect to hear a lot about this year, is Mariner IV, which was launched on 28th November 1964. This is now well on its way to Mars and is travelling at some 7,000 miles an hour. When it reaches Mars it will have covered 325 million miles and it is due to arrive in its neighbourhood at 8.11 p.m. E.S.T. on 14th July this year. The closest approach to Mars is expected to be 5,400 miles.

Mariner is continually transmitting data about itself and conditions in space and recently the information rate was switched from  $33\frac{1}{2}$  bits a second to  $8\frac{1}{2}$  bits. This is because of the increasing distance from the earth and the new reduced rate is to be operative for the rest of the journey. Among the equipment on board is a television camera, but because of the slow information rate only still pictures will be possible. It is stated that it will take  $8\frac{1}{2}$  hours to transmit a picture to earth. The direct Mars to earth distance will be about 140 million miles, so that the actual transmission time will be  $12\frac{1}{2}$  minutes. The  $8\frac{1}{2}$  hours clearly refers to the time taken to scan the picture. With this time and at  $8\frac{1}{2}$  bits a second, there will be 250,000 bits to a picture, which is a reasonable enough figure.

We have come a long way since 5th October 1957, when the first satellite, Sputnik 1, was launched by Russia. Ten years ago, satellites were in the realm of science fiction and few believed that they would ever become real. We can now not only launch a satellite, but to some extent we can control its course after launching. We can transmit command signals to it and receive vast quantities of information from it over distances of many millions of miles. Ten years ago it was all incredible, now it is commonplace.

There is, of course, no industrial application of most satellites. Their main purpose is to gain information from outer space. This increase of knowledge may in the end prove of benefit to industry. Where industry does gain directly, however, is in the improved knowledge of automatic control and telemetry, to say nothing of the knowledge of how to produce reliable apparatus, which has resulted from all the work on satellites.

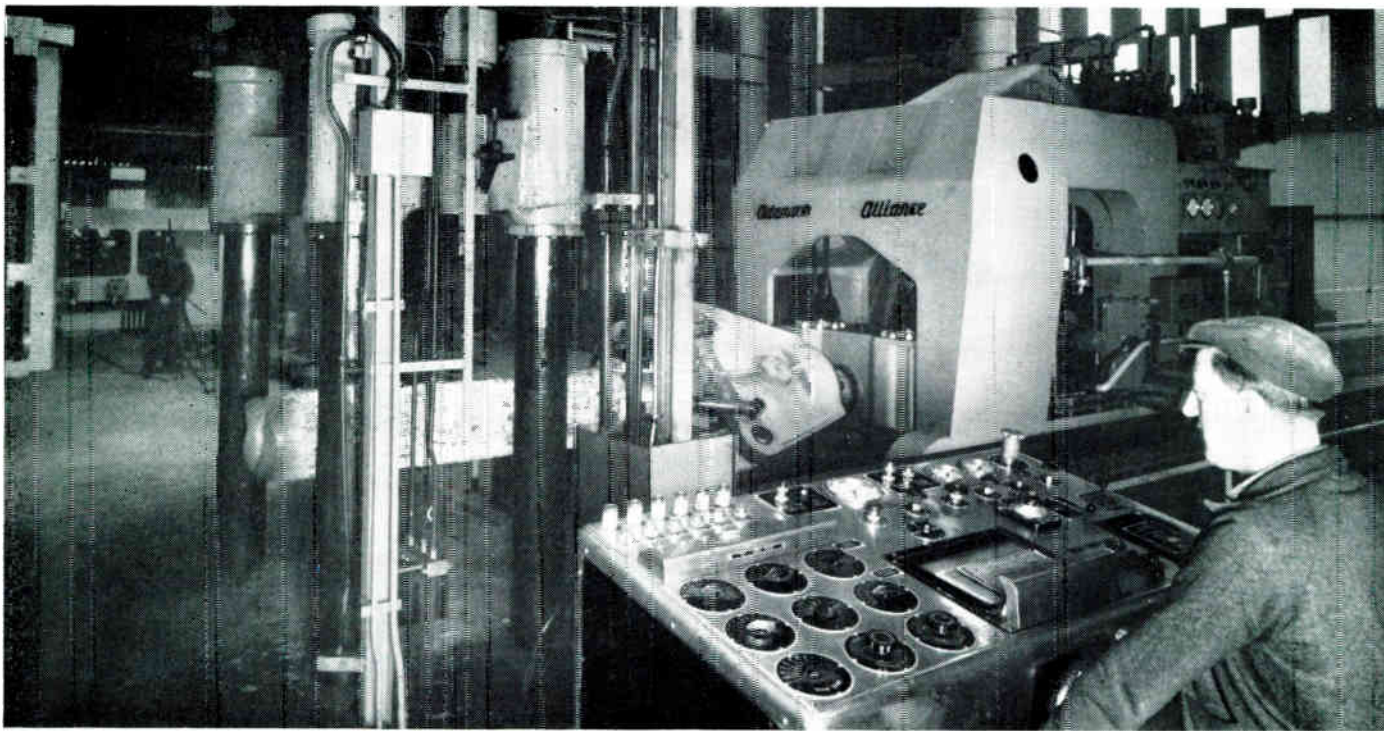

Forging requires a double control system, for the hot ingots of metal must be manipulated and the press controlled. This article describes a digital electronic control system which operates in conjunction with hydraulic actuation of the machinery.

# HIGH-SPEED

**I**N the last ten years considerable development has taken place in the steel industry. New machines and electronic devices and systems have been combined to produce steel more efficiently.

Modern high-output hydraulic drives provide forging presses with high potential productivity. Likewise manipulators which hold and position large red-hot ingots of metal have been improved. When combining a high-speed forging press with a modern manipulator the limiting factor is a human one. Operators cannot co-ordinate the operations of the two high-speed machines to achieve maximum output.

In order to utilize plant of this nature to its fullest extent it is therefore necessary to integrate both manipulator and press movements. Lancashire Dynamo Electronic Products have developed an electronic digital position-control system for the integrated control of manipulator and press movements.

A plant which has been provided with such control is that at Parks Forge, Wigan. This is illustrated on the front cover of this issue. The installation of this equipment

coupled with improved furnace facilities for heating blooms and ingots has resulted in the output being almost doubled.

## The Forging Press

This is hydraulically powered by eight fixed-delivery piston pumps mounted in pairs and driven by four 100-h.p. electric motors. The total flow from these pumps is 180 g.p.m. at a maximum pressure of 4,480 lb/sq in., with a total peak output of 560 h.p. and a maximum number of strokes of 120/min. A vane pump delivers 12.5 g.p.m. at 500 lb/sq in. to operate the pilot system. It is in this pilot system that the high-speed electro-hydraulic valves are mounted which provide the interface between the electronic control and the hydraulic control systems.

## The Manipulator

This is a large power-driven chuck or jaw-like mechanism which grips and positions the mass of metal being worked. The chuck is mounted on an extension arm, known as the peel, which can be rotated and moved longitudinally. Also the complete manipulator is mounted on a 56-ft long track.

The manipulator is of 30 ft tons capacity, constructed as an overhung type, the peel being supported from above by wire ropes and springs.

The hydraulic power unit consists of two fixed-delivery piston pumps driven by a double-ended 75-h.p. electric





(Left) View from pump house of Parks Forge press and manipulator

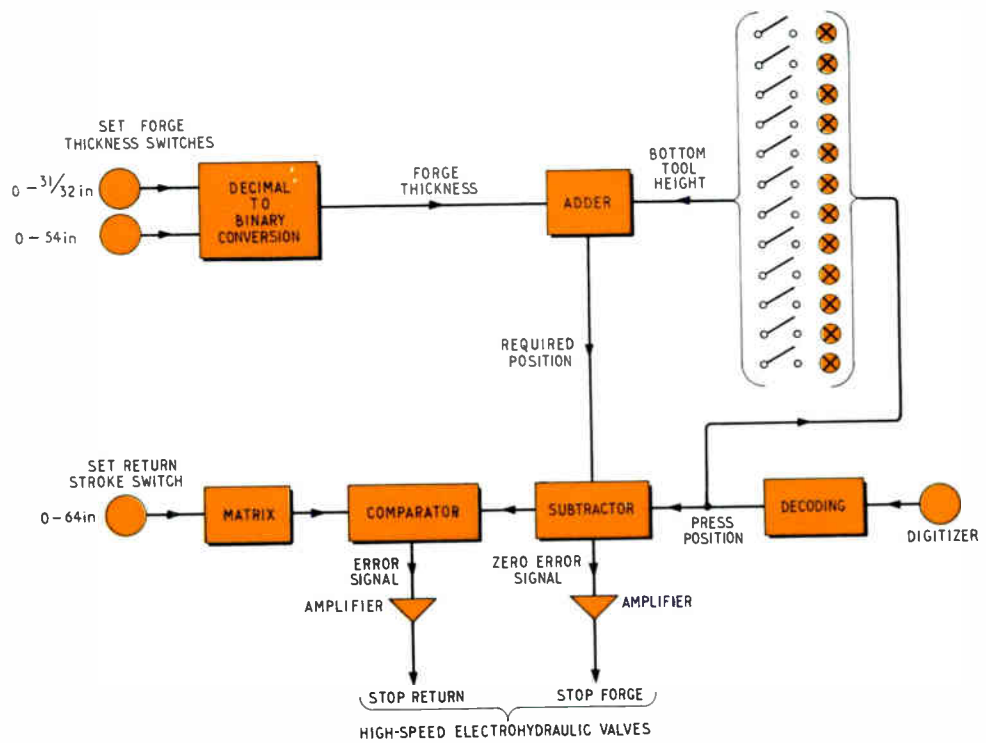

Fig. 1. Simplified block diagram of automatic press control

# FORGING CONTROL

By A. HADFIELD\*

motor, mounted on a bedplate which is in turn built into the main structure of the manipulator. Since the oil supply tank is also part of the machine structure the only connections which are required are electric cables running to the main supply and the electronic-control cubicle.

## Forging Press Automatic Thickness Control

The process of forging is one of squeezing the hot metal between a stationary anvil and a moving press. This means that, on each cycle, control must be applied to start the stroke, end the stroke and raise the press to a fresh starting position. The position of the end of the stroke determines the thickness of the metal. For automatic thickness control a non-contacting magnetic digitizer is used to convert the linear motion of the press to an electrical output signal (in 12-digit binary form). This provides a resolution of  $\frac{1}{8}$  in. over a possible stroke of over 100 in. The input shaft of the rotary digitizer is driven by means of a steel cable wrapped around a spring-loaded drum on the shaft. This has the advantage of very low inertia. The input shaft drives three binary-coded discs geared to the shaft. The digitizer itself is mounted on the fixed crosshead of the forging press, the free end of the driving cable being fixed to the moving tool of the press.

The required forging thickness is set in on multipole switches which feed into diode matrices which perform the decimal to binary conversion. To this is added the height

of the anvil above the digitizer zero. This is obtained by bringing the press tool into contact with the anvil, and displaying the digitizer output on a set of twelve lamps which then show the bottom tool height in binary form. Twelve switches mounted below the lamps are then used to set into the electronic control system an arbitrary zero. The switches are fed from a common negative supply and feed directly into the 'adder unit'. The output of the 'adder' is thus the required position at which the top tool of the press must reverse. The arrangement is shown in Fig. 1.

The output from the digitizer is fed to decoding circuits. V-scanning is used to overcome the ambiguity which can occur when two or more digits change at the same instant where mechanical imperfections prevent perfect alignment. It can be seen from Fig. 2 that the pick-offs are in the form of a V, the spacing between the pick-offs being equal to the length of a digit on the previous track. If the outputs from the pick-offs are connected to the terminals shown in Fig. 3, it can then be seen that the 'a' digit controls the changeover point for all digits and hence no ambiguity occurs at changeover points. The decoding circuit outputs are fed to the 'subtractor' along with the output of the 'adder'.

As the press descends, the digitizer generates a continually-changing 12-digit binary number which defines the

\* Lancashire Dynamo Electronic Products Ltd.

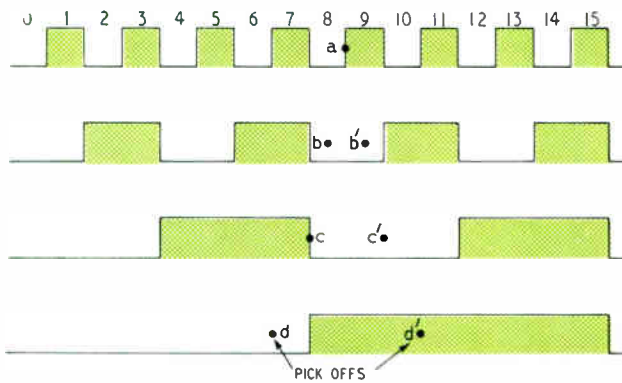

Fig. 2. (Left) Digitizer disc shown linearly

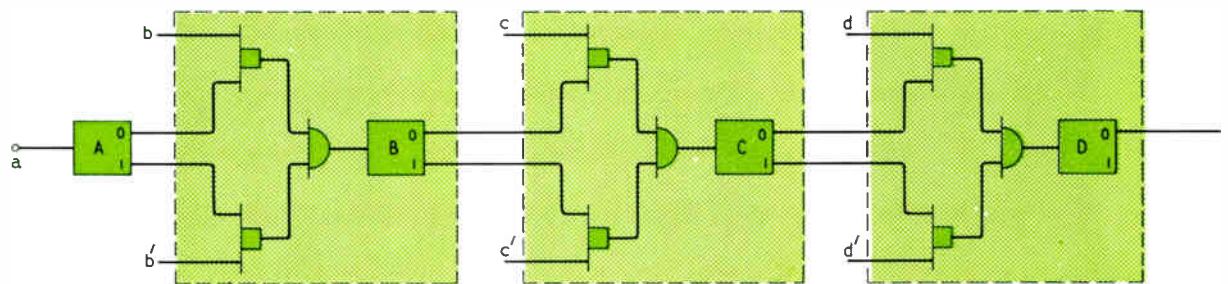

Fig. 3. (Below) Decoding circuits

lower edge of the moving tool. In the 'subtractor unit' the required position is subtracted from this number. When the 'subtractor' output reaches zero, the press will have reached the required reversal position and a signal is generated which, via an amplifier, operates the electro-hydraulic valve in the pilot system, which in turn reverses the press.

The press now moves upwards, the increasing error signal being continually compared with the return stroke setting. When these two numbers are equal, a signal is generated which, via a second electro-hydraulic valve, reverses the hydraulic directional control valve, and the press commences a further stroke.

Facilities are provided for a dwell period (0-5 sec) at the top of the press stroke to allow manipulation to take place, and also for slow down, to allow the press to fall at up to five times its forging speed to a point above the stop forge position where the fast approach solenoid will be de-energized.

Compensation is provided to allow for the stretch of the press columns by the incorporation of pressure-transducers, and for velocity by the incorporation of a tachometer driven by the digitizer. The velocity and stretch signals are added algebraically in an analogue summing unit, to produce a single correction signal. This signal is fed to a static encoder which gives out a four-digit binary number which can be applied to the digital system.

### Manipulator Control

Full manual control of the manipulator actions are provided by joysticks which operate the required high-speed electro-hydraulic valves via the selecting control logic. The motions provided are: traverse right (fast/slow); traverse left (fast/slow); peel rotate clockwise (fast/slow); peel rotate anti-clockwise (fast/slow); rear hoist up; rear hoist

down; parallel hoist up; parallel hoist down; grips close (high/low pressure) and grips open, a total of 15 motions in all. In addition both automatic traverse and peel rotation are provided.

### Automatic Traverse During Forging (Fig. 4)

To be able to obtain the point at which the manipulator must retreat, it is necessary to compare the clearance height which has been set with the error signal from the 'subtractor' of the forging press control. The timer shown

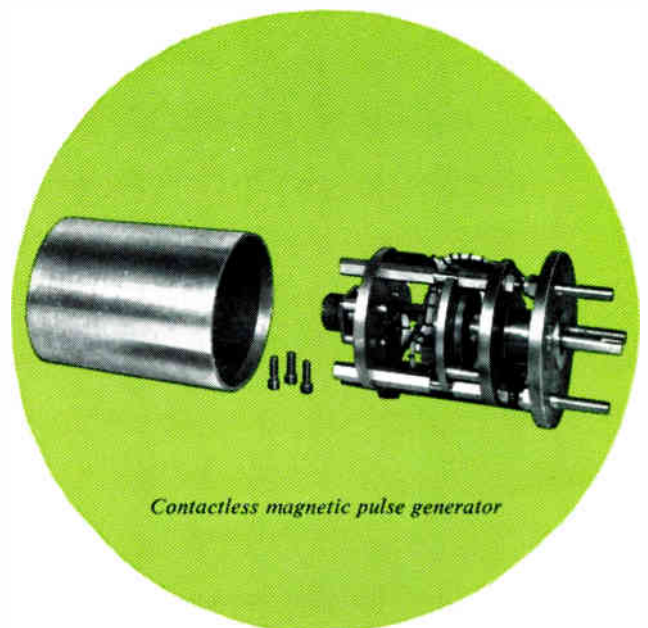

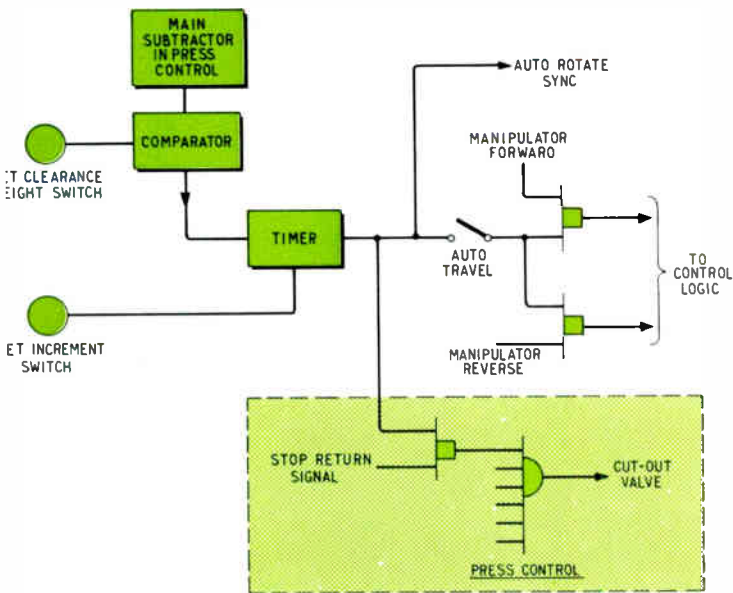

Fig. 4. Automatic traverse

speed electro-hydraulic valves for the traverse motions. Thus for each stroke of the press, when the automatic traverse is switched in, a longitudinal increment of travel takes place.

Although the units of increments are arbitrary the increments obtained are better than  $\pm \frac{3}{16}$  in. varying the loading of the manipulator from empty to full load.

### Automatic Rotation (Fig. 5)

The rotation of the peel of the manipulator is measured by means of a contactless magnetic pulse generator which generates 12 pulses for  $11\frac{1}{4}^\circ$  of rotation. When the automatic rotation is initiated either on 'one shot' by means of a pushbutton or from the clearance signal from the forging press, the angle on the set-rotation switch is set into the rotational counter. This error in the counter causes the rotational electro-hydraulic valves to be energized. The pulses from the pulse generator, generated by the rotation of the peel, are used to count down the number set into the counter. Fast rotation (10 r.p.m.) is energized while the output of the counter is greater than 7 digits (7 degrees approximately), when the fast solenoids are de-energized and the peel is allowed to complete its rotation at a creep speed of 1 r.p.m. The peel deceleration is such that it only attains creep speed approximately 1 degree before the desired stopping position. The reversible counter is fed via direction-discriminating circuits; should any overshoot occur these cause the peel to reverse direction to find the required null position.

Once the correct position (zero output from the counter) has been held for 0.5 sec the counter control locks out the rotation until the next initiate pulse.

### Productivity

The introduction of the manipulator with the controls described has allowed the number of men employed on the press to be reduced from five to three (an extra man is

in this configuration generates an output pulse each time its input signal is removed. Therefore during each stroke of the press, the top tool descends to the 'stop forge' position, reverses and, at the point where the 'subtractor' output is coincident with the clearance setting, the input to the timer is removed and an output pulse generated. The length of the pulse generated is controlled by the set-increment switch and is variable from 0.4 to 2.4 sec which correspond to increments of travel from  $\frac{1}{4}$  in. to 20 in. in 20 steps when these pulses are fed to the high

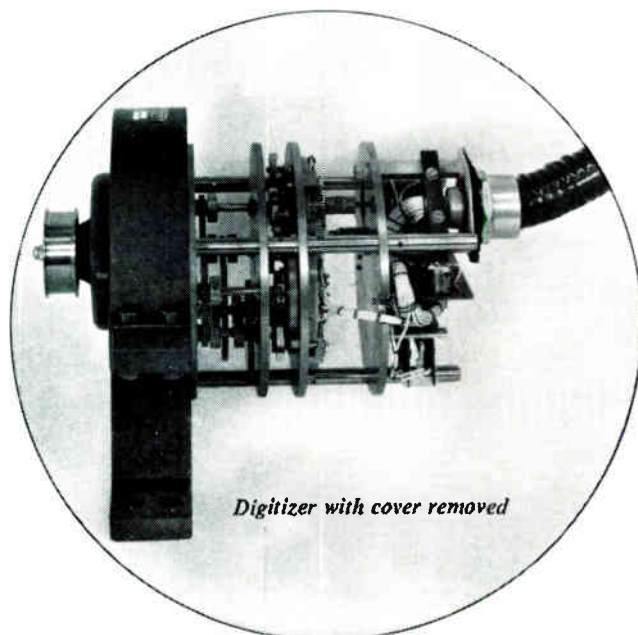

Digitizer with cover removed

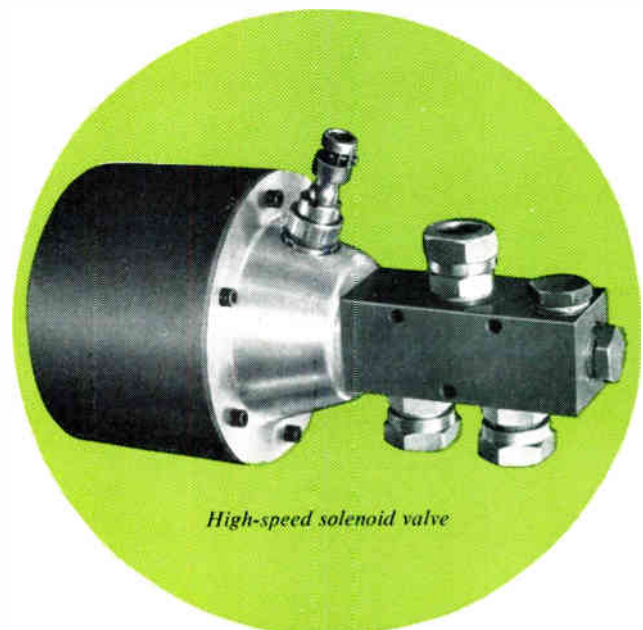

High-speed solenoid valve

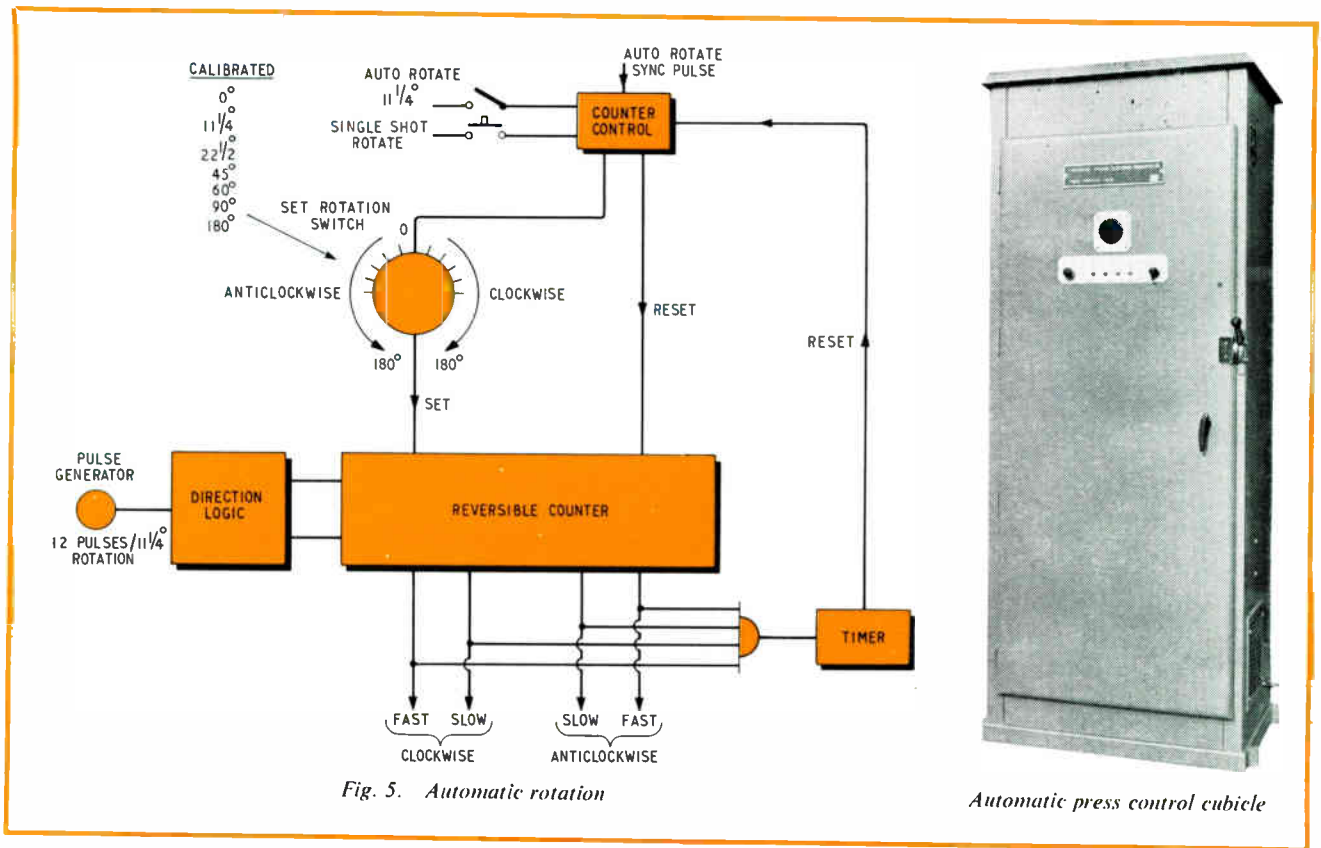

used for special knifing operations) and at the same time increase the output by almost 100%. In addition to this a large reduction has been obtained in heating costs by eliminating a large number of the re-heats which were previously required.

#### Acknowledgments

The author would like to thank the following companies for allowing information contained in this article to be published. Parks Forge Limited, Towler Brothers (Patents) Limited, Adamson-Alliance Co. Limited.

*This view shows the complete manipulator mounted on its track*

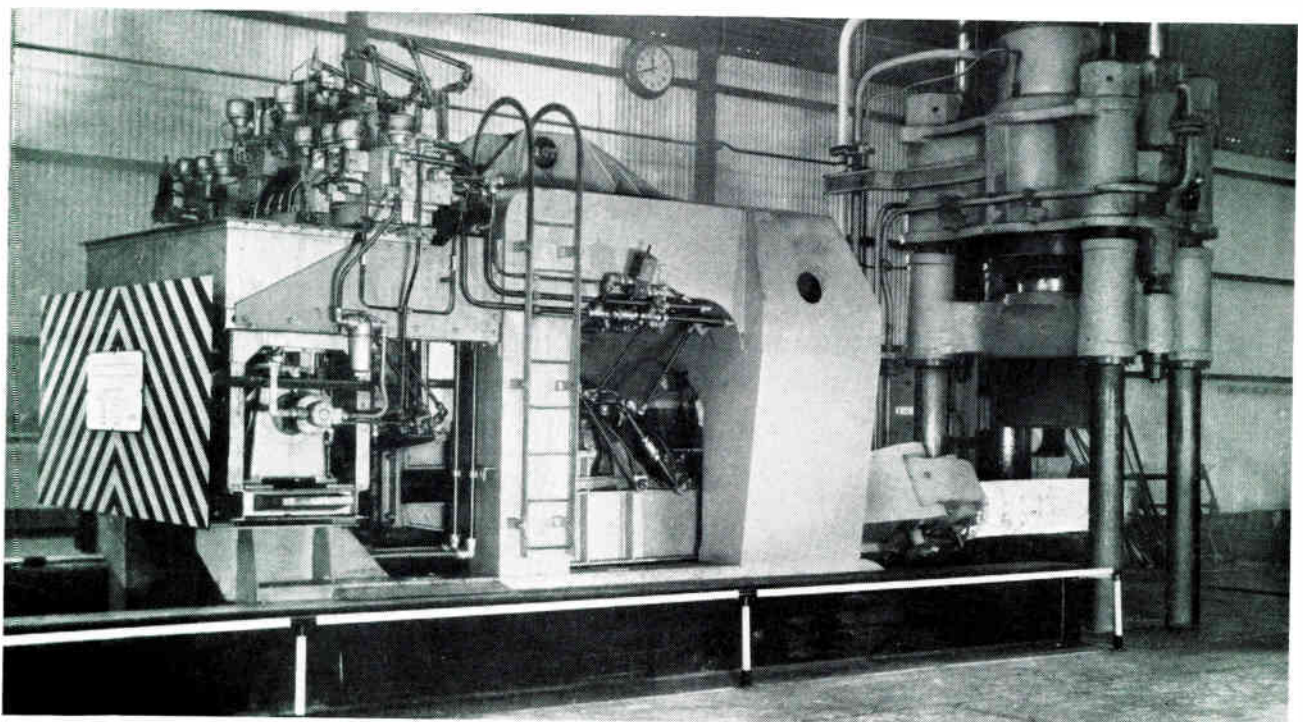



# SELF-TUNING COMMUNICATIONS SYSTEM

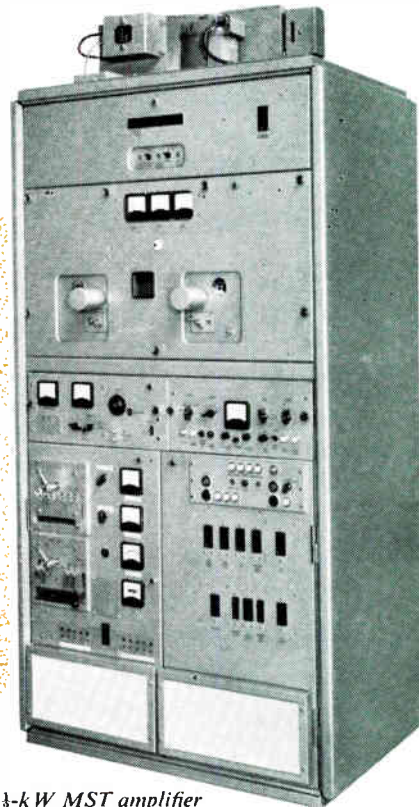

A 7½-kW MST amplifier

With any long-distance communications system the operating frequency is changed two or three times a day when the received signal-to-noise ratio falls below an acceptable level. At the present time a change of operating frequency takes from 15 to 60 minutes, depending on the system. This means loss of valuable traffic time and the change requires a skilled engineer. In addition, having taken, say, 30 minutes to make a change, one may find that the new operating frequency chosen is already being used by another transmitter.

*This shows the decade frequency controls and a number of plug-in units in an MST receiver*

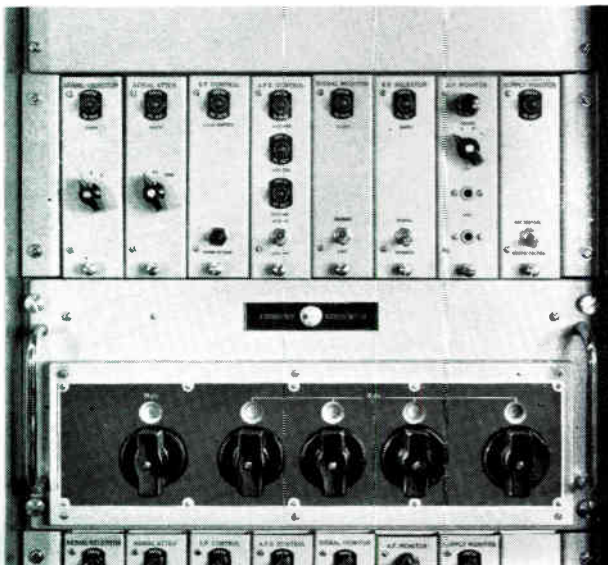

To overcome the delay in changing operating frequencies The Marconi Company have developed, and recently demonstrated, self-tuning h.f. communications equipment which will undoubtedly cut the running costs for long-distance telegraph and telephone systems.

Both the h.f. transmitters and receivers incorporate 'Marconi Self Tuning' (MST). With this facility, operating frequencies are selected on simple decade dials and all the tuning operations are performed automatically. This means that one semi-skilled operator can control every receiver in a major communications centre. Likewise, only one operator is required to control a number of transmitters.

For the purposes of the demonstration a working mock-up communications system was assembled with the transmitters working into dummy loads. Visitors were asked to take over the 'station' and to make a frequency change. In every case, an end-to-end frequency change was made in just under one minute.

Although MST is a highly integrated system of modular units, each item may be fitted into existing systems during progressive stages of modernization. Wideband amplifiers are used in place of tuned circuits requiring mechanical controls. Semiconductor high-voltage rectifiers are employed in the high-power amplifier stages. And all units in the receiving system are fully transistorized.

For further information circle 44 on Service Card

## WHAT'S ON AND WHERE ?

This new forthcoming-events feature is to be found facing the inside back cover.

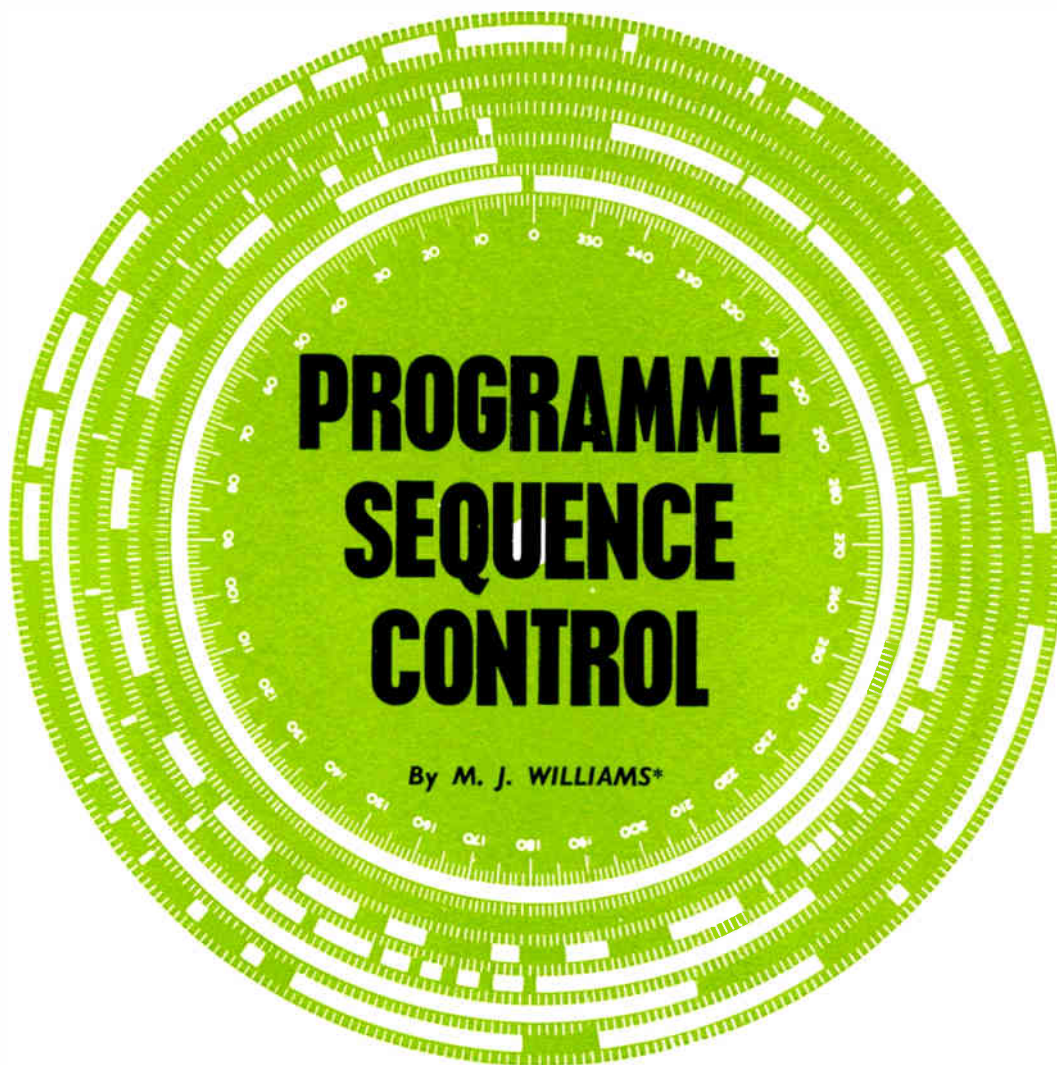

The equipment described in this article utilizes an entirely novel lamp, photocell and programme store arrangement to produce extremely complex process control sequences that can be changed in a moment.

**S**CISSORS and String do not appear to form a very likely approach to complex programme or industrial process-control preparation. But in essence they may well be said to form the basis of a system of control that is finding very wide application in many engineering fields.

So many processes today can be resolved into a simple ON-OFF function in one or more channels, but are limited by an inevitable stiffness when even minor changes are required. Flexibility can be obtained only by divorcing the controlling medium from the items being controlled

\* Lectromec Engineering Ltd.

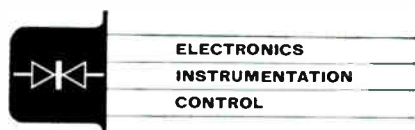

so that the former can be readily modified or completely changed with only the desired effect on the latter. Once this principle is established, it becomes possible not only to compose more complex programmes but to change and store alternative programmes with the ease of a gramophone record. By translating a programme into a detachable component it is also possible to allow even unskilled hands to carry out complete sequence changes in a complicated process.

#### Photo-Electric Cams

Translation of an ON-OFF-ON function related to time can conveniently be represented by a length of opaque tape, paint, ink or metal strip attached to a piece of moving clear plastic sheet. A photocell placed on one side of this sheet will be screened from a light source placed on the other for the length of time that it takes for the opaque strip to pass between them. The output from the photocell will vary sharply between maximum and minimum and, after squaring by means of a suitable Schmitt trigger circuit, can control a multiple relay.

In practice, the plastic sheet can take the form of a disc with a number of annular bands, a cylinder with a number of peripheral bands, or a rectangular card or length of film with a number of parallel stripes. A typical

arrangement is shown diagrammatically in Fig. 1 from which it is obvious that there is practically no limit to the number of actions in the form of optical obstructions or cams that can be applied to each channel. As, and when, the need arises to change the duration of an action, it is necessary only to extend or shorten the length of the tape or other optical obstruction at that point in the programme.

The four carrier shapes or programme stores adopted (i.e., disc (as shown in the title block), cylinder, card and film) all lend themselves to simple insertion into and removal from their respective machines. In addition to this the plug-in driving motor and gear assembly can be simply changed after loosening two or three screws.

**Reliability**

The question of reliability is perhaps uppermost in most engineers' minds today. A new system inevitably comes under severe observation for this quality, but here this problem can be resolved into three major sections, the answers to each of which are already known.

Firstly, the optical system might suggest a weakness. The photocells are solid-state devices whose life is practically indefinite. Light sources are normally incandescent lamps which are considerably underrun to extend their life: once switched on, they remain illuminated until the requisite number of programme cycles have been completed. Some programme controllers, particularly those with the larger number of channels, are fitted with a gas-discharge strip lamp.

Secondly, the programme disc, drum, card or film is of a low temperature coefficient material. Strictly speaking, even a large change in dimension of a disc or drum will cause no change in the various time intervals since the angular disposition of the various on and off commands remains unaltered. In truth, of course, the amount of expansion is negligible. Long-term stability of an opaque area is achieved by using a highly stable self-adhesive tape: transverse strips up to 1/8 in. wide are used for short actions, lengthwise strips for slightly longer actions and two transverse strips denoting the start and finish for long actions, the gap between being filled in with a general purpose tape or paint. Thus any unforeseen contraction of the tape will take place radially and so will not affect the timed period.

Finally, the motor and gearbox unit are all very well proved components that have been in production and improved upon over a number of years. Interconnection between the motor unit and the programmer chassis is by means of an approved plug and socket.

**Design Considerations**

Accuracy and repeatability can probably be put on a par with reliability in any process or sequence programmer. These two qualities can be an inherent aspect of the design at very little cost with a photo-electric system. In the system considered here, the photocell is enclosed in a light alloy block with only a small (3/4 in. diameter) hole or light guide to permit the entrance of the light. The light levels employed are comparatively low, because of the underrun lamps. They are, however, kept sufficiently high for the part of the photocell characteristic that is actually used to remain sensibly the same no matter how sensitive or insensitive the cell, or how bright or dim the lamp. Thus, as the programme store moves the edge of an obstruction over the entrance to the light guide, the Schmitt trigger and hence the associated relay will always be changed to their other state at exactly the same time in the programme. This will hold true no matter the com-

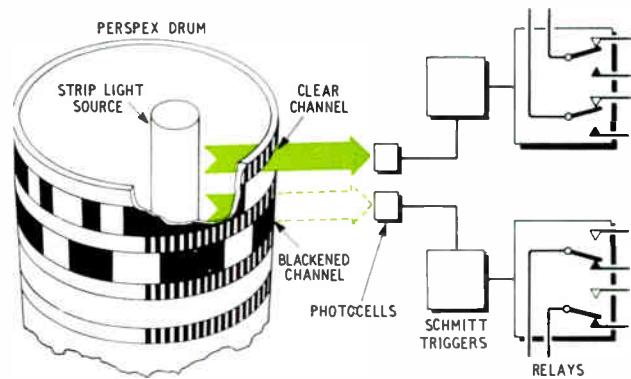

Fig. 1. Simplified practical arrangement of the light source, programme store and sensing circuitry



Applying a tape strip to a programme drum

Complete controller with a taped drum inserted



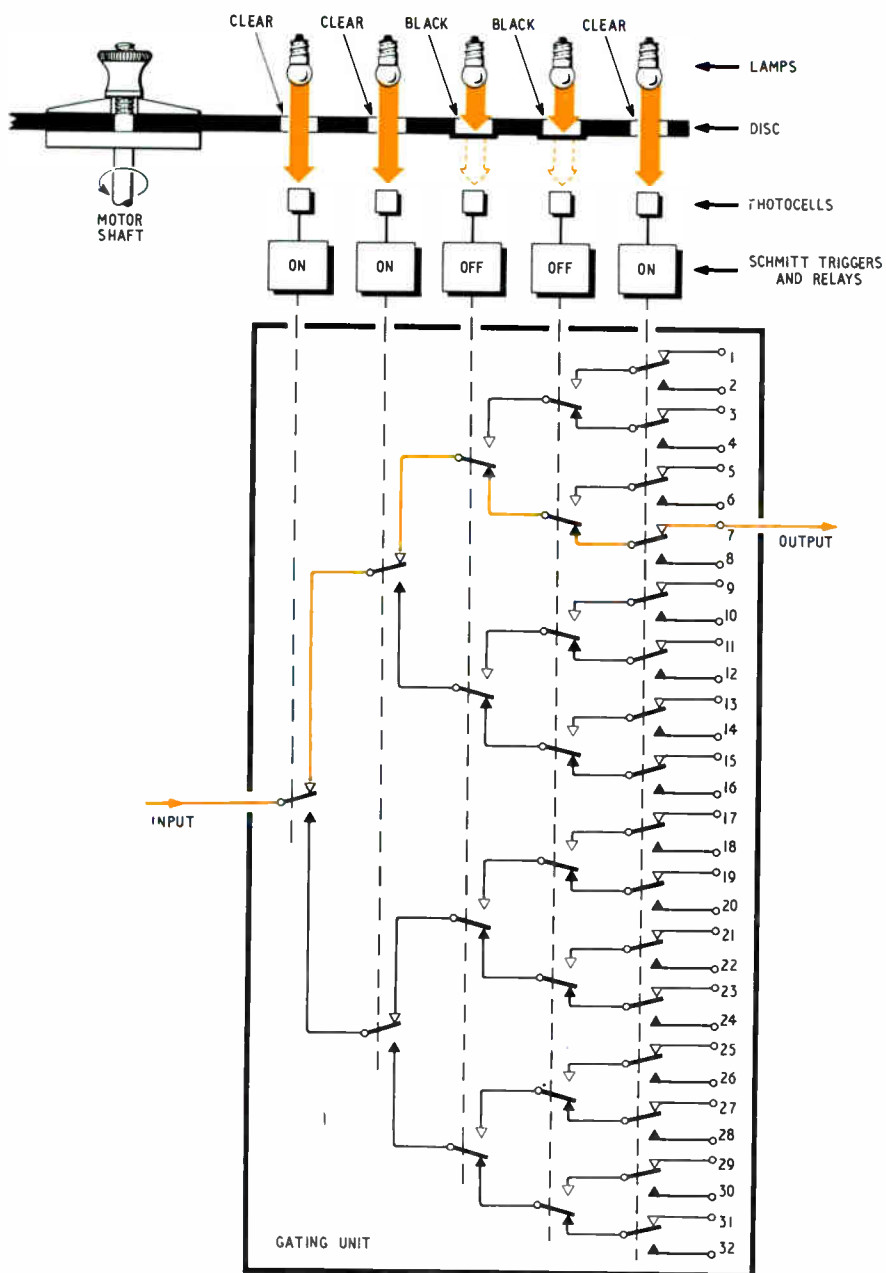
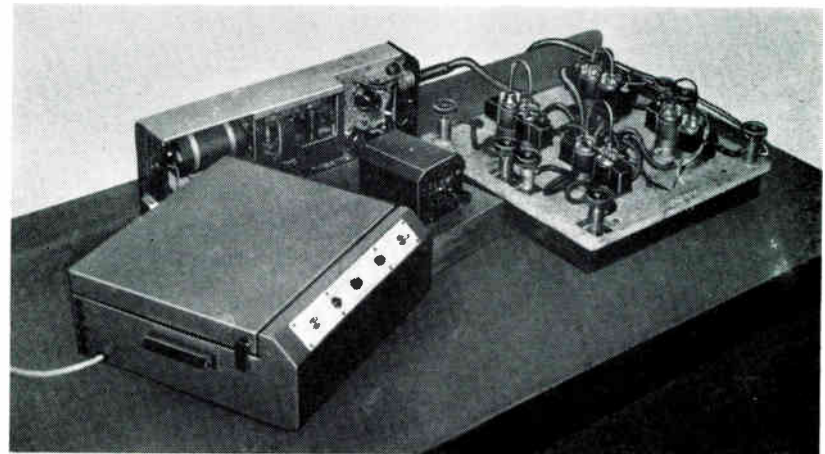

Fig. 2. Basic arrangement of a simple gating unit showing how only one output at a time may be selected

Life test on a precision altimeter. (Courtesy of S. Smith & Sons Ltd.)





bination of good or poor photocell and good or weak lamp so that no changes need be made to the programme store after any necessary servicing.

The trigger level is normally adjusted during manufacture so that a clearly defined ON-OFF-ON action occurs when a  $\frac{1}{64}$  in. (0.015 in.) wide obstruction passes the photocell. An obstruction of this size could well represent a pause of only 4 minutes in a seven-day programme!

So far we have spoken only in terms of synchronous motor drives. There are, of course, many variations upon this basic theme that can be introduced by using non-synchronous, d.c. and stepping motors. Using this last possibility and, for example, a programmed card, it becomes a simple matter to replace complex plug selector boards in machine tool and similar applications.

The card can be read in many ways, e.g. line-by-line, all channels simultaneously; line-by-line, one channel after another; scan down one channel, up the next then down the third and so on. An extension to this idea employs an open-topped rectangular frame to which the drive is applied. User's own stiff-card planning sheets complete with holes punched through can be slipped into the frame and the holes read in sequence automatically. This offsets the difficulty of missed pins sometimes met by manufacturers employing semi-skilled labour to insert pins in the various holes to set up certain conditions on a machine. The automatic scanning and/or single or multiple-cycle operation is accommodated by the use of an additional track reserved, and programmed, exclusively for the driver-motor circuit.

### Ancillary Equipment

While considerable versatility can be achieved with any of the standard equipments already available, there are, nevertheless, occasions when yet more flexibility is necessary. To cater for these contingencies a master timer and/or a gating unit is available. Both are simple plug-in units.

The master timer simply generates a single pulse at predetermined times which triggers the main motor of the programmer proper into action. Thus, a highly complex and accurate programme lasting, say, 1 minute can be executed once every 10 minutes, hour, day or week for example. The other addition, the gating unit, comprises a battery of relays wired together in banks, one bank for each track on the programmer store, as shown in Fig. 2. By this means the common inlet to the gating unit can be routed to only one outlet at any one time. The dwell time at any particular outlet can be of any desired duration and, of course, any particular outlets can be revisited as often as necessary in any order.

The total number of outlets from a particular gating unit will increase in a binary fashion according to the number of channels or tracks on the store. Thus a five-track programmer can have 32 outlets while a 10-track programmer yields 1,024 outlets. This type of unit finds particular use in systems employing considerable quantities of strain gauges, thermocouples, etc., that need to be scanned and monitored according to a prescribed routine.

Combined use of both a master timer and a gating unit means that a highly intricate sampling programme can be undertaken at predetermined intervals, day and night, week-day and weekend alike.

### Applications

It is practically impossible to define any limits to the potential fields of application for this equipment. Nearly every industry, whether it involves the process blending of multiple constituents or the laborious checking of dozens



*Programme controller using a disc with annular rings*

of test points will sooner or later need a programme system that can be changed easily.

On the process side of the story are to be found controllers in command of water-softening equipment, metal-plating and food-preparation machinery. These are but set-and-forget applications that could be in any factory employing semi-skilled labour.

As research studies advance, applications are to be frequently found where tedious evaluation regimes can be handed over to one of these predictable 'black boxes'. A typical example in this sphere is shown in one of the photographs. Here VC10-type altimeters are taken through a complete simulated flight cycle every  $\frac{1}{2}$ -hour for 21 days. If the test conditions at this Smiths Aviation works should have to be changed, then it is simply a matter of altering the taping to meet the new conditions.

## City and Guilds Syllabuses 1964-65

The City and Guilds of London Institute have published syllabuses for the 1964-65 session. Details of selected syllabuses are given here. These are available from the Institute, 76 Portland Place, London, W.1, at a cost of 1s each. Course 47, Electronics Servicing; Course 48, Radio & Television Servicing; Course 49, Telecommunication Technicians' Course including Course 300, Supplementary Studies in Telecommunication and Electronics; Course 51, Electrical Installation Work; and Course 58, Electrical Fitters' Courses.

This article describes a method of measuring the water content of materials by determining the extent to which microwave power is absorbed. The method is in use in the fertilizer, toffee, marzipan, soap powder and nylon tow industries and is under investigation in the nitro-cellulose, foundry sand, coal, grain and soap industries. It is also being applied for research into wood pulp, roads and building.

**T**HIS article describes a microwave moisture meter, the principles upon which its operation is based, and some of its applications.

Although attenuation due to rain has long been recognized as a factor affecting radar performance, the idea of using the absorption of microwave energy in a material as an indication of its water content does not appear to have been considered until about 1956.

Since then the interest aroused by this approach to the problem of measuring water content has been considerable and the behaviour of a great variety of materials has been assessed with a view to applying the method in industry.

### Principles of Operation

The principle on which the instrument works is based upon the fact that at centimetre wavelengths the loss tangent and dielectric constant of water are very high compared

to operate at two frequencies to provide a rapid means of accurate attenuation measurement. A schematic diagram of the low-frequency transmitter and receiver is shown in Fig. 1. Both units are fully transistorized with the exception of the disc-seal triode oscillator operating at 2.45 Gc/s.

Basically the schematic of the high-frequency instrument is also as shown in Fig. 1 except that the receiver is mains operated, ferrite isolators are employed instead of attenuators and a low-power klystron valve is used in the transmitter. The photograph shows this equipment, which operates at 10.688 Gc/s.

### Methods of Measurement

To measure solids or liquids, the transmitter and receiver are set up with transmitting and receiving horns facing each other in a horizontal plane. The distance between the horns is set to be the same as the thickness of the material being measured, and the attenuator is adjusted to give mid-scale reading on the meter. The material is then placed in the gap and the attenuator reset to give the same reading on the meter. The difference between the two attenuator readings gives the attenuation of the material.

When measuring powders or granular materials, a constant weight is used in a cell. Because of the variations in packing density which may be experienced, it has been found necessary to measure the attenuation through the cell in a vertical direction. Under these conditions, as a

# MICROWAVE MOISTURE MEASUREMENT

By H. B. TAYLOR\*

with those of most materials in which the water is absorbed. This, therefore, means that the microwave energy absorbed by a material is a measure of the moisture content of that material. At normal temperature in the 1.0 Gc/s to 30 Gc/s frequency range, the dielectric constant of water is in the region of 40 to 80, and the loss tangent varies from 0.15 to 1.2. Most dry materials have a dielectric constant of the order of 1 to 5 and loss tangent between 0.001 and 0.05 unless some conducting material is involved. Differences of the above order mean that the loss due to the water is at least ten times greater than the loss in the material in which the water is absorbed. In most cases, the factor is much greater than this.

### Apparatus

A microwave moisture meter basically comprises a transmitter and a separate receiver. Instruments are designed

\* Associated Electrical Industries Ltd.

given weight of the material packs down in the cell, the sample thickness changes but the amount of water per unit area remains constant.

In all measurements, the cross-sectional area of the sample must be larger than the horn aperture so as to limit the leakage of energy round the material to a low level. For assessing granular materials at 2.45 Gc/s with a 5½-in. × 7¼-in. horn aperture a simple and convenient cell consists of a Perspex box 13 in. × 11 in. in cross section and of a height adjusted to suit the material. At 10.688 Gc/s with 3-in. × 3-in. horns a Perspex tube has been used giving a sample of a 5½-in. diameter circular cross section. For most materials these cell dimensions prove to be adequate. The sample is levelled and ideally the horns should be in contact with the material or be held in a constant relationship close to the surfaces. It is found, however, that with many materials a fixed horn spacing can be used with a constant cell height.

In some cases the cell may consist of a waveguide directly coupled between transmitter and receiver. The small cross-sectional area enables the amount of material to be minimized when only small samples are available, or for low water content it permits measuring through a great thickness without requiring an excessive amount of material.

The water content of the material is determined by one of the conventional methods available and a calibration



prepared showing percentage water plotted against dB attenuation. This calibration can be subsequently used in conjunction with the instrument to ascertain the water content.

In all measurements the percentage water is expressed in terms of the wet weight of the material. Using a constant wet weight of sample, the weight of water in the sample, and hence the attenuation, varies linearly with the percentage water. A similar situation arises if a constant dry weight of material is used and the percentage water is expressed in terms of the dry weight but this involves the use of a sample weight for measurement which varies with water content.

### Instrument Performance

In a measurement of this kind, where the difference of two attenuator readings is taken, the accuracy is dependent mainly on the attenuator. This is accurate to 0.1 dB and can be read to 0.1 dB. Thus if the sample is thick enough to give a change of attenuation of at least 3 dB for a 1% change of water content, the error introduced by the instrument itself will not exceed 0.07%.

### Leakage

In its original role, that of measuring the moisture content of brick walls, the meter was used on samples many square feet in area. The leakage of microwave energy around the sample, and the error caused by this, could be neglected. Using the cell of limited area, some trouble has been experienced due to leakage. However, if the sample has less than 35 to 40 dB attenuation, the effects of leakage are generally small. There are materials whose reflection coefficients are very high, and these will require either a screen or microwave absorbing material around the horn even though the attenuation is below 40 dB.

### Standing Waves

At each air-material interface, there is an impedance mismatch and consequent reflection of microwave energy. In the case of a sample of low attenuation, the reflected wave from the output interface can either add to, or subtract from, the reflected wave from the input interface, and cause variations in the measured attenuation. If the minimum attenuation through the sample is kept above about 7 dB the reflection from the output interface is absorbed in the sample and the interaction can be neglected. The loss of power due to reflection increases the apparent attenuation of the material, but this is accounted for in the calibration.

### Particle Size

In a granular material the attenuation can be regarded as due to two causes. One is the dielectric losses in the water; the other is the scattering of the beam at the particle surfaces in the material. This scattered energy will be absorbed but the degree of scattering and hence the losses will be dependent on the particle size. To avoid unpredictable variations in loss due to scatter, the particle should be small compared with the wavelength, preferably less than  $\lambda/4$ . It is important to remember that the wavelength in a material depends upon its dielectric constant: for example, the wavelength in lean meat with a dielectric constant of 40 is 2 cm at 2.45 Gc/s, so that the maximum permissible particle size is about 0.5 cm.

The magnitude of variation of losses due to scattering can be checked simply by shaking and rearranging a given sample. The effect will of course be reduced if fine material is present filling the spaces between the large particles.

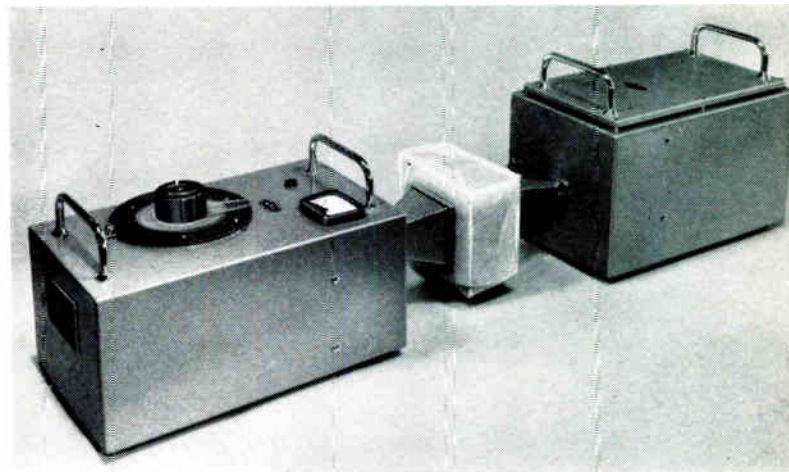

This illustration shows the 10-688-Gc/s transmitter and receiver with a sample between their horns

### Packing

Granular materials are measured looking vertically through a constant weight in a cell. However, as the packing density increases so does the dielectric constant and the reflection from the two air material interfaces, thus increasing the measured attenuation.

Some indication of the overall effects of packing, particle size and standing waves can be seen in the results on the following materials. These were obtained by measuring the same material many times under various conditions of packing, shaking and refilling the sample in the cell, with a fixed horn spacing.

A 1-kilogramme sample of wheat at 16% water content shows a total peak-to-peak change of attenuation of 1.2 dB. This corresponds to about 0.5% water content at room temperature. The density change due to packing can be ignored on this material, since the volume does not change. Of the 1.2 dB, 0.6 dB is due to levelling in the cell which could be overcome by using a plunger for levelling. The other 0.6 dB is caused by a variation of scattering due to rearrangement of the particles.

A similar experiment on sand at approximately 12% water content showed a peak-to-peak variation of 1.5 dB, corresponding again to about 0.5% water content. This is caused by standing waves and packing since the particle size is small. In this test, the change in density as the sand was packed down in the cell was about 30%.

Fig. 1. Block diagram of the 2.45-Gc/s transmitter and receiver. The 10-688-Gc/s apparatus is similar

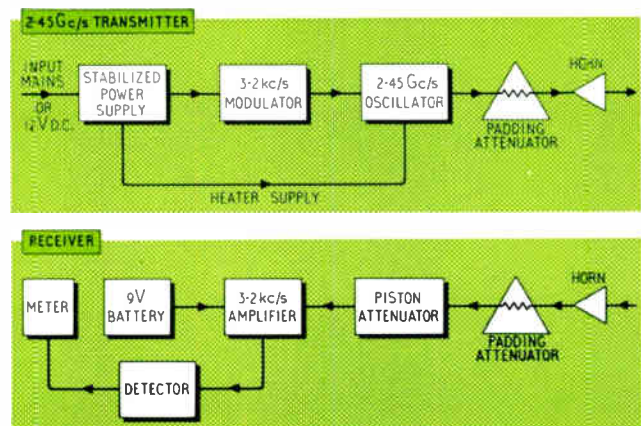

Fig. 2 (Below). Results on tests with wood pulp bales at 2.45 Gc/s

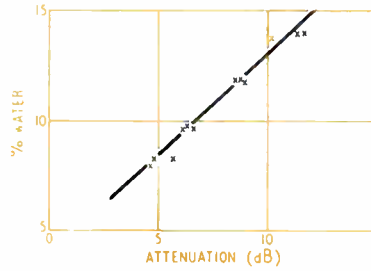
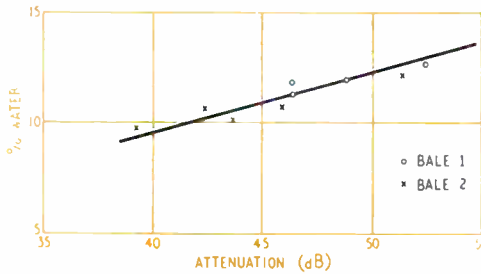
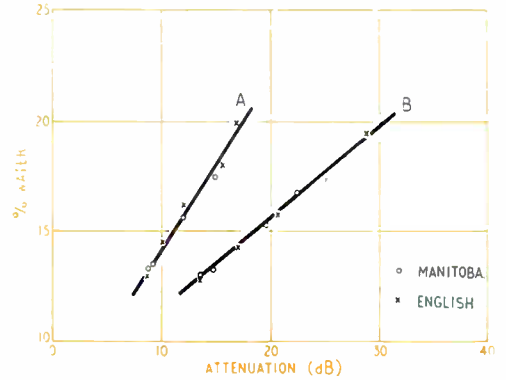

Fig. 3 (Above). Results on tests with animal feed at 2.45 Gc/s and 20 °C

Fig. 4 (Below). Tests on wheat at 20 °C; curve A is at 2.45 Gc/s and curve B at 9.368 Gc/s



**Polarization**

The radiation from the moisture meter is polarized in one plane. It has been observed that many materials show different attenuations when the sample is rotated in the beam from the horns. An extreme case is wood, in which water can be regarded as being held in tubes separated by cellulose. Another is nylon thread, in which the water is carried by thin filaments which tend to align themselves when baled under pressure. For materials like these, it is necessary to ensure that they are always measured with a fixed alignment between the horns and the material. Two rather surprising materials are margarine and butter, which both become polarized under pressure. The effect is least in the direction of pressure, which suggests that the water particle shape may be changed from a sphere to an ellipsoid.

**Results**

Despite the complex nature of the microwave losses due to water in materials, the measurement of these has proved

to be reasonably straightforward. Measured results are presented to illustrate the range of interest and to give some idea of the accuracies obtainable. Those obtained at 2.45 Gc/s are shown graphically in Figs. 2, 3 and 4, curve A.

Two wood pulp bales 36.5-in. × 21.5-in. in area, 18-in. thick, and weighing 375 lb were measured horizontally through the 18-in. thickness. Five positions were measured on each bale and the bales were sectioned and sampled to determine the water content through the bale at each position. The variation of water content throughout the bales was large enough to obtain the curve shown in Fig. 2. The slope of the curve shows 4 dB for 1% change in water content. The accuracy appears to be ±0.5% and it is likely that part of this is due to errors in determining the water content and variations in bale density. Results on 30-lb samples of animal feed measured vertically in a 12-in. × 12-in. cell are shown in Fig. 3. Fig. 4, curve A, shows results on 46-lb samples of wheat in a cell 15½ in. × 13 in. Two types were measured, a soft large grain English and a

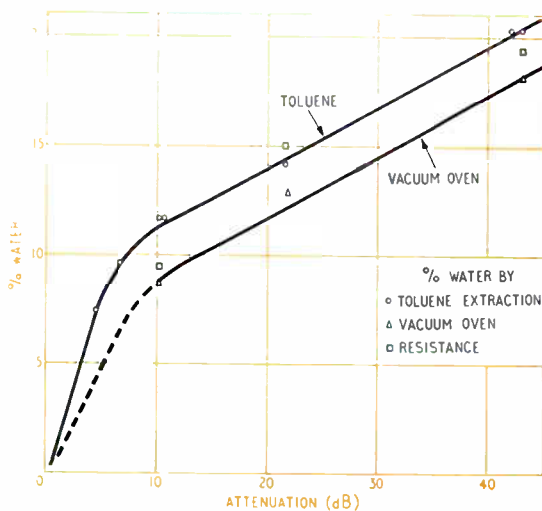
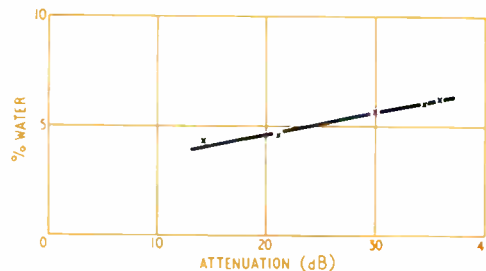

Fig. 5 (Left). Water content of raisins at 20 °C and 9.368 Gc/s obtained by various methods

Fig. 6. Nylon tow measured at 20 °C and 10.688 Gc/s



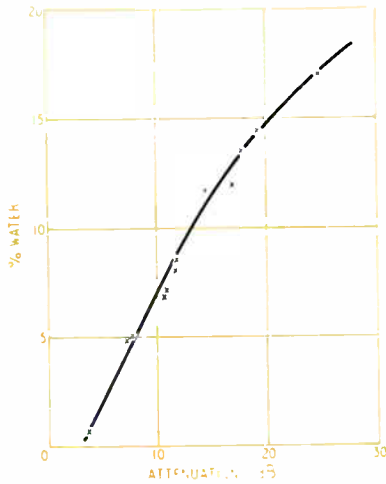

Fig. 7 (Left). Coal measured at 20 °C and 10.688 Gc/s

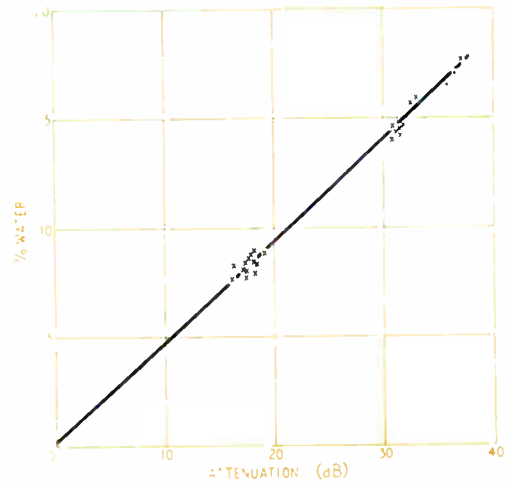

Fig. 8 (Right). Marzipan measured at 20 °C and 10.688 Gc/s. This material exhibits a polarization effect

hard small Manitoba. It is found that the results for both types lie on the same curve and the accuracy indicated is  $\pm 0.4\%$ .

Curve B of Fig. 4 shows results on 2½-lb samples of the same types of wheat in a 5½-in. i.d. cell 4-in. high at 9.368 Gc/s. This indicates a linear relationship to an accuracy of  $\pm 0.3\%$ . Similar samples of raisins were measured at 9.368 Gc/s, but there are insufficient results to draw any conclusions regarding accuracy. However, the water content of three of the samples was determined by three conventional methods and the results in Fig. 5 show the dependence of the calibration on these methods. The upper line represents a calibration based on toluene extraction, the lower line upon vacuum oven extraction of the water. Other points plotted are based on a resistance method using a meter calibrated against a vacuum oven. This method appears to be less consistent than the other two. The effects of bound water below 11% can also be seen.

The following materials were measured at 10.688 Gc/s. Bags of nylon tow weighing 70 lb were measured in an aluminium tube 18-in. diameter and 22-in. long. Large horns 6½ in.  $\times$  8 in. aperture were used to make the measurement more representative of the mean for the whole bag. Ten samples were removed from each bag, along the line of transmission, for evaluation of water content. The mean water content is plotted against attenuation in Fig. 6, which shows a peak scatter of 0.15%. To obtain Fig. 7, 750 gramme samples of one type of coal crushed to 6 mesh size were measured in a cell 5½-in. i.d. by 3-in. high, and the results show a peak deviation of 0.8% on the mean line. The ash content was estimated not to vary by more than  $\pm 2\%$  of a mean value.

The results in Fig. 8 were recorded on samples of marzipan 2-in. thick. The available range of water contents is limited in production to narrow bands for each type of material creating groups of points at specific water levels. Further samples of wheat of 1 kilogramme weight

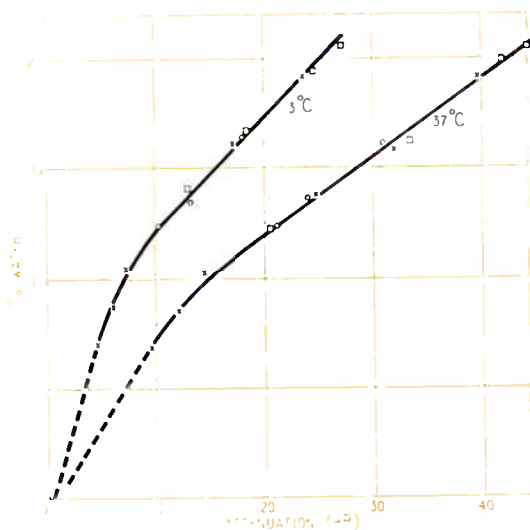
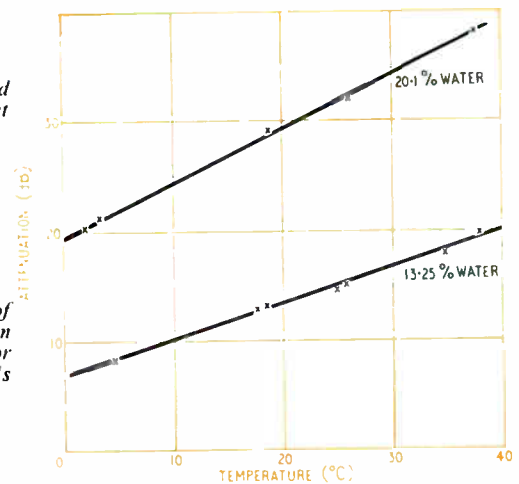

Fig. 9 (Left). Wheat measured at 10.688 Gc/s at 3 °C and at 37 °C

Fig. 10 (Right). The effect of temperature on the attenuation of the sample is shown here for wheat measured at 10.688 Gc/s



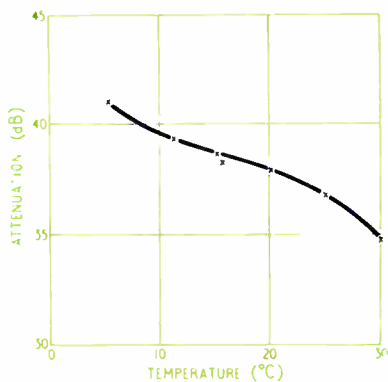

Fig. 11. Fireclay with 11.5% water content measured at 9.368 Gc/s gives the results shown here at various temperatures

were measured in a 5½-in. i.d. cell 4-in. high. The wheat used was English and Manitoba both in the natural state and rewetted to produce intermediate values of water content. Two curves, Fig. 9, are shown for temperatures of 3 °C and 37 °C. A large part of the 1-kg sample was used for water content evaluation and the estimated accuracy of this evaluation is  $\pm 0.15\%$ . The results show a scatter of  $\pm 0.5\%$  and a linear relationship could be used from 11% to 22% water content. Again the type of wheat does not affect the performance.

Two measurements of temperature coefficient are shown in Figs. 10 and 11; wheat shows a positive coefficient and fireclay negative. The temperature coefficients of soap, tobacco, artificial fertilizer and marzipan are positive while those for margarine and sand are negative. Under the various conditions of measurement for these materials the rate of change of attenuation with temperature when expressed in terms of water content lay in the region of 0.05% to 0.2% water per degree centigrade.

## Computer Typesetting

Computer typesetting for the printing industry is now operating in Britain. This is being used by Rocappi Ltd., of Otford, Kent, for the production of what is believed to be the first book published in Europe to employ this technique. Rocappi Ltd. (the name stands for Research on Computer Applications in the Printing and Publishing Industries) is a company jointly owned by The British

Printing Corporation, Westerham Press and Rocappi Inc. of the U.S.A. The book is 'The Proceedings of the Institute of Printing's Computer Typesetting Conference'.

In the Rocappi technique a computer is used to convert manuscripts via punched paper tape into signals on magnetic tape. By this system complete book assembly takes place at computer speeds. In the final computer stage a fresh punched paper tape is produced for use by automatic line-casting or film-typesetting machines, either in the plant or, by means of high-speed wire transmission, at a distance.

The manuscript is first converted into punched paper tape on a special keyboard machine. This tape is fed into a programmed computer and stored on magnetic tape. All told, four high-speed computer runs can take place, each giving a visual printed-out version.

In the first or galley proof stage a high-speed print out is produced for the corrector of errors. In the second stage corrections are fed into the system on paper tape together with instructions as to type style and line lengths. The computer then arranges the manuscript into justified hyphenated lines. Stage three provides complete page by page book assembly, as make-up instructions are given to the computer. Stage four produces a punched paper tape for use by either a line-casting or film automatic typesetting device.

In the production of the book 'The Proceedings of the Institute of Printing's Computer Typesetting Conference', one chapter only was set using the Rocappi technique. The manuscript was first perforated into teletypesetter code in unjustified unhyphenated form by a modified Fairchild 214 tape perforator. This paper tape was then processed on a computer to produce a justified hyphenated tape.

Using a modified Teletypesetter reader on a Linotype 79 at Northumberland Press, it was possible to use the paper tape produced by the computer directly on their hot metal line caster to produce the type.

Now that manuscripts can be stored on magnetic tape it means that they can be revised, edited and repaginated for subsequent editions without rekeyboarding and at computer speeds.



The American Rocappi Inc. computer at Swarthmore, Pennsylvania, in operation on a typesetting programme. A similar ICT computer will be installed shortly at British Rocappi's Kent factory

# NEW TV/PHONE AERIAL

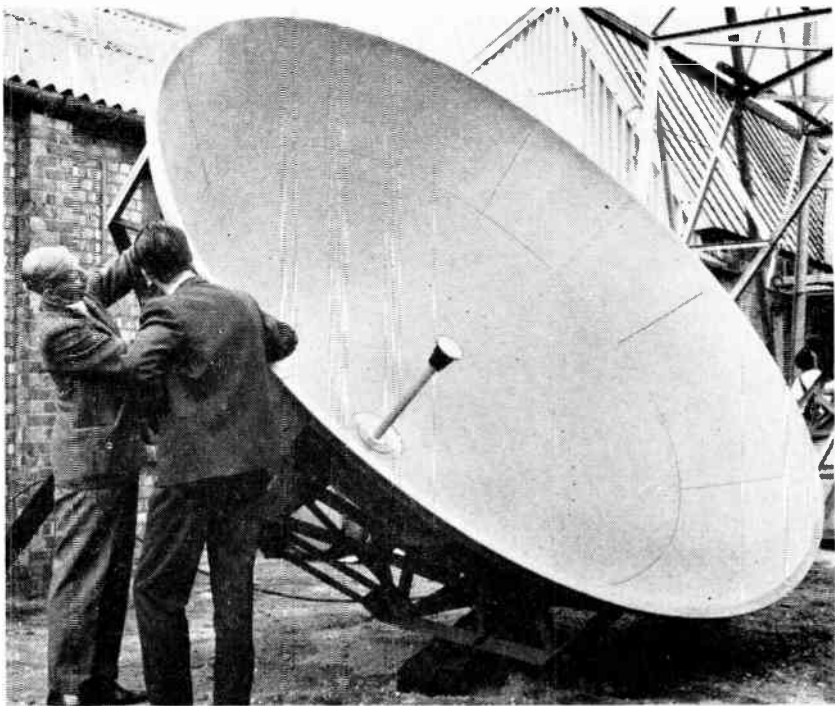

*An STC Cassegrain aerial ready for hoisting to the top of a microwave tower*

Standard Telephones and Cables have produced a new low-cost aerial for microwave radio links. The £175,000 TV/telephone link between London and France, now being built for the GPO, will be the first to use this aerial.

The aerial uses an idea originally put forward in 1672 by Professor Cassegrain of Chartres University to improve astronomers' telescopes. The principle involves double focusing to obtain sharper and clearer images.

By the application of Professor Cassegrain's invention to microwaves the 29-ft high 'hog-horn' aerials used on many radio towers can now be replaced with Cassegrain aerials of only 12½-ft diameter without loss of performance.

The STC Cassegrain aerial is not only half the size but also about one-quarter the cost of the equivalent hog-horn aerial. The reduction in weight also means that strengthening of tower structures is no longer required.

## The Cassegrain Principle

In the Cassegrain telescope a small convex mirror is placed near the focus of the main large concave mirror. The received image is viewed through a hole in the large mirror. The incoming rays are therefore subjected to focusing and re-focusing. Both optical and radio arrangements are sketched in the diagram.

When applied to microwave aerials the radio energy is collected by a 12-ft 6-in. diameter concave reflector and directed on to a 6-in. diameter convex reflector near the horn-shaped end of the circular waveguide that feeds the energy down the tower to the receiving equipment. The transmission process is exactly the reverse, the double-focus action producing an extremely parallel and efficient microwave beam aimed exactly at the next radio tower, some 40 miles away.

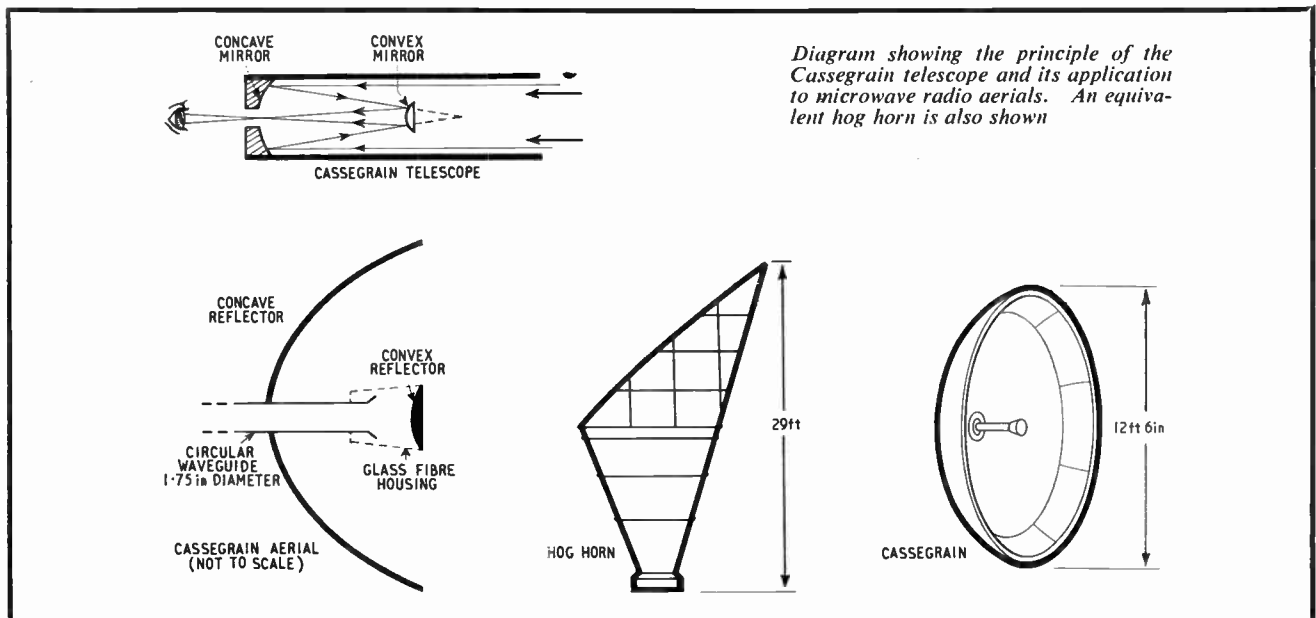

*Diagram showing the principle of the Cassegrain telescope and its application to microwave radio aerials. An equivalent hog horn is also shown*

This article describes a navigational system which has been developed primarily for military purposes. Starting from a known position it provides continuous dead reckoning of position based on mileage and compass course.

**L**OSSES of many military vehicles behind enemy lines in the last war were attributed to the fact that the vehicle commanders became lost in unfamiliar terrain and were unable to navigate back to their base positions. To navigate a vehicle across country in strange territory particularly in the dark or in fog or smoke, or in areas where there are no landmarks, such as the desert

or Arctic, can be extremely difficult and at time almost impossible. A commander operating in a rotating tank turret while the vehicle is also changing direction in any of the environments mentioned, is subjected at times to an extremely confusing situation and unless he is highly skilled in navigation this can lead to a complete loss of position and sense of direction. This has been frequently proved in recent tests conducted by the military to establish whether, during the hours of darkness in particular, there is a significant difference between vehicles equipped with a navigational aid and vehicles which are unequipped. The result of extensive manoeuvres demonstrated that the future trend will lean toward the adoption of modern navigation equipment not only for the military but for airport use in determining the location of aircraft on the ground under conditions of zero visibility and also for geographical and oil and mineral survey groups working in remote and unmapped areas of the world.

The navigation system described is dead reckoning. It is contained completely within the vehicle in which it is fitted and does not depend on radio transmission and was designed and developed jointly by the Canadian Army and Aviation Electric Ltd.

The system comprises a vehicle position plotter, offering the quick-look feature for instant orientation, a more comprehensive and accurate heading and position indicator, a driver's heading indicator, a computer, a heading reference (compass) and a power supply. The heading indicator may be dispensed with if the driver and navigator are so located that they can both see the heading and position indicator. The system will also function without the vehicle position plotter and this unit may be dispensed with in installations and environments which are not likely to cause loss of orientation of the crew within their operating envelope. In this instance the vehicle would be navigated by relating the information displayed by the heading and position indicator to a map of the area. The heading reference and

\*Aviation Electric Ltd., Montreal, Canada.  
Title picture Crown Copyright reserved.

# LAND-VEHICLE NAVIGATION SYSTEM

By S. G. SPRACKLAN\*





power supply are not produced by Aviation Electric Ltd. leaving a choice of alternatives to the user depending upon his technical or logistic preferences.

Briefly the functions of the units are described below:

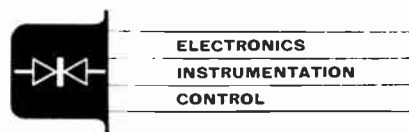

### Vehicle Position Plotter

This quick-look unit may be used as a portable hand held unit, connected to the heading and position indicator by a flexible cable, or could be permanently installed if desired.

It works on an X-Y plot principle; the X being the east-west displacement of the vehicle and the Y the north-south displacement, relative of course to the scale of the map being used. Maps should be of the Universal Transverse Mercator type (U.T.M.) (true distance in any direction) with a numbered grid printed thereon. Standard NATO maps are metric with the distances between the grid lines equivalent to 1,000 metres. However some countries are still using the English measure for the map with 1,000 metre grid markings (0.6214 miles between grid lines)

If the world could be cut into sixty slices through the axis and the surface or skin laid flat in a similar manner to peeling an orange, each slice or zone would be widest at the equator, curving to zero at the north and south poles on the centre-line of the zone. Starting from this centre-line in one direction and the equator in the other each zone is divided into 1,000 metre squares.

Numbering of the grid squares starts beyond the extreme west of *each* zone in one direction and below the south pole in the other in a similar manner to plotting a graph in the first quadrant. Travelling anywhere within each zone will therefore only increase or decrease the grid co-ordinates with respect to the grid origin. Thus the reason for the terms eastings and northings (increasing or decreasing) when referring to vehicle movement.

Given some thought, it can be seen therefore that only one perpendicular (meridian) datum grid line in each zone passes through the north pole. All others will pass to the left or the right and, depending on the latitude of operation (or vehicle position), will create a deviation from the true north direction to the north-south grid line known as grid declination. Correction for this grid declination is made manually by turning a knob in the computer the amount indicated on each map. To function, the plotter needs eastings and northings scale-corrected electrical pulses to provide position and a synchro heading transmitter signal for orientation (heading). These are provided from the heading and position indicator and are displayed in the form of a lighted image (arrow with a spot at its apex) projected on to the underside of the map. At the side of the plotter push buttons provide for electrically setting the initial or starting position of the image and two knobs control the image light and background light intensity.

### Heading and Position Indicator

This unit, mounted in the vehicle where it can be used by the commander, displays automatically and continuously the vehicle position and its orientation. By converting electrical pulses from the computer representing eastings and northings motion of the vehicle it provides a comprehensive and accurate eight-figure digital readout (four eastings and four northings) representing the vehicle position in map grid co-ordinates to the nearest 10 metres. Vehicle orientation, or heading relative to grid north, is displayed by a pointer on a dial marked in degrees and is controlled by a synchro heading transmitter signal from the computer.

Knobs adjacent to the eastings and northings digital displays provide for setting the starting grid co-ordinates and making adjustments manually. Operation of a switch

provides illumination of the displays when necessary. Within this unit the pulses accepted from the computer are scale-corrected according to the scale selected at a switch on the display panel and transmitted to the plotter.

### Heading Indicator

The heading indicator is usually located for use by the driver and is connected via an electric cable to the computer. This unit displays the grid heading of the vehicle, by a pointer on a dial marked in degrees, and is controlled by the same synchro heading transmitter in the computer. A cursor in front of the dial can be manually set by the driver to indicate an instructed course.

### Computer

This unit is usually located in any convenient position that can provide attachment of the odometer (speedometer) cable. It converts the heading input from the heading reference and distance input from the vehicle odometer cable into electrical pulses representing the east-west (eastings) and north-south (northings) displacement of the vehicle. Provision is made to change the heading signal manually to represent the heading relative to grid north and adjust the distance input to suit the vehicle in which the system is installed.

### Heading

Mounted according to the suppliers' requirements it provides the vehicle heading in the form of an electrical synchro signal. Depending on the application and accuracy required the heading reference can be provided by a true north-seeking gyro compass, directional gyroscope, magnetic compass, etc.

### Power Supply

Supplies of three-phase 400 c/s, for use by the heading reference (if necessary), and single-phase 400 c/s for use by the computer and vehicle position plotter, are required. They are developed in the power-supply unit which is fed from the vehicle's d.c. battery supply.

### Description of Operation

To provide the required information to the position-indicating elements of the displays, it is necessary to resolve continuously the hypotenuse and an angle of a right triangle into its horizontal and perpendicular components (see Fig. 1). This can be expressed:

$$x = d \sin \alpha$$

$$y = d \cos \alpha$$

where  $d$ , the hypotenuse, is equivalent to the displacement of the vehicle as registered by the odometer.

That is

$$d = n/k$$

where  $n$  = number of revolutions of the speedometer or odometer cable

$k$  = number of revolutions per metre of the cable for the vehicle in use

and  $\alpha$  is the heading for each increment of distance, and is equivalent to the angle subtended by the line of direction of the vehicle and grid north of the operational area.

It might be argued that the value of  $d$  in the above

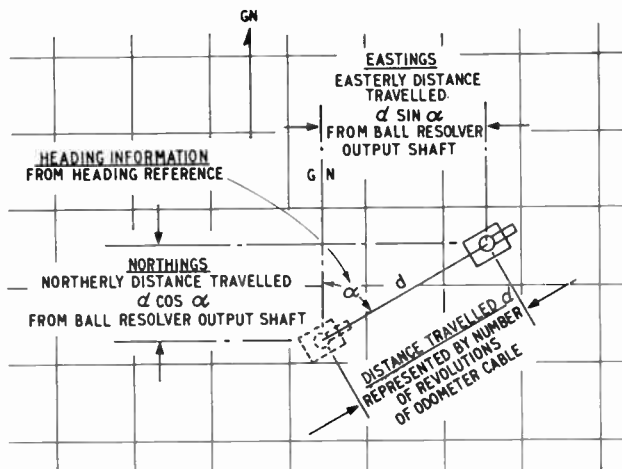

Fig. 1. Illustrating the method of resolving distance travelled and course into eastings and northings

equations is not a true map distance since the odometer cable registers the total distance travelled by the vehicle including hills. Strictly,  $d$  should therefore be replaced by  $d_t$  which is  $d$  corrected to give the plan or map distance. This could be achieved by continuously resolving another right triangle for its horizontal component only, expressed by  $d_t = d \cos \theta$  where  $d_t$  would now be the true map displacement of the vehicle and  $\theta$  would be the slope of the hill on which the vehicle is moving.

It has been proven by statistical analysis and field evaluation that the overall navigation error that results by ignoring this error (actual distance  $d$  — map distance  $d_t$ ) is insignificant for the present operational requirements but is being considered for future systems where extreme accuracy is required. The addition of a slope sensor and distance corrector would considerably increase the complexity of the system, be sensitive to vehicle acceleration and would increase system cost considerably.

The equations for  $x$  and  $y$  could be resolved by using an electrical resolver but as it requires considerable circuitry and its accuracy would be affected by temperature variations, it was decided to use a mechanical triangle solver, produced by Aviation Electric Ltd, for many years, known as a ball resolver. The principle is very old and well known to most engineers but the technique of fabrication, materials used, etc., to obtain the desired accuracy and reliability can only be achieved by considerable experience and development. The ball resolver, located in the computer, is the heart of the system. It is a precision analogue mechanical computing device, unaffected by temperature, which has an accuracy better than 0.1 per cent. It continuously resolves distance travelled into its rectangular components ( $x$  and  $y$ ). One output shaft ( $x$ ) of the resolver will give the distance travelled east or west (eastings, increasing or decreasing) and the other ( $y$ ) the distance travelled north or south (northings, increasing or decreasing). Rotation of the output shaft in one direction increases the co-ordinates displayed (north and east); in the other direction, it decreases the co-ordinates displayed (south or west).

Referring to Fig. 1 and the signal flow diagram of Fig. 2

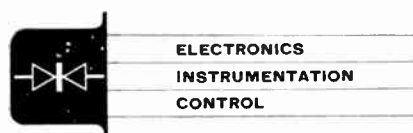

it can be seen that one input to the resolver is the distance  $d$ , a mechanical input, taken from the odometer cable. Because  $k$ , in the above equation, varies from country to country and, to a lesser extent, from vehicle to vehicle, it is necessary to adjust this variable to obtain  $d$  as a specific number of revolutions per kilometre (NATO standard). This is done by mechanically connecting between the odometer cable and the resolver an extremely accurate variable drive, with a repeatability of better than 0.05 per cent, specially developed for this application in conjunction with Graham Transmissions Inc. This variable drive, once adjusted by the manual control in the front of the computer, operates at the set ratio for long periods reliably and accurately.

The other input to the resolver is the heading  $\alpha$ . This is a mechanical input converted from an electrical synchro signal supplied by the compass and corrected for grid declination. The conversion is made through a conventional electrical servo system.

Mechanically linked in the servo loop are the ball resolver heading input, a synchro control transformer, a synchro transmitter which transmits the heading information to the display units and a servo motor and gearhead. The synchro transmitter signal in the compass is received by the control transformer, transformed to an output voltage whose magnitude is proportional to the difference in rotor shaft angles of the transmitter and control transformer. This is amplified approximately  $\times 30$  and applied to the control winding of the servo motor which will then rotate in a direction to null the amplifier input. At this time both transmitter and control transformer rotor shaft angles are equal. Correction of the heading information received from the compass is achieved by manually turning the case (stator) of the control transformer using the heading adjustment knob located at the front of the computer.

Each of the two outputs from the ball resolver ( $x$  and  $y$ ) is in terms of revolutions per kilometre and to transmit this information directly to the position and heading indicator and the plotter would require four complete servo systems. This would become extremely involved when trying to apply scale correction for the plotter. D.c. pulsing could be adopted using say, two pulses per revolution to operate electrical counters in the position and heading indicator and solenoids in the plotter. As each output shaft will rotate in either direction, depending in which quadrant the vehicle is moving, the pulses would have to be polarized according to direction. The counters must then be of the add and subtract type and four solenoids would be required in the plotter. This system suffers from several undesirable characteristics. Intermittency in the electrical signal due to vibration, poor contact, etc., would cause erroneous pulse action resulting in counter and position errors. With the vehicle stationary the pulse could be in the on condition causing unnecessary drain on the battery and possible overheating of the solenoid windings. Being inductive loading the switching from on to off at the commutator would cause arcing between the brushes and commutator segments reducing the brush and commutator life.

The approach used is considered rather novel and utilizes a three-wire d.c. pulsing system which drives motors in both the heading and position indicator and plotter from commutators mounted on each of the ball resolver output shafts. Two brushes feed d.c. to each commutator while three others transmit the pulse signals to the motors. The commutators are direction sensitive and control the polarity of the control wire in the three-wire system. The circuit to the pulse receiving motors is such that they are permitted to rotate a specific number of revolutions for each pulse received and then come to an immediate stop. This principle has the advantages the above method lacks:

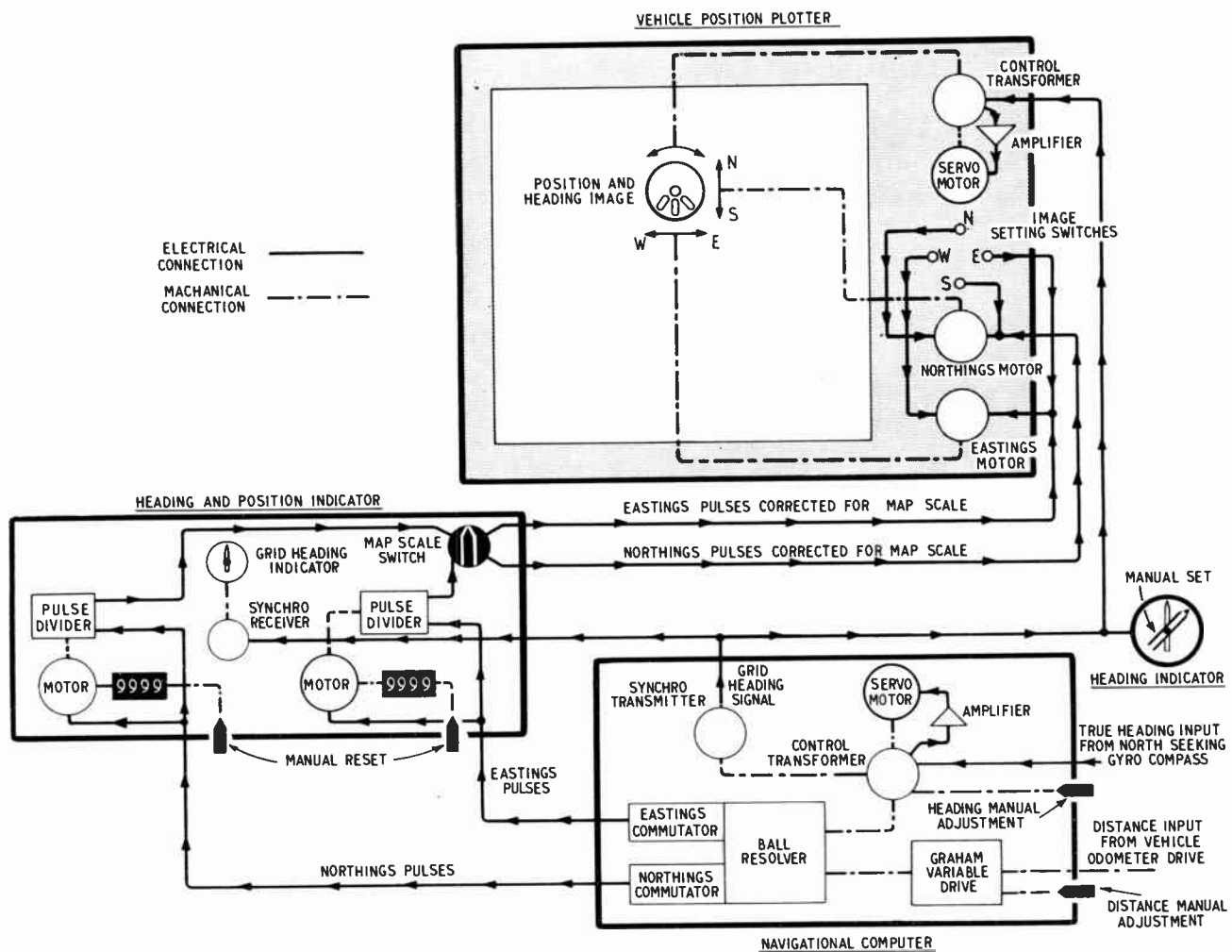

Fig. 2. The functional form of the equipment

1. Because the speed of the pulse-receiving motors is so much greater than the speed of the transmitting commutators for maximum speeds of the vehicle, the motor has completed its operation before the brushes on the commutator have left the segment, thus preventing arcing.

2. As soon as the motor has completed its operation it draws no current from the battery, an advantage when the vehicle is stationary.

3. Provided the brushes are in contact with the commutator segment for a total time sufficient for the motors to complete their operation loss of contact between brush and commutator due to vibration, etc., will have no effect and will not cause the motors to operate more than once for each pulse transmitted.

The heading and position indicator contains three separate circuits. An eastings grid position, northings grid position and the heading. The heading is simply a synchronous heading receiver slaved to the synchro transmitter in the computer. The eastings and northings grid position circuits are identical and differ only in the interface connection to the computer. Each motor, when receiving a pulse from its control commutator, will rotate at maximum speed in a clockwise or counter-clockwise direction, depending on pulse polarity, until a switch controlling the movement operates and the motor stops. During this operation the Geneva lock-operated counter mechanism increases or decreases by one unit the digital counter readout and at

the same time a pulse-dividing commutator moving in discrete steps, accepts the pulses from the computer and routes them in proportions of 1:2, 1:4, 1:8 and 1:20 to the map scale-selector switch. Setting or correcting the position display is done by manually depressing and turning the appropriate knob. Carrying out this operation affects only the digital counter display and will not in any way affect the information to the plotter.

The standard NATO map scales for which most systems have been built are 1:25,000, 1:50,000, 1:100,000 and 1:250,000. By setting the map scale-selector switch to the scale of the map to be used on the plotter, only pulses proportional to that scale will be routed to it. While the above scales are those in general use, systems have been provided and are being used for map scales of 1:12,500 and 2 in., 1 in. and  $\frac{1}{2}$  in. per mile.

The vehicle position plotter is a pictorial map presentation of the information displayed by the heading and position indicator. A U.T.M. grid map of one of the four scales selected is fitted into a map holder which in turn is attached to the top surface of the plotting board. The map holder being easily detached or attached to the board provides flexibility in operation permitting several maps, mounted in map holders, to be carried, or stored, or taken and used at briefings or conferences. The top plastic cover of the map holder can be written or sketched on with a grease pencil without affecting the map.



The plotter functions in a similar manner to the heading and position indicator. The eastings and northings pulses and the synchro heading signal transmitted from the IHP are received by motors driving lead screws and the control transformer of the heading servo loop respectively. Eastings pulses received from the IHP operate a motor, causing the image carriage to move in discrete steps east or west. Similarly northings pulses from the IHP operate a motor causing the image carriage to move north or south in discrete steps.

The image rotates on its own axis to simulate the vehicles heading and is controlled by a servo loop located in the control box at the right-hand side. The synchro transmitter signal from the computer, routed via the position and heading indicator, drives a control transformer to a null via an amplifier and servo motor gear train in a similar manner to that for the servo loop in the computer. The lighted image, set to the desired intensity, is projected on to the underside of the map and is positioned electrically, to the vehicle co-ordinates position on the map, by operating any one or two of the four push buttons (N, S, E and W) located in the control panel.

Should the image carriage reach an extremity of travel in any direction a limit switch is triggered, opening the circuit controlling motion in that axis and illuminating a map limit warning in the position and heading indicator. A map of the adjacent area is then placed on the plotter and the image positioned, by means of the set buttons, to the grid co-ordinate position on the map to that displayed on the position and heading indicator.

For installations where the heading and position indicator cannot be located convenient to both the driver and commander of the vehicle then a heading indicator is provided for the driver. This unit is electrically connected to the computer and contains a synchro receiver also driven by the transmitter in the computer. A pointer mounted on the

receiver rotor shaft indicates on a dial the heading of the vehicle at all times.

### Characteristics

The following are some of the characteristics applicable to the computer and display units described above.

#### Power Requirements

A.c. 26 V 400 c/s single-phase, 2 A obtained from the power supply.

D.c. 24 V 0.5 A continuous, pulsing to 1.5 A when vehicle is in motion. Obtained from the battery. (Note: 12-V systems can be produced).

#### Speed Range

Zero to 70 m.p.h.

#### Operational Range

Computer and heading and position indicator, no limit.

Plotter image travel, 15.5 in. (395 mm) E-W × 12.8 in. (325 mm) N-S.

#### Map Scales

1 : 25,000, 1 : 50,000, 1 : 100,000 and 1 : 250,000 standard 2 in., 1 in. and  $\frac{1}{2}$  in. per mile available.

1 : 12,500 can be added to the standard unit while other special scales can be incorporated.

The system will operate over a temperature range  $-54^{\circ}\text{C}$  ( $-65^{\circ}\text{F}$ ) to  $+65^{\circ}\text{C}$  ( $150^{\circ}\text{F}$ ) and withstand such shock and vibration encountered when the equipment is mounted in any type of vehicle travelling over extremely rough terrain. The system is also waterproof and capable of total immersion in fresh or salt water at covering depths up to 3 ft for at least 2 hours.

### Conclusion

The system provides a simple, reliable, accurate, dead reckoning solution to the fundamental requirement of land navigation, vehicle position and heading. With a heading reference accuracy of better than 30 minutes an overall system accuracy of better than 1 per cent of distance travelled can easily be achieved.

## STC Form New Electronic Services Division

Standard Telephones and Cables Ltd. have recently formed the new Electronic Services Division based at Harlow, Essex.

This division has been created with two main objects in mind. One is to establish a really fast supply service for

*This shows the combined laboratory and model shop of the new STC Electronic Services Division—here customer project evaluation is undertaken*

active and passive components, circuit modules, sub-assemblies, equipment wiring, racking and cubicles.

The second aim is to provide an extensive and complete service for the equipment builder. Technical queries on orders will be dealt with immediately by engineers. Backing up the engineers is a combined laboratory and model shop. The function of this model shop is to provide rapid technical evaluation for customers' projects and to produce one-off models quickly. This facility is extended to expert electronic companies who know and understand what they want. It is also available to companies without expert knowledge of electronics.

The heart of the communications between the Electronic Services Division and its customers is the stock catalogue which will be mailed every two months. The first issue is now available. All items are illustrated, specified and priced.

Full address for the new enterprise is Electronic Services Division—STC, Edinburgh Way, Harlow, Essex. Phone: Harlow 26811. Telex 81146.

For further information circle 46 on Service Card



Multichannel transmission of digital data and speech information can be made with a new close-spaced loop communications system. Its improved performance offers many advantages over existing communication systems.

**A** NEW communications system for cranes and similar mobile equipment has been developed by BISRA which gives greatly improved performance under adverse industrial conditions. Advantages of the system are its high noise rejection characteristics and consistent performance. These allow it to operate in situations where a high level of electrical interference exists and in corrosive atmospheres. Both digital data and speech can be transmitted by the system.

#### System Developed by BISRA

Basically, the system uses a close-spaced loop connecting transmitting and receiving stations located respectively on a ground station and on any mobile equipment travelling on a fixed rail. A flexible cable is used for the loop, which is laid in a V-shaped trough running alongside the fixed rail. This ensures that the two sides of the loop are always close together, reducing induced noise signals to a minimum. One side of the loop is threaded through a pair of transformer cores, one for reception and one for transmission, fitted to each piece of mobile equipment using the system. In this way, the loop forms a single-turn primary winding on each of the transformer cores. Guide rolls lift the cable out of the trough, feed it through the centre of each core as the mobile plant travels along the fixed rail, and lay it back in the trough. A similar arrangement is used to couple the fixed station, or stations, to the loop.

In a crane in which the driver's cab is free to move across the crane structure, a double-loop system is used to connect the cab and the ground stations (Fig. 1). The secondary loop is laid along the length of the crane bridge passing through a pair of transformer cores on the cab and the existing cores carrying the main loop. By tuning each transformer, it is possible to pass signals between the ground station and the moving cab without the need for intermediate amplification at the junction of the two loops.

Transfer of information from one station to another can be achieved by any of the carrier modulation techniques used in telephony. The information (speech or data) is used to modulate a carrier wave, which after amplification is fed into the loop via one of the transmitting transformers. The current induced in the loop produces an output at the secondary of all the other toroidal transformers. Filters in each of the receivers allow only the desired receiver to accept the signal. After amplification the received signal is demodulated and the information recovered. Using this filtering it is possible to send simultaneous transmissions of different signals by using a different carrier frequency for each channel.

The extent to which this multichannel transmission can take place depends on the bandwidth available. This varies with the length of the loop, but tests have shown that with a 300-ft loop bandwidths in excess of 100 kc/s are readily obtainable. In a system of this type, it is possible to operate 100 digital information channels.

Similarly, the wide bandwidth and low noise characteristics of this type of close-spaced loop system make it ideal for multichannel speech communication.

More detailed information on the system is given in Report PE/B/6/64—'Design and Construction of a Data Transmission System for an Automatic Crane'. Copies of this report can be obtained from The Information Officer, BISRA, 24 Buckingham Gate, London, S.W.1. (Phone: Tate Gallery 7931).

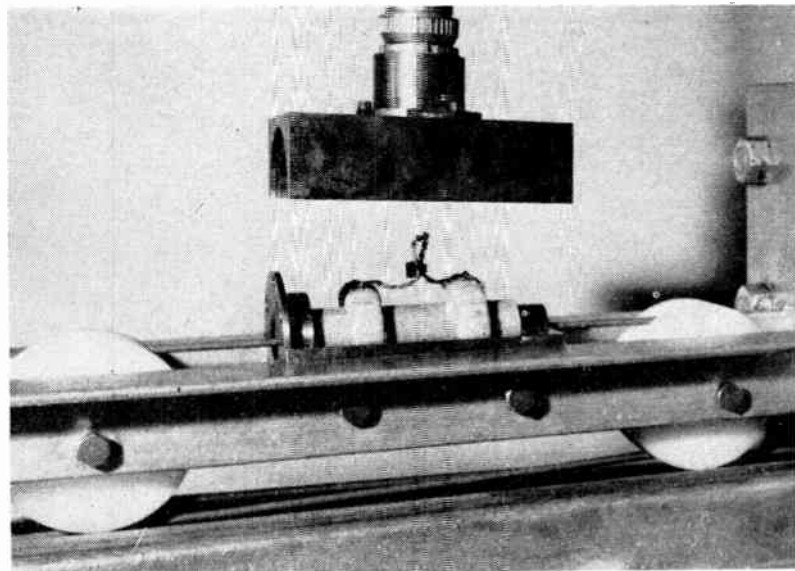

*A view of the cable lifting unit showing the cable as it passes through the centre of the transformer cores*

# COMMUNICATIONS SYSTEM FOR CRANES

*Fig. 1. The basic crane communication system*

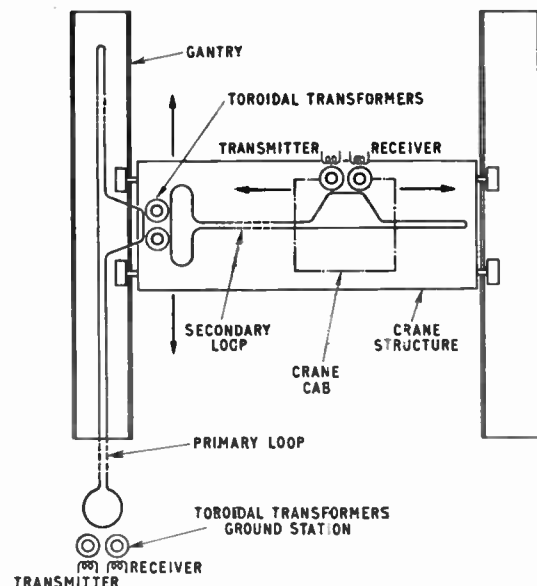

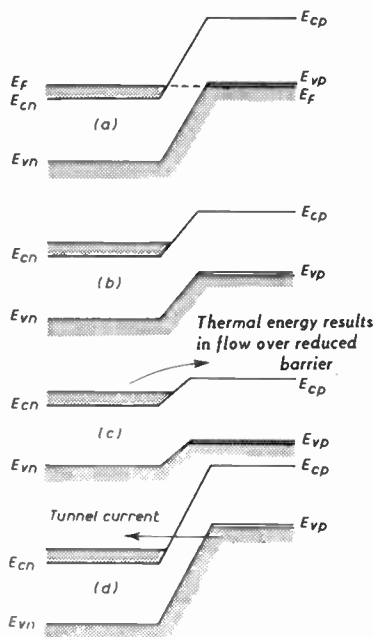

EF, Fermi level; Ecn, conduction band edge in n-type region; Ecp, ditto in p-type region; Evn, valence band in n-type region; Evp, ditto in p-type region. Shaded regions are occupied electron levels

Fig. 1. Displacement of energy levels in a backward diode

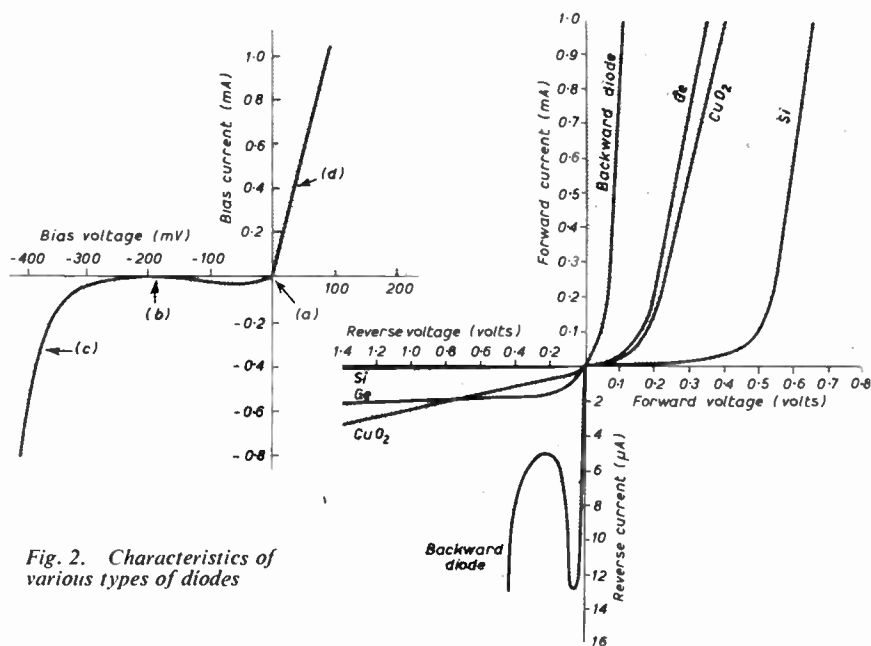

Fig. 2. Characteristics of various types of diodes

The use of backward diodes in measurement is discussed in this article. This diode is one which relies upon the tunnel effect for its operation.

By B. STUTTARD, M.Sc.\*

# MEASURING ALTERNATING VOLTAGES WITH BACKWARD DIODES

THE application of the moving-coil instrument to the measurement of alternating currents and voltages is usually achieved by means of instrument rectifiers. The most widely used rectifier for this purpose is the copper-oxide type which, though first developed in the 1920s, is still the most economical. The copper-oxide rectifier suffers from a number of defects. The self-capacitance of such a rectifier restricts its frequency response to about 20 kc/s, the forward and reverse characteristics are temperature sensitive, and about 400 mV, the offset voltage, is required before appreciable current flows. Instrument rectifiers made from the semiconductors germanium and silicon overcome to some extent the limitations of the copper-oxide type. For example, both germanium and silicon rectifiers have far less stray capacitance than a copper-oxide rectifier of the same current-carrying capacity.

In the case of a silicon rectifier the leakage current is extremely small, of the order of  $10^{-8}$  amp, though the offset voltage may be as high as 700 mV. The corresponding values for a typical germanium rectifier are  $10^{-6}$  amp and 250 mV. As in the case of the copper-oxide rectifier, the characteristics of both silicon and germanium rectifiers are influenced by changes in temperature though the effects may be relatively unimportant.

An increasingly useful semiconductor device of the p-n junction type is the backward diode. A complement to the tunnel diode, the backward diode relies for its operation on the tunnel effect; that is, the passage of electrons directly from the valence band of the p-type region to the conduction band of the n-type region, through the barrier layer. The diode derives its name from the fact that when it has its normal forward bias, little or no current flows since the electron energies in the valence band of the p-type region are opposite the forbidden gap between the valence and conduction bands. Fig. 1 shows the displacement of the energy levels and the corresponding regions of the characteristic for various values of applied bias. It is observed that the diode requires only a few tens of millivolts forward bias in order to cause current to flow. The

\* Royal College of Advanced Technology.



ELECTRONICS  
INSTRUMENTATION  
CONTROL

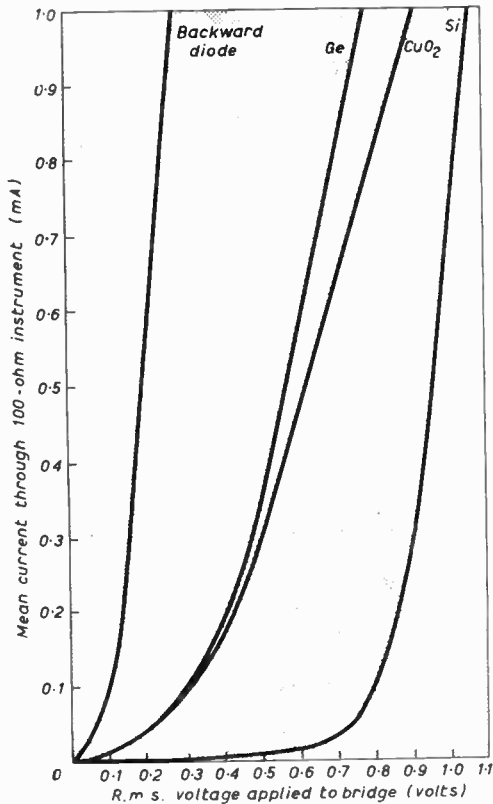
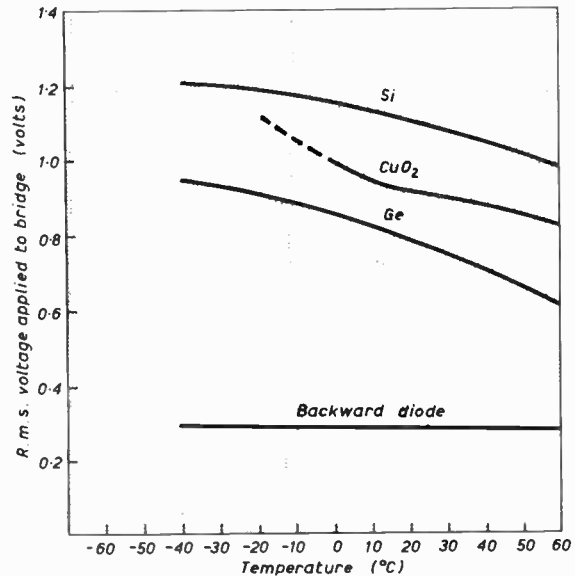

Fig. 3 (Left). Relationship between direct current through a 100-ohm instrument fed from a bridge of diodes, and the r.m.s. voltage applied to the bridge

Fig. 4. The r.m.s. voltage required by a bridge to produce f.s.d. on a 100-ohm instrument, as a function of temperature



forward and reverse characteristics of a number of diodes with similar current carrying capacity are shown in Fig. 2. It is seen that the offset voltage in the case of the backward diode is significantly less than the other three types. The maximum reverse voltage of the backward diode is also very small, of the order of 350 mV. It would appear from Fig. 2 that the low peak inverse voltage rating of the backward diode would render it unsuitable for use in circuits where the applied voltage is greater than 350 mV. If the diodes are bridge connected, however, current flows on each half cycle and the only condition which must be fulfilled is that the forward voltage for maximum forward current is less than the peak inverse voltage rating of the diode.

The reverse characteristics of backward diodes often show a characteristic hump with a corresponding negative resistance region. The hump may be minimized by careful design, though the maximum reverse current is usually so small as to be unimportant. Another feature of the backward diode is its relative insensitivity to changes in temperature. It is known that semiconductors in which minority carriers are responsible for the conductivity are extremely temperature sensitive. In the case of the backward diode the current flow is a majority carrier phenomenon and thus not greatly influenced by changes in temperature. Fig. 3 shows the relationship between the mean direct current through a 100-ohm moving-coil instrument, fed from a bridge arrangement, and the r.m.s. voltage applied to the input terminals of the bridge. The four curves correspond to results obtained on bridges using silicon, germanium, copper-oxide and backward diodes. It is seen that the backward diode bridge gives an output which is much more linear than the other three bridges. Fig. 4 shows the alternating voltage required to produce full-scale deflection on a 100-ohm moving-coil

millimeter, as a function of temperature. From the figure it is clear that the backward diode is least affected by changes in ambient temperature. The copper-oxide type rectifier shows an extreme temperature sensitivity at low temperatures but it has a small temperature coefficient at room temperature. The frequency response of the bridges, measured under conditions of constant current, is shown in Fig. 5 and indicates the superiority of the Si and Ge rectifiers over the copper-oxide type with its relatively high stray capacitance. When used in applications where pre-amplification of the signal is not possible and the voltage to be measured is small then the backward diode bridge has a distinct advantage over the other three forms.

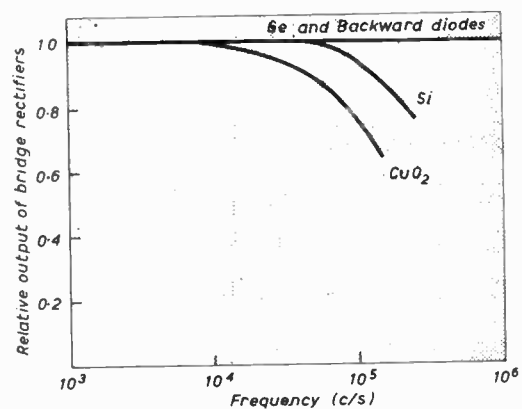
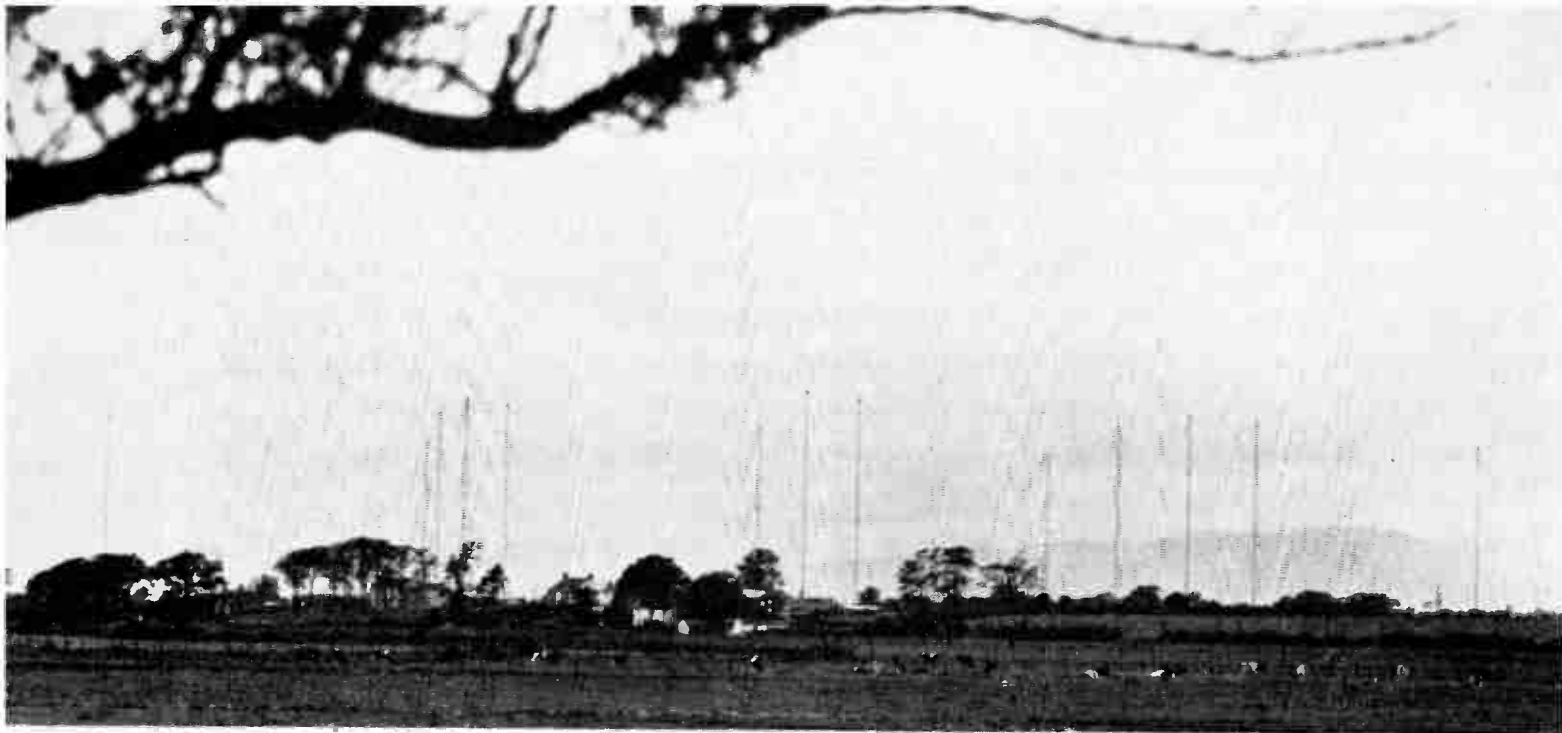

Fig. 5. The relative output of a bridge rectifier as a function of frequency



*Anthorn aerial system seen from about 1 1/2 miles away*



## EUROPE'S LARGEST AERIAL SYSTEM

British Insulated Callender's Construction have completed a £1½ million contract for the design, supply and erection of 13 tall masts, with foundations and stays, for supporting the aerials at the North Atlantic Treaty Organisation's V.L.F. radio station at Anthorn, near Carlisle. The main contractor for this station was Continental Electronics Systems Inc. of Dallas, Texas, working to the requirements of the British Post Office. This station, now the largest of its kind in Europe, is to be used primarily for Fleet communications by N.A.T.O.

*The arrangement of the six halyard winches around the base of the centre mast*

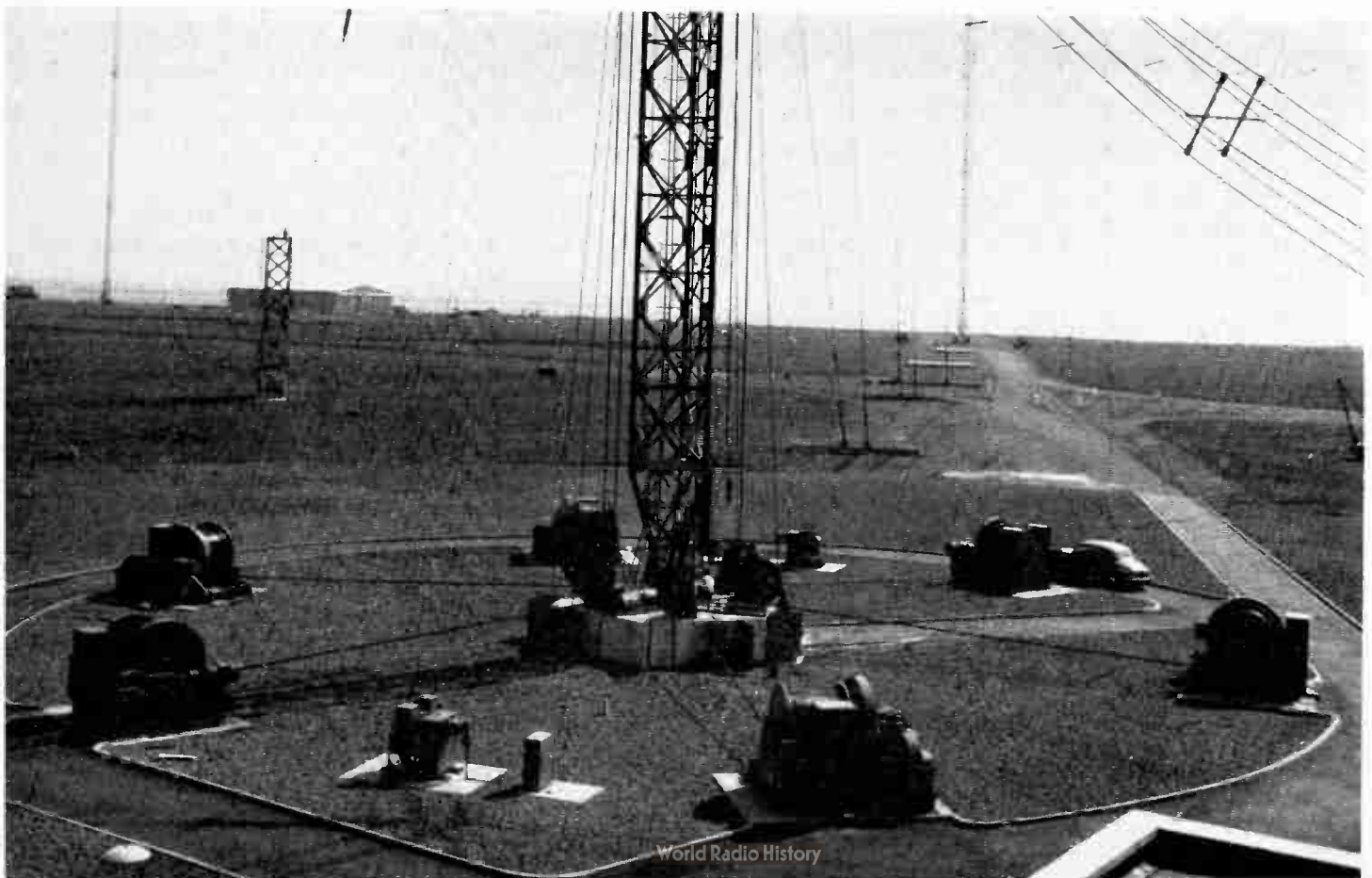



*(Right) 'Alimak' petrol-powered self-climbing hoist on rack and pinion tracking mounted on the face of the centre mast*

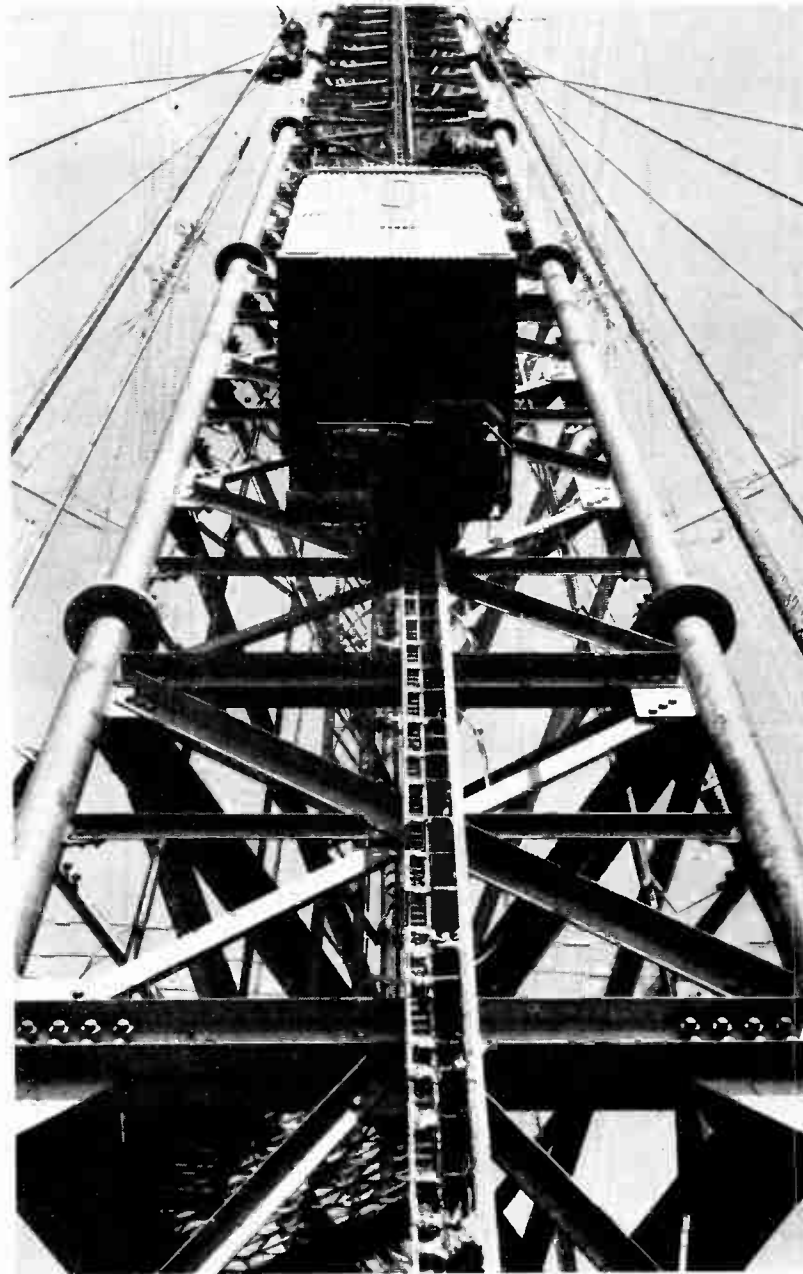

*(Below) Centre mast and transmitter building viewed from the top of one of the 618 ft outer masts*

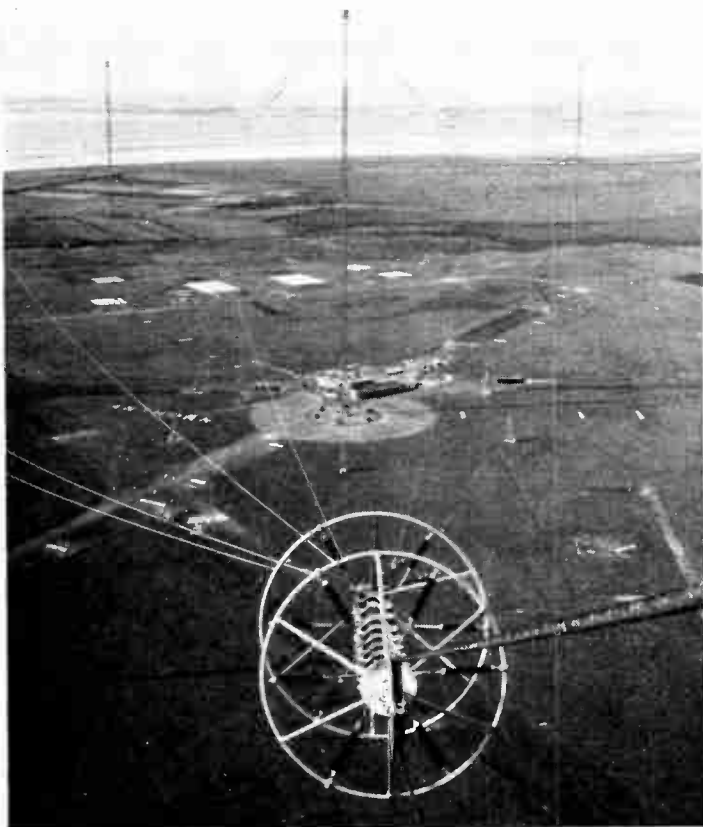

*Insulator and corona ring assembly at the end of an aerial panel viewed from one of the 618-ft outer masts*

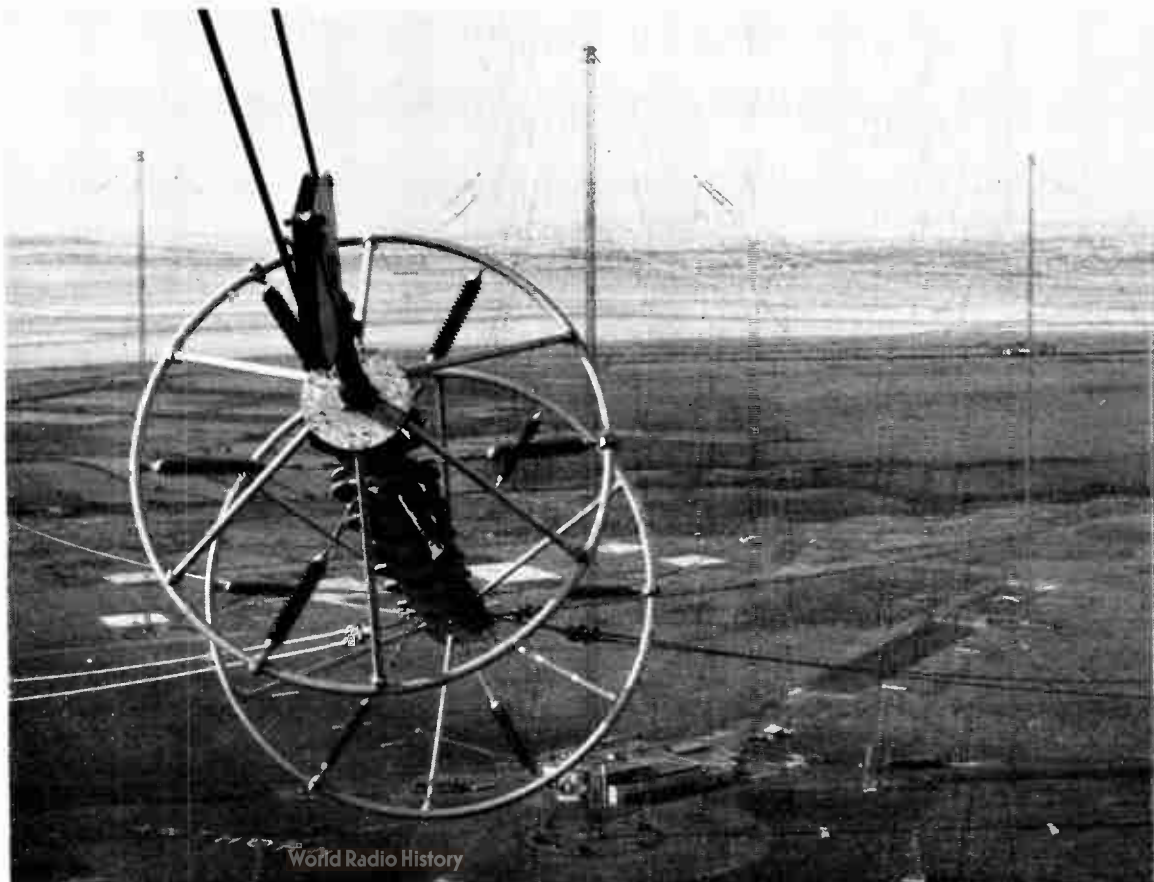

For controlling the flow of fluid in a pipe line valves are needed. In this article the various forms of valve are described and their characteristics are indicated.

By J. C. McVEIGH, M.A.(*Cantab.*),  
M.Sc., Ph.D., A.M.I.Mech.E., A.F.R.Ae.S.\*

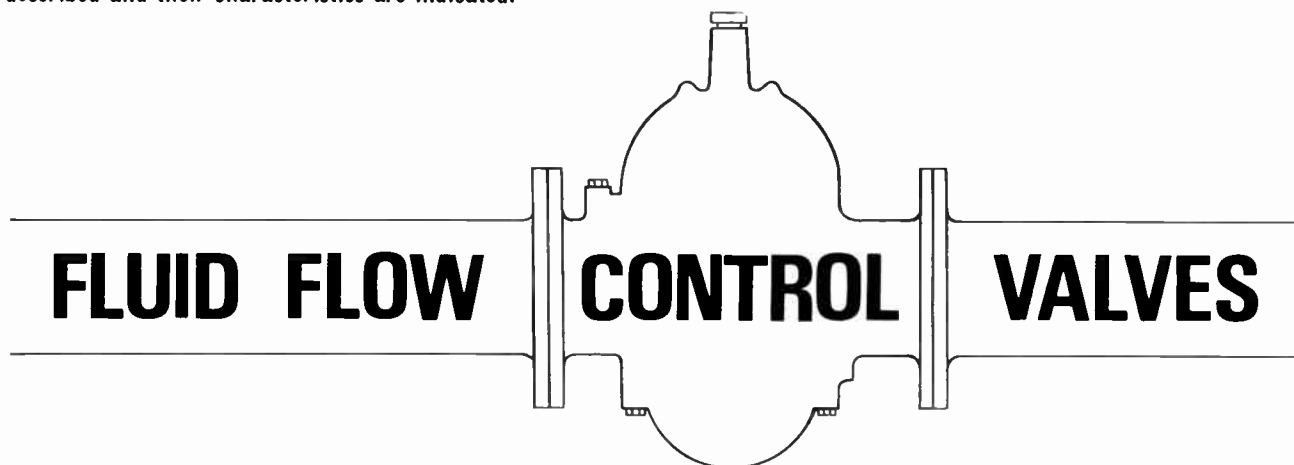

**I**N an automatic control system, the final control element, or correcting unit, regulates the rate of flow in a pipeline in response to a signal received from the automatic controller.<sup>1</sup> In most industrial applications a control valve is used in which the port area is varied by an actuator or motor element. Actuators are classified according to their input signal and output and may be either pneumatic, hydraulic, electrical, mechanical, electro-pneumatic or electro-hydraulic. While a discussion of all these different types of actuator is beyond the scope of this article, one which deserves special mention because of its wide use is the pneumatic actuator. In its simplest form, a pneumatic input signal varying between 3 and 15 lbf/in.<sup>2</sup> is received and acts directly upon a diaphragm, resulting in a force which positions the control valve. With the spring type of actuator shown in Fig. 1 the valve movement continues until the spring force balances the air pressure force and it is generally assumed that the travel of the valve stem is linear with changes in air pressure. In practice some deviations from this simple assumption should be expected as the spring response may not be linear and the effective area of the diaphragm can alter as it deflects. The friction force on the valve stem and thrust force from the controlled fluid may also vary with valve position.

#### Valve Action

If the actuator should fail to operate, the valve could either remain in its existing position, open fully or closed. Safety considerations govern which action is suitable for each application. With the pneumatic actuator, the air-to-close valve closes with increasing air pressure and therefore opens fully if the air supply fails as in Fig. 2(a). The air-to-open valve closes if the air supply fails, as in Fig. 2(b), and would be used where the full flow of the controlled fluid could dangerously overload the process, e.g., in a steam line or the fuel-oil supply line to a furnace. Some valves have reversible bodies and these allow a direct actuator to

be fitted for an air-to-open valve or a reverse actuator for an air-to-close valve.

#### Valve Seating Arrangements

The control valve can be either single-seated or double-seated. With single-seated valves the flow normally enters beneath the seat and as the valve plug nears its closed position it is subjected to the full force caused by the differential pressure across it. This characteristic tends to make it more stable than the double-seated valve. The single-seated valve can also be shut tightly but it cannot be used where a large differential pressure is anticipated unless a powerful valve actuator is fitted. A powerful actuator is also needed when the valve is designed for flow to enter above the seat and the valve plug is specially shaped to give a pressure recovery. While this flow passage is somewhat similar to a venturi meter, with converging-diverging walls, the pressure recovery is much less. As the flow enters between the seats in the double-seated valve the differential pressure forces are nearly balanced and for any given differential pressure a considerably smaller force is needed from the actuator. This type of valve is less sensitive to pressure fluctuations in the pipeline but cannot be expected to shut so tightly as the single-seated valve, mainly because of thermal expansions and contractions caused by the controlled fluid.

#### Valve Characteristics

The flow characteristic of a control valve can be defined as the relationship between the flow rate and the valve lift for the particular pipeline conditions in which the valve will be operating. Unfortunately the actual operating characteristic, also known as the effective flow characteristic, depends on several factors which are unique to each particular system; e.g., the variations in differential pressure across the system that occur as the flow rate varies. These factors can result in the effective characteristic differing considerably from the theoretical values derived from ideal conditions, the inherent flow characteristic. The inherent characteristics form the basis of comparison used in most publications and are generally presented in graphical form, the valve lift percentage of maximum being plotted against the flow-rate percentage of maximum and not vice-versa, which would be more correct as the flow rate depends on the valve lift. The inherent characteristics of the three main types of valve plug are shown in Fig. 3.

\* Borough Polytechnic.



Table 1

$y$ (%)	$Q$ (%)	% increase in $Q$ from the previous value
30	6.46	—
40	9.56	48
50	14.14	48
60	20.92	48

(i) *The On-Off or Quick-Opening Valve Plug.* While this characteristic cannot be defined mathematically, it is approximately linear for most of its range. As the plug is lifted from its seat, the full flow area is rapidly available and maximum valve capacity is usually achieved with less than 25% of valve lift. The most common types have bevelled seating surfaces.

(ii) *The Equal Percentage Valve Plug.* The rate of change of flow rate is constant for equal increments of valve lift; i.e., the change in the magnitude of the flow rate is small at low flow rates and large at high flow rates for equal increments of valve lift. This characteristic can be expressed by the equation

$$Q = ae^{by}$$

where  $Q$  is the flow rate percentage of maximum,  $y$  is the valve lift percentage of maximum,  $e$  is the base of natural logarithms and  $a$  and  $b$  are constants. The most commonly-used values quoted to illustrate this type are based on the assumption that the flow rate is 2% of the maximum at zero valve opening. These values also give a rate of change of flow rate of just under 4% for each 1% change in valve lift. Putting  $Q = 2\%$  when  $y = 0$  and  $Q = 100\%$  when  $y = 100\%$  the equation can then be transformed into

$$y = 25.6 \log_e Q/2$$

Some values based on this equation are shown in Table 1 where it can be seen that the percentage increase in  $Q$  from the previous value is a constant.

While similar expressions and tables can be obtained for other flow rates at zero valve opening, a semi-logarithmic plot is sometimes used to present the information in a more convenient form as shown in Fig. 4. Equal percentage plugs can be made either with V-ports or they can be lathe-turned.

(iii) *The Linear Valve Plug.* As its name indicates, the flow rate is directly proportional to the valve lift, the equation being

$$Q = cy$$

where  $c$  is a constant. Table 2 shows the values of  $Q$  obtained for the linear plug compared with the equal percentage plug values taken from Table 1.

Table 2

$y$ (%)	$Q$ (%) equal percentage	$Q$ (%) linear
30	6.46	30
40	9.56	40
50	14.14	50
60	20.92	60

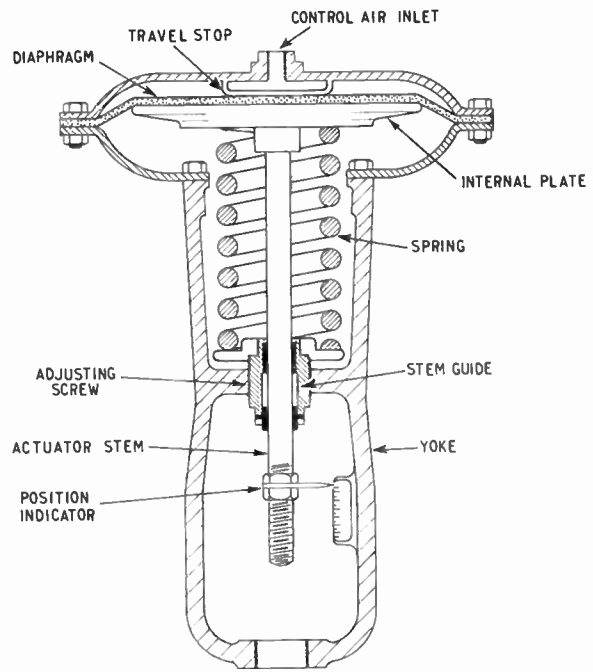

Fig. 1. General form of spring type actuator

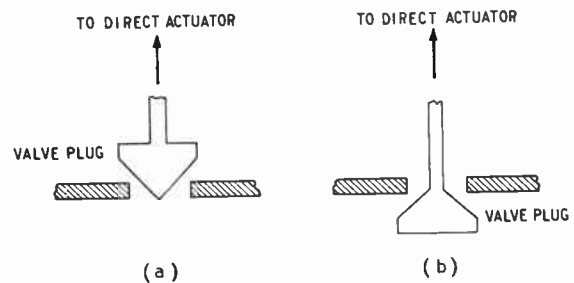
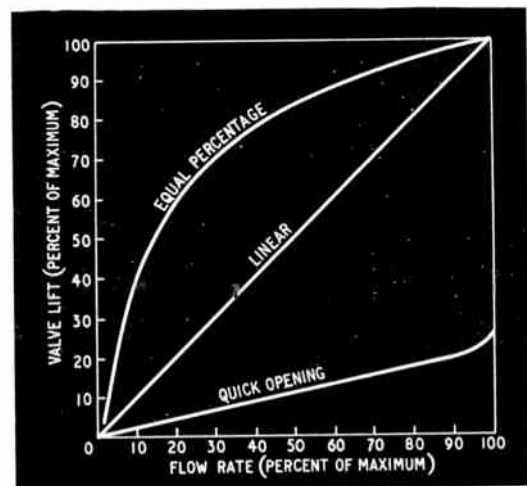

Fig. 2. Pneumatic valve; (a) air pressure closes the valve, (b) air pressure opens the valve

Fig. 3. Relation between flow rate and valve lift



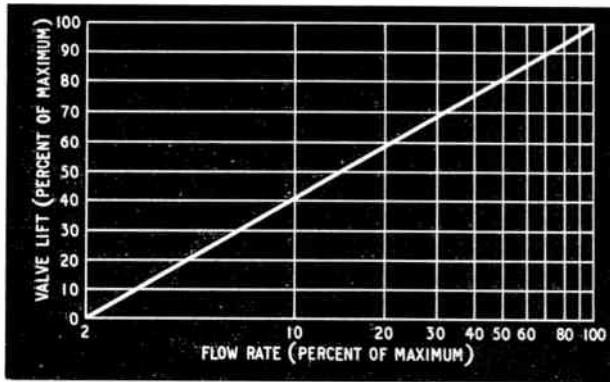

Fig. 4. Semilogarithmic plot of the characteristic of an equal percentage valve

### Rangeability

The original definition of rangeability as 'The ratio of the maximum flow rate to the minimum flow rate' was unsuitable as it meant that the rangeability was limited only by the leakage rate in the fully closed position. The definition has now been qualified by adding '... within which the flow characteristic can be maintained within prescribed limits'. However, even this expression is based on a constant differential pressure across the control valve and Holzbock<sup>2</sup> warns that the rangeability values provided by manufacturers should be taken only as an indication and not used as accurate data for actual operations. As an example, the equal percentage valve discussed in the previous section would have a rangeability of 50:1 according to the manufacturers, while a linear valve of the same size would have a rangeability of no more than 30:1, although the practical limitations to both valves would appear to be identical. The lower figure quoted for the linear valve is empirical as it has been demonstrated that a linear characteristic is particularly difficult to maintain as the valve plug nears its seat. Hence the linear valve is used in applications where high rangeability is not required and where the process changes tend to be linear, e.g., liquid level. Holzbock recommends the inclusion of a term to allow for variations in differential pressure so that the actual rangeability becomes

$$\frac{Q_1}{Q_2} \sqrt{\frac{p_2}{p_1}}$$

where  $Q_1$  and  $Q_2$  are the maximum and minimum flow rates and  $p_1$  and  $p_2$  are the corresponding differential pressures. This gives a practical average rangeability of about 10 for most valves except bevelled disc valves, but much higher values are often achieved.

### Valve Sizing

Perhaps the most important point to understand about the selection of a valve size is that the valve size should never be blindly related to the actual pipeline size, but should be based on a complete knowledge of the actual flow conditions. The main factors to consider are the range of flow and the differential pressure, but the type of fluid,

specific gravity, viscosity, or the possibility of critical flow conditions for gases and vapours are also important. The maximum flow rate anticipated in the process should be augmented by between 25% and 60% in calculating the valve size. This is a safety factor as it would be undesirable to have the valve controlling flow near the fully-open position. For good control the differential pressure, or pressure loss, across the valve should be greater than one-third of the total pressure losses through the system. With too small a valve pressure loss, the valve has difficulty in increasing the flow rate. However, for very high pressure systems in which a total system pressure loss of 15,000 lbf/in.<sup>2</sup> or more may be expected, the valve pressure loss can be as low as one-sixth of the total system pressure loss. It is essential in all applications that the valve is physically capable of withstanding the upstream pressure. Errors in valve sizing arise from an incomplete knowledge of the actual flow conditions and the consequent tendency to add extra safety factors. This usually leads to a valve size which is too large for adequate control of the process. In general, the control valve size is smaller than the pipeline size. It may be useful to remember an example taken from an oil refinery where a 1-in. control valve is installed in a 10-in. pipeline.

### Valve Flow Coefficient

The complex problem of valve sizing outlined above has been greatly simplified by the use of an American term, the valve-flow coefficient  $C_v$ . By definition, the valve-flow coefficient  $C_v$  is the number of U.S. gallons\* of water per minute at 60 °F which will flow through a valve in its fully-open position when the differential pressure across the valve is 1 lbf/in.<sup>2</sup>. The  $C_v$  is a capacity index. Its use is not confined to the automatic control valve and it can be applied to other types of restriction, e.g., a hand-operated valve or an orifice plate. The  $C_v$  is derived as follows.

#### (i) Liquid Flow

The basic flow equations for velocity  $v$  and flow rate  $q$  are

$$v = \sqrt{2gh} \text{ ft/sec}$$

and

$$q = av \text{ ft}^3/\text{sec}$$

where  $g$  is the gravitational constant (32.17 ft/sec<sup>2</sup>),  $h$  is the fluid head in feet and  $a$  is the flow area (ft<sup>2</sup>). Substituting for  $v$  and converting the flow rate into U.S. gallons per minute, the equation becomes

$$Q_L = C \left\{ 38.1A \sqrt{\frac{\Delta p}{G}} \right\}$$

where  $Q_L$  is the flow rate in U.S. gallons/minute,  $A$  is the flow area (in.<sup>2</sup>),  $\Delta p$  is the differential pressure across the valve in lbf/in.<sup>2</sup> at the maximum flow rate,  $G$  is the specific gravity and  $C$  is a factor similar to the discharge coefficient of an orifice plate which allows for the effects of fluid friction, jet contraction and other losses. When  $\Delta p = 1$  and  $G = 1$  (water), the constant  $C\{38.1A\}$  is, by definition, the  $C_v$ , so that the equation giving the  $C_v$  for liquid flow is

$$Q_L = C_v \sqrt{\frac{\Delta p}{G}}$$

In all fluid-flow problems the Reynolds number must be watched in case a correction has to be made for viscous effects. Most manufacturers supply a simple chart relating a correction factor to the flow rate and viscosity. The  $C_v$  is calculated from the above equation and then multiplied

\* 1 Imperial gallon = 1.2 U.S. gallons.

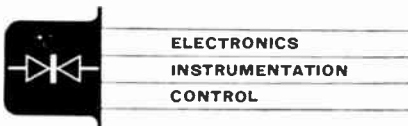

ELECTRONICS  
INSTRUMENTATION  
CONTROL

by the correction factor, which can be about 3 for very viscous conditions.

(ii) Gas Flow

In dealing with gases, great care must be taken in using the sizing formulae given in manufacturers' handbooks or reference books as units and symbols have different meanings. The symbol  $P$  representing pressure in the  $C_v$  equation shown below has been called the inlet pressure, the outlet pressure and the mean gas flow pressure by different sources using the same equation. The flow rate  $Q_G$  is in ft<sup>3</sup>/hour, not ft<sup>3</sup>/minute, yet both definitions have appeared in different sources with this same equation. Applying the basic flow equations to compressible flow, omitting the expansibility\* factor for simplicity, the equation giving  $C_v$  for gas flow is

$$Q_G = 1360 C_v \sqrt{\frac{\Delta p P}{GT}}$$

where  $Q_G$  is the flow rate in ft<sup>3</sup>/hour  
 $\Delta p$  is the differential pressure across the valve in lbf/in.<sup>2</sup> at the maximum flow rate  
 $P$  is the absolute pressure at the valve throat (lbf/in.<sup>2</sup>)  
 $T$  is the absolute temperature at the valve throat (°R)  
 $G$  is the specific gravity of the gas at 14.7 lbf/in.<sup>2</sup> and 60 °F (s.g. of air = 1 at this point).

It is less accurate to refer  $P$  or  $T$  to the inlet or outlet conditions and the further assumption that  $P$  is the mean of the inlet and outlet pressures is quite reasonable. When 'critical'\* flow conditions are reached, further reduction in the downstream pressure will not increase the flow rate. For practical purposes the limiting value of the pressure drop for critical flow is half the inlet pressure  $P_1$ . This means that the values  $\Delta p = 0.5P_1$  and  $P = 0.75P_1$  can be substituted to give the equation for critical gas flow

$$Q_{GC} = \frac{833 C_v P_1}{\sqrt{GT}}$$

where  $Q_{GC}$  is the flow rate under critical flow conditions in ft<sup>3</sup>/hour.

(iii) Vapour Flow

Applying the basic flow equations the equation for  $C_v$  becomes

$$Q_v = 63.3 C_v \sqrt{\frac{\Delta p}{v_s}}$$

where  $Q_v$  is the flow rate in lb/hour  
 $\Delta p$  is the differential pressure across the valve in lbf/in.<sup>2</sup> at the maximum flow rate  
 $v_s$  is the specific volume in ft<sup>3</sup>/lb measured at the valve throat.

The critical flow conditions mentioned above also apply to vapours. Further equations have been specially derived for steam applications as there is a vast amount of data available. For nearly all  $C_v$  calculations flow charts have been developed from the three basic equations.

**Flashing Across the Valve**

The differential pressure across the valve may be enough to create a two-phase system. While the inlet conditions may be entirely liquid, partial or complete vaporization can occur as the fluid passes through the valve and a valve sizing based on liquid flow is no longer adequate. One method of dealing with this problem is to make an approximate calculation of the amount of vaporization which has taken

place up to the valve seat and then calculate two  $C_v$  values, one for the fraction of the total flow which has vaporized, based on the equation for vapour flow, and the other for the fraction which remained liquid, based on the equation for liquid flow. The sum of these two  $C_v$  values gives the required  $C_v$ . The fraction of liquid vaporized up to the valve seat is given by the following empirical equation:—

$$f = \frac{0.5s(T_1 - T_2)}{L}$$

where  $T_1$  and  $T_2$  are the inlet and outlet temperatures respectively,  $s$  is the mean specific heat of the liquid and  $L$  the mean latent heat between the two temperatures. The whole subject of flashing is very complex and has been studied by many research workers who have suggested other methods for calculating  $C_v$  values.

**Some Special Control Valves**

The mixing of two different fluids or the diverting of a flow into two outlets is achieved with a three-way valve. The three-way valve has two seats and three outlets, generally arranged in a T-shape. Used as a mixing valve, flow A enters from the right-hand side and flow B from below and the mixed flow of A + B leaves from the left-hand side. As a diverting valve the flow is in the reverse direction, part of the flow leaving from the right-hand side and part from below. Full capacity can be obtained through either valve seat.

The butterfly valve is now taking an increasing share of control applications as it is comparatively cheap to manufacture and has larger  $C_v$  values than similar-sized conventional valves. A rough guide to the  $C_v$  of a conventional valve is  $C_v = 10d^2$  where  $d$  is the valve diameter in inches. For the butterfly valve  $C_v \approx 16d^2$ . It is particularly suitable where a large volume must be passed with a low pressure loss and where suspended solids are held in the fluid, but it cannot be used if a high pressure loss is anticipated.

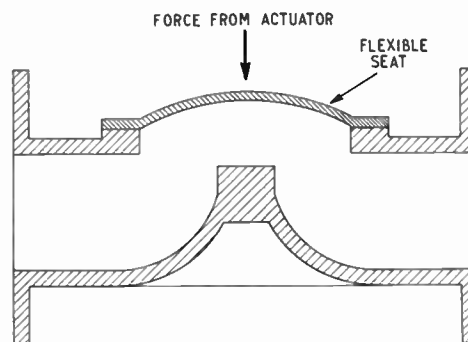
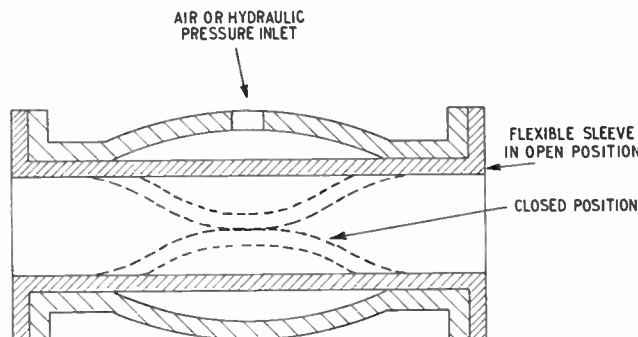

Fig. 5. Diaphragm valve

Fig. 6. Pinch valve specially-designed to handle slurries



\* For further information see B.S. 1042: Part 1: 1964, pp. 15-20.

The diaphragm valve, shown in Fig. 5, has a flexible seat and no other form of seal comes in direct contact with the controlled fluid. It is often used with difficult fluids, e.g., corrosive or flammable, but the weir makes it unsuitable for dealing with fluids containing suspended solids. One valve which is specially designed for slurries is the pinch valve, shown in Fig. 6. The characteristics of the pinch valve are very similar to the linear valve, but entire concept is completely different. Air or hydraulic pressure in the annular space between the valve housing and the flexible sleeve opens and closes the valve. As the flow direction remains unaltered in passing through the valve, it can withstand abrasive materials such as metallic ores, sand, coal and wood chips. As it has the same circular cross-sectional area as the pipeline, there are no pressure losses in passing through it. Even with solids trapped in it as it closes, a positive seal can be maintained. The simplicity of this design is outstanding as it has only one wearing part, the flexible sleeve, which has at present a lower size limit of  $\frac{1}{8}$ -in. diameter fully open.

A  $C_v$  value of less than one is only found in small valves, but in many applications, particularly in pilot-plant work, it is essential to control very small flow rates. The  $\frac{1}{4}$ -in. valve shown in Fig. 7 can be fitted with 28 different plugs and seats, the smallest having a  $C_v$  of 0.0000018. Linear characteristics can only be obtained at these very low flow rates as it is not practical to produce an equal percentage valve with a  $C_v$  of less than about 0.050. As the rangeability is 15:1, these valves cannot be expected to shut tightly without ruining their profiles and a quick-opening soft-seated valve should be placed in series for complete

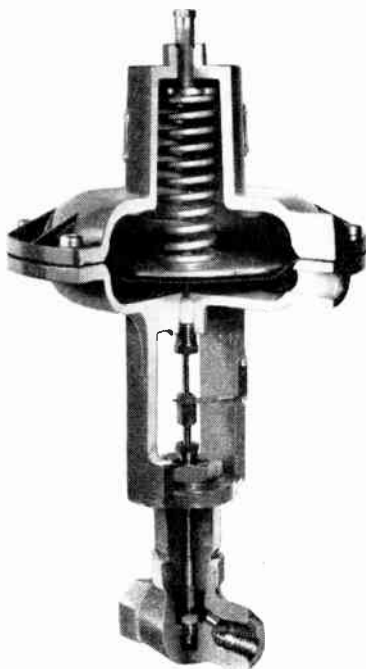

Fig. 7. A  $\frac{1}{4}$ -in. valve which can be fitted with 28 different plugs and seats

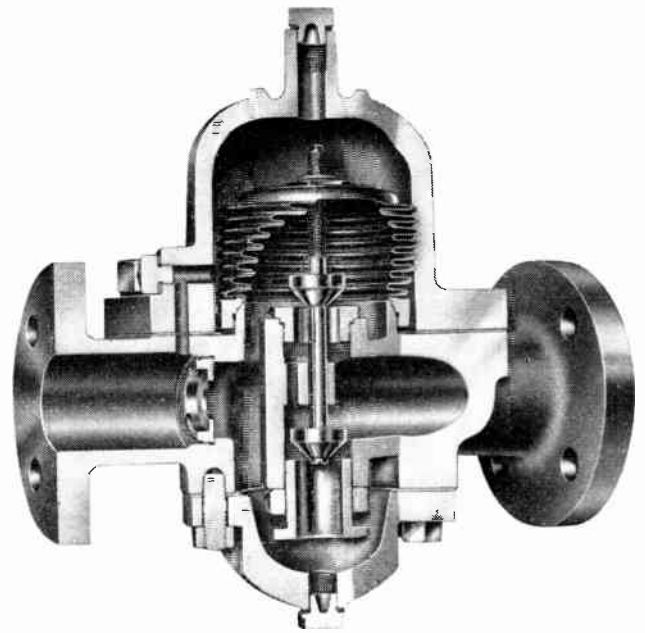

Fig. 8. An automatic closed-loop controller which needs no external power source

closure. The valve shown in Fig. 7 has a reverse actuator giving an air-to-open action.

The unusual feature of the automatic closed-loop controller shown in Fig. 8 is that no external power source is required. The fluid enters from the left-hand side and passes through an orifice. The upstream pressure acts on the outside of the bellows which position the double-seated valves while the downstream pressure acts on the inside of the bellows. Any increase in the flow rate increases the differential pressure acting on the bellows and they start closing until the flow rate is returned to its original value. The smallest diameter in which these controllers are available at present is  $\frac{1}{2}$  in.

#### Acknowledgment

The information on the pinch valve, the small flow valve, Fig. 7, and the automatic flow controller, Fig. 8, were kindly supplied by G. A. Platon Ltd., Davidson Road, Croydon, Surrey.

#### References

- <sup>1</sup> J. C. McVeigh, 'Automatic Process Control', *Measurement and Control*, Vol. 3, No. 10, 1964.
- <sup>2</sup> W. G. Holzbock, 'Instruments for Measurement and Control', Reinhold, New York, 1962.

#### INFORMATION WANTED ?

If you require further details of products or processes described or advertised in INDUSTRIAL ELECTRONICS you will find it convenient to use the enquiry cards which will be found immediately preceding page 93. The sheet of cards can be folded out to enable you to make entries while studying the editorial and advertisement pages.

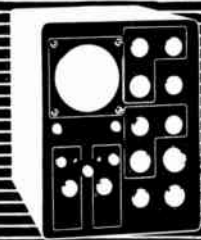

# NEW APPARATUS

ELECTRONICS  
INSTRUMENTATION  
CONTROL

## 1. Compact 30-Ton Press

Research & Industrial Instruments have announced a bench-mounted hydraulic press which is extremely compact for its capacity. Hand-lever operated, the press, known as the C 30, develops a pressure of up to 30 tons on the ram.

In this 20-in. high press the bottom 6-in. diameter platen rises from the base to engage the workpiece to be pressed against a hardened steel top platen of 1-61 in. diameter. Platen movement is 1 in.—*Research & Industrial Instruments Co., 116 Lordship Lane, London, S.E.22.*

For further information circle 1 on Service Card

## 2. Combined Pressure/Vacuum Pumps

A range of combined blower and vacuum pumps now available from Anthony Pratt & Co. and known as

the HSP.3P range, has been developed specifically to meet the demand from various industries for simultaneous pressure and vacuum from a single unit.

This range of rotary pumps comprises three models—HSP.3P.O, HSP.3P.1 and HSP.3P.2, with displacements of 5.0, 7.0 and 11.2 c.f.m., respectively. They will give pressures of up to 6 p.s.i.g. and vacua of up to 15 in. Hg. The pumps, which require no lubrication, provide clean oil-free air and a vacuum with fume-free exhaust. Many special variations of the three standard models are available for specific duties.

The HSP.3P range has a wide variety of applications, particularly in the printing and duplicating industries and in sorting and counting machinery. The pumps, which are light in weight, easily portable and vibration-free, are

fitted with exhaust silencers to ensure quiet operation. Installation is easy and, because of their simple design, maintenance requirements are negligible. The low starting torque enables the use of split-phase motors for operation on single-phase supply.—*Anthony Pratt & Co. Ltd., 251 Burlington Road, New Malden, Surrey.*

For further information circle 2 on Service Card

## 3. Heavy-Duty Clamps

Four clamps rated at 1,650 lb maximum holding pressure and designed for heavy-duty work have been added to the Destaco range of quick-action toggle clamps. All four models feature  $\frac{3}{4}$  in. square cold-drawn steel hold-down bars and forged steel bases with hardened steel bushes and pins at pivot points. Finish is in bright zinc plate to prevent rust.

Model 528 has a standard flanged base with vertical handle. Model 527 is also equipped with a standard flanged base but the handle is arranged in a trailing position to reduce overall height. Models 528-F and 527-F are similar but have vertical flanged bases for front mounting. A full range of accessories is available.—*Insley Industrial Ltd., Insley House, 5 Windmill Street, London, W.1.*

For further information circle 3 on Service Card

## 4. Spectra Demonstration Kit

An educational absorption spectra kit now available from Bausch & Lomb enables science teachers to display the spectrum and its absorption bands to large groups of students by projection on to a screen. The kit can be used with any standard slide projector which will accept a slide 4 mm thick.

In addition to a diffraction grating which is mounted on a stand for easy use, the kit consists of two cuvette and slit combinations. When the cuvette and slit combination is placed in the slide holder of the projector, the grating and projector lens form a spectrum of the slit image on the screen. The slit is attached to the cuvette so that

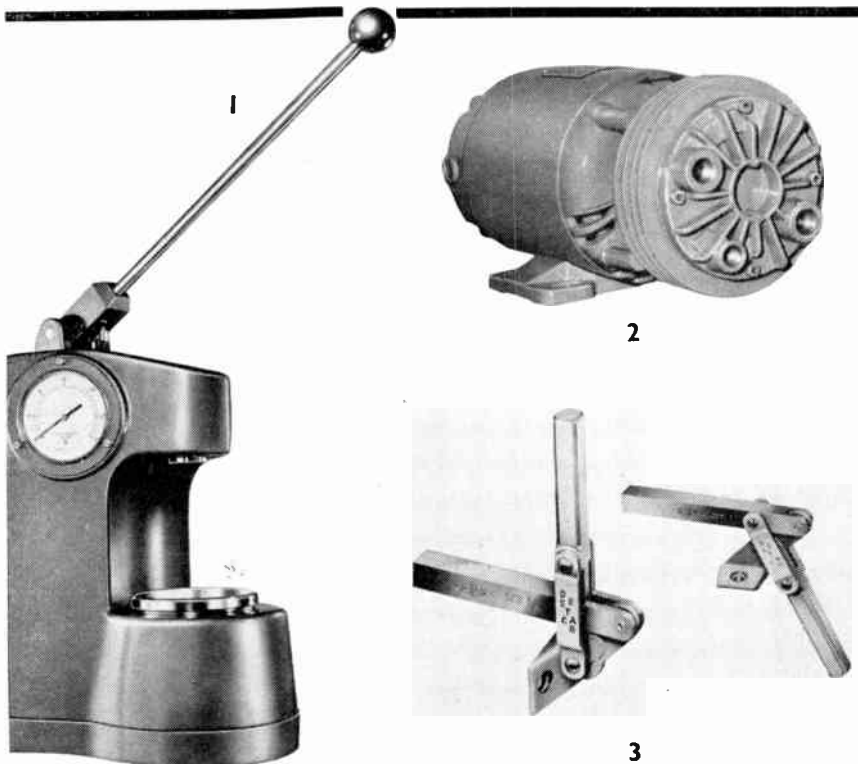

# NEW ELECTRONICS INSTRUMENTATION CONTROL

light passing through the top half of the slit passes through the sample in the cuvette; the bottom half of the slit is clear. Thus a double spectrum is formed at the screen.—*Bausch & Lomb Inc., Rochester 2, New York 14602, U.S.A.*

For further information circle 4 on Service Card

## 5. Modular Rack Unit

With the introduction of a 5¼-in. modular rack unit Vero Electronics now cover the full range of popular standard sizes: 5¼, 7 and 8¼ in. unit heights, and module panel widths of 1, 2, 4 and 8 in. The overall width of the unit is 19 in. with depths of 11 and 14 in.

This system permits over 400 variations, using standard components. Only a screwdriver is required to complete a rigid and permanent structure of any size or combination in the space of a few minutes.—*Vero Electronics Ltd., 7 South Mill Road, Southampton.*

For further information circle 5 on Service Card

## 6. Cryogenic Liquid Transfer Pipes

Spemby Technical Products are now marketing a range of flexible vacuum-insulated cryogenic liquid transfer

pipes, suitable for use with most liquefied gases.

The lines consist of concentric stainless-steel flexible tubes sealed at each end with male and female low-loss bayonet couplings. All joints are welded and tested on a mass spectrometer to better than  $10^{-8}$  1/μsec.

The pipes are initially pumped out to a vacuum of better than  $10^{-6}$  torr and with the help of a built-in cryopumping capsule will maintain a good vacuum while transferring liquid. A vacuum valve is provided should re-evacuation be necessary.

Standard sizes are available in ¼, ½, ¾, 1 and 1½ in. nominal bore in 3, 5 and 10 ft lengths. Special lengths and alterations to end fittings to suit customers' requirements can also be supplied.—*Spemby Technical Products Ltd., New Road Avenue, Chatham, Kent.*

For further information circle 6 on Service Card

## 7. Finger-Tip Pressure Regulators

Norgren have announced the availability of a range of compressed air pressure regulators in six pipe sizes from ¼ in. to 1½ in. A.N.P.

These 'Micro-Trol' regulators are extremely compact and are designed for finger-tip adjustment. The regulated pressure range is 0 to 250 p.s.i. For maximum protection these regulators are fitted with full flow ½ in. relief valves.

All three outlet ports, in sizes up to

½ in., can be used as either secondary ports or gauge ports. Side ports are ½ in. when through ports are ¾, 1 and 1½ in.

The adjusting knob can be pre-set to limit maximum and minimum pressure setting.—*C. A. Norgren Ltd., Shipston-on-Stour, Warwickshire.*

For further information circle 7 on Service Card

# ELECTRONICS

## 8. Analogue/Hybrid Computer

Electronic Associates have announced the 8800 analogue/hybrid computer featuring improvements which make possible a considerable reduction in programming time.

Automatic calculation of coefficient-potentiometer settings and static check values are effected by a digital input/output computer, designed specifically for use by analogue computer programmers.

A 4,000-word stored programme capacity is provided, and the use of a fully-transistorized ±100 V operational amplifier extends the useful computing frequencies. Special considerations in mechanical design, patch-panel connections, and packaging of the components provide high-fre-

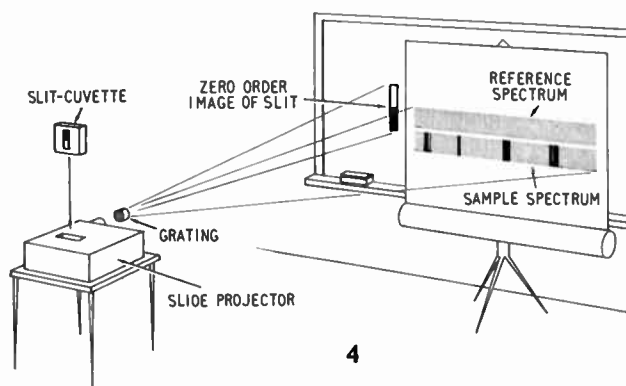

4

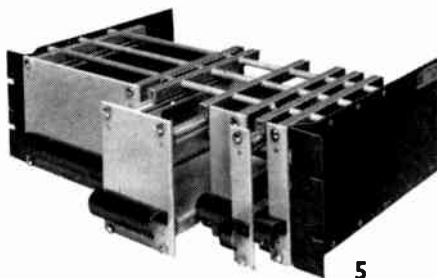

5

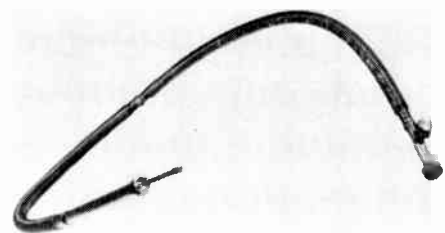

6

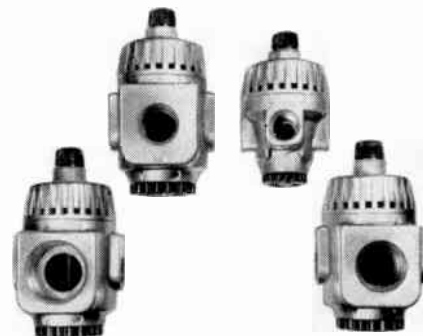

7



quency operation with minimum cross-talk.

New peripheral equipment available for use with the 8800 includes a cathode-ray tube display system, with improved flexibility, resolution, accuracy, and convenience for high-speed read-out, and a transistorized multi-channel strip-chart recorder.—*Electronic Associates Ltd., Victoria Road, Burgess Hill, Sussex.*

For further information circle 8 on Service Card

### 9. Miniature Transmitter

Multitone's pocket talk-back paging device (now on trial) incorporates a miniature 5-V mercury battery pack giving about 6 months' life under normal usage conditions. The transmitter has been developed for use in conjunction with a personal paging system (indoor or outdoor) and has an open-air range of 2 miles.

Measuring  $2\frac{1}{2} \times 1\frac{7}{8} \times \frac{3}{8}$  in. and weighing only  $2\frac{1}{2}$  oz, the device is completely self-contained. The power pack is formed by two 2.5-V TM152 Mallory batteries which, on the current consumption of 12 mA, will give some 24 hours of continuous service.

The voltage stability of the mercury-battery system, even under adverse climatic conditions, imparts a further advantage to the talk-back device: a constant signal strength is maintained throughout a large proportion of battery life. This means that range is not reduced as the battery ages, or in cold weather.

In addition the batteries can be stored for two years or more without any appreciable loss of capacity, so that the device could be out of use (during holidays, for example) without having to worry about replacing the batteries because of 'shelf-life' deterioration.—*Multitone Electric Co. Ltd., 12-20 Underwood Street, London, N.1.*

For further information circle 9 on Service Card

### 10. Function Generator

The Exact Electronics model 255 function generator, now available from Livingston Laboratories, provides simultaneous output functions of square, sine, sawtooth and triangular waveforms up to 25 V peak-to-peak over a frequency range from 0.001 c/s to 10 kc/s. It is intended especially to meet low-frequency applications encountered in such fields as vibration work, computer programming and medical electronics.

Apart from the main function generator the instrument incorporates a separate ramp generator which is

capable of delaying, triggering or gating the main generator. By this means an almost unlimited variety of different waveforms composed of the basic sine, triangle, sawtooth and square functions may be generated.—*Livingston Laboratories Ltd., 31 Camden Road, London, N.W.1.*

For further information circle 10 on Service Card

### 11. VHF/UHF Receiver

VHF/UHF Communications Co. have announced the TR40/20 v.h.f./u.h.f. receiver, a portable and fully-transistorized instrument for the reception of a.m. speech transmissions.

It is designed for single-channel operation in the 430 to 470 Mc/s u.h.f. band and, in addition, will operate on a single channel in the 70 to 90 Mc/s v.h.f. band. It is intended for narrow-band 25-kc/s channel spacing; a triple superhet circuit is employed when used at u.h.f., and a double superhet at v.h.f., three stages of crystal control being utilized.

A small loudspeaker is provided and an internal 8-V mercury cell will give approximately 70 hr of use.



8



9

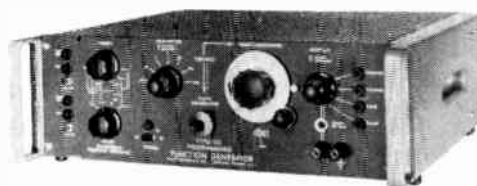

10



11

# NEW ELECTRONICS INSTRUMENTATION CONTROL

Plug-in whip aerials or external 75-Ω aerial systems can be used. The TR40/20 weighs 4 lb and is 8 in. high, 7 in. wide and 2 in. deep.—*VHF/UHF Communications Co., 16 Abbey Street, Crewkerne, Somerset.*

For further information circle 11 on Service Card

## 12. Training Computer

A training computer designed specifically for teaching computing technology has been announced by Elliotts. It is essentially an advanced training aid which clearly demonstrates both computer logic and the way information is organized inside the digital computer. It is intended for training engineers in industry and for use in universities, technical colleges and schools.

The kit for a basic machine comprises a set of 'Minilog' logic elements, other necessary hardware and a comprehensive set of diagrams and drawings.

The basic kit costs £350; the addition of mounting accessories, cabinets and so forth could bring this figure up to £700, and a fully-wired machine costs £1,025.

The computer has been designed in

conjunction with the Electrical Engineering Department of the Battersea College of Advanced Technology. It operates at clock frequencies of either 1 c/s or 5 kc/s and 'one-shot' operation is also available. All arithmetic operations are performed in serial form on word lengths of 16 bits and data is read in or out in parallel via switches and lamps. The machine is capable of performing addition, subtraction, shift, negation, multiplication and transfer.

Should the user wish to construct configurations in logic which differ from those of the basic machine, this can be done by simply inter-changing connections and plug-in boards.

It is expected that students will first be given a theoretical appraisal of how computers work which can then be demonstrated on the machine. The instructor can insert faults for the student to correct. He can remove entire logic sections, leaving the student to reconstruct the machine from a plug-in board, suitable components and a performance specification. In this way the student will have been given experience of all the basic problems possible with a digital computer, and a real understanding of computer logic, organization and design.—*Elliott Brothers (London) Ltd., Elstree Way, Borehamwood, Herts.*

For further information circle 12 on Service Card

## 13. Constant-Current D.C. Power Supply

Manufactured by Electronic Measurements Co. and available in the U.K. from Roberts Electronics, the model C612A constant-current power supply is capable of outputs from less than 1 μA up to 100 mA d.c., regulated as closely as 0.1% against load variations over virtually its entire output range. The model C612A is remotely programmable, can deliver up to 260 V to its load at lower current settings, and features an a.c. modulation input for use in small-signal transistor measurements.—*Roberts Electronics Ltd., 17 Hermitage Road, Hitchin, Herts.*

For further information circle 13 on Service Card

## 14. Digital Servo Comparator

Epsilon Industries announce that they have developed a digital servo comparator, the broad function of which is to compare two frequencies and produce an output proportional to their difference. This may take the form of pulses the frequency of which is the difference between the originals, or it may be an analogue voltage which is proportional to the frequency difference. Input signals from 3 to 100 V r.m.s. can be of any waveform shape. Input impedance is 10 kΩ.

The special features of this comparator are that it operates over a wide

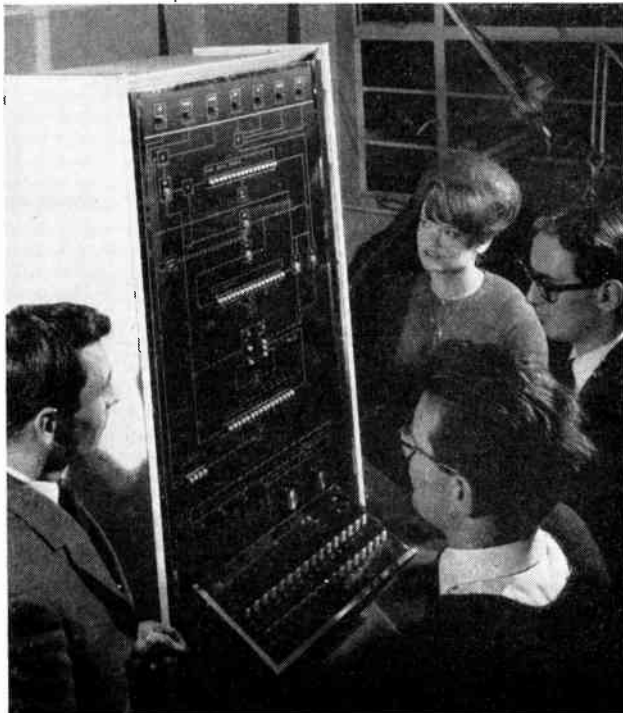

12



13



14



15



16



17

frequency range (d.c.—10 Mc/s) and has an output proportional to the instantaneous difference between the frequencies or speeds. It provides remote control of equipment and produces either digital (6 V peak at 1 mA) or analogue (0–6 V peak at 1 mA) output signals. In designing this equipment for use in severe industrial environments, the manufacturers offer a range of accessories including digital displays and power amplifiers up to 2.5 kW.—*Epsylon Industries Ltd., Faggs Road, Feltham, Middlesex.*

For further information circle 14 on Service Card

### 15. Miniature Power Supply Unit

Industrial Instruments have introduced what they claim to be the smallest fully-stabilized power supply available, the Transipack type 3021. It measures only  $4\frac{1}{2} \times 3 \times 2\frac{1}{2}$  in. and weighs 2 lb.

Operating from a mains input of 100–250 V 45–65 c/s  $\pm 10\%$ , the type 3021 will provide a maximum output current of 0.5 A at any voltage up to 30 V. D.C. output resistance varies between 0.05  $\Omega$  and 0.01  $\Omega$ . Ripple: approximately 5 mV peak-to-peak.

This power supply, which will operate in ambient temperatures between  $-10$  and  $+40$  °C, and features full overload protection, is intended to be regarded as a 'component' and

built into equipment, but may be used as a separate power supply if desired.—*Industrial Instruments Ltd., Stanley Road, Bromley, Kent.*

For further information circle 15 on Service Card

### 16. General-Purpose H.F. Receiver

A high-stability general-purpose h.f. receiver, type H2301, covering the frequency band from 500 kc/s to 30.5 Mc/s, is now available from Marconi. This compact receiver is suitable for reception of a.m., c.w. and s.s.b. signals, and with the addition of an adaptor it can be used with single-channel teleprinter circuits.

The frequency range is covered in thirty steps of 1 Mc/s with an overlap of 100 kc/s and the calibration accuracy is within 1 kc/s. The dial calibration is linear and presented in such a manner that the frequency is given by combining the readings on separate 'Mc/s' and 'kc/s' scales. Calibration can be checked at any time with a built-in 100-kc/s crystal oscillator.

Five positions of selectivity are available, two of which employ band-pass filters. An a.f. filter is fitted for selective c.w. reception. The receiver incorporates a built-in loudspeaker, and separate audio outputs are available with independent gain controls.

It is suitable for either rack or bench mounting and will operate from any normal a.c. mains supply.—*The Marconi Co. Ltd., Chelmsford, Essex.*

For further information circle 16 on Service Card

### 17. Telegraph Adaptor

Operation of teleprinters and high-speed data transmitters over military radio systems is provided for by a telegraph adaptor from The M.E.L. Equipment Co., which can be used with all British and many other standard military radio equipments. The adaptor converts d.c. impulses from a transmitting teleprinter or data sender into voice-frequency two-tone signals for frequency-shift radio transmission. It also accepts similar received signals and converts them back into d.c. impulses to drive a receiving teleprinter or data equipment.

Teleprinter signals of up to 100 bauds or data signals up to 750 bauds may be accommodated. Simplex and duplex operation over a.m., f.m., f.s.k. and s.s.b. radio systems is provided. There are, in addition, facilities for simultaneous a.m. speech and f.m. telegraphy. The unit can also be used for voice-frequency telegraphy over lines.

The adaptor is a compact rugged unit hermetically sealed in a metal case which requires no special mounting arrangements. Transistors are employed throughout and the built-in power pack operates from a 24-V battery. The type number is L.607 and dimensions are: height 7 in., width  $10\frac{1}{2}$  in. and depth  $14\frac{1}{2}$  in. An alternative model is available for a.c. mains operation.—*The M.E.L. Equipment Co. Ltd., Manor Royal, Crawley, Sussex.*

For further information circle 17 on Service Card

## INSTRUMENTATION

### 18. Continuous-Loop Recorder

A continuous-loop recorder/reproducer designed for data reduction or data monitoring and storage where machine work-load is heavy has been introduced by the Consolidated Electrodynamics Division of Bell & Howell. This instrument, designated the GL-2810, handles continuous magnetic-tape loops at any of six tape speeds from 60 in./sec down to  $1\frac{1}{2}$  in./sec. The tape transport accommodates  $\frac{1}{2}$  or 1 in. wide tape loops.

A high-mass closed-loop capstan drive provides high tape-speed

# NEW ELECTRONICS INSTRUMENTATION CONTROL

accuracy and low flutter and, in turn, low time-displacement error and high f.m. signal-to-noise ratio. Separate plug-in record and reproduce amplifiers of direct, f.m., or p.d.m. types provide a flexible system.

Applications include analysis of vibration and acoustic data recorded from structural tests, pressure transient recordings, and parameters with complex waveforms. The instrument can also be used for environmental testing and life testing of products requiring a complex analogue repetitive input function. — *Consolidated Electrodynamics Division, Bell & Howell Ltd., 14 Commercial Road, Woking, Surrey.*  
For further information circle 18 on Service Card

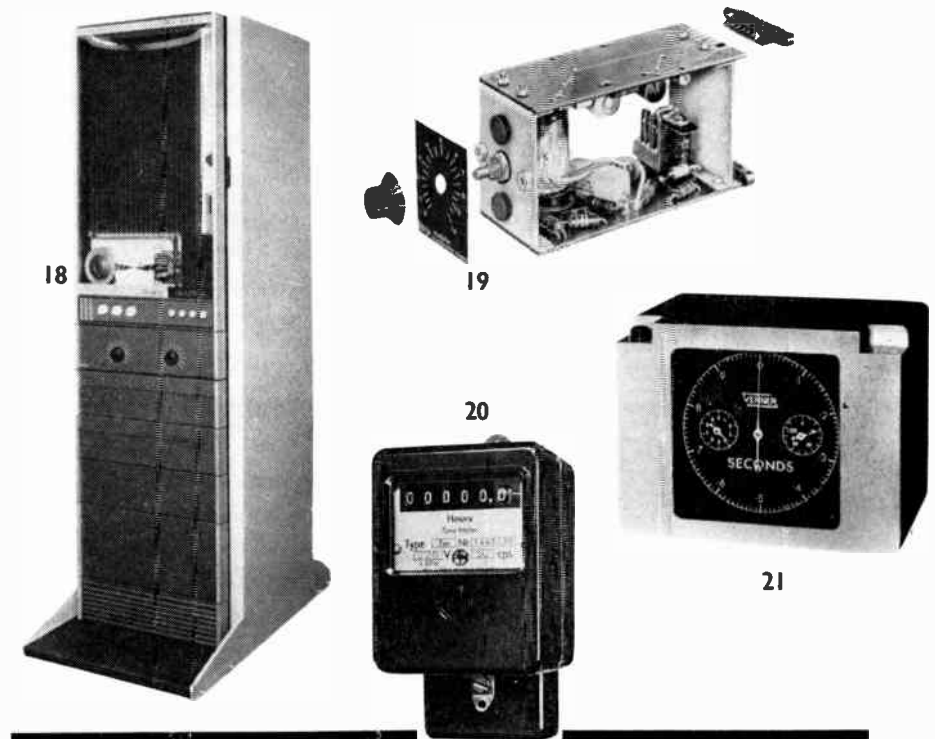

## 19. Modular Process Timer

Herga Electric have introduced a compact electronic timer primarily intended for back-of-panel mounting where small size, light weight and interchangeability are important. Printed-circuit construction is employed and voltage stabilization is incorporated to give a repetitive accuracy of  $\pm 1\%$  irrespective of normal mains variations. Various ranges up to 1 min are available.

Single-hole fixing is provided for mounting on panels up to  $\frac{1}{8}$  in. thick and two 4 B.A. tapped bushes, together with two rubber support pads, are provided for use with thicker panels. The relay has 250 V, 5 A, s.p.c.o. contacts.

Plug-in edge connections for the external wiring are provided to ease installation and to simplify removal and replacement for servicing. Timing is variable by a control knob and scale numbered 0–10. In the open form, as illustrated, the space taken on the back of the panel is 3 in. high  $\times$  2 in. wide with a projection of 5  $\frac{1}{2}$  in. to the rear. — *Herga Electric Ltd., Wallingford Road, Uxbridge, Middlesex.*

For further information circle 19 on Service Card

## 20. Hours-of-Work Meter

The LG ZYN hours-of-work meter, announced by Landis & Gyr, totalizes the actual working hours of machinery, vehicles, oil burners, electrical and electronic equipment. This information is often required for supervisory and control purposes, costing and periodic maintenance.

The standard model, complete in a dust-proof moulded case, provides

readings on a 6-digit register (one a decimal), and is fitted with synchronous motor for frequency-stabilized a.c. circuits of 220 V 50 c/s (permissible voltage fluctuation  $\pm 20\%$ ).

Variations are available for other voltages and frequencies, and also with alternative registers (e.g., 999.999 min). Versions with a front frame for flush mounting can also be supplied. — *Landis & Gyr Ltd., Victoria Road, Acton, London, W.3.*

For further information circle 20 on Service Card

## 21. Educational Stop Clock

An electrical stop clock introduced by Venner provides a new and accurate means of direct experiment for physics classes down to elementary level. It eliminates the processing of data necessary, for example, in experimental methods used to determine the acceleration due to gravity or to study accelerated motion by use of a trolley.

It is simple in operation and has electrical start/stop and electrical or manual re-set. It is synchronous motor-driven, operating from a 12-V 50-c/s a.c. supply. Contacts provide an output pulse every second, and a continuous outgoing supply of 12 V d.c. can also be obtained. The clock is as accurate as the supply frequency.

The main dial, with a diameter of 2  $\frac{1}{2}$  in., has white lettering on black

and is calibrated in 1/100 sec with a large sweep hand revolving once per sec. Two small hands revolve once in 10 sec and once in 150 sec, respectively; the 10-sec dial is calibrated in 1-sec divisions and the 150-sec dial in 10-sec divisions. All socket outlets and the manual re-set push-button are set below the top level of the shock-resisting case for ease of stacking in bulk. Measuring 4  $\frac{1}{2}$  in. wide  $\times$  3 in. deep  $\times$  3  $\frac{1}{8}$  in. high, this Venner stop clock costs £10 15s. — *Venner Ltd., Kingston By-Pass, New Malden, Surrey.*

For further information circle 21 on Service Card

## 22. Suspended Solids Recorder

Many attempts have been made to produce a satisfactory and economical method for the continuous measurement of turbidity; the Water Pollution Research Laboratory has had considerable success in the measurement of suspended solids in sewage effluents, by determining the ratio of transmitted to scattered light in a flow cell.

This system has been further developed by Southern Analytical and production has commenced of an instrument which is capable of measuring turbidity in the range 1–1,000 p.p.m. The measurement is independent of light source and photocell

(continued on page 93)

# SEAELECTOBOARD

## TWO-DECK WITH SHORTING PIN

The shorting pin passes through top deck into bottom deck, providing a direct path at the desired co-ordinate of X- and Y- axis. Any number of functional characteristics may be established by means of multiple insertions.

## TWO-DECK COMPONENT HOLDER

The Seaelectoboard Component Plug permits the positioning of any desired component at any point in the matrix. Diodes, resistors, pilot lights and capacitors can thus be introduced—just by plugging in!

## THREE-DECK WITH SKIP-PIN

Three-deck Seaelectoboard doubles the number of points without increasing panel area. Here we show a skip-pin connecting the top and bottom decks whilst missing the centre. Any deck may be isolated or all joined by means of the correct pin, and, of course, components can be introduced.

## FOUR-DECK WITH SKIP-PIN

Seaelectoboard can be supplied with any number of decks together with appropriate interconnecting pins for all requirements. Below we illustrate four decks with a two-pole skip-pin pairing the two top and two lower decks. In this manner circuitry sophistication can be increased and functions can be multiplied.

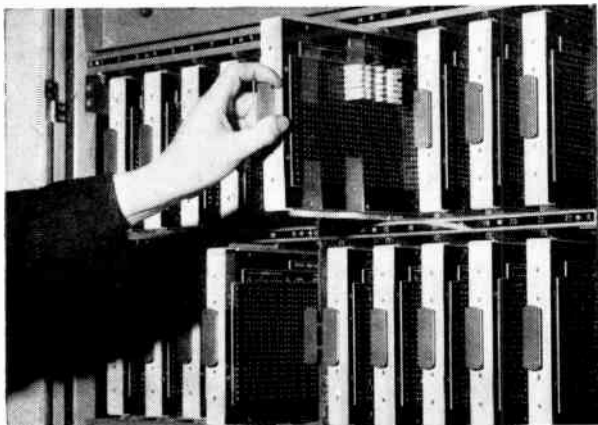
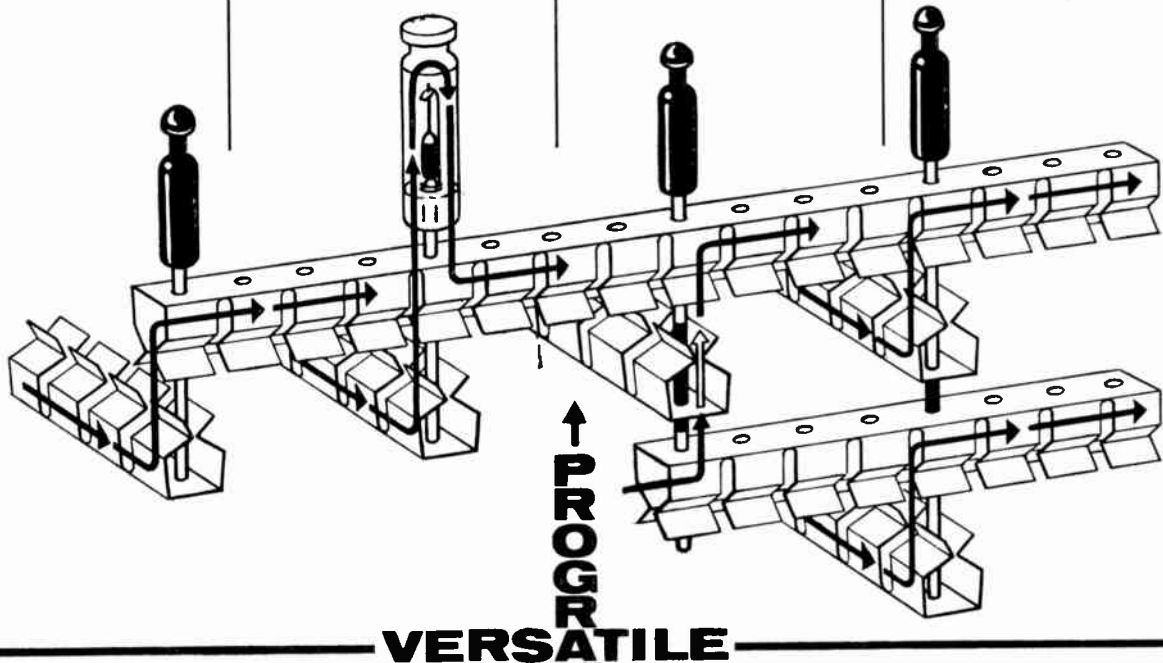

Seaelectoboard pinboard stores in the 1000-point Data Logger/Alarm Scanner manufactured by the Process Computing Division of Elliott-Automation for the O.E.E.C. 'Dragon' Reactor project at Winfreth Heath, Dorset. These stores hold details of alarm limits and operating details of monitoring points in the reactor.

Complete programming for multiple functions in systems, equipments, processes, bread-boarding and trouble-shooting readout centres. Replaces patchboards using bothersome plugs and jumper cords, costly multi-point switches and other expensive and less flexible designs for programming. Applications are practically unlimited. It is applicable and used in computers, signal or energy distribution networks, flight simulators, lighting systems for special effects, data loggers, telephone switching, machine tool control, telemetry systems, circuit test centres, process control, radar control, thermocouple and other transducer control centres, aircraft instrumentation programming, and a host of other industrial and military applications.

## SEAELECTRO LIMITED

Hersham Trading Estate · Walton-on-Thames · Surrey  
Telephone: Walton-on-Thames 26285



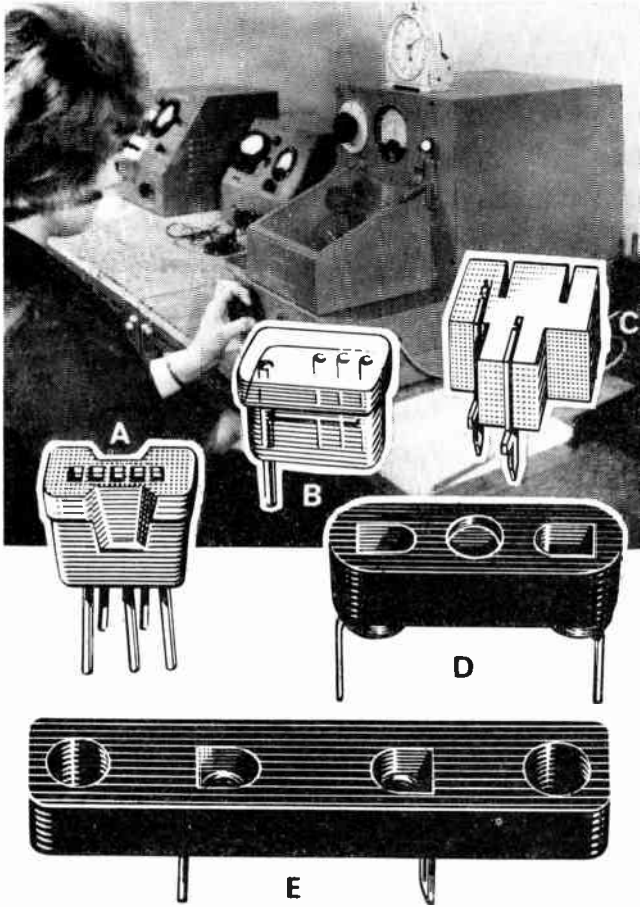

## Transistor Sockets

**McMurdo** make a range of sockets for subminiature valves and transistors a selection of which we illustrate.

(A) 5-lead subminiature XSM5C/US. Chassis mounting in punched hole secured with a clip. (B) Chassis Mounting Transistor Support TS1 Moulded in nylon. Snap-fit into chassis. (C) Printed Circuit Style Type TS4. For vertical mounting of 3 or 4-lead transistors on printed circuit. (D) TS2 & (E) TS3 Power Transistor Sockets. Designed for use with 2-lead power transistors in conjunction with normal heat sink.



**Inspection**  
The High Voltage  
Breakdown Test

# McMurdo

**McMurdo Instrument Co. Ltd.**

Rodney Rd., Portsmouth, Hants.  
Tel. Portsmouth 35555. Telex 8612.  
Contact our Sales Office for details of our full range

# G SODECO

## COUNTERS

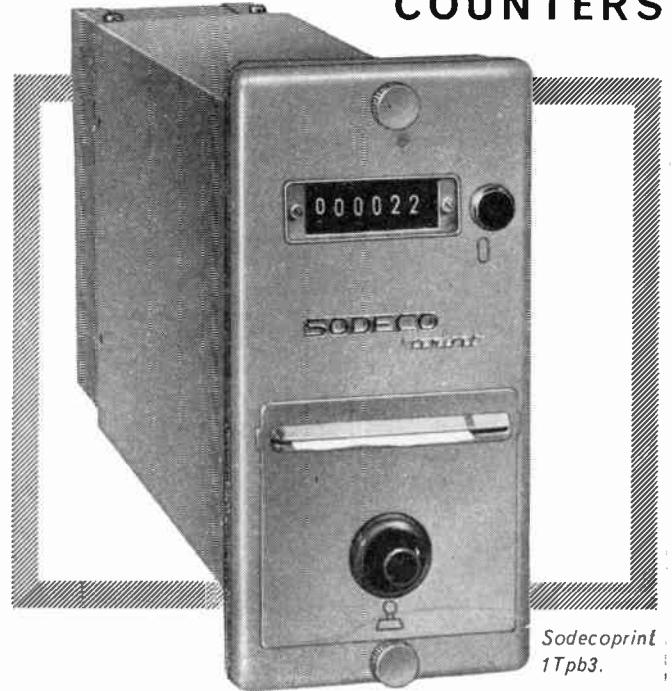

*Sodecprint*  
1Tp3.

## SODECO *print*

### IMPULSE COUNTERS . . .

. . . give direct reading of results on an indicating counter as well as printing them on a paper tape. They provide three functions: counting; printing, and resetting to zero. These can be controlled remotely, or by an automatic operating cycle, or by the push button provided on the instrument.

**The 1Tp3** is a decimal counter with six digits.

**The 1Tp4** is a time counter for hours, minutes, seconds and tenths of a second.

**The 1Tp7** is fitted with independent monodecade counting elements.

**The 1Tp8** is a date counter indicating either  
—days, months, hours, minutes  
—days, months, years, hours  
—days, hours, minutes.

It is possible to combine two of these in a single instrument.

# LANDIS & GYR

**LANDIS & GYR LIMITED**

Victoria Road . Acton . London W.3 . ACORN 5311

For further information circle 245 on Service Card

**ADCOLA**  
PRODUCTS LIMITED  
(Regd. Trade Mark)

**SOLDERING  
EQUIPMENT**

**SPECIALISING FOR THE  
SOLDERING JOINTING INDUSTRY**

**Illustrated**

$\frac{3}{16}$ " BIT INSTRUMENT  
(LIST 64)  
IN  
PROTECTIVE SHIELD  
(LIST 700)

ALL VOLT RANGES  
FROM  
6/7 TO 230/250 V

BRITISH & FOREIGN PATS.  
& REG. DESIGNS, ETC.

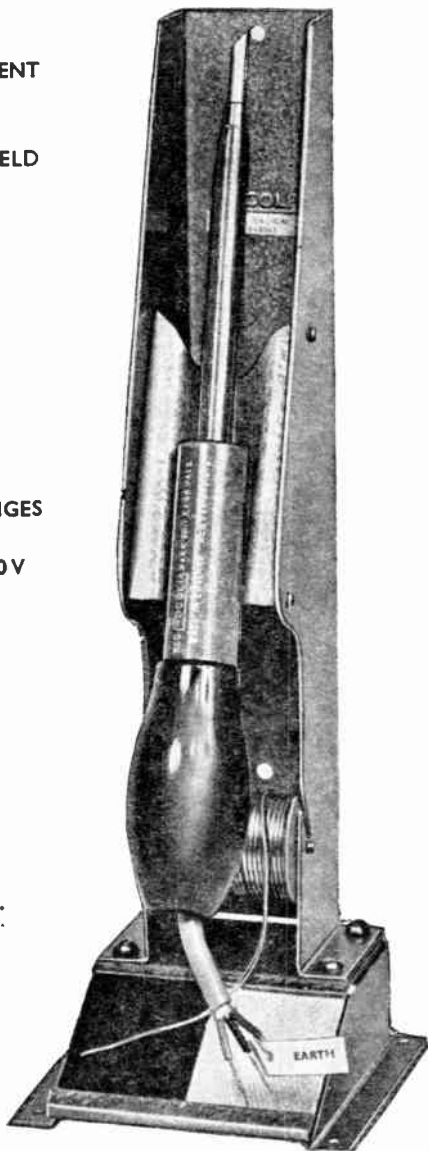

Apply Direct for Catalogues :

**ADCOLA PRODUCTS LTD.**

**ADCOLA HOUSE**

**GAUDEN ROAD**

**LONDON, S.W.4**

Telephones MACaulay 4272 and 3101

Telegrams SOLJOINT LONDON S.W.4

*Industrial Electronics February 1965*

F\*

37

# Let the

## INDUSTRIAL ELECTRONICS

### READER ENQUIRY SERVICE

# help you to obtain more information

To obtain further details of any of the coded items mentioned in the Editorial or Advertisement pages of this Issue, please complete one or more of the attached cards circling the appropriate reference number(s). Your enquiries will be passed on to the manufacturers concerned and you can expect to hear from them direct in due course. Cards posted from abroad require a stamp.

PLEASE USE CAPITAL LETTERS

Pour obtenir tous renseignements sur les produits codés mentionnés dans les articles ou dans les pages publicitaires de ce numéro, nous vous prions de remplir une ou plusieurs des cartes ci-jointes en encerclant le ou les numéros de référence appropriés. Vos demandes de renseignements seront transmises aux fabricants intéressés qui, en temps voulu, vous feront parvenir une réponse. Il est nécessaire d'affranchir les cartes postées de l'étranger.

PRIÈRE D'UTILISER DES CARACTÈRES D'IMPRIMERIE

Weitere Einzelheiten über irgendwelche Artikel, die auf redaktionellen oder Anzeigenseiten erscheinen, erhalten Sie, indem Sie eine oder mehrere der beigefügten Karten ausfüllen und die entsprechende(n) Kennnummer(n) einrahmen. Ihre Anfrage wird an den Hersteller weitergeleitet, und Sie werden dann direkt von ihm hören, Karten, die im Ausland aufgegeben werden, müssen frankiert werden.

BITTE IN BLOCKSCHRIFT AUSFÜLLEN

Per ulteriori particolari in merito agli articoli menzionati nel testo o nelle pagine pubblicitarie di questo numero, Vi preghiamo di completare una o più delle schede allegate chiudendo in un cerchietto il numero o i numeri di riferimento. La Vostra richiesta sarà inoltrata ai fabbricanti interessati che Vi risponderanno direttamente. Le schede dall'estero devono essere regolarmente affrancate.

SI PREGA DI COMPILARE LE SCHEDE A  
TAMPATELLO

Con objeto de obtener más detalles de cualquiera de los artículos mencionados en las páginas editoriales o de anuncios de este número, sírvase rellenar una o más de las unidas tarjetas poniendo un círculo al número o números de referencia. Sus consultas serán transmitidas a los fabricantes interesados de quienes tendrán noticias directamente a su debido tiempo. Las tarjetas enviadas desde el extranjero requieren franqueo.

SÍRVASE ESCRIBIR CON LETRAS MAYUSCULAS

# This is a combined transformer, rectifier and controller...just like the other six Dexion Slotted Angles.

**Transforming**—a mountain of small components into tidy, instant-selection, small part storage.

**Rectifying**—production line bottlenecks (Dexion conveyors—work stations—trolleys).

**Controlling**—for change. It's easier, quicker and cheaper with Dexion Slotted Angle . . . . adapt at the turn of a spanner.

And all 7 Dexion Slotted Angles are **Versatile**—tailor-made equipment need no longer be expensive.

**Flexible**—adjust or dismantle equipment at a moment's notice.

**Economic**—with 7 Angles to choose from you always get the right strength for a particular structure.

**But don't take our word for all this. You need facts, case histories, proof . . . .**

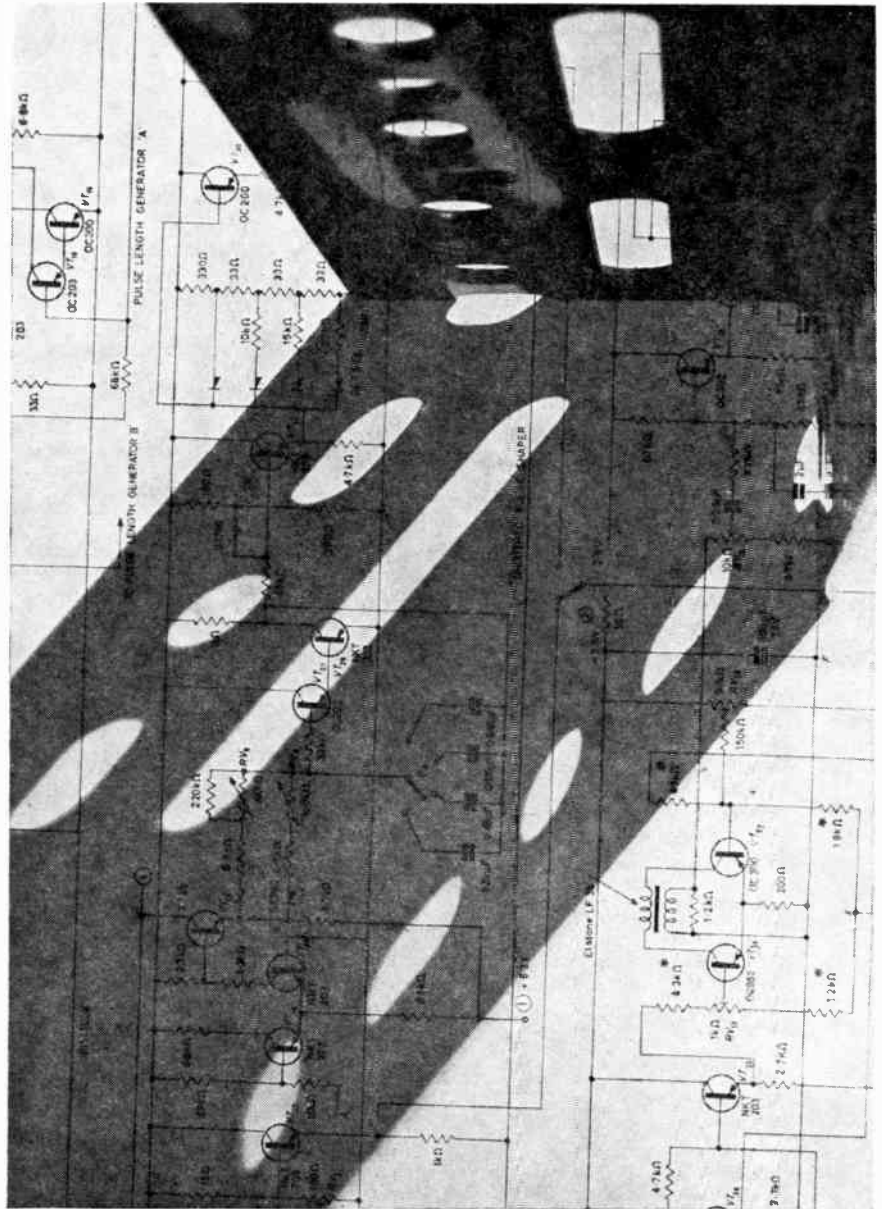

**Here are the Angles.**

The largest and most stringently tested range in the world.

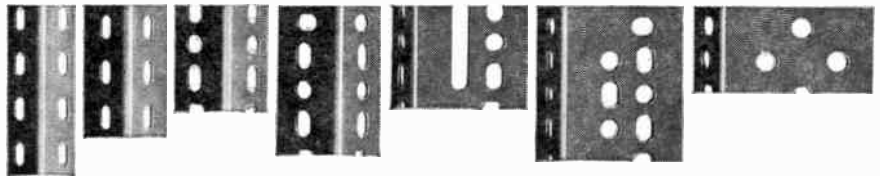

100 125 140 160 225 260 Steel Channel 345

And this fully illustrated literature isolates problem areas—offers solutions—and is free. *Clip the coupon and post it today.*

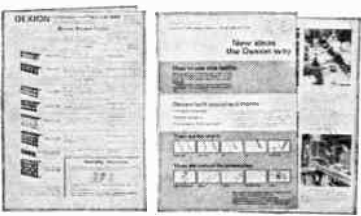

Name .....

Position.....

Company.....

Address.....

Phone.....

**Dexion Ltd**

Storage & Materials Handling Division,  
2/4 Empire Way, Wembley, Middlesex.  
Telephone: **WEMbley 1281**

B194/F



sensitivity and also of colour changes in the sample and of window fouling in the flow cell.

The A.1690 equipment is made in two separate parts; the flow cell and optical unit is completely weatherproof and the electronic unit may be mounted some distance away. Although basically developed for measurement in sewage and industrial effluents there are many possible applications in the field of industrial process control.—*Southern Analytical Ltd., Frimley Road, Camberley, Surrey.*

For further information circle 22 on Service Card

### 23. Pocket Probe Pyrometer

Budgen Instruments are now marketing the 'pocket probe indicating pyrometer', a miniature instrument complete with thermocouples which are permanently connected or may be plugged-in, according to the type chosen. In addition to the standard types listed, special versions can be supplied to order.

Models PW and AW, utilize a bead-type thermocouple on a lead 43 in. long designed for insertion into an oven or heated enclosure. Various tempera-

ture ranges are available of up to 600 °F or 320 °C. The complete instrument, including a probe, costs between £21 and £23, according to type.

Models MP and IP are supplied complete with a choice of thermocouples (surface probe, 1-in. or 2-in. needle probe or roller contact), each with a lead length of 24 in. These are designed for measuring the temperature of surfaces, fluids or semi-fluids, pipes or rollers. Several choices of temperature range are available up to 800 °F or 430 °C. The cost of this instrument, complete with one probe, is approximately £31.

Model MPSP incorporates a needle probe 12 in. long. It is available only in specific Fahrenheit or Centigrade ranges and costs about £32.—*Budgen Instruments Ltd., 25a Tangier Road, Guildford, Surrey.*

For further information circle 23 on Service Card

### 24. Pocket Sound-Level Meter

General Radio has added to its line of sound and vibration measuring instruments a transistorized sound-level meter that fits easily in one hand

## NEW ELECTRONICS INSTRUMENTATION CONTROL

and yet complies fully with international standards. The type 1565-A measures sound levels from 44 to 140 dB (ref. 0.0002 microbar). Weighting networks and both slow and fast meter responses are in accordance with ASA and IEC specifications.

The built-in microphone design and tapered cabinet configuration yield essentially non-directional response. Vibration pickups and other transducers can be connected in place of the microphone through an auxiliary adaptor, and a front-panel output jack is provided for connection to an analyser or recorder. One torch battery supplies power for 35 hours of use. The overall dimensions are 78 × 190 × 54 mm, and the instrument weighs 0.8 kgm.—*General Radio Company (U.K.) Ltd., Marlow Road, Bourne End, Bucks.*

For further information circle 24 on Service Card

### 25. Preset Batch Counter

A robust electronic preset batch counter has been introduced by Research Electronics. It counts the input signals and closes a relay momentarily upon attainment of the preset count, which may be set with four decade selector switches to any number from 1 to 9,999.

This instrument, the model 6202A, may be used for the control of production lines, hopper filling, flow control, counting objects on a belt and subsequent batching, process and machinery control, etc. Price £85.—*Research Electronics Ltd., Bradford Road, Cleckheaton, Yorks.*

For further information circle 25 on Service Card

## CONTROL

### 26. Thyristor Heating Control Systems

W. H. Sanders have established a comprehensive range of power amplifiers and trigger units to provide manufacturers of furnaces and industrial heating equipment with components for achieving more accurate control of temperature than is possible with conventional ON/OFF controllers. Use of a thyristor power amplifier with a proportional controller allows the current through the heating element to be

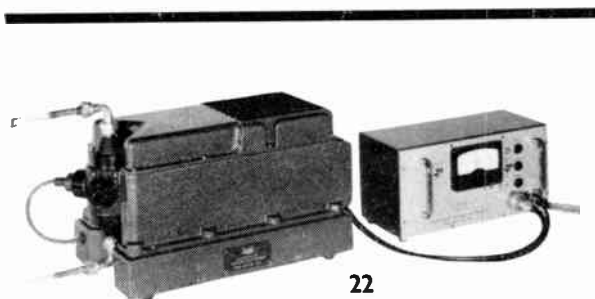

22



24

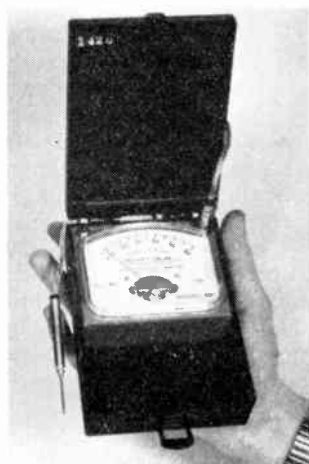

23



25

# NEW ELECTRONICS INSTRUMENTATION CONTROL

varied smoothly to maintain the temperature within very close limits. Contactors are not used in the system and a longer life, greater reliability, silent operation and the absence of excess current demands are advantages claimed.

With standard catalogue ratings up to 6 kW, and special designs for higher powers, this range of compact, fully-protected power amplifiers is suitable for controlling multi-zone diffusion furnaces and the heaters of injection moulders. When used with appropriate control gear, temperatures can be controlled to within  $\pm 0.1\%$  of the maximum temperature.

The thyristor switching elements are controlled by a choice of two trigger units which allow the amplifiers to be used in complex systems calling for a wide variety of input configurations. These amplifiers offer the facility of continuously switching 40 A in less than 0.15 sec from a control signal of 5 mA.—*W. H. Sanders (Electronics) Ltd., Gunnels Wood Road, Stevenage, Herts.*

For further information circle 26 on Service Card

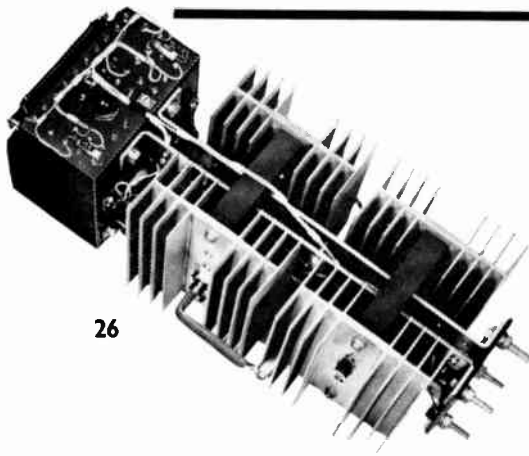

26

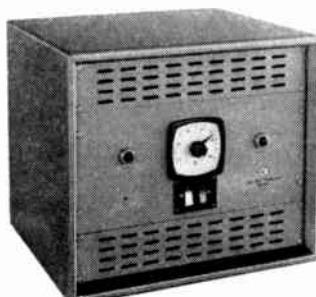

27

## 27. Furnace Control Systems

Kent Precision Electronics have produced a range of semiconductor temperature controls for electric furnace temperatures up to 2,000 °C with an accuracy of 0.5%. The systems consist of conventional temperature transducer elements which feed a signal proportional to temperature into a transistor d.c. amplifier. This input signal is compared with a stable and accurate reference signal, the magnitude of which is set as required on an indicating scale on the front of the instrument, and the error voltage is used to control the thyristor power output system to regulate the power delivered to the heating elements.

For low powers, proportional control of the output power is achieved by variation of the phase angle at which the thyristor circuit is fired during each half-cycle of the a.c. mains. For high powers, to overcome interference, surges and poor power factors, the thyristor circuit is switched on for integral half-cycles, proportional control being achieved by variation of the ratio of the number of ON and OFF cycles. In all cases proportional control is operational over approximately 3% of the scale.

For control of currents over 100 A, when thyristor control becomes uneconomical, standard low-power thy-

ristor output circuits may be used to control saturable reactor elements. The photograph shows a standard 10 kW proportional temperature control unit.

The instruments are available as panel or rack mounting units.—*Kent Precision Electronics Ltd., Vale Road, Tonbridge, Kent.*

For further information circle 27 on Service Card

## 28. Adjustable-Contact Thermometer

Fisons Scientific Apparatus have recently announced the introduction of a range of adjustable-contact thermometers which are particularly useful for controlling temperatures in ovens and constant-temperature baths. A novel feature is a 2-A 2-pin socket built into the head. A corresponding plug and 6 feet of twin-core flex is provided for connection to a suitable relay.

A tungsten contact wire protrudes into the capillary and its position may be raised or lowered, thus altering the temperature setting, by rotating the magnetic head at the top of the thermometer. Two locking screws are fitted to hold the temperature setting.

When used in conjunction with a relay and heating element, the thermometer operates by completing a circuit when the mercury reaches the tip of the tungsten contact wire. This operates the relay and so cuts out the heater. The temperature begins to fall, until the secondary circuit is broken again, thus cutting in the heater. The process repeats itself, and, with good stirring in the heating bath, temperatures can be controlled with a high degree of accuracy.—*Fisons Scientific Apparatus Ltd., Loughborough, Leicestershire.*

For further information circle 28 on Service Card



28

## 29. Delay Timer

Appliance Components have recently introduced a delay timer known as the series 55. This timer is designed primarily for use where relatively short cycling times are required, and it is adjustable so that the time interval can readily be changed to meet changes in requirements. Four different models are available with total times of 15, 30, 60 and 120 sec respectively, and each one is capable of adjustment to provide time intervals from the maximum down to 1 sec or less. A pointer moves across the scale to indicate the progress of the timer while it is running.

When power is applied to the timing motor it runs for the time preset on the dial. At the end of this time an electrically-separate changeover switch

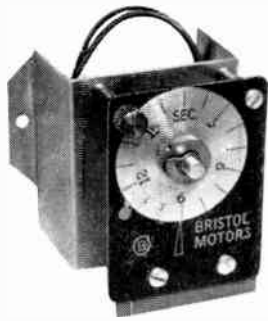

29

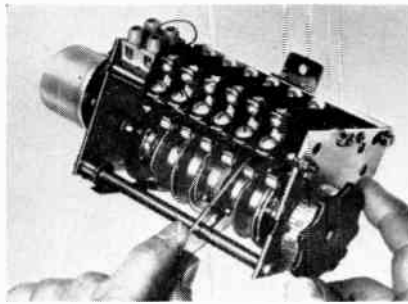

30

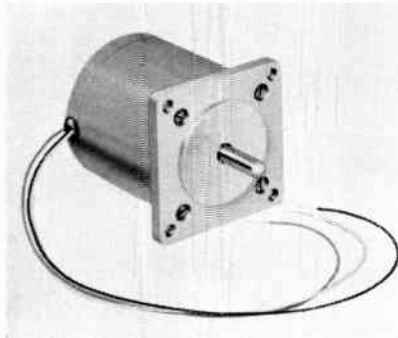

31

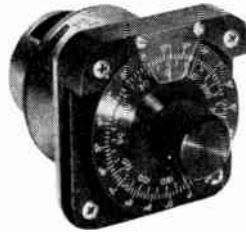

32

is operated to activate the external control circuit. The motor remains electrically stalled; it is rated continuously for this purpose. When the motor circuit is opened the timer resets and is then ready for the next cycle. The reset time is approximately 1 sec for the full stroke of the 15-sec timer and 8 sec for the 120-sec model, but these times are reduced when the setting is less than the maximum.—*Appliance Components Ltd., Martin Road, Cordwallis Industrial Estate, Maidenhead, Berks.*

For further information circle 29 on Service Card

### 30. Simplified Cam Timer

Easily adjustable multi-circuit timing programmes for industrial control systems are provided by the 'Rotaset' adjustable-cam timer which has been developed by Londex.

The setting up of motor-driven cam timers normally entails tedious adjustment of grub-screws. In the 'Rotaset', a graduated drum is operated in association with a setting key to set up programmes accurately, speedily and simply. The setting drum, calibrated in 60 divisions, is fixed to the end of the cam-shaft, thus serving to indicate the progress of the cycle as

well as providing a reference for setting the cams.

Three, six and nine-way models with standard cam-shaft speeds giving cycle times between 6 sec and 1 week are available, and alternative driving motors and additional gear assemblies enable units of an almost infinite variety of cycle times to be constructed.

Standard motors are suitable for 200/250 V 50 c/s, but other voltages and frequencies as well as certain d.c. ranges can be supplied if required. Typical switch contact ratings are: a.c., 5 A at 250 V or 2 A at 440 V; d.c. non-inductive, 3 A at 50 V or 0.25 A at 250 V.—*Londex Ltd., Anerley Works, 207 Anerley Road, London, S.E.20.*

For further information circle 30 on Service Card

### 31. D.C. Stepping and A.C. Synchronous Motors

The Superior Electric Co.'s products are now being distributed in the U.K. through Kempston Electrical. The products include the novel Slo-Syn motor and associated control equipment.

The Slo-Syn motor is both an a.c. synchronous motor and a d.c. stepping motor. As a stepping motor it

can be operated up to 600 steps per second with 1.8 degrees per step.

Motors are available in ratings from 25 in.-oz to 1,800 in.-oz. The motors are used in machine tool, process control, valve control and printing machine applications.—*Kempston Electrical Co. Ltd., 24 High Street, Kempston, Bedford.*

For further information circle 31 on Service Card

### 32. Precision Drive for Servos

Shortly to be manufactured in this country, these small dual speed drives are offered with two accuracies.

The DSD-7 (18:1) provides an angular setting to 0.2° with zero backlash up to 3 oz in. torque and has a 'coarse' inner scale, which is divided 0 to 360° in 10° increments, directly coupled to the component via a precision coupling. An outer scale divided 0 to 10° twice in 0.2° divisions is coupled by precision gearing of 18:1 ratio to the main drive. Both scales read out on a single vertical hairline.

The DSD-7 (36:1) provides an accuracy of 0.1°, the 'coarse' scale divided 0 to 360° in 10° steps, the fine outer scale divided 0 to 10° in 0.1° steps. Coupling is via a 36:1 ratio precision gear box.

Mounting of servo component is by means of an adaptor plate available for size 05, 08 and 11 synchro housings.

Both units utilize a 2¼-in. square mounting escutcheon.—*Bowmar Instrument Ltd., Sutherland Road, London, E.17.*

For further information circle 32 on Service Card

## PRODUCTION AIDS

### 33. Self-Tuning Ultrasonic Generator

A self-tuning ultrasonic generator, the type 1191B Soniclean Automatic, is now available from Dawe Instruments. It continuously maintains the resonant frequency of the transducers, whatever the tank loading, temperature and other operating conditions. The only control is a simple ON/OFF switch and warning light. The system is particularly suitable for cleaning large quantities of similar components using unskilled or semi-skilled labour, or for any situation where the cleaning system is to be left permanently switched on.

Because of the strains imposed by the permanent adjustment to resonance, the transducer employs lead zirconate titanate active elements. These type 1166 transducers are sup-

## NEW ELECTRONICS INSTRUMENTATION CONTROL

plied already fitted to the standard tanks, but are available separately. They have a high conversion efficiency and can operate at temperatures as high as 300 °F. Heated versions of the standard tanks are also available, with thermostatic control.

Pulses at the resonant frequency of the system (about 25 kc/s) are produced at a repetition rate of 100 pulses/sec, or twice mains frequency, obtained by full-wave rectification. Peak power output is 600 W (about 300 W average). The generator is fully transistorized, and supplied in a bench-mounting metal cabinet measuring 16 × 14 × 6½ in. high. Weight: 40 lb.—*Dawe Instruments Ltd., Western Avenue, Acton, London, W.3.*

For further information circle 33 on Service Card

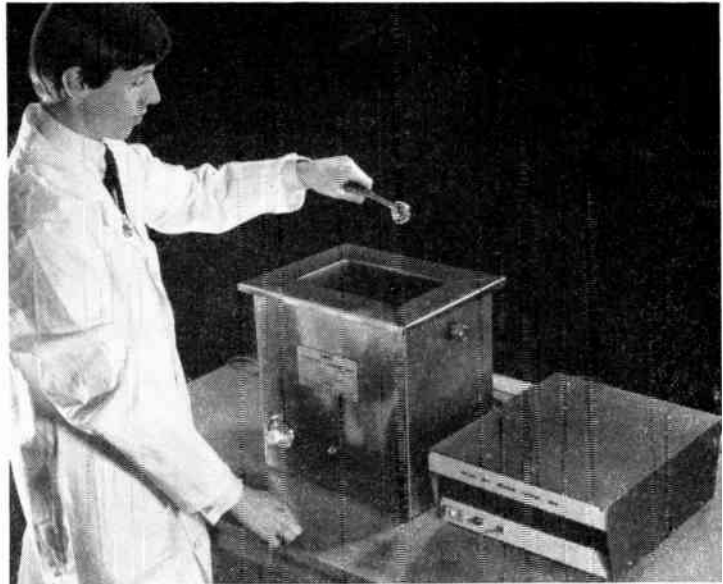

33

### 34. Microscope for Mask Alignment

Designed to facilitate the alignment of small photographic masks with images on photographic or photo-resist material, the Watson double microscope is especially suitable for the production of silicon planar transistors and elements for solid-state and micro-circuitry where the usual need is to align small contact-print masks with patterns produced during earlier stages of manufacture.

Whereas a conventional microscope will allow one point on the mask to be aligned in north-south and east-west directions, the double microscope permits the simultaneous alignment of two widely separated points. Such simultaneous alignment guarantees not only perfect north-south and east-west register, but also that the azimuth (rotation about a vertical axis) is automatically correct.

The separation between the two areas viewed is continuously variable so that alignment marks can be positioned conveniently in each field. The fields may be viewed either alternately or simultaneously by the operation of left and right foot switches. A range of magnifications is available to suit a variety of applications, and binocular viewing minimizes operator fatigue during prolonged use on the production line.—*W. Watson & Sons Ltd., Barnet, Herts.*

For further information circle 34 on Service Card

### 35. Environmental Test Chamber

Montford Instruments have announced the 19CO2 test chamber which has a range from -70 to +200 °C and

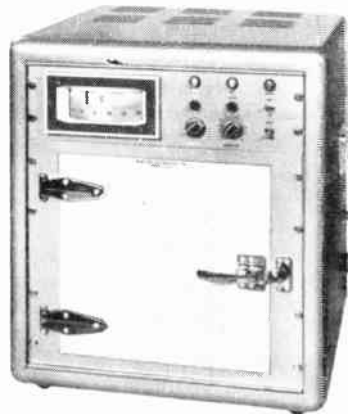

35

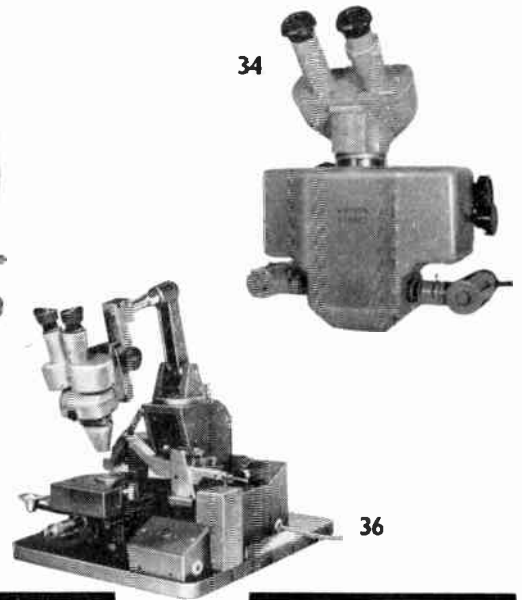

34

36

offers a rapid temperature change which can be controlled from the front panel. As well as variable rates of temperature change a manual/auto switch permits cycling between two preset temperatures or high stability at one temperature.

Programmes can be stopped or reversed at any desired time. Cooling employs CO<sub>2</sub> injection on to the heat exchanger being governed by an electrical timer. Heating is incorporated in the forced airflow circulation, eliminating hot spots and minimizing temperature gradients.

The chamber and control panel are of modular construction and are housed in standard-width racking

which can be extended to mount programme controllers, amplifiers and other associated equipment. Facilities for electrical connections into the test chamber are provided, making it suitable for the dynamic testing of components and equipment. — *Montford Instruments Ltd., 79 Lots Road, Chelsea, London, S.W.10.*

For further information circle 35 on Service Card

### 36. Laboratory Wafer Prober

An addition to their range of equipment for the semiconductor industry is announced by Vacwell Engineering. Called the laboratory wafer prober type PR.61, it is intended primarily for

the spot checking of transistor dice while still in the wafer form, but has other uses, particularly in micro-circuit work.

The instrument is bench-mounted and is normally supplied with two probe heads, although provision is made for fitting as many as four. They are raised and lowered on to the wafer by operation of a small hand-lever. A separate motorized inking probe, with push-button control, enables any faulty wafers to be marked in situ.

The specification of the PR.61, which can be readily coupled to a Vacwell semi-automatic 3-parameter transistor tester or other test equipment, includes a  $\times 50$  binocular microscope and provision for illumination of the work platform. The microscope attachment is arranged to swing clear of the platform while initial placing of the wafer is being carried out.—*Vacwell Engineering Co. Ltd., Willow Lane, Mitcham, Surrey.*

For further information circle 36 on Service Card

than  $2 \mu\text{A}$  after 3 min at  $25^\circ\text{C}$ . The illustration shows a sectional view of the capacitor.—*Plessey-U.K. Ltd., Dielectric and Magneto Division, Towcester, Northants.*

For further information circle 38 on Service Card

### 39. Magnetic Proximity Switch

The Magnaswitch type 610 proximity/limit switch has been introduced by Bon Automation to meet the industrial demand for proximity and limit switches requiring no physical contact actuation, yet being capable of switching reasonably high current loads.

The unit is actuated with exact position repeatability by the proximity of a permanent magnet to the sensing face on the switch. This magnet can be as small as  $\frac{1}{8}$  in. square by  $\frac{3}{8}$  in. long, the single-pole changeover contacts switching 7.5 A at 250 V a.c.

Overall dimensions are  $1.5 \times 1.7 \times 3.9$  in. with conduit entry provided.

The Magnaswitch 610 is available in the normal coil operating voltages up to 230 V a.c. or 200 V d.c., the coil consumption being not greater than 2.3 VA a.c. or 1.5 W d.c. The contacts have maximum voltage ratings of 440 V a.c. or 200 V d.c. The switch has an operating speed of up to 1,700 operations per min on a.c. or 1,000 operations per min on d.c.—*Bon Automation Ltd., Industrial Electronics Division, Arcade Chambers, Bognor Regis, Sussex.*

For further information circle 39 on Service Card

### 40. Improved Torque Transducers

The Saunders-Roe Division of Westland Aircraft has recently introduced a range of torque transducers featuring considerably reduced physical size,

## COMPONENTS

### 37. Vacuum Components

Torvac are fabricating vacuum components in stainless steel to meet customers' specific requirements. These include a range of bell jars and base plates for ultra-high vacuum work.

Standard sizes from 6 to 24 in. diameter are available, but these can be modified as required. The photograph shows a unit 12 in. in diameter by 15 in. long.—*Torvac Ltd., Histon, Cambridge.*

For further information circle 37 on Service Card



37

### 38. Non-Polar Tantalum Capacitors

A range of tantalum electrolytic capacitors, designated ANP, has been introduced by Plessey for applications requiring non-polar properties in the smallest possible space. Similar in appearance to the A and AHS 'Castanet' types, they make the small size and robust construction of the latter available in a non-polar form.

The ANP-series capacitors feature twin electrodes of sintered high-purity tantalum powder to give maximum surface area per unit volume, thus giving better power factors, lower noise levels and enhanced reliability.

Two case sizes,  $\frac{1}{4}$  in. and  $\frac{1}{8}$  in. deep, cover the capacitance/voltage range of 15–470  $\mu\text{F}$ , 3–75 V, at  $125^\circ\text{C}$ . Leakage current at rated voltage is not greater

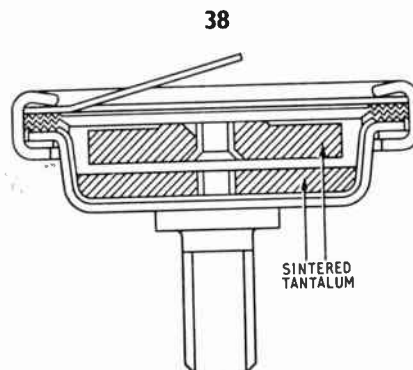

38

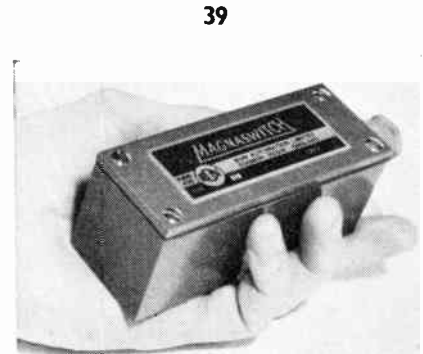

39

weight and cost. The type 2 mark 4 features both rotor and stator assemblies in one-piece moulded fibreglass construction. The total errors of the transducer due to linearity, hysteresis and repeatability are less than  $\pm 0.2\%$ .

Instrumentation is provided by the type TM6 indicator which gives two full-scale torque ranges from any one transducer. Apart from the direct Cirscale readout of the true mean torque, sockets are provided for the connection of ancillary recorders, oscilloscopes and other equipment. The accuracy of the true mean torque readout is unaffected by large cyclic variations of torque.

The system operates from zero speed to the maximum rating according to the size of the transducer, and has a very high frequency response for transient and cyclic investigations. The indicator may be powered either by a.c. mains or battery supplies, and the transducers are available in seventeen ratings varying from 0.5 lb ft up to 0.50,000 lb ft, and speeds from

0-8,000 r.p.m. down to 0-800 r.p.m.—*Westland Aircraft Ltd., Saunders-Roe Division, Electronics Department, East Cowes, Isle of Wight.*

For further information circle 40 on Service Card

#### 41. Squirrel-Cage Motors

British Brown-Boveri announce the introduction of the 'Compax' range of lightweight T.E.F.C. three-phase, squirrel-cage motors, of output from  $\frac{1}{2}$  to 10 h.p. and suitable for supply voltages of up to and including 500 V. The range consists of six standard frame sizes which are designed in accordance with I.E.C. recommendations as regards principal dimensions and ratings.

Frame, end shields and terminal boxes are die-cast in light aluminium alloy of high mechanical strength. The frame is cast with the stator pack incorporated in the casting operation, enabling a monobloc construction for strength and maximum heat transfer. All motors have class 'E' insulation.

The range includes foot, flange (illustrated), combined foot and flange, and pad-mounted motors, all of which are fitted with non-friction labyrinth seals to ensure constant proofing. All

models can be protected against overheating by the insertion at certain points of the winding of precision thermostats known as 'Stoptherms', which ensure that adequate and automatic cut-off or warning is given as soon as the temperature limit is exceeded.—*British Brown-Boveri Ltd., Glen House, Stag Place, London, S.W.1.*

For further information circle 41 on Service Card

#### 42. Miniature Bead Thermistors

A range of miniature bead thermistors recently announced by Mullard are more robust, have improved electrical stability and will work at a higher temperature than types previously available.

Four basic types are being offered, with resistance values (at 25 °C) ranging from 1 k $\Omega$  to 470 k $\Omega$ . These consist of a basic encapsulated bead (VA3100 range) in three different mounting configurations: double-ended glass-encapsulated (VA3200 range), glass-dipped (VA3400 range), and 'thermometer-type' mounting (VA3700 range).

Overall dimensions (excluding leads) are as follows: VA3100, 0.6 mm diameter bead; VA3200, 10 mm long  $\times$  2 mm diameter; VA3400, 1.5 mm diameter bead; VA3700, 32 mm long  $\times$  2.5 mm diameter. The picture shows (from top to bottom) types VA3100, VA3400, VA3700 and VA3200. — *Mullard Ltd., Mullard House, Torrington Place, London, W.C.1.*

For further information circle 42 on Service Card

#### 43. Rotary Switch Valve

Drallim have introduced a rotary switch valve which allows two double-acting pneumatic cylinders to be controlled either in phase or in anti-phase.

Designated the series 8000, the valve is fitted with a special connector in each port which allows exhaust air from the inactive side of the piston to vent to atmosphere without entering the valve body. Thus a simple four-port valve can completely control both ends of two cylinders. Multi-bank valves are also available.

As in standard rotary switch valves, air from a permanently-open base connection enters the body and from there is distributed through peripheral ports opened in turn by rotation of the spindle. The new model incorporates special hollow stems, giving about 60% greater flow, thus allowing very fast cylinder operation if required.—*Drallim Industries Ltd., Bourne Works, Station Approach, Whyteleafe, Surrey.*

For further information circle 43 on Service Card



40

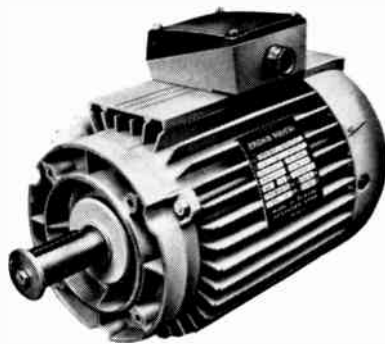

41



42



43

## COMPLETE INSTRUMENTATION SYSTEMS

# NEW

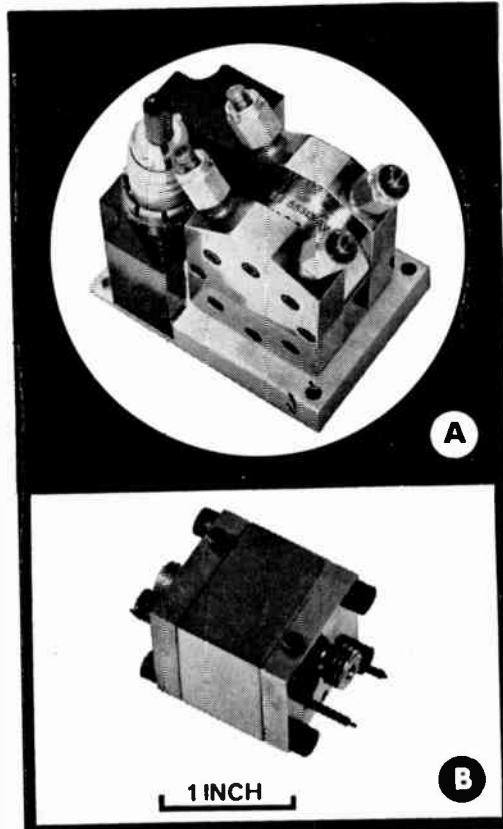
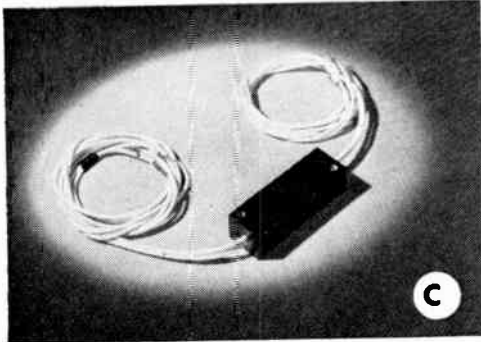

- A** SE 30—DC-AC-DC Pressure transducer system requires D.C. voltage input, to provide an output voltage proportional to pressure.
- B** SE 71—Miniaturised pressure transducer for high temperature (220°C MAX 300°C for 5 mins) and corrosive application.
- C** SE 62—Oscillator/Demodulator encapsulated unit for use with variable reluctance transducer. Operates up to 80°C in local or remote operation.

# S.E. offers a wide range of instruments



**S E LABORATORIES | ENGINEERING | LTD**

A subsidiary of S.E. Laboratories (Holdings) Ltd.

606 North Feltham Trading Estate, Feltham, Middlesex. Telephone: Feltham 5876



**REMOTE MEASUREMENT**  
 pressure vibration torque transducer level temperature displacement

Let's examine the problem — measuring physical parameters and transmitting the information over long distances.

Solartron have been making transducers for many years and have accumulated a wealth of practical application experience.

Whether for recording data in plant or research establishments, for monitoring and controlling continuous process plant, or for transmitting precise information great distances, there is probably a Solartron Transducer to suit your requirements.

Typical applications include instrumentation of high speed aircraft and missiles, marine, nuclear, chemical and plastic plant monitoring and research.

If you feel you have a remote measurement transducer problem which might benefit by applying Solartron Transducers, our specialists, who have wide application experience, will be pleased to help you with your enquiries.

# SOLARTRON

For—

Data Systems · Transducers · Computers

Military Systems · Electronic Instrumentation

**THE SOLARTRON ELECTRONIC GROUP LIMITED**

Victoria Road · Farnborough · Hants

Telephone · Farnborough · (Hants) 3000

Telex · 85245 Solartron Fnbro

Cables · Solartron · Farnborough

**A MEMBER OF THE SCHLUMBERGER GROUP**



# The Phase-Advance Network and Compensation Procedures

By N. G. MEADOWS, B.Sc., A.M.I.E.E.\*

THE phase-advance network shown in Fig. 1 is widely used for the series compensation of d.c. control systems. The network transfer function, assuming zero source impedance and load admittance, is

$$\frac{e_0}{e_1} = A \frac{1 + sT}{1 + sAT} \dots\dots\dots(1)$$

where  $A = \frac{R_1}{R + R_1}$  and  $T = CR$ .

The approximate proportional plus derivative action can be seen by writing eqn. (1) as

$$e_0 = \frac{A}{1 + sAT} [e_1 + Tse_1]$$

necessitating  $A$ , small. Typically values of  $A$  from 1/20 to 1/5 are used.

For the series compensation of a system with open-loop transfer function  $KF(s)$  the compensated transfer function should be

$$C(s) = \frac{K}{A} \frac{s + 1/T}{s + 1/AT} F(s)$$

A pre-amplifier of gain  $1/A$  may be used to offset the d.c. attenuation  $A$  of the network and to buffer the network from the preceding stage, as shown in Fig. 2.

### Frequency Response

From eqn. (1), with  $s = j\omega$ , and  $a = 1/T$

$$\frac{e_0}{e_1} = \frac{a + j\omega}{a/A + j\omega} \dots\dots\dots(2)$$

$$\left| \frac{e_0}{e_1} \right| = \left[ \frac{a^2 + \omega^2}{(a/A)^2 + \omega^2} \right]^{\frac{1}{2}} \dots\dots\dots(3)$$

and

$$\angle \frac{e_0}{e_1} = \phi = \tan^{-1} \frac{\omega}{a} - \tan^{-1} \frac{\omega A}{a} \dots\dots\dots(4)$$

Writing  $e_0/e_1 = x + jy$  in eqn. (2) gives, on equating real and imaginary parts and eliminating  $\omega$ ,

$$\left[ x - \frac{1+A}{2} \right]^2 + y^2 = \left( \frac{1-A}{2} \right)^2 \dots\dots\dots(5)$$

The frequency-response locus, based on this equation, is a leading semicircle for positive  $\omega$ , as shown in Fig. 3.

Here  $|OQ| = \frac{1+A}{2}$ ,  $|PQ| = |QS| = \frac{1-A}{2}$  (radius) and

$|OS| = \sqrt{A}$ , where  $OT$  is the tangent to the locus giving maximum phase advance  $\phi_m$  at frequency  $\omega_m$ . For these,

$$\begin{aligned} \omega_m &= \frac{1}{T\sqrt{A}} \text{ and } \phi_m = \tan^{-1} \frac{1}{\sqrt{A}} - \tan^{-1} \sqrt{A} \\ &= \tan^{-1} \frac{1-A}{2\sqrt{A}} \end{aligned}$$

The breakpoint frequencies for the network are  $\omega_1 = \frac{1}{T}$  and

$\omega_2 = \frac{1}{AT}$ .  $\therefore \omega_m = \frac{1}{\sqrt{\omega_1\omega_2}}$ , the geometric mean of these frequencies.

\*Battersea College of Technology.

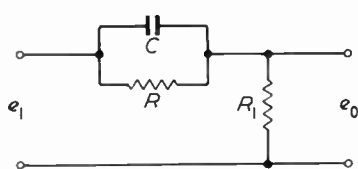

Fig. 1 (Left). Phase advance network

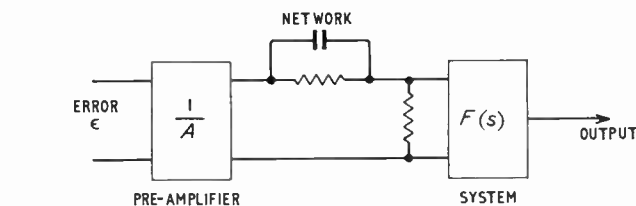

Fig. 2 (Below). Compensation scheme

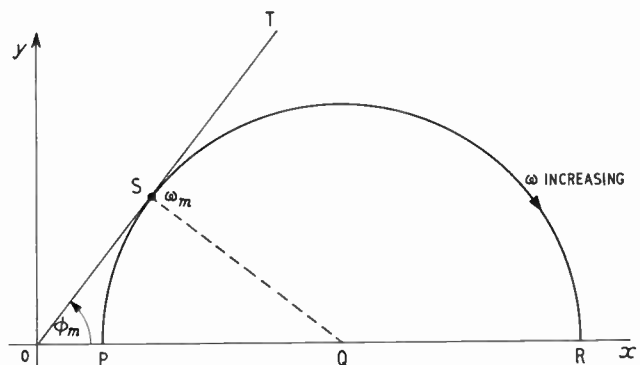

Fig. 3. Frequency response locus

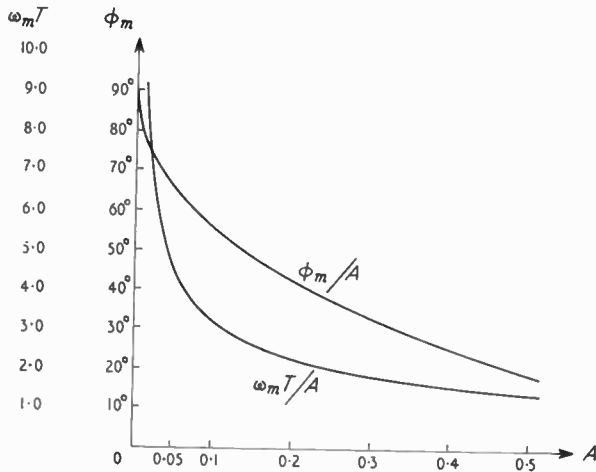

Fig. 4. Graphs showing variation of  $\phi_m$  and  $\omega_m$  with  $A$

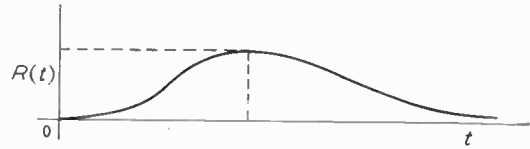

Fig. 5. Impulse response

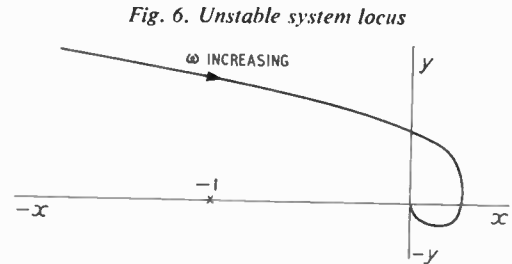

Fig. 6. Unstable system locus

In non-dimensional form, from eqn. (2),  $\frac{e_0}{e_1} = \frac{1 + jZ}{1/A + jZ}$ , where  $Z = \omega/a = \omega T$  is a non-dimensional frequency. Graphs showing the variation of  $\omega_m T$  and  $\phi_m$  against  $A$  are given as Fig. 4.

### Pole-Zero Cancellation Compensation

This compensation technique enables a pole near the origin to be cancelled and replaced by one farther out; i.e., a long time-constant term is replaced by a shorter one.

**Example**—A system with uncompensated transfer function

$$F(s) = \frac{\omega_n^2}{s(s + 2\zeta\omega_n)}$$

can be modified to

$$C(s) = \frac{\omega_n^2/A}{s(s + 2\zeta\omega_n)} \frac{s + a}{s + a/A}$$

using a phase-advance network and additional amplification  $1/A$ .

If  $a = 2\zeta\omega_n$  then

$$C(s) = \frac{\omega_n^2/A}{s(s + 2\zeta\omega_n/A)}$$

The new natural frequency is  $\omega_n\delta/A$ , giving a bandwidth increase of  $1/A$  (as  $A < 1$ ). For loop closure giving the

closed-loop transfer function  $\frac{R}{C} = \frac{C(s)}{1 + C(s)}$ , the unit impulse

response is

$$R(t) = \frac{\delta\omega_n}{\sqrt{A - \zeta^2}} e^{-t\zeta\omega_n/A} \sin \omega_n \sqrt{\frac{1}{A} \left(1 - \frac{\zeta^2}{A}\right)} t$$

for  $A < \zeta^2$ . If  $A = \zeta^2$  the system is critically damped and

$$R(t) = \frac{\omega_n^2}{\zeta^2} t e^{-t\omega_n/\zeta}.$$

This has the maximum value  $R(t)_{max} = \frac{\omega_n}{\zeta e}$  at time  $t = \frac{\zeta}{\omega_n}$  (Fig. 5). For the uncompensated system,

$$R(t) = \frac{\omega_n}{\sqrt{1 - \zeta^2}} e^{-\zeta\omega_n t} \sin \omega_n t \sqrt{1 - \zeta^2} \text{ for } \zeta < 1$$

and  $R(t) = \omega_n^2 t e^{-\omega_n t}$  for  $\zeta = 1$ , with a maximum value of  $\omega_n/e$  at time  $t = \frac{1}{\omega_n}$

### Type 2 Systems

$$\text{If } F(s) = \frac{K}{s^2 P(s)},$$

where  $P(s)$  is a polynomial having all powers of  $s$  present and all of the same sign, the system is closed-loop unstable. A Nyquist diagram for  $P(s) = s^3 + as^2 + bs + c$  is shown in Fig. 6 and typifies unstable conditions as the  $-1$  point is on the right of the diagram for increasing  $\omega$ . Phase-advance compensation may produce a curve as in Fig. 7 where the  $-1$  point is on the left, giving closed-loop stability.

**Example**

$$F(s) = \frac{K}{s^2(s + 1)} \text{ with } C(s) = \frac{(K/A)(s + a)}{s^2(s + 1)(s + a/A)}$$

Here pole-zero cancellation cannot be applied.

Selecting  $A = 0.1$  gives the characteristic equation

$$s^4 + (10a + 1)s^3 + 10as^2 + 10Ks + 10Ka = 0$$

The application of Routh's criterion gives  $K < 10a(0.9 - a)$  ( $0.1 + a$ ) for closed-loop stability, necessitating  $a < 0.9$  as  $K$  positive. Replacing the inequality sign by an equality and

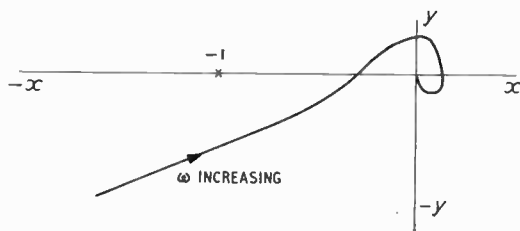

Fig. 7. Locus for stable system

determining  $\frac{dK}{da} = 0$  for the turning points gives  $a = 0.585$  for a maximum gain of  $K_{max} = 1.26$ .

With  $A = 1/20$ ,  $a = 0.625$  and  $K_{max} = 2.74$ .

### Conclusion

Phase-advance can be achieved only at the expense of gain reduction at d.c. by the factor  $A$ , which should be offset by a loop-gain increase of  $1/A$ . Practical limits are set by the enhancement of noise effects in the error channel due to the high-pass action of the network.

Design procedures using Bode plots, Nyquist diagrams, Nichols' charts or root-locus techniques are essentially

trial and error methods. Pole-zero cancellation methods are easy to apply but may not yield the best response. Manipulations using Routh's criterion can serve as a general guide to an appropriate selection for values of  $a$  and  $A$ .

### Errata

In the article in the January issue  $x/y$  should be substituted for  $y/x$  wherever it occurs on p. 45.

On p. 46, substitute  $y$  for  $y_2$  and  $y_1$  in equations (8) and (10). In equation (11) read  $\cot \alpha$ , for  $\tan \alpha$ , and equation (12) should read

$$K = \frac{\omega_2}{\omega_1} (\omega_3^2 - \omega_2^2) y \frac{y_2}{x_2}$$

## G.P.O. Tries P.C.M. Telephone System

An electronic way of increasing the number of speech paths between telephone exchanges without digging up the streets to lay new cables is being tried out by the G.P.O. in Britain. Clearer calls, speedier connections and fewer 'busy' signals are some of the benefits claimed for the new system.

Known as pulse-code modulation (p.c.m.) and invented in 1937 by A. H. Reeves of Standard Telecommunication Laboratories, the technique has only recently become economic with the advent of low-cost transistors. It is being adopted on a substantial scale in the United States.

Equipment built by STC is being tested on a cable route between Guildford and Haslemere in Surrey. The present design is based on the successful equipment which was operated for a trial period in 1960 between the Norte and Delicias exchanges in Madrid.

The p.c.m. 'local area' system is designed for use over junction cables of 10-25 miles length between exchanges. The equipment provides 23 speech circuits on four wires in

the cable with one pair carrying the 'go' channels and the other the 'return' channels. Normally a single pair carries only one two-way circuit. The factor of improvement is thus  $11\frac{1}{2}$  to 1, but since it is not expected that all wires in a cable will prove suitable for p.c.m., a ten-fold circuit increase is more likely.

Speech from each of 23 subscribers is sampled sequentially 8,000 times per second. Each sample is then 'measured' against a 125-level scale and a coded pulse train produced corresponding to the level of each sample. This information is transmitted along the line in the form of pulses at the rate of  $1\frac{1}{4}$  million per second. A 24th channel is used for synchronization of the system.

The pulses are regenerated every 2,000 yards along the cable by transistorized repeaters housed in metal cases placed in manholes. This repeater spacing permits the use of existing loading-coil manholes. Power to operate the repeaters is fed along the telephone cable from the terminal station.

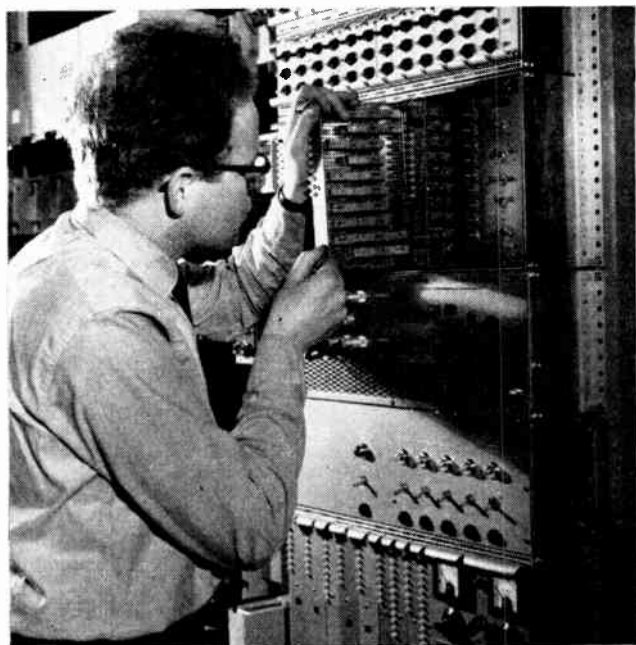

*This single terminal rack at Haslemere contains all the equipment for two self-contained 23-circuit telephone terminals. The picture illustrates the plug-in module construction*



*A p.c.m. repeater in a loading-coil manhole. When fully equipped this framework will hold regenerators for 24 complete systems, each of 23 two-way circuits*



## Personal News

With the Prime Minister's approval, the Minister of Technology proposes to appoint **Dr. B. K. Blount, C.B.**, at present deputy secretary in the Department of Scientific and Industrial Research, to be deputy secretary in the Ministry of Technology when the D.S.I.R. is dissolved. In the meantime Dr. Blount will be particularly concerned with those functions of D.S.I.R. which will become the responsibility of the Ministry of Technology.

**J. I. Bernard, B.Sc.Tech.(Hons.), M.I.E.E., M.I.H.V.E.**, director and secretary of the Electrical Development Association has retired. He has been succeeded by **R. H. Phillips, T.D.**

The B.B.C. announces the appointment of **H. Henderson, B.Sc.(Hons.), A.Inst.P., A.M.I.E.E.**, as head of the Engineering Training Department in succession to **A. E. Robertson, B.Sc.(Eng.), A.M.I.E.E.**, who is retiring in April.

The Council of the Scientific Instrument Manufacturers' Association has confirmed the appointment of **Frank Donald Outridge** as director.

The Marconi Company announces the retirement of **B. N. MacLarty, O.B.E., M.I.E.E.**, who first joined the company in 1921 and who has been closely associated with many of the major developments in broadcasting for the past 43 years. For the last two years he has held the position of engineering consultant to the company.

**D. H. W. Busby** has been appointed manager of the **Mullard Service Department** in succession to **F. E. Debenham** who has retired.

**A. V. Cottam** has been appointed manager information services of **Rank-Bush Murphy**. He will be responsible for providing an information service for **Bush Radio and Murphy Radio**, as well as for all **Rank-Bush Murphy** activities in electronics, medical equipment, nucleonics, controls and telecommunications.

**J. C. Gladman** has been appointed technical manager of the Public Exchange Division of **G.E.C. (Telecommunications) Ltd.**

Three managing directors of subsidiary companies in the **G.E.C. Group** have been appointed associate directors of the main G.E.C. board. They are **J. Ayres, of G.E.C. (Telecommunications) Ltd.**, **R. J. Clayton, of G.E.C. (Electronics) Ltd.**, and **T. C. Standeven, of Radio & Allied (Holdings) Ltd.**

The Council of The Television Society announce that **F. N. Sutherland**, deputy chairman and managing director of The Marconi Co. Ltd., has become the new president of the Society.

Two appointments have been announced by the **A.E.I. Power Group** at Trafford Park, Manchester: **M. N. John, B.Sc., A.M.I.E.E.**, has been appointed chief engineer, **A.E.I. Systems Engineering Department**, and **Dr. C. B. Cooper, Ph.D., B.Sc., A.M.I.E.E.**, has been appointed engineer-in-charge of a.c. studies in the power systems unit of the same department.

**Metal Industries Ltd.** announce the appointment of **A. I. Mackenzie** as chairman.

**The Hymatic Engineering Co. Ltd.** have appointed **D. M. E. Rawling, B.Sc.**, as senior quality engineer. He will be responsible for the inspection and testing of components and assemblies manufactured by Hymatic's Aircraft and Allied Division, as well as for product type approval.

## New Year Honours

### C.B.E.

Instructor Rear Admiral **Charles Roy Darlington** (Director, Naval Education Service).

**Richard D'Arcy Marriott, D.F.C.** (Assistant Director of Sound Broadcasting, B.B.C.).

**Francis John Enoch Tearle** (Managing Director, A.E.I. (Overseas) Ltd.).

### O.B.E.

**Cyril Leslie Page** (Assistant Controller, Television Administration, B.B.C.).

**William John Edward Tobin** (Staff Engineer, G.P.O.).

### M.B.E.

**Stanley Gwalter Bishop** (Senior Experimental Officer, S.R.D.E.).

**Victor James Cox, B.E.M.** (Chief

Development Engineer, Aviation Division, Ekco Electronics Ltd.).

**Walter Hogg** (Production Supervisor, Sperry Gyroscope Co. Ltd.).

**Frederick James Frank Properjohns** (Engineer II, Electrical Inspection Division, M. of A.).

**Arthur Edward Robertson** (Head of Engineering Training, B.B.C.).

**John Conway Walling** (Senior Physicist, Mullard Research Laboratories).

**Arthur James Woodward** (Works Manager, Electronics Division, Ferranti Ltd.).

### B.E.M.

**Ronald Charles James** (Laboratory Mechanic, Radio Research Station, D.S.I.R.).

**Alexander William Morgan** (Foreman, G.E.C. (Telecommunications) Ltd.).

**Aircraft Marine Products (G.B.) Ltd.** have appointed **R. W. Buffham** as senior sales engineer, in the Company's Consumer Products Division, with particular responsibility for industries in the north of England.

**Keyswitch Relays Ltd.** has appointed **Peter A. Stocken** as overseas sales manager. He will have special additional responsibilities for marketing and publicity policy both abroad and in the U.K.

**Michael Hare** has been appointed data processing manager of **Brookhirst Igranic**.

**Derek E. Morris, Grad.I.E.E.**, has been appointed publicity manager of **The M.E.L. Equipment Co. Ltd.** and its associated company, **Philips Welding Ltd.**

**Parmeko Ltd.** announce the appointment of **D. A. Pilly**, as equipment sales executive.

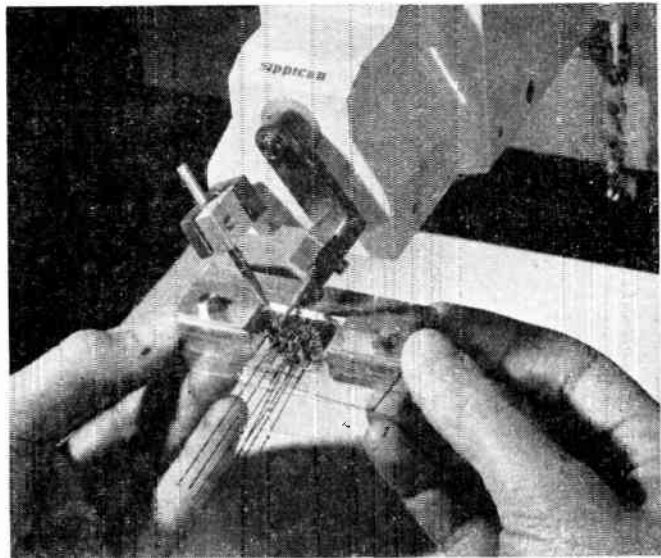

**ELECTRONICS FOR UK.3 SATELLITE**—G.E.C. (Electronics) has been appointed the main contractor for the electronic equipment aboard UK.3 which will be the first satellite to be completely manufactured in Britain. The Ministry of Aviation has awarded to the G.E.C. Applied Electronics Laboratories, Portsmouth, contracts for the provision of all the electronic equipment except that incorporated in the scientific experiments: this includes the data-handling system for the experiments data and for satellite performance parameters, the telemetry transmitter and telecommand receiver, and the power control and regulation equipment. The technique adopted for the majority of the G.E.C. equipment employs circuit modules consisting of a cordwood assembly of components. Interconnections are made by welding a crossed-wire matrix supported on a film produced by precision copying cameras. The film serves not only as a guide to the weld operator but also forms the insulating medium. The photographs, taken at Portsmouth, show (left) completed matrices undergoing inspection and (right) a module assembly being welded.

**British Insulated Callender's Cables Ltd.** announce that A. E. Wernly, O.B.E., M.A., has been appointed general manager of the Export Division.

J. W. Hatch has been appointed a director of **The Chloride Electrical Storage Co. Ltd.**

### Obituaries

Charles Samuel Franklin died on 10th December 1964. Born in 1879, Franklin joined The Marconi Co. in 1899 and was concerned with introducing wireless into warfare during the Boer War. In 1902 he sailed with Marconi across the Atlantic to conduct experiments in wireless reception at sea, signals from Poldhu being received at ranges up to 1,500 miles.

He retired from The Marconi Co. in 1939, but retained a connection as Research Consultant.

J. H. Owen Harries died on 8th January 1965 in Bermuda. He was at one time a contributor to *Wireless Engineer* and carried out much original work on valve development. He produced (1936) an early tetrode which avoided secondary-emission effects by using a large but critical spacing between the screen-grid and the anode. Of recent years he was acting as a consulting engineer in Bermuda.

### Company News

The London training centre of **English Electric-Leo-Marconi Computers Ltd.** has moved into new accommodation at Radley House, 35-39 South Ealing Road, London, W.5. The new centre has twelve lecture rooms, back projectors for films and slides and a computer simulator on which students will be able to practice operating techniques.

**SASCO** (Stewart Aeronautical Supply Company) have opened a holding branch office and stores at Hitchin, Herts. This branch facility is the first of a series of about eight which will be set up throughout the country during 1965/66.

**Diamond Power Speciality Ltd.** and **Babcock & Wilcox Ltd.** announce that Diamond have purchased the former Dewrance factory at Dumbarton, Scotland.

The **De La Rue Company** has today completed negotiations to purchase a Dutch company, N.V. Machinefabriek M. J. De Goeje, Ing., of Zaandam. The company produces electronic quality control machines, primarily for the food industry. G. G. Riddick, deputy chairman of De La Rue, will be chairman of the company. The present owner, M. J. De Goeje, will become a director and technical manager. R. Jenkins, previously with De La Rue Bull Machines, has been

appointed a director and general manager, and E. G. Brooks, also a member of The De La Rue Company board, becomes a director.

**West Instrument Ltd.**, of Brighton, announce that in addition to their range of temperature controllers, they will now be marketing some of the products of their associate company **Gulton Industries (Britain) Ltd.** These include capacitors, thermistors, accelerometers, low-noise cable and piezo-electric ceramic transducers.

**Nuclear Enterprises (G.B.) Ltd.**, of Sighthill, Edinburgh, has just completed an extension to its laboratories and administration buildings. The total investment in buildings, now covering 45,000 sq ft, and plant is approximately £250,000.

**Telomex Ltd.** are to build a new factory in 1965 at Okehampton, Devon. Although the Devon plant may initially undertake sub-contract work for the main factory at Horscham, Sussex, it will eventually operate independently and will manufacture and sell products other than checkweighers.

An agreement has been concluded between **United Aircraft International Inc.** and **Ketay Ltd.** for transfer to **Vactric Control Equipment Ltd.** of the Ketay sale franchise for Norda encoders manufactured by United

Aircraft Corp. Vactric Control Equipment Ltd. has also undertaken to service Norden encoders now in use.

The **Painton Group of Companies** have now acquired the remaining shares in Svenska Painton AB, Stockholm, which now becomes a wholly owned subsidiary of the group.

Mac Panel control panels and wires, magnetic tapes and portable card punches are now available in the U.K. through the distributors, **C.E.A. Group (Marketing) Ltd.**, 98 Moseley Road, Birmingham 12.

**Vero Electronics Ltd.** have appointed official agents in India: Western Agencies Company, 421 Lannington Road, Bombay 4. S. C. Israni is managing director.

**George Meller Ltd.**, of 26 Hallam Street, London, W.1 (telephone: Museum 0303), have been appointed U.K. distributors for Hoke Inc., of New Jersey, U.S.A. Hoke manufacture a wide range of flow-control devices, including valves, regulators and sampling cylinders.

**Hursant Developments**, the sales division of Hursant Electronics, have moved to 28 Uxbridge Road, Ealing, W.5. Telephone: Ealing 8556.

**Electronic Instruments Ltd.**, of Richmond, Surrey, have set up a separate office to deal with sales and service in southern England. The new address is: 209 Crescent Road, New Barnet, Herts. Telephone: Hadley Green 3083.

### European Space Simulators

A three-company team representing interests in Britain, France and Germany, has been asked by the European Space Technology Centre (ESTeC) to prepare a design study for a 35-ft diameter space simulation chamber. The A.E.I. Electronics Group has been commissioned to join W. C. Heraeus of Germany and Societe Generale du Vide, France, in a design study to show whether the installation of such a large chamber is essential for the ESTeC satellite test and launch programme. It is estimated that a 35-ft chamber, if considered necessary, would cost around £2m.

The same companies have also received an order from ESTeC to design and build a smaller space simulation chamber of 15-ft diameter. This will simulate the thermal conditions to which a satellite is exposed, and will be provided with equipment to simulate radiation, pressures and temperatures in space. It will also simulate the orbital motion of satellites.

The European Space Technology

Centre in Delft, Holland, is a major establishment of the European Space Research Organization (ESRO) with responsibilities for Europe's satellite programme. It has a budget of £100m to be spent over the next eight years, subscribed to by all major European governments in the West; Britain, France and Germany have been the largest subscribers. ESTeC's terms of reference include the design and testing of satellites for research purposes, launching, tracking and the collection of scientific data.

### Drawing Office Automation

One of the Netherlands' largest industrial concerns, the Royal Engineering Works, Gebr. Stork & Co. Ltd., are using a computer to save many hours' work in their drawing and estimating departments and thereby overcome production problems that have arisen due to the acute shortage of local labour in Hengelo, Eastern Holland, where the factory is situated.

The computer is programmed to make drawings and calculations for boiler design and construction, so that once an initial design has been prepared, the basic details can be transferred to punched tape, which is then checked for errors by a standard IBM 1620 computer.

The next process uses a Calcomp 563 plotter. This is a computer-controlled drawing machine which is able to produce a complete design of the proposed boiler. This, of course, is a copy of an original design drawing and any initial faults at this stage can easily be rectified by the designer.

Once cleared by him, the design data is fed back into the computer which calculates the necessary data for pipe bending; e.g. bending angles and stretched lengths. Detailed drawings are produced in either isometric or orthogonal projection, and subsequently delivered to the estimating departments where they may be used for preparation of instructions for the bending machines.

### Transistor Patent

The Western Electric Co. Ltd., Bell Telephone Laboratories Inc. and American Telephone and Telegraph Co. recently applied for an extension of the term of Patent No. 694,201 which refers to 'apparatus employing bodies of semi-conducting material'. The application was opposed by a number of British manufacturers, including Pye Ltd.

The petition was heard by Mr. Justice Lloyd-Jacob and was refused.

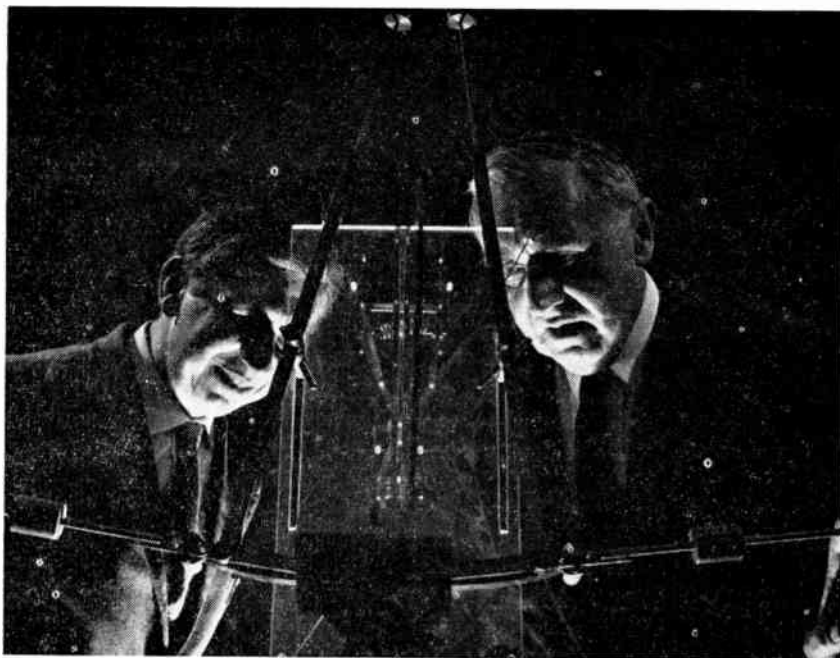

**P.C.M. ANALOGUE**— This mechanical analogue of pulse-code modulation has been built for instructional purposes by the inventor of p.c.m., A. H. Reeves (right). He is seen here with K. W. Cattermole, leader of the STL team that developed the equipment at present being considered by the G.P.O. for local-area telephone systems (see page 101)

# CORRESPONDENCE

## Simple Transistor Circuits for Industrial Use

Sir,—In the introductory paragraphs of this article (November, December 1964 and January 1965) the object was stated to be to present basic inexpensive transistor switching circuits, suitable for use in 'simple industrial applications'. The exclusive use of silicon semiconductor devices is noted, these being used exclusively in the circuits discussed. In view of these points, it seems undesirable and unnecessary to (a) incorporate a negative voltage bias supply  $V_{BB}$  to hold the transistors fully 'off', and (b) to incorporate speed-up capacitors across every base input resistor  $R_{B1}$ , etc.

The former point is, of course, essential in all germanium transistor circuits to stabilize the 'off' condition, but one of the advantages of silicon circuits is surely the economic one of being able to eliminate satisfactorily a separate bias supply, returning if absolutely necessary bias resistors to the earthy supply line.

The latter point of speed-up capacitors, while being desirable or necessary in high-speed computer-type circuitry, is fraught with danger in lower speed industrial applications, due to inherently lower noise and interference immunity of circuits with speed-up capacitors present.

Finally, in the second part of this article, the use of silicon planar epitaxial transistors type ZT80 is shown. The reverse base-to-emitter voltage of these transistors is quoted as being 4 volts, but in the monostable and astable circuits shown, these transistors receive a peak reverse voltage pulse of value equal to the collector supply voltage (either 6 or 12 volts). The use of silicon alloy junction transistors, with their usually higher reverse base-emitter voltage rating, would appear to be preferable in those circumstances.

Bristol College of Science  
and Technology.  
15th December 1964.

S. L. HURST.

base lead of  $Tr_3$  in Fig. 10 and of  $Tr_5$  in Fig. 11, which are repeated in Fig. 14(b) and Fig. 18(b). The diodes should be connected with cathode to transistor base and anode to the base resistor and capacitor. Diodes should similarly be included in the base leads of  $Tr_5$  and  $Tr_6$  in Fig. 27. The combination of diode and transistor gives a greatly increased reverse breakdown voltage which is also effective during the switching transient.

The maximum reverse base-to-emitter voltage developed in any of the given circuits is always less than 6 V. In the monostable circuit (Fig. 11),  $Tr_4$  does not receive a high reverse voltage and the voltage presented to  $Tr_5$  is developed from the +6-V supply. The actual reverse voltage obtained is less than the supply voltage due to the effects of  $V_{CE(sat)}$ ,  $V_{BE(ON)}$ , and transistor capacitance and storage effects. The reverse voltage applied to  $Tr_1$  and  $Tr_2$  in series, is further decreased by the forward voltage drop of diode  $D_1$  and the increased  $V_{BE(ON)}$  voltage of the transistor pair, so that the ZT80 is satisfactory in this case. The warning given on page 585 against raising the supply voltage should still be observed.

Although, in fact, typical ZT80 transistors have ample safety margin to operate in the  $Tr_4$  and  $Tr_5$  positions, it is advisable to keep within the specified ratings and include a ZS130 diode as mentioned earlier. It is because of its low  $V_{EB}$  rating that the faster ZT706 transistor, referred to in the caption to Fig. 14, is restricted to use in the inverter stage.

Ferranti Ltd.  
5th January 1965.

F. BAMFORTH.

## NEW BOOKS

### Subjective Standards in Industrial Inspection

By A. E. M. SEABORNE and L. F. THOMAS. Pp. 28. Published by H.M.S.O. for D.S.I.R., State House, High Holborn, London, W.C.1.

This booklet is No. 17 in the series 'Problems of Progress in Industry'. The object of this series is to present as briefly as possible the results of new research into human and economic problems in industry.

The way in which a factory inspector judges the quality of a product by sight, touch and hearing has been studied at Brunel College, London, and results of this research are reported in this booklet.

Twenty-five different factory situations ranging from paint making to vacuum cleaner assembly are dealt with in the study, and eight of these have been described. The aim of the research was to find out how inspectors learn to make judgements of quality, and develop and maintain their standards. The ways in which an experienced inspector views the product were studied. It was found that inspectors depend on certain features in the product as cues, and to a very large extent use their knowledge and experience of the faults most likely to occur, to guide their checking.

In certain situations an inspector's standards may vary because he is being subjected to social or physical pressures in his job. The booklet gives a check-list of factors affect-

Sir,—For reasons which will become apparent it is convenient to consider Mr. Hurst's comments in a different order from his own. The 'speed-up' capacitors were included since it was intended to describe circuits which are capable of working over a wide range of speeds; e.g., the monostable pulse-width generator described in the second article has one range of 0.5 to 2  $\mu$ sec. Fast switching circuits are also desirable to ensure reliable operation of the ring counter described in the final article. However, in this article, the speed-up capacitors have been removed in certain instances where slow-speed switching is necessary. As mentioned in the circuit description, this, along with other measures, improves the noise and interference immunity.

One advantage in the use of a negative supply with silicon switching transistors is to improve the noise immunity, which Mr. Hurst has agreed is desirable. In integrated silicon switching circuits, where the cost of two additional diodes in the base circuit is of secondary consideration, circuits without a negative supply are quite reliable.

I am indebted to Mr. Hurst for his final comment, which brings to light an error introduced in re-draughting the circuit diagrams from the original design which used the earlier mesa transistors with a higher  $V_{EB}$  rating. A high-speed diode type ZS130 should have been included in the

ing an inspector's job, applicable to all types of manufacturing situation, and describes some of the experiments used to investigate the subjective content of quality control.

#### **Medium Power Silicon Rectifiers**

Pp. 54. Published by International Rectifier Co. (G.B.) Ltd., Hurst Green, Oxted, Surrey. Price 12s. 6d.

International Rectifier Company (Great Britain) has added another rectifier engineering handbook to its list of publications. The new book covers the application details of the IR range of silicon diodes from 6 to 60 A.

It gives details of diode performance under actual operating conditions and includes information on ratings of medium power rectifier assemblies.

#### **A Programmed Book on Semiconductor Devices**

Pp. 23 (plus 10-page supplement). Published by Mullard Educational Service, Mullard House, Torrington Place, London, W.C.1. Price (including supplement) 3s. 6d.

This linear programmed instruction book on semiconductor devices, believed to be the first of its kind published by an industrial organization, treats the subject in a non-mathematical way. Emphasis is given to the physical aspects of electron and hole conduction. A supplementary booklet containing coloured diagrams illustrates semiconductor action. This supplement is referred to by the reader as he progresses through the programme.

In this programmed instruction book, the subject is broken down into many small numbered units called frames. Each frame requires from the reader a written response which is compared with the model answer given alongside the frame. The reader goes through the programme at the rate which he finds most natural, an advantage of this new system of learning.

It is intended that a short test, included at the back of the book, should be attempted before and after completing the programme. In this way the reader is able to assess how much he has learnt from the book.

This book is based on information previously published in 'A Simple Explanation of Semiconductor Devices'.

#### **Thermocouples: Their Instrumentation, Selection and Use**

By B. F. BILLING, M.I.E.I., A.R.Ae.S. (Senior Experimental Officer, Royal Aircraft Establishment). Pp. 30. Published by the Institution of Engineering Inspection, 616 Grand Buildings, Trafalgar Square, London, W.C.2. Price 15s. (postage 9d.).

This monograph provides all the basic information for the practical selection and use of thermocouples and the inspection of thermocouple installations.

The properties of all thermocouples generally available are described, together with the principles and practical application of current-sensitive and potentiometric instrumentation in manual and automatic forms.

#### **Index of Electrical Measuring Apparatus Used in Connection with Ionizing Radiation**

I.E.C. Publication 181 : 1964. Pp. 62. Available from British Standards Institution, 2 Park Street, London, W.1. Price 45s.

The aim of the publication is to facilitate the study of the instruments for ionizing radiation by giving each a recognized title and clear definition. The index covers measuring instruments currently manufactured, or likely to be so in the near future. As a general rule, the instruments mentioned do not include the terminal apparatus which supplies the information unless it forms an integral part of the apparatus.

In the field of control and safety of nuclear reactors, this publication defines certain apparatus which does not belong to the category of electrical measuring instruments, but is included in view of the necessity of considering nuclear reactor instruments as a whole.

**On the Early History of Radio Guidance**, by BENJAMIN FRANKLIN MIESSNER. Pp. 86. Price 19s.

**Popov and the Beginnings of Radiotelegraphy**, by CHARLES SUSSKIND. Pp. 30. Price 8s. 9d.

**The Invention of the Traveling-Wave Tube**, by RUDOLPH KOMPENER. Pp. 30. Price 10s. 6d.

W. Heffer & Sons Ltd., 3-4 Petty Cury, Cambridge.

These little books are all part of a series of monographs on the history of technology.

## **Manufacturers' Literature**

**General Information Manual dp/f-5022: 'Discfile' Storage System.** A multi-disc magnetic random access storage system is described in this 17-page brochure. Advantages claimed include: low cost, rapid access and high transfer rates. *Data Products Corporation, 8535 Warner Drive, Culver City, California, U.S.A.*

**For further information circle 47 on Service Card**

**Characteristics and Applications of Brimistors.** The applications section of this STC 10-page booklet, publication MK/116X, includes circuit diagrams and circuit descriptions for surge suppression in electronic equipment. These circuits are designed for the protection of relays, time-delay circuits, projector lamps, transformers, rectifier valves and radio and television receivers.

*Standard Telephones and Cables Ltd., Semiconductor Division, Footscray, Sidcup, Kent.*

**For further information circle 48 on Service Card**

**G.E.C. SCR Control Units.** A recently-introduced G.E.C. thyristor-operated control unit type SCR is described in this 4-page publication E.158. The unit was developed to provide a compact, efficient and versatile means of controlling the operation of 'Sherwen' electromagnetic feeders but it can be used with other G.E.C. electromagnetic vibrating equipment. *G.E.C. (Engineering) Ltd., Mechanical Engineering Works, Erith, Kent.*

**For further information circle 49 on Service Card**

**Standard Hydraulic Units.** Listed in this 12-page brochure are the basic characteristics of 500 hydraulic units, including valves, cylinders, motors and accumulators. They are classified by function and listed according to flow characteristic and port size. *Keelavite Hydraulics Ltd., Allesley, Coventry, Warwickshire.*

**For further information circle 50 on Service Card**

**Anelex Equipment.** Described in this 12-page brochure is the full range of high-speed printer systems and random-access disc files manufactured by *Anelex Corporation, 150 Causeway Street, Boston, Massachusetts 02114, U.S.A.*

**For further information circle 51 on Service Card**

**Perkin-Elmer Gas Chromatography Supplies.** The 8-page brochure lists an extensive range of gas chromatography supplies. It includes solid supports, liquid phases, column packing materials and columns.

*Perkin-Elmer Ltd., Beaconsfield, Bucks.*

**For further information circle 52 on Service Card**





**WE'VE GOT EVERYTHING UP OUR SLEEVE!** Sasco can provide the widest range of Connectors, Semiconductors and other Components at the drop of a hat. The products of over 33 leading electronic component manufacturers. If you want to learn more of Sasco magic, write for a Products List to:



**Stewart Aeronautical Supply Co. Ltd.**  
*P.O. Box 20, Gatwick Road, Crawley, Sussex.*  
*Tel: Crawley 28700*  
*Telex No. 87131. Cables: SASCO, Crawley, Telex.*

# KEEP COUNT

## with ENM Electrical Impulse counters

Any measurements of quantity, size, time, weight, speed, temperature, fluid-flow, when converted to electrical impulse, can be recorded and printed.

### Model 481

Six figures—Add only or add and subtract. Manual, Semi-Automatic and Fully Automatic printing on paper roll, card or card sets.

Up to 3000 counts per minute (add)—2600 (add and subtract). Electrical reset to zero, or non-reset.

Panel Size: 3.75 in. (95.3 mm.) x 8.30 in. (210.8 mm.).

1 2 3 4 5 6  
Actual Printing Size

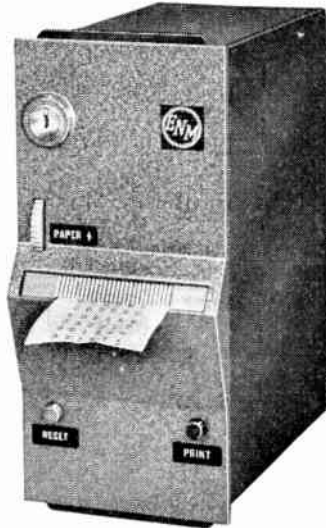

### Model 443

Six figures—Add only or add and subtract. Manual or Electrical Reset—or non-reset.

Standard Models—up to 2100 counts per min.

High Speed Models—up to 3000 counts per min.

Panel Mounted only.

Panel Size: 1.8 in. (46.0 mm.) x 2.75 in. (69.0 mm.).



1 2 3 4 5 0  
Actual Indicating Size

Write for fully illustrated data sheets and information regarding your particular counting applications.



**ENGLISH NUMBERING  
MACHINES LTD**

DEPT. E.10, QUEENSWAY, ENFIELD, MIDDLESEX. TEL: HOWARD 2611. TELEX: 24725

# introducing the Mk. 2 GRAVITYMASTER

100°C  
100 p.s.i.



Patents applications pending

FOR CONTINUOUS **IN-LINE**  
**DENSITY** MEASUREMENT  
OF LIQUIDS AND SLURRIES

- HIGH ACCURACY
- LONG-TERM STABILITY
- MAINTENANCE-FREE OPERATION
- ON-SITE CALIBRATION
- HIGH CORROSION RESISTANCE

Contact David R. McNaught for further information or literature



**INDUSTRIAL GROUP**

SPERRY GYROSCOPE COMPANY LTD., Brentford, Middx. Phone ISLeworth 1241

# AUTOMATIC WATCHMAN

## FREES MEN FOR PRODUCTION



### FOR INSTANT WARNING OF VARIATIONS IN

- PRESSURES
- TEMPERATURES
- FLOWS
- HUMIDITY
- WEIGHTS
- ETC. ETC. or
- STOPPAGE OF MOTORS
- OR MECHANICAL FAILURE

### INSTALL -

Alarm Scanning and Data Logging for any Number of Points.

Continuous Scanning with High and Low Limit Settings for Critical Quantities.

Display on Mimic Diagrams.

Logging at Preset Time Intervals, On Demand or On Alarm.

Print-out by Electric Typewriter, Strip Printer or Tape Punch incorporating Time, Identification Codes, Values, etc.

Reliability and Minimum Maintenance assured by use of Solid State Circuitry.

A Westinghouse Automatic Watchman can be tailored to YOUR exact requirements.



## ALARM SCANNING & DATA LOGGING FOR LOW COST AUTOMATION

For further information write to:—

**WESTINGHOUSE BRAKE AND SIGNAL CO. LTD. AUTOMATION DEPT., NEW ROAD, CHIPPENHAM, WILTS**

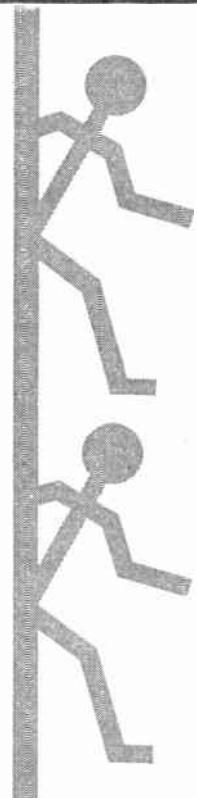

For further information circle 253 on Service Card

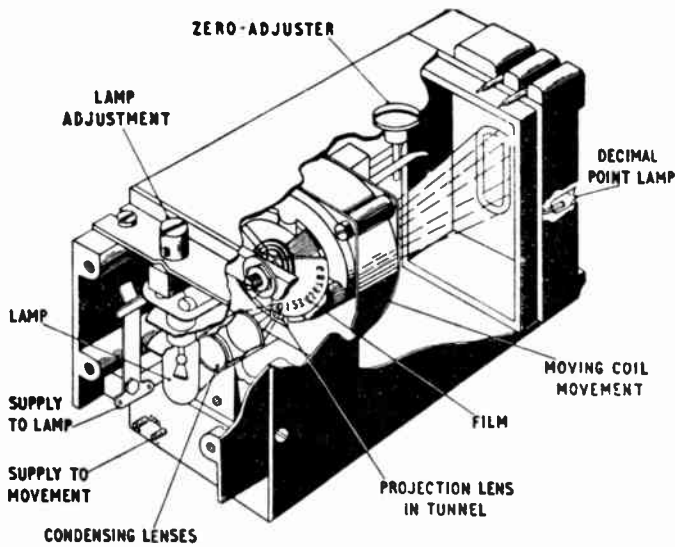

- One plane image.
- Single lamp.
- Bright readout with wide viewing angle, 160°.
- Decimal point in correct position.
- Economy in decoding from binary input.

# The DIGIVISOR

The E.A.C. Digivisor is a ten position—one plane—in-line readout device that will display the digits 0-9 upon command and is the only device of its kind available with a brightness of 60 foot lamberts.

The Digivisor is capable of being used for analogue, decimal or binary inputs, and the Mark 2 pattern, illustrated here, projects a figure  $\frac{7}{8}$ " high employing a robust high torque moving coil movement which carries a translucent scale through a simple optical system using a single commercial lamp.

Write for leaflet 409

THE ELECTRICAL APPARATUS COMPANY LTD



ST. ALBANS

For further information circle 254 on Service Card



Accurate and versatile, Rustrak miniature recorders give you great flexibility of application. With any one drive motor 11 different chart speeds can be obtained using standard rapidly interchangeable gear trains. Altogether 99 chart speeds from 1/16" per hour to 450" per hour are available. The chart drive may be powered either by A.C. synchronous motors or low consumption D.C. motors. Smooth clear traces are produced on pressure sensitive paper without the need for ink, heated stylus or voltage sensitive paper. The use of this paper combined with the rugged design enables the recorder to be used under extremely adverse conditions of ambient temperature, pressure and humidity. A wide range of models is available so that the Rustrak recorder can be used to replace almost any indicating meter thereby eliminating the necessity for costly continuous surveillance. For full information on the comprehensive Rustrak range write to:

**rusttrak**  
WEST Instrument Ltd.  
A division of  
GULTON INDUSTRIES (BRITAIN) LIMITED  
The Hyde, BRIGHTON 7, Sussex, England. Tel.: Brighton 66271. Telex 87172

For further information circle 255 on Service Card

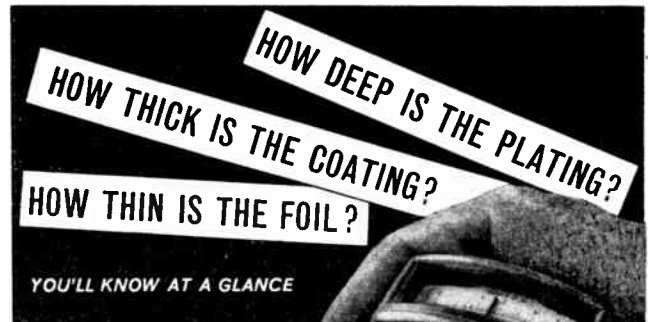

with the **POCKET**

## elcometer

The depth of plating, paint or plastic on iron or steel . . . the thickness of non-ferrous coatings on iron or steel or non-ferrous foil . . . you can take these and many other measurements at a glance by means of the Elcometer. Completely non-destructive—like all our surface-metrology instruments—the Elcometer gives an accurate direct reading with fuss-free reliability, even in unskilled hands, even in the middle of a production run.

Choice of over 40 scales ranging from 0-0.002" to 0- $\frac{3}{4}$ "  
**13 GNS.**

**elcometer** FAIRFIELD RD. DROYLSDEN 11 MANCHESTER  
INSTRUMENTS LTD

Please send me free literature on the Elcometer and its companion instruments, the Elcotector and the Pin Hole Detector.

Name of Organisation.....

Address.....

..... For the attention of..... 11

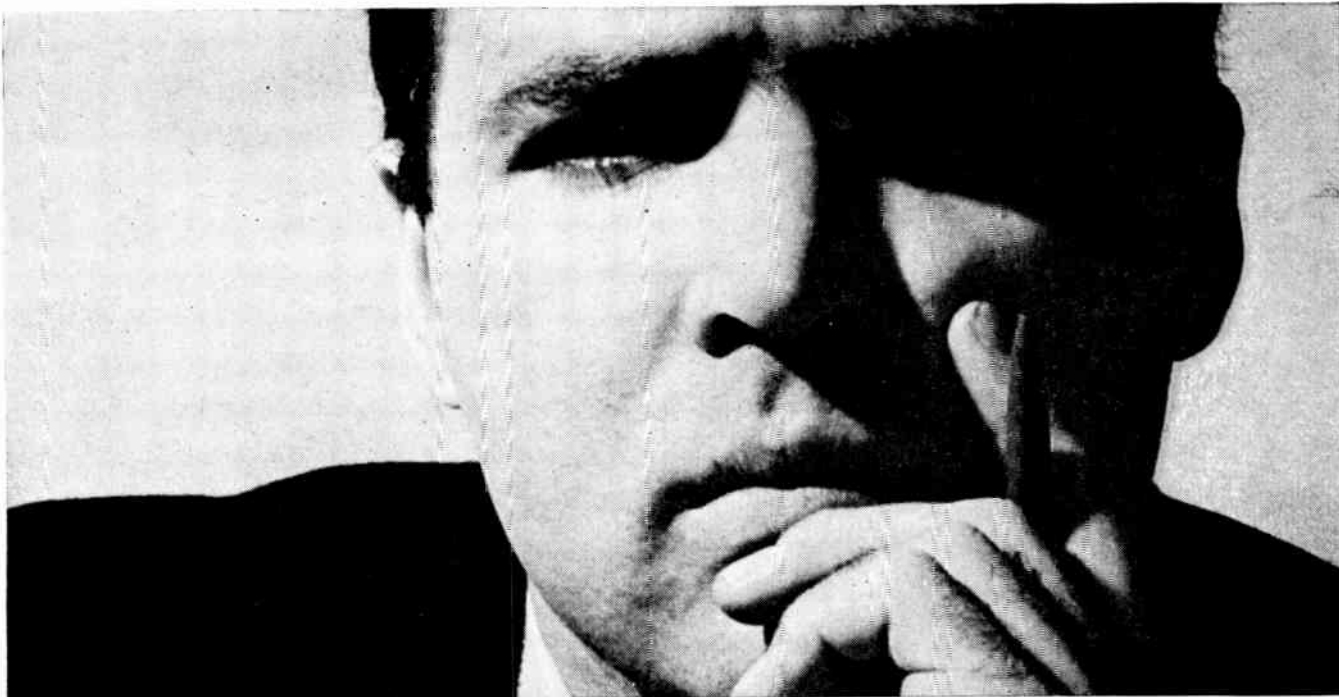

# “What I could really use in this circuit is . . .

### For economy, General Electric silicon power semiconductors

1. Power Thyristor (Silicon Controlled Rectifier) <b>C6</b>	1A @ TC=85°C/200V
2. Power Thyristor (SCR) <b>C20</b>	4.7A @ TC=65°C/400V
3. Power Thyristor (SCR) <b>C30</b>	16A @ TC=70°C/400V
4. Power Diode <b>A40</b>	20A @ TC=110°C/600V

### For high voltage, General Electric silicon power semiconductors

5. Power Thyristor (SCR) <b>C145</b>	35A @ TC=80°C/1300V
6. Power Thyristor (SCR) <b>C150</b>	70A @ TC=75°C/1300V
7. Power Thyristor (SCR) <b>C180</b>	150A @ TC=90°C/1300V

### For high speed, General Electric silicon power semiconductors

8. Signal Thyristor (Silicon Controlled Switch) <b>13B</b>	IGTC=1 μA; IH=.2MA
9. High-Frequency Power Thyristor <b>C140</b>	.16A @ TC=70°C/400V
10. High-Frequency Power Thyristor <b>C155</b>	.70A @ TC=70°C/500V
11. High-Frequency Power Thyristor <b>C185</b>	1.50A @ TC=90°C/600V
12. Silicon Power Transistor <b>6B</b>	60W @ TC=100°C/120V
13. Silicon Power Transistor <b>20A</b>	30W @ TC=100°C/80V
14. Silicon Power Transistor <b>7A-T</b>	4-40W @ TC=25°C/200V

### For proved, industry-standard types,

#### General Electric silicon power semiconductors

15. Power Thyristor (2N1595-99) <b>C5</b>	1A @ TC=100°C/400V
16. Power Thyristor (2N1770A-77A) <b>C10</b>	4.7A @ TC=105°C/400V
17. Power Thyristor (2N681-92) <b>C35</b>	16A @ TC=65°C/800V
18. Power Thyristor (2N1909-16) <b>C50</b>	70A @ TC=75°C/900V
19. Power Thyristor (2N2542-48) <b>C80</b>	150A @ TC=80°C/800V
20. Power Thyristor <b>6RW75</b>	300A @ TC=80°C/1000V
21. Power Diode <b>A70</b>	100A @ TC=130°C/1200V
22. Power Diode <b>A90</b>	250A @ TC=135°C/1000V
23. Power Diode <b>6RW62</b>	200A @ TC=125°C/2000V
24. Controlled Avalanche Diodes (6 sizes)	0.5A to 250A, 500V to 1000V
25. Fast Recovery Diodes (4 sizes)	6A to 35A, 400V; trr=200 nsec Max.

... an SCR—but can I afford to put one in a light dimmer?” (See No. 2 at left)

... a thyristor designed for high frequencies—one that has low turn-off time.” (See No. 9)

... a silicon rectifier that can handle 80,000 peak watts in the reverse direction.” (No. 24)

Spend a minute or two with the listings at the left, and you'll find that General Electric\* makes a silicon power semiconductor for almost any application you can think of.

You'll find one for a cordless shaver, another for a motor-speed control, still others for mighty industrial equipment and military applications.

While you think of it, clip the list. Or better still, ask for General Electric's free “Reference Guide to Silicon Power Semiconductors.” It lists *twice* as many types as we do here, with detailed descriptions and photographs as well. Contact your G.E. representative or *International General Electric Company of New York Ltd., Lincoln House, 296-302 High Holborn W.C.1.*

\*General Electric Company U.S.A. is not connected with the British Company of the same name.

*Progress Is Our Most Important Product*

**GENERAL ELECTRIC**  
—U.S.A.—



# INFRA-RED DETECTORS

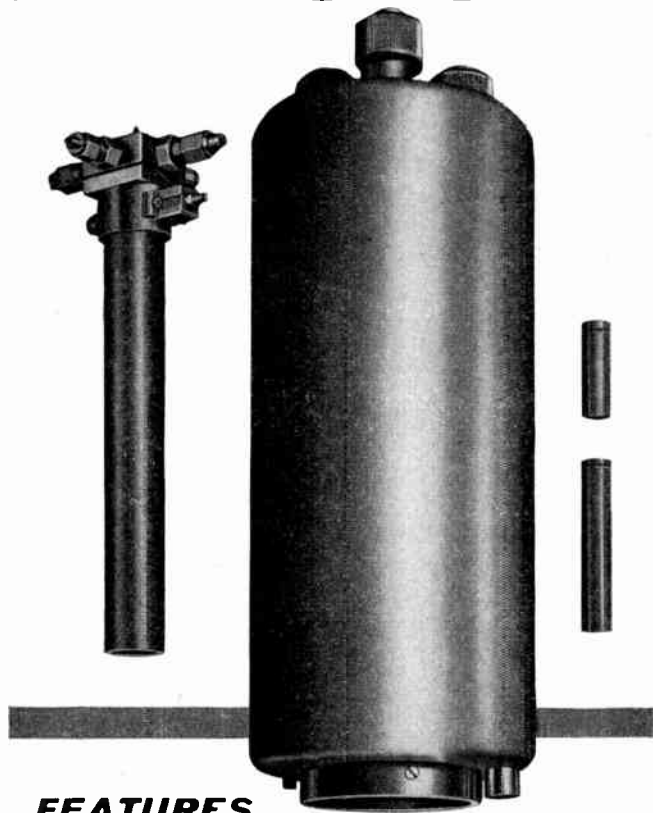

## FEATURES

- PHOTOCONDUCTIVE**—Germanium detector activated by gold, mercury, cadmium or copper.
- LOW TEMPERATURE**—operating temperatures in range up to 78° Kelvin.
- SPECTRAL RANGE**—covers from visible to microwave frequencies.
- HIGH SENSITIVITY · RUGGED**
- SHORT TIME CONSTANTS**

## APPLICATION AREAS

- High temperature shock wave measurements*
- \* Non-destructive testing \* Chemical analysis
- \* Near-space investigations
- \* Terrain mapping \* Process-stream analysis

---

**WALMORE ELECTRONICS LTD**  
 11-15 BETTERTON ST., DRURY LANE, LONDON W.C.2  
 TELEPHONE : TEMple Bar 0201-5

---



**Porcelain**

**Steatite**

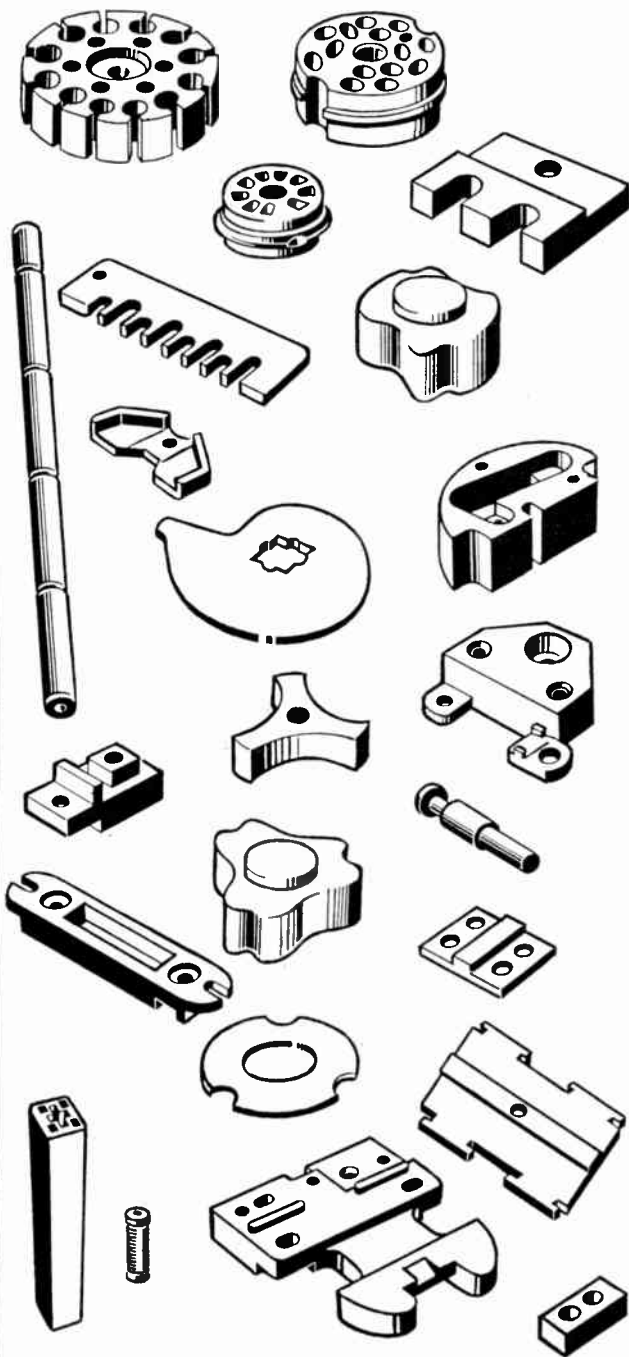

**V. G. PORCELAIN CO LTD**

GORST ROAD  
 PARK ROYAL  
 LONDON, N.W.10

Telephones:  
 ELGAR 1411/7  
 Telex:  
 London 25589

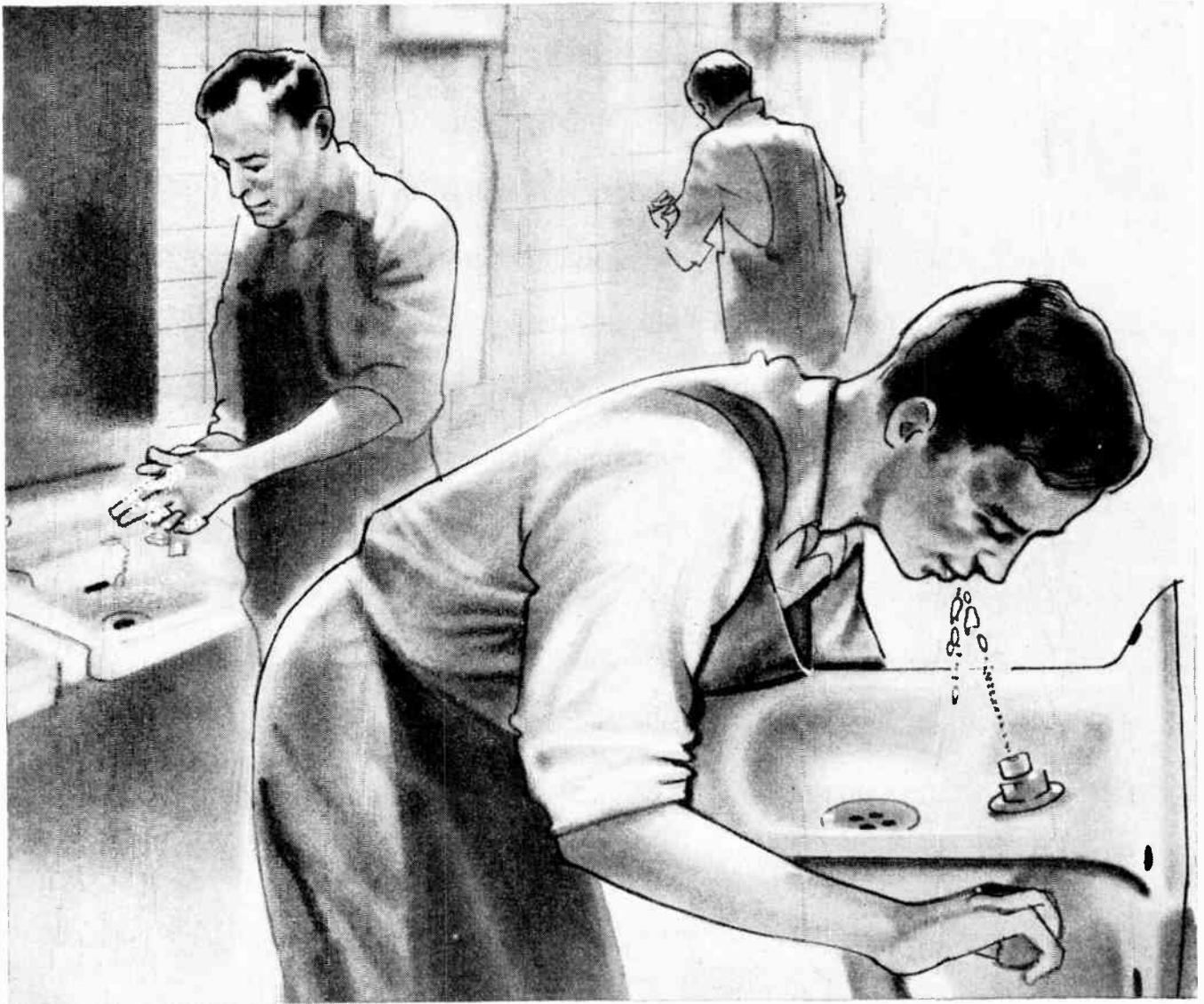

**WHEN  
THE  
PRESSURE  
IS  
ON...**

The pressure is on right now in the fight to conserve water. Birflo valves are being used increasingly to control water flow for industrial processes, the balancing of supplies in multi-storey buildings and washroom facilities, for example showers, drinking fountains, wash basins etc.

Wherever efficient economical control of water or air or light oils is essential—in factories, offices and homes—Birflo valves not only keep maintenance bills down to the very minimum, but they also help to reduce wastage and cut costs all round. If your firm needs valves, be sure that they are Birflo. Write now for full details of the Birflo range.

**BIR FLO VALVES**

for efficient economical control

Member of the



**Birfield Group**

**LAYCOCK ENGINEERING LIMITED**

DEPT. 1E/1, MILLHOUSES, SHEFFIELD 8 Telephone: SHEFFIELD 368221

*Industrial Electronics February 1965*

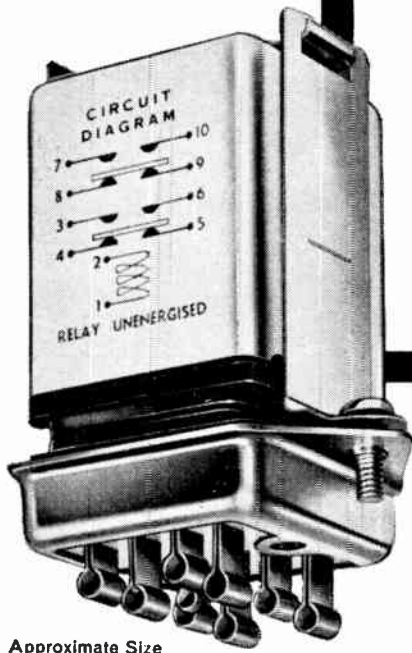

# DIAMOND H GENERAL PURPOSE RELAYS (BW SERIES)

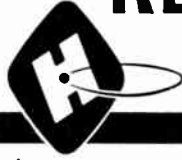

Versatile Mounting Arrangements

Panel Mounting with Solder Tag



Side Mounting



Socket Mounting



- 25 amp 250 volt A.C. double pole double throw
- Compact—only 1½" x 1½" x 1⅞" without socket
- Plug-in, solder tag or fast on terminations
- Coils available for 4-250 V., A.C. 50-60 cycles & 4-250 V., D.C.
- Mechanical life expectancy—in excess of 10 million cycles
- Weight—10 ozs. or less
- Plug-in, Side or Panel mounting

**PROVED PERFORMANCE! RELIABILITY! LONG LIFE! SILENT!  
PROMPT DELIVERY!**

**DIAMOND H CONTROLS LTD.** GUNNERSBURY AVENUE, CHISWICK, LONDON, W.4. CHISWICK 6444

For further information circle 261 on Service Card

for  
precise  
speed  
control  
use  
a

**HEENAN  
DRIVE**

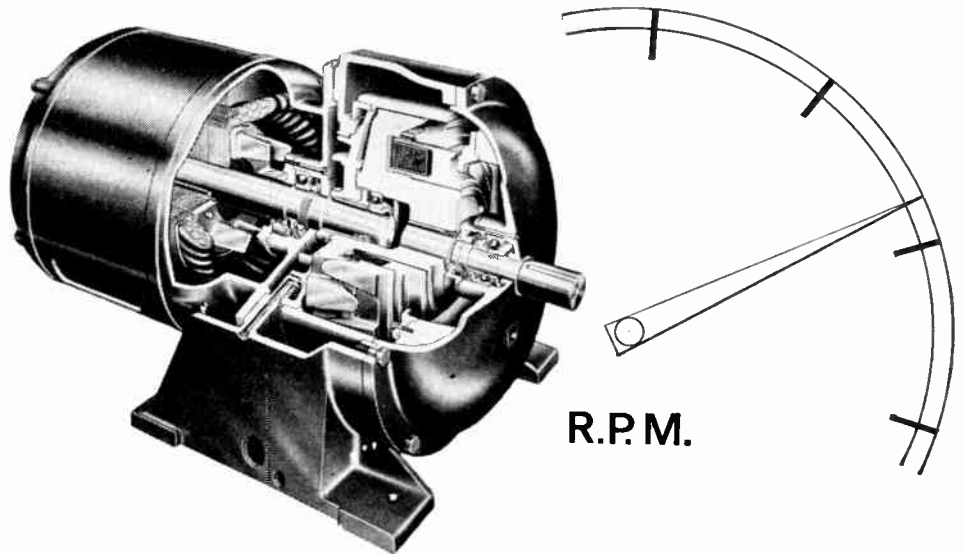

Today, modern machines and processes require more than just Variable Speed; they need a drive which is capable of dealing with many diverse requirements, e.g.:

**Infinitely Variable Speed from maximum to zero against constant torque  
Controlled acceleration and deceleration · Local or remote control  
Torque control · Very close speed holding · Synchronisation of individual drives, etc., etc. . . .**

The AJUSTO-SPEDE and DYNASPEDE DRIVES can provide the above, and many more features, with compact, robust equipment.

*REMEMBER—there is NO substitute for experience*



**Heenan & Froude Ltd** · WORCESTER · ENGLAND





# AVEL INSTRUMENTATION

Time is Money,  
Can YOU Buy Time?

YES!

With the  
Unique

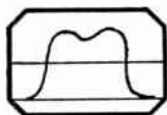
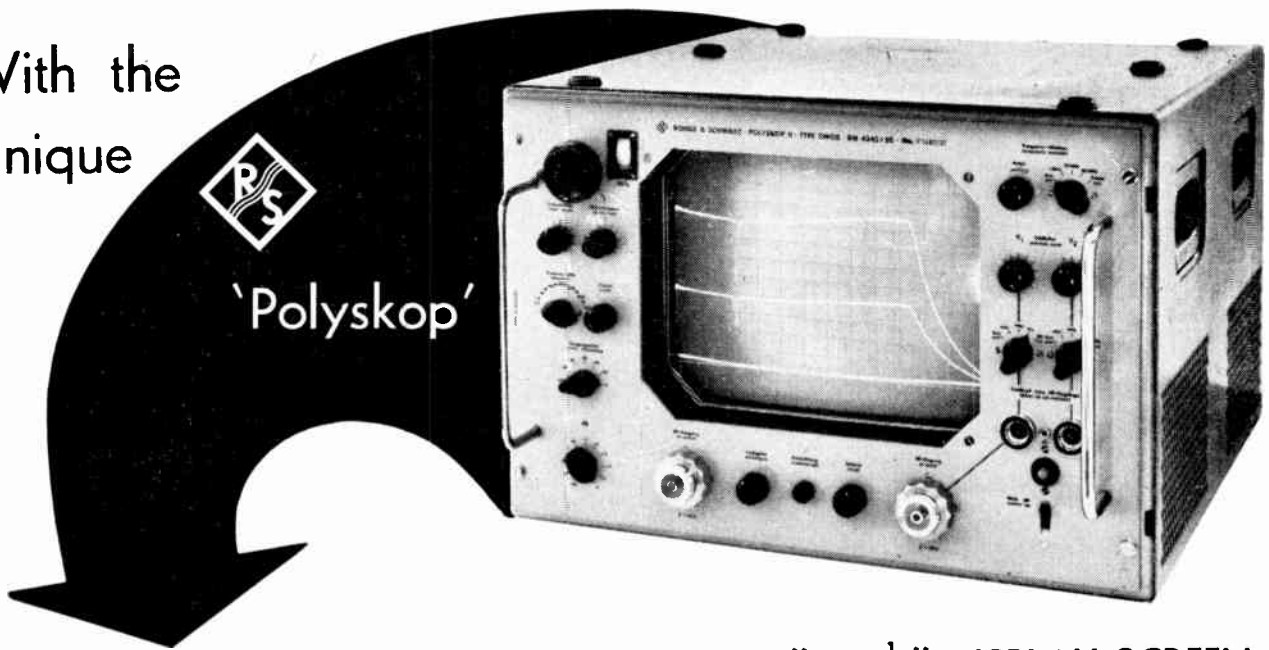

### Broadband Filters & Amplifiers

The alignment of amplifiers and filters using point by point methods can be eliminated with the 'Polyskop' in one Fiftieth of the time normally taken.

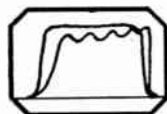

### Alignment of Test Items and Comparison against Standard

The large screen display and versatility of the 'Polyskop' provides for greater accuracy and time saving.



### Multi-Section Filters

The facility for direct comparison of sections and the inherent high accuracy and versatility of the 'Polyskop' results in improved accuracy in a much shorter time.



### Band-Pass Filters

Alignment and analysis of filter characteristics in the shortest possible time is a feature of the reliability and versatility of the 'Polyskop'.

- \* 11" x 8½" DISPLAY SCREEN
- \* DUAL TRACE DISPLAY
- \* FREQUENCY RANGE  
UP TO 1200 Mc/s.

This is the only instrument which eliminates the necessity of 'point by point' measurements by providing sweep signal generator, visual indicator, attenuator, and frequency markers in ONE INSTRUMENT. The 'Polyskop' combines simplicity of operation and versatility with high degree of accuracy at frequencies up to 1200 Mc/s.

Leading manufacturers throughout the world have proved that the use of this instrument in both production and research has resulted in greater efficiency and reliability.

## Aveley Electric

## Limited

Distributors in United Kingdom for:

Measuring instruments of quality

SOUTH OCKENDON · ESSEX  
TELEPHONE: SOUTH OCKENDON 3444  
TELEX: 24120 AVEL OCKENDON

For Further Information Write or Phone

# Fielden

## NEW transistorised LEVEL equipment

... a Fielden low-cost,  
reliable LEVEL CONTROLLER  
for every application

### TELSTOR 62 Continuous Level Indicator

A new approach to level equipment. Potted solid-state transmitting circuit can be in probe head—low cost, ideal for multi-point applications—simple to install—accurate, no moving parts—linear scale—alarm or control available.

Fully described on leaflet TEL62/1.

### TEKTOR TT6 Level Controller

Complete transistor circuit in probe head—versatile and economic—single and multiple applications—extremely stable, no adjustment required.

See leaflet TT6/1.

### PNEUMATIC LEVEL CONTROLLER PnL3

Provides pneumatic signal proportional to level of material—signal can be applied to a pressure gauge, existing pneumatic receiver/controller or diaphragm-operated control valve.

See leaflet PnL/3.

### AQUATROL LEVEL CONTROLLER

For conducting liquids.

Ask for leaflet AQ/NF2.

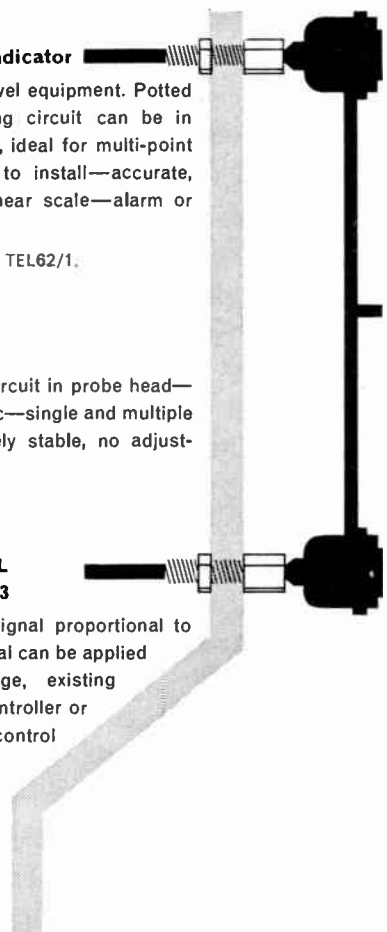

# Fielden

**FIELDEN ELECTRONICS LTD** WYTHENSHAW - MANCHESTER

Tel: Wythenshawe 3251 (6 lines) Grams: Humidity Manchester Telex 66531  
Branch Offices: London, Walsall, Harrogate and Scotland  
Overseas Subsidiaries: AUSTRALIA: Fielden Electronics (Aust.) Pty. Ltd., 61 Betula Ave., Vermont, Victoria, and 107 Alexander Street, Crows Nest, New South Wales  
ITALY: Fielden Electronics Italiana, Milan. Agents throughout the world

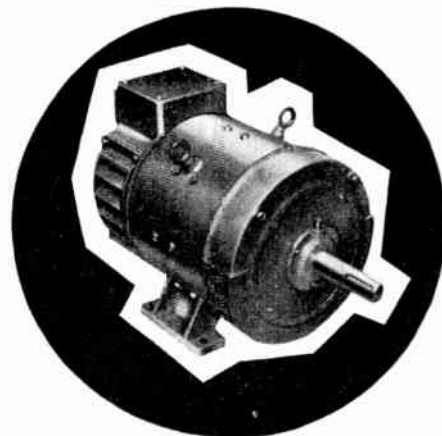

'X' type D.C. motors, 1/2 - 40 h.p.

You can't say **DEPENDABLE**  
without **EPE**

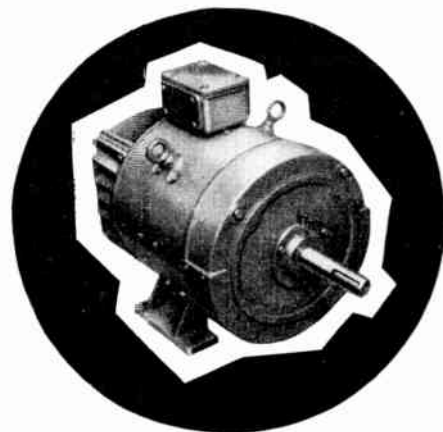

'Y' type D.C. motors, 1/2 - 40 h.p.

## D.C. Motors for electronic speed control



THE ELECTRICAL POWER ENGINEERING CO. (B'HAM) LTD.  
EPE WORKS, BROMFORD LANE, BIRMINGHAM 8  
Telephone: SEChford 2261  
Grams: Torque Phone, Birmingham

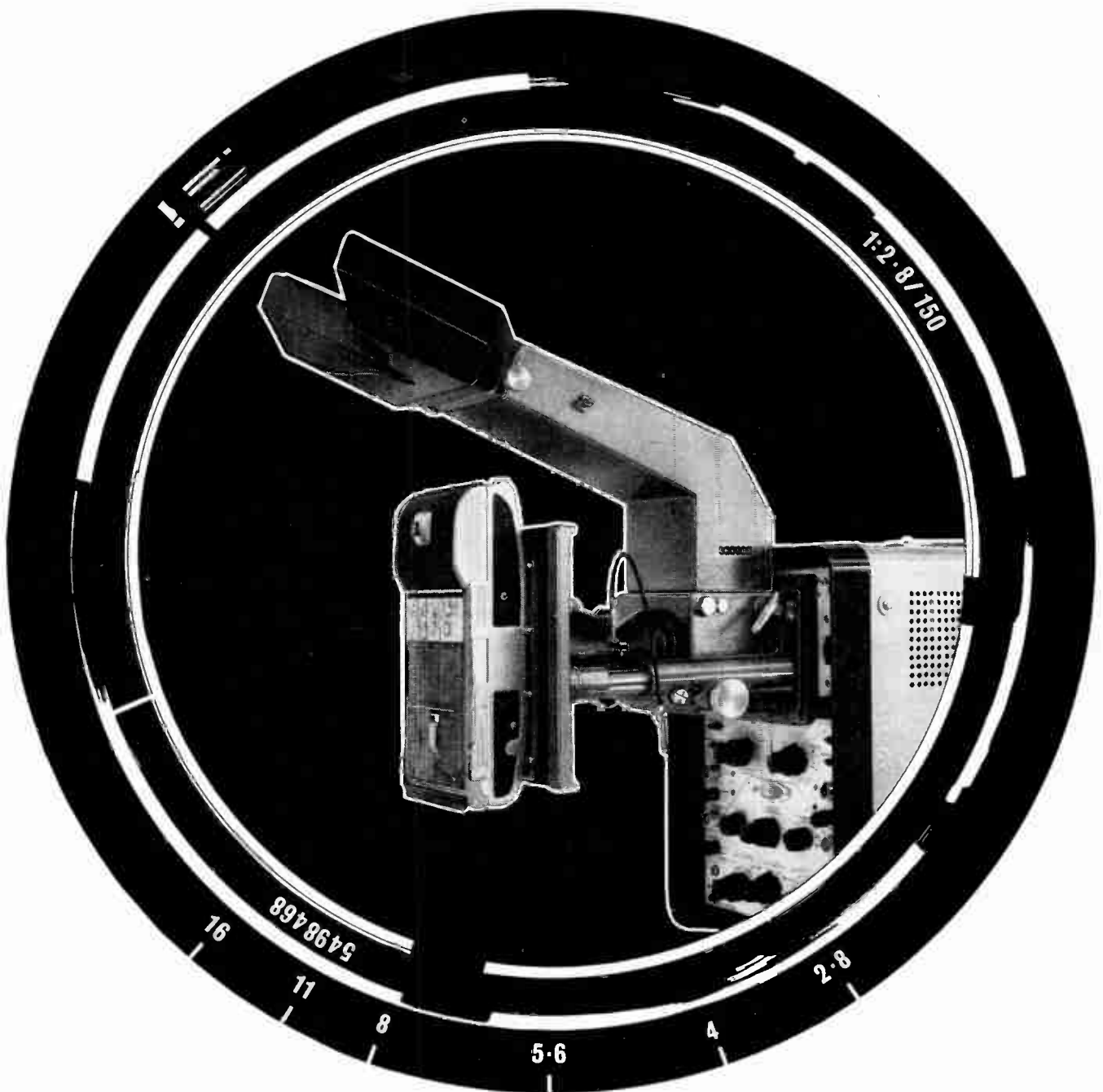

This camera is a universal model for oscilloscope recording. It incorporates a Polaroid\* Land Film back which enables a photographic record to be produced in 10 seconds. A unit construction principle enables a variety of specifications to be achieved. It provides for the use of lenses from  $f/1.5$  and film backs ranging from that for the Polaroid\* Land roll films to conventional 35 mm. A viewing hood provides a binocular parallax-free view of the graticule area.

The camera may be fitted to all Cossorscopes and adaptors are provided to fit other equipments. The camera is hinged to the adaptor affording ease of operation.

\*Registered trade mark of the Polaroid Corporation.

- Oscillograms in 10 seconds
- Employs Polaroid\* Land picture rolls with speeds up to 10,000 A.S.A.
- Interchangeable lens
- Interchangeable film backs
- Multiple exposures
- Viewing while recording

# COSSOR

A Member of the Raytheon International Group.

**COSSOR INSTRUMENTS LIMITED**  
**The Pinnacles, Harlow, Essex.**

*Telephone: Harlow 26862. Cables: Cossor Harlow*

# TYPE 'A' OSCILLOSCOPE CAMERA

# LEWCOS

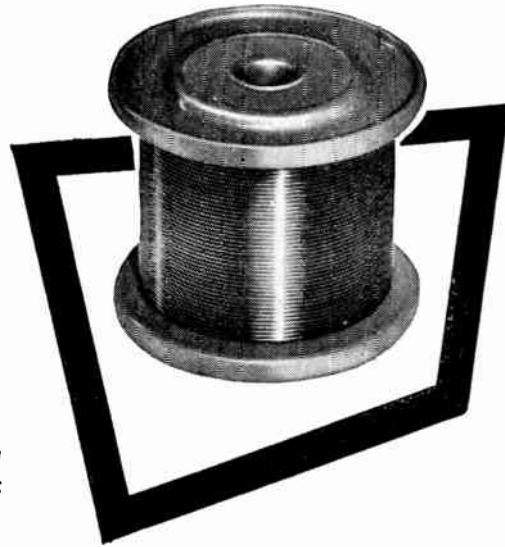

## INSULATED RESISTANCE WIRES

Available over a range of sizes in VACROM (nickel-chrome) 80/20 or 15% and EUREKA (cupro-nickel). All conform to BS 115/1954.

Supplied with standard coverings of cotton, silk, rayon, enamel, LEWMEX (synthetic enamel), glass and asbestos.

A technical information and advisory service is offered.

**THE LONDON ELECTRIC WIRE COMPANY & SMITHS LTD · LEYTON · LONDON · E.10**

For further information circle 267 on Service Card



### PORTRAIT OF A GROWING FAMILY

The Emflux family has grown . . . improved . . . become more versatile – making it possible to build a flow measurement system tailored to meet your specific needs.

At the head is the Emflux flowmeter – *proved in operation*, but now with the extra advantage of an amplifier that's *interchangeable with any other type of detector head*. And backing it up are a multi-point unit that cuts costs by allowing up to six Emflux detector heads to be used with *one* amplifier, an automatic range change unit, a liquid level monitor and a reverse flow indicator.

Interested? Send for the new Mawdsley Magnetic Flowmeter Handbook; in addition to full details of the complete Emflux range, it contains an invaluable section on the best lining materials to use with *over 130 different liquids*.



EMFLUX –  
MADE TO  
MEASURE BY

**MAWDSLEY'S LTD**

ELECTRONICS DIVISION  
DURSLEY, GLOUCESTERSHIRE, ENGLAND



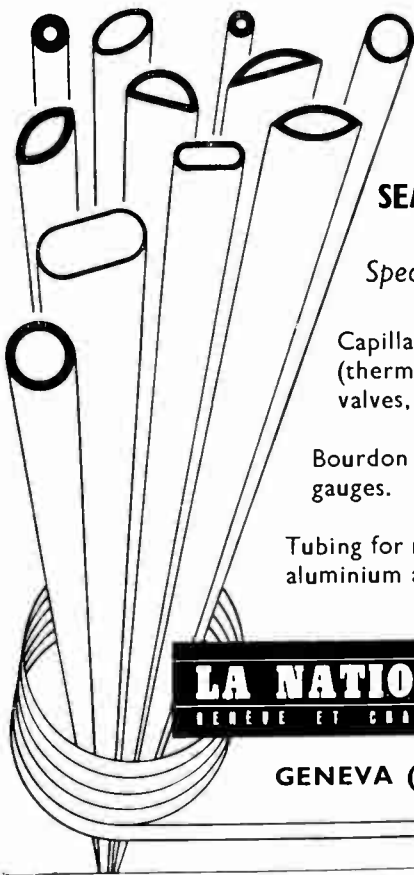

**PRECISION SEAMLESS TUBING**

Specialists in :

Capillary tubing for controls (thermostats, thermostatic valves, thermometers, etc.)

Bourdon tubing for pressure gauges.

Tubing for measuring pointers in aluminium and aluminium alloys.

**LA NATIONALE S.A.**  
GENÈVE ET CHAMPAUNE, SUISSE

GENEVA (Switzerland)

For further information circle 269 on Service Card

**For Improved Efficiency in Flow Control**

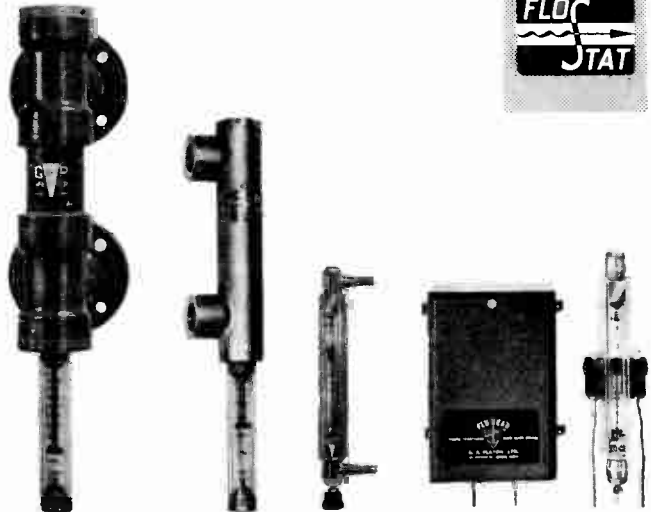

Gapmeter rate-of-flow meters —compact, safe, inexpensive—are now made in a wider range of types, sizes and materials (including new all-stainless steel 'Shunt' Gapmeters).

The Flo-scan 'fail-safe' alarm switch can be fitted to any Gapmeter to give warning of low or high flow deviation.

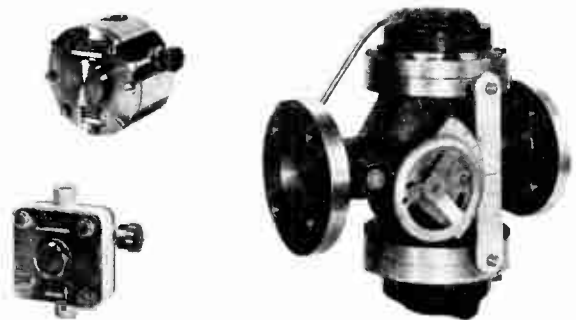

The unique Flostat self-acting rate-of-flow controller continues to offer the only truly effective method of automatic flow control at a sufficiently low capital cost to permit large-scale application to any flow rates and all kinds of fluids.

**G. A. Platon Ltd.**

281 Davidson Road, Croydon, Surrey

ADDiscombe 1168 Telegrams: GAPMETER, Croydon

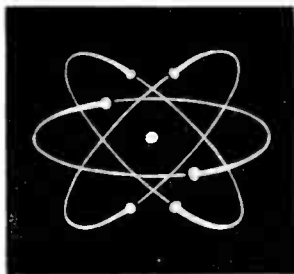

an important **ILIFFE** technical book

**BASIC INDUSTRIAL ELECTRONICS**

ALFRED HAAS

Aimed to assist those industrial engineers whose initial training did not include electronics, this new book provides a sound readable introduction to the technology of the subject. The introductory chapters cover the many and varied industrial applications followed by a description of the various devices by which mechanical movements and physical changes can be converted into electrical signals. Subsequent chapters discuss automatic inspection, automatic machine control, electronic heating, welding and machining, electronic safety devices and power conversion control. This practical book will prove invaluable to engineers without previous knowledge of the subject and also as an introduction for students of electronics.

35s net by post 36s 3d 208 pp. 203 illustrations

obtainable from leading booksellers

Published by **ILIFFE Books Ltd.**  
DORSET HOUSE STAMFORD STREET LONDON SE1

# SEMIKRON

## controlled avalanche silicon diodes

Type	Forward I. Amb. 50°C	Applied Volts RMS	Avalanche Voltage	
SKa 0.5/10	0.5A	480	1300	1700
	0.5/12	550	1700	2100
SKa 0.9/10	1A	480	1300	1700
	0.9/12	550	1700	2100
SKa 1/10	1.2A	480	1300	1700
	1/12	550	1700	2100
SKa 2.5/10	2.5A	480	1300	1700
	2.5/12	550	1700	2100
SKa 5/10	6A	480	1300	1700
	5/12	550	1700	2100



These high quality avalanche diodes are manufactured under ultra-modern manufacturing conditions giving consistent quality and stable characteristics in the forward and reverse direction. We list below a selection of the types available and details of the higher voltages can be obtained upon request.

**SEMIKRON** SILICON & SELENIUM RECTIFIERS  
 NUREMBURG • W. GERMANY

SOLE REPRESENTATIVES IN U.K.:

**HCD Research Ltd.**

Laboratories and Works  
 77 GLOUCESTER RD • CROYDON • SURREY  
 Phone: THOrnton Heath 7485

For further information circle 272 on Service Card

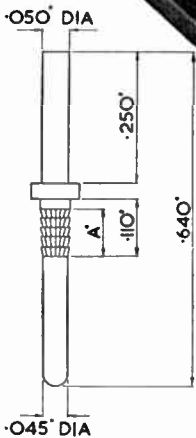
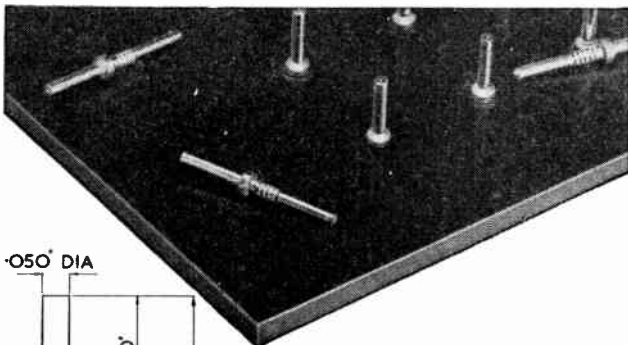

THE **OXLEY** SNALE  
 PRINTED CIRCUIT  
 LEAD-THROUGH FOR  
 .05" dia HOLES

1. TAPERED for ease of assembly into inaccurate holes.
2. SPLINED to inhibit rotation and avoid chipping the printed circuit board.
3. BARBED in order to attain high extraction force.

By ingenious design (Patents applied for) the Oxley "Snale" (P.C. nail) includes the features indicated. Oxley "Snales" are supplied heavily gold plated in sealed containers of 1,000. Write for technical details of these and other Oxley products.

**OXLEY DEVELOPMENTS CO. LTD.**  
 ULVERSTON, LANCASHIRE Telephone: Ulverston 2567

For further information circle 273 on Service Card

NUMBER ONE IN ELECTRICAL CONNECTORS...



**MS.K AND CA-KE  
 SERIES**

High Temperature Firewall Connectors  
 for 350 degrees F constant working.  
 1-52 Contacts Sealed or Unsealed.

**CANNON ELECTRIC  
 (GREAT BRITAIN) LTD.**  
 25-27 Bickerton Road, Upper  
 Holloway, London, N.19  
 Telephone: ARChway 3088



**Every  
time you  
need a  
capacitor  
in a hurry**

phone **Lemco  
express**



In addition to the usual Lemco bulk supplies, the new Lemco EXPRESS service exists specifically to provide quality Capacitors by return, at moderate cost, in small quantities—particularly for development, prototypes and small batches. Over 250 types and sizes of Lemco Mica, Ceramic, Polystyrene and Polyester Capacitors from 1 pF upwards; over 1,000,000 Lemco-tested Capacitors always in stock for immediate despatch. All orders dealt with by return. Write, ring or fill in coupon for FREE detailed Lemco EXPRESS stock chart. Write, ring or telegraph for Lemco EXPRESS supplies.

**LEMCO** LONDON ELECTRICAL MANUFACTURING CO. LTD.

Bridges Place, Parsons Green Lane, London S.W.6  
Telephone: RENown 7071 Telegrams: Condenser London

To Lemco EXPRESS  
London Electrical Manufacturing Co. Ltd  
Bridges Place, Parsons Green Lane, London S.W.6  
Please send me FREE Lemco EXPRESS Capacitor Stock Chart

NAME .....

FIRM .....

ADDRESS .....

IE

**BERCOTROL<sup>®</sup>**  
**A NEW ALL SOLID  
STATE SPEED  
REGULATOR AND  
STARTER**



**Bercotrol motor speed  
regulators for closed  
loop control**

The smallest, most accurate, combined starter and speed regulator, allowing commutator motors of up to 5 h.p. to be direct on line started and controlled accurately over the speed range of up to 100:1, with no load to full load regulation better than 1% of base speed.

- \* all solid state
- \* no moving parts
- \* facilities for remote control, dynamic braking and reversing
- \* standard models for ½, 1½, 2, 3½, and 5 h.p.
- \* simple to install
- \* requires only nominal 200/250V 50 cycle A.C. supply.

Ask Mr. Radford to send you list IED 103/M.V. and arrange a practical demonstration.



Industrial Electronics Division.  
**THE BRITISH ELECTRIC  
RESISTANCE CO. LTD.**  
Queensway, Enfield, Middlesex.  
Tel: HOWard 2411

# CLASSIFIED ADVERTISEMENTS

**FULLY DISPLAYED** : 55/- per single column inch.  
**SEMI-DISPLAYED** : 45/- per single column inch.  
**RUN-ON** : 4/6 per line of approximately 7 words.  
Where an advertisement includes a Box Number 1s. extra.  
**SERIES DISCOUNTS** : 12 insertions, 15%.  
Remittances payable to "Industrial Electronics".

Copy is required by 23rd of the month for insertion in the following month's issue, by 17th of the month if proofs are required.

Address to:  
Classified Advertisement Dept.  
Industrial Electronics  
Dorset House, Stamford St., London, S.E.1.

## SITUATIONS VACANT



Important new positions are being created in a young company for outstanding men with experience in electronics, measurement and computing applied to industrial processes. Successful applicants would join a small, dedicated group of individualists who are given every opportunity to shine. Work is hard and exciting. No committees, internal politics, remote managements. Enormous prospects for those who grow with us.

**CONTRACTS ENGINEER** (LONDON) to organise running of projects involving special purpose computers, and non-conventional instrumentation. A sound technical and commercial background, attention to detail and joy in making order from chaos are more important than design ability. Knowledge of French or German useful. Opportunities for foreign travel.

**ASSISTANT DRAUGHTSMAN** for development work. The way up for a keen young man.

**CUSTOMER ENGINEER** (NORTH) to be based on his home and to assist in commissioning and maintaining our steelworks installations in Sheffield, Scunthorpe and Middlesbrough areas. A certain amount of sales work will also be required. Load cell weighing, photo-electronics and complex digital instruments are highly involved and good experience in at least one of these topics as well as steelworks practice is essential.

All posts carry attractive starting salaries which will rise in relation to performance. Generous expenses and car allowance. Sickness benefit scheme. Age immaterial but ability, energy and initiative vital. Please apply fully and in confidence to the managing director.

**SETPOINT LIMITED 26/28 TABERNACLE STREET LONDON EC2 379**

## INSTRUMENTATION ENGINEER

Wanted for our Research and Development Department to be responsible for instrumentation of test components and rigs. This will include the design of simple electronic equipment where necessary, although this aspect of the work forms a relatively small proportion of the total responsibility involved.

The appointment would suit someone in the 26-35 age range, with H.N.C. in Electrical Engineering or Electronics, who has preferably had experience in experimental instrumentation in the motor industry or a related field.

Good salary and conditions.

Please apply, in strict confidence, giving age and brief details of qualifications and career to:

**PERSONNEL MANAGER (Ref. RD/3)**  
**HARDY SPICER LIMITED,**  
**CHESTER ROAD, ERDINGTON,**  
**BIRMINGHAM 24**

*A member of the Birfield Group.*

378

## TELEVISION ENGINEER Uganda

Applications are invited from candidates preferably under 45, with wide experience in all types of Broadcasting Television equipment including television transmitters, antenna and television studio equipment. Preference will be given to candidates with technical qualifications in Television Engineering. Duties include day-to-day responsibility for technical operation and maintenance of television equipment of National Television Service, and to assist in the installation of such equipment.

The appointment will be for one or two tours each from 21-27 months in the first instance with a salary in the range of £1,287 p.a. to £1,956 p.a. plus a gratuity of 25% of total emoluments.

Free family passages.

Free medical attention and furnished quarters provided at moderate rentals.

Generous leave and children's education allowance.

Apply to

**Appointments Officer**  
**Room 301**  
**Ministry of Overseas Development**  
**Eland House, Stag Place**  
**Victoria, S.W.1**

giving full name, age and qualifications and quoting RC 237/183/04.

383

**WHEN REPLYING TO  
ADVERTISEMENTS  
PLEASE MENTION  
INDUSTRIAL  
ELECTRONICS**





# VICKERS-ARMSTRONGS

(SHIPBUILDERS) LIMITED  
BARROW-IN-FURNESS, LANCASHIRE

## VACANCIES

### EXPERIENCED ENGINEERS

to assist in the technical control of the Polaris project.

### MECHANICAL TEST ENGINEERS

to assist in the commissioning of Polaris Submarines.

### ELECTRICAL DRAUGHTSMEN

of all grades who would like to be considered for Drawing Office Work.

### INSTRUMENT CALIBRATION TECHNICIANS

of either sex, for the calibration of electronic test equipment.

### SENIOR TECHNICAL AUTHOR

to assist in the preparation of hand-books on electrical systems and equipment.

## TECHNICAL STAFF FOR ADVANCED PROJECTS

### QUALIFICATIONS

Applicants should preferably have a degree or H.N.C. in electronics, light current electrical engineering or mechanical engineering, but wide experience could be more important than academic qualifications.

H.N.C. or equivalent qualifications in mechanical engineering would be desirable, as would experience of fluid systems. Training for these posts will include a period in the U.S.A. accompanied by wives and families.

Qualifications range up to O.N.C. or H.N.C. with practical experience of preparing circuits of electrical or instrument systems and/or control equipment: however some of the vacancies could be filled by competent people with a knowledge of the job (particularly in shipbuilding) and the desire to work in a Drawing Office.

O.N.C. or equivalent in electronics would be desirable, and experience of this type of work is essential.

H.N.C. or equivalent is desirable, and several years' experience in publications work is essential: practical experience would be an advantage.

### LOCATION

Barrow-in-Furness, on the Lancashire Coast, near the Lake District. The Company will make a generous contribution towards removal expenses and will assist with resettlement problems.

### SALARIES

will be in accordance with age and qualifications. A Company pension scheme is in operation.

### APPLICATIONS

should give brief details of experience, qualifications and present salary and should be addressed to:—

W. C. Robertson, VICKERS-ARMSTRONGS (SHIPBUILDERS) LIMITED, Barrow-in-Furness, Lancs.

386

# INDUSTRIAL ELECTRONICS

We intend to remain the foremost Company in the design and construction of electronic equipment for industrial automation.

## DESIGN ENGINEERS

Opportunities await Engineers with an interest in electronic techniques as applied to adjustable speed drives, power converters or control systems.

We are not looking for supermen, but if you have your feet on the ground and would like to join our design team situated in a pleasant rural part of Staffordshire, please write in confidence quoting Ref. I.E.1.

## INSTRUMENTATION DESIGNER

This position would concern itself with industrial instrumentation and process control, making use of electronic instruments and controllers.

Applicants should have a sound knowledge of the electrical and mechanical design of potentiometric instruments, together with experience in the design of instrumentation systems for industrial processes.

Applications should be in writing, stating age, qualifications and previous experience, and quoting Ref. I.E.2.

## TECHNICAL WRITER

An opportunity occurs for a person who is interested in the preparation of Customers' Handbooks on a wide range of electronic equipment for industrial control and measurement.

Technical Writers with experience in similar work will be considered most favourably. Engineers with experience in design, installation/ commissioning or service of electronic equipment, who wish to take up Technical Writing, are also invited to apply.

Applications, which will be treated in strictest confidence, quoting Ref. I.E.3, should be addressed to the Personnel Manager.

**LANCASHIRE DYNAMO ELECTRONIC  
PRODUCTS LIMITED**  
Rugeley, Staffordshire



387

## **DORMAN LONG**

NEED AN

### **ELECTRONICS ENGINEER**

aged 25—35 to assist in the design, commissioning and maintenance of electronic equipment in a large iron and steel company.

Applicants should have design experience in logic systems and be familiar with servos and heavy plant electrical engineering techniques.

Details of qualifications and experience to :

The Chief Development Engineer (Electrical Plant)  
Dorman Long (Steel) Ltd.  
G.P.O. Box 11  
Middlesbrough

381

## **INDUSTRIAL REPORTER**

*Electrical Review* has a vacancy for an industrial reporter, age not over 23. The work will include news and feature writing on commercial, economic and management subjects and offers an excellent opportunity to someone with initiative and ideas. Keen news sense and ability to write clearly and quickly are essential.

Applications to the Editor,  
*Electrical Review*, Dorset House, Stamford Street, London, S.E.1

387

## **Some of the brightest opportunities in the computer business are ready now for some of the brightest electronic engineers.**

English Electric Leo Marconi are going places in the computer industry. Just now we're well advanced on a research and development programme that will take us over the next ten years. We're working hard on the design and application of solid logic and micro-electronic circuits and we have today's most sophisticated techniques right at our finger-tips. We have big plans and we need men and women of intelligence, originality and broad imagination to help us see them through. Those who come to us whether at Kidsgrove or London will work as Assistant Chief Engineers, Senior Project Engineers (Computers), Senior Project Engineers (Peripherals), Development Engineers or Equipment Design Engineers. They will get the right kind of project environment. They will bear a large measure of personal responsibility and will have the satisfaction of seeing a job through all its stages.

They will have access to experts in a wide range of engineering specialisations and will have the R & D resources of the English Electric Group at their disposal.

Assisted house purchase scheme is available in certain cases.

Write now to

**I. V. Pugh, Department IN.K20,  
English Electric-Leo-Marconi Computers Ltd.  
Kidsgrove, Stoke-on-Trent, Staffordshire.**

**ENGLISH ELECTRIC LEO MARCONI**

385

## ARTICLES FOR SALE

### PHOTO-ELECTRIC CONTROLS

for industry

Quick delivery      Send for Catalogues

### Hird-Brown Limited

Flash Street, Bolton, Lancs.  
Tel. 27311

[305]

### MEDIUM VACUUM TEST PUMPING PLANTS

Type VT.11. Metropolitan Vickers Ltd.

Comprising, Rotary type SRS 107083.  
Oil Diffusion type 063 G.  
Oil Diffusion type 03B.

Self contained units. 3 phase 50 cycle supply.  
Mobile. Brand new condition. 3 Units available.  
Price £400 each or near offer.

### TINSLEY POLAROGRAPH

Type V722/15

Recorder complete with spares. No electrode stand available.

Brand new condition. Accept £250.

### W. A. HOLDEN & CO.

Shore Road, PERTH  
Phone: Perth 24544

382

## CAPACITY AVAILABLE

### AIRTRONICS LTD.

for coil winding assembly and wiring of electronic equipment, transistorised sub-units, sheet metal work. 4 Ashmead Road, London, S.E.8. Telephone: TIDeway 2249. [311]

# MICRO-ELECTRONICS (THIN FILMS)

This Company, a member of one of the largest engineering groups in the Country, situated in West Middlesex, invites applications from Physicists, Engineers and Technicians with experience in micro-electronics to join their Electronics Department, which provides the research function in this field for the group.

A high salary will be paid to the successful candidates in each of the above categories who will form a team charged with the development application and manufacture of thin film devices to be used in the Company's present range of digital equipments.

The Company offers attractive conditions of employment with excellent prospects.

Write for special application form and further details of these appointments, or telephone

Personnel Manager

BELL PUNCH CO. LTD.

The Island, Uxbridge, Middlesex

Tel : Uxbridge 38211

380

TO INSERT AN  
ADVERTISEMENT

IN THE

CLASSIFIED  
SECTION

TELEPHONE

INDUSTRIAL ELECTRONICS

WATERLOO 3333

EXT. 210



## CONTROL ENGINEERING

There are Senior and Junior appointments with good salaries and excellent prospects with the North Thames Gas Board.

Previous experience in ONE OF THE FOLLOWING FIELDS and an interest in the others is needed, together with a technical qualification for the Senior posts.

**PNEUMATIC OR ELECTRONIC CONTROLLERS**  
**TRANSISTOR AMPLIFIER DESIGN AND LOGIC ELEMENTS**  
**DIGITAL COMPUTERS**  
**DATA HANDLING CHEMICAL PLANT INSTRUMENTATION**

This is a live industry planning for expansion.

The successful applicants may be based at Fulham, or required to work at other London sites.

Applications, giving a brief history, to the Staff Controller,

**NORTH THAMES GAS BOARD**  
**30 Kensington Church Street, London, W.8**

quoting reference IE/2188

377

Classified continued on page 60

# GAS COUNCIL RESEARCH

## ENGINEERING RESEARCH LABORATORY

The rapid technological advance of the Industry requires an expanding research effort. A new Engineering Research Laboratory is now being set up and several senior posts are to be filled. Applications are invited for appointment as

### GROUP LEADER — Control and Instruments

The Group Leader will be required to plan his programme, equip the laboratory, and direct the work of his Group, which will be concerned with problems of automatic control, transient studies, and sensing equipment.

**QUALIFICATIONS:** Honours Degree and experience of instruments in a laboratory or the field.

**SALARY:** Will be negotiated above £2,000.

**LOCATION:** London Research Station, Fulham, London, S.W.6.

Applications, giving full details, should be sent to the Staff Controller, North Thames Gas Board, 30 Kensington Church Street, London, W.8, quoting reference IS/2170.

384

## REGISTER NOW WITH SCIENTIFIC & TECHNICAL APPOINTMENTS LTD.

FOR OPPORTUNITIES WITH NUMEROUS COMPANIES IN VARIED FIELDS.  
FREE SERVICE TO ALL APPLICANTS.

Ring MALden 8720 for APPLICATION FORMS

376

For further information circle 276 on Service Card

## INEXPENSIVE & RELIABLE

Remember the name — EMI Shaded 2 Pole Motor Type Z. Consider the reliability — over 3,000 hours running without re-oiling — able to withstand continuous mechanical overload. Send for the Type Z data sheet.

■ Geared motor — approximate speeds 2,900 r.p.m. geared down to 16 r.p.m. ■ Low resistance rotor with copper bars and end plates. ■ Rotor has critically skewed bars for smooth running — dynamically balanced to special limits where required. ■ Sizes approx.  $2\frac{1}{2}'' \times 3'' \times 1\frac{1}{4}''$ . ■ Weight 17 $\frac{3}{4}$  oz. (standard), 21 oz. (Long Bearing A Motor). ■ Low mechanical noise — no electrical interference.

## EMI SHADED 2 POLE AC MOTORS

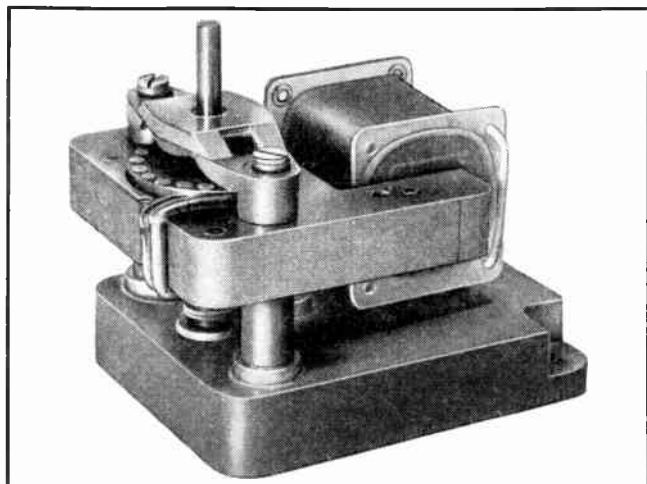

Full details from:—  
EMI SOUND PRODUCTS LIMITED, COMPONENTS DIVISION, HAYES  
MIDDLESEX. TEL.: HAYES 3888 • EXT. 2515

IF YOU REQUIRE  
**DATA PROCESSING STAFF**  
WHY NOT ADVERTISE  
IN THE  
**MARCH ISSUE**  
OF  
**DATA PROCESSING**

FULL DETAILS FROM  
Classified Advertisement Manager  
Dorset House, Stamford Street, S.E.1

WAT: 3333 Ext: 210

## BOOKS

"ABACS or Nomograms." By A. Giet. Translated from the French by H. D. Phippen and J. W. Head. Most engineers have made use of nomograms at some time in their careers, and are fully alive to the fact that they are a very convenient tool when the same formula has to be solved repeatedly for several sets of variables. It is fair to say, however, that only a small proportion of even those who habitually employ nomograms know how to construct them for their own use. Most of the comparatively small literature on the subject is written for mathematicians and is extremely difficult for the practical engineer to comprehend. This book is essentially practical, and not only demonstrates the many and varied applications of the abac or nomogram, but shows how even those without highly specialised mathematical knowledge may construct their own charts. 35s net from all booksellers. By post 36s from Hiffe Books Ltd., Dorset House, Stamford Street, London, S.E.1.

For further information circle 277 on Service Card



$\frac{1}{8}$ " BSP

instrument valves by ...

**HONE**

- ★ TESTED AT 5,000 p.s.i.
- ★ POSITIVE SHUT-OFF
- ★ FINE CONTROL
- ★ IN STAINLESS STEEL, MONEL or BRASS
- ★ P.T.F.E. or METAL SEATS
- ★ STRAIGHT THROUGH or ANGLE CONNECTIONS

Write or telephone for full information to:—

**HONE INSTRUMENTS LIMITED**

19 Eldon Park, London, S.E.25 Tel.: ADDiscombe 3117  
GD476

For further information circle 278 on Service Card

## INDUSTRIAL TRAINING ELECTRONICS

?

**HAVE ALL YOUR PERSONNEL**, in need of further education, been entered for courses in electronics suited to their particular capability and circumstances?  
**HAVE ALL YOUR JUNIOR STAFF**, already covered, at this stage in their studies, the subject related to their present occupation?  
**HAVE ALL YOUR failures**, at least as far as conventional courses are concerned, been given special qualitative training to ensure a maximum contribution to the group effort?  
**HAVE ALL YOUR SENIOR STAFF** had an opportunity to familiarise themselves with the fundamentals of new devices, dealt with in detail by their assistants?  
**HAVE ALL YOUR MAINTENANCE STAFF**, servicing electronic plant, been given a grounding in related fundamentals?  
**IN THE EVENT THAT THE ANSWER**, to any or all of these questions, IS NO, then perhaps it may be assumed that your training section will be extended to cover electronics or, if no educational facilities already exist within your organisation, the real costs involved may be reconsidered in the light of possible Training Levy assessments.  
**YOUR INVESTMENT FOR THE FUTURE**, which is never far away, will be in employee's time, instructor's salary, classroom space, educational equipment, etc. In discussions relating to our Training Equipment most of these topics arise and it is rewarding to learn that the use of our products helps make the overall investment worthwhile.  
 May we assist you with your programmes?

**PHILCO INTERNATIONAL LTD.**  
 SOUTH STREET, BISHOP'S STORTFORD, HERTS., B.S. 4971

For further information circle 279 on Service Card

**New KEYWAY TERMINAL BLOCKS**

**METWAY PRODUCTS**  
 REGISTERED TRADE MARK

- 4 Amperages: 5-20, 30-40, 50-60, 75-100.
- All 4 sizes can be interlocked.
- No limit to the number of ways.
- Non tracking. Clamp down or pillar terminals.
- Press-on cable markers in letters and numerals.

Ask for Cat. No. NBQ16/IE.

**METWAY · KEMP TOWN · BRIGHTON 7**

For further information circle 280 on Service Card

## TRANSMETRIX

For the highest quality and most rapid service in  
 DESIGN LAYOUT MANUFACTURE CAPACITY

### PRINTED CIRCUITS

and

### WIRING ASSEMBLY

The expert staff and unique facilities of T.E.S.  
 can save you **TIME AND MONEY.**

Phone: **SHANKLIN 3096**

**TRANSMETRIX ELECTRONIC SYSTEMS LTD.**  
 SHANKLIN · ISLE OF WIGHT · HAMPSHIRE

Ad. Auriema Ltd. ....	26	International General Electric Co. of New York Ltd. ....	45
Adcola Products Ltd. ....	37	International Rectifier Co. Ltd. ....	31
Aircraft Marine Products (G.B.) Ltd. ....	2	Kent. George. Ltd. ....	Cover ii
Ampex Great Britain Ltd. ....	17	Kodak Ltd. ....	18
Anglo-American Vulcanized Fibre Co. Ltd. ....	28	La Nationale S.A. ....	53
Appointments Vacant 56, 57, 58, 59. 60	60	Lancashire Dynamo & Electronic Products Ltd. ....	7
A.P.T. Electronic Instruments Ltd. ....	27	Landis & Gyr Ltd. ....	36
Arrow Electric Switches Ltd. ....	2c	Laycock Engine ring Ltd. ....	47
Automation Ltd. ....	6	Livingston Control Ltd. ....	3
Aveley Electric Ltd. ....	49	London Electric Wire Co. & Smiths Ltd. ....	52
B & R Relays Ltd. ....	62	London Electrical Mfg. Co. Ltd. ....	55
Bell & Howell Ltd. ....	19	Magnetic Devices Ltd. ....	30
British Electric Resistance Co. Ltd. ....	55	Mallory Ltd. ....	25
British Rototherm Co. Ltd. ....	20	Mawdsley's Ltd. ....	52
Bryans Ltd. ....	14	McMurdo Instrument Co. Ltd. ....	36
Cannon Electric (Great Britain) Ltd. ....	54	Metway Electrical Industries Ltd. ....	61
Classified Advertisements	56, 57, 58, 59, 60	Murex Ltd. ....	20
Cossor Instruments Ltd. ....	51	Oxley Developments Co. Ltd. ....	54
Dawe Instruments Ltd. ....	13	Painton Ltd. ....	Cover iv
Dexion Ltd. ....	38	Pergamon Press Ltd. ....	26
Diamond H Controls Ltd. ....	48	Phileo International Ltd. ....	61
Elcometer Instruments Ltd. ....	44	Philco. G. A., Ltd. ....	53
Electrical Apparatus Co. Ltd. ....	44	Salford Electrical Instruments Ltd. ....	14
Electrical Power Engineering Co. (B'ham) Ltd. ....	50	Sealectro Ltd. ....	35
E.M.I. Sound Products Ltd. ....	60	SE Laboratories (Eng'g) Ltd. ....	39
English Electric Valve Co. Ltd. ....	31	Solartron Electronic Group Ltd. ....	21, 33, 40
English Numbering Machines Ltd. ....	42	Sperry Gyroscope Co. Ltd. ....	42
Ericsson Telephones Ltd. ....	8	Standard Telephones & Cables Ltd. ....	9, 10, 11
Ether Ltd. ....	12	Stewart Aeronautical Supply Co. Ltd. ....	41
Ferranti Ltd. ....	23	Tektronix U.K. Ltd. ....	16
Fielden Electronics Ltd. ....	32, 50	Telegraph Condenser Co. Ltd. ....	Cover iii
G.E.C. (Electronics) Ltd. ....	4, 5	Transmetrix Electronic Systems Ltd. ....	61
HCD Research Ltd. ....	54	V.G. Porcelain Co. Ltd. ....	46
Heenan & Froude Ltd. ....	48	Walmore Electronics Ltd. ....	46
Hone Instruments Ltd. ....	60	Wayne Kerr Laboratories Ltd. ....	61
Honeywell Controls Ltd. ....	Loose Insert	Welwyn Electric Ltd. ....	1
Hughes International (U.K.) Ltd. ....	22	West Instrument Ltd. ....	44
Iliffe Books Ltd. ....	53	Westinghouse Brake and Signal Co. Ltd. ....	24, 43
Imhof, Alfred, Ltd. ....	15		

For further information circle 281 on Service Card



### A full performance Digital Voltmeter for under £150

- |                   |                         |
|-------------------|-------------------------|
| Accuracy :        | 0.1% or 0.2%            |
| Ranges :          | 1, 10, 100, 1,000V d.c. |
| Input Impedance : | 2.2 megohms             |
| Size :            | 5½" x 8" x 7"           |

Please send me further details of Digitec.

NAME \_\_\_\_\_

ADDRESS \_\_\_\_\_

**WAYNE KERR** The Wayne Kerr Laboratories Limited  
 Coombe Road, New Malden, Surrey. Tel. MALden 2202

WVKD54

INDEX TO ADVERTISERS

# CONTROL

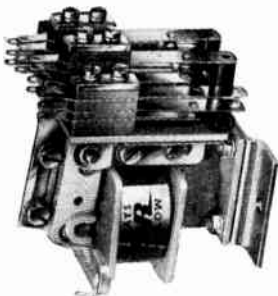

**J.01**  
Robust and reliable—up to 10 make, break or changeover 2.5 Amp contacts—laminated frame—oilite bearings.

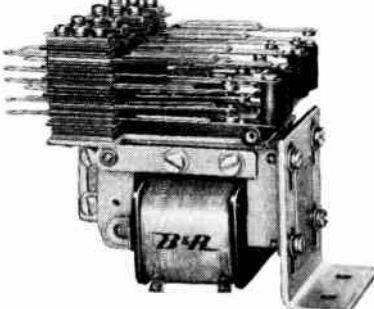

**C.01**  
12 make, break or changeover 5 Amp contacts may be fitted—low coil consumption—laminated frame—silent—oilite bearings—long life.



**M.01/M.51 & M.01/M.51/P (as shown)**  
Both open and plug-in types available—up to 4 changeover or 6 make or 6 break 5 Amp contacts—plug-in version has aluminium cover—screw terminal sockets available for 8 and 11 pin plug-in versions.

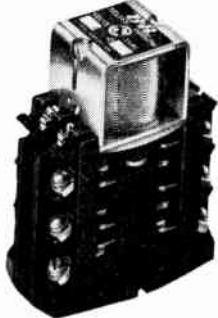

**Q.01/Q.51**  
Ideal for machine tool control and motor switching duties—can be fitted with up to 4 make and 4 break contacts. Suitable for switching 3 phase 440V supplies at 10 Amps inductive—latching and interlocking units available.



**D.03/D.53**  
Two changeover 6 Amp contacts—no wiring between contacts and base connections—Makrolon cover—wiring or screw terminal sockets.

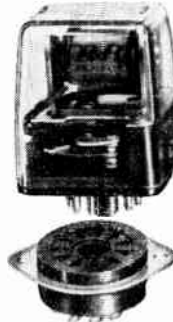

**D.05/D.55**  
Three changeover 6 Amp contacts—no wiring between contacts and base connections—Makrolon cover—wiring or screw terminal sockets.

Control equipment requires versatile and reliable relays. The B. & R. relays shown here have different advantages for different applications, covering all requirements.

If you are concerned with any aspect of control, mechanisation or automation, these relays, which may be supplied for A.C. or D.C. operation, merit your closest attention.

All are well designed, meticulously tested, quality relays.

Write or 'phone for details:

**B & R RELAYS LIMITED**  
 Temple Fields, Harlow, Essex. Telephone: Harlow 25231-4. Telex: 81140. Cables: Brelay—Harlow.

**Best in Relays**



## Meetings

### Institution of Electronic and Radio Engineers

All meetings will be held at 9 Bedford Square, London, W.C.1. and tickets will be required, unless otherwise stated.

(Wed) 17th Feb. 6 p.m. 'Transistorized Equipment Designed for Television Exploitation of Radar Information'.

(Wed) 24th Feb. 6 p.m. at the London School of Hygiene and Tropical Medicine, Keppel Street, Gower Street, London, W.C.1. 'A Low Cost Video Tape Recorder for Professional Applications'.

(Wed) 3rd Mar. 6 p.m. Discussion on 'Teaching of Control Engineering'.

(Wed) 10th Mar. 6 p.m. at the London School of Hygiene and Tropical Medicine, Keppel Street, Gower Street, London, W.C.1. 'Problems in Listening'.

(F) 12th Mar. 5.30 p.m. Joint I.E.E./I.E.R.E. discussion at the I.E.E., Savoy Place, London, W.C.2. 'The Training of Computer Engineers'.

(Wed) 17th Mar. 6 p.m. Joint I.E.R.E./I.E.E. discussion on 'Implanted Stimulators for Bladder and Rectum'.

(Wed) 7th Apr. 6 p.m. 'Inertial Navigational Systems for Airborne and Shipborne Uses'.

(Wed) 14th Apr. 6 p.m. at the London School of Hygiene and Tropical Medicine, Keppel Street, Gower Street, London, W.C.1. 'Solid State Scanning Circuits'.

(Wed) 21st Apr. 6 p.m. at the London School of Hygiene and Tropical Medicine, Keppel Street, Gower Street, London, W.C.1. 'Effect on the Ionosphere of Nuclear Explosions'.

(Wed) 28th Apr. 6 p.m. 'Synchronously Tuned Methods of Harmonic and Intermodulation Distortion Analysis'.

(Wed) 12th May, 6 p.m. Joint I.E.R.E./I.E.E. meeting at the London School of Hygiene and Tropical Medicine, Keppel Street, Gower Street, London, W.C.1. 'Random Access Mass Stores'.

(Wed) 19th May, 6 p.m. 'A Groove Control System for Phonograph Disc Cutting Equipments'.

### Institution of Electrical Engineers

All meetings will be held at 5.30 p.m. at Savoy Place, London, W.C.2, unless otherwise stated.

(Th) 11th Feb. Discussion on 'The Electrometer Amplifier: Its Design and Applications'.

(Tue) 16th Feb. Discussion on 'Universities Under Fire'.

(Mon) 22nd Feb. 'Layer Structure of the Troposphere'.

(Tue) 23rd Feb. Discussion on 'What is Systems Engineering?'.

(F) 12th Mar. Joint I.E.E./I.E.R.E. discussion 'The Training of Computer Engineers'.

(Wed) 17th Mar. 6 p.m. at I.E.R.E., 9 Bedford Square, London, W.C.1. Joint I.E.R.E./I.E.E. discussion on 'Implanted Stimulators for Bladder and Rectum'.

(Wed) 12th May, 6 p.m. at the London School of Hygiene and Tropical Medicine, Keppel Street, Gower Street, London, W.C.1. Joint I.E.R.E./I.E.E. meeting. 'Random Access Mass Stores'.

### Institution of Mechanical Engineers

All meetings will be held at 6 p.m. at 1 Birdcage Walk, London, S.W.1, unless otherwise stated.

(Th) 11th Feb. Discussion on 'Should there be Less Specialization in University Courses?'.

(Wed) 24th Feb. The first John Player lecture on 'Oxygen Steelmaking Processes'.

### The Television Society

All meetings will be held at 7 p.m. in the Conference Suite, I.T.A., 70 Brompton Rd., London, S.W.3, unless otherwise stated.

(F) 5th Mar. 'Non-Entertainment Television'.

## Conferences, Symposia and Colloquia

(Mon) 15th Feb. 3 p.m. at I.E.E., Savoy Place, London, W.C.2. Colloquium on 'The Design of Solid State Power Supplies'. Registration is required.

(Th) 18th Feb. 10.30 a.m. at the I.E.E., Savoy Place, London, W.C.2. Joint I.E.E./I.E.R.E. colloquium on 'Automatic Aids to Fault Finding in Computers'. Registration is required.

(F) 19th Feb. 2.30 and 5 p.m. at the I.E.E., Savoy Place, London, W.C.2. Colloquium on 'Electrostatic Precipitators'. Registration is required.

(Th-F) 25th-26th Feb. at 1 Birdcage Walk, London, S.W.1. Institution of Mechanical Engineers Symposium on 'Gyros'.

(Tue-Th) 23rd-25th Mar. Conference on 'Automating Engineering Manufacture'. Held by PERA at Melton Mowbray, Leics.

(Tue-Wed) 25th-26th Mar. at 1 Birdcage Walk, London, S.W.1. Conference on 'Vacuum Technology' to be held by the Institution of Mechanical Engineers in conjunction with the Joint British Council for Vacuum Science and Technology.

(Mon) 5th Apr. 2.30 and 5.30 p.m. at the I.E.E., Savoy Place, London, W.C.2. Joint I.E.E./I.E.R.E. colloquium on 'Design of Real Time Computer Systems'.

(Mon-F) 5th-9th Apr. at Nottingham University. Conference on 'Advances in Automatic Control', held by Institution of Mechanical Engineers.

(Tue-F) 13th-14th May. Conference on 'New Materials and Processes in Instrument Manufacture' at Grand Hotel, Eastbourne. Held by The British Scientific Instrument Research Association (SIRA), South Hill, Chislehurst, Kent. (Phone: Imperial 5555).

(Mon-Th) 17th-20th May at the I.E.E., Savoy Place, London, W.C.2. Joint I.E.E./I.E.R.E. international conference on 'Components and Materials used in Electronic Engineering'. Registration forms and further information from the I.E.R.E., 9 Bedford Square, London, W.C.1.

(Tue-Th) 18th-20th May. Conference on 'Design Engineering and Management' organized by the Production Engineering Research Association of Great Britain (PERA) and held at their headquarters at Melton Mowbray, Leicestershire. Phone: Melton Mowbray (OMM4) 4133.



# WHAT'S ON AND WHERE

Continued

**(Wed-F) 30th June-2nd July** at University College, London. Joint I.E.R.E./I.E.E. symposium on 'Microwave Applications of Semiconductors'. Papers and requests for further information should be sent to The Secretary, Joint Organizing Committee, Symposium on Microwave Applications of Semiconductors, The Institution of Electronic and Radio Engineers, 8-9 Bedford Square, London, W.C.1.

**(Mon-Sat) 13th-18th Sept.** Engineering Materials & Design Conference. Held in conjunction with an exhibition at Olympia, London. Organized by Industrial & Trade Fairs Ltd., Commonwealth House, 1-19 New Oxford Street, London, W.C.1. ('Phone: Chancery 9011).

**(Tu-F) 21st-24th Sept.** First European Conference on Magnetism, Vienna. To be held at Technischen Hochschule, Vienna. Conference Secretariat: Verein Deutscher Eisenhüttenleute, 4 Dusseldorf, Breite Strasse 27.

## Exhibitions

**(Sun-Th) 21st-25th Feb.** International Trade Fair (Spring), Frankfurt. U.K. representatives Lep Transport, Sunlight Wharf, Upper Thames Street, London, E.C.4. ('Phone: Central 5050).

**(Sun-Tue) 28th Feb.-9th Mar.** Leipzig Fair, Leipzig. Organized by Leipziger Messeamf, Post Box 329, Leipzig.

**(Mon-Tue) 8th-16th Mar.** International Spring Trade Fair, Utrecht. U.K. representatives Exhibition Consultants Ltd., 11 Manchester Square, London, W.1. ('Phone: Hunter 1951).

**(Mon-F) 29th Mar.-2nd Apr.** LABEX—Laboratory Apparatus and Materials Exhibition at Earls Court. Sponsored by Scientific Instrument Manufacturers Association, 20 Peel St., London, W.8. ('Phone: Park 2614).

**(Mon-Th) 5th-8th Apr.** The Physics Exhibition, Manchester (College of Science and Technology). Organized by the Institute of Physics and the Physical Society, 47 Belgrave Square, London, S.W.1. ('Phone: Belgravia 6111).

**(Th-Tue) 8th-13th Apr.** Salon International des Composants Electroniques in Paris. Organized by Fédération Nationale des Industries Electroniques (FNIE), 16 rue de Presles, Paris, 15e. ('Phone: 273-24-70).

**(Wed-F) 21st-30th Apr.** International Engineering Exhibition, London (Earls Court) and Olympia. Organized by F. W. Bridges & Sons Ltd., Commonwealth House, 1-19 New Oxford Street, London, W.C.1. ('Phone: Whitehall 1353).

**(Sat-Sun) 24th Apr.-2nd May.** Hanover Fair, Hanover. U.K. representatives Schenkers Ltd., Royal London House, 13 Finsbury Square, London, E.C.3. ('Phone: Metropolitan 9711).

**(Mon-Sat) 17th-22nd May.** Business Efficiency Exhibition, Birmingham (Bingley Hall). Organized by the Business Equipment Trade Association, 64 Cannon Street, London, E.C.4. ('Phone: Central 7771).

**(Tue-F) 18th-21st May.** Radio and Electronic Component Show at Olympia, London. Organized by Industrial Exhibitions Ltd., 9 Argyll Street, London, W.1. ('Phone: Gerrard 1622).

**(Wed-Tue) 19th-25th May.** Electronic Exhibition, Amsterdam. Organized by Elvabé, Molenallee 63A, Wilp, Gld., Netherlands.

**(Tue-Sat) 15th-19th June.** 1st Pumping Exhibition, Earls Court, London. Organized by Iliffe Exhibitions Ltd., Dorset House, Stamford St., London, S.E.1. ('Phone: Waterloo 3333).

**(Tue-Sat) 15th-19th June.** NAVREX—Noise and Vibration Reduction Exhibition, Earls Court, London. Organized by Iliffe Exhibitions Ltd., Dorset House, Stamford St., London, S.E.1. ('Phone: Waterloo 3333).

**(Wed-Sat) 16th-26th June.** Interplas 65—The International Plastics Exhibition in Europe for 1965, Olympia, London. Organized by Iliffe Exhibitions Ltd., Dorset House, Stamford St., London, S.E.1. ('Phone: Waterloo 3333).

**(Wed-Sat) 25th Aug.-4th Sept.** Radio Show, Earls Court, London. Organized by Industrial and Trade Fairs, 1-19 New Oxford Street, London, W.C.1. ('Phone: Whitehall 1353).

**(Tue-Sat) 7th-11th Sept.** INEL 65 International Exhibition of Industrial Electronics, Basle, Switzerland. 61 Clarastrasse, 4000 Basle. ('Phone: Basle (061) 323850).

**(Th-Sun) 9th-19th Sept.** Salon International de la Radio et de la Television, Paris.

**(Mon-Sat) 13th-18th Sept.** Engineering Material & Design Exhibition. Held in conjunction with a conference at Olympia, London. Organized by Industrial & Trade Fairs Ltd., Commonwealth House, 1-19 New Oxford Street, London, W.C.1. ('Phone: Chancery 9011).

**(Tue-F) 28th Sept.-1st Oct.** Medical Electronic and Instrumentation Exhibition (in conjunction with The European Symposium on Medical Electronics) at Exhibition Hall, Brighton, Sussex. Organized by Events Promotions Ltd. Ashbourne House, Alberon Gardens, London, N.W.11. ('Phone: Meadway 5555).

**(Mon-Wed) 4th-13th Oct.** Business Efficiency Exhibition, London (Olympia). Organized by Business Equipment Trade Association, 64 Cannon Street, London, E.C.4. ('Phone: Central 7771).

**(Wed-Tue) 13th-19th Oct.** 3rd International Congress and Exhibition of Measuring Instrumentation and Automation (Interkama), Dusseldorf, Germany. Represented by John E. Buck (Trade Fair Agencies) Ltd., 47 Brewer Street, Piccadilly, London, W.1. ('Phone: Gerrard 7576).

**(Wed-Sat) 27th-30th Oct.** R.S.G.B. Radio Communications Show, Seymour Hall, London. Organized by P. A. Thorogood, 35 Gibbs Green, Edgware, Middlesex.

**(Mon-Sat) 15th-20th Nov.** Industrial Photographic & Television Exhibition at Earls Court, London. Organized by Industrial & Trade Fairs Ltd., Commonwealth House, 1-19 New Oxford Street, London, W.C.1. ('Phone: Chancery 9011).

## Courses

**Commencing 16th Feb. at 10 a.m.** 'Flow Measurement and Control'.

A special full time, three day course intended as a refresher for practising engineers. Fee: £7. Borough Polytechnic, Borough Rd., London, S.E.1. ('Phone: Waterloo 7654).

**Commencing 18th Feb. at 6 p.m.** 'Cryogenics—Low Temperature Engineering'.

A course of six lectures held Thursday evenings at the Civil and Mechanical Engineering Dept., Enfield College of Technology, Queensway, Enfield, Middlesex. ('Phone: Howard 1126).

**Commencing 2nd Mar.** 'Quality Control'.

**Commencing 30th Mar.** 'Production Inspection'.

Two of a number of refresher courses being held by the Production Engineering Research Association at their headquarters at Melton Mowbray, Leics. ('Phone: Melton Mowbray 4133) for personnel of member-firms.

## ★ FOR THE BUYER

You must have read about a number of products and processes in this issue of which you would like further details. You can obtain this information very easily by filling in and posting one or more of the enquiry cards to be found immediately preceding page 93.





# 'DRITAN'

## SOLID TANTALUM CAPACITORS



- Working Voltages** 6, 10, 15, 20, 35 and 50.
- Capacitance Tolerance** ± 20% standard  
± 10% or ± 5% to special order
- Temperature Range** -55°C to +125°C, with voltage derating over 85°C
- Maximum leakage current**  $I(\mu A) = 0.02 C(\mu F) V(\text{volts})$  at 25°C  
 $I(\mu A) = 0.2 C(\mu F) V(\text{volts})$  at 85°C

Made to the most stringent performance characteristics, T.C.C. "Dritan" Capacitors have a porous sintered tantalum anode, with a solid, non-corrosive manganese dioxide electrolyte. Low levels of dissipation factor and high frequency impedance, unrivalled in the industry, afford higher permissible ripple currents than ever before. Their small size makes them particularly suitable for use in transistorised equipment such as R.F. timing, integrating and differentiating circuits, and servo systems in which high capacitance with small physical size is essential.

All sizes and ratings comply with Mil-C-26655A. T.C.C. "Dritans" are rated for operation over a temperature range of -55°C to +125°C, with appropriate voltage derating over 85°C.

### JOINT SERVICE APPROVAL

T.C.C. "Dritan" Capacitors with capacitance tolerances of ±10% and ±20%, up to and including 35 volts working, have been granted full Joint Service Advance Approval by the Radio Components Standardisation Committee to DEF-5134-A-1 (which is in final draft form and will shortly be published by H.M.S.O.) Humidity Classification H6. Temperature Category T5. Grade SP3, as detailed in DEF-5011.

Full details of "Dritan" Electrolytics are given in T.C.C. Technical Bulletin No. 83, a copy of which will be sent on request.

**THE TELEGRAPH CONDENSER CO. LTD.**

Electronics Division - North Acton - London, W.3 - Tel. ACOrn 0661 - Telex: 261383  
also at CHESSINGTON, SURREY and BATHGATE, SCOTLAND

For further information circle 202 on Service Card

# PAINTON RELIABILITY

at the right price for these

# FIVE NEW CONNECTORS

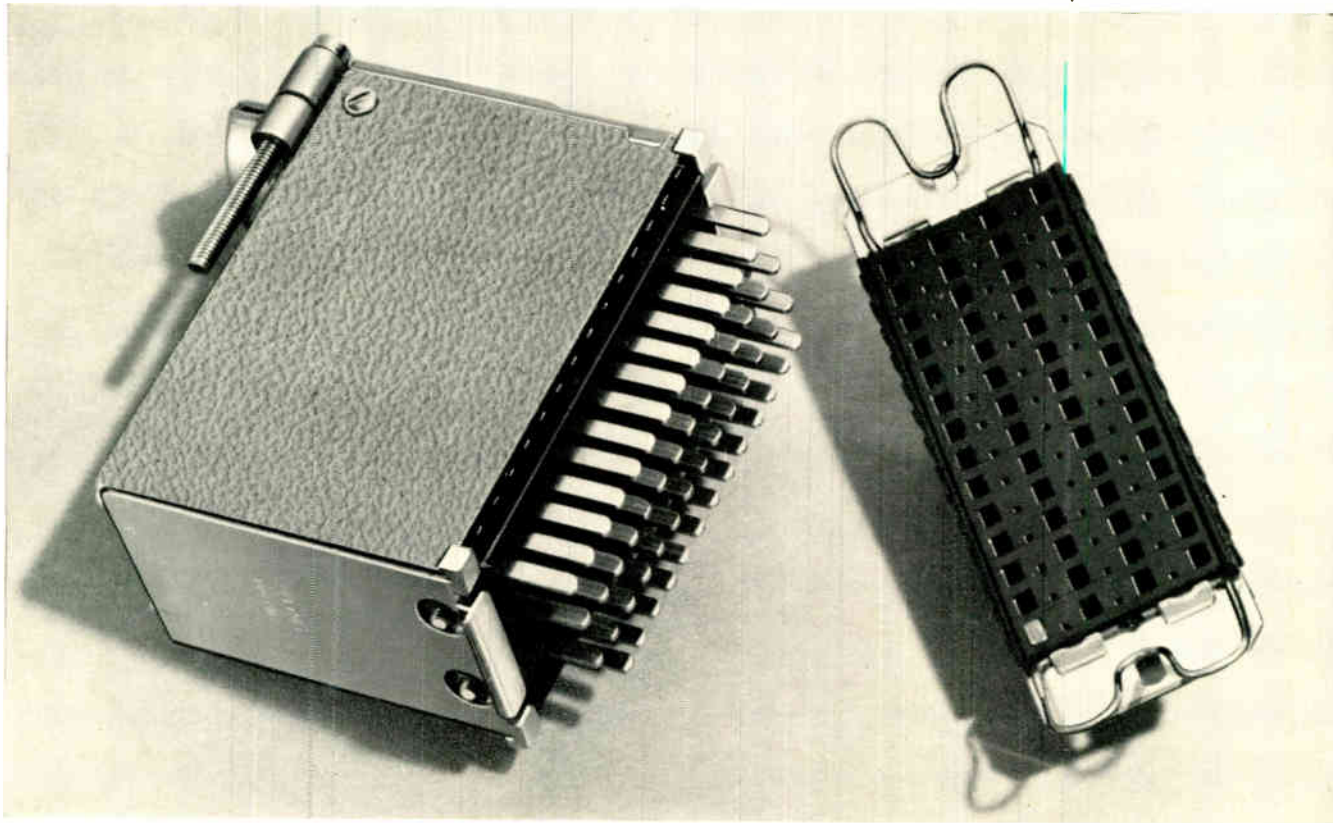

**35** WAY

**47** WAY

**\*55** WAY

**59** WAY

**71** WAY

These new additions to the Painton **159 Series** Connectors embody the space-saving configuration and high standards of reliability already well established for this range of components, and are offered at sensible prices. Send for leaflet P.S. 12

\* This type specially developed for the G.P.O. & approved by them as P0203.

**Painton**

& CO LIMITED

KINGSTHORPE · NORTHAMPTON

Tel: 34251 (10 lines) · Grams: 'Ceil' Northampton · Telex 31576

Overseas Associated Companies Australia Painton Australia Pty. Ltd. · Benelux Painton S.A. · Germany Painton G.m.b.H. Italy Painton Italiana · Sweden Svenska Painton A.B. · U.S.A. Painton Inc.