

BICC

in Television

BICC manufacture every type of cable and associated product that is necessary for the transmission and reception of the visual image—including camera cables and polypole couplers, coaxial distribution cables, power cables, equipment wires and downloads. Transmitting aerial towers are supplied and erected by the British Insulated Callender's Construction Company Limited.

BICC products contribute to the development and expansion of the television industry.

British Insulated Callender's Cables Limited
21 Bloomsbury Street London WC1

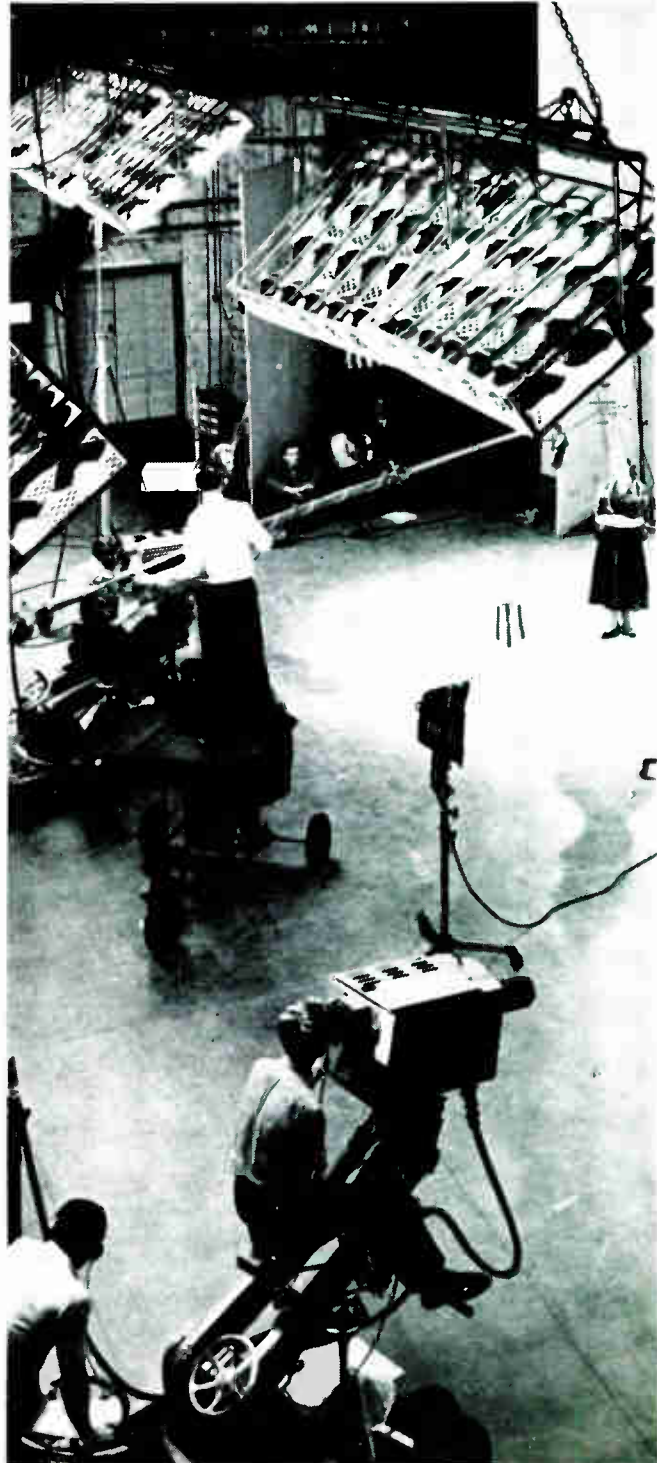
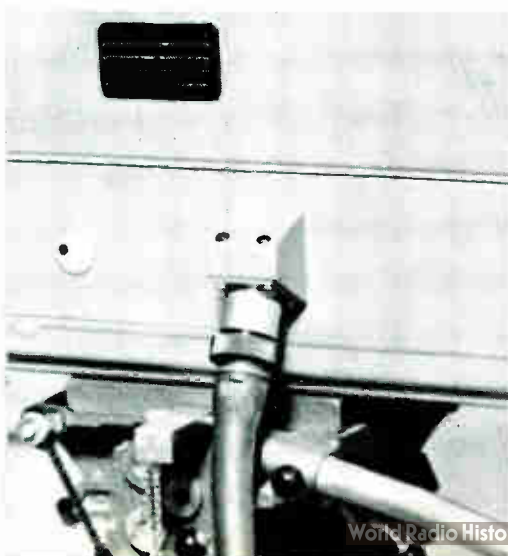
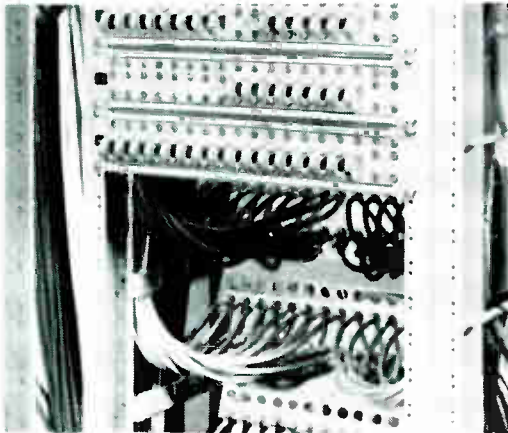
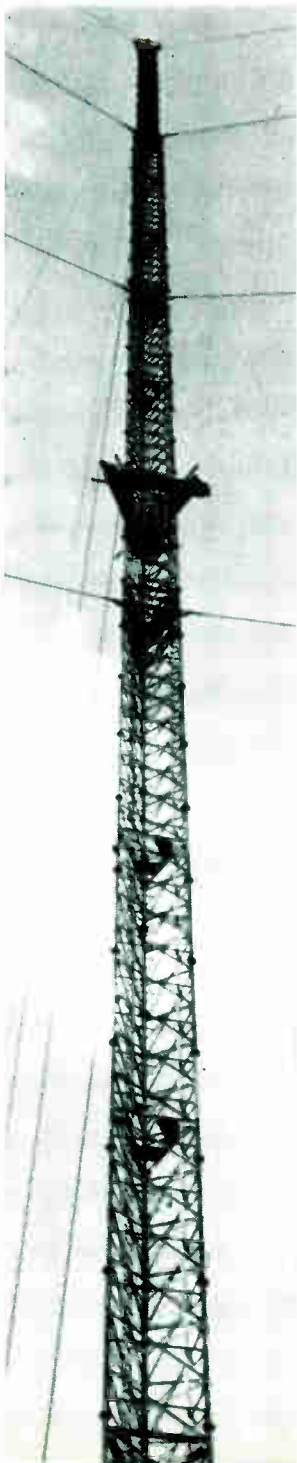

REPEATED GARBAGE TEXT AT TOP RIGHT

INDUSTRIAL ELECTRONICS

incorporating *ELECTRONIC TECHNOLOGY*

Volume 2 Number 8 August 1964

REPEATED GARBAGE TEXT IN MIDDLE RIGHT

contents

Editor **W. T. COCKING, M.I.E.E.** 355
Assistant Editor **T. J. BURTON**

Advertisement Manager **G. H. GALLOWAY** 357

Comment

Check Weighing Equipment by *J. A. Musto and R. W. Newman*
Packages have often to include a prescribed weight of content. A checkweigher will automatically weigh each package and cause over and underweight packages to be rejected. Sorting according to weight is also possible, as well as automatic control of filling.

362 **Industrial Telemetry** by *R. C. Griggs*
The acquisition of data from remote plant and the remote control of such plant are becoming increasingly necessary in many industries. Telemetry can provide these facilities and this article discusses the subject in general terms.

369 **Digital Counters Used in Length Measurement** by *G. Cooper*
This article describes the way in which digital techniques are used to control a 'flying shear'. This is a machine which cuts rolled steel rod and bar to convenient lengths as it comes from the rolling mill.

386 **High-Speed Radiography** by *D. J. Davis and D. C. Laval*
It is now possible to apply X-rays to high-speed photography so that radiographs of objects moving at velocities up to 40,000 ft/sec can be obtained. This article describes the principles involved and the way in which very short duration 'bursts' of X-rays are produced.

391 **A Hybrid Approach to Integrated Circuits**
by *D. R. Tibbetts, B.Sc.*
Various forms of integrated circuit are discussed in this article. It is suggested that a hybrid system consisting of thin-film components deposited on a semiconducting base which contains the transistors may be the best form of construction.

continued overleaf

Published on the first Thursday after the 5th of each month by
ILIFFE ELECTRICAL PUBLICATIONS LTD.
Managing Director: W. E. Miller, M.A., M.I.E.E., M.I.E.R.I.
Dorset House, Stamford Street, London, S.E.1.
Telephone: Waterloo 3333.
Telegrams: Wirenger, London. Telex
Cables: Wirenger, London, S.E.1.

ANNUAL SUBSCRIPTION, HOME £3 0s. 0d.
OVERSEAS £3 10s. 0d.
CANADA and U.S.A. \$10.00.

contents

INDUSTRIAL ELECTRONICS

AUGUST 1964

continued

- 397 **Developments in Electronic Reading Machines—I**
by John B. Rudkin
In this introductory article the basic problems of a 'reading machine' are discussed. Further articles will describe two machines in some detail and consider applications and economics.

FEATURES

- | | |
|--|--|
| 361 Analogue Computer for Road Research | 395 Quality-Control Aid in Turbine Blade Production |
| 368 Polyester / Glass Fibre Aerials | 396 Britain's First Permanent Video-Phone Link |
| 372 Making Animated Films by Computer | 399 Oscilloscope Display Projection |
| 373 Growing Quartz Crystals | 400 Industrial News |
| 374 Equipment Review | 403 New Books |
| 390 Central Read-Out System for Radio-Isotope Assay | 404 Manufacturers' Literature |
| 394 Microwave Band Designations | 32 <i>Classified Advertisements</i> |
| | 34 <i>Index to Advertisers</i> |

Next Month

The use of digital techniques to control a pallet loading machine will be explained in next month's issue. Other articles will include descriptions of some accurate pressure transducers and of some silicon switches.



OUR COVER

Illustrated on the cover this month is the Rhyll control centre of the North Wales Gas Grid. From this centre, 10 remote stations along a 200-mile grid are controlled with the aid of a radio telemetry system. Elsewhere in this issue an article discusses industrial telemetry systems

TO SAVE YOUR TIME

We will assist you to obtain further information on any products or processes described or advertised in this issue. Just use the enquiry cards to be found in the back of the journal.

© Iliffe Electrical Publications Ltd., 1964

Permission in writing from the Editor must first be obtained before letterpress or illustrations are reproduced from this journal. Brief abstracts or comments are allowed provided acknowledgment to the journal is given.

For further information
circle 202 on Service Card

BRITAIN'S WIDEST RANGE OF RESISTORS TO DEF 5115 SPECIFICATION ...from WELWYN

DEF 5115 CLASSIFICATION	DEF 5115 STYLE	WELWYN TYPE AND STYLE
2% Stability Fixed General Purpose Insulated 2% Stability Fixed General Purpose Non Insulated	CARBON FILM RESISTORS RFG-3 RFG-4	C80 Series C20 Series
5% Stability High Temperature 0.1% Stability Precision	WIRE WOUND RESISTORS RFH-2 RFP-1	W Series RB Series
15% Stability Fixed General Purpose Insulated 3% Stability Fixed General Purpose Insulated 1% Stability Fixed General Purpose Insulated 2% Stability High Temperature	OXIDE FILM RESISTORS RFG-1 RFG-2 RFG-5 RFH-1	F931 Series F252 Series F255 Series F64 Series
0.5% Stability Fixed General Purpose Insulated	METAL FILM RESISTORS RFG-7	M807 Series

WRITE NOW FOR FULL DETAILS



WELWYN ELECTRIC LIMITED

BEDLINGTON - NORTHUMBERLAND - ENGLAND

Telephone : Bedlington 2181-9 - Telegrams : Resistor' Bedlington.

FACTORIES IN AUSTRALIA AND CANADA

practical planar

Three new silicon planar transistors, which maintain germanium saturation voltages over several decades of current, now make practical a wide range of amplifying, oscillating and switching applications. They are immediately available at practical prices and are backed with performance data and circuit design information.

A significant feature of these transistors is that a saturation voltage of less than +200mV at 150mA, and less than 1V at 1.0A, is achieved. These voltages are typical of germanium rather than silicon devices.

The current gain – which is maintained over four decades of current – and f_T of greater than 50Mc/s, enable most general purpose applications to be readily met.

A booklet, giving performance data and circuits showing typical applications, is available on request. For price and delivery information contact Mullard at the address below.



Mullard Limited,
Industrial Semiconductor Division,
Mullard House,
Torrington Place, London WC1
Telephone: LANgham 6633

	BFY50	BFY51	BFY52	
$V_{CB} (I_E = 0)$	+80	+60	+40	V
V_{CE} (cut-off)	+80	+60		V
I_{CM} max.	1	1	1	A
P_{tot} max. ($T_{amb} = 25^\circ C$)	800	800	800	mW
$h_{FE} (I_C = 150mA)$	>30	>40	>60	
$f_T (V_{CE} = +6V, I_C = 50mA)$	>60	>50	>50	Mc/s
$V_{CE(sat)} (I_C = 150mA, I_B = 15mA)$	<+200	<+350	<+350	mV
Encapsulation	TO-5	TO-5	TO-5	

Mullard



MIS 11c

10⁻¹⁰ TORR

PUMPING SPEEDS INCREASED

NO EXTRA COST

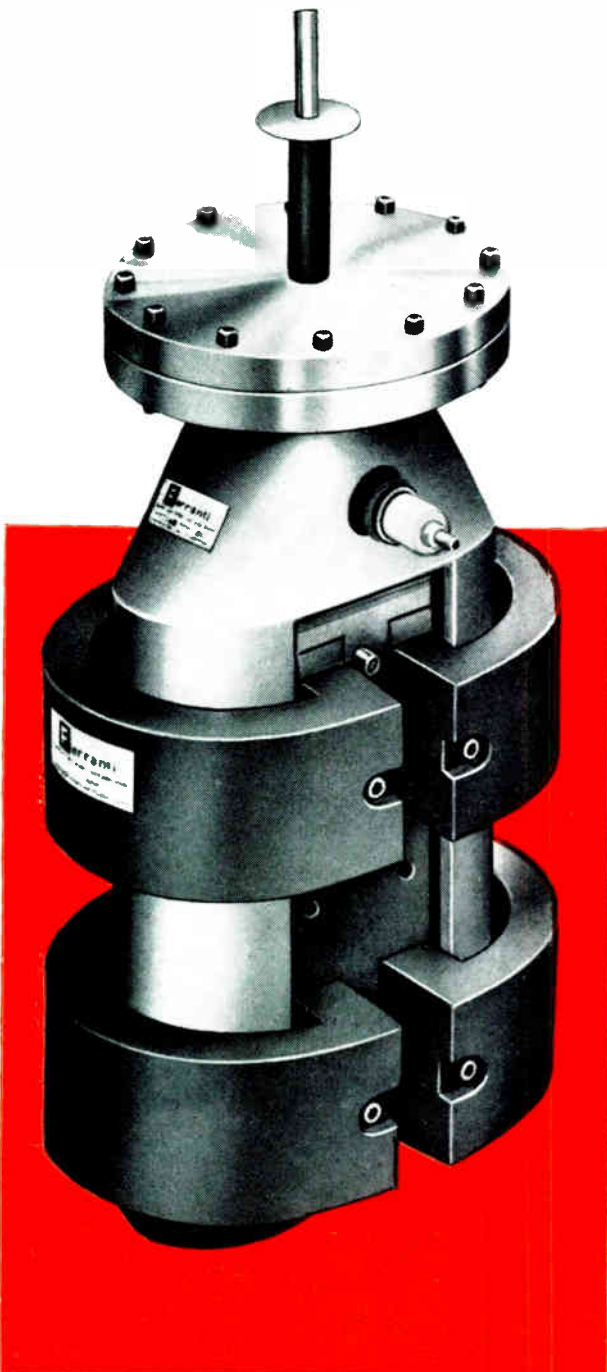

GETTER ION PUMPS

- Vacuum obtained electronically
- Pump current indicates degree of vacuum
- Uniform pumping speed
- Freedom from contamination
- Closed system ensures immunity from power failures
- No oil or other pumping fluid required
- Long life and very reliable
- Can be operated by remote control in any position
- Cold trap not necessary

Ferranti offer a series of Getter Ion Pumps with pumping speeds up to 500 litres per second. Higher speeds can be manufactured to customers' special requirements.

ABSORPTION PUMPS

The Ferranti Absorption Pump produces the initial vacuum for Getter Ion Pumps. It quickly produces a pressure of 10⁻² Torr from atmosphere by cooling a molecular sieve to liquid air temperature.

A full range of accessories such as Control Units, Flanges, Gaskets, T-pieces and High Vacuum Valves is available for use with these pumps.



FERRANTI

First into the Future

FERRANTI LTD GEM MILL
CHADDERTON, OLDHAM, LANCS. Tel: MAIn 6661

FE 255/2

More precise particle-velocity measurements now possible with new Mullard image converter

The first commercially available image converter with a large-diameter photocathode has been developed by Mullard for use as the pre-amplifier tube in equipment for measuring particle velocity by observing the Cerenkov radiation. The characteristics of this image converter make it particularly suitable for the high-speed photography of random events in atomic physics where small light outputs are produced. The increased number of photons that can be collected by the large photocathode enables more precise measurements to be made.

The converter has two stages, and the decay characteristic of the fluorescent screen of the first stage has been chosen so that the image is retained long enough for an auxiliary circuit to operate an electronic shutter built into the second stage. By these means, an event exhibiting a particular characteristic can be selected from other events and recorded. Equipment incorporating this image converter provides atomic physicists with a powerful experimental tool.

Features of the image converter

Because the light output from the events to be observed by the image converter is extremely low, the photocathode has been made large to collect as many photons as possible. The minimum useful diameter of the photocathode is 150mm, and it is of the antimony-caesium, S11 type, with a minimum overall sensitivity of $30\mu\text{A}/\text{l.m.}$

The fluorescent screen of the first stage and photocathode of the second stage are deposited on opposite sides of a mica sheet only $15\mu\text{m}$ thick so that the coupling between the two stages is extremely efficient. The fluorescent screen of the first stage consists of zinc oxide and releases 50% of the total light output within $1.5\mu\text{s}$. The photocathode of the second stage is also of the S11 type, and the fluorescent screen of the second stage is a zinc sulphide, metal-backed and silver-activated, P11 type, which will release 50% of the light output in $30\mu\text{s}$. The minimum useful screen diameter is 20mm.

Each stage of the image converter operates at a potential of 15kV and the potential change required to operate the electronic shutter in the second stage is approximately 2%. The resolution of the final screen is 30 line-pairs per millimetre at the centre, and the overall image demagnification is 8 times.

Fibreglass case

The tube is mounted in a Fibreglass case which acts not only as a protective cover but also as an insulating holder for the high voltage connections. The case is fitted with feet so that it can be

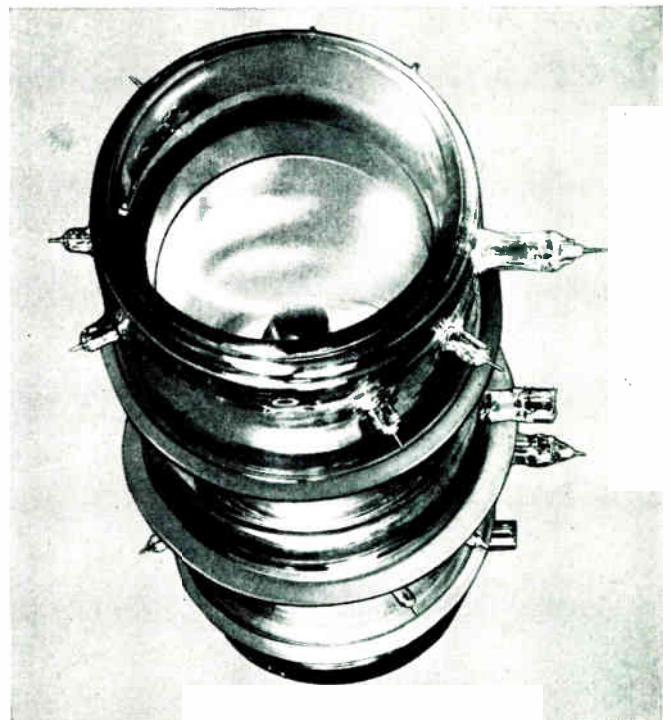

Two-stage image converter shown without Fibreglass case

firmly mounted onto an optical bench when lining-up and focusing the tube with ancillary equipment. The overall dimensions of the case are 730mm in length, with a cross-section of 378 by 312mm.

Applications

Although developed primarily for the measurement of particle velocities by observing the Cerenkov radiation, the image converter will have application in other branches of atomic physics where events produce small light outputs. It is envisaged that the equipment used typically in this work would use the two-stage image converter as an pre-amplifier tube followed by a high-gain image intensifier. The output of the image intensifier would be recorded on photographic film.

For further information on the two-stage image converter, please use the reader reply card of this journal (see reference number opposite).

What's new from Mullard

Voltage range of power-control thyristors increased to 700V

The four series of thyristors intended for use in high-current power-control circuits—the BTY87, BTY91, BTY95, and BTY99 series—have each been increased by three high-voltage types. These new types in each series have maximum repetitive peak reverse voltage of 500, 600, and 700V respectively.

The new devices in the BTY91, BTY95, and BTY99 series have the same current ratings and mechanical outlines as the other devices in the series. The maximum mean forward current of BTY91 series is 16A, that of the BTY95 series is 50A, and that of the BTY99 series 70A. The mechanical outlines used are SO-36 for the BTY87 and BTY91 series, and SO-30A for the BTY95 and BTY99 series.

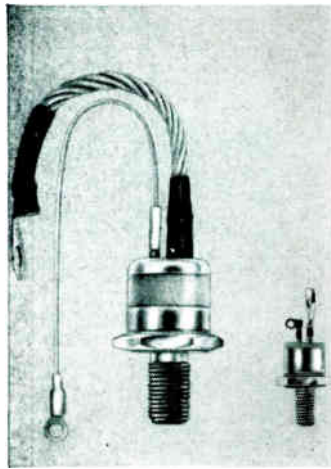

The BTY87 series is an improved version of the series of thyristors BTY42 to BTY47 inclusive, to which the three new high-voltage types have been added. The current rating of the new BTY87 series has been increased to 12A.

With the introduction of these new types, the range of power-control applications for thyristors will be considerably increased.

Silicon devices with germanium saturation voltage

Three planar transistors meet general applications requirements

With the introduction of three new planar transistors, designers will have to remember only three type numbers—BFY50, BFY51, BFY52—when selecting transistors for a wide range of professional equipment. These devices are truly general purpose, and can be used in many different circuit configurations in a wide range of amplifying, oscillating, and switching applications.

A significant feature of the devices is the exceptionally low saturation voltage. The values of 200mV for the BFY50 and 350mV for the BFY51 and BFY52, measured at a collector current of 150mA, are typical of germanium rather than silicon devices. The current gain is maintained over four decades of current, and the value of f_r , greater than 50Mc/s, enables most general-purpose applications to be readily met.

The introduction of these general-purpose devices will simplify considerably the designer's task of selecting transistors for his application. Instead of being faced with a multiplicity of type numbers for particular applications, he will be able to use a few general-purpose types for all but the most specialised applications.

Brief data for the BFY50, BFY51, and BFY52

	BFY50	BFY51	BFY52	
$V_{CB(max)}$	+80	+60	+40	V
V_{CE} (cut-off)	+80	+60	—	V
$V_{CE(sat)}$ ($I_C = 150mA$)	+200	+350	+350	mV
h_{FE} ($I_C = 150mA$)	> 30	> 40	> 60	
T_j (max)		+200		°C

HIGH-POWER TRAVELLING-WAVE TUBE FOR COMMUNICATIONS LINKS

25W saturation power output now available

A travelling-wave tube recently introduced, the YH1030, has the high saturation power output of 25W. The operating frequency range is 5.9 to 7.2Gc/s, so the tube therefore complements the existing low-power type LB6-12 which has a similar frequency range.

The YH1030 has been designed for use in the power output stages of wideband high-capacity telecommunications links. Because of the high saturation power output, the tube will deliver a useful output power of 15W at 5.9Gc/s, falling to

10W at 6.5Gc/s, and maintaining this power over the range 6.5 to 7.2Gc/s. The gain over the complete frequency range is 36dB.

The mount for the tube contains the uniform-field permanent magnet used for focusing. The alignment of this magnet is easily carried out by the adjustment of two screws. Since the YH1030 has been designed for a plug-in match of the helix to the waveguide circuit over the whole frequency band, no tuning adjustments are necessary. Replacement of the tube in equipment is therefore extremely simple.

As the magnet is completely shielded by the mount, external magnetic fields will not affect the focusing, and the tube will not affect other equipment in the vicinity.



TWO NEW LOW-COST SILICON P-N-P TRANSISTORS

Developments from OC204 series and updated BCY38 series

Two new high-voltage medium-gain silicon transistors, the BCY54 and OC207, have been introduced by Mullard. Developed from the highly successful BCY38 series and OC204 series, they are particularly suitable for pulse and audio applications, compact d.c. converters, servo process control, power switching, and relay drivers.

With a typical gain of 50 and a collector voltage of 50V, these two transistors will find special application in equipment where the full voltage of the OC205 and BCY39 is not required, but where a higher gain would be of advantage.

Updated BCY38 series

The BCY54, which is in TO-5 encapsulation, joins the recently updated BCY38 series which now has a power dissipation of 400mW in free air at 25°C, and 500mW at a case temperature of 88°C.

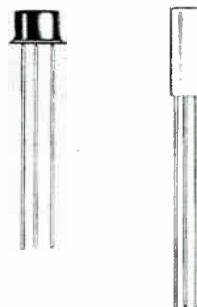

FURTHER DETAILS of the Mullard products described in this advertisement can be obtained from the address below or through the Reader Enquiry Service of Industrial Electronics using the appropriate code number shown below.

Two-stage image converter	206
Planar transistors BFY50, BFY51, BFY52	207
Travelling-wave tube YH1030.....	208
High-voltage thyristors	209
Silicon transistors OC207, BCY54.....	210



Mullard Limited, Mullard House, Torrington Place, London, WC1. Telephone: LANgham 6633

**millions of
tube-hours
behind
them**



**millions of
tube-hours
ahead of
them**



**confirm
Dekatron[®]
reliability
and economy**



Described as the most significant advance in the technique of slow and medium speed counting during the last decade, Dekatron tubes have logged millions of international tube-hours in thousands of equipments—signalling when a pre-set count is reached: timing to accuracies of up to 1/10 milli second: dividing or frequency measuring: providing time reference marks on pen recorders: controlling machine tools: counting pulses from photocells, geiger tubes, magnetic pick-ups: acting as sequence switches: generating pulse trains: adding and subtracting and a host of other applications.

Are you taking full advantage of the reliability, economy, long-life and versatility of these tubes. Perhaps you would like data sheets or a copy of "Dekatron applications"—if so write or phone "Tube Division", Beeston, Nottingham. Tel: 254831.

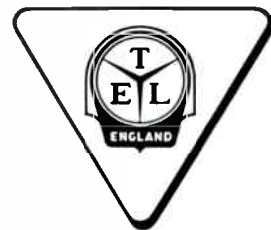

ERICSSON TELEPHONES LTD. ETELCO LTD.

A Principal Operating Company of the Plessey Group: Head Office and Main Works Beeston Nottingham. Telephone 254831. Telex 37666.
ER 83

SPECIFY HUGHES DIODES

... diodes with superior performance and maximum reliability

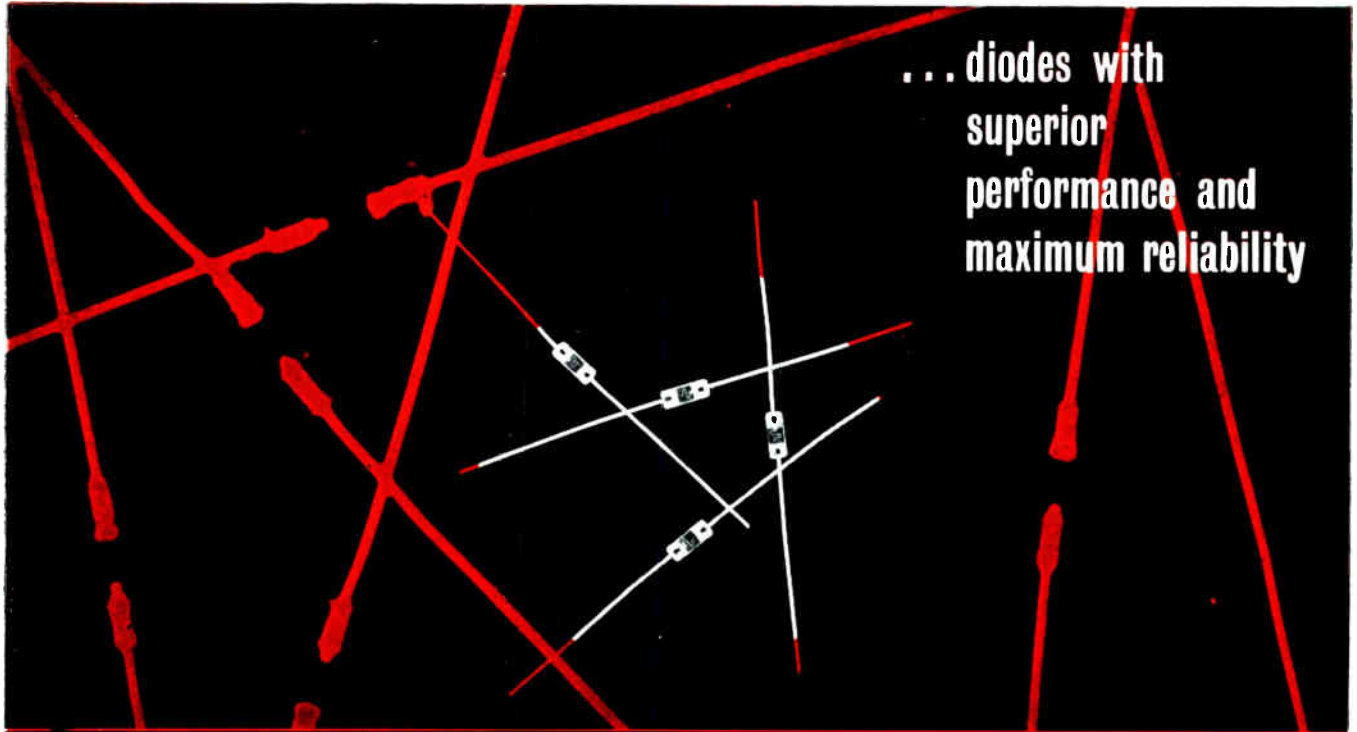

CV7040 CV7332 CV7099-7106 CV7138-7146

**SILICON SUB-MINIATURE POWER DIODES/RECTIFIERS ● ZENER DIODES
CARTRIDGE RECTIFIERS ● VOLTAGE VARIABLE CAPACITORS**

HS1020 HS1001 HS1004 HS1007 HS1010	General Purpose Diodes	PIV - - - - 50-200V Max. Avge. Rectified Current - - - 165mA Ib at PIV - <0.2 μ A CV 7040 CV 7332	HS2000 Series (250mW) HS7000 Series (400mW)	Zener Diodes	Available in all preferred voltage values from 2.7-33V Low dynamic impedance High stability over wide temperature range CV7099-7106 CV7138-7146
HS3103 HS3104 HS3105 HS3106 HS3108 HS3110	200mA Power Diodes	PIV - - - 300-1000V Max. Avge. Rectified Current - - - 165mA Ib at PIV - <0.2 μ A	HSC1 HSC2 HSC3 HSC4 HSC5 HSC6 ↕ HSC30	High Voltage Cartridge Rectifiers	PIV - - - - 1-30kV Max. Avge. Rectified current - - 100mA Case size 0.55" dia. x approx. 0.25" per kV Welded assemblies of selected high voltage diodes, encapsulated in high grade epoxy resin
1N645 1N646 1N647 1N648 1N649	600mA Power Diode/Rectifiers	PIV - - - - 225-600V Max. Avge. Rectified Current - - - 400mA Ib at PIV - <0.2 μ A	HC7001 HC7002 HC7004 HC7005 HC7006 HC7007 HC7008	Voltage Variable Capacitors	Capacitance range " -4V - - - 35-100pF Peak voltage range - - 25-130V Ib " max. voltage - - <1 μ A " 25 C Standard Tolerance - - \pm 20% (\pm 10% and \pm 5% also available)

Hughes—originators of the world's first sub-miniature all-glass diode—manufacture at their Glenrothes, Scotland, factory an unequalled range of germanium and silicon devices for the most diverse diode applications. Add Hughes service and second-to-none product quality and solve your diode problems in the simplest way—SPECIFY HUGHES.

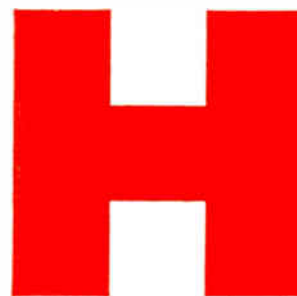

Write now for complete data on the full range of Hughes semiconductor products, which also includes:—Silicon and Germanium Signal and Switching diodes: PNP and NPN Silicon Transistors.

HUGHES INTERNATIONAL (U.K.) LTD

GLENROTHES · FIFE · SCOTLAND

All enquiries to:
KERSHAW HOUSE, GREAT WEST ROAD, HOUNSLOW, MIDDLESEX. TEL: HOUNSLOW 5222.

M & P HM23

STC

components review

AUGUST 1964

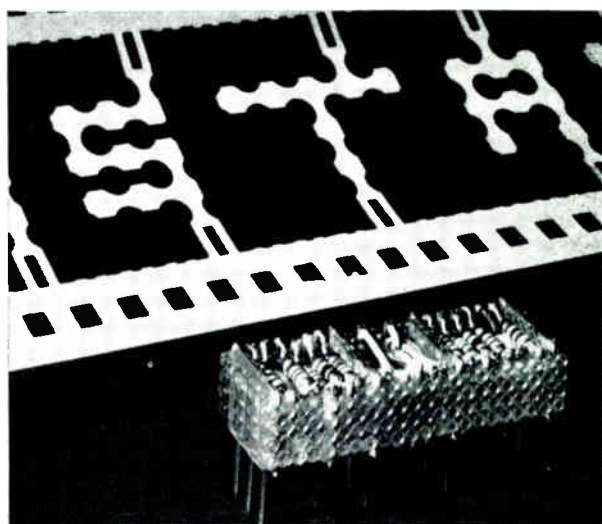
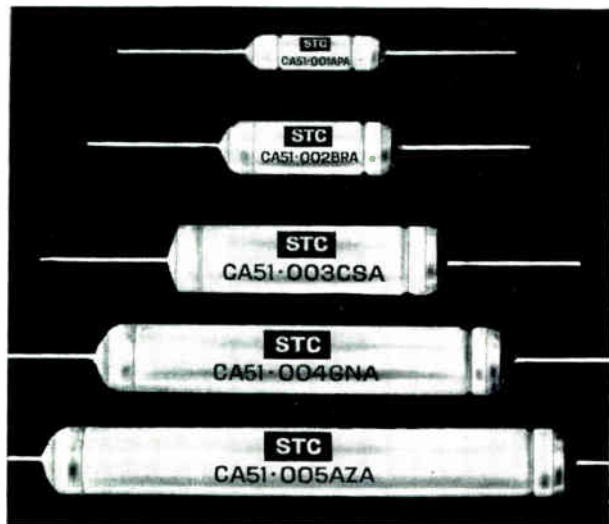

FOURFOLD CAPACITANCE INCREASE WITH ETCHED TANTALUM FOIL

Increased capacitance/volume ratio is a prime feature of the new STC range of Etched Tantalum Foil Capacitors. Etched capacitors have up to four times more capacitance than equivalent plain foil types and, for a given capacitance and voltage, are over twenty times smaller than miniature foil/paper types of similar quality.

The capacitors are designed to Specification MIL-C-3965/2A. Where miniaturization is important they can be used in place of foil/paper, metallized/paper, aluminium electrolytic and, of course, plain tantalum foil capacitors. There are over one hundred components in the preferred range and a choice of capacitance values is available at rated voltages of 6, 16, 25, 40, 63, 100 and 160V. Polarized and non-polarized types are available. The table below is typical of the 6V range of polarized types.

STC CODE	CAPACITANCE AT 6V d.c. AT 85° C
CA51.001 ANA	33
001 APA	47
002 ASA	150
002 ATA	220
003 AVA	330
003 AWA	470
004 AXA	680
004 AYA	1000
005 AZA	1500

} μ F

Write 'phone or Telex for Data Sheet MC/124 to STC Capacitor Division, Brixham Road, Paignton, Devon, or London Sales Office, Footscray, Sidcup, Kent. Telephone FOOTscray 3333. Telex 21836.

MINISTAC KITS

Apart from the prototype and production type MINISTAC facilities at STC Semiconductor Division, MINISTAC kits are available to enable customers to make their own prototypes using the simple hand tools provided. The kits include: tools, circuit strip, side mouldings, end plates and connecting tags and the kit sizes give a choice of amounts of material to suit individual projects. The MINISTAC Manual, included in each kit, is freely available as a separate item.

The MINISTAC system of modular circuit construction enables a large quantity of active and passive components to be assembled in the minimum space, with the inside conducting walls of the modules forming pre-punched circuit paths.

Write, 'phone or Telex for literature and prices to STC Semiconductor Division (Rectifiers), Edinburgh Way, Harlow, Essex. Telephone Harlow 26811. Telex 81146.

STC AT FARNBOROUGH

A full range of STC components for aerospace electronics will be shown at the SBAC Exhibition, Farnborough, Sept. 7th-13th. Stands 176-179.

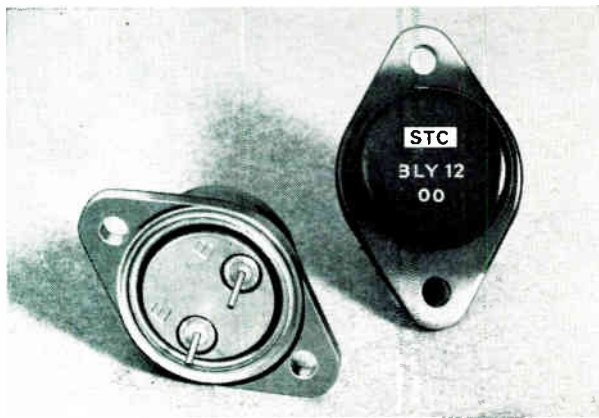

A NEW SILICON POWER TRANSISTOR

has been added to the STC range. This is the BLY12, a silicon epitaxial planar high frequency transistor with a collector dissipation of 25 watts and encapsulated in a JEDEC TO-3 package. It is suitable for use both as a high current high voltage switch and as a high frequency power amplifier up to 20 Mc/s. Delivery is available from stock.

BRIEF DATA

f_T at 100mA:.....60 Mc/s (This figure is maintained for currents approaching 1A.)
 h_{FE} at 2A:.....30-100
 $V_{CE(sat)}$ at $I_C=2A, I_B=0.2A$:.....1 V max.

RATINGS

V_{CBM} :.....60V
 V_{CEM} :.....30V
 $I_{C(pk)}$:.....5A
 P_{CM} :.....25 W in a heat sink

OUTLINE: JEDEC TO-3

SILICON PLANAR DOUBLE TRANSISTORS FROM STOCK

The BFY20 is a matched pair of BFY18 silicon planar transistors mounted together on a 6-lead header and encapsulated in a TO-5 case, the transistors being electrically isolated. The common mounting minimizes the temperature difference between the two transistors, making the device ideal for use in D-C amplifiers. The BFY20 is now fully available from stock.

BRIEF DATA

f_T at 10mA:.....245 Mc/s typ
 I_{CBO} at 9 V:10 nA max
 h_{FE} at 100 μ A:.....10 min
 V_{BE} matched to within 10 mV
 P_{CM} rating:..... 600 mW total

Write, 'phone or Telex for Data Sheets to STC Semiconductor Division (Transistors), Footscray, Sidcup, Kent. Telephone FOOTscray 3333. Telex 21836.

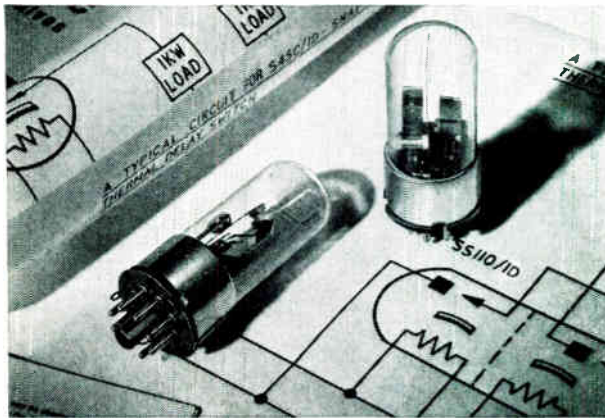

SNAP ACTION AND DOUBLE THERMAL DELAY SWITCHES

TYPE S45C/1D is a snap action single pole changeover switch which features high contact pressure and a rapid make and break action. It is designed for switching on comparatively high powers (up to 250V at 5A a.c.). The nominal switching delay time is 42 seconds, and by connecting a number of switches in series, one may obtain multiples of the delay time given by a single switch.

TYPE SS110/1D consists of two mechanically separate switches mounted in a common glass envelope, each unit giving a maximum closing delay time of 110 seconds. The switches can be used independently or in conjunction with one another. When used in a circuit which gives a delay comprising the sum of the two making times and the two opening times, the switch unit will give a delay of about 240 seconds; this delay is virtually independent of heater voltage variation and ambient temperature and retains close tolerance throughout switch life.

Thermal delay switches are very suitable for providing delay times between the application of heater voltage and other circuit voltages, particularly anode voltage to indirectly heated valves. In addition, they can be used as v.l.f. relaxation oscillators, for switching 3-phase circuits from star to delta arrangements when starting induction motors, and for automatically re-closing a circuit breaker after a temporary current surge has caused it to trip. These applications are fully described in STC booklet MS/117 which is available on request.

ABRIDGED DATA

* per section

	Base	V_h (V)	I_h (A)	Delay time at 20°C		Contact Ratings (Max.)	
				Min. (sec)	Min. (sec)	On make	On break
S45C/1D	Small Wafer Octal	6-3	0.75	35	50	250V 5A a.c. 250V 3A d.c.	250V 5A a.c. 250V 3A d.c.
SS110/1D	Small Wafer Octal	6-3*	0.5*	90	110	100V 1A a.c. 220V 1A d.c.	50V 0-1A d.c.

Write, 'phone or Telex for data sheets to STC Valve Division, Brixham Road, Paignton, Devon. Telephone Paignton 58685, Telex 4230 or London Sales Office, Footscray, Kent. Telephone FOOTscray 3333, Telex 21836.

high-grade electronic components by

STC

COMPONENTS GROUP

A versatile system, with maximum flexibility, designed for the sequential switching of the outputs from most electrical measuring systems including thermocouples, strain gauges and other transducers generating low level electrical signals. From the basic modular units—20 point Switch Unit, Automatic Cycler Unit and Input Unit—systems varying from simple monitoring to complex data-logging may be designed and constructed. Any input may be selected manually and monitored individually.

allscott

type 247

DATA SCANNING SYSTEM

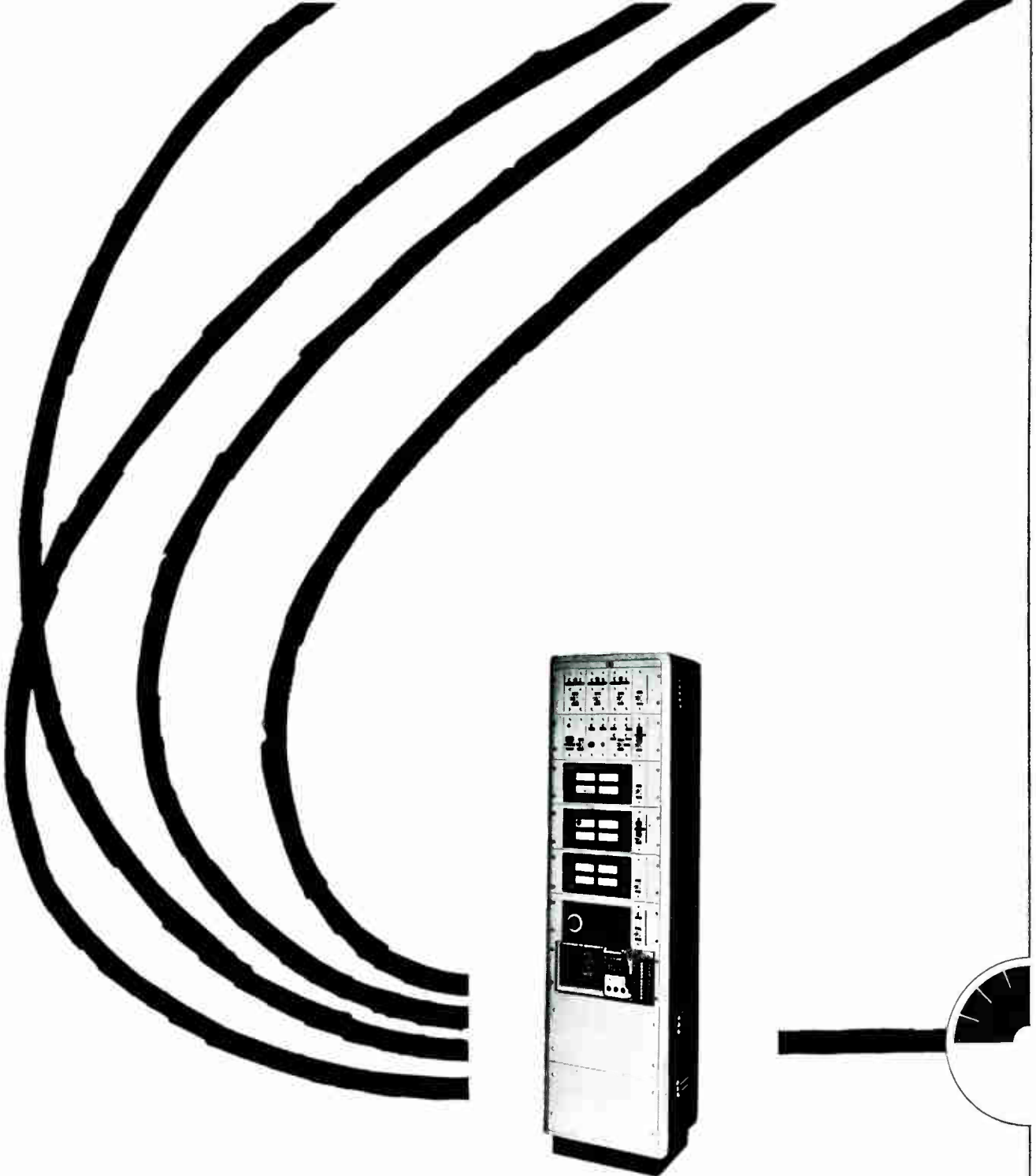

James Scott (ELECTRONIC ENGINEERING) Ltd., 68 BROCKVILLE STREET, CARNTYNE INDUSTRIAL ESTATE, GLASGOW, E.2. TEL.: SHE 4206

quality
instruments
need
quality
batteries—

MALLORY

Precision-made Mallory batteries are built differently—inside and out—to last many times longer, to deliver power more steadily, to retain their energy while lying idle (for two years or more, if necessary), to be leakproof and corrosion free in short, to meet all the requirements of quality equipment. That's why so many leading manufacturers now fit or recommend Mallory batteries for their products, why **other leading battery manufacturers elect to sell them under licence!**

When performance quality counts, Mallory batteries are always the choice. Fit them to *your* test instruments and prove for yourself—they make a power of difference!

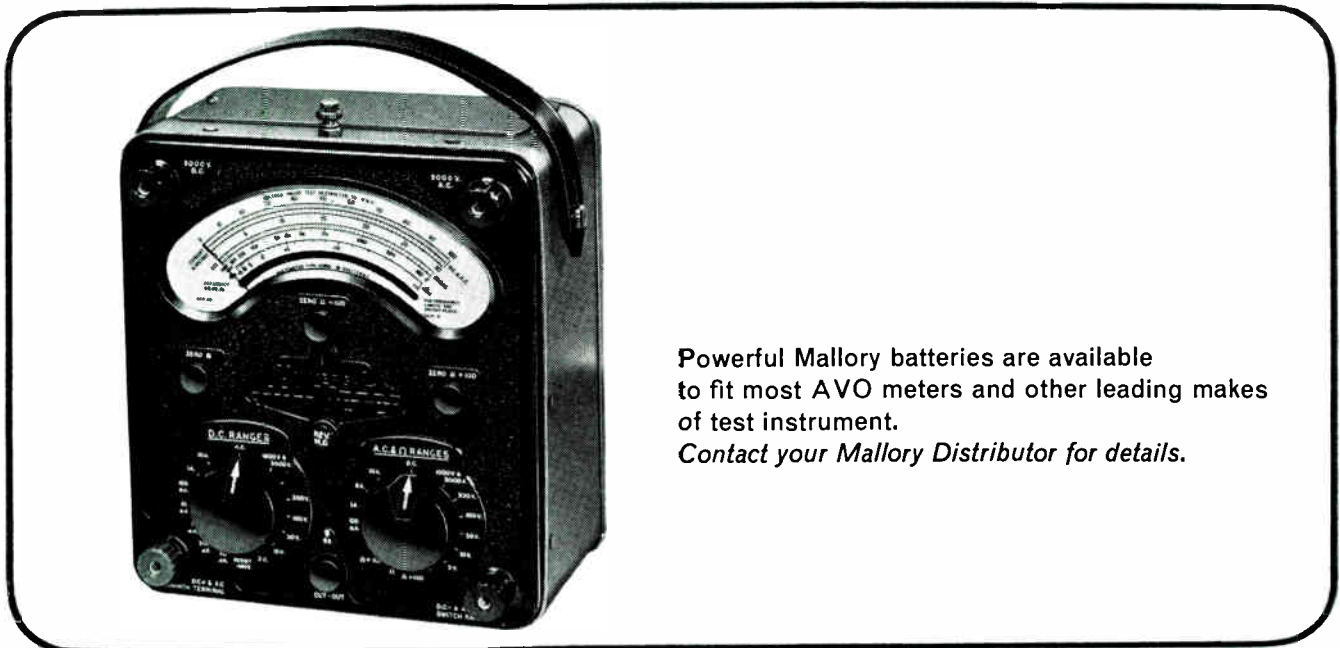

Powerful Mallory batteries are available to fit most AVO meters and other leading makes of test instrument.
Contact your Mallory Distributor for details.

MALLORY

for new ideas in batteries

MALLORY BATTERIES LIMITED Crawley Sussex Crawley 26041

Distributors to the Electronics Industry:

A. C. Farnell Ltd. Leeds 2; Wireless Electric Ltd. Bristol 1; Hawnt & Co. Ltd. Birmingham 6; Needham Engineering Co. Ltd. Sheffield 1; Harper, Robertson Electronics Ltd. Glasgow C2; Stewart Aeronautical Supply Co. Ltd. Crawley, Sussex; Scientific Furnishings Ltd. Poynton, Cheshire; Cables & Components Ltd. London NW10

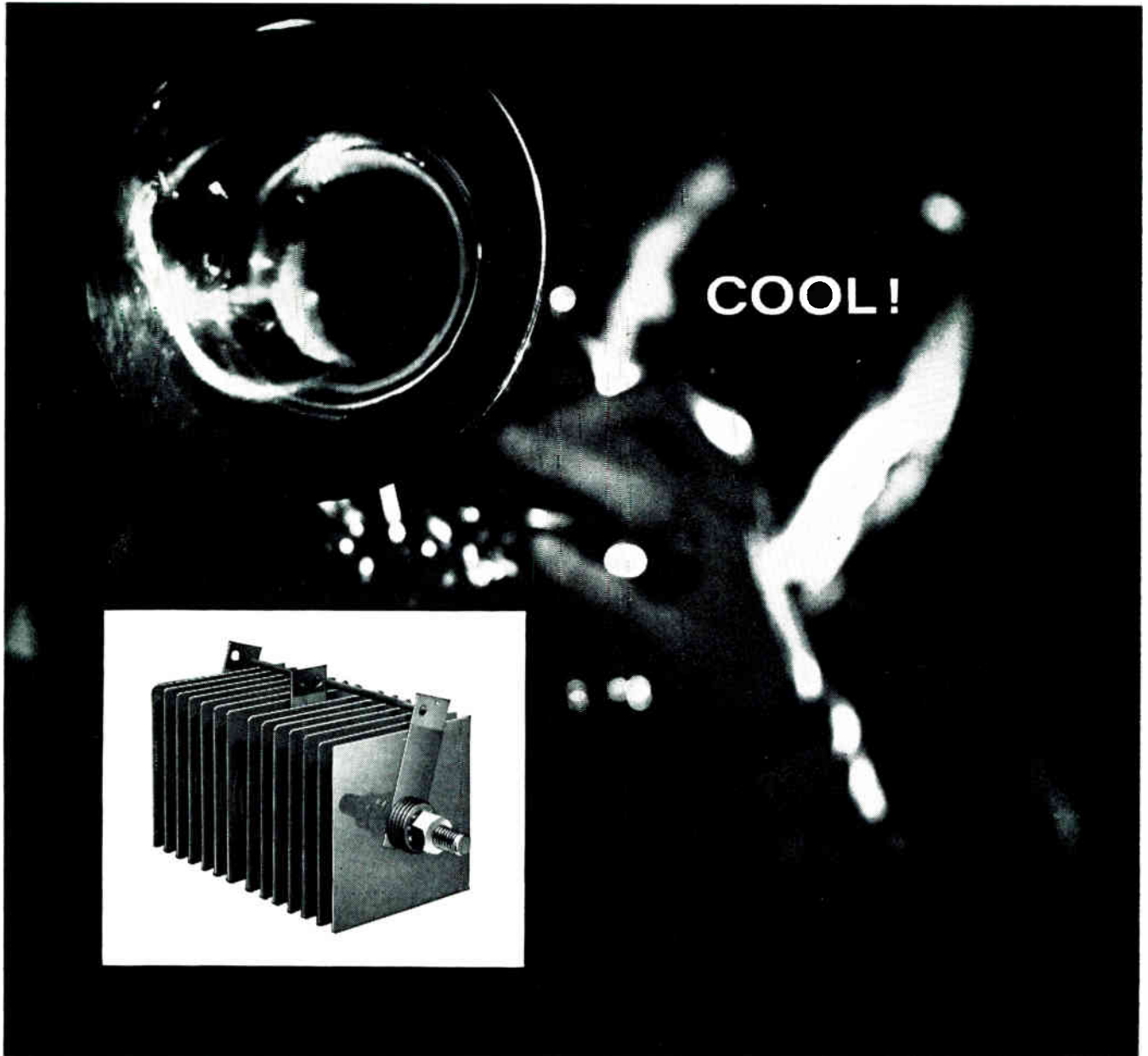

IR Selenium Rectifiers know how to take it easy.

Even when running in an ambient temperature of 45°C, they deliver full power. Overloads don't worry them.

High current, "double density" plates in ratings up to 36V RMS are the reason. They are coated with fine-grain, vacuum-deposited selenium; unique bellow-spring contacts ensure low forward voltage drop. Special plate-lock design prevents the plates from twisting.

Your equipment will benefit from the small size, high reliability and exceptional performance of IR Selenium Rectifiers. Send for full details set out in Bulletin SR 2005A.

INTERNATIONAL RECTIFIER



Immediate off-the-shelf delivery from IR distributors—phone

GLASGOW DOUGLAS 8671 · (MIDDLESEX) SKYPORT 1314 · COLCHESTER 6173 · LEEDS 35111
(LONDON S.E 27) GIPSY HILL 6166 · PORTSMOUTH 61785 · LEICESTER 25071 · CRAWLEY 28700



International Rectifier Europe S.A. · 38 Avenue Des Arts · Brussels · Belgium · Telephone 11.17.38/74 · Telex 02/22201
INTERNATIONAL RECTIFIER CO. (GREAT BRITAIN) LTD · HURST GREEN · DXTED · SURREY · TELEPHONE OXTED 3215 · TELEX RECTIFIER OXTED 8819

New from Sigma/OED



Actual size

Photochoppers with superior signal-to-noise capability and higher conversion efficiency

Higher Conversion Efficiency: 99% at 60 cps*; 90% at 400 cps*; usable signals to 10,000 cps.

Improved Signal-to-Noise Capability: Low offset voltage; random noise below 2 microvolts; drive circuit electrically isolated from output circuitry through optimum electrostatic and electromagnetic shielding.

Solid-State Reliability: Over 10,000 hour life. No moving parts, resists vibration and shock.

Reduced Power Requirements: OED photochoppers accept 115 volt AC (at 2 ma) and need less drive power than mechanical choppers.

Interchangeability: Directly interchangeable (physically and electronically) with existing photochoppers while providing higher performance.

System Economy: Lower cost than equivalent mechanical choppers yet provides considerably longer life; eliminates the need for phase shift tuning circuitry.

Specify Sigma/OED photochoppers for your high gain operational amplifier designs. Call your Sigma/OED representative today, Scientific Furnishings Ltd., Poynton, Cheshire.

Or for further information write International Sales Manager, Sigma Instruments, Inc., Braintree, Mass. 02185, U.S.A.

*with PC 3 MC: Source impedance $R_s = 0$ Load impedance $R_L = 1 \text{ meg } \Omega$
Dynamic Switching ratio at 60 cps. = 1000:1 400 cps. = 10:1

OPTO-ELECTRONIC DEVICES  SIGMA INSTRUMENTS INC
Inc. Subsidiary Advanced Design Through Optical-Electronic s/Braintree, Massachusetts 02185



*for
'high heat'
insulation*

YOU'LL NEED TO KNOW ABOUT DELANCO GLASS FIBRE LAMINATES

If you need a material with a working temperature of up to 250 C very high dielectric strength and low loss properties PLUS high mechanical strength and exceptional machining properties you need look no further than the DELANCO range of glass fibre laminates, in sheet, tube, rod or in parts accurately machined to your drawings.

In fine and medium weave glass cloth base, with a bonding agent of silicone, Epoxy, melamine or phenolic, each grade having characteristics suitable for specialised applications. These applications are mainly in the electro-mechanical fields, but more recent technological advances in other fields are bringing regular enquiries for many new trades.

Class C Transformers, for example, Aircraft construction, and plating jigs, give some idea of the versatility of this material.

For machined parts only, we have one of the most modern

tool departments in the country, and all tools and fixtures are made by operators with first-hand knowledge of the materials on which these tools will be used.

Parts can be blanked, routed, milled, drilled and counter-bored, and metal tags and terminals can be fitted. Engraving on the finished parts is also done in our own works.

For further Technical Details send for Delanco Catalogue.

Delanco

for Electrical Insulation

Anglo-American Vulcanized Fibre Co. Ltd.,
Cayton Works, Bath Street, London, E.C.1.
CLE 848E. Grams: Prompserv, Cent, London.
Delanco Works, Leonard Street, London, E.C.2.



GETTING THE MEASURE OF SOUND

Fully meets B.S. and I.E.C. specifications

Sound-Level Range:	Sound levels above the standard sound pressure level of 0.0002 dyn/cm ² . 30dB to 140dB in 10dB steps with the three standard A, B and C weighting curves (I.E.C. and B.S.) covering the frequency range 31.5c/s to 8kc/s
Microphone:	Rochelle-salt crystal diaphragm type microphone. Temperature range 0°C to 45°C. Maximum relative humidity 85%
Meter:	Calibrated from -6dB to +10dB
Output:	Full scale deflection of the meter corresponds to approximately 1V into a resistive load of 10k Ω
External Filters:	Jacks are provided for connecting external filters which require a source impedance of 600 Ω and a load impedance of either 600 Ω or 10k Ω
Power Supply:	Three dry cells Type PP4 Ever-Ready or equivalent, or external mains-operated power unit which can be supplied as an accessory
Weight:	Only 3lb (1½kg) approx.

The Dawe range includes a complete series of equipment for measuring, analysing and recording sound and vibration. Ask for details.

DAWE Type 1400F TRANSISTOR SOUND-LEVEL METER

U.K. LIST PRICE : £95
complete with leather carrying case



DAWE

Full technical data from:—

DAWE INSTRUMENTS LTD., WESTERN AVE., LONDON, W.3 Tel: ACOrn 6751

A member of the *Simms* group of companies



RCA CERMOLUX FAMILY

Just five years ago RCA introduced the first members of the CERMOLUX "family," a new concept in power tubes incorporating precision-aligned grids, and ceramic-metal construction. Today, "second generation" types are emerging and forming individual "type-families." Highlighted here are just two of these "type-families:" RCA-7650 and RCA-7213. These rugged beam power designs provide the power required for virtually every type of electronic application. They are easily tailored to a variety of air-cooled or conduction-cooled techniques for communications, control, radar, UHF-TV, phased array, and distributed amplifier applications. CERMOLUX design is adaptable in power and size from watts to megawatts, and in frequency from kilocycles to gigacycles.

Tube Type	Capabilities	Applications	Cooling
7650	800 watts power output	CW Amplifier	Forced-Air
7651	39,000 watts peak power output	RF-Pulse Amplifier	Forced-Air
4614	2,500 max. plate volts 0.5 max. plate amperes	Voltage Regulator	Forced-Air
A2697	3,000 max. plate volts 1.25 min. peak plate amperes at zero bias	Hard-Tube Modulator	Conduction
7213	1,350 watts power output	CW Amplifier	Forced-Air
7214	65,000 watts peak power output	RF-Pulse Amplifier	Forced-Air
4600A	3,500 max. plate volts 1.0 max. plate amperes	Voltage Regulator	Forced-Air
A2627	15,000 max. plate volts 20 max. peak plate amperes	Hard-Tube Modulator	Conduction
4618	1,350 watts power output	CW Amplifier	Forced-Air



THE MOST TRUSTED NAME IN ELECTRONICS

FOR FULL DETAILS AND SPECIFICATION PLEASE WRITE OR PHONE

RCA GREAT BRITAIN LIMITED, Sales Division, Lincoln Way, Windmill Road, Sunbury-on-Thames
Telephone: Sunbury 5511

ASSOCIATE COMPANY OF RADIO CORPORATION OF AMERICA.



AVEL INSTRUMENTATION

A. C. MEASURING

INSTRUMENTS

and ANALYSING

From



**NORTH ATLANTIC
industries inc.**



FEATURES

- Direct Reading Of
Phase Angle
Total Voltage
In-phase Voltage
Quadrature Voltage
Nulls

BROADBAND PHASE ANGLE VOLTMETER Model VM 301

The Model VM 301 Broadband Phase Angle Voltmeter combines in one instrument the ability to measure both phase angle and magnitude of complex A.C. signals and their vector components with respect to reference voltage.

This is BUT ONE item from a wide range of A.C. instruments.

Aveley Electric Limited

Distributors in United Kingdom for

Measuring instruments of quality

For Further Information Write or Phone

SOUTH OCKENDON · ESSEX
TELEPHONE SOUTH OCKENDON 3444
TELEX 24120 AVEL OCKENDON

NUMBER ONE IN ELECTRICAL CONNECTORS...

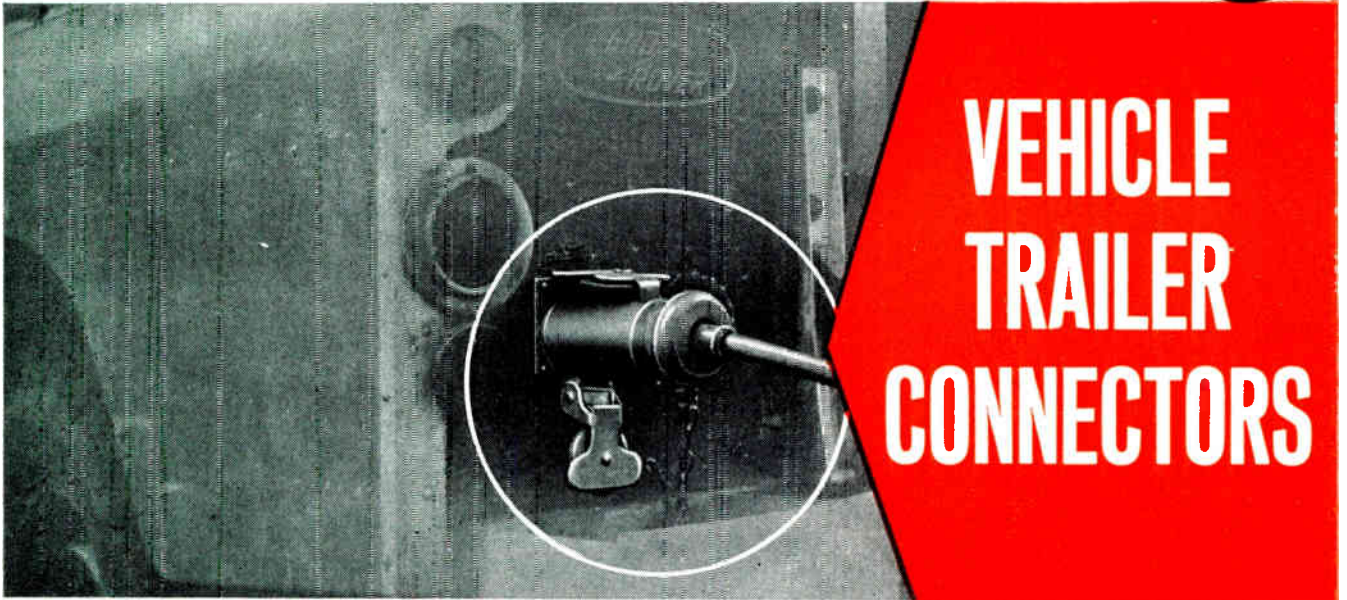

For the most arduous conditions. The AO connector has been designed to meet the performance requirements of MIL-C-13993A (ORD) covering applications to vehicles, and is fitted with inserts carrying size 12 contacts. Alternatively any MS'E size 28 layout can be fitted under the AOQ nomenclature. Provision is made for the mechanical locking of the two halves of the connector in the mated condition and for spring loaded dust caps to protect automatically the mating faces of both free and fixed halves immediately the free connector is dis-engaged. The free connector has a heavy Neoprene moulded body which offers protection against damage under the most arduous conditions of ground usage.

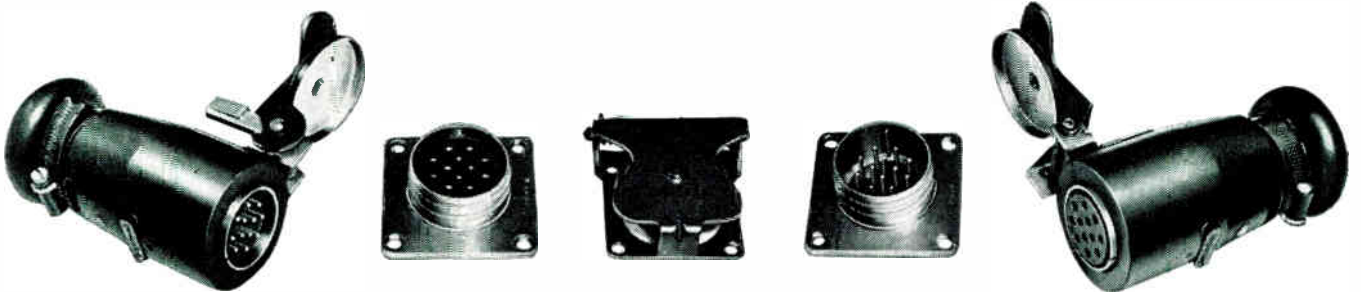

Technical details. The main body of the free connector is a robust Neoprene moulding. This carries a steel lining which provides the retention system for the insulator and to which is attached the spring loaded dust cap which seals the mating face in the disengaged condition. A locking mechanism holds the dust cap in the open position for connector engagement. In the fully engaged position this lock is automatically unlatched so that on subsequent disengagement the dust cap immediately seals the mating face. The fixed connector mounted on the vehicle also carries a dust cap which acts as a mechanical coupling lock with the free connector when the two halves of the connector are fully engaged. The standard AO design incorporates inserts having 12 in number size 12 A.W.G. contacts with solder type terminations. The insert size is, however, identical to

the standard MIL-C-5015 size 28 MS'E/R inserts and under the AOQ nomenclature the connector can be provided with layouts having 9, 10, 14, 15, 20, 22, 26, 35 or 37 contacts. Snap-in crimp contacts can be supplied as an alternative to the standard solder type.

The insulator of the free connector is supplied loose for insertion into the body after the solder connections to the cable have been made. A clamping clip at the rear of the body moulding facilitates strain relief for the cable.

The materials and finishes of the component parts of the connector conform to both British and American standards.

For further information write for technical bulletin GB-2. For any connector requirement consult the world's most foremost name in this highly specialised field.

© "CANNON" IS A TRADEMARK REGISTERED IN U. S. PATENT OFFICE AND IN OTHER COUNTRIES BY CANNON ELECTRIC COMPANY

CANNON ELECTRIC (GREAT BRITAIN) LTD.

168 Old Street, London E.C.1, England

PLANTS IN: LONDON • BORNEM, BELGIUM • PARIS • TOKYO • MELBOURNE • TORONTO
LOS ANGELES, SANTA ANA & ANAHEIM, CALIF. • PHOENIX, ARIZ. • SALEM, MASS.

Sales offices and representatives in principal cities of the world

© 1963 CANNON ELECTRIC COMPANY

European Enquiries: Cannon Electric International Inc., Bornem, Belgium. Telephone: (03) 77.06.14.

Scandinavian Enquiries: Sweden: Ab Gosta Backstrom, Box 12089 Stockholm 12. Denmark: Tage Schouboe, 7 Skyttegade, Copenhagen.

Norway: Morgenstjerne & Co., Wessels Gate 6, Oslo.

Finland: OY Chester AB, Uudenmaankatu, 23.A, Helsinki.



INDUSTRIAL ELECTRONICS

Comment

There are a good many institutions and societies connected in some way with electronics. In the main they are either professional organizations, membership of which is regarded as a technical qualification, or they are specialist societies whose members are interested in some special sector of electronics.

The Institution of Electrical Engineers and the Institution of Electronic and Radio Engineers are both bodies for the professional engineer. Although they both welcome and encourage student members, the students must be students of engineering. They are both examining bodies and require candidates for graduate and higher membership to demonstrate their qualifications by passing their examinations or to show that they are already equivalently qualified.

By no means everyone in the electronics industry is, or intends to become, an engineer in the sense in which this word is used by these institutions. By engineer they mean a professional engineer, or Chartered Engineer, and not the many technical people who are often generally known as engineers but who are classed by these institutions as technicians. These people are highly important in industry; in general, they have had less academic training than professional engineers, but they are often more practically minded; they tend to be concerned more with work on actual apparatus than with general planning. Technicians are especially concerned with the details of development and with installation, maintenance and repair.

Technicians are commonly known as engineers although, as we have already said, they are not regarded as such by the institutions and are not eligible for membership. Up to the present there has been no institution or society catering for their needs except in certain specialities. For example, the Television Society covers many of the requirements of both engineers and technicians who are specialists in this field and in doing so it fulfils a very useful function.

The more general needs of technicians, however, will now soon be met by a new society or, perhaps, by two. The position is not at the moment quite clear, but we are sure that before very long at least one will be functioning. There is no doubt at all that this will be a good thing.

S.E.R.T.

A Society of Electronic and Radio Technicians is being formed under the aegis of the Radio Trades Examination Board. The intention seems to be that the qualification for entry should be the possession of a Final Certificate of the R.T.E.B. or a higher qualification. We say the intention because this has been the suggestion, but so far no rules of the Society have appeared. Indeed, we understand that its constitution has not yet been decided.

During June, meetings were held in London, Birmingham, Manchester and Glasgow which technicians in the radio and electronics industry who had views on the establishment of the Society were invited to attend. The London meeting was under the chairmanship of E. A. W. Spreadbury, M.I.E.R.E., who is chairman of the Radio Trades Examination Board.

We shall await with interest more details of the new organization. In the meantime we would like to offer the organizers some advice. We do not

think it is sound that membership should be restricted to holders of the Final Certificate of the Radio Trades Examination Board. We explain below what this means, but briefly it is a qualification for what is normally called servicing. In our view that is too narrow a qualification and would result in turning the Society into one of radio and electronic servicing technicians.

There are very many technicians who are not at all concerned with servicing and who are as much in need of a society as their servicing brethren. We do thus strongly advise the organizers not to be too narrow, that is, too specialized, in fixing entry qualifications.

R.E.T.B.

The first moves towards the foundation of the R.E.T.B. were made in 1938 when the Educational Committee of the I.E.R.E. (then the Brit.I.R.E.) recommended to the Radio Manufacturers' Association that all education authorities, radio manufacturers and trade associations should collaborate in promoting one national examination for radio craftsmen and technicians. As a result, the Radio Trades Examination Board was eventually formed and held its first examination in November 1943. In 1947 the City and Guilds of London became associated with the Board in arranging and holding examinations, and in 1955 the Board became incorporated under the Companies Act, 1948.

The examinations include both intermediate and final in Radio and Television as well as intermediate and final in Electronics. In the written papers the questions are designed to find out the candidates' knowledge of how circuits work. There are also practical tests which can be taken only after passing the written examination. In the Final Examination for Radio and Television, the candidate is required to find and remedy faults in actual receivers. In the case of Electronics, it is an oral discussion with the examiner lasting 45 minutes 'in which circuit diagrams of equipment are discussed and fault conditions on actual electronic equipment are considered'.

I.E.E.T.E.

At the very beginning we said that possibly two technicians' societies are in process of formation. The second is proposed by the Association of Supervising Electrical Engineers and is to be for what they call 'technician engineers in the electrical and electronics fields'. It is not clear just what is meant by this hybrid term but we suspect that it may be intended to cover technicians other than servicing technicians.

The new body is being called The Institution of Electrical and Electronics

Technician Engineers and qualifications for graduateship will include the Higher National Certificate and certain final certificates of the City and Guilds of London Institute. The extent of industrial experience will also be taken into account. It is intended that the I.E.E.T.E. shall itself become a qualifying body.

In view of all this there is the probability that we shall end up with two technician societies, one distantly related to the I.E.E., the other to the I.E.R.E. As things look at the moment it seems as though the latter might be for servicing technicians with the former for other technicians.

We are not at all sure that this would best serve technicians and we are inclined to think that one society of broader scope would be better. Alternatively, we might have two more or less rival societies, which might not be a bad thing.

Words

Apart from the technical terms of our field, which are often confusing enough to the non-specialist, we continually meet with quite ordinary words used with new meanings. The result can be startling to anyone who does not know that someone has decided to change the meaning of a word!

We recently came across a reference to 'captivated screws' and wondered what these special 'fascinated screws' were. We decided that the writer had thought the usual 'captive screws' to be too mundane and had coined a 'posher' word without realizing that it was a real word with a definite and quite inappropriate meaning.

A recent favourite to describe electronic equipment is 'sophisticated'. Its use is now widespread and it is clearly intended to convey that the equipment is highly refined and complex. Anyone who did not know this and referred to his dictionary would be very puzzled. He would find a whole list of quite derogatory meanings, such as, 'deprived of simplicity, made artificial, adulterated!'

Out of all the dictionaries which we have consulted, which was quite a lot, in only one did we find an allowable meaning akin to that of current usage. That was in Webster, an American dictionary, which does give among all the usual meanings, 'highly complicated, and refined'. The present usage is thus probably of American origin.

In this connection may we add a word of warning about 'presently'. This is beginning to creep in with its American meaning of 'now'. In England, it means 'soon' which is not at all the same thing. If the tendency persists no one will be able to use the word at all, for no reader will know which meaning is intended.

Packages have often to include a prescribed weight of content. A checkweigher will automatically weigh each package and cause over and underweight packages to be rejected. Sorting according to weight is also possible, as well as automatic control of filling.

CHECK WEIGHING EQUIPMENT

By J. A. MUSTO* and R. W. NEWMAN*

THE term 'checkweigher' is currently used to describe equipment which will weigh and classify various packaged goods on a continuous flow basis. With the introduction of pre-packed consumer goods on to the market an accurate and fast means of weight control has become increasingly necessary. One method of ensuring that the new legal requirements for marked weight are being met is to overfill each packet to ensure no underweights are distributed; this method can be costly to the manufacturer and the increased cost must inevitably be passed on to the consumer.

The solution is a fast, accurate, automatic system of weight control which will keep production-line capacity to a maximum and 'give-away' to a minimum. The type of equipment described here will weigh packages up to 10 lb in weight on a continuous-flow basis, at belt speeds of up to 150 ft/minute and is Board of Trade approved.

Basic Principles of Operation

The package to be weighed is conveyed from the production line over a weigh table by means of a thin Mylar belt. As the package moves across this table, a light beam is broken (Fig. 1) and an interlock photocell energizes relay RW which initiates the weighing cycle.

The weigh cell is a precision mechanical unit employing

the principle of a torsion arm balance. The torsion bar is continuously variable over the weight range with both a coarse and a fine micro adjustment. When used in conjunction with the set-up meter, it is possible to detect variations in weight of less than 0.5 gram. Combined with the weigh cell are two further photocells together with movable precision apertures and a light source.

Between the light source and the photocells, a flag which is attached to the end of the weigh-cell beam (Fig. 2) is free to move between two stops. If the flag is covering the lower slit the interlock light beam is broken by the package and the underweight channel is initiated and can be used to operate a reject system and to energize an electro-mechanical counter. If the flag covers the upper slit, the overweight is rejected; if the flag is central the package will pass as an onweight.

The main advantages gained in using this type of weigh cell are as follows:—

- (a) The accuracy obtained is completely independent of the speed of the Mylar belt.
- (b) Movement of the weigh table is limited to 0.003 in.
- (c) The output information is digital.

This means, therefore, that the weighing accuracy is only limited by the basic design and construction of the weigh cell, and the electronic control circuitry is simplified to a 'go'-'no go' system (Fig. 3).

* Rank Cintel.

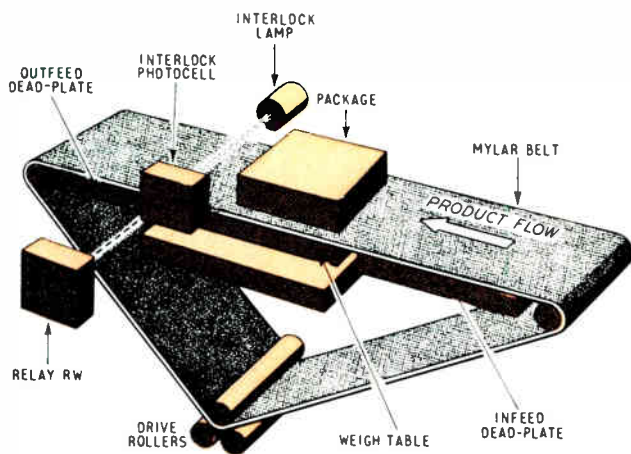
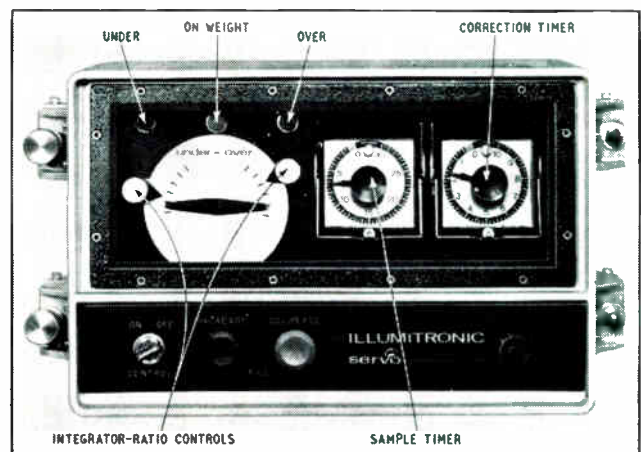

Fig. 1. The package moves over the weigh table on a Mylar belt and interrupts a light beam to initiate the weighing cycle



This picture illustrates a servo feedback accessory for controlling the filling of packages

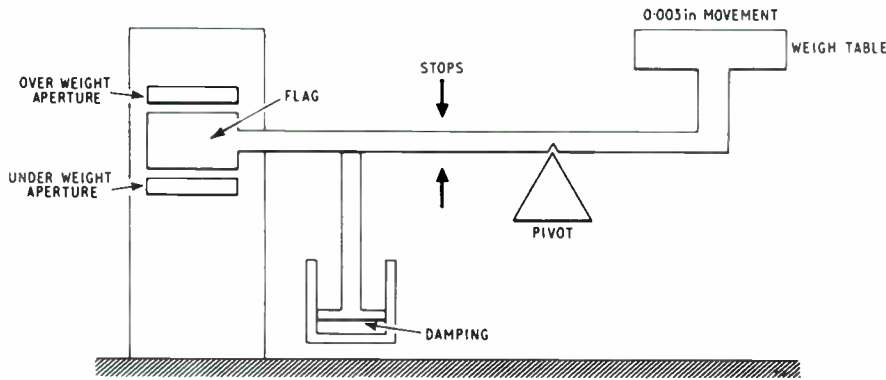

Fig. 2. The balance arm carries a flag which covers separate apertures for over or underweight and so interrupts one or other of two light beams. This sets in operation the mechanism for diverting the package concerned

The latest machines in this range incorporate transistorized electronic circuits and, as the system is digital, widely varying supply voltages and ambient temperature conditions have little or no effect on the performance obtained.

The construction of the circuit is based on the modular principle, so that if a fault should occur the unit can be put back into operation within a few minutes, by locating and changing the faulty module, as these are of the plug-in variety. This, then, obviates the need for skilled personnel to be available, which is a very important aspect, especially as this equipment is installed in many factories which do not normally have trained electronics technicians readily available.

Reject Systems

After the product has been weighed it is necessary to segregate it into three main categories, underweight, overweight and onweight. Overs and unders can be dealt with

in several ways. The simplest method is to use a flipper or air blast reject operated at some point downstream with a fixed time delay initiated from the interlock photocell.

This system cannot be used with open or basically unstable packs or where multi-channel weight classification into as many as five channels is required. To this end, a novel reject mechanism has been developed.

Diversion of a package or container by this mechanism is achieved by moving a number of conveyor slats to left or right as the conveyor carries the pack downstream. The number of slats diverted is governed by the length of the pack which is sensed by the interlock photocell.

Fixed to the underside of each slat (which is generally moulded in nylon) is a stainless steel pin, which when the appropriate reject solenoid is operated, is pulled over and engages with a rail. These rails are positioned to give various reject patterns as shown in Fig. 4. The slats are returned to the central position during their return to the underside of the traverse.

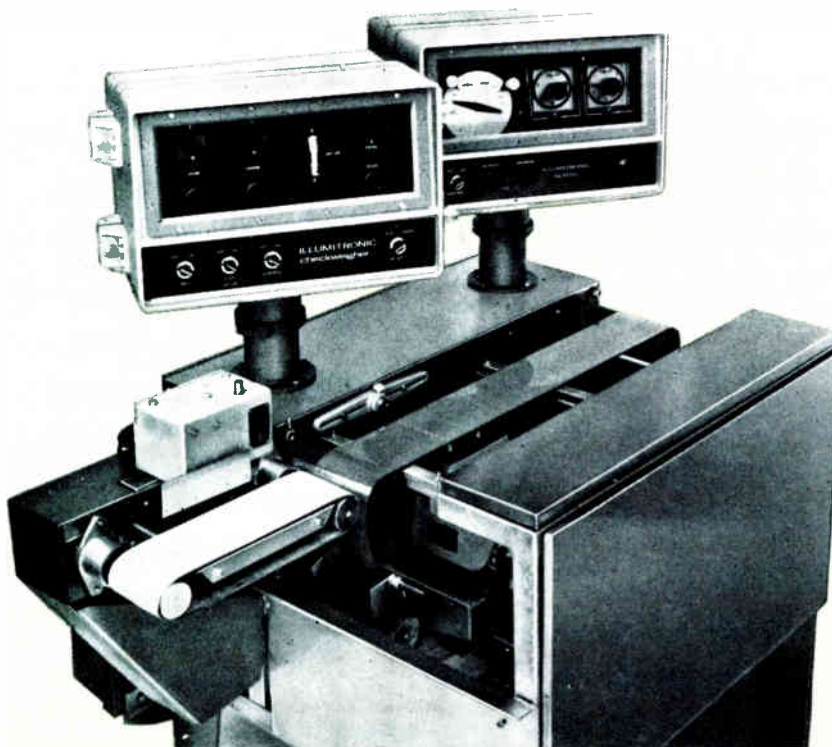

Checkweigher with flipper rejection of over and underweights and servo control of filling

Fig. 3. Block diagram of the apparatus associated with the weigh-cell

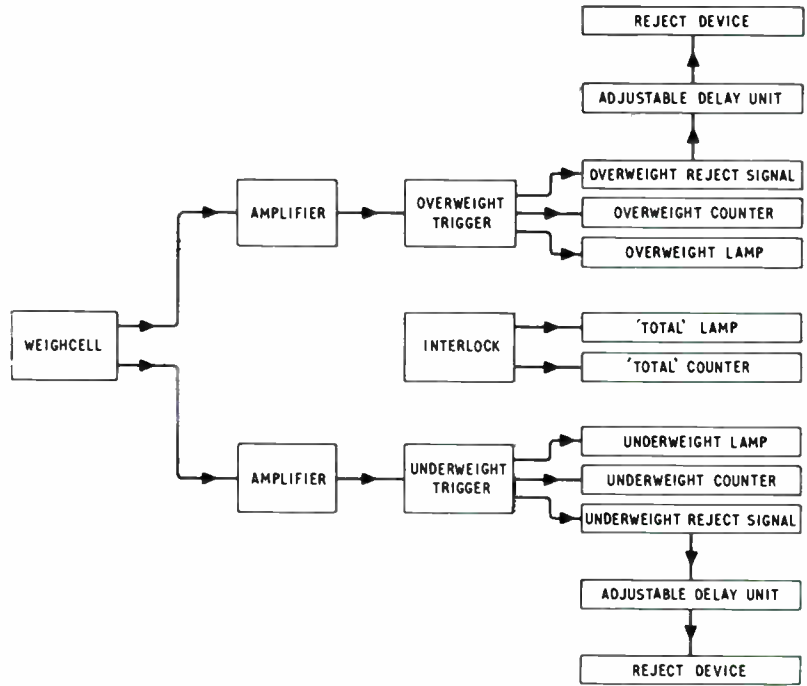

This type of reject unit has also been used as a channelizer to split a high speed conveying line into two or more separate channels.

Servo Control Unit

The purpose of this equipment when used with a check-weigher is to apply automatic correction to the filler. The servo unit is very flexible as all parameters are readily variable from the control panel as depicted in a photograph. Lamp indicators are used as a quick visual aid to the situation, and manual override controls for increasing or decreasing the fill are incorporated.

On the basis of weight samplings taken from the check-

weigher a servo motor can be used to control the filling equipment. When a positive underweight trend is established on the production line fed by the filler, a correction motor, which drives the control mechanism, is set to run for a pre-determined period, thus regulating the fill into the package. In order to determine the parameters for setting up the servo control unit, it is necessary to establish the normal distribution curve of the filler, using standard techniques of hand checkweighing (Fig. 5).

The pre-determined ratio points are set up on the unit and the weigh cell passes the weight status of each package to the servo unit which totals all packages over and under the pre-determined ratio points. If the totals on either

Fig. 4. Gentle reject mechanism giving three-way segregation (left) and five-way (right)

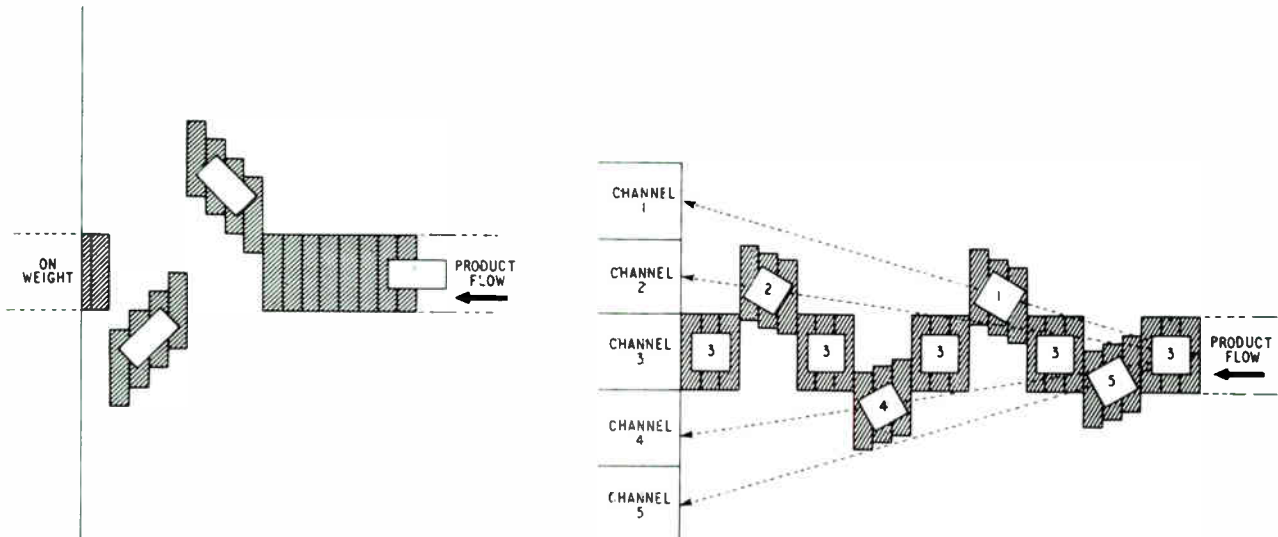

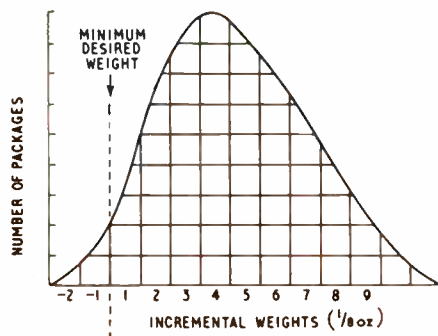

Fig. 5. Basic curve used in the analysis and control of package filling operations. Each square indicates the incremental weight represented by each pack

the under or overweights do not equal the ratio point, feedback circuitry controls the correction motor of the filler to increase or decrease the fill, as required.

As an example, if the servo point has been set at the apex of the normal distribution curve, the servo ratio would be 50/50. A set ratio of 25/75 is probably the most practical solution to meet the contradictory requirement of holding as low as possible both the average give-away and the number of rejects.

Thus the average fill can be reduced to the lowest possible degree just above the weight increment which would cause an excessive number of underweight packs to be rejected. By holding the tolerance band of the filler as close to the underweight cut-off point as is practicable, the servo/

weigher system cuts the product give-away to a minimum.

The performance of the servo unit replaces the manual correction of the filler, and is faster in response and more accurate in the degree of adjustment. It is faster because it is continuous in action, apart from the time required to operate the correction motor, and the time required for the corrected fill pack from the next sampling cycle to reach the checkweigher.

Types of Illumitronic Checkweighers

Basic units are made for underweight, under and overweight rejection and up to five-way classification of package weights.

Stainless steel is used widely in the construction of this range of weighers and all units can be subjected to hosing down. Where product spillage or carry-over on to the weigher belt is experienced the weigher belt can be fed with a constant supply of water to keep the belt as clean as possible.

Choice of Model

In specifying the type of checkweigher and ancillary equipment most suitable for a particular application a number of factors must be taken into account. Not the least is the accuracy obtainable under operating conditions. Purchase price considerations need careful comparison against possible product savings.

Reliability, ease of maintenance by factory personnel, suitability of the rejection system to the type of package or container, flexibility for various sizes and weights of packs, ability to withstand hosing down and damp environments must be considered. Others factors such as container configuration, stability, weight variation of the container, product spillage and indexing of the packages

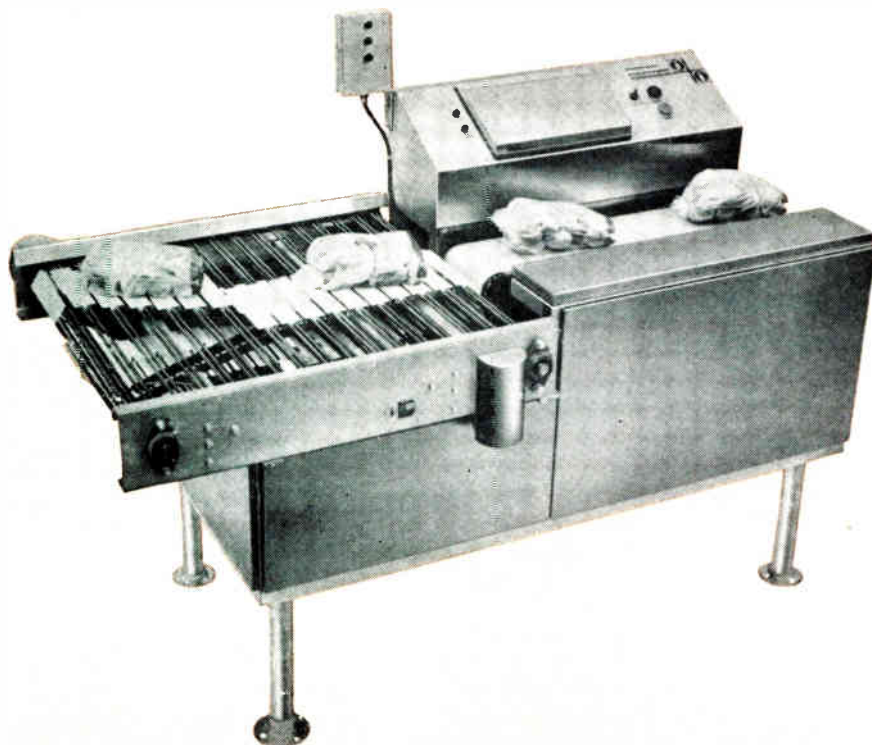

Basic checkweigher with gentle three-channel segregation

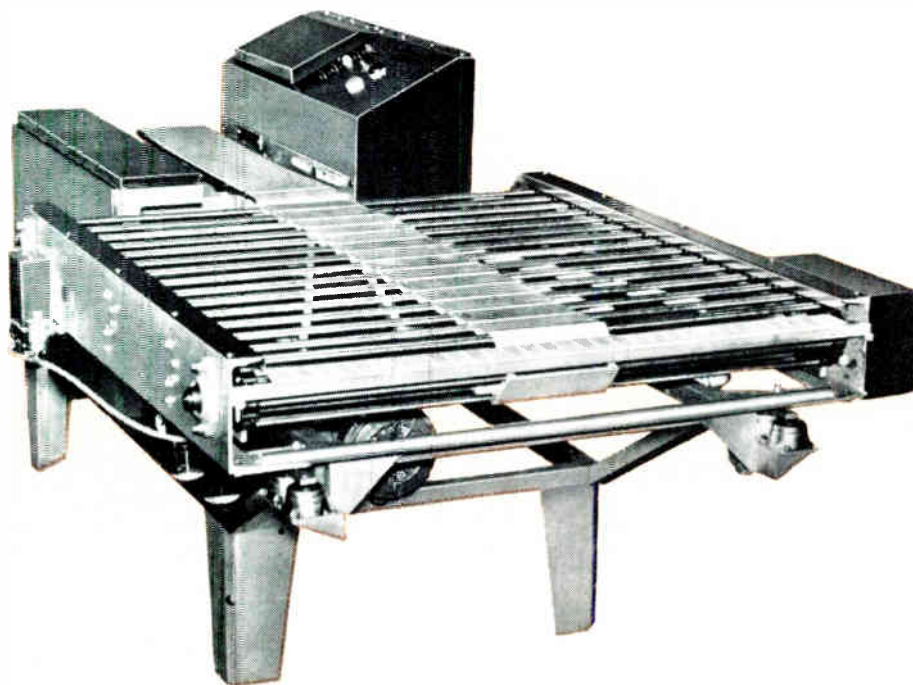

40-in. reject bed which can accommodate 8-in. wide packages and has five-channel segregation

on the infeed conveyor, must not be forgotten when making the final decision about the most suitable type of checkweigher for the specific application.

The ability to handle future production capacity with respect to speed and accuracy is an important factor in

a checkweigher. So, too, is its ability to operate with servo equipment and other ancillary equipment.

The role of the checkweigher is more than a device for underweight protection; its versatility can be utilized as a production tool.

Analogue Computer for Road Research

A Redifon 10/20 analogue computer, recently acquired by the D.S.I.R. Road Research Laboratory at Harmondsworth, Middlesex, will be used to simulate various road problems such as the behaviour of different types of vehicles on varying road surfaces. The simulation of vehicle suspensions will be studied, as also will be the problem of finding the optimum road profile to provide a smooth transition for all vehicles from one road section to another.

Among the other subjects for which the computer will be used are investigations into heated roads where heating is automatically switched on when icy conditions are threatening. These studies will include problems of heat flow, depth of heating grids, and the effect of thermal shock when ice-up roads are salted.

The future programme also includes the feeding of road profile constants to the computer to discover a profile which will give the best riding properties, and the study of road stresses in relation to wheel loading. In addition, there is the optimum shape of a snow-plough blade to be determined and the 10/20 will be used to take a closer look at the behaviour and flight of a snow particle from the blade.

For further information circle 51 on Service Card

The Road Research Laboratory's Redifon 10/20 analogue computer

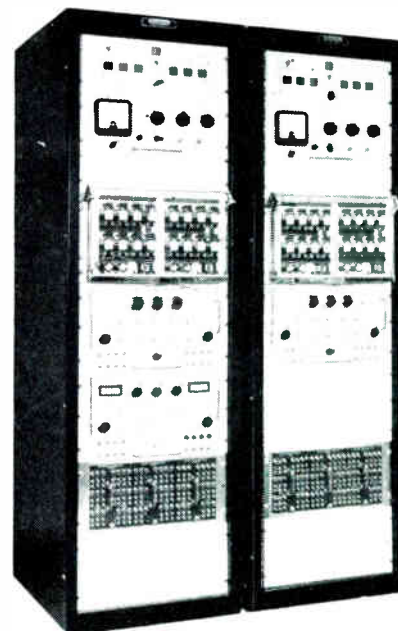

INDUSTRIAL TELEMETRY

By R. C. GRIGGS *

THROUGHOUT industry considerable time and effort are spent in improving efficiency. By so doing, costs are reduced and production can be increased. The fact that improved lines of communication will increase efficiency cannot be disputed, and modern management provides for effective communication within and between all departments. The almost universal acceptance of modern office equipment and business machines has accentuated the desirability of providing more efficient and flexible methods for the interchange and storage of information.

A modern approach to the problem of increasing efficiency is decentralization and the creation of local areas which are autonomous. This practice is as true of the operational side of industry as of the administrative, and is evident from the growing trend towards the semi-automatic operation of remote plant. In such circumstances, however, overall efficiency can only be maintained by providing means by which information can be obtained and over-riding control can be undertaken. Furthermore this control action should only be initiated in the light of precise information being available from the controlled and adjacent stations. The collection and presentation of such information and the required remedial action must be undertaken in accordance with a strict procedure, and systems which will enable these functions to be effected are known by the general term: Telemetry Systems.

Historical

Patents for telemetering systems were issued as far back as the 1880s, but were not exploited until the early part of this century when traction companies and public utilities began to take advantage of simple wired systems, usually of the current or voltage type. In the 1930s, weather balloons fitted with radio-telemetry equipment were flown in Germany. World War II saw the use of radio control and telemetering for pilotless aircraft, and the telemetering, during a test flight, of data which might have been

lost in the event of a crash. Towards the end of the war the development of guided missiles increased the demand for sophisticated high-speed systems, and over the last decade many technological advances have been made in the missile and satellite telemetry field.

In the industrial field, progress has been stimulated by the missile development, but in many cases the problems are so different that alternative solutions have had to be found. Most telemetry systems fall into two broad categories, analogue and digital, and it is in the latter field where the most significant advances have been made. The advent of computers and their associated logic circuits, together with miniature components possessing long life and high intrinsic reliability, have aided the telemetry design engineer in his work.

Instruments and Transducers

Fig. 1 shows a basic telemetry system in the form of a block diagram and the functions of the various blocks will now be described.

Many of the prime measuring or sensing devices used in industrial telemetry applications are instruments which respond quantitatively to a physical property or condition which is converted into a mechanical movement or electrical signal. Coupled to the instrument is a transducer which converts the movement or signal into a form which may be suitable for transmission, but in many cases additional signal processing may be necessary. For instance, it is sometimes necessary to produce a non-linear relationship between the prime quantity and the transducer signal, and it is often convenient to adjust this relationship at the transducer stage, e.g. $Q \propto \sqrt{P}$.

The basic measuring instrument or transducer may employ a variable-duration impulse (v.d.i.) signal to represent the measured parameter. Other instruments work on a strain-gauge principle, e.g., the resistance varies directly with pressure. Some instruments employ a differential transformer with a movable link connected to the prime measuring device. Movement of this link will alter the coupling between the primary and the two secondary wind-

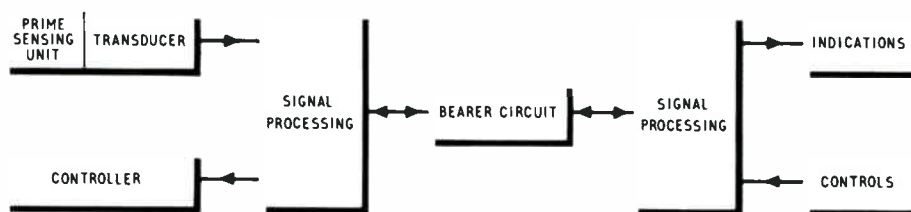
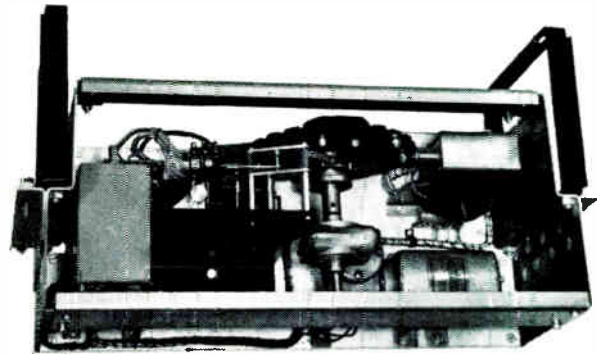

Fig. 1. Block diagram of a basic telemetry system

* Pye Telecommunications Ltd.

The acquisition of data from remote plant and the remote control of such plant are becoming increasingly necessary in many industries. Telemetry can provide these facilities and this article discusses the subject in general terms.



Digital to pneumatic (set-point) controller

ings, which are connected in a series opposing manner. The resultant output is an a.c. signal, the amplitude of which depends on the position of the movable link. This signal can be converted from an a.c. to a d.c. signal for further processing.

Most modern instruments, however, operate on a force-balance principle. In this case the mechanism which converts the basic parameter (e.g., pressure) into mechanical movement causes a lever to be displaced from its rest position. This causes a d.c. signal to flow in a coil, which tends to restore the lever to its original position. As already mentioned, the magnitude of the current and hence the restoring force can be arranged to follow a predetermined law.

Signal Processing

The kind of signal processing necessary will depend upon the type of information presented and the method by which this information has to be transmitted. For example, if the transducer provides a variable current or voltage output of sufficient magnitude, it is possible to display this by providing a metallic connection between the transducer and the indicating device. If, however, the transducer output is extremely small (e.g., a thermocouple) it is necessary to provide signal amplification before any direct wire connection can be used. In many cases it is desirable to change the form of the signal completely. Most modern telemetry systems employ digital techniques, and it is therefore necessary to convert the transducer signal, which is generally in an analogue form, into a digital signal which takes the form of a series of pulses.

Apart from the process parameters it will also be necessary to know the condition of various two-state devices such as switches, circuit breakers and alarm equipment. In these cases associated contacts are used as the initiating devices and their condition may be indicated at the control station by arranging for them to transmit or inhibit a d.c. or audio signal.

In most telemetry applications it is desirable to be able to perform control functions at the distant plant. It is often convenient to do this by simply reversing the procedure already described for signal processing. Outgoing signals in the form of a command from the control station will enable desired values to be set remotely, interposing relays to be operated in two-state control functions, and variable control devices to be positioned. In order to accomplish this the electrical signal, which is received by the remote station, is converted into a new signal in electrical, mechanical, pneumatic or hydraulic form.

Methods of Transmission

Each of the basic telemetry elements affects the design of the complete system, but basically the choice is governed by the type of transmission which is best suited to the require-

ments. If, however, the telemetry system has to be applied to existing instrumentation, the available instrument outputs may determine the transmission methods. Generally, information may be transmitted in an analogue or digital manner.

Analogue Transmission

Transducers are continuously sampling the level of the quantity being measured, and the outputs are in an analogue or quantitative form, which is continuously varying. If the output is in the form of a varying d.c. signal there will be a limit to the distance to which this function can be transmitted before distortion occurs. Other transducers

Electro-mechanical force balance unit. This is a part of the Commander 0-10 mA d.c. transmitting system

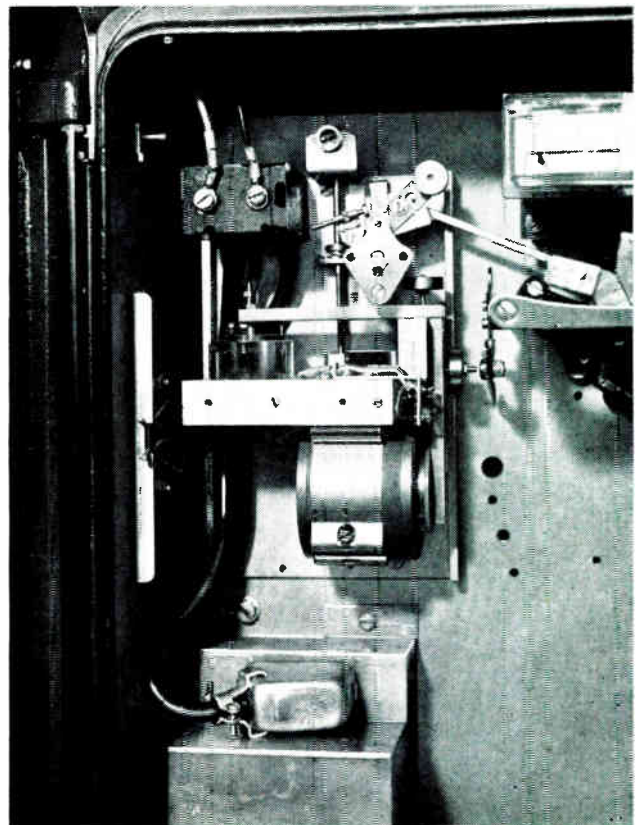

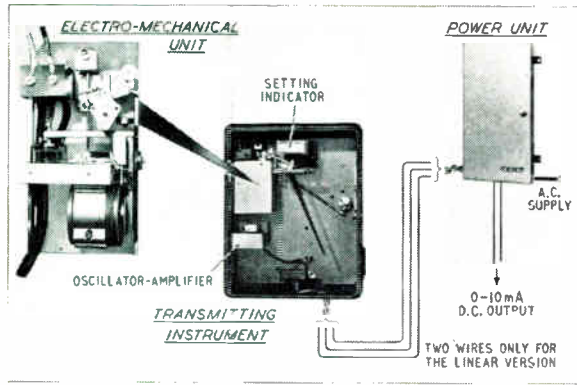

Commander 0-10 mA transmitter

give an audio tone output, and the level or frequency of the tone can be varied in accordance with the measured quantity. This requires the measured quantity to be sampled over relatively short periods of time, and it is during these periods that the tone is varied in frequency, amplitude, duration, etc. In order that the resultant information may be displayed correctly it will be necessary to synchronize the transmitted and received signals. This type of transmission is particularly suited to those applications requiring a continuous display, and since the function is continuous, a separate channel must be provided for each quantity. The transmission channels must be free from interference which would distort the information. Similar signals can be transmitted in the reverse direction to open or close relays which are often used to control the operation of actuating devices.

In an analogue system each measurement and alarm point often has a direct circuit connecting it with an indicator, and each control button has a direct circuit connecting it with the controlled device.

Digital Systems

In a digital system the information regarding prime quantities is converted into a pulse code for transmission. It is possible to introduce automatic means for checking or proving these codes at the receiver, and therefore only correct codes need be accepted for subsequent conversion and display. Then no accuracy need be lost during transmission, and it is therefore possible to display a precise reading for a particular measurement.

Many systems depend upon the presence or absence of a pulse, and such systems normally employ binary codes. Binary codes employ a combination of two digits, 1 and 0 (mark and space), known as binary digits or bits, in which

any decimal digit between 0 and 9 can be represented by the equivalent four-bit binary number. A decimal digit will finally be represented by a series of four bits, which will cause pulses to be formed in accordance with the binary arrangement. It is clear that some ambiguity may arise in the transmission since there is no check on the total number of marks or spaces which are transmitted. Interference may cause a pulse to be deleted or inserted with a consequent incorrect translation. In some cases error checking or Gray codes are employed and in other cases it is possible to transmit codes on two independent channels with means for checking the inter-relationship of the two codes received. All methods necessitate the inclusion of a measure of redundancy in the codes transmitted. By including redundant bits it is possible to devise checking circuits which test the integrity of codes being received. For example, it is possible to count the number of bits and also to check that an even or odd number of 1 or 0 bits is always received before the code is accepted.

Bearer Circuits

An important part of a telemetry system is the link or connecting circuit, generally referred to as the bearer circuit, which carries the information from the remote transducer or signal-processing equipment to the indicating device. As already mentioned, this bearer circuit could be in the form of a conductor or conductors. Sometimes a phantom circuit is used on an existing communications network, but more recently, radio bearer circuits have become increasingly popular.

There are basically four different types of circuit which may be used to convey the information, and these are:—

- (a) Power-line carrier circuits.
- (b) Private-wire circuits, owned by the user.

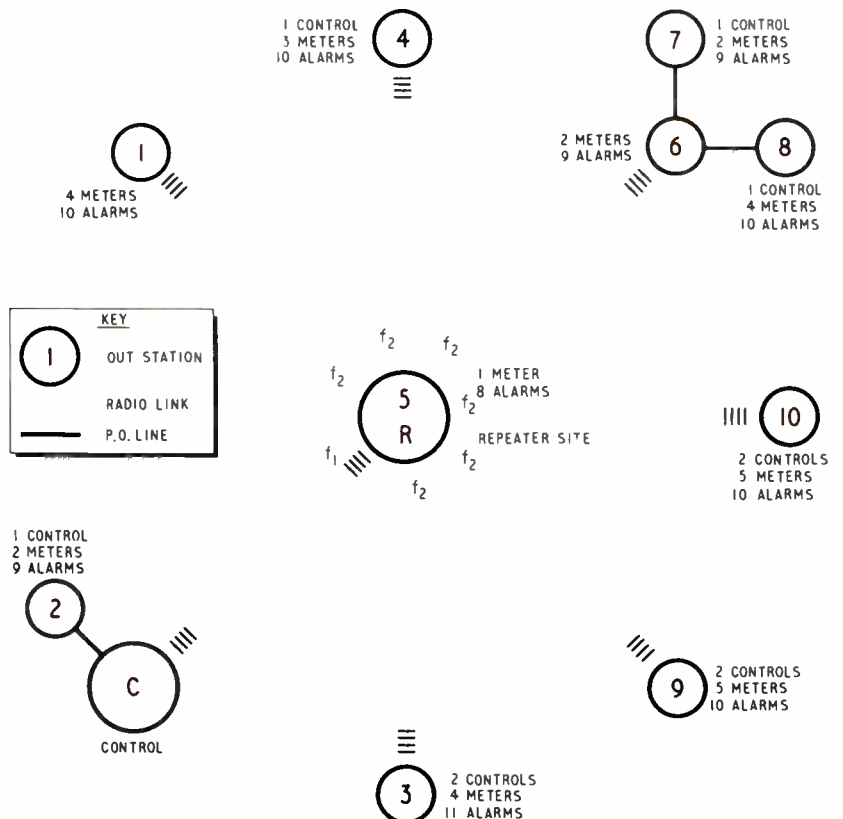

Fig. 2. An example of a possible arrangement of outstations in which radio links are mainly used

- (c) Lines hired from the G.P.O.
- (d) Radio links.

As the use of (a) is confined to the electricity industry it is not used very extensively, and this method will not be described here. The choice between the three remaining methods will be governed by consideration of their relative cost, reliability and flexibility and these aspects are reviewed below.

If a network of private-wire circuits is available before the implementation of a telemetry system then undoubtedly this should be used. The installation of a private network can only be considered when (1) the system to be installed is within the company's premises or (2) in cases where a pipeline, cable or similar supply is being installed at the same time. It should be borne in mind, however, that trenching within the confines of a factory could cost approximately £4 per yard. The disadvantages of (2) are twofold. If cables are laid with the pipeline, catastrophic damage to the line may sever the communications link. Furthermore, the time taken to terminate and prepare the cable will interfere with the main project of laying the pipeline, and thus the equipment provided for this operation could be idle during such periods.

Standard Tariff S lines may be obtained from the P.O. at an average annual rental charge of £18 per mile, and this breaks even with a typical u.h.f. single-channel radio link at approximately 15 miles. If the distances involved are greater than this, some cost advantage will be gained in respect of radio links. If, however, a common radio repeater station is already in use, an additional radio link compares in cost with a rented line at a distance of about six miles.

Insofar as reliability is concerned, statistics are available which indicate that the figure for United Kingdom rented underground lines is no higher than 99.75% which, in terms of hours of outage time is 25 hours per annum. A comparable figure for radio links with standby equipment is 99.98%, or 25 minutes per annum.

Rented lines are routed through G.P.O. exchanges and thus in rural areas the availability of such lines is limited. Radio links can usually be provided to cover a given area, and are particularly advantageous where natural barriers preclude the use of physical circuits. It is normal practice in radio-link systems carrying essential information to provide either main and standby transmitters and receivers at focal points or to duplicate links. When main and standby units are used, changeover from the working to the standby equipment is effected automatically on loss of signal by a receiver, and a failure or drop in output power of a transmitter. With duplicate links, failure of any one unit in the working channel will effect an automatic changeover of the audio circuits at each terminal to the standby link. A total loss of service therefore is unlikely to occur, and the necessity for immediate repair is not so critical. The provision of standby rented-line circuits, particularly in rural areas, is not always practicable, and thus the flexibility of radio systems is apparent. Fig. 2 shows a possible arrangement of outstations in a scheme mainly embodying radio links.

Indication and Display

The method of display will often be determined by the type of transmission employed and the frequency at which it is required to update the measurement information. Analogue transmission usually infers a continuous cycle of operations, and thus when this type of signal is used an analogue display is normally preferred. The display may be in the form of an indicating or recording meter having

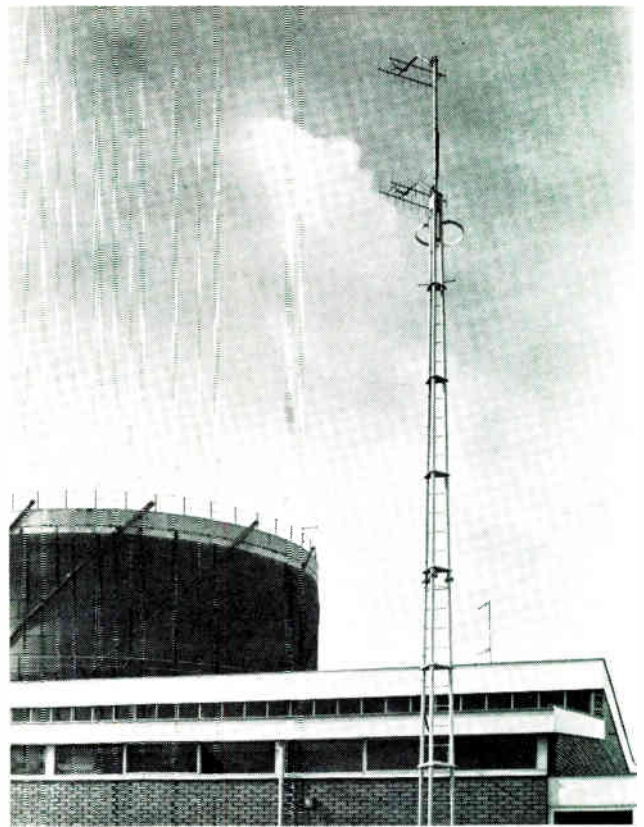

Typical v.h.f. telemetry aerial installation

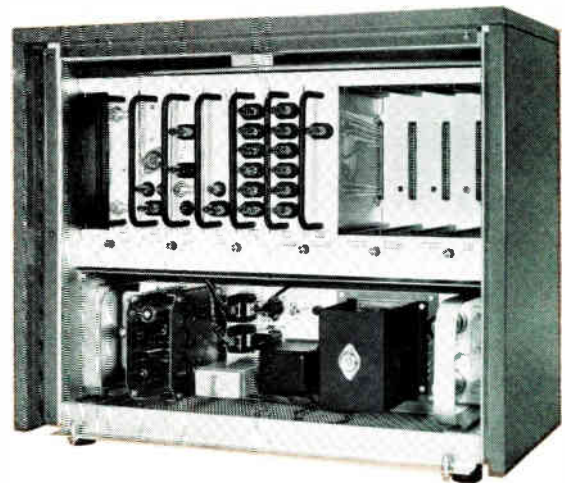

Tele-alarm equipment giving up to 68 indications from each of 16 outstations

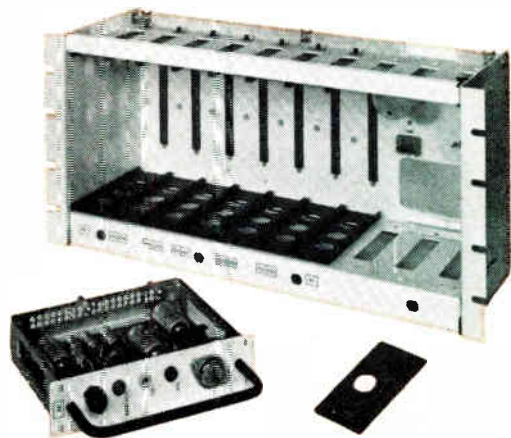

Typical module and housing assembly

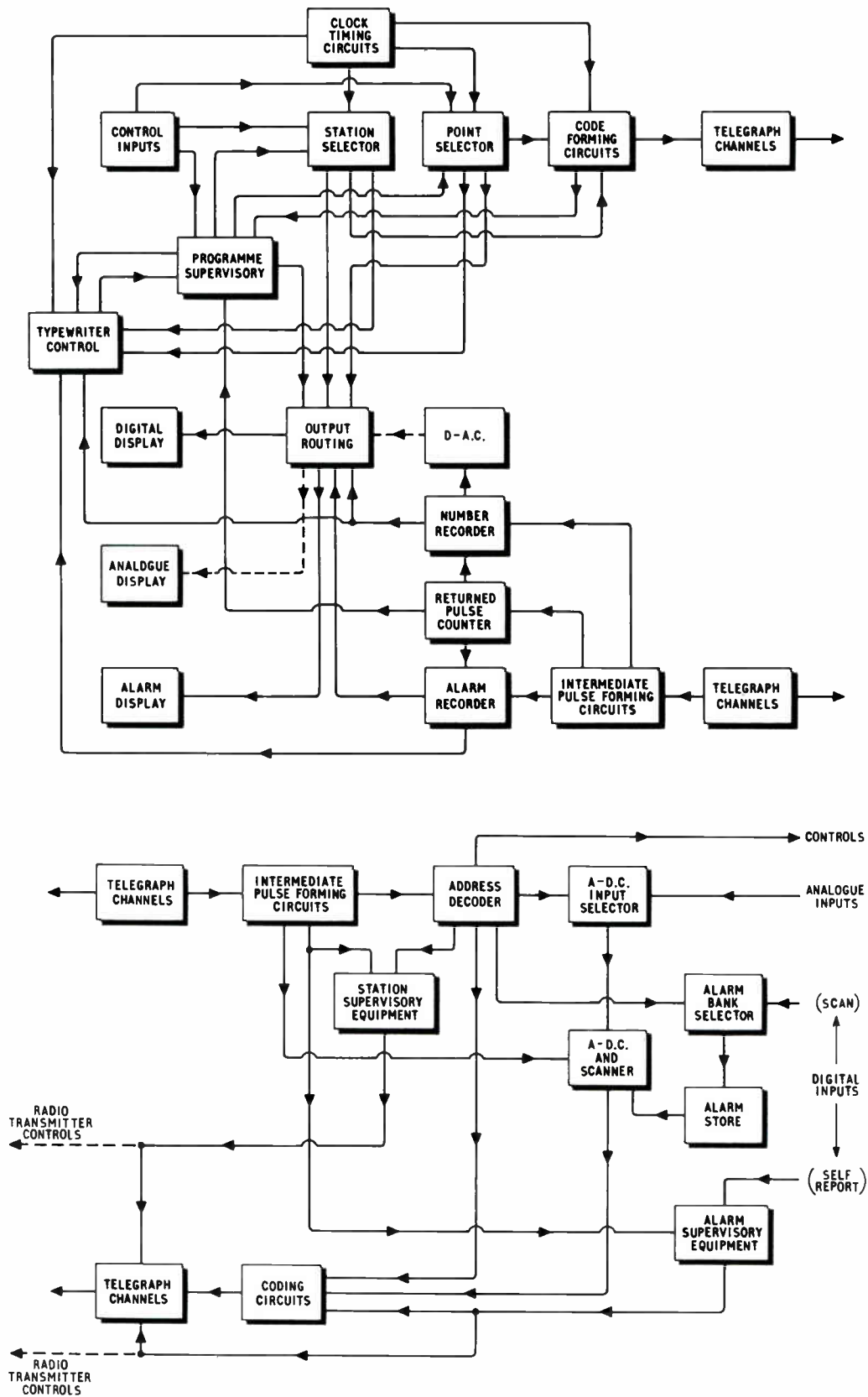

Fig. 3. Block diagrams of the apparatus comprising a central station and of that in an outstation

a sector scale indicator or chart recorder. These instruments are normally mounted in floor-standing panels, and may be positioned so as to coincide with the appropriate symbol on a mimic diagram. In all cases the display will be required to present a clear picture as to the functioning of the remote plant and often this can best be achieved by animating a graphic diagram of the system. The condition of remote equipment can be indicated by coloured lamps, rotating discs or discrepancy switches. The latter provide a flashing light when remote conditions are not in agreement with the setting of a controlling switch. Indications regarding the level of water in a reservoir may also be incorporated in an animated graphic diagram. Each of the above examples can be derived from both analogue and digital signals but are, apart from the equipment state indicators, analogue in form. When such display methods are used a full diagram, incorporating an indicator for each point, will normally be necessary and suitably scaled meters will be used for each measurement.

The normal variations of product parameters may, however, change relatively slowly, and in such cases continuous observations of the measured points would be superfluous, although it might be essential to give an alarm when preset limits were reached or a change of state occurred. When such semi-active systems are used a common diagram form of display is most beneficial. The common diagram form of display, as its name implies, uses a display which is shared between each one of the stations in the system. It is usual to display the information in such a system only when it is required to observe the functions at a particular station. Normally the indication of the operating condition of remote plant is given priority, and is presented in a full diagram form so that conditions obtaining at adjacent stations are always available.

If the received signals are analogue in form then it is generally expedient to display them in such a manner, but this is not necessarily the case if digital transmission is used. The digital signals may readily be reconverted and displayed on indicating or recording meters. The most significant advantage of a digital display, however, is that the incoming signals can be fed without further processing to an automatic print-out device. This immediately obviates the need for the supply, collection and sometimes tedious interpretation of instrument chart recordings. The signals may also be in a form suitable for feeding in to an information reduction equipment, or for retransmitting to a further display centre.

Various forms of digital display may be employed ranging from electro-mechanical through projection to electronic. The latter are becoming increasingly popular because of their reliability, clarity and circuit simplification. Each of these devices will give a single numerical indication at any one time, and are usually grouped in sets of three. Decimal point indicators may be included in the complete display to cater for scaling factors when such displays are used to indicate similar functions having different ranges.

Equipment Practice and Reliability

Since it is unlikely that any two telemetry systems will ever be alike it is essential to adopt a flexible equipment practice. This can be achieved by producing a modular form of construction in which each module will be capable of performing a set number of operations. In certain cases it is possible to design the module so that, with the minimum of modification, the number of functions catered for can be doubled, enabling future extensions of the system to be readily incorporated. Fig. 3 shows block diagrams of the apparatus at the central station and at an outstation of a typical telemetry system.

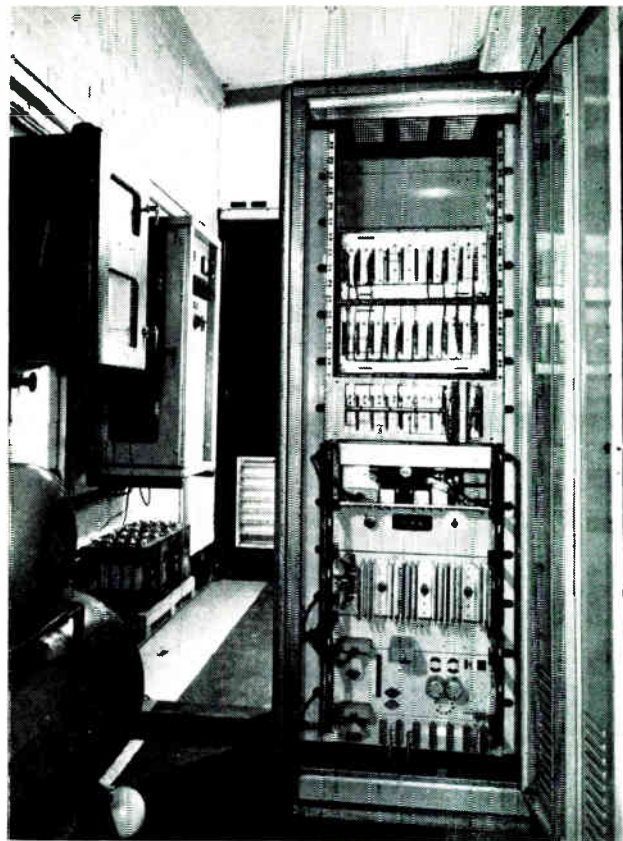

Rear view of telemetry outstation assembly comprising digital to pneumatic converter, 21-V stabilizer, line panel and, separate, float-charged battery

In some applications wrapped joints and encapsulation are employed, but it should be remembered that in any sophisticated system employing a large number of components, equipment failures will occur, and it is then necessary to rectify the fault with the minimum of delay. This can more readily be done if a system of plug-in modules is used.

When designing a reliable equipment it is essential that the spread and life variations of the major characteristics of the components employed be known. In this connection many 'active' circuit components have benefited as a result of extensive reliability work, but many of the 'passive' components have not yet received the same attention and often these devices limit the life expectancy of an equipment. It is becoming increasingly apparent that the choice of electronic elements is often influenced by general tendencies and opinions, rather than by careful appraisal of the problem and a subsequent choosing of the most suitable elements for the function it has to perform. Any element which possesses proved reliability should be considered when attempting to solve a particular problem.

Telemetry Systems

In any telemetry scheme the geographical arrangement of the remote stations will only permit them to be connected to a control station by either radial or tandem circuits, or, in some instances, by a combination of both methods.

Economic considerations usually necessitate the provision of single circuits for the transmission of several prime measurements, equipment states and control functions between outstations and a control station. In such cases the bearer circuit must be shared by all points at any one station, and also between stations in tandem systems. Each station or point can be switched into circuit for a particular period of time, and this is known as time-division multiplexing (t.d.m.). Alternatively, each point may be

allocated a particular frequency band within the total bandwidth available, and this is known as frequency-division multiplexing (f.d.m.). In some large systems it is often expedient to combine these multiplexing methods and this is more readily achieved in tandem arrangements.

In such cases, measurements, indications and controls operating on separate channels can be transmitted simultaneously enabling the effect of the control to be observed at the time of operation and still allowing the equipment states at all stations to be continuously monitored.

When physical connections are used between outstations and a control station the circuits so provided are available continuously and each circuit may be monitored simultaneously. This arrangement does not apply to radial radio systems, however, since, in the interests of frequency and equipment economy, each outstation is allocated the same pair of frequencies. It is necessary, therefore, in such systems to switch the transmitters into circuit sequentially or on demand.

Analogue systems employing f.d.m. techniques are suitable for operation over reliable physical circuits. The total number of functions which can be transmitted over a single pair of wires is limited by the frequency response of the line, and the transmission distance is limited by the d.c. resistance or attenuation. The flexibility of such

systems is therefore restricted. Digital systems employing f.d.m. and t.d.m. techniques are not so restricted, and may readily be applied to tandem or radial radio links. Extreme flexibility can be built into digital systems, and additional stations and points within a station may be incorporated in existing systems with the minimum of inconvenience. Greater reliability and accuracy can be achieved with digital systems.

Conclusions

The application, by industry, of modern telemetry methods is playing an increasing part in the expanding economy of this country. The availability of channels for the interchange of data, however, is limited, and development must be towards a more efficient use of the available line and radio circuits. There is a growing economic need for the development of integrated telecommunications systems in which speech communication, telemetry, fixed-to-mobile services and data-processing techniques are combined.

The development of means for the efficient interchange and storage of data is as significant to modern technology as was the formulation of spoken or written language to earlier progress.

Polyester/Glass Fibre Aerials

The increasing use of the centimetric waveband for radio communication has created a need for special aerials to operate at the higher frequencies up to and beyond 10 Gc/s. To obtain maximum forward gain at such frequencies, paraboloidal dish aerials are required with very high surface accuracy. Development work by Marconi has

resulted in a range of dish aerials using glass fibre/polyester resin construction designed to cover frequencies ranging from 1.8 to 11.5 Gc/s. and having a surface accuracy of better than 0.030 in. r.m.s. departure from a true paraboloid. These microwave aerials are already in use for telecommunications work.

The necessary surface accuracy is ensured by stretching galvanized steel wire-mesh over the surface of a highly accurate epoxide coated concrete mould so that it conforms closely to the mould surface. Glass fibre is then laid on the mesh to the requisite thickness, and polyester resin is made to penetrate the mesh so as to enclose it completely. Further layers of glass fibre and polyester resin are then bonded to the back of the surface, and galvanized steel plates are let into this structure to pick up and transfer loads to the supporting tower.

The moulded dish is fitted at the focal point with a fronted waveguide horn, which is sealed against the weather by a sheet of dielectric material. The waveguide feed runs down the centre of the face of the dish to join up with the vertical tower waveguide run. Alternatively, a centre feed can be fitted.

Panning arrangements are of novel design, involving a universal joint and a system of supporting rods. The system allows panning to be carried out independently in elevation and azimuth to a maximum of 45° total angle movement. Other features of these dish aerials are low weight/stiffness ratio and high resistance to extreme environmental conditions. Aerials 10 ft (illustrated) and 15 ft in diameter have been developed as standard for the present, though other sizes are contemplated. They can be supplied either solid, or in halves for ease of handling.

For further information circle 52 on Service Card

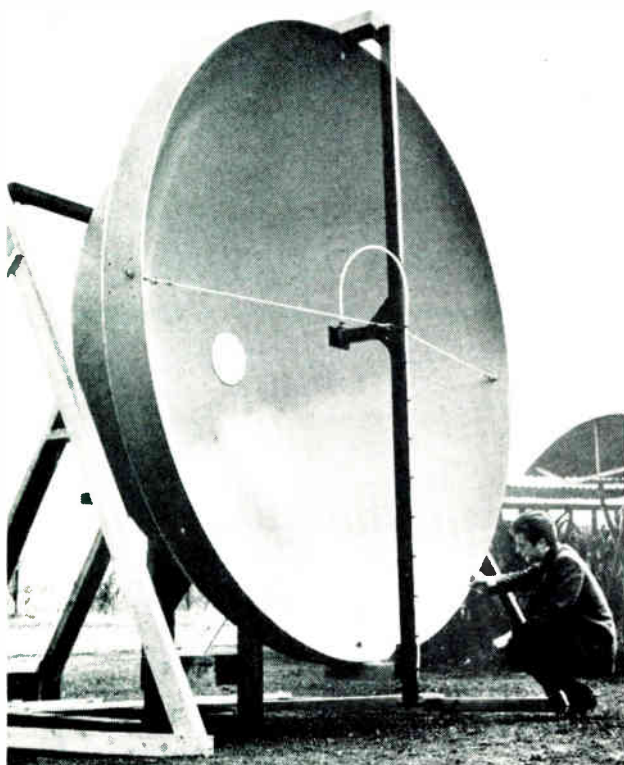

A 10-ft diameter microwave dish aerial moulded in glass fibre and polyester resin

Rotary type of flying shear

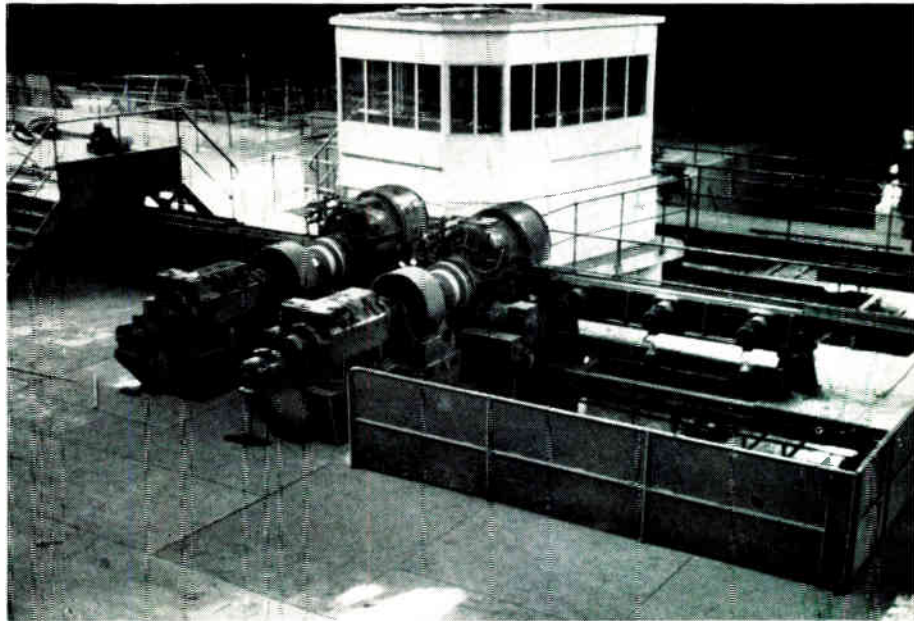

This article describes the way in which digital techniques are used to control a 'flying shear'. This is a machine which cuts rolled steel rod and bar to convenient lengths as it comes from the rolling mill.

DIGITAL TECHNIQUES IN INDUSTRY

DIGITAL COUNTERS USED IN LENGTH MEASUREMENT

By G. COOPER*

THERE is nothing particularly novel in using counters in conjunction with measuring rolls for the length measurement of sheet steel, fibre board, etc. Both electromechanical and Dekatron counting systems have been in use for some years. However, the electromechanical counter is incapable of counting more than 50 counts per second, which is severely limiting in its application. The Dekatron type will run at up to around 3,000 counts/sec, but works at high voltages and high impedances, which render it not too suitable for operating in conjunction with transistor gating circuits, the much less reliable thermionic valve normally being used.

Transistor binary circuits suffer from neither of these disadvantages, and offer a very reliable and flexible technique for building up length measurement counters. When, as in the case of the L.D.E.P. Digital System, the binary units form part of a complete logical and numerical range of units, the counters can be integrated into all-static counting and sequencing control systems.

The problems encountered and the techniques used can be best illustrated by an actual example of a counter already in service. The example illustrates that to apply digital control successfully requires careful design of many other aspects of the electrical and mechanical equipment involved.

Flying Shear Control Counter

It is common practice to shear rolled steel rod and bar into conveniently handleable lengths of say 20-30 ft as the

material comes from the rolling mill. In addition to cutting up the main body of the bar into lengths, it is necessary automatically to crop the first two feet or so from the nose end of each bar, this length being of imperfect material.

The shearing is carried out by a 'Flying Shear', which can be of several mechanical forms, but all of which from a control point of view are similar to the simple rotary type, illustrated in the photograph. A continuously running motor, often carrying a fly-wheel, is speed-matched to the rolling mill, and on receipt of an initiating signal, the two shear blade discs are clutched on to the motor. The blades now come together travelling in the same direction as the bar being rolled, and at the same (or very slightly higher) speed, and crop through the bar. The shear is now declutched, and the shear blade discs braked to come to a standstill in the starting position, ready for the next operation.

The control problem is therefore in two parts:

1. Correct initiation of the shear.
2. Consistent control of the response time of the shear action.

Correct Initiation

The block diagram of Fig. 1 shows the main features of the counter used to measure the length of steel rolled and to initiate the shear.

In the particular shear under consideration, the rolling speed is of the order of 4.5 metres/sec, and the setting increments 1 cm. This means that 1 pulse must be produced

* Lancashire Dynamo Electronic Products Ltd.

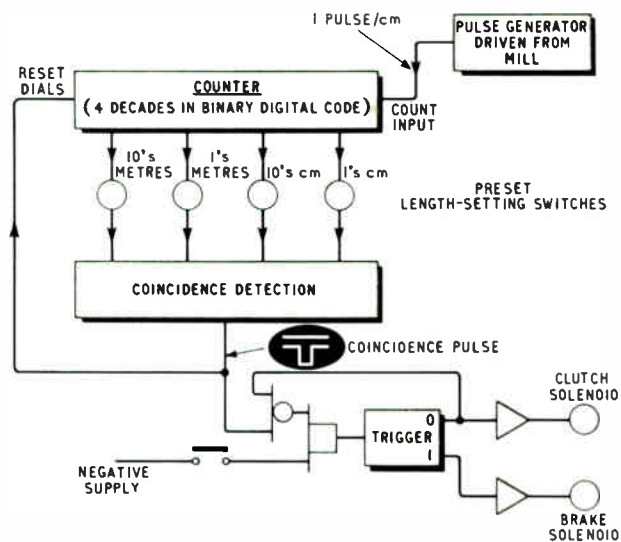

Fig. 1. Block diagram of counters

for each 1 cm of bar passing; i.e., 450 pulses/sec. This is very comfortably within the capacity of the standard binary circuit, which will count at up to 5 kc/s. The pulses are produced by an electromagnetic pulse generator, driven in this case from a mill roll. This means that slip between bar and rolls will affect accuracy, and accurate length setting is achieved when setting up by check measurements. An alternative method perhaps more commonly employed is to use a special measuring roll, which is not liable to slip, and better accuracy can be achieved by this means. However, in this particular type of application additional rolls are undesirable because of the added risk of 'cobble' caused by the nose end failing to enter the rolls correctly. More complex measuring systems based on self-calibrating counters have also been used.

Pulse Generator

The pulse generator consists of a shaft-mounted epoxy-resin disc into which are cast tracks of permanent magnets (see photographs). As the disc rotates, the flux pattern generated by the magnets is detected by small ($\frac{3}{16}$ -in. dia.) ferrite cores which are excited by a single-turn primary winding which is fed at 70 kc/s by a simple oscillator built into the pulse generator. When no magnet is near the pick-off, a 70-kc/s output is obtained from a multi-turn secondary winding. However, when a magnet is over the pickoff, the magnet flux holds the ferrite core saturated in one direction and no 70-kc/s output is induced. The secondary output is rectified and smoothed at the pulse generator and can then be fed after pre-amplification to a trigger circuit which gives a cleanly switching output. The pulse generator can be situated several hundred feet from the control cubicle and wired in conventional cabling. The impedance levels of the signal are so low that screening is unnecessary, although it is good practice to keep the pulse generator cables separate from power cables to avoid 'inductive loop' pickup of spurious signals.

By selecting the appropriate track of the four available, 2, 4, 8, or 16 pulses

per revolution can be obtained, and this eases the problem of providing the correct drive gear-ratio. If necessary 32 pulses per revolution can be generated by making use of two pickoffs displaced $\frac{1}{4}$ cycle apart on the outer track, in conjunction with gating circuits.

Binary-Decade Counting

The counter proper consists of four identical sets of four binaries, each set being connected to count in binary-decimal scale (see below).

	Binary-Decimal Scale			
	8	4	2	1
Binary Digits				
Decimal number 0:—	0	0	0	0
1:—	0	0	0	1
2:—	0	0	1	0
3:—	0	0	1	1
4:—	0	1	0	0
5:—	0	1	0	1
6:—	0	1	1	0
7:—	0	1	1	1
8:—	1	0	0	0
9:—	1	0	0	1
0:—	0	0	0	0

The four binaries count up in normal 'binary' fashion from '0' to '9'. On the next count impulse they would normally take up the state 1010 (i.e., ten); however, they are so connected as to reset to 0000 (zero) instead, thus giving a closed cycle of ten states, by use of the connection shown in Fig. 2.

Each binary when resetting to OFF feeds a 'shift' signal to the next more significant binary, and changes its state from OFF to ON or vice versa, and by this means the counter counts from '0' to '8'. On the ninth count impulse, however, the 'one' binary sets to the ON state, but the trigger feeding the shift of the 'two' binary does not turn on due to the missing '1' signal from the 'eight' binary on its controlling AND gate (all inputs to an AND gate must be present before an output is obtained). When the tenth impulse arrives, therefore, the 'one' binary resets without passing a count pulse to the 'two' binary. Simultaneously, the resetting of the 'one' binary feeds a resetting pulse to the 'eight' binary, via a second set of shift and gate inputs, and this also turns off. Thus the required transition from 1001 to 0000 has been achieved.

The resetting of the 'eight' binary on the 1001 to 0000 transition feeds a pulse to the next more significant decade, which, receiving a pulse at every tenth input to the first decade, now counts in tens. The 'hundreds' and 'thousands' decades are similarly connected.

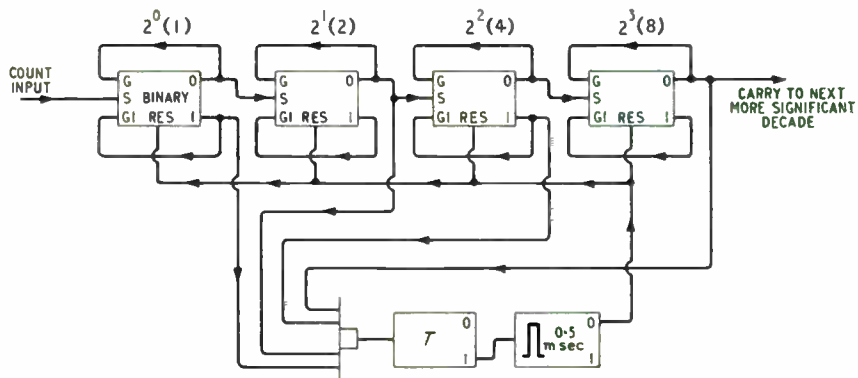

Fig. 2. Four binaries connected to give a count of ten

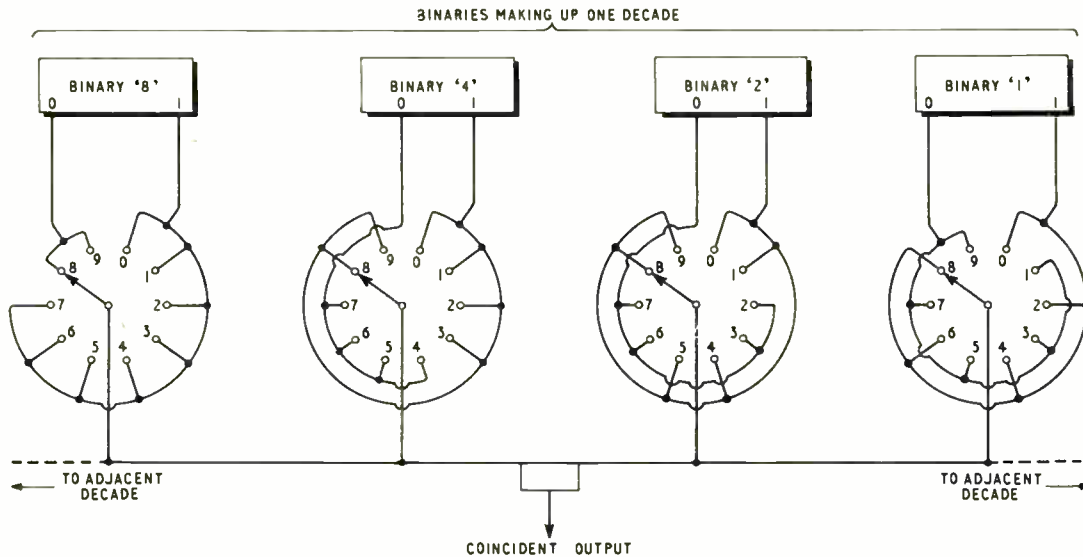

Fig. 3. Coincidence detection system

Determination of Shear Initiation Point

To use the counter described above to control a shear, it is necessary to obtain an output signal when the required number of pulses has been counted. This is done by connecting the 0 and 1 outputs of the four binaries making up each decade to a 4-pole 10-position setting switch as shown in Fig. 3. In the figure the switch is set at '8', and clearly, when the counter state is 1000 (i.e., 5), all the switch inputs will carry '1' signals. Thus, coincidence between the preset number for the decade and the counter content in that decade can be detected by connecting the switch wipers to the inputs of a 4-input AND gate. At coincidence, the AND gate output will appear. Simultaneous coincidence of all four decades at the same time (i.e., completion of count) is detected in practice by connecting the wipers of all the four 4-pole decade switches to a 16-input AND. The appearance of an output from this AND gate initiates the shear action, and also resets the counter to zero. This is done by feeding a 1-millisecond pulse to the Reset inputs of all the binaries making up the counter. The counter then recommences immediately to count off the pulses for the next length to be cut. This cycle of 'count-detect coincidence—initiate shear and reset to zero' is repeated until the whole billet has been cut up.

Control of Shear Response Time

However accurately the counter initiates the shear cycle, imperfect results will be obtained if the shear mechanism does not respond in the same time to every initiation. The following chain of events takes place at each initiation.

1. The clutch contactor closes.
2. Flux builds up in the clutch.
3. The clutch grips and rotates the shear.
4. The shear cuts the material.
5. A limit switch on the shear operates and de-energizes the clutch contactor.
6. The clutch contactor drops out and the brake contactor comes in.
7. Brake flux builds up.
8. The brake grips and stops the shear at its starting point.

Each of these steps is a potential source of inaccuracy, and the following steps are taken to reduce the errors to a minimum.

1. Transistor power amplifiers are used to drive the clutch and brake contactors so as to eliminate intermediate relays.
2. Low-voltage contactor coils are used with a series resistor, to reduce the effective L/R ratio of the coil circuit, and thus improve the closing speed.
3. The contactor coils are fed from constant-voltage supplies, since the closing time of a contactor varies as the inverse square of the coil supply voltage.
4. The clutch and brake are operated at several times over-voltage to give rapid operation and to reduce the effect of supply-voltage variation. In the case of the brake, the current is reduced about 1 second after operation, to prevent over-heating.
5. A high-accuracy electrically-controlled variable-speed drive is used for the shear, a tachometer driven by the main mill motor being used to provide the reference.
6. A heavy flywheel reduces momentary dip of drive speed when the clutch closes.

Control of Nose-end Crop

Clearly, initiation of shear and counter should only take place when a bar is in the shear. The presence of a bar is therefore detected by a radiation detector mounted some feet 'upstream' of the shear. The detector is capable of

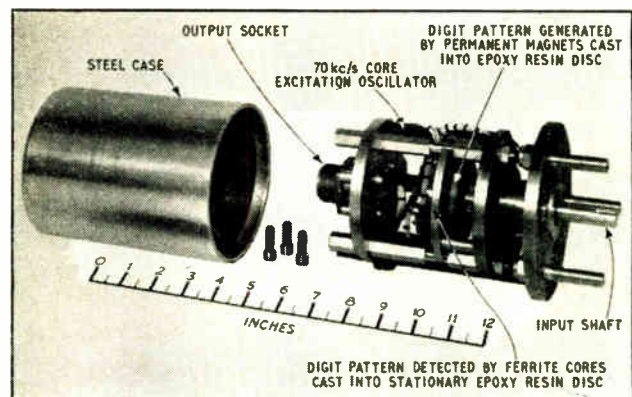

Electromagnetic digitizer pulse generator

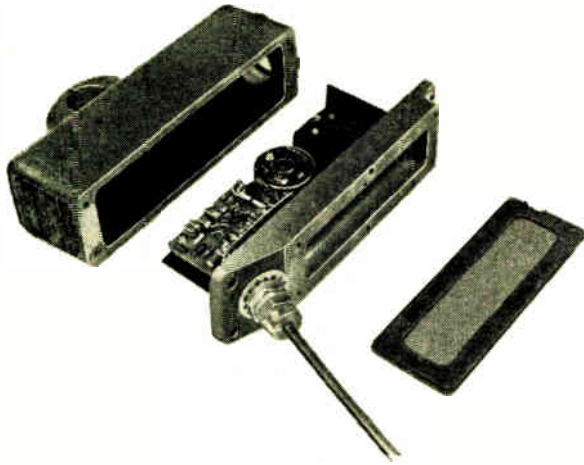

seeing a typical rolled rod of, say, $\frac{1}{2}$ -in. diameter at 700 C at up to 2 ft distance, and can therefore be mounted safely away from the rolls. It is housed in a robust sealed cast case, with provision for water-cooling where necessary and with the optical system protected by an armoured glass window.

If the mill speed were constant, it would be possible to site the detector so that its output signal could initiate the shear directly. The shear delay would match the traverse time of the nose end of the rod from detector to shear so as to strike the rod the required two feet back from the nose.

Since the mill speed is not constant, however, the transit time of the nose end is not constant, and therefore a variable delay must be introduced between the detector seeing the nose end and the shear cycle being initiated.

The delay D must be governed by the following formula:—

$$D = (\text{Nose-end transit time}) - (\text{Shear pick-up time}) - (\text{Shear transit time from rest to crop}).$$

The first and last terms are inversely proportional to V , the rod speed, since mill speed and shear rotational speed

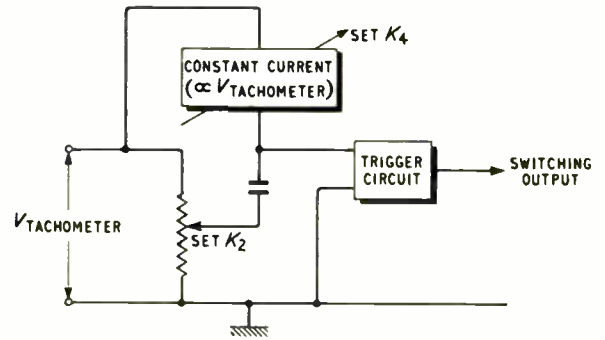

Fig. 4. Circuit to produce a delay dependent on mill speed

Left: Radiation detector

are matched. The second term is, however, a constant, being made up of clutch contactor and clutch response times.

The expression therefore takes on the form:—

$$D = \frac{K_1}{V} - K_2 - \frac{K_3}{V} = \frac{(K_1 - K_3)}{V} - K_2 - \frac{K_4}{V} - K_2,$$

$$\text{where } K_4 = K_1 - K_3$$

The K_1/V term can be produced by using a simple integrator fed from the mill tachometer—little more, in fact, than an RC type timer. The $(-K_2)$ term is produced by effectively starting the earth side of the integrating capacitor on a voltage 'pedestal' proportional to V . This has the effect of cutting the integrator time by the period which would have been required to charge the capacitor to the pedestal voltage. Since this voltage is proportional to the charging current the time is a constant and is preset to equal the shear delay. The circuit is shown schematically in Fig. 4.

The use of this circuit allows accurate cropping of the nose-end over the full range of mill speeds.

Making Animated Films by Computer

A general programming language has been developed at Bell Telephone Laboratories for making simple animated films quickly and cheaply with a computer. The programmed computer generates a magnetic tape which is fed to a microfilm recorder. The recorder then produces drawings on the face of a c.r.t., which are photographed by a ciné camera.

Called Beflix (Bell Flicks), the 'movie language' was developed within the framework of the Macro Fap programming language. Appropriately, it was first used to programme a computer at Bell Laboratories to make a 17-minute self-explanatory film entitled 'A Computer Technique for the Production of Animated Movies'.

The Beflix language includes instructions for drawing pictures consisting of straight lines, arcs, complex curves, letters, simple geometric shapes and shaded areas. Special effects are also possible, such as 'dissolving' by gradually 'sprinkling' a new picture on to the previous one.

Computers can thus be programmed to make educational and training films and to generate visual displays for psychological experiments or depict certain of their own operations.

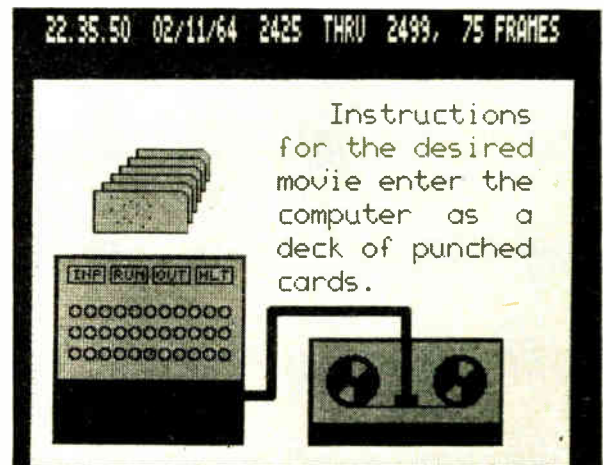

A scene from the self-explanatory film. The notation above the frame, also produced by the computer, gives the time and date of the computer run and indicates that 75 frames of the final film (frames 2425 to 2499) are to be printed optically from this original master frame

Quartz crystals grown at the STC factory. The frame on the left contains a batch of crystals as they appear on withdrawal from the pressure vessel

GROWING QUARTZ CRYSTALS



UP to the present substantially all quartz crystals for radio purposes have been produced from natural quartz and the raw material comes almost entirely from Brazil. The quartz has to be carefully selected, sawn into slices on the proper optical axis, and lapped. There is a great deal of wastage for the natural quartz is in irregularly shaped lumps and often exhibits defects such as twinning.

For many years there have been attempts to grow quartz artificially. It has now become possible to do so on a commercial scale and Standard Telephones & Cables Ltd.

have installed plant at their crystal factory at Harlow. The 'manufactured' quartz is produced from natural quartz but requires only chips, which are plentiful and relatively cheap, and the resulting crystal is regular in shape and of standard size. Consequently, there is much less wastage in cutting it.

In essence, the natural quartz chips are dissolved in sodium hydroxide and a seed crystal of natural quartz is suspended in this solution, the whole being maintained at a suitable temperature and pressure. The quartz in solution gradually 'grows' on to the seed, and the process is completed in about three weeks.

A pressure vessel comprises a steel tube capable of safely withstanding pressures up to 30,000 p.s.i. The tube is about 12 in. diameter and 10 ft tall. The lower half of the vessel contains quartz chips; the upper half contains seed crystals supported by a framework. Part of the remaining space is filled with a solution of sodium hydroxide. The vessel is then sealed and heated. The solution then expands to fill the whole vessel and as it is further heated the pressure rises to about 24,000 p.s.i.

The top part of the vessel is maintained at about 350 °C by a control system, but the bottom part is kept some 50 °C higher in temperature. Convection currents in the solution bring up liquid containing dissolved quartz from the chips in the bottom half to surround the seed crystals, quartz from the liquid grows on to the seeds, and the liquid returns to the bottom again to pick up fresh quartz. The whole process is controlled automatically and is continuous. It is stopped when the crystals have grown to the required size, about 1 lb in weight, and this takes 21 to 23 days.

The completed crystals have, of course, to be sawn and lapped just as with natural quartz. The processes are simpler, however, because the crystals are grown with substantially the required axis and they are much more regular and free from defects than natural quartz.

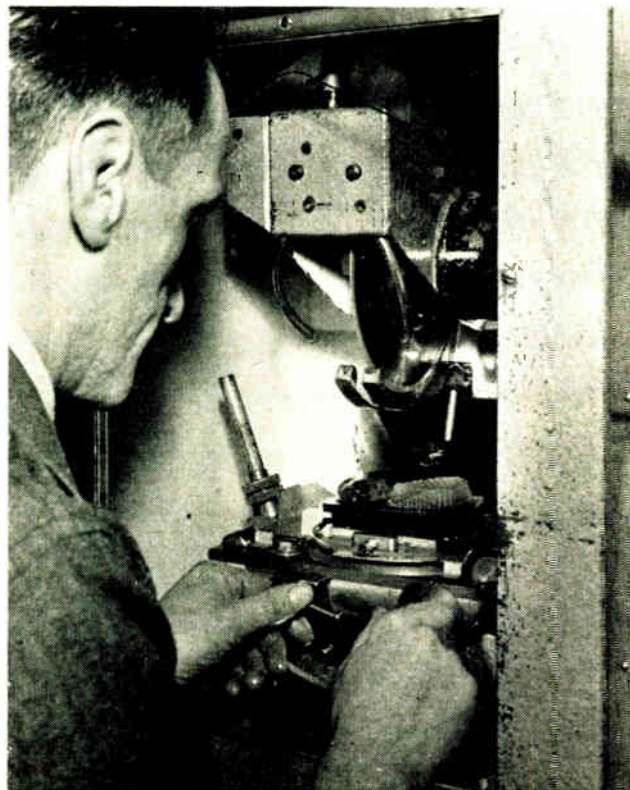

The picture shows a slab of quartz which has just been cut into slices by a diamond-edge saw. The cutting angle is determined by X-ray diffraction

EQUIPMENT REVIEW

1. Modular Chassis System

A.P.T. Electronic Industries announce the introduction of a modular chassis construction system intended for electronic equipment, and marketed under the name 'Minar'. The system was designed by the B.B.C., by whom it has been used experimentally for some time, and it is based on a standard 19 × 5¼-in. rack, into which units of various sizes may be inserted. The system is particularly suitable for transistor or printed-circuit assemblies.

The frame assembly, which is intended for fitting directly into a 19-in. rack, is drilled and tapped to accept modules of various widths, all of which are multiples of the basic unit width of ¾ in. Modules up to 20 times this basic width may be fitted in any order in one frame assembly, and there is provision for permanent fixing, if desired. Dimensions are arranged so that once the first module is fitted, the fixing screws on other modules automatically line up with the corresponding holes in the frame.

The system includes a case and lid, into which a frame assembly may be fitted for portability, and covers for enclosing individual units or complete assemblies. Other items available are chassis and printed-circuit boards of the correct size for fitting directly into the modules.—*A.P.T. Electronic Industries Ltd., 111 Cherisey Road, Byfleet, Surrey.*

For further information circle 1 on Service Card

2. Miniature Latching Relay

A miniature Sperry relay measuring 1¼ in. overall, now being marketed by Roberts Electronics, operates on a rotary latching principle, the direction of rotation being determined by the polarity of the d.c. pulse applied to the stator coil. No current is necessary to maintain the contacts in the latched position. Operating time is less than 8 msec.

The Latchmaster relays can be supplied in a cylindrical fibreglass case

or tubular alloy case with mounting feet. Each relay has two pairs of contacts, one pair open and one pair closed and these can be wired externally to give single-pole changeover action. Continuous current rating is 5 A at 30 V d.c. and resistance less than 5 mΩ. Insulation is greater than 5 MΩ at 500 V d.c. and the relays have an operating life of over 10,000 operations.—*Roberts Electronics Ltd., 17 Hermitage Road, Hitchin, Herts.*

For further information circle 2 on Service Card

3. Cable Entry Sleeves

A solution to the problem of passing cables and wiring through concrete bases into power houses, telephone exchanges, and similar multi-cable installations has been provided by a recent development of Turner & Brown.

The technique is based on a method

of bending large-bore rigid unplasticized p.v.c. tubing which leaves the internal bore polished and free from distortion. This process can be applied to pipes up to 12 in. in diameter, and bunched pipe assemblies in manifold form can be supplied which are capable of carrying a complete range of cables.

The smooth internal surface and easy radius bends of these pipes ensure that cable threading can be achieved without difficulty, and the manifold form of construction reduces the contractors work required, as no sump is needed and concrete can be poured directly round the pipes.—*Turner & Brown Ltd., Turbo Works, Gibraltar Street, Bolton, Lancs.*

For further information circle 3 on Service Card

4. Cadmium Selenide Cells

A range of cadmium selenide photoconductive cells is now available from Hird-Brown. These cells are encased in standard transistor-type cans, dimensionally the same as the existing range of cadmium sulphide cells.

Cadmium selenide cells are similar in sensitivity to cadmium sulphide, but have a dark resistance approximately one hundred times higher. Dependent upon illumination, cadmium selenide cells are generally from twenty to one hundred times faster than cadmium sulphide.

Applications for these new cells will be mainly in the automation fields, e.g., counting, positioning, headlight

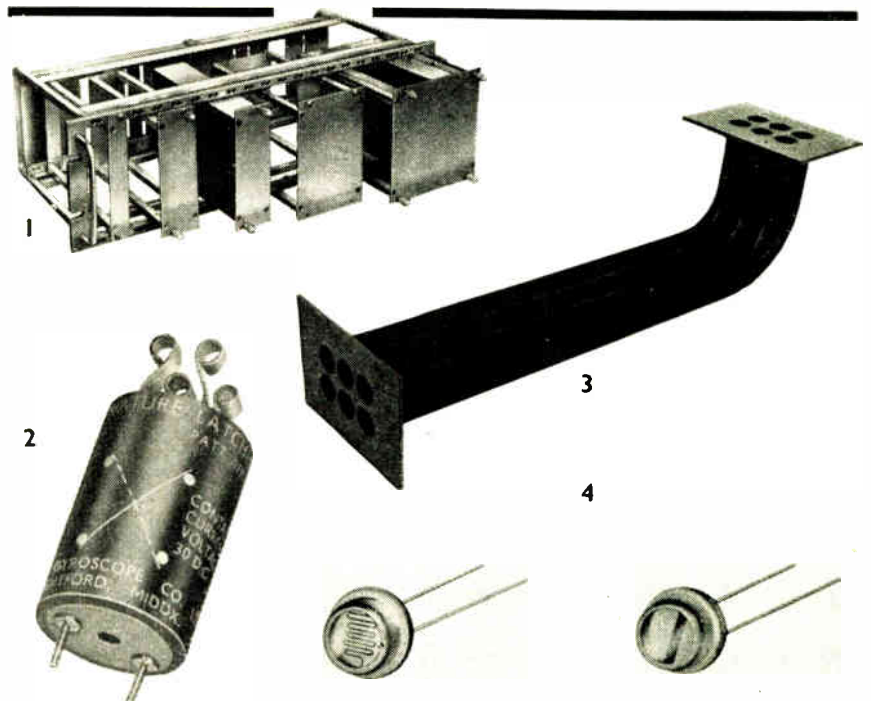



5



6

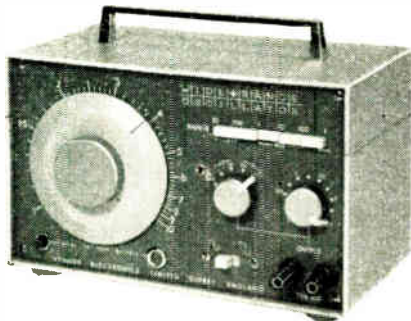

7

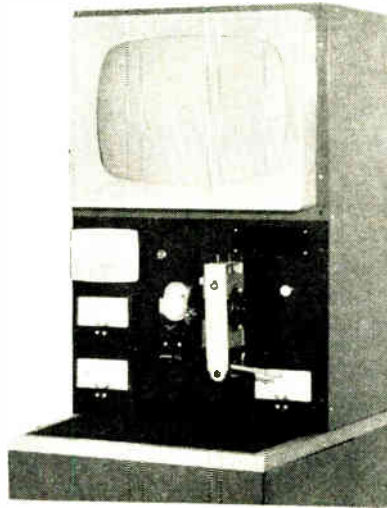

8

dimming, burglar alarms, computer logic circuits, etc.—*Hird-Brown Ltd., Flash Street, Bolton, Lancs.*

For further information circle 4 on Service Card

5. Sonic Strain-Gauge Comparator

A portable comparator for use with vibrating-wire sonic strain gauges has been produced by Westland Aircraft. It is completely self-contained and includes its own lightweight rechargeable battery.

The comparator has been designed with particular emphasis on simplicity of operation and indication. The controls are limited to an on-off switch, and the instrument reads sonic vibration frequency directly by comparison with an internal quartz crystal, the frequency being indicated on a 4-digit projection display.

A source of energy for plucking the gauge wire is included in the unit, together with drive circuits to make the measurement process completely automatic. On connecting a gauge to the comparator, the gauge is plucked,

measured and the reading displayed, this process being repeated at 4-second intervals. — *Westland Aircraft Ltd., Saunders-Roe Division, Strain Gauge Department, East Cowes, Isle of Wight.*

For further information circle 5 on Service Card

6. Small Depth Sounders

Two 'Fathometer' depth sounders for pleasure boatmen and sport fishermen have been introduced by Raytheon. Although similar in appearance and operation, the DE-720A has a 60-foot scale while the DE-722 (illustrated) is scaled to 120 feet.

Magnetic keying is employed in both models to increase the life of moving parts, and also to eliminate the need to adjust or replace contacts. Engine noise and ignition suppression circuits assure interference-free operation without engine suppression accessory equipment.

These depth sounders are fully transistorized for long life and reliability, and the current consumption for both models is 0.12 A. They can be

supplied with any of three optional transducers: the standard through-hull type, a recessed flush-mounted type for sailing boats, and an externally-mounted model that attaches to a boat's transom. — *Cossor Communications Co. Ltd., The Pinnacles, Elizabeth Way, Harlow, Essex.*

For further information circle 6 on Service Card

7. Wide-Range Oscillator

An oscillator which covers 10 c/s to 1 Mc/s in five switched ranges and provides sine or square-wave outputs, has been introduced by Venner Electronics. Features of the TSA 625 include pushbutton range selection and battery test, attenuator settings covering 2.5 mV to 2.5 V full scale, and output impedance close to 600 Ω on all ranges.

Square-wave rise time is approximately 100 nsec irrespective of frequency; sine-wave distortion is better than 2%, up to 100 kc/s. Power supply is from 2 PP9 (or equivalent) batteries, the instrument weighing 4.6 lb including batteries, 2.7 lb without. Dimensions are 8 $\frac{1}{4}$ \times 5 \times 5 in. Price £35.—*Venner Electronics Ltd., Kingston By-Pass, New Malden, Surrey.*

For further information circle 7 on Service Card

8. Torque Testing Equipment

M.S.E. have announced the introduction of a torque measuring instrument, designed particularly for batch testing and quality control of f.h.p. motors. The instrument employs a new type of electronically-controlled absorption dynamometer which enables torque readings to be measured accurately independently of rotational speed.

The model shown in the photograph has a torque measurement range of 5–50 oz in., with a claimed accuracy of 1.5% of full-scale torque range; other ranges are available. The rotational speed of the motor can also be simultaneously measured and indicated up to 5,000 r.p.m.

Readout can be obtained on an open-scale meter, or alternatively displayed on a 17-in. long-persistence c.r.t. The trace of the speed-torque characteristic thus obtained can then either be photographed or measured directly by means of a graticule.—*Mining & Scientific Equipment Ltd., 317 Kennington Road, London, S.E.11.*

For further information circle 8 on Service Card

9. Low-Cost Nucleonic Scaler

A general-purpose transistorized nucleonic scaler has been added to the range of instruments produced by

EQUIPMENT REVIEW

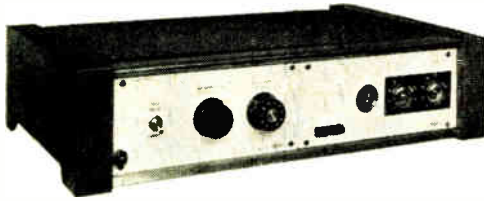

9

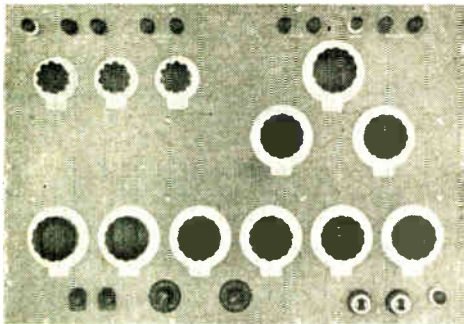

10

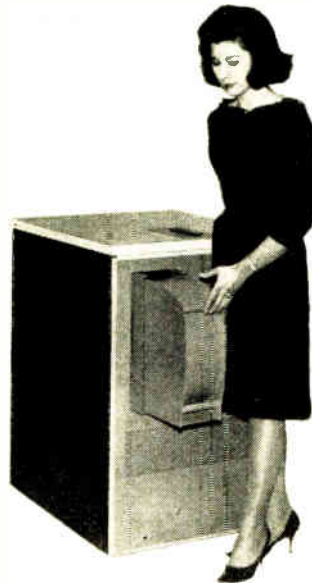

11

Panax for school science purposes. It is an economically-priced instrument designed to withstand rough handling, but with a performance which will give students a good introduction to the handling of modern nucleonic instrumentation.

Known as scaler type P.7802, it has a maximum counting speed of 1,000 counts per sec for regularly-spaced pulses, and the display features two decade tubes and a 4-digit electro-mechanical register, giving in effect a 6-digit count presentation within very small space requirements. Maximum count capacity is 999,999 counts and a built-in 100-c/s signal-generator is included for check-calibration purposes. There is pushbutton control of counting and resetting.

The specification also includes a built-in stabilized 0 to 2-kV e.h.t. supply unit and a discriminator input range of 1.5 to 50 mV, thus making the scaler suitable for use with most types of Geiger and scintillation counters commonly used in research and school science laboratories. The P.7802 scaler can be operated from either a mains supply or a 12-V car battery. Overall dimensions are: $19\frac{1}{2} \times 11\frac{1}{2} \times 4\frac{1}{2}$ in. and the weight 19 lb.—Panax Equipment Ltd., Holmethorpe Industrial Estate, Redhill, Surrey.

For further information circle 9 on Service Card

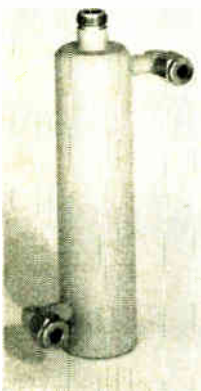

12

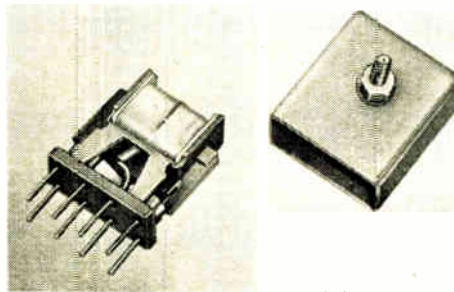

13



14



15

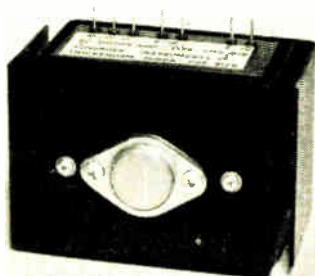

16

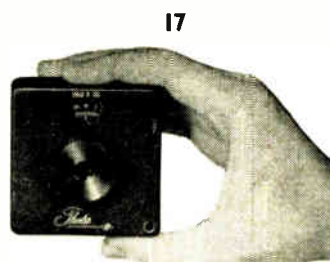

17

10. Precision Resistance Bridge

A d.c. Wheatstone bridge recently announced by Cambridge Instruments is designed to measure resistance values between 1Ω and $111 \text{ M}\Omega$ with an accuracy of $\pm 0.005\%$ over most of the range.

Each ratio arm comprises four coil resistors with values of 10, 100, 1,000, and 10,000 Ω , respectively. These are adjusted to within $\pm 0.002\%$ of their nominal values and, by means of two selector switches, provide seven different ratios between $\times 0.001$ and $\times 1,000$. For equal ratio measurements, selected coils can be interchanged to overcome any slight inequality of ratio. For unequal ratios, average readings can be obtained by selecting two or more different coil combinations.

The measuring arm consists of six in-line decades ranging from $10 \times 0.1 \Omega$ up to $10 \times 10,000 \Omega$, giving a total resistance of $111,111 \Omega$. Three additional cascade resistors, in series with the arm, provide a further 84.4Ω of resistance, in steps of 0.01Ω , to balance out lead and zero resistances.

A feature of the instrument is the guard circuit to eliminate leakage errors on the three highest ratios. This is maintained at panel potential and

can be extended to all external accessories, thereby providing complete protection for the measuring system.—*Cambridge Instrument Co. Ltd., 13 Grosvenor Place, London, S.W.1.*

For further information circle 10 on Service Card

11. Small-Scale Memory System

A random access disc file, model 80, has been announced by Anelex Corporation. This low-cost system uses removable disc kits, with a storage capacity of 27,600,000 bits per kit. It was designed primarily for use with medium to small scale data-processing systems and sub-systems, but it is suitable for application to large scale systems in many instances.

The disc kits—modular packages containing six discs—are light and easily interchangeable, and the self-storing packages provide complete protection for the discs when not in use.

Though compact in size (occupying less than a 1 cu yd of space), the model 80 includes solenoid-actuated mechanical linkage which automatically retracts the read/write heads in cases of power failure.—*Anelex Corporation, 150 Causeway Street, Boston 14, Massachusetts, U.S.A.*

For further information circle 11 on Service Card

12. High-Power Coaxial Termination

Sage Laboratories, Inc., has developed a compact high-power coaxial termination that operates from 1 to 2 Gc/s. Designated model 9800F, its peak power rating is 5 kW with an average power rating of 300 watts. Maximum v.s.w.r. over the entire frequency range is 1.2.

The 9800F is water-cooled and has a body length of 5½ in. Overall length, including the type N female connector, is 6½ in. Body diameter is 1½ in. The total weight, with water connectors, is 26 oz. This unit meets the environmental requirements of MIL-E-5400 CL II.—*Sage Laboratories, Inc., 3 Huron Drive, East Natick, Massachusetts, U.S.A.*

For further information circle 12 on Service Card

13. Sub-Miniature Relay

The sub-miniature relay type CF, now available from Plessey-UK, has received approval to Ministry specification DEF 5165. This component is a fully-sealed, rotary-action, two-pole changeover relay with a maximum contact resistance of 0.030 Ω ensured by twin gold-plated contacts. Contact rating is 1 A to 3 A at 28 V d.c. or 115 V a.c. resistive, according to the number of operations.

Connecting pins are spaced on the standard 0.1-in. module for printed-

circuit mounting and are brought out through glass-to-metal seals. Coil and contact connections to these pins are arranged symmetrically so that correct operation is ensured whichever way the relay is plugged into its holder.—*Plessey-UK Ltd., Professional Components Division, Abbey Works, Titchfield, Fareham, Hants.*

For further information circle 13 on Service Card

14. Miniature Fuseholders

Belling & Lee has introduced two robust miniature fuseholders for panel use. Type L1596 (illustrated) is for ⅝ × ⅞-in. (size 00), and type E6011 for 20 × 5 mm (continental) fuse-links; both units are designed for single-hole back-of-panel safety fixing. They supersede the type L575.

These units have greater mechanical strength and improved appearance with the provision of a circular flange on the front and the transference of the fixing nut to the rear of the panel. The length of the threaded portion has been increased to accommodate panels up to ¼ in. thick, and contact access is available on each side of the phenolic resin moulded body to facilitate multiple wiring.

Other features include automatic isolation and withdrawal of the fuse-link from the front; an internal spring to compensate for fuse-link length variations; a probe hole in the lid; and very small volume and panel coverage.—*Belling & Lee Ltd., Great Cambridge Road, Enfield, Middlesex.*

For further information circle 14 on Service Card

15. Decimal Shaft Encoders

A line of 10, 36 and 100-turn decimal encoders for translating shaft position to digital display or print-out has been announced by Perkin-Elmer. In providing an analogue-to-digital conversion, the new encoder systems are self-contained with necessary power supplies, interconnecting cables, and connectors.

Typical applications include radar-tracking repeater stations, navigation displays, and X-Y plotters. These units are especially suited to monitoring applications in which high-resolution or low-torque encoders are uneconomical or impracticable.

Each encoder features an accuracy of better than ±1 count and an operating life of 2 million revolutions. The four readout ranges are 0.000° to 359.9°, -179.9° to +179.9°, 0000 to 9999, and 000 to 999. Readout is possible 'on the fly', and decimal output is available for Victor, Monroe, and Clary printers. Weight of the encoder is 15 oz. diameter 2.5 in. and

length 3.25 in.—*Lectropon Ltd., Kinbex House, Wellington Street, Slough, Bucks.*

For further information circle 15 on Service Card

16. Motor Driving Amplifier

Ashgrove Instruments have announced the type SMA 818 amplifier which has been designed to drive the range of servo motors 08-18 and will supply a maximum output of approximately 10.0-10 V into the centre-tapped control winding. Input impedance is 3 kΩ and the overall dimensions are 3½ × 2¼ × 2½ in. Weight: 12 oz.

The input voltage required to give maximum output power (9 W) is 10 mV r.m.s. There is a built-in limiting circuit, which permits a maximum input of 7.0 V at 70 mA, i.e. 0.5-W input power, and any source that is capable of supplying more than 0.5 W must be used with appropriate summing resistor.

The push-pull output is connected directly to the control winding, which must be tuned with a capacitor, the value depending on the size of the motor used; suitable for this purpose are miniature metallized-film or lacquer-film capacitors. The 90° phase shift required between reference and control windings is incorporated in the unit.—*Ashgrove Instruments Ltd., 96 Amyand Park Road, Twickenham, Middlesex.*

For further information circle 16 on Service Card

17. Miniature Dial Assembly

Occupying 3¼ in. of panel space, a geared dial assembly available from Theta Instrument Corporation can be used to position potentiometers, synchros, and tuning devices. A built-in 100-to-1 vernier control ensures easy accurate setting. The high turns-ratio effectively locks the output shaft against movement due to jarring or vibration. For rapid turning, another knob is directly connected to the output shaft.

Continuous rotation in either direction can be obtained and a slip-clutch is provided to prevent damage to devices which have stops. There is also provision for zeroing the dial with respect to the output shaft. Scale markings available: 0° to 360° or 0 to 100. Graduation accuracy is 12 min. of arc.—*Theta Instrument Corporation, Saddle Brook, New Jersey, U.S.A.*

For further information circle 17 on Service Card

18. Square Wave Generator

A transistorized square-wave generator, the type 791, with nanosecond rise and fall times and a wide opera-

EQUIPMENT REVIEW

tional frequency range is announced by Fairchild. Rise and fall times of the square waves are kept constant throughout all frequencies from 7 c/s to 10 Mc/s.

A coincident trigger output is provided in addition to the square-wave output. Its timing may be phased to either the rising or falling edge of the square wave to permit alignment of video systems having minimum inherent delay. The repetition rate of the trigger output is the same as the frequency of the square wave.

A front panel switch provides a choice of either 600- Ω or 50- Ω output impedance. In the 50- Ω mode, a fall time of 3 nsec is specified and a rise time of less than 6 nsec. Open-circuit voltage is 40 V minimum. Flat tops and overshoots are within 1%.—*Aveley Ltd., South Ockendon, Essex.*

For further information circle 18 on Service Card

19. 1,600 °C Pyrometer

Fielden 'Bikini' temperature instruments are now available for use with thermocouples at temperatures up to 1,600 °C. Like the resistance-bulb versions, these thermocouple instruments are of rugged construction employing transistors throughout and have a servo-motor drive, with no galvos, pivots or other delicate mechanisms.

They are easily installed with a simple clamp and have a high input impedance which permits operation using almost any length of inexpensive compensating cable without the trouble of setting up or re-calibrating. Having a circular scale length of 12½ in., the instruments are easily read from an appreciable distance. The long sweep of the precision slide wire enables the indicator/controller to provide a control differential of better than 0.1% of full scale. These units are unaffected by vibration and have built-in cold-junction compensation.—*Fielden Electronics Ltd., Wythenshawe, Manchester.*

For further information circle 19 on Service Card

20. H.F. Communications Receiver

Racal have introduced the RA.217 h.f. communications receiver. Using a frequency-changing system it provides high sensitivity and high stability with great accuracy of tuning. Frequency coverage extends from 1 to 30 Mc/s, with setting information presented on a digital scale. In addition to this continuous tuning, it can be controlled by a synthesizer or by a pre-set channel crystal oscillator.

The RA.217 is suitable for reception of a.m., m.c.w. and c.w. signals and

incorporates a special local-oscillator system to permit s.s.b. reception. Suitable i.f. bandwidths and a.g.c. constants are available for all modes of reception. The receiver is suitable for a.c. mains operation or battery supply.

The basic receiver is a simple portable unit of robust mechanical construction and is fully protected against severe environmental conditions of humidity and temperature. Supplementary units are being designed to permit extension of frequency range to 10 kc/s, i.s.b. reception, diversity operation and employment for precision frequency measurement.—*Racal Electronics Ltd., Western Road, Bracknell, Berks.*

For further information circle 20 on Service Card

21. Power Supply Modules

Belix have announced three additions to their line of stabilized power-supply equipments. These are the types ST 3001 (30 V, 1 A, twin or 60 V, 1 A), ST 3005 (30 V, 5 A, twin or 60 V, 5 A) and S 3015 (30 V, 15 A). All models are rated at up to 45 °C ambient and provide a stabilization ratio of better than 2,000 to 1. Forced-air cooling will permit operation at higher temperatures.

While models are despatched with a fixed output setting (within the above maxima) the output is readily change-

able by the customer without impairment of the quoted specification. Electronic protection against overloading provides auto-reset for short duration pulses and tripping of a manual reset for prolonged overloads. The four-terminal output caters for line loss in any circumstances of installation.

Construction features include cadmium plating and zinc passivation of all metal parts. Weights of the above types listed are, respectively, 8, 27 and 46 lb.—*The Belix Company Ltd., Victoria Road, Surbiton, Surrey.*

For further information circle 21 on Service Card

22. Regenerative Repeater

A series of repeaters which remove distortion from start-stop and/or synchronous data/telegraph signals for retransmission at speeds between 20 and 1,200 baud (speeds may be extended to 9,800 baud if required) has been announced by Pulse Communications, Inc. The basic unit can handle any standard start-stop teleprinter code including 5-level baudot, 6-level teletypesetter, and the new 8-level ASA code used by the Teletype models 33 and 35. It may be programmed by switches for any other code levels between 5 and 13.

A plug-in adapter is available to make the regenerative repeater operate

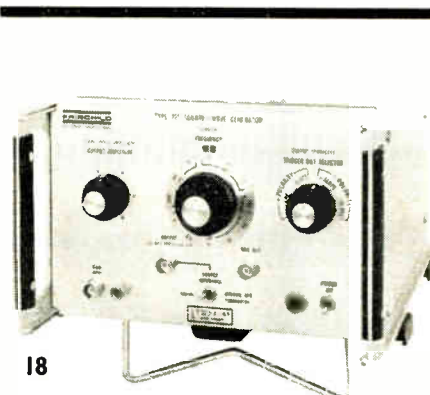

18

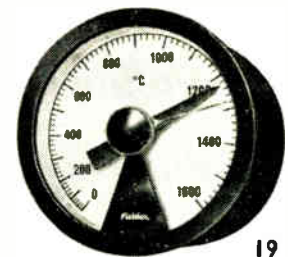

19



20

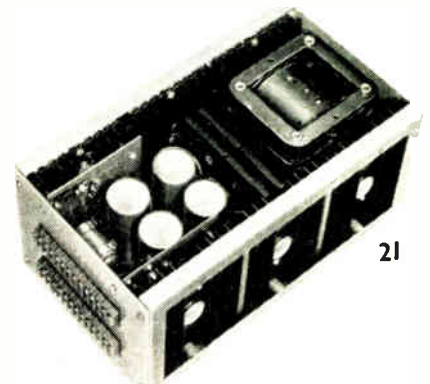

21

on synchronous signals. With a different adapter the unit will automatically change speeds and shift between start-stop and synchronous signalling modes depending upon the type detected at the input. Versions are available for use on current or voltage keyed circuits.

Ten units mount on one $5\frac{1}{4} \times 19 \times 10$ in. deep shelf suitable for relay rack mounting. A clock module of the same size is available to mount two common timing oscillators. For larger applications a clock standard is available which will provide ten accurate timing frequencies to as many as 400 units.—*Pulse Communications, Inc., 100 Early Street, Alexandria, Va., 22304, U.S.A.*

For further information circle 22 on Service Card

23. In-Circuit Capacitor Tester

KLB Electric are now marketing the PACO C.25 capacitor tester which will detect open or shorted capacitors without removing them from the circuit, and also locate dried-out electrolytics by directly indicating capacitance in one quick test.

This portable instrument is priced at £15 19s. 6d. complete, or may be purchased in kit form at £14 12s. 6d.—*KLB Electric Ltd., 335 Whitehorse Road, Croydon, Surrey.*

For further information circle 23 on Service Card

24. Interchangeable Thermistors

Interchangeable thermistors are now available from Gulton Industries in five resistance values at 25 °C: 1, 2, 3, 4 and 5 k Ω . These components will track a specified resistance/temperature characteristic to a tight tolerance over the temperature range -55 °C to +150 °C. Similar types can thus be interchanged without the calibration of associated equipment being affected.

These components are small (0.1 \times 0.1 \times 0.05 in.) and thus have a rapid response time. The maximum deviation from the specified resistance between 0 °C and +100 °C is 1% and between -50 °C and +150 °C, 3.3%. This infers a maximum temperature measurement error of 0.8 °C.—*Gulton Industries (Britain) Ltd., Technical Products Division, Regent Street, Brighton 1, Sussex.*

For further information circle 24 on Service Card

25. Low-Cost Digital Computer

A low-cost, engineers' digital computer, the PDS 1020, is now available in this country from Electronic Associates. Although it includes many of the features usually obtainable only on larger machines, it is claimed to be as simple to operate as a desk calculator.

The PDS 1020 is a desk-size, general-purpose digital computer with variable-field word length of 4-, 8-, or

12-decimal digits, and maximum memory capacity of 4,096 words. Problem solution can be by simple step-by-step procedure or by an internally-stored programme.

Input data and instructions can be fed into the computer by an input keyboard or by paper tape. Similarly, output is via a typewriter or paper tape, and software is provided to enable the user to communicate with the computer using everyday mathematical terms.—*Electronic Associates Ltd., Victoria Road, Burgess Hill, Sussex.*

For further information circle 25 on Service Card

26. R.F. Heating Valves

The addition of several valves has recently extended the STC range of industrial triodes.

Important features of these valves are high safety factors on grid and anode dissipation and large reserves of peak cathode current emission. Some valves from this range are available with a metal-and-ceramic envelope for use at high frequencies in dielectric heating: these are particularly suitable for grounded-grid operation since their drive power requirements are very low. Cheaper glass-and-metal envelope versions are available for lower frequency operation. A number of valves in the range give customers a choice of anode cooling: forced-air, water and

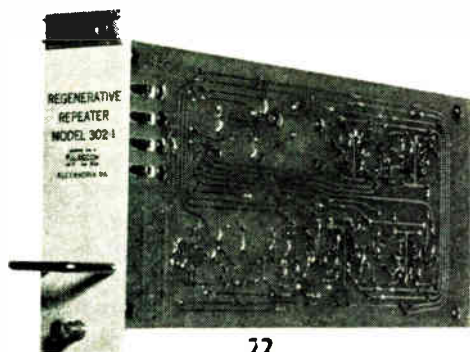

22



23

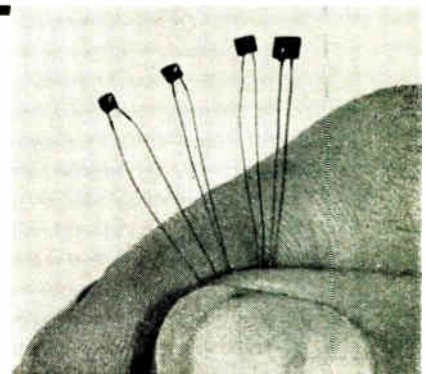

24

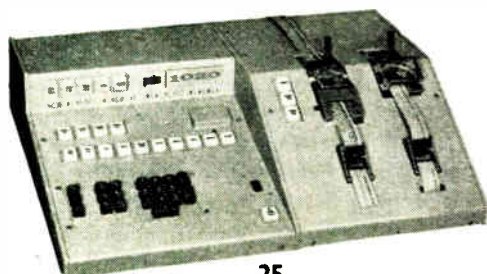

25

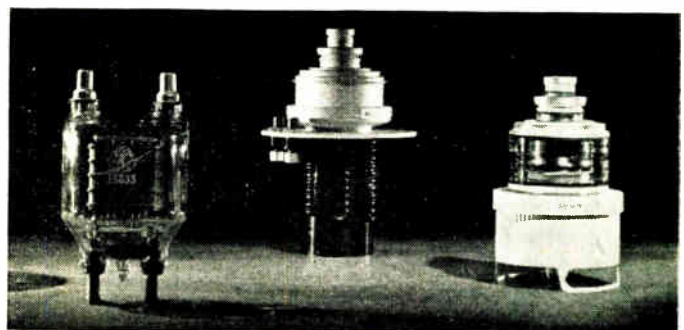

26

27

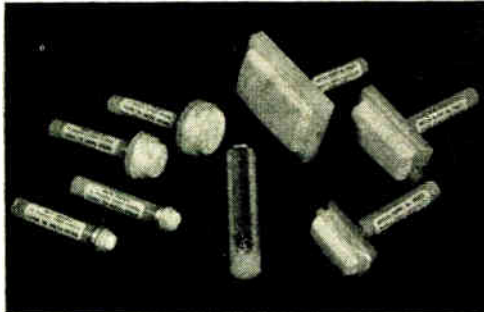
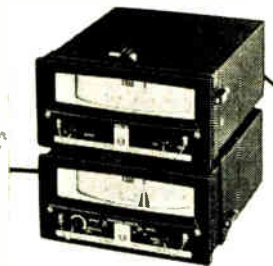

29

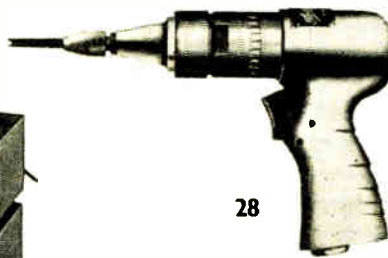

28

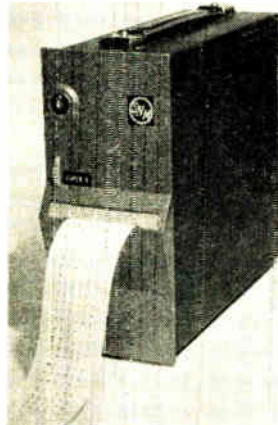

30

29. Electrochemical Markers

Lectroetch announce the introduction of a new range of cartridge and hand markers for use in electro-chemical marking.

The cartridge markers (illustrated) carry their own reservoir, and stencils are simply attached to the head of the marker by means of a ring. The electrolyte is metered to the stencil from the cartridge by capillary attraction. There are seven different sizes of marker head, three rectangular and four round. The smallest size is $\frac{1}{4}$ in. in diameter (designed for inspection marks) and the largest $1\frac{1}{2} \times 2\frac{1}{2}$ in., any one of which will fit into a common holder (centre of photograph).

The hand markers are in three sizes and have no exposed conductive parts which could cause a short circuit. The method of attaching the electrolyte pad is far more positive than hitherto and, by means of a new type of bridge attachment, it is possible to etch as deep as 0.006 in. in 20 sec.

These inexpensive markers can be operated with any type of electro-chemical marking power unit and are suitable for use with photographic stencils, or stencil papers cut on a typewriter. — *Lectroetch Ltd., Spur Road, Feltham Trading Estate, Feltham, Middlesex.*

For further information circle 29 on Service Card

vapour cooled versions can be supplied.

Power outputs of this valve range extend from 0.3 to 40 kW and frequencies from 30 to 220 Mc/s. Two typical examples from the range of more than 50 types are: the 3 JC/203E which will deliver 12 kW at 220 Mc/s and 3RC/262E giving 40 kW at 80 Mc/s.—*STC Valve Sales, Footscray, Sidcup, Kent.*

For further information circle 26 on Service Card

27. Proportional Controller

The latest instrument in the E.I.L. range of miniature pH control instruments is the model 92B proportional controller. This has been introduced for use particularly in the effluent and water treatment fields.

The controller operates over the range 0–14 pH and the set point can be anywhere within this range. The main feature of the model 92B is that it has a wide proportional band (variable from 10–78%) and a manual reset facility, enabling the control system to be characterized to the shape of the pH titration curve. In many cases this does away with the need for more elaborate control systems. Another advantage gained by using

only one instrument to cater for a variety of titration curve shapes is that the controller can easily be adjusted if changes are made to the process.

This model will operate most types of reagent control devices, such as dry feeders, in which a reversing motor is fitted with a re-transmitting slide wire. Alternatively, a motor can be provided which will give a shaft rotation of a given number of turns or swing an arm through a given arc, depending upon the setting of the controller. Although calibrated as a pH controller the model 92B may be used with any signal providing 0–1.4 mA into 100 Ω , 1.5 k Ω or 5 k Ω .—*Electronic Instruments Ltd., Lower Mortlake Road, Richmond, Surrey.*

For further information circle 27 on Service Card

28. Pneumatic Wire-Wrapping Tool

To complement their range of electrically-powered wire-wrapping tools, Thor Tools have now introduced a pneumatically-powered version.

The tool is available with pistol grip, lever or button control, and comes complete with bit and sleeve of the required size.—*Thor Tools Ltd., Tynemouth, Northumberland.*

For further information circle 28 on Service Card

30. Elapsed Time Counter/Printer

A unit designed by English Numbering Machines allows the time between the operation of switches or contacts to be successively recorded to an accuracy greater than 0.1 sec. The equipment is based on conventional E.N.M. counting and printing equipment and the elapsed time is recorded in decimal form: e.g., seconds and tenths of seconds, minutes and hundredths of minutes or hours and tenths of hours, etc.

Initially the counter registers zero; counting, started by closure of a contact, is by means of pulses derived direct from the 50-c/s mains signal or from a synchronous motor itself driven by the mains supply. Thereafter the counter continues to count until the opening of the contacts inhibits any further counting. If the counter is of the visual type the count register is held available for reading, after which it may be reset to await the next counting operation.

The printing counter produces a printed record of the elapsed time and can be automatically reset to zero after the printing operation. Interlocks

(Continued on page 381)

Wandleside make

CABLES

for every job!

Whatever the application, whatever the industry
 Wandleside Cables have the right cable for the
 job. Wherever reliability, efficiency are
 required . . . whether it's transport, electronics,
 entertainment or flying . . . Wandleside carry the
 load. There is a comprehensive range of
 Wandleside cables to cover the specific
 requirements of almost every kind of industry.
 Why not discuss your problem with us.

See us on
STAND No. 273
 at the Farnborough Air Show



For reliability and efficiency, railway signalling and control systems depend on Wandleside Cables.



Wandleside are specialists in the manufacture of electric wires and cables for all high temperature applications.



In the Television studio you will find Wandleside Cables playing their part in the programme.

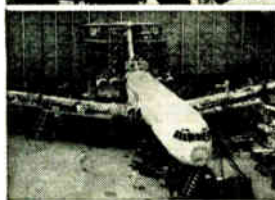

Wandleside Cables were used for flight test instrumentation on the first Vickers Armstrong V.C.10.

Wandleside Warren Wire Company Limited now hold M.O.A. Design Approval for P.T.F.E. Aircraft Cable.

**WANDLESIDE WARREN
 WIRE COMPANY**

In Association with
**WANDLESIDE CABLE
 WORKS LIMITED**

Dunmurry, N. Ireland. Telephone: Dunmurry 2536. Telex: 74339. Telegrams: Derriaghy, Dunmurry, N. Ireland
 London Office: 106 Garratt Lane, S.W.18. Telephone: VANdyke 7544. Telex: 261355. Telegrams: Wandleside, London, S.W.18
 (Falks Group)

MIL-T-55155

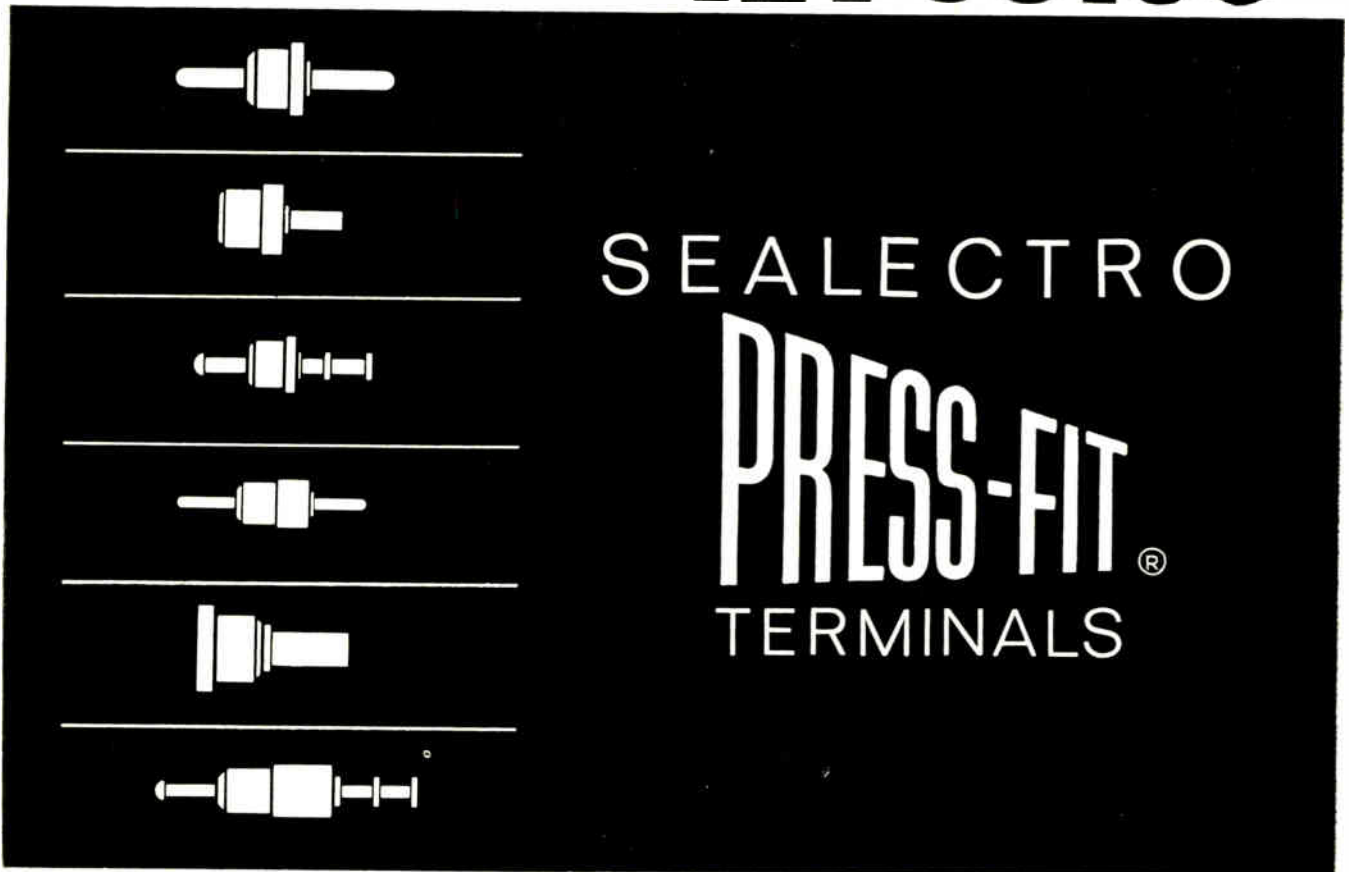

APPROVED

TEFLON TERMINALS

Conformity with the rigid and exacting Mil Specification MIL-T-55155 puts the final seal of quality on SEAELECTRO — THE ORIGINAL PRESS-FITS. This means that SEAELECTRO PRESS-FITS can be used in all equipment with the absolute certainty that they will comply with the required standards anywhere in the world. Over ten years' specialised experience and quantity production guarantees highly competitive prices. Release notes or certificates can be supplied for all U.K. or overseas requirements. A MIL-T-55155 cross reference, together with the SEAELECTRO PRESS-FIT Catalogue, is available on request.

SEAELECTRO Applications Engineers are on call at all times.

SEAELECTRO LIMITED

Hersham Trading Estate • Lyon Road • Walton-on-Thames, Surrey ■ Telephone: Walton-on-Thames 28285 ■ Telex No. 28350

can be provided to ensure that counting does not occur while printing or resetting is taking place. Dimensions: $8 \times 3\frac{1}{2} \times 9$ in.—*English Numbering Machines Ltd., 25 Queensway, Enfield, Middlesex.*

For further information circle 30 on Service Card

31. Portable Electronic Air Cleaner

A portable electronic air cleaner which is claimed to remove 90% of airborne impurities such as dirt, dust and smoke, and 99% of pollen and bacteria, has been introduced by Honeywell Controls.

The unit weighs 28 lb and measures $16 \times 16 \times 11$ in. It provides an air flow of 175 cu. ft/min and can adequately serve an average 400 sq. ft room (say 3,400 cu. ft) in which there are as many as twelve people. In a room 12×14 ft (about 1,350 cu. ft) it will circulate the air eight times an hour. Power consumption is about 40 W.

The filter, which is easily removed for cleaning, utilizes a two-stage 'charge' and 'collect' process. In the first stage, airborne particles are given a 5,250-V charge; then they enter a second stage where they are attracted and held by collector plates having the opposite electrical charge.—*Residential Division, Honeywell Controls Ltd., Ruislip Road East, Greenford, Middlesex.*

For further information circle 31 on Service Card

32. Skeleton Preset Potentiometer

A skeleton preset potentiometer, type PR.14, $\frac{1}{2}$ in. in diameter, is now available from East Grinstead Electronic Components. It is designed for vertical or horizontal mounting on printed-circuit boards and is capable of extremely precise screwdriver adjustment. The method of track deposition used, while giving high stability and performance, allows economical production and a low selling price.

Standard values are 50, 100, 250 and 500 Ω ; 1, 1.5, 2, 2.5, 5, 10, 20, 25, 50, 100, 200, 250 and 500 k Ω ; 1, 1.5, 2, 2.5, 3, 5 and 10 M Ω . Power rating: 0.2 W up to 100 k Ω , 0.15 W for values under 1 M Ω and 0.1 W for values above.—*East Grinstead Electronic Components Ltd., Imberhorne Industrial Estate, East Grinstead, Sussex.*

For further information circle 32 on Service Card

33. Microphone Amplifier

The latest addition to the Elcom range of audio equipment is the microphone amplifier type EM 40, which is a plug-in transistorized unit for use as a low-level microphone. These units are

supplied in a screening can on an international octal base. In order that various input impedances can be obtained as required with the same amplifier, metal-screened transformers can be supplied as a separate unit.

Input impedance of the EM40 is 30 to 300 Ω , or as required. The optimum load is not less than 600 Ω and insertion gain is 60, 40 or 20 dB, selected by a variable link on the base. Frequency response is ± 0.5 dB from 30 c/s to 25 kc/s with total harmonic distortion not greater than 0.25%, at -20 dBm. — *Elcom (Northampton) Ltd., Equipment Division, Weedon Road Industrial Estate, Northampton.*

For further information circle 33 on Service Card

34. Laboratory Resistance Standards

Alma Components have announced a range of laboratory resistance standards with a tolerance of $\pm 0.01\%$. Each one is supplied with a test certificate giving the exact value at 20 $^{\circ}\text{C}$ against $\pm 0.001\%$ N.P.L. certified standards.

Having a temperature coefficient guaranteed by measurement less than

$\pm 0.0005\%$, per $^{\circ}\text{C}$ (5 p.p.m.) over the range 10 to 40 $^{\circ}\text{C}$, the loose-wound resistors are specially aged and have a long-term stability of better than $\pm 0.005\%$ per year. They are guaranteed (up to $\frac{1}{4}$ -W dissipation) for five years and may be returned for recalibration if necessary.

Decade multiples of 1 k Ω , 2 k Ω , or 5 k Ω are available up to 1 M Ω and the metal cases are designed so that the units can be bolted together to form multiple units. Dimensions: $2 \times 3 \times 3$ in. high. Typical price (for 100-k Ω model): £12 10s.—*Alma Components Ltd., Park Road, Diss, Norfolk.*

For further information circle 34 on Service Card

35. 6-Way Intercom System

Adding to their range of low-cost intercom telephones, D.J.P. Telephones have introduced a 6-way system which they are offering for £28 complete. The system comprises a 5-button central station and 5 single-button extensions, together with 100 yards of cable. Easy to operate, the central station is able selectively to



31

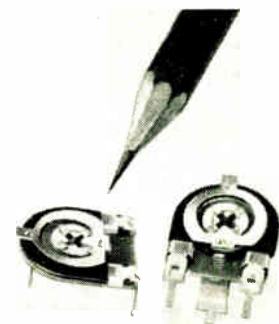

32



33

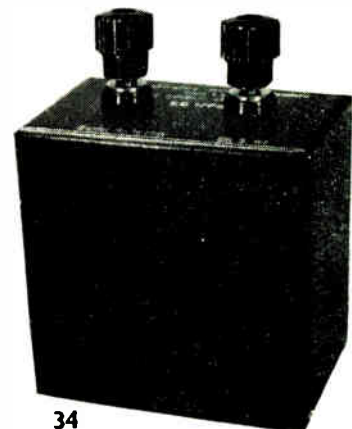

34

EQUIPMENT REVIEW



35

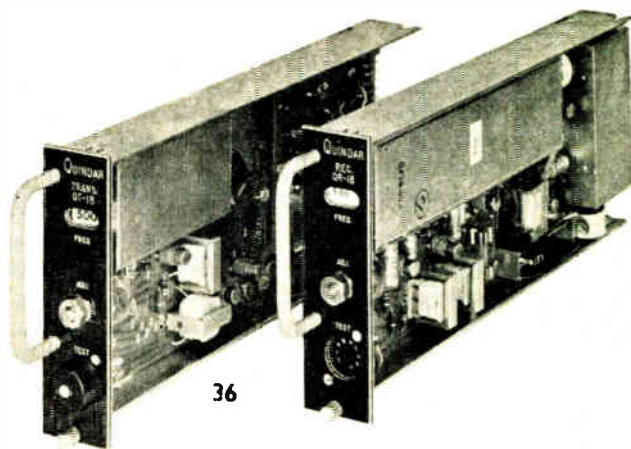

36

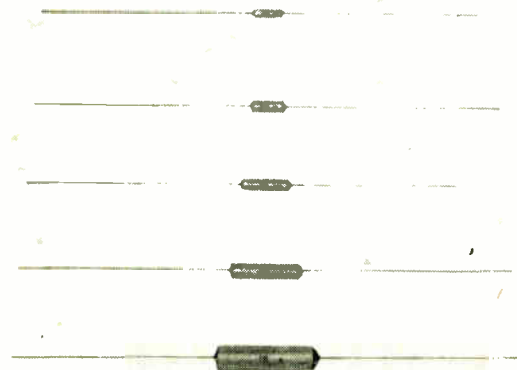

37



38

call or be called by the extensions.

Fitted with the latest type of lightweight handsets, the telephones are conventional in operation. A buzzer forms the usual calling signal but extension bells can be fitted at noisy locations. The cable is suited to indoor or outdoor use and the manufacturers claim that the system operates satisfactorily over distances of 500 yards between 'phones.—*D.J.P. Telephones Ltd., 156 Camden High Street, London, N.W.1.*

For further information circle 35 on Service Card

36. Signalling Transmitter/Receiver

Quindar Electronics have announced the development of single-frequency signalling transmitter and receiver units. The QT-18 and QR-18 will transmit and receive an in-band modulated-tone ringing signal.

The QT-18 is an a.m.-tone ringing transmitter designed to transmit in response to a circuit closure at its 'keying' terminal. The unit is of modular design and is completely solid-state with a plug-in oscillator and line-coupling network which determines operating frequency. Standard units use a 1-kc/s ringing tone modulated at 20 c/s or a 500-c/s tone modulated at 17 c/s. Any desired

frequency can be furnished. A front-panel control provides adjustment of the output level.

When the correct modulated ringing tone is received, the QR-18 responds by closing its output relay which may be used to provide lamp indications or audible signal.—*Quindar Electronics, Inc., 5 Lawrence Street, Bloomfield, N.J., U.S.A.*

For further information circle 36 on Service Card

37. Lightweight Tantalum Capacitors

A range of small lightweight tantalum capacitors has been introduced to Britain by International General Electric. These liquid-electrolyte porous-anode Tantalytic capacitors are expected to fill many d.c. electrolytic capacitor requirements where large capacitance values are needed in minimal space. They are particularly suited to low-voltage transistor applications, such as filtering, coupling and by-pass.

Available in 31 ratings from 6 to 60 V and from 0.1 to 325 μ F, they are supplied in five case sizes, from 0.08 \times 0.25 in. to 0.225 \times 0.875 in.; total weight is from 0.25 gm. Operating temperature range is from -55 to $+85$ $^{\circ}$ C, and these capacitors can be stored down to -65 $^{\circ}$ C. The units

meet the U.S. Army vibration specification of 2,000 c/s, acceleration up to 15 g, and all normal shock requirements.—*International General Electric Co. of New York Ltd., 296 High Holborn, London, W.C.1.*

For further information circle 37 on Service Card

38. High-Accuracy Digital Voltmeter

Digital Measurements have announced a high-accuracy digital voltmeter, the DM2010, with maximum reading of 109999 and a precision of one digit over the entire scale. Incorporated in the instrument is a saturated Weston standard cell, temperature calibrated. The principle of operation relies on a sequential comparison using an inductive potentiometer having a division accuracy of 1 part in 10^6 . The d.c. input voltage is compared directly with an a.c. standard divided by the inductive potentiometer, thus eliminating errors due to resistive standards used in other techniques.

The DM2010 features a sensitivity of 10 μ V on the 1.1-V range and an input impedance of 25,000 M Ω on both the 1.1 V and 11-V ranges. The ranging accuracy between the 1.1-V range, which can be calibrated by the internal standard cell, and the 11-V range is better than 1 part in 10^5 .

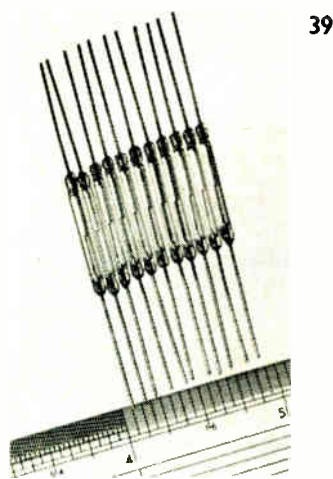

39

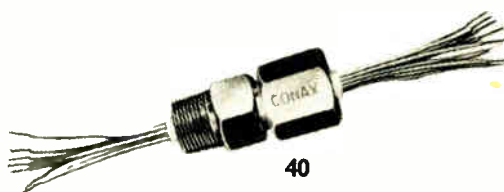

40



41



42

Two further ranges of 110 V and 1,100 V utilize resistive attenuators which may result in some degradation of ranging accuracy unless they are calibrated on the individual range.—*Digital Measurements Ltd., 25 Salisbury Grove, Mychett, Aldershot, Hants.*

For further information circle 38 on Service Card

39. Subminiature Reed Switch

The Hamlin MSRS-2, a subminiature magnetic reed switch designed specifically for low-level logic switching is now available from Flight Refuelling.

A silver-alloy contact material is used to provide uniform contact resistance and long life. The high drop-out to pull-in ratio simplifies the design of basic AND logic circuits where the omission of one contributing condition will cause drop-out, or prevent pull-in, depending upon the state of the circuit.

Tests indicate a pull-in to drop-out ratio of 66% to 75% and a maximum contact resistance of 150 mΩ after 100 million operations. The switch is rated at 0.5 W d.c. with a maximum current of 10 mA. The switch can be supplied with a sensitivity of 20 to 100 A-turns, according to requirements.

Overall length (including leads) is 2.25 in., the length of the switch body

is 0.80 in., and the diameter of the glass envelope is 0.090 in.—*Flight Refuelling Ltd., Industrial Electronics Division, Wimborne, Dorset.*

For further information circle 39 on Service Card

40. Sealing Glands

West Instrument are to market a range of Conax pressure and vacuum sealing glands. The glands are available with either insulating or non-insulating seals. Glands, together with sealant materials, are available for a wide range of environments including pressures up to 10,000 p.s.i., vacua down to 0.005 μ (5 × 10⁻⁶ mm Hg) and temperatures between -180 and +1,000 °C.

When the seal is for electrical conductors the compressive force is transmitted to the preformed plastic sealant via high-strength ceramic insulators, and a variety of sizes is available permitting up to 16 conductors, which may be of different diameters, to be sealed in one gland.

The range includes glands suitable for sheathed thermocouples, multiple transducer leads, electrical conductors carrying currents up to 500 A, multiple thermocouple probes and other applications where pressure or vacuum sealing is required. The gland illus-

trated will accommodate up to 8 leads (12- to 18-gauge wire) rated at 600 V.—*West Instrument Ltd., The Hyde, Brighton 7, Sussex.*

For further information circle 40 on Service Card

41. Varactor Diodes

Production has been announced of a complete line of silicon epitaxial abrupt-junction varactor diodes by Solitron Devices, Inc. The range will provide a wide choice of characteristics, including Q up to 200, low to microwave frequencies, capacitances from 6.5 to 500 pF, working voltages from 15 to 200 V, power ratings from 0.5 to 2.0 W, and low inductance.

Applications include shifting frequency and power in the communications field. Other uses are in tuning, harmonic generation, and parametric amplification.—*Auto-Electronics Ltd., Peel Grove, London, E.2.*

For further information circle 41 on Service Card

42. R.F. Microvoltmeter

The Millivac MV-28B r.f. microvoltmeter, now available from Claude Lyons, is designed for measurements in the v.h.f. and u.h.f. fields.

The MV-28B has eight voltage ranges from 1 mV to 3 V full-scale over the frequency range 10 kc/s to 1.2 Gc/s, the lowest readable voltage being 300 μV. Accuracy is 3% from 100 kc/s to 60 Mc/s, 5% from 50 kc/s to 200 Mc/s and 10% over the remainder of the range. Input impedance with the high-impedance probe tip is approximately 2 to 3 pF and 75 kΩ. A 50-Ω BNC termination adaptor is supplied as standard and accessories available include 100 : 1 capacitive voltage divider, N, and G.R. terminations and type N 'Tee' bridging adaptor.

The mirror-scaled meter is calibrated in both volts and dBm (relative to 1 mW into 50 Ω). Response is close to r.m.s. up to 30 mV and peak above 30 mV, calibrated in equivalent terms of r.m.s. sine wave. A useful point is that by the use of the 100 : 1 capacitive voltage divider the range as an r.m.s.-responsive instrument can be increased to 3 V.—*Claude Lyons Ltd., Valley Works, Hoddesdon, Herts.*

For further information circle 42 on Service Card

43. High-Sensitivity Panel Meters

Small panel meters of extreme sensitivity and high precision are the latest addition to the range of recording and laboratory instruments offered by Smiths Industrial Division. These meters have taut-ligament suspended movements with glass pointers giving

HIGH-SPEED RADIOGRAPHY

By D. J. DAVIS* and D. C. LAVAL†

It is now possible to apply X-rays to high-speed photography so that radiographs of objects moving at velocities up to 40,000 ft/sec can be obtained. This article describes the principles involved and the way in which very short duration 'bursts' of X-rays are produced.

THE industrial usage of X-rays for non-destructive testing has been rapidly established as a useful analytical technique, and the ability to examine phenomena in an opaque medium has led to a new class of inspection and quality-control methods. However, from the industrial user's point of view, conventional X-ray systems suffer from certain limitations which restrict their general application. Perhaps the most significant of these disadvantages is the inability of conventional X-ray systems to radiograph moving objects. Examination of the dynamic characteristics of industrial machinery and processes not otherwise observable can be of considerable interest. However, it may not be generally known that recent developments in X-ray generating techniques have provided the industrial user with inspection systems capable of radiographing fast-moving phenomena: objects and substances moving at velocities up to 40,000 ft/sec can be 'frozen' and examined in detail. An understanding of the fundamental principles involved is necessary in order to obtain an overall appreciation of this revolutionary technique.

It is perhaps a truism to observe that electronic devices are heavily dependent upon their electron sources. Current density of the electron source determines information rate and resolution, and the power required to achieve the electron flow has considerable bearing on physical size and maximum power dissipation. Thermionic emission has severe disadvantages in this regard and much research has been done of recent years into alternative electron sources. Semiconductor devices have achieved considerable success in combining small size, robustness and circuit flexibility, though still suffering from limitations of low power dissipation and poor high-frequency performance. An alternative solution to this problem is the electron source commonly called field emission. This technique combines the advantages of cold cathode, high current density, and on the experimental data available, good high-frequency performance.

Field emission was discovered by R. W. Wood¹ in 1897. However, it remained a scientific curiosity till the empirical work of R. A. Millikan and his colleagues at California Institute of Technology in the early 1920s. Unfortunately, Millikan's observed phenomenon were completely inexplicable by the prevailing classical theory. Conventional emission models in which electrons were energized sufficiently to surmount the potential barrier at the metal vacuum interface failed to explain why emission occurred even in the absence of energy. However, wave mechanics supplied the solution and the theoretical confirmation of Millikan's empirical work by Fowler and Nordheim^{2, 3} was one of the early successes of what was then a revolutionary hypothesis. According to the Fowler-Nordheim theory, electron waves impinging on the electron barrier had a

finite probability of penetrating the barrier and causing electron emission.

In spite of the early promise of this technique, the only useful field emission device that had appeared prior to World War II was the field emission microscope. The problems were limited life and poor stability and it was not until the post-war work at Linfield College^{4, 5} that the field emitter appeared as a practical engineering possibility.

From the point of view of electronic device applications, the important properties of field emission are:—

- emission can be obtained from a cold cathode, without the need to supply and dissipate heater power.
- very high emission densities are possible, something like a million times larger than in the thermionic case. It is, therefore, feasible to draw useful currents from microscopically small areas and low impedance beams from moderate-sized structures.
- electrons are emitted with a relatively narrow range of energy, even at very high current densities, which is favourable from the standpoint of beam noise, bunching and focusing.
- the response of the emitted current to changes in applied field is instantaneous, sensitive and very non-linear.
- the clean smooth cathode has long life and good stability at useful levels of both average and peak power.

Several of the foregoing properties were originally predicted by the Fowler-Nordheim theory which is fundamentally based on the potential energy diagram shown in Fig. 1. Field emission occurs when sufficient electric field is applied to reduce the potential barrier at the metal surface to the

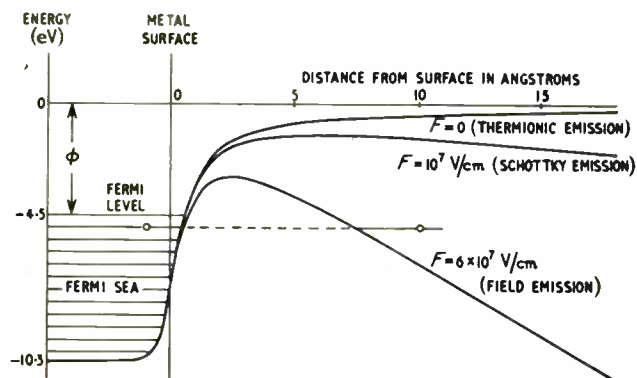

Fig. 1. Potential barrier at the surface of a tungsten cathode, for various values of the applied electric field F

* Livingston Laboratories Ltd. † Formerly Livingston Laboratories Ltd.

extent where electrons with Fermi energy have an appreciable probability of tunnelling through the barrier and out of the metal. The basic Fowler-Nordheim equation is as follows:

$$J = AF^2 \exp. (-B\phi^{3/2}/F)$$

where J = the emitted current density in amp/cm²
 F = electric field applied at the surface in V/cm
 ϕ = work function in eV
 $B = 6.12 \times 10^8$ in the above units
 A = dependent on work function, not on field.

In the case of tungsten, which is the emitter material most often used in practice, the average work function is 4.5 eV and the corresponding value of A is 3.5×10^{-5} amp/V². The field dependence of J in field emission is similar to the temperature dependence of J in thermionic emission; in both cases the emission varies rapidly with work function.

It is interesting to note that thermionic emission and field emission represent the two extreme cases in a continuous range of emission processes. Schottky and thermionic-field emission are intermediate processes in which both temperature and field are combined to produce emission. Thermionic-field emission is defined as the emission from a heated conductor in the presence of an applied electronic field large enough for a majority of the electrons to be emitted through rather than above the barrier. Thermionic-field emission is of practical interest because it obviates the high-vacuum requirements associated with long-term stability of cold field emission cathodes, and thus provides a very high density emission process compatible with present commercial vacuum conditions.

Fig. 2 shows the theoretical relationship between J , T and F for a ϕ of 4.5 eV (tungsten). Cold field emission is included as a special case $T = 0$. To the left of point B, the majority of the emitted electrons are evaporated over the surface barrier; the emission is thermionic in nature; i.e., J is very sensitive to T and relatively insensitive to F . To the right of points B (thermionic-field emission), emission occurs primarily by tunnelling and has the characteristics of field emission. J is very high, increases rapidly with F and becomes relatively insensitive to T .

Field emission from the cold metal at useful current densities requires applied fields above 10^7 V/cm. In order to reconcile this high field requirement with reasonable grid voltages and convenient cathode-to-grid spacings, the cathode is shaped in the form of a very sharp needle. Emitters, usually of tungsten, are formed by electrolytic etching, then cleaned and rounded to the desired tip radius; typically a few tenths of a micron. For single-tip cathodes, beam perveance is limited to some 0.2 microamp/V^{3/2}. Thus single-needle field cathodes are best suited to devices such as cathode-ray tubes which use low perveance beams. Much higher beam perveances are required by devices in the areas of microwaves, X-rays and beam switching. Linear arrays consisting of one or two rows of regularly-spaced, nearly-identical needles mounted on a common supporting filament as illustrated in Fig. 3 have been used in experimental devices.

Some of the practical applications of field emission have been:—

1. *Cathode-Ray Tube.* The high emission densities of the field emitter has certain advantages in terms of the resolution of electron optical devices. Resolutions of 2,000 lines per inch have been obtained on experimental cathode-ray tubes.
2. *Hard-Vacuum Switch.* This device utilized the ability offered by the use of a compact multiple-needle cold field cathode to form a high density beam and to extract

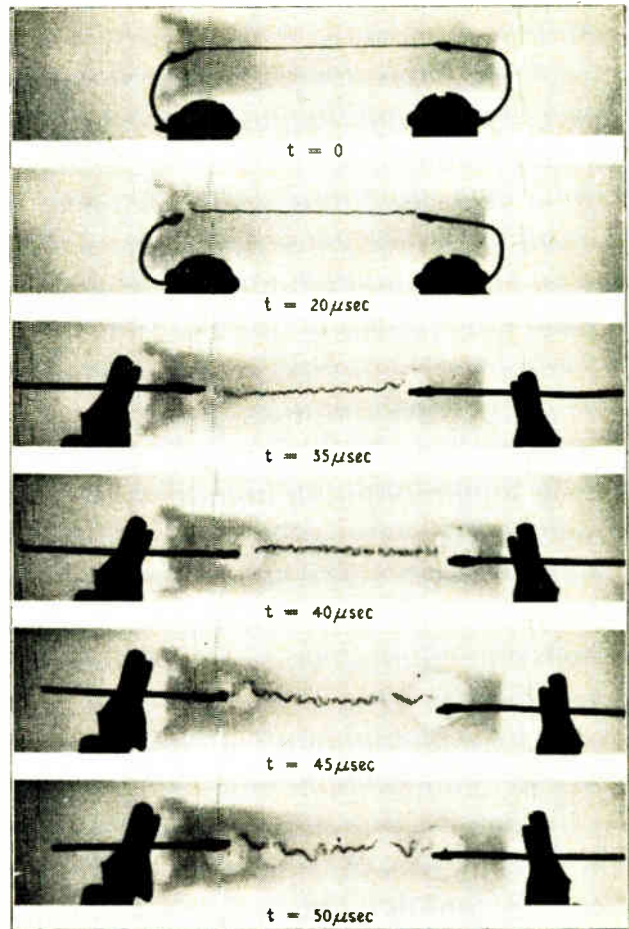

A sequence of flash radiographs of exploding copper wire, 0.016 inch in diameter, in a polyethylene capsule filled with water. The explosion was initiated by a 168-joule discharge. These 0.07-μsec exposures at 1,400 A and 105 kV were made with a model 732 Fexitron X-ray system

Fig. 2. Emitted current density vs. applied field, for $\phi = 4.5$ eV (tungsten)

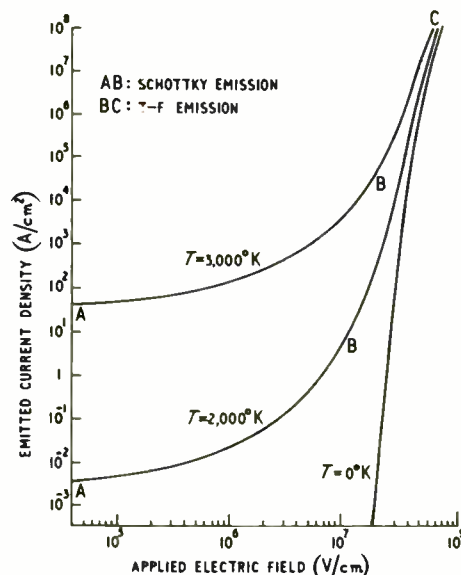

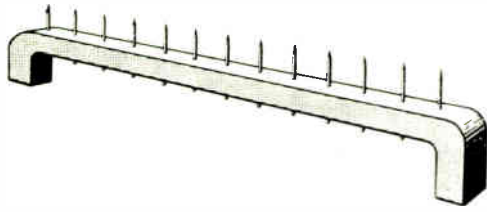

Fig. 3. (Above) Layout of a typical multiple-needle field-emission cathode

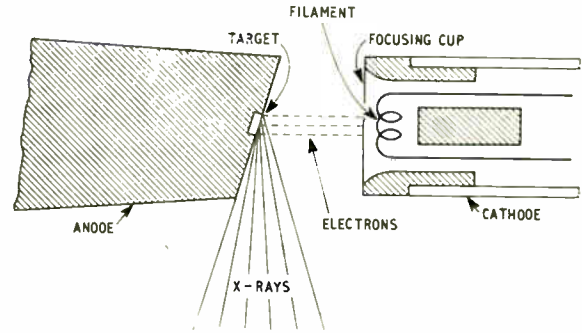

Fig. 4. (Right) Layout of a conventional X-ray tube

this beam through a small aperture in the control grid. Advantages are low power dissipation and high voltage gain.

3. *Microwave Devices.* Field-emission microwave devices exploit the high beam-current density and the strong non-linearity of the current-voltage relationship which characterize compact multiple-needle cathodes. Because of the high emission density of the cathode useful power levels can be achieved at frequencies well above 10 Gc/s.

Flash X-Ray Devices

Since the application of field emission to X-rays has made a significant practical contribution to the art, this subject will be dealt with in greater detail than the foregoing. The performance of an X-ray tube is closely related to the properties of its electron source. Conventional tubes extract their electrons from heated metal cathodes as in Fig. 4. Such cathodes when of convenient size can normally produce mean currents up to a few hundred milliamperes and require corresponding radiographic exposure times in the order of 1/100th to one second. There have never been any real claims for the efficiency of conventional X-ray tubes, but it is generally agreed that approximately 98% of the power which is used unfor-

tunately produces heat rather than useful X-rays. The design of tubes, therefore, has to accommodate some means of disposing of this unwanted heat. This is normally achieved by circulating oil and water through the tube anode, thus making portability difficult. Bearing in mind the theory of field emission, it will be appreciated that the field emission tube has a totally different construction (see Fig. 5). The tube illustrated is a model 524 which is suitable for voltages from 75 kV up to 105 kV. In this case the anode instead of being of copper with a tungsten target insert consists of a thin tungsten needle, the diameter of which is in the order of 1 to 3 mm. The point of the needle is surrounded by a cylindrical cathode structure which contains arrays of tungsten cathode needles.

It will be remembered that to cause the electrons to tunnel out of cold metal it is necessary to apply a potential in excess of 10^7 volts per cm. This would not be possible with a conventional cathode, but by concentrating the potential on to these needle tips the required density can be achieved. This tube can pass currents up to 1,400 amps for the very short times which are necessary to produce X-radiation. It requires no heating, neither does it produce heat and, therefore, it can be reduced in size. In the case of the tube shown the dimensions are 1 in. \times 6 in. This tube, even when enclosed in its shielded remote head,

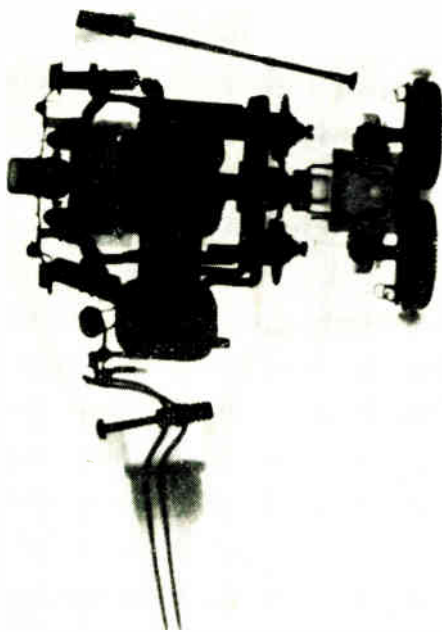

Radiograph of electric shaver taken while it was working

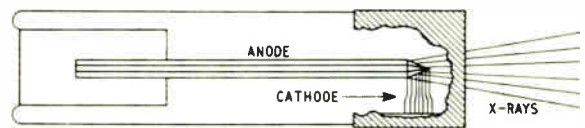

Fig. 5. Layout of a field-emission cold-cathode tube

Fig. 6. Block diagram of a typical Fexitron flash X-ray system

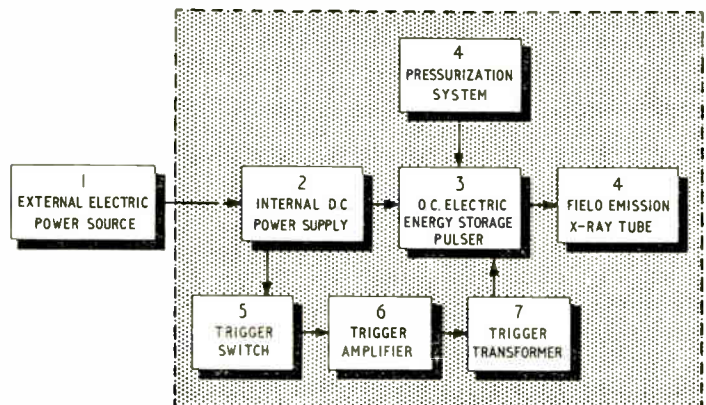
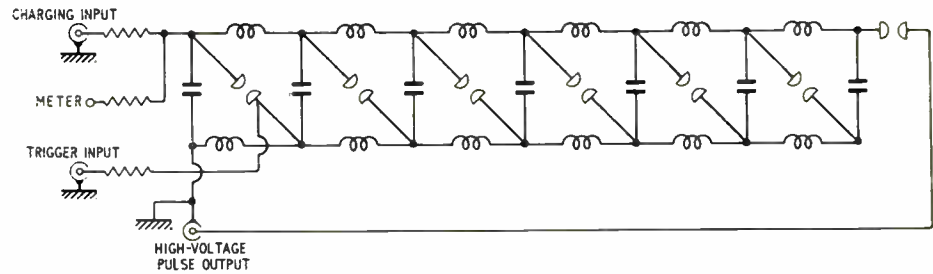

Fig. 7. The Fexitron pulser network



weighs only 3 lb. The head, by the way, can be operated at distances up to 100 ft from the main equipment and is fed by 70-Ω coaxial cable. A complete single-channel system is shown in Fig. 6. The other components of the system consist of the power supply which provides an adjustable d.c. charging voltage to the pulser. The pulser (Fig. 7), which is a modified Marx generator, consists basically of a number of capacitor modules, each of which is terminated by a spark gap, the first containing a trigger electrode. The spark gap is pressurized with nitrogen to provide protection against atmospheric variables such as dust, moisture or altitude. With the pulser charged, it is necessary only to provide a trigger pulse to the first module. This pulse causes breakdown in the module and the transfer of energy to the next module. The sequence then continues to the last module when the accumulative voltage, which takes the form of a square-wave pulse, is applied across the tube. The pulse, dependent upon particular model of pulser and tube, will vary in length from 30 nanoseconds to 100 nanoseconds. The resultant short-period intense radiation enables the equipment to be used for stop-motion radiography. The trigger pulse can be fed into the delay trigger amplifier which amplifies and delays the pulse by a prearranged amount (1–1,000 μsec). This makes it possible to 'freeze' an object travelling in air at velocities up to 40,000 ft per second. Naturally, in only a limited number of applications will these high speeds be encountered; e.g., in ballistic studies. It does, however, emphasize the fact that many engineering problems may be solved where machinery can be radiographed during its normal operation, thus enabling phenomena to be observed that previously could not be seen. This would apply to the moving parts of internal combustion engines or the examination of turbine blades as simple examples. Complete cine-radiographic pictures can be produced in one of two ways. Where the event is repetitive a series of radiographs can be taken and, by using different delay settings of each shot, the specimen can be observed at many parts of its cycle. The alternative method is to build up a multi-channel system. To do this it is necessary to add extra tubes, pulsers and trigger amplifiers; these will all run off the single d.c. power supply and can be arranged to fire sequentially. An example produced by this method is shown in the exploding wire picture. As well as the mechanical applications, some of which have been mentioned, this equipment is being used in the United States to study the effects of transient nuclear radiation on electronic components. It will be appreciated that such radiation can cause components, such as semiconductors, to change their characteristics either temporarily or permanently, and while for obvious reasons it is not practicable to expose them to nuclear radiation, the same effect can be produced by exposure to short pulses of high energy X-rays. The system which is being used for this purpose

is a 600-kV model which produces a dose equal to 100 million roentgens per second. At this high level X-rays are indistinguishable from gamma rays without knowing the source.

The latest development in this field is to produce even smaller and more compact systems. One of these, the Fexitron model 846, weighs 50 lb. This set can be operated from an ordinary 5-amp supply or a portable generator or inverter. Whereas the previous models produce their radiation in single pulses, the model 846 can be set to produce a chain of pulses up to 99 with a repetition rate which at 100 kV is 25 pulses per second and at 150 kV is 14 pulses per second. This repetition rate is very dependent on the mains supply stability and while unwanted fluctuations can cause an embarrassing change of repetition rate, this characteristic can be exploited to synchronize the X-ray pulses with a moving device within quite narrow limits. An X-ray set of this size with such a high penetra-



Portable Fexitron machine capable of radiographing all parts of the human anatomy

tion has intriguing possibilities in the aircraft industry since it is feasible for it to be airborne, providing the opportunity of investigating various structures under normal environmental conditions.

Much of the early application of stop-motion radiography, particularly in the United States, was in the field of ballistics. The examination of shells, bullets, fuses, etc., actually in operation was possible for the first time. However, since then a host of industrial applications have arisen, a few of which are detailed below.

The examination of moving objects in otherwise inaccessible areas.

Dynamic characteristics of engines, including pistons, piston-rings, valves and fuel systems.

Suspension systems of motor vehicles and aircraft.

The examination of sealed electronic devices under conditions of stress and vibration.

The explosive forming of metals.

Examination of exploding wires.

Behaviour of devices under shock test and impact conditions.

Examination of materials under fatigue conditions.

Examination of turbine blades in motion.

Analysis of the behaviour of coolants under working conditions.

References

- ¹ Wood, R. W., *Phys. Rev.*, Vol. 5, p. 1 (1897).
- ² Fowler, R. H. and Nordheim, L. W., *Proc. Roy. Soc.*, A119, p. 173 (1928).
- ³ Nordheim, L. W., *Proc. Roy. Soc.*, A121, p. 626 (1928).
- ⁴ Martin, E. E., Trolan, J. K. and Dyke, W. P., *J. Appl. Phys.*, Vol. 31, p. 782 (1960).
- ⁵ Dyke, W. P. et al., *J. Appl. Phys.*, Vol. 31, p. 790 (1960).

Central Read-out System for Radio-isotope Assay

A Philips system of nucleonic instrumentation has been announced which enables substantial savings to be effected wherever regular measurements have to be made on large numbers of isotope samples. By centralizing the read-out from a number of measuring sets, less equipment is required and supervision is simplified. In a typical ten-channel measuring facility, the cost of read-out equipment is reduced to less than a third of that of earlier systems.

The system employs measuring heads that are already incorporated in manual or automatic sample changers, or in gamma spectrometers. Each measuring set has its own detector as well as a scaler and timer assembly. But only one digital printer or punched tape machine is needed to serve all sets.

The timers and scalers are individually adjusted for pre-set time or pre-set count in the conventional manner, and their output points are continuously scanned. When a measuring set is reached that has completed its count, the scanning switches stop cycling and the information from that particular set is read out together with an identification

number. In the event of a number of sets completing their count simultaneously, the information is held until it is read out in sequence by the printer.

A major advantage of the system is that it will operate efficiently even when there is a wide difference between the counting times of the different channels. The read-out equipment locks only to 'stopped' counters and is then occupied in reading out and resetting for approximately 3 seconds, irrespective of whether the actual counting time was a fraction of a second or several hours. The accuracy of the timer at all settings is $\pm 0.01\%$.

The electronic units employed are fully transistorized and are now incorporated in the Philips modular system of nucleonic instrumentation. Numerous configurations are possible and the maximum capacity of the automatic arrangement for measuring radio-isotopes is 100 channels. Automatic measurement of decay curves is also possible, and a system is available for the measurement of the decay curves of isotopes with short half-lives.

For further information circle 53 on Service Card

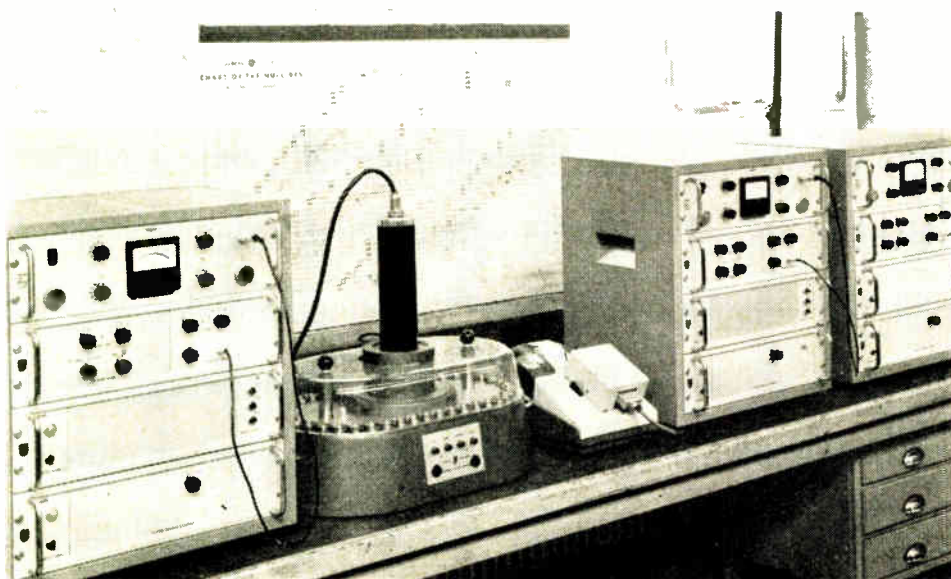

Some of the equipment from the Philips system for large-scale radio-isotope assay, including (centre) a 40-position automatic sample changer and a digital-type printer

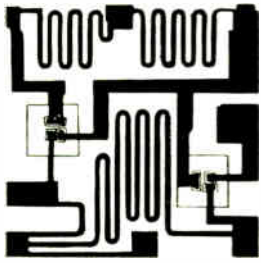

A Hybrid Approach to Integrated Circuits

By D. R. TIBBETTS, B.Sc., A.R.C.S., A.Inst.P.*

Various forms of integrated circuit are discussed in this article. It is suggested that a hybrid system consisting of thin film components deposited on a semiconducting base which contains the transistors may be the best form of construction.

THE development of integrated circuits has been a logical development of component manufacturing techniques. In the case of semiconductor devices only a very small part of the encapsulation is taken up by the actual semiconductor material and a very natural development is to increase the size of this material to incorporate further transistors or other components. In the case of resistor manufacture, thin films have long been used and a natural development here is to form several interconnected resistors simultaneously. The fact that capacitors can also be made in thin-film form suggests the possibility of forming complete passive networks on one substrate.

Various advantages of integrated circuits have been claimed by the manufacturers. These have included reduced size and weight, increased reliability, reduced power consumption, reduced cost and reduced time cycle between design and production. However, the advantages of semiconductor integrated circuits are not necessarily the same as those of thin-film circuits and in some cases the advantages claimed for either system may in fact be disadvantageous. It is true that both systems can reduce size and weight although semiconductor circuits tend to have the advantage. Semiconductor circuits are claimed to lead to higher reliability because of the low number of interfaces between different materials. However, analysis of failure rates of components in service tends to support thin films rather than semiconductors¹. Reduced power operation is a necessity for microminiaturization rather than an advantage of it and in many cases the power level of a particular circuit must be maintained in order to carry out its particular function. The advantage of reduced cost has not been apparent so far but, as the number of applications rise, the price will presumably drop considerably. The reduced time cycle between design and production depends on the ease with which a design may be changed, and, at the moment, thin films appear to be superior in this respect.

This article reviews the chief characteristics of tantalum thin-film integrated circuits and semiconductor integrated circuits and then describes how a hybrid of the two systems may incorporate the advantages of both.

Tantalum Thin-Film Integrated Circuits

Tantalum circuitry has been described by several authors^{2, 3}. Both resistors and capacitors can be made from tantalum film sputtered on to a glass substrate.

*Ultra Electronics Limited.

Resistors are made by an extension of the photographic techniques used in printed circuitry and resistance can normally be controlled within $\pm 4\%$. If necessary this tolerance can be reduced by a factor of a hundred by a further adjustment process. The stability of pure tantalum resistors is not satisfactory but by incorporating certain impurities in the films stable resistors can be achieved. Fig. 1 shows the results obtained on six unencapsulated 4.5-k Ω resistors each dissipating $\frac{1}{2}$ watt (i.e., 4 watts/sq cm of film) in an oven at 140 °C. With no load at this temperature the resistors are stable to 0.1%. At room temperature with a dissipation of 4 watts per sq cm the stability is better than 0.1%. The temperature coefficient is approximately -100 p.p.m./°C and is reproducible to ± 10 p.p.m./°C.

Capacitors are made by anodic oxidation of the tantalum film and the subsequent deposition of an evaporated gold counter electrode. A capacitance of 0.1 μ F per sq cm can be obtained and the tolerance of such capacitors appears to be of the order of $\pm 5\%$. Breakdown voltages depend on formation voltage but average values are in the region of 70-80 volts and leakage resistances at normal working voltages are of the order of 10^{10} to 10^{11} ohms/sq cm. Temperature coefficients are approximately $+250$ p.p.m./°C. The working stability of these capacitors has not been investigated fully but under storage conditions there has been no noticeable change over several thousand hours.

Tantalum circuits can be made very small, the limitation being set ultimately by the power dissipation allowable per unit area of substrate. Fig. 2 shows a thin-film amplifier giving a voltage gain of 600 with a drop in gain of 3 dB at just over 1 Mc/s. The output available is 7 volts peak-to-peak. The circuit of this amplifier is shown in Fig. 3 (a) and discussed in a later section.

The reliability of tantalum circuitry should be high. Extremely pure conditions are maintained throughout the manufacturing process and the process variables are strictly controlled.

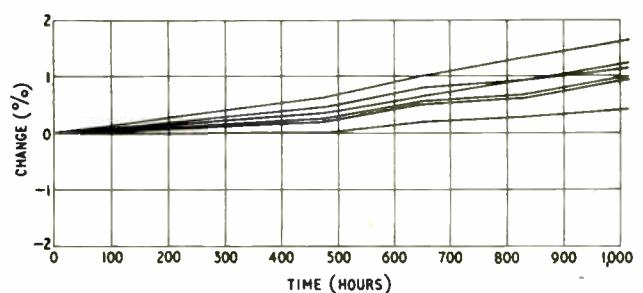

Fig. 1. Six unencapsulated 4.5 k Ω resistors on the same substrate each dissipating $\frac{1}{2}$ W (i.e., 4 W/sq cm of film) in an oven at 140 °C

could then be produced from these chips by carrying through a few simple photographic and chemical steps. Thus the cost of such circuits would be small and the time between designing a circuit and measuring its properties would be reduced to reasonable proportions.

Acknowledgment

This article describes the work of several people in the Research Department of Ultra Electronics Ltd., in particular R. Duckworth, G. Shrank, P. Simons and D. Talbert.

References

- ¹ N. Griffin. Reliability of Electronic Equipment, Vol. 1, pp. 3-10.
- ² T. V. Sikina. High-Density Tantalum-Film Microcircuits, Vol. 1, pp. 311-319.
- ³ D. Gerstenburg and E. H. Mayer. Properties of Tantalum Sputtered Films, Vol. 1, pp. 353-358.
- ⁴ J. M. Allen, B. L. H. Wilson and D. H. Roberts. The Principles of Integrated Single Crystal Circuit Design, Vol. 1, pp. 141-161.

MICROWAVE BAND DESIGNATIONS

In view of the several different official systems, and innumerable commercial ones, for allocating letter and number designations to the microwave frequency bands, Claude Lyons Ltd. have

prepared and published a table correlating all the designation systems in popular use. This table is reproduced below by permission of Claude Lyons Ltd.

FREQUENCY RANGE (Gc/s)	WAVE BANDS										WAVE GUIDES					
	COMMERCIAL DESIGNATIONS										INTERNAL DIMENSIONS (inches)	OFFICIAL DESIGNATIONS				
	U.K.	D-B	FXR	H-P	MRI	Narda	P	Philips	Sperry	TRG		U.K. (RCSC)	U.S. (EIA)	U.S. (JAN) W/G	U.S. (JAN) Flange	I.E.C.
0.32 - 0.49											23.0 × 11.0	WG00	WR2300			
0.35 - 0.53			J								21.0 × 10.5	WG0	WR2100			
0.41 - 0.625											18.0 × 9.0	WG1	WR1800	RG-201/U		
0.49 - 0.75											15.0 × 7.5	WG2	WR1500	RG-202/U		
0.64 - 0.96											11.5 × 5.75	WG3	WR1150	RG-203/U		
0.75 - 1.12					P						9.75 × 4.875	WG4	WR975	RG-204/U		
0.96 - 1.45											7.7 × 3.85	WG5	WR770	RG-205/U		
1.12 - 1.7	L		L		L	L	L	L (25 cm)	L	L	6.5 × 3.25	WG6	WR650	RG-69/U	UG-417A/U	R14
1.45 - 2.2								D			5.1 × 2.55	WG7	WR510			R18
1.7 - 2.6			R		M	LS	B				4.3 × 2.15	WG8	WR430	RG-104/U	UG-435A/U	R22
2.2 - 3.3											3.4 × 1.7	WG9A	WR340	RG-112/U	UG-533/U	R26
2.6 - 3.95	S	L	S	S	S	S	S	S (10 cm)	S	S	2.84 × 1.34	WG10	WR284	RG-48/U	UG-53/U	R32
3.3 - 4.9								A (7.5 cm)			2.29 × 1.145	WG11A	WR229			R40
3.95 - 5.85	C	K	H	G	C	C	C	G (6 cm)	C	C	1.872 × 0.872	WG12	WR187	RG-49/U	UG-149A/U	R48
4.9 - 7.05				C				C			1.59 × 0.795	WG13	WR159			R58
5.85 - 8.2		J	C	J	X _B	X _N	J	J (4.5 cm)	G		1.372 × 0.622	WG14	WR137	RG-50/U	UG-344/U	R70
7.05 - 10.0		H	W	H	X _L	X _B	H	H (3.5 cm)	H	X _L	1.122 × 0.497	WG15	WR112	RG-51/U	UG-51/U	R84
8.2 - 12.4	X	G	X	X	X	X	X	X (3 cm)	X	X	0.9 × 0.4	WG16	WR90	RG-52/U	UG-39/U	R100
10.0 - 15.0			FA		M						0.75 × 0.375	WG17	WR75			R120
12.4 - 18.0	J	F	Y	P	K _U	K _U	U	P (2 cm)	U	K _U	0.622 × 0.311	WG18	WR62	RG-91/U	UG-419/U	R140
15.0 - 22.0				N	K						0.510 × 0.255	WG19	WR51			R180
18.0 - 26.5		E	K	K	K	K	k		K	K	0.420 × 0.170	WG20	WR42	RG-53/U	UG-595/U	R220
22.0 - 33.0											0.340 × 0.170	WG21	WR34			R260
26.5 - 40.0	Q	D	U	R		V		Q (8 mm)	V	A	0.280 × 0.140	WG22	WR28	RG-96/U	{ UG-381/U UG-599/U }	R320
33.0 - 50.0		C	Q			Q			Q	B	0.224 × 0.112	WG23	WR22	RG-97/U	UG-383/U	R400
40.0 - 60.0										U	0.188 × 0.094	WG24	WR19			R500
50.0 - 75.0		B	M			M			V		0.148 × 0.074	WG25	WR15	RG-98/U	UG-385/U	R620
60.0 - 90.0	O	A	E			E		E (4 mm)	E		0.122 × 0.061	WG26	WR12	RG-99/U	UG-387/U	R740
75.0 - 110.0										W	0.100 × 0.050	WG27	WR10			R900
90.0 - 140.0		W	F			N			F		0.080 × 0.040	WG28	WR8	RG-138/U		R1200
110.0 - 170.0								B (2 mm)	D		0.065 × 0.0325	WG29	WR7	RG-136/U		
140.0 - 220.0			G			A			G		0.051 × 0.0255	WG30	WR5	RG-135/U		
170.0 - 260.0									H		0.043 × 0.0215	WG31	WR4	RG-137/U		
220.0 - 325.0						R			J		0.034 × 0.017	WG32	WR3	RG-139/U		

U.K. = United Kingdom D-B = De Mornay Bonardi FXR = FXR Division of Amphenol Borg H-P = Hewlett Packard MRI = Micro-Radionics Inc.
 P = Paradyamic TRG = Technical Research Group

“And does it work, Papa?”

ALICE :
‘Puce’, Papa?

PAPA:
P.U.C.E., child. Price unit computing engine - a modest device whereby I hope to revolutionise price computation methods in business.

ALICE :
And does it work, Papa?

PAPA:
I felt at liberty to indulge a mild whimsey in the choice of name. Who knows? It may even set a fashion.

ALICE :
But, dear Papa, does it work?

PAPA:
Upon my soul, at times you are the image of your mother.

ALICE :
Mama has sent me to show you this picture. I am to tell you that it illustrates the small electronic digital computer which W. & T. Avery incorporate in their price computing weighing machine. You will notice it also prints both weight and price automatically.

PAPA:
Oh, the monstrous regiment of women!

A fully transistorised digital computer is neatly built into the Avery prepack scale. Entirely designed and built by Avery, the complete unit calculates value in £.s.d. from weight in lb. oz. and fractions and from the pre-set unit price, printing this and other information on a heat-seal ticket all within 2-3 seconds with stampable accuracy.

For further information and advice on all aspects of the use of electronics in weighing control, write to:

W. & T. AVERY LTD., BIRMINGHAM 40

No. 1 of a series



TANTALUM CAPACITORS (CLASS W AND S)

7 DAY DELIVERY FROM THORN

You can now get Tantalum Capacitors in just seven days from Thorn. This is a special service for Development Engineers and is not intended or available for production quantities. Only quantities of up to 25 off are offered of Class W or S capacitors. Tolerances available: Class W -15% to $+75\%$ and Class S $\pm 20\%$. Want to know more about these capacitors? Just read on.

TANTALUM TYPE W TANTALUM CAPACITORS consist of a sintered porous anode sealed in a fine silver case. The following qualities are inherent: * unusually high capacitance per unit volume * reliable operation over temperature range -55°C to $+85^{\circ}\text{C}$ without derating * operation at 125VDC and under * lowest leakage current of any tantalum capacitor * low power factor * long shelf and operating life.

MIL-C-3965B.

Voltage depending on capacitance: 6VDC to 125VDC
Temperature Range: -55°C to $+85^{\circ}\text{C}$
Capacitance depending on voltage: $1.7\mu\text{F}$ to $560\mu\text{F}$
Tolerance of capacitance: -15% to $+75\%$
Polar construction
Insulated or non-insulated

TANTALUM TYPE S TANTALUM CAPACITORS are small solid type units with the following qualities: * extreme reliability over wide temperature range of -80°C to $+125^{\circ}\text{C}$ * low leakage current * low loss factor * polar or non-polar construction * extremely long shelf and operating life. Meets the requirements of MIL-C-26655A.

Voltage: 6VDC to 35VDC
Temperature range: -80°C to $+125^{\circ}\text{C}$
Capacitance Polar: $0.0047\mu\text{F}$ to $330\mu\text{F}$
Tolerance of capacitance: $\pm 20\%$
Insulated or non-insulated

Convinced? Try the service and the capacitors by ringing Enfield 5353 now! And ask about other Thorn Tantalum Capacitors.

THORN ELECTRICAL INDUSTRIES LIMITED
SPECIAL PRODUCTS DIVISION
105-109 Judd Street, London, W.C.1

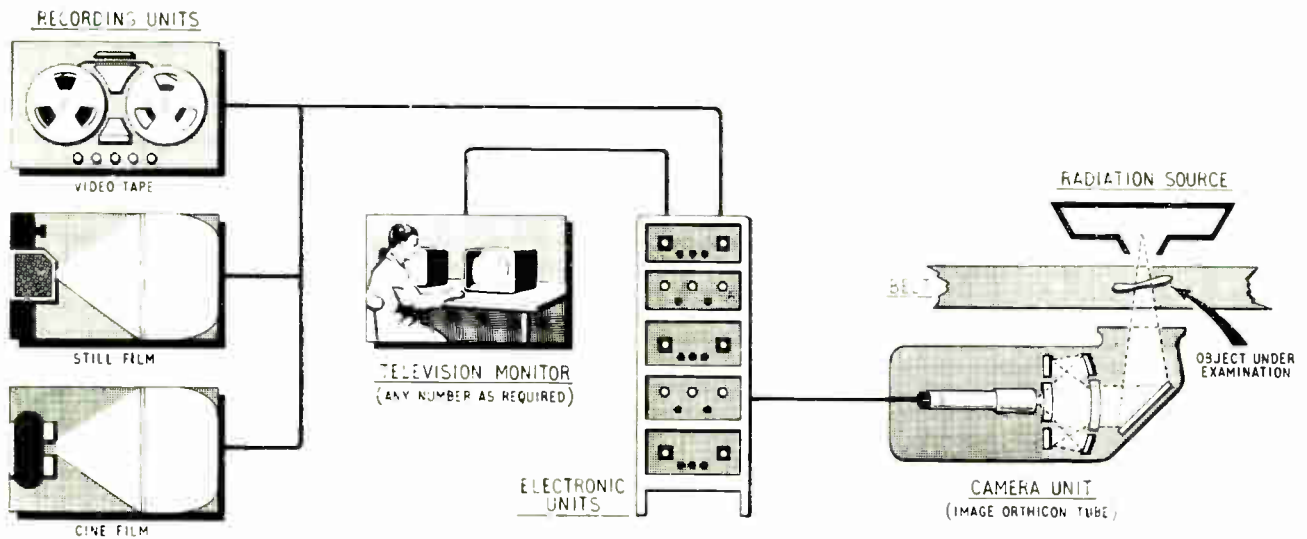

Schematic diagram showing the basic system used in the industrial X-ray image amplifier

QUALITY - CONTROL AID IN TURBINE BLADE PRODUCTION

An industrial version of the Marconi Instruments' 12-in. image amplifier is now available. This can provide a visual image of metal structures up to 1½-in. thick for the examination of flaws, etc.

The first production model, known as type OE 1280B, has been installed in the Willans Works of English Electric at Rugby, where it is materially assisting the production of steam turbine blades of consistently high quality.

The image amplifier is a high-definition, closed-circuit television system designed for direct viewing of a fluores-

cent image produced by the passage of X-rays through the specimen under examination. The image is focused by a mirror and lens system on to the photocathode of a 4½-in. image-orthicon tube, and is finally displayed on one or more 17-in. television monitor screens which, by means of electronic magnification, can have an 800-line definition in the central eight inches of the screen. Outlets are also available for recording on video tape and film.

At the English Electric works, the installation is being used to examine the adhesion of the Stellite erosion shields

(Left) Here the instrument is being used to examine the adhesion of Stellite erosion shields which are brazed, by induction heating, on to the leading edges of low-pressure reaction steam turbine blades. The X-ray source and television tubehead (not shown in picture) are contained in a lead lined box of radiation-proof construction. (Right) The electronic rack of the industrial X-ray image amplifier, installed at English Electric, Rugby

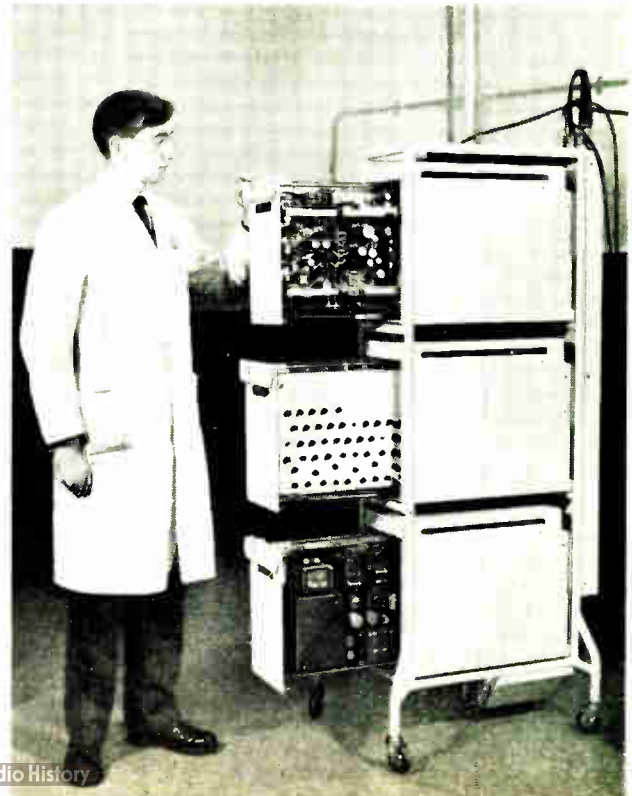
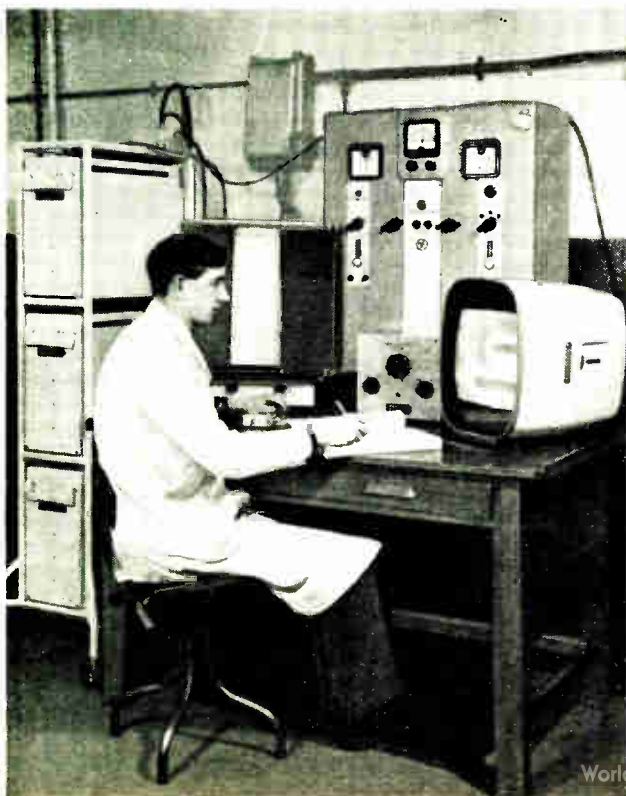

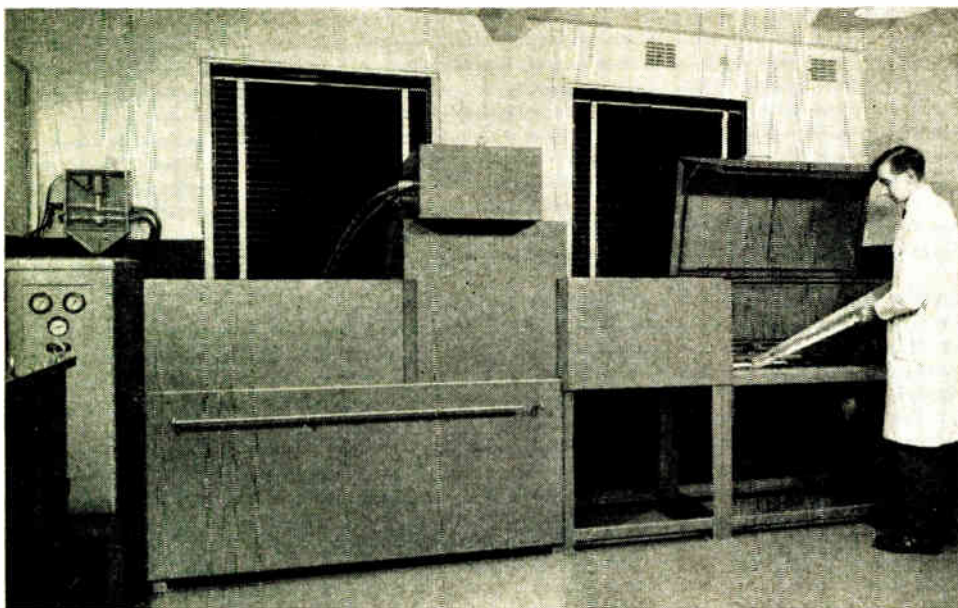

A steam turbine blade about to be examined at the Willans Works of English Electric

which are brazed, by induction heating, on to the leading edges of low-pressure reaction blades ranging in length from 3 in. to 36 in. Each blade is placed on a variable-speed, remotely-controlled trolley which passes between the X-ray source and fluorescent screen, a complete detailed examination taking less than five minutes per blade. Maximum thickness of steel that can be examined visually,

using a 250-kV source at 10 milliamperes, is $1\frac{1}{2}$ in., giving a sensitivity of 2 per cent.

No special room or building is required as the inspection unit is of radiation-proof construction. If a thicker lead lining is fitted, a 300-kV source can be employed. An interlocking mechanism ensures that the X-ray tube cannot be energized with the cover open.

Britain's First Permanent Video-Phone Link

Two London businessmen recently made history when they talked to each other on the first permanent television-phone to be installed in this country for commercial use.

As well as being able to see each other while conversing, they can use the system to hold conferences and, when required, examine documents remotely.

This video-phone system links the Millocrat House, Eastcheap, offices of Ranks Hovis McDougall, the food manufacturers, with the offices of the general manager of

In his office at Millocrat House, Eastcheap, Mr R. R. Thom, of Ranks Hovis McDougall, discusses the latest corn prices over the video-phone with Mr W. H. Denning, general manager of the firm's Animal Feeding Stuffs Division at the London Corn Exchange

the firm's Animal Feeding Stuffs Division in the London Corn Exchange, a quarter of a mile away. The equipment (costing approximately £1,000) was installed to meet the needs of the general manager, Mr. W. H. Denning, to be in constant, intimate touch with the wheat buying director, Mr. R. R. Thom, on the state of the market.

Standard G.P.O. loudspeaker telephones—leaving the hands free—are used on a direct line. When the general manager presses a button in his office the telephone rings on the desk of the director at Millocrat House, and a picture appears on the screen of a 23-inch television monitor. When he also operates a switch, he in turn is seen on a monitor in the general manager's office. All the subtleties of normal face-to-face conversation can be exchanged.

Ranks Hovis McDougall report that the system saves a great deal of time and trouble when holding the morning marketing conferences on corn prices—usually with about three people at each end of the link—and the success so far achieved has encouraged them to look for further applications of television-phones in other parts of their organization.

The equipment consists of standard Rank Telecommunications television monitors and 625-line MR 765 vidicon cameras linked by an existing G.P.O. video-cable. The cameras are fitted with a revolving turret containing a standard lens for normal visual communications and a wide-angle lens to enable three or four people to appear on the screen together. The wide-angle lens can be focused down for close-up views of documents, etc.

For further information circle 54 on Service Card



A typical electronic reading machine. The Farrington optical scanner used by the Franklin Life Insurance Company at Springfield, Illinois (by whose kind permission the photograph is reproduced) for reading information from premium remittance stubs

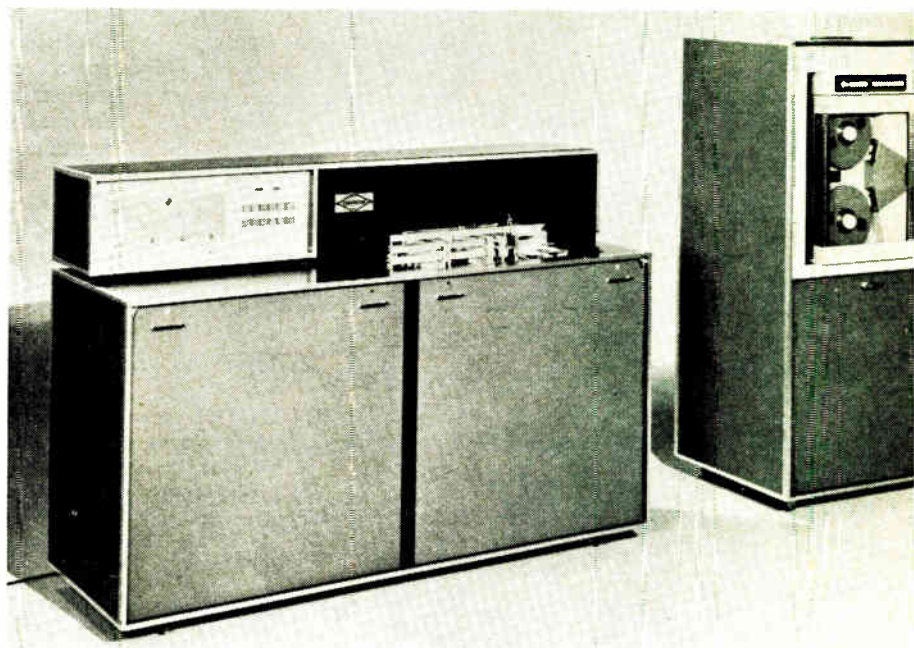

In this introductory article the basic problems of a 'reading machine' are discussed. Further articles will describe two machines in some detail and consider applications and economics.

DEVELOPMENTS IN ELECTRONIC READING MACHINES

By JOHN B. RUDKIN

1. Introduction and Principles

EVER since the first machine was used for any form of data-processing, the idea of developing machines which could read printed, typed and even hand-written material without translation into some other form has fascinated system users and engineers alike. As data-handling and processing systems have speeded up, the problem of translating data from man-sensible to machine-sensible form, an 'input preparation', has limited the economics, practicable applications, or both, of modern systems. In some cases this is a gross understatement, for the data translation is of itself the major processing operation to be performed.

For a number of years, work has gone on to develop practical reading machines. In early days, some companies in the field were bold enough to take provisional orders for equipment which proved to be much further from realization than was believed at the time.

In this article, the writer will attempt to summarize the problems and the principles upon which solutions are possible or have been achieved. The second article will describe two actual readers, working on different principles, both of which are now marketed by the Univac Division of the Sperry Rand Corporation. This Corporation and the London offices of the Univac Computer Division have provided a great deal of the information on which these articles are based and the author expresses his appreciation. A final

article will describe some actual and some suggested applications and consider the economics in general terms.

Nature of the Problem

To communicate information using the western alphanumeric character system, about 50 separately-identifiable characters are needed, including symbols, punctuation marks and so on. (Purely numeric information can be conveyed with many fewer characters, and some readers have been built with this limited facility.) A little elementary arithmetic demonstrates that the number of discrete elements to be spatially related in order to give positive identification is quite small—arithmetically six would more than cover the field, but practical reading machines use nine in order to introduce sufficient similarity to 'normal' characters for manual recognition to be instantaneous.

In fact, our characters have evolved in such a way that they contain a great deal of redundant symbolism which conveys no additional information though it may aid recognition if a character is badly printed or written. Moreover, printed and typed characters come in a wide variety of sizes and fonts, while the number of 'fonts' of handwriting is infinite. Finally, we have no exact reference point in space for any character while some of them are incredibly similar despite the large number of redundant elements available to anyone designing a new font based



Personal and Company News

Plessey-UK Ltd. and **Bendix Corporation** of U.S.A. have concluded an agreement whereby Plessey-UK becomes responsible for the interests of Bendix in the U.K. and certain European countries. It provides for contract servicing of American equipment as well as the manufacture and supply of new models in the U.K.

L. Edwin Smart Jr. has been appointed vice-president (international operations) of **The Bendix Corporation**. Mr. Smart has also been appointed a director of Bendix Electronics Ltd.

An agreement has been concluded between **A. T. & E. (Bridgnorth) Ltd.** and **The Marconi International Marine Co. Ltd.**, under which the latter will acquire exclusive world marketing rights for the A. T. & E. 'Inductorfone' frequency-modulated radio transceiver so far as the use of this equipment in crane communication installations is concerned.

Bowthorpe Holdings Ltd. have announced the appointment of Peter Bowthorpe as a director.

David Cunningham has been appointed U.K. sales manager of **SGS-Fairchild Ltd.**

C-E-I-R Ltd. have announced the following senior appointments to their staff: Dr. D. A. Eyeions as computer centre manager; Miss J. Morthland as a mathematician in the Linear Programming Division; N. D. Isaac as a programmer in the Data Processing Division; and T. P. McCarthy as a programmer/analyst in the Data Processing Division.

F. W. Andrews has been appointed general manager of the newly-formed Engineering Products Division of **Union Carbide Ltd.**

Redifon Ltd. announce the appointment to the board of directors of K. E. Harris, manager of the Communications Division.

Hellermann Electric Ltd. have appointed Alfred Newnes as national sales manager.

Brian Noble has been appointed commercial manager of **Rotunda Ltd.** (B.I.C.C. Group), manufacturers of industrial and electrical adhesive tapes.

Tektronix Inc. has acquired the assets of the **Pentrix Corporation** of Brooklyn in exchange for Tektronix stock. Pentrix is a manufacturer of spectrum analyser plug-in units, designed to fit into several Tektronix oscilloscopes.

E. E. Rosen, while retaining the chairmanship of **Ultra Electric (Holdings) Ltd.**, has relinquished his full-time executive responsibilities. Dr. F. W. Stoneman has been appointed to the board of the subsidiary, Ultra Electronics Ltd., and becomes joint managing director with Mr. A. V. Edwards. Mr. Edwards has been appointed managing director of Ultra Electric (Holdings) Ltd. and, as the senior joint managing director of the electronics company, retains responsibility to the board for the operations of that company.

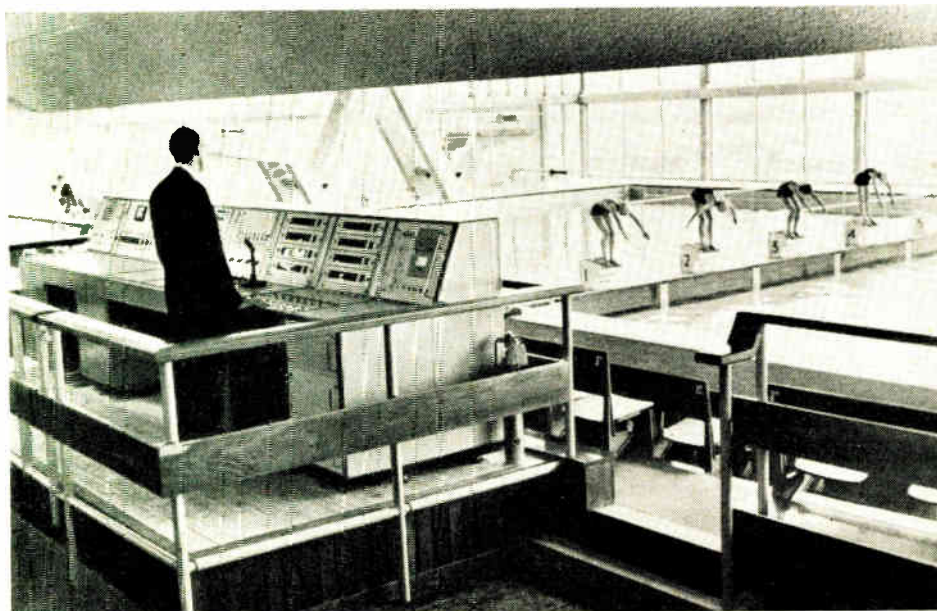

A view of ESTA (electronic swim timing assembly) installed at the new swimming hall at the Crystal Palace National Recreation Centre. Designed to L.C.C. specifications, the assembly enables times to be displayed to one thousandth of a second for each of eight swimming lanes with an additional 'order of finish' display, the times being simultaneously transcribed by print-out equipment incorporated in the console. Venner Electronics supplied the complete timing equipment, including the read-out and print-out facilities. Maximum continuous reading given by the equipment is 39 min 59.999 sec

For further information circle 56 on Service Card

A technician at the research laboratories of T.I. Stainless Tubes using conductrimetric apparatus to determine the carbon content of a stainless steel sample. A weighed sample is burned off at a temperature of 1200 °C in a stream of oxygen by means of the furnace (on the operator's right) and the carbon present is thus converted to carbon dioxide. This is then passed through a specially designed cell containing an absorbent, in this case potassium hydroxide. The amount of potassium hydroxide converted to potassium carbonate in the cell is proportional to the carbon content in the sample. The actual measurement is based on the change in reagent conductivity and is performed on a Wheatstone bridge circuit. This apparatus has particular value for determining low carbon contents, especially below 0.05%.

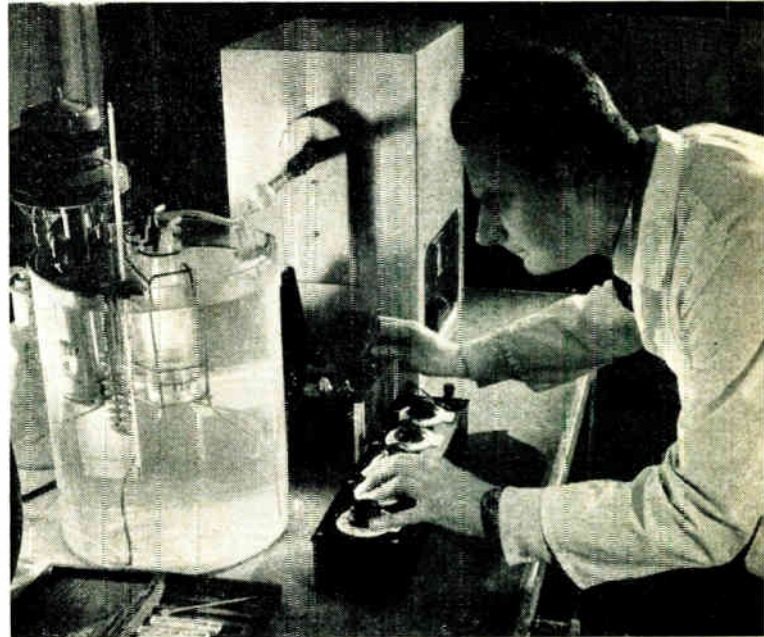

An exclusive licensing agreement to manufacture and sell the Hamilton Standard electron-beam welding machine was announced this week by **Hawker Siddeley Dynamics Ltd.** The licensed territory comprises the countries of the Commonwealth (with exception of Canada), Norway, Sweden, and the Union of South Africa.

Dr. L. G. Brazier has accepted an invitation to join the board of **Metal Industries**. He will be a non-executive director and his main concern will be with research and development.

A tripartite licensing agreement to manufacture printed-circuit boards using an American die-stamp process, has been concluded between **Plessey-UK Ltd.** and **Pressac Ltd.**, the main U.K. licensees of the Resources and Facilities Corporation of New York (REFAC).

Two appointments have been announced by the Electronics Division of **Rank Bush Murphy Ltd.**: H. J. E. Shayler, B.Sc., has been appointed executive marketing manager and T. E. Evans has been appointed general sales office manager of the combined sales offices of Rank Bush Murphy Electronics (Military and Contracts), Rank Nucleonics and Control, Rank Medical Equipment, and Rank Telecommunications.

Decca Radar Ltd. have appointed P. E. G. Bates as commercial manager.

Quindar Electronics, Inc., have concluded a licensing agreement with **General Electric Co. Ltd.** of England, covering the manufacture and marketing of its entire line of telemetering and remote control equipment in the United Kingdom, the Commonwealth, and Scandinavia.

Welwyn Electric Ltd. announce the retirement of L. F. Bull from its board of directors.

The entire share capital of H & B Precision Engineers Ltd. has been acquired by **Soag Machine Tools Ltd.** V. Lovett, A.M.I.Prod.E., who continues to serve as director of H & B, has been appointed research and development manager of the Soag Group.

The Public Relations and Advertising Division of **Creed & Company Ltd.** has moved to Hollingbury, Brighton, Sussex. Tel. Brighton 507111.

Harrison Reproduction Equipment Ltd., a member of the Movitex Group, have appointed Jay-R Industrial Sales Ltd. as representatives for the South East of England.

R. McL. Fairfield, at present joint managing director of **British Insulated Callender's Cables Ltd.**, has been appointed deputy chairman and managing director of the company from 1st September.

J. N. Fuller-Shapcott has recently been appointed to the board of directors of **Chilton Electric Products Ltd.** and **Chilton Aircraft Co. Ltd.**

The International General Electric Company of New York Ltd. has appointed Jermyn Industries to stock and distribute the range of U.S. General Electric semiconductors.

Obituary

Melville Eastham, founder and retired president of General Radio Company, has died at the age of 79. In 1915 he founded General Radio Company to manufacture electrical measuring instruments, and he served as president until 1944. From 1944 to his retirement in 1950, he held the title of chief engineer. He was responsible for many electrical standards, components, and construction techniques. As one of the leaders of the Office of Scientific Research and Development, Eastham was instrumental in marshalling the U.S. electrical engineering effort during World War II, and played a principal role in the development of the Loran navigational guidance system.

Laser Conference

To provide a forum for the exchange of new ideas and information among those working on lasers, the Electronics and Science and General Divisions of the Institution of Electrical Engineers are arranging a conference on 'Lasers and Their Applications'. It will be held at the I.E.E. headquarters, at Savoy Place, from 29th September to 1st October 1964. The aim of the conference is to survey present knowledge of lasers, coherent light and quasi-coherent light sources and the possible applications of lasers, as a guide to potential users and those concerned with device developments.

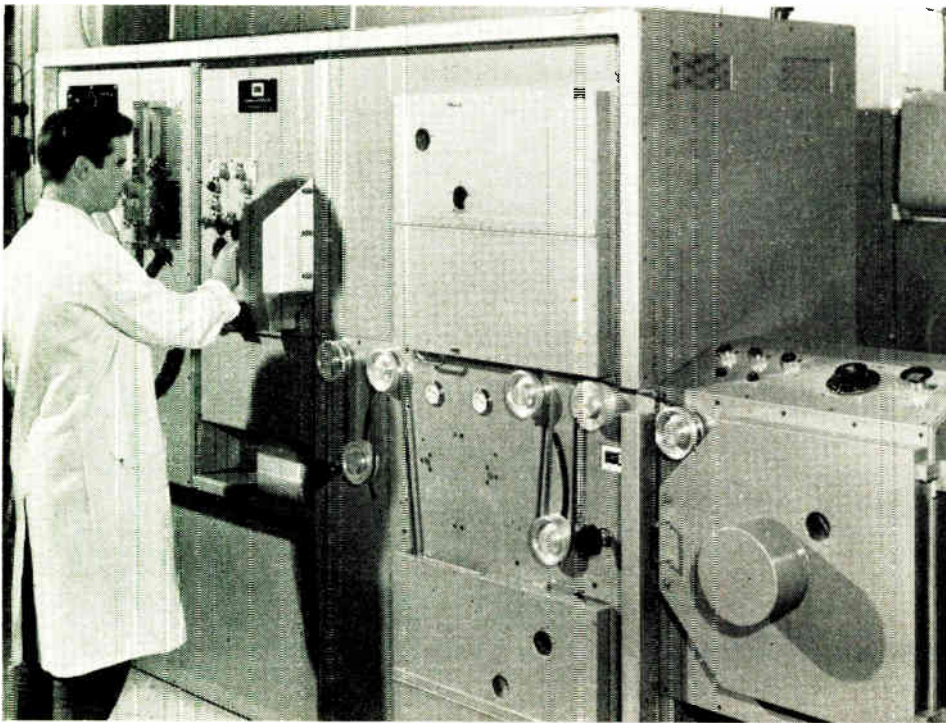

Tape-wound transformer cores in high permeability magnetic alloys are now wound at the Crawley works of Telcon Metals on this fully-automatic machine. The magnetic alloy tape is fed from a spool on to the winding mandrel and the transformer core completely fabricated in a few seconds. Two pay-off spools are available, one feeding strip to the final winding stage while the other is supplied with tape ready for winding. The advantages of this machine are very close control of transformer core dimensions and weight, leading to greater consistency in magnetic properties, and also substantial increase in speed of operation. The machine was designed and constructed in the McFadzean Laboratory of the B.I.C.C. Research Organization

Computers in the City

Offices in the City of London for English Electric Leo Computers have recently been opened at Enterprise House, Wilson Street, E.C.2. This follows increasing orders and enquiries for computers, and for hiring time on them, which have been received by the company from banks, insurance companies, stockbrokers and jobbers. As well as co-operating with businesses in the City, the new office will provide expert assistance to other divisions and overseas companies of English Electric Leo whenever enquiries or orders are received by them from financial organizations.

Recent development of City work now enables the company's computer bureaux to carry out far more sophisticated analytical work. One firm of stockbrokers has ordered a major suite of programmes to be prepared to do all its accounting and monitoring of records. Some of these programmes are already operating and the whole suite will be in use by next Spring. They will cope with clients' and stock records, ticket accounting, jobbers' ledger, list book, checking sheets and dividend records. Much of this work must be done after the Stock Exchanges close each afternoon and be finished before they re-open the next day.

To cope with this demand English Electric Leo provide all-night computer time through the new City office. Similar facilities for processing financial business on computers are available through English Electric Leo offices in Birmingham and Manchester.

Comprehensive suites of programmes have also been developed to cope with share registration, dividend, annual returns, address lists, rights and bonus issues and debenture draws. English Electric pioneered the use of computers for debenture redemption drawings and have used them to make drawings of their own debenture stock. The whole operation, including the drawing of lot numbers, is completely processed by computer.

Time is now being used on English Electric Leo computers by nine firms to keep nearly 750,000 separate share registration accounts.

P.O. Data Transmission Service

A telegraph private circuit service which will transmit data to and from computers at 14 characters per second—twice the existing rate—is shortly to be introduced by the Post Office. The cost of this service will be only about one-third more.

Data can already be transmitted over Post Office telex and private telegraph circuits at about 7 characters a second. All these services are being grouped and will be known as Datel 100 Service.

Next year facilities for data transmission over telephone circuits up to 150 characters per second will be supplemented by the provision of a new Data Set No. 1A for the modulation of signals. This service will then be known as Datel 600 Service.

Other Datel services planned for the future are Datel 200 and Datel 300 which, respectively, will provide facilities for two-way data transmission at up to 25 characters per second and one-way data collection at up to 20 characters per second. Further additions to the range of Datel Services will be made as the need arises.

Remotely-Controlled Signalling for British Railways

Electronic remote control equipment for signalling has been ordered from Hawker Siddeley Dynamics' Industrial Electronics Division for British Railways' modernization scheme at Stoke-on-Trent, after the successful operation of a trial installation at Thorpe-le-Soken, near Clacton.

The new system remotely controls the signals, avoiding long runs of expensive cables incorporated in the traditional signalling systems. Only four small connecting wires at the side of the track are needed by the transistorized equipment, which is completely self-contained. Up to 250 control or indication signals can be sent in both directions at the same time over a range of ten miles without repeaters.

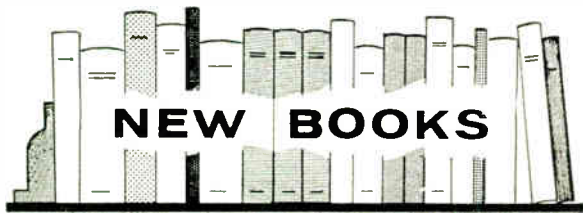

E.E.A. Guide for a Method of Measuring the Solderability of Round Wires

Pp. 26. Published free of charge by The Electronic Engineering Association, 61 Green Street, London, W.1.

This guide has been published by the E.E.A. to meet the need for a precise and objective method of assessing the solderability of round wires and component terminations, in order to meet the more exacting requirements of printed wiring as well as conventional circuit wiring.

In 1962, the E.E.A. were requested by the B.S.I. to carry out some work on this subject with a view to providing a revised draft of Test T-Soldering, for inclusion in JEC Publication 68. A few years previously a new method had been described in the *Philips Technical Review* by Mr. ten Duis (Vol. 20 (1959) pp. 158/161).

It became evident that some redesign of the Philips test apparatus was necessary in order to achieve more reliable test results. The working party therefore modified the apparatus, and the reproducibility of test results achieved by the E.E.A. method is now most satisfactory.

The working party have produced the final report covering this phase of their task, and this, together with the proposed test methods and drawing of the apparatus have been put into this E.E.A. guide.

The Technique of Sound Reproduction

Loudspeakers by E. J. JORDAN. Pp. 227. Price 42s.

Radio Reception by H. HENDERSON. Pp. 250. Price 42s.

Amplifiers by H. LEWIS YORK. Pp. 254. Price 42s.

Tape Recording and Reproduction by A. A. MCWILLIAMS. Pp. 287. Price 42s. Focal Press Ltd., 31 Fitzroy Square, London, W.1.

These books are from a series of six in which the other two cover acoustics and disc recording and reproduction. They are intended for those interested in high-quality reproduction of speech and music. The treatment is largely descriptive but a little simple algebra is used at times.

Théorie et Technique de la Transmission Télégraphique Vol. 1 Théorie by R. ROQUET. Pp. 254. Editions Eyrolles, 61 boulevard Saint-Germain, Paris Ve. Price F40.65.

The Physics of Magnetic Recording

By C. D. MEE. Pp. 270 + xv. North-Holland Publishing Co., 68-70 N.Z. Voorburgwal, Amsterdam, The Netherlands. Price 60s.

This is Vol. 2 of a series of monographs on selected topics in solid-state physics. After the introductory chapter there are two on the magnetic-recording process, one dealing with a.c. bias and the other with zero and unidirectional bias. One on the reproducing process follows and then come two on magnetic tape, in one of which theory is covered and in the other the preparation and properties of tape. The final chapter deals with experimental recording techniques.

The treatment is largely descriptive. Mathematics are employed wherever necessary but are by no means overdone. The book is well illustrated.

Dictionnaire Générale d'Acoustique et d'Electroacoustique

By HENRY PIRAUX. Pp. 329. Editions Eyrolles, 61 boulevard Saint-Germain, Paris Ve. Price F50.80.

This book actually falls between a dictionary and an encyclopaedia. The terms included are arranged alphabetically and are followed by an explanation of their meaning; these explanations range in length from a single line to several pages, and sometimes include graphs, circuits or photographs. At the end of each item is given the equivalent English term.

One of the longest entries is under 'Caractéristiques des tubes électroniques'. It occupies four pages and includes eight graphs.

The coverage of the book is wider than its title would imply for there is a great deal in it about amplifiers and electronic circuits generally. There is even a reference to sensitometry.

Vacuum Technology

By ANDREW GUTHRIE. Pp. 532 + xii. John Wiley & Sons Ltd., Glen House, Stag Place, London, S.W.1. Price 94s.

The various forms of vacuum pump and the measurement of pressure and pumping speed form the major part of this book. The properties of vacuum materials, cleaning and fabrication techniques are also treated, and there are chapters on very-high and ultra-high vacuum systems, and on the finding and repairing of leaks.

Mesures Electriques et Electroniques

By JACQUES THURIN. Pp. 445. Editions Eyrolles, 61 boulevard Saint-Germain, Paris Ve. Price F54.65.

Problèmes d'Electronique

By ROBERT GUILLIEN. Pp. 430 + xxi. Editions Eyrolles, 61 boulevard Saint-Germain, Paris Ve. Price F77.80.

Digital Magnetic Recording

By ALBERT S. HOAGLAND. Pp. 154 + x. John Wiley & Sons Ltd., Glen House, Stag Place, London, S.W.1. Price 60s.

As its title implies this book deals with the magnetic recording of pulses with especial reference to computer storage devices. It is a serious book and there is a good deal of mathematics, which includes vector analysis.

Magnetohydrodynamic Generation of Electrical Power

Edited by R. A. COOMBE, Ph.D., M.A., M.Sc. Pp. 207 + viii. Chapman & Hall Ltd., 11 New Fetter Lane, London, E.C.4. Price 30s.

This book is based on a series of lectures given at the Royal College of Advanced Technology, Salford, towards the end of 1962. It is intended that a non-specialist, starting without previous knowledge of the subject, may by its end be able to read and understand the latest research papers.

The early chapters give a good general description of the subject and are easy reading. In chapter 4, however, the mathematical development starts and from then on close study is needed.

Etude des Circuits Electriques Vol. 2 : Regimes de Fonctionnement

By JEAN LAGASSE. Pp. 301 + xi. Editions Eyrolles, 61 boulevard Saint-Germain, Paris Ve. Price F52.70.

Einführung in die Anwendung moderner Rechenautomaten

By H. BUHLER. Pp. 143. Birkhauser Verlag, Basel, Switzerland. Price SF23.

Manufacturers' Literature

Microfile Catalog: Sage Microwave Components. Sage Laboratories has introduced a completely new concept in component catalogues. The new 'Microfile' is a concise, factual and easy-to-use card-file. This first edition presents 90 pages of complete product data on quick-reading $4 \times 7\frac{1}{2}$ in. file-cards. Text on each product data card is limited to 50-100 word summaries. Detailed product data is presented via tables, curves and drawings. Data cards describing Sage's complete line of coaxial and waveguide components, packages and subsystems constitute the bulk of the catalogue. Also included are conversion factors and formulae, technical discussions, a brief description of Sage's facilities and R & D capabilities, and a section for notes and memoranda. The data cards are contained in a black and green leatherette case.

Sage Laboratories, Inc., 3 Huron Drive, East Natick, Massachusetts, U.S.A.

For further information circle 57 on Service Card

Nickel Plating from Sulphamate Solutions. The first important commercial application of nickel plating from the sulphamate solution occurred in 1950. The main advantages claimed for nickel plating produced from the sulphamate bath are the low internal stress in the deposit and the high rates of deposition. These features are particularly valuable in electroforming. Research work into the process has been undertaken in a number of countries and one of the leading scientists in this field in the U.K. is R. A. F. Hammond, former head of the Electro Deposition Section of the Royal Armament Research and Development Establishment. His latest work on the subject, 'Nickel Plating from Sulphamate Solutions' has been published as a 24-page booklet. In this he reviews the development of the process, its applications and gives recommended solution compositions. Equipment and operating conditions are dealt with, together with the structure and properties of sulphamate nickel deposits, applications involving fatigue strength and the throwing power of the nickel-sulphamate bath. Graphs, diagrams and tables illustrate the publication.

The International Nickel Company (Mond) Ltd., 20 Albert Embankment, London, S.E.1.

For further information circle 58 on Service Card

Oxide Batteries for Light Electrical & Electronic Applications. Technical data on 71 dry batteries and 14 portable lead-acid types is set out in this 10-page brochure. The information is presented in tabular form to enable designers to select quickly the right battery for their purpose.

Chloride Batteries Ltd., 50 Grosvenor Gardens, London, S.W.1.

For further information circle 59 on Service Card

Lectromec Control Equipment. Programme controllers, automatic timers, voltage and frequency sensing units, and ancillary control equipment are all described by 10 leaflets contained in a stiff-backed folder.

Lectromec Engineering Ltd., 77 Peascod Street, Windsor, Berks.

For further information circle 60 on Service Card

Westool Have Textile Machinery Under Control. In 8 pages, this brochure gives details of the Westool electrical components and controls which are available for textile machinery.

Westool Ltd., St. Helen's Auckland, Bishop Auckland, Co. Durham.

For further information circle 61 on Service Card

Levick 'Magnematic' & 'Limpet' Permanent Magnet Devices. A standard range of magnetic separators, supporting pots, sheet rifflers, lifters with release and sweepers is included in this 8-page fold-out brochure.

Swift Levick & Sons Ltd., Clarence Steel Works, Leveson Street, Sheffield 4.

For further information circle 62 on Service Card

G.E.C. Thyristor-Controlled Variable Speed Drives $7\frac{1}{2}$ -75 h.p. This 6-page publication RCD 132 describes recently-introduced variable speed drives. It covers constant-torque d.c. motors from $7\frac{1}{2}$ to 75 h.p. Designed for 400/440 V three-phase 50 c/s supplies, the units have a maximum output of either 400 or 460 V and provide a range of speed control greater than 20 : 1.

G.E.C. (Engineering) Ltd., Rectifier & Control Engineering Division, Birmingham 6.

For further information circle 63 on Service Card

Catalog of Semiconductor Devices from Crystalonics. In this short-form, 8-page catalogue the entire range of Crystalonics' semiconductors is briefly described. Key parameters for hundreds of silicon devices are included and it covers field-effect transistors, p-n-p amplifiers, choppers, p-n-p differential amplifiers, integrated choppers, etc.

Crystalonics, Inc., 147 Sherman Street, Cambridge 40, Mass., U.S.A.

For further information circle 64 on Service Card

Berco CVS Continuous Voltage Stabilisers. A 4-page leaflet which lists details of a range of single- and three-phase, mains-voltage stabilizers. The single-phase units range in capacity from 0.8 to 20 kVA and the three-phase units from 2.4 to 147 kVA. These stabilizers provide a high-speed correction action of up to 85 V/sec.

The British Electric Resistance Co. Ltd., Queensway, Enfield, Middlesex.

For further information circle 65 on Service Card

English Electric Hydrogen Thyratrons. This 50-page booklet is a useful guide to all users and potential users of hydrogen thyratrons. Fifteen of the 50 pages are devoted to the characteristics of the English Electric range of tubes. The remaining 25 pages are devoted to basic information on hydrogen thyratrons such as 'definition of terms' and 'operating notes on tubes'.

English Electric Valve Co. Ltd., Chelmsford, Essex.

For further information circle 66 on Service Card

Optica Grating Spectrophotometers. Four basic instruments and a number of attachments are specified and illustrated in this 6-page leaflet. Each of the instruments cover the u-v, visible and near infra-red regions of the electromagnetic spectrum and give linear dispersion and high resolution throughout their working range.

Optica United Kingdom Ltd., Higham Lodge, Blackhorse Lane, Walthamstow, London, E.17.

For further information circle 67 on Service Card

STL Image Converter Cameras. An ultra high-speed image converter camera is described in this 21-page catalogue, No. 0164. Designed for experimental studies in plasma physics, ballistics, etc., this camera can resolve luminous signals of sub-nanosecond periods.

Photographic Instrumentation Ltd., Chipperfield, King's Langley, Herts.

For further information circle 68 on Service Card

INFORMATION WANTED ?

If you require further details of products or processes described or advertised in INDUSTRIAL ELECTRONICS you will find it convenient to use the enquiry cards which will be found in the back of the journal. The sheet of cards can be folded out to enable you to make entries while studying the editorial and advertisement pages.

YOU NEED ONLY HAVE PHONED SIR!



If you're in a tearing hurry for those vital components, no need to panic. Sasco have the widest range of components available instantly. Connectors, Semiconductors, and other Components; products of over 33 leading electronic component manufacturers. *A Products List is available on request.*

SASCO

Stewart Aeronautical Supply Co. Ltd.

P.O. Box 20, Gatwick Road, Crawley, Sussex.

Tel: Crawley 28700.

Telex No. 87131 Cables: SASCO, Crawley, Telex.

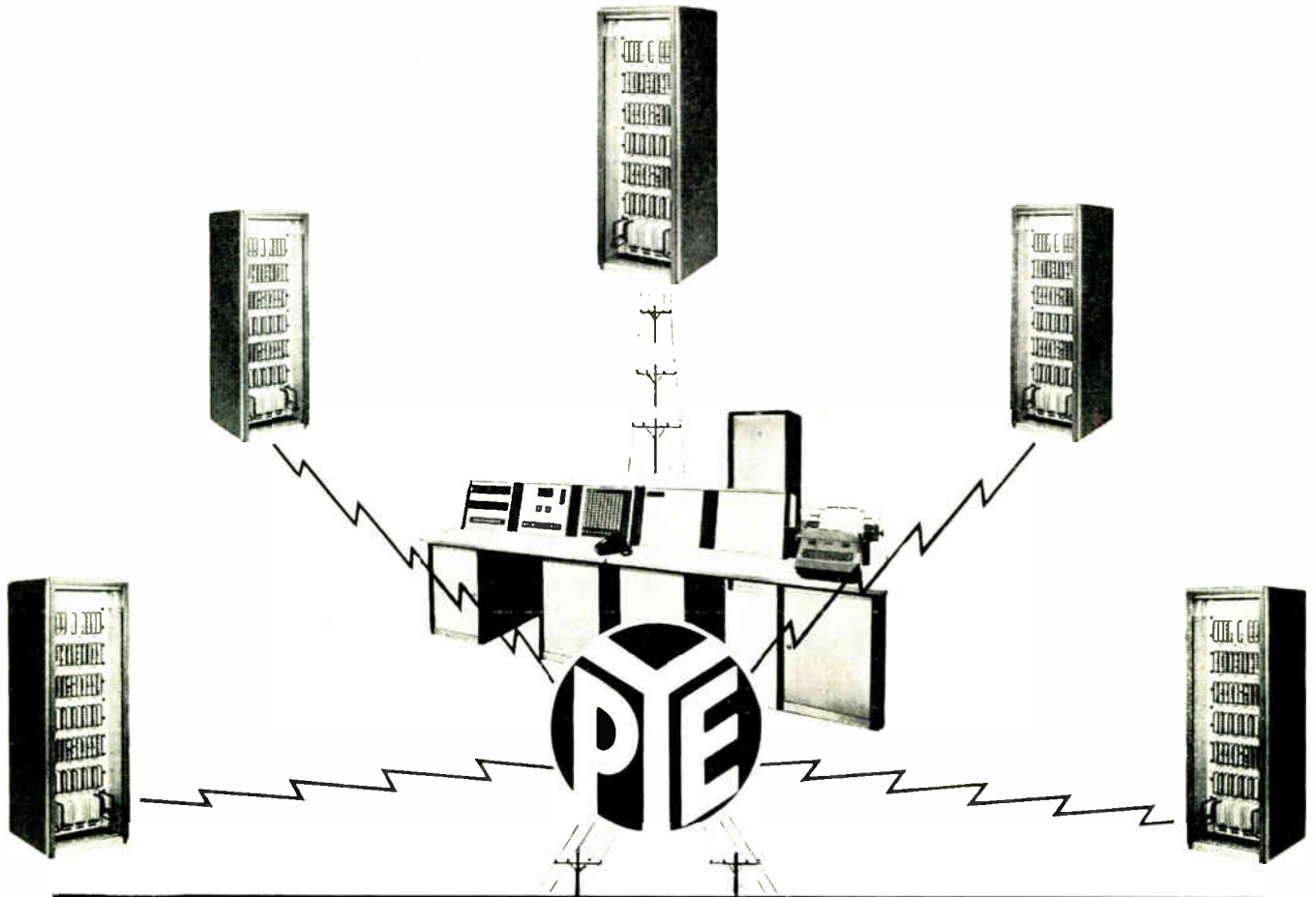

TELEMETRY SYSTEMS

for industries including:

**GAS · WATER
ELECTRICITY
PETROLEUM
CHEMICAL**

Pye Telemetry Systems are flexible in application and are used in Industry for monitoring and control of equipment located in remote or hazardous areas. They may be used for measurements, controls, alarms and surveillance of distant equipment over radio links or telephone lines

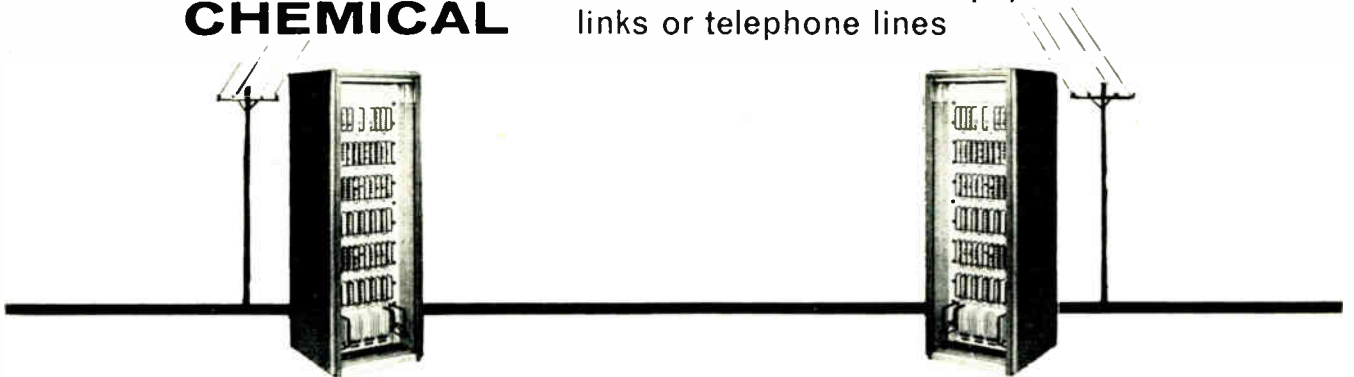

**PYE TELECOMMUNICATIONS LTD.
CAMBRIDGE ENGLAND**

Telephone: TEVERSHAM 3131

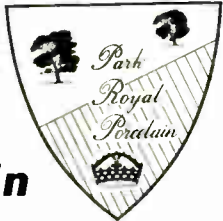

Porcelain
Steatite

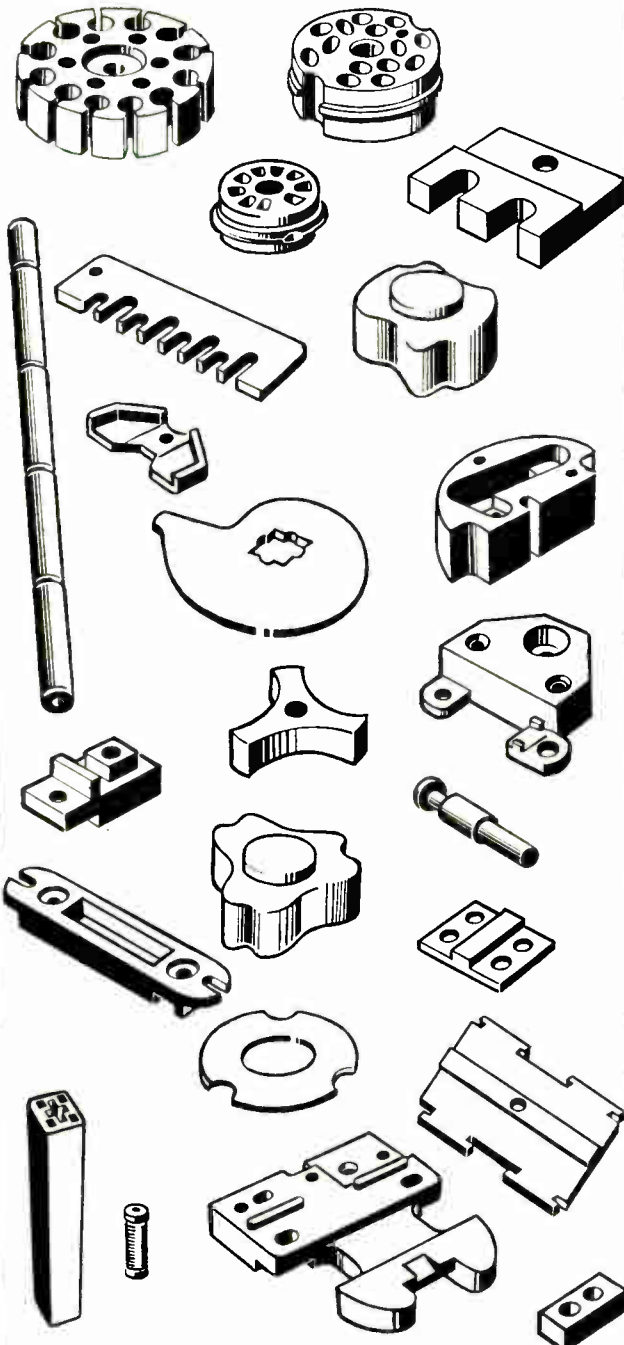

V. G. PORCELAIN CO LTD

GORST ROAD
PARK ROYAL
LONDON, N.W.10

Telephones:
ELGAR 1411/7
Telex:
London 25589

WHITELEY

**waterproof plugs
and sockets**

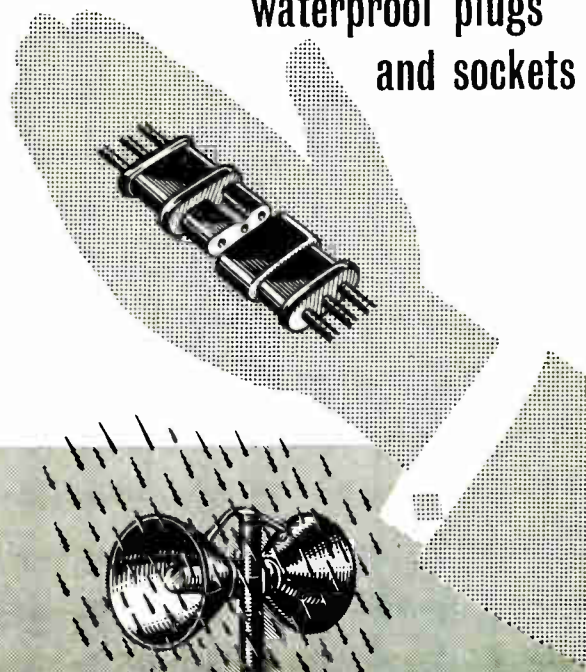

Specially designed for use in underwater junctions and in positions exposed to the weather, Whiteley waterproof Plugs and Sockets are moulded in Alkathene in single, double or triple units. Special types can be quickly supplied to order.



WHITELEY Alkathene Control Knobs

A very wide standard range of Whiteley Alkathene-moulded Control Knobs is available. Normally grey, they can be moulded in other colours if required. Most fit $\frac{1}{4}$ " dia. spindle but others are available for $\frac{1}{8}$ " or $\frac{5}{16}$ " dia. spindles.

*Please write for full details of
Waterproof Plugs and Sockets,
and of Control Knobs to*

WHITELEY

ELECTRICAL RADIO CO LTD

MANSFIELD · NOTTS Tel: Mansfield 1762/5

For further information circle 237 on Service Card

Rotary Magnetic Latching



Latchmaster Magnets
(enlarged)

Latchmaster Pole piece

ACTUAL SIZES

Technical personnel are available for immediate consultation upon the use and application of these materials.



SPERRY Latchmaster Relay

Murex magnets and iron pole pieces are used on the Sperry Latchmaster miniature Relay. Maintenance of limits down to ± 0.0005 " on the machined magnet and ± 0.002 " on the unmachined iron and consistent performance are absolutely essential for the successful operation of this Relay. The high standard set by Sperry is rigidly maintained by the Murex components. More detailed information on our materials, together with design data and a list of standard shapes and sizes currently available, can be provided on request.

MUREX LTD · RAINHAM · ESSEX
(Powder Metallurgy Division)

London Sales Office: CENTRAL HOUSE · UPPER WOBURN PLACE · WCI

Telephone: Rainham, Essex 3322 Telex 28632

Telegrams: Murex, Rainham-Dagenham Telex

Telephone: EUSon 8265

For further information circle 238 on Service Card

METWAY PRODUCTS

Steel Black Enamelled

ADAPTABLE BOXES

45 STANDARD SIZES
Any Size Made to Order

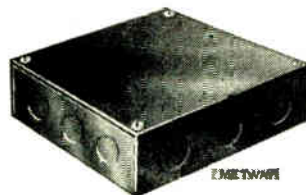

- Standard or heavy duty
- Flanged or Flat covers

- With Knockouts
- Without Knockouts



Galvanized Flexible METALLIC TUBING

Sizes 3.16" to 2"

Watertight. Non-Watertight.

BRASS ADAPTORS

For Flexible Tubing

- Male conduit to female flexible
- Female conduit to female flexible

- Write for list 130/133/1E



METWAY · KEMP TOWN · BRIGHTON 7

For further information circle 239 on Service Card

OXLEY DEVELOPMENTS CO. LTD

OXLEY

SUBMINIATURE AIR DIELECTRIC TRIMMERS

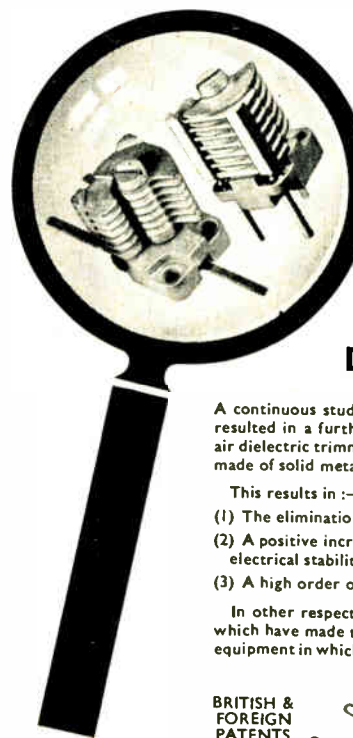

A continuous study in the laboratory and in the field has resulted in a further development in Oxley subminiature air dielectric trimmers, the rotor and the stator both being made of solid metal.

This results in:—

- (1) The elimination of practically all soldered joints.
- (2) A positive increase in mechanical rigidity and improved electrical stability.
- (3) A high order of consistency in capacity.

In other respects the trimmers retain all those facilities which have made them the inevitable choice of professional equipment in which reliability is the dominant requirement.

BRITISH & FOREIGN PATENTS

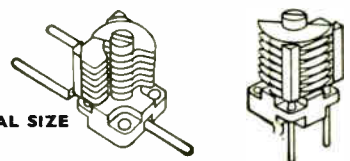

ACTUAL SIZE

Write for technical details of these and other Oxley products
OXLEY DEVELOPMENTS CO. LTD., ULVERSTON, LANCASHIRE

There's a Thorn

LOW COST LEVEL CONTROLLER

for every industrial application

- CAPACITANCE, CONDUCTIVITY, RADIOISOTOPES and ULTRASONICS for high and low level switching in tanks and bulk containers.
- CAPACITANCE and SERVO MECHANISM for continuous level indication.

A wide selection of electrodes is available for use with each type to cover the maximum possible range of problems—the measurement of liquids and semi-liquids, including acids, oils and corrosive additives; powders and granular free-flowing materials; bulky solids; and 'difficult' materials involving extreme temperature and pressure, including molten glass, strong glues and adhesives, liquified gases, coarse solids, materials in moving conveyors and catalysts in catalytic cracking plants.

Thorn offers today's widest and most versatile range of low-cost level controllers. Each is a precision electronic instrument—robust, stabilised against mains variations, designed to give completely dependable service under all industrial conditions.

Technical Service

The Thorn service includes technical advice and assistance on every aspect of bulk measurement and level control.

THORN ELECTRONICS LIMITED

Wellington Crescent
New Malden, Surrey. Tel: MALden 8701

A MEMBER OF THE THORN ELECTRICAL INDUSTRIES GROUP OF COMPANIES



Thorn Electronics Limited

TE46

For further information circle 243 on Service Card



CERBERUS

GK 11 electronic touch button

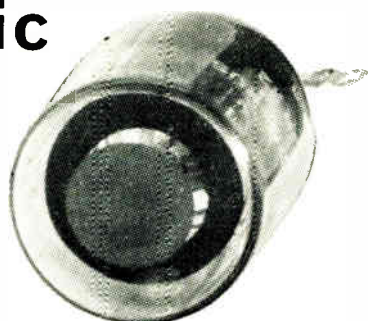

cold cathode relay tube
controlled by touching
external electrode
visual indication
supply voltage: 220 V. D.C.

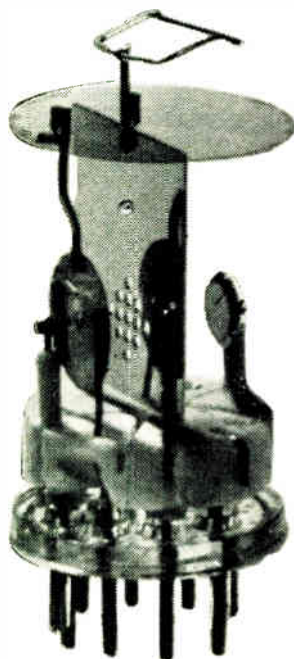

GT21 glow thyatron

cold cathode
thyatron
control voltage:
5 volts
(suitable for use
with transistor
drivers)

supply voltage:
180 to 250 V. A.C.
or
250 to 350 V. D.C.

WALMORE ELECTRONICS LTD

11-15 BETTERTON STREET, DRURY LANE
LONDON, W.C.2

Telephone: TEMple Bar 0201-5

For further information circle 244 on Service Card

**PROMPT
DELIVERY**

Many Types
Ex Stock

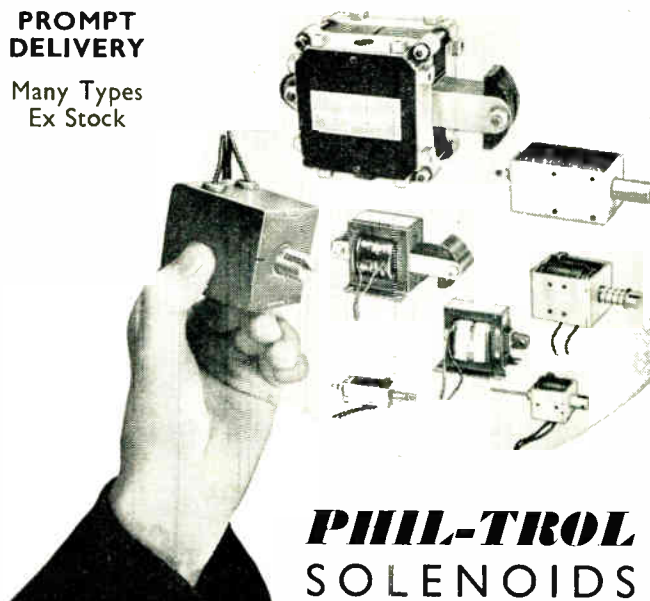

PHIL-TROL SOLENOIDS

NEW! We are now able to offer Types 38, 39, 40 and 35, 36 and 37 solenoids in encapsulated versions suitable for exposed positions and with fully protected coils. We can also supply these solenoids with chromium plated and polished plungers for more rigorous conditions.

Send for full details and copy of pamphlet 108A.

The Phil-trol range of solenoids goes from miniatures to extra strong power types in both AC and DC versions.

PHILLIPS CONTROL (G.B.) LTD.

Dept. K.7, Farnborough Road, Farnborough, Hants

Telephone : Farnborough 1120

Grams & Cables : Philtrol, Farnborough, Hants

For further information circle 245 on Service Card

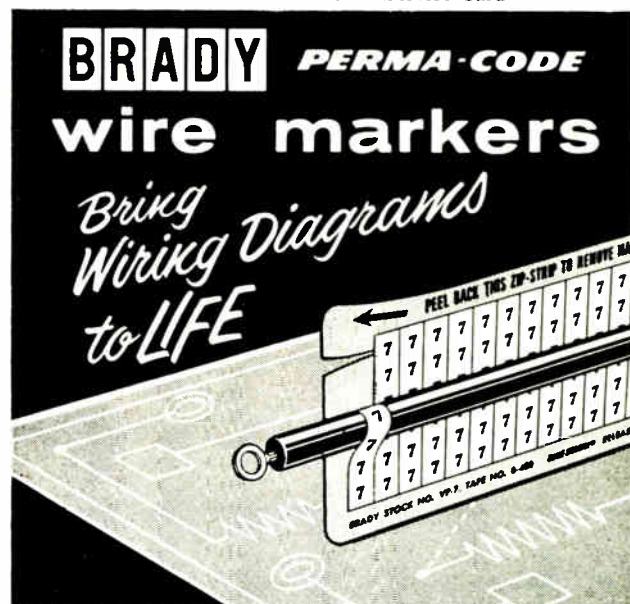

Brady self-sticking Wire Markers tell which wire goes where, permanently . . . *directly*. The number on the wire list is the number on the wire. No confusing colors and tracers to convert. Brady stocks thousands of standard legends in five different sizes — four job-tested materials. Dispenser card mounted for fast application.

Write for new bulletin and testing samples. **FREE!**

W. H. **BRADY**

Manufacturers of Quality Pressure-Sensitive Industrial Tape Products, Self-Bonding Nameplates, Automatic Machines for Dispensing Labels, Nameplates, Masks and Tape.

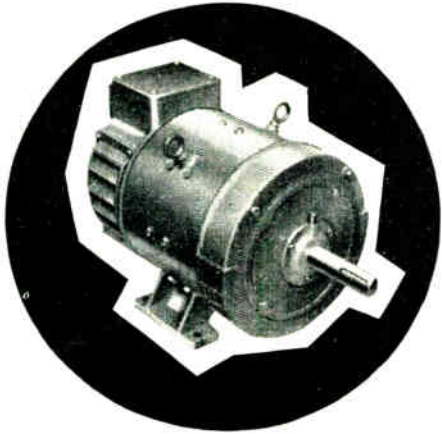

'X' type D.C. motors, $\frac{1}{4}$ - 40 h.p.

**You can't say DEPENDABLE
without EPE**

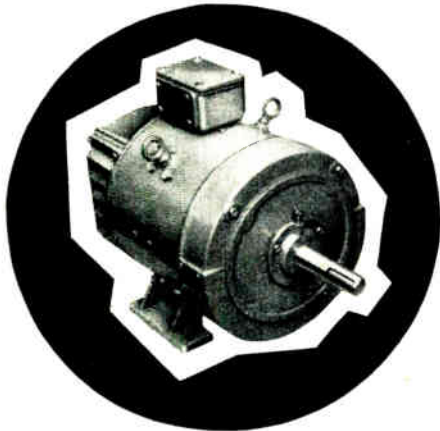

'Y' type D.C. motors, $\frac{1}{4}$ - 40 h.p.

D.C. Motors for electronic speed control



THE ELECTRICAL POWER ENGINEERING CO. (B'HAM) LTD.
EPE WORKS, BROMFORD LANE, BIRMINGHAM 8
Telephone: SEchford 2261
Grams: Torque Phone, Birmingham



RAYSISTOR[®]

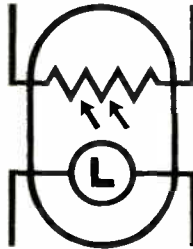

The RAYSISTOR consists of a light source and a photocell assembled in one package. Changes in input to the light source vary the light output and hence change the resistance of the photocell. The input and output are electrically isolated.

Features

- Wide dynamic range
- Noise-free control of AC or DC
- No moving parts
- Rugged
- Long life

Typical Applications

- A.G.C.
- Choppers
- Variable resistor
- Switch or Relay
- Voltage or signal isolator
- Phase shifter

Brief Characteristics

- Output resistance—OFF: 10^7 to $10^8\Omega$
- ON: 10^2 to $10^3\Omega$

There are two main types:

- Neon Lamp—control voltage: 1-25 volts
- typical switching times: ON: 10 m.sec
- OFF: 60 m.sec

Incandescent Lamp

- control voltage: 120-150 volts
- typical switching times: ON: 10 m.sec
- OFF: 300 m'sec

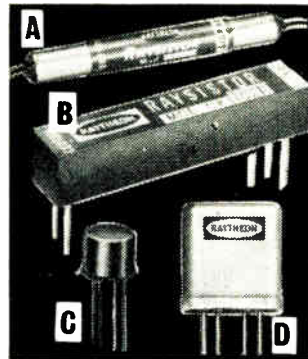

- A Cylindrical
Length 2.25"
Diameter 0.28"
- B Printed Circuit
Package
1.94" x 0.42" x 0.375"
- C TO-5 can
- D Crystal Holder

WALMORE ELECTRONICS LTD

11-15 BETTERTON STREET, DRURY LANE
LONDON, W.C.2
Telephone: TEMple Bar 0201-5

CLASSIFIED ADVERTISEMENTS

FULLY DISPLAYED : 50/- per single column inch.
SEMI-DISPLAYED : 35/- per single column inch.
RUN-ON : 3/6 per line of approximately 7 words.
Where an advertisement includes a Box Number Is. extra.
SERIES DISCOUNTS : 12 insertions, 15%.
Remittances payable to "Industrial Electronics".

Copy is required by 20th of the month for insertion in the next issue. If proofs of displayed classified are wanted by 15th of the month.

Address to :
Classified Advertisement Dept.
Industrial Electronics
Dorset House, Stamford St., London, S.E.1.

SITUATIONS VACANT

PROJECT ENGINEERS DEVELOPMENT ENGINEERS

Ultra Electronics Limited have vacancies for Engineers to work on the design of data processing and calculating instruments using advanced digital techniques. Applicants should have a degree or an H.N.C. and previous experience in pulse and logical circuits using transistors. They will also be required to exercise initiative and take full responsibility for the technical design of equipment to production standard. These positions carry a competitive salary and above average conditions of employment. Please write giving salient details of your career to:—

**The Personnel Officer,
ULTRA ELECTRONICS LIMITED,
Western Avenue, London, W.3.**

310

ELECTRICAL ENGINEERS

with power engineering experience

—an important job with travel throughout the U.K.

Are you a power engineer? Are you familiar with the installation of medium voltage machinery in industry of H.M. Forces? Then this important new job could be yours.

I.C.T. are looking for power engineers, to advise on site preparation for second generation computers throughout the U.K. (knowledge of air conditioning or ventilation systems would be an advantage). Knowledge of electronics is not required as you will be specially trained for this work.

After training, on full pay, you will be based in Letchworth, Hertfordshire.

Salary depends on your qualifications, but will initially be not less than £1,000 p.a. Prospects of advancement with this company are excellent. We offer generous holidays, sick pay and retirement schemes.



Write now for further information and your application form.

Personnel Section

Field Engineering Division

INTERNATIONAL COMPUTERS AND TABULATORS LTD.

85/91 Upper Richmond Road, Putney, London S.W.15

308

3

EXCELLENT POSTS IN THE RADIO MAST AND AERIAL FIELD

Coubro & Scrutton Ltd. are moving to new premises and require the following additional staff for their expanding Radio Mast and Aerial Division.



AERIAL PROJECT ENGINEERS with good knowledge of radio propagation and preferably with a degree or equivalent qualifications and experience in the field as installer or engineer at a major centre. Work will include preparation of tenders for aerial projects and may involve visits to overseas sites.

MECHANICAL ENGINEERS for design and development work on HF aerials and associated masts and towers. Applicants with A.M.I.Mech.E. or equivalent qualifications preferred.

DESIGNER DRAUGHTSMEN who should be of HNC standard and should preferably have experience in mast or tower design.

All posts offer good prospects and attractive salaries.

APPLY in writing, giving details of age, qualifications and previous experience to the Manager, Radio Division, Coubro & Scrutton Ltd., 11 West India Dock Road, London, E.14.

[312]

TOOL DESIGNERS

wanted for medium sized firm of Instrument Manufacturers for work on press tools and for special purpose assembly jigs and fixtures. Modern factory. Five-day week. Good prospects. Apply:

LEEDS & NORTHRUP LTD.

Wharfedale Road, Tyseley

Tel.: ACO 6171

[313]

TEST ENGINEERS

Applications are invited from Senior and Junior Test Engineers with experience of transistor circuits.

These posts provide unique opportunities to join a dynamic young company which has already gained a prominent position in the field of digital instrumentation.

WEEKEND & EVENING INTERVIEWS by appointment. Write or telephone Mr. K. Daniels



DIGITAL MEASUREMENTS LIMITED
SALISBURY GROVE, MYTCHETT
ALDERSHOT, HANTS TEL: FARNBOROUGH 3551

304

G.K.N. GROUP RESEARCH LABORATORY

ELECTRICAL ENGINEER (or PHYSICIST) for INDUSTRIAL INSTRUMENTATION and CONTROL

A young project engineer is required to tackle a wide range of interesting problems throughout a large engineering, steelmaking, rolling and metal-forming Group of companies.

He will be concerned with the development or application of new instruments to measure and control production processes. Current projects include, for example, infra-red measurement of shape and form of hot metal, and instrumentation of hot-rolling mills. A considerable amount of freedom will be given to the individual to develop his own ideas from initiation of a project to final completion in a works.

Applications are invited from graduates with an Honours Degree or Diploma in Technology in Electrical Engineering (or Physics with relevant post-graduate experience) who are interested in the challenge of applying modern technology to an established industry.

Conditions of employment and prospects are good: terms include contributory pension and life assurance schemes.

Please write, in confidence, including details of age, education, qualifications and experience to the:

PERSONNEL OFFICER

G.K.N. GROUP RESEARCH LABORATORY
BIRMINGHAM NEW ROAD
LANESFIELD, WOLVERHAMPTON 303

LOUIS NEWMARK LTD.
CROYDON

ELECTRONIC & ELECTRICAL ENGINEERS & ASSISTANT ENGINEERS

Applications are invited to fill vacancies in the Research and Development Department of the Aircraft Division.

Minimum requirements are:

Age: between 22 and 35.

Engineering degree or H.N.C. in Electronics or Electrical Engineering. Approximately 5 years' experience of either:

- (1) Electronic circuit design or development of electronic or light electrical equipment, or
- (2) Control Systems and/or analogue computers preferably with some experience in the Aircraft Industry.

Applications, giving details of your career, should be addressed to:

Mr. A. G. R. Stainer
Research and Development Dept.
Louis Newmark Ltd.
Vulcan Way
New Addington, Croydon, Surrey

311

ELECTRONIC ENGINEERS

for design and development of flux sensitive devices or miniature electronic components and associated test equipment. The successful candidates must be capable of carrying a project through to the production stage and establishing quality control techniques. 5-day week. Canteen facilities. 1st-class pension scheme. Apply in writing to Personnel Manager, Ancillary Developments Ltd., Ancillo Works, Surrey Ave., Camberley, Surrey. [315]

SCRAP METAL

Non-ferrous Scrap Metals, all grades, Swarf, Off-cuts, etc., purchased at highest rates.

H. Barnett Ltd.,
Victor Road, London, N.7.

Est. 1865

ARChway 5461

[307]

ARTICLES FOR SALE

PHOTO-ELECTRIC CONTROLS

for industry

Quick delivery

Send for Catalogues

Hird-Brown Limited

Flash Street, Bolton, Lancs.
Tel. 27311

[305]

Nameplates, engraving, diesinking, stencils.—Stilwell & Sons Ltd., 153 Far Gosford Street, Coventry.

[309]

TELEVISION ENGINEER

Uganda

Applications are invited from candidates preferably under 45, with wide experience in all types of Broadcasting Television equipment including television transmitters, antenna and television studio equipment. Preference will be given to candidates with technical qualifications in Television Engineering. Duties include day to day responsibility for technical operation and maintenance of television equipment of National Television Service, and to assist in the installation of such equipment.

The appointment will be for one or two tours each from 21-27 months in the first instance with a salary in the range of £1,287 p.a. to £1,956 p.a. plus a gratuity of 25% of total emoluments. Free family passages. Free medical attention and furnished quarters provided at moderate rentals. Generous leave and children's education allowance.

Apply to

Appointments Officer

Room 301, Department of Technical Co-operation

Eland House, Stag Place, Victoria, S.W.1

giving full name, age and qualifications and quoting RC 237/153/05. 301

VACANCIES IN ELECTRONICS

Dawe Instruments, the Manufacturers of Precision Electronic Equipment, have vacancies for the following Technical Staff:—

FIELD SERVICE ENGINEER

Based in the London Area with occasional travel to other parts of the country. Applicants must have a good Electronics background and be able to converse freely with customers at varying levels.

FAULT FINDER/TEST ENGINEER

For work on a variety of instruments including sound level and vibration meters, Stroboscopes, Oscilloscopes and other laboratory equipment. Previous experience of similar equipment or service in a technical branch of the Forces preferred.

All the posts carry full staff status including sickness benefits, participation in the Company pension scheme and other welfare benefits as well as good salaries.

Apply in writing to the Personnel Manager.

DAWE INSTRUMENTS LTD.
WESTERN AVENUE, ACTON, W.3

[316]

ELECTRONICS TECHNOLOGY INSTRUCTORS

required by

SASKATCHEWAN TECHNICAL INSTITUTE
MOOSE JAW, SASKATCHEWAN

SALARY RANGES: \$6,972-\$7,836 per annum (without Teaching Certificate)
\$7,248-\$8,808 per annum (with Teaching Certificate)

REQUIREMENTS: Bachelor's Degree in Electrical Engineering, including special training in Electronics and/or Mathematics. To instruct in a two-year post-high school electronics programme in one or more of the following fields: semi-conductor electronics; instruments; servo-mechanisms; communications; U.H.F. and microwave.

BENEFITS: Three weeks' holiday, three weeks' accumulative sick leave allowance annually with pay, excellent pension and group life insurance plans and other benefits.

APPLICATIONS: Forms and further information available at Public Service Commission, Legislative Building, Regina, Saskatchewan. Interested persons should refer to File No. 9006. Appointments will be made as soon as qualified applicants are obtained.

317

ARTICLES WANTED

Following back numbers of Industrial Electronics. Volume 1 numbers 1 to 3 inclusive. Replies to Mrs. Marian C. O'Donnell, Principal Librarian, San Francisco Public Library, Civic Center, San Francisco 2, California.

[318]

SERVICES OFFERED

Precision Sheet Metal Work for the Radio & Electrical Trade. Chassis, Panels, Brackets, etc. Power Press Capacity up to 100 tons. Press brake capacity up to 105 tons 8ft. x 7/32in. All spray and stove finishes. A.I.D. approved.—The Kaymet Company, Kaymet Works, Sylvan Grove, London, S.E.15. Telephone: NEW Cross 6644.

[306]

CAPACITY AVAILABLE

**WIRING ASSEMBLY AND
DESIGN FACILITIES**

G.P.O. and E.I.D. Approved

Ours is a specialist organisation run and staffed by qualified engineers to meet the design, development and production needs of research groups and industry in an economical and competitive manner.

Our sub-contract wiring and assembly group has acquired a considerable reputation for its quality on both "one-offs" and production runs, as some of Industry's most discerning manufacturers will readily confirm. Come and see why.

DEAKIN PHILLIPS ELECTRONICS LTD.
Tilly's Lane, High Street, STAINES 53777

302

AIRTRONICS LTD.

for coil winding assembly and wiring of electronic equipment, transistorised sub-units, sheet metal work, 4 Ashmead Road, London, S.E.8. Telephone: TIDE-way 2249. [311]

Design/Dev. Prototype and small batch production
SOMERSET ELECTRONICS LTD., Croscombe Wells, Somerset. Shepton Mallet 2219. [314]

**INSTRUMENT
SERVICING
DIVISION**

All types of Electronic, Scientific, and Precision Instruments repaired and overhauled.



BRENSALL ELECTRONICS LIMITED
Charles Street, Bristol 1
Tel: Bristol 28167

For further information circle 248 on Service Card

FOR IMMEDIATE SUPPLY . . .

- VOLTAGE STABILISERS
- DC-AC ROTARY CONVERTORS
- TRANSFORMERS
- RECTIFIERS

WRITE, CALL OR PHONE . . .

UNIVERSAL ELECTRIC MOTOR CO.
(ENFIELD) LTD.
43-47 RIVINGTON ST. · LONDON E.C.2
TEL: SHOREDITCH 8574

For further information circle 249 on Service Card

TRANSMETRIX

*For the highest quality and most rapid service in
DESIGN LAYOUT MANUFACTURE CAPACITY*

PRINTED CIRCUITS

and

WIRING ASSEMBLY

*The expert staff and unique facilities of T.E.S.
can save you TIME AND MONEY.*

Phone: SHANKLIN 3096

TRANSMETRIX ELECTRONIC SYSTEMS LTD.
SHANKLIN · ISLE OF WIGHT · HAMPSHIRE

For further information circle 250 on Service Card

TEXAS TRANSISTORS

**available now
ex-stock from**



QUARNDON ELECTRONICS LIMITED

Slack Lane, Derby. Telephone 46695

Index to Advertisers

Adcola Products Ltd.	25	Oxley Developments Co. Ltd.	28
Anglo-American Vulcanized Fibre Co. Ltd.	14	Phillips Control (G.B.) Ltd.	30
Appointments Vacant	32, 33, 34	Pye Telecommunications Ltd.	24
Aveley Electric Ltd.	17	Quarndon Electronics Ltd.	34
Avery, W. & T. Ltd.	21	R.C.A. (Gt. Britain) Ltd.	16
Brady, W. H. Co. Ltd.	30	Scott, James (Electronic Engineering) Ltd.	10
Brensall Electronics Ltd.	34	Sealectro Ltd.	20
British Insulated Callender's Cables Ltd.	Cover ii	Sigma Instruments Inc.	13
Cannon Electric (G.B.) Ltd.	18	Standard Telephones & Cables Ltd.	8, 9
Cossor Instruments Ltd.	26	Stewart Aeronautical Supply Co. Ltd.	23
Dawe Instruments Ltd.	15	Telegraph Condenser Co. Ltd.	Cover iii
Electrical Power Eng. Co. (B'ham) Ltd., The	31	Thorn Electrical Industries Ltd.	22
Eriesson Telephones Ltd.	6	Thorn Electronics Ltd.	29
Erie Resistor Ltd.	Cover iv	Transmetrix Electronic Systems Ltd.	34
Ferranti Ltd.	3	Universal Electric Motor Co. (Enfield) Ltd.	34
Hughes International (U.K.) Ltd.	7	V.G. Porcelain Co. Ltd.	27
International Rectifier (Gt. Britain) Ltd.	12	Walmore Electronics Ltd.	30, 31
Mallory Batteries Ltd.	11	Wandleside Cable Works Ltd.	19
Metway Electrical Industries Ltd.	28	Welwyn Electric Ltd.	1
Mullard Ltd.	2, 4, 5	Whiteley Electrical Radio Co. Ltd.	27
Murex Ltd.	28		



ANNOUNCE ANOTHER NEW RANGE OF PLAIN AND ETCHED FOIL TANTALUM CAPACITORS

TO SIZES AND VALUES SPECIFIED BY MIL-C-3965B

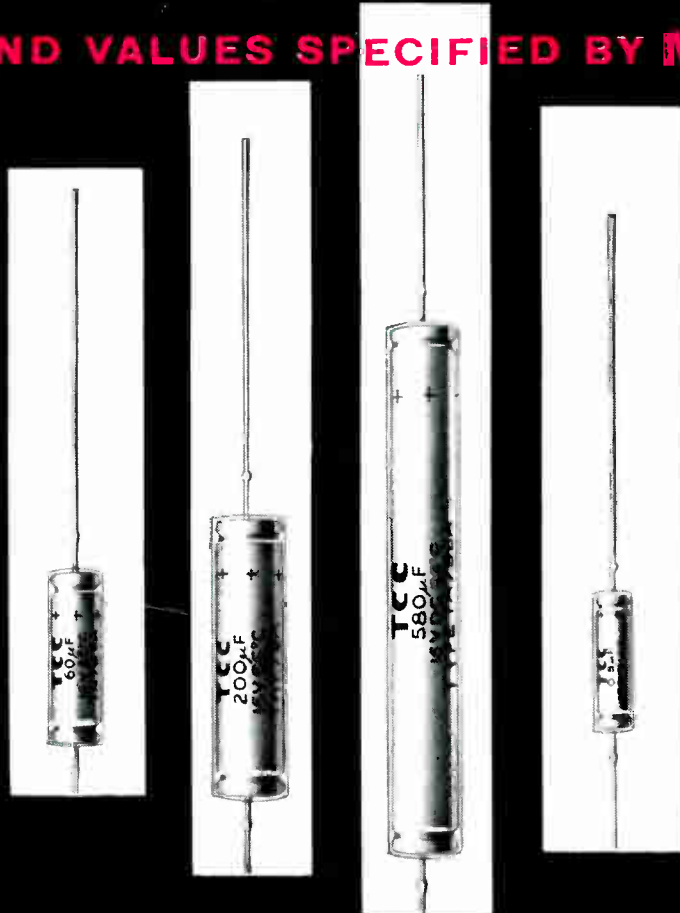

For -55°C to $+85^{\circ}\text{C}$ operation.

These outstanding new capacitors have been specially designed to conform to the case sizes and values required by the U.S. specification MIL-C-3965B. They will immediately function satisfactorily at high temperatures after long dormant periods.

Their very low leakage current makes them possible alternatives to bulkier types, e.g. paper, whilst their small size and great reliability render them specially suitable for

airborne, computer, industrial control and communications equipment. Non-polarised types can be used for certain A.C. applications.

Non-corrosive electrolyte is used, and thus, in the event of leakage due to mechanical damage or to inadvertant overloading, associated equipment will not be affected.

TCC etched foil tantalums have greatly increased capacitance for a given case size and retain the excellent characteristics of the plain foil types.

For full details please write for Technical Bulletin No. 101, and associated Bulletins Nos. 82, 84 and 85.

THE TELEGRAPH CONDENSER CO. LTD.

North Acton, London, W.3. Telephone: ACOm 0081. Telegrams: Telefaraid, Weaphona, London. Telex: 281303
Chessington, Surrey & Balhagale, Scotland

For further information circle 202 on Service Card



ERIE

The
sub-miniature
resistors
with the
GREAT
performance...

Type N6 and N6A
INSULATED HIGH STABILITY
RESISTORS

BRIEF SPECIFICATIONS

STYLE	N6	N6A
Length, maximum	0.359in	0.438in
Diameter, maximum	0.131in	0.162in
Resistance range ohms	10 to 100K Ω	10 to 1M Ω
Wattage rating	$\frac{1}{4}$ Watt 70°C	$\frac{1}{4}$ Watt 70°C
Voltage rating	200V d.c.	200V d.c.

- ★ The world's smallest ceramic insulated resistors.
- ★ Special ceramic case to ensure perfect bonding of carbon film resulting in low inherent noise and excellent life characteristics.
- ★ Special "heavy carbon film" to ensure uniform high standard of stability and reliability throughout resistance range.
- ★ Ceramic encased to ensure maximum protection from mechanical shock and adverse climatic conditions.

The N6 is Defence Approved to DEF 5112A.



Registered Trade Marks

ELECTRONIC COMPONENTS

ERIE RESISTOR LIMITED GREAT YARMOUTH NORFOLK Telephone 4911 Telex 1720