

INDUSTRIAL ELECTRONICS

APRIL 1964 5s 0d

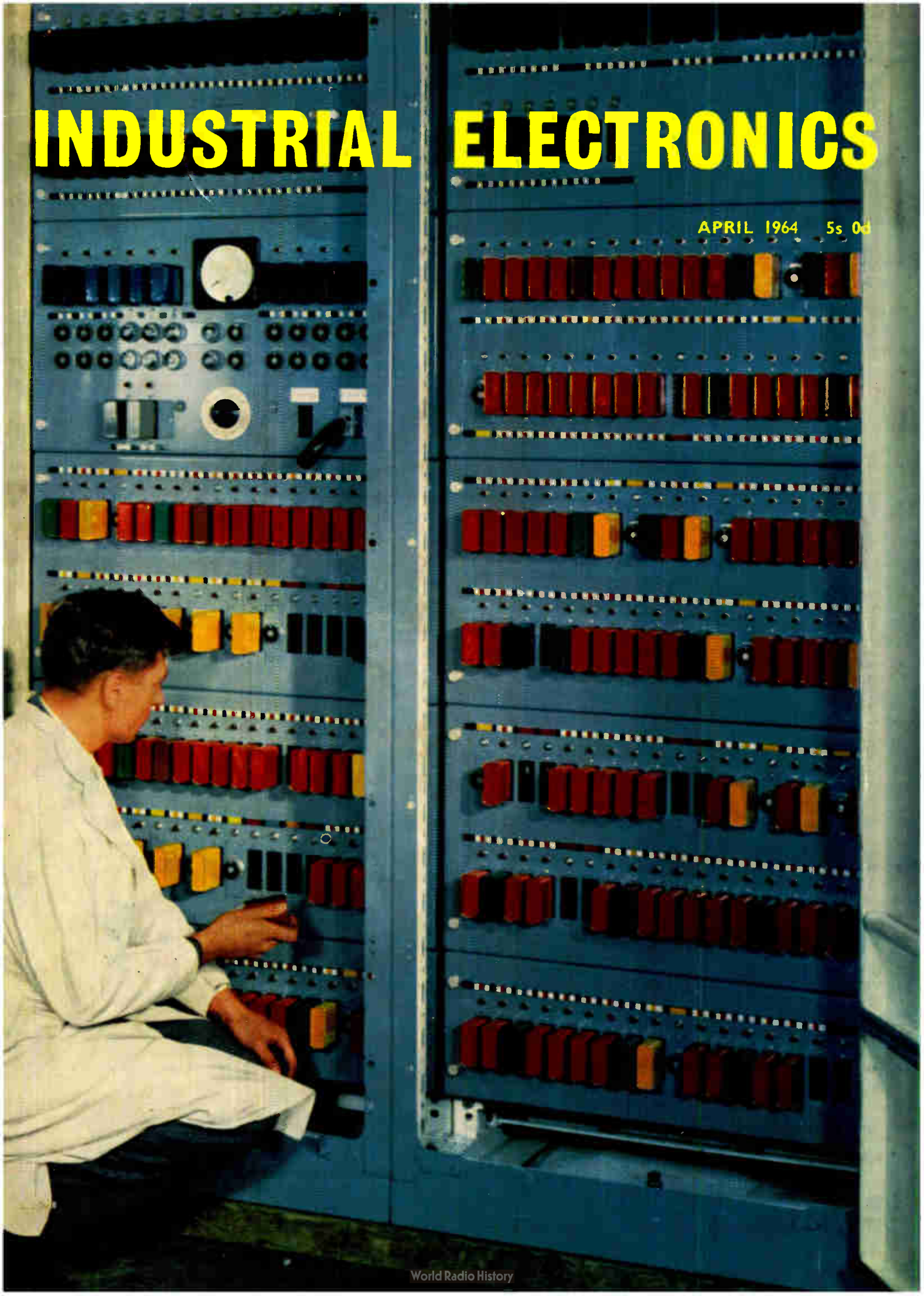

gallium arsenide and faster computers

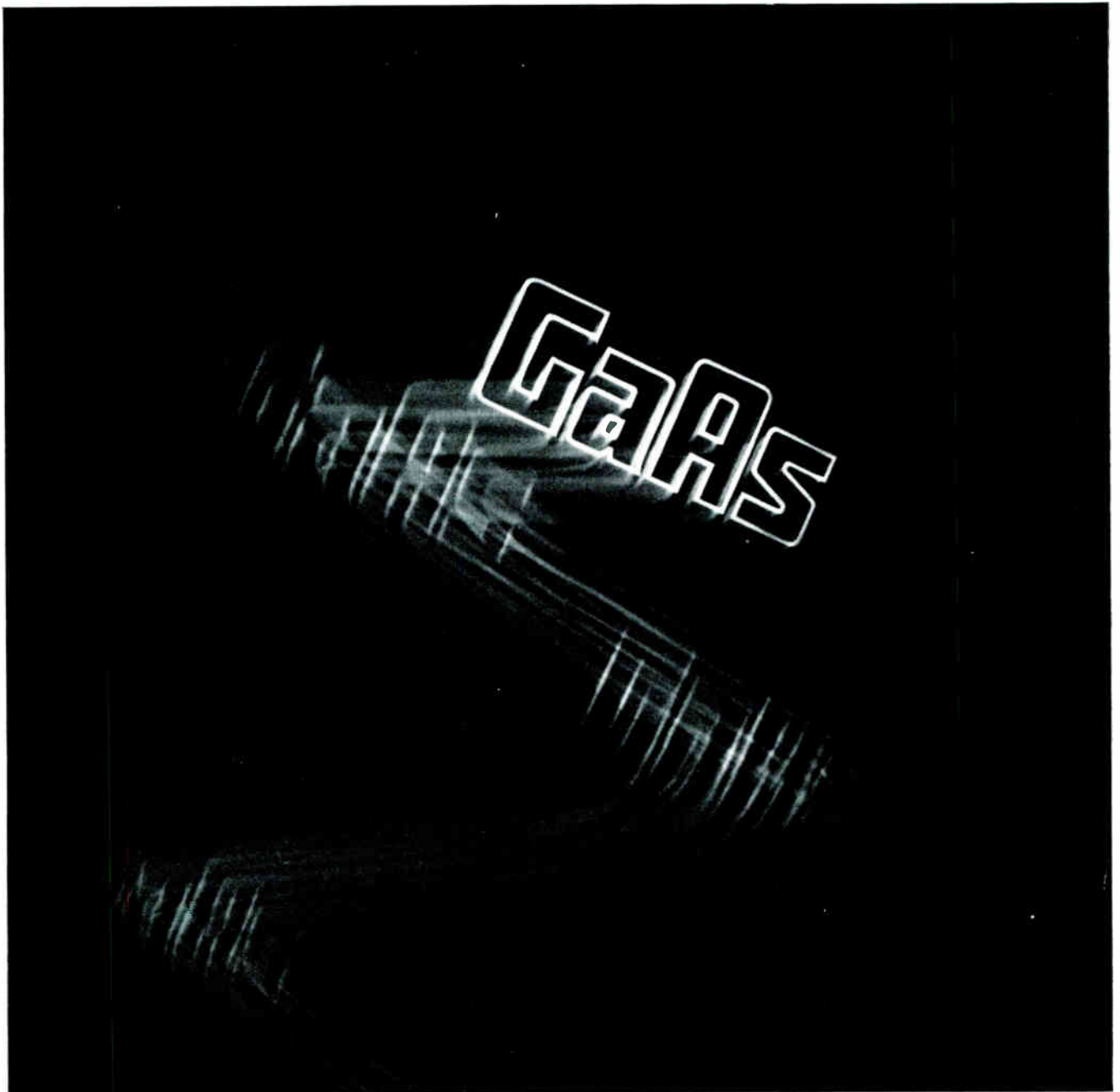

With the introduction of the Mullard Gallium Arsenide Diode, computer designers can for the first time ignore the transient phenomena associated with high speed switching circuits. This significant contribution to computer design is the result of extensive research into high energy-gap elements and their application to present and future equipment needs. As with all other Mullard semiconductor devices, the Gallium Arsenide Diode is readily available at a competitive price. For full details contact Mullard at the address below.

Brief data

Recoverable charge (From $I_F = 10\text{mA}$ to $V_R = 10\text{V}$)	Less than 6pC total of which only 1pC is due to carrier storage.
Capacitance	Typical value 0.8pF
Reverse current	Less than 200 μA for 10V applied at 100 C.
V_F at $I_F = 10\text{mA}$	Typical value 0.9V

MULLARD LIMITED, Industrial Semiconductor Division,
Mullard House, Torrington Place, London WC1
Telephone LANgham 6633



MIS 1011a

Industrial Electronics April 1964

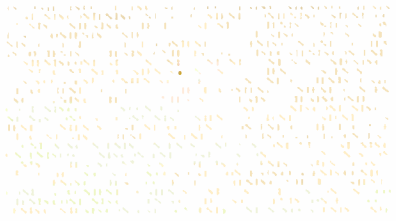

INDUSTRIAL ELECTRONICS

incorporating *ELECTRONIC TECHNOLOGY*



Volume 2 Number 4 April 1964

contents

Editor **W. T. COCKING, M.I.E.E.**

Assistant Editor **T. J. BURTON**

Advertisement Manager **G. H. GALLOWAY**

155 **Comment**

157 **The C.E.G.B. Telemetry System, Pt. 1**

by J. W. Dillow, B.Sc.(Eng.)

The grid system of electricity bulk power transmission would be impossible in its present form without an elaborate telemetry system. Over 2,000 telemeters are used and this article describes the system employed. Part 2 will deal with the communication network involved.

161 **Logicon Building-Block System** *by R. E. Young, B.Sc.(Eng.)*

A series of logical units which enables the non-specialist engineer to construct control systems is described. Most logical functions can be covered by two basic units.

163 **Electronic Counters Today and Tomorrow** *by D. R. Ollington*

Forms of display system are discussed in this article as well as types of counter and applications. The article ends with a look at the future.

168 **Continuous Weighing of Bulk Cement** *by A. Ditcher*

A simple, accurate and reliable means of continuously weighing bulk products on a belt conveyor has received Board of Trade approval. It has considerable potential in process control.

171 **Transistor Operating Conditions, Pt. 2** *by W. Tusting*

The effect of collector-base leakage current upon the collector current is discussed in this article and the need for stabilizing is brought out. After pointing out the limitations of one circuit, the most practical circuit is derived.

185 **Digital Techniques in Industry** *by G. Cooper*

This series of articles will deal with industrial applications of digital systems. This first article starts by explaining the functions and basic circuits of the logic units which are the building blocks for even complex control systems.

continued overleaf

Published on the
first Thursday after the 5th of each month by
ILIFFE ELECTRICAL PUBLICATIONS LTD.
Managing Director: W. E. Miller, M.A., M.I.E.R.E.
Dorset House, Stamford Street, London, S.E.1.
Telephone: Waterloo 3333.
Telegrams: Wirenger, London, Telex
Cables: Wirenger, London, S.E.1.

ANNUAL SUBSCRIPTION, HOME £3 0s. 0d.
OVERSEAS £3 10s. 0d.
CANADA and U.S.A. \$10.00.

c o n t i n u e d

191 **Chemical and Biological Applications of High-Intensity Ultrasonics** *by B. Brown, B.Sc., Ph.D.*

In this final article of the series on ultrasonics, a number of diverse applications is discussed. Among them are beer fobbing, electroplating and atomizing.

195 **Solid Tantalum Capacitor Production**

The processes involved in the production of solid tantalum capacitors are described in this article. Individual processes are largely automatic but there is a manual transfer between processes and at these stages quality control inspection takes place.

FEATURES

- 170 **S.C.R. Regulator for Cathodic Protection**
- 199 **Industrial News**
- 173 **Digital Transmission System**
- 202 **New Books**
- 174 **Equipment Review**
- 202 **Manufacturers' Literature**
- 194 **Electron Microscope Features Ease of Operation**
- 41 *Classified Advertisements*
- 42 *Index to Advertisers*

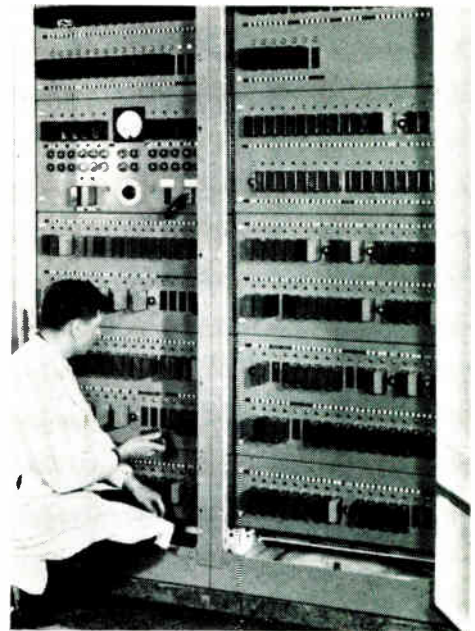

OUR COVER

The picture shows a Logicon static-switching system which provides full control switching for a hot-strip mill. The apparatus replaces conventional relays and contactors which occupied a panel 60 ft long.

Next Month

The use of thyristors for the speed control of d.c. motors will be discussed in an article in next month's issue. Other articles will include a preview of the Instruments, Electronics and Automation Exhibition at Olympia.

TO SAVE YOUR TIME

We will assist you to obtain further information on any products or processes described or advertised in this issue. Just use the enquiry cards to be found in the front of the journal.

© Iliffe Electrical Publications Ltd., 1964

Permission in writing from the Editor must first be obtained before letterpress or illustrations are reproduced from this journal. Brief abstracts or comments are allowed provided acknowledgment to the journal is given.

**THE SMALLEST
OXIDE RESISTOR
IN THE U.K. OBTAINS
QUALIFICATION APPROVAL**

**WELWYN'S
"METOX"
MIDGET OXIDE RESISTOR
TYPE F.25**

**IS NOW R.C.S.C. QUALIFICATION APPROVED
TO DEF 5114A STYLE R02-E**

WELWYN TYPE F.25

RATING	APPROVED RANGE	COMMERCIAL RANGE	BODY LENGTH	BODY DIAMETER
1/4 watt @ 70 C	47Ω-47K @ ± 5%	100Ω-22K @ ± 1% 47Ω-50K @ ± 2% 47Ω-100K @ ± 5%	0.25" MAX.	0.098" MAX.



(Actual Size)

This further Welwyn success follows naturally the success of the F20 "METOX" Resistor which is already Approved to DEF 5114A; (1/2 watt, Style R02-C).

WRITE NOW FOR FULL DETAILS

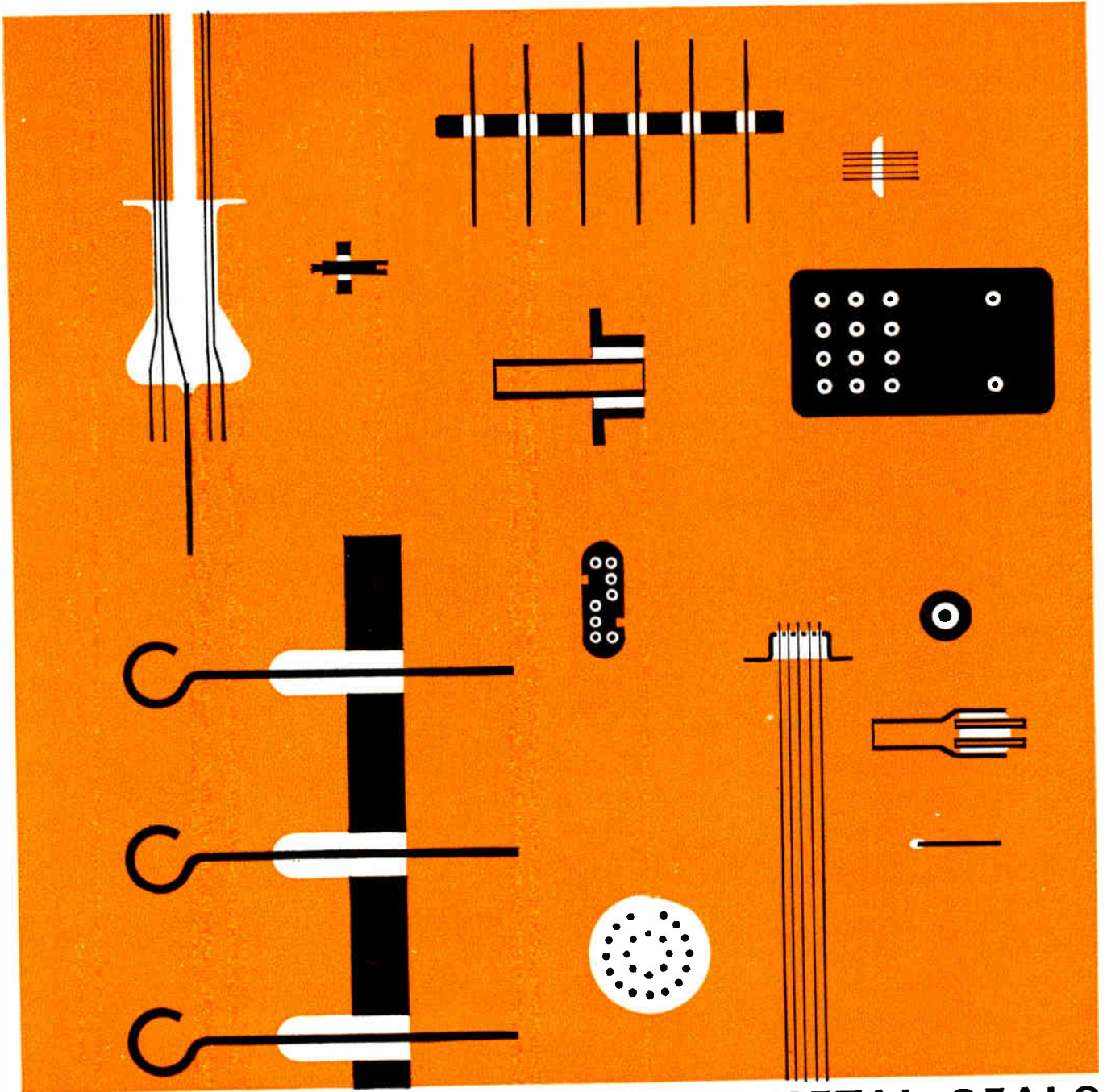

GLASS TO METAL SEALS

We are now able to offer a wide range of glass to metal seals (simple, compound and multiple). This range is further extended by facilities to produce the seals in compression, matched or fully bonded vacuum forms with a wide variety of finishes including precious metals. Deliveries are good and prices highly competitive. High quality and uniformity are ensured by advanced manufacturing techniques. Our technical liaison engineers will be pleased to meet you at any time to discuss glass to metal seal design and applications. If you would like further data on this new service to industry, please phone or write to the address below.



A TYPICAL MULTIPLE COMPRESSION SEAL

a NEW service to industry



**ERICSSON TELEPHONES LIMITED
ETELCO LIMITED**

A Principal Operating Company of the Plessey Group

ERICSSON TELEPHONES LIMITED · ETELCO LIMITED · TUBE DIVISION · BEESTON · NOTTINGHAM · TEL: 254831
ER69

MUREX MAGNETS

to small accurate sizes for
**INTERNAL MAGNET
SYSTEMS**

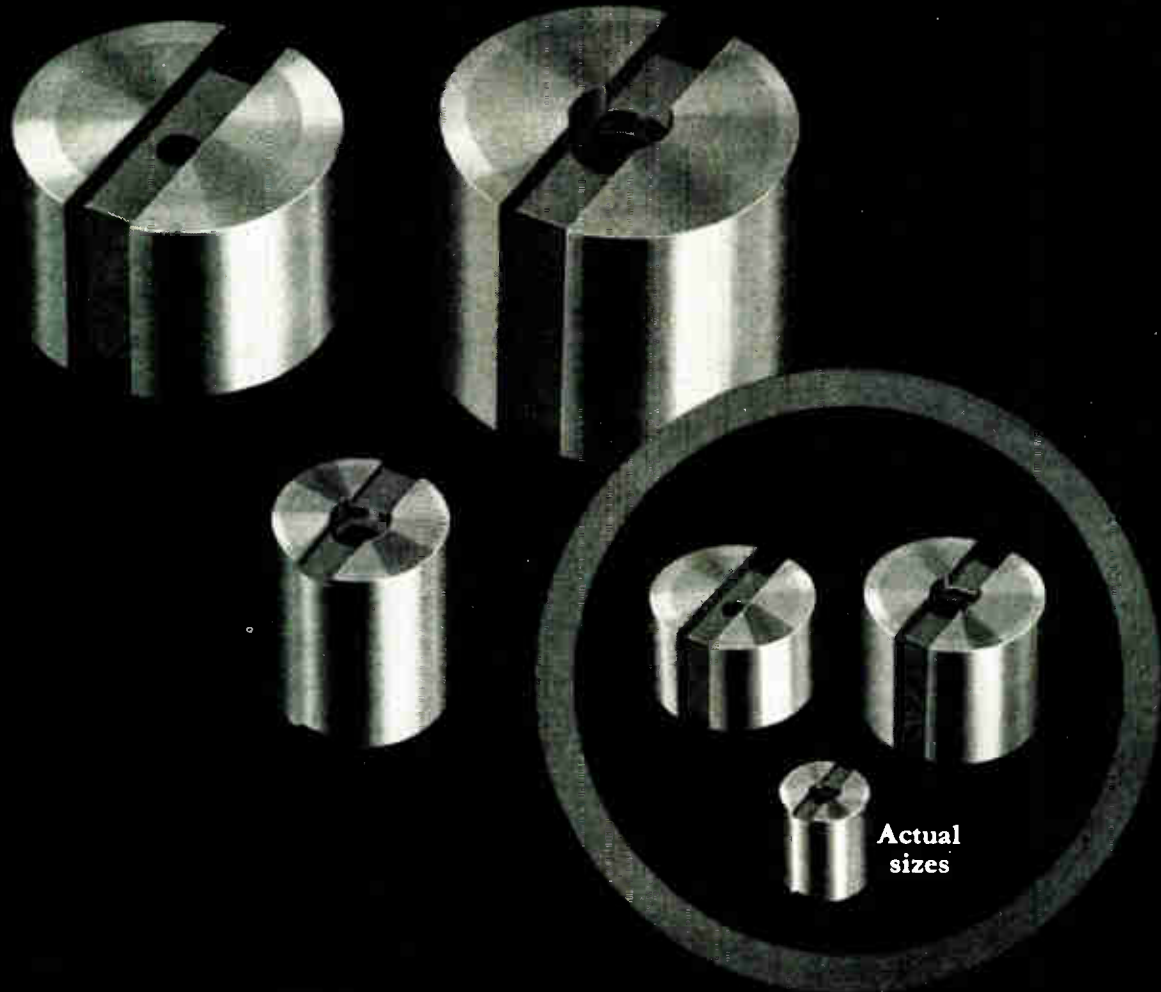

Murex offer to Instrument Manufacturers the new internal magnets manufactured by the 'SINCOMAX' technique. This provides a magnetic system in which the symmetrical iron shoes and magnet are made as a single unit, thus avoiding gaps of high reluctance between magnet and pole pieces.

MUREX LIMITED (*Powder Metallurgy Division*)

RAINHAM · ESSEX · Telephone: Rainham, Essex 3322

Telex 28632 Telegrams: Murex, Rainham-Dagenham Telex.

London Sales Office: Central House, Upper Woburn Place, W.C.1

Stringent linearity requirements of Bands IV and V translator service met by Mullard power valves

Special investigations into the performance characteristics of Mullard klystrons and tetrodes for frequency translator service in Bands IV and V have now been completed. Results show that the high power klystron YK1001 and three medium power tetrodes can meet the high linearity and low differential phase distortion limits imposed by this type of service.

Medium and low power relay transmitters are becoming increasingly necessary in order to give adequate signal coverage over all areas of the country. Such transmitters must re-broadcast on a frequency sufficiently different from the original in order to eliminate interference. In addition, consideration must be given to the even more exacting requirements of future colour television transmissions.

The Mullard valves being offered for this application cover the power range 10W to 2kW and include the YK 1001 klystron and the tetrodes QY3-1000A, YL1110 and YL1100.

MEDIUM POWER TRANSLATORS

The nominal output power of the YK1001 klystron when used under normal television transmission conditions is 12kW. By operating it at the 2kW level for translator service an intermodulation product of 58dB can be obtained. Additional advantages of the YK1001, particularly where installation in remote areas is being considered, are its reduced power consumption due to permanent magnet focusing, depressed collector operation and its air-cooling facility. Water-cooled versions can be supplied as required.

Experience has shown that even after 10 000 hours of u.h.f. television transmitter duty, the YK1001 still retains its initial performance characteristics.

LOW POWER TRANSLATORS

For power levels of the order 10 to 200W, three tetrodes, the QY3-1000A, YL1110 and the YL1100 are recommended.

The results of measurements carried out on these valves show that they are suitable for operation both as linear power amplifiers and mixers. The QY3-1000A has been measured at 200W output with >51dB intermodulation distortion.

All three tetrodes are of ceramic/metal construction. Concentric ring seals are used to obtain high efficiency at ultra high frequencies.

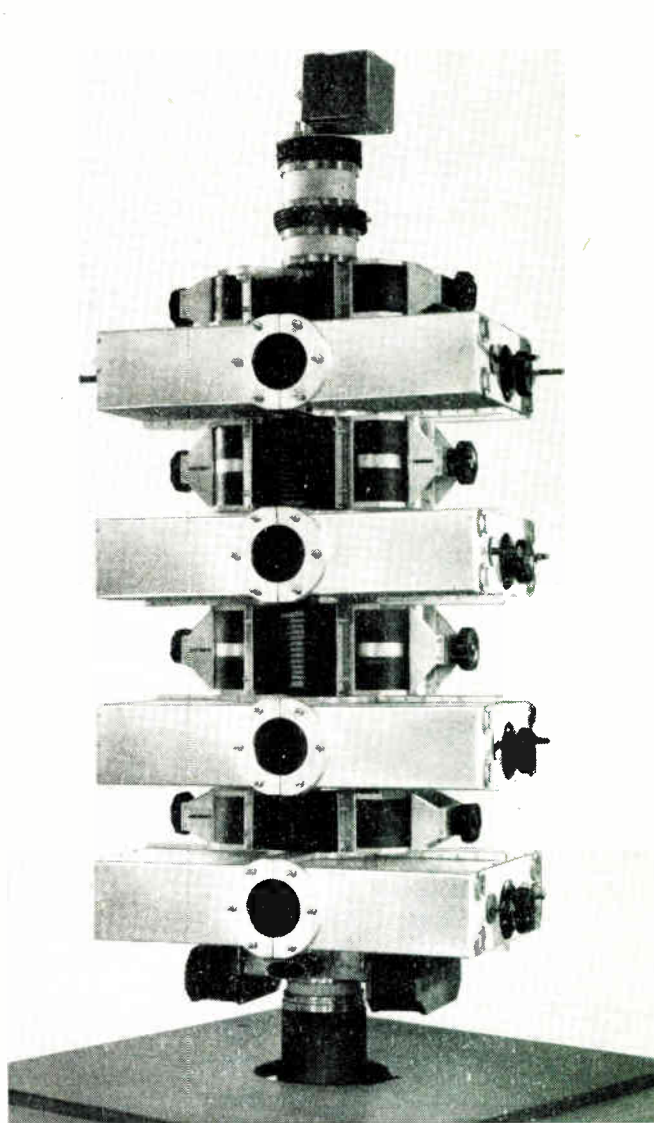

For further information on Mullard valves for u.h.f. service, please use the reader reply card of this journal (see reference number opposite).

What's new from Mullard

Close-tolerance zener diode range in SO-6 encapsulation

400mW power dissipation

A new range of close-tolerance zener diodes, with a power dissipation of 400mW at an ambient temperature of 25 C, has been introduced by Mullard. These small-signal devices are housed in an all-glass subminiature encapsulation and are suitable for use in voltage reference circuits, coupling and bias circuits for d.c. amplifiers, and as voltage-shift elements in digital circuits.

At present, types are available with operating voltages between 4.7V and 9.1V, but the range is being expanded up to 36V and down to 3.3V.

In common with some other Mullard semiconductor devices, zener diodes are being branded with a type number which contains within it the characteristics of the diode.

Diodes with the same power dissipation will be given a range

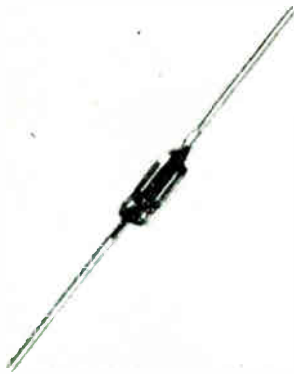

All-glass subminiature SO-6 encapsulation

number—the 400mW series having a range number BZY88. Individual diodes with different nominal voltages will then be identified by adding further letters and figures to the range number. For example, in the case of BZY88-C4V7, C indicates a nominal zener-voltage tolerance of $\pm 5\%$. V replaces a decimal point and the figures indicate an operating voltage of 4.7V.

Because of the small size of the glass encapsulation, the BZY88 range is colour coded to denote voltage and tolerance.

First oscilloscope tube with sectioned Y-plates

Oscilloscopes for operation up to about 100Mc/s can now be built using the D13-16GH oscilloscope tube. These improved high-frequency characteristics are mainly due to the reduced capacitance of the sectioned Y-plates. The D13-16GH is the first oscilloscope tube with sectioned Y-plates to be marketed in this country.

A lumped constant delay line is often inserted between the signal amplifier and the deflection plates. The large capacitance of these plates causes either a low cut-off frequency or an extremely low characteristic impedance. By dividing the Y-plates into sections and inserting each section into its own section of the delay line, it becomes possible to increase either the cut-off frequency or the characteristic impedance of the line. The design of the deflection amplifier is therefore eased considerably.

Other features of the D13-16GH are a 5in flat faceplate with a metal-backed screen, and a helical p.d.a. system working at 10kV. The deflection sensitivity of the Y-plates is 6V/cm, and that of the X-plates is less than 18V/cm. The capacitances of the Y-plates are shown in the table.

Table of Capacitances for Y-Plates

High-potential Electrodes	Low-potential Electrodes	Earthed Electrodes	Capacitance (pF)
y1-1	all	(y1-2,1-3,1-4) (y2-1,2-2,2-3,2-4)	1.2
y2-1	all	(y1-1,1-2,1-3,1-4) (y2-2,2-3,2-4)	1.2
y1-1	y2-1	all	0.8

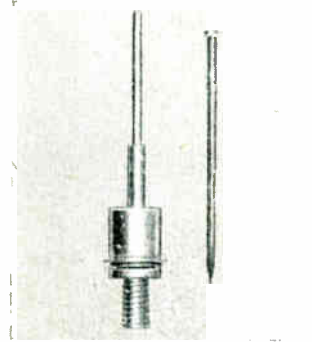

Varactor diode BAY66 compared with one-inch pin

Reader Enquiry Service

Further details of the Mullard products described in this advertisement can be obtained through the Reader Enquiry Service of Industrial Electronics using the appropriate code number shown below.

Klystrons and tetrodes	206
Zener diodes	207
Oscilloscope tube	208
Varactor diode	209
Penning pump	210

One varactor diode for operation over V.H.F. and U.H.F. bands

The introduction of a varactor diode capable of operating over a wide range of output frequencies obviates the need for different diodes in each stage of frequency multiplier chains. This silicon varactor diode, type number BAY66, is the first of its kind to be manufactured in the United Kingdom. Its operation becomes effective at input frequencies of about 100Mc/s, and output frequencies up to at least 1000Mc/s can be produced at adequate efficiencies. In applications where efficiency is not of prime importance, even higher frequencies can be produced.

The BAY66 will handle input powers of up to 12W, and has a reverse voltage rating of 100V. The cut-off frequency is typically 30Gc/s.

15 LITRE PER SEC PENNING PUMP INTRODUCED

COMPACT STYLING OF ASSOCIATED CONTROL UNIT

A recent addition to the Mullard range of vacuum devices is a 15 l/s Penning pump and its control unit. This pumping unit will be of particular use in such applications as electron microscopes and linear accelerators, or in a laboratory pump set. In the design, care has been taken to minimise the stray magnetic field of the pump to prevent interaction with the magnetic fields of other equipment.

The control unit, type WPS-15, uses the same compact styling as the WPS-1 and WPS-3 control units. Like these, it is equally suitable for bench or rack mounting, and the monitoring of pressures is provided by a direct-reading meter. The range of pressures that can be measured is from 10^{-9} to 10^{-2} torr, either by a single logarithmic scale covering the whole range or by

expanded scales covering the range in decades. The latter facility allows the unit to be used for leak detection. Provision is also made for the connection of a line recorder if continuous monitoring is required.

The Penning pump itself, type VPP-15, is compact in design and has a standard connecting flange using a gold-wire seal. It is bakeable up to a temperature of 450 C.



Penning pump VPP-15



Mullard Limited, Mullard House, Torrington Place, London, WC1. Telephone: LANgham 6633

CAM10

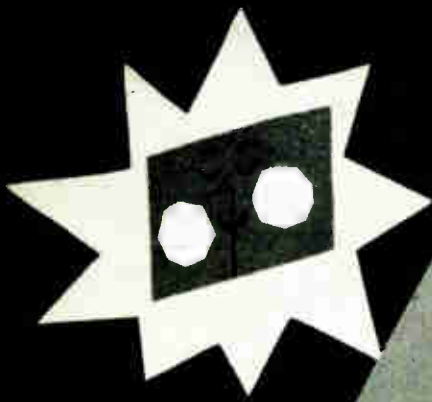

a pint-sized blower with a quart-sized performance

Plannair blowers provide double—or even treble—normal performance, because they are half—and sometimes only a third—the size of blowers of equivalent output.

Take the Plannair 4PL366-526, for example, where top quality performance is not based on mere size. Design includes six axial stages—unique on small axial blowers—and impellers mounted on the rotating stator sleeve of the inside-out motor.

Consider the performance! At 2 in. s.w.g., it provides 80 c.f.m.—a performance for which a blower of normal design would require up

to 600 cu. in. of space. The Plannair 4PL366-526 needs only 160 cu. in.—a saving in space of two-thirds. And fourteen thousand hours without maintenance . . . only Plannair blowers could claim such a performance. But then, Plannair designers are specialists in aero-thermal control—so let *them* advise *you* which blower is exactly right for the job you have in mind.

Write to Plannair, and put your problem to them. You can be sure of a satisfactory solution.

PLAN WITH  **PLANNAIR** — SPECIALISTS IN AERO-THERMAL CONTROL

PLANNAIR LIMITED · WINDFIELD HOUSE · LEATHERHEAD · SURREY · TELEPHONE: LEATHERHEAD 4091

For further information circle 211 on Service Card

World Radio History

PLA3

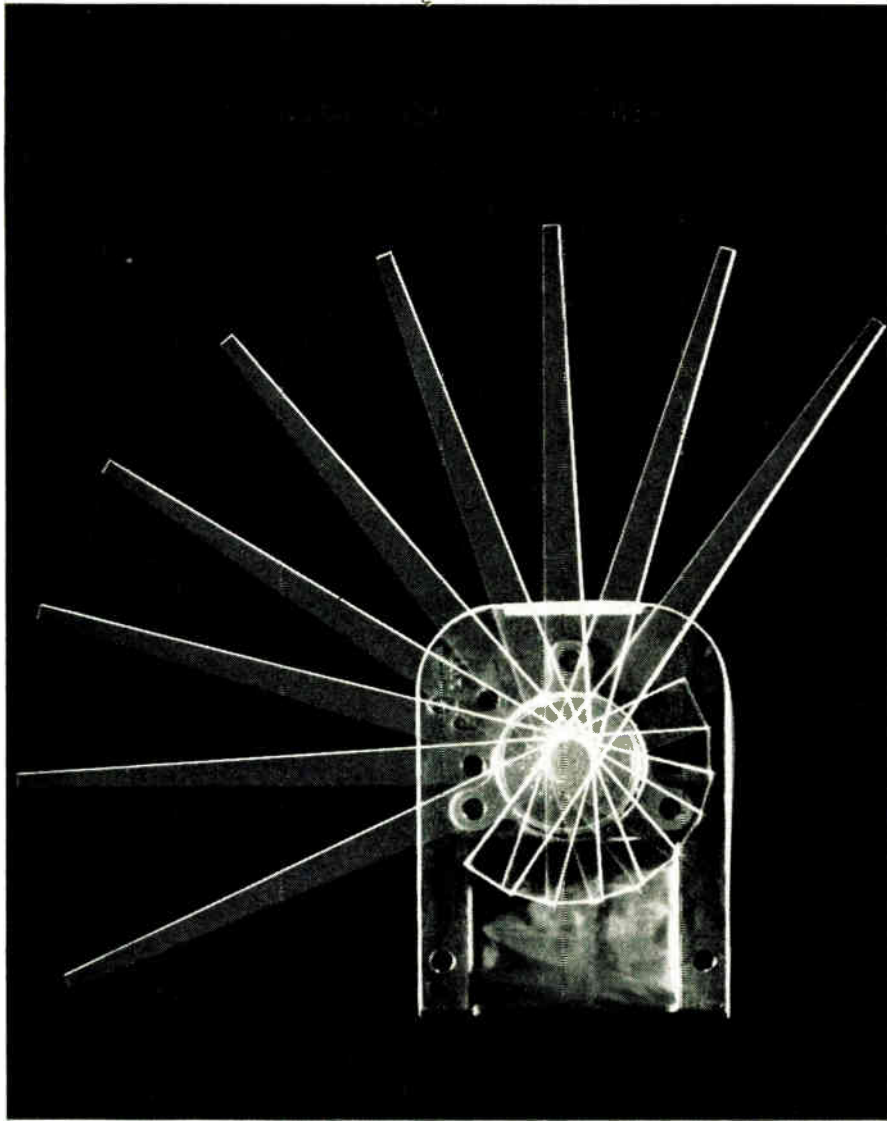

**Sigma's Cyclonome[®] Stepping Motor—
An uncomplicated approach to accurate
positioning, counting, synchronizing, converting**

From Sigma comes an electro-magnetic drive that delivers torque in precise 18° steps...
... up to 1,000 steps per second
... up to 5 inch-ounces of torque
... with no standby power to maintain high holding torque
... with only one moving part (no catches, ratchets, escapements)

... with size as small as 1 cubic inch.
... and requiring only the simplest input circuitry.

Engineers are already applying the Cyclonome stepping motor in chart and tape drives, in analog-digital converting, in impulse counting, in step servos, in remote positioning, in timing.

If you position, count or convert, the Cyclonome stepping motor can benefit you.

Our application engineers will be glad to work with you. If you would like to learn more about the Sigma Cyclonome stepping motor, contact Ad. Auriema, Ltd., Impectron House, 125 Gunnersbury Lane, London W3.

SIGMA DIVISION  **SIGMA INSTRUMENTS INC**
Assured Reliability With Advanced Design/Braintree 85, Mass.

What is a Stepping Motor?

A stepping motor is like a synchronous motor in principle, except that its rotor does not revolve smoothly and continuously when the motor is energized. Instead, on command from the input, the rotor travels an incremental step,

stops instantly and locks magnetically in position. When a signal of opposite polarity is applied, the rotor advances another precise step, delivering torque in exact proportion to and at the same rate as the input.

need an IR rectifier ?

send the lad for one

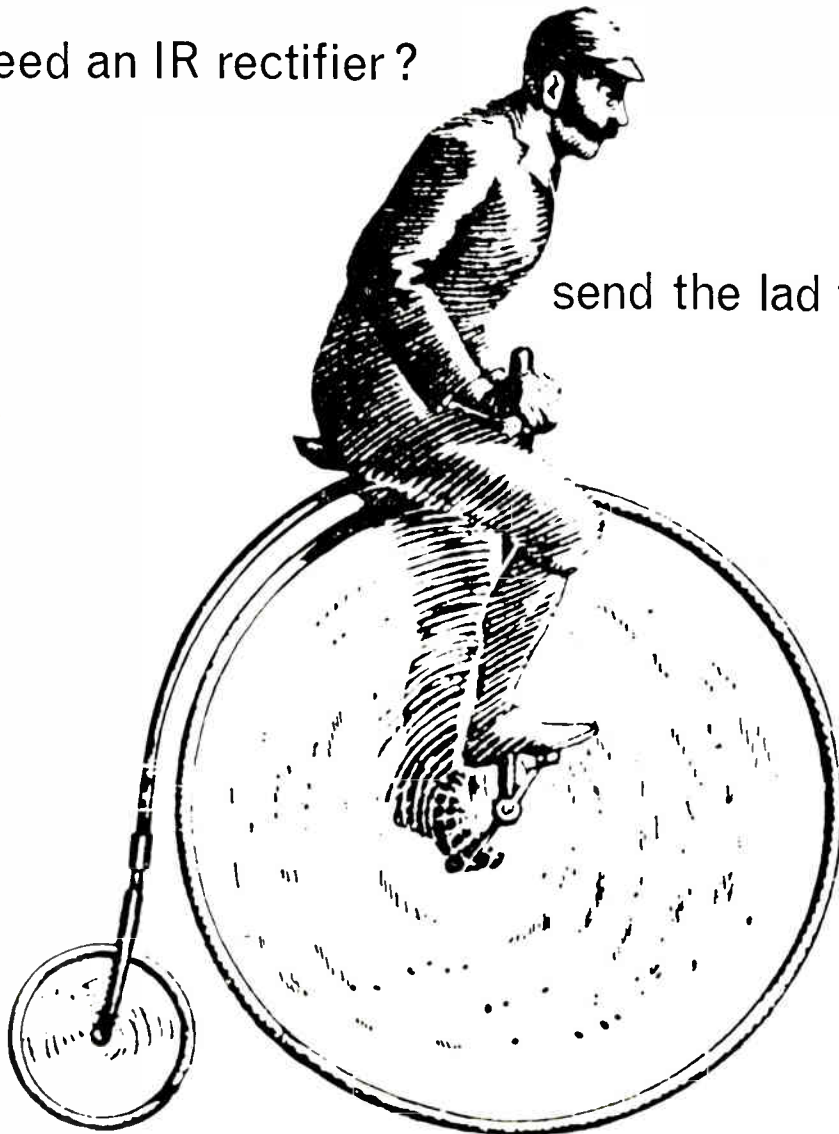

So that industrial users can get IR rectifiers for experimental work or for small batch production *quickly*, IR have appointed Approved Industrial Distributors throughout the country. Each one carries a representative stock of IR products (impossible to carry the whole range!) and will supply them over the counter at *normal list prices*. Orders for non-stock items will be handled at Oxted with the usual—or even greater than usual—speed.

INTERNATIONAL RECTIFIER

Immediate off-the-shelf delivery from IR distributors—phone



GLASGOW DOUGLAS 8671 · (MIDDLESEX) SKYPORT 1314 · COLCHESTER 6173 · LEEDS 35111
(LONDON S.E.27) GIPSY HILL 6166 · PORTSMOUTH 61785 · LEICESTER 25071 · CRAWLEY 28700

International Rectifier Europe S.A. · 38 Avenue Des Arts · Brussels · Belgium · Telephone 11.17.38/74 · Telex 02/22201
INTERNATIONAL RECTIFIER CO. (GREAT BRITAIN) LTD · HURST GREEN · OXTED · SURREY · TELEPHONE OXTED 3215 · TELEX RECTIFIER OXTED 8819

GETTING THE MEASURE OF THE PROBLEM

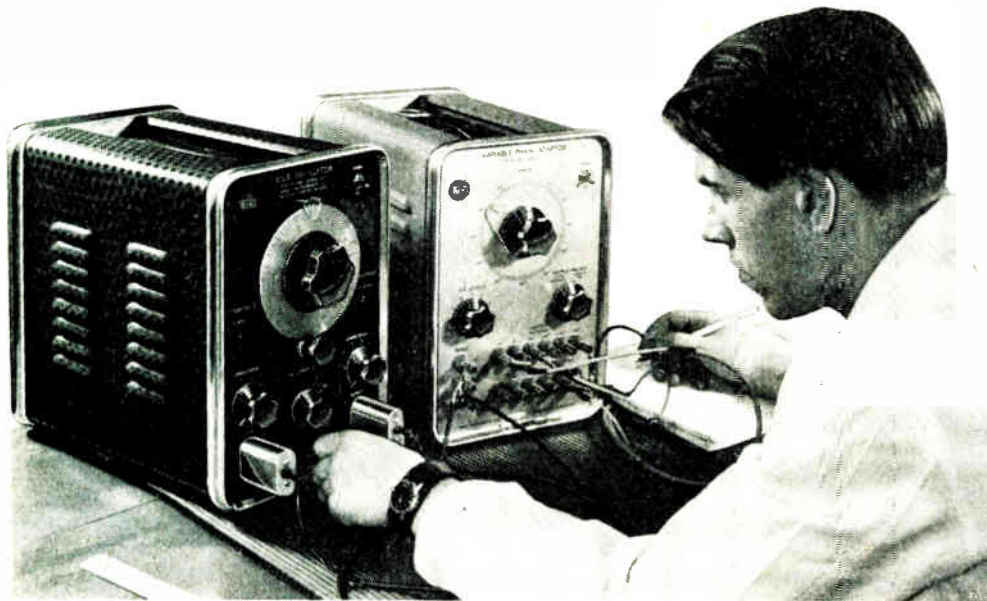

WHATEVER THE PROBLEM, there's almost certainly a **DAWE** instrument specifically designed to help you "get the measure" of it! Dawe manufacture a wide range of equipment not only for measuring, analysing, and recording sound, vibration, etc., but also for ultrasonic cleaning, non-destructive testing, electronics and radio testing, stroboscopic viewing, dynamic balancing, etc. Our research teams and staff of Sales Engineers are always glad to assist you in the application of **DAWE** instruments to any specific problem.

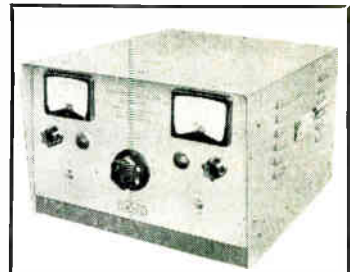

**ULTRASONIC
CLEANING AND TESTING**



**SOUND AND VIBRATION
MEASUREMENT**

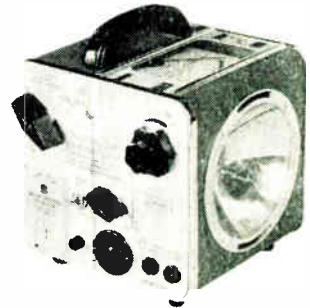

STROBOSCOPIC VIEWING

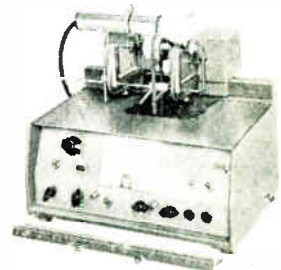

DYNAMIC BALANCING

Are you on our mailing list? If you let us have your name and office address we will send you every month the latest technical information concerning our new products, and future issues of our technical bulletin "Dawe Digest"



Full technical data from:—

DAWE INSTRUMENTS LTD., WESTERN AVENUE, ACTON, LONDON, W.3 Tel: ACOrn 6751

A member of the *Simms* group of companies

NOW from United States capacitor technology come...

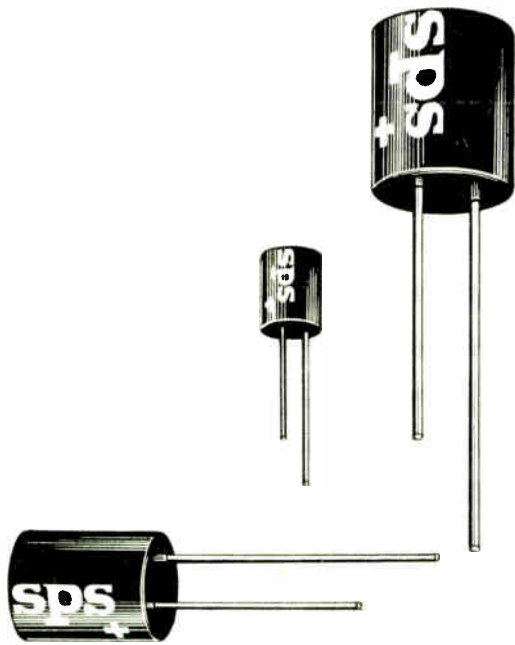

Available in 42 standard ratings, with intermediate values at no extra cost. For complete technical information and assistance write or telephone SPS International Ltd., European manufacturing arm of a leading U.S. supplier of quality capacitors.

SPS SUBMINIATURE ALUMINIUM FOIL ELECTROLYTIC CAPACITORS

The most modern and efficient capacitors obtainable today

For 8 years SPS International has been producing in the U.S.A. a range of miniature lightweight capacitors designed to cope with every extreme of temperature. Now the whole benefit of this experience has been brought to the new SPS factory at Shannon, Ireland, making the same high-quality capacitors available at short notice to any part of Britain. SPS capacitors guarantee complete reliability and long life thanks to the techniques of total encapsulation perfected over a long period in the U.S.A.

Ideal for transistorized communications equipment, portable radios, hearing aids, electronic instruments, audio cross-over networks, hi-fi tuners and amplifiers, recorders, test equipment and other low voltage circuits.

CAPACITANCE: -20% $+100\%$ of rated capacity

DISSIPATION FACTOR: Less than 8% at 50 WVDC

D.C. Leakage: Less than $6\ \mu\text{A}$ after 1 min. applied WVDC

OPERATING TEMPERATURE: 65 C at rated WVDC

SPSI

SPS INTERNATIONAL LIMITED

SHANNON AIRPORT, IRELAND

Telephone Shannon 245

APRIL 1964

STC components review



PULSE MODULATOR VALVES

STC Valve Division can now offer a full range of high quality valves for pulse amplifier applications. Their characteristics are summarised in the following table.

ABRIDGED DATA

CODE	CV No.	HEATER		gm (mA/V)	Vg2 (V)	Max Va (kV)	Max Ia (peak) (A)	Max Pa (W)
		(V)	(A)					
6F17	415	6.3	0.3	8.3	600	0.6	0.1	3.5
56F17*	4043							
56F17F*	4041							
11E2	276	6.3	0.9	—	550	12.5	1.0	5.0
11E3	73	4.2	2.5	—	700	3.5 (Break Modulator) 12.5 (Series Modulator)	1.0 2.0	1.0
11E14	—	6.3	1.2	7.0	550	5.0	4.0	10
3D21A	2659	6.3	1.7	5.5	800	3.5	11.0	15
		12.6	0.85					
4B/550E	—	26	1.2	—	700	12	10	40
4B/603E	398	26	2.0	—	1250	15	15	60
4B/602E	427	26	2.0	—	1250	20	15	60

* Special quality va.v35.

Other forms of pulse modulator valves available from STC are Hydrogen Thyatrons (ITT-KUTHE manufacture) and cold cathode Trigatrons. Of the latter, the principal type is 24B1 (CV85) which has the undermentioned characteristics.

Cathode Voltage (V) (anode earthed)		Peak Cathode Current (A)	Peak Trigger Voltage (kV)	p.r.f. p.p.s.	Peak Output Power (kW)	Pulse Length (µs)
Min.	Max.					
-6 600	-7 400	45	8.5 (unloaded)	2 500 1 200	150	0.25 1.0

Write, 'phone or Telex for Data Sheets to Valve Division, STC, Brixham Road, Paignton, Devon or London Sales Office, Footscray, Sidcup, Kent. Telephone FOOTscray 3333. Telex 21836.

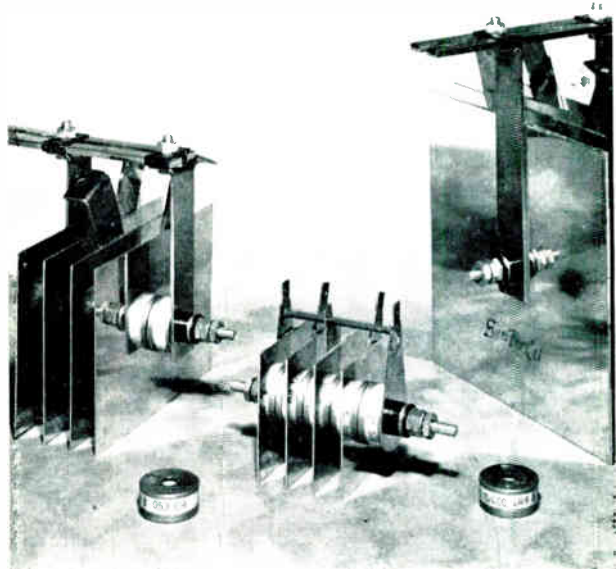

SILRING RECTIFIERS

New in Britain, SILRING rectifier stacks from STC offer the circuit designer and equipment engineer a unique combination of compactness, simplicity and low cost.

□ The SILRING stacks shown above have outputs of 4.2 kW, 2.1 kW and 9.45 kW. □ SILRING power diodes are rugged ceramic/metal case ring diodes with diffused silicon junctions. Their heavy gauge copper end-plates from the anode and cathode of the device and act as thermal conductors to the stack cooling fins. This arrangement provides maximum efficiency without overloading and consequent lowest price-per watt rectification

□ The simplicity of stack construction enables STC to offer quick delivery of SILRING diodes in the range 50-600V_{RWM}. When assembled into stacks these diodes give outputs from 5 to 232A.

For Data Sheets and prices write, 'phone or Telex STC Semiconductor Division (Rectifiers), Edinburgh Way, Harlow, Essex. Telephone Harlow 26811. Telex 81146.

CONTINUED OVER

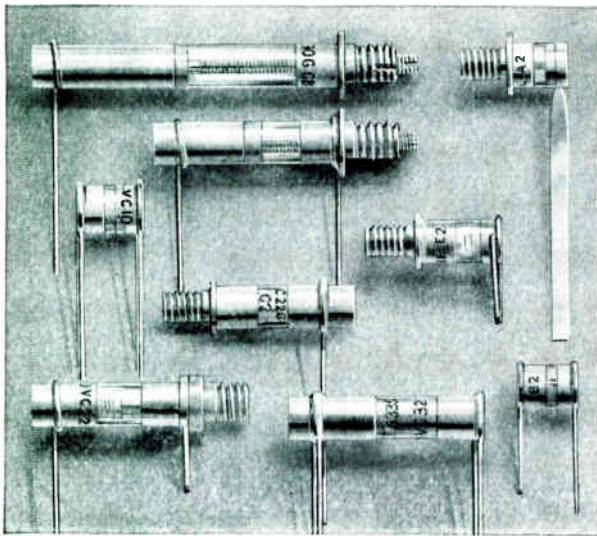

PISTON CAPACITORS • NEW DIELECTRIC OFFERS 30% MORE CAPACITANCE, 25% HIGHER Q

JFD 'Green Glass' Trimmer Piston Capacitors, marketed in the UK and other EFTA countries by STC, provide 30% more capacitance and 25% higher Q per volume than similar types. The new dielectric utilizes metallic salt additives to greatly increase the shielding properties of the dielectric. This guarantees improved stability, since it reduces the effects of oxidization from light exposure. Also—an important consideration for aerospace applications—the material shields the device from infra-red and ultra-violet radiation.

Another important feature of these trimmers is the JFD 'Hi-Life' adjustment mechanism. It greatly increases adjustment life (500 cycles as compared to 75 cycles required by Mil-C-14409B). These trimmers are used extensively in aerospace equipment in the USA Apollo programme. Panel mounting and printed circuit types are available. Code references for these new devices are: NVC, NPT, NMC and NSC.

LOW COST TRIMMERS WITH QUARTZ DIELECTRIC—NMQ SERIES

JFD also announce new 'Hi-Life' counterparts of the JFD 'MQ' Miniature Trimmer Quartz Series. JFD fused quartz is retained as the dielectric in these units but the 'Hi-Life' adjustment mechanism replaces the miniature telescopic types

For Data Sheets giving full details of all types of JFD capacitors write, 'phone or Telex Standard Telephones and Cables Limited, Capacitor Division, Brixham Road, Paignton Devon or London Sales Office, Footscray Kent. Telephone FOOTscray 3333. Telex 21836.

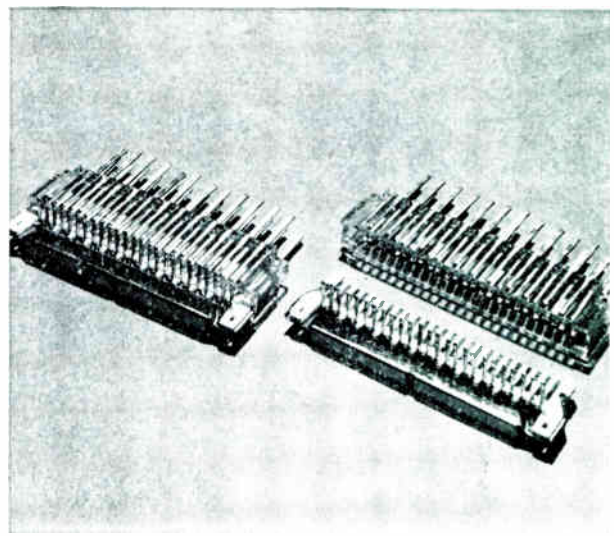

EDGE CONNECTORS WITH HIGH DENSITY CONTACT GROUPING

ISEP (International Standard Equipment Practice) Edge Connectors from STC have contacts with a pitch of only 0.1 in. (2.54 mm) between contact centres.

ISEP Connectors are the answer to the equipment engineer's requirements for high density, multi-pole edge connectors for use on printed circuit boards carrying large numbers of miniature components.

Features of the new ISEP Connectors are:

Three sizes: 11, 25 and 33-way.

Only printed circuit connector to meet B P O tests in full. 0.1 in. contact pitch conforms to latest international standards.

Precious metal contacts rolled flat from wire to eliminate sharp edges.

Available with wrap or solder tags.

Fully integrates with ISEP racking system.

Competitively priced.

Write, 'phone or Telex for full details and prices to STC Electro-mechanical Division, West Road, Harlow, Essex. Telephone Harlow 21341. Telex 81184.

STC components review

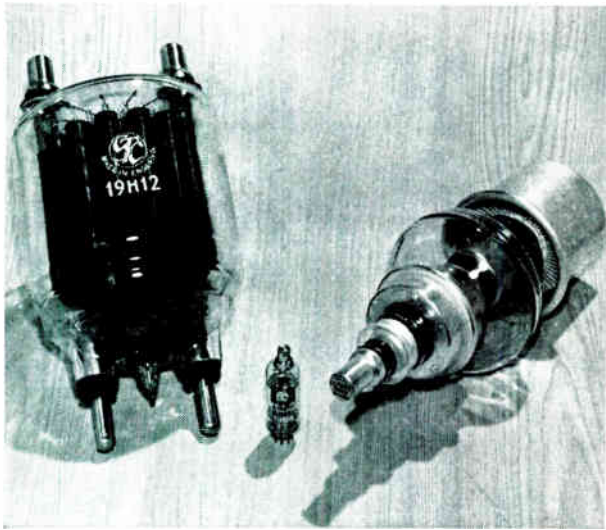

VACUUM RECTIFIER VALVES

STC produce a comprehensive range of vacuum rectifier valves for applications which include high voltage power supplies, line charging and overswing damping. Notable features are the high power dissipation combined with compact structure of the forced-air-cooled type 2J/262E and the low pulse impedance of the type 19H12 (23Ω at 30A).

ABRIDGED DATA

Code	CV No.	Fil/Heater		Max. P.I.V. (kV)	Peak I _a (A)	Average I _a (A)	Max. P _a (W)
		(V)	(A)				
2J/262E	—	5.0	40	50	7.5	1.5	1500
19G6	371	4.0	0.5	6.0	0.18	0.03	—
S19G6*	4057	4.0	0.5	6.0	0.18	0.03	—
S19G6F*	4042	4.0	0.5	5.0	0.18	0.03	—
19E2	265	4.0	2.1	4.0	12	—	—
ESU112	—	4.0	12	40	1.1	—	130
ESU77	2160	4.0	12	50	1.1	—	130
19H5	490	4.0	4.0	20	0.35	0.125	—
19G3	277	4.0	1.4	7.0	0.4	0.05	—
19H4	2180	2.5	1.7	20	0.18	0.03	—
19H12	—	4.0	12	25	30	—	50
705	3587	5.0	5.0	30	0.4	0.1	60

* Special quality valves

Write, 'phone or Telex for Data Sheets to STC Valve Division, Brixham Road, Paignton, Devon or London Sales Office, Footscray, Sidcup, Kent. Telephone FOOTscray 3333. Telex 21836.

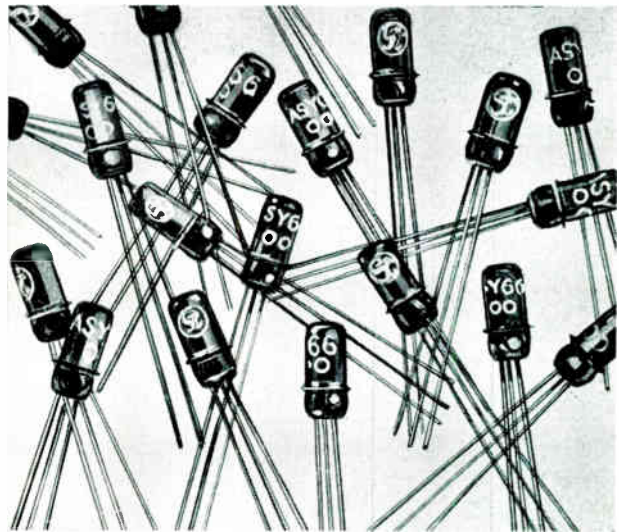

GERMANIUM TRANSISTORS

Another three devices have been added to the range of STC germanium low frequency transistors. These new p-n-p types are designed for use in driver and output stages, oscillators and low speed switching applications. All three have a collector dissipation of 200 mW and they conform to VASCA SO-2 outline □ These new transistors are competitively priced and are available with immediate delivery.

BRIEF CHARACTERISTICS

	ACY34 (Driver)	ACY35 (Driver)	ACY36 (Class B o/p, Switching)
<i>h_{fe}</i> at -2V, -0.5 mA	20-40	—	—
<i>h_{fe}</i> at -2V, -3.0 mA	—	30-75	—
<i>h_{FE}</i> at -7V, -80 mA	—	—	30-90
<i>V_{CBM}</i> (emitter open circuited)	-30V	-30V	-32V
<i>V_{CEM}</i> (base open circuited)	-10V	-10V	-16V
<i>I_{CB0}</i> at <i>V_{CB}</i> -30V	-12μA	-12μA	-12μA

IMPROVED SOLDERABILITY

This is a new feature of STC germanium alloy junction transistors. An improved tinning process on the leads now enables them to be soldered into circuit with greater ease and flexibility. This is especially advantageous to equipment manufacturers employing automatic soldering methods since the risk is considerably minimized of dry joints occurring, either during manufacture or in the field. Maintenance of solderability standards is part of the inspection routine on STC transistors.

Write, 'phone or Telex for details of the whole range of STC germanium transistors to STC Semiconductor Division (Transistors), Footscray, Sidcup, Kent. FOOTscray 3333. Telex 21836.

STC

COMPONENTS GROUP

high-grade electronic components by

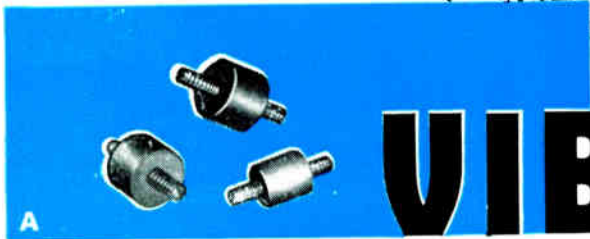
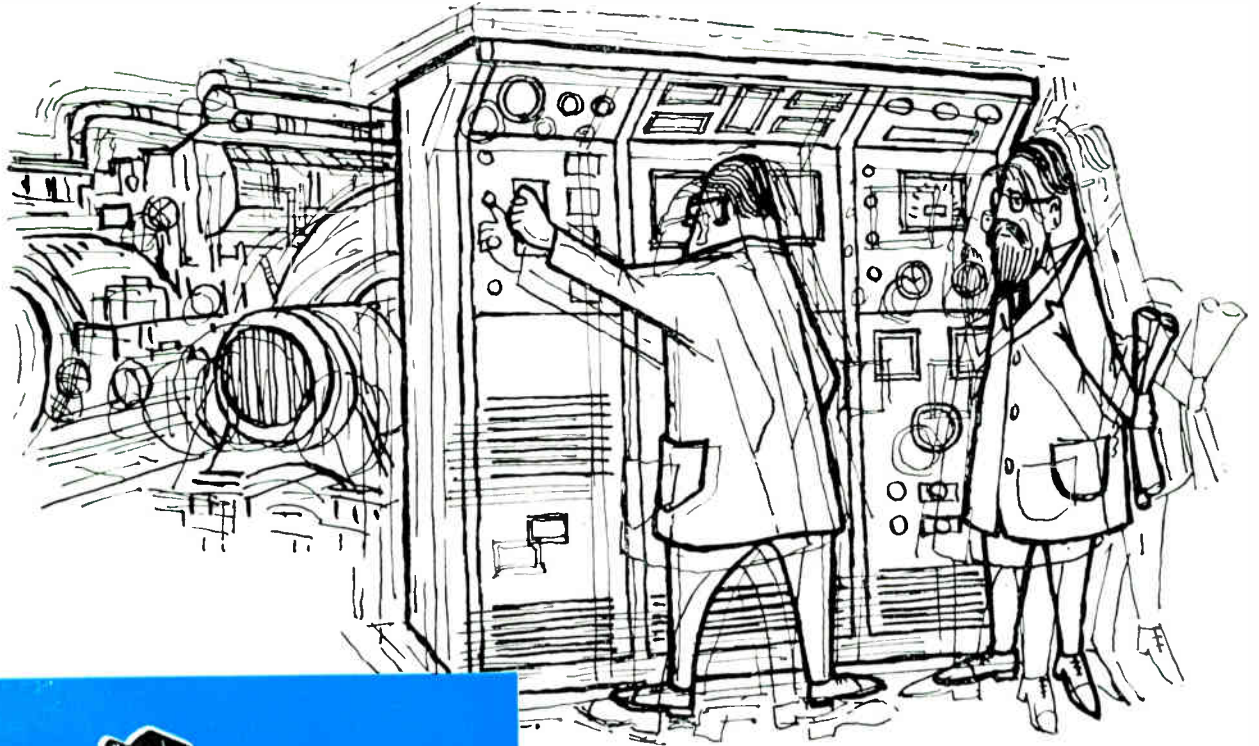

VIBRATION?

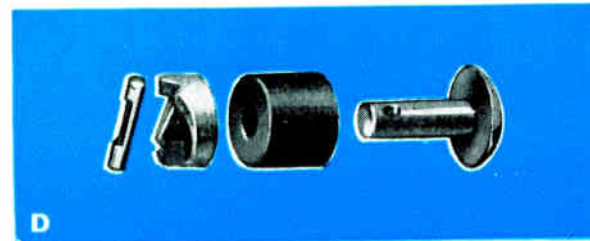

The wide use of electronic equipment in industry, often in close proximity to machinery, presents new vibration problems. Every effort should be made to eliminate the trouble at its source by the use of Silentbloc machinery mountings, bearings and couplings; but local precautions in the electronic apparatus itself are also desirable, and there is an extensive Silentbloc range of devices for this purpose. A few are described here.

- A.** Bonded rubber/metal stud mountings for supporting apparatus of light weight. There is a range of sizes of various degrees of stiffness.
- B.** Ring-type resilient mountings giving extra flexibility for shock insulation of sensitive equipment. Available in sizes to suit a great variety of applications.
- C.** Instrument mountings for general service offering good insulation with a useful degree of mechanical stability. Sizes and characteristics for every conceivable purpose.
- D.** "Vibrex" panel fasteners—quick one-hand action, with or without electrical and mechanical insulation between panel and base. Easier to fit than any other panel fastener: simple drilling of panel and base; no screwing, tapping, sweating or brazing.

MOUNTINGS • BEARINGS • "VIBREX" PANEL FASTENERS

ANTI-VIBRATION DEVICES BY

SILENTBLOC

Andre Rubber Co. Ltd. is another Silentbloc Company

SILENTBLOC LTD • MANOR ROYAL • CRAWLEY • SUSSEX

Telephone: Crawley 27733 Telegrams: Silentbloc Crawley

Silentbloc products are also manufactured by Silentbloc (Australia) Pty. Ltd., Melbourne Broadway/S304

semiconductoritis?



Reliability + Consistent Quality + Proved Service + Fast Delivery

Semiconductoritis can be cured...prescribe Hughes... service and deliveries will improve immediately and Hughes quality control will ensure no unpleasant side-effects. Hughes prescribe from a comprehensive list of PNP/NPN Silicon planar Transistors, Silicon planar and Germanium computer diodes, Silicon power and Zener diodes and voltage variable capacitors—for immediate and regular application. Be sure, too, that Hughes research is constantly alert for new strains of semiconductoritis* and will be ready with appropriate remedies.

*Semiconductoritis: a production frustration caused by the failure or non-availability of solid-state components.

Why not phone or write now for Technical Data or Quotations. Alternatively, our Sales Engineers will be delighted to call and discuss your immediate or future needs.



HUGHES INTERNATIONAL (U.K.) LTD

U.K. SALES: KERSHAW HOUSE, GREAT WEST ROAD, HOUNSLOW, MIDDLESEX. TELEPHONE: HOUNSLOW 5222
OVERSEAS ENQUIRIES: HUSINT S.A., 3 RUE AMI LULLIN, GENEVA

M & P HM19



'Triple Rating' means 3 sizes of metal oxide film resistors cover most requirements

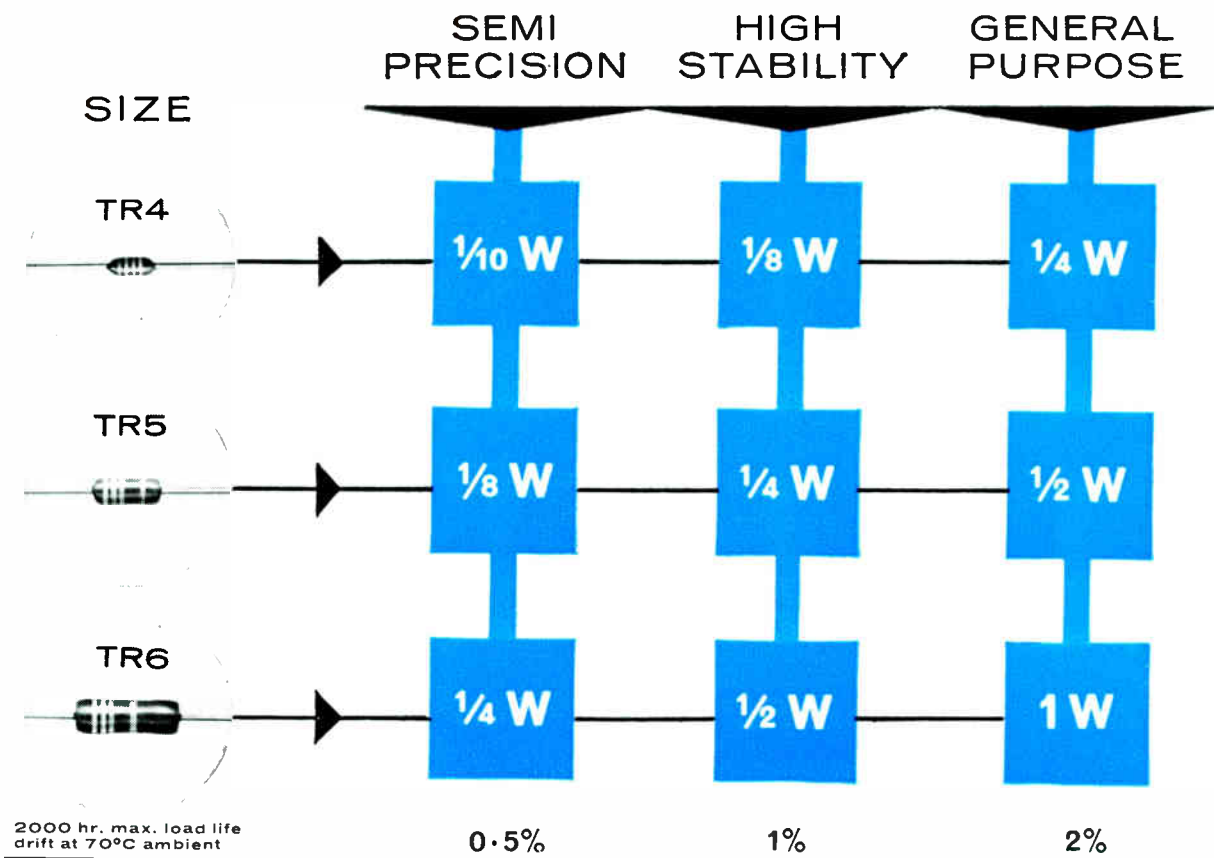

The semi precision resistor NJ60 1/8 Watt and the general purpose CJ20 1/4 Watt are now identical and are supplied colour coded. The same applies to NJ65 1/4 Watt and CJ32 1 Watt resistors. For convenience the various style references are retained; these signify rating and performance. The common link is a basic TR size reference. Thus the same Electrosil resistor can be used at different ratings for semi precision, high stability and general purpose applications. This can result in extensive saving in stock, economy in bulk purchase and standardisation in design. The full test conditions of DEF 5114 which cover the temperature range -55°C to +125°C can be applied to the triple ratings of each resistor size. The requirements such as maximum change of resistance for 2000 hr load endurance vary according to the rating as indicated. The average change of resistance on load is well within these limits.

The Electrosil 'Triple-rated' range

	Ohmic Range	Dimensions
TR4	51-150K	0.25" x 0.09"
TR5	10-470K	0.375" x 0.15"
TR6	10-1M	0.593" x 0.19"



Pallion, Sunderland, Co. Durham
Tel: Sunderland 71557 • Telex: 53273

Quick! Simple! Efficient! Space-saving!

A bull's-eye every time with **ADDA-SHAFTS**



Unique Separate Spindle System (Patented) for all Volume Control and Potentiometer requirements

- * Spindles for "Grub-screw" and "Push-on" fittings
Pre-sets and other 'specials'
- * Control units with or without D.P. Switch. Log
or Linear Tracks



Radiospares Ltd.

4-8 MAPLE STREET · LONDON · W.1 · ENGLAND

Telephone: Euston 7232 (8 lines)

By Return
Service for
all
Electronic
Components

Telegrams: RADOSPERES, WESDO, LONDON

Cables: RADOSPERES, LONDON—W.1

'ENGLISH ELECTRIC'

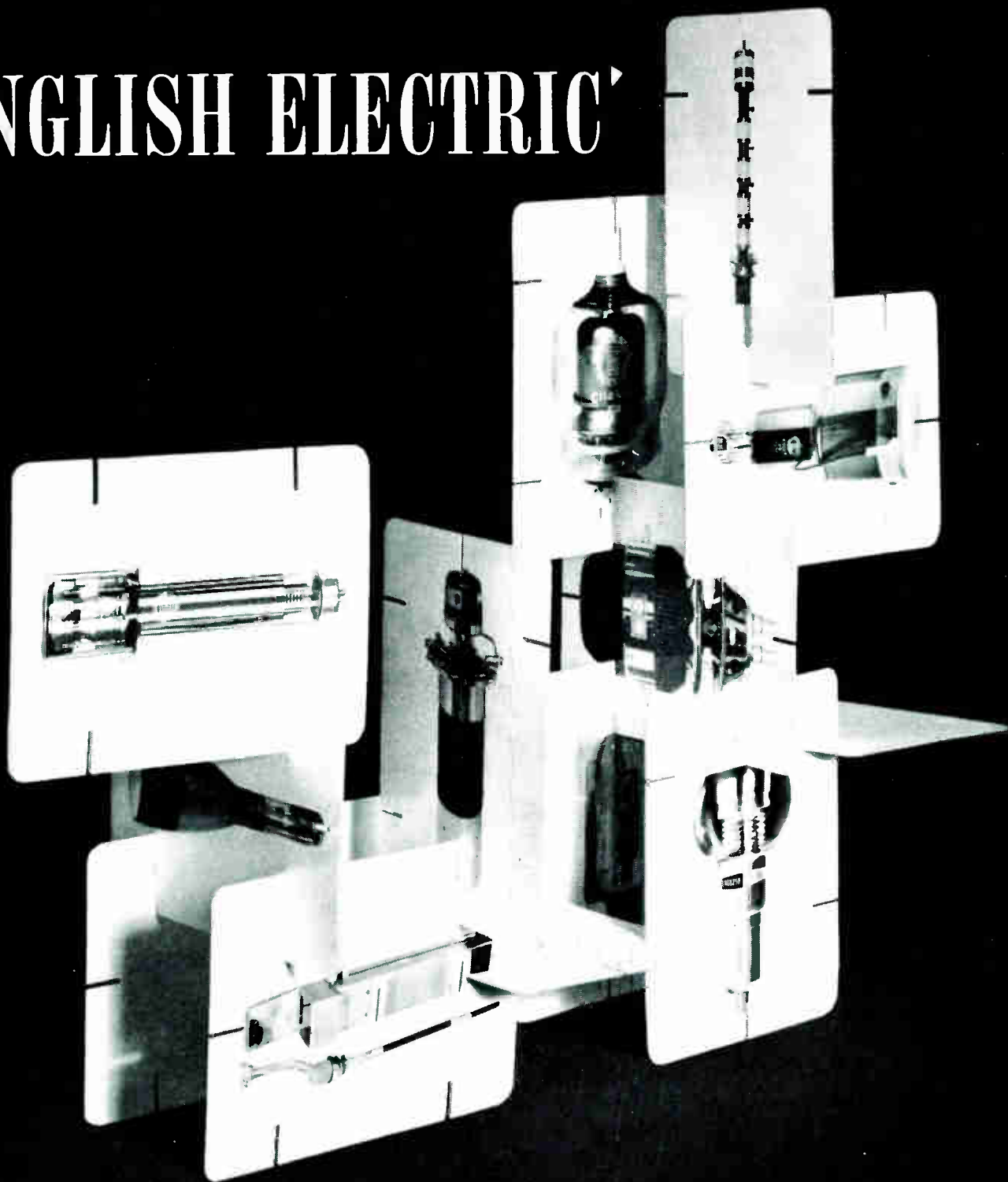

So many projects rely on English Electric Valves

Valves and tubes for radar, industry, communications and television

Thermionic Rectifiers
R.F. Heating Valves
Transmitting Valves
Klystrons
Magnetrons
Travelling Wave Tubes

Backward Wave Oscillators
Thyratrons
Pulse Amplifier Valves
Storage Tubes
Image Orthicons
Vidicons

Cathode Ray Tubes
Trigger Tubes
Voltage Reference Tubes
Voltage Stabilisers
Vacuum Capacitors

ENGLISH ELECTRIC VALVE COMPANY LIMITED

AGENTS THROUGHOUT THE WORLD | Chelmsford, England. Telephone: Chelmsford 3491

INDUSTRIAL ELECTRONICS

Comment

On 25th May the Instruments, Electronics and Automation Exhibition will open at Olympia. Our May issue will contain a preview of the exhibition together with a plan and a list of exhibitors. As this will be published some time before the opening of the exhibition, it must necessarily be compiled from advance information supplied by exhibitors.

The present indications are that something like 600 companies will have their products on view. Not all of these products are of application in our field, of course. There are many instruments, for example, which are neither electronic in themselves nor intended for use in conjunction with electronics. However, the penetration of electronics into instrumentation is very deep, for so many things can be measured or detected better with its aid, and it is probably true that at least 50% of instruments are in some way connected with electronics.

Since automation depends so heavily on electronics, there is no doubt at all that the exhibition is one in which electronic apparatus and its applications will dominate the scene. It follows that most readers will find a great deal of interest to them.

Next month's preview will be a guide to the exhibition but it is not intended that it should be a substitute for a visit to Olympia. We should perhaps remind intending visitors that they will have only six days in which to see the exhibits, for it closes on Saturday, 30th May.

Lasers

We keep talking about lasers, but fresh news about them keeps coming along, and this must be our excuse. There is now news from I.B.M. of an electrical way of deflecting a laser beam of light. The deflector comprises a pair of crystals, the first of which is called a switch and the second of which provides the actual deflection.

The switch comprises a potassium dihydrogen phosphate crystal with semi-transparent electrodes to which the switching voltage is applied. This voltage alters the polarization of the light beam. The second crystal of the pair is of birefringent calcite. Ordinary light is split into two beams on passing through this and emerges as two displaced beams. The polarized light from the laser, however, emerges on one or the other of these two paths according to its incident polarization.

By passing the light in turn through

a number of pairs of crystals the position of the beam on a final screen can be rapidly changed to any desired predetermined position. The idea is that it should be used as a high-speed display system. If a stencil-like mask is placed between the laser and the switching deflector system, a letter or numeral can be projected on to a screen at any required position. It is expected that several million deflections a second will be possible.

Colour Television

Hopes that European agreement on a colour television system would be reached at the recent meeting of the Sub-Group of C.C.I.R. Study Group XI in London have been disappointed. Three systems are rivals for adoption and, naturally enough, each has its advantages and disadvantages. The U.K. representatives pressed for the adoption of the N.T.S.C. system but

most foreign delegations felt that insufficient work had yet been done to enable a decision to be made. This must, of course, refer to the newer Secam and Pal systems, for as the N.T.S.C. has been operational in the U.S.A. for the last 10 years there is plenty of experience of it available.

The Sub-Group, however, decided to defer a decision until its next meeting. As this is not until the spring of 1965, we in this country are now faced with having to delay the introduction of colour television by a year or to 'go it alone'.

The Television Advisory Committee is meeting this month to decide upon its recommendations to the Postmaster-General. The final decision is, of course, one for the Government. It should not be long, therefore, before the Industry knows what is going to happen.

Motor Cars

So far electronics finds little place in the motor car, but it is beginning to creep in. There is a trend towards replacing the d.c. generator for charging the battery by an alternator with semiconductors for rectification and control. In the ignition system, development is towards using a transistor to 'make and break' the coil circuit and using the 'contacts' only to control the transistor.

Now comes news from Russia of an electronic control of fuel injection. The proper quantity of fuel for the load, atmospheric pressure and air temperature is determined and measured out and then injected into the engine by electromagnetic sprayers, all under electronic control. No details of the device are available as yet, but a 20% increase of speed is claimed to result as well as great fuel economy.

Tesla

As a unit the tesla is unfamiliar to most people. The name is by no means a new one, but it has never been much used. We have recently come across it in American literature, however, and in case it is being revived it may be useful to say what it is. The tesla is a name for the unit of magnetic flux density B and is the same as the m.k.s. unit, weber/square metre which is, of course, equal to 10 kilogauss.

Electronic Industry's 1963 Turnover

It is interesting to note that, according to a recent report by The Electronic Engineering Association, the 1963 turnover of the capital equipment section of the electronics industry was over 10% up on the 1962 figure. Sales in 1963 amounted to £186 million compared with £167.7 million in 1962.

Approximately 25% of the output of this sector of the industry is exported. About 8% of the turnover is ploughed back into research and development.

The U.K. electronics as a whole, components, valves, and domestic and capital equipment, had an output of £379.3 million in 1963 compared with £345.9 million in 1962.

Economic Development Committee

The National Economic Development Council is establishing five Economic Development Committees for five industries of which electronics is one. Each Committee will include representatives of management and unions, the government department concerned, the National Economic Development Office, and members with special knowledge and experience.

The Chairman of the Electronics Committee is Sir Edward Playfair, K.C.B. (International Computers and Tabulators Ltd.) and the members representing the electronics industry are:—W. H. D. Gregson (Ferranti Ltd., and E.E.A.), C. A. W. Harmer, O.B.E. (Pye Ltd.), W. S. Steel (A.E.I. Ltd.), R. Telford (The Marconi Co. Ltd.), J. Thomson (Morganite Resistors Ltd. and R.E.C.M.F.), and A. Weinstock (G.E.C. Ltd.). The union members are:—L. Cannon (E.T.U.), W. John (A.E.U.), D. Lewis (A.E.U.), and W. M. Tallon, O.B.E. (A.E.U.). In addition, there are John Duckworth (N.R.D.C.) and E. S. Foster (M.o.A.).

The Committee's terms of reference are:—'Within the context of the work of the National Economic Development Council and in accordance with such working arrangements as may be determined from time to time between the Council and the Committee, each Committee will—

1. Examine the economic performance, prospects and plans of the industry and assess from time to time the industry's progress in relation to the National growth objectives, and provide information and forecasts to the Council on these matters;
2. Consider ways of improving the industry's economic performance, competitive power and efficiency and formulate reports and recommendations on these matters as appropriate.'

Brit.I.R.E.

This well-known abbreviation is now to disappear. The British Institution of Radio Engineers is changing its name to The Institution of Electronic and Radio Engineers, so its abbreviation will now be I.E.R.E. Every corporate member of the Institution is now entitled to describe himself as a Chartered Electronic and Radio Engineer.

The C.E.G.B. Telemetry System

Part 1

By J. W. DILLOW, B.Sc.(Eng.), A.M.I.E.E.*

The grid system of electricity bulk power transmission would be impossible in its present form without an elaborate telemetry system. Over 2,000 telemeters are used and this article describes the system employed. Part 2 will deal with the communication network involved.

THE Central Electricity Generating Board operates a grid network which is the largest system under unified control in the world. In the winter of 1962/63 the potential demand was in the region of 32,000 MW and this figure is increasing at a rate of more than 7% per annum.

This system has evolved from the days when each city and large town had its own 'Electricity Works' which provided for the needs of localized areas by means of a simple distribution system. When the Central Electricity Board was formed, a series of district grids was set up which enabled each undertaking to run more efficiently and economically, taking advantage of spare generating capacity which could be made available to the whole group.

This involved power flows from one undertaking to another and control centres were set up to co-ordinate activities. In these control centres it was necessary to know the power flow between each undertaking and the grid and telemetry systems were set up to provide this information. These were on a comparatively small scale by today's standards (about thirty readings to each control centre) and many different systems were used.

The evolution continued and the separate grids began to join up and by the time the war came in 1939 the whole of England, Wales and the South of Scotland were running as a fully interconnected system, known as the Grid.

After the war, the Electrical Supply Industry was nationalized and a higher voltage network (275 kV) was superimposed to form a 'Super Grid' which provided a much higher capacity transmission system.

With the increasing complexity of the power system, more and more telemetry was required and when the seven new Grid Control Centres were set up about 1957, facilities were provided for nearly 300 telemeter readings at each centre. Today, the Generating Board has well over

2,000 telemeters with nearly 3,000 channels available on the communication circuits.

Without the aid of this comprehensive telemetry network it would be impossible to operate the Grid as a complete entity and it would have to be broken down into a number of smaller systems operating independently.

Basic Characteristics for a Telemetry System

The design of such a system is governed by a number of requirements which are not always compatible and some compromise is needed in order to give the best service. The first requirement is reliability which is of paramount importance in order that the system control engineer may operate with complete confidence that the readings presented to him are an authentic picture of the state of the network.

A telemeter must operate equally well on any communication channel whether a d.c. line, a voice-frequency telegraph channel, a power-line carrier or a radio link and, once installed, should require a minimum amount of maintenance. For economic reasons, a number of telemeters should share a communication channel.

For most purposes an overall accuracy of the order of 2-3% is adequate and for a manually-operated system without automatic frequency control, a response time of

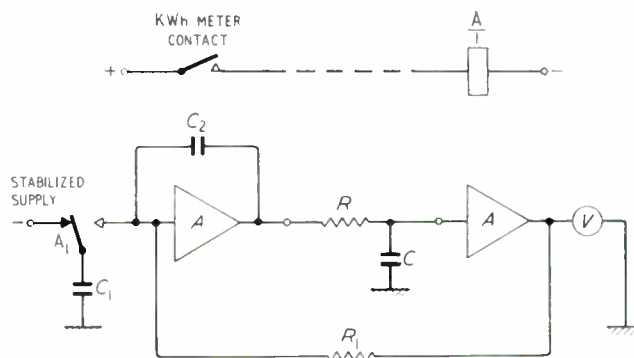

Fig. 1. Basic form of telemeter

* Central Electricity Generating Board.

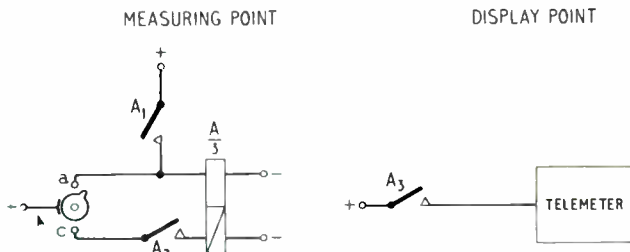

Fig. 2. Corridor pulsing circuit

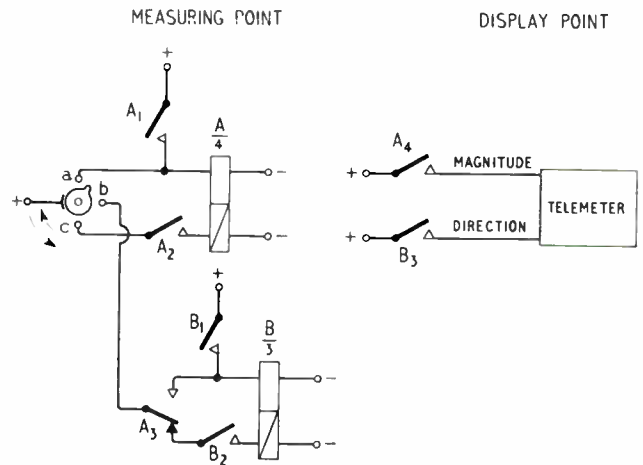

Fig. 3. Three-contact pulsing system to indicate direction of power flow

the order of 10-30 seconds is generally satisfactory and times up to two minutes have been used.

Basic System

The factors determining the choice of system have been described elsewhere^{1, 2}; it is sufficient here to say that a pulse frequency system at a slow rate was adopted. Pulses are generated at a rate of approximately 1 per second and are generally derived from rotating kilowatt-hour meters fitted with auxiliary impulsing contacts. The speed of rotation of a kilowatt-hour meter is directly proportional to the instantaneous value of power and thus the pulse-repetition frequency is also directly proportional to power.

The pulse frequency is converted into a proportional direct current by means of electronic circuits and this current is used to operate conventional indicating instruments scaled in the appropriate quantities. A basic circuit of a telemeter is shown in Fig. 1. A capacitor C_1 is charged to a constant voltage and is discharged into a capacitor C_2 at each operation of the impulsing relay. C_2 is connected across a high gain amplifier A and subsequent smoothing stages which produce a voltage output which is proportional to the average charge on C_2 . The output voltage causes a current to flow through R_1 into C_2 .

Successive operations of the relay may be considered to produce a current from C_1 into C_2 which is balanced by a current through R_1 as the result of an output voltage V which corresponds with an impulse rate f .

This arrangement is analogous to a leaky bucket being filled by cupfuls of water wherein the level of the water in the bucket is dependent upon the rate at which the cupfuls are topped in. This analogy had led to this type of telemetering being known as the 'Cup and Bucket' system.

The response time of the telemeter is governed by the size of the 'bucket capacitor' and the subsequent smoothing stages and will be considered in more detail later.

Impulse Sources

Many varieties of integrating meters exist which differ in detail in the method by which the contacts are fixed. A typical arrangement is shown in Fig. 2. Here two fixed 'a' and 'c' contacts are placed 180° apart and a rotating contact closes with each in turn and remains closed for a

fixed angle of rotation. The associated circuit is so arranged for two principal reasons. Firstly, since the contacts must not impose an appreciable burden upon the rotating member, the contacts are essentially delicate in nature and only exert light pressures on each other. While these can make and carry the current necessary to operate a relay, they are not suitable for breaking an inductive circuit. Thus the relay locks itself, so that when the meter contacts open there is no change of potential across them and no arcing occurs. When the next meter contact closes (180° later) the relay is knocked down by a current in its second winding which is in the opposite sense to the current in the first winding so that the net flux in the core reduces to zero and the relay releases and opens the circuit to both its holding and knock-off windings. Any sparking that may occur is on the relay contacts rather than on the meter.

A second advantage of this arrangement is that when the meter is rotating at very low speeds (and hence low torques) there is a tendency for the contact to close and be forced off again by the spring pressure of the contacts. Thus the contact tends to judder for a short period and it is essential that the following relay should not repeat the movement. As soon as the relay operates it locks itself and can only be released when the meter has rotated a full 180° so that none of the judder is transmitted to the telemeter.

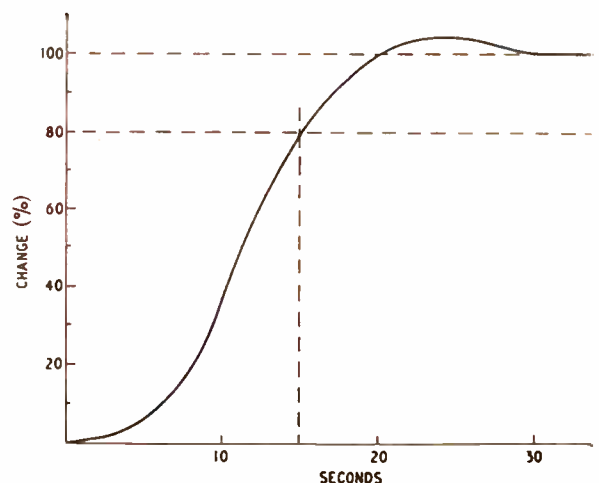

¹ Dunn, R. H., and Chambers, C. H., 'Telemetering for System Operation', *Proceedings I.E.E.*, Paper No. 1400 M, October 1952 (Vol. 100, Part I, p. 39).

² Burns, G. A., Fletcher, F., Chambers, C. H., and Gunning, P. F., 'The Development of Communication, Indication and Telemetering Equipment for the British Grid'.

A modified form of contact is shown in Fig. 3 which illustrates a sensing contact to indicate the direction of power flow. In this case the pulse rate is taken from the 'a' and 'c' contacts which are placed 180° apart and the 'b' contact (at 90°) is used in conjunction with a second relay B. If the direction of rotation is 'a b c' then when the rotating contact passes through 'b' the A relay is already operated so that B relay operates and locks itself. As long as the clockwise rotation continues, the B relay will remain operated, but when the direction reverses to 'a c b', then when the 'b' closure occurs the A relay is not operated so that the B relay gets knocked down. B remains unoperated for anti-clockwise rotation and is used to reverse the connections between the telemeter and a two-terminal centre-zero indicating instrument.

Response Time

The response characteristics of the telemeter incorporating CR smoothing is logarithmic in form and the response time is defined as the time taken to reach 80% of the final value as a result of an instantaneous change. The two most commonly used full-scale impulsing rates are 66 2/3 i.p.m. for megawatt load flows and 33 1/3 i.p.m. for the corresponding megavar flow. The corresponding response times are 15 and 30 seconds respectively.

A typical response curve for a 66 2/3 i.p.m. telemeter is shown in Fig. 4. Although 80% of the change is reached in 15 seconds, it is apparent in two or three seconds that the change is occurring and this is psychologically important when a change has been ordered and a response is expected.

For a gradually increasing load, the actual response time is approximately half the normal response time since the telemeter is operating continuously on the steep part of its characteristic. Fig. 5 shows the relationship between the load changing at a rate of 10% a minute and the value indicated by the display instrument. For a telemeter having a normal response time of 15 seconds, the response to slow changes is 7 1/2 seconds so that the error due to response time is $7\frac{1}{2} \div 600$ or 1 1/4%. If the load were to change at only half the rate (i.e. 5% per minute) then the response error would only be 1/2% and in most cases the load changes occur at a much slower rate so that the error attributable to response time is negligible.

Telemeters for Use With Summated Readings

For tariff purposes measurement of the combined output of a number of generators in a power station is required. This is generally achieved by adding together pulses from

Fig. 4. (left) Response characteristic of a 66 2/3-i.p.m. telemeter

Fig. 5. (below) Telemeter response to a gradually changing load

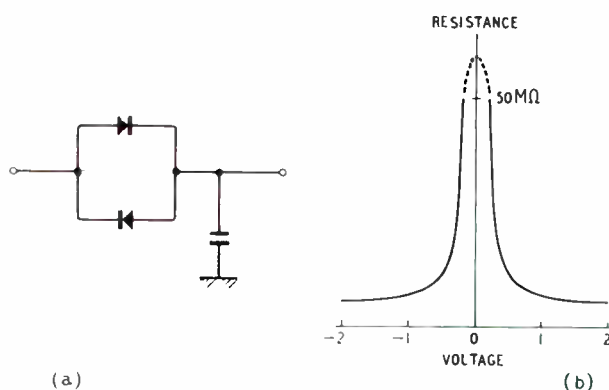
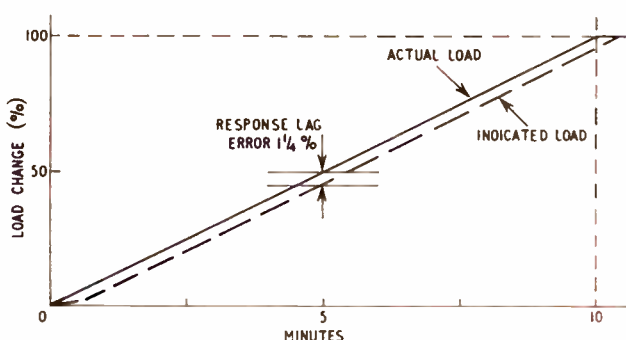

Fig. 6. Circuit giving variable time constant (a) and its variation of resistance with voltage (b)

the integrating meters associated with each generator. The input pulses operate stepping motors which in turn drive shafts through differential gears. A set of contacts is fitted to the output shaft whose average speed of rotation is then proportional to the total power being generated.

A telemeter which receives pulses from a tariff summator has a time constant which is governed by the input pulse rate to the summator and not by the output pulse rate from the summator. The inputs to the summator occur at random and a beat frequency can occur at the output which has the appearance of rapidly increasing or decreasing loads. This would cause an undesirable swing on the needle of the display instrument unless the integration period is sufficient to average out the beat frequency. In practice, a compromise is needed between having a rock steady reading on the display instrument and the shortest possible time constant. It is customary to tolerate some slight wobble on the meter needle when the reading is less than 20% of full scale.

Feeder-Flow Readings

The operational requirements for loads in interconnectors necessitates that near-zero readings shall be steady so that the floating conditions can be seen, but sudden changes in load, such as a circuit tripping out, must be rapidly displayed. This condition is met by a modified form of telemeter which adjusts its response time according to the pulsing conditions.

The conventional RC smoothing circuit is replaced by the circuit shown in Fig. 6. The resistor is replaced by two multi-plate selenium rectifiers connected in opposite senses. The forward resistance of a selenium rectifier is a function of the voltage across it and the characteristic of a back-to-back pair is also shown in Fig. 6. Under steady impulsing conditions a state of near equilibrium is reached in the telemeter so that the voltage difference between the output of the integrating stage and the output cathode follower is very small and the rectifier behaves as if it were a very high resistor (of the order of 50 megohms), and the corresponding time constant is very high so that a steady reading is maintained even at very slow pulse rates. When a load change occurs accompanied by a change of pulse rate, then a potential difference appears across the smoothing stage which immediately unblocks the rectifier which drops to a low resistance value and allows the change of pulse rate to appear at the output of the telemeter.

Thus a telemeter for feeder-flow readings has a long

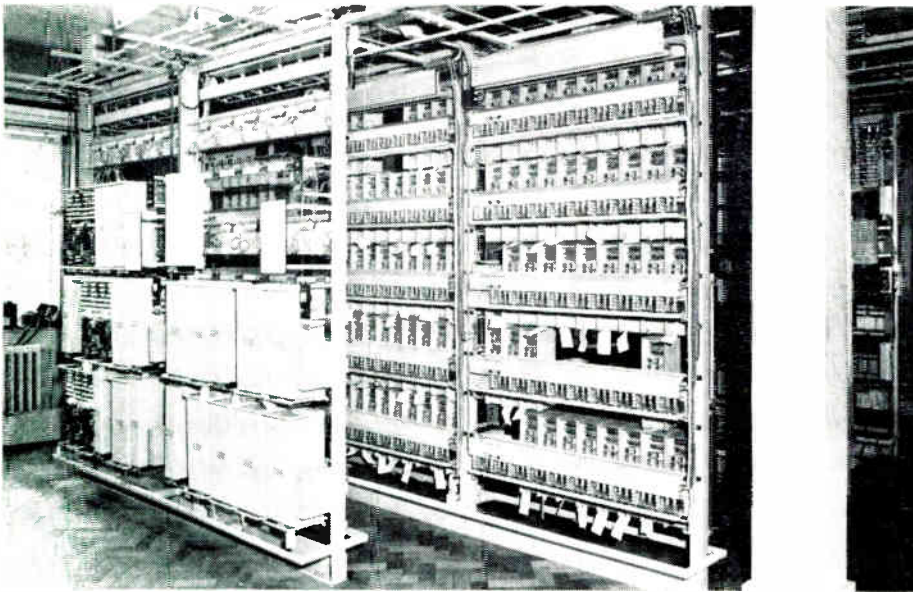

Suite of telemeter racks fed from a common power supply

time constant under steady conditions and a short time constant under changing conditions and is quite unsuitable for use with a mechanical summator in which a bunching of pulses occurs, giving a constantly changing pulse rate so that the feeder-flow telemeter would be permanently in the short time constant state which would give rise to severe excursions of the needle on the display instrument.

Arrangement at the Grid Control Centres

Telemeter impulses are transmitted to the Grid Control Centres by means of time-division multiplex systems using private circuits rented from the Post Office. (The Multiplex Transmission System will be described in detail in Part 2 of this article.) The pulses are fed to individual telemeter receivers which are mounted in groups of 48 on conventional type Post Office open racks. One of the photographs shows a suite of telemeter racks which are fed from a common 250-0 250-V d.c. power supply. Each telemeter normally draws about 12 milliamps from the h.t. supply and it is interesting to note that filament lamps are used as ballast resistors to prevent a fault which might occur in any one telemeter interfering with any other reading. It is arranged that the full-scale output shall be the same for all telemeters regardless of the quantities that are being displayed and 2½-mA d.c. moving-coil ammeters are used with appropriate scalings. The corresponding voltage at

the output terminals of the telemeter is 75 volts so that the total resistance of the indicating meter circuit is padded up to 30,000 ohms. Several meters may be connected in series to give simultaneous display at more than one place

Summation of Readings

The output of each telemeter is 75 volts corresponding to the full-scale pulse rate and the output is fully linear over the whole working range. This permits a simple direct-current summation scheme to be used. Currents are fed from the individual telemeters through suitable scaling resistors to a common summing resistor which has a self-balancing potentiometer slide-wire recorder connected across it. The current values normally used are such that one microamp represents one megawatt. Thus, for example, a telemeter whose full-scale output corresponds with 150 MW of load flow must inject 150 µA of current into the summing resistor. The maximum volt drop across the summing resistor is 50 millivolts so that for all practical purposes the full output voltage of the telemeter (75 V) can be regarded as appearing across the scaling resistor. Thus the scaling resistor for 150 MW load should be 0.5 megohm. In order to give algebraic summation a centre-tapped summing resistor is used and all the adding inputs are connected to one side and all the subtracting inputs to the other. The chart recorder uses 11-in. paper and the pointer takes a maximum of 15 seconds to traverse from one side to the other. A paper speed of 3 in. per hour is used.

Two principal summations are made in each Grid Control Centre, one to determine the total generated output from all the generators in the area and the other to determine the net area transfer via the tie lines to adjacent Grid Control areas.

With this method of summation, it is simple to inject a current which can represent certain fixed loads which would not justify having individual telemeters. Also a 'lost-load' reading can be added by the use of a hand-set potentiometer with a calibrated pointer, in the event of any failure of the telemetering system.

Certain minor summations are carried out by passing currents through a common meter as well as the individual display meters. This technique is well known and is satisfactory accurate as long as the resistance of the common meter is low compared with the 30,000 ohms of the contributing circuits.

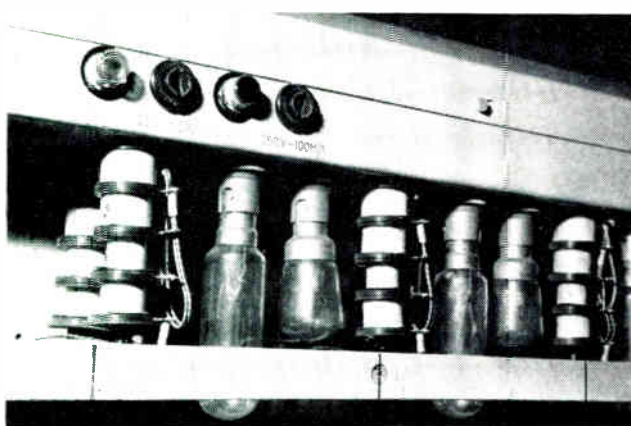

Part of power supply unit showing filament lamps used as ballast resistors

LOGICON

A series of logical units which enables the non-specialist engineer to construct control systems is described. Most logical functions can be covered by two basic units.

BUILDING – BLOCK

SYSTEM

By R. E. YOUNG,
B.Sc.(Eng.), M.I.E.E., A.F.R.Ae.S.

THE 'Logicon' system and its building-block components have been designed by Associated Electrical Industries Ltd. specifically for the industrial user, both basic units and complete sets of equipment being supplied. The building blocks are essentially solid-state logic units which offer a number of advantages in control applications where interlocked or programmed switching is required.

Such applications are exemplified by the installation shown in the cover photograph, where a Logicon system provides full control switching for a hot-strip mill. Originally this facility was given by conventional electromagnetic relays and allied contactor gear which occupied a panel space some 60 ft long. The equivalent static-switching system is housed in a cubicle with a width of about 6 ft, which is an order down on the original. This example is typical of the saving in space which can be expected with a changeover to the solid-state equipment.

One of the cardinal points in the design of the Logicon system has been to avoid undue complication and to give a complete range of control facilities with the minimum number of types of building-block unit. Such an approach obviously has a number of advantages, particularly for the main user in industry, the non-specialist engineer.

Thus it has been found possible to cover the various logical functions required in practice by two basic units. The PLUS unit (colour code, red), which switches on when the requisite inputs are present, can perform the same control switching actions as a group of NOR gates or combinations of AND, OR, NOT and MEMORY gates. Similarly the MINUS unit (colour code, green), which switches to off, covers NOR and AND NOT gating, and combinations of the two.

A useful practical feature is the provision of visual indication of the switching state of individual units by neon lamps connected directly to each of their outputs. This facilitates maintenance and fault-finding without additional test equipment being required, by taking full advantage of the two-state action of logic switching.

As part of the design approach adopted by A.E.I. to satisfy industrial requirements, the system and its components have been developed to withstand worst-case environments—both mechanical and electrical.

Thus, taking the mechanical aspect, direct protection for the printed-circuit basic units is provided by plate shields of

black anodized aluminium which also act as heat sinks when required. A rigid shallow box-section structure is thereby produced—vertical mounting being adopted to take full advantage of natural convection cooling through the ventilating ducts formed by the sides of the units. In cases where completely encapsulated units are specified for particularly severe conditions, cooling fins are brought out from the epoxy resin block itself whenever power dissipation within the block warrants it. Even when units are not en-

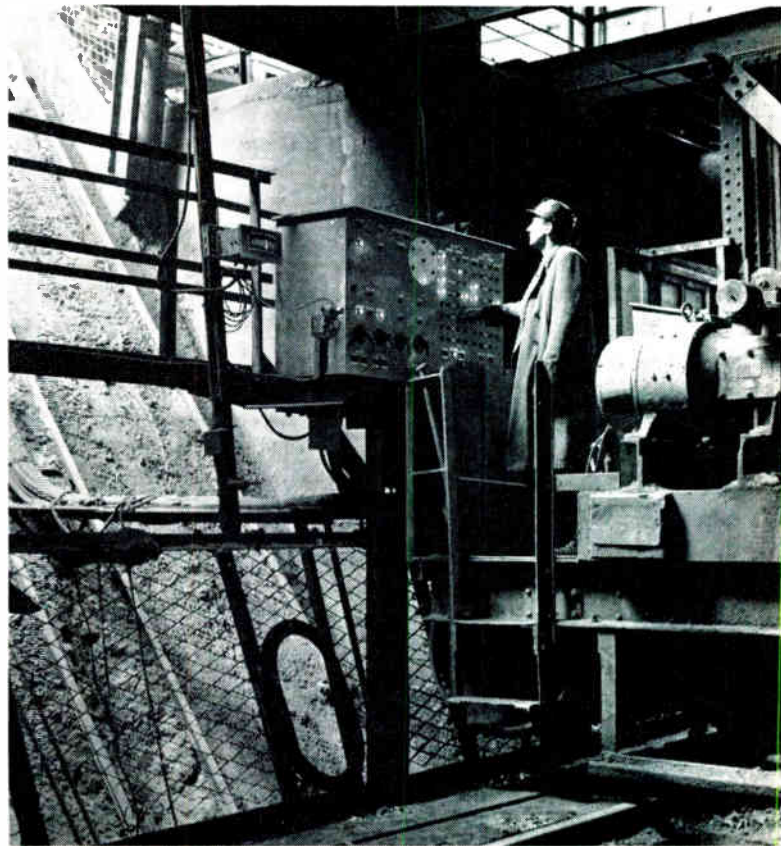

A.E.I. control for blast furnace skip hoist: operator's control station (Workington Iron & Steel Co.)

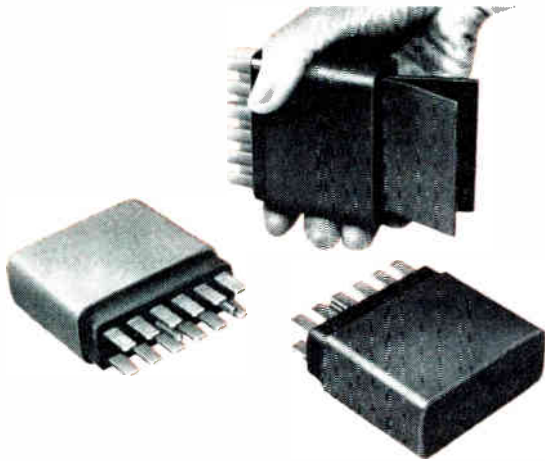

A group of A.E.I. Logicon units including a 200-watt output unit with cooling fins.

encapsulated an epoxy resin coating is given to the board surfaces.

A code of practice for the construction of equipment incorporating Logicon units has been evolved which has particular application where users produce the overall control system themselves. The horizontal sub-frames between which the units are mounted are made from standard steel top-hat sections with a channel depth of approximately $\frac{1}{2}$ in. Except for heavy output types, units are plugged in to appropriate multi-way sockets, and are retained either by spring clips or by 'Vibrex' fasteners. Pegs associated with the latter can be disposed to provide non-interchangeability between different types of unit.

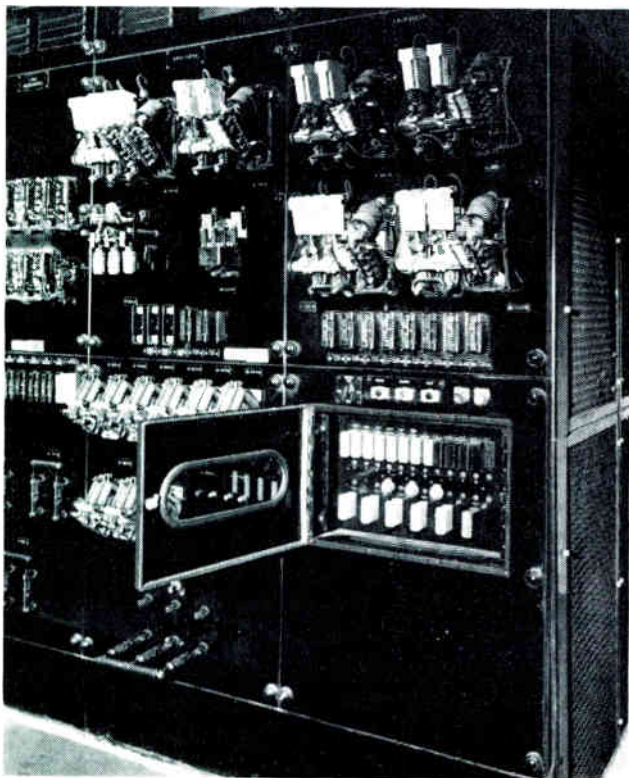

A.E.I. static control equipment for flying shear (Steel, Peech & Tozer). This, the first Logicon installation, has been operating for three years without a failure

This form of construction enables cabling to be run conveniently to meet electrical requirements. Thus heavy-current output wiring is segregated from the lower-level signal input circuits; while special precautions can be taken with regard to earth connection through individual conductors where this is necessary as, for instance, with power output units feeding contactors or electromagnetic clutches.

It will be appreciated that these and similar precautions form part of a general design pattern aimed at ensuring utterly reliable operation under industrial conditions. It will also be realized that an outstanding problem in this context is to avoid the acceptance of any spurious signals which may be injected into the system. As indicated earlier, this situation is likely to arise especially with the impulses set up by the large starting currents of heavy electrical machinery.

This, then, is the background against which electrical design has been carried out. In general, Logicon units are single network blocks, various functions being covered by individual types, each type having a specific colour coding.

In addition to the basic logic functions (e.g., the 'Brown or Unit' gives the or gate action of only one input being necessary for an output to appear) other specialized facilities are provided by units developed for each purpose. Thus for instance a 'Blue Voltage Detection Unit' has been produced to give the equivalent of a voltage sensitive relay which switches at pre-set levels. High-stability resistors and (silicon) transistors are employed to keep drift to a low value, 0.2% of the maximum switching voltage. A differential snap action is obtained with an adjustable minimum overlap usually set in the 0.2-1 V region.

Supply voltages, $-36, 0, +50$ V, are made high in order that the corresponding signal levels may be kept well above that of the interfering spikes, etc. Hence with limit switches, for example, the full input voltage is sent to line and is well in excess of the spurious signals. Even in these cases, however, signal and power supply runs are segregated; while for low output devices such as photo-transistors working over long cable runs individually screened balanced pairs are recommended to give a good safety margin between signal and interference.



Further precautions include the use of diodes as spill-over devices across transistor inputs to protect them against any excessive base-emitter voltages which may be built up. Voltage surges produced by switching off inductive loads in the outputs of amplifiers are dealt with in much the same manner by discharge diodes.

A type of power pack has been selected which is especially suited to industrial use, in that with a regulation value of the order of 6% at full load but with a steep fall-off from 150% full load, it is virtually impossible to sustain damage in the event of an external short fault condition.

Finally, a valuable feature of the Logicon system has been found in its flexibility when used in development installations. Major alterations can be made rapidly to produce a finalized version without disturbance to the remainder of the equipment.

INFORMATION WANTED ?

If you require further details of products or processes described or advertised in INDUSTRIAL ELECTRONICS you will find it convenient to use the enquiry cards which will be found in the front of the journal.

	DIGITAL DISPLAY	ONE PLANE READOUTS	ENSURE ACCURATE READABILITY	EACH UNIT EMPLOYS	12 INDIVIDUAL LAMPS	TO DISPLAY UP TO
12	INDIVIDUAL NUMBERS OR LETTERS	-OR SYMBOLS SUCH AS	 OR	!	UP TO 10 NUMBERS	CAN BE COMBINED WITH
POLARITY SIGNS SUCH AS	-2	+9	AND COLOUR CAN BE ADDED	 PRODUCE	INDUSTRIES MOST VERSATILE RANGE	OF ONE-PLANE READOUTS- THESE ARE
ACTUAL SIZE SERIES 660	5/8"	WITH CHARACTERS 5/8" HIGH	OTHERS ARE SERIES 600 WITH	1"	CHARACTERS AND SERIES 640 CHARACTER HEIGHT-	3 3/4"

*Only **CI** give you such versatility*

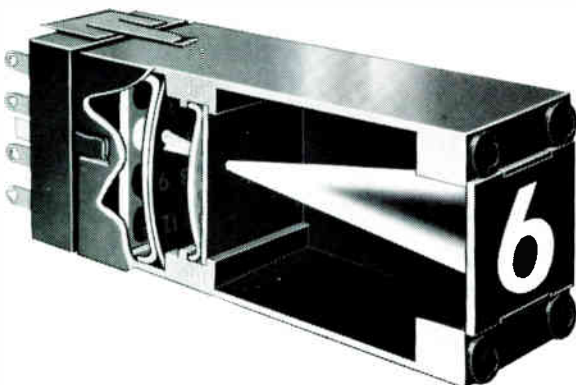

C.I. one-plane readouts consist basically of 12 lamps rear-projecting through 12 lenses. Each lamp can be illuminated separately or in combination with others. Thus it will be seen that by using one lens for one word or number, multiple word/number messages may be projected. Alternatively each lamp may be used to project a complete message giving 12 messages in all. Colour can be added by using one lamp for each colour or by colouring the message carrying lens. Characters are bright and distinct with unused characters completely invisible.

Counting Instruments Limited

Elstree Way · Boreham Wood · Herts
Telephone: Elstree 4151

ELECTRONIC COUNTERS TODAY AND TOMORROW

By D. R. OLLINGTON, A.M.I.E.E., D.F.H.(Hons.), Grad.I.E.R.E.*

Forms of display system are discussed in this article as well as types of counter and applications. The article ends with a look at the future.

THE electronic counter in use today is a more sophisticated instrument than its predecessor. The last ten years has seen the general-purpose counter change from a large console containing 100 valves or so, to a small package which can be held in one hand. Today's counter contains printed circuits, is fully transistorized, and has a general acceptance undreamed of in the 1950s. This change in status is almost entirely attributable to the transistor.

Early valve counters had many problems of pulse pick-up due to the inherent high input impedance grid circuits and high anode voltage swings. Output pulses were typically 200 V in amplitude and great care had to be

taken to prevent stray pulses being picked up on the grid circuits (with sensitivities of the order of one volt or so). Wiring layout was extremely important. Stray capacitance between circuits had to be kept to a bare minimum. The transistor, however, is normally operated with a collector swing of, say, 6 V while the base requires a 1.2-V swing. The input impedance is relatively low and consequently pick-up problems are minimized and wiring requires far less critical control. The tendency today is therefore towards smaller portable counters using transistors throughout. There are a number of portable counters available at the present time, a four-digit model of which is shown in Fig. 1. The counter illustrated contains printed-circuit boards, a small stabilized power supply, and the four display units.

It would appear there is no right or wrong method of display, it is a matter of personal choice. The instrument in Fig. 2 uses a moving-coil meter movement which carries a piece of microfilm bearing the numbers 0, 1, 2, 3, 4, 5, 6, 7, 8 and 9 on a black background. A beam of light

Venner Electronics Ltd.



Fig. 1. Portable 4-digit counter

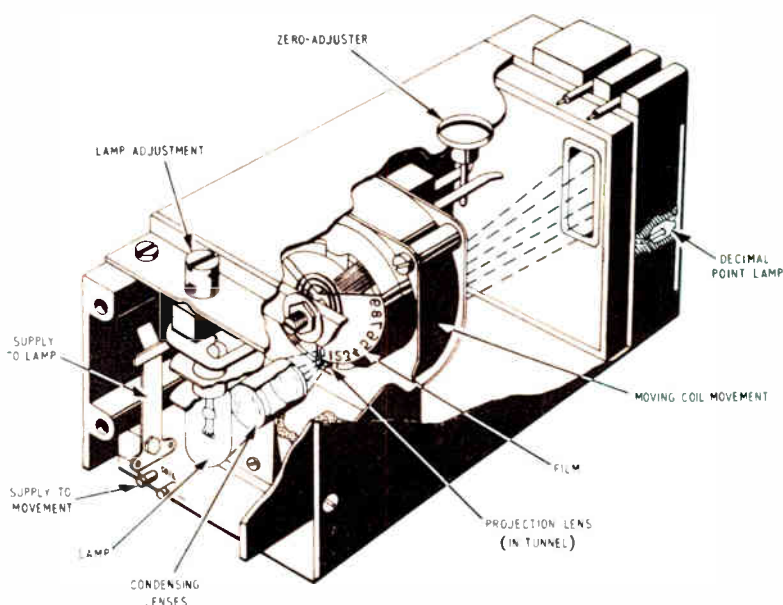

Fig. 2. (Right) Interior of Digivisor in which numerals on a piece of film are projected on to a screen. The film is attached to the pointer of a microammeter (The Electrical Apparatus Co., Ltd.)

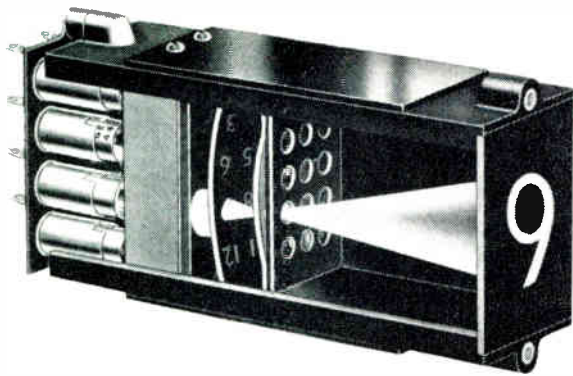
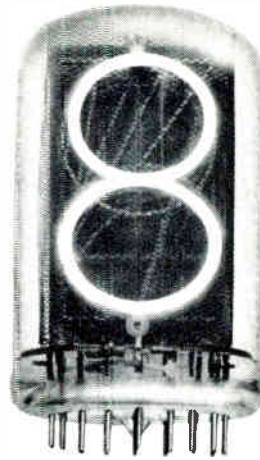

Fig. 3. (Above) Multi-lamp, multi-lens display unit (Counting Instruments Ltd.)

Fig. 5. (Right) Gas-filled display tube (Burroughs Corp.)



0	1	0	5
2	3	1	6
4	5	2	7
6	7	3	8
8	9	4	9
(a)		(b)	

Fig. 7. Split column display

shines through the microfilm and the resultant image is projected on to a frosted plastic screen. The moving-coil movement has a typical full-scale deflection value of 250 μ A and it is fed with a staircase of current derived from the four binary stages which make up a decade in the counter. Each binary contributes a unit of current corresponding to its own importance in the total count. Thus the first binary may contribute one unit of current, the second two, the third four, and the fourth two. If all binary stages are switched over, then a total contribution of 9 units of current is fed to the meter, which, if this totals 250 μ A, will mean that the 9 on the microfilm is in the light beam and the 9 is therefore projected on to the screen.

Multi-lamp indicators are popular for certain applications. These are available from several manufacturers but either consist of a lamp shining through a lens assembly carrying the number to be projected (Fig. 3) (for example, lamp 9 illuminates a lens bearing the legend 9 and thus projects this number on to the screen*), or consists of ten sheets of Perspex which have engraved on them, by a line

*In recent months these indicators have become available not only with the numbers 0-9 but also with such shapes as apples, cherries, and so on. The random patterns so produced from such indicators form an 'electronic fruit machine' which has certain other uses.

or a series of dots, a number (Fig. 4). When a lamp is illuminated at the edge of the Perspex light is transmitted within the plate and illuminates the engraved image.

Another popular form of display consists of a number of wires shaped into figures within a gas-filled envelope arranged so that when a voltage is applied to the appropriate wire a glow appears (Fig. 5).

The columnar display has been in use for some years and consists of a column of figures, each with a lamp behind the figure so that when lamp 3 lights the number 3 appears illuminated. Whereas all previous displays presented a different number in the same place on a screen, in the columnar display each number appears in a different position. If several of the previously mentioned displays are assembled side by side, then all figures displayed will appear as they would be read in a book; i.e. 1 2 3 4. They thus form an 'in-line' readout since all figures would be on the same line. If a number of columnar indicators are assembled side by side, then the pattern is a zig-zag one. This can give rise to misreading. In the example shown in Fig. 6 a six-figure display is illustrated, but because of the nearness or association of certain numbers an incorrect result can be observed by an operator. For this reason attempts were made to minimize the difference



Fig. 4. (Above) Multi-indicator comprising ten sheets of Perspex each carrying a numeral. The sheets are edge lit by separate lamps (K.G.M. Electronics Ltd.)

Fig. 6. (Right) Six-figure columnar display

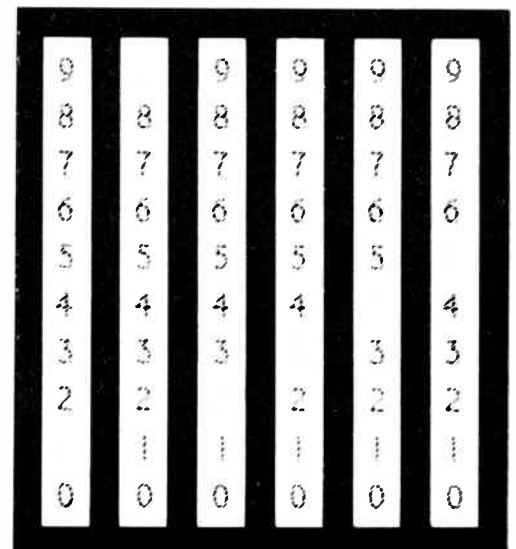

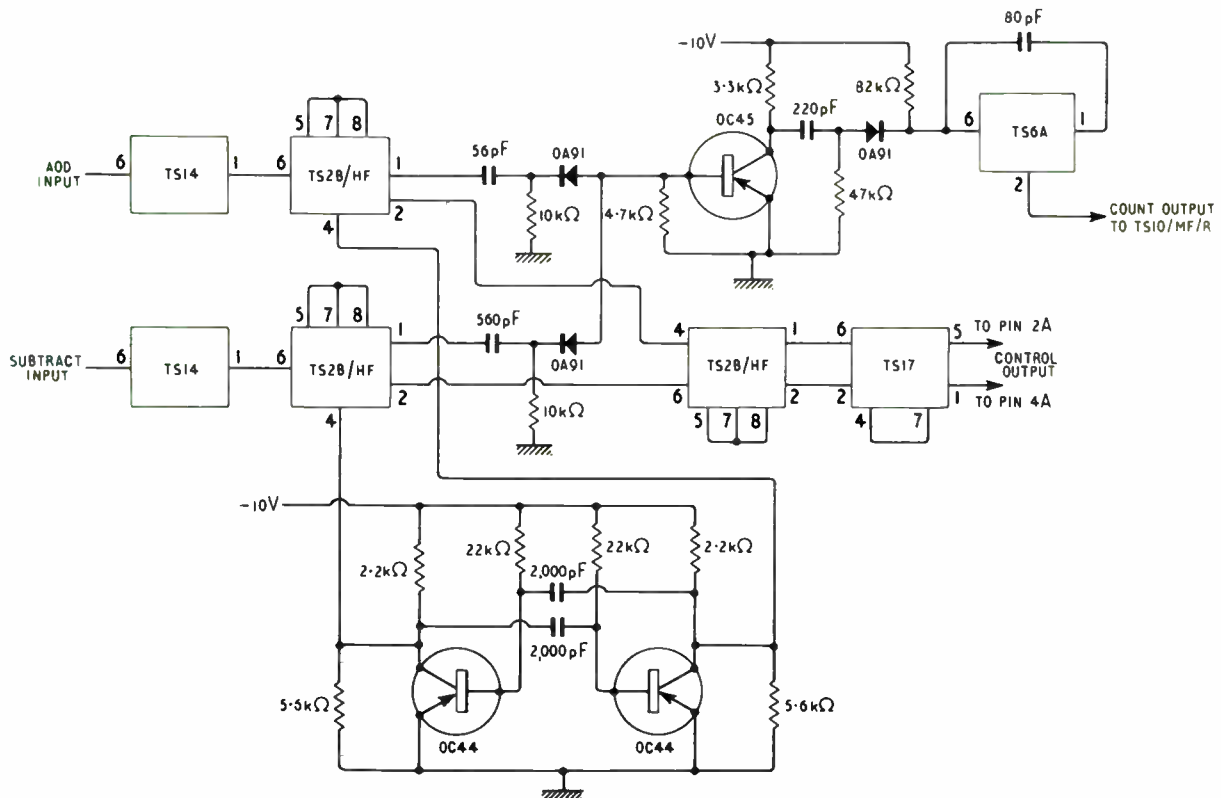

Fig. 8. Circuit diagram of coincident signal dual-input arrangement

between the 0 and the 9 on the columns of a display. This involves the breaking of the column into a double column. The double column can be arranged in two ways. These are shown in Fig. 7 (a) and (b). It can, however, be argued that these attempts to reduce the difficulty of reading the straightforward columnar display merely introduces further difficulties. It nevertheless remains a cheap system and is still used by some manufacturers.

In a simple counter, as so far described, the display is only stationary at the end of a count. The instrument can either automatically reset or it can be reset by pressing the manual pushbutton. Immediately this happens the count continues again. If the operator controlling a machine has to glance quickly at the display in order to determine a shaft speed, a frequency, or a time delay, it could be that the count is progressing during the interval of time that the display is examined and consequently only a blur of figures is seen. In order to get round this problem a memory is sometimes built into the equipment. This can take a number of forms. In one arrangement a duplicate of the counter chain is incorporated with gating diodes from the normal counter to the memory counter. At the end of the count the gating diodes are biased so that the duplicate binary chain takes up the same state as that of the main chain. The gating diodes are open-circuited and the main counting chain is immediately reset and recommences counting. The display is derived from the duplicate counter chain and remains displaying the answer while the new count is progressing. Once the main counting chain stops the duplicate counter is again connected to the main counter, the new result is transferred, the main counting chain is reset and counting re-commences. The duplication of the counter can be an

expensive addition and to avoid this relays are sometimes fitted, these being arranged to be driven by the four binary stages in the decade, the contacts being interconnected so as to give a decimal output from the binary-coded decimal input to the coils. At the end of each count the relays are connected to the counter chain, the self-hold contacts make and the counter resets and counting re-commences. The indicators display a fixed result until the end of the new count period, when the self-hold contacts are open circuited and the relays are energized in the new sequence. In order to simplify the relays they can be driven from a 10-wire system which has already been decoded by the diode matrix from the b.c.d. input from the decade.

A system employed by at least one manufacturer uses bulbs which are driven from each of the binary stages in the decade. These bulbs illuminate a photo-sensitive pattern which is arranged in such a way as to decode the binary-coded decimal input and provide a 10-wire output which can be used to drive further bulbs in the display system. This arrangement may be given an inherent memory by arranging that the bulb-maintaining transistors in the binary circuit are themselves self-held by a photo-transistor which is illuminated by the corresponding bulb. This transistor requires a pulse at the end of each count so as to paralyse the self-holding facility.

Reversible Counters

A counting technique which sometimes ensures a quick solution to a problem is that of reversible counting. There are two ways in which a reversible counter can be employed: (i) Where two continuous counting trains are injected, one of which is to be added and one of which is

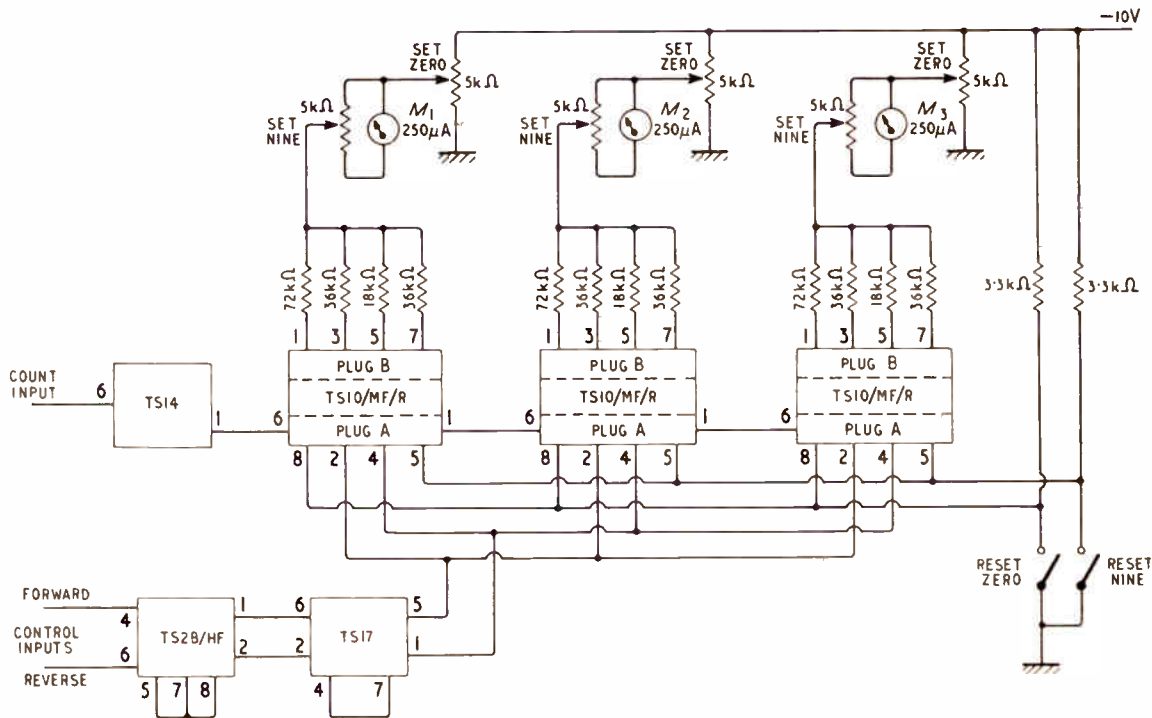

Fig. 9. Simple 3-digit reversible counter, having a count input and forward and reverse control inputs

to be subtracted. (ii) Where one count input is injected and where there is either one or two control lines which can instruct the counter to either add or to subtract.

The counting circuitry will be basically the same for each of these applications. The method of arranging the control lines is shown in Fig. 8 and Fig. 9. Applications here are numerous. When rolling strip or wire it is necessary to transfer from one roll to the other having reduced the thickness of the material. As the material is transferred from, say, the left roll to the right, the number of turns on the right-hand roll will be greater than the left as the material is thinner and consequently the strip is longer. If a counter is used to total the revolutions made by the roll it can be arranged that the count increases positively as the strip moves from left to right and negatively from right to left. The number remaining at the end gives an indication of the decrease in thickness. A pick-off fitted to each shaft simultaneously feeding an input to the counter as in Fig. 9 will give a difference total at the end of one roll. It will give a continuous indication of the thickness, for the operator can judge the increase in the stored number as he looks at the progression of the material from one roll to the other.

One use for which the reversible counter is ideal is for those applications where no change is expected, but if it occurs then it is important to know by how much. Successive counts are fed in alternately on the add and subtract inputs. The result should be zero. If not, then the difference is shown. For example, if it were important to a machine operator that a frequency was constantly 500 c/s, then by feeding a train of pulses to the 'add' input for one second and another train to the 'subtract' input for the following second a resultant count of zero should be obtained. A 'zero testing' circuit could be switched in every second time the gate closes. If the input frequency varied, then a light could be arranged to flash if no zero were found. The

operator could then observe the change, say 2 cycles. This circuit would accept this new figure as correct and only warn if the next result was again different. If an exact 500 c/s was to be monitored then a crystal frequency divided to 500 c/s should be used for the first count of each pair.

Machine-tool applications make such a counter attractive. If two gratings are fitted on the machine at right angles, and if they are arranged so that a photocell receives, say, 1,000 pulses for each inch of movement, then an add-and-subtract counter fitted to each cell could indicate the X and Y co-ordinates of the tool in thousandths of an inch.

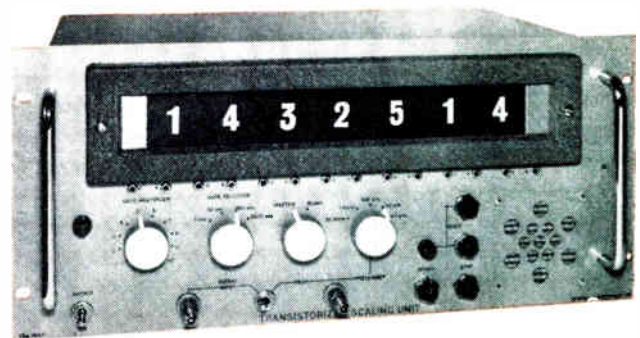

Fig. 10. Nuclear counter having long gating time

Finer gratings could be arranged to give indication to the nearest ten-thousandth. An inspection device can be built using these principles—this time indicating the co-ordinates of the tip of a probe. If necessary another grating could be fitted in the vertical axis to indicate the Z co-ordinate.

Nuclear Counting

Nuclear counting has its own special problems. Here pulses come, not regularly, as with frequency measurement, but in 'bunches'. Two pulses can follow each other with rapidity and yet the next pulse may be spaced a long time after. It is the 'paired-pulse resolution' that is specified with nuclear counters. Many commercial counters designed for industrial or laboratory use would 'lose' the second pulse if the repetition rate were low. Special input circuits have to be designed to ensure that this does not happen. Because of the low count rate long gating times are required. These typically run up to 10,000 seconds or more. The counter shown in the photograph (Fig. 10) can measure pulses over a period of 10,000 seconds. Long count times make it inconvenient for the operator so on the counter shown in Fig. 10 a loudspeaker is fitted which 'bleeps' at the end of the period. An 'economy' version of the counter is shown in Fig. 11. This has no loudspeaker. Both counters have a paired pulse resolution of 0.8 μ sec.

Time Measurement

Time measurement presents no problem to a high-speed counter since it is a question of counting pulses from a known frequency oscillator for the unknown time. For example, if 984 pulses were counted for an unknown time but the frequency of the oscillator was known to be 10 kc/s, then the time would be 98.4 msec. A time measuring instrument is shown in Fig. 12. This embodies all facilities for measuring time intervals from tenth milliseconds to several hours. Microsecond time measurement has been with us for some years but time measurements are required for some applications to tenth micro-seconds, or deci-microseconds. Since the latest counters will measure 100 Mc/s signals there is no reason why centi-microsecond counters should not be built.

The Future

The tendency in recent years has been to reduce both the size and price of commercial counters. To achieve con-

tinuation of this trend it will be necessary to go over to microminiaturization. It is very doubtful whether the average user will be prepared to pay for a reduction in size, but if microminiaturization brings with it a reduction in cost only then will manufacturers incorporate microminature units. The bonus will, we all hope, be an increase in reliability. Since the current counter largely consists of the display units these, too, will have to be smaller. The counter of the future will almost certainly have a fixed display; that is, it will incorporate some form of memory to store the count. Digital techniques can be used in almost every application; it is to be hoped that they will be applied still more.

At the present time the research organizations of the larger companies are using digital electronics, but the majority of factories in the country employ a thousand workers or less. It is the path that these companies take that affects national productivity figures and it is here that new thought can have the greatest impact. It is to be hoped that the next five years will see some major changes in the application of digital techniques. The tape-controlled milling machine may be a device for application in only a few industries, but tape-controlled drilling machines might be expected to have general appeal. The inspection machine mentioned earlier would simplify and speed up a painfully slow process, but even then the X and Y co-ordinate system still meets with resistance in all but the younger industries.

The petrol station of tomorrow will see self-service petrol metered by flowmeters and charged automatically. Decimal coinage simplifies the quantity/monetary conversion. A similar system can be used when fuel oil is supplied for heating systems, a printed advice being provided of the exact metered quantity of fuel supplied. Coal trucks fitted with load cells could give a similar service.

The future for counting systems is a bright one, the means are there; it is now up to the applications engineer.

Acknowledgments

The author would like to express his thanks to the Directors of Venner Ltd. for permission to publish this article. Also to Counting Instruments Ltd., Electrical Apparatus Co. Ltd., Burroughs Corporation and K.G.M. Electronics Ltd. for permission to reproduce diagrams of their indicators.



Fig. 11. Inexpensive nuclear counter



Fig. 12. Millisecond timer

Continuous

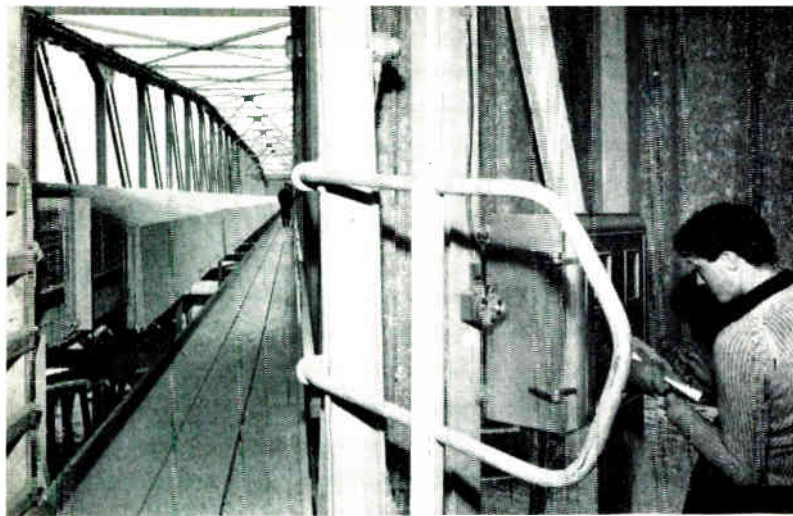

Fig. 1. Sensing devices on the conveyor at the left, operating through the control box at the right, give precise indication of rate of delivery of cement, and cut off the feed when a preset total has been delivered

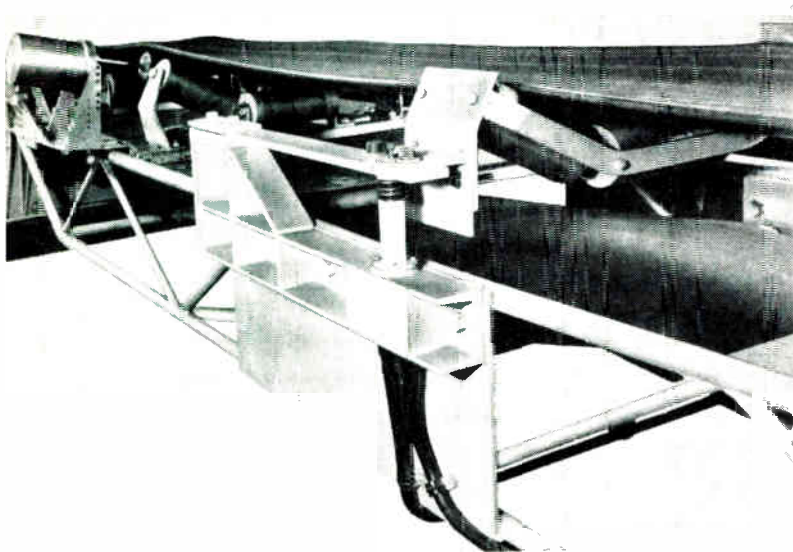
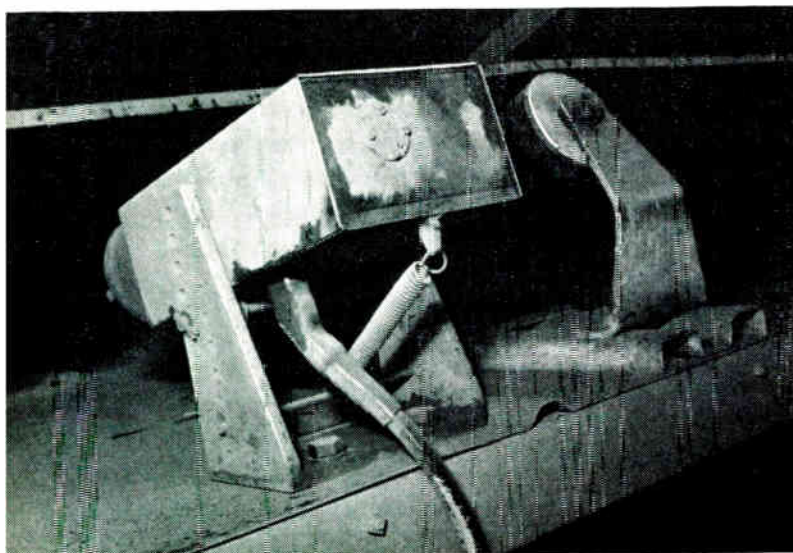

Fig. 2. The cantilever arm is deflected by the weight on the idler set, the displacement being sensed by a transducer. The latter is energized by a tachometer, the combined output being proportional to the rate of flow

Fig. 3. The tachometer-generator is driven by the underside of the belt. Like the rest of the equipment, it is totally enclosed and proof against dangerous industrial atmospheres



A simple, accurate and reliable means of continuously weighing bulk products on a belt conveyor has received Board of Trade approval. It has considerable potential in process control.

A NEW cement handling installation for Associated Portland Cement Manufacturers Ltd. has recently been completed at Northfleet, in Kent. The new plant supplements an existing bagging facility, and provides continuous delivery to both road lorries and ships. In designing the installation, Richard Sutcliffe Engineering Systems Ltd. of Horbury, Yorkshire, who are the main contractors, have taken pains to provide control of weight delivered at least as accurate as that obtainable with bagged cement. The electronic continuous-weighing device used has been developed by Craven Electronics Ltd., one of the companies of the Sutcliffe group, which specializes in the overall design of integrated handling systems.

Simple Principle

The weighing device is fitted to the 30-in. wide conveyor shown in Fig. 1, which carries bulk cement a distance of about 240 ft to loading towers from which it is delivered by fluidizing trunks directly to the holds of ships or barges.

The basis of operation is to weigh continuously a section of the conveyor, multiply by a factor corresponding to belt speed, and integrate the resultant with time, due correction being made for the unladen weight of the conveyor. When a preset weight of cement is recorded as having passed the weighing point, the cement feed to the conveyor system is stopped, an allowance being made in the setting for the very constant weight of cement on the belts at any one time.

The essential elements of the device are a weigh idler set, shown in Fig. 2, and a tachometer-generator, shown in Fig. 3. The schematic diagram in Fig. 4 shows the principle of operation. The weigh idler set comprises a floating idler assembly, which carries the weight of the loaded belt. The idler set is supported at the ends of two cantilever arms, only one of which can be seen here. The stiffness of the arms is such as to permit a very small but linear deflection proportional to the weight on the idler set. Each arm bears on a differential transformer type of transducer, which produces an alternating voltage whose amplitude varies with the weight. The energizing current for the transducers is produced by the belt-driven tachometer-generator, whose output is of course proportional to belt speed. The weight and belt speed signals are thus multiplied to produce an output signal corresponding directly to rate of flow. After linear amplification, the rate of flow of cement is indicated on a meter in the control box, which is seen at the right of the illustration used for Fig. 1 and, opened up, in Fig. 5. The meter is calibrated in tons/hour.

Weighing of Bulk Cement

By A. DITCHER*

Integration

Conversion to total weight delivered is achieved in a neat adaptation of the principle of the ordinary electric mains consumption meter. The watt-hour meter at the bottom of the control unit in Fig. 5, driven by the rate signal, is fitted with a perforated disc. A lamp and photocell unit generates a pulse every time one of the holes gates the light beam, the pulses being used to actuate electromagnetic counters reading directly in tons. This gives a continuous indication of total weight delivered. Limit switches operated by the counter energize the control relays, which in this application actuate pneumatic valves in the cement supply system, thus cutting off the flow to the conveyor at the appropriate moment.

Detail Features

The use of two weighing transducers automatically cancels out any possible error due to uneven loading of the belt, so that the weigher is also suited to deal with lumpy products such as broken rock. A switch is incorporated which, if required, brings in a low-level cut-out set to operate when the load falls below a small pre-determined fraction of the normal load. This avoids the danger of variations in belt thickness causing weight to be recorded when the belt is running at near-zero conditions. In most cases the belt will be either empty or somewhere near its normal loading, so that the elimination of readings for very low levels has negligible effect on the overall accuracy.

The absence of mechanical elements ensures freedom from error due to dirt, dampness or lack of lubrication. In fact, virtually the only maintenance required by the Craven weigher is an annual change of oil in the tachometer-generator gearbox.

* Richard Sutcliffe Engineering Systems Ltd

All the equipment, including the control box, is damp-proof and dust-proof, so that it can safely be used in hazardous locations. It is already widely used where conditions are usually severe, for instance, in collieries.

Various extras are available. Additional flow-rate indicators can be driven, and remote counters added, so that the performance can be monitored from a central control room or accounts office. A strip-chart recorder can be fitted, offering a useful check on plant utilization. A printing totalizer is also available as a valuable aid to accounting.

An important feature of the weigher is that it takes up no additional space in the often cramped conditions of a conveyor belt installation. The special weight idler set can be fitted without difficulty to any type of conveyor installation.

Field Performance

Since its installation at Northfleet, the Craven weigher has more than fulfilled expectations. The claimed accuracy of the system is within 0.5% of total weight delivered, under average conditions. That this performance is exceeded is confirmed by the fact that, after exhaustive tests, the Board of Trade has given approval of the installation for Weights and Measures purposes. Thus one of the major difficulties of bulk cement delivery has been overcome. The customer can safely accept the Craven figure, without further checks during either loading or unloading. Belt loading is so constant that delivery rate does not vary significantly. The fluidized delivery to the ship's hold continues at maximum rate right up to the end, and stops when the hold is full, or when the preset quantity has been delivered.

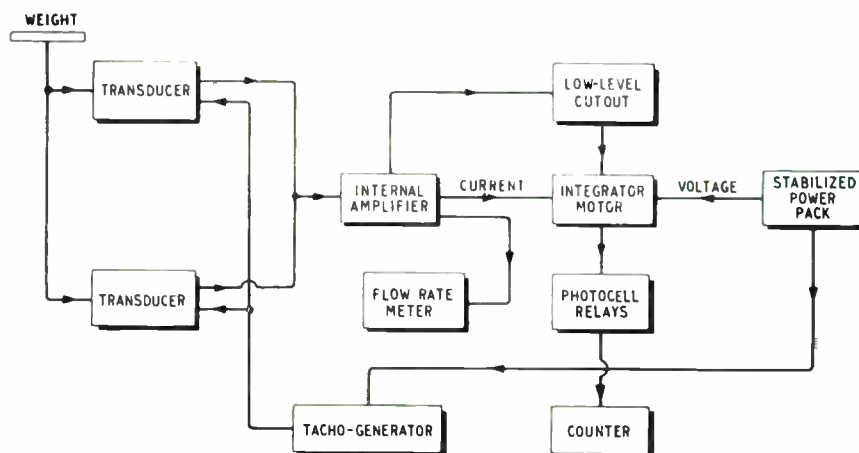

Fig. 4. Schematic diagram of the Craven weigher

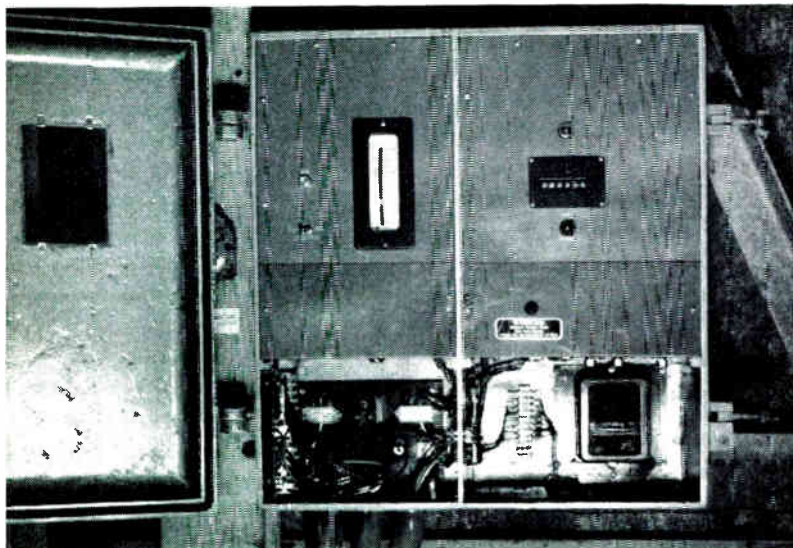

Fig. 5. The vertical scale meter indicates rate of flow in tons/hour, the counter at the right showing total weight delivered. The latter reading is derived by a modified watt-hour meter, bottom right, driven by the rate output

Completely automatic control of delivery allows the installation to be operated by a very small team, amounting to three or four men according to whether only ships, or ships and lorries, are being served at one time. The normal rate of delivery is 200 tons/hour, so that a 1,000-ton vessel can be loaded in five hours.

The principle is equally applicable to light industry, such as food and pharmaceutical production, the stiffness of the cantilever arms determining the sensitivity of the device. Current developments are centred on the design of fully solid-state versions of the weigher, with considerable reduction in bulk. This type of unit will shortly be in service in an automatic coal loading station for rail trucks, the amount to be loaded being determined by recognition of the wheelbase of each truck. A small weigh-conveyor fitted with the weighing set will control the actual loading accurately.

The next step in continuous weighing techniques, under active development by the Craven company, is the application of novel logic techniques to provide extremely accurate weight measurement, based on high-frequency sampling. Development of this kind may be expected to bring to conveyor handling much of the potential for accurate control usually associated only with pipelines for the handling of liquids.

S.C.R. Regulator for Cathodic Protection

THE 80,000 ton tanker 'Esso Pembrookshire' has been fitted with a cathodic protection system against corrosion which is the first to incorporate the new automatic s.c.r. current regulator introduced by A.E.I. Known as the Type FX27, it has been developed for Morgan, Berkeley & Co.'s impressed current protection system.

Automatic s.c.r. current regulator

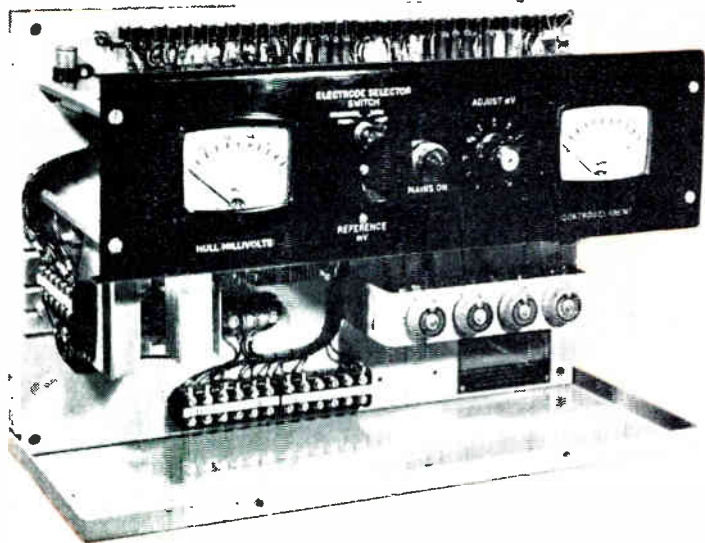

It is essential that corrosion by chemical action on ships' hulls be eliminated. Corrosion often extends the time spent by a vessel in dry dock for maintenance—thousands of pounds per ship per day for some shipping companies—and hull roughening reduces a ship's speed and increases fuel consumption in meeting design performance figures. The chemical action causes a flow of electricity from the metal of the hull into the sea, corrosion occurring at the point where the current leaves the metal. This can be prevented by introducing a third electrode, an anode, and passing a current from the anode into the sea water and back to the ship's hull.

The 'Morgan' system of cathodic protection, using streamlined anodes, has completely suppressed hull corrosion, but requires that the value of current be controlled under all conditions: too low a current value would fail to provide protection, and too high a current value would in itself cause corrosion. The new A.E.I. regulator, which meets this requirement, eliminates contacts and moving parts by the use of s.c.r.s. is strongly built to meet marine conditions, and has a quick response whenever a change of current is required. All the components have been liberally rated and special safety measures prevent a failure of semiconductor devices.

The regulator supplies a controlled a.c. input to a transformer-rectifier assembly, which provides a low-voltage high-current for cathodic protection. It incorporates a variable reference voltage circuit, a transistor amplifier with a firing circuit for the s.c.r. output stage, and a current-limit circuit. The output of the regulator is dependent on a reference cell voltage, but a second control circuit overrides this control if the current exceeds a preset value, so limiting the current.

For further information circle 50 on Service Card

**NEW
EMIDATA
SERIES**



Multitrack Heads

Manufactured to close tolerances, these entirely new EMIDATA Magnetic Heads are designed for multi-channel instrumentation and data processing systems. They are split-constructed to eliminate the cumulative errors inherent in track-stacking techniques. Heads have precise gap alignment, accurate track location.

- Available in I.R.I.G. and other track configurations for 1 inch and $\frac{1}{2}$ inch tape.
- Precise azimuth ensures complete interchangeability of heads.
- Resin encapsulated to ensure mechanical and electrical stability.

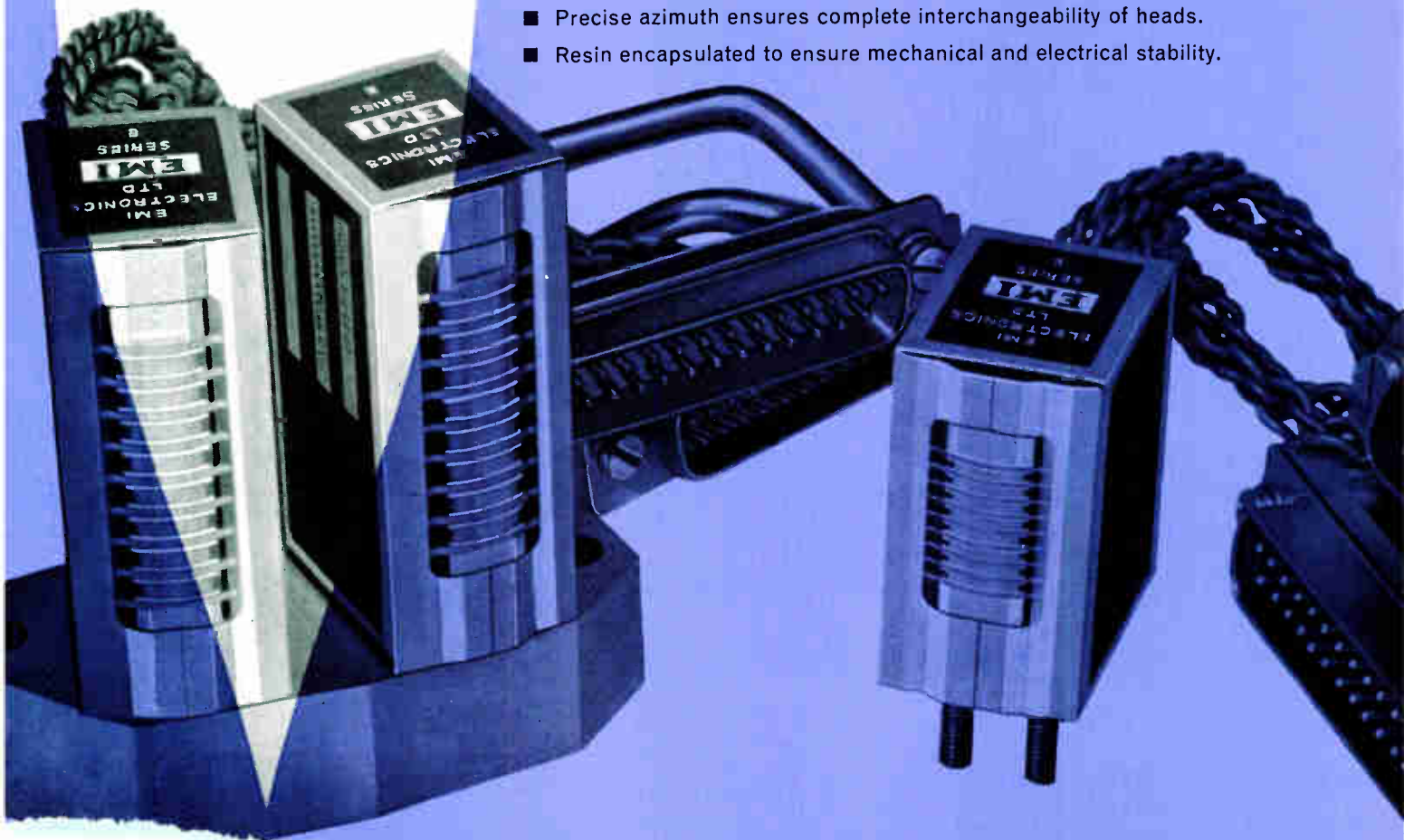

EMIDATA TAPE DECKS

These Tape Decks are efficient, flexible, precision storage instruments, and have a wide range of applications in data processing and dynamic simulation. Particular attention has been paid to the safe handling of instrumentation tape. Precise servo-controlled tape tension, end-of-tape and capstan speed sensing devices are standard.

- Choice of six tape speeds at the turn of a switch
- Tape speed ratios up to 128:1
- Tape spools up to 14 in. diameter
- Separate control unit
- Comprehensive range of D.R., F.M. and digital solid state recording channels.

TD3
AND
TD4

**Performance,
precision,
reliability**

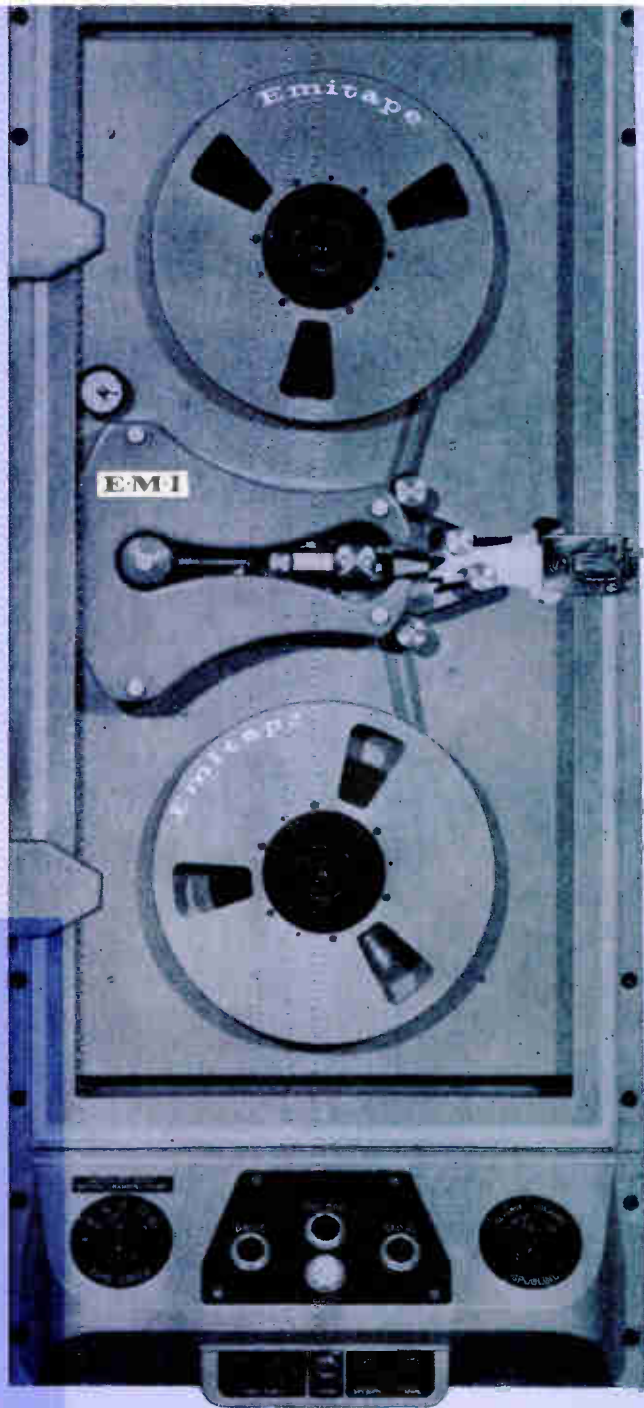

TRANSISTOR OPERATING CONDITIONS-2

The effect of collector-base leakage current upon the collector current is discussed in this article and the need for stabilizing is brought out. After pointing out the limitations of one circuit, the most practical circuit is derived.

By W. TUSTING

IN the transistor the emitter current I_e divides between the base and collector, a fraction $(1 - \alpha)I_e$ passing to the base and the rest αI_e to the collector. The symbol α is the so-called common-base current amplification factor. It is always less than unity in a junction transistor, but only a very little less.

There is current in collector and base additional to these fractions of the emitter current, however. With the usual p-n-p transistor it flows into the base and out of the collector. It is a leakage current which flows even with the emitter on open-circuit and it is usually designated I_{co} . Unfortunately, it is very dependent on temperature. Approximately, it doubles for each 10°C rise of temperature. Since I_{co} flows through resistances in the base and collector circuits it affects the voltage drops across them and indirectly affects I_e . Variations of I_{co} with temperature can thus have a large effect upon the operating conditions of a transistor and it is necessary to arrange the circuit to reduce the effect to tolerable limits.

Fig. 1 shows an equivalent circuit which represents the d.c. conditions of a transistor reasonably well. It is less well-known than the small-signal a.c. equivalent circuits, but it frequently appears in the more modern textbooks. Internal resistances are not included, since they are usually negligible in comparison with external ones.

The current flowing out of the collector terminal is

$$I_c = \alpha I_e + I_{co} \quad (1)$$

while that flowing out of the base terminal is

$$I_b = (1 - \alpha)I_e - I_{co} \quad (2)$$

and, of course, the emitter current is

$$I_e = I_b + I_c \quad (3)$$

The generator I_{co} represents the leakage current and, as already mentioned, it is temperature sensitive. The battery V_o is also temperature sensitive but is generally of less importance. For a germanium transistor V_o is usually about 150–200 mV and it changes with temperature at the rate of about $-2.5 \text{ mV}/^\circ\text{C}$.

Some further explanation of how this battery V_o arises in the equivalent circuit may be desirable. The relation between base current and base-emitter voltage is of the form sketched in Fig. 2. The relation is non-linear and so it cannot be readily handled mathematically. A linear approximation is thus used and this is found by replacing the curve by a straight line which most nearly approximates to it. This line is shown dotted in Fig. 2, and it meets the voltage axis at V_o . The line is of slope $1/r_b$ and its equation is

$$V_{be} = V_o + I_b r_b$$

The equivalent circuit of the base-to-emitter part of the transistor is thus a battery V_o in series with a resistance r_b . However, r_b is normally small, and certainly small compared with the external base resistance, so that it may be omitted from the equivalent circuit of Fig. 1 with only small error.

The simplest transistor circuit is shown in Fig. 3 (a) and its equivalent, based on Fig. 1, in Fig. 3 (b). We can write at once

$$I_c = (\alpha I_e + I_{co})$$

$$E_{cc} = [(1 - \alpha)I_e - I_{co}]R_b + V_o$$

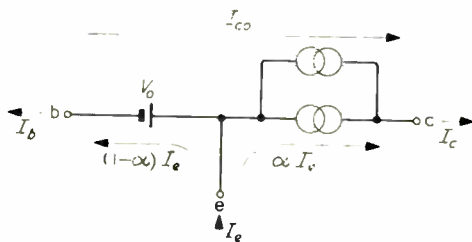
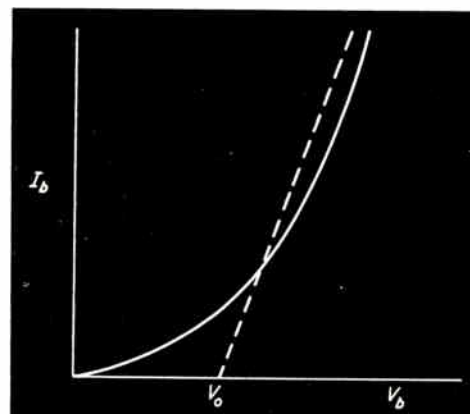

Fig. 1. Equivalent circuit of transistor for calculating operating conditions

Fig. 2. General form of base current-voltage characteristic



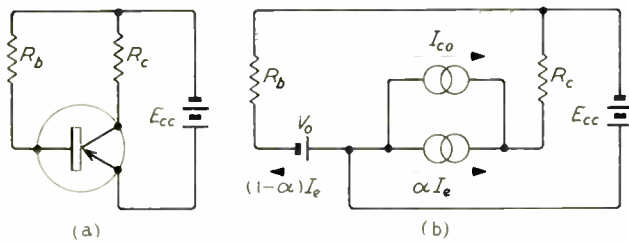

Fig. 3. Simple earthed-emitter circuit (a) and its equivalent (b)

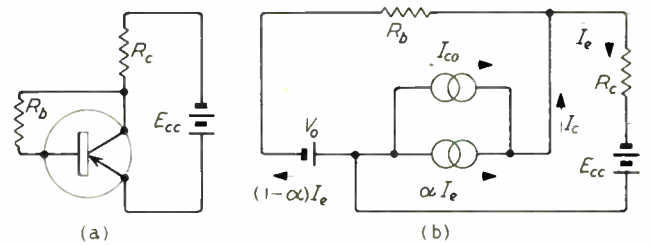

Fig. 4. Simple stabilized circuit (a) and its equivalent (b)

$$\begin{aligned} \text{from which } I_c &= \frac{\alpha}{1-\alpha} \frac{E_{cc} - V_o}{R_b} + \frac{I_{co}}{1-\alpha} \\ &= \alpha' \frac{E_{cc} - V_o}{R_b} + I_{co}(1 + \alpha') \end{aligned} \quad (4)$$

where $\alpha' = \alpha/(1 - \alpha)$ and is the base-collector current amplification factor.

For the present, assume $V_o = 0$; α' is often about 50 and I_{co} may be $5 \mu\text{A}$ at 25°C . Suppose we want $I_c = 1 \text{ mA}$ and $E_{cc} = 4.5 \text{ V}$. We then have

$$1 = \frac{50 \times 4.5}{R_b} + 51 \times 0.005$$

$$\text{or } R_b = \frac{50 \times 4.5}{1 - 0.255} = 300 \text{ k}\Omega$$

With this value,

$$\begin{aligned} I_c &= \frac{50 \times 4.5}{300} + 51 I_{co} \\ &= 0.75 + 51 I_{co} \end{aligned}$$

Remembering that I_{co} doubles for each 10°C rise of temperature we can work out as in Table 1 the value of I_c for a series of temperatures. A change from 25°C to 55°C results in I_c rising from 1 mA to 2.79 mA . Suppose $R_c = 3 \text{ k}\Omega$, the maximum possible current through it is $4.5/3 = 1.5 \text{ mA}$. The higher currents in Table 1 will thus not be reached because the collector voltage will drop to zero because of the voltage drop in R_c . This collector voltage is $E_{cc} - I_c R_c$. At 1 mA , the drop in R_c is 3 V , leaving 1.5 V for the collector. At 35°C , I_c becomes 1.26 mA and the drop is 3.78 V with the result that the collector voltage falls to 0.72 V only. At a little higher temperature the current will rise a little more, the collector voltage will drop to about 0.2 V and both current and voltage will stay constant at all higher temperatures.

The transistor will be bottomed and just as the grid of a pentode valve loses control in this condition so does the base of the transistor. It is just as useless as an amplifier as it would be if current were cut off.

What happens physically is not hard to see. A nearly

Table 1

T (°C)	I_{co} (μA)	$51 I_{co}$ (mA)	I_c (mA)
25	5	0.255	1.005
35	10	0.51	1.26
45	20	1.02	1.77
55	40	2.04	2.79

constant current flows through R_b . When I_{co} rises it increases the true base current $(1 - \alpha)I_e$ because it flows through R_b in opposition to it. As a result, the collector current increases by α' times this change of true base current. The importance of I_{co} arises because changes of it are multiplied by the current amplification factor.

An improvement can be effected by returning R_b to the collector, as in Fig. 4 (a) instead of directly to the power supply. A feedback effect then occurs. As before, an increase of I_{co} increases the true base current, and hence the collector current. Again as before, this reduces the collector voltage because of the greater voltage drop across R_c . The collector voltage, however, is now the bias voltage to which R_b is returned and because it becomes smaller the base current drops too, or rather, does not increase as much as it otherwise would.

The equivalent circuit is shown in Fig. 4 (b). The two basic equations are easily written and from them we find

$$I_c = \frac{\alpha'(E_{cc} - V_o) + I_{co}(1 + \alpha')(R_b + R_c)}{R_b + R_c(1 + \alpha')} \quad (5)$$

If, as before, we take $V_o = 0$, $\alpha' = 50$, $I_{co} = 5 \mu\text{A}$ at 25°C , $I_c = 1 \text{ mA}$, $E_{cc} = 4.5 \text{ V}$ and $R_c = 3 \text{ k}\Omega$, we have

$$1 = \frac{50 \times 4.5 + 0.005 \times 51(3 + R_b)}{R_b + 3 \times 51}$$

whence $R_b = 98.3 \text{ k}\Omega$

We now have

$$I_c = 0.895 + 20.6 I_{co}$$

At $I_{co} = 5 \mu\text{A}$, $I_c = 1 \text{ mA}$; at 45°C , $I_{co} = 20 \mu\text{A}$ and so I_c becomes 1.31 mA and V_{cc} drops to $4.5 - 3 \times 1.31 = 0.57 \text{ V}$. This is a possible operating condition for small signals. Under the given conditions a 20°C rise of temperature has increased the collector current from 1 mA to 1.31 mA , whereas with the unstabilized circuit of Fig. 2 the increase is to 1.77 mA . There is thus a considerable improvement. It is, however, not nearly enough for most applications.

If in equation (5) we call the factor by which I_{co} is multiplied

$$S = \frac{R_b + R_c}{R_b + \frac{R_c}{1 + \alpha'}}$$

we can turn the expression round to get

$$\frac{R_b}{R_c} = \frac{S - 1}{1 - \frac{S}{1 + \alpha'}}$$

and we can see that for a given value of α' there is a fixed relation between S and R_b/R_c . In the example, R_c was

fixed and we computed R_b to give a desired collector current at a given supply voltage. Thus S was fixed by these requirements and as long as they are unchanged there is nothing that can be done to improve matters. If α' is very large, $S \approx 1 + R_b/R_c$ and the only way to make S small is to make R_b small and R_c large.

In practice, the only thing that can be done to improve matters is to increase R_c and E_{cc} together. Thus, suppose E_{cc} is made 20 V. This is an increase of 15.5 V and to keep everything else unchanged R_c must be increased by 15.5 k Ω , making it 18.5 k Ω in all. We now have

$$I_c = 0.96 + 5.72 I_{c0}$$

At 45 °C, we now have $I_c = 1.074$ mA and the stabilization can be regarded as good.

The value of S has been brought down from 51 for the unstabilized circuit, to 20.6 for our first attempt, and finally to 5.72. In practice, a figure of between 5 and 10 is usually regarded as satisfactory. What is most unsatisfactory is the need for increasing the supply voltage from 4.5 V to 20 V in order to achieve this. Now we have had to do this so that we could increase R_c without affecting other conditions and we have had to do this to reduce R_b/R_c since we could not reduce R_b itself. If we could reduce R_b , we could leave R_c and the supply voltage unchanged. With Fig. 4 we can reduce R_b only if we insert a bias battery in series with it to oppose the supply voltage E_{cc} . The total voltage acting in the base circuit will then be less and so for the same current R_b can be smaller.

This arrangement is shown in Fig. 5 (a) and is obviously impracticable because of the floating battery. However, if we interchange R_c and E_{cc} , as in (b), the batteries have a common terminal, and the base-bias battery can be replaced by a tapping on E_{cc} . The circuit has, in fact, become like an emitter follower.

The next step is to Fig. 5(c). Here the bias battery, now designated E_{bb} is reversed in polarity and returned to the positive of E_{cc} instead of the negative, which makes no difference if its value is appropriately altered. The emitter resistance R_c of (b) has now been designated R_e and a new resistance R_c included in the collector. One more change,

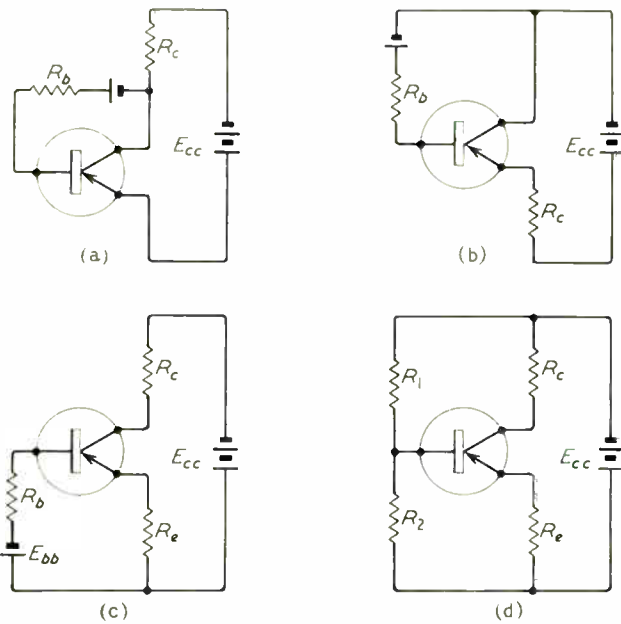

Fig. 5. The circuit of Fig. 3 can be greatly improved by adding a battery in series with R_b as in (a). Interchanging R_c and E_{cc} gives circuit (b). Relabelling R_c as R_e and adding a new R_c gives (c) which has an exact equivalent (d), the most popular practical circuit

and we can get rid of E_{bb} as in (d). Fig. 5 (c) and (d) are identical if

$$E_{bb} = E_{cc} \frac{R_2}{R_1 + R_2} \text{ and } R_b = \frac{R_1 R_2}{R_1 + R_2}$$

This circuit, Fig. 5(d), is the most widely used in practice and it is thus the one to which we shall devote most attention. However, this must be deferred to Part 3.

Digital Transmission System

The Allscott 'Teledigit' system, which has been designed by the James Scott Engineering Company Ltd., provides an inexpensive means of sending digital information by wire from any number of points to a single print-out station. The distance from transmitter to receiver can be up to several miles, provided the resistance of the line pair does not exceed 1 k Ω .

A complete system would consist of a number of conventional dial transmission mechanisms, a Teledigit receiver and any suitable electric printer. The receiver itself contains a store which accepts a number as a series of dialled digits, the design being sufficiently flexible to cater for any number of decades up to the maximum handling capacity of the printer. When the last digit has been dialled, the complete number is automatically printed together with digital time indication from a clock housed in the receiver. A flashing indicator at each transmitting station shows when the line is busy or clear.

For further information circle 51 on Service Card



A basic Teledigit system consisting of (left to right): transmitter, Addo-X 7-digit printer, and receiver unit

EQUIPMENT REVIEW

1. 4-Stage Image Intensifier

E.M.I. have announced the first 4-stage cascade image intensifier to be made available commercially. It has important advantages over existing thin-film image intensifiers: it is far more robust and its output phosphor has a useful picture of 2-in diameter. The gain is of the order of 1 million.

When the type 9694 tube is used for night vision (e.g., in military or astronomical applications), it can be coupled to a television camera and events can be viewed immediately on one or more television receivers. In nuclear work the type 9692 tube can be left unattended in darkness and, when the event which is of interest occurs, the picture on the output phosphor can be photographed by a camera of which the shutter has been left open. The novel switching arrangement, which takes only 1 μ sec, prevents any light from previous thermionic emission or subsequent events from reaching the film.—*E.M.I. Electronics Ltd., Hayes, Middlesex.*

For further information circle 1 on Service Card

2. Strain Gauge Indicator

Consolidated Electroynamics have introduced an amplifier, excitation and display unit designed for use with strain-gauge transducers of 350- Ω resistance which require 10-V excitation. The amplifier and excitation unit is mounted on the meter barrel, giving an overall depth of less than 6 $\frac{1}{4}$ in., excluding connectors.

From the normal full-scale input of 40 mV the amplifier provides an output of ± 2 V at 1 mA. This is used to drive a 5-in. Cirscale meter, calibrated to suit individual applications. The closed-loop stabilizer provides an excitation voltage which changes less than 50 mV for power-supply voltage variations of 11 to 15 V.

The stabilizer output can be varied between 9.5 and 10.5 V and the amplifier gain between 40 and 60. In ambient temperatures from 0 to 50 $^{\circ}$ C the drift of the amplifier zero with

temperature is less than 0.05% full scale per $^{\circ}$ C and the gain stability 0.1% per $^{\circ}$ C.—*Consolidated Electroynamics Division of Bell & Howell Ltd., 14 Commercial Road, Woking, Surrey.*

For further information circle 2 on Service Card

3. Low-Cost Teleprinter Equipment

Westrex are introducing to the European market the Teletype model 32 and model 33 teleprinters (illustrated left and right respectively). They can be used as ancillary equipment for computer installations, for the preparation of paper tape for subsequent

computer processing or high-speed transmission to a remote point, and for rapid transfer of information to remote factories, or within a single factory.

Transmission is simultaneous, and a permanent written record is available both at the receiving and transmitting station. Operating speeds are up to 100 words per min on 5-level or 8-level standard communications and data communications code. Facilities are available for automatically switching on and off remote unattended stations, and transmitting messages to them.

Systems applications include remote interrogation of a central computer, receiving answers to problems and automatically producing a written record of the answer. Automatic answer-back devices are fitted, and unattended receivers can automatically notify the operator of the transmitting station that they are ready to receive.—*Westrex Company Limited, Coles Green Road, London, N.W.2.*

For further information circle 3 on Service Card

4. Subminiature Relays

Hi-G, Inc. have announced the availability of a miniature relay meeting military specifications MIL-R-5757/D.



1

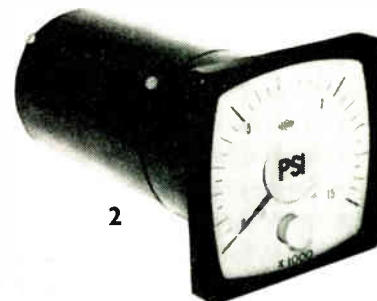

2

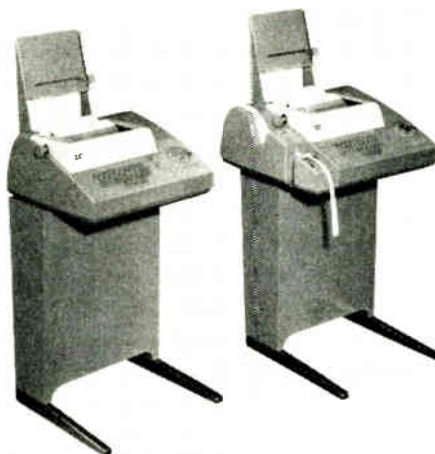

3

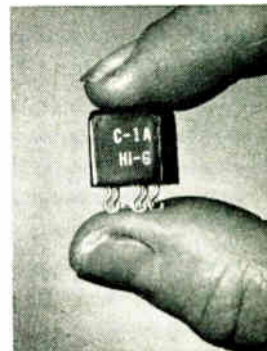

4

The series C is a single-pole double-throw d.c. relay with a contact rating of 1 A resistive at 30 V d.c. This unit measures 0.5 × 0.5 × 0.5 in. and is currently available in nominal coil ratings of 6, 12, and 26.5 V d.c. Standard sensitivity is 150 mW at 25 °C.

Available with straight or hook terminals, and with or without mounting brackets, the 'Dice Cube' is hermetically sealed and may be filled with nitrogen and helium, or dry air, if required. Operating temperature range is -65 °C to +125 °C.—*Hi-G Inc., Spring Street & Route 75, Windsor Locks, Connecticut, U.S.A.*

For further information circle 4 on Service Card

5. Silvered-Mica Capacitors

Johnson, Matthey & Co. have announced the addition of five new types to the Silver Star range of high-stability silvered-mica capacitors.

Four of the new types are encapsulated in synthetic resin and each has alternative working voltages of 200 and 350 V. Types A12E and C12E provide capacitances up to 2,000 pF in small volume. With axial and radial leads respectively, they measure 0.5 × 0.3 × 0.2 in. Types A22E (up

to 4,300 pF) and A33E (up to 47,000 pF) are larger, being similar to the established types C22E and C33E, but with axial leads.

The fifth addition to the range is the synthetic resin dipped type C12S. This is the smallest capacitor in the range, measuring 0.5 × 0.275 × 0.165 in. In addition to working voltages of 200 and 350 V, a 50-V version is available with a maximum capacitance of 5,000 pF.—*Johnson, Matthey & Co. Ltd., 73-83 Hatton Garden, London, E.C.1.*

For further information circle 5 on Service Card

6. Low-Cost Microwave Heating System

An inexpensive 'modular magnetron' microwave heating system for cooking and industrial processing applications has been announced by Comtek Inc. U.S.A. As a heating system, it is claimed to operate at 50% greater efficiency and 30% greater power output than comparable systems now on the market.

The tube uses only 18 W of heater power: as a consequence, continuous application of power to the heater is practical, allowing instant tube start-up. An important feature is the replaceable miniature cathode, which

can be replaced for a modest service charge.

The compact tube (5½ in. high by 2½ in. diameter) is considerably more rugged than earlier types in its resistance to shock and vibration. It is capable of high-efficiency operation using either a solenoid or permanent magnet with air- or liquid-cooling, and may be operated at 1-kW power output from a d.c. supply or unfiltered line current. The price is less than \$100 in small quantities.—*Comtek Inc., 135 Main Street, Woburn, Massachusetts, U.S.A.*

For further information circle 6 on Service Card

7. Digital Phase Meter

B & K Laboratories have introduced the Ad-Yu digital phase meter type 524A for the measurement of phase angles from 0 to 360° at frequencies from 20 c/s to 500 kc/s, by means of a 4-digit, one-inch numeral indicator, the last digit indicating tenths.

The 524A provides direct reading of phase angle between any two alternating voltages irrespective of amplitude fluctuations of either or both within the range from 0.3 to 50 V r.m.s., or frequency variations between 40 c/s and 40 kc/s. Accuracy is maintained within the limits of ±0.1° relative between 20 c/s and 20 kc/s, or 0.3° absolute. Above 20 kc/s the error increases slowly to ±1° relative or ±2° absolute at 300 kc/s, and slightly higher at 500 kc/s.

Small fractions of a degree can be measured in the vicinity of either 0 to 360° with good stability and without self-triggering. Input impedance is 3 MΩ shunted by 30 pF on both channels. Output signals in both digital and analogue form can be made available for recording or system programming.—*B & K Laboratories Ltd., 4 Tilney Street, Park Lane, London, W.1.*

For further information circle 7 on Service Card

8. Low-Noise Photo-Electric Chopper

The type DPH photo-electric chopper manufactured by A.O.I.P. of Paris and available from Claude Lyons, is a solid-state device with a maximum noise level of 20 nV. It comprises essentially a photo-resistive cell illuminated by a small neon lamp, both housed together with the necessary optical elements in a robust metal casing which acts also as a shield. Due to the striking and extinction of the lamp, the photo-resistive cell acts as a solid-state switch, chopping the d.c. input signal at twice mains frequency.

The chopper is mounted on a base providing a.c. excitation connections,

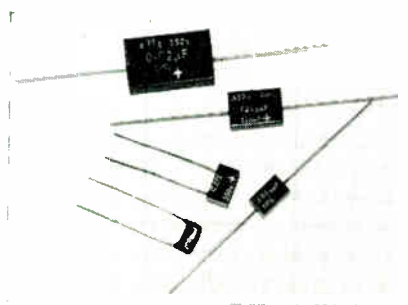

5



6

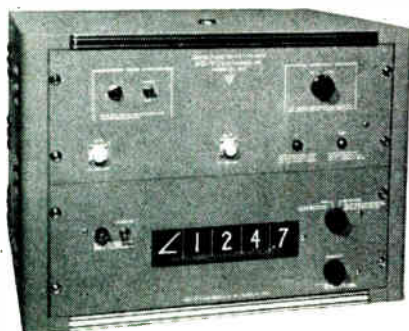

7



8

EQUIPMENT REVIEW

while the signal input and output is by a twin screened lead at the top. It may be used in any position, and is provided with a retainer. With dimensions of under 3½ in. long by 1 in. diameter, and a weight of only 4 oz, it lends itself to incorporation in transistorized instruments. One-off price is £25, with quantity discounts available.—*Claude Lyons Ltd., Instruments Division, Valley Works, Hoddesdon, Herts.*

For further information circle 8 on Service Card

9. A.C.-D.C. Converter

The a.c.-d.c. converter type LM 1219 has been designed by Solartron to convert accurately an a.c. input voltage to d.c. for measurement by digital voltmeter. It operates between 30 c/s and 10 kc/s for inputs ranging from 30 mV to 300 V (mean value or r.m.s.), and its resolution is better than 0.005%. The unit may be used in conjunction with any digital voltmeter. The inputs are covered by the four ranges of the converter, the full scale being 3 V for each range.

An accuracy of $\pm 0.02\%$ of full scale, $\pm 0.05\%$ of reading, is achieved from 30 c/s to 2.5 kc/s and the response is flat to within $\pm 0.2\%$ of reading up to 10 kc/s. A direct input-to-output connection through the converter is provided in one position of the range switch to enable d.c. voltages to be measured directly without changing leads.—*The Solartron Electronic Group Ltd., Farnborough, Hants.*

For further information circle 9 on Service Card

10. High-Slope U.H.F. Triode

STC have announced a forced-air-cooled, high-slope, tetrode which conforms to the U.S.A. JAN-7289 specification. The construction, which includes a ceramic/metal envelope, is more rugged than that of the 2C39A. Moreover, the distributed inductance and capacitance of the grid-cathode and grid-anode configurations are more tightly controlled.

In most instances the valve can be used as a unilateral direct replacement for the 2C39A. Applications for the STC 7289 include use as a power amplifier, oscillator or frequency multiplier at frequencies up to 3 Gc/s.—*Standard Telephones and Cables Ltd., Valve Division, Brixham Road, Paignton, Devon.*

For further information circle 10 on Service Card

11. Automatic Ranging Unit

Digital Measurements have announced the DM2053 automatic ranging unit for use with their DM2001

Mk. 2 and DM2020 digital voltmeters.

When coupled with a digital voltmeter, it enables the instrument to select automatically the range which provides optimum resolution for the applied input voltage. Besides containing the logic circuits for automatic range selection, the unit also incorporates input attenuators and filters which duplicate those in the voltmeter. Thus, range and filter selection can be made on the new unit using the pushbuttons provided. An important feature is a remote manual facility whereby the range can be changed by a 4-position mechanical or semiconductor switch at a remote location.

The unit, which contains its own power supplies, is a rack-mounting module, 19 in. wide, 1½ in. high and 12½ in. deep. A case to take both the digital voltmeter and the automatic ranging unit is available.—*Digital Measurements Ltd., 25 Salisbury Grove, Mytchett, Aldershot, Hants.*

For further information circle 11 on Service Card

12. 150 Mc/s Amplifiers

Wide response and high output characterize a series of solid-state amplifiers by C-COR Electronics Inc. Band pass is 100 kc/s to 150 Mc/s. Output is 6 V p-p into 50 Ω at 10 Mc/s. Input and output impedances are 50 Ω with noise and hum of 12 μ V r.m.s. equivalent input.

Three gains available are 20, 40 and 60 dB nominal. Amplifiers are packaged as signal chassis only (3000 series) and complete amplifier and power supply in an instrument case (4000 series).—*Sylvan Ginsbury Ltd., 8 West 40th Street, New York 18, N.Y., U.S.A.*

For further information circle 12 on Service Card

13. Unity-Gain Delay Module

A unity-gain delay module that provides delays of up to 2,000 μ sec at standard logic levels is now available from Delttime Inc., a subsidiary of Sealectro. An RZ-1 write-read circuit module is packaged with a model 192A magnetostrictive delay line to meet long digital delay requirements with a single compact module. The unit operates in a return-to-zero mode and features output pulse characteristics of -6.6 -V amplitude and 0.50- μ sec width. Input pulse requirements are -6.6 -V amplitude, 0.50- μ sec width, and rise and fall times of 0.08 μ sec. The maximum pulse repetition frequency is 1 Mc/s. No external circuitry other than d.c. power is required for time delay application. The addition of external clocking and feedback loop provides

a recirculating system which can be utilized for digital data storage.—*Sealectro Ltd., Hershams Trading Estate, Walton-on-Thames, Surrey.*

For further information circle 13 on Service Card

14. Radial Resolution C.R.T.

A radial resolution cathode-ray tube has been developed by Raytheon. The CK1378 can be used as a multiplexer for coded transmission, a frequency multiplier from 60 c/s to 30 kc/s, an analogue-to-digital converter, for time sharing of any type, and other applications where it is desirable to segregate signals into narrowly defined angular sectors. In its present configuration the tube can separate signals into 10° sectors.

From a single cathode-ray gun at the input end an electron beam is projected to the target end where the 3-in. diameter target face is precision-etched into 36 equal and electrically-isolated sectors. The tube can also be supplied with any number of divisions of the target screen. Outputs of the discrete sectors are terminated through the fritted glass faceplate with four E9 nine-pin bases. Each sector is connected to a separate output lead terminating in one of the external bases. The tube's output end also has an externally-visible screen to facilitate focusing and alignment of the quadrants within particular systems.—*Raytheon-ELSI, S.p.A., Villagrazia, Palermo, Italy.*

For further information circle 14 on Service Card

15. Synchro Test Set

Featuring semi-automatic operation and direct-reading outputs, the Theta model MST-5SSA synchro tester conforms to the requirements of specification MIL-S-20708B. It will test electrical zero, electrical error, fundamental null, and total null.

According to the manufacturer, 1,000 synchros per month may be completely tested with this equipment by an unskilled operator. The main specifications are as follows: electrical error measured every 5° up to 360°; nulls measured every 60°.—*Theta Instrument Corporation, Saddle Brook, New Jersey, U.S.A.*

For further information circle 15 on Service Card

16. Magnetic Recording Heads

Magnetic recording heads for professional applications are now available to customers' specifications through a new design and manufacturing service announced by Mullard. Recording heads for tape, magnetic discs and drums can be supplied for either single-track or multi-track applica-



9

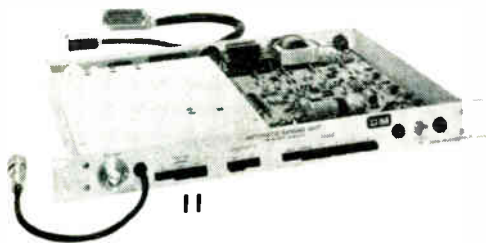

11



12

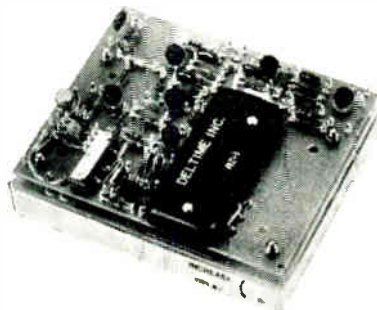

13



10



14

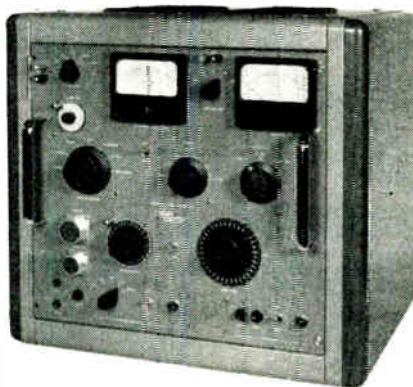

15

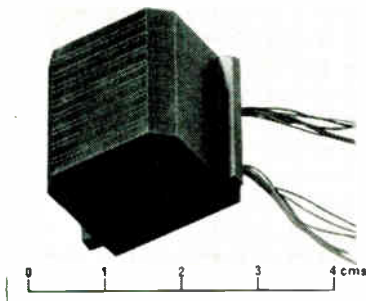

16

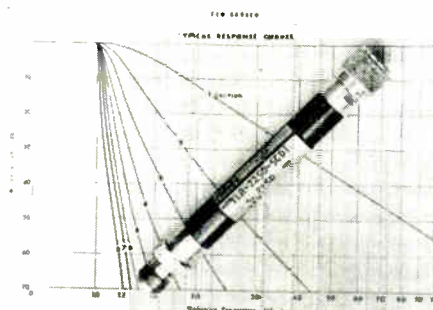

17

tions. Typical uses include video tape-recorders, computers and professional audio-frequency recording equipment.

The heads use a high-density ferrite in place of the conventional laminated-metal construction. As a result, their life expectancy is increased by ten times and they will work at frequencies up to 10 Mc/s. They also have a lower power loss and a lower head noise. By moulding glass in the gap between the pole pieces a sharply defined gap is obtained and erosion of the ferrite at the pole pieces eliminated. Ease of manufacture permits heads to be supplied with gap sizes down to 1 μm .—Mullard Ltd., Mullard House, Torrington Place, London, W.C.1.

For further information circle 16 on Service Card

17. Resonant Line Filters

A series of Telonic resonant-line filters operating in the frequency range from 200 to 3,000 Mc/s is available from Livingston Laboratories. These filters are designated the TLR series and have been designed to provide high performance at low cost. They are tubular and constructed in sections, with characteristics dictated by the number of sections used. Any number of sections from 1 to 8 may be specified depending on the degree of filtering required: an 8-section filter, for example, will provide 70 dB attenuation at 20% above cut-off frequency.

Classified as a 0-1-dB Chebishev type, this series has a maximum v.s.w.r. of 1.5 : 1. Impedance is a standard 50 Ω , and the power rating is 30 W. They are constructed to withstand any major environmental stress such as shock, vibration, temperature and acceleration. Their small diameter and light weight make them well-suited for airborne as well as ground installations, and they may be specified with BNC, TNC, N, TM, or any special connector. Livingston Laboratories Ltd., 31 Camden Road, London, N.W.1.

For further information circle 17 on Service Card

18. Educational Tape Recorder

A magnetic tape recorder designed specifically for educational use in language laboratories or in the field has been introduced by Ampex.

The E-65, a two-channel recorder/reproducer, is engineered to take the abuse of daily student operation and provides simplified controls. Its electronic components are good for 50,000 hours of service, more than five times the life of ordinary home recorders, and it is backed by a three-year warranty.

In addition to use by students in

EQUIPMENT REVIEW

language laboratories, the E-65 can be used by instructors for recording master tapes. Enclosed in a portable case, this compact unit contains a fully-transistorized amplifier and a loudspeaker, which makes it ideal for home study.—*Ampex Great Britain Ltd., 72 Berkeley Avenue, Reading, Berks.*

For further information circle 18 on Service Card

19. Vacuum Gauges

Two Tempcor vacuum gauges are now available in this country from Four Winds Trading Co.

The thermocouple vacuum gauge model 5505/6/7, is for pressure measurements in the micron range. Direct indication of a 1,000 to 0 span is available and through the use of noble element thermopiles good long-term stability is achieved. The instrument, which contains a stabilized power supply, can be supplied to resolve measurements from up to three separate measuring stations. Its dimensions are 8 × 6 × 7 in. and it weighs 8 lb.

The cold-cathode vacuum gauge model 5511 is of the discharge (Phillips) type and effects continuous pressure measurements in the range of 10^{-1} to 10^{-6} mm Hg. The tube design reduces the time normally required for cleaning and degassing, whilst the ring-type anode ensures a high-density ion discharge beam with consequent low contamination and good long-term stability. The robust metal construction renders special handling procedures unnecessary. The unit is self-contained, measures 10 × 10 × 9 in. and weighs 17 lb.—*Four Winds Trading Co. Ltd., 59 Swinton Street, Grays Inn Road, London, W.C.1.*

For further information circle 19 on Service Card

20. Subminiature Bulkhead R.F. Jack

A subminiature recessed bulkhead r.f. jack has been added to Sealectro's 'Conhex' line. This connector provides an improved method of connecting r.f. transmission lines through a chassis or instrument panel. The jack, being sunk behind the panel surface, is protected from accidental damage.

Other features include optimum impedance matching for maximum energy transfer, single-hole mounting, and improved appearance. Constructed of machined brass with 0.0001 in. gold plating, this new connector is available in both 50-Ω (part No. 5581) and 75-Ω (part No. 5563) versions.—*Sealectro Ltd., Hersham Trading Estate, Walton-on-Thames, Surrey.*

For further information circle 20 on Service Card



18

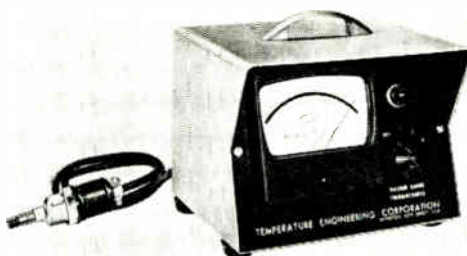

19



20

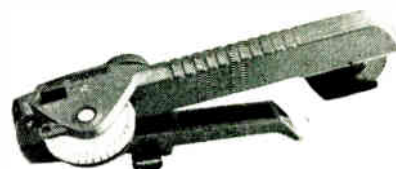

21

21. New Dymo Tapewriter

Hellermann Equipment have announced the M1054 Dymo tapewriter which produces permanent embossed plastic labels in Dymo tape $\frac{1}{8}$ in. wide by any length up to 10 ft.

You spin the dial to select the characters required and squeeze the handle to produce a self-adhesive label with the information in white on any of 11 high-gloss background colours. This robust model costs £8 12s. 6d.—*Hellermann Equipment Ltd., Gatwick Road, Crawley, Sussex.*

For further information circle 21 on Service Card

22. Clothes Dryer Control

A solid-state control for clothes dryers designed to 'feel' individual garments electronically for exact desired dryness has been announced by Metals & Controls Inc., a corporate division of Texas Instruments. An accurate degree of dryness can be selected by means of a control knob mounted on the console without considering operating time or mixed load characteristics. The control also provides a setting for air fluffing. No mechanical or electromechanical timing mechanisms are used.

Sensors in the dryer drum come in periodic contact with each article of clothing as it is tumbled and dried. The electrodes measure the moisture

content of the clothing in terms of resistance. As moisture is reduced and the desired level of dryness coincides with the setting, the electrodes signal the solid-state module and the machine shuts off.—*Metals & Controls Inc., 34 Forest Street, Attleboro, Massachusetts, U.S.A.*

For further information circle 22 on Service Card

23. Quartz Bolometers

Bolometers now available from MSI Electronics Inc. of New York in 1N23 type cartridges use quartz instead of styrene package dielectrics. The advantage of quartz is that it has about half the dielectric losses present in the styrene copolymer, thus improving mount efficiency.

The lower thermal conductivity of quartz also contributes to the greater stability of the bolometer, thereby making it useful for the more sensitive ranges of conventional power meters. These units can be supplied in 4.5- and 8.75-mA bias ratings.—*MSI Electronics Inc., 116-06 Myrtle Avenue, Richmond Hill, N.Y., U.S.A.*

For further information circle 23 on Service Card

24. Silvered-Mica Capacitors

Two alternative standard versions of silvered-mica capacitor are now available from Plessey. The wax-dipped

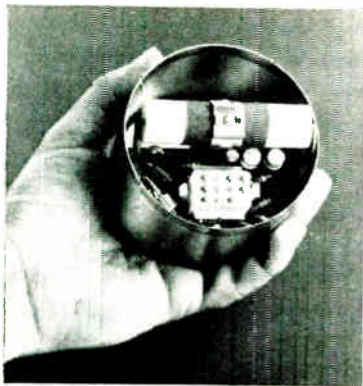

22

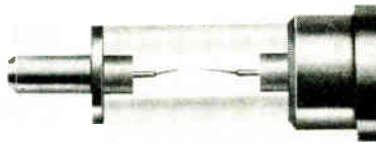

23

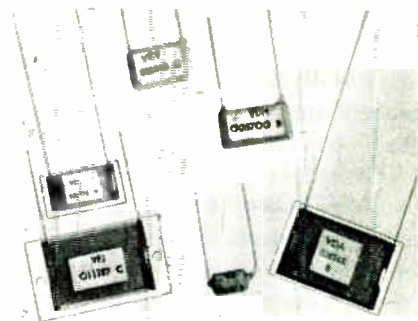

24

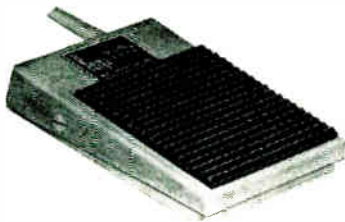

25

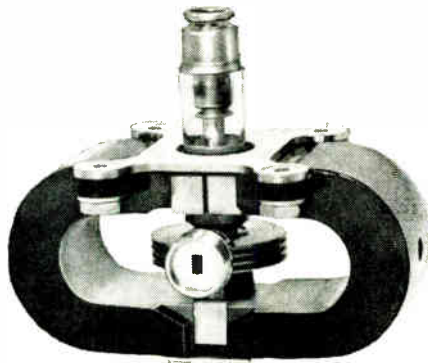

26

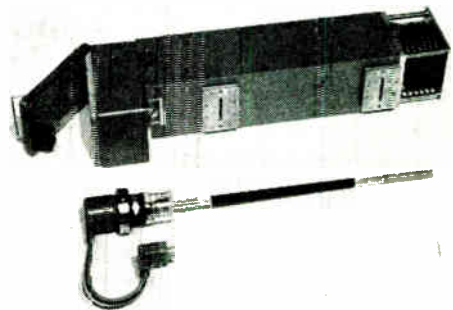

27

type utilizes a special non-cracking wax-and-lacquer coating and is suitable for the temperature range -25 to $+70$ °C. The epoxy resin encapsulated types provide humidity protection to H.2 standards and extend the temperature range from -40 to $+85$ °C.

The capacitors can be supplied in any value up to $1.0 \mu\text{F}$ at 200 V d.c. working; $0.75 \mu\text{F}$ at 350 V ; $0.5 \mu\text{F}$ at 500 V ; and $0.05 \mu\text{F}$ at 750 V . Four sizes of plates are used in the standard range, from $\frac{7}{16} \times \frac{1}{4}$ in. to $1 \times \frac{1}{2}$ in. depending on the capacitance. Terminations are tinned-copper wire (normally radial, but axial on request). Mica capacitors for use at temperatures up to 250 °C are also available. —*Capacitor Division, Plessey-UK Ltd., Kembrey Street, Swindon, Wiltshire.*

For further information circle 24 on Service Card

25. Miniature Foot Switch

The latest addition to the Herga range of foot control switches measures $3\frac{1}{2} \times 2\frac{1}{2} \times \frac{1}{4}$ in. high. It has a rating of 5 A at 250 V a.c. and the switch mechanism has been tested to millions of operations.

It is suited to the control of office machinery where minimum dimensions are of utmost importance, but it is robust enough for industrial use where

a switch smaller than the standard industrial models is desirable. The base is covered with a non-slip plastic material giving a firm grip, even on polished surfaces, and the standard finish is in silver-grey hammertone stove enamel. —*Herga Electric Ltd., Wallingford Road, Uxbridge, Middlesex.*

For further information circle 25 on Service Card

26. 33 Gc/s Magnetron

A magnetron to meet the international frequency requirements of the recently allocated 33 Gc/s civil marine radar band has been introduced by Mullard. The YJ1020 is an air-cooled packaged magnetron based on the already established JP35-30.

The operating frequency is fixed within the band 31.8 Gc/s to 33.4 Gc/s . Under typical operating conditions with an anode pulse current of 12.5 A , the peak pulse output power is 40 kW for a pulse duration of $0.1 \mu\text{sec}$ and a duty cycle of 0.0002 . Weight is $4 \text{ lb } 3 \text{ oz.}$ Cooling is by low-velocity air flow.—*Mullard Ltd., Mullard House, Torrington Place, London, W.C.1.*

For further information circle 26 on Service Card

27. Travelling-Wave Tubes

English Electric have announced two microwave link travelling-wave tubes

developed specifically to comply with the requirements of designers of multi-channel microwave links, where their low a.m./ph.m. conversion and noise figure enable cross-talk and distortion to be kept to a minimum. Both tubes are focused in p.p.m. mounts.

The N1055 covers the frequency band $5.8\text{--}7.2 \text{ Gc/s}$ with a working power output of 10 W . The a.m./ph.m. conversion is typically $1.5^\circ/\text{dB}$ with a noise figure of 26 dB .

The N1056 t.w.t. covers the frequency band $3.6\text{--}4.2 \text{ Gc/s}$ with a working power output of 10 W . The a.m./ph.m. conversion is typically $1^\circ/\text{dB}$ with a noise figure of 25 dB . —*The English Electric Valve Co. Ltd., Chelmsford, Essex.*

For further information circle 27 on Service Card

28. Turret-Head Welder

Now available from Agron Manufacturing Co. is the Peco capacitor discharge welder model FPR3K. This machine is an air-operated bench welder equipped with an indexing table and electrodes for 8 stations. Suitable for spot, projection and annular projection welding of small articles, especially for leak-proof welding of semiconductor housings size TO18, TO5 and SO33.

The equipment is complete with electronic controls for welding current,

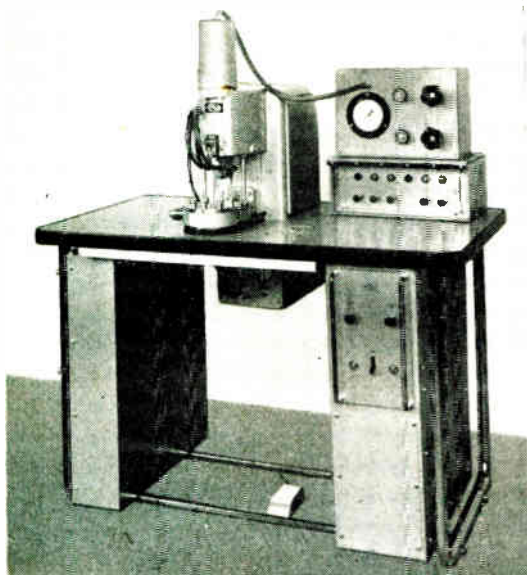

28



30

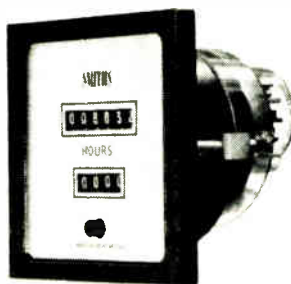

29

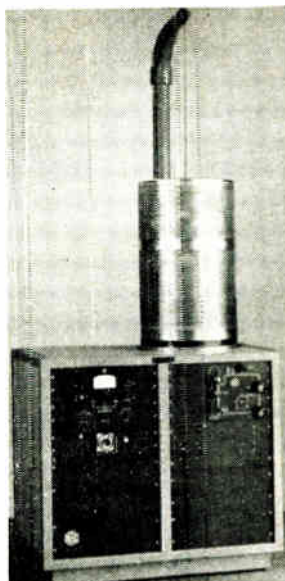

31

welding force and mechanical cycling. It has an operating speed of approximately 20 welds per minute, depending on stroke, loading time and energy required.—*Agron Manufacturing Co. Ltd., 96 Park Lane, Croydon, Surrey.*

For further information circle 28 on Service Card

29. Synchronous Hour Counters

Smiths have introduced a range of panel-mounting counters designed to give consistent long life and reliability under industrial operating conditions at a reasonable price.

Connected in parallel with any equipment operated from controlled frequency a.c. supplies or operated by limit switches, pressure switches or time switches, these counters indicate the cumulative operating time with the additional feature of a secondary reset counter with an easily accessible frontal reset button.

A heavy-duty, self-starting, synchronous motor is employed to drive the 6-digit total counters and 4-digit

reset counters. Models with total or reset counters only are also available. The total counters indicate to 99,999.9 hours or nearly one million minutes, while the reset counters indicate up to 9,999 hours or minutes.

A choice of 12, 24, 125 or 250-V models for 50 or 60 c/s operation and minute counters instead of hour counters make it possible to select exact customer requirements from 48 variations. For 440-V operation a small transformer is available as an accessory.—*Smiths Industrial Division, Kelvin House, Wembley Park Drive, Wembley, Middlesex.*

For further information circle 29 on Service Card

30. A.C. Voltage Stabilizers

Claude Lyons have announced the availability of a full range of series BTR stabilizers comprising three basic sizes for 240-V nominal operation, and three for 115-V nominal operation. For 240-V models, the operating voltage can be set as required from 200

to 254 V, and output current ratings available are 2 A (illustrated), 5 A and 13 A. For 115-V models, the operating voltage is adjustable from 100 to 127 V, and current ratings are 3.5 A, 9 A and 23 A. For all models, three alternative input ranges are provided, selected by a link, these being -15% to +5%, or $\pm 10\%$, or -5% to +15% relative to the set operating voltage.

Each model is available in basic form or with filtering. The basic models are suitable for the great majority of applications and have total distortion below 6% or 7% according to model, output accuracy of $\pm 0.3\%$ at any load current from zero to full load, and are unaffected by frequency variations from 45 to 65 c/s. For critical applications the filtered models are available in which, at the filter frequency, the total distortion is below 2% or 2.5% according to model, and the output accuracy $\pm 0.2\%$ from zero to full load.—*Claude Lyons Ltd., Valley Works, Hoddesdon, Herts.*

For further information circle 30 on Service Card

31. Portable Vacuum Units

NRC Equipment Corp. have announced the availability of two new packaged portable high-vacuum pumping systems. These systems (NRC models SC-04 and SC-06) are claimed to provide higher net pumping speeds than other commercially available units.

Designed as 'work-horse' vacuum equipment, these systems are suitable for applications which include research and testing in electronics, aerospace, metallurgy and materials. An optional automatic valve control enables use of the systems for production work and eliminates any possible error in valve sequencing.

Measured speed at the system inlet is 300 litres/sec for the model using 4-in. vacuum components and 600 litres/sec for the 6-in. version. Both systems have a vacuum performance capability in the 10^{-8} torr range.

The entire unit is castor-mounted for ease of movement from one job location to another; the castors retract and the mechanical pump rests on the floor to reduce vibration when the system is operating.—*NRC Equipment Corporation, 160 Charlemont Street, Newton 61, Mass., U.S.A.*

For further information circle 31 on Service Card

32. Modular Oscilloscopes

The transistorized modular oscilloscope series, now available from Cossor, follows the current trend towards

(Continued on page 181)

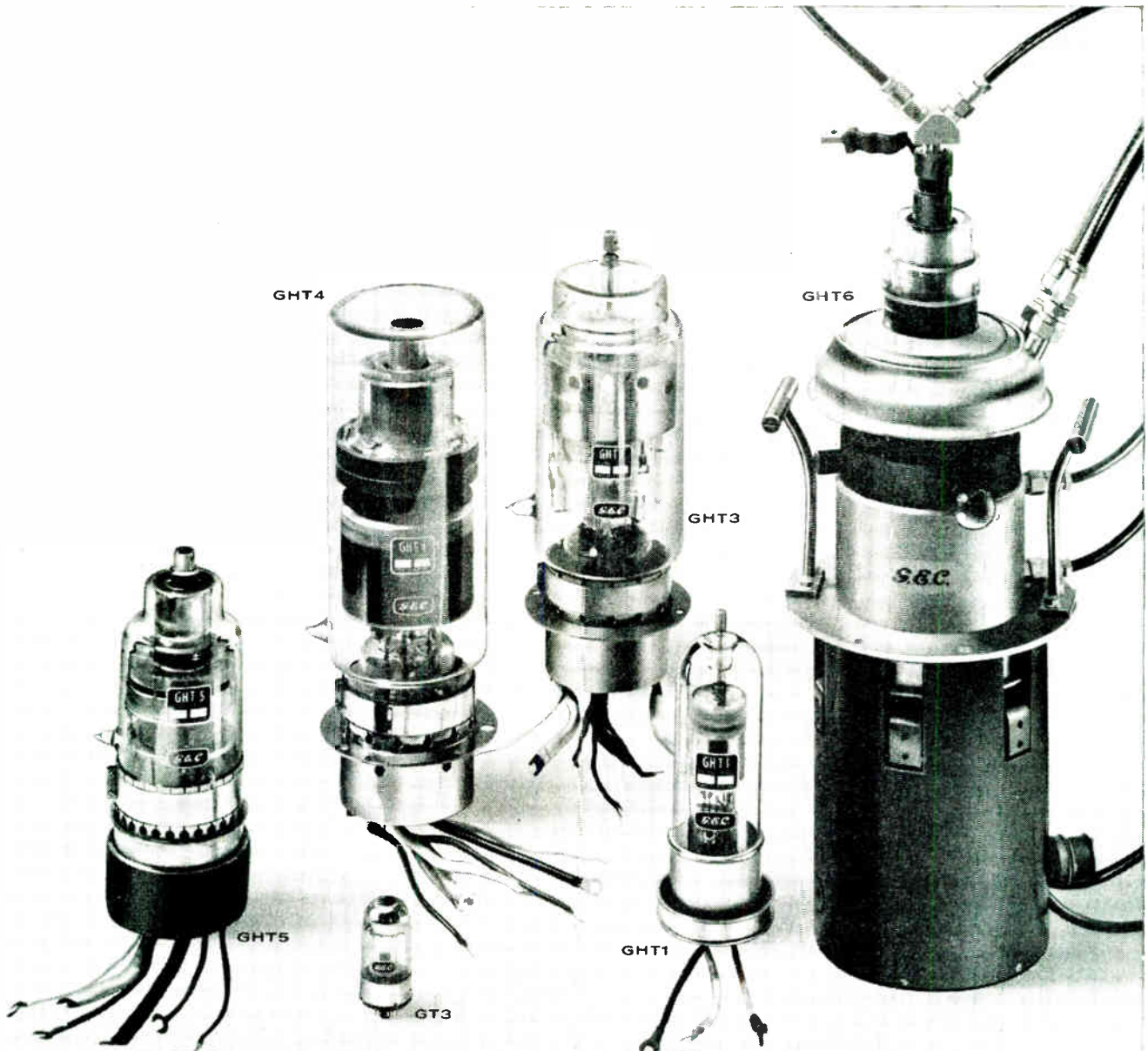

CHOOSE G.E.C FOR THYRATRONS

(a magnificent range, including the world's largest)

Here's a selection of G.E.C. thyratrons, from the low-power argon-filled GT3 to the high power deuterium filled GHT6 — the largest thyatron available in the world today.

All high power thyratrons incorporate a unique replenisher system controlled by a barretter and thermistor. This maintains a constant gas pressure, despite wide variations of supply voltage and ambient temperature, and greatly extends operational life.

	GT3	GHT1	GHT5	GHT3	GHT4	GHT6
V_a (kV)	0.5	16	18	25	25	40
i_a (pk) (A)	1.0	200	700	1000	2000	10000
i_a (av) (A)	0.3	0.35	1.25	1.0	3	15
Pb factor	1000	2200	10000	10000	20000	80000



Our technical information centre is ready to help your application problems. Write for full data sheets on these or other M-O V products, or telephone RIVerside 3431. Telex 23435.

M-O VALVE CO LTD

BROOK GREEN WORKS • HAMMERSMITH • LONDON W6 • RIVERSIDE 3431

* SATURABLE REACTORS

are chokes whose impedances may be varied by the flow of the direct current in the special winding. Fully tapped reactors are designed to vary the input voltage to any load between half and full rating of the reactor itself, from near zero to the full operating voltage, at mains voltages between 380/440v, 200/250v and 100/120v, A.C., 50 cycles, by the application of a small direct current on the control winding.

Correx reactors are available in standard ranges for powers up to 180 kVa per circuit on three phase operations. This refers to the 100% rating and not the possible uprating granted where reactors may be used on an intermittent rating i.e. furnace control where the rating utilization at control point may be as low

as 60%. In addition to the well known Correactor and A.C.R. reactor this range includes Toroidal reactors and Auto-excited transductors.

ABSENCE OF MOVING PARTS

No brushes, contacts, etc. to wear out. No maintenance is required.

CONSERVATIVE RATING

For intermittent use particularly where current is drawn for a short period, these reactors will stand large overloads. They can therefore be considerably uprated for those applications where these intermittent requirements obtain.

REMOTE CONTROL

As a small potentiometer only is required for the D.C. control, the reactor need not be mounted on the control panel, and may be installed elsewhere.

SMOOTH CONTROL ...

Can be set to any predetermined voltage. There are no steps.

HIGH EFFICIENCY

Very low losses at all loadings.

CORREX

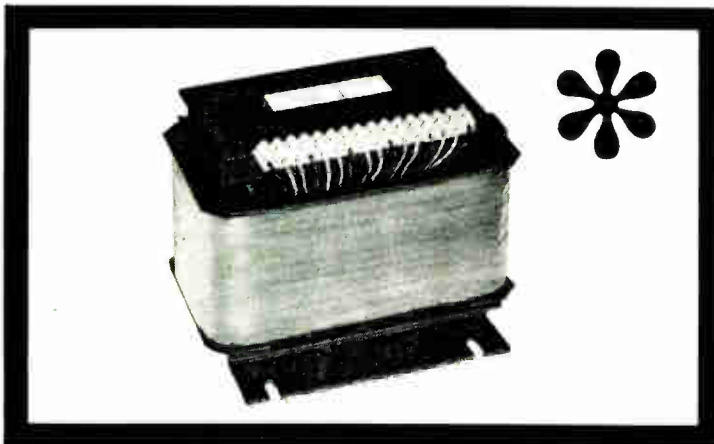

MODULAR EQUIPMENT

FOR STEPLESS PROPORTIONAL CONTROL OF VOLTAGE, SPEED, POWER, HEAT, LIGHT, ETC.

This range is readily available as individual units or as packaged systems designed to enable you to construct control schemes using the CORREX modular "add on" system.

Included, for use with and in this range are:—

- PROPORTIONAL CONTROLLERS
- MAGNETIC INSTRUMENT AMPLIFIERS
- MAGNETIC AMPLIFIER DRIVER STAGES
- TRIP AMPLIFIERS (MAGNETIC)
- SATURABLE REACTORS in a wide range UP TO 180 KVA
- TRANSFORMERS

Other specialised control equipment for all purposes.



PHOENIX TELEPHONES LIMITED

GROVE PARK, LONDON, N.W.9

Telephone COLindale 7243 Telegrams PHONOFENIX LONDON NW9



modular instrumentation: the main frame, containing the cathode-ray tube and power supplies, has one large aperture designed to accept a range of plug-in modules. Depending on the application, one module may supply both X and Y axes, or individual modules may be inserted to feed either axis of the display.

Typical modules will include a range of single-trace, dual-trace and differential d.c. amplifiers with bandwidths up to 50 Mc/s and sensitivities of up to 500 μ V/cm; sweep generators, with or without delay facilities suitable for use with the above amplifiers; sampling units for bandwidths up to 1,000 Mc/s; and a range of swept-frequency oscillators from 20 c/s to 1,000 Mc/s.—*Cossor Electronics Ltd., The Pinnacles, Harlow, Essex.*

For further information circle 32 on Service Card

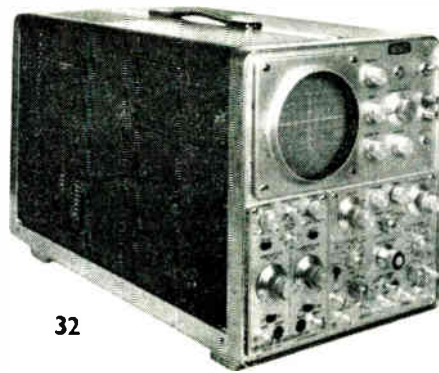

32

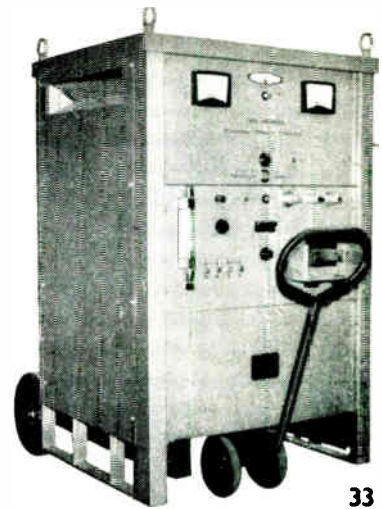

33

33. Plasma-Arc Power Sources

Hirst Electronic have introduced a range of plasma-arc power sources with a maximum output of 500 A at 120 V.

These high-current, medium-voltage power supplies utilize a motor-driven variable transformer combination to provide precise control over the output. All units are self-contained and include auxiliaries such as gas and water economisers, the arc itself being initiated by an efficient 'high-frequency starter'.

Present applications of the plasma arc include high-speed metal cutting, high-speed metal spraying and chemical processes requiring a high transfer arc temperature.—*Hirst Electronic Ltd., Gatwick Road, Crawley, Sussex.*

For further information circle 33 on Service Card



34

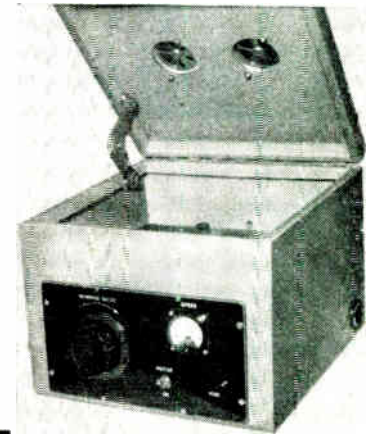

35

34. Optical Encoder

An optical encoder has been added to the range of encoding devices manufactured by Moore, Reed and Co. It is suitable for applications where very high count-to-shaft-angle-movement is required, e.g., one bit = 2 minutes 38 seconds of shaft angle; where a very high counting rate is necessary, e.g., 6,000 to 8,000 counts per second; and where very long life is essential.

The unit is housed in a 2½-in. diameter case and mounting is to frame size 23 standard. The resolution is 1 part in 2¹³ per shaft revolution in Gray code. Aircraft requirements in accordance with BS.2G 100 of environmental performance for acceleration, humidity and vibration are featured in the design. Output from the photocells is maintained at a

minimum current ratio of 20:1 light-to-dark over the temperature range -40 °C to +70 °C.—*Moore, Reed & Co. Ltd., Durnsford Road, London, S.W.19.*

For further information circle 34 on Service Card

35. Miniature Coating Machine

A miniature whirler designed to meet the special needs of the electronics industry for the manufacture of micro-printed circuit boards has been developed by Lee-Smith Photomechanics. The Micro whirler has a circular worktable and is used for applying coating solutions evenly over the surface of any component having a diagonal dimension of 9 in. or less. Worktable rotational speed can be pre-set at any value between 0 and 600 r.p.m. Actual speed of rotation is indicated on a dial gauge.

As spirit-base photo-resist solutions are often employed for micro-circuit work, two adjustable louvres are fitted in the hinged lid of the basic model

for ventilation. If required, the Micro whirler may be equipped with a heater and air filter. The table can be removed easily to facilitate cleaning and a drain for excess solution is provided.

The basic unit measures 12 × 12 × 8 in. high and costs £84.—*Lee-Smith Photomechanics Ltd., Lyon Way, Hatfield Road, St. Albans, Herts.*

For further information circle 35 on Service Card

36. Chromatogram Scanning System

A flexible radioactive chromatogram scanning system suitable for windowless scintillation counters or Geiger counters is now going into production. Based on the Panax 'PX' plug-in modules, the assembly is available with ratemeter and recorder or scaler and automatic print-out facilities.

The scanner unit type RCMS-2 (left) accepts chromatograms up to 2 in. wide, and 2 in. diameter and scintillation detectors.

**EQUIPMENT
REVIEW**

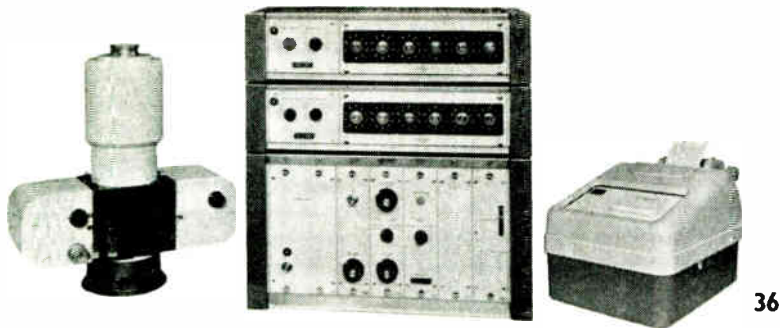

36

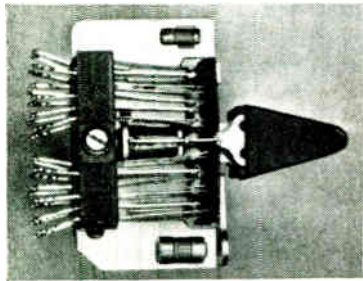

37

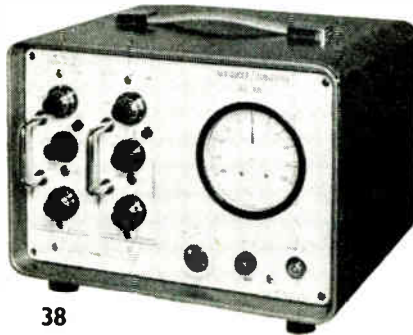

38



39



40

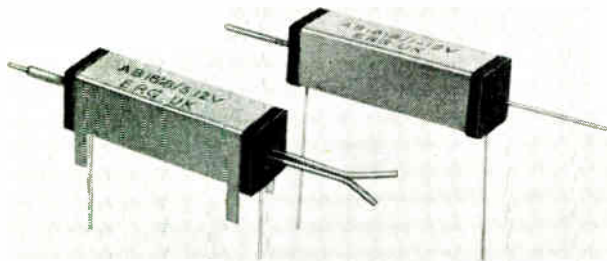

41

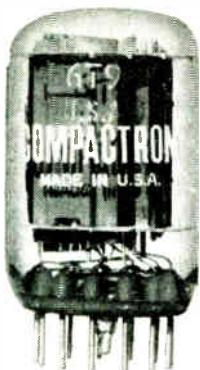

42

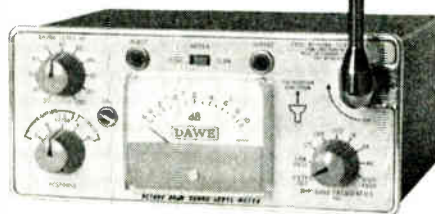

43

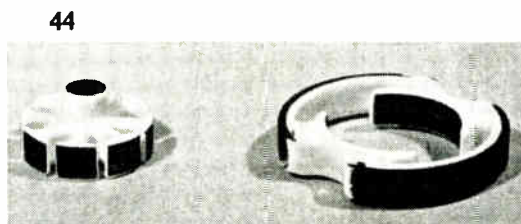

44

4 p.i. arrangements. A control module provides for incremental movement of the paper through the scanner for the automatic print-out system, the step lengths being adjustable from $\frac{1}{4}$ in. to $\frac{1}{2}$ in. The continuous paper movement range for the ratemeter and recorder system is $1\frac{1}{2}$ to 60 in. per hr.

The PX modules used include a power supply unit, a highly-stabilized 200 V-2.2 kV e.h.t. unit, a pulse height analyser, scanner and printer control units, and a high-gain non-overload amplifier. A six-decade fast scaler, a six-decade timer and a 14-digit Kienzle D.11 printer (right) provide automatic recordings of time and counts. Alternatively, less versatile systems can be provided for routine work.—Panax Equipment Ltd., Holmethorpe Industrial Estate, Redhill, Surrey.

For further information circle 36 on Service Card

37. Miniature Lever Keys

Now available from Keyswitch Relays for light current switching applications is a range of P.O. 1000 type miniature double-throw lever keys with a mechanical life in excess of 750,000 operations. The contact action provided is a changeover, and is available in combinations of locking, non-locking and stop actions, with a maximum of four changeovers per action. Silver twin contacts are standard.

Contact ratings are 100 V at 300 mA d.c., 12 V at 1 A d.c., 100 V at 1 A a.c., with contact pressures initially 15 gm minimum (10 gm minimum after 750,000 operations). Each key is supplied with two fixing screws, and handles are available in red, green, yellow, grey, ivory or black.—Keyswitch Relays Ltd., Cricklewood Lane, London, N.W.2.

For further information circle 37 on Service Card

38. Low-Cost Portable Converter

S.E. Laboratories have introduced a low-cost portable and self-contained one- or two-channel transducer/converter system, the S.E. 905. This unit is ideally suited for indicating and/or recording information from inductive or strain-gauge-type transducers. Pressure, strain, acceleration, displacement measurements, etc., may therefore be carried out on-site.

A special feature is a mains-operated power supply with a built-in rechargeable battery cell, which enables the unit to be used in the field without recourse to a mains supply. It contains a stable 3-kc/s oscillator. Dimensions: 11 x 7 x 10 in. deep. Weight: 15.1 lb.

Two types of plug-in amplifiers are

available: S.E. 423, primarily intended for static and dynamic measurements from strain-gauges or strain-gauge-type transducers, and S.E. 449, used for static and dynamic measurements from inductive-type transducers and differential transformers. A built-in Cirscale meter can be directly calibrated to customers' requirements. Outputs are also available for driving galvanometers, tape recorders, and oscilloscopes.—*S.E. Laboratories (Engineering) Ltd., North Feltham Trading Estate, Feltham, Middlesex.*

For further information circle 38 on Service Card

39. Film Scanning C.R.T.

The type MX57 film-scanning cathode-ray tube is the latest addition to the E.M.I. range of flying-spot scanning tubes for use in telecine equipment.

It has a 7-in. diameter face and, operating at up to 30 kV, is capable of a spot size of 0.15 mm diameter. Both deflection and focus are magnetic. The tube is available with a short-persistence green phosphor and a later version will be produced having a very short afterglow blue (gehlenite) phosphor.—*E.M.I. Electronics Ltd., Hayes, Middlesex.*

For further information circle 39 on Service Card

40. Precision Resistors

Electrothermal have extended their series G 101 range of all moulded wire-wound 'Precistor' precision resistors to include two new tag versions. These are the type 3505T $\frac{1}{4}$ W and type 3507T $\frac{1}{2}$ W. They employ the same moulded-in anchoring features used in all series G 101 Precistors, to ensure robust construction, a high reliability factor and 100% positive humidity sealing.

The values available are from 0.1 Ω to 1 M Ω in the $\frac{1}{4}$ -W type and 0.1 Ω to 2 M Ω in the $\frac{1}{2}$ -W type. Tolerances are from 0.1% to 0.01% dependent on value, while the stability is better than $\pm 0.02\%$. Maximum working voltages are 550 V and 750 V respectively.—*Electrothermal Engineering Ltd., 270 Neville Road, London, E.7.*

For further information circle 40 on Service Card

41. Compact Dry-Reed Relay

A compact dry-reed relay, known as style AB.1618, designed for the industrial process control, computer and allied equipment fields, has been introduced by Erg Industrial Corporation. Main features include a fast switching time—down to 1 msec—coupled with a long working life.

The gold-plated contacts are hermetically sealed in an inert atmosphere,

and are available either as single change-over (s.p.d.t.) or one normally-open contact (s.p.s.t.). The mounting of the dry-reed switch enables it to be changed, and magnetic screening of the relay minimizes effects of extraneous magnetic fields.

The bobbin of the relay is moulded from fibreglass-reinforced epoxy resin, and the integrally moulded coil leads are designed to suit the latest printed-circuit mounting technique. Fixing lugs, incorporated in the metal screen (style AB.1652) are available at no extra cost. Prices begin at 13s. 6d. each for quantities of four or more, and substantial discounts are available for quantities in excess of 24.—*Erg Industrial Corporation, Luton Road Works, Dunstable, Beds.*

For further information circle 41 on Service Card

42. Compact Triode-Pentode

A valve that combines a 5-W audio output pentode and a voltage-amplifier triode in a very small space can now be ordered through International General Electric. The GE type 6T9 Compactron device has a seated height of 2 in. and a diameter of 1.188 in. It is suitable for single-valve gramophone applications and other audio uses.

Significant ratings of the pentode section include 12-W plate dissipation and 6,500 micromhos transconductance. The pentode has a relatively large cathode which contributes to easy driving—about 8-V peak signal, easily obtainable from the triode section. Amplification factor for the triode is 90 and transconductance is 3,000 micromhos.—*International General Electric Company of New York Ltd., 296 High Holborn, London, W.C.1.*

For further information circle 42 on Service Card

43. Sound Level Meter

The Dawe type 1419A octave band sound level meter is designed for the accurate measurement of overall sound levels and for the analysis of sounds in eight wave bands by means of built-in octave band filters. The sound level range covered is from 24 to 140 dB (or up to 200 dB with a special microphone).

A reading can be obtained for the whole frequency range from 31.5 c/s to 8 kc/s or, by switching in filters, for the low-pass band up to 90 c/s; for octave bands with mid-band frequencies of 125, 250, 500, 1,000, 2,000 or 4,000 c/s and for a high-pass band above 5.6 kc/s.

An attenuator provides a sensitivity coverage from 30 to 140 dB in 11 steps

of 10 dB. The indicating meter is calibrated from -6 dB to +10 dB.

The substantially non-directional microphone is mounted on a stalk combined with an on-off switch. For operation, the stalk is pivoted through 90° away from the operator. The instrument is powered by three internal dry cells (PP4 or equivalent), which provide about 60 hr of operation, or by a separate mains-operated power unit. A leather carrying case and shoulder strap is provided with the instrument. The unit measures $10 \times 9\frac{1}{2} \times 4\frac{1}{2}$ in. and weighs 7 lb with batteries.—*Dawe Instruments Ltd., Western Avenue, Acton, London, W.3.*

For further information circle 43 on Service Card

44. Nylon Coating Process

A nylon dip-coating process for electric motor cores, etc., has been developed by Plastic Coatings. A new masking technique permits the tips of the pole pieces and the exterior surface of the armature system to be left entirely free of the nylon coating. This type of insulation is claimed to be cheap, reliable and very hard-wearing.

The coating prevents relative movement between the laminations, is impervious to oil and is unaffected by vibration. The photograph shows both the armature and field systems of a fractional h.p. electric motor insulated by dip coating in nylon Deconyl RP.95. Nylon coating is offered in a range of ten colours on these and other items of electronic equipment, as part of a 7-day coating service.—*Plastic Coatings Ltd., Industrial Estate, By-Pass, Guildford, Surrey.*

For further information circle 44 on Service Card

45. Mechanical Latching Relay

The (AE) class EML relay now available from Thorn is basically a conventional class E relay, but has the additional feature of a mechanical latch, allowing a step-pause-step operation. The armature mechanism is so designed that on the application of the first voltage pulse to the coil, the relay is energized, operating the contacts. Cessation of the pulse leaves the contacts set in the energized position. The second pulse causes the contacts to reset and remain in the de-energized position until a third pulse restarts the complete cycle. This operation is achieved with a single coil, and while one set of contacts can be latched, the second set can be allowed to operate in a conventional manner.

The main advantages claimed for this technique over remanent hold-

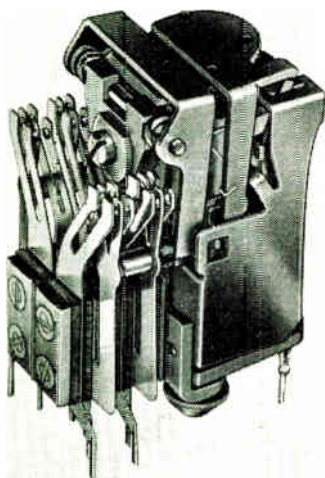

45

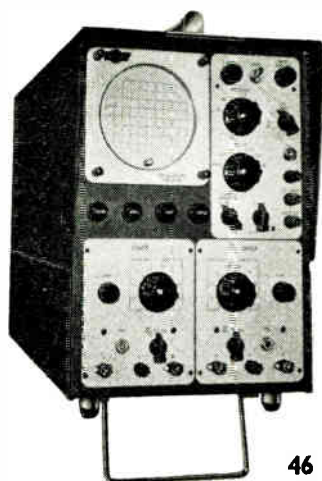

46

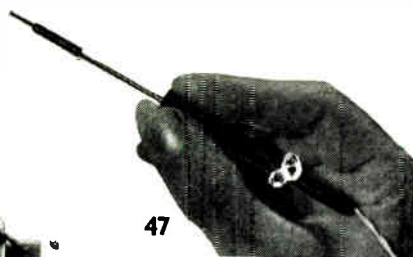

47

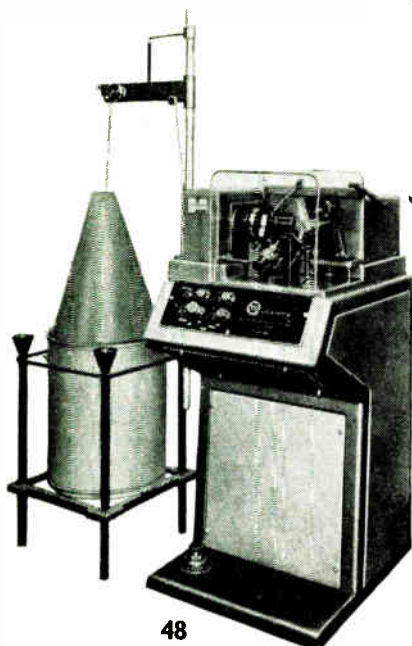

48

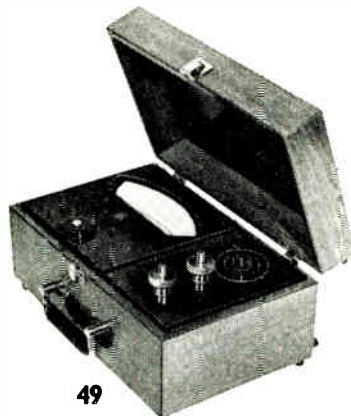

49

in relays is that a larger number of contacts is possible, and the release mechanism is inherent in the design. Several types are available: plug-in hermetically sealed, printed circuit or a version with terminals suitable for wire-wrapping techniques. — *Thorn Electronics Ltd., 105-109 Judd Street, London, W.C.2.*

For further information circle 45 on Service Card

46. Oscilloscope System

Furzehill have introduced their 0.190 oscilloscope system. The basic instrument comprises a 5-in. dual-trace tube with the customary controls, together with stabilized supplies and timebase circuitry. The timebase provides sweep

speeds from 0.2 μ sec/cm to 5 sec/cm.

For the vertical deflection on the two beams additional plug-in pre-amplifiers are used. The standard units are identical balanced amplifiers having a common mode rejection of over 500:1, and providing sensitivities from 1.5 mV/cm to 50 V/cm in 10 ranges with a maximum bandwidth from d.c. to 150 kc/s. One of the amplifiers can be switched to the X plates if desired, giving identical (single-beam) performance on both axes, for curve tracing or similar applications.

Alternative units are available covering sensitivities down to 150 μ V/cm and bandwidths up to 10 Mc/s, along with a low-capacitance probe, a current probe and an audio pre-

amplifier with a noise level of 10 μ V.—*Furzehill Laboratories Ltd., Theobald Street, Borehamwood, Herts.*
For further information circle 46 on Service Card

47. Miniature Soldering Iron

A soldering iron weighing 4 gm, measuring 140 mm in overall length and designed for micro-miniature assemblies, hair-spring soldering, etc., is being marketed by W. Greenwood Electronic.

This Oryx iron is fitted with an interchangeable $\frac{1}{16}$ in. tip and heats up to 320 °C within 18 sec. It operates at 6 V and has a consumption of 5 W.—*W. Greenwood Electronic Ltd., 677 Finchley Road, London, N.W.2.*

For further information circle 47 on Service Card

48. Armature Winding Machines

Midland Dynamo announce the addition to their 'Quickway' range of two fully-automatic armature winding machines for the production of portable tools, domestic appliances and small automobile armatures; 2-pole only. Both of these models are sturdily constructed self-contained units and will operate at very fast winding speeds giving a high production rate.

Model 2H is fitted with a single head for low voltage armatures and has automatic lead pulling or commutator hook-up. Model 2dH has twin heads and is able to accommodate both low voltage and portable tool/appliance armatures. It has automatic lead pulling for 1, 2 or 3 commutator loops or single coil commutator hook-up.—*Midland Dynamo Co. Ltd., 64 Belgrave Gate, Leicester.*

For further information circle 48 on Service Card

49. High-Current True R.M.S. Ammeter

A high-current high-frequency true r.m.s. ammeter (model 560-CT) has been announced by the Greibach Instruments Corporation. Using a miniature current transformer, this self-contained multi-range meter can measure true r.m.s. currents in seven ranges from 100 A down to 1 A full scale, with an accuracy of $\pm 0.5\%$. At 100 A the frequency response is from 30 c/s to 25 kc/s. With a slight reduction in accuracy the frequency response is extended to 50 kc/s.

Irregular waveforms (without d.c. components) with crest factors up to 4 can also be measured. Range selection is accomplished by indexing a small light-duty rotary switch mounted on the meter panel. The heavy-current circuit is never interrupted.—*Greibach Instruments Corporation, 315 North Avenue, New Rochelle, N.Y., U.S.A.*

For further information circle 49 on Service Card

AVALANCHE RECTIFIERS

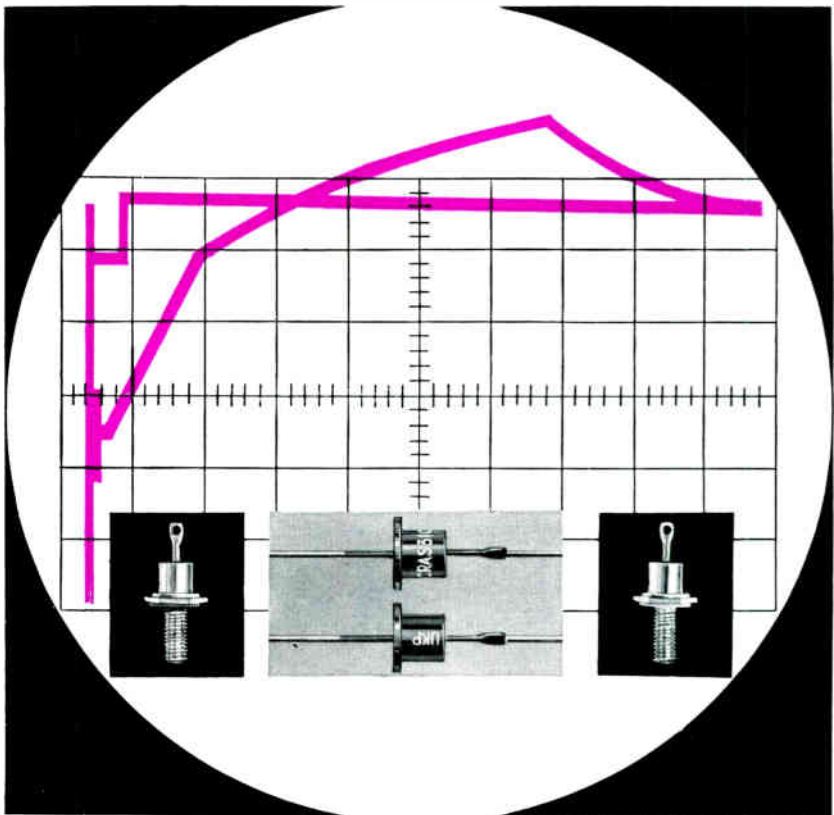

NOW AVAILABLE FROM PRODUCTION —two silicon avalanche rectifiers from STC. These are diffused junction silicon rectifiers with 4 kW reverse power surge ratings. Avalanche rectifiers are self-protecting against voltage transients and the avalanche property of these devices has a voltage limiting characteristic that permits surges fifty times greater than the conventional silicon rectifier can withstand. High voltage stack construction is simplified, the rectifiers can be series-connected without voltage equalizing resistors and, in many applications, equalizing capacitors are unnecessary.

TYPE	RAS310AF	RAS508AF
Rated mean forward current (25°C ambient)	1.25 A	5 A
Rated mean forward current (125°C stud)		800 V
Rated Crest Working Voltage	1 000 V	1 000 V
Minimum Reverse Avalanche Voltage	1 250 V	4 kW
Rated Maximum Reverse Surge Power	4 kW	125°C
Rated Maximum Temperature	140°C	VASCA SO-10
Standard Outlines	VASCA SO-16 JEDEC DO-1 IEC 1-101	JEDEC DO-4 IEC 1-103

RAS310AF now has Joint Services Type Approval to CV7476.

Write, 'phone or Telex for Data Sheet MF/132Z to STC, Semiconductor Division (Rectifiers), Edinburgh Way, Harlow, Essex. Telephone Harlow 26811. Telex 81146.

high-grade electronic components by **STC**
COMPONENTS GROUP

For further information
circle 234 on Service Card

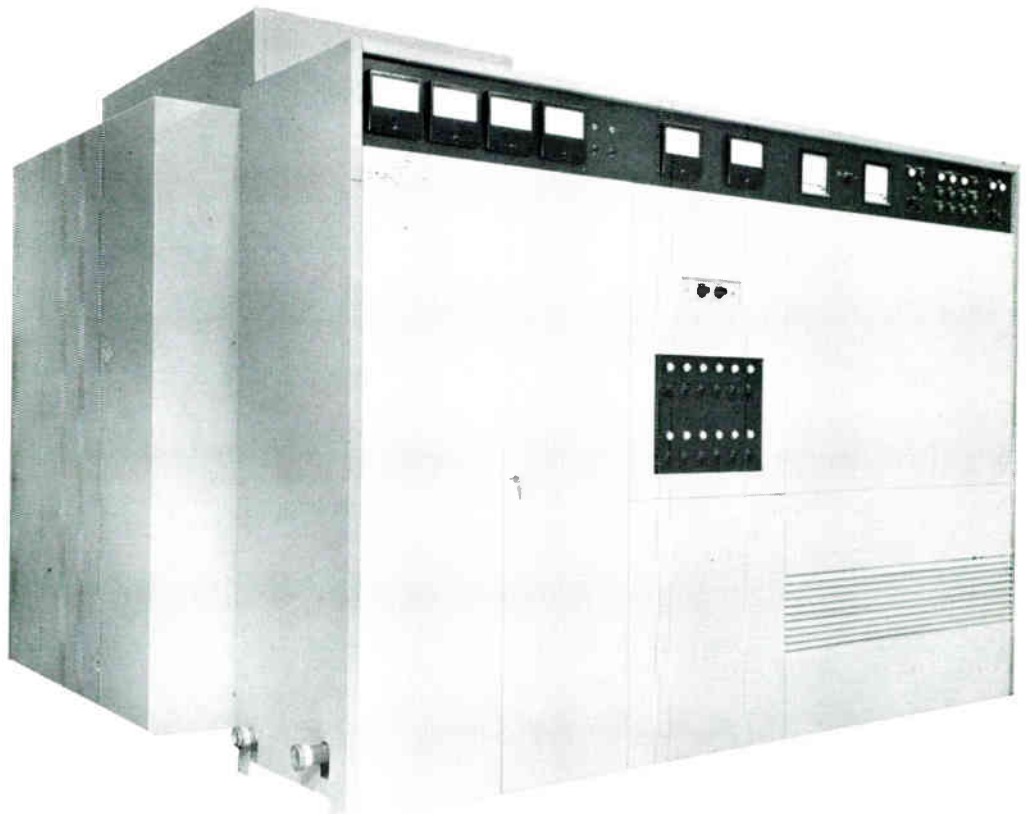

**50 kVA
AMPLIFIERS**

PHILIPS HIGH-POWER AMPLIFIERS

Philips High-power Amplifiers are suitable for power supply in Laboratories, Research Centres, Test Departments, Universities, etc.

High-power amplifiers differ from normal amplifiers not only by their larger output, but also by the fact that they are capable of supplying this power continuously. The input signal need not necessarily be sinusoidal. These amplifiers are used as sources of A.C. energy with two specific aspects: the continuous supply of the required energy, and the easy variability of frequency, voltage and wave-form.

Full information from:

PETO SCOTT ELECTRICAL INSTRUMENTS LTD.
Addlestone Rd., Weybridge, Surrey. Weybridge 47271



Various specifications can be met, for example:

- Output frequency equal to or different from that of the mains, constant to within stringent degrees of accuracy, as for driving synchronous motors, counting mechanisms, calibration of instruments, etc.

- Output frequency easily variable (simply by turning a knob) as for processes the speed of which needs to be adjustable, and for the investigation of fluorescent effects, etc.

- Voltage wave-form very regular in shape (less than 2% distortion) as for the study of the effects of voltage distortion on the accuracy of meters.

- Stable voltage at varying loads (by the insertion of a stabiliser), at either fixed or variable frequency.

- Abnormal voltages of accurate sine form between 10 v. and 2 kv., with frequencies from 5 c/s to 10 kc/s.

- For the production of random noises as for the supply of vibration test tables.

Amplifiers may be constructed to suit almost any specification.



**1 kVA
AMPLIFIER**



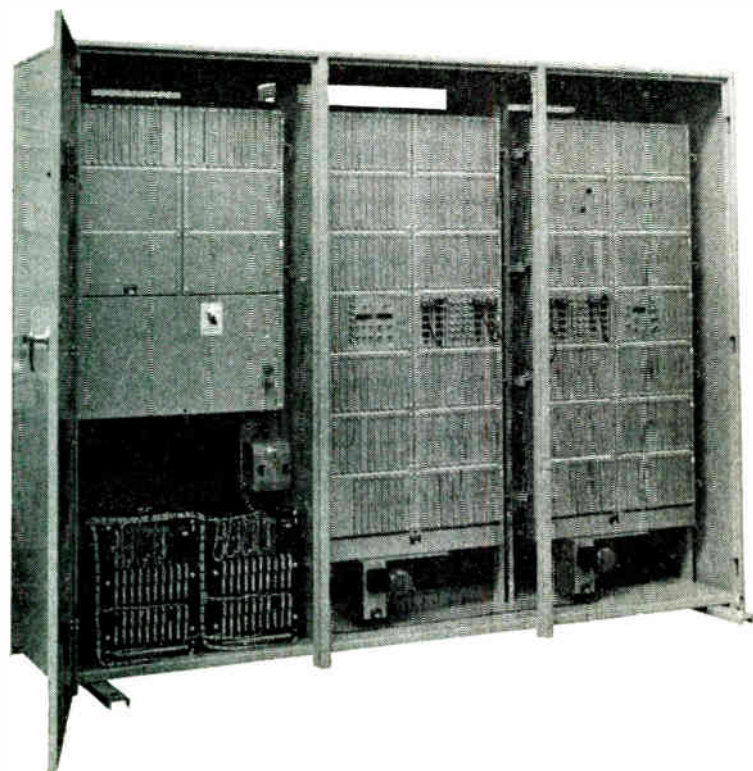

One of the range of large standard cubicles, available in single and multibay arrangements. This cubicle shows the use of two large standard power supplies, and the use of an extensive monitoring system, permitting one set of lamps to be used to monitor several points by the use of a flying plug arrangement. The ventilating fans are shown below the racks

DIGITAL TECHNIQUES IN INDUSTRY

By G. COOPER*

This series of articles will deal with industrial applications of digital systems. This first article starts by explaining the functions and basic circuits of the logic units which are the building blocks for even complex control systems.

IT is only relatively recently that 'Digital' has become an O.K. word in the industrial control field. So recently, in fact, that most of the available literature deals with the system components, describing and eulogizing the elegant conception and superb construction of a particular range of proprietary digital units. There is also a substantial body of literature dealing with what systems *could* be constructed with the units, often at the 'How to Build Yourself a Fully Automatic Steel Mill' level. But there is very little available in the way of case histories of actual equipments which have been designed, installed and commissioned as practical, economic, digital control systems. It is the intention in this series of articles to try to fill this gap by describing some of the equipments built by the Automation Systems Division of Lancashire Dynamo Electronic Products. Some of the applications will be simple, some rather more complex. None will be described as sophisticated, since anything less sophisticated than a grey steel box with a few flashing lights one finds it difficult to visualize.

For the purpose of the series, 'Digital Techniques' will be defined as 'The use of simple low-speed semiconductor circuits, working in a two-state mode (ON-OFF) to handle logical and numerical information'. This definition is purely the author's own, as no doubt numerous correspondents will point out, and to clarify things still further, the words 'simple low-speed' are inserted to exclude the full-scale 'Digital Computer' from the field of consideration.

The applications to be described can be divided into logical systems, sometimes called 'static-switching' systems;

numerical control (position controls and counters); and data-handling systems, where the output is in the form of information rather than action (another custom-built definition). Some applications will, of course, involve combinations of these techniques.

All the applications have been built up from a standard range of transistor logical units, and all could have been built up from any of the several other logical unit systems available. This latter point is made to emphasize that from the application point of view there is less fundamental difference between the commercially-available ranges of units than the system manufacturers (variously allied to ANDS, ORS, NORs, PLUSs AND MINUSs, etc.) perhaps imply. Prospective users would be well advised to weigh the simpler issues such as to plug-in or not to plug-in, to buy the system or to buy the units, etc., rather than to ponder too deeply on the pros and cons of the different techniques of logic, to which an old proverb involving swings and roundabouts can often be applied.

This is, however, another subject, and one which it would not be ethical for an interested party to expound.

Having said this, it will be necessary to define a few terms and symbols as they are applied to the particular digital units under discussion. These are tabulated under the heading of Logic Functions. Only the units of basically different logical function are described, power amplifiers, for instance, covering in practice several amplifiers of different power rating.







These seven items listed are the functions of the main elements of a digital system. Purists could correctly argue that even some of these can be fabricated from groups of other functions. But for practical purposes, in describing applications, the seven functions are distinct.

It must be stressed that the newcomer to the subject will have to study the table of logic functions carefully, and probably frequently refer back to it. The symbols are freely used in functional diagrams and it will not be possible to

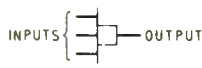
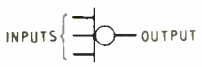
* Lancashire Dynamo Electronic Products Ltd.

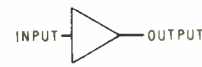
LOGIC FUNCTIONS

Throughout, an ON signal is defined as '1', an OFF signal as '0'. In practice '1' = -10 V d.c. nominal, '0' = 0 volts. The negative signal is used, as in almost all transistor systems, because it suits the characteristics of the normally-used p-n-p transistor.

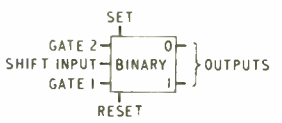
FUNCTION	SYMBOL	NOTES
AND		An AND may have any number of inputs. All inputs must be at '1' before an output '1' signal is obtained.
OR		An OR may have any number of inputs. One or more inputs at '1' gives a '1' signal at the output.
TRIGGER		This unit has the double function of amplifying the input signal and of providing complementary outputs. The outputs are defined as '0' and '1' by the signals they generate when no input is present. Each output can drive up to 10 inputs.
POWER AMPLIFIER		Used to amplify logic signals to the level at which lamps, contactors or solenoids can be driven.
DELAY		<i>Delay ON</i> A '1' signal applied to the input causes the outputs to change after a delay of X secs. Reset is substantially instantaneous on removal of the input.
		<i>Delay OFF</i> A '1' signal applied to the input causes the outputs to change over immediately. On removal of the '1' signal, the outputs revert to the OFF condition after a delay of X secs.
PULSE		When the input is changed from '1' to '0' the outputs change over immediately and revert after X secs (or more typically msec). No output action occurs when the input is changed from '0' to '1'.
BINARY		Like the trigger, the binary has '0' and '1' outputs. Unlike the trigger, however, its output state is changed by a positive-going change of signal on the shift input ('1' to '0') not by the level of input applied. By appropriately connecting up the gate inputs to the outputs, the binary can be made to reverse its state every time the input goes from '1' to '0', rather like a bathroom light pull-switch. Thus a square wave applied to the shift input will appear as a square wave of half the frequency at the outputs. By connecting up binaries in cascade, the output of one binary (the shift input ('1' to '0')) can be produced. The second main use of binaries is in 'Shift Registers' where the binary units are connected so that the outputs of one binary feed the gates of the next in a chain. The shift inputs are connected in parallel, and on application of a shift signal (1/p from '1' to '0') the pattern of '0' and '1' outputs existing at that time on the binaries moves bodily one step along the chain.

In addition to responding to the shift input, the binary can also be controlled by the SET and RESET inputs. These inputs are 'level' as opposed to 'edge' controlled. Application of a '1' signal to the RESET input holds the binary in the off condition ('0' o/p = 0). Application of a '1' signal to the SET input holds the binary in the ON condition ('0' o/p = 1).

understand these if the actions denoted by the basic symbols are not held clearly in mind.

Digital Representation of Numerical Information

Most digital applications involve the handling of numerical information and it is worthwhile commenting briefly in this introduction on the means of doing this in practice.

Binary Code

The normal decimal number system works on a radix of 10; i.e., for each digit ten states (0-9) must be capable of recognition and differentiation. To use this code in digital equipments would require either ten separate logic elements (triggers, binaries) to represent one state each, or a logic element capable of generating, say, ten different output voltages which could be recognized as the ten states by all parts of the system into which the number is to be fed.

This first solution uses a vast amount of hardware, and the second would be a tolerancing nightmare. Recourse is therefore made to the binary code, or its main variation, described below.

The binary code uses a radix of two, and two states only of

each digit need to be recognized, '1' and '0'; it is, therefore, very suitable for use with logic units. In constructing a decimal number, the digits represent 10^3 , 10^2 , 10^1 , 10^0 , or thousands, hundreds, tens and units, in more familiar terminology. In a binary number the digits are 2^3 , 2^2 , 2^1 , 2^0 (i.e., 8, 4, 2, 1). In the general case, of course, they are 2^{n-1} , ..., 2^2 , 2^1 , 2^0 in an n digit number. Thus, the example below shows that all decimal numbers up to 4095 can be represented by 12 binary digits.

	2^{11}	2^{10}	2^9	2^8	2^7	2^6	2^5	2^4	2^3	2^2	2^1	2^0
	2048	1024	512	256	128	64	32	16	8	4	2	1
Typical binary number												
	0	1	1	0	0	0	1	0	1	1	0	1
Decimal equivalent												
		1024	+ 512				+ 32		+ 8	+ 4		+ 1 =
												1581

Note for future reference that while binary-decimal conversion is straightforward enough it is not 'dead-simple'; and that the decimal equivalent of a binary number cannot be recognized on sight. Note also that since every combination of '1's and '0's of the 12 digits is used to represent a number,

full utilization is made of the logic equipment, and the binary code can be said to be, in this context, 100% efficient.

Binary-Decimal Code

Since in many applications, ready man-machine and machine-man communication is required, a modified binary code is often used for number representation. Here, each decimal digit is coded *separately* into four binary digits. This yields a number which can be readily converted back to decimal form for driving numerical display, or printers, as the example shows.

Decimal Number	5	8	7
Binary-decimal equivalent	'800' '400' '200' '100'	'80' '40' '20' '10'	'8' '4' '2' '1'
	0 1 0 1	1 0 0 0	0 1 1 1

As with everything else, one has to pay for this ready conversion facility; 12 binary digits can now only represent up to 999, or rather less than one quarter the capacity of pure binary code. This is because the four binary digits used in each decade could in fact represent up to 15 (8 + 4 + 2 + 1), whereas they are in practice used only up to 9.

The binary-decimal code is thus a less efficient way of utilizing the hardware. However, the applications will show both codes being used, binary for its efficiency and simple arithmetic, binary-decimal for its simple conversion into human terms.

Binary Arithmetic

There is neither available space nor is there necessity to go into details of the subject of the manipulation of binary and binary-decimal codes. However, this short section is included to give an idea of what is involved, and to show how the logic functions already described can carry out arithmetic. For this demonstration, binary addition will be used. The rules are on exactly the same basis as decimal addition rules, but are very much simpler, thus:—

$$\begin{array}{r}
 0 + 0 = 0 \\
 0 + 1 \} = 1 \\
 1 + 0 \} \\
 1 + 1 = 0 \text{ and carry } 1 \text{ into next digit.}
 \end{array}$$

The example illustrates the method:

	2 ⁶	2 ⁵	2 ⁴	2 ³	2 ²	2 ¹	2 ⁰	
	(64)	(32)	(16)	(8)	(4)	(2)	(1)	Dec. Equiv.
Number A	0	1	1	1	0	0	1	57
Number B	0	1	0	1	1	0	0	44
Carry	1	1	1					1
Sum	1	1	0	0	1	0	1	101

The logic shown in Fig. 1 will perform the addition shown for one digit of the two numbers.

There are three possible input conditions; both inputs '0', one input '0' the other '1', and both inputs '1'.

In the first case, the outputs of the OR and first AND gates are both '0'. The carry trigger output is '0' since its input is '0'. This trigger passes a '1' to the second AND gate which receives a '0' from the OR gate. The output is thus '0' and is applied to the sum trigger, which gives an output '0'.

In the second case, one input is '0' and the other '1'. The first AND gate thus gives a '0' output to the carry trigger which gives '0' to carry and '1' to the second AND gate as before. The OR gate gives a '1' output to the second AND gate, which now gives a '1' output to the sum trigger, so that its output becomes '1'.

In the third case, both inputs are '1' and the OR gate passes a '1' to the second AND gate. The first AND gate has two '1' inputs and gives a '1' output to the carry trigger, which changes state to give a carry output of '1' and a '0' to the second AND gate. The output of this is '0' and so the output of the sum trigger is '0'.

Thus the sum output is '0' when both inputs are either '0' or '1', and is '1' when one input is '0' and the other '1'. The carry output is '1' when both inputs are '1', but in both other cases is '0'.

To take account of the carry, the above logic must be repeated or, as in practice, extended to take account of the three inputs.

Similar techniques for binary subtraction, multiplication and division exist, and the interested reader is referred to the bibliography for full description. For our present purpose, however, let the bald statement that such operations can be carried out using groups of the basic functions suffice.

We shall now briefly describe the realization of the functions

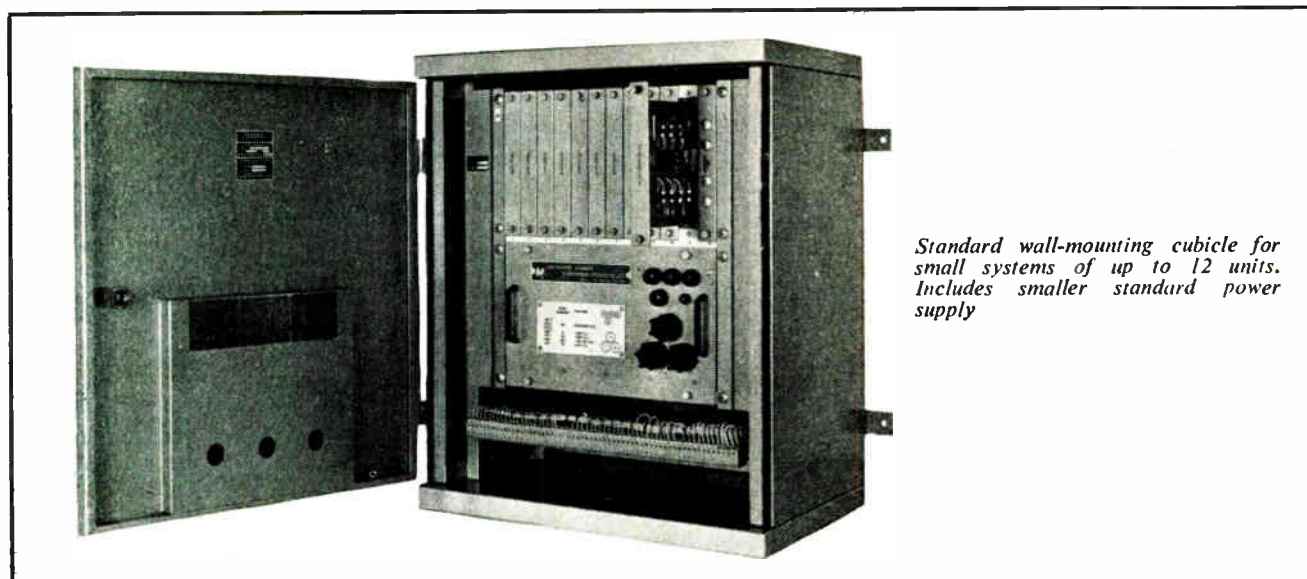

Standard wall-mounting cubicle for small systems of up to 12 units. Includes smaller standard power supply

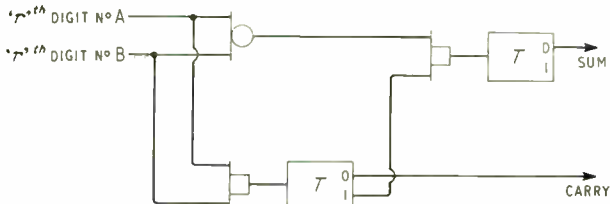

Fig. 1. Circuit for adding two binary digits, comprising one OR, two AND and two trigger units

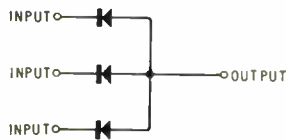

Fig. 2. Circuit of three-input OR unit

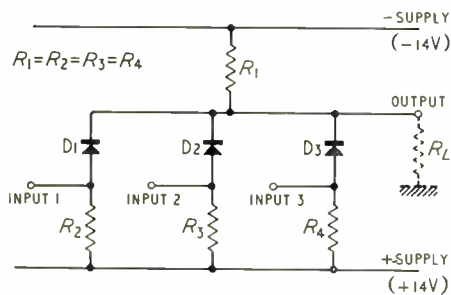

Fig. 3. Circuit of three-input AND unit

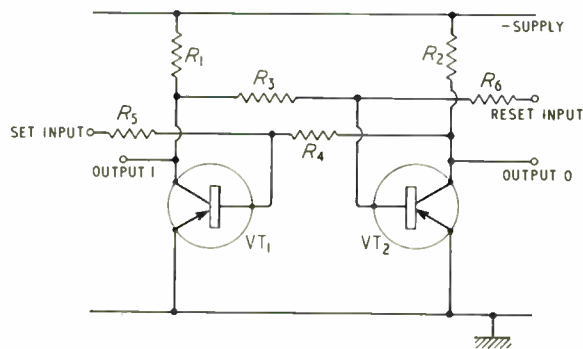
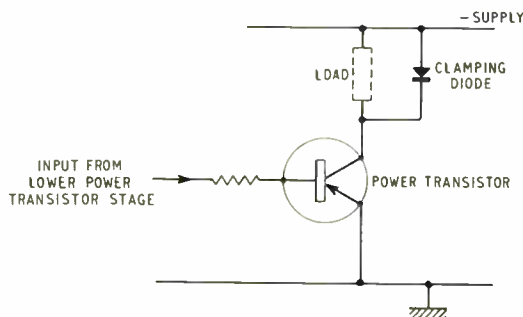

Fig. 4. Basic trigger circuit

Fig. 5. Typical power amplifier



in terms of resistors, diodes, capacitors and transistors, and how the components are physically assembled into a usable system. After this, we can get down to the real business of applications study.

Basic Circuits

To be able to understand, or indeed, design digital systems it is quite unnecessary to know the circuit details. In practice, however, no engineer is really happy to use black boxes unless he knows, in general terms at least, how they work. The circuit descriptions given here are very much the bare bones of the actual circuits used, so as to present clearly their essentially very simple nature.

Passive Units

OR Unit

The function of the OR unit is to generate an output when any one or more than one input is at '1'. This function can be very simply realized in practice by the circuit shown in Fig. 2. The diodes are of the germanium point-contact type, and inspection shows that if any input or group of inputs is taken to a '1' (-10 V) signal, the output must follow.

The photograph shows the actual L.D.E.P. Digital System OR unit. This unit contains 12 separate OR elements, ten of two inputs each, and two of three inputs each. Higher input ORs can be constructed by simply linking the necessary output terminals together. For example, a seven input OR can be made up by linking up two two-input units and one three-input.

AND Unit

The AND unit only generates a '1' output when all inputs are at '1'. In the AND circuit, shown in Fig. 3, R_1 is capable of giving a '1' signal at the output provided no current is flowing up to R_1 through any of the diodes D_1 , D_2 , D_3 . If all the inputs are at '1', this will be the case, since R_L is such that a '1' signal on the inputs will cause the diodes to be reverse biased, and therefore current flow is cut off. If, however, any one (or more) inputs is taken to '0' (0 volts) then the output will be clamped substantially at earth by current flowing through the appropriate diode. Equally, if this input (I/P 1, say) instead of being switched to earth is open-circuited, as it would be if fed from a push-button or limit switch, then sufficient current flows from the +14-V supply line, through the resistor R_2 to ensure that the output is held to earth. To look at this another way R_1 and R_2 form a potential divider of equal resistors between equal supply rails, and hence the centre point is at earth ('0').

Amplifying Units

The AND and OR units are 'passive'. That is, they contain no amplifying components, and therefore the output must always be less than the input. To enable free interconnection the signals must be 're-standardized' after passing through ANDs or ORs (the maximum permissible chain in the L.D.E.P. system being OR-AND-OR), and this is achieved by amplifying units containing transistors. All the remaining basic logic elements can be considered as variations of the two-transistor circuit shown in Fig. 4.

Trigger

Consider the circuit with R_4 disconnected, and with the input at '0'. Since the input is at earth, no base current will be drawn in VT_1 hence no collector current will flow, and O/P1 will be at a negative value determined by R_1 and R_3 . In practice, this output generates a '1' signal. Base current is drawn from VT_2 via R_3 , which is so selected as to saturate

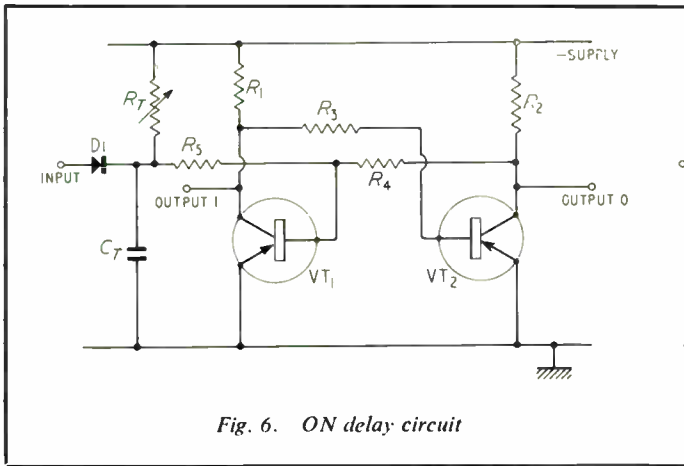

Fig. 6. ON delay circuit

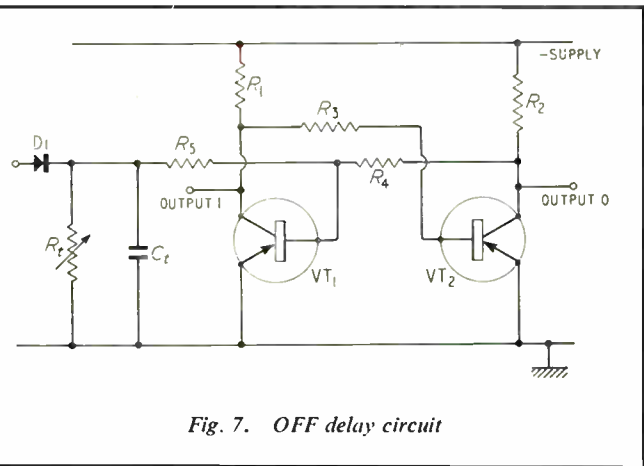

Fig. 7. OFF delay circuit

VT₂, bringing its collector to '0', and thus generating the '0' output at O/P0.

If now the input is taken to '1' (still with R₄ disconnected) base current drawn in VT₁ through R₅ will cause it to saturate, the '1' changing to '0'. This will remove the base current from VT₂, causing the O/P0 to go to '1'. This circuit therefore performs the function of the Trigger, and is essentially a double inverter. In practice, R₄ is connected, a relatively high value being used. This permits a slowly changing input to be applied, since R₄ gives positive feedback, and ensures that once the outputs start to change, they flip over cleanly due to the regenerative action.

Power Amplifier

The range of power amplifiers is based on the same circuit, that of Fig. 5, extra stages of successively higher power being

added until the final transistor can carry the required load current. The solenoid, contactor coil, lamp, etc., being driven forms the collector load, and a 'clamping' diode is connected as shown across the load to prevent transistor damage due to inductive spikes when the load current is switched off.

Delay

The delay circuits are again based on the basic two-transistor circuits, this time with a preceding stage, as shown in Fig. 6.

When the input is at '0', C_T is short-circuited by the diode D₁. When the input is taken to '1' the diode cuts-off, and C_T is charged through R_T, thus generating a time delay. When the voltage across C_T is sufficient to start VT₁ conducting, regenerative action takes place, and the outputs change over. On the input reverting to '0' the capacitor discharges very rapidly through D₁, and the outputs revert back to the off state almost immediately.

The Delay-off function is produced by connecting R_t across C_t, Fig. 7, and reversing diode D₁. When a '1' input is removed, C_t discharges through R_t. When the voltage across C_t has fallen sufficiently, the 'trigger' circuit turns off regeneratively.

Binary Unit

By reducing R₄ to equal R₃ in the basic circuit, a symmetrical arrangement is formed which will stay stably in either of the ON or OFF states without any input being applied. If

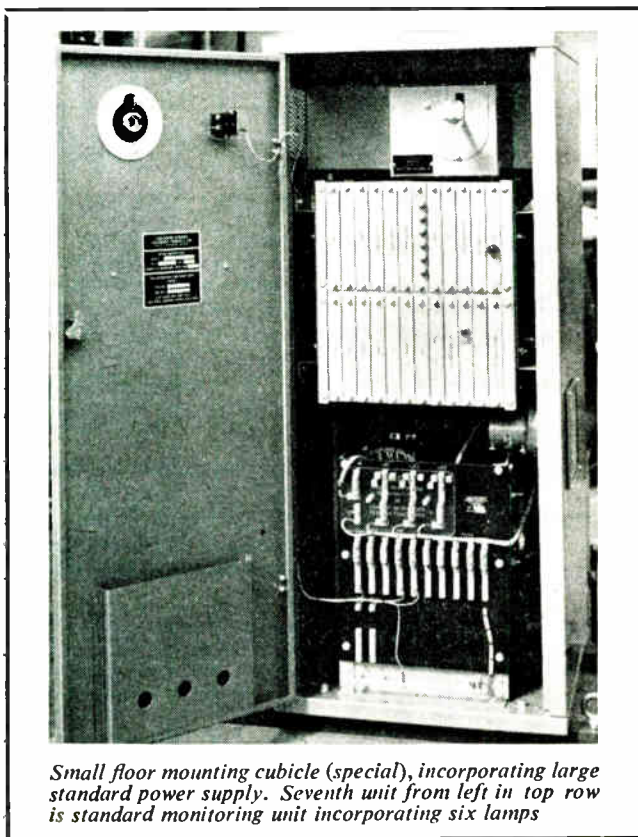

Small floor mounting cubicle (special), incorporating large standard power supply. Seventh unit from left in top row is standard monitoring unit incorporating six lamps

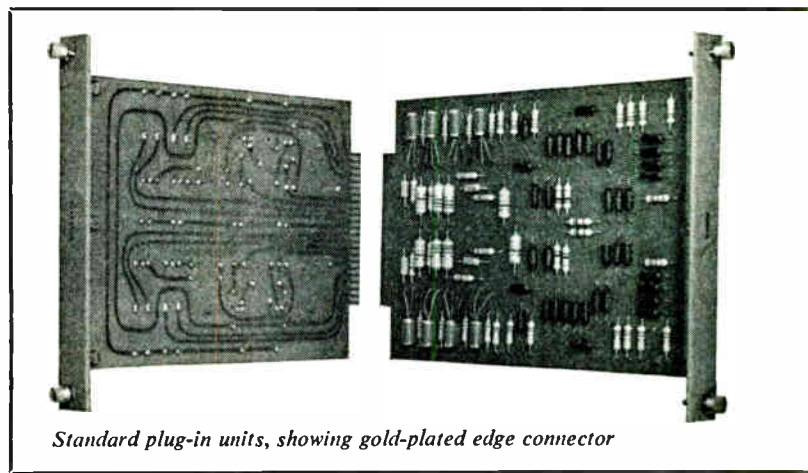

Standard plug-in units, showing gold-plated edge connector

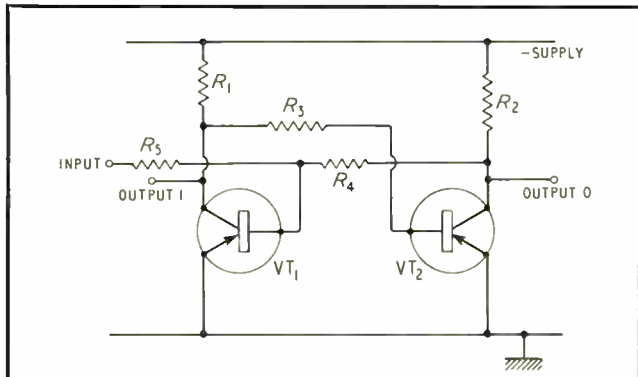

Fig. 8. Basic toggle circuit

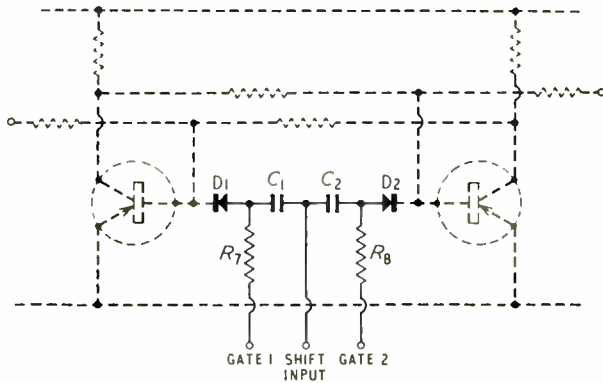

Fig. 9. The binary unit has the additions shown here to the circuit of Fig. 8 (dotted)

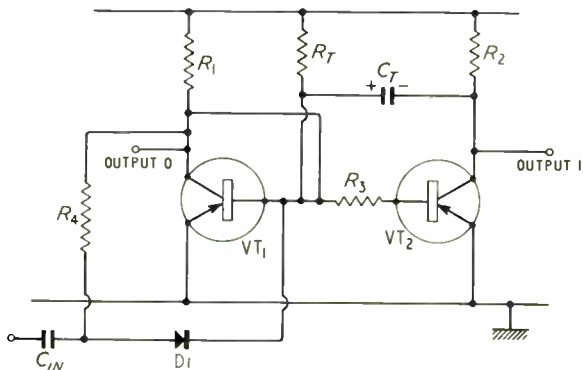

Fig. 10. Circuit of pulse unit

the circuit of Fig. 8 is in the OFF state (O/P1 at '1'), a '1' signal applied to R_5 will turn it on, and it will stay on after the input is removed, VT_1 being held on by the current flowing in R_2 and R_3 . If the circuit is ON, application of a signal to R_5 has no effect, but a '1' signal applied to R_3 will turn it off. These two inputs are called SET and RESET respectively, and the circuit in this form is sometimes called a flip-flop.

In order to perform as a binary, the additional input 'gates' shown in Fig. 9 are required.

If a positive-going edge is applied to the shift input (leaving gates 1 and 2 disconnected), by switching it from '1' to '0', a positive pulse of current will be induced in the bases of both transistors, tending to turn these both off. The action of the

circuit under these circumstances will be unpredictable, and it may settle back into either ON or OFF condition. If, however, gate 1 is connected to O/P1 and gate 2 to O/P0, the positive current pulse can reach only the base of the conducting transistor, since the diode feeding the base of the non-conducting transistor will be reverse biased, thus blocking the current pulse. The conducting transistor is thus turned off, turning on the other via R_3 or R_4 , and the circuit tips over into the opposite state. On the application of the next positive-going input, the circuit will turn back, since the gate voltages are now reversed, thus producing the 'binary' dividing action previously described. The gates can alternatively be connected to the output of another binary (or trigger), when application of the shift 'edge' will cause the binary to take up the state of the unit feeding the gates, and this is the connection used in shift-register applications.

Pulse Unit

In the pulse unit of Fig. 10, the regenerative feedback resistor is replaced by the network R_T and C_T . Current flowing through R_T keeps VT_1 turned on in the no-input condition, hence VT_2 is turned off. C_T is therefore charged as shown.

When a positive edge (such as will shift a binary) is applied to the input, the base of VT_1 is taken momentarily positive via diode D_1 . VT_1 turns off, and VT_2 therefore turns on. The charge on C_T therefore now retains the base of VT_1 positive and the circuit is stable in the new state. C_T now discharges through R_T , the base of VT_1 becomes again negative, VT_1 conducts, and the circuit reverts to the off condition. Thus a pulse whose duration is governed by R_T and C_T appears at the '0' output. Negative-going edges applied to the input have no effect since the current they tend to induce is blocked by D_1 . R_1 biases D_1 during the period of pulse generation to prevent further input changes affecting the output length.

Summary

This completes the 'bookwork' of the subject as far as it is necessary to understand the principles behind the applications to be described. It is perhaps worth emphasizing again that the logic circuits are shown in outline only, and that although the basic principles apply to all the available systems of units, the circuit details vary from one to the other.

Construction of Logic Systems

All the units are mounted on approximately 8-in. \times 6-in. printed circuits of the plug-in type, using a gold-plated edge-type connector. The units are mounted in racks constructed from standard pressings in modules of 12 units. Considerable economies in one-off system costs can be made by using standard cubicle/rack/power-supply assemblies rising in 24-unit multiples, e.g. 24, 48, 72, 96, 120, and as the application photographs in the later articles will show, this is done wherever possible.

The photographs show the rack assembly, a standard power-supply capable of powering up to about 120 units, and some of the standard units. To help give an idea of the relative complexity of the various functions, Table 1 gives the number of separate circuits on some typical units.

Table 1

Unit	No. of Circuits per Unit
AND	8 = (4 \times 2 input,
TRIGGER	5 2 \times 3 input,
BINARY	4 2 \times 4 input)
2/40 AMPLIFIER*	2
4/40 AMPLIFIER*	1

* 2, 40 = 2 A, 40 V; 4/40 = 4 A, 40 V.

CHEMICAL AND BIOLOGICAL APPLICATIONS OF HIGH-INTENSITY ULTRASONICS

In this final article of the series on ultrasonics, a number of diverse applications is discussed. Among them are beer fobbing, electroplating and atomizing.

UNDER this broad heading the applications of ultrasonics to many different processes are discussed. Actual initiation of chemical reactions by ultrasonic irradiation is discussed as well as the acceleration of established reactions. Other applications described are degassing, electroplating and atomization. The biological applications of ultrasonics are many and these are discussed under the headings of extraction, bacteriocidal action and mutation. Mention is also made of the use of ultrasonics by electron microscopists.

The application of ultrasonics to the initiation of chemical reactions has been studied for many years and the information amassed over this long period has led to the conclusion that cavitation is essential for producing the observed effects. It is not known which aspect of cavitation is of fundamental importance in initiating these reactions (i.e., local pressure increase, local temperature increase, etc.) but it is generally agreed that the reactions are basically stimulated by free radicals of H and OH produced by one or more of the phenomena associated with cavitation. From primary reactions induced by the free radicals many secondary reactions can result and processes such as oxidation, reduction, hydrolysis, polymerization, depolymerization, and molecular rearrangement have all been observed as a result of ultrasonic irradiation.

While many different reactions can be initiated the yields from these reactions are always very small. In fact, the quantities involved are of academic rather than commercial interest and from an industrial point of view, direct initiation of chemical reactions by ultrasonic irradiation is of no interest at present. However, ultrasonic irradiation has been successfully used to accelerate certain reactions on account of the fine mixing of the reactants produced by the cavitation. Ultrasonic irradiation has also been used to produce a reactant in a finely dispersed form which subsequently results in many advantages in the ensuing reaction. An example of this technique is provided by the work of Pratt and Helsby.¹ They used the apparatus shown in Fig. 1 to produce fine dispersions of sodium which were subsequently used with great advantage in several reactions. Irradiation of mercury to produce fine dispersions offers similar advantages in reactions involving mercury. This application of ultrasonics to the acceleration of chemical reactions, improving the yields, etc., seems to offer more

commercial possibilities than direct initiation of reactions by ultrasonics.

Ultrasonic degassing of liquids is a well-established process and finds a number of applications in industry. The degassing process may be briefly summarized as follows. When the ultrasonic wave passes through the liquid, dissolved gas is liberated in the rarefaction regions. Many small gas bubbles are produced in this manner and these tend to coalesce and drift to nodal points in the liquid. At these points larger bubbles are formed by further coalescence and eventually these rise to the liquid surface where the gas is liberated. Experimental work has shown that quite low ultrasonic intensities produce effective degassing and it has also been shown that the effectiveness of degassing improves as the ultrasonic frequency is

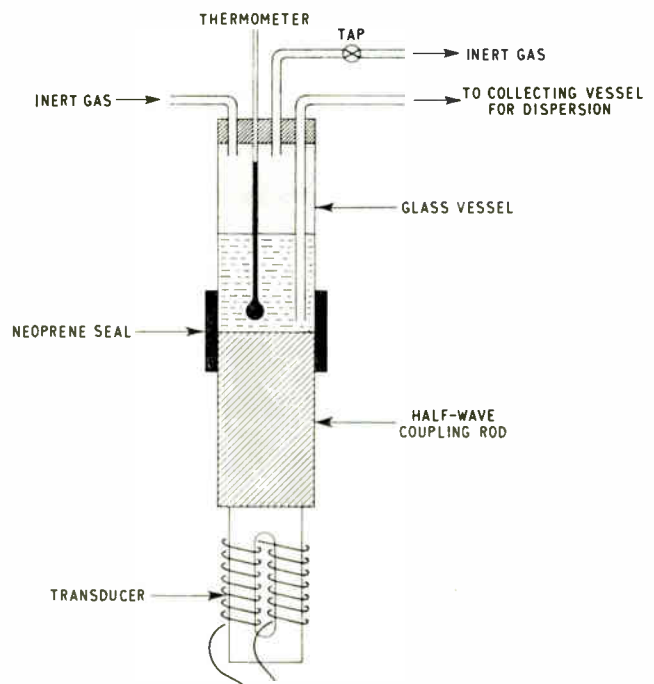

Fig. 1. Apparatus for the ultrasonic dispersion of sodium

* Royal College of Advanced Technology, Salford.

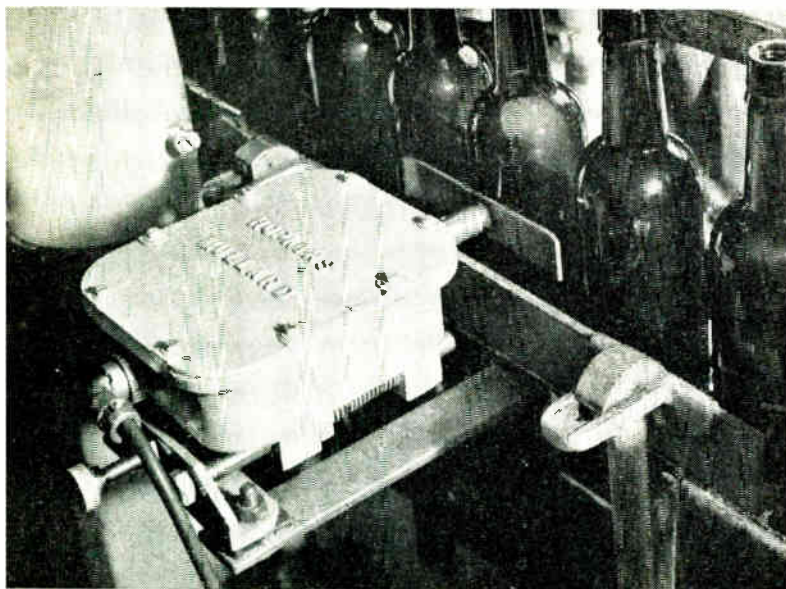

Fig. 2. Transducer assembly for ultrasonic beer fobbing (Mullard Equipment Ltd.)

decreased. Most industrial equipment works in the frequency range 20–40 kc/s. The low power required to produce efficient degassing in most liquids means that the equipment used can be fairly crude. For instance, good coupling facilities between the ultrasonic transducer and liquid being treated are not necessary since if only a small part of the energy gets into the liquid it will produce the required degassing.

Undoubtedly the most important industrial application of ultrasonic degassing is the fobbing of carbonated beverages, particularly beer. Fobbing refers to the removal of all air from the neck of a bottle immediately prior to the bottle being capped. The ultrasonic equipment used consists of the usual electronic generator, control box, and a transducer, arranged so that bottles rub against the vibrating face as they pass along a conveyor belt. Several designs are in use and Fig. 2 shows the transducer assembly used in equipment developed by Mullard Equipment Ltd. and G. Hopkins and Son Ltd. A magnetostrictive transducer vibrates at 20 kc/s and is fed from a variable power supply up to a maximum of 60 W. In the diagram it can be seen that the vibrations are transmitted into the bottles via a flat plate attached to the end of a half-wave rod. Effective coupling between the vibrating plate and bottles is assisted by the use of a continuous cascade of water between the plate and the bottle. The passage of ultrasonic waves through the beer causes a large number of CO₂ bubbles to rise to the surface and fill the bottle neck where they remain until the cap is applied. This equipment can be used at quite high bottling speeds and a rate of 30,000 bottles per hour has been reported.

The application of ultrasonics to electroplating has been the subject of much research in recent years and it has now been established that with certain metals and under suitable conditions, ultrasonic irradiation can considerably assist electroplating processes.² In an electroplating process bubbles form at the electrode faces and can accumulate to an extent such that the current is limited. If the electrolyte is ultrasonically irradiated then it has been found that higher current densities can be achieved enabling faster

plating speeds to be realized. It is also likely that the ultrasonic cleaning action plays some part since it has been found possible to plate heavily-contaminated components such that ordinary electroplating would be quite impossible. The structural characteristics of certain deposited metals can be affected by ultrasonic irradiation during plating and coatings have been produced in a purer form and with a higher tensile strength and hardness. Cavitation is necessary for the production of the effects described and ultrasonic irradiation of electrolytes is usually carried out in the frequency range 20–40 kc/s. The ultrasonic intensity must be carefully controlled since too high an intensity can lead to undesirable effects such as cavitation erosion of the coating being formed. Ultrasonic irradiation in this manner has been successfully used in the electrodeposition of many metals. Considerable work has been done on nickel plating³ and chromium plating⁴ and several advantages have been found such as an increase in current density realizable, etc. A little work has been done also on silver and zinc plating but conclusive results have not been obtained so far. Recently, work on the electrolytic deposition of metallic manganese and manganese dioxide⁵ has shown that ultrasonic irradiation may be applied with advantage to these processes. An increase in current efficiency is achieved and smooth, glossy, adherent and pit-free deposits are obtained. Some advantages of the application of ultrasonics to gold plating have also been reported and Fig. 3 shows the system used by I.D.M. Electronics Ltd. who applied 40-kc/s radiation to a system for the gold plating of commutators and sliprings.

Ultrasonic atomization does not fit very readily under the heading of 'Chemical Applications' but it is included here since a good deal of work is being carried out on the utilization of ultrasonic atomization in industrial oil burners and this application could be loosely fitted under the title of this article. Ultrasonic atomization has been known for many years and was demonstrated by Wood and Loomis⁶ in 1927. It may be demonstrated quite simply by the equipment shown in Fig. 4, where a high-frequency ultrasonic beam is being focused on to the liquid-air interface. A fountain is produced and this is accompanied by a dense fog of very small liquid droplets. The theory of ultra-

Fig. 3. Gold plating with ultrasonic irradiation (I.D.M. Electronics Ltd.)

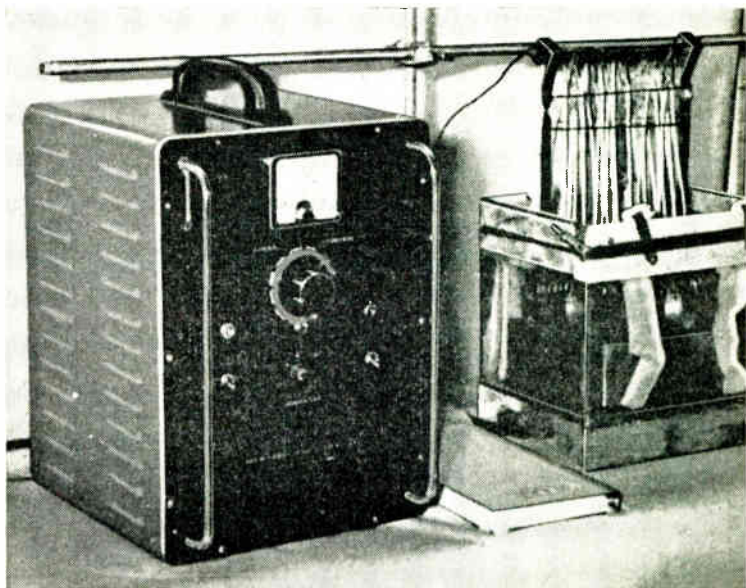

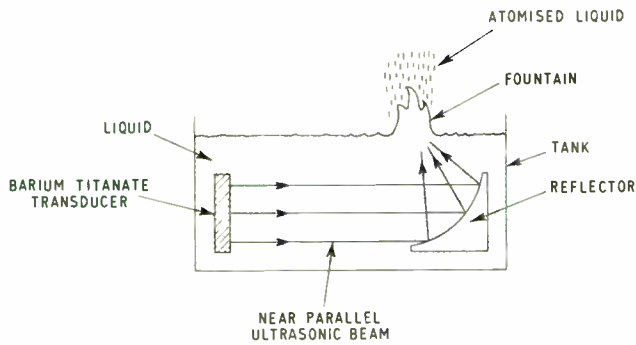

Above: Fig. 4. Ultrasonic atomization

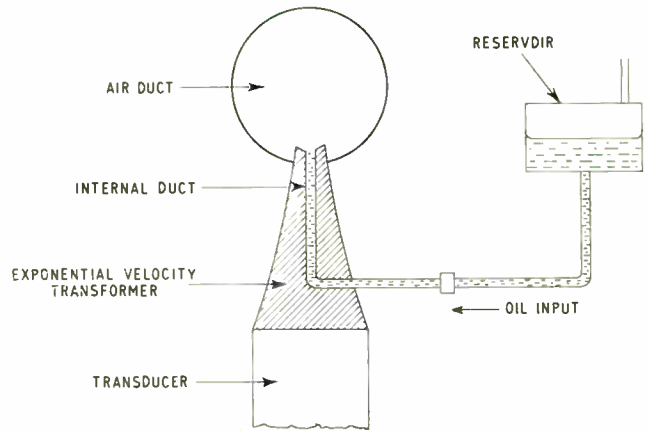

Right: Fig. 5. Ultrasonic atomization equipment

sonic atomization is not quite clear yet but it is probable that cavitation plays an important part in the process. A high-intensity is necessary to produce atomization and in Fig. 4 this was achieved by focusing the ultrasonic beam. Alternatively, however, a velocity transformer coupled to a magnetostrictive or lead zirconate transducer may be used. With such a device, drops of liquid placed on the radiating face of the transducer are effectively atomized and this technique has been used with some success for the atomization of fuel oil in industrial furnaces. Esso Research have found ultrasonic atomization offers several advantages in low firing-rate oil burners. Good combustion performance can be obtained at feed rates well below those used with conventional burners, no high pressure oil supply is needed and blockage in the oil-feed passage is effectively prevented. Considerable work is at present being carried out on the use of ultrasonic atomization in the place of conventional pressure jets in large industrial oil-fired furnaces and it has

been established that ultrasonic atomization provides a far better control of the flame. The apparatus developed by Mullard Equipment Ltd. is shown diagrammatically in Fig. 5 and Fig. 6 shows the flame achieved at a high setting. Other work on the atomization of fuel oil is being carried out by the use of mechanical generators and this work shows promising results.

The use of ultrasonic cavitation in the disruption of cellular membranes with the consequent release of the cell contents is now a well-established technique in the field of experimental biology. The apparatus used is very simple and Fig. 7 shows the M.S.E. 60 W ultrasonic disintegrator which is typical of the type of equipment used. In this apparatus an output of about 60 W at a frequency of 20 kc/s is supplied by the electronic generator to a magnetostrictive transducer to which is attached a velocity transformer. The tip of the transformer is inserted into the liquid to be treated when the intense cavitation produced liberates the cell contents. This application of ultrasonics has found widespread use in the laboratory in the preparation of such things as DNA and various antigenically active extracts. The extracting effects of ultrasonics is not limited to laboratory work but has also been successfully applied to certain processes in the brewing, soft drinks, and perfumery industries when the normal methods of extraction have not been satisfactory. In such industrial processes the ultrasonic equipment used is basically the same as in laboratory work but with certain modifications to enable increased quantities of material to be treated. An important industrial application is in the brewery industry where ultrasonic extraction has been developed in order to eliminate the need for dry hopping.

The bacteriocidal action of ultrasonics has been investigated by many workers and in general it has been shown that the destruction of bacteria is accomplished when cavitation is produced. The irradiation time necessary to destroy bacteria varies considerably with the type of organism being treated and intensity of irradiation, etc. and a range of treatment times from one minute to nearly an hour has been reported. The destruction of bacteria is often associated with extraction processes and a wide variety of bacteria have been destroyed in order to extract bacterial enzymes. An important industrial application of this bacteriocidal action is in the field of hospital cleaning by ultrasonic irradiation where articles are not only visibly cleaned but also sterilized to some extent.

Fig. 6. Flame achieved with ultrasonic atomizing of boiler fuel oil (Mullard Equipment Ltd.)

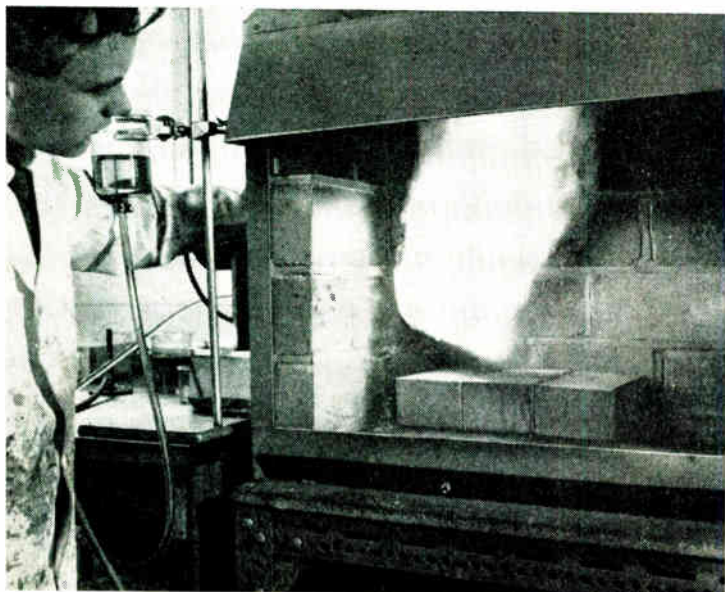

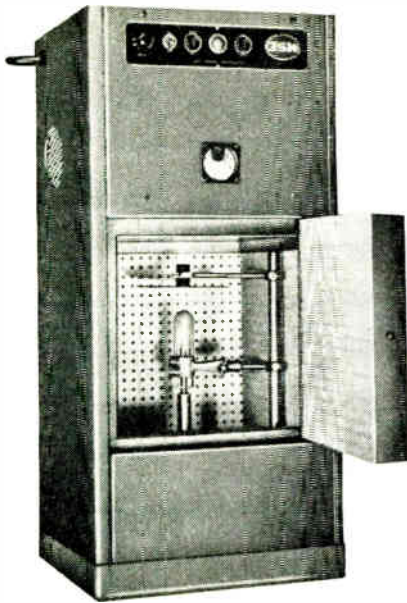

Fig. 7. 60-W ultrasonic disintegrator (M.S.E. Ltd.)

The use of ultrasonic irradiation to induce mutation is still in an experimental stage but some promising results have been reported. Mutation refers to the changes which can be brought about in spores and strains in order to produce a strain of changed bacteriocidal properties. Mutation experiments are usually carried out in order to obtain a new strain with more desirable properties than the existing strain. Irradiation of the spores must be carefully controlled and the apparatus used is similar to that shown in Fig. 7 with certain modifications. Sterilized conditions are necessary, as well as cooling of the liquid being treated. In

addition, the degassing produced by the ultrasonic irradiation is sometimes undesirable and it is necessary to bubble air continuously through the liquid being treated. Some experimental work has been done by Topa⁷ who showed that the irradiation of spores of streptomyces griseus and penicillium chrysogenum had a marked effect on the subsequent growth of the spores, their sporulation, and antibiosis. Up to the present time all the results available confirm that ultrasonic irradiation can cause permanent morphologic and functional changes in various spores and strains and it may well be that new antibiotics will be obtained as a result of this technique.

The use of ultrasonic irradiation by electron microscopists to prepare fine dispersions for examination is becoming increasingly widespread. Specimens to be dispersed are prepared as a suspension in a small glass tube and the suspension can either be treated by immersing a transducer directly into the liquid or by immersing the specimen tube in water contained in an ordinary ultrasonic cleaning bath. This application of ultrasonics cuts out much laborious work which was previously necessary in order to produce suitable dispersions for electron microscope examination. Ultrasonic cleaning also finds considerable use in the field of electron microscopy and the cleaning of many pieces of equipment used in electron microscopes, such as the pole pieces of the instrument, have been reported. The high standard of cleanliness achieved proves extremely useful in this work.

References

- ¹ M. W. T. Pratt and R. Helsby, *Nature*, Vol. 184, p. 1694 (1959).
- ² S. R. Rich, *Am. Elect. Soc. Proc.* Vol. 42, p. 137 (1955).
- ³ S. R. Rich, *Am. Elect. Soc. Proc.*, Vol. 44, p. 87 (1957).
- ⁴ E. Yeager et al., *J.A.S.A.*, Vol. 29, p. 769 (1957).
- ⁵ C. B. Kenahan and D. Schlain, U.S. Bureau of Mines Report, 6073 (1962).
- ⁶ R. W. Wood and A. B. Loomis, *Phil. Mag.*, Vol. 4, p. 417 (1927).
- ⁷ M. Topa, *Ultrasonic News*, Vol. 2, p. 20 (1961).

Electron Microscope Features Ease of Operation

There is scarcely a field of science in which the electron microscope cannot be used with advantage. It is therefore important that the instrument should be easy to handle and automatic as far as possible, so that it can be operated by scientific personnel who are non-specialists in the field of electron microscope physics.

The Carl Zeiss EM9 is designed to combine ease of operation with high performance. It has a guaranteed resolution of better than 15 Å; under optimum conditions this may be improved to 12 Å. A binocular viewing tube gives a further magnification of $\times 10$ and has a completely flat field of view. The specimen is changed quickly and easily by means of a fool-proof air lock. Other features such as an electron diffraction device, automatic photographic equipment and a very fast pumping system make this an efficient multi-purpose instrument.

For further information circle 52 on Service Card

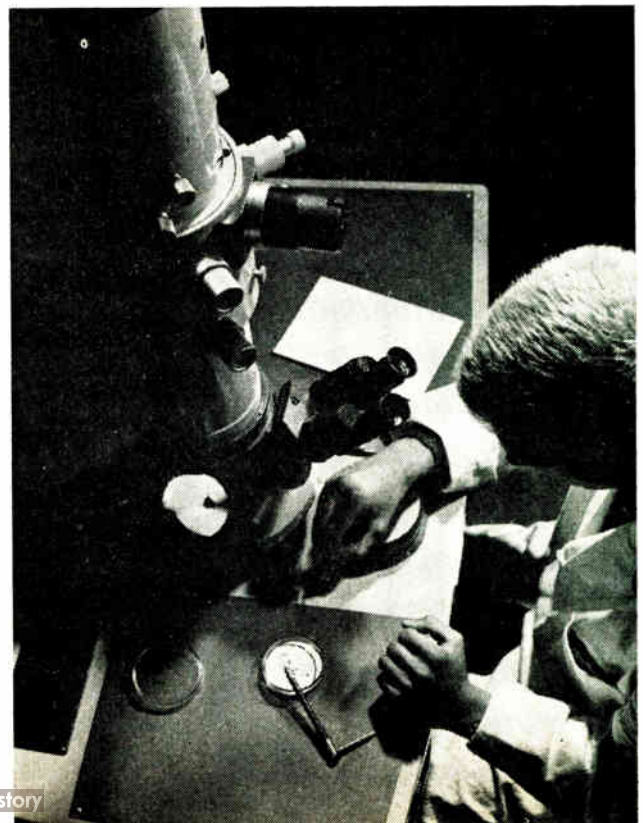

six big digits

IN A VERY SMALL BOX

... and a
megacycle
too!

No other instrument of this size and performance has such clear, unambiguous readout; six big digits, bright and steady. A newly-developed blanking system eliminates flicker.

Measures to a microsecond!

This new portable meter is easy to use, with its simplified front panel—and extremely easy to read, with its adjustable support which holds steady at any convenient angle—and, of course, the clear, bright, steady, six-figure readout.

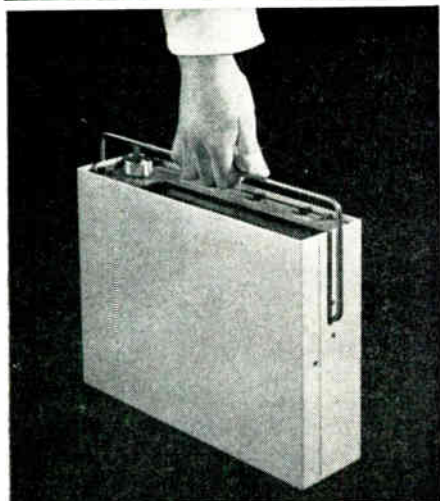

Smaller and smaller!

Design of the new TSA 3436 is based on solid experience of applying transistorized digital techniques to measuring instruments. Small as it is, the TSA 3436 will read frequencies up to one megacycle, and measure time down to one microsecond.

ONLY £195

Laboratories and technical colleges will welcome the compactness, strength and simplicity-in-use of the TSA 3436. In industry, its dependability, and the clarity of its display, make it uniquely suitable for inspection and quality control applications.

Full technical details will be sent on request.

VENNER TSA 3436 TIME/FREQUENCY METER

VENNER

ELECTRONICS LIMITED

Kingston By-Pass · New Malden · Surrey · MALDEN 2442

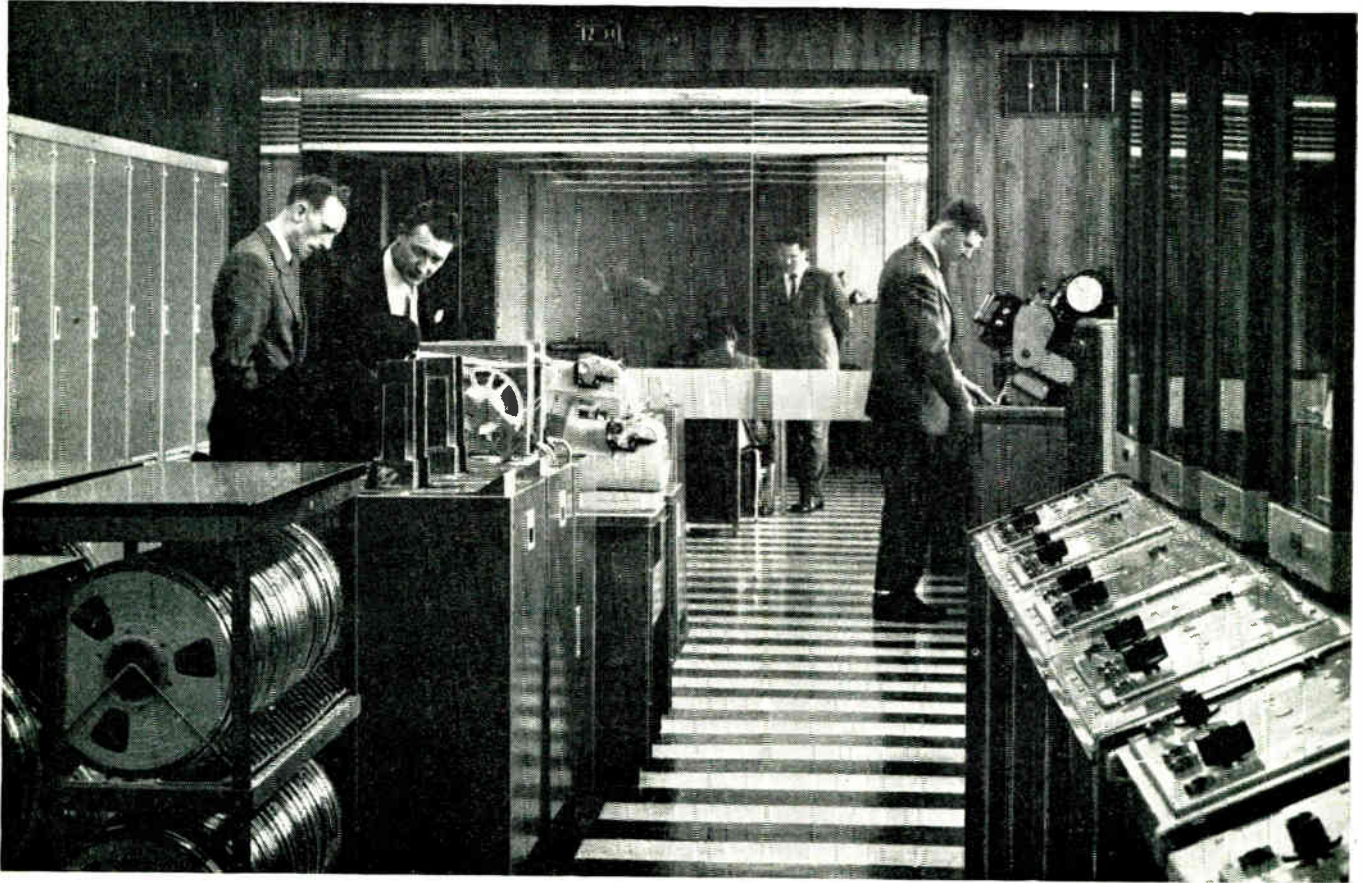

ENGLISH ELECTRIC **LEO**

count on Wandleside p.t.f.e. computer wiring

And in addition Wandleside wiring is the life-blood to many other branches of engineering. From television to aircraft, instruments to missiles . . . in fact wherever electronics and automation play a vital part, you can rely on Wandleside

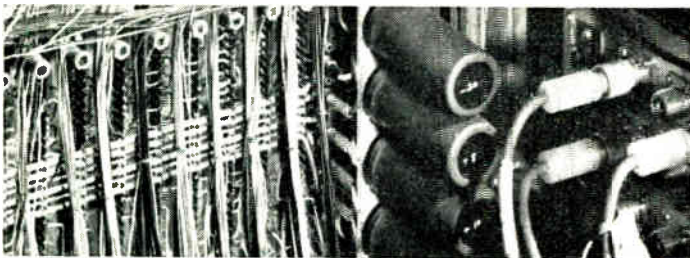

Section of panel of English Electric 'Leo' computer showing PTFE connecting wires

Our inspection has full A.I.D. and A.R.B. approval. We hold M.O.A. design approval for PTFE aircraft cables

**WANDLESIDE WARREN
WIRE COMPANY**

In Association with
**WANDLESIDE CABLE
WORKS LIMITED**

Dunmurry, N. Ireland. Telephone: Dunmurry 2536 Telex: 74339 Telegrams: Derrriaghy, Dunmurry, N. Ireland
London Office: 106 Garratt Lane, S.W.18
Telephone: VANDyke 7544 Telex: 261355 Telegrams: Wandleside, London, S.W.18 (Falks Group)

SOLID TANTALUM CAPACITOR PRODUCTION

At the Paignton factory of Standard Telephones & Cables Ltd. the manufacture of solid tantalum capacitors is carried out by semi-automatic methods. Most of the processes involved are automatic, but some are done by hand, and the loading of the machines and the transfer between them are carried out manually. One reason for this is the large amount of quality control employed. Two separate staffs work in the manufacturing area, the manufacturing and the quality control. They function in an interlaced fashion, the quality control staff operating in the manual stages where the product is transferred from one machine to another.

As distinct from the foil and wet sintered types of tantalum capacitor, the solid kind has no liquid electrolyte. It comprises a slug of compressed tantalum powder which

is sintered. The slug is of a porous nature and has about one-half the density of solid tantalum. It may be likened to a sponge. Because of this a cubic centimetre of the material has an effective area of about a square metre. This area is, of course, mainly internal and surrounding the pores of the sponge-like material.

A layer of tantalum pentoxide is formed over this surface area. This is the dielectric and has a thickness of only some tens of Angstrom units. Even when this layer has been applied, the slug is still porous and the pores are now filled with manganese dioxide which forms the second electrode of the capacitor.

The manufacturing process is outlined in Fig. 1 and the form of a tantalum capacitor is shown in Fig. 2. Production starts with a mixture of tantalum powder and camphor

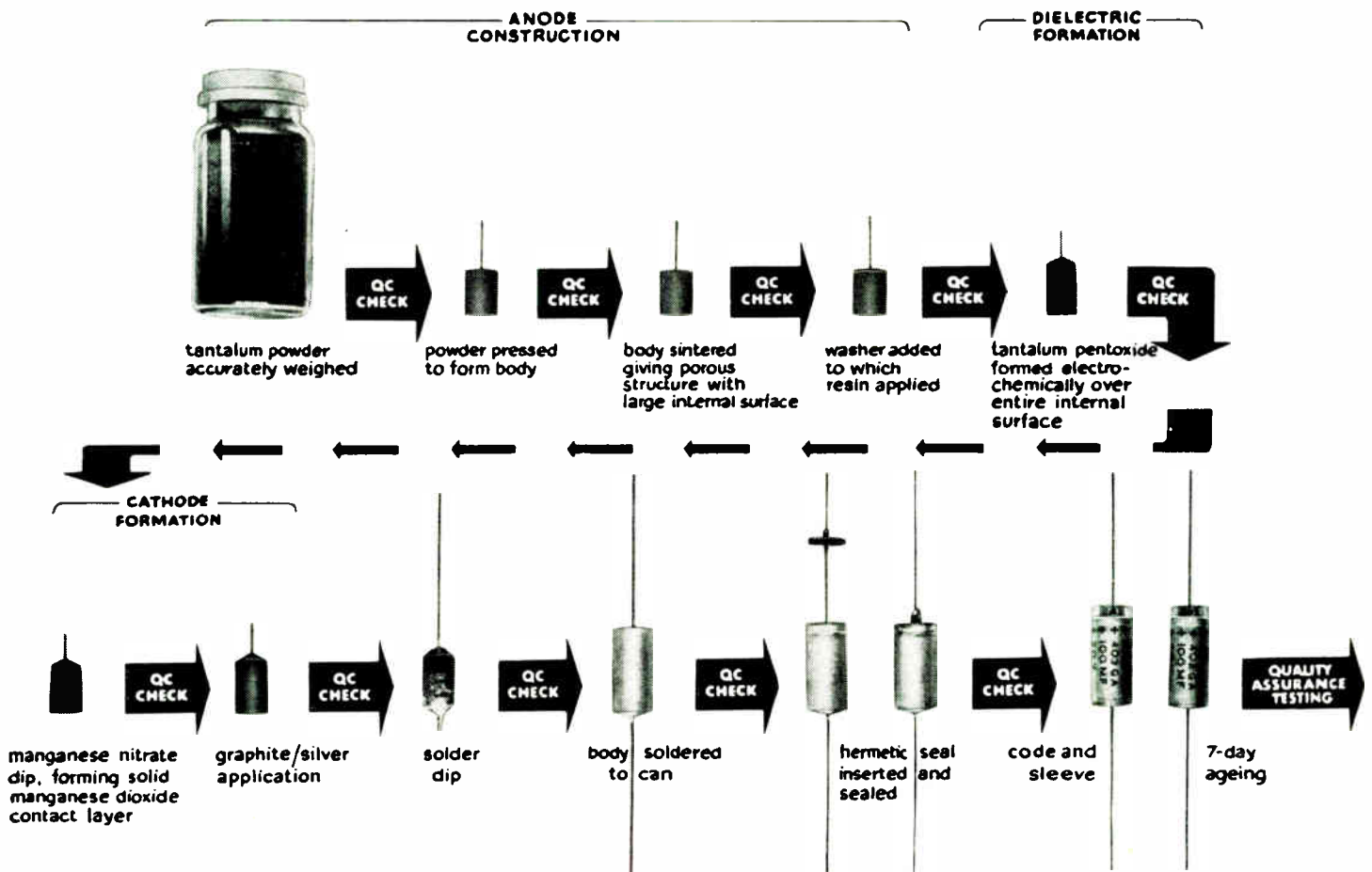

Fig. 1 Steps in the production process

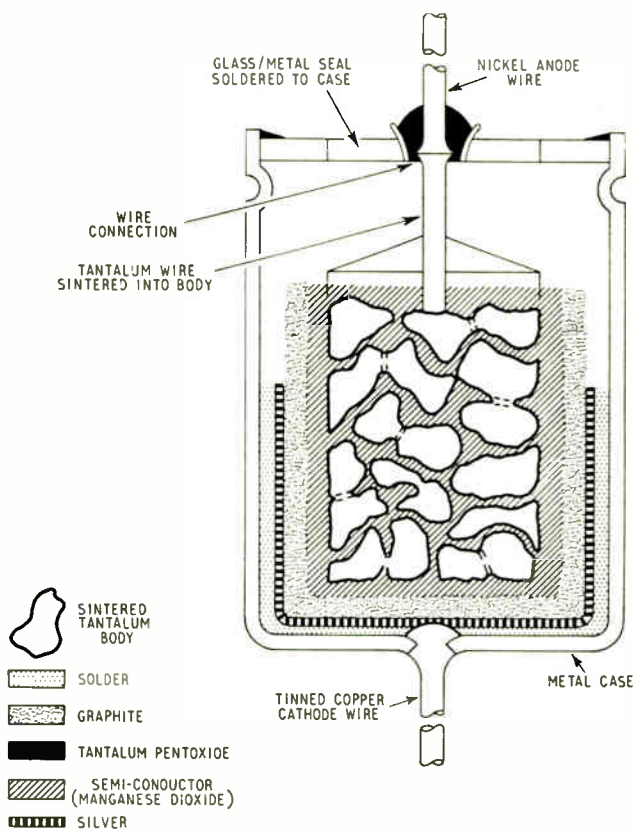

Fig. 2 This sketch indicates the constructional form of a solid tantalum capacitor

Fig. 3 Electronic dispenser for the tantalum and phosphorous powder



Fig. 4 Slug pressing machine

The camphor is used as a binding agent to hold the compressed slug together until the sintering process. Camphor is employed because it can be evaporated away without leaving any impurity.

Tantalum Slugs

The tantalum-camphor mixture is weighed accurately into the proper quantities for an individual slug. The machine which does this is a form of electronic dispenser, Fig. 3, and it places the proper quantity of the mixture into a little jar.

The next step is to pour the powder from the jar into a die which has a centrally-positioned support wire of tantalum. Then the powder is pressed to the required density, Fig. 4, and emerges as a formed slug of compressed powder, with an axial wire protruding from one end. This wire eventually forms the connection to the tantalum electrode of the capacitor, but in the meantime it is a support for handling.

The slug is now baked for 12 hours in an oven with gas extraction equipment. This not only drives off the camphor but institutes the initial binding of the tantalum powder itself.

Sintering

The next step is sintering, which is done in the same oven and takes about 3½ hours and is a fully automatic process. To avoid any risk of contaminating the slugs, all supports and trays which enter the furnace are made of tantalum. Evacuation down to 10^{-5} torr, and the rise, hold, and fall of temperature (about 2,000 °C) are all operations which are automatically time controlled and monitored. Control equipment and part of a furnace are shown in Fig. 5.

The sintered slugs are now fitted in batches to processing pallets. A plastic washer is first pushed over the wire of each and then the wire is spot welded to a temporary support wire of tantalum in the pallet, Fig. 6.

Forming the Dielectric

The loaded pallets are placed in tanks for washing and then into tanks of phosphoric acid, Fig. 7. In this they



Fig. 5 Twin semi-automatic furnaces for sintering tantalum slugs

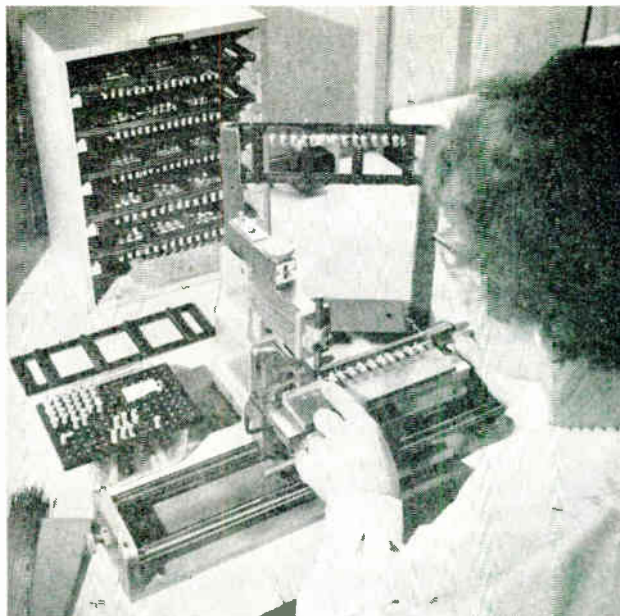

Fig. 6 Slugs being welded into a pallet

are connected to a voltage source and electrolysis takes place at the surface of the tantalum so that tantalum pentoxide is formed over this surface. Because of the porous nature of a slug the acid penetrates it and so the pentoxide is formed over the interior area of its sponge-like structure. The process takes about eight hours.

The thickness of the pentoxide layer can be controlled by the applied voltage and what is required depends upon the capacitance and voltage rating needed in the finished product. As the layer is only some tens of Angstrom units in thickness, interference effects occur in it with the result that it has a colour which depends on the layer thickness. The colour of the slug is thus an indication of the thickness of the layer.

The slugs are next coated with manganese nitrate, the pallets being carried through nitrate baths several times, Fig. 8. They then pass through tunnel ovens where the manganese nitrate is decomposed to manganese dioxide, which forms the cathodes of the capacitors. After this, the slugs are boiled in water, dried and re-formed electrically.

Black Dip

The next step is a bath of manganese nitrate, black manganese dioxide and silica in which the pallets are vibrated to obtain an even coating and good adherence of the liquid. Solid manganese dioxide is then applied by a flocking process to give a rough outer surface.

In all this there is a good deal of repetition, for the various stages are gone through several times. For instance, after the flocking process, the slugs are passed through the tunnel ovens again, have another black dip and again go through the oven. Then they are boiled, re-formed, and again boiled before being finally dried.

The slugs are now removed from the pallets and dipped several times into graphite with half-hour cures in ovens between the dips. This is done to deposit a coating of graphite on the surface of each slug at the end remote from the anode wire.

Silver 'paint' is then brushed over the graphite and cured for 20 minutes, after which the slugs are dipped in silver



Fig. 7 Semi-automatic forming bath for producing the dielectric layer of tantalum pentoxide

Fig. 8 Manganese nitrate baths with tunnel ovens in the background

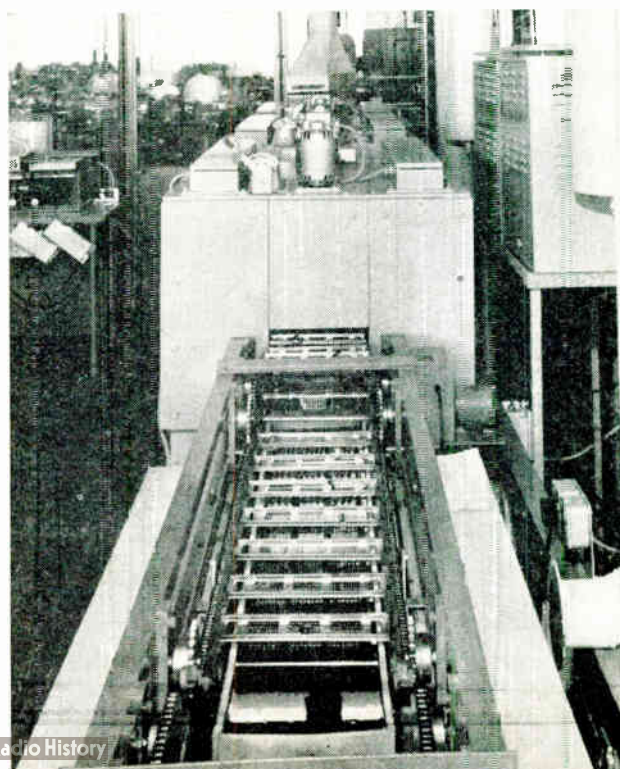

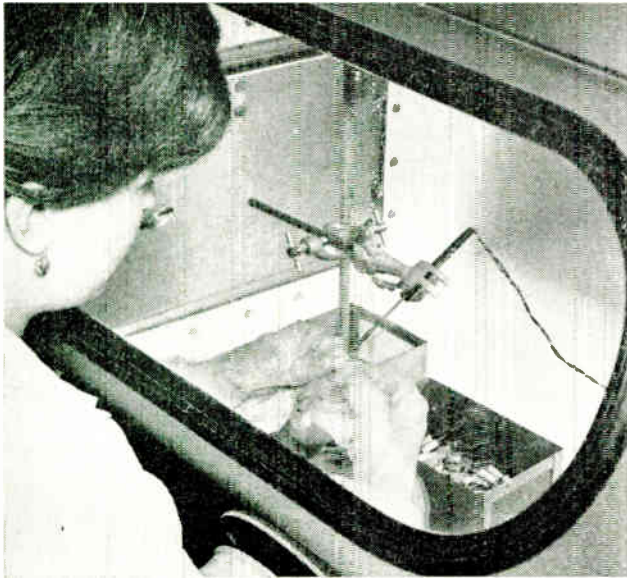

Fig. 9 Final soldering of the anode wire to the metal-glass seal in pressurized boxes

solder. The support wires are now cropped and nickel lead wires welded to the remaining stubs.

Silver-plated cylindrical copper cases are used. Solder is put into the base of each case and it is held in an r.f. heated jig. The slug is dropped in and the anode lead-out wire held central while the slug is soldered to the case. A die then presses a groove near the top of the case and a glass-to-metal seal is threaded over the anode wire and soldered to the case.

There is now a vacuum drying period of 16 hours at 110 °C, and the nearly finished components pass from the drying ovens into pressurized work boxes fitted with rubber arms and hands through which the operators solder the anode wires to the seals to complete the final sealing, Fig. 9.

There are now degreasing baths, short-circuit tests, printing of designations on the cases and fitting transparent sleeves. Finally, there is ageing, Fig. 10. The capacitors spend two days on over-voltage and then five at their working voltage.

Capacitors normally have a $\pm 20\%$ tolerance on capacitance, but $\pm 10\%$ and $\pm 5\%$ types are available. Ranges of 6, 10, 13, 17, 28 and 40 V working at 125 °C and in high impedance circuits are available. Capacitance values range from 6.8 μF to 330 μF at 6 V to 1 μF to 22 μF at 40 V. Leakage current is of the order of 0.006 $\mu\text{A}/\mu\text{F-V}$ at 50 °C. The physical dimensions vary according to type but range from 0.462 in. to 0.962 in. in length and 0.143 in. to 0.36 in. in diameter.

Fig. 10 Part of the ageing room for capacitors

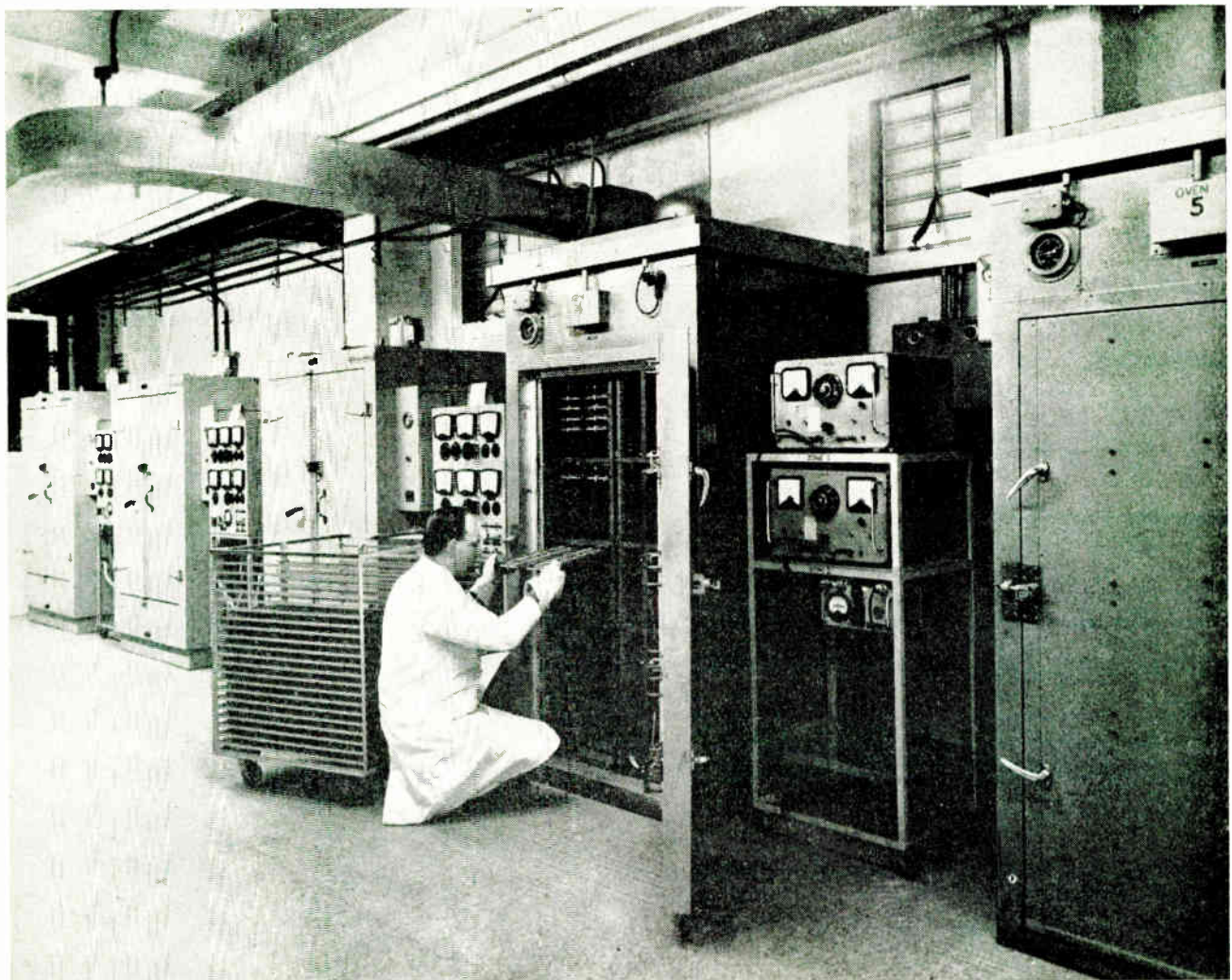



Personal and Company News

Electro Mechanisms Ltd. have announced a merger between their affiliated company, Schaevitz Engineering of New Jersey, and the Bytrex Corporation of Massachusetts. As a result of this merger, Electro Mechanisms have the marketing rights in the U.K. of Bytrex semiconductor strain gauges and a wide range of transducers and instrumentation based on the application of the semiconductor strain-gauge techniques.

Winston Riley, who was until recently **C-E-I-R's** operational research manager in London, has been appointed manager of management sciences at C-E-I-R's Washington Centre, U.S.A. In his new position he will direct the development of electronic computer programmes to improve management control of complex manufacturing and scheduling projects.

British Insulated Callender's Cables Ltd. announce that L. J. de Wynter, formerly Ipswich branch manager, has become transmission sales engineer in the London region. He is now responsible for specialist sales of power cables and accessories and is senior assistant to A. H. Hughes, London regional manager. H. M. Lillistone has been appointed branch manager at Ipswich. It is also announced that B. King has become manager of the Chelmsford branch.

G. C. Gifkins, A.M.I.E.R.E., for many years a senior colour television development engineer with **Murphy Radio**, has been appointed manager of Rank-Bush Murphy Colourvision Engineering Services. Mr. Gifkins' headquarters will be at the R.B.M. Welwyn Garden City factory, and his duties will include technical liaison within the company on colour television development and research; technical help in arranging colourvision training courses and literature for service engineers; and supervision of the company's new mobile colourvision demonstration unit.

Thorn Electrical Industries Ltd. and C. A. Parsons & Co. Ltd. announce the formation on a 50/50 basis of a new company (**Thorn-Parsons Ltd.**) for the commercial exploitation of products resulting from fundamental researches in new fields in which the two companies are interested. Initially, Thorn-Parsons Ltd. will be concerned with the exploitation of positive temperature coefficient ceramics and devices which have been developed by International Research & Development Co. Ltd. These devices have immediate applications in industrial control equipment and temperature sensitive devices.

Polypenco Ltd. announce the appointment of Stratoflex (U.K.) Ltd. as distributors for Polypenco 'Nylaflow' pressure hoses throughout the British Isles.

The mechanical products division of **The Marconi Company** have announced the conclusion of an agreement whereby they will undertake sales, in the industrial field, of a range of hydraulic pumps developed by Donkin and Co. The pumps sold by Marconi will be incorporated into a range of power units, suitable for a variety of other applications in industry. In addition, some development work will be undertaken to increase the possible applications in fields where remote control and servo control functions are required.

Norrie McFarlane, A.Inst.M.S.M., has been appointed group regional manager of **Solartron's** new sales and service region covering Scotland, Northern Ireland, Fire and North East England as far as Gateshead, Middlesbrough and Newcastle-on-Tyne, centred at Edinburgh.

Cyril W. Fletcher has been appointed sales manager of **Power Auxiliaries Ltd.**, a subsidiary of Plessey-UK Ltd.

At the annual general meeting of the **Electronic Engineering Association**, W. D. H. Gregson (Ferranti Ltd.) was re-elected chairman and R. Telford (The Marconi Co. Ltd.) was elected vice-chairman.

An operator feeds instructions into an ARCH computing system supplied by Elliott-Automation to the Velindre tin-plate works of the Steel Company of Wales. This is one of two identical ARCH computing systems which S.C.O.W. are using for 'on-line' quality control of high speed continuous tin strip production, the other being in operation at their Trostre works



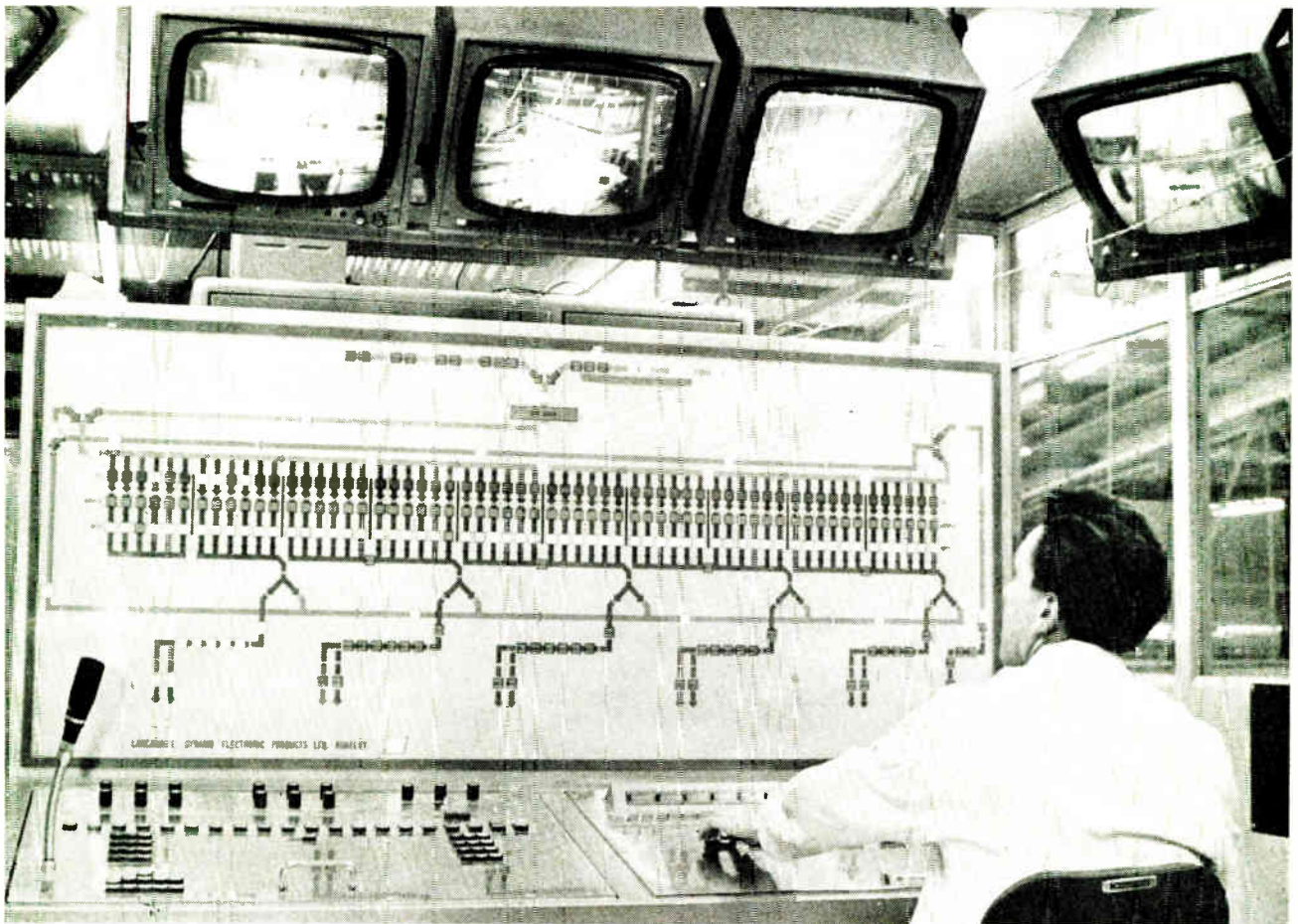

A fully automated shoe warehouse over a quarter of a mile in length, the largest of its kind in Europe, has been opened by the British Shoe Corporation at Braunstone near Leicester. More than five miles of conveyors, operated by remote control, are surveyed by nine closed-circuit television cameras installed by Pye. Pictures from the loading and unloading bays and the conveyor system are relayed to monitors above the control consoles, enabling operators to view and control the flow of all goods from a central point

James A. Purdy has been appointed to the new post of organization and planning director of **Standard Telephones and Cables Ltd.** He will be responsible for company organization and the planning of its various businesses, covering telecommunications, electronic systems, components, and consumer products. It has also been announced that Douglas Stevenson has been appointed marketing manager of the STC components group. Mr. Stevenson, who is based at Footscray, now controls the marketing operations of STC's capacitor and valve divisions at Paignton; the semiconductor division at Harlow, Footscray and Taunton; the magnetic materials division at Harlow; and the quartz crystal division, also at Harlow.

Dr. Peter James Campion has been appointed superintendent of the applied physics division of the **National Physical Laboratory**, in succession to Dr. B. W. Robinson who is retiring from the Laboratory in the autumn. Dr. Campion is at present head of the radiology section of the division.

Leeds & Northrup announce the appointment of Frank Haley, Graduate I.E.E., as field applications engineer, Northern Counties and Scotland. His duties will be to assist and support all area representatives in the North-East, North-West and Scottish regions, principally on technical matters. The appointment is part of the company's general expansion programme in North Britain, which includes a Northern service depot.

English Electric Valve Company Ltd. announces the appointment of M. J. Pitt, A.M.I.E.E., as a technical sales engineer.

Ekco Electronics Ltd. have appointed an additional assistant technical sales manager in their Instrumentation Division. R. G. Davis, M.I.R.E.(Aust.), joins the company as assistant technical sales manager (medical research and reactor equipment).

A full range of Philips high-power valve amplifiers, with outputs from 250 VA to 200 kVA is now available from **Peto Scott Ltd.**

I.E.E. Election and Award

The Council of the Institution of Electrical Engineers elected to honorary membership P. Dunsheath, C.B.E., M.A., D.Sc.(Eng.), LL.D., for his notable contributions to electrical science and engineering, both nationally and internationally, particularly in the fields of industry and education. The Council have also made the forty-second award of the Faraday medal to J. R. Mortlock, B.Sc.(Eng.), Ph.D., for his conspicuous services to the advancement of electrical science, particularly for his outstanding work on the analysis of power systems and networks.

A partly-transistorized reactor control system is being supplied by Ekco Electronics for the Pve A.M.F. 100-kW "Educator" reactor now nearing completion at Risley for the Manchester and Liverpool Universities. This shows the control console undergoing final testing in the Ekco Works at Southend-on-Sea prior to despatch

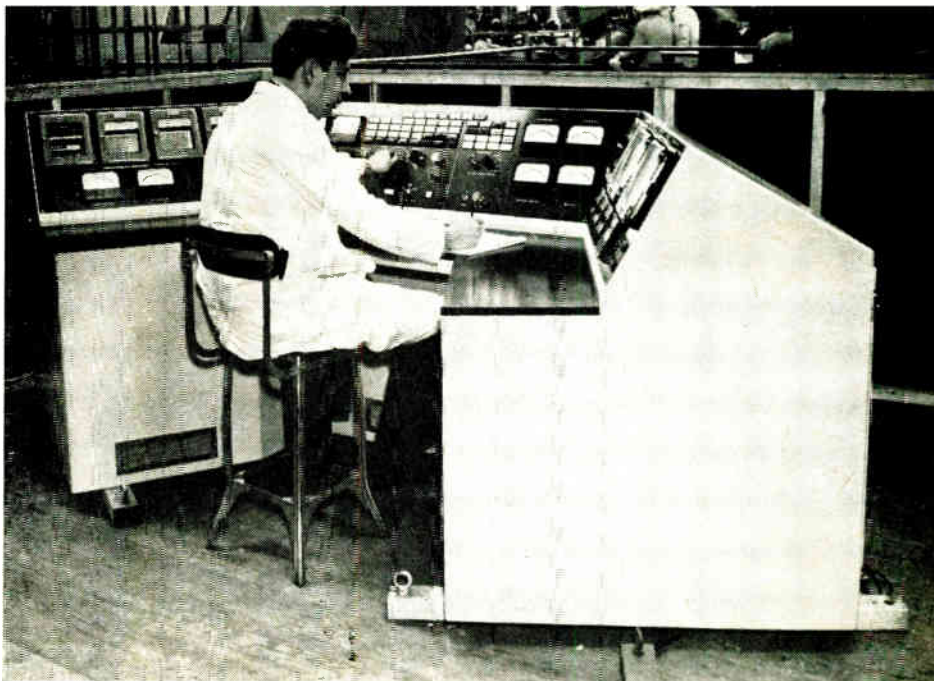

Europe's First Facsimile Newspaper

The first facsimile newspaper transmission in Europe has been inaugurated by Sweden's *Dagens Nyheter* (Expressen) using the British-designed Muirhead system. Expressen is printing the original in Stockholm and the facsimile in Jonkoping (a distance of 180 miles). This system makes possible the simultaneous printing of the newspaper at widely separated places. A whole page is proofed and placed on the transmitter. In 10 minutes a negative is received at the distant printing house from which a plate is made ready for the press. Similar types of equipment have already been supplied to Japan's *Asahi Shimbun* and America's *Wall Street Journal*.

Superconducting niobium thin films developed at National Research Corporation, U.S.A., are checked through the viewing glass of an electron beam furnace. The technique offers the first means of commercially producing these films which are considered highly desirable for development of rapid response cryo-computers, gyroscopes, alternating current from superconducting generation techniques, and fundamental research

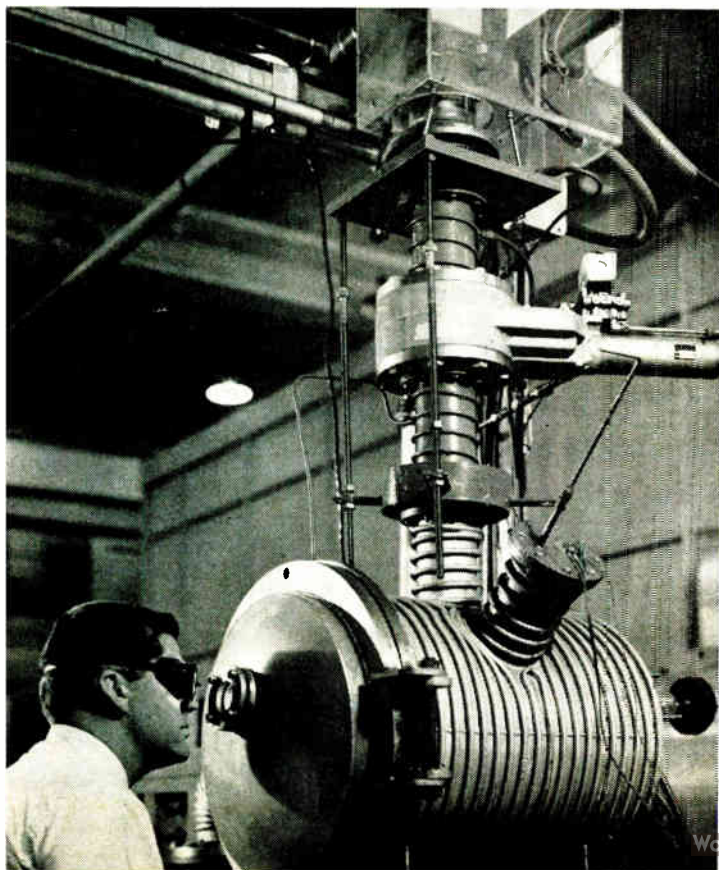

Grant for Computer Control of Printing

A grant of £28,650 has been made by the D.S.I.R. to the University of London to enable Dr. Michael P. Barnett to carry out research into the control of printing by computer. About half the grant will be used for the purchase of equipment including a photo-composing unit. Dr. Barnett is returning next month from the United States, where he is at present director at the Co-operative Computing Laboratory of the Massachusetts Institute of Technology.

The research, which will form part of the programme of the University's Computer Unit, will be concerned with the application of a computer to the production of paper tape to control type-setting equipment or photographic printing processes. Computer languages and programmes will be adapted to specify the format and editorial details needed to set up books and publications.

An Atlas computer will be used to carry out the work, in conjunction with the S-561 photo-composing unit. This is the most suitable type-setting device at present available. It is relatively inexpensive and has the necessary flexibility for a wide variety of applications to be explored.

New Digital System Logs Flight Information

Sperry have now completed the development of an airborne solid-state digital data-acquisition system, capable of handling from six to many thousands of parameters.

The airborne system has been designed as a series of modules, a combination of which will meet impending air safety regulations and the customer's own requirements for additional parameters. Because the system uses digital conversion of information it offers the advances in accuracy demanded for flight test work.

Immediate applications are as an incident and crash recorder; as a flight test recorder; or as a maintenance recorder, for finding faults and indicating trends. Parallel industrial and marine applications are also foreseen.

Lasers

A symposium on the applications of lasers is being held at the National Physical Laboratory on 23rd and 24th April. The first day will be devoted to gas lasers and the second to solid-state types. Papers are limited to 10 minutes so that the emphasis can be on discussion.

Anyone interested in the industrial use of lasers or in laser research should write to The Secretary, Laser Symposium, National Physical Laboratory, Teddington, Middlesex.

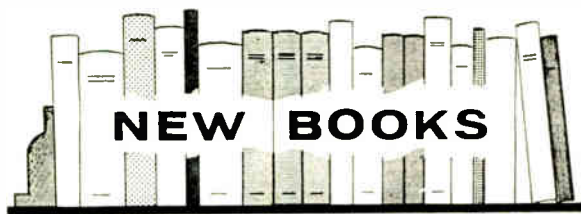

The BEAMA Directory (2nd Edition) : 1964-65

Pp. 500. The British Electrical and Allied Manufacturers' Association, 36 Kingsway, London, W.C.2. Overseas sales by Pergamon Press, Headington Hill Hall, Oxford. Price £3.

Coinciding with the news of the electrical industry's record export achievement in 1963—the highest-ever figure of £360 million—is the publication this month of the second edition of The BEAMA Directory, nearly 15,000 copies of which are now going overseas to the electrical markets of the world.

Planned on very similar lines to the first edition published in 1961, the new volume lists manufacturers' names, U.K. addresses and their overseas companies and agents, and includes a classified Buyers' Guide covering more than 1,000 items of electrical and allied equipment. A quick-reference cross-index system relates this section to the foreign language sections in French, German, Portuguese, Spanish and Russian (each printed on distinctively-coloured paper), so that the user can immediately locate the suppliers of any item.

Two new features have been incorporated in this edition in response to requests from many users of the earlier volume. These are tabbed divider pages for the quick and easy location of the various sections, and the inclusion under the manufacturers' names of a summary of their complete range of products.

The pictorial section with which the Directory opens illustrates examples of the electrical and allied industry's products.

Distributed individually to a mailing list specially compiled by the BEAMA, the new edition of the Directory will, like its predecessor, provide a valuable guide and work of reference for buyers in the markets of the world.

Ultrasonic Delay Lines

By C. F. BROCKELSBY, B.Sc., A.R.C.S., A.M.I.E.E., J. S. PALFREEMAN and R. W. GIBSON, B.Sc.(Eng.), Grad.I.Mech.E. Pp. 297 + 7. Iliffe Books Ltd., Dorset House, Stamford Street, London, S.E.1. Price 65s.

This is a serious book which includes a mathematical treatment of the subject. There is, however, a great deal of general explanation as well. The introductory chapters cover waves and transducers and there are four separate chapters on the various kinds of delay line. Electronics for delay lines has a chapter to itself and there is one on measurements and a final one on applications. There are five appendixes of which four deal with transducers.

Ceramic Insulating Materials for General Electrical Purposes

British Standard 1598:1964. Pp. 32. British Standards Institution, 2 Park Street, London, W.1. Price 10s.

In this publication tests to determine the electrical, mechanical and thermal properties and porosity of ceramic insulating materials for general electrical purposes are given.

This revision of a standard has recently been published to bring the requirements into line with modern practice, particularly as regards the methods of test. Specialized capacitor materials are not now covered. Tensile and

impact strength tests have been omitted, since they provide no information beyond that which can be obtained from the cross-breaking test. The standard does not include all the tests appropriate to materials intended for refractories and gas-tight envelopes.

An appendix has now been introduced to give guidance to designers of ceramic articles.

Electrical Control Systems in Industry

By CHARLES S. SISKIND. Pp. 496 + xii. McGraw-Hill Publishing Co. Ltd., McGraw-Hill House, Shoppenhangers Road, Maidenhead, Berkshire. Price 70s.

The subject of this book is mainly the control of electric motors by methods which do not involve the use of electronics. There is, however, one chapter on static-switching circuits in which there are a few pages dealing with transistor circuits.

Maintainability Design

Edited by F. L. ANKENBRANDT. Pp. 247. Engineering Publishers, 350 Morris Avenue (P.O. Box 2), Elizabeth, New Jersey 07207, U.S.A. Price \$11.

Manufacturers' Literature

Westool Miniature Solenoids MM2/4/6/8. Four 4-page leaflets which give the performance and dimensions of the latest miniature solenoids produced by *Westool Ltd., Bishop Auckland, Co. Durham.*

For further information circle 53 on Service Card

Trinistor Silicon Controlled Rectifiers. The latest additions to Westinghouse s.c.r.s are described in these four leaflets. The new basic devices handle 3 A at 400 V, 4.7 A at 480 V and 70 A at 600 V. *Westinghouse Brake and Signal Co. Ltd., 82 York Way, London, N.1.*

For further information circle 54 on Service Card

Electronic Test Instruments: Short Form Catalog 1963/64. In this 27-page catalogue the current ranges of products produced by Hewlett-Packard, Boonton Radio, Harrison Labs, Sanborn, Dymec and F. L. Moseley Co. are listed. These include oscilloscopes, audio and video instruments, oscillators, pulse generators, counters, power supplies, microwave test gear and data handling and recording equipment. Brief but relevant specifications are given for each item. *Hewlett-Packard Ltd., Dallas Road, Bedford.*

For further information circle 55 on Service Card

Mullard Semiconductors: 1964 Designers Guide. A 23-page quick reference to semiconductors for industrial and communication equipment. This publication gives brief specifications for the current Mullard transistors, diodes and thyristors. In this year's guide three new 'quick-find charts' for transistors have been introduced. These list devices under the main headings of collector voltage, total dissipation and cut-off frequency. *Mullard Ltd., Mullard House, Torrington Place, London, W.C.1.*

For further information circle 56 on Service Card

STC Reliability: Life Test Bulletin 5. This 12-page bulletin deals with a product line from which several germanium alloy junction transistors are derived. Types tested include the ACY, CV and ASY series. The tests include vibration fatigue, temperature cycling, moisture resistance and lead bending. *Standard Telephones and Cables Ltd., Components Group, Semiconductor Division, Footscray, Kent.*

For further information circle 57 on Service Card



AVEL INSTRUMENTATION

Time is Money,
Can YOU Buy Time?



YES!

With the
Unique

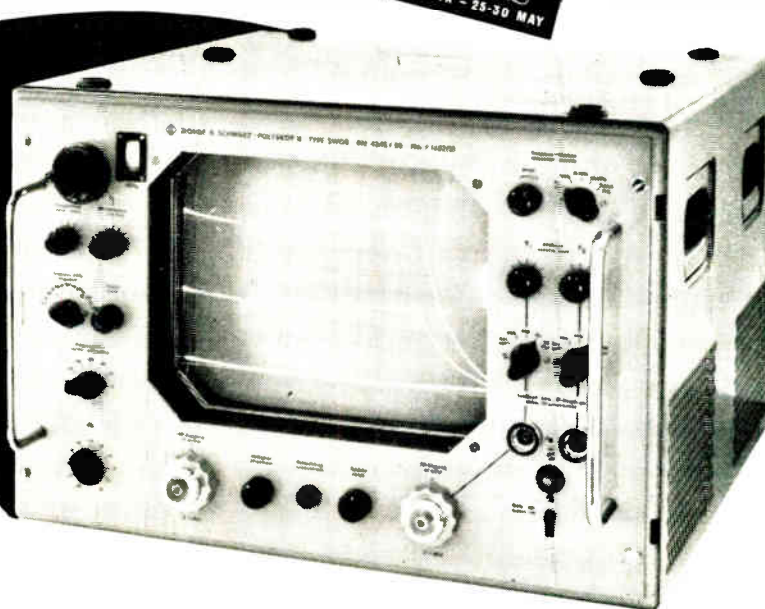
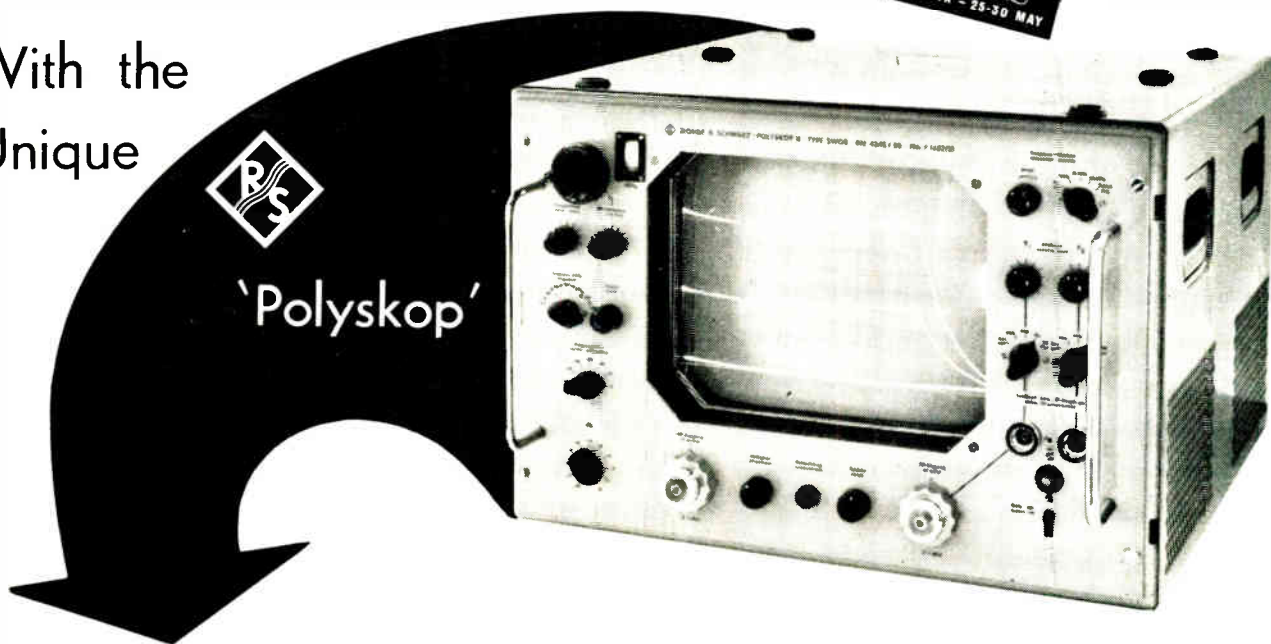

- * 11" x 8½" DISPLAY SCREEN
- * DUAL TRACE DISPLAY
- * FREQUENCY RANGE
UP TO 1200 Mc/s.

This is the only instrument which eliminates the necessity of 'point by point' measurements by providing sweep signal generator, visual indicator, attenuator, and frequency markers in ONE INSTRUMENT. The 'Polyskop' combines simplicity of operation and versatility with high degree of accuracy at frequencies up to 1200 Mc/s.

Leading manufacturers throughout the world have proved that the use of this instrument in both production and research has resulted in greater efficiency and reliability.

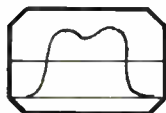

Broadband Filters & Amplifiers

The alignment of amplifiers and filters using point by point methods can be eliminated with the 'Polyskop' in one Fiftieth of the time normally taken.

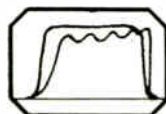

Alignment of Test Items and Comparison against Standard

The large screen display and versatility of the 'Polyskop' provides for greater accuracy and time saving.

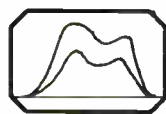

Multi-Section Filters

The facility for direct comparison of sections and the inherent high accuracy and versatility of the 'Polyskop' results in improved accuracy in a much shorter time.

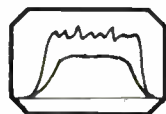

Band-Pass Filters

Alignment and analysis of filter characteristics in the shortest possible time is a feature of the reliability and versatility of the 'Polyskop'.

Aveley Electric

Limited

Distributors in United Kingdom for:

Measuring instruments of quality

SOUTH OCKENDON · ESSEX
TELEPHONE: SOUTH OCKENDON 3444
TELEX: 24120 AVEL OCKENDON

For Further Information Write or Phone

The Materials with the 101 Applications

Ask the

Delanco

BAKELITE TUBE DIVISION

TO ANSWER YOUR PROBLEM

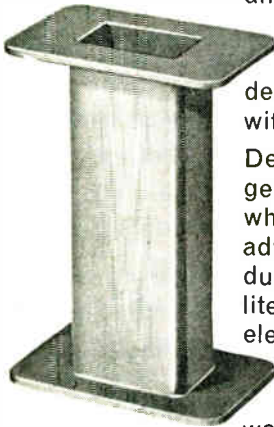
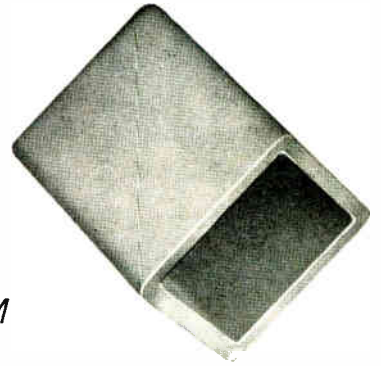

You'll be surprised at the number of applications for Delanco S.R.B.P. and S.R.B.F. tube, both in the electrical and mechanical sections of industry.

In the radio and T.V. worlds they are extensively used for coil formers, sleeves and stand-off insulators and for internally threaded tuning coils to take iron dust cores, as Transformer Bobbins.

In the Condenser trade they are used as condenser casings, from $\frac{5}{8}$ " up to 8" internal diameters, with wall thicknesses up to $\frac{1}{2}$ ".

Delanco S.R.B.F. material has a host of uses in general engineering, for example as pump sleeves, where its resistance to corrosion is a definite advantage over metal. Fuse holders made from a dual material Vulcanized fibre and Delanco Bakelite, giving on the one hand the highest degree of electrical insulation and on the inner tube (vulcanized fibre) the best insurance against arcing.

These are only a few of the many uses, but we want to know of YOUR special problems wherein a bakelite tube might well be a cheaper and more efficient medium.

Delanco tube can be threaded, drilled, tapped, slotted and metal insertions can be incorporated where necessary and desirable.

It is made in round, square and rectangular sections, and we will gladly send your design department an actual sample with technical data, on request.

It conforms to British Standards specs S.B.AC LPT 59, 40, 42, and 58. BS 1314. Types A and C DEF. 500. S.E.S. 12 and BS 1885 Grades 1 and 2. (rectangular).

For reliability and quality use only DELANCO S.R.B.P. Tubes.

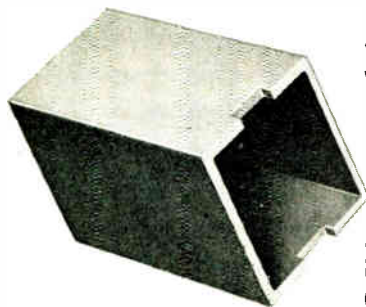

ANGLO-AMERICAN VULCANIZED FIBRE CO LTD

CAYTON WORKS · BATH STREET · LONDON E.C.1

CLE 8484 (20 LINES) GRAMS: PROMPSERV, CENT, LONDON

For further information circle 239 on Service Card

SMALLER...STURDIER

MINIATURE TRANSDUCERS

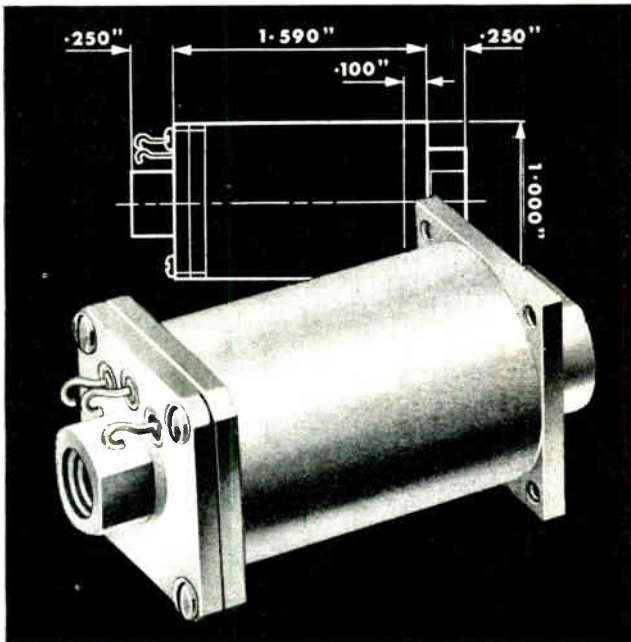

for higher outputs without amplifiers

Great accuracy, robustness and reliability make these miniature transducers specially suitable for use in aircraft and missile applications. They comply fully with military vibration shock and temperature specifications, and their performance is unaffected by a wide range of adverse conditions, including accelerations up to 30G.

Colvin transducers, supplied by Rotax, have extremely small space requirements, yet produce the fast responses and high output voltages necessary for advanced systems. Why not contact Rotax and talk over your transducer problems with one of their engineers?

Rotax supply transducers in three ranges:

Differential Pressure	± 0.5 to ± 200 psid
Absolute and gauge pressure	0-0.5 p.s.i. to 0-10,000 p.s.i.
Displacement	Strokes from 0.1 to 0.5 in.



INSTRUMENTATION DIVISION

ROTAX LIMITED, INSTRUMENTATION DIVISION,
WILLESDEN JUNCTION, LONDON, N.W.10 TELEPHONE ELGAR 7777

For further information circle 240 on Service Card

IEA

INSTRUMENTS
ELECTRONICS
AUTOMATION

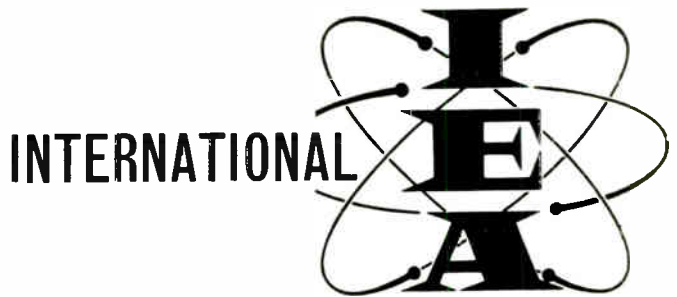

INTERNATIONAL
EXHIBITION
OLYMPIA LONDON 25-30 MAY

The fifth International IEA Exhibition opens on Monday 25th May, occupying all halls of Olympia. Nearly 700 British and foreign manufacturers of electronic equipment, scientific instruments and industrial controls are showing their newest products and developments in **the 1964 IEA — the largest exhibition of its kind in the world.**

Times : 10 a.m. — 6 p.m. daily
Admission : 5/-, Season Ticket 10/-
(or by ticket obtainable only from exhibitors)

1964

IEA INDUSTRIAL EXHIBITIONS LTD 9 ARGYLL ST LONDON W1

ALLSCOTT TELEDIGIT SYSTEM

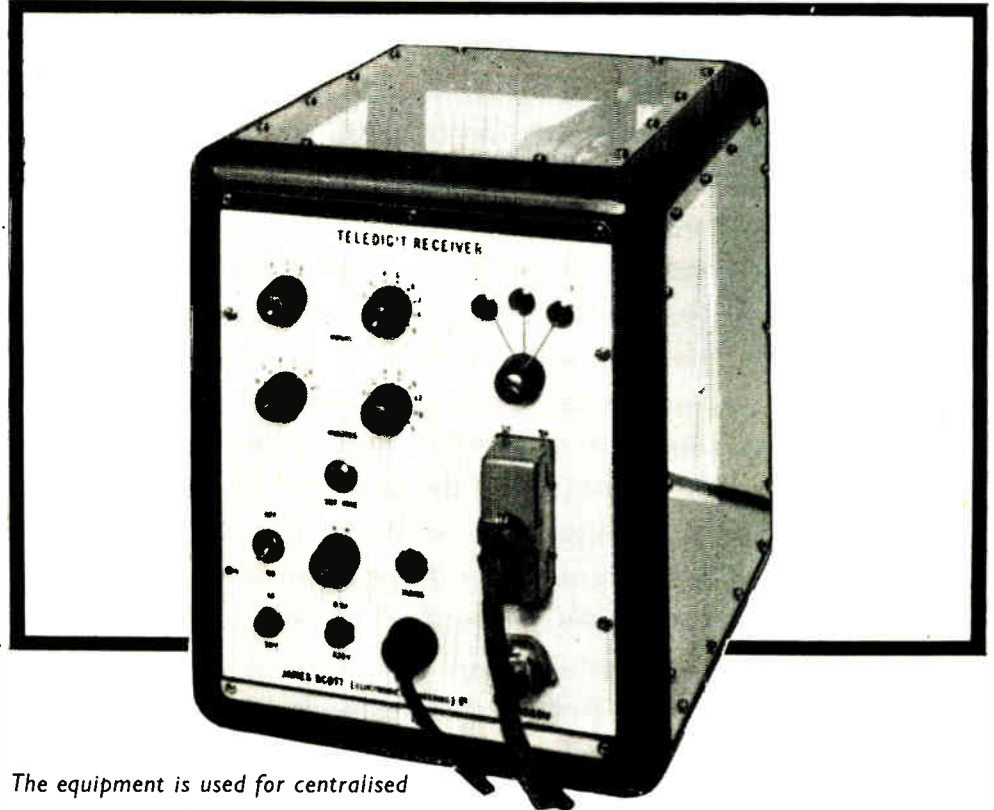
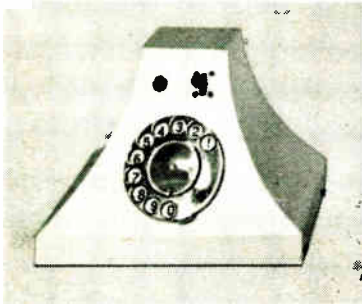

The equipment is used for centralised recording of digital information from a remote transmitter or a network of transmitters.

Applications in

**PUBLIC TRANSPORT SYSTEMS
PROCESS OPERATIONS
STOCK ROUTING • WAREHOUSING
MULTIPLE STORES
SECURITY PATROLS, etc.**

James Scott (ELECTRONIC ENGINEERING) **Ltd**

68 Brockville Street, Carntyne Industrial Estate,
Glasgow, E.2

Telephone: Shettleston 4206



Fragile or robust



Large or small

Hot or cold

Electrothermal Valve Retainers

hold them all

firmly . . . but gently

 <p>VRA For metal-capped retainers, octal based valves, plug-in crystals, canned relays, synchronous choppers etc.</p>	 <p>VRY Woven glass nets sewn on to phenolic rings for retaining high temperature valves. Self-supporting.</p>	 <p>VRE Neoprene self-adjusting strips for retaining low temperature valves, electrolytic condensers etc.</p>
--	--	---

For detailed information and cross-reference data, send for Publications 325 & 392

Electrothermal®

ELECTROTHERMAL ENGINEERING LTD. London, E.7. Tel.: GRA 9911 Telex: 24176

Industrial Electronics April 1964

NEW



BURROUGHS

NIXIE® TUBE

B 5971

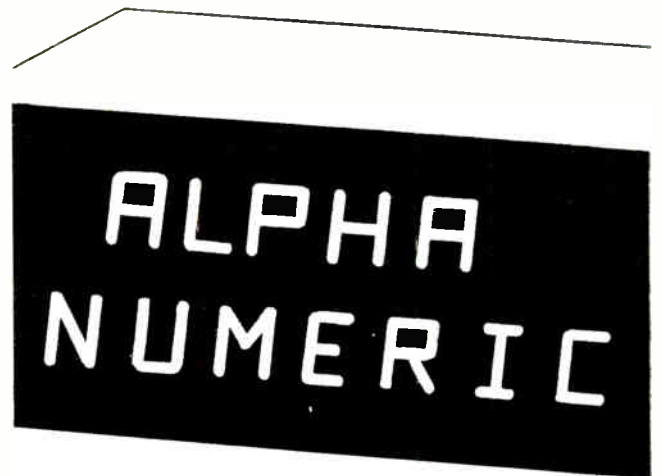

Displays in one tube:

- all letters of the alphabet
- numerals 0-9
- special characters

U.K. REPRESENTATIVES

WALMORE ELECTRONICS LIMITED

11-15 BETTERTON STREET, DRURY LANE
LONDON, W.C.2

Telephone: TEMple Bar 0201-5



Porcelain **Steatite**

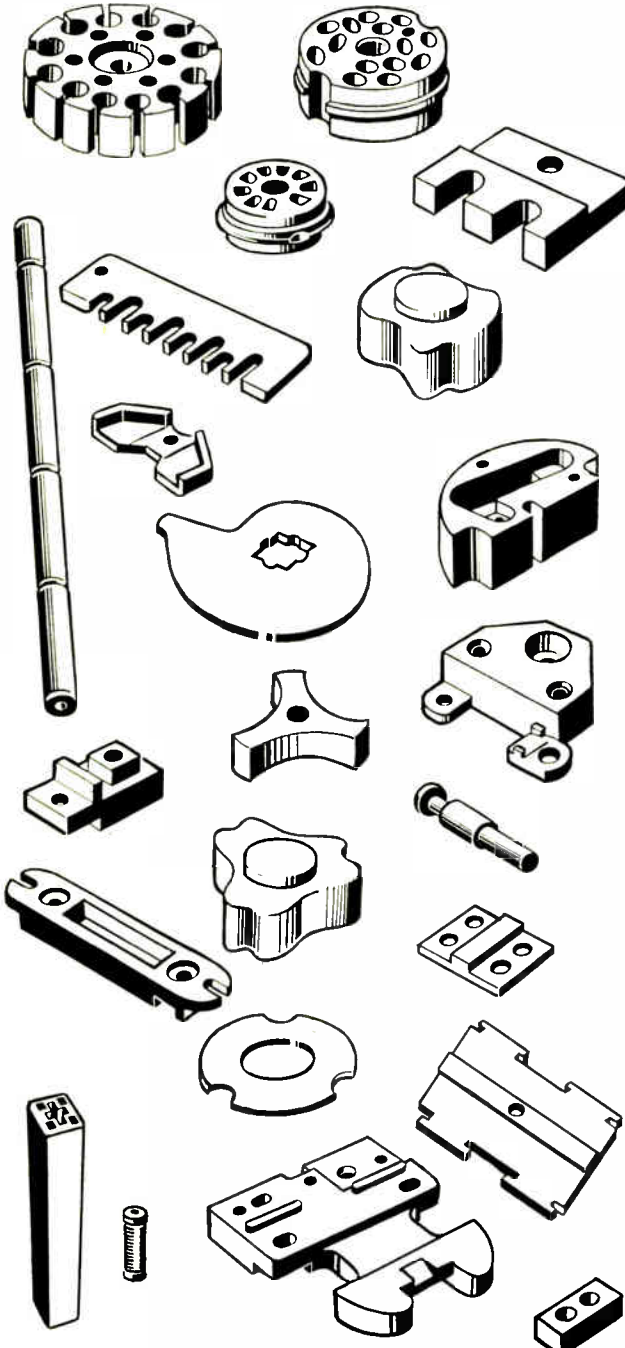

**V. G. PORCELAIN CO
LTD**

GORST ROAD
PARK ROYAL
LONDON, N.W.10

Telephones:
ELGAR 1411/7
Telex:
London 25589

**PROMPT
DELIVERY**

Many Types
Ex Stock

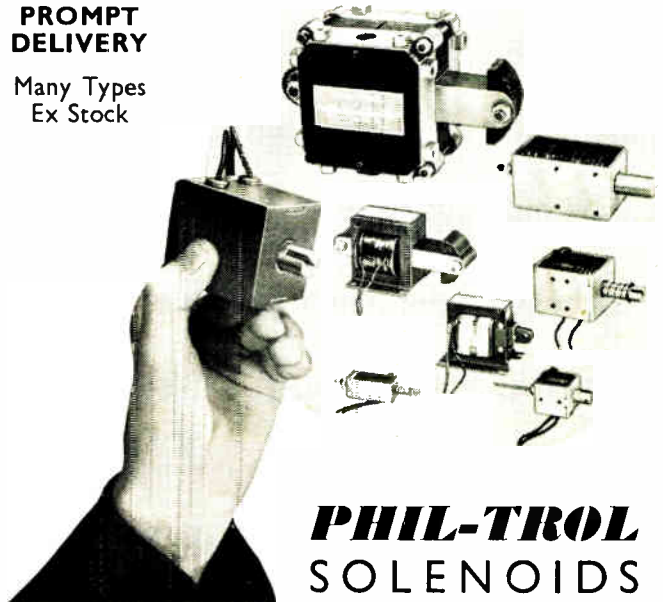

**PHIL-TROL
SOLENOIDS**

NEW! We are now able to offer Types 38, 39, 40 and 35, 36 and 37 solenoids in encapsulated versions suitable for exposed positions and with fully protected coils. We can also supply these solenoids with chromium plated and polished plungers for more rigorous conditions.

Send for full details and copy of pamphlet 108A. The Phil-trol range of solenoids goes from miniatures to extra strong power types in both AC and DC versions.

PHILLIPS CONTROL (G.B.) LTD.

Dept. K.7, Farnborough Road, Farnborough, Hants

Telephone : Farnborough 1120

Grams & Cables : Philtrol, Farnborough, Hants

A unique and indispensable
guide to prominent people
in the electrical industry

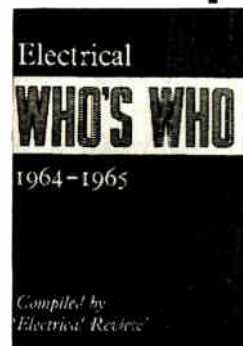

1964-1965

Electrical

Who's Who

This is the eighth edition of ELECTRICAL WHO'S WHO, the established guide to prominent people in all branches of the electrical industry, and in related organisations such as Government Departments. Every entry has been carefully checked, particular attention having been taken of the many reorganisations by electrical manufacturers. Executives, technologists, consultants — everyone in the industry will find ELECTRICAL WHO'S WHO 1964-1965 even more useful and necessary than its predecessors.

55s net

by post 57s 3d
9" x 6" 534 pp

obtainable from
leading
booksellers

Published for
'Electrical Review'
by

ILIFFE Books Ltd DORSET HOUSE STAMFORD ST LONDON SE1

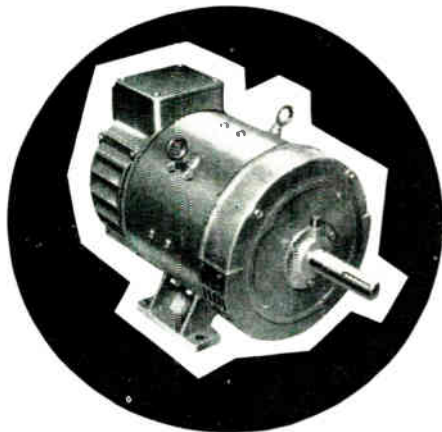

'X' type D.C. motors, $\frac{1}{4}$ - 40 h.p.

You can't say **DEPENDABLE**
without **EPE**

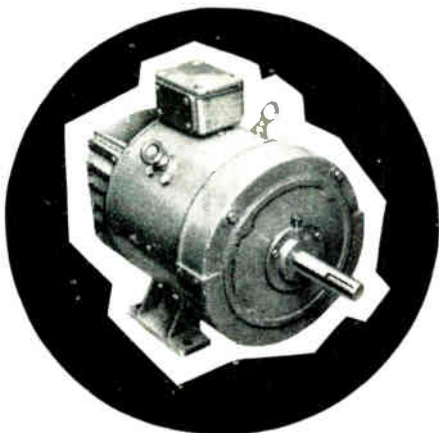

'Y' type D.C. motors, $\frac{1}{4}$ - 40 h.p.

D.C. Motors for electronic speed control



THE ELECTRICAL POWER ENGINEERING CO. (B'HAM) LTD.
EPE WORKS, BROMFORD LANE, BIRMINGHAM 8
Telephone: SEChford 2261
Grams: Torque Phone, Birmingham

KEEP COUNT

with ENM Electrical Impulse counters

Any measurements of quantity, size, time, weight, speed, temperature, fluid-flow, when converted to electrical impulse, can be recorded and printed.



Model 481

Six figures—Add only or add and subtract. Manual, Semi-Automatic and Fully Automatic printing on paper roll, card or card sets.

Up to 3000 counts per minute (add)—2600 (add and subtract). Electrical reset to zero, or non-reset.

Panel Size: 3.75 in. (95.3 mm.) x 8.30 in. (210.8 mm.).

1 2 3 4 5 6
Actual Printing Size

Visit Stand G.35
I.E.A. Exhibition
Olympia
25th to 30th May, 1964

Model 443

Six figures—Add only or add and subtract. Manual or Electrical Reset—or non-reset.

Standard Models—up to 2100 counts per min.

High Speed Models—up to 3000 counts per min.

Panel Mounted only.

Panel Size: 1.8 in. (46.0 mm.) x 2.75 in. (69.0 mm.)



1 2 3 4 5 0
Actual Indicating Size

Write for fully illustrated data sheets and information regarding your particular counting applications.



ENGLISH NUMBERING MACHINES LTD

DEPT. E.10, QUEENSWAY, ENFIELD, MIDDLESEX. TEL: HOWARD 2611 TELEX: 24725

For further information circle 249 on Service Card

The NEW

DIGIVISOR

The E.A.C. Digivisor is the one lamp moving coil digital indicator with an extremely bright readout, adequately visible at very wide viewing angles. The Mark 2 model (illustrated) has a readout $\frac{7}{8}$ " high and projects only $4\frac{1}{2}$ " into your panel. Other models also available. Write for further details.

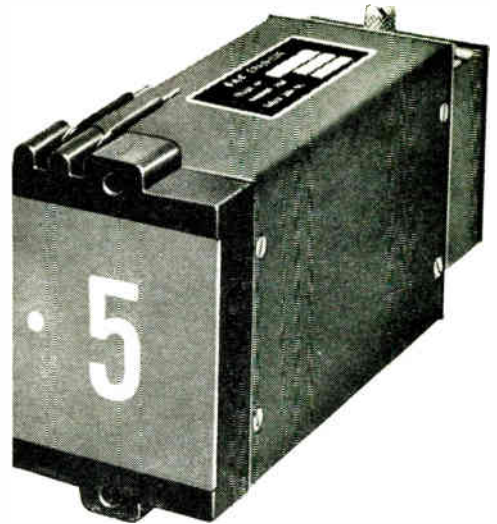

- One lamp only
- Large robust moving coil movement
- Built-in decimal point

EAC

ST. ALBANS

THE ELECTRICAL APPARATUS COMPANY LTD

For further information circle 250 on Service Card

NUMBER ONE IN ELECTRICAL CONNECTORS...

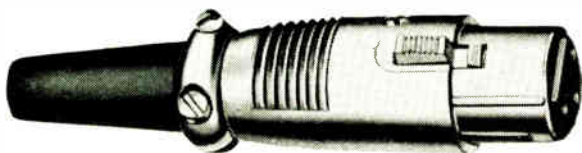

XLR AUDIO PLUGS

The industry standard for low-level sound circuitry requirements. Attractively styled with satin nickel finish.

**CANNON ELECTRIC
(GREAT BRITAIN) LTD.**
168 Old Street
London E.C. 1, England



For further information circle 251 on Service Card

Tension Gauge

Kontaktur

For checking and adjusting springs of all kinds; especially to adjust contact pressures on relay springs for automatic telephone stations, to check pressures and tensions on switches, brushes of motors, and in the production and service of Radios, TV, Record Changers, Tape Recorders, Typewriters, Pianos, Cameras, Projectors, Calculators, Dial Indicators and gauges of all kinds.



	dia. of dial 36 mm	dia. of dial 72 mm
size 000	0.3-3g	size 5 50-500g
.. 00	0.6-6g	.. 6 100-1000g
.. 0	2-15g	.. 7 200-2000g
.. 1	3-30g	.. 8 300-3000g
.. 2	5-50g	.. 9 400-4000g
.. 3	10-100g	.. 10 500-5000g
.. 4	20-250g	



GEORG KARSTENS GMBH
7304 RUIT/Stuttgart - W. Germany
Cables: Gekarstens Stuttgart - Telex 07-23 498

Mfrs. of Measuring Tools and Instruments - Cylindrical Grinders

**FERRANTI
SILICON**

Strain GAUGES

FERRANTI
First into the Future

available **now** 

- For Low Cost Systems
- High Gauge Factor
- Matched Pairs & Quads supplied

Also available:

Gauges with negative response to positive loading.

Transducer elements.

Piezoresistive elements grown on to silicon substrates.

TYPES	ZPG12 † ZPG12E	ZPG14 † ZPG14E	ZPG16 † ZPG16E	
GAUGE FACTOR	110-140	110-140	110-140	Positive
RESISTANCE RANGE	330 ± 1.5%	560 ± 1.5%	750 ± 1.5%	Ohms
RECOMMENDED POWER RATING	0.1	0.1	0.1	Watts
LINEARITY WITH STRAIN	1%	1%	1%	per 1000 μ Strain
MAXIMUM STRAIN	> 3000			μ Strain
OPERATING TEMP. RANGE	- 40 to 65 or 300 ⁺			°C

† unencapsulated gauges

Write now for details:

FERRANTI LTD · Gem Mill · Chadderton · Oldham · Lancs · Tel: MAIn 6661 London Office · Tel: TEMple Bar: 6666 FE245

Industrial Electronics April 1964

For further information circle 253 on Service Card



Groove for easy cutting

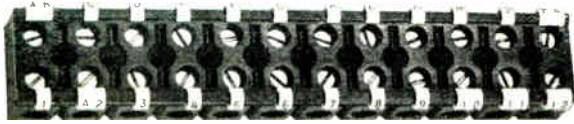

With cable markers



Crimping Protecting Ferrule

JUST WHAT YOU HAVE BEEN LOOKING FOR!

MARKWAY Bakelite Terminal Blocks

Patent applied for

A "METWAY" PRODUCT WITH SPECIAL FEATURES:-

- 12 Way - Grooved for easy Cutting
- Spring-on Cable Markers
- Crimping Ferrule for Cable Protection
- Max. Volts - 500. Working Temp. +115°C-45°C

● For details ask for List No. NBQ/15/1E

METWAY · KEMP TOWN · BRIGHTON

For further information circle 254 on Service Card

Principles of Semiconductors

by M. G. Scroggie, B.Sc., M.I.E.E.

21s net by post 21s 11d. 156 pp inc diagrams and 12 pp plates
obtainable from leading booksellers

A straightforward introduction to the properties and applications of semiconducting materials

The introductory chapters give a general survey of semiconductors and the simple theory of their peculiar properties. The author then discusses the action of typical semiconductors and of the various types of junctions. The final chapters illustrate the applications of semiconducting materials. The style makes for easy reading and all who require a straightforward introduction to this increasingly important subject, will find the book invaluable.

Published for WIRELESS WORLD by ILIFFE Books Ltd
DORSET HOUSE, STAMFORD STREET, LONDON S.E.1

For further information circle 255 on Service Card

OXLEY

PRINTED CIRCUIT SOCKETS

The OXLEY printed circuit sockets are designed for direct mounting on .1" module printed circuit board with standard .05" minimum diameter holes, and accepts our standard plug Type 50P/156.

The mounting is arranged so that the plugs may be inserted in a plane parallel printed circuit board thus permitting close stacking of circuit boards.

Sockets can be supplied from 1 to 12 ways, colours can be in black, brown, red, orange, yellow, green, blue, violet, pink, grey and white.

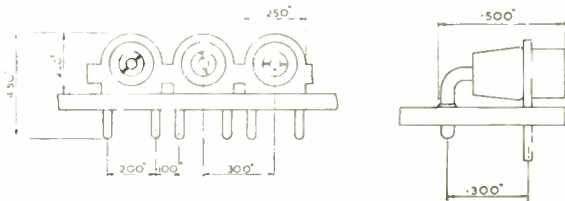
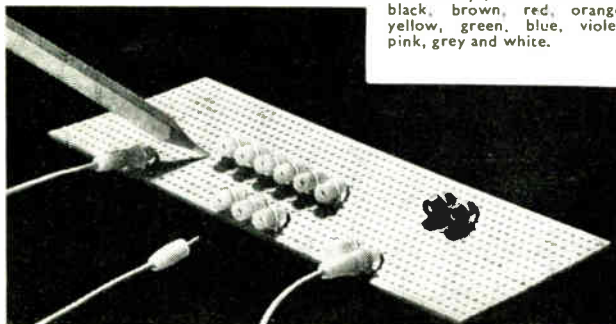

Write for technical details of these or any other Oxley products

OXLEY DEVELOPMENTS CO. LTD.
ULVERSTON, LANCASHIRE Tel: Ulverston 2567

For further information circle 256 on Service Card



Brady Pressure-Sensitive, All-Temperature Wire Markers for small gauge wires are exactly $\frac{3}{4}$ " long to fit wires under $\frac{1}{4}$ " o.d. They cut your small gauge wire marking costs in half because:

1. They cost half the price of Standard Markers, and
2. They go on the wire twice as fast.

You can't drop Brady Wire Markers—they stick to your finger from Card to wire.* Stick and stay stuck—at temperatures to 400°F.! Choose from over 3,000 different stock markers—both Standard and Small Gauge Size. Specials made to order. Write for big new bulletin and free testing samples today!

* Remember, too, Brady makes the only marker that can be machine applied.

W. H. BRADY CO. LTD. (formerly SIMPSON BRADY LTD.)
BREAKSPEAR ROAD, RUISLIP, MIDDX. Tel: RUISLIP 2245

Manufacturers of Quality Pressure-Sensitive Industrial Tape Products, Self-Bonding Nameplates, Automatic Machines for Dispensing Labels, Nameplates, Masks and Tape.

INDUSTRIAL ELECTRONICS

Press date for the May 1964 issue is
first post 23rd April 1964

SITUATIONS VACANT

TELEVISION ENGINEERS, UGANDA

Applications are invited for the following posts.

TELEVISION ENGINEER (TRANSMITTER)

To assume responsibility for a 5 kW vision transmitter and associated 1 kW sound transmitter.

To be in sole charge of the transmitting station at Kampala under the Chief Engineer.

To supervise day to day running of the station and to control a staff of 6.

To maintain all the sound vision equipment and recommend on maintenance of aerials tower, etc.

To prepare reports for the Chief Engineer.

Candidates must have the Higher National City and Guilds full Technological Certificate and extensive practical experience in the operation and maintenance of modern vision and associated sound transmitters, in the use of transmitter test equipment including side band analysers and the ability to test and maintain a modern high power vision transmitter.

Candidates should also have practical experience of T.V. aerials filter plexers and associated equipment.

TELEVISION ENGINEER (VIDEO TAPE RECORDING)

To operate and maintain two portable Video Tape Recorders—one of which is used in the studio and the other in a small vehicle together with one Videcon camera channel and ancillary equipment.

The officer appointed must be prepared to travel and work long and awkward hours.

Candidates must be Grad. Brit. I.R.E. or equivalent City and Guilds and have experience of Video Tape recorder operation and maintenance.

Both appointments will be for one/two tours of from 21-27 months with salaries in the scale £1,725-£1,956 p.a. plus GRATUITIES of 25% of total emoluments. Free family passages. Free Medical attention and furnished quarters provided at moderate rentals. Generous leave and education allowances.

Apply to: Director of Recruitment, DEPARTMENT OF TECHNICAL CO-OPERATION, Eland House, Stag Place, Victoria, S.W.1. giving full details of qualifications and experience and quoting RC.237/183.02.

[2052]

SERVICES OFFERED

Precision Sheet Metal Work for the Radio & Electrical Trade. Chassis, Panels, Brackets, etc. Power Press Capacity up to 100 tons. Press brake capacity up to 105 tons 8ft. x 7/32in. All spray and stove finishes. A.I.D. approved. — The Kaymet Company, Kaymet Works, Sylvan Grove, London, S.E.15. Telephone: NEW Cross 6644.

[2036]

MISCELLANEOUS

PHOTO-ELECTRIC CONTROLS

for industry

Send for catalogues

HIRD-BROWN LIMITED

FLASH STREET, BOLTON

Telephone 27311

[2027]

SCRAP METAL

Non-ferrous Scrap Metals. all grades, Swarf, Off-cuts, etc., purchased at highest rates.

H. Barnett Ltd.,

Victor Road, London, N.7.

Est. 1865

ARChway 5461

[2041]

CLASSIFIED ADVERTISEMENTS

Advertisement Rates. 6d. per word, minimum charge 6/-, each paragraph charged separately. Remittances payable to "Industrial Electronics", Dorset House, Stamford St., S.E.1. Series discount of 15% is allowed for 12 consecutive insertions.

Box Numbers are available at an additional charge of 2/- to defray cost of registration and postage. Replies should be addressed Box No. 0000, c/o "Industrial Electronics", Dorset House, Stamford Street, London, S.E.1.

Semi-Display advertisements with centralized lines £1/15/- per single column inch, Display advertisements £2/10/- per single column inch—no additional charge for Box Numbers. The Publishers are not responsible for clerical or printers' errors although every care is taken to avoid mistakes.

CAPACITY AVAILABLE

FOR PRINTED CIRCUIT MANUFACTURE

ANY TYPE OF BOARD CONSIDERED: SMALL OR LARGE VOLUME ORDERS WITH RAPID SERVICE AT COMPETITIVE PRICES. HIGH QUALITY WORKMANSHIP GUARANTEED

Proto-type service by return of post.

TRANSMETRIX ELECTRONIC SYSTEMS

Printed Circuit Division
SHANKLIN, I.O.W., HANTS.

[2050]

AIRTRONICS LTD.

for coil winding assembly and wiring of electronic equipment, transistorised sub-units.

4 Ashmead Road, London, S.E.8

Telephone: Tideway 2249

[2043]

Ring Newbury 347 for a quick and efficient service in manufacture Wiring and Assembly of printed circuits at attractive prices. Or write to Newbury Electronics Ltd., West Mills, Newbury, Berks, where this capacity is available immediately.

[2049]

BOOKS, ETC.

"LAPLACE Transformers for Electrical Engineers."

By B. J. Starkey, Dipl. Ing., A.M.I.E.E. A presentation of the theory of the Laplace transformation in which a physical vocabulary rather than a purely mathematical one is used as far as possible in an attempt to attain the utmost simplicity. This method of analysis has become of increasing importance to electrical engineers in many fields during recent years. 30s net from all booksellers. By post 31s 2d from the publishers: Iliffe Books Ltd., Dorset House, Stamford Street, London, S.E.1.

"RADIO Interference Suppression: As Applied to Radio and Television Reception."

By G. L. Stephens, A.M.I.E.E. 2nd Ed. An up-to-date guide to the various methods of suppressing electrical interference with radio and television reception. Many practical applications are given, particular attention being paid to the problem of interference at television frequencies. Other chapters deal with the design and choice of suppressor components, methods of locating the source of interference, and suppression at the receiver itself. 10s 6d net from all booksellers. By post 11s 2d from Iliffe Books Ltd., Dorset House, Stamford Street, London, S.E.1.

"WIRELESS Servicing Manual."

By W. T. Cocking, M.I.E.E. This is the tenth edition of a book which since 1936 has been known to radio servicemen everywhere as a reliable, thorough and comprehensive guide to solving most of the problems that arise in the repair, maintenance and adjustment of the modern radio receiver. In the present edition a major addition is a chapter devoted to transistors and transistor sets. The author of WIRELESS SERVICING MANUAL is well known to a wide circle of readers as former editor of *Electronic Technology* and now of *Industrial Electronics*. His crisp lucid style makes this hand-book of utmost value to the service man and amateur alike. 25s net. By post 26s from Iliffe Books Ltd., Dorset House, Stamford Street, London, S.E.1.

"RADIO Circuits: A step-by-step Survey."

By W. E. Miller, M.A. (Cantab.), M.Brit.I.R.E. Revised by E. A. W. Spreadbury, M.Brit.I.R.E., associate editor of *WIRELESS & ELECTRICAL TRADING*. This established introduction to superheterodyne receiver circuits has been greatly enlarged and brought completely up to date with the inclusion of transistor and f.m. receivers; there are new chapters covering battery receivers and car radio sets, while the modern a.m./f.m. receiver is fully described. Mathematics and obscure theoretical considerations are entirely omitted, and over 80 easy-to-follow circuit diagrams are explained in a simple but practical manner, splitting up the circuit into sections and working from the aerial terminal through to the loudspeakers. 15s net from all booksellers. By post 15s 10d from Iliffe Books Ltd., Dorset House, Stamford Street, London, S.E.1.

"ULTRASONIC Delay Lines."

By C. F. Brockelsby, B.Sc., A.R.C.S., A.M.I.E.E., J. S. Palfreeman and B. W. Gibson, B.Sc.(Eng.), Grad.I.Mech.E. The authors are members of a team which has been working on ultrasonic delay lines, since the early days, at the Mullard Research Laboratories. This is the first book to be written specifically on the subject, which has important applications in radar, radio and television, electronic computers, pulse-forming networks, correlation techniques, and multi-channel communication systems. The early chapters discuss basic principles and the various types of delay lines are then covered. The chapter on electronics for delay lines deals fully with the design of broad-band amplifiers, oscillators, etc., either with transistors or valves. The last two chapters are devoted to delay line measurements and the many applications of delay lines. Among the five appendices there is one containing nearly 60 curves which give the characteristics of many delay line materials. The final appendix discusses one of the latest developments, ceramic transducers. 65s net. By post 66s 3d from Iliffe Books Ltd., Dorset House, Stamford Street, London, S.E.1.

"TRANSISTOR Inverters and Converters."

By Thomas Roddam. The rapid development in recent years of portable transistor equipment such as radio receivers, tape recorders, record players, and scientific instruments including those incorporated in rockets and satellites, has brought in its train the need for a light and efficient means of providing both a.c. and d.c. voltages from low voltage d.c. sources. The transistor inverter and converter between them satisfy these requirements, the inverter which changes d.c. to a.c. being used either alone or as the heart of a converter which can supply as many d.c. voltages as may be needed.

This is the first definitive book to be published on the subject and the author has produced a single theory to cover all the various types of transistor inverter circuits available. Earlier chapters deal with the large signal operation of transistors, and linear and saturable inductors. He then develops a unified circuit theory for transistor inverters from a consideration of the negative circuit impedance of oscillators which is followed by consideration in detail of various types of inverters such as push-pull, square wave, transistor bridge, sine-wave and driven. Containing many well tried designs as well as original designs by the author, this book will be invaluable to the electronic engineer with no previous experience of inverters and to the established designer who wishes to widen his knowledge of the subject. 42s net. By post 43s from Iliffe Books Ltd., Dorset House, Stamford Street, London, S.E.1.

"RADIO Designer's Handbook" (4th Edition.)

Editor: F. Langford-Smith, B.Sc., B.E., Senior Member I.R.E.(U.S.A.), A.M.I.E.(Aust.). A comprehensive reference book, the work of ten authors and twenty-three collaborating engineers, containing a vast amount of data in a readily accessible form. The book is intended especially for those interested in the design and application of radio receivers or audio amplifiers. 65s net from all booksellers. By post 67s 9d from Iliffe Books Ltd., Dorset House, Stamford Street, London, S.E.1.

"SECOND Thoughts on Radio Theory."

By Cathode Ray of WIRELESS WORLD. Forty-four articles reprinted from popular WIRELESS WORLD series, in which the author examines various aspects of elementary radio science, explains them clearly, and shows that there may be more behind them than is apparent from the usual text-book. This volume deals with basic ideas; circuit elements and techniques; circuit calculations; and some matters in lighter mood. An entertaining and helpful text-book for the student, refresher course for the engineer, and reference book for all, combined. 35s net from all booksellers. By post 36s 4d from Iliffe Books Ltd., Dorset House, Stamford Street, London, S.E.1.

"ABACS or Nomograms."

By A. Giet. Translated from the French by H. D. Phippen and J. W. Head. Most engineers have made use of nomograms at some time in their careers, and are fully alive to the fact that they are a very convenient tool when the same formula has to be solved repeatedly for several sets of variables. It is fair to say, however, that only a small proportion of even those who habitually employ nomograms know how to construct them for their own use. Most of the comparatively small literature on the subject is written for mathematicians and is extremely difficult for the practical engineer to comprehend. This book is essentially practical, and not only demonstrates the many and varied applications of the abac or nomogram, but shows how even those without highly specialised mathematical knowledge may construct their own charts. 35s net from all booksellers. By post 36s from Iliffe Books Ltd., Dorset House, Stamford Street, London, S.E.1.

'Diamond H' Series BW Relays

PROVED PERFORMANCE
RELIABILITY
LONG-LIFE



ARRANGEMENTS
MOUNTING
VERSATILE



Panel Mounting
with Solder Tag



Side Mounting



Socket Mounting

25 amp. 250 volt A.C. double pole
 double throw. Compact only.
 1½" × 1½" × 1⅞" without socket. Silent.
 Plug in, solder tag or fast on terminations.
 Coils available for 4-250 V., A.C.
 50-60 cycles and 4-250 V., D.C.

AVAILABLE FOR IMMEDIATE DELIVERY

SERIES BW RELAYS ARE MANUFACTURED BY

DIAMOND H CONTROLS LIMITED

GUNNERSBURY AVENUE, CHISWICK, W.A. PHONE: CHISWICK 6444

Index to Advertisers

Adcola Products Ltd.	11	English Numbering Machines Ltd.	37	Peto Scott Electrical Instruments Ltd.	28
Anglo-American Vulcanized Fibre Co. Ltd.	32	Ericsson Telephones Ltd.	2	Phillips Control (G.B.) Ltd.	36
Appointments Vacant	41	Erie Resistor Ltd.	Cover iv	Phoenix Telephones Ltd.	26
Arrow Electric Switches Ltd.	21	Ferranti Ltd.	39	Plannair Ltd.	6
Aveley Electric Ltd.	31	Hughes International (U.K.) Ltd.	17	Radiospares Ltd.	19
Brady, W. H. Co. Ltd.	40	Iliffe Books Ltd.	36, 42	Rotax Ltd.	33
Cannon Electric (G.B.) Ltd.	38	Industrial Exhibitions Ltd.	33	Scott James (Electronic Eng.) Ltd.	34
Counting Instruments Ltd.	22	International Rectifier (Gt. Britain) Ltd.	8	Sigma Instruments Inc.	7
Datum Metal Products Ltd.	12	Karstens Georg GMBH	38	Silentbloc Ltd.	16
Dawe Instruments Ltd.	9	Metway Electrical Industries Ltd.	40	SPS International Ltd.	10
Diamond H. Controls Ltd.	42	M.O. Valve Ltd.	25	Standard Telephones & Cables Ltd.	13, 14, 15, 27
Electrical Apparatus Co. Ltd.	38	Mullard Ltd.	Cover ii	Telegraph Condenser Co. Ltd.	Cover iii
Electrical Power Eng. Co. (B'ham) Ltd.	37	Mullard Combined Ltd.	4, 5	V.G. Porcelain Co. Ltd.	36
Electrosil Ltd.	18	Murex Ltd.	3	Venner Electronics Ltd.	29
Electrothermal Eng. Ltd.	35	Oxley Developments Co. Ltd.	40	Walmore Electronics Ltd.	35
EMI Electronics Ltd.	23, 24			Wandleside Cable Works Ltd.	30
English Electric Valve Ltd.	20			Welwyn Electric Ltd.	1



SCORES AGAIN!

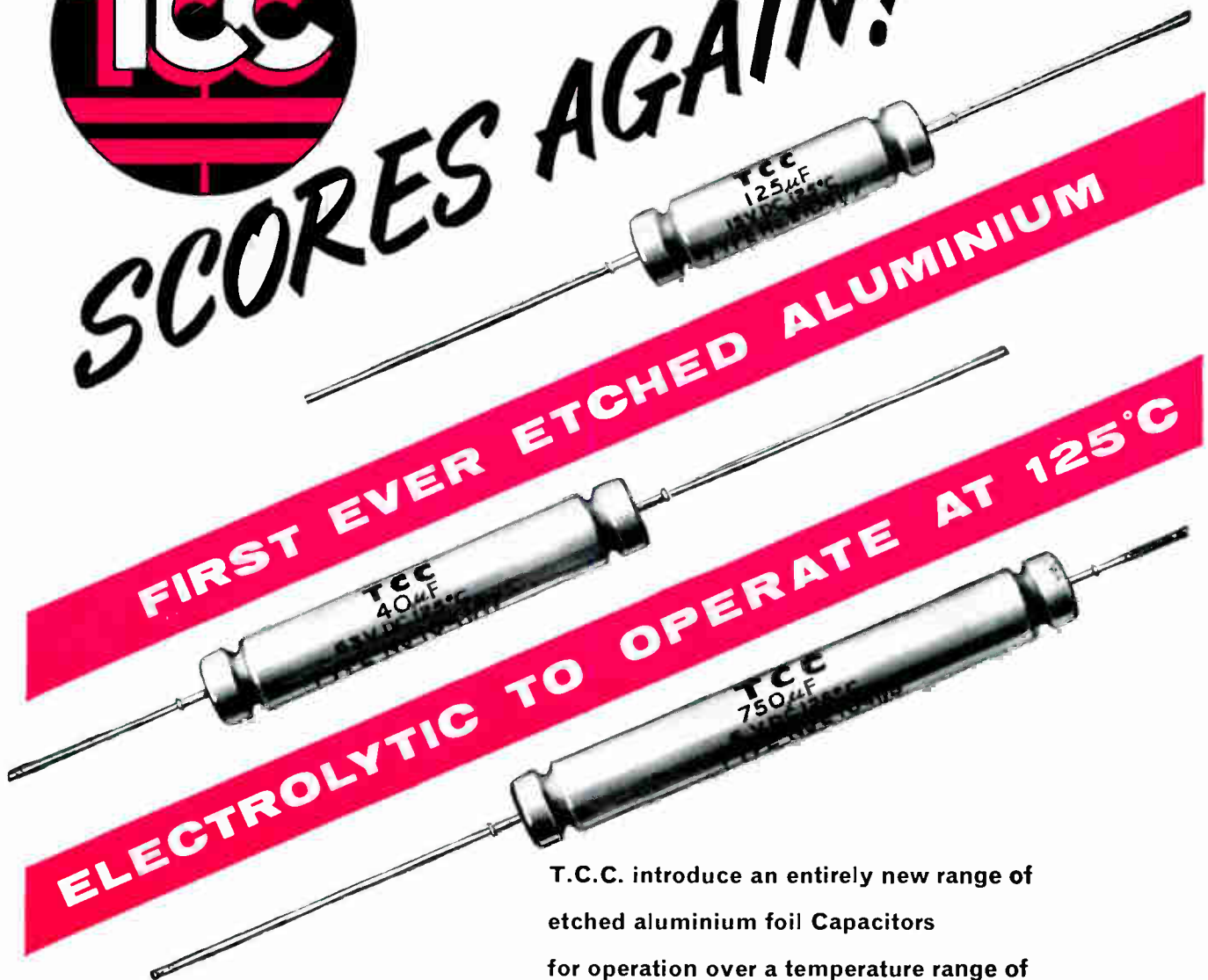

T.C.C. introduce an entirely new range of etched aluminium foil Capacitors for operation over a temperature range of -55° to 125°C , and for working between 6 to 150V. D.C.

In performance, these new Capacitors approach the tantalum foil type, and will meet similar specifications. Their electrical characteristics remained stable during life tests of over 2,000 hours at 125°C . They provide a low cost alternative to tantalum Capacitors for many applications.

For full details of this latest T.C.C. achievement please write for a copy of Technical Bulletin No. 100

THE TELEGRAPH CONDENSER CO. LTD.

North Acton, London W.3

Telephone: ACOrn 0061 (16 lines)

Telegrams: Telefarad, Westphone, London • Telex 261383

(also at) CHESSINGTON • SURREY • BATHGATE • SCOTLAND

For further information circle 202 on Service Card

REAL PLUS MINIATURIZATION... LOW LOSS FOR UHF

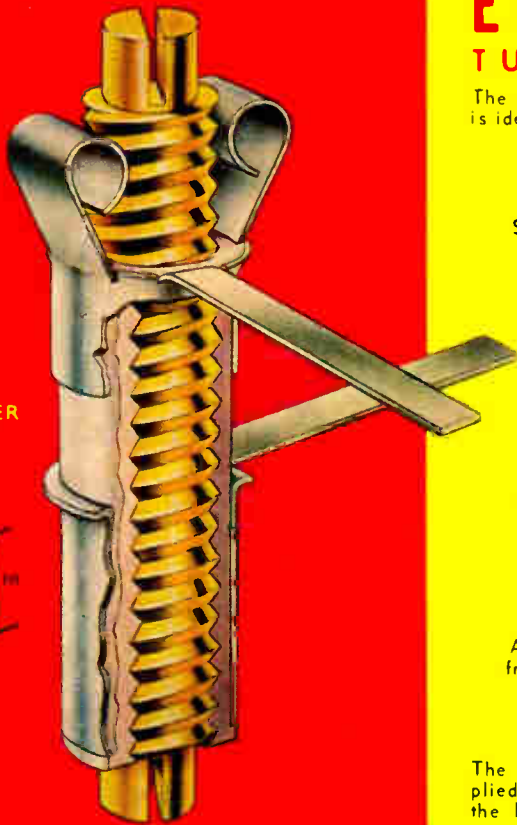

STYLE 535
TUBULAR TRIMMER
(PATENTED)
ILLUSTRATED
ACTUAL SIZE



ERIE STYLE 535 TUBULAR TRIMMER

The chassis punch-out required for the Style 535 is identical to that required for the tubular ceramic trimmers that are in general usage.

FIT THIS SIMPLE WAY

1
Push in hole

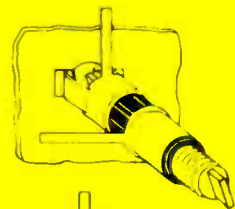

2
Lock in hole by
turning adjusting
screw through
top terminal

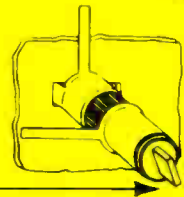

3
Adjust capacitance
from top of final test
station

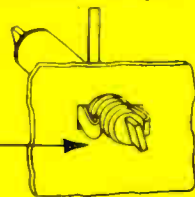

The capacitance adjusting plunger can be supplied with either the screwdriver slot shown in the large illustration, or with a milled flat end illustrated above.

The simplicity of design of the Style 535 trimmer results in very low inductance and uniform, linear, noiseless adjustment: the ribbon-type leads help to minimise inductance in UHF circuits. When mounted, the high-temperature polystyrene body extends only 0.531in from the underside of the chassis and is only 0.218in in diameter. The Style 535

Tubular Trimmer combines the desirable features of small size, easy mounting, stable performance and economical price. Capacitance range is from 0.7 to 3pF and working voltage is 500 d.c.

Variations in terminal orientation and hardware can be provided on request, according to demand.

Write for 535 literature



*Registered Trade Mark

ELECTRONIC COMPONENTS

We will welcome a visit from you to Stand G.350
I.E.A. Exhibition, May 25 to 30

ERIE RESISTOR LIMITED GREAT YARMOUTH NORFOLK Telephone 4911 Telex 1720