

INDUSTRIAL ELECTRONICS

SEPTEMBER 1964 5s 0d

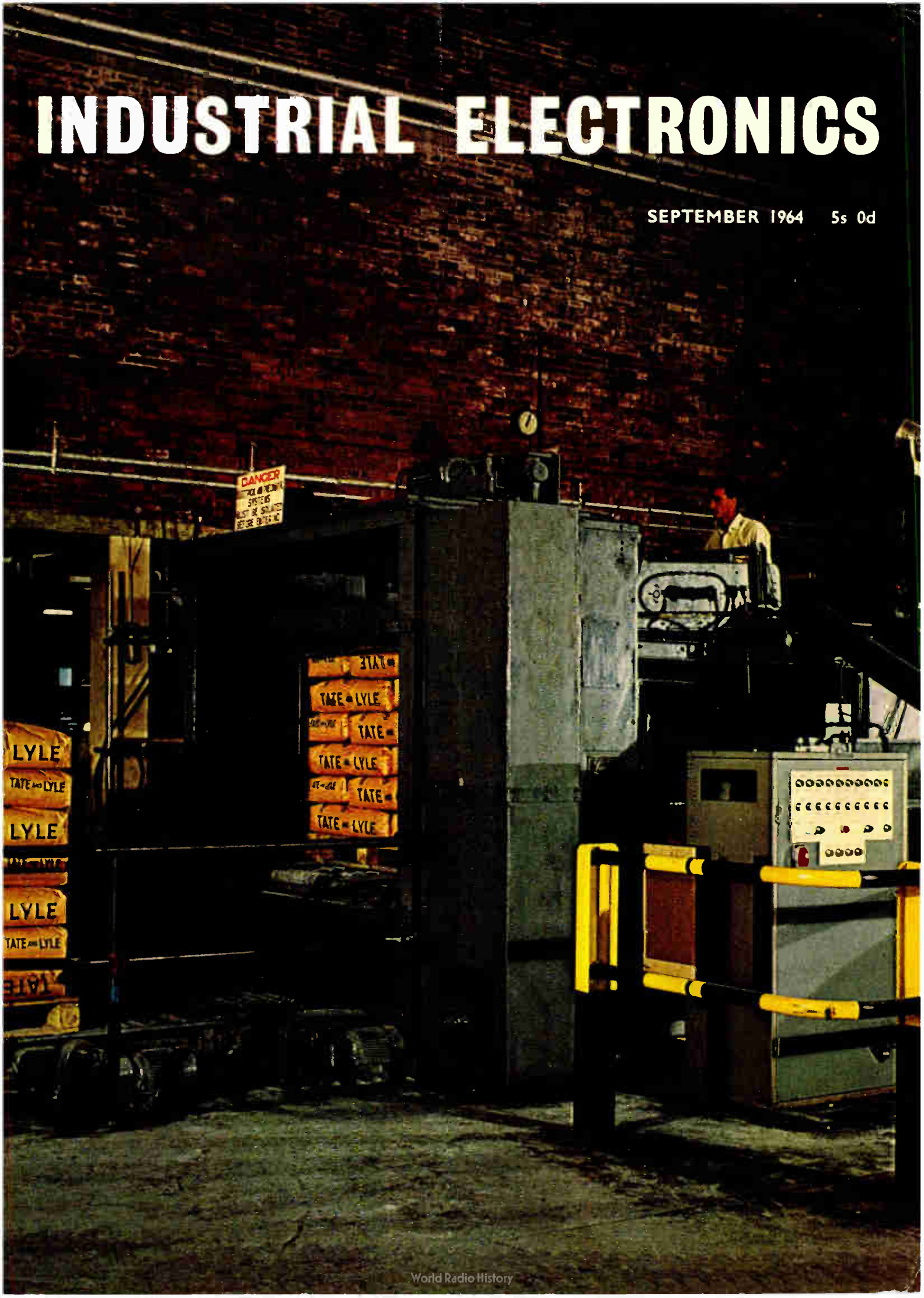

For further information circle 200
on Service Card

55swg!



← This is the size of the needle shown in the macro-photograph on the left. It has been threaded with copper wire and fine nylon. We cannot illustrate the wire actual size; no printing process is sensitive enough to show a line .0005" thick.

At BICC we draw wires as fine as this for a wide range of micro-miniature applications.

If you have any fine wire problems, discuss them with our engineers at BICC Wire Mill Division, Prescott, Lancashire.

They know the answers.

BICC

FOR THE FINEST COPPER WIRE

BRITISH INSULATED CALLENDER'S CABLES
LIMITED
21, BLOOMSBURY STREET, LONDON W.C.1

REPRODUCTION OF THIS PUBLICATION IN WHOLE OR IN PART IS PROHIBITED WITHOUT THE WRITTEN PERMISSION OF THE PUBLISHERS. THE PUBLISHERS ACCEPT NO RESPONSIBILITY FOR THE CONTENTS OF ADVERTISEMENTS OR FOR THE RETURN OF UNCLAIMED MATERIALS. THE PUBLISHERS ACCEPT NO RESPONSIBILITY FOR THE RETURN OF UNCLAIMED MATERIALS. THE PUBLISHERS ACCEPT NO RESPONSIBILITY FOR THE RETURN OF UNCLAIMED MATERIALS.

INDUSTRIAL ELECTRONICS

incorporating *ELECTRONIC TECHNOLOGY*

REPRODUCTION OF THIS PUBLICATION IN WHOLE OR IN PART IS PROHIBITED WITHOUT THE WRITTEN PERMISSION OF THE PUBLISHERS. THE PUBLISHERS ACCEPT NO RESPONSIBILITY FOR THE CONTENTS OF ADVERTISEMENTS OR FOR THE RETURN OF UNCLAIMED MATERIALS. THE PUBLISHERS ACCEPT NO RESPONSIBILITY FOR THE RETURN OF UNCLAIMED MATERIALS.

Volume 2 Number 9 September 1964

contents

Editor **W. T. COCKING, M.I.E.E.** 405
Assistant Editor **T. J. BURTON**

Advertisement Manager **G. H. GALLOWAY** 407

Comment

Accurate Pressure Transducers for Extreme Environments
by P. J. Colburn, B.Sc.(Eng.)
The various forms of pressure transducer are reviewed and a new moving-iron type described. This offers a large reduction of size and weight.

Developments in Electronic Reading Machines 2
by John B. Rudkin
In this second article on electronic reading machines, the operating principles of two practical machines are described. The concluding article will deal with applications and economics.

A New Suspended Solids Recorder *by G. B. Thorpe, B.Sc.*
This article describes an instrument for measuring the quantity of suspended solids in fluids. It is intended for measurements on, for example, trade effluents so that they may meet legal requirements.

Static-Switching Control System for a Pallet Loading Machine
by G. Cooper and F. Shaw
The advantages and disadvantages of static switching as compared with relay systems are discussed in some detail. The article concludes with a description of a static-switching system which is used to control a pallet loading machine.

Application of Silicon Planar P-N-P-N Switches *by S. Lukens*
Some circuits using p-n-p-n switches are described and their modes of operation are explained. Some performance figures are given also.

continued overleaf

Published on the first Thursday after the 5th of each month by
ILIFFE ELECTRICAL PUBLICATIONS LTD.
Managing Director: W. E. Miller, M.A., M.I.E.E.E.
Dorset House, Stamford Street, London, S.E.1.
Telephone: Waterloo 3333.
Telegrams: Wiringer, London, Telex
Cables: Wiringer, London, S.E.1.

ANNUAL SUBSCRIPTION, HOME £3 0s. 0d.
OVERSEAS £3 10s. 0d.
CANADA and U.S.A. \$10.00.

For further information circle
281 on Service Card

Following
22 years experience in the
manufacture of **FILM RESISTORS**
WELWYN ELECTRIC LIMITED
now introduce
INTEGRATED FLAT FILM NETWORKS
for incorporation in
MICRO-ELECTRONICS ASSEMBLIES

*Actual size illustrations of typical
networks and assemblies*

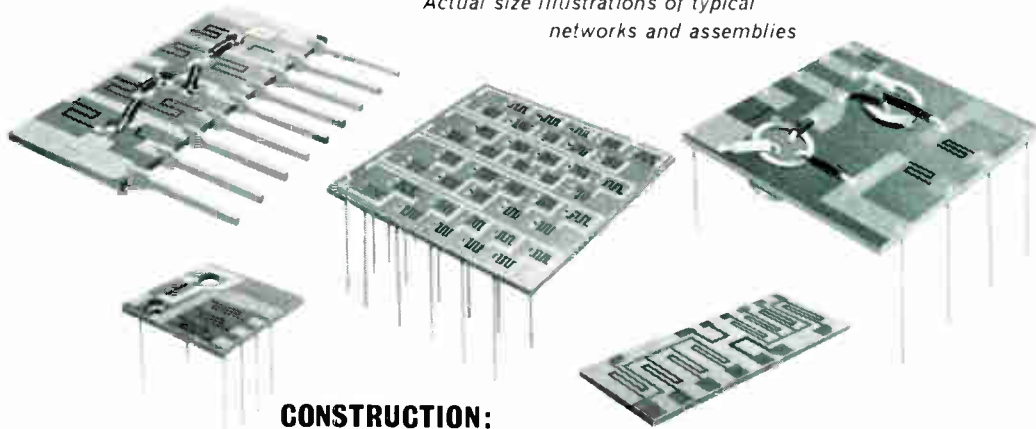

CONSTRUCTION:

SUBSTRATE: High alumina content ceramic.

RESISTOR FILM: Nickel Alloy.

CAPACITOR FILM: Plates; Aluminium.
Dielectric; Silicon Dioxide.

INTER-CONNECTIONS: Copper.

RESISTORS:

VALUE RANGE: Combinations of single resistors from
 10Ω to $100K\Omega$ on one substrate.

TOLERANCE: 5% Total Excursion
or $\pm 5\%$ and $\pm 10\%$ Selection.

TEMPERATURE COEFFICIENT: Less than ± 50 p.p.m./ $^{\circ}C$.
On any one substrate the T.C. of all resistors
will be matched to within ± 15 p.p.m./ $^{\circ}C$.

LOAD PERFORMANCE: During 1st 1000 hrs. change is less than
 $\pm 0.1\%$. Subsequent change is less than
 $0.04\%/1000$ hrs.

CAPACITORS:

VALUE RANGE: Up to 30,000 pF.

WORKING VOLTAGE: 20 to 100 volts according to
capacitance/unit area.

**TEMPERATURE
COEFFICIENT:** 0 to ± 100 p.p.m./ $^{\circ}C$.

WRITE NOW FOR FULL DETAILS



WELWYN ELECTRIC LIMITED

BEDLINGTON - NORTHUMBERLAND - ENGLAND

Telephone: Bedlington 2181-9 - Telegrams: Resistor' Bedlington.

FACTORIES IN AUSTRALIA AND CANADA

For further information circle 204 on Service Card

2 NEW LOW PRICE ADDITIONS

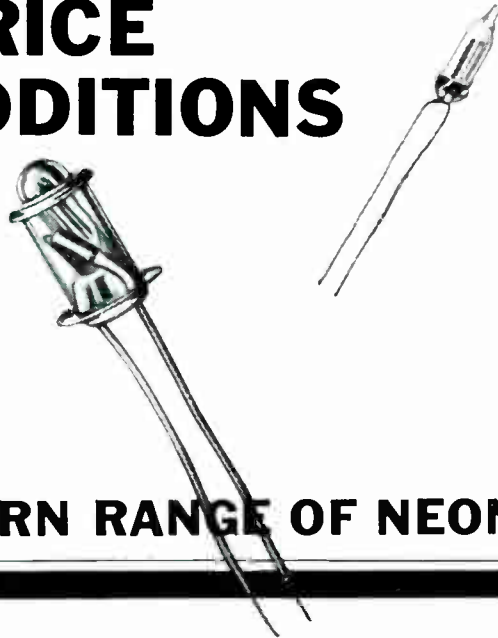

...TO THE THORN RANGE OF NEON SIGNAL LAMPS



TYPE HBN – the larger of the two illustrated above is the lowest-priced lampholder ever to be featured in the Thorn range. Suitable for use within the 210-250V range, a welded-on 100k resistor is contained within the lamp-holder. Readily available in red polycarbonate, amber and clear, or 105-125V types can be supplied to special order.

TYPE AMN – new miniature lamps from Atlas, supplied without lampholders, for wiring in permanent position.

Designed to be interchangeable with contemporary British or American types and suitable for use within the 100-120V and 200-250V ranges, reliability, prolonged life – 5,000 hours minimum – and negligible current consumption are their main features.

TYPE SGF – (illustrated left) proved by worldwide use in a multitude of applications, these types remain supreme.

Available in a variety of colours and in the following striking voltage ranges: 70-130V., 185-280V., 300-400V., they are all integral units and easily installed.

THORN

Thorn Electrical Industries, Ltd.,
Special Products Division,
105-109 Judd St., London,
W.C.1. EUSTon 4433

DIV 2

£260

K-126-A DECADE OSCILLATOR

RANGE
1c/s-222.2kc/s

ACCURACY
±0.1c/s up to 50c/s
±0.2% up to 10kc/s
±0.4% at 222.2kc/s

STABILITY
±0.02% per hr.

DISTORTION
0.1% 40c/s-10kc/s
0.2% at 20c/s
<1% 1c/s-220kc/s

TEMPERATURE COEFFICIENT
1c/s-30c/s ±0.0015c/s/°C
30c/s-220kc/s ±0.005%/°C

MUIRHEAD

PRECISION
ELECTRICAL INSTRUMENTS

Muirhead & Co. Limited, Beckenham, Kent
England.

Telephone: Beckenham 4888.

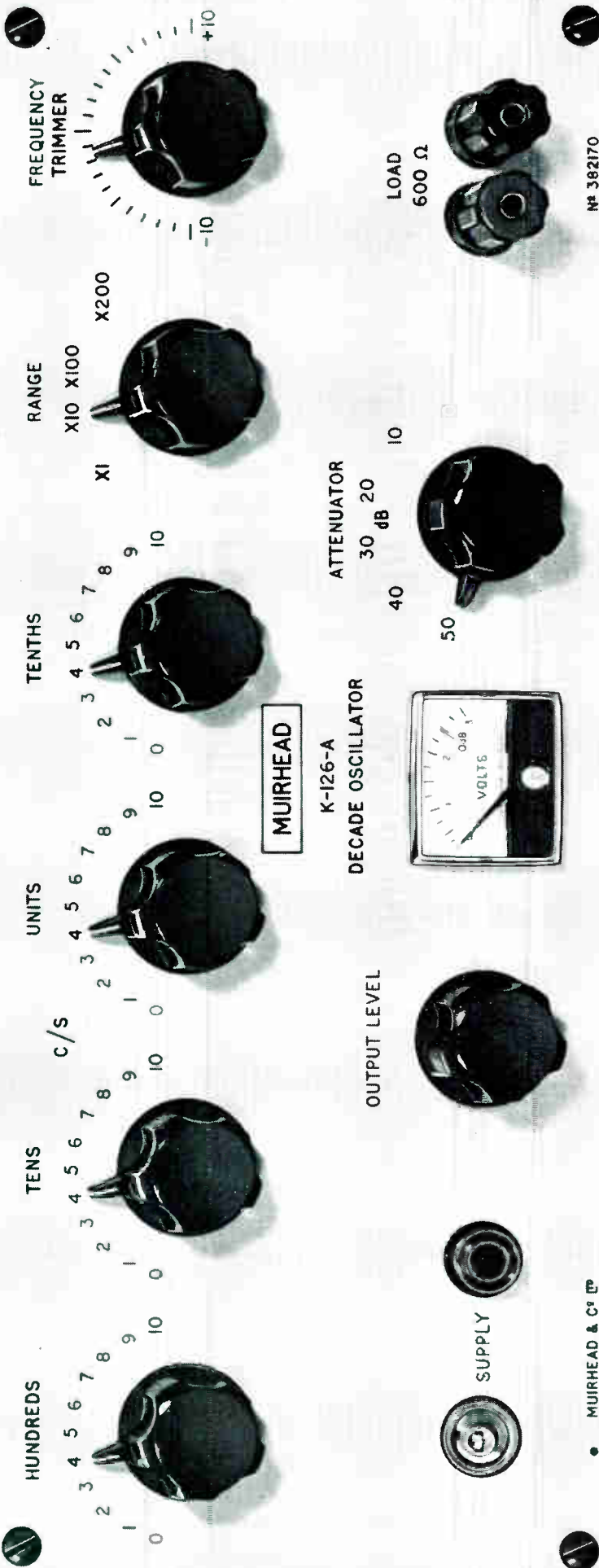

750 million component test hours target to confirm thin-film reliability

Mullard issue interim report on components life

A test programme to establish thin-film reliability has been started by Mullard in conjunction with the Ministry of Aviation. There are two aspects to this programme: life testing thin-film components, and testing complete systems. This system test programme will, when completed, have achieved a total of 750 million component test hours.

One of the advantages of the thin-film approach to micro-miniaturisation over the use of the subminiature form of conventional components is the increased reliability. The main reason for this increased reliability is the considerable reduction in the number of joints in the thin-film form of a circuit in comparison with that in the conventional subminiature form. Not only are joints between components on a particular substrate eliminated because of the deposition technique used, but joints in the components themselves (between end caps and the resistive or capacitive element, for example) are also eliminated.

Although there is qualitative information on reliability available, there is, as yet, little information that is of direct use to the design engineer. It is to provide such information that work at Mullard has started on this life test programme of thin-film components, circuits, and complete systems.

Component reliability

An important step towards the assessment of the reliability of thin-film components was made nearly two years ago when the methods of manufacture were standardised on a production-line rather than a development-laboratory basis. From this time, it has been possible to collect information that can eventually be expressed in such terms as failure rates per thousand hours with acceptable confidence limits.

Thin-film resistors and capacitors are being tested under conditions that are likely to be encountered in practice. For resistors, this means testing at a normal dissipation level (1/6 watt per square centimetre of resistance film area) in an ambient temperature of 25°C. Capacitors are being tested with an applied potential of 25V, also at 25°C.

Although it is too early to enable definite conclusions to be drawn from these tests, the trend appears to be particularly satisfactory. An interim report on these life tests is being published and copies are available.

Complete systems test

A test programme to assess the reliability of a complete system under normal operating conditions is also under way. This programme involves the testing of several of the digital integrators developed by Mullard for R.A.E., Farnborough. Since each



Part of the equipment for the testing of the digital integrators. The integrator is being placed in a vibrator prior to testing

integrator contains approximately 3500 components and the tests are expected to last for some years, it is estimated that a total of 750 million component test hours will be achieved. The results obtained from these tests will not only enable component reliability to be assessed, but will also yield information on circuit design, and the operation and reliability of a complete system. In this way, the influence of circuit design on component performance can be assessed.

For a copy of the interim report on component reliability, please use the reader reply card of this journal (see reference number opposite).

What's new from Mullard

Silicon devices with germanium saturation voltage

Three planar transistors meet general application requirements

With the introduction of three new planar transistors, designers will have to remember only three type numbers—BFY50, BFY51, BFY52—when selecting transistors for a wide range of professional equipment. These devices are truly general purpose, and can be used in many different circuit configurations in a wide range of amplifying, oscillating, and switching applications.

A significant feature of the devices is the exceptionally low saturation voltage. The values of 200mV for the BFY50 and 350mV for the BFY51 and BFY52, measured at a collector current of 150mA, are typical of germanium rather than silicon devices. The current gain is maintained over four decades of current, and the value of f_T , greater than 50Mc/s, enables most general-purpose applications to be readily met.

The introduction of these general-purpose devices will simplify considerably the designer's task of selecting transistors for his application.

HIGH-VACUUM DIFFUSION PUMPS JOIN RANGE

Three fractionating oil diffusion pumps are now available for high-vacuum applications. Although these pumps have only recently been marketed, they have been used for many years in various Mullard factories, and the experience gained has enabled many 'practical' features to be built into the design.

The pumps are constructed from stainless steel so that they are non-magnetic. A three-stage jet system is used which, combined with an integral helical cooling system, enables both a low final pressure to be obtained and the pump to operate efficiently against a high backing pressure. The helical-cooling system, already familiar to users of industrial power valves, has considerable advantages over the conventional water jacket. For the same degree of cooling, the required water flow is considerably less so that a smaller and therefore cheaper circulating pump is required. The top flange of the pump can be rotated to allow easy positioning with other equipment.

The pumping speeds of the devices are 55, 300, and 3 500 litres per second.

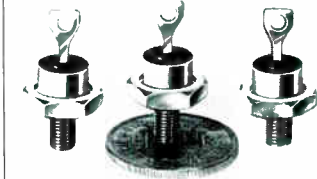
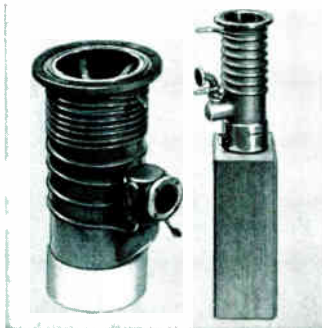

Zener diodes for shunt stabiliser circuits

75W rating with excellent surge protection

The BZY91 series of zener diodes has been introduced for use in shunt stabiliser circuits, and is particularly useful in applications where equipment has to be protected from surges. The diodes in this series will dissipate 75W at a stud temperature of 65°C and the surge ratings are 4.4kW for 100µs and 170W for 100ms.

The range of zener voltages is from 10 to 75V with nominal zener voltage tolerance of ±5%. The diodes use stud mounting and are in the DO-5 encapsulation. Reverse polarity versions are also available.

Thyristors for computer print-out equipment and telegraph relays

Two thyristors have been specially introduced for high-speed applications. The BTX18 is designed for use in fast line-at-a-time print-out devices for computers, while the BTX19 is designed for electronic telegraph relays.

Fast print-out thyristor

A device with a very high gain and fast operating time is required between the logic circuits of a computer and the print-out equipment. The BTX18 can provide sufficient current to operate the print-hammer solenoid directly from the gating pulse produced by a transistor or defluxing core. The maximum value of gate current required to fire the thyristor is 15mA with a pulse length of 6µs.

The BTX18 is in TO-5 encapsulation for ease and economy of mounting. Because of the short duty cycle encountered in this application (about 5%), the device will handle peak currents of 3.5A without exceeding the dissipation limit. The rapid rise in current necessary to operate the print-hammer solenoid quickly requires a high driving voltage, and the BTX18 has a 150V rating to enable it to be used with wide voltage margins.

Although specifically designed for print-out applications, the BTX18 can also be used for other applications, such as d.c. inverters and for firing other thyristors, where a high current is required for a short time.

Telegraph relay thyristor

The BTX19 has been specially designed for operation in a telegraph relay where it is required to switch +80 and -80V alternately to line at high speed. This switching can be done efficiently by an electronic polarised relay using thyristors with considerable advantages over the existing mechanical types. In particular, an electronic relay requires considerably less maintenance and adjustment than the mechanical type.



New twelve-stage photomultiplier for Cerenkov counters

The XP1020 twelve-stage photomultiplier is intended primarily for use in Cerenkov counters. The advanced electron-optical system used minimises the spread in electron transit times and allows the tube to deliver 2ns pulses up to a maximum current of 1A.

The tube has a plano-concave window for easy coupling to the scintillator. The caesium-antimony photocathode is highly uniform, with a typical sensitivity of 60µA/lm and a spectral response mainly in the visible region, peaking at 0.42µm.

Although only twelve stages are used the gain is 10⁸, because of the higher dynode voltages used, and the average overall sensitivity is 5000A/lm.

Transit-time difference between electrons emitted at the edge and the centre of the photocathode is 0.4ns when the maximum aperture of 42mm is used. This figure can be halved if the aperture is reduced to 30mm.

FURTHER DETAILS of the Mullard products described in this advertisement can be obtained from the address below or through the Reader Enquiry Service of Industrial Electronics using the appropriate code number shown below.

| | |
|---------------------------------|-----|
| Thin-film reliability | 206 |
| Silicon devices | 207 |
| Diffusion Pumps | 208 |
| Thyristors BTX18, BTX19 | 209 |
| Zener diodes BZY91 series | 210 |
| Photomultiplier XP1020 | 211 |



Mullard Limited, Mullard House, Torrington Place, London, WC1. Telephone: LAngham 6633

measure frequency and time interval over the ranges 1c/s to at least 3Mc/s and 3 μ s to 27.77 hours with the utmost simplicity of operation.

UNIVERSAL COUNTER
TIMERS
Types TM51B & TM51C

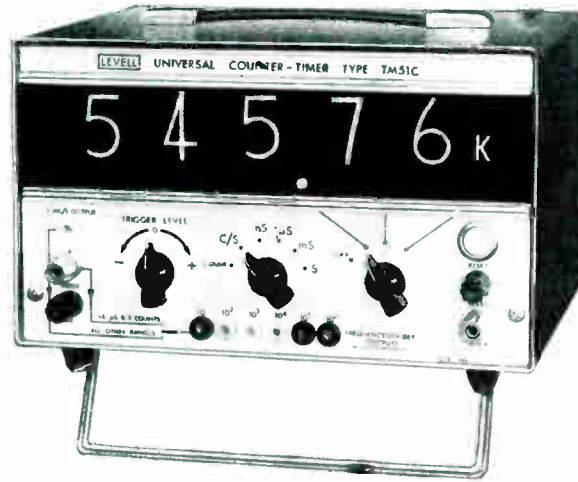

High sensitivity of 35mV at frequencies up to 100kc/s; Low input noise level to minimise trigger error on period measurement; Display storage to minimise operator fatigue.

The in-line display is on five long-life neon numerical indicating tubes controlled by a latching circuit which holds the display stationary whilst a count is in progress and automatically resets the display at the completion of a count. This feature dispenses with the need for hold controls or display blanking and ensures a high sampling rate down to very low frequencies.

The capacity as a counter is extended from 10^3 counts to 10^7 counts by the kilo-count ranges on which every tenth or hundredth input pulse is displayed. On "Count" operation, the counter is controlled by pulses applied to "Start" and "Stop" terminals.

Provision is made for an external frequency standard to be used in place of the internal 1Mc/s crystal oscillator. Pulse outputs are available on the front panel at decade divisions of either the internal 1Mc/s oscillator or the input trigger frequency, thus the instrument may be used as a frequency divider up to 1Mc/s.

SPECIFICATION

| | |
|----------------------------------|---|
| FREQUENCY RANGES | 1c/s to at least 3Mc/s measured on 3 ranges with gate times of 10ms, 100ms and 1 second. Accuracy: ± 1 count \pm crystal error |
| TIME RANGES | 3 μ s to 27.77 hours measured on 7 ranges in units of 1 μ s, 10 μ s, 100 μ s \pm 1 second. Accuracy: ± 1 count \pm crystal error \pm trigger error. |
| PERIOD AVERAGE RANGES | 10^{-1} , 10^2 , 10^3 input periods measured in units of 1 μ s on 5 ranges Accuracy: ± 1 count \pm crystal error \pm trigger error number of periods. |
| 1Mc/s CRYSTAL ERROR | TM51B: $\pm 0.001\%$ at 20 C after 1 minute. $\pm 0.003\%$ from -10 C to $+45$ C after 1 minute. TM51C: $\pm 0.0001\%$ at 20 C after 20 minutes. $\pm 0.0003\%$ from -10 C to $+45$ C after 20 minutes. |
| TRIGGER ERROR | Any trigger circuit operated by a sinusoidal signal of amplitude 5 in the presence of noise N is subject to a trigger error of $0.3N/5$. The input trigger circuit has an equivalent input noise of less than 300 μ V r.m.s. thus for 100mV r.m.s. input the trigger error is $\pm 0.1\%$. |
| TRIGGER INPUT SENSITIVITY | 35mV r.m.s. on sine waves 0 to 100kc/s, decreasing to 100mV at 1Mc/s and 300mV at 3Mc/s. |
| TRIGGER INPUT INPEDANCE | 100 kilohms in parallel with 10pF. |
| TRIGGER LEVEL | The trigger level is continuously variable from -750 mV to $+750$ mV. |
| TEMPERATURE RANGE | -10 C to $+45$ C. |
| POWER SUPPLY | 100 125V or 200 250V, 45 65 c/s, 25 VA. |
| SIZE AND WEIGHT | 6 $\frac{1}{2}$ " high \times 10 $\frac{1}{2}$ " wide \times 9" deep. 11 lbs. |

LEVELLE
PORTABLE INSTRUMENTS

TM51B £275 • TM51C £295

LEVELLE ELECTRONICS LTD., PARK ROAD, HIGH BARNET, HERTS., ENGLAND.
Telephone: BARNET 5028

design engineers

KEEP IN FRONT... USE

WESTINGHOUSE

MOLECULAR CIRCUITS

NOW!

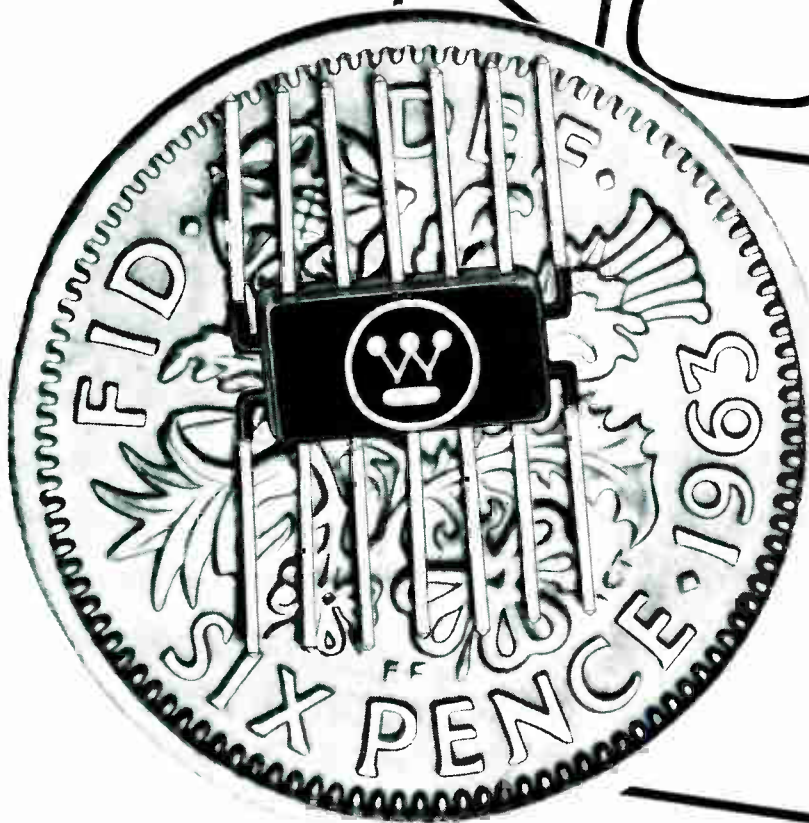

Westinghouse have a comprehensive range of molecular logic and linear units available

ADVANTAGES ARE

- 1 INCREASED RELIABILITY**
- 2 IMPROVED PERFORMANCE**
- 3 HIGH NOISE IMMUNITY**
- 4 LOW POWER DISSIPATION**
- 5 SMALL SIZE AND WEIGHT**

The unit illustrated is a DTL Dual Nand Gate replacing 18 discrete components

2 TRANSISTORS · 12 DIODES · 4 RESISTORS

For full details write to Dept. 1E9/64

WESTINGHOUSE BRAKE AND SIGNAL CO LTD

82 YORK WAY · KING'S CROSS · LONDON N1
Terminus 6432 · Telex 2-3225

SUB-MINIATURE COMPONENTS

These components have gained a high reputation for reliability of performance and are widely used in the Radio, Television and Electronic industry at home and overseas.

SOLID DIELECTRIC TRIMMERS

- S.56-11/1 P.T.F.E. Dielectric. Bush Mounting. Cap: .5 pf. to 7 pf.
- S.50-01/2 P.T.F.E. Dielectric. 20 s.w.g. Wire Mounting or
- S.50-01/4 Screwed Stem Mounting. Cap: .7 pf. to 3.3 pf.
- S.50-11/3 P.T.F.E. Dielectric. 20 s.w.g. Wire Mounting or
- S.50-11/6 Screwed Stem Mounting. Cap: 1 pf. to 12 pf.
- S.55-13/1 Mycalon Dielectric. With Locking Nut. Cap: 1 pf. to 10 pf.
- S.55-11 Mycalon Dielectric. Without Locking nut.

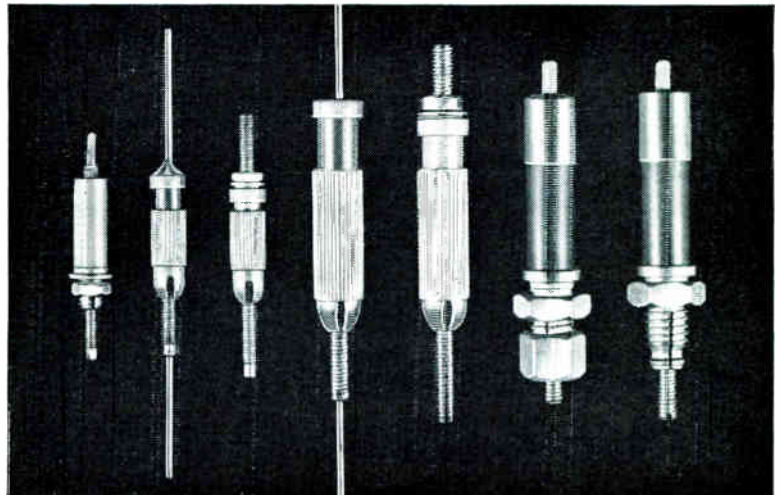

Actual size

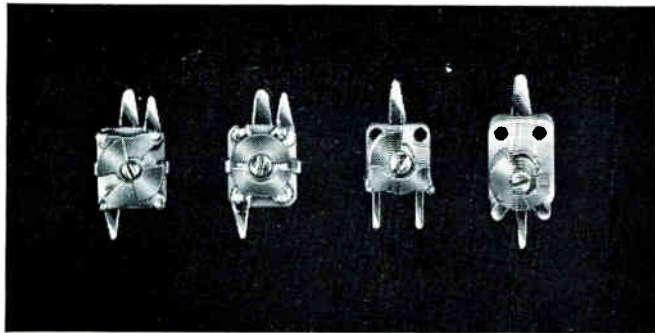

Actual size

AIR DIELECTRIC TRIMMERS

- C.39-52 Butterfly type Cap: 7.75 pf. max. each section.
- C.39-32 Differential type Cap: 10 pf. max.
- C.37-01 Printed Board type Cap: up to 16.5 pf. max.
- C.32-01 Cap: 11 pf. max.

COMPRESSION TRIMMERS

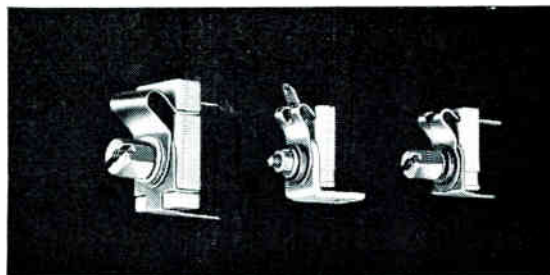

Actual size

- S.14-01 Printed Board Mounting Cap: up to 140 pf.
- S.15-01 Bracket, or
- S.15-11/2 Printed Board Mounting. Cap: 2 - 25 pf.



Actual size

STAND OFF INSULATORS P.T.F.E. LEADTHROUGHS

- P.T.F.E. Leadthroughs: LT. 2-02 LT. 2-02/2.
- T.S. 6-01
- T.S. 6-01/12 with spill, and internal thread.
- T.S. 6-01/6 with spill.
- T.S. 6-01/3 Stand Off Alumina Insulator with bollard, and internal thread.
- T.S. 6-01/4 Stand Off Alumina Insulator with bollard.

WINGROVE & ROGERS LTD

DOMVILLE ROAD · LIVERPOOL 13 · Tel: Stoneycroft 2265

LONDON OFFICE: 75 Uxbridge Road, Ealing, W.5. Tel: Ealing 7046

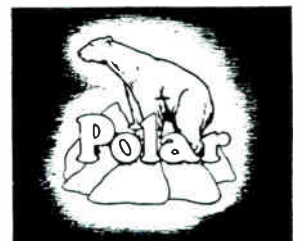

ELECTROTHERMAL CHAMBERS



ENVIRONMENTAL TEST CHAMBER

The Environmental Chamber is a portable, precision built yet robust miniature heating chamber designed for the testing of samples or small printed circuit boards under dry heat test conditions. Operated from the standard A.C. mains supply it allows elevated temperature measurements to be carried out without a long heating-up period being required.

Two complementary units, a thermal chamber and control unit, are connected to form the complete instrument FC 7921.

The hermetically sealed, double glazed door allows perfect observation of the component under test. Two shelves are positioned within the chamber and these can be removed when larger modules or circuit bricks are to be tested.

The operating range is 40 C to 150 C which conforms with the upper limit of T6 DEF 5011. Any temperature within this range can be selected and controlled within ± 0.35 C by the Temperature Controller.

| CAT. NO. | DESCRIPTION | PRICE |
|----------|--|---------|
| | | £ s. d. |
| FC 7921 | Environmental Chamber complete with temperature control system | 57 10 0 |



THERMAL CHAMBERS

The Electrothermal Chamber is a small but robustly constructed thermostatically controlled oven, designed to accommodate small temperature sensitive components, and is particularly suitable for equipment mounting.

The chamber is preset to operate at the required temperature within the range 40-90 C, with a stability of ± 0.3 C. Operation is from 28V D.C.

A small mounting platform is supplied for fixing components or boards within the chamber and 14 colour-coded leads are available for external circuit connection.

| CAT. NO. | DESCRIPTION | PRICE |
|-----------|--|---------|
| | | £ s. d. |
| FC 7902/1 | Thermal chamber with transistor switch | 28 0 0 |
| FC 7902 | Thermal chamber without transistor switch | 21 10 0 |
| FC 7902/2 | Fitted with silicone transistors for operation at high ambient temperatures (80 C). Performance specification as for Cat. No. FC 7902/1, but input voltage range is 26 to 35 volts | 32 0 0 |

Literature sent on request

Electrothermal ENGINEERING LTD

LONDON E.7

TEL: GRA 9911

TELEX 24176



announce a new distribution scheme

STOCK SERVICE

In order to provide an efficient and speedy service of capacitors for manufacturers of ELECTRONIC EQUIPMENT, Hunts have appointed seven NATIONAL DISTRIBUTORS strategically situated throughout the country.

They will all carry comprehensive stocks of those types of capacitors commonly required by electronic manufacturers and they will be pleased to supply you at the same net prices as A. H. Hunt (Capacitors) Ltd. would charge. It should be noted that each distributor has Bonded Stores for items requiring E.I.D. Release Certificates.

Further details supplied freely on request.

full names and addresses

A. C. Farnell Ltd.,
Hereford House, North Court,
Vicar Lane, Leeds 2. LEEDS 35111

Gothic Electrical Supplies Ltd.,
Gothic House, Henrietta Street,
Birmingham 19. BIRMINGHAM
CENTRAL 5060

Harper Robertson Electronics Ltd.,
372 Argyle Street, Glasgow C.2.
CENTRAL 5297

Holiday & Hemmerdinger Ltd.,
71 Ardwick Green North, Man-
chester 12. ARDWICK 6366



Lugton & Co. Ltd.,
209-212 Tottenham Court Road,
London, W.1. MUSEUM 3261/9

Stewart Aeronautical Supply Co. Ltd.,
Gatwick Road, Crawley, Sussex.
CRAWLEY 28700 TELEX 87131

Wireless Electric Ltd.,
Wirelect House, St. Thomas St.,
Bristol 1. BRISTOL 26434



A. H HUNT (Capacitors) LTD.,
WANDSWORTH, LONDON,
S.W.18 VANDYKE 6454
TELEX 25640
Factories also in Surrey
and North Wales.

TERMINALS FOR HOT SPOTS

300-1200°F

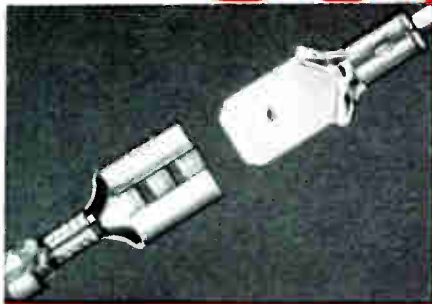

High Temperature *FASTON Connectors for use in electric cookers and space heating appliances with connection temperatures up to 650°F. FASTON tabs are crimped direct to sheathed element tails.

Heat Resistant Terminals and Connectors *STRATOTHERM heat resistant terminals and connectors are suitable for temperatures up to 650°F, for solid and stranded wires.

High Temperature Terminals and Connectors STRATOTHERM high temperature terminals and connectors are rated for temperatures up to 1200 F. They are used on hard drawn wires such as nickel, manganese nickel, and Nichrome conductors.

A-MP heat resistant and high temperature products eliminate problems inseparable from welding and brazing practice and the use of screw connections. AMP also supply ring tongue terminals and splices for application by automatic machines, and flanged flag terminals—all rated at 650°F. All Stratotherm products can be supplied with or without insulation support.

*Markings is a Registered Trade Name



TERMINAL HOUSE, STANMORE, MIDDX. TEL: STOnegrove 6341

A-MP products and engineering assistance are available through associated companies in: U.S.A. · Australia · Canada · France · Germany · Holland · Italy · Japan · Mexico · Puerto Rico
* TRADE MARK OF AMP INCORPORATED HARRISBURG U.S.A.

STC

SEPTEMBER 1964

components review

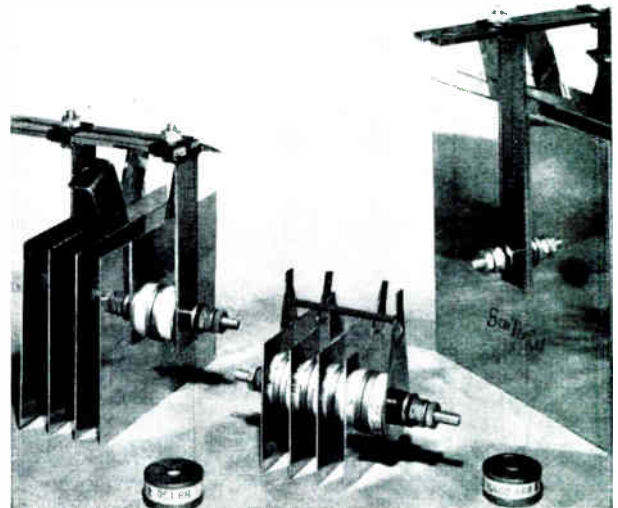

NEW METALLIZED POLYESTER CAPACITORS

Low cost and capacitances up to 10 μ F are two of the plus-points of the new STC Polyester Capacitor range. For equivalent performance, they are 40% smaller than foil and paper capacitors and they can be used as replacements in most instances. STC Polyester Capacitors are ideal for use in communication, control and measuring equipment, in coupling, filter and timing elements and for any application where reliable performance, high operating temperatures and small size are important factors. The capacitors have axial terminal wires, are wrapped in polyester and are sealed at each end with thermosetting resin.

| ABRIDGED DATA | | | | | |
|------------------------|-----|------------------------|-----|------------------|------|
| 150V DC WKG | | 250V DC WKG | | 400V DC WKG | |
| Capacitance (μ F) | | Capacitance (μ F) | | Capacitance (F) | |
| 0.1 | 1.0 | 0.1 | 1.0 | 0.032 | 0.33 |
| 0.15 | 1.5 | 0.15 | 1.5 | 0.047 | 0.47 |
| 0.22 | 2.2 | 0.22 | 2.2 | 0.068 | 0.63 |
| 0.33 | 3.2 | 0.33 | 3.2 | 0.1 | 1.0 |
| 0.47 | 4.7 | 0.47 | 4.7 | 0.15 | 1.5 |
| 0.68 | 6.8 | 0.68 | 6.8 | 0.22 | 2.2 |
| | 10 | | 10 | | 3.2 |

Write, 'phone or Telex for Data Sheet to STC Capacitor Division, Brixham Road, Paignton, Devon or London Sales Office, Footscray, Sidcup, Kent. Telephone FOOTscray 3333, Telex 21836.

SILRINGS · SILICON RECTIFICATION USING SELENIUM STACK PRACTICE

New in Britain, SILRING rectifier stacks from STC offer the circuit designer and equipment engineer a unique combination of compactness, simplicity and low cost. The SILRING stacks shown above have outputs of 4.2 kW, 2.1 kW and 9.45 kW. SILRING power diodes are rugged ceramic/metal case ring diodes with diffused silicon junctions. Their heavy gauge copper end-plates form the anode and cathode of the device and act as thermal conductors to the stack cooling fins. This arrangement provides maximum efficiency without overloading and consequent lowest price-per watt rectification The simplicity of stack construction enables STC to offer quick delivery of SILRING diodes in the range 50-600Vrwm. When assembled into stacks these diodes give outputs from 5 to 232A.

For Data Sheets and prices write, 'phone or Telex STC Semiconductor Division (Rectifiers), Edinburgh Way, Harlow, Essex. Telephone Harlow 26811. Telex 81146.

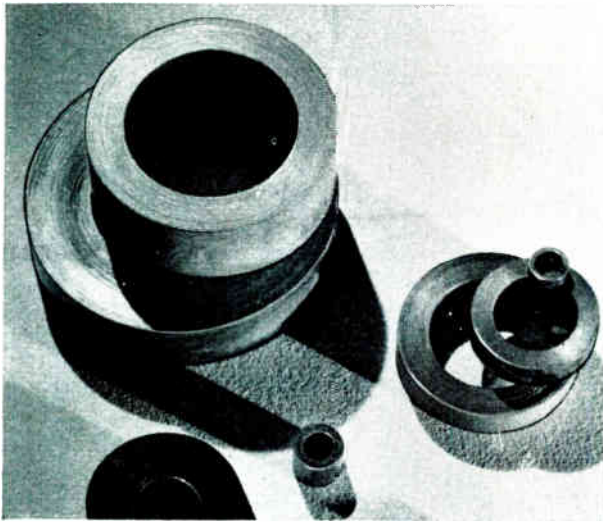

PERMALLOY AND PERMENDUR

These magnetic materials are nickel-iron and cobalt-iron alloys giving high permeability and low loss. The nickel-iron group of strip cores feature especially low hysteresis loss, whilst the cobalt-iron group is noted for high permeability over a wide range of flux densities. Applications for Permalloy and Permendur include: Specialized transformers, chokes and relays, magnetic shields and aircraft generators and servos. Our engineers are available to help you to select the best magnetic material for your special requirements. Prices are extremely competitive and delivery is prompt.

PHYSICAL PROPERTIES AND MAGNETIC CHARACTERISTICS

| | Permalloy B | Permalloy C | Permalloy D | V-Permendur |
|---|------------------|-------------------|------------------|----------------|
| Specific gravity | 8.3 | 8.8 | 8.15 | 8.2 |
| Electrical resistivity—microhms per cm. cube | 55 | 60 | 90 | 26 |
| Temperature for heat treatment C | 1 100 | 1 100 | 1 100 | 793 |
| Initial permeability μ_0 | 2 000 to 4 000 | 15 000 to 40 000 | 1 800 to 3 000 | 700 to 1 000 |
| Maximum permeability μ_{max} | 15 000 to 40 000 | 50 000 to 150 000 | 12 000 to 20 000 | 3 000 to 6 000 |
| Magnetising force for μ_{max} —oersteds | 0.20 to 0.40 | 0.025 to 0.04 | 0.2 to 0.5 | 2.0 to 6.0 |
| Maximum flux density—gauss | 16 000 | 8 000 | 13 000 | 24 000 |
| Coercive force in oersteds for $B_{max.} = 5 000$ gauss | 0.15 | 0.03 | 0.15 | 2.3* |
| Remanence in gauss for $B_{max.} = 5 000$ gauss | 4 000 | 3 500 | 3 500 | 16 000* |
| Hysteresis loss in ergs per c.c. per cycle for $B_{max.} = 5 000$ gauss | 160 | 40 | 200 | 11 500* |
| Total loss in watts/lb. $B = 5 000$ gauss, 50 c/s 0.015 in. sheet | 0.11 | 0.04 | 0.2 | 4* |

*For $B_{max.} = 20 000$ gauss, 50 c/s 0.010 in. sheet

Write, 'phone or Telex for Data Sheet MM1105 to STC Magnetic Materials Division, Edinburgh Way, Harlow, Essex. Telephone Harlow 21421. Telex 81146.

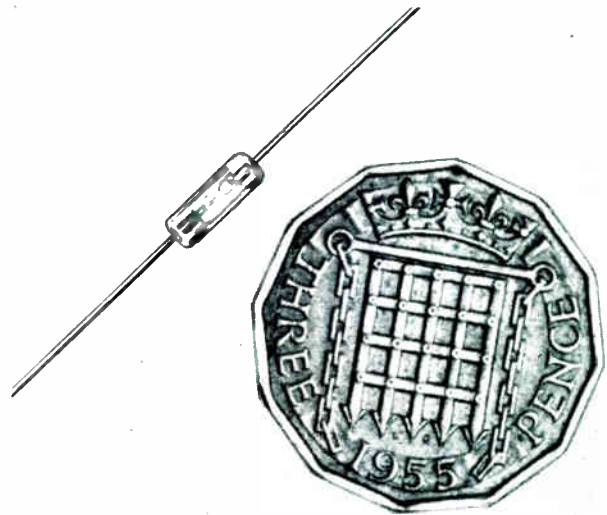

GOLD-BONDED DIODES... RANGE INCREASED

Three new germanium gold-bonded diodes have been added to the STC range. These are the DK19, DK20 and DK21 which are specially designed for use in high speed switching applications; and along with existing types DK13, DK14 and DK15, represent a range having extremely good electrical stability and robust mechanical construction. Each type has a sub-miniature glass encapsulation and conforms to the JEDEC DO-7 outline. They are competitively priced and available from stock.

BRIEF DATA

| Type | V_R max (V) | I_R at V_R max (μA) | I_F max (mA) | Typical capacitance (pF) | Typical stored charge at 10mA (pC) | Equivalent to |
|------|---------------|--------------------------------|----------------|--------------------------|------------------------------------|---------------|
| DK19 | 25 | 10 | 110 | 1.0 | 280 | 0A47 |
| DK20 | 50 | 25 | 100 | 0.4 | 350 | H65004 |
| DK21 | 8.0 | 30 | 30 | 1.3 | 20 | AA213 |

For further information, write, 'phone or Telex Semiconductor Division (Transistors), Footscray, Sidcup, Kent. Telephone FOOTscray 3333. Telex 21836.

high-grade electronic components by

STC

COMPONENTS GROUP

LEADERSHIP IN VISUAL PRESENTATION

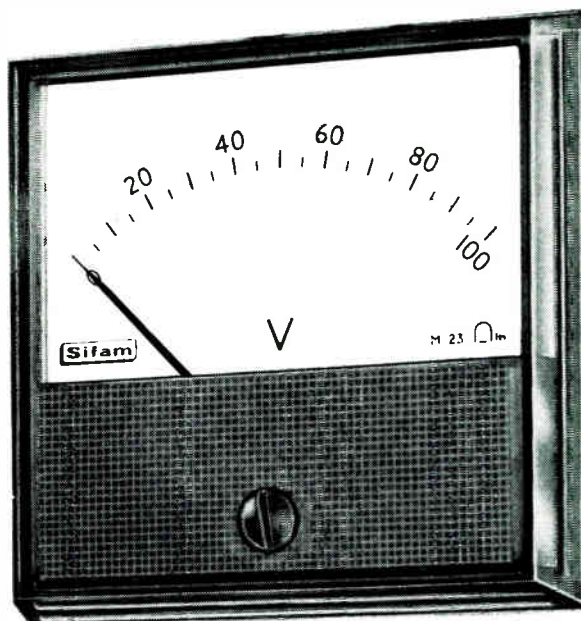

"Clarity" Type 23. 2.4 in. square. Scale length: 1.96 in.

Designers and engineers concerned with the production of modern equipment, and looking for instruments with the same contemporary approach to styling, will find their need completely satisfied in the SIFAM CLARITY Range.

Uncluttered, functional, with well-proportioned scale and body, this new range is a masterly expression of modern instrument design at its best, and represents an advance in visual presentation which has won recognition and approval from users and independent authorities alike.

Scale areas or markings can be supplied in accordance with the new British Standard recommendations, or to customers' requirements. The instruments can be supplied as Millivoltmeters, Temperature Indicators for use with thermocouples, Decibel Meters or with special calibrations to suit particular applications.

Let us arrange for a Sifam Technical Representative to show you the new "CLARITY" range or write for the new Data Sheets 106/C and 106/C1.



Instruments

SIFAM ELECTRICAL INSTRUMENT CO. LTD. Woodland Road, Torquay, Devon Telephone: Torquay 63822/3/4

CLARITY

- * The completely transparent moulded fronts permit a greater scale length for a given frontal area.
- * Interchangeable masks are available in a choice of contemporary colours to blend with customers' equipment.
- * The lance type pointer is readily visible when the instrument is read at a distance, whilst its fine point allows accurate reading of indicated values.
- * Elimination of solid surround provides both greater clarity and readability.

"CLARITY" Type 22
Scale length:
2.2 in. (56 mm)

"CLARITY" Type 32
Scale length:
2.75 in. (70 mm)

"CLARITY" Type 42
Scale length:
3.75 in. (95 mm)



Series 590/596 Relay in plastic covers

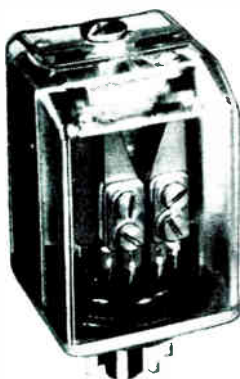

A basic relay that can be supplied in many forms. Here it is shown mounted in one of a range of transparent, non inflammable plastic covers which can house several of our relay series.

Open, enclosed as above or in metal can, we have many variants on numerous themes.

SMALL, SENSITIVE, STURDY
MAGNETIC DEVICES LIMITED

Newmarket · England
Tel: Newmarket 3451 (10 lines) · Grams: Magnetic Newmarket

P.9089

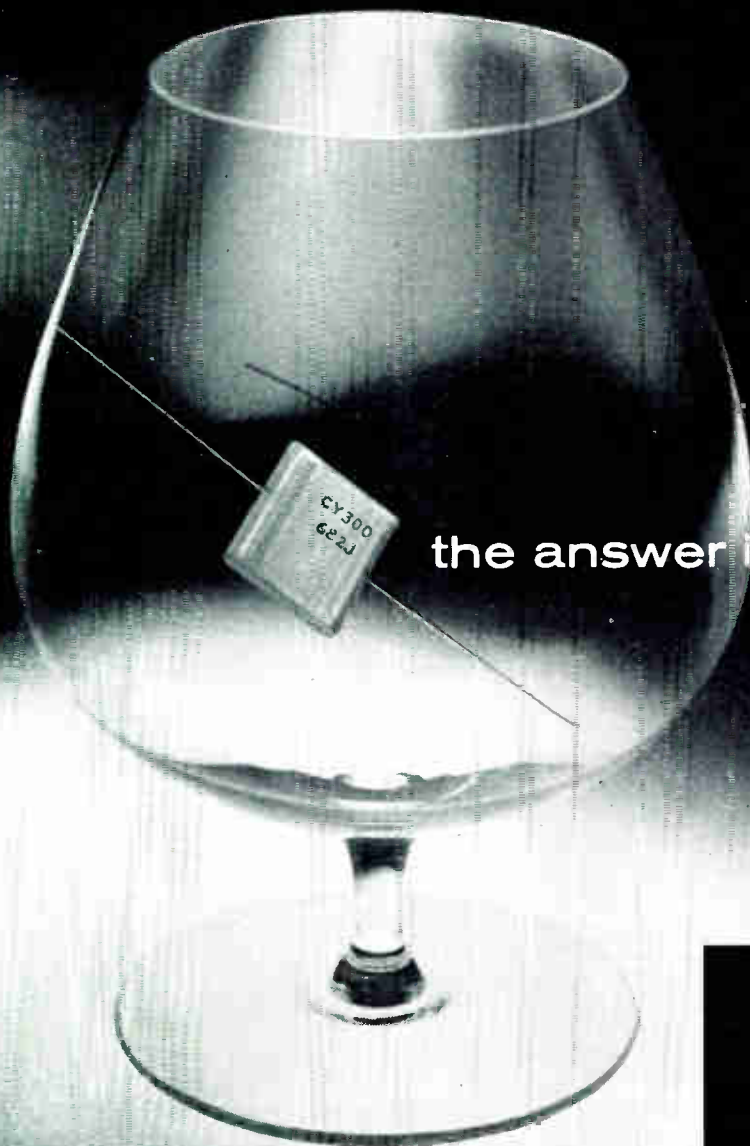

the answer is in the glass

The completely predictable performance of this glass-dielectric capacitor hermetically sealed into its solid glass body, makes CYFiM the most stable and reliable component available.

- Range 0.5 to 10,000 pF
- V.W. 300V & 500V at -55°C to $+125^{\circ}\text{C}$
- Life:— After 2000 hrs at 125°C and 50% overload on rated voltage, capacitance change is less than 0.5% at 1Mc or 1kc. I.R. is 10^{10} ohms. Dissipation factor 0.007

ELECTROSIL LIMITED
Pallion, Sunderland, Co. Durham
Telephone: SUNDERLAND 71557. Telex 53273



gives capacitor
reliability

—clearly the best
capacitors

ERSIN *Multicore* SOLDER



UNDER THE SEA

Ersin Multicore Solder is made in Europe's largest cored solder factory, and contains only the purest tin and lead plus five cores of extra-active non-corrosive Ersin flux. It is undoubtedly the world's finest and most reliable cored solder. **THERE IS AN ERSIN MULTICORE SOLDER FOR YOUR PURPOSE . . .** whether it be the rapid soldering of miniature components by a production soldering process, or the individual production of large units of equipment such as fully transistorised submersible repeaters. Alloy, diameter of the solder, type and percentage of flux in the solder are all points to be considered.

For production soldering processes Ersin Multicore Solder with 362P Ersin flux in 60/40 and Savbit No. 1 alloys, and containing an exclusive agent Pentacol, promote the extra rapid spread of the lower percentage of flux in the cores—less fumes are liberated—less flux residue is left.

Multicore Savbit Alloy, to which a precise amount of copper is added prolongs bit life up to ten times, ensures more consistent soldered joints, and eliminates maintenance of soldering iron bits.



Ersin Multicore Solder is shown being used at the Erith factory of Submarine Cables Ltd., in the production of a submersible repeater designed to last for a minimum of 20 years under the sea without attention.

The life and reputation of any piece of electronic equipment can rest entirely on the solder used in assembly, a minute fraction of its cost. That is why the finest, most dependable cored solder is invariably the most economical and best. Ersin Multicore is the most widely used cored solder in the U.K. and is exported to over 50 overseas countries.

THERE IS AN ERSIN MULTICORE SOLDER FOR EVERY PURPOSE WHERE PRECISION SOLDERING IS REQUIRED

CHMS17



Engineers and technicians are invited to write on their Company's letter heading for the completely revised 6th Edition of the 24-page booklet "MODERN SOLDERS" containing data on melting points, gauges, alloys, etc. Also, reprint of "Industrial Electronics" article "Erosion of Soldering iron bits", by P. Sharples.

MULTICORE SOLDERS LIMITED, MULTICORE WORKS, HEMEL HEMPSTEAD, HERTS. (BOXMOOR 3636)



*for
high heat
insulation*

YOU'LL NEED TO KNOW ABOUT DELANCO GLASS FIBRE LAMINATES

If you need a material with a working temperature of up to 250°C very high dielectric strength and low loss properties PLUS high mechanical strength and exceptional machining properties you need look no further than the DELANCO range of glass fibre laminates, in sheet, tube, rod or in parts accurately machined to your drawings.

In fine and medium weave glass cloth base, with a bonding agent of silicone, Epoxy, melamine or phenolic, each grade having characteristics suitable for specialised applications. These applications are mainly in the electro-mechanical fields, but more recent technological advances in other fields are bringing regular enquiries for many new trades.

Class C Transformers, for example, Aircraft construction, and plating jigs, give some idea of the versatility of this material.

For machined parts only, we have one of the most modern

tool departments in the country, and all tools and fixtures are made by operators with first-hand knowledge of the materials on which these tools will be used.

Parts can be blanked, routed, milled, drilled and counter-bored, and metal tags and terminals can be fitted. Engraving on the finished parts is also done in our own works.

For further Technical Details send for Delanco Catalogue.

Delanco

for Electrical Insulation

*Anglo-American Vulcanized Fibre Co. Ltd.,
Cayton Works, Bath Street, London, E.C.1.
CLE 8481. Grams : Promserv, Cent, London.
Delanco Works, Leonard Street, London, E.C.2.*



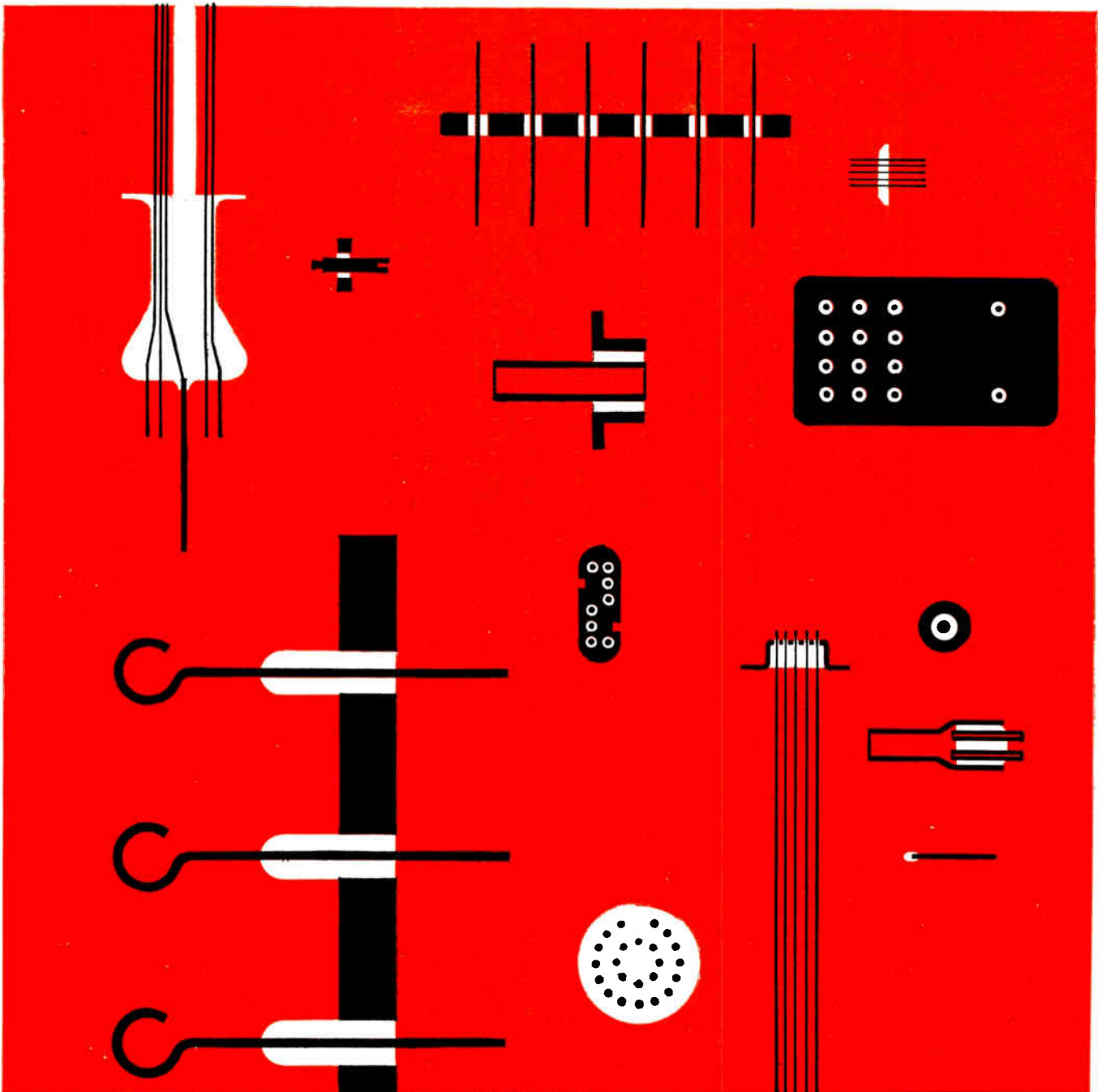

GLASS TO METAL SEALS

We are now able to offer a wide range of glass to metal seals (simple, compound and multiple). This range is further extended by facilities to produce the seals in compression, matched or fully bonded vacuum forms with a wide variety of finishes including precious metals. Deliveries are good and prices highly competitive. High quality and uniformity are ensured by advanced manufacturing techniques. Our technical liaison engineers will be pleased to meet you at any time to discuss glass to metal seal design and applications. If you would like further data on this new service to industry, please phone or write to the address below.



A TYPICAL MULTIPLE COMPRESSION SEAL

a NEW service to industry



**ERICSSON TELEPHONES LIMITED
ETELCO LIMITED**

A Principal Operating Company of the Plessey Group

ERICSSON TELEPHONES LIMITED · ETELCO LIMITED · TUBE DIVISION · BEESTON · NOTTINGHAM · TEL: 254831

ER69

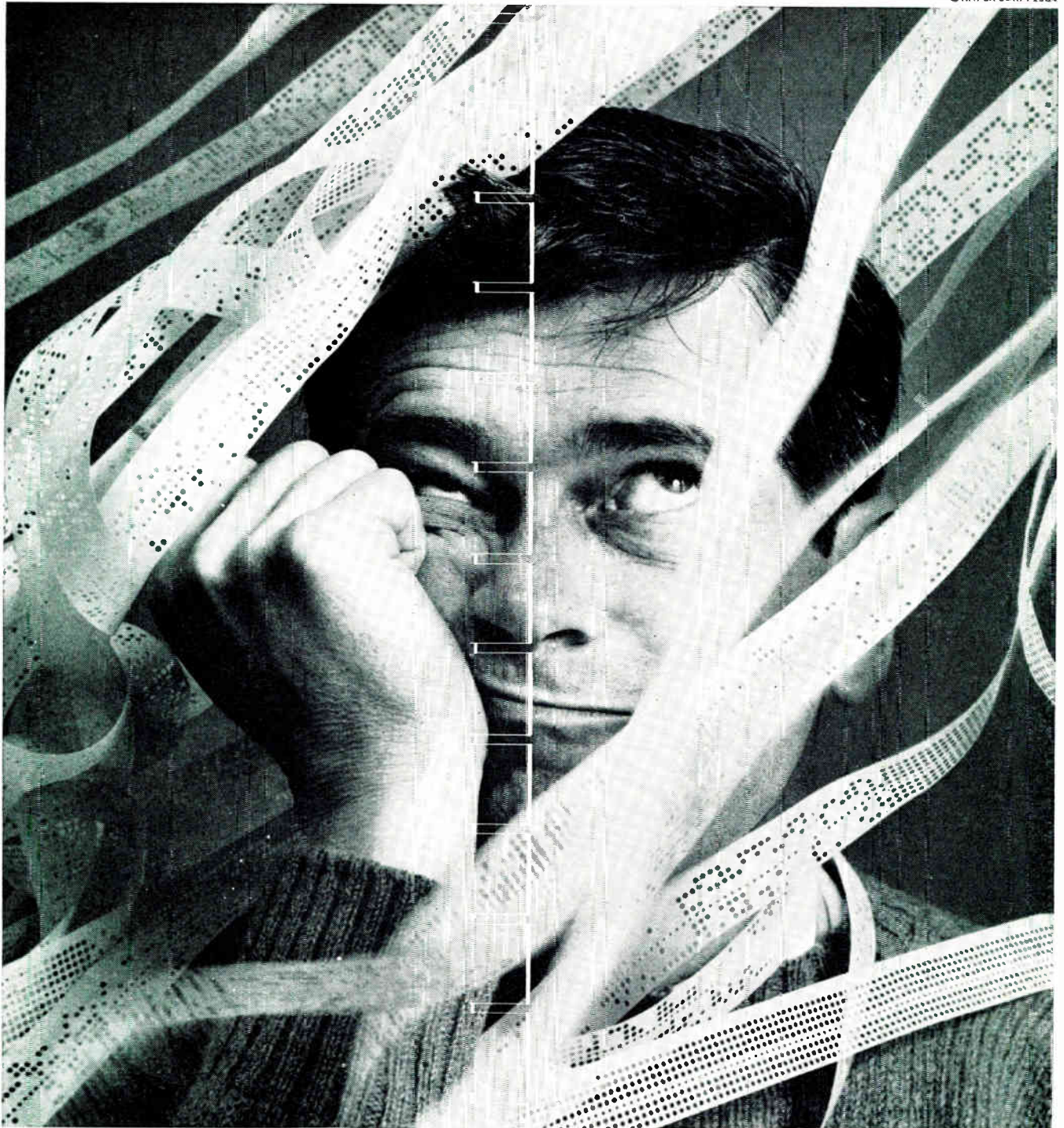

Don't tie yourself up in paper tape. Now Ampex magnetic tape is faster, more accurate and costs less.

And it's more efficient. One small Ampex CDR-1 tape cartridge stores as much data as 7000 feet of paper. And can be erased and used again. Paper tape systems are slow. The CDR-1—an incremental digital recorder—records 2400 bits of information per second. Plays back up to 3840 bits per second. Paper tape systems need operators. The CDR-1 is automatic. Paper tape systems make mistakes. With the CDR-1 mistakes are less than 1 in 10,000,000. And mistakes are spotted—the CDR-1 automatically verifies every bit of data it records. In short: Ampex



has made all the benefits of magnetic tape available to manufacturers of systems incorporating other input/output devices. The CDR-1 is comparably priced, incomparably better. And available now for evaluation by manufacturers of systems designed for communications, factory data acquisition, data logging, machine tool control, computer input/output devices, and many other applications. For full details, write Ampex Great Britain Limited, 72 Berkeley Avenue, Reading, Berkshire. Telephone No. Reading 55341. World-wide sales and service.

CAPACITOR & RESISTOR

DECADE UNITS

These units are sturdy and inexpensive instruments suitable for both industrial and academic use. High grade industrial components are used throughout the construction and the cases are made up from standard components of the Lektrokit Chassis Construction System

£8-10-0



LKU-111 DECADE CAPACITOR

The Decade Capacitor covers the range 50 pF to 0.111 uF with an accuracy of 5%. The unit consists of a variable air-spaced capacitor covering 50-1000 pF in parallel with two switched decades

£13-0-0



LKU-121 CAPACITOR BOX

This unit covers the range 0.05 to 28 uF in steps of 0.05 uF, each capacitor being separately switched. An additional switch is provided enabling the total capacitance of the box to be switched in or out of circuit in one operation

£13-0-0

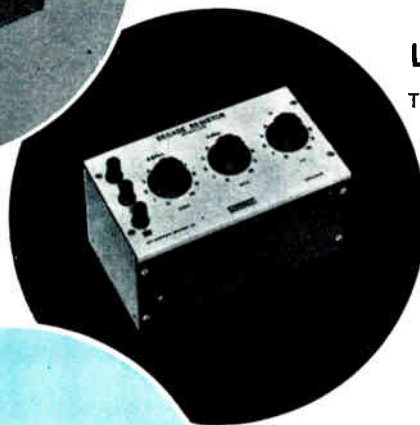

LKU-211 DECADE RESISTOR

This unit covers the range 0 to 1.11 kΩ in steps of 1Ω with an accuracy of ±2% the resistance elements being heavy-duty wirewound resistors made from low temperature coefficient wire

£13-0-0



LKU-221 DECADE RESISTOR

This unit, which covers the range 0 to 1.11 M in steps of 1 k with an accuracy of 0.5% is very similar in construction to the LKU-211. The two units together form a convenient and inexpensive 6-decade resistor

ALL THESE UNITS ARE AVAILABLE FROM STOCK

A.P.T

**ELECTRONIC
INDUSTRIES
LIMITED**

CHERTSEY ROAD, BYFLEET, SURREY
Phone: BYFLEET 411311/2/3/4 PABX Grams: APTRAN BYFLEET

Please send me your leaflet on:

- DECADE RESISTORS
 CAPACITOR BOXES

NAME

ADDRESS

IE 964

Lee 2558



Valve Characteristic Meter *Mk. IV*

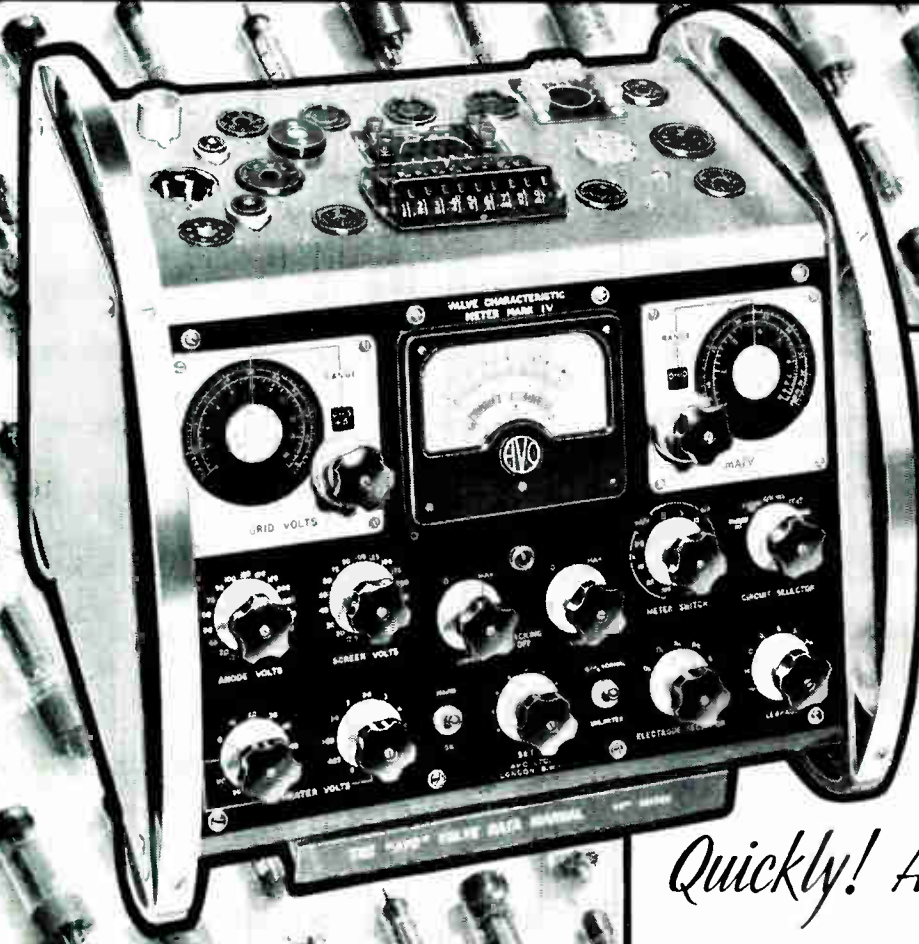

Tests over
6,000
types of
valves—

Quickly! Accurately!

| | |
|-------------------------|----------------------------|
| Range of Anode Voltage | 12.6—400 volts |
| Range of Screen Voltage | 12.6—300 volts |
| Range of Heater Voltage | 0.625—117.5 |
| Heater Current | 3A max. |
| Anode Current | 100mA max. |
| Mutual Conductance | 0.1—60 mA/V max. |
| Negative Grid voltage | 0—100V in 9 ranges |
| 'Gas' Current | 2 μ A first indication |

This instrument has been designed to test any standard receiving or transmitting valve having up to a maximum anode dissipation of 25W.

Inter-electrode insulation, anode current, mutual conductance and 'gas' current can be measured, and by making a series of tests, complete families of curves may be plotted.

Rectifiers and signal diodes are tested under suitable load conditions. A comprehensive data manual is supplied with the instrument, which operates from 100-120 volts and 200-260 volts 50-60 c/s A.C. mains.

More than 6,000 different kinds of valves can be tested on this instrument without recourse to Manufacturers' data or charts.

Write for fully illustrated brochure.

The 16th Edition of the AVO VALVE DATA MANUAL is now available. Price £1 : 15 : 0. Post & packing free.

AVO LTD AVOCET HOUSE · 92-96 VAUXHALL BRIDGE ROAD · LONDON S.W.1 Telephone: VICTORIA 3404 (12 lines) 

VC8

WASHING MACHINES
AUTOMOTIVE ENGINES
ELECTRIC SIGNS
THERMOSTATS
HAIR DRYERS
SWITCHES

DRILLS
POWER TOOLS
WELDING PLANT
PROCESS HEATING
INDUSTRIAL MOTORS

**IF
NOISE
OFFENDS**

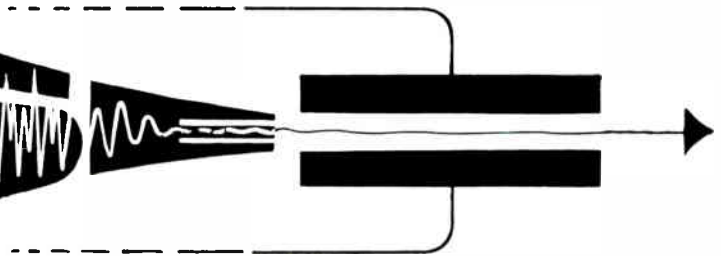

**LET
TMC
SUPPRESS
IT**



TMC is a Registered Trade Mark

**CAPACITOR DIVISION
TELEPHONE MANUFACTURING COMPANY LIMITED**

Sevenoaks Way, St. Mary Cray, Orpington, Kent · Tel: Orpington 27020 · Telex: 28115

A MEMBER OF THE  GROUP OF COMPANIES

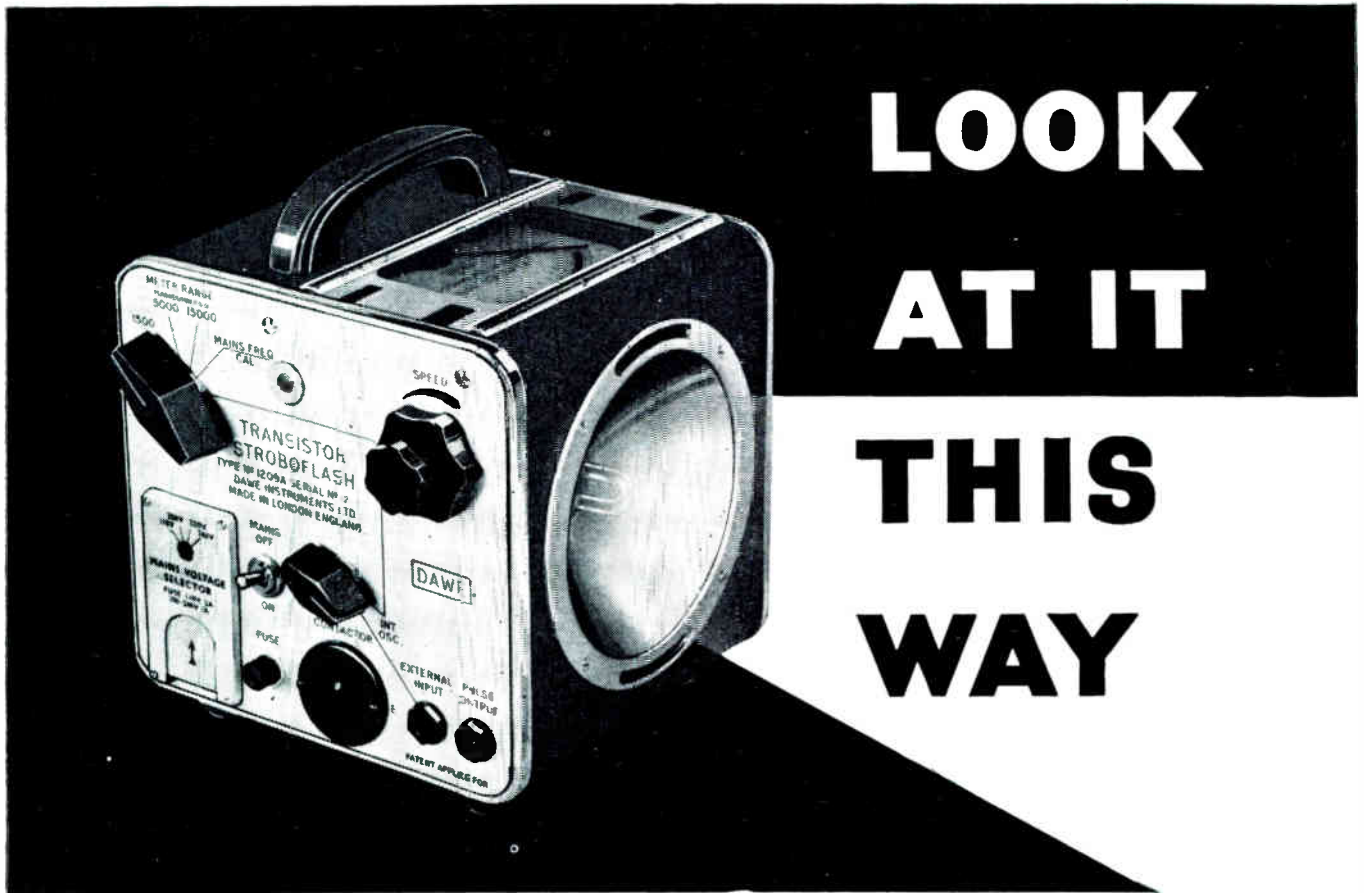

DAWE TRANSISTOR STROBOFLASH TYPE 1209A

Study rotary, reciprocatory and vibratory movements in slow motion with the DAWE Transistor Stroboflash Type 1209A.

The high intensity, white light Xenon flash tube — a marked improvement over Neon flash tubes — transistor circuitry and Dawe's long experience in stroboscope design, make the Stroboflash the perfect research instrument. The built-in Xenon flash tube ensures accurate colour rendering and excellent illumination of the subject even when the ambient lighting is of moderately high intensity. Transistor circuitry makes it possible to produce an instrument of remarkable compact proportions ($7\frac{1}{4}$ in. x $7\frac{1}{4}$ in. x $8\frac{1}{2}$ in.) and light weight (approximately 8 lb.)

Other outstanding features of the Stroboflash are:

- Mean illuminations up to 100 lux at one metre distance.
- A range of 300 to 15000 flashes per minute.
- Three overlapping full-scale ranges of 1500, 500 and 15000 flashes per minute.
- Speeds of up to 150000 per minute may be measured indirectly.
- Flash duration 5 to 10 microseconds.
- Accuracy $\pm 1\%$ of f.s.d. when standardised.
- UK LIST PRICE £85

Also available: Strobosun, Type 1203B, similar to the Stroboflash but with higher power Xenon flash tubes giving mean illuminations up to 1,000 lux at one metre distance.

DAWE

Full technical data from:—

DAWE INSTRUMENTS LTD., WESTERN AVENUE, ACTON, LONDON, W.3 Tel: ACO rn 6751

A member of the *Simms* group of companies

| | | | | |
|------|----|-----|-----|---------------|
| DR'N | DO | DES | LAB | ENG. |
| CH'D | | | | |
| | | | | ORIGINAL W.O. |

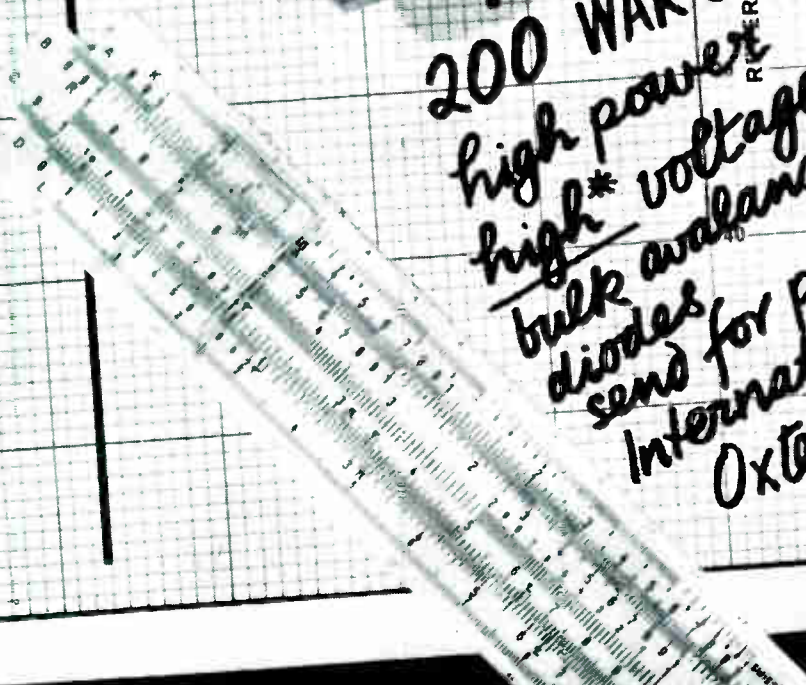
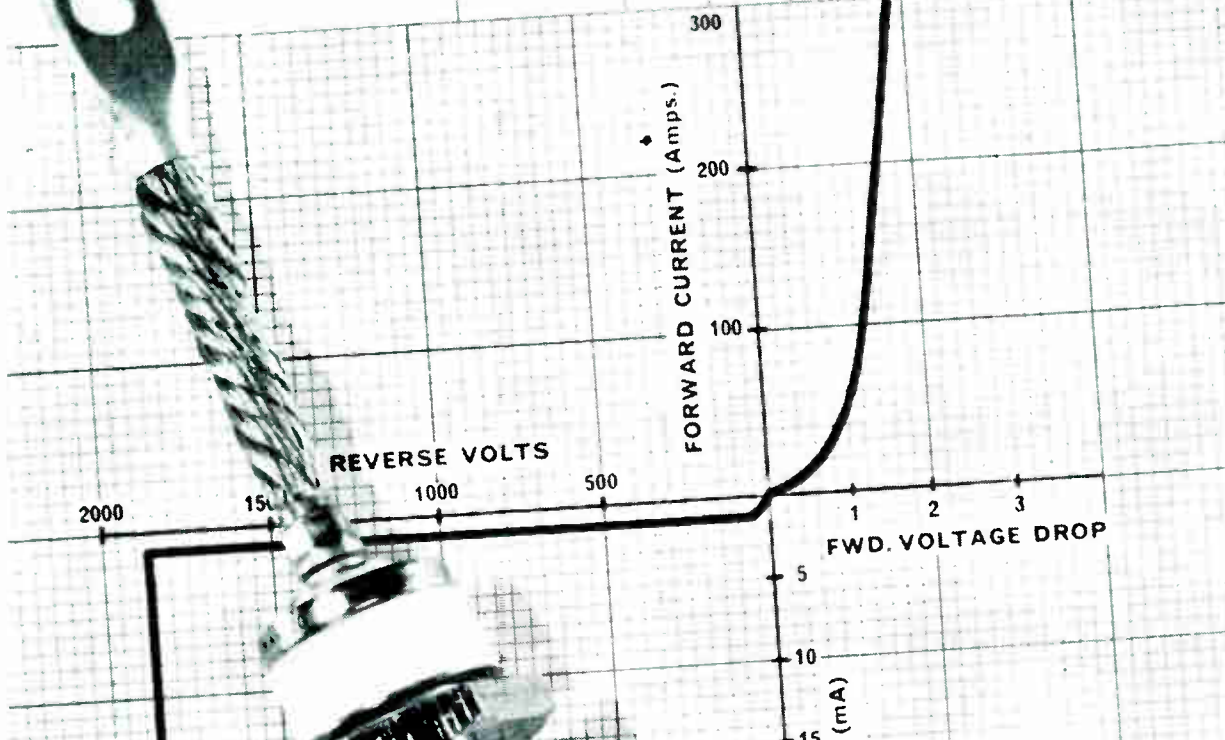

NEW!
 200 WAR Series
 high power
 high* voltage
 bulk avalanche
 diodes
 send for pub SR 2032
 International Rectifier,
 Oxted, Surrey.

*1600V reverse
 1700V min avalanche

'ENGLISH ELECTRIC'

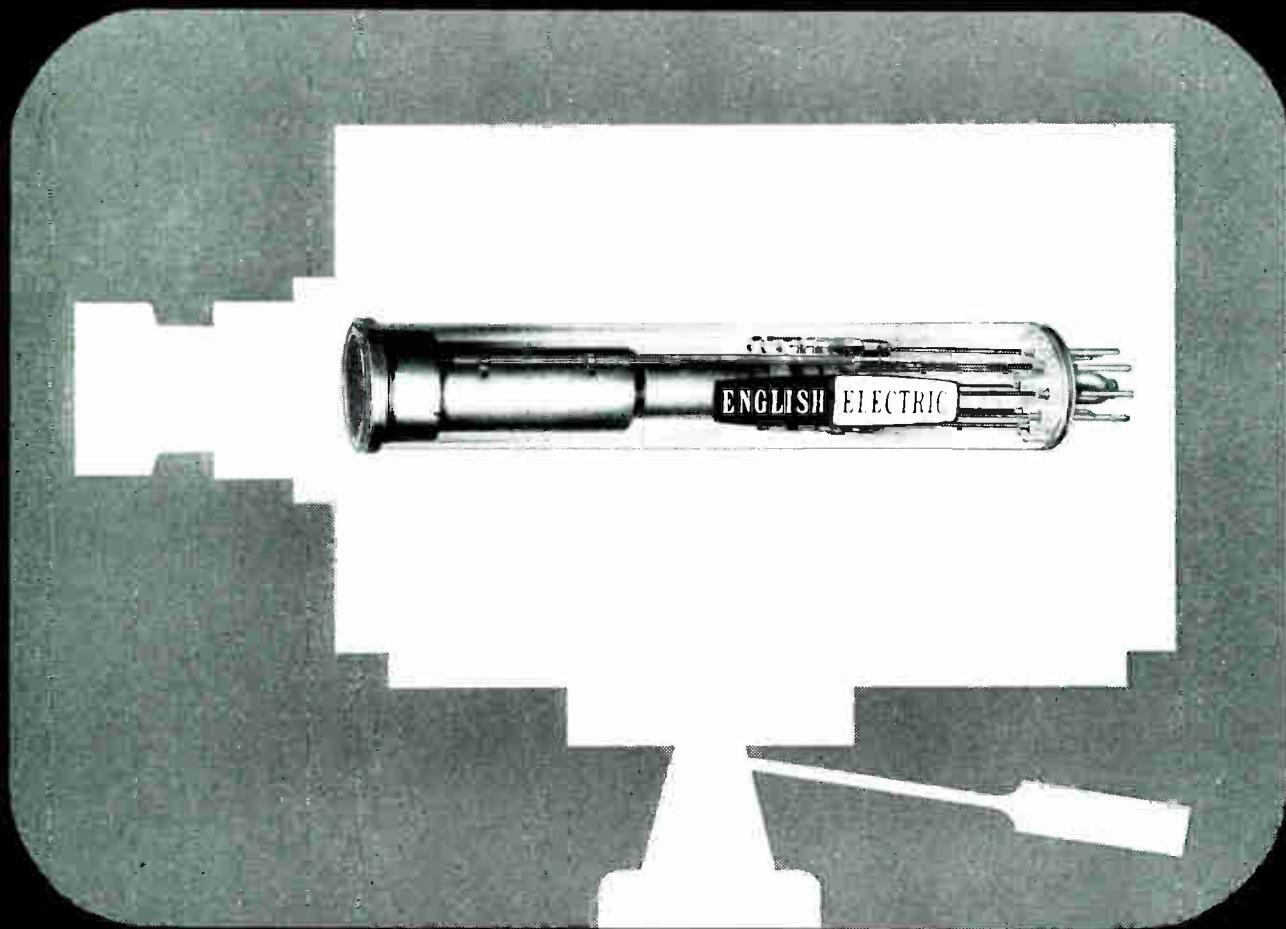

VIDICONS

The basis of Compact Low Cost TV Systems

EEV separate mesh 1-inch high resolution vidicons for studio, CCTV and OB applications.

Separate mesh construction gives resolutions up to 1000 T.V. lines for these *NEW* Tubes.

P831 This tube features a low power 0.6 watt heater. It is ruggedised for industrial and military applications and has a short overall length.

P842 (JEDEC 8541) The P842 also features a low power heater and is intended for the majority of broadcast, educational and industrial applications. A graded version is available for colour and special

broadcast purposes.

P841 (JEDEC 8507) This tube is a standard 4 watt heater version of the P842 and is designed for use in existing equipment.

Information on the complete range of television camera tubes, including 4½ and 3-inch Image Orthicons is available on request, or by telephoning Extension 262.

ENGLISH ELECTRIC VALVE COMPANY LIMITED

AGENTS THROUGHOUT THE WORLD

Chelmsford, England. Telephone: Chelmsford 3491

Comment

An organization with the title of National Electronics Research Council came into being on 22nd July. Under the chairmanship of Admiral of the Fleet the Earl Mountbatten of Burma, the general committee comprises seven members nominated by various government ministries and organizations, three nominated by universities, twelve nominated by the Conference of the Electronics Industry and one representing The Society of British Aerospace Companies Ltd.

The purpose of N.E.R.C. is to 'initiate and encourage the co-ordination of electronics research in industry, universities and colleges of advanced technology, and government research establishments'. Its purpose is to ensure that the best use is made of the existing research effort and facilities, but it is not a research association.

N.E.R.C. will be supported by voluntary contributions from industry and, it is hoped, by government grants, and it is empowered to use its capital to make grants for research projects, award bursaries, give support to universities for the extension of a particular research effort and to advance education in the field of research.

The secretary is Graham D. Clifford, C.M.G., M.I.E.R.E., and the registered office is 8-9 Bedford Square, London, W.C.1.

In spite of its not being a research association, N.E.R.C. is already tackling one problem itself, by a working party of representatives of government, industry and the universities. This problem is that of the retrieval of information. It is obviously desirable that any research worker should have access to all relevant published information, but this is difficult just because of its vast quantity. In electronics alone some 25,000 papers and other documents were issued in 1963 and all told over a million scientific papers. To discover how best to find the information one wants out of the vast quantity of existing literature, let alone the new papers, is a major research project in itself.

There are no easy solutions to the problems involved and we cannot hope that N.E.R.C. will find the answers quickly. That solutions are urgent becomes obvious when it is remembered that some companies already find it cheaper to carry out research into a problem which may have already been solved than to search the literature to find that existing solution!

Units

Talking about the retrieval of information has made us wonder how some of the present generation get on when they turn up a really old book. What do they make of an inductance (or capacitance) of so many centimetres? A book published in 1922 ('The Radio Experimenter's Handbook' by Philip R. Coursey) includes formulae with induc-

tance in centimetres but capacitance in microfarads. Formulae for calculating the inductances of coils appear in two forms: in one, all physical dimensions and inductance are in centimetres, in the other, the dimensions are in inches and inductance is in microhenrys.

What would the average engineer of today make of these units? And where would he find conversion factors? Actually, a centimetre of inductance is

COMMENT (Continued)

10^{-9} H or 1 nH while a centimetre of capacitance is about 1.1 pF. The centimetre of capacitance has not been obsolete as long as one might think. We remember capacitors of continental manufacture with the value marked in cm well into the 30's.

These centimetre units are actually identical with c.g.s. units. The centimetre of inductance is the absolute e.m.u. of inductance in the c.g.s. system while the centimetre of capacitance is the absolute e.s.u. of capacitance in the c.g.s. system. They are sometimes now called the abhenry and statfarad respectively.

Another obsolete unit which few have now even heard of is the jar. Originally it was the capacitance of the Leyden jar. At one time it was widely used in the Navy and there is still a reference to it in the 'Admiralty Handbook of Wireless Telegraphy', published in 1938 and reprinted in 1948. The value of 1 jar is given as 1,000 cm (!), which is $0.0011 \mu\text{F}$.

Obsolete units do cause difficulty in reading old literature, for it is often quite hard to discover the proper conversion factors.

World-Wide Communications

It has been announced that the U.K. will contribute about £6 million towards the cost of a communications satellite system. This represents about 8.4% of the total; the U.S.A. is contributing 61%.

The satellites and the ground installations for their control are to be a co-operative international enterprise, but the telecommunications ground stations will be owned by the countries, or groups of countries, in which they are situated.

Arrangements for international contracting procedures have been agreed. The International Committee which will be in control will allocate the major contracts, but they will usually be placed in the name of the U.S. Communications Satellite Corp. When tenders are comparable, the intention is that they should be distributed among the countries in proportion to their financial contributions.

Negative Temperature

From time to time we come across references to negative temperature in the more highbrow articles and they are extremely puzzling to those of us who are not very well up in modern physics. It is, in fact, not easy to explain just what a negative temperature is. It is much easier to say what it is not.

The term negative temperature makes one

think at once that what is meant by it is a temperature lower than absolute zero, 0°K . This seems inconceivable and, of course, it is. That is not at all what is meant. Negative temperature is not a temperature lower than absolute zero; it is a temperature on the other side of infinite temperature!

It is not a thing which arises in ordinary life; it occurs in the rather topsy-turvy world of atomic physics and, in our field, we may meet it only when we delve into the intricacies of such things as masers and lasers.

Normally, when particles in two different energy states are all in thermal equilibrium, there are more particles in the lower state than in the higher. It is possible for this normal condition to be inverted and for there to be more particles in the higher energy state than in the lower, and when this happens the temperature is negative.

The important things to remember are that the temperature is not the sort of thing one can measure with a thermometer and it is not less than absolute zero.

Gas Lenses

We tend to think of optical lenses as lumps of glass ground to shape and to forget that any transparent substance having a refractive index which varies with distance will refract a light beam. There is news from the Bell Telephone Laboratories about the use of gas for a lens.

The object is to keep the beam of light from a laser in the centre of a long pipe. This beam is only slightly divergent and a very weak lens suffices to confine it to the central region of the pipe. This requires that the pipe be filled with a medium having a refractive index which is a maximum at the centre of the pipe and decreases away from the centre.

One way of achieving this is to fit a helix within the pipe which is kept a few degrees warmer than the pipe. This heats the gas and produces convection currents which concentrate the gas towards the centre of the pipe. An experimental lens includes a helix 75 cm long and produces a focal length of about 5 metres.

In another type of lens two gases of different refractive indices flow in opposite directions through a mixing chamber. The constant non-turbulent flow produces a symmetrically curved boundary region which acts as a lens.

Although they are still very much in the experimental stage, gas lenses may enable the light output from a laser to be piped over long distances and so provide a new communications medium.

ACCURATE PRESSURE TRANSDUCERS FOR EXTREME ENVIRONMENTS

The various forms of pressure transducer are reviewed and a new moving-iron type described. This offers a large reduction of size and weight.

By P. J. COLBURN, B.Sc. (Eng.), A.M.I.E.E.*

MANY different types of pressure transducers are available nowadays for many different purposes but the number available with an accuracy of the order of 0.1% is quite limited. Add to this a requirement for operation over wide temperatures with the same accuracy and the available range narrows very considerably. If fast response is also required, and perhaps other difficult environments, there are practically no instruments that can be bought.

Of all the various pressure-sensing elements—flat plates, standard diaphragms, bellows—the pressure displacement characteristics, variation with temperature, the hysteresis, and the non-linearity, each give errors greater than the value quoted above so that a direct system is out of the question. We are therefore forced either to think of some new pressure-sensing element—of which none suitable are forthcoming—or to use a force-balance system.

A force-balance instrument is one in which the pressure sensing element is used to generate a force rather than a displacement. The elements of such a system are shown in Fig. 1. The displacement of the pressure-sensing element is measured with a position pick-off; this signal is processed in the amplifier, which drives the force motor which balances the force from the pressure-sensing element. Each of these elements has its problems and we will consider these one by one. Firstly, however, as we are concerned with producing an accurate instrument we must study the way in which errors can arise in such a system. Non-linearity in, or variation of, the pressure-to-force characteristic of the sensing elements are, of course, primary errors as also are similar errors in the means of detecting the force from the force motor. The only other errors which can arise are due to spurious forces upsetting the balance. The principal cause of forces of this nature, assuming reasonable design, arise from the product of the system spring rate and the position drift.

Choice of the Force-Balance Element

The requirement of the element used to produce the balancing force is simply that it shall produce a force roughly proportional to a signal in such a way that it can be accurately measured. Two types of device are commonly used in force-balance instruments, firstly a moving coil in a

magnetic field and secondly an electric motor compressing a spring.

The moving-coil arrangement is shown diagrammatically in Fig. 2. It consists of a current-carrying coil which moves in a constant magnetic field produced by a permanent magnet. If the field remains constant then the force on the coil will be accurately proportional to the current in the coil. The current can be detected by passing it through a temperature stable resistor in series with the coil. This makes a simple and accurate force motor with few parts. However, as the coil has to have room to move within the poles of the magnet, the magnetic circuit has large air gaps in it. Consequently, this type of force motor tends to be large and heavy for the force it produces.

The second common arrangement is to produce the balancing force by compressing an accurately-made spring and measuring its compression with a position pick-off. The spring is normally compressed by means of servo-motors

Photograph of pressure transducer



* Ultra Electronics Ltd.

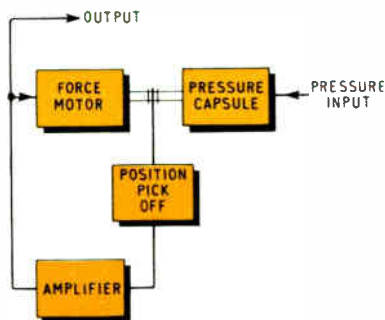

Fig. 1. Schematic of force-balance pressure transducer

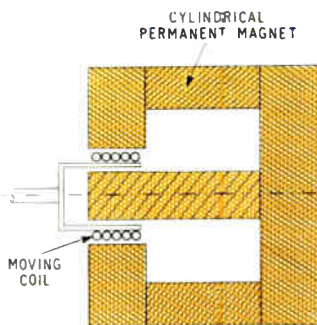

Fig. 2. Sketch of moving-coil force motor

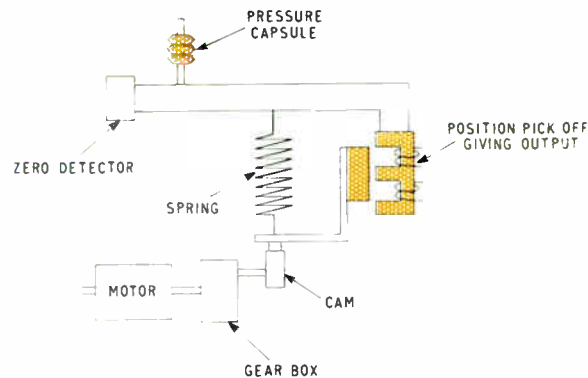

Fig. 3. Motor and spring force motor schematic

with suitable gearing. An example is shown diagrammatically in Fig. 3.

The accuracy of the instrument depends directly upon the constancy of stiffness of the spring and so great care must be taken in its manufacture. High precision springs are made by machining a double helix from the solid metal thus minimizing errors due to inhomogeneity and forming stresses. It is necessary to use a material which has a low temperature coefficient of change of its modulus of elasticity, such a material being Ni-Span C. However, for high-temperature applications all materials show some change of Young's Modulus and so temperature compensation will be necessary. If temperatures up to 150 °C or 200 °C are contemplated it is preferable to use a material which has a constant temperature coefficient of modulus which can be easily compensated rather than one with a lower but more variable coefficient.

Further errors arise in this system due to inaccuracies in the position pick-off used for measuring the deflection of the spring and giving the output signal. Using a synchro, accuracies of the order of 1% of actual value are possible over a fairly wide range of temperature. It is clear, however, that this component contributes considerable errors to the instrument.

Choice of Pressure Sensing Element

The requirements for the pressure sensing element can then be deduced from the above. Firstly, it must have a linear force-to-pressure characteristic; that is to say, if it is restrained from moving, the force it produces will be proportional to the applied pressure. Secondly, the ratio between the force and pressure (the equivalent piston area as it is known) must be constant and independent of temperature. Lastly, it must have a low mechanical stiffness so that when deflected the forces produced will be small compared with those dependent upon pressure.

The device best known to fit these requirements is a stack of convoluted diaphragms. The convolutions serve the dual purpose of reducing the stiffness and preventing unsymmetrical distortions with increasing temperature. If the stiffness is too high using the thinnest material that gives sufficient strength then it can be made less stiff by stacking sets of diaphragms in line. A typical design is shown in Fig. 4.

Various brasses, bronzes and steels are used to make such diaphragms as these. However, for high temperature appli-

cations especially where it is required to hold a reference vacuum Ni-Span C—a nickel steel—is a favourite. This material has the further advantage that it has a very low temperature coefficient of its modulus of elasticity over a wide temperature range. This means not only that the stiffness of the diaphragms remain constant, but also that changes in the force/pressure characteristics are less likely as this relationship is dependent upon the elasticity of the material.

Another possible configuration that can be used is the convoluted bellows which are formed from the tube either by rolling or pressure forming. However, present designs have not proved as accurate as the stacked diaphragms.

For the higher pressures, or where for other reasons the forces that need to be developed are large, the motor and spring arrangement is smaller than the moving-coil type. Additionally, the motor gives the advantage that it is an integrator so that more accurate control may be achieved with simpler electronics. On the debit side, this arrangement is complicated, and hence unreliable, slow acting, and cannot be made extremely accurate over a wide temperature range without a considerable amount of compensation being applied.

What is required then is a force-balance element which has the accuracy of the moving-coil arrangement without its size penalty and which preferably has a simple construction. A force motor has recently been developed for this purpose having these properties. It is essentially an iron armature moving between two coil yokes as shown in Fig. 5. To make the force proportional to current rather than to its square the magnetic circuit is polarized by means of a permanent magnet. By choosing the parameters and materials of this design carefully, the force-to-current relationship can be made extremely linear and stable. For typical designs the weight saving over moving-coil devices having similar characteristics is about eight fold. It is not very easy to test accurately the characteristics of devices of this nature outside a closed loop. But from closed loop tests it would seem that linearity and zero errors from this device can be kept within 0.1% of full scale over a temperature range of -40 °C to +150 °C without external compensation.

Null Detector

To detect the balance condition for controlling the force motor a null detector is required. This detector must have excellent zero stability to minimize instrument errors

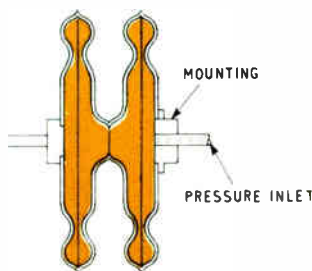

Fig. 4. Section through stacked diaphragms

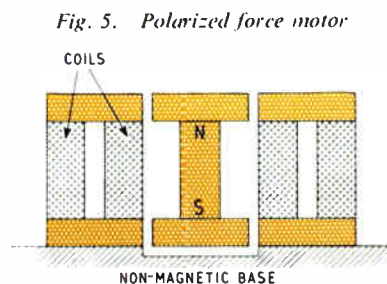

Fig. 5. Polarized force motor

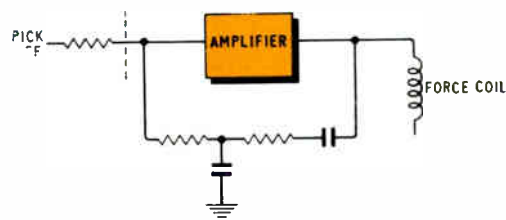

Fig. 6. Amplifier with stabilizing circuit

due to mechanical spring rates but otherwise no particularly difficult requirements exist. It should have a reasonably linear output with position to simplify the servo problems. From time to time many different devices have been used for this purpose, and the most suitable must depend upon the particular applications. Differential capacitance pick-offs are commonly used and are probably the most generally useful as they can be made to have a small detecting range and hence give comparatively large outputs for the minute movements that must be controlled if a very accurate instrument is to be built. Differential inductance pick-offs may also be used although they are not quite so adaptable for small movements. Finally Hall elements have been used in crossed magnetic fields which have the advantage of giving a d.c. output of fairly high power level, but at present these are not stable over the extremes of the temperature range.

Amplification and Stabilization

To complete the closed loop between the position pick-off and the force motor an amplifier is required. Naturally, this amplifier must be such that it can accept signals from the pick-off and be capable of driving the force motor and its reference resistor (if required). Beyond this it must have sufficient gain over a wide enough bandwidth to keep transient excursions below certain limits. Those limits are determined by the hysteresis that may be introduced and by the spring-rate errors mentioned earlier. In general a high gain will be required. Further, the drift referred to the input must be small for similar reasons.

In addition, the amplifier may be required to assist in the stabilization of the instrument's closed loop. The mechanical spring rate is made as small as possible; any force error in the loop produces an acceleration which, integrated twice, gives the position error that is detected. This double integration plus any lags in the pick-off, amplifier and force motor make this control loop inherently unstable and positive action is required to stabilize it. This stabilization can take two forms; it can either be done in the amplifier using filters (or possible rate feedback) or it can be done by applying a force to the moving parts proportional to their speed, viscous damping.

Again the most suitable method will depend upon the application but in systems with low natural frequencies it is often found difficult to provide sufficient force from dampers especially as the use of dash pots may introduce coulomb friction in addition, which gives instrument

errors. For these applications electronic filtering is preferable. Fig. 6 shows a way of making such phase advance filters by using feedback around the amplifier. The arrangement shown gives full amplifier gain, for high accuracy, at low frequencies, a fixed but lower gain in the mid-frequency band for the prevention of transient errors and to permit stabilization, and phase advance in the region of the instrument's natural frequency.

For the higher frequency instruments it may be found sufficient to immerse the moving parts in a damping fluid to provide stability. Where this condition applies it is preferable to introducing complications into the electronic circuitry.

Where the amplifier is to be mounted with the rest of the instrument in the high temperature rugged environment it will probably use silicon transistors as the active elements which will restrict the top temperature to at most 150 °C. Ceramic miniature valves are becoming available which would be suitable at higher temperatures, but they are larger and less efficient than transistors and the temperature range could not be increased very greatly owing to limitations of other electronic components.

Description of Instrument

The photograph shows a self-contained instrument of the type discussed which has recently been developed. It works over a temperature range of -40 °C to 150 °C (complete with electronics) giving errors of $\frac{1}{3}\%$ of fullscale over this range measuring absolute pressures up to 15 p.s.i.a. It will withstand very high vibration levels without giving erroneous outputs and can be mounted in an aircraft without anti-vibration mounts. Its response time is of the order of 20 msec. The output is 1 volt d.c./p.s.i. from 1 k Ω .

This instrument incorporates two pressure capsules acting differentially upon a beam, one being evacuated to act as a reference and the other taking the pressure to be measured. The beam is supported on crossed flexings so as not to introduce any friction and its position is detected by a differential capacitance pick-off. The force balance is provided by a polarized force motor as described which accounts for the small size of the instrument. All the mechanical parts including pick-off and force motor are in an oil bath which has an expansion chamber at one end. Attached to the other end is a cylinder containing the amplifier and its power supplies.

THE two readers to be described operate on quite different principles electronically. The first, the Readatron, was developed by the National Data Processing Company of Dallas, which is now part of the Univac Division of the Sperry Rand Corporation. The second, the Univac Optical Character Reader, is marketed by Sperry Rand as an extended configuration using the basic machine originally developed by the Farrington Manufacturing Company and Farrington Electronics Inc.

The Readatron

This machine uses a vidicon tube, similar to the type used in television cameras, for scanning the characters to be read. Fig. 1 shows a system block diagram. The entire field of characters from a card presented by a transport mechanism is illuminated by a flash tube and projected through an optical system on to the screen of the vidicon. The maximum capacity of each exposure is three fields of 15 characters, making 45 characters in all, for which the total reading time required is 90 milliseconds. The output is punched into cards on an I.C.T. type 34 punch operating at 200 cards per minute. (Versions of the machine have been built with incandescent lamp illumination and an electro-mechanical shutter linked to the card transport, but the flash tube method is clearly better for high-speed operation.)

The vidicon tube is used as an interim store of the entire field. The central logic unit includes a timing control and clock pulse generator. Under control of this unit the images stored on the face of the vidicon after exposure are scanned by the electron beam (as shown in Fig. 2) one line of characters at a time, in a series of vertical 'slices'. Hence the signal information relating to each complete character leaves the read-out circuit in one continuous train. After passing through a video amplifier it is stored in a 340-bit shift register. The amplifier is designed to heighten the contrast (by lowering the background signal level to a fixed percentage below that of the 'black' signal level) and hence improve the dynamic range and discrimination power of the reader. The amplifier output is quantized at two levels, representing 'image' and 'background'.

The 340-bit shift register is used to store one character at a time only. The raster for each character-space makes fourteen vertical sweeps, the image being 'read' twenty-five times during each sweep under the control of the clock pulse. Only about 13 samples are taken from each character during each vertical sweep. The additional storage capacity relates to the added height of the character-space allowed for inaccuracies in registration.

As the signal train passes into the shift register, the central logic unit monitors it, detects the approach of a valid character and decides if the stored information is sufficient to be recognizable. The logic unit also determines the time at which the recognition unit should sample the information in the shift register and finally re-sets the shift register to zero when recognition is complete.

Recognition is achieved by sampling 'black' and 'white' (i.e., 'image' and 'background') areas and comparing them with the stored images on resistor matrices. Each matrix contains between 60 and 100 black and white points, connected to the portions of the shift register known to be the most reliable in printing the character concerned. Some points known to be reliable and unique are weighted by using lower register values at such points in the matrix. As all comparative matrices are permanently connected to the sample points in the shift register, recognition is achieved by measuring matrix output voltage.

Fig. 3 shows diagrammatically how the scan is achieved, while Fig. 4 shows a portion of a sample matrix area. Reference to Fig. 5 will clarify the shift register sampling and recognition procedure. If the shift register can be imagined as wound into a helix with sample points marked, the outline of a character would be seen. If the video signal train were also visible as it was fed into one end of the register, the character would appear to flow round the helix towards the sample area and would finally coincide with it. It will now be apparent why the vertical registration is unimportant, providing the character falls within the allotted space on the face of the vidicon tube. A difference in vertical registration merely means that coincidence of actual and sample signals will occur a fraction earlier or later, by a matter of 40 microseconds in the worst case.

Referring again to Fig. 5, the lower portion shows the first two strings of the shift register stages and the first two vertical strokes of video analysis approaching the matched condition in the sample area. As the signal train approaches the matrix, the matrix output will start rising. When the output reaches a preset threshold level it is stored as a voltage on a capacitor, one for each matrix.

Capacitor storage only begins when the peak matrix voltage correlating to the pulse train reaches 90% of a perfect match. The cross-correlation voltages caused by lesser peaks generated in the matrices for other characters might cause premature thresholds when the video train is not completely driven in and happens to match a portion of the wrong matrix.

In this second article on electronic reading machines, the operating principles of two practical machines are described. The concluding article will deal with applications and economics.

DEVELOPMENTS IN ELECTRONIC READING MACHINES

By JOHN B. RUDKIN

2. Two Commercial Machines

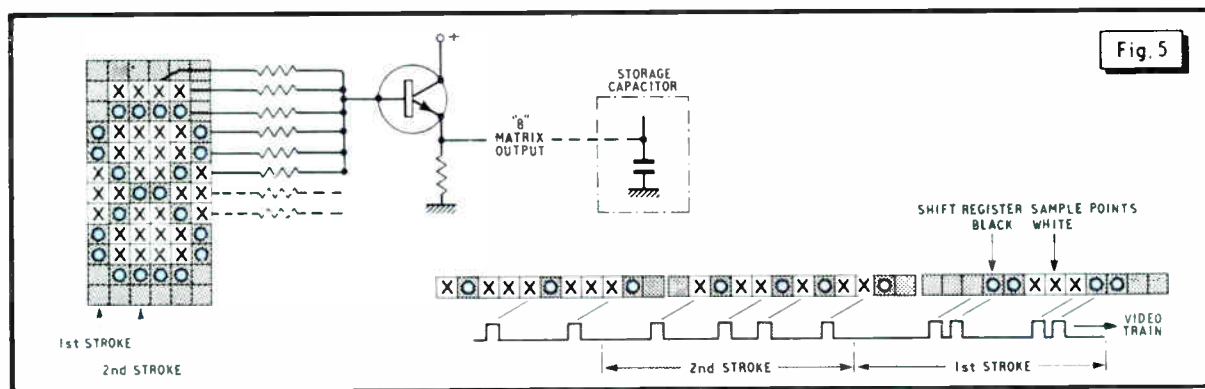
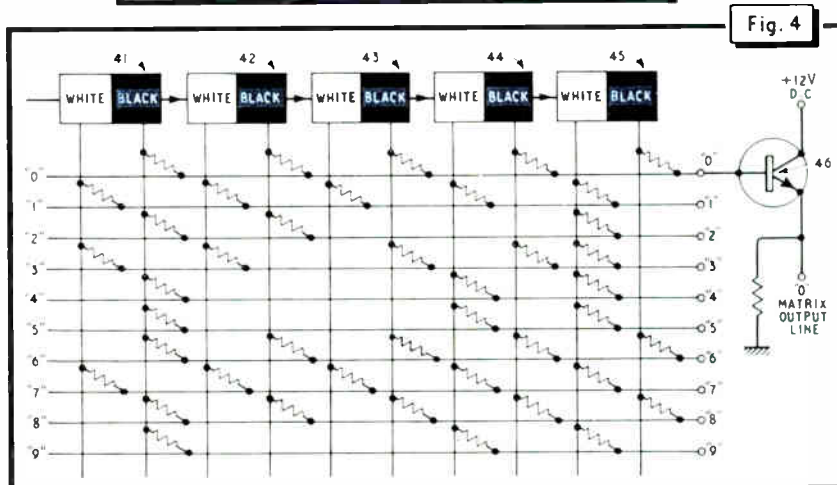
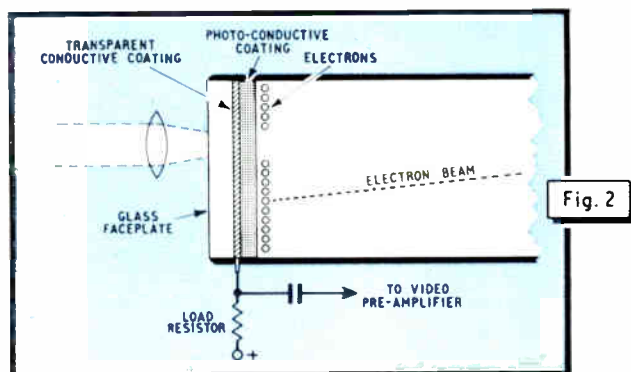
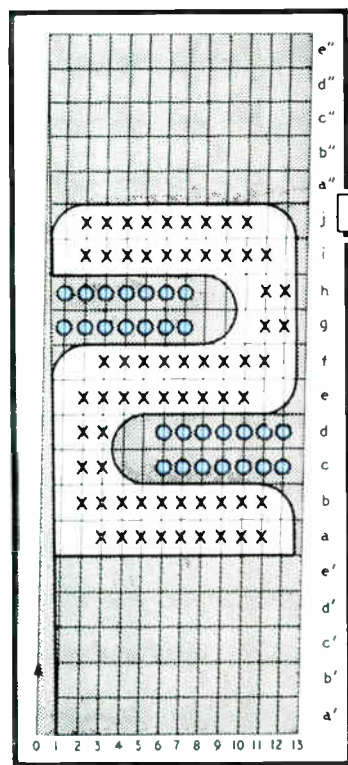
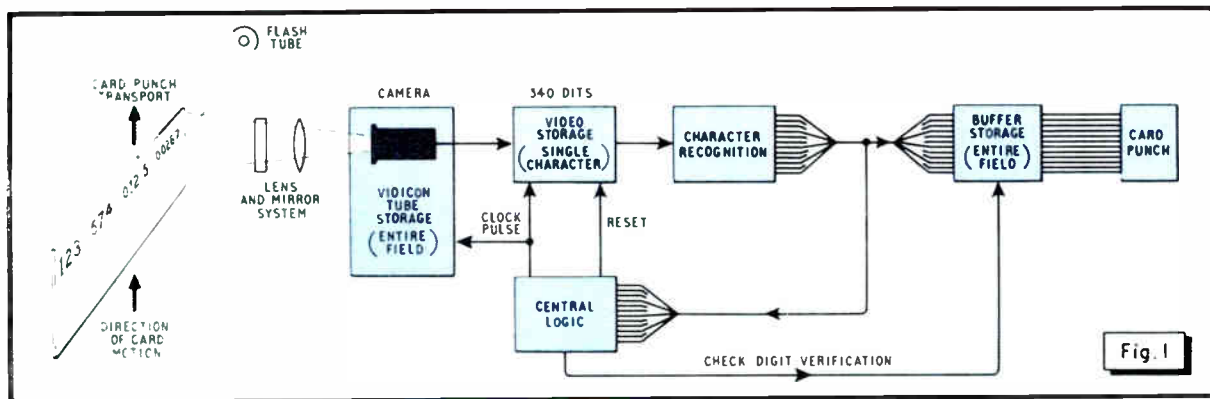

Fig. 1. General block diagram of the Readatron system. Fig. 2. Cross-section of the vidicon tube face used in the Readatron. Fig. 3. Diagrammatic representation of the scan of the numeral '2' in the Readatron. Fig. 4. Portion of the Readatron sample matrix area. Fig. 5. Simplified sketch of shift-register sampling in the Readatron

This is avoided by a 'blinking' technique, whereby the previous character sets a minimum time limit before the next threshold can be reached, and by careful selection of the sample points. The blinking technique also helps to prevent extraneous marks from generating spurious or premature thresholds.

When two vertical sweeps have passed without any black video signal it is certain that the whole image is situated on the matrix and a 'read' command pulse is generated. If this is prevented by extraneous smudges, a read pulse is generated at a fixed maximum time after the last previous character.

The read command adds a staircase voltage to that stored on the capacitor and when this reaches a pre-set trigger level the state of a flip-flop is changed. A positive triggering action regardless of the slope of the correlation wave shape is assured by the staircase voltage. When the flip-flop associated with a character is triggered the staircase generator is halted and the proper character output results.

A badly mutilated character might still cause two or more capacitor stores to reach the trigger level simultaneously and if this occurs all the character outputs are inhibited.

Finally, a check digit, if used, is examined by the central logic unit, and if it proves satisfactory the entire field of characters stored on the vidicon is gang-punched on to a card and the buffer store cleared.

It may be noted that as the exposure flash has a duration of about 10 microseconds only it is not necessary for the material being read to be stationary at the instant of exposure, nor is any synchronization necessary. In fact, unless the original material is moving very fast indeed it is possible to take a second look (under control of the logic unit) at doubtful or marginal recognitions.

The positioning of fields on the material is unimportant, the optical system being adjusted to bring them into correct position on the vidicon face. As the recognition rate is constant and independent of the speed of original documents, the standard camera, system and logic can be used for all applications—it is only the external mechanical parts which need to be changed.

It will be seen that the Readatron is both a stroke analysis and a matrix-matching machine, but the use of the vidicon tube and shift register, and the form of logic applied, enable it to overcome many of the disadvantages of matrix-matching. The absence of any mechanical moving parts in the scan obviously contributes to long-term reliability and low first-cost.

The Univac Optical Character Reader

This machine operates entirely by stroke analysis, through a mechanical scan, and reads characters printed on documents from a special font. The output is recorded on magnetic tape by a Uniservo model IIa Tape Handler, through an intermediary Tape-Control Unit. The font read by the machine was designed by Farringtons and given the registered trade mark 'Selfchek'.

Selfchek characters are made-up from combinations of the presence or absence of nine straight lines or strokes in pre-determined positions. Fig. 6 shows at (a) the three possible horizontal-stroke positions and at (b) the six possible vertical-stroke positions.

A simplified diagram of the scanning system is shown in Fig. 7. The fixed slit plate represents one slice of the vertical analysis of strokes, and the passage of the scanning disc, with its 30 horizontal slits, between the mirror system and the fixed slit makes the signal generated in the photomultiplier represent one vertical slice of the scan. The mirror system is carried on a synchronized oscillating assembly (not shown) so that it rocks the reflected image across each character space once per revolution of the disc. The effect of this is that consecutive slits of the scanning disc admit horizontally successive vertical slices of the scan. The fixed and moving slits are each 0.010 in. wide.

Fig. 8 shows how a numeral '2' would scan in slices and shows as examples the pulse train which would be the output of the photomultiplier for three slices.

Recognition is accomplished by first measuring the pulses and then logically determining which character they represent. Vertical strokes are measured directly; horizontal strokes are detected by counting the number of vertical slices through the horizontal-stroke area. This

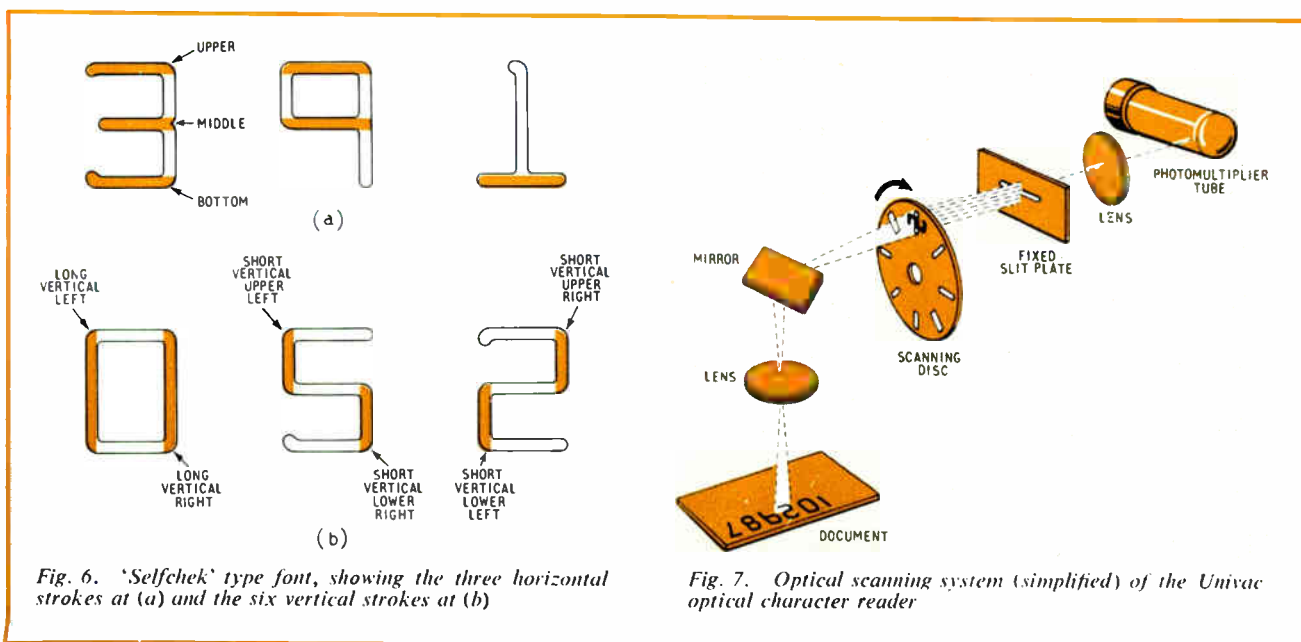
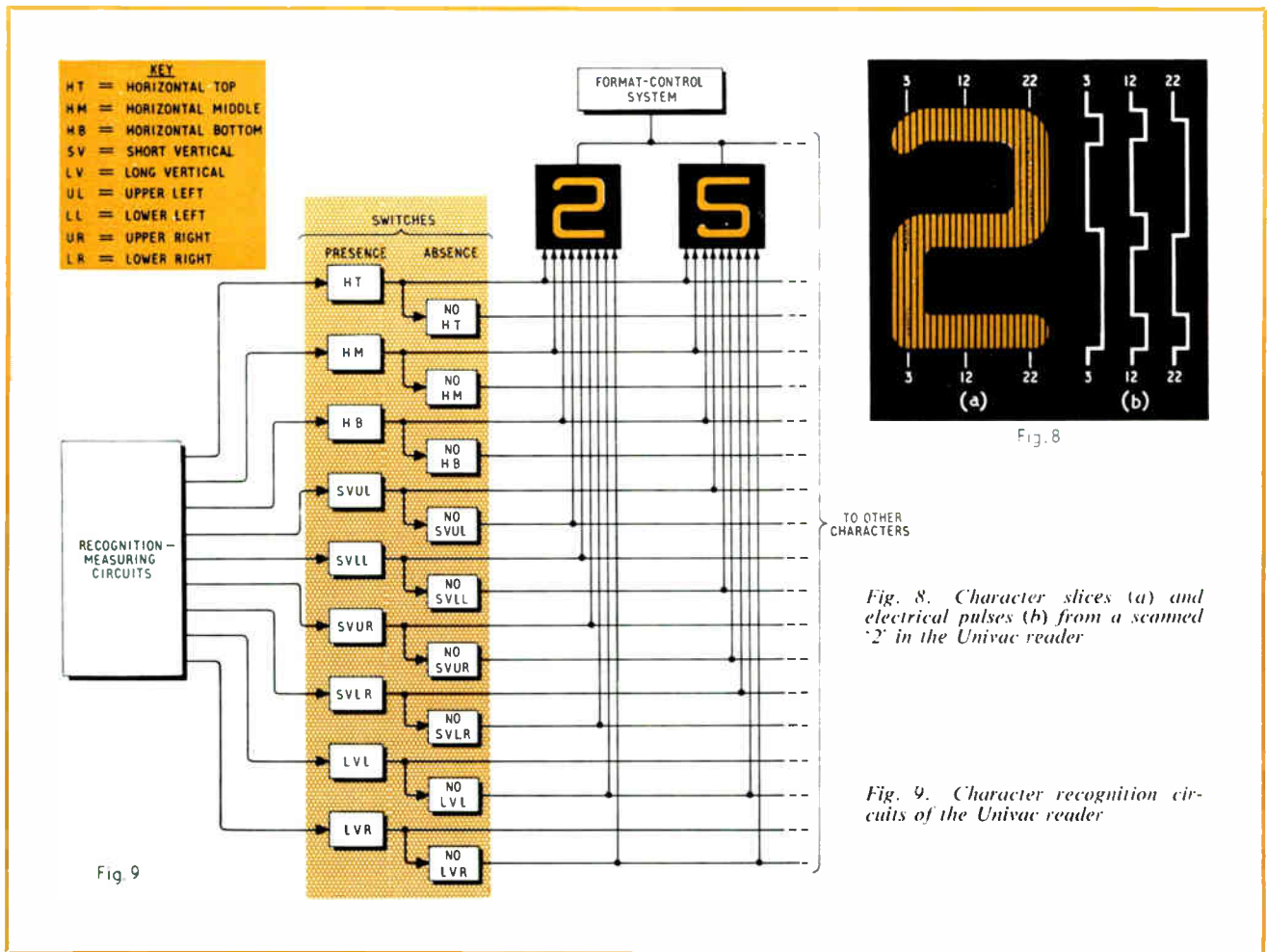

Fig. 6. 'Selfchek' type font, showing the three horizontal strokes at (a) and the six vertical strokes at (b)

Fig. 7. Optical scanning system (simplified) of the Univac optical character reader



count is also used to determine the lateral position of the vertical strokes. As shown in Fig. 9, the character-determination circuits employ a pair of electronic switches for each of the nine possible strokes, positively denoting presence or absence of each. For any given character, a unique combination of switch outputs is produced and will in turn trigger an output in only one of the separate character-recognition circuits.

For example, the numeral '2' already illustrated requires the *presence* of horizontal top, middle and bottom strokes, and short vertical lower-left and upper-right strokes. It also requires the *absence* of short vertical upper-left and lower-right and long vertical left and right strokes. Only the recognition circuit for the numeral '2' receives all these necessary presence and absence signals.

The signals from the character-recognition circuits pass to format-control and encoder circuits ready for tape-writing, and are held in that state in an output buffer store.

The font read by this machine is regarded as self-checking because the logic is so arranged that at least two strokes of a character must be changed or missing before recognition breaks down. If a character is so badly printed that it is still unreadable, the line of characters is automatically and continuously rescanned up to a preset limit. If recognition still fails at this point a reject mechanism is triggered and the document is fed to a reject stack.

The format-control circuits are programmed by means of a plug-board. This enables such operations to be carried

out as deletion or insertion of characters and data fields in the recorded output, filling-out variable-length fields to a fixed length, and so on. A further plugboard controls the encoder, which encodes the signals from the format-control system in six-bit binary-coded decimal, plus a parity check bit, making seven channels in all. (The half-inch tape has eight channels, including a sprocket-bit or clock-track.)

The output buffer store is a single-track magnetic drum holding 120 characters, which are transferred to the output tape via the tape control unit as soon as the track is full.

A feature of the machine is the fast handling system for documents being read. Documents are transported by suction through holes against a rubber belt. The vacuum is applied as soon as scanning is complete under control of a transport signal emitted by the reader. Air jets directed down on to the documents in the feed hopper prevent them sticking together, so that only the one nearest the belt (and which has just been read) will be picked up and transported either to the 'accepted' or 'rejected' stack.

The tape-control unit is a comprehensive device which equalizes signal levels between the scanner and the tape-handler, controls bad-spots on the tape, counts the blocks of information recorded, and provides power for the handler.

Recording takes place in 'blockettes' of 120 characters, the first and last from each document being always within

the same blockette. If the left-over capacity is insufficient to record another document, the logic circuitry fills up the space with binary zeros. Blockettes are grouped in sixes to make up blocks.

End-of-batch and end-of-tape marks are recorded automatically.

Error detection is by parity check. When an error is located, the system stops and an 'error' indicator is illuminated. A bad-spot on the tape is automatically bypassed so there is no danger of drop-out.

Representative maximum operating speeds for this machine are 38 characters from each of 312 documents per minute, 48 characters from each of 250 documents per minute, or 63 characters from each of 196 documents per minute.

The full vocabulary of Selfchek alpha-numeric characters and symbols totals 42.

When the full font of 42 characters and symbols is used, the discrimination of the Selfchek system is not so high as with numerals only. In particular, the system cannot discriminate so well between 'D' and 'O' or between 'B' and '8'. However, the Univac Optical Character Reader also embodies a check digit system in its logical structure. Where the documents being read have been originated by a computer, that machine is programmed to calculate a check digit by reference to the characters and to their position in the scan line. If there is an error in the printing or in the subsequent reading by the O.C.R., the check digit as recomputed by the logic in the reader will not agree, and the document will be routed to the reject stack.

High Sensitivity Image Intensifiers for U.K.A.E.A.

Mullard Research Laboratories in conjunction with the Atomic Energy Research Establishment have developed a high-sensitivity image-intensifier tube for use in experiments involving sub-atomic particles. The U.K.A.E.A. has placed a contract with Mullard to supply six of these tubes, which are being made at the company's Mitcham factory.

In many experiments involving sub-atomic particles it is necessary to photograph one event of special interest among a million or so others which occur within a particular period. For example, it may be necessary to record the light track of a single particle involved in a collision process, or to determine the energy of the particle by means of the Cerenkov radiation it causes.

The amount of light produced by a single particle is extremely small. In the example quoted, the light produced would barely affect one grain of the emulsion on a photographic plate. Therefore, if useful photographs are to be

obtained, the light must be intensified without its pattern being distorted. This can be done by means of image-intensifier tubes incorporating photo-emitters which have a much higher quantum efficiency than photographic emulsions.

The Mullard two-stage image intensifier being supplied to the A.E.R.E. is such a device. It will be used as a low-noise pre-amplifier in a system that produces useful photographs from extremely low-level light sources. The tube intensifies the light from a single particle into an image that provides a suitable input for a high-gain image amplifier.

Another difficulty which arises when investigating sub-atomic particles is the short duration of the light produced in a scintillation or by Cerenkov radiation. The ancillary circuit needed first to recognize an event as one of interest, and make the decision to photograph it, takes longer to operate than the duration of the event. The event must therefore be recorded and stored: the image intensifier does this by means of fluorescent screens with an afterglow which can range from a fraction of a microsecond to several milliseconds. The choice of phosphor is determined by the response of the detecting and switching circuits and by the maximum rate at which events could occur without overlapping.

The image intensifier contains two similar stages, in each of which the electrons emitted from the photo-cathode are focused electrostatically on to a fluorescent screen. Hence, the image on the final screen is a reproduction of the pattern of the active region on the first photo-cathode and its screen. The first photo-cathode has a diameter of more than 150 mm and the maximum diameter of the final image is 20 mm, making a total demagnification of 7.29:1.

The screen of the first stage and the photo-cathode of the second stage are on the opposite sides of a mica sheet 15 μ thick. This arrangement ensures highly efficient coupling between the two stages with little loss in image resolution. Unlike the first stage of the image converter, the second stage has an electrode fitted between the photo-cathode and the focus anode. When this electrode has a negative potential of about 200 V, no electrons from the photo-cathode can reach the output screen. This electrode is used as a shutter to select the required event and to prevent noise generated by the system reaching the output screen.

One of the image intensifier tubes undergoing final assembly

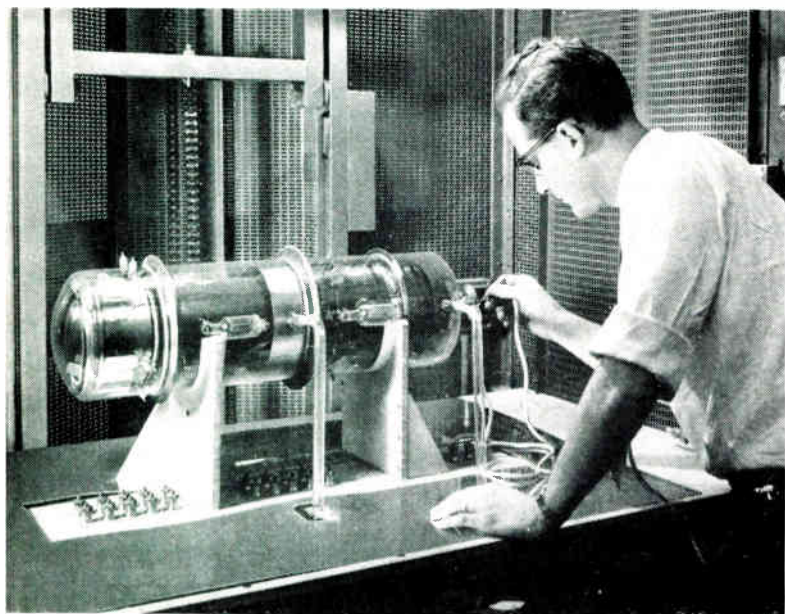

IN 1961 the Rivers (Prevention of Pollution) Act extended the powers of River Boards in England and Wales to lay down and enforce maximum limits of impurities in trade and sewage effluents discharged into rivers and streams. In the same year, the Public Health Act gave increased powers to Sewage Disposal Authorities to charge for the treatment of trade effluents on a strength and volume basis. The passing of these two Acts meant that maximum limits for the concentration of suspended solids could be enforced on all trade effluents, whether discharged into sewers or directly into rivers and streams.

The standard method for the determination of suspended solids is to filter a known volume of sample and weigh the residue. However, this method is impracticable on a continuous basis. About five years ago the Water Pollution Research Laboratory examined this problem with a view to making a continuous measuring device working on an optical principle. Optical methods suffer from the disadvantage that the sensitivity to suspended solids depends on the particle size distribution of the solids and to their reflectivity or refractive index. However the W.P.R.L. was able to show that on particular installations the error produced by changes in particle size distribution is generally less than 5%. In exceptional cases when highly reflective particles such as titanium dioxide are present the error may be up to 10%. This is still of a sufficiently high order of accuracy to make the method worthwhile as a continuous system.

After examining several systems of measurement, it was decided that the determination of the ratio of scattered light to the transmitted light gave the best indication of a reliable continuous instrument. Several prototype models were constructed and have been used by W.P.R.L. in its research programme for the past two years.

In the light of this experience Southern Analytical Ltd. have developed a version of the W.P.R.L. instrument for measurement in the range 1-1,000 p.p.m. which is suitable for installation in a wide range of industrial conditions. The equipment is built in two units. The optical unit is fully weatherproof and may be mounted in any situation while the electronic unit may be installed under cover up to 200 yards away.

The Optical Unit

Fig. 1 shows the layout of the optical unit. Light from a tungsten-filament light source falls on two converging lenses separated horizontally by about 2 in. and mounted in apertures in a vertical metal plate. The light source is a 12-volt 100-watt projection lamp which is under-run to give a life of at least 6 months.

On the far side of the plate is an induction motor the spindle of which carries a Perspex disc. The disc is painted to leave two clear sectors, so that its rotation causes the inner sector to cut off in turn each of the emergent parallel beams from the lenses. Between each lens and the disc provision is made for neutral density filters to be inserted if required. The 'chopped' beams are reflected by a pair of mirrors so that they converge at right angles into two windows of the flow cell. One beam passes through the cell and falls on a silicon photo-diode mounted behind a window on the opposite side and the other beam passes straight through the cell via a fourth window. A component of its scattered light at right angles to its direction falls on the photo-diode which thus generates alternate current pulses due to the transmitted and scattered light. Their magnitudes depend on the nature and concentration of the suspension in the flow cell.

Two auxiliary photo-diodes are mounted immediately

*Formerly Southern Analytical Ltd.

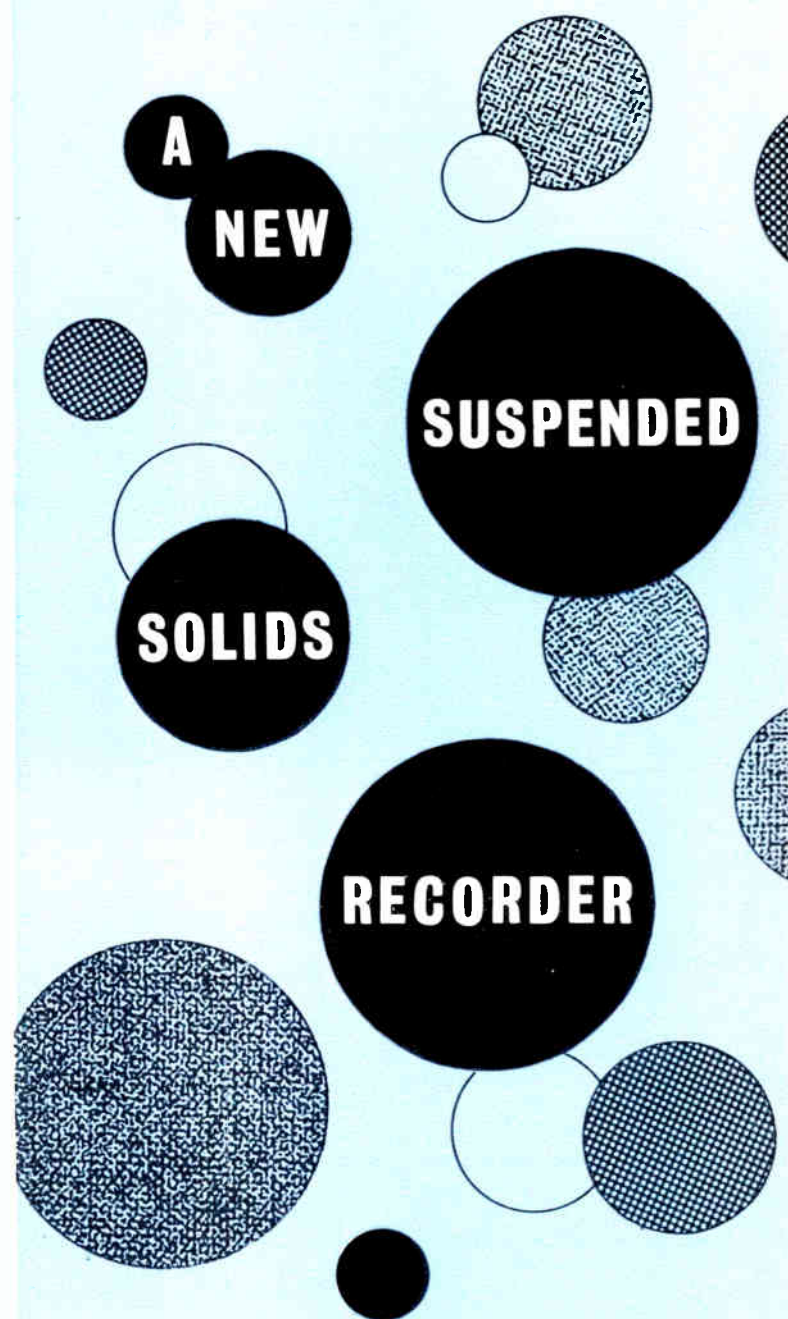

By G. B. THORPE, B.Sc.*

This article describes an instrument for measuring the quantity of suspended solids in fluids. It is intended for measurements on, for example, trade effluents so that they may meet legal requirements.

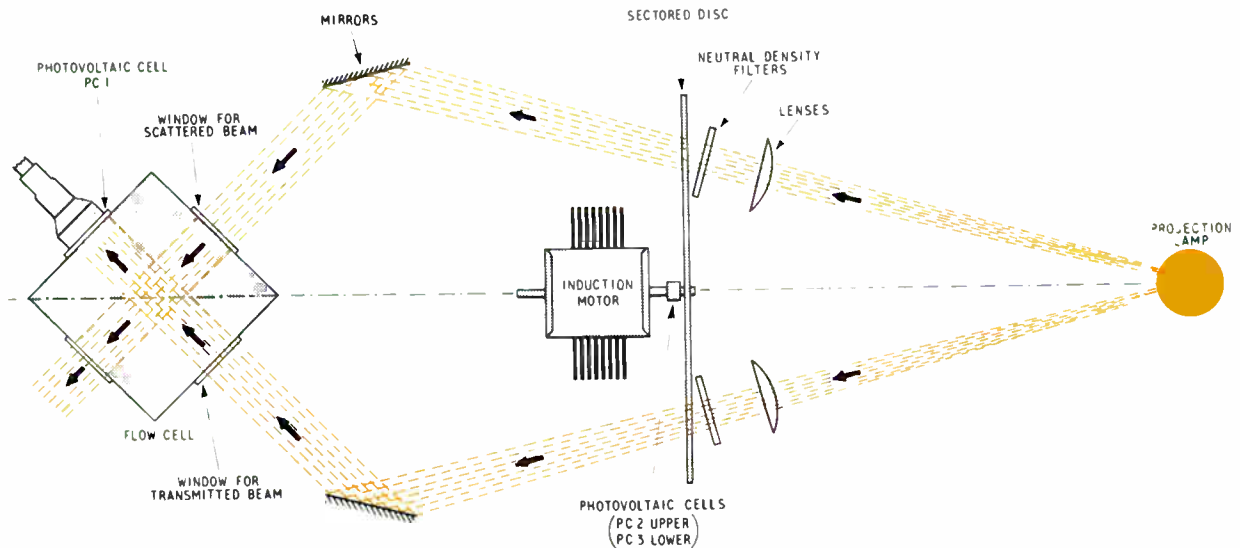

Fig. 1. Optical layout of the system. The sectored disc alternately interrupts the two light beams while PC2 and PC3 generate gating pulses in synchronism

behind the outer clear sector of the Perspex disc. These two photo-diodes generate pulses in synchronism with the transmitted and scattered beam signals respectively and, being of slightly longer duration than these signals, are used as gating pulses in the electronic unit.

The Electronic Unit

The electronic unit is fully transistorized and consists of two linear amplifiers and a logarithmic amplifier followed by two transistor switches and an output circuit (Fig. 2). The first linear amplifier is a five-stage circuit. The input stage has collector-to-base feedback to ensure an input resistance of less than 100 ohms. Under these conditions the photo-diode acts as a current generator and its output current is directly proportional to the incident light intensity. The next three stages are grounded-emitter circuits with undecoupled emitter resistors to ensure linearity. A preset gain control is incorporated in the second stage. The final stage is a compound emitter-follower circuit. Capacitance coupling is used throughout and d.c. restoration is achieved in the final stage. The transfer resistance of the amplifier is approximately 1 megohm at maximum gain and the peak signal output is 10 volts.

The output signal of the first linear amplifier is applied to the input of the logarithmic amplifier. This consists of a high gain d.c. amplifier with a logarithmic diode connected between its input and output terminals. Two cascaded emitter-coupled transistor pairs, followed by a compound emitter-follower, provide a high forward gain. In the interests of drift-free operation and the retention of useful current gain at low base current, the input stage consists of a pair of n-p-n silicon planar epitaxial transistors. The characteristic of the logarithmic amplifier is such that a change of a decade in input current causes a change of 0.12 volt in output voltage.

Amplification of the output of the logarithmic amplifier is desirable for two reasons. First, the voltage level of the signal must be raised to a value which, after impedance conversion in the output circuit, will produce sufficient power to drive both a meter and current recorder. Secondly, the effect of base-emitter voltage drift in the output circuit is reduced by further signal amplification.

Amplification by a factor of 10 is sufficient and is

accomplished by a grounded-emitter amplifier followed by a compound emitter-follower, with current feedback to the input base. The feedback circuit includes a diode and a thermistor. The diode serves to limit the output to signals of unwanted polarity, and the thermistor compensates for the effect of temperature on the characteristic of the logarithmic diode.

The signal is now fed to two transistor switches which are operated by amplified pulses from the auxiliary photo-diodes. The signal pulse due to the transmitted light passes through one switch and the signal pulse due to the scattered light passes through the other switch. Each signal is passed into a diode-capacitor peak-reading circuit and thence through a compound emitter-follower circuit. These circuits offer a sufficiently high input resistance to the peak-reading circuits and provide enough power to drive most

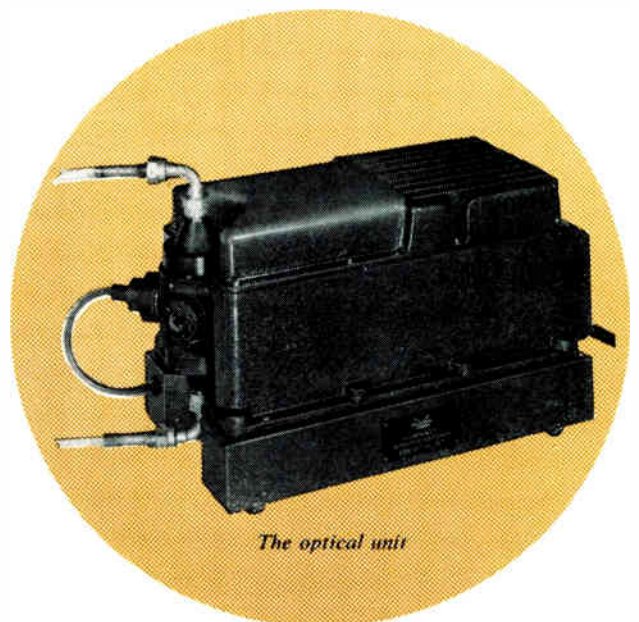

The optical unit

types of current recorder. The two signals are each fed to one terminal of an indicating meter, in parallel with a recorder, if used. The meter reading is thus proportional to the logarithm of the ratio of the scattered and transmitted light intensities.

It will be seen that over a considerable range the ratio will be unaffected by the following factors:—

1. The intensity of the light source.
2. The sensitivity of the main photo-diode.
3. The gain of the first linear amplifier.
4. The speed of rotation of the disc.

In addition, light from the two beams has equal path lengths in the flow cell and so colour or absorption changes in the sample do not affect the ratio.

Also both beams pass through two windows in the flow cell and assuming that each window fouls equally, this effect is cancelled by the ratio measurement.

An additional circuit is provided to enable the peak signal input to the logarithmic amplifier to be monitored during the setting of the neutral density filters on any particular type of sample. This should be selected to give a peak signal not exceeding 10 volts at extremes of ratio.

Method of Construction

Considerable thought has been given to the design of the flow cell to ensure that it will have useful applications in a wide range of industrial conditions. It is made as a gun-metal casting with an inside diameter of 2 in. The cell may be coupled directly to a 2-in. diameter pipeline but adaptor flanges are available to reduce the pipe size down to 1/2 in. These adaptors are conical so that there are no sharp edges to encourage the accumulation of solids which may block the pipes.

The flow cell is painted with an epoxy resin paint which withstands continuous immersion in liquids in the pH range 2–12.

Four symmetrical windows are fitted into the flow cell. Each one has an aperture of 1/4 in. and is backed by a second window. There is a gap of 1/4 in. between the two. This has the effect of stopping misting when the temperature of the sample is below that of the surrounding air. A triple 'O' ring seal is used between the windows and has been pressure tested up to 250 p.s.i. The cell is rated for continuous operation at 100 p.s.i. The windows may be readily removed for cleaning and replacement.

The maximum temperature of the flow cell is limited to that of the silicon photo-diode; i.e., 85 °C.

The flow cell is mounted rigidly on to the main casting

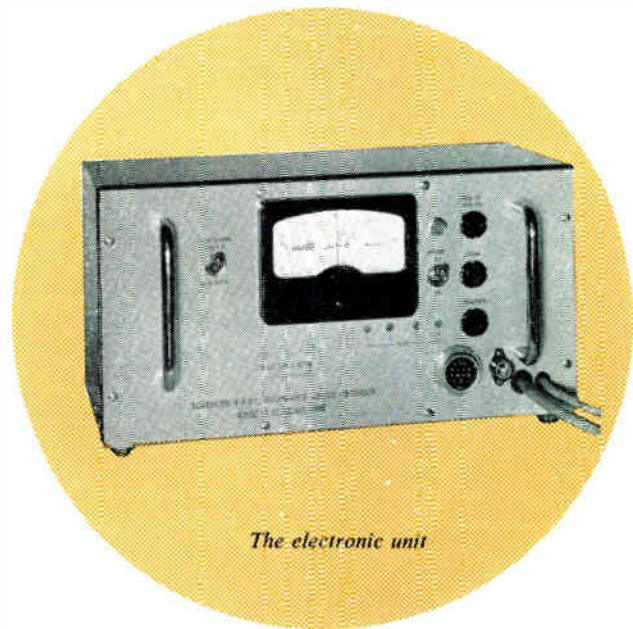

The electronic unit

of the optical unit. The components of the optical unit are mounted on a rigid sheet steel plinth to which the main casting is bolted and accurately located by dowel pins.

In order to provide one mains tap setting and to remove as much self-generated heat as possible from the electronic unit, the lamp transformer and mains tapping panel are mounted in the optical unit behind the light source. The a.c. mains supply and the signals from the auxiliary gating photo-diodes are fed along an eight-way cable to the electronic unit. A separate single-core screened cable is used to feed the main photo-diode signal to the electronic unit. A separate small mains transformer is employed for the electronic circuitry, which is contained almost entirely on two printed-circuit boards.

The optical unit is closed by a cast aluminium lid and sealed with a rubber sealing strip. The two castings are finned to provide efficient dissipation of the heat from the light source.

There are only two controls on the front panel, the mains on/off switch and a switch to cause the meter to display either log ratio or peak signal voltage. Operation

Fig. 2. Block diagram of the electronic unit

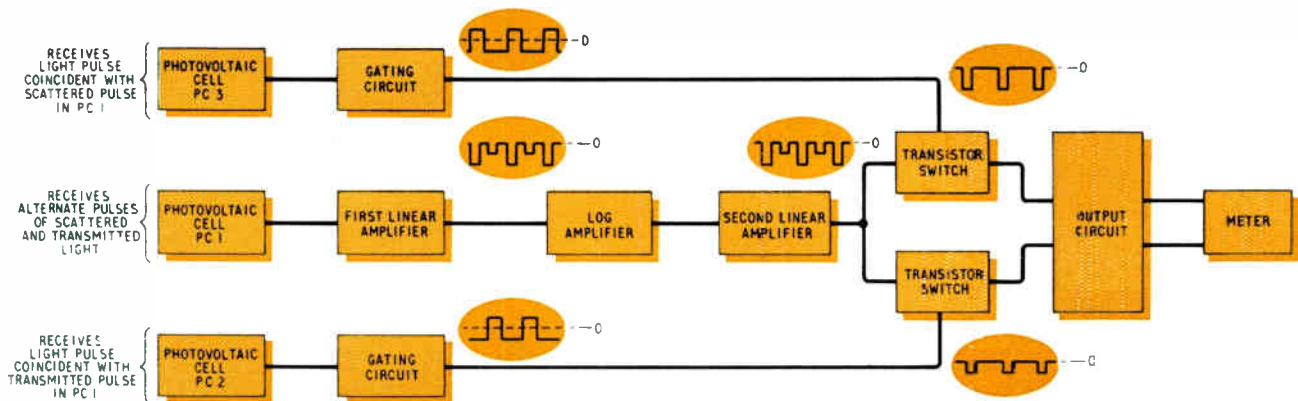

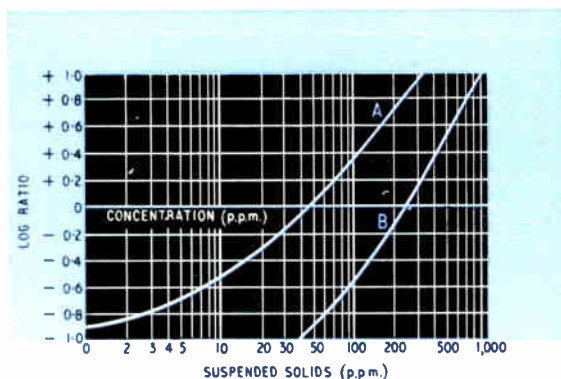

Fig. 3. Calibration curve of the equipment for a stable suspension of fullers' earth. Curves A and B are for transmission filters of 5.7 and 3.2 optical density respectively. No scatter filter was used

of this latter switch however will not effect an external recorder which will continue to read log ratio in either position.

Test points are provided to enable oscilloscope traces to be displayed of each gating pulse and of the input of the logarithmic amplifier and the output of the second linear amplifier.

Provision is made for the connection of a 10-mV potentiometric recorder or a 500-0-500 μ A current recorder having a coil resistance of 350 Ω . However, a minor alteration of the output resistor network will enable the equipment to drive any potentiometric recorder having a full-scale sensitivity of less than 1.8 volts and any current recorder having a full-scale sensitivity of less than 1 mA and a coil resistance of less than 1,800 Ω .

Applications

Fig. 3 shows two calibration graphs which have been plotted, against stabilized suspensions of Fulbent 570 (a grade of fullers' earth). Calibration curves for other samples may be plotted by carrying out a gravimetric determination on one high level sample and by plotting meter readings against various dilutions of that sample.

River Boards

Mention has already been made of the primary reason for the development of this method of measurement by W.P.R.L. It is intended for use by Sewage Authorities and industrial concerns which will have to monitor the effluents discharged directly into rivers as in the next few years the River Boards will intensify their efforts to safeguard the rivers and streams in their areas.

Sewage Works

In addition, the Sewage Authorities will implement their powers under the Public Health Act 1961, to charge for the treatment of trade effluents. It is hoped that this will relieve the burden on the local rates but will undoubtedly result in adjustment of the economics of some industries. It is only by continuous measurement that either party will be able to substantiate a claim for an increase or decrease of charges.

As well as effluent monitoring, the Water Pollution Research Laboratory has used its instruments to check the various stages of sewage treatment. The results obtained should lead to greater efficiency in treatment as well as improvements in the design of new works and plant extensions.

Water Treatment

Although finally treated drinking water usually has a suspended solids content of less than 1 p.p.m., the measurement of the solids content of the raw water being fed into a treatment process will give a good indication of the type of treatment required. Marked reductions in the quantity of flocculating materials may be possible and in some cases the cost of an instrument may be recovered within the first few months.

Re-Cycling Water

In the steel, paper and other industries, large quantities of water are required which need not be of the best drinking quality. In such cases, it is common practice to carry out a simple settling or filtering process and to re-cycle the water. The use of a suspended solids recorder will enable the maximum effective use to be made of existing plant and will provide invaluable data about the capacity required when extensions are planned. In some cases the treatment also involves the recovery of valuable raw material and continuous monitoring may increase the efficiency of recovery.

Filtration

The efficient operation of filter systems can best be studied by using a suspended-solids recorder on input and output. In many instances the operation of filters is left in the hands of semi-skilled people whose judgement may affect the quality of the Company's products to a marked degree. Examples may be found in oil refineries, breweries, food processing and pharmaceutical plants.

The range of application of a continuous suspended-solids recorder is very wide and it is expected that in the next few years extension of the measuring range both to higher and lower concentrations will widen the possible fields still further.

Thanks are due to the Directors of Southern Analytical Limited for permission to publish this article.

Electronics Development of Golf Ball Resilience

Rank Cintel are developing a golf ball resilience measuring equipment for Dunlop. This equipment will be based on the principles employed in Rank Cintel's projectile velocity measuring and ballistics timing equipments.

In operation, a pneumatically-propelled projectile is made to impinge upon a stationary golf ball in such a way that both the ball and the projectile pass down a range on a common axis at different speeds, but in reasonably close proximity. Situated across this range are two light screens and their associated light sources. The light screens are fitted with photo-voltaic cells.

Interruption of the light beam which is focused on to the photocell causes electrical output pulses to be generated. The pulses pass into a trigger separator which is arranged so that the first interruption of the light beam causes a pulse to arrive at the gate circuit of a microsecond chronometer, whereas the second pulse triggers a digital delay and microsecond chronometer.

The first light screen generates 'start' pulses and the second screen generates 'stop' pulses, thus the microsecond chronometer times the passage of the golf ball while the digital delay and microsecond chronometer times the passage of the projectile.

The central production planning computer, linked to two further computers controlling the primary mill and billet shear, exercises overall control of production from orders to final product

ELECTRONICS IN A NEW STEEL PLANT



A new £32 million plant comprising a steel-making department, a bloom, slab and billet mill and a continuous narrow hot-strip mill has recently been completed at the works of Park Gate Iron & Steel Co.

This will increase Park Gate's output of steel from some 425,000 to 800,000 tons a year, and will eventually raise the number employed by 1,300 to 6,500.

The obvious increase in efficiency is due in part to the extensive use of electronics in the plant. Three computers form an integrated production control system to provide production planning and automatic control of billet shear-

ing. Electronic tubular displays present instructions to operators in the mill. A closed-circuit television camera provides the bloom-mill operator with a view of the reverse side of the mill, and extensive audio-communication facilities provide the very necessary links between various parts of the plant.

Computer Functions

The first computer is used for production planning and data processing, including the preparation of cast lists and rolling programmes. The second receives information

(Left) Seventy-four photoelectric cells measure length and elongation of the billet. Optimum-yield cutting is carried out by a computer-controlled flying shear. (Right) The operator in the bloom shear pulpit cuts the bloom to instructions shown on the screen of the tubular display

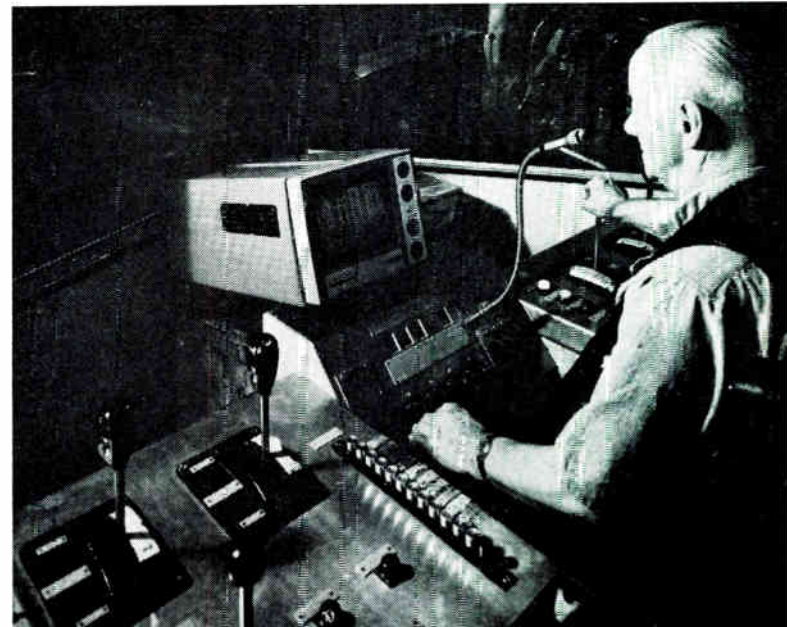
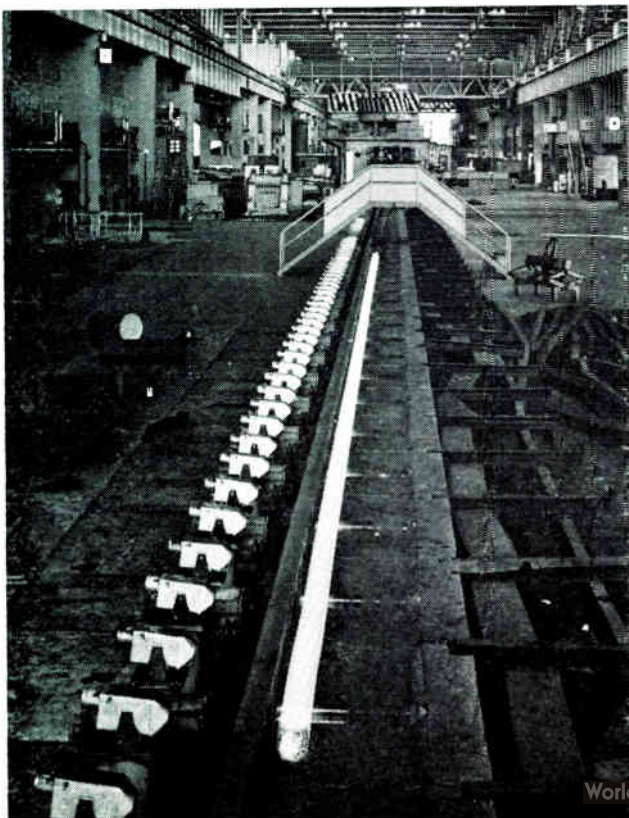

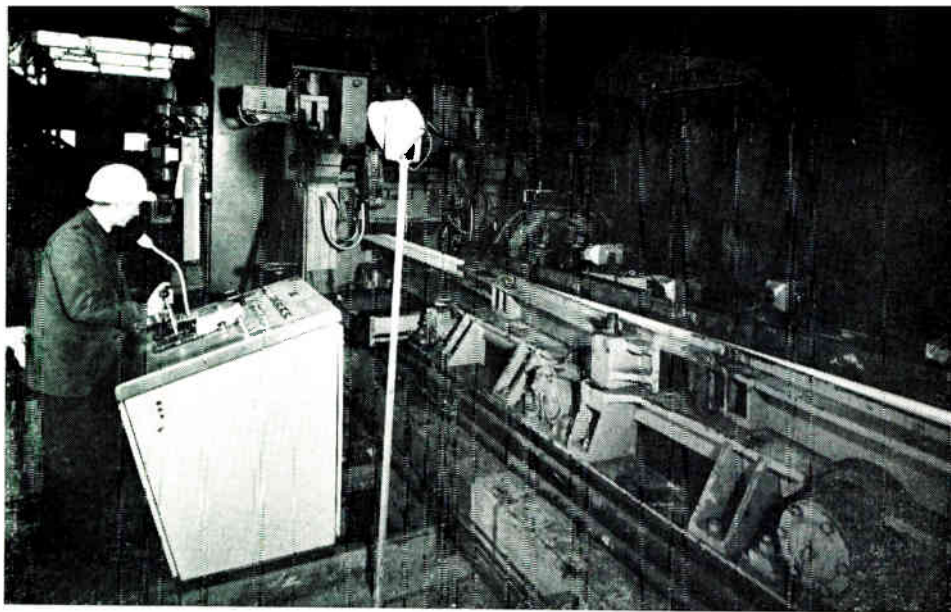

This illustrates one of the many audio-communication stations about the plant. Here a 'Mimco' microphone/loudspeaker unit is installed at the pendulum shear position in the continuous billet mill

from the central computer and displays information to the furnace and mill operators, who in turn feed back data on the history of the processing of each ingot. The third computer is linked to the flying snear in the billet mill to provide control to ensure maximum yield. A fourth computer is to be installed later this year to enable the central planning installation to provide a more extensive production planning service and to undertake payroll and other accounting and statistical work.

Tabular Displays

In order to take full advantage of the high-speed computer systems, dynamic tabular displays have been included in the plant. These present instructions to the different operators in the mill. The instructions which appear on the display screens are in plain language form and are continually up-dated as information is fed back to the

central controlling computer from various parts of the plant.

Repeat displays of the bloom and billet mill schedules and a number of input keys and switches are mounted on the production controller's desk. This makes it possible for the controller to monitor the mill operation and to instruct the computer to modify any of the information being displayed to the mill operators.

Closed-Circuit TV

The closed-circuit television camera channel is mounted on the reverse side of the bloom mill which is normally out of sight of the mill operator. This enables the operator to see 'fishtailing' or other rolling faults which may result in damage to the rolls.

The computers are by English Electric-Leo, the tabular display system by The Marconi Company and the audio-communication systems by Marconi International Marine.

Visual Display Trainers

Elliott-Automation has developed a range of visual display trainers for instructing operators and technicians in the use and maintenance of complex control systems. Typical applications include electrical power and distribution systems, nuclear-reactor controls, engine and fuel systems, hydraulic systems, air-conditioning and refrigeration systems, railway-signalling procedures and process-control systems.

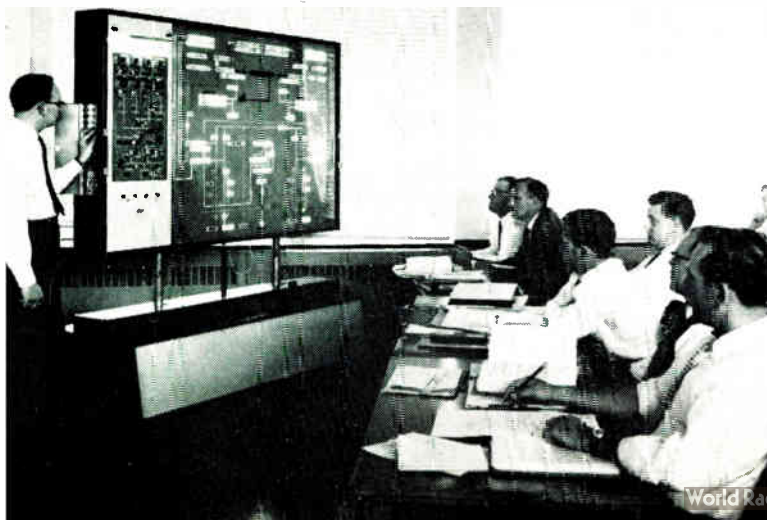

The equipment consists basically of a display panel on which the system to be studied is represented in diagrammatic form. Coloured lighting (either honeycomb or electroluminescent) indicates the operation of the system. A system control panel, which is a replica of that used in the system under study, enables the pupil to operate the trainer in the same way as he would operate the real system. By means of another panel the instructor can introduce 'faults' for the pupils to correct.

A logical sequence controller, constructed of 'Minilog' solid-state logic elements, controls the illumination of the system diagram in response to the pupil's control demands and the faults fed in by the instructor. The whole unit is mounted on castoring wheels, and the display can be raised by a powered hydraulic system so that it can be seen clearly from a distance of 20 ft or more.

For further information circle 53 on Service Card

A class of flight engineers on a VC10 conversion course at B.O.A.C.'s Cranebank training centre being instructed with the aid of an Elliott visual-display trainer. The panel on the left is a reproduction of the control panel in the aircraft and the mimic-diagram represents the aircraft's electrical system

The control cubicle installed alongside the pallet loading machine which it controls. The front cover shows another view of this installation

DIGITAL TECHNIQUES IN INDUSTRY

STATIC-SWITCHING CONTROL SYSTEM FOR A PALLET LOADING MACHINE

By G. COOPER* and F. SHAW*

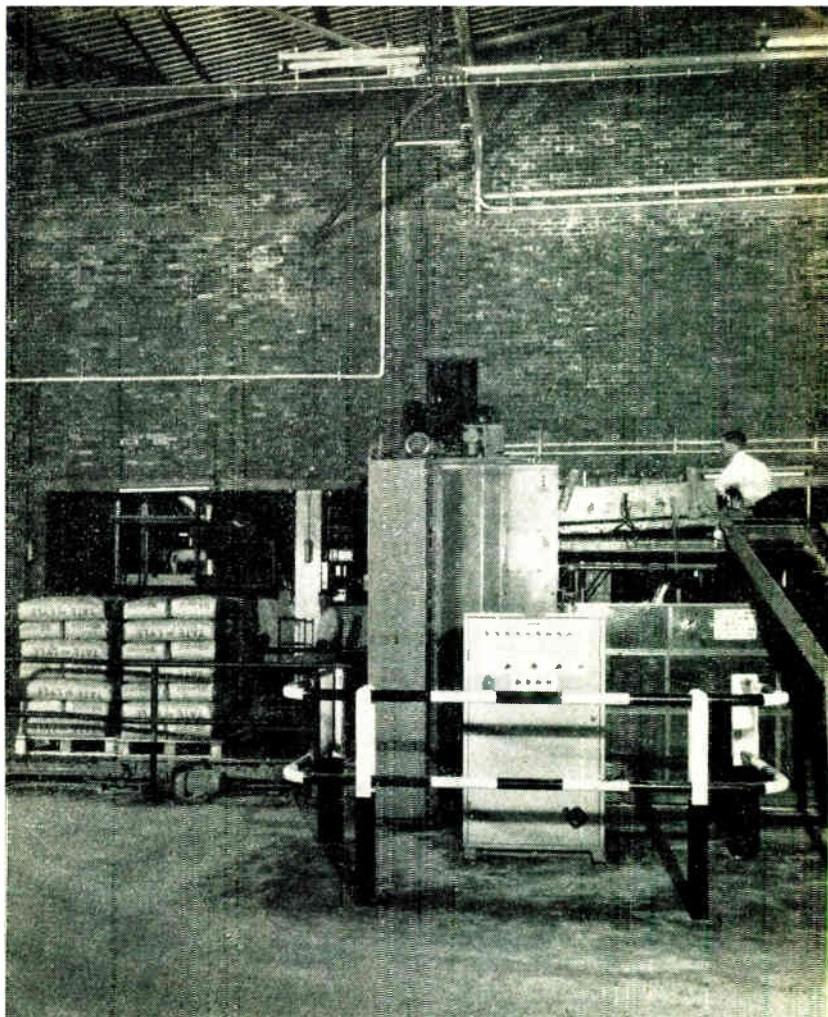

The advantages and disadvantages of static switching as compared with relay systems are discussed in some detail. The article concludes with a description of a static-switching system which is used to control a pallet loading machine.

THE use of contact-less switching elements (static switching) to replace relays and uniselectors has come into increasing use since the introduction of the technique in the United States in the early 1950s. Early systems used magnetic amplifiers or, rather later, cold-cathode switching tubes as logic elements. Systems using these techniques are still widely used, and were joined in the late 1950s by transistor systems, which have the advantage of, in general, lower cost, smaller size, higher speed and greater flexibility. Even today, however, it is fair to say that in most cases static-switching systems are still more expensive than relay systems doing the same job, and only the most rabid static-switching enthusiast would claim that the day of the relay is over in all applications.

It is, therefore, something of a problem for engineers responsible for designing switching control systems to judge when to use solid-state logic in place of relays.

The following notes, which will be concluded by a description of a typical static control panel, are based on some five years' experience of the subject, and are offered as, at best, an objective assessment of the current position; at worst, a basis for controversy.

Advantages

First, what are the advantages claimed for statics over relays?

*Lancashire Dynamo Electronic Products Ltd.

Reliability. The modern relay, conservatively rated and carefully dust-protected, is a much more reliable device than designs of ten or twenty years ago. Nevertheless, it is inherently limited in the number of cycles which it will perform before it wears out, and like all mechanical devices, has a liability to occasional random failures. Further, there are many materials which seem to be proof against any sort of protection—carbon black, plaster dust, molasses vapour, etc.—and which cause contact fouling. It is also relevant that no way of commissioning a control panel with the doors shut has yet been developed, and very often contamination occurring while the equipment is being put to work nullifies the effects of the carefully dust-proofed cubicle.

It is not easy to put figures to reliability of either static or relay systems. So far as we can assess it, however, our experience indicates that after completion of commissioning, an equipment of 100 L.D.E.P. digital-system logic units, which is equivalent to a relay equipment of perhaps 150–250 multi-contact relays, will not *on average* fail more than once per year. There is, of course, no preventive maintenance requirement to achieve these results.

Speed. In simple control systems, where a limit switch operates and closes a relay, which in turn operates a contactor or solenoid, the 30–50 msec response time of a typical relay is not normally inconvenient. However, in complex systems, a limit-switch operation may initiate the closure

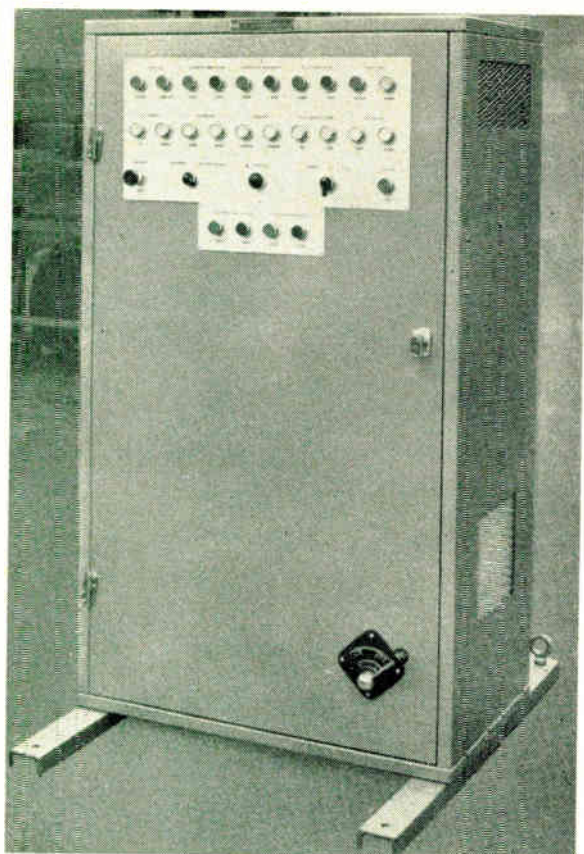

General view of cubicle containing the static-switching apparatus

The control cubicle with its front open

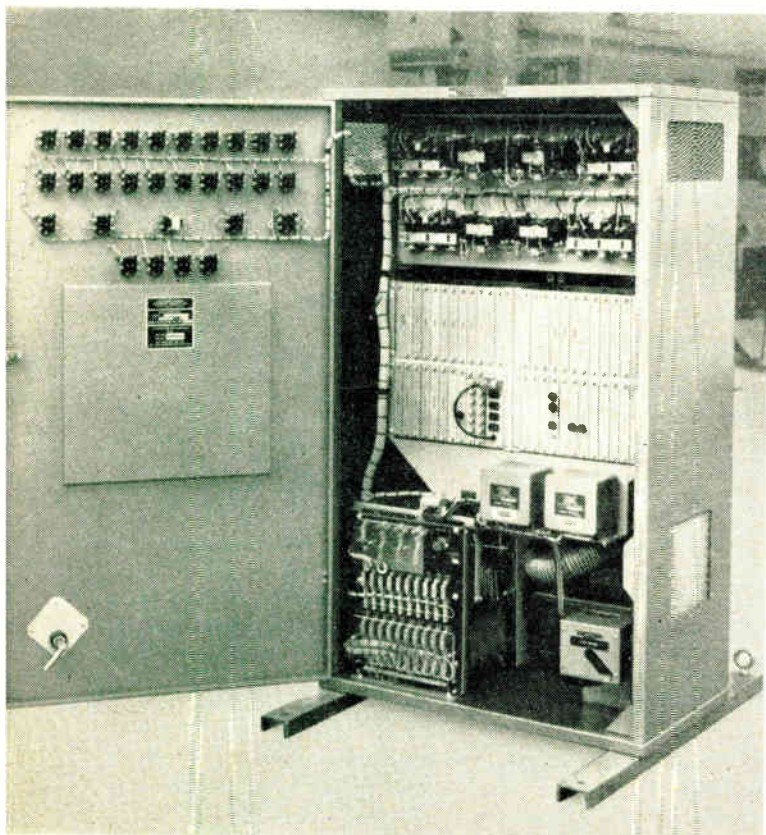

or opening of several relays in sequence before the power output is operated, and in fast cycling machines this build-up of delays can be significant. A typical transistor logic element responds in a small fraction of a millisecond, and hence for all practical purposes the 'thinking' delay is negligible, however complex the system.

As well as the loss of time slowing the cycle, the inconsistency of relay delays can affect accuracy on such functions as cutting-to-length sheet or strip material moving along a conveyor, and the 'zero-delay' logic unit can eliminate this source of error.

Ease of System Design. The design of simple relay schemes is not difficult, nor is it difficult to see how they work from a key diagram. However, as the system becomes more involved, with complex inter-related sequences and interlocks, economic system design becomes something of a black art. Obscure 'sneak paths', where current can flow in quite unintended directions under certain unforeseen system conditions, often cause difficulty, and are not easy to recognize at first sight. Perhaps more important, it is difficult to determine from the key diagram under what conditions of limit switches, selectors, pushbutton operation, etc., a particular solenoid is supposed to be energized.

In point of fact, one of the problems in designing a static-switching system to carry out the same function as an existing relay panel is that even the relay system designer, trying to think back over a couple of years is unable to work out why a particular contact is in a circuit. He feels sure it was put in during commissioning on the Bigglesthorpe job, because they got the Sprang Slide traversing during the indexing of the No. 3 Proggie Shaft; but he can't remember quite how this happened, and very often the truth of the matter is that when the problem arose, someone noticed that a certain relay with a spare pair of contacts just happened always to be open, and these had been wired in. That the particular relay used to overcome the difficulty had no direct logical connection with the circuit in trouble was probably not a source of concern at the time.

The reason for all these difficulties is simple and fundamental. When changing a system to make a contactor close or a solenoid energize at the right moment, one is concerned with *one* output and many inputs, all of which are conditional on the correct working of the output. Unfortunately, a relay has one input (the coil) and many outputs (the contacts), and it is this basic fact which means that a relay is shown on a key with the contacts often spread over several sheets, each in the section concerned with the output it controls.

The basic logic system elements, for instance, AND and OR gates, have, conversely, many inputs and one output, and the individual elements, which correspond to the control relays of a relay scheme are therefore directly associated with the outputs, and shown with them on diagrams. Further, while a relay contact can pass signals in both directions (a frequent factor in the occurrence of 'sneak paths') logic elements are unidirectional, and signals will only flow in the designed direction.

Disadvantages

This is one side of the picture. What is the case against statics?

Cost. This is by far the larger barrier to rapid acceptance of static switching, and certainly if by cost one means only initial cost, which is typically greater by 10%-300%, the static technique shows up unfavourably, particularly on small simple systems. There are two reasons for this 'simple systems' problem. The first is that if a system is simple, nearly all the logic of the system can be carried

out by using multiple contacts on the limit switches and auxiliary contacts on the contactors or power relays. Thus few 'thinking relays' are used, the input and output equipment, which is still necessary with static techniques, doing most of the thought. Note that this pattern is not true where proximity switches replace limit switches, nor where electro-hydraulic or electro-pneumatic solenoids are the links from control to power, since the relays which must follow the proximity switches and precede the solenoids can be replaced by logic elements.

The second point is that in general a relay system requires only 110 V a.c. or, say, 50 V full-wave rectified d.c. as its special power supply, whereas most logic systems require two d.c. rails (often stabilized) or stabilized a.c. low-voltage supplies. This power supply would be necessary for a system with only one logic element, and clearly imposes a heavy 'overhead' burden on small systems.

The cost problems tend to decrease with larger systems, and one manufacturer suggests 50 intermediate relays as the cross-over point. In fact, because of the fundamental multiple-input one-output nature of the basic elements, the cost varies with the ratio of number of inputs/number of outputs, a high ratio giving a more economic system. Thus the crossover point must vary with this factor, and is in the author's view very difficult to define.

The above comments refer only to 'first cost'. It is, however, instructive to examine the true cost of a control system.

Consider a control system operating one section of a continuous process—say a cut-up shear in a steel rolling plant or following a fibre-board making machine. A sack-loading and handling machine working with a blending plant or a component feed conveyor system for a production line are other good examples. The control systems are probably fairly simple, and the machines they directly control not very expensive. But a single control failure stops completely several machines amounting to several hundred thousand pounds worth of plant. The cost of down time could quite easily be £1,000 an hour.

Suppose a control system is to be bought, and to be written off in five years. Suppose a relay panel costs £1,000, a static panel £1,500. Suppose the static panel fails twice in five years (a realistic figure), and suppose the relay panel fails once per year (the normally obtained improvement in reliability is much greater than this). Suppose that a failure takes 30 minutes on average to put right in either case.

Total cost of control over five years:—

$$\text{Relay Panel } \quad \text{£1,000} + 5 \times \frac{\text{£1,000}}{2} = \text{£3,500}$$

$$\text{Static Panel } \quad \text{£1,500} + 2 \times \frac{\text{£1,000}}{2} = \text{£2,500}$$

Looked at in this light, the static control system, with its accepted higher reliability, begins to look a much better prospect than the comparison of initial costs would indicate.

Familiarity. Next to cost, the most common worry is whether the average electrician, who is used to relay schemes, can look after an unfamiliar static-switching equipment. The answer is yes, quite definitely he can. Our experience is that the type of electrician who is capable of effective snag-shooting on reasonably complex relay schemes takes a keen interest in the first static panel in his care, and within the commissioning period picks up from the commissioning engineer sufficient confidence and know-how to tackle breakdowns.

Particularly with plug-in unit systems, fault rectification is very simple especially if replacement units are carried—

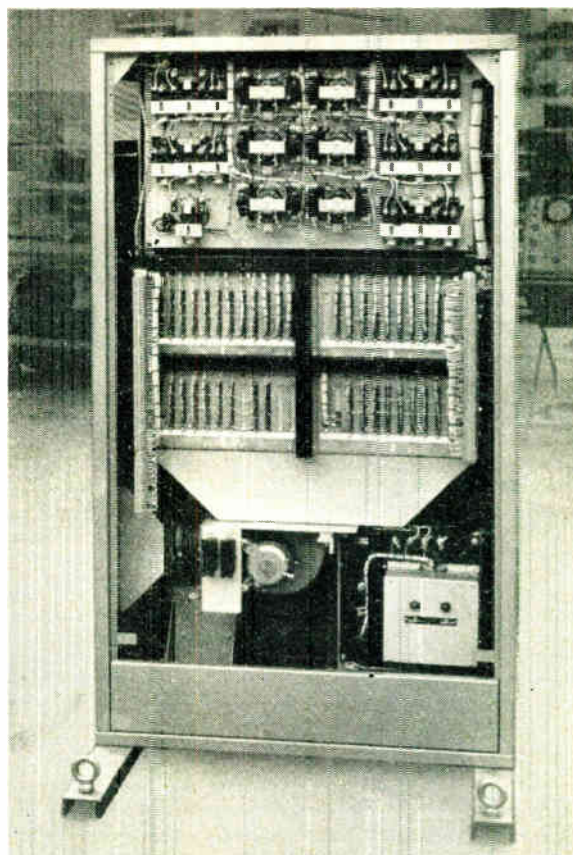

Rear view of cubicle with cover removed

a policy we strongly recommend. It boils down, in fact, to three steps.

- Step 1. Check that the inputs from limit switches, push-buttons, etc. are healthy, and that the output device is not faulty. This step is exactly the same as for relay system rectification.
- Step 2. Refer to the key diagrams and list which units are involved in the faulty section—typically not more than three or four.
- Step 3. Change the units one by one until the fault is cleared.

None of these steps involve the slightest knowledge of electronics, and none is beyond the ability of a sound electrician. The essential thing is to give the electrician confidence, and we believe that the best way to do this is for the servicing staff to spend two or three days in our test department during the final stages of testing the equipment, as well as helping on the commissioning.

It is perhaps worth adding as a tailpiece that the very reliability of static switching adds a further problem to servicing. This is that very often it is so long since a failure occurred that no-one can remember how the sequencing and interlocking is supposed to work. There is, of course, no preventive maintenance work to keep one's hand in!

To summarize, then, for what factors should we look when deciding when to go static? Mainly the problem is one of deciding whether the expected saving in downtime cost will offset the probably higher initial cost. Therefore, look for the following.

1. Control equipment for high capital cost plant.

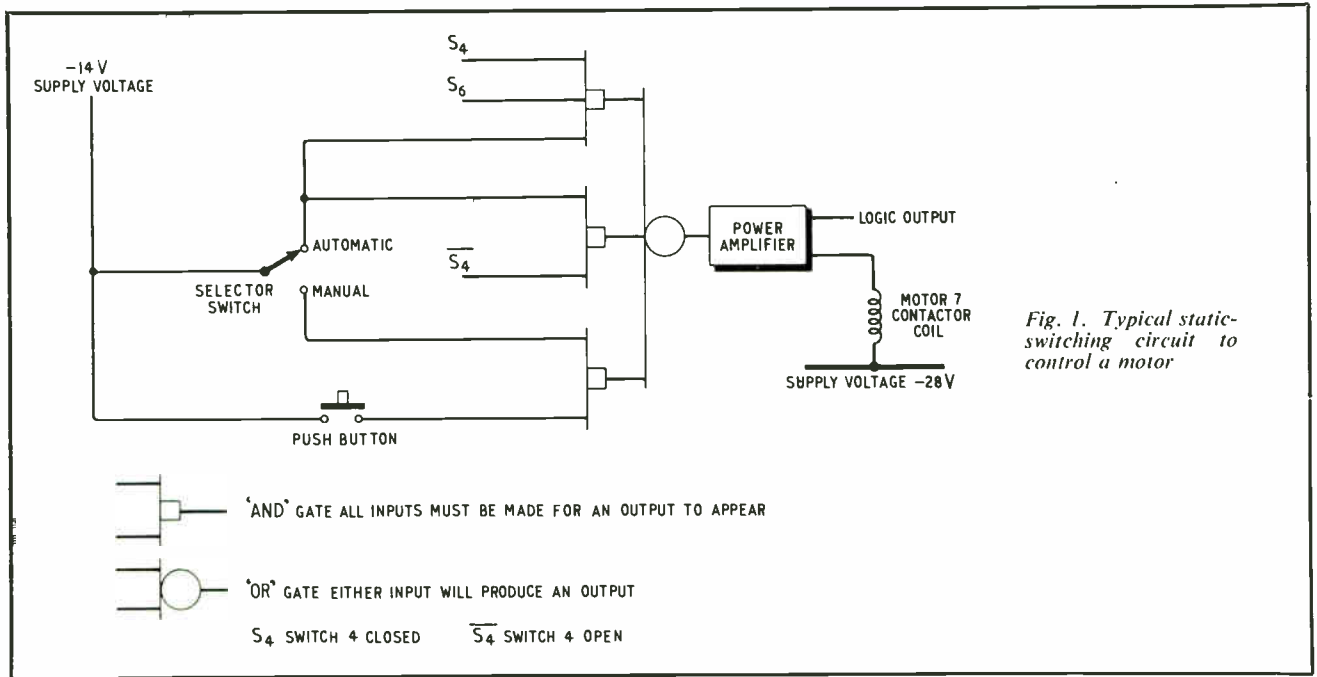

Fig. 1. Typical static-switching circuit to control a motor

2. Control equipment for machines or handling equipment working on continuous production processes, where a breakdown in the control equipment of one part holds up several interconnected pieces of plant.
3. Control equipment for fast cycling machinery, particularly such machinery working on multiple shifts, where the wear-out problem on relays is significant, or where the relay operating delays are slowing cycle times.
4. Control equipment working in difficult ambient conditions. Here sometimes the fact that a static panel can be located close to the plant rather than in a remote protected structure permits a wiring cost saving which exceeds the difference in basic equipment cost, in addition to the saving on downtime.
5. Control equipment for plant using hydraulic or pneumatic power rather than electrical power, contactor controlled.

Pallet Loader Control System

The pallet loader to which the control system is applied is manufactured by the Lawrence Engineering Co. and is used by Tate & Lyle in the mechanical handling of paper sacks and parcels of paper packets of sugar. The machine can be used for various sizes of pallet or hardboard 'skid-stacks'.

The limit switches on the machine are of the contactless proximity type relying on the unbalance of a magnetic bridge by an iron 'operator' for their operation. The drive oscillator and the signal detectors associated with the limit switches are part of the standard range of system units and are packaged on standard sized printed-circuit cards.

There are 21 contactless limit switches on the machine, twenty true proximity types and one lever operated type housed in a standard oil-tight limit-switch case. In addition to the static limit switches there are four safety limit switches which use normally-closed contacts to prevent possible damage in failure conditions.

The control system has 20 outputs from power amplifiers controlling movements on the machine. The power amplifiers are of a standard type capable of supplying up

to 2 amps, and working at 28 V d.c. Eight outputs operate contactors supplying power to induction motors. Two others supply power to a reversible contactor controlling a reversing induction motor. The other outputs drive solenoids for pneumatic, hydraulic and vacuum valves.

The sequence of operations is started by the operator who orientates the packages to be palletized and operates a pushbutton when a layer is ready. He also serves the useful purpose of inspecting the packages for damage.

After a predetermined number of layers the machine automatically discharges the load and collects a new pallet or skidstack. If the operator has a layer ready the push-button initiation will be remembered until the machine is in position.

The machine can store a number of empty pallets or skidstacks in a hopper and issue them automatically one at a time to the area used for palletizing.

Manual control of all the moving parts of the machine is provided from the control cubicle door.

The logic elements used in the system comprise 48 AND gates and 47 OR gates, mostly feeding directly into the power amplifiers, which in addition to the power output generate logic outputs for interlocking purposes. Fourteen trigger-type logic amplifiers are used to boost signals at intermediate points in the logic and enable signals to be fed from intermediate points to the logic associated with more than one output.

There are also three timers in the equipment, giving adjustable delays of the order of 10 secs. The timers are standard units, and work on the RC principle.

The AND/OR terminology allows description of the system in more or less ordinary every day language and is a great help in explaining the sequencing to the user of the machine and in discussions with the machine designer. A typical design-stage discussion might include:—

We require Motor 7 to run automatically when a pallet operates switch 4 *and* the bottom limit (switch 6) is made *or* when we are charging the machine after the discharge of the pallet from switch 4 *or* from the manual push-button. The logic discussed is shown in Fig. 1.

new materials

EXPANDED COBALT

PURE cobalt expanded metal is now being offered by Sherritt Gordon Mines of Toronto, Canada. Produced in continuous coils, the material has adequate ductility for precision slitting, cutting, and forming, and can be brazed or soldered. Because it is ductile, a quality usually lacking in wrought forms of pure cobalt, it appears to be suited for a number of new design engineering applications in electronics, metalworking, and the chemical industry.

Projected uses include the fabrication of support structures for catalyst preparation, radioactive source material, magnetic screen shielding, and current-carrying applications where good electrical conductivity combined with magnetic properties is required, especially at high temperatures.

As an electrical material, fine expanded cobalt has two important properties: it has a higher electrical conductivity than pure nickel and its Curie point, 2,050 °F, is the highest known among the magnetic materials. In addition, it provides continuous electrical conduction by virtue of being a single unit structure of metal, whereas woven materials conduct by means of pressure contacts.

Key to the successful development of fine expanded cobalt is the use of 99.9% pure cobalt strip, produced by the direct rolling of high-purity cobalt powder. This method makes possible a substantial reduction in the level of impurities of the finished material and, as a result, ductility and workability are adequate for the production of expanded cobalt within certain limits of mesh size and shape.

The technology of fine expanded metals, which was developed by Exmet Corporation, Bridgeport, Conn., U.S.A., is applicable to all ductile metals and, within certain limits, to many 'difficult' metals such as stainless steel,

A demonstration of the ductility of fine expanded cobalt

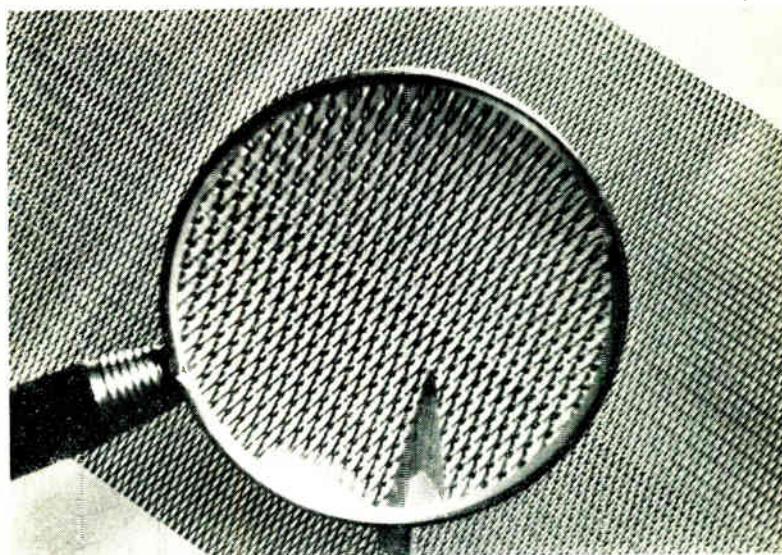
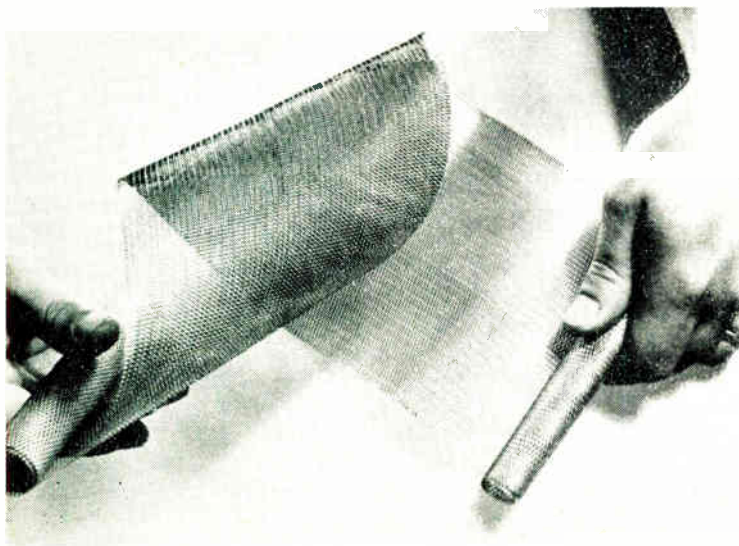

A section of 6-in. wide expanded cobalt with a portion magnified to illustrate the diamond-pattern openings

tantalum, columbium, and titanium. Metal in strip form is slit and stretched in one operation by specially designed tools which give their form to the product while providing controlled strand width and opening sizes. The only pattern available now for fine expanded cobalt is a diamond shape; but for more ductile metals, a wide variety of decorative or functional patterns may be had.

Maximum width is 6 in., and approximately 170 openings per sq in. are contained in the material as processed in the standard diamond pattern. Individual opening dimensions are approximately 0.187 in. LWD (long way of diamond) by an average 0.062 in. SWD (short way of diamond). Maximum thickness of original material before expanding is 0.015 in.

Because fine expanded cobalt is a unit structure, it will not unravel or permit changes in the size and shape of mesh openings. The material can be die-cut without fraying and it can be bent or folded into tubular, cupped, or other shapes. It is also joined readily to similar or dissimilar materials. The material is produced to individual customer specifications, so no standard price can be quoted.

For further information circle 54 on Service Card

Control Systems M.Sc. Course

The Department of Electrical Engineering of The College of Advanced Technology, Gosta Green, Birmingham 4, will be starting a graduate course in control systems in October this year.

Qualifications for admission are broadly: a suitable first degree, Diploma in Technology or an equivalent award. The course is for one year and the syllabus covers: Theory of automatic control systems, components of control systems, mathematics, and engineering materials. Successful students will be awarded the degree of Master of Science.

Further details may be obtained from the Course Tutor, Mr. K. B. Wilson, B.Sc.(Eng.), A.C.G.I., A.M.I.E.E.

EQUIPMENT REVIEW

1. Strain-Gauged Extensometer

Westland Aircraft have developed a simple form of strain-gauged extensometer for surface mounting on large structures. It consists of a strip of steel, or other suitable material, which is sprung into position between end fittings attached to the structure. Any deflection over the extensometer length causes a change in the amount of bending in the strip, which is measured by strain gauges attached at its midpoint; the strain gauge output is calibrated directly in terms of change in the effective length of the strip.

The device has advantages over rigidly attached extensometers in that it is only held in contact with the surface of the structure at the ball ends by the end load on the strip. This minimizes the effects of end rotation, local distortion and shear, so that the device will measure only the actual linear movement between the end contact points.

The end fittings which locate the strip can be attached by adhesives, screws in tapped holes, or by masonry plugs in the case of concrete or brick structures. The nominal length of the extensometer is 12 in. but it may be made in other lengths to suit particular applications.—*Westland Aircraft Ltd., Saunders-Roe Division, Strain Gauge Department, East Cowes, Isle of Wight.*

For further information circle 1 on Service Card

2. P.C. Board Connector

Sealectro is now offering the 7017 sub-miniature coaxial plug receptacle for printed-circuit board application.

The 50- Ω Conhex 7017 plug receptacle features a slide-on type of engagement which requires approximately 8 oz of mating or unmating force. This protects printed circuits from excessive mechanical loading while providing a reliable electrical connection.

Additional features include Teflon insulation, captive contacts and heavy gold plating. A 75- Ω version of this

connector is also available.—*Sealectro Ltd., Hersham Trading Estate, Walton-on-Thames, Surrey.*

For further information circle 2 on Service Card

3. Level Controller

Fielden Electronics have introduced the Tektor TT6 capacitance-sensitive high/low level controller designed to give high stability with good discrimination, in a compact, robust and inexpensive form.

The TT6 has good stability against mains voltage and temperature variations and is relatively insensitive to any resistive changes in the electrode system. The transistorized 'switch', moulded in silicone rubber, is designed to fit the entire range of Fielden type 40 electrodes.

The bi-stable transistor output will switch 0.25 A—sufficient for a 2.5-W lamp. Single and two-channel kits are available to provide power to control relays and indication lamps.—*Fielden Electronics Ltd., Wythenshawe, Manchester 22.*

For further information circle 3 on Service Card

4. Laboratory pH Meter

Recently introduced is the low-cost Pye model 79 pH meter giving 0.02 pH discrimination with very good zero stability. Design features include a robust pivotless meter movement, a calibrated buffer control, both automatic and manual temperature compensation, a measuring range from -350 to $+350$ mV, an output for

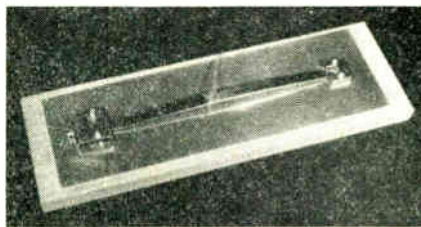

1



2

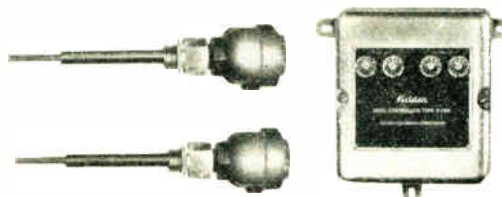

3



4

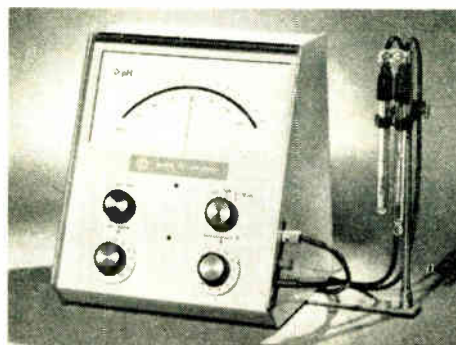

5

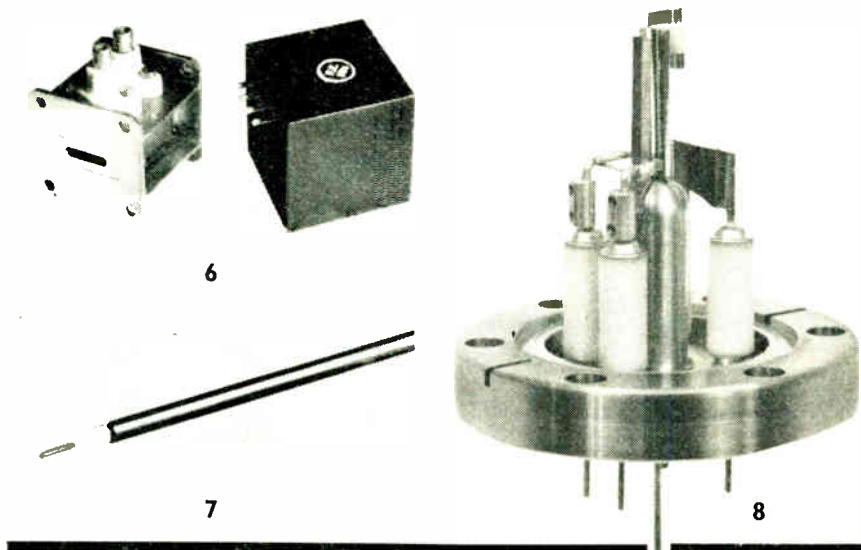

potentiometric recorders and an integral electrode/resistance thermometer holder.

A Pye Ingold E₀(7) combined glass and reference electrode is provided with the instrument and a wide range of additional electrodes and accessories can be supplied. The model 79 can also be used as an accurate millivoltmeter (e.g., for electro-analytical techniques).—*W. G. Pye & Co. Ltd., P.O. Box 60, Cambridge.*

For further information circle 4 on Service Card

5. Photo-Electric Switching Unit

A photo-electric switching unit, series LPC.2, the 'Vigilite', produced by L.D.E.P., is available in two forms—one with two remote heads and one with a built-in cell and a single remote head. It is suitable for indoor or outdoor use and controls all forms of counting, sorting, batching and detecting operations at a maximum rate of five per second.

The circuitry is fully-transistorized printed-card design and fits within a control case measuring $6\frac{1}{4}$ in. wide, $8\frac{1}{2}$ in. high and $3\frac{1}{16}$ in. deep. The internal relay is fitted with one pair of normally-open and one pair of normally-closed contacts, rated at 5 A, 230 V, or 1 A, 440 V a.c.

By appropriate positioning of a pair of internal plug links, either 'fail to light' or 'fail to dark' operation is afforded at the option of the user. Preset sensitivity and differential controls are also provided. The unit requires 110/250 V, 50 c/s single-phase supplies.—*Lancashire Dynamo Electronic Products Ltd., Rugeley, Staffs.*

For further information circle 5 on Service Card

6. Power Supply for TR Cell

Ferranti have developed a lightweight and compact high-voltage power supply which provides a 'keep alive' supply for their TR cell type WF42 (CV2311). It has been designed to overcome the problem of obtaining such a d.c. supply in an aircraft.

Two versions are produced, one having an input voltage of 115 V, 400 c/s and the other 200 V, 400 c/s. Both versions have a striking voltage of 1,050 V d.c. $\pm 10\%$. Variants within the same frame size are possible for use with other Ferranti TR cell specifications.

The assembly, encapsulated in epoxy resin, measures $1.4 \times 1.4 \times 1.5$ in. and weighs 2.7 oz. It meets the joint Services humidity classification H.6 and DEF spec. 5214 for resin-cast transformers. The ambient temperature range is -40 to $+100$ °C. The power supply will withstand a p.i.v. of 4 kV for 10 μ sec and cannot be damaged by a short-circuit of the output.—*Ferranti Ltd., Ferry Road, Edinburgh 5, Scotland.*

For further information circle 6 on Service Card

7. Cable for Extreme Temperatures

Now available from the MicroDelay Division of Uniform Tubes, Inc., is stainless-steel solid-jacketed coaxial cable which features reduced thermal conductivity for cryogenic input leads. It can also withstand high temperatures for long periods of time.

Type UT-141-SS can be supplied from stock in lengths of up to 20 feet. It is available in 50- Ω configuration with 0.141-in. outside diameter to mate with available types of connec-

tor. The dielectric material is TFE type Teflon and standard centre conductor is SPCW (silver-plated copperweld wire). Other diameters and impedances are also available from stock or on special order.—*Ad. Auriema, Ltd., Impectron House, 125 Gunnersbury Lane, Acton, London, W.3.*

For further information circle 7 on Service Card

8. Ion Gauge System

As a complement to its series of low-pressure ionization gauges, Varian Associates now offer the 'MilliTorr' to measure the higher pressures from 1 torr to 5×10^{-6} torr. Pressures from 10^{-3} to 2×10^{-11} torr are measured with a standard Varian ion gauge. A gauge control unit provides the switching for operating both gauges using a single meter to indicate pressures over the entire range.

This system is claimed to offer faster response and greater accuracy in pressure measurements during routine system pumpdown for plasma studies, shock-wave and sputtering experiments, environmental testing, thin-film evaporation, etc. The MilliTorr gauge operates like other ionization gauges, but with very short electron paths, and it is operated at very low emission current. The filament design allows operation with active gases and prevents burn-out even at atmospheric pressure.

The dual-range control unit operates both gauges with a three-decade overlap. All controls are on the front panel, which is colour-coded for the high and low pressure ranges. Jacks on the control unit make it possible to record the pumpdown, and the unit also includes special features for degassing of the gauge filaments and for automatic protection of the filament.—*Varian Associates Ltd., Fox Oak, Seven Hills Road, Walton-on-Thames, Surrey.*

For further information circle 8 on Service Card

9. Digital Shaft Encoder

Now available from B & K Laboratories is the Peekel type PP3A1 digital shaft encoder, for attachment to potentiometric recorders or similar apparatus in which analogue information relates to the angular position of a rotary shaft. The PP3A1 converts this into digital form for direct feed into supplementary read-out or display units.

The unit is attached to the recorder or other instrument by means of clamps and a mounting plate, and can either be directly driven or coupled to

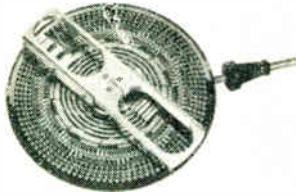
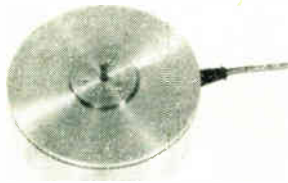

9



10

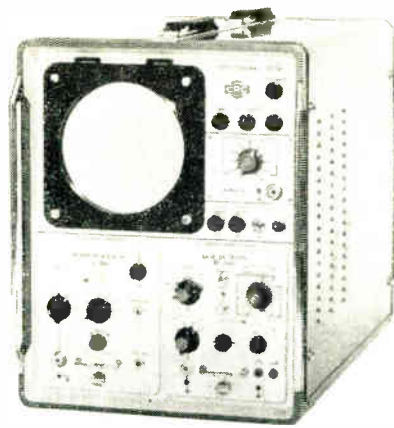

11

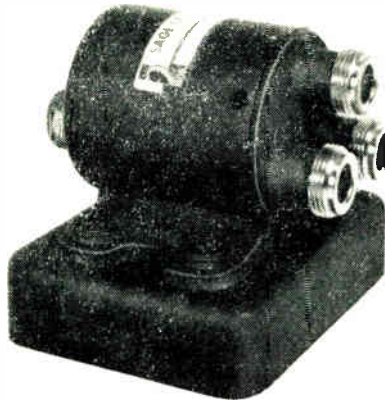

12

the shaft with cable and pulleys, etc. A special model is available for use with the Bruel & Kjaer 2305 recorder.

The output is presented in the form of three-decade decimal information from 0 to 999, related to one complete shaft revolution. Units designed to be used in conjunction with the PP3A1 include: a digital indicator, print-out and punch-tape converters, a digital memory, a digital clock, a pulse counter, and input commutators which enable up to 200 channels to be connected to one digital instrument or system.—*B & K Laboratories Ltd., 4 Tilney Street, Park Lane, London, W.1.*
For further information circle 9 on Service Card

10. Miniature Amplifier

Westinghouse have developed a miniature amplifier especially for use in aerospace radar and communications systems work.

Built for high reliability, this 60-Mc/s bandpass i.f. amplifier measures $\frac{1}{4} \times \frac{1}{4} \times \frac{1}{4}$ in. and weighs 4.3 gm. It consumes 18 mA at 12 V d.c.

The unit's overall bandwidth is

8.7 Mc/s and its overall gain is 42.5 dB. Four synchronous single-pole bandpass networks provide the frequency selectivity.

The amplifier is made with Westinghouse molecular electronic functional blocks and welded modular construction for high-density packaging. Each individual stage of the unit is shielded.—*Westinghouse Electric International Company, 200 Park Avenue, New York 10017, U.S.A.*

For further information circle 10 on Service Card

11. Large-Screen Oscilloscopes

The gap between the small-screen measuring oscilloscope and the television-tube display oscilloscope is filled by a range of instruments manufactured by Constructions Radioelectriques et Electroniques du Centre (C.R.C.) and available through Claude Lyons. A 7-in. c.r.t. is used to provide twice the usable display area of a normal 5-in. model.

A recent addition to the range is the type OC 746 large-screen X-Y oscilloscope. This instrument has identical

X and Y channels, each designed to accept any one of a variety of plug-in units. As an X-Y oscilloscope, two identical amplifier plug-ins (single-trace, dual-trace, differential or low-level) are used. With a single amplifier plug-in and the timebase unit type BT 7461 in the X channel, the instrument functions as a conventional oscilloscope.

With the HF 5661 (single-trace) and BT 7461 plug-in units, the OC 746 provides a vertical sensitivity of 50 mV/cm to 20 V/cm from d.c. to 1 Mc/s. Timebase range is 0.5 μ sec/cm to 2.5 sec/cm with sweep expansion and full sync, and trigger facilities. A voltage calibrator (in the main chassis) provides an accurate 1-kc/s square wave at levels from 0.5 mV to 100 V. The BF 5662 plug-in provides differential input and sensitivity from 1 mV/cm to 0 V/cm, and the low-level unit BF 5672 provides sensitivity from 100 μ V/cm to 50 V/cm, with differential input, while the dual-trace unit type CE 5673 provides chopped or alternate sweep presentations with sensitivity from 50 mV/cm to 20 V/cm.—*Claude Lyons Ltd., Valley Works, Hoddesdon, Herts.*

For further information circle 11 on Service Card

12. Fail-Safe Coax Switch

Sage Laboratories has announced the model SAN521E fail-safe two-position coaxial switch, which provides a maximum v.s.w.r. of 1.3 from d.c. to 4.2 Gc/s.

Designed for remote operation from a 28-V supply (other a.c. and d.c. drive voltages can be accommodated), the mechanism is spring-returned when power is removed. Switching time is less than 10 msec.

Production lots of these switches have been life-tested over 2,000,000 cycles, and have demonstrated a mean-time-between-failures of more than 1,000 hr. Model SAN521E withstands the water immersion, shock, and vibration requirements of MIL-S-25879A, and operates over an ambient temperature range of -62°C to $+95^{\circ}\text{C}$. It is available with type N, C, TNC, or BNC connectors. The mounting is a quick-disconnect assembly.—*Sage Laboratories, Inc., 3 Huron Drive, East Natick, Massachusetts, U.S.A.*

For further information circle 12 on Service Card

13. Electronic Hygrometer

A multi-range electronic hygrometer, capable of moisture indication in air, gas or liquids, is announced by Shaw Moisture Meters. The instrument has

(continued on page 429)

“Who uses such curious things?”

ALICE:

Tell me, Papa, of transistors. It saddens me that they should be always in a sorry state.

PAPA:

Solid state, child. They are very wonderful and very small. Tiny pieces of crystal which in electronics replace other more cumbersome devices, doing the same work but far better and for a longer time.

ALICE:

Who, then, uses such curious things?

PAPA:

Everybody, my dear. They are all around us. In weighing, for instance, W. & T. Avery have now a whole department which concerns itself with nothing but these and other electronic devices. They are vital to the weighing industry. One transistor, for instance, can be no greater than the head of a match, yet it may help to weigh a hundred and fifty tons of molten steel.

ALICE:

Steel, Papa?

PAPA:

Or anything else. Wherever large quantities need to be strictly controlled by weight, wherever weighing equipment is used as part of an automatic process, wherever... Really, the list is too long to go through. Avery equipment is a particularly apt example, though. For Avery are far sighted and thorough. They saw from the beginning the possibilities of the transistor in conjunction with their hypersensitive weighing equipment.

ALICE:

And how do transistors work, Papa?

PAPA:

Really, is there no bound to your questions? There! I believe I hear your Mother calling. Hasten to see what she wants...

The extensive use of semi-conductors in Avery electronic weighing equipment ensures that units are both compact and mechanically stable. By the use of such devices as photo-transistors, electronic weight recording units can be designed almost free from inertia, thus affording a very fast response with stampable accuracy. For further information and advice on all aspects of the use of electronics in weighing control, write to:

W. and T. AVERY LIMITED, BIRMINGHAM 40

No. 4 of a series

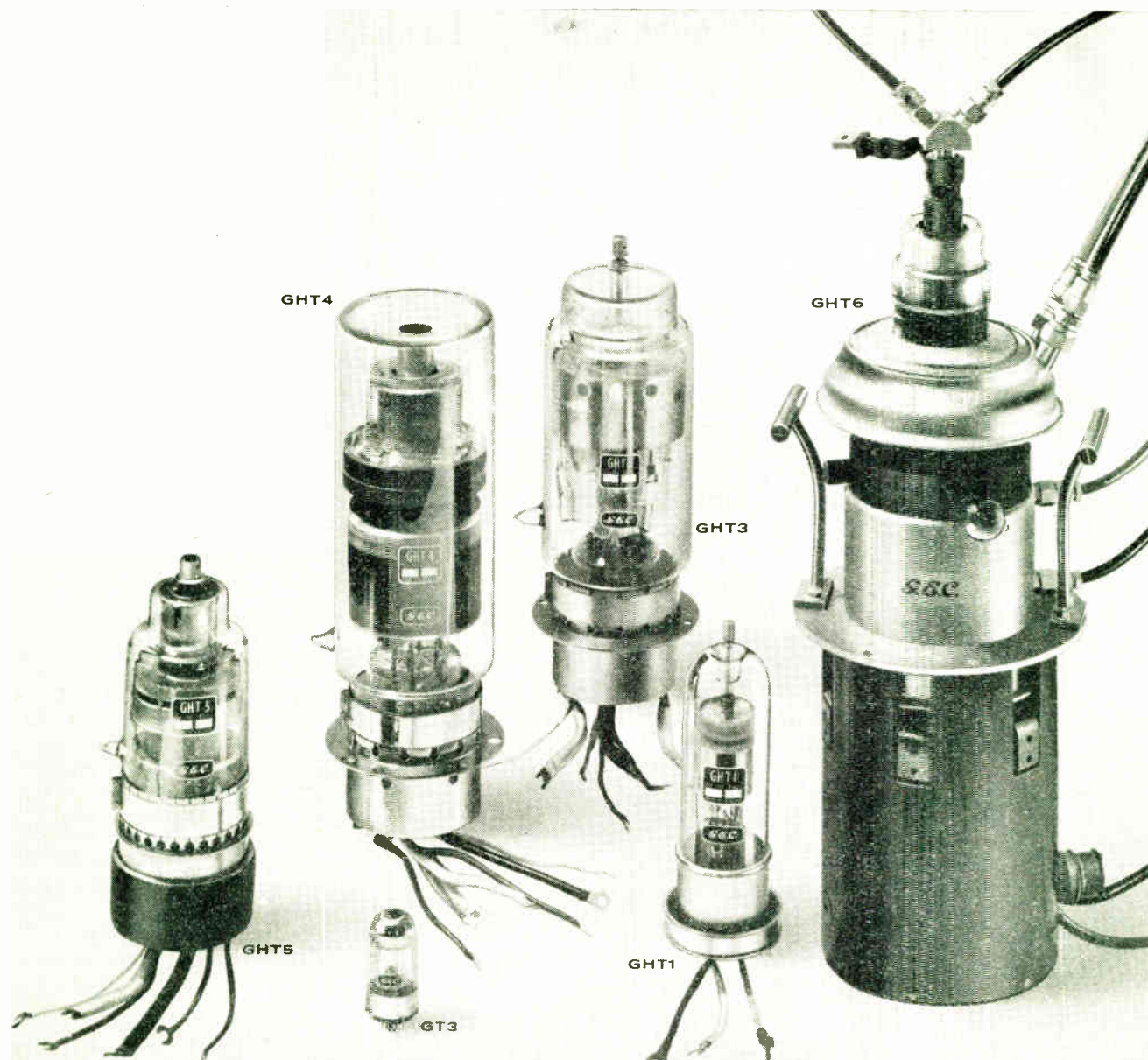

CHOOSE G.E.C FOR THYRATRONS

(a magnificent range, including the world's largest)

Here's a selection of G.E.C. thyratrons, from the low-power argon-filled GT3 to the high power deuterium filled GHT6 — the largest thyatron available in the world today.

All high power thyratrons incorporate a unique replenisher system controlled by a barretter and thermistor. This maintains a constant gas pressure, despite wide variations of supply voltage and ambient temperature, and greatly extends operational life.

| | GT3 | GHT1 | GHT5 | GHT3 | GHT4 | GHT6 |
|----------------|------|------|-------|-------|-------|-------|
| V_a (kV) | 0.5 | 16 | 18 | 25 | 25 | 40 |
| i_a (pk) (A) | 1.0 | 200 | 700 | 1000 | 2000 | 10000 |
| I_a (av) (A) | 0.3 | 0.35 | 1.25 | 1.0 | 3 | 15 |
| Pb factor | 1000 | 2200 | 10000 | 10000 | 20000 | 80000 |



Our technical information centre is ready to help your application problems. Write for full data sheets on these or other M-O V products, or telephone RIVERSIDE 3431. Telex 23435.

M-O VALVE CO LTD

BROOK GREEN WORKS • HAMMERSMITH • LONDON W6 • RIVERSIDE 3431

Industrial Electronics September 1964

three scales marked:— -100°C to -20°C dewpoint, -60°C to -20°C dewpoint, 0–100% relative humidity.

The hygrometer features straight-forward dial readings which are obtained without the need for temperature corrections, fixed flow rates, manual dexterity or skilled operators. It is claimed to have one thousand times the sensitivity of any other hygrometer. No change in calibration is found even at temperatures up to 180°C , and the industrial-type sensing elements withstand pressures of 100 atm without damage.

Applications include: checking moisture in dry sawdust for wallboard manufacture; drying of cables and transformers, transformer oil, confectionery, drugs, detergents, foodstuffs, polymer gases and plastics; refinery gases and products, cigarette processing; CO_2 and SO_2 gases; dry boxes during semiconductor manufacture; town gas and liquid gases; inert gas for sintering or endothermic gas for metal heat treatment; leak testing, etc.—*Shaw Moisture Meters, Rawson Road, Westgate, Bradford, Yorks.*

For further information circle 13 on Service Card

14. Electronic Thermometers

G. H. Zeal have recently introduced the 'Zealelectronic' range of a.c. mains or battery-operated electronic thermometers. This equipment can be single or multi-point; remote reading, recording or controlling; and uses a thermistor as the basic sensing element. This gives a fast response time combined with the ability to position the probe upwards of 1,000 yd away from the instrument with an uncompensated connecting lead.

Probes designed for air, liquid, or surface temperature measurements can be supplied, and the smallest is 0.0625 in. o.d. for industrial plant installations where accuracies of $\pm 1\%$, or 2% are acceptable. Equipment covering 50, 100 or 150°C f.s.d. is available with interchangeable probes for air or liquid measurement.

For laboratory use, high-accuracy instruments with f.s.d. down to 5°C and with a sensitivity of 0.01°C can be supplied. Probe interchangeability is achieved by the use of a plug-in circuit board. The equipment is invariably custom-built to individual specifications.

The unit illustrated is a 4-probe battery-operated instrument reading from 35 to 43°C (and equivalent $^{\circ}\text{F}$), with an ice-point accuracy check circuit.—*G. H. Zeal Ltd., Lombard Road, Morden Road, Merton, London, S.W.19.*

For further information circle 14 on Service Card

15. Voltage Rate-of-Change Indicator

A portable battery-powered voltage rate-of-change indicator, now being offered by Pastoriza Electronics, Inc., can be used to detect very low rates of change of an output voltage. The inherent resolution is ± 0.5 mV per minute and a range switch gives scales of 100 mV/min or 1 V/min f.s.d.

Being battery-powered, the indicator can be used to test ungrounded voltage sources. The first application has been in conjunction with charge and discharge tests of batteries. Other possible uses include the measurement of slow rates of charge of a variable in the presence of a large steady component; for example, in hill-climbing controllers.—*Pastoriza Electronics, Inc., 285 Columbus Avenue, Boston 16, Massachusetts, U.S.A.*

For further information circle 15 on Service Card

16. Thyristor Lighting Control Switch

A lighting control switch has been introduced by the Regentone Division of STC which enables room lighting to be adjusted to any level required for reading, television viewing, ciné shows, or for decorative effect.

Called the 'Varilite', it replaces the normal on/off wall switch. Unlike

previous lighting control units it uses a thyristor (s.c.r.) which enables it to control up to 300 W without generating heat and without taking up too much space. The unit requires no power itself.

The 'Varilite' costs $6\frac{1}{2}$ gns, fits any standard wall switch box and can be installed in a few minutes. It is designed for filament bulb lighting only and is not suitable for controlling fluorescent tubes.—*Regentone Division, STC, Footscray, Kent.*

For further information circle 16 on Service Card

17. Thermal Wire Stripper

Now available from Wessex Electronics is the model PM 1056-B thermal wire stripper. This latest model features higher power, heavier duty plug-in heating elements, and a 'guide guard' which automatically centres the wire to be stripped over the warmest area. The operator is protected against burns and the stripper can be utilized in the tightest places without burning adjacent wires. The 'guide guard' is claimed to produce a significant increase in operator speed.

The PM 1056-B melts all types of thermoplastic wire, including Teflon



13

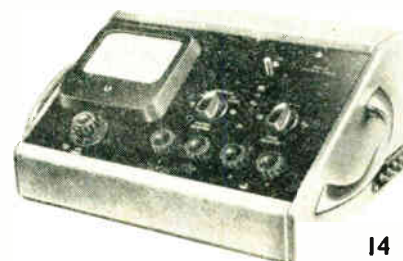

14

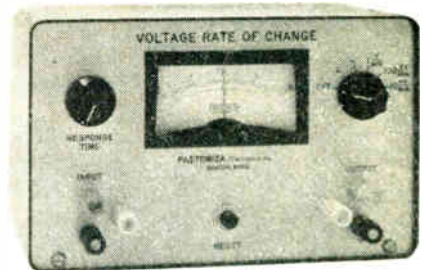

15



16

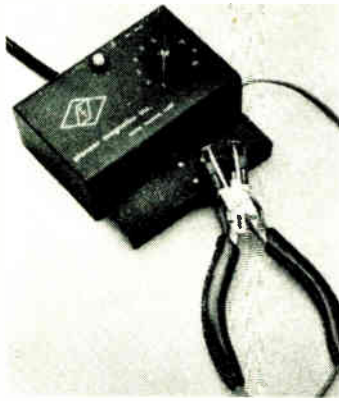

17

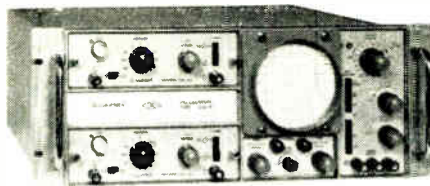

18

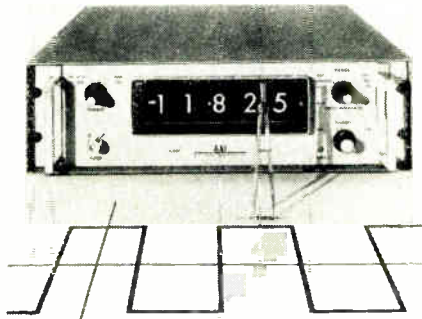

20



19



21

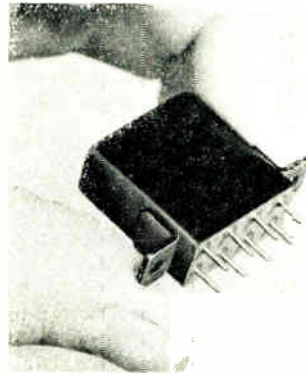

22



23



24

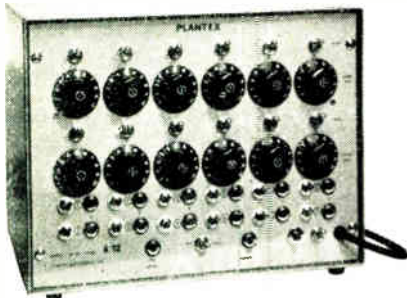

25

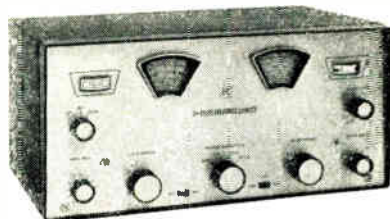

26

(p.t.f.e.), with negligible heating of the stripped wire, resulting in insulation separation which is extremely clean and leaving the wire free from annealing, nicks or cuts.

The stripper is recommended for use on wire gauges from 12 to 36 without adjustment or change of setting. The hand tool is supplied with a compact control box which includes a full-range temperature control, treadle rest to turn off the power when the tool is laid aside, an on-off indicator light, and a three-wire cable.—*Wessex Electronics Ltd., Midsomer-Norton, Bath, Somerset.*

For further information circle 17 on Service Card

18. Rack-Mounting Oscilloscope

Telequipment has introduced the D43R, a 19 × 7 × 6-in. rack-mounting oscilloscope designed for a wide range of industrial, laboratory and medical electronic applications and available with a choice of five plug-in amplifiers.

With a 4-in. flat-faced PDA tube operated at 4 kV, the D43R has a timebase providing 18 pre-set calibrated sweep speeds from 0.5 sec/cm to 1 μsec/cm. Rise time is 23 nsec, input impedance 1 MΩ, and the unit operates on 100–240 V (50–100 c/s) power supplies.

Plug-in amplifiers available are types A, B and C (general purpose, differential and ultra-high gain), in addition to two new units, types D and G. Type D, an envelope monitor, is a tuned amplifier with four switched ranges from 2.5 to 32 Mc/s. When tuned to resonance, sensitivity is approximately 1 V/cm; modulation frequency is available as a sync. output, and input impedance is 50 Ω.

Type G is a combined wideband and differential amplifier, the differential inputs having a common mode rejection greater than 200:1 from d.c. to 1 Mc/s (sine-wave input), reducing to not less than 30:1 at 12 Mc/s. Maximum input voltage is 10 V peak-to-peak (on the 10-mV/cm range).—*Telequipment Ltd., 313 Chase Road, Southgate, London, N.14.*

For further information circle 18 on Service Card

19. Three-Phase Meters

The Cambridge Instrument Co. has developed three instruments to measure the r.m.s. values of low-frequency a.c. voltages and currents in a balanced 3-phase system. They comprise a voltmeter and two ammeters, which incorporate vacuo-junctions in each phase circuit. The vacuo-junction thermocouples are connected in series and their total output, being constant over a cycle, is fed to a Unipivot galvanometer. The vacuo-junction

heaters are connected between each phase and neutral in the voltmeter, and across shunts inserted in each phase circuit in the ammeters.

The voltmeter (illustrated), which is provided with a three-position switch giving range factors of $\times \frac{1}{2}$, $\times 1$ and $\times 2$, is suitable for measurements up to 300 V, having a basic scale calibrated for any line voltage value between 1 and 150 V. One of the two ammeters contains internal shunts and is suitable for measuring currents below 10 A; the other has a scale graduated from 0–150 A and is used with external shunts for measuring currents up to 750 A.

The instruments have been particularly designed for use at frequencies below 2.5 c/s, and can be used to measure the voltages and currents arising in the rotors of induction motors due to slip frequencies, and in low-frequency servo applications. Steady readings can be obtained down to a few tenths of a cycle per second.—*Cambridge Instrument Co. Ltd., 13 Grosvenor Place, London, S.W.1.*

For further information circle 19 on Service Card

20. High-Speed Digital Voltmeters

A line of high-speed digital voltmeters has been introduced by Electronic Associates.

Designed to operate at speeds of one conversion per msec, the series 6000 and 6001 digital voltmeters are used to drive a variety of output accessories or for direct integration into an instrumentation system. They are completely programmable through circuit closures to earth and provide both binary-coded decimal and ten-line decimal outputs. Programmable filters are available for normal and common mode rejection.

The units have four ranges up to 1,200 V and a resolution of 100 μ V. They are calibrated to $\pm 0.01\%$ of reading plus 1 digit absolute accuracy. A switch selects two different internal trigger rates, or external or manual trigger. In addition, the series 6001 has an automatic ranging facility.

These DVM's operate on 115/230 V $\pm 10\%$, 50–60 c/s. Size: $5\frac{1}{2} \times 19\frac{1}{2} \times 17$ in. deep.—*Electronic Associates Ltd., Victoria Road, Burgess Hill, Sussex.*

For further information circle 20 on Service Card

21. Elapsed Time and Events Indicators

Bowmar Instrument announce the production shortly in this country of their elapsed-time indicator type 1440 and events indicator type 1989. High readability, 4-drum digital read-out and miniature size make these units

suitable for airborne equipment applications.

The display is engraved with $\frac{1}{8}$ in. high white numerals on black drums, giving a total time of 9,999 hr. Overall diameter is 0.67 in., length 1.8 in. and weight 1.8 oz. Various types of mountings can be supplied including panel-sealing versions. Power consumption is 1.1 W on a 115-V 400-c/s single-phase supply. Inverters are available to enable the units to work from 28 V d.c. and these measure approximately $1 \times 1 \times 1\frac{1}{2}$ in.

The events indicator is housed in a similar case and is capable of 9,999 counts. Input is either 24–28 V d.c. at 2 W or 115 V 400 c/s at 2 W. Maximum counting rate: 10 per sec with pulse length of 50 msec. Both the time and events indicators are non-resettable and are designed to meet the specification MIL-M-7793C.—*Bowmar Instrument Ltd., Sutherland Road, London, E.17.*

For further information circle 21 on Service Card

22. Crystal-Case Relay

Hi-G has developed a standard-size crystal-case relay, which pulls in at 100 mW, while meeting all applicable portions of relay specification MIL-R-5757/D.

Known as the BA series, this relay incorporates internal design improvements which provide greater sensitivity without increase in either size or weight. Available in two-pole, double-throw configuration only, the series BA contacts are rated for 2 A resistive at 30 V d.c., or 1 A resistive at 115 V r.m.s., 400 c/s.

When specified on order, relays will be off-load tested for 5,000 operations before shipment. Additionally, the relay will operate reliably while undergoing 20 g (10–2,000 c/s) vibration or 50 g 11-msec shock. Standard dielectric strength is 1,000 V r.m.s., 60 c/s between contacts and case, and 500 V r.m.s. between mutually insulated terminals.—*Hi-G, Inc., Spring Street & Route 75, Windsor Locks, Conn., U.S.A.*

For further information circle 22 on Service Card

23. Half-Inch Labelling Machine

To satisfy the demand for larger lettering on wider tape, Dexion have introduced the TP335 half-inch Tape-Printer.

It has 20% larger lettering than other half-inch machines, features a pound sterling sign on the standard dial, and incorporates a tab cut-off device which makes it easy to peel off the backing.

Retail price is £18 10s.; 12-ft tapes

are 13s. each or £3 5s. per box of five.

—*Dexion Ltd., Empire Way, Wembley, Middlesex.*

For further information circle 23 on Service Card

24. Variable Transformer

An encapsulated variable auto-transformer has recently been introduced into the Torovolt range of variable ratio units by The Cressall Manufacturing Co. The model 33Y is designed to handle continuously-rated loads of up to 0.6 A.

This transformer is designed for direct connection to a 240-V a.c. supply, and enables smooth variations of output to be obtained from zero up to line voltage at a maximum current rating of 0.8 A. The wound core is potted in a substantial insulated moulding and is $3\frac{3}{8}$ in. in diameter and $2\frac{3}{8}$ in. deep.

Models can be supplied for front-of-board or back-of-board mounting. Connections are by means of terminals mounted in blocks moulded integrally with the case. Complete with knob and dial, the price is 85s.—*The Cressall Manufacturing Company Ltd., Cheston Road, Birmingham 7.*

For further information circle 24 on Service Card

25. Mono-Stereo Mixer Unit

Plantex Electronics have announced the model SM 6/12 mains-operated 12-channel mixer unit, in which six channels are mixed independently of the remaining six channels. It is therefore possible for this unit to be used for either 6-channel stereo or 12-channel mono mixing. A mono/stereo switch links the two sets of channels for monaural use.

Each of the 12 channels has both high impedance (unbalanced) and low impedance (balanced) inputs, together with its own gain control and muting switch. The output of both mixer sections is intended to feed into a load impedance of 100 k Ω or greater, but other impedances can be supplied. The frequency response of the unit is 40 c/s to 16 kc/s (± 3 dB).

Two other models available incorporate 8 mono/4 stereo channels and 4 mono/2 stereo channels. Monaural only versions can be supplied for 4, 6, 8, 10 or 12 channels.—*Plantex Electronics Ltd., 74 Myddleton Road, Bowes Park, London N.22.*

For further information circle 25 on Service Card

26. General-Coverage Radio Receiver

A low-cost general-coverage radio receiver recently announced by Hammarlund features a 10-valve superheterodyne circuit, electrical band-

EQUIPMENT REVIEW

spread tuning with direct dial calibration, a temperature-compensated h.f. oscillator and a built-in automatic noise limiter.

The HQ-66 is continuously tunable from 540 kc/s to 30 Mc/s in four bands. An 'Auto-Response' circuit permits a complete range of audio bandwidth—from the sharp response required in short-wave reception to the broad response necessary for hi-fi broadcast reception. This function is entirely automatic within the receiver. —*Hammarlund Manufacturing Co., 53 West 23rd Street, New York 10, N.Y., U.S.A.*

For further information circle 26 on Service Card

27. Moisture Meter for Paper

Baldwin Industrial Controls have developed a versatile instrument for measuring and controlling the moisture content of paper. The series B Baldwin Kenley Hygromat moisture meter can be adjusted for use with all grades of paper by means of a variable linearizing device which eliminates the need for separate plug-in units. The instrument incorporates facilities to enable the user to establish the calibration curve from which the necessary settings for the linearizing controls can be determined.

The instrument's standard ranges are: up to 400 gm/m² for paper and up to 1,000 gm/m² for board, with a moisture range of 2–15%. Other ranges can be supplied if required. Temperatures up to 110 °C and static electricity do not affect the accuracy. The output signal may either be an absolute measurement of moisture content or a percentage deviation from a predetermined figure. Multi-head arrangements can be supplied with either manual or sequential switching.

The full range of Baldwin scanning mechanisms, both manual and motor-driven, is available for use with this instrument. Cascaded pneumatic steam-pressure control and electronic speed control are two examples of control systems that can be operated from the meter.—*Baldwin Industrial Controls, Dartford, Kent.*

For further information circle 27 on Service Card

28. Neon Indicator Light

Carr Fastener have introduced a circular bright neon indicator light with a 'top-hat' shaped lens which is fluted on the sides. It is designed to operate at 250 V a.c. with a striking voltage of 80 to 100 V.

This type of indicator light is a one-piece nylon moulding equipped with blade-type connections for use with 'Lucar' quick-release connectors.

The light can be supplied in three colours (red, amber and green) with or without the chrome-plated brass bezel. The application hole size is 0.531 in. and the lamp is held in position by a ratchet plate which is supplied loose.—*Carr Fastener Co. Ltd., Stapleford, Nottingham.*

For further information circle 28 on Service Card

29. Zener-Regulated Delay Timer

The series ELT transistorized electronic delay timer, recently introduced by Industrial Timer Corporation, is available in six models, offering time delays of up to 0.5, 1, 5, 10, 30 and 60 sec. The minimum time cycle is 0.03 sec (in the 0.5-sec model).

No warm-up time is required and stability under fluctuating input voltage has been minimized through the use of a built-in power supply incorporating Zener diodes; fluctuations of ±20 V a.c. have no appreciable effect on timing accuracy. Power required is 4.2 W nominal. Load contacts are isolated, and rated at 10 A, non-inductive.—*Industrial Timer Corporation, U.S. Highway No. 287, Parsippany, N.J., U.S.A.*

For further information circle 29 on Service Card

30. Closed-Circuit Television Camera

Now available from Visual Engineers is the FA 41 lightweight fully-transistorized television camera. The control circuitry is contained within the camera case.

Output signal from the FA 41 is either video or r.f. with negative modulation. 625-line random interlace is standard, but additional panels are available to connect to full interlace. Sensitivity control is fully-automatic.

Weighing less than 10 lb, the camera is 11½ in. long by 5¼ in. square, and will operate on 110–240 V a.c., 50–60 c/s or 12-V battery. Price, less tube and lens, is £238.—*Visual Engineers Ltd., Stocklake, Aylesbury, Bucks.*

For further information circle 30 on Service Card

31. Clutch Motor

Appliance Components have introduced to the U.K. a Bristol clutch motor designed especially for high-speed output, with a minimum of lag in starting and stopping. Designated as model CM, this unit can also be used where a load must be driven at synchronous speed but must be free

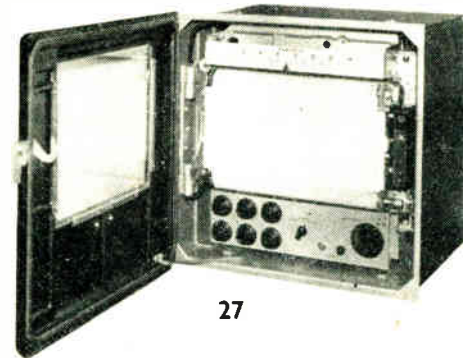

27

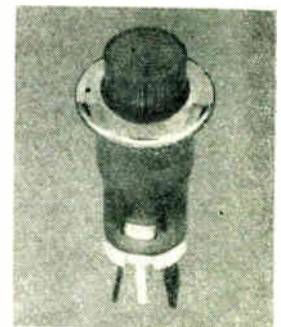

28



29

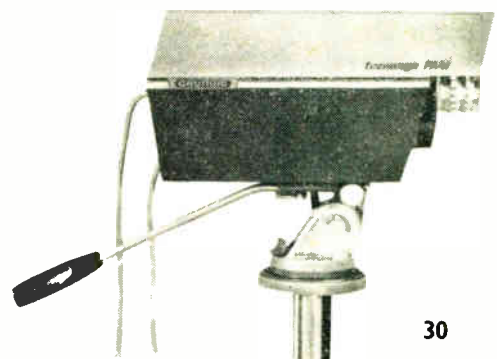

30

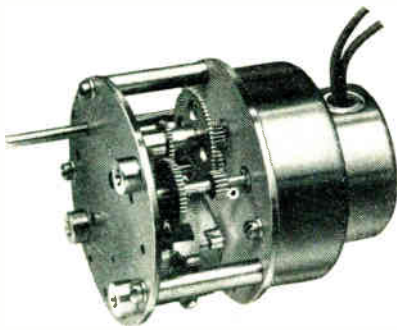

31

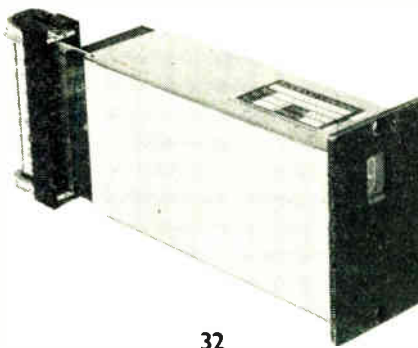

32

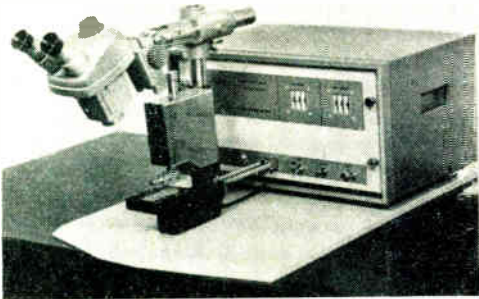

33



34

to be set manually when the motor is de-energized. Applications include resettable and high-speed timers, chart drives, potentiometer drives, recorders and remote controls.

Among the principal features of the motor is a direct or reverse clutch, and full running torque may be used to start a load. Standard reset springs are also available with reset forces of 25 and 50 gm/in. Drop-out time of the clutch relay is less than 0.02 sec.

Output torque of the model CM is 20 oz in., limited by the developed torque of the motor used. The speed range is 50 r.p.m. to 1 rev. per month. Uni-directional or reversible motors can be supplied. — *Appliance Components Ltd., Martin Road, Cordwallis Industrial Estate, Maidenhead, Berks.*

For further information circle 31 on Service Card

32. Single-Decade Counting Unit

Now available from Landis & Gyr are Sodeco 5TD 'monodecade' counters with single-digit drums that count up to 9 impulses. They are equipped with control and read-out contacts, and can be connected together to form a multi-digit counting chain of any required length.

The unit has been designed to combine a maximum counting speed of

10 impulses per second with security of operation and long life. The contacts are made of gold-plated beryllium-bronze and all the connections to the contacts and the counter are by means of a printed circuit.

The 5TD is for panel mounting with front-plate fixing. The numbers are engraved white on black and are large enough (10 × 4 mm) for easy reading at a distance. The standard model is constructed for forward counting; an alternative model 5TDi is available for count-down operation. — *Landis & Gyr Ltd., Victoria Road, Acton, London, W3.*

For further information circle 32 on Service Card

33. Microcircuit Welding System

Now available from Hughes International is a modular electronic welding unit, model MCW/EL, designed for high-speed production welding of microcircuitry, etc., specifically for welding external leads of integrated-circuit packages to p.c. boards. Other applications include interconnections of discrete microcomponents in hybrid assemblies and welds of fine wires and ribbons to evaporated, silk-screened or laminated conductors on insulative substrates. The optical assembly utilizes a Bausch & Lomb zoom

microscope, with a magnification from ×5 to ×22.5.

The power supply is regulated during the weld discharge to maintain a constant preset voltage across the weld. Voltages from 0 to 1.5 V and weld duration (from 1 msec to 9.9 sec) are dialled into the machine by use of digital selectors. Once set, the power supply will compensate automatically for variation in thickness of the object being welded, virtually eliminating the possibility of a blowout.

The energy supplied is suitable for single-point welding of wire leads up to 0.012 in. in diameter and ribbon leads up to 0.008 in. thick and up to 0.030 in. wide. Maximum weld current is in excess of 400 A.

The weld head permits continuous adjustment of the welding gap between 0 and 40 mils. In addition, each electrode tip is suspended on blade-like cantilevers, thus permitting necessary compliance with irregularities in material surfaces. The power supply can also be used with any type of split electrode or 'dual' series weld head of either fixed or variable gap spacing, and conversion kits for present Hughes weld heads are available. — *Hughes International (U.K.) Ltd., Kershaw House, Great West Road, Hounslow, Middlesex.*

For further information circle 33 on Service Card

34. Load Indicator

Evershed & Vignoles has been appointed sole U.K. agent for a load indicator made by the James G. Biddle Co., of Pennsylvania, U.S.A. This instrument is a maximum-demand ammeter which indicates a thermally-equivalent ampere load on a circuit over a time period which depends on temperature. Its main use is to assess and monitor transformer loadings.

The ammeter has two indicating pointers. The first shows the average current demand over a 30-min period; the second indicates the maximum 30-min demand since the last reading period. The second pointer is reset by means of a magnetic resetting stick. A range of indicators is available from 50 to 500 A, each with an accuracy of ±5% of full scale rating.

The indicator has a time constant of approximately 7 min at 25 °C; i.e., in an ambient temperature of 25 °C, it indicates 99% of a constant load in amperes in a time of approximately 30 min. In 15 min the meter will indicate 94% of the constant load.

Attachment is by two 'J' bolts and the core is clipped-in after attachment. The indicator can therefore be attached to the conductor without inter-

EQUIPMENT REVIEW

ference to the supply. The maximum conductor size is $\frac{7}{8}$ -in. diameter.—*Instrument Division, Evershed & Vignoles Ltd., Acton Lane Works, Chiswick, London, W.4.*

For further information circle 34 on Service Card

35. Magnetic Test Systems

Recently announced by F. W. Bell and available in the U.K. through Livingston Laboratories is a range of magnetic testing and inspection systems. These instruments rely for their operation on the Hall effect and are capable of measuring flux density to a repeatability of 0.1%.

The Hall device is placed in the field of the magnet or magnetic structure and provides a visual lamp indication with simultaneous relay-contact closure at adjustable pass or reject limits. Pass or reject points may be set anywhere on full scale range of $\pm 1, 2, 5, 10, 20$ or 100% of the field used to set the limits.

Systems with 1, 2 or 5 adjustable limits are available which may be used for grading magnets into 2, 3 or 6 categories with visual indication for each category. The relay contacts may be used to reject assemblies mechanically or cut off the demagnetizing current at pre-set points. Counters are available which count the magnets in each group.—*Livingston Laboratories Ltd., 31 Camden Road, London, N.W.1.*

For further information circle 35 on Service Card

36. Solid-State Electronic Commutators

ATI has recently developed a series of solid-state electronic commutators for missile and airborne environments. Standard 15 and 30-channel commutators have been provided; however, any number of channels can be accommodated at low cost as a result of the modular construction technique employed. The robust encapsulated packaging results in a hermetically-sealed unit that will withstand typical missile and high-performance aircraft environments while operating.

Voltage levels of ± 6 V can be accommodated. Sampling rates of 15 to 3,000 samples per sec are available and a start-cycle synchronization pulse is provided. An 'off channel' is provided between each input channel and this may be clamped to ground or any reference voltage. The total volume for the 15-channel commutator is 9 cu in. and the weight is approximately 9 oz.—*Applied Technology Inc., 3410 Hillview Avenue, Stanford Industrial Park, Palo Alto, California, U.S.A.*

For further information circle 36 on Service Card

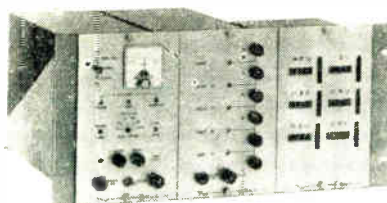

35



36

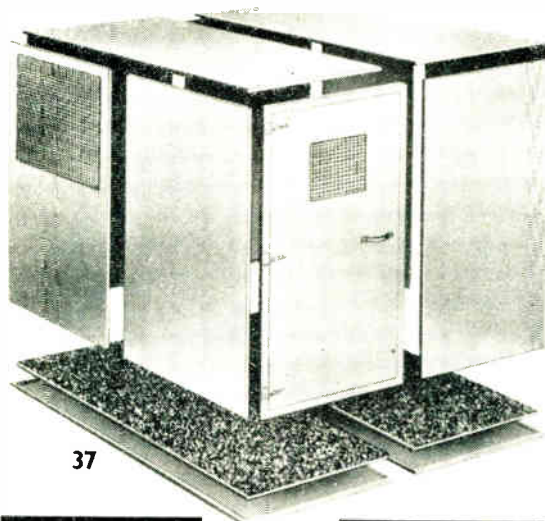

37



38

37. Shielded Room Kits

Now available from Belling-Lee is the '100' series of modular enclosures, based on a range of interchangeable metal-framed sub-units, which can be quickly assembled to provide a shielded room with attenuation of up to 100 dB at frequencies between 1 and 500 Mc/s.

Outstanding features of the series include special conducting gaskets for efficient r.f. bonding of the panels, and a new design of push-fitting door which is self-bonding and holding. The unit panels are 7 ft 4 in. high \times 3 ft 8 in. wide, and the doors and services feed-through panels are all of this size module. Half modules, work benches, etc., are available for specialized applications, and there is a comprehensive range of electrical filters.—*Belling & Lee Ltd., Great Cambridge Road, Enfield, Middlesex.*

For further information circle 37 on Service Card

38. Rotary Transducer

The rotary pulse generator type 491, now available from Bendix Electronics, has been designed for the unidirectional measurement of shaft rotation or speed where only low resolution is required. It consists essentially of a slotted disc mounted on a shaft and a simple photo-electric

detection system comprising a silicon photo-cell and exciter lamp. Rotation of the shaft causes light falling on the cell to be interrupted thus producing pulses proportional in number to angle of rotation.

The number of pulses per revolution can be varied to suit customers' requirements up to a maximum of 60. Maximum output pulse amplitude is 50 V d.c. Standard shaft length is $1\frac{1}{2}$ in.; diameter, $\frac{1}{4}$ in. Overall body size, excluding mounting flange is $2\frac{1}{4} \times 3\frac{1}{4}$ in. Shaft torque: 0.1 oz in.—*Bendix Electronics Ltd., High Church Street, New Basford, Nottingham.*

For further information circle 38 on Service Card

39. Miniature Programming Board

A miniature programme board device capable of switching multiple inputs to multiple outputs is now available from Sealectro.

The Sealectroboard Proto-Kit is available in a 10×10 -hole matrix of bussed-contact design, whereby parallel inputs and/or outputs may be achieved merely by inserting a connecting pin at the desired points in the matrix.

This provides a simple, efficient means of combining various amplifier and speaker equipment complements.

(continued on page 435)

What's cooking at EMI?



New developments in electron tubes are very much on the EMI menu! And new techniques unthought of a few years ago.

EMI experience is at the service of design and development engineers in tackling application problems.

To keep up-to-date on the latest developments send the reply-paid card to EMI.

REPLY CARD

Please send data sheets and application information for the following:—

- Cathode Ray Tube Type MX51
- Photomultipliers Type 9558B and 9558Q
- UV Vidicon Type 9677 UV
- 'O' Band Klystron Type R9653

Also a copy of

- Photomultiplier Tube Short Form Catalogue
- I would also like to receive regular information regarding new developments

NAME AND POSITION

(BLOCK LETTERS PLEASE)

COMPANY'S NAME

ADDRESS

TELEPHONE

EXT. NO.



CATHODE RAY TUBE TYPE MX51

The MX51 is a 5 inch, high sensitivity, high brightness oscilloscope tube, using post deflection acceleration, for applications where fast response time is essential.

Characteristics

Phosphor Green sulphide, short persistence (equivalent to P.31)

Useful screen area 100 mm X by 60 mm Y

Electrical

(All voltages are referred to cathode)

Heater voltage V 6.3 Typical

Heater current A 0.55 Typical

A₁ voltage kV 1.5 Typical

PDA voltage kV 12.0 Typical

PDA ratio to A₃ 10:1 Max.

Deflection sensitivity

X plates 10.5 V/cm

Y plates 3.1 V/cm



PHOTOMULTIPLIERS TYPE 9558B AND 9558Q

The 9558 photomultiplier has an end window trialkali cathode giving high response at wavelengths up to 0.8 microns. The high quantum efficiency at wavelengths between 0.6 and 0.8 microns, compared with other types of cathode, makes the tube of great interest to spectroscopists and astronomers and workers in the laser field. The dark current from the trialkali cathode is very low and is around 500 electrons per second per cm² (at room temperature).

Characteristics

Dimensions Cathode diameter 44 mm min.

Seated height 140 ± 3 mm.

Bulb diameter 51.5 mm max.

Photocathode Trialkali—Caesium Sodium

Potassium Antimony.

Window 9558B—Pyrex (0.3—0.85μ)

9558Q—Fused Silica (0.16—0.85μ).

Dynodes 11 Venetian Blind, SbCs coated.

Photosensitivity 140 μA/lm typical

100 μA/lm minimum.

Voltage for 200 A/lm* 2000V typical.

Dark current at 200 A/lm† 10⁻⁸ A max.

2 x 10⁻⁹ A typical.

*Measured with 2870°K Tungsten lamp;

150V C-D1, uniform dynode chain

thereafter. 200 A/lm corresponds to a gain

of circa 1.5 x 10⁶ in a median tube.

†At 20°C, measured after one hour

operation in dark.



ULTRA-VIOLET VIDICON TUBE TYPE 9677 UV

This new ultra-violet sensitive television camera tube can be used to observe cracks and other defects in the surfaces of red hot ingots. It has equally significant applications in medical diagnosis and biological research.

EMI Vidicon Type 9677 UV has a specially developed target layer to give high sensitivity in the ultra-violet region of the spectrum to at least 2500 AU. The high ultra-violet sensitivity of the tube allows a television camera to be fitted directly to a UV microscope, so providing a continuously visible image of the material being studied. High sensitivity also enables the UV radiation to be reduced to a sufficiently low level for living cells to be studied.

Type 9677 employs the latest EMI electrode structure which increases the ease of operation by allowing it to be overbeamed without loss of resolution, so enabling it to cope with a wide range of light levels.



O-BAND KLYSTRON TYPE R9653

This Reflex Oscillator is a recent addition to the range of EMI millimetre tubes. Applications include electron spin resonance, materials research, and microwave testing and development work, including scaled aerial experiments.

The tube has a mechanical tuning range of about 4 Gc/s in the 4 mm band and variants are being developed to cover the frequency range 65 Gc/s to 85 Gc/s.

A resonator voltage of between 2.0 kV and 2.5 kV at 25 mA produces a power output in excess of 10 mW and electronic tuning is of the order of 100 M/cs between the half-power points. Output is taken from waveguide size WG 26 (RG 99/U) and the standard flange is the American type UG 378/U, although other types can be fitted by special request.

Postage
will be
paid by
Licensee

No Postage
Stamp necessary
if posted in
Great Britain or
Northern Ireland

FOR FURTHER INFORMATION PLEASE
SEND THE REPLY PAID CARD TO EMI



EMI ELECTRONICS LTD
VALVE DIVISION, HAYES, MIDDLESEX
TELEPHONE: HAYES 3888 · EXT. 2165

BUSINESS REPLY CARD
Licence No. SOX 64

VALVE DIVISION · DEPT. EG5
EMI ELECTRONICS LTD.
HAYES · MIDDLESEX · ENGLAND

For example, a single amplifier output can be 'pinned' to several speakers in order to produce various listening effects.

In hi-fi showrooms, the Sealecto-board eliminates the need for various switching devices, and will handle any audio wattage used in hi-fi systems. The contacts are noise-free.—*Sealectro Ltd., Hersham Trading Estate, Walton-on-Thames, Surrey.*

For further information circle 39 on Service Card

40. Pushbutton Switches

Londex announce an extension to their range of pushbutton switches, for which they hold the U.K. marketing rights. These switches are styled to the latest design for panel components, including a finger-recessed pushbutton.

The ratings for the contacts are from $\frac{1}{2}$ A to 4 A at 250 V a.c.; also covered is a number of contact arrangements from 1 normally-open to 4 normally-open and 4 normally-closed. There is a choice of colours, and chromium bezels and buttons can be supplied. The photograph illustrates type 1001C.—*Londex Ltd., 207 Anerley Road, London, S.E.20.*

For further information circle 40 on Service Card

41. Versatile Signal Tracer

The PACO Z.80 r.f./a.f. signal tracer, now available from KLB Electric, is a fault-finding instrument for use in a.m. and f.m. television and audio circuitry. High gain coupled with coarse and fine attenuators make it suitable for detecting signals from the aerial circuit or from the output stage.

In addition to normal signal tracing, this instrument offers noise test, wattmeter and loud speaker substitution facilities. The PACO Z.80 is priced at £23 17s. 6d. complete with input probe, or may be purchased in kit form at £22 4s.—*KLB Electric Ltd., 335 Whitehorse Road, Croydon, Surrey.*

For further information circle 41 on Service Card

42. Oscilloscope Calibrator

A portable oscilloscope calibrator, type CI, has been introduced by Telequipment. It provides in one unit all waveforms and frequencies necessary for the complete alignment of oscilloscopes, and operates from fully-stabilized power supplies.

Weighing 24 lb and measuring $13 \times 6\frac{1}{2} \times 13$ in., the type CI has four separate outputs available which may be used independently or, without interaction, concurrently. Using com-

parison techniques, the calibrator can also test other signal sources.

Signals available are a square wave switched at either 100 kc/s or 1 Mc/s repetition rate, a square wave switched at either 10 kc/s or 1 kc/s repetition rate, time marker pulses at switched rates of 1 Mc/s, 100 kc/s, 10 kc/s, 1 kc/s, 50 c/s; and a timing comb, negative-going with respect to earth.

The calibrator incorporates a crystal source with an accuracy of 0.2%. A non-interlaced television waveform is available, switched +ve with 200 lines approximately. Amplitude 1 V peak-to-peak (sync. + video). Total power consumption is 90 W approximately.—*Telequipment Ltd., 313 Chase Road, Southgate, London, N.14.*

For further information circle 42 on Service Card

43. Infra-Red Detector

Now available from B & K Laboratories is the model 4001 infra-red detector by Huggins Laboratories Inc. This ferro-electric bolometer incorporates a temperature-sensitive capacitor utilizing a barium-strontium titanate ceramic dielectric.

The window material is anti-reflection coated for maximum transmission at 10μ , and the usable field of view is greater than 90° . The spectral absorption exceeds 80% of an ideal absorber within the limits of the window supplied. The model 4001 operates without cooling over a broad range of temperatures, and a built-in preamplifier ensures minimum noise and optimum impedance matching;

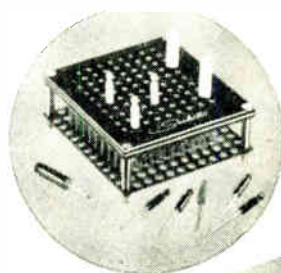

39

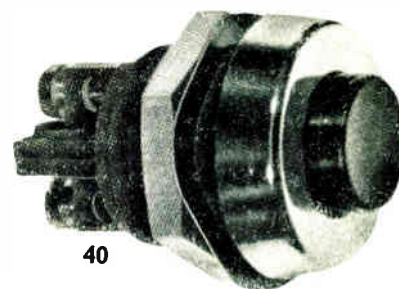
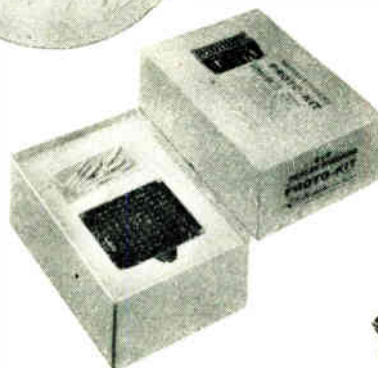

40



41

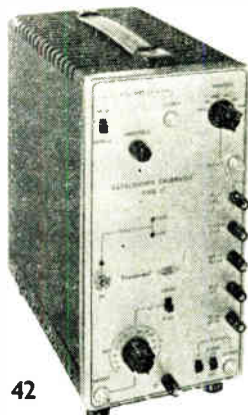

42

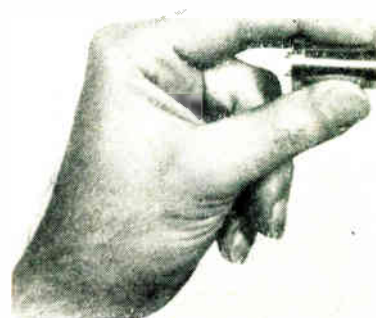

43

EQUIPMENT REVIEW

output impedance is 125 k Ω . The spectral response is 1 to 12 μ . Size of the unit is approximately 1.325 in. long including base pins, with a diameter of 0.850 in. Weight: 2 oz.—*B & K Laboratories Ltd., 4 Tilney Street, Park Lane, London W.1.*

For further information circle 43 on Service Card

44. Precision Wirewound Resistors

Type P8S is a new addition to the family of encapsulated precision wirewound resistors manufactured by Miniature Electronic Components.

It is $\frac{5}{16}$ in. in height and $\frac{3}{16}$ in. in diameter, with printed-circuit leads to 0.2-in. spacing. This is the smallest resistor in the range, rated at 0.2 W at 85 °C. Temperature range is -65 to +150 °C.

The range includes 16 types with axial or printed-circuit leads, or radial lugs. Resistance values up to 4.5 M Ω are available, the standard tolerances being 1%, 0.25% and 0.1%.—*Miniature Electronic Components Ltd., St. John's, Woking, Surrey.*

For further information circle 44 on Service Card

45. 360° Phase Shifter

Recently introduced is a model of the Theta phase generator, PG-3, which provides continuous phase shift of a carrier voltage without amplitude change. This purely passive device operates from -40 °C to +55 °C. Intended primarily for use as a single-frequency phase meter, it also provides a variable reference to phase-angle voltmeters.

The main specifications of this panel-mounting unit are: phase accuracy, 30 min-of-arc; input, 110 V; output, 32 V; dial size, 5 in. o.d.; range, 0-360° continuous; dial resolution, 6 min-of-arc; and depth behind panel, 4 in.—*Theta Instrument Corporation, Saddle Brook, New Jersey 07663, U.S.A.*

For further information circle 45 on Service Card

46. High-Resolution C.R.T.

A high-resolution cathode-ray tube, WX-5063, complete with a magnetic-deflection yoke is available from Westinghouse. It has a pre-engineered tube-yoke combination enclosed in a magnetic shield, and is designed to record electronic data on photographic film for data block or military data recording. The tube meets all applicable temperature, vibration, and shock conditions in military specification Mil-T-5422E.

The tube features compact size and rugged construction. It has a useful

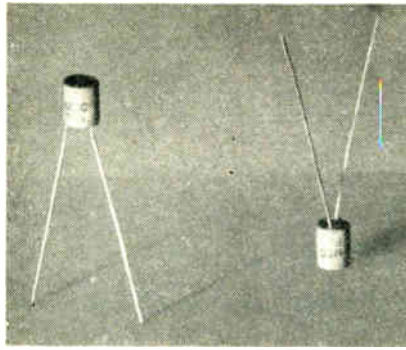

44

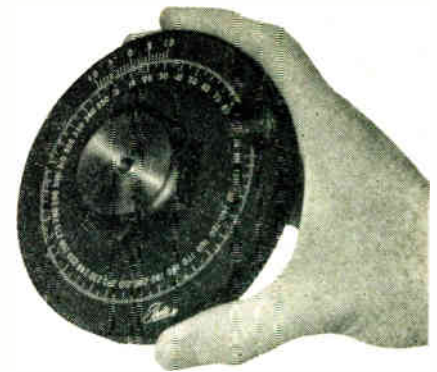

45

face diameter of 0.6 in., a spot size of 0.0008 in., and employs electrostatic focusing. Weighing 2 lb with an overall length of 7.25 in., the tube-yoke package is 2.4 in. in diameter. Anode voltage of the WX-5063 is 8 kV. Other electrical characteristics are equivalent to similar tubes.—*Westinghouse Electric International Company, Electronic Tube Division, 200 Park Avenue, New York, N.Y., U.S.A.*

For further information circle 46 on Service Card

47. Wattmeter

The multiplying properties of the Hall effect are used in a Bell wattmeter now available in the U.K. through Livingston Laboratories.

The HPM 501 wide-band wattmeter, priced at £144, will measure power in four ranges from 100 W to 3 kW to an accuracy of $\pm 2\%$. Frequency range is from 40 c/s to 50 kc/s. External output terminals provide voltages proportional to real power and to VA product, which can be used for recording, power waveform display, power versus frequency plotting, etc.

This instrument can also be used for the measurement of ultrasonic power and the tuning of ultrasonic systems. Dimensions are $6\frac{1}{4} \times 9\frac{1}{4} \times 4\frac{1}{4}$ in. and the instrument weighs 6 lb.—*Livingston Laboratories Ltd., 31 Camden Road, London, N.W.1.*

For further information circle 47 on Service Card

48. High-Voltage Capped Bushings

Two designs for capped bushing type terminals have been added to the range of sealed terminals manufactured by the Spark Plug & Ceramics Division of S. Smith & Sons.

These bushings, designated CS 671

and CS 671/1, are designed to insulate the passage of a conductor through the wall of a capacitor unit working at up to 500 V a.c. The improved electrical characteristics, in comparison with earlier designs, are largely imparted by an annular rib about the insulator which increases the flash-over voltage in air between the top cap and collar to 7 kV peak at 50 c/s; maximum capacitance at 1 Mc/s is 1.3 pF.

The insulators are of high-alumina ceramic to which controlled-expansion alloy top caps and collars are chemically sealed; each unit is tested at an air pressure of 300 p.s.i. during manufacture. The bushings are robust and will withstand high mechanical shock loads, high thermal shock and vibration.—*Spark Plug & Ceramics Division of S. Smith & Sons (England) Ltd., St. Peter's Road, Rugby, Warwickshire.*

For further information circle 48 on Service Card

49. Continuous-Loop Tape Magazine

D.T.V. Group are marketing the Beulah-Cousino 'Audio Vendor' which will convert a standard tape recorder into a continuous loop recorder, with no rewinding or further attention required. Applications include advertising, language practice, telephone answering, etc.

The device is supplied complete with special lubricated tape for recording times from 3 min to 1 hr. In the case of the 1-hr unit, the tape length is actually for 30 min, but it is double-sided and the 1-hr playing time is obtained by joining it into a Mobius loop.

There are two types of Audio Vendor magazine, one classed as counter-clockwise and the other as clockwise. The counter-clockwise unit suits most types of tape recorder,

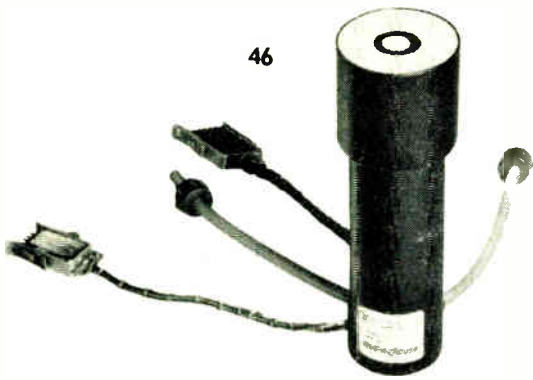

46



47



48

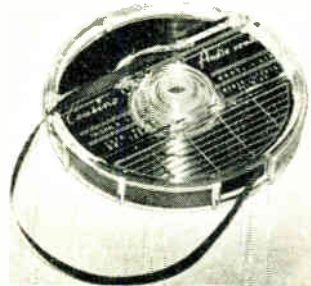

49

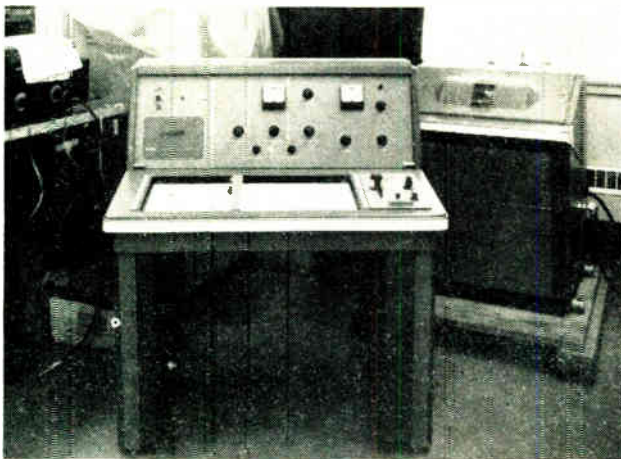

50

but where the supply spool of the recorder is on the right-hand side, the clockwise version is required. The Audio Vendors are priced from 67s. 6d. to £7 15s. depending on the length of tape.—*D.T.V. Group, 126 Hamilton Road, London, S.E.27.*

For further information circle 49 on Service Card

50. Analytical Spectrometer

Announced by Varian Associates is the A-56/60 nuclear magnetic resonance spectrometer. It can be operated at either of two selected frequencies: 56.4 Mc/s for F^{19} studies, or 60.0 Mc/s for H^1 studies.

Operating over the wide range of chemical shifts encountered in fluorine

and proton studies, the A-56/60 provides a routine method of obtaining accurate qualitative and quantitative data on F^{19} and H^1 compounds.

The required frequency is selected at the front panel, and the probe is tuned for optimum sensitivity at the frequency chosen. The change from one operating frequency to the other is rapidly effected, and all control calibrations are true for both F^{19} and H^1 operating modes, conversion tables being unnecessary.

Incorporated in the A-56/60 is a new flat bed recorder offering the standard sweep widths used in proton studies, plus a special 5-kc/s sweep width for F^{19} resonance searching. Both F^{19} and H^1 spectra are provided on pre-

calibrated charts. Sample temperature may be varied from -60 to $+200$ °C.—*Varian Associates Ltd., Fox Oak, Seven Hills Road, Walton-on-Thames, Surrey.*

For further information circle 50 on Service Card

51. Radio Multiplex Terminal Equipment

A thirteen-channel version of the A.T. & E. type 900 radio multiplex terminal equipment is now available for use in radio-telephone networks. The equipment is designed to handle a complete group of twelve channels plus an engineer's order-wire circuit, compared with the seven circuits available in the earlier version.

Compact, easily installed and economical to run, it can provide all the normal dialling, supervisory and metering facilities used in manual or automatic, public or private telephone networks. Facilities are also provided for the easy addition of telegraph, telemetry or facsimile services.

The type 900 (1 + 12) has been developed from the type 900 (1 + 6) version by increasing the bandwidth from 36 to 60 kc/s and including additional multiplexing equipment to produce a basic twelve-channel group in the 6 to 54 kc/s band, together with an audio channel. The equipment is primarily designed for unattended operation from 110–250 V a.c., 50–60 c/s mains supplies but other arrangements can be supplied to order.—*Automatic Telephone & Electric Co., Ltd., Strowger House, 8 Arundel Street, London, W.C.2.*

For further information circle 51 on Service Card

52. Improved Beam Tetrodes

Recent modifications made by The M-O Valve Co. to the TT21/22 beam tetrodes enable these valves to be completely stabilized by using cathode drive. Formerly the beam plates were connected internally to the cathode, but now these connections have been modified to bring out the beam plates to pin 1. Existing applications will not be affected by the change as pin 1 will always be earthed.

The TT21/22 beam tetrodes have an anode dissipation of 37.5 W and are widely used as output valves in h.f. radio transmitters, both as class C amplifiers and as linear class AB1 amplifiers for single-sideband applications. The modified connections will increase the versatility of the valve by permitting its use in cathode-drive applications.—*The M-O Valve Co., Ltd., Brook Green Works, London, W.6.*

For further information circle 52 on Service Card

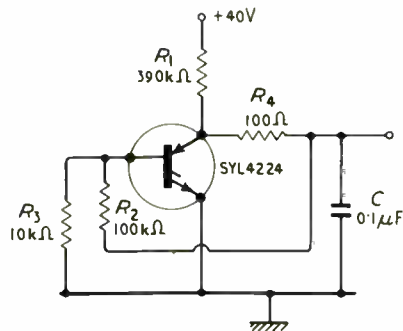
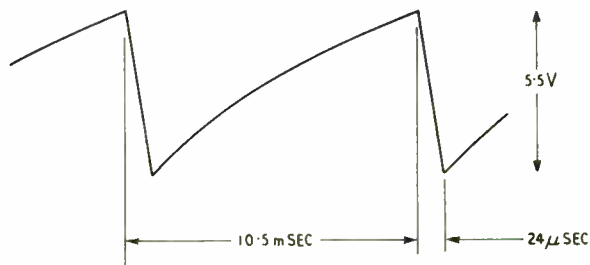

Fig. 1. Simple saw-tooth waveform generator

Fig. 2. Typical waveform obtained with the circuit of Fig. 1



Some circuits using p-n-p-n switches are described and their modes of operation are explained. Some performance figures are given also.

THE p-n-p-n switch is a bistable device that offers a very high resistance to current flow when in the 'off' condition (of the order of several thousand megohms) and exhibits a voltage drop of approximately 1.0 volt when in the 'on' condition. The device may be switched from the 'off' condition to the 'on' condition by

By S. LUKENS*

the application of a pulse to the gate terminal. Turn-off requires that the anode current be reduced below the holding current, or that a negative gate pulse large enough for the gate current to approach the anode current in magnitude be applied.

In the interest of stable operation, an external resistor (10 kΩ or less) is usually connected between the gate and cathode terminals. This has the effect of increasing the holding current I_H as well as the effective gate current to fire, and these effects must be taken into account when designing circuits using p-n-p-n switches.

Several circuits, intended to illustrate ways in which p-n-p-n switches may be used in practical circuits, have been constructed. These circuits are described in some detail below.

Free-Running Saw-Tooth Generator

A free-running saw-tooth generator is shown in Fig. 1. The action of this circuit is as follows:

When power is initially applied, the capacitor C begins to charge towards a voltage given by the expression

$$V = V_{supply} \frac{R_2 + R_3}{R_1 + R_2 + R_3}$$

with a time constant RC , where $R = \frac{R_1(R_2 + R_3)}{R_1 + R_2 + R_3}$; R_1 is assumed to be negligibly small.

The voltage across C appears across the divider network R_2, R_3 , and the portion appearing across R_3 is applied to the gate terminal.

When the 'Gate Voltage to Fire' is reached, the p-n-p-n switch is turned on, and the capacitor C discharges through R_4 and the switch. When the capacitor has discharged, the current through the switch drops below the 'holding current' required to maintain the switch in the 'on' condition, and the switch returns to the 'off' condition and the cycle is repeated.

The waveform observed for this circuit is shown in Fig. 2. The amplitude and time factors can be varied by appropriate variation of the supply voltage, the capacitor and the resistors. Resistor R_1 must be chosen sufficiently large for the current available through this resistor to be less than the holding current.

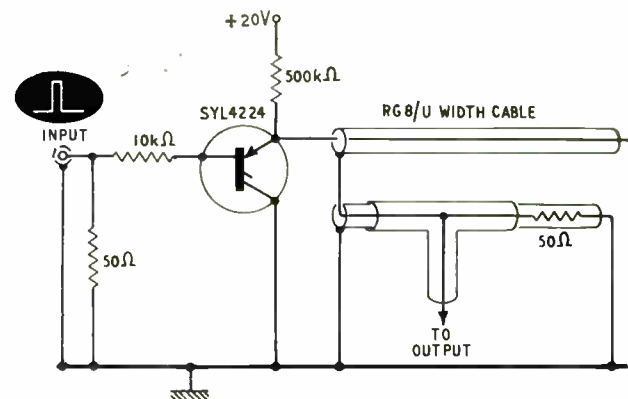
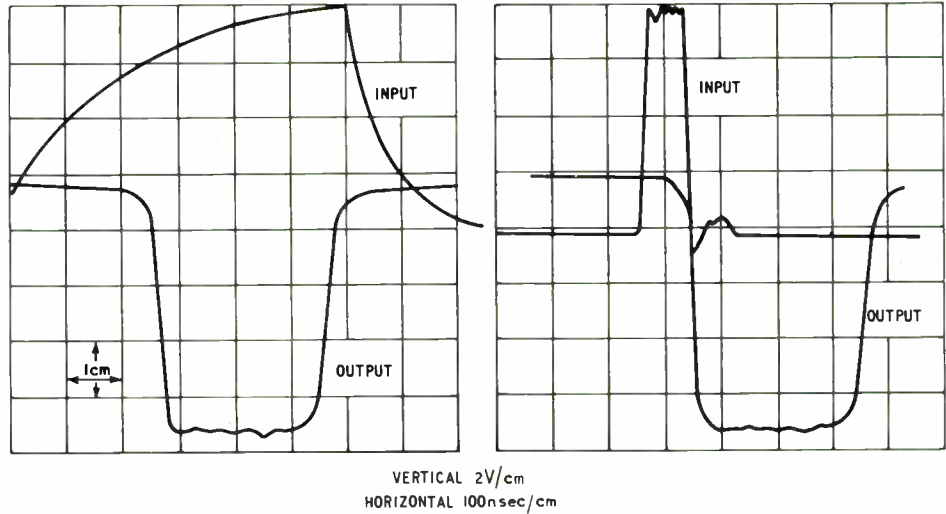

Fig. 3. Triggered pulse generator with delay line to determine the pulse width

* Sylvania International, Switzerland.

Fig. 4. Waveforms obtained with the circuit of Fig. 3



Silicon Planar P-N-P-N Switches

Pulse Generator

If the capacitor in the saw-tooth oscillator is replaced by an open transmission line, the discharge will occur as a pulse with a flat top. The duration of the pulse will be for the time it takes for a signal to travel twice the electrical length of the transmission line. The rise time of this pulse will be determined by the rise time of the 4-layer switch.

Fig. 3 shows a triggered pulse generator of this type. In this case an external trigger is applied to the gate to initiate the discharge. Assuming that the line is fully charged to the supply voltage, which will normally be the case, the amplitude of the output pulse will be one-half the supply voltage.

Since the only function of the trigger pulse is to initiate the switching action, the output pulse shape is independent

of the shape and duration of the input pulse. This is illustrated in Fig. 4, which shows the output pulse obtained with two different input pulses. When the input pulse shown in the upper drawing was increased by a factor of 10, the output pulse remained unchanged.

Output pulse rise and fall times observed with five random units are given in the table.

| Unit No. | Rise Time (nsec) | Fall Time (nsec) |
|----------|------------------|------------------|
| 26 | 18 | 32 |
| 27 | 28 | 28 |
| 29 | 28 | 38 |
| 30 | 20 | 26 |
| 31 | 18 | 24 |

Fig. 5. Three-stage ring counter. Resistors R_2 are 75 Ω in series with G.E. 1850 lamps. All diodes are 1N 3731

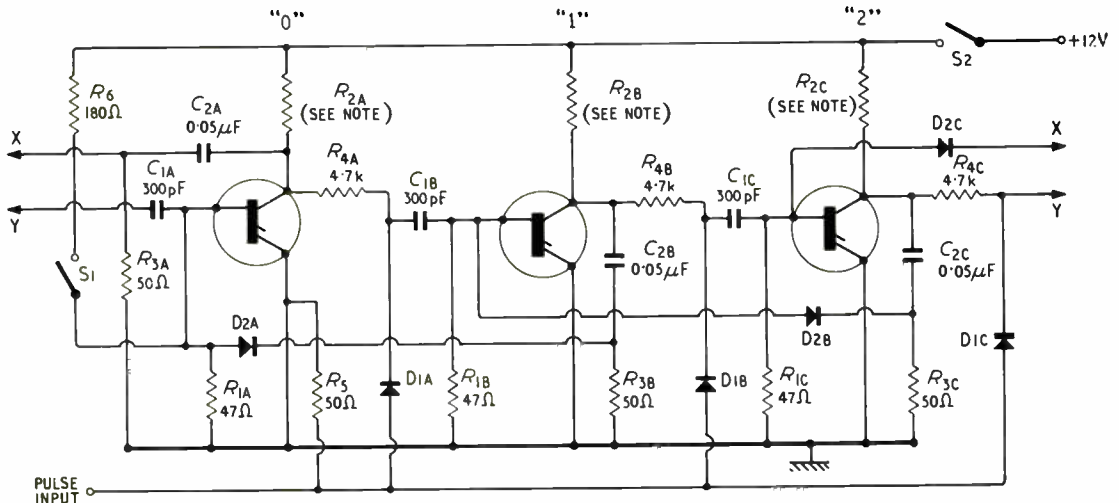

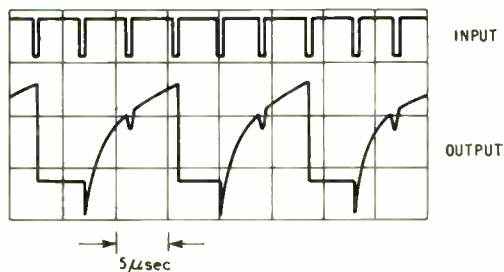

Fig. 6. Waveforms in ring counter

Ring Counter

A three-stage ring counter using Sylvania silicon planar p-n-p-n switches is shown in Fig. 5. To understand the operation of this circuit, assume that switch S_2 has just been closed. Since no signal has been applied to any gate terminal, none of the stages are in the 'on' condition. If switch S_1 is now closed momentarily, the '0' stage will turn 'on' and the counter will be 'set'. The anode voltage in the '0' stage drops to the anode-cathode 'on' voltage, approximately 1.0 volt, and diode D_{1A} is now reverse biased 1.0 volt. Diodes D_{1B} and D_{1C} are reverse biased at the supply voltage level, in this case 12 volts.

If a positive pulse of approximately 5 volts amplitude is now applied to the 'Pulse Input' terminal, diode D_{1A} will become forward biased, while diodes D_{1B} and D_{1C} remain

reverse biased. This pulse will be differentiated by C_{1B} and R_{1B} and a positive-going spike will be applied to the gate of the '1' stage, causing it to turn 'on'.

The anode of the '1' stage p-n-p-n switch drops rapidly from 12 volts to approximately 1.0 volt when this stage turns 'on', causing the junction of R_{2B} and C_{2B} to be driven to a negative potential. Diode D_{2A} is now forward biased and a negative potential is supplied to the gate of the p-n-p-n stage, causing the '0' stage to be turned 'off'.

This completes the cycle. A subsequent input pulse will turn the '2' stage 'on' and '1' stage 'off' in the same manner.

The speed of operation of this circuit is limited by the turn-off time of the p-n-p-n devices. Since there is no external connection to the upper n region, there is no way to sweep charge away from this junction, and it is necessary to wait for recombination to deplete the stored charge sufficiently for the anode voltage to be blocked when the negative voltage is removed from the gate. Thus C_{2A} and R_{2A} must be sufficiently large to insure a sufficiently long negative pulse on the gate. C_{2A} and R_{2A} also determine the maximum pulse rate that may be counted, since it is necessary that C_{2A} discharge during the time that the associated p-n-p-n switch is in the 'off' condition.

Fig. 6 shows the anode waveform and the input pulse when the counter is running at just under the maximum speed, which was observed to be approximately 110,000 c/s per stage or 330,000 c/s for this three-stage counter. The inclusion of incandescent lamps in the load allows a read-out to be made at the end of a pulse train.

Alignment of U.H.F. Television Tuners

Equipment for the rapid alignment of u.h.f. tuners for dual-standard television receivers has been developed by G.E.C. Electronics in collaboration with Radio & Allied Industries, as a crash programme after a serious fire at the

latter's Hirwaun factory in South Wales. Delivery was accomplished in 10 weeks from the start of development.

A set of equipment for one operator includes a display unit, incorporating a 23-in. c.r.t., time-base and vertical-deflection amplifier, which provides two horizontal traces representing the bands 400-600 Mc/s and 600-800 Mc/s. The vertical deflection represents the r.f. or i.f. response curve of the tuner. Bright-up markers are provided at 22-Mc/s intervals.

The jig to hold the tuner under test has contacts for all supplies, for the r.f. input and i.f. output connections, and a means of engaging the tuner shaft for setting it to the calibration points. The tuner may be rotated in the jig for access to the adjustment points without its operation being affected. All high-voltage points on jig and tuner are inaccessible with the tuner inserted, and are dead when the tuner is removed.

Also included is a control box and i.f. amplifier unit, which carries the controls required by the operator during alignment, and a wide-band i.f. amplifier and detector. Indicators are provided for h.t. overload and l.t. earth faults. An undertray unit, containing a u.h.f. motor-driven wobulator, marker generator and output level stabilizer, is situated under the display unit.

U.h.f. tuners being aligned prior to installation in dual-standard television sets



reliability at the right price

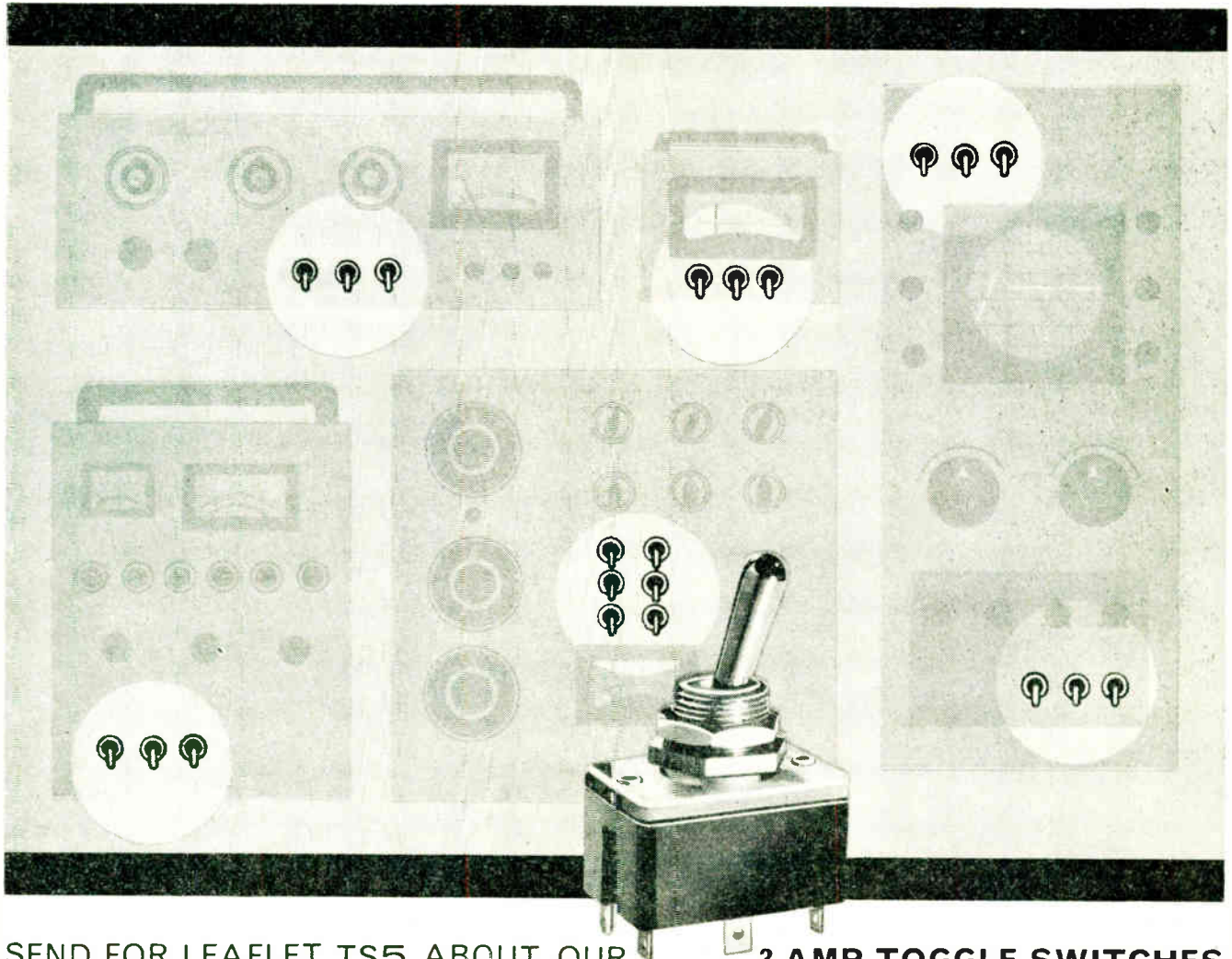

SEND FOR LEAFLET TS5 ABOUT OUR **3 AMP TOGGLE SWITCHES**



Painton & Co. Ltd

KINGSTHORPE
NORTHAMPTON

Telephone: Northampton 34251 (10 lines) · Telegrams 'Ceil' Northampton · Telex 31576

Australia Painton (Australia) Pty. Ltd. · Benelux Painton S.A. · Germany Deutsche Painton G.m.b.H. · Italy Painton Italiana S.p.A. · Sweden Svenska Painton A.B. · U.S.A. Painton Inc

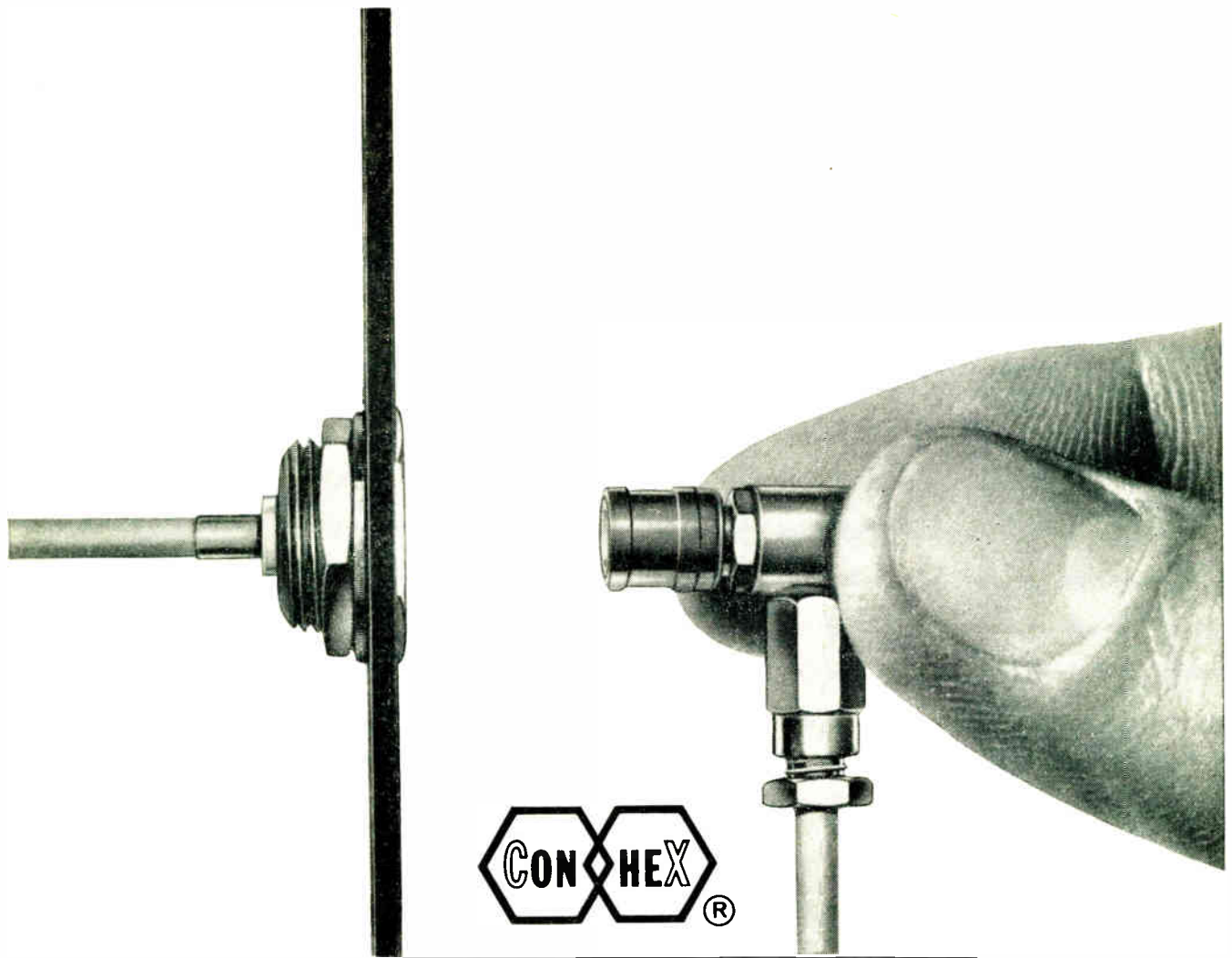

THE APPROVED SUB-MINIATURE RF CO-AXIAL CONNECTORS

Check these features

SPECIFICATION — Produced to Mil-C-22557 and shortly to DEF 5322A (PROV).

CONSTRUCTION—Built-in strength and reliability. Robust functional design with captivated beryllium copper contacts ensuring perfect alignment, ease of assembly without special tools and incorporating a patented cable grip stronger than the breaking strain of the cable.

RANGE — Widest range of cable end and chassis mounting, straight and right-angle styles, in screw-on, snap-on and slide on types, 50 ohm and 75 ohm impedance, with full range of adaptors to BNC, TNC, etc. Flexible or semi-rigid cables.

PERFORMANCE — Optimum impedance matching with specified cables, very low contact resistance, suitable for use at frequencies up to 10 Gc/s.

AVAILABILITY — Popular styles from stock. Wide usage by Government research organisations and all leading manufacturers.



Hersham Trading Estate · Lyon Road · Walton-on-Thames · Surrey. Telephone: Walton-on-Thames 26285 · Telex: 28350

Small components are frequently encapsulated for protection. This article explains the advantages of using pre-formed plastic shells instead of moulds. The shells are left in place and form permanent outer covers to the actual encapsulating material.

ENCAPSULATING electronic components in plastic shells is easier, faster and less expensive than encapsulating in metal moulds. Each time a new mould is needed it must be carefully designed and machined, an expensive investment. Plastic shells, however, can be purchased from a number of suppliers, ready for use, and in any quantity required. Further, their availability in a variety of shapes and sizes (Fig. 1), allows them to be used for a great many types of components requiring encapsulation.

Mould Encapsulation May Limit Production

The major disadvantage of encapsulating in a mould is the limitation it places on production. The number of moulds available determines the number of units which can be encapsulated at any particular time. When a unit is encapsulated in a mould, it must be cured before it can be removed. Thus, to encapsulate 300 units in a four-hour period, it is necessary to have 300 moulds. Before the moulds are used again, they must be carefully cleaned and treated with a parting agent to assure removal of the casting from the cavity. The parting agents are applied to the mould by brushing, wiping, slushing, or spraying.

Moulds also have a tendency to produce poor surface areas. Air trapped in the encapsulating material produces surface bubbles which deface the component. To correct this condition, moulded components are often made over-size and machined or ground down after they are removed from the moulds. Even when machining is not required, it is generally necessary to clean moulded components before they can be used.

Storage of moulds is also a problem. Because of the expense involved in machining, they must be carefully stored and maintained for future use. When a company encapsulates a variety of components, mould-storage considerations become major factors.

Plastic Shells are Suited for High-Volume Production

For high-volume production, a faster, simpler technique is to encapsulate the components in plastic shells. With shells, no mould is required and as many components can be encapsulated at one time as desired. Since a mould is not used, the capital investment is less because the machining and maintenance costs are eliminated.

Plastic shells do not require any cleaning before or after encapsulation. As soon as the encapsulant cures, the components are ready to be used. The smooth outside plastic shell makes a neat, attractive package. Even if some small air bubbles do appear on the surface of the encapsulant, the shell covers them and the component is completely protected. In addition to having high moisture and chemical resistance, the plastic shells can withstand continuous operating temperatures as high as 450° F.

Encapsulated in plastic shells, components or circuit modules are mounted on plastic-to-metal seal (p.m.s.) headers before they are encapsulated. A header is simply a plastic seal with metal pins permanently moulded to it. Many of the different types of standard and special p.m.s. headers are shown in Fig. 2. They are designed for

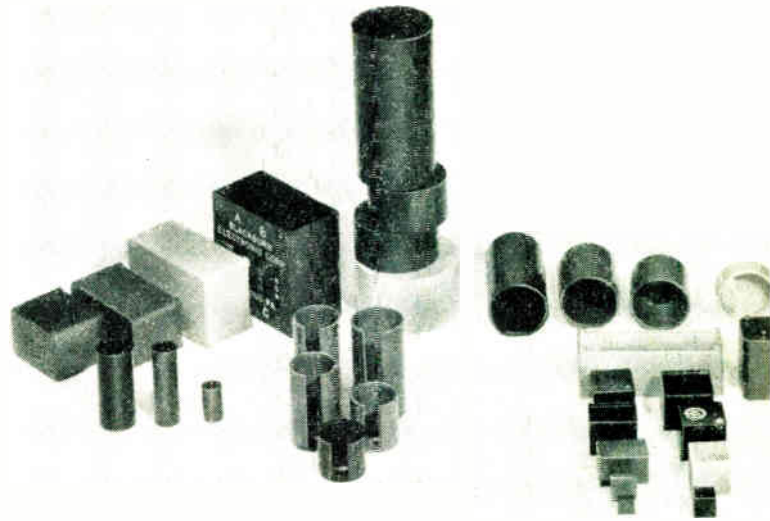
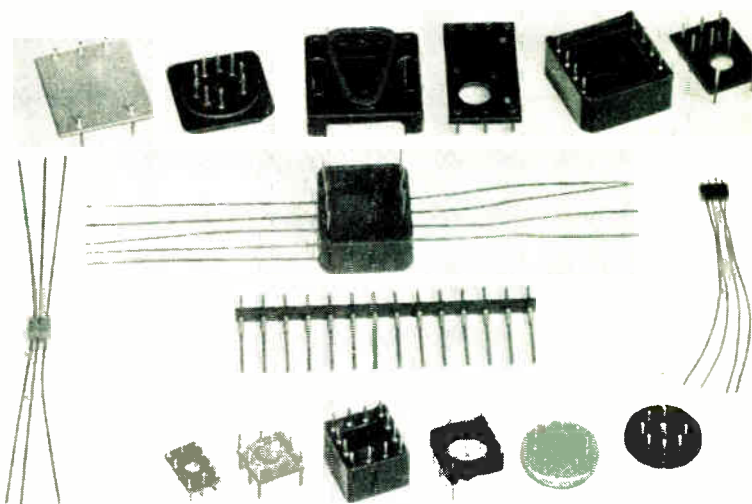

Fig. 1. A selection of standard plastic shells for encapsulating electronic components

ENCAPSULATING WITH PLASTIC SHELLS

By MILTON ROSS*

Fig. 2. Some standard headers for mounting electronic components before encapsulation in the shells



* The Milton Ross Co. Ltd.

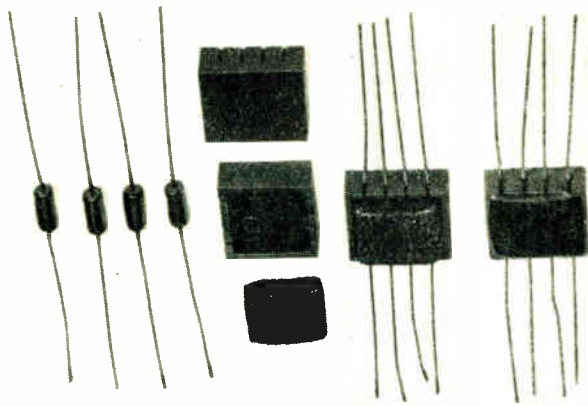

Fig. 3. Four matched diodes placed in a plastic shell have an encapsulating pellet set on top of them. The finished diode package after curing at 85 C is shown on the extreme right

Fig. 4. Component leads can be left to extend straight out of the shell after encapsulation

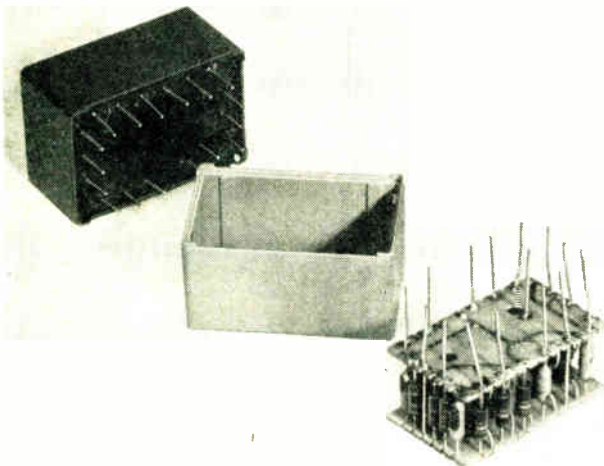
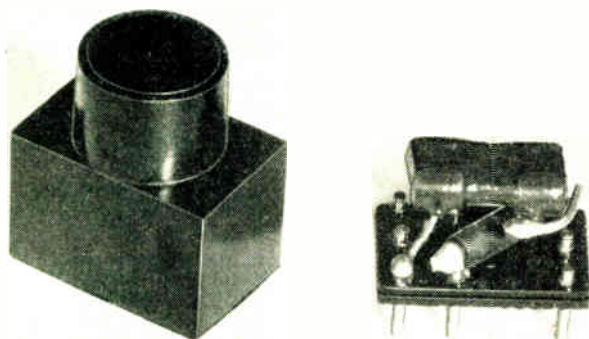

Fig. 5. Component can be soldered permanently to a p.m.s. header before encapsulation. This particular shell has a chimney which holds extra encapsulant to provide for any shrinkage



printed-circuit sockets and direct mounting on printed-circuit boards. Mounted on p.m.s. headers, components can be easily inserted into test sockets for a final check before the encapsulating material is added.

Shells are available in almost any colour, a desirable feature for colour-coding components. They can be moulded with code numbers and trade names and made with riser feet to keep the shell off the printed-circuit board during soldering. The riser feet also permit air to circulate around the components and provide a longer lead length for the soldering heat to travel before reaching them.

There are many techniques for filling the shell with encapsulant. The most convenient, especially for small manufacturers, is to use a precision pellet. Encapsulating material, which has been very carefully compounded, is purchased in the form of these small pellets.

The component to be encapsulated is placed inside a properly sized shell and a pellet is placed on top of the component. A package of four matched diodes encapsulated with a pellet is shown in Fig. 3.

A tray full of units is prepared in this manner and then placed in an oven. Under heat, the pellet melts and completely encapsulates the component. In a period of two or three hours, depending on the type of pellet, the epoxy has flowed, encapsulated, and cured. The pellets are exactly the right size to encapsulate the component and fill the shell.

Most companies are not expert in mixing encapsulents, and pellets provide them with material characteristics they can depend on. However, pellets can be made with a variety of electrical and adhesion properties.

The same material is also available in powdered form. Using the powder, a component can be either partially or completely encapsulated, depending on the amount of powder used.

In one application of powder, a company wanted to prevent a small toroidal-wound ferrite core from vibrating within the shell, but did not want to encapsulate the entire core. With the right amount of powder, engineers were able to encapsulate the core partially, protect the leads, and keep the core from vibrating.

For those who prefer to mix their own encapsulant, pressure guns can be used to fill the shells. The mixed epoxy is put into a polyethylene container in the gun and shot into the encapsulating shell.

For void-free encapsulation, the mixed epoxy is put into a vacuum chamber to remove the air. Sometimes heat is used in the chamber and other times only the exotherm of the epoxy is needed.

Encapsulating Materials Used in the Process

The particular application of the component to be encapsulated determines the encapsulating material. There are many materials available: diallyl phthalate, alkyd, phenolic materials, epoxies, and thermoplastics such as polyethylene, nylon, styrene, and polycarbonate.

Epoxies are generally made up of three components: the resin, a curing agent, and a filler. Pot life, jelling time, exotherm, curing time, and heat resistance are directly dependent on the curing agent. Important factors to consider when selecting an epoxy are electrical-dielectric strength, arc resistance, volume resistivity and surface resistivity, physical-impact strength, heat distortion, temperature susceptibility, water absorption, flammability and shrinkage. Physical and electrical properties of epoxies can be varied through the use of appropriate curing agents, fillers and thickening agents.

The bond between a thermosetting resin and the shell is generally superior to the bond of a thermoplastic. With

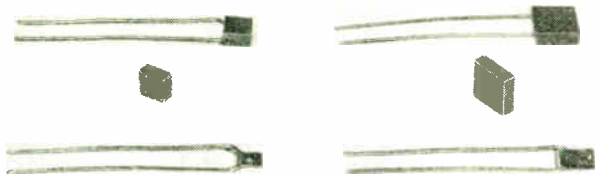
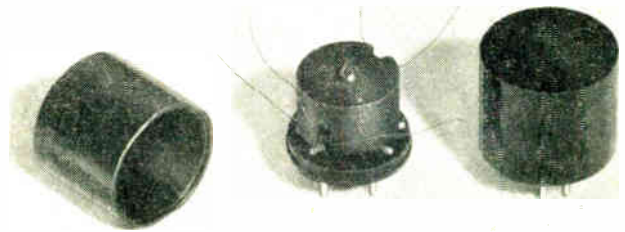

Fig. 6. (Above) Plastic shells give mechanical stability and environmental immunity to 'VK' micro-miniature ceramic capacitors manufactured by Vitramon, Inc.

Fig. 7. (Right) Pulse transformer attached to a p.m.s. header ready for soldering and encapsulation



a properly moulded encapsulating shell, the bond of the epoxy to the shell is as strong as the bond of the epoxy to itself. Thermoplastics are less expensive and have a higher flexural and impact strength than thermosetting resins, but most engineers prefer thermosetting resins because of the strong bond they make with the shell.

Sealing and Header Combination Can be Varied

When a component is encapsulated in a shell the leads can be handled in three different ways. They can be simply left extending out of the shell, Fig. 4; they can be inserted through a lid with drilled or moulded holes placed over the protruding leads; or they can be soldered to metal pins permanently moulded in a plastic seal, Fig. 5.

If the encapsulated component must also be hermetically sealed, a glass-to-metal seal should be used. For many applications, however, hermetic sealing is not necessary and a plastic-to-metal seal will actually do a better job because the encapsulating material adheres better to plastic than it does to the smooth glass surface.

Plastic-to-metal seals are available in various shapes and pin sizes, from soft copper lead wires to rigid pins 0.080-in. in diameter. They are also made in 7-pin, 9-pin, 13-pin and 15-pin sizes to fit standard miniature sockets. It is always advisable to pick a standard-size header and shell with a standard pin spacing of 0.1, 0.15, or 0.2 in. because it eliminates tooling cost. Pin spacing tolerances of plus or minus 0.002-in. non-accumulative can be held on p.m.s.

headers in sizes to fit all available printed-circuit connectors.

Header pins are available in various metals. Brass, copper, nickel and covar are common, and many varieties of plating, including gold and silver, can be done on request.

Because of the mass-production techniques used by manufacturers of plastic-to-metal seal headers, it is usually more expensive to push pins into a punched board or moulded lid than it is to buy a p.m.s. with the pins permanently moulded in place. The quality and tolerances of a standard p.m.s. will also be higher than a punched or moulded board with pin inserts.

Examples of Plastic Shell Encapsulation

Practically any electronic component can be easily encapsulated in a plastic shell. Two Vitramon 'VK' ceramic capacitors are shown in Fig. 6. The plastic shell offers several important advantages for capacitor manufacturers. Varying wall thickness and cracking of the meniscus at the junction of the leads and body, faults commonly associated with dipped capacitors, are totally eliminated. Plastic shells permit internal as well as external visual and mechanical inspection. Shells with thin spots, bubbles, or pin holes can be culled out before the capacitor is potted in its case. Uniform size of the shells permits them to be cartridge-fed for automatic insertion of the capacitors.

Standard plastic shells are also made for various trans-

Fig. 8. (Left) Hook-like arm holds tape-wound core while leads are being soldered to p.m.s. header

Fig. 9. (Below) Shown here are two of the variety of plastic forms and shells available for coils and wire-wound resistors

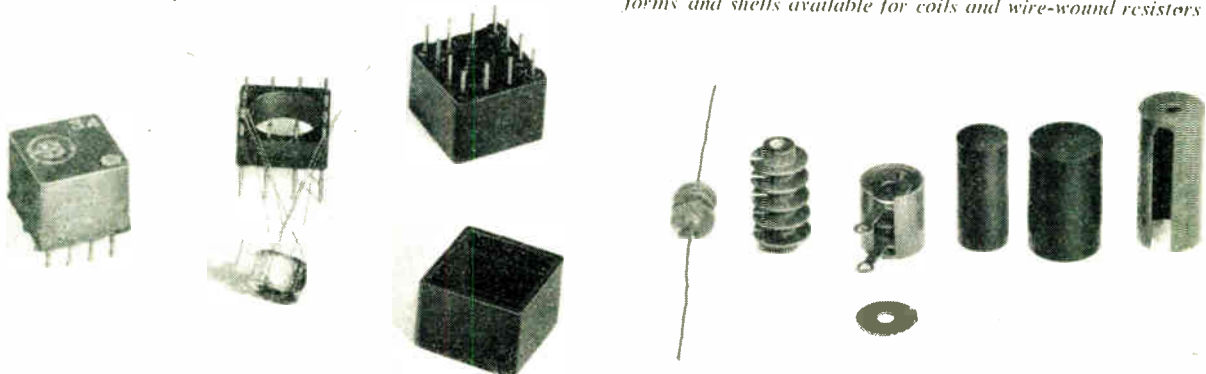

former sizes. The leads are soldered to pins moulded in the plastic shells. A pulse transformer is attached to a p.m.s. header in Fig. 7.

An unusual header used for mounting a tapewound core is shown in Fig. 8. The core is held in position for soldering the leads by a hook-like arm which fits in a slot in the p.m.s. header.

A variety of shells is available for wirewound resistors and coils. Two different types are illustrated in Fig. 9.

One type uses a slotted shell with the leads protruding through a hole in the end cup.

Plastic shells and headers offer a convenient, reliable and economical method for encapsulating electronic components. They eliminate many of the problems associated with encapsulating in metal moulds and the extra facilities needed for machining, cleaning and storing moulds. When properly used, they can provide engineers with a simple solution to many of their encapsulating problems.

G.P.O. Computer Handles 6,000,000 Telephone Accounts

THE preparation of six million telephone accounts per year for part of the London area is now entrusted to a Leo III computer at the G.P.O. Computer Centre in Kensington. Since its installation the computer has also been engaged on the calculation of amounts and the printing of warrants for the repayment of National Savings certificates.

The Post Office has operated a number of computers for some years, and it is extending its computer working over a wide range of activities. Two English-Electric Leo computers were ordered in June last year, and the one at Kensington was the first to come into operation. The present Leo III will be replaced by the improved Leo 326—a larger and more powerful machine—in March next year, at a cost of about £650,000. A second Leo III computer has recently been installed at the Post Office Savings Department at Lytham St. Annes, and is now fully operational.

The G.P.O. expects to secure substantial economies in staff and other costs by the operation of these two centres. It is planned that, under full load, they will each operate

for 15 hours a day, five days a week. Other tasks will be undertaken for various branches of the Post Office. For example, the London computer will shortly start experimental work connected with the scheduling of the centrally-controlled postal vehicle fleet in London and the distribution of instructions on engineering procedures.

The G.P.O.'s Leo III computer has facilities for reading 40- and 80-column punched cards and paper-tape. It is equipped with ten 96K magnetic tape decks (i.e., each tape deck is capable of transferring information at a rate of 96,000 characters a second). It has 16,000 words of core store, and its output facilities include a 1,000 line per minute printer, punched cards and paper tape. This equipment is to be augmented by two further tape decks and a second printer.

The Leo 326 computer will be nine times faster than the Leo III, and will be fully compatible with it, particularly in instruction code and the linking of peripheral equipment. Features of the Leo 326 are fully-concurrent buffered input and output and, like the Leo III, the ability to time share or run several programmes simultaneously.

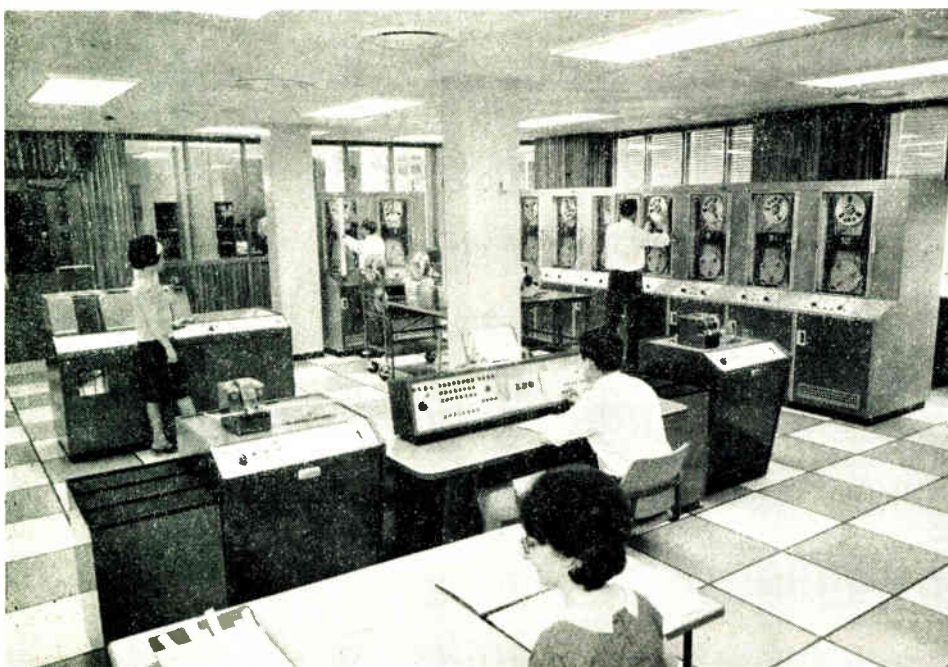

The Leo III installation at the G.P.O. Computer Centre in Kensington. (Picture by courtesy of the Postmaster General; Crown copyright reserved)

We don't make
supersonic jets

- but we help to
make them better

**UNION
CARBIDE**

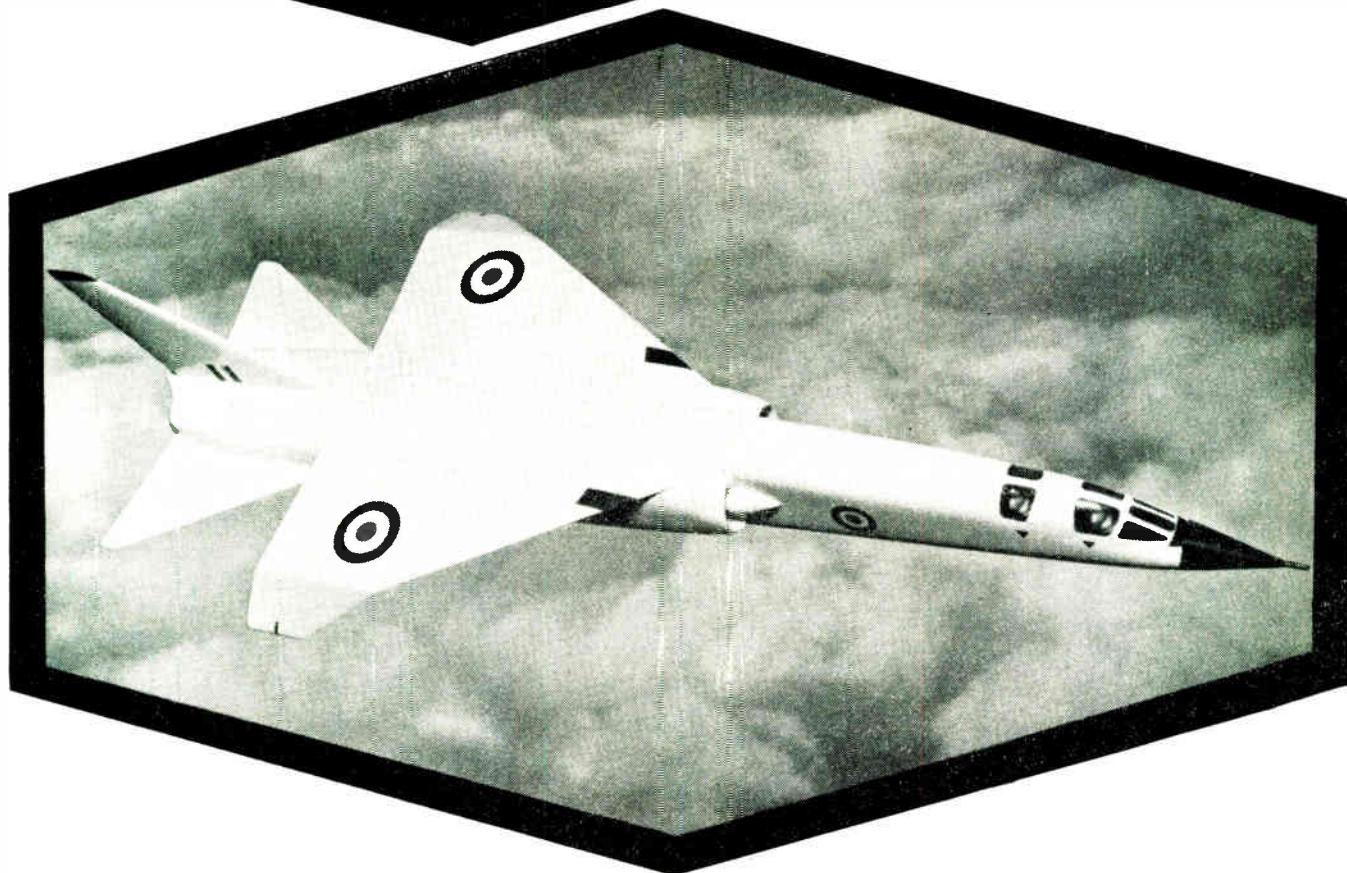

The electronic components in a supersonic jet *must* work without failure. Their selection therefore is most critical as only components of the highest reliability and closest tolerances can be accepted. The electronic system in the British Aircraft Corporation TSR2 includes Kemet solid tantalum capacitors. Kemet capacitors are also used in the British Aircraft Corporation VC10, the Hawker Siddeley ship-to-air guided missile Sea Slug, and their air-to-ground guided bomb Blue Steel—fair proof of their reliability in performing vital functions in extreme conditions. But Kemet tantalum capacitors can be more down to earth too. They are best for all terrestrial electronic equipment including computers wherever accuracy and consistent reliability are essential.

KEMET J-SERIES CAPACITORS comply with US MIL-C-26655A UK DEF/5134-A/1.
EID & ARB release available.

KEMET PRODUCTS.

Polar and non-Polar solid tantalum capacitors—'J' and 'N' series (standard), 'C' series (for commercial applications), 'P' series (for printed circuits); Barium Getters; Silicon Monoxide; Laser/Maser Crystals; Alumina; Dunker motors.

UNION CARBIDE LIMITED,

ENGINEERING PRODUCTS DIVISION,
8 GRAFTON STREET, LONDON W1.
Sales & enquiries: Aycliffe Industrial Estate, Co. Durham.
Aycliffe 2180. Telex 58568.

U.K. distributors for 'J' series capacitors:
SASCO, GATWICK ROAD, CRAWLEY, SUSSEX. CRAWLEY 28700.

CAPACITORS ANOTHER PRACTICAL PRODUCT OF UNION CARBIDE

CHEMICALS · CRYOGENICS · DYNEL FIBRE · ELECTRONIC COMPONENTS · FERRO-ALLOYS · FLAME PLATING · MOLECULAR SIEVES · SILICONES · SUPER ALLOYS · UCON LUBRICANTS

The terms Kemet, Dynel, Ucon and Union Carbide are trademarks of Union Carbide Corporation.

wcw1

six big digits

IN A VERY SMALL BOX

... and a
megacycle
too!

No other instrument of this size and performance has such clear, unambiguous readout; six big digits, bright and steady. A newly-developed blanking system eliminates flicker.

Measures to a microsecond!

This new portable meter is easy to use, with its simplified front panel—and extremely easy to read, with its adjustable support which holds steady at any convenient angle—and, of course, the clear, bright, steady, six-figure readout.

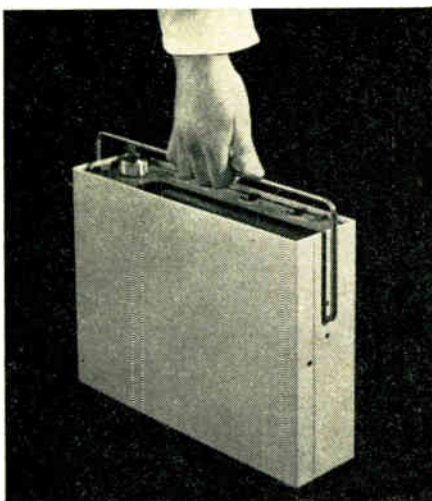

Smaller and smaller!

Design of the new TSA 3436 is based on solid experience of applying transistorized digital techniques to measuring instruments. Small as it is, the TSA 3436 will read frequencies up to one megacycle, and measure time down to one microsecond.

ONLY £195

Laboratories and technical colleges will welcome the compactness, strength and simplicity-in-use of the TSA 3436. In industry, its dependability, and the clarity of its display, make it uniquely suitable for inspection and quality control applications.

Full technical details will be sent on request.

VENNER TSA 3436 TIME/FREQUENCY METER

VENNER

ELECTRONICS LIMITED

Kingston By-Pass · New Malden · Surrey · MALden 2442

This shows an operator loading golf-club shafts into the automatic weighing machine

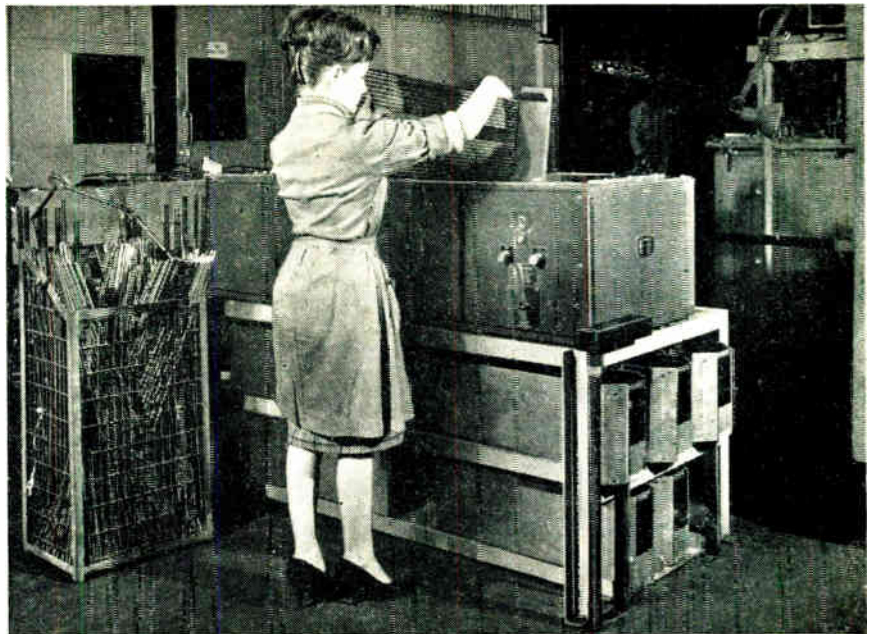

Electronics in Golf-Club Shaft Production

THE steady improvement in the design of golf equipment has made the manufacturer's task a more exacting one—particularly in the production of golf-club shafts. Specifications demand that the weight of each shaft must be within fine limits and the wall thickness controlled to within ± 0.00025 in.

Two special weighing machines which automatically classify golf shafts by weight have recently been introduced into the Sporting Goods Department at the Oldbury factory of Accles & Pollock Ltd. They were designed and built by Henry Pooley & Son Ltd., Birmingham 2. Each machine is capable of sorting shafts to within $\pm \frac{1}{16}$ oz into five weight grades at a rate of up to 800 per hr. It can accommodate

shafts from 32 to 46 in. long and from $3\frac{1}{4}$ to $4\frac{1}{8}$ oz in weight.

The magazine guides which hold the shafts are adjusted to the correct length for each consignment. Once an initial setting has been made, all that is required is to start the machine and keep it loaded with shafts until the end of the production run.

The schematic diagram of Fig. 1 shows the principle of operation. Two feed cams, one at each end of a continuously revolving spindle, pick off one golf shaft at a time and deposit it on a vee-shaped weighing platform. Another cam fitted to the same spindle actuates an ejector which tips the shaft off the platform.

A projected band of light, focused on a ground-glass screen, indicates the weight of the shaft as to whether it is heavy or light. Normally this indicator is only used for initial setting or checking purposes as the machine is completely automatic and does not require the operator to take a reading.

An arrangement of photo-electric cells mounted behind the screen interprets the weight, dependent on how many of them are cast into shadow. (The diagram shows the weight as just under zero, with two cells in shadow. Therefore, the shaft is to within $\pm \frac{1}{16}$ oz.) This information is then fed through an amplifier which actuates a solenoid which in turn by mechanical linkage opens the correct gate for the golf shaft to enter. After being tipped off the weighing platform, the shaft rolls slowly down, steadied by an arrangement of studs on a moving chain, to fall through the appropriate gate into the container below. Shafts which are outside the specified limits are rejected.

Fig. 1. A schematic diagram illustrating the principle of operation of the machine

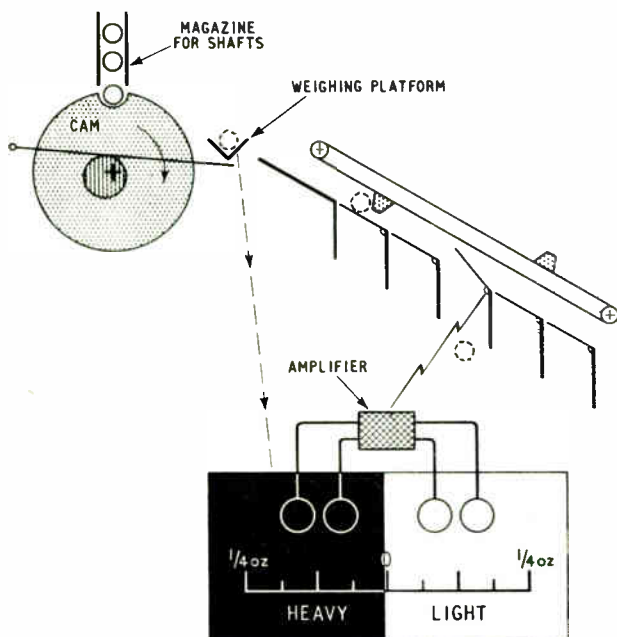

★ FOR THE BUYER

You must have read about a number of products and processes in this issue of which you would like further details. You can obtain this information very easily by filling in and posting one or more of the enquiry cards to be found inset in the back of the journal.



Personal and Company News

The Electro-Tec Corporation of New Jersey has signed an agreement with **Standard Telephones and Cables Ltd.**, granting the British company sole rights for the exploitation of 'Wedge-Action' and other Electro-Tec relays in the U.K. and continental Europe. The U.K. outlet is the STC Electromechanical Division, Harlow, Essex. European sales are through I.T.T.-Standard, Brussels, and the various I.T.T. Companies in Europe which are associates of STC.

H. A. Thomas of the Instrumentation and Control Department of **Unilever Ltd.** has retired; he has been succeeded by W. M. Houston. Dr. Thomas is to act as a consultant to Elliott-Automation Ltd. from October 1st.

Welwyn Electric Ltd. announce the appointment of R. M. Shepherd as liaison engineer (European market).

The appointment of L. R. Price to a new position, managing director of EDP Europe, is announced by **Honeywell Controls Ltd.** This gives Mr. Price overall responsibility for Honeywell electronic data-processing operations throughout Britain and the Continent. Honeywell Controls have also made the following management changes at their Newhouse and Hemel Hempstead plants: C. H. Offord, director and general factory manager, is now responsible for overall direction and administration of both plants; appointed manager of the Hemel Hempstead plant is J. Hughes; succeeding him as manager of the Precision Components Division at Newhouse is J. G. Kerr.

Captain C. F. Booth, C.B.E., M.I.F.E., who until his recent retirement was deputy engineer-in-chief at the Post Office, has been appointed communications consultant to **Plessey-UK Ltd.**

Telex-Southern Ltd. announces that it has now changed its name to **J.A.C. Electronics Ltd.** This is as a result of Southern Instruments Ltd. acquiring the full share capital of this company which was previously jointly owned by themselves and Telemechanics Ltd. One of the original founder-directors of Southern Instruments, John Colls, assumes the position of director in charge of the newly named company. John Bell, previously sales manager of Southern Instruments, moves over as commercial manager. J.A.C. Electronics plans an immediate expansion, and for this purpose has moved into a new factory at No. 4 Station Estate, Blackwater, Camberley, Surrey. (Telephone: Camberley 5399).

H. G. Lillicrap has been appointed director, Radio Services Department, at the Post Office in succession to **Alan Wolstencroft, C.B.**, who becomes deputy director-general.

Sir Albert Mumford, K.B.E., has accepted the invitation of the Association of Supervising Electrical Engineers to become president. He will succeed Sir Hamish D. MacLaren, K.B.E., C.B., on the 1st October 1964.

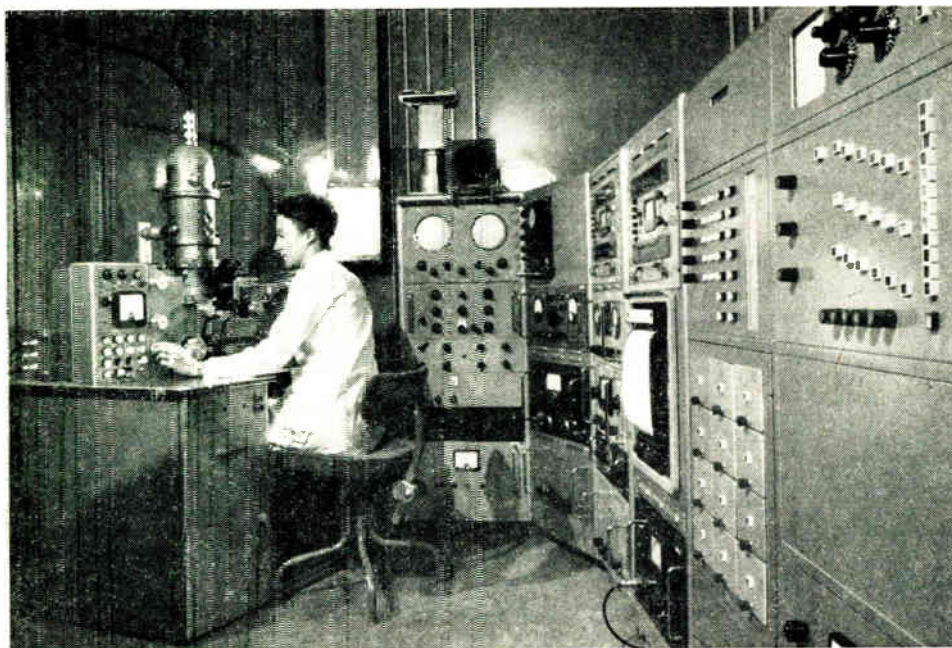

INCLUSION IDENTIFIER — An automatic inclusion counter and identifier (on the right), developed by scientists of Tube Investments Research Laboratory at Hinxton Hall, near Cambridge, identifies and counts inclusions in steel samples detected by the scanning microanalyser (on the left), which was also developed at Hinxton Hall. Identification is based on the X-ray emission from the inclusions as the electron probe scans across them

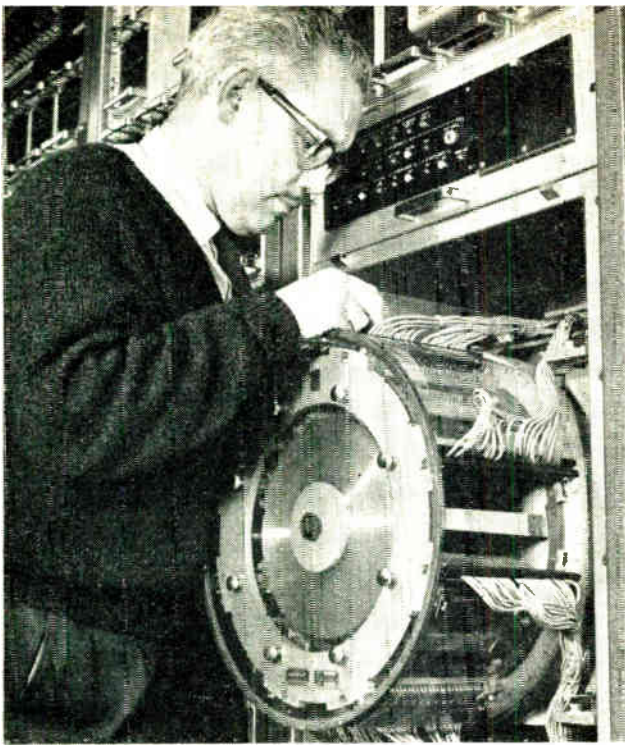

WIDE-AREA ROAD TRAFFIC CONTROL BY COMPUTER— An A.T. & E. development engineer checking the magnetic drum store of a computer designed for the wide-area control of road traffic. Central computer control will probably be used in the West London experiment which the Minister of Transport has announced will take place in 1965. The experiment is designed to see whether traffic flow in a wide area of West London can be improved

The U.K. agency for electronic components distributed by the Sylvania International Division of General Telephone and Electronics International S.A. of Geneva has been transferred from Thorn Electronics Ltd. to **Thorn-AEI Radio Valves and Tubes Ltd.** The products concerned are Sylvania valves, semiconductors, microwave devices, industrial and television cathode-ray tubes, manufactured in the U.S.A. by Sylvania Electric Products Inc. All future orders and enquiries should be sent to: Thorn-AEI Radio Valves and Tubes Ltd., Head Office, 155 Charing Cross Road, London, W.C.2. Communications concerning accounts should be addressed to: Thorn-AEI Radio Valves & Tubes Ltd., Financial Division, Mollison Avenue, Brimsdown, Enfield, Middlesex.

The Marconi International Marine Co. Ltd. announces that, under the terms of an agreement with the Canadian Marconi Company, it has acquired exclusive distributing rights for the ENAC D-X Navigator Loran-C in the United Kingdom, the Republic of Ireland, Hong Kong, and Singapore.

Simms Motor & Electronics Corporation Ltd. announce the establishment of **Simms Group Research & Development Ltd.** which will absorb its existing subsidiary, Mono-Cam Ltd. The new company will undertake systematic long-term research into the evolution of new products up to the development prototype stage. The directors are:— G. E. Liardet (chairman), C. H. Bradbury (managing), M. J. Ronayne and S. Surrey (secretary). Premises have been acquired at Park Royal, adjacent to the S.M.E.C. electro-mechanical and Dawe Instruments' electronic laboratories.

Hewlett-Packard Ltd. and Livingston Laboratories Ltd. in a joint announcement, state that, under new arrangements, Hewlett-Packard Ltd. have become sole distributors for the whole range of Hewlett-Packard instruments whether produced by the American parent company in the U.S.A. or by the British subsidiary. The instruments include those produced by Hewlett-Packard's associate companies, the Boonton Radio Co., Dymec, Harrison Laboratories, F. L. Moseley Co. and Sanborn Co.

£25,000 'PHONE BEAM SYSTEM— A new £25,000 demonstration microwave radio telephone and television link is being built in Kent by Standard Telephones and Cables Limited to help boost its export business.

Visitors to STC's microwave engineering laboratories at St. Mary Cray, Kent, will see the equipment bouncing telephonic calls and TV pictures back and forth between a 100-ft-high tower there and a smaller tower two miles away at Footscray, Kent.

Since a true long-distance link would be impracticable for demonstration purposes this STC link will be made to simulate one about 175 miles long by sending the radio signals back and forth for a total of six transits. Each transit will simulate a microwave station-to-station hop of about 30 miles, the usual distance between such stations. 175 miles is the international reference distance for measuring the performance of microwave systems

G. M. Hasler has assumed the appointment of acting secretary of the Conference of the Electronics Industry. Mr. Hasler and the Conference secretariat will be accommodated at 61 Green Street, London, W.1. (Telephone: Hyde Park 8388).

Obituary

H. C. Willson, the founder of Reproducers and Amplifiers Ltd., has died after a short illness. Well known in the industry and prominent amongst the pioneers who founded the R.E.C.M.F., Mr. Willson was chairman and managing director of R. & A. from the formation of the company in July 1930 until he retired in July 1962.



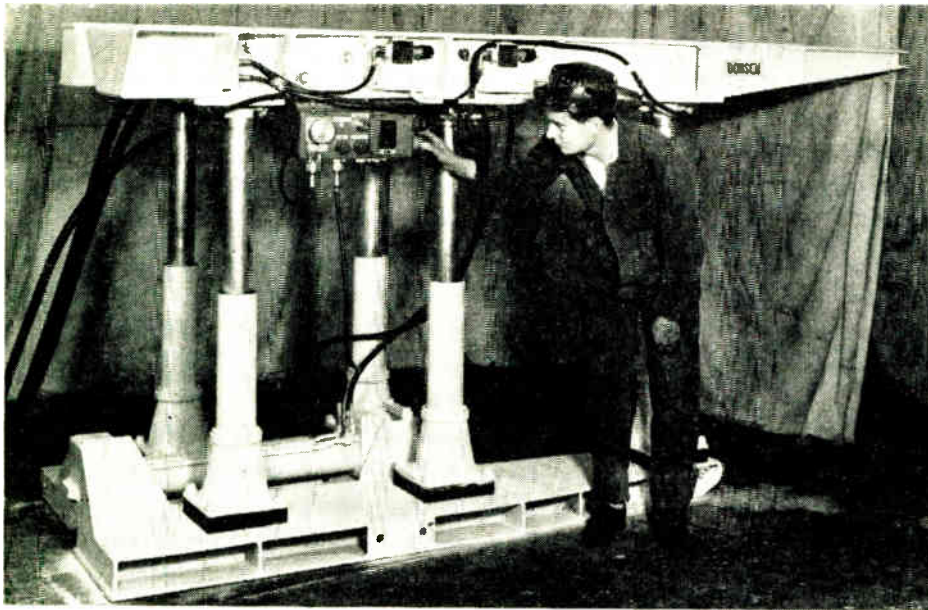

AUTOMATIC CONTROL FOR COALFACE ROOF SUPPORTS—

An automatic control system for self-advancing roof supports, which can be used at nearly all long-wall coalfaces has been developed by E.M.I. Electronics. A demonstration of the equipment fitted to a set of Dobson Atlantic roof supports was recently given to the National Coal Board. When using this system, the number of miners required to work at the coalface under dangerous conditions is reduced from eight to two, and they can operate the equipment from a safer position than before

Television Society Premiums

The Television Society has awarded the following premiums, for outstanding papers read before the Society in 1962/1963:—

The Mullard Premium to Mr. G. B. Townsend, B.Sc., F.Inst.P., M.I.E.E., A.K.C. (Rank-Intel Ltd.), for his paper on 'New Developments in Secam'.

The Wireless World Premium to Dr. P. Schagen (Mullard Research Laboratories) for his paper on 'Electronic Aids to Night Vision'.

The Electronic Engineering Premium to Mr. A. C. Dawe, B.Sc.(Eng.), A.C.G.I., A.M.I.E.E. (E.M.I. Electronics Ltd.), for his paper on 'Characteristics of Special Vidicon Camera Tubes and their Applications'.

The Pye Premium to Mr. Kenneth Fawdry (B.B.C.) for his paper on 'Education by Television'.

The T.C.C. Premium to Mr. C. F. Whitbread (Associated Aerials Ltd.) for his paper on 'Receiving Aerials for U.H.F. Television'.

Dawe Instruments Sponsor Lectureship

Dawe Instruments Ltd. have sponsored the founding of a lectureship (to be known as The Dawe Lectureship) at Southampton University's Institute of Sound and Vibration Research, which will foster research and teaching in the field of noise measurement, under the directorship of Professor E. J. Richards, O.B.E., M.A., D.Sc., F.R.Ae.S. P. L. Tanner, M.Sc.(Eng.), has been appointed to the position of Dawe lecturer.

VASCA Appointments

The following appointments are announced by the Electronic Valve and Semiconductor Manufacturers' Association (VASCA) for the year beginning July 1964:— Chairman of the Association and the General Management Committee—C. A. W. Harmer, O.B.E. (Pye Ltd.); Chairman of Group A—Industrial Valves & Tubes Management Committee—R. H. Deighton (English Electric Valve Co. Ltd.); Chairman of Group B—Semiconductor Devices Management Committee—Dr. E. G. James (General Electric Co. Ltd.).

Inductors Design and Manufacturing Service

A new specialized design-and-build service for research and development organizations is being offered by the recently-formed Pandect Precision Components Ltd., Wellington Road, High Wycombe, Bucks. This company is making available design facilities and production, in limited quantity, of any small or medium-sized wire-wound devices such as potentiometers, trimmers, and position transducers.

Among the types of techniques offered will be windings with wire thicknesses down to 0.0005 in. (0.0127 mm) and the use of formers down to 0.020 in. (0.51 mm) diameter.

Digital Techniques Course

A course of 10 lectures on digital techniques, designed for students from industry with graduate or H.N.C. qualifications, is starting at the Portsmouth College of Technology on 5th October 1964. It is intended to give an introduction to the logical design of digital systems and the electrical design of the circuits involved for those not already specializing in this subject. Further details and enrolment forms are obtainable from The Registrar, College of Technology, Mercantile House, Commercial Road, Portsmouth.

G.E.C. Electronics Launches P.C. Service

A comprehensive service for the design and manufacture of high quality, competitively priced, printed circuits is announced by G.E.C. (Electronics) Ltd. The service will be operated by the Printed Circuit Division at Spon Street, Coventry. All the boards are made by the photographic etched-foil technique, using a fully-automatic etching, washing and drying plant.

Notable among the facilities now offered by the company to all users, both large and small, of printed boards, is a 48-hour prototype and pre-production service, supported by its own photographic section.

Equally important, the company's wide experience will be freely available, at all stages of development and manufacture, on problems of design, materials, and technique.

Correspondence

Words

Sir.—You do well to warn us of the diverse meanings attached to ordinary words and to urge us to take more care not to misuse them. May I express the hope that the widespread attention being devoted to computer logic will help to end the use of 'either' to mean 'each' or 'both', when these words are available whereas there is no short alternative to 'either' for saying 'one or the other'. Confusion of OR and AND in computer circuitry would hardly make for intelligible results, so why should we confuse them by saying such things as 'on either side' when we mean 'on each side'?

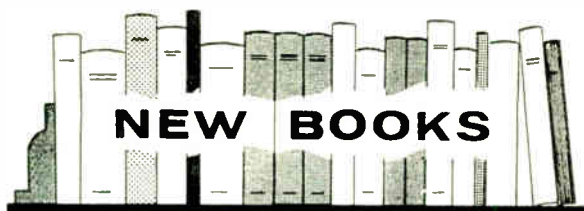

Units and Standards of Measurement Employed at the National Physical Laboratory: Light

Pp. 10. Published for D.S.I.R. by Her Majesty's Stationery Office, York House, Kingsway, London, W.C.2. Price 1s. 6d.

Units and systems of measurement in photometry, colorimetry and radiometry are defined in this booklet. They are those normally used by the National Physical Laboratory, Teddington, Middlesex.

This is the second edition and in it the sections on equivalent luminance and the scotopic system of photometry have been brought up to date.

Two questions in this field, still under discussion in scientific circles, are not resolved by this publication. One is the defining of the properties of the eye under conditions of partial light-adaptation. The other is the adoption of standard colour-matching functions appropriate to a ten degree field of view.

However, the booklet lists C.I.E. (International Commission on Illumination) publications which give recent information on these topics.

Single Sideband Principles and Circuits

By E. W. PAPPENFUS, WARREN B. BRUENE and E. O. SCHOENIKE. Pp. 382 + xvi. McGraw-Hill Publishing Co. Ltd., Shoppenhangers Road, Maidenhead, Berks. Price 118s.

There are 22 chapters in this book of which the first three form an introduction, cover propagation and describe the basic requirements of apparatus for single-sideband operation. The next 12 chapters cover the transmitting side

To your examples of words that have been vitiated by misuse may I add 'infer', which is so commonly heard when 'imply' or 'insinuate' is probably the meaning intended. So now one has to say 'draw a conclusion from' to make sure. Then there is 'protagonist', which often wrongly appears as the opposite of 'antagonist' in the belief that the word is derived from 'pro' (= for) instead of 'proto' (= first). Advertisers who copy the American habit of describing their products as 'rugged' are unlikely to have in mind such qualities as 'rough', 'wrinkled', 'harsh', 'unpolished', or 'with no mark of refinement', which even Webster's Dictionary gives as meanings!

In audio engineering, communication with musicians is desirable, but uncertain because they use 'resonance', 'modulation' and 'tone' with quite different meanings from ours. It is unlikely that we can agree on a common usage, but it is something if we are at least aware of the pitfalls.

M. G. SCROGGIE.

Bromley, Kent.

and are followed by three on receivers. The remaining four deal with transceivers, signal processing, and receiver and transmitter tests and measurements.

The coverage is substantially complete and mainly in a descriptive form. Only a modest amount of mathematics is included and this is largely quoted formulae.

A good deal of the material is not peculiar to s.s.b. operation. Thus, frequency generation, r.f. power amplifiers and neutralization are no more peculiar to s.s.b. transmitters than are noise level and frequency changers to receivers. While much of the i.f. amplifier material is also of a general nature, it is definitely slanted towards the particular needs of s.s.b. operation.

British Valve and Semiconductor Industry

Pp. 8. Published by the British Radio Valve Manufacturers' Association (B.V.A.) and the Electronic Valve and Semiconductor Manufacturers' Association (V.A.S.C.A.). Available free from B.V.A., Mappin House, 156 Oxford Street, London, W.1.

This booklet is primarily intended as a brief for British Commercial Attachés and Information Officers abroad. It provides a guide to the structure of the British electronic valve and semiconductor industry. First published two years ago, it is now brought up to date and broadly classifies 62 types of valves, tubes and other devices and gives the names and addresses of the firms making each type.

Microwave Solid-State Engineering

Edited by L. S. NERGAARD, Ph.D., and M. GLICKSMAN, Ph.D. Pp. 229 + xx. D. Van Nostrand Co. Ltd., 358 Kensington High Street, London, W.14. Price 62s.

This book is based upon a series of lectures on solid-state phenomena and their microwave applications by members of the staff of the R.C.A. Laboratories and they were originally given in the autumn of 1960. The coverage is wide and embraces many diverse branches of physics. The result is, as the editors point out, that symbols have different meanings in different parts of the book. Also m.k.s. and c.g.s. units are both employed, since the customary usage

in any particular branch is retained. The list of symbols runs to over seven pages and gives the chapters in which they are used.

There are eleven chapters. The first deals with elementary quantum mechanics and the second with solids, under which are included band structure, band occupancy, electron transport mechanisms and contacts. A chapter on semiconductor devices follows and then one dealing with microwave diode devices.

Chapter 5 turns to molecular resonance, leading to the following one on masers. There are then chapters on ferrites and ferrite devices after which it is the turn of plasmas and plasma devices. The book ends with a summary of microwave solid-state devices.

In spite of the apparently formidable start with quantum mechanics, the book is not a highly-mathematical one. There is a great deal of description and the mathematics tends to be in patches.

Manufacturers' Literature

Mullard Semiconductors Designers' Guide. This 24-page guide gives specifications and outline drawings with dimensions for the current range of industrial and communication semiconductors produced by Mullard Ltd., Mullard House, Torrington Place, London, W.C.1.
For further information circle 55 on Service Card

Belclere Transformer Design Kits. For miniature prototype transformers this single-page leaflet describes 19 kits of parts, most of which are available with a choice of three lamination materials. The transformers range in size from $\frac{3}{4}$ -in. cube to approximately 2-in. cube.
The Belclere Co. Ltd., 385/387 Cowley Road, Oxford.
For further information circle 56 on Service Card

D.T.V. Industrial Electronic Distributors: Catalogue. In 80 pages the products and services of The D.T.V. Group are concisely described. They range from making and supplying components to complete industrial systems. The hundreds of items are listed by the E.E.M. Group numbering system. This groups products under section numbers and provides a ready made index.
D.T.V. Group, 126 Hamilton Road, London, S.E.27.
For further information circle 57 on Service Card

Westinghouse Silicon Rectifiers for Electroplating. This Engineering Publication 10-4 gives details of natural air-cooled silicon rectifiers for electroplating. Types in the range provide d.c. outputs of 8, 12 or 16 V from 250 A up to the largest currents required for electrodeposition. Rectifier control, protection and mounting are also briefly mentioned.
Westinghouse Brake & Signal Co. Ltd., 82 York Way, London, N.1.
For further information circle 58 on Service Card

'Variac' Catalogue V-64. The current range of well-known 'Variac' variable transformers is described in this catalogue. Over 600 types are listed together with their prices. Distributed by
Claude Lyons Ltd., Valley Works, Hoddesdon, Herts.
For further information circle 59 on Service Card

Massa Accelerometers, Microphones and Measurement Systems. In this 4-page brochure, crystal accelerometers for vibration measurements and sound pressure microphones for precise acoustical tests are described. Associated electronic equipments are also included.

Massa Division, Cohu Electronics, Inc., 280 Lincoln Street, Hingham, Massachusetts, U.S.A.

For further information circle 60 on Service Card

Model KF Electronic Timer. A 4-page leaflet which describes an instrument that has been designed for a variety of timing sequences. It provides both on and off periods, with multiple switching facilities, over the range 0 to 10 sec in 1-sec steps and 0 to 100 sec in 10-sec steps.

Copley Haddon & Co. Ltd., Ferndale, Gipsy Lane, London, S.W.15.

For further information circle 61 on Service Card

Mullard Photodiodes and Photo-transistors. The 8-page booklet describes the characteristics of photovoltaic diodes and photo-transistors. In this, circuits are given which illustrate an infra-red relay alarm and a read-out arrangement. A short section on the photoelectric effect and basic illumination theory is also included.

Mullard Ltd., Mullard House, Torrington Place, London, W.C.1.

For further information circle 62 on Service Card

Etchneering: A Service for Industry. The 'Etchneering' process of photo-etching metals is set out in this 8-page booklet. Although the process is known for the production of small metal component parts, it can be used for components measuring up to 2 x 2 ft.

Microponent Development Ltd., 17 Newhall Hill, Birmingham 1.

For further information circle 63 on Service Card

Lunartron Short Form Catalogue. In 8 pages, this catalogue briefly describes the Lunartron range of products which include flash sources, e.h.t. and trigger supplies.

Lunartron Electronics Ltd., 42 Langley Street, Luton, Beds.

For further information circle 64 on Service Card

Unit Contactors by Allen West. To meet increasing demands for 'self-build' schemes of control, Allen West have extended their UAC range of unit contactors to six sizes up to 300 A. This 6-page Publication 190.1 gives details of the range.
Allen West & Co. Ltd., Brighton 7.

For further information circle 65 on Service Card

Morganite Resistors. This 6-page fold out leaflet gives brief details of the full range of products made by Morganite. The range includes potentiometers, resistors (carbon and high stability), ceramic bonded heavy duty and non-linear resistors and a variety of special products.



Morganite Resistors Ltd., Bede Trading Estate, Jarrow, Co. Durham.

For further information circle 66 on Service Card

INFORMATION WANTED ?

If you require further details of products or processes described or advertised in INDUSTRIAL ELECTRONICS you will find it convenient to use the enquiry cards which will be found in the back of the journal. The sheet of cards can be folded out to enable you to make entries while studying the editorial and advertisement pages.

Yes, it's 1964

Once upon a time, potentiometers were large, solid, ugly brutes, with only one virtue—they looked reliable. Now in 1964 you can use Mecpot miniature trimmer potentiometers that are small, compact, especially designed for modern instrumentation and control circuits—and more reliable than ever before. Resistance values from 10 to 20,000 ohms. Maximum rating 1 watt at 20°C. de-rating to $\frac{1}{4}$ watt at maximum temperature of 85°C. Three models: MP30 with solder tags for conventional chassis mounting; MP31  with L-shaped tags for insertion into printed circuits;  MP32 with pins spaced along the body, for direct mounting on printed boards, no other fixing being necessary. Write for full specification and samples Miniature Electronic Components Ltd., St. John's, Woking, Surrey. Woking 5211.

m-e-c





Porcelain **Steatite**

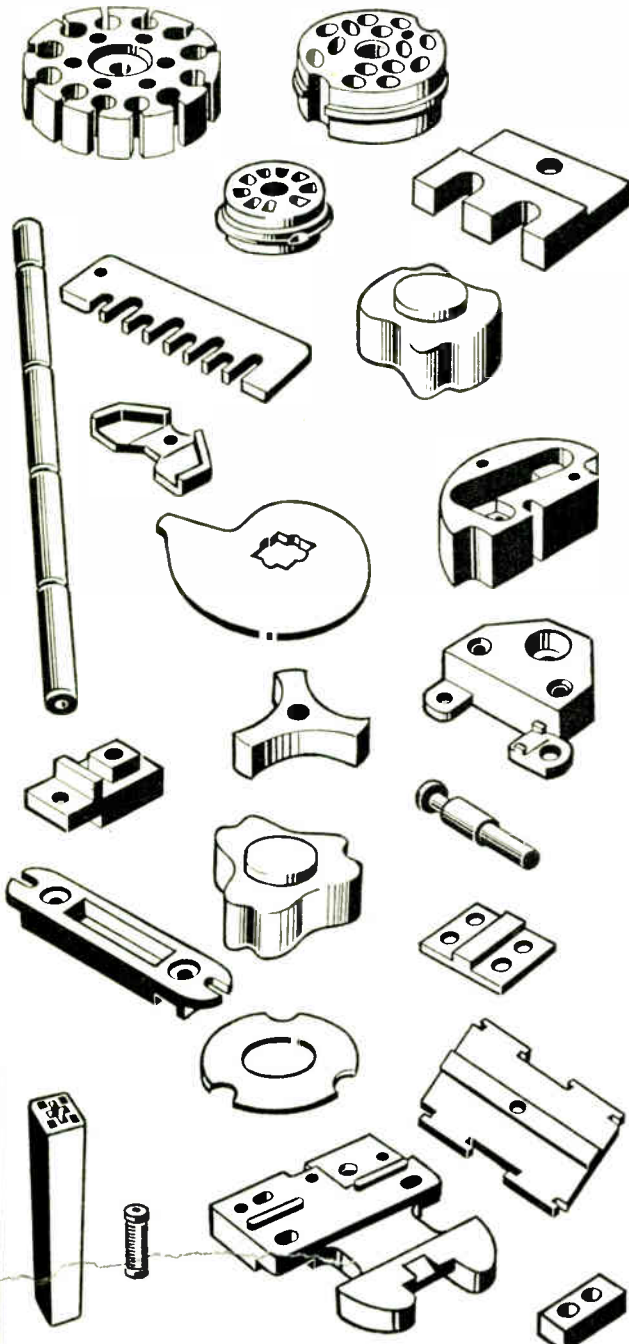

**V. G. PORCELAIN CO
LTD**

GORST ROAD Telephones:
PARK ROYAL ELGAR 1411/7
LONDON, N.W.10 Telex:
 London 25589

**CLEAR
INDICATION
BY**

KGM



TRACE 242

This may not be the largest portable tester in the world, but it must be one of the most comprehensive. It is a Tape Controlled Recording and Automatic Check-out Equipment by Hawker Siddeley Dynamics Ltd. and



the version shown was recently demonstrated at a R.E.M.E. Symposium on Automatic Testing. Similar equipment has been ordered by B.O.A.C. for use with the V.C.10 fleet.

K.G.M. Indicators read out the results to the operator in bright digits, to give a CLEAR INDICATION of the results of the punched tape programme of testing.

**Ask for the brochure about In-line Indicators—
or for information as to how K.G.M. engineers can
help you present a CLEAR INDICATION.**

KGM

electronics limited
BARDOLPH RD RICHMOND
Phone: RICHmond 7171 Surrey

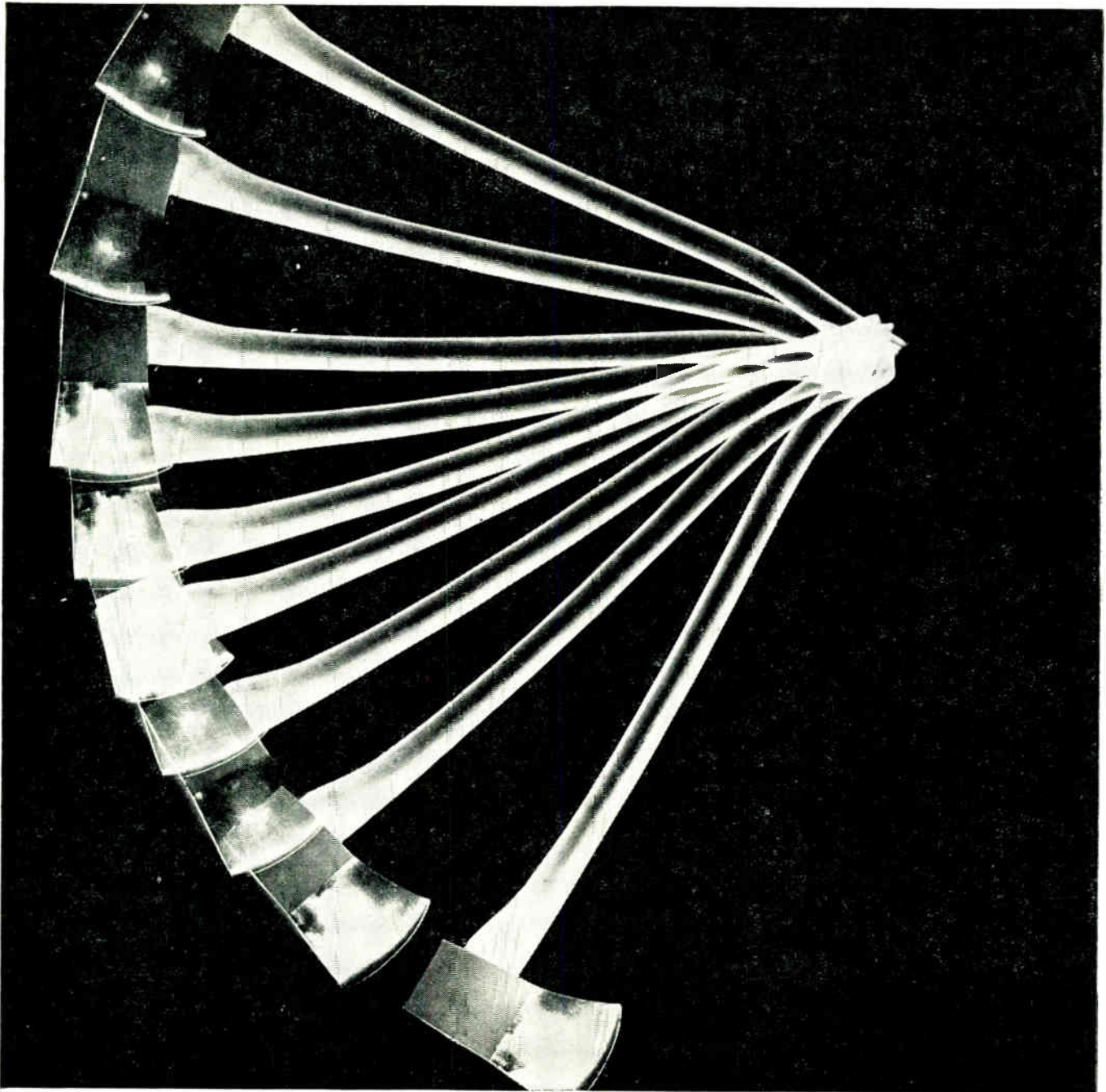

Cheapest way to chop

DC to AC—with an AEI Synchronous Chopper. It fits a standard B9A 9-pin thermionic valve holder, is suitable for feeding both high resistance and transformer-coupled low impedance circuits, its low noise level allows a 1 microvolt signal to be detected. Typical applications are: recording thermo-couple and ionisation chamber outputs; drift correction in analogue computer amplifiers; general instrumentation. Stability is high, operational life is long. Available in two models: CK3 for 50 c/s; CK4 for 100 c/s.

CK3 & CK4 SYNCHRONOUS CHOPPER

WRITE FOR DETAILS AND TECHNICAL DATA TO: AEI INSTRUMENTATION DIVISION, INSTRUMENT AND METER DEPARTMENT, TRAFFORD PARK, MANCHESTER 17



Associated Electrical Industries Limited
Instrumentation Division

S M302



Vital Electronics Data from Pergamon

New Components

An International Electronics Journal
Editor: A W Robinson, Atomic Weapons Research Establishment, Aldermaston, Berkshire

A new bi-monthly publication which serves designers and manufacturers of electronic equipment by providing them with data concerning new component materials and processes, in addition to extracts from relevant British and American publications. The provision of such material, together with reports on visits to manufacturers and Government research and development establishments, enables the designer and manufacturer to keep fully informed of current developments without wasting valuable time searching a variety of sources.

Contents of the First Issue

"New Components"; DEF Specification DEF-5001-C; Joint Service Qualification Approval Certificate; Scanning to Locate Microelectronic Flaws; A Non-Thermionic Electron Gun; Quality Control at S.T.C. Capacitor Factory; News Jottings; Automation, Computers, Control, Timing and

Counters; Components; Materials and Processes; Meters and Measurements; Miniature Components; Plugs and Sockets; Printed Circuits; Thin-films, Integrated and Solid Circuits; Valves, CR Tubes, Semiconductors; Wires and Cables

Microelectronics and Reliability

An International Journal (Formerly Electronics Reliability and Microminiaturization)

Editor-in-Chief: G W A Dummer, Royal Radar Establishment, Great Malvern, Worcestershire

A much respected quarterly which brings together the various publications concerning reliability and microminiaturization which at present appear in journals not specializing in these subjects. The subject matter of the journal covers the practical, theoretical and statistical aspects of reliability and the design, construction, engineering, testing and theoretical appraisal of microminiaturization systems.

Contents of a Recent Issue

An Aid to Efficient Maintenance—*W S Mortley*; Thin Film Circuits—

Part I. The Uses of Photomechanical Processes in the Manufacture of Microminiature Circuits—*H G Manfield*; Thin Film Circuits—Part II. The Development of Thin Film Resistors and Capacitors for Microcircuits—*H G Manfield*; Thin Film Circuits—Part III. Engineering a Microcircuit Module—*H G Manfield* and *A Letchford*; Current Developments in Microminiaturization—*A Bobenrieth*; A Punched-tape Comparator Using Integrated Circuits—*P D Forte*; A Comparison of Duplicate and Triplicate Redundancy Schemes for Binary Logical Networks—*J C Cluley*; The Structure of Vacuum Condensed Ni-Cr Films—*R W Bicknell, H Blackburn, D S Campbell* and *D J Stirland*; Abstracts on Microelectronics and Reliability.

A free specimen copy of any journal together with details of subscription rates will be sent on request. Please write to the most convenient address below:

Pergamon Press Ltd
Headington Hill Hall, Oxford

Pergamon Press Inc
44-01 21st Street, Long Island City I, New York

For further information circle 246 on Service Card

AVO TAYLOR BELLING LEE DYMO ELECTROLUBE

HEAT SINKS FROM STOCK!

NEW in Heat Sinks
NO MICA WASHERS REQUIRED WITH D.T.V. 4800901
THEY HAVE INSULATED SPACERS

Standard DTV Heat Sinks
Size 3 in. × 4.75 in. × 1.25 in.

Prices

| | Qty. 1-5 | Qty. 6-11 | Qty. 12-49 |
|---------|------------|-----------|------------|
| 4800900 | 8/6d. ea. | 7/6d. ea. | 6/- ea. |
| 4800901 | 10/6d. ea. | 9/6d. ea. | 8/- ea. |

Quotations for larger quantities on application
WIDE RANGE OF OTHER TYPES TO ORDER

THOUSANDS OF OTHER ELECTRONIC COMPONENTS, SPARES AND ACCESSORIES

FROM STOCK

Send today for your free copy of the DTV Group Catalogue

THE D.T.V. GROUP, (DEPT. IE)
126 HAMILTON RD., WEST
NORWOOD, LONDON S.E.27
Tel. GIPsy Hill 6166 PBX



INDUSTRIAL INSTRUMENTS

ERIE

EVERSHED & VIGNOLES

GILTON TRANSDUCERS

AMBERSIL

VITALITY

MCMURDO

A.B. METAL (CLAROSTAT)

For further information circle 247 on Service Card

NUMBER ONE IN ELECTRICAL CONNECTORS...

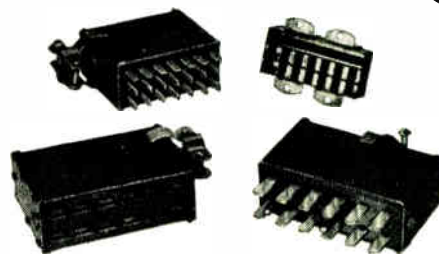

JONES MINIATURE & STANDARD SERIES

General purpose connectors with five or fifteen amp contacts. Insert arrangements from two to thirty-six contacts.

CANNON ELECTRIC (GREAT BRITAIN) LTD.
168 Old Street
London E.C. 1, England



Telephone: CLErkenwell 4954

ELECTROSIL

STERIDE

BULGIN

INTERNATIONAL RECTIFIERS

RAY-O-VAC

COAXIAL DIRECTIONAL COUPLER SERIES 20050

TUNNEL DIODE DETECTOR

6 db COAXIAL DIRECTIONAL COUPLER

COAXIAL CRYSTAL DETECTOR

BETWEEN-SERIES COAXIAL ADAPTER

MINIATURE COAXIAL TERMINATION

WAVEGUIDE TO OSM COAXIAL ADAPTER

SUBMINIATURE COAXIAL CONNECTORS

COAXIAL MICROWAVE COMPONENTS

The OMNI SPECTRA miniature coaxial microwave range of components, have been designed and developed to satisfy the requirements for rugged, highly reliable service. Attention to mechanical and electrical design, extensive testing and quality control in manufacture insure performance suitable for modern electronic systems. Included in the range of components are directional couplers, transmission line terminations, crystal detectors, ASTROLINE and TERRALINE series and OSM series of miniature coaxial connectors.

MANUFACTURED BY
OMNI SPECTRA, INC. DETROIT, MICHIGAN.

Sole U.K. representatives **Ad. AURIEMA Ltd**
125 GUNNERSBURY LANE,
ACTON W3 (Telephone ACOm 8762)

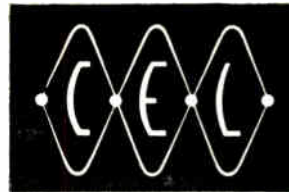

FOR PRESSURE AND TENSION

TRANSDUCERS

1. CP types give up to 1.5V at max. pressure.
2. XT 33 is 0.25% accurate; ranges to 0-30,000 psi.
3. RV 22 measures down to 0-3 psi; 0.5% accuracy.
4. EM 50 checks tension; 0-500 lb. to 0-10,000 lb.
5. Precision die-cut strain gauges; $\frac{1}{16}$ in. to $\frac{1}{2}$ in.

WRITE OR PHONE FOR FULL DATA—

COULTANT ELECTRONICS LIMITED

Transducer Division, TRAFFORD ROAD
RICHFIELD INDUSTRIAL ESTATE
READING · BERKSHIRE
Telephone: Reading 55391.



CERBERUS

GK 11 electronic touch button

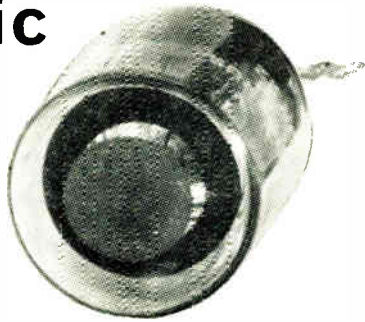

cold cathode relay tube
controlled by touching
external electrode
visual indication
supply voltage: 220 V. D.C.

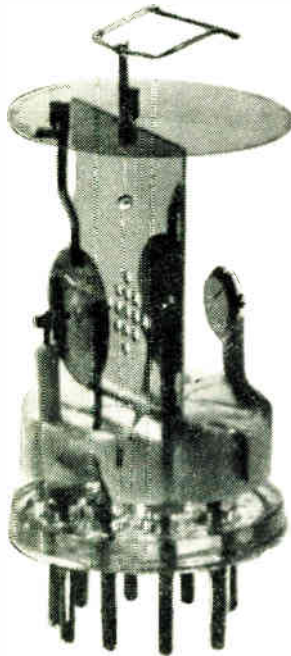

GT21 glow thyatron

cold cathode
thyatron
control voltage:

5 volts

(suitable for use
with transistor
drivers)

supply voltage:
180 to 250 V. A.C.
or
250 to 350 V. D.C.

WALMORE ELECTRONICS LTD

11-15 BETTERTON STREET, DRURY LANE
LONDON, W.C.2

Telephone: TEMple Bar 0201-5

OXLEY

The OXLEY printed circuit sockets are designed for direct mounting on '1" module printed circuit board with standard '050" minimum diameter holes, and accepts our standard plug Type 50P, 156.

The mounting is arranged so that the plugs may be inserted in a plane parallel to the printed circuit board thus permitting close stacking of circuit boards.

PRINTED CIRCUIT SOCKETS

Sockets can be supplied from 1 to 12 ways, colours can be in black, brown, red, orange, yellow, green, blue, violet, pink, grey and white.

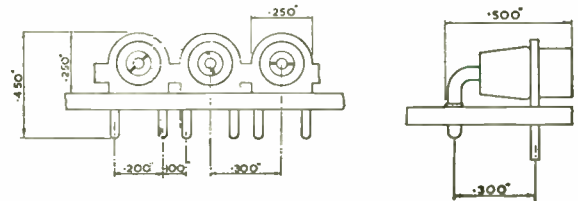
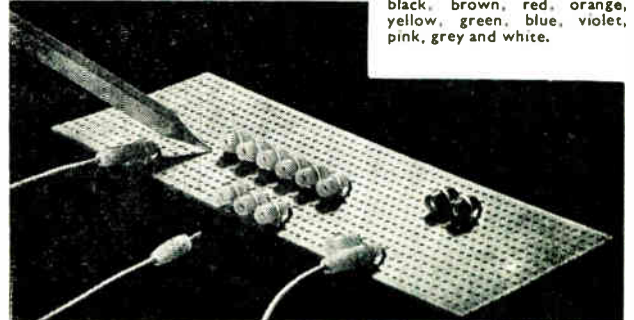

Write for technical details of these and other Oxley products

OXLEY DEVELOPMENTS CO. LTD.
ULVERSTON, LANCASHIRE Tel: Ulverston 2567

an important new ILIFFE technical book

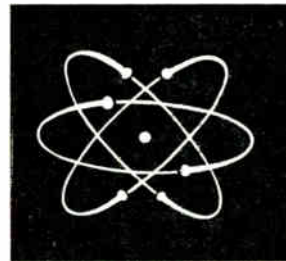

BASIC INDUSTRIAL ELECTRONICS

Alfred Haas

Aimed to assist those industrial engineers whose initial training did not include electronics, this new book provides a sound readable introduction to the technology of the subject. The introductory chapters cover the many and varied industrial applications followed by a description of the various devices by which mechanical movements and physical changes can be converted into electrical signals. Subsequent chapters discuss automatic inspection, automatic machine control, electronic heating, welding and machining, electronic safety devices and power conversion control. This practical book will prove invaluable to engineers without previous knowledge of the subject and also as an introduction for students of electronics.

35s net by post 36s 3d 208 pp 203 illustrations

obtainable from leading booksellers

Published by ILIFFE Books Ltd.

DORSET HOUSE STAMFORD STREET LONDON SE1

For further information circle 252 on Service Card

Hendrey Spark Recorder Type 1487A

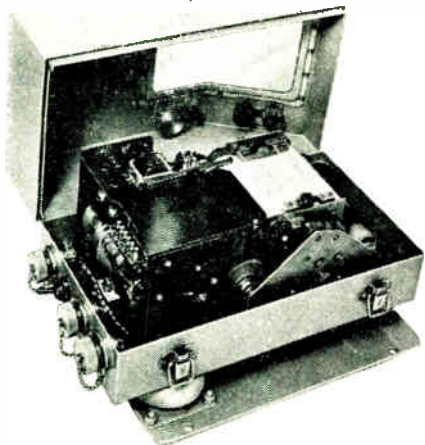

For full details and
specification ask for
Catalogue Sheet

A4



Compact and weatherproof, this single channel recorder is light in weight and easily portable. The perspex window gives a clear view of the heat sensitive chart for approximately 6 in. of its length.

The instrument can also be used mounted on bench, wall or panel and is supplied with mounting plate incorporating three anti-vibration mountings which render the instrument shock-proof and vibration-proof to service standards.

An electro-magnetically operated stylus, operated by a separate switch not supplied with the recorder, provides transverse markings near the edge of the chart. Provision is made for an external alarm circuit which can be pre-set to operate at any deflection from zero to full scale by means of a control on the case.

Sensitivity—50 micro-amps. Full scale. Supply—12 Volt, D.C.

Hendrey Relays

HENDREY RELAYS LIMITED
390-394 BATH ROAD, SLOUGH, BUCKS. Burnham 609/612

Telegrams: *Hendrelay, Slough*
MANUFACTURING ELECTRICAL ENGINEERS
CONTROL AND LABORATORY APPARATUS
A.R.B. & M.O.A. APPROVED DESIGN & INSPECTION



BIPCO[®] MODULES

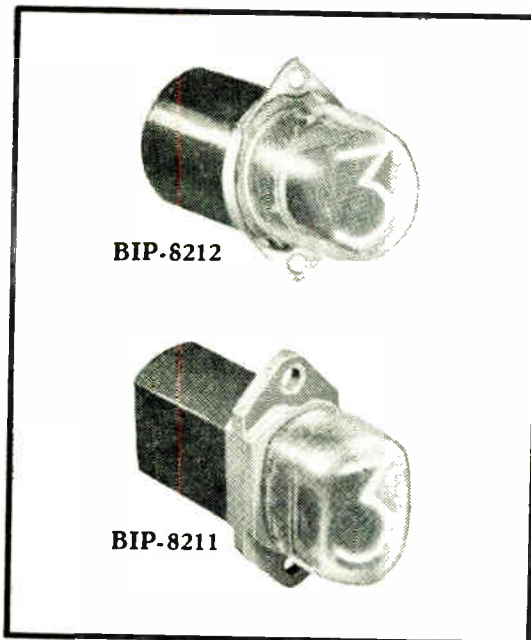

BINARY DECODERS provide decimal readout from 8-wire 8-4-2-1 binary-coded-decimal

BIP-8211 is for use with Nixie tubes 8422 (standard rectangular)

BIP-8212 for use with Nixie tubes 8421 (standard circular)

Solid state circuitry

Decoder and socket is an integral unit

Other input codes available on request, e.g. 2-4-2-1; 4-2-2-1; 5-4-2-1

WALMORE ELECTRONICS LTD

11-15 BETTERTON STREET, DRURY LANE,
LONDON, W.C.2

Telephone: TEMple Bar 0201-5

For further information circle 255 on Service Card

Registered Design Nos. 894767 to 894770.

NOW... an even wider range of WESTON CLEAR FRONT contemporary instruments

The Weston Clear Front Contemporary Series now includes square, rectangular, miniature and fan shaped instruments.

Clear moulded covers give excellent light transmission. Behind the new-look face is the traditional accuracy and reliability of Weston instrumentation. For current or voltage measurement. Cover masks available in 7 attractive colours.



SANGAMO WESTON LIMITED
ENFIELD · MIDDLESEX · ENGLAND

Telephone: Enfield 3434 (6 lines) and 1242 (6 lines)
Telegrams: Sanwest Enfield Telex: 24724

Scottish Factory: Port Glasgow, Renfrewshire. Branches:
London, Glasgow, Manchester, Newcastle-upon-Tyne, Leeds,
Liverpool, Birmingham, Nottingham, Bristol, Southampton.

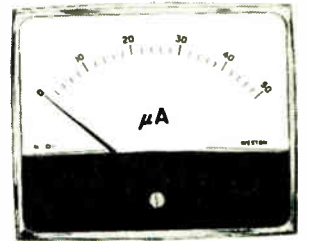
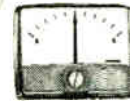
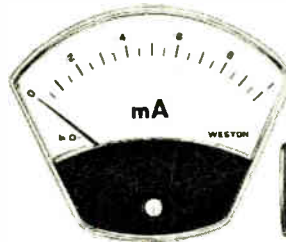
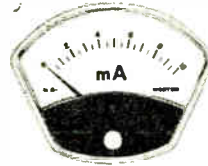
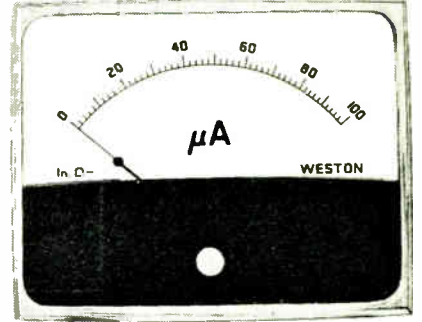
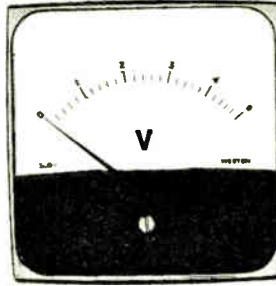
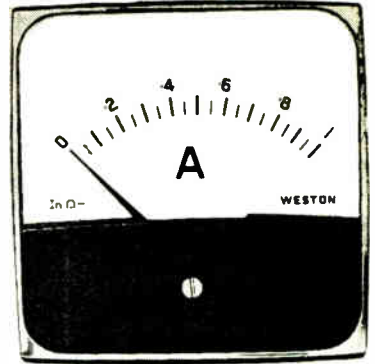
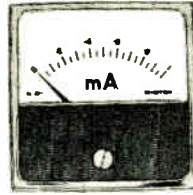
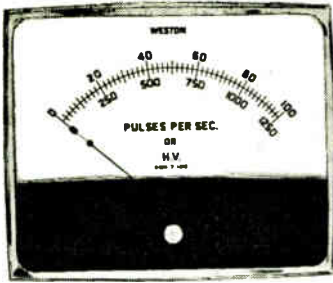

For further information circle 256 on Service Card

HAVE YOU A GLASS TO METAL SEALING PROBLEM?

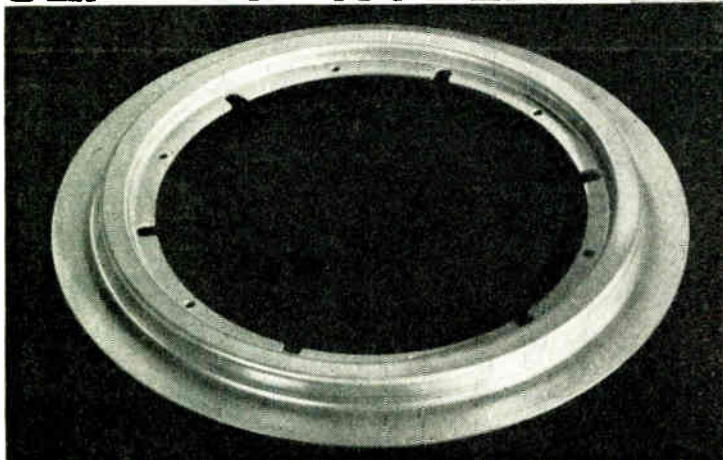
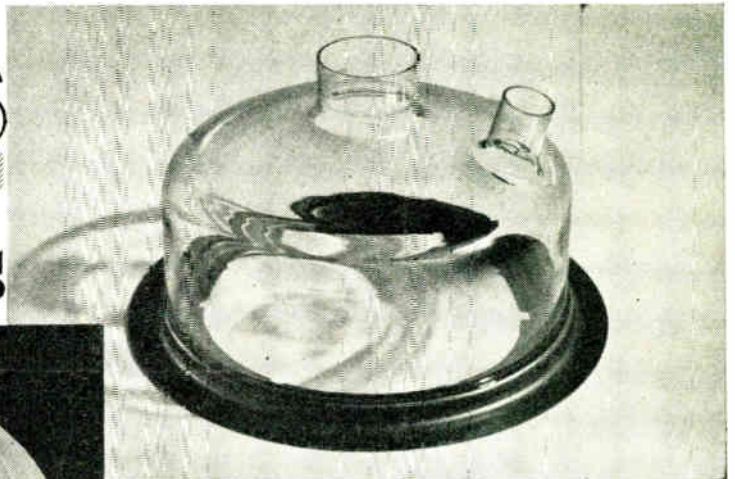

For this 9 inch diameter glass to metal sealing ring

MULLARD LTD

use TELCOSEAL 1, one of the five glass sealing alloys
manufactured by

TELCON METALS LTD

These are available as strip up to 6" wide (normal
production) in thicknesses down to 0.008", but widths
of 10", 12" and 18" can be specially produced. All alloys
can be supplied in the forms of drawn wire and rod.

For further details, please apply to:

TELCON METALS LTD

P.O. Box 12 · Manor Royal · Crawley · Sussex · Telephone: Crawley 28800 · Telex: 87248 · Telegrams: Telcon, Crawley

MEMBER OF THE **BICC** GROUP OF COMPANIES

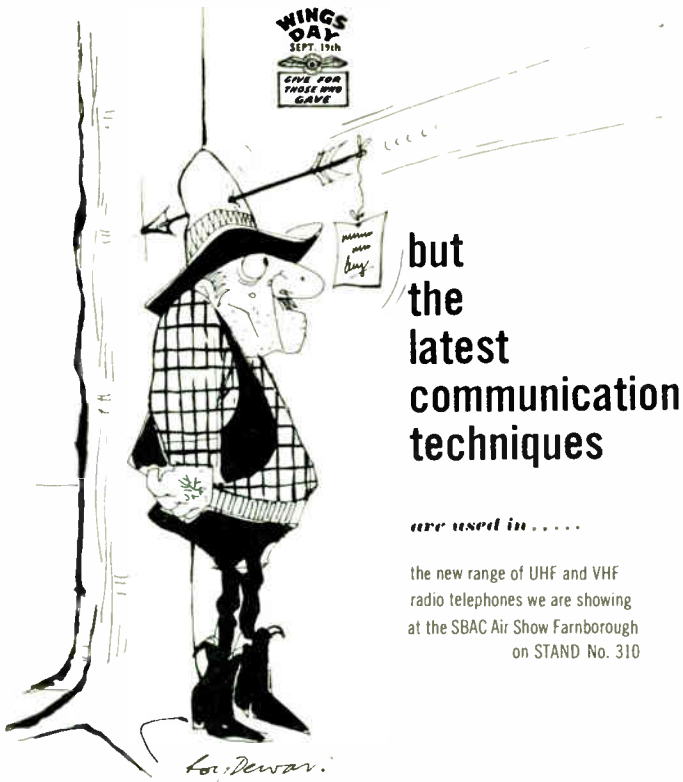

but the latest communication techniques

are used in

the new range of UHF and VHF radio telephones we are showing at the SBAC Air Show Farnborough on STAND No. 310



Further information from—
BRITISH COMMUNICATIONS CORPORATION LTD.,
SOUTH WAY, EXHIBITION GROUNDS, WEMBLEY, MIDDLESEX
Telephone Wembley 1212. Telegrams: BEECEEECE WEMBLEY

For further information circle 260 on Service Card

New! THE MINITOR

TRADE MARK

THICKNESS GAUGE

For measuring the thickness of paint, enamel, plastic, varnish and other non-conductive coatings on aluminium, brass, copper, Austinitic stainless steels, etc.

The Minitor meets the need for a stable and reliable lightweight instrument for the measurement of non-conductive coatings on non-ferrous bases. This pocket-size precision instrument, fully transistorised and with miniaturised printed circuit for lasting reliability, is designed to provide simplicity of operation. Setting procedure and calibration to a new base material are straightforward. Choice of five scales, from 0.5 thou. to 0.500 microns, built-in probe in base with contact tip capped with hard wearing compound. Three ball contact for general use; flat base model for measurements on flat surfaces or soft materials; V base model for measurements on round bar; separate probes for confined spaces.



£48

Complete with 60-hour stable voltage Mallory battery, scale to choice, calibration tools, tide-leather case.

The Minitor can also be used to measure conductive coatings on non-conductive bases and to segregate ferrous metals and their alloys, etc.

elcometer

INSTRUMENTS LTD
FAIRFIELD ROAD
DROYLSDEN 11
MANCHESTER
Tel: DROylsden 2790

Send this coupon now for full details of the Minitor Thickness Gauge

NAME.....
POSITION.....
COMPANY.....
ADDRESS.....

11

ROTAX

COMPONENTS & TRANSDUCERS

ROTAX C.A.V. Transducer

401 Transducer

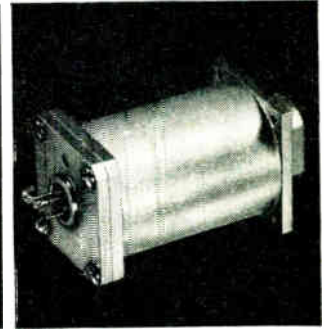

200 Series Encode



H.T. 500 Trimmer Potentiometer

Reliable instrumentation to suit your needs exactly

Rotax produce a specialised range of equipment to very high standards of precision and reliability. Existing stocks provide for most normal needs. If your specification cannot be met exactly, Rotax will manufacture to your requirements.

| | |
|------------------------|--------------------------|
| Pressure transducers | potentiometric |
| Strain gauges | pressure transducer type |
| Digital shaft encoders | photo-electric |
| Trimmer potentiometers | miniature, metal-film |

These instruments are designed to meet military environments. To find out more about Rotax Components and Transducers, ring Elgar 7777, Ext. 302—now, or see us at the S.B.A.C. Exhibition, Farnborough, on stand no 146.

ROTAX

INSTRUMENTATION DIVISION

ROTAX LIMITED, INSTRUMENTATION DIVISION
WILLESDEN JUNCTION, LONDON, N.W.10. TELEPHONE: ELGAR 7777

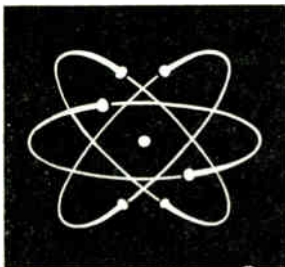

two important new books for electronics students and technologists

Transistor Circuits in Electronics

Basic principles for amplifier, oscillator and switching applications

S. S. Hakim, Ph.D., B.Sc., A.M.I.E.E. : R. Barrett, B.Sc., A.M.I.E.E.

Specially written for students taking electronics as their main subject in degree Dip. Tech. and H.N.C. courses. No mathematical knowledge higher than elementary calculus is assumed but the reader is expected to be familiar with Kirchhoff's Laws. Numerical examples have been introduced wherever necessary to illustrate the principles involved.

63s net by post 64s 5d 341 pp illustrated

Electronics and Instrumentation

Robert L. Ramey

The purpose of this book is to provide a sound groundwork for understanding the basis of existing instruments and their applications. It will prove a useful introduction to instrumentation for students of electronics and a single course in electronics and instrumentation for students in other branches of science and engineering.

55s net by post 56s 4d 321 pp 207 illustrations

obtainable from leading booksellers

ILIFFE Books Ltd. DORSET HOUSE STAMFORD STREET LONDON SE1

For further information circle 263 on Service Card

FOR IMMEDIATE SUPPLY . . .

VOLTAGE STABILISERS
DC-AC ROTARY CONVERTORS
TRANSFORMERS
RECTIFIERS

WRITE, CALL OR PHONE .

UNIVERSAL ELECTRIC MOTOR CO.
(ENFIELD) LTD.
43-47 RIVINGTON ST. · LONDON E.C.2
TEL: SHOREDITCH 8574

For further information circle 264 on Service Card

VITALITY BULBS

FROM 1V to 50V IN SIZES FROM 4.5mm to 18mm DIAMETER

Tested and Proven
Miniature and Sub Miniature
Indicator Bulbs: Catalogue
Vitality Bulbs Ltd.
Neville Place, Wood Green, N.22
Bowes Park 0016



Groove for easy cutting



With cable markers



Crimping Protecting Ferrule

JUST WHAT YOU HAVE BEEN LOOKING FOR!

MARKWAY Bakelite Terminal Blocks

Patent applied for

A "METWAY" PRODUCT WITH SPECIAL FEATURES:-
12 Way - Grooved for easy Cutting
Spring-on Cable Markers
Crimping Ferrule for Cable Protection
Max. Volts - 500. Working Temp. +115°C-45°C

● For details ask for List No. NBQ/15/IE

METWAY · KEMP TOWN · BRIGHTON

For further information circle 265 on Service Card

From Europe's most modern capacitor plant—
Subminiature aluminium
Foil capacitors in 42
standard ratings

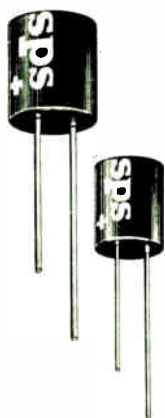
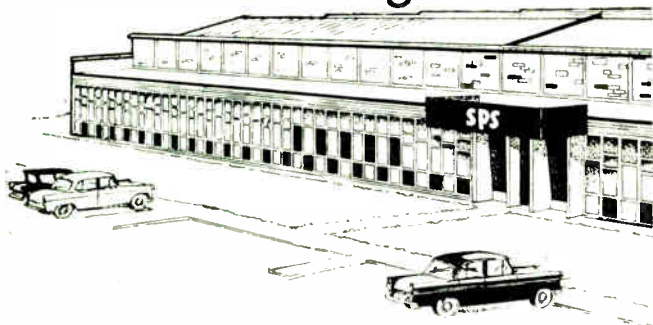

The most modern and efficient capacitors obtainable today.

For 8 years SPS International has been producing in the U.S.A. a range of miniature lightweight capacitors designed to cope with every extreme of temperature. Now the whole benefit of this experience has been brought to the new SPS factory at Shannon, Ireland, making the same high-quality capacitors available at short notice to any part of Britain. SPS capacitors guarantee complete reliability and long life thanks to the techniques of total encapsulation perfected over a long period in the U.S.A.

Ideal for transistorized communications equipment, portable radios, hearing aids, electronic instruments, audio cross-over networks, hi-fi tuners and amplifiers, recorders, test equipment and other low voltage circuits.

CAPACITANCE—20% + 100% of rated capacity.

DISSIPATION FACTOR: Less than 8% at 50 WVDC.

D.C. Leakage: Less than 6 μ A after 1 min. applied WVDC.

OPERATING TEMPERATURE: 65°C at rated WVDC.

Available in 42 standard ratings, with intermediate values at no extra cost. For complete technical information and assistance write or telephone SPS International Ltd., European manufacturing arm of a leading U.S. supplier of quality capacitors.

SPSI

SPS INTERNATIONAL LIMITED
SHANNON AIRPORT, IRELAND. Tel: Shannon 245

WHITELEY

Epoxy Resin Mouldings

S.B.A.C.
Show
Stand
255

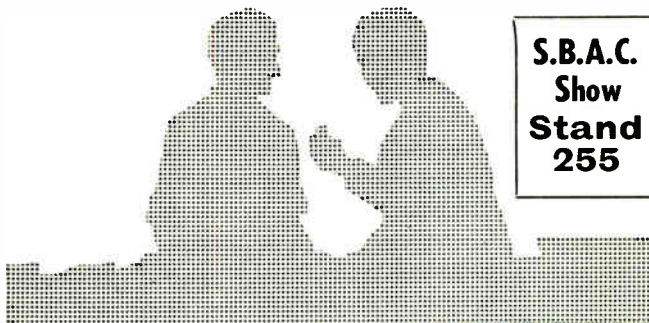

Great mechanical strength, excellent electrical insulation and complete climatic protection are ensured in Whiteley Epoxy Resin mouldings. Low shrinkage and strong adhesion to components and leads renders these Resins particularly suitable for encapsulation. Full details will be gladly sent on request.



Line Isolating Transformer

Transformer Y.17525 is a low loss audio frequency transformer, for use as an isolating transformer on circuits employing 17 c/s signalling, i.e. Post Office telephones. The insulation of the 'line' winding provides isolation against voltage surges of up to 25 KV rms. and continuously applied voltages of 14 KV rms. Please write for full details.

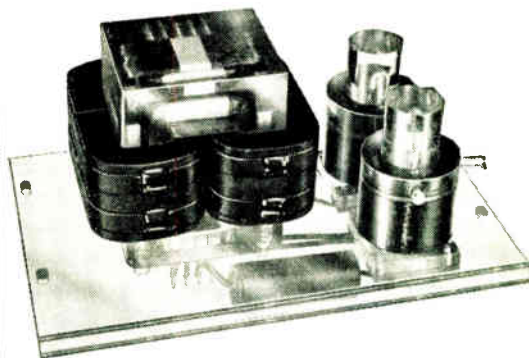

WHITELEY ELECTRICAL RADIO CO LTD

MANSFIELD · NOTTS Tel: Mansfield 1762/5

You'd hardly expect a process plant amplifier like the ER 500 to perform as well as a research amplifier

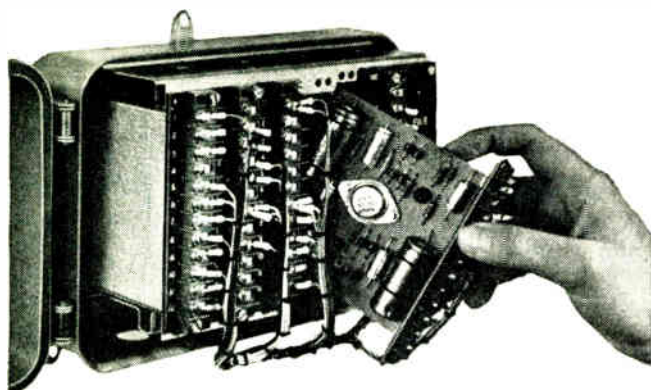

but it does!

FIND OUT ABOUT the Evershed Series 500 DC amplifier—performance worthy of a 'special' at the price of a field amplifier. Accuracy and flexibility characterise the ER 500. Stability is good: high gain is coupled with high negative feedback. Drift is negligible; linearity error is less than 0.1% Series mode error is less than 0.1% for 5 mV r.m.s., 50 c.p.s. Common mode error is less than 0.1% for 250 V, 50 c.p.s. The new Evershed amplifier offers the full advantages of printed circuitry and solid state techniques.

Write for leaflet ISSS/67.

Evershed and Vignoles Ltd., Acton Lane Works, Chiswick, W.4.

Tel: Chiswick 3670

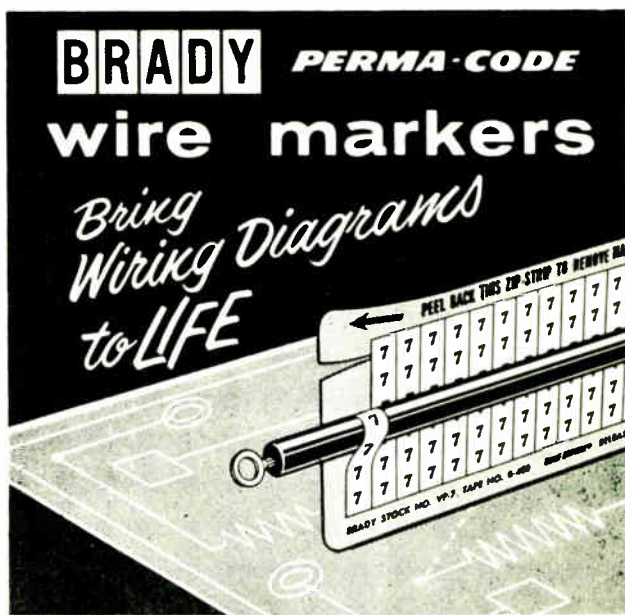

Brady self-sticking Wire Markers tell which wire goes where, permanently . . . directly. The number on the wire list is the number on the wire. No confusing colors and tracers to convert. Brady stocks thousands of standard legends in five different sizes — four job-tested materials. Dispenser card mounted for fast application.

Write for new bulletin and testing samples. FREE!

W. H. BRADY CO., LTD., Breakspear Rd., Ruislip, Middx. Telephone: Ruislip 2245

Manufacturers of Quality Pressure-Sensitive Industrial Tape Products, Self-Bonding Nameplates, Automatic Machines for Dispensing Labels, Nameplates, Masks and Tape.

For further information circle 270 on Service Card

further thoughts by 'Cathode Ray'

ESSAYS IN ELECTRONICS

M. G. SCROGGIE, B.Sc., M.I.E.E.

This book may be regarded as a sequel to an earlier work, 'Second Thoughts on Radio Theory' but widened in scope to include electronics. The 22 essays adapted from the popular 'Wireless World' series cover a wide range of subjects including: scientific theories; what is electric current?; Kirchhoff's Laws; Flux-cutting or Flux-linking; negative feedback and non-linearity, etc. This is a book that every electronic and electrical engineer should read. It can be guaranteed that no one will fail to learn something to his advantage.

42s net by post 43s 1d 301 pp. 204 illustrations

obtainable from leading booksellers

ILIFFE Books Ltd.

DORSET HOUSE STAMFORD STREET LONDON S.E.1

Industrial Electronics September 1964



WE'VE GOT EVERYTHING UP OUR SLEEVE! Sasco can provide the widest range of Connectors, Semiconductors and other Components at the drop of a hat. The products of over 33 leading electronic component manufacturers. If you want to learn more of Sasco magic, write for a Products List to:



Stewart Aeronautical Supply Co. Ltd.
P.O. Box 20, Gatwick Road, Crawley, Sussex.
Tel: Crawley 28700
Telex No. 87131. Cables: SASCO, Crawley, Telex.

CLASSIFIED ADVERTISEMENTS

FULLY DISPLAYED: 50/- per single column inch.
SEMI-DISPLAYED: 35/- per single column inch.
RUN-ON: 3/6 per line of approximately 7 words.
 Where an advertisement includes a Box Number 1s. extra.
SERIES DISCOUNTS: 12 insertions, 15%.
 Remittances payable to "Industrial Electronics".

Copy is required by 21st of the month for insertion in the following month's issue, by 15th of the month if proofs are required.

Address to:
 Classified Advertisement Dept.
 Industrial Electronics
 Dorset House, Stamford St., London, S.E.1.

SITUATIONS VACANT

THORN ELECTRICAL INDUSTRIES (Special Products Division)

require

additional Staff for the following Technical and Administrative positions:

DEVELOPMENT ENGINEER

Familiar with the latest materials and techniques employed in the design of R.F. connectors. The possession of H.N.C., together with the ability to lead and co-ordinate a project is desirable.

PLANNING ENGINEERS

accustomed to planning batch production runs of a variety of electro-mechanical assemblies. A comprehensive knowledge of current production methods and the ability to prepare detailed layouts is essential.

TECHNICAL WRITER

for the preparation of specifications, technical information and service manuals for a wide range of electrical components. Age 20-25 years.

DRAUGHTSMAN

Experienced in layout and detailing of light mechanical and electro-mechanical components. Age 20-25 years.

TECHNICAL ASSISTANT

for laboratory duties in connection with quality control and type approval of electrical components. O.N.C. Elect. an advantage; Day Release facilities available.

Applications, which will be treated in the strictest confidence, should contain brief details of age, qualifications, experience, present salary, and be submitted to:

**Personnel Manager,
 Great Cambridge Road,
 Enfield, Middx.**

328

NÍTRIGIN ÉIREANN TEORANTA
 SHELTON ABBEY, ARKLOW,
 CO. WICKLOW, IRELAND
 require

INSTRUMENT MECHANICS

for their new Nitrogenous Fertiliser Factory currently under construction. Applicants, preferably with experience in pneumatic and or electronic instruments should send full particulars of age, education and experience to:

The Secretary
NÍTRIGIN ÉIREANN TEORANTA
 60 Northumberland Road
 DUBLIN, 4, Ireland
 or
 Alternatively ring Avoca 35

324

INSTRUMENT ENGINEER

Service Engineer for Midlands Area, based at Birmingham, for Instrument Maintenance in the Industrial, Medical and Research Laboratory fields. A knowledge of Electronic circuitry is an advantage but not essential.

Apply in writing giving age, experience and an indication of salary expected to:—

CAMBRIDGE INSTRUMENT CO. LTD.
 63 HOCKLEY HILL, BIRMINGHAM 18

323

Original testimonials should not be sent with applications for employment

BRIGHTON EDUCATION COMMITTEE Brighton College of Technology

Required from 1st January, 1965 for Dip. Tech. and/or other courses of similar standard.

LECTURER or ASSISTANT LECTURER (grade B) in **ELECTRICAL ENGINEERING** with good degree or Dip.Tech. plus corporate membership of an appropriate professional institution and preferably with experience in control systems or industrial electronics. Teaching and/or research experience desirable.

Salary Scales—Lecturer: £1,670 x £45—£1,895. Assistant Lecturer: (Grade B): £930—£1,760.

Increments may be granted for approved experience.

Application forms and further particulars obtainable from the Registrar, Brighton College of Technology, Moulsecomb, Brighton 7, to whom completed application forms should be returned by 28th September, 1964.

W. G. Stone
 Director of Education
 325

SITUATIONS WANTED

REPRESENTATIVE WELL EXPERIENCED in sales and Negotiating techniques calling on Electronic firms (Greater London Area) wishes to handle more business on commission or agreed basis. All enquiries answered. Box 322

CAPACITY AVAILABLE

INSTRUMENT SERVICING DIVISION

All types of Electronic, Scientific, and Precision Instruments repaired and overhauled.



BRENSAL ELECTRONICS LIMITED
 Charles Street, Bristol 1
 Tel: Bristol 28167

INDUSTRIAL ELECTRONIC CONTROLS

We are specialists in this field, and have capacity for sub-contract work, for design and manufacture.



Brensal Electronics Ltd.
 Charles Street, Bristol 1. Tel: 28167

AIRTRONICS LTD.

for coil winding assembly and wiring of electronic equipment, transistorised sub-units, sheet metal work. 4 Ashmead Road, London, S.E.8. Telephone: THDe-way 2249. [311]

Precision Sheet Metal Work for the Radio & Electrical Trade. Chassis, Panels, Brackets, etc. Power Press Capacity up to 100 tons. Press brake capacity up to 105 tons 8ft. x 7/32in. All spray and stove finishes. A.I.D. approved. — The Kaymet Company, Kaymet Works, Sylvan Grove, London, S.E.15. Telephone: NEW Cross 6644. [306]

SENIOR TELEVISION ENGINEER UGANDA

Applications are invited from candidates with a good educational background and the Higher National City and Guilds full Technological Certificate; extensive experience in the operation and maintenance of a modern 5 K.W. vision transmitter and associated F.M. sound transmitter; and the ability to train and control a local staff.

The officer appointed will be required to take complete charge of an upcountry station which normally takes the network programme but will occasionally have to originate simple local programmes.

The appointment will be for one or two tours at candidate's option, each of from 21-27 months in duration, with a salary in the range £2,025-£2,328 plus a GRATUITY of 25% of total emoluments. Free family passages. Free Medical attention and furnished quarters provided at moderate rentals. Generous leave and education allowances.

Apply to

Appointments Officer
Room 301, Department of Technical Co-operation
Eland House, Stag Place, Victoria, S.W.1

giving full name, age and qualifications and quoting RC 237, 183/03.

321

HEWLETT-PACKARD LIMITED

TEST ENGINEERS

with ambition and sense of vocation required for responsible posts in a rapidly expanding organisation. Starting salaries over £1,000 per annum with unique benefit schemes including profit-sharing and share purchase plan. Excellent opportunities for promotion for well qualified enthusiastic engineers. Holiday arrangements honoured. All interview expenses paid.

Write, in confidence, to the

PERSONNEL OFFICER
HEWLETT-PACKARD LIMITED
DALLAS ROAD, BEDFORD
or telephone **BEDFORD 68052**

327

TO INSERT AN
ADVERTISEMENT
IN THE
CLASSIFIED
SECTION

TELEPHONE MR. A. VICKERS
INDUSTRIAL ELECTRONICS
WATERLOO 3333
EXT. 210

ARTICLES FOR SALE

PHOTO-ELECTRIC CONTROLS

for industry

Quick delivery Send for Catalogues

Hird-Brown Limited

Flash Street, Bolton, Lancs.
Tel. 27311

[305]

Nameplates, engraving, diesinking, stencils.—Stilwell & Sons Ltd., 153 Far Gosford Street, Coventry.

[309]

SCRAP METAL

Non-ferrous Scrap Metals, all grades, Swarf, Off-cuts, etc., purchased at highest rates.

H. Barnett Ltd.,
Victor Road, London, N.7.
Est. 1865

ARCHway 5461

[307]

TUITION

BRUNEL COLLEGE

DEPARTMENT OF ELECTRICAL ENGINEERING AND ELECTRONICS

A part-time day course at post-graduate level in

Advanced Electrical Engineering

Classes meet for one day a week over a period of two years, and the course content covers most aspects of electrical/electronic engineering. Designed primarily for the recent graduate in Engineering and Physics, its aim is to acquaint the student with modern practice in the industry. A college Diploma is awarded to those students who successfully complete the course.

The next course commences Tuesday, 29th September, 1964.

Further details may be obtained from the Academic Registrar, Brunel College, Woodlands Avenue, Acton, London, W.3. Telephone: ACOrn 6661.

320

BRUNEL COLLEGE

DEPARTMENT OF ELECTRICAL ENGINEERING AND ELECTRONICS

The following evening courses for engineers and scientists will be held during the coming academic term commencing October, 1964:

- Advanced Automatic Control
- Introduction to Information Theory
- Varactor Diodes
- Electrical Instrumentation and Measurements
- Electric Power Distribution
- Network Analysis

There will also be short full-time courses on the following topics:

- Principles and Application of Thyristors
- Theory and Design of Switching Circuits
- Digital Engineering Techniques

Further details from the Academic Registrar, Brunel College, Woodlands Avenue, Acton, London, W.3. ACOrn 6661

319

WEST HAM COLLEGE OF TECHNOLOGY

Department of Electrical Engineering

The following part-time Specialist Courses will commence September, 1964.

- (1) SEMICONDUCTOR CIRCUIT DESIGN THEORY.
A Postgraduate course leading to a Proficiency Certificate.
- (2) ELECTRONICS AND INSTRUMENTATION FOR THE MEDICAL PROFESSION.
A course dealing with the fundamental principles of Electronics and Instrumentation and their application in the field of Medicine.
- (3) INTRODUCTION TO GENERALISED MACHINE THEORY AND ITS APPLICATIONS.
A unified approach to electrical machine theory of interest to the practising Engineer in industry and engineering students.
- (4) AUTOMATIC CONTROL.
A Postgraduate course leading to a Proficiency Certificate.
- (5) STATISTICAL COMMUNICATION THEORY.
An advanced Postgraduate course of interest to physicists and engineers presenting a modern approach to Communication Engineering.

For further details write to:—

The Principal
West Ham College of Technology
Romford Road
Stratford, E.15

326

standing firm in a vibrating world

linvar OSCILLOSCOPE TROLLEYS



Extremely rigid in construction this modern styled, compact unit, has been designed to meet all the exacting demands of the Laboratory, Workshop and Field.

Available in the following sizes

| Shelf size | Basic width | Type |
|------------|-------------|-------|
| 14" x 22½" | 16½" | LHT-1 |
| 14" x 24" | 16½" | LHT-2 |
| 16" x 22½" | 18½" | LHT-3 |
| 16" x 24" | 18½" | LHT-4 |

Write for full details of our complete range of Instrument Trolleys.

linvar Ltd. LABURNUM ROAD, CHERTSEY, SURREY. CHERTSEY 2159 & 4219

Index to Advertisers

| | | | | | |
|--|------------------|---|------------|--|--------|
| Ad. Auriema Ltd. | 39 | EMI Electronics Ltd. | 29, 30 | Rotax Ltd. | 45 |
| Adcola Products Ltd. | 43 | English Electric Valve Co. Ltd. .. | 26 | Sangamo Weston Ltd. | 42 |
| A.E.I. Ltd. (Instrumentation Division) | 37 | Ericsson Telephones Ltd. | 19 | Sealectro Ltd. | 32 |
| Aircraft Marine Products (G.B.) Ltd. | 11 | Evershed and Vignoles Ltd. | 48 | Sifam Electrical Instrument Co. Ltd. | 20 |
| Ampex Great Britain Ltd. | 14 | Hendrey Relays Ltd. | 41 | SPS International Ltd. | 47 |
| Anglo-American Vulcanized Fibre Co. Ltd. | 18 | Hughes International (U.K.) Ltd. | 10 | Standard Telephones & Cables Ltd. | 12, 13 |
| Appointments Vacant | 50, 51 | Hunt, A. H. (Capacitors) Ltd. | 10 | Stewart Aeronautical Supply Co. Ltd. | 49 |
| A.P.T. Electronic Industries Ltd. ... | 21 | Ilfie Books Ltd. | 40, 46, 48 | Telcon Metals Ltd. | 42 |
| Avery, W. & T. Ltd. | 27 | International Rectifier Co. Ltd. .. | 25 | Telephone Manufacturing Co. Ltd. | 23 |
| Avo Ltd. | 22 | KGM Electronics Ltd. | 36 | Thorn Electrical Industries Ltd. .. | 2 |
| Brady W. H. Co. Ltd. | 48 | Levell Electronics Ltd. | 6 | Union Carbide Ltd. | 33 |
| British Communications Corp'n. Ltd. | 45 | Linvar Ltd. | 52 | Universal Electric Motor Co. (Enfield) Ltd. | 46 |
| British Insulated Callender's Cables Ltd. | <i>Cover ii</i> | Magnetic Devices Ltd. | 15 | Venner Electronics Ltd. | 34 |
| Cannon Electric Ltd. | 38 | Metway Electrical Industries Ltd. ... | 46 | V.G. Porcelain Co. Ltd. | 36 |
| CIBA (A.R.L.) Ltd. | <i>Cover iii</i> | Miniature Electronic Components Ltd. | 35 | Vitality Bulbs Ltd. | 46 |
| Classified Advertisements | 50, 51 | M-O Valve Co. Ltd. | 28 | Walmore Electronics Ltd. | 40, 41 |
| Coutant Electronics Ltd. | 39 | Muirhead & Co. Ltd. | 3 | Welwyn Electric Ltd. | 1 |
| Dawe Instruments Ltd. | 24 | Mullard Ltd. | 4, 5 | Westinghouse Brake and Signal Co. Ltd. | 7 |
| Direct T.V. Group | 38 | Multicore Solders Ltd. | 21 | Whiteley Electrical Radio Co. Ltd. | 47 |
| Elcometer Instruments Ltd. | 45 | Oxley Developments Co. Ltd. | 40 | Wingrove & Rogers Ltd. | 8 |
| Electrosil Ltd. | 16 | Painton & Co. Ltd. | 31 | | |
| Electrothermal Engineering Ltd. .. | 9 | Pergamon Press Ltd. | 38 | | |
| | | Plannair Ltd. | 44 | | |

**all in
one
piece**

C I B A



Permali Ltd made this tap selector housing for the new 132 kV on-load tap changer designed and patented by AEI. It is a one-piece gravity casting in Permacast CRS-10, a mix based on Araldite epoxy resin. The strong adhesive properties of Araldite ensure that the metal inserts form an integral part of the unit.

Components cast in Araldite are purpose-designed to take advantage of the excellent electrical and mechanical properties of the resin. As shrinkage on curing is negligible, dimensions are accurate to very close limits. Components can be compact, saving cost and space. The castings are tough, strong and shock-resistant. In addition to their excellent insulating and anti-tracking qualities, Araldite castings provide protection against moisture, damage and vibration; they also ensure the permanent oil tightness required by designers of components such as this changer, and the good electrical discharge characteristics of the components.

Further information on Araldite resins for electrical purposes will be sent gladly on request.

ARALDITE EPOXY RESINS ARE USED:

- for casting large high-grade electrical insulators and insulation around equipment such as transformers, switchgear components etc.
- for impregnating, potting and sealing electrical windings and components.
- for constructing glasscloth laminates in electrical, nuclear, mechanical and aircraft engineering.
- for bonding metals, ceramics, glass, rubber, plastics, wood etc.
- for constructing tools for forming plastics or sheet metal, patterns for moulding foundry sand, jigs and fixtures for checking accuracy of assembly etc.
- for chemical resistant flooring and floor surfacing.
- for anti-corrosion protection of wood, concrete, metals etc.

Araldite

epoxy resins

Araldite is a registered trademark

C I B A (A.R.L.) LIMITED, DUXFORD, CAMBRIDGE; TELEPHONE: SAWSTON 2121

AP831

For further information circle 202 on Service Card

MEMOSCOPE[®] . . .

the
oscilloscope
with a
memory!

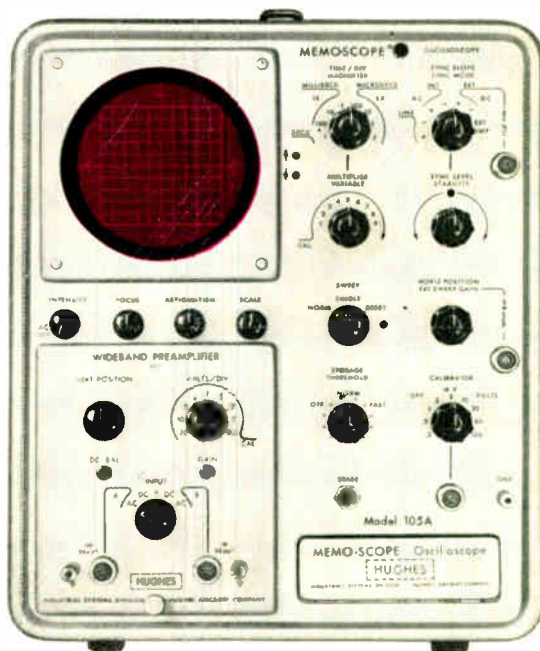



DISPLAYS
As a conventional precision oscilloscope, with a choice of plug-in Wideband, Dual Trace or High Gain Differential Pre-amplifiers. Passband DC to 10Mc/s.

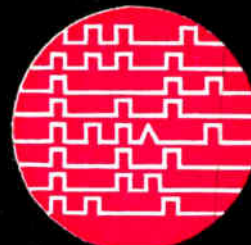

STORES
For as briefly or as long as required, traces of non-recurrent phenomena—at a writing speed of 1,000,000 Inches/second. Eliminates costly trial and error inherent with photographic techniques.

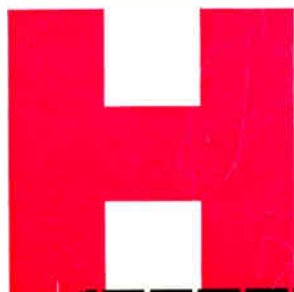

COMPARES
Stored traces of up to 10 consecutive sweeps, using the MULTI-TRACER accessory unit. The display is repeated continuously by automatic re-set or may be re-set manually, permitting observation of the display for as long as desired.



Seeing is believing—if you can believe what you saw!

The Hughes 105A MEMOSCOPE is a precision high frequency oscilloscope which will "memorise" transient phenomena at writing speeds of over 1,000,000 inches per second and display them as a bright, steady trace for leisurely analysis. No time wasted setting up elaborate photographic facilities—the "memory" is ready at the touch of a switch. With a comprehensive range of plug-in accessory units, it is the most versatile oscilloscope available today—for *complete* oscilloscope facilities you must have a MEMOSCOPE. Write NOW for full details:-

HUGHES INTERNATIONAL (U.K.) LTD

GLENROTHES · FIFE · SCOTLAND

All enquiries to:
KERSHAW HOUSE, GREAT WEST ROAD, HOUNSLOW, MIDDLESEX. TEL: HOUNSLOW 5222.