

# Hobby Electronics

Project Electronics For Everyone

90p

**50p**  
**off**  
entrance to  
Britain's largest  
electronics  
exhibition

## GENERAL PURPOSE LIGHT METER

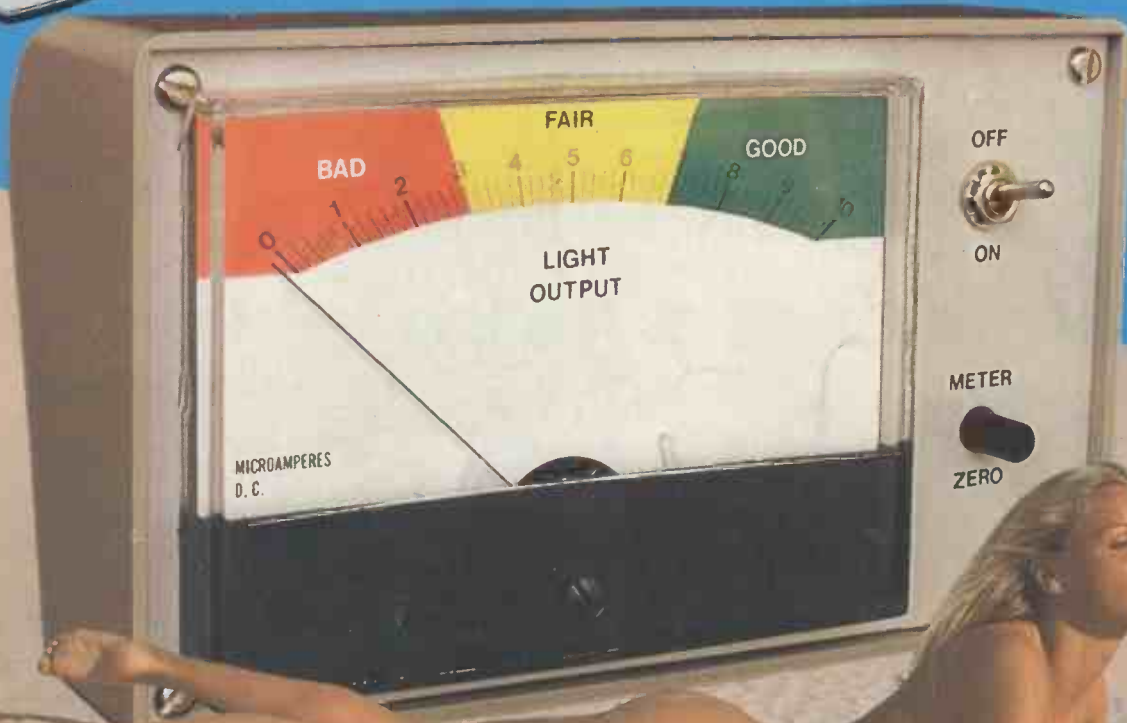

Measure the light output  
from solarium tubes, flood lights,  
UV tubes or any  
other light source.

**Damp  
Meter Project**



**The HE Bassman – bass guitar  
synthesizer project**  
**Continuity Tester – easy to build project  
with 1001 uses**

# ambit INTERNATIONAL

ambit  
INTERNATIONAL

A topical selection from the current ambit parts and equipment catalogue — 148 pages plus 3 £1 discount vouchers! Send 80p for your copy now!

★ mix quantity prices apply for callers to our sales counters



## NiCad battery bonanza time

0.5Ah

2.2Ah

4.0Ah\*

0.11Ah



AA

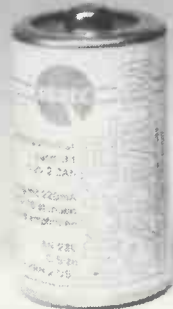

C



D



PP3

1-9      80p      £2.35      £3.05      £3.70

10-49    74p      £1.99      £2.65      £3.50

Stockcode 01-12004    01-12024    01-12044    01-84054

CH4/RX4

£7.49

01-02204



CHARGERS

CH4/50

£4.95

01-00409



BATTERY ADAPTORS

01-12001



A unique battery sleeve adaptor set that converts AA to C or D dimensions, and C to D. Ideal for emergencies.

1-9      10-24  
96p    65p

*The ideal Christmas Gift!*

200 North Service Road, Brentwood, Essex CM14 4SG  
Tel: (0277) 230909

CALL AT OUR SALES COUNTERS AT  
SOLENT COMPONENT SUPPLIES,  
53 Burrfields Road, Portsmouth, Hants  
BROXLEA ELECTRONICS, Park Lane,  
Broxbourne, Herts.  
& at Brentwood, of course!

REMEMBER to add 15% VAT & 60p postage to all orders — THANKS!

# Hobby Electronics

DECEMBER 1983  
VOL 5 No 12

## PROJECTS

- ★ GENERAL PURPOSE LIGHT METER ..... 12  
*Let the sun shine in.*
- ★ HE BASSMAN ..... 29  
*Sing like a string.*
- ★ MOISTURE GAUGE ..... 49  
*The flood waters are rising!*
- ★ SIMPLE CONTINUITY TESTER ..... 56  
*Give us a break.*

## FEATURES

- ★ A ZENER DIODE PRIMER ..... 20  
*Zener diode lately?*
- ★ ALL ABOUT ELECTRONICS PART 6 ..... 36  
*In one gate and out the other.*
- ★ I ALMOST MET ..... 42  
*Close encounters of the near-miss kind.*
- ★ UP THE JUNCTION ..... 44  
*The Life and Likings of a Junction FET.*

## REGULARS

- Monitor ..... 6
- Readers' Service ..... 17
- What's On Next ..... 18
- Points Of View ..... 24
- Forward Bias ..... 26
- HE Bookshelf ..... 33
- Buylines ..... 34
- Breadboard 1983 ..... 62
- HE PCB Service ..... 63
- HE PCB Printout ..... 64
- Classified Advertisements ..... 65

Careers In Electronics has been held up this month but we hope to be able to bring you a feature on the UK Armed Forces in January's issue.

Editor: Ron Keeley  
Assistant Editor: Helen Armstrong BA  
Technical Illustrator: Jerry Fowler  
Advertisement Manager: Joanne James  
Managing Editor: Ron Harris BSc  
Chief Executive: T. J. Connell

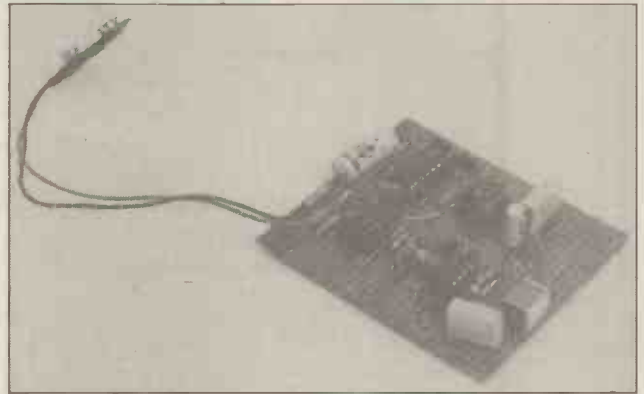

HE Bassman — page 29

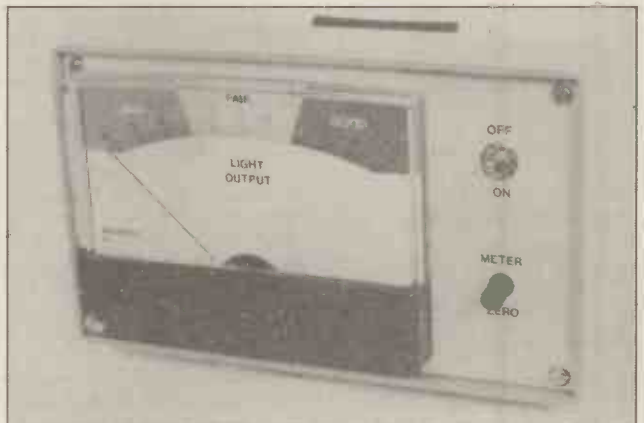

General Purpose Light Meter — page 12

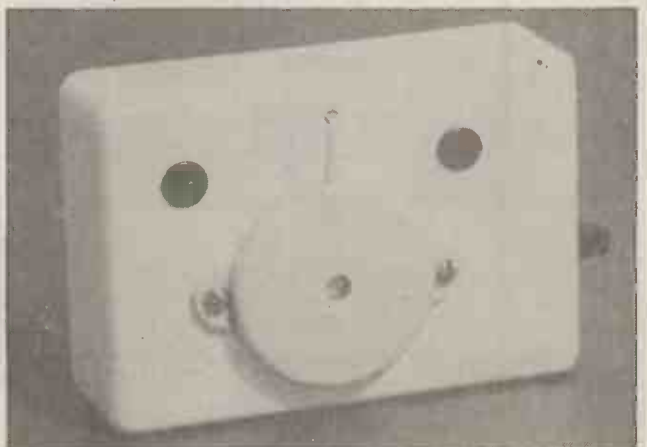

Continuity Tester — page 56

Hobby Electronics is normally published on the second Friday of the month prior to the cover date.  
Hobby Electronics, 145 Charing Cross Road, London WC2H 0EE, 01-437 1002. Telex No 8811896. Published by Argus Specialist Publications Ltd.  
Origination by Ebony Typesetting, Trion House, 13 Dean Street, Liskeard, Cornwall PL14 4AB.  
Distributed by S. M. Distribution Ltd, 16/18 Trinity Gardens, London SW9 8DX.

Printed by The Garden City Press Ltd., Letchworth, Herts SG6 1JS. Covers printed by Alabaster Passmore.

Notice: The contents of this publication including all articles, designs, plans, drawings and programs and all copyright and other intellectual property rights therein belong to Argus Specialist Publications Limited. All rights conferred by the Law of Copyright and other intellectual property rights and by virtue of international copyright conventions are specifically reserved to Argus Specialist Publications Limited and any reproduction requires the prior written consent of the Company. All reasonable care is taken in the preparation of the magazine to ensure accuracy, but Argus Specialist Publications Ltd cannot be held responsible legally. ©Copyright 1983 Argus Specialist Publications Ltd. Member of Audit Bureau of Circulation.

Step-by-step fully illustrated assembly and fitting instructions are included together with circuit descriptions. Highest quality components are used throughout.

# Sparkrite

SELF ASSEMBLY ELECTRONIC KITS

PRICES REDUCED ON SUPER SAVE D.I.Y. KITS

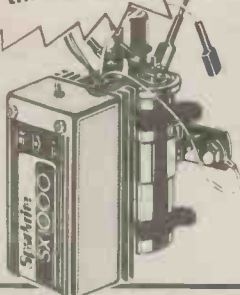

## SX 1000 Electronic Ignition

- Inductive Discharge ● Extended dwell circuit stores greater energy in coil ● Three position changeover switch ● Patented clip-to-coil fitting ● Easy to assemble, easy to fit ● Contact breaker triggered - includes bounce suppression circuit.

**SUPER SAVE**

## SX 2000 Electronic Ignition

- Reactive Discharge ● Combines inductive & capacitive energy storage ● Gives highest possible spark energy ● Patented clip-to-coil fitting ● Easy assembly sequence ● Contact breaker triggered - includes bounce suppression circuit.

**SUPER SAVE**

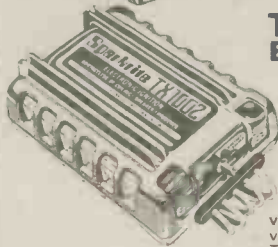

## TX 1002 Electronic Ignition

- Inductive discharge ● Extended dwell circuit stores greater energy in coil ● Three position changeover switch ● Contactless or contact breaker triggered ● Clip-to-coil or remote mounting ● Rugged die-cast case ● Contactless adaptors included for majority of 4 & 6 cylinder vehicles ● Easy to build ● For details of vehicles fitted by contactless trigger, ring Technical Service Dept on (0922) 611338-9.

## TX2002 Electronic Ignition

- Two separate systems in one unit! ● Reactive Discharge OR Inductive Discharge, with three position changeover switch ● Gives highest possible spark energy ● Clip-to-coil or remote mounting ● Rugged die-cast case ● Contactless or contact breaker triggered ● Contactless adaptors included for majority of 4 & 6 cylinder vehicles ● For details of vehicles fitted by contactless trigger, ring Technical Service Dept on (0922) 611338-9.

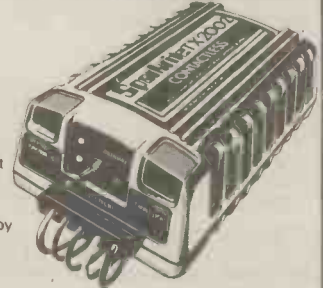

## AT-40 Electronic Car Alarm

- Guards doors, boot, bonnet from unauthorised entry ● Armed/disarmed using concealed switch ● 30 second delay-to-arm: 7 second entry delay ● Can alternatively be wired to exterior key switch ● Flashes headlights & sounds horn intermittently for 60 seconds when activated ● Security loop protects accessories ● Low consumption C-MOS circuitry.



**NEW**

## AT-80 Electronic Car Security System

- Guards doors, boot, bonnet from unauthorised entry ● Armed/disarmed from outside vehicle by magnetic key fob passed across sensor pad adhered to inside of windscreen ● Individually programmable code ● 30 second delay-to-arm ● Flashes headlights and sounds horn intermittently for 60 seconds when activated ● Security loop protects accessories ● Function lights to assist setting-up ● Low consumption C-MOS circuitry.

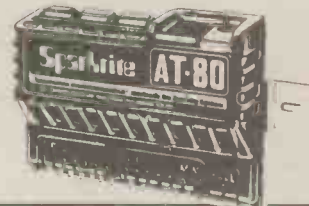

**SUPER SAVE**

## ULTRASONIC Intruder Detector

- Supplementary to AT-40 & AT-80 ● Will work in conjunction with any door switch input or voltage sensing alarm ● Detects attempted break-in and movement within passenger compartment & triggers alarm ● Includes high efficiency ultrasonic transducers ● Crystal controlled for low drift ● Ingenious sensitivity control allows freedom from false alarms ● Low current consumption



**NEW**

## VOYAGER Car Drive Computer

- 12 functions centred on Fuel, Speed, Distance and Time ● Single chip microprocessor ● Large high brightness fluorescent display with auto-dimming feature ● High accuracy distance & fuel transducers included ● Displays MPG, L/100km and miles/litre at the flick of a switch ● Visual & audible warnings of excess speed, ice, lights-left-on ● Independent LOG & TRIP functions ● Low consumption crystal controlled circuitry.



**SPECIAL OFFER**  
"FREE" MAGIDICE KIT WITH ALL ORDERS OVER £40.00



## MAGIDICE Electronic Dice

- Triggered by waving hand over dice ● Completely random selection ● Bleeps & flashes during 4 sec tumble ● Throw displayed for 10 seconds then flashes to conserve battery ● Low consumption C-MOS circuitry.

**SUPER SAVE**

SPARKRITE (A Division of Stadium Ltd.) 82 Bath Street, Walsall, WS1 3DE England Tel: (0922) 614791

Allow 28 days for delivery

KIT	OLD PRICE	NEW PRICE
SX 1000	<del>£12.95</del>	£11.95
SX 2000	<del>£18.95</del>	£18.95
TX 1002	<del>£22.95</del>	£22.95
TX 2002	<del>£32.95</del>	£32.95
AT 40	—	£9.95
AT 80	<del>£32.95</del>	£24.95
ULTRASONIC	—	£17.95
VOYAGER	<del>£64.95</del>	£64.95
MAGIDICE	<del>£9.95</del>	£6.95

NAME \_\_\_\_\_

HE/12

ADDRESS \_\_\_\_\_

I ENCLOSE CHEQUE(S)/POSTAL ORDERS FOR

£ \_\_\_\_\_ KIT REF. \_\_\_\_\_

CHEQUE No. \_\_\_\_\_

PRICES INC VAT, POSTAGE & PACKING.

PHONE YOUR ORDER WITH



**BRANDLEADING BRITISH ELECTRONICS**  
CUT OUT THE COUPON NOW!

# H.E. PROJECT KITS

I.C.s  
TRANSISTORS  
CAPACITORS

TOOLS  
RESISTORS  
HARDWARE

CASES  
KITS  
PCBs

# MAGENTA

Full Kits inc. PCBs (or veroboard), hardware, electronics, cases (unless stated). Less batteries. If you do not have the issue of H.E. which includes the project — you will need to order the instruction reprint as an extra — 50p each. Reprints available separately 50p each + p&p 50p.

ULTRASONIC INTRUDER ALARM no case Oct 83	£14.85	IN CAR CASSETTE POWER SUPPLY Dec 81	£4.77
WHISTLE SWITCH Aug 83 less mic	£18.89	SCRATCH FILTER Nov 81 Mono	£5.82 Stereo £8.96
STEREO SPREADER July 83	£3.79	LEVO METER Nov 81 less case	£4.87
SOFT FUZZ July 83	£10.25	SIMPLE STYLUS ORGAN Nov 81 less case	£4.96
SINCLAIR SOUND BOARD Jun 83 less case	£18.90	METRONOME Nov 81	£12.71
BALIGHT (cath ray) indicator June 83 less case	£6.96	TELEPHONE BELL REPEATER Oct 81	£13.97
TTL LOGIC PROBE June 83	£7.98	Med linking wire extra	14p metre £18.65
AUTO TESTER May 83	£8.68	COMBINATION LOCK Oct 81 less solenoid	£18.85
STALL THIEF May 83 (inc relay)	£11.72	BBY ALARM Oct 82	£8.70 Fig 8 linking wire 7p metre £34.50
STEREO VOICE OVER UNIT April 83	£17.52	'DIANA' METAL LOCATOR Sept 82	£12.81
OPTIONAL MIC PRE AMP April 83 (no case)	£4.28	REACTION TESTER GAME Sept 81	£12.81
AUTO POWER DOWN April 83 no case	£6.05	VARIABLE BENCH POWER SUPPLY Aug 81	£26.98
LINE DRIVER Mar 83	£13.55	ULTRASONIC BURGLAR ALARM July 81	£19.98
LOW RANGE OHM METER Mar 83	£10.30	ELECTRONIC DOOR BUZZER July 81	£5.98
PHASE FOUR Dec 82	£18.71	ELECTRONIC METRONOME July 81	£4.98
STEREO NOISE GATE Dec 82	£19.36	CONTINUITY CHECKER June 81	£5.71
TAPE SLIDE SYNCHRONIZER Dec 82	£21.73	ENVELOPE GENERATOR June 81	£17.96
MICROMETER ADAPTOR Dec 82	£4.99	AUDIO MIXER June 81	£5.33
ODOMETER Nov 82	£14.90	PUBLIC ADDRESS AMPLIFIER March 81	£19.48
DIANA V.C.O. Nov 82	£4.89	Extras — horn speakers £8.83 each	PA MIC £24.40
CB SQUELCH UNIT Oct 82	£9.19	FUZZBOX March 81	£10.86
'JUNIOR' BLOT CONTROLROLLER Sept 82	£5.80 (less case)	WINDSCREEN WIPER CONTROLLER March 81	£8.20
ZX INTERFACE BOARD Sept 82 inc edge con	£11.33	STEAM LOGIC WHISTLE March 81	£12.86
T.V.I. FILTER July 82	£8.33	PHOTOGRAPHIC TIMER March 81	£3.50
AUTO WAX June 82 £18.98 inc case or £12.28 less case		HEATSEAT MONITOR Feb 81	£24.96
AUTO GREENHOUSE SPRINKLER June 82	£14.38	TWO-TONE TRAIN HORN Feb 81	£5.60 less case
POWER SUPPLY DESIGN 12V 500mA June 82	£33.98	MEDIUM WAVE RADIO Feb 81	£8.20
ECHO REVERB UNIT May 82. Less case Economy case WB3	£3.78 extra	BENCH AMP Jan 81	£10.80
DIGITAL THERMOMETER May 82 excluding case + case		NICAD CHARGER Jan 81	£8.20
AUDIO SIGNAL GENERATOR May 82	£18.90	CHIEF Jun 81, less case	£7.53
CABLE TRACKER May 82	£9.98	BATTERY CHARGE MONITOR Dec 82	£6.77
DIGITAL CAPACITANCE METER Apr 82	£21.37	MEMORY BANK — MINI SYNTHESIZER Nov 81	£31.48
SIGNAL TRACER Apr 82	£8.85	TRANSISTOR TESTER Nov 81	£8.54 inc test leads
BIKE ALARM Apr 82	£12.74	GUITAR PRE-AMP Nov 80	£6.85
DIGITAL DICE Mar 82	£7.29	INTRUDER ALARM Oct 80	£20.96
BI-CYCLE SIREN Mar 82	£10.89	TOUCH SWITCH Sept 80	£2.75 less case & contacts
NOISELESS FUZZBOX Feb 82	£10.45	GUITAR PHASER Sept 80	£16.28
MASTHEAD AMPLIFIER Feb 82	£14.74	SOUND OPERATED FLASH TRIGGER July 80 no sskt	£5.33
DRUM SYNTHESIZER Dec 81, Full kit	£24.37	DOG HORN June 80	£6.84
GUITAR HEADPHONE AMPLIFIER Dec 81	£3.72	SPEED CONTROLLER FOR R/C April 80	£17.55 (less case)
		FDC FREQUENCY METER April 80	£39.96
		GUITAR TUNER Nov 79	£12.82
		CAR ALARM Feb 79	£12.81

## SOLDERING/TOOLS

ANTEX X5 SOLDERING IRON 25W	£5.48
SOLDERING IRON STAND	£1.98
SPARE BITS, Small standard, large, For X5 + X25	65p each
SOLDER, Handy size	99p
SOLDER CARTON	£1.84
DESOLDER BRAID	69p
HEAT SINK TWEEZERS	29p
DESOLDER PUMP	£6.48
HOW TO SOLDER LEAFLET	12p
LOW COST CUTTERS	£1.69
LOW COST LONG NOSE PLIERS	£1.68
WIRE STRIPPERS & CUTTERS	£2.89
PRICED PETITE	
12V P.C. DRILL	£11.67
DRILL STAND	£7.98
GRINDING STONE	50p
GRINDING WHEEL	50p
SAW BLADE	85p
BRASS WIRE BRUSH	50p
BURR	50p
VERO SPOT FACE CUTTER	£1.48
pin insertion tool	£1.98
VEROPINS (pk of 100) 0.1"	52p
MULTIMETER TYPE 1 (1.00 opv)	£5.48
CROCODILE CLIP TEST LEAD SET, 10 leads with 20 clips	99p
RESISTOR COLOUR CODE CALCULATOR CONNECTED WIRE PACK TYPE ED, 11 colours	48p
ILLUMINATED MAGNIFIERS	
Small 2" dia (5 x mag)	£1.14
Large 3" dia (4 x mag)	£2.40
CAST IRON VICE	£2.98
SCREWDRIVER SET	£1.98
POCKET TOOL SET	£3.98
DENTIST INSPECTION MIRROR	£2.85
JEWELLERS EYEGLASS	£1.50
PLASTIC TWEEZERS	69p
PAIR OF PROBES WITH LEADS (cc)	77p
Q MAX PUNCHES	
1/2" £2.98; 1/4" £3.08; 3/8" £3.17; 5/16" £3.24	



**MULTIMETER TYPE 1 (V330TR)**  
20K ohm p.v. with transistor tester.  
£14.75  
AC to DC volts  
DC current: 4 very useful resistance ranges.  
We've used it and we like it.

**HELPING HANDS JIG**  
£6.30  
Heavy base, six ball and socket joints allow infinite variation of clips through 360°. Has 2 1/2" diameter (2.5 magnifier attached), used and recommended by our staff.

## BOOKS: ELECTRONICS & COMPUTING

205 First Book of Hi-Fi Loudspeaker Enclosures	£0.95	Semiconductor Data Book Newsnes	£6.95
221 28 Tested Transistor Projects	£1.25	Basic Electronics Theory and Practice	£9.98
223 50 Projects Using IC CA3139	£1.25	Microprocessor for Hobbyist	£4.75
225 A Practical Introduction to Digital IC's	£1.25	Burglar Alarm Systems	£5.55
228 How to Build Advanced Short Wave Receivers	£1.95	Electronics, Build and Learn	£3.80
229 Essential Theory for the Electronic Hobbyist	£1.95	Electronic Projects in Music	£3.90
BP39 50 (RF) Field Effect Transistor Projects	£1.75	Electronic Projects in Photography	£2.70
BP40 Digital IC Equivalents and Pin Connections	£3.50	Electronic Projects in Home Security	£3.90
BP41 Linear IC Equivalents and Pin Connections	£3.50	Questions and Answers Electronics	£2.70
BP42 50 Simple L.E.D. Circuits	£1.50	Electronic Projects in the Car	£3.90
BP43 How to Make Walkie-Talkies	£1.95	20 Solid State Projects Car and Garage	£4.80
BP45 Projects in Field Effect Transistors	£1.95	110 Electronic Alarm Projects	£5.98
BP47 Mobile Discotheque Handbook	£1.35	Computing is Easy	£4.25
BP48 Electronic Projects for Beginners	£1.95	ZX81 Users Handbook	£5.75
BP49 Popular Electronics Projects	£1.95	ZX81 Basic Book	£5.75
BP56 Electronic Security Devices	£1.95	Fun with Electronics	£1.25
BP59 50 Circuits Using 7400 Series IC's	£1.75	20 50 CMOS J.C. Projects	£1.35
BP59 Second Book of CMOS IC Projects	£0.95	BP24 52 Projects Using IC T41	£1.25
BP61 Beginners Guide to Digital Techniques	£0.95	BP44 IC555 Projects	£1.85
BP70 Transistor Radio Fault-Finding Chart	£0.50	BP50 IC LM3900 Projects	£1.35
BP71 Electronic Household Projects	£1.75	BP65 Single IC Projects	£1.50
BP75 Electronic Test Equipment Construction	£1.75	BP69 Electronic Games	£1.75
BP78 Practical Computer Experiments	£1.75	BP72 A Microprocess or Primer	£1.75
BP79 Radio Control for Beginners	£1.75	BP73 Remote Control Projects	£1.95
BP80 Popular Electronic Circuits — Book 1	£1.95	BP74 Electronic Music Projects	£1.75
BP81 Electronic Synthesiser Projects	£1.75	BP76 Power Supply Projects	£1.75
BP82 Electronic Projects Using Solar Cells	£1.95	BP83 VMO5 Projects	£1.95
BP85 International Transistor Equivalents Guide	£1.75	BP84 Digital IC Projects	£1.95
BP87 Simple L.E.D. Circuits — Book 2	£1.35	BP88 How to Use OP-Amps	£2.25
BP92 Easy Electronics — Crystal Set Construction	£1.75	BP90 Audio Projects	£1.95
BP94 Electronic Projects for Cars and Boats	£1.95	BP93 Electronic Timer Projects	£1.95
BP98 Popular Electronic Circuits — Book 2	£2.25	BP95 Model Railway Projects	£1.95
BP101 How to Identify Unmarked IC's	£0.85	BP97 IC Projects for Beginners	£1.95
BP103 Multi-Circuit Board Projects	£1.95	BP99 99 Matrix Board Projects	£1.95
P108 International Diode Equivalents Guide	£2.25	BP105 Aerial Projects	£1.95
BP108 The Art of Programming the 1K ZX81	£1.95	BP106 Modern OP-Amp Projects	£1.95
BP114 The Art of Programming the 16K ZX81	£2.50	BP115 The Pre Computer Book	£1.95
BP119 The Art of Programming the ZX Spectrum	£2.50	Electronic Science Projects	£2.25

### MEMORY BANK SYNTHESIZER

Miniature synthesiser featuring vibrato, envelope, tempo, volume + pitch controls. Uses 24 push button switches in a keyboard style layout. Based on a custom designed L.C. The accessible memory stores a 32 beat length sequence of notes + spaces. Can be played 'live'. Fitted with an internal speaker. Jack socket allows the use of an external amplifier if wished.

**Memory Bank Synthesiser £31.48**

Complete kit inc. case, pcb's etc. Reprint extra 50p. Available separately 50p + 50p p&p

## CHRISTMAS DECORATIONS

Three project kits — same style as usual H.E. projects. Instructions/reprint included in project price. Please use code when ordering.

CM1. TWINKLING STAR DECORATION £6.98  
 CM2. TABLE DECORATION £9.98  
 CM3. TREE LIGHTS FLASHER £12.54

## CHRISTMAS DECORATIONS

**FUN WITH ELECTRONICS**

Enjoyable introduction to electronics. Full of very clear full colour pictures and easy to follow text. Ideal for all beginners — children and adults. Only basic tools needed. 64 full colour pages cover all aspects — soldering — fault finding — components (identification and how they work). Also full details of how to build 6 projects — burglar alarm, radio, games, etc. Requires soldering — 4 pages clearly show you how.

**COMPONENTS SUPPLIED ALLOW ALL PROJECTS TO BE BUILT AND KEPT, supplied less batteries & cases.**

**FUN WITH ELECTRONICS COMPONENT PACK £15.78**  
**BOOK EXTRA £1.25**  
 Book available separately.

## ADVENTURES WITH MICROELECTRONICS

Entertaining and instructive. Includes details of some digital ICs and 8 projects: shooting gallery, 2 way traffic lights, electronic adder, computer space invaders game etc. No soldering.

Adventures with Digital Electronics book £3.25  
 Component pack including breadboards £42.50 less batteries.

PCB etching kit	£4.98
ZX81 edge connector	£2.25
Ferrite rod 5 inch	59p
PP3 clips 10p.	PP9 clips 11p
2 Station Intercom	£7.48
IC Sockets 8 pin 16p; 14 pin 17p; 16 pin 18p	
Traditional Style Bell	£1.75
Public Address Mic 50K	£4.40
Mic Insert Crystal	45p
Cassette Mic	£1.29p
Pinlow Speaker	£2.85
Horn Speaker 5W 8 ohm	£8.75
Speakers Min 8 ohm 87p; 64 ohm 99p; 80 ohm	99p
Crystal earpiece	65p
Magnetic earpiece	15p
Stethoscope attachment	69p
Mono headphones	£2.98
Stereo headphones	£4.35
Telephone pickup coil	72p
Min buzzer 6V 50p, 12V 85p	
Euro breadboard	£8.40
S-Dec breadboard	£3.98
Bimboard breadboard	£8.98
Verobloc breadboard	£4.20

**30 SOLDERLESS BREADBOARD PROJECTS**  
 Book 1 by R.A. Penfold

Clear verobloc layouts and circuit diagrams. Includes fuzz box, radio, metronomes, timers, transistor checker, switches, etc. Introduction gives basic information on components including resistors, capacitors, I.C.s, transistors, photocells etc. Ideal for beginners as well as those with some experience.

**Complete kit includes verobloc, book and components (less batteries) £24.75. Less book £22.50, less verobloc £20.25. Book only £2.25.**

## ADVENTURES WITH ELECTRONICS

An easy to follow book suitable for all ages. Ideal for beginners. No soldering, uses an S-Dec breadboard. Gives clear instructions with lots of pictures. 16 projects — including three radios, siren, metronome, organ, intercom, timer, etc. Helps you learn about electronic components and how circuits work. Component pack includes an S-Dec breadboard and all the components for the projects.

Adventures with Electronics £2.85. Component pack £18.98 less battery.

## MORE KITS AND COMPONENTS

**IN OUR LISTS**  
**FREE PRICE LIST**  
 Price list included with orders or send 9p (9 x 4)  
**CONTAINS LOTS MORE KITS, PCBs & COMPONENTS**

## ELECTRONICS CATALOGUE

Illustrations, product descriptions, circuits all included. Up-to-date price list enclosed. All products are stock lines for fast delivery. Send 80p in stamps or add 80p to order. FREE to Schools/Colleges requested on official letterhead.

**MAGENTA ELECTRONICS LTD**  
 HE4, 135 Hunter St., Burton-on-Trent  
 Staffs., DE14 2ST. Mail Order Only  
 (0283) 65435. S.A.E. enquiries  
 Add 50p p&p to all orders. Prices include VAT. Access & Visa phone/post

Official school orders welcome.  
**OVERSEAS:** Payment must be in sterling  
**IRISH REPUBLIC** + BFO — UK PRICES.  
**EUROPE:** UK PRICES + 10%  
**ELSEWHERE:** WRITE FOR QUOTE.  
 Goods normally despatched by return of post.

# MONITOR

## Sir Clive's Flat TV Ironed Out At Last

Sinclair Research have revealed their pocket-sized portable television at last.

Technically, the monochrome mini-television encompasses a few revolutions. The screen is flat, and the electron gun is set off to one side of, and parallel to, the screen. The electrons strike the same side of the phosphor screen that is viewed, making the screen three times brighter than conventional TVs, and three sets of electrostatic deflection plates work together to get the electron beam round its unconventional 90° bend. A series of electronic and optical adjustments is used to present a sharp, flat and squared-off picture on the 2in screen.

The TV, which is smaller than a paperback book and weighs only 9.5 oz (280gm), is multi-standard, uses a 15-hour battery, (a mains adaptor will also be available) and has a personal earphone so that you can watch breakfast telly on the train without annoying the neighbours.

The design of the TV, which took six years and over £4M to develop, has enormously reduced the number of components needed, not least because it only uses one IC to perform the majority of its signal-processing functions. The IC has been designed by Sinclair Research and produced by Ferranti Ltd. Among other things, the IC automatically monitors all the audio and video inputs, and adjusts the receiver for local broadcast standards.

For the time being, the telly is only going to be available mail-order, and that only by application. This should forestall non-availability problems such as Sinclair have suffered from before until production is up to sufficient levels to supply on demand. The cost will be around £80.00.

Application forms can be had on request from the TV Division, Sinclair Research Ltd., Stanhope Rd., Camberley, Surrey GU15 3PS.

## Exhibition Cancelled

Brainwave, the home electronics show scheduled for the Birmingham Exhibition Centre in November, has been cancelled due to lack of support from exhibitors.

## Exhibition Attended

A small contingency representing Hobby Electronics called in at the Great Home Entertainment Spectacular, Olympia, London in mid-September to see what was new.

We had been promised plenty to look at and do, and the exhibition came pretty good on that score; there was a fair bit we could touch, as well as look at: video games, including Atari, Mattel, Imagic, Milton Bradley, and Parker; a selection of electronic synthesisers and organs,



Sinclair, Acorn and Elan computers, a big selection of hifi and various other gadgets either being demonstrated or there for trial. We went late and didn't have time to catch any of the live entertainments being staged, but there was a full schedule of celebrity appearances and demonstrations, including sophisticated theatre-type sets from JVC among others. There was even Radio One broadcasting live from a glass cubicle at the back of the Hall.

Compliments to those who provided headphones for messing about with sound equipment, video games stands that had plenty of screens (not surprisingly, these were the stands which had pinned down the larger proportion of visitors), Sinclair's mini-TV picture which really is as bright and sharp as they claim (the pocket-sized TVs were cleverly exhibited behind perspex, set into pillars on the Sinclair stand), and Elan, whose forthcoming Enterprise 64 micro (due out early next year, more details to follow next month) elicited the comment 'it makes the Spectrum/Oric/Ace etc. look like chocolate biscuits' from our technical department (but it was getting late and he was hungry). Raspberries to people who didn't remember to provide headphones, and the chumps who turned their demonstration music up when we were trying to listen to another stand. Raspberries may also be in order for the exhibitors' decision to hold the exhibition after the beginning of the school year, thus depriving the exhibition of much of its natural audience during the week when, I hear, attendance was disappointing, only to pick up dramatically on the last day, which was (surprise) a Saturday.

Ain't no good laying out lots of goodies if the hungry can't reach the table, right?

Apart from this, this was one of the more occupying exhibitions I have been to, and I hope to see the same again next year. More drum machines and some guitar effects, please!

## Chop Logic

An intriguing oddment has landed on my desk from N. Darwood Ltd. This is a card game, based originally on Lewis Carroll's "Game Of Logic" (Lewis Carroll, when he wasn't writing *Alice In Wonderland* and his other fantasy classics, was an advanced mathematician. Rather like Tom Lehrer, in fact.), which employs Boolean algebra and digital logic in the course of play. Not to be recommended for the easily confused, it nevertheless teaches the fundamentals of computer operations as a side-effect of playing. Usefully, the beginner's pack is only 68p, and can be extended by buying other packs up to a more complex level which imparts further secrets of computer logic. So it is a very minor investment to try the game and see what you can make of it.

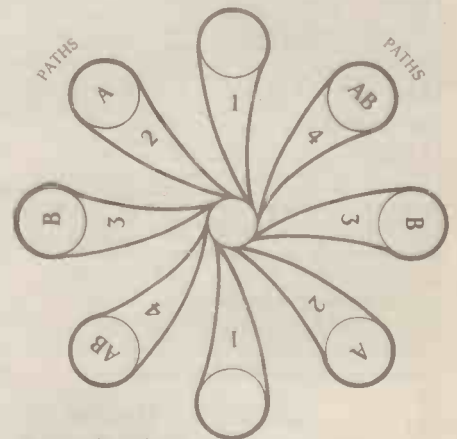

TRUE/FALSE BITS

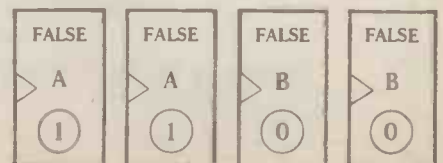

The picture shows the cut-out True and False cards (the True is, logically enough, on the reverse of the False) and the path cards which are used to formulate patterns representing computer operations. To complete the logic, the game is called **Computer**, and is obtainable from N. Darwood Ltd., Halfacre, Stroud, Petersfield, Hants.

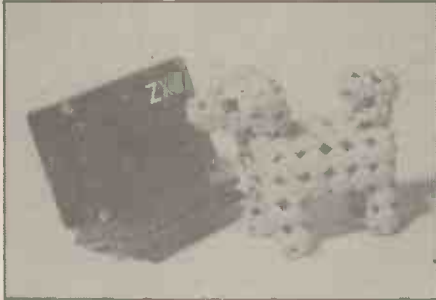

## Sinclair Speech Synth

Timedata have introduced another add-on for Sinclair computers, the ZX5 Speech Synthesiser. Retailing at £32.50 inclusive of VAT and P&P, this is reckoned to be the cheapest synthesiser available. It is based on the SP-0256 chip, which produces 'allophones' — the basic components of speech — and can be programmed to produced virtually any English word and many foreign ones.

The output signal from the ZX5 can be fed to any normal audio amplifier, or to the loudspeaker in Timedata's recently released ZXM Sound Box. Active filtering has been used to give good speech quality. The ZX5 can be used with either the ZX81 or the Spectrum, and other Sinclair add-ons can be plugged onto the back.

For further information contact Timedata Ltd., 16 Hémells, High Road, Laindon, Basildon, Essex SS15 6ED. Tel: (0268) 418121. And if anybody has any ideas about what the basketworth pooch is thinking — please let me know!

## But You Can Put It Back Together . . . ?

Melbourne House, the book and software publishing house which brought you *The Hobbit* (I am still horribly lost, and occasionally stangled, in the Misty Mountains) are publishing a book by Drs. Frank O'Hara and Ian Logan entitled **The Complete Spectrum ROM Disassembly**.

In this book, the doctors not only examine the 16K ROM program which controls the operation of the Spectrum, but also explain exactly what makes the Spectrum operate. By completely disassembling the ROM they can comment on the function of every routine and explain how it relates to other routines. The extensive range of BASIC commands and functions available are fully explored and all functions and their entry points are

made available to Spectrum owners for their own use.

The books has been written with more advanced users in mind but should be of interest to any Spectrum owner who is serious about machine language programming and wants to understand the Spectrum system from the inside.

*The Complete Spectrum ROM Disassembly* has 250pp and is priced £9.95, mail order or from technical bookshops.

Less technical but not less terrifying is a new game from the same, *Terror-Daktil 4D*, with 'super sound and graphics', for the 48K Spectrum, at £6.95.

Orders and enquiries to Melbourne House Publishers, Glebe Cottage, Glebe House, Station Rd., Cheddington, Leighton Buzzard LU7 7NA. Tel: 01 405 6347.

## This Is Your Computer Calling

It's what-shall-we-gettem-for-Christmas time again. Electroplay Ltd. are marketing some suggestions, in the form of an electronic talking game, and a "talking computer" for teaching the nippers to count, read, tell the time, etc.

"Pass Me" is a game which resembles a plastic sea-urchin with coloured handles, a vocabulary of twenty words and a loudspeaker. It has a formal repertoire of seven games which are all based loosely on the idea that it can be passed to and fro among a group of players trying to guess or locate a sequence of numbers. If you win, it plays you a tune. Inventive players can probably think of variations on the standard seven games — just the thing to break the ice at parties? It's more articulate than a beachball, needs less space, and costs £19.95.

"My Talking Computer" is a purpose-designed mini-computer with a series of graphic overlays which act as keypads appropriate to the program being used, apparently to avoid causing confusion to "very young children and mothers" by asking them to operate a "querity" (sic) keyboard. Hoping that this rather patronising attitude has not infected the

design of the machine unduly, the idea of a computer which adjusts the skill level according to the answers it gets, and explains errors to the pupil, starting at a very simple level, sounds like a good 'un, if only because young children like things they can tamper with and this takes some of the weight off mother in starting junior out on literacy, numeracy and telling the time (temporality?). Can't be a bad thing. Apparently it teaches spelling as well.

"My Talking Computer" runs on program modules, can be powered from the mains or batteries, and can be operated through an earpiece for total peace and quiet. The introductory price for the computer plus five program modules is £60. It has obviously been carefully designed to motivate youngsters to want to use it, but I question the advisability of giving it a "clear, friendly female voice", or anything else which sounds like an adult. Wouldn't it be more likely to grab their attention if it spoke in metallic, bossy, computoid tones? What the kids need is a really compelling rôle model: C3PO, for instance.

More data from Electroplay Ltd., 93 High St., Esher, Surrey KT10 90A. Tel: Esher 67031. The games will be on sale in high street shops. Now excuse me, my Invaders Revenge is calling.



# MONITOR

## Tapes For The Blind

QTI Tape Magazine will be changing its name to QTI Talking Newspaper to assist in its registration with the Charity Commissioners. This is a free service of recorded readings from magazines which has reached quite a number of blind radio amateurs and short-wave listeners around the world. New members are welcome. For information, contact QTI Talking Newspaper, 179 Narrow Lane, North Anston, Sheffield S31 7BJ. (I expect they would appreciate an SAE with enquiries).



## Pro Fault Finder

A new British manufactured and designed portable Audio/Visual fault locator is now available from Antron Electronics. Codenamed Toneohm 700 this instrument is used to locate short and partial short circuits caused by solder bridges, poor etching and partial device failure such as substrate shorts, leaking capacitors etc., by tone or meter readout, without removing components or cutting tracks.

Incorporating four ranges to allow resistance measurement up to 20k, and DC voltages between  $\pm 20V$ , the 700 has a complete range of diagnostic capabilities in one instrument. Kelvin needle probes are used for fault finding and are protected against accidental connection up to  $\pm 30V$ .

An external drive source is used to stimulate the circuit under test, with a maximum output voltage of 0V55 and a maximum output current of 150mA. This rugged product measures 252 x 262 x 60mm and weighs 1.8kg. Standard accessories supplied include needle probes, current trace probes and drive source leads, and the price is £436.00 before VAT. For further information contact Antron Electronics Ltd., Hamilton House, 39 Kings Road, Haslemere, Surrey GU27 2QA. Tel: (0428) 54541.

## Versatile Solder

Jimi Heat of Watford have announced the introduction of a new British made all-purpose solder to replace their widely acclaimed, all-metal solder launched nearly 12 months ago. "Supa

Solder" is lead free, non corrosive and is said to be capable of handling all metals including aluminium. It can be apparently shaped, polished and even chromed, and its relatively low melting point and capillary action makes it suitable for even the most delicate applications where in the past, expensive silver based solders have been applied!

Supa Solda comes in two forms: reels for industrial use and specially designed bubble packs for retail, each complete with a generous quantity of Superflux which is suitable for all applications.

The suggested retail price of the 'bubble pack' is £1.65, and it is available from Halfords and other retail outlets. We haven't been given a contact address for Jimi Heat Ltd., so ask in your local supplier if you are interested.

## Dim The Lights

Two new kits from Electronic and Computer Workshop: an electronic powerswitch dimmer, and a two-channel infra-red controlled light dimmer.

The Electronic Powerswitch Dimmer is designed to be used for a wide variety of applications, and is particularly suitable for use in dark rooms, as a slide projector controller. The switch is built round a CMOS IC which has been developed for the purpose and can be used for under a much wider range of conditions than the classic dimmer switch. An infinite number of single-pole switches may be mounted in parallel and the whole unit is connected directly to the mains supply.

Apart from On, Off and Dimmer functions the specification includes a typical maximum output power of 400W, and single-pole press button use. Dimming time over a range of 5% to 95% in both directions is typically 3.5 seconds. The kit costs £8.70 plus £1.00 VAT/p&p.

The Two Channel IR Remote Controlled Light Dimmer is sold as two separate parts, a transmitter and a receiver. The receiver, which is intended to be controlled by the transmitter, gives independent remote On/Off and variable control (DIM) functions. Applications are said to include automatic adjustment of room temperature and lighting. In use, either of the two channels may be assigned to any one receiver, or two identical kits may be assigned to different channels and controlled individually by only one transmitter, hence the virtue of selling the two parts separately.

The receiver, supplied complete with housing, has a 240VAC, 50Hz power supply and current consumption is 25mA maximum on standby, with a maximum control output of 300W. Reaction times from zero to maximum or vice versa are seven seconds, with ensured noise immunity.

The transmitter, designed to operate an IR light dimmer, will control two receivers, with On/Off and Dim

commands. The specification includes bi-phase coded modulation, CMOS technology and power LED outputs, giving 15mW/cm<sup>2</sup> maximum beamed power. Beam deflection angle is 30° with a reflector and 60° without reflector.

The transmitter unit costs £15.06 plus £1.00 VAT/p&p and the receiver costs £33.60 plus £1.00 ditto.

Orders and enquiries to Electronic and Computer Workshop Ltd., 171 Broomfield Rd., Chelmsford, Essex CM1 1RY. Tel: (0245) 62149.

## New Spectrum Company

Multitron Electronic Appliances, "Specialists In Digital Control" are a new company which has been formed to deal with all aspects of Sinclair Spectrum hardware.

The product range includes a 24 line I/O port, with each bit accessed either by a single wire or by a 28 way edge connector, and an adaptor module which can join all the Spectrum edge connections to single wire sockets. The latter has a 5V power supply booster which maximises the current that can be drawn from the Sinclair power pack.

These two units are priced at £13.50 and £12.95 respectively, plus 35p p&p each. Soon available is an A/D converter for use with the I/O port. It has two ranges, 0 to 5V and -5 to +5V, with sampling rates up to 40kHz. Full software backup is to be provided. Multitron say that the use of single wire sockets throughout their product range eliminates the need for soldering and/or edge card connectors when fast connection is required to experimental circuitry. Suitable wire, available as a wire pack, which will connect directly with the breadboard circuits as well as edge connectors (female and male card types) are available from stock.

Multitron's stocks include a range of control ICs, and they are happy to try and advise on any interfacing problems that arise when using their products (please send SAE).

Multitron is mail-order only; for details contact them at Multitron Electronic Appliances, 5 Milton Close, Headless Cross, Redditch, Worcs B97 5BQ. Tel: (0527) 44785.

## Beasties

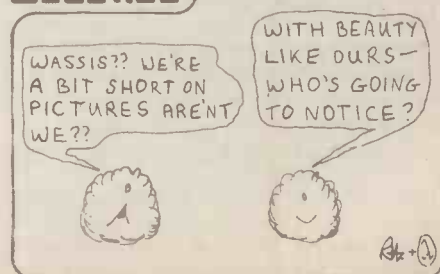



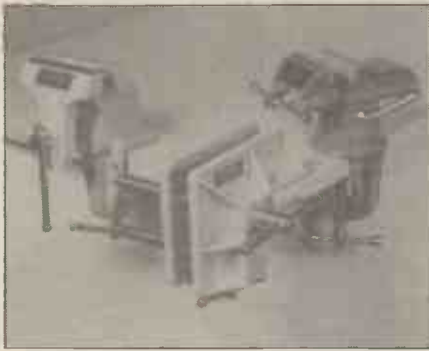

## Vice Squad

Three new portable vices have been introduced by **Draper Tools** for hobbies, DIY, woodworking and modelmaking. The basic model 1709 is a general

purpose hobby vice fitted with a bench clamp with round pipe section jaws positioned below the main jaws — jaw width and opening are 75mm and 54mm respectively. The vice features accurately machined jaw faces and anvil, and is priced £7.95.

Draper's model N 725 is a portable woodworking corner vice with die-cast aluminium body intended to firmly hold timber for the home handyman. The jaw width is 125mm and maximum grip is 60mm and the vice is priced at £10.40. The top of the range portable bench vice is the Model 1122 which features a high quality finished zinc aluminium alloy die-cast body with steel main screw, anvil and replaceable jaws. The universal bench fixing incorporates a 360 degree swivel mounting ideal for precision assembly operations, model making and home DIY. The jaw width is 60mm and the maximum opening 80mm, and the vice is priced at £13.49.

All three models feature nickel plated main screws, and bench clamps. All prices are VAT.

A range of precision instrument pliers have been added to the Draper selection of hand tools. Draper pliers are all manufactured in induction hardened chrome vanadium steel with blue PVC coated handles. A lap joint combined with precision machined jaws ensure accurate register at the tip of the nose of the pliers, and the handles are spring loaded to minimise user fatigue.

The range includes both short, straight, and bent needle nose pliers, flat nose pliers and plain, thin jaws and angle head cutting pliers. All are ideal for miniature electronic assembly, model making and precision engineering applications. Competitively priced between £5.26 and £6.85 each (plus VAT), the new Draper Precision Instrument Pliers are also likely to appeal to the home handyman looking for quality hand tools.

Further details are available from **Draper Tools Ltd.**, Hursley Rd., Chandlers Ford, Eastleigh, Hants SO5 5YF. Tel: (04215) 66355.



## Disk Drives For BBC

**Advanced Memory Systems** have produced the smallest possible disk system for the BBC Microcomputer using the new Hitachi 3in drives. The drives are cased in rigid steel and cost £225 and £399 for the single and double versions. The system comes complete with cables, manuals, utilities on disk and EPROM, as well as free disks.

The Hitachi drive has a brushless direct motor and when cased fits neatly on top of the BBC Micro. The casing has been textured and painted to match the computer. The new disk is totally enclosed in rigid plastic, with no exposed surfaces which makes it ideal for personal and educational use. Another feature is a mechanical tab which prevents overwriting.

You use either side by simply flipping it over in the same way as a music cassette. Each side holds 100K of storage. A small light on the drive casing reminds you which side you are using. At present the product is only available mail order but it is intended to set up a dealer network in due course.

For more information contact **Advanced Memory Services Ltd.**, Woodside Technology Centre, Green Lane, Appleton, Warrington. Tel: (0925) 62682.

## On Yer Bike

Car computers we have heard of. Now we have heard of bicycle computers. What does a bicycle computer compute? Things of use to keep-fit fanatics and bicycle racers, it seems.

Designed to fit bikes with 20, 24, 26 or 27 inch wheels, the **Zemco** computer functions as a speedometer and quartz crystal clock, but will show the average speed over a trip, and distance travelled up to 999.9 miles or kilometers. The stop watch mode reads in hours, minutes, seconds and tenth-seconds, and the whole unit is lit for use at night.

Speed is displayed by a bargraph, and other information is shown digitally. Sensibly, the computer detaches easily when not in use, and can be used as a freestanding clock in between trips. The price from **Zemco** is £19.95, and four 1.5V penlite-type batteries are included.

**Zemco** call themselves 'Automotive Microcomputer Specialists' so would probably also welcome enquiries about other kinds of vehicle computer. The **Bicycle Computer** is an attractive device; indeed, they only have to produce a gadget which measures calorie consumption, calculate stopping distances in wet weather, compensates automatically for the lump in the rear tyre, displays the number of minutes and seconds remaining before the 8.46 leaves the station, gives level readings on the personal stereo, and fits a 24½ in wheel with rod brakes and I shall start feeling positively possessive instead of merely tempted. Oh yes, and a bank-and-turn indicator with a stall warning siren wouldn't go amiss, either.

Be that as it may, all enquiries to **Zemco (UK) Ltd.**, 66 Earlsdon St., Coventry CV5 6EJ. Tel: (0203) 79969. Or ask your local bicycle dealer.



## Organ Bulletin

I was wrong about **Electronic Organ Magazine**, the bulletin of the **Electrical Organ Constructors Society** — it comes out considerably more often than twice a year, as I have had two issues since that one! The September issue, as well as reporting local meetings, has articles on filtering squarewaves into sinewaves, circuits for a clock oscillator for top octave generator chips and string chorus, a design for a digital organ, and members' small ads.

Enquiries to the **Membership Secretary**, Mr. W. Lewis, 8 St. Johns Wood Rd., London NW8 8RE.

# MONITOR

## Fish Probe

The TOBIE Award for Research Achievement has this year been won by the Physics Research Team at the Royal Signals and Research Establishment, Malvern. For some years now this team has been working on the various uses of liquid crystals, including displays and addressing methods; this technology has made possible the 128 x 256 matrix liquid crystal cell developed in conjunction with Scopex Instruments Ltd., for use in their Voyager digital storage oscilloscope.

The Voyager is now finding a wide market by virtue of its extreme portability, as it can be used to make measurements and record the results where this is usually impossible. Many of its applications are linked to water or marine life. Water Boards find its lightness and ease of handling very useful on certain of their very remote pumping and control locations; one of the strangest of applications to date has been for use on an expedition to the Amazon where it will be used for tests on a type of electric fish... and the first person to mention electronic chips will be personally AAArrgh...



## Beeb Robot

Economatics of Sheffield have teamed up with the BBC to launch an educational robot kit designed to improve understanding of control technology in schools and industry. The so-called BBC Buggy was created by Economatics and Microelectronics Education Programme (MEP) in conjunction with the Continuing Education team from BBC TV. A prototype was seen in the BBC's 'Making The Most Of The Micro'.

Two Buggies even assisted in the signing of the contract by delivering their pens to the signatories.

The buggy will be on sale in kit form — not a full-scale electronics kit, but a series of bolt together modules "requiring only a small M4 spanner".

The kit, at £190 (where art thou HEBOT?) includes all the software, twelve structured programs, for operating and experimenting with the buggy.

More information from Economatics (Educational Division) Ltd., 4 Orgreave Crescent, Dore House Industrial Estate, Handsworth, Sheffield S13 9NQ. Tel: (0742) 690801.

## BBC Expansion

Control Universal, a Cambridge-based hardware house, has just introduced a product of interest to users of the BBC Microcomputer. 'BEEB-EX' is a simple, low-cost interface card which attaches by a 34-way ribbon connector to the 1MHz bus port (hidden, but easily accessible from underneath the case). BEEB-EX opens the door on the complete CUBE range of Eurocards produced by Control Universal. BEEB-EX is also compatible with Acorn Eurocards. The CUBE range, in the forefront of Cambridge-based Eurocard development, now comprises over thirty master modules.

With that much hardware to choose from, it's not easy to pick a 'typical' application for BEEB-EX, but most likely passengers on the bus will be 64/80 channel digital I/O, 8 or 12-bit analogue interfaces and extra memory. 256 bytes of memory are addressed directly, but up to 1 Mbyte may be addressed in page mode. This capability offers the exciting possibility of a 'silicon disk' (or 'virtual disk') of battery-operated CMOS RAM, or up to 1Mbyte of paged DRAM.

A second permutation of extension products could include the battery-backed Real-Time Calendar Clock, additional independent video outputs, heavy duty industrial switch outputs and additional independent serial I/O.

BEEB-EX itself is in Eurocard format (100 x 160mm) and is available in two versions. The first is a stand-alone unit which holds up to four other Eurocard devices by their edge connectors, and costs £49.00. The second type is designed for more ambitious applications, slotting into a standard rack-mounted system of up to fourteen backplane connectors. It costs £41.00 for the interface, with racks from £72.00.

Data transfer along the 1MHz bus is achieved by using 'FRED' and 'JIM', the two special pages of the BBC's MOS (Machine Operating System) which control memory mapped I/O. To make programming of data transfer even easier, Control Universal will soon be releasing a paged ROM — entered simply by using \*IO. This will enable BBC BASIC to take directly to the input/output devices.

For further information, including details of quantity and dealer discounts, contact Control Universal Ltd., Unit 2, Anderson's Court, Newnham Road, Cambridge CB2 9EZ. Tel: (0223) 358757.



## Raising The Alarm

Superswitch are marketing a new range of household smoke alarms, promoting in the process the not-very-well-known fact that smoke and other fumes produced by common materials burning kill more people in fires than the fire does. To this end they have produced an explanatory leaflet which explains how smoke does its damage, dispels a few common and dangerous misconceptions about household fires, explains how the smoke alarms work and how and where they should be installed, and add notes on fire protection and safety.

The smoke alarms themselves have dual chamber ionization sensors, 85dB electronic alarms, full function test switches and a circuit which monitors the 1-year zinc carbon batteries and emits a bleep when the battery needs replacing. One model has a built in escape light which lights up if the alarm is activated.

The alarms are independent and straightforward to install. Enquiries to Superswitch Ltd., 7 Station Trading Estate, Blackwater, Camberley, Surrey. Tel: (0276) 34556.

## B.A.E.C. Bulletin

Bulletin No. 70 of the British Amateur Electronics Club contains part 3 of its back to basics series Electronics A-Z, covering capacitors in detail, complete with experiments, a bleeper circuit, lots of members' enquiries and letters, a short book and exhibition reviews. Membership enquiries to Mr. C. Bogod, "Dickens", 26 Forrest Rd., Penarth, S. Glamorgan.

HE

# You win every time!

When you get this NEW & FREE project from GSC

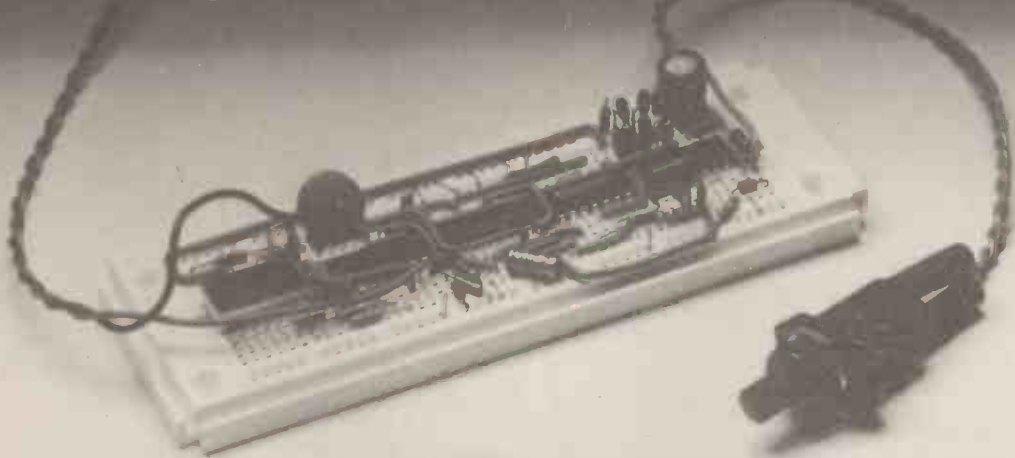

**NEW:** an exciting range of projects to build on the **EXP300** breadboards.  
**NOW** anybody can build electronics projects; it's as easy as **A.B.C.** with **G.S.C.!**

## EXPERIMENTOR BREADBOARDS

The largest range of breadboards from GSC. Each hole is identified by a letter/number system. EACH NICKEL SILVER CONTACT CARRIES A LIFE TIME GUARANTEE. Any Experimentor breadboard can be 'snap-locked' with others to build a breadboard of any size.



1. **EXP 325** £2.00 The ideal breadboard for 1 chip circuits. Accepts 8, 14, 16 and up to 22 pin ICs. Has 130 contact points including two 10 point bus-bars.
2. **EXP 350** £3.45 Specially designed for working with up to 40 pin ICs perfect for 3 & 14 pin ICs. Has 270 contact points including two 20 point bus-bars.
3. **EXP 300** £6.00 The most widely bought breadboard in the UK. With 550 contact points, two 40 point bus-bars, the EXP 300 will accept any size IC and up to 6 x 14 pin DIPS. Use this breadboard with Adventures in Microelectronics.
4. **EXP 600** £7.25 Most MICROPROCESSOR projects in magazines and educational books are built on the EXP 600.
5. **EXP 650** £4.25 Has 6" centre spacing so is perfect for MICROPROCESSOR applications.
6. **EXP 4B** £2.50 Four more bus-bars in "snap-on" unit.

## PROTO-BOARDS

The ultimate in breadboards for the minimum of cost. Two easily assembled kits.

7. **PROTO-BOARD 6 KIT** £11.00 630 contacts, four 5-way binding posts accepts up to six 14-pin Dips.
8. **PROTO-BOARD 100 KIT** Complete with 760 contacts accepts up to ten 14-pin Dips, with two binding posts and sturdy base. Large capacity with kit economy. £14.25



For further details of our FULL PROTO-BOARD RANGE, please send for our free catalogue.

## GLOBAL SPECIALTIES CORPORATION



G.S.C. (UK) Ltd. Dept. 14B  
 Unit 1, Shire Hill Industrial Estate,  
 Saffron Walden, Essex CB11 3AQ  
 Telephone: Saffron Walden (0799) 21682

## FREE project:

### AUTO-DICE

Live up your board games with this sophisticated electronic dice circuit! When the 'throw' switch is pressed, a numerical display flashes up rapidly changing numbers. After a few seconds, the 'rolling' stops, and the final result is displayed; any number, randomly selected, from 1 to 6. A few seconds later the display turns off to conserve your battery, letting the games go on uninterrupted for weeks!

### HOW DO YOU MAKE IT?

Our FREE project sheet gives you a large, clear diagram of the components layed out on an EXP 300 breadboard. Each component is labelled, and the values are given in a component listing. Even the 'row and column' lettering of our EXP 300 is shown to make the location of the correct holes, in which to push the components, easy to find. There's no soldering involved; it couldn't be easier! As an extra bonus, there's a full circuit description, and the details of a regulated power supply on the other side of the sheet.

"Clip the coupon" and get your FREE project sheet with each EXP 300 bought. AND a free catalogue! Just ask about our other free projects too.



GOODS DESPATCHED WITHIN 24 HRS FROM RECEIPT OF ORDER

G.S.C. (UK) Limited Dept. 5B, Unit 1, Shire Hill Industrial Estate, Saffron Walden, Essex CB11 3AQ  
 Prices include P & P and 15% VAT

1	QTY.	2	QTY.	3	QTY.	4	QTY.	5	QTY.	6	QTY.	7	QTY.	8	QTY.
	£3.16		£4.83		£8.05		£9.40		£5.75		£3.73		£13.80		£17.53

Name \_\_\_\_\_ Address \_\_\_\_\_

I enclose Cheque/P.O. for £ \_\_\_\_\_ or debit my Barclaycard/Access/  
 American Express card no. \_\_\_\_\_ expiry date \_\_\_\_\_

FOR IMMEDIATE ACTION - The G.S.C. 24 hour, 5 day a week service  
 Telephone (0799) 21682 and give us your Barclaycard, Access, American  
 Express number and your order will be in the post immediately

For FREE  
 catalogue  
 tick box

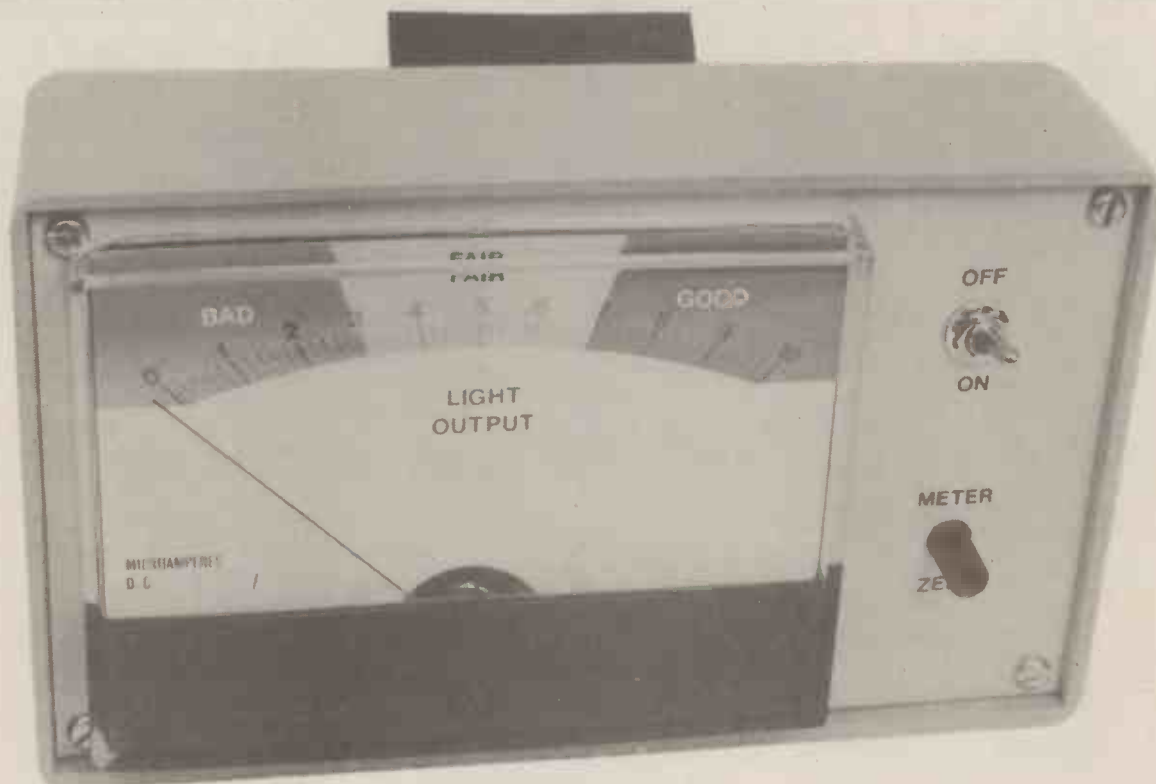

Is your sunbed giving value for volts? How much light are those indoor plants getting? Find out the answers to these and other striking questions of brilliance with HE's

# General Purpose Light Meter

James E. Aman

IN WINTER when the sun retreats below the Tropic of Cancer, thousands of sun-loving Britons take to their sunbeds, hoping to maintain the tawny tan carefully and expensively built up on the beaches of the Costa Del Sol.

This project started life as a simple meter to give an indication of the level of radiation from a sunbed lamp, but it soon became apparent that it had other uses, too. In fact the "Solarium Meter", as it was originally named, can give an indication of the light intensity of any part of the visible and near-visible spectrum, or all of it. It must be stressed, though, that this is not a scientific instrument, since it is not calibrated in meaningful physical quantities; nevertheless it can give a useful indication of light intensities for a number of applications.

Apart from the original application it can, for example, be used to judge the output from a UV exposure tube so that PCB exposure times can be adjusted for consistent results. It could also function as a simple spectrophotometer, for measuring light intensities of a narrow band of wavelengths.

## Light Matters

All semiconductor junctions are

sensitive to light, and photodiodes are especially manufactured to exploit this. The photon energy of light striking a P-N junction liberates electron-hole pairs which move to opposite sides of the junction, creating a current through the diode. Not surprisingly, the current is directly proportional to the intensity of the light.

Photodiodes are usually operated under reverse bias, so that the reverse current is controlled by the light intensity; however silicon photodiodes can be operated as photovoltaic cells. In this mode the liberated electrons move towards the positively charged n-type material while the holes move towards the negative p-type silicon. This sets up a voltage across the junction, which can drive a small current in an external circuit. Since the voltage developed across the cell can never be more than 0V6, the forward voltage drop of a silicon diode, the current available is very small so the impedance of the external circuit must also be small, to obtain maximum current.

Figure 1 shows the short circuit current (ie, zero load impedance) versus voltage characteristic for a typical photovoltaic (solar) cell, and Figure 2 shows a simple photometer

circuit, which converts the short circuit current into a voltage output.

The simple circuit of Figure 2 is quite adequate for measuring light intensity over the range of wavelengths to which the photodiode is sensitive, but unfortunately silicon photodiodes are not very sensitive to ultra-violet wavelengths, where most of the output of a sunlamp tube is concentrated (it is the ultraviolet wavelengths which stimulate a tanned skin). In fact the response peak of a typical general purpose silicon photodiode (Figure 3) is generally in the infrared region, at the opposite end of the scale!

Of course there are devices which have peak response in the UV region, but they are exotic high-technology devices out of the range of the electronic hobbyist. An ordinary photodiode, which after all has at least some response to UV, could be used with a high gain amplifier if a way could be found to limit the response just to ultraviolet wavelengths. Such a "UV acceptor" filter is not available, either — but there is another way.

## Differential Photometry

The method finally devised uses a

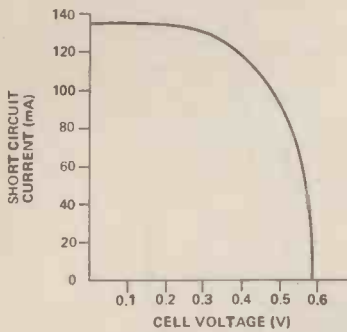

Figure 1. Voltage versus current performance characteristics of a typical solar cell operated into a zero impedance load. In the Light Meter circuit the virtual earth at the op-amp input is equivalent to a short circuit across the cells.

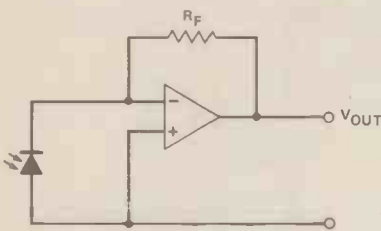

Figure 2. This simple circuit transforms the current output of a solar cell into a proportional voltage. If the current vs illumination characteristic is linear, the output voltage will be directly proportional to the intensity of the light falling on the cell.

differential technique: since the current due to a photodiode is proportional to the intensity of light at the wavelengths to which it is sensitive, by connecting two photodiodes back to back (so that the currents are opposing each other), the total current is proportional to the difference in light intensity between the two cells.

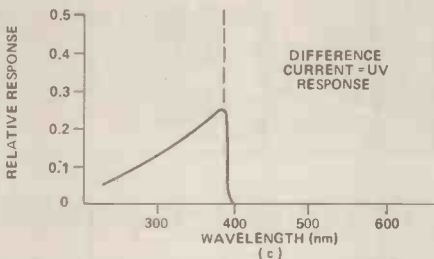
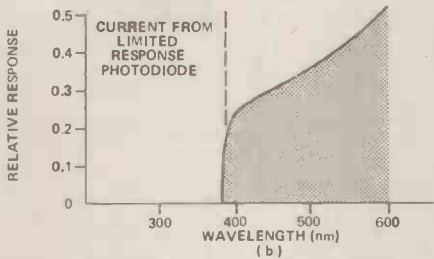
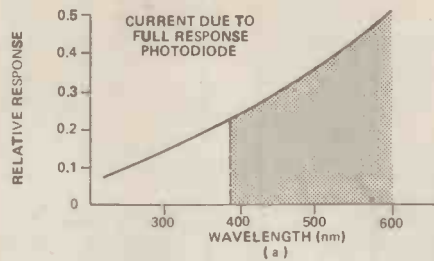

Figure 4. Equal and opposite currents subtract, leaving an output proportional to the intensity of short wavelength illumination.

If identical cells connected this way are illuminated by the same source then obviously the net current will be zero — but if one cell is allowed its full response while the other is covered by a UV filter (so that its response to UV is greatly attenuated), the total signal current will be that contributed only by the UV portion of the spectrum.

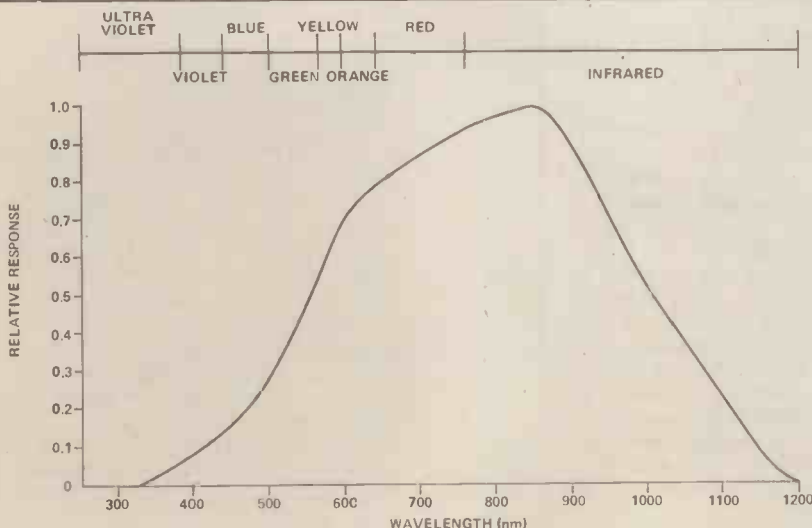

Figure 3. The spectral response of this typical silicon photodiode peaks in the near-infrared but produces significant output, still, at near-UV wavelengths.

The graphs of Figure 4 show the relevant portions of the spectrum and illustrate how the photocell currents subtract, leaving a small current proportional only to the illumination at UV wavelengths. Since the current from a photocell 1 cm square can be as much as 200mA/watt of illumination (on a sunny day in the UK the light energy can be more than 50mW/cm<sup>2</sup>), significant will be generated at UV wavelengths by the right photocell.

Unfortunately all commercial photodiodes are encapsulated and sealed by a glass window, which is itself virtually opaque to UV. However, "naked" solar cells — silicon photovoltaic cells to give them another name — are available, and although spectral response figures for these devices are not published, it turns out that they do have significant response at near UV wavelengths. At 450nm a typical solar cell chip produces 42% of its peak response so although the response tails off fairly rapidly, there is still significant output at wavelengths shorter than 400nm.

And since the UV output of solar lamps and PCB exposure tube is 'Near UV', between 300 and 400nm, the response with a high gain amplifier is quite adequate. EPROM erasure tubes have their radiation peak at around 250nm, in the Far UV region, and so the meter will not respond satisfactorily to these.

*UV light from an EPROM erasure tube can injure the eyes, cause burns or other painful effects, so exposure to short wavelength UV should be avoided. Even the longer wavelengths of Near UV can cause discomfort if viewed for a long time. Sunlamp radiation has a carefully tailored spectrum and is perfectly safe provided the manufacturer's instructions are carefully followed.*

### The Circuit

The full circuit is shown in Figure 5. IC1 is a 3140 MOSFET op-amp, used because its high input impedance and low drift minimise errors due to diode leakage currents ('dark currents' which are present even when the cell is not illuminated). Capacitor C1, connected across the input terminals, maintains the inverting input at 0V for AC, thereby preventing the possibility of oscillation.

The output of IC1 is taken to IC2 via an integrator, R2 and C4; IC2 is an LM3914, a device that ought to be familiar by now! It is normally used to drive a LED array, lighting up a succession of LEDs as the input voltage increases.

Here, instead, the current outputs are summed and fed to an analogue meter, so that for a given increase in voltage at pin 5, IC2 proportionally increases the current drive to the meter. R4 sets the maximum meter current and the reference voltage fed to pin 6 is generated by Q1 and ZD1.

The advantage of using an analogue meter rather than a LED array is that

# Light Meter

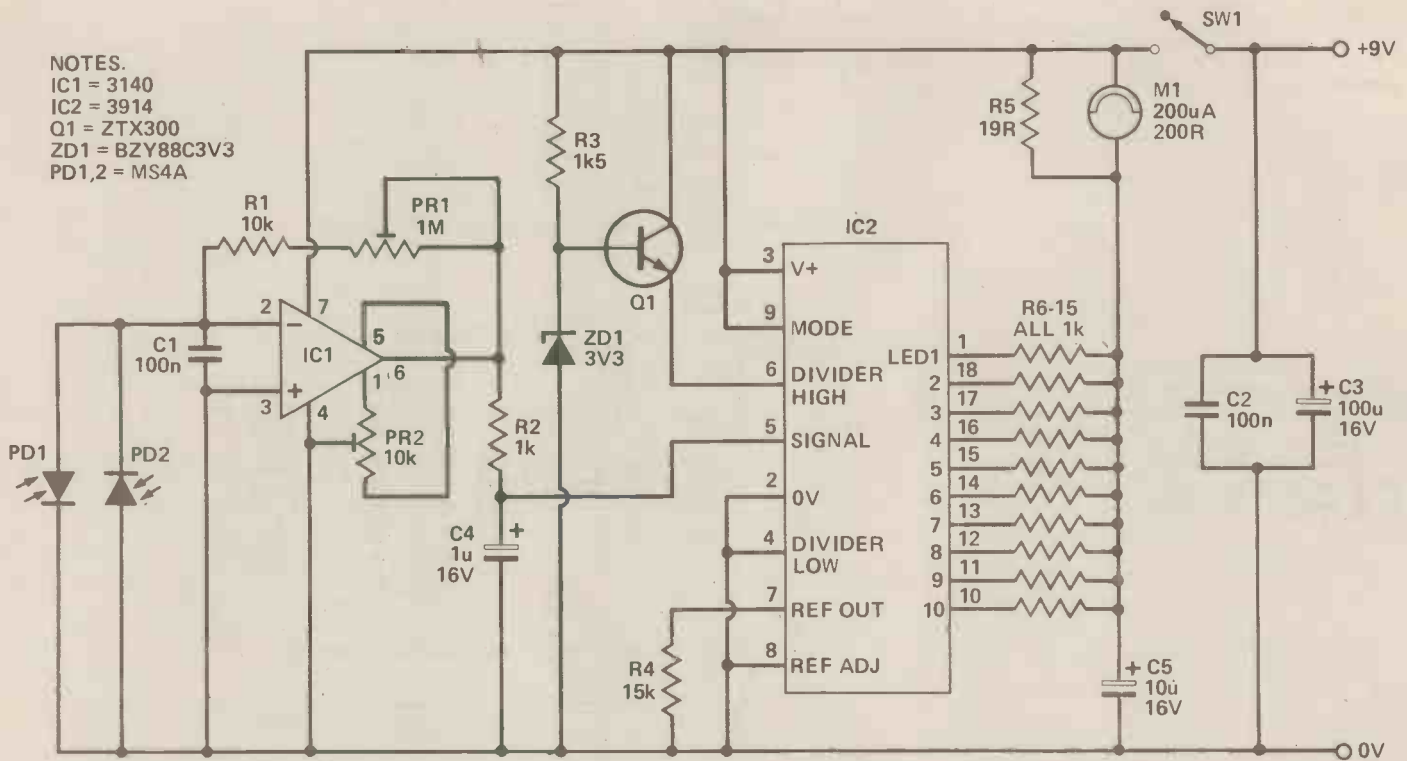

NOTES:  
 IC1 = 3140  
 IC2 = 3914  
 Q1 = ZTX300  
 ZD1 = BZY88C3V3  
 PD1,2 = MS4A

Figure 5. The Light Meter Circuit. PD1 (actually a solar cell chip) is covered either by a UV filter or opaque tape, for most applications.

the entire circuit consumes less than 10mA. This makes it more portable and simplified the layout; where earth loops in a circuit of LEDs that draw 50 times more than the control circuitry can cause problems!

## Construction

With the printed circuit board (Figure 6), assembly of electronics is quite simple, however the method of mounting the photocells requires further explanation.

The cells are mounted in the bottom of the box, on its curved edge so that both horizontal and vertical exposures may be taken. First four holes are drilled in the case, two for each photocell, sufficiently far apart to allow a cell to be fixed between each pair of holes. The leads are then pushed through the holes and the cells fixed to the case using model glue (for a less permanent mounting, use blobs of rubber-based glue).

A focussing shield should be made and placed around the cells; the shield is cut from the corner of a small black potting box, as indicated in Figure 7. The cut-off section should be trimmed with a sharp blade, the edges sanded smooth and then glued in place.

## Applications

For measuring the light intensity of sunbed lamps or UV exposure tubes, one cell must be covered with a UV filter. The best material for the job is a small piece of photographic skylight filter which is obtainable, unmounted, from photographic materials suppliers. This has to be fixed over one cell — it is recommended that the filter be

mounted *over* rather than *on* the cell, since other applications call for a different filter.

For example to use the device as a general purpose light meter, one cell should be covered by black opaque tape so that the remaining cell responds to full spectrum light. The light intensity of a particular portion of the spectrum can be measured by covering one cell with black tape and the other by a filter of the appropriate colour, so that only the wanted wavelengths reach the sensor. For example to measure the green content of artificial light the cell

should be covered by a small piece of green filter material.

*Note that when the device is being used as a differential light meter for measuring UV content, it is PD1 (anode connected to the op-amp inverting input) that must be covered by the skylight filter; and when operating as a simple photometer, the same diode should be covered by the black tape. The circuit will not produce the desired result if PD2 is covered.*

For any of the applications mentioned so far, the photocells must be mounted close together so that

## Parts List

### RESISTORS

(All 1/4 watt 5% carbon)

R1	10k
R2, 6-15	1k
R3	1k5
R4	15k
R5	19R (22R//150R)

### POTENTIOMETERS

PR1	1MR
PR2	horit preset 10R min. rotary
PCB; 1 x 8-pin; 1 x 18-pin DIL sockets; wire, solder, nuts and bolts etc.	

### CAPACITORS

C1	100n polyester
C2	100n disc ceramic
C3	100u 16V radial electro

C4	1u 16V radial electro
C5	10u 16V radial electro

### SEMICONDUCTORS

IC1	CA3140 MOSFET op-amp, 8-pin DIL
IC2	LM3914 LED bar driver
Q1	ZTX300 NPN transistor
ZD1	BZY88C3V3
PD1, 2	MS4A (see Buylines)

### MISCELLANEOUS

M1	analogue meter 100uA FSD, 200R
SW1	SPST toggle
Case, BIM 1005; PP3 battery + clips; PCB, 1 x 8-pin; 1 x 18-pin DIL sockets; wire, solder, nuts and bolts etc.	

BUYLINES ..... page 34

Figure 6. The PCB component layout is quite simple, with only a few off-board components. The meter shunt resistor R5 is formed by 22R in parallel with 150R and is soldered directly across the terminals of M1 (not shown).

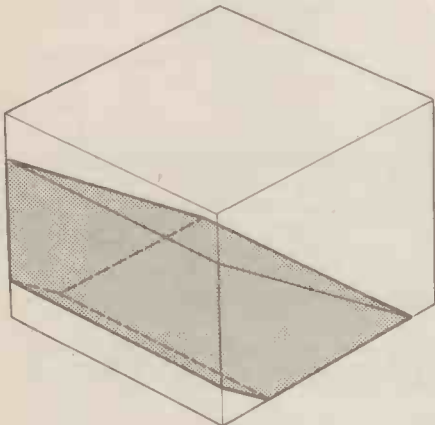
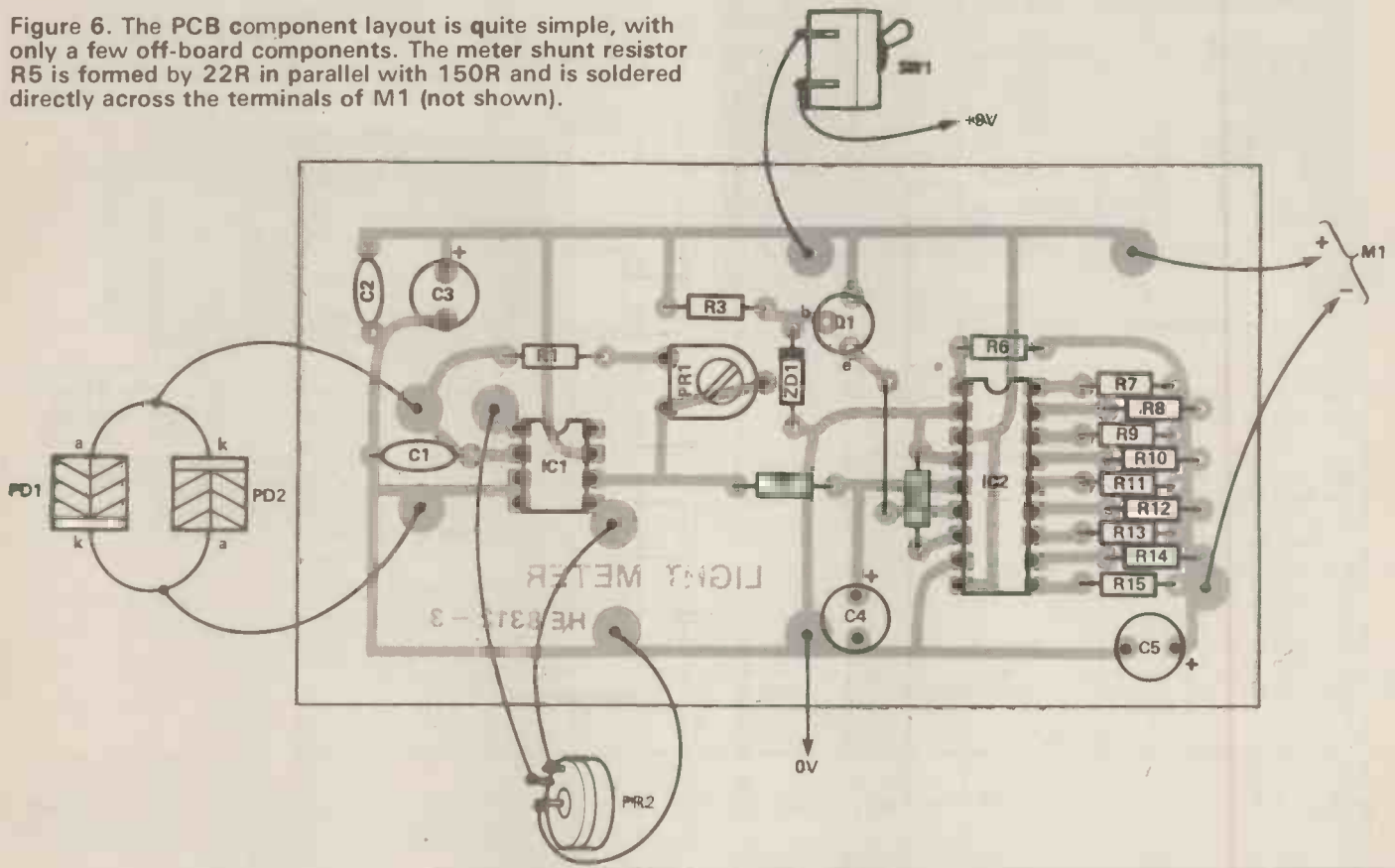
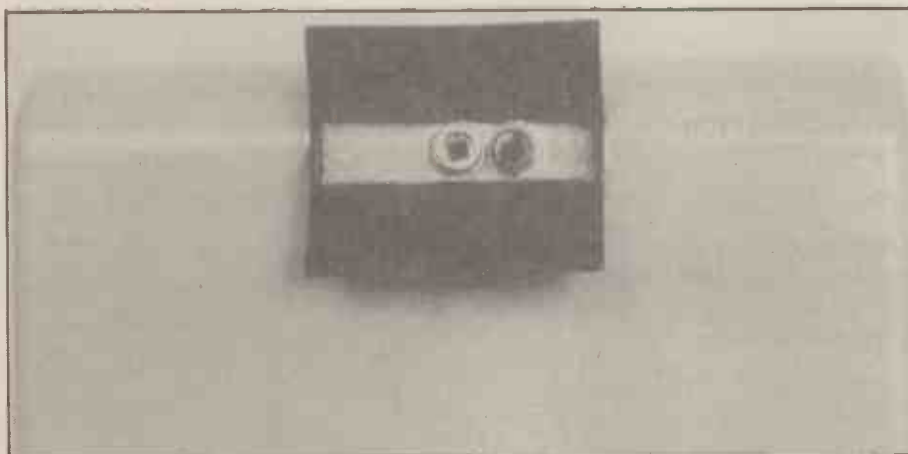

Figure 7. The focussing shield is cut from a small potting box and glued in place, as seen in the photograph below.



The BPW21 photodiodes used in the prototype (above) were replaced by solar cell chips, which are more sensitive to UV radiation.

they are equally illuminated by the source. However if they are spread apart, the circuit still produces an output proportional to the difference in light intensity falling on the cells, and this system could be used as the basis of a control system for a tracking solar heating unit, for example.

### Calibration

The calibration procedure is quite simple: first both sensors are covered with opaque black tape and the metered zeroed by adjusting the op-amp offset, via PR2.

It is impossible to calibrate the scale in meaningful quantities (lumens or watts, say) without access to a light source whose output intensity and spectral distributions is accurately

known. Instead the scale is calibrated relatively; it is divided into ten sections, each corresponding to an increment in light intensity. The scale is further divided into three sections labelled 'Good', 'Fair' and 'Bad', for quick indication of relative light levels.

Full scale deflection is adjusted using PR1 while exposing the sensors to a known, good light source. For instance to calibrate the meter for sunlamps, PR1 would be adjusted while the sensors were held up to a new sunlamp tube; a new UV exposure tube should be used when calibrating the meter for that purpose, and so on.

If the meter cannot be zeroed on maximum sensitivity with both sensors blanked (due to large dark current from the forward-connected cell) reverse the leads of PD1 and PD2. This will give a negative offset which can be zeroed by PR2.

### Variations

The full-scale calibration must be carried out for each separate application, so if the meter is to be used for a number of purposes, it might be as well to use a linear rotary potentiometer in place of PR1, and mount it through the front panel.

If R1 is replaced by a number of different resistors, switch selectable, then a complete range of light intensities can be measured. Alternatively the LM3914 could be directly replaced by an LM3915, which produces a logarithmic display of 3dB increments, allowing a much wider range of light intensities to be measured.

**TWO GREAT HOBBIES  
... IN ONE GREAT KIT!**



The K5000 Metal Detector Kit combines the challenge of DIY electronics assembly with the reward and excitement of discovering Britain's buried past.

As a Metal Detector—the K5000 boasts the proven pedigree of C-Scope, Europe's leading detector manufacturer. As a Kit—simplified assembly techniques require little technical knowledge, and no complex electronic test equipment. All stages of assembly are covered in a finely-detailed 36 page manual.

*Detector Features Analytical Discrimination & Ground Exclusion*

Ask at your local Hobby/Electronics shop or use the coupon and send with your remittance to:-  
C-Scope International Ltd., PO Box 36, Ashford, Kent TN23 2LN

Please send me ..... K5000 Kits @ £119.99(+£3.00 p+p) each.

\_\_\_\_\_

Please debit my Barclaycard/Access  I enclose Cheque/PO

£ \_\_\_\_\_

Name \_\_\_\_\_

Address \_\_\_\_\_

HE

**FEEL HEALTHIER  
WITH ZEPHION**

Bring fresh clean air into your home with the Zephion Air Ioniser.



Air free from smoke, dust and other pollutants of modern day living can bring to many the relief of breathing comfortably once again.

We are confident that you will be delighted with the Zephion Air Ioniser, but if you are not entirely satisfied a full money back guarantee is available if items are returned in good condition within 28 days.

**BUILD IT YOURSELF!**

clip the coupon

TO:- Dataplus Developments 81, Cholmeley road Reading, Berks. RG1 3LY TEL:- 0734 67027

NAME:- \_\_\_\_\_

ADDRESS:- \_\_\_\_\_

PLEASE SEND :-

ZEPHION KITS @ £24.15p (Kits include all parts)

ZEPHION AIR TONERS BUILT AND TESTED. @ £34.50p

Money immediately refunded if items returned in good condition.

Prices include VAT & postage; allow 14 days for delivery. DATAPLUS.HE



A. MARSHALL (LONDON) LTD



A. Marshall (London) Ltd.  
Electronic Component Distributors  
85 WEST REGENT STREET  
GLASGOW G2 2QD  
TELEPHONE: 041 332 4133

**1984 CATALOGUE NOW OUT**

The new Marshalls 1984 catalogue is now available — one of the biggest and best catalogues ever produced by Marshalls.

56 pages crammed from back to front with components, accessories and testgear

New products include I.D.C. plugs & sockets, "D" plugs & sockets, DIL Headers, Ribbon Cable, Kits, Toroidal transformers, I.C.'s, Capacitors, test probes, and lots more.

*Something for Everyone*

**Trade, Export, Retail and Mail Order Supplied**

75p to callers, £1.00 post paid Europe, £1.50 rest of the world.

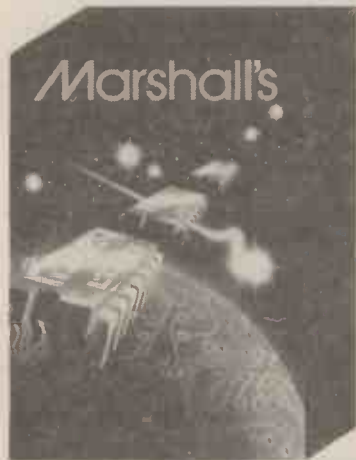

WHERE TO FIND US	CALL IN AND SEE US	MAIL ORDER	TELEPHONE
<p>BATH ST</p> <p>WEST REGENT ST</p> <p>WEST GEORGE ST</p> <p>WELLINGTON ST</p> <p>MARSHALLS</p> <p>MOPE ST</p>	<p>9-5.30 MON TO FRI</p> <p>9-5.00 SAT</p> <p>EXPRESS MAIL ORDERS</p> <p>ACCESS/BARCLAYCARDS</p> <p>WELCOME</p> <p>SAME DAY SERVICE</p>	<p>WE REGRET WE CANNOT ANSWER MAIL ORDER/ STOCK ENQUIRIES WITHOUT AN S.A.E.</p> <p>SAME DAY SERVICE</p> <p>TRADE AND EXPORT ENQUIRIES WELCOME</p>	<p>MAIL ORDER</p> <p>041-332-4133</p> <p>SHOP AND STOCK ENQUIRIES</p> <p>041-332-4133</p> <p>TRADE</p> <p>041-332-4135</p>



# READERS' SERVICES

Feeling stumped?  
Looking for the  
right connection?  
It must be time to  
reach for HOBBY  
ELECTRONICS!  
Here's how . . .

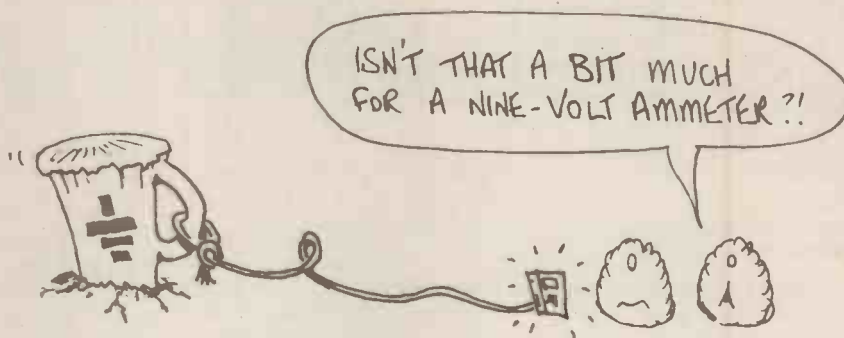

## Letters

While we are always happy to receive correspondence from readers, it is simply not possible for the editorial staff to reply to every letter. Because of staff limitations and the fact that producing the monthly editions of HE must take precedence, *we cannot even guarantee to answer letters accompanied by an SAE*. Hopefully this situation will prove temporary and we can shortly resume a full service to readers.

In the meantime, to reduce the amount of mail to which we attempt a reply, certain guidelines have had to be imposed:

- Letters from readers who have been unable to successfully build a Hobby project will receive first claim on our attention. But we urge readers to first make sure they understand the problem, and to read all parts of the article thoroughly; it is wasting our time (which is better spent ensuring that current projects are error free) to reply (to pick a common case) that the supplier of certain components is given in Buylines, on page 34.

- Many enquiries are concerned with drafting errors in circuit diagrams or component overlays; corrections for most errors have been published in subsequent issues, so please check your back numbers before writing to us — the information may already be in your hands.

- Where there is a definite problem, we ask that readers first try to solve the problem themselves; again, reading the article carefully will often resolve what appears to be a contradiction between, say a Veroboard layout and the circuit diagram.

- If it is necessary to write, please try to supply useful information: it is impossible to give constructive advice to the reader who says "My project doesn't work. Can you help?". The short answer, and the only one possible, is *no!*

- We would like to hear from any reader who has had difficulty with a Hobby project and who has come up with a solution, but we cannot advise when a project has been modified and fails to work: if you decide to make

changes you will have to live with the consequences. Similarly, we are pleased to take readers suggestions for projects they would like to see in the magazine, or for modifications to improve a published project, but we cannot design circuits on request or re-design a project to suit the requirements of a single reader.

- We will try to answer any readers' questions on electronics in general, to suggest sources for components for old projects or to offer whatever advice we can when circumstances permit; however, we cannot advise on the purchase, use or modification of commercial equipment.

- We are unable to advise on the purchase of components in foreign countries; overseas readers are advised to read carefully the advertisements placed in HE by mail-order component suppliers and to write to them directly (this advice also applies to many UK readers wishing to obtain components for projects!).

- Unless specifically requested to the contrary, any letter to Hobby Electronics may be selected for publication in the magazine, including letters with an SAE if they are sufficiently interesting; in such a case a copy of the editorial comment will be returned to the reader prior to publication.

- Letters not accompanied by a stamped, self-addressed envelope may be selected for publication but will not receive a personal reply. We will attempt to reply to all enquiries backed by an SAE (if writing from outside the UK please include the correct number of International Reply Coupons, available from Post Offices) but we cannot guarantee a reply, nor can the publishers, Argus Specialist Publications, be held legally responsible for the accuracy of the information supplied.

## Writing For HE

- Hobby Electronics' editor is continually looking for good projects, ideas for projects and designers to

develop an idea into working project.

However unless you are already a seasoned contributor, it is unlikely that your first effort will reach the standard required for publication in the magazine. So if you have an idea or a design and you personally think it would be suitable as a Hobby project, write and tell us about it — and please include a telephone number (night or day, we're open all hours here) where you can be contacted.

Similarly if you are a designer, perhaps with time to develop someone else's ideas, please write or phone the editor!

## Any Old Rope?

We will also undertake to publish any suitable but undeveloped ideas as experimental "Reader's Projects". The article will generally fill one page when published and should include a circuit diagram and description, parts list, component overlay (the projects should generally be on Veroboard) and some brief suggestions as to how the device might be constructed by the adventurous reader! A working prototype will not be needed, and the flat rate for Reader's Projects will be £20.

Simple circuits are also needed for publication as "Short Circuits"; no constructional information is needed, and contributors of "Shorts" will be rewarded with £10 per idea.

## The Back-Log

The above guidelines for writing to Hobby Electronics have had to be drawn up in response to the growing pile of yet un-answered letters from readers.

We apologise to all those still awaiting a reply; we are doing everything possible to clear the jam, but to enable us to do so in reasonable time we are retrospectively imposing the above restrictions on the type of enquiry with which we will deal. Therefore, any letter or question not relating to a Hobby Electronics project or a general electronics enquiry will be returned, with the SAE, to the reader.

# COMING SOON TO . . .

# Hobby Electronics

## HE QUIZMASTER

A buzz with a bus: the Quizmaster is an individual "buzzer station" which can be linked with any number of other stations on a two-way bus-line, so that the first buzzer to be operated locks out the others. No more arguments about who was the first to reach the buzzer, and there is also a light incorporated.

Quizmaster units can be used for adjudicating any type of quiz or reaction-timing game. A set "time out" period nobbles any notions of cheating, but in the case of a true tie two Quizmasters can sound at once, allowing a further test.

In addition to all this, the Quizmaster makes a truly impressive noise and a superb conversation piece. Don't take our word for it — put one where your visitors can see it, and watch what happens.

## SLOT CAR LAP COUNTER

Minute modifications to slot-driven model racing cars make them suitable for an electronic lap-counter, which not only counts up to nine laps, but signals when the set number of laps have been completed, and can be reset to carry on counting for longer competitions.

## TRANSATLANTIC POWER REDUCER

Not, unfortunately, an invention for keeping the world's Superpowers in check — but it does a fine job on the mains voltage. Proud possessors of Yankee waffle-irons, indeed almost any appliance with a *heating element* and rated at 110 or 120 volts can now run them from a 240 volt mains supply without huge expense or major modification.

## SOFTWARE ROCK

HE meets the group Mainframe who, among other things, are breaking the barriers between discs and disks.

## CAREERS IN ELECTRONICS

Careers returns briefly from its Christmas break to wrap up its run with a look at electronics opportunities in the UK Armed Forces.

Please reserve me ..... copies of the January issue

**Hobby  
Electronics**

for  
Name .....

Address .....

.....

.....



**Hobby  
Electronics**

**January issue on sale at  
your newsagent from 9th  
December. Place your  
order now!**

Although these articles are being prepared for the next issue, circumstances may alter the final content.

## NEW ITEMS FROM OUR BARGAIN LIST

- Screws enable wires to be quickly joined and insulated in one simple operation without screwdriver or pliers. Ideal for hooking up experimental circuits but quite safe to use inside metal or plastic boxes for joining mains wiring. Sample pack, 5 large, 5 small **£0.57**
- 2Kw Immersion heater — 10" long standard mounting **£2.30**  
10 for **£17.25**
- Clockwork timer — basically a 2 hr timer, very easily adaptable to 1 hr or 1/2 hr. Approx 2" diameter. 2 screw mounting 1/2" spindle **£2.30**  
10 for **£17.25**
- 5C to 2 Twin Adaptors for operating Christmas tree lights etc from a lamp holder **£0.75**  
10 for **£5.00**
- Multimeter Stand — a neat plastic adjustable holder, ideal for pocket sized multimeter, calculator etc. Makes it so much easier to read and at the same time protecting the instrument from being damaged **£0.69**
- PP3 Replacer Kit comprising plastic case, transformer, rectifiers, condensers, and wiring diagram **£1.95**
- Fixing staples — always useful to have a few of these around the house. Consist of hardened pin on plastic piece shaped to take cable. Various sizes — suit wires from speaker wires, to ring main cable 100 assorted **£1.15**
- Trigger Mats — a simple and sure way of setting off a burglar alarm. Place this under the carpet at windows or doorways, directly it is walked on it will switch on the alarm. Ideal for use with our burglar alarm panel. Size 24"x18" **£2.30**
- Wall Mounting Thermostat by Danfoss has a really pretty 2 tone grey case with circular white scale and dial. Setting temperature from 0-30c 13 amp 250v contacts **£4.95**
- Thermo Couple Prod — when used with a suitable millivolt meter this could be used to find the centre temperatures of say, meat or liquids **£3.45**

### 3 CHANNEL SOUND TO LIGHT KIT

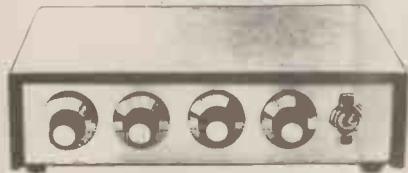

Complete kit of parts for a three channel sound to light unit controlling over 2000 watts of lighting. Use this at home if you wish but it is plenty rugged enough for disco work. The unit is housed in an attractive two-tone metal case and has controls for each channel, and a master on/off. The audio input and output are by 1/2" sockets and three panel mounting fuse holders provide thyristor protection. A four pin plug and socket facilitate ease of connecting lamps. Special price is £14.95 in kit form or £25.00 assembled and tested.

### 12 volt MOTOR BY SMITHS

Made for use in cars, etc. These are series wound and they become more powerful as load increases. Size 3 3/4" long by 3" dia. They have a good length of 1/4" spindle — Price **£3.45**.  
Ditto, but double ended **£4.25**.  
Ditto, but permanent magnet **£3.75**.



### EXTRA POWERFUL 12v MOTOR

Probably develops up to 1/2 h.p. so it could be used to power a go-kart or to drive a compressor, etc. **£7.95 + £1.50 post.**

### THERMOSTAT ASSORTMENT

10 different thermostats. 7 bi-metal types and 3 liquid types. These are the current stats which will open the switch to protect devices against overload, short circuits, etc., or when fitted say in front of the element of a blow heater, the heat would trip the stat if the blower fuses; appliance stats, one for high temperatures, others adjustable over a range of temperatures which could include 0 — 100°C. There is also a thermostatic pad which can be immersed, an oven stat, a calibrated boiler stat, finally an ice stat which, fitted to our waterproof heater element, up in the loft could protect your pipes from freezing. Separately, these thermostats could cost around £15.00 — however, you can have the parcel for **£2.50**.

### MINI MONO AMP on p.c.b., size 4"x 2" (app.)

Fitted volume control and a hole for a tone control should you require it. The amplifier has three transistors and we estimate the output to be 3W rms. More technical data will be included with the amp. Brand new, perfect condition, offered at the very low price of **£1.15 each**, or 10 for **£10.00**.

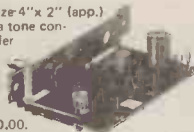

### — BARGAIN OF THE YEAR — THE AMSTRAD Stereo Tuner.

This ready assembled unit is the ideal tuner for a music centre or an amplifier, it can also be quickly made into a personal stereo radio — easy to carry about and which will give you superb reception.

Other uses are a "get you to sleep radio", you could even take it with you to use in the lounge when the rest of the family want to view programmes in which you are not interested. You can listen to some music instead.

Some of the features are: long wave band 115 — 270 KHz, medium wave band 525 — 1650KHz, FM band 87 — 108MHz, mono, stereo & AFC switchable, tuning meter to give you spot on stereo tuning, optional LED wave band indicator, fully assembled and fully aligned. Full wiring up data showing you how to connect to amplifier or headphones and details of suitable FM aerial (note ferrite rod aerial is included for medium and long wave bands. All made up on very compact board.

Offered at a fraction of its cost: **only £6.00**  
+ £1.50 post + Insurance.

## THIS MONTH'S SNIP

12v DRILL WITH CHUCK to take up to 2.5mm drills — miniature but very powerful. Ideal model for p.c.b. work. Wonderful present for dad or son. Only **£8.50**.

### REVERSIBLE MOTOR WITH CONTROL GEAR

Made by the famous Framco Company this is a very robust motor, size approximately 7 1/2" long, 3 1/2" dia. 3/8" shaft. Tremendously powerful motor, almost impossible to stop. Ideal for operating stage curtains, sliding doors, ventilators etc., even garage doors if adequately counter-balanced. We offer the motor complete with control gear as follows:

1 Framco motor with gear box 1 push to start switch  
1 manual reversing & on/off switch 2 limit stop switches  
**£19.50 plus postage £2.50** 1 circuit diag. of connections

### FOR SOMEONE SPECIAL

Why not make your greeting card play a tune? It could play 'Happy Birthday', 'Merry Christmas', 'Wedding March', etc. or 'Home Sweet Home', etc. Wafer thin 3 part assemblies, for making cards musical. Mini microchip speaker and battery with switch that operates as the card is opened. Please state tune when ordering. Complete, ready to work **£1.25**.

### REEL TO REEL TAPE DECKS

Ex-Language Teaching School. Second, but we understand these are in good order; any not so would be exchanged. The deck is a standard BSR with normal recorder, replay facilities and an additional feature is tape rev counter. Nicely finished in teak type box. We have 30 only of these. Price **£8.50 each + £3 carriage**.

### MAINS CLOCK SWITCH

Bold, easy to read clock with coupling to operate 25a switch. Made for cooks but if you throw away the switch section you can have a very neat and accurate clock at a fraction of today's cost. We are overstocked with these and are making a special offer price of 10 for **£6.50 + £2 post**. Or 100 for **£50 carriage paid**.

### 6v POWER SUPPLY UNIT

Mains operated fully smoothed 6V 200 ma output. Enclosed in neat plastic case only **£1.15 each**, but we are offering these at such a silly price because they are intended to plug into shaver sockets but it is a simple matter to remove the pins and solder on a flex lead. The 6v output termination is a 3.5 jack plug, thus making it suitable for many cassettes and radios.

### A PRESTEL UNIT, brand new

and complete except for 7 plug in ICs — so far as we know the unit would work once the missing ICs are fitted. Price: **£19.75 + £2.00 post.**



### WATERPROOF HEATING WIRE

100 ohms per yard, this is a heating element wound on a fibre glass coil and then covered with pvc. Dozens of uses — around water pipes, under grow boxes, in gloves and socks. Price: **23p per metre**.

### TIME SWITCH BARGAIN

Large clear mains frequency controlled clock, which will always show you the correct time + start and stop switches with dials. Complete with knobs **FOR ONLY £2.50**.



### ROPE LIGHT

4 sets of coloured lamps in translucent plastic tube arranged to give the appearance of a running or travelling light. With variable speed control box, ideal for disco or shop window display. Complete, made up, ready to plug into mains. **£36.00 + £2 post.**

## 50 THINGS YOU CAN MAKE

Things you can make include Multi range meter, Low ohms tester, A.C. amps meter, Alarm clock, Soldering iron minder, Two way telephone, Memory jogger, Live line tester, Continuity checker, etc., and you will still have hundreds of parts for future projects. Our 10kg parcel contains not less than 1,000 items — panel meters, timers, thermal trips, relays, switches, motors, drills, taps, and dies, tools, thermostats, coils, condensers, resistors, neons, earphones/microphones, nicad charger, power unit, multi-turn pots and notes on the 50 projects.

**YOURS FOR ONLY £11.50 plus £3.00 post.**

### MINI-MULTI TESTER Deluxe pocket size precision moving coil instrument, Jewelled bearings - 2000 o.p.v. mirrored scale.

11 instant range measures: DC volts 10, 50, 250, 1000, AC volts 10, 50, 250, 1000, DC amps 0 — 100 mA.

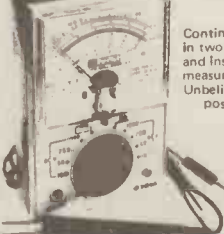

Continuity and resistance 0 - 1 meg ohms in two ranges. Complete with test leads and instruction book showing how to measure capacity and inductance as well. Unbelievable value at only **£6.75 + 60p post and Insurance**.

FREE Amps range kit to enable you to read DC current from 0 - 10 amps, directly on the 0 - 10 scale. It's free if you purchase quickly, but if you already own a Mini-Tester and would like one, send **£2.50**.

## J. BULL (Electrical) Ltd.

(Dept. HE), 34 - 36 AMERICA LANE, HAYWARDS HEATH, SUSSEX RH16 3QU. Established 30 YEARS

MAIL ORDER TERMS: Cash, P.O. or cheque with order. Orders under £12 add 60p service charge. Monthly account orders accepted from schools and public companies. Access & B/card orders accepted day or night. Haywards Heath (0444) 454563. Bulk orders: phone for quote. Shop open 9.00 — 5.30, Mon to Fri, not Saturday.

## EXTRACTOR FANS — MAINS OPERATED

- Woods extractor.  
5" — **£5.75, Post £1.25**.  
6" — **£6.95, Post £1.25**.  
5" Planair extractor **£6.50, Post £1.25**.  
4"x 4" Muffin 115v. **£4.50, Post 75p**.  
4"x 4" Muffin 230v. **£5.75, Post 75p**.  
All the above ex-computer, those below are unused.  
4" x 4" **£8.50, Post 75p**.  
9" American made **£11.50, post £2.00**.  
Tangential Blower 10x3 air outlet, dual speed **£4.60, Post £1.50**.



## TANGENTIAL BLOW HEATER

by British Solartron, as used in best blow heaters. 2Kw approx 9" wide **£5.95**, 3Kw either 9" or 12" wide (your choice) **£6.95** complete with 'cold' half and 'full' heat switch, safety cut out and connection dlg. Please add post **£1.50** for 1 or **£2.30** for two.



2.5 Kw KIT still available: **£4.95 + £1.50 post.**

**BLEEP TONE** These work off 12v and are an unusual and pleasant bleep 69p each.

**CONNECTING WIRE PACK** 48 lengths of connecting wire, each 1 metre long and differently colour coded, a must for those difficult interconnecting jobs. 85p the lot.

**GPO PLUG & SOCKET** Ideal for connecting extension telephone, Prestel and similar equipment. Socket fits onto skirting. **£3.45 per pair**.

**RED LEDS** 10 for 69p. 100 for **£5.75**. 1000 for **£52**.

**IN LINE SIMMERSTAT** Ideal heat controller for soldering iron and many other hand-held appliances. **£2.30**. 10 for **£17.25**.



### VENNER TIME SWITCH

Mains operated with 20 amp switch, one on and one off per 24 hrs, repeats daily automatically correcting for the lengthening or shortening day. An expensive time switch but you can have it for only **£2.95**. These are without case but we can supply a plastic case — **£1.75**.

Also available is adaptor kit to convert this into a normal 24 hr. time switch but with the added advantage of up to 12 on/off's per 24 hrs. This makes an ideal controller for the immersion heater. Price of adaptor kit is **£2.30**.

### IONISER KIT

Refresh your home, office, shop, work room, etc. with a negative ION generator. Makes you feel better and work harder — a complete mains operated kit, case included. **£11.95 plus £2.00 post.**

## OTHER POPULAR PROJECTS

- Short Wave Set — covers all the short wave bands using plug-in coils. Kit complete **£14.50**
- R C Bridge Kit **£9.95**
- 3 Channel Sound to Light — with fully prepared metal case. **£14.95**  
Ditto — made up **£25.00**
- Big Ear, listen through walls **£9.50**
- Robot controller — receiver/transmitter **£9.50**
- Ignition kit — helps starting, saves petrol, improves performance **£13.95**
- Silent sentinel Ultra Sonic Transmitter and receiver **£9.50**
- Car Light 'left on' alarm **£3.50**
- Secret switch — fools friends and enemies alike **£1.95**
- 3 — 30v Variable Power Supply **£13.80**
- 2 Short & Medium wave Crystal Radio **£3.99**
- 3v to 16v Mains Power Supply Kit **£1.95**
- Light Chaser — three modes **£17.50**
- Mullard Uniflex HiFi stereo amplifier with speakers **£16.75**
- Radio stethoscope — fault finding aid **£4.80**
- Mug stop — emits piercing squawk **£2.50**
- Morse Trainer — complete with key **£2.99**
- Drill control kit **£3.95**
- Drill control kit — made up **£6.95**
- Interrupted beam kit **£2.50**
- Transmitter surveillance kit **£2.30**
- Radio Mike **£6.90**
- FM receiver kit — for surveillance or normal FM **£3.50**
- Seat Belt reminder **£3.00**
- Car Starter Charger Kit **£15.50**
- Soil heater for plants and seeds **£16.50**
- Insulation Tester — electronic megger **£7.95**
- Battery shaver or fluorescent from 12v **£6.90**
- Matchbox Radio — receives Medium Wave **£2.95**
- Mixer Pre-amp — disco special with case **£16.00**
- Aerial Rotator — mains operated **£29.50**
- Aerial direction indicator **£5.50**
- 40 watt amp — hifi 20hz — 20kHz **£9.50**
- Microvolt multiplier — measure very low currents with ordinary multimeter **£3.95**
- Pure Sine Wave Generator **£5.75**
- Linear Power output meter **£11.50**
- 115 Watt Amplifier 5Hz 25KHz **£13.50**
- Power supply for one or two 115 watt amps **£17.50**
- Stereo Bass Booster, most items **£8.95**

# A ZENER DIODE PRIMER

Tony Bailey G3WPO

## A to Z on the subject of voltage stabilising diodes.

THOSE WHO ADMIT to being around for a few years, may remember the days when stabilised voltages of any highish value were dependent on that healthy purple glow which emanated from the vacuum tube stabiliser, such as the VR90/105/150 series. As with many vacuum tubes, they were not particularly reliable, consumed lots of wasted power, generating lots of heat as a result, and were quite large. Today, the evolution of the semiconductor replacement now enables voltages in excess of 200V to be stabilised with one diode, obtainable in power ratings from a few hundred milliwatts in small glass encapsulated devices, to 50 watts in stud mounted versions.

The purpose of this article is to run through the basic facts concerning the Zener diode, mainly for the benefit of those unfamiliar with them, using the minimum maths possible.

### Basics

How do you design your Zener circuits? Shove in a suitable value of diode, with a few hundred ohms in series and hope for the best? Or do you get out the calculator and actually do some maths? For any sort of reliable results you need the latter approach, and it isn't difficult if attacked from first principles.

The discovery of the this diode phenomenon fell to Dr. Carl Zener, who found that, beside the ability of the diode to rectify, it could also stabilise a low voltage if biased correctly. As you are no doubt aware, an ordinary rectifier diode

## Beasties



such as the 1N4001, if forward biased to ground (Figure 1a), will have the ability to maintain a stabilised voltage of around 700mV, for a current variation from a few milliamps to 1 amp or more. This is not unfortunately of much practical use in power supplies, as a large number of diodes in series would be required to achieve any worthwhile voltage. However, this characteristic can be used to limit the voltage on a line to 0V7 maximum, or more if several are used in series. RF users will be familiar with this technique.

### Reverse Biased Diodes

If a diode is connected so that it is reverse biased, with the current drawn limited by a suitable value of resistor in series (Figure 1b), and the voltage is

slowly increased from zero, a point will be reached at which the voltage stabilises and does not increase further (Figure 2). This voltage at which the diode stabilises, or conducts, is known by a number of terms — reverse breakdown voltage, avalanche voltage, knee voltage, all refer to the same thing.

The true Zener effect only occurs at voltages up to about 5V, above this the control is by avalanche breakdown, but the terms tend to be mixed in practice. Again, a simple diode does exhibit a reverse breakdown voltage, and it is possible to use these as Zener diodes. The problems arising from the fact that they have not been specifically designed as avalanche diodes are that the actual stabilised voltage can vary between any two samples of the same diode by a factor of two or more, and the effect of

temperature on the stabilised voltage is more than would be expected from a diode designed for the purpose. Also, the current which can be drawn from the stabilised circuit is severely limited by the current which can be allowed to be drawn by the diode itself, in the range of only a few milliamps. However, in the absence of a suitable Zener diode, the spares box could yield suitable diodes to get you out of a jam.

## The Series Resistor

In the diagram of reverse voltage versus reverse current (Figure 2), you will see that as the voltage increases from zero, the current rises slowly at first until the knee voltage is reached, and then suddenly soars upwards. Without any means of limiting the current taken by the diode, the device will self-destruct fairly soon, and hence a series limiting resistor is required to maintain the current within a safe boundary.

In designing a simple Zener regulated power supply, we will assume that the initial supply voltage is higher than that of the stabilised voltage required (otherwise the diode cannot be provided with a working current), and that both the input voltage and the current drawn by the load only vary a little: possibly an oscillator circuit.

The usual minimum diode current for correct regulation is normally between 5 and 10mA, and the maximum will be limited by the stated maximum dissipation of the Zener diode. A typical BZY88 series device is rated at 400mW, so for the purposes of illustration, let us assume that our unregulated voltage is nominally 20V, and that we wish to stabilise this to 8V. Also, that the current drawn by the load is around 15mA (Figure 1c). Firstly, a suitable value of diode has to be selected, and these come in similar steps to resistors, the E12 series being the easiest to find, so the nearest that can be used will be 8V2. All Zener diodes have tolerances, often plus or minus 5%, so in this case you would expect your output voltage to be within 0V4 of the nominal figure.

We will allow a nominal 10mA to pass through the actual Zener diode as its minimum current, and hence the total current drawn by the circuit will be 25mA (Zener current plus load current). So we need to drop the difference between the supply voltage (20V) and the regulated voltage (8V2) across our series resistor. To maintain the current, Ohms Law comes to the rescue for the value of the resistor:

$$R = \frac{\text{Source voltage} - \text{regulated voltage}}{\text{Load current} + \text{Zener current}}$$

$$= \frac{20 - 8V2}{.015 + .010}$$

$$= 472 \text{ ohms}$$

We we have defined our load as stable and supply voltage as reasonably stable, the power dissipated by the diode will be 8V2 at 10mA or 82mW, which is within the diode's rating.

## Varying Loads

The problems start to come when the

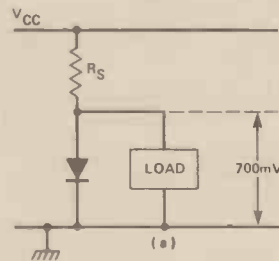

Figure 1a. Forward biased diode regulator.

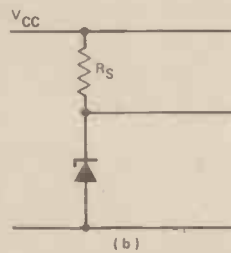

Figure 1b. Basic reverse biased Zener regulator.

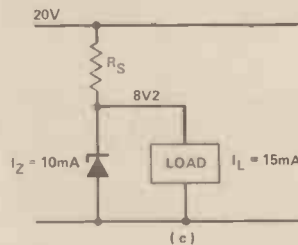

Figure 1c. Example Values.

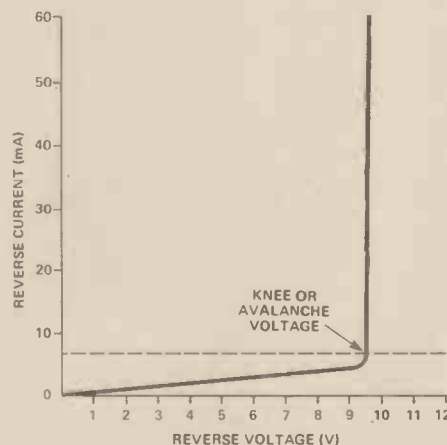

Figure 2. Graph of reverse current vs. reverse voltage for a Zener.

current taken by the load varies, as the resistor value then has to be such that it will limit the current taken by the diode to a safe value under all conditions, possibly even if the load is open circuit, leaving all the current passing through the diode. The only way here, is to do the calculations and see what happens.

If the load in question is no longer stable, but varies between say 15 and 45mA, then the value of the resistor should first be calculated at the maximum load current, to ensure that the 10mA Zener current is still available. Dropping the new figures into the formula gives an answer of 204

ohms — in practice we would pick the next lowest resistor value at 180 ohms. The next problem to face is what happens to the Zener when the load current drops to 15mA.

The voltage drop across the 180 ohm resistor is still 11V2, so the current passing is  $11V2/180R = 62mA$ . Of this, 15mA is drawn by the load, so the rest is passed by the diode, or 47mA, which at 8V2 represents 384mW — just inside the maximum dissipation. For long life, and reduced heating of the junction, we would need to pick a higher rated Zener of at least 1W, or preferably higher. Don't forget that the series resistor is also dissipating heat, in this case  $11V2$  at 62mA = 694mW, so don't use a  $1/4W$  resistor! If you want, you can now work out what happens when the load fails to draw any current at all.

## Varying Input Voltages

More problems arise when the unregulated input voltage varies, with possibly the load current also varying. If the input voltage is only just a little above the Zener stabilising voltage, it may not be possible to design a suitable circuit which will maintain sufficient voltage differential across the series resistor under varying load conditions to ensure stabilisation at all times.

The same calculations as before apply when the load current and input voltage both vary. Take the previous case of a load current varying between 15 and 45mA, but additionally the input voltage also varying between 15V and 25V. The formula for the series resistor will now use the minimum voltage input, again so that the minimum Zener current is maintained at maximum load current. The calculation now becomes:

$$\frac{\text{Min. output voltage} - \text{Zener voltage}}{\text{Max. load current} + \text{Zener current}}$$

$$= \frac{15 - 8V2}{.045 + .010}$$

$$= 124 \text{ ohms, or use } 120 \text{ ohms}$$

Continuing as before, maximum current passed by the 120R resistor is  $25 - 8.2/120 = 140mA$ . Minimum load current is 15mA so the maximum Zener current is 125mA, or equivalent to 1W025 dissipation. In this case we would have to move up to an even higher rated diode of at least 5W rating, or reduce the variation in the maximum load current drawn, or maximum excursion of the input voltage.

It should already be apparent that as variations in load current and input voltage increase, the efficiency of the Zener stabiliser becomes less, with much of the power drawn being lost as heat. The series resistor in the last example would not be dissipating just under 2W5 maximum.

## Regulation

Throughout the above, we have ignored the effect of the varying load current through the Zener on the value of the stabilised output voltage. There are no real problems when the input voltage and load current are stable, but as you might expect, varying the current

## A Zener Diode Primer

through the Zener will have some effect on the voltage stabilisation. The question is, how much?

Figure 3 shows an actual plot of a nominal 8V2 Zener diode output voltage, against the current drawn by the diode. If you remember our example where the load current varied from 15 to 45mA, the actual Zener current varied from 47 to 10mA as a result. Looking at the graph shows that the output voltage will vary by 200mV. Depending on the circuit, this may or may not be acceptable, representing a variation of plus or minus 2%. This variation in output voltage is caused by the effective resistance of the diode, or its output impedance, changing as the current varies through it — hence the voltage drop across the diode varies. This variation is lowest, and will therefore give the best regulation, for diodes with nominal voltages around the 6V8 region.

You will observe from the graph that as the current increases, the voltage output also increases, fairly rapidly at first, but then levels off somewhat. A way of improving the stability of the output with varying load current is to allow the diode to take higher current at all times, moving the variations to the flatter part of the curve, in the example shown this could improve the regulation to about 1%. The penalties are more power dissipation in the series resistor, and if an inadequately rated diode is used, more heating of its junction.

### Thermal Effects

As the junction temperature varies with load, some drift in the output voltage will be experienced. This is not so serious as the effects of load current itself, and depending on the diode, will be of the order of .01 to .1% per degree C of the nominal Zener voltage. Also, the direction of the drift varies with the zener nominal voltages. Below about 6V it is a negative coefficient, and above, positive. Nevertheless, in the case of a Zener stabilised supply feeding an oscillator, where the load current is stable, the effects of temperature need to be minimised, as for the oscillator circuit proper.

You will have noticed that the temperature coefficient is lowest at around 6V, for the same reason that regulation is best at around this voltage and the choice of a 6V2 or 6V8 Zener will provide the lowest drift. As Zeners can be cascaded quite happily (and do not need any form of voltage equalisation across them) a nominal 12V stabilised line would be better off using two 6V2 diodes in series, rather than a single 12V diode.

Another useful fact is that a normal rectifier diode when forward biased exhibits a negative temperature coefficient. This can be useful to counteract the positive coefficient of Zeners above 6V, by inserting one or more forward biased diodes in series with the reverse biased Zener diode. Also, a non standard value of stabilised voltage can be achieved by using additional rectifier diodes to bump up the Zener voltage in 0V7 increments. 1N4148s are often used for this

purpose, however, watch out that they can handle the likely current excursions through the diode chain.

### Reference Diodes

A special class of Zener diodes are those which have actually had additional forward biased diodes built in during manufacture. These very low temperature drift diodes are known as reference diodes, and are very useful as precision voltage references only — you should not take any power directly from the device. Such a diode is normally fed from a constant current, or high impedance source, at only a few milliamps of bias current.

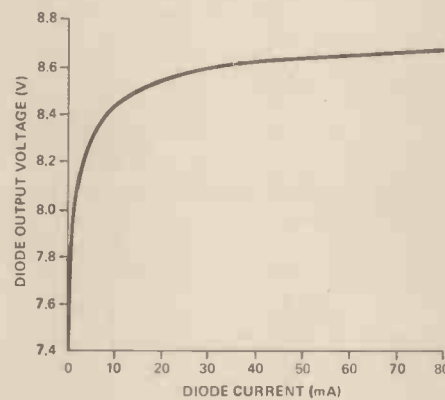

Figure 3. Typical current/voltage curve for a 400mW 8V2 Zener diode.

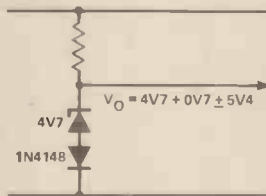

Figure 4. Increasing Zener voltage by 0V6/0V7. Also a temperature stabilising technique.

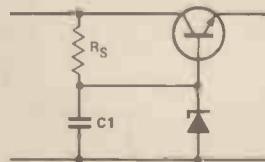

Figure 5. Using a Zener as a reference diode, allowing the transistor to pass the majority of the current. C1 can be added to improve ripple characteristics.

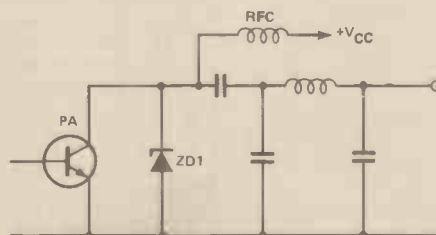

Figure 6. Protecting PA transistor against overvoltage, parasitic oscillations etc. ZD1 is chosen to suit circuit conditions.

A typical example is the 1N821, which is a nominal 6V2 plus or minus 5%, with a temperature coefficient of .01% per degree C. Or the 1N8127, having a similar voltage but improved temperature coefficient of .001% per degree C. Both require around 8mA of bias current. The 1N3499 at the same voltage will maintain stabilisation to within .0005% per degree C.

### Improving The Regulation

You should now be aware of some of the limitations of the Zener diode as a source of regulated volts, and can see that the best results for the least effort occur when the load current is not more than about 100mA, preferably less, and the source voltage/load current are reasonably stable, or the load voltage regulation is not very critical. If greater currents are required, the better way is to use a Zener as a reference at low current, with the majority of the current passing through an additional series pass transistor (Figure 5). Several advantages accrue from this technique — the output ripple is lower, and as the load resistance seen by the Zener is increased by a factor of Hfe (current gain) of the pass transistor, the regulation is improved by a similar factor.

There are a number of limitations of this circuit, but as we are concerned with Zener diodes, and these latest limitations are really the subject of power supply design, we will not discuss this further.

### Other Uses Of Zener Diodes

Besides their obvious use already described, Zeners lend themselves to a number of other applications. One which you may already be aware of is not to limit the maximum voltage on a line to some predetermined safe value. Placing a high current rated 15V Zener diode across the power leads to a mobile rig will safeguard the rig — if the voltage exceeds 15V, the Zener will conduct and blow the protective fuse, or if the overvoltage is transient in nature, at least limit it to 15V for the duration of the transient.

Stabilisation of valve heater supplies is another application which can easily be undertaken using a combination of a 5V6 zener and one silicon diode to bring the voltage up to 6V3.

Transistor PA stages are susceptible to damage if the peak collector voltage exceeds the ratings for the device. This can occur if the load inadvertently goes open circuit, or parasitic oscillations occur. The addition of a Zener diode between collector and chassis with a rating sufficient to protect the device under such circumstances would be a sensible addition.

At audio frequencies, Zeners can be used in the back to back configuration to clip AF waveforms at some predetermined value. Bear in mind that the clipping voltage of either the +ve or -ve cycle of the waveform will be that of one Zener's nominal voltage PLUS 0V7 (as one diode is forward, and the other reverse, biased).

HE

# HENRY'S AUDIO ELECTRONICS

COMPUTERS • COMMUNICATIONS • TEST EQUIPMENT • COMPONENTS

VISIT OR PHONE • OPEN 6 DAYS A WEEK • ALL PRICES INC VAT

## THERMAL MATRIX & LINE PRINTER

NEARLY 1/2 PRICE

COMPLETE WITH FULL HANDBOOK 3 ROLLS PAPER  
**£99.95** INC VAT  
 £86.91 - VAT, (UK post etc £1.05) (List approx £187)  
 150 to 180 LPM • Full 96 CH ASC II • 40 CPL • 280 Dots P/L  
 Auto-underline • 50 Graphic Symbols • Back Space • Self  
 Test • VU/HOR TABS • 7 x 10 Matrix • 4.4" Wide Paper  
 Bidirectional • 220/240 V AC • Size Approx 9.8 x 2.8 x 7.2"  
 SUITABLE FOR: TANDY • BBC • ORIC • NASCOM • GEMINI •  
 ACORN • NEW BRAIN • ORAGON • etc. etc.  
 (Your enquiries invited).  
 (Interface unit with leads £15 - state model).

## 'CHERRY' ADD-ON KEYPAD

A compact 16 button keypad suitable for use with cherry keyboard to extend its functions. Supplied brand new with data. A 4 x 4 non-encoded single mode keyboard.  
**£5.95** (inc. V.A.T.)  
 UK C/P Free

## SANYO DM21 12 HIGH RESOLUTION MONITOR

12" green display.  
 Composite video.  
 1280 characters.  
 Over 15 MHz B/W.  
 240V AC 34 w.  
 16" x 11 1/2" x 12 1/2".  
 Alphanumeric and  
 Graphic display. Usually **£89.95 - £99.95**  
**£69.95** (incl. VAT)  
 (UK C/P & Ins £2.05)

## I.T.T. 2020 CABINET

Complete PROFES-  
 SIONAL Case  
 beautifully constructed  
 with cut out for one  
 'CHERRY' keyboard, plus  
 ample room to house a COMPLETE SYSTEM and power  
 supply. Complete with fittings. (Case top detachable). Unit is  
 silver-grey in colour. Robust construction. Sloping front  
 with side ventilation. Ideal for NASCOM, ACORN, TANGENTINE  
 or your own system. Size 18" x 15 1/2" x 4 1/2". (front sloped)  
**£27.50** (inc. VAT) (UK C/P £2.50)

## LOGIC PROBES

LP10 10 MHZ **£26.95**  
 LP50 50 MHZ with carry case and  
 accessories **£49.95**

## HIGH VOLTAGE METER

Direct reading 0/40 KV.  
 20K/Volt. **£23.00** (UK C/P 65p)

## DIGITAL CAPACITANCE METER (UK C/P 65p)

0.1 pf to 2000 mfd LCD 8 ranges  
 DM6D13 **£52.75**

## TRANSISTOR TESTER

Direct reading PNP, NPN, etc.  
 TC1 **£21.95**  
 (UK C/P 65p)

## VARIABLE POWER SUPPLIES

(UK C/P £1.00)  
 PP241 D/12/24V, D/1A **£35.00**  
 PP243 3 amp version **£59.95**  
 PS1307S 8/15V  
 7 amp twin meter **£24.95**

## FREQUENCY COUNTERS

PFM200A 200 MHz hand held pocket  
 8 digit LED **£77.60**  
 MET100B digit LED bench 2 ranges 100 MHZ **£102.35**  
 MET1600B digit LED bench 3 ranges 600 MHZ **£132.25**  
 MET1000 8 digit LED 3 ranges 1 GHz **£182.85**  
 TF040 8 digit LCD 40 MHz. Thandar **£126.50**  
 TF200 3 digit LCD 200 MHz. Thandar **£166.75**

## DIGITAL MULTIMETERS

■ with case (rotary switches)  
 + Side button - case **£2.95**  
 KD25C ■ 13 range 6.2A DC  
 2 meg ohm **£23.50**  
 KD30S ■ 16 range 10A DC  
 2 meg ohm **£26.95**  
 KD30C ■ 26 range 1A  
 AC/DC 20 meg ohm **£29.50**

KD55C ■ 28 range 10A AC/DC 20 meg ohm **£33.50**  
 Metlex 3000 ■ 30 range 10A AC/DC,  
 20 meg ohm **£33.24**  
 6010 ■ 28 range 10A AC/DC 20 meg ohm **£34.40**  
 7030 4+ AS6010 high acc. 0.1% basic **£41.30**  
 K0615 ■ 16 range 10A DC 2 meg plus  
 Hie tester **£39.95**  
 SIFAM 2200B 21 range 2A AC/DC 20 meg **£29.95**  
 Bench Models  
 TM355 29 range LED 10A AC/DC 20 meg **£86.25**  
 Thandar  
 TM356 26 range LCD 10A AC/DC 20 meg **£97.75**  
 Thandar (Replaces TM353)  
 TM351 29 range LCD 10A AC/DC 20 meg,  
 Thandar **£120.75**  
 SIFAM 2500 24 range LCD 2A AC/DC 20 meg **£79.95**  
 ALSO IN STOCK Thurlby, Metrix and Beckman.  
 Professional series incl. True Rms, etc.

## MULTIMETERS (UK C/P 65p)

CT081 50 K/Volt range doubler, 10A DC,  
 Total 36 ranges, Special Offer **£12.50**  
 HM102BZ 20K/V 10A DC 22  
 range & cont. buzzer **£13.50**  
 TMK500 23 ranges 30K/V,  
 12A DC plus cont. buzzer **£23.95**  
 NM56R 20K/V, 22 range pocket **£10.95**  
 830A 26 range 30K/V, 10A AC/DC overload  
 protection, etc. **£23.95**  
 360TR 23 range 100K/V, Large scale 10A  
 AC/DC plus Hie **£39.95**  
 AT2100 31 range 100K/V deluxe, 12A  
 AC/DC **£33.50**  
 AT1020 18 range 20K/V, Deluxe plus Hie  
 tester **£18.95**  
 YN360TR 19 range 20K/V plus Hie tester **£15.95**

## SIGNAL GENERATORS (220/240V AC)

FUNCTION: All sine/square/triangle/TTL etc.  
 TG100 1HZ-100 KHZ **£90.00**  
 TG101 1HZ-200 KHZ **£113.85**  
 TG102 0.2HZ-2 MHz **£166.75**  
 PULSE  
 TG105 Various facilities 5 HZ-5 MHZ **£97.75**  
 AUDIO: Multiband Sine/Square  
 LA627 10HZ to 1 MHZ **£90.85**  
 AG202A 20 HZ to 200 KHZ (list £94.50) **£83.50**  
 LA6 120A 10 HZ-1MHZ Low Distortion **£159.85**  
 RF  
 SG402 100 KHZ to 30 MHZ (list £79.50) **£69.50**  
 LSG17 100 KHZ to 150 MHZ **£79.35**

## OSCILLOSCOPES

Full specification any model  
 on request, SAE by post.  
 'HM' Series HAMEG: 'SC'  
 THANDAR: 'CS' TRIO:  
 '3' CROTECH 'V' HITACHI  
 SINGLE TRACE UK C/P £3.00  
 3030 15 MHZ 5mv, 95mm tube plus component  
 tester **£177.10**  
 SC110A ■ Miniature 10 MHZ battery portable **£171.00**  
 Post free  
 ■ Optional carry case EG 94 AC adaptor EG 59  
 Nicads £12.50  
 HM103 15 MHZ 2mv, 6 x 7 display plus  
 component tester C/P £3.00 **£181.70**  
 DUAL TRACE (UK C/P £4.00)  
 HM203/4 Dual 20 MHZ plus component  
 tester **£303.60**  
 CS1562A Dual 10 MHZ (list £321.00) **£269.50**  
 3131 Dual 15 MHZ + component tester **£276.00**  
 CS1566A Dual 20 MHZ All facilities (list £401.35) **£349.50**  
 HM204 Dual 20 MHZ plus component tester  
 sweep delay **£419.75**  
 HM705 Dual 70 MHZ sweep delay **£676.00**  
 V212 Dual 20 MHZ **£399.25**  
 V222 Dual 20 MHZ plus extra facilities **£391.00**  
 V222 Dual 40 MHZ portable **£586.50**  
 V203F Dual Trace 20 MHZ sweep delay **£408.25**  
 VT34 Dual Trace 10 MHZ storage **£1092.50**

## OPTIONAL PROBE KITS

X1 **£7.95** X10 **£9.45** X1 - X10 **£10.50**

# SECURITY Build your own system and SAVE POUNDS!

## DIGITAL ULTRASONIC DETECTOR US 5063



● 3 levels of discrimination against false alarms  
 ● Crystal control for greater stability  
 ● Adjustable range up to 25ft.  
 ● Built-in delays  
 ● 12V operation  
 This advanced new module uses digital signal processing to provide the highest level of sensitivity whilst discriminating against potential false alarm conditions. The module has a built-in exit delay and timed alarm period, together with a selectable entrance delay, plus many more outstanding features. This advanced new module is available at  
**only £13.95 + V.A.T.**

## ULTRASONIC MODULE US 4012



● Adjustable range from 5-25ft.  
 This popular low cost ultrasonic detector is already used in a wide range of applications from intruder detectors to automatic light switches and door opening equipment, featuring 2 LED indicators for ease of setting up, the unit represents outstanding value at  
**£10.95 + V.A.T.**

## INFRA-RED SYSTEM IR 1470



Consisting of separate transmitter and receiver both of which are housed in attractive moulded cases, the system provides an invisible modulated beam over distances of up to 50ft, operating a relay when the beam is broken. Intended for use in security systems, but also ideal for photographic and measurement applications, the system is available at  
**only £25.61 + V.A.T.** Size 80 by 50 by 35mm.

## POWER SUPPLY & RELAY UNIT PS 4012

Provides stabilised 12V output at 85mA and contains a relay with 3 amp contacts. The unit is designed to operate with up to 2 ultrasonic units or 1 infra-red unit IR 1470. Price **£4.25 + V.A.T.**

## SIREN MODULE SL 157

Produces a loud penetrating sliding tone which, when coupled to a suitable horn speaker, produces S.P.L.'s of 110db at 2 metres. Operating from 9-15V, the module contains an inhibit facility for use in 'break to activate' circuits. Price **£2.95 + V.A.T.**

## 5 1/2" HORN SPEAKER HS 588

This weather-proof horn speaker provides extremely high sound pressure levels (110db at 2 metres) when used with the CA 1250, PS 1865 or SL 157. Price **£4.95 + V.A.T.**

## 3-POS. KEY SWITCH 3901

Single pole, 3-pos. key switch intended for use with the CA 1250. Price **£3.43 + V.A.T.**

All modules are supplied with comprehensive instructions. Units on demonstration. Shop hours 9.00-5.30 p.m. Wed. 9.00-1.00 p.m. SAE with all enquiries.

## ALARM CONTROL UNIT CA 1250



The heart of any alarm system is the control unit. The CA 1250 offers every possible feature that is likely to be required when constructing a system whether a highly sophisticated installation, or simply controlling a single magnetic switch on the front door.  
 ● Built-in electronic siren drives 2 loudspeakers  
 ● Provides exit and entrance delays together with fixed alarm time  
 ● Battery back-up with trickle charging facility  
 ● Operates with magnetic switches, pressure pads, ultrasonic or I.R. units  
 ● Anti-tamper and panic facility  
 ● Stabilised output voltage  
 ● 2 operating modes - full alarm/anti-tamper and panic facility  
 ● Screw connections for ease of installation  
 ● Separate relay contacts for switching external loads  
 ● Test loop facility

Price **£19.95 + V.A.T.**

## SIREN & POWER SUPPLY MODULE PSL 1865



A complete siren and power supply module which is capable of providing sound levels of 110db at 2 metres when used with a horn speaker. In addition, the unit provides a stabilised 12V output up to 100mA. A switching relay is also included so that the unit may be used in conjunction with the US 5063 or US 4012 to form a complete alarm.  
 Price **£9.95 + V.A.T.**

## HARDWARE KIT HW 1250



only **£9.50** + V.A.T.  
 This attractive case is designed to house the control unit CA 1250, together with the appropriate LED indicators and key switch. Supplied with the necessary mounting pillars and punched front panel, the unit is given a professional appearance by an adhesive silk screened label. Size 200 by 180 by 70mm

## HARDWARE KIT HW 5063

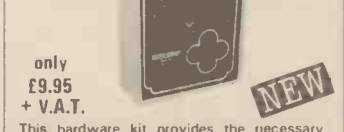

only **£9.95** + V.A.T.  
 This hardware kit provides the necessary enclosure for a complete self-contained alarm system which comprises the US 5063, PS 1865, loud speaker type 305 and key switch 3200. Attractively styled, the unit when completed, provides an effective warning system without installation problems.

## ULTRASONIC MODULE ENCLOSURE

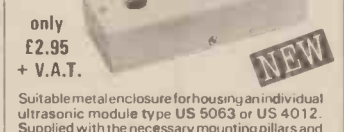

only **£2.95** + V.A.T.  
 Suitable metal enclosure for housing an individual ultrasonic module type US 5063 or US 4012. Supplied with the necessary mounting pillars and screws etc. For US 5063 order SC 5063; for US 4012 order SC 4012.

## RISCOMP LIMITED

Dept. HE7  
 21 Duke Street,  
 Princes Risborough,  
 Bucks. HP17 0AT  
 Princes Risborough (084 44) 6326

Add 15% VAT to all prices.  
 Add 50p post & packing to all orders.  
 Order by telephone or post  
 using  
 your credit card.



# POINTS OF VIEW

Feel like sounding off?  
Then write to the Editor stating your Point of View!

## Chasing A Career

Dear Sir/Madam,  
Having just read your article on Careers In Electronics which I do so enjoy I would like to know more about this field of work. So if it would be possible for you to let me have any information regarding a career as a transmitter engineer as you covered in your August edition, I would be more than grateful.

Your faithfully,  
K. Henry,  
Lytham,  
Lancs.

This is an easy one: just write to the addresses we put at the bottom of the article. What I think we publish them for, ay? But seriously, we do try to include some kind of contact address with Careers In Electronics, but where this isn't possible or appropriate, there are other sources: most local authorities have some kind of careers office for school leavers; local and central libraries have trade periodicals with jobs advertised: if you see something you fancy, it is worth writing to the firm for information on the kinds of jobs they offer, even if you are not applying for a job at the time — get careers brochures from several big companies to build up a picture of the whole employment field in your chosen area; some trades have trade organisations or institutes which will hand out information. But transmitters is not difficult; there are only two authorities dealing with transmitters. Write and ask them for their careers brochures.

## Components Conflicts (And Resolutions)

Dear Sir,  
A recent phenomenon of the recession has been the number of trade suppliers who have turned to the amateur market as a means of widening their outlets. One welcomes them but hopes they realise that the amateur should be taken seriously. There are those who regard us as useful repositories for surplus stock and the lowest grades of usable devices.

Projects are expensive. Costs have to be watched. Advertised prices can be misleading, as postage (both ways) and VAT can increase costs by a surprising amount. "Shopping around" is not feasible. The best strategy is to buy project components from a single source, if possible. (That

single source may be the supplier who can supply whatever esoteric IC the designer has unearthed from the back of the RS Components' catalogue — a source unavailable to his readers!) If that supplier offers good prices for any useful component, it makes sense to order a stock at the same time. To be cost-effective though, this practice should be rigorously restricted to the most-used items. Best to avoid those bargain opto devices and unmarked transistors that may never be used.

It follows that the best suppliers are those who hold a comprehensive stock and can fulfil all needs in a single order — right down to screws and solder. Maplin set the standard with their prepaid envelopes, VAT-inclusive prices and modest postal charge, but not even they are perfect (99p for a CA3140?). Electrovalue maintain a smaller, but useful, range, and their postal charge is only 40p, VAT included. Marco Trading give prepaid envelopes and a fast, courteous service. However, their range is rather restricted and as with many otherwise excellent suppliers, this prevents them from receiving regular orders from cost-conscious amateurs like me.

We do not need more suppliers who think that amateurs can be served in an amateurish way. They may tempt us with 2N3055s at 35p each (plus a 12½p stamp, 50p postage and VAT, that's £1.10 please) but without a decent range of components in support the temptation can be dismissed.  
Yours faithfully,  
R. Leach,  
Hurst Hill,  
West Midlands.

Dear Sir,  
Ultrasonic Intruder Alarm, HE October '83

On your recommendation, I sent a component list to Maplin and their invoice is enclosed herewith.

You will see that certain small items are not supplied under their Code D system.

I must tell you that this is a most annoying practice which leaves the hobby constructor in a very frustrated position.

I now have to travel twenty miles to a small shop in the hope that they can oblige. I wonder how many more of your readers will be caught out by this Maplin nonsense.

Also, without explanation they failed to supply the ceramic resonator. I hope you decide to inform this firm

that you will not recommend them to people like me in the future if we cannot rely on getting an order 100% if the items are in stock. In view of the publicity you give them don't you think they should now send me the deficient items?

Yours sincerely,  
E. P. Leahy,  
Widnes,  
Cheshire.

Two rather different angles on the question of component supply here. As Maplin are on the receiving end of Mr. Leahy's criticism, I'll look at that first and work backwards, as I know from the number of letters we receive that the quest for the ideal supplier is a continual and controversial one.

We did recommend, in Buylines, that readers wanting components for the Ultrasonic Intruder Alarm should try "one of the larger mail order component suppliers, such as Maplin Electronics." In the past, HE has occasionally arranged with a certain supplier to provide components against a full Parts List of a given project, but this is always made perfectly clear in Buylines, and was not the case for this project.

As their own Stock Numbers were not supplied with the Parts List, Maplin's order department had to identify thirty-two separate parts from their catalogue — they succeeded in identifying thirty-one and the thirty-second one was the missing ceramic resonator.

"Code D" (which should be explained on the invoice) means that the item has been out of stock for some time and is likely to be out of stock for some time to come. This practice frees the buyer to find his components elsewhere instead of waiting, perhaps weeks (and there is a world shortage of components at present) for the missing parts. Credit card and trade orders are not charged for the missing items, and prepaid customers are refunded for the missing items.

To be fair, the chances of getting 100% of requirements from one supplier at one time are very small, especially at present, and in the circumstances the best the supplier can do is let the customer know where he stands.

Finally, if readers arm themselves with the phone numbers of their local/favourite suppliers, or more than one, they won't find themselves making long, fruitless trips in search of components. Most suppliers are in the telephone Yellow Pages. Also,



many small suppliers will be happy to arrange a mail order deal over the phone with a regular customer, even if they don't normally advertise mail order.

I think Maplin came out of that one rather well, don't you?

While a big firm like Maplin can offer computerised efficiency most of the time (it only took them five minutes to trace Mr. Leahy's original order out of thousands) their small-order prices will often be much higher than those from smaller, local suppliers. **RS Components**, for instance attain their legendary levels of efficiency (overnight delivery) by the simple ploy of *not* supplying non-trade customers!

This is where it pays the amateur to cultivate local supplies (by mail order and otherwise) and to shop around for prices. Advertisements must indicate whether prices are inclusive or exclusive of VAT. Many mail-order advertisements include postal charges, but where they do not, a phone call should establish their charges or at least the basis on which they will charge. The phone is a greatly underrated tool, and an investment in time now, crosschecking prices and obtaining a few catalogues, will save time and anguish in the future. On the other hand, attempting to shave the odd penny or so off common resistors is a waste of effort. Try looking for the supplier with the best prices on medium cost popular components, the best turnaround time and the most helpful attitude. A few small experimental purchases of stock components won't go amiss.

And if you are dissatisfied with a suppliers' service, give them a chance to explain by making a courteous complaint, in writing, giving all the details. Most dealers want to know if something is amiss and are quick to rectify it.

In the case of persistently frustrating service, change your supplier.

Mr. Leach's warning about 'bargains' is fair, but, with a practised eye, there are real bargains to be had. A few mistakes will be made in developing that practised eye — try to make cheap mistakes, not costly ones!

It's easy to give the impression that obtaining components is a little like finding a route through the Amazon jungle with only a knife and fork (and no dog), but 99% of parts come home to roost without problems, so be not discouraged.

## A Moral Tale

Dear Sir,  
*This poor little story I do tell,  
 From my wife's grace oh how I fell,  
 For building a circuit one afternoon,  
 Our poor little flat I plunged into gloom.  
 On application of volts the main fuse I did blow,*

*I was then told "Electronics must go!"  
 The reason was clear, but not at the time.  
 The circuit I thought would work real fine.*

*The mains input to the box I thought was right,*

*But unknown to me wasn't tied up tight.  
 The lead I had tugged, but I couldn't see,  
 The leads for the mains were now bare and free.*

*They shorted to earth, thank goodness for me,  
 Or heaven or hell would have got me for tea.*

*My wife wasn't happy as I could see,  
 Cos by heck that pan didn't half hit me.  
 The lump now protrudes from the back of my head,*

*Mind you it's better than being dead!  
 Bind up those things and keep them right,*

*Or heaven will get a hell of a fright.  
 You might not get a second chance!  
 PS. I had wrongly rated the fuse on my 13A plug, the one I used was too big. How about an article on fusing factors, ie. 13A fuse, F/F = 1A5 or is it 1A2?*

*Keep up the excellent work.  
 Eric Olyott,  
 West Glamorgan,  
 Swansea.*

There isn't a lot to say about fuses, just — don't rely on them! As a rule of thumb an old-fashioned re-wireable fuse will blow at around *twice* its rated current, while a standard cartridge fuse may take more than one and a half times the current it's supposed to blow at.

For safety in the workshop, nothing beats an Earth Leakage Circuit Breaker, which will trip at around 30mA fault current, well below lethal level.

Several plug-in types are now easily available, or you could make a project of it and build the design published in the December '82 issue of *Electronics Today International*. That may well cure the lump on your head, if not the lump in our collective throat after reading your tale of woe!

## Designer Missing Again

Confirming his and our worst suspicions about the filing system in this office, we have succeeded in losing Mr. Peter Walton's address again, despite my assurances to him on the phone that it was sitting in the pending tray waiting to be dealt with. It was dealt with, but we know not by whom; probably the cleaners in a hyperactive fit of enthusiasm.

What we wanted to say was: we liked his Selective Caller project but could not run it as we had already arranged to publish a similar project. If he has anything else to offer, we would like to see it. We haven't lost the manuscript, only the address, and if he wants it back, it is here.

Regular readers and contributors will be glad to know that this case is

so far unique, and also that Mr. Giggs of *POV HE* August 83 was successfully passed on to the reader with the Heathkit manual.

Another mission completed.

## Detecting The Detector

Dear Sir,  
 With reference to *HE* September '81, on page 10 you featured the 'Diana' metal detector.

*I am currently building a metal detector in my school technology project. Your metal detector has given me a great deal of help, but a bit more information would be helpful. Please could you give me some more specific information such as the dimensions of it?*

*Also, if it is possible please could you give me the address of any other firms that supply metal detectors?  
 Yours faithfully,  
 Duncan Read,  
 Billericay,  
 Essex.*

I'm afraid that information is, like the original 'Diana', lost in the mists of history. However the designers at Magenta Electronics (whose advertisement and address are elsewhere in this issue) might be able to help you.

Nor do we have these names and addresses on file — why don't you try one of the magazines that specialise in the subject?

## Open-Reel Recorders

Dear Sir,  
*Could you please put me in touch with a manufacturer who could provide equipment such as tape head pre-amps, bias oscillators, headphone amplifier and any electronic equipment associated with open-reel tape recording.*

*In effect, I need to modify a Brenell MkV. Series 2 mono recorder to be capable of recording/playing back not only in conventional stereo but also mono for headphones on the third track and fourth track independently. I already have two sets of R/P and erase stereo heads, and the Brenell deck can carry four heads.*

*Excellent magazine — keep up the good work.  
 Yours sincerely,  
 Michael R. Hanscomb,  
 Trowbridge,  
 Wilts.*

Write to Hart Electronic Kits, Ltd., Oswestry, Shropshire SY10 9BR, and/or Monolith Electronics Co. Ltd., 7 Church St., Crewkeane, Somerset TA18 7HR, for their catalogues of tape heads and recording equipment.

# FORWARD BIAS

Questions, answers and errata from readers and writers.

## The Big Ear Aid (HE December '82)

After considerable investigation beyond the obvious misprints in the circuit diagram and component overlay for this project, a number of changes have been made which will considerably enhance both the possibility of the project actually working, and of the performance of the circuit.

There were two original misprints in the text; first on page 81, the mic input is to the positive (non-inverting) input of IC1a, not the negative input as stated. Second, and again on page 81, the junction of R2, R3 and R6 is bypassed to ground by C5, not C3.

The errors in circuit and overlay diagrams have been corrected in the revised versions on this page.

The main problem readers have had with the project, once the basic errors were sorted out, were of the "it doesn't work properly" type. These sort of complaints, while quite reasonable, are the most difficult to correct, because one can never actually pinpoint specific faults. Therefore, we handed a slightly deaf Big Ear over to our technical department, in Birmingham, who recently returned it to use with the following comments...

"The main difficulty appears to be that the microphone inserts are a bit too noisy for this application; and one in a unit built by a reader simply didn't work at all".

The solution, if your microphone insert is suspect, is to try another from a different source. Inserts are fairly readily available, or a cheap cassette mic could be stripped down

and used for the project.

"Some of the noise level is contributed by the circuit itself. An op-amp with a lower noise level is recommended — the NE5532 is the best option. If the mic input is shorted out, the noise that you hear is all from the circuit, and the level with a 5532 in is half that of with the original IC".

"With all the amplification in the first stage, distortion can occur with a louder than average sound."

The value of R6 has been changed and a resistor added to the circuit, to improve the dynamic range. Also,

owing to the higher bias current drawn by a 5532, the values of R2 and R7 have been changed to prevent differences in bias resistance causing serious input offset voltages.

"One item missing from the original circuit was a de-coupling capacitor across the supply. If this is omitted from a circuit like this, it may turn into an oscillator".

C6, a 100u 16V electrolytic capacitor, has been added to the circuit. "A fine point, this, but carbon resistors tend to generate high noise levels, and metal film or metal oxide

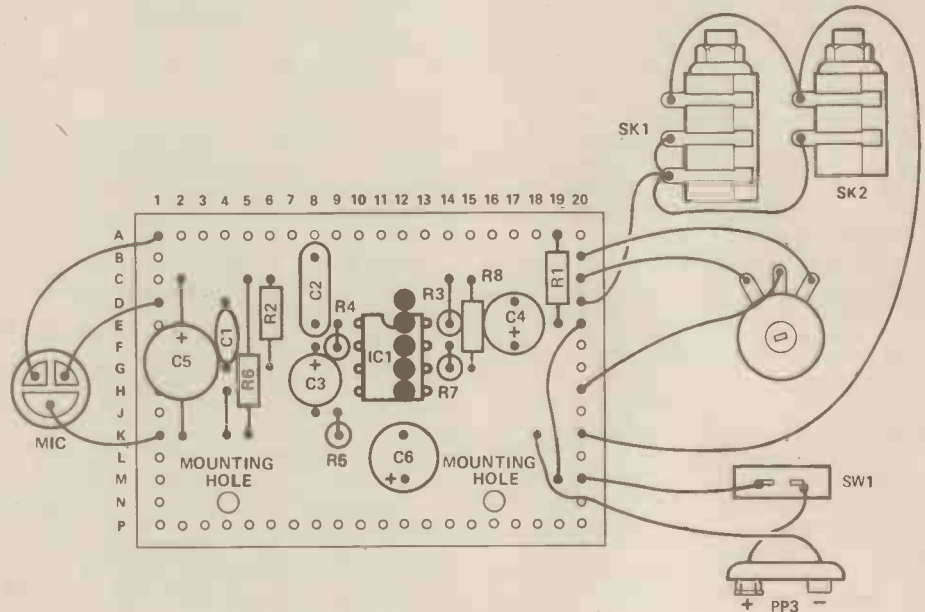

Above: The Veroboard layout of the Big Ear, with corrections and modifications. Below: The circuit.

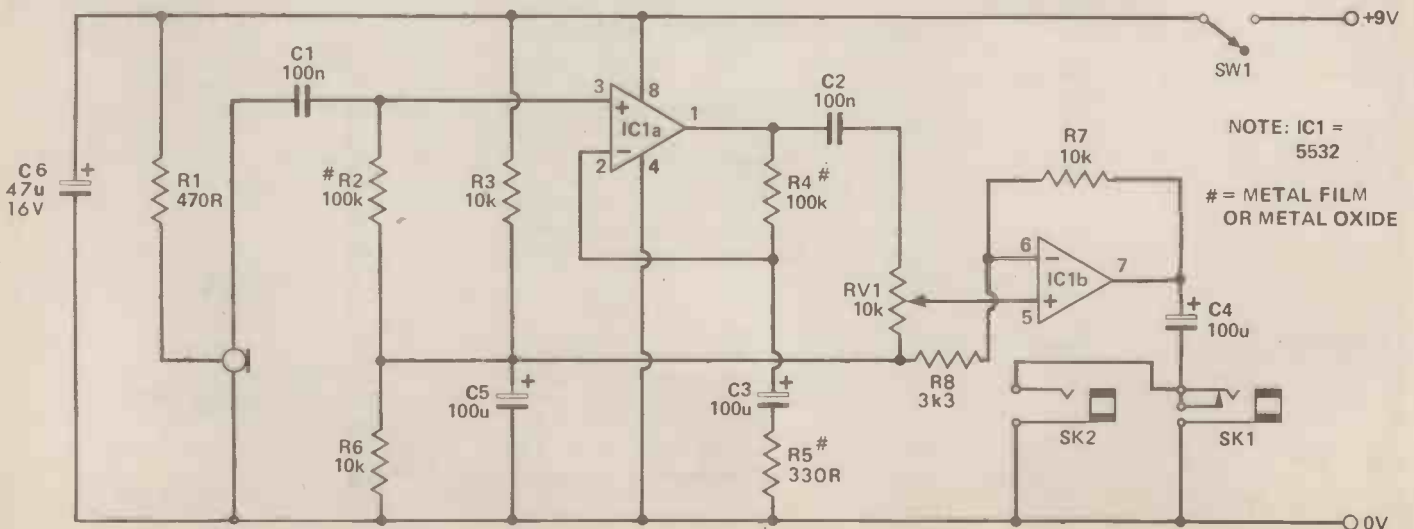

types should be used for preference".

The important resistors have been indicated by an asterisk in the revised circuit. "The microphone is sensitive to light shining on its back — that is to mains hum picked up from artificial lighting — and also to sound from the rear, transmitted through the plastic case".

To prevent mains pickup, the inside of the box should be screened — aluminium foil firmly glued to the

inside should do the trick. The acoustic pickup is harder to prevent, but various tricks, such as isolating the microphone in a rubber grommet, filling the inside of the case with acoustic wadding, and so forth, ought to help.

All the circuit changes mentioned have been made in the revised diagrams shown on this page, and with their aid any reader's Big Ear ought to be restored to full hearing.

### Short Circuits (HE November '83)

Readers who have experimented with the circuit at the bottom of page 58 may have discovered by now that its better suited for checking guitar or speaker leads than for monitoring incoming telephone calls.

On the other hand, the circuit at the bottom of page 59 is that for the Telephone Monitor, not the Lead Tester. Look left, look right, look left . . .

## COLLECTED BOOBS

Continuing excerpts from the Hobby Electronics Errata Box

### Miniboards: 2 Watt Amplifier (HE June '80)

In Figure 1, C4 is shown going to pin 9 of the IC, whereas it should go to pin 11. The component overlay is correct.

### Car Booster (HE July '80)

If your car booster has developed a 1Hz click, put a 2R2 resistor in series with both C7 and C8 (on the earth side) and remove the link from pin 7. Take the speaker connection via a flying lead from pin 7 making sure it is well away from IC1.

### Hazard Flasher (HE July '80)

There is a discrepancy in the positions and values of C1 and 2 between the circuit diagram and the component overlay. The overlay is correct.

In the Parts List, C1 is a 100u 16V tantalum, and C2 is a 10n ceramic.

If TIP146 transistors prove unobtainable, TIP 147s can be used instead.

On the Foil Pattern, the track adjoining IC1 pins 4 and 9 should be broken. The link shown in bottom left of the photo is not necessary.

### Short Circuit: Infra Red Intruder Alarm (HE July '80)

On the Receiver circuit, TIL78 is actually a phototransistor, not an LED. Connect the emitter to ground (OV), the collector to junction of C2 and R1, and the base open.

### Hi Resolution Graphics Board (HE July '83)

In Figure 1, the Sinclair ROM +5V and OV pins are 24 and 12 respectively, not 18 and 9 as shown.

In Figure 3, the Sinclair ROM (IC8) is laterally inverted; pin 1 should be top right.

## FREE GREEN CATALOGUE

SEND SAE TODAY

### HOME LIGHTING KITS

These kits contain all necessary components and full instructions & are designed to replace a standard wall switch and control up to 300w. of lighting

- TDR300K Remote Control Dimmer £14.30
- MK6 Transmitter for above £4.20
- TD300K Touchdimmer £7.00
- TS300K Touchswitch £7.00
- TDEK Extension kit for 2-way switching for TD300K £2.50



### DVM/ULTRA SENSITIVE THERMOMETER KIT

This new design is based on the ICL7126 (a lower power version of the ICL7106 chip) and a 3 1/2 digit liquid crystal display. This kit will form the basis of a digital multi-meter (only a few additional resistors and switches are required—details supplied), or a sensitive digital thermometer (-50°C to +150°C) reading to 0.1°C. The basic kit has a sensitivity of 200mV for a full scale reading, automatic polarity indication and an ultra low power requirement—giving a 2 year typical battery life from a standard 9V PP3 when used 8 hours a day, 7 days a week

Price £15.50



## CHRISTMAS PRESENTS GALORE

**3-NOTE DOOR CHIME**  
Based on the SA80600 IC the kit is supplied with all components, including loudspeaker, printed circuit board, a pre-drilled box (95 x 71 x 35mm) and full instructions. Requires only a PP3 9V battery and push-switch to complete. AN IDEAL PROJECT FOR BEGINNERS. Order as XK102. **£5.00**

**LIGHT DIMMER KIT**  
Contains all components, including front panel and knob, to make a dimmer for lights up to 300W. **£3.50**

**LCD 3 1/2 DIGIT MULTIMETER**  
16 ranges including DC voltage (200 mv-1000 v) and AC voltage, DC current (200 mA-10 A) gain and diode check. Input impedance 10M. Size 155x88x31 mm. Requires PP3 9v battery. Test leads included. **ONLY £29.00**

**MW RADIO KIT**  
Based on ZN414 IC, kit includes PCB, wound aerial and crystal earpiece and all components to make a sensitive miniature radio. Size: 5.5 x 2.7 x 2 cms. Requires PP3 9V battery. **IDEAL FOR BEGINNERS. £5.00**

### BEGINNERS STARTER PACKS

Containing selection of electronic components including transistors, LEDs, diodes, capacitors, ICs etc. together with a descriptive booklet with 10 easy-to-build projects plus a solderless circuit board enabling the components to be re-used. Requires 9V battery. Discreet component pack (no ICs) £5.00 Integrated circuit pack £6.00

### STOCKING FILLERS All full spec. branded devices.

- PACK (1) 650 Resistors 47 ohm to 10Mohm — 10 per value £4.00
- PACK (2) 40 x 16V Electrolytic Capacitors 10µF to 1000µF — 5 per value £3.25
- PACK (3) 60 Polyester Capacitors 0.01 to 1µF/250V — 5 per value £5.55
- PACK (4) 45 Sub-miniature Presets 100 ohm to 1 Mohm — 5 per value £2.90
- PACK (5) 30 Low Profile IC Sockets 8, 14, and 16 pin — 10 of each £2.40
- PACK (6) 25 Red LEDs (5mm dia.) £1.25

## NOW OPEN COMPUTER SHOWROOM

JUPITER ACE · SPECTRUM  
ORIC 1 · BBC (Model B)  
DRAGON 32

### ELECTRONIC LOCK KIT XK101

This KIT contains a purpose designed lock IC, 10-way keyboard, PCBs and all components to construct a Digital Lock, requiring a 4-key sequence to open and providing over 5000 different combinations. The open sequence may be easily changed by means of a pre-wired plug. Size: 7 x 6 x 3 cms. Supply: 5V to 15V d.c. at 40uA. Output: 750mA max. Hundreds of uses for doors and garages, car anti-theft device, electronic equipment, etc. Will drive most relays direct. Full instructions supplied. **ONLY £10.50**

Electric lock mechanisms for use with latch locks and above kit **£13.50**

### DISCO LIGHTING KITS

**DL 1000K**  
This value-for-money kit features a bi-directional sequence, speed of sequence and frequency of direction change, being variable by means of potentiometers and incorporates a master dimming control. **£14.60**

**DL2100K**  
A lower cost version of the above, featuring unidirectional channel sequence with speed variable by means of a pre-set pot. Outputs switched only at mains zero crossing points to reduce radio interference to a minimum. **Only £8.00**

Optional opto input DLA1 Allowing audio ("beat") —light response. **60p**

**DL3000K**  
This 3 channel sound to light kit features zero voltage switching, automatic level control & built in mic. No connections to speaker or amp required. No knobs to adjust — simply connect to mains supply & lamps. (1Kw/Channel) **Only £11.95**

## FAST SERVICE · TOP QUALITY · LOW LOW PRICES

No circuit is complete without a call to —

**TK ELECTRONICS**  
11-13 Boston Road  
London W7 3SJ

Add 65p postage & packing +15% VAT to total Overseas Customers;  
Add £2.50 (Europe), £6.00 (elsewhere) for p&p  
Send S.A.E. for further STOCK DETAILS.  
Goods by return subject to availability

OPEN

9am to 5pm (Mon to Fri)  
10am to 4pm (Sat)

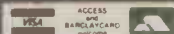

TEL: 01-567 8910 ORDERS  
01-579 9794 ENQUIRIES  
01-579 2842 TECHNICAL AFTER 3PM

ALL PRICES EXCLUDE VAT

electronize

# AUTO-ELECTRONIC PRODUCTS

KITS OR READY BUILT

## TOTAL ENERGY DISCHARGE ELECTRONIC IGNITION



### IS YOUR CAR AS GOOD AS IT COULD BE?

- ★ Is it **EASY TO START** in the cold and the damp? Total Energy Discharge will give the most powerful spark and maintain full output even with a near flat battery.
  - ★ Is it **ECONOMICAL** or does it "go off" between services as the ignition performance deteriorates? Total Energy Discharge gives much more output and maintains it from service to service.
  - ★ Has it **PEAK PERFORMANCE** or is it flat at high and low revs. where the ignition output is marginal? Total Energy Discharge gives a more powerful spark from idle to red line (even with 8 cylinders).
  - ★ Is the **PERFORMANCE** better? The more powerful spark of Total Energy Discharge eliminates the "near misses" whilst an electronic filter that is designed to protect against interference etc.
  - ★ Do the **PLUGS** always foul? Total Energy Discharge eliminates contact arcing and erosion, removing the heat of electrical load. The timing stays spot on and the coil voltage doesn't affect the performance. Interference is kept down and can be easily removed by wet or badly fouled plugs. The timing of this system is perfect.
  - ★ **TOTAL ENERGY DISCHARGE** is a fully featured, the most powerful on the market. It has the power of inductive systems - 3½ times the energy and 10 times the rate of discharge of ordinary capacitive systems. These are the facts:
 

Performance at only 16 volts	—	36mJ
SPARK POWER	—	36mJ
SPARK DURATION	—	135mJ
LOADED OUTPUT VOLTAGE	—	26kV
50pF load	—	38kV, 50pF + 500k
- We challenge any manufacturer to publish better performance figures. Before you buy any other make, ask for the facts, its probably only an inductive system. But if an inductive system is what you really want, we'll still give you a good deal.
- ★ All **ELECTRONIZE** electronic ignitions feature: **EASY FITTING, STANDARD/ELECTRONIC CHANGEOVER SWITCH, STATIC TIMING LIGHT** and **DESIGNED IN RELIABILITY** (14 years experience and a 3 year guarantee).
  - ★ **IN KIT FORM** it provides a top performance system at less than half the price of comparable ready built units. The kit includes: pre-drilled fibreglass PCB, pre-wound and varnished ferrite transformer, high quality 2uF discharge capacitor, case, easy to follow instructions, solder and everything needed to build and fit to your car. All you need is a soldering iron and a few basic tools.

Most NEW CARS already have electronic ignition. Update YOUR CAR

## ELECTRONIZE ELECTRONIC CAR ALARM



### HOW SAFE IS YOUR CAR?

More and more cars are stolen each week and even a steering lock seems little help. But a car thief will avoid a car that will cause him trouble and attract attention. If your car has a good alarm system - well there are plenty of other cars to choose from.

#### LOOK AT THE PROTECTION AN ELECTRONIZE ALARM CAN GIVE:

- ★ **MINIATURE KEY PLUG** A miniature jack plug attaches to your key ring and is coded to your particular alarm.
- ★ **2025 INDIVIDUAL COMBINATIONS** The key plug contains two 1% tolerance resistors, both must be the correct value and together give 2025 different combinations.
- ★ **ATTRACTS MAXIMUM ATTENTION** This alarm system not only intermittently sounds the horn, but also flashes the headlight and prevents the engine being started.
- ★ **60 SECOND ALARM PERIOD** Once triggered the alarm will sound for 60 seconds, unless cancelled by the key plug, before resetting ready to be triggered again.
- ★ **30 SECOND EXIT DELAY** The system is armed by pressing a small button on a dashboard mounted control panel. This starts a 30 second delay period during which the owner can open and close doors without triggering the alarm.
- ★ **10 SECOND ENTRY DELAY** When a door is opened a 10 second delay operates to allow the owner to disarm the system with the coded key plug. Latching circuits are used and once triggered the alarm can only be cancelled by the key plug.
- ★ **L.E.D. FUNCTION INDICATOR** An LED is included in the dashboard unit and indicates the systems operating state. The LED lights continuously to show the system is armed and in the exit delay condition. A flashing LED indicates that the alarm has been triggered and is in the entry delay condition.
- ★ **ACCESSORY LOOP - BONNET/BOOT SWITCH - IGNITION TRIGGER** These operate three separate circuits and will trigger the alarm immediately, regardless of entry and exit delays.
- ★ **SAFETY INTERLOCK** The system cannot be armed by accident when the engine is running and the car is in motion.
- ★ **LOW SUPPLY CURRENT** CMOS IC's and low power operational amplifiers achieve a normal operating current of only 2.5 mA.
- ★ **IN KIT FORM** It provides a high level of protection at a really low cost. The kit includes everything needed, the case, fibreglass PCB, random selection resistors to set the code and full set of components etc. In fact everything down to the last washer plus easy to follow instructions.

fill in the coupon and send to:

Please send more information

**ELECTRONIZE DESIGN** Dept E · Magnus Rd · Wilnecote · Tamworth · B77 5BY · tel 0827 281000

#### TOTAL ENERGY DISCHARGE (6 or 12 volt negative earth)

- Assembled ready to fit                    £26.70 £19.95  
 D.I.Y. parts kit                                £15.90 £14.95

#### TWIN OUTPUT for cars and motor cycles with dual ignition

- Twin, Assembled ready to fit            £36.45 £29.95  
 Twin, D.I.Y. parts kit                        £24.55 £22.95

#### INDUCTIVE DISCHARGE (12 volt only)

- Assembled ready to fit                    £15.95 £12.75

Prices Include VAT                    £1-00 PP(UK) per Unit, E

#### CAR ALARM (12 volt negative earth)

- Assembled ready to fit                    (All wires and    £33.70  
 D.I.Y. parts kit                                connectors incl. £22.40

I enclose cheque/postal order OR debit my Access/Visa card

VISA  M/C  A/C

Name \_\_\_\_\_

Address \_\_\_\_\_

Code \_\_\_\_\_

HE

# BASSMAN

Sack the bass guitarist, and do it yourself.

THE HE BASSMAN is a fairly simple and inexpensive project but it does contain several interesting features and produces quiet unusual effects. The input can be a human voice or a musical instrument; the output is a roughly triangular or square waveform, one or two octaves below the fundamental. The idea seems to be simple enough: square the input waveform so that it will drive a CMOS divider, filter the output and there you have a frequency divider. In practice matters are not quite so simple.

## The Theory

Sounds, whether produced by the human voice or musical instruments, are quite complex in nature. The distinctive sound of an individual human voice consists of a fundamental frequency produced by the vocal chords, harmonics of that frequency, produced by the various resonating cavities in the vocal system, and noise. The positions of the tongue and lips are particularly important in producing harmonics: the 'a' in 'father' for instance, requires quite a different tongue position from the 'u' in 'full' or the 'oo' in 'coot'. Try saying "bee" and then, without changing the tongue position, bring the lips together (as if you were about to say "cool") — the change in vowel sound (and harmonic content) is very obvious.

Certain sounds are initiated by a brief explosion of breath caused by the lips being suddenly parted. Put the palm of your hand about two inches from your lips and say "partial" — you should feel the sudden rush of breath. Such sounds show on a spectrum analyser as noise spreading over a wide band of frequencies. Clearly they present difficulties for an instrument which attempts to separate out a single frequency!

The Bassman does not cope with 'noise' very successfully — to do so would require much more sophisticated and expensive circuitry — but it does deal more effectively with harmonics and once the technique of using it has been acquired (my stepson took about ten minutes) it behaves fairly predictably. It uses a

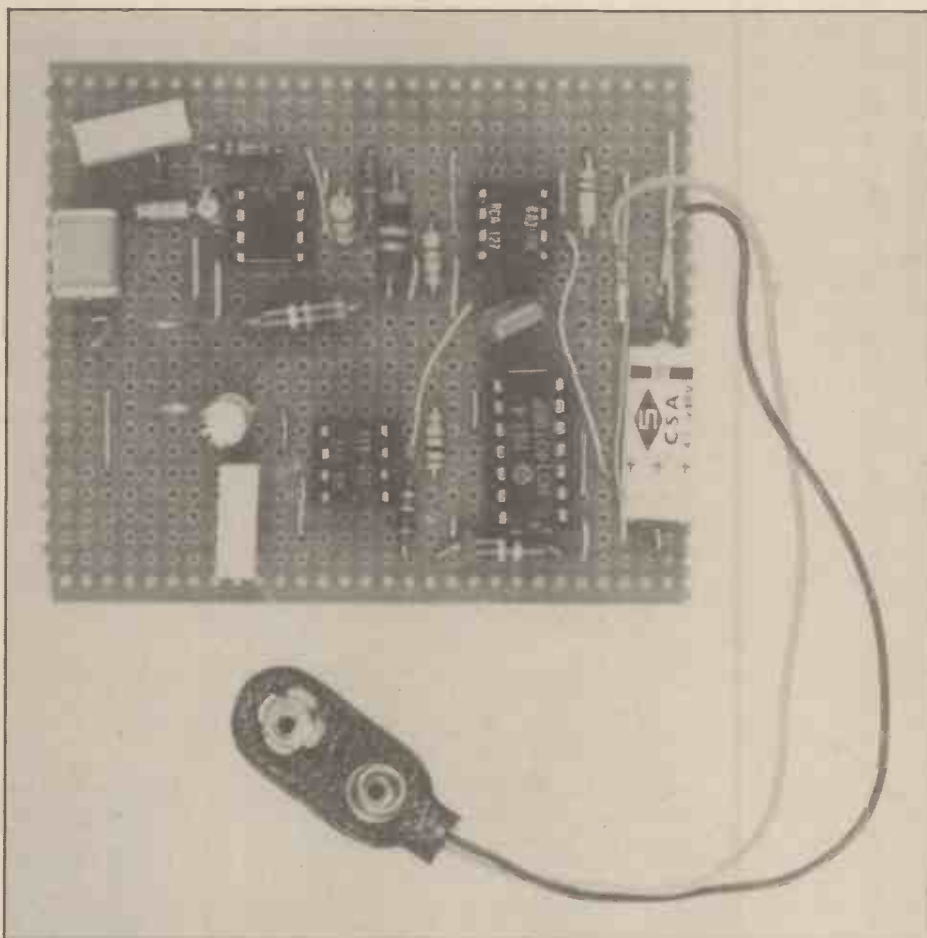

low pass filter to progressively reduce the level of frequencies other than the fundamental (the fundamental being the lowest frequency in a complex wave-form will always be the frequency least affected by the action of the filter) and a Schmidt trigger circuit (which may also be thought of as a kind of filter) to isolate the frequency of greatest amplitude.

Figure 1 shows a waveform consisting of two sine waves precisely one octave apart (fundamental and second harmonic). The highest peaks and lowest troughs follow the frequency of the fundamental, but if you try to square the waveform by using a comparator circuit which triggers positive or negative every time the waveform passes through

zero, then you get a square wave at the frequency of the second harmonic — which is not what is required in this case. What *is* required is a comparator that responds only to large positive or negative excursions of the waveform, and ignores smaller ones.

The circuit needed is known as a Schmidt trigger, and it is one much used in digital circuits to 'clean up' slow rising input waveforms. It is often described as a comparator with 'hysteresis', the 'hysteresis' being the difference between the negative and positive trigger points. For an explanation of how this works, read on . . .

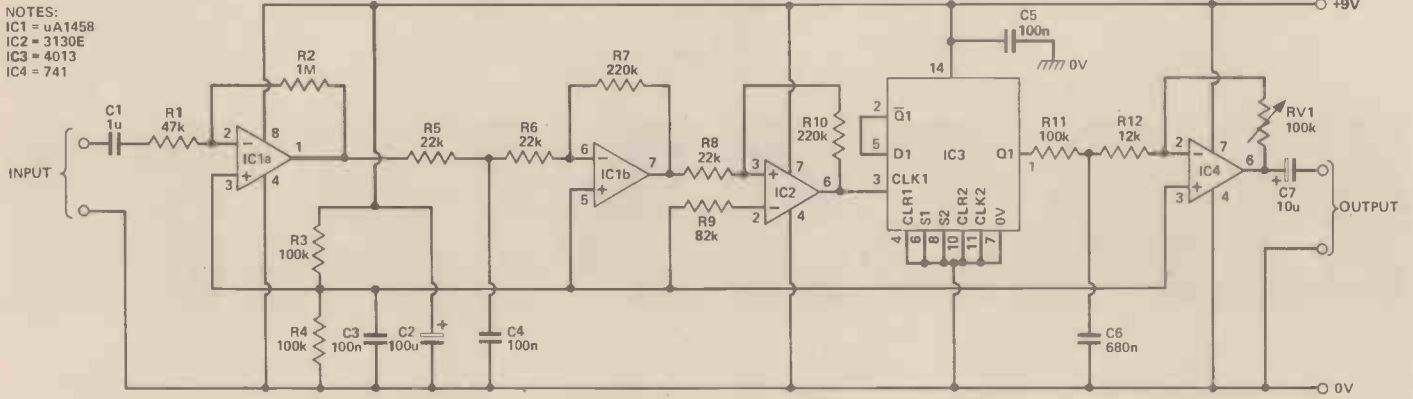
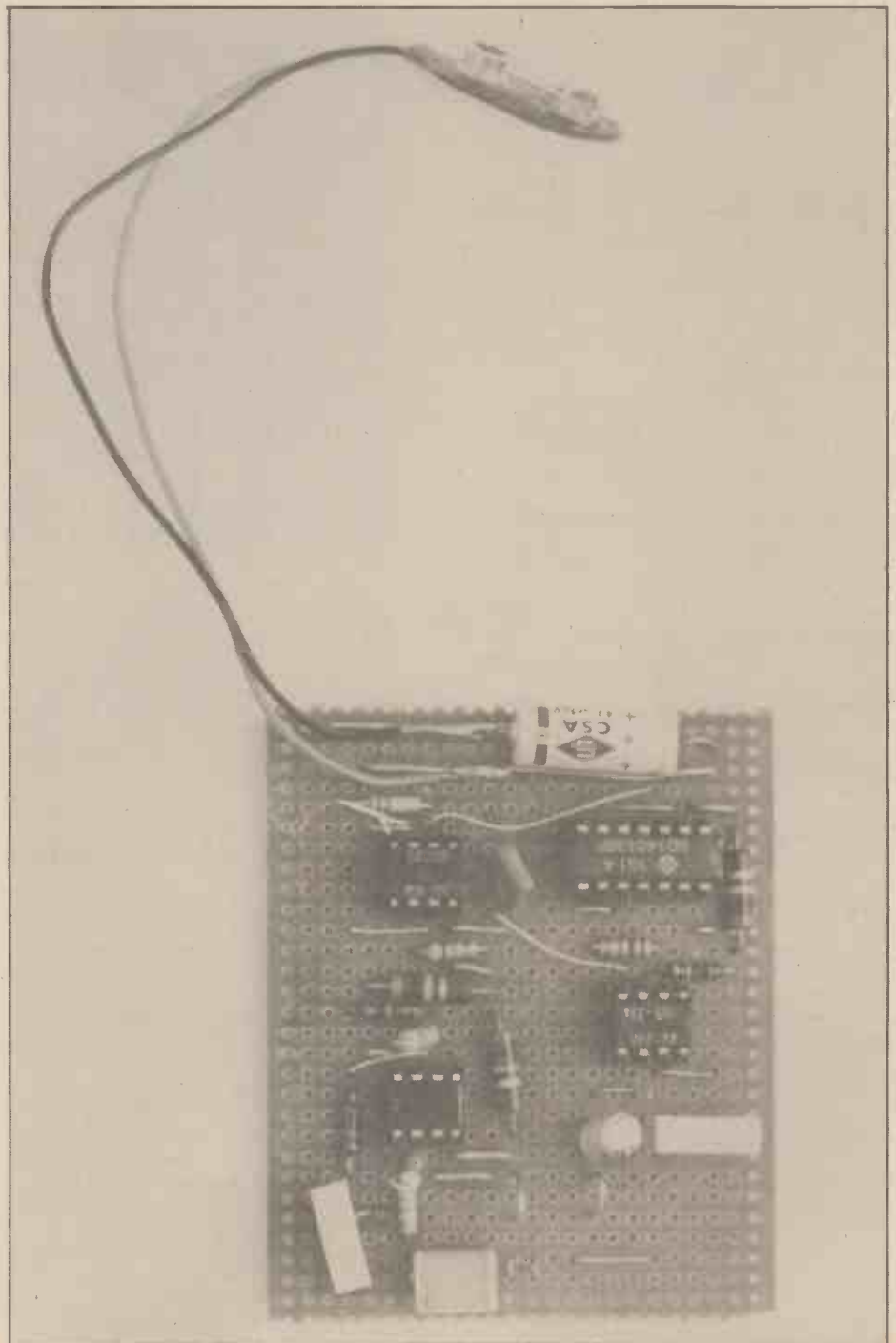

Figure 1. The Bassman circuit, with single-stage frequency division.

## The Circuit

IC1a in Figure 2 is a conventional op-amp non-inverting amplifier with a gain of about 20. The low-pass filter which follows is a first order filter with a cut off frequency of about 300Hz and a roll off of about 6dB per octave; the filter must not be too sharp otherwise the frequency response of the device is too limited. The cut-off point of 300Hz was chosen to suit the piping treble of my stepson whose voice, as you will gather, has not broken yet.

The cut off point can be lowered, if necessary, by increasing C3. The idea is that the lowest frequency produced by the voice should be near the cut off point of the filter so that the second harmonic will be reduced by 6dB relative to the fundamental, with higher harmonics reduced still further. In practice, the unit triggered reliably with input frequencies up to about 1kHz (a range of just over two octaves). Above 1kHz the amplitude of the filtered waveform is insufficient to drive the Schmidt trigger. IC1b is a buffer for the filter and has a gain of about five. IC2 and its associated components form the Schmidt trigger and this works as follows: the inverting input of the IC, a CA3130, is set at about half the power supply voltage. For the output to swing negative or positive, the non-inverting input must swing above or below that mid-point. R8 and R10 form a voltage divider between the input of the trigger and the output of IC1b. If the output of IC2 is positive (almost the positive rail voltage in the case of a CA3130) and the output of IC1b is about 4V5 then the voltage at the non-inverting input of IC2 will be the voltage at the output of IC1b plus the voltage dropped by R8. The voltage across R8 is given by:  $4.5 \cdot R8 / (R8 + R10)$ , which is approximately 0.4 volts. Therefore the voltage at the non-inverting input is about 4V9 and above the voltage necessary to send the output negative. In fact the output of IC1b must swing below 4V before the CA3130 (IC2) will swing negative. In the case where the trigger output is negative then, by the same principle,



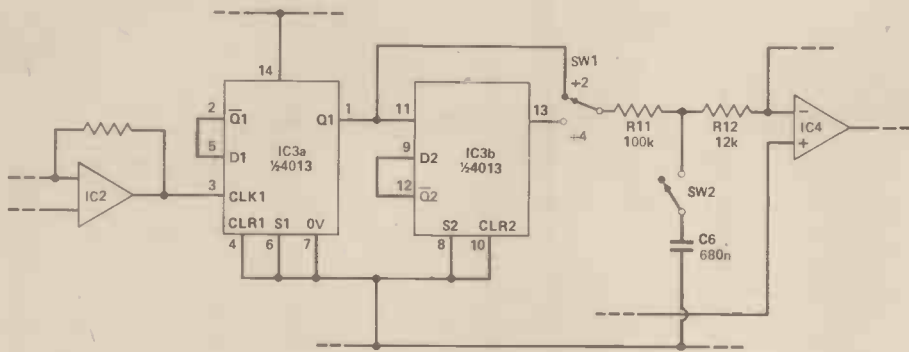

Figure 2. An additional stage of frequency division which can be incorporated in the Bassman. Voices of a higher pitch work better with the extra stage.

the output of IC1b must swing above 5V for the CA3130 to trigger positive. The hysteresis is therefore  $\pm 0.5V$ . Different switching points could be set by changing the values of R8 and R10. The positive feedback (ie feedback in rather than out of phase with the input) ensures that when the device *does* trigger it will trigger very cleanly. The CA3130 was chosen both because it will switch very fast from one state to the other and because it will swing very close to the power supply rails. These conditions are necessary to ensure reliable operation of the next stage, which is the actual frequency divider.

IC3 is a CMOS dual flip-flop configured as a single divide-by-two frequency divider. This works as follows: the outputs of each flip-flop will change state according to the logic level at the Clock, Data, Set and Reset inputs. In this circuit Set and Reset are held low and have no effect, so the state of the Data and Clock

inputs controls events. The outputs at pins 1 and 2 (Q and  $\bar{Q}$ ) are in antiphase (opposite polarity). When the Clock input goes high, the  $\bar{Q}$  output will follow the logic-level at the D input. As the D input is connected to the Q output, in antiphase to the Q output, then a train of pulses applied to the C input produces the results shown in Table 1.

	C	D	Q	$\bar{Q}$
pulse 1	1	0	1	0
	0	0	1	0
pulse 2	1	1	0	1
	0	1	0	1
pulse 3	1	0	1	0
	0	0	1	0
pulse 4	1	1	0	1
	0	1	0	1

The original Veroboard layout in the photographs has been tidied up to produce the design shown below. A PCB layout is given overleaf.

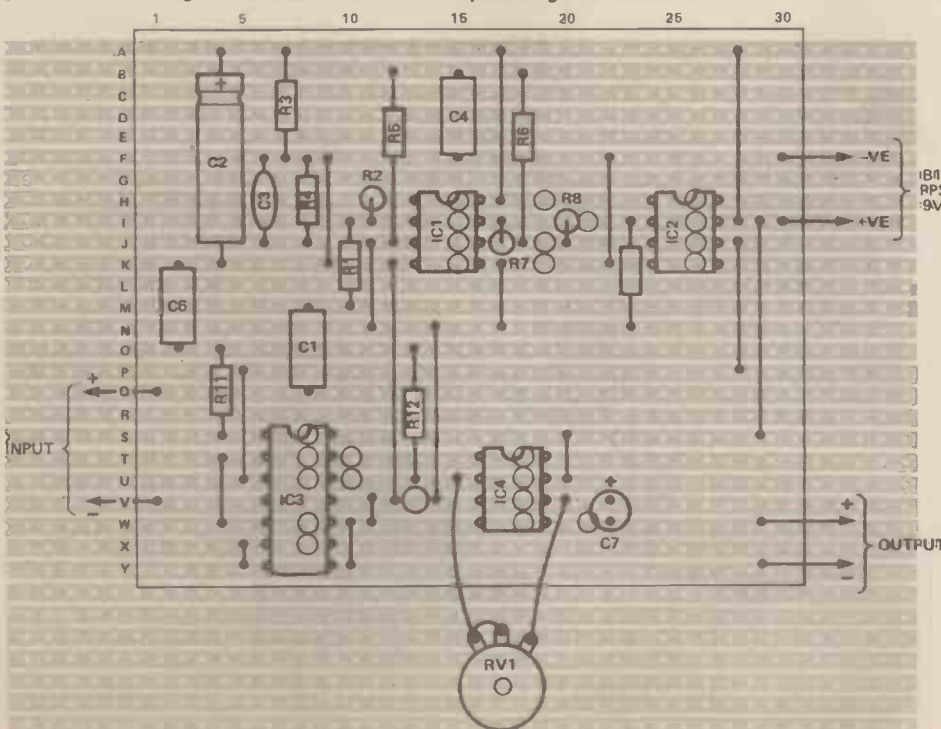

From the table it is clear that the changes at the Q output occur at only half the frequency of the changes at the C input — we have frequency division.

A low-pass filter follows the divider stage. This is included to clean up the harmonics from the Square-wave output of the dividers. IC4 is a buffer for the filter, with RV1 adjusting the output level.

### The Circuit Reconsidered

As described above, the Bassman incorporates a single stage of frequency division and produces a triangle wave output. The circuit of Figure 3 goes a step further — there is another stage of frequency division so that the input frequency is divided by four. A switch, SW1, has been added to allow either the divide-by-

### Parts List

#### RESISTORS

(All 1/4 watt 5% carbon)

R1	47k
R2	1M
R3, 4, 11	100k
R5, 6, 8	22k
R7, 10	220k
R9	82k
R12	12k

#### POTENTIOMETERS

RV1	100k 1in carbon
-----	--------------------

#### CAPACITORS

C1	1u min. layer
C2	100u 16V radial electro
C3, 4, 5	100n min. layer
C6	680n min layer
C7	10u 35V tantalum

#### SEMICONDUCTORS

IC1	1458 dual op-amp
IC2	3130E MOSFET op-amp
IC3	4013 CMOS dual D-type flip flop
IC4	741 op-amp

#### MISCELLANEOUS

PCB or Veroboard; case to suit; wire, solder etc.

BUYLINES .....page 34

## Bassman

Figure 4. The PCB layout for the Bassman, as an alternative to the Veroboard layout given on the previous page. Which one you choose is entirely a matter of personal preference, and a case can be designed according to use.

two or the divide-by-four output to be selected. Another switch allows the final low-pass filter to be switched out of circuit, so that the square wave output can be used — this has a much rougher sound, due to the extra harmonics.

These modification produce a more flexible unit. For instance, a child's or woman's voice would be more effective with the extra stage of frequency division, while a man's voice needs only the one stage. The option of square or triangle wave outputs adds variety to the sounds available.

### Construction

The first and simpler circuit has been laid out on Veroboard (Figure 4) but for the second version of the Bassman there is a full PCB layout. Because of the range of uses for this simple project, a case has not been specified for either version — the application will suggest the best method of finishing the job.

Neither version should present any difficulties in construction. It is preferable to use sockets for the CMOS devices, IC2 and IC3, and certainly one should observe normal handling precautions (though I must admit that in the past I have soldered, desoldered, handled, dropped, trodden-on and generally abused all manner of CMOS devices and still found them serviceable!) The unit is designed to be used with a cheap crystal microphone or mic-insert and virtually any kind of amplifier and speaker. In use you will probably find that, at first, the output of the device will shift octave somewhat unpredictably when you sing into it, however you soon learn to produce sufficiently clean sound for it to operate correctly — as I remarked earlier my stepson took about ten minutes to master it. If you use a mic-insert you may like to try another technique, which is to strap the mic on your throat just by the vocal chords. By humming gently you will probably get the best results of all — I certainly did with the prototype and I suspect that this is because the fundamental is strongest and the partials weakest in the larynx where the vocal chords are situated.

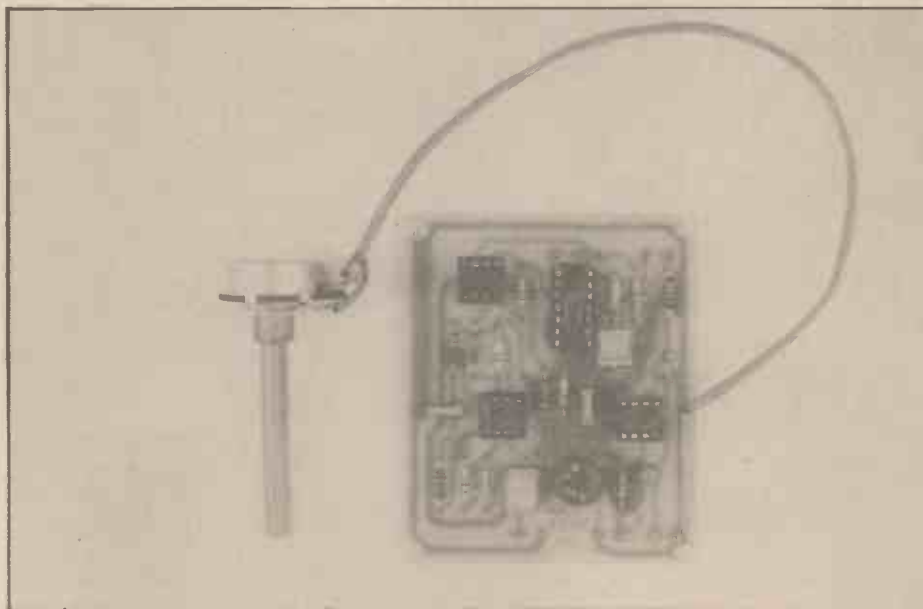
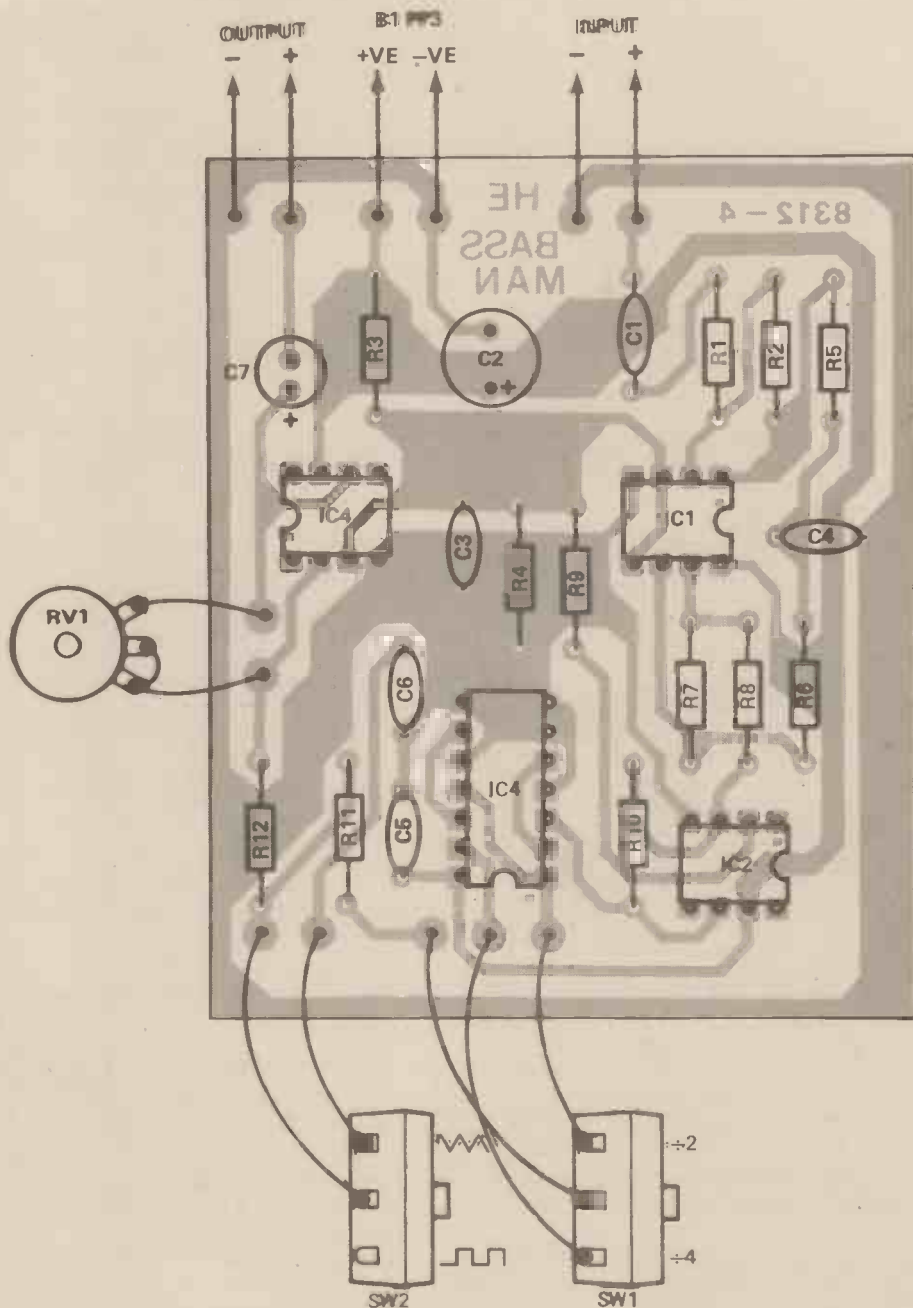

HE





# BUYLINES

## Bassman

The 1458 dual-comparator op-amp used in this project is not widely available, but is stocked by **Rapid Electronics**, who also carry all the other components required. The cost of the bits and pieces for the basic circuit should be around £4.00; the PCB version, with choice of one or two octave division and sawtooth or squarewave outputs, cost a little over £1 more for the switches plus, of course, the cost of the PCB.

A case has not been specified since it was thought that, in most cases, the Bassman would be built into an existing item of equipment. If a separate case is wanted it will need to measure at least 80 x 70mm to accommodate either the Veroboard or the PCB, plus whatever depth of extra length is needed for the battery, switch bodies, etc.

## Continuity Tester

It's not often that simple projects are so useful... but this one is! The parts count is small, too, so it isn't even going to cost much — we estimate under £2.00 without the case or PCB (the circuit is simple enough that reader's wishing to do so should easily be able to construct the project on Veroboard, to keep the cost down further).

The components are all readily available, for once, but if the polycarbonate capacitor proves difficult, substitute a polyester type (of the same value of course). Alternatives to the Verobox may be offered, but must be no smaller than 71 x 49 x 25mm.

## Damp Meter

There has been a rash of projects, lately, using the 3914 bargraph driver

... and yes, this is another! The great advantage of this device is that, generally, few other components are needed — as is the case this time. The cost of the components ought to be in the region of £4.00, excluding the case and PCB as usual. Once again, a Veroboard layout should not present any great difficulty for those without the facilities or funds for the PCB.

The prototype was built into a plain aluminium case, measuring 133 x 72 x 39mm; any type of enclosure no smaller than that will be suitable.

## Light Meter

A more costly project, this, but one that will prove extremely useful both as a practical tool and as an experimental instrument.

Most of the cost lies in the sensors, type MS4A solar cell chips from **Maplin Electronics**. The prototype

Turn to page 64 ...

# TOROIDALS

The toroidal transformer is now accepted as the standard in industry, overtaking the obsolete laminated type. Industry has been quick to recognise the advantages toroidals offer in size, weight, lower radiated field and, thanks to I.L.P., PRICE.

Our large standard range is complemented by our **SPECIAL DESIGN** section which can offer a prototype service within 7 DAYS together with a short lead time on quantity orders which can be programmed to your requirements with no price penalty.

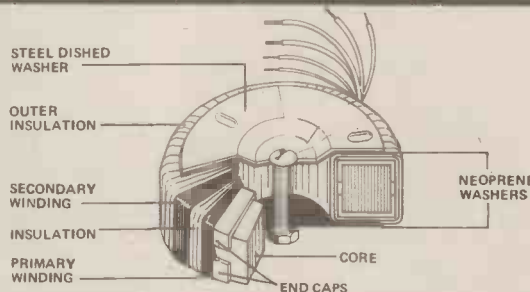

15 VA 62 x 34mm Regulation 19%	50 VA 80 x 35mm Regulation 13%	120 VA 90 x 40mm Regulation 11%	225 VA 110 x 45mm Regulation 7%	500 VA 140 x 60mm Regulation 4%	Why a Toroid?
<b>SERIES SECONDARY RMS</b> <b>No Volts Current</b>	2x010 6+6 4.16 2x011 9+9 2.77 2x012 12+12 2.08 2x013 15+15 1.66 2x014 18+18 1.38 2x015 22+22 1.13 2x016 25+25 1.00 2x017 30+30 0.83 2x018 110 0.45 2x029 220 0.22 2x030 240 0.20	4x010 6+6 10.00 4x011 9+9 6.66 4x012 12+12 5.00 4x013 15+15 4.00 4x014 18+18 3.33 4x015 22+22 2.72 4x016 25+25 2.40 4x017 30+30 2.00 4x018 35+35 1.71 4x028 110 1.09 4x029 220 0.54 4x030 240 0.50	6x012 12+12 9.38 6x013 15+15 7.50 6x014 18+18 6.25 6x015 22+22 5.11 6x016 25+25 4.50 6x017 30+30 3.75 6x018 35+35 3.21 6x026 40+40 2.81 6x025 45+45 2.50 6x033 50+50 2.25 6x028 110 2.04 6x029 220 1.02 6x030 240 0.93	8x016 25+25 10.00 8x017 30+30 8.33 8x018 35+35 7.14 8x026 40+40 6.25 8x025 45+45 5.55 8x033 50+50 5.00 8x042 55+55 4.54 8x028 110 4.54 8x029 220 2.27 8x030 240 2.08	<ul style="list-style-type: none"> <li>• Smaller size &amp; weight to meet modern 'slimline' requirements.</li> <li>• Low electrically induced noise demanded by compact equipment.</li> <li>• High efficiency enabling conservative rating whilst maintaining size advantages.</li> <li>• Lower operating temperature.</li> </ul>
30 VA 70 x 30mm Regulation 18%	80 VA 90 x 30mm Regulation 12%	160 VA 110 x 40mm Regulation 8%	300 VA 110 x 50mm Regulation 6%	625 VA 140 x 76mm Regulation 4%	Why ILP?
1x010 6+6 2.50 1x011 9+9 1.66 1x012 12+12 1.25 1x013 15+15 1.00 1x014 18+18 0.83 1x015 22+22 0.68 1x016 25+25 0.60 1x017 30+30 0.50	3x010 6+6 6.64 3x011 9+9 4.44 3x012 12+12 3.33 3x013 15+15 2.66 3x014 18+18 2.22 3x015 22+22 1.81 3x016 25+25 1.60 3x017 30+30 1.33 3x028 110 0.72 3x029 220 0.36 3x030 240 0.33	5x011 9+9 8.89 5x012 12+12 6.66 5x013 15+15 5.33 5x014 18+18 4.44 5x015 22+22 3.63 5x016 25+25 3.20 5x017 30+30 2.86 5x018 35+35 2.66 5x026 40+40 2.00 5x028 110 1.45 5x029 220 0.72 5x030 240 0.66	7x013 15+15 10.00 7x014 18+18 8.33 7x015 22+22 6.82 7x016 25+25 6.00 7x017 30+30 5.00 7x018 35+35 4.28 7x026 40+40 3.75 7x025 45+45 3.33 7x033 50+50 3.00 7x028 110 2.72 7x029 220 1.36 7x030 240 1.25	9x017 30+30 10.41 9x018 35+35 8.92 9x026 40+40 7.81 9x025 45+45 6.94 9x033 50+50 6.25 9x042 55+55 5.68 9x028 110 5.68 9x029 220 2.84 9x030 240 2.60	<ul style="list-style-type: none"> <li>• Ex-stock delivery for small quantities.</li> <li>• Gold service available. 21 days manufacture for urgent deliveries.</li> <li>• 5 year no quibble guarantee.</li> <li>• Realistic delivery for volume orders.</li> <li>• No price penalty for call off orders.</li> </ul>

Prices including P&P and VAT

VA	Size	£	VA	Size	£
15	0	6.79	160	5	11.67
30	1	7.58	225	6	13.64
50	2	8.60	300	7	14.87
80	3	9.64	500	8	19.30
120	4	10.51	625	9	22.62

For 110V primary insert "O" in place of "X" in type number.  
For 220V primary (Europe) insert "1" in place of "X" in type number.  
For 240V primary (UK) insert "2" in place of "X" in type number.  
**IMPORTANT:** Regulation - All voltages quoted are **FULL LOAD**.  
Please add regulation figure to secondary voltage to obtain off load voltage.

Mail Order — Please make your crossed cheques or postal orders payable to ILP Electronics Ltd.

Trade — We will open your credit account immediately upon receipt of your first order.

Post to: ILP Electronics Ltd., Dept. 5  
Graham Bell House, Roper Close,  
Canterbury, Kent. CT2 7EP  
Tel: (0227) 54778 Telex: 965780



**ELECTRONICS LTD.**

# MICROTANIC COMPUTER SYSTEMS LTD.

## MICROTAN 65 NO OTHER COMPUTER IS AS PERSONAL!

For less than £60 you can start building your own Computer that truly suits your needs and, of course, eventually far more superior to any Computer available off-the-shelf.

MICROTAN 65 comes in kit form, complete with manual, full instructions, board with components, (kit form or fully built) our full back-up service, and your own Microtan World Magazine available on subscription.

### FLEXIBLE & EXPANDABLE SYSTEM — 1K to 256K!

Just look at the options:

- |                      |                               |
|----------------------|-------------------------------|
| 1 DISK CONTROLLER    | 7 MASS EPROM STORAGE BOARD    |
| 2 REAL TIME CLOCK    | 8 INDUSTRIAL CONTROLLER BOARD |
| 3 EPROM PROG. CARD   | 9 40K RAM BOARD               |
| 4 SOUND BOARD        | 10 HIGH RES. GRAPHICS 256x256 |
| 5 SERIAL I/O BOARD   | 11 PRINTER FACE BOARD         |
| 6 PARALLEL I/O BOARD | 12 ASC11 KEYBOARD             |



Microtan World Magazine

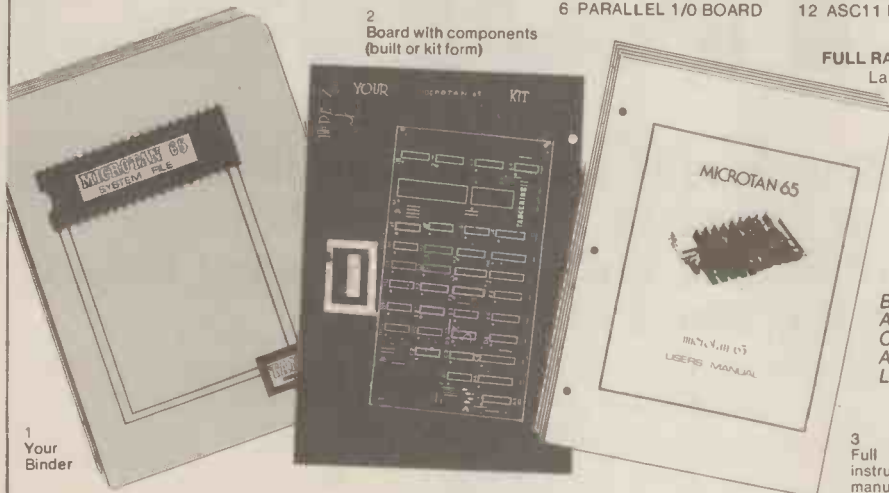

1 Your Binder

2 Board with components (built or kit form)

3 Full instructions manual

### FULL RANGE OF SOFTWARE

Languages available: Machine Code, Assembly, Basic, Forth, and Pilot

### HOW TO ORDER:

Enter details in the coupon below, enclosing your cheque made payable to: Microtan Computer Systems Ltd. Prices include VAT add £1.50 p&p. Please allow 14 days for delivery.

Post to:  
MICROTANIC COMPUTER SYSTEMS LTD  
16 UPLAND RD. LONDON SE22  
Tel No. 01-693 1137

Please rush me my starter kit:  
(Please tick)

- kit form — I will build myself £59.95  
 Fully Built £69.95  
 Complete system wall chart

I enclose my cheque/P.O. for £

Name .....

Company .....

Address .....

Tel (Day) .....  
Tel (Eve) .....

**MICROTANIC COMPUTER SYSTEMS LTD**  
SHOWROOM: 16 UPLAND RD  
DULWICH, LONDON SE22  
TEL: 01-693-1137

MAIL ORDER:  
235 FRIERN RD. DULWICH  
LONDON SE22

Also available from:  
Waltham Forest Computer Centre  
889 Lee Bridge Rd.  
Nr Whipps Cross, Walthamstow E7  
Tel: 01-520 7747

**BUILD AS FAST OR SLOW AS YOU LIKE!**

**The MIGHTY MIDGETS SOLDERING IRONS AND ACCESSORIES TYPE 1**

**£5.46 inc vat**

postage 35p

**12 month guarantee**

**18 WATT**

From your Local Dealer or Direct from Manufacturers

**S & R BREWSTER LIMITED**

86-88 UNION ST. PLYMOUTH PL1 3HG

0752-665011 TRADE ENQUIRIES WELCOME

VISA ACCESS

## Look what your ZX81 or Spectrum can do with a TIME CONTROLLER

### REAL TIME CLOCK & INPUT/OUTPUT PORT

AMAZING FEATURES AT A VERY LOW COST  
Battery backed up Real Time Clock with month, day, date, hours, minutes and seconds.  
Program to control the Clock in on board PROM MEMORY — saves your computers memory.

Only ONE LINE in your BASIC PROGRAM is needed to read or write the date and time.  
Eight programmable OUTPUT channels (TTL compatible)

Eight programmable INPUT channels (TTL compatible)

EXTENSION for Rampack, Printer etc. included

PRICE AMAZING VALUE

ZX81 TIME CONTROLLER only £34.50, SPECTRUM TIME CONTROLLER only £38.50. If you can buy a similar product at a lower price, we will match it.

BUILT IN PROGRAMME IN PROM MEMORY

POSSIBLE APPLICATIONS INCLUDE:  
Home Control, Electronic Diary with Alarm, Programmable Timer, Sophisticated Burglar Alarm, Auto Stopwatch, Sound Effects, Time & Date Displays, Light Chaser, Disco Control Console, Auto Telephone Dialer, On/Off Switch Control, Temperature Control, Power Monitoring, Automatic Testing, Robot Control, Counter, Process Control, Scientific Applications, Lab. Experiments, Time Recorder etc.

EXTENSION FOR RAMPACK ETC.

Merry Christmas From



EIGHT INPUTS

EIGHT OUTPUTS

CLOCK DATE AND TIME

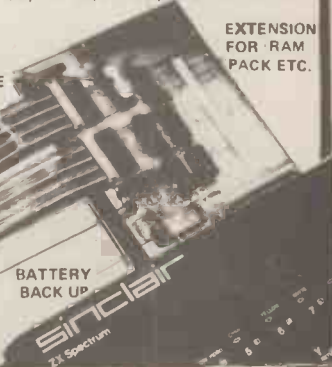

**Glanmire Electronics**

MAIL ORDER  
Westley House,  
Trinity Avenue,  
Bush Hill Park  
Enfield,  
EN1 1PH  
Telephone: 01-366 3245 (24 hrs)

INFORMATION & ENQUIRIES  
Maonane,  
Watergrasshill, Co. Cork, Ireland  
Telephones: Cork: 869206 (24 hrs)  
Telex: 75444 CTT

### FOR FURTHER INFORMATION

Please send me more information on the following.

- Time Controller for ZX81 & Spectrum  
 Products for the Apple II Computer

NAME .....

ADDRESS .....

TEL .....

DEALER ENQUIRIES WELCOME — GENEROUS QUANTITY DISCOUNTS AVAILABLE

# ALL ABOUT ELECTRONICS

Our new Beginner's Series tells you all you'd like to know about electronics. From start to finish. All about components and circuits, all the theory you need to get started in the world of electronics.

IF YOU TAKE a close look at an industrial process — any industrial process — you will always find some part of it which is automatic. By this, I mean that some mechanism is established which controls the process to some extent without human involvement. All modern industrial equipment relies, to a greater or lesser degree, on automatic control: this could be as simple as a thermostat switching off the burners of a boiler when water temperature reaches a predetermined heat level, or a car production line where all vehicles are built by robots. The higher the level of automatic control and manufacture the lower the level of human involvement.

Our example of a thermostat controlling water temperature can be constructed using simple electro-mechanical components (see All About Electronics, HE October 83, Figure 19). But electromechanical components are quite bulky and tend to be somewhat unreliable because they have moving parts which can wear with time. So more complex automatic control systems, such as the example of a robotised car production line, need to be based on less bulky and more reliable electronic methods of control.

## Gate Control

We saw the basis of such small, reliable control methods last month in the second part of our venture into the study of semiconductor components — digital logic gates. Such gates are constructed using transistors and therefore can be built into integrated circuits (ICs), so that a complete control system is still small in size and very reliable — because individual gates are not asked to do any

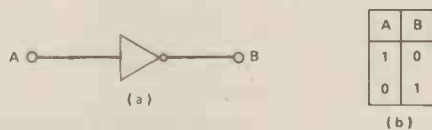

Figure 1. (a) shows the symbol for a NOT gate; (b) shows the Truth Table.

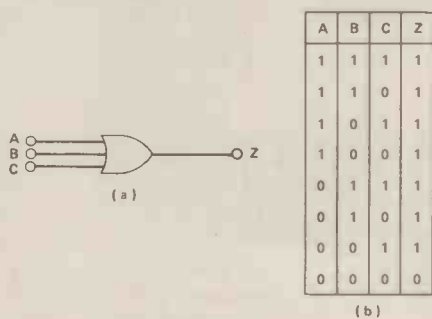

Figure 2. (a) shows the symbol for an OR gate; (b) shows the Truth Table.

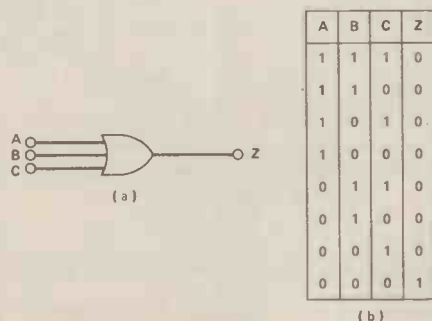

Figure 3. (a) shows the symbol for a NOR gate; (b) shows the Truth Table.

more than decide whether one of two different voltage levels is applied and act on this decision to give one of two voltage levels at the output.

Such digital logic gate control systems have a simple language of their own: all inputs/outputs to/from a system are of the form 0 or 1. The voltage levels corresponding to these inputs and outputs are not important: a level of 0V could mean a logic state of 0, and a level of, say, 5V could mean a logic state of 1 — as long as the voltage levels and corresponding logic state are predetermined and fixed, it doesn't really matter. The important point is that there are only two possible states for all inputs and outputs of a system. Hence another name for such systems is binary (meaning 'two-state'). The language of binary systems is essentially mathematical and was first used in the nineteenth century by George Boole and so is called *Boolean algebra*. It is, however, unlike standard mathematical algebra and takes a little time to study before we can use it to design control systems.

## Boolean Algebra

Inputs and outputs to and from digital systems are denoted by letters of the alphabet A, B, C etc. and each input or output can be in one of two states: 0 or 1. So, for example, we can say A = 1, B = 1, C = 0, etc., etc.

Now, of course in any system, the output will be dependent on the input(s). Let's take as an example the simplest logic gate which we encountered last month — the inverter (Figure 1a). Figure 1b shows the corresponding truth table for such a gate. Now, if input

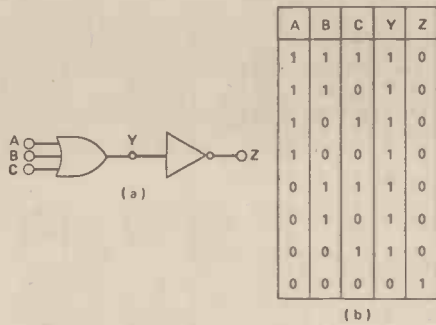

Figure 4. (a) shows the make-up of a NOR gate using an OR gate and a NOT gate; (b) gives the Truth Table.

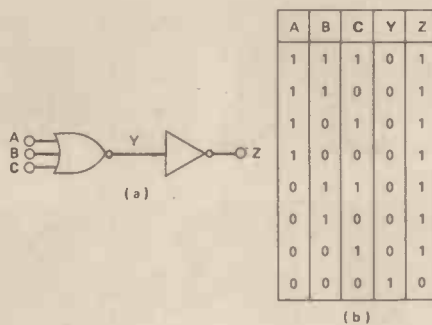

Figure 5. (a) shows the make-up of an OR gate using a NOR gate and a NOT gate; (b) gives the Truth Table.

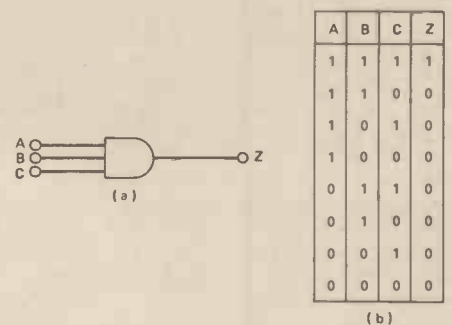

Figure 6. (a) shows the symbol for an AND gate; (b) shows the Truth Table.

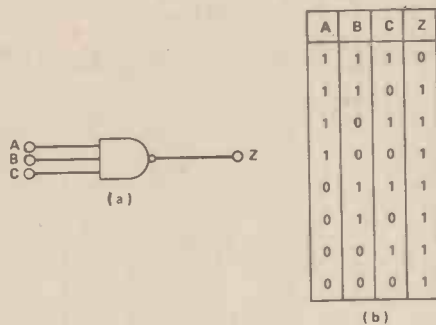

Figure 7. (a) shows the symbol for a NAND gate; (b) shows the Truth Table.

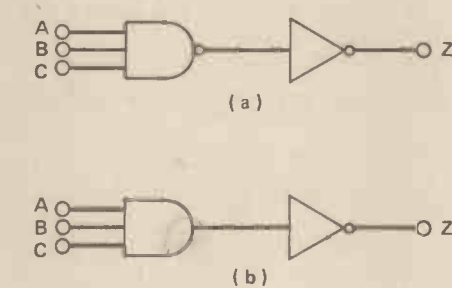

Figure 8. (a) the make-up of an AND gate using a NAND gate and a NOT gate; (b) a NAND gate using an AND gate and a NOT gate.

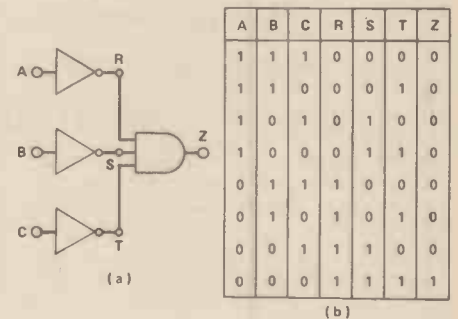

Figure 9. (a) a NAND gate with its inputs inverted by NOT gates; (b) the Truth Table shows it to be a NOR gate.

A = 1, we know that output B must be the inverse ie, 0. And if A = 0 then B = 1. The actual logic states are irrelevant, all we actually need to know is that the output B is the inverse of input A — whatever the state of input A. In Boolean algebra we write this much more succinctly as  $A = \bar{B}$ . The bar above the letter B indicates what we call a NOT function ie, the logic state of A is NOT the logic state of B. Alternatively we could equally well say that B is NOT A, ie  $B = \bar{A}$ .

Both Boolean statements are true with respect to an inverter and are synonymous. Incidentally inverters are often called NOT gates for this very reason.

You should be able to see that the Boolean statement(s) for the gate simply allows us a convenient method of writing down the way the gate operates, without the necessity of drawing the gate symbols or forming the gate truth table.

Now inverters (NOT gates) aren't the only form of logic gate available. Last month we looked at another one in depth (a NOR gate) and summarised three others: OR, AND, NAND. Figures 2, 3, 4, and 5 show the four gates with truth tables. All of these gates differ from the NOT gate of Figure 1 in that they have more than one input. Because of its very function a NOT gate can only have one input, but the other gates can have (in theory) any number of inputs from two, upwards.

For example, Figure 2 shows a three-input OR gate. The truth table of the gate

shows that the output, D, of the gate is high when either input A OR B OR C is high. Operation of the gate can be shown in Boolean terms as  $Z = A + B + C$ , where '+' indicates the OR function and has nothing whatsoever to do with the more usual mathematical 'plus' sign. Don't be confused: just remember that everytime you see the sign '+' in Boolean algebra it means OR.

### Simple, Isn't It?

The NOR gate of Figure 3 is as you can see from the truth table, simply the inverse function of an OR gate. The Boolean statement which corresponds to a NOR gate is  $Z = \overline{A + B + C}$ , which is simply the Boolean statement of an OR gate with a bar, indicating a NOT or inverse function. Output is high when neither A NOR B NOR C is high.

You would be correct to assume that a NOR gate can be produced from an OR gate and a NOT gate. Figure 4 shows such a circuit and its truth table shows logic states not only of the circuit output but of the junction between OR gate output and NOT gate input just to prove that no magic is involved. Likewise, of course, an OR gate can be produced from a NOR gate followed by a NOT gate (Figure 5).

An AND gate (Figure 6) is exactly what its name suggests. Its truth table shows that output is high only when A AND B AND C are high. As a Boolean

statement this is expressed much more simply as  $Z = A \cdot B \cdot C$  — a NAND gate is (you've guessed it) the inverse of an AND gate and its circuit symbol with truth table is shown in Figure 7. It is difficult to express a NAND gate's operation in words but — here goes: output is high when NOT A AND, NOT B AND, NOT C are high, ie output is high when A AND B AND C are low. It is much easier to express operation as logical Boolean statement  $Z = \overline{A \cdot B \cdot C}$  which, no doubt, you had already guessed for yourself!

In the same way that OR gates can be created from NOR gates and NOT gates and NOR gates created from OR and NOT gates, so can NAND and NOT gates be combined to produce AND gates, and AND and NOT produce NAND gates (Figure 8).

I said earlier, when discussing the interchange between OR and NOR gates using NOT gates, that no magic was involved. Well that may be true, but now I'm going to show you something which, even though I'll have to prove otherwise, I am absolutely sure in my own mind that nothing but Merlin's wand could have conjured up! Figure 9 shows an AND gate with NOT gates, but instead of a NOT gate being at the AND output, the NOT gates are at the inputs of the AND gate. The circuit truth table shows intermediate logic states between gates. The Boolean statement for the circuit mirrors the fact that the inputs are inverted before the AND gate:  $Z = \bar{A} \cdot \bar{B} \cdot \bar{C}$ .

### That Ol' Black Magic

This is not the Boolean statement of a NAND gate as you might casually assume at first sight — so what is it? Well, take a closer look at the truth table and compare input and output logic states with those of Figure 3. Yes, they are the same — we have produced a NOR gate from NOT gates and an AND gate! This means that the circuit Boolean statement is also  $Z = \overline{A + B + C}$  ie, a conventional NOR gate Boolean statement. So  $\overline{A \cdot B \cdot C} = \overline{A + B + C}$ . Interesting!

Similarly, NOT gates and an OR gate can be used as in Figure 10. The Boolean state is  $Z = \overline{A + B + C}$ , but the truth table inputs and output shows us that the circuit forms a NAND gate! So also  $Z = \overline{A \cdot B \cdot C}$ , therefore  $\overline{A + B + C} = \overline{A \cdot B \cdot C}$ ; these two Boolean statements,  $\overline{A \cdot B \cdot C} = \overline{A + B + C}$  and  $\overline{A + B + C} = \overline{A \cdot B \cdot C}$  are very useful in the design of digital logic circuits. Just before we move onto other things we'll take a quick look at NAND and NOR gates again. Figure 11 shows a three-input NOR gate with two of its inputs tied (ie connected) to logic 0. If you look back at the truth table in Figure 3 you'll see that with two inputs at logic 0, it doesn't matter which logic state the remaining input has, the gate output is always the remaining input's inverse, ie we have created a NOT gate from a NOR gate!

Similarly, Figure 12 shows a three-input NAND gate with two inputs tied to logic 1. A quick look back to the truth table in Figure 7 shows that this again is effectively a NOT gate.

Gates can also be cascaded to create more inputs than would at first sight seem impossible. Figure 13 shows three, three-input AND gates cascaded to form what is, in effect, a seven-input AND gate.

And because AND gates can be created from NAND and NOT gates, or NOR and NOT gates, and because NOT gates can be created from NAND or NOR gates, this means that virtually any digital logic circuit can be built using NAND or NOR gates alone, if required.

### Practical Aspects

So, we now have the tools for the job — what sort of job can we tackle and how do we go about it? Well, the answer to the first question is simple — virtually any type of control system or application where an input is required to switch on or off equipment in direct response from system inputs.

The answer to the second question (ie, how to go about it) is even simpler:

- 1) Draw up a truth table corresponding to the required output from the given inputs.
- 2) Create a Boolean statement from the truth table in the required form.
- 3) Design the circuit.

Let's take an example to illustrate the process. Consider a control mechanism on, say, a metal-turning lathe. The mechanism is essentially used to prevent the motor of the lathe being turned on unless a) the work-piece is

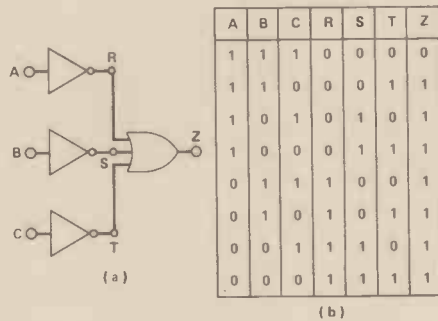

Figure 10. (a) an OR gate with inputs inverted by NOT gates (b) the Truth Table shows it to be a NAND gate.

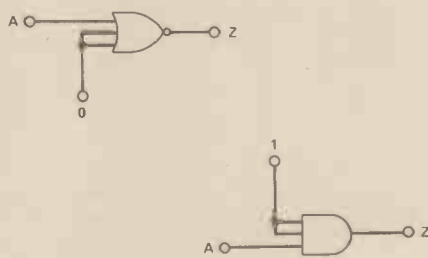

Figure 11 and 12. A NOT gate constructed from a NOR gate with its spare inputs tied to logic 0, and a NOT gate made with a NAND gate with its spare inputs tied to logic 1.

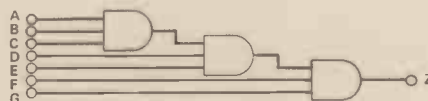

Figure 13. Cascading three three-input AND gates to form a seven input AND gate.

lubricated b) the safety-guard is in position c) the operator's key has been turned.

In addition to these three criteria a 'panic button' at a distance from the lathe allows any observer to prevent operation and stop the motor if an accident (such as the lathe operator's clothing being caught in the lathe) occurs.

- So we can define the inputs as being:
- A if the work-piece is lubricated
  - B if the safety-guard is in position
  - C if the operator's key is turned
  - D if the 'panic button' is pressed

The output Z turns on the lathe motor.

As a further constraint, I'm going to suggest that the engineer who has been given the job to design and build the control circuit has run out of stock of all gates except NOR gates.

### Tell The Truth

A truth table for the control system can

A	B	C	D	Z
1	1	1	1	0
1	1	1	0	1
1	1	0	1	0
1	1	0	0	0
1	0	1	1	0
1	0	1	0	0
1	0	0	1	0
1	0	0	0	0
0	1	1	1	0
0	1	1	0	0
0	1	0	1	0
0	1	0	0	0
0	0	1	1	0
0	0	1	0	0
0	0	0	1	0
0	0	0	0	0

Figure 14. The Truth Table for the theoretical control system described in the text (below).

be worked out and is shown in Figure 14. You can see from this table that the only line where Z = 1 (ie, turning the motor on) is the line where A = 1 AND B = 1 AND C = 1 D = 0. As a Boolean statement this is  $Z = \overline{A \cdot B \cdot C \cdot D}$  (1).

By the appearance of this statement it is fairly obvious that we can build the control circuit up from an AND gate with one NOT gate at input D. But, if you remember, the final design was to consist of only NOR gates. So, we have to change the Boolean statement to suit. This can be done with the help of one of the two statements we worked out earlier:  $A + B + C = \overline{A \cdot B \cdot C}$ .

We now have a fourth input (D) of course but that doesn't effect this statement except by D's inclusion:  $A + B + C + D = \overline{A \cdot B \cdot C \cdot D}$  (2).

Now, there are certain similarities between the second part of the statement and the second part of the circuit statement (1), ie  $\overline{A \cdot B \cdot C \cdot D}$  and  $\overline{A \cdot B \cdot C \cdot D}$ . By inverting statement (2) to get  $\overline{A + B + C + D} = \overline{A \cdot B \cdot C \cdot D}$  (3), we find

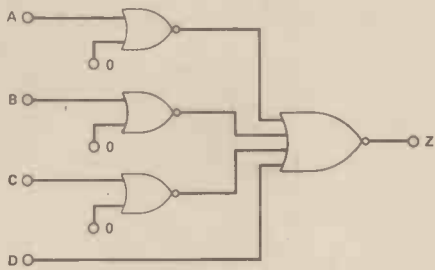

Figure 15. The circuit for the control system described in the text.

that the second half is even closer to the circuit statement, but now only input D is inverted. So let's invert D in the statement (3), ie  $\overline{A+B+C+D} = A \cdot B \cdot C \cdot \overline{D}$  so that  $Z = \overline{A+B+C+D}$  (4).

We have altered circuit statement (1) and produced a statement (4) which involves only NOR and NOT gates. And, because NOT gates can be built from NOR gates, we can now build the circuit using only NOR gates. The circuit is, of course, one four-input NOR gate with NOT gates at inputs A, B, C and is shown in Figure 15. This example has been a particularly simple one and the circuit

only involves four gates. Many control systems are far more complex and can involve many hundreds of gates. I have really only scratched the surface in showing how to design such circuits, but I hope you at least understand the principles involved.

### Let's Not Be Discrete

We know from last month that digital logic gates can be constructed using transistors. But no-one in their right mind would begin to design and construct a complex digital logic control — and the example in Figure 15 is by no means a complex one by industrial standards — using transistors. For this reason ICs have been developed and manufactured which contain transistors and all other components necessary to form logic gates. This means that a designer does not need to think in terms of discrete (ie, individual) components — all he has to do is design the circuits using gates on paper and then build it using the gates held within the ICs.

Figure 16 shows the theoretical

layout and pin connection details of such an IC — a 7400 to be precise. Before I explain about the IC in detail, a quick word about its numbering (ie, 7400) first. The first two digits (74--) indicate that it is in the range of devices known as transistor-transistor-logic (TTL) devices. The last two digits (--00) indicate which IC this is in the range. Other ICs in the range would be 7401, 7402, 7403, etc, etc. The 7400, as you can see from Figure 16 has four, two-input NOR gates within its body. For this reason the 7400 is often classed as a quad, two-input NOR.

With two inputs and one output per gate, and four gates on the IC, twelve pins are used as connections to and from the gates. The two remaining pins (the IC is a 14-pin DIL device) are used as power supply connections. Power supply voltage for the 7400 range is 5VDC. Hardly by coincidence, the logic level states are, for a low state, less than about 2VDC, and for a high state, greater than about 3V5DC. So, 0V for logic 0 and 5V for logic 1 are best used because these voltages are always present in the locality of the IC (because they are the power supply connection voltages).

Figure 16. Connection details for a 7400 TTL logic IC.

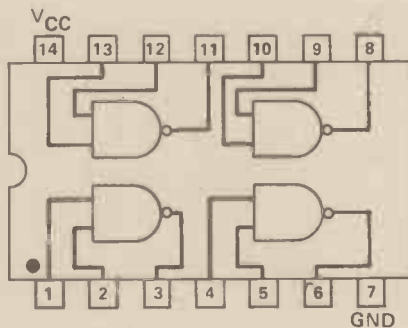

7400 QUADRUPLE 2 - INPUT NAND GATE

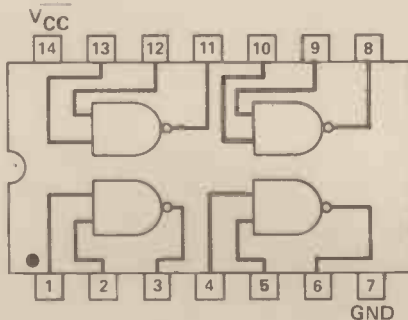

7404 HEX INVERTER

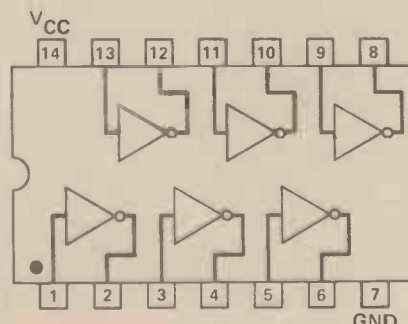
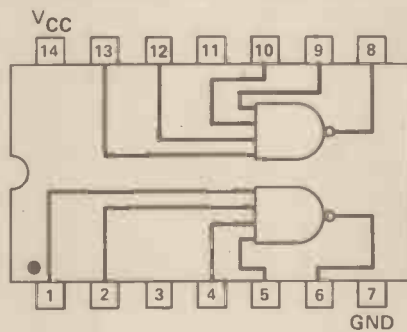
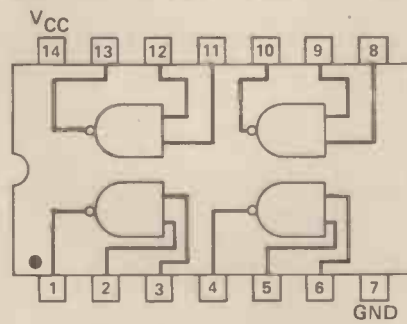

Figure 17. Sample connection details for eight ICs in the 7400 range.

7420 DUAL 4 - INPUT NAND GATE



7401 QUADRUPLE 2 - INPUT NAND GATE



7430 8 - INPUT NAND GATE

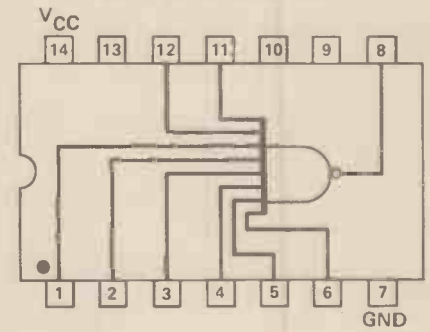

7402 QUADRUPLE 2 - INPUT NOR GATE

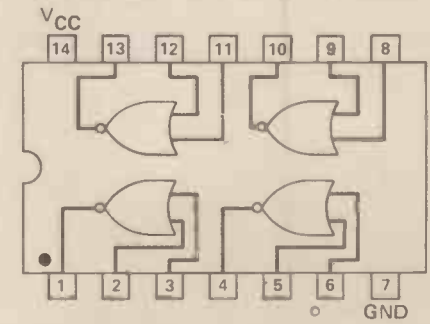

7408 QUADRUPLE 2 - INPUT AND GATE

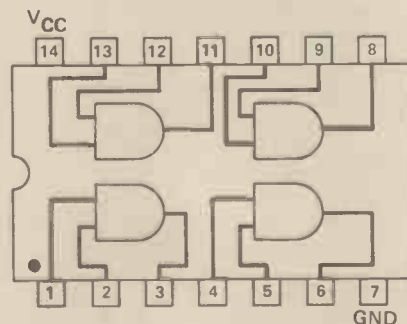

7410 TRIPLE 3 - INPUT NAND GATE

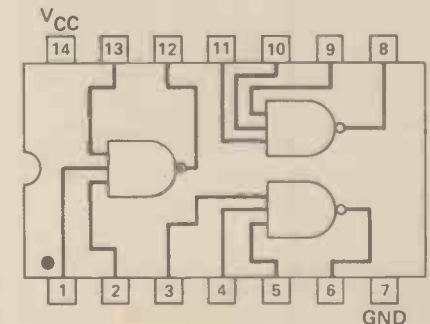

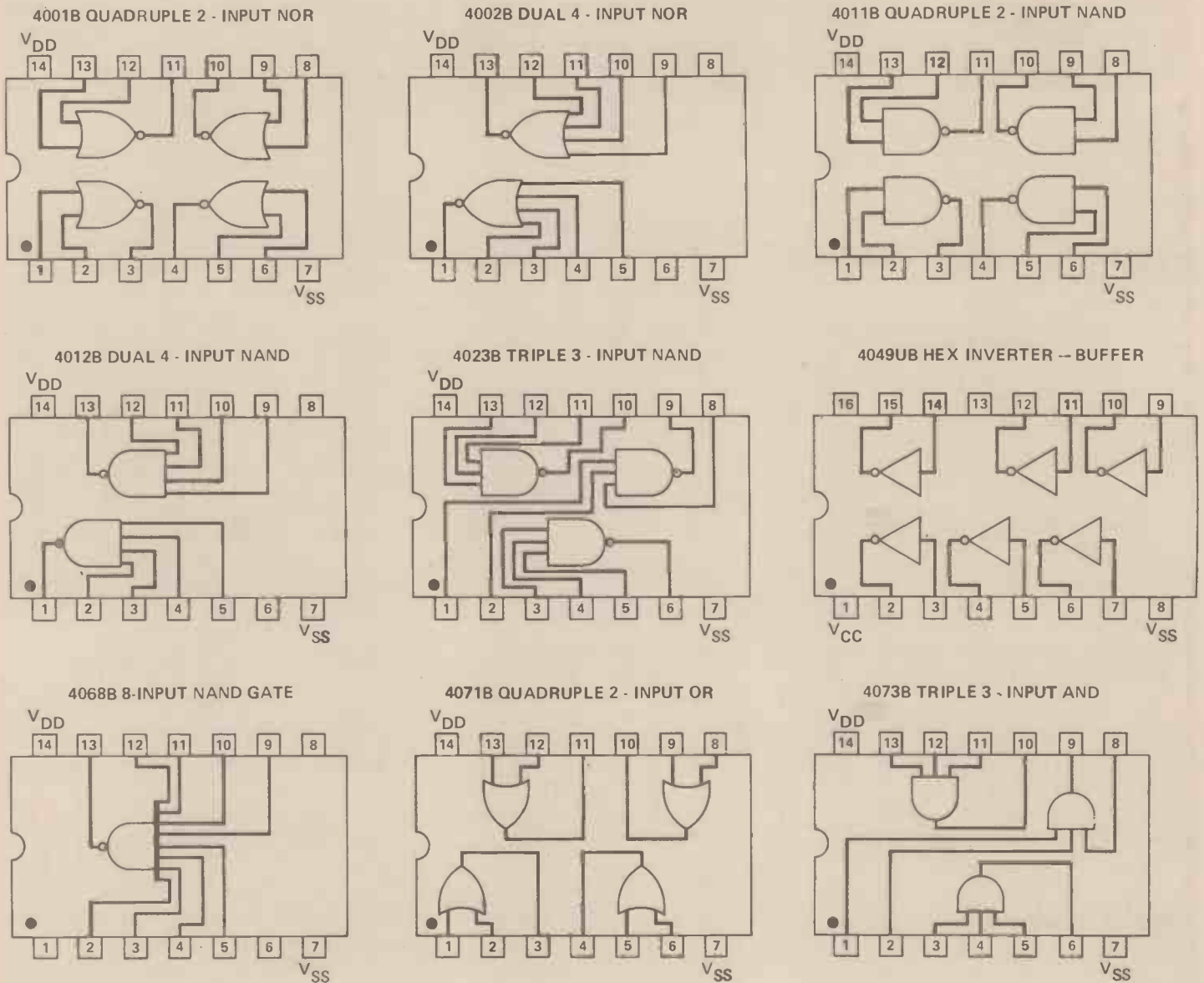

**Figure 18.** Connection details for nine CMOS ICs in the 4000 series. CMOS ICs, popularly known for their delicacy (hence the warnings often issued in HE to handle them carefully) do not need a fixed power supply voltage, making them popular amongst home constructors.

A selection out of the TTL logic range of ICs is shown in Figure 17 and you can see that all gates we've covered are included in the range, with a varied number of inputs.

Another range of logic ICs is shown in Figure 18. This is known as the CMOS range (complementary metal oxide semiconductor) and is similar to the TTL range but instead of a fixed voltage power supply requirement, power supply voltage can be anything between 3 to 15VDC, making the range more suitable in this respect to the hobbyist. As all devices in the range are prefixed 4---, the range is often called the 4000 series.

## Home On The Range

Either of the two logic ranges can be

used in the design and construction of digital logic control circuits but it is generally better not to mix the two in one circuit — if you start a circuit with one type finish it with the same type. Both ranges have their merits and demerits but I haven't got space left in this instalment of All About Electronics to discuss advantages and disadvantages to any more depth — perhaps another month.

Well, where do we go from here? What do these control circuits give us? For one thing they form the basis for all modern computer systems, believe it or not — but not in the form I have presented them here.

You see the circuits and the gates I have shown so far are combinational ie, any output is totally dependent on the overall combination of the inputs. Computer systems are sequential ie,

they perform functions in a set sequence — one after the other. True, these functions may be performed exceptionally fast: so fast that the whole operation may appear to an observer as being instantaneous (and therefore combinational) but it is not!

Tuning combinational circuits such as those in this month's All About Electronics will be the subject of another instalment later on; and if you thought that this instalment was a brain-teaser, I can guarantee that the one on computer systems will be totally mind-blowing.

Well, that's enough of digital systems for the time being. Next month we go back to linear systems and look at what I personally feel is the most important device in the whole history and development of electronics — the operational amplifier.



# EUROPA ELECTRONICS

Mail Order to 160 High Road, Willesden, London NW10 2PB

TEL: 01-907 1659

**SEND FOR A FREE LIST OF OUR LARGE RANGE OF ITEMS  
ALL DEVICES ARE NEW, FULL SPEC AND GUARANTEED**

Post & Packing: Add 30p to all orders under £5.

VAT: All UK orders add 15% to total cost including p&p.

74LS SERIES		TRANSISTORS		COMPUTER CHIPS		LINEAR IC's		4000 CMOS	
74LS00	20p	74LS154	74p	AD181	42p	280A	320p	741	14p
74LS01	20p	74LS155	40p	BC107	10p	280401C	250p	CA3018	90p
74LS02	20p	74LS156	40p	BC108	10p	280ADART	70p	CA3048	70p
74LS03	20p	74LS157	40p	BC109	10p	280AP10	250p	CA3048	220p
74LS04	20p	74LS158	35p	BC109C	12p	280A10	910p	CA3059	285p
74LS05	20p	74LS159	910p	BC176	16p	8802	225p	CA3060	250p
74LS08	20p	74LS161	50p	BC178	16p	8821	100p	CA3080	72p
74LS09	20p	74LS162	45p	BC179	20p	8840	375p	CA3086	48p
74LS10	20p	74LS163	45p	BC193L	10p	8850	110p	CA3130E	90p
74LS11	20p	74LS164	48p	BC193L	10p	8852	290p	CA3130T	110p
74LS12	20p	74LS165	48p	BC184L	10p	8875	500p	CA3140C	90p
74LS13	20p	74LS166	80p	BC212L	10p	8085	450p	CA3140E	50p
74LS14	20p	74LS167	140p	BC213L	10p	8154	950p	CA3160E	150p
74LS15	20p	74LS168	140p	BC214L	10p	8156	350p	CA3161E	150p
74LS16	20p	74LS169	110p	BC547	12p	8212	100p	CA3162E	450p
74LS20	20p	74LS170	100p	BC548	12p	8216	100p	CA3189E	300p
74LS21	20p	74LS173	90p	BC648C	14p	8229	370p	CA3240E	110p
74LS22	20p	74LS174	48p	BC655	15p	8250	850p	CA3280G	200p
74LS24	20p	74LS175	45p	BC657	15p	8253	390p	LF347	150p
74LS27	20p	74LS181	120p	BC658	15p	8255	255p	LF381	48p
74LS28	20p	74LS183	120p	BC659	15p	8259	400p	LF353	85p
74LS30	20p	74LS190	60p	BF50	23p	BF151	23p	LF355	89p
74LS32	25p	74LS191	60p	BF151	23p	BF151	23p	LF358	89p
74LS33	25p	74LS192	60p	BF151	23p	BF151	23p	LF357	110p
74LS37	20p	74LS193	60p	BF151	23p	BF151	23p	LM301A	25p
74LS38	20p	74LS194	60p	BF151	23p	BF151	23p	LM310	120p
74LS40	20p	74LS195	50p	BF151	23p	BF151	23p	LM311	70p
74LS42	38p	74LS197	80p	BF151	23p	BF151	23p	LM318	150p
74LS47	40p	74LS197	50p	BF151	23p	BF151	23p	LM319	218p
74LS48	60p	74LS221	80p	BF151	23p	BF151	23p	LM324	30p
74LS51	20p	74LS240	70p	BF151	23p	BF151	23p	LM324	30p
74LS54	20p	74LS241	70p	BF151	23p	BF151	23p	LM324Z	80p
74LS55	20p	74LS242	60p	BF151	23p	BF151	23p	LM335Z	140p
74LS73	20p	74LS243	60p	BF151	23p	BF151	23p	LM339	80p
74LS74	30p	74LS244	100p	BF151	23p	BF151	23p	LM339	80p
74LS75	30p	74LS245	140p	BF151	23p	BF151	23p	LM339	80p
74LS78	27p	74LS247	70p	BF151	23p	BF151	23p	LM339	80p
74LS83	60p	74LS248	70p	BF151	23p	BF151	23p	LM339	80p
74LS85	60p	74LS249	70p	BF151	23p	BF151	23p	LM339	80p
74LS86	25p	74LS251	45p	BF151	23p	BF151	23p	LM339	80p
74LS90	32p	74LS253	48p	BF151	23p	BF151	23p	LM339	80p
74LS91	60p	74LS256	200p	BF151	23p	BF151	23p	LM339	80p
74LS92	25p	74LS256	200p	BF151	23p	BF151	23p	LM339	80p
74LS93	32p	74LS258	45p	BF151	23p	BF151	23p	LM339	80p
74LS95	50p	74LS259	80p	BF151	23p	BF151	23p	LM339	80p
74LS96	50p	74LS260	35p	BF151	23p	BF151	23p	LM339	80p
74LS107	33p	74LS261	25p	BF151	23p	BF151	23p	LM339	80p
74LS109	33p	74LS273	100p	BF151	23p	BF151	23p	LM339	80p
74LS112	33p	74LS273	100p	BF151	23p	BF151	23p	LM339	80p
74LS113	30p	74LS275	175p	BF151	23p	BF151	23p	LM339	80p
74LS114	32p	74LS279	50p	BF151	23p	BF151	23p	LM339	80p
74LS122	60p	74LS280	80p	BF151	23p	BF151	23p	LM339	80p
74LS123	90p	74LS283	50p	BF151	23p	BF151	23p	LM339	80p
74LS124	32p	74LS290	50p	BF151	23p	BF151	23p	LM339	80p
74LS125	34p	74LS293	50p	BF151	23p	BF151	23p	LM339	80p
74LS126	34p	74LS295	70p	BF151	23p	BF151	23p	LM339	80p
74LS132	42p	74LS364	180p	BF151	23p	BF151	23p	LM339	80p
74LS133	32p	74LS364	180p	BF151	23p	BF151	23p	LM339	80p
74LS136	42p	74LS386	34p	BF151	23p	BF151	23p	LM339	80p
74LS138	42p	74LS386	34p	BF151	23p	BF151	23p	LM339	80p
74LS139	42p	74LS367	34p	BF151	23p	BF151	23p	LM339	80p
74LS145	75p	74LS375	34p	BF151	23p	BF151	23p	LM339	80p
74LS147	120p	74LS373	100p	BF151	23p	BF151	23p	LM339	80p
74LS148	120p	74LS374	100p	BF151	23p	BF151	23p	LM339	80p
74LS151	50p	74LS375	50p	BF151	23p	BF151	23p	LM339	80p
74LS153	50p	74LS390	60p	BF151	23p	BF151	23p	LM339	80p
		74LS593	120p	BF151	23p	BF151	23p	LM339	80p

VOLTAGE REGULATORS (PLASTIC) TO220		TRANSISTORS		DIODES		7 SEGMENT DISPLAYS		RESISTORS	
7805	40p	7805	48p	1N4148	13p	LD7A	240p	Carbon Track 0.25W log & linear	30p
7812	40p	7812	48p	1N4149	13p	LD7B	240p	SK-2M single gang D/P switch	76p
7815	40p	7815	48p	1N4149	13p	LD7C	240p	SK-2M dual gang stereo	88p
7818	40p	7818	48p	1N4149	13p	LD7D	240p	PRESET POTENTIOMETERS	7p
7824	40p	7824	48p	1N4149	13p	LD7E	240p	Horizontal & Vertical	10p
				1N4149	13p	LD7F	240p	E12 values	1p
				1N4149	13p	LD7G	240p	E24 values	1p
				1N4149	13p	LD7H	240p	E96 values	1p
				1N4149	13p	LD7I	240p	0.5W 1R-5M	1.5p
				1N4149	13p	LD7J	240p	0.5W 1R-5M	1.5p
				1N4149	13p	LD7K	240p	0.5W 1R-5M	1.5p
				1N4149	13p	LD7L	240p	0.5W 1R-5M	1.5p
				1N4149	13p	LD7M	240p	0.5W 1R-5M	1.5p
				1N4149	13p	LD7N	240p	0.5W 1R-5M	1.5p
				1N4149	13p	LD7O	240p	0.5W 1R-5M	1.5p
				1N4149	13p	LD7P	240p	0.5W 1R-5M	1.5p
				1N4149	13p	LD7Q	240p	0.5W 1R-5M	1.5p
				1N4149	13p	LD7R	240p	0.5W 1R-5M	1.5p
				1N4149	13p	LD7S	240p	0.5W 1R-5M	1.5p
				1N4149	13p	LD7T	240p	0.5W 1R-5M	1.5p
				1N4149	13p	LD7U	240p	0.5W 1R-5M	1.5p
				1N4149	13p	LD7V	240p	0.5W 1R-5M	1.5p
				1N4149	13p	LD7W	240p	0.5W 1R-5M	1.5p
				1N4149	13p	LD7X	240p	0.5W 1R-5M	1.5p
				1N4149	13p	LD7Y	240p	0.5W 1R-5M	1.5p
				1N4149	13p	LD7Z	240p	0.5W 1R-5M	1.5p
				1N4149	13p	LD7A	240p	0.5W 1R-5M	1.5p
				1N4149	13p	LD7B	240p	0.5W 1R-5M	1.5p
				1N4149	13p	LD7C	240p	0.5W 1R-5M	1.5p
				1N4149	13p	LD7D	240p	0.5W 1R-5M	1.5p
				1N4149	13p	LD7E	240p	0.5W 1R-5M	1.5p
				1N4149	13p	LD7F	240p	0.5W 1R-5M	1.5p
				1N4149	13p	LD7G	240p	0.5W 1R-5M	1.5p
				1N4149	13p	LD7H	240p	0.5W 1R-5M	1.5p
				1N4149	13p	LD7I	240p	0.5W 1R-5M	1.5p
				1N4149	13p	LD7J	240p	0.5W 1R-5M	1.5p
				1N4149	13p	LD7K	240p	0.5W 1R-5M	1.5p
				1N4149	13p	LD7L	240p	0.5W 1R-5M	1.5p
				1N4149	13p	LD7M	240p	0.5W 1R-5M	1.5p
				1N4149	13p	LD7N	240p	0.5W 1R-5M	1.5p
				1N4149	13p	LD7O	240p	0.5W 1R-5M	1.5p
				1N4149	13p	LD7P	240p	0.5W 1R-5M	1.5p
				1N4149	13p	LD7Q	240p	0.5W 1R-5M	1.5p
				1N4149	13p	LD7R	240p	0.5W 1R-5M	1.5p
				1N4149	13p	LD7S	240p	0.5W 1R-5M	1.5p
				1N4149	13p	LD7T	240p	0.5W 1R-5M	1.5p
				1N4149	13p	LD7U	240p	0.5W 1R-5M	1.5p
				1N4149	13p	LD7V	240p	0.5W 1R-5M	1.5p
				1N4149	13p	LD7W	240p	0.5W 1R-5M	1.5p
				1N4149	13p	LD7X	240p	0.5W 1R-5M	1.5p
				1N4149	13p	LD7Y	240p	0.5W 1R-5M	1.5p
				1N4149	13p	LD7Z	240p	0.5W 1R-5M	1.5p
				1N4149	13p	LD7A	240p	0.5W 1R-5M	1.5p
				1N4149	13p	LD7B	240p	0.5W 1R-5M	1.5p
				1N4149	13p	LD7C	240p	0.5W 1R-5M	1.5p
				1N4149	13p	LD7D	240p	0.5W 1R-5M	1.5p

# I ALMOST MET . . .

Some very Famous Names. Ian Sinclair muses on near misses.



Thanks to Marconi Marine for the photograph.

The venerable Elettra II at Poole Harbour in the 1950s.

## Ian Sinclair

OF ALL THE SERIES I have written — which must by now amount to a tidy number — the **Famous Names** has probably given me the greatest personal pleasure, and in many cases has been prompted by personal involvement of a curiously second-hand nature.

Take one example to start with, that of Sir John Turton Randall. He, along with his fellow researcher Boot, invented the cavity magnetron in 1940 — an inventive step which did as much as Mitchell (Spitfire) and Watson-Watt (Radar) to prevent us from being invaded (at a time when the Peace-Pledge Union, the 30s equivalent of CND, were declaring how unwilling we really were to defend ourselves). Now as it happened, Randall became Professor of Natural Philosophy (the old name for Physics) at the University of St. Andrews in 1944, and was there until 1946, a year in which I started secondary school in that delightful town. When, a few years later, I sat in the Physics lecture theatre listening to Professor Allen, I didn't realise that some day I would be writing a short biography of his predecessor, but the influence was there. I was, as they say in those days, "madkeen" on all aspects of radio, radar and TV, and my interest was kept on the boil by the Chief Technician in the Physics Department, a keen experimenter whose main interest was in narrow-bandwidth transmission and reception.

Another coincidence concerned Armstrong. I was in New York in the summer of 1977, at which time the temperature was 105°F and the relative humidity close to 100%, being taken round as advisor to a small British company. My host, driving along the Palisades Parkway to New City, a popular commuter town in upstate New York, drew my attention to a radio mast

high up in the hills. This was Armstrong's pioneering FM transmitter, and it prompted me to learn more of a man whose name I recognised but of whose life I had previously known very little. Several of the other Famous Names from the US were prompted by that trip, and on its follow up to the Wescon Electronics Show in San Francisco in the autumn.

## Serendipity

Coincidences never come singly, as I have learned. When I first started work in 1956, at the Research Laboratories of English Electric Valve Co., I found myself in touch with the RCA research labs where colour TV had been developed comparatively recently, and where Zworykin and his team had been the US pioneers of electronic TV. I also found myself in the factory where the Randall-Boot magnetron had been developed and put into wartime production, and where these pioneers were well remembered. Most of all, though, I was living in Marconi's adopted town of Chelmsford.

When I graduated, my choices as far as employment was concerned were to be a fisherman, a ploughman — or to move four hundred miles south. Not fancying the first two choices, I took the advice that is so sneered at today, and got on my bike. It was a BSA Star Twin (no-one had ever heard of Japanese motorcycles in those days), and it took me to Chelmsford, where I signed up as a junior engineer for British Electric. I arrived there to start work, newly married and with the bike (89,000 trouble-free miles on the clock), swapped it for a 1937 MG, and started looking for digs.

We rented the lower of a pair of flats, chatted to the elderly lady in the upper flat and shortly afterwards found

ourselves looking at Marconi's family Bible. All those years ago, I remember what it looked like, but I can't for the life of me remember how she came to possess it. You can't escape memories of Marconi at Chelmsford, nor can you escape the memories of the many colourful, distinguished, or just plain eccentric people who came there as researchers into all aspects of radio and radar. Many of them worked all hours, and seemed rather surprised to collect a pay-cheque for something they enjoyed so much.

## Marconi Afloat

At that time, the Marconi Marine section was still the principle training ground for marine radio and radar operators, and regarded itself, with some justification, as the Senior Service of Marconi. One friend we knew well, Ron Gillibrand, had been an old-time Marconi man, torpedoed out of more tankers than I can remember. The Marine Company is probably as pre-eminent now as it was then, but I started to lose touch with it after Ron died in 1967. If the BBC had ever realised what a rich fund of stories they could have recorded from the old Marconi operators, Chelmsford would have been surrounded by interviewers. As it is, the BBC, an industry founded on Technology, is still desperately afraid of any mention of such subjects in its broadcasts. We're all supposed to be fascinated by fourth rate *artistes* and sportsmen, but anyone whose life has affected ours so profoundly as Marconi is regarded as a tricky subject — too technical for our consumption!

One of the products of the Research Lab. was the direct viewing storage tube (DVST), and it was very much my favourite project. This was a form of radar display tube which presented an image that could be retained for comparatively long periods (several minutes), with very bright pictures. At a time when the conventional radar tubes presented dim traces, with only just enough persistence to see the shape of the previous few traces if the room was almost blacked out, the DVST was a revelation in more ways than one. The natural reaction of Marconi's to any development of this type was to try it out at sea, a tradition that had been firmly established by Marconi himself, using his yacht Elettra, in the twenties.

## Tossing And Turning

Now the first Elettra, which Marconi had used up to the time of his death, had been lost in honourable service at Dunkirk and, after the war, a rather hasty conversion of an old MTB (Motor

Torpedo Boat to you youngsters) had been christened Elettra II. When I first boarded it, Elettra II was skippered by Bert Christie and based in Poole harbour, and so it was to Poole that I went for my first radar installation and sea trials.

Bert Christie and the resident radar mechanic, Lee Smythe, were the best introduction any raw young engineer ever had to marine radar, and on the Elettra II we certainly needed all we could get. The old hulk was top-heavy with radar gear, and when she heeled over, there was always a sickening wait until she decided to right herself again. The time was always just enough to sow the seed of doubt that she would, if left to herself, and Bert was a past master at twitching her back if she took too long about it. When I first went on board, she had just come through a trip to Norway in which Bert and Lee had taken her through a Force 9 gale, an experience neither of them wanted to repeat. The effects of the gale were evident on more than the crew, however, as I discovered when I took up planks to lay cables. Of the eleven stringers, wooden beams which ran the whole length of the vessel, ten were broken, making the vessel distinctly flexible, especially when the twin Gardner diesels were put on full power!

We confined our tests to Poole harbour, and later on to leisurely trips down the Medway in good weather. A few months later, she was scrapped,

and a new Electra III commissioned. I hope Bert had many happy hours with her — and if you read this, Bert, all my best to Peggy Sue.

My prize almost-met has to be Einstein. No, I didn't meet him, but I was taught astronomy for a year by Prof. Freundlich, who corresponded with Einstein, and would often arrive in class clutching a letter. Let's face it, that's close than most of us have got! The only time when I did meet a Famous Name, face to face, was at a conference on low light-level TV techniques, where I met Prof. McGee, the legendary McGee of the EMI team which developed TV in the late 30s. The irony of it was that I didn't realise at the time what his claim to fame was!

### A First Rate Artist

There are two questions I am often asked in relation to the Famous Names series. One is, "Who do you feel most strongly about?" My invariable answer is Heaviside (HE September '81), a man never understood by his fellow engineers, but whose brilliant work laid the foundations of much that we take for granted today. The other question is "Who do you regard as the greatest genius of all time?" That one is easy. Wolfgang Amadeus Mozart rates this title for me, and for thousands of other people, as the supreme creative genius of all time, and would still in my opinion, deserve the title even if nothing else had

survived but Cosi Fan Tutte. I'm listening to it right now, on my Sanyo portable stereo set. Why didn't I choose Newton or Einstein? Simply because creation just has to rate above discovery, and some varieties of genius leave a deeper mark than others. The results of the work of Newton and Einstein will always be with us, but understanding them fully will always be only for a few. The work of Mozart is available to anyone with a pair of ears which have not been blasted into insensibility by Radio 1 (or *Motorhead - Ed.*) He's one of the Famous Names, though, that didn't fall within the scope of my series.

*Thanks again to Ian Sinclair for his personal reminiscences. We read about Famous Names in books and newspapers (and in Hobby Electronics . . .) but not often with a perspective on how Famous Persons have influenced Less Famous Persons who in turn may have influenced Persons Not Famous At All, by personal contact. It's also fascinating that Ian's own Hero is a composer rather than a scientist.*

*What comments do readers have on their own encounters, near-misses, influences and personal heroes? Write and tell us, and we'll print a selection of the most interesting. You don't have to stick to inventors.*

HE

# IT LIVES AGAIN!

From the past it came, growing daily, striking terror into the hearts of lesser publications, and spreading its influence across the country in its quest to infiltrate every town, every home, every mind

Not a horror story, but a success story. And if electronics theory strikes terror into you, then you need the help of **Electronics — It's Easy**. Originally a long-running series in Electronics Today International, **Electronics — It's Easy** was printed as a set of three books. They sold out. It was reprinted as a single volume. It sold out. Now this phenomenally successful publication is available again, in its third reprint. **Electronics — It's Easy** is a comprehensive and simply written guide which explains the theory (and the practice) of electronics step by step. Every aspect of the subject is covered, starting with the basic principles and working through to the how and why of today's technology.

You can obtain your copy of **Electronics — It's Easy** by mail order using the coupon below. Make cheques or postal orders payable to ASP Ltd, alternatively you may pay by Access or Barclaycard

Send to: Sales Office (Specials),

513 London Road, Thornton Heath  
Surrey CR4 6AR

Please send me . . . . . copies of **Electronics — It's Easy**. I have enclosed £ . . . . . (£4.95 each including p&p).

NAME . . . . .

ADDRESS . . . . .

. . . . .

. . . . .

Please debit my account

My Access/ Barclaycard No. is . . . . .

Signature . . . . .

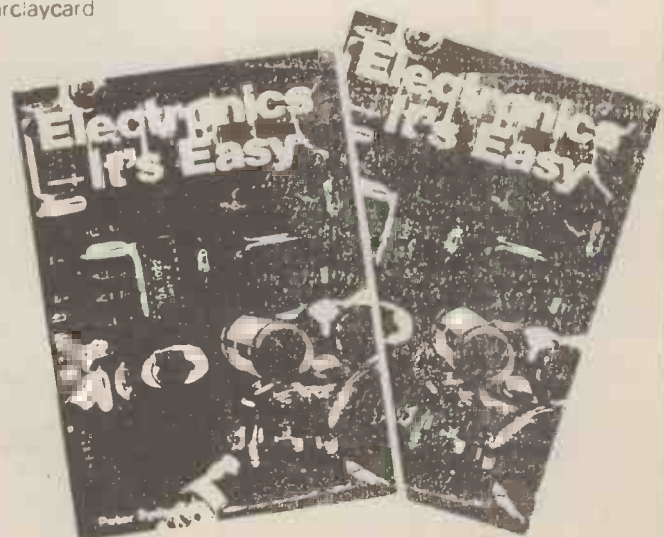

# UP THE JUNCTION

Brian Dance

The first in a whole family of field effect transistors, the junction FET is found in many and varied applications. If you're new to electronics or unfamiliar with the device, this article should introduce you to the haunts and habits of the JFET.

THE JUNCTION Field Effect Transistor or JFET is a small device, much like a transistor in appearance, which normally has three connections, although a fourth connection is attached to the metal case of some types for high frequency screening. Junction field effect transistors are one of the two main types of field effect transistor, the other type being known as the MOSFET (Metal Oxide Semiconductor Field Effect Transistor) or as the IGFET (Insulated Gate Field Effect Transistor).

Field effect transistors can be used as amplifiers and oscillators as well as for other applications for which an ordinary or bipolar transistor could be employed, but have particular advantages for certain applications. Field effect transistors are also used in the internal circuitry of integrated circuits.

## Connections

As in the case of NPN and PNP bipolar transistors, junction field effect transistors can be obtained in two polarities, these being known as N-channel and P-channel types. A far wider variety of N-channel types is manufactured than P-channel devices, since they tend to have a better performance, but devices of both polarities are readily obtainable.

The electrodes and circuit symbols for the two types are shown in Figure 1. The current flowing in a channel between the drain and the source is controlled by a voltage applied to the gate electrode. The gate is therefore input electrode and may be compared with the base of a conventional transistor. Similarly the drain and the source may be compared with the collector and the emitter, respectively.

One of the main differences between

field effect transistors and bipolar transistors is that FETs are essentially voltage amplifiers whereas bipolar transistors are basically current amplifiers. Thus the field effect transistor behaves more like the old thermionic valve in its circuits.

Field effect transistors tend to be more expensive than most bipolar types — probably because the bipolar types are sold in much larger numbers. The economical 2N3819 N-channel field effect transistor is probably the most commonly used type and is very suitable for readers who wish to carry out their first experiments with FETs. This device is encapsulated in a black plastic or epoxy body and has the connections shown in Figure 2. The 2N3820 is a similar economical P-channel device.

## High Input Impedance

One of the main advantages of a field effect transistor is that it has a very high input resistance and therefore takes very little current from the circuit which feeds it — typically, far less than a microamp. This means that it has very little effect on the circuit, even if this has such a high output impedance that it can deliver only a very minute current.

In order that an N-channel device can operate correctly and have a high input impedance at its gate, it must be suitably biased with its gate negative with respect to the other electrodes. Similarly a gate of a P-channel device has a high impedance when it is positively biased.

## How Do They Work

An N-channel field effect transistor consists of a chunk of N-type semiconductor material surrounded by

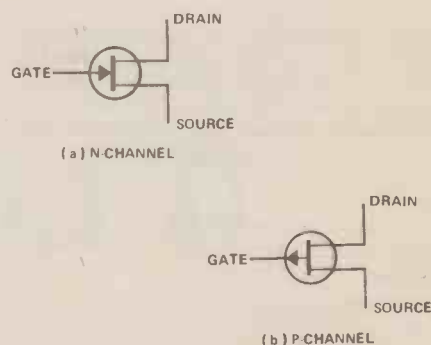

Figure 1. Symbols for n-channel (a) and p-channel (b) junction FETs.

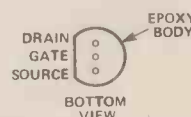

Figure 2. Connections for the common 2N3819 plastic-encapsulated n-channel JFET.

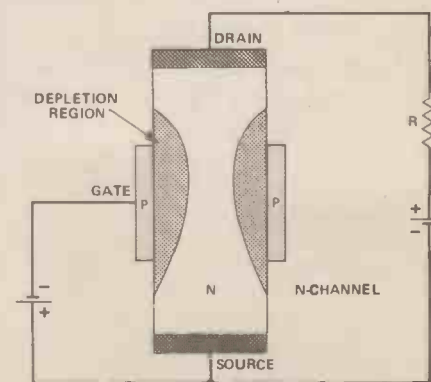

Figure 3. Control of channel width in an n-channel device.

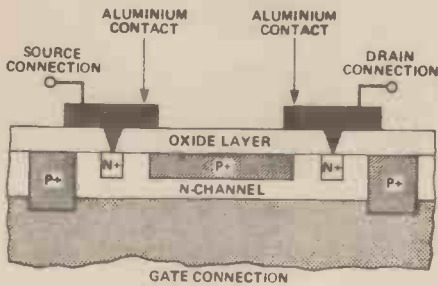

Figure 4. Structure of a silicon planar device.

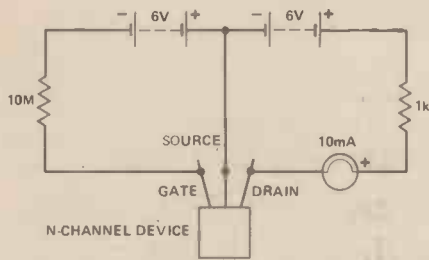

Figure 6. Testing an n-channel device.

P-type material of the gate electrode. Almost all of the devices are made of silicon, but a few special devices are produced in other semiconductor materials. As shown in Figure 3, the gate normally receives a negative bias relative to the source and the drain a positive bias.

As the P-type gate material receives a negative bias, the junction between this material and the N-type channel is reverse biased. In any reverse-biased junction, a region is formed which is depleted of charge carriers (electrons and holes). As this depletion region contains very few mobile charges, it acts almost as an insulator and has a very high resistance.

The gate is normally much more heavily doped than the channel material, and this results in the depletion region spreading fairly deeply into the channel but not very far into the material of the gate. As the drain and the negative gate is larger than that between the source and the gate. The electric field is therefore greater on the drain side and thus producing a narrower channel, as shown in Figure 3.

If the voltage applied to the gate becomes more negative, the depletion region goes deeper into the N-channel material until eventually the channel becomes completely cut off on the drain side of the gate. Very little current can then flow through the device. As the gate voltage becomes less negative, the channel opens again and becomes wider as the gate voltage approaches that of the source; the widening of the channel under the control of the gate voltage results in the current from the drain to source increasing.

As the gate-to-channel region comprises a reverse-biased PN junction, the gate has a very high input resistance

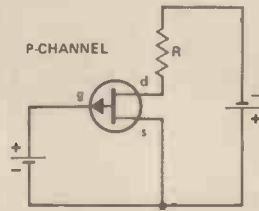

Figure 5. A p-channel device requires supplies of the opposite polarity to those used with n-channel devices.

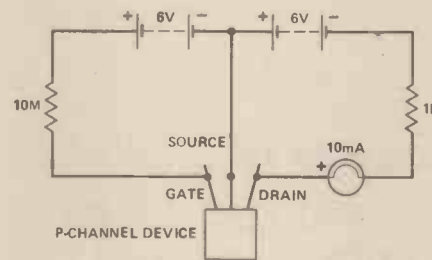

Figure 7. Testing a p-channel device.

and passes only a very minute current (often in the picoamps region). However, the gate-to-channel capacitance is appreciable and therefore an alternating current may flow into this electrode at high frequencies. Even when the gate and source potentials become equal, there is still a small depletion region and the gate input resistance is high. However, if the gate of an N-channel device receives a positive bias of more than about 0V65, current can flow in the gate circuit and this may damage the device.

## Structure

The design of a modern field effect transistor is not exactly as shown in Figure 3, which has been used for explanatory purposes; silicon planar technology is usually employed to produce a structure such as that of the Mullard/Philips BFW 11, shown in Figure 4. This has a surface (or planar) structure which is covered with a protective layer of silicon dioxide at all points except where electrode connections are attached. This oxide layer prevents impurities from contaminating the surface of the material and thus producing unwanted currents.

The aluminium contacts at the source and drain electrodes allow current to flow from them into the heavily doped small N+ regions, which make good contact with the N-channel region. In some devices a number of N-type channels are connected in parallel to enable a larger current to flow at the expense of an increased gate capacitance.

## P-channel Types

P-channel field effect transistors have

the same type of structure as those shown in Figures 3 and 4 but the P and N type materials are interchanged. The gate is made of N-type material and must therefore be biased positively as shown in Figure 5. The drain is normally biased negatively.

## Limiting Voltages

If the bias applied to the gate is taken far beyond that required for normal operation, a point will eventually be reached at which reverse breakdown occurs. Similarly there is a limit to the voltage which can be applied between the drain and the source electrodes. However, junction devices cannot be damaged by the ordinary electrostatic charges which can accumulate on people and clothing, and which can damage MOSFET devices.

## Testing JFETs

It is relatively easy to check that a junction field effect transistor is able to function correctly. The circuit of Figure 6 may be used for an N-channel device and that of Figure 7 for a P-channel device.

If the gate is initially connected directly to the source (instead of as shown), it will be found that the meter provides a reading of a few mA. This current is limited by the 1k resistor in the drain circuit to a safe value.

If the gate electrode is now connected to the 10M resistor as shown, the gate to channel junction is reverse biased. Thus the channel width decreases and with most devices the drain current will fall to zero in the circuits shown. As the gate circuit has a very high resistance, the voltage can be applied to it through a high-value resistor; indeed it is interesting to note that the human body can be used in place of the 10M resistor shown when testing the junction field effect devices.

If you wish to test a device and do not know the connections, first find two connections in which a small current will pass in either direction. These are the source and drain connections.

A current should pass from the third electrode, the gate, only in one direction to either of the other two electrodes. If conduction takes place when the gate is positive, one has an N-channel device, whereas if conduction takes place when the gate is negative, the device is of the P-channel polarity.

One cannot easily determine which electrode is the drain and which is the source, but these electrodes are to some extent electrically interchangeable.

## Applications

In the circuit of Figure 8 the field effect transistor is employed as a Pierce oscillator whose frequency is controlled by the quartz crystals shown. The advantage of using a FET in this circuit is that the gate imposes only a very small load on the crystal and therefore the quality factor or Q of the crystal is not appreciably affected, so excellent frequency stability can be obtained.

## Junction FETs

National Semiconductor recommend their 2N3823 N-channel device for use in this circuit, but the more economical 2N3819, which is made by the same type of process, is also suitable. The supply voltage is not at all critical, but the radio frequency chokes used in the supply lead should have a high impedance at the frequency of oscillation.

An advantage of this circuit is that one can change the crystal over quite a wide range of frequencies without making any other changes to the circuit and still obtain a satisfactory performance. The exact frequency range over which the circuit will operate depends very much on the choke used and, to some extent, on the circuit layout.

This type of circuit is suitable for use in a crystal calibrator for a receiver. If a 1MHz crystal is employed, the output may be fed to radio receiver to produce a signal at 1 MHz and at each multiple of 1 MHz up through the shortwave bands, to provide calibration points.

## Electronic Attenuator

A JFET can be used as a variable resistor, the value of which is controlled by the voltage applied to the gate electrode. As the applied bias becomes smaller, the resistance between the drain and the source electrodes falls.

This property is used in the circuit of Figure 9 to an electronic attenuator for audio signals. When the negative control voltage applied to the gate electrode is relatively large, a little drain current passes through the device and the circuit behaves as if the FET were not present. However, as the control voltage falls at the gate electrode, the drain draws current from the junction of R1 and R2 so that the output signal amplitude is progressively attenuated.

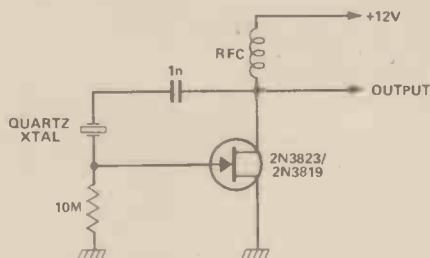

Figure 8. A pierce crystal oscillator.

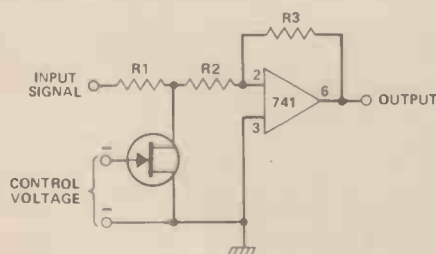

Figure 9. An electronic attenuator.

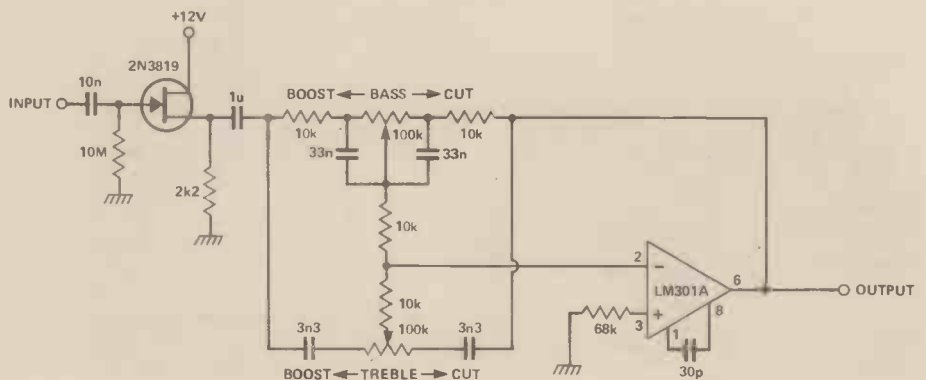

Figure 10. High input impedance tone control circuit.

METER RANGE	R1
250mV	40M
500mV	6M67
1 V	2M5
10 V	204k
50 V	40k
100 V	20k
250 V	8k
500 V	4k

Table 1 showing the value of R1 to be used in Figure 9 for various ranges.

## Tone control

The circuit of Figure 10 is a tone control circuit with bass and treble boost and cut facilities. In this circuit the 2N3819 is used to enable the circuit to have a very high input impedance. It is used as a source follower circuit (analogous to an emitter follower) which provides a low output impedance signal coupled by a 1uF capacitor to the tone control network. This network is in the feedback circuit of the LM301A operational amplifier circuit.

## Lambda oscillator

A very simple sinewave oscillator is shown in Figure 11; it is essential that one N-channel and one p-channel field effect transistor are used in this circuit. The two source electrodes are connected together and the gate of each device is connected to the drain electrode of the other device. This type of connection produces a negative resistance region in the current/voltage graph for the circuit with a peak in the graph like a Greek lambda (λ) — hence the name given to this type of circuit.

It is only necessary to connect the dual device circuit in series with a parallel tuned circuit, as shown in Figure 11, to produce oscillations at the resonant frequency of the tuned circuit. It will oscillate at any frequency from the low audio region up to some tens of MHz, but the gate capacitances of the devices used prevent operation above 100MHz.

It is interesting to note that two separate parallel tuned circuits may be connected in series with the lambda circuit, instead of the single tuned circuit shown in Figure 11. If one of these tuned circuits resonates at an audio frequency and the other at a radio frequency, the output will consist of an amplitude modulated radio frequency oscillation. This is perhaps one of the simplest possible modulated signal generators!

The output voltage from the circuit is equal to twice the steady power supply voltage. Therefore this type of circuit can be very useful when one requires an output oscillation whose amplitude is accurately related to a steady applied voltage.

Complementary pairs of field effect transistors used in lambda circuits have other applications apart from simple oscillator uses.

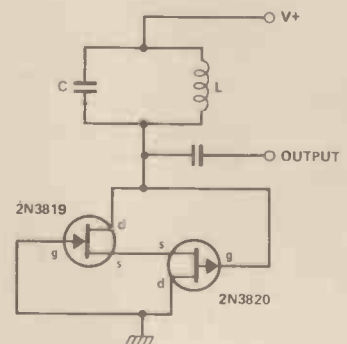

Figure 11. Sinewave oscillator using a "Lambda" circuit.

## High impedance buffer stage

The circuit of Figure 12a shows a buffer or isolating amplifier which has a very high input impedance and low input capacitance. National Semiconductor recommended a 2N4416 for this circuit because it has a low input capacitance, but this is further reduced by the circuit feedback. The device is used as a source follower, so the voltage gain is about unity.

Although a 25139 PNP transistor is specified for this circuit, the 2N3906 plastic encapsulated type is much more

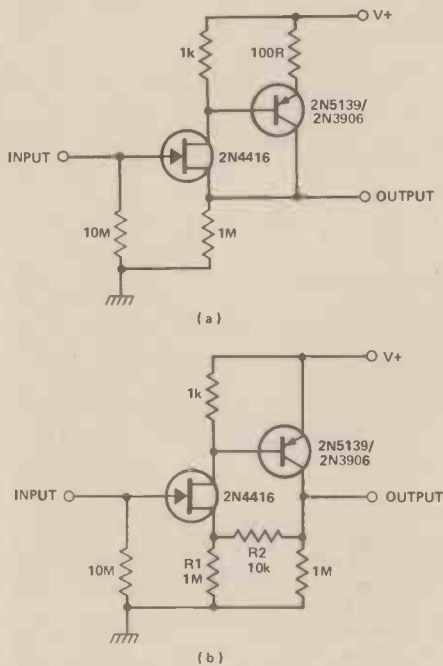

Figure 12. A unity gain buffer stage (a) with high input impedance and a similar stage (b) with gain.

readily available, so it can be used in this application.

### High impedance amplifier

The circuit of Figure 12b is very similar except that the feedback circuit has been modified so that a voltage gain can be obtained. The circuit provides a gain of  $R2/R1$  or 10, with the component values shown. Both the circuits of Figure 12 and of Figure 13 can be operated at high frequencies, into the tens of MHz region.

### RF amplifiers

Junction field effect transistors are much used in the radio frequency stages of HF, VHF, and UHF receivers, since they offer a noise performance equivalent to that of bipolar transistors with improved crossmodulation and intermodulation performance. Crossmodulation is the transfer of the modulation of one carrier onto the carrier of another

signal. Intermodulation occurs when two or more signals outside the passband combine in the circuit to form a signal within the passband which causes interference with the wanted signal.

The better linearity of field effect transistors over bipolar transistors is responsible for this improvement. Mullard have quoted a 12 dB improvement in a VHF broadcast receiver, achieved by the replacement of a bipolar mixer circuit with a junction field effect transistor circuit.

Figure 13 shows a high-performance amplifier using two JFETs connected in 'cascade' (series) with automatic gain control (AGC) applied to the gate of the upper device. The supply is applied to the 'cold' or 'ground' end of  $L2$  via a feed-through capacitor. Only the L-C values need to be changed to operate this stage on other frequencies, to the limits of the JFETs.

### Simple voltmeter

The high input impedance of a junction field effect transistor is used in the circuit of Figure 14 to produce a volt-meter with an input resistance of over 10M; in some measurements this high input impedance is necessary to prevent the current taken by a conventional voltmeter from dragging down the voltage being measured.

The input voltage being measured is divided by  $R1$  and  $R2$  so that a voltage of +0V2 is present at the gate electrode when the full scale input voltage is applied.  $R1$  should consist of a fixed resistor of a value somewhat less than that shown in Table 1, in series with a preset potentiometer so that the sensitivity of the range can be adjusted. If desired,  $R1$  may be switched to provide a number of ranges.

No two field effect devices have exactly the same characteristics, and the 2k2 resistor in series with the meter enables the full-scale current to be adjusted to allow for the characteristics of the particular device used. The diode protects the meter from over-loading.

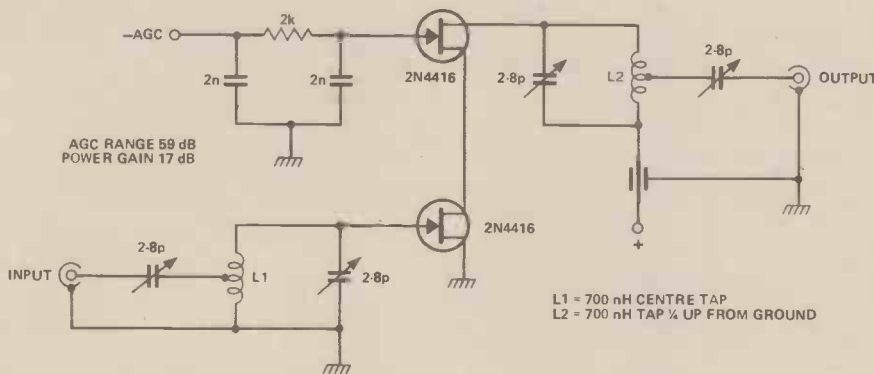

Figure 13. Typical high-performance amplifier stage employing two FETs in 'cascade'. Values are given for 200MHz. A wide variety of RF FETs may be substituted.

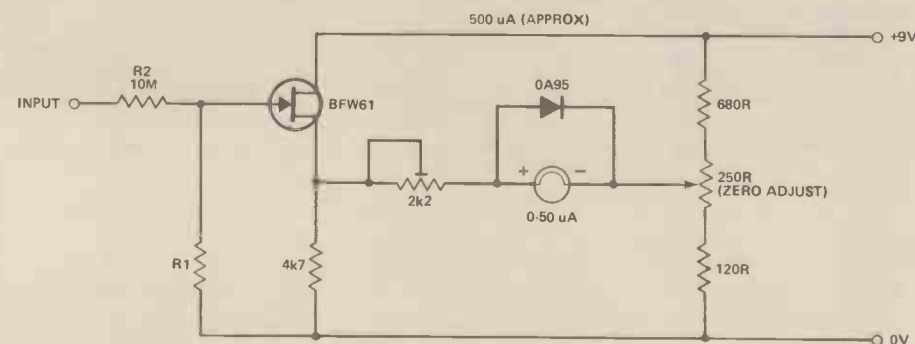

Figure 14. High input impedance voltmeter. Note that a BFW10 could substitute for the BFW61.

### PhotoFET

Photosensitive field effect transistors (photoFETs) can be made which have a window or a lens, so that any light falling on this window affects the junction and hence the drain current of the device in much the same way that light affects a phototransistor. However, photoFETs are not very common devices.

An application of a Teledyne Crystals photoFET as a light-controlled variable attenuator is shown in Figure 15. The drain-to-source resistance of the photoFET is a function of the intensity of the illumination, so as more light shines on the device, the output rises. The negative voltage to which the resistor  $R3$  is returned determines the range in which the drain-to-source resistance falls. Like other silicon photosensitive devices, the photoFET is sensitive to the red and near infrared regions of the spectrum, such as the radiation from an incandescent filament bulb.

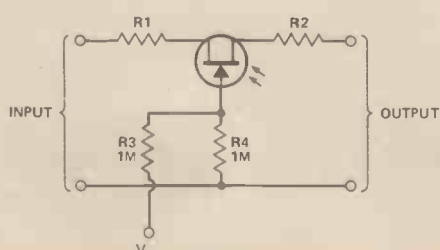

Figure 15. Example of a light-controlled attenuator.

# MASTER ELECTRONICS NOW! The PRACTICAL way!

YOUR CAREER..YOUR FUTURE..YOUR OWN BUSINESS..YOUR HOBBY  
THIS IS THE AGE — OF ELECTRONICS!  
the world's fastest growth industry...

There is a world wide demand for designers/engineers and for men to service and maintain all the electronic equipment on the market today — industrial — commercial and domestic. No unemployment in this walk of life!

Also — the most exciting of all hobbies — especially if you know the basic essentials of the subject. . . .

A few hours a week for less than a year — and the knowledge will be yours. . . .

We have had over 40 years of experience in training men and women successfully in this subject.

Our new style course will enable anyone to have a real understanding of electronics by a modern, practical and visual method. No previous knowledge is required, no maths, and an absolute minimum of theory.

You learn by the practical way in easy steps, mastering all the essentials of your hobby or to start, or further, a career in electronics or as a self-employed servicing engineer.

All the training can be carried out in the comfort of your own home and at your own pace. A tutor is available to whom you can write personally at any time, for advice or help during your work. A Certificate is given at the end of every course.

You will do the following:

- Build a modern oscilloscope
- Recognise and handle current electronic components
- Read, draw and understand circuit diagrams
- Carry out 40 experiments on basic electronic circuits used in modern equipment using the oscilloscope
- Build and use digital electronic circuits and current solid state 'chips'
- Learn how to test and service every type of electronic device used in industry and commerce today. Servicing of radio, T.V., Hi-Fi, VCR and microprocessor/computer equipment.

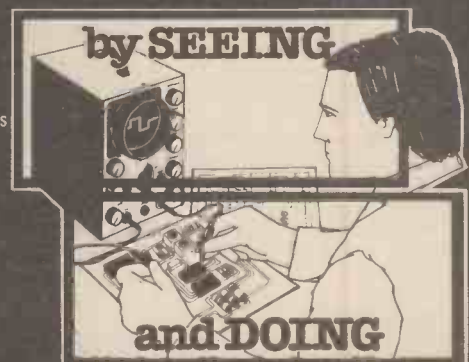

CACC  
www

**British National Radio & Electronics School** Reading, Berks. RG1 1BR

**FREE!**  
COLOUR BROCHURE



Please send your brochure without any obligation to

NAME \_\_\_\_\_

ADDRESS \_\_\_\_\_

HE/12/841

BLOCK CAPS PLEASE

I am interested in:

- COURSE IN ELECTRONICS as described above
- RADIO AMATEUR LICENCE
- MICROPROCESSORS
- OTHER SUBJECTS please state below

OR TELEPHONE US  
0734 51515 OR  
TELEX 22758  
(24 HR SERVICE)



POST NOW TO

**British National Radio & Electronics School** Reading, Berks. RG1 1BR



# MOISTURE GAUGE

HE's simple damp meter uses ten LEDs and can be calibrated to measure the moisture content of various materials.

R. A. Penfold

MOISTURE INDICATION devices are used in a variety of applications, such as testing for dampness and rot in buildings, or boats, and testing the water content of soil. Equipment of this type is usually very simple and in its most basic form can consist of little more than a battery wired to a moving coil meter via a pair of test prods. The principle is that water conducts readily, whereas wood, plaster, dry soil, and most other substances are good insulators. In fact pure water is *not* a good conductor, but in practical applications water is almost certain to be contaminated with impurities from the wood, soil, (or whatever) that will drastically improve its conductivity. There is a paradox here in that the water or plaster etc. on their own have a very high resistance, but have a low resistance when mixed. As every O level chemistry student will know, this is due to the fact that salts have a high resistance when in solid form but are reasonable conductors when in solution.

The exact level of resistance that is detected across the prods is dependent on many factors, including such things as the distance between the prods and how hard they are pressed into the material being tested. This makes measurements somewhat less precise than is normal for an electronic checking device, but in practice this is not too much of a problem. The difference between the resistance of a reasonably dry test sample and a fairly moist one is very large, and for many purposes a simple two state (wet/dry) indicator is adequate. The unit featured here is a little more sophisticated, and it has a ten LED display so that it does not indicate just that dampness is present, but also gives some idea of how bad (or otherwise) the problem happens to be.

## LM3914N

The unit is built around the popular LM3914N bargraph driver IC, and this has the internal arrangement shown in Figure 1. The resistor and zener diode at the input are to provide protection against excessive input voltages and play no active role in the device.

As can be seen from Figure 1, there are ten voltage comparators at the centre of things. The outputs of these feed the ten LEDs in the bargraph display (one output to each LED); the LEDs are connected between the outputs and the positive supply rail.

The inverting inputs of the comparators are connected together and fed with the input voltage via a buffer amplifier, which gives the device a reasonably high input impedance. The non-inverting inputs are fed with a series of reference voltages that are provided by a precision 1V2 reference source and a potential divider. This gives

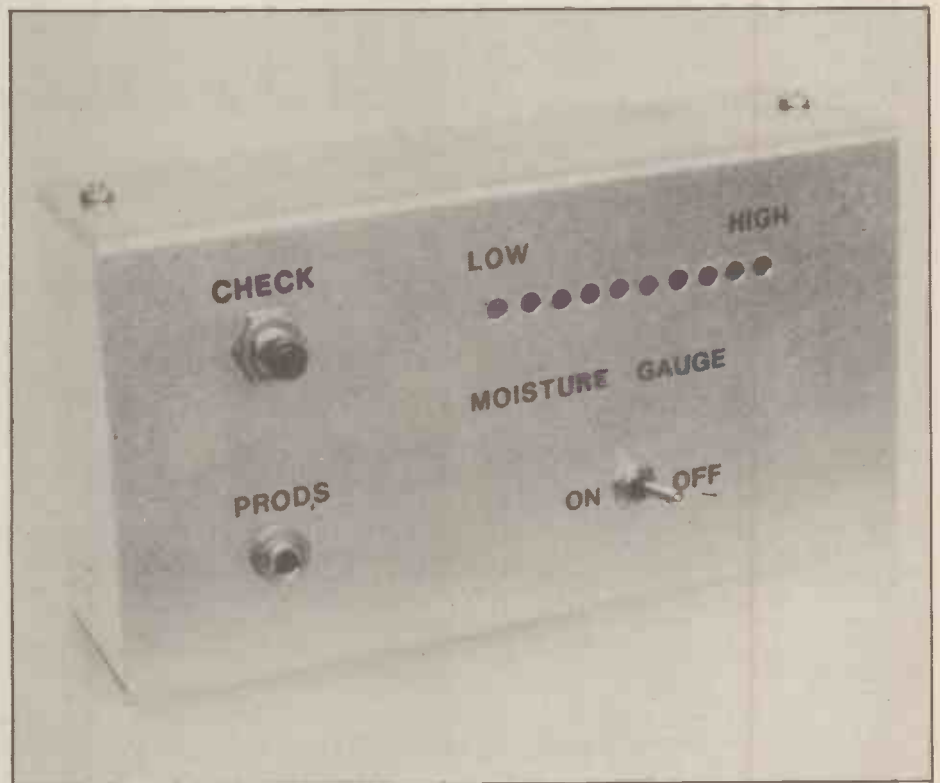
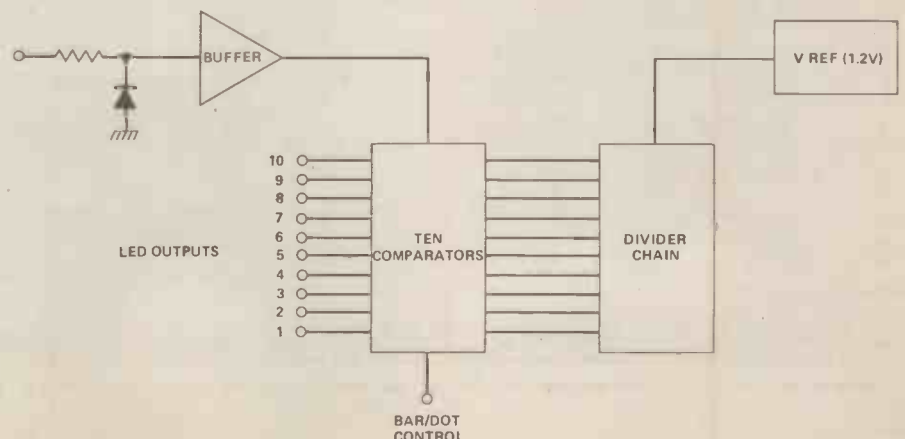

Figure 1. The internal arrangement of the LM3914N driver IC.



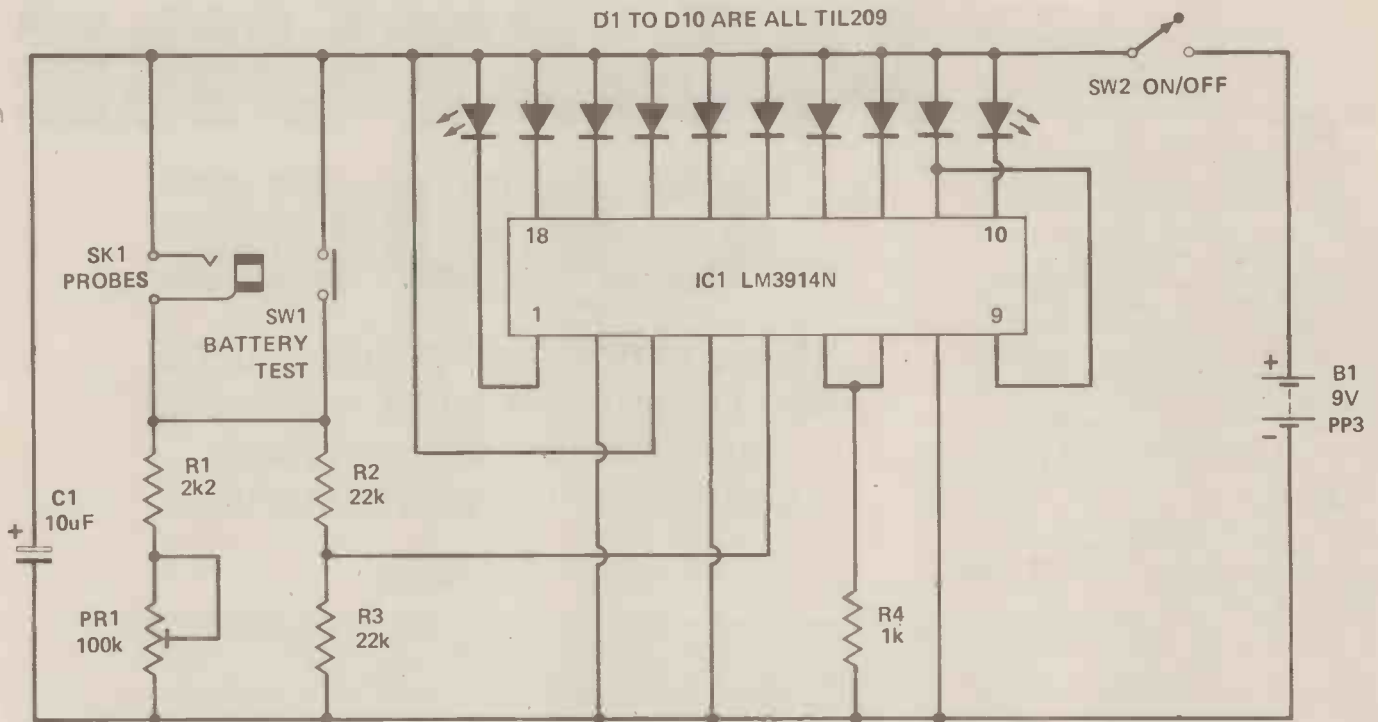

Figure 2. The circuit diagram shows the simplicity of the Moisture Gauge design.

reference voltages from 0V12 to 1V2 in equal increments of 0V12.

If the input voltage is zero, the inverting inputs must be at a lower voltage than the non-inverting inputs, so that the outputs are all high and none of the LEDs are switched on. If the input voltage is gradually increased, then as it goes past 0V12 the inverting input of one comparator will go higher in potential than its non-inverting input. The output of this comparator then goes low and switches on the first LED in the display. As the input voltage goes past 0V24 a similar action occurs and the second LED is switched on, and so on until the input voltage goes past 1V2 and all ten display LEDs are switched on. The device therefore gives a simple meter type action with ten display levels and a full scale value of 1V2.

A bargraph gives a very clear and easily-read display, even under very dark conditions. However, it does have the disadvantage of taking a substantial amount of supply current when all or most of the display LEDs are operating. A much lower level of current consumption can be achieved using the so called "dot" mode display where only one display LED is switched on at any one time. For instance, rather than six LEDs being switched on, only the sixth LED in the display would be activated.

The LM3914N has built-in logic circuitry which can be used to suppress the appropriate LEDs to give "dot" mode operation. It was stated above that only one LED in the display is activated at any one time, but this is not strictly true. The switch-over from one LED to the next is quite

"sharp", but during the transition from one LED to the next both do switch on. Only a very narrow range of input voltages activate two LEDs though, and in use this is something that will only rarely happen, if at all.

## The Circuit

Figure 2 shows the full circuit diagram of the Moisture Gauge, and as will be apparent from this, the unit uses little more than the LM3914N and the display.

Pin 9 of IC1 is used to set the "bar" or "dot" mode of operation, and in this case it is tied to pin 11 so as to give a "dot" display. For a "bar"

display pin of 9 of IC1 should instead be connected to the positive supply rail. The reference voltage and divider chain are arranged in such a way that it is possible to alter the voltage range of the device, and it could, for example, be set for a range of 1V12 to 2V2, but the method of connection used here gives a straight forward 0V12 to 1V2 scale.

R4 sets the LED current (brightness); and the current (in milliamps) is approximately equal to twelve divided by the value of R4 (in kilohms). With the specified value this gives a LED current of about 12 milliamps which produces excellent LED brightness. If the "bar" mode of operation is used R4 should be

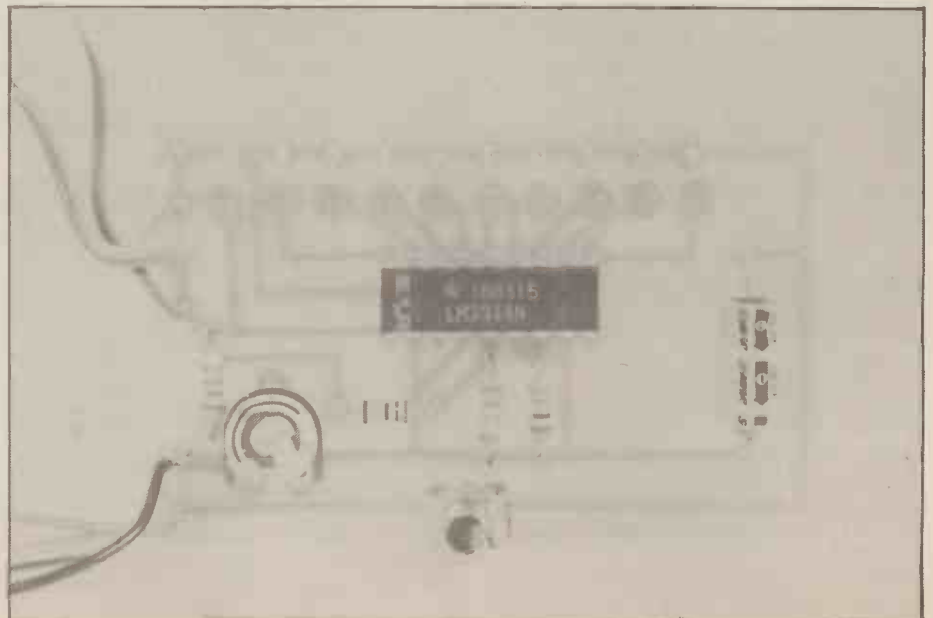

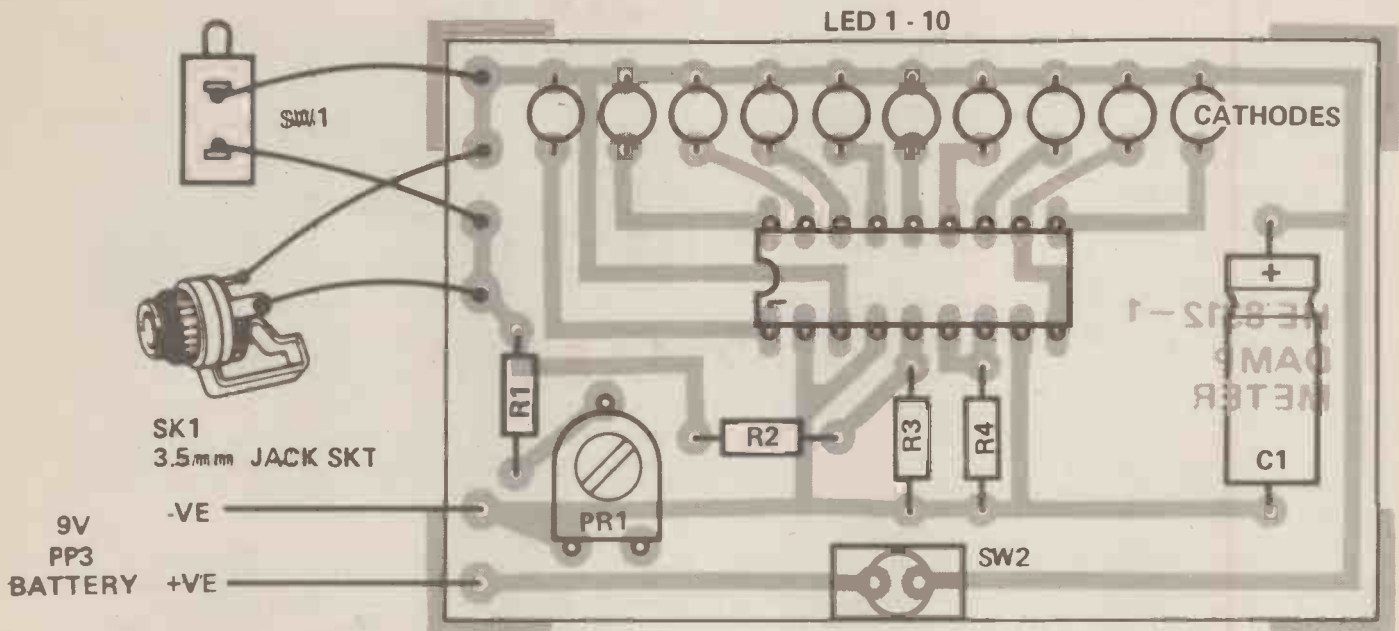

Figure 3. The component overlay. Drilling the LED holes neatly is a tricky job requiring care.

increased to 2k2 or more in value, to ensure that the maximum permissible power rating of IC1 is not exceeded.

R3 biases the input of IC1 to the negative supply rail under quiescent conditions so that all the LEDs are switched off. R2 is used to increase the full scale input voltage of the circuit to a more satisfactory value for this application. SW1 is the battery test switch, and it simply connects the input of the circuit across the supply rails. If the battery is in a usable condition the tenth LED of the display should switch on when it is operated.

RV1 enables the sensitivity of the circuit to be adjusted so that it can be set to suit the probes used with the unit. R1 is a current limiting resistor which protects RV1. C2 is a supply decoupling capacitor and SW2 is a straight forward on/off switch. The

quiescent current consumption of the unit is about 6 milliamps, rising to around 18 milliamps when one of the LEDs is switched on.

### Construction

Most of the components fit onto the printed circuit board, as shown in Figure 3. The LEDs must be small (3mm diameter) types if they are to fit in this layout properly, and they are left with their leadout wires at full length. SW2 is mounted vertically on the board via a couple of Veropins, and must be a subminiature toggle type. The front panel of the case is drilled to take SW2 and the display LEDs, done in such a way that when

SW2 is fixed in position the LEDs fit into their mounting holes in the front panel. The board is quite small and light, and the mounting provided by SW2 is all that is needed.

Drilling the line of ten mounting holes for the LEDs is not quite as easy as it might seem; it is quite tricky to make a really neat job of it. Probably the best way to tackle it is to first mark out the position of the holes (which are 0.2 inches apart) as accurately as possible, and make small indentations at these points using a bradawl or a similar pointed tool. Then drill out the holes using a miniature drill and drill bit about 1mm in diameter, as used for making printed circuit boards. Finally, the holes can be drilled out to the correct size (3.2mm is suitable).

On the prototype SW1 and SK1 are mounted on the front panel to the left of the display and SW2 respectively, but any sensible front panel layout which has SW2 and the display in suitable relative positions can be used. The final wiring of the unit is shown in Figure 3.

The test probes are simply two pieces of stout non-insulated wire about 10 to 25mm apart, insulated from one another. They must be *reliably* insulated, and ideally should be held together as a single assembly so that they are always the same distance apart so that consistent results are obtained. The probes connect to the main unit via a twin cable (which does not need to be a screened type) terminated in a 3.5mm jack plugged into SK1.

A little ingenuity must be used when building the probes but this aspect of construction is unlikely to give much difficulty. One easy approach is to use a couple of test prods of the type sold as replacements for use with multimeters. It is usually

## Parts List

### RESISTORS

(All 0.25W 5% carbon)

- R1 ..... 2k2
- R2 ..... 100k
- R3 ..... 1k

### POTENTIOMETER

- RV1 ..... 220k  
0.1W horiz preset

### CAPACITOR

- C1 ..... 10uF 25V  
axial electro

### SEMICONDUCTORS

- IC1 ..... LM3914N  
bar/dot display driver
- D1-10 ..... TIL209  
3mm red LEDs

### MISCELLANEOUS

- SK1 ..... 3.5mm jack socket
- SW1 ..... Push to make  
non-locking
- SW2 ..... SPST  
submin toggle
- B1 ..... 9 volt (PP3)
- Case; printed circuit board; battery  
connector; probes with lead and  
plug; Veropins, wire, etc.

BUYLINES ..... page 34

# Beasties

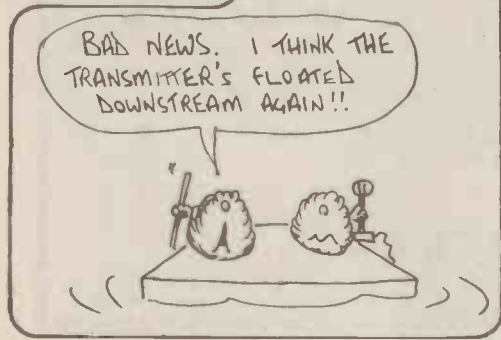

quite easy to fix these together somehow, such as using a clip fabricated from aluminium, or it might even be possible to just glue them together. Whatever method of construction is used for the probes, they must be mechanically very strong, or they will soon become damaged with use.

## Adjustment

RV1 must be given a suitable setting before the unit is ready for use, and the printed circuit must be temporarily removed from the case to give access to this components.

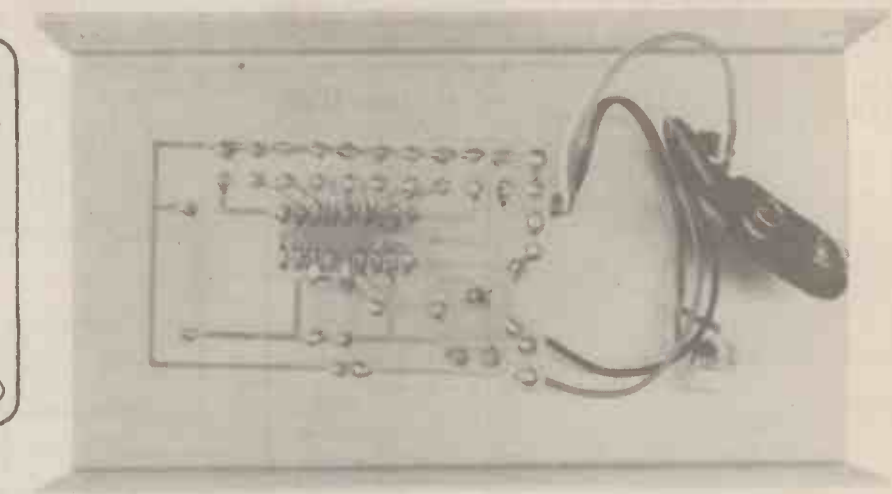

The best way of finding the correct setting for RV1 is to use trial and error. For instance, if the unit is to be used to test wood for dampness, obtain a few samples of wood of known condition and then try RV1 at various settings until one which gives suitable readings is obtained. Adjusting RV1 in a clockwise direction increases the sensitivity of the circuit incidentally.

Note that the circuit should be adjusted so that all the LEDs are normally switched off, and one or

more LEDs switch on to indicate the degree of dampness. Do not try to adjust the unit for a high degree of sensitivity so that one LED switches on even with a (normal) low level of moisture, or results will become difficult to interpret. RV1 will probably need to be set in an almost fully anticlockwise direction. Always try to get a reasonable probe area in contact with the sample under test, and keep the probes reasonably clean so that they are in good electrical contact with the materials under test.

HE

# Tomorrow's WORLD Self-Build Radio Controlled Car Kits

**NOW AVAILABLE!**  
Complete Car Kit and Transmitter Kit  
Clear build-up instructions included  
only **£9.95 + 50p P&P**

Also  
Porsche 935 Turbo Kit (2 speed)  
Kit includes transmitter and full build-up instructions  
only **£17.00 + 50p P&P**

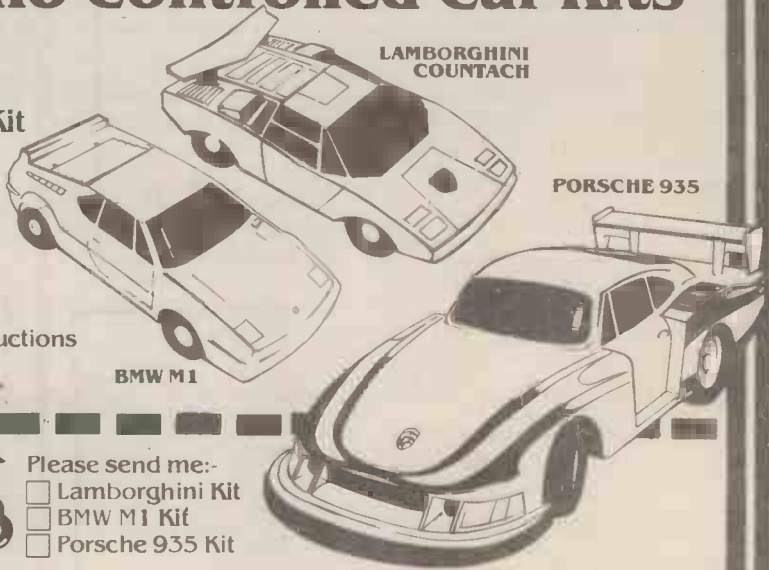

Order now from:-  
Tomorrow's World  
Car Kit Dept.,  
Hadleigh Road Ind. Estate,  
Hadleigh Road,  
Ipswich, Suffolk.  
Tel: Ipswich (0473) 59175



Please send me:-  
 Lamborghini Kit  
 BMW M1 Kit  
 Porsche 935 Kit

Name \_\_\_\_\_  
Address \_\_\_\_\_

Please allow 14 days delivery in U.K.

# Send for my CATALOGUE ONLY 75p (plus 25p post/packing)

My all-inclusive prices quoted in the Catalogue are the lowest. All below normal trade price — some at only one tenth of manufacturers quantity trade.

Millions of components : thousands of different lines

Watch/Calculator/Lighter etc, Mercury batteries  
 RW52(PX675) RW54 Made by Ray-O-VAC  
 RW56 (DH323,WH8) 31p each or  
 RW57, RW58 10 for £2.60, 100 for £21  
 IN4004 or IN4006 Diodes. 300 for £6.48p  
 TO5 or TO18 Heatsinks 7½p, 100 for £6.50, 1000 for £55  
 Clipover Heatsink for I/C or TO202 device 21 x 18mm  
 18p or 100 for £16.50 per 1000 for £155  
 Heatsink for TO3 or Plastic Power 19p, 100/£17.50, 1000/£165  
 Modern Telephone Handset and lead in white, red, blue, grey, yellow,  
 green or black £2  
 BU508A TV line output transistor, 1,500v, 15A, 125watt  
 £1.53p or 40 for £40 or 400 for £300

SEND PAYMENT PLUS 16p SAE OR LABEL ONLY

Prices you would not believe before inflation!

## BRIAN J. REED

TRADE COMPONENTS  
ESTABLISHED 26 YEARS

161 St. Johns Hill, Battersea, London SW11 1TQ

Open 11am till 7pm Tues. to Sat. Telephone: 01-223 5016

# ALARMS

FREE BOOKLET

on  
BURGLAR ALARMS  
with

LOWEST U.K. DIY PUBLISHED PRICES

PHONE OR WRITE FOR YOUR COPY

051-523 8440

AD ELECTRONICS

DEPT HE, 217 WARBRECK MOOR  
AINTREE, LIVERPOOL L9 0HU



## WHY WRITE TO LONDON

When you can walk to the Midlands largest selection of DIY.

Plugs, sockets, connectors, cable, flex, leads, boxes, Aerials, styli, components, elements, semi-conductors, meters.

In fact the lot!

Spares and repairs for all electronic, electrical and audio.

H. G. Electronics Co.

1350 Stratford Road, Hall Green,  
Birmingham B28 9EH

Telephone: 021-777 2369

## 'BARGAIN TIME'

<b>UV PROMS</b>		<b>DIODES</b>		<b>VOLTAGE REGS. T0220 39p each</b>	
2716	£2.30	In4148 2p each or £1.50/100	+7805	+7818	-7905
2732	£4.12	In4001/4002/4003 3p each	+7812	+7824	-7912
<b>I.C. SOCKETS</b>		Zener Diodes 400mW (BZY88C)	+7815	-7915	-7915
Pins	Low profiles	4p each or £3 per 100	<b>LED'S - 5mm All with Clips</b>		
8	8p		Red 9p; Green 10p; Yellow 11p	Special pack 10 of each £2.50	
14	9p	<b>RESISTORS -</b>	<b>HEATSINKS</b>		
16	9p	E24 Range Carbon	T0220/S0T32 Finger Heatsinks Vert. or	Horiz. Mounting 18 deg c/w 20p each;	
18	12p	Film, Bandlered	15 deg c/w 24p each	To 5 push on 9p each	
20	14p	100 Assorted values	46 x 46mm Finger type drilled To3 7 deg	c/w 28p each	
22	16p	10 per value . . . 95p	55 x 55mm Finger typed drilled To3	4.5 deg c/w 31p each	
24	15p	1000 Assorted values	65mm x 20mm x 50mm extruded sink	2.75 deg c/w 98p each	
28	19p	50 per value . . . £8			
40	26p				
64	-				

TERMS: Strictly cash with order. All prices inclusive of VAT.  
 HANDLING: Charge of 50p on orders under £5. Heatsink Listing and Data Sheets sent with all orders or on receipt of large sae with 25p of postage.

**CAMTEC CIRCUITS AND SYSTEMS LIMITED**

5 York Road, Bognor Regis, West Sussex PO2 1QW  
Tel: (0243) 862911

## PARNDON ELECTRONICS LTD.

Dept. 22, 44 Paddock Mead, Harlow, Essex. CM18 7RR. Tel: 0279 32700

**RESISTORS:** ¼ Watt Carbon Film E24 range ± 5% tolerance  
 Bandlered and colour coded. Full Range 1R0-10M.  
 £1.00 per hundred mixed (Min 10 per value) £8.50 per thousand mixed (Min 50 per value)  
 Special stock pack 60 values. 10 of each £5.50

<b>RECTIFIERS</b>	<b>3½ Digit LCD Display:</b> 1 colon, 3 decimal points plus/minus sign and lo bat indicator.
1 Amp 3 Amp	Complete with low power 7106 A/D converter display driver.
50V 3p 14p	Driver set £8.95
100V 4p 14p	Display £3.50 Driver £6.50
200V 5p 14p	
400V 6p 19p	
600V 8p 20p	
1000V 9p 25p	

**DIL SOCKETS** 8 pin - 10p, 14 pin - 11p, 16 pin - 12p, 18 pin - 19p, 20 pin - 21p  
 22 pin - 23p, 24 pin - 25p, 28 pin - 27p, 40 pin - 42p.

Full List Available — Send SAE  
 ALL PRICES INCLUDE V.A.T. & POST & PACKING — NO EXTRAS  
 MIN ORDER — UK £1.00 OVERSEAS £5 CASH WITH ORDER PLEASE  
 Same Day Despatch

# hobbyboard

The Complete Printed Circuit Workshop

## NEW FULL HOBBYBOARD CATALOGUE & PRICE LIST

Supplies all your PCB needs including Draughting Aids, Process Materials, Hand Tools, Hardware, Instrument Cases etc. Also introducing a choice of PC Prototyping Systems and the Daylight Fototool System for precision photography (no darkroom) and superb label/panel-making. PLUS 2 pages of Add-ons which give your home computer useful "real world" applications and offer fascinating program/hardware development.

Newly Published Full Catalogue - price £1.50  
 (Refundable with 1st order over £10)

Easy Add-ons for ZX Spectrum & ACE

17 exciting electronic projects to build and run your own micro.

- LIGHT PEN
- WEATHER STATION
- PICTURE DIGITISER
- + OTHER EXCITING & INTERESTING PROJECTS
- KEY PAD
- MODEL CONTROLLER

A newly released book by well known author Owen Bishop, published by Bernard Babani, describes in detail 17 projects to build (using low cost materials) to bring your micro into the real world.

The most complex component (the DECODER) is supplied in kit form ready to assemble with all components and plated through PCB

Order ref HB/2000 "EASY ADD-ONS" BOOK + DECODER KIT	£24.00
Order ref HB/2001 "EASY ADD-ONS" BOOK ONLY	£3.00
Order ref HB/2002 DECODER KIT ONLY	£22.00
Order ref HB/2003 DECODER PCB ONLY	£8.00

Please state computer when ordering. Prices inclusive of VAT & carriage



complete P.C.B. workshop

a division of  
**KELAN ENGINEERING LTD**  
 Hookstone Park  
 Harrogate, N. Yorks

HE/12/83



# GET BIG POWER

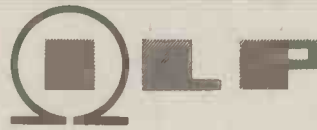

## Modular Amplifiers the third generation

Due to continuous improvements in components and design ILP now launch the largest and most advanced generation of modules ever.

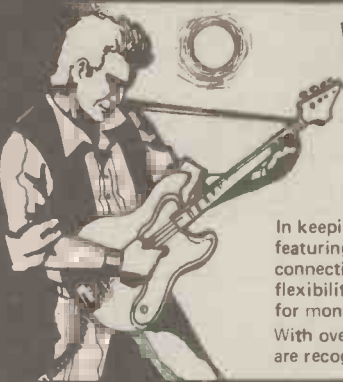

### WE'RE INSTRUMENTAL IN MAKING A LOT OF POWER

In keeping with ILP's tradition of entirely self-contained modules featuring, integral heatsinks, no external components and only 5 connections required, the range has been optimized for efficiency, flexibility, reliability, easy usage, outstanding performance, value for money.

With over 10 years experience in audio amplifier technology ILP are recognised as world leaders.



#### BIPOLAR MODULES

Module Number	Output Power Watts rms	Load Impedance $\Omega$	DISTORTION		Supply Voltage Typ	Size mm	WT gms	Price inc. VAT
			T.H.D. Typ at 1KHz	I.M.D. 60Hz/7KHz 4:1				
HY30	15	4-8	0.015%	<0.006%	$\pm 18$	76 x 68 x 40	240	£8.40
HY60	30	4-8	0.015%	<0.006%	$\pm 25$	76 x 68 x 40	240	£9.55
HY6060	30 + 30	4-8	0.015%	<0.006%	$\pm 25$	120 x 78 x 40	420	£18.69
HY124	60	4	0.01%	<0.006%	$\pm 26$	120 x 78 x 40	410	£20.75
HY128	60	4	0.01%	<0.006%	$\pm 35$	120 x 78 x 40	410	£20.75
HY244	120	4	0.01%	<0.006%	$\pm 35$	120 x 78 x 50	520	£25.47
HY248	120	8	0.01%	<0.006%	$\pm 50$	120 x 78 x 50	520	£25.47
HY364	180	4	0.01%	<0.006%	$\pm 45$	120 x 78 x 100	1030	£38.41
HY368	180	8	0.01%	<0.006%	$\pm 60$	120 x 78 x 100	1030	£38.41

Protection: Full load line. Slew Rate: 15v/ $\mu$ s. Rise time: 5 $\mu$ s. S/N ratio: 100db. Frequency response (-3dB) 15Hz - 50KHz. Input sensitivity: 500mV rms. Input Impedance: 100K  $\Omega$ . Damping factor: 100Hz > 400.

#### PRE-AMP SYSTEMS

Module Number	Module	Functions	Current Required	Price inc. VAT
HY6	Mono pre amp	Mic/Mag. Cartridge/Tuner/Tape/Aux + Vol/Bass/Treble	10mA	£7.60
HY66	Stereo pre amp	Mic/Mag. Cartridge/Tuner/Tape/Aux + Vol/Bass/Treble/Balance	20mA	£14.32
HY73	Guitar pre amp	Two Guitar (Bass Lead) and Mic + separate Volume Bass Treble + Mix	20mA	£15.36
HY78	Stereo pre amp	As HY66 less tone controls	20mA	£14.20

Most pre-amp modules can be driven by the PSU driving the main power amp. A separate PSU 30 is available purely for pre amp modules if required for £5.47 (inc. VAT). Pre-amp and mixing modules in 18 different variations. Please send for details.

#### Mounting Boards

For ease of construction we recommend the B6 for modules HY6-HY13 £1.05 (inc. VAT) and the B66 for modules HY66-HY78 £1.29 (inc. VAT).

#### POWER SUPPLY UNITS (Incorporating our own toroidal transformers)

Model Number	For Use With	Price inc. VAT
PSU 21X	1 or 2 HY30	£11.93
PSU 41X	1 or 2 HY60, 1 x HY6060, 1 x HY124	£13.83
PSU 42X	1 x HY128	£15.90
PSU 43X	1 x MOS128	£18.70
PSU 51X	2 x HY128, 1 x HY244	£17.07

Model Number	For Use With	Price inc. VAT
PSU 52X	2 x HY124	£17.07
PSU 53X	2 x MOS128	£17.86
PSU 54X	1 x HY248	£17.86
PSU 55X	1 x MOS248	£19.52
PSU 71X	2 x HY244	£21.75

Please note: X in part no. indicates primary voltage. Please insert "O" in place of X for 110V, "1" in place of X for 220V, and "2" in place of X for 240V.

#### MOSFET MODULES

Module Number	Output Power Watts rms	Load Impedance $\Omega$	DISTORTION		Supply Voltage Typ	Size mm	WT gms	Price inc. VAT
			T.H.O. Typ at 1KHz	I.M.D. 60Hz/7KHz 4:1				
MOS 128	60	4-8	<0.005%	<0.006%	$\pm 45$	120 x 78 x 40	420	£30.41
MOS 248	120	4-8	<0.005%	<0.006%	$\pm 55$	120 x 78 x 80	850	£39.86
MOS 364	180	4	<0.005%	<0.006%	$\pm 55$	120 x 78 x 100	1025	£45.54

Protection: Able to cope with complex loads without the need for very special protection circuitry (fuses will suffice).

Slew rate: 20v/ $\mu$ s. Rise time: 3 $\mu$ s. S/N ratio: 100db

Frequency response (-3dB): 15Hz - 100KHz. Input sensitivity: 500mV rms

Input Impedance: 100K  $\Omega$ . Damping factor: 100Hz > 400.

#### 'NEW to ILP' In Car Entertainments

##### C15

Mono Power Booster Amplifier to increase the output of your existing car radio or cassette player to a nominal 15 watts rms.

Very easy to use.

£9.14 (inc. VAT)

Robust construction.

Mounts anywhere in car.

Automatic switch off.

Output power maximum 22w peak into 4 $\Omega$ .

Frequency response (-3dB) 15Hz to 30KHz, T.H.O. 0.1% at 10w 1KHz

S/N ratio (DIN AUDIO) 80dB, Load Impedance 3 $\Omega$ .

Input Sensitivity and impedance (selectable) 700mV rms into 15K  $\Omega$ . 3V rms into 8  $\Omega$ .

Size 95 x 48 x 50mm. Weight 256 gms.

##### C1515

Stereo version of C15.

£17.19 (inc. VAT)

Size 95 x 40 x 80. Weight 410 gms.

ILP Electronics Ltd., Dept 2, Graham Bell House, Roper Close, Canterbury CT2 7EP, Kent, England.  
Telephone: (0227) 54778 Technical (0227) 64723. Telex: 965780.

# SAVE HUNDREDS ON YOUR HI-FI-NOW!

**HI-FI NOW!** – the new magazine with a new way of giving you the buying information you need – NOW!

**HI-FI NOW!** – will tell you the £99 speaker that sounds like £200 – NOW!

**HI-FI NOW!** – will help you spend £15 to make your personal stereo like a million dollars – NOW!

**HI-FI NOW!** will even make sure you spend £2,000 wisely – NOW!

**HI-FI NOW!** – answers the questions you are asking about hi-fi – NOW!



Wharfedale, KEF, Rotel, Sansui, Marantz, Koss, Sony, Pioneer, Hitachi. Just some of the names in the first issue of HI-FI NOW!

**HI-FI NOW! AT YOUR NEWSAGENT NOW! ONLY 85p!**

## HAM

# RADIO TODAY

## NEXT MONTH

**FREE INSIDE** – A QTH Locator Map Of Europe

Locate quickly the positions of stations throughout Western Europe with this month's wallposter give-away. Indispensable for the serious VHF operator or listener!

**SPECIAL REVIEW** – Yaesu FT726 VHF/UHF Multimode Transceiver

Wonderful? Value for money? Find out from our in-depth review of Yaesu's all-the-eggs-in-one-basket machine.

**PLUS MUCH MORE**, including.

The G4DHF Transverter on 160, 80, and 40m

G5UM 'down under' – VHF in Australia

Wire antennas on 2m

# CONTINUITY TESTER

Inexpensive and portable, this Continuity Tester project features an audio tone instead of a visual signal — so you can keep your eyes on your work.

W. Leung

MOST people, these days, regard a continuity tester as being old-fashioned and not very useful considering that a multimeter set to measure resistance can do the same job.

However there are jobs — simple circuit tracing task, checking the car wiring for example — where a continuity tester is more convenient to use. Also the instant audio indication means that frequent glances at a multimeter scale (during which the probes *always* slip off the measurement points) are not necessary.

The HECTOR (Hobby Electronics Continuity Tester!) does all that could be expected of a simple tester and, in addition, has the facility of not responding to semiconductor junctions which would otherwise register as a short circuit. When in its 'PN' mode, HECTOR will respond only to a short circuit which is developing a potential of less than 0.7, ie less than the voltage developed across a forward biased semiconductor junction.

This facility is most useful: consider the circuits of Figure 1. A conventional continuity tester would indicate a short in either case, whether there was one actually present or not, because whichever way 'round the probes were connected one diode would always be forward biased. However HECTOR in 'PN' mode would not respond to the Figure 1a, because of the forward voltage drop of 0.7 volts across the forward biased diode, but will respond to the genuine short circuit of Figure 1b, assuming only that the short circuit resistance was insufficient to develop 0.7 volts.

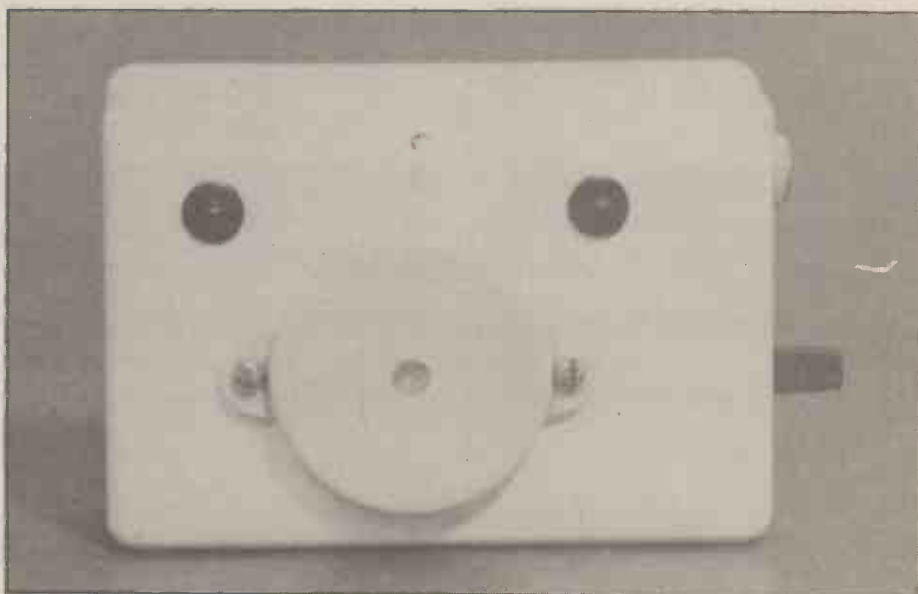

Figure 1. Most continuity testers would indicate a short circuit given either (a) or (b), but HECTOR is designed to respond only to a true short as in (b).

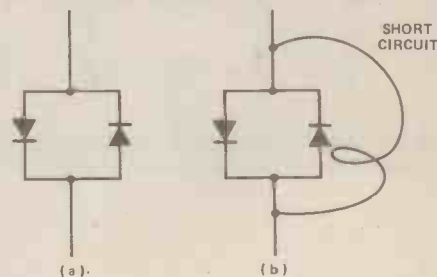
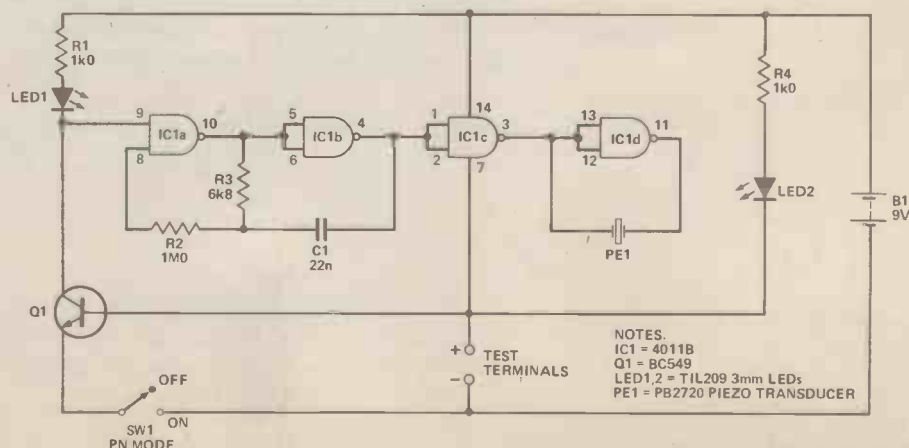

Figure 2. The circuit with all fourteen pins of IC1 in use.

## Continuous Circuits

In Figure 2, IC1a and IC1b form a conventional astable oscillator using CMOS 2-input NAND gates. The oscillator output is buffered by IC1c, connected as an inverter, and IC1d drives the piezo electric transducer PE1.





Parts List

RESISTORS

(All 1/4 watt 5% carbon)

- R1, 4 ..... 1k
- R2 ..... 1M
- R3 ..... 6k8

CAPACITORS

- C1 ..... 22n polycarbonate

SEMICONDUCTORS

- IC1 ..... 4011B CMOS quad 2-in NAND
- Q1 ..... BC549 NPN transistor
- LED1, 2 ..... 3mm LED any colour

MISCELLANEOUS

- PE1 ..... PB2720 piezo sounder
- SW1 ..... min slide or toggle
- PCB; LED clips; Veropins; box — Vero 202-21025K; PP3 battery + clips; 3.5mm jack socket; 14-pin DIL socket; 3.5mm jack, leads and probes; nuts, bolts, wire solder etc.

BUYLINES ..... page 34

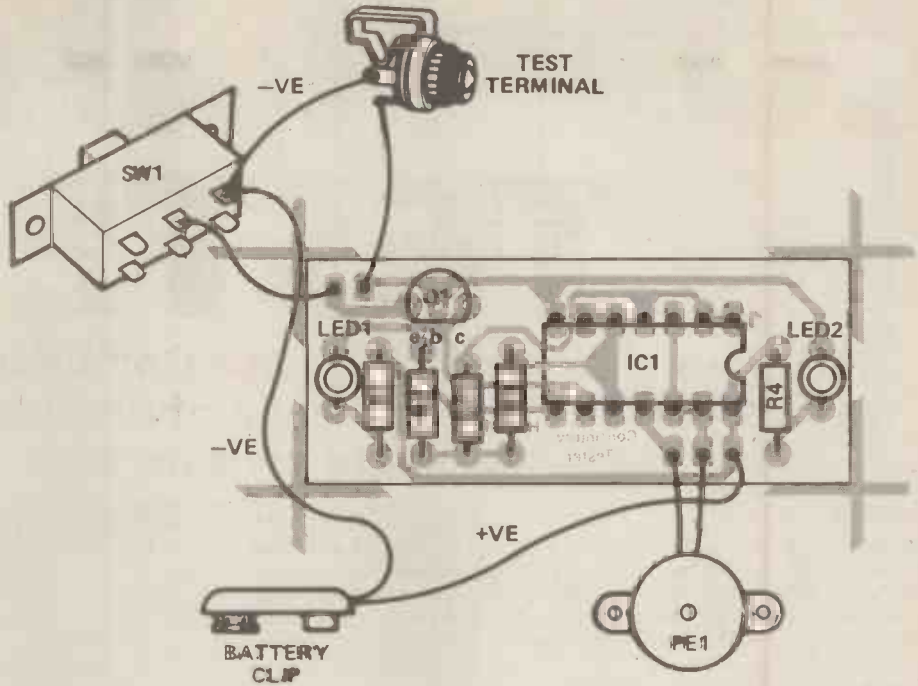

Figure 3. The component overlay. Don't solder in the LEDs until the PCB is installed in its box as described.

The circuit is powered from a single 9V PP3 battery; with SW1 open (normal mode), Q1 is biased off and the oscillator is enabled because pin 9, IC1a, is High. The battery negative supply is connected via the test probes, however, so the circuit can only begin to oscillate when they are shorted out. So with SW1 open HECTOR is just like any other continuity tester; LED2 provides a visual indication and also increases the test current to around 20mA.

When SW1 is closed (PN mode) the story is slightly different: Q1 is biased into conduction and LED1 turns on, indicating that the unit is in PN mode. In this state pin 9 of IC1 is pulled low, so the oscillator is disabled. LED2 will also be on, since it is supplying the base current for Q1, but when the probes are connected across a direct short the base-emitter junction is shorted out, Q1 turns off, pin 9 goes high and the oscillator is therefore enabled. LED2 will stay on, of course, but now LED1 will go out, indicating a short circuit.

However if the probes are connected across a PN junction then Q1 will remain forward biased and the HECTOR will remain silent. When making measurements in PN mode, the polarity of the test probes is important: if the emitter (negative probe) is connected to the positive potential and the base (positive probe) to 0V Q1 will be biased off and the tester will indicate a short circuit. Therefore it is best, when using PN mode, to make two tests, with the probes reversed for the second try.

Also HECTOR will not respond in PN mode with the probes connected

TEST	RESULT			
Short Test Probes	SW1 OPEN	LED1 OFF	LED2 ON	TONE YES
"	CLOSED	OFF	ON	YES
Connect a silicon diode to probes, with anode to positive probe.	CLOSED	ON	ON	NO
Reverse probes	CLOSED	OFF	ON	YES

across a DC resistance of between 60 and 300 ohms — though the probe polarity is not important in this case.

Construction

The complete project including the 9 volts PP3 battery is housed in a Vero Box. Having obtained or manufactured your own PCB for this project, proceed in the usual fashion. Solder in the five Veropins before soldering the 14-pin DIL socket in place. Having done this, insert all the resistors, C1, Q1 and IC1 into its socket making sure that Q1 and IC1 have been inserted the correct way around. Remember — IC1 is CMOS so don't maul it!

Make the appropriate mounting holes in the box for the external components, paying particular attention to the holes for the LED clips. Having done this, insert the LED clips, then insert the LEDs (Do not solder) onto the PCB, making sure that they are inserted the correct

way around. Then insert the PCB into the box with Q1 closest to the hole for the 3.5mm test socket, such that the LEDs fall into the LED clips. After having made sure that the LEDs are properly in their clips, (they should protrude about 3mm outside the clip), push the PCB gently down so that the body of the IC is in contact with the box before finally soldering the LEDs permanently in place onto the PCB.

To finish off the construction, make the appropriate wiring between the external components and the PCB. It is advisable to remove the IC from the socket when doing this.

Testing and Use

After having checked for any errors, connect a 9 volt battery to HECTOR and carry out the tests show in Table 1.

When making continuity tests, always make sure that there is no power applied to the equipment under test.

## Continuity Tester

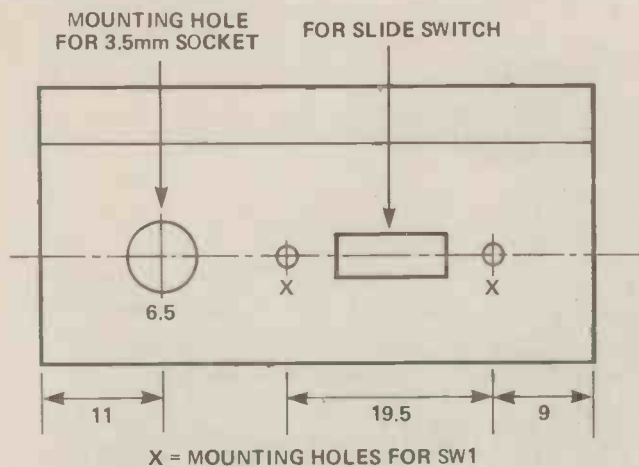

X = MOUNTING HOLES FOR SW1

When HECTOR is not being used SW1 must be in the open position, otherwise the battery life will be shortened considerably!

The author has found that on some bipolar silicon power transistors, with HECTOR in 'PN mode' and connected across the base-to-emitter junction of the transistor, HECTOR has responded when it is not supposed to. This should be kept in mind when one encounters a similar situation. Two possible solutions are to either reduce the value of R4 so as to increase the test current, or replace Q1 with a germanium device, which has a lower base-to-emitter bias voltage (around 0.2 to 0.4 volts).

Figure 4. Pattern guide for external mounting holes. Take particular care with the mounting holes for the LED clips.

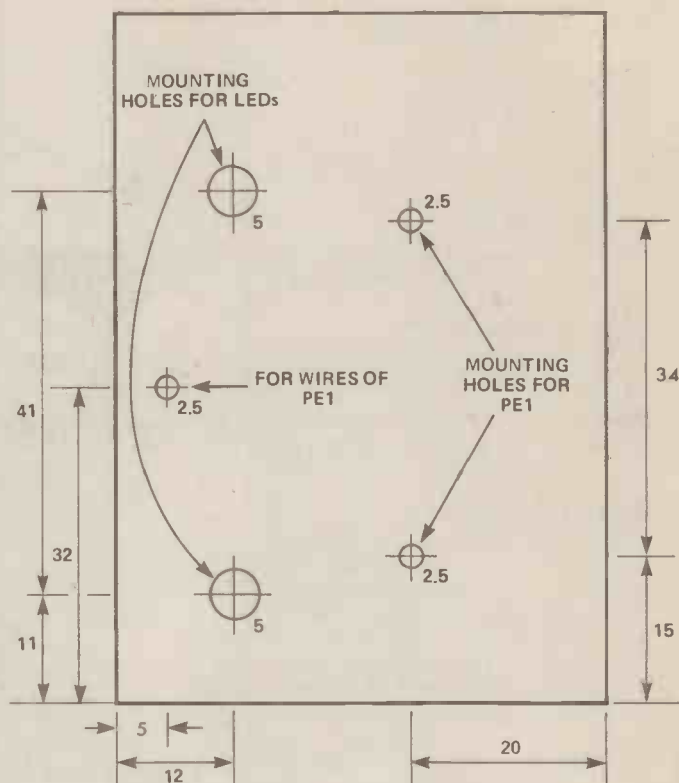

ALL DIMENSIONS IN mm  
DIAMETERS STATED (NOT RADII)

HE

# Multicore makes solder

## The Five Core Advantage

Only Multicore wire solders have a 5-core, or 4-core flux construction. The 5-cores identify non corrosive fluxes; the 4-core, water soluble fluxes.

If you were to slice through a section of Multicore cored solder you would see separate round cores of flux symmetrically arranged around its perimeter. Only a thin wall of solder separates the flux cores from the surface.

What are the advantages of the Multicore construction?

1. Because the flux is peripherally arranged it will react and flow faster.
2. Flux voids are eliminated with Multicore. That's why you can depend on continuity of the flux stream for complete wetting... every time.
3. Because wetting is faster, complete and uniform, you use less solder and transmit less heat to the joint area. With Multicore Solders, you get the highest purity metals, vigorous fluxing action and a wire solder that meets all applicable International standards.



## Ersin Multicore

Contains 5 cores of non-corrosive flux.  
Uses: For all electrical joints.  
Handy Pack: Size 19A 60/40 tin/lead 1.22mm dia  
**£1.50 RRP**  
Tool Box Reel: Size 3 60/40 tin/lead 1.6mm dia  
**£4.37**



## Ersin Multicore

Contains 5 cores of non-corrosive flux.  
Uses: Small transistors, components and fine wire.  
Handy Pack: Size PC115 60/40 tin/lead 0.7mm dia  
**£1.61 RRP**  
Tool Box Reel: Size 10 60/40 tin/lead 0.7mm dia **£4.37**



## Multicore Savbit

Increases the life of your soldering bit by 10 times.  
Uses: For all electrical work.  
Reduces copper erosion.  
Handy Pack: Size 5 1.2mm dia **£1.38 RRP**  
Tool Box Reel: Size 12 1.2mm dia **£4.37**

# LITESOLD ARE OFFERING A COMPLETE SOLDERING KIT FOR ONLY

**£14.55**  
inc. VAT & P.P.



Contains all you need to solder/de-solder any electronics project:

LITESOLD LC18H 240v high performance iron, made to professional standards in our own works, fitted with 3.2mm bit. 2 alternative bits, 1.6 and 2.4mm. Reel of 3 metres 18 swg flux-cored solder. Stainless steel tweezer. 3 soldering aids. Reel of 1.5 metres de-soldering braid. Packed in clear PVC presentation/storage wallet. Superb present — Ideal for beginner or expert.

SK18H KIT SPECIAL PRICE £14.55 inc. VAT & P.P. (normal resale value £18.45 inc.) LC18H IRON only £6.00 (normally £7.39)

Spares, accessories and after-sales service available from us.

16-page colour catalogue — 60p. Send cheque/P.O. to LITESOLD or ring for Access/Barclaycard sales.



**LITESOLD**  
LIGHT SOLDERING DEVELOPMENTS LTD.

Spencer Place, 97/99 Gloucester Road, Croydon CR0 2DN, Surrey. Tel: 01-689 0574

## New concept in miniature soldering iron design G.P.E. Self-Feed Soldering Iron <sup>Patented</sup>



- ★ Unique one-handed operation — solder is housed in the transparent handle and applied directly to the joint by turning the serrated wheel (located in the handle) with index finger.
- ★ Clean bright joint every time.
- ★ Light weight — (only 80g).
- ★ Easy to refill — just release spring clip at the end of handle. Remove cap and insert refill.

Available by Mail Order Only.  
Send coupon to:-

### Gardner Precision Engineering

North Road, Woking, Surrey GU21 5DS.  
Tel: Woking 20722 or send SAE for details.

Name .....

Address .....

Soldering Iron 240V, 18w. Fitted with 2.3mm Dia. Bit.  
complete with 4 metres solder

@ £14.95

Solder refills (Pack of 4)

@ £2.44

Spare Bits. Tip Dia. (Long Life) 2.3mm, 3m or 4.7mm

@ £1.36

All prices include VAT and P&P. S.A.E. for details.

# ing easy, fast and reliable

**Multicore Solder Cream**  
Mixture of powdered 60/40 (tin/lead metal alloy and rosin flux).  
Uses: Micro electronics and printed circuits.  
Handy Tube: **Size BCR 10**  
**£1.73**



**Bib Wire Strippers and Cutters**  
With precision ground and hardened steel jaws.  
Adjustable to most wire sizes.  
With handle locking-catch and easy-grip plastic covered handles.  
Wire Strippers: **Size 9**  
**£2.88**



**Multicore Alu-Sol**  
Contains 4 cores of flux.  
Uses: Suitable for aluminium and aluminium alloys. (non-electrical)  
Handy Dispenser: **Size HP27**  
1.6mm dia **£0.99 RRP**  
Tool Box Reel: **Size 4**  
1.6mm dia **£7.82**



**Multicore Solder Wick**  
Absorbs solder instantly from tags and printed circuits with the use of a 40 to 50 watt soldering iron. Quick and easy to use. desolders in seconds.  
Handy Pack: **Size AB10**  
**£1.43**

**Multicore All Purpose Handyman Solder Pak**  
Contains three types of solder for electrical, metal and aluminium repairs, all in handy easy to use dispensers.  
Handy Pak: **Size 8**  
**£2.99**



All prices include VAT

Bib Audio, Video Products Limited,  
(Solder Division),  
Kelsey House, Wood Land End,  
Hemel Hempstead, Hertfordshire, HP2 4RQ  
Telephone: (0442) 61291 Telex: 82363



NEXT MONTH

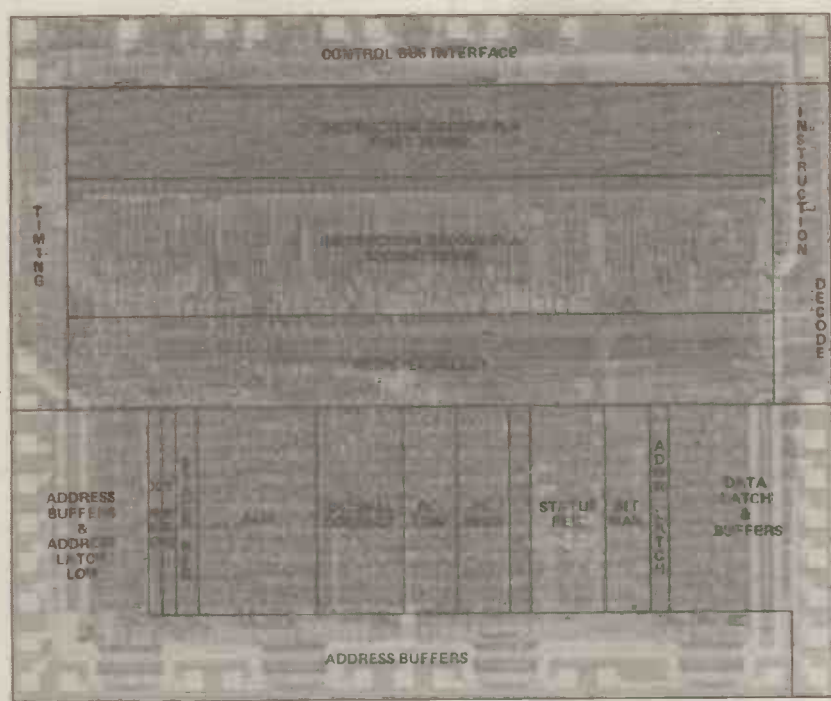

Photo of the CMOS 6502 processor courtesy of Rockwell International.

## 16 Channel A-to-D Board

Following on in our series of projects aimed at but not exclusively for the Mircotan, here is an A-to-D board to help you connect your computer to the outside world. If you built the D-to-A board of some months ago or would like to use your computer for control or monitoring, here is the project for you, as it will be suitable for 6502 and Z80 systems.

## ZX Controlled Burglar Alarm

The idea of using a home computer to control a burglar alarm would have seemed crazy a few years ago. Laterly, however, the ZX81 seems to have become so common that many are languishing on shelves gathering dust. Well here's a job for them — controlling a buglar alarm system. The system can also be used with the Spectrum.

## Modular Preamplifier

Just so that the computer freaks don't get it all their own way, here's a top-quality preamplifier that is modular in construction. The author himself describes the design as an Audio Leggo Kit, and that's just what it is. The basic unit is a motherboard into which you slot the modules that you want — so if you don't want tone controls, you don't have to have them. But unlike other preamps, you can change your mind at a later date.

## Lightsaver

Problem: when light-bult filaments are cold, their resistances are very low, so when you turn on the light a very heavy current will flow momentarily: this problem is exacerbated if you just happen to turn on when the mains cycle is near its maximum voltage. Solution: buy next month's ETI and find out!

**ALL THIS AND MORE IN THE DECEMBER ETI!  
RESERVE YOUR COPY NOW OR RISK MISSING OUT!**

Articles described here are in an advanced state of preparation. However, circumstances may dictate changes to the final contents.

60

## TYPE 161B

# DUAL POWER SUPPLY KIT

INCORPORATES A POSITIVE & A NEGATIVE REGULATED SUPPLY

**BOTH ARE ISOLATED & ADJUSTABLE 1.3V TO 16V D.C.**

Interconnect to give 2.6V to 32V or  
-1.3V/0/+1.3V to -16V/0/+16V

Output current 1A at 16V to 0.35A at 1.3V

Ripple is less than 1mV

# £25.99

inc. P & P and VAT



Built & Tested

£37.95 inc. P&P and VAT

Comprehensive design details with calculations are included so that the kit is an exercise in power supply design. The kit, which uses quality components, is complete with instructions. Case punched and stove enamelled in attractive blue and grey with a printed front panel to give a professional finish. Excellent for the beginner, the experienced amateur and as a tutorial for schools and colleges.

SEND CHEQUE OR P.O.

ALLOW 21 DAYS FOR DELIVERY

**BRANIME MARKETING LTD** DEPT. HE/12  
BALTHANE IND. EST., BALLASALLA, ISLE OF MAN

## FOR HI-FI & ELECTRONICS ENTHUSIASTS

# CONCEPT ELECTRONICS LTD

51 Tollington Road, London N7 6PB

Mall order only

We are the specialist of electronic kits and rack mounting cabinets. A catalogue with complete range of products including pre-amp modules, power amp modules, pre and power amplifier modules, complete kits of amplifiers, equalizers, reverberation amplifiers (with cases), alarm clocks, appliance timers, CB amplifiers, test equipment, control modules, music generator, battery fluorescent light and high quality rack mounting cabinets etc. with illustrative pictures now available at the cost of 35p + 25p p&p.

Professional rack mounting cabinet

Panel Size	Rear Box		Price	
	WH (Inch)	WHD	AL	STEEL
19 x 5	17 x 4.5 x 10	27.54	23.54	
19 x 4	17 x 3.5 x 10	25.24	21.24	
19 x 3.5	17 x 3 x 10	24.09	20.09	
19 x 3	17 x 2.5 x 10	24.09	—	
19 x 2.5	17 x 2 x 10	22.94	18.94	
19 x 6	17 x 5.5 x 12	28.69	24.69	
19 x 5	17 x 4.5 x 12	27.54	23.54	
19 x 4	17 x 3.5 x 12	25.24	21.24	
19 x 3.5	17 x 3 x 12	24.09	20.09	
17 x 3.5	15.5 x 3 x 9	21.79	17.79	
17 x 2.5	15.5 x 2 x 9	20.64	16.64	
17 x 4	15.5 x 3.5 x 12	25.24	21.24	
17 x 3	15.5 x 2.5 x 12	24.09	20.09	

Please add £2.50 p/p per item

★ Wholly made of black anodised aluminium sheets ★ Suitable for high quality amplifiers and many other purposes ★ Top, side and rear cover removable for access ★ Separate front mounting plate ★ Heavy gauge front panel is of brushed aluminium finish enhanced with two professional handles ★ With ventilation slits and plastic feet.

The low cost steel version is also available. The size and features as well as the front panel is the same as the aluminium cabinets except the rear box is manufactured from steel painted in black.

### CONTROL MODULES

### HI-FI AMPLIFIER MODULES



TY-7 Electronic touch switch  
£2.90 Kit £4.50 Ass.  
TY-11 Light activated switch  
£2.20 Kit £3.50 Ass.  
TY-18 Sound activated switch  
(Clap switch) £4.50 Kit £5.95 Ass.  
TY-38 Sound activated switch  
(voice-switch) £5.50 Kit £7.50 Ass.  
TY-41 Infra-red remote control  
(Receiver and transmitter)  
£17.20 Kit £21.95 Ass.

TA-323A 30W + 30W stereo amplifier  
£18.95 Kit £23.95 Ass.  
TA-820 60W + 60W stereo amplifier  
£27.50 Kit £33.50 Ass.  
TA-920 70W + 70W stereo amplifier  
£35.50 Kit £42.50 Ass.

# CAMBRIDGE LEARNING

## SELF-INSTRUCTION COURSES

### NEW IDEA!

## TEACH YOURSELF ELECTRONICS

with the Cambridge Learning SUPERKIT, and then use our breadboard to build lots of exciting projects from the well known Babani range of books.

### HOW?

The SUPERKIT contains a breadboard, seven integrated circuits, a 4-pole switch, and many more components as well as a fully-tested instruction manual. It helps you to build the circuits and learn how they work at the same time.

SUITABLE FOR BEGINNERS; ALL AGES; BATTERY POWERED (not included) and STILL ONLY £19.90 inc VAT and p&p.

**NOW available** a brand-new theory course to go with the kit. DIGITAL COMPUTER LOGIC costs just £7.00 and covers all the contents of the SUPERKIT in detail up to A-level standard.

**NEW** EVERYONE CAN HAVE FUN WITH THESE PROJECT BOOKS:

Electronic Games	£2.05
Electronic Projects using Solar Cells	£2.25
Solid State Novelty Projects	£1.15
50 Simple LED Circuits	£1.80
Digital IC Projects	£2.25
Projects in Opto-Electronics	£2.25
How to get your Electronic Projects Working	£2.25

Other courses from Cambridge Learning include:

DIGITAL COMPUTER DESIGN	£9.50
MICROPROCESSORS & MICROELECTRONICS	£6.50
COMPUTER PROGRAMMING IN BASIC	£11.50

If you would like further information on any of our books, please write for our free booklist.

**GUARANTEE** No risk to you. If you are not completely satisfied, your money will be refunded upon return of the item in good condition within 28 days of receipt.

CAMBRIDGE LEARNING LIMITED, UNIT 93, RIVERMILL SITE, FREEPOST, ST IVES, CAMBS, PE17 4BR, ENGLAND.  
TELEPHONE: ST IVES (0480) 67446. VAT No 313026022

All prices include worldwide postage (airmail is extra - please ask for prepayment invoice). Giro A/c No 2789159. Please allow 28 days for delivery in UK.

Please send me the following books:

..... @ £.....  
 ..... @ £.....  
 ..... @ £.....  
 ..... @ £.....

I enclose a \*cheque/PO payable to Cambridge Learning Ltd for £..... (\*delete where applicable)

Please charge my:

\*Access / American Express / Barclaycard / Diners Club  
Eurocard / Visa / Mastercharge / Trustcard

Expiry Date..... Credit Card No .....

Signature.....

Telephone orders from card holders accepted on 0480 67446  
Overseas customers (including Eire) should send a bank draft in sterling drawn on a London bank, or quote credit card number.

Name.....

Address.....

Cambridge Learning Limited, Unit 93, Rivermill Site, FREEPOST, St Ives, Huntingdon, Cambs, PE17 4BR, England, (Registered in England No 1328762).

**50p  
OFF!**

Please present at ticket office  
for 50p off admission. Offer limited to  
1 voucher per person.



**BREAD  
BOARD**

**'83**

**FRIDAY** November 25th      10am – 6pm  
**SATURDAY** November 26th      10am – 6pm  
**SUNDAY** November 27th      10am – 4pm

## **THE PREMIER SHOW FOR THE ELECTRONICS ENTHUSIAST!**

Cunard International Exhibition Centre, Cunard Hotel,  
Hammersmith, London W6

### **Improved Venue**

We have transferred BREADBOARD to the Cunard Hotel, offering improved facilities to the visitor, including car parking and ease of access by rail, tube and car, all in a modern attractive setting.

### **Planned Features include**

- Lectures: covering aspects of electronics and computing.
- Electronics/Computing Advice Centre.
- Demonstration: electronic organs/synthesisers.
- Holography presentation.
- Practical demonstration: 'How to produce printed circuit boards'.
- Computer Corner - 'Try before you buy'.
- Amateur Radio Action Centre.
- Computer controlled model railway competition.
- Pick of the projects - Demonstration of the best from ELECTRONICS TODAY INTERNATIONAL, HOBBY ELECTRONICS and ELECTRONICS DIGEST.
- Giant TV screen video games.
- Robotic display.

The Breadboard Exhibition is sponsored by Electronics Today International, Hobby Electronics, Electronics Digest and Digital and Micro Electronics

Breadboard '83    ASP Exhibitions    145 Charing Cross Road    London WC2H 0EE

# HE PCB SERVICE

Ready made  
PCBs  
For Readers!

PRINTED CIRCUIT BOARDS (PCBs) for HE projects have often represented an obstacle for our readers. Some of you, no doubt, make your own but our PCB Service saves you the trouble.

NOW you can buy your PCBs direct from HE. All (non-copyright) PCBs will be available automatically from the HE PCB Service. Each board is produced from the same master as that used for the published design and so each will be a true copy, finished to a high standard.

Apart from the PCBs for this month's projects, we are making available some of the popular designs from earlier issues. See below for details. *Please note that only boards for projects listed below are available: if it isn't listed we can't supply it.*

October 81 HE/8110/1	Combination Lock	£2.65
November 81 HE/8111/1&2	Sound Torch (Set of Two)	£5.31
December 81 HE/8112/1	Pedalboard Organ	£5.64
January 82 HE/8201/1	Intelligent NiCad Charger	£2.83
February 82 HE/8202/1 HE/8202/2	Relay Driver Mast-Head Amp	£2.07 £1.08
March 82 HE/8203/1	Digital Dice	£1.40
April 82 HE/8204/1 HE/8204/2 HE/8204/3	Digital Capacitance Meter Dual Engine Driver Bike Alarm	£4.02 £3.27 £2.45
May 82 HE/8205/1&2 HE/8205/3 HE/8205/4	Digital Thermometer (Set of Two) Echo-Reverb Cable Tracker	£4.62 £5.63 £1.85
June 82 HE/8206/1 HE/8206/2 HE/8206/3 HE/8206/4&5	Power Supply Design Auto-Wah Auto Greenhouse Sprinkler Telephone Timer (Set of Two)	£2.48 £3.08 £3.45 £6.50
July 82 HE/8207/1 HE/8207/2 HE/8207/3 HE/8207/4	Tanover TVI Filter Computer PSU Solar Radio	£2.13 £1.78 £7.68 £1.98

August 82 HE/8208/1&2 HE/8208/3&4	Digital Millivoltmeter (Set of Two) Audio Analyser (Set of Two)	£4.34 £11.55
September 82 HE/8209/1&2 HE/8209/3 HE/8209/4	Signal lights Main Module Junction Module ZX Interface Slot Car Controller	£1.96 £1.70 £3.34 £1.98
October 82 HE/8210/1 HE/8210/2 HE/8210/3	Flash Point Alarm Negative Voltage Generator Squelch Unit	£2.13 £1.49 £2.52
November 82 HE/8211/1	Pedometer/ Odometer	£2.13
December 82 HE/8212/1 HE/8212/2 HE/8212/3&4 HE/8212/5 HE/8212/6 HE/8212/7 HE/8212/8	Phase Four Microlog Tape/Slide (Set of Two) TV Amp Lofty Noise Gate Low Cost Alarm	£2.83 £3.98 £5.26 £5.70 £2.61 £3.60 £2.30
January 83 HE/8301/1 HE/8301/2	Chip Probe Switched Mode Regulator	£1.82 £1.96
February 83 HE/8302/1 HE/8302/2	Incremental Timer DigiTester PSU	£7.13 £6.70
March 83 HE/8303/1 HE/8303/2	Loudspeaker Protector Overvolt Cutout	£2.51 £2.25

April 83 HE/8304/1 HE/8304/2&3	6502 EPROMMER Ducker Main Board Preamp Board	£7.18 £3.56 £2.31
HE/8304/4	Power Down	£2.10
May 83 HE/8305/1 HE/8305/3 HE/8305/4	BBC Interface Stall Thief Auto-Test	£4.82 £2.50 £2.50
June 83 HE/8306/1 HE/8306/2 HE/8306/3 HE/8306/4	Sinclair Sound Board CB Rap Latch Bat Light (Car battery monitor) Traffic Light Toy	£2.80 £1.65 £2.25 £2.56
July 83 HE/8307/1	Soft Fuzz	£2.77
August 83 HE/8308/1 HE/8308/2 HE/8308/3 HE/8308/4	Whistle Switch Ace Interface Enlarger Timer Auto-Winder	£4.40 £3.52 £2.92 £2.98
September 83 HE 8309 1 HE 8309 2	Tremoleko SPL Meter	£3.14 £4.22
October 83 HE 8310/1 HE 8310/2 HE 8310/3	Ultrasonic Alarm Audio Level Meter High Voltage Meter	£3.19 £3.09 £3.47
November 83 HE 8311/1 HE 8311/2	Wiper Delay Light Delay	£2.80 £2.79
December 83 HE 8312/1 HE 8312/2 HE 8312/3 HE 8312/4	Damp Meter Continuity Tester Light Meter Bassman	£2.81 £1.21 £3.16 £2.39

PLACE an order for your PCBs using the form below (or a piece of plain paper if you prefer not to cut the magazine), then simply wait for your PCBs to drop through your letterbox, protected by a Jiffy bag.

HE PCB Service, Argus Specialist Publications Ltd, 145 Charing Cross Road, London WC2H 0EE

I enclose a cheque/Postal Order made payable to ASP Ltd, for the amount shown below Price.

OR

I wish to pay by Barclaycard. Please charge my account number



OR

I wish to pay by Access. Please charge to my account number



SIGNATURE

NAME

(BLOCK CAPITALS)

ADDRESS

(BLOCK CAPITALS)

Boards Required	Price
Add 45p p & p	0.45
Total Enclosed	£

Please allow 21 days for delivery

# PCB FOIL PATTERNS

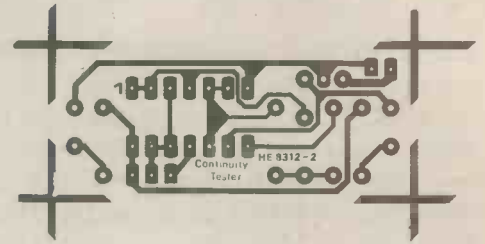
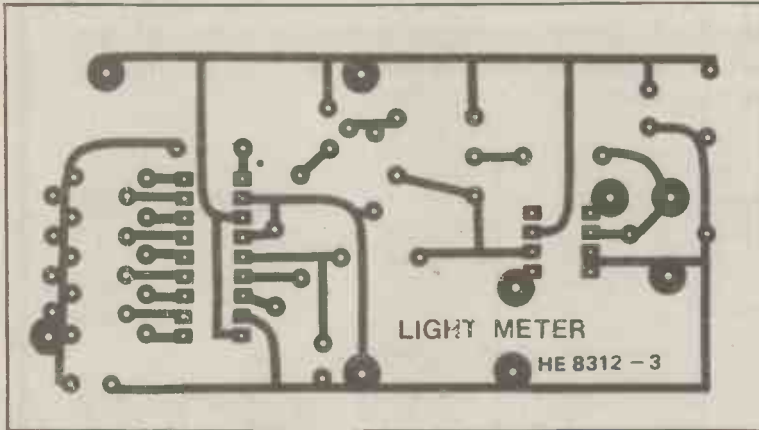

Above:  
The smallest PCB pattern this year is for the Continuity Tester. Don't lose it!

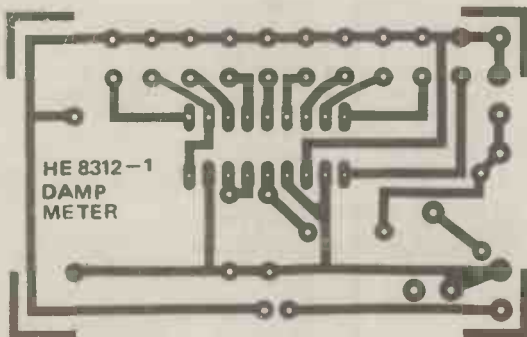

Above:  
Foil pattern for the Damp Meter, a useful project for DIY enthusiasts and homebuyers.

Below:  
The HE Bassman PCB foil pattern; use this if the full range of effects is required.

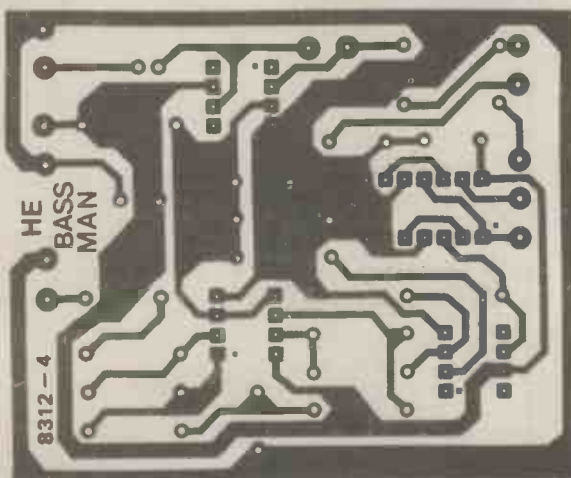

## BUYLINES continued

was actually built around two BPW21 photodiodes, which have an integral glass window tailored to produce a special response matched to that of the human eye, however the solar cell chips were found to produce better response at Near UV wavelengths and were substituted after being 'proved' in the circuit.

The other cost factor is due to the use of an analogue panel meter which, as explained in the text, is used to enable the unit to be portable while keeping battery consumption to an acceptable level. The recommended meter is a type T042 from Greenweld Electronic Components (it is in fact a 100uA 730R coil meter, not 200R as stated in the article).

The remaining components are available from either Maplin or Greenweld. A suitable box, which should have a rounded back edge for mounting the solar cell chips, is also available from Maplin, as is a suitable potting box for making the shield (although reader's may wish to devise their own methods for completing this part of the construction). The main case dimensions are 161 x 57 x 96mm, and the potting box should be one of the larger types, at least 70mm or so long.

The cost, excluding cases and PCB, should be in the region of £20.00.



### Lineage:

30p per word (minimum 15 words)  
Semi-display £7.50 per single column centimetre  
Ring for information on series bookings/discounts



01-437 1002  
EXT 282

Send your requirements to:  
Debbie Miller  
ASP Ltd.,  
145 Charing Cross Road,  
London WC2H 0EF

All advertisements in this section must be prepaid.  
Advertisements are accepted subject to the terms and conditions printed on the advertisement rate card (available on request)

## BOOKS & PUBLICATIONS

**PARAPHYSICS JOURNAL** (Russian translations). Psychotronics, Kirlianography, heliophonic music telekinetics. Computer software. SAE 4 x 9"—Paralab, Downton Wilts.

## COMPONENTS

**BUMPER BOX OF BITS**  
WOW!! We've got so many components in stock, we can't possibly list them all!! — So buy a box, in it you'll find resistors, capacitors, displays, switches, panels with transistors, diodes, IC's, etc., coils, pots... and so on. All modern parts — guaranteed at least 1000 items. Minimum weight 10lbs. ONLY £8.50 Inc. 48 page catalogue 50p.  
**ELECTRONICS WORLD**  
1F Dews Road, Salisbury  
Wilts SP2 7SN

**BARGAIN — Semiconductor packs;** transistors, IC's 12 items £1.60. Full specification components; BC107 9p; BC108 9p; BC109 11p; 2N3055 55p; BY50 21p; 741 17p; 555 18p; 556 43p. 40 pence p&p. VAT 15%. W.R. Carr, 26 Lawton Road, Roby, Merseyside L36 4HW.

**IN STOCK** New telephone plugs and sockets also ZX81 plugs and spectrum plugs and wide range of burglar alarm equipment and all accessories for same plus large range of components. Shudehill Supply Co. Ltd., 53 Shudehill, Manchester 4. 061-834 1449.

## KITS

**PRINTED CIRCUITS.** Make your own simply, cheaply and quickly! Golden Fotolac light-sensitive lacquer — now greatly improved and very much faster. Aerosol cans with full instructions, £2.25. Developer 35p. Ferric chloride 55p. Clear acetate sheet for master 14p. Copper-clad fibreglass board, approx. 1mm thick £1.75 sq. ft. Post/packing 75p. White House Electronics, Castle Drive, Praa Sands, Penzance, Cornwall.

**DIGITAL WATCH** replacement parts, batteries, displays, backlights, etc. Also reports publications charts. S.A.E. for full list: Profords Copners Drive, Holmer Green, Bucks. HP15 65GE.

## ALARMS

**BURGLAR ALARM EQUIPMENT.** Please visit our 2,000 sq. ft. showrooms or write or phone for your free catalogue. C.W.A.S. Ltd., 100 Rooley Avenue, Bradford BD6 1DB. Telephone 0274-308920.

## KITS

### IS ACCURATE TIMING ESSENTIAL TO YOU?

PRECISION DIGITAL TIMER KIT.



All solid state. No relays. Will switch 240V AC @ 8A for time periods for 1 sec to 44 minutes in 1 or 10 sec steps. Accurate to better than 1/100 sec. for all time periods. No RC time constants involved. Ideal for darkroom, UV lamp, egg timing etc. Smart case, D.S. PCB, all components, screws, miniature 3 pin plug & socket AC outlet, wire incl. 4 ft mains lead. Full circuit assembly instructions. Can be wired for 240V or 120V. State if to be used on 50 or 60 cycles.

PRICE £37.50 + £2.00 P&P.  
Ready built: £12 extra.

ANTEX SOLDERING IRONS £4.65  
SPARE BITS ALL SIZES 65p ea.

### COMPUTERS

VIC-20 starter pack £130.42

COMMODORE 64 £199.99

VIC games cartridges including

Sargon Chess all reduced to

£8.65 each + P&P

Add 15% VAT to all UK orders

**GPT ELECTRONICS**

63 Cambridge Street, Godmanchester

Cambridgeshire PE18 8AY.

Ph. Geoff Miller 0480 56382

### TIME WRONG?

**MSF CLOCK IS ALWAYS CORRECT** — never gains or loses, SELF SETTING at switch-on, 8 digits show Date, Hours, Minutes and Seconds, auto GMT/BST and leap year, also parallel BCD (including Weekday) output for alarm, computer etc, receives Rugby 60KHz atomic time signals, built-in antenna, 1000km range, £72-70.

**AUDIO OSCILLATOR**, 10Hz-200KHz,

TTL and 0-1V sine/square outputs,

£21-60. Each fun-to-build kit includes

all parts, printed circuit, case, instructions,

by-return postage etc. money back assurance, SEND away NOW.

**CAMBRIDGE KITS**

45 (HZ) Old School Lane, Milton, Cambs.

**MAKE SURE YOU GET THE BEST RESPONSE PHONE DEBBIE ON 01-437 1002**

## PLANS 'N DESIGN

**AMAZING** electronic plans, lasers, gas, ruby, light shows, high voltage teslas, van de graph, surveillance devices, ultrasonics, pyrotechnics, new solar generator, 150 more projects, catalogue S.A.E., Plancentre, Bromyard Road Industrial Estate, Ledbury HR8

### "ROBOT'S, DROIDS & FUTURISTIC THING'S"

Experimental Designs & ideas  
£5.00

### THOMSON ELECTRONICS

Droids Office  
5 David Place, St Helier  
Jersey, C.I.

**CONFUSE YOUR FRIENDS** with the 'Darkalarm'. Bleeps after a delay in darkness — stops in light. Easy to make (and hide!). £2.00 to build. Plans £1.50. SAE to H.C. Pearce, 108 Hill Lane, Southampton.

## CHRISTMAS GIFTS

**PRESENTS?** Give a slave!! ... 30W + V/C £2.50 — 100 watt/£7.00. Stereoamps boxed and tested £10. Case controls and sockets 120 watt (60 + 60) KIA-8, LS29 9DZ. Merry Christmas.

**FOR ALL YOUR CLASSIFIED NEEDS PHONE 01-437 1002**

## EQUIPMENT

**AERIAL AMPLIFIERS** improve weak television reception. Price £6.70. S.A.E. for leaflets. Electronic Mailorder, Ramsbottom, Lancashire BLO 9AGH.

**SPEAKER SWITCH** for two pairs of speakers. Uses Din speaker plugs/sockets. £6.00 + 70p p&p. Mr G Whittaker, 12 Church Lane, Clayton Le Moors, Accrington, Lancs. BB5 4DE.

## FOR SALE

**SOLDERING IRONS** 25 watt free spare bit, flux paste and solder £5.49. Paul Bannister, 51 Victoria Road, Stowmarket, Suffolk IP14 4AJ.

## HOBBY SHOP

## DAVENTRY

**EMOS** HIGH MARCH  
DAVENTRY NN11 4HQ  
Tel: (03272) 5523

- ★ Open Mon-Sat 9am-4pm
- ★ Both retailers and wholesalers
- ★ Vast stocks of components
- ★ Large 'walk-round' electronics supermarket

## TYNE & WEAR

**NOW OPEN IN NEWCASTLE FOR THE BEST IN ELECTRONIC TEST EQUIPMENT AND ACCESSORIES**

Marlborough Electronic Components  
15 Waterloo Street,  
Newcastle NE1 4DE1  
Tel: 618377

Open 9am-6pm Mon-Sat Easy Parking  
Stockists of: Transistors, Resistors, Capacitors, I.C. Diodes, Electronic Books  
Etc. Repairs undertaken

## W YORKSHIRE

**ACE MAILTRONIX LIMITED**  
3A Commercial Street  
Batley, West Yorkshire  
Tel. 0924 441129

Open: 9-5.30pm Weekdays  
9.30-1pm Saturdays

Retailers and wholesalers

## COMPUTING

**BARGAIN PRICE** electronic and computer components, ZX Spectrum and cassette accessories, low cost electronic goods — digital watches etc. SAE for detailed price lists. Ness Micro Systems, 100 Drakies Avenue, Inverness IV2 3SD.

**SPY CASSETTE** Spectrum/ZX81 let's you stop and copy any previously unstoppable tape. Simply press C for instant copy. If a Spectrum £3.95. ZX81 version £2.50. Bobker 29, Chadderton Drive, Unsworth, Bury, Lancs.

# HOBBY ELECTRONICS

## CLASSIFIED ADVERTISEMENT — ORDER FORM

If you have something to sell now's your chance! Don't turn the page — turn to us!  
**Rates of charge:** 30p per word per issue (minimum of 15 words).  
 and post to HOBBY ELECTRONICS, CLASSIFIED DEPT., 145 CHARING CROSS ROAD, LONDON WC2

Please place my advert in **HOBBY ELECTRONICS** for . . . . . issues commencing as soon as possible.  
 I am enclosing my Cheque/Postal Order/International Money Order for: (delete as necessary) £. . . . . (Made payable to A.S.P. Ltd)



OR Debitmy Access/Barclaycard  
 (Delete as necessary)



--	--	--	--	--	--	--	--	--	--	--	--	--	--	--	--	--	--	--	--	--

*All classified advertisements must be paid for in advance.*

Please use **BLOCK CAPITALS** and include post codes.

**Classification** .....

**Name (Mr/Mrs/Miss/Ms)** .....

**Address** .....

**Signature**..... **Date**.....

**Daytime Tel. No.**.....

### FREE CAREER BOOKLET

## Train for success, for a better job, better pay

Enjoy all the advantages of an ICS Diploma Course, training you ready for a new, higher paid, more exciting career.

Learn in your own home, in your own time, at your own pace, through ICS home study, used by over 8 million already!

Look at the wide range of opportunities awaiting you. Whatever your interest or skill, there's an ICS Diploma Course there for you to use.

Send for your **FREE CAREER BOOKLET** today—at no cost or obligation at all.

TICK THE FREE BOOKLET YOU WANT AND POST TODAY

<b>ELECTRONICS ENGINEERING</b> <input type="checkbox"/>	<b>TV &amp; AUDIO SERVICING</b> <input type="checkbox"/>
<b>ELECTRICAL ENGINEERING</b> <input type="checkbox"/>	<b>RUNNING YOUR OWN BUSINESS</b> <input type="checkbox"/>

Name .....

Address .....



Post to: Dept P261  
 ICS School of Electronics  
 165 Stewarts Road  
 London SW8 4UJ

01-622 9911  
 (All Hours)

BIMSOLES — METAL					Brown base		Beige top		BIMBOARDS	
Part No	A	B	C	D	E	Type	No of Con.	Points		
BIM 2601	178	51	210	38.5	70	9.15	Eurobreadboard	500	6.25	
BIM 2602	280	51	210	38.5	70	10.15	Eurobreadboard PCB	500	0.75	
BIM 2603	381	51	210	38.5	70	11.75	Bimboard 1	550	6.55	
BIM 2604	483	51	210	38.5	70	13.35	Bimbusstrip	80	2.50	
BIM 2605	480	51	261	38.5	70	14.90	Bimboard PCB	630	1.44	
BIM 2701	178	76	210	38.5	70	9.60	Bimboard Layout Pad		0.46	
BIM 2702	280	102	210	38.5	70	11.20	MPUobreadboard	1422	17.25	
BIM 2703	381	102	210	38.5	70	12.40	Bimboard Designer		77.00	
BIM 2704	483	102	210	38.5	70	14.15	Prototype with plug-in breadboards Component support brackets supplied with all except Eurobreadboard.			

BIMSOLES — ABS					Black or Grey base		with Grey Aluminium top.	
BIM	A	B	C	D	E			
BIM 6005	105	55.5	143	31.5	37.5	2.25		
BIM 6006	170	55.5	143	31.5	37.5	2.80		
BIM 6007	170	81.8	21.8	31.5	57.8	3.85		

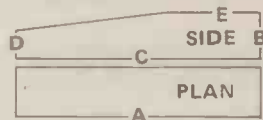

All prices inc VAT. Add 50p per order on Bimboards. £1.50 per order on Bimsoles for p&p. SAE for full list. Mail Order only.



**BIMSALES**  
 Dept HE1, 48a Station Road, Cheadle Hulme, Cheshire, SK8 7AB. Tel: 061 485 6667.

### HE -- ADVERTISERS INDEX

A D Electronics	53	Gardner Precision Eng.	59
Ambit International	1FC	Glanmlre	35
Audio Electronics	23	G.S.C.	11
Bib Audio	58, 59	H.G. Electronics	53
Bicc Vero	41	ICS	66
Bimsales	66	ILP	34, 54
B K Electronics	1BC	Kejan Engineering	53
B.N.R.&E.S.	48	Litesold	59
Branlme Marketing	61	Magenta Electronics	5
Brian J. Reed	53	Marshall's Ltd	16
J. Bull	19	Microtanic	35
Cambridge Learning	61	Parndon Electronics	53
Camtec	53	Riscomp	23
Concept Electronics	61	Silica Shop	OBC
C-Scope	61	Sparkrite	4
Dataplus Developments	16	S & R Brewster	35
Electronize Design	28	T K Electronics	27
Europa Electronics	41	Tomorrows World	52



### MULLARD SPEAKER KITS

Purposefully designed 40 watt R.M.S. and 30 watt R.M.S. 8 ohm speaker systems recently developed by MULLARD'S specialist team in Belgium. Kits comprise Mullard woofer (8" or 5") with foam surround and aluminium voice coil. Mullard 3" high power domed tweeter. B.K.E. built and tested crossover based on Mullard circuit, combining low loss components, glass fibre board and recessed loudspeaker terminals. SUPERB SOUNDS AT LOW COST. Kits supplied in polystyrene packs complete with instructions. 8" 40W system — recommended cabinet size 240 x 216 x 445mm Price £14.90 each + £2.00 P & P. 5" 30W system — recommended cabinet size 160 x 175 x 295mm Price £13.90 each + £1.50 P & P.

Designer approved flat pack cabinet kits, including grill fabric. Can be finished with iron on veneer or self adhesive vinyl etc. 8" system cabinet kit £8.00 each + £2.50 P & P. 5" system cabinet kit £7.00 each + £2.00 P & P.

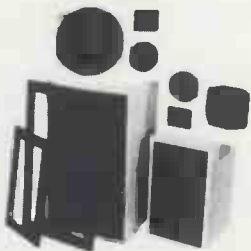

### STEREO CASSETTE TAPE DECK MODULE

Comprising of a top panel and tape mechanism coupled to a record/play back printed board assembly. Supplied as one complete unit for horizontal installation into cabinet or console of own choice. These units are brand new, ready built and tested.

Features: Three digit tape counter. Autostop. Six piano type keys, record, rewind, fast forward, play, stop and eject. Automatic record level control. Main inputs plus secondary inputs for stereo microphones. Input Sensitivity: 100mV to 2V. Input Impedance: 68K. Output level: 400mV to both left and right hand channels. Output Impedance: 10K. Signal to noise ratio: 45dB. Wow and flutter: 0.1%. Power Supply requirements: 18V DC at 300mA. Connections: The left and right hand stereo inputs and outputs are via individual screened leads, all terminated with phono plugs (phono sockets provided). Dimensions: Top panel 5 1/2" x 11 1/2". Clearance required under top panel 2 1/2". Supplied complete with circuit diagram and connecting diagram. Attractive black and silver finish. Price £26.70 + £2.50 postage and packing. Supplementary parts for 18V D.C. power supply (transformer, bridge rectifier and smoothing capacitor) £3.50.

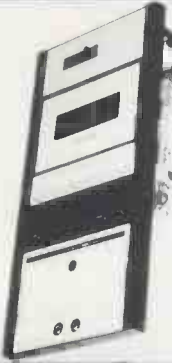

### LOUDSPEAKERS POWER RANGE

THREE QUALITY POWER LOUD-SPEAKERS (15", 12" and 8" See Photo). Ideal for both Hi-Fi and Disco applications. All units have attractive cast aluminium (ground finish) fixing escutcheons. Specification and Prices.

15" 100 watt R.M.S. Impedance 8 ohms. 50oz. magnet. 2" aluminium voice coil. Res. Freq. 20 Hz. Freq. Resp. to 2.5KHz. Sens. 97dB. Price: £34.00 each + £3.00 P&P  
12" 100 watt R.M.S. Impedance 8 ohms. 50oz. magnet. 2" aluminium voice coil. Res. Freq. 25Hz. Freq. Resp. to 4 KHz. Sens. 95dB. Price: £24.50 each + £3.00 P&P  
8" 50 watt R.M.S. Impedance 8 ohms. 20 oz. magnet. 1 1/2" aluminium voice coil. Res. Freq. 40Hz. Freq. Resp. to 6 KHz. Sens. 92dB. Black Cone. Price: £9.50 each. Also available with black protective grille Price: £9.99 each P&P £1.50.

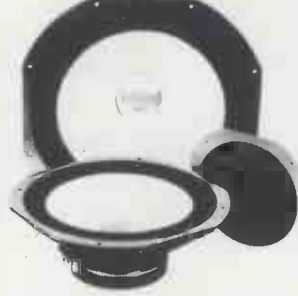

12" 85 watt R.M.S. McKENZIE C1285GP (LEAD GUITAR, KEYBOARD, DISCO) 2" aluminium voice coil, aluminium centre dome, 8 ohm imp., Res. Freq. 45Hz., Freq. Resp. to 6.5KHz., Sens. 98dB. Price: £23.00 + £3 carriage.  
12" 85 watt R.M.S. McKENZIE C1285TC (P.A., DISCO) 2" aluminium voice coil. Twin cone, 8 ohm imp., Res. Freq. 45Hz., Freq. Resp. to 14KHz. Price £23 + £3 carriage.  
15" 150 watt R.M.S. McKENZIE C15 (BASS GUITAR, P.A.) 3" aluminium voice coil. Die cast chassis. 8 ohm imp., Res. Freq. 40Hz., Freq. Resp. to 4KHz. Price: £47 + £4 carriage.

### PIEZO ELECTRIC TWEETERS - MOTOROLA

Join the Piezo revolution. The low dynamic mass (no voice coil) of a Piezo tweeter produces an improved transient response with a lower distortion level than ordinary dynamic tweeters. As a crossover is not required these units can be added to existing speaker systems of up to 100 watts (more if 2 put in series). FREE EXPLANATORY LEAFLETS SUPPLIED WITH EACH TWEETER.

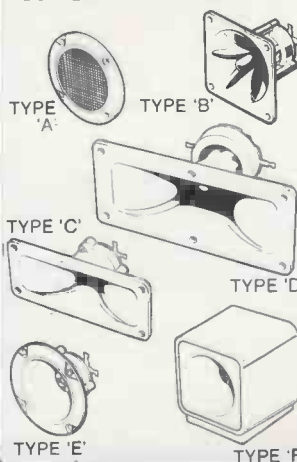

TYPE 'A' (KSN2036A) 3" round with protective wire mesh, ideal for bookshelf and medium sized Hi-fi speakers. Price £4.29 each.

TYPE 'B' (KSN1005A) 3 1/2" super horn. For general purpose speakers, disco and P.A. systems etc. Price £4.99 each.

TYPE 'C' (KSN6016A) 2" x 5" wide dispersion horn. For quality Hi-fi systems and quality discos etc. Price £5.99 each.

TYPE 'D' (KSN1025A) 2" x 6" wide dispersion horn. Upper frequency response retained extending down to mid range (2KHz). Suitable for high quality Hi-fi systems and quality discos. Price £7.99 each.

TYPE 'E' (KSN1038A) 3 3/4" horn tweeter with attractive silver finish trim. Suitable for Hi-fi monitor systems etc. Price £4.99 each.

TYPE 'F' (KSN1057A) Cased version of type 'E'. Free standing satellite tweeter. Perfect add on tweeter for conventional loudspeaker systems. Price £10.75 each P&P 20p ea. for SAE for Piezo leaflets.

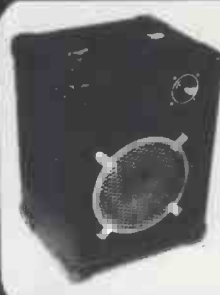

### OMP 80 LOUDSPEAKER

The very best in quality and value.

Ported tuned cabinet in hard-wearing black vinylite with protective corners and carry handle. Built and tested, employing 10in British driver and Piezo tweeter. Spec: 80 watts RMS; 8 ohms; 45Hz-20KHz; Size: 20in x 15in x 12in; Weight: 30 pounds.

Price: £49.00 each  
£90 per pair  
Carriage: £5 each £7 per pair

### BK ELECTRONICS

Prompt Deliveries  
VAT inclusive prices  
Audio Equipment  
Test Equipment  
by  
Thandar  
and  
Leader

### PANTEC

HOBBY KITS. Proven designs including glass fibre printed circuit board and high quality components complete with instructions.

FM MICROTRANSMITTER (BUG) 90/105MHz with very sensitive microphone. Range 100/300 metres. 57 x 46 x 14mm (9 volt) Price: £7.99p

DIGITAL THERMOMETER -9.9°C to +99.9°C. LED display. Complete with sensor. 70 x 70 mm (9 volt) Price: £27.60p

3 WATT FM TRANSMITTER 3 WATT 85/115MHz varicap controlled, professional performance. Range up to 3 miles 35 x 84 x 12 mm (12 volt) Price: £12.49p

SINGLE CHANNEL RADIO CONTROLLED TRANSMITTER/RECEIVER 27MHZ Range up to 500 metres. Double coded modulation. Receiver output operates relay with 2amp/240 volt contacts. Ideal for many applications. Receiver 90 x 70 x 22 mm (9/12 volt) Price: £16.49 Transmitter 80 x 50 x 15 mm (9/12 volt) Price £10.29 P&P All Kits +50p. S.A.E. for complete list.



3 watt FM Transmitter

### BSR P256 TURNTABLE

P256 turntable chassis ● S shaped tone arm ● Belt driven ● Aluminium platter ● Precision calibrated counter balance ● Anti-skate (bias device) ● Damped cueing lever ● 240 volt AC operation (Hz) ● Cut-out template supplied ● Completely manual arm. This deck has a completely manual arm and is designed primarily for disco and studio use where all the advantages of a manual arm are required.

Price £31.35 each. £2.50 P&P



### OMP POWER AMPLIFIER MODULE

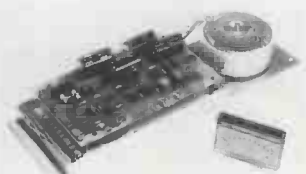

New model.  
Improved specification

NEW OMP100 Mk.II POWER AMPLIFIER MODULE Power Amplifier Module complete with integral heat sink, toroidal transformer power supply and glass fibre p.c.b. assembly. Incorporates drive circuit to power a compatible LED Vu meter. New improved specification makes this amplifier ideal for P.A., Instrumental and Hi-Fi applications.

SPECIFICATION  
Output Power:— 110 watts R.M.S.  
Loads:— Open and short circuit proof 4/16 ohms.  
Frequency Response:— 15Hz - 30KHz -3dB.  
T.H.D.:— 0.01%  
S.N.R. (Unweighted):— -118dB ±3.5dB  
Sensitivity for Max Output:— 500mV @ 10K.  
Size:— 360 x 115 x 72 mm Price:— £31.99 + £2.00 P&P. Vu Meter Price:— £7.00 + 50p P&P.

MOSFET versions available up to 300W. R.M.S.

### HOME PROTECTION SYSTEM

Better to be 'Alarmed' than terrified. Thandar's famous 'Minder' Burglar Alarm System. Superior microwave principle. Supplied as three units, complete with interconnection cable. FULLY GUARANTEED.

Control Unit — Houses microwave radar unit, range up to 15 metres adjustable by sensitivity control. Three position, key operated facia switch — off — test — armed. 30 second exit and entry delay.

Indoor alarm — Electronic swept freq. siren. 104dB output.

Outdoor Alarm — Electronic swept freq. siren. 98dB output. Housed in a tamper-proof heavy duty metal case.

Both the control unit and outdoor alarm contain rechargeable batteries which provide full protection during mains failure. Power requirement 200/260 Volt AC 50/60Hz. Expandable with door sensors, panic buttons etc. Complete with instructions

SAVE £128 Usual price £228.85

BKE's PRICE £99.p&p£4

SAE for colour brochure



### MIXERS DISCO

OMP PRO MIX MONO

OMP PROMIX MONO DISCO MIXER (As illustrated). 4 Inputs: — 2 Mag. Disc. 1 Aux. plus i/vic. with override. Active bass and treble tone cont's. Individual level controls plus master volume. Monitor output (headphone) for all inputs. Output: 775mV Supply 240Vac. Size: 19" x 5 1/4" x 2 1/2". Price: £49.99 + £2.00 P&P

ALSO Stereo Version as above price £69.99 + £2 p&p

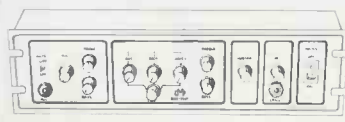

# B.K. ELECTRONICS

UNIT 5, COMET WAY, SOUTHEND-ON-SEA, ESSEX, SS2 6TR

★ SAE for current lists. ★ Official orders welcome. ★ All prices include VAT. ★ Sales Counter. ★ All items packed where applicable in special energy absorbing PU foam. ★ Please phone 0702 527572 ★

# 100 FREE PROGRAMS

FROM SILICA SHOP — WITH EVERY PURCHASE OF AN

# ATARI 400

# 800



### ATARI PRICES REDUCED!

We at Silica Shop are pleased to announce some fantastic reductions in the prices of the Atari 400/800 personal computers. We believe that the Atari at its new price will become the U.K.'s most popular personal computer and have therefore set up the Silica Atari Users Club. This club already has a library of over 500 programs and with your purchase of a 400 or 800 computer we will give you the first 100 free of charge. There are also over 350 professionally written games and utility programs, some are listed below. Complete the reply coupon and we'll send you full details. Alternatively give us a ring on 01-301 1111 or 01-309 1111.

**ATARI 400** £99  
with 16k

**ATARI 400** £148  
with 32k

**ATARI 800** £249  
with 16k

## 400/800 SOFTWARE & PERIPHERALS

Don't buy a T.V. game! Buy an Atari 400 personal computer and a game cartridge and that's all you'll need. Later on you can buy the Basic Programming cartridge (£35) and try your hand at programming using the easy to learn BASIC language. Or if you are interested in business applications, you can buy the Atari 800 + Disk Drive + Printer together with a selection of business packages.

Silica Shop have put together a full catalogue and price list giving details of all the peripherals as well as the extensive range of software that is now available for the Atari 400/800. The Atari is now one of the best supported personal computers. Send NOW for Silica Shop's catalogue and price list as well as details on our users club.

### THE FOLLOWING IS JUST A SMALL SELECTION FROM THE RANGE OF ITEMS AVAILABLE:

- |   |  |   |   |   |   |   |   |  |   |   |  |   |   |  |  |  |   |   |   |  |
|---|--|---|---|---|---|---|---|--|---|---|--|---|---|--|--|--|---|---|---|--|
| <b>ACCESSORIES</b><br>Cables<br>Cassettes<br>Diskettes<br>Joysticks<br>Le Stick - Joystick<br>Misc. Supplies<br>Paddles | Mountain Shoot<br>Rearguard<br>Star Flite<br>Sunday Golf | <b>AUTOMATED SIMULATIONS</b><br>Crush Crumble Cmp<br>Datstones of Ryn<br>Dragons Eye<br>Invasion Orion<br>Rescue at Rigel<br>Ricochet<br>Star Warrior<br>Temple of Apsah<br>Upper Reaches Aps | <b>BOOKS</b><br>Basic Refl Manual<br>Compute Atari DOS<br>Compute Bk Atari<br>Compute Magazine<br>De Re Atari<br>DOS Utilities List<br>DOS2 Manual<br>Misc Atari Books<br>Op System Listing<br>Wiley Manual | <b>CRYSTALWARE</b><br>Beneath The Pyram<br>Fantasyland 2041<br>Galactic Quest<br>House Of Usher<br>Sands Of Mars<br>Waterloo<br>World War III | <b>BUSINESS</b><br>Calculator<br>Database Management<br>Decision Maker<br>Graph-It<br>Invoicing<br>Librarian<br>Mort & Loan Anal<br>Nominal Ledger<br>Payroll<br>Personal Finl Mgmt<br>Purchase Ledger<br>Sales Ledger<br>Statistics 1<br>Stock Control<br>Teletink 1<br>Visicalc<br>Weekly Planner<br>Word Processor | <b>DYNACOMP</b><br>Alpha Fighter<br>Chomelo<br>Crystals<br>Forest Fire<br>Intruder Alert<br>Monarch<br>Moonprobe<br>Moving Maze<br>Nominoes Jigsaw<br>Rings of The Emp<br>Space Tilt<br>Space Trap<br>Stud Poker<br>Triple Blockade | <b>EDUCATION</b><br>from APX<br>Alqalc<br>Atlas of Canada<br>Cubbyholes<br>Elementary Biology<br>Frogmaster<br>Hickory Dickory<br>Inst Compng Dem<br>Lemonade<br>Letterman<br>Mapware | Maths Tac-Toe<br>Metric & Prob Solvg<br>Mugwump<br>Music Terms/Notatn<br>Musical Computer<br>My First Alphabet<br>Number Blast<br>Polycalc<br>Presidents Of U.S.<br>Quiz Master<br>Starware<br>Stereo 3D Graphics<br>Three R Math Sys<br>Video Math Flash<br>Wordmaker | <b>EDUCATION</b><br>from ATARI<br>Conv French<br>Conv German<br>Conv Italian<br>Conv Spanish<br>Energy Czar<br>European C & Caps<br>Hangman<br>Invit To Prog 1/2/3<br>Kingdom<br>Music Composer | Sram<br>States & Capitals<br>Touch Typing | <b>EMI SOFTWARE</b><br>British Heritage<br>Cribbage/Dominoes<br>Darts<br>European Scene Jig<br>Hickory Dickory<br>Humpty Dumpty<br>Jumbo Jet Lander<br>Shooker & Billiards<br>Submarine Comdr<br>Super Cubes & Tilt<br>Tournament Pool | Castle<br>Centurion<br>Checker King<br>Chinese Puzzle<br>Codecracker<br>Comedy Diskette<br>Dice Poker<br>Dog Dare<br>Domination<br>Downhill<br>Eastern Front<br>Galahad & Holy Gr<br>Graphics/Sound<br>Jax O<br>Jukebox<br>Lookahead<br>Memory Match<br>Midat Touch<br>Minotaur<br>Outlaw/Howitzer<br>Preschool Games<br>Pro Bowling<br>Pushover<br>Rabbitz<br>Reversi II<br>Salmon Run<br>747 Landing Simul<br>Seven Card Stud | Steazy Adventure<br>Solitaire<br>Space Chase<br>Space Trek<br>Sultans Palace<br>Tact Trek<br>Terry<br>Wizards Gold<br>Wizards Revenge | <b>ENTERTAINMENT</b><br>from ATARI<br>Asteroids<br>Basketball<br>Blackjack<br>Centepede<br>Chess<br>Entertainment Kit<br>Missile Command<br>Pac Man<br>Space Invaders<br>Star Raiders<br>Super Breakout<br>Video Easel | <b>ON LINE SYSTEMS</b><br>Crossfire<br>Frogger | Jawbreaker<br>Mission Asteroid<br>Mouskattack<br>Threshold<br>Ulysses/Golden Fl<br>Wizard & Princess | <b>PERIPHERALS</b><br>Centronics Printers<br>Disk Drive<br>Epsom Printers<br>Program Recorder<br>RS232 Interface<br>Thermal Printer<br>16K Memory RAM<br>32K Memory RAM | <b>PERSONAL INT</b><br>from APX<br>Adv Music System<br>Banner Generator<br>Going To The Dogs<br>Keyboard Organ<br>Morse Code Tutor<br>Personal Fitness Prg<br>Player Piano<br>Sketchpad | <b>SANTA CRUZ</b><br>Basics of Animation<br>Bobby Business<br>Display Lists<br>Graphics Machine<br>Kids 1 & 2<br>Horizontal Scrolling<br>Master Memory Map<br>Mini Word Processor<br>Page Flipping<br>Player Missile Gr<br>Player Piano<br>Sounds<br>Vertical Scrolling | <b>SILICA CLUB</b><br>Over 500 programs<br>write for details |
|---|--|---|---|---|---|---|---|--|---|---|--|---|---|--|--|--|---|---|---|--|

## FOR FREE BROCHURES - TEL: 01-301 1111

For free brochure and reviews on our range of electronic products, please telephone 01-301 1111. To order by telephone, just quote your name, address, credit card number, and order requirements and leave the rest to us. Post and packing is FREE OF CHARGE in the UK. Express 24 hour delivery available at an additional charge.

- **SHOP DEMONSTRATION FACILITIES** - we provide full facilities at our shop in Sidcup, Monday to Saturday 9am to 5.30pm (closing Thursday 1pm, Friday 8pm)
- **MAIL ORDER** - we are a specialist mail order company and are able to supply goods direct to your door
- **MONEY BACK GUARANTEE** - if you are totally unsatisfied with your purchase, you may return it to us within 15 days. On receipt of the goods in satisfactory condition, we will give you a full refund.
- **PART EXCHANGE SECOND HAND MACHINES** - we offer a part exchange scheme to trade in many makes of TV, games for personal computers.
- **COMPETITIVE PRICES** - our prices, offers and service are very competitive. We are never knowingly underpriced and will normally match any lower price quoted by our competitors.
- **HELPFUL ADVICE** - available on the suitability of various computers.
- **AFTER SALES SERVICE** - available on all computers out of guarantee.
- **VAT** - all prices quoted above include VAT at 15%.
- **CREDIT FACILITIES** - we offer credit over 12, 24 or 36 months, please ask for details.

**SILICA SHOP LIMITED**  
Dept. HE 12 83 1-4 The Mews, Hatherley Road, Sidcup,  
Kent DA14 4DX Telephone 01-301 1111 or 01-309 1111

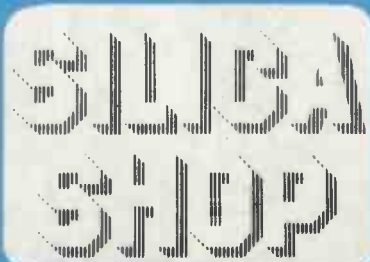

### FREE LITERATURE

I am interested in purchasing an Atari 400/800 computer and would like to receive copies of your brochure and test reports as well as your price list covering all of the available Hardware and Software.

Name

Address

Postcode

Hobby Electronics  HE 12 83