

Hobby Electronics

AUGUST '82

ISSN 0142-6192

70p

Project Electronics For Everyone

ZX Interfaces Explained



POPULAR
COMPUTING
PROJECT

Introduction
to Electronics
Beginner's Guide
to Construction



PROJECT: MUSIC-
Audio Analyser
TEST EQUIPMENT-
LED Millivoltmeter
INTO RADIO-SWR Meter

NICADS: UK's LOWEST PRICES

AMBIT'S NEW CONCISE COMPONENT CATALOGUE IS OUT NOW -

Available at your
newsagent or
direct, for 70p inc.

Ambit's new style catalogue continues to lead the market with low prices, new items, info, 3 £1 discount vouchers. In a recent supplier survey, we were one of only two suppliers listed in all categories!

There's a few examples of some super low prices

78XX 1A	37p
BC237/8/9	8p
3SK51	54p
10MHz XTALS	£2
8 Pole 10.7MHz XTAL filters	£14.50
2GHz coax relay	
150W	£10.95

All the "usual" stuff at rock bottom prices + Toko coils, crystal and ceramic filters, micrometals toroids, Fairite ferrites, Alps switches, OKI LSI, Piezo sounders, RF, IF Modules + Kits etc.



**RECHARGEABLE
UP TO 400
TIMES PER
CELL!**

CAPACITY	TYPE	1-9	10-49
500 mAh	AA	80	74
2200 mAh	C	2.35	1.99
1200 mAh	D	2.14	2.06
4000 mAh	D	3.05	2.85
110 mAh	PP3	3.70	3.50

Price on the page

CMOS

4000	0.11	4514	1.25	7406N	0.22
4001	0.11	4515	1.25	7407N	0.22
4002	0.12	4516	0.60	7408N	0.15
4007	0.13	4518	0.35	7409N	0.15
4008	0.50	4520	0.80	7410N	0.12
4008AE	0.90	4521	1.30	7411N	0.18
4009	0.25	4522	0.89	7412N	0.19
4010	0.30	4527	0.80	7413N	0.27
4011AE	0.24	4528	0.85	7414N	0.51
4011	0.11	4529	0.70	7416N	0.27
4013	0.25	4531	0.85	7417N	0.27
4015	0.50	4532	0.80	7420N	0.13
4016	0.22	4534	4.00	7421N	0.28
4017	0.40	4536	2.50	7423N	0.22
4019	0.38	4538	0.85	7425N	0.22
4020	0.55	4539	0.80	7426N	0.22
4021	0.55	4543	0.80	7427N	0.12
4022	0.55	4549	3.50	7430N	0.22
4023	0.15	4553	2.70	7432N	0.23
4024	0.33	4554	1.20	7437N	0.22
4025	0.15	4555	0.35	7438N	0.12
4026	1.05	4556	0.40	7440N	0.24
4027	0.26	4557	2.30	7441N	0.54
4028	0.50	4558	0.80	7442N	0.42
4029	0.55	4559	3.50	7443N	0.62
4030	0.35	4560	2.50	7444N	0.62
4035	0.67	4561	1.00	7445N	0.62
4040	0.50	4562	1.50	7446N	0.62
4042	0.50	4566	1.20	7447N	0.62
4043	0.50	4568	1.45	7448N	0.56
4043AE	0.93	4569	1.70	7450	0.14
4044	0.60	4572	0.22	7451N	0.14
4046	0.60	4580	3.25	7453N	0.14
4047	0.68	4581	1.40	7454N	0.14
4049	0.24	4582	0.70	7460N	0.14
4050	0.24	4583	0.80	7470N	0.28
4051	0.55	4584	0.27	7472N	0.27
4052	0.55	4585	0.45	7473N	0.28
4053	0.55	4702	4.50	7474N	0.28
4054	1.30	4703	4.48	7475N	0.35
4055	1.30	4704	4.24	7476N	0.30
4056	1.30	4705	4.24	7480N	0.26
4059	5.75	4706	4.50	7481N	0.20
4060	0.75	4720	4.00	7482N	0.75
4063	1.15	4723	0.95	7485N	0.75
4066	0.30	4724	0.95	7486N	0.24
4067	4.30	4725	2.24	7489N	1.05
4068	0.16	40014	0.54	7490N	0.30
4069AE	0.14	40085	0.99	7491N	0.55
4070	0.16	40098	0.54	7492N	0.35
4071	0.16	40106	0.69	7493N	0.35
4072	0.16	40160	1.05	7494N	0.70
4073	0.16	40161	1.05	7495N	0.70
4075	0.16	40162	1.05	7496N	0.60
4076	0.55	40163	1.05	7497N	0.40
4077	0.18	40174	1.05	74100	1.10
4078	0.18	40175	1.05	74104	0.62
4081	0.12	40192	1.08	74105	0.62
4082	0.18	40193	1.08	74107	0.26
4093	0.30	40194	1.08	74109N	0.35
4099	0.80	40195	1.08	74110N	0.54
4175	0.80			74111N	0.68
4502	0.60			74112N	1.70
4503	0.50	TTL	N	74116N	1.98
4506	0.70	7400N	0.10	74118N	0.85
4507	0.37	7431N	0.10	74119N	1.20
4508	1.50	7402N	0.20	74120N	0.95
4510	0.55	7403N	0.11	74121N	0.34
4511	0.45	7404N	0.12	74122N	0.34
4512	0.55	7405N	0.12	74123N	0.40

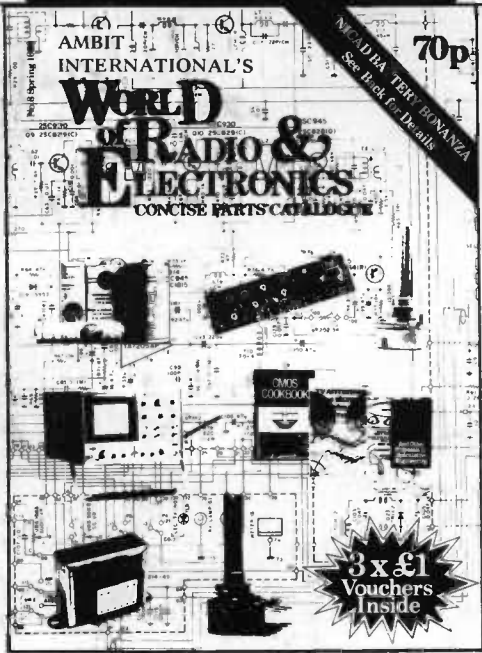

Prices shown EXCLUDE VAT.
Access/Barclaycard may be used
with written or telephone orders,
official MA details on application.
E & O.
POSTAGE AND PACKING
50p per order

74125N	0.40	74153N	0.55	74170N	1.25
74126N	0.40	74154N	0.55	74173N	1.10
74128N	0.65	74155N	0.55	74174N	0.75
74132N	0.50	74156N	0.55	74175N	0.75
74136N	0.65	74157N	0.55	74176N	0.75
74141N	0.45	74159N	1.90	74177N	0.75
74142N	1.85	74160N	0.55	74178N	0.90
74143N	2.50	74161N	0.55	74179N	1.35
74144N	2.50	74162N	0.55	74180N	0.75
74145N	0.75	74163N	0.55	74181N	1.22
74147N	1.50	74164N	0.55	74182N	0.70
74148N	1.09	74165N	0.55	74184N	1.20
74150N	0.79	74166N	0.70	74185N	1.20
74151N	0.55	74167N	1.25	74188N	3.00

74190N	0.55	74LS74N	0.16	74LS248N	1.35
74191N	0.55	74LS75N	0.22	74LS249N	1.35
74192N	0.55	74LS76N	0.20	74LS251N	0.35
74193N	0.55	74LS78N	0.19	74LS253N	0.35
74194N	0.55	74LS83N	0.40	74LS257N	0.40
74195N	0.55	74LS85N	0.60	74LS258N	0.37
74196N	0.55	74LS86N	0.14	74LS259N	0.60
74197N	0.55	74LS90N	0.32	74LS260N	0.50
74198N	0.85	74LS91N	0.28	74LS266N	0.22
74199N	1.00	74LS92N	0.31	74LS273N	0.70
74221N	1.00	74LS93N	0.31	74LS275N	3.20
74246N	1.50	74LS95N	0.40	74LS279N	0.35
74247N	1.51	74LS96N	1.20	74LS280N	2.50
74248N	1.89	74LS107N	0.25	74LS283N	0.42
74249N	0.11	74LS109N	0.20	74LS290N	0.50
74251N	1.05	74LS112N	0.20	74LS293N	0.40
74265N	0.66	74LS113N	0.20	74LS295N	1.50
74273N	2.67	74LS114N	0.18	74LS298N	0.76
74278N	2.49	74LS122N	0.35	74LS365N	0.32
74279N	0.89	74LS123N	0.35	74LS366N	0.34
74283N	1.30	74LS124N	1.80	74LS367N	0.32
74284N	3.50	74LS125N	0.24	74LS368N	0.35
74285N	3.50	74LS126N	0.24	74LS373N	0.70
74290N	1.00	74LS132N	0.42	74LS374N	0.70
74293N	1.05	74LS133N	0.24	74LS375N	0.40
74297N	2.36	74LS136N	0.20	74LS377N	0.85
74298N	1.85	74LS138N	0.30	74LS378N	0.65
74365N	0.85	74LS139N	0.30	74LS379N	0.60
74366N	0.85	74LS145N	2.20	74LS384N	2.50
74367N	0.85	74LS151N	0.30	74LS385N	2.05
74368N	0.85	74LS153N	0.27	74LS390N	0.68
74390N	1.85	74LS154N	0.89	74LS393N	0.61
74393N	1.85	74LS155N	0.35	74LS395N	2.10
74490N	1.85	74LS156N	0.37	74LS396N	1.99
		74LS157N	0.30	74LS398N	2.75
		74LS158N	0.30	74LS399N	2.30
		74LS160N	0.37	74LS445N	1.40
		74LS161N	0.37	74LS447N	1.95
		74LS162N	0.37	74LS490N	1.10
		74LS163N	0.37	74LS668N	1.05
		74LS164N	0.14	74LS669N	1.05
		74LS165N	0.13	74LS670N	1.70
		74LS166N	0.80		
		74LS168N	0.70		
		74LS169N	0.85		
		74LS170N	0.80		
		74LS173N	0.80		
		74LS174N	0.40		
		74LS175N	0.40		
		74LS181N	1.05		
		74LS183N	1.75		
		74LS189N	1.25		
		74LS190N	0.45		
		74LS191N	0.45		
		74LS192N	0.45		
		74LS193N	0.45		
		74LS194N	0.32		
		74LS195N	0.35		
		74LS196N	0.55		
		74LS197N	0.60		
		74LS200N	3.40		
		74LS202N	3.45		
		74LS221N	0.50		
		74LS240N	0.80		
		74LS241N	0.80		
		74LS242N	0.70		
		74LS243N	0.70		
		74LS244N	0.60		
		74LS245N	0.60		
		74LS247N	1.35		

Processors 8080 series

8080AFC	17.30
8212	2.30
8214	3.50
8216	1.95
8224	3.50
8251	8.21
8255	5.40

Z80 series

Z80A	13.75
Z80ADRT	7.50
Z80API	3.50
Z80ASIO 1	11.00
Z80ASIO 2	11.00
Z80ASIO 9	9.85
Z80CTC	4.00
Z80ACTC	4.50
Z80U1	65.00

PROM

2708	2.00
2716	13.00
2532	0A
2732	14.00

Hobby Electronics

AUGUST 1982
Vol 4 No 8

PROJECTS

- ★ **DIGITAL VOLTMETER** 20
Not quite a one-chip-wonder, but close!
- INTO RADIO**
- SWRMETER** 48
Cheap and cheerful, but it does the trick.
- POPULAR COMPUTING**
- HE MICROTRAINER** 57
Continuing with the constructional details.
- PROJECT: MUSIC**
- AUDIO ANALYSER** 53
Spectrums analysed here.



FEATURES

- POPULAR COMPUTING**
- ZX INTERFACES EXPLAINED** 10
The ins and outs of the ZX Spectrum and ZX81.
- SPOTLIGHT ON THE SPECTRUM** 14
Analysing Sinclair's latest.
- ★ **BEGINNER'S GUIDE TO CONSTRUCTION** 28
A practical introduction.
- GADGETS, GAMES AND KITS**
- METERTECH DVM** 37
Digital multimeter reviewed.
- ★ **FAMOUS NAMES** 39
Julius Plucker
- INTO RADIO**
- RADIO RULES** 43
Resonant with meaning.

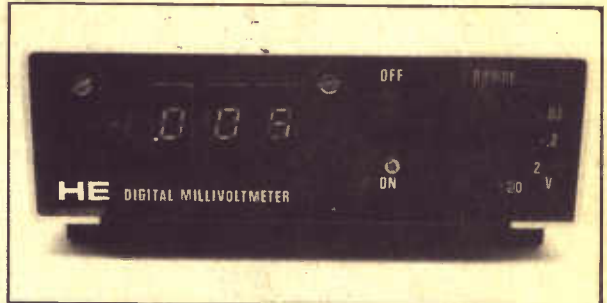

REGULARS

- Monitor 6
- Points Of View 17
- What's On Next 18
- Breadboard Exhibition 26
- Buylines 34
- Clever Dick 35
- Backnumbers 40
- Bookshelf 46
- HE Subscriptions 60
- PCB Service 63
- PCB Printout 65
- Index to Advertisements 65
- Classified Advertisements 66

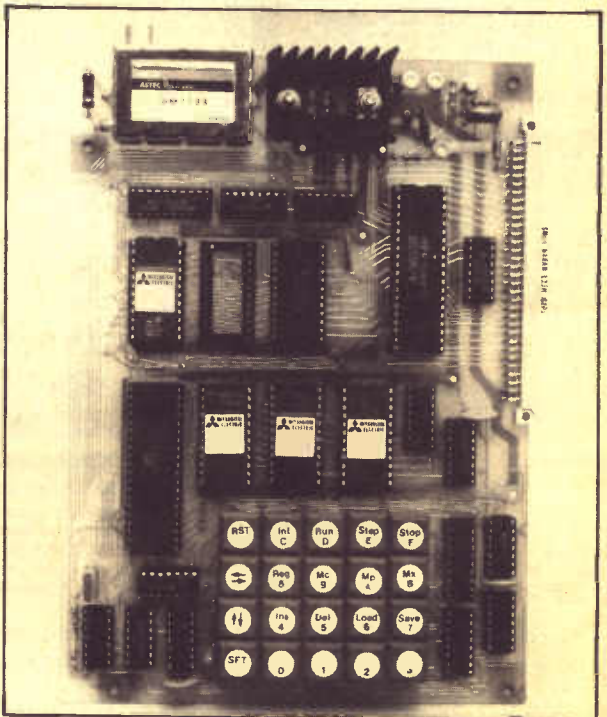

Editor: Ron Keeley
 Editorial Assistant: Paul Coster BSc
 Advertisement Manager: Gary Price
 Managing Editor: Ron Harris BSc
 Managing Director: T.J. Connell

Hobby Electronics is normally published on the second Friday of the month prior to the cover date.
 Hobby Electronics, 145 Charing Cross Road, London WC2H 0EE, 01-437 1002. Telex No 8811896. Published by Argus Specialist Publications Ltd.
 Design and Organisation by MM Design and Print Ltd, 145 Charing Cross Road, London WC2H 0EE, 01-437 1002.
 Distributed by S. M. Distribution Ltd, 16/18 Trinity Gardens, London SW9 8DX.
 Printed by QB Ltd, Colchester. Covers printed by Alabaster Passmore.

Notice: The contents of this publication including all articles, designs, plans, drawings and programs and all copyright and other intellectual property rights therein belong to Argus Specialist Publications Limited. All rights conferred by the Law of Copyright and other intellectual property rights and by virtue of international copyright conventions are specifically reserved to Argus Specialist Publications Limited and any reproduction requires the prior written consent of the Company.
 ©Copyright 1982 Argus Specialist Publications Ltd. Member of Audit Bureau of Circulation.

BI-PAK

"IRRRESISTABLE RESISTOR BARGAINS"

Pak No.	Qty	Description	Price
SX10	400	Mixed All type Resistors	£1
SX11	400	Pre formed 1/4 watt Carbon Resistors	£1
SX12	200	1/4 watt Carbon Resistors	£1
SX13	200	1/2 watt Carbon Resistors	£1
SX14	150	1/2 watt Resistors 22 ohm 2m2 Mixed	£1
SX15	100	1 and 2 watt Resistors 22 ohm 2m2 Mixed	£1

Paks SX12-15 contain a range of Carbon Film Resistors of assorted values from 22 ohms to 2.2 meg. Save pounds on these resistor paks and have a full range to cover your projects.
Quantities approximate, count by weight

"CAPABLE CAPACITOR PAKS"

Pak No.	Qty	Description	Price
SX16	250	Capacitors Mixed Types	£1
SX17	200	Ceramic Capacitors Miniature Mixed	£1
SX18	100	Mixed Ceramics 1pf-5 pf	£1
SX19	100	Mixed Ceramics 68pf-0.5µm	£1
SX20	100	Assorted Polyester/Polystyrene Capacitors	£1
SX21	60	Mixed C280 type capacitors metal foil	£1
SX22	100	Electrolytics, all sorts	£1
SX23	50	Quality Electrolytics 50 1000µm	£1
SX24	20	Tantalum Beads, mixed	£1

Quantities approximate, count by weight

AUDIO PLUGS, SOCKETS AND ACCESSORIES

25 pieces of Audio Plugs, Sockets and Connectors to include DIN 180°, 240°, Inline 3-6 Pin Speakers, Phono Jack, Stereo and Mono etc. Valued at well over £3 normal. Order No. SX25. Our Price £1.50 per pak. Guaranteed to save you money

SX26	3 Pcs of 6 pin 240° DIN Plugs and Chassis Sockets	50p
SX27	1 x Right Angle Stereo Jack Plug 6.3mm plus matching metal chassis mounting socket	30p
SX28	4 Phono plugs and 2 dual phono connectors	30p
SX29	1 x 2.5mm Plug to 3.5mm Socket adaptor	20p
SX30	1 x 3.5mm Plug to 2.5mm Socket adaptor	20p
SX31	1 x 3.5mm Plug to Phono Socket adaptor	20p

1 Amp SILICON RECTIFIERS

Glass Type similar IN4000 SERIES IN4001-IN4004 50 — 500v — uncodded — you select for VLTS ALL perfect devices — NO dudz Min 50v 50 for £1.00 — worth double ORDER NO SX76

Silicon General Purpose NPN Transistors TO-18 Case Lock lit leads — coded CV7644 Similar to BC147 — BC107 2T89 ALL NEW! VCE 70v IC500mA Hfe 75-250 50 off 100 off 500 off 1000 off
PRICE £2.00 £3.80 £17.50 £30.00
Order as CV7644

Silicon General Purpose PNP Transistors TO-5 Case Lock lit leads coded CV9507 similar 2N2905A to BFX30 VC 60 IC 600mA Min Hfe 50 ALL NEW! 50 off 100 off 500 off 1000 off
PRICE £2.50 £4.00 £19.00 £35.00
Order as CV9507

BARGAINS

SX91	20 x Large 2" RED LED	£1
SX42	20 small 125 Red LEDs	£1
SX43	10 Rectangular Green LEDs 2	£1
SX46	30 Assorted Zener Diodes 250mw 2 watt mixed voltages all coded New	£1
SX47	4 Black Instrument Knobs—winged with pointer 1/4" Standard screw Fit size 29 x 20mm	50p
SX49	20 Assorted Slider Knobs Black/Chrome, etc	£1
SX80	12 Neons and Filament Lamps. Low voltage and mains — various types and colours — some panel mounting	£1

Silicon NPN'L' Type Transistors

TO-92 Plastic centre collector Like BC182L — 183L — 184L VCBO 45 VCEO 30 IC200mA Hfe 100-400 ALL perfect devices — uncodded ORDER AS SX183L 50 off 100 off 500 off 1000 off
£1.50 £2.50 £10.00 £17.00

PNP SILICON TRANSISTORS:

Brand New — Uncodded — Perfect Devices 50 off 100 off 500 off 1000 off
£2.00 £3.50 £15.00 £25.00
Order as ZTXPNP

BI-PAK PCB ETCHANT AND DRILL KIT

Complete PCB Kit comprises 1 Expo Mini Drill 10,000RPM 12v DC incl 3 collets & 1 x 1mm Twist bit 1 Sheet PCB Transfers 210mm x 150mm 1 Etch Resist Pen 1 1/2 lb pack FERRIC CHLORIDE crystals 3 sheets copper clad board 2 sheets Fibreglass copper clad board Full instructions for making your own PCB boards
Retail Value over £15.00
OUR BI-PAK SPECIAL KIT PRICE £9.75
ORDER NO SX81

BI-PAK SOLDER — DESOLDER KIT

Kit comprises ORDER NO SX80 1 High Quality 40 watt General Purpose Lightweight Soldering Iron 240v mains incl 3/16" (4.7mm) bit 1 Quality Desoldering pump High Suction with automatic ejection Knurled, anti-corrosive casing and teflon nozzle 1 5 metres of De-soldering braid on plastic dispenser 2 yds (1.83m) Resin Cored Solder on Card 1 Heat Shunt tool tweezers Type Total Retail Value over £12.00
OUR SPECIAL KIT PRICE £8.95

BI-PAK'S COMPLETELY NEW CATALOGUE

Completely re-designed Full of the type of components you require, plus some very interesting ones you will soon be using and of course, the largest range of semiconductors for the Amateur and Professional you could hope to find. There are no wasted pages of useless information so often included in Catalogues published nowadays. Just solid facts i.e. price, description and individual features of what we have available. But remember, Bi-Pak's policy has always been to sell quality components at competitive prices and THAT WE STILL DO.

BI-PAK'S COMPLETELY NEW CATALOGUE is now available to you. You will be amazed how much you can save when you shop for Electronic Components with a Bi-Pak Catalogue. Have one by you all the time—it pays to buy BI-PAK

To receive your copy send **75p** plus 25p p&p

Send your orders to Dept:HE8
BI-PAK PO BOX 6 WAREHERTS
SHOP AT 3 BALDOCK ST
WAREHERTS

Use your credit card. Ring us on Ware 3182 NOW and get your order even faster. Goods normally sent 2nd Class Mail. Remember you must add VAT at 15% to your order. Total. Postage add 75p per Total order

THE PROJECT KITS

Make us your No. 1 SUPPLIER OF KITS AND COMPONENTS for H.E. Projects. We supply carefully selected sets of parts to enable you to construct H.E. projects. Kits include ALL the electronics and hardware needed. Printed circuit boards (fully etched, drilled and roller tinned) or Veroboard are, of course, included as specified in the original article, we even include nuts, screws and I.C. sockets. PRICES INCLUDE CASES unless otherwise stated. BATTERIES ARE NOT INCLUDED. COMPONENT SHEET INCLUDED. If you do not have the issue of H.E. which includes the project — you will need to order the instruction reprint at an extra 45p each.

Reprints available separately 45p each + p. & p. 40p.

T.V.I FILTER Jly 82 £4.98
SUNBURN TIMER — TANOVER Jly 82 £8.99

AUTO WAH JUNE 82 £17.89 inc case or £11.48 less case.
AUTO GREENHOUSE SPRINKLER JUNE 82 £14.38 less pump and power supply (12V 2A).

TELEPHONE TIMER JUNE 82 £31.24 less power supply (suitable type below).

POWER SUPPLY DESIGN 12V 500mA JUNE 82 £9.79.

ECHO REVERB UNIT MAY 82. Less case £31.82. Economy case WB3 £3.76 extra
DIGITAL THERMOMETER MAY 82 excluding case + bezel £15.80

LIGHT SEEKER MAY 82 £4.99

AUDIO SIGNAL GENERATOR MAY 82 £19.69

CABLE TRACKER MAY 82 £9.37

DIGITAL CAPACITANCE METER APR 82 £19.98

SIGNAL TRACER APR 82 £3.61

BIKE ALARM APR 82 £10.98

DIGITAL DICE MAR 82 £6.82

BICYCLE SIREN MAR 82 £10.18

NOISELESS FUZZBOX FEB 82 £9.77

SOUND SWITCH FEB 82 £8.31

MASTHEAD AMPLIFIER FEB 82 £13.74

DRUM SYNTHESIZER DEC 81. Full kit £19.98

GUITAR HEADPHONE AMPLIFIER DEC 81 £3.48

IN CAR CASSETTE POWER SUPPLY DEC 81 £4.46

SCRATCH FILTER NOV 81 Mono £5.44 Stereo £8.40

LED VU METER NOV 81 less case £4.56

SIMPLE STYLUS ORGAN NOV 81 less case £4.74

METRONOME NOV 81 £11.88

TELEPHONE BELL REPEATER OCT 81 £12.78

Med Linking wire extra 14p metre

VAIBRATOR LOCK OCT 81 less solenoid £17.43

BABY ALARM OCT 81 £8.14, Fig 8 linking wire 7p metre

'DIANA' METAL LOCATOR SEPT 81 £32.25

POWERPACK SEPT 81 £9.58

REACTION TESTER GAME SEPT 81 £11.98

VARIABLE BENCH POWER SUPPLY AUG 81 £25.35

ULTRASOUND BURGLAR ALARM JULY 81 £18.67

ELECTRONIC DOOR BUZZER JULY 81 £5.65

ELECTRONIC METRONOME JULY 81 £4.67

CONTINUITY CHECKER JUNE 81 £5.34

ENVELOPE GENERATOR JUNE 81 £16.85

AUDIO MIXER JUNE 81 £4.99

PUBLIC ADDRESS AMPLIFIER MARCH 81 £18.21, Extras — horn speakers £6.83 each, PA MIC £4.40

FUZZBOX MARCH 81 £10.35

WINDSCREEN WIPER CONTROLLER MARCH 81 £7.67

STEAM LOCO WHISTLE MARCH 81 £12.26

PHOTOGRAPHIC TIMER MARCH 81 £3.28

HEARTBEAT MONITOR FEB 81 £23.40

TWO-TONE TRAIN HORN FEB 81 £5.24 less case

MEDIUM WAVE RADIO FEB 81 £7.67

BENCH AMP JAN 81 £10.10

NICARD CHARGER JAN 81 £7.67

CHUFFER JAN 81, less case £7.04

BATTERY CHARGE MONITOR DEC 80 £5.40

MEMORY BANK — MINI SYNTHESIZER NOV & DEC 80 £28.40

TRANSISTOR TESTER NOV 81 £6.12 inc test leads

GUITAR PRE-AMP NOV 80 £5.65 case (diecast) extra £2.29

INTRUDER ALARM OCT 80 £19.61

TOUCH SWITCH SEPT 80 £2.57 less case & contacts

GUITAR PHASER SEPT 80 £15.22

SOUND OPERATED FLASH TRIGGER JULY 80 no skt £4.99

FOG HORN JUNE 80 £6.21

SPEED CONTROLLER FOR R/C APRIL 80 £16.41 (less case)

DIGITAL FREQUENCY METER APRIL 80 £39.35

DIGI-DICE JAN 80 £10.97

GUITAR TUNER NOV 79 £11.99

CAR ALARM FEB 79 £12.07

CABLE TRACKER AS FEATURED IN MAY 82 H.E.

A SUPERB PROJECT FOR THE HOME HANDYMAN — PICKS UP NAILS, SCREWS, CABLES AND PIPES (and other buried metal objects).

QUICKLY SAVES ITS OWN COST
BE SURE — BE SAFE

FULL KIT INCLUDES ALL HARDWARE, ELECTRONICS & PCB

£9.37 + P&P

MORE PROJECT KITS — SIMILAR STYLE TO H.E. INSTRUCTIONS INCLUDED (SEPARATELY 45p EACH) PLEASE QUOTE REF. NO. WHEN ORDERING

B1 PEST CONTROL 'Ultrasonic cat scarer' £6.98

B2 COMPONENT TESTER £8.38

B3 ENLARGER TIMER — relay output £26.99

B4 GUITAR NOTE EXPANDER £16.87

B5 CAMERA OR FLASH GUN TRIGGER Infra red system £11.98

B6 SIMPLE INFRA RED REMOTE CONTROL £16.39

B7 0-12V POWER SUPPLY £16.99

B8 SOIL MOISTURE MONITOR £4.23

B9 SOUND TO LIGHT — single channel £7.97

B10 THREE CHANNEL SOUND TO LIGHT £19.98

B11 IN SITU TRANSISTOR TESTER £6.73

B12 WEIRD SOUND EFFECTS GENERATOR £5.68

B13 AUDIBLE VISUAL METRONOME £5.98

B14 ELECTRONIC DICE £5.71

B15 2K RAM PACK Less case for ZX81 £13.34

B16 MINI EGG TIMER £4.14

B17 AUDIO EFFECTS UNIT FOR WEIRD SOUNDS £12.71

B18 LED JEWELLERY — Cross brooch £2.77 Star brooch £9.71 Spiral brooch £7.50

SPECIAL OFFER



PLIERS



CUTTERS

GOOD QUALITY TOOLS. IDEAL FOR CIRCUIT BUILDING
PLIERS £1.68 NOW £1.48
CUTTERS £1.69 NOW £1.49

MAGENTA ELECTRONICS LTD.

MEMORY BANK SYNTHESISER

Miniature synthesiser featuring vibrato, envelope, tempo, volume + pitch controls. Uses 24 push button switches in a keyboard style layout. Based on a custom designed L.c. The accessible memory stores a 32 beat length sequence of notes + spaces. Can be played 'live'. Fitted with an internal speaker. Jack socket allows the use of an external amplifier if wished.

Memory Bank Synthesizer £28.40

Complete kit inc. case, pcb's etc. Reprint extra 45p. Available separately 45p + 45p p&p.



MULTIMETER TYPE 2 - £14.75

20,000 opv. Includes transistor tester. AC + DC volts. DC current. 4 very useful resistance ranges.

We've used it and we like it.

DIGITAL CAPACITANCE METER H.E. April 82 (H1) £19.98

Fast and accurate. Reads from 100pF to 9,900uF with 2 digit ac-

curacy. Portable. Battery powered. Easy to use - Easy to build. Complete kit includes pcb, all components and case.

DIANA METAL LOCATOR H.E. Sept 81 (H2) £32.25

A powerful pulse induction metal locator. Exciting design using modern technology. Simple to set up and use.

Complete kit includes all hardware for the handle and coil, cases, meter, pcb and all components. Available less handle and coil hardware and cases £19.29

ECHO REVERB UNIT H.E. May 82 (H3) £31.82 less case. Economy case WB3 £3.76 extra.

A modern all electronic CC0 design with independent echo and reverb controls. Delay fully variable up to 50 m sec.

METRONOME H.E. Nov 81 (H4) £11.88

A comprehensive battery powered instrument with audible and visual outputs. Switch selectable accented beat 2/4, 3/4, 4/4 and 5/4 times. Speed range 40-240 beats per minute. Variable volume and pitch.

BOOKS

SEMICONDUCTOR DATA BOOK. Newnes	£5.90
PRACTICAL ELECTRONIC PROJECT BUILDING. Ainalie & Colwell.	£3.95
CONSTRUCTORS PROJECT BOOKS	
ELECTRONIC GAME PROJECTS. Rayer	£3.35
ELECTRONIC PROJECTS FOR HOME SECURITY. Bishop	£3.35
ELECTRONIC PROJECTS IN AUDIO. Penfold	£3.35
ELECTRONIC PROJECTS IN MUSIC. Flind	£3.35
ELECTRONIC PROJECTS IN PHOTOGRAPHY. Penfold	£3.35
ELECTRONIC PROJECTS IN THE CAR. George	£3.35
PROJECTS IN AMATEUR RADIO & SHORT WAVE LISTENING. Rayer	£3.35
PROJECTS IN RADIO AND ELECTRONICS. Sinclair	£3.35
ELECTRONIC PROJECTS IN HOBBIES. Rayer	£3.35
ELECTRONIC PROJECTS IN THE HOME. Bishop	£3.35
ELECTRONIC PROJECTS IN THE WORKSHOP. Penfold	£3.35
ELECTRONIC TEST EQUIPMENT PROJECTS. Ainalie	£3.35
MORE ELECTRONIC PROJECTS IN THE HOME. Flind	£3.35
110 ELECTRONIC ALARM PROJECTS FOR THE HOME CONSTRUCTOR. Marston	£5.35
MODEL RAILWAY PROJECTS. Penfold	£1.95
SOLID STATE SHORT WAVE RECEIVERS FOR BEGINNERS. Penfold	£1.30
BEGINNERS GUIDE TO BUILDING ELECTRONIC PROJECTS. Penfold	£1.50
IC555 PROJECTS. Parr	£1.90
BASIC ELECTRONICS. A super book covering theory and practice	£7.95
RADIO CONTROL FOR BEGINNERS. Rayer	£1.75
INTERNATIONAL TRANSISTOR EQUIVALENTS GUIDE. 320 pages. Michaels	£2.06
ELECTRONIC PROJECTS FOR CARS AND BOATS. Penfold	£1.95
SECOND BOOK OF CMOS IC PROJECTS. Penfold	£1.50
50 SIMPLE L.E.D. CIRCUITS: Book 2.	£1.35
ELECTRONIC MUSIC PROJECTS. Penfold	£1.75
ELECTRONIC HOUSEHOLD PROJECTS. Penfold	£1.75
ELECTRONIC GAMES. Penfold	£1.75
PROJECTS IN OPTO ELECTRONICS. Penfold	£1.25
52 PROJECTS USING IC 741. Redmer	£1.25
ELECTRONIC TIMER PROJECTS. Rayer	£1.95
POWER SUPPLY PROJECTS. Penfold	£1.75
REMOTE CONTROL PROJECTS. Bishop	£1.95
POPULAR ELECTRONIC CIRCUITS: Book 2.	£2.35

MORE KITS AND COMPONENTS IN OUR LISTS

FREE PRICE LIST
Price list included with orders or send sae (3 x 4) CONTAINS LOTS MORE KITS, PCBs & COMPONENTS

1982 ELECTRONICS CATALOGUE

Illustrations, product descriptions, circuits all included. Up-to-date price list enclosed. All products are stock lines for fast delivery. Sends 80p in stamps or add 80p to order.

MORE H.E. PLUS E.E. and E.T.I. PROJECT KITS IN THE PRICE LIST

SOLDERING / TOOLS

ANTEX X5 SOLDERING IRON 25W

SOLDERING IRON STAND..... £5.48
SPARE BITS. Small standard, large, 65p each. For X5 + X25
SOLDER. Handy size..... 99p
SOLDER CARTON..... £1.84
DESOLDER BRAID..... 69p
HEAT SINK TWEEZERS..... 29p
DESOLDER PUMP..... £6.48
HOW TO SOLDER LEAFLET..... 12p
LOW COST CUTTERS..... £1.69
LOW COST LONG NOSE PLIERS..... £1.68

WIRE STRIPPERS & CUTTERS..... £2.69

HELPING HANDS JIG £6.30

Heavy base. Six ball and socket joints allow infinite variation of clips through 360°. Has 2 1/2" diameter (25 x) magnifier attached, used and recommended by our staff.

VERO SPOT FACE CUTTER..... £1.49
PIN INSERTION TOOL..... £1.98
VEROPINS (pk of 100) 0.1"..... 52p
MULTIMETER TYPE 1 (1,000 opv)..... £6.66
MULTIMETER TYPE 2 (20,000 opv) with transistor tester. Very good..... £14.75
CROCODILE CLIP TEST LEAD SET. 10 leads with 20 clips..... 99p

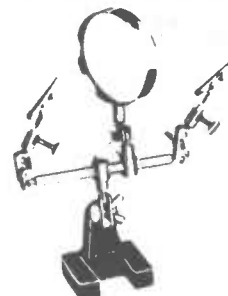

RESISTOR COLOUR CODE
CALCULATOR..... 21p
CONNECTING WIRE PACK TYPE ED. 11 colours..... 49p
ILLUMINATED MAGNIFIERS
Small 2" dia. (5 x mag.)..... £1.14
Large 3" dia. (4 x mag.)..... £2.40
CAST IRON VICE..... £2.98
SCREWDRIVER SET..... £1.98
POCKET TOOL SET..... £3.98
DENTISTS INSPECTION MIRROR..... £2.85
JEWELLERS EYEGLASS..... £1.50
PLASTIC TWEEZERS..... 69p
PAIR OF PROBES WITH LEADS (cc)..... 77p

SPEAKERS. Miniature, 8 ohm..... 87p
64-75 ohm..... 89p
CRYSTAL EARPIECE..... 85p
MONO HEADPHONES..... £2.96
TELEPHONE PICK-UP COIL..... 72p
MIN. BUZZERS. 6V. 50p. 9V. £1.10. 12V. 85p.
MAGNETIC EARPIECE..... 15p
STEREO HEADPHONES..... £4.35
F.M. AERIAL..... 49p

VEROBOARD 0.1" COPPER STRIPS 10 strips 24 holes..... £1.20 per 5 24 strips 37 holes..... 78p 24 strips 50 holes..... 89p 36 strips 37 holes..... 89p 36 strips 50 holes..... 99p Terminal pins 0.1"..... 52p/100	PP3 CLIPS 10p PP9 CLIPS 11p	PANEL METERS 50uA; 100uA; 1mA, 1A, 25V. 100uA-0- 100uA; 5A. AU £4.98 each. State value.
EUROBREADBOARD..... £6.20 S OEC BREADBOARD..... £3.98 BIMBOARD 1 BREADBOARD..... £8.98 VEROBLOC BREADBOARD..... £4.20		

INTEGRATED CIRCUITS

CMOS4001	20p	LM301A	36p
CMOS4011	20p	LM317K	£3.20
CMOS4017	62p	LM334Z	£1.50
CMOS4046	69p	LM380N	89p
CMOS4049	32p	LM386N	92p
CMDS4050	30p	LM387	£1.10
CMOS4093	38p	LM389	£1.11
CMOS4098	66p	LM3909N	82p
CMDS4511	68p	MC3340	£2.15
CMDS4518	60p	OM335	£8.98
555	26p	SN76477	£2.59
556	79p	TD1022	£5.58
741	22p	TL064	£1.64
7555	99p	TL071	47p
CA3130E	98p	TL082	74p
CA3140E	52p	TL083	£1.52
HA1388	£3.50	U237B	£1.69
ICL7611	88p	U267B	£2.20
LF351N	58p	ULN2283	£1.57
LF353N	99p	ZN414	98p
LF355N	£1.14	ZN419CE	£2.21
LF356N	£1.15	ZN1034E	£2.89

PCB ETCHING KIT £4.98

Virtually all you need to make your own printed circuit boards. Includes tray, etch resist pen, ferric chloride even drills.

OPTO

LEDS with clips.
3mm Red 15p, Green 18p,
Yellow 20p, 5mm Red 18p,
Green 22p, Yellow 23p, 0.5"
C.C. 7 segment display 99p,
ORP12 99p.
P82270 ceramic resonator
65p, BC850 transistor 22p,
ZTX300 11p.

ADVENTURES WITH MICROELECTRONICS

Similar to 'Electronics' below. Uses I.C.s. Includes dice, electronic organ, doorbell, reaction timer, radio, etc. Based on Bim-board 1 bread board.

Adventures with Microelectronics..... £2.55
Component pack £29.64 less battery.

ADVENTURES WITH ELECTRONICS

by Tom
Duncan

An easy to follow book suitable for all ages. Ideal for beginners. No soldering, uses an S-Dec breadboard. Gives clear instructions with lots of pictures. 16 projects—including three radios, siren, metronome, organ, intercom, timer, etc. Helps you learn about electronic components and how circuits work. Component pack includes an S-Dec breadboard and all the components for the projects.
Adventures with Electronics £2.40. Component pack £17.98 less battery.

MAGENTA gives you FAST DELIVERY OF QUALITY COMPONENTS & KITS. All products are stock lines and are new & full specification. We give personal service & quality products to all our customers—HAVE YOU TRIED US?

MAGENTA ELECTRONICS LTD

HM27, 135 HUNTER ST., BURTON-ON-TRENT, STAFFS,
DE14 2ST. 0283 65435. MON-FRI 9-5. MAIL ORDER ONLY
ADD 45p P&P TO ALL ORDERS

PRICES INC VAT P&P 45p



OFFICIAL ORDERS WELCOME.
IRISH REPUBLIC & B.F.P.O. EUROPE:
Deduct 10% from prices shown Payment,
must be in Sterling.
ACCESS AND BARCLAYCARD (VISA)
ORDERS ACCEPTED BY PHONE OR
POST.
SAE ALL ENQUIRES.

MONITOR

IN NOVEMBER, the 5th Breadboard Exhibition comes to London. The most successful show of its type, it will offer electronics enthusiasts the opportunity to see for themselves what they have been reading about in their favourite magazine (that's us of course!). This year, a series of lectures and demonstrations will allow the visitor to learn at first hand how some of these circuits and projects work — and how they may be modified to suit personal needs.

There is also the opportunity to see mail order firms display the contents of their catalogues, and the latest on offer from firms that are "household names" to the electronics buff.

This year, too, a number of exciting competitions are being planned, to fire the imagination and interest of the competitive visitor . . . so, whatever your interest in the hobby of electronics, don't miss BREADBOARD '82!

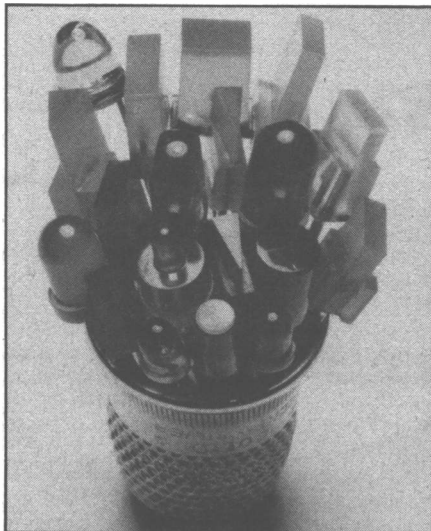

Let there be LEDs! A complete new 'family' of these devices have been recently introduced by Zaerix Electronics. As the picture (above) shows, they have rectangular, square, domed, dot and arrow shapes, as well as the standard 3 mm and 5 mm types. Altogether the range comprises 30 lens shapes, three lead frame designs and seven basic colours, diffused or transparent. Typical power handling is 105 mW. For details, contact Zaerix Electronics Limited, Electron House, Cray Avenue, St Mary Cray, Orpington, Kent BR5 3QJ; 'phone 0732 460424.

An interesting development in remote control around the home has been made by TK Electronics. The system allows control of up to 16 appliances plugged into receiver units, which are themselves plugged into the mains. The transmitter is hand-held (more than one may be used) and transmits a coded signal which may be altered to prevent interference with other units.

Possibly the most interesting aspect of the system is that the transmitter may be controlled by external logic, enabling automatic control of appliances from a single, central controller such as a digital timer, or microcomputer, thus providing a convenient interface between the control system and the controlled elements.

The system is supplied as a kit, consisting of a transmitter and two receivers and is priced at around £48, including VAT. The transmitter is housed in a black plastic hand-held box while the receivers (additional units are also available separately) are not supplied with a case, allowing it to be installed inside the controlled appliance.

As a new service for customers, TK Electronics have arranged a simple telephone number for orders placed on Access or Barclaycard. The number is: 01 567 8910 - easy enough to remember, isn't it! Finally, TK's new free short-form catalogue is also available in return for a large SAE addressed to TK Electronics, 11 Boston Road, London W7 3SJ. A full sized technical and information brochure is planned for later this year.

The only item missing in the range of activities supported by the Technical Leisure Centre appears to be — electronics! However, they do offer an interesting range of tools and materials for model and precision engineers, clock and jewellery makers, and they also offer 'home computer items'. The centre is located at 1, Grangeway, Kilburn, London NW6 2BW; Tel; 01 328 3128. Further news of their activities will be included in their free newspaper, Technical Leisure News, which is available on receipt of a large stamped and self addressed envelope.

Monitor has become quite a connoisseur of catalogues, of late. Greenweld's 1982/83 number, just published, promises 'a veritable cornucopia of components' and at both first and second glances, it certainly seems to contain quite a large range, consisting of just about everything needed for hobby electronics. The catalogue is available by mail for 50p plus 25p postage and includes a free Bargain list, five 12p discount vouchers and a First Class reply-paid envelope. Write for the catalogue to Greenweld, 443 Millbrook Road, Southampton SO1 0HX. Don't forget that the listed prices include VAT.

Speaking of test equipment (well?) Stotron Ltd have a new 10 Mhz Logic Probe by Sabtronics. The LP-10 is a high speed probe with the capability of detecting pulses down to 50 nS. The input impedance is 100k, to avoid loading the circuit under test, and it will detect 'floating' inputs caused by open lines, dirty contacts, etc. Two LEDs indicate '0' and '1' logic levels while a third LED displays logic transitions detected by the pulse stretching circuitry. The probe is powered by the circuit under test via clip leads and pulls approximately 35 mA. For further details, contact Stotron Ltd Haywood Way, Ivyhouse Lane, Hastings, Sussex; 'phone 0424 442160.

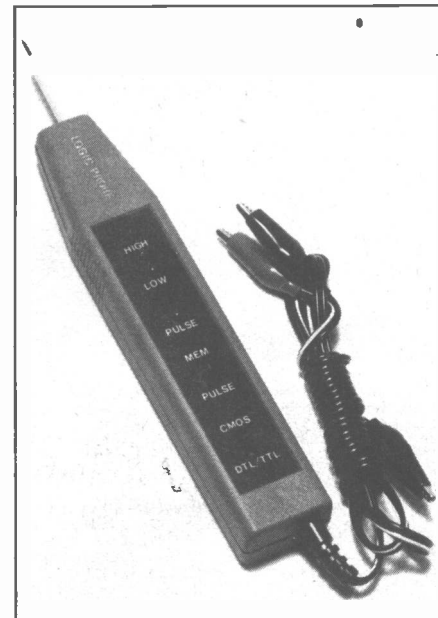

TEST & MEASUREMENT '82

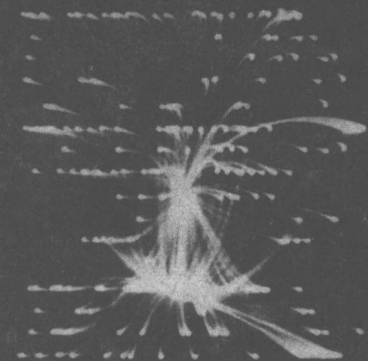

Lawtronics

0732 865191

One of the greatest problems for the amateur electronics constructor is the availability of accurate, reliable and (most importantly) reasonably priced test equipment. The catalogue from Lawtronics, recently arrived on the Monitor desk, offers quite a few items which meet this requirement.

The range includes dual-trace oscilloscopes from £223, hand-held digital meters from £37 (analogue meters for less than £15), bench meters from £92, plus logic analysers, signal sources and other, more specialised equipment. The full range is described in the catalogue from Lawtronics, 139 High Street, Edenbridge, Kent TN8 5AX; 'phone 0732 865191.

The listed prices do not include either VAT or p&p, and the company offers a 14-day 'Sale or Return' evaluation period.

MONITOR

Martello Sound, better known to Monitor as the makers of the Rello range of compact and versatile radio microphones, have now produced a CB rig suitable either as a mobile, hand portable OR as a base station. The Spirit (right) is powered by 9 AA size dry or rechargeable batteries (which fit into the integral compartment) or from a standard 12 V vehicle battery or power supply unit. The non-polarised chassis allows installation in either positive or negative earth cars.

Facilities include 40 PLL synthesized channels, on/off volume, squelch, LED channel selector, battery check and saver, anti-cross modulation control, an 'S' meter and high SWR indicator. Standard equipment includes a lightweight dynamic mic, locking mobile mounting bracket, stainless steel mobile aerial, DC power lead and a carrying strap.

Priced at £143.75, the Spirit contains just about everything needed to get you on the air at once, in any situation. It is available by mail-order (post free) from Martello Sound Limited, Haywood Way, Ivyhouse Lane, Hastings, East Sussex.



This one is almost — but not quite — too good to be true. Welcome to computerised golf! The GL-500 has been developed by Mitsubishi Electric to help golfers improve their stroke-making by measuring and displaying a multitude of esoteric information (club head speed, face angle, swing arc, direction, distance and much more), all of which add up to indicate whether Jack Nicklaus should be keeping an eye on your game, too. The press release didn't mention a price and we haven't asked!

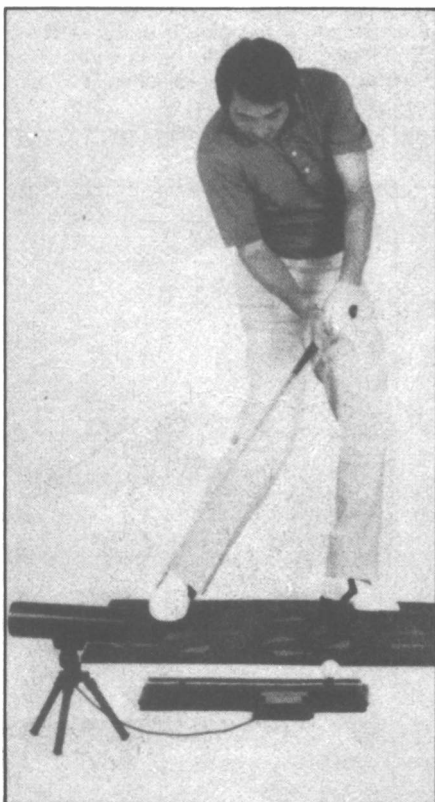

The latest ZX81-related product to come to our notice is a 'no-frills' 16K RAM pack, below, from EconoTech. The price (£19.95, including VAT plus £1.50 p&p worldwide) is the result of cost-effective design and manufacturing methods. The chips are industry standard 4116 16K NMOS Dynamic RAMs, and the board is powered from the edge connector's +9 V line and the internal 5 V regulator. The board uses a 44-way connector with gold plated contacts and fits against the back of the computer in such a way as to prevent wobble — and inadvertant loss of memory. It is fully compatible with the ZX Printer and is supplied complete with comprehensive instructions and a six month guarantee. Further information is available from EconoTech, 30 Brockenhurst Way, London, SW16 4UD, Tel: 01 764 8671.

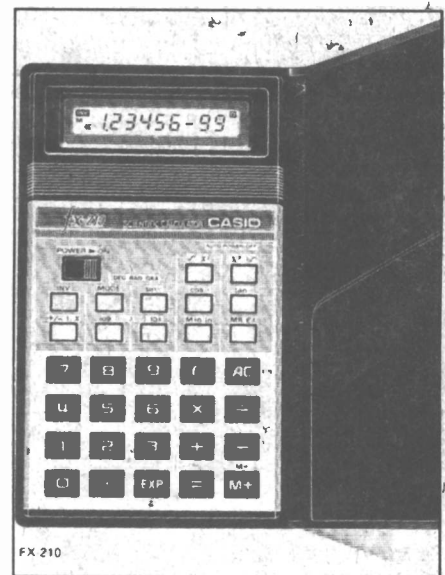
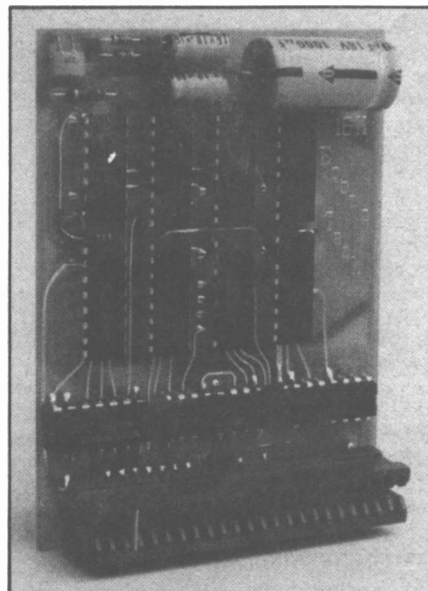

Does anyone remember when a pocket calculator, of any kind, was a rare and very expensive toy? The times, they do change! Now Casio's latest, the FX210, provides '23 useful scientific functions' for just £12.95 (recommended retail price).

The functions include the usual trig and log, powers, roots and reciprocals. The memory is independent and elements within equations can be partitioned, with up to three levels of bracketing (now if they'd used Reverse Polish, that wouldn't have been necessary...).

The FX210 is powered by a lithium battery which will run for about 570 hours of continuous use before replacement is required. Battery life is enhanced by the use of an LCD display (eight digits total) and an automatic power-down feature which operates five minutes after the last keystroke.

HE

The MICRO PROFESSOR solves the 'mystery' of micro-processors.

Micro-Professor is a low-cost Z80A based microcomputer which provides you with an interesting and inexpensive way to understand the world of microprocessors.

Micro-Professor is a microprocessor learning tool for students, hobbyists and engineers. It is also an ideal educational tool for teaching in schools and universities.

The main object of **Micro-Professor** is for the user to understand the software and hardware of a microcomputer easily and conveniently. Besides the complete hardware/software system you have the users experimental manual. It includes self-learning text with 20 experiments which range from simple, software

programming to designing a complex electronic game. Completed programmes can be stored and re-read via the cassette interface. 2K bytes of monitor source program with documentation is also provided in the manual.

Micro-Professor provides a wide range of other applications: Low cost prototyping tool • Low

cost development tool • Process controller • Electronic music box • Timer • Noise generator • Home appliance control • Burglar alarm • System control simulation Tester

... and much more!

New Add on products
Speech synthesiser board
EPROM programmer board

TECHNICAL SPECIFICATION

- CPU** Z80A CPU high performance microprocessor with 158 instructions
- SOFTWARE COMPATIBILITY** Capable of executing Z80/8080/8085 machine language program
- RAM** 2K bytes expandable to 4K bytes
- ROM** 2K bytes of sophisticated monitor expandable to 8K bytes
- INPUT/OUTPUT** 24 system I/O lines
- DISPLAY** 6 digit 0.5" red LED display
- AUDIO CASSETTE INTERFACE** 165 bit per second average rate for data transfer between memory and cassette tape.
- EXTENSION CONNECTORS** Provides all buses of CPU, channel signals of CTC and I/O port bus of PIO for user's expansion
- COUNTER TIMER CIRCUITS** Socket is provided Z80-CTC IC extra
- PARALLEL I/O CIRCUITS** Socket is provided Z80-PIO IC extra
- SPEAKER AND SPEAKER DRIVER CIRCUITS** A 2.25" - diameter speaker is provided for user's applications.
- USER'S AND EXPERIMENT MANUAL** Complete self-learning text with experiments and applications
- OPTIONS** (Prices on application) Z80-CTC EPROM programmer board Prototyping Board Z80-PIO Speech synthesiser board Audio Cassette 2K Ram
- KEYBOARD** 36 keys including 19 function keys, 16 hex-digit keys and 1 user defined key



A 9V, 0.5A adaptor and 350 page manual is provided.
Formal orders requiring
Acc & 30 days credit.
Please ask for price list.

New "BASIC" EPROM & Keyboard Overlay £9.95

Use the unique Micro-Computer to truly understand the inside workings of microprocessors, or simply use as a Z80A evaluation system

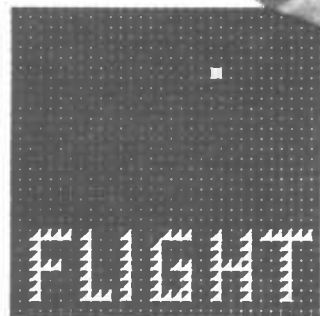

£69.95* + p & p

Flight Electronics Ltd. * Mail Order only

MICRO-PROFESSOR is a trade mark of Multitech Industrial Corporation. Z80 is a trade mark of Zilog Inc.

To receive your MICRO-PROFESSOR complete the coupon today!
Please send me MICRO-PROFESSOR(S) (+ £2.95 p & p)
I enclose cheque/P.O. for £.....
Name
Address

Please allow 28 days for delivery
Flight Electronics Ltd. Flight House
Quayside Road, Southampton
Hants SO2 4AD.
Tel: (0703) 346031/27721
Telex: 477793
H.E.

ZX INTERFACES EXPLAINED

Mike Lord

The ins and outs of Sinclair's ZX81 and ZX Spectrum computers.

ADVERTISEMENTS for Sinclair's original ZX80 said that it could be used to control a power station. We doubt whether many readers will be that ambitious! On a more practical level, the ZX81 and the new ZX Spectrum can be used to control activities such as model train layouts, a robot arm, or a sophisticated burglar alarm/deterrent system. Many entrants in recent 'micro-mouse' competitions have used a ZX to control their mouse's progress through the maze. And in the 'professional' world, many laboratories are now using ZX computers to control simple experiments and record the results.

The main attraction of the Sinclair machines for these applications is, of course, their low cost. But their small size can also be an advantage on a crowded workbench, as well as their ability to survive the rough and tumble of life outside the hallowed precincts of a computer room — an important feature if, like the author, you are prone to dropp-

ing pieces of equipment on the floor or spilling cups of coffee over everything.

Input and Output

To be of any use, a computer has to be able to communicate with the outside world. It has to be able to take in data (and remember that a computer sees your program as just another form of data that it has to deal with), and it also has to be able to put out the results of its computations.

Normally, the input signal to your ZX come from the keyboard or from a cassette recorder, and it sends outputs to the TV display or to a cassette recorder. This article will show you how to make your ZX81 or Spectrum able to accept signals from other sources, and how to make it generate signals which can be used for purposes other than driving a TV set or tape recorder.

Because the ZX is an electronic device (and because this is an elec-

tronics magazine), we shall only be considering electrical inputs and outputs. Most real applications, however, will also have a mechanical aspect, such as how to actually move the robot's arm, or how to sense that a train is passing through the station. Solving these problems will have to be left to your ingenuity!

The Key To Input

Each key on the ZX keyboard is — electrically speaking — a normally open single pole switch. Pressing the key closes the switch and this can be detected by routines built into the computer's ROM. The function INKEY\$, for example, can be used in a BASIC program to detect if a single key has been pressed and to tell which key it was.

So, if we wire a normally open switch or relay contact in parallel with one of the ZX's keys, then the operation of the switch or the closing of the relay contact will appear to the ZX exactly as if that



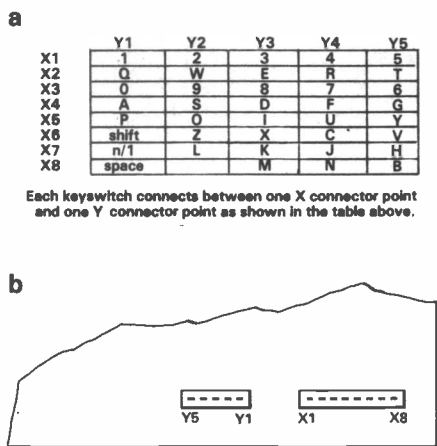

Figure 1(a). The ZX81 keyboard connections ; (b) component-side view of the ZX81 board, showing the keyboard sockets.

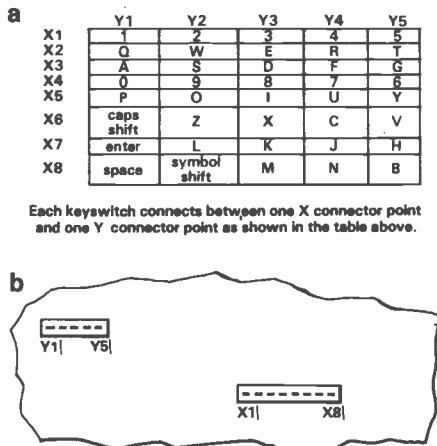

Figure 2(a). The Spectrum keyboard connections; (b) the keyboard sockets from the component side of the Spectrum PCB.

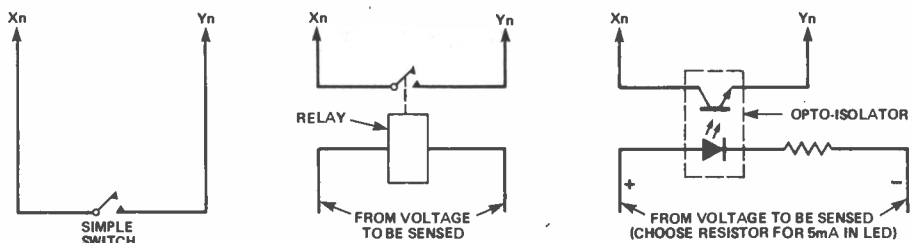

Figure 3. Inputs to the ZX keyboard matrix.

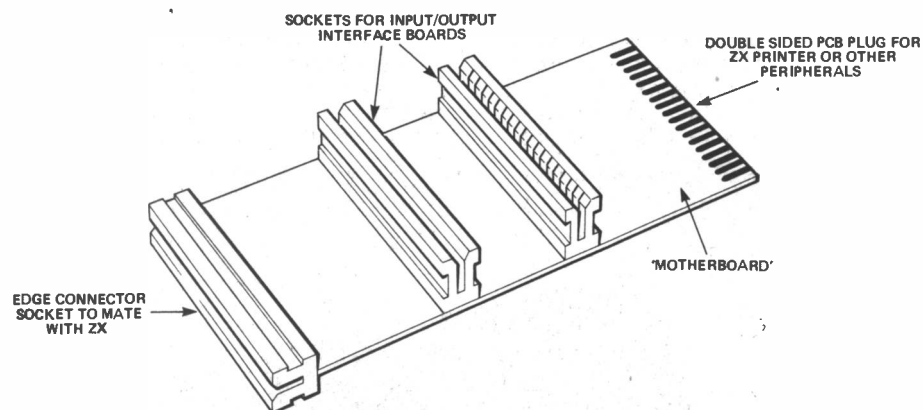

Figure 5. A mother board with sockets for I/O interfaces, connections for a ZX printer or Rampack, etc.

key had been pressed, and it can be detected by your program.

You can't get at the actual switch contacts themselves on the ZX81 or Spectrum keyboards as they are sealed units, so you will have to connect your added switch(es) to the 5 and 8 way film-cable sockets mounted on the computer PCB. One contact of each keyboard switch is connected to one lead in the 5 way cable, the other contact is connected to one lead in the 8 way cable, so that the 40 keys are arranged in a 5 x 8 matrix. The actual connections for each key are shown in Figures 1 and 2, so if you wanted your added switch to appear to the computer as key '2', it would have to be connected between connector points X1 and Y2.

This technique is usefully simple, but there are a few points to watch. Any

leads connected to the keyboard must be relatively short — say less than 30 cm — or they are liable to confuse your ZX by picking up stray noise. Also, INKEY\$ will refuse to recognise any of them. And, of course, you have to be sure that any contacts you may add are open-circuit whenever you want to use the normal keyboard.

A simple joystick can be made using this technique to add interest to games programs. Four normally open switches should be used, mechanically connected to the joystick so that one switch is closed when you move the stick in a particular direction. The switches could be wired in parallel with the four cursor control keys (numbered 5 to 8), corresponding to movements of the stick as Up, Down Left and Right.

Since neither side of the keyboard

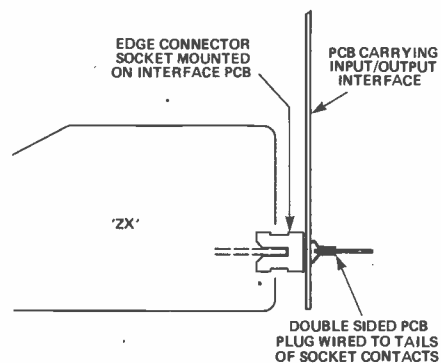

Figure 4. An add-on board must allow access to the ZX socket contacts.

switches can be connected to ground (doing so would prevent the ZX from working properly), some form of isolating device is needed if you want the ZX to sense an electrical signal. As illustrated in Figure 3, a suitable relay could be used, or perhaps a phototransistor/LED opto-isolator. If an opto-isolator is used, the emitter of the phototransistor should be connected to the 8 way keyboard connector, and the collector to the 5 way connector.

The Rear Connector

If we want our ZX to provide outputs — for controlling motors, lights or whatever — or if we want it to be able to detect more than one input signal at a time, then we have to add an interface circuit to the ZX's rear connector.

This connector consists of two rows of contact pads spaced 0.1" apart along the rear edge of the ZX's printed circuit board. Row A is on the top surface of the PCB and row B is immediately underneath. The ZX81 connector has 23 contact positions on each side, the Spectrum has 28; in both cases a slot has been cut into the PCB in one of the contact positions to locate a polarising key fitted to the mating socket. Suitable sockets are readily available from a number of specialised ZX hardware suppliers.

The connector carries the computer's address, data and control signals as well as power lines and was intended for use with add-on devices such as the ZX81's 16K Rampack or the ZX printer; but, as described in the remainder of this article, it also allows you to plug on your own Input/Output interface board. One point to remember when building any add-on for the ZX is that it doesn't prevent you from adding other extensions. This means, in effect, that it should include a double sided PCB plug which is wired to carry the same signals as the actual ZX connector, and to which other extensions can be fitted. One way of achieving this is illustrated in Figure 4. Alternatively, you could make up a 'motherboard' as shown in Figure 5. This would have sockets for accepting I/O interface boards and a double sided PCB plug at the end for connecting to the ZX printer or Rampack. Again, suitable PCB plugs are available from some ZX hardware suppliers.

Pin No.	Side A (top)	Signal	Side B (bottom)
1	A15		A14
2	A13		A12
3	D7		+5V
4		Slot	+9V
5			
6	D0		0V
7	D1		V
8	D2		CK
9	D6		A0
10	D5		A1
11	D3		A2
12	D4		A3
13	INT		IORQE
14	NMI		OV
15	HALT		VIDEO
16	MREQ		Y
17	IORQ		V
18	RD		U
19	WR		BUSRQ
20	-5V		RESET
21	WAIT		A7
22	+12V		A6
23	-12V		A5
24	M1		A4
25	RFSH		ROMCS
26	A8		BUSACK
27	A10		A9
28			A11

Figure 6. The Spectrum rear connector signals.

Pin No.	Side A (top)	Signal	Side B (bottom)
1	D7		+5V
2	RAMCS		+9V
3		Slot	
4	D0		0V
5	D1		0V
6	D2		0
7	D6		A0
8	D5		A1
9	D3		A2
10	D4		A3
11	INT		A15
12	NMI		A14
13	HALT		A13
14	IORQ		A11
16	RD		A10
17	WR		A9
18	BUSACK		A8
19	WAIT		A7
20	BUSREQ		A6
21	RESET		A5
22	M1		A4
23	REFSH		ROMCS

Figure 7. ZX81 connector signals.

The signals on the ZX rear connectors are shown in Figures 6 & 7. The ones which are most useful for an Input/Output interface are:

The Power supplies; The +9 V line comes directly from the unstabilised output of the ZX mains adaptor. It can vary between about 7V5 and 11 V, and has 1 to 2 volts of 100 Hz ripple on it. Depending on what else is connected to your ZX, you should be able to draw about 200 mA from this line. The +5 V line comes from the ZX's internal 5 volt regulator, which runs hot at the best of times, so don't try to take more than about 100 mA from this supply. The Spectrum also provides a +12 V output, which can supply about 30 mA, and a -5 V line from which you shouldn't take more than a couple of milliamps. Also on the Spectrum rear connector is a point labelled '-12 V'. In fact this is not actually a negative 12 V DC supply, but rather a high frequency square wave of about 13 V peak-to-peak. It can be used to generate a low current (10 mA) negative rail of approximately 12 volts by adding a suitable rectifier circuit such as that shown in Figure 8.

Other useful lines on the connector are the signals which come from the Z80 microprocessor at the heart of the ZX computer. They are:

The Microprocessor Data Bus lines DO to D7. These carry data to and from the Z80, one 8-bit byte at a time. The voltage levels are TTL compatible, but not more than one LSTTL (Low Power Schottky TTL) input should be

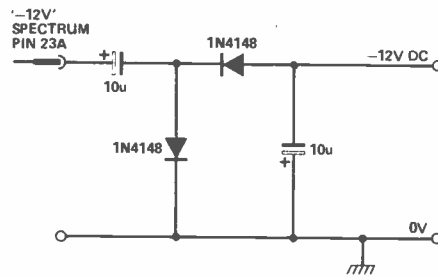

Figure 8. Deriving a negative DC supply from the Spectrum '12 V' output.

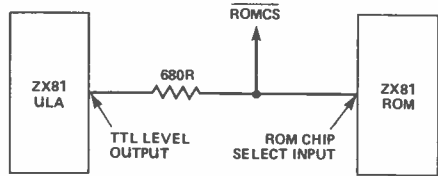

Figure 9. The ROMCS circuit of the ZX81.

connected to each line. To input signals to the ZX computer, you have to put signals onto the data bus and this should be done using a device which has tri-state outputs, so as not to load the bus lines when data is not being input.

The Microprocessor Address lines A0 to A15. These carry address information from the Z80 and can each drive one or two LSTTL inputs.

The Z80 Control lines RD, WR, MEMRQ and IORQ. These are all outputs from the Z80, used to control the reading and writing of data to and from memory and I/O devices; they are all TTL compatible, capable of driving one or two LSTTL inputs. These lines are normally 'high'; the RD line goes low when the Z80 wants to read data from memory or I/O, the WR line goes low when it wants to write. The MEMRQ line going low signifies that the Z80 wants to read or write to memory, similarly a low level on the IORQ line indicates that the Z80 is reading or writing to I/O. (Note that the term 'I/O' is used in a special sense, as will be discussed later).

Finally, there are two interesting lines called RAMCS and ROMCS (RAMCS only appears on the ZX81; not on the Spectrum). These are signals generated within the ZX to select its internal RAM or ROM memories, but are brought out to the rear connector to allow an externally applied signal to override this selection. For example, the ZX81's 16K Rampack uses the RAMCS Line to disable the ZX81's internal 1K RAM. As will be described later, we can use these lines to make the ZX81 communicate with an external I/O interface rather than with its internal memory. The levels on these lines are somewhat non-standard, being TTL output levels fed through a 680R resistor. This is illustrated in Figure 9 which shows, as an example, how the ROMCS signal is generated in a ZX81. To enable the internal ROM, the ULA chip in the ZX81 presents a 'low' output level which

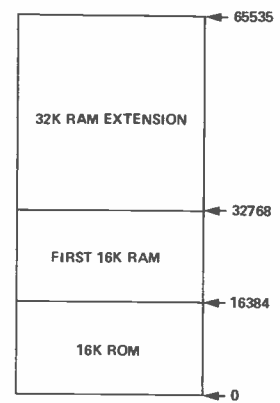

Figure 10. The Spectrum memory map.

normally passes directly to the ROM chip-select input without being significantly affected by the 680R resistor, as the ROM input is a very high impedance. We can, however, connect an external circuit to the ROMCS line to prevent the voltage at the ROM chip select input from going low enough to enable the ROM. We would then be free to feed signals from an external interface onto the data bus lines. Similarly, on the ZX81, we can disable the RAM memory by pulling the RAMCS line high.

Memory Addressing

If the ZX is to be able to communicate with an Input/Output interface, it must be able to select that interface when it wants to write to or read from it, but the interface mustn't interfere with the ZX's normal communications with its ROM and RAM memories or other Input/Output devices such as the keyboard and printer.

One way of doing this is to see if there are any memory addresses that the ZX doesn't normally use. If there are any such 'free' addresses, then we can allocate some of them to the Input/Output interface. The interface can then be designed to look to the computer like added memory, appearing at the otherwise free locations, and can be accessed by using the ZX BASIC's PEEK and POKE commands.

Since the ZX has 16 address lines (A0 to A15), it can theoretically handle 65536 (64K) different memory locations. The 'memory map' for the Spectrum is shown in Figure 10, and it can be seen that a fully expanded Spectrum equipped with 16K of ROM and 48K of RAM does not have any room left in its memory address space for an Input/Output interface.

The ZX81, however, is different. Normally only 8K of ROM and a maximum of 16K of RAM are fitted, which would appear to leave plenty of room for an Input/Output interface. But, because the circuits in the ZX81 which select the ROM and RAM don't decode the address lines as fully as they could, 'echoes' of the ROM and RAM appear throughout the memory map, as shown in Figure 11. Thus the 8K ROM not only occupies ad-

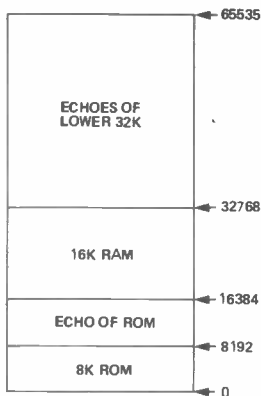

Figure 11. The ZX81 memory map.

addresses 0 to 8191, but it also *appears* to occupy addresses 8192 to 16383. Similarly, multiple echoes of the RAM appear throughout the address space. In fact, one of these RAM echoes, which starts at address 49152, is essential to the circuits in the ZX81 which produce the TV display. There are, however, a lot of unnecessary echoes which could be removed — by holding the RAMCS or ROMCS lines high when required — to make room for our interface. In practice, because it interferes least with the use of really large RAM expansions such as the Memopack 64K (reviewed in the June issue of HE), the best address to put an interface is just above the ROM, at address 8192.

Z80 I/O Addressing

As well as 64K of memory, the Z80 processor can also handle 64K special 'I/O' addresses. From a hardware point of view, these use the same 16 address lines (A0 to A15) as memory, but are accessed when the Z80 \overline{IOR} output goes low, whereas a normal memory access is signalled by \overline{MEM} going to a low level. We could, therefore, design an Input/Output interface so that it responded to these special 'I/O' addresses, rather than appearing in the normal memory map. From a software point of view, the Z80's I/O addresses are handled by a special class of Z80 machine code instruction. There is no equivalent instruction in ZX81 BASIC, so a special machine code routine would have to be written to handle an Input/Output interface mapped into the 'I/O' address space. Spectrum BASIC, however, includes IN and OUT commands which act like PEEK and POKE — but on this 'I/O' space, rather than on memory. This is fortunate because, as we have seen, there is no room in the Spectrum's memory map for an Input/Output interface.

Some of the I/O address space is already used by the keyboard and cassette ports, and other parts have been allocated to Sinclair add-ons such as the printer and the eagerly awaited Spectrum disc drive. Instead of allocating specific blocks of the I/O address space for these functions, the ZX designers have, instead, used the state

of individual address lines to select individual 'I/O' functions. For example, bringing A1 low, while leaving the other address lines high, would select the ZX printer. Overall, lines A0 and A8-A15 are allocated for ZX peripherals. In all cases a 'low' level on an address line selects the function. This means that if we want to put our Input/Output interface in the 'I/O' map, we must choose an address which as A0-A4 and A8-A15 all '1'.

Theory and Practice

Many different kinds of interface have been designed for the ZX81, ranging from straightforward I/O boards for controlling relays, lights etc, through joystick controllers and full-sized keyboards to analogue-to-digital converters. No doubt similar products for the Spectrum will appear in due course. Now that we know what signals are available at the rear connector of a ZX computer, and how we can use them to communicate with the outside world, we are better able to understand how these work.

There's nothing like hands-on experience, though, so the next practical step is to consider such a circuit or, better still, to build it! Accordingly, next month's HE will contain a simple, effective I/O Board project, providing eight TTL-level input and output lines and suitable for use with either a ZX81 or a ZX Spectrum.

HE

IT LIVES AGAIN!

From the past it came, growing daily, striking terror into the hearts of lesser publications, and spreading its influence across the country in its quest to infiltrate every town, every home, every mind.

Not a horror story, but a success story. And if electronics theory strikes terror into you, then you need the help of **Electronics — It's Easy**. Originally a long-running series in Electronics Today International, **Electronics — It's Easy** was printed as a set of three books. They sold out. It was reprinted as a single volume. It sold out. Now this phenomenally successful publication is available again, in its third reprint. **Electronics — It's Easy** is a comprehensive and simply-written guide which explains the theory (and the practice) of electronics step by step. Every aspect of the subject is covered, starting with the basic principles and working through to the how and why of today's technology.

You can obtain your copy of **Electronics — It's Easy** by mail order using the coupon below. Make cheques or postal orders payable to ASP Ltd; alternatively you may pay by Access or Barclaycard.

Send to: Sales Office (Specials),
513 London Road, Thornton Heath
Surrey CR4 6AR

Please send me.....copies of Electronics —
It's Easy. I have enclosed £..... (£4.95 each
including p&p).

NAME

ADDRESS

Please debit my account

My Access/ Barclaycard No. is

Signature

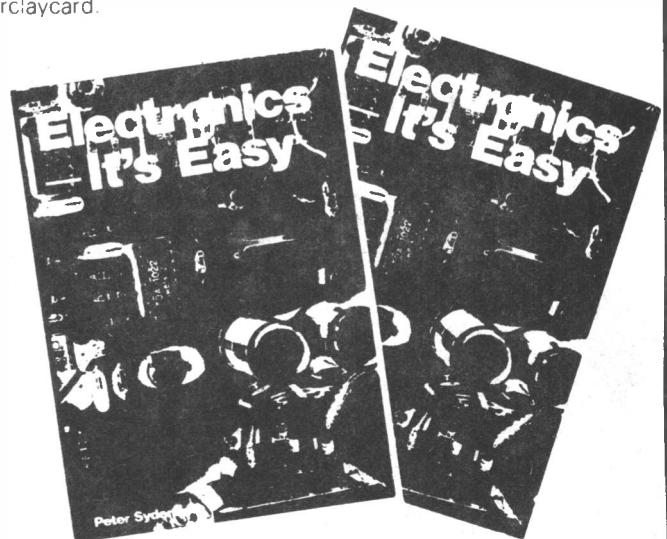

SPOTLIGHT ON THE

" . . . an excellent machine, it offers by far the best performance of any computer in its price range . . . "

SPECTRUM

Mike Lord

THERE IS no doubt that Sinclair's new Spectrum has already caused a lot of interest among potential customers — and a lot of consternation among his competitors! We were lucky enough to have a prototype machine on loan for a week and so able prepare this review for HE readers.

The Spectrum is suprisingly small (233 x 144 x 30 mm) but has a nice 'chunky' feel to it; it looks robust enough to withstand a lot of rough treatment yet simple enough to be reliable. The keyboard is a great improvement over that used on the ZX80 and 81, as the keys are spaced further apart and they actually *move* when you press them. Perhaps the word 'collapse' would be better, as the keytops are made of hollow rubber mouldings which act as their own return springs. The effect is a bit disconcerting at first — it's rather like typing with galoshes on your hands.

As with the ZX80 and ZX81, BASIC words are entered by pressing a single key but, because the Spectrum has so many functions (most keys have up to 5 meanings), a complicated sequence of shift keys has to be used to select the least frequently used commands. This can be annoying for the beginner, and one wonders occasionally whether Sinclair were right in keeping with 'one touch' keyword entry. Some symbols on the prototype's keys were difficult to read, being very small dark red print on a grey background, but we have been informed that the lettering on production models will be better. All keys have a useful 'auto-repeat' facility, and a click is given by the internal loudspeaker when a key is pressed.

Sound Spectrum

Yes, the Spectrum does have sound. The BEEP command will generate a note of

specified frequency and length, and it is quite easy to program simple tunes or space invader type noises.

The TV display is the usual Sinclair standard of 24 rows of 32 characters each, the bottom two rows being reserved for keyboard input or reports from the computer. The display is always present — there is no equivalent of the ZX81's FAST mode, as the TV signal is generated by special hardware which frees the Z80 processor to work full time at your program.

The character set includes both upper and lower case letters, block graphics characters familiar to ZX81 users, an assortment of miscellaneous symbols, including the copyright symbol, ©, and no less than three distinct types of brackets! You can also define your own characters; each character on the screen is made up of dots in an 8 x 8 matrix and there are 21 spare character codes which you can program to whatever shapes you want. Alternatively, you can even redefine the complete set of 133



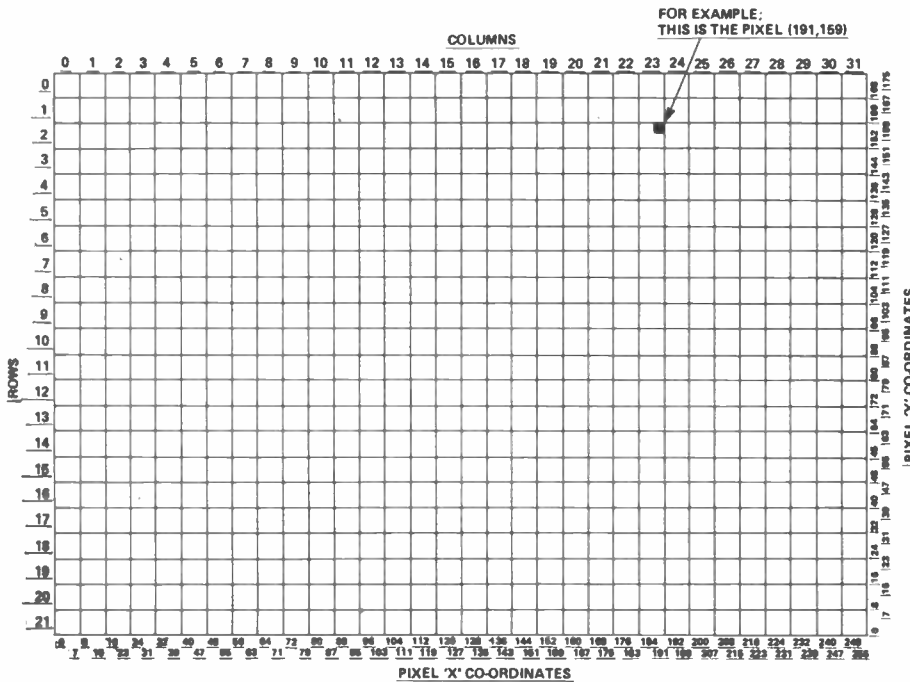

Figure 1. The Spectrum display map.

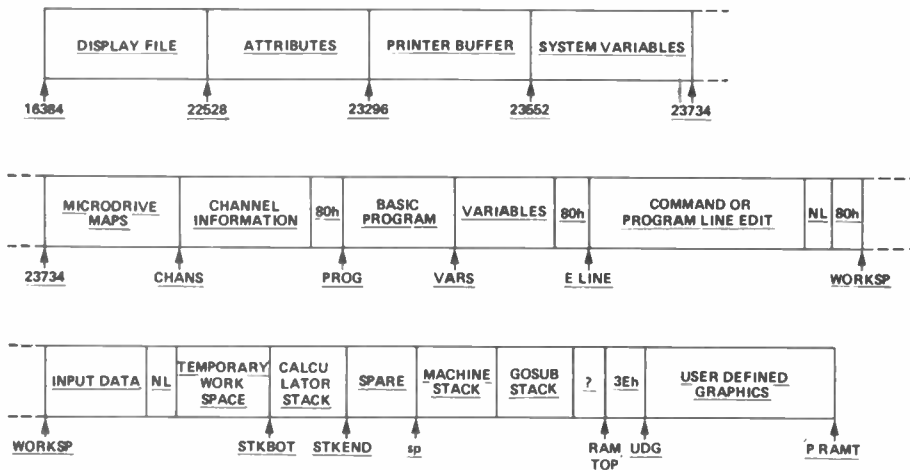

Figure 2. The memory map of the RAM area — RAMT (RAMTOP) is normally 32768.

displayable characters! This is ideal for moving graphics games, as you can define characters to look like — say — different types of spaceship, then move the ships rapidly around the screen by PRINT AT commands.

Then there is the matter of colour. For each of the 32 x 22 programmable character positions on the screen, you can control the background (PAPER) and foreground (INK) colours; also, whether or not the character will appear flashing or steady and whether it is displayed at normal or bright intensity. Six colours, plus black and white are available and they all showed up clearly and distinctly on the author's television, except for a slight 'fringing' which may have been due to the model under test being a much worked-on prototype. The colour of the border around the edges of the screen can also be controlled by your program.

The Spectrum also has PLOT, DRAW and CIRCLE commands which let you plot points and draw straight lines, circles or parts of circles on a 256 x 176

grid. This grid is made up of the 8 x 8 dot matrices used for each of the 32 x 22 programmable character positions on the screen, so that while you can use colour with the PLOT, DRAW and CIRCLE commands, you are limited to a single foreground colour and a single background colour in each of the character positions.

Spectrum BASIC is essentially ZX81 BASIC plus a number of new features. It is not the fastest BASIC around, but it is quick enough for most applications. As well as the plotting, colour and sound commands mentioned earlier, it now has READ, DATA and RESTORE instructions for handling lists of fixed data, and can include user defined functions in the programs. The new BIN function allows you to express a number in binary form as eight '1's or '0's, which must be useful sometimes! The functions ATTR, POINT and SCREEN\$ will be valuable in programming moving action games, as they allow you to find out exactly what is being displayed at any point or character

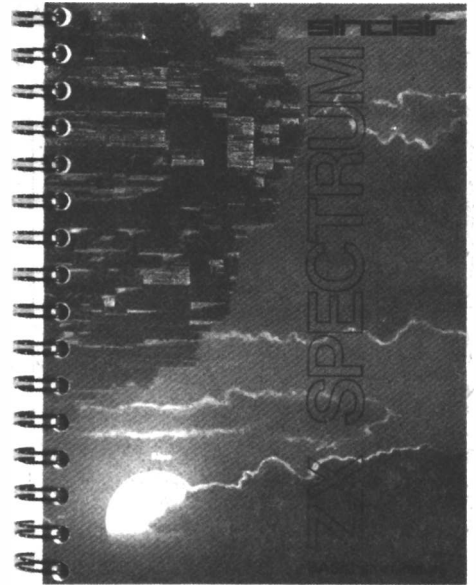

Figure 3. The Spectrum BASIC programming manual is clearly written and well illustrated, as usual.

position on the screen. Hardware freaks will be pleased by the IN and OUT instructions, which act like PEEK and POKE but on the Z80's I/O space rather than on memory locations.

SAVE It

The rate at which programs and data can be SAVED to tape is now 1500 bits per second (five times faster than the ZX81) and the cassette interface has been made more tolerant of imperfections in the cassette recorder. A new VERIFY command allows you to check a program or block of data, in the Spectrum's memory, against information stored on tape, which is a useful safeguard but surely a checksum added to the saved data would have been more practical. You can also MERGE data and programs from tape with those already present in the machine, which allows the Spectrum to handle masses of data by taking in a chunk at a time, or you could MERGE previously written routines from tape into a new program.

The most tantalising aspect of the Spectrum's launch was the mention of new add-ons to be available 'later this year'. They are a RS232/Network interface which will allow the Spectrum to be connected to a whole range of standard computer peripherals, including printers and modems, and the ZX Microdrive. The Microdrive will be Sinclair's answer to the floppy disc drives found on more expensive computer systems. For only £50, it will hold up to 100K bytes on an interchangeable microfloppy, and transfer data or programs to and from the Spectrum at 16K bytes per second. This will turn the Spectrum into a serious business machine as well as greatly extending the possibilities for the hobbyist. We can't wait!

In Conclusion

The Spectrum is an excellent machine. It offers by far the best performance of any computer in its price range, and seems to be easy to use without any particular 'vices'. Place your order now!

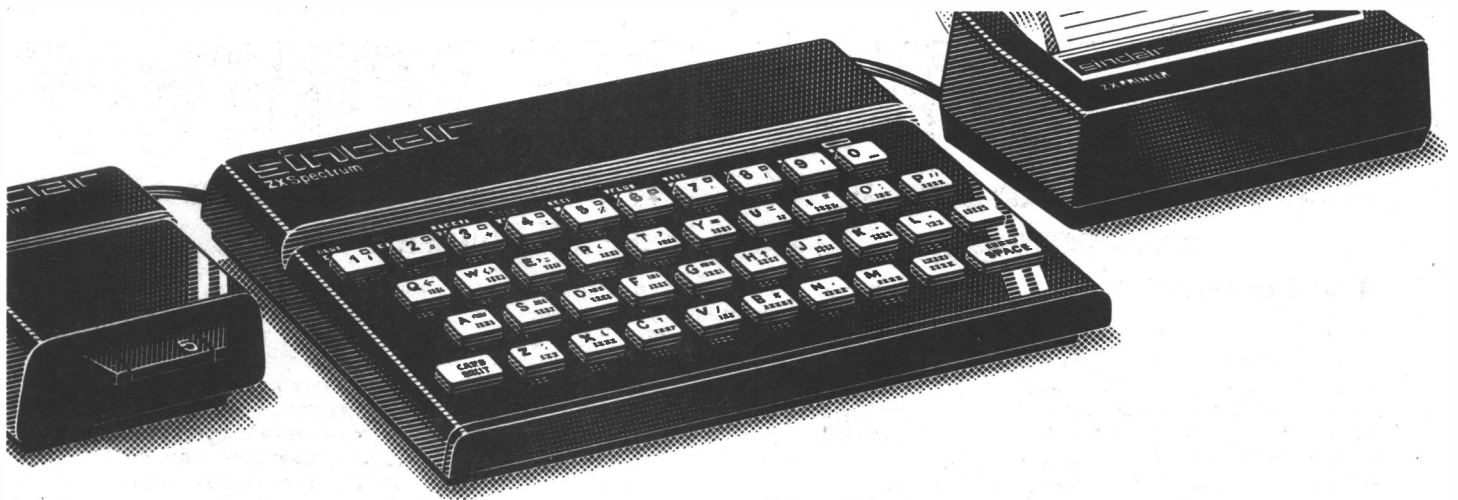

"...the quality of the colour display is excellent". Popular Computing Weekly.
"The graphics facilities are great fun". Personal Computer World.
"...the Spectrum is way ahead of its competitors". Your Computer.

"The world's best personal computer for under £500."

Chris Sinclair

Sinclair ZX Spectrum 16K RAM £125, 48K RAM £175.

This is the astonishing new ZX Spectrum – a powerful professional's computer in everything but price!

There are two versions – 16K or a really powerful 48K. Both have a full 8 colours, sound generation, a full-size moving-key keyboard and high-resolution graphics. Plus established Sinclair features such as 'one-touch' keyword entry, syntax check and report codes!

Key features of the Sinclair ZX Spectrum

Full colour – 8 colours plus flashing and brightness-intensity control.

Sound – BEEP command with variable pitch and duration.

Massive RAM – 16K or 48K.

Full-size moving-key keyboard – all keys at normal typewriter pitch, with repeat facility on each key.

High resolution – 256 dots horizontally x 192 vertically, each individually addressable for true high-resolution graphics.

ASCII character set – with upper- and lower-case characters.

High speed LOAD & SAVE – 16K in 100 seconds via cassette, with VERIFY and MERGE for programs and separate data files.

The ZX Printer – available now

The printer offers ZX Spectrum owners the full ASCII character set – including lower-case characters and high-resolution graphics.

Printing speed is 50 characters per second, with 32 characters per line and 9 lines per vertical inch.

ZX Microdrive – coming soon

Each Microdrive will hold up to 100K bytes on a single interchangeable microfloppy – with a transfer rate of 16K bytes per second. And you'll be able to connect up to 8 ZX Microdrives to your ZX Spectrum – they're available later this year, for around £50.

How to order your ZX Spectrum

BY PHONE – Access, Barclaycard or Trustcard holders can call 01-200 0200 for personal attention 24 hours a day, every day.

BY FREEPOST – use the coupon below. You can pay by cheque, postal order, Access, Barclaycard or Trustcard.

EITHER WAY – please allow up to 28 days for delivery. And there's a 14-day money-back option, of course. We want you to be satisfied beyond doubt – and we have no doubt that you will be.

sinclair ZX Spectrum

Sinclair Research Ltd,
 Stanhope Road, Camberley, Surrey,
 GU15 3PS. Tel: Camberley (0276) 685311.

To: Sinclair Research, FREEPOST, Camberley, Surrey, GU15 3BR.				Order
Qty	Item	Code	Item price £	Total £
	Sinclair ZX Spectrum – 16K RAM version	100	125 00	
	Sinclair ZX Spectrum – 48K RAM version	101	175 00	
	Sinclair ZX Printer	27	59 95	
	Printer paper (pack of 5 rolls)	16	11 95	
	Postage and packing orders under £100	28	2 95	
	orders over £100	29	4 95	
TOTAL £				

Please tick if you require a VAT receipt:

*I enclose a cheque/postal order payable to Sinclair Research Ltd for £.

*Please charge to my Access/Barclaycard/Trustcard account no Please print

*Please delete/complete as applicable

Mr/Mrs/Miss

Address

FREEPOST – no stamp needed. Prices apply to UK only. Export prices on application. HEL 808

POINTS OF VIEW

Topics this month are CB, the MEMOPAK 64K RAM, and a point concerning our "Scaling the HiFi Heights" series.

CB vs Computers

Dear Sir,
Firstly, in answer to N. J. Treacher's letter (HE, June '82) re CB circuit diagrams; the only one presently obtainable from the makers is the Amstrad 900-901. This is really a super service sheet, including junction voltages, parts list and numbers for spares. The circuit is printed on a large folded sheet and is available from Amstrad to anybody for £2.50 plus 20p p&p. Hope this helps.

Now, my comments. I have taken HE from issue No. 1 and I think is has been a very good mag. It was even better when you included a bit of CB (which must have helped your sales) but this was stopped when CB mags appeared. So how about finishing up the section on computing when this session comes to an end, as there are plenty of computing mags now, and stick to basic electronics.

How about articles on wind generator control circuits, charging car batteries by solar cells and other energy savers — but please stick to what HE is about; basic, useful projects and teachings.

B. J. Shelford,
Sheerness,
Kent.

Firstly, then, thanks for your Point of View, and also for the tip on CB service sheets. Let's hope N. J. Treacher is still in touch!

Your comments on CB radio and computing are interesting. We don't see this as a straight-forward contest, though. As a long-term regular reader, you will be aware that we did as much as anybody else to publicise CB radio in the UK — but when CB magazines (including our own Citizens' Band Magazine) began to appear, it seemed that the dedicated CB nut would be better served by those specialist publications. This was confirmed by the lack of response (best described as 'underwhelming') to the demise of our Breaker One-Four page. Nevertheless, we know that many readers are still interested in CB, and that many more would like to learn more about radio generally, so we introduced the 'teach-in' series, Radio Rules, together with regular CB/radio projects and features, under the title 'Into Radio'.

We also felt that the best way we could contribute to a better understanding of computers was to devote a number of pages to the basic electronics of micro computers — the 'nuts and bolts', as we like to say. We are still the only magazine to deal with computer technology on this level.

Lastly, our July issue contained a number of projects which could be 'solar-powered' (for further information on sources of relatively inexpensive cells, see the Monitor pages), and other energy-saving projects are being planned!

Memopak

Dear Sir,
We have read your review of our MEMOPAK 64K on page 65 of Hobby Electronics for June 1982. May I say we thought it very fair? There are, however two points I would like to make.

The first concerns the amount of RAM available in our pack. There is 64K RAM physically present, but as the ZX81 can only address 56K locations above the 8K of its own ROM, we can only provide an additional 56K to the Sinclair user. However, the MEMOPAK 64K was not intended solely for use on the ZX81, and it would provide 64K of RAM to any Z80 processor that could address it. It might, for example, be used in conjunction with the Spectrum (with paging). Another possibility is that it could be combined with a disc operating system for use with the ZX81.

Secondly, the ZX81 arrays are not restricted to the upper 32K of RAM, as your diagram indicates. What happens is that the ZX81 allocates space to the instruction file, the display file and the arrays (in that order) from about 16K onwards. Although the instruction file cannot climb above the 32K address limit, the arrays may start lower down — an array of 45K is possible.

We take your point about the sticky tabs and we are considering replacing them with Velcro tabs.

Perhaps you would consider publishing this letter in the interests of clarification for the ZX public.

Yours Faithfully,
D. J. Jay,
Technical Consultant,
Memotech Ltd.

We are only too happy to oblige, and hope that this clears up any misconceptions concerning the MEMOPAK 64K.

Hi-Fi Heights Revisited

Dear Sir,
I bought your magazine for the first time last week, solely to read your article on "Makin' Tracks", which was well set-out for first-time PCB etchers. Reading further into the magazine, I

noticed some comments about "Gremlins" (Letters, page 23), then further still, in "Scaling the Hi-Fi Heights", a reference to Centrifugal Force throwing the cartridge away from the centre of a circle. Was this the Gremlins in action again, or have I just misunderstood your meaning?

This was, of course, that the frictional force between the stylus and the groove walls tends to drag the cartridge in the direction of travel of the groove. Where there is an offset angle in the cartridge mounting (you don't offer much background to this in your paragraph on Tracking Error!) this frictional force has a component inwards, at right angles to the arm and this is compensated for by a bias outwards, which varies according to the load on the stylus.

Perhaps you could have a word with your printers and get them to sort out their Gremlins?
B. A. L. Morgan,
Ledbury.

A month (or two) in publishing, as in politics, is a long time (with apologies to Sir H. Wilson); apologies also to D. G. Parker of Stroud in Gloucestershire, for our late comments on this subject.

Remembering that the series was, after all, an introduction to hi-fi and not a thesis, we admit that the explanation was less than complete. In fact, there are two mutually opposed forces acting on the cartridge. The first, due to centrifugal force, tends to throw the arm away from the centre of the disc and some compensation for this force (which is readily observable when using a flat, ungrooved test disc) must be applied. The second force is, as the writers correctly point out, due to the drag of the stylus tip against the groove wall and it tends to pull the arm into the centre of the disc. Once the effects of centrifugal force, or any misalignment of the arm tending to reinforce this, have been corrected, a small adjustment to the bias can then be made to compensate for the inwards-acting force. As with all measurements and adjustments, it is first necessary to have a stable reference point; this is the reason for the first adjustment, made using a test record. We hope this explanation has not been a drag.

Lastly, lest our printers feel gravely insulted, we must also admit that the Gremlins (or 'the fairies at the bottom of the darkroom', as a colleague calls them) mostly reside in our typewriters, here at the lavish offices of A.S.P.

COMING SOON TO . . .

Hobby Electronics

POPULAR COMPUTING

ZX INTERFACE BOARD

An uncomplicated I/O port that can be adapted to suit either the ZX81 or the Spectrum.

MICROTRAINING

The HE MicroTrainer project concludes with detailed explanations and applications.

MODEL PROJECTS

THREE-ASPECT LIGHTS CONTROLLER

Red, green and amber signalling lights indicate that the way is clear — or not. With a little ingenuity, this project can be further adapted . . . but more about that next month!

HE 'JUNIOR' SLOT-CAR CONTROLLER

Better control for improved performance.

PROJECT: MUSIC

STEREO NOISE GATE

Eliminates hisses and buzzes during pauses in music or speech.

TEST EQUIPMENT

VARIABLE PULSE GENERATOR

Crystal controlled pulses from 100nS to 1S in eight ranges, with independently variable mark/space ratio within each range. See it and believe it!

Please reserve copies of the September issue of

**Hobby
Electronics**

for
Name

Address

.

.



**Hobby
Electronics**

**September issue on sale at
your newsagent
from 13th August.
Place your order now!**

Although these articles are being prepared for the next issue, circumstances may alter the final content.

WATFORD ELECTRONICS

35 CARDIFF ROAD, WATFORD, HERTS., ENGLAND
MAIL ORDER, CALLERS WELCOME. Tel. Watford 40588

ALL DEVICES BRAND NEW, FULL SPEC. AND FULLY GUARANTEED. ORDERS DESPATCHED BY RETURN OF POST. TERMS OF BUSINESS: CASH/CHEQUE/P.O.s OR BANKERS DRAFT WITH ORDER. GOVERNMENT AND EDUCATIONAL INSTITUTIONS' OFFICIAL ORDERS ACCEPTED. TRADE AND EXPORT ENQUIRY WELCOME. P&P ADD 50p TO ALL CASH ORDERS. OVERSEAS ORDERS POSTAGE AT COST. AIR/SURFACE. ACCESS ORDERS WELCOME.

VAT

All prices exclusive of VAT. Please add 16% VAT to the total cost incl. P&P. We stock thousands more items. It pays to visit us. We are situated behind Watford Football Ground. Nearest underground/BR Station. Watford High Street. Open Monday to Saturday: 9am to 6pm

POLYESTER CAPACITORS: Axial Lead Type
400V: 1nF, 1.5nF, 2n2, 3n4, 4n7, 6n8 11p; 10n, 15n, 18n, 22n 12p; 33n, 47n, 68n 16p; 100n, 150n 20p; 220n 30p;
330n 42p; 470n 52p; 680n 60p; 1uF 68p; 2.2uF 82p; 4.7uF 85p;
10uF: 10nF, 12n, 100n 11p; 150n, 220n 17p; 330uF, 470uF 30p; 680uF, 33p; 1uF 42p; 1u5 45p; 2u2 48p.
1000V: 1nF 17p; 10nF 30p; 15n 40p; 22n 36p; 33n 42p; 47n 48p; 100n 50p; 470n 99p.

POLYESTER RADIAL LEAD CAPACITORS: 250V:
10nF, 15n, 22n, 27n 6p; 33n, 47n, 68n, 100n 7p; 150n, 220n 10p.
330n, 470n 13p; 680n 19p; 1uF 23p; 1u5 40p; 2u2 46p; 4u7 60p.

ELECTROLYTIC CAPACITORS: (Values are in uF) 500V: 10 52p; 47 78p; 250V: 100 65p; 63V: 0.47, 1.0, 1.5, 2.2, 2.5, 3.3 3p; 6.8, 10 10; 15, 22, 12p; 33, 100, 19p; 47 12p; 100, 19p; 1000 30p.
220V: 220 24p; 470 32p; 2200 90p; 40V: 4.7, 15, 22 9p; 3300, 90p; 4700, 120p; 25V: 1.5, 6.8, 10, 22 8p; 33 8p; 47 8p; 100 11p; 150 12p; 220 15p; 330 22p; 470 25p; 680, 1000, 34p; 2200, 50p; 3300, 76p; 4700 92p; 16V: 4.7, 100 9p; 125, 12p; 220 13p; 470, 20p; 680 34p; 1000 27p; 1500, 31p; 2200 36p; 3300 74p; 4700 79p.

TANTALUM BEAD CAPACITORS:
35V: 0.1uF, 0.22, 0.33 15p; 0.47, 0.68, 1.0uF, 1.5 16p; 2.2, 3.3 18p; 4.7, 6.8 22p;
10uF 28p; 16V: 2.2, 3.3 16p; 4.7uF 6.8, 10 18p; 15, 30p; 22 30p; 33, 47 40p; 100 70p; 220 89p; 10V: 15, 22, 26p; 33, 47 35p; 100 56p; 6V: 100 42p.

POTENTIOMETERS: Rotary, Carbon, Track, 0.25W Log & 0.5W Lin.
5000, 1K & 2K (Linear only) Single Gang 30p
5K & 2M Single Gang 30p
5K & 2M Single Gang D/P Switch 79p
5K & 2M Double Gang 88p

SLIDER POTENTIOMETERS
0.25W Log and linear values 60mm
5K & 500K single gang 70p
10K-500K dual gang 110p
Self Stick Graetog Bezel 42p

MYLAR FILM CAPACITORS
100V: 1nF, 2, 4, 4n7, 10 6p; 15nF, 22n, 30n, 40, 47 7p; 56, 100n, 200 9p; 470n/50V: 12p.

MINIATURE TYPE TRIMMERS
2-8pF, 2 10pF, 2.25pF, 5 56pF 30p.

COMPRESSION TRIMMERS
3-40pF, 10-80pF 20p, 20 250pF 28p, 100-500pF 39p, 400 1250pF 48p.

PRESET POTENTIOMETERS
Vertical & Horizontal
0.1W 50 M 5 Miniature 7p
0.25W 100 M 3.3 MD horiz. 10p
0.25W 200 M 4.7 MD vert. 10p

VOLTAGE REGULATORS
1A TO3 +ve 7905 45p
5V 7805 145p 7905 220p
12V 7812 145p 7912 220p
15V 7815 145p
18V 7818 145p

1A TO220 Plastic Casing
5V 7805 7095 45p
12V 7812 40p 7912 45p
15V 7815 40p 7915 45p
18V 7818 40p 7918 45p
24V 7824 40p 7924 45p

100mA TO92 Plastic Casing
5V 78L05 30p 79L05 60p
6V 78L12 30p
8V 78L12 30p
12V 78L12 30p 79L12 60p
15V 78L15 30p 79L15 60p

CA3085 95p LM317P 99p TBA625B 75p
LM300H 170p LM323K 175p TDA1142 150p
LM305H 150p LM723 35p 78H05 550p
LM309A 135p LM723 50p 78H12 580p
LM317K 350p TAA525 50p 78H05 550p
79HG 785p

DIL SOCKETS
Low Wire Prof. wrap
8 way 8p 25p
14 pin 9p 35p
16 pin 10p 42p
18 pin 16p 52p
20 pin 22p 60p
22 pin 25p 70p
24 pin 27p 70p
28 pin 28p 80p
40 pin 30p 99p

PROTO DEC
Euroboard 520
S Dec 450
Bimbold 1 500
Veroblock 375
Advantages with Electronics by Tom Duncan Complete Kit: £15

DENCO COILS
"DP" VALVE TYPE
Range 1 to 5 BL.
RD, Tl,Wh, 122p
6-7-B-Y-R 110p
1.5 Green 150p
"C" Type 1 to 5, Bl, 18/1.6 135p
Rd, Wh, Yl 150p
B9A Valve Holder 124p
42p
RD2T 145p

VEROBOARD
0.1" Pitch clad plain
21 x 31" 73p 52p
21 x 5" 83p
31 x 31" 83p
31 x 5" 95p 79p
31 x 17" 326p 211p
41 x 17" 426p
Pkt of 100 pins 50p
Spot face cutter 118p
Pin insertion tool 162p

COPPER CLAD BOARDS
Fibre glass
6 x 6" 90p
6 x 12" 150p
S.R.B.P. 9 x 8" 95p
Ferric Chloride
1lb Anhyd. 195p

OPTO ELECTRONICS
LEDs with Clips
TIL209 Red 11
TIL211 Grn. 14
TIL212 Yel. 14
2" Red 12
2" Yell or Grn
Square LEDs 14
Bi-Colour R/G 65
Bi-Colour G/Y 75
Tri-colour R/G/Y 120
OC71 79p
ORP12 78
2N5777 45
LD271 46
SFH205 51
5K & 500K single gang 70p
10K-500K dual gang 110p
Self Stick Graetog Bezel 42p

POTENTIOMETERS: Rotary, Carbon, Track, 0.25W Log & 0.5W Lin.
5000, 1K & 2K (Linear only) Single Gang 30p
5K & 2M Single Gang 30p
5K & 2M Single Gang D/P Switch 79p
5K & 2M Double Gang 88p

SLIDER POTENTIOMETERS
0.25W Log and linear values 60mm
5K & 500K single gang 70p
10K-500K dual gang 110p
Self Stick Graetog Bezel 42p

MINIATURE TYPE TRIMMERS
2-8pF, 2 10pF, 2.25pF, 5 56pF 30p.

COMPRESSION TRIMMERS
3-40pF, 10-80pF 20p, 20 250pF 28p, 100-500pF 39p, 400 1250pF 48p.

PRESET POTENTIOMETERS
Vertical & Horizontal
0.1W 50 M 5 Miniature 7p
0.25W 100 M 3.3 MD horiz. 10p
0.25W 200 M 4.7 MD vert. 10p

VOLTAGE REGULATORS
1A TO3 +ve 7905 45p
5V 7805 145p 7905 220p
12V 7812 145p 7912 220p
15V 7815 145p
18V 7818 145p

1A TO220 Plastic Casing
5V 7805 7095 45p
12V 7812 40p 7912 45p
15V 7815 40p 7915 45p
18V 7818 40p 7918 45p
24V 7824 40p 7924 45p

100mA TO92 Plastic Casing
5V 78L05 30p 79L05 60p
6V 78L12 30p
8V 78L12 30p
12V 78L12 30p 79L12 60p
15V 78L15 30p 79L15 60p

CA3085 95p LM317P 99p TBA625B 75p
LM300H 170p LM323K 175p TDA1142 150p
LM305H 150p LM723 35p 78H05 550p
LM309A 135p LM723 50p 78H12 580p
LM317K 350p TAA525 50p 78H05 550p
79HG 785p

DIL SOCKETS
Low Wire Prof. wrap
8 way 8p 25p
14 pin 9p 35p
16 pin 10p 42p
18 pin 16p 52p
20 pin 22p 60p
22 pin 25p 70p
24 pin 27p 70p
28 pin 28p 80p
40 pin 30p 99p

PROTO DEC
Euroboard 520
S Dec 450
Bimbold 1 500
Veroblock 375
Advantages with Electronics by Tom Duncan Complete Kit: £15

DENCO COILS
"DP" VALVE TYPE
Range 1 to 5 BL.
RD, Tl,Wh, 122p
6-7-B-Y-R 110p
1.5 Green 150p
"C" Type 1 to 5, Bl, 18/1.6 135p
Rd, Wh, Yl 150p
B9A Valve Holder 124p
42p
RD2T 145p

VEROBOARD
0.1" Pitch clad plain
21 x 31" 73p 52p
21 x 5" 83p
31 x 31" 83p
31 x 5" 95p 79p
31 x 17" 326p 211p
41 x 17" 426p
Pkt of 100 pins 50p
Spot face cutter 118p
Pin insertion tool 162p

COPPER CLAD BOARDS
Fibre glass
6 x 6" 90p
6 x 12" 150p
S.R.B.P. 9 x 8" 95p
Ferric Chloride
1lb Anhyd. 195p

7400	11	74147	90	LS124	90	4053	50	CA3020	210	MC1848	290
7401	11	74150	50	LS125	24	4054	85	CA3023	210	MC1709G	90
7402	11	74153	40	LS126	30	4055	85	CA3025	256	MC1710	79
7403	12	74156	40	LS132	40	4056	85	CA3028	256	MC3302	150
7404	11	74159	55	LS133	30	4057	1915	CA3045	365	MC3340P	120
7405	15	74162	48	LS136	26	4059	435	CA3046	70	MC3380P	120
7406	20	74165	80	LS138	28	4061	1195	CA3048	220	MC3401	65
7407	14	74168	60	LS145	75	4062	995	CA3059	285	MC3403	75
7408	14	74171	48	LS148	85	4066	24	CA3075	213	MC3403	110
7409	14	74174	48	LS151	40	4067	245	CA3080E	70	MF6040	75
7410	16	74177	48	LS153	40	4068	14	CA3081	190	MK50398	635
7411	16	74180	48	LS155	30	4069	13	CA3085	95	ML294	250
7412	18	74183	48	LS157	30	4070	13	CA3086	220	MM5052	635
7413	18	74186	150	LS158	30	4071	13	CA3090A	375	MM5037	1275
7414	20	74189	125	LS160	37	4072	13	CA3123E	150	MM5387	47
7415	20	74192	275	LS161	37	4073	13	CA3130	90	NE529	225
7416	20	74195	50	LS162	37	4074	13	CA3140	40	NE531	14
7417	20	74198	50	LS163	37	4075	13	CA3160	95	NE543	225
7418	20	74201	54	LS164	43	4076	50	CA3171	160	NE544	210
7419	15	74204	54	LS165	60	4077	15	CA3189	275	NE555	16
7420	15	74207	45	LS166	62	4081	13	CA3196	200	NE556	45
7421	20	74210	80	LS170	70	4082	13	ICL7107	975	NE560	325
7422	20	74213	80	LS173	55	4085	50	ICL7107	975	NE561	398
7423	20	74216	115	LS174	90	4086	60	ICL7107	975	NE562	410
7424	20	74219	60	LS175	40	4089	125	ICM7205	150	NE563	420
7425	20	74222	90	LS181	95	4093	20	ICM7216A	190	NE565	120
7426	28	74225	245	LS191	36	4094	70	ICM7224	785	NE566	155
7427	28	74228	245	LS192	36	4096	70	ICM7224	785	NE567	140
7428	28	74231	245	LS193	36	4095	70	ICM7224	785	NE570	410
7429	28	74234	245	LS194	36	4096	70	ICM7555	150	NE571	400
7430	14	74237	245	LS195	36	4097	190	ICM7555	150	NE573	225
7431	14	74240	245	LS196	36	4098	190	LA4031	250	RC1436	69
7432	22	74243	245	LS197	45	4099	190	LA4032	296	S5668	225
7433	22	74246	245	LS198	45	4100	190	LA4033	296	SAB3209	425
7434	22	74249	245	LS199	45	4101	190	LA4034	296	SAB3210	425
7435	22	74252	245	LS200	45	4102	190	LA4035	296	SAB3211	465
7436	22	74255	245	LS201	45	4103	190	LA4036	296	SAB3212	465
7437	22	74258	245	LS202	45	4104	190	LA4037	296	SAB3213	465
7438	22	74261	245	LS203	45	4105	190	LA4038	296	SAB3214	465
7439	22	74264	245	LS204	45	4106	190	LA4039	296	SAB3215	465
7440	15	74267	245	LS205	45	4107	190	LA4040	296	SAB3216	465
7441	62	74270	245	LS206	45	4108	190	LA4041	296	SAB3217	465
7442	62	74273	245	LS207	45	4109	190	LA4042	296	SAB3218	465
7443	62	74276	245	LS208	45	4110	190	LA4043	296	SAB3219	465
7444	62	74279	245	LS209	45	4111	190	LA4044	296	SAB3220	465
7445	62	74282	245	LS210	45	4112	190	LA4045	296	SAB3221	465
7446	62	74285	245	LS211	45	4113	190	LA4046	296	SAB3222	465
7447	62	74288	245	LS212	45	4114	190	LA4047	296	SAB3223	465
7448	62	74291	245	LS213	45	4115	190	LA4048	296	SAB3224	465
7449	62	74294	245	LS214	45	4116	190	LA4049	296	SAB3225	465
7450	62	74297	245	LS215	45	4117	190	LA4050	296	SAB3226	465
7451	62	74300	245	LS216	45	4118	190	LA4051	296	SAB3227	465
7452	62	74303	245	LS217	45	4119	190	LA4052	296	SAB3228	465
7453	62	74306	245	LS218	45	4120	190	LA4053	296	SAB3229	465
7454	62	74309	245	LS219	45	4121	190	LA4054	296	SAB3230	465
7455	62	74312	245	LS220	45	4122	190	LA4055	296	SAB3231	465
7456	62	74315	245	LS221	45	4123	190	LA4056	296	SAB3232	465
7457	62	74318	245	LS222	45	4124	190	LA4057	296	SAB3233	465
7458	62	74321	245	LS223	45	4125	190	LA4058			

Digital Millivoltmeter

Owen Bishop

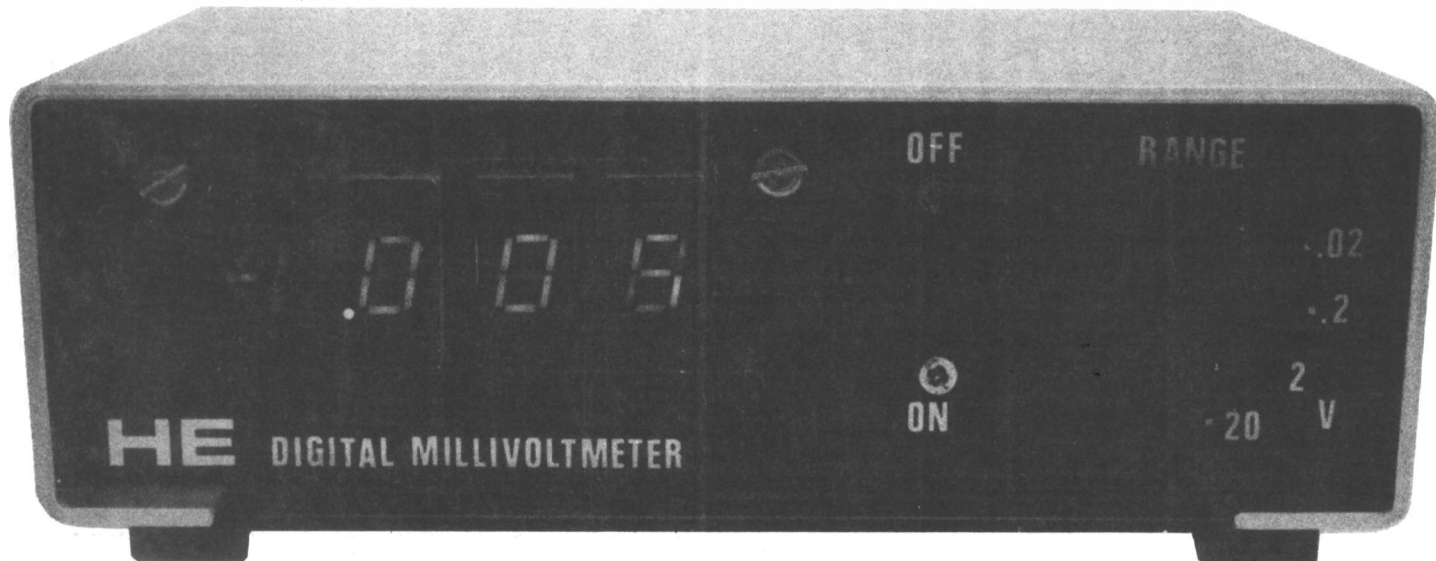

A high precision bench instrument based on a single VLSI chip.

THIS IS an item of precision test equipment which will be in constant use on the electronics work-bench, as well as being frequently called on for jobs around the home. It is battery-powered, to give it portability, and its compact layout makes it almost pocket-sized. In spite of the fact that it is built from only two ICs, its detailed specification (see box) includes most of the features found in an instrument costing appreciably more to buy ready-made.

Compared with its analogue counterpart, a digital voltmeter is an instrument of considerable complexity. To assemble an analogue voltmeter, you need only a milliammeter, a set of precision resistors and a rotary switch. An essential part of a digital voltmeter is the ingeniously designed circuit which converts the analogue voltage input into its digital equivalent. This, in itself, is a fairly complex operation if it is to be performed with precision (see **How It Works**). The final stage of conversion consists of the output from a series of decimal counters, one for each digit. The next step is to convert the counter output to a decimal number to be shown on a set of 7-segment displays. When the number of digits in the display is 3 or greater, it is more economical to use a multiplexed display, where the digits are each illuminated, in turn, for a very short period. The rate of turning the digits on and off is so high that, to the eye, it

appears that they are continuously lit. As each digit is illuminated, the output from the corresponding counter is decoded to produce the correct figure for that display. Only one decoder IC is needed to serve all the digits, instead of one for each digit. This saves expense on decoder ICs but the multiplexing circuit requires a pulse generator (or clock) to time its operations, plus the switches required to connect each counter, in turn, to the decoder.

To build such a circuit using MSI (Medium Scale Integration) ICs requires 2 dual counters, a decoder, a clock IC, another IC for the multiplexing counter and 2 or more for the multiplex switches, making a total of 7 ICs — as a modest estimate! The complexity of the wiring, and the difficulties of setting up and testing each stage, make the assembly of a circuit of this kind a daunting project for the inexperienced constructor. Fortunately, VLSI (Very Large Scale Integration) has made it possible to put all of the above (and more) on to a single slice of silicon!

Although it costs only as much as the total cost of the individual ICs listed above, the 7107 chip carries a complete digital millivoltmeter, including the analogue-to-digital converter, the counter, and all the circuitry required to multiplex and drive the display. All the constructor needs to do is to provide the circuits which

cater for the various ranges of input voltage, to add the few external components which the 7107 requires, and to assemble the display digits on a panel. This is still plenty enough to do, so VLSI does not rob the constructor of the interest and satisfaction of building a useful and attractive instrument.

Circuit Details

The input potential dividers consist of R1, together with RV1 and R2 (2 V range) or RV2 and R3 (20 V range). These are set to divide the input voltage by 10 and 100 respectively. The dividers are brought into action by grounding the lower resistor of each, using switch SW2b. The voltage from the potential dividers is selected and passed to the IC by SW2a. For the 200 mV range, neither potential divider is grounded, so only the 10M resistor (R1) comes between the input socket and the IC. It might be thought that such a high resistance would seriously reduce the voltage reaching the IC, however, the current needed by the +ve or -ve inputs for a full-scale reading is only 1 pA (a millionth of a millionth of an amp). With so little current, the maximum voltage drop across R1 is only 0.05 mV, which can certainly be ignored.

The high resistance of R1 also serves to protect the IC from a high voltage, accidentally applied. If, by chance, the +ve socket is connected to 1000 V, say, the current flowing

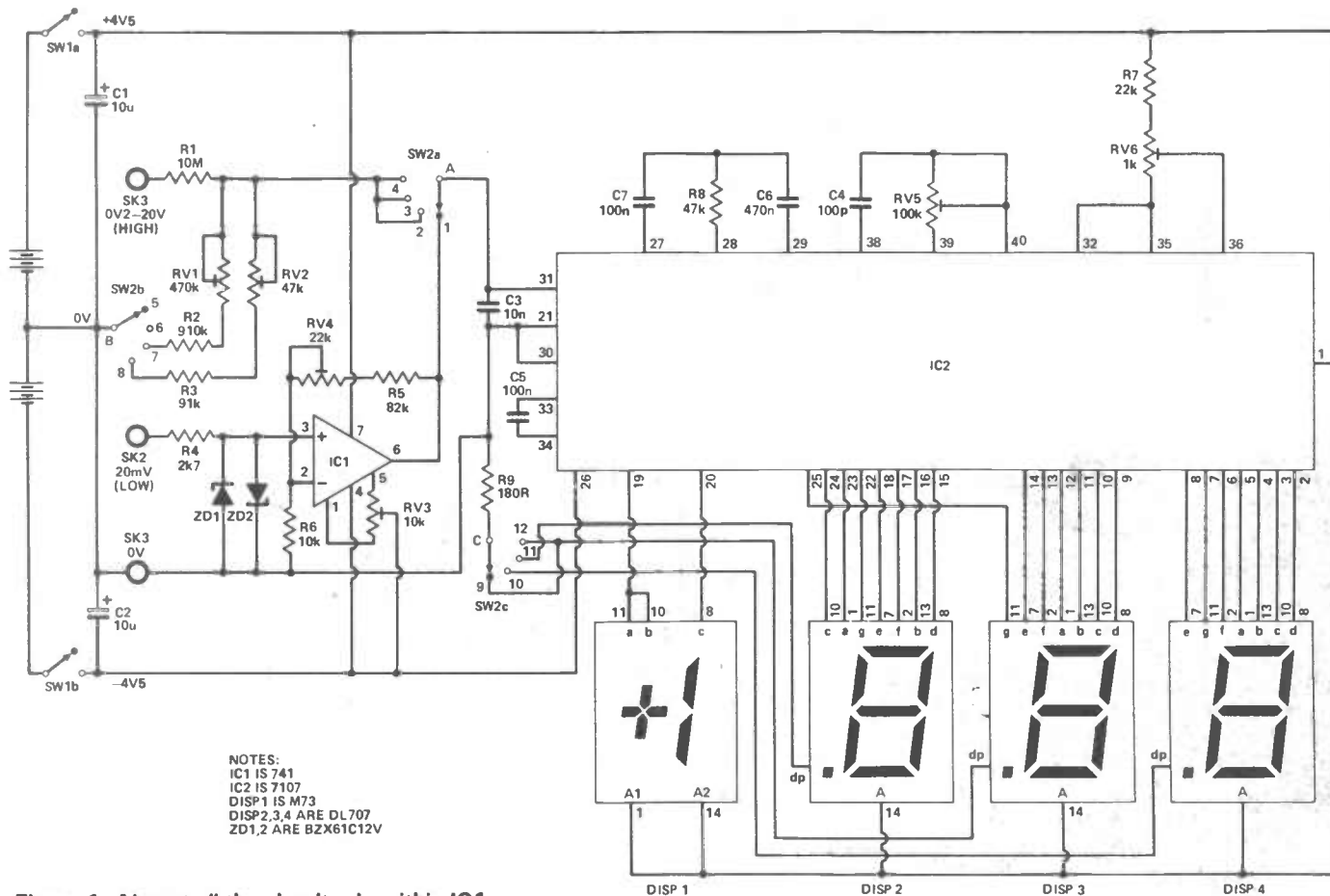

Figure 1. Almost all the circuitry is within IC1.

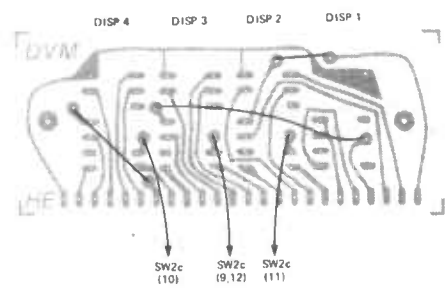
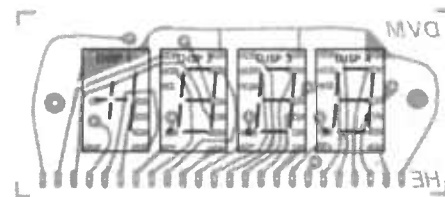
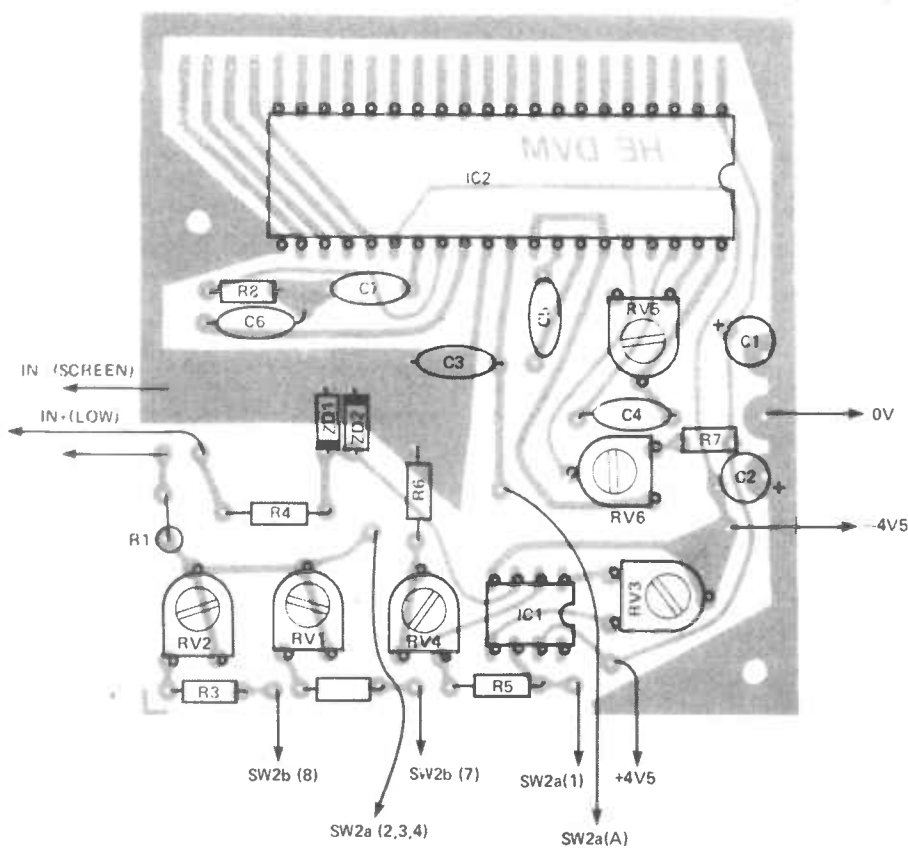

Figure 2. The component layout (Left) is straightforward, but care is needed when wiring the jumper leads to the display board (see Figure 4).

Figure 3. The display board; top, the view from the component side; bottom, the foil side, showing the wire links which must be soldered in place.

Project

through R1 will be only 100 μ A. Since the input can take up to this current without damage, R1 gives full voltage protection against ± 1000 V on the three upper ranges. On the 2 V and 20 V ranges, R1 and one of the potential dividers are connected across the input lines. The input impedance on these ranges is therefore a little over 10M Ω . On the 200 mV range, the input impedance is that of the input of IC2 itself, equivalent to 2×10^{11} ohms.

The operational amplifier (IC1) used on the 20 mV range is connected in a non-inverting configuration. There is a potential-divider (R5, RV4, R6) connected to the output (pin 6), so that one tenth of the output voltage is fed back to the inverting input. The offset null compensation is provided by setting RV3. Input protection is a little more elaborate on this range; R4 provides part of the protection, the remainder being provided by the zener diodes ZD1 and 2. The diodes are connected with opposite polarity, so that protection is independent of the polarity of the input. The input of IC2 can withstand up to 15 V but before this voltage is reached one of the diodes begins to conduct. The resistor, R4, serves to reduce the current through the zeners when an excessively high voltage is applied. With 100 V on the input the voltage drop across R4 is 88 V, giving a current of 33 mA, which is well within the rating of the zeners. In normal use, R4 presents only a small addition resistance, in series with the input impedance of IC1, so its effect on input voltage may be ignored.

DVM Circuits

The oscillator in IC2 uses the external components RV5 and C4. RV5 is adjusted to give a clock frequency of approximately 48 kHz, which is divided down by internal logic to give a display renewal rate of 3 times per second. RV6 and R7 set the reference voltages; to give 200 mV full-scale reading, RV6 is adjusted until the voltage at its wiper is 100 mV. C7 is the capacitor used in the integrator, while C6 stores the correcting charge required for the auto-zero function. R8 links the input buffer amplifier to the integrator, and is the resistor through which C6 and C7 are charged and discharged during ramp and auto-zero operations.

One of the advantages of the 7107 is that it drives the segments of the displays directly eliminating the need for 23 current-limiting resistors. The displays are of the common anode type, the cathodes of the individual segments being wired to the corresponding pins of IC2. Each of these sinks the right amount of current, to illuminate the segment. The decimal points are switched by the range-change switch SW2c. A single current-limiting resistor (R9) is required in the return connection of the 0 V line.

Construction

If the circuit is to be assembled in a case of the recommended type, keep carefully to the specified dimensions

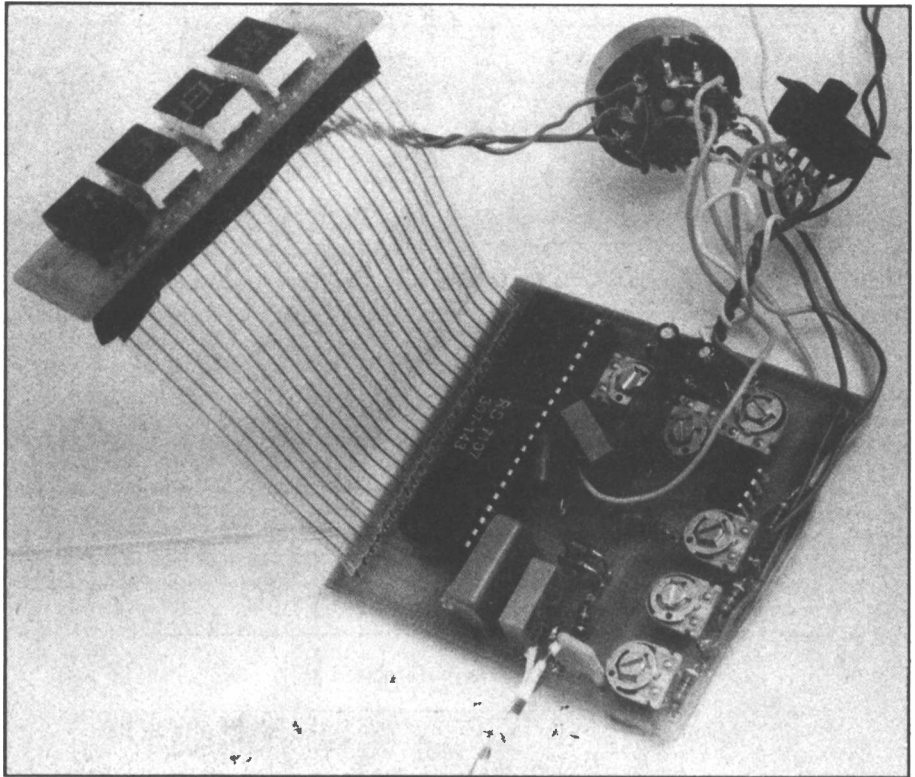

Figure 4. An 'exploded' view of the Millivoltmeter, before final assembly.

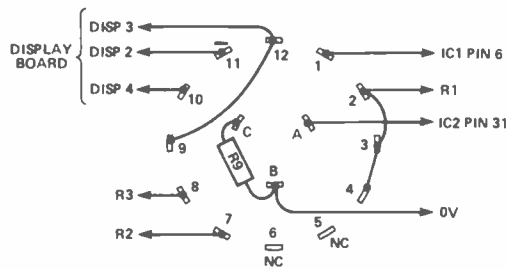

Figure 5. Wiring diagram for the range switch (SW2).

because the individual items fit closely together within the case. Before laying out the etching pattern on the boards, check that all the components have sufficient space, particularly the preset resistors and the polycarbonate capacitors. Both boards may then be etched and drilled.

The LED board (Figure 3a,b) is simple to assemble. Insert the terminal pins before soldering the displays in position; they are placed with their heads flush with the display side, with the pins projecting out on the track side of the board. The displays are then pushed into position. Solder the pins of the displays and the terminal pins, then make the wire links as shown in Figure 3b — except for the connections to the decimal-point pins, which are best left until later. Connections between the LED board and the main board are by 24 wires. The 20-way jumper cables suggested for this purpose make it very easy to insert the ends of the wires in the row of holes and solder them in position. The standard 20-way jumper

cable is only 85 mm long so the relative positions of the boards, as shown in the internal photograph, Figure 4, must be closely adhered to. If you wish to mount the boards further apart, use 20-way ribbon cable instead, or even 24 separate wires, though either will take a lot longer to solder, with increased possibility of short-circuits between adjacent wires. Now solder the jumper cables to the LED board; use one complete 20-way cable and split a 5-way or 20-way cable to make the 4-way cable needed for the remaining 4 connections.

To test the board, connect the +4V5 line to a 4V5 or 6 V battery, through a 180R resistor. Then touch a wire, connected to the 0 V terminal of the battery, to each of the other wires of the cable, in turn. Check that each segment lights correctly and, if it does not, inspect the soldering and tracks. In the +1 digit, both segments 'a' and 'b' of the '1' light together. Only segment, c of the '+' sign is used, giving a '-' sign to indicate reversed polarity. When

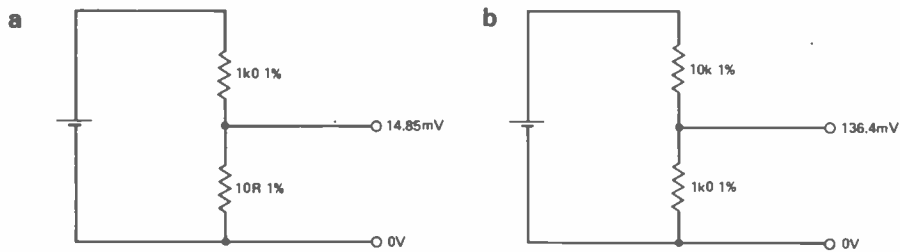

Figure 6. (a) a low voltage source for testing the 20mV input; (b) a battery-based voltage reference.

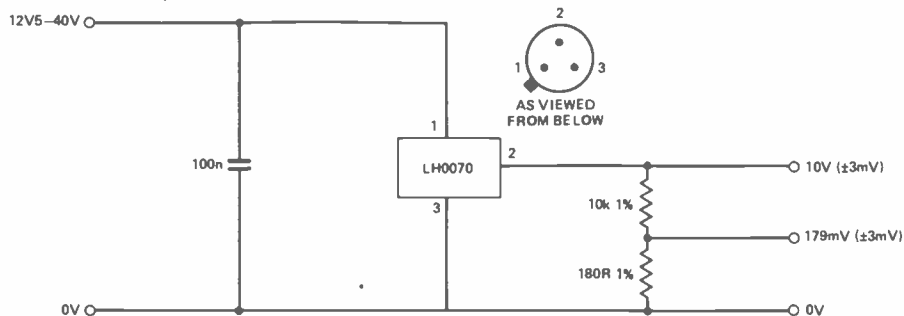
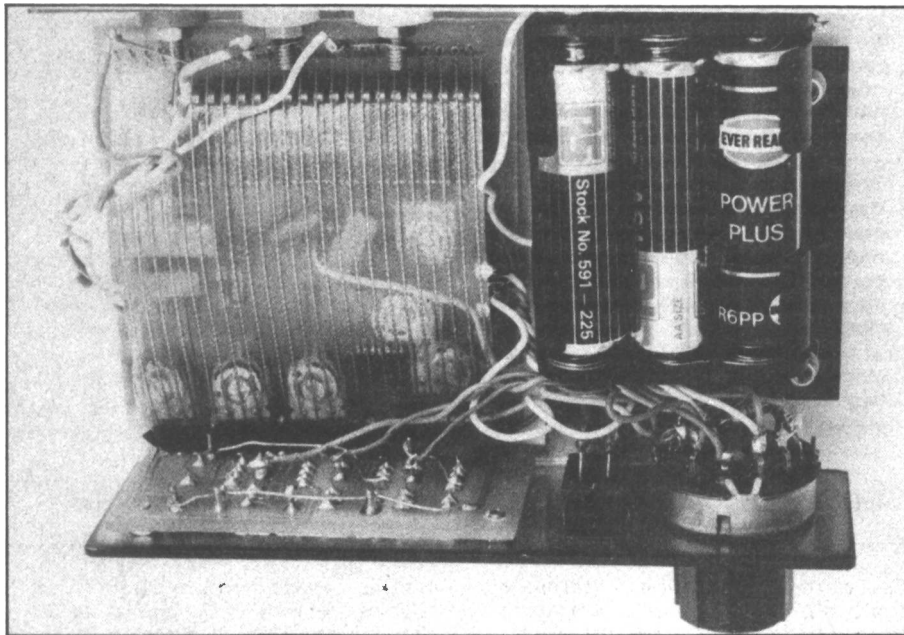

Figure 7. A precision voltage reference is preferable.



polarity is normal, the '+' sign is not lit.

It is highly advisable to use a socket for IC2, but it is not worth while for IC1. Mount the socket and other components, but do not insert IC2 until the whole board has been assembled and tested as far as possible. Solder leads to the power supply pins, the input terminal pins and the leads to the rotary switch, SW2 (Figure 5), taking care that these are long enough to run from the board to the intended position of SW2, but not so long that they will take up an undue amount of room in the enclosure. Finally, solder the jumper cable to the board.

Testing The Main Board

To test the input circuits, temporarily connect the power supply and connect a 6 V battery to the +ve and -ve input pins. With SW2 switched to the

appropriate range and using a borrowed meter, measure the voltage at its wiper. All voltages are measured with respect to the 0 V line, which is common with the -ve input terminal. Unless your test instrument has very high input impedance, the voltage you find at SW2 will be very much lower than expected. For example, if your test meter has 2MΩ input impedance then, since it is in series with R1, five-sixths of the voltage is dropped across R1 and the voltage at SW2a will be only one sixth of the expected value. At this stage, though, the point is simply to check that some sort of signal gets through, showing that none of the soldered joints are 'dry' and that no tracks are incomplete. This is also a check against unintended high voltages (from the power supply) appearing, due to short-circuits between tracks.

To adjust the offset null of IC1, first connect the 20 mV input pin to the -ve input pin. Adjust RV3 until the output of IC1 (read at pin 6 or at the wiper of SW2a) is 0 V. Next, make up a low-voltage source (Figure 6a) for testing the 20 mV input circuit.

Connect this to the 20 mV and -ve input pins and adjust RV4 until the reading on the test meter is approximately 150 mV, indicating an input voltage of 15 mV. Exact setting can be left until later, but it is worth while getting it approximately correct at this stage. Now position the wipers of RV5 and RV6 to the middle of their tracks.

After a thorough check to see that all components directly connected to IC2 have been correctly mounted and properly soldered, and that there are no broken tracks or short-circuits, plug IC2 into its socket. This is a CMOS IC and the usual precautions, to avoid static charges, must be taken when handling it.

Power Supplies

The specified supply is a battery-pack consisting of six HP7 cells, wired to produce $\pm 4V5$. The 7107 is actually designed to operate at $\pm 5V$ so, if you are a TTL enthusiast or frequent builder of microprocessing systems and already have a bench power supply delivering 5 V DC, it is quite in order to use this instead. You will need a -5 V supply too, a point which is discussed later.

The maximum supply rating for the IC is +6 V and -9 V, so it is also feasible to use an 8-cell split supply, giving $\pm 6V$. The main effect of this is to brighten the display, which could be a useful feature under bright ambient light. You will need a larger case to accommodate the extra cells though, so while you are about it, you might as well adopt 'C' size or 'D' size cells, for longer life.

The negative supply does not need to have exactly the same voltage as the positive supply. The current required on the negative side is much smaller too, since it is from the positive side, only, that the current for the display is drawn. This makes it possible to adopt a different method of providing the negative supply, in which the positive supply comes from a battery (or a mains power-pack), but the negative supply is generated by diode level shifting. There is a very inexpensive inverter IC for doing just this and a very simple project for using it will appear next month. This, in fact, was the method used for the prototype of the DVM, in which three 'C' cells and an inverter gave entirely satisfactory results.

Calibration

The following instructions are for a preliminary calibration, which serves also to check the operation of the circuits and the IC; it is best carried out before mounting the boards in the case. If the circuit fails to respond correctly, switch off the power and check it. This procedure should also be

repeated for the final calibration, after the board has been mounted in the enclosure.

On applying power, the display should light and, after flashing one or two random figures, should settle down and display figures close to '000' and '-000'. For accurate calibration it is best to use a precision voltage reference, with a potential divider (Figure 7). This IC is relatively expensive and most readers will probably be content with the less accurate alternative, a single dry cell (Figure 6b).

Connect the 0V rail of the reference source to the -ve input, turn SW2 to the 200 mV range and connect the +ve input to the 136.4 mV point. As the reading settles, the display should change about 3 times a second; adjust RV5 so that this rate is obtained, approximately. Alternatively, monitor pin 40 with an oscilloscope and adjust RV5 to obtain a frequency of 48 kHz. You may see the display flash (the last 3 digits extinguished and the '1' flashing); this is the *over-range* indication — but don't worry about it at this stage.

Adjust RV6 until the display reads '1364', (no decimal points, yet), occasionally showing close values between about '1360' and '1370'. Now change the range switch to 2 V and use the 1V5 cell direct. Adjust RV1 until the reading '1500' is obtained, then change to the 20 V range and adjust RV2 until a reading of '0150' is obtained. Change to the 20 mV range and connect the 14.85 mV source to the +20 mV input; adjust RV4 to obtain a reading of '1485'.

It must be stressed that although this is a high-precision instrument, giving a *reading* to 1 in 2000 counts (0.05% of full scale), its *accuracy* depends on the care with which it is calibrated and the accuracy of the sources used. If you have access to a meter of similar high precision and input impedance, it is worth while checking your instrument against this.

DVM Specification

Four switched DC ranges with 0.05% counting precision on all ranges:

- 0 — 20.00 mV
- 0 — 200.0 mV
- 0 — 2.000 V
- 0 — 20.00 V

High-impedance input: Over $2 \times 10^{11} \Omega$ on 200 mV range, over 10M on 2 V and 20 V ranges, over 2M on 20 mV range.

Conversion rate: display refreshed 3 times per second.

Automatic polarity indication.

Over-range indication.

Auto-zero.

Battery-powered (6 x HP7 cells), allowing measurement of differential voltage levels.

How It Works

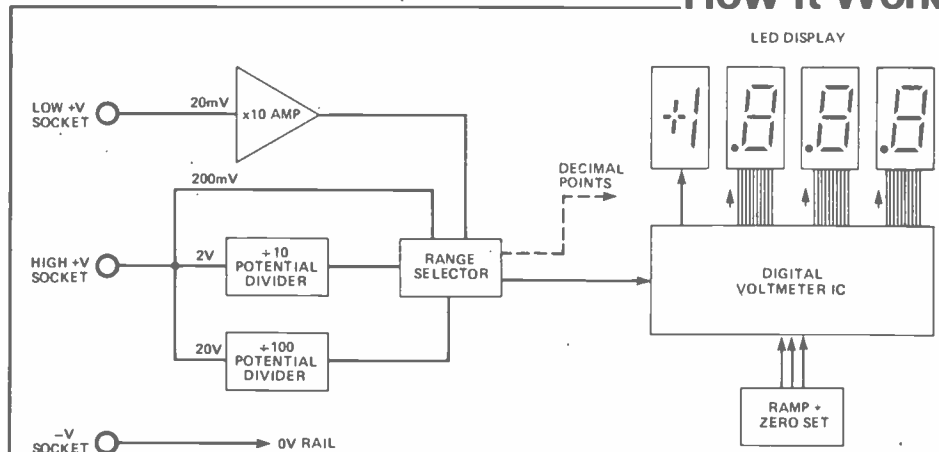

THE DVM IC requires an input of 200 mV to give a full-scale reading of 2000 counts. The attenuator stages of the circuit produce an input to the IC of up to 200 mV for each of the input ranges except on the 20 mV range, where there is a x10 operational amplifier. On the 200 mV range, the input goes direct to the IC; on the 2 V and 20 V ranges, potential dividers reduce the input to 200 mV, maximum.

The IC converts an input voltage in the range 0 to 200 mV to a digital count in the range 0 to 2000 counts. The operating principle is known as the 'dual ramp technique'. The IC goes through three stages of operation automatically, three times a second; at the first stage, the input is connected to an integrator circuit, charging a capacitor for a fixed period of time, determined by the internal clock of the IC. The voltage to which this capacitor is charged depends on

the input voltage and it is charged positively or negatively, depending on the polarity of the input.

In the second stage of operation, the capacitor is discharged by connecting it to a reference voltage. There are two reference voltages; + REF, which is used when the polarity of the input is negative and - REF, which is used when the polarity is positive. While discharging is occurring, a counter operates at a fixed rate, determined by the internal clock. Discharge is terminated when the charge on the capacitor has reached zero, at which point (the beginning of the third stage of operation) the number of counts registered is a measure of the original input voltage. This count is then decoded and sent to the LED display.

In the third stage, the +ve and -ve input lines are connected together and a special auto-zero capacitor is charged with a small

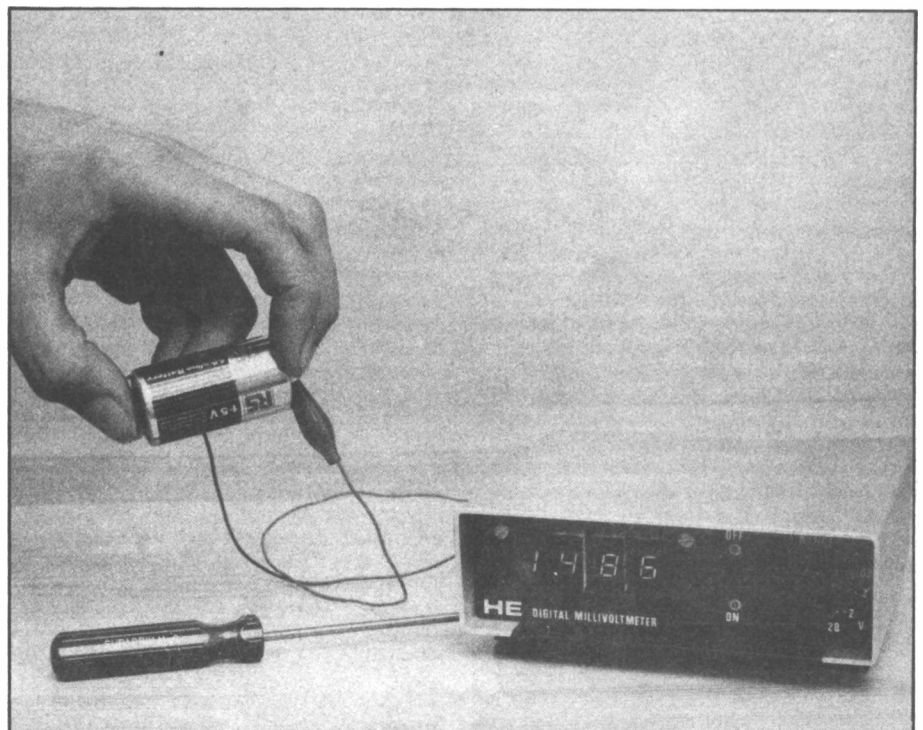

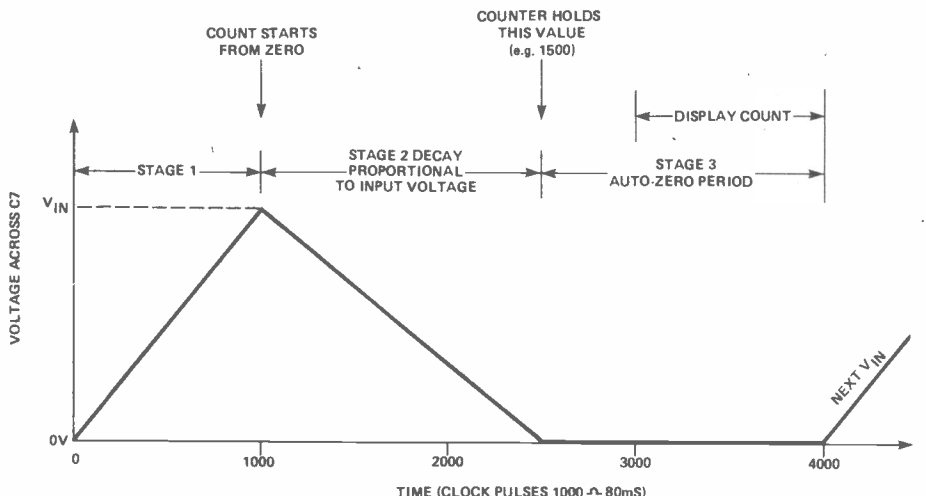

If you are unable to do this, do not rely on the fourth figure of your reading as an absolute indicator of voltage. Even the third figure is suspect when 2% resistors are used in the calibration procedure. However, if you measure two voltages and merely want to know by how much they differ, subtraction of one reading from another, made on the same range, removes many of the inaccuracies of calibration and you can be reasonably confident of the result to the nearest millivolt.

Final Assembly

The first step is to cut and drill the front and rear panels, and to add the legends. Also, cut a notch in the cover of the case, to allow for one of the bolts holding the main board. There is not much room to spare inside the case but, provided that you tackle assembly in the right order, everything will slip smoothly into position. First, mount the main board on its two bolts; take care that the tracks do not contact any metal parts of the case beneath the board. The recommended case has bosses, to which the cover of the case is bolted; one of these projects upward, beneath the board, and may make contact. To guard against this, stick a square of insulating tape on the track side of the board in this region. Next, mount the rotary switch, which is already wired to the board.

The input sockets project from the back panel and come close to IC2. You may find it more convenient to remove the back panel from the case before fitting the sockets to it. Note the V-shaped notches cut in the mounting holes. These align the sockets so that wires may be inserted in a vertical direction. When the sockets are in place, connect them to the main board, remembering that the jumper cable lies across the top of the board, eventually, so make these connections long enough to go around the cable.

Next wire up the power supply and connect it to the board. The easiest way to secure the battery pack in position is to fix it to the bottom of the case, using a 'Sticky Fixer' or a lump of Blu-Tack. At this stage, the circuit is complete and it is worth running through the calibration procedure once again to check that nothing has been altered during assembly. At this stage, the display is still suspended on the end of the jumper cable allowing access to the presets. Before closing up, run a strip of insulating tape across both sides of both ends of the jumper, to guard against short circuits.

When all is working correctly, gently bend the jumper so that the display board comes to its correct location. Fix it to the front panel by its bolts — you may need to use insulating washers to avoid short-circuiting the tracks. Check that nothing is protruding from the top or sides of the case, then slide the cover into position. The digital millivoltmeter is now complete and ready for action!

voltage, to compensate for differential voltages appearing at the amplifier outputs; any drift in the output is reflected as a change in the charge on this capacitor. At the next stage-one operation, this charge is used to correct the reading; should there be no input voltage, the charge compensation gives an all-zero reading, but should there be an input voltage, a small value is added to or subtracted from the result, compensating for amplifier drift.

The dual ramp technique gives a precise result yet does not require many high-precision or high-stability components. For example, charging and discharging both involve the same capacitor (C7) and resistor (R8), so that their exact values do not matter and there are no problems if these should alter with temperature or with age. In addition, each stage

begins and ends at the same voltage, thus cancelling out errors and the effects of drift in the comparator amplifier.

Nor must the frequency of the clock be exact or stable; if the clock is running slow, charging proceeds for longer, and a higher voltage is reached, but during the longer discharge stage, the counter counts more slowly because it is triggered by the same clock. The clocking error cancels out completely, leaving the final count entirely unaffected!

Precision circuits are required only in setting the voltage levels and holding the discharge current constant. Circuits of this kind are relatively easy to incorporate into an IC, making it possible to produce a precise instrument for relatively low cost.

Parts List

RESISTORS (All 1/4 watt 5% metal film unless noted)

R1	10M (1%)
R2	910k
R3	91k
R4	2k7 (1%)
R5	82k
R6	10k (1%)
R7	22k
R8	47k
R9	180R

POTENTIOMETERS (All Cermet min. horizontal presets)

RV1	470k
RV2	47k
RV3	10k
RV4	22k
RV5	100k
RV6	1k

CAPACITORS

C1,2	10u 6V radialelectrolytic
C3	10n metallised polycarbonate
C4	100p silver mica
C5,7	100n metallised polycarbonate

C6	470n metallised polycarbonate
----	----------------------------------

SEMICONDUCTORS

ZD1,2	BZX61C12V zener diode
DISP1	M73 common anode ± 1 LED display
DISP2,3,4	DL707 common anode seven segment display
IC1	741 op-amp
IC2	7107 digital panel meter IC

MISCELLANEOUS

SW1	DPDT miniature slide switch
SW2	3P4W rotary switch
SK1,2,3	4mm terminal post
20-way jumper or ribbon cable; 40 pin DIL socket; small knob; case (see Buylines); 9V x 'AA' battery holder; PP3 clip; nuts, bolts, wire, solder etc.	

Buylines page 34

BRITAIN'S LEADING EXHIBITION FOR ELECTRONICS ENTHUSIASTS

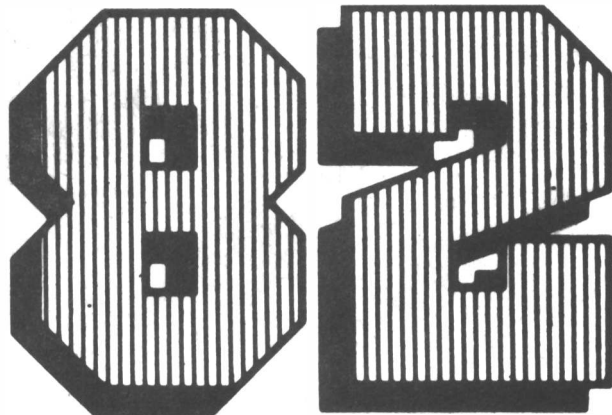
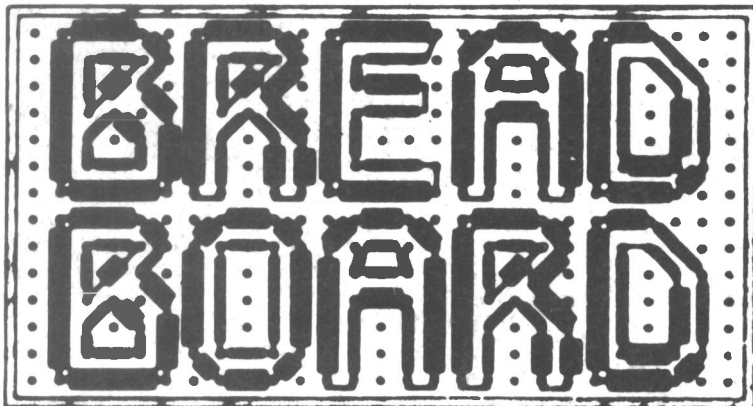

10-14 NOVEMBER 1982 at:
ROYAL HORTICULTURAL SOCIETY'S NEW HALL
GREYCOAT ST, WESTMINSTER, LONDON SW1.

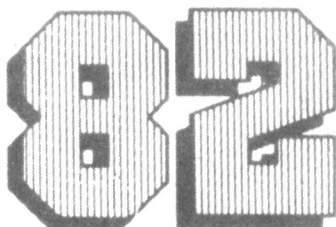
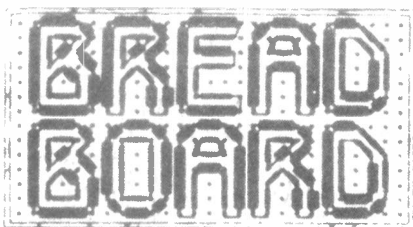

**MORE
COMPREHENSIVE
THAN EVER BEFORE:**

- ★ COMPUTERS
- ★ LOGIC
- ★ KITS
- ★ AUDIO
- ★ TEST GEAR
- ★ COMPONENTS
- ★ RADIO
- ★ C.B.
- ★ DEMONSTRATIONS
- ★ MUSIC
- ★ GAMES
- ★ LECTURES
- ★ MAGAZINES
- ★ BOOKS
- ★ SPECIAL OFFERS

SPECIAL TICKET OFFER

For the fifth consecutive year BREADBOARD is back with even more to offer electronics enthusiasts.

This is the best opportunity to update yourself on all the latest equipment, ideas and developments.

COME AND SEE THEM IN ACTION.

Book your tickets now at this special low rate.

50^p OFF BOOK NOW

(OFFER ENDS SEPTEMBER 30th)

SPECIAL ADVANCE BOOKING PRICE
ADULTS £1.50 — STUDENTS/SENIOR CITIZENS £1.

PLEASE SEND tickets @£1.50 and tickets @£1.
I enclose cheque/P.O. for.....

NAME.....
ADDRESS.....
.....
.....

Send to: BB 82, Argus Specialist Publications Ltd,
145 CHARING CROSS ROAD, LONDON WC2H 0EE.



THE EXHIBITION YOU CAN'T AFFORD TO MISS

THE CASE FOR

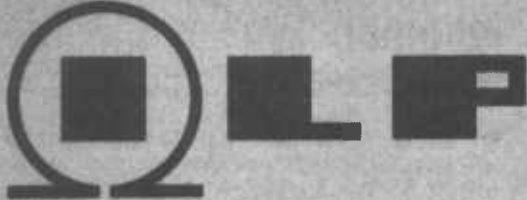

It's the chance every constructor wants



POWER AMPS



P.S.U's



PRE-AMP MODULES

It's something you have always wanted....something to build your equipment into that's smart, modern, strong, adaptable to requirement and not expensive. The 'UniCase' is yet another triumph of I.L.P. design policy. It presents totally professional appearance and finish, ensuring easier and better assembly to make it equal to the most expensive cased equipment. The all-metal 'UniCase' is enhanced by precision aluminium extruded panels engineered for speedy and perfect aligned assembly within a mere five minutes. Designed in the first case to accommodate I.L.P. power amps with P.S.U's, the range will shortly be extended to house any other modular projects.

WHAT WE DO FOR CONSTRUCTORS

Our product range is now so vast we cannot possibly hope to show it all in our advertisements without overcrowding or abridging information to the point of uselessness. So we have devised a solution which we invite you to take advantage of without delay. ALL YOU NEED DO IS FILL IN AND FORWARD THE COUPON BELOW TO RECEIVE OUR NEWEST COMPREHENSIVE I.L.P. CATALOGUE POST FREE BY RETURN. It gives full details of all current I.L.P. products for the constructor together with prices, full technical and assembly details, wiring and circuit diagrams etc. and it's yours, FREE. You don't even have to stamp the envelope if you address it the way we tell you.



ELECTRONICS LTD.

FREEPOST 6

GRAHAM BELL HOUSE, ROPER CLOSE, CANTERBURY CT2 7EP
Telephone Sales (0227) 54778 Technical Only (0227) 64723 Telex 965780

FREEPOST

Mark your envelope clearly **FREEPOST 6** and post it **WITHOUT** a stamp to I.L.P. at address above. We pay postage when your letter reaches us.

Did you know

I.L.P. are the world's largest designers and manufacturers of hi-fi audio modules?

I.L.P. pioneered encapsulated power amps and pre-amps for enhanced thermal stability, mechanical protection and durability?

There are **TWENTY** power amplifiers from 15 to 240 watts RMS including the very latest super-quality Mostlets to choose from?

TWENTY pre-amp modules allow you to incorporate exciting professional applications to your equipment never before available to constructors and experimenters?

I.L.P. are suppliers to the B.B.C., I.B.A., N.A.S.A., British Aerospace, Marconi, Racal, Ferranti, G.E.C., Rolls Royce etc?

Goods are despatched within 7 days of your order reaching us and covered by our 5 year no-quibble guarantee?

SEND COUPON
(NO STAMP NECESSARY)
FOR YOUR FREE I.L.P. CATALOGUE AND OPEN UP TO A NEW WORLD OF QUALITY & VALUE

To: **I.L.P. ELECTRONICS LTD.**
PLEASE SEND ME I.L.P. CATALOGUE.
POST PAID BY RETURN

Name _____

Address: _____

I HAVE/HAVE NOT PREVIOUSLY BUILT WITH I.L.P. MODULES

I.L.P. products are available also from Henry's, Marshall's, Technomatic & Watford.

Beginners Guide To Construction

Roger Harrison

We continue our occasional series for newcomers with this concise, practical guide to constructing electronic circuits and projects.

THERE ARE several different ways of building electronics projects. The simplest by far is to use a printed circuit board. Other methods of construction include stripboard (Veroboard), matrix board and tag strips. Each method has advantages and disadvantages.

Matrix Board

This is a phenolic material (like very hard cardboard) perforated in a grid pattern. It is a brittle material though quite strong - don't bend it too much or it will fracture. Cutting it to size is a simple matter. Score along a line of holes with a pen knife or similar, clamp it along the score on the edge of a sharp corner, such as the edge of a bench or table, and bend or strike the overhanging portion sharply. It should fracture cleanly along the score.

You use it by inserting the components through the holes and making interconnections by joining the components across the back (non-components side) of the board. It all sounds a bit messy but it's surprising how quickly circuits can be assembled, and with a bit of care they look quite neat.

Another advantage of matrix board is that components and wiring can be placed exactly as shown on the circuit diagram. The main disadvantage is that the back of the board becomes a bit of a rat's nest if you try to build a complex circuit. Another minor drawback is that the finished job doesn't look like a totally professional unit.

Tag Strips

Tag strips consist of a series of metal tags mounted on an insulating strip. The strips in turn are mounted on two or more further metal tags which are used to screw the whole lot down onto a chassis.

Component leads should never be wrapped more than three quarter-way round a tag. If you twist them right round you'll have an awful job trying to remove them, if you need to, at a later date.

Tag strip construction is quick, cheap, and simple but the method is only really suitable for small scale projects as inter-tag wiring is otherwise extensive and tedious. This method also wastes space.

Veroboard

This is made from a material similar to

that used for matrix board, but with lines of copper (referred to as 'strips' or 'tracks') embedded in it. The strips are spaced 0.1" apart and the holes in the strips, though which components are inserted, are also at 0.1" intervals.

Veroboard is easily obtainable in large pieces which can be used for a big job, or cut down to suit a smaller circuit. It is simple to use and if the component layout is worked out in advance, it can result in a neat finished appearance. It is fairly easy to make mistakes, though. One very important point to watch is that components which are not meant to be

connected are isolated by cuts in the copper strip (these are easily made either with a suitable sized drill bit or with a special tool). A wise constructor will always check the layout against the circuit diagram to make sure that all components are in the right holes, in the right strip, and that the leads of a transistor, for example, are only joined to those components shown on the circuit, and to no others. Two other points to note are that the loose copper which results from cutting the tracks is not joining adjacent strips, and that after soldering, no solder bridges have been accidentally made.

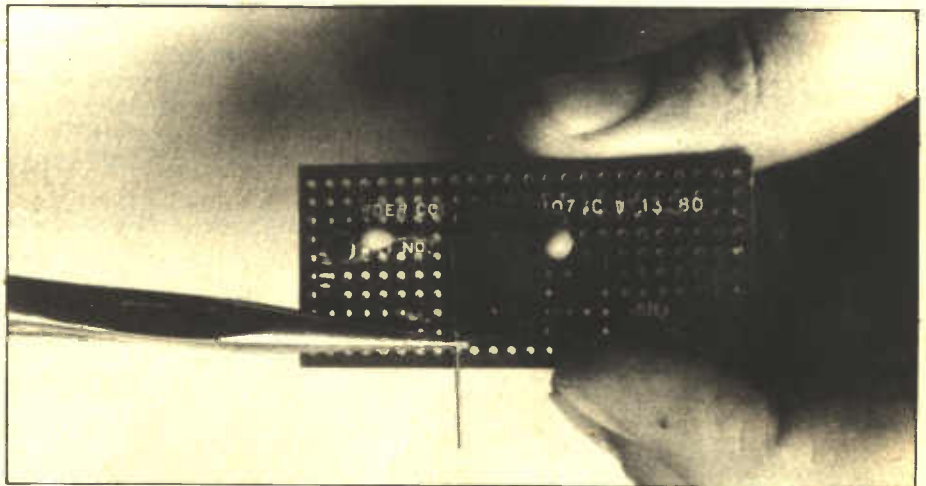

Assembling a circuit on matrix board.



Using the special tool to cut Veroboard tracks. A drill bit is as useful

Printed Circuits

Printed circuit boards simplify electronic circuit building enormously.

The board material is made of phenolic resin or glass fibre with a thin copper sheet bonded to (generally) one face. Intercomponent wiring is formed by etching away the unwanted copper — so that only the tracks and components mounting pads remain.

Holes are drilled for the components which are then inserted through from the non-copper side and their leads soldered directly to the copper pads. Printed circuit boards have a number of significant advantages over other methods of construction. The biggest is that mistakes are less likely to occur. Most of the wir-

ing is right there, etched onto the board, and the drilled pattern is such that in many instances components will only fit the right way round. The finished article looks professional — it is how most professional equipment is made.

The disadvantages are that printed circuit boards are more expensive than other methods; there is also less personal involvement.

Most component suppliers stock PCB material for those who wish to make their own. It is not that difficult but may be messy and even dangerous, because of the powerful chemical used to etch away the unwanted copper. A complete description of how to make PCBs is beyond the scope of this article; a detail-

ed description of the method, using a sealed etch kit, appeared in the February issue of *Hobby Electronics*. Pre-etched and drilled PCBs, ready for assembly, are available for most HE projects from our PCB Service.

Soldering

Good soldering is vital — most of the problems that beginners have with their first projects are due to poor joints. The following hints will aid you to become adept at soldering.

- Purchase a good quality iron with a rating between 15 and 25 watts.
- Use only resin-cored solder (60/40 tin-lead content). Do not use acid flux.
- A new, or worn, iron will need tinning. To do this let the iron get quite hot and file the tip smooth to expose fresh clean copper. Quickly, before the copper has time to discolour, apply resin-cored solder — it should flow all over the tip forming a shiny coating.
- Keep your soldering iron clean. Wipe it frequently with a damp cloth or sponge.
- Make sure the connection to be soldered is clean. Wax, frayed insulation and other foreign substances will result in inferior joints.
- With older components, or copper wire, it will be necessary to clean and tin the individual components before soldering them together.
- Attach the wires to be soldered. Do not make more than a half turn in a lead to be soldered — twisting makes subsequent removal difficult.
- Heat the connection with the iron and apply solder to the joint.
- Keep the iron on the point until the solder just commences to flow on the connection. Too little heat results in a high-resistance joint (known as a dry joint). Too much causes component damage and evaporates the tin component, again causing a poor joint. This step requires practice.
- Let the solder harden before moving the connection. Then check for a smooth bright joint. A joint that has been moved will have a crystalline appearance, may have a high resistance and will fracture easily.

Good soldering is a matter of practice. If you follow the above hints, it will be only a matter of time till you are making professional joints.

Finding Your Way

Most beginners have little trouble identifying components after a little experience, but remembering which way around they go can often prove somewhat confusing! Here's how to avoid the pitfalls and assemble projects knowing you've put the components in correctly and how to make simple substitutions.

Resistors

Resistors are fairly straightforward components. If you see the value and wattage specified for a project, there's little that can go wrong. A colour code chart is a handy guide if you are not completely

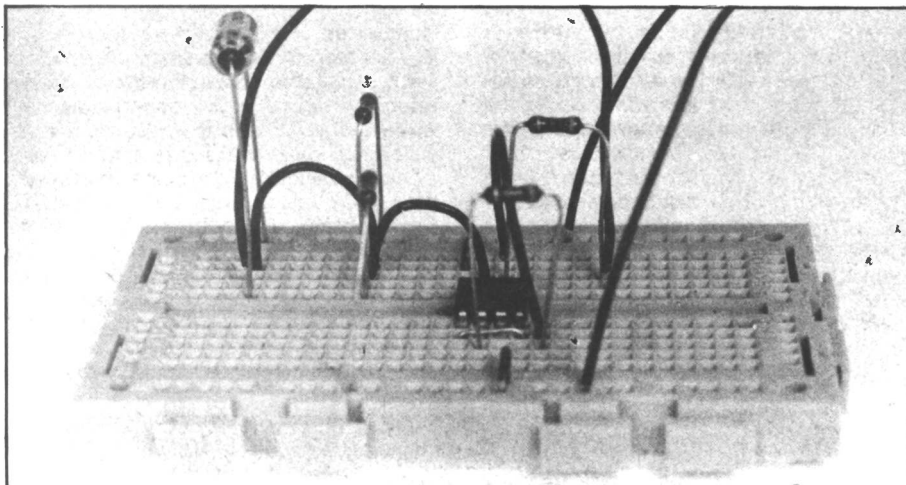

A modern 'breadboard' block — useful for prototyping a circuit but not for permanent use!

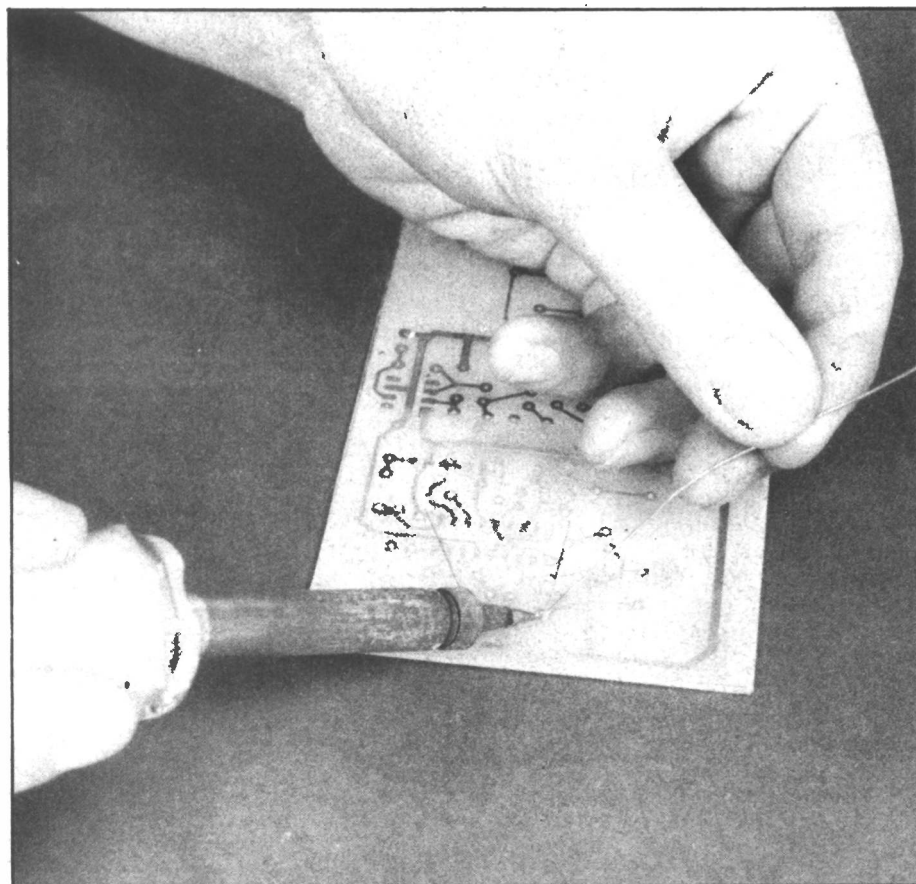

Soldering components onto a printed circuit board.

Feature

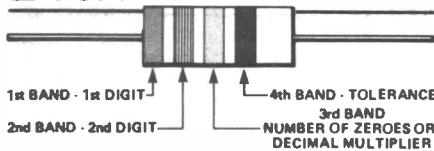

STANDARD RESISTOR COLOUR CODE			
COLOUR	DIGIT VALUE	MULTIPLIER (No. OF ZEROES)	TOLERANCE +%
BLACK	0	1	
BROWN	1	10	1
RED	2	10 ² or 100	2
ORANGE	3	10 ³ or 1k	
YELLOW	4	10 ⁴ or 10k	
GREEN	5	10 ⁵ or 100k	
BLUE	6	10 ⁶ or 1M	
VIOLET	7	10 ⁷ or 10M	
GREY	8	10 ⁸ or 100M	
WHITE	9	10 ⁹ or 1000M	
GOLD	-	0.1 or 10 ⁻¹	5
SILVER	-	0.01 or 10 ⁻²	10
NONE	-	-----	20

HIGH STABILITY (GRADE 1) RESISTORS ARE DISTINGUISHED BY A SALMON-PINK FIFTH RING OR BODY COLOUR

Reading resistance values from a colour-code chart.

familiar with how to read the value from the coloured bands painted on the body of the component.

Resistors are not 'polarised' — that is, it doesn't matter which way round you put them in.

They can be damaged by clumsy handling. Don't bend the leads too near the body of the component, this can fracture the end or the main body — the lead may even come right off. Don't apply excessive heat to the leads when soldering or hold the iron to the joint for too long. It is sufficient just to have the solder flow properly to make a good joint — a 'little extra' may do more harm than good.

In many instances the exact value of a resistor in a circuit is not too important and you can substitute a resistor one value up or one value down from that specified without causing any great change in a circuit's operating conditions. For example; either a 2k7 or a 3k9 resistor may be substituted where a 3k3 value is specified. Don't do this with high wattage resistors or high stability resistors (1% or 2%). A resistor having a smaller tolerance rating may always replace one of a greater tolerance rating of the same value. For example: a 4k7, 10% resistor may be replaced by a 4k7, 5% type.

Similarly, half-watt resistors may be substituted for quarter-watt resistors, provided they physically fit.

Potentiometers

These are simply adjustable resistors. Commonly, they consist of a resistance 'track' with a moveable 'wiper' connection that can be varied from one end of the resistance track to the other. Thus, they have three terminals.

This is where most newcomers come unstuck. The one in the middle is always connected to the wiper (shown as an arrow on the circuit symbol). This leaves the other two connections to sort out! On a rotary pot, with the shaft pointing at you and the terminals pointing at your feet, when the shaft is rotated clockwise (normal direction for 'up' or 'increase' — whatever the control is doing) the wiper

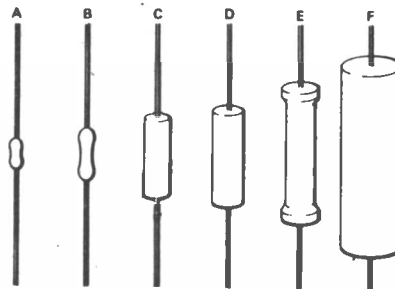

The characteristics of some common resistors.

will be approaching the right hand terminal. If it's a volume control, that'll be maximum volume and therefore the maximum signal point should connect to the right hand terminal. Got it?

Even if you don't get it right in your project, it's easy to correct — simply reverse the connections to the two outer terminals!

The value and 'law' of the potentiometer required for a circuit will be specified with the project. It is not a good idea to substitute. The 'law' of the potentiometer simply refers to the way in which the resistance varies as you move the wiper. The two most common forms are 'linear' and 'logarithmic'. A linear law (or 'curve') pot changes its resistance in a manner directly proportional to the amount the wiper has been moved, whereas logarithmic (or log) law pot varies resistance logarithmically as the wiper is moved linearly.

Log pots are predominantly used as volume controls. Linear pots are used for current or voltage control in circuits. A linear pot will be marked 'A', while a log pot will be marked 'C'.

Capacitors

Capacitors come in a wide variety of shapes, and sizes, types and ratings. The important thing to remember is that there are polarised and non-polarised types. Electrolytic and tantalum capacitors are polarised and you must take care which way round they are connected in a circuit. All the others are non-polarised. Of the latter, we mainly specify polyester and ceramic types.

SIZE	TYPE	WATTAGE RATING			LENGTH	DIA
		@40°C	@25°C			
A	CARBON FILM		0.05		4mm	1.5mm
B	COMPOSITION		0.25		6.5mm	2.3mm
	CARBON FILM		0.25		7mm	2.3mm
C	METAL FILM		0.25		7mm	2.5mm
	METAL OXIDE		0.125/0.25		7.2mm	2.5mm
D	COMPOSITION	0.5	0.5		10mm	3.5mm
	CARBON FILM	0.35	0.33		8mm	3mm
E	COMPOSITION	0.5	0.2		10.3mm	4.3mm
	CARBON FILM	0.35	0.25		11.5mm	4.1mm
F	COMPOSITION	0.35	0.2		12.7mm	5.3mm
	CARBON FILM	0.5	0.25		11mm	4mm
E	METAL FILM		1.0		12mm	5.5mm
	METAL OXIDE		0.25/0.5		11.2mm	4.2mm
F	COMPOSITION	0.75	0.35		17.8mm	4.1mm
	CARBON FILM	2.0	1.0		14mm	4.8mm
F	COMPOSITION		1.0		30mm	7.8mm
	CARBON FILM		4.0		24mm	8mm

These are the most common. They may be inserted either way round.

A polarised capacitor always has some marking to indicate which lead is which. Many are made with a black stripe adjacent to the negative lead. Some have a '+' and a '-' sign near the respective leads. Always check that you have inserted or connected polarised capacitors the right way round. They won't work otherwise — and that's about the worst that will happen in a battery-operated circuit. A wrongly-connected electrolytic in a mains-operated circuit (even at low voltages) may very well explode! Messy... worse if you have your face nearby when it happens.

In general, capacitor values should be adhered to; substitution is not recommended unless you are very familiar with the way a circuit works and the role of the particular capacitor. Voltage rating is important, particularly with electrolytics and tantalums. Never use a capacitor rated at a lower voltage than specified. You can go upwards, though. For example; if a project calls for a 10 uF, 16 V type then a 25 V rated capacitor of the same value may be substituted.

Diodes

Diodes are polarised components. There is always a right way and a wrong way round. If you use it the wrong way round you may well destroy the device. Fortunately, they always have some sort of mark identifying the cathode end. It may be a band around that end of the body ad-

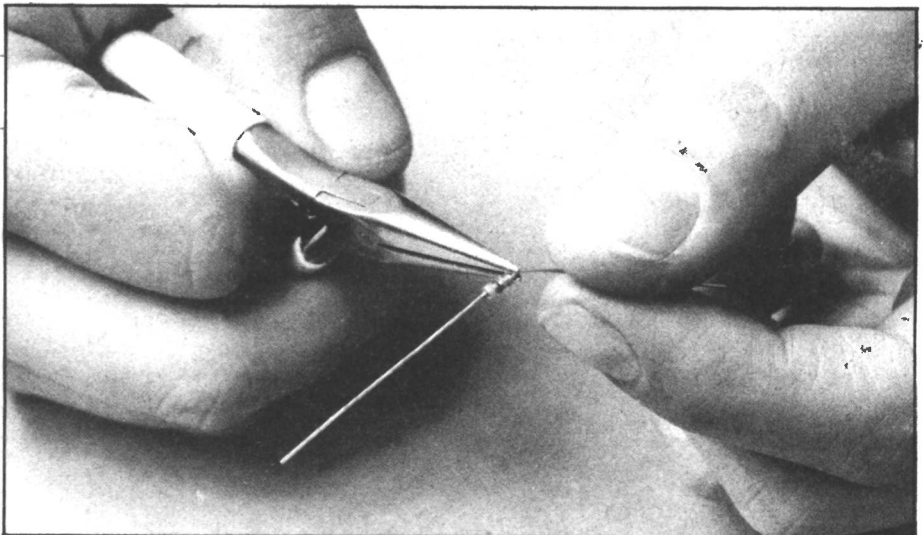

Bend it but don't break it!

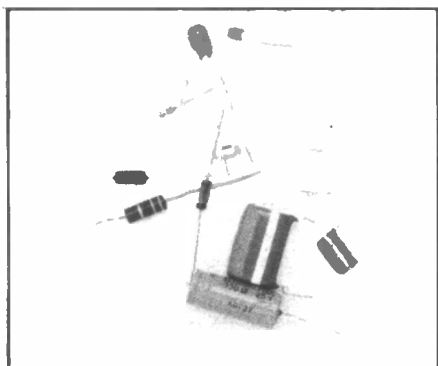

A selection of components.

Adjacent to the cathode lead, or the body maybe chamfered at the end. We generally indicate on the construction diagram with our projects the polarity of any diodes. Alternatively, a small diagram may accompany either the circuit or the construction diagram showing diode body shapes and markings and how these relate to the diode symbol.

Any substitutes will usually be mentioned in the parts list accompanying a project or in the Buylines page. However, as diodes are generally rated in terms of voltage (maximum reverse voltage, not conducting), it is always safe to substitute a diode with one having a higher rating than specified — never the other way around, and never substitute a silicon signal diode for a germanium signal diode.

Transistors

For most purposes a transistor is either the right one or it's not. It is rarely possible to substitute another type which some one may recommend as 'just the same', though, substitutes or equivalents may be mentioned in the parts list, or in Buylines.

A transistor can only be connected one way round — the right way! The construction diagram or component overlay with a project will indicate which way the pins are to be inserted in a PCB. Connected incorrectly, there's a good

chance you'll destroy the device when first switched on.

Incredibly, not all transistors of the same type number have the same pin connection. Sometimes a manufacturer may vary the pin connections of a type at different times! Transistor pin connections and orientations are given in the construction diagram or component overlay.

Transistors (and diodes) may be damaged by excessive heat when soldering. Although, these days, it is no longer really necessary to use a 'heat-sink' (pliers or a special tool) when soldering small transistor leads — as has been often recommended in the past — a little care and speed when soldering is a good idea. Just get the solder flowing neatly over the joint, 'wetting' it properly, and things should be fine. Don't overdo it.

Integrated Circuits

Integrated circuits must be soldered in the right way round. They always have some identification — usually in the form of a small scallop in one end of the case or a small indentation adjacent to a pin at one end (this is pin 1). They should be inserted exactly as shown in our overlay drawings. Do make sure they are the right way round before soldering because once in they're very hard to get out again.

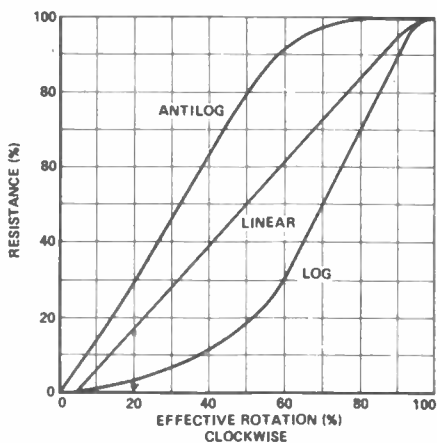

Linear and log are the two most common potentiometer 'laws'. Antilog, though useful in some cases, is not often found in our circuits.

COLOUR CODE FOR TANTALUM CAPACITORS			
COLOUR	VOLTAGE	TENS & UNITS	MULTIPLIER
BROWN	—	1	x10
RED	—	2	x100
ORANGE	35 V	3	—
YELLOW	6V3	4	—
GREEN	18 V	5	—
BLUE	20 V	6	—
VIOLET	—	7	—
GREY	25 V	8	x10n
WHITE	3 V	9	x100n
BLACK	10 V	0	x1u
PINK	35 V	—	—

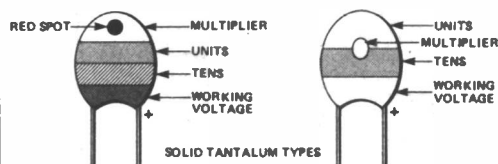

EXAMPLE:
UNITS = BLUE = 6
TENS = GREY = 8
MULT. = WHITE = x100n
BODY = GREY = 25 V
6u8/25 V

WHEN VIEWED WITH SPOT SHOWING POSITIVE LEAD IS AS MARKED
COMMON COLOUR CODE FOR TANTALUM CAPACITORS

Interpreting the colour-code of tantalum capacitors.

Because of this it's well worth while spending a bit more on IC sockets. These are plastic sockets which have identical pin connections to the IC and into which, in turn, the IC is plugged. It's not always worthwhile because some ICs are so cheap that the socket costs more than the IC, but they are worth considering for use with expensive devices.

Like transistors, most ICs are stronger than they look, but don't overdo the soldering — it is very easy to get a tiny solder 'bridge' between the pins.

CMOS ICs are a bit different. These are very tough — once soldered in — but are a bit fragile until then.

They should be handled with care as they are easily damaged by quite small static charges. CMOS ICs are supplied inserted in a conductive plastic foam or foil-wrapped styrene block. Remove them carefully. Take care to pick them up with your thumb and forefinger grasping the ends of the package, not touching the pins. Make sure you have them correctly oriented before inserting them into a PCB.

When soldering CMOS ICs use an iron having an earthed tip and barrel. If you're unsure about this, use a clip lead to connect the iron's barrel to the negative supply rail on the board. These measures will ensure you don't 'blow' CMOS ICs from either static or leakage currents.

HE

COLOUR	1st	2nd	Multipl. Factor	Tolerance	Voltage
BLACK	0	1	±20%		
BROWN	1	1	10		250 V
RED	2	2	10 ²		
ORANGE	3	3	10 ³		
YELLOW	4	4	10 ⁴		400 V
GREEN	5	5	10 ⁵		
BLUE	6	6			630 V
VIOLET	7	7			
GREY	8	8			
WHITE	9	9	±10%		

The values of polycarbonate and polyester capacitors can be read from the chart.

Feature

Always leave CMOS ICs until last when assembling a project. Once removed from the packaging, insert them quickly and first solder those pins connected to the power rails — generally pins 7 and 14 for most 14-pin packages, but check with the diagram beforehand. This ensures any static charges are dissipated by the other components.

LEDs

Light emitting diodes are very handy little solid-state indicators and for that reason are widely used. Common colours are red, yellow and green although orange is available and we believe blue will be available shortly. Some are clear but glow red.

Being diodes they are polarised. They are not usually damaged if incorrectly connected — but they won't work. The polarity of the leads may be indicated in several ways. The most common is to have a flat section on the case adjacent to the cathode lead. Some have one lead shorter than the other — the cathode lead being shorter.

LEDs will last forever. We don't know of any that have worn out yet! They must be used at the correct current rating and if this is exceeded . . . poof! You will generally find a resistor connected in series with a LED in a circuit. Don't ever test a LED by connecting it across a battery. Best way to test one is to wire it into a circuit known to work.

LED connection diagrams generally accompany the circuit or component overlay with our projects.

Loudspeakers

Small speakers are a common item in simple projects. In general, the unit chosen is not critical.

They are made in varying levels of quality, size and impedance. Quality is unimportant. Frankly we'd go for the cheapest you can find! Impedance is specified in each project parts list.

Speakers are not polarised — you may connect them either way round.

If the speaker doesn't make a noise when the project seems to work otherwise it's fairly easy to check if you've got a faulty one. Check by touching the leads momentarily across a 1 1/2 volt cell — not a nine volt battery. If the speaker is working it produces a loud click. Don't leave the cell connected for more than a fraction of a second or you'll end up knowing that the speaker was working but isn't any longer!

Conclusion

As a last caution, make sure you connect the battery or power supply to your project correctly, otherwise you may never know whether it worked or not! Most of our battery-operated projects use 9 V batteries. The battery clips used with these have a red and black lead for connections. The red one is the positive lead, the black, negative. This is the colour coding for supply connections. Keep it in mind.

That just about wraps up the majority of things you should learn and keep in mind when it comes to constructing basic projects, and you will learn a whole host of other interesting and useful

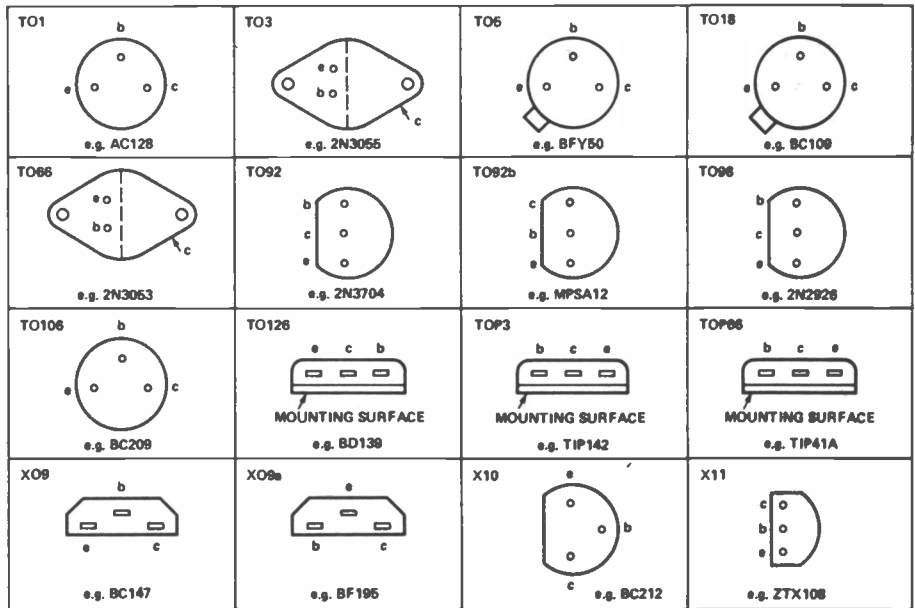

The pin configurations of some often-used transistors.

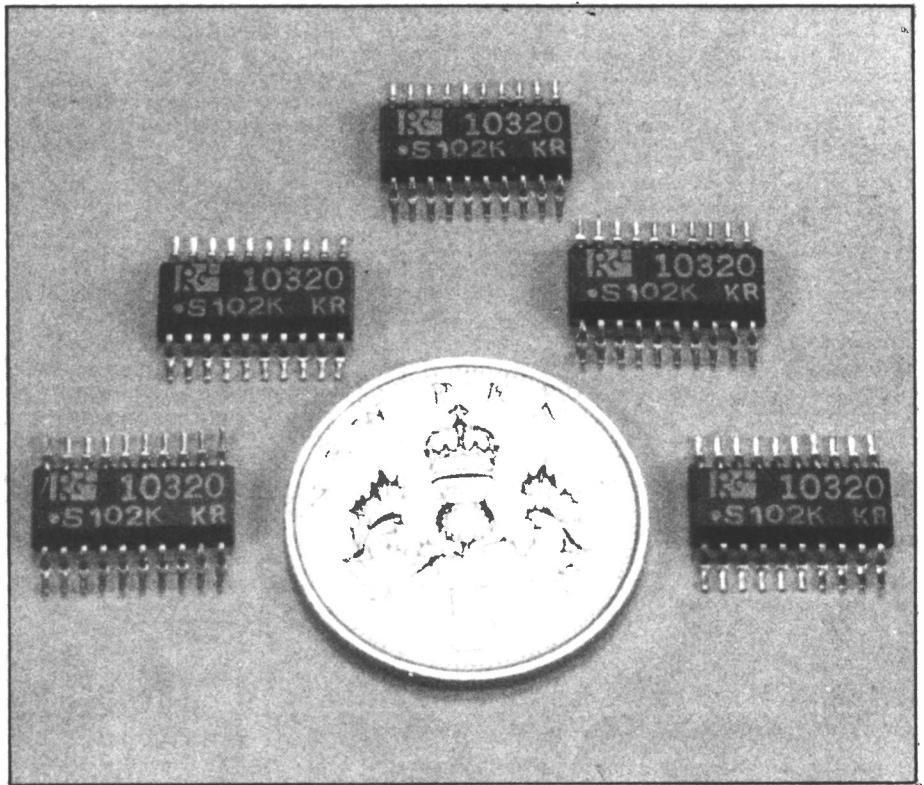

ICs continue to become smaller while packing in more functions.

things as you progress. The best teacher is experience, as they say in the classics!

Light Blue Touchpaper

Electronic circuits are not fireworks but they sometimes share a tendency to do the unexpected — or simply not to perform as expected. If a circuit doesn't work, the most probable causes of the trouble are:

(a) Components inserted the wrong way round or in the wrong place.

(b) Faulty soldering.
(c) Solder bridges between tracks.
(d) Faulty components.

These are simply the *most* probable causes of a project not working — there are many others which are more difficult to detect. Further articles in this magazine will deal with some of the techniques used in fault-finding. These are applicable both to previously built projects and to brand new circuits, hot off the breadboard. So, if all else fails — keep reading *Hobby Electronics!*

HE

Rapid Electronics

Tel: 0206 36412
Hill Farm Industrial Estate
Boxted, Colchester
Essex CO4 5RD



HARDWARE	
PP3 battery clips	6p
Red or black crocodile clips	6p
Black pointer control knob	15p
Pi Ultrasonic transducers	350p
*6V Electronic buzzer	80p
*12V Electronic buzzer	85p
*P82720 Piezo transducer	75p
*64mm 64 ohm speaker	70p
*64mm 8 ohm speaker	70p
20mm panel fuseholder	25p

CABLES	
20 metre pack single core connecting cable ten different colours	65p
Speaker cable	10p/m
Standard screened	16p/m
Twin screened	24p/m
2.5A 3 core mains	23p/m
10 way rainbow ribbon	65p/m
20 way rainbow ribbon	120p/m

PANEL METERS	
Size 60 x 46 x 35mm	
0-50uA	0-500mA
0-100uA	0-1A
0-500uA	0-50V AC
	VU
0-10mA	0-300V AC
0-50mA	0-25V
0-100mA	0-30V DC
	495p each

TRANSISTORS					
BC108	10 BC108	25 TIP29C	60 ZTX300	14 *2N3702	6
BC109	10 BC109	25 TIP29A	45 ZTX301	14 2N3703	9
BC121	10 BC121	25 TIP30B	45 ZTX302	15 *2N3704	6
BC122	10 BC122	25 TIP30C	45 ZTX341	17 2N3705	9
BC123	10 BC123	25 TIP31A	45 ZTX343	30 2N3706	9
BC124	10 BC124	25 TIP31C	55 ZTX500	15 2N3707	10
BC125	10 BC125	25 TIP32A	45 ZTX501	15 2N3708	10
BC126	10 BC126	25 TIP32C	45 ZTX502	16 2N3709	10
BC127	10 BC127	25 TIP33A	55 ZTX503	18 2N3770	10
BC128	10 BC128	25 TIP33C	75 ZTX504	25 2N3771	18
BC129	10 BC129	25 TIP34A	60 2N697	20 *2N3819	18
BC130	10 BC130	25 TIP34C	85 2N698	40 2N3820	40
BC131	10 BC131	25 TIP35A	180 2N706A	20 2N3823	65
BC132	10 BC132	25 TIP35C	180 2N708	20 2N3825	65
BC133	10 BC133	25 TIP36A	170 2N918	35 2N3903	10
BC134	10 BC134	25 TIP36C	195 2N1132	22 2N3904	10
BC135	10 BC135	25 TIP37A	60 2N1613	30 2N3905	6
BC136	10 BC136	25 TIP42A	60 2N2218A	45 2N3906	10
BC137	10 BC137	25 TIP42B	90 2N2219A	25 2N4037	45
BC138	10 BC138	25 TIP42C	90 2N2221A	25 2N4038	45
BC139	10 BC139	25 TIP42D	90 2N2222A	20 2N4060	10
BC140	10 BC140	25 TIP42E	120 2N2223A	25 2N4061	10
BC141	10 BC141	25 TIP42F	120 2N2224A	16 2N4062	10
BC142	10 BC142	25 TIP42G	120 2N2225A	25 2N4063	36
BC143	10 BC143	25 TIP42H	120 2N2226A	46 2N4064	36
BC144	10 BC144	25 TIP42I	120 2N2227A	25 2N4065	36
BC145	10 BC145	25 TIP42J	120 2N2228A	46 2N4066	36
BC146	10 BC146	25 TIP42K	120 2N2229A	25 2N4067	36
BC147	10 BC147	25 TIP42L	120 2N2230A	25 2N4068	36
BC148	10 BC148	25 TIP42M	120 2N2231A	25 2N4069	36
BC149	10 BC149	25 TIP42N	120 2N2232A	25 2N4070	36
BC150	10 BC150	25 TIP42O	120 2N2233A	25 2N4071	36
BC151	10 BC151	25 TIP42P	120 2N2234A	25 2N4072	36
BC152	10 BC152	25 TIP42Q	120 2N2235A	25 2N4073	36
BC153	10 BC153	25 TIP42R	120 2N2236A	25 2N4074	36
BC154	10 BC154	25 TIP42S	120 2N2237A	25 2N4075	36
BC155	10 BC155	25 TIP42T	120 2N2238A	25 2N4076	36
BC156	10 BC156	25 TIP42U	120 2N2239A	25 2N4077	36
BC157	10 BC157	25 TIP42V	120 2N2240A	25 2N4078	36
BC158	10 BC158	25 TIP42W	120 2N2241A	25 2N4079	36
BC159	10 BC159	25 TIP42X	120 2N2242A	25 2N4080	36
BC160	10 BC160	25 TIP42Y	120 2N2243A	25 2N4081	36
BC161	10 BC161	25 TIP42Z	120 2N2244A	25 2N4082	36
BC162	10 BC162	25 TIP42AA	120 2N2245A	25 2N4083	36
BC163	10 BC163	25 TIP42AB	120 2N2246A	25 2N4084	36
BC164	10 BC164	25 TIP42AC	120 2N2247A	25 2N4085	36
BC165	10 BC165	25 TIP42AD	120 2N2248A	25 2N4086	36
BC166	10 BC166	25 TIP42AE	120 2N2249A	25 2N4087	36
BC167	10 BC167	25 TIP42AF	120 2N2250A	25 2N4088	36
BC168	10 BC168	25 TIP42AG	120 2N2251A	25 2N4089	36
BC169	10 BC169	25 TIP42AH	120 2N2252A	25 2N4090	36
BC170	10 BC170	25 TIP42AI	120 2N2253A	25 2N4091	36
BC171	10 BC171	25 TIP42AJ	120 2N2254A	25 2N4092	36
BC172	10 BC172	25 TIP42AK	120 2N2255A	25 2N4093	36
BC173	10 BC173	25 TIP42AL	120 2N2256A	25 2N4094	36
BC174	10 BC174	25 TIP42AM	120 2N2257A	25 2N4095	36
BC175	10 BC175	25 TIP42AN	120 2N2258A	25 2N4096	36
BC176	10 BC176	25 TIP42AO	120 2N2259A	25 2N4097	36
BC177	10 BC177	25 TIP42AP	120 2N2260A	25 2N4098	36
BC178	10 BC178	25 TIP42AQ	120 2N2261A	25 2N4099	36
BC179	10 BC179	25 TIP42AR	120 2N2262A	25 2N4100	36
BC180	10 BC180	25 TIP42AS	120 2N2263A	25 2N4101	36
BC181	10 BC181	25 TIP42AT	120 2N2264A	25 2N4102	36
BC182	10 BC182	25 TIP42AU	120 2N2265A	25 2N4103	36
BC183	10 BC183	25 TIP42AV	120 2N2266A	25 2N4104	36
BC184	10 BC184	25 TIP42AW	120 2N2267A	25 2N4105	36
BC185	10 BC185	25 TIP42AX	120 2N2268A	25 2N4106	36
BC186	10 BC186	25 TIP42AY	120 2N2269A	25 2N4107	36
BC187	10 BC187	25 TIP42AZ	120 2N2270A	25 2N4108	36
BC188	10 BC188	25 TIP42BA	120 2N2271A	25 2N4109	36
BC189	10 BC189	25 TIP42BB	120 2N2272A	25 2N4110	36
BC190	10 BC190	25 TIP42BC	120 2N2273A	25 2N4111	36
BC191	10 BC191	25 TIP42BD	120 2N2274A	25 2N4112	36
BC192	10 BC192	25 TIP42BE	120 2N2275A	25 2N4113	36
BC193	10 BC193	25 TIP42BF	120 2N2276A	25 2N4114	36
BC194	10 BC194	25 TIP42BG	120 2N2277A	25 2N4115	36
BC195	10 BC195	25 TIP42BH	120 2N2278A	25 2N4116	36
BC196	10 BC196	25 TIP42BI	120 2N2279A	25 2N4117	36
BC197	10 BC197	25 TIP42BJ	120 2N2280A	25 2N4118	36
BC198	10 BC198	25 TIP42BK	120 2N2281A	25 2N4119	36
BC199	10 BC199	25 TIP42BL	120 2N2282A	25 2N4120	36
BC200	10 BC200	25 TIP42BM	120 2N2283A	25 2N4121	36
BC201	10 BC201	25 TIP42BN	120 2N2284A	25 2N4122	36
BC202	10 BC202	25 TIP42BO	120 2N2285A	25 2N4123	36
BC203	10 BC203	25 TIP42BP	120 2N2286A	25 2N4124	36
BC204	10 BC204	25 TIP42BQ	120 2N2287A	25 2N4125	36
BC205	10 BC205	25 TIP42BR	120 2N2288A	25 2N4126	36
BC206	10 BC206	25 TIP42BS	120 2N2289A	25 2N4127	36
BC207	10 BC207	25 TIP42BT	120 2N2290A	25 2N4128	36
BC208	10 BC208	25 TIP42BU	120 2N2291A	25 2N4129	36
BC209	10 BC209	25 TIP42BV	120 2N2292A	25 2N4130	36
BC210	10 BC210	25 TIP42BW	120 2N2293A	25 2N4131	36
BC211	10 BC211	25 TIP42BX	120 2N2294A	25 2N4132	36
BC212	10 BC212	25 TIP42BY	120 2N2295A	25 2N4133	36
BC213	10 BC213	25 TIP42BZ	120 2N2296A	25 2N4134	36
BC214	10 BC214	25 TIP42CA	120 2N2297A	25 2N4135	36
BC215	10 BC215	25 TIP42CB	120 2N2298A	25 2N4136	36
BC216	10 BC216	25 TIP42CC	120 2N2299A	25 2N4137	36
BC217	10 BC217	25 TIP42CD	120 2N2300A	25 2N4138	36
BC218	10 BC218	25 TIP42CE	120 2N2301A	25 2N4139	36
BC219	10 BC219	25 TIP42CF	120 2N2302A	25 2N4140	36
BC220	10 BC220	25 TIP42CG	120 2N2303A	25 2N4141	36
BC221	10 BC221	25 TIP42CH	120 2N2304A	25 2N4142	36
BC222	10 BC222	25 TIP42CI	120 2N2305A	25 2N4143	36
BC223	10 BC223	25 TIP42CJ	120 2N2306A	25 2N4144	36
BC224	10 BC224	25 TIP42CK	120 2N2307A	25 2N4145	36
BC225	10 BC225	25 TIP42CL	120 2N2308A	25 2N4146	36
BC226	10 BC226	25 TIP42CM	120 2N2309A	25 2N4147	36
BC227	10 BC227	25 TIP42CN	120 2N2310A	25 2N4148	36
BC228	10 BC228	25 TIP42CO	120 2N2311A	25 2N4149	36
BC229	10 BC229	25 TIP42CP	120 2N2312A	25 2N4150	36
BC230	10 BC230	25 TIP42CQ	120 2N2313A	25 2N4151	36
BC231	10 BC231	25 TIP42CR	120 2N2314A	25 2N4152	36
BC232	10 BC232	25 TIP42CS	120 2N2315A	25 2N4153	36
BC233	10 BC233	25 TIP42CT	120 2N2316A	25 2N4154	36
BC234	10 BC234	25 TIP42CU	120 2N2317A	25 2N4155	36
BC235	10 BC235	25 TIP42CV	120 2N2318A	25 2N4156	36
BC236	10 BC236	25 TIP42CW	120 2N2319A	25 2N4157	36
BC237	10 BC237	25 TIP42CX	120 2N2320A	25 2N4158	36
BC238	10 BC238	25 TIP42CY	120 2N2321A	25 2N4159	36
BC239	10 BC239	25 TIP42CZ	120 2N2322A	25 2N4160	36
BC240	10 BC240	25 TIP42DA	120 2N2323A	25 2N4161	36
BC241	10 BC241	25 TIP42DB	120 2N2324A	25 2N4162	36
BC242	10 BC242	25 TIP42DC	120 2N2325A	25 2N4163	36
BC243	10 BC243	25 TIP42DD	120 2N2326A	25 2N4164	36
BC244	10 BC244	25 TIP42DE	120 2N2327A	25 2N4165	36
BC245	10 BC245	25 TIP42DE	120 2N2328A	25 2N4166	36
BC246	10 BC246	25 TIP42DF	120 2N2329A	25 2N4167	36
BC247	10 BC247	25 TIP42DG	120 2N2330A	25 2N4168	36
BC248	10 BC248	25 TIP42DH	120 2N2331A	25 2N4169	36
BC249	10 BC249	25 TIP42DI	120 2N2332A	25 2N4170	36
BC250	10 BC250	25 TIP42DJ	120 2N2333A	25 2N4171	36
BC251	10 BC251	25 TIP42DK	120 2N2334A	25 2N4172	36
BC252	10 BC252	25 TIP42DL	120 2N2335A	25 2N4173	36
BC253	10 BC253	25 TIP42DM	120 2N2336A	25 2N4174	36
BC254	10 BC254	25 TIP42DN	120 2N2337A	25 2N4175	36
BC255	10 BC255	25 TIP42DO	120 2N2338A	25 2N4176	36
BC256	10 BC256	25 TIP42DP	120 2N2339A	25 2N4177	36
BC257	10 BC257	25 TIP42DQ	120 2N2340A	25 2N4178	36
BC258	10 BC258	25 TIP42DR	120 2N2341A	25 2N4179	36
BC259	10 BC259	25 TIP42DS	120 2N2342A	25 2N4180	36
BC260	10 BC260	25 TIP42DT	120 2N2343A	25 2N4181	36
BC261	10 BC261	25 TIP42DU	120 2N2344A	25 2N4182	36
BC262	10 BC262	25 TIP42DV	120 2N2345A	25 2N4183	36
BC263	10 BC263	25 TIP42DW	120 2N2346A	25 2N4184	36
BC264	10 BC264	25 TIP42DX	120 2N2347A	25 2N4185	36
BC265	10 BC265	25 TIP42DY	120 2N2348A	25 2N4186	36
BC266	10 BC266	25 TIP42DZ	120 2N2349A	25 2N4187	36
BC267	10 BC267	25 TIP42EA	120 2N2350A	25 2N4188	36
BC268	10 BC268	25 TIP42EB	120 2N2351A	25 2N4189	36
BC269	10 BC269	25 TIP42EC	120 2N2352A	25 2N4190	36
BC270	10 BC270	25 TIP42ED	120 2N2353A	25 2N4191	36
BC271	10 BC271	25 TIP42EE	120 2N2354A	25 2N4192	36
BC272	10 BC272	25 TIP42EF	120 2N2355A	25 2N4193	36
BC273	10 BC273	25 TIP42EG	120 2N2356A	25 2N4194	36
BC274	10 BC274	25 TIP42EH	120 2N2357A	25 2N4195	36
BC275	10 BC275	25 TIP42EI	120 2N2358A	25 2N4196	36
BC276	10 BC276	25 TIP42EJ	120 2N2359A	25 2N4197	36
BC277	10 BC277				

BUY LINES

LAST MONTH we presented several projects that were — or could be — powered from solar cells, but we found considerable difficulty in locating inexpensive sources for them.

Now we have found a reasonably inexpensive source of solar cells — somewhat after the event, but "better late than never". The company concerned is **Rheinbergs Sciences Ltd**, Sovereign Way, Tonbridge, Kent TN9 1RN. They do a bag of mixed solar cell 'chips', of varying size, producing between one and six milliamps at 0V45 under load. The bag contains 50 chips and costs £10.95, all inclusive.

Digital Millivoltmeter

The 1% resistors (vital for accuracy) are available from several of the larger suppliers, but for a good bargain, try **Ace Mailtronix Ltd.**, at 3A Commercial Street, Batley, West Yorks WF17 5HJ. **ElectroValue** are a good company to contact for the cermet presets — quite hard to find — and the 20-way ribbon or jumper cable. They can also supply the case used for our prototype. The M73 (± 1) and DL707 displays come from **Watford**, along with the 7107

digital panel meter IC. The cost of components (excluding case and PCBs) will be about £20.

Audio Analyser

Naturally, with a project of this kind, there are quite a few components you may have problems obtaining. The 430R resistor is quite critical — 470R or 390R won't do — but they are not too hard to find; try **Ace Mailtronix**, who can also supply the LF353 dual BIFET op-amp. The only supplier we could find for the 1u0 metallised polycarbonate capacitor was **Maplin** (PO Box 3., Rayleigh, Essex SS6 8LR) and since they sell a cheap electret microphone (code YB33L) as well, it's worth contacting them.

The 220u 16V axial electrolytic capacitor is sold by **Watford**, who can also supply the TL064 as well as the CMOS ICs. For a suitable case, try writing to **Lightning Electronics** and, for the IC sockets, **Rapid** and **TK** are both very reasonable. The LEDs used on our prototype were from **Bi-Pak**, who do a bargain pack of these commonly used devices. Alternatively, and for that special touch, **Zaerix** will supply — to

Hobby readers only — 100 off quantities of their high intensity cylindrical LEDs at £12.30 plus VAT and postage. Their address is **Zaerix Electronics Ltd.**, Electron House, Cray Avenue, St. Mary Cray, Orpington, Kent BR5 3QJ.

The cost of the analyser will be between £45 and £65, depending on the case and LEDs you use.

MicroTrainer

Since this project requires specially programmed EPROMs and a high-quality double-sided, through-hole-plated PCB, we do not recommend that readers attempt to build it other than from the kit supplied by **Technomatic** (£68-94 inclusive). However, the PCB and EPROMs are available separately for £17.19 and £28.75 (plus £1 postage), respectively. One final point about the kit, it does NOT include the case featured on the cover of the June 82 issue of *Hobby*.

SWR Meter

Since the project uses very few parts, you shouldn't have problems getting hold of them. The 100uA meter and SO239 UHF sockets are available from **Rapid Electronics**, who have recently moved to new premises in Colchester. A good source for the enamelled copper wire is the **Scientific Wire Company** (PO Box 30, London E4). Total cost to build the meter; £10.

RELAY-A-QUIP 19 RACK MOUNTING CASE

Top, bottom and rear cover removable for access. Plates have heavy duty grey paint finish. Front panel is heavy gauge 3mm aluminium. Strong, screwed construction throughout — screws included. Heavy gauge chassis mounting plate is pre-drilled and has four mounting positions to choose from. Front panel is of brushed aluminium finish enhanced with heavy chromed handles.

Front Panel 480 x 150 mm
Rear Case 425 x 250 x 140 mm

£23.05
£19.50

TOP QUALITY

Or Free Standing

This is a professional rack mounting cabinet that will allow you to get your equipment off the bench. Rack mounting provides security for your equipment and easy access for maintenance. This Precision rack mounting cabinet has all of the features you would expect from a professional unit.

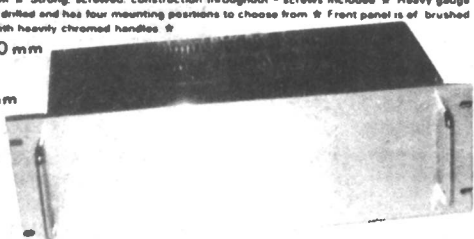

METAL CABINETS

These are beautifully manufactured cabinets with an aluminium base and 18 gauge steel covers. They come fitted with rubber feet (to please the wife!), louvers for ventilation and finished in an attractive two tone finish. They make excellent cabinets for power supplies, remote control units and many more projects.

A £1.70 ~~£2.12~~
B £2.55 ~~£3.20~~
C £3.04 ~~£3.80~~
D £4.08 ~~£5.00~~

a - 102(d) x 64(h) x 83(w)mm
b - 150(d) x 81(h) x 103(w)mm
c - 150(d) x 78(h) x 134(w)mm
d - 184(d) x 70(h) x 160(w)mm

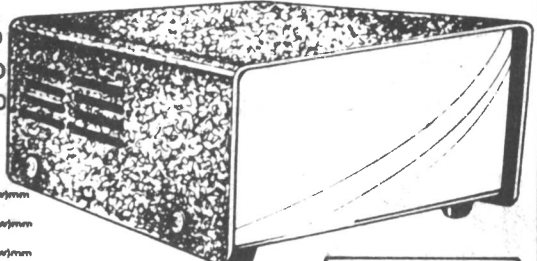

RELAY-A-QUIP

Z-BOX

high impact styrene
natural aluminium lid

a - 150(d) x 90(h) x 50(w)mm
b - 198(d) x 113(h) x 60(w)mm
c - 130(d) x 68(h) x 41(w)mm
d - 83(d) x 54(h) x 28(w)mm

A - £1.55
B - £2.05
C - £1.10
D - £0.80

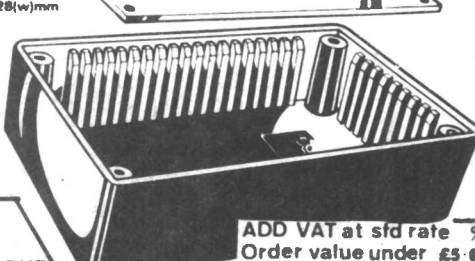

FREE!
NEW CATALOGUE

ADD VAT at std rate %
Order value under £5.00
Add 50p, P and Pkg

POWERSINK £1.35 ~~£1.70~~

drilled to accept two power transistors of most types including TO-3 TO-18 TO-220 TO-99 Size 75(h) x 102(w) x 25(d)mm Thermal resistance mounting surface to ambient -1°C/Watt (2.0h/sac air velocity) Mounting surface temperature rise above ambient 80°C @ 30W heat dissipation

Bridge Rectifier 1amp 50v W0.005 - 16-5p

SLIDE SWITCHES

1P2T	£0.10	4P4T PCB	0.45
2P2T	0.12	6P3T ALI KNOB	0.45
2P3T	0.19	1P2T Mom	0.20
4P2T PCB	0.28	ROCKER 6amp	
4P3T	0.35	250VAC	
2P2T	0.12	ON/OFF	0.24
1P4T	0.26	ON/ON	0.26
6P3T	0.42		

EXPORTS & TRADE ENQUIRIES ARE WELCOME.

TELEX 995801 GLOTLX-G
Quote ref R7



Access  EUROCARD  master charge 
THE INTERBANK CARD

Relay

4P 2T
(COIL)
12 VDC
185 OHM

SPECIAL OFFER
Relay+Base £2.95
Two for £5.00

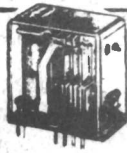
Contact details:
5amp at 28 VDC/115 VAC





DIODES

1N4148 - 2p
1N4001 - 3p
1N4002 - 3½p
1N4003 - 4½p
1N4004 - 5p

SEIKO 30w Soldering Iron £2.95

RELAY-A-QUIP PRODUCTS
Moat Lodge, Stock Chase,
Maldon, Essex, U.K. CM9 7AA.
Tel 0621-57242 & 58686 (24hour)



Clever Dick

After a month's absence, CD returns with his usual page of wit and wisdom.

Yes, I'm back . . . but did anybody even notice that I was away? Here we go again, another page another . . . well, let's not get into the sordid details. Ready then?

*Dear CD,
I have been reading HE for a year and I enjoy it apart from two things. Why have you stopped (in April '82 issue) printing the approximate cost of projects? This was very useful information.*

Also, why do you only rent binders to people like me who are kind, and who grovel, like me?

*T.L. Homer,
Stratford-upon-Avon,
Warwicks.*

No Bard, this . . . a mere thousand monkeys could produce a better letter. As to the project costs, due to circumstances beyond my control (someone forgot) projects costs did not appear, as you say. However, He Who Decides has assured me that the matter will be attended to. 'Nuff said?.

Your idea concerning the Rental of binders has a certain appeal . . .

Here's a slightly dated letter I found in my files (so you've been wondering what's happened to that letter you wrote six months ago, have you? Don't worry — I've still got it!)

*Dear CD,
Yours Sincerely,
A. Barnes,
Brentwood,
Essex.*

*PS I didn't have anything to say.
PPS Are you still doing that silly short-letter stuff? I was going to send a blank sheet of paper but then you wouldn't know where to send the binder.*

Since I'm still getting a selection of "that silly short-letter stuff", I thought I'd print this one to give me the opportunity of saying NO, I'M NOT.

When will you all realise that urgent, desperate pleas for help can only be answered quickly (and I don't mean instantly) if a stamped, self-addressed envelope is enclosed. I hope this gentleman had not been waiting too long . . .

*Dear Clever Dick,
I am writing to you in a state of desperation and this letter, I hope, will receive prompt attention, for which I will be very grateful.*

*What I would like to know is — where can I obtain a slider potentiometer of value 5MO, log scale?
M. McHugh,
Dublin.*

He's probably given up by now — but the answer is, you'll have to make one up by putting a fixed resistor in series with a high value pot. Potentiometers from Electrovalue are available up to 1MO and RadioOhm of East Grinstead can supply pots up to 2M2, log.

Please remember, if you would like an early reply, to send in an SAE next time you write. I don't have an unlimited budget for postage, you know (anything extra comes out of my salary, so you can calculate your chances . . .).

Our very clever design team are always getting suggestions for new projects — and, occasionally, an idea for modification for an old project. Here's one they've taken note of.

*Dear Brilliant Richard,
I have been reading Hobby Electronics for about two years now, and I think it is brilliant. I was scanning through my numerous back copies looking for something to build when I saw the 'Diana' Metal Detector.*

After carefully transferring the PCB foil pattern on to copper-clad board, I realised that the design did not make provision for headphones or a loudspeaker. Could you please send me a circuit diagram for an audio output that can be added to this project?

*S. Goddard,
Gwynedd,
North Wales.*

PS I am still at school but I have learnt a lot about electronics from both HE and ETI. I think that your staff all deserve medals for producing such high quality magazines.

If you're a regular reader, as you claim to be, you should know quite well that I don't send off circuits in the mail. However, you're in luck. In response to earlier requests, our design team has produced an audio output for the 'Diana' and I am reliably informed (an impeccable source) that it will appear shortly.

I approached the Editor with your idea for awards but he only suggested that if I wanted a medal I should join the Navy.

*Dear CD,
Would it be possible to have a project for a computer in HE, explaining it as you go along?
Yours very hopefully,
F. McDonald,
Dublin.*

*PS The ZX81 has only four ICs.
PPS This is my fourth letter — binder, please.
PPPS Please print this.*

Short and sweet, that's the way I like them. As a matter of fact it is quite possible to have a computer project in HE; we started on in June and it continues in this issue. This month, I believe, the component overlay and assembly instructions will be given. The design is rather advanced, but most readers will be able to learn from it how the various components of a microcomputer go together. In the case of the ZX81, as you point out, there are four of them. Now tell something I didn't know.

At last an astute reader has penetrated one of Hobby Electronic's deepest, darkest secrets — but I don't mean the secret of my identity.

*Dear CD,
Having loyally collected all your mags, I've noticed that your numbering system has gone somewhat hay-wire (no pun intended). I noticed that in the 80/81 volume, the numbers go up to 14. Why is this, when all the previous volumes were numbered from one to twelve?
K. Dutton,
Walsall,
West Midlands.*

PS My wife said you've got to send a binder to put my HEs in, so she can tidy the place up.

The solution of the mystery is devastatingly simple. The first edition of HE was published in November 1978, and since there are twelve months in a year (just kidding), the issues were numbered from one to twelve. Last year, we decided to bring our issue numbers in line with the calendar year, so that No. 1 would be January issue, No. 2 February, and so on. To do this, though, we had to bring out 14 issues in one volume. It's that simple . . . isn't it?

Let it never be said that Clever Dick was the cause of domestic wife . . . er, strife. A binder has been dispatched with all speed.

Step-by-step fully illustrated assembly and fitting instructions are included together with circuit descriptions. Highest quality components are used throughout.

Sparkrite

BRANDLEADING ELECTRONICS

NOW AVAILABLE IN KIT FORM

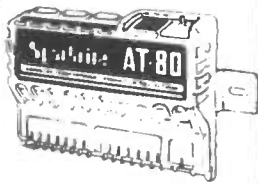

AT-80 Electronic Car Security System

- Arms doors, boot, bonnet and has security loop to protect fog/spot lamps, radio/tape, CB equipment
- Programmable personal code entry system
- Armed and disarmed from outside vehicle using a special magnetic key fob against a windscreen sensor pad adhered to the inside of the screen
- Fits all 12V neg earth vehicles
- Over 250 components to assemble

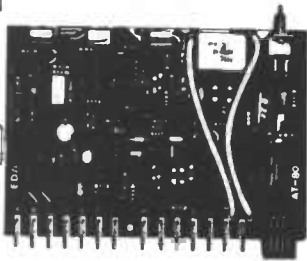

VOYAGER Car Drive Computer

- A most sophisticated accessory
- Utilises a single chip mask programmed microprocessor incorporating a unique programme designed by EDA Sparkrite Ltd
- Affords 12 functions centred on Fuel, Speed, Distance and Time
- Visual and Audible alarms, warning of Excess Speed, Frost/Ice
- Lights-left-on
- Facility to operate LOG and TRIP functions independently or synchronously
- Large 10mm high 400ft-L fluorescent display with auto intensity
- Unique speed and fuel transducers giving a programmed accuracy of + or - 1%
- Large LOG & TRIP memories 2,000 miles, 180 gallons, 100 hours
- Full Imperial and Metric calibrations
- Over 300 components to assemble
- A real challenge for the electronics enthusiast!



SX1000 Electronic Ignition

- Inductive Discharge
- Extended coil energy storage circuit
- Contact breaker driven
- Three position changeover switch
- Over 65 components to assemble
- Patented clip-to-coil fitting
- Fits all 12v neg. earth vehicles

TX1002 Electronic Ignition

- Contactless or contact triggered
- Extended coil energy storage circuit
- Inductive Discharge
- Three position changeover switch
- Distributor triggerhead adaptors included
- Die cast weatherproof case
- Clip-to-coil or remote mounting facility
- Fits majority of 4 & 6 cyl. 12V. neg. earth vehicles
- Over 145 components to assemble.

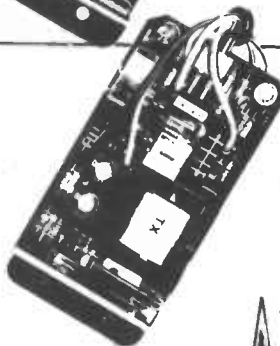

SX2000 Electronic Ignition

- The brandleading system on the market today
- Unique Reactive Discharge
- Combined Inductive and Capacitive Discharge
- Contact breaker driven
- Three position changeover switch
- Over 130 components to assemble
- Patented clip-to-coil fitting
- Fits all 12v neg. earth vehicles

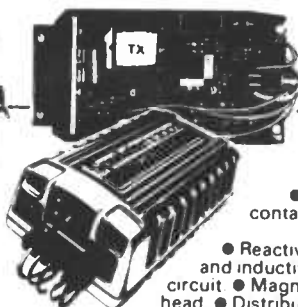

TX2002 Electronic Ignition

- The ultimate system
- Switchable contactless
- Three position switch with Auxiliary back-up inductive circuit
- Reactive Discharge
- Combined capacitive and inductive
- Extended coil energy storage circuit
- Magnetic contactless distributor triggerhead
- Distributor triggerhead adaptors included
- Can also be triggered by existing contact breakers
- Die cast waterproof case with clip-to-coil fitting
- Fits majority of 4 and 6 cylinder 12v neg. earth vehicles
- Over 150 components to assemble

All EDA SPARKRITE products and designs are fully covered by one or more World Patents

SPECIAL OFFER

"FREE" MAGIDICE KIT WITH ALL ORDERS OVER £45.00

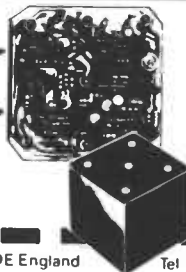

MAGIDICE Electronic Dice

- Not an auto item but great fun for the family
- Total random selection
- Triggered by waving of hand over dice
- Bleeps and flashes during a 4 second tumble sequence
- Throw displayed for 10 seconds
- Auto display of last throw 1 second in 5
- Muting and Dfl switch on base
- Hours of continuous use from PP7 battery
- Over 100 components to assemble

EDA SPARKRITE LIMITED 82 Bath Street, Walsall, West Midlands, WS1 3DE England

Tel (0922) 614791 Allow 28 days for delivery

	SELF ASSEMBLY KIT	READY BUILT UNITS
SX 1000	£12.95	£25.90
SX 2000	£19.95	£39.90
TX 2002	£29.95	£59.90
TX 1002	£22.95	£45.90
AT 80	£29.95	£59.90
VOYAGER	£59.95	£119.90
MAGIDICE	£9.95	£19.90

PRICES INC VAT POSTAGE & PACKING

NAME _____ HE8
ADDRESS _____

I ENCLOSE CHEQUE(S)/POSTAL ORDERS FOR

£ _____ KIT REF _____

CHEQUE NO _____
24 hr. Answerphone
PHONE YOUR ORDER WITH ACCESS/BARCLAYCARD
SEND ONLY SAE IF BROCHURE IS REQUIRED

BRANDLEADING BRITISH ELECTRONICS

CUT OUT THE COUPON NOW!

Hobby Electronics, August 1982

Metertech DVM

Paul Coster

A no-nonsense, push button multimeter with useful extra facilities.

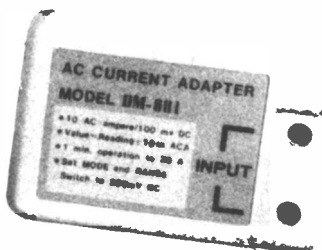
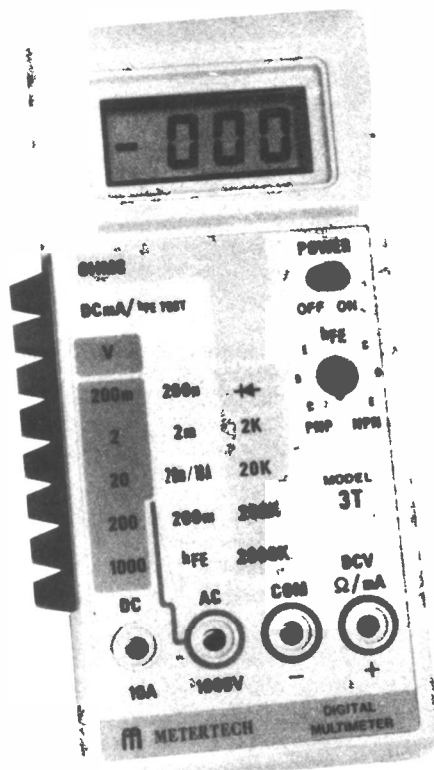

FROM TIME TO TIME the Hobby offices receive pieces of electronic equipment for review and evaluation. This month we were sent a new digital multimeter from Centemps. The Metertech model 3T is an attractive, portable multimeter with a large four digit LCD display. In addition to the usual functions the meter also has a built-in transistor tester. This makes it extremely versatile for its a small size — the case measures just 180 x 82 x 38 millimetres.

The basic measuring ranges are selected by a row of pushbutton switches along the side of the unit. Three red buttons set the required function: Ohms, Voltage and DC current. AC current can be measured via the optional adapter; though no specification data is available at present, we were assured that technical information would be on hand soon. However the plug-in unit performed well, albeit after a slight struggle to understand it!

Each function has a number of ranges provided by the remaining five black buttons. This colour coding is quite a nice touch and makes operation just that bit easier — you've always got to ensure that one black and one red button are depressed to take a reading. Another advantage of this facility is that it permits one-handed testing, leaving the other free to position the test prods. Something I did miss though, is that the leads do not come

with interchangeable tips or extras like crocodile clips — so be prepared to buy your own clips or having to hold the leads in place when taking measurements.

The DC voltage scale has five steps; 200mV, 2V, 20V, 200V, and 1kV. This provides a staggering resolution of less than one millivolt on the lowest range, with a quoted accuracy of 0.5%. All five settings have an input impedance of 10M, so they will not significantly load the circuit under test. A very useful protection arrangement allows overloads up to 500V DC, so it's virtually impossible to damage the meter.

The two AC voltage ranges are equally well protected, up to 350 V RMS AC, but do not have such a high resolution. Sinusoidal voltages are measured with the red test lead plugged into a special AC socket (one of four at the bottom end of the meter). The lower two black buttons select either 200 V or 1kV and work over a frequency band from 40 Hz to 500 Hz. This stated narrow bandwidth did not prove a serious limitation, however, since readings up to about 20 kHz were founded to be possible! However, the lack of a really low AC setting was found to be a drawback when dealing with audio signals within low-level circuitry.

The DC current scale has five steps, like the voltage scale. This gives readings from 100nA (not 100uA as in

the booklet) up to 200mA with a separate socket for measurements of currents up to 10A. All these ranges are protected by a 0A5 fuse and an extra fuse is supplied with the meter. With an accuracy of 1.2% (our meter was actually better than 1%), it is possible to work out exact current demands of battery powered equipment. This also allows precise setting up of regulator circuits in PSU's for minimum ripple. In fact the only slight reservation I had about the current ranges is that you have to change test sockets to move up from 200mA to 10A.

The uppermost red function button puts the meter into resistance mode. There are five steps covering the range 2k to 2M with one ohm resolution on the lower end. Accuracy is stated as 1%, but I measured several 0.1% resistors without detecting any discrepancies. The resistance ranges are protected against an overload of up to 250V AC and DC (though I didn't test this!) and test currents — the currents put through the circuit being tested — are very low (100 uA maximum).

One interesting aspect about this range is that you can check the 'resistance stability' of presets and pots by watching the final digit on the display changing, even though you're not moving the wiper on the pot. The first black selector, in conjunction with the ohms range, also allows checking of diodes by providing an output current of 2 mA. By multiplying the display value by ten, an approximate measure of forward voltage is obtained. Short or open circuits are signified by a reading of '1' or '00.0' respectively.

The model 3T has an extra facility in that it can be used to measure the DC current gain or h_{FE} (common emitter mode) of small transistors. On the right of the case below the display is a transistor socket, clearly marked to take PNP and NPN transistors. The mode is selected by the lowest black button on the DC mA/ h_{FE} setting. This makes light work of matching transistors from a bargain pack, or simply selecting the best one for a specific purpose. Indeed, backed up by such an accurate voltage/current capability, the transistor testing range makes the whole unit extremely versatile.

So, here is a no-nonsense precision multimeter with all the extras you could want from such a device. The ranges are wide and accurate, and though a low AC voltage range would have been advantageous, for most applications the unit performs admirably. I found it easy to use, due to the clear markings and colour coding on the front panel, and consider it to be a valuable addition to any hobbyist's test bench. The Metertech DVM we reviewed was from Centemp, 62 Curtis Road, Whitton, Hounslow, Middx. TW4 5PT. It is available from them, priced at £49.95 (including VAT, p&tp). The optional case is £6.90, as is the AC current adaptor.

HE

Julius Plucker

We see one of his discoveries every night.

JULIUS PLUCKER was born in 1801 at Elberfeld, Germany, of well-to-do parents. His education was conventional for the time; high school, followed by the University of Heidelberg, where he showed considerable promise in mathematics. He pursued further courses at the Universities of Berlin and of Paris and, in 1825, took a job as a lecturer at Bonn University. This post carried no salary — it was deemed such an honour that the lecturer was expected to be able to support himself either by inherited wealth or (less likely) by private teaching. Plucker did so for four years, in which time he distinguished himself sufficiently to be appointed Assistant Professor of Mathematics, at Bonn, in 1829.

His achievements in Mathematics were considerable; Plucker's most notable achievements were in what is termed analytical geometry, an algebraic system for dealing with geometrical problems. His discoveries resulted in his appointment to a Professorship at Halle in 1834 then, in 1836, he returned to Bonn.

Faraday Fever

Within nine years, however, his interests totally changed. He became fascinated by the work of Faraday in England and decided to devote the rest of his life to studying this and other electrical work. The contrast between these two men, who never met, could not have been greater. Faraday was the son of a blacksmith, self-educated, with little more than simple arithmetic to his credit and a considerable aversion to mathematical ideas. Plucker, from a wealthy background and well-educated, mathematically a near-genius, was completely bowled-over by Faraday's ideas — which Faraday himself could not express mathematically! Plucker, better able to analyse the ideas but lacking the feeling for the subject that Faraday had by instinct, saw them as totally revolutionary. He was, of course, correct — they were the most revolutionary steps in Physics since Newton's Laws of Motion.

Plucker's interest in, and devotion to, Electrical Science led to his appointment, in 1847, as Professor of Physics at Bonn, a post which left him time and provided the resources to extend very greatly his research interests; at that time, these centred on magnetism. Plucker became fascinated by the behaviour of materials in strong magnetic fields. His contemporary in England, James Prescott Joule, had already demonstrated one remarkable effect, that of magnetostriction. Magnetic materials change length as they are magnetised and demagnetised, and the effect is used nowadays as a way of producing ultrasonic waves with very high power. Plucker was interested from a different angle. He saw the effect, correctly, as evidence for the idea that atoms

of materials, for so long regarded as single units, were made up of electrically charged smaller particles.

Plucker soon launched himself into completely original work, however and, in 1852, announced the discovery of diamagnetism. This is a little-known effect which can be observed in crystals of materials that we normally think of as non-magnetic. In fact, all materials are magnetic to some extent, in the sense that they respond to magnetic fields, but only iron and its close relatives, nickel and cobalt, are strongly magnetic. We call such substances ferromagnetic, meaning magnetic like iron (*Ferrum* in Latin).

Plucker, using very powerful electromagnets (another idea borrowed from Faraday), was able to classify two other types of magnetism; paramagnetism and diamagnetism. The differences depend, as Plucker suspected, on fundamental differences in the way the atoms of these materials are constructed but the very incomplete knowledge of atoms, at the time, did not permit him to go much further.

Like many before and since, he turned to another line of research; the conduction of electricity through gases. It had been known for some time that gases were not completely insulating. Measurements made using the very sensitive leaf electroscopes of the 18th century, had shown that gases would start to conduct electricity when their temperature was raised. By the middle of the 19th century, the remarkable effects produced by lowering the pressure of gases had been discovered and it was to this area that Plucker directed his research. It proved to be a most rewarding study.

Gas Displays

It's not difficult to understand why gas discharges (passing electric currents through gases at low pressures) were so fascinating; they provide some of the most beautiful spectacles in Physics. When a high voltage is placed across two metal plates, at opposite ends of a tube which can be connected to a vacuum pump, nothing much happens until the pressure of the gas in the tube (air or anything else) has been considerably reduced. The first indication of activity is a series of irregular sparks which flash between the plates (or 'electrodes'). As the pressure is reduced, the sparks merge into a continuous discharge, becoming a glow which fills the tube completely, apart from a dark space near the negative electrode (the cathode dark space). The colour of the glow is vivid and bright and depends on the type of gas that filled the tube. When neon is the filling material, the effect is the familiar orange glow of the neon lamp. This much had already been noted by Geissler and several others,

though they had little idea of what caused the effect.

We know now that the reduced pressure causes the molecules of gas to separate, and that any one molecule which splits into atoms and then into charged particles can cause all the rest of the molecules of the gas to split in the same way. What happens is that any charged particle will be accelerated to a high speed, because of the electric field, and will crash into other molecules, splitting them into fragments; each fragment will in turn be accelerated and will split up others in a chain reaction. The cause of the glow is the energy given out when the fragments recombine and the dark space near the cathode is the region in which the fragments are accelerating rather than recombining. Most of the voltage drop is across this dark space.

Plucker, in 1859, was determined to take the process a stage further. Using an improved vacuum pump, only just invented, he reduced the pressure in such a tube very much further. As the pressure dropped, the glow in the gas broke up into bands and eventually disappeared. Examining the tube in a darkened room, however, Plucker found that there was still a glow — but it was not inside the tube. A faint glow now seemed to be on the wall of the tube, near the positive electrode (the anode), and was green in colour. Plucker found that any object placed between the anode and the cathode would cast a shadow under these conditions, so that it looked as if there were a ray emitted from the cathode and striking the glass. The phrase 'cathode rays' has been with us ever since!

Deflections

By 1860, Plucker had gathered a team of researchers around him, all of whom were to make their names in connection with cathode rays. An early result of their work was the discovery that the rays travelled in straight lines, but Plucker's interest in magnetism led him to test the effect of a magnet on the rays — and he found that they were deflected. Deflection by a voltage applied between metal plates was also demonstrated, along with the heating effect produced when the 'rays' hit any material, an effect we make use of nowadays in electron-beam welding. To crown it all, an elegant experiment proved that the rays were probably moving particles, with mass and speed, because they were capable of turning a wheel held within the evacuated tube.

Plucker's publication of the results of his work, and that of his associates, produced great excitement in scientific circles because cathode rays were the first firm evidence that atoms could be split, to produce smaller charged particles. As an academic, Plucker did not exploit the discoveries in any way, but he undoubtedly paved the way for the elegant measurement of the charge/mass ratio of the electron, by J.J. Thomson, at the end of the century, and to the invention of the first practical cathode ray tube by Braun, at about the same time.

HE

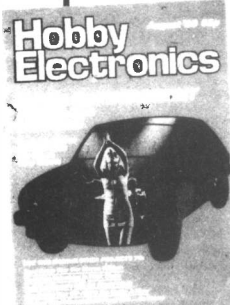

BACKNUMBERS

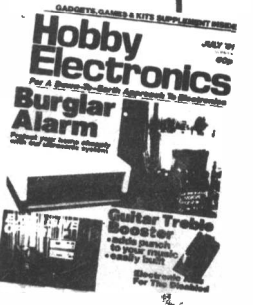
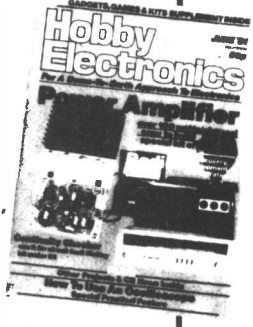
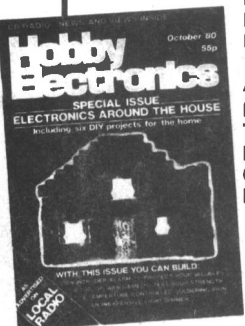
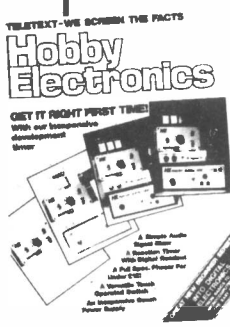

February 1980
Passion Meter, Win Indicator, Short Circuit Special, Kit Review Special, Into Electronics Construction Part 1.

May 1980
MiniClocks, 5080 Preamp, Model Railway Track Cleaner, 5080 Loudspeakers, Loudspeaker Crossover Design, Radio Controlled Model Survey.

June 1980
Microbe Radio Control System, Egg Timer, Two Watt Amplifier, Fog Horn, Short Circuits, LEDs and LED Displays.

July 1980
Sound-Operated Flash Trigger, 18+ 18 Car Stereo Booster, Hazard Flasher, Electronics in Photography, Electronic Espionage, Piezo Electricity.

August 1980
EquiTone Car Equaliser, Pass-The-Loop Game, Gaztec Gas Detector, OP-Amp Checker, In-Car Entertainment Survey, Introducing Microprocessors.

September 1980
MicroMixer, Reaction Tester, Guitar Phaser, Development Timer, Teletext Explained, Into Digital Electronics Part 1.

October 1980
Kitchen Timer, Tug 'o' War Game, Light Dimmer, Freezer Alarm, Intruder Alarm, Temperature-Controlled Soldering Iron.

January 1981
Car Rev-Counter, Bench Amplifier, Sound-Into-Light Converter, Chuffer, Electronic Games reviewed.

February 1981
Heartbeat Monitor, High-Impedance Voltmeter, Medium Wave Radio, Two-Tone Train Horn, Audio Signal Generator.

March 1981
Public Address Amplifier, Windscreen Wiper Controller, Bicycle Speedometer, Photographic Timer, Microcassettes.

April 1981
Pre-Amplifier Part 1, Super Siren, Guitar Tremolo, Russian Roulette Game, Doorbell Monitor, Anatomy of a Space Shuttle.

May 1981
Electronic Organ, Voice-Operated Switch, Infra-Red Controller, Pre-Amplifier Part 2, Audio Millivoltmeter.

June 1981
Power Amplifier Part 1, Continuity Checker, Envelope Generator, Early Radio, Gadgets, Games and Kits Supplement.

July 1981
Burglar Alarm, Doorbuzzer, Treble Booster, Electronic Aids for the Disabled, Power Amplifier Part 2.

August 1981
Electronic Ignition, Thermometer, Electronic Organ (final part), RPM Meter, Bench Power Supply, Radio Control Survey, Into Electronic Components Part 1.

All of the 1980 issues, except January and April, are still available together with the remaining issues from 1981.

All backnumbers cost £1.25 each. For those of you who only want copies of articles, we do offer a photocopying service. Each copy costs £1.25 and information as to its title and publication date should be given. Ordering backnumbers and photocopies could hardly be easier, just fill in the coupon, cut it out and send it to:

**Hobby Electronics,
145 Charing Cross Road,
London WC2H 0EE**

Please remember to mark your envelope with the service you require, **BACKNUMBERS** or **PHOTOCOPIES**, otherwise our mailroom won't like you.

HOBBY ELECTRONICS BACKNUMBER ORDER FORM

Please send me the following items:

NAME

ADDRESS

.....

.....

.....

Back issues at £1.25 each

I enclose £.....
Cheques and Postal Orders should be made payable to ASP Ltd.

HOBBY ELECTRONICS PHOTOCOPY ORDER FORM

Please send me the following items:

NAME

ADDRESS

.....

.....

.....

Photocopies of in the

..... issue at £1.25 each

I enclose £.....
Cheques and Postal Orders should be made payable to ASP Ltd.



Breadboards

This month we have two of our own circuits that may be easily modified to suit many purposes. The first is a simple two watt audio amplifier, based around the LM380 IC, which can be used as a bench amplifier, as a guitar practice amp or for any other purpose that requires an audio power output. The second features a TL082 BIFET op-amp (with two FET amplifiers in the

package) wired as a 50 Hz hum filter; it is also adaptable to notch out and other desired — or undesirable — frequency.

Gaining Power

The most impressive fact about the LM380 is that it can be turned into a practical amplifier with the addition of only a few extra components. With a

quiescent current (ie, no signal input) around 7 mA, battery operation is not a problem, and it will drive almost any load with an impedance greater than four ohms.

The circuit we have here couldn't be much simpler. The input signal is fed to the non-inverting input (the LM380 is essentially an op-amp with power gain) via coupling capacitor C1 and potentiometer RV1, which functions as a simple volume control. Although the gain of the IC may be increased to as much as 300, by the application of positive feedback, the pre-set gain of 50 — 34 dB — is enough for this application.

The network R2, C3, connected across the output, is to aid the stability of the amplifier (preventing feedback), however it can be omitted if the load is high impedance (more than 16R). High impedance loads mean less current drain, therefore the battery life will be extended — but at the cost of reduced power output. Low impedance loads — a four ohm speaker, for example — will generate greater power, but with the risk that the IC will 'shut down' because its maximum current rating (1 A3, peak) is being exceeded.

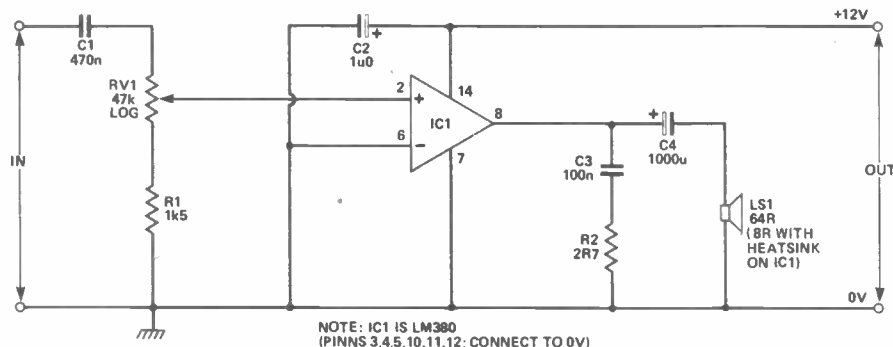

Figure 1. Circuit diagram of the LM380 2-watt amplifier.

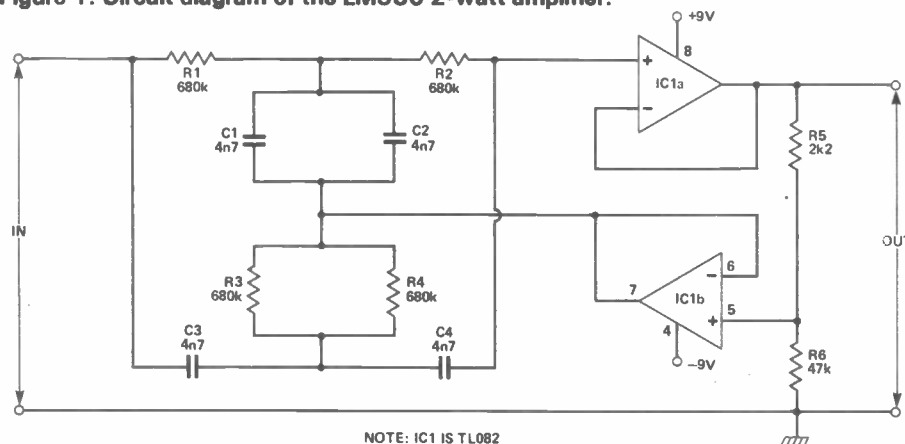

Figure 2. The 50 Hz hum rejection filter circuit.

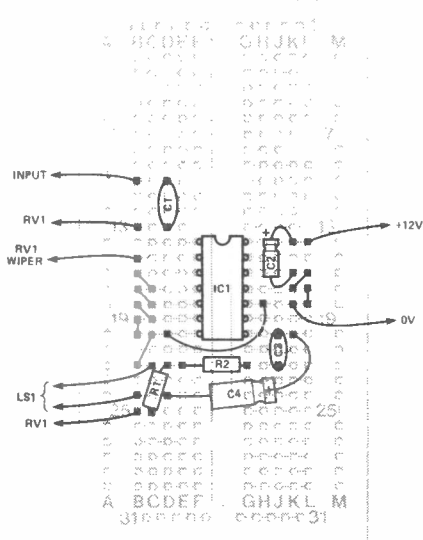

Figure 3. Component layout for breadboarding the amplifier.

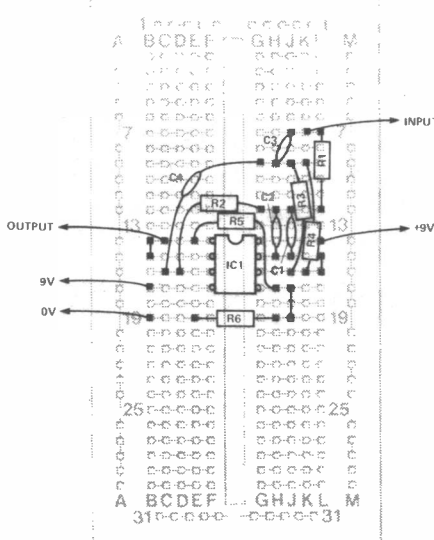

Figure 4. Breadboarding layout of the notch filter.

INTRODUCING TWO NEW HANDHELD DIGITAL MULTIMETERS

28 Ranges each with full overload protection

MODEL 6010

DC accuracy 0.5%

£29.95

plus VAT

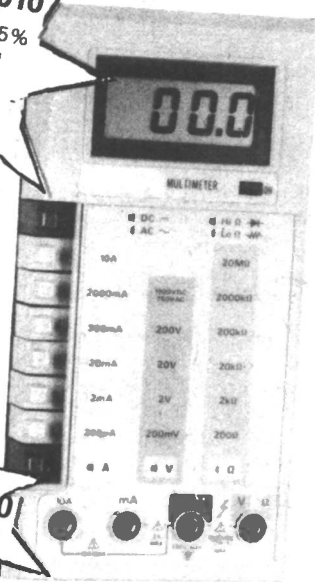

MODEL 7030

DC accuracy 0.1%

£35.95

plus VAT

SPECIFICATION 6010 & 7030

BATTERY: Single av dry cell

BATTERY LIFE: 200 hours

DIMENSIONS: 170 × 89 × 38mm

WEIGHT: 400g inc battery

MODE SELECT: Push button

AC DC CURRENT: 200µA to 10A

AC VOLTAGE: 200mV to 750V

DC VOLTAGE: 200mV to 1000V

RESISTANCE: 200Ω to 20MΩ

INPUT IMPEDANCE: 10MΩ

DISPLAY: 3½ Digit 13mm LCD

O/LOAD PROTECTION: All ranges

OTHER FEATURES:

Auto polarity, auto zero,

battery-low indicator,

ABS plastic case with tilt stand,

battery and test leads included,

optional carrying case.

Please add 15% to your order for VAT. Postage & Packing is free of charge. Trade prices available on application

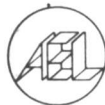

ARMON ELECTRONICS LTD.

Cottrell House, 53-63 Wembley Hill Road, Wembley, Middlesex HA9 8BH, England

Telephone 01-9024321 (3lines)

TELEX No 923985



You'll find it just as enjoyable... cruising on the motorway.

Now! No matter where you live in Britain you can enjoy the pleasure of cruising.

Any boat in the Shetland range of family cruisers can be towed behind the average family car.

Think of the advantages to be enjoyed—the rivers, the lakes, the Broads, estuary and coastal waters whenever the fancy takes you.

This year take the cruise you always promised yourself...buy Shetland.

Clip the coupon for free brochure and name of your nearest dealer.

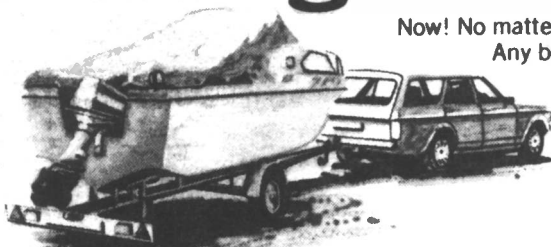

Shetland

FAMILY CRUISERS

BRITAIN'S NO.1 SETS THE STANDARD

To: Shetland Boats Ltd.,
Stanton, Nr. Bury St. Edmunds, Suffolk. Tel: (0359) 50355.

HEB/82

Name _____

Address _____

Tel _____

For towing: Make of car _____

Model _____ c.c.

Please tick for further information: Family Cruisers
 Dories Stratos Sportsboat Fisherboats



RADIO RULES



Carrying on from last month, we now look at the behaviour of capacitance, inductance and resistance in series and parallel circuits.

A circuit that contains inductance and capacitance behaves in a very interesting way when the reactance of the capacitor equals the reactance of the inductor. If the capacitor and the inductor are connected in series (Figure 1) then the AC voltage across them will be equal and opposite and they will cancel, leaving only the voltage across the resistor. This is in phase with the current, as the phase diagram of Figure 1 shows. For any combination of inductance and capacitance, then, there will be a frequency, called the resonant frequency or frequency of resonance, at which this happens and we can use the equations for reactance to calculate what the resonant frequency will be. This is shown, with examples, in Figure 2.

The algebraic formula for impedance also shows that when a capacitor and an

inductor are connected in series and are in resonance, all that is left is resistance. At the frequency of resonance, therefore, the impedance of a series resonant circuit reaches its minimum possible value, equal to the amount of resistance, and the phase angle is 0°. Figure 3 shows the variations of impedance and of phase in a series resonant circuit. It is also possible to have parallel resonant circuit, in which a capacitor and an inductor are connected in parallel. In this circuit, the impedance becomes a maximum at the frequency of resonance; this maximum impedance is called the 'dynamic resistance'. The voltage across a parallel resonant circuit is also in phase with its current, but its value does NOT correspond to the value of any resistance in the circuit. The value of dynamic resistance, R_D , when the circuit is at resonance, is given by the formula of Figure 4. The size and phase of the voltage across a parallel circuit is plotted, assuming a constant current, in Figure 5.

At resonance, very large currents can flow in resonant circuits and these can cause large voltages to be generated — in some cases, larger than the input voltage! For example suppose that, in a series circuit, we have reactances of $X_L = X_C = 1000$ ohms, a resistance of 10 ohms and there is a constant AC voltage of 10 V across the circuit. Now if we vary the frequency of the AC until it equals the resonant frequency, the current will increase until it reaches a maximum of 1A, assuming that the source of the AC can

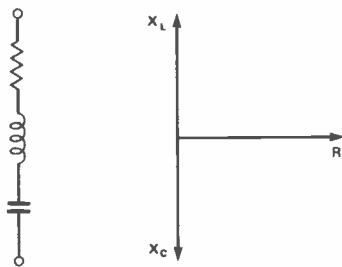

Figure 1. A simple series RLC circuit and the phasor diagram representing the voltages across each component.

SINCE $X_L = X_C$
 THEN $2\pi fL = \frac{1}{2\pi fC}$
 SO THAT $(2\pi f)^2 = \frac{1}{LC}$
 AND $2\pi f = \frac{1}{\sqrt{LC}}$
 THEREFORE $f = \frac{1}{2\pi\sqrt{LC}}$

eg. $L = 15$ mH. $C = 10$ nF

RESONANT FREQUENCY, $f = \frac{1}{2\pi\sqrt{15 \times 10^{-3} \times 10 \times 10^{-9}}}$
 = 12995 Hz OR 12.995 kHz

Figure 2. Deriving the formula for the resonant frequency of a series-resonant circuit, together with a practical example.

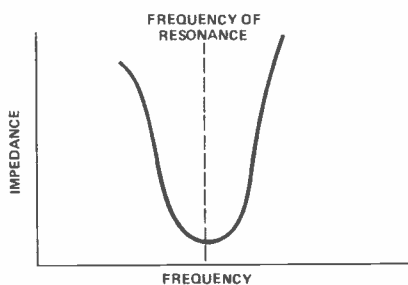
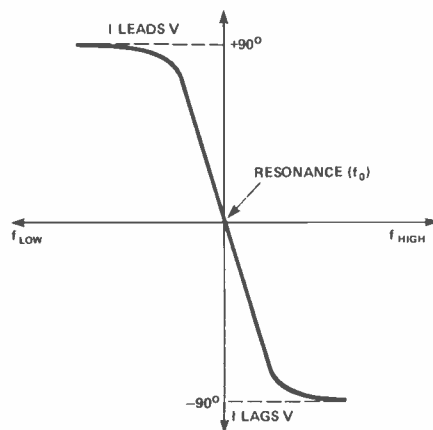
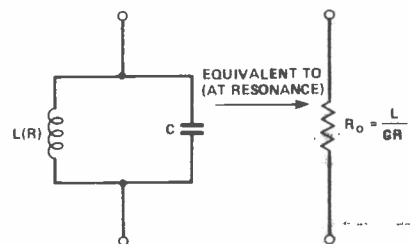

Figure 3, top. At resonance, the phase shift through a series resonant circuit is zero; bottom, the impedance plotted against frequency — It reaches a minimum at resonance.



eg. $L = 22$ mH. $C = 6$ nF. $R = 1.2$ OHMS

$R_D = \frac{22 \times 10^{-3}}{5 \times 10^{-9} \times 1.2}$
 = 3.7 MEGOHMS

Figure 4. A parallel resonant circuit and its equivalent 'dynamic resistance' at resonance. In contrast to the series circuit, this reaches a maximum.

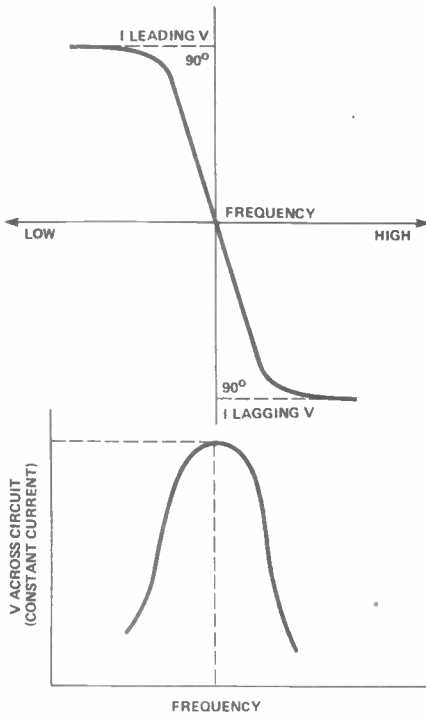

Figure 5, top. The phase shift through a parallel resonant circuit; bottom, the voltage across the circuit plotted against frequency — compare this with the series resonant circuit.

supply this much. With 1A flowing in the circuit, though, we have to remember that it flows through *all* of the components and that there will be a voltage developed across each component. Across the capacitor, for example, there will be a voltage equal to the current times the reactance which in this example, will be 1000 V! There will also be equal voltage across the inductor, though its phase will be opposite. Remember also that the phase of both of these voltages will be 90° to the phase of the voltage across the resistor — which is also the phase of the supply voltage.

This effect is called 'voltage magnification' and the voltage magnification factor is defined as V_x/V_T , where V_x is the voltage across a reactive component (either C or L) and V_T is the total applied voltage. The voltage magnification factor is given the symbol 'Q' and its size can be calculated, as illustrated in Figure 6. A parallel resonant circuit also causes magnification but it's *current* magnification, with large currents flowing in each leg of the resonant circuit but only a small current actually flowing *through* it (Figure 7). The same formula can be used for Q, providing the value of R is not too high.

Bandwidth and Damping

If a tuned circuit had no resistance it would be in resonance at one frequency and only one frequency but every inductor, being made from wire, must have some amount of resistance so that, in practice, the resonance will extend to a range of frequencies that we call the 'bandwidth'. If we imagine a parallel-resonant circuit used as the load of a transistor (as it usually is), then a graph of signal output plotted against frequency,

AT RESONANCE, $Z = R$
THEREFORE $I = \frac{V_T}{R}$

THE VOLTAGE ACROSS THE CAPACITOR IS

$$V_x = I \times X_c = \frac{V_T}{R} \times \frac{1}{2\pi f C}$$

$$= \frac{V_T}{2\pi f C R}$$

AND

$$Q = \frac{V_x}{V_T} = \frac{V_T}{2\pi f C R} \times \frac{1}{V_T}$$

$$= \frac{1}{2\pi f C R}$$

$$= \frac{1}{\omega C R}$$

WHERE $\omega = 2\pi f$

THE VOLTAGE ACROSS THE INDUCTOR IS

$$V_x = I \times X_L = \frac{V_T}{R} \times 2\pi f L$$

AND

$$Q = \frac{2\pi f L V_T}{R} \times \frac{1}{V_T}$$

$$= \frac{2\pi f L}{R}$$

$$= \frac{\omega L}{R}$$

eg, $C = 4.7 \text{ nf}$, $R = 1.5 \text{ OHMS}$, $f = 400 \text{ kHz}$

$$Q = \frac{1}{2\pi f C R} = \frac{1}{2\pi \times 400 \times 10^3 \times 4.7 \times 10^{-9} \times 1.5}$$

Figure 6. The phase differences between current and voltage in reactive circuits; (top) current leads voltage in a capacitive circuit; (bottom) voltage leads current in inductive circuits.

assuming a constant amplitude input to the transistor, would look as shown in Figure 8. We take the frequency of resonance as being that frequency represented by the top of the curve, but the frequencies around this one are also *selectively amplified* and we have to decide what amplitude will be large enough to count as part of this bandwidth. As with so many other examples, the amplitude limit is taken to be 70% of the peak (or peak x 1.4, if you prefer), so that the two frequencies, one on each side of the resonant peak, whose amplitudes are equal to 70% of the peak are the limits of bandwidth.

As you might suspect, there is a relationship between bandwidth and the magnification factor Q, as shown in Figure 9. There are two important points about this; one is the effect of frequency. Suppose you have a resonant circuit which has a Q-factor of 100 (determined mainly by the inductor, which has all the resistance) and it operates at 1 MHz. Your bandwidth, then, is 1/100 of a MHz, which is 10 kHz. If your resonant circuit with a Q of 100 were to operate at 100 MHz, though, then the bandwidth would be 1 MHz. This illustrates the difficulties of working with high frequencies; it also illustrates why we use very wide bandwidths — we can't help it! Unless very high-Q circuits can be used, high resonant frequencies automatically mean large bandwidths.

We can increase the bandwidth of any parallel-resonant circuit, at the expense of voltage magnification, by adding some resistance across the tuned circuit. The smaller this resistance is, the wider the bandwidth (Figure 10) and the lower the peak, because the Q of the circuit has been reduced. This called 'damping' and a

$$f = \frac{1}{2\pi\sqrt{LC}}$$

$$= \frac{1}{2\pi\sqrt{22 \times 10^{-3} \times 5 \times 10^{-8}}}$$

$$= 15.175 \text{ kHz}$$

IF $V_T = 1.5 \text{ V}$ THEN

$$I_T = \frac{V_T}{R_D} = \frac{1.5}{3.6 \times 10^6} = 0.417 \mu\text{A}$$

AT RESONANCE, $X_L = X_C = 2\pi f L$

$$= 2\pi \times 15175 \times 22 \times 10^{-3} = 2.1 \text{ KILOHMS}$$

THEREFORE, $I_L = \frac{V_T}{X_L} = \frac{1.5}{2.1 \times 10^3} = 715 \mu\text{A}$

AND THE CURRENT MULTIPLICATION

$$= \frac{I_L}{I_T} = \frac{715 \times 10^{-6}}{0.417} = 1715$$

COMPARE THIS WITH THE VALUE OF Q:

$$Q = \frac{2\pi f L}{R} = \frac{2\pi \times 15 \times 10^3 \times 22 \times 10^{-3}}{1.2} = 1728$$

Figure 7. Current multiplication in a parallel resonant circuit. Notice that the value compares closely with the Q of the circuit.

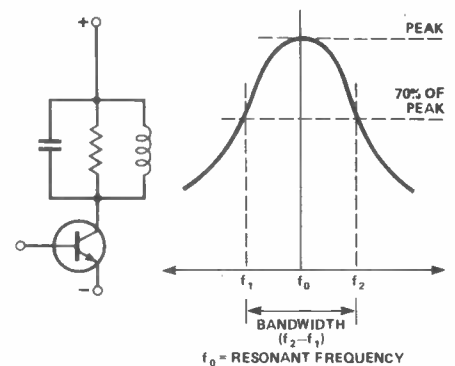

Figure 8. The bandwidth of a tuned circuit is taken from the frequencies at which the amplitude is 70% of the peak value.

resistor used in this way is called logically, a damping resistor.

Coupled Circuits and Filters

We can achieve interesting effects by placing the inductors of two resonant circuits, tuned to the same frequency, close enough together to cause some mutual inductance. If the mutual inductance is small, the circuit is said to be loosely coupled and only a fraction of the signal in one circuit will be transferred to the other, the bandwidth of the induced signal will be smaller — narrower than we could achieve with either tuned circuit alone. As the coils are brought closer together, the coupling increases until a point, known as the 'critical' coupling point, is reached (Figure 11) where the amplitude of the signal in the secondary coil is at a maximum at the frequency of resonance. If

$$Q = \frac{f_0}{f_2 - f_1}$$

AND THE BANDWIDTH = $f_2 - f_1 = \frac{f_0}{Q}$

IF $Q = 100$ AT 1 MHz THEN:
 $f_2 - f_1 = \frac{10^6}{100} = \frac{10^8}{10^2} = 10^6 = 10 \text{ kHz}$

HOWEVER, AT 100 MHz.
 $f_2 - f_1 = \frac{10^8}{10^2} = 10^6 = 1 \text{ MHz}$

Figure 9. For a circuit with a Q of 100 operating at 1 MHz, the bandwidth is 10 kHz. To achieve the same bandwidth at 100 MHz we would need a Q of 10000!

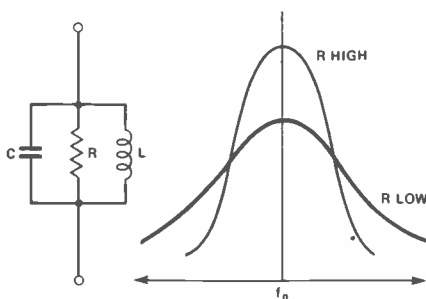

Figure 10. Using a damping resistor to obtain greater bandwidth, at the expense of Q. Note that the bandwidth is narrowest (and Q highest) when R is an open circuit (high resistance).

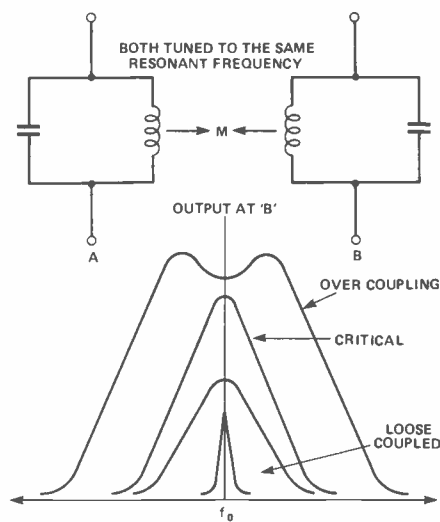

Figure 11. Mutually coupled circuits; the Q reaches a maximum at the critical coupling point. Increasing the coupling further results in a dip in the response at the resonant frequency.

the coupling is increased beyond this point by bringing the coils closer still, then the shape of the curve changes to a double-hump with the amplitude at the resonant frequency less than the amplitude of the frequencies on each side of it. Overcoupling, as this is called, can be combined with the use of damping resistors to give a shape which is almost flat-topped and is ideal wideband amplifiers.

The double-tuned circuit is a type of filter circuit which selects one range of frequencies. This particular one is called a band-pass filter, because it selects and passes (from one circuit to another) a

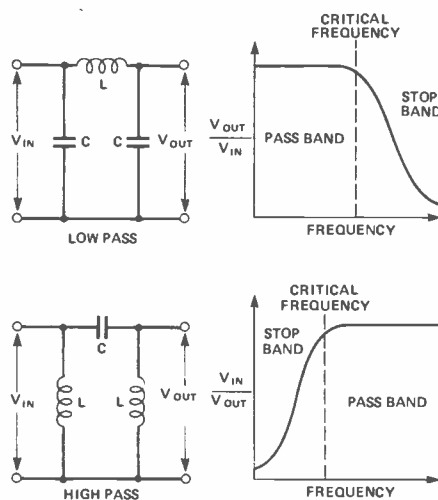
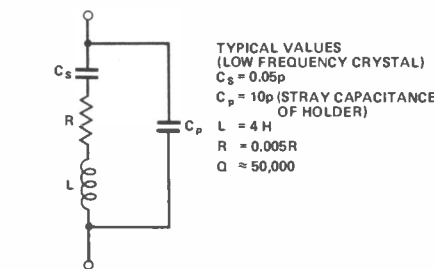

Figure 12. Pi-section LC filters can be made to give either low-pass or high-pass response. Bandpass response is produced by a resonant circuit.



TYPICAL VALUES (LOW FREQUENCY CRYSTAL)
 $C_s = 0.05 \text{ pF}$
 $C_p = 10 \text{ pF}$ (STRAY CAPACITANCE OF HOLDER)
 $L = 4 \text{ H}$
 $R = 0.005 \Omega$
 $Q = 50,000$

NOTE: C_s , R AND L ARE NOT 'REAL' COMPONENTS, THEY ARE THE EQUIVALENT ELECTRICAL COMPONENTS WHICH WOULD GIVE THE SAME EFFECT AS THE MECHANICAL RESONANCE OF THE CRYSTAL. C_p IS REAL, HOWEVER, IT IS THE STRAY CAPACITANCE ACROSS THE TERMINALS.

Figure 13. The equivalent circuit of a quartz crystal. Note the extremely high value of Q!

range (band) of frequencies. We can also use inductors and capacitors to form other useful filter circuits, such as the low-pass and high-pass circuits of Figure 12. Any filter will have a pass-band, the range of frequencies which it will allow to pass with no attenuation (reduction in amplitude) and a stop-band, which is the range of frequencies that will be greatly attenuated. A low-pass filter has its pass band at low frequencies, a high-pass filter at high frequencies.

Mixing

Mixing (also called Heterodyning) is the name given to the process of frequency changing or conversion. The idea is that we can mix together two sinewave signals to produce a signal whose frequency is equal to the difference between the frequencies of the original signals. For example, we could mix 1.2 MHz with 1.15 MHz to give 0.05 MHz, which is 50 kHz. The mixing process, which is carried out in a diode or a transistor, will also produce a frequency which is equal to the sum of the frequencies of the mixed signals but, since all of the signals are at high fre-

quencies except for the difference signal (50 kHz) we can pick it out using a low-pass filter. If one of the signals that we mixed happened to be modulated and the other was just a sinewave, then the difference frequency will carry the modulation of the original modulated signal. This is the principle which makes the superhet receiver possible.

Piezoelectricity and Quartz Crystals

A crystal is an arrangement of atoms and, since the forces which help to hold the atoms in place are electrical, it's not surprising that certain types of crystals will generate a voltage across opposite faces when they are compressed or expanded. The process will also work in the opposite direction, so that applying voltage across the faces of a crystal can cause it to change size and if the voltage is alternating then the crystal will vibrate at the frequency of the AC. The effect is called the 'piezoelectric effect'.

Quartz crystals, which occur naturally, are piezoelectric and natural quartz crystals can be cut, like diamonds, in certain preferred directions. Crystal cutters refer to certain standard directions in a crystal as AT, BT, DT and so on. When a thin plate or bar of quartz crystal is supported between metal plates, or has metal deposited on its opposite faces, it can be used to form a resonant circuit, with very high values of Q. The electrical equivalent of a vibrating crystal is shown in Figure 13 — the values of Q range from 25000 to over 50000; these are values which could not possibly be obtained by using coils and capacitors in resonant circuits! Crystals are therefore used: (a) in oscillators, to generate a good pure sinewave at a precise frequency, and (b) in filters, to achieve very narrow bandwidths.

Because the resonance of the crystal is mechanical (it's vibrating), the dimensions of the crystal and the way it is cut greatly affect the resonance. The maximum natural frequency of resonance is around 15-20 MHz and crystals which can operate at higher frequencies do so by vibrating when the frequency applied to them (the 'exciting' frequency) is a harmonic of the natural frequency — some crystal cuts do this very readily, (others don't) and a crystal that is designed to operate in this way is called an 'overtone' crystal. Alternatively, the crystal can be used at its natural frequency and the waveform squared to generate harmonics, which can be filtered to select a wanted harmonic, usually the second or third.

The resonant frequency of a crystal varies as you change the temperature of the crystal. The variations are small, never more than 50 Hz per MHz per degree Celsius change, but the AT cut crystal has a much lower change with temperature (almost zero). So for the best possible frequency stability, an AT cut crystal would be used inside a thermostatically-controlled oven.

So much for the hard facts. Next month we return to more practical matters — using these basic elements in radio frequency circuits.

Bookshelf

THE HE BOOKSHELF is the easiest way to build up your library of electronics books. Order today to have these top titles delivered **DIRECT TO YOUR DOOR.**

52 Projects Using IC 741
52 (FET) Field Effect Transistor Projects
£1.25
More than 50 ways of using the ubiquitous IC741.

Beginners Guide to Microprocessors and Computing
IC 555 Projects
£1.75
Basic introduction to binary arithmetic, micro-processor operation and machine language programming.

Remote Control Projects
REMOTE CONTROL PROJECTS £1.95
Practical information about many applications of remote control.

Electronic Projects Using Solar Cells
ELECTRONIC PROJECTS USING SOLAR CELLS £1.95
A range of practical applications using silicon solar cells.

50 (FET) FIELD EFFECT TRANSISTOR PROJECTS £1.75
Contains a wide range of projects, all based on Field Effect Transistors.

IC 555 PROJECTS £1.95
The 555 timer users 'Bible'!

ELECTRONIC MUSIC PROJECTS £1.75
Many practical circuits for less complex items of electronic music equipment.

VMOS PROJECTS £1.95
Contains a number of varied and interesting projects using VMOS power FETs.

COUNTER DRIVER AND NUMERAL DISPLAY PROJECTS £1.75
Features many varied projects using numeral displays, counter and driver ICs.

CHOOSING AND USING YOUR HI-FI £1.65
Concise information for all hi-fi enthusiasts.

ELECTRONIC TEST EQUIPMENT CONSTRUCTION £1.75
How to build and use a wide range of test equipment for the hobbyist.

DIGITAL IC PROJECTS £1.95
Simple and advanced projects based on digital ICs.

RADIO CIRCUITS USING IC'S
RADIO CIRCUITS USING IC'S £1.35
All you need to know about using IC's for AM or FM reception.

ELECTRONIC GAMES £1.75
Amusing electronic games which can easily and inexpensively be constructed by the enthusiast.

POWER SUPPLY PROJECTS £1.75
Packed with circuits for building various kinds of power supply.

INTERNATIONAL TRANSISTOR EQUIVALENTS GUIDE £2.95
Find possible equivalents for a popular user-orientated selection of modern transistors.

IC LM3900 PROJECTS £1.35
Provides the ground work for simple and more advanced uses of IC LM3900.

ELECTRONIC HOUSEHOLD PROJECTS £1.75
Packed with circuits for projects that can be used in or around the home.

HOW TO USE OP-AMPS £2.25
All you need to know about Op-Amps, a source book of circuits and design calculations.

PRACTICAL CONSTRUCTION OF PRE-AMPS, TONE CONTROLS, FILTERS AND ATTENUATORS £1.45
Contains practical designs for use with home constructed equipment or commercial modules.

A MICROPROCESSOR PRIMER £1.75
A painless approach to understanding computers and computing.

SINGLE IC PROJECTS £1.50
Easy to construct projects based around a single IC.

AUDIO PROJECTS £1.95
Clear information on how to build pre-amps, mixers, power amps, tone controls etc.

To receive your books you have only to fill in the form below and send it, together with your payment, to the address stated.

Please allow up to 21 days for delivery. This offer applies only within the U.K. Prices may be subject to change without notice.

SEND TO: HE BOOKSHELF, 513 London Road, Thornton Heath, Surrey CR4 6AR.

I am enclosing my Cheque/Postal Order/for: (delete as necessary)

£..... (Made payable to A.S.P. Ltd)

OR Debit my Access/Barclaycard (delete as necessary)



--	--	--	--	--	--	--	--	--	--	--	--	--	--	--	--	--	--	--	--	--

Please use BLOCK CAPITALS and include post codes.

Name (Mr/Mrs/Miss)
(delete accordingly)

Address

.....

.....

.....

.....

Signature Date

Books Required	Price
Add 75p p&tp	0.75
Total Payment	£

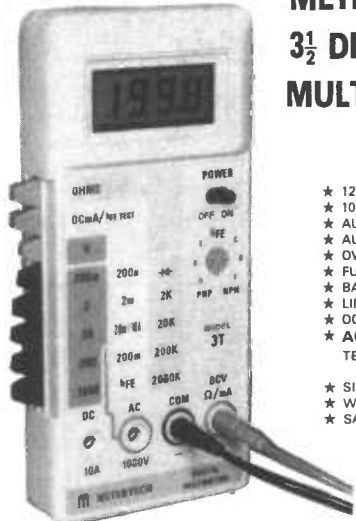

METERTECH MODEL 3T 3 1/2 DIGIT LCD MULTIMETER

- ★ 12.5mm DISPLAY
- ★ 10MM INPUT IMPEDANCE
- ★ AUTOMATIC ZERO ADJUSTMENT
- ★ AUTOMATIC POLARITY SWITCHING
- ★ OVER RANGE INDICATION
- ★ FUSE CIRCUIT PROTECTION
- ★ BATTERY LOW INDICATION
- ★ LIFE MEASUREMENT
- ★ OOPDE/CONTINUITY CHECK
- ★ ACCESSORIES INCLUDED
- ★ TEST LEADS, BATTERIES & INSTRUCTION MANUAL
- ★ SIZE 180 x 90 x 35mm
- ★ WEIGHT 300g
- ★ SAMPLING TIME 0.25 sec

DC VOLTAGE (5 ranges) 0.8% accuracy 100 μ V to 1000V
AC VOLTAGE (2 ranges) 1.2% accuracy 100mV to 1000V
DC CURRENT (5 ranges) 1.2% accuracy 100nA to 10A
RESISTANCE (4 ranges) 1% accuracy 1 Ω to 2M Ω

Price £49.95 includes VAT, postage & packing optional accessories.

Deluxe protective case £6.90 including VAT p&p
10AC current shunt £6.90 including VAT p&p



62 CURTIS ROAD, WHITTON,
HOUNSLOW, MIDDLESEX TW4 5PT
TEL (01) 894 2723

Goodmans Fane Richard Allan Celestion Altai

Multimeters & Accessories

- UK P/P 65p or £1.00 for two
- KRT 100 12 range pocket 1K/volt £4.95
- NH55 10 range pocket 2K/volt £5.95
- NH56R 22 range pocket 20K/volt £10.95
- YW360TR 19 range plus hfe test 20K/volt £14.95
- 5T303TR-21 range plus hfe test 20K/volt £17.95
- TMK500 23 range plus 12 adc plus cont. buzzer £23.95



High Quality Speakers
8" 25W to 50W
10" 25W to 100W
12" 30W to 200W
15" 100W to 250W
18" 100W to 350W



PIELO ELECTRIC TWEETERS
Up to 100 watts each. No crossover required. Flared Horns. Mid range Flared Horns in stock. New Large range of speakers, public address equipment, microphones, mics, ham equipment, Heavy chromed Floor Stand. £9.95
Boom Arm £8.50
Echo Chamber £99.95
Analogue Echo Chamber £99.95

CROSSOVERS

2 way	100W	8 ohm
3 way	100W	8 ohm
4 way	80W	8 ohm

Power Amplifier Modules 100W to 200W

Stockists of leading makes of Disco Units & Lighting Equipment.

CITRONIC, FAL, TK, ICE,
OPTIKINETICS, PLUTO.

SEND LARGE SAE FOR LIST
ALLOW 10 DAYS FOR DELIVERY

All prices include VAT at 15%. Mail Orders welcome

MUSICRAFT
303 EDGWARE ROAD,
LONDON W 2 1 ENGLAND
TELEPHONE 01 402 9729 01 402 2898

It's easy to complain about advertisements.

The Advertising Standards Authority. ✓
If an advertisement is wrong, we're here to put it right.

A.S.A. Ltd., Brook House, Torrington Place, London WC1E 7HN.

HOME LIGHTING KITS

These kits contain all necessary components and full instructions & are designed to replace a standard wall switch and control up to 300w. of lighting.

- TDR300K Remote Control Dimmer £14.30
- MK6 Transmitter for above £4.20
- TD300K Touchdimmer £7.00
- TDEAK Extension kit for 2-way switching for TD300K £2.00
- LD300K Rotary Controlled Dimmer £3.50

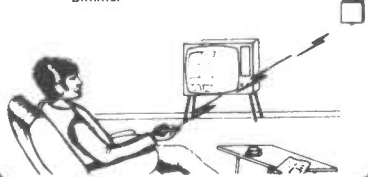

3-NOTE DOOR CHIME

Based on the SAB0600 IC the kit is supplied with all components, including loudspeaker, printed circuit board, a pre-drilled box (95 x 71 x 35mm) and full instructions. Requires only a PP3 9V battery and push-switch to complete. AN IDEAL PROJECT FOR BEGINNERS. Order as XK102. £5.00

DISCO LIGHTING KITS

DL 1000K

This value-for-money kit features a bi-directional sequence, speed of sequence and frequency of direction change, being variable by means of potentiometers and incorporates a master dimming control. Only £14.60



A lower cost version of the above, featuring unidirectional channel sequence with speed variable by means of a pre-set pot. Outputs switched only at mains zero crossing points to reduce radio interference to a minimum.

Optional opto input DLA1
Allowing audio ("beat")
—light response. Only £8.00
60p

DISPLAYS

COX87A 0.5" dual, c.a. Red £1.80
DL340M 0.1" 4-Digit c.c. £4.50
FND 500 0.5" c.c. 85p
FND 507 0.5" c.a. 85p



MP463 4-digit 0.5" multiplexed c.c. £2.20
LED Clock Display £2.20

Liquid Crystal Display, 3 1/2 digit, 0.5" digits, d.i.l. package £6.00

KL901 9-digit, 7-seg. 0.1" c.c. LED calculator display with red filter 55p

TRIACS

- 400v Plastic case (Texas) 3AT1C206D 49p
- 8AT1C2260 58p
- 12AT1C236D 85p
- 16AT1C 246D 96p
- 25AT1C2630 190p



- 6A with trigger Q4006LT 85p
- 8A isolated tab TXAL2288 65p
- Diac 18p
- Opto isolated triac MOC3020 0.1 A/400v .. 110p

LCD 3 1/2 DIGIT MULTIMETER

16 ranges including DC and AC voltage, DC current and resistance + NPN & PNP transistor gain and diode check. Input impedance 10M. Size 155x88x31mm. Requires PP3 9v battery. ONLY £31.00

TRANSISTORS

- BC108 8p
- BC109 15p
- BC182 8p
- BC182L 8p
- BC212 9p
- BC212 9p
- BC327 12p
- BC337 13p
- BFY50 20p
- TIP31A 40p
- TIP32A 40p
- 2N3055 45p
- 2N3442 20p
- 115w 140v 90p
- 2N3819 N ch fet 20p

VMOS POWER FETS

- VN10KM 0.5A/60v 52p
- VN66AF 2A/60v 88p

24 HOUR CLOCK/APPLIANCE TIMER KIT

Switches any appliance up to 1kW on and off at preset times once per day. Kit contains: AY-5-1230 IC, 0.5" LED display, mains supply, display drivers, switches, LEDs, triacs, PCBs and full instructions.



- CT1000K Basic Kit £14.90
- CT1000K with white box (56/131 x 71mm) £17.40 (Ready Built) £22.50

FREE SHORT FORM CATALOGUE - send SAE (6" x 9"). We also stock Vero, Books, Resistors, Capacitors, Semi-Conductors etc.

FAST SERVICE · TOP QUALITY · LOW LOW PRICES

No circuit is complete without a call to -

TK ELECTRONICS HE
11 Boston Road
London W7 3SJ

ALL PRICES EXCLUDE VAT

Add 55p postage & packing +15% VAT to total. Overseas Customers: Add £1.75 (Europe), £4.50 (elsewhere) for p&p. Send S.A.E. for further STOCK DETAILS. Goods by return subject to availability. 9am to 5pm (Mon to Fri) 10am to 4pm (Sat)

OPEN



DVM/ULTRA SENSITIVE THERMOMETER KIT

This new design is based on the ICL7126 (a lower power version of the ICL7106 chip) and a 3 1/2 digit liquid crystal display. This kit will form the basis of a digital multimeter (only a few additional resistors and switches are required—details supplied), or a sensitive digital thermometer (-50°C to +150°C) reading to 0.1°C. The basic kit has a sensitivity of 200mV for a full scale reading, automatic polarity indication and an ultra low power requirement—giving a 2 year typical battery life from a standard 9V PP3 when used 8 hours a day, 7 days a week.



Price £15.50

SWR Meter

Designed for 27 MHz CB rigs.

R. A. Penfold

ALTHOUGH a random length of wire may give acceptable — or even excellent — results for reception purposes, for transmission it is important that the transmitter, aerial feeder, and antenna are all properly matched. An SWR (standing wave ratio) meter enables the feeder to be trimmed or adjusted to match the antenna and transmitter properly, so that maximum signal is transferred and a minimum of power is wasted. In CB radio, however, it is more usual to trim the antenna, for example by adjusting the length of a telescopic whip-antenna, to obtain the correct SWR.

This simple and inexpensive SWR Meter is primarily intended for use with 27 MHz FM Citizens Band rigs, but should also work properly with similar (50Ω output impedance) high frequency transceivers.

Matching

There is not usually any problem in matching the output impedance of a transmitter to a feeder (coaxial cable) since transmitter output impedances and co-ax impedances are limited to a few standard values. Most CB rigs and other high frequency communications equipment have an output impedance of 50Ω and so they should be used with a 50Ω coaxial cable, such as RG58C or an equivalent cable.

While it might at first seem strange to refer to the impedance of a cable, it should be borne in mind that there is inductance in the two conductors of the cable and capacitance between them. This is analogous to the circuit shown in Figure 1 where the longer the cable, the more inductors and capacitors are added into the system. The impedance, or 'characteristic impedance' of a cable, as it is more correctly known, always varies somewhat with changes in frequency. However, both coaxial and ribbon cables are designed to have inductance and capacitance values that give a virtually constant characteristic impedance over a wide frequency range.

If the feeder is terminated in a resistor, or other load having an impedance which is identical to that of the cable, the load effectively acts as a continuation of the cable and there is a perfect transfer of power from the cable and to the load. In practice, there is always a small loss through the cable, which is primarily caused by its series resistance, and should not be

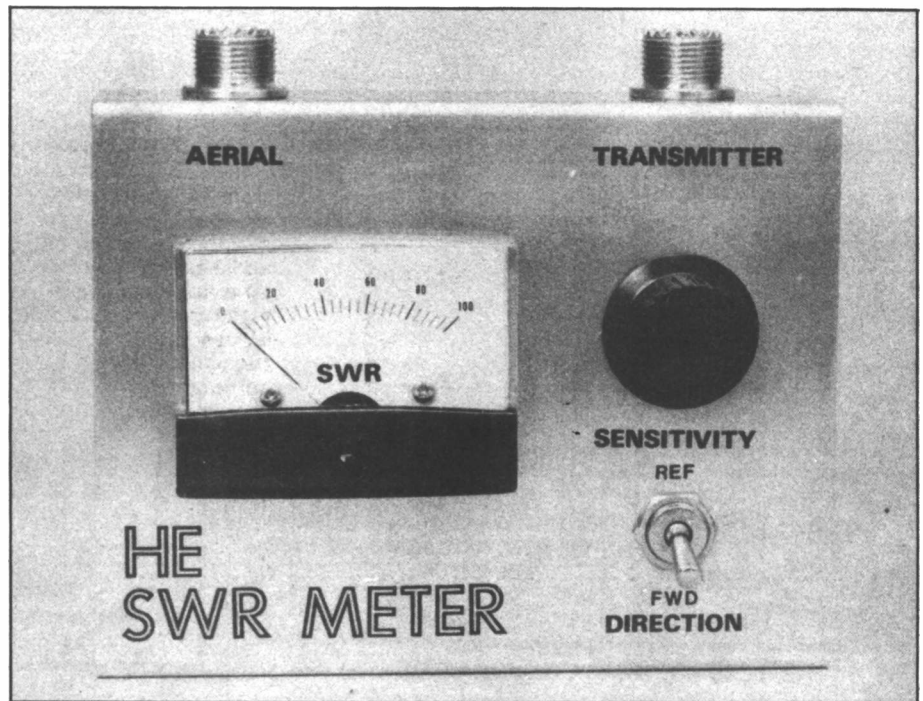

significant unless an unusual cable is used.

If the load has the wrong impedance this results in some of the signal being reflected from the load back down the cable to the signal source and the greater the impedance mismatch, the greater the reflected power. With a matched system, the voltage at any point along the feeder varies from zero to some peak level as the wave travels down the feeder. With any degree of mismatch this does not occur, as the forward and reflected waveforms add together to produce a waveform that is static and does not move along the cable; this is known as a 'standing wave'.

In an extreme case, all the power fed into the cable is reflected, so that the

voltage in the standing wave varies from zero to a high peak level, and the standing wave ratio (the ratio of the maximum to the minimum voltage in the standing wave) is infinite. With a perfect match there is no standing wave, so with both the maximum and minimum standing wave voltages at zero, the SWR is 1 to 1. Thus one should aim for the lowest possible SWR, as this gives the maximum signal transfer to the aerial.

The Circuit

BASICALLY, the unit first measures the power fed down the feeder to the aerial, and then the power level reflected back down the cable, so that the efficiency of the aerial matching can be assessed.

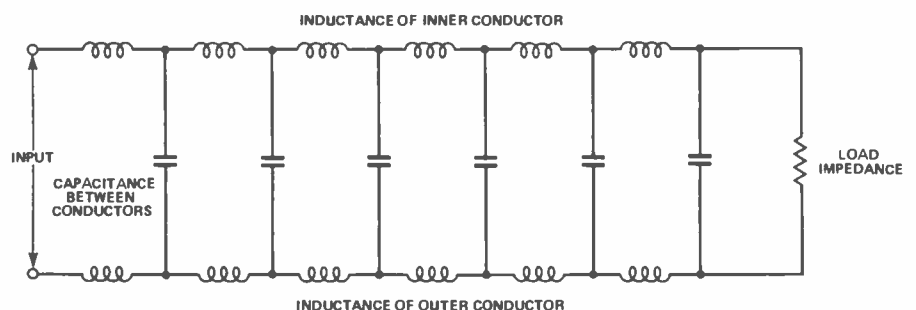

Figure 1. The equivalent circuit of a length of coaxial cable.

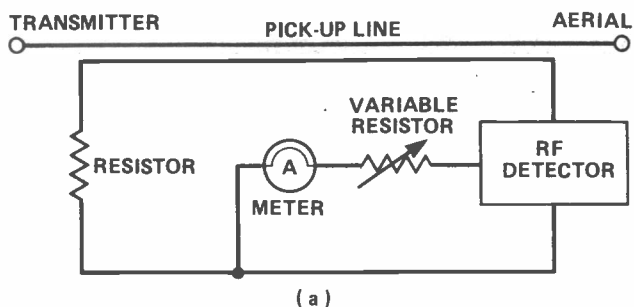

Figure 2(a). Forward power is measured by detecting the voltage induced at the aerial end of the pick-up wire. A simple meter is adequate for this.

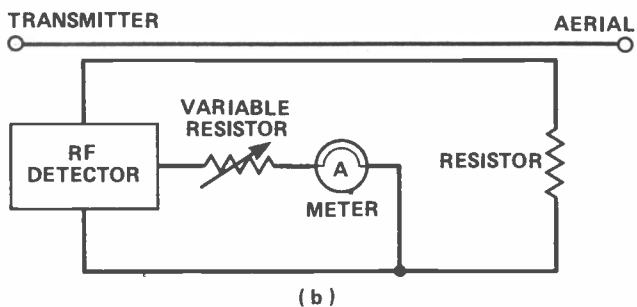

Figure 2(b). Reference power, from the transmitter, is measured by the reverse procedure; the aerial end of the pick-up is earthed via a resistor and the voltage induced at the transmitter end is detected and measured.

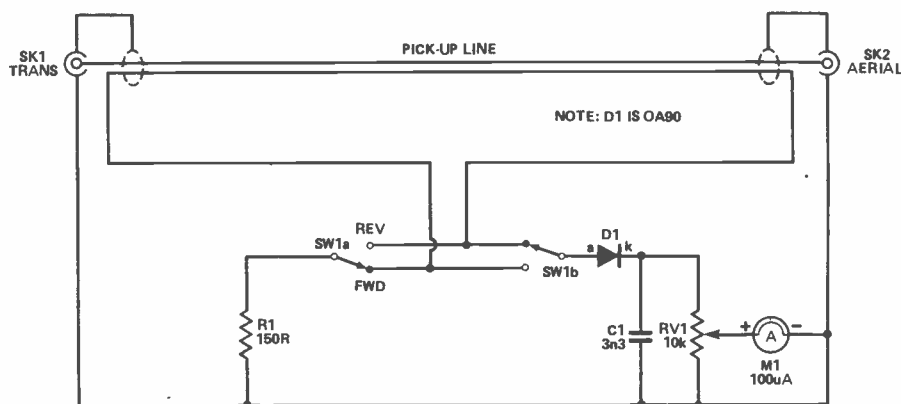

Figure 3. The complete circuit is simply a combination of the two circuits of Figure 2.

To measure forward power, the input end of the pick-up line is connected to earth via a resistor and the signal from the other end of the line is fed to an RF detector circuit which produces a DC output signal proportional to the RF signal level. This voltage is fed to a meter via a potentiometer, and the latter is adjusted to give a full scale reading on the meter. This arrangement is illustrated in Figure 2(a).

Basically the same set-up is used to measure the reverse power, as can be seen from Figure 2(b). The only change here is that the aerial end of the pick-up line now connects to the resistor and the input end connects to the RF detector. So, by simply transposing the connections to the pick-up line, the circuit indicates the power reflected down the feeder from the antenna. Thus a reading of 100 (full scale) at this stage, would mean that all the

transmitter power was being reflected and the SWR would be infinite. The ideal case would be a reading of '0' — no reflected power — indicating an SWR of 1:1.

The SWR meter uses a conventional bridge circuit; the full circuit diagram appears in Figure 3. The pick-up line is simply a piece of 50R coaxial cable, to which an extra wire is added between the inner conductor and the outer braiding. The detector circuit is a straight-forward half wave type, which uses D1, C1 and RV1, with the latter enabling a proportion of the resultant DC voltage to be fed to meter M1. S1 is used to switch the pick-up line to give 'forward' or 'reverse' power reading, as desired. R1 is part of the bridge circuit and it is important to use the specified value here, if accurate results are to be obtained.

Strictly speaking, the circuit is measuring forward and reverse

voltages, rather than power, so it is really a VSWR (voltage standing wave ratio) meter. However, units of this type are usually — and more accurately — just referred to as SWR meters because the ratio of forward to reverse power, current or voltage, will be the same in each case.

Construction

There are few components in the circuit and the most practical method of construction is to hard-wire the unit. Use a metal case for this project — one having dimensions of about 193 x 102 x 38 mm is ample to accommodate all the components.

The two sockets, the two controls and the meter are fitted as shown in the photograph. It is strongly recommended that the general layout used on the prototype should be copied fairly closely, as it might otherwise be awkward to wire up the unit.

If the meter is a standard 60 x 45 mm plastic front type, it will require a main 38 mm diameter cutout and four 3.2 mm diameter mounting holes. The 38 mm hole can be cut using a fretsaw or a miniature round file; a third alternative is to drill a ring of small, closely spaced holes, and then punch out the metal within the ring. With the last method it will be necessary to use a large half-round file to suitably enlarge the cutout and to produce a neat finish.

It is not necessary to use an expensive meter in the circuit; there are inexpensive types of around 100 uA sensitivity which will work perfectly well! Most ready-built SWR meters seem to use inexpensive meter movements, incidentally. It may be necessary to vary the mounting of the meter to suit the particular component employed; many inexpensive meters do not have provision for screw fixing and it will then be necessary to glue the component in position.

All the wiring of the unit is shown in Figure 4 and this is mostly straight-forward. D1 is a germanium device and care should be taken not to overheat this component when wiring up the unit.

The pick-up line is made from a piece of RG58C or similar 50R coaxial cable, about 300 mm long. This is the type of cable that is usually used as the aerial feeder for CB rigs and it will probably be possible to trim a suitable piece from the aerial lead. Do not use a heavy-duty 50R coaxial cable, such as UR67, as this would probably be too thick and inflexible, and consequently unusable.

Step one in the construction of the pick-up line is to remove the plastic sheath from the cable; this is done by using a modelling knife to cut through the sheath along the full length of the cable. However, do be careful not to damage the copper braiding beneath the plastic sheath.

Next the braiding is bunched up slightly by pushing both ends of it towards the middle. The point of this is that it makes the outer braiding rather

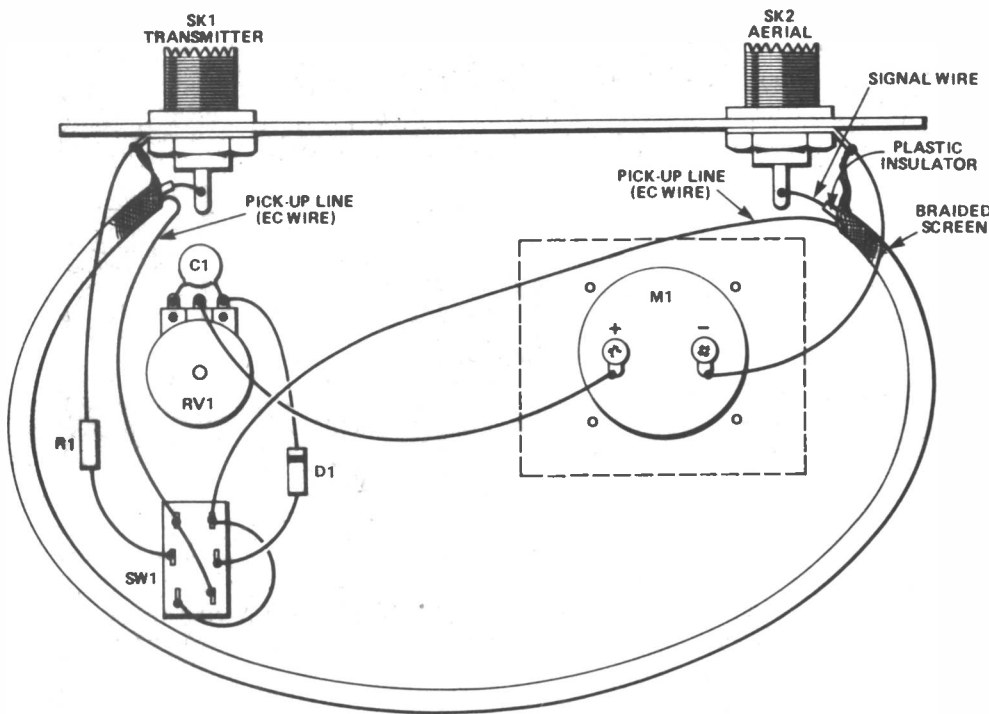

Figure 4. The component layout.

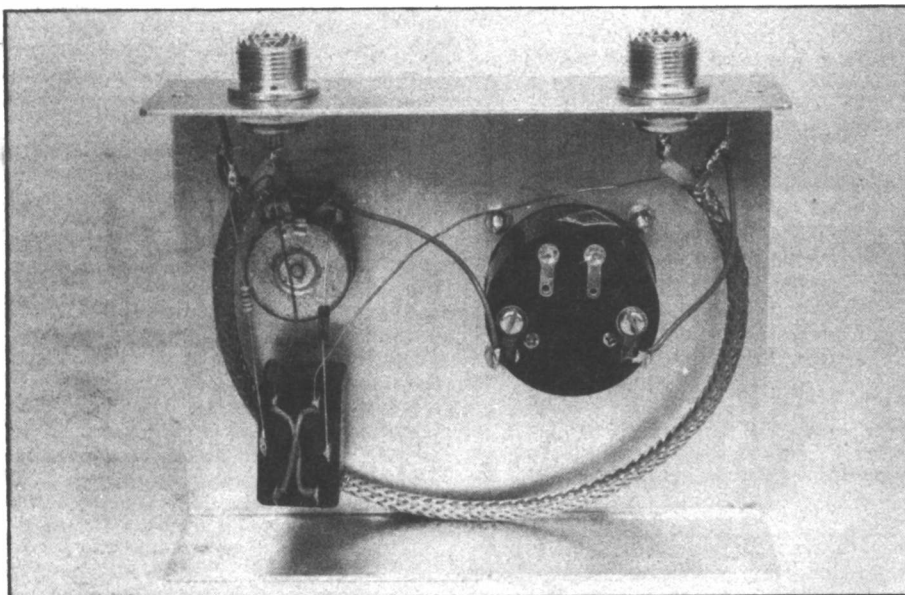

Figure 5. The internal view of the completed unit. Since there is no PCB, the construction is identical to the component layout.

Parts List

RESISTORS (All 1/4 Watt 5% carbon)		MISCELLANEOUS	
R1	150R	M1	100uA FSD moving coil panel meter (see text)
CAPACITORS		SW1	DPDT toggle switch
C1	3n3 ceramic	SK1,2	S0239 50R UHF socket
POTENTIOMETERS		Aluminium case (133 x 102 x 38); knob; coaxial cable (50R); enamelled copper wire (24 SWG); connecting wire, solder etc.	
RV1	10k linear carbon	Buylines	page 34
SEMICONDUCTORS			
D1	0A90 signal diode		

loose, so that the additional wire can easily be slipped under. The additional wire is a piece of 24 SWG (or any thin gauge) enamelled copper wire about 450 mm long, so that a leadout wire about 75 mm is left at each end of the pick-up line.

After stretching the braiding, so that it is as close to its original condition as possible, the pick-up line is complete and ready for connection.

Setting Up

The input socket (SK1) is fed from the transceiver via a short 50R coaxial cable fitted with PL259 plugs. Many CB shops can supply ready-made leads of this type, or you can easily put one together yourself. The aerial plug connects to SK2 of the SWR Meter instead of the output socket of the rig.

Start with RV1 adjusted almost fully anticlockwise and SW1 set to the 'forward' position. With the rig set to 'transmit', there should be a small forward reading on the meter and it should be possible to adjust RV1 for full scale deflection. Now with SW1 set to 'reverse', a much lower reading should be obtained. It is this second reading that indicates the SWR.

The SWR is 3 to 1 at half full-scale, 5 to 1 at two thirds of full-scale, 7 to 1 at three quarters of full-scale, 9 to 1 at 80% of full-scale, and infinite at full-scale. A reading anywhere in this part of the scale indicates poor efficiency and a possibility of the reflected power damaging the rig.

Readings of 5, 10, 20 and 33% of full scale correspond to SWR values of 1.1 to 1, 1.2 to 1, 1.5 to 1, and 2 to 1 respectively. As an SWR of 2 to 1 represents 88% of the output power being transferred to the aerial, and a lower SWR will not give a significant improvement, results are satisfactory provided a reverse reading of no more than one third full scale is obtained in any channel. Note that in order to ensure good accuracy, the unit should be switched to the 'forward' mode and RV1 should be re-adjusted for full scale deflection of the meter after adjustments to the aerial have been made.

A new scale, calibrated in SWR values can be added to the meter but, as the precise SWR is not of great importance and the purpose of the unit is simply to ensure that a reasonably low SWR is being obtained, it is obviously far from essential to recalibrate the meter.

It is perfectly acceptable to leave the meter permanently connected in the aerial lead and set to the 'reverse' mode and the unit will then give warning if a fault develops in the aerial or feeder.

An important point to bear in mind is that a low SWR does not mean that a strong signal is being radiated; it simply shows that the output of the transmitter is being effectively transferred to the aerial. How effectively the aerial radiates the signal is another matter!

HE

MASTER ELECTRONICS NOW!

The PRACTICAL way!

This new style course will enable anyone to have a real understanding of electronics by a modern, practical and visual method. No previous knowledge is required, no maths, and an absolute minimum of theory.

You learn the practical way in easy steps mastering all the essentials of your hobby or to start or further a career in electronics or as a self-employed servicing engineer.

All the training can be carried out in the comfort of your own home and at your own pace. A tutor is available to whom you can write personally at any time, for advice or help during your work. A Certificate is given at the end of every course.

You will do the following:

- Build a modern oscilloscope
- Recognise and handle current electronic components
- Read, draw and understand circuit diagrams
- Carry out 40 experiments on basic electronic circuits used in modern equipment
- Build and use digital electronic circuits and current solid state 'chips'
- Learn how to test and service every type of electronic device used in industry and commerce today. Servicing of radio, T.V., Hi-Fi and microprocessor/computer equipment.



New Job? New Career? New Hobby? Get into **Electronics Now!**

FREE!
COLOUR BROCHURE



POST NOW TO

Please send your brochure without any obligation to

NAME _____

ADDRESS _____

I am interested in:

- COURSE IN ELECTRONICS as described above
- RADIO AMATEUR LICENCE
- MICROPROCESSORS
- LOGIC COURSE

OTHER SUBJECTS _____

HE/8/821

BLOCK CAPS PLEASE

British National Radio & Electronics School Reading, Berks. RG1 7BR

AITKEN-BROS.

ELECTRONIC COMPONENTS AND TEST EQUIPMENT
35, HIGH BRIDGE, NEWCASTLE
UPON TYNE NE1 1EW TEL: 0632 326729

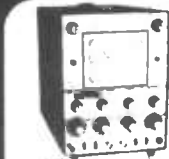

SAFGAM OSCILLOSCOPES - 5 mV/div sensitivity. Choice of Bandwidth 10, 20, 40, 80, 150, 300, 600, 1200, 2400, 4800 Hz. 1S/div-100nS/div. Calibrated timebase. Solid trigger with bright line auto, normal and TV. XY facility. 2 modulation. Calibration output. Bright and clear display. Portability. ● Model DT410-10 MHz £205.85. Model DT415-15 MHz £217.35. ● Model DT420 20 MHz £228.85. Send S.A.E. FOR FULL spec.

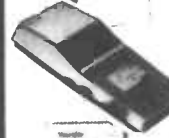

THANDAR PDM35 3 1/2 DIGIT L.E.D. DIGITAL PCKET MULTI-METER. ● DC volts (4 ranges) 1mV to 1000V. ● AC volts 1V to 500V ● DC current (6 ranges) 1nA to 200MA ● Resistance (5 ranges) 1Ω to 20 meg. £2. ● £39.95. ● AC adaptor £5.95. ● carrying case £3.65 ● MN1604 Battery £1.57.



THANDAR TM354 3 1/2 DIGIT LCD DIGITAL PCKET MULTIMETER ● DC volts 1mV to 1000V ● AC volts 1V to 500 V AC rms ● DC current 1µA to 2A ● Resistance 1Ω to 2 MΩ ● Diode check ● Basic accuracy ± (0.75% of reading + 1 digit) ● Battery life typically 2000 hrs ● leads inc. ● £45.94 ● 40KV Probe £34.95 ● Universal test lead set £12.95.



THANDAR TM352 3 1/2 DIGIT LCD DIGITAL PCKET MULTIMETER ● DC volts: 100µV to 1000V ● AC volts: 1V to 1000V ● DC current: 100 nA to 10A ● Resistance 1Ω to 2 MΩ ● Diode check ● hFE measurement ● Audible continuity check ● Basic accuracy ± (0.5% of reading + 1 digit) ● Battery life 150 hrs + ● £57.44 inc. leads ● Battery ● Universal test lead set £12.95 ● 40 KV probe £34.95



THANDAR SC110 SINGLE TRACE LOW POWER 2" OSCILLOSCOPE ● Bandwidth DC to 10 MHz ● Sensitivity: 10mV/div to 50 V/div. ● Sweep speeds: 0.1µsecs/div to 0.5secs/div. ● Power requirements 4-10 V DC 4 "C" cells ● Size & weight 255x150x40mm ● 800gms £159.85 a truly portable and superb instrument ● Carrying case £8.86 ● AC Adaptor £5.69 ● Nicad Batt pack £8.63 ● x1 probe £9.78 ● x10 probe £11.50 Complete range of Thandar instruments available from stock S.A.E. for CAT. & prices.

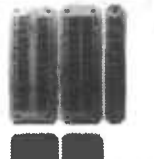

G.S.C. SOLDERLESS BREADBOARDS ● Accepts all components with leads up to .033" ● Replaceable nickel-silver spring clip contacts. ● Combines bus strip with board ● Unlimited expansion ● .3" and .6" centre channels ● Three free experimental circuits with every purchase

	Centre Channel	Strip Length	Strip Width	Tie Points	Term Cls	i.c. Cpts.	Price
EXP-600	15mm	152mm	61mm	550	110	3 28pin	£7.25
EXP-300	8mm	152mm	53mm	550	110	6 14pin	£6.62
EXP-4B	n/a	152mm	25mm	160	32	n/a	£2.65
EXP-650	15mm	91mm	61mm	270	54	1 40pin	£4.14
EXP-350	8mm	91mm	53mm	270	54	3 14pin	£3.62
EXP-325	8mm	48mm	53mm	130	26	1 22pin	£1.84

Please send S.A.E. for catalogue listing complete range of G.S.C. Instruments and Boards.



SABTRONICS LCD MULTIMETER MODEL 2033. ● DC volts 100 µV-1000V Accuracy + .5% ● AC volts 100µV-1000 V Accuracy ± 1% ● DC current 10µA-2A Accuracy ± 1% ● AC current 10µA-2A Accuracy ± 1% ● Resistance 1Ω-20 MΩ Accuracy ± 1% ● £42.27. ● Please send 30p for full Sabtronic catalogue and price list

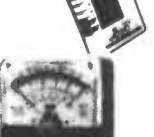

TMK 500 MULTIMETER ● 30 kopv. ● AC volts 2.5 10 25 100 250 500 1000V ● DC volts 0.25 1 2.5 10 25 100 250 1000 ● DC current 50µA 5MA 50MA 12 amp ● Resistance 0-6K 60K, 60 meg. ● Decibels -20 to + 56 d/b ● Buzzer continuity test ● Size 160x110 x65 ● Batteries and leads inc. £26.95



YN360 TR MULTIMETER ● AC volts 10 50 250 1000 ● DC volts 0.1, 0.5, 2.5, 10v 150v 250v, 1000v. ● DC current 50µA 2.5 MA, 25MA, 250 MA ● Resistance 0-2K 20K 2M Ω, 20 M Ω. ● Transistor check ● DB -10db - - 22db £16.95



DESOLDERING TOOL £6.45



SCHOOLS, COLLEGES, UNIVERSITIES SUPPLIED PHONE OR SEND YOUR ACCESS OR BARCLAYCARD NUMBER. PRICES INCLUDE VAT. PLEASE ADD 75p POSTAGE TO ORDERS UNDER £10.00

ELECTRONIC IGNITION

Makes a good car
better



TOTAL ENERGY DISCHARGE electronic ignition gives all the well known advantages of the best capacitive discharge systems.

PEAK PERFORMANCE — higher output voltage under all conditions.

IMPROVED ECONOMY — no loss of ignition performance between services.

FIRES FOULED SPARK PLUGS no other system can better the capacitive discharge system's ability to fire fouled plugs.

ACCURATE TIMING — prevents contact wear and arcing by reducing load to a few volts and a fraction of an amp.

SMOOTH PERFORMANCE — immune to contact bounce and similar effects which can cause loss of power and roughness.

PLUS

SUPER POWER SPARK — 3½ times the energy of ordinary capacitive systems — 3½ times the power of inductive systems.

OPTIMUM SPARK DURATION 3 times the duration of ordinary capacitive systems — essential for use on modern cars with weak fuel mixtures.

BETTER STARTING — full spark power even with low battery.

CORRECT SPARK POLARITY unlike most ordinary C.D. systems the correct output polarity is maintained to avoid increased stress on the H.T. system and operate all voltage triggered tachometers.

L.E.D. STATIC TIMING LIGHT for accurate setting of the engine's most important adjustment.

LOW RADIO INTERFERENCE fully suppressed supply and absence of inverter 'spikes' on the output reduces interference to a minimal level.

DESIGNED IN RELIABILITY an inherently more reliable circuit combined with top quality components — plus the 'ultimate insurance' of a changeover switch to revert instantly back to standard ignition.

IN KIT FORM

it provides a top performance electronic ignition system at less than half the price of competing ready-built systems. The kit includes everything needed, even a length of solder and a tiny tube of heatsink compound. Detailed easy-to-follow instructions, complete with circuit diagram, are provided — all you need is a small soldering iron and a few basic tools.

AS REVIEWED IN

ELECTRONICS TODAY INTERNATIONAL June '81 Issue
and EVERYDAY ELECTRONICS December '81 Issue

FIRES ALL NEGATIVE EARTH VEHICLES.

6 or 12 volt, with or without ballast

OPERATES ALL VOLTAGE IMPULSE TACHOMETERS

Some older current impulse types (Smiths pre '74) require an adaptor — PRICE £2.95

STANDARD CAR KIT £ 14.85

Assembled and Tested £ 24.95

TWIN OUTPUT KIT £ 22.95

**For MOTOR CYCLES and CARS with twin ignition systems
Assembled and Tested £ 34.70**

PLUS
£1.00
U.K.
P. & P.
Prices
Include
VAT.

ELECTRONIZE DESIGN

Dept. E, Magnus Road, Wilnecote,
Tamworth, B77 5BY

Phone: (0827) 281000



NAMAL ASSOCIATES

25 Gwydir Street, CAMBRIDGE

Tel: 355 404

Telex: 817445

MEMORY EXPANSION

FOR ZX81

ASSEMBLED £25.00

KIT £18.95

with full Assembly
instructions

SPECIAL OFFER

Edge connector 23 Way

For ZX81 £2.25

ICL 7660 £1.60

4116 - 200ns £0.65

6845 £5.25

74 LS series

00	.10	37	.15	113	.21	175	.45	4099	.50
02	.12	38	.15	122	.40	193	.45	4503	.45
03	.12	40	.12	123	.36	196	.57	4512	.55
04	.12	42	.33	124	.90	197	.60	4518	.40
08	.18	48	.59	125	.24	240	.87	COMP: 1.0	
09	.20	49	.59	126	.25	242	.78	2114-LP.80	
10	.20	51	.14	132	.44	244	.60	200ns	
11	.20	54	.14	133	.25	245	.88	2532	3.75
12	.20	55	.12	138	.32	247	.60	2716	1.95
13	.20	73	.21	139	.32	248	.60	2732	3.75
14	.38	74	.16	145	.72	251	.40	4116-2	0.68
15	.12	75	.24	148	.85	257	.43	4816	3.99
16	.12	76	.20	151	.30	259	.78	4864	4.75
17	.12	78	.19	153	.28	266	.22	4164	4.75
18	.12	83	.44	154	.80	273	.70	5516AP	7.50
19	.12	85	.60	155	.38	373	.70	6116LP	6.00
20	.12	86	.15	156	.36	374	.72	6116PS	3.95
21	.12	90	.30	157	.30	393	.60	6800 Series	
22	.12	91	.74	161	.37	CMOS		6800	2.50
26	.16	92	.33	162	.40	4011	.09	6802	3.60
27	.12	93	.33	163	.38	4013	.22	6809	8.75
28	.15	95	.42	164	.46	4024	.28	6810	1.15
30	.12	107	.40	165	.90	4066	.24	6821	1.10
32	.12	109	.22	173	.68	4069	.15	6845	5.35
33	.16	112	.21	174	.46	4093	.30	6847	4.90

6500 series

6502 4.25

6520 3.00

6522 4.50

6532 5.75

Z80 series

Z80P10 3.25

Z80CPU 3.25

Z80CTC 2.75

Z80ACPU 3.25

Z80AP10 2.75

Z80ACTC 2.75

Z80S10 9.00

8080 series

8080A 4.20

8085A 3.25

8212 1.70

8216 1.50

8226 3.00

8228 3.75

8255 3.50

CRYSTALS

1.00MHZ 2.75

2.00MHZ 2.65

3.575MHZ 0.60

4.00MHZ 1.40

6.144MHZ 1.25

8.00MHZ 1.25

10.00MHZ 1.50

PLEASE SEND ME THE FOLLOWING:

ITEM	QTY	PRICE	TOTAL
1	-----	-----	-----
2	-----	-----	-----
3	-----	-----	-----

Please attach a schedule if space is not sufficient.

TOTAL £ _____ inclusive of £1.00 P/P + VAT at 15%

I enclose a cheque/P.O for £ _____

Please debit my Access Card/Euro Card/Master Card

No: _____ Signature _____

Name (Please Print) _____

Address _____

Telephone No: _____ Post Code _____

Audio Analyser

For creative audio applications.

AUDIO spectrum analysers can be used for a variety of tasks. Their most valuable use is to set up a room acoustically, for live music or in conjunction with a graphic equaliser connected to your hi-fi — something you'll be keen to do if you've caught the hi-fi bug after reading our 'Scaling the Hi-Fi Heights' series. This will allow you to compensate for deficiencies in either your speaker system alone, or the system/living room combination. The procedure used involves feeding pink noise (more on this later) into the room via your hi-fi system and monitoring the sound with the Analyser. The Analyser points out the peaks and troughs in the audio so that you can get rid of them by adjusting the graphic equaliser controls — hopefully this will produce a flat response.

Other uses for a spectrum analyser include monitoring live programme material or (let's be honest!) as a great little gadget to impress your friends.

To Sweep Or Not To Sweep

There are two main methods of

performing spectrum analysis. The first uses a single tuneable filter which can have its centre frequency swept across the band of interest. When the filter output is displayed on an oscilloscope screen it constitutes a graph of amplitude against frequency for the input signal. This gives a well-formatted and accurate display but unfortunately it has the disadvantage of not being 'real time'; if something happens at one frequency while the filter is sweeping somewhere else, it will not be recorded. Consequently, this method is normally only used where the spectral content is constant and the sweep is to be made over a small percentage of the total frequency. A typical example of this would be checking that the emissions of a CB rig were within legal limits; the rig is turned on, with no audio input, so that only the carrier wave is being transmitted; a sweep is then made either side of 27 MHz to check that there are no spurious emissions.

When the spectrum of the input is rapidly changing, as is the case with an audio signal, then we must choose a

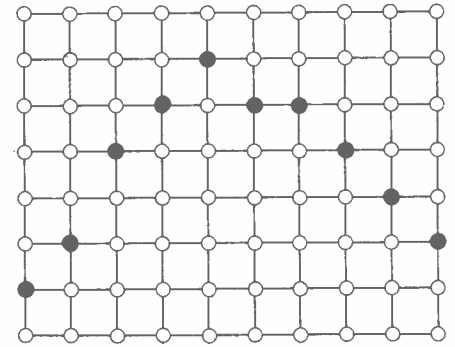

different method. For real time analysis we use several bandpass filters, with fixed centre frequencies, to chop up the frequency spectrum into several bands. The content of each band is rectified, averaged and displayed on an oscilloscope or, as in this project, on columns of LEDs. Commercial spectrum analysers are available with anything from 10 one-octave steps to 30 third-octave steps, but the cost and complexity of the filters increases dramatically as you make the bands narrower. Consequently, we have opted for a 10 channel version, the filters' outputs being 12 dB down one octave from the centre frequency. The centre frequencies of the filters follow the standard scale; measured in Hertz they are 32, 63, 125, 250, 500, 1k, 2k, 4k, 8k, and 16k. The amplitude scale has 3 dB steps.

Admittedly, the fact that this type of analyser breaks up the frequency spectrum into octave chunks means that it isn't capable of picking out individual harmonics in the way that the sweep analyser can. Nevertheless, it does allow you to instantaneously

Parts List

RESISTORS (All 1/4 watt 5% carbon)

R1,2	220k
R3	2k2
R4,5	15k
R6-10,31-35,72	10k
R11-15,21-25,	
36-40,46-50,78	1M
R16-20,41-45	220R
R26-30,51-55,76	100k
R56	680k
R57	6k8
R58-67	27k
R70	430R
R71	27k
R73	4k7
R74	180k
R75	18k
R77	390k

POTENTIOMETERS

RV1	47k
	log carbon
PR1-10	220k
	min horiz preset

CAPACITORS (All metallised Polycarbonate unless noted)

C1,13,43,49,50	100n
C2,3,41	10u 16V
	tantalum bead

C4,5,7	1u0
C6	56n
C8,10	27n
C9,11	270n
C16-20,35-39	2u2 35V
	tantalum bead
C12	6n8
C14	18n
C15	3n9
C21,22	39n
C23	1n5
C24	33n
C25,32,33	2n2
C26,44	820p
	ceramic disc
C27	12n
C28	3n3
C29	470p
	ceramic disc
C30	10n
C31	180p
	ceramic disc
C34	100p
	ceramic disc
C40	22n
C42	1n
C45	2n7
C46	5n6
C47,48	220u 16V
	axial electrolytic

SEMICONDUCTORS

IC1	LF353
	dual BIFET op-amp
IC2-6	TL064
	quad lo-power op-amp
IC7	4011
	CMOS quad 2-input NAND
IC8,9,10	4016
	CMOS quad analogue switch
IC11	LM3915
	bargraph driver
IC12	4017
	CMOS decade counter/divider
	CMOS quad exclusive-OR
IC14	4006
	CMOS 18-stage shift register
Q1-11	BC184L
	silicon NPN transistor
D1-22	1N4148
	signal diode
LED1-100	high efficiency red LED
	(see Buylines)

MISCELLANEOUS

SK1	1/4" jack socket
	with break contacts
MIC1	electret microphone
PP3	battery clips (2 off); IC sockets
	(13 off); case; wire; solder; PCBs,
	etc.
Buylines	page 34

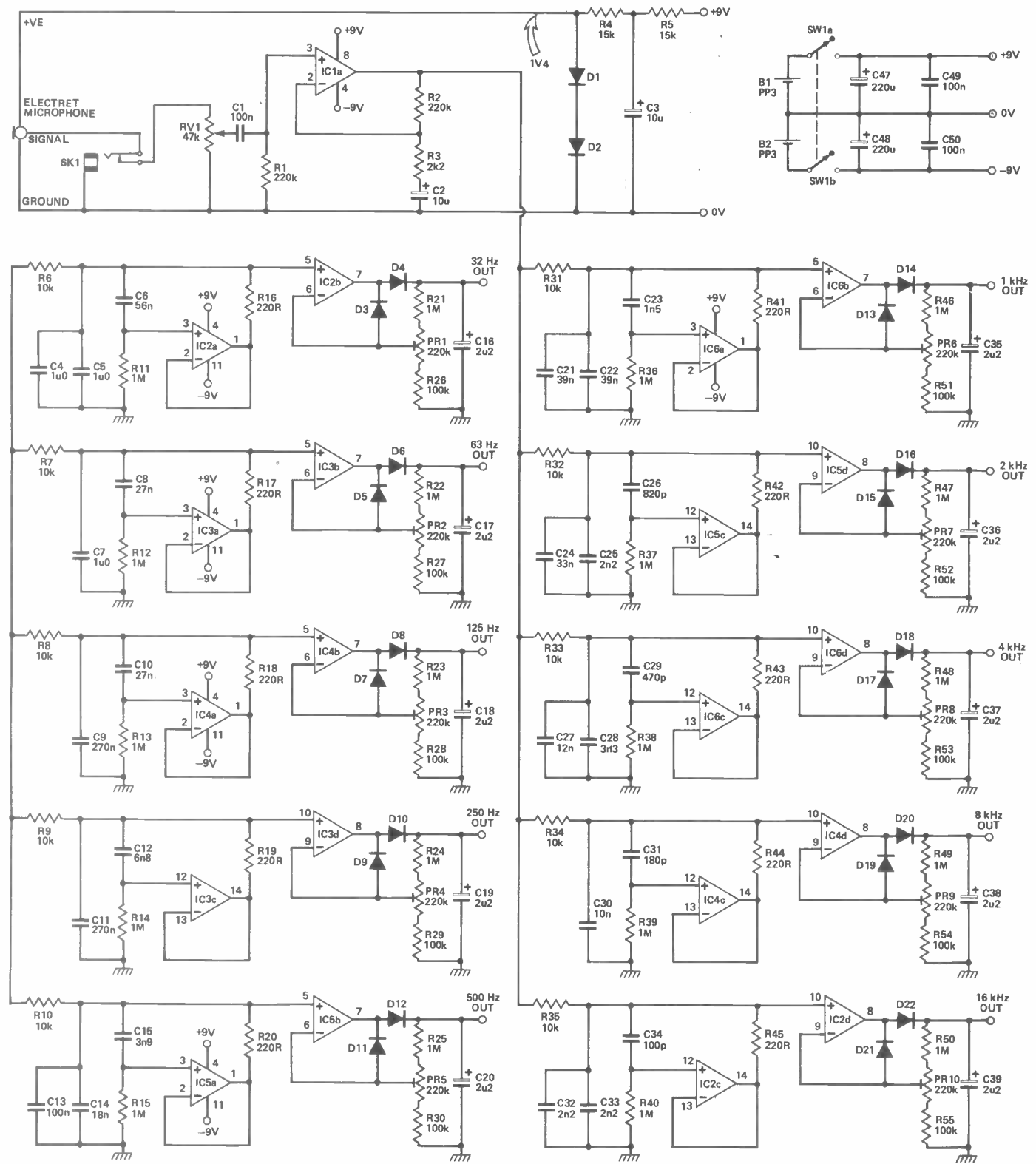

Figure 1. The input and filter stages of the circuit.

determine the average spectrum of a sound, which is all we require.

The Circuit

The input to the circuit (Figure 1) is either from the built-in microphone or via the external input socket. The jack socket automatically disconnects the mic if a plug is inserted. The microphone requires a reasonably flat frequency response but must be

relatively inexpensive, so we chose an electret condenser type which meets these requirements. However, electret mics require a 1V5 power supply, normally provided by an AA cell. Ours has a built-in regulated supply built around D1-D2-R4-R5-C5. Zener diodes with a value of 1V5 aren't available but, by using two ordinary diodes in series, we can get an output voltage of about 1V2-1V4 (each diode has a

forward voltage drop of about 0V6-0V7).

The input sensitivity can be adjusted with level control RV1, while IC1a boosts the signal to a suitable level to drive the filter bank. The gain of IC1a is set at 101, ie, $(R2 + R3)/R3$. Each of the ten filter-rectifier blocks is identical in structure. To obtain a bandpass response with the required roll-off, the simplest solution is to use a parallel LC

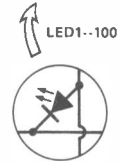
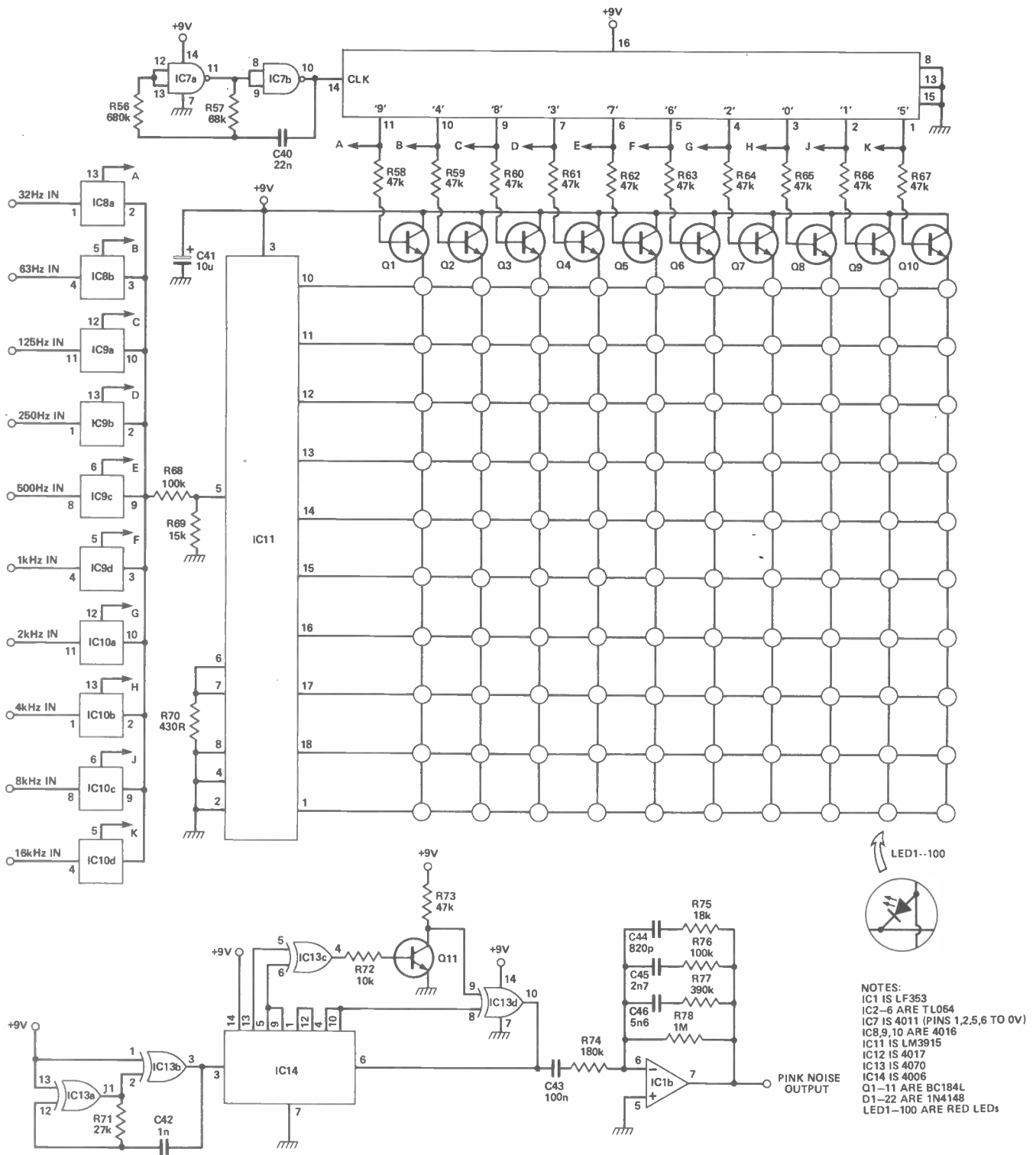

NOTES:
 IC1 IS LF353
 IC2-6 ARE TL064
 IC7 IS 4011 (PINS 1,2,5,6 TO 0V)
 IC8,9,10 ARE 4016
 IC11 IS LM3915
 IC12 IS 4017
 IC13 IS 4070
 IC14 IS 4006
 Q1-11 ARE BC184L
 D1-22 ARE 1N4148
 LED1-100 ARE RED LEDs

Figure 2. The display generation circuitry.

network with a series resistor. Unfortunately, large value inductors are both bulky and expensive, which rules out their use. We can overcome this easily, however, since the only *electrical* difference between an inductor and a capacitor is the phase relationship between the current and the voltage. By using an op-amp to reverse the phase relationship of a capacitor we can make it look like an inductor — this type of circuit (Figure 3) is known as a gyrator. The value of the equivalent inductance is given by:

$$L1 = C1 \times R1 \times R2 \text{ Henries}$$

where C is in Farads, R in ohms. Just like a real inductor, we also have a series resistance (winding resistance) which is R2, and a parallel resistance, R1 (in a real coil this is due to winding capacitance). Hence we can tune our filters to the required frequencies by altering the capacitor values in each one, using parallel pairs in some cases, to get the correct values.

The rectifier section is a half-wave type, with a gain variable

from about four to 12, using the presets. When the output of the op-amp swings positive, capacitor C1 charges rapidly via the diode; D1; when the output falls, the capacitor can only discharge slowly via the resistor chain. The second diode D2, from the op-amp output back to the inverting input, keeps the op-amp in the linear region on the negative half-cycle.

The outputs of the ten rectifiers are multiplexed to reduce the component count and cost; if we drove each column of LEDs separately we'd need

How It Works

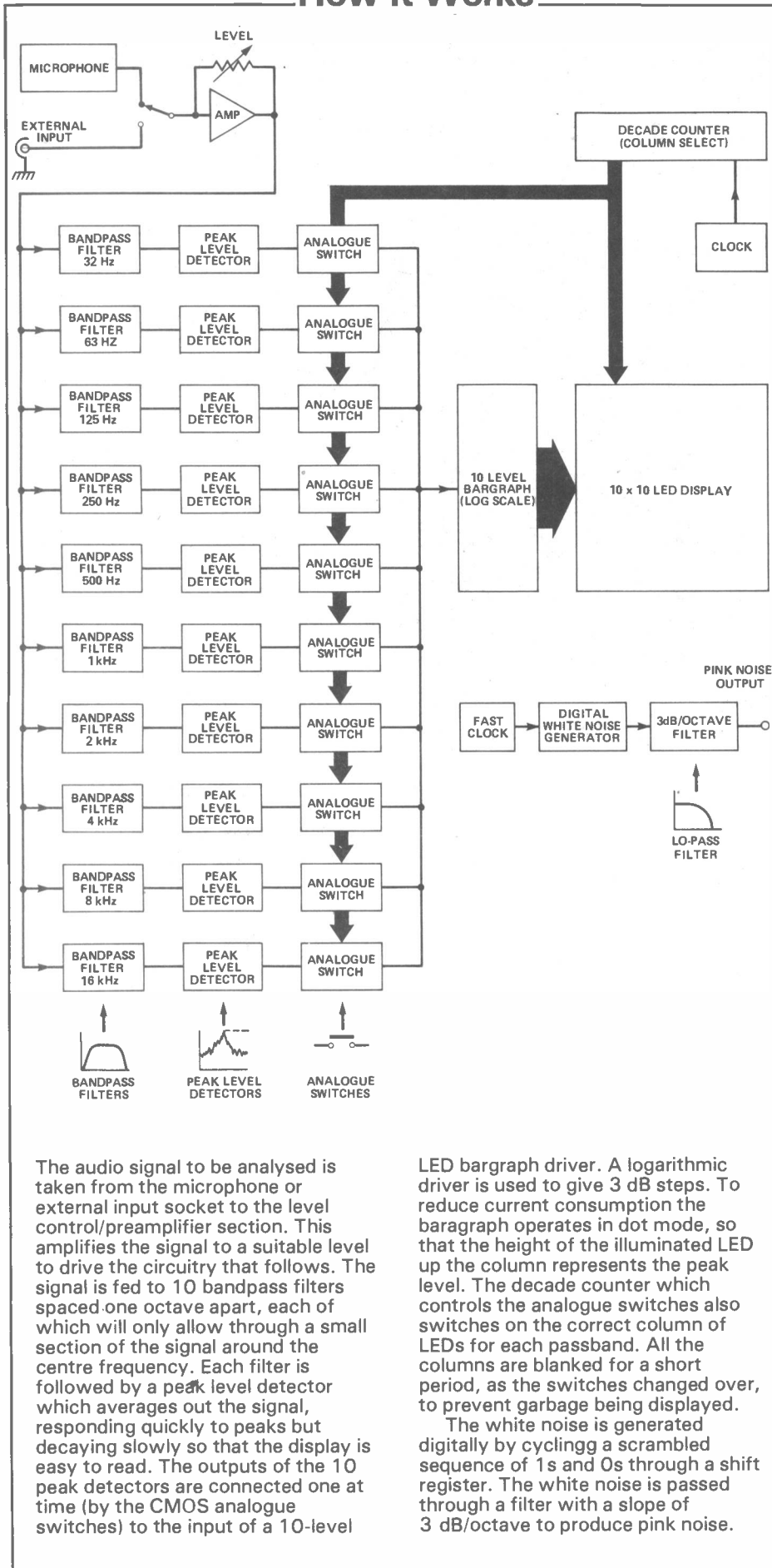

The audio signal to be analysed is taken from the microphone or external input socket to the level control/preamplifier section. This amplifies the signal to a suitable level to drive the circuitry that follows. The signal is fed to 10 bandpass filters spaced one octave apart, each of which will only allow through a small section of the signal around the centre frequency. Each filter is followed by a peak level detector which averages out the signal, responding quickly to peaks but decaying slowly so that the display is easy to read. The outputs of the 10 peak detectors are connected one at time (by the CMOS analogue switches) to the input of a 10-level

LED bargraph driver. A logarithmic driver is used to give 3 dB steps. To reduce current consumption the bargraph operates in dot mode, so that the height of the illuminated LED up the column represents the peak level. The decade counter which controls the analogue switches also switches on the correct column of LEDs for each passband. All the columns are blanked for a short period, as the switches changed over, to prevent garbage being displayed. The white noise is generated digitally by cycling a scrambled sequence of 1s and 0s through a shift register. The white noise is passed through a filter with a slope of 3 dB/octave to produce pink noise.

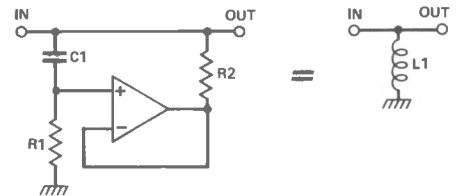

Figure 3. A gyrator circuit 'looks like' an inductor.

ten LM3915s, which is a bit expensive! Multiplexing means that each rectifier output is switched to the input of the LM3915 (IC11) one after another, by the analogue switches IC8, 9 and 10. The switches are controlled by a 4017 decade counter (IC12) with ten decoded outputs, each of which is high for one clock period only. These outputs also switch on one of the transistors Q1-10, connecting the required column of LEDs to the positive supply rail. Meanwhile the LM3915 has turned on one of its outputs corresponding to the voltage on its input (remember, it's wired in dot mode). Hence a current path between the supply rails exists for only one LED of the 100 in the display, so at any moment only one LED is turned on. By clocking the 4017 at a fairly slow speed (about 500 Hz) the display cycles through all ten columns 50 times a second and the eye sees ten LEDs 'continuously' lit.

To generate an adequate light level, a red LED requires at least 4 or 5 mA continuous current. Since each LED is only on for one-tenth of the total time, it requires ten times the current to give the same apparent brightness. The maximum current capability of the LM3915 is only 30 mA, so high efficiency LEDs must be used (see Buylines). The 4017 is even worse at supplying current, hence the use of the drive transistors.

The clock generator for IC12 is a standard configuration built round IC7a,b.

White noise is an audio signal which contains all frequencies and has equal energy per unit bandwidth. However, what we require here is equal energy per *percentage* bandwidth (ie, equal energy per octave). This is known as pink noise and it is obtained by passing white noise through a filter (IC1b) with a slope of 3 dB/octave. The white noise is generated digitally rather than by a Zener noise diode, which can be temperamental. IC14 is an 18-stage shift register clocked by the 30 kHz oscillator IC13a,b. Two EX-OR gates and an inverter (IC13c,d and Q11) are used to feed various outputs of IC14 back to the input (pin 6) so that a complex sequence of 1s and 0s flows through the register, repeating once every few seconds. This produces an apparently random jumble of fundamental frequencies with a vast number of harmonics — ie, noise. And that's about enough to digest for one month! Next issue, we'll present the PCB foil patterns and all the information needed to complete the Audio Analyser.

HE MicroTrainer

For ease of construction, the MicroTrainer is built on a double-sided, through-hole-plated printed circuit board.

THE HE MicroTrainer is a fairly complex piece of computer hardware, and for this reason, its construction must be carried out very carefully, with close attention to detail. All of the parts and components of the MicroTrainer (with certain exceptions — see the Parts List) are available from Technomatic Ltd. These include a high quality double-sided, through-hole plated PCB (this keeps the size of the board to practical dimensions and simplifies construction by eliminating the need for large numbers of wire links) and the specially programmed EPROM ICs, which are used to implement many of the logic functions, eg in generating the video display.

The box shown on the cover of the HE June issue, in which the MicroTrainer was introduced, is NOT part of the kit!

Construction

Assembling the kit should be easy provided that your soldering is neat and that you are careful to check the placement of components. You will need to refer to the component overlay diagram and the Parts List.

First, fit and solder in position all the IC sockets. You may find it easier to do this one socket at a time, ensuring that the pins are pushed right through the holes and that the socket is flush with the board. Do not use excess solder, or short circuits will be formed on the component side of the board; $\frac{1}{8}$ " of 22 SWG solder should be sufficient for each joint and the sign of a well formed joint is a cone of solder, surrounding the pin, which is neither sunken nor bulbous. Next, fit and solder all the passive components, with the capacitors and the crystal standing upright, close to the board. Bend the leads of the resistors so that they lie horizontally on the board. After soldering each of these components, cut away the excess leads. Finally, fit and solder the modulator, the regulator, with its heatsink, and the 20 keyswitches. A thin smear of silicone grease should be applied to the metal tab of the regulator which, together with the heatsink, should then be bolted tightly to the PCB as shown in the component overlay diagram. Take care that each keyswitch is pushed firmly onto the board before soldering, to produce a neat and level keypad.

Testing

Do not, at this stage, attempt to fit the IC's to their sockets. It is worthwhile carefully checking over the board looking for solder 'bridges' or otherwise

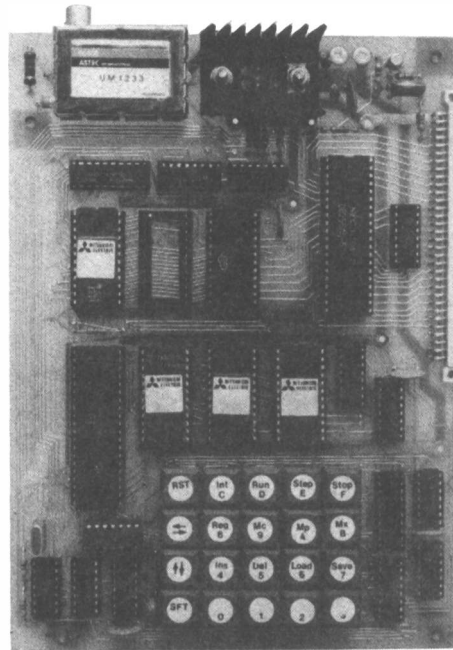

badly made joints. Now connect a DC power supply (8-12 volts @ 800 mA or more) again using the overlay to provide the connection details. Check the sockets from the top side of the PCB with a voltmeter, to ensure that the supply voltage (5 V) is correct for each IC, using the circuit diagram (published last month) to determine the correct pins. Now, having switched off the power supply, fit each IC into its (correct) socket and check that no pins are folded under, or folded outside the socket.

Connect a coaxial lead from the

modulator to a TV set and tune it to channel 36, UHF. Switch on the power supply and press reset (RST). By fine tuning the TV set and adjusting the brightness and contrast controls, it should be possible to produce a sharp display that looks something like Figure 1.

If there is no display, or the display is distorted in some way, it is likely that there is a fault in the construction, therefore once again check the board against Figure 2 and check for solder splashes or bent IC pins. If, despite all checks and precautions, your MicroTrainer still does not produce the above display, it is probable that something more serious has gone wrong. Unless you are very experienced with microcomputers — and have to hand all the necessary test equipment — it is better not to attempt further fault-finding. Technomatic Ltd will repair any unsuccessful efforts at constructing their MicroTrainer kit, so contact them immediately. Their service charge is £10, including return postage, plus any component replacement costs, of course.

MicroTraining

After power-up, or pressing reset, the machine generates a display of the contents of the first 32 bytes of RAM, in Hexadecimal. Immediately below this is a four digit, Hexadecimal 'cursor' address, initially 0000H, which gives the memory address of the data byte indicated by the flashing cursor. Programs, in the form of Hexadecimal data, can be stored in memory, at the address of the cursor, by typing on the

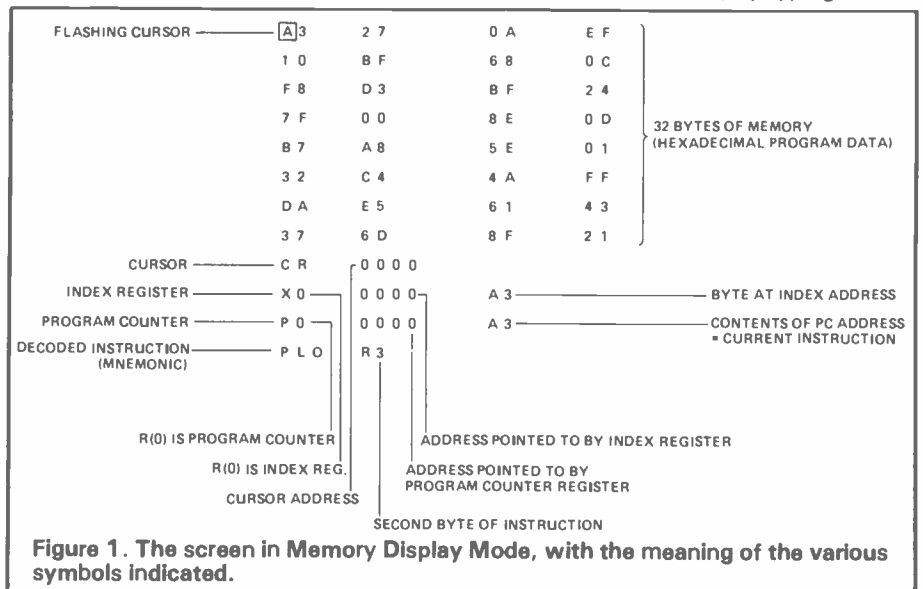

Figure 1. The screen in Memory Display Mode, with the meaning of the various symbols indicated.

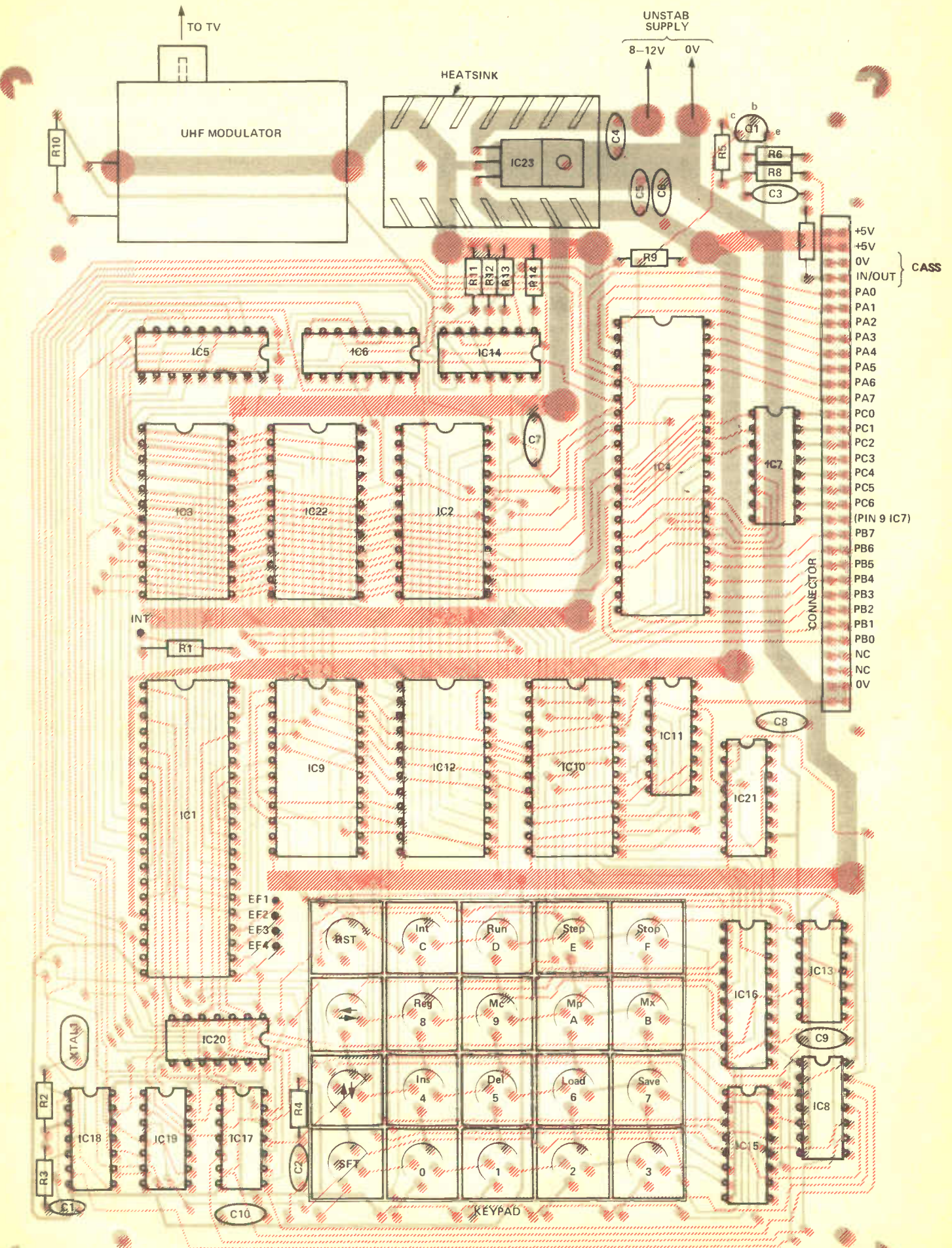

Figure 2. The component layout diagram. The tracks printed in colour are those on the TOP (component side) of the PCB.

keypad. For example, try typing in the following data:

```
F8 20 B1 F8 00 A1
51 11 81 3A 06 00
```

Notice that, as you type, the data appears at the cursor position and the flashing cursor advances; the cursor address increments each time. In the event of typing mistakes, the key labelled with a left-right arrow, in conjunction with the shift key (SFT), can be used to step the cursor backwards.

The above data is, in fact, a simple program, as shown in Figure 3. This program will write the character codes 00H to FFH in memory locations 2000H to 20FFH respectively, ie display the complete character set over the entire screen. We can now use the MicroTrainer itself to illustrate the working of this program — and introduce some of the machine's more important features at the same time.

Having entered the program into memory, put the machine in register display mode (Figure 4) by holding down 'SFT' and pressing 'REG'. You will see displayed on the screen the contents of the 1802's internal register set: the 16-bit address registers R(0) through R(F), and the minor registers CF (carry flag), AC (accumulator), IE (interrupt enable flag) and T (temporary register). R(0) is, for the moment of particular concern because it is the register used by the 1802, after reset, as the program counter and it has the initial value of 0000H. This is indicated by the 4 bit register P, displayed near the bottom of the screen together with the contents of the program counter register and the memory byte to which it points (you should see: PO 0000 F8). This latter byte is, in fact, the current instruction code, which has been 'decoded' or disassembled into its mnemonic representation on the bottom line. Thus, the mnemonic of F8 is LDI, which means Load Immediate (data into the accumulator); this is much easier to remember and understand than simply 'F8'. The full instruction is, in fact, 'LDI \$20', meaning that the data byte immediately following the instruction (\$20) is to be loaded into the accumulator (AC). Now, hold down the shift key and press 'STEP'. Observe the effect this has on the accumulator; notice also that the program counter, R(0), has automatically incremented by two so as to point to the next instruction. Now, the bottom two lines of the display show the next instruction, B1, mnemonic PHI R1. Execute this next instruction by using the STEP function again, and observe the effect on R(1) and on the program counter; the accumulator is copied into the high order byte of R(1) and the program counter is incremented by one.

After the execution of the first four instructions, the address 2000H will have been copied into R(1); this now points to the first byte of the display RAM. The following instruction, STR(R1) causes the accumulator contents (which in this case are the same as the contents of the low byte

```
0000 F8 20 LDI $20 ; Load high byte of register 'I' with
0002 B1     PHI R1  ; hex '20'
0003 F8 00 LDI $00 ; Load low byte of register 'I' with
0005 A1     PLO R1  ; hex '00'
0006 51     STR (R1) ; register 'I' points to display address
                    ; range
0007 11     INC R1  ; advance to next display position
0008 81     GLO R1  ; get next character code
0009 3A 06 BNZ $06 ; loop until 256 characters displayed
000B 00     DLE     ; stop
```

Figure 3. A simple program to inspect the character set.

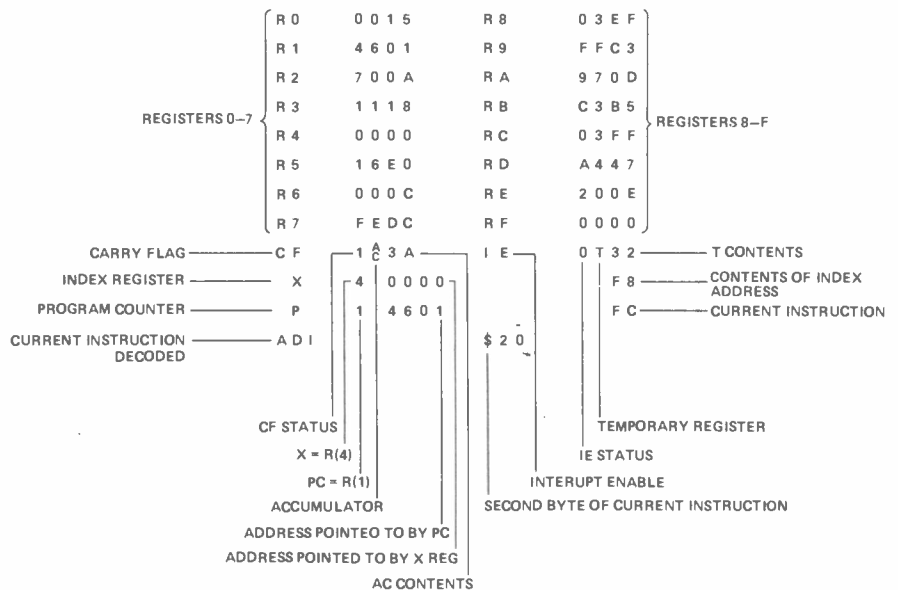

Figure 4. The screen in Register Display Mode.

RST	Reset:	the machine assumes its initial power-up state; P = 0, X = 0, R(0) = 0000H, CR = 0000H; the display is of 32 bytes of memory with independent cursor.
INT	Interrupt:	executes the current instruction and then simulates the normal interrupt action of the 1802.
RUN		Perform simulated execution of the 1802 code, commencing from the present program counter address.
STEP		Perform one instruction at the preset program counter address and update display.
STOP		Stop program simulation and await display command.
REG		Display registers.
MX		Display memory using index register as cursor address.
MP		Display memory using program counter as cursor address.
MC		Display memory using independent cursor.
INS	Insert:	move all data, at and forward of the cursor, forward one byte in RAM.
DEL	Delete:	eliminate the byte under the cursor, thus moving back, by one byte, all data previously forward of the cursor.
	→	Move cursor forward one byte.
	←	Move cursor back one byte.
	↓	Move cursor forward one page (32 bytes).
	↑	Move cursor back one page.
SAVE		Save the contents of the entire 1K5 of RAM on cassette tape.
LOAD		Load into ram any program previously stored on cassette.

Figure 5. The Command Table. All except Reset and two of the Cursor Control Commands are entered using the Shift (SFT) key.

of R(1)) to be stored at the memory address pointed to by R(1). During single step operation, the characters will not be displayed, as the screen is over-written by the display of the register data and this prevents the effect of this last instruction from being seen. Briefly, what is happening is: INC

R1 increments R(1); GLO R1 copies the low order byte of R(1) into the accumulator; BNZ \$06 (Branch if Not Zero) causes the byte immediately following the instruction (\$06) to be copied into the low byte of the program counter if the accumulator is non-zero, else the program counter is increment-

Parts List

RESISTORS (All 1/4 watt 5% carbon)
 R1,4,8*,15,16,17,18,19 ... 4k7
 R2,3,7*,9,14 ... 470R
 R5* ... 5k6
 R6*,13 ... 680R
 R10,11,12 ... 220R

CAPACITORS
 C1 ... 33p disc ceramic
 C2 ... 47u 6V3 tantalum bead
 C3*,6,7,8,9,10 ... 100n disc ceramic
 C4,5 ... 2u2 16V tantalum bead

SEMICONDUCTORS
 Q1* ... BC108 silicon NPN transistor
 IC1 ... 1802 microprocessor
 IC2 ... 6116 8-bit RAM
 IC3,22* ... 2532 EPROM
 IC4* ... 8255 programmable peripheral interface
 IC5,16 ... 74LS374 TTL octal D-type flip-flop
 IC6 ... 74LS138 TTL 3-8 line decoder/multiplexer
 IC7* ... ULN2003 darlington array
 IC8 ... 74LS113 TTL dual J-K flip-flop
 IC9,10,12 ... 2716 EPROM
 IC11 ... 74LS165

TTL 8-bit parallel-to-serial converter
 IC13 ... 74LS74
 TTL dual D-type flip-flop
 IC14 ... CA3086 transistor array
 IC15 ... 74LS156 TTL dual 1-of-4 decoder/demultiplexer
 IC17 ... 74LS14 TTL hex Schmitt trigger
 IC18 ... 74LS04 TTL hex inverter
 IC19 ... 74LS00 TTL quad 2-input NAND
 IC20 ... 74LS08 TTL quad 2-input AND
 IC21 ... 74LS163 TTL binary counter
 IC23 ... 7805 voltage regulator
 UHF MOD ... UM1233 UHF TV modulator

MISCELLANEOUS
 Heatsink (TV-21, for regulator); switch-caps (20, for keypad); IC sockets (optional); power supply (800mA 8-12V unregulated); double-sided, through-hole-plated PCB.

NOTE: The 2716 and 2532 EPROM's (IC's 3,9,10,12) are only available from Technomatic — they have to be specially programmed.

* These components are NOT included in the kit supplied by Technomatic.

Buylines ... Page 34

ed by two. With these limited explanations, you should be able to arrive at an understanding of the program, aided by stepping through the instructions and carefully observing what has happened. A much more detailed description of the 1802's instruction set will be given next month, together with further program examples. However, for the time being, the real point of exercise is to familiarise yourself with the operation of the MicroTrainer; the more you can work out for yourself the better.

To round off the example in hand we should now attempt to Run this program. First, type 'SFT MP'; this enables the program to be displayed as before, however the program counter itself now becomes the cursor address counter. You can now step the cursor back using the 'left-arrow' so that the program counter points to the first byte of the program; then type 'RUN'. The TV screen will fill up with a set of characters and then stop, leaving a steady display. With a program this simple, some of the characters are placed outside the main display area and, by their proximity to the SYNC pulses, there may be some slight distortion. How this can be avoided will be explained in a later issue.

In addition to details of the instruction set, next month, we shall be describing how to interface the MicroTrainer to external devices, with the addition of the I/O port.

HE

Subscriptions

Do yourself a favour. Make 1982 the year you start to take Hobby Electronics, regularly. Delivered fresh every month.

SUBSCRIPTION ORDER FORM

Cut out and SEND TO:
 Hobby Electronics Subscriptions
 513, LONDON ROAD,
 THORNTON HEATH,
 SURREY,
 ENGLAND.

Please commence my personal subscription to Hobby Electronics with the issue.

SUBSCRIPTION RATES
 (tick as appropriate)

£10.75 for 12 issues U.K.
 £12.75 for 12 issues overseas surface
 £25.70 for 12 issues Air Mail

I am enclosing my (delete as necessary)
 Cheque/Postal Order/International Money
 Order for £.....
 (made payable to A.S.P. Ltd)
 OR
 Debit my Access/Barclaycard*
 (*delete as necessary)



.....

Please use BLOCK CAPITALS and include post codes.

Name (Mr/Mrs/Miss)
delete accordingly

Address

.....

Signature

Date

ELECTROVALUE

**A SPECIAL
SUMMER
PROMOTION**



**FREE VOUCHERS
TO SAVE YOU UP TO**

£2.10



THREE 70p REFUND VOUCHERS FREE for spending singly at any time on any one C.W.O. (U.K.) order minimum list value £10. This can quickly save you up to £2.10 in addition to the other benefits you enjoy by buying from Electrovalue. *Send 70p for Catalogue 82 + 3 free vouchers by return now*

+ USUAL DISCOUNTS + FREE POSTAGE

DISCOUNTS

5% on orders over £23 (inc. V.A.T.)
10% on orders over £57.50 (inc. V.A.T.)
on most catalogue items, but not on payments by credit cards.

POSTAGE

Not charged on U.K. orders over £5.75 inc. V.A.T. If under, add 40p handling charge

- SEMI-CONDUCTORS/ICs/OPTOs
- COMPUTERS/SOFTWARE etc.
- CAPACITORS/RESISTORS
- CONNECTORS/SWITCHES/KNOBS
- POTS/FERRITES/METERS
- BOOKS/SOLOER TOOLS

AND MORE AND MORE AND MORE

ELECTROVALUE LTD. 28E St. Junes Road, Englefield Green Egham, Surrey TW20 0HB
Phone: Egham 33003 (STD 0704; London 071). Telex: 264475
Northern Branch (Personal Shoppers only) 680 Burnage Lane, Burnage, Manchester M19 1MA. Phone: (051) 42 4945

MAKE IT WITH
BRADLEY

Marshall's

OF LONDON

SPECIALIST ELECTRONIC COMPONENT DISTRIBUTORS

Tel: 723-4242

**PROBABLY THE
LARGEST STOCK
OF ICs &
TRANSISTORS
IN THE SOUTH
TRY US FIRST**

**LARGE RANGE OF
ACCESSORIES**

Plugs
Sockets
Audio Connectors
Veroboards
IC Sockets
Soldering equipment
Screw drivers
(BAHCO)
Sifam Knobs
etc.

**LARGE RANGE OF
ICs**

Transistors
Capacitors
Diodes
Triacs
Thyristors
Opto
Resistors
Potentiometers
Fuses
Bridges

Please send S.A.E. for list.

**SPECIAL
OFFER**

STEINAL 2132 £7.10
MULTICHECK 2112 £9.40
£7.50
+ VAT

Normal price £10.26

**BUY WITH
ACCESS
BARCLAYCARD
A/EXPRESS
DINERS**

Just phone we do the rest

**MAIL
ORDER
FASTER
SERVICE
PHONE
723-4242**

**40 WAY RIBBON
CABLE £2.29 metre**
Header plugs 14 way,
16 way, 40 way

**BAHCO TOOLS
SIDE CUTTERS**

2132 £7.10
2112 £9.40

END CUTTERS

2211 £10.43
PLIERS
2411 £6.75
2415 £6.78

ICE MULTIMETERS
Microtest 80 £16.60
Supertest 680 R £32.00
Supertest 680E £24.50

**EXPERIMENTER
BREADBOARD'S**
EXP 325 EXP 600
EXP 350 EXP 650
EXP 300 EXP 4B

LOGIC PROBES
LP1 £31.00
LP2 £18.00

**EXPERIMENTER
KITS**
PB6 £9.20
PB100 £11.80

**PLEASE REMEMBER
To ADD 15% VAT**

325 EGWARE ROAD LONDON W2 1BN

BARCLAYCARD * ACCESS * DINERS * A/EXPRESS

G.M. MICROTRONICS LTD.

UNIT 14, GODINTON WAY INDUSTRIAL ESTATE,
GODINTON ROAD, ASHFORD, KENT TN23 1JB
Telephone: ASHFORD (0233) 38671/38672

*"Add the power of speech
to your computer"*

TMS 5100 TALKING BOARD as featured in ELEKTOR

Features 170 word vocabulary in
3 Eproms

Easily interfaced to any computer
(via Bus or Parallel port) ie:
Acorn, Atom, Apple, Atari, Pet,
Vic, and ZX80/81.

Requires $\pm 12v$ (≈ 50 ma and
 $+5v$ (≈ 300 ma.

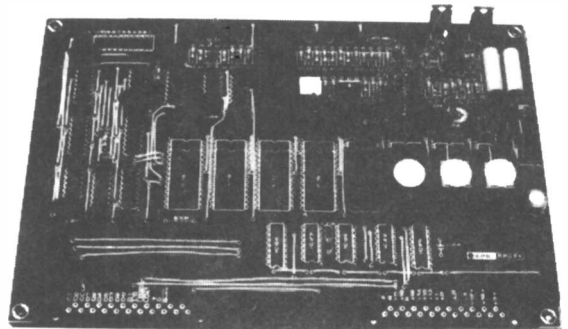

GM510 Talking Board Kit (with interface IC's) £82.95p
GM511 Power supply Kit to Power above £16.10p
GM5100 Ready Built with power supply and cased £144.00p
Design notes (inc in above) if bought separately £1.00p

SOFTY II NOW IN STOCK
@ £182.00 inc VAT

ALSO AVAILABLE SHORTLY

6808/6809 6u Board
Expandable Computer System

Send for further details and specification



Please send the following items:

- \ Box
- Softy II
- GM510 Talking Board Kit
- GM511 P.S.U. Kit
- GM5100 Ready Built Cased Unit
- Further Details
- Design Notes
- 6808/9 Details

I enclose cheque P O for value of £..... please add £2.00 p&p. All prices inc. VAT.

Name

Address

Post Code

Send for my CATALOGUE ONLY 75p

(plus 25p post/packing)

My VAT and post/packing inclusive prices are the lowest. All below normal trade price — some at only one tenth of manufacturers quantity trade.

See my prices on the following:

CAPACITORS . . . ELECTROLYTIC; CAN, WIRE END, TANTALUM, MULTIPLE, COMPUTER GRADE, NON POLAR, PAPER BLOCK, CAN, POLY, MICA, CERAMIC. LOW AND HIGH VOLTAGE, RESISTORS. 1/8th WATT TO 100 WATT; 0.1% TO 10% CARBON, METAL AND WIRE WOUND + NETWORKS. FANS, BATTERIES, SOLENOIDS, TAPE SPOOLS, VARIABLE CAPACITORS AND RESISTORS, TRIMMERS, PRESETS, POTS . . . SINGLE, DUAL, SWITCHED, CARBON, CERMET AND WIREWOUND, SINGLE OR MULTITURN, ROTARY AND SLIDE. DIODES, RECTIFIERS, BRIDGES, CHARGERS, STYLII, SOCKETS, PLUGS, RELAYS, TRANSISTORS, IC'S, CLIPS, CRYSTALS, ZENERS, TRIACS, THYRISTORS, BOXES, PANELS, DISPLAYS, LED'S, COUPLERS, ISOLATORS, NEONS, OPTO'S, LEADS, CONNECTORS, VALVES, BOOKS, MAGAZINES, TERMINALS, CHOKES, TRANSFORMERS, TIMERS, SWITCHES, COUNTERS, LAMPS, INDICATORS, BELLS, SIRENS, HOLDERS, POWER SUPPLIES, HARDWARE, MODULES, FUSES, CARRIERS, CIRCUIT BREAKERS, KNOBS, THERMISTORS, VOR'S, INSULATORS, CASSETTES, METERS, SOLDER, HANDLES, LOCKS, INDUCTORS, WIRE, UNITS, MOTORS, COILS, CORES, CARTRIDGES, SPEAKERS, EARPHONES, SUPPRESSORS, MIKES, HEATSINKS, TAPE, BOARDS and others.

Prices you would not believe before inflation!

BRIAN J. REED

TRADE COMPONENTS

ESTABLISHED 25 YEARS

161 St. Johns Hill, Battersea, London SW11 1TQ
Open 11 am till 7 pm Tues. to Sat. Telephone: 01-223 5016

USED EQUIPMENT INTERCOM TELEPHONE

All you need is a PP9 battery and plenty of wire. Our Instructions tell you how to wire up these push button intercom phones.
10-button phone £5.50
15-button phone £6 + £1.80 p&p

MF (Multi Frequency) PHONES
Use them as they are or use 3x4 keypad and PCB as the heart of a remote control transmitter (will not work on most GPO lines) £5 + £1.80 p&p

Recent Style P.O. Telephones £4.75 + £1.80 P&P
2 for £9 + £2.50. 5 for £20 + £5

COMPACT TELEPHONE
With wall-mount bell £6.50 Older style black telephones, £3.00 as above. Our leaflet explains how to use G.P.O. phones in home intercom systems.

5 Digit Counters 48V coil. Non resetable 75p

UNISELECTORS, 50v, 4 Bank + Homing Bank, 25 way £3.50

500V ELECTRONIC BRIDGE MEGGER £15 + £2 p&p

PRICE T.T.L.
7420/7430 10p 7496 30p 74118 50p

FREE on request Leaflet "O.I.Y. Telephone Systems and Automatic Exchange Design"

LOW-COST, RUGGED TEMPERATURE CONTROL

HIGH QUALITY



TEMP. GAUGE 0° - 120°C
Remote sensor on 38" capillary, panel mounting dial 55mm. dia.
ONLY £2.50

16A 240V RANCO THERMOSTAT
Wide control range (low room temp. to over boiling point). Sensor on 22" capillary. £2.30, including control knob

RANCO THERMAL CUT-OUT 100°C
15A 240V. Sensing coil on 4in. capillary panel mounting with reset button £1.20

BUY ONE EACH OF ABOVE FOR £5.50

LIGHT DEPENDENT RESISTORS in plastic housing with window, heavy-duty lead. Similar to ORP 61. You normally pay well over double for resistor alone. Only 30p or £2.35 for 10.

GEARED Synchronous motor, 8 r.p.m., 240V A.C. 3 Watt £2.

SOLENOID GAS VALVE, 240V A.C. 5 P.S.I. suitable for non-corrosive fluids. £2.20

BULGIN 3 pin free plug & panel socket, 2A 240V 50p

AUTOMATIC DIAL UNIT. (mains powered). These units connect into a telephone and dial a number when a punch-card is inserted. Card & instructions supplied. Cards readily available. Many uses. Only £8 + £1 p&p



L.E.M. SERVICES
239 RUGBY ROAD
LEAMINGTON SPA CV32 6DY
WARWICKSHIRE

ADD 50p P&P
ORDERS OVER
£7.50 POST FREE
unless stated otherwise

TEL: 0926 30622 FOR QUANTITY DISCOUNTS ETC.
ALL ITEMS — MONEY BACK IF NOT DELIGHTED.

DESOLDERING TOOL Now everyone can afford one of these superb, blue anodised aluminium high pressure hand desoldering tools at nearly half our normal price. Normal Price £6.50 + VAT. With this ad £3.85 + VAT. Spare Teflon screw in noses 75p + VAT.
JAPANESE TRANSISTORS Equivalents available for most types. Please call, phone or write.
LOW COST VERSATILE MULTIMETER
THE MIGHTY MINI MULTI-TESTER 2,000 ohms per volt. DC & AC Voltage ranges: 10v, 50v, 250v, 1000v. DC current ranges 100mA. Resistance ohms x 10 x 100db from -10db to +22db. Mirror arc scale, overload protected, complete with battery, test leads & instructions. Usual price £8.65 + VAT; with this Ad £4.95 + VAT.



ORDER FORM
Name
Address

Desoldering tools at £3.85 £
Spare Teflon noses at 75p £
Mighty Mini Testers at £4.95 £

Postage, packing and insurance at 60p per one device, 25p for each additional device £

Sub total £
Add 15% VAT £

I enclose cheque no/P.O. no
Alternatively please credit my VISA/ACCESS No.

Signature

This offer applies to UK only. Please allow 7-10 days delivery. Overseas customers please do not add VAT but allow to cover postage. TRADE ENQUIRIES WELCOME.

CRICKLEWOOD ELECTRONICS LTD.
40 Cricklewood Broadway, London NW2 3ET. Tel: 01-452 0161

COMPONENTS IN BIRMINGHAM

CMOS-LSTTL-LINEAR-ICs NOW!!! IN DEPTH STOCK

From National Semiconductor:

Some Egs:	4011	15p	4013	34p	4017	42p
	4093	38p	40161	69p	4543	134p
	74LS00	12p	74LS90	33p	74LS386	28p
	LM380	75p	TBA120	90p	TOA2640	216p

Full range list available + Quantity discounts. Ask for details

PCBs. The FOTOway. — Brochure on Request.

NEW BARGAIN Packs:

16 TTL ICs	£1.10	6 — Slide Switches	60p
9 — CMOS ICs	£1.10	100 — 1/8 Watt Resistors	60p
10 — Croc Clips	£0.60	30 — 1 Watt Resistors	60p
5 — Ex Equipment Bds	£1	5 — Large Elect Caps	£1
8 — Knobs	£1.20	4 — Rotary Switches	£1.20

Post & packing 60p per order. FREE over £10
ALL PRICES + VAT

P.A.T.H. Electronic Services Wholesale + Retail
369 Alum Rock Road, Birmingham B8 3DR. Tel: 021 327 2339

Open 10 till 6 week days, 9.30 till 5 Saturdays
Distributors for: Antex — Altai — Babani — Hills — Servisol — PATH FOTOway — PATH Box — Safgan — Vero Electronics + MUCH MUCH MORE . . .

ZX81 Keyboard £25.95 (fully built) A NEW 45 KEYBOARD FOR THE ZX81

- 45 keys, including single keys for RUBOUT, EDIT and FUNCTION
- 2 Shift Keys (left and right)
- Full repeat on all keys, including single function keys
- Large space key, and in proper place!
- Typewriter switches, with full movement — not touch sensitive type
- All symbols, graphics etc shown in two colours
- Simply plugs into the ZX81 (RAM etc operation not impaired). Will fit a ZX80 but requires 13 solder joints

Kit version available £22.95

Send stamped address envelope for illustrated catalogue and data sheet for keyboard

Harris & Lockyer Associates

DEPT HE, 33 PEDMORE CLOSE, WOODROW SOUTH, REDDITCH, WORCS.

Tel: (0527) 24452

Prices include VAT and postage. Overseas add £1.80.
Cash with order or now COD. Phone orders welcome

RECHARGEABLE BATTERIES AND CHARGERS

PRIVATE OR TRADE ENQUIRIES WELCOME

FULL RANGE AVAILABLE SEND SAE FOR LISTS. £1.45 for Booklet "Nickel Cadmium Power" plus Catalogue. Write or call:

* NEW SEALED LEAD RANGE AVAILABLE *

SANDWELL PLANT LTD.
2 Union Drive, Boldmere
Sutton Coldfield, West Midlands
021-354 9764
After hours 0977 84093

ELECTRONIC **Lightning** COMPONENTS

DO YOU NEED:— Electronic components, Tools, Test Equipment, Cases, Cabinets and Hardware etc. **IN A HURRY ??????????**
THEN YOU NEED:— LIGHTNING Electronic Components.

WHY ??? Because LIGHTNING Strikes out where others fail:—
Express Despatch
In Depth Stock
All New Guaranteed Goods from Leading Manufacturers

With all that going for us, Going to you can you really afford to be without a copy of our brand new exciting CATALOGUE
Many Prices Reduced — Many More Stock Lines
Send for YOUR Copy Now ONLY 70p Post Paid.

LIGHTNING ELECTRONIC COMPONENTS
84 Birchmoor Road, Birchmoor, Tamworth Staffs B78 1AB
(NOTE New Address)

Trigger Switch on/off Built-in-Light 4 foot, 3 core wire

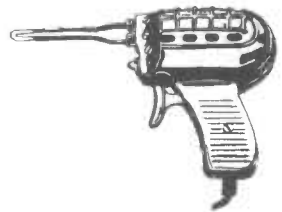

Tired of waiting for ordinary Irons to heat up, but put off by high price of instant guns?

Now you can purchase a superb Instant Heat Gun with features for only **£5.95 plus £1.30 p. & p.**

* Money back if not delighted *

Send Cheque or Postal Order for £7.25 for immediate despatch, to: Nash Smithfield Ltd., Mail Order Dept., 11 Victoria Road, Saltaire, Shipley, West Yorkshire Telephone 582967

SUMMERTIME SALE!!

DEDUCT 20% OFF ALL ORDERS OVER £10 From this advertisement.

All prices include VAT at 15% — just add 50p post

1982/3 CATALOGUE

Bigger! Better!! Buy one!!!

- Only 75p inc. post — Look what you get!!!
- Vouchers worth 60p
- 1st class reply paid envelope
- Wholesale list for bulk buyers
- Bargain List with hundreds of surplus lines
- Huge range of components
- Low, low prices

Sent free to schools, colleges etc.

COMPONENTS

- 2200uF 100V cans 77 x 35mm 75p each; 10 for £5.50
- MK4027 shift register 8 for £6
- 2102B RAM 8 for £3
- 2708 EPROM £1.50
- MIR50 infra red 5mm LED 30p
- DM160 tuning indicator 50p
- AY-5-4007D 24DIL chip counter/. 4 decade up/down 7 seg o/p 0-6MHz. —12, —5V supply £1
- FND501 + 1 0.5in red display comm. cathode 25p
- MAN6710 Dual digit Red 0.56in 7 seg display. Supplied with pin-out and data £1.00
- Murata ceramic filter 5.5MHz 40p
- 10M 1/4W resistors 5% carbon film. Pack of 200 for £1.

COMPONENT PACKS

- K503 150 wirewound resistors, 1W-12W. Wide range of values. £2
- K518 200 disc ceramic caps. Big variety of values and voltages £1

DISC CERAMICS

- 0.22uF 12V 9mm dia. Ideal for decoupling. 100 for £2.75; 1000 £20
- 0.5uF 12V 15mm dia. 100 £1.50; 1000 £12

SWITCH BARGAIN

- Push-on, push-off "table lamp" type, rated 2A 250V ac. 10p each, 15 for £1, 100 for £5

741 OP-AMP — 12 for £1

- A recent purchase of Raytheon IC's included a large quantity of 14 DIL 741 op-amps, so take advantage while stocks last! 12 741's £1

GREENWELD

443F Millbrook Road, Southampton, SO1 0HX



LIE DETECTOR

This beautifully made precision instrument is not a toy or gimmick, it was originally used on an Open University course to measure changes in emotional balance by detecting small changes in skin resistance. Full details of how to use it are provided, together with a circuit diagram. Supplied complete with probes, leads and conductive jelly. Needs 2 x 4 1/2V batteries. Overall size 155 x 100 x 100mm. The 100-0-100uA 4" panel meter is worth more than we're asking for the whole unit!! £7.95

'STARBIRD'

Gives realistic engine sounds and flashing laser blasts — accelerating engine noise when module is pointed up, decelerating noise when pointed down. Press contact to see flash and hear blast of lasers shooting. PCB tested and working complete with speaker and batt. clip (needs PP3). PCB size 130 x 60mm. Only £2.95

1000 RESISTORS £2.50

We've just purchased another 5 million preformed resistors, and can make a similar offer to that made two years ago, at the same price!!! K523 — 1000 mixed 1 and 1/4W 5% carbon film resistors, preformed for PCB mntg. Enormous range of preferred values. 1000 for £2.50; 5000 £10; 20k £36.

MIXED LED PACK

All new full spec by Micro, Fairchild, etc. Red, Yellow, Green, Amber, Clear, 3mm & 5mm. Pack of 50 asstd £3.95; 250 £15.

TECHNICAL TRAINING IN ELECTRONICS, TELEVISION AND AUDIO

IN YOUR OWN HOME — AT YOUR PACE

ICS can provide the technical knowledge that is so essential to your success, knowledge that will enable you to take advantage of the many opportunities open to the trained man. You study in your own home, in your own time and at your own pace and if you are studying for an examination ICS guarantee coaching until you are successful.

City & Guilds Certificates

Radio Amateurs
Basic Electronic Engineering (Joint C&G/ICS)

Certificate Courses

TV and Audio Servicing
Radio & Amplifier Construction
Electronic Engineering* and Maintenance
Computer Engineering* and Programming
Microprocessor Engineering*
TV, Radio and Audio Engineering
Electrical Engineering,* Installation and Contracting *Quality for IET Associate Membership



Approved by CACC



Member of ABCC

POST OR PHONE TODAY FOR FREE BOOKLET

Please send me your FREE School of Electronics Prospectus.

Subject of Interest _____

Name _____

Address _____



Post to: Dept 262X
ICS School of Electronics
160 Stewarts Road,
London SW8 4UJ



01-622 9911
(All Hours)

PCB FOIL PATTERNS

The two foilside PCB patterns for the Digital Millivoltmeter. Both boards must be cut exactly to fit the case.

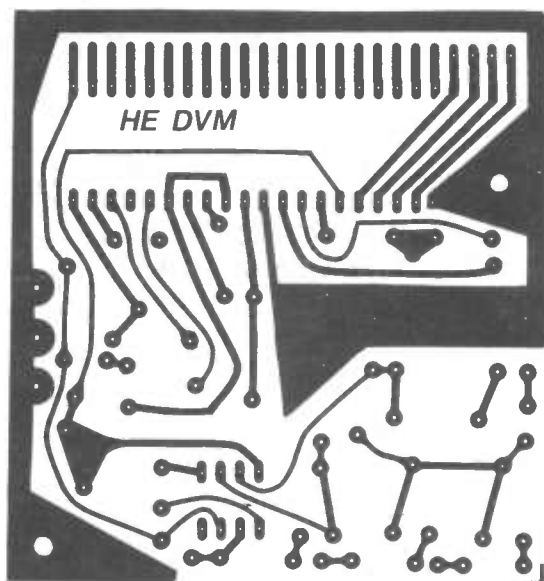
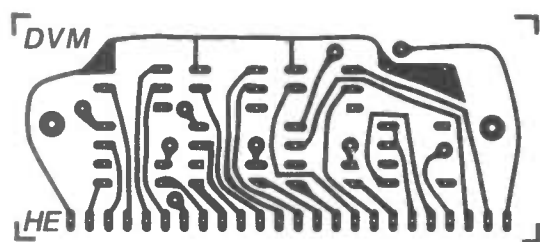

ADVERTISEMENT INDEX

Aitken Bros	51	ILP	27
Ambit International.....	2	LEC.....	64
Armon Electronics.....	42	LEM Services	62
Bi-Pak	4	Magenta Electronics	4 & 5
BK Electronics	67	Musicraft	47
BNRS.....	61	Namal Associates	52
J. Bull	38	Nash Smithfield	64
Bradley Marshall	61	Path	62
Centemp.....	47	Rapid	33
Compton Glass.....	40	Brian J. Reed.....	62
Cricklewood Electronics	62	Relay-A-Quip	34
E.D.A. Sparkrite.....	36	Sandwell Plant	64
Electronize.....	52	Shetland Boats.....	42
Electrovalue	61	Sinclair	16
Flight Electronics	9	Technomatic	8
G. M. Microtonics	51	Tempus.....	68
Greenweld	64	TK Electronics.....	47
Harris & Lockyer	62	Watford Electronics	19
ICS	64		



ADVERTISEMENT RATES

Semi-Display (min 2 cms)

1-3 insertions **£6.00** per cm

4-11 insertions **£5.50** per cm

12+ insertions **£5.00** per cm

Lineage 21p per word (min 15 words)

Box Nos. **£2.00**

Closing date 2nd Friday of the month preceding publication date.

All advertisements in this section must be prepaid. Advertisements are accepted subject to the terms and conditions printed on the advertisement rate card (available on request)

Send your requirements and cheque P/O to:

HOBBY ELECTRONICS CLASSIFIED
ADVERTISING, 145, CHARING CROSS RD,
LONDON WC2H 0EE.



CLASSIFIED

THE PATH TO
SUCCESSFUL SALES!

01-437 1002

Ext 213

PARAPHYSICS JOURNAL (Russian translations); Psychotronic Generators, Kirlianography, gravity lasers, telekinesis. Details: S.A.E. 4 x 9" Paralab, Downton, Wilts.

FIND-A-FRIEND through FIND-A-FRIEND'S new confidential, inexpensive service. Your ideal friendship/relationship — all ages — countrywide. SAE/Telephone: FIND-A-FRIEND (HE), Temple House, 43-48 New Street, Birmingham B2 4LH. 021-429 6346.

BURGLAR ALARM equipment. Ring Bradford (0274) 308920 for our catalogue, or call at our large showrooms opposite Odsal Stadium. C.W.A.S. Ltd.

TELETEXT (Oracle/Ceefax) add-on adaptors for your existing television. Only £159.95 including VAT/delivery. Access/Barclaycard. Also Prestel. Send for free details. Avon Office Services, Freepost, Bristol BS10 6BR. (0272) 502008 anytime.

OSCILLOSCOPE £12. Easy built unit plugs into T.V. aerial socket and converts it to large screen oscilloscope. Costs approx. £12 to make. Circuit and plans £3. J. Bobker, 29 Chadderton Drive, Unsworth, Bury, Lancs.

CLOSE ENCOUNTERS GROUP Personal introductions and social events. Meet interesting, attractive people. Local, 051-931 2844 (24 hours).

TELEPHONE MONITOR KIT connects between telephone line and your cassette recorder and automatically records all phone usage. Complete kit including case and PCB only £9.95. Dep-t. HE1, Unitech (Midlands), Freepost, Sutton Coldfield, West Midlands, B74 3BR.

WANTED: Valve — Hivac 38E XFY 51 — Write Roche Grange Cottage, Mulhuddart, Co Dublin, Ireland. Phone Dublic 256575

ELECTRONICS component shop in **MAIDSTONE, KENT!** Thyronics Control Systems, 8 Sandling Road, Maidstone, Kent. Maidstone 675354.

AERIAL AMPLIFIERS Improve weak television reception. Price £6.70. S.A.E. for leaflets. Electronic Mailorder, Ramsbottom, Lancashire BL0 9AGH.

AMAZING ELECTRONICS PLANS. Lasers; Super-powered Cutting Rifle, Pistol, Light Show. Ultrasonic Force Fields, Pocket Defence Weaponry, Giant Tesla, Satellite TV Pyrotechnics, 150 more projects. Cata-logue 95p. — From The Plan Centre, 46 Bye St, Ledbury HR8 2AA.

STEREOPOWER 120 WATT AMPLIFIERS!! (60 + 60W protected). Case + controls. D.I.N. sockets. Fibreglass. Boxed + Data. **£10.85.** A. Law, 8 Cunliffe Road (Over Incatile), Ilkley LS29 9DZ.

DIGITAL WATCH REPLACEMENT parts. Batteries, displays, backlights etc. Also reports, publications, charts. S.A.E. for full list. Profords, Copnersdrive, Holmergreen, Bucks HP15 6SGE.

PRINTED CIRCUITS. Make your own simply, cheaply and quickly! Golden Fotolac 'light-sensitive lacquer' — now greatly improved and very much faster. Aerosol cans with full instructions, £2.25. Developer 35p. Ferric Chloride 55p. Clear acetate sheet for master 14p. Copper-clad fibreglass board, approx. 1mm thick £1.75 sq. ft. Post/packing 75p. White House Electronics, Castle Drive, Praa Sands, Penzance, Cornwall.

BUILT TRANSMITTERS £2.90 88-110 MHz
FM range 150 yds. Refund guarantee (unlicensable). P. Faherty, 37, College Dr., Ruislip.

CENTURION BURGLAR ALARM EQUIPMENT Send S.A.E. for Free list or a Cheque/PO for £5.95 for our Special Offer of a Full Sized Decoy Bell Cover, to: Centurion, Dept HE, 265 Wakefield Rd., Huddersfield, W. Yorkshire. Access & Barclaycard. Telephone orders on 0484-35527.

RADIATION DETECTORS

BE PREPARED



VIEW THRU LENS ▶



- THIS DOSIMETER WILL AUTOMATICALLY DETECT GAMMA AND X-RAYS
- UNIT IS SIZE OF FOUNTAIN PEN & CLIPS ONTO TOP POCKET
- PRECISION INSTRUMENT METAL CASED WEIGHT 20Z
- MANUFACTURERS CURRENT PRICE OF A SIMILAR MODEL OVER £25 EACH

British design & manufacture. Tested & fully guaranteed. Ex-stock delivery

£6.95 inc. VAT

Post & Pack 60p

Ideal for the experimenter

COMPLETE WITH DATA

HENRY'S

404 EDGWARE ROAD. LONDON W2 1ED

ELECTRIFY YOUR SALES! • CLASSIFIED ADVERTISEMENT

1	2	3
4	5	6
7	8	9
10	11	12
13	14	15

Please place my advert in Hobby Electronics for _____ months.
Please indicate number of insertions required.

Advertise Nationally in Hobby Electronics for only 21p per word (minimum charge 15 words). Simply print your message in the coupon and send with your cheque or postal order made payable to Argus Specialist Publications Ltd

Name

Address

Tel. No. (Day)

Send, together with your cheque P/O to: Bridgete Sherliker, H.E. Classified
145 Charing Cross Rd., London WC2H 0EE.
Tel: 01-437 1002 Ext. 50.



MULLARD SPEAKER KIT

40 watt R.M.S. 8ohm DESIGNED BY MULLARD SPECIALIST TEAM IN BELGIUM comprising a Mullard 8" woofer with foam rolled surround, Mullard 3" high power dome tweeter and a cleverly designed B.K. Electronics crossover combining spring loaded loudspeaker terminals and recessed mounting panel. Supplied complete with assembly and cabinet details. Recommended cabinet size 240 x 216 x 445mm.

PRICE £13.90 + £1.50 P&P per kit

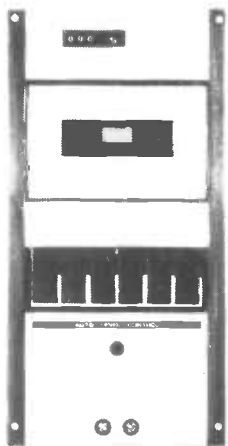

STEREO CASSETTE TAPE DECK MODULE. Comprising of a top panel and tape mechanism coupled to a record/play back printed board assembly. Supplied as one complete unit for horizontal installation into cabinet or console of own choice. These units are brand new, ready built and tested.

Features: Three digit tape counter Auto stop Six piano type keys, record, rewind, fast forward, play, stop and eject Automatic record level control Main inputs plus secondary inputs for stereo microphones **Input Sensitivity:** 100mV to 2V **Input Impedance:** 68K **Output level:** 400mV to both left and right hand channels **Output Impedance:** 10K **Signal to noise ratio:** 45dB **Wow and flutter:** 0.1% **Power Supply requirements:** 18V DC at 300mA **Connections:** The left and right hand stereo inputs and outputs are via individual screened leads, all terminated with phono plugs (phono sockets provided) **Dimensions:** Top panel 5 1/2" x 11 1/2" Clearance required under top panel 2 1/2" Supplied complete with circuit diagram and connecting diagram Attractive black and silver finish

Price £26.70 + £2.50 postage and packing
Supplementary parts for 18V D.C. power supply (transformer, bridge rectifier and smoothing capacitor) £3.50.

NEW RANGE QUALITY POWER LOUD-SPEAKERS (15", 12" and 8"). These loudspeakers are ideal for both hi fi and disco applications. Both the 12" and 15" units have heavy duty die cast chassis and aluminium centre domes. All three units have white speaker cones and are fitted with attractive cast aluminium (ground finish) fixing escutcheons. Specification and Price:

15" 100 watt R.M.S. Impedance 8ohm 59 oz magnet 2" aluminium voice coil Resonant Frequency 20Hz Frequency Response to 2.5KHz Sensitivity 97dB Price £32 each, £2.50 Packing and Carriage each

12" 100 watt R.M.S. Impedance 8 ohm 50 oz magnet 2" aluminium voice coil Resonant Frequency 25Hz Frequency Response to 4KHz Sensitivity 95dB Price £23.70 each, £2.50 Packing and Carriage each

8" 50 watt R.M.S. Impedance 8 ohms 20 oz 1 1/2" aluminium voice coil. Resonant Frequency 40Hz Frequency Response to 6KHz Sensitivity 92dB Also available with black cone fitted with black metal protective grill. Price: White cone £8.90 each Black cone/grill £9.50 each, P & P £1.25 each

PIEZO ELECTRIC TWEETERS MOTOROLA

Join the Piezo revolution. The low dynamic mass (no voice coil) of a Piezo tweeter produces an improved transient response with a lower distortion level than ordinary dynamic tweeters. As a crossover is not required these units can be added to existing speaker systems of up to 100 watts (more if 2 put in series). **FREE EXPLANATORY LEAFLETS SUPPLIED WITH EACH TWEETER.**

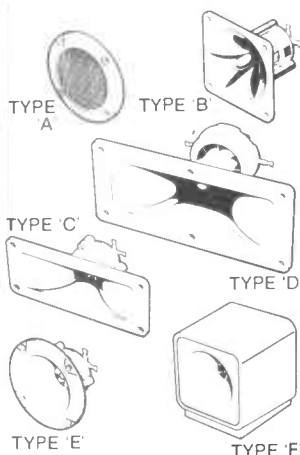

TYPE 'A' (KSN2036A) 3" round with protective wire mesh, ideal for bookshelf and medium sized Hi fi speakers. Price £3.45 each.

TYPE 'B' (KSN1005A) 3" super horn. For general purpose speakers, disco and P.A. systems etc. Price £4.35 each.

TYPE 'C' (KSN6016A) 2" - 5" wide dispersion horn. For quality Hi fi systems and quality discos etc. Price £5.45 each.

TYPE 'D' (KSN1025A) 2" - 6" wide dispersion horn. Upper frequency response retained extending down to mid range (2KHz). Suitable for high quality Hi fi systems and quality discos. Price £6.90 each.

TYPE 'E' (KSN1038A) 3 1/2" horn tweeter with attractive silver finish trim. Suitable for Hi fi monitor systems etc. Price £4.35 each.

TYPE 'F' (KSN1057A) Cased version of type 'E'. Free standing satellite tweeter. Perfect add on tweeter for conventional loudspeaker systems. Price £10.75 each.

U.K. post free for SAE for Piezo leaflets.



1000 MONO DISCO MIXER

A superb fully built and tested mixer/pre-amp with integral power supply. 4 inputs 2 turntables (ceramic cartridge). Aux. for tape deck etc., plus Mic. with override switch, all with individual level controls. Two sets of active tone controls (bass and treble) for Mic. and main inputs. Master volume control. Monitor output with select switch and volume control. Outputs Main 750 mV Monitor 500 mV into 8 ohms. Size 22 1/2" x 4 1/2" x 2 1/2"

Price £39.99 + £2.50 P&P

1K.WATT SLIDE DIMMER



- Controls loads up to 1KW
- Compact size 4 1/4" x 13 1/2" x 2 1/2" 16
- Easy snap in fixing through panel/cabinet cut out
- Insulated plastic case
- Full wave control using 8amp triac
- Conforms to BS800
- Suitable for both resistance and inductive loads

Innumerable applications in industry, the home and discos theatres etc

Price: £11.70 each + 50p P&P (Any quantity)

BSR P256 TURNTABLE

P256 turntable chassis • S shaped tone arm • Belt driven • Aluminium platter • Precision calibrated counter balance • Anti-skate (bias device) • Damped cueing lever • 240 volt AC operation (Hz) • Cut out template supplied • Completely manual arm. This deck has a completely manual arm and is designed primarily for disco and studio use where all the advantages of a manual arm are required.

Price: £28.50 + £2.50 P&P



POWER AMPLIFIER MODULES

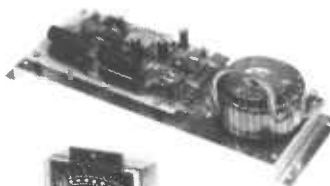

Vu Meter

100 WATT R.M.S.

Power Amplifier Modules with integral toroidal transformer power supply and heat sink. Supplied as one complete built and tested unit. Can be fitted in minutes. Auxiliary stabilised supply and drive circuit incorporated to power an L.E.D. V.u. meter, available as an optional extra.

SPECIFICATION:
Max. output power 100 watts R.M.S. (OMP100)
Loads (Open and short circuit proof) 4 16 ohms
Frequency Response 20Hz 25KHz ± 3dB
Sensitivity for 100 watts 500mV at 10K
T.H.D. 00.1%
Size 360 x 115 x 80mm
Prices: OMP 100W £29.99 £2.00 P&P
V.u. Meter £6.50

Matching 3-way loudspeakers and crossover

Build a quality 60watt RMS system 8ohms

Build a quality 60 watt R.M.S. system

- ★ 10" Woofer
- ★ 3" Tweeter
- ★ 5" Mid Range
- ★ 3-way crossover

Fitted with attractive cast aluminium fixing escutcheons and mesh protective grilles which are removable enabling a unique choice of cabinet styling. Can be mounted directly on to baffle with or without conventional speaker fabrics. All three units have aluminium centre domes and rolled foam surround. Crossover combines spring loaded loudspeaker terminals and recessed mounting panel.

Price £22.00 per kit + £2.50 postage and packing. Available separately, prices on request.

12" 80 watt R.M.S. loudspeaker

A superb general purpose twin cone loudspeaker 50 oz magnet 2" aluminium voice coil. Rolled surround Resonant frequency 25Hz Frequency response to 13KHz Sensitivity 95dB Impedance 8ohm Attractive blue cone with aluminium centre dome

Price £17.99 each + £2.50 P&P

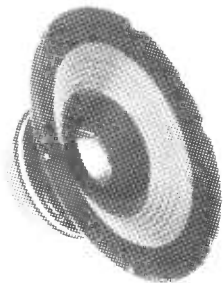
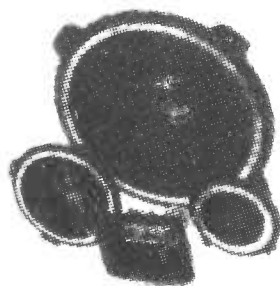

BK ELECTRONICS

Prompt Deliveries
VAT inclusive
prices
Audio Equipment
Test Equipment
by
Thandar
and
Leader

B.K. ELECTRONICS

37 Whitehouse Meadows, Eastwood, Leigh-on-Sea, Essex SS9 5TY

★ SAE for current lists. ★ Official orders welcome. ★ All prices include VAT. ★ Mail order only. ★ All items packed (where applicable) in special energy absorbing PU foam. Callers welcome by prior appointment, please phone 0702-527572.



NEW**CASIO WATCHES****100 METRE WATER RESISTANT**

W-100
Black resin case/strap
£16.95

W-450
Stainless steel
£24.95

W-450C
(Not shown) resin strap
£21.95

Time and auto calendar Alarm and hourly chimes
Count-down alarm timer with repeat memory function
Professional 1/100 second stopwatch Time is always on display, regardless of display mode 5 year lithium battery life

NEW**CASIOTONE KEYBOARDS****NEW****NEW****CASIO AX-5 £19.95**

BLACK RESIN CASE & STRAP
version of the AX-210, below

AX-210. The world's most versatile watch?

Analog Display
LC Display of hours and minutes

Digital Display

- Local time, 12 or 24 hour
- Full calendar display
- Dual time, 12 or 24 hour
- Countdown alarm timer with memory function
- Professional 1-100 second stopwatch

Hourly time signal. Daily alarm electronic buzzer or 3 selectable melodies. Rapid forward/back setting. 9.4 x 35.4 x 36mm



AX-250 £24.95

50 METRE WATER RESISTANT

W-35 s/s
£19.95

W-20 Resin
£12.95

AA-92W s/s
£25.95

W-35 Identical functions to the W-450 opposite.
W-20 Similar to W-100 but without c/down alarm.
AA-92W LCD analog display of time, or digital time and calendar. Professional stopwatch. Selectable hourly chimes. Daily alarm and countdown alarm with amazing moving graphics display.

NEW

FROM CASIOTONE — THE CT 1000P DIGITALIZED SYNTHESIZER AND THE VL-5

Bar-coded Programmable Mini Keyboard

VL-5

(RRP £89.95)

ONLY £79.95

Even a non-player can become an instant musician!

The VL-5 can read and store Casio's unique bar-coded music, or alternatively you can program the memory directly from the 3 octave keyboard. Select one of the 10 instrument voices and choose one of the 8 auto rhythms, then play back your stored melody by means of the One Key Play button, or by the Auto Play button. The 4 note polyphonic mini keyboard can also be played manually. With integral amplifier and speaker, Line Out and Headphone jacks, Sustain and Pitch control. Powered by 5 AA size batteries, or the optional mains adaptor, AD 1F (£5). Supplied with light pen, instruction manual and music book. Dimensions: 33 x 320 x 86mm (1 1/4" x 12 1/2" x 3 1/2"). Weight 510g (18oz).

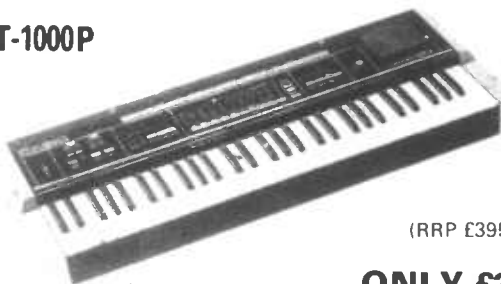
CT-1000P

(RRP £395)

ONLY £325

This revolutionary synthesizer has 10 pre-set instrument voices. PLUS variable FEET, ENVELOPE and MODULATION — the three elements of sound creativity giving 10 x 10 x 10 options. Each sound has a digital code and any 10 sounds may be stored in the battery protected memory for instant selection. The 5 octave, 8 note polyphonic keyboard can be split into 2 and 3 octaves with two different instrument sounds. There is a pre-set arpeggio, or a 127 step programmable arpeggio function which can be used as a real time sequencer. Frequency is displayed digitally and the wide range pitch control allows transposition between -1 octave and +0.5 octave. With Sustain and 3 Vibrato functions etc. Integral amplifier speaker. Output and Headphone jacks. Protective moulded end plates. Dimensions: 117 x 916.5 x 363.5mm (4 1/2" x 36" x 14 1/2"). Weighty 10Kg (22lbs).

CASIO POCKET COMPUTER

FX 702P
Usual Price £99.95
Elsewhere £97.95

PRICE-BEATING £95.95



FX 702P PLUS MICROL Professional Programming Pack (worth £9.95) **ONLY £99.95**
BASIC programming. Up to 1,680 program steps, up to 226 memories, 55 scientific functions. **£24.95**
OR with MICROL Viscalc type software on tape. FP 10 Printer for 702/602/502/501. Usually £44.95. Price elsewhere £43.95. **PRICEBEATING £42.95**
FA-2 Cassette interface for 702/602/1/502/1. **£19.95**

PROGRAMMABLES

FX-602
Usual price £74.95
Price elsewhere £71.95
PRICE BEATING £69.95
OR with MICROL Professional Programming Pack worth £9.95
ONLY £74.95
Up to 512 steps, up to 88 memories, 50 scientific functions.



FX-601 128 steps, 11 memories, etc **ONLY £39.95**
FX-3600P 38 steps, 2 memories, 50 sc functions. Price elsewhere £21.25
PRICEBEATER £20.85

CALCULATORS

Scientifics
FX 950 50 functions, 10 digits, SOLAR POWER **£22.95**
FX 900 8 digit version with less functions **£19.95**
FX 550 501, 10d. Lithium battery. Wallet size **£15.95**
FX 8100 Clock, calendar, alarms, stopwatch **£19.95**
FX 82 £11.95, **FX 100** £14.95, **FX 7** £9.95, **FX-5** £7.95
Calculating alarm clocks
FT 7 Fortune Teller **£16.95**, **BG 15** Boxing game **£16.95**, **ML 75** Card size, 12 melody alarms **£12.95**, **BQ-1100** Biorhythm **£16.95**, **UC 365** Wallet **£19.95**, **UC 360** Card size **£19.95**
Basic
LC 950 Metric conversions. Double display **£16.95**
SL 801 SOLAR **£8.95**, **MG 777** 3 games, clock **£14.95**, **MG 880** **£10.95**, **MG 885** **£10.95**

WATCHES

Calculator watches
CA-95 4 alarms, hourly time signal, stopwatch, black resin case, strap **£19.95**; **CA-951** metal version **£29.95**
CA-85 Invader game, alarm, stopwatch, Resin **£19.95**
CA-851 Metal version **£29.95** (Replaces CA 90/901)
Others
MM-400 Daily weekly monthly melody alarms, pre and snooze alarms, hourly chimes, stopwatch **£29.95**
WS-70 6 digits 50m water resistant ultra slim s.s. case **£22.95**
Stopwatch/countdown alarm, alarm, chimes **£14.95**
SA-50 As WS 70 but non W.R. chrome case **£19.95**
GM-10 Invader game, alarm, stopwatch, Resin **£19.95**
A656A Alarm, dual time, stopwatch, chrome **£9.95**

SHARP PORTABLE COLOUR COMPUTER

16K ROM extended BASIC, 3.5K RAM (expandable). 7 x 156 dot matrix display. With clock, calendar, alarm and around 30 scientific functions on board.
Colour brochure on request
PRICEBEATERS
PC-1500 Computer (elsewhere £158.95) **£157.50**
CE-150 Printer/interface (elsewhere £139.95) **£137.50**
CE151 4K RAM expansion module (£47.95) **£46.95**
CE-155 8K RAM expansion module (£77.95) **£76.50***
CE-15A 14 application programs on tape **£14.95**
CSR-150 Paper rolls (box of 20) **£5.84**
PENS EA-850C coloured, EA-850B black **Set £2.69**

MICROL 1500 SOFTWARE

PROCOS 'Visicalc' type system **£34.95**
I-M-S Information Management System **£34.95**
PROCOS GRAPHIX for graphic presentation **£14.95**
PROCOS STATIX adds statistics to the 1500 **£14.95**
PAYROLL A versatile system. Available soon. **T.B.A.**

MORE SOFTWARE AVAILABLE SOON

* Providing the advertiser has stocks and we do not sell at a loss

Price includes VAT and P&P. Send cheques, PO, or phone your ACCESS, VISA or B'CARD number to:

TEMPUS

LEADING CASIO SPECIALISTS
Dept HE
38 Burleigh Street, Cambridge CB1 1DG
Telephone: 0223 312866

DELIVERY NORMALLY BY RETURN