

# Hobby

APRIL '82

ISSN 0142-6192

70p

# Electronics

Project Electronics For Everyone

## Inside Colour TV

A Non-Technical Guide

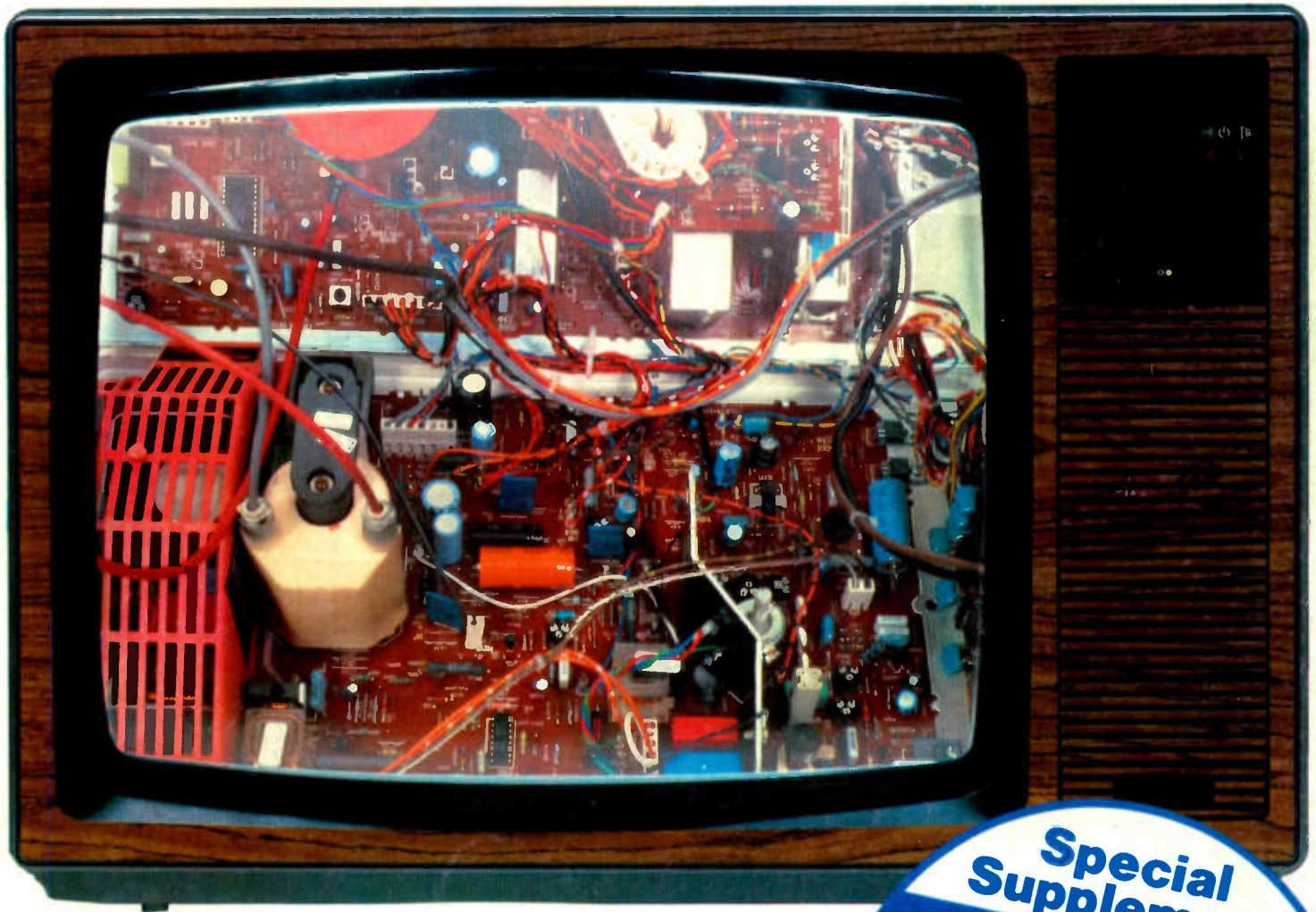

Special  
Supplement  
**POPULAR  
COMPUTING** N°1

A New Monthly  
Supplement  
for Budding  
Computer  
Experts

**Special Features:**  
Creative Recording • Into Radio

**Special Projects:**  
HE Dual Engine Driver  
Digital Capacitance Meter





# Hobby Electronics

APRIL 1982  
Vol 4 No 4

## PROJECTS

- ★ **DUAL ENGINE DRIVER** ..... 11  
*Two controllers, with simulated inertia.*
- ★ **DIGITAL CAPACITANCE METER** ..... 25  
*It's fast, accurate and simple to build*
- ★ **QUICK PROJECT** ..... 34  
*A simple AF/RF Signal Tracer.*
- ★ **BIKE ALARM** ..... 72  
*Personalised protection for your wheels.*

## FEATURES

- ★ **INSIDE COLOUR TV** ..... 16  
*The technology, without the tears.*
- FAMOUS NAMES** ..... 30  
*The story of Guglielmo Marconi.*
- INTO ELECTRONIC COMPONENTS** ..... 61  
*Part 9 introduces the 741 IC.*
- SCALING THE HI-FI HEIGHTS** ..... 67  
*Installing and setting-up your system.*

## SPECIALS

- POPULAR COMPUTING No. 1**  
*A special supplement for beginners.* ..... 35
- ★ **MICRO-MANIA** ..... 36  
*Separating publicity from practicality.*
- ★ **COMPUTER TALK** ..... 41  
*Understanding the jargon.*
- ★ **THE AFFORDABLE COMPUTER** ..... 45  
*A comprehensive survey of inexpensive models.*
- INTO RADIO**
- ★ **RADIO RULES** ..... 55  
*The first installment of our new series.*
- PROJECT: MUSIC**
- ★ **CREATIVE RECORDING** ..... 76  
*Are you creative?*

## REGULARS

- Monitor ..... 6
- ★ **BUYLINES** ..... 21
- ★ **POINTS OF VIEW** ..... 22
- Clever Dick ..... 52
- HE Subscriptions ..... 58
- Backnumbers ..... 64
- Bookshelf ..... 70
- What's On Next ..... 75
- PCB Service ..... 78
- PCB Print Out ..... 80
- Index to Advertisers ..... 81
- Classified Advertisements ..... 81

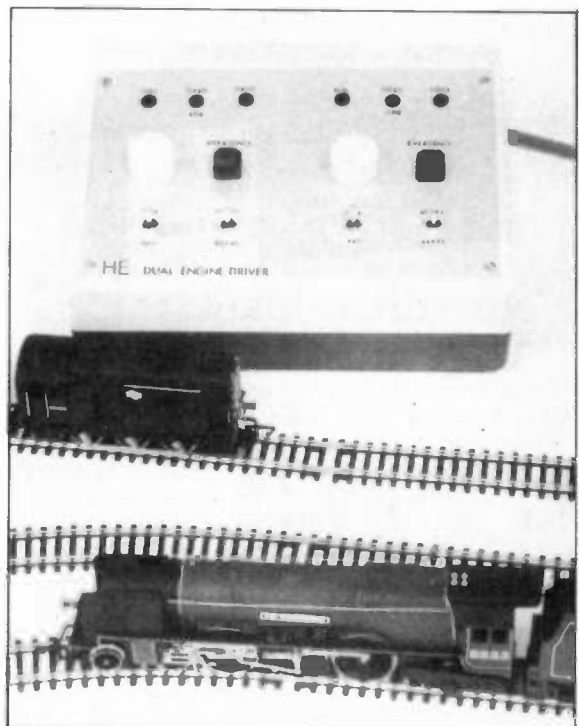

Editor: Ron Keeley  
 Editorial Assistants: Paul Coster BSc  
 Tina Boylan  
 Senior Art Editor: Andrew Sawyer  
 Assistant Art Editor: Enzo Grando  
 Group Advertisement Manager: Ron Moore  
 Managing Editor: Ron Harris BSc  
 Managing Director: T.J. Connell

Hobby Electronics is normally published on the second Friday of the month prior to the cover date.  
 Hobby Electronics, 145 Charing Cross Road, London WC2H 0EE, 01-437 1002. Telex No 8811896. Published by Argus Specialist Publications Ltd.  
 Distributed by Argus Press Sales & Distribution Ltd, 12-18 Paul St, London EC2A 4JS. Printed by QB Ltd, Colchester. Covers printed by Alabaster Passmore.  
 Copyright: All material in this publication is subject to world-wide copyright protection. Permission to reproduce printed circuit board patterns commercially or marketing of kits of the projects must be sought from the Publisher. All reasonable care is taken in the preparation of the magazine to ensure accuracy but Argus Specialist Publications Ltd, cannot be held responsible for it legally. ©Copyright 1982 Argus Specialist Publications Ltd **ABC** Member of Audit Bureau of Circulation.

# Beginners' luck

**30% OFF**  
10 selected kits  
for first-time  
builders



Shortwave  
Listener's  
Receiver

With Heathkit, you're all set for a great deal. And not just big savings. Whichever kit you choose, you'll find it easy to build. Simple, but detailed instructions take you through every stage. Everything is included. Even the solder you need is there.

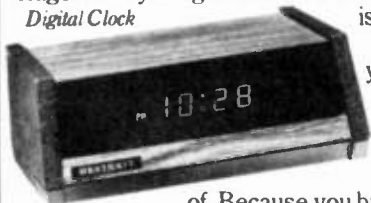

Follow the steps and you'll end up with a hand-crafted, well-designed piece of equipment. One you'll be proud of. Because you built it yourself.

There are 10 great kits to start you off. An interesting choice of a digital clock to a metal locator, including a short wave listener's receiver, windspeed and direction indicator, digital readout electronic scale and five more useful kits.

All at 30% off to first-timers. Send for your catalogue right now for a start.



Windspeed and Direction  
Indicator



Metal  
Locator

To Heath Electronics  
(UK) Limited, Dept (HE4),  
Bristol Road, Gloucester GL2 6EE

HE4

To start me off, please send me a copy of the Heathkit catalogue. I enclose 28p in stamps.

Name \_\_\_\_\_

Address \_\_\_\_\_



HEATH **You build on our experience**

# HEATHKIT

# HE PROJECT KITS

Make us your No. 1 SUPPLIER OF KITS and COMPONENTS for H.E. Projects. We supply carefully selected sets of parts to enable you to construct H.E. projects. Kits include ALL the electronics and hardware needed. Printed circuit boards (fully etched, drilled and roller tinned) or Veroboard are, of course, included as specified in the original article, we even include nuts, screws and I.C. sockets. PRICES INCLUDE CASES unless otherwise stated. BATTERIES ARE NOT INCLUDED. COMPONENT SHEET INCLUDED. If you do not have the issue of H.E. which includes the project — you will need to order the instruction reprint at an extra 45p each.

Reprints available separately 45p each + p. & p. 40p.

- NOISELESS FUZZBOX Feb 82 £9.77
- SOUND SWITCH Feb 82 £8.31
- UNIVERSAL RELAY DRIVER Feb 82 £6.94 less case
- MASTHEAD AMPLIFIER Feb 82 £13.74
- DRUM SYNTHESIZER Dec 81. Full kit £21.17
- GUITAR HEADPHONE AMPLIFIER Dec 81 £3.48
- IN CAR CASSETTE POWER SUPPLY Dec 81 £4.46
- SOUND TORCH Nov 81 less torch — mic £17.98
- SCRATCH FILTER Nov 81 Mono £5.44 Stereo £8.40
- LED VU METER Nov 81 less case £4.56
- SIMPLE STYLUS ORGAN Nov 81 less case £4.74
- METRONOME Nov 81 £11.88
- TELEPHONE BELL REPEATER Oct 81 £12.78
- Med Linking wire extra 14p metre
- COMBINATION LOCK Oct 81 less solenoid £17.43
- DOOR INTERCOM Oct 81 (less solenoid) £22.39
- BABY ALARM Oct 81 £8.14, Fig 8 linking wire 7p metre
- TOUCH LAMP Oct 81. Bulb version £4.51, Mains version £7.16
- 'DIANA' METAL LOCATOR Sept 81 £33.95
- LOWER POWER PILOT LIGHT Sept 81, less case £1.30
- LIGHT/WATER ALARM Sept 81 £5.98
- CAR LIGHTS DELAY Sept 81 £5.99
- POWER PACK Sept 81 £9.58
- SHORT WAVE RADIO Sept 81 £23.98, Extra: Mono headphones £2.98
- REACTION TESTER GAME Sept 81 £11.98
- THERMOMETER Aug 81 £12.98
- R.P.M. METER Aug 81, inc. probe £15.48
- VARIABLE BENCH POWER SUPPLY Aug 81 £26.35
- ULTRASOUND BURGLAR ALARM July 81 £18.67
- ELECTRONIC DOOR BUZZER July 81 £5.65
- ELECTRONIC METRONOME July 81 £4.67
- TREBLE BOOST July 81 £10.93
- CONTINUITY CHECKER June 81 £5.34
- ENVELOPE GENERATOR June 81 £16.85
- AUDIO MIXER June 81 £4.99
- VOICE OPERATED SWITCH May 81 £10.37, Microphone extra £1.41
- SUPER SIREN April 81 £19.52
- DOORBELL MONITOR April 81 £3.28
- WINDSCREEN WASHER ALARM April 81 £5.78
- PUBLIC ADDRESS AMPLIFIER March 81 £18.21, Extras — horn speakers £6.83 each, PA MIC £4.40
- FUZZBOX March 81 £10.35
- WINDSCREEN WIPER CONTROLLER March 81 £7.67
- STEAM LOCO WHISTLE March 81 £12.26
- PHOTOGRAPHIC TIMER March 81 £3.28
- HEARTBEAT MONITOR Feb 81 £23.40
- HIGH IMPEDANCE VOLTMETER Feb 81 £9.87
- AUDIO SIGNAL GENERATOR Feb 81 £18.93
- TWO TONE TRAIN HORN Feb 81 £5.24 less case
- MEDIUM WAVE RADIO Feb 81 £7.67
- LADDER OF LIGHT (Sound into Light) Jan 81 £32.97
- BENCH AMP Jan 81 £10.10
- NICARD CHARGER Jan 81 £7.67
- CHUFFER Jan 81, less case £7.04
- MODEL TRAIN CONTROLLER Dec 80 £18.54
- BATTERY CHARGE MONITOR Dec 80 £5.40
- STEREO POWER METER Dec 80 £20.87
- MEMORY BANK — MINI SYNTHESIZER Nov 80 Dec 80 £28.40
- PARTY GRENADE Nov 81 £8.77
- TRANSISTOR TESTER Nov 81 £6.12 inc test leads
- DOUBLE DICE Nov 80 £15.18
- GUITAR PRE-AMP Nov 80 £5.65 case (diecast) extra £2.29
- NOBELL DOORBELL Oct 80 £11.98
- INTRUDER ALARM Oct 80 £19.61
- FREEZER ALARM Oct 80 with probe £10.36
- TUG O'WAR Oct 80 £17.57
- KITCHEN TIMER Oct 80 (2% resistors) £7.98
- MICROMIX Sept 80 £8.60
- AUTO PROBE Sept 80 £3.99 less case
- TOUCH SWITCH Sept 80 £2.57 less case & contacts
- GUITAR PHASER Sept 80 £15.22
- BENCH PSU Sept 80 £31.35
- OP AMP CHECKER Aug 80 £4.99
- MOVEMENT ALARM Aug 80 £6.24
- PASS THE LOOP GAME Aug 80 £15.37
- SOUND OPERATED FLASH TRIGGER July 80 no skt £4.99
- FOG HORN June 80 £8.21
- SPEED CONTROLLER FOR R/C April 80 £16.41 (less case)
- DIGITAL FREQUENCY METER April 80 £39.35
- ELECTRONIC IGNITION (CD) April 80 £23.95
- DIGI-DICE Jan 80 £10.97
- BARGRAPH CAR VOLTMETER Dec 79 £7.98 less case
- RING MODULATOR Dec 79 £14.24
- GUITAR TUNER Nov 79 £11.99
- ANALOGUE FREQUENCY METER Oct 79 £16.98
- MULTI-OPTION SIREN Oct 79 £17.57
- HOME SECURITY UNIT Aug 79 £31.41 less siren
- SIREN £5.69 less case
- LED TACHOMETER Aug 79 £19.77
- INJECTOR TRACER Aug 79 £4.77
- LINEAR SCALE OHMMETER July 79 £17.57
- GSR MONITOR June 79 £10.59
- WHITE NOISE EFFECTS UNIT May 79 £19.51
- CAR ALARM Feb 79 £12.07
- PUSH-BUTTON DICE Dec 78 £7.67

## MEMORY BANK SYNTHESIZER

Miniature synthesizer featuring vibrato, envelope, tempo, volume + pitch controls. Uses 24 push button switches in a keyboard style layout. Based on a custom designed L.C. The accessible memory stores a 32 beat length sequence of notes + spaces. Can be played 'live'. Fitted with an internal speaker. Jack socket allows the use of an external amplifier if wished.

**Memory Bank Synthesizer £28.40**

Complete kit inc. case, pcb's etc. Reprint extra 45p. Available separately 45p + 45p p&p.

## GUITAR TUNER — SUPERB PROJECT

Featured by us in E.T.I., Jan 82. Highly stable internal reference. Microprocessor generates fundamental frequencies. Special asynchronous rectifier circuit compares input frequency from guitar pick up or microphone with internally generated pitch. Beat frequency is displayed on a large moving coil panel meter. Also operates with bass guitar, or acoustic instruments via a high impedance microphone.

Complete kit includes smart case, pcbs, panel meter etc. £28.98. Reprint extra 45p. Available separately 45p + 45p p&p.



## SOLDERING/TOOLS

**ANTEX XS SOLDERING IRON 25W** £5.48  
**SOLDERING IRON STAND** £2.40  
**SPARE BITS** Small, standard, large. For XS and X25 irons 65p each  
**SOLDER** Handy size 99p  
**SOLDER CARTON** £1.84  
**DESOLDER BRAID** 69p  
**DESOLDER PUMP** £6.48  
**HEAT SINK TWEEZERS** 29p  
**HOW TO SOLDER LEAFLET** 12p  
**LOW COST CUTTERS** £1.89  
**LOW COST LONG NOSE PLIERS** £1.66  
**WIRE STRIPPERS + CUTTERS** £2.69  
**HELPING HANDS JIG** £6.30  
 Heavy base. Six ball and socket joints allow infinite variation of clips through 360°. Has 2 1/2" diameter (2.5x) magnifier attached. Used and recommended by our staff.  
**VERO SPOT FACE CUTTER** £1.49  
**PIN INSERTION TOOL** £1.98  
**VEROPINS** (pk of 100) 0.1" 52p  
**MULTIMETER TYPE 1** (1,000 opv) £6.66  
**MULTIMETER TYPE 2**, 20,000 opv with transistor tester. Very good £14.75  
**ILLUMINATED MAGNIFIERS** Small 2"

dia (5 x mag) £1.14. Large 3" dia (4 x mag) £2.40  
**DENTISTS INSPECTION MIRROR** £2.85  
**JEWELLERS EYEGLASS** £1.50  
**HAND MAGNIFIER 3"** £2.99  
**CAST IRON VICE (Small)** £2.98  
**SCREWDRIVER SET** £1.98  
**POCKET TOOL SET** £3.98  
**PCB ETCHING KIT** £4.98  
**PLASTIC TWEEZERS** 69p

\*\*\*\*\*  
**USEFUL BITS & PIECES**  
 CROCODILE CLIP TEST LEAD SET 10 leads with 20 clips 99p  
 RESISTOR COLOUR CODE CALCULATOR 21p  
 CONNECTING WIRE PACK (5 x 5 vd coils) 66p  
 LETTERS/NUMBERS TRANSFERS £2.48  
 SCREWS/NUTS/WASHERS 40p each  
 M2 pack £1.80. M3 £1.78. M4 £1.84  
 SOLDER TAGS M3 33p/50. M4 54p/50  
 INSULATING PILLARS + SCREWS SET 65p  
 STICK DN FEET 23p/4  
 \*\*\*\*\*

## BOOKS . BOOKS . BOOKS

**BASIC ELECTRONICS.** A super book covering theory and practice. Educational. Suits age 14 upwards. Lots of useful projects - circuits built on an S-Dec breadboard. Approx 525 pages... £7.98

### CONSTRUCTOR'S PROJECT BOOKS

Specially written for the electronics enthusiast. Each book contains a collection of constructional projects, giving details of how the circuit works, how it may be assembled and how setting up and trouble shooting problems may be solved. The colour in the text helps to clarify details. Delightful books.

ELECTRONIC GAME PROJECTS Rayer	£3.36
ELECTRONIC PROJECTS FOR HOME SECURITY Bishop	£3.36
ELECTRONIC PROJECTS IN AUDIO Penfold	£3.36
ELECTRONIC PROJECTS IN MUSIC Flind	£3.36
ELECTRONIC PROJECTS IN PHOTOGRAPHY Penfold	£3.36
ELECTRONIC PROJECTS IN THE CAR George	£3.36
PROJECTS IN AMATEUR RADIO & SHORT WAVE LISTENING Rayer	£3.36
PROJECTS IN RADIO AND ELECTRONICS Sinclair	£3.36
ELECTRONIC PROJECTS IN HOBBIES Rayer	£3.36
ELECTRONIC PROJECTS IN THE HOME Bishop	£3.36
ELECTRONIC PROJECTS IN THE WORKSHOP Penfold	£3.36
ELECTRONIC TEST EQUIPMENT PROJECTS Ainslie	£3.36
MORE ELECTRONIC PROJECTS IN THE HOME Flind	£3.36
110 ELECTRONIC ALARM PROJECTS FOR THE HOME CONSTRUCTOR Marston	£3.36

### PAPERMAC - ELECTRONIC PROJECTS

A set of 4 books full of interesting circuits and projects.

COST EFFECTIVE PROJECTS AROUND THE HOME Watson	£3.26
PROJECTS FOR THE CAR AND GARAGE Bishop	£3.26
AUDIO CIRCUITS AND PROJECTS Bishop	£3.96
TEST GEAR PROJECTS Dixon	£3.26

SEMICONDUCTOR DATA BOOK Newnes	£5.90
MICROPROCESSORS FOR HOBBYISTS R. Coles	£3.65
PRACTICAL ELECTRONIC PROJECT BUILDING Ainslie and Colwell	£3.36

### POPULAR LOW COST BOOKS

Most titles new this month

RADIO CONTROL FOR BEGINNERS Rayer	£1.75
INTERNATIONAL TRANSISTOR EQUIVALENTS GUIDE. 320 pages. Michaels	£2.95
ELECTRONIC PROJECTS FOR CARS AND BOATS Penfold	£1.95
SECOND BOOK OF CMOS IC PROJECTS Penfold	£1.50
60 SIMPLE L.E.D. CIRCUITS BOOK 2	£1.35
ELECTRONIC MUSIC PROJECTS Penfold	£1.75
ELECTRONIC HOUSEHOLD PROJECTS Penfold	£1.75
ELECTRONIC GAMES Penfold	£1.75
PROJECTS IN OPTO ELECTRONICS Penfold	£1.26
52 PROJECTS USING IC 741 Redmer	95p
ELECTRONIC TIMER PROJECTS Rayer	£1.95
POWER SUPPLY PROJECTS Penfold	£1.75
REMOTE CONTROL PROJECTS Bishop	£1.95
SOLID STATE SHORTWAVE RECEIVERS FOR BEGINNERS Penfold	£1.25
BEGINNERS GUIDE TO BUILDING ELECTRONIC PROJECTS Penfold	£1.50
MODEL RAILWAY PROJECTS Penfold	£1.95
IC 555 PROJECTS Parr	£1.95
ELECTRONIC MUSIC AND CREATIVE TAPE RECORDING Berry	£1.75

## MORE KITS AND COMPONENTS IN OUR LISTS

**FREE PRICE LIST**  
 Price list included with orders or send 50p (9 x 4) CONTAINS LOTS MORE KITS, PCBs & COMPONENTS

## 1982 ELECTRONICS CATALOGUE

Illustrations, product descriptions, circuits all included. Up-to-date price list enclosed. All products are stock lines for fast delivery. Send 70p in stamps or add 70p to order.

MORE H.E. KITS PLUS E.E. and E.T.I. PROJECT KITS IN THE PRICE LIST.

IC106D	58p	2N5457	58p	BFY51	24p	INTEGRATED CIRCUITS			
TIC46	48p	2N5434	63p	BFY52	23p	4001	20p	LM387	£2.10
OA47	11p	40673	98p	BFX88	32p	4011	20p	LM387	£1.10
DA90	9p	AC118	29p	BRV39	48p	4013	32p	LM389N	£1.90
OA202	16p	AC141	38p	MPS A65	39p	4017	62p	LM11830	£1.10
WO05	33p	AC142	39p	RPV58A	£1.18	4020	65p	LM3909	82p
W06	47p	AC176	37p	TIP31A	52p	4024	60p	LM3914	£2.99
Z5J	£2.92	BC182	11p	TIP32A	83p	4069	20p	LM3915	£3.95
IN4001	54p	BC182L	11p	TIP33A	94p	4061	20p	MC3340	£2.15
IN4005	6p	BC183	11p	TIP34A	99p	4093	38p	NE700N	£4.98
IN4148	5p	BC184	11p	TIP121	£1.12	40174	£1.20	NE571N	£4.84
IN5404	18p	BC134L	11p	TIP2955	69p	4522	£1.26	OM335	£8.98
IN5408	19p	BC212	11p	TIP3055	69p	555	26p	SN76477	£2.69
BF244	87p	BC212L	11p	TIS43	38p	556	79p	TL064	£1.64
MPF102	69p	BC213	11p	TPSA13	35p	741	22p	TL071	47p
TIS88A	57p	BC214	11p	SN3053	25p	CA3130E	98p	TL082	74p
VN67AF	£1.21	BC214L	11p	2N3055	59p	CA3140E	52p	TL083	£1.62
2N3819	28p	BD131	48p	2N3702	11p	MA1388	£3.20	TL084	£1.54
2N3820	78p	BFY50	25p	2N3704	11p	ICL7611	88p	TL430	95p

**1W CARBON FILM RESISTORS**  
 E12 SERIES. 1R-10M ..... 1p each  
 MIN. HORIZ. PRESETS. 100R-4M7. 12p each  
 MIDGET POTS. LINEAR. 470R-4M7 37p each  
 LOG. 4K7-2M3 ..... 38p each  
 SWITCHED POTS. 4K7-1M. LIN. 75p. LOG 76p

**POLYESTER (C200) CAPACITORS. 250V**  
 10nF. 15nF. 22nF. 33nF. 47nF 7p each. 68nF. 100nF 8p. 150nF. 220nF 12p. 330nF 15p. 470nF 20p. 680nF 28p. 1µF 33p. 1.5µF 49p. 2.2µF 65p

**SUB MINIATURE PLATE CERAMICS. 63V**  
 Values in pF: 2, 3, 3.3, 4, 7, 5, 6, 6.8, 8, 2, 10, 15, 22, 33, 47 & 56pF 7p each. 68pF. 100pF 7p each. 150pF. 220pF. 330pF 11p each. 390pF. 470pF. 1000pF 5p each. 2200pF 8p each. 3300pF. 4700pF 7p each. 10nF 13p. 100nF 22p. 47nF 14p.

**ELECTROLYTIC CAPACITORS**  
 AXIAL Leads: 1µF/18V 11p; 1µF/63V 1µF/100V 12p; 2.2µF/63V 3.3µF/63V 4.7µF/63V 10p; 10µF/16V 11p; 10µF/25V 10µF/63V 12p; 22µF/10V 22µF/25V 12p; 22µF/63V 15p; 33µF/40V 47µF/25V 12p; 47µF/40V 15p; 47µF/63V 18p; 100µF/16V 12p; 100µF/25V 15p; 100µF/40V 18p; 100µF/63V 29p; 220µF/10V 15p; 220µF/25V 19p; 470µF/16V 29p; 470µF/25V 36p; 470µF/40V 55p; 680µF/16V 32p; 1000µF/10V 39p; 1000µF/16V 33p; 1000µF/25V 48p; 1000µF/40V 58p; 1000µF/63V 79p; 2200µF/10V 39p; 2200µF/25V 64p; 2200µF/63V £1.10

**SWITCHES**  
 MIN. TOGGLE spst 59p; spdt 69p; dpdt 79p.  
 MIN. PUSH ON. 18V. 15M OFF. 22p.  
 FOOTSWITCH & ALT. ACTION spco £1.39; dpco £1.88.  
**ROTARY SWITCHES.** 1p 12 way, 2p 6w, 3p 4w, 4p 3w ..... 89p each  
**12V 185R DPCC RELAY** ..... £2.98

**SPEAKERS.** Miniature. 8 ohm ..... 87p  
 64-75 ohm ..... 89p  
**CRYSTAL EARPIECE** ..... 65p  
**MONO HEADPHONES** ..... £2.96  
**TELEPHONE PICK-UP COIL** ..... 72p

**VEROBOARD 0.1" COPPER STRIPS**  
 10 strips 24 holes ..... £1.20 per 5  
 24 strips 37 holes ..... 78p  
 24 strips 50 holes ..... 89p  
 36 strips 37 holes ..... 89p  
 36 strips 50 holes ..... 99p  
 Terminal pins 0.1" ..... 52p/100

**PP3 CLIPS** 10p  
**PP9 CLIPS** 11p

**EUROBREADBOARD** ..... £6.20  
**BIMBOARD 1" BREADBOARD** ..... £3.98  
**VEROBLOC BREADBOARD** ..... £4.20

**PANEL METERS**  
 50µA; 100µA; 1mA, 1A, 25V, 100µA AU  
 100µA; 5A, A-O  
 £4.98 each. State value.

**OPTO**  
 BPX25 ..... £2.24  
 2N577 ..... 60p  
 ORP12 ..... 89p  
 TIL32 ..... 81p  
 TIL78 ..... 74p  
**LEDS WITH CLIPS**  
 3mm. Red 15p. Green 18p. Yellow 20p.  
 5mm. Red 16p. Green 28p. Yellow 29p.  
**FLASHING LED** ..... 78p  
**RECTANGULAR Red** ..... 24p  
**MAINS PANEL. Neon** ..... 32p

**ZENER DIODES.** 400mW.  
 BZY88. Range 2V7 to 33V. 12p each.

**I.C. SOCKETS**  
 8 pin ..... 16p 18 pin ..... 22p  
 14 pin ..... 17p 24 pin ..... 48p  
 16 pin ..... 18p 28 pin ..... 45p

**JACKSON**  
 300pF dilecon ..... £2.36  
 500pF dilecon ..... £2.92  
 C804 Ver. Capac. 100pF £2.28  
 25pF £2.46. 50pF £2.48. 100pF £2.83. 150pF £3.48.  
 '01' 365pF £3.48. '02' 365pF. £4.49  
 '02' 208 + 176pF £3.98.

## ADVENTURES WITH MICROELECTRONICS

by Tom Duncan

An easy to follow book suitable for all ages. Ideal for beginners. No soldering. Uses a Bi-board 1 breadboard, gives clear instructions with lots of pictures. 11 projects based on integrated circuits - includes dice, two-tone doorbell, electronic organ, MW/LW radio, reaction timer, etc. Component pack includes a Bi-board 1 breadboard and all the components for the projects.  
 Adventures with Microelectronics £2.55. Component pack £29.64 less battery.

## ADVENTURES WITH ELECTRONICS

by Tom Duncan

An easy to follow book suitable for all ages. Ideal for beginners. No soldering, uses an S-Dec breadboard. Gives clear instructions with lots of pictures. 16 projects - including three radios, siren, metronome, organ, intercom, timer, etc. Helps you learn about electronic components and how circuits work. Component pack includes an S-Dec breadboard and all the components for the projects.  
 Adventures with Electronics £2.40. Component pack £17.98 less battery.

MAGENTA gives you FAST DELIVERY OF QUALITY COMPONENTS & KITS. All products are stock lines and are new & full specification. We give personal service & quality products to all our customers - HAVE YOU TRIED US?

**MAGENTA ELECTRONICS LTD.**  
 HG23, 135 HUNTER ST., BURTON-ON-TRENT, STAFFS., DE14 2ST. 0283 65435. MON-FRI 9-5. MAIL ORDER ONLY. ADD 45p P&P TO ALL ORDERS.

**OFFICIAL ORDERS WELCOME.**  
 IRISH REPUBLIC & B.F.P.O. EUROPE:  
 Deduct 10% from prices shown Payment must be in Sterling.  
**ACCESS and BARCLAYCARD (VISA) ORDERS ACCEPTED BY PHONE OR POST.**  
**SEE ALL ENQUIRES.**  
 Normal despatch by return of post.



# MONITOR

**NEW PRODUCTS** for home electronics enthusiasts are sometimes thin on the ground. Every month brings a number of announcements concerning the release of new instruments, chips or other components, but many are only of interest to specialists working in industry or institutions.

Specialist equipment does have its place, however. The **ECR81 cassette recorder** from **Monolith Electronics** is a good example. It is specially designed as a low-cost data storage medium for home computer systems, such as the Sinclair ZX81.

The problems with using ordinary cassette recorders are well known to home computer operators; the level of the output signal from the computer is often so low that errors are introduced or the data lost altogether. Tape stretching can also cause loss of information, because the computer loses synchronisation with the recorded signal.

The **ECR81** (top) has a number of features designed to overcome these commonplace difficulties. It has a high quality cassette mechanism with certified tape tension, torque, speed and head alignment, signal enhancement and shaping circuits for peak performance, and a long-life head matched to TDK's "Super Avilyn" cassette tape. The output level control is preset to eliminate fiddly volume adjustments and a write-protect microswitch is fitted to prevent the accidental erasure of valuable tapes.

The **ECR81** is supplied for £47.50, including VAT, and comes fully tested and complete with mains lead, DIN connector and certification tape. All machines have their serial number and performance records (which are checked against the certification tape) kept at the factory. For further information, contact **Monolith Electronics Co. Ltd.**, 5-7 Church Street, Crewkerne, Somerset; Tel. 0460 74321.

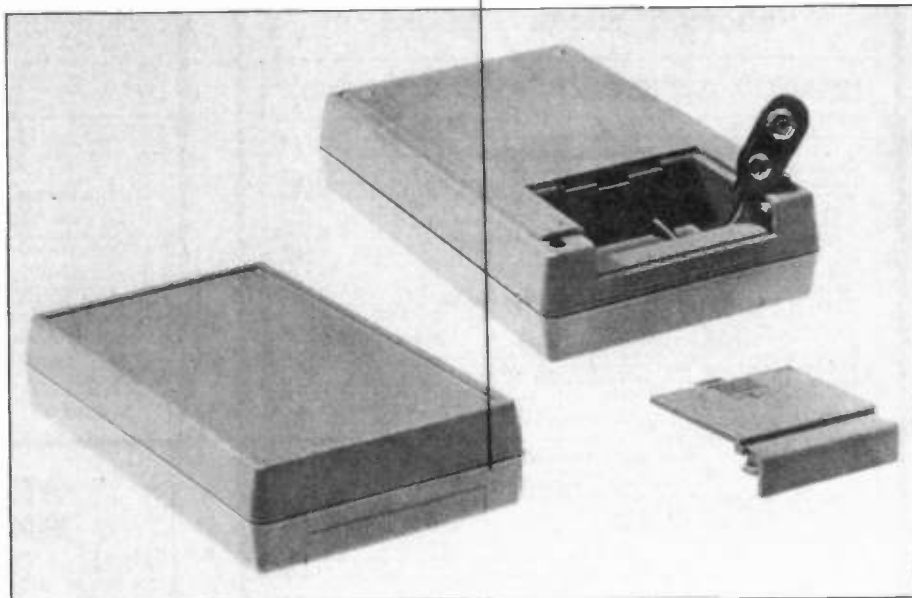
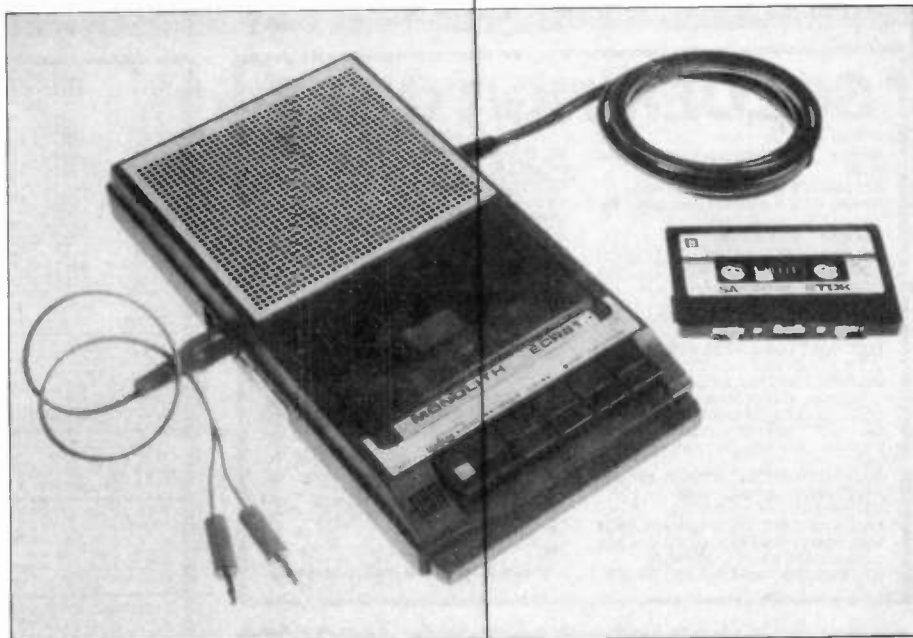

One of the most interesting new releases this month is a new range of **PacTec cases** from **OK Machine & Tool (UK) Ltd.** The special feature of this series, the **HP series**, is a battery compartment for standard 9 V batteries. The **HP-BAT-9 V** (middle) is typical; it has a removable battery hatch in the back panel and comes complete with battery clip and lead, as with the other cases in the series.

All are constructed from **ABS material** for strength and durability and have a textured appearance. They are available in four standard colours (grey, tan, black and blue) and there are a number of useful options, including belt-clips, shoulder straps and wrist straps. Other options provide flame-proof material and electromagnetic/radio frequency shielding.

The **HP series** cases are available from **Watford Electronics** or direct from **OK Machine & Tool (UK) Ltd.**, Dutton Lane, Eastleigh, Hants SO5 4AA, Tel. 0703 610944.

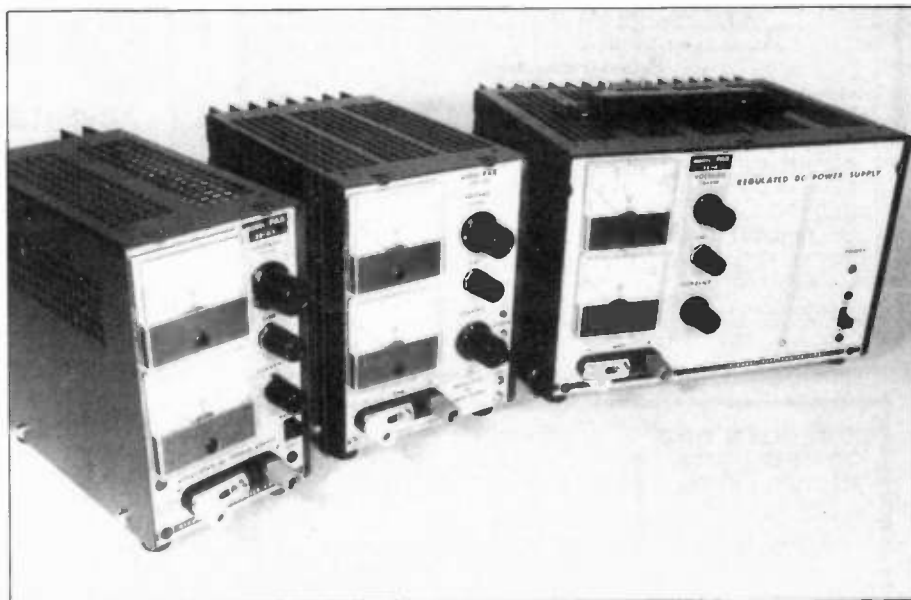



One rather essential piece of equipment for the electronics workshop is a reliable DC power supply. It will soon repay its cost with savings on batteries! **Telonic Berkeley UK Limited's** new range of **Kikusui PAB Series** supplies (below, left) offer practical features and a wide range of output options but, best of all, they are attractively priced for the home electronics enthusiast.

There are 17 models in the range, with outputs from 32 V at 0.5 A up to 18 V at 5.5 A. The output voltage may be varied from zero up to the rated output by the use of two variable controls, giving coarse and fine adjustment (some models have a 10-turn potentiometer). Output current is variable from 10% to 100% of the rated value so that a unit may be operated as constant current source, as well as the usual regulated voltage supply. Output voltage and current are displayed on separate meters and overload protection is by constant current transfer.

Prices range from £59 to £138, excluding VAT, and interested readers should contact **Telonic Berkeley UK Limited** at 2, Castle Hill Terrace, Maidenhead, Berks; Tel. 0628 73933.

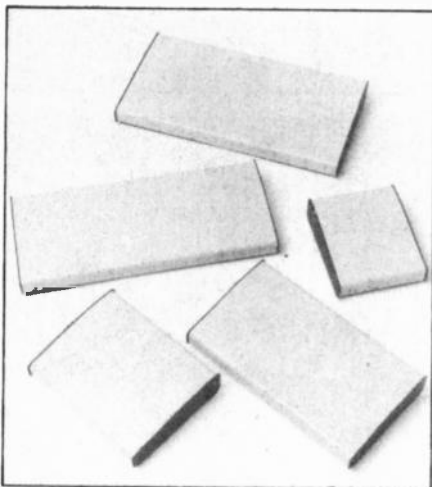

A new range of boxes, suited for more ambitious projects, have been released by **Boss Industrial Mouldings Ltd.** Their new **BIM 2600** range of small and medium sized desk consoles (above) are intended for applications where meters, keyboards or switches are incorporated, with adequate space available on the side and rear panels for mains sockets and connectors.

They range in size from 178 x 210 mm to 483 x 261 mm with an overall height of 51 mm. The sloping front panel is designed to permit comfortable operation of panel-mounted controls and to provide excellent display visibility. Construction is two-piece aluminium in standard colours (brown base and beige top panel) with the whole unit held together by screws running through base rubber feet into hank bushes.

For price and availability contact **Boss Industrial Mouldings Ltd.**, James Carter Road, Mildenhall, Suffolk IP28 7DE; Tel. 0638 716101.

Back in the dim, Dark Ages of Electronics (ie, pre-1956 and the invention of the transistor), all electronic equipment used these funny, tubular-shaped things made of glass and metal; they were called valves (or tubes, as the Americans would have it). There is still considerable interest in much of this obsolete equipment, either as collector's items (on the principle that anything antique will eventually be worth something) or as functioning equipment (an old valve radio makes an excellent 'kitchen set').

One of the main sources of information on the subject is **'The Antique Wireless Newsheet'**, published by **The Vintage Wireless Company** of 64 Broad Street, Staple Hill, Bristol BS16 5NL. The company deals in obsolete electronics of most kinds, including antique wireless, industrial electronics and old components such as valves and speakers.

Their newsheet contains information on all these, plus lists of service data — circuits and manuals — and "complete equipment" for sale. Keen readers of our Famous Names series would also be interested in the occasional feature on some of the less well-known pioneers of radio, such as T. Graham Farish (printed in Newsheet No. 75), who was one of the largest manufacturers of electronic components in the Golden Age of amateur radio, 1920-1933.

Interested readers should contact the **Vintage Wireless Company** at the above address.

New developments in consumer electronics — the gadgets that we buy for personal use — are sometimes quite rapid. No sooner had last month's article on the **Sinclair** pocket TV been printed, than the **Sony Corp.** of Japan announced their own small-screen TV system. What next? Watch this space!

If **Sinclair's** past performance is any example, though, they will continue to beat the Japanese manufacturers at their own game — making and selling cheap but efficient products for the mass market (that's us, folks).

Already plans are being made to combine the flat-screen TV with **Sinclair's** existing computer technology, to develop a low cost integrated terminal/digital phone/work station. This project, which is being undertaken in conjunction with **ICL** (Britain's one-and-only mainframe computer giant) has been dubbed the "One Per Desk IT Work Station"; it is intended to operate as a peripheral to **ICL's** recently announced digital PABX system and, pending final agreement, production is scheduled to start in 1983.

**Sinclair's** "existing computer technology" refers, naturally, to the amazing **ZX81**. With monthly production running at 50,000 units (over 60% of which are for export), the **ZX81** has achieved worldwide sales of more than 250,000 computers. **Sinclair** now has "... more units installed than any other personal computer manufacturer worldwide..." and a good thing that is, too!

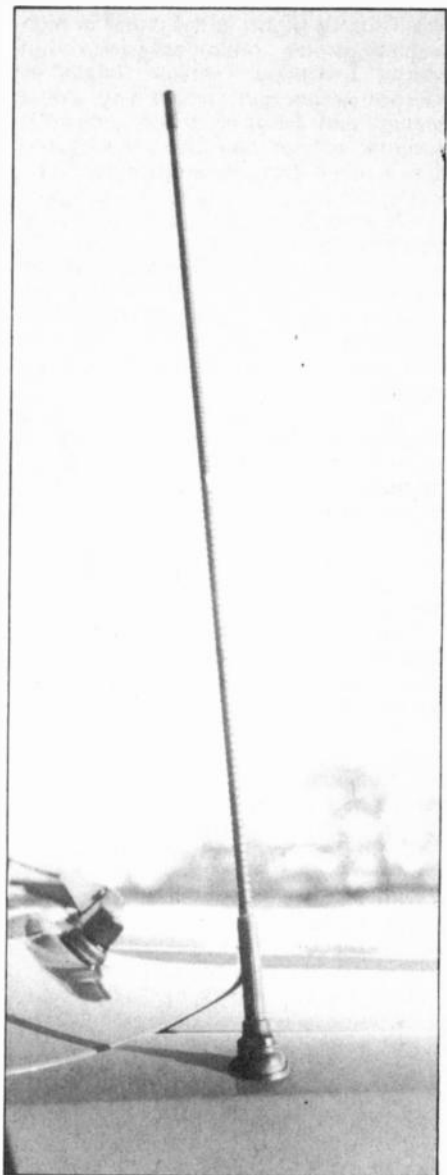

Meanwhile, the in-car entertainment industry continues to produce new and more powerful products for us to spend our money on.

The latest from **Blaupunkt** include the **Autoflex** aerial range, the **Toronto** "state of the art technology" radio/cassette combination and the **Blue Magic** line of hi-fi speakers.

The **Autoflex** (above) is described as a "new breed" of car aerial. It is miniaturized (non-telescopic) but provides the highest quality reception on both AM and FM. There are four variations available, for different mounting requirements, but the basic aerial is the same in every case; it is only 45 cm long and consists of a two-direction copper coil wound about a slim glass fibre rod. It is specially designed to reduce wind noise and is virtually indestructible; a highly flexible section at the base ensures that it cannot be snapped off. The non-telescopic construction means that it can never seize-up — and of course it does not need cleaning, greasing or special maintenance. The **Autoflex** aerials are priced from £21 to £24, including VAT.

# MONITOR

The Toronto (right) is the latest in high technology car radio/cassettes, with special operating features (such as microprocessor controlled tuning, digital display and fully electronic controls) designed for optimum performance and ease in use — and, therefore, safety. Unfortunately it is priced accordingly (£275 excluding VAT), but we can all dream.

The Blue Magic (below) series speakers, however, are much more accessible. They are designed for flush mounting in door panels or on the rear shelf and can cope with high power outputs up to 40 watts (music power).

The line starts with the SL 1225, a single cone model rated for 25 W music power; there are three dual-cone models, rated from 25 to 30 W and, finally, the top-of-the-line CL 1340 triple cone model. The speakers are supplied in pairs, complete with leads and mounting template, priced from £30.76 to £63.25 per pair, including VAT.

For details, write to Blaupunkt, Robert Bosch Ltd., PO Box 166, Rhodes Way, Watford, Herts WD2 4LB; Tel. 01-606 2023.



Now, if there is any room left in the car's dash board, perhaps you are contemplating installing a CB rig? If so, there are several new items which have come to our attention, lately, that may be of interest.

A new entry in the field, which is definitely worth considering if your space is becoming limited, is the Domico Convoy I, a slim-line CB transceiver made in Japan and distributed in the UK by Domicrest Fancy Goods Ltd. The rig is government approved and carries "all the usual features". The retail price is "something under" £80, including VAT, and Domico also provide a full range of aeriels, mikes, SWR meters etc. All items carry a one-year guarantee, with parts and service facilities available at the company's premises, at 31-37 Hoxton Street, London N1 6NJ; Tel. 01-729 4600. Domico products are available from the usual retail outlets but in case of difficulty, contact them at the above address.

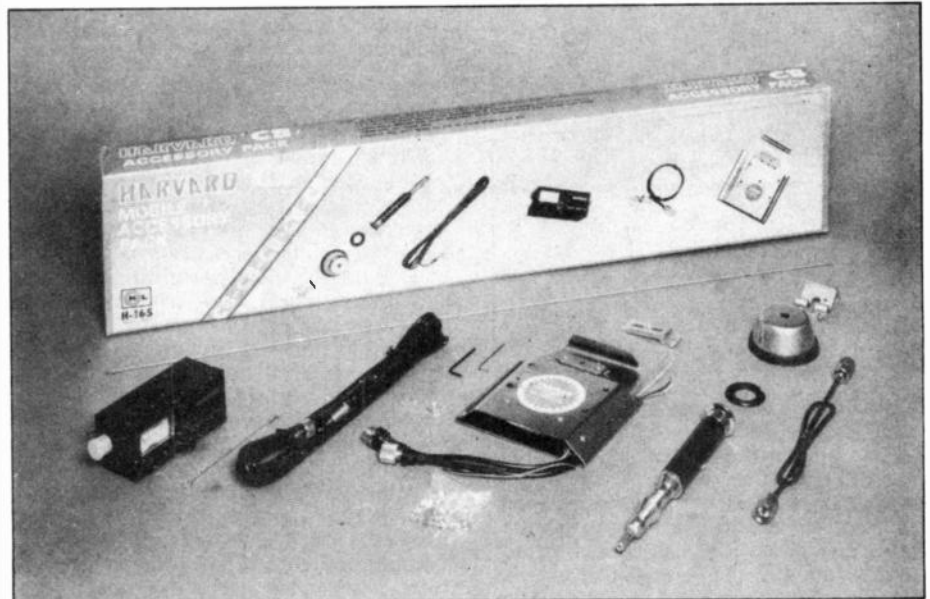

Major, (above) manufactured by Cybernet, is a more established name among CB operators. Three transceiver models are available — the 2000, 3000 and 5000, plus the Model 4000 base station. Specifications include PLL (Phase Locked Loop) digital synthesiser circuitry, dynamic microphone and built-in circuit protection and they meet all Home Office CB regulations for 27 MHz operation. They are supplied complete with mike, mounting bracket, cable and instruction manual. For more detailed information, contact Major (UK) Ltd, Unit 2, Station Yard, Wilbraham Road, Fulbourne, Cambridge CB1 5ET; Tel. 0223 881055.

Finally, you've just bought a rig but have forgotten all the little bits and pieces that (should) go with it, consider the new H 165 CB accessory kit from Harvard (above). It contains an MPT 1320 "legal" base loaded 27 MHz FM antenna, a locking slide bracket with key, patch leads, a three-function SWR meter and a gutter-mount for the antenna. The recommended retail price does not appear to have been finalised, but is expected to be around £20. Contact Harris Overseas Ltd, Harvard House, 14-16 Thames Road, Barking, Essex IG11 0HX; Tel. 01-594 5533, for up to date price information and availability. **HE**





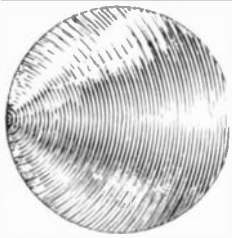

APPROVED  
**thandar**  
STOCKIST

# B.K. ELECTRONICS

## A SOUND CHOICE

APPROVED  
**thandar**  
STOCKIST

★ PROMPT DELIVERY ★ PRICES INCLUDE V.A.T. ★ AMPLE STOCKS  
A PERSONAL SERVICE FROM A SMALL EXPANDING COMPANY

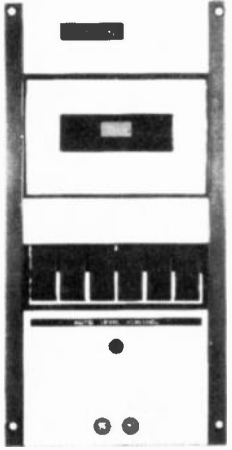

6 piano type keys

### STEREO CASSETTE TAPE DECK MODULE

Comprising of a top panel and tape mechanism coupled to a record/play back printed board assembly. Supplied as one complete unit for horizontal installation into cabinet or console of own choice. These units are brand new, ready built and tested.

**Features:** Three digit tape counter Auto-stop Six piano type keys, record, rewind, fast forward, play, stop and eject Automatic record level control Main inputs plus secondary inputs for stereo microphones  
**Input Sensitivity:** 100mV to 2V **Input Impedance:** 68K **Output level:** 400mV to both left and right hand channels. **Output Impedance:** 10K **Signal to noise ratio:** 45dB **Wow and flutter:** 0.1% **Power supply requirements:** 18V DC at 300mA **Connections:** The left and right hand stereo inputs and outputs are via individual screened leads, all terminated with phono plugs (phono sockets provided) **Dimensions:** Top panel 5 1/2" x 11 1/4" **Clearance required under top panel:** 2 1/4" **Supplied complete with circuit diagram and connecting diagram Attractive black and silver finish**

**Price £26.70 + £2.50 postage and packing**  
Supplementary parts for 18V D.C. power supply (transformer, bridge rectifier and smoothing capacitor) £3.50.

**NEW RANGE QUALITY POWER LOUD-SPEAKERS (15", 12" and 8").** These loudspeakers are ideal for both hi fi and disco applications. Both the 12" and 15" units have heavy duty die cast chassis and aluminium centre domes. All three units have white speaker cones and are fitted with attractive cast aluminium (ground finish) fixing escutcheons. **Specification and Price**

**15" 100 watt R.M.S.** Impedance Bohm 59 oz magnet 2" aluminium voice coil Resonant Frequency 20Hz Frequency Response to 2.5KHz Sensitivity 97dB **Price £32 each.** £2.50 Packing and Carriage each

**12" 100 watt R.M.S.** Impedance 8 ohm, 50 oz magnet 2" aluminium voice coil Resonant Frequency 25Hz Frequency Response to 4KHz Sensitivity 95dB **Price £23.70 each.** £2.50 Packing and Carriage each

**8" 50 watt R.M.S.** Impedance 8 ohms, 20 oz 1 1/2" aluminium voice coil, Resonant Frequency 40Hz, Frequency Response to 6KHz, Sensitivity 92dB. Also available with black cone fitted with black metal protective grill. **Price: White cone £8.90 each. Black cone/grill £9.50 each.** P & P £1.25 each

### PIEZO ELECTRIC TWEETERS MOTOROLA

Join the Piezo revolution. The low dynamic mass (no voice coil) of a Piezo tweeter produces an improved transient response with a lower distortion level than ordinary dynamic tweeters. As a crossover is not required these units can be added to existing speaker systems of up to 100 watts (more if 2 put in series) **FREE EXPLANATORY LEAFLETS SUPPLIED WITH EACH TWEETER.**

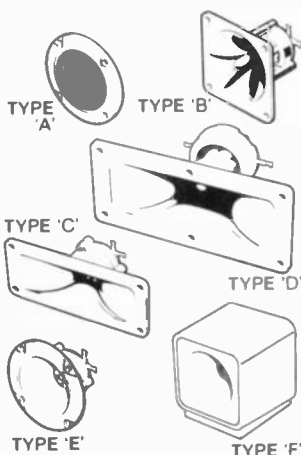

**TYPE 'A' (KSN2036A)** 3" round with protective wire mesh, ideal for bookshelf and medium sized Hi fi speakers. **Price £3.45 each.**

**TYPE 'B' (KSN1005A)** 3 1/2" super horn. For general purpose speakers, disco and P.A. systems etc. **Price £4.35 each.**

**TYPE 'C' (KSN6016A)** 2" - 5" wide dispersion horn. For quality Hi fi systems and quality discos etc. **Price £5.45 each.**

**TYPE 'D' (KSN1025A)** 2" - 6" wide dispersion horn. Upper frequency response retained extending down to mid range (2KHz). Suitable for high quality Hi fi systems and quality discos. **Price £6.90 each.**

**TYPE 'E' (KSN1038A)** 1 1/2" horn tweeter with attractive silver finish trim. Suitable for Hi fi monitor systems etc. **Price £4.35 each.**

**TYPE 'F' (KSN1057A)** Cased version of type 'E'. Free standing satellite tweeter. Perfect add on tweeter for conventional loudspeaker systems. **Price £10.75 each.** U.K. post free (for SAE for Piezo leaflets).

### 1K.WATT SLIDE DIMMER



- Controls loads up to 1KW
- Compact size
- 4 1/2" x 13" x 2 1/2"
- 16
- Easy snap in fixing through panel/cabinet cut out
- Insulated plastic case
- Full wave control using Ramp triac
- Conforms to BS800
- Suitable for both resistance and inductive loads

Innumerable applications in industry, the home, and discos/theatres etc.

**Price: £11.70 each + 50p P&P**  
(Any quantity)

### BSR P256 TURNTABLE

P256 turntable chassis ● S shaped tone arm ● Belt driven ● Aluminium platter ● Precision calibrated counter balance ● Anti skate (bias device) ● Damped cueing lever ● 240 volt AC operation (Hz) ● Cut out template supplied ● Completely manual arm. This deck has a completely manual arm and is designed primarily for disco and studio use where all the advantages of a manual arm are required.

**Price £28.50 + £2.50 P&P**



### GENERAL PURPOSE 4 1/2" MINI SPEAKER

General purpose full range loudspeaker, ideal for mini systems etc.

- Rolled fabric surround
- Twin cone
- 8ohm impedance
- 15 watt RMS
- 1" voice coil
- 13oz magnet
- Frequency range 50/15000Hz

**Price: £6.90 each + 75p P&P**



### POWER AMPLIFIER MODULES



Vu Meter

### 100 WATT R.M.S.

Power Amplifier Modules with integral toroidal transformer power supply and heat sink. Supplied as one complete built and tested unit. Can be fitted in minutes. Auxiliary stabilised supply and drive circuit incorporated to power an L.E.D. V.u. meter, available as an optional extra.

#### SPECIFICATION:

Max. output power 100 watts R.M.S. (OMP100)  
Loads: (Open and short circuit proof) 4-16 ohms  
Frequency Response 20Hz-25KHz + 3dB  
Sensitivity for 100 watts 500mV at 10K T.H.D. 00.1%

Size: 360 x 115 x 80mm  
Prices: OMP 100W £29.99 £2.00 P&P  
OMP 150W £39.99 £2.00  
V.u. Meter £6.50

### Matching 3-way loudspeakers and crossover

Build a quality 60watt RMS system 8ohms

Build a quality 60 watt R.M.S. system

- ★ 10" Woofer
- ★ 3" Tweeter
- ★ 5" Mid Range
- ★ 3-way crossover

Fitted with attractive cast aluminium fixing escutcheons and mesh protective grills which are removable enabling a unique choice of cabinet styling. Can be mounted directly on to baffle with or without conventional speaker fabrics. All three units have aluminium centre domes and rolled foam surround. Crossover combines spring loaded loudspeaker terminals and recessed mounting panel.  
**Price £22.00 per kit + £2.50 postage and packing.** Available separately prices on request.

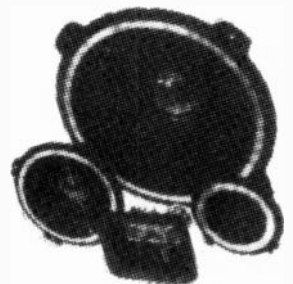

### 12" 80 watt R.M.S. loudspeaker.

A superb general purpose twin cone loudspeaker 50 oz magnet 2" aluminium voice coil. Rolled surround. Resonant frequency 25Hz. Frequency response to 13KHz. Sensitivity 95dB. Impedance Bohm. **Attractive blue cone with aluminium centre dome.**  
**Price £17.99 each + £2.50 P&P**

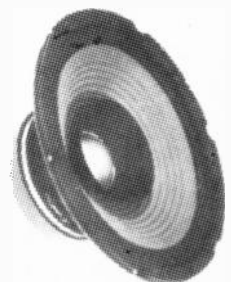

# B.K. ELECTRONICS

37 Whitehouse Meadows, Eastwood, Leigh-on-Sea, Essex SS9 5TY

★ SAE for current lists. ★ Official orders welcome. ★ All prices include VAT. ★ Mail order only. ★ All items packed (where applicable) in special energy absorbing PU foam. Callers welcome by prior appointment, please phone 0702-527572.





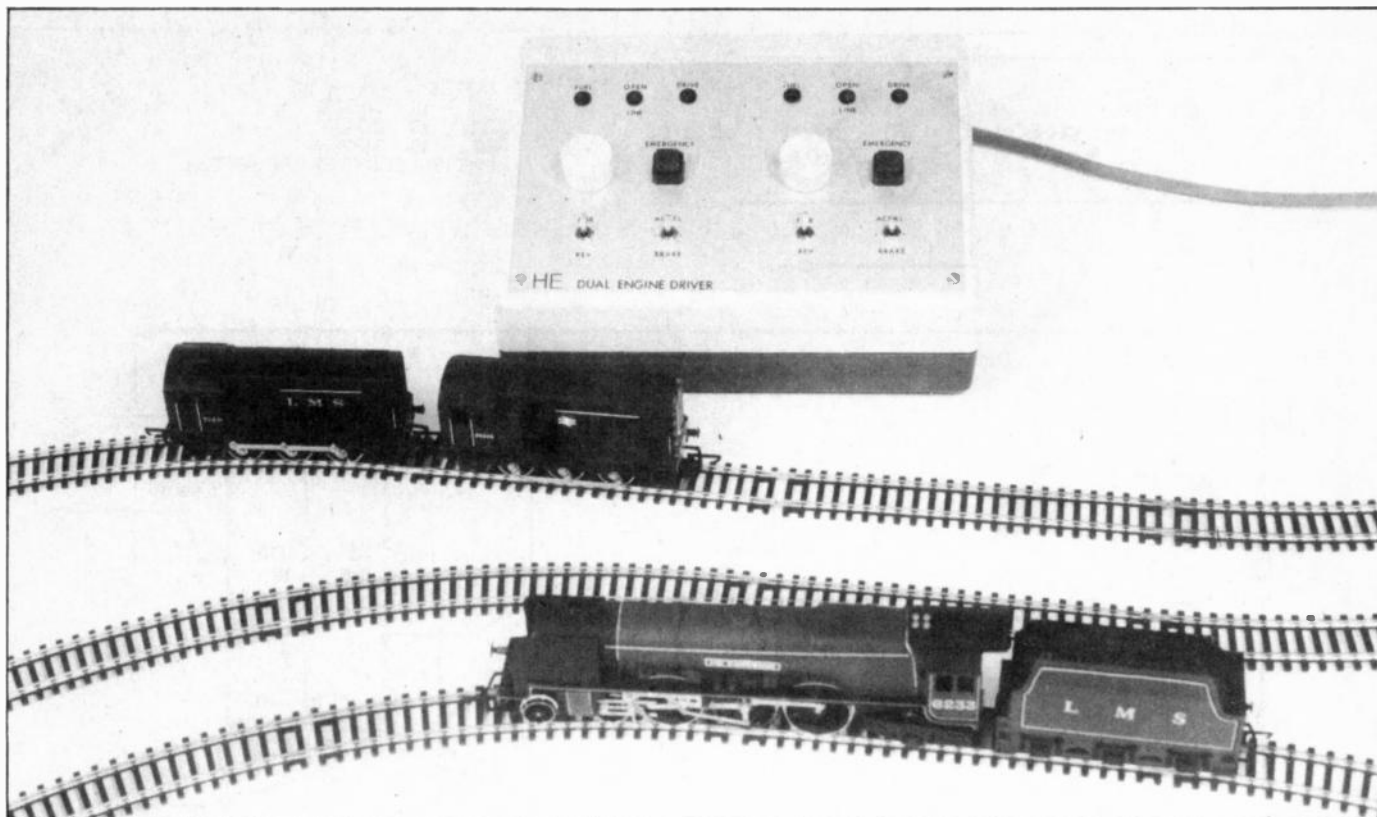

# Dual Engine Driver

Jonathon Scott

MODEL TRAIN CONTROLLERS aren't new; in fact, HE has presented two in the last few years. However, none that we have seen have offered all the features of this one! Our new device offers simulated inertia, twin controllers in one box, real engine-like control layout, realistic pick-up and current drive, which provides automatic compensation for bad contacts. It also has full short/open circuit indication. Whether you are a habitual Hamley's first floor addict or just starting with the beginnings of a railway set-up, this project will give you scale-realism.

Our controller will drive any DC locomotives, up to 15 volt rating at up to 1 1/2 amps per track and has two controllers in the one base (most people have at least two lines in their layout).

You may also notice that our Dual Engine Driver has rather an unusual control layout. There is a 'throttle', as well as a three-way control switch with positions, labelled 'Accel' and 'Brake' and a centre-off 'Coast' position. When the switch is thrown up to the accelerate position, the controller pulls the train slowly up to the power level set by the throttle and it can be left there for long journeys. Pushed to the centre position, the train will 'coast' and eventually come to a halt. For controlled braking, push the switch to the (momentary) brake position (released, it springs back to 'off'); repeated brake pulses will allow you,

## A double-value model train controller with simulated inertia for scale realism.

with a little practice, to stop neatly at a station. This 'power-coast-brake-coast-brake' sequence may be familiar from travelling on the Tube or on short Main-line runs. In fact a short station-to-station run rarely requires the operator to touch anything but the accel/brake control. For long runs, the throttle needs to be adjusted to set a steady pace — as is the case on an Inter-City run. This controller action is as 'realistic' as we could devise with readily available components. However, real engine-like controls could be made up and fitted to a panel, rather than the base that we used. For example, we could have used a 10-turn potentiometer for the throttle and a 'steam-valve' knob, but we opted for a simpler, less expensive approach. Since these are mechanical, rather than circuit, modifications we leave it up to you!

### Construction

Construction is relatively straightforward — if you follow the steps below and the accompanying layout diagram. Firstly, drill the box and front panel; make the holes for the

cable on the rear of the box, and the mountings for heatsinks, PCB, transformer, feet, etc, on the bottom. Once this is done, label the panel with rub-down lettering and spray it with protective lacquer. While this is drying, fit the terminals, transformer, diode bridge, feet and mains cable. The diode bridge should not require a heatsink if it is a 6 Amp type, as specified. We did not use an on-off switch in the AC mains line, as is usual on train controllers, but of course you may if you wish.

Next, fit the components to the PCB, following the overlay (Figure 2). Take care to orient the components correctly — only the resistors may be mounted either way around! Finally, fit the transistors to the heatsinks and mount them as shown. If you use a box similar to ours, there is plenty of room for the heatsinks to be individually bracket-mounted on the base and, as they are then isolated, there is no need to insulate the transistors with washers and thermal compound. If, however, you use a metal case as a heatsink, or one heatsink for both channels, you must then insulate Q1, Q2, Q101 and Q201 from the heatsink. Be sure to remove all burs and to use thermal compound; the transistors can develop tens of watts during momentary overloads and this demands several square inches of heatsink and good thermal contact!

When the panel has dried, fit all the knobs, switches etc. Then, all the flying leads should be connected; use

# Dual Engine Driver

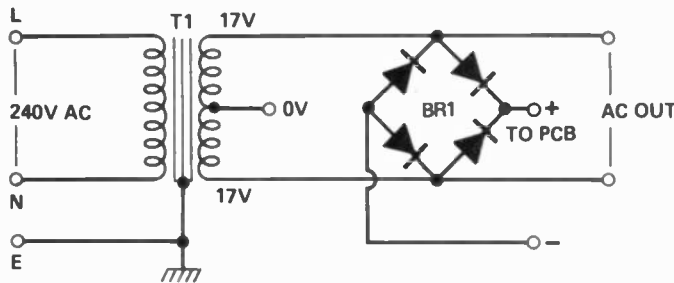

NOTES  
 IC1 IS CA 3140  
 Q1 IS BD139  
 Q2 IS TIP3055  
 SW1 IS A CENTRE-OFF SWITCH

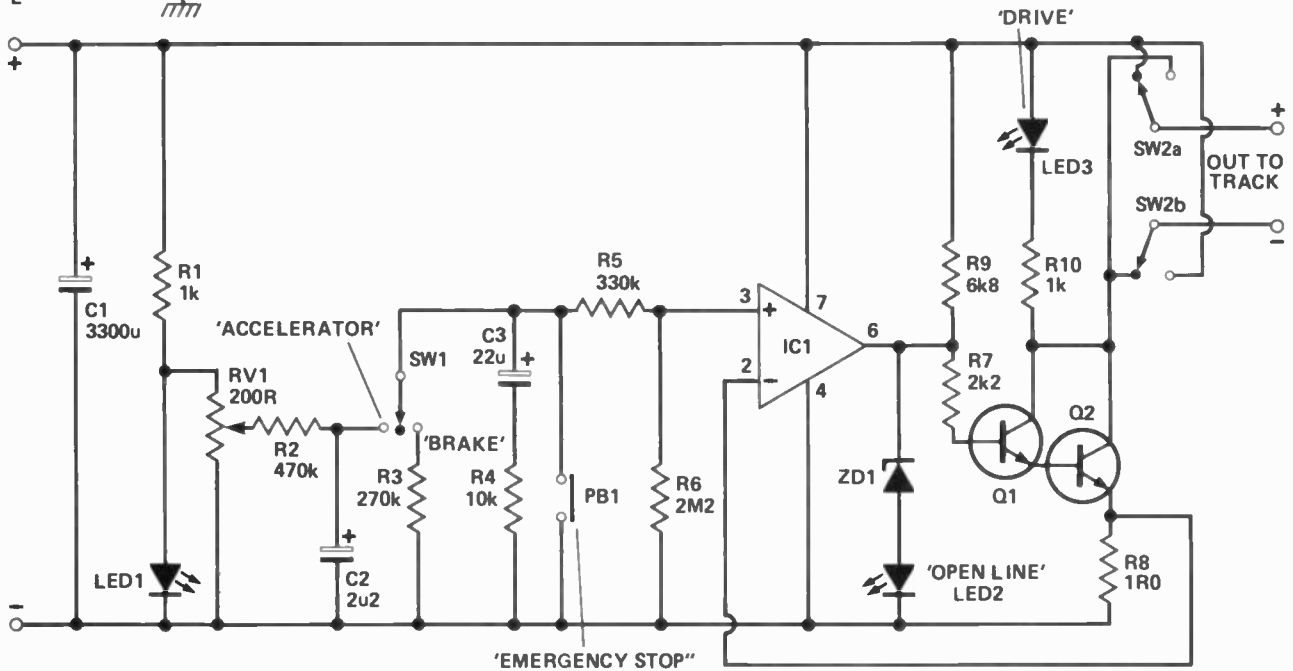

▲ Figure 1. The circuit for a single controller; the other half is identical.

◀ Figure 2. Component overlay for half the board. The full PCB foil pattern is reproduced on page 78

controls and the LEDs on the front panel, the terminals (6) and the AC 32/0.2 (32 conductors, each 0.2 mm diameter) or heavier gauge wire for the lines which carry 1.5 amps. The remaining connections can be made with ordinary hook-up wire. Now it is time to test the controller. If everything is in order, you should be rolling!

The Dual Engine Driver is capable of controlling any size train, of any gauge, that uses up to 15 V supply. Once it is operational, there are several adjustments that can be made to set up the controller to suit your system. You may, for example, vary the start-up impulse, change the maximum throttle setting or alter the amount of inertia to obtain better performance from your trains. These changes are described below.

## The Circuit

The unit consists of two separate, identical controllers, each supplying sufficient power to drive one train, and a common DC supply. The controllers each need 30 VA, maximum, and the specified transformer, rated at 65 VA, will comfortably run both controllers with 'headroom' left for an AC output, as is usual on model train controllers.

Smoothing capacitor C1 lifts the DC supply rail to about 20 V but, as

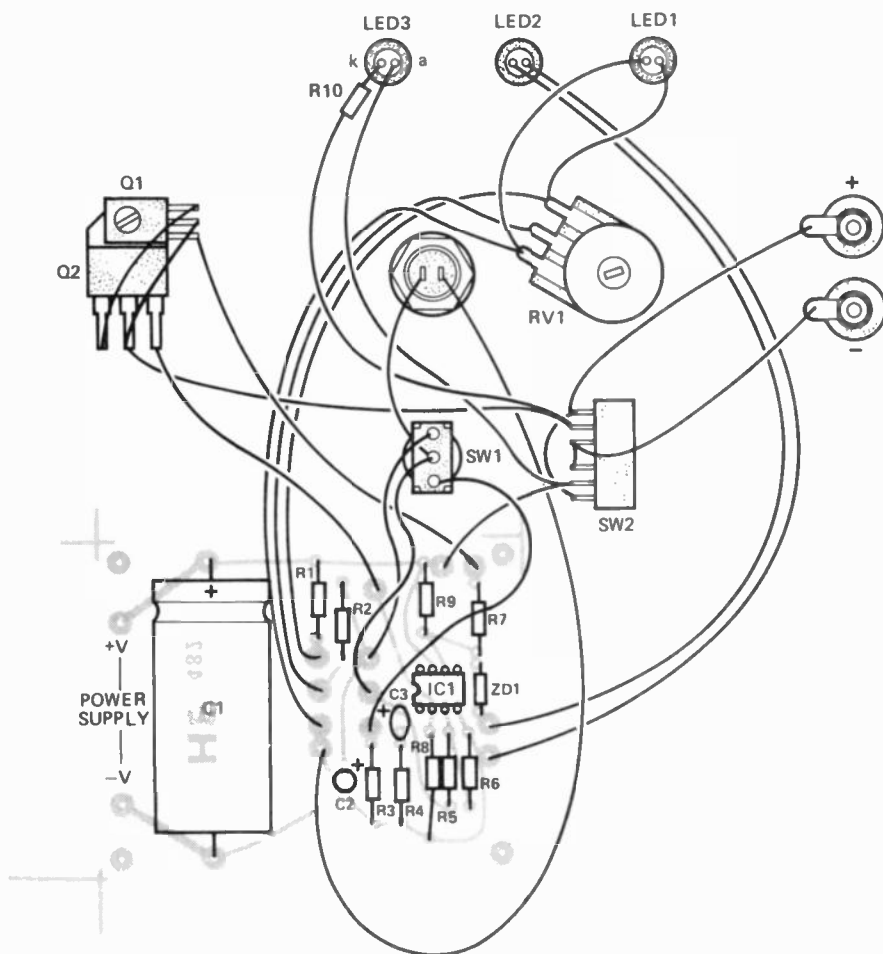



## Parts List

### RESISTORS

All  $\frac{1}{4}$ W 5% except where stated

R1,10	
101,110	1k
R2,102	470k
R3,103	270k
R4,104	10k
R5,105	330k
R6,106	2M2
R7,107	2k2
R8,108	1R0 2.5 watts
R9,109	6k8

### CAPACITORS

C1,101	3300u electrolytic 25 V
C2,102	2u2 radial electrolytic 16 V
C3,103	22u tantalum 16 V

### POTENTIOMETERS

RV1,101	200R wirewound
---------	----------------

### SEMICONDUCTORS

IC1,101	CA3140
ZD1,101	BZX61C 10 V zener diode
LED1,101	0.2" LED red
LED2,102	0.2" LED yellow
LED3,103	0.2" LED green
Q1,101	BD139
Q2,102	TIP3055

### MISCELLANEOUS

T1	Transformer 17-0-17 centre-tapped 4A
BR1	6A 100 V bridge rectifier
SW1	SPDT centre-off toggle switch (momentary action)
SW2	DPDT toggle switch
DP1	push-to-make push button switch

Case, knobs, PCB, grommets, cable, solder etc.

See Buylines, page 21 for cost and availability of these components.

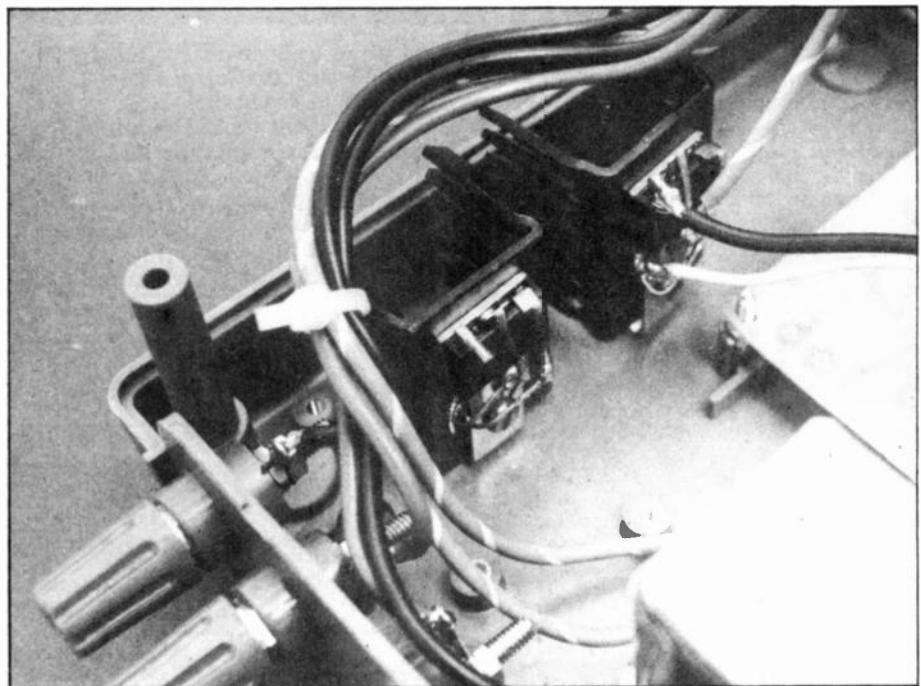
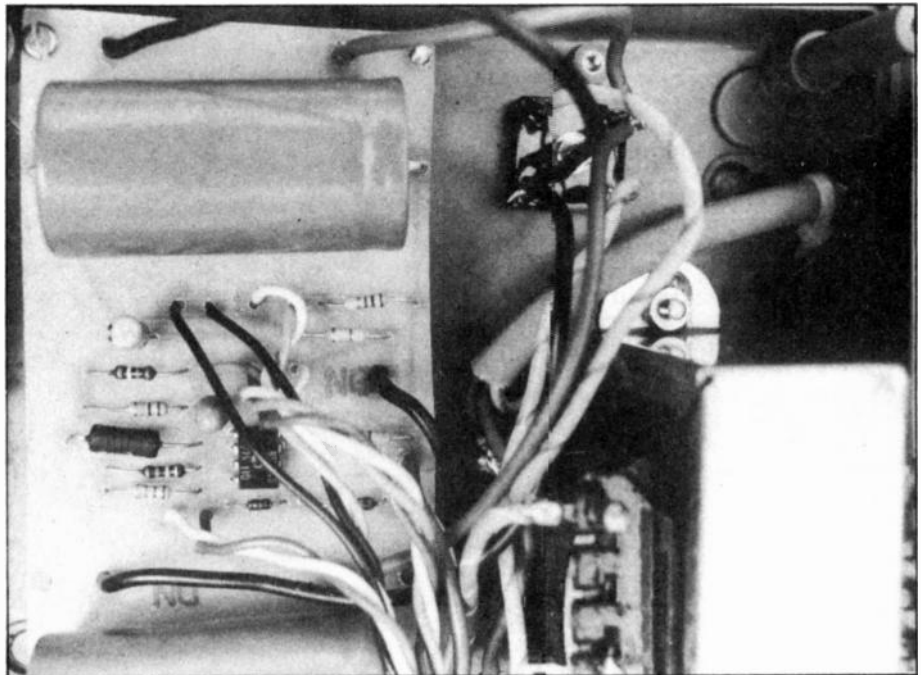

several volts are lost in the controller circuitry, the voltage supplied to the train is about the same as it would be if the supply were unsmoothed. As well as providing 'Power On' indication, R1 and LED1 put a regulated 1V65 across RV1, the throttle control.

Assume, for the moment, that SW1 is in the centre-off position, C3 is discharged and the throttle is set to about  $\frac{1}{3}$  maximum; C2 will be charged to about 0V5. If SW1 is then switched to the 'Accelerate' position, the voltage on C2 suddenly appears on C3, but rapidly discharges through C3 and R4, the voltage on C3 falling to about  $\frac{1}{10}$ th of its peak value of 0V5. Then, however, C3 begins to charge through R2, ultimately reaching the voltage set by the wiper of RV1. The net effect is a fast voltage pulse on Pin 3 of IC1 which quickly falls, nearly to 0 V, but then gradually rises back up to 0V5. This voltage pulse is translated into a current pulse by IC1 and Q1/Q2, giving that sudden engaged-gear jerk characteristic of certain engines, particularly steam engines, as the slack is taken out of the couplings and the engine begins to build-up full power.

The intensity of the start up pulse can be modified by changing C2 and/or

R4; increasing R4 produces a stronger 'jerk' but does not alter the start-up ( $\frac{1}{10}$ th of the throttle setting) while decreasing the value of R4 reduces the 'jerk'. Increasing C2 gives both a larger pulse and start-up power while decreasing C2 reduces both. Thus by adjusting the values of both components, you can produce a suitable jolt (one that doesn't lift the engine off the track) and a realistic start-up.

At this point, the voltage on C3 has risen to the value set by the wiper of RV1, the throttle control. Any further adjustments of the throttle will take effect slowly, as the charge on C3 adjusts to the new level, thus simulating the large weight and inertia of an actual train. Increasing C3 increases the inertia while decreasing its value produces a less pronounced effect.

The maximum current drawn by a train, and so its maximum speed, is set by R5/R6. If your engine demands much less than the 1.5 amps which the controller is capable of supplying, it may be necessary to reduce the top speed by increasing the value of R5 and, possibly, reducing the value of R6 — together, they should add up to about 2M5. For example, values of 1M each for R5 and R6 would give a maximum current of approximately 0.8 amps.

Look again at IC1, Q1 and Q2. The transistors are connected as a Darlington Pair, with the engine as their collector load (via reversing switch SW2a, b) and current-sense resistor R8 as the emitter load. The voltage developed across R8 is in the feedback loop of the op-amp, and IC1 tries to drive the Darlington Pair so that the current through Q1/Q2 develops a

## ■ Dual Engine Driver

voltage across R8 equal to the voltage on the non-inverting input, pin 3. Effectively, this forces the current through the load to be proportional to the voltage at pin 3 (which is, of course, proportional to the voltage on C3!).

Should the impedance of the load be too high — for example, when there is a bad track connection or an open circuit on the output — IC1 output is unable to force more current through Q1/Q2 and so moves towards the positive rail, lighting LED2 and indicating a fault condition.

LED3 is normally on, when a voltage is applied to the output, but is extinguished by a short circuit — thus, all fault conditions are indicated. By its current regulating action, the controller tends to counteract the effects of bad contacts or high resistance paths, but a continuous flicker in LED2 is normal as the engine moves over insulators or particles on the track.

Returning, now, to the control section, if SW1 is moved into the 'Coast' (centre-off) position, C3 discharges slowly through R5 and R6; the current drive also drops, as the voltage on pin 3 decays, and eventually the engine will come to a halt. Of course, if the values of C3, R5 or R6 have been adjusted, the time taken for this to happen will also be effected.

The train can be halted rather more rapidly by switching SW1 into the 'Brake' position (this position is a

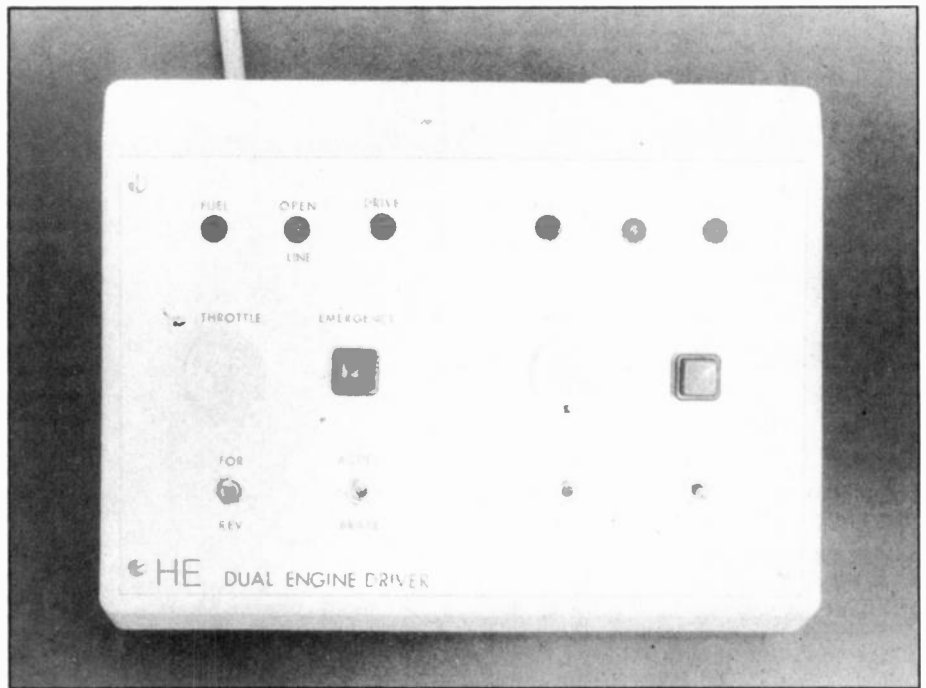

'momentary action' ie, the switch springs back into 'Coast' when released). In this position, C3 discharges fairly rapidly through R3, removing the current drive and bringing the engine to a stop. With practice it is possible it is possible to use the brake-coast-brake sequence to bring the train to an exact halt.

Should it be necessary to bring the train to an abrupt stop, the 'Emergency Stop' switch, PB1, shorts C3 to ground through R4, stopping the train in about 1 second.

*Our thanks to Hamley's Ltd of Regent Street, who supplied the trains for the picture.*

**HE**

# Guess who builds this great

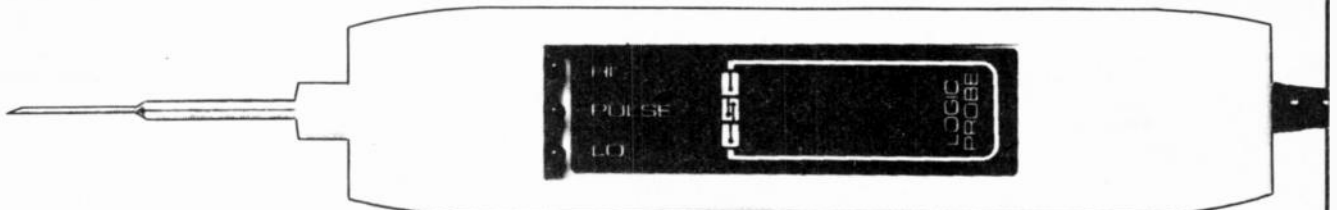

## Logic Probe...**YOU!** for only £12.50

With this easy-to-build Logic Probe Kit from GSC and just a few hours of easy assembly — thanks to our very descriptive step-by-step manual — you have a full performance logic probe.

With it, the logic level in a digital circuit is indicated by light from the Hi or Lo LED; pulses as narrow as 300 nanoseconds are stretched into blinks of the Pulse LED, triggered from either leading edge. You'll be able to probe deeper into logic with the LPK-1, one of the better tools from GSC.



Complete, easy-to-follow instructions help make this a one-night project.

### GLOBAL SPECIALTIES CORPORATION



G.S.C. (U.K.) Limited, Dept. 14Z  
Unit 1, Shire Hill Industrial Estate,  
Saffron Walden, Essex. CB11 3AQ.  
Telephone: Saffron Walden (0799) 21682  
Telex: 817477.

GLOBAL SPECIALTIES CORPORATION. DEPT 14Z  
Unit 1, Shire Hill Industrial Estate, Saffron Walden, Essex.

Name \_\_\_\_\_

Address \_\_\_\_\_

Inc P&P and 15% VAT  
**LPK-1 £15.52**

I enclose cheque/  
PO for £ \_\_\_\_\_

FREE Catalogue  
tick box

Phone your order with Access, Barclaycard  
or American Express Card No. \_\_\_\_\_

Expiry date \_\_\_\_\_

# BI-PAK BARGAINS



**ST21 SCREWDRIVER SET**  
6 precision screwdrivers in hinged plastic case. Sizes — 0.8, 1.4, 2, 2.4, 2.9 and 3.8mm **£1.75**

**ST31 NUT DRIVER SET**  
5 precision nut drivers in hinged plastic case. With turning rod. Sizes: — 3, 3.5, 4, 4.5 and 5mm **£1.75**

**ST41 TOOL SET**  
5 precision instruments in hinged plastic case. Crosspoint (Phillips) screwdrivers: — H 0 and H 1 Hex key wrenches: — 1.5, 2 and 2.5mm **£1.75**

**ST51 WRENCH SET**  
5 precision wrenches in hinged plastic case. Sizes: — 4, 4.5, 5, 5.5 and 6mm **£1.75**

BUY ALL FOUR SETS ST21-ST51 and get HEX KEY SET FREE  
HEX KEY SET ON RING  
Sizes: 1.5, 2, 2.5, 3, 4, 5, 5.5 and 6mm.  
Made of hardened steel  
HX/1 **£1.25**



## BI-PAK PCB ETCHANT AND DRILL KIT

Complete PCB Kit comprises  
1 Expo Mini Drill 10,000RPM 12v DC incl 3 collets & 1 x 1mm Twist bit.  
1 Sheet PCB Transfers 210mm x 150mm.  
1 Etch Resist Pen  
1 1/2 lb pack FERRIC CHLORIDE crystals  
3 sheets copper clad board  
2 sheets Fibreglass copper clad board.  
Full instructions for making your own PCB boards  
Retail Value over **£16.00**  
OUR BI-PAK SPECIAL KIT PRICE **£9.75**  
ORDER NO. SX81



## BI-PAK SOLDER - DESOLDER KIT

Kit comprises ORDER NO. SX80  
1 High Quality 40 watt General Purpose Lightweight Soldering Iron 240v mains incl. 3/16" (4.7mm) bit  
1 Quality Desoldering pump High Suction with automatic ejection Knurled, anti-corrosive casing and teflon nozzle  
1.5 metres of De-soldering braid on plastic dispenser.  
2 yds (1.83m) Resin Cored Solder on Card  
1 Heat Shunt tool tweezer Type  
Total Retail Value over **£12.00**  
OUR SPECIAL KIT PRICE **£8.95**



## BRAND NEW LCD DISPLAY MULTITESTER.

RE 188m  
LCD 10 MEGOHM INPUT IMPEDANCE  
\*3 1/2 digit \*16 ranges plus hFE test facility for PNP and NPN transistors \*Auto zero, auto polarity \*Single-handed, pushbutton operation \*Over range indication \*12.5mm (1/2-inch) large LCD readout \*Diode check \*Fust circuit protection \*Test leads, battery and instructions included  
Max indication 1999 or — 1999  
Polarity indication Negative only  
Positive readings appear without + sign  
Input impedance 10 Megohms  
Zero adjust Automatic  
Sampling time 250 milliseconds  
Temperature range — 5°C to 50°C  
Power Supply 1 x PP3 or equivalent 9V battery  
Consumption 20mW  
Size 155 x 88 x 31mm  
RANGES  
DC Voltage 0-200mV  
0-2-20-200-1000V Acc 0.8%  
AC Voltage 0-200-1000V  
Acc. 1.2% DC Current 0-200uA  
0-2-20-200mA 0-10 A Acc. 1.2%  
Resistance 0-2-20-200K ohms  
0-2 Megohms Acc. 1%  
BI-PAK VERY LOWEST POSS PRICE  
**£35.00** each



## SEMICONDUCTORS FROM AROUND THE WORLD

**100** A Collection of Transistors, Diodes, Rectifiers, Bridges, SCR's, Triacs, IC's both Logic and Linear plus Opto's all of which are current everyday usable devices **100**

Guaranteed Value over £10 at Normal Retail Price

£4.00 Data etc. in every pak Order No. SX56

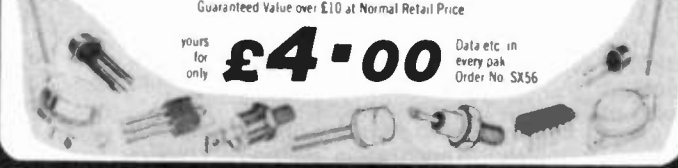

## EXPERIMENTER BOXES - ALUMINIUM - PLASTIC ALUMINIUM BOXES

Made with Bright Aluminium folded construction with deep lid and screws  
SIZE " L W H Order No. Price

## Plastic Boxes

Coloured Black Close fitting Flanged Lid, fixing screws into brass bushes  
SIZE " L W H Order No. Price

4	2	1	141	£1.00	
4 1/2	2 1/2	1 1/2	143	£1.30	
6	3 1/2	2	144	£1.50	
Plastic as above but with aluminium top panel					
4	2 1/4	1	146	£1.40	
Plastic sloping front					
5 1/2	4 1/4	2 1/2	slope		
			to		
6	4	2	1 1/2	148	£2.14

All measurements for boxes are shown in inches L = Length, W = Width, H = Height

## The Third and Fourth Hand...

... you always need but have never got until now  
This helpful unit with Rod mounted horizontally on Heavy Base Crocodile clips attached to rod ends Six ball & socket joints give infinite variation and positions through 360° also available attached to Rod a 2 1/2 diam magnifier giving 2.5 x magnification Helping hand unit available with or without magnifier Our Price with magnifier as illustrated ORDER NO. T402 **£5.50**  
Without magnifier ORDER NO. T400 **£4.75**



## "IRRESISTABLE RESISTOR BARGAINS"

Pak No.	Qty.	Description	Price
SX10	400	Mixed All Type Resistors	£1
SX11	400	Pre-formed 1/4-watt Carbon Resistors	£1
SX12	200	1/4-watt Carbon Resistors	£1
SX13	200	1/4-watt Carbon Resistors	£1
SX14	150	1/2-watt Resistors 22 ohm-2m2 Mixed	£1
SX15	100	1 and 2 watt Resistors 22 ohm-2m2 Mixed	£1

Paks SX12-15 contain a range of Carbon Film Resistors of assorted values from 22 ohms to 2.2 meg. Save cover your projects  
Quantities approximate, count by weight.

## "CAPABLE CAPACITOR PAKS"

Pak No.	Qty.	Description	Price
SX16	250	Capacitors Mixed Types	£1
SX17	200	Ceramic Capacitors Miniature Mixed	£1
SX18	100	Mixed Ceramics 1pf-5 pf	£1
SX19	100	Mixed Ceramics 68pf-0.5mf	£1
SX20	100	Assorted Polyester/Polystyrene Capacitors	£1
SX21	60	Mixed C280 type capacitors metal foil	£1
SX22	100	Electrolytics, all sorts	£1
SX23	50	Quality Electrolytics 50 1000mf	£1
SX24	20	Tantalum Beads, mixed	£1

Quantities approximate, count by weight

## AUDIO PLUGS, SOCKETS AND ACCESSORIES

25 pieces of Audio Plugs, Sockets and Connectors to include DIN 180° 240° Inline 3-6 Pin Speakers, Phono Jack Stereo and Mono etc. etc. Valued at well over £3 normal. Order No. SX25 Our Price £1.50\* per pak. Guaranteed to save you money

SX26	3 Pks of 6 pin 240° DIN Plugs and Chassis Sockets	50p
SX38	100 Silicon NPN Transistors—all perfect Coded mixed types with data and eqvt sheet No rejects. Real value	£2.50
SX39	100 Silicon PNP Transistors—all perfect Coded mixed types with data and eqvt sheet No rejects. Fantastic value	£2.50

## Silicon NPN'L' Type Transistors

TO-92 Plastic centre collector  
Like BC182L — 183L — 184L  
VC80 45 VCE0 30 IC200mA Hfe 100-400  
ALL perfect devices — uncoded ORDER AS SX183L  
50 off 100 off 500 off 1000 off  
**£1.50 £2.50 £10.00 £17.00**

## PNP SILICON TRANSISTORS:

Similar ZTX500 — ZTX214 — E-Line  
VCE0 40 VCE0 35 Ic 300mA Hfe 50-400  
Brand New — Uncoded — Pencil Devices  
50 off 100 off 500 off 1000 off  
**£2.00 £3.50 £15.00 £25.00**  
Order as ZTXPNP

## MOTOROLA PIEZO ELECTRIC TWEETER

Maximum Ratings  
25 volts rms which is equal to:  
200 watts across 4 ohms  
100 watts across 8 ohms  
50 watts across 16 ohms  
BI-PAK SPECIAL OFFER PRICE **£4.65**  
ORDER NO. 1907

## HOME TWEETER

Home Tweeter for systems up to 50w  
Impedance: 8 ohms  
Frequency Response: 2000-20,000Hz  
Dims 98mm diam. x 31mm deep  
Our Price **£2.85** DMT200



## TECASBOTY

The Electronic Components and Semiconductor Bargain of the Year. A host of Electronic components including potentiometers — rotary and slider, presets — horizontal and vertical Resistors of mixed values 22ohms to 2M2 — 1/8 to 2 Watt. A comprehensive range of capacitors including electrolytic and polyester types plus disc ceramics etcetera. Audio plugs and sockets of various types plus switches, fuses, heatsinks, wire, nuts/bolts, gromets, cable clips and ties, knobs and P.C. Board. Then add to that 100 Semiconductors to include transistors, diodes, SCR's opto's, all of which are current everyday usable devices. In all a Fantastic Parcel. No rubbish! All identifiable and valued in current catalogues at well over £25.00. Our Fight Against Inflation Price —

— Beat the Budget  
— Down with Depression  
**JUST £6.50.**  
O/no SX85

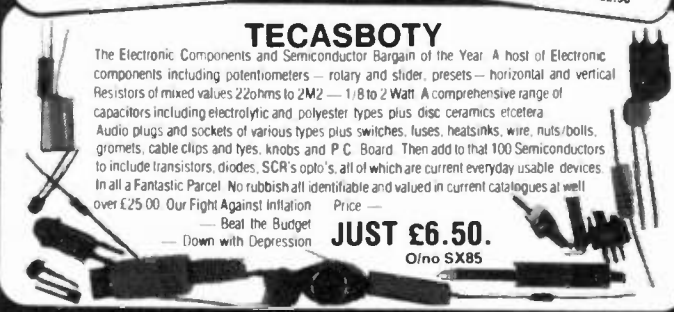

# BI-PAK

Send your orders to Dept ME4 BI PAK PO BOX 6 WARE HERTS  
SHOP AT 3 BALDOCK ST, WARE HERTS  
TERMS: CASH WITH ORDER SAME DAY DESPATCH. ACCESS  
BARCLAYCARD ALSO ACCEPTED. TEL (0920) 3182 GIRO 388 7006  
ADD 15% VAT AND 50% PER ORDER POSTAGE AND PACKING



Use your credit card. Ring us on Ware 3182 NOW and get your order even faster. Goods normally sent 2nd Class Mail.  
Remember you must add VAT at 15% to your order.  
Total Postage add 50p per Total order.



# INSIDE COLOUR TV

Interested in how a colour TV works? Want to know what makes it tick? This special feature by guest writer Don Keithley explains all.

MOST of you will have read the article (if not, why not?!), 'How A TV Receiver Works', in the December 1981 issue of Hobby Electronics, so you will know how a black and white TV works. As you'll soon see, colour TV uses all the principles used for black and white TV so you must understand those first.

Briefly, then, you should recall that a black and white TV scene is made up from lots of separate lines (625, in the British TV system) on the face of a phosphor-coated tube. The lines are made by guiding an electron beam from an electron gun across the inside surface of the tube. Controlling voltages applied to the electron gun, and to its deflection coils, tell the beam where to point and how many electrons to send in the beam. As the electrons hit the phosphor, energy is given off in the form of light and the greater the number of electrons, the brighter the light.

Using these very same principles, we can make a colour TV, because the light given off by the phosphor doesn't have to be white (as it is in a black and white TV tube) — it can be red, green, yellow, pink, blue, orange, brown, turquoise, or any colour we want it to be. All we require is a selection of different coloured phosphor spots (say, 10) arranged in groups on the TV screen. All we have to do after *that* is to fire a beam of electrons at the right coloured phosphor spot within each group and *hey presto*, we have a colour TV.

## It's Not That Easy

Unfortunately, there are some impossible problems with such a colour TV system. For instance:

- If the picture is to be in sharp focus the groups of phosphor spots will have to be very small — in fact, each group must occupy about the same space as the gap between lines on the screen, ie 1/625th of the screen. This means that each spot will be about 1/10th of this size — but this is too small to be accurately manufactured.

- Not only would it be impossible to manufacture such a tube, it would also be impossible to focus the electron beam on to the correct coloured spot in each group. Blurring of colours would occur, with greens becoming blues, reds becoming browns, etc. etc.

- Even if the gods were on our side and we were able to produce such a tube, and even if we could focus an electron beam to the required accuracy, there would *still* be another impossible bridge to cross — can you imagine just how complex the controlling voltages would have to be? The beam would have to be accurately positioned on one exact spot in one exact group of dots; the number of electrons fired in the beam would have to be specified, the beam would have to be fired, then stopped, then moved on to the next group and the whole process started again — *for every group on the TV screen*. All-in-

all, the controlling voltages applied to the electron gun and its deflection coils would be so complex that to transmit them over the air would require far more air-space than there is to spare!

- We must also consider the people who won't have colour TV, because a black and white TV won't be able to produce a picture from such a colour signal (and vice versa) so two completely separate systems would be required, one for black and white and one for colour.

As you'll have guessed by now, this colour TV system is not the one for us. So what do we do? How do we make a better system? One which is technically possible to build, doesn't use any more valuable air-space, and which we can use alongside the existing black and white system without the two interfering. Let's go back to basics and find out just exactly what 'colour' is and perhaps that will give us the answer.

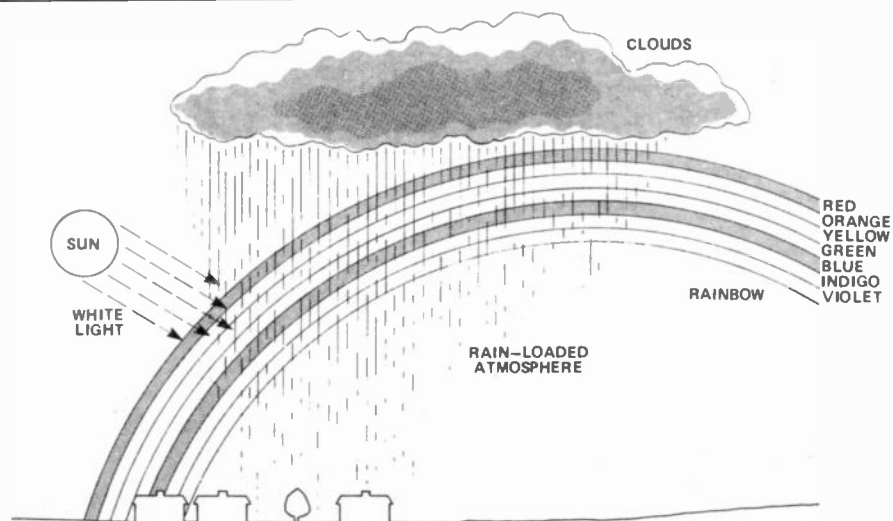
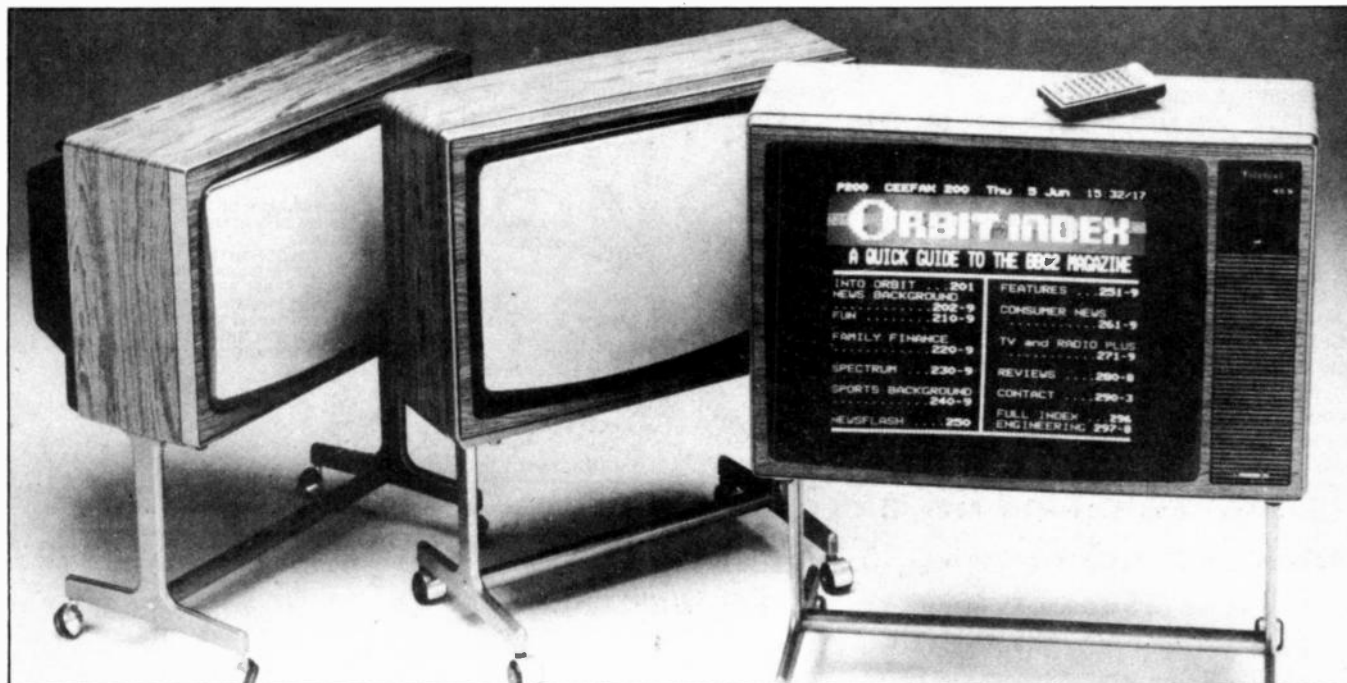

Figure 1. One of the most natural sources of colour is a rainbow. White light from the sun, refracted through a rain-loaded atmosphere, breaks-up into seven colours.



## Mother Nature

Colour is a natural phenomenon. You've only to look at the green grass, the blue sky, or the flowering yellow daffodils to see that. Take the example of a rainbow — it's a natural phenomenon, too, but believe it or not a rainbow can be used to show the main principle of colour TV.

A rainbow is formed when light from the sun (white light, that is) shines through an atmosphere loaded with minute rain particles. Rain particles refract the white light (ie bend it) and literally break it up into the seven colours of the rainbow: red; orange; yellow; green; blue; indigo; violet (Figure 1).

The rain-loaded atmosphere acts as a prism, similar to the glass prism used in the simple classroom physics experiment. What that experiment proves is that the colour which we call 'white' is simply a combination of other colours. Theoretically, it should be possible to combine the seven colours of a rainbow, or from a prism, back into white light

with another prism.

Figure 2 shows how seven colours can be used to create white light but, given the right conditions, we find that we can get white light from *only three colours*, red, green and blue. These three colours are called primary colours. The interesting thing is that white light is created by the three primary colours only when they are in the correct proportion: if the proportions differ, then a non-white colour is created. By controlling the proportion of primary colours, then, a very wide range of non-white colours can be created.

We can show the range of colours obtained with the three primary colours of red, green and blue in what is called a colour triangle (Figure 3), where each corner of the triangle corresponds to a pure primary-coloured light. Each point inside the triangle represents a different perceived colour. White light, at the point of equal primary strengths, is at the centre of the triangle.

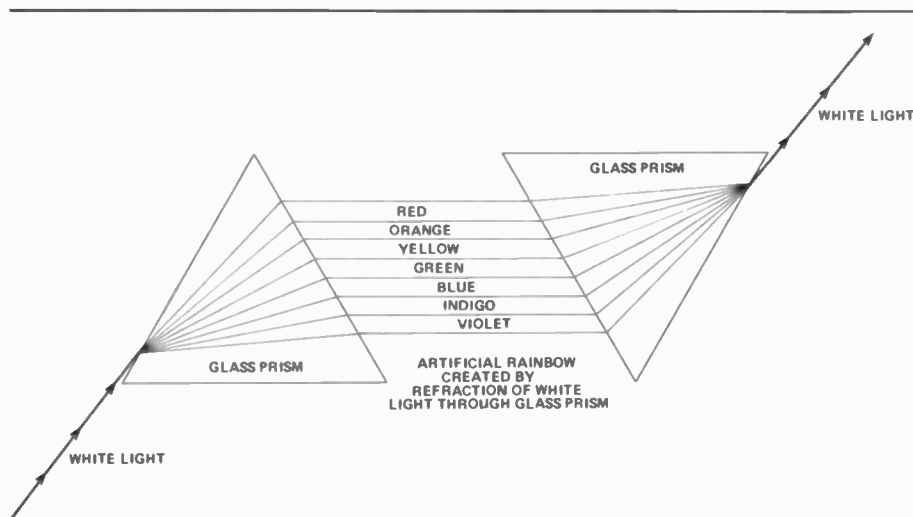

Figure 2. Using a glass prism to create an artificial rainbow from white light and another prism to recreate the white light from the seven colours of the rainbow. It would make a good LP cover!

You can see from this that we can now make a colour TV with a tube which has only three coloured phosphor spots — and not the ten coloured spots of our first example. Manufacturing such a three-colour tube is complex, but not impossible. The coloured spots in the tube are arranged in what are called triads (ie groups of three), so that each spot has one of a different colour next to it. When colour TV tubes were first made, these triads consisted of circular spots, as shown in Figure 4a, but later designs have rectangular spots as in Figure 4b. There are only a few spots shown in Figures 4a and b but, in reality, a colour TV tube contains many hundreds of thousands.

## Implications

The use of only three coloured spots means that, to get any non-primary colour, more than one spot in a group will have to emit light at the same time. To cope with this requirement, more than one electron gun is needed — three, in fact — arranged to fire separate electron beams at each spot in a triad. The electron guns which fire the beams are called red, blue and green guns, not because they fire red, blue and green electrons, but because they are aimed at red, blue and green spots.

Obviously, the red beam in a colour TV tube must hit only the red spot of a triad; similarly, the green beam must hit only the green spot and the blue beam — the blue spot. Any cross-over of electron beams, causing the wrong coloured spot to emit light, would mean that the wrong colour will be emitted and the overall TV scene displayed on the tube will be incorrect: can you imagine blue grass, yellow sky or perhaps pale green people? This is prevented by inserting a metal plate between the tube's screen and the electron guns. In the plate are small holes or slots (one at each triad), which make sure each coloured spot is hit only by the beam from the same colour gun. The plate is accurately positioned so that

## Inside Colour TV

each beam is cut-off or 'shadowed' from the other two spots of the triad and thus they can never emit their colour when a different beam is fired. Figure 5 shows such a plate (called a shadow mask) and the three electron guns firing beams at the spots of a triad.

Also shown in Figure 5 are the convergence coils which allow the individual electron beam to be adjusted so that, at any one time, they all hit the same triad of spots. If the beams hit spots of the wrong triad, the scene displayed by the tube will have a blurred, out-of-focus appearance, especially in areas of sharply contrasting colour changes. By altering the current through the convergence coils, the magnetic fields around them change and hence the deflection of each electron beam can be minutely adjusted until they all hit the same triad. When this is true, the tube is said to be correctly converged.

So — we know how a colour TV tube works: the question now is — how do we actually transmit and receive the controlling voltages which drive the guns in the tube? Remember that our aim is to produce a colour TV system which doesn't interfere with the existing black and white system — the two must be compatible! Well, once again we find the answer is to go back to basics, this time to find out just what the actual differences between 'black and white' and 'colour' are.

### Mono And Chrome

A black and white (monochrome) scene consists only of brightness information, called luminance. We only see the 'grey'ness of any particular part of that scene; if part of the scene is very bright we'll see it on the screen as light grey, or perhaps white; if a part is very dark we'll see it as dark grey or perhaps black.

Colour scenes possess luminance information too — we can always tell how bright a coloured object is — but they also have chrominance. Chrominance is the 'magic' ingredient which defines the actual colour of an object. It's interesting to note that, although human eyes can detect the two different sorts of visual information, some animals' eyes can't. Cattle, for example, can't 'see' chrominance information (their eyes simply do not respond to the frequencies which make up 'colour'). They can only see in black and white! It's the same thing with TV: a black and white TV transmitter doesn't use chrominance information and so the receiver can only display a black and white picture; a colour TV system uses both luminance and chrominance information and thus can display the scene in colour.

What we have to ensure, though, is that we can transmit both luminance and chrominance without the chrominance information interfering with the luminance. As long as this is so, black and white TV and colour TV systems will be compatible and both types of TV receiver will display a picture from the same transmitted signal.

A convenient way of studying a system's waveform (such as that in a black and white TV) is to look at its spectrum. Special machines, known as spec-

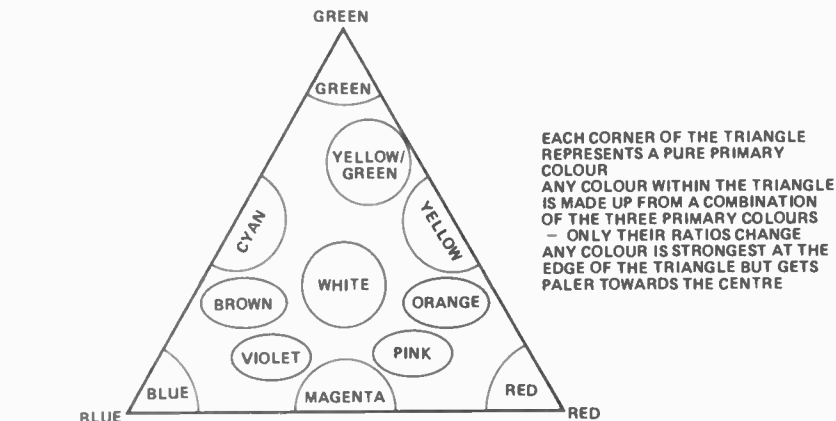

Figure 3. A colour triangle. Every colour that can be shown on a TV screen can be located in a colour triangle.

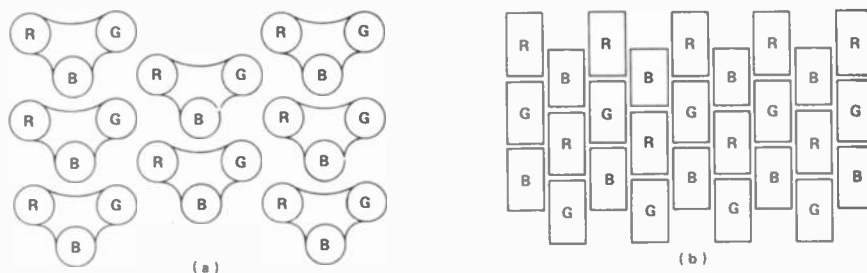

Figure 4. Colour triads of phosphor spots; (a) how triads were originally made; (b) the more usual form in use today.

trum analysers, can be used to find out the size of the signal present at any frequency and display it (much like an oscilloscope displays a simple waveform) on a cathode ray tube. A typical spectrum, which could be obtained from the screen of a spectrum analyser, of a black and white TV signal is shown in Figure 6. Any other black and white TV signal would be similar. In the spectrum, you can see the band of frequencies which holds the luminance information, corresponding to the number of lines per screen, the position of the electron beam on the screen, and the brightness of the beam at any time. You can also see the narrow peak, at a frequency of +6 MHz, which is used to send sound information. The information transmitted for sound is a lot less than that for luminance, hence the sound peak is a lot narrower than the luminance curve.

Darker luminance information, eg dark grey and black, is transmitted on the lower end of the luminance curve while lighter information, eg light grey and white, is transmitted on the upper end. You'll appreciate from the curve that much less 'lighter' information is needed in a black and white TV picture than 'darker' information.

If we were to look at the spectrum of only the chrominance information of a colour scene, we would find it much smaller (about 1/5th) than the scene's luminance information. It is this fact which enables us to transmit the two types of information, together, without interference. The possible spectrum of a

colour TV signal is shown in Figure 7 and the differences between it and the previous spectrum are obvious. The peak holding the chrominance information is at a frequency which, on the previous spectrum, would have been slap bang in the middle of the upper slope of the luminance curve. In the colour spectrum you'll see that the upper luminance slope has been taken back a bit so that the chrominance peak doesn't interfere with it. If you remember, the upper end of the luminance curve contains the information of lighter parts of the TV scene, so all we've done in combining luminance and chrominance into one TV signal is to reduce the overall brightness of the received picture — a colour TV scene is, therefore, *slightly darker than the same scene transmitted in only black and white*. To a large extent, a user can compensate for this by turning up the brightness control: so the lack of brightness information isn't regarded as a serious deficit. Hence, a colour TV system is compatible with a black and white TV system and the two can run side-by-side without interference.

### Colour Sums

The way in which chrominance is added to the luminance signal to produce the complete colour signal is interesting. There are three gun signals as well as the original luminance signal, so theoretically there should be four separate signals. However, because of a mathematical relationship between the chrominance



and the luminance signals of any colour TV scene, the number of signals actually transmitted is reduced to three. If you remember, the three primary colours — red, blue and green — can be added together in the correct proportions to produce white light. Similarly, by keeping the proportions identical but varying the three guns' controlling voltages, grey light can be made. By turning all three guns off, 'black light' is produced too. By keeping the proportions the same, you see, we have in effect made a black and white TV out of a colour TV. We can state this mathematically:

$$xR + yB + zG = L$$

where: R, B and G are the controlling voltages of the three guns and L is the effective luminance signal voltage which would be applied to a black and white TV gun to produce the same scene; x, y and z are the colour proportions required for the condition to exist. Because the proportions are parts of a whole, then  $x + y + z$  must equal 1.

Now, in order that a black and white TV can produce a black and white picture from a colour signal, we know that the luminance signal, L, must be transmitted unaltered. But instead of duplicating the information (which we would be doing if we transmitted the three colour signals as well) we use a clever bit of maths to reduce the number of colour signals: we can send only two *colour difference* signals along with the luminance signal. The three colour difference signals are:

$$R - L; B - L; G - L.$$

Now, from the luminance signal already sent in a black and white signal, and two of the colour difference signals (say,  $R - L$  and  $B - L$ ), the third colour difference signal ( $G - L$ ) can be calculated. From the above equation we know that:

$$xR + yB + zB = L$$

And we know that  $x + y + z = 1$ , so:

$$xR + yB + zG = (x + y + z)L$$

Expanding the bracket:

$$xR + yB + zG = xL + yL + zL$$

So:

$$xR - xL + yB - yL + zG - zL = 0$$

Grouping (you'll see the colour difference signals appear now):

$$x(R - L) + y(B - L) + z(G - L) = 0$$

So, if we know two colour difference signals ( $R - L$  and  $B - L$ ), the third:

$$G - L = -\frac{x}{z}(R - L) - \frac{y}{z}(B - L)$$

This can all be accomplished electronically by a circuit, known as a colour matrix circuit. You can buy them, nowadays, on a single integrated circuit.

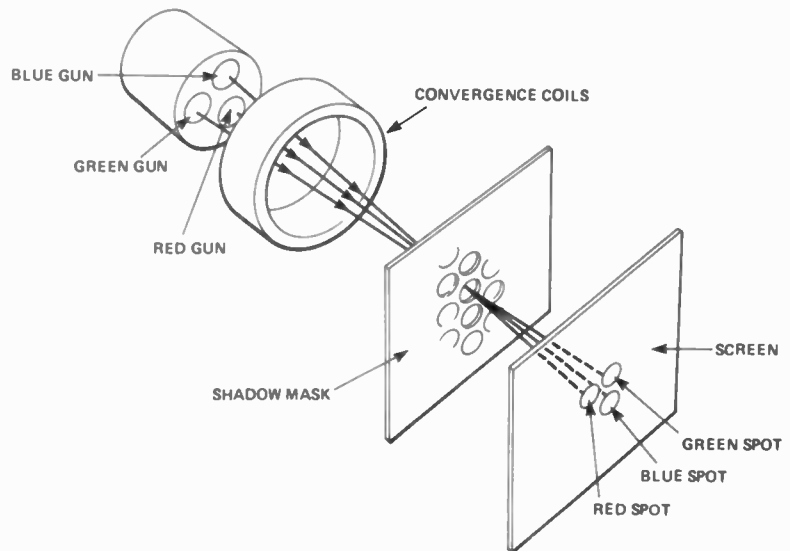

Figure 5. How a shadow mask makes each colour-beam strike a spot of its own colour; you will appreciate the shadow mask needs to be very accurately positioned. Also shown are convergence coils to position all three beams on to the same triad of spots, at any one time.

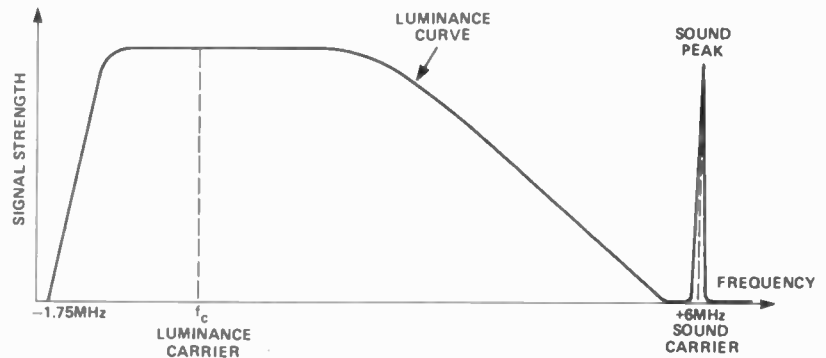

Figure 6. A spectrum of a black and white TV signal showing luminance curve and sound peak.

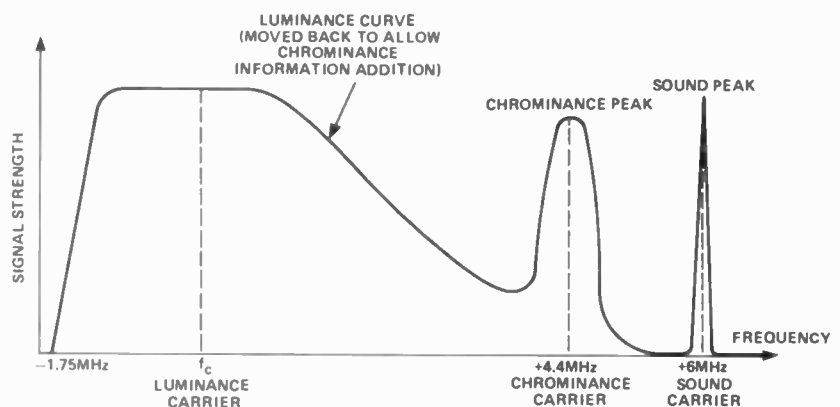

Figure 7. A colour TV signal spectrum. The luminance curve is reduced to allow inclusion of the chrominance peak.

With the aid of a colour matrix IC all the TV has to do is receive the luminance signal along with two colour difference signals and the third colour difference signal is automatically produced. The TV can then display the complete colour picture.

And there you have it; a colour TV system can be made using the same principles which a black and white TV

system uses — plus just a few more, of course. We've looked at how the transmitted colour signal differs from a black and white signal, and from this, we've seen how the two TV systems can run together at the same time, without interference. It's all quite simply really, isn't it?  
Roll-on 3D TV!

# MASTER ELECTRONICS NOW!

## The PRACTICAL way!

This new style course will enable anyone to have a real understanding of electronics by a modern, practical and visual method. No previous knowledge is required, no maths, and an absolute minimum of theory.

You learn the practical way in easy steps mastering all the essentials of your hobby or to start or further a career in electronics or as a self-employed servicing engineer.

All the training can be carried out in the comfort of your own home and at your own pace. A tutor is available to whom you can write personally at any time, for advice or help during your work. A Certificate is given at the end of every course.

You will do the following:

- Build a modern oscilloscope
- Recognise and handle current electronic components
- Read, draw and understand circuit diagrams
- Carry out 40 experiments on basic electronic circuits used in modern equipment
- Build and use digital electronic circuits and current solid state 'chips'
- Learn how to test and service every type of electronic device used in industry and commerce today. Servicing of radio, T.V., Hi-Fi and microprocessor/computer equipment.



## New Job? New Career? New Hobby? Get into Electronics Now!

**FREE!**  
COLOUR BROCHURE



POST NOW TO:

Please send your brochure without any obligation to  
NAME \_\_\_\_\_

ADDRESS \_\_\_\_\_

BLOCK CAPS PLEASE

I am interested in:

- COURSE IN ELECTRONICS as described above
- RADIO AMATEUR LICENCE
- MICROPROCESSORS
- LOGIC COURSE
- OTHER SUBJECTS \_\_\_\_\_

HE/4/821

**British National Radio & Electronics School Reading, Berks. RG1 7BR**

# AITKEN BROS.

## ELECTRONIC COMPONENTS AND TEST EQUIPMENT

35, HIGH BRIDGE, NEWCASTLE  
UPON TYNE NE1 1EW TEL: 0632 326729

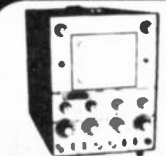

**SAFGAM OSCILLOSCOPES** - 5 mV/div sensitivity. Choice of Bandwidth 10, 100, 15 MHz, 20 MHz. 1S/div-100n S/div. Calibrated timebase. Solid trigger with bright line auto, normal and TV. XY facility. Z modulation. Calibration output. Bright and clear display. Portability. • Model DT410-10 MHz £205.85 + 6.00 carr. Model DT415-15 MHz £217.35 + 6.00 carr. • Model DT420 20 MHz £228.85 + 6.00 carr. Send S.A.E. FOR FULL spec

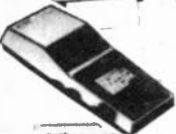

**THANDAR PDM35 3 1/2 DIGIT L.E.D. DIGITAL POCKET MULTIMETER.** • DC volts (4 ranges) 1mV to 1000V. • AC volts 1V to 500V • DC current (6 ranges) 1nA to 200mA. Resistance (5 ranges) 1Ω to 20 meg. Ω. • \$39.95. • AC adaptor \$5.95. • carrying case \$3.65 • MN1604 Battery \$1.57.



**THANDAR TM354 3 1/2 DIGIT LCD DIGITAL POCKET MULTIMETER** • DC volts 1mV to 1000V • AC volts 1V to 500V AC rms • DC current 1µA to 2A • Resistance 1Ω to 2 MΩ • Diode check • Basic accuracy ± (0.75% of reading + 1 digit) • Battery life typically 2000 hrs • leads inc. • \$45.94 • 40KV Probe \$34.95 • Universal test lead set \$12.95.



**THANDAR TM352 3 1/2 DIGIT LCD DIGITAL POCKET MULTIMETER** • DC volts: 100µV to 1000V • AC volts: 1V to 1000V • DC current: 100 nA to 10A • Resistance 1Ω to 2 MΩ • Diode check • hFE measurement • Audible continuity check • Basic accuracy ± (0.5% of reading + 1 digit) • Battery life 150 hrs + • \$57.44 inc. leads • Battery • Universal test lead set \$12.95 • 40 KV probe \$34.95



**THANDAR SC110 SINGLE TRACE LOW POWER 2" OSCILLOSCOPE** • Bandwidth DC to 10 MHz • Sensitivity: 10mV/div to 50 V/div. • Sweep speeds: 0.1µ secs / div to 0.5 secs/div. • Power requirements 4-10 V DC 4 'C' cells • Size & weight 255×150×40mm: 800gms \$159.85 a truly portable and superb instrument • Carrying case \$8.86 • AC Adaptor \$5.69 • Nicad Batt. pack \$8.83 • ×1 probe \$9.78 • ×10 probe \$11.50 Complete range of Thandar instruments available from stock S.A.E. for CAT. & prices.

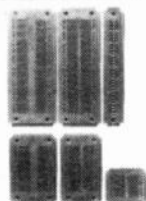

**G.S.C. SOLDERLESS BREADBOARDS** • Accepts all components with leads up to .033" • Replaceable nickel-silver spring clip contacts. • Combines bus strip with board • Unlimited expansion • 3" and 6" centre channels • Three free experimental circuits with every purchase

	Centre Channel	Strip Length	Strip Width	Tie Points	Term Clips	i.c. Cpty.	Price
EXP-600	15mm	152mm	61mm	550	110	28pin	\$7.25
EXP-300	8mm	152mm	53mm	550	110	14pin	\$6.82
EXP-4B	n/a	152mm	25mm	180	32	n/a	\$2.85
EXP-650	15mm	91mm	61mm	270	54	14pin	\$4.14
EXP-350	8mm	91mm	53mm	270	54	14pin	\$3.82
EXP-325	8mm	48mm	53mm	130	26	12pin	\$1.84

Please send S.A.E. for catalogue listing complete range of G.S.C. Instruments and Boards.



**SABTRONICS LCD MULTIMETER MODEL 2033.** • DC volts 100 µV-1000V Accuracy + .5% • AC volts 100µV-1000 V Accuracy ± 1% • DC current 10µA-2A Accuracy ± 1% • AC current 10µA-2A Accuracy ± 1% • Resistance 1Ω-20 MΩ Accuracy ± 1% • \$42.27. • Please send 30p for full Sabtronic catalogue and price list



**TMK 500 MULTIMETER** • 30 kopv. • AC volts 2.5 10 25 100 250 500 1000V • DC volts 0.25 1 2.5 10 25 100 250 1000 • DC current 50µA 5MA 50MA 12 amp • Resistance 0-6K 60K, 60 meg. • Decibels -20 to + 56 d/b • Buzzer continuity test • Size 160×110 ×65 • Batteries and leads inc. \$26.95



**YN360 TR MULTIMETER** • AC volts 10 50 250 1000 • DC volts 0.1, 0.5, 2.5, 10v 150v 250v, 1000v. • DC current 50µA 2.5 MA, 25MA, 250 MA • Resistance 0-2K 20K 2M Ω, 20 M Ω, • Transistor check • DB -10db -- 22db \$16.95

**DESOLDERING TOOL** \$6.45

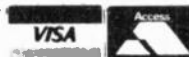

SCHOOLS, COLLEGES, UNIVERSITIES SUPPLIED. PHONE OR SEND YOUR ACCESS OR BARCLAYCARD NUMBER.

PRICES INCLUDE VAT, PLEASE ADD 75p POSTAGE TO ORDERS UNDER \$10.00

# BUYLINE

As a result of our constant search for ways to make life easier for our readers, we have changed the format of the project pages. One of the changes was to remove the ubiquitous Buylines boxes, in favour of a single source-and-supply page — yes, this is it!

## Dual Engine Driver

There are only a couple of unusual items in the project, as it was constructed using 'bulk-buy' parts. The 2.5 watt resistor is supplied by Electrovalue (74 EV series), who could be used as a source for the remaining components, thereby saving on postage costs! Otherwise the wirewound pot may be bought from Maplin (250 ohms instead of 200 ohms), and the transformer from Watford (15 volts, centre tapped).

All the LEDs and other semiconductors are available from Technomatic, who specialise in these particular components. The case used for the prototype was from BICC-Vero, who also supply other designs — it's well worth sending off for their catalogue ("Hobby Herald"), which is free on request.

## Capacitance Meter

Most of the components used in this project are easily obtained.

The displays must be of the common cathode type, and 0.5 inch size to fit the PCB; they can be bought along with the CMOS ICs from Technomatic.

The normal type of rotary switch comes set for its maximum number of positions; these will have to be reduced to four, via the retaining clip. Also, care must be taken when handling the CMOS ICs, so as to prevent accidental damage. If you are not using sockets, then a low leakage soldering iron is essential — a suitable type is being offered as part of a package by Litesold, who advertise in this magazine.

## Signal Tracer

There should be no trouble in obtaining the components for the tracer, especially since there are only around twelve of them! The BC 650 is a special low noise type, but should be fairly easy to buy — Magenta have assured us that they will be getting some in.

## Bike Alarm

If you wish to avoid the hassle of shopping around for individual components, then Magenta Electronics are the people to contact. Not only will they send you a complete kit, they can also supply any of those hard-to-find items to supplement your usual sources.

If you wish to buy from separate suppliers, then the capacitors and tilt switches, along with the 7611 CMOS op-amp, are contained in the RS catalogue. However, since they only supply to the trade (as so many of you have written to tell us!) you would be advised to contact Crewe Allan & Co. Ltd. at 51, Scrutton Street, London EC2A 4PJ; they can supply any of the components advertised by RS.

The transistors and CMOS timer (7555) are also available from Watford Electronics and the miscellaneous hardware from Maplin. Other items, termed as extras, can be bought from Electrovalue, whose catalogue is well worth getting hold of.

As a guide to the price of this project, take a look at Magenta's advertisement — bearing in mind that this is for a complete kit.

## Now for the next big date in the CB calendar...

MARCH 19-21 1982 — ROYAL HORTICULTURAL HALLS LONDON

LARGER HALL  
— BIGGER AND  
BETTER SHOW

**CB**  
**Citizens' Band**

Britain's Leading CB Monthly

PRESENTS THE

## 1982 National Citizens' Band Show!

TRADE/PRESS PREVIEW — MANUFACTURERS — IMPORTERS — WHOLESALE  
— RETAIL — ACCESSORIES — PUBLICATIONS

Advance details, floor plans and booking forms are now available. There are some very special terms for 'early bird' company's who reserve their stands — quickly! This is your chance to display, demonstrate and **Sell** your products to the national CB audience both trade and public.

FULL DETAILS PHONE OR SEND COUPON  
TO: ROY PERRYMENT Citizens Band  
01-437-1002

Return to: Roy Perryment — Advertisement Manager —  
Citizens Band Magazine, 145 Charing Cross Rd, London  
WC2H 0EE. Please send all available show information to:

M.....

Messrs.....

.....

.....

Tel: .....

Our products are: .....



# POINTS OF VIEW

Something to say? Let's hear it.

Hobby Electronics' monthly mail is usually a mixed bag of enquiries, requests, suggestions and complaints. Occasionally, too, someone writes in to say how much they like us — or not, as the case may be!

This month's letters are much the usual assortment, but we'd like to hear more about what you want in YOUR electronics monthly magazine. After all, a lot of effort goes into producing HE and we'd certainly like to get it right for you. So why not use this opportunity, every month, to tell us what you like about HE, or what you don't like; what subjects you are interested in and which ones put you to sleep!

In short, we'd like to hear your POINT OF VIEW.

## Intruder Confusion

Dear Sir,  
While I would agree with most of your readers that your magazine is instructive and comprehensible, I have to say that printing errors would seem to be your downfall.

It has got to the point, now, where one has to wait until the following month for the mistakes to be rectified, before constructing any project.

I have recently spent about £10 on components for your Intruder Confuser (HE January 1982). After constructing two of the devices, neither of which worked, I waited for the following issue for corrections to the circuit.

After turning the IC right way up, I would have thought that this would have solved the problem — but, no. I then had the unit completely checked by an electronics shop; they said they thought it would not work with a 1V5 supply, however, we have not tried putting more voltage onto the device.

Can you please help. The unit is needed because our neighbour's house has just been burgled.

Yours sincerely,  
B.M. Haddock,  
Wimbledon.

The electronics shop got it wrong too. The LM3909 IC is specifically designed as a low-power LED flasher and is intended to operate from a 1V5 supply, as indicated in the circuit.

As to printing errors, they do arise from time to time but we are making every effort to ensure that the 'times' are fewer. We hope that future excellence will make up for past mistakes, and that we have not fallen too far, in your estimation.

## Flushed With Success?

Dear Sirs,  
I would be most grateful for any help you can give me.

I started making the 'Diana' Metal Detector but, as I was ill for some time, soon stopped.

I recently bought some more parts for the project, brought out the magazine — and then my youngest daughter put it down the toilet and flushed it!! I now have a half-completed metal detector — and lots of bits.

Please help. I will gladly buy another copy of the magazine, if it is available, or a photocopy of the item concerned, so long as the overlay diagram is clear enough for me to get going again.

I would like to complete the detector before the weather revives.

Sincerely,  
J.W. Frith,  
Cheshire.

The problems hobbyists encounter are sometimes almost beyond belief! Can any of our readers match this tale of woe? A £10 mixed bag of components, donated by Magenta Electronics, will be sent to any reader who can top Mr. Frith's story. Meanwhile, if Mr. Frith would like to turn to our Backnumbers page, he will be able to send in for the article he requires.

## Circuit Suggestions

Dear HE,  
Do you think your backroom boys are clever enough to design a circuit to solve the following problem?

Time and time again, I walk out of a room and leave the stereo turned on — which can't be that good for the amplifier and other components. What about a circuit which would turn the stereo off after, say, five minutes, if no music had been played for that length of time?

I bet you a binder you can't do it.

Yours,  
L. Poltawski,  
Manchester.

Although a gadget such as you describe is not, strictly, necessary — an amplifier is unlikely to be damaged merely because the power is on — our 'backroom boys' have been called 'front and centre' and they will look into it.

They won't accept your bet, though — they don't need another binder, thanks all the same.

## Radio Research

Dear Sir,  
I wonder if you could send me any information you have on the beginnings of radio and electronics in general, and their development up to the present time.

I need this for a sixth Form General Studies project. I am a faithful reader of

your magazine and have nearly every copy.

I will be grateful if you can help.  
Yours,  
M. Ford,  
Trowbridge, Wilts.

Much of the information you need can be found by reading through the Famous Names series, but the development of electronics will be covered more extensively in a new series, called The Electronic Revolution, which we are planning to start in the May issue of Hobby Electronics.

## Telephone Tricks

Dear Hobby Electronics,  
I would like to build an amplifier and speaker for my telephone, and also a digital counter to indicate how many units I am using.

Could you use this as one of your projects? If you already have, could you send me details of how to obtain a copy?

Yours faithfully,  
R.W. Almond,  
Dagenham, Essex.

Neither of these projects are simple, but we will look into the possibilities.

## Danger! UXBattery

Dear Sir,  
I have recently constructed a NiCad charger/battery eliminator unit based on a design published in Hobby Electronics. This unit will allow me to use NiCads in most of my battery powered equipment, however, I still need 'dry cells' for my DMM (Digital Multimeter) and electronic flash gun, both of which require the higher voltage obtainable from HP7/MN1500 cells.

Can you publish a circuit or tell me where I can find details of a circuit to re-charge or refresh such batteries? I know that it is possible to purchase commercially manufactured units for this purpose though I would, of course, prefer to build my own.

Yours faithfully,  
M.L. Peake,  
Bilston, West Midlands.

Charging units for dry cells are commercially available, as you mention, however there are a number of problems in using them. Firstly, the batteries cannot be allowed to become more than half-discharged because, beyond that point, holes have been eaten through the zinc electrode and these cannot be re-plated. Secondly, it is possible that a build-up of gas inside the cell will cause it to swell and go

open circuit. Thirdly, there is a danger of explosion, if the charge rate is too high. For these and other reasons, we do not consider the idea suitable for a Hobby Electronics project.

## Hobby Indexed

Dear Sir,  
I have subscribed to Hobby Electronics for about a year, now, and I find it very useful and interesting. I have two questions which I would be glad if you would answer for me:

1. Do you produce (annual) indexes of all the articles published in HE? If so, what is their cost?

2. Have you ever published an article on the construction of a hand-held device to detect wires, nails or screws in wood? If so, in what issue? If not, could you suggest any source where I might find the details of such a project? It would be very useful to someone, like myself, who sometimes needs to run an electric saw through second-hand timber.

Yours faithfully,  
A.H. Jansley,  
Tonbridge, Kent.

An annual index is published each January, listing articles which have appeared during the previous year. Indexes for 1979, 1980 and 1981 are available from our Backnumbers Department for the usual cost — see page 64.

This is Mr. Jansley's lucky day (month?); a metal/cable/pipe locator project is being prepared for publication, soon.

## 'Diana' Speaks

Dear Sir,  
I have just purchased my first HE magazine and now I'm hooked.

I am thinking of buying a 'Diana' Metal Detector kit and was wondering if a speaker could be incorporated into it. If so, could you tell me how, and what components would be needed (please explain simply for a beginner).

Many thanks.  
Yours sincerely,  
T. Fletcher,  
Gravesend, Kent.

Adding a 'voice' to the metal detector is a bit more complicated than simply connecting up a speaker. However, we have had a number of requests for this, and a suitable modification will appear shortly.

## Fair Comment

Dear Sir,  
With regard to Your Letters, HE February 1982, page 23, I feel I should errata your Errata.

In the very last sentence, not only should the notch appear at the top, but should should be spelt should.

Should you find this worth mentioning (I doubt it), I should waste no time in correcting it. Should I? Or should you? Or should we forget it? — I should.

Yours it's a stupid word anyway,  
Sincerely,  
A. Barnes,  
Brentwood, Essex.

I don't think I should comment. Shall I? I shan't.

## Astronomical Observations

Dear Sir,  
I received your excellent magazine the other day and at once began to read Your Letters. I was absolutely delighted to read the letter from Mr. Robin Cartley, Vice-Chairman of the Crofton Astronomical Society. Myself and a number of friends were just about to write to you regarding a relatively simple radio telescope.

I now write on behalf of my friends, who are hoping that you will feature such a project. We are all students who make the odd kit out of various mags and we believe that this would be an excellent project. We hope that you will give it a shot.

We would also like to take this opportunity to congratulate you on your magazine. It really is marvellous. Please keep up the good work.  
Yours sincerely,  
M. Carroll,  
Wexford, Rep. of Ireland.  
PS Any chance of finding out who Clever Dick is?

On our part, we hope that we continue to live up to your good opinion of us, so keep reading HE! Our research on a simple radio telescope is progressing (the theoretical background is quite demanding), but we can't promise anything definite, just yet.

Clever Dick? Never heard of him!

## Optical Allusions

Dear Sir,  
Having phoned once, to locate this particular item, I was asked to ring back when the person who could help me would be in. Upon phoning again I was told to write in, including an SAE, for all technical enquiries. My enquiry could have been answered in one word; the name of a supplier. However I am writing in, since the lady at the end of the second call put the phone down on me.

Next time I hope I get the first one again!

Issue: November  
Article: Flashmeter  
Item: BXP25 Photo-diode.

Where is this, or a suitable equivalent, available? No advertisers in your magazine carry one.

Yours waitfully,  
B.C. Baldwin,  
Hutton Cranswick, East Yorkshire.  
PS Give my love to the Switchboard!

Item: BPX25 Photo-diode (note the difference) is stocked by Magenta Electronics (see their advert in any recent issue).

Price: £2.24

Technical Enquiries: In general, 'phone enquiries cannot be answered.  
Switchboard: Sorry, they're engaged.

## Tug-o-War

Dear Sir,  
I have twice built the Tug-o-War project from the October issue of HE. The first time I made my own PCB from a Hobbyprint. I made up the circuit but, when I switched on, it made a continuous buzz. I then found that the enable pin (pin 4) of IC3 was open circuit; when this was corrected the buzz stopped but the project still did not work.

I dismantled it and sent off for a ready-made PCB from the service which now replaces Hobbyprints. Pin 4 of IC3 was open circuit, again, and the same fault was found. When that was corrected, the only part I could not get to work was PB2 — it had no effect, when pushed.

Are there any other faults that you may have published in a later issue of HE? I do hope you can help.  
Yours faithfully,  
D. Duncan,  
Darlington, Co. Durham.

There were two faults in this project. The first, and most serious, was on the PCB foil pattern. Pin 4 of IC3 should be connected to R19; the missing section of copper track should be replaced by a piece of tinned copper wire or a line of conductive paint. Secondly, R20 should be 2k2, not 8k2. We hope the game can now be brought to a successful conclusion. May the best man win.

## Windscreen Wipe-Out

Dear Sir,  
I built the Windscreen Wiper Controller (HE, March '81) but it will not drive the wipers, in any mode. It pulses once, but the relay merely chatters after that.

The wiper switch as three wires and the motor is single-speed, self-parking. I tried the local auto-electrician but, when he saw the unit, his comments were unprintable.

Can you suggest how to connect the unit to the wiper switch?

Yours faithfully,  
J. Mapley,  
Aberdeen.

The Controller is intended to be 'wired across' ie, in parallel with, the existing wiper switch which can still be used to obtain continuous sweeps, in the usual way. However, given that you have three wires to contend with, this does not appear to be as simple as it sounds (auto electricians do seem to be designed to confuse the non-specialist). We can only suggest that you consult the manual for your car, or carefully trace the wiper circuit to determine which two of the three should be used. Failing that, you should perhaps consult another auto-electrician. Before you do, though, check that the Veroboard tracks between the IC pins have been cut; these track breaks, which were omitted from the bottom view of the layout, should be at D11, E11, F11 and G11.





# Digital Capacitance Meter

Owen Bishop

**It's fast, accurate and not too fancy. The HE Digital Capacitance Meter is easy to build and will become one of the most used items in your workshop.**

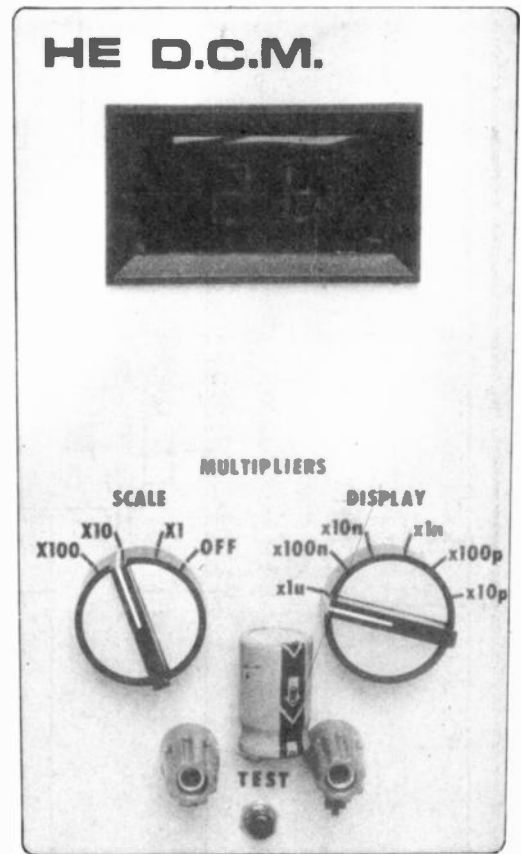

A GLANCE through an electronics catalogue soon shows that most of the cheaper multimeters do not measure capacitance. A few may measure values in the microfarad range, but not many measure in the nanofarad or picofarad ranges. This low-cost meter will, therefore, be very useful; it covers values from 100pF to 9900uF with two digit accuracy, it's cheap and easy to build. It also provides a good indication for values in the 10-100pF range but, in general, the main ranges will satisfy the requirements of most hobbyists.

Many types of capacitor are manufactured to about 10% tolerance yet, for building filters, tuned circuits, timers and the like, it is often important to be able to know the precise value of a capacitor. Electrolytic capacitors, for example, are notorious for having very wide tolerance and for changing capacitance with age and use. Then there are all those look-alike polystyrene capacitors, which are marked in ink that seems specially prone to rub off at the first handling (their physical size is no real guide to their value, by the way). Finally, there are the bargain packs, containing an assortment of imported capacitors whose markings bear no recognisable relationship to any known classification system. When using these, the perplexing question is: "What have we here?". So, a capacitance meter is a distinct asset for these and many other circumstances.

## The Circuit

The circuit uses the 556 dual timer IC in two common configurations. One

## How It Works

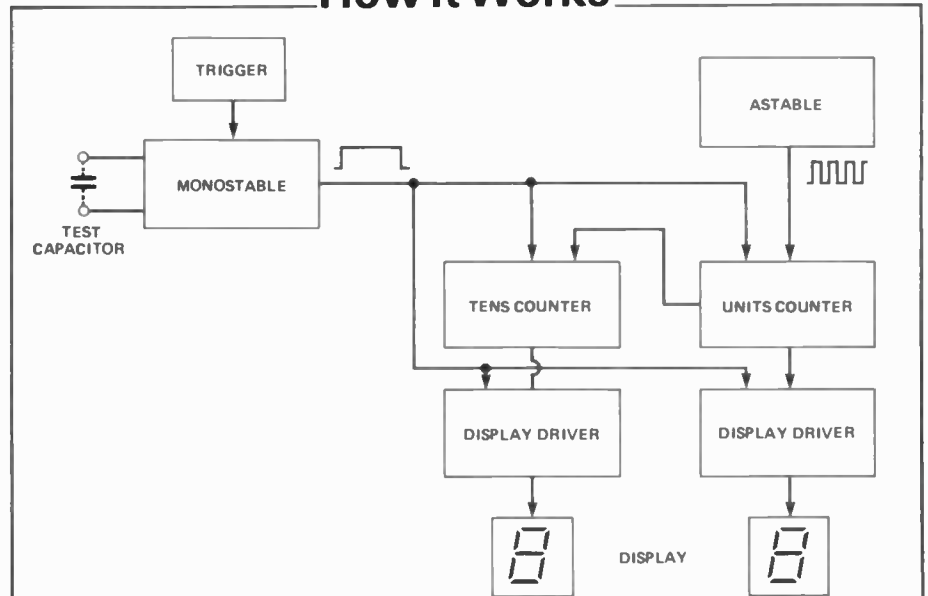

The HE DCM measures an unknown capacitor by counting the number of clock pulses which occur during the period of a gating pulse, produced by the monostable. The pulse is triggered by operating a push button switch (the trigger circuit ensures a clean start to the pulse) and its width is proportional to the value of the test capacitor, which is connected into the RC timing network of the monostable.

The gate pulse 'enables' the display drivers and the counters, which then begin to register pulses from the

astable multivibrator. At the end of the monostable gate pulse, the display drivers are locked and a two digit number is displayed. The counters are reset to zero, ready to begin a new count.

The DCM has eight ranges, produced by changing the frequency of the astable multivibrator and by controlling the width of the monostable pulse by using different resistors in combination with the test capacitor. This is described more fully in the text.

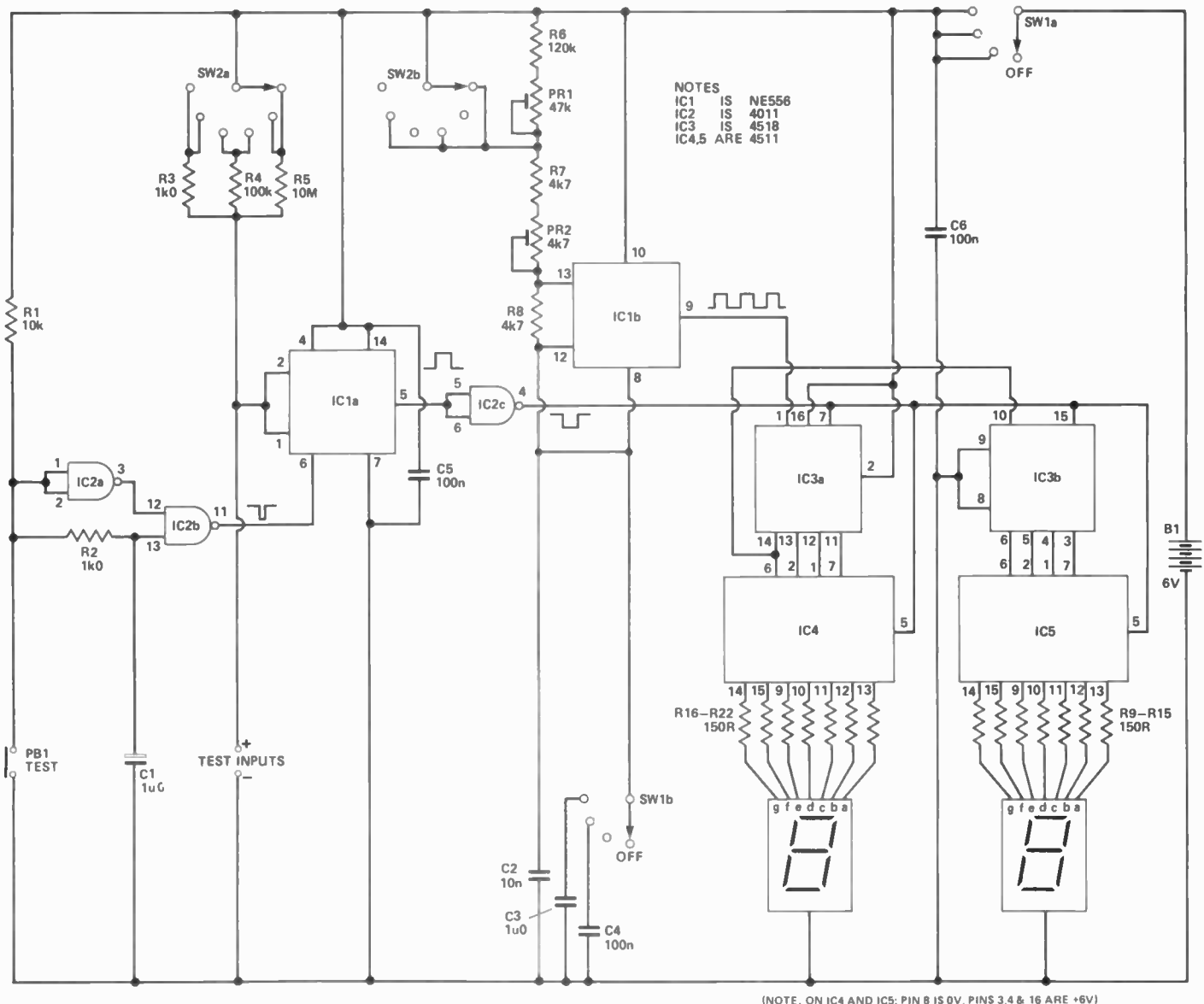

Figure 1. The circuit of the Digital Capacitance Meter.

half, IC1b is an astable multivibrator used to produce a square wave at either of two fixed frequencies. The pulses from the astable are counted by IC3, which contains two complete decimal counters. The first counts units and its output carries over to the second, which counts tens. The display drivers, IC4 and IC5, convert the BCD (Binary Coded Decimal) outputs from the counters to provide the outputs required for driving the 7-segment displays.

The counting action is controlled by the other half of the timer, IC1a, connected as a monostable multivibrator; when triggered, this gives a single positive pulse. As the pulse begins (rises), the counters and display drivers are 'enabled' and pulses from the astable are counted. As the pulse ends (falls), the display drivers are latched to 'hold' and the count is displayed. The counters are reset to zero at this time, ready to restart the count at the next high pulse, but the display 'holds' the count. The display is

returned to zero by the enable pulse at the beginning of each run and counting begins immediately.

The length of the pulse from the monostable, IC1a, is proportional to the capacitance of the test capacitor; the greater the capacitance, the longer the pulse and, therefore, more pulses from the astable are counted. The two-figure display is read according to the format indicated by the range-setting knob.

The period of the monostable is set by the test capacitor and whichever resistor, R3, R4 or R5, is selected by SW2a. The frequency of the astable, IC1b, is set by the timing capacitors C2, C3 or C4 and resistors R6, PR1, R7 and PR2. By selecting the appropriate combination of timing components, the meter provides eight decade ranges from 100pF upwards.

### Construction

Most of the circuit is accommodated on the printed circuit board. It is best to begin construction with the display

circuit. The two 7-segment LED displays are soldered to the board first; make sure the iron is hot and work quickly, so as not to overheat the LEDs. It is better to solder a few pins, then wait a few minutes for the heat to escape before continuing; the decimal point pins (dp) do not need to be soldered. Next, mount R9-22 (or you could use two 14-pin DIL resistor arrays, if you wish).

When you have mounted the displays and resistors, make the battery connections and test the display. Temporarily join the positive line to each of the resistors in turn and check that the correct segments light up on the display. **WARNING** — the current *must* go through a resistor before it goes to a segment.

The two segment-drivers, IC4 and IC5, are wired in next. The counter, IC3, completes the display section of the meter. To check its operation, connect a pulse generator to pin 1 of IC3; the displays should show a regular count up to 99, returning to 00 and

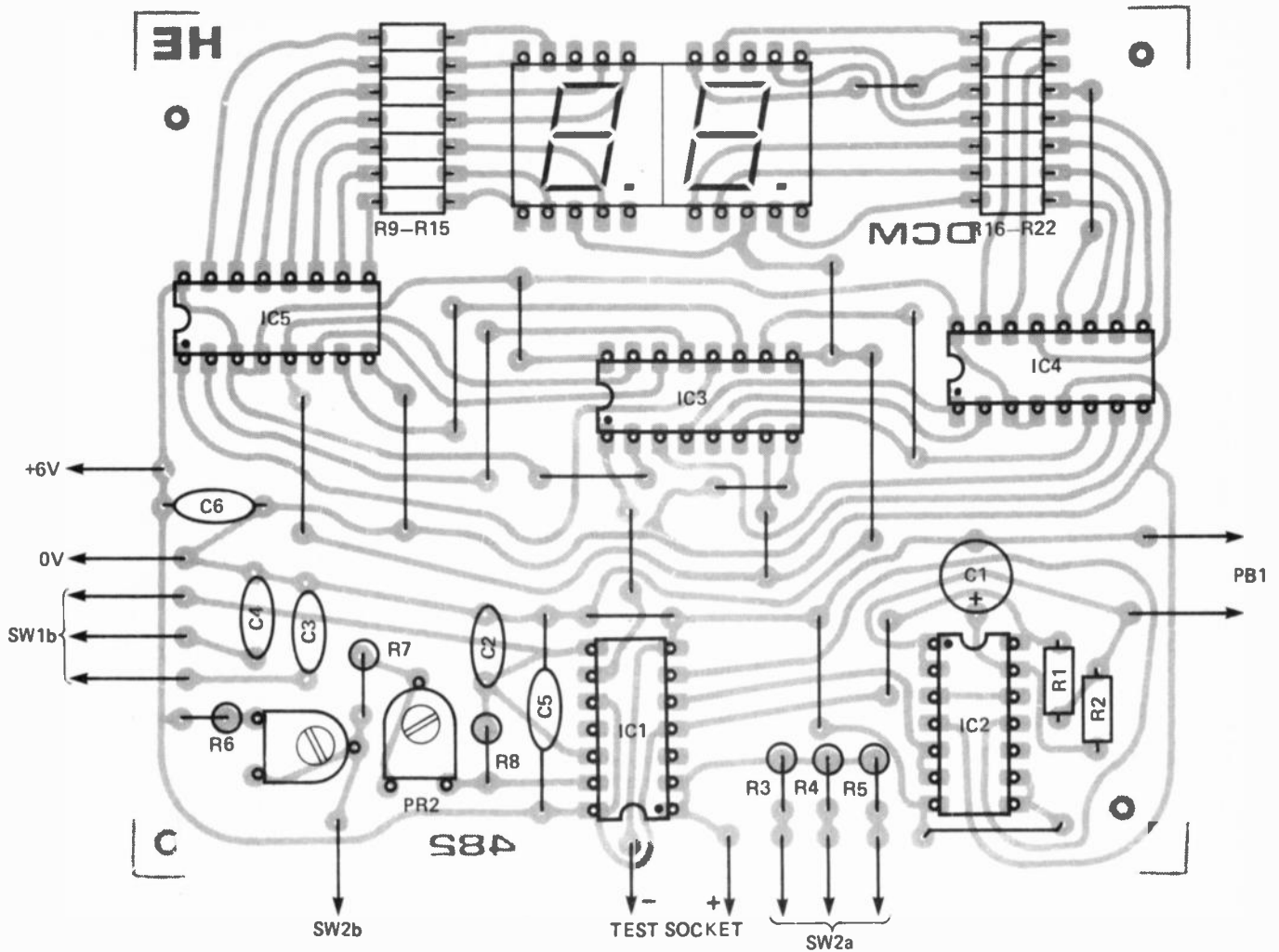

Figure 2. The component layout; note that R9-15 and R16-22 can be either individual resistors (as shown) or 14-pin DIL resistor arrays.

repeating. If you do not have a generator, you can use the output from IC1b which, with its associated components, is the next section of the circuit to be completed.

When the pulse generator (or astable) circuit is complete, connect the power supply. When pin 4 of IC2c is taken low (to 0 V), the display should count rapidly at about 1 kHz. When it is taken high, the count freezes at its current value. The rate of counting is too fast to see properly (the display will appear to show a steady '8'), but you can slow it down by temporarily wiring a large value capacitor (say, 10uF) in parallel with C2. This will let you check that the counters are working properly.

Finally, complete the monostable and trigger circuits, IC1 and IC2, and the remaining components. You will need to make off-board connections to SW2, PB1 and the capacitor test sockets before this part can be tested. It is probably best to mount the panel components and complete all the off-board wiring now. Determine the orientation of SW1 and SW2 and drill the registration holes accordingly. If PB1 and the negative capacitor test socket are correctly positioned, the tag of the socket can be soldered directly to one of the lugs of PB1. The power comes from four HP7 (or similar) cells

in a battery holder, which can be held in place by a 'sticky fixer'. To test the complete circuit, mount a capacitor in the test sockets; it is useful to have a pair of test leads, with 4 mm plugs at one end and crocodile clips at the other, for short-lead and otherwise 'difficult' capacitors. Remember to observe polarity, when testing electrolytic or tantalum capacitors.

You are now ready to switch on and . . . the display should immediately show a value. If nothing happens when you switch on, check that the trigger circuit, which normally has a high output (IC2b, pin 11), goes low for an instant (about 1 mS) when PB1 is pressed. The output of IC1a (pin 5) should normally be low, going high for an instant when PB1 is pressed. If you use a 100 uF test capacitor with SW2 at X1n, the output should stay high for about 10 seconds and, during this time, the display will run from 00 to 99 several times.

### Calibration

IC1a is a monostable oscillator that controls the period for which the display counts pulses from IC1b. The period,  $t$ , is equal to  $1.1RC$ , where  $C$  is the value of the test capacitor and  $R$  is the value of whichever resistor (R3 to

R5) is switched into circuit. For example, if the test capacitor is 10 nF and we use R4 (100k),  $t = 1.1 \times 100 \times 10^3 \times 10 \times 10^{-9} = 1.1 \text{ mS}$ . During this brief period the counter has to count 10 pulses from IC1b so that the display shows '10' at the end of the counting period. Now 10 pulses in 1.1 mS is equivalent to a frequency of 9.09 kHz, and this is the frequency to which IC1b is set when PR1 and R6 are short-circuited out of the timing chain by SW2b. If the test capacitor is 100 nF, the period becomes 11 mS; the display must again count 10 pulses, to show '10', so the frequency of IC2 must be reduced to 0.909 kHz by switching PR1 and R6 into circuit.

To calibrate the instrument we simply have to adjust PR1 and PR2 to give frequencies of 9.09 kHz and 0.909 kHz. The easiest method is to use an oscilloscope. Switch SW2 to position 1, bypassing PR1 and R6; monitor the output from pin 9 of IC1b and adjust PR2 until the period of the signal is 1.1 mS (9.09 kHz). Now switch SW2 to position 2 and adjust PR1 until the period is 11 mS (0.909 kHz) — do not re-adjust PR2 at this stage.

The astable is not calibrated for the two slow frequencies, which are used with test capacitors over 100 uF in

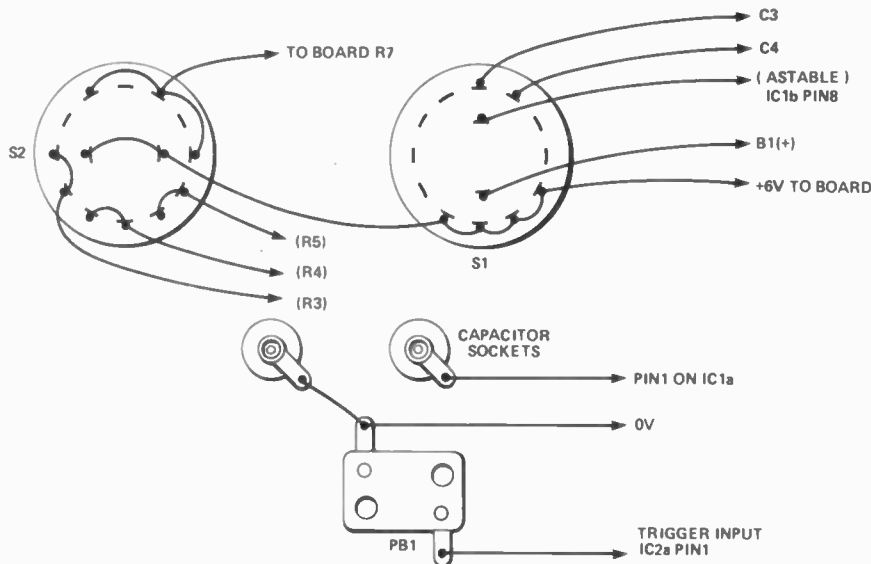

Figure 3. Wiring diagram for the panel-mounted components. Check against the circuit to ensure all the wires go to the right place!

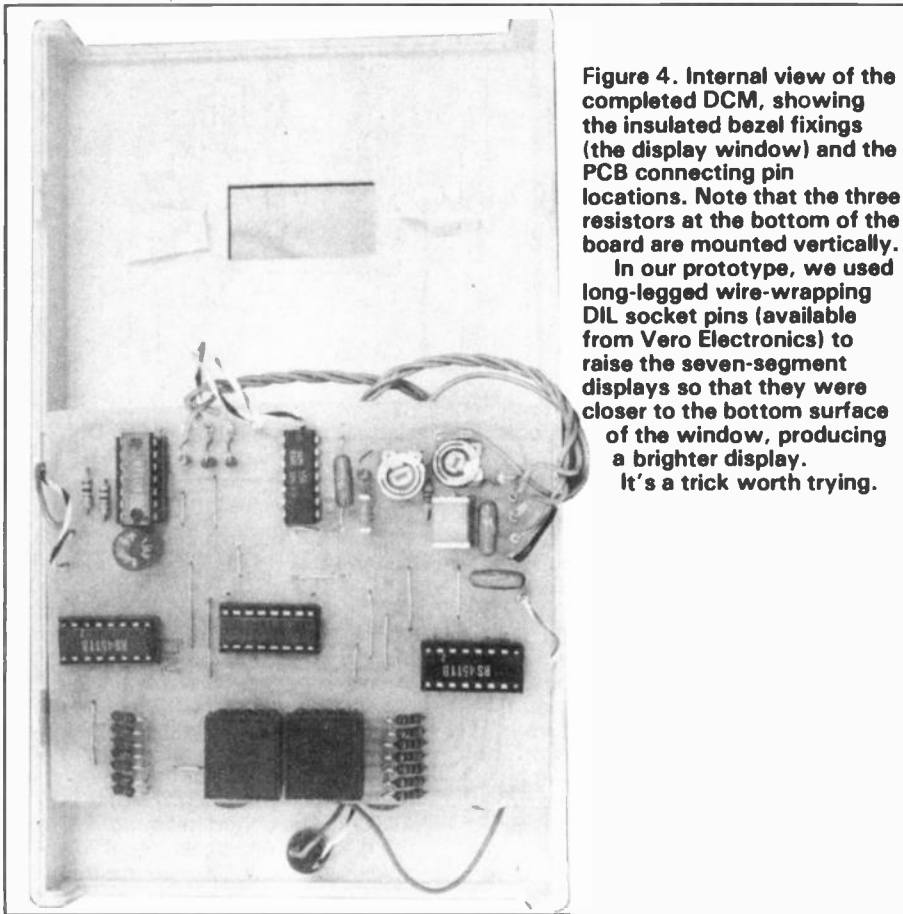

Figure 4. Internal view of the completed DCM, showing the insulated bezel fixings (the display window) and the PCB connecting pin locations. Note that the three resistors at the bottom of the board are mounted vertically.

In our prototype, we used long-legged wire-wrapping DIL socket pins (available from Vero Electronics) to raise the seven-segment displays so that they were closer to the bottom surface of the window, producing a brighter display. It's a trick worth trying.

value. Additional timing capacitors, C3 and C4, are simply added to the timing chain by switching them in via SW1. With C4 in circuit and SW2 in position 6, the frequency becomes 90.9 Hz; with C3 in, it becomes 9.09 Hz.

The accuracy of these two ranges depends on the tolerance of C3 and C4. The polyester capacitors recommended have a tolerance of 10%, which is close enough for this end of the range. You could, of course, purchase several of the same nominal value and test them (using this meter!) to find two closest to the specified values.

If you have no oscilloscope, the only method of calibration is to put a close tolerance capacitor in the test socket and adjust the astable circuit until the correct reading is obtained. It is better not to do this on the lowest range, for stray capacitance may bias the results. Use a 47 nF polyester capacitor on the X1 nF range and adjust PR2 to get a reading of '47' almost every time (you may occasionally get '46' or '48', but errors should be no greater than this). Then use a 4n7 polystyrene capacitor on the X100 pF range and adjust PR1 until '47' is obtained. The meter should then be correct for all the other ranges.

## Parts List

### RESISTORS

All 1/4 W, 5% except where specified

R1	10k
R2	1k0
R3	1k0, 2%
R4	100k, 2%
R5	10M, 10%
R6	120k
R7,8	4k7
R9-22	150R

(or two 14-pin DIL thick film resistor networks)

### POTENTIOMETERS

PR1,2 47k sub-miniature vertical presets

### CAPACITORS

C1	1u0 35 V tantalum
C2	10n polyester
C3	1u0 polycarbonate
C4-6	100n polyester

### SEMICONDUCTORS

IC1	556 dual timer
IC2	4011B quadruple 2-input NAND
IC3	4518B dual decade counter
IC4,5	4511 7-segment decoder/drivers

### MISCELLANEOUS

PB1 push button switch  
 SW1,2 2-pole 6-way rotary switches  
 PCB, two 7-segment LED displays (common cathode 0.5"); ABS case 190 mm x 110 mm x 60 mm; knobs for SW1,2; 2 x 14-pin, 3 x 16-pin DIL sockets; 4 mm terminal sockets (1 red, 1 blue); battery holder for 4 x HP7; 1.0 mm terminal pins; self-adhesive feet; connecting wire; solder, etc.

For sources of components for the HE DCM, see **Buylines**, page 21. A full-sized PCB foil pattern is reproduced on page 78.

## Using The Meter

Plug the test capacitor into the socket and select the required range. If in doubt, select a range greater than the one you expect the capacitor to lie in. Switch on, and press PB1. The value will be displayed instantly (though it actually takes a few milliseconds to get there). On all ranges, the displayed figure is multiplied by the display range and the scale factor. For example, if the display switch, SW2, is set to x1u, the scale switch to X10 and the display reads '26', the value of the capacitor is  $26 \times 10 \times 1\mu = 260 \mu\text{F}$ .

If the tens digit is zero, switch to the next lower range and press PB1 again. For the two highest ranges; SW2 must be in position 6 (x1u) and SW1 turned to X10 or X100, as necessary.

Switch the meter off when it is not in use, since the display consumes considerable power. In use, however, the meter works so quickly that the reading can be taken in a couple of seconds and the battery will last for many months.





# GUGLIELMO MARCONI

A name that needs no introduction, particularly to residents of Chelmsford, Essex.

Marconi had a decidedly good start to life. Born in Bologna, Italy, of a titled Italian father and an Irish mother, he was brought up on his father's estate and educated in Bologna and in Florence. He then went to technical college in Leghorn, where he specialised in physics (still the best grounding for any engineer) and interested himself, particularly, in the work of Maxell, Hertz and Sir Oliver Lodge.

By 1894, his interest in radio was such that he started a series of experiments at his father's estate. His transmitter used the classic design of Heinrich Hertz — an induction coil with a spark-gap (Figure 1); and his receiver used the equally well-established coherer (Figure 2). What distinguished Marconi's work from that of the many other pioneers, working with the same equipment at the same time, was his particular interest in aerials, an interest which had sprung from his study of Maxwells beautifully symmetrical equations of electromagnetic radiation.

His own notes on these early experiments show that he was using a vertical aerial with a ground plane, the classic type of aerial still in widespread

use today. Very significantly, his notes show that he was obtaining ranges of about 1½ miles and that he had found that, by using a reflector behind an aerial, he could beam the radiation, increasing the range and obtaining better directional characteristics.

Finding that there was little interest in Italy for his pioneering work, in 1896 he travelled to London to work with Sir William Preece, then Chief Engineer of the Post Office. The Post Office, at that time, was taking a keen interest in the new developments (a change from our usual, contemporary attitude) and Preece encouraged the young Marconi to file patents on his work. Marconi backed up his patents with a series of demonstrations which indicated the increased ranges that were possible by the use of aerials held up by balloons or kites. He achieved a range of four miles on Salisbury Plain, nine miles down the Bristol Channel and, in 1897 at Le Spezia, was able to demonstrate communication between warships at sea and a land station 12 miles away.

## The Wireless Telegraph Co.

By this time, Marconi and his co-workers were convinced that radio could be put to serious use so Marconi and his cousin, Jameson Davies, an engineer, financed a number of patent applications and formed the Wireless Telegraph and Signal Company Ltd. In 1900 the company changed its name to Marconi Wireless Telegraph Co., a name which it retained up to the 60s.

During this time, each demonstration by Marconi indicated greater, and therefore more useful, range of communication — 75 miles, between battleships, in 1899, for example. Transmission and reception conditions proved to be better at sea than on land so that, after several demonstrations of this type, the Marconi International Marine Co. (MIMCO) was formed specifically to equip and maintain radio in sea-going vessels. For the first time, it had been possible to communicate between ships which were not visible to each other and, given the importance of sea transport at that time and the length of sea journeys, it was a most sensible approach. Another clutch of patents followed, the most significant of which was one which described the principles of tuning both the transmitter and the receiver, so that it was possible for several transmitters to operate at the same time on different wavelengths without interfering with each other.

Several navies around the world were now installing the 'Marconi Apparatus', as radio was known, and the design of transmitters, receivers and aerials was progressing with every new model that was constructed. Marconi, however,

was not satisfied with gradual development and insisted that nothing short of a signal sent across the Atlantic would convince his many sceptical opponents that radio was an invention of real importance. His proposals were scoffed at, because enough was known of radio waves to make it clear that they travelled, like light waves, in almost straight lines and were most unlikely to follow the curvature of the Earth across the Atlantic. Marconi, however, seems to have had different ideas, probably due to the long ranges he had already achieved at sea. Oddly enough, the work of the shy genius Oliver Heaviside, decades earlier, had showed that long-range radio communication would be possible because of the probable existence of an 'ionosphere', a layer of split atoms high above the atmosphere which would reflect long-wave radio signals like a sheet of chicken-wire. Very few engineers, however, had read Heaviside's report and fewer still could follow his arguments, so that it seems likely that Marconi was not familiar with the theoretical basis of his experiment. In December 1901, amid foul weather on each side of the Atlantic, he succeeded in transmitting one signal, the Morse coded letter S (three dots) from St. John's in Newfoundland to Poldhu, Cornwall, establishing for the first time that long-distance radio communication was possible and in the process knocking thousands of pounds off the shares of companies concerned with transatlantic cables!

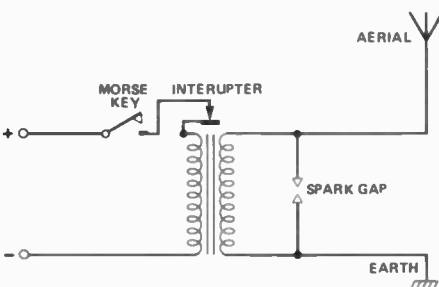

Figure 1. The classic spark-coil transmitter. The spark gap used two spheres, which had enough capacitance between them to tune the secondary of the coil, to some extent.

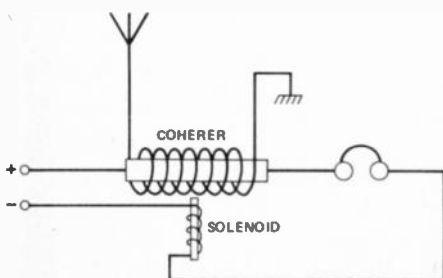

Figure 2. The coherer. The input from the aerial is interrupted continuous waves, and each pulse caused the iron filings in the tube to cling together, carrying current to the earphone and operating the solenoid which loosened the particles again ready for the next burst of RF.

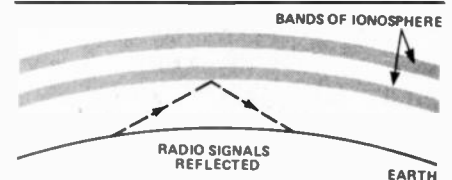

Figure 4. The ionosphere. The layers of ionised (conducting) gas above the Earth act as reflectors of waves, particularly the longer wavelengths. The reflecting action is more pronounced at night when the remaining ionisation is further away from the surface of the Earth.

This success gave Marconi the impetus to press ahead with the development of long-range radio and he installed equipment of his latest design in the liner 'Philadelphia', which was then able to attain 300 miles by day and a staggering range of 2000 miles by night. It was this difference between day and night ranges, incidentally, which helped to confirm Heaviside's idea of the ionosphere (Figure 4), which then gained support from a number of distinguished physicists.

## Famous Names

Patents continued to pour out from the Marconi development laboratories, including improved detectors and, significantly, a horizontal directional aerial system. The first spectacular broadcast across the Atlantic was followed by events which captured the imagination of the public; the capture of the mass murderer Crippen on board ship, thanks to a radio message sent out from London, and the use of radio during the sinking of the Titanic in 1912. The Titanic disaster eventually led to the full-scale installation of radio in all ocean-going ships and the establishment of an emergency wavelength which was kept clear at all times and which operators were obliged to monitor for distress calls. The Marconi Marine Co., then as now, not only supplied equipment but trained operators and service engineers and a 'Marconi man', with this enviable background, had a passport to work anywhere in the world. By 1916, Marconi was working with shorter wavelengths (around 15 metres) and was demonstrating beam aerials with very strong directional characteristics. In 1918 the ultimate long-distance signal, England to Australia, was achieved. Marconi had, like Puck in *Midsummer Night's Dream*, encircled the Earth.

By this time Marconi, awarded the Nobel Prize in 1909, could have retired, assured of fortune and fame in equal proportions and with the inherited Italian title of Marchese. The work of the true pioneer, however, is always concerned

with the next step and by the end of the First World War, Marconi was ready with more new ideas. By this time too, his employee David Sarnoff, in the USA, was convinced that radio had an equally bright future as an entertainment medium. Marconi was totally opposed to this, though he took an interest in the first demonstration of public broadcasting from Writtle (near the Marconi works in Chelmsford) when the diva Dame Nellie Melba, using a microphone hastily rigged up with a cigar-box mouthpiece, made what was *almost* the first broadcast using Amplitude Modulation (she had been preceded by one of the office secretaries who had been asked to test the equipment before Melba arrived). Marconi, however, refused to consider involving the Marconi company in the business of public radio reception and defined the firm's role as that of providing transmitting equipment and specialised receivers for communications only. Sarnoff resigned to form his own company, the Radio Corporation of America, but Marconi sold the use of his name for domestic receivers. This was a step that his fellow-directors bitterly opposed and, after Marconi's death, the Company tried to buy back the Marconiphone trademark, but without success.

Moving on with more experiments, Marconi converted his steam yacht, the *Elettra*, to act as a floating laboratory, for the development of short-wave transmitters and receivers. By 1924, he had

obtained a contract from the Post Office to manufacture short-wave transmitters and receivers for the cablegram service and, by 1932, he was working with half-metre wavelengths, getting close to the wavelengths that would soon be used in the early radar experiments. There is little doubt that Marconi himself would have taken the initiative in radar had his health been better. As it was, he died in 1937 surrounded by the tangible evidence of his success and with a worldwide organisation centred on his adopted home town of Chelmsford, Essex; a town so packed with mementos of Marconi that you can hardly move without coming across some evidence of Marconi's long stay there.

As a footnote, the career of the yacht *Elettra* is worth recording. She was used as a test laboratory by MIMCO after Marconi's death but met her end, like so many others of her age, at Dunkirk. After the Second World War, a converted Motor Torpedo Boat was bought and named *Elettra II*, to be used for the same purposes. It was a remarkable hulk, so top-heavy with aerials and radar equipment that when it rolled, there was a sickening delay before it righted itself. Then, after a tour of Norway, it was found that all but one of the stringers (the longitudinal beams that were supposed to hold the ship together) was broken! Shortly after that it was scrapped and a new *Elettra III* commissioned.

HE

# EXCITING OFFERS!

## DIGITAL VOLTMETER MODULE

Fully built & tested



- Positive and negative voltages with an FSD of 999mV which is easily extended.
- Requires only single supply 7 - 12V.
- High overall accuracy  $\pm 0.1\% + 1$  digit.
- Large bright 0.43" (11mm) LED displays.
- Supplied with full data and applications information.

ONLY  
£11.95  
+VAT

Using this fully built and calibrated module as a basis now means that you can easily build a wide range of accurate equipment such as multimeters, thermometers, battery indicators, etc. etc. at a fraction of the cost of ready-made equipment. Full details are supplied with each module showing how to easily extend the voltage range and measure current, resistance and temperature. Fully guaranteed, the unit has been supplied to electricity authorities, Government departments, universities, the P.O. and many companies.

## Temperature Measurement £2.15 +VAT

An easily constructed kit using an I.C. probe providing a linear output of 10mV/°C over the temperature range from -10°C to +100°C. The unit is ideal for use in conjunction with the above DVM module providing an accurate digital thermometer suitable for a wide range of applications.

## Power Supply £4.95 +VAT

This fully built mains power supply provides two stabilised isolated outputs of 9V providing current levels of up to 250mA each. The unit is ideally suited for powering the DVM and the Temperature Measurement module.

## ULTRASONIC ALARM MODULE

Fully built & tested

ONLY  
£10.95  
+VAT

## Power Supply & Relay Unit £3.95 +VAT

Incorporating a stabilised 12V supply and a s.p.c.o. relay with 3A contacts, this unit is designed to operate in conjunction with the above ultrasonic unit. Fully built and tested, its compact size makes it ideal for constructing the smallest of units.

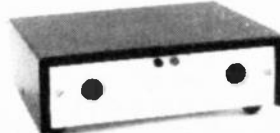

## Range adjustable from 5' - 25'

A really effective fully built module which contains both ultrasonic transmitter and receiver, together with the necessary circuitry for providing the appropriate delays and false alarm suppression. Using this module with a suitable 12V power supply and relay unit such as that shown, a really effective though inexpensive intruder alarm may be constructed. The module, which is supplied with a comprehensive data sheet, is easily mounted in a wide range of enclosures. A ready drilled case, together with all the necessary hardware, is available below.

## Siren Module £2.57 +VAT

Producing a very loud and penetrating wailing sound, this module operates from 9-15V. Capable of driving one or two 8 ohm speakers. Suitable horn speakers available at £4.30 each +VAT.

## Hardware Kit £3.95 +VAT

A suitable ready drilled case together with the various mounting pillars, nuts and bolts, and including a mains switch and 2mm sockets designed to house the ultrasonic alarm module, together with its associated power supply. Size 153mm x 120mm x 45mm.

In addition to the above a wide range of competitively priced electronic components is stocked. Please telephone your specific requirements.

- V.A.T. must be added on all items.
- Shop hours 9 - 5.30 (Weds. 9 - 1)
- ex-stock delivery on all items.
- Units on demonstration, callers welcome.
- Post and packing charge 50p per order.
- S.A.E. with all enquiries please.



## RISCOMP LIMITED

Dept. H.E.5.  
21 Duke Street,  
Princes Risborough, Bucks.  
Tel: Princes Risborough (084 44) 6326

WE WILL BEAT BY 5% ANY LOWER PRICE ADVERTISED BY COMPETITORS\*

**WATER RESISTANT WATCHES**

With Alarm, Hourly Time Signal, Stopwatch and Calendar  
100 METRE WATER RESISTANT



**W-100**  
Resin case/strap  
£19.95



**W-150C**  
S/S case, resin strap  
£21.95



**W-150**  
All S/S  
£24.95

Time and auto calendar. Alarm and hourly chimes. Countdown alarm timer with repeat memory function. Professional 1/100 second stopwatch. Time is always on display, regardless of display mode. Amazing 5 year lithium battery life. Superior to the W-250.

**50 METRE WATER RESISTANT**



**AA-92W**  
(left)  
All S/S  
£25.95



**W-51**  
(right)  
All S/S  
£22.95

**AA-92W.** LCD Analog display of hours and minutes, with sync. digital seconds. Dual time. Digital display of time and calendar. Alarm, with "carousel" display. Countdown alarm timer with amazing "Starburst" display. Half hourly chimes. Long life lithium battery.  
**W-51.** The same module and functions as the W-150.



**W-20**  
Resin case/strap  
£12.95



**W-21**  
Resin S/S trim  
£14.95



**W-30**  
All S/S  
£19.95

12/24 hour time and auto calendar. Alarm and hourly chimes. Professional 1/100 second stopwatch to 12 hrs. Compact and slim cases, approx. 8mm thick. Lithium.

**OTHER MODELS**



**CA-85**  
Resin  
Usually £19.95  
Price elsewhere  
★ £18.95



**CA-901**  
Chrome  
Usually £29.95  
Price elsewhere  
★ £27.95



**J-100**  
Resin  
£19.95

**CA 85/901.** Time and auto calendar. Calculator. Alarm and hourly chimes. Stopwatch. Dual time. DIGITAL SPACE INVADER game.

**J-100.** Similar to the CA-85 but without dual time and with a JOGGING COMPUTER instead of the game function.

**GM-10.** Alarm chrono with SPACE INTERCEPTOR game £19.95

**AA 85.** As AA-92W but in chrome, non W/R case £22.95

**F-82.** Alarm chronograph. Resin case and strap £10.95

**Ladies models**

**LM-3.** Melody alarm, stopwatch. Resin, S/S trim. £14.95

**LW-5.** Time/date/stopwatch. 50m W/R resin case £8.95

**LW 800C.** 6 digits. Time, date, 1/100 second stopwatch.

**100m Water Resistant S/S case with resin strap £18.95**

\*Providing the advertiser has stocks and we do not sell at a loss.

**AX-210.** The world's most versatile watch?

Analog Display  
LC Display of hours and minutes  
Digital display

- \* Local time, 12 or 24 hour
- \* Full calendar display
- \* Dual time, 12 or 24 hour
- \* Alarm time display
- \* Countdown alarm timer with memory function.
- \* Professional 1/100 second stopwatch.

Hourly time signal. Daily alarm-electronic buzzer or 3 selectable melodies. Rapid forward/back setting 9.4 x 35.4 x 36mm.

Usual Price £29.95

Lowest price elsewhere

★ £27.95



**CALCULATORS**

**£100 POCKET COMPUTER.** Casio FX-702P

**FX-602P.** Usual price £74.95 NOW ONLY £99.95

**FP-10 Printer** £44.95 (elsewhere £41.95) Price elsewhere £71.95

**FA-2** £19.95

**OUR BEST SELLING SCIENTIFIC**

**FX-3600P**

10 digits, 61 scientific functions including Integrals and Regression analysis. Up to 38 program steps, 2 programs and 7 memories, all non-volatile. Wallet size. 1,300 hour battery.

Usual Price £22.95

Price elsewhere

★ £21.95



**FX-180P.** Hand held version without hyperbolics £19.95



**FX-8100 Scientific with Clock, Alarms and Stopwatch**

8 digits, 49 scientific functions. Clock, hourly chimes, alarm. 2 countdown alarm timers. Auto calendar. 1/100 second pro stopwatch. Complete with wallet.

Usual Price £19.95

Price elsewhere £23.95 ★

**FX-550**  
10 digits, 50 scientific functions including hyperbolics, standard deviations, etc. 5/16 x 2 7/8 x 5 1/4". Wallet. 1,300 hour lithium battery life.

Usual Price £19.95

Price elsewhere

★ £18.95



**FX-5** £8.95; **FX-7** £10.95; **FX-82** £12.95; **FX-100** £16.95

**CALCULATING ALARM CLOCKS**



**FT-7 Fortune Teller and Matchmaker**

Clock, alarm, hourly chimes, calendar. Predictions of individual fortunes (health, gambling/investment, business and love), or the compatibility between two persons on any given day. Usual Price £16.95

Price elsewhere ★ £15.95

**BG-15.** Boxing game, alarm clock, calculator. Usual Price £16.95. Price elsewhere £15.95

**ML-76.** 12 melody alarms, clock, calculator £14.95

**ML-120.** Wallet version of above £14.95

**ML-2000** £22.95. **UC-3000** £27.95. **UC-360/365** £19.95

**BASIC CALCULATORS**

**MG-77 Compendium of Games**

A game of chance, a game to test your reactions and a game to tax your intelligence. Plus a very useful clock as well and, of course, a wallet size calculator.

ONLY £14.95

**SL-801 Solar** £8.95. **HQ-25 Time calculations** £9.95.



CATALOGUE ON REQUEST. 15½p STAMP APPRECIATED

**SENSATION**

of the Japanese Music Fair

**CASIOTONE 701 COMPUTERISED ORGAN**

Fully Programmable, 5 Octave, Polyphonic Keyboard "THE instrument of 1982... probably the best instructive keyboard I have come across. But it is also a top line musical instrument capable of satisfying even the most proficient musician." Keyboards & Music Player.



**CT-701**

(RRP £555)

**ONLY £495**

Program the 343 melody steps and the 201 chord steps, (max.) with music specially scored in bar code and read by a light pen, or enter your own chords and melody via the keyboard, with full editing and repeat facilities. 3-way replay—Automatic; One Key Play; Melody Guide, (lights above the keyboard indicate the next note to play). Split keyboard; 20 superb instrument voices; 16 rhythm accompaniments; fingered or auto chords with walking bass and arpeggio; fill-in and effect buttons. 37 1/4 x 13-7/16 x 5 inches. Weight: 12.5kg (27.6lbs).  
**CT-601.** As 701 but without programming functions

**COMMON SPECIFICATIONS**

All Casiotones (except VL-Tones) are 8-note polyphonic. They all have built-in amplifiers and speakers, with output jacks for headphones and external amplification and a pitch control. CT models are mains only and have volume and sustain pedal jacks.

**CT-403**



RRP £325  
**ONLY £275.00**

25 instruments over 4 octaves. Four voice memory function with push button selection. Vibrato and sustain switches. 16 rhythm accompaniments with fill-in variation Casio Auto Chord for one finger or auto playing of major, minor and 7th chords with bass. Ten functional controls 4 3/8 x 30 3/8 x 11 3/4. Weight 17.6lbs.

**CT-202**



RRP £325  
**ONLY £275**

"Son of success... The two harpsichords demonstrate the Casiotone's talent for sparkling crystal clear tones. Even more impressive is the clav..."  
(Melody Maker)

49 instruments over 4 octaves. 4 voice memory function with push button selection. 3 vibrato settings and sustain. 3 1/2 x 34 1/2 x 11 1/4". 16.8lbs.

**CT-101.** Similar to 202 but has 22 voices

**ONLY £195**

**MT-40**

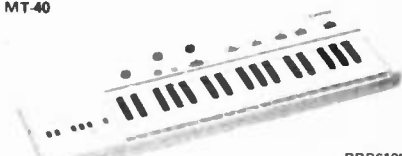

RRP £125  
**ONLY £99**

37 key, 3 octave keyboard plus 15 key bass keyboard with automatic, synchronised bass function. 22 instrument voices; 6 auto rhythms with dual fill-in. Sustain and Vibrato. Battery powered, or optional mains adaptor AD-1E (£5). 23 x 7 x 2-7/16 inches. Weight 4.9lb.

**VL-TONE.** Become an Instant Musician with this amazing programmable Musical Instrument. 10 auto rhythms, four voices + ADSR. 2 extra books worth 5.00 FREE.

£35.95

Price includes VAT and P&P. Send cheques, PO, or phone your ACCESS, VISA or B'CARD number to:

**TEMPUS**

LEADING CASIO SPECIALISTS  
Dept HE  
38 Burleigh Street, Cambridge CB1 1DG  
Telephone: 0223 312866

CATALOGUE ON REQUEST  
15½p stamp appreciated



**COMPUTER KEY SWITCHES** (make your own keyboard)  
These are for making up on a p.c.b. and consist of a vertical mounting computer type reed switch, which makes circuit when a magnet passes over it. The magnet is located in the plastic plunger which in turn is depressed by a push rod, to which the legendary top is fixed. These are made up in banks of 6, price £2.30 per bank of 6 (including tops)

**OUR CAR STARTER AND CHARGER KIT** has no doubt saved many motorists from embarrassment in an emergency you can start car off mains or bring your battery up to full charge in a couple of hours. The kit comprises: 250w mains transformer, two 10 amp bridge rectifiers, start/charge switch and full instructions. You can assemble this in the evening, box it up or leave it on the shelf in the garage whichever suits you best. Price £12.50 + £3.00 post.

**GPO HIGH GAIN AMPSIGNAL TRACER.** In case measuring only 5 1/2in x 3 1/2in x 1 1/2in is an extremely high gain (70dB) solid state amplifier designed for use as a signal tracer on GPO cables, etc. With a radio it functions very well as a signal tracer. By connecting a simple coil to the input socket a useful mains cable tracer can be made. Runs on standard 4 1/2v battery and has input, output sockets and on-off volume control, mounted flush on the top. Many other uses include general purpose amp, cueing amp, etc. An absolute bargain at only £1.85. Suitable 800hm earpiece 69p.

**COMPUTER PRINTER FOR ONLY £6.95**  
Japanese made: Epson 310 — has a self-starting, brushless, transistorised d.c. motor to drive the print hammer, print drum — tape forward/reverse and paper feed. Complete in module form with electronics including Printer Synchro Signal Amplifier & Printer Reset Signal Amplifier. Brand new and with technical data. £6.95 + £1.35 post. Data separately for £1.00.

**SUPER HI-FI SPEAKER CABINETS**

Made for an expensive Hi-Fi outfit — will suit any decor. Resonance free. Cu-outs for 6 1/2" woofer and 2 1/2" tweeter. The front material is Dacrom. The completed unit is most pleasing. Supplied in pairs, price £6.90 per pair (this is probably less than the original cost of one cabinet) carriage £3.00 the pair.

**GOODMANS SPEAKERS**  
6 1/2" 8 ohm 25 watt £4.50. 2 1/2" 8 ohm tweeter. £2.50. No extra for postage if ordered with cabinets. Xover £1.50.

**VU METER SNIP**  
Approximately 1 5/8" square, suitable for use as a recording level meter power output indicator or many similar applications. Full vision front, cover easily removable if you wish to alter the scale. Special snip price £1.00 or 10 for £9.00.

**MOTORISED DISCO SWITCH**

With 10 amp changeover switches. Multi-adjustable switches all rated at 10 amps, this would provide a magnificent display. For mains operated 8 switch model £6.25, 10 switch model £6.75, 12 switch model £7.25.

**12v MOTOR BY SMITHS**  
Made for use in cars, these are series wound and they become more powerful as load increases. Size 3 1/2" long by 3 1/2" dia. These have a good length of 1/2" spindle — price £3.45. Ditto, but double ended £4.25.

**EXTRA POWERFUL 12v MOTOR**  
Made to work battery lawnmower, this probably develops up to 1/2 h.p., so it could be used to power a go-kart or to drive a compressor, etc. etc. £6.90 + £1.50 post.

**THERMOSTAT ASSORTMENT**  
10 different thermostats. 7 bi-metal types and 3 liquid types. These are the current stats which will open the switch to protect devices against overload, short circuits, etc., or when fitted say in front of the element of a blow heater, the heat would trip the stat if the blower fuses; appliance stats, one for high temperatures, others adjustable over a range of temperatures which could include 0 — 100°C. There is also a thermostat pod which can be immersed, an oven stat, a calibrated boiler stat, finally an ice stat which, fitted to our waterproof heater element, up in the loft could protect your pipes from freezing. Separately, these thermostats could cost around £15.00 — however, you can have the parcel for £2.50.

**UNIVAC KEYBOARD BARGAIN**  
50 keys, together with 5 miniature toggle switches all mounted on a p.c.b. together with 12 i.c.'s, many transistors and other parts. £13.50 + £2.00 post. This is far less than the value of the switches alone. Diagram of this key-board is available separately for £1.

**SOLENOID WITH PLUNGER**  
Mains operated £1.99  
10 — 12 volts DC operated £1.50.

**FREE** OUR CURRENT BARGAIN LIST WILL BE ENCLOSED WITH ALL ORDERS.

**MULLARD UNILEX**

A mains operated 4 + 4 stereo system. Rated one of the finest performers in the stereo field this would make a wonderful gift for almost anyone. In easy to assemble modular form this should sell at about £30 — but due to a special bulk buy and as an incentive for you to buy this month we offer the system complete at only £16.75 including VAT and post. **FREE GIFT** — buy this month and you will receive a pair of Goodman's elliptical B"x5" speakers to match this amplifier.

**3 CHANNEL SOUND TO LIGHT KIT**

Complete kit of parts for a three-channel sound to light unit controlling over 2000 watts of lighting. Use this at home if you wish but it is plenty rugged enough for disco work. The unit is housed in an attractive two-tone metal case and has controls for each channel, and a master on/off. The audio input and output are by 1/4" sockets and three panel mounting fuse holders provide thyristor sockets and special plug and socket facilitate ease of connecting lamps. Special snip price is £14.95 in kit form or £25.00 assembled and tested.

**FIVE UNUSUAL SWITCHES**

For inventors, experimenters, service engineers, students or in fact anyone interested in making electrical gadgets. The parcel contains: — delay switch — motor driven switch — two-way and off switch — polarity changing switch — and humidity switch. Our regular price for these switches bought separately is over £10, but this month you can have the 5 for £2.50.

**THIS MONTH'S SNIP**  
**IONISER — AIR FRESHENER**  
Headaches, tiredness and that "Tundry Weather Feeling" — Scientist's say are caused by an excess of positive ions, they also say that heaters and other modern aids can cause this ion imbalance. The answer is a negative ion generator or ioniser — this mains operated device will fill your home, office or workshop with a refreshing breeze neg. ions, which you will find both stimulating and invigorating. Complete kit in neat sturdy plastic case. £14.95.

**SPIT MOTORS**  
These are powerful mains operated induction motors with gear box attached. The final shaft is a 1/4" rod with square hole, so you have alternative coupling methods — final speed is approx. 5 revs/min, price £5.50. — Similar motors with final speeds of 80, 100, 160 & 200r.p.m. same price.

**EXTRACTOR FAN**  
Mains operated — ex. computer.  
6" Woods extractor £5.95. Post £1.50  
6" Plannair extractor £6.50. Post £1.25  
4" x 4" Muffin 115v. £4.50. Post 75p.  
4" x 4" Muffin 230v. £5.75. Post 75p.

**8 POWERFUL BATTERY MOTORS**  
For models, maccanos, drills, remote control planes, boats, etc. £2.95.

**TAPE PUNCH & READER** For controlling machine tools, etc. motorised 8 bit punch with matching tape reader. Ex-computers, believed in good working order, any not so would be exchanged. £17.50 pair. Post £4.00.

**MINI-MULTI TESTER** Deluxe pocket size precision moving coil instrument, Jewelled bearings - 2000 o.p.v. mirrored scale. 11 instant range measures: DC volts 10, 50, 250, 1000. AC volts 10, 50, 250, 1000. DC amps 0 — 100 mA. Continuity and resistance 0 - 1 meg ohms in two ranges. Complete with test prods and instruction book showing how to measure capacity and inductance as well. Unbelievable value at only £6.75 + 60p post and insurance. **FREE** Amps range kit to enable you to read DC current from 0 - 10 amps, directly on the 0 - 10 scale. It's free if you purchase quickly, but if you already own a Mini-Tester and would like one, send £2.50.

**TRANSMITTER SURVEILLANCE**

Tiny, easily hidden but which will enable conversation to be picked up with FM radio. Can be made in a matchbox — all electronic parts and circuit. £2.30. (not licenceable in the U.K.)

**RADIO MIKE**

Ideal for discos and garden parties, allows complete freedom of movement. Play through FM radio or tuner amp. £6.90 comp. kit. (not licenceable in the U.K.).

**FM RECEIVER**

Made up and working, complete with scale and pointer needs only a headphone. Ideal for use with our surveillance transmitter or radio mike. £5.85.

**LEVEL METER**

Size approximately 1/2" square, scaled signal and power but cover easily removable for rescaling. Sensitivity 200 uA. 75p.

**POCKET AUDIO COMPONENT TESTER**

With it you can quickly test diodes, rectifiers, transistors, capacitors, check wiring and p.c. boards for open circuits, find the anode and cathode of a diode or rectifier and whether a transistor is PNP or NPN, which are the base collector and emitter connections. Condensers, if bad, give a continuous signal, but if good, give intermittent signals of varying length depending on their value. The test current is very low (2uA) and the voltage only 1.4V, so it is also possible to check MOS devices, as well as sensitive transistors without fear of damaging them. The unit is supplied complete with internal battery, which should last many months. Price £3.45.

**VENNER TIME SWITCH**  
Mains operated with 20 amp switch, one on and one off per 24 hrs. repeats daily automatically correcting for the lengthening or shortening day. An expensive time switch but you can have it for only £2.95. These are without case but we can supply a plastic base £1.75 or metal case with window £2.95. Also available is adaptor kit to convert this into a normal 24 hr. time switch but with the added advantage of up to 12 on/off's per 24 hrs. This makes an ideal controller for the immersion heater. Price of adaptor kit is £2.30.

**STEREO HEADPHONES**  
Very good quality, 8 ohm impedance, padded, terminating with standard 1/4" jack-plug £2.99 post 60p.

**TIME SWITCH BARGAIN**  
Large clear mains frequency controlled clock, which will always show you the correct time + start and stop switches with dials. Complete with knobs. £2.50.

**DELAY SWITCH**  
Mains operated — delay can be accurately set with pointers knob for periods of up to 2 1/2 hrs. 2 contacts suitable to switch 10 amps — second contact opens a few minutes after 1st contact. £1.95.

**6 WAVEBAND SHORTWAVE RADIO KIT**  
Bandspread covering 13.5 to 32 metres. Based on circuit which appeared in a recent issue of Radio Constructor. Complete kit includes case materials, six transistors and diodes, condensers, resistors, inductors, switches, etc. Nothing else to buy if you have an amplifier to connect it to or a pair of high resistance headphones. Price £11.95.

**MEDIUM & 2 SHORT WAVE CRYSTAL RADIO**  
All the parts to make up the beginner's model. Price £2.30. Crystal earpiece 65p. High resistance headphones (gives best results) £3.75. Kit includes chassis and front but not case.

**RADIO STETHOSCOPE**  
Easy to fault find — start at the aerial and work towards the speaker — when signal stops you have found the fault. Complete kit £4.95.

**INTERRUPTED BEAM**  
This kit enables you to make a switch that will trigger when a steady beam of infra red or ordinary light is broken. Main components — relay, photo transistor, resistors and caps, etc. Circuit diagram but no case. Price £2.30

**MUGGER DETERRENT**  
A high-note bleeper, push latching switch, plastic case and battery connector. Will scare away any villain and bring help. £2.50 complete kit.

**TANGENTIAL BLOW HEATER**  
2.5 Kw quiet, efficient instant heating from 230/240 volt mains. Kit consists of blower as illustrated, 2.5 Kw element, control switch and data all for £4.95. post £1.50.

**12V SUBMERSIBLE PUMP**  
Just join it to your car battery, drop it into the liquid to be moved and up it comes, no messing about, no priming, etc. and you get a very good head. Suitable for water, paraffin and any non-explosive non-corrosive liquid. One use if you are a camper, make yourself a shower. Price: £9.50.

**J. BULL (Electrical) Ltd.**  
(Dept. HE), 34 - 36 AMERICA LANE, HAYWARDS Heath, SUSSEX RH16 3QU. **Established 30 YEARS**

**MAIL ORDER TERMS:** Cash, P.O. or cheque with order. Orders under £10, add 60p service charge. Monthly account orders accepted from schools and public companies. Access & Barclaycard orders phone Haywards Heath (0444) 54563. Bulk Orders: Write for quote. Normal delivery by return.

# QUICK PROJECT!

## SIGNAL TRACER

A SIGNAL TRACER for audio work consists of an audio amplifier driving an earphone or loudspeaker, so that small signals can be detected at various points in the circuit. It is a simple refinement, however, to include an AM detector, which will allow signals in the RF (Radio Frequency) and IF (Intermediate Frequency) stages of medium-wave radios to be traced. The circuit shown in Figure 1 is easy to construct and suitable for audio, RF and IF signal tracing.

The circuit is divided into two stages. The first stage uses Q1 as a source follower, providing no voltage gain but a high input impedance (about 1 Megohm) to prevent loading of the circuit being tested. The second stage supplies all the voltage gain (more than 40 dB) by using Q2 in a common emitter configuration. Q2 is biased near to cut-off by R5 and R6, so that it provides a crude form of rectification, as well as gain. Capacitor C3 acts as an RF filter and, in conjunction with the distortion from Q2, produces AM demodulation.

The input signal to Q2 normally comes directly from Q1 via C2, but when a high level input is present, SW1 can be set to the 'low' position; this avoids overloading by sending the signal through an attenuator network, R3, R4.

Figure 2 shows the component layout on a piece of Veroboard (24 x 10). The device is housed in a small plastic case, so that it can be handheld, and is connected to the circuit under test via a long M3 bolt (file the tip to a point) with a crocodile clip (on the end of a wire) used for the earth.

The best technique for tracing a signal through a radio is to start at a point, in the signal path, near the first gain stage and work along the signal path towards the output. When you reach a point where the signal 'vanishes' you have roughly located the fault. For example, if there is a signal present at the base of a transistor but not at its collector (or emitter, if it's an emitter follower), then the fault is probably in the transistor or the components around it.

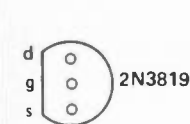
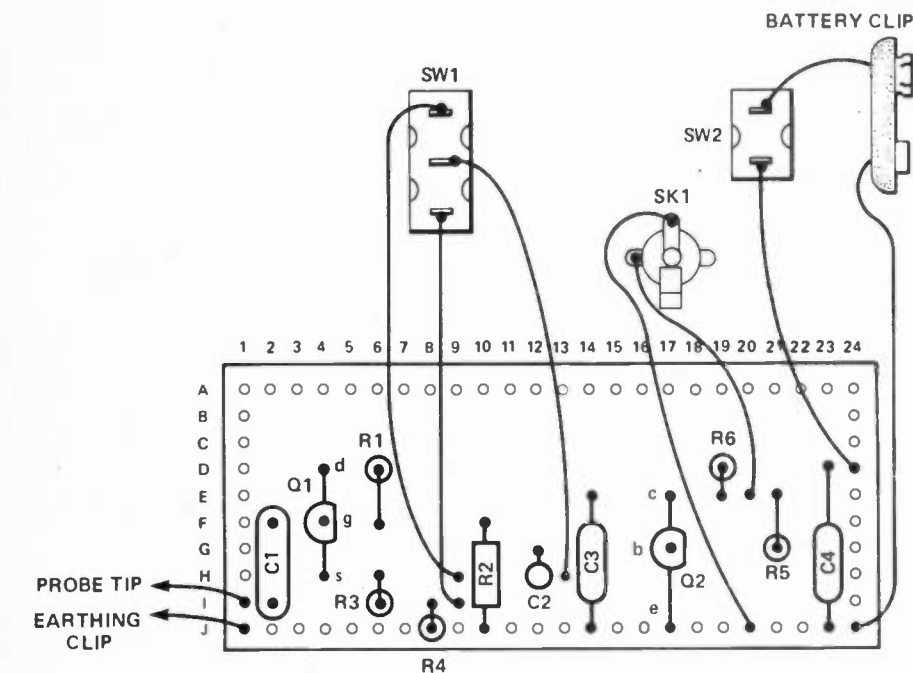
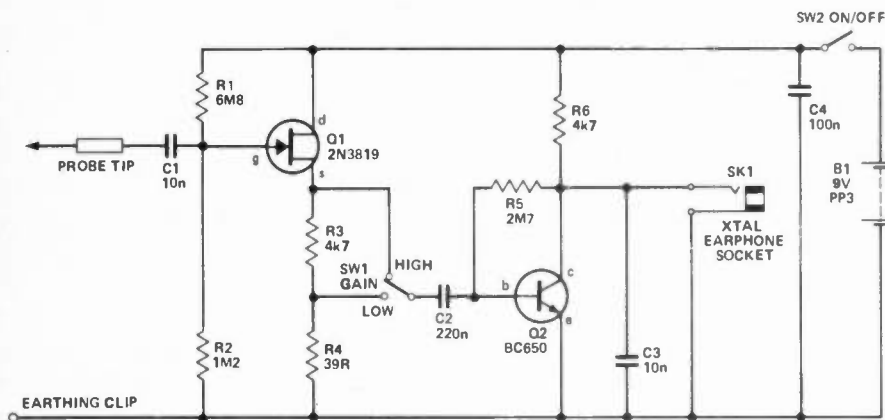

AS VIEWED FROM BELOW

### Parts List

#### RESISTORS

R1	6M8
R2	1M2
R3,R6	4k7
R4	39R
R5	2M7

#### CAPACITORS

C1,C3	10n polyester
C2	220n polyester
C4	100n polyester

#### SEMICONDUCTORS

Q1	2N3819 FET
Q2	BC650 NPN silicon transistor



# POPULAR COMPUTING

The home computer has been around for some time, now. So why are we, at this late stage, introducing a special supplement on the subject? After all, it already has enormous coverage in specialist magazines, in the daily press, on radio and even on nationwide television.

Quite simply, because we believe that there is a side to computing that is NOT adequately covered anywhere else.

For most people, the fun of owning a computer is in being able to write clever programs for games, to keep mailing lists or to do the household accounts. So it's not surprising that most magazines are basically software magazines. The other side of computers — the hardware side — is either ignored, glossed-over or written for experts.

As a magazine for electronics enthusiasts, we think it's about time the balance was adjusted. Hobby Electronics' Popular Computing supplement is intended to do just that. We'll look at the computer from both sides.

We begin with a critical look at computers and computing. What is a microcomputer and just what can you do with it? Do you really need one? To many people, the computer is The Marvel Of The Age and The Answer To All Their Problems. This is a condition that Jonathon Scott calls

## MICRO-MANIA . . . . . 36

Every trade or profession develops a new set of words — or new meanings for old words — that are peculiar to the subject. Our glossary of computer jargon is by no means complete, but it will start to give you a better understanding of

## COMPUTER TALK . . . . . 41

Reading and discussion play a large part in understanding any subject — but there is no substitute for 'hands-on experience'. So, if you are really determined to learn, you'll need a computer — but which one and how much will it cost? You'll have a better idea of the answer to the first question after reading MICRO-MANIA. The second question is answered in our specially prepared guide to

## THE AFFORDABLE COMPUTER . . . . . 45

Popular Computing will appear monthly in Hobby Electronics. We're not going to give away our plans, just now, but we've got some really good ideas for you in the months to come. Look out for our special computer projects — you won't see them anywhere else, only in

**POPULAR COMPUTING**

Hobby Electronics' Popular Computing Supplement.



# MICRO-MANIA

Jonathan Scott

## What's really lurking beneath the keyboard of a PET, TRS-80 or ZX81? What can you do with it?

ALL HOME COMPUTERS are based on the microprocessor integrated circuit. In fact this is physically a rather small part of that thing which comes in the box marked 'home computer'. It is a plain integrated circuit with 40 to 64 pins, and looks just like a lot of other ordinary integrated circuits. You could buy a common one for much less than £10, or for a classy one you might pay £100 or so. Most of the cost of the complete unit is the 'support' equipment — the PCB, memory, keyboards and so on. But more of that later.

How should we briefly characterise this device, upon which books have been written in abundance? Well, for anyone who has a good knowledge of computers two single descriptions are enough, so we'll start there and work back. These are called the 'chip architecture', and the 'instruction set'. Let us draw an analogy to make it clear. We will discuss a microprocessor, and consider a man sitting at a desk as the model.

The architecture of a microprocessor (or CPU, for Central Processing Unit) is usually presented in the form of a small map showing the locations of significant 'places' in the chip. It corresponds to the places in or on the desk where something may reside. In the CPU there will be several spots where a number can be held, just like the memory on a pocket calculator. Our man at the desk has, for example, the top of the desk, which we will suppose can hold only one number of the size the computer deals with at a time. There might be several drawers which can also hold one number apiece. If you want to hang on to a bigger number than will fit in one drawer, you must break it up and put it in several drawers.

One popular CPU is the 6502; it has six locations. Some of these have fixed jobs. To keep a record of where the CPU is up to in its program — this corresponds to two drawers in the desk which hold

the page number in a book the man is reading. The book is telling him what to do — it corresponds to the program. Another location is called the 'accumulator' and is the place where the result of a calculation usually goes — this is like the top of the desk. In your pocket calculator it is what you see in the display — the result. A third location is known as 'stack pointer' and also holds a specific piece of information — the place where there is some free memory for holding any numbers you need to keep for a while. It is like a drawer in the desk in which a piece of paper is kept; written on the paper is where to find some blank pages in a pad kept elsewhere (ie outside the CPU).

### Temporarily Registered

The other two registers in the 6502 are general purpose registers, typically used for temporary jobs, counting or indexing. The latter need not concern us yet but gives its name to these locations, called 'index registers'. These are like two spare but handy drawers in the desk. If all this has left you confused, then we'll recap using figures. We have chosen the 6502 as it is relatively simple (not a complex architecture) and yet has most of the fundamental bits we need to discuss. It is used in Apple, PET and Acorn computers, among others.



The common CPUs on the market today, like the 6502, 8080 and Z80, are 'eight bit' units. This means that each number is eight bits wide, or is an eight digit binary number. Such numbers span a decimal range of 0-255, of course. Bigger numbers, or fractional ones, must be kept in several locations at once; this need not be a worry yet, as it falls naturally into place later.

So now we know that CPUs have places in them like pocket calculator memories. What can they do with the numbers in these locations? The 'instruction set' is a list of all the possible commands. In a pocket calculator there are a fixed number of keys which either input a number, execute a function such as 'x', or get a result (=). Our man at the desk can do a variety of things, such as "put the number on the next page of the book of instructions into the X-index register", or "go to such-and-such a place if the accumulator is zero". In the 6502 there are about 150 different things which it can do in any one 'move' or instruction. A program understandable by the CPU is composed entirely of these.

The next most fundamental bit in the box is memory. This comes in two kinds — memory that you can put numbers into yourself, rubbing out and replacing the numbers as you will, and memory which contains fixed numbers, which can



neither be changed by you nor rubbed out, even by turning off the power. The former is called RAM, (short for Random Access Memory); the latter is ROM, for Read Only Memory. In the computers you buy in the shops, a lot of useful programs which you need frequently are perpetually available within the computer memory because they are in ROM. The size of the ROM (typically 4-16K for BASIC) reflects how comprehensive and convenient are the programs that you buy with the unit. For instance, '4K-BASIC' is relatively small, and consequently a coarse and limited version of BASIC. 8K would be more reasonable. Expensive commercial units might offer 16K or more of language interpreter — quite big, and sporting many clever and useful work-saving pieces of program. The types of 'program' and their merits and uses will be covered in the 'Languages Within Languages' section.

RAM is where the computer holds numbers and where the programs you type in are kept. Thus, the more of it you have, the bigger a program you can put in (in any given language) and/or the more numbers you can store at any time. Machines with only 1-4K of RAM must be regarded as small, and will be adequate only if you are programming simple jobs in a very compact form. 16K is typical, and does most 'household' jobs. Machines with 64K or more are now available, but only a tough business job or a large commercial game will demand this.

### Peripheral Matters

As well as the CPU and memory, a complete computer will need some way of getting things from you — a keyboard; a way of getting things to you — a screen or printer; and a way of recording your program permanently so you can turn the machine off and not waste all your work — mass storage, usually a disk drive or audio tape facility. The keyboard can be like an electric typewriter, which is nice but adds to the cost, or it can be one of various sorts of economy measures ranging from one with only a few keys to one with those 'solid state' touch sensitive keys, with no moving parts. All will do the job, though if you are at all serious you will find that a full typewriter-style keyboard is the only one which does not eventually get on your nerves.

The cheapest output, and the one used by many manufacturers, is a signal which will put words and numbers on the screen of a home TV set. This is neat and clear. Some computers just put out RF which you tune into with an unused slot in your TV tuner. This is quick, though not so good as the ones that put out video signals which can be fed directly to the video amplifier stages, bypassing the tuner. Video monitors, as they are called, give a clearer picture, although they must be specially purchased — a measure to consider if you are serious. Some units (eg, PET) include a video monitor, so you get one with the purchase price.

Finally, the mass storage. This just means a way of permanently recording your programs in a fashion which allows

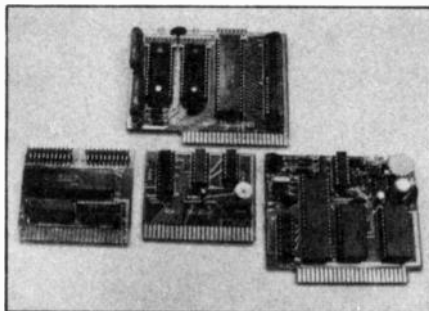
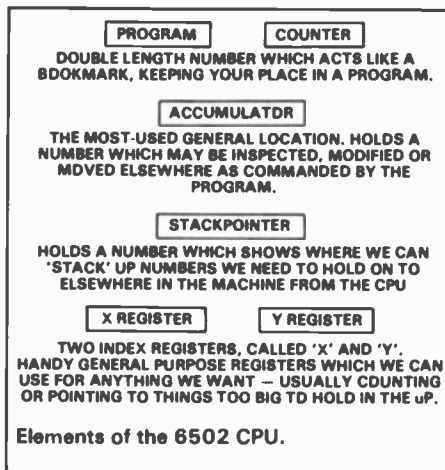

you to load them back into the computer whenever you want. Most computers allow programs to be put onto an ordinary cassette recorder. This is adequate at first, and it's cheap; but it is also slow, and you have to keep track of where on the tapes you have put various programs. Also, there is the occasional failure and you lose a recording — very painful. Once you are addicted and committed, a disc drive is really necessary. It is fast, reliable and keeps its own catalogue of what you have stored away. By the 40th program, this looks like a godsend!

### Languages Within Languages

We have now discussed all the factors which reflect the comprehensiveness and the cost of home computers, and we have abstractly discussed CPU architecture and said that they have a fixed range of instructions which they can execute. Now we will discuss what various 'levels of instructions' are available. These can all be called languages.

The set of instructions which are native to a particular processor — say the 6502 — are said to comprise its 'machine language'. These are fixed and unchangeable with any given CPU. The most fundamental program to a processor is called its 'monitor', and this is a program written in and designed to deal with machine language. Consider what happens when power is first applied to a computer. It must have some starting place, some logical first move. In the Z80, the machine sets the program counter to 0 — which is to say that our man at the desk opens his book of instructions at the first page and puts the book mark there. In the 6502 the 'reset location', as this place is called, is near the very end of the range, rather like the index of the book. When power is first turned on, or when you push the 'reset' button because some catastrophe has scrambled up what you were doing, the bookmark gets back to this place — always the same place for a given brand of CPU.

Living around this place is usually the 'monitor' program. In computer jargon we say that "the monitor takes control", by which we mean that the processor is doing what the monitor program is telling it to do. What does the monitor do? Well, first it prepares the computer for use by getting the keyboard and screen ready for action and generally checking that all is well. Our man at the desk might suddenly wake up, and he will first put his bookmark in the appropriate place, as he does each time he comes to the desk. That page tells him to adjust his chair, close all the filing cabinet drawers, turn on a light if it is dark, and so on. This will all be listed in the book — his 'program'.

Once this has been done, the man will probably sit waiting for some work to come his way. The computer will, when it has finished setting up the job, wait for you to give it something to do by hitting a key or set of keys. The monitor has a few commands which allow you to effectively look at any memory locations you may wish to inspect and to change them, to enter a number representing one of the instructions in the instruction set of the

CPU. It allows you to execute a group of these instructions and also to look, at any time, at the registers in the processor. It may also give you some commands helpful in finding errors in such a program — an act called 'debugging'. (mistakes in a program, of any type, are called 'bugs'.)

Whatever commands a monitor understands will be outlined in some paperwork accompanying the unit, and need only be read up when you want to use the monitor. It is sufficient, at this time, to say that the monitor is a crude mechanism which is very close to the actual machine language of the processor. You need a knowledge of the architecture and the instruction set to use it, and even then it is a slow and tedious process to write and enter programs in machine code.

However, suppose we had a dictionary — a dictionary which would allow us to look up nice familiar English words like 'multiply', and get the machine code instructions to do this. And suppose this dictionary lived in the machine already, so that you could type in a phrase like "if E/C = MC then beep" and know that if E/C *does* equal MC the machine will beep. Such a dictionary is often built in, and it is called a 'BASIC interpreter', or just 'BASIC'. Interpreters come in other languages, too, though BASIC is more common today. Some machines have monitors that know if BASIC is in the machine and when they have finished getting the machine in order they hand control over to the BASIC program at once. Others require you to hit some specific key — mentioned in the sheet of instructions that go with the monitor — to cause BASIC to be executed.

### BASIC English

With BASIC in control, you can type in a lot of these words, recognised by BASIC, and then have them executed — or 'interpreted', as the jargon goes. There are words to make calculations, words to make decisions, words to collect bits of information from the user via the keyboard, and words to make things happen on the screen. These new words may be regarded as a new 'instruction set', just like the one we mentioned before, except that they are more English-like, and they are also substantially similar from one machine to another. *These are the two major advantages — BASIC is easier to think out, and does not demand a knowledge of the CPU inside the machine.* The price is speed — BASIC is very slow compared to machine language — but the reward is speed of writing and the ability to put the program into your neighbour's machine (although it has perhaps a different CPU in it), because the words of BASIC are standardised. The 'dictionary' inside the machine does the translation for you.

There are better languages than BASIC, each with advantages, which will come soon to home computers. Pascal is even more 'English-like' in its appearance, for instance, and FORTH is much faster to execute — you can take your pick on some machines.

This "language within a language" is

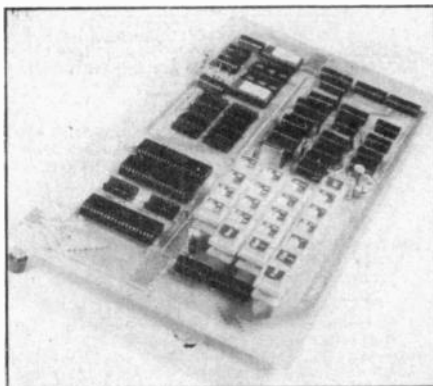

just one more level of flexibility. In fact there is, within the IC itself where you cannot see or change it, another language called 'microcode' and a dictionary to translate this into the particular machine languages of your CPU. The microcode carries out the range of machine language instructions using an even cruder set of instructions which are actually hardware implemented (with, yes, transistors!).

One more point about the languages. We have called them 'interpreters'. An interpreter will take a lot of words in BASIC, say, which are your program, and execute them (in machine code) as it goes. This is slow because it does the 'dictionary-looking-up' as it goes. There is another type of 'dictionary program' which spends some time translating all the words before it even commences the actual running of the program. This process is called 'compilation', and such programs are called 'compilers'. The advantage is that the actual program runs faster than before, but the penalty is that you have to spend some time compiling beforehand, and if you make a change in the original ('source', in the jargon) you have to re-compile the whole thing. In general, the enthusiast's home machine is not geared up for this, and you are better off with an interpreter and a little machine level programming if need be.

### What Can You Do With It?

This is of course the £200-plus question. As you take it out of the box, there are really only two valuable uses for a home computer in its basic form: teaching yourself about computers and playing games. Now the skill of writing computer programs has two good points; first it will help you get into the computer industry or make it easier for you to talk to people in it already, and second it is an excellent mental exercise like chess or Mastermind. If these are not of interest to you, perhaps it is time to think again. Playing games is really self-explanatory — if you pour lots of 10p pieces into video games, then you have an idea what this function is worth to you.

But there must be other areas where the home computer can be useful in the home. There *are* other uses, but they fall into two categories — ones that only pay off when you do things on a grander scale than you can at home, and jobs which require some specific 'peripheral' connected to your machine (which costs extra, of course). Now the keeping of mailing lists or stock inventories is one well-known task. Quite honestly, these require expensive printers and only begin to be labour-saving with more than 50 people and two mass-mailings a year. You, the private householder, are very unlikely even to save effort, let alone cost.

The keeping of cross-reference recipes is another potential job, but you have to be a fantastic cook, not to mention a religious bookkeeper and typist to get all the data into the machine and benefit from its being there. The closest you will *ever* get to that as a useful pastime is if someone markets a disk with them all on it, for about £10.

Next come the programs which require some additional peripheral, such as modems, joysticks, plotters, heat sensors, position sensors, movement sensors, switched mains sockets, or a custom peripheral, such as a morse code translator . . .

In future issues, we'll be developing a whole range of simple, but interesting, gadgets you can hang off the end of your computer. We will conclude this article with a few ideas that will give you a hint of what you can get up to with your home computer.

### The Morse Maniac

One of the most ingenious purposes to which a computer has been put is the operation of a morse radio station in an amateur DX contest. In these contests, you score points for simply exchanging call signs, often going through a simple ritual of introduction. All the communication is by morse, and what is said is simple, fixed, and repetitive. Once the contact has been made you need only record time, callsign, etc, and maybe post off an acknowledgement later.

This can be done easily with a computer — it searches regularly through the bands, finds a station, sends the appropriate message (in morse), receives and decodes the morse response, records it all on a printer or a disk, and says goodbye. This it does as fast as possible, night and day, taking not the slightest break. When the contest is over it can print out all the acknowledgements. All that is required is a small box capable of keying the transmitter (allowing the computer to send), and capable of telling the computer when carrier and modulation is being received — a minor electronic feat. This job is specifically for the ardent ham, of course, but then most computer jobs are specific to some pastime.

### The Clever Watchdog

Burglar alarms, particularly the quickly installed area types such as radar units, are prone to false alarms because the unit cannot tell the difference between the odd disturbance of a rattling window, or power surge on the supply, from a man walking across a room. However, a computer can analyse the doppler response and eliminate freak or definitely non-human responses. If you hook an analogue-to-digital converter between the radar and the computer (only a few £'s worth of bits and pieces), the latter will perform quite sophisticated event filtering, giving alarm only when intrusion is fairly definite. It even simplifies the electronics in the radar module, very considerably reducing its cost!

This function ties up your machine, of course, but only when you are out, so it might pay off if you live in a risky area. In addition it can turn lights and appliances off and on, making the house look inhabited — with the right peripherals, needless to say. If you devise an excellent program to do this, you might even end up selling it to one of the computer houses who buy such things and make them available to others, or to a magazine like this one.

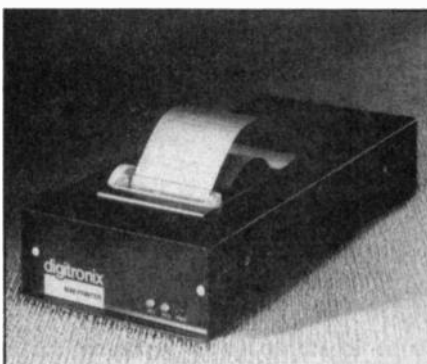
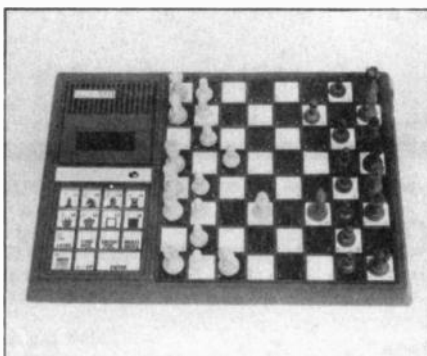
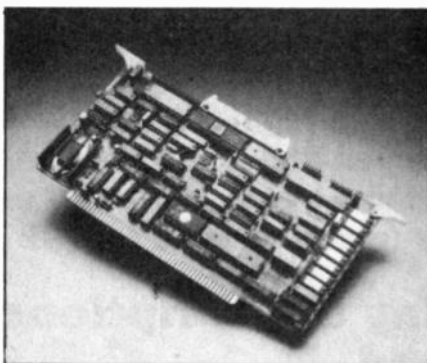
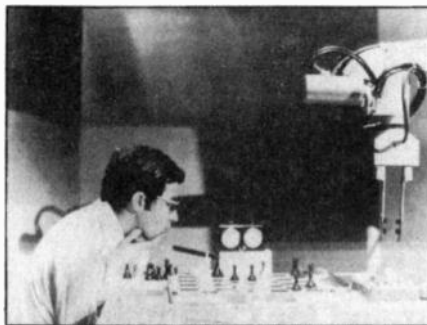

### The Formula One Computer

The author of this article has interfaced a common home computer to a slot car track. This required the computer to have control of the current into the car and a set of position reporting sensors dotted around the track. It makes for very interesting programming, working out how to enable the computer to adjust its driving habits to adapt to a car or layout and achieve close to the best possible performance. In the same vein, a computer can make a very realistic and varied model railway organiser, giving interesting hands-off movement and shunting, though this requires quite a lot of interfacing hardware.

### The Computer Mail Order

At least one chain of electronic component and hi-fi stores in far-off Australia sell a small peripheral for their line of home computers which allows your computer to do your mail ordering direct to *their* computer. You prepare your order; a program that comes with the peripheral does this on your screen. Next you phone up the store's computer. Then you hand the phone over to your computer, tell it to go, and in a couple of hours their computer has despatched the goods and charged your account or credit card. Very neat indeed, and there are no middlemen to lose or confuse your order. This is going to become more common, thought not quickly.

### The Wordprocessing Wizard

Wordprocessing may once have been the domain of commercial computers, but it has now really taken off at the domestic level. All you need is a printer with a pleasant typeface. Programs are becoming available which will correct your spelling of up to 10,000 common words, and then set out anything from a party invitation to a business letter. While you might not be able to justify the expense of a home computer, or the printer, just for this purpose, it is worth having the program if you already have the equipment. There is some value to be gained from a precise and correct job application, for example. In addition, if you are in it for the programming experience, it may be worthwhile writing your own program for the job, or a copy of one you have seen used but want to improve.

### Conclusion

Well, there are some ideas to start your imagination rolling. If you have a little constructional experience, so much the better, as you may be able to fashion your own interfaces so you can more cheaply hook up the computer to your train or your home appliances. Here at HE it is our intention to publish programs and constructional articles to assist those with home computers. If you are thinking about it, we hope this article has given you some idea of what's possible, and how involved you must get to reap the benefits. For those such as your children, who are growing up in a very computer-involved world, the experience will be invaluable, and for you it may become a very productive hobby, especially if you get involved in the hardware side as well as programming. **HE**

# Subscriptions

The ever increasing demand for Computing Today has meant that, despite our printing more each month, some readers seem to be missing out on their regular copy.

If you would like to ensure a regular supply for the next twelve months, each issue lovingly wrapped and posted to you, nothing could be simpler. Just fill in the form below, cut it out and send it with your cheque or Postal Order (made payable to ASP Ltd) to:

**Computing Today Subscriptions,  
513 London Road,  
Thornton Heath,  
Surrey CR4 6AR**

Alternatively you can pay by Access or Barclaycard in which case simply fill in your card number, sign the form and send it off. Do NOT send your card.

Do yourself a favour, make 1982 the year you start to take Computing Today every month, we'll give you a truly  
**Personal Approach To Microcomputing.**

## SUBSCRIPTION ORDER FORM

Cut out and SEND TO :  
Computing Today Subscriptions  
**513, LONDON ROAD,  
THORNTON HEATH,  
SURREY,  
ENGLAND.**

Please commence my personal subscription to Computing Today with the ..... issue.

### SUBSCRIPTION RATES

(tick  as appropriate)

£11.50 for 12 issues U.K.   
£15.15 for 12 issues overseas surface   
£34.75 for 12 issues Overseas Air Mail

I am enclosing my (delete as necessary)  
Cheque/Postal Order/International Money  
Order for £.....  
(made payable to A.S.P. Ltd)  
OR  
Debit my Access/Barclaycard\*  
(\*delete as necessary)



.....

Please use BLOCK CAPITALS and include post codes.

Name (Mr/Mrs/Miss) .....

Address .....

.....

.....

Signature .....

.....

Date .....



# COMPUTER TALK

If the *Microcomputer Bug* has taken a *Byte*, you'll need an *Interpreter* to *Decode* the jargon of *Computer-Talk*. Keep this *Print Out* handy to *Refresh* your *Dynamic Memory*!

## Accumulator

The *register* where arithmetic or logic results are held. Most *CPU instructions* manipulate or test the accumulator contents.

## Address

A label or name (usually a *binary* or *hexadecimal* number) specifying a particular *memory* location.

## Alphanumeric

Letters and numbers.

## ALU

Arithmetic Logic Unit. That portion of the *microprocessor* which performs calculations according to a set of *instructions*.

## Array

A group of related *variables* or constants — generally given a name or a label. Arrays are often located in consecutive *memory* locations.

## ASCII

American Standard Code for Information Interchange — representing letters, numbers etc by 128 permutations of a 7-bit code.

## Assembly Language

Means of representing *program* statements in *mnemonics* and conveniently handling *memory* addressing by use of symbolic terms.

## Asynchronous

Operations that initiate a new operation immediately upon completion of current one — not timed by system *clock*.

## BASIC

Beginner's All Purpose Symbolic Instruction Code. An easy to learn, widely used *high level language*.

## Batch Processing

A method of computer working in which a large number of transactions are grouped together before processing and which are then passed through the various stages of processing as a group or batch. This was the original method of

data processing for commercial work and contrasts with *interactive* processing.

## Baud

Measure of speed of transmission line. Number of times a line changes state per second. Equal to *bits per second* if each line state represents logic 0 or 1.

## Baudot Code

Five-bit code used to *encode alphanumeric data*.

## BCD

Binary Coded Decimal. Means of representing *decimal* numbers where each figure is replaced by a *binary* equivalent.

## Benchmark:

A standard computing task used to measure the relative speeds of different processors.

## Bit

A single *binary* digit, representing either a 'one' or a 'zero'.

## Boot

An *instruction* or very short *program* which will initiate a computer's *operating system* (short for bootstrap).

## Binary:

Numbering system with the base 2, using the digits 0 and 1 instead of the *decimal* series 0 to 9. All *digital* computers work on *data* and *instructions* presented as *binary* numbers.

## bps

Bits Per Second — a rate of *data* transmission between services. Eg 300 bps is a popular rate for some *terminals*, roughly equivalent to 30 characters per second (cps or chps).

## Branch

A certain *instruction* included in a *program* which makes the *processor* perform a step out of the usual sequence, usually if a specified condition is satisfied. A branch *instruction* will skip or jump following instructions.

## Bubble Memory

A compact, high-capacity random ac-

cess memory device (*RAM*) which holds *data* as minute magnetic domains or 'bubbles'. The data is not lost when power is removed.

## Buffer

(1) An area of *memory* designated to hold *data* being transferred between devices working at different speeds, eg the fast processor and the slower *keyboard*, *printer* or *disc*.

(2) An electronic device in a signal path designed to allow signals to pass in one direction but to hold back unwanted reverse voltages which might damage the sending apparatus.

## Bug

An error in *software*.

## Bus

(Sometimes spelt Buss). Basically, the multiple wiring common to several parts of a computer and the number of channels therein — eg a 16-bit bus addressing 64K *memory* locations or a 20-way bus addressing 1 *megabyte*. Bus is now generally identified with the pattern of connections to the plugs and sockets whereby optional units (eg more *memory*) may be connected to a computer.

## Byte

A *binary* number, usually of eight *bits*. It can represent a number from 0 to 255 (8-bit byte) as there are 256 possible combinations of ones and zeros eight bits long.

## CAD/I/L

Computer Aided Design/Instruction/Learning.

## Chain

A process whereby one computer *program* automatically follows another.

## Clock

An oscillator that provides timing signals which synchronise the operations carried out by the *microcomputer*.

## COBOL

Common Business Oriented Language. A *high level language*.

## Compiler

*Software* which converts *high level language* statements into either *assembly language* statements, or into *machine code*.

## CP/M

Control Program/Microprocessor. A popular *disc*-based *operating system* for *microcomputers* using the 8080 and Z80 *processors*.

## CPU

Central Processor Unit. The part of a system which performs calculation and data manipulation functions.

## CUTS

Computer Users Tape System. Definition of system for storing *data* on cassette tape as series of tones to represent *binary* 1's and 0's.

### Data

Simply, information. The raw material that the computer processes.

### Data Base

A system for organising elements of information in a *machine code* file so that a *program* can readily select from this *data* any particular abstraction or combination of information that may be called for. For instance, a customer data base might include full details of all customers (as required for service and distribution departments as well as sales and marketing) and also of every service call and delivery as well as each item invoiced to these customers during a year or longer. A suitable program could access that data base to answer such questions as "identify the customers buying more than £1,000 of item 'A' in less than five deliveries and receiving less than two service calls in the year."

### Debug

To correct the errors in a *program*.

### Decimal

The familiar counting system, 1 to 10. In computing, however, it is more usual to count from 0 to 9.

### Decoder

A device which changes one code to another. For example, a 4-bit *binary* code may be changed to a 1-of-16 code. Certain ICs are made to perform such a function, generally called 4-to-16 line decoders. A 4-bit to 1-of-10 decoder is called a *BCD to decimal* decoder — for each 4-bit code in, the decoder will activate the appropriate one of its ten output lines.

### Digital

The use of discrete signal levels to represent a value as a coded number or letter.

### Disable

The opposite to *enable*. To halt an operation — to turn something off (if only temporarily).

### Disc (Disk)

Magnetic storage device allowing fast random access to a large volume of *data*. A full-size hard disc will hold, say, 5 megabytes or more; a smaller *floppy disc* typically holds from 80 to 250 kilobytes but in either case the capacity is being increased all the time.

### DMA

Direct Memory Access (or Direct Memory Address). The term refers to the practice of fetching *data* directly from *memory* by an external (or *peripheral*) device without the need for intervention by the *microprocessor*. A good technique for speeding data transfer.

### DOS

Disc Operating System — a computer *operating system* held on magnetic *disc* rather than in *ROM*. An *initialisation* process will copy the operating system into *memory* whenever the computer is first turned on. Also an operating system which controls the disc themselves and

may supplement, rather than replace, the computer's original operating system.

### Duplex

A mode of *data* transmission where each station can send and receive simultaneously.

### Dynamic (Memory)

Random Access Memory (*RAM*) requiring constant *refresh* signals but normally using less electrical power than *static* memory.

### EAROM

Electrically Alterable Read Only Memory. Typically taking 10 msec to erase and 1 msec to write, this non-volatile storage might be better considered as 'Read Mostly Memory' as the write capability is likely to be limited to say 100,000 cycles.

### Edit

Alteration of text in *program* or *data* files. Often necessary, some systems make editing easier than others.

### Enable

The opposite to *disable*. To start an operation.

### Encoder

The opposite of a *decoder*. A device which accepts uncoded *data* and turns it into the appropriate code.

### EPROM

Erasable Programmable Read Only Memory. Writing typically takes one minute and erasing, by ultra-violet light, 10 minutes or longer.

### Execute

To perform a sequence of *program* steps.

### Execution Time:

The time taken to perform an *instruction* in terms of *clock* cycles.

### Firmware

*Instructions* or *data* permanently stored in *ROM*.

### Flag

A linen object that one salutes — but sailors use them to send messages. So do computers. A flag is an indicator signal (usually just one *bit*) that generally signals a condition.

### Floppy (disc)

Mass storage which makes use of flexible *discs* made of a material similar to magnetic tape.

### FORTRAN

FORmular TRANslation, an early and still popular *high-level* programming *language*, mainly used for scientific purposes.

### Graphics

Literally — drawings; a method of producing graphs or pictorial figures on a suitable output device, usually a video monitor (TV set for most hobby com-

puters) but sometimes a chart recorder or printer.

### Hard Copy

A computer printout or listing on paper.

### Hardware

All the electronic and mechanical components making up a system.

### Hex

Shortened version of Hexadecimal, meaning '6 plus 10', which is a funny way of saying 16. It refers to the number system with a base of 16. This uses 0 to 9 and then A to F of the alphabet to represent its 16 digits. Two hex digits can be conveniently used to represent a byte (eight bits).

### High-Level Language

Programming language usually claimed to resemble a natural language and with powerful *instructions*, each generating several *machine language instructions*. Examples include *BASIC*, *COBOL* and *FORTRAN*.

### IEEE

Institute of Electronic and Electrical Engineers (in USA) — a body which has set a number of standards for more orderly interchange of information between various electronic devices, including computers.

### Initialisation

The process by which the *processor* is got going after you turn the power on. In some systems you have to do it, in others it's done automatically.

### Instruction

A set of *bits* which causes the *CPU* to carry out a particular task. Usually a basic or fundamental command understood by the *microprocessor*.

### Instruction Set

That set of fundamental *instructions* which control a *microprocessor's* or computer's basic set of possible operations. In general, the larger the instruction set the more powerful the *microprocessor*.

### Intelligent Terminal

An input/output (*I/O*) device which includes its own logic circuits and *memory* so that, for instance, *data* may be validated or changed in format before transmission to the main computer.

### Interactive

A working arrangement under which the computer reacts immediately to respond to any mistakes which may be made by the user or to reply to his enquiries as soon as they are expressed. In some business activities, as also in program writing, this leads to much faster progress than would otherwise be possible.

### Interface

Circuit which connects different parts of system together and performs any processing of signals in order to make transfer possible (ie serial-parallel conversion).

**Integer BASIC**

Concerned only with whole numbers, cutting off any fractions or decimal parts.

**Interpreter**

An interpreter is a *software routine* which accepts and *executes a high level language program*, but unlike a *compiler*, does not produce intermediate *machine code* but converts each instruction as received.

**Interrupt**

A signal which suspends processing to allow some other command to be obeyed.

**I/O**

Input/Output. A computer generally has one or more *ports* through which it communicates with 'the outside world' — *peripheral devices* such as a *keyboard*, video display (*VDU*), *printer* etc. An I/O port may be just an input or just an output or it can be bidirectional.

**Kilo (K)**

Normally means 1000, but 1024 (2<sup>10</sup>) when referring to *memory*.

**Kansas (City)**

A standard for recording *programs* and *data* on cassette tape, named after the city where a conference was held, at which the standards were agreed.

**Keyboard**

A device, similar to a typewriter, which is used to *encode alphanumeric* characters in a form that the computer can recognise. The usual method of interacting with a microcomputer, for hobbyists.

**Language**

A repertory of commands — symbols, expressions etc, used to 'call up' the instructions or procedures a *processor* can execute. Higher-level languages are easily understood by mere humans and computers designed to work with such languages (*BASIC*, for example) use an *interpreter* to change this into the *machine code* under which the processor operates.

**Latch**

Retains previous input state until overwritten.

**Light Pen**

A stylus with a light sensor which allows a computer to identify the point at which a Video Display Unit (*VDU*) screen is being touched.

**Load**

To copy a *program* (eg from tape or *disc*) into *memory*, ready for *execution*.

**Location**

Physical position; *memory* location is the same as *address*.

**Loop**

*Program* technique where one section of program (the loop) is performed many times over.

**LSI**

Large Scale Integration — the combination of circuit elements in a small silicon chip.

**Machine**

Short-hand term a for computer or, more usually, a *microprocessor*.

**Machine Language (Code)**

The lowest (and tediously detailed) level of *program instructions*. All higher level coding must be converted to *machine language* (by *compiler* or *interpreter*) before a *processor* can obey it.

**Mainframe**

A relatively large computer. The term derives from times before integrated circuits, when *processors* were wired up with large numbers of separate components mounted on circuit cards or boards which were in turn mounted in metal racks or frames enclosed in one or more large metal cabinets.

**Mask**

*Bit* pattern used in conjunction with a logic operation to select a particular bit or bits from a machine *word*.

**Mega**

Prefix for 1 000 000 (10<sup>6</sup>).

**Memory**

Immediate access *data* storage, directly addressable by a central processor (*CPU*) and typically comprising a combination of *RAM* and *ROM*.

**Memory Map**

Chart showing how *memory* is used by a computer. The arrangement of *data* and *program* within the memory.

**Memory Mapped I/O**

A technique of implementing I/O facilities by addressing I/O *ports* as if they were *memory locations*.

**Micro (also u)**

Prefix signifying one millionth. Also used descriptively of something very small, though not as small as nano- or pico-.

**Microcomputer**

A computer system based around a *microprocessor* and generally addressing up to 64K of *memory*.

**Micro Cycle**

Single *program* step in a *CPU micro program*. The smallest unit of micro program.

**Microprocessor**

*CPU* implemented by use of large scale integrated circuits. Frequently implemented in a single chip.

**Micro Program**

*Program* inside *CPU* which controls the *CPU* chip.

**Minicomputer**

A somewhat vague term for the middle range of computers. Machines addressing up to 64K bytes or words of *memory* tend (at the present time) to be called *microcomputers* and machines able to

address more than 64K memory locations tend to be called minicomputers unless they separate into distinct parts, in which case it may be called a *mainframe*.

**Mini-Floppy**

The smaller size of *floppy disc*, 5 1/4" in diameter.

**Mnemonic**

A word or phrase which stands for another (longer) phrase and is easier to remember.

**MODEM**

Acronym for MOdulator/DEModulator — a device adapting computer *data* for transmission by telephone line and vice versa.

**Modulator**

A device, included in every good hobby computer, which takes the computer's output and converts it to an RF signal on a suitable TV channel, giving you a cheap, convenient visual display — even if you don't understand what's on the screen.

**Monitor**

The first level of computer *operating systems*: the *program* which turns *machine code* commands into action, managing input, output etc.

**Multiplex**

The principle of arranging or communicating information from a number of sources by selecting each source sequentially.

**n-sec**

Nanosecond, one-thousand-millionth of a second.

**Non Volatile**

*Memory* which will retain *data* content after power supply is removed, eg *ROM*.

**Object Code**

Two-bit patterns that are presented to the *CPU* as *instructions* and *data*.

**Octal**

Base 8 number system. Character set is decimal 0-8.

**Op Code**

Operation Code. A bit-pattern which specifies a machine operation in the *CPU*. The basic unit of *machine code*.

**Operand**

*Data* used by *machine code instructions*.

**Operating System**

The computer's resident *program* which determines how *instructions*, input and output (I/O) devices etc are managed.

**Overlay**

A *program* too long for the available *memory* may be entered and processed by instalments, each segment overlaying or replacing the code previously stored while the various values allotted to common *variables* would continue from one program to the next.

### Parallel

A method whereby *data*, so many *bits* wide, can be transferred simultaneously over a group of wires — one wire per bit. An 8-bit system requires eight wires. In effect, the bits are transferred 'in parallel'.

### Peripheral

Device attached to a computer, eg *printer*, *plotter*, *disc* unit, but not necessarily essential to its use.

### PIA

A Peripheral Interface Adaptor. A device that does the *interfacing* between the *microprocessor* and/or *memory* and *peripherals*, converting the outgoing *binary* coded signals to the appropriate signals for the peripherals and converting any incoming signals to the appropriate code for the computer.

### Pointer

In the *microprocessor*, or in *memory* external to it, pointers can be *registers* allocated to listing *memory address* — they 'point' to memory locations.

### Port

*Terminal* which the *CPU* uses to communicate with the outside world.

### Printer

A device for producing typed or printed copy (*hard copy*).

### Print Out

Same as *hardcopy*.

### Processor

See *CPU*.

### Program

A set of *instructions*, either in *mnemonics*, in *digital (binary)* form or in a *high-level language*, which tells the computer to perform a sequence of tasks.

### Program Counter

*Register* in the *microprocessor* which keeps track of which part of the program is being *executed*.

### PROM

Programmable Read Only Memory. Proms are a special form of *ROM*, which can be individually programmed by the user.

### RAM

Random Access Memory. Read write memory. *Data* may be written to or read from any location in this type of memory.

### Reset

Simply — go back to the start, do not pass GO, do not collect 200 bytes. A switch whereby computer control is returned to the *monitor* or low-level *operating system* and all internal *variable* values are changed to zero. This may be the only way of getting out of some endless *loop* which has arisen from a programming error.

### Refresh

Usually refers to the process required by *dynamic memory* to ensure continued storage of *data* that has been sent to it.

Dynamic memory can be thought of as consisting of large numbers of small capacitors. When the *CPU*, for example, wants to store a specific bit of information in memory it charges one of these small capacitors. The capacitor will slowly discharge itself, however, so additional hardware is used to look periodically at all of the capacitors and refresh the charge on each one.

### Register

A general-purpose *memory*, or set of *memory locations*, built into the *microprocessor* itself. Sometimes, particular registers may be designated for a specific purpose.

### Relative Addressing

Mode of addressing whereby the *address* is formed by combining the current program count with a displacement value which is part of the *instruction*.

### Return

The key and corresponding computer instruction which sends the contents of *keyboard buffer* into a computer's *memory* for *execution* (term derives from 'carriage return' on a typewriter).

### ROM

Read Only Memory. *Memory* device which has its *data* content established as part of manufacture and cannot be changed.

### Routine

A whole *program* or part of a program designed to perform a single function or action.

### RS232

A communications *interface* used for *modems* and for *serial printers*.

### Run

*Instruction* to *execute* a *program*.

### S-100

Name of a *bus* or connection standard shared by many manufacturers and employing 100 connection positions. Unfortunately, there are some minor variations between different manufacturers' versions of the S-100 bus but the *IEEE* has now defined a universal standard for it.

### Serial

Transfer of *data* one *bit* at a time.

### Software

The different kinds of *program* required to work a computer.

### Source Code

*Program* written in one of the *high-level languages* and requiring *compilation* into *machine language* before use.

### Stack

A last-in-first-out store made up of *registers* or *memory* locations used for temporary storage.

### Stack Pointer

*Address* that specifies the location of the last entry in the *stack*.

### Static RAM

Random Access Memory which does not require continuous *refresh* signals. It tends to use more power than *dynamic RAM* and still loses its contents when power is removed.

### String

A sequence of *alphanumeric* characters.

### Subroutine

A part of a *program* which performs a specific task and which is available for use elsewhere in a program, as often as you like.

### Syntax

The grammar of a programming *language*.

### Terminal

A device, normally remote from the computer, at which *data* can enter or leave a communication network — eg a teletypewriter working over telephone lines.

### Time-Sharing

A method of operating a computer whereby two or more users apparently enjoy simultaneous access to, and control of the machine. In practice what is happening is that the computer is attending to the users one at a time, but in a sequence of time intervals so short that none is normally aware of any delay.

### Tri State

Description of logic devices whose outputs may be disabled by placing them in a high impedance state.

### Two's Complement Arithmetic

System of performing signed arithmetic with *binary* numbers.

### TTY

Teletype.

### Variable

A specified location in *memory* (usually *RAM*) which is allocated a specific meaning in a *program* or *routine*.

### VDU

Visual Display Unit. Usually a TV set in hobby computers, but may be a video monitor which accepts the output directly from the computer.

### Vector

*Memory address* provided to the *processor* to direct it to a new area in memory.

### Volatile

*Memory* devices that will lose *data* content if power supply removed (ie *RAM*).

### Word

*Parallel* collection of *binary* digits much as *byte*.

### Word Processor

A computer with *software* for entering, editing, storing, formatting and printing text, rather than processing figures. **HE**



# THE AFFORDABLE COMPUTER

## Acorn Computers

Acorn Computers,  
4A, Market Hill,  
Cambridge.  
Tel: 0223-312772

### Acorn

CPU	6502
RAM	1K/8K
I/O	Bus Parallel
Cassette	Yes
Price	£65 upwards

The Acorn is a single-board computer with a piggy-back Hex keypad and cassette interface. Although able to be programmed in machine code only, the Acorn micro is designed with rack-based expansion capability allowing extras, including BASIC, to be added.

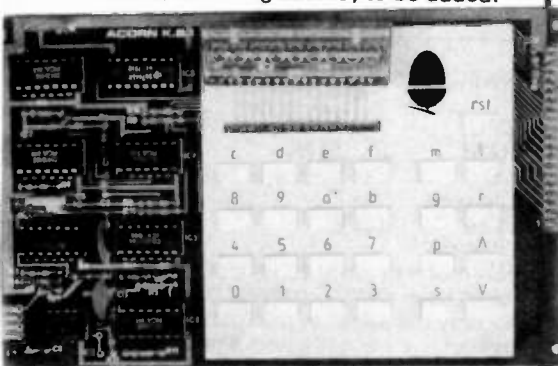

### ATOM

CPU	6502
RAM	2K/11K
I/O	Bus Parallel
Cassette	Yes
Price	£125 kit, £150 built

The ATOM is a cased, single-board microcomputer, able to be programmed in either BASIC or assembly code; it also allows nested assembler programs to be written at the same time as BASIC.

Although the ATOM BASIC is an Integer BASIC (it can't handle fractions), an additional ROM chip can be added, providing a full range of mathematical functions, floating point arithmetic and colour graphics commands.

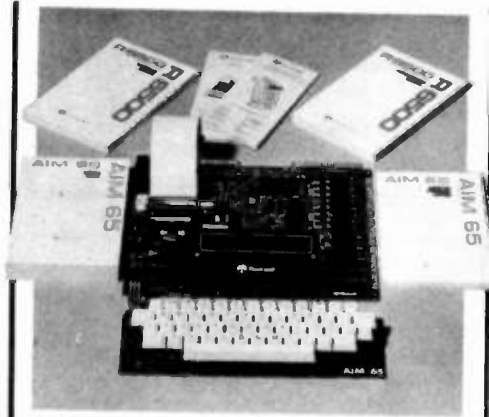
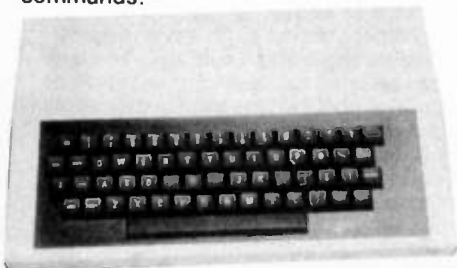

### AIM 65

Pelco Electronics,  
Enterprise House,  
83-85 Wester Road,  
Hove, Sussex BN3 1UB.  
+ many regional outlets  
Tel: 0273-722155

### Rockwell AIM 65

CPU	6502
RAM	1K/4K
I/O	Serial Parallel
Cassette	Yes
Price	£265 upwards

The AIM 65 consists of two boards, one holding the 54-key keyboard and the other, the processor, the 20 character, 16-segment LED display and the 20 column printer. When first introduced the AIM 65 had no video interface, however, it now has a video option — so all of you interested in interactive games can breathe again. The machine includes a Text Editor as part of the standard system software and includes 8K of BASIC, an 8K machine code monitor and Assembler options. Other extras include additional RAM, a disc option and a case for the complete system.

### ATARI

Ingersoll Electronics,  
202, New North Road,  
London N1 7BL.  
Tel: 01-226 1200

### ATARI 400

CPU	6502
RAM	16K
I/O	Serial
Cassette	Yes
Price	£400

The ATARI 400 can be programmed in machine code and BASIC and is supported by a wide range of software packages.

Additional extras include a plug-in board incorporating four RS232 interfaces and a parallel Centronics printer interface port. You will need to buy a special cassette deck as the ATARI 400 supports its own and no other — however, don't worry, the Atari cassette deck comes complete for around £50.

There is also a down-grade model of the ATARI 400, soon to be available in this country for £299.95. Before you rush and order one, though, bear in mind that it is only an ATARI 400 without the essential BASIC pack, which you'll need anyway.



### BBC Microcomputers

BBC Microcomputer Systems,  
PO Box 7,  
London W3 6JX.

### BBC Model A

CPU	6502
RAM	16K
I/O	Various
Cassette	Yes
Price	£299

The introduction of the BBC micros caused quite a stir earlier in the year . . . simply because they were exceptional value for money! Since then, the prices have been increased but they still command a significant share of the home computer market.

## ■ Popular Computing

The Model A can be programmed in BBC BASIC (probably the most powerful adaptation of BASIC yet) allowing fully structured programming techniques and, in a similar way to the ATOM, can handle nested assembler programs.

A number of additional extras are available, including a floppy disc controller, a speech synthesiser, an Econet interface and a universal expansion interface called the TUBE. This last feature is available on BBC machines alone, providing a direct communications link to the processor. To give an example of the expansion possibilities, plans are under way to develop a 16-bit processor, to connect to the TUBE, that will provide a further 256K of RAM!

The Model A includes sound and bus interfaces and is completely expandable to the Model B.

### BBC Model B

CPU	6502
RAM	32K
I/O	Various
Cassette	Yes
Price	£399

Similar in format to the Model A, the Model B machine includes the following extras: a serial interface to RS432 standard; an 8-bit 'Centronics-type' parallel printer port and an I/O port. There is also a 1 MHz buffered extension bus provided for connection to PRESTEL, Teletext or various other expansion units.



### HEATHKIT H8

Heath Electronics,  
Bristol Road,  
Gloucester GL2 6EE.  
Tel: 0342-29451

#### Heathkit H8

CPU	8080
RAM	4K/56K
I/O	Various
Cassette	Yes
Price	£275 upwards

The Heathkit H8 is a bus-based kit system incorporating BASIC and a 4K machine code monitor with full 'front panel' — the front panel (a hangover from the mini-computer days) allows you to inspect and modify the internal workings of the processor.

Extras for the H8 include a disc option, various printers and a VDU. A number of high level languages can be added to the system, loaded from tape or disc.

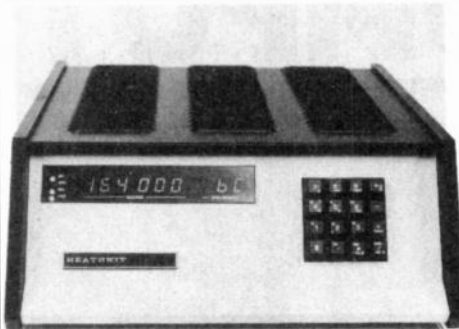

### Nascom Microcomputers

Lucas Logic,  
Nascom Microcomputers Division,  
Welton Road,  
Wedgcock Industrial Estate,  
Warwick CV34 5PZ.  
Tel: 0926-497733

#### NASCOM 1

CPU	Z80
RAM	1K/227K
I/O	Serial Parallel Bus
Cassette	Yes
Price	£125

The NASCOM 1, simplest of the NASCOM range, is a full 47-key keyboard machine code system available in kit form or as an assembled, but uncased, system.

Although programmable in machine code only, there is an option for BASIC. Other extras include a motherboard, additional RAM, ROM and discs. A case for the complete system is also available.

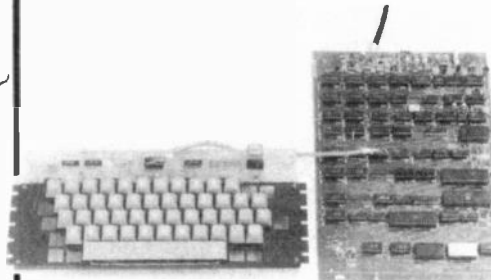

#### NASCOM 2

CPU	Z80
RAM	1K/227K
I/O	Serial Parallel Bus
Cassette	Yes
Price	£225

Supplied in kit form or as an assembled, but uncased, system, the NASCOM 2 is an upgrade of the NASCOM 1.

The NASCOM 2 comes complete with 8K of Microsoft BASIC, assisted

by the NAS SYS operating system with full screen editing. Other optional extras including additional RAM, discs, a high resolution graphics board and a case.

Using a ROMcard for firmware expansion, the NASCOM 2 can also support a wide range of compatible software including enhanced BASIC; MBASIC — a compiled BASIC for fast program execution running under CP/M; NASCOM Pascal; NAS-PEN — NASCOM's word processing package; ZEAP — a Z80 editor-assembler package; NAS-DIS — a companion disassembler for ZEAP; NAS-DEBUG — a debugging aid; NAS-DOS — NASCOM's own disc operating system; and CP/M 2.2 — a full implementation of the CP/M disc operating system.

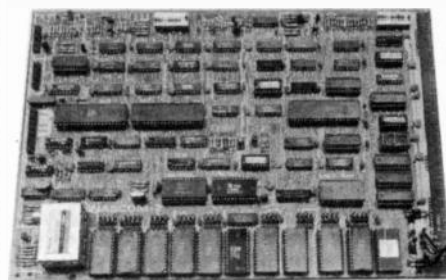

#### NASCOM 3

CPU	Z80
RAM	8K/227K
I/O	Serial Parallel Bus
Cassette	Yes
Price	£376

Not much to write about this system — its all been said! The NASCOM 3 is exactly the same as the NASCOM 2 system . . . but it's packaged in a strong case with a high quality QWERTY keyboard.

### Netronics

Newtronics,  
255, Archway Road,  
London N6.  
Tel: 01-348 3325

#### ELF II

CPU	1802
RAM	¼K/4K
I/O	Parallel
Cassette	Optional
Price	£60

The ELF II is a fairly basic kit system incorporating CPU and RAM as described above, an 1852 VDU controller, a two digit, seven segment display and a Hex keyboard. The unit can be used for development work or control applications but is particularly suitable for training and education purposes as the system hardware and software is built up in easy stages. Optional extras for the ELF include

additional RAM and a motherboard (called the Giant) providing a 1K machine code monitor and an interface for a cassette. Using the cassette interface, various software options are available including ELF-bug — a debugging aid; an Assembler; and BASIC, although to program the system with BASIC an ASCII keyboard will be required.

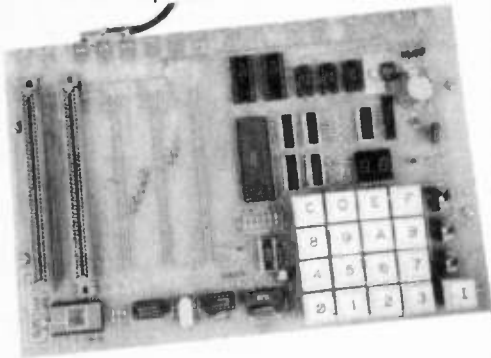

**EXPLORER 85**

CPU 8085  
 RAM 4K  
 I/O Parallel Bus  
 Cassette Yes  
 Price £285

The EXPLORER 85 is an S100-based kit system that when fully expanded can cope with up to six S-100 boards. Complete with a 2K machine code monitor, 8K of Microsoft BASIC can be added via ROM or cassette. No keyboard is supplied with the EXPLORER 85 and neither does it have the ability to directly drive a display, thus you may be glad to hear that an ASCII keyboard and video card are available from Netronics. There is also available a case and a power supply to run the full expansion.



**PC 1211**

Sharp UK Ltd,  
 Thorn Road,  
 Newton Heath,  
 Manchester M10 9BE.  
 + growing network of dealers  
 including Microdigital.  
 Tel: 061-205 2333

**PC 1211**

CPU 2 x 4-bit custom processor  
 RAM Approx 1.5K  
 I/O No  
 Cassette Optional  
 Price £120 upwards (inclusive of cassette adaptor)

The PC 1211 is a pocket-sized (about the size of a cheque book) 1424 step programmable computer working in the BASIC language. The display consists of a 24 character, 5 x 7 dot matrix LCD strip which rolls to give an 80 character line. A cassette adaptor and a printer interface are available as optional extras. The silver oxide battery cells can be expected to last around 300 hours and the machine thoughtfully turns itself off after seven minutes if you have left it on. A useful little machine!



**Tangerine Computers**

Tangerine Computers,  
 Forehill,  
 Ely, Cambs.  
 Tel: 0353-3633

**MICROTAN 65**

CPU 6502  
 RAM 1K/48K  
 I/O Bus  
 Cassette Optional  
 Price £69 upwards

Containing a 1K machine code monitor (Tanbug), the MICROTAN 65 can be expanded with a Tanex board providing a 10K Microsoft BASIC, parallel and serial I/O, an additional 7K of RAM and XBUG (an extension monitor). Tangerine offer Tanram as an expansion system offering a further 40K of user RAM; another system promised a year ago, Tandisc (offering the option to use floppy discs), has still yet to appear on the UK market. With an additional Hex keypad or full ASCII keyboard, this system becomes a very powerful beast indeed.

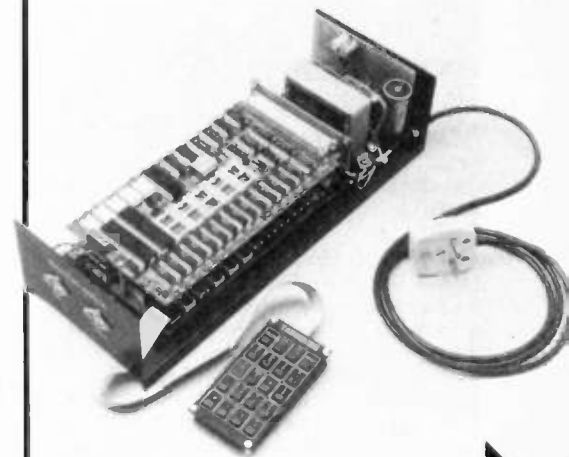

**SUPERBOARD II**

Mutek,  
 Quarry Hill,  
 Box, Wiltshire.  
 + many regional dealers  
 Tel: 0225-743289

**SUPERBOARD II**

CPU 6502  
 RAM 4K/32K  
 I/O Parallel Bus  
 Cassette Yes  
 Price £150

The SUPERBOARD II is a ready-built single board computer with a 2K machine code monitor and 8K of Microsoft BASIC in ROM. Options for the SUPERBOARD include room for an additional 4K of plug-in RAM, discs and an RS232 interface. A case for the complete system is also available. A large range of software, on both tape and disc, supports the SUPERBOARD.

## MICRON

CPU	6502
RAM	8K/227K
I/O	1 serial, 4 parallel
Cassette	Yes
Price	£395

Complete with 10K of Microsoft BASIC and a 3K machine code monitor, the MICRON also provides XBUG, an extension monitor providing Assembler/Disassembler functions, as a standard feature. The unit has a soundboard and is capable of high resolution graphics. Extras offered include additional RAM, an I/O rack system and a disc option.



## Tandy Corporation

Tandy Corporation,  
12th Floor, Tameway Tower,  
Bridge Street, Walsall,  
West Midlands WS1 1LA.  
+ many regional shops

### TRS-80 Model 1

CPU	Z80
RAM	4K/48K
I/O	Optional
Cassette	Yes
Price	£380 upwards

The TRS-80 Model 1 is available with two levels of BASIC: a fairly standard BASIC and one with a few luxury items such as Auto Line Numbering and IF . . . THEN . . . ELSE; and a 48K machine code monitor. A number of options are offered on the Model 1 allowing discs, printers, I/O, high resolution graphics and lower case characters to be used.

### TRS-80 Model III

CPU	Z80
RAM	4K/48K
I/O	Parallel
Cassette	Yes
Price	£499 upwards

The Model III is a complete packaged version of the TRS-80 Model I with the added extra of enhanced Level III BASIC. All the options for the Model I are also available for the Model III with the addition of an RS232 interface.



### Color Computer

CPU	6809
RAM	16K
I/O	Serial
Cassette	Yes
Price	£449

The new Tandy Color Computer incorporates Color BASIC, different to the BASIC languages used in the Models I and III. Including an option for disc expansion, the Color Computer is also ably supported by a number of Program Paks that actually plug into the machine.



### Pocket Computer

CPU	2 x 4-bit custom processor
RAM	Approx 1.5K
I/O	No
Cassette	Optional
Price	£119

The Tandy Pocket Computer is a hand-held BASIC programmable computer almost identical to the Sharp PC 1211 (see description of the Sharp).

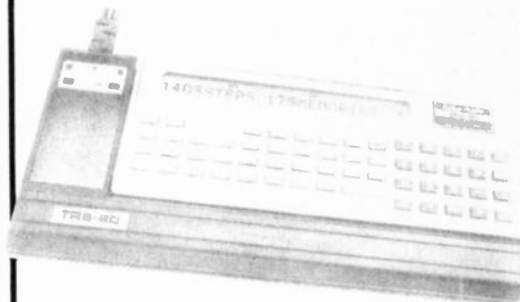

### TI-99/4A

Texas Instruments,  
European Consumer Division,  
Manton Lane,  
Bedford MK41 7PA.  
Tel: 0234-67466

### TI-99/4A

CPU	TMC 9900
RAM	16K
I/O	Various
Cassette	Yes
Price	£299

Based on TI BASIC, the TI-99/4A is capable of reproducing 16-colour graphics. Expandable up to 32K, various additional options can support the basic system including a speech synthesiser, a thermal printer, an RS232 peripheral adaptor and a disc memory system. Software options include Pascal and the TMS 9900 Assembler. The TI-99/4A is fully supported by over 400 software packages.

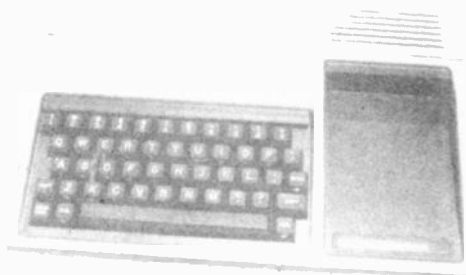



**TUSCAN**

Transam,  
59-61 Theobalds Road,  
London WC1.  
Tel: 01-405 5240

**TUSCAN**

CPU Z80  
RAM 1K/8K  
I/O Serial Parallel  
Cassette Yes  
Price £195 upwards

The TUSCAN is an S-100 based development system (kit or ready-built) containing a 2K machine code monitor. Options for both BASIC and Pascal are available. Other extras include casing for the complete system, VDU, a disc option, various firmware and S-100 boards.

**UK 101**

CompShop,  
14, Station Road,  
New Barnet,  
Herts EN5 1QW.  
Tel: 01-441 2922

**UK 101**

CPU 6502  
RAM 4K/32K  
I/O Serial Parallel  
Cassette Yes  
Price £149 kit, £199 built

The UK 101, incorporating 8K of BASIC and a 2K machine code monitor (allowing programs to be written in machine code), is basically a UK adaptation of the Superboard II microcomputer.

Allowing expansion of user memory via a RAM pack, extra interfaces and optional disc facilities via an expansion board, the UK 101 can also be upgraded with new machine code monitors.

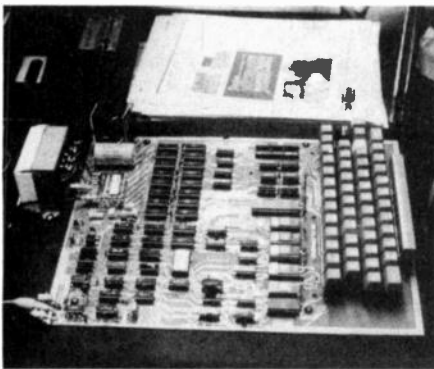

**VIC-20**

Commodore,  
675, Ajax Avenue,  
Slough,  
Bucks.  
+ many regional dealers



**VIC-20**

CPU 6502  
RAM 3K/32K  
I/O IEEE-488 Parallel  
Cassette Yes  
Price £199.99 + VAT

The VIC-20 is a personal computer system incorporating 8K of Microsoft BASIC with colour and sound. However, a word or two about the screen formats. The resolution is not particularly good and very awkward to program in colour. Also, the screen format is not compatible with the PET, so you will find much of the software available on the market will have to be drastically rewritten for the VIC. The system allows for additional memory and an RS232 interface to be added. A special cassette is required for the VIC-20 system costing around £50.



**Video Genie**

Low Electronics,  
Bentley Bridge,  
Chesterfield Road,  
Matlock, Derbyshire DE4 LEF.  
+ dealer network  
Tel: 0629-2817

**Video Genie**

CPU Z80  
RAM 16K/48K  
I/O Parallel Bus  
Cassette Yes  
Price £425

The Video Genie is basically a Hong Kong copy of the TRS-80 with Level II BASIC. The machine contains 10K of BASIC and a 2K machine code monitor. Newer versions of the Video Genie contain an upgraded keyboard and no internal cassette; other versions are capable of colour graphics. Extras include a printer and discs via an expansion unit à la Tandy.



**ZX81**

Science of Cambridge,  
6, Kings Parade,  
Cambridge CB2 1SN.  
Tel: 0223-311488

**ZX81**

CPU Z80A  
RAM 1K/16K  
I/O Bus  
Cassette Yes  
Price £49.95 kit, £69.95 built

You'll all have heard of Clive Sinclair's ZX81 — replacing the successful ZX80; this is the one that has really taken the computer into the home and at less than £50 for the kit you can see why. Complete with 8K of BASIC, the ZX81 can interface to an additional 16K of RAM and a Sinclair printer. There is a wide range of software available for the ZX81.

**HE**

AT YOUR NEWSAGENTS NOW!  
ONLY £1.60!

# ELECTRONICS

# DIGEST

Vol. 2 No. 3

£1.60

## 150 CIRCUITS FOR THE EXPERIMENTER

GAMES • RADIO • AUDIO • MUSIC and DISCO INDICATORS and ALARMS

TEST GEAR • HOUSE and HOME LIGHTING and PHOTOGRAPHY • POWER SUPPLIES • POWER CONTROL

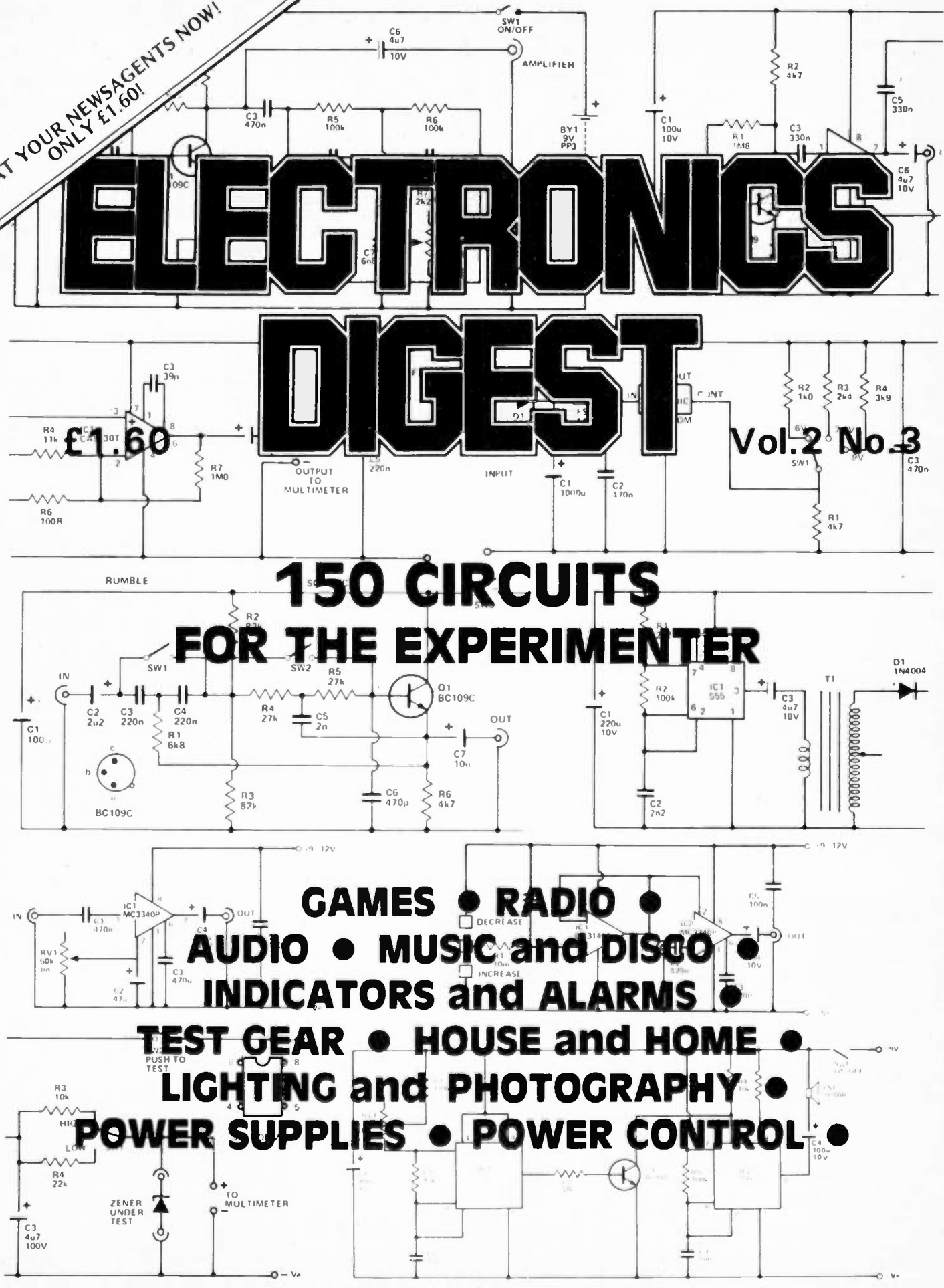

# CAMBRIDGE LEARNING SELF-INSTRUCTION COURSES

**Microcomputers are coming - ride the wave! Learn to program.** Millions of jobs are threatened but millions more will be created. Learn BASIC - the language of the small computer and the most easy-to-learn computer language in widespread use. Teach yourself with a course which takes you from complete ignorance step-by-step to real proficiency with a unique style of graded hints. In 60 straightforward lessons you will learn the five essentials of programming: problem definition, flowcharting, coding the program, debugging, clear documentation.



Book 1 Computers and what they do well, READ, DATA, PRINT, powers, brackets, variable names, LET, errors, coding simple programs.  
Book 2 High and low level languages, flowcharting, functions, REM and documentation, INPUT, IF...THEN, GO TO, limitations of computers, problem definition.  
Book 3 Compilers and interpreters, loops, FOR...NEXT, RESTORE, debugging, arrays, bubble sorting, TAB  
Book 4 Advanced BASIC, subroutines, string variables, files, complex programming, examples, glossary

## COMPUTER PROGRAMMING IN BASIC

£10.50

Book 1 Computers and what they do well, READ, DATA, PRINT, powers, brackets, variable names, LET, errors, coding simple programs.  
Book 2 High and low level languages, flowcharting, functions, REM and documentation, INPUT, IF...THEN, GO TO, limitations of computers, problem definition.  
Book 3 Compilers and interpreters, loops, FOR...NEXT, RESTORE, debugging, arrays, bubble sorting, TAB  
Book 4 Advanced BASIC, subroutines, string variables, files, complex programming, examples, glossary

## Understand Digital Electronics

Written for the student or enthusiast, this course is packed with information, diagrams and questions designed to lead you step-by-step through number systems and Boolean algebra to memories, counters and simple arithmetic circuits and finally to an understanding of the design and operation of calculators and computers.



## DESIGN OF DIGITAL SYSTEMS £14.00

Book 1 Octal, hexadecimal and binary number systems, conversion between number systems, representation of negative numbers, complementary systems.  
Book 2 OR and AND functions, logic gates, NOT, exclusive OR, NAND, NOR and exclusive NOR functions, multiple input gates, truth tables, De Morgan's Laws, canonical forms, logic conventions, karnaugh mapping, three state and wired logic.  
Book 3 Half adders and full adders, subtractors, serial and parallel adders, processors and ALU's, multiplication and division systems.  
Book 4 Flip flops, shift registers, asynchronous and synchronous counters, ring, Johnson and exclusive OR feedback counters, ROMS and RAMS.  
Book 5 Structure of calculators, keyboard encoding, decoding display data, register systems, control unit, program ROM, address decoding.  
Book 6 CPU, memory organisation, character representation, program storage, address modes, input/output systems, program interrupts, interrupt priorities, programming, assemblers, computers, executive programs, operating systems.

### GUARANTEE No risk to you.

If you are not completely satisfied, your money will be refunded upon return of the books in good condition.

**CAMBRIDGE LEARNING LIMITED, Unit 94, RIVERMILL SITE**  
FREEPOST, ST. IVES, HUNTINGDON, CAMBS., PE17 4BR, ENGLAND.  
TELEPHONE: ST. IVES (0480) 67446

All prices include worldwide postage (airmail is extra - please ask for prepayment invoice). Please allow 28 days for delivery in U.K.

Please send me the following books -

Computer Programming in BASIC @ £10.50

Design of Digital Systems @ £14.00

I enclose a cheque/PO payable to Cambridge Learning Ltd for £ (delete where applicable)

Please charge my

\* Access/American Express/Barclaycard/Dimis/Club Eurocard/Visa/Mastercharge/Trustcard

Expiry Date Credit Card No

Signature  
Telephone orders from credit card holders accepted on 0480 67446 (Ansalone)

Overseas customers (incl. Eire) should send a bank draft in sterling drawn on a London bank or quote credit card number.

Name

Address

Cambridge Learning Limited, Unit 94, Rivermill Site  
FREEPOST St Ives Huntingdon Cambs PE17 4BR England  
(Registered in England No 1328762)

# YOU CAN'T BEAT ILP BIPOLAR POWER AMPS FOR POWER AND PRICE

Get maximum power at minimum price, yet still with hi-fi specifications and a wide choice of outputs. ILP Bipolar power amps, now with or without heatsinks are unbeatable value for domestic hi-fi — but for disco, guitar amplifiers and PA choose the new range of heavy duty power amps, again with or without heatsinks, with protection against permanent short circuit, added safety for the disco or group user. Connection in all cases is simple — via 5 pins.

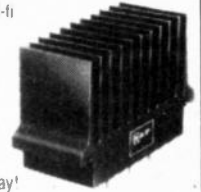

Every item has a 5 year no quibble guarantee and includes full connection data. So send your order FREEPOST today!

Load impedance, all models, 4 ohm — infinity. Input impedance, all models 100k ohm. Input sensitivity, all models, 500 mV. Frequency response, all models 15Hz-50kHz-3db.

### BIPOLAR Standard, with heatsinks

Model No	Output power Watts rms	DISTORTION		Supply voltage Typ/Max	Size mm	Wt gms	Price inc VAT	Price ex VAT
		T H D Typ at 1kHz	I M D 50Hz/7kHz 4:1					
HY 30	15w/4-8Ω	0.015%	<0.006%	+18±20	76×68×40	240	£8.28	£7.29
HY 60	30w/4-8Ω	0.015%	<0.006%	+25±30	76×68×40	240	£9.58	£8.33
HY 120	60w/4-8Ω	0.01%	<0.006%	+35±40	120×78×40	410	£20.10	£17.48
HY 200	120w/4-8Ω	0.01%	<0.006%	+45±50	120×78×50	515	£24.39	£21.21
HY 400	240w/4Ω	0.01%	<0.006%	+45±50	120×78×100	1025	£36.60	£31.83

### BIPOLAR Standard, without heatsinks

HY 120P	60w/4-8Ω	0.01%	<0.006%	+35±40	120×26×40	215	£17.83	£15.50
HY 200P	120w/4-8Ω	0.01%	<0.006%	+45±50	120×26×40	215	£21.23	£18.46
HY 400P	240w/4Ω	0.01%	<0.006%	+45±50	120×26×70	375	£32.58	£28.33

Protection: Load line, momentary short circuit (typically 10 sec). Slew rate 15V/μs. Rise time, 5μs. S/N ratio 100db. Frequency response (-3dB) 15Hz-50kHz. Input sensitivity 500mV rms. Input impedance 100kΩ. Damping factor (8Ω/100kΩ)>400.

### HEAVY DUTY with heatsinks

Model No	Output power Watts rms	DISTORTION		Supply voltage Typ/Max	Size mm	Wt gms	Price inc VAT	Price ex VAT
		T H D Typ at 1kHz	I M D 50Hz/7kHz 4:1					
HD 120	60w/4-8Ω	0.01%	<0.006%	+35±40	120×78×50	515	£25.85	£22.48
HD 200	120w/4-8Ω	0.01%	<0.006%	+45±50	120×78×60	620	£31.49	£27.38
HD 400	240w/4Ω	0.01%	<0.006%	+45±50	120×78×100	1025	£44.42	£38.63

### HEAVY DUTY without heatsinks

HD 120P	60w/4-8Ω	0.01%	<0.006%	+35±40	120×26×50	265	£22.82	£19.84
HD 200P	120w/4-8Ω	0.01%	<0.006%	+45±50	120×26×50	265	£27.17	£23.63
HD 400P	240w/4Ω	0.01%	<0.006%	+45±50	120×26×70	375	£39.42	£34.28



Protection: Load line, PERMANENT SHORT CIRCUIT (ideal for disco/group use should evidence of short circuit not be immediately apparent). The Heavy Duty range can claim additional output power devices and complementary protection circuitry with performance specs as for standard types.

How to order Freepost: Use this coupon or a separate sheet of paper, to order these products, or any products from other ILP Electronics advertisements. No stamp is needed if you address to Freepost. Cheques and postal orders must be crossed and payable to ILP Electronics Ltd. Cash must be registered. C.O.D. — add £1 to total order value. Access and Barclaycard welcome. All UK orders sent post free within 7 days of receipt of order.

Please send me the following  
ILP modules

Total purchase price

I enclose Cheque  Postal Orders  Int. Money Order

Please debit my Access/Barclaycard No

Name

Address

Signature

Post to: ILP Electronics Ltd, Freepost 2, Graham Bell House, Roper Close,  
Canterbury, CT2 7EP, Kent, England.  
Telephone: 02271 54778. Technical 02271 64723. Telex 965780.

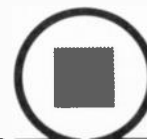

**ILP  
ELECTRONICS LTD**

HE2/4

# STAY AHEAD. STAY WITH US

# Clever Dick

In an unusual spirit of helpfulness, I'll start this month's offerings with a piece of useful information. Don't get too excited, though . . .

Dear Clever Dick,  
Reference the Audio Millivoltmeter project, HE May 1981.

The transistor specified is a BC 558A but I cannot trace this through the usual suppliers. As I'm keen on constructing this project, perhaps you could suggest where I could obtain the transistor? Alternatively, you might be able to name an equivalent.

Thank You,  
D. Summersby,  
Canterbury, Kent.

Perhaps? Might? Does this man doubt my wisdom?

Of course I can . . . just let me think a moment.

I'm surprised you haven't been able to find it, though. The BC558 is a fairly common general purpose PNP silicon transistor available from Rapid Electronics and Watford Electronics, among others, and appears in their advertisements in the latest issue of HE. The 'A' designation indicates a different pin configuration; otherwise it is the same as the BC558.

Producing a monthly magazine is like politics — you can please all of the people some of the time, or some of the people all of the time — but you can't please all of the people all of the time (with apologies to A. Lincoln). Sometimes though, we win one . . .

Dear CD,  
After buying HE and binders for three years I decided to stop because my money supply was short and it seemed as though most of the circuits you print are just 'mods' of those from Volume 1. But, on the way home one night, I noticed the February '82 issue and thought I'd give you a second chance.

Not bad, I thought, except that you've made a boo-boo in the last paragraph of column one on page 54, in the feature Solder/Soldering.

You state that tin melts at 327°C and lead melts at 232°C; surely this is the other way round? Otherwise it wouldn't tie in with the Eutectic curve on page 54 (I'm an industrial chemist working in the motor industry and just lately I've been investigating solder melting points, as it is used as a car body filler — "lead loading").

Now I've caught you out, don't you think I deserve a binder eh? I've started saving HE again!

Also, was it not Lee De Forest who wrote and worked on photo-resists? Come clean — how about a review of his work on this subject?

Thanks,  
A. Mason,  
Birmingham.

After a promising start, it appears that we lose, after all. Yes, tin actually melts at 232°C and lead at 327°C, as shown in the diagram at the top of page 54. As for Lee D. Forest, I'm investigating and will let you know when — and if — I find out!

A perceptive reader in Dundee, Scotland, has spotted an error in one of my earlier replies.

Clever Dick,  
I read with interest your reply to I. Scholey's request for a supplier of a thyristor (February '82), your answer being R.S. Components.

I have access to the R.S. catalogue where I work and, as I have been searching for some 1% resistors for a digital meter, here was my problem solved! But on the back page, under their "terms of business", R.S. state that they will only accept orders from "bona fide" trade users. Or is it only in your area (south of Watford Gap) that locals can use the trade counter?

Meanwhile I am still searching for the resistors.  
Yours sincerely,  
T. Bowman,  
Dundee.

It seems that I allowed my enthusiasm for R.S. Components well-ordered (and well stocked) catalogue to obscure the fact that they only accept orders from "full time Industrial, Educational and Trade users of electronic and electrical components". Fortunately, there is a solution to your problem: Crewe Allan, 51 Scrutton Street, London EC2A 4PJ, (Tel. 01-739 4846) can supply components from R.S.'s catalogue.

Many thanks to all those readers who suggested methods for reversing the polarity of a dynamo. Meanwhile, Mr. Lawrence (and, presumably, his car stereo) is still alive and well.

Dear CD,  
As a beginner in electronics, I find your magazine very readable and comprehensible. I have now been an avid reader of HE since June '81.

My interest in electronics really takes me to hi-fi and some of its applications and for this reason I am

indebted to you for your marvellous new feature, Scaling the Hi-Fi Heights. It really has been very helpful.

I have built your Ladder of Light (January '81) with great success but would like to extend my effects. I would be grateful if you could see your way to publishing a circuit for a strobe light (possibly for use with car tuning, as well) or maybe a circuit for smoothly switching from one pair of speakers to another (for those among us whose amps have only one pair of outputs), or perhaps a series on sequencers and sound lights.

Keep up the good work and thanks for a great mag.  
Yours sincerely,  
A.M. Lawrence,  
Chessington, Surrey.

A couple of interesting suggestions there, which have been passed to the editor for consideration (that's what he calls it).

Some of the subjects we like to talk about — and you like to read — are a little too complex to be covered in just one article. One of the problems with a series, though, is that readers who miss the first few instalments sometimes manage to miss a vital point.

Dear CD,  
I am new to HE and have only the last three issues. What do I think about them? Here's what I think: "brilliant, fantastic, super, irresistible, educational — and funny".

I enjoy the feature Into Electronic Components but I have a major problem. I can't build the HE Meter used for the tests 'cause I don't have a circuit or any information about it.

So please, please, please, can you send me those articles?  
Yours sincerely,  
A. Hunt,  
Bath, Avon.

Regular readers of HE can stop chuckling, now. They know that the HE Meter was never a project but a standard multimeter which was on special offer in the August 1981 issue. Although the series was written around this meter, almost any regular multimeter will do the trick — just be careful to switch to an equivalent or higher range than that mentioned in the article.

As the magazine which supported Citizens' Band radio in the days before it became really popular, we have



always maintained an interest in the subject, as have at least a few readers.

*Dear Clever Dick,  
Is the TV/FM Masthead Amplifier suitable for a Citizens' Band radio antenna? Also, the PCB design is not very clear (especially the top foil). Could you please clarify these for me?*

*While I'm on the subject of CB, I have found that my loft is unsuitable for an antenna. Is it possible to line my bedroom floor with silver foil, with a biscuit tin underneath, and stick a magnetic mount to the biscuit tin? Yours faithfully,  
R. Castley,  
Fareham, Hants.*

Without knowing in what way your loft is unsuitable, it is difficult to advise how to rig up a suitable antenna — but I would certainly NOT recommend lining the floor with silver foil, or using a biscuit tin as a base for a mag-mount antenna. Try one of the commercially available base station antennas from Telecomms, 189 London Road, North End, Portsmouth (Tel. 0705 662145).

The Masthead Amplifier will operate down to 40 MHz, according to the data sheet, which means that it probably is not useful for the CB band (27 MHz). The component overlay on page 42 shows the bottom PCB foil, viewed from the top ie, through the board. Although it is slightly blurred (due to peculiar production problems that month) it is ACCURATE; the important point is that pin 1, the input, is one on the right of the board, as shown.

I have had many letters suggesting methods for reversing the polarity of a negative earth car electrical system, all of which corresponded to the information I sent on to Mr. Lawrence. Mr. Banks, of Dartford, Kent, also had another interesting suggestion.

*Dear CD, . . . .  
Oh, and one more bit of genius (modest, isn't he?) this time regarding your Switch-Tuned Radio project (January 1982). Why not replace one of the presets with a normal potentiometer of the same value, and bring it out to the front panel? This would then give five preset stations and the complete freedom of the dial for those 'on-off' stations you never otherwise listen to.  
Yours sincerely,  
R. Banks,  
Dartford, Kent.*

An excellent suggestion which should not prove difficult for HE constructors. If anyone tries it, let me know 'how it works'!

Now for another instalment from the Helpful Hints Department, Ancient History Division.

*Dear Clever Dick,  
Could you please tell me which relay was used in the Car Alarm project (February 1979) and also, where I can*

*purchase one?  
Yours sincerely,  
J. Beardswood,  
Liverpool.*

The relay is listed as a 12 V/280R type with contacts rated at 6 amps; you could try TK Electronics at 11 Boston Road, London W7 3SJ (Tel. 01-579 9794) for a suitable equivalent. Unfortunately, Hobbyprints are no longer produced, so you will have to make your own PCB; take a look at HE's February issue for the easy way.

We always try to make clear where components for HE projects can be obtained, but not always successfully.

*Dear Clever Dick,  
As a newcomer to your magazine, I would be most grateful if you could help me.*

*Why is it that nearly every time I try to get components, eg resistors, diodes, capacitors and transistors, I am told to write away to the makers?*

*As I have decided to build your Noiseless Fuzz Box (HE, February '82), I'm worried that I may not be able to get the components I require. Does the Fuzz Box come in kit form? If not, can you recommend a reliable supplier?*

*Finally, may I congratulate you on Makin' Tracks; it shows step-by-step, easy-to-follow instructions on how to make PCBs.*

*Thanks,  
G. Logan,  
Yorkshire.*

Well, I have certainly never advised anyone to "write away to the makers"; they are generally not in the business of supplying parts to small customers (no offence) such as you and I. We try to indicate where parts are commonly available in Buylines and, as of this issue, these have been collected into a single page of information which will make the laws of supply easier to handle. The law of demand is up to you!

That particular project is not available as a kit but all the parts should be available from one of the many mail-order suppliers who advertise in HE.

Occasionally I receive a letter marked "not for publication", which is OK by me (some of them I couldn't print, anyway!), but those who do not include an SAE cannot expect a reply by post, either. Would the lads from Kenmare, Co. Kerry, please take note?

I appear to have quite a few fans in the Emerald Isle.

*Dear CD,  
I am fourteen and trying to pick up electronics as a hobby, but so far I am only able to make a few simple kits.  
I find that HE is the best magazine about. Please, could you send me some information on electronics or old HE magazines?  
Yours faithfully,  
J. Kilgannon,  
Co. Galway, Ireland.*

*PS Your page is the best in Hobby Electronics.*

Well, thanks for the compliment, but I suggest you try reading a few of the other pages, too. Like the Backnumbers and Book Service pages.

Fault-finding by remote control (ie, your letters) is impossible unless the symptoms of the fault are accurately described (it's no use writing in that "it doesn't go!"), so take note of this next letter, when next you have a problem for me to solve!

*Dear Clever Dick,  
I am operating two televisions from one aerial via a splitter box. One is a 26" colour set with pre-set tuning and the other is a mains-operated portable with a rotary tuning control. If I turn both sets on, leaving the portable un-tuned, I get a perfect picture on the colour set.*

*However, when I tune the portable, the picture on the colour TV becomes unstable and various interference patterns occur.*

*It is possible to get a good picture on the colour set by extremely careful adjustment of the tuning of the portable set — but it is difficult. The portable picture is OK at all times.*

*Can you help?  
P.K. Spruce,  
Stoke-on-Trent.*

Running more than one TV off a single aerial is always a chancy business; you may get two good pictures, but usually you don't. It all depends on the strength of the signal you are picking up from the transmitter. The effect you are describing sounds like insufficient signal strength, so the HE Masthead Amplifier (February 1982) is what you need for a little extra boost down the wire.

Many HE readers are interested in models, of one kind or another; others have more special interests.

*Dear CD,  
I was recently asked, by a friend, if I knew a way to take an electronic steam whistle effect for use on a model railway. I could only offer a modern diesel engine horn circuit, which would not suit a steam train.*

*Please could you help tidy up his problem, and mine.  
Yours grovellingly,  
A. Donaldson,  
Solihull.*

This is an easy one; a Steam Loco Whistle project appeared in the March 1981 issue. Your friend might also be interested in the Steam Chuffer (January 1981), not to mention our super Dual Engine Driver in this month's issue.

That's it for this month. Perhaps they'll let me go home, now.

# It's easy to complain about advertisements.

**The Advertising Standards Authority.**  
**If an advertisement is wrong, we're here to put it right.**

A.S.A. Ltd., Brook House, Torrington Place, London WC1E 7HN.

## DO YOU LONG TO HEAR YOUR DOORBELL RING?

Our latest kit gives you a pleasing three-note harmonically related sequence instead of the usual annoying continuous buzz of the same old ding-dong at a touch of a button. This kit, based on a new integrated circuit, is supplied complete with a pre-set control knob, loudspeaker and detailed text and requires only 9V battery and push button to install in most households.

It may also be switched by logic in such applications as car alarms, clocks, toys, P.A. systems, etc. The unit produces a 150mW output and draws less than one 1uA from a PP3 battery when the tone ceases. Supplied complete with circuit and assembly instructions.

**IDEAL PROJECT FOR BEGINNERS—Only £5**

## REMOTE CONTROL

Published remote control systems tend to be quite complex, requiring difficult-to-get components and a well-equipped lab to get them to work. If this has put you off making your own system we have just the kits for you. Using infra-red, our kits range from simple on/off controllers to coded transmitter/receivers with 16 on/off outputs or three analogue outputs for controlling e.g. TV or Hi-Fi systems. The kits are easy to build and simple to set up—and they are extremely versatile, controlling anything from garage doors to room lighting just by adding the required output circuits (i.e. relays, triacs, etc.). If you can design your own system we stock a wide range of remote control components at very competitive prices.

We have substituted a booklet on remote control—containing circuit boards, data sheets and details of our remote control kits and components. Section 1 control yourself. **SEND US 30p and a stamped addressed envelope for your copy TODAY!**

## KITS & COMPONENTS

### HOME LIGHTING KITS

These kits contain all necessary components and full instructions & are designed to replace a standard wall switch and control up to 300W of lighting.

- |         |  |        |
|---------|--|--------|
| TDR300K | Remote Control Dimmer                        | £14.30 |
| MK6     | Transmitter for above                        | £ 4.20 |
| TD300K  | Touch-dimmer                                 | £ 7.00 |
| TDE K   | Extension kit for 2 way switching for TD300K | £ 2.00 |
| LD300K  | Retrofit Controlled Dimmer                   | £ 3.50 |



### 24 HOUR CLOCK/APPLIANCE TIMER KIT

Switches any appliance up to 1kW on and off at present times once per day. Kit contains: AY5-1230 IC, 0.5" LED display, mains supply display drivers, switches, LEDs, triacs, PCBs and full instructions.

- |  |        |
|--|--------|
| CT1000K Basic Kit                      | £14.90 |
| CT1000K with white box (56 131 x 71mm) | £17.40 |
| Ready Built!                           | £22.50 |



**FOR FREE SHORT FORM CATALOGUE SEND SAE TODAY**

### DISCO LIGHTING KITS

**DL1000K.** This value-for-money kit features a bi-directional sequence speed of sequence and frequency of direction change being variable by means of potentiometers and incorporates a master dimming control. **Only £14.60**

**DL21000K.** A lower cost version of the above featuring unidirectional channel sequence with speed variable by means of a pre-set pot. Outputs switched only at mains zero crossing points to reduce radio interference to a minimum. **Only £8.00**

Optional opto input DL A1 allowing audio 'beat' light response. **60p**



### LEDs

3mm & 5mm Round Red 09p Green... 12p  
 Clips 3mm & 5mm D3p Yellow... 12p

### [Shaped Leds]

	Red	Green	Yellow
Rectangular (11x5mm)	16p	16p	16p
Rectangular (5x2.5mm)	17p	20p	20p
Square (5x5mm)	17p	20p	20p
Triangular (5mm)	17p	20p	20p
Arrowhead (2.5x5mm)	17p	20p	20p



### [Flashing Leds]

5mm diameter Red 39p Flashing/Continuous 42p

### [Tri Colour Leds]

5mm Round 30p 5mm Rectangular 32p

**FAST SERVICE · TOP QUALITY · LOW LOW PRICES**

No circuit is complete without a call to—

**TK ELECTRONICS**  
 11 Boston Road  
 London W7 3SJ

**ALL PRICES EXCLUDE VAT**

**DEPT. H.E.**

Telephone: 01 579 9794/2842

Add 50p postage & packing + 15% VAT to total  
 Overseas Customers:  
 Add £1.75 (Europe), £4.50 (elsewhere) for p & p.  
 Send S.A.E. for further STOCK DETAILS.  
 Goods by return subject to availability.  
 9am to 5pm (Mon to Fri)  
 10am to 4pm (Sat)



### DVM/ULTRA SENSITIVE THERMOMETER KIT

This new design is based on the ICL7126 (a lower power version of the ICL7106 chip) and a 3 1/2 digit liquid crystal display. This kit will form the basis of a digital multimeter (only a few additional resistors and switches are required—details supplied) or a sensitive digital thermometer (—50°C to +150°C) reading to 0.1°C. The basic kit has a sensitivity of 200mV for a full scale reading, automatic polarity indication and an ultra low power requirement—giving a 2 year typical battery life from a standard 9V PP3 when used 8 hours a day, 7 days a week. **Price £15.50**



# RADIO RULES

A new series, introducing the theory and practice of radio.

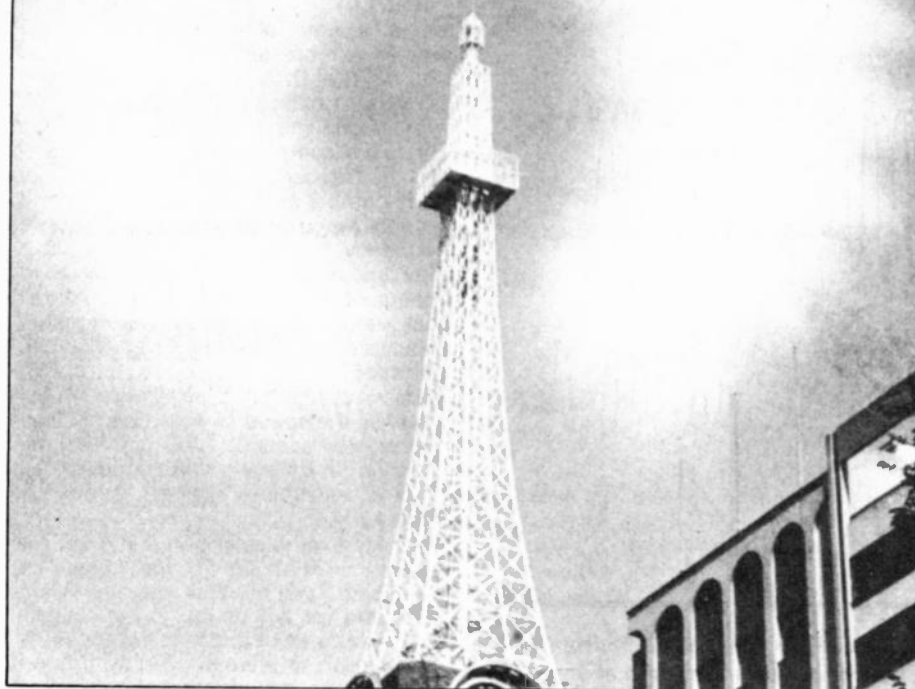

ONE of the few ways in which Man differs from the rest of the animal kingdom is in his ability to communicate. All creatures 'talk' to each other, but there are no other animals that can communicate with such flexibility or over such great distances.

Somehow, in the dim distant past, Man evolved past the grunt and snort stage and developed several extremely complex languages. These enabled him to pass on information to other people in his vicinity. If he wanted his message to travel further, he shouted louder. If he wanted to communicate with someone who was out of earshot, he wrote down his message and asked someone to deliver it for him. Several days, weeks or months later, depending on the distance involved, he would receive a reply.

Then the discovery of electricity led to a dramatic change in communication techniques. It became possible to activate electrically operated devices such as buzzers or clicking relays from a considerable distance by simply turning on the current and letting it flow down the cable. In 1838, Samuel Morse invented a code that is based entirely on the relationship between the length of time that the current is turned on and the time that it is turned off. Every letter of the alphabet was allocated a sequence of 'dots' and 'dashes'. A 'dot' is indicated by an audio device, often a buzzer, sounding for a very short period. A 'dash' is indicated by the buzzer sounding for a period three times as long as for a 'dot'. Skilled operators could use this code to send messages at 20 to 30 words per minute and Telegraphy, as this system is called, spread rapidly around the world, especially in America where the cables were nearly always laid alongside the newly built railroads.

The next breakthrough came in 1876 when Alexander Graham Bell invented the telephone. He proved that it was possible to send a *voice* signal along a wire, and the telephone rapidly replaced telegraphy for mass communication. Gradually, a telephone system evolved that uses dozens of cables, running across continents and oceans, so that many hundreds of conversations can be held simultaneously, over vast distances. The system works reasonably well, but it is more suited to short-range communications because of the many thousands of miles of very expensive cable that have to be laid across continents and under oceans.

Fortunately, at the same time as the telephone was establishing itself, a new medium was evolving. In the mid-19th century a physicist, James Maxwell Clark, put forward the theory that electrical waves could be made to travel through the air. He was never able to prove his theory and it was not until some years after his death that Heinrich Hertz managed to generate the very first radio waves. As these waves 'vibrate' many millions of times every second, it was not possible to generate them mechanically and Hertz used a gadget called a Spark Transmitter. This was, simply, a very large capacitor or inductor, fed by an interrupted DC voltage. When the voltage was interrupted, the

*ALTHOUGH* Hobby Electronics was the first magazine to support Citizens' Band radio in this country, the subject of radio (in general) has never been fully explained in HE. So, now that CB is well-established, we've decided that it's time our readers had a chance to further explore one of the most fascinating aspects of electronics — amateur radio.

Like many electronic hobbies, radio requires some skill, not just in building the equipment, but in operating it. In particular, operating a radio transmitter calls for a very good understanding of the principles of radio, and of operating procedures and practices, propagation (the ways in which radio waves travel through the atmosphere) and interference. An inexperienced — or unqualified — operator can cause untold havoc to essential services such as the Fire Brigade and Ambulance services,

who also use radio communications, as well as to other radio amateurs. This is the main reason why anyone wishing to operate an amateur radio station must obtain a licence from the Home Office, establishing that they are competent to use a transmitter without causing interference to other users. Many radio enthusiasts, though, are interested only in short-wave listening, pulling in signals from broadcast or amateur stations in far-off countries, but even this simpler form of amateur radio requires considerable skill and understanding.

This series, then, is intended both to explain the principles of radio and to give an understanding of the skills necessary to become a radio amateur. So whatever your intentions — short-wave listening or operating an amateur radio station — here's your chance to get Into Radio!

# Into Radio

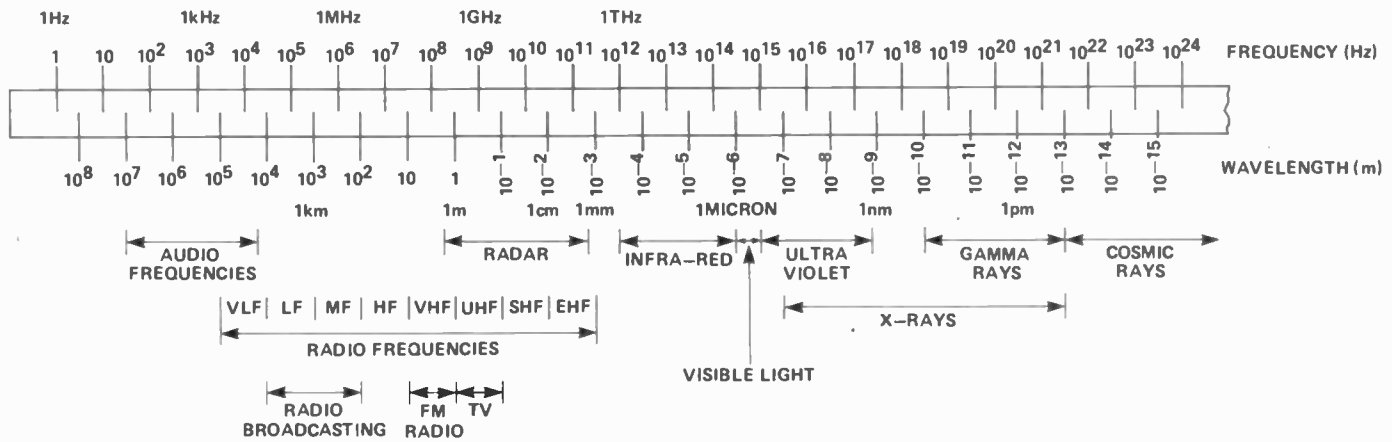

Figure 1. The electromagnetic spectrum covers the range of frequencies from audio up to cosmic rays.

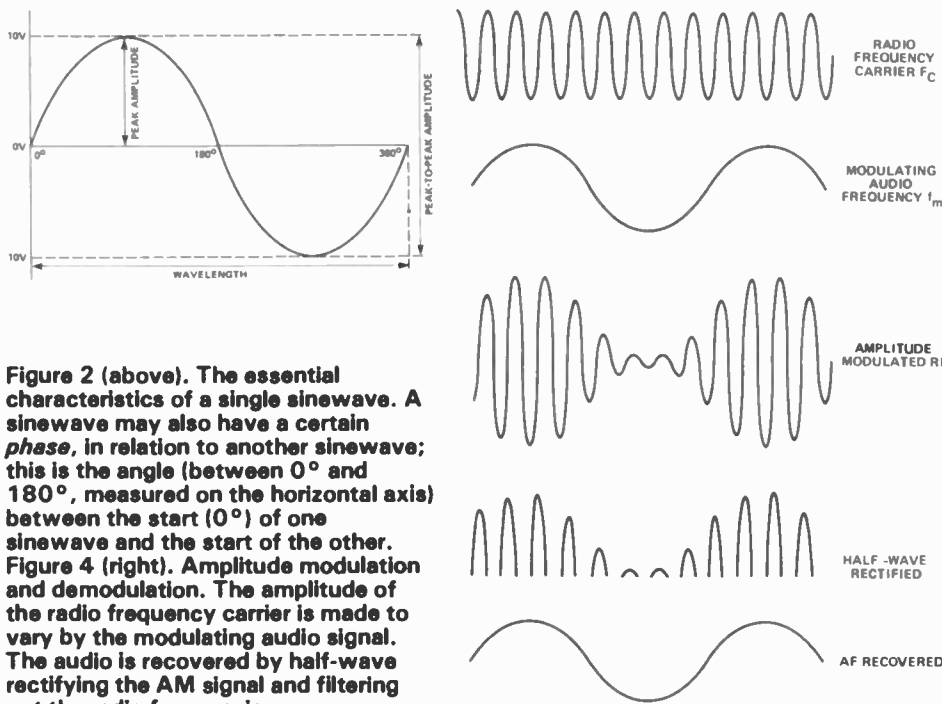

Figure 2 (above). The essential characteristics of a single sine wave. A sine wave may also have a certain phase, in relation to another sine wave; this is the angle (between 0° and 180°, measured on the horizontal axis) between the start (0°) of one sine wave and the start of the other. Figure 4 (right). Amplitude modulation and demodulation. The amplitude of the radio frequency carrier is made to vary by the modulating audio signal. The audio is recovered by half-wave rectifying the AM signal and filtering out the radio frequencies.

energy stored in the capacitor or inductor was discharged across a narrow 'spark gap', and the spark produced radio waves. These waves are sinusoidal and, in order to understand the principals of radio, it is important to fully understand sine waves.

## Sine On

The sine wave shown in Figure 2 is a graphical representation of a voltage that starts at 0 V, gradually increases to 10 V, falls back to 0 V again, sinks to -10 V and then rises back up to 0 V. This is one complete cycle of a sine wave and the frequency of a sinusoidal signal is the number of cycles that occur in one second. Some older textbooks still quote frequency in 'cycles per second' but they are now usually called Hertz, in honour of Heinrich Hertz. The peak-to-peak value (amplitude) of the signal is measured from point A1 to A2. The length of one complete cycle. B1 to B2, is the wavelength and, as all radio waves travel at the speed of light (300 million metres per second), we can find the wavelength of any given frequency by dividing the velocity by its frequency (Figure 3).

As these examples show, the lower the frequency of a signal, the longer its wavelength will be. This is an important point and we will be looking at it again when we come to examine antennas, as their length is always directly proportional to the wavelength of the signal they are designed to work with.

The spark transmitter that Hertz used is considered to be a 'dirty' transmitter because it radiated radio signals on dozens of different frequencies. During the Second World War, for example, these transmitters were used to jam the enemy's signals because it was not necessary to tune them to a specific frequency — a spark will generate interference across almost the entire radio spectrum.

For practical communications, though, sparks gave way to RF oscillators, electronic circuits that can produce sine waves at radio frequencies; we will explain them in a later issue.

It's not much use being able to send electrical signals through the air if they can't be made to carry information with them. Initially, the process of impressing the information on to the signal used the Morse code and, as cables were no

Figure 3. Electromagnetic waves are sinewaves of energy that result from the acceleration of charged particles. The frequency and wavelength of any electromagnetic wave are related by the speed of light (*c*).

To find the wavelength ( $\lambda$ ) of a certain frequency (*f*), simply divide *c* by *f*. That is:

$$\lambda = \frac{c}{f}$$

For example, a 27 MHz radio signal has a wavelength of:

$$\lambda = \frac{300 \times 10^6}{27 \times 10^6} = \frac{300\,000\,000}{27\,000\,000} = 11 \text{ metres.}$$

The frequency of a station with a known wavelength is found by dividing *c* by  $\lambda$ . That is:

$$f = \frac{c}{\lambda}$$

So, the frequencies of Radio One are:

$$f = \frac{300 \times 10^6}{275\text{m}} = 1.09 \text{ MHz} \quad \text{or} \quad \frac{300 \times 10^6}{285\text{m}} = 1.05 \text{ MHz}$$



## Into Amateur Radio

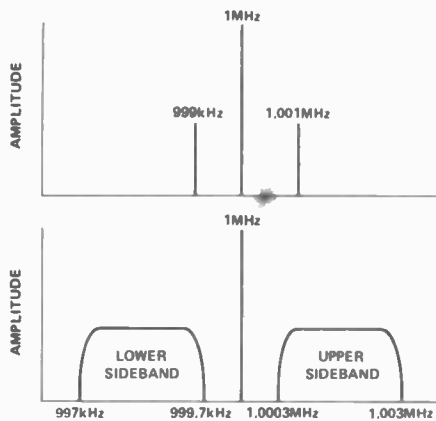

Figure 5. Sidebands, generated by amplitude modulation.

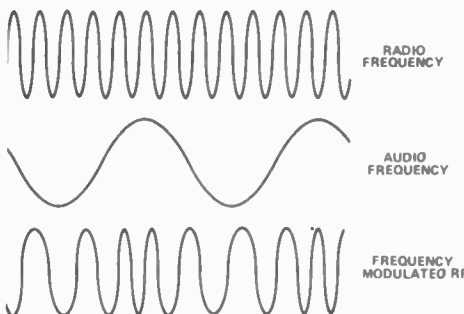

Figure 6. Frequency modulation.

longer used to carry the signal, it was only natural that this system soon became known as 'Wireless Telegraphy'. Unfortunately, 'WT' suffered from the old problem of needing skilled operators, and the search was on for a way of letting people *talk* to each other via radio.

It was soon found to be possible to vary the amplitude of an RF (Radio Frequency) signal in proportion to an AF (Audio Frequency) one, by a process called modulation (Figure 4).

However, when one signal is used to modulate another, the result is not really as simple as you might expect. If we were to modulate a radio frequency of 1 MHz with an audio signal of 1 kHz, we would end up with four frequencies — not two (Figure 5). The resultant signal always consists of the higher frequency (the 'carrier'), the lower frequency, the higher plus the lower and the higher minus the lower. The 'sum' and 'difference' frequencies, are called the sidebands: the sum signal is the upper one because it is above the carrier and the difference signal is the lower sideband because it is below. When the carrier is being modulated by a constant tone, the sidebands are constant, but when the carrier is modulated by a varying waveform, such as speech, the frequencies of the sidebands will vary within a range of frequencies governed by the modulating frequencies. If the range of the speech frequencies used were to be 300 Hz to 3,000 Hz, then the sidebands would cover the frequencies shown in Figure 5.

In fact the bottom half of a modulated carrier wave is a mirror image of the upper half and it carries exactly the same information — using more bandwidth than is actually necessary. To overcome

Before setting up an amateur radio station, it is necessary to obtain a licence from the Home Office. Unfortunately, it is a little more complicated than obtaining a CB licence, but the rewards of amateur radio (the world at your fingertips) are well worth the effort.

There are actually two classes of licence, A and B, and the basic requirement for either is a pass in the Radio Amateur's Examination (RAE). This is something HE readers should not find too difficult, though, because much of the material will already be familiar!

The other common requirements are (a) British nationality (although Commonwealth or alien residents in the UK may take out a licence under certain conditions) and (b) payment of a fee (£8). To qualify for the full A licence, it is also necessary to pass the Post Office Morse Test not more than 12 months before applying for the licence. The A licence allows operation on any of the amateur bands and permits the use of morse telegraphy; B licence holders are restricted to frequencies below 144 MHz and may not transmit morse.

The RAE consists of two papers; Part 1 contains 23 multiple-choice questions on licencing conditions (the usual bureaucratic stuff), 12 questions on transmitter interference, and takes one hour. Part 2 takes 1 1/2 hours and consists of 60 multiple-choice questions; five questions are on operating practices and procedures, 11 are on electrical theory, nine on semiconductors, nine on radio receivers, nine on transmitters, 10 questions on propagation and antennas and seven questions on measurements. The RAE is held twice yearly at the City and Guilds of London Institute, Electrical and Telecommunications Branch, 20 Portland Place, London W1N 4AA, but may also be taken at local colleges and examination centres throughout the country.

this problem, Single Sideband transmissions are often used. For this sort of transmission, the carrier and one of the sidebands is 'suppressed' at the transmitter and only the other sideband is transmitted. This also means that audio power is not wasted modulating two sidebands. Single sideband transmitters and receivers will be explained in a future article.

Another way to modulate a carrier is to vary its frequency by an amount that is proportional to the amplitude of the modulating signal. This means that the frequency of the carrier is made to vary in frequency either side of its mean frequency, and the greater the amplitude of the modulating frequency, the more the 'deviation' from the mean. As the frequency of the modulating frequency rises, so will the rate of change of the carrier. Figure 6 shows a typical frequency modulated carrier wave and the modulating sine wave.

FM carriers do not vary in amplitude but, because of the complex nature of the many changing frequencies, they tend to generate a lot of sidebands. This

Morse tests can be taken throughout the year at the Post Office headquarters, in London, at any Post Office Coast Station or at any of the Radio Surveyor's Offices. The Home Office Publication "How to Become a Radio Amateur", which is free of charge from the Radio Regulatory Department, Licencing Branch (Amateur), Waterloo Bridge House, Waterloo Road, London SE1 8UA, contains all the addresses of the Post Office Centres, as well as full details of the requirements for obtaining an amateur licence. The Morse Test is not hard, but does require practice! It involves sending 36 words in three minutes, with up to four corrected errors allowed, and receiving 36 words in the same period. Four corrections may be made in transmission and four errors are allowed in reception. Then, 10 groups of five figures must be sent and received in two periods of 1 1/2 minutes; two receiving errors are allowed and two corrections may be made in sending.

Any reader seriously interested in applying for an amateur licence should contact the authorities at the addresses given, for detailed information on the RAE and the other requirements for a licence. They should also contact the Radio Society of Great Britain. The RSGB, with 29,000 members, is the national society for UK radio amateurs and is their recognised spokesman and representative, both in the UK and internationally. Membership is open to anyone with an interest in amateur radio, whether or not they hold a licence. The RSGB publication "Radio Amateur's Examination Manual", by G.L. Benbow, is an excellent text book for anyone intending to sit the RAE. It is available from the RSGB, 35 Doughty Street, London WC1N 2AE; Tel. 01-837 8688.

means that an FM signal takes up more room on the RF spectrum, however an FM signal is also relatively immune to noise and interference. In this country, FM is normally used to modulate broadcasts in the VHF (Very High Frequency) band, and the combination of VHF and FM means that the quality of these broadcasts is far better than medium wave AM radio.

NBFM (Narrow Band Frequency Modulation) is a special form of FM. In NBFM signal the total amount of deviation from the carrier frequency is limited to quite a small figure, often 2.5 kHz. This type of FM is usually only used for speech transmissions, as such a narrow band will not carry the quantity of information that is needed for hi-fi quality. The main use for NBFM is in amateur radio and commercial two-way radio, such as the police, taxis, boats and most recently, British CB.

Next month we will be looking at the basic elements of a radio system. We'll be dissecting a transmitter/receiver and getting to grips with some essential ideas of radio circuitry.

# Subscriptions

## WE DELIVER!

If you would like to ensure a regular supply of Hobby Electronics for the next twelve months, each issue lovingly wrapped and posted to you, nothing could be simpler. Just fill in the form below, cut it out and send it with your cheque or Postal Order (made payable to ASP Ltd) to:

**Hobby Electronics Subscriptions,  
513 London Road,  
Thornton Heath,  
Surrey CR4 6AR**

Alternatively you can pay by Access or Barclaycard in which case simply fill in your card number, sign the form and send it off. Do NOT send your card.

Do yourself a favour. Make 1982 the year you start to take Hobby Electronics, regularly. Delivered fresh every month.

### SUBSCRIPTION ORDER FORM

Cut out and SEND TO :  
Hobby Electronics Subscriptions  
513, LONDON ROAD,  
THORNTON HEATH,  
SURREY,  
ENGLAND.

Please commence my personal subscription to Hobby Electronics with the ..... issue.

#### SUBSCRIPTION RATES

(tick  as appropriate)

- £10.75 for 12 issues U.K.
- £12.75 for 12 issues overseas surface
- £25.70 for 12 issues Air Mail

I am enclosing my (delete as necessary)  
Cheque/Postal Order/International Money  
Order for £. ....  
(made payable to A.S.P. Ltd)  
OR  
Debit my Access/Barclaycard\*  
(\*delete as necessary)



.....

Please use BLOCK CAPITALS and include post codes.

Name (Mr/Mrs/Miss) .....  
delete accordingly

Address .....

.....

.....

Signature .....

Date .....

Send for my **CATALOGUE ONLY 75p**  
(plus 25p post/packing)

My VAT and post/packing inclusive prices are *the* lowest. All below normal trade price — some at only one tenth of manufacturers quantity trade.

See my prices on the following:

CAPACITORS . . . ELECTROLYTIC; CAN, WIRE END, TANTALUM, MULTIPLE, COMPUTER GRADE, NON POLAR, PAPER BLOCK, CAN, POLY, MICA, CERAMIC. LOW AND HIGH VOLTAGE, RESISTORS. 1/8th WATT TO 100 WATT; 0.1% TO 10% CARBON, METAL AND WIRE WOUND + NETWORKS. FANS, BATTERIES, SOLENOIDS, TAPE SPOOLS, VARIABLE CAPACITORS AND RESISTORS, TRIMMERS, PRESETS, POTS . . . SINGLE, DUAL, SWITCHED, CARBON, CERMET AND WIREWOUND, SINGLE OR MULTITURN, ROTARY AND SLIDE. DIODES, RECTIFIERS, BRIDGES, CHARGERS, STYLII, SOCKETS, PLUGS, RELAYS, TRANSISTORS, IC'S, CLIPS, CRYSTALS, ZENERS, TRIACS, THYRISTORS, BOXES, PANELS, DISPLAYS, LED'S, COUPLERS, ISOLATORS, NEONS, OPTO'S, LEADS, CONNECTORS, VALVES, BOOKS, MAGAZINES, TERMINALS, CHOKES, TRANSFORMERS, TIMERS, SWITCHES, COUNTERS, LAMPS, INDICATORS, BELLS, SIRENS, HOLDERS, POWER SUPPLIES, HARDWARE, MODULES, FUSES, CARRIERS, CIRCUIT BREAKERS, KNOBS, THERMISTORS, VDR'S, INSULATORS, CASSETTES, METERS, SOLDER, HANDLES, LOCKS, INDUCTORS, WIRE, UNITS, MOTORS, COILS, CORES, CARTRIDGES, SPEAKERS, EARPHONES, SUPPRESSORS, MIKES, HEATSINKS, TAPE, BOARDS and others.

Prices you would not believe before inflation!

**BRIAN J. REED**  
TRADE COMPONENTS

ESTABLISHED 25 YEARS  
161 St. Johns Hill, Battersea, London SW11 1TQ  
Open 11 am till 7 pm Tues. to Sat. Telephone: 01-223 5016

## COMPONENTS IN BIRMINGHAM

### CMOS-LSTTL-LINEAR-ICs NOW!!! IN DEPTH STOCK

From National Semiconductor:

Some Egs:	4011	15p	4013	34p	4017	42p
	4093	38p	40161	69p	4543	134p
	74LS00	12p	74LS90	33p	74LS386	28p
	LM380	75p	TBA120	90p	TDA2640	216p

Full range list available + Quantity discounts. Ask for details . . . . .

PCBs. The FOTOWay — Brochure on Request.

#### NEW BARGAIN Packs:

16 — TTL ICs	£1.10	6 — Slide Switches	60p
9 — CMOS ICs	£1.10	100 — 1/8 Watt Resistors	60p
10 — Croc Clips	£0.60	30 — 1 Watt Resistors	60p
5 — Ex Equipment Bds	£1	5 — Large Elect Caps	£1
8 — Knobs	£1.20	4 — Rotary Switches	£1.20

Post & packing 60p per order. FREE over £10

**P.A.T.H. Electronic Services Wholesale + Retail**  
369 Alum Rock Road, Birmingham B8 3DR

Open 10 till 6 weekdays. 9.30 till 5 Saturdays

Distributors for: Antex — Altai — Babani — Hills — Servisol — PATH FOTOWay — PATH Box — Safgan — Vero Electronics + MUCH MUCH MORE . . .

## PARNDON ELECTRONICS LTD.

Dept. No. 22, 44 Paddock Mead, Harlow, Essex CM18 7RR. Tel. 0279 32700

**RESISTORS:** 1/4 Watt Carbon Film E24 range ± 5% tolerance. High quality resistors made under strictly controlled conditions by automatic machines. Banded and colour coded.  
£1.00 per hundred mixed (Min 10 per value)  
£8.50 per thousand mixed (Min 50 per value)  
Special stock pack 60 values 10 off each £5.50

**DIODES:** IN4148 3p each Min order quantity - 15 items  
£1.60 per hundred

**DIL SWITCHES:** Gold plated contact in fully sealed base — solve those programming problems  
4 Way 86p each 6 Way £1.00 each 8 Way £1.20 each

**DIL SOCKETS:** High quality, low profile sockets  
8 pin — 10p. 14 pin — 11p. 16 pin — 12p. 18 pin — 19p. 20 pin — 21p.  
22 pin — 23p. 24 pin — 25p. 28 pin — 27p. 40 pin — 42p.

ALL PRICES INCLUDE V.A.T. & POST & PACKING — NO EXTRAS  
MIN ORDER — UK £1.00 OVERSEAS £5 CASH WITH ORDER PLEASE

# WHY AN ILP MOSFET POWER AMP?

Because ILP MOSFET power amps give you ultra-fi performance without costing big money. Performance you thought you couldn't afford at a price you know you can.

All ILP modules are compatible with each other — you'll find many more in other ILP ads in this magazine. Choose ILP MOSFET power amps when you need the fastest possible slew rate, low distortion at high frequencies, better thermal stability. MOSFET power amps work with complex loads without difficulty and without crossover distortion. Connection is simple — via 5 pins. With other ILP modules you can create almost any audio system, whatever your age or experience.

ILP MOSFET power amps are now available with integral heatsink (no extra heatsink required), or ready for mounting on to your own heatsink or chassis. Full dissipation detail on data sheet, available on request. Each carries a 5 year no quibble guarantee and comes with full connection data.

Send your order FREEPOST today on the coupon at the foot of this ad.

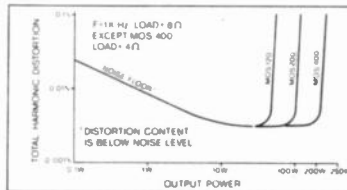
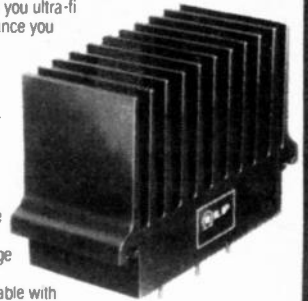

**Load impedance,** all models, 4 ohm — infinity  
**Input impedance,** all models 100K ohm  
**Input sensitivity,** all models, 500 mV  
**Frequency response,** all models 15Hz-50KHz-3db

### MOSFET Ultra-Fi, with heatsinks

Model No	Output power Watts rms	DISTORTION T H D Typ 50Hz/7kHz I M D 4:1		Supply voltage Typ/Max	Size mm	Wt gms	Price inc VAT	Price ex VAT
MOS 120	60w/4-8Ω	<0.005%	<0.006%	+45±50	120 x 78 x 40	420	£29.76	£25.88
MOS 200	120w/4-8Ω	<0.005%	<0.006%	+55±60	120 x 78 x 80	850	£38.48	£33.46
MOS 400	240w/4Ω	<0.005%	<0.006%	+55±60	120 x 78 x 100	1025	£52.20	£45.39

### MOSFET Ultra-Fi without heatsinks

MOS 120P	60w/4-8Ω	<0.005%	<0.006%	+45±50	120 x 26 x 40	215	£26.82	£23.32
MOS 200P	120w/4-8Ω	<0.005%	<0.006%	+55±60	120 x 26 x 80	420	£32.81	£28.53
MOS 400P	240w/4Ω	<0.005%	<0.006%	+55±60	120 x 26 x 100	525	£44.75	£38.91

#### Protection

Able to cope with complex loads, without the need for very special protection circuitry (fuses will suffice)

#### Ultra-fi specifications:

Slew rate 20V/μs Rise time 3μs S/N ratio 100db Frequency response (-3dB) 15Hz-100kHz Input sensitivity 500mVrms Input impedance 100k. Damping factor (8Ω, 100Hz) >400

#### How to order Freepost:

Use this coupon, or a separate sheet of paper, to order these products, or any products from other ILP Electronics advertisements. No stamp is needed if you address to Freepost. Cheques and postal orders must be crossed and payable to ILP Electronics Ltd. cash must be registered. C O D — add £1 to total order value. Access and Barclaycard welcome. All UK orders sent post free within 7 days of receipt of order.

Please send me the following  
ILP modules \_\_\_\_\_

Total purchase price \_\_\_\_\_

I enclose Cheque  Postal Orders  Int Money Order

Please debit my Access/Barclaycard No \_\_\_\_\_

Name \_\_\_\_\_

Address \_\_\_\_\_

Signature \_\_\_\_\_

Post to: ILP Electronics Ltd. Freepost 2 Graham Bell House Roper Close  
Canterbury CT2 7EP Kent England  
Telephone (0227) 54778 Technical (0227) 64723 Telex 965780



**ILP**  
ELECTRONICS LTD

HE 3/4

**STAY AHEAD. STAY WITH US**

# ELECTRONIC IGNITION

Makes a good car  
better



As a  
KIT  
or  
READY  
BUILT

**TOTAL ENERGY DISCHARGE** electronic ignition gives all the well known advantages of the best capacitive discharge systems.

**PEAK PERFORMANCE** — higher output voltage under all conditions.

**IMPROVED ECONOMY** — no loss of ignition performance between services.

**FIRES FOULED SPARK PLUGS** no other system can better the capacitive discharge system's ability to fire fouled plugs.

**ACCURATE TIMING** — prevents contact wear and arcing by reducing load to a few volts and a fraction of an amp.

**SMOOTH PERFORMANCE** — immune to contact bounce and similar effects which can cause loss of power and roughness.

## PLUS

**SUPER POWER SPARK** — 3½ times the energy of ordinary capacitive systems — 3½ times the power of inductive systems.

**OPTIMUM SPARK DURATION** 3 times the duration of ordinary capacitive systems — essential for use on modern cars with weak fuel mixtures.

**BETTER STARTING** — full spark power even with low battery.

**CORRECT SPARK POLARITY** unlike most ordinary C.D. systems the correct output polarity is maintained to avoid increased stress on the H.T. system and operate all voltage triggered tachometers.

**L.E.D. STATIC TIMING LIGHT** for accurate setting of the engine's most important adjustment.

**LOW RADIO INTERFERENCE** fully suppressed supply and absence of inverter 'spikes' on the output reduces interference to a minimal level.

**DESIGNED IN RELIABILITY** an inherently more reliable circuit combined with top quality components — plus the 'ultimate insurance' of a changeover switch to revert instantly back to standard ignition.

## IN KIT FORM

it provides a top performance electronic ignition system at less than half the price of competing ready-built systems. The kit includes everything needed, even a length of solder and a tiny tube of heatsink compound. Detailed easy-to-follow instructions, complete with circuit diagram, are provided — all you need is a small soldering iron and a few basic tools.

## AS REVIEWED IN

ELECTRONICS TODAY INTERNATIONAL June '81 Issue  
and EVERYDAY ELECTRONICS December '81 Issue

**FITS ALL NEGATIVE EARTH VEHICLES,**  
6 or 12 volt, with or without ballast

**OPERATES ALL VOLTAGE IMPULSE TACHOMETERS**  
Some older current impulse types (Smiths pre '74) require an adaptor —  
PRICE £2.95

**STANDARD CAR KIT** £ 14.85  
**Assembled and Tested** £ 24.95

**TWIN OUTPUT KIT** £ 22.95  
For MOTOR CYCLES and CARS with twin ignition systems  
**Assembled and Tested** £ 34.70

PLUS  
£1.00  
U.K.  
P. & P.  
Prices  
include  
VAT.

## ELECTRONIZE DESIGN

Dept. E, Magnus Road, Wilnecote  
Tamworth, B77 5BY



Phone (0827) 281000

# RECHARGEABLE BATTERIES AND CHARGERS

## PRIVATE OR TRADE ENQUIRIES WELCOME

FULL RANGE AVAILABLE SEND SAE  
FOR LISTS. £1.45 for Booklet "Nickel  
Cadmium Power" plus Catalogue.  
Write or call:

\* NEW SEALED  
LEAD RANGE AVAILABLE \*

**SANDWELL PLANT LTD.**  
2 Union Drive, Boldmere  
Sutton Coldfield, West Midlands  
021-354 9764  
After hours 0977 84093

Please mention **HE**  
when replying  
to advertisers

# ALARMS



## DIY KITS 'N' BITS

PROFESSIONAL EQUIPMENT AT DISCOUNT PRICES!

●KITS £32, £50, £75, £85 including full instructions ●CONTROL  
PANELS £18, £23, £29, £37 ●BELL BOXES £6.25, £7.50 ●  
●PRESSURE PADS £1.06, £1.45, £1.95 ●4 CORE CABLE  
(100m) £8 ●SIRENS £7.50 ●CONTACTS 72p, 74p, 76p ●  
●ULTRASONIC £34.50 ●DOOR PHONES £49.42 ●

**BUY A KIT OR DESIGN YOUR OWN SYSTEM**  
SEND SAE OR PHONE NOW FOR **FREE** FULLY ILLUSTRATED CATALOGUE.  
IT TELLS YOU ALL YOU NEED TO KNOW!

Carriage Included. VAT Extra 15%

A.D. Electronics, 217 Warbeck Moor, Aintree, Liverpool L9 0HV 051 523 8440

Trade Enquiries Welcome



# INTO ELECTRONIC COMPONENTS

Part 9 is all about the popular 741 op amp.

ONCE upon a time, engineers used to spend a lot of their time designing transistor voltage amplifiers. The most difficult to design were direct-coupled amplifiers, which used no coupling capacitors. A direct-coupled amplifier will amplify very low frequencies as well as the normal audio range and it will even amplify signals with no frequency at all, that is, DC signals. This means that a small DC voltage at the input of the amplifier will produce a larger DC voltage at the output; the design of these amplifiers is a real headache, because the slightest change in the bias voltage at the input will send the output voltage rocketing up or down.

That all seems a long time ago, because we very seldom need to go through those aspirin-consuming exercises, these days. The reason is that we can be altered by the amount of doping, a single chip of silicon in the form of an integrated circuit. In the previous couple of chapters we've hinted of what can be done. The resistance of a strip of silicon can be altered by the amount of doping so that we can create resistors on a strip of silicon just as easily as we can create junctions. We can also use the silicon to create capacitors, by oxidising the surface and then depositing metal on top of the oxide, just like the gate of a MOSFET. Since silicon can be used to create the four main electronics components (diodes, transistors, resistors, capacitors), there is no reason why complete circuits should not be made from silicon. This fact was first realised, even before the use of silicon in transistors had been established, by W. Dummer, who worked at the Radar Research Establishment in Malvern, in the early 1950s. The idea was much too advanced for British industry (and quite inconceivable to the Civil Service who ran the Radar Establishment and told Dummer to cease work on the idea), but it was enthusiastically taken up in the USA. If the

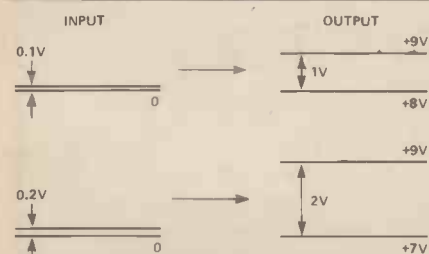

Figure 1. DC amplification illustrated for an inverting amplifier with a voltage gain of 10.

story sounds familiar, you're probably thinking of jet engines, swing wings, or any of the dozens of ideas which had to leave this country to be developed!

Nowadays, of course, we can buy complete direct-coupled amplifiers in IC form for about the cost of a single transistor. This is because the complete IC amplifier is made in one set of operations — almost the same set of operations as are needed to make that single transistor. One of the best-known direct-coupled amplifiers is the 741; that's the component to which we are devoting the whole of this month's story.

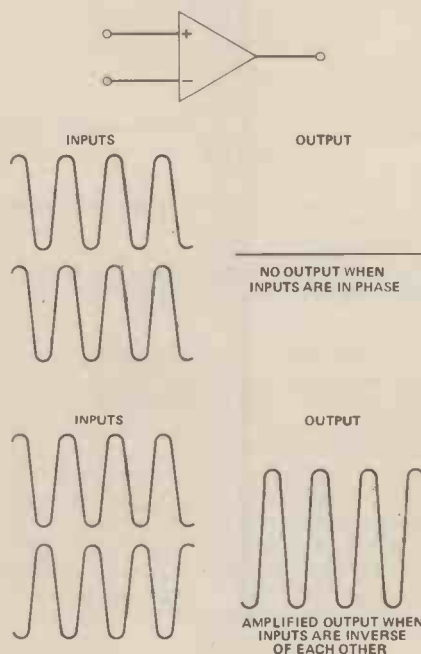

Figure 2. Differential amplification.

It seems odd to think of a complete amplifier as a single electronic component but, as it comes as a single unit, that's what it is. Sometimes we think we would like to know the circuit inside the IC, but we really don't need to know what goes on inside because it doesn't help us to design circuits. What we need to know about the 741 is, in fact, what we need to know about any electronic component — how do we connect it and what does it do? The more we use this approach the better, because the day is rapidly approaching when no-one, apart from the designer, will know exactly what the circuit of an IC is.

## What's The Difference?

The 741 is a differential amplifier; unlike the simple voltage amplifier that we are more accustomed to, a differential amplifier has two inputs and the signal which is amplified is the difference between these two inputs. For example, if we put the same sine wave to both inputs, nothing will be amplified because there is no difference. If one of the signals is inverted however (Figure 2), then there is plenty to amplify because the difference between them is a large signal.

What's the point of this arrangement? One reason is that it allows us to use balanced input signals. A balanced signal consists of a pair of identical signals, one the inverse of the other. Now, if any interference is added to these signals, it will be in the same phase on both and won't be amplified by a differential amplifier, whereas the balanced signal will. This allows us to amplify signals which are very weak, weaker than hum or other interference, and to carry them over long cables without risk of interference.

Another reason for using two inputs is that it allows us to use the amplifier in two different ways; when a signal is put in at one input (the 'positive' or non-inverting input), it will result in an output which is in phase with the input, so that connection from the output back to the input will cause positive feedback. The other input ('negative' or inverting input) will, by contrast, result in an output which is phase-inverted compared with the input and, if fed back, this will give negative feedback.

## IC It All

The 741 chip can be obtained in various packages, such as a "top-hat" TO-5 transistor casing, but the most useful

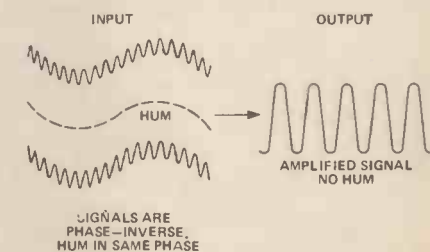

Figure 3. How differential amplification overcomes interference problems.

## Into Electronics Components

form for most purposes is the DIL (Dual-In-Line) 8-pin package, shown in Figure 4. Not all of the eight pins are used, but identification of pin numbers is easy and the DIL package is used for many other ICs. Notice the two inputs, labelled (+) and (-). The (+) and (-) markings have nothing to do with battery positive and negative; they simply tell you which input is in phase (non-inverting) and which is out of phase (inverting). There is a single output from pin 6, two other terminals which we'll discuss later, and the two supply connections at pins 7 and 4.

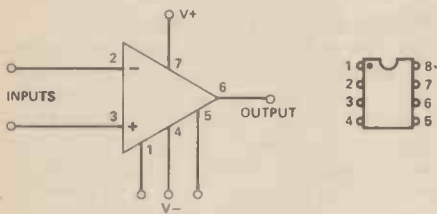

Figure 4. The 8-pin DIL version of the 741.

Many 741 circuits use balanced power supplies, meaning that there are two equal voltages, one positive, the other negative to earth. A popular arrangement is +9 V on pin 7 and -9 V on pin 4. This arrangement leads to very simple amplifier circuits, particularly if the 741 is being used for DC or balanced signals, but it is possible to operate the 741 from normal 9 V-and-zero supplies (unbalanced, or single-ended supplies) and we shall look at ways of doing this later.

As it comes, the 741 has a voltage gain for AC or DC of around 100,000 times. This is frighteningly large compared to the transistor voltage amplifiers that we knock up ourselves and it makes nonsense of our usual bias systems. Try this out, using the Eurobreadboard and the circuit of Figure 5. The HE meter measures the voltage at the output and the inverting pin (pin 2) is earthed. Now by adjusting the potentiometer RV1, we should be able to adjust the bias on the other input so that the output voltage is exactly zero. Try it — and the chances are you'll find the meter reading either +9 V or, with its needle pressed firmly against the stop, trying to read -9 V. Even if you do manage to get the needle exactly to zero, it's not likely to stay there for long. The reason is not difficult to see. With a voltage gain of 100,000 times at DC, you'll get a shift of 1 V at

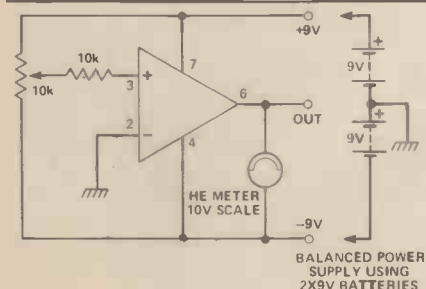

Figure 5. Can you find a bias voltage for the 741?

the output for a change of only 1/100,000 V at the input. That is only 10  $\mu$ V and you can get 10  $\mu$ V or so just by exposing a soldered joint to some cold air (as we will see in Part 12 when we look at thermocouples). No ordinary method of biasing is much use when we have gain figures of this magnitude.

### Getting It Under Control

The simplest way of getting it all under control is to use DC negative feedback. Try the circuit in Figure 6 — you should find that the output voltage is now exactly zero, with no adjustments to worry about. Why? Well, the non-inverting input has been earthed and the inverting input is connected to the output through a 100k resistor. Now, if the voltage at the inverting input is lower than zero (negative) at some time, then the output will go positive because of the inverting action of the amplifier and this positive voltage, connected to the inverting input through resistor R1, will take the voltage at the inverting input in a positive direction. Suppose, now, that the voltage of the inverting input is positive — more than zero. Because of the inverting action, the output voltage must now be negative and the feedback resistor will

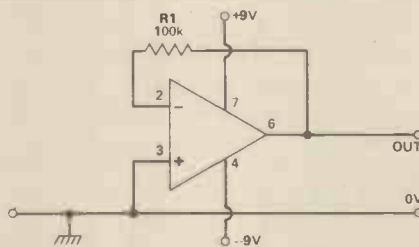

Figure 6. Using negative-feedback bias, with balanced power supplies.

make sure that the voltage at the inverting input also goes negative. So, with any voltage change at the output causing the opposite effect at the input, the result is that both input and output settle at zero volts, neither one disturbing the other. This type of bias circuit is used almost universally for 741 circuits, but for a few specialised circuits which need to make use of the full gain of the 741; in these circuits the connections to pins 1 and 5 are used to adjust the bias inside the IC. The circuit used is shown in Figure 7. Both inputs are earthed, to set up the circuit, and the potentiometer RV1 is then adjusted until the DC voltage at the output is exactly zero.

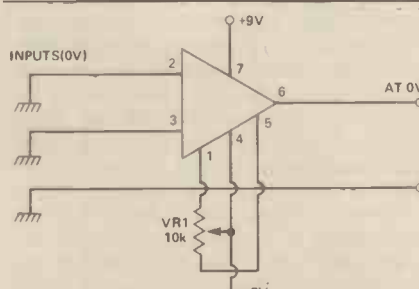

Figure 7. Using the offset adjustment pins of the 741 for a DC amplifier.

### Drop It, Drop It

Most uses of the 741 call for much less than its full gain of 100,000 so we're going to look at some of the standard circuits, all of which make use of negative feedback to reduce the gain. The usual method is to use a combination of AC and DC feedback, with all the DC at the output and a fraction of the AC fed back.

One typical circuit, which uses an input to the inverting input terminal of the 741, is shown in Figure 8. In this circuit, the resistor shown as R1 can consist entirely of the output resistance of the circuit that is connected to this input, or it can be partly output resistance, partly a resistor wired in place. The feedback is through R2, and the gain of the whole circuit is, quite simply,  $R2/R1$ . If, for example, the values are  $R2 = 100k$ ,  $R1 = 1k$ , the gain is  $100/1 = 100$  times; the DC voltage at the output terminal is zero, because of the DC feedback.

This circuit is that of an inverting amplifier whose input resistance is equal to R1 and whose output resistance is very low. The circuit of Figure 8 is shown using two power supplies to obtain a balanced +9 V and -9 V, but we can re-design the circuit to use just a single 9 V supply.

The single-ended version is shown in Figure 9. The non-inverting input has been biased to a voltage of 4V5 by the two 10k resistors, R3 and R4, and the inverting input will be biased to the same voltage by feedback through R2, as before. We do have to be careful, though, not to connect anything to the input which will alter the DC voltage of the inverting terminal, even by a few millivolts DC. The safest way to ensure this is to couple signals to the input through a capacitor, so that using this circuit means abandoning DC amplification. This is seldom a hardship, because few applications of the 741 call for a DC amplifier used with a single-ended power supply.

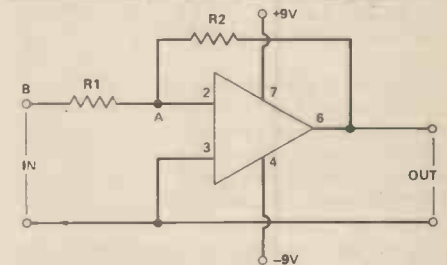

Figure 8. A 741 inverting amplifier circuit using balanced power supplies.

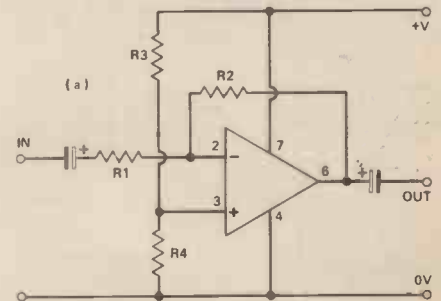

Figure 9. The inverting amplifier circuit rearranged to use a single-ended power supply.



Setting the gain to a fixed value is easy, but varying the gain isn't quite so simple. We could, of course, make either R1 or R2 variable, but it's not really desirable to have potentiometers with none of their terminals at earth voltage, so this method of controlling gain is seldom used. A better method, if we simply want gain control, is shown in Figure 10. R2 is the fixed resistor which provides both AC and DC feedback, but additional AC feedback is obtained by using the potentiometer RV1 and capacitor C1 across R2.

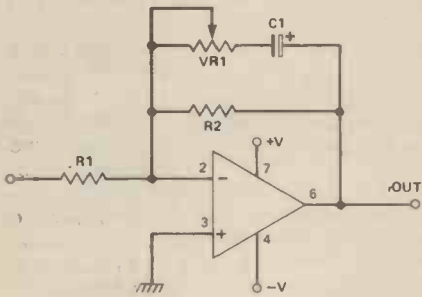

Figure 10. One method of gain control, using variable AC feedback.

The alternative to the inverting amplifier is, reasonably enough, the non-inverting amplifier. A non-inverting amplifier circuit uses feedback to the inverting input, as before, to keep the gain and bias under control but the signal is taken to the non-inverting input, so that the output is in phase with the signal at this input.

A typical circuit, using balanced power supplies, is shown in Figure 11. The feedback of both AC and DC to the inverting input is through a potential divider, R1 and R2, and a high-value resistor, R3, is connected between the non-inverting input and earth. The gain is given by  $(R1 + R2)/R2$ , which is the inverse of the loss caused by the potential dividing action of R1 and R2. For example, if we used  $R1 = 100k$ ,  $R2 = 10k$ , then the gain would be  $110/10 = 11$  times.

The input resistance of this circuit can be very high, 1MO or more, and the output resistance is very low, a fraction of an ohm, so that this is a very useful circuit indeed, particularly since in its balanced form it can be used for DC as well as for AC signals.

Like the inverting amplifier, the non-inverting type can be used with a single

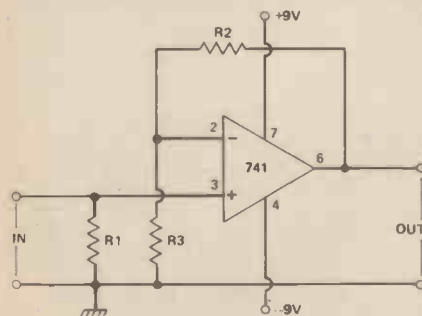

Figure 11. A non-inverting 741 amplifier, using balanced power supplies.

power supply, though at the price of a few complications. The complications arise because the DC level of the inverting input must be the same as the DC level of the output, despite the potential dividing action of the resistors R1 and R2.

A suitable circuit is shown in Figure 12. The non-inverting input is biased to half of the supply voltage by means of two equal resistors R1 and R4. The feedback is through the potential divider formed by R2 and R3, but C3 isolates the inverting input from earth for DC, so that the DC voltage of the inverting input is the same as the DC voltage of the output. For AC signals, however, the effect of C3 is so small that R3 behaves as if it were connected to earth. The resistors R2 and R3, therefore, behave as a potential divider for AC signals, but not for DC and the DC bias is therefore unaffected.

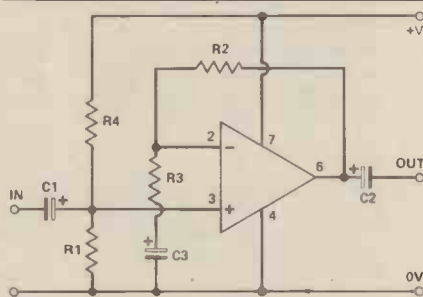

Figure 12. The single-ended power supply version of the non-inverting amplifier.

Since the DC input voltage is half of the supply voltage, the coupling of the signal to the input has to be by a capacitor and if low frequency signals are to be amplified without too much loss, this capacitor must be of a value large enough to pass low frequencies without too much attenuation. The input resistance of the circuit is not as high as that of the circuit which used a balanced power supply, because of the two bias resistors R4 and R1. The input resistance of the circuit is the parallel combination of these two (ignoring the resistance of the 741 itself, because it is very high), so that if each is 100k, then the total input resistance is only 50k. This looks crazy when you glance at the circuit — surely R4 is in series with R1? — but the point is that we are talking about input resistance for AC signals and as far as these are concerned, the positive supply line is as much at earth voltage as the earth line itself because there will be a large-value electrolytic connected somewhere in the power supply between positive and negative supply lines, passing signal frequencies easily. As far as AC is concerned, then, the resistors are in parallel, though they are in series for DC bias currents. The output resistance of the circuit is, as usual, low.

This non-inverting circuit is sometimes called a "follower with gain", because its action is similar to that of an emitter-follower but with voltage gain, which a real emitter follower does not have.

A circuit which actually simulates

emitter-follower action is shown in Figure 13. The circuit is shown in its double-ended power-supply form, with a single resistor connecting the output to the inverting input. Because there is no division of the signal that is fed back, the gain is unity (one). We often assume that the gain of a transistor emitter-follower is exactly unity, but it seldom is (it's always slightly less than one). Using a 741 in this way is a better way to get true unity gain, with high input resistance and very low output resistance. It is equally possible to achieve unity gain and inversion, but with a lower input resistance, using the circuit of Figure 14.

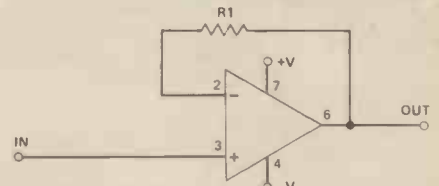

Figure 13. The follower circuit, which has unity gain with very high input resistance and very low output resistance.

### There's Always A Drawback . . .

The bias systems of the 741 works perfectly, even if the supply voltage changes, but only so long as it doesn't exceed the maximum working voltage of the chip, which is  $\pm 18$  V. The one fly in the ointment is bandwidth.

The 741, you see, was never designed as an audio amplifier chip. It was intended for analogue computers, devices which use very low-frequency signals, so bandwidth was always a minor detail. For a 741 operated at full gain, in fact, the bandwidth is only about 10 Hz, which is hardly hi-fi performance.

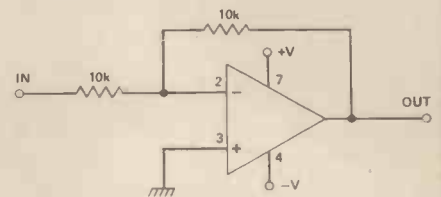

Figure 14. An inverter with unity gain. The actual resistance values are not too important, providing they are equal.

The use of negative feedback obviously helps, but you always have to remember that the bandwidth will be poor if the 741 is used with a high value of gain. At a gain of 100 times, the bandwidth is approximately DC to 10 kHz; this is reasonable, but not as large as a single transistor stage with this much gain, which could easily have a bandwidth of several MHz.

The 741 is a very useful, general purpose op amp but, for special circuits or when high quality is needed, it must be replaced by one of the many ICs which have come after it.

Next month, we'll look at the 'ants' of the electronics world — the vast range of digital ICs.

# BACKNUMBERS



**February 1980**  
 Passion Meter, Win Indicator, Short Circuit Special, Kit Review Special, Into Electronics Construction Part 1.

**September 1980**  
 MicroMixer, Reaction Tester, Guitar Phaser, Development Timer, Teletext Explained, Into Digital Electronics Part 1.

**April 1981**  
 Pre-Amplifier Part 1, Super Siren, Guitar Tremolo, Russian Roulette Game, Doorbell Monitor, Anatomy of a Space Shuttle.

**May 1980**  
 MiniClocks, 5080 Preamp, Model Railway Track Cleaner, 5080 Loudspeakers, Loudspeaker Crossover Design, Radio Controlled Model Survey.

**October 1980**  
 Kitchen Timer, Tug 'o' War Game, Light Dimmer, Freezer Alarm, Intruder Alarm, Temperature-Controlled Soldering Iron.

**May 1981**  
 Electronic Organ, Voice-Operated Switch, Infra-Red Controller, Pre-Amplifier Part 2, Audio Millivoltmeter.

**June 1980**  
 Microbe Radio Control System, Egg Timer, Two Watt Amplifier, Fog Horn, Short Circuits, LEDs and LED Displays.

**January 1981**  
 Car Rev-Counter, Bench Amplifier, Sound-Into-Light Converter, Chuffer, Electronic Games reviewed.

**June 1981**  
 Power Amplifier Part 1, Continuity Checker, Envelope Generator, Early Radio, Gadgets, Games and Kits Supplement.

**July 1980**  
 Sound-Operated Flash Trigger, 18 + 18 Car Stereo Booster, Hazard Flasher, Electronics in Photography, Electronic Espionage, Piezo Electricity.

**February 1981**  
 Heartbeat Monitor, High-Impedance Voltmeter, Medium Wave Radio, Two-Tone Train Horn, Audio Signal Generator.

**July 1981**  
 Burglar Alarm, Doorbuzzer, Treble Booster, Electronic Aids for the Disabled, Power Amplifier Part 2.

**August 1980**  
 EquiTone Car Equaliser, Pass-The-Loop Game, Gaztec Gas Detector, OP-Amp Checker, In-Car Entertainment Survey, Introducing Microprocessors.

**March 1981**  
 Public Address Amplifier, Windscreen Wiper Controller, Bicycle Speedometer, Photographic Timer, Microcassettes.

**August 1981**  
 Electronic Ignition, Thermometer, Electronic Organ (final part), RPM Meter, Bench Power Supply, Radio Control Survey, Into Electronic Components Part 1.

All of the 1980 issues, except January and April, are still available together with the remaining issues from 1981.

All backnumbers cost £1.25 each. For those of you who only want copies of articles, we do offer a photocopying service. Each copy costs £1.25 and information as to its title and publication date should be given. Ordering backnumbers and photocopies could hardly be easier, just fill in the coupon, cut it out and send it to:

**Hobby Electronics,  
 145 Charing Cross Road,  
 London WC2H 0EE**

Please remember to mark your envelope with the service you require, **BACKNUMBERS** or **PHOTOCOPIES**, otherwise our mailroom won't like you.

**HOBBY ELECTRONICS BACKNUMBER ORDER FORM**  
 Please send me the following items:

NAME .....

ADDRESS .....

.....

.....

.....

Back issues ..... at £1.25 each

I enclose £.....

Cheques and Postal Orders should be made payable to ASP Ltd.

**HOBBY ELECTRONICS PHOTOCOPY ORDER FORM**  
 Please send me the following items:

NAME .....

ADDRESS .....

.....

.....

Photocopies of ..... in the  
 ..... issue at £1.25 each

I enclose £.....

Cheques and Postal Orders should be made payable to ASP Ltd.





# GREENWELD

443F Millbrook Road, Southampton, SO1 0HX

All prices include VAT at 15% — just add 50p post

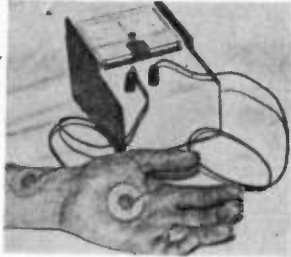

## LIE DETECTOR

Not a toy, this precision instrument was originally part of an "Open University" course, used to measure a change in emotional balance, or as a lie detector. Full details of how to use it are given, and a circuit diagram. Supplied complete with probes, leads and conductive jelly. Needs 2 4.5 batts. Overall size 155 x 100 x 100mm. Only £7.95 — worth that for the case and meter alone!

## AMAZING! COMPUTER GAMES PCBs FOR PEANUTS!!

A bulk purchase of PCBs from several well-known computer games including Battleships, Simon and Starbird enable us to offer these at incredible low prices:

### COMPUTER BATTLESHIPS

Probably one of the most popular electronic games on the market. Unfortunately the design makes it impractical to test the PCB as a working model, although it may well function perfectly. Instead we have tested the sound chip, and sell the board for its component value: SN76477 sound IC; TMS1000 u/processor; batt clips. R's, C's etc. Size 160 x 140mm. Only £1.50

Instruction book and circuit 30p extra

### STARBIRO

Gives realistic engine sounds and flashing laser blasts — accelerating engine noise when module is pointed up, decelerating noise when pointed down. Press contact to see flash and hear blast of lasers shooting. PCB tested and working complete with speaker and batt clip. (Needs PP2) PCB size 130 x 60mm. Only £2.95

### MICROVISION CARTRIDGES

These are a small PCB with a micro-processor chip, designed to plug in to the microvision console. Only snag is, we don't have any consoles!! However, they can be used as an oscillator with 4 different freq. outputs simply by connecting a battery and speaker. Tested and working (as an osc) with pin out data. PCB size 72 x 60mm. Only 25p each!!

### 'SIMON'

The object of this game is to repeat correctly a longer and longer sequence of signals in 3 different games. (Instructions included) PCB contains chips, lampholders and lamps, and is tested working, complete with speaker. Needs PP3 and 2 x HP11. PCB size 130 x 130mm. Only £3.95

### LOGIC 5 PANEL

Tested Logic 5 now sold out — but we have some PCB's with 10 LED's and chip on, but no keyboard. Not tested. 50p

### OPTO/REGS/OP-AMPS

FNAS5220 2 digit 1/2" 7 seg. display on PCB. CB With data. £1.50  
7-seg displays: FND360, 367, 501, all 50p; 530, 847, 850, all £1.50  
Regs: T03 case 7924 120p, 7885 100p, 7808 100p, 7912 100p, 78CB 230p. Others on B/L 13.  
Op-Amps: uA4136 130p; uA776 145p; uA777 300p; uA318 245p.  
IC301s: FCD831, IL15, TIL118, all 60p  
TIL311 Hexadecimal display with decoder, 0-9 and A-F. With data. £3.50

### COMPONENT PACKS

K503 150 wirewound resistors from 1W to 12W, with a good range of values. £1.75  
K505 20 assorted potentiometers, all types including single ganged, rotary and slider. £1.70  
K511 200 small value poly. mica. ceramic caps from a few pF to 0.2uF. Excellent variety £1.20  
K514 100 silver mica caps from 5pF to a few thousand pF. Tolerances from 1% to 10%. £2  
K520 Switch Pack, 20 different, rocker, slide, rotary, toggle, push, micro, etc. Only £2.  
K521 Heatshnk Pack, 5 different sizes each 200mm, 50p

### PANELS

Z521 Panel with 16236 (2N3442) on small heatsink, 2N2223 dual transistor, 2 BC108, diodes, caps, resistors, etc. 60p  
Z482 Potted Oscillator Module works from 1.20V, can be used as LED flasher (3V min.) Supplied with connection data, suitable R, C & LED  
Z527 Reed relay panel — contains 2 x £1 reeds, 6 x 25030 or 25230, 6 x 400V reeds — 50p  
Z529 Pack of ex-computer panels containing 74 series ICs. Lots of different gates and complex logic. All ICs are marked with type no. or code for which an identification sheet is supplied. 20 ICs £1; 100 ICs £4.  
A504 Black case 50 x 50 x 78mm with octal base. PCB inside has 24V reed relay, 200V 7A SCR, 4 x 5A 200V reeds, etc. 60p

### RELAY/TRIAC PANEL

Z537 PCB 100 x 75mm containing a wealth of components:  
2 x 12V DPCO min. relays, 2 x 47uF 16v tants, SC196E 10A 500V triac, CT12d BA 400V SCR, 555 timer, 10 x 1N4001 diodes, 2N5081, 2 x 3mm leds 3 x 2N3704, also R's and C's  
Amazing value!! — if bought separately parts would cost around £8!! — Price for the panel just £2.00

### 1W AMP PANELS

A011 Compact audio amp intended for record player on panel 95 x 65mm including vol control and switch, complete with knobs. Apart from amp circuitry built around LM380N or TBA820M, there is a speed control circuit using 5 transistors. 9V operation, connection data supplied. ONLY £1.50.

### TOROIDAL TRANSFORMER

110mm dia. x 40mm deep 110/240V pri., sec. 18V 4A, 6.3V 1A, 240V 0.3A Ideal for scopes, monitors, VDUs etc. Reduced to £2.95

### 1,000 RESISTORS, £2.50

We've just purchased another 5 million preformed resistors, and can make a similar offer to that made two years ago, at the same price!! K523 — 1,000 mixed 1/4 and 1/2W 5% carbon film resistors, preformed for PCB mntg. Enormous range of preferred values, 1,000 for £2.50; 5,000 £10; 20k £36.

### 200 ELECTROLYTICS, £4

K524 Large variety of values/voltages, mostly cropped leads for PCB mntg. 1-1000uF, 10-63V. All new full spec. components, not chucked-outs!! 200 £4; 1,000 £17.50.

### FILAMENT DISPLAYS

Z653 7 seg display 12.5mm high. Ideal for TTL operation, taking 5V 8mA per seg. Std 14 OIL package. Only £1 each, 4 for £3.00. Data supplied.

### RELAY

24 ac coil, but works well on 6V DC. 2 x 10A, c/o contacts Ex-equip, only £6.00

### REGULATED PSU PANEL

Exclusive Greenweld design, fully variable 0-28V & 20mA-2A. Board contains all components except pots and transformer. Only £7.75. Suitable transformer and pots £6. Send SAE for further details.



### ELECTRO-DIAL

Electrical combination lock — for maximum security — pick proof. 1 million combinations!! Dial is turned to the right to one number, left to a second number, then right again to a third number. Only when this has been completed in the correct sequence will the electrical contacts close these can be used to operate a relay or solenoid. Overall dia. 65 x 60mm deep. Only £3.95. Also available without combination. Only £3.95

### DEVELOPMENT PACKS

These packs of brand new top quality components are designed to give the constructor a complete range so the right value is to hand whenever required. They also give a substantial saving over buying individual parts.  
K001 50V ceramic plate capacitors: 5%, 10 of each value 22pF to 1,000pF, total 210. £4.80.  
K002 Extended range 22pF to 0.1 Values over 1000pF are of a greater tolerance, 10 of each value 22 27 33 39 47 56 68 82 100 120 150 180 220 270 330 390 470 560 680 820 1000 1000 2200 3300 4700 6800 01 015 022 033 047 1. PRICE: £7.86.  
K003 C280 or similar Polyester capacitors, 10 each of the following: .01, .015, .022, .033, .047, .068, .1, .15, .22, .33 and 47uF. PRICE: £5.40.  
K004 Mylar capacitors. Small size, vertical mounting 100V, 10 each of the following: .001, .0012, .0015, .0018, .0022, .0027, .0033, .0039, .0047, .0056, .0068, .0082, .01 Total 130 capacitors. PRICE: £4.70.  
K007 Electrolytic capacitors 25V working, small physical size axial or radial leads, 10 each of the following: 1, 2.2, 4.7, 10, 22, 47, 100uF. Total 70 capacitors. PRICE: £3.59.  
K008 Extended range, as above, also including 220, 470 and 1000uF all at 25V. Total of 100 capacitors. PRICE: £8.35.  
K021 CR25 resistors or similar, miniature 1/4 watt carbon film 5%, as used in nearly all projects, 10 of each value from 10 ohms to 1M, £12 series. Total 610 resistors. PRICE: £5.95.  
K041 Zener diodes 400mW 5%, 10 of each of all the values from 2V7 to 36V. Total 280 zeners. PRICE: £15.95.  
K061 LEDs — pack of 60, comprising 10 each red, green and yellow 3mm and 5mm, together with chips. PRICE: £8.95.

### CAPACITOR BANKS

2200uF 100V cans 77 x 35mm dia 75p; 10/£5.50.  
220uF 10V axial 5p; 100 £2.30; 1000 £16.  
400 x 100uF 275V 102 x 44mm dia. 75p; 10 £5.50.  
200uF 350V, 100 x 100 x 50uF 300V can 75 x 44mm dia. 40p; 10/£3; 100/£20.  
100uF 25V axial 100/£3.

# LOTS OF NEW ILP ENCAPSULATED PRE-AMPS— COMPATIBLE WITH ALL ILP MODULES

Suddenly, instead of two ILP encapsulated pre-amps, there are eight — everything from the simple mono pre-amp (HY6), through mixing mono pre-amps (HY12 and HY69), to a dual stereo pre-amp (HY71). Plus a new guitar pre-amp (HY73).

Each gives the very best reproduction from your equipment that your money can buy, and all are protected against short circuit and wrong polarity.

All ILP modules are compatible with each other — combine them to create almost any audio system. Every item carries a 5 year no quibble guarantee and includes full connection data.

So send your order today — the Freepost coupon needs no stamp

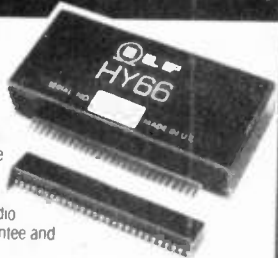

### PRE-AMPS

Model No	Module	What it does	Current required	Price inc. VAT	Price ex. VAT
HY 6	Mono pre-amp	Provides inputs for mic/mag. cartridge/tuner/tape/auxiliary with volume/bass/treble controls	10 mA	£7.41	£6.44
HY 9	Stereo pre-amp	Two channels mag. cartridge mic + volume control	10 mA	£7.71	£6.70
HY 12	Mono pre-amp	Mixes two signals into one with bass/mid-range/treble controls	10 mA	£7.71	£6.70
HY 66	Stereo pre-amp	Two channels, with inputs for mic/mag. cartridge/tape/tuner/auxiliary with volume/bass/treble/balance	20 mA	£14.02	£12.19
HY 69	Mono pre-amp	Two input channels mag. cartridge mic. with mixing and volume/treble/bass controls	20 mA	£12.02	£10.45
HY 71	Dual stereo pre-amp	Provides four channels for mag. cartridge/mic with volume control	20 mA	£12.36	£10.75
HY 73	Guitar pre-amp	Provides for two guitars (bass + lead) and mic with separate volume/bass/treble and mixing	20 mA	£14.09	£12.25
HY 75	Stereo pre-amp	Two channels, each mixing two signals into one with bass/mid-range/treble controls	20 mA	£12.36	£10.75



For easy mounting we recommend: B 6 mounting board for modules HY6-HY13 £0.90 inc. VAT (0.78 ex. VAT) B 66 mounting board for modules HY66-HY77 £1.12 inc. VAT (0.99 ex. VAT) All modules are encapsulated and include clip-on edge connectors. All operate from +15V minimum to +30V maximum needing dropper resistors for higher voltages. Modules HY6 to HY13 measure 45 x 20 x 40mm. HY66 to HY77 measure 90 x 20 x 40mm.

How to order Freepost: Use this coupon, or a separate sheet of paper, to order these products, or any products from other ILP Electronics advertisements. No stamp is needed if you address to Freepost. Cheques and postal orders must be crossed and payable to ILP Electronics Ltd. cash must be registered C O D — add £1 to total order value. Access and Barclaycard welcome. All UK orders sent post free within 7 days of receipt of order.

Please send me the following ILP modules

Total purchase price

I enclose Cheque  Postal Orders  Int. Money Order

Please debit my Access/Barclaycard No

Name

Address

Signature

Post to: ILP Electronics Ltd, Freepost 2, Graham Bell House, Roper Close, Canterbury CT2 7EP, Kent, England. Telephone (0227) 54778. Technical (0227) 64723. Telex 965780.

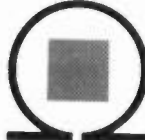

ILP ELECTRONICS LTD

HE 4/4

# STAY AHEAD. STAY WITH US

# DON'T SHORT CIRCUIT YOUR PROJECTS

With our books you can be sure of getting them right!

- BEGINNERS GUIDE TO BUILDING ELECTRONIC PROJECTS** R.A. PENFOLD  
An essential first book for newcomers to this fascinating hobby covering component identification, tools, soldering and construction techniques with some easy and useful projects to get you into the swing of things..... £1.50
- ELECTRONIC PROJECTS FOR BEGINNERS** F.G. RAYER  
Another MUST for beginners. Many, many, easily made projects for the newcomer, both amusing and useful, some don't even need soldering..... £1.35
- DIGITAL I/C PROJECTS** F.G. RAYER  
A highly recommended book for both the beginner and more advanced enthusiast alike. Packed full of easy and advanced projects based on handy digital integrated circuits..... £1.95
- IC 555 PROJECTS** E.A. PARR  
This exceedingly popular book lets you enjoy two hobbies in one. Crammed full of projects for the I/C 555 Timer it includes circuits for your car, Model Railway, Home and Family Entertainment. Also includes a special section on 556, 558 and 559 i.c.'s..... £1.95
- POPULAR ELECTRONIC CIRCUITS. BOOK 1** R.A. PENFOLD  
1½ CIRCUITS INCLUDING Audio, Radio, Test Gear, Musical effects, Household gadgets etc. This book is intended for those readers who can build projects from just a circuit diagram..... £1.95
- HOW TO MAKE WALKIE-TALKIES** F.G. RAYER  
Britain's No. 1 selling book on walkie talkies. Includes chapters on transmission, reception, aeriels and C.B..... £1.50
- REMOTE CONTROL PROJECTS** OWENS BISHOP  
Remote control does not stop with Radio control Infra-red, Ultrasonic and visible light remote control systems have come into their own over the last decade and now you too can use these fascinating techniques in a wide variety of applications..... £1.95
- ELECTRONIC MUSIC PROJECTS** R.A. PENFOLD  
Fuzz Box, Waa-Waa pedal, Sustain unit, Reverb & Phaser units, Tremelo generators and many more. Build these projects and enhance your music with this excellent book..... £1.75
- MODEL RAILWAY PROJECTS** R.A. PENFOLD  
Be the envy of your Model Railway Club. With this book your layout can be brought to life easily and simply. Constant voltage and pulsed controllers, Points Controllers, Automatic signalling, Electronic steam whistle, Steam sound unit, Diesel horn unit are all here. If you are a railway modeller, can you afford to be without one?..... £1.95
- AN INTRODUCTION TO BASIC PROGRAMMING TECHNIQUES** S. DALY  
A recommended first book for the home computer buff. Basic language explained in easily understandable terms together with lots of information on programming..... £1.95
- A MICROPROCESSOR PRIMER** E.A. PARR  
A must for those interested in microprocessors, subjects covered include computer architecture, instruction formats, instruction sets, sub-routines, assemblers and much, much more..... £1.75

**Postage & Packing on Books**

1 Book .....	40p
2 Books .....	55p
3 Books .....	60p
4 Books .....	75p
Over four .....	£1.00

## WE ALSO STOCK FIBRE OPTICS

**Fibreflex Light Guide.**  
Fine flexible glass optical strands bound in a plastic sheath.  
Light guide Dia. 1mm. Overall Dia. 2mm ..... 80p per metre  
**Crofon**  
A .020" Dia. single strand Crofon Fibre light guide, unsheathed.  
Can be bent at right angles if required ..... 70p per metre  
*Both the above available in lengths up to 25 metres.*

**Crofon Spray**  
Comprising 110 x .020" single strands ferruled and polished one end. Gives 110 light points from one single light source.  
..... £3.75 each

**Plastic Ferrules**  
For use with Fibreflex to give neat, precise, terminations.  
..... 10p each

Postage & Packing on Fibre optics 45p



**D'JUSON LTD**  
PO BOX 298,  
ASCOT,  
BERKS. SL5 9UR

## PCB HOLDERS

- PCB's may be rotated through 360 degrees and locked at any angle
- Simple adjustment for different board sizes
- Foam pad available enabling a number of components to be inserted prior to soldering

### CNC 6

PCB Capacity: 10" x 7"

PCB's held by spring clips which also allow the holder to be used as a small soldering jig.

PRICE: £13.80 INC. VAT

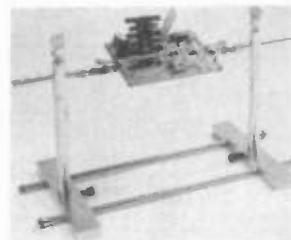

### CNC 9

PCB Capacity: 8" x 8"

PCB's held by adjustable Vee Clamps which eliminate the risk of damage to the face sides of the PCB and allow a high degree of accessibility.

PRICE: £15.95 INC. VAT

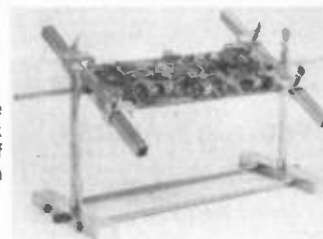

### FOAM PAD

Size: 8" x 8" Clips onto Holder. PRICE: £5.50 INC. VAT

AVAILABLE DIRECT FROM THE MANUFACTURER. PLEASE ADD £1.50 TO COVER POST AND PACKING.

**CARLTON NICHOL & CO. LTD.,**  
GOLDKEY INDUSTRIAL ESTATE, KELVEDON, ESSEX

7 HUGHENDEN ROAD, HASTINGS, SUSSEX TN34 3TG  
Telephone: HASTINGS (0424) 436004



LTD  
ELECTRONIC KITS

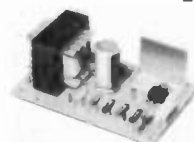

KS490 NICAD BATT CHARGER.  
10-20-45-100-150 mA, 15V D.C. MAX.  
240V A.C. £9.06 inc VAT



KS470 SOUND OPERATED SWITCH  
9-12V D.C. £11.27 inc VAT



KS370 2 TONE SIREN, OUTPUT 10W  
at 4 OHM, 6W at 8 OHM, 1000BPM  
£5.14 inc VAT



KS143 L.E.D. VU DISPLAY,  
INPUT 1-100W, 5-12V D.C. £9.15 inc VAT



KS445 COURTESY LIGHT TIMER FOR CARS  
10-15V D.C. £7.79 inc VAT



KS200 MINI F.M. TRANSMITTER  
88-108 MHz 9V D.C.  
(NOT LICENCEABLE IN UK) £7.39 inc VAT

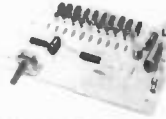

KS262 10 CHAN CHASE LIGHT  
300W PER CHAN, 240V A.C. £18.72 inc VAT



UK993 CROSS MATCH GENERATOR  
R.F. OUTPUT, U.H.F. INTERNAL  
9V D.C. SUPPLY £22.94 inc VAT



Post & Packing 50p per KS kit, 75p per UK kit. Send 20p S.A.E. for catalogue of our extensive range of kits & cabinets. Trade, Educational & Export enquiries welcomed.



# SCALING the Hi-Fi HEIGHTS Part 4

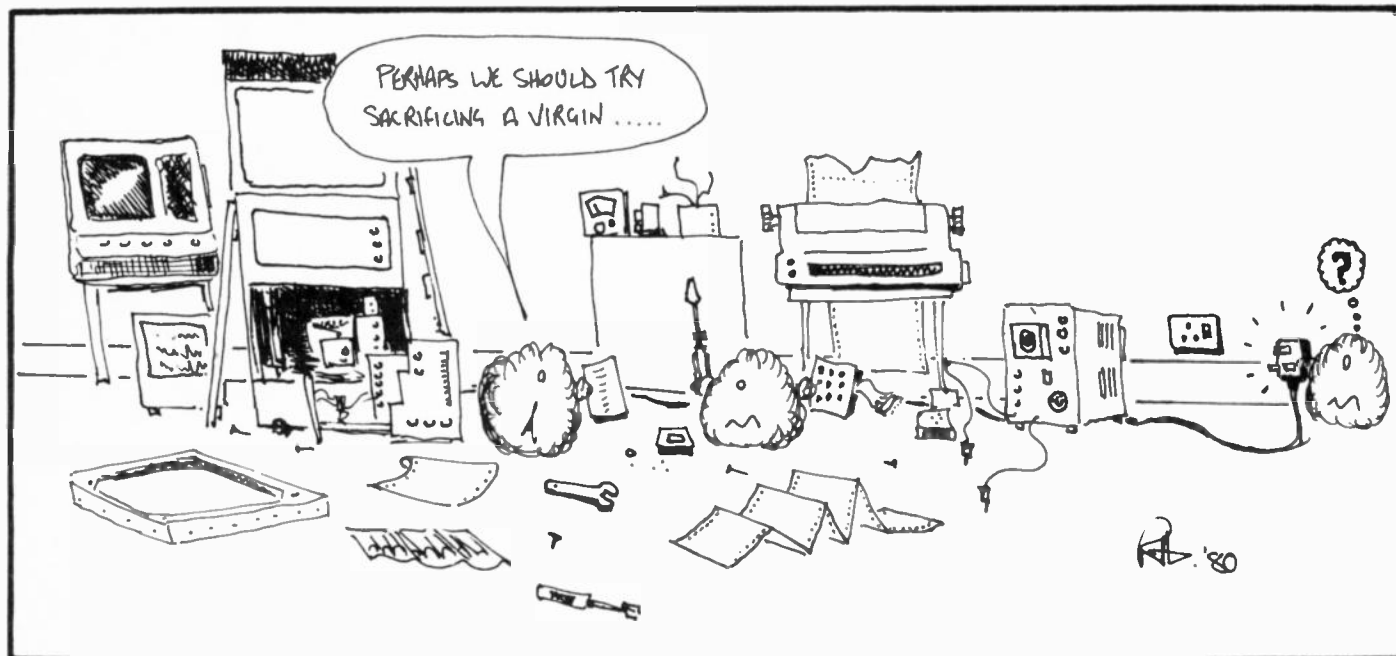

Home from the wars, standing in the centre of the living room, surrounded by large brown boxes and an air of confusion. Thus begins the final act of the 'Quest for Music'.

YOU'VE SURVIVED the demos and the deadly salesman's coffee to return home with the hi-fi of your choice. Only one thing now stands between you and success, the Rite of Installation. Usually rushed, rarely planned, and often botched, this final hurdle can bring to nought many of the gains made earlier, in the buying process.

So put the scissors to one side for a while and let us look at each stage in a logical order, then follow it closely to guarantee the best from those expensive boxes. Read right through and don't do anything until you've got to the end, lest smoking ruin befall you.

**Now I've got it — where do I put it?:**

Earlier on, you decided the size of your proposed loudspeakers on the basis of fitting them into your living room — this is the moment of truth! Has it worked? Take a look at Figure 1 for some ideas on the siting of seating and speakers. If you can't accommodate one of the schemes shown therein, then take your courage (and couch) in both hands and re-arrange the room! Having spent the time and money to achieve sonic happiness, don't spoil it now for the sake of a few marks on the carpet. Whilst perusing the speaker plans, look around for a possible site for the record deck. Unless the floor is concrete, the deck

has to go on a separate, wall-mounted shelf. Sorry, but there it is. No coffee table, wall divider and/or cupboard will compensate for a set of floorboards determined to lead your new stylus a merry dance across the vinyl. If you're clever you can hide the shelf brackets behind a wall unit or equipment rack, so that the shelf appears part of the structure. Just make it *solid*. After you've positioned the deck and/or loudspeakers — preferably *not* directly facing each other, the rest of the system will probably site itself. Go for longer speaker leads, rather than extended runs of screened cable from deck to amp.

**Now it's there — what do I do with it?:**

Before setting-up the deck, or switching anything on, consider how to link the units together. The record-deck to amp connection can be accommodated with high-quality screened leads and phono plugs. If you've acquired an SME arm, then use their excellent connectors. An integrated deck might have phono sockets on the rear somewhere. If it does, then invest in a couple of these expensive gold-ended leads; they will repay the cost, over the years. A lot of nonsense has been spouted about speaker leads in recent times — a little sense has come through, too, thank goodness, and the basic requirement

for the link seems, at last, undisputed. Simple as it may sound, all that the cable has to do is to join the amplifier to the speaker without offering any resistance (or impedance) of its own to confuse the issue. In this way the amplifier is able to preserve its control over the cones in the speaker, as the damping factor (see Part 1, January '82) is not reduced. Use *at least* thirteen-amp wire, regardless of the power of the amp. Your local electrical retailer will supply the stuff by the yard. If the amp is more than 50 W a channel, then use *two* lengths per speaker, twisting the ends together, at both ends, to form one huge wire for each terminal! This will work out cheaper than the specialised 'Super-wires' and provide a performance comparable to any of them (if you do buy one of these, get 'Monster Cable', as it is indisputably the best of the bunch).

**I switched it on and nothing happened:**

Hang on a minute — it wouldn't, would it? No mains connections yet. Let that be a lesson to you. Patience — music comes to him who waits. First we go down to earth literally, while we discuss the avoidance of the dreaded 'hum-loop'. This occurs when there is more than one way for a current to get to earth from the amp or record deck. The symptom is a horri-

# Scaling The Hi-Fi Heights

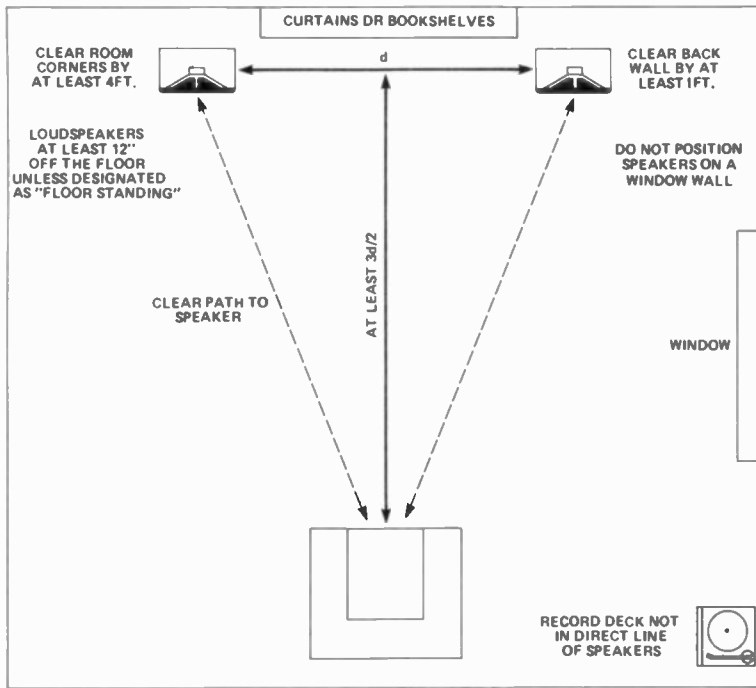

Figure 1. Some pointers of position; keep your listening 'throne' at least 1 1/2 times as far away as the speakers are apart. Don't put the speakers in corners but be prepared to angle them inwards if the sound is at all 'booming'. Record decks should be out of the direct line of the speakers, on a wall-mounted shelf. Putting the speakers on a window wall will greatly impair the stereo image and lead to a dramatic change in sound quality when you pull the curtains at night.

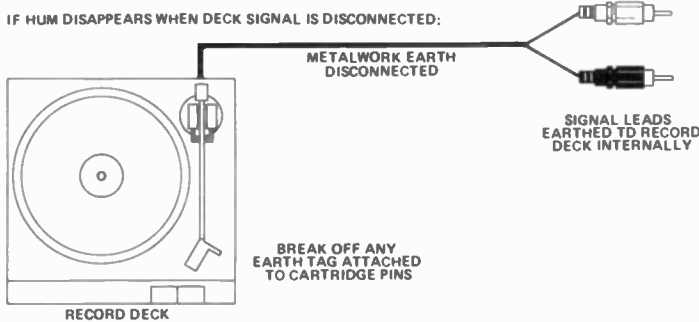
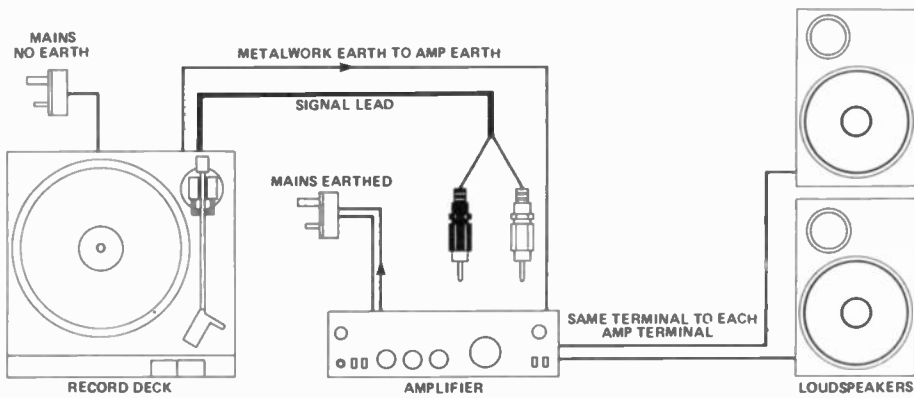

Figure 2. Earthing arrangements. These are the most basic and most successful set-ups, but don't be afraid to experiment to get the best results from your particular system. Make sure only one wire goes to mains earth. Some cartridges (eg. Shure) have a small metal tag wrapped around one pin on the back of the body. If you get hum in one channel only, CAREFULLY bend this away from the pin.

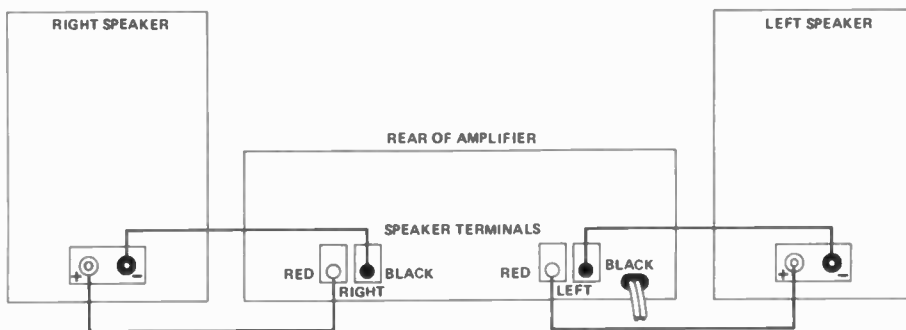

Figure 3. Looks simple doesn't it? Loudspeaker phasing is just a matter of connecting the + ve on the speakers to the same terminal on both channels. Use coloured or 'ribbed' cable and make sure you get it right. If you don't? Very poor bass and no stereo image. Just two small pools of sound around the enclosures.



ble, music-destroying, 50 Hz (or 100 Hz, if the transformer is injecting noise into the circuits) buzz that both saps power from the amp and endangers speakers. Connect the amplifier, only, to the mains earth. There will also be an earth or ground terminal on the back of the amp and a wire from the turntable should be attached here to earth the deck. Some turntables will connect the deck earth to the outer of the phono plugs and thus there will be no external connection. The golden rule is, "so long as it doesn't hum — don't worry about it!" If you intend to expand the system later, it will prove a good idea to get one of those blocks of multiple mains sockets now, rather than later. QED make a nice one, but it's expensive, as are the nice special plugs to fit it — it's up to you whether you feel like splashing out. Bear in mind, though, that a mass of wires all snaking off to one mains socket is neither safe nor conducive to expansion. It's better to "do it right" at the start. One more thing before pushing the button — make sure that the speakers are wired the same way round, ie with the black and red of each enclosure to the corresponding terminal on the amp (use red to +ve). This will ensure the 'phasing' is correct so that the cones move together, rather than against each other. Incorrect speaker wiring would destroy the stereo image as well as the bass response.

**Is This a Set-up?** If you *have* to set-up the record deck yourself — do try to get the dealer to do it, if possible — then now is the hour! An integrated player is simple. Just set the distance between the rear of the headshell and the stylus to the manufacturer's figure. This is usually 49 mm, but check anyway. Use an alignment protractor to set the cartridge parallel to the headshell sides; again, individual decks vary so much that you'll have to consult the instructions. If you've assembled a record player from separate turntable, arm and cartridge then *have the dealer set it up*. Without wishing to be unkind, this is the only sensible course for a first system. The necessary adjustments are unbelievably precise and involve the use of test records to some degree. If you get it wrong, not only will you remove large amounts of plastic from the LP, like as not you'll re-arrange the anatomy of your beloved cartridge, too. And, before you say it — yes, I *am* trying to frighten you off! It would take a four-page article to explain how to do the job properly and, if demand proves sufficient, you may well see the feature in HE. Until then, let the shop earn its money (you know it makes sense!).

**What a Turn-on . . .** This is it. You've plugged the deck into 'phono', earthed it properly, set the loudspeakers up in the correct place in the room, fitted all the mains plugs and finally checked everything again. If you haven't, go back two spaces and do it. Do not pass "go" and do not push any mains

UNIT	APPROX. PRICE	SYSTEM CODE	
<b>CARTRIDGES</b>			
Grado FCE + 1	£12	A	
Shure M97 HE	£37	B	
Goldring G920 IGC	£25	B	
Dynavector 10xII	£47	C	
Coral MC88E	£20	A	
Shure V15 IV/MV30HE	£70/£90	D	
Dynavector Ruby	£100	E,X	
Ortofon FF15	£11	A	
Stanton 881S	£60	D	
Audio Tech AT-31E	£55	F	
<b>TURNTABLES</b>			
Thorens TD160S	£150	A,B,C,D,E,F	
Oracle	£700	E,X	
Kitdeck	£100	A,B,C,F	
Logic DM101	£250	B,C,D,E,F	
<b>ARMS</b>			
SME Series III/IIIS	£110/£75	ALL	
Linn 1TTOK	£250	ALL (except E)	
Audio Tech AT1100	£100	D,F	
ADC LMF1	£65	A	
Mission 774	£150	E,F,D	
Syrinx PU2	£170	E,F,D	
<b>INTEGRATED DECKS</b>			
Dual CS505	£70	A	
Thorens TD 160C	£150	B,C,D	
Trio LO7D	£1100	X	
Technics SL10	£300	S	
Pioneer PL300	£90	A	
<b>AMPLIFIERS</b>			
	<b>POWER</b>		
Crimson 310/520	50W	£200	A,B,C
Trio KA 1000	100W	£500	C,D,E,F,S
Monogram 106/109	150W	£440	D,E,F,X,S
Crimson CK1010/1100	120W	£250	B,C,D,F
Quad 44/405	100W	£450	A,B,C,D
Pioneer A9	100W	£450	A,B,C,D
NAD 3020	35W	£90	A,B
Seoum SA 4130	35W	£70	A,B
Sansui A9	75W	£130	A,B,C,D
Lentek	70W	£700	E,F,X
<b>LOUDSPEAKERS</b>			
Wharfedale Laser 80	£90	A,B	
KEF 105II	£900	E,F,X,S	
Gale 401	£500	E,F,X,S	
KEF 103.2	£250	C,D,E	
Celestion 200	£185	A,B,C	
Tangent TM3	£120	A,B,C,S	
Wharfedale TSR 108	£240	C,D,F	
Monitor Audio MA 9	£110	A,B,C,D	
Mourdant-Short Carnivals	£115	A,B,C,D	
Harbeth HL1	£330	D,E,F,S	

buttons. Now switch on and advance the volume control to 12 o'clock. All you should be able to hear from your listening position is a faint hiss. If there is any obtrusive humming sound, then check your earthing arrangement against Figure 2. If all is well, put a record on, sit back and forget all the hassles.

**Now That It's Working . . .** What do I Upgrade First? If you're asking this question then you're hooked on hi-fi already and nothing short of a £3000 system will eventually satisfy your evil desires. You have my sympathy. Table 1 shows a list of recommended

units and systems which will assist in choosing a first system and in selecting upgrade-units. It is not complete and will conflict with other magazine's favourite equipment. After all, everyone is entitled to their own opinions — and these are ours. Everything mentioned herein is a model that we have tested and found to represent both good value for money and excellent engineering. The list should be used as a "shopping guide" — not as a Bible. If you don't like the sound of any of it, don't buy it!

HE

# Bookshelf

Here is a small selection of the books available from HE's book service. New titles will appear each month



**ELEMENTS OF ELECTRONICS**  
by F A Wilson

This series of books covers the basics of electronics, in an easy to understand manner. The topics are written so that important concepts can be grasped by the beginner and yet they can also provide an in-depth reference source for the practising engineer.

**Book 1: THE SIMPLE ELECTRONIC CIRCUIT AND COMPONENTS . . . £2.25**

This book contains all the fundamental theory necessary to lead to a full understanding of the simple electronic circuit and its main components.

**Book 2: ALTERNATING CURRENT THEORY . . . £2.25**

Sinewaves, complex waveforms, time constants, reactance, resonance and other important aspects of AC are covered.

**Book 3: SEMICONDUCTOR TECHNOLOGY . . . £2.25**

From simple atomic structure models through to complex integrated circuits and the elements of computers.

**Book 4: MICROPROCESSING SYSTEMS AND CIRCUITS . . . £2.95**

Starting with simple computer models, this book takes the reader up to complete microprocessing systems and theoretical circuits.

**Book 5: COMMUNICATIONS . . . £2.95**

All aspects of communication systems such as channel bandwidth, transmission systems and signal processing, are discussed in this final book of the series.

**A MICROPROCESSOR PRIMER**  
by EA Parr . . . . . **£1.75**

Newcomers to electronics and computing tend to be overwhelmed when first confronted with literature about microprocessors. This book helps to alleviate the problem by recounting the design of a simple computer in an easy to understand manner.

**PRACTICAL COMPUTER EXPERIMENTS**  
by EA Parr . . . . . **£1.75**

Readers of this book will find themselves involved in experiments which help to explain the inner workings of computers and microprocessors. All circuits and experiments use discrete logic circuits to demonstrate such things as 'adders', 'stores', 'arithmetic and logic units' etc.

**HOW TO MAKE WALKIE-TALKIES**  
by FG Rayer . . . . . **£1.50**

Low power hand-held, or portable, radio transmitting/receiving equipment need not be complicated — as this book shows. A book of great interest, not only to the licensed operator, but also to those enthusiasts without transmitting licences who wish to participate as

listeners with the described receiving equipment.

**ELECTRONIC PROJECTS FOR BEGINNERS**  
by FG Rayer . . . . . **£1.35**

The newcomer to electronics will find this a very useful book. It contains a wide range of easily made projects including component and wiring layouts. A number of projects can be constructed without the use of a soldering iron.

**POPULAR ELECTRONIC PROJECTS**  
by RA Penfold . . . . . **£1.45**

A collection of circuits and projects to interest most electronics constructors, covering four popular main areas: radio; audio; household projects and test equipment.

**INTERNATIONAL TRANSISTOR EQUIVALENTS GUIDE**  
by A Michaels . . . . . **£2.95**

Transistors from over 100 international manufacturers are tabulated in this book in an easy to understand, cross-referenced format, to enable the reader to quickly locate equivalent devices from an alternative source. This book is an extremely useful addition to the electronics enthusiast's library.

To receive your books fill in the form below (or write the details on a sheet of paper) and send it, with your payment, to the address given.

Please wait 28 days for delivery. The offer applies to the UK only. Prices may be subject to change without notice.

To: HE Bookshelf, 513, LONDON ROAD,  
THORNTON HEATH, SURREY, ENGLAND.

I enclose a cheque/postal order made payable to ASP Ltd, for the amount shown below

OR

I wish to pay by Barclaycard/Access. Please charge to my account number



Signature .....

Name .....  
(BLOCK CAPITALS)

Address .....  
(BLOCK CAPITALS)

.....  
.....  
.....

Books Required	Price
<b>Add 75p p&amp;p</b>	<b>0.75</b>
<b>Total enclosed £</b>	

## TECHNICAL TRAINING IN ELECTRONICS AND TELECOMMUNICATIONS

ICS can provide the technical knowledge that is so essential to your success, knowledge that will enable you to take advantage of the many opportunities open to the trained man. You study in your own home, in your own time and at your own pace and if you are studying for an examination ICS guarantee coaching until you are successful.

### City & Guilds Certificates

**Telecommunications Technicians  
Radio Amateurs  
Electrical Installation Work**

### Certificate Courses

**Colour TV Servicing  
Electronic Engineering and Maintenance  
Computer Engineering and Programming  
Radio, TV, Audio Engineering and Servicing  
Electrical Engineering, Installation  
and Contracting**

**POST OR PHONE TODAY FOR FREE BOOKLET**

**To: International Correspondence  
Schools**

**ICS**

Dept 263T, Intertex House, London SW8 4UJ  
or telephone 622 9911

Subject of Interest \_\_\_\_\_

Name \_\_\_\_\_

Address \_\_\_\_\_

Tel \_\_\_\_\_

## JOIN UP WITH LITESOLD

Litesold's new 'L' Series soldering iron — now at a bargain price. Outstanding performance. Light weight. Easy to maintain. Elements are enclosed in Stainless Steel shafts, insulated with mica and ceramic. Non-seize interchangeable bits, choose from 'copper' or 'long life'. A very special tool at a very special 'direct' price. Just £5.58 for iron fitted with 3.2mm copper bit. Just £2.40 for 3 spare copper bits (1.6; 2.4; 4.7).

A mere £4.38 for professional spring stand! Or buy the lot for **£11.12!** and save 10%.

All prices inc. VAT P. & P.

Please allow 14 days delivery.

Write today. Send Cheque/P.O. to Litesold, 97-99 Gloucester Road, Croydon CR0 2DN or phone 01-889 0574 for Barclaycard/Access sales.



**£5.58**

**LITESOLD  
LIGHT SOLDERING  
DEVELOPMENTS LTD**

### LIMITED OFFER!

As an introduction **CRICKLEWOOD ELECTRONICS LTD.** (Marshall's Old Shop), 40 Cricklewood Broadway, London NW2 3ET. Tel: 01-452 0161 *Whilst stocks last and only if accompanied by this Ad.*

**DESOLDERING TOOL** Now everyone can afford one of these superb, blue anodised aluminium high pressure hand desoldering tools at nearly half our normal price. Normal Price £6.50 + VAT. With this ad **£3.95 + VAT.** Spare Teflon screw-in noses 75p + VAT.

**JAPANESE TRANSISTORS** Equivalents available for most types. Please call, phone or write.

**LOW COST VERSATILE MULTIMETER**

**THE MIGHTY MINI MULTI-TESTER** 2,000 ohms per volt. DC & AC Voltage ranges: 10v, 50v, 250v, 1000v. DC current ranges 100mA. Resistance ohms x 10 x 100db from -10db to +22db. Mirror arc scale, overload protected, complete with battery, test leads & instructions. Usual price £8.65 + VAT; with this Ad: **£4.95 + VAT.**

**ORDER FORM**

Name \_\_\_\_\_

Address \_\_\_\_\_

Desoldering tools at £3.85 = £ \_\_\_\_\_

Spare Teflon noses at 75p = £ \_\_\_\_\_

Mighty Mini Testers at £4.95 = £ \_\_\_\_\_

Postage, packing and insurance at 60p per one device, 25p for each additional device £ \_\_\_\_\_

Sub total £ \_\_\_\_\_

Add 15% VAT £ \_\_\_\_\_

I enclose cheque no/P.O. no. £ \_\_\_\_\_

Alternatively please credit my VISA/ACCESS No. \_\_\_\_\_

Signature \_\_\_\_\_

This offer applies to UK only. Please allow 7-10 days delivery. Overseas customers please do not add VAT but allow to cover postage. TRADE ENQUIRIES WELCOME.

**CRICKLEWOOD ELECTRONICS LTD.**  
40 Cricklewood Broadway, London NW2 3ET. Tel: 01-452 0161

# MIXERS, FADERS, VU METER DRIVERS AND MORE— ALL NEW FROM ILP!

Just some of the 28 new amazingly compact modules from ILP Electronics, Britain's leader in electronics modules — you'll find more new products in the amps and pre-amps advertisements.

All ILP modules are compatible with each other — you can combine them to create almost any audio system. Together they form the most exciting and versatile modular assembly system for constructors of all ages and experience.

Every item from ILP carries a 5 year no quibble guarantee and includes full connection data. So send your order on the Freepost coupon below today!

### MIXERS

Model No.	Module	What it does	Current required	Price inc. VAT	Price ex. VAT
HY 7	Mono mixer	Mixes eight signals into one	10 mA	£5 92	£5 15
HY 8	Stereo mixer	Two channels, each mixing five signals into one	10 mA	£7 19	£6 25
HY 11	Mono mixer	Mixes five signals into one — with base/treble controls	10 mA	£8 11	£7 50
HY 68	Stereo mixer	Two channels, each mixing ten signals into one	20 mA	£9 14	£7 95
HY 74	Stereo mixer	Two channels, each mixing five signals into one — with treble and bass controls	20 mA	£13 17	£11 45

### AND OTHER EXCITING NEW MODULES

Model No.	Module	What it does	Current required	Price inc. VAT	Price ex. VAT
HY 13	Mono VU meter	Programmable gain/LED overload driver	10 mA	£6 84	£5 95
HY 67*	Stereo headphone driver	Will drive stereo headphones in the 4 ohm-2K ohm range	80 mA	£14 20	£12 35
HY 72	Voice operated stereo fader	Provides depth/delay effects	20 mA	£15 07	£13 10
HY 73	Guitar pre-amp	Handles two guitars (bass and lead) and mic with separate volume/bass/treble and mix.	20 mA	£14 09	£12 25
HY 76	Stereo switch matrix	Provides two channels, each switching one of four signals into one	20 mA	To be announced	
HY 77	Stereo VU meter driver	Programmable gain/LED overload driver	20 mA	£10 64	£9 25

For easy mounting we recommend:

B 6 mounting board for modules HY6 - HY13 £0 90 inc. VAT (0 78 ex. VAT)

B 66 mounting board for modules HY66-HY77 £1 12 inc. VAT (0 99 ex. VAT)

\*All modules are encapsulated and include clip-on edge connectors. All operate from ±15V minimum to ±30V maximum, needing dropper resistors for higher voltages. HY67 can be used only with the PSU 30 power supply unit. Modules HY6 to HY13 measure 45x20x40mm. HY66 to HY77 measure 90x20x40mm.

### FP 480 BRIDGING UNIT FOR DOUBLING POWER

Designed specially by ILP for use with any two power amplifiers of the same type to double the power output obtained and will function with any ILP power supply. In totally sealed case, size 45x50x20mm with edge connector. It thus becomes possible to obtain 480 watts rms (single channel) into 8Ω. Contributory distortion less than 0.005%. Price: £5.51 inc. VAT. (Ex. VAT £4.79.)

How to order Freepost:

Use this coupon, or a separate sheet of paper, to order these products, or any products from other ILP Electronics advertisements. No stamp is needed if you address to Freepost. Cheques and postal orders must be crossed and payable to ILP Electronics Ltd; cash must be registered. C.O.D. — add £1 to total order value. Access and Barclaycard welcome. All UK orders sent post free within 7 days of receipt of order.

Please send me the following  
ILP modules

Total purchase price \_\_\_\_\_

I enclose Cheque

Postal Orders

Int. Money Order

Please debit my Access/Barclaycard No \_\_\_\_\_

Name \_\_\_\_\_

Address \_\_\_\_\_

Signature \_\_\_\_\_

Post to: ILP Electronics Ltd, Freepost 2, Graham Bell House, Roper Close,  
Canterbury CT2 7EP, Kent, England  
Telephone (0227) 54778 Technical (0227) 64723 Telex 965780



**ILP  
ELECTRONICS LTD**

HE 5/4

**STAY AHEAD. STAY WITH US**

# Bike Alarm

BICYCLE theft is a sad fact of life, but to save you the expense and inconvenience of losing your machine, we have designed a super alarm that safeguards your 'wheels'. In fact this alarm, unlike many others, really will protect the wheels, and other valuable parts from theft, as well as the complete bicycle!

The secret is in the sensing method — the alarm is triggered by movement of the bicycle. This operates one or other of the mercury tilt switches mounted on the printed circuit board inside the alarm. Two mercury switches are used to detect tilt in either direction.

Your bicycle can be left in any position (even upside down!) because the alarm detects *movement* of the bicycle — not its position. Very slight movement or vibration will not accidentally sound the alarm. The circuit is switched on all the time the bicycle is protected, so the use of low current consumption devices is essential.

The alarm is switched on and off by the use of a coded jack plug. When the jack plug is inserted, the alarm is off and the bicycle can be moved freely. If the bicycle is moved when the jack plug is out, however, the loud buzzer will sound for approx 20 seconds. The circuit then resets, so if the bicycle is moved again the alarm is re-activated and the complete cycle is repeated. Limiting the buzzer to 20 seconds is important because, if the alarm is triggered accidentally, or by the bicycle falling over, it avoids annoyance and saves the battery.

**Only your personal key can de-activate this movement-sensitive alarm.**

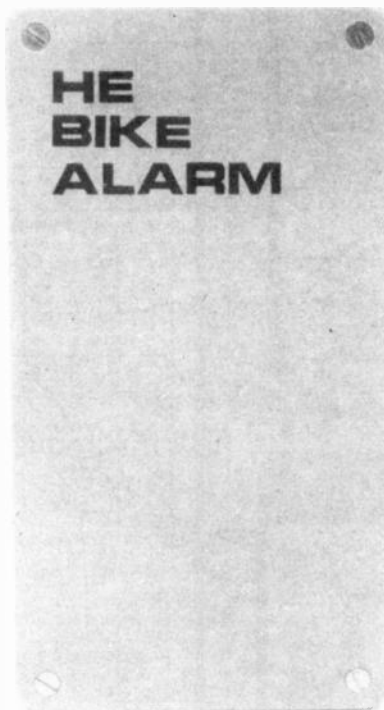

## The Circuit

The twin 'hearts' of the Bike Alarm are a pair of mercury tilt switches, SW1 and SW2. Inside each is a pair of contact pins and a blob of mercury which is free to move within the glass bulb. Being a metal, mercury is a conductor, so that when the blob is surrounding the contact pins, they are shorted together — the switch is closed (Figure 1).

Each time either of the switches closes, a negative pulse is generated by a pulse-forming network, R7, R8, C1 (SW1) or R9, R10, C2 (SW2). Pulses from either switch are coupled, via D1 or D2, to the trigger pin (pin 2) of the 555 CMOS timer, IC3. When it is triggered, the timer output (pin 3) goes positive and turns on Q2, via R15, which drives the alarm buzzer SP1. The alarm will continue to sound for a period set by R14 and C3 (20 seconds for the component values specified), after which IC3 resets — pin 3 goes low — and the 'orrible noise ceases.

However, any further movement of the bike will once more disturb the mercury and set off the alarm.

Because the circuit detects movement, the bike can be left in almost any position — it will function equally well when the bike is lying down, standing in a rack or propped against a wall.

Now we come to the cunning bit; the alarm is activated or cancelled by removing or inserting an individually-coded 'key' plug, PL1. Inside the key is a resistor, R1, which must match R2 in the circuit in order to cancel the alarm.

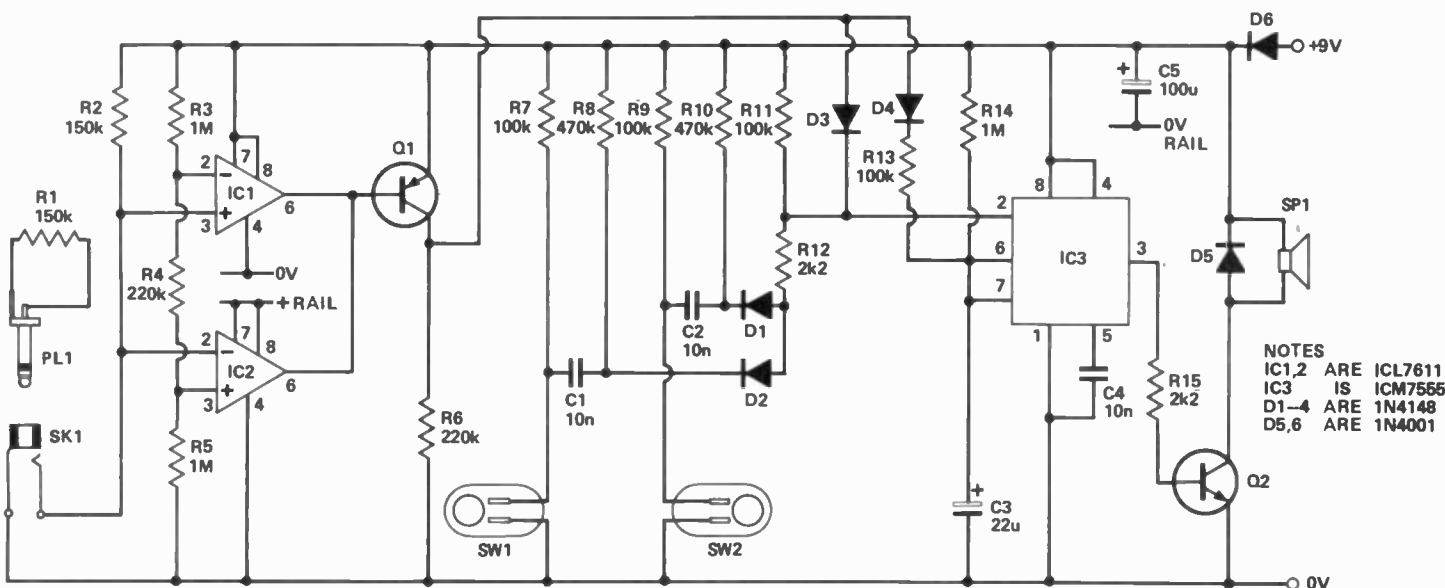

Figure 1. The Bike Alarm circuit.



Thus only the plug made-up to match your chosen value for R2 will deactivate the alarm. Any value of resistance between the limits of 47k and 470k may be used, but they must be equal to within  $\pm 5\%$ . A shorted or open circuit plug cannot be used.

The value of R1 is compared with that of R2 in a bridge circuit formed by R1, R2, R3, R4 and R5 (Figure 2). If R1 and R2 are equal, the voltage at point 'A' is  $V/2$ . If R3 and R5 are equal and R4 is small, the voltage at point 'B' will be slightly above  $V/2$  and the voltage at 'C' slightly below  $V/2$ ; the values chosen give  $V_B$  and  $V_C$  a range of 5% above and below  $V/2$ .

The next section of the circuit, IC1 and IC2, form a 'Window Comparator' which produces an output only when the input (from the junction of R1, R2) falls between  $V_B$  and  $V_C$ . If the input is outside this range, one of the IC outputs will be held high, turning Q1 off and activating the alarm buzzer.

When the bridge is balanced, by the insertion of the correct resistive 'key', both IC inputs are taken low so that Q1 is turned on.

When Q1 is turned on, two things happen: Pin 2 of IC3 goes positive via D3 to prevent triggering the alarm, and timing capacitor C3 is quickly charged via R13 and D4. Thus when the key is inserted, the alarm is prevented from

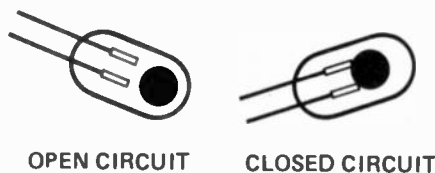

Figure 2. How mercury switches operate.

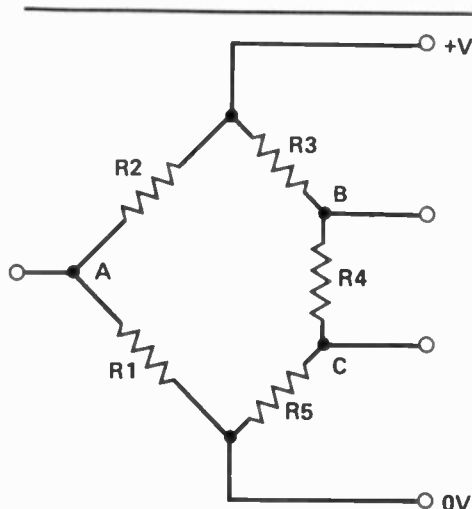

Figure 3. The secrets of the key-code.

triggering and, if the alarm has been sounded, shuts it off in about two seconds.

ICs 1, 2 and 3 are all very low power types, drawing less than 200 uA except when the alarm is sounding, so that a long battery life can be expected. In fact, six AA cells (HP7) should last for up to a year, depending on how often the alarm is triggered.

### Construction

This should be straightforward — virtually everything is on the printed circuit board. With the help of the PCB overlay diagram, Figure 2, insert the resistors and solder them into place. Next insert and solder the capacitors, being careful to get the electrolytic types the correct way round. Multicoloured polyester capacitors fit either way round.

Now the semiconductors; the diodes must have their cathode (broad band) at the correct end. The transistors must also be oriented correctly, as in the overlay. The IC sockets can be soldered in next — leave the ICs themselves until later. Now solder the wire link, the battery clip, diode D6 and the wire to the buzzer; the second connection to the buzzer is made via its mounting screw.

Finally, the mercury tilt switches are put in; these must be mounted with the

## Parts List

### RESISTORS

- R1,2 See Text
- R3,5,14 1M $\Omega$
- R4,6 220k
- R7,9,11,13 100k
- R8,10 470k
- R12,15 2k2

### CAPACITORS

- C1,2,4 10n, C280
- C3 22u 35 V sub-miniature low-leakage radial electrolytic
- C5 100u 10 V radial electrolytic

### SEMICONDUCTORS

- D1,2,3,4 1N4148
- D5,6 1N4001
- Q1 BC212 PNP transistor
- Q2 BFY51 NPN transistor
- IC1,2 1N4001
- IC3 7555 CMOS Timer (8-pin DIL)

### MISCELLANEOUS

- SP1 6 - 9 V mechanical buzzer, 250 mA max. current
- PL1,SK1 3.5 mm jack plug and socket
- SW1,2 mercury tilt switches
- 3 x 8-pin DIL IC sockets, PP3 battery clip, double-sided tape, case, solder etc.

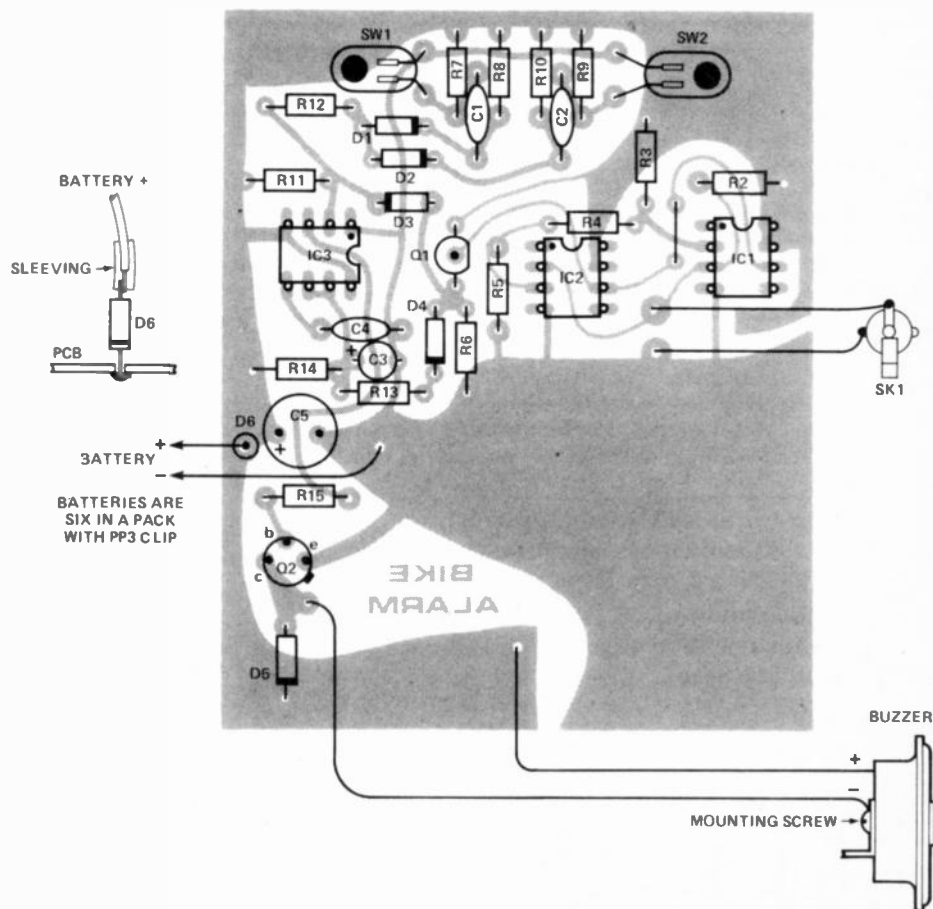

Figure 4. The component overlay. Take care to mount the mercury switches as described in the text.

## ■ Bike Alarm

contacts inside the switch in a horizontal position, otherwise they will not operate correctly. Bend the pins at right angles to the switch and solder them in position. Stick the glass body of the switch to the PCB using a small piece of double-sided tape and be careful not to break the glass — the switches are quite strong but, if there is an accident, remember that **MERCURY IS POISONOUS** and should not be handled.

Now the case; drill a hole for the jack socket and a set of holes near the buzzer so that it can be well-and-truly heard. The position of these holes depends on where, on the bike, the alarm is to be mounted — drill the holes so that the rain won't beat straight into the works! — so decide how the case is to be mounted, at this stage.

With personal needs and bicycles varying so much, we have left the method of mounting up to the constructor. However, the case must *not* be mounted on its side, as this would place one or the other of the mercury switches in a vertical position and the Alarm would not work.

The jack socket should now be fixed to the case and wired to the appropriate points on the PCB. Then the ICs should be inserted in their sockets; be careful to get them the right way round — and in the correct sockets — so check carefully against the layout diagram.

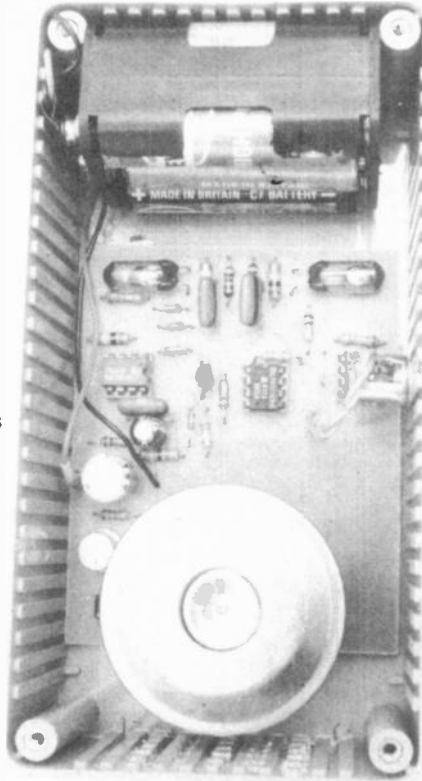

Next, make up the jack-plug 'key'; this is simply a matter of soldering the resistor between the two terminals inside the plug, but make sure the cover will fit!

### Testing

With the PCB flat on a table, insert the plug 'key' and connect the battery clips; wait for about four seconds — all should be quiet. Now remove the plug and tilt the board — makes quite a noise, doesn't it! The buzzer will stop after approximately 20 seconds, and should not sound again unless the case is tilted. To test the 'key', tilt the board, then insert the key plug; the alarm should stop in just a few seconds.

With the 'key' in position, the alarm is inactivated, even when the board is tilted.

Assuming all is well, the PCB and the battery holder can be fixed inside the case using double-sided tape. Screw on the lid and the Alarm is ready to be mounted on your bicycle. Then, as long as you are within hearing range of the buzzer (and it is LOUD), your bike is well protected from any would-be thief!

◀ Figure 5. Note the position of the mercury switches.

**HE**

# IT LIVES AGAIN!

From the past it came, growing daily, striking terror into the hearts of lesser publications, and spreading its influence across the country in its quest to infiltrate every town, every home, every mind.

Not a horror story, but a success story. And if electronics theory strikes terror into you, then you need the help of **Electronics — It's Easy**. Originally a long-running series in *Electronics Today International*, **Electronics — It's Easy** was printed as a set of three books. They sold out. It was reprinted as a single volume. It sold out. Now this phenomenally successful publication is available again, in its third reprint. **Electronics — It's Easy** is a comprehensive and simply-written guide which explains the theory (and the practice) of electronics step by step. Every aspect of the subject is covered, starting with the basic principles and working through to the how and why of today's technology.

You can obtain your copy of **Electronics — It's Easy** by mail order using the coupon below. Make cheques or postal orders payable to ASP Ltd; alternatively you may pay by Access or Barclaycard.

Send to: Sales Office (Specials),  
Argus Specialist Publications Ltd,  
145 Charing Cross Road, London WC2H 0EE.  
Please send me . . . . . copies of **Electronics — It's Easy**. I have enclosed £ . . . . . (£4.95 each including p&tp).

NAME . . . . .

ADDRESS . . . . .

Please debit my account

My Access/ Barclaycard No. is . . . . .

Signature . . . . .



# WHAT'S ON NEXT?

## Audio Frequency Signal Generator

It's so simple it's almost laughable — but it provides an output of up to 1 volt RMS at any frequency from 20 Hz to 30 kHz, in three decade ranges. A most useful addition to any workshop.

## Digital Thermometer

Based on display circuitry similar to that used in our Digital Capacitance Meter, last month this attractively finished project will find many uses around the house — or it would make perfect gift.

## HE Reverb

Part of our **Project Music** series, this flexible device is mainly intended to add depth to flat recordings or to put a bit of life in vocal performances — but the creative musician will find many other uses for it, as well.

## The Electronic Revolution

The first part of a new series, tracing the history and development of electricity and electronics, from the beginning. Once upon a time in a country far away . . . .

## Sines of the Times

We all know what sine waves are, don't we? If you think you know it all, this feature will give you a surprise — or two.

## Scaling the Hi-Fi Heights

The final part of our popular series for first-time hi-fi buyers looks at adding a tuner or cassette deck to your brand new sound system.

**May issue on sale 9th April.**

### PLACE YOUR ORDER NOW!

Simply fill out and cut the coupon, then hand it to your newsagent. Your personal copy of the May issue of HE will be reserved for you.

Please reserve . . . . . copies of the May issue of  
**Hobby Electronics**  
for  
Name . . . . .  
Address . . . . .  
. . . . .  
. . . . .

Although these articles are being prepared for the next issue, circumstances may alter the final content.

# CREATIVE



# RECORDING

IT IS not entirely out of the question, these days, for a group of friends to set up a small semi-professional recording studio. The cost is about the same as that of equipping a five-piece band with instruments, amplification and PA equipment. It's not cheap, but neither is it ridiculously expensive.

However, even this relatively modest investment is impossible for many people — so what options are there, then, for those who would like to experiment with recording, but cannot afford even the cheapest semi-professional gear? Fortunately, lots, because it is not absolutely necessary to have top quality equipment to produce *useful* recordings. The fact is that a recording need only be of *sufficient* quality for the use intended.

For example, a recording of a band in rehearsal, made for the purpose of perfecting an arrangement, must allow

every instrument to be heard clearly, but doesn't need to be 'studio quality'. Similarly, the sound track for an Audio/Visual presentation (a tape/slide show, say, about a local industry), or a sound effects track for an amateur theatrical production, need only match the quality of the equipment on which it is to be played.

Recording a 'demo' tape of a band is a very common application, but these tapes are made only to persuade a record company representative that a band deserves all the facilities of a top-class studio and that, once this minor technical detail has been attended to, a string of Top Ten albums and singles will result. The record-company man will not be expecting a studio quality demo tape, because a top studio, together with the services of a recognised producer, will always produce a better, and

therefore more commercially acceptable, result.

## Creative Recording

Of course, there are good recordings — and not so good ones, and the object of any 'session' should always be to produce the best possible result with the funds and equipment available. It's simply not good enough, for example, to just place a microphone in front of a band, plug it in to a cassette recorder and hope it will come out alright. It won't, because this very basic technique will always produce very basic recordings, no matter how good or expensive the equipment. Recording is essentially a creative activity; it's not so much the equipment that determines the result as the way it is used and the important thing, always, is to use whatever tools are available in the most creative way.

Figure 1 (below). Standard recording formats; (a) half-track stereo; (b) half-track mono; (c) quarter-track stereo; (d) four-track recording.

Figure 2 (right). The layout of a three-head open-reel tape deck. The heads could be any of those shown in Figure 1.

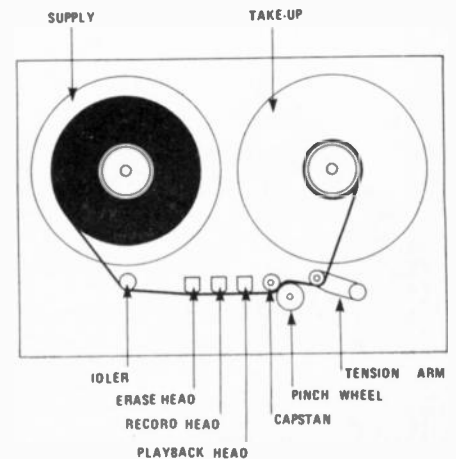
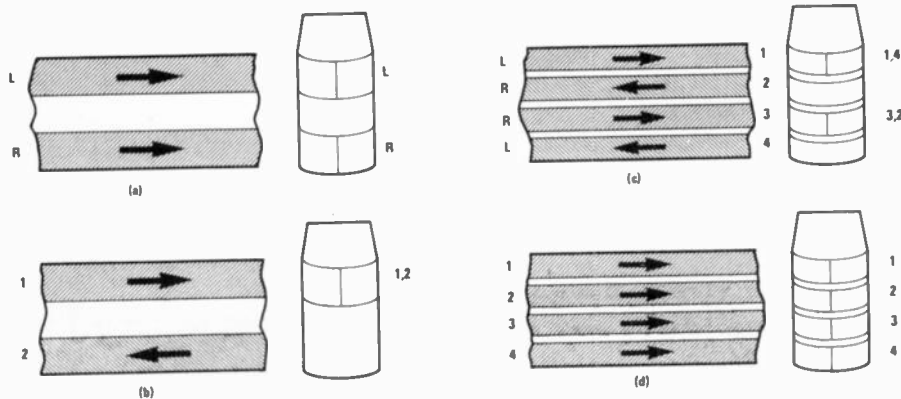



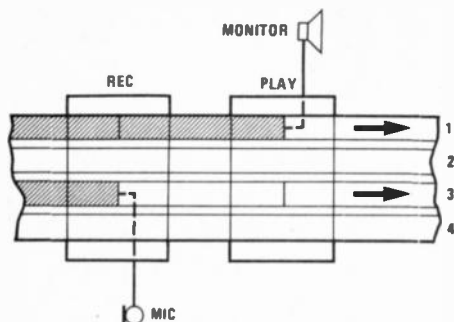
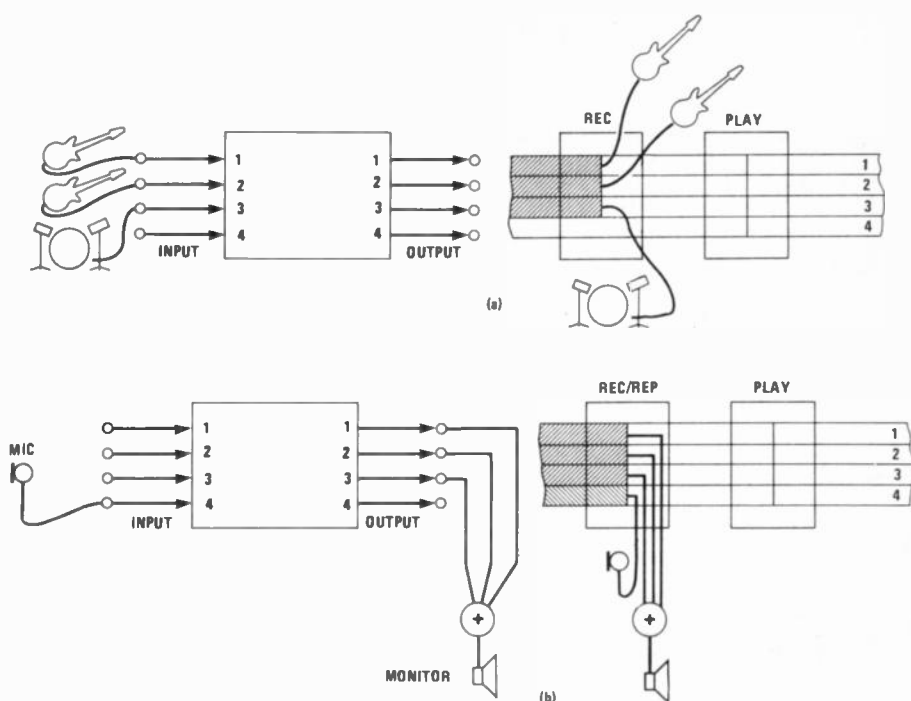

Figure 3 (top). Because of the physical separation between the record and play heads of a quarter-track recorder, it is not possible to record while simultaneously monitoring a pre-recorded track.

Figure 4 (right) The Record/Reproduce heads of a four-track recorder can be independently switched to either record or reproduce, so that a new recording and the pre-recorded tracks are synchronised. The playback head is used only for quality reproduction when transferring to a stereo master tape.



Accepting that £100,000 worth of complicated equipment is not really necessary to produce useful recordings, what gear *is* necessary? Not very much, really.

It's possible to get by with just one open-reel tape recorder, if you don't mind working in mono, rather than stereo. With care, it is possible to make surprisingly good recordings.

Better still, two tape recorders or cassette recorders (even the portable types are adequate) will, with the same amount of care and attention to detail, produce even better results. Higher up the price scale, one of the new four-track cassette recorders are much easier to use and will give really excellent recordings — again, provided sufficient care is taken.

A tape recorder is the 'heart' of a recording set-up, but a certain amount of other gear is also necessary. One or two microphones will certainly be required, as well as a small mixer for blending two or more signals. You'll want to listen to

the results of your efforts so some kind of playback system — an amplifier and speakers — will come in handy. A good hi-fi amplifier is quite suitable and, if it has tape monitor facilities, so much the better; one with preamp/main amp connections is even more useful. Then, there are the signal processing units, devices such as compressors and limiters, noise gates and noise reduction units, that can be used to improve the quality of a recording. Finally, there are the various effects — echo, reverb, phasing and so on.

If this list of equipment seems too expensive and formidable, stop and reconsider for a moment; it's not impossible. If you already have a tape recorder or cassette recorder, you need only borrow another — or find a like-minded friend with one! Microphones must be bought, of course, but it's not difficult to get quite good mics at reasonable cost, and these can always be upgraded when funds permit. A mixer? No problem — just keep reading *Hobby Electronics*! As

for signal processors and effects units, these have been presented as HE projects since our first issue and more will appear in the months to come. Next month, for example, we have a simple but efficient reverb unit project, together with a full length feature article explaining just what reverb is, and how this electronic effect can be used to enhance a performance or recording.

### Are You Creative?

So, given the absolute basics of the set-up — one or two tape or cassette recorders and a couple of microphones — the rest is easy! But once you've got everything together, how do you use it? What can you do with it?

The answer to the last question is really down to you, because it depends on your imagination, on your creativity. Remember, all you need is an open reel recorder with "Sound-on-Sound" or (preferably) a pair of tape or cassette recorders, and an ordinary hi-fi system. Think about it!



HE

# HE PCB SERVICE

Ready made PCBs For Readers!

PRINTED CIRCUIT BOARDS (PCBs) for HE projects have often represented an obstacle for our readers. Some of you, no doubt, make your own but our PCB Service saves you the trouble.

NOW you can buy your PCBs direct from HE. All (non-copyright) PCBs will be available automatically from the HE PCB Service. Each board is produced from the same master as that used for the published design and so each will be a true copy, finished to a high standard.

Apart from the PCBs for this month's projects, we are making available some of the popular designs from earlier issues. See below for details. *Please note that only boards for projects listed below are available: if it isn't listed we can't supply it.*

<b>May 80</b>	
5080 Pre-amplifier	£3.50
<b>June 80</b>	
Fog Horn	£1.40
Egg Timer	£1.58
<b>July 80</b>	
18 W + 18 W Car Stereo Booster (two required for stereo) each	£1.20
<b>August 80</b>	
Equitone Car Equaliser	£1.79
Pass The Loop Game	£1.98
<b>September 80</b>	
Auto Probe	£1.25
Guitar Phaser	£1.48
Development Timer	£1.35
Bench PSU	£2.20
<b>October 80</b>	
Nobell Doorbell	£1.98
Intruder Alarm	£1.88
Tug O' War	£1.99
<b>November 80</b>	
Memory Bank Synth:	
Mainboard PCB	£2.48
Keyboard PCB	£2.70
Party Grenade (set of three)	£2.60
Double Dice	£2.20

<b>December 80</b>	
Stereo Power Meter	£2.12
Digital Speedo (set of two)	£3.50
<b>January 81</b>	
Car Rev Counter	£2.24
<b>February 81</b>	
Heartbeat Monitor	£1.90
Audio Signal Generator	£1.85
<b>March 81</b>	
Steam Loco Whistle	£1.99
<b>April 81</b>	
Super Siren	£1.48
Russian Roulette Game	£1.20
<b>May 81</b>	
Voice Operated Switch Organ 1	£1.25 £3.48
<b>June 81</b>	
Envelope Generator Organ 2	£1.40 £1.90
<b>July 81</b>	
Organ 3	£4.50
Organ 4	£4.50
Ultrasound Burglar Alarm	£1.90

<b>August 81</b>	
RPM Meter	£1.33
Thermometer	£1.25
<b>September 81</b>	
Power Pack	£1.27
Reaction Tester Game	£1.28
'Diana' Metal Detector	£2.48
<b>October 81</b>	
Combination Lock	£1.99
<b>November 81</b>	
Sound Torch (Set of Two)	£3.98
<b>December 81</b>	
Pedalboard Organ	£4.48
<b>January 82</b>	
Intelligent NiCad Charger	£2.28
<b>February 82</b>	
Relay Driver	£1.65
Mast-Head Amp	£0.98
<b>March 82</b>	
Digital Dice	£1.46
<b>April 82</b>	
Digital Capacitance Meter	£3.55
Dual Engine Driver	£2.53
Bike Alarm	£1.98

PLACE an order for your PCBs using the form below (or a piece of plain paper if you prefer not to cut the magazine), then simply wait for your PCBs to drop through your letterbox, protected by a Jiffy bag.

HE PCB Service, Argus Specialist Publications Ltd, 145 Charing Cross Road, London WC2H 0EE

I enclose a cheque/postal order made payable to ASPLtd, for the amount shown below

OR

I wish to pay by Barclaycard. Please charge to my account number



OR

I wish to pay by Access. Please charge to my account number



SIGNATURE

NAME

(BLOCK CAPITALS)

ADDRESS

(BLOCK CAPITALS)

Boards Required	Price
Add 40p p & p	0.40
Total Enclosed	£

Please allow 14 days for delivery

# EXPO DRILLS

KITS TOOLS ACCESSORIES

## TITAN DRILL AND STAND

Engineering in miniature, the most powerful British, 12 Volt D.C. drill made, producing 10,000 R.P.M., 1740 C.M.P. comes complete with tommy bar, allen key, steel chuck + 4 collars, size zero, 1/16, 3/32, 1/8. Specially designed for drilling P.C. Board, mild steel, and many other uses in electronics, other crafts and hobbies.

Also available specially designed Dura Life P.C.B. Drills, very hard and durable, but not brittle like Tungsten

Price £1.10

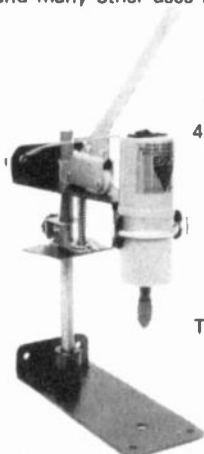

Titan Drill, complete 4 collars, Cat No 0175

£10.28

Dual purpose Stand Cat No 0209

£12.00

Hundreds of tools and kits to choose from

Transformer Rectifier also available



Available from your local stockists  
EXPO Prices are approximately 40% cheaper than all other makes. Distributors, Wholesale, Retail and Export enquiries welcome

Many other Expo drills, tools, kits available  
Send for your copy of latest catalogue and price list today

EXPO (DRILLS) LTD Unit 10, Sustanum Works  
Titchfield, Hants Tel Titchfield (03294) 41752

### LOW COST COMPUTER COMPONENTS

	Price £	Price £	Price £	Price £
2114-L2	1.24	6821	1.45	8259
2708	1.95	6845	9.45	8279
2716	2.50	6850	1.65	8280 CPU
2732	4.25	8080	3.45	8280 PIO
4116-2	1.10	8085	5.45	8280 CTC
4116-3	0.96	8212	1.65	8280 DMA
4118-4	3.80	8216	1.65	8280 SIO
6502	4.45	8224	2.40	8280 DART
6520	3.85	8226	2.45	8280 DART
6522	4.30	8228	2.45	8280 DART
6551	6.90	8251 A	3.65	FD1771
6802	4.95	8253	7.90	FD1791
6809	9.95	8255	3.70	WD1691 WD139X
6810	1.30	8257	7.95	WD2143
			7.95	Crystals
			9.45	32 768 kHz
			3.50	1 MHz
			3.07	18432 M
			3.07	2 MHz
			7.31	3 57954 M
			13.90	4 M
			7.15	
			17.12	

Prices are exclusive of VAT Please add VAT at 15% and 45p P & P

ELECTRONIC HOBBIES LTD

17 Roxwell Road, Chelmsford, Essex CM1 2LY  
Tel: (0245) 62149

## RADIATION DETECTORS

BE PREPARED

VIEW THRU LENS

Ideal for the experimenter

- THIS DOSIMETER WILL AUTOMATICALLY DETECT GAMMA AND X-RAYS
- UNIT IS SIZE OF FOUNTAIN PEN & CLIPS ONTO TOP POCKET
- PRECISION INSTRUMENT
- MANUFACTURERS CURRENT PRICE OF A SIMILAR MODEL OVER £25 EACH

British design & manufacture

Tested and fully guaranteed. Ex-stock delivery.

**HENRY'S**

01-723 1008/9

404 EDGWARE ROAD, LONDON W2 1ED

FREE RECHARGE SERVICE AFTER PURCHASE

£6.95

inc. VAT Post & Pack 60p

COMPLETE WITH DATA



# ILP POWER SUPPLIES - MOST WITH ILP TOROIDAL TRANSFORMERS

Space-saving, efficient ILP power supplies are designed to give you flexibility in planning audio assemblies. Nine of the eleven models have toroidal transformers manufactured on new cost-efficient high technology machines in our own factory. So we keep the quality up, and the price down.

ILP power supplies are compatible with all other ILP modules — combine them to produce almost any audio system. All carry the ILP 5 year no quibble guarantee and include full connection data.

So send your order on the Freepost coupon below today!



### POWER SUPPLY UNITS

Model No	For use with	Price inc. VAT	Price ex. VAT
PSU 30	±15V combinations of HY6/66 series to a maximum of 100 mA or one HY67	£5.18	£4.50
	The following will also drive the HY6/66 series except HY67 which requires the PSU 30		
PSU 36	1 or 2 HY 30	£9.32	£8.10
PSU 50	1 or 2 HY 60	£12.58	£10.94
PSU 60	1 x HY 120/HY 120P/HD 120/HD 120P	£15.00	£13.04
PSU 65	1 x MOS 120/1 x MOS 120P	£15.32	£13.32
PSU 70	1 or 2 HY 120/HY 120P/HD 120/HD 120P	£18.31	£15.92
PSU 75	1 or 2 MOS 120/MOS 120P	£18.63	£16.20
PSU 90	1 x HY 200/HY 200P/HD 200/HD 200P	£18.63	£16.20
PSU 95	1 x MOS 200/MOS 200P	£18.77	£16.32
PSU 180	2 x HY 200/HY 200P/HD 200/HD 200P or 1 x HY 400/1 x HY 400P/HD 400/HD 400P	£24.54	£21.34
PSU 185	1 or 2 MOS 200/MOS 200P/1 x MOS 400 1 x MOS 400P	£24.68	£21.46

All models incorporate ILP toroidal transformers except PSU 30 and PSU 36 which include our own laminated transformers.

#### How to order Freepost:

Use this coupon, or a separate sheet of paper, to order these modules, or any products from other ILP Electronics advertisements. No stamp is needed if you address to Freepost. Cheques and postal orders must be crossed and payable to ILP Electronics Ltd, cash must be registered. C.O.D. — add £1 to total order value. Access and Barclaycard welcome. All UK orders sent post free within 7 days of receipt of order.

Please send me the following ILP modules

Total purchase price

I enclose Cheque  Postal Orders  Int. Money Order

Please debit my Access / Barclaycard No

Name

Address

Signature

Post to ILP Electronics Ltd, Freepost 2 Graham Bell House Roper Close, Canterbury CT2 7EP, Kent, England  
Telephone (0227) 54778 Technical (0227) 64723 Telex 965780



**ILP ELECTRONICS LTD**

HE 6/4

STAY AHEAD. STAY WITH US

# PCB FOIL PATTERNS

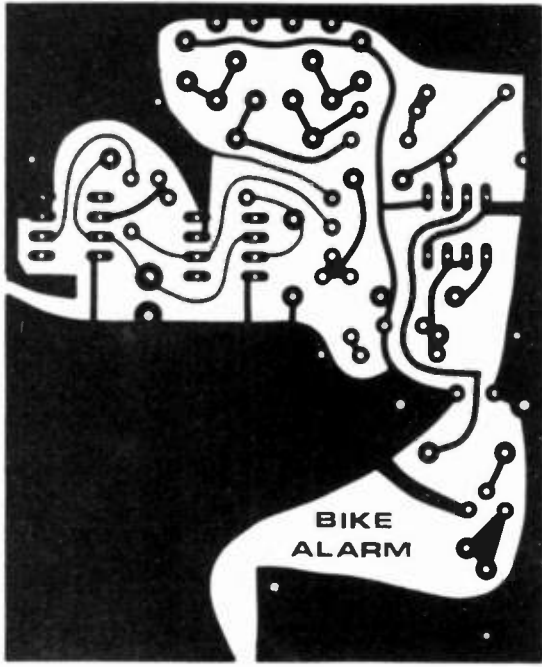

Top: PCB foil pattern for the HE Bike Alarm.

Right: Dual Engine Driver PCB foil pattern. If only one Controller is required, simply cut the pattern in half at the centre key-lines.

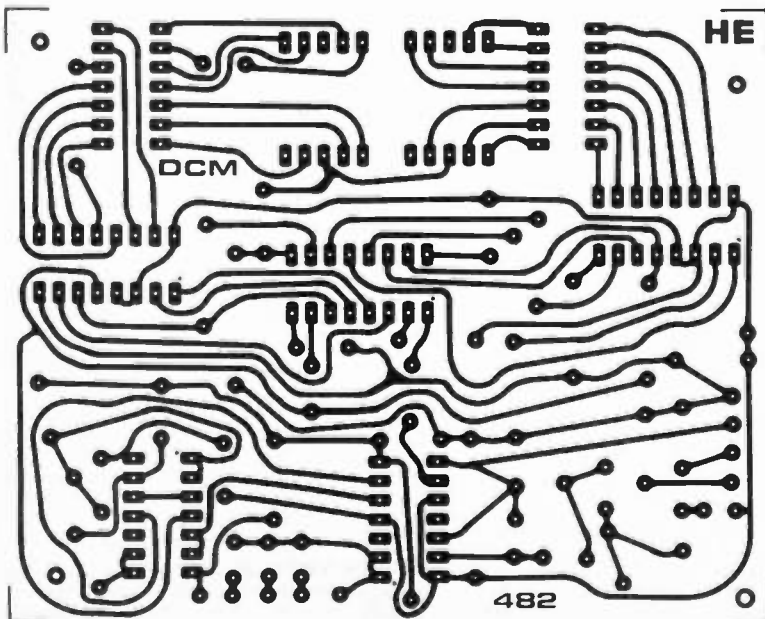
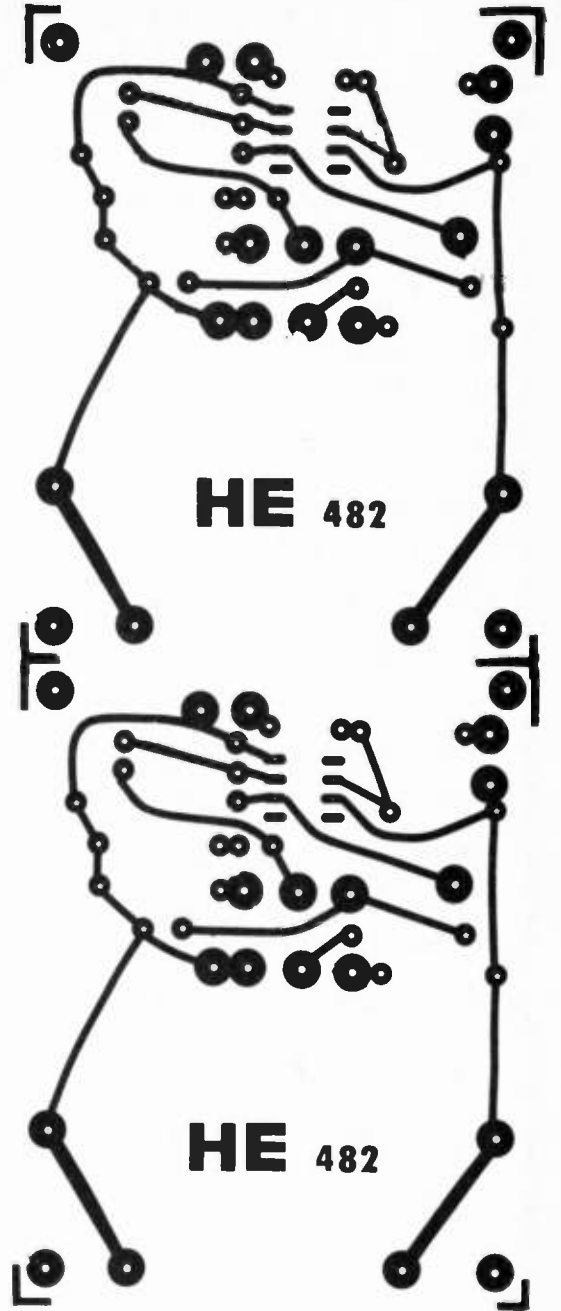

Left: The HE Digital Capacitance Meter PCB foil pattern. The many fine lines require considerable care when copying the pattern on to the PCB blank. Take care not to bridge the tracks when soldering in the components.

**HE**



# ADVERTISEMENT INDEX

A.D. Electronics . . . . .	60	Heath Electronics . . . . .	4
Aitken Bros . . . . .	20	Henry's Radio . . . . .	79
Ambit International . . . . .	2	ICS . . . . .	71
Amtron (UK) Ltd . . . . .	66	ILP . . . . .	51, 59, 65, 71 & 79
Bi-Pak Semiconductors . . . . .	15	Litesold . . . . .	71
BK Electronics . . . . .	10	Magenta Electronics . . . . .	4 & 5
B.N.R.S. . . . .	20	Parndon Electronics . . . . .	59
J. Bull (Electrical) Ltd . . . . .	33	P.A.T.H. Electronics . . . . .	59
Cambridge Learning . . . . .	51	Rapid Electronics . . . . .	9
Carlton Nichol & Co. Ltd. . . . .	66	Brian J. Reed . . . . .	59
Cricklewood Electronics . . . . .	71	Riscomp Ltd . . . . .	31
D'Juson Ltd . . . . .	66	Sandwell Plant . . . . .	60
E.D.A. Sparkrite . . . . .	84	Silica Shop . . . . .	83
Electronic Hobbies Ltd . . . . .	79	Technomatic . . . . .	24
Electronize Design . . . . .	60	Tempus . . . . .	32
Expo (Drills) Ltd . . . . .	79	TK Electronics . . . . .	54
Greenweld Electronics . . . . .	65	Watford Electronics . . . . .	29

# CLASSIFIEDS

<p style="text-align: center;"><b>ETI RATES</b></p> <p>1-5 Insertions £10.00 per scc          6-11 Insertions £9.00 per scc          12+ Insertions £8.00 per scc          35p per word (min 15 words)          Box No. £2.50          Closing date 1st Friday in month preceding publication</p>	<p style="text-align: center;"><b>HE RATES</b></p> <p>1-3 Insertions £6.00 per scc          4-11 Insertions £5.50 per scc          12+ Insertions £5.00 per scc          21p per word (min 15 words)          Box No. £2.00          Closing date 2nd Friday in month preceding publication</p>
<p>Classified Advertisements must be prepaid          Advertisements are accepted subject to the terms and conditions printed on the advertisement rate card (available on request).</p>	

**SEND TO:- ETI/HE CLASSIFIED, 145, CHARING CROSS ROAD, LONDON WC2H 0EE. TEL: 01-437 1002 Ext. 50.**

**AERIAL AMPLIFIERS** Improve weak television reception. Price £6.70. S.A.E. for leaflets. Electronic Mailorder, Ramsbottom, Lancashire BL0 9AGH.

**GUITAR/PA  
MUSIC AMPLIFIERS**

100 watt superb treble/bass overdrive, 12 months' guarantee. Unbeatable at £50. 60 watt £44. 200 watt £68. 100 watt twin channel sep. treble/bass per channel £65. 80 watt £52. 200 watt £78. 100 watt four channel sep. treble/bass per channel £75. 200 watt £90. sleeves 100 watt £37. 200 watt £90. 250 watt £70. 500 watt £140. fuzz boxes, great sound. £12. bass fuzz £12.50. overdriver fuzz with treble and bass boosters. £28. 100 watt combo, superb sound, overdrive, sturdy construction, castors, unbeatable. £100. twin channel. £115. bass combo £118. speakers 15m 100 watt £36. 12m 100 watt £24. 80 watt £18. microphone shure unidyn B 728.

Send cheque/P.O. to: **WILLIAMSON AMPLIFICATION**  
 82 Thorncliffe Avenue, Dukinfield, Cheshire. Tel. 061-308 2064

**CENTURION BURGLAR ALARM EQUIPMENT** Send S.A.E. for Free list or a Cheque/PO for £5.95 for our Special Offer of a Full Sized Decoy Bell Cover, to: Centurion, Dept HE, 265 Wakefield Rd., Huddersfield, W. Yorkshire. Access & Barclaycard. Telephone orders on 0484-35527.

**PRINTED CIRCUITS.** Make your own simply, cheaply and quickly! Golden Fotolac light-sensitive lacquer - now greatly improved and very much faster. Aerosol cans with full instructions, £2.25. Developer 35p. Ferric Chloride 55p. Clear acetate sheet for master 14p. Copper-clad fibreglass board, approx. 1mm thick £1.75 sq. ft. Post/packing 75p. White House Electronics, Castle Drive, Praa Sands, Penzance, Cornwall.

**NEW 1982 ACE COMPONENT CATALOGUE** Let your problems be our business. Be certain; have your components delivered quickly and efficiently and get that project working. **Send 30p now** for the easy to use 1982 Catalogue to: Ace Mailtronix, Dept H.E.3A, Commercial Street, Batley, W. Yorks WF17 5HJ.

**BURGLAR ALARM** equipment. Ring Bradford (0274) 308920 for our catalogue, or call at our large showrooms opposite Odsal Stadium. C.W.A.S. Ltd.

**PARAPHYSICS JOURNAL** (Russian translations); Psychotronic Generators, Kirliano-graphy, gravity lasers, telekinesis. Details: S.A.E. 4 x 9" Paralab, Downton, Wilts.

**ZX81 KEYBOARD SOUNDER** Made from easily obtainable components. Send £3 for P.C.B. instructions and transducer or S.A.E. for details to: R. Mitchell, 20 Gorse Close, Portslade, Sussex.

**AMAZING ELECTRONICS PLANS.** Lasers; Super-powered Cutting Rifle, Pistol, Light Show. Ultrasonic Force Fields, Pocket Defence Weaponry, Giant Tesla, Satellite TV Pyrotechnics, 150 more projects. Catalogue 95p. — From Plancentre, 16 Mill Grove, Bilbrook, Codsall, Wolverhampton.

**DIGITAL DESIGN DECK PLANS** for breadboarding prototype — experimental circuits. Educational aid. £3. From R. Caunt, 16 Baggley Crescent, Mansfield, Notts. NG19 7DS.

**CORDLESS TELEPHONES** Build your own simple and inexpensive units. Send £3.00 for plans to: J.F. Ashley, Birley Grange Cottage Farm, Baslow Road, Cutthorpe, Derbyshire.

**PERSONAL** introductions and social events. Meet interesting, attractive people. Local 051-931 2844 (24 hours).

**1000 ASSTD 5% resistors**, pre-formed for PCB mounting. £2.50. 50 asstd full-spec LED's, 3x5mm, all colours £3.20. 500 asstd full-spec transistors, BC182/212/237/308 etc £3.00. 100 asstd PC mntg electrolytics £3.00. One of each pack £11. All post free. SAE Wholesale list. PC Electronics, 2 Thornhill HE, Romsey Road, Whiteparish, Salisbury, Wilts.

**16K ZX81 SUPER INVADERS** On cassette with graphic HANGMAN, SWAT, GOLF and BREAKTHROUGH. £3.50. J. Prince, 29 Brook Ave., Levenshulme, Manchester M19.

**DIPLOMA IN ELECTRONICS** Full time courses in Electronic Engineering. Also courses leading to CITY & GUILDS examinations. Courses commence in April, October and January. Tel: LONDON SCHOOL OF ELECTRONICS 263 5938.

**HIGH QUALITY COMPONENTS:** Low profile sockets 24 pin 22p, 40 pin 30p. Resistors ¼ W 5% 100 mixed 90p. Cermet potentiometers 10 mixed £1.95. P&P 40p. Large SAE for lists. T. Milner, 203 Goodman Park, Slough, Berkshire.

## RADIATION DETECTORS

**BE PREPARED**

VIEW THRU LENS ▶ 

- THIS DOSIMETER WILL AUTOMATICALLY DETECT GAMMA AND X-RAYS
- UNIT IS SIZE OF FOUNTAIN PEN & CLIPS ONTO TOP POCKET
- PRECISION INSTRUMENT METAL CASED WEIGHT 20Z
- MANUFACTURERS CURRENT PRICE OF A SIMILAR MODEL OVER £25 EACH

British design & manufacture.  
Tested & fully guaranteed  
Ex-stock delivery

**£6.95** inc VAT  
Post & Pack 60p

Ideal for the experimenter  
**COMPLETE WITH DATA**

HENRY'S

404 EDGWARE ROAD, LONDON W2 1ED



**LEARN ELECTRONICS** at home. **EXPERIMENT KIT** covers **AUDIO, RADIO, DIGITAL, OPTO-ELECTRONICS, TIMERS.** Instruction book with full circuits for **FORTY PROJECTS**, component layouts, and theory section. **SIXTY PARTS** supplied, including transistors, LED's, earphone, loudspeaker, ferrite-rod, reed-switches etc. No soldering, components can be re-used many times. Uses two 3-volt batteries (not supplied). Send cheque/PO for £25 (includes UK P&P and VAT) to VYTRON (HE-03), 5 Mariners Drive, Portishead, Bristol BS20 8ET.

### BOOKS BOOKS BOOKS

Practical Computer Experiments E.A. Parr ... £1.76  
 Practical Introduction to Digital IC's D.W. Easterling ... £1.25  
 Beginners Guide to Digital Techniques G.T. Rubaroo ... £0.95  
 Second Book of CMOS Projects R.A. Penfold ... £1.50  
 52 Projects Using IC741 Rudi & Uwe Redmer ... £1.25  
 I.C.555 Projects E.A. Parr ... £1.95  
 Essential Theory For The Electronics Hobbyist G.T. Rubaroo ... £1.25  
 Radio Control For Beginners F.G. Rayer ... £1.76

### NEW SELECTION FOR THIS MONTH

Practical Construction of Pre-Amps, Tone Controls, Filters and Attenuators A.D.M. Smith ... £1.45  
 Electronic Calculator Users Handbook M.H. Babani ... £1.50  
 Model Railway Projects R.A. Penfold ... £1.95  
 ADD ONLY 35p P&P TO TOTAL ORDER  
 ORDERS OVER £5.00 STILL POST FREE

### ALPHA BOOKS

REG. OFFICE:  
**18 CONNAUGHT CLOSE,**  
**HEMEL HEMPSTEAD,**  
**HERTS HP2 7AB**

### IONISER KIT (MAINS OPERATED)

This Negative Ion Generator gives you the power to saturate your home or office with millions of refreshing ions. Without fans or moving parts it puts out a pleasant breeze. A pure flow of ions pours out like water from a fountain, filling your room. The result? Your air feels fresh, pure, crisp and wonderfully refreshing.

All parts, PCB and full instructions ..... £12.50  
 A suitable case including front panel, neon switch, etc ..... £10.50  
 Price includes Post & VAT ..... Barclaycard/Access welcome

### T. POWELL

ADVANCE WORKS  
 44 WALLACE ROAD, LONDON N.1.  
 TEL: 01-226 1489  
 Hours: Mon-Fri 9-5 p.m. Sat 9-4.30 p.m.

## ELECTRIFY YOUR SALES! • CLASSIFIED ADVERTISEMENT

1	2	3
4	5	6
7	8	9
10	11	12
13	14	15

Advertise nationally in Electronics Today International/Hobby Electronics. Simply print your advertisement in the coupon here (left), indicating which magazine you require. Or telephone for more information.

Name .....

Address .....

.....

Tel. No. (Day) .....

Please place my advert in: Electronics Today International  
 (Delete as applicable) Hobby Electronics

Send, together with your cheque to:  
**Jenny Naraine, ETI/HE,**  
**145 Charing Cross Rd., London WC2H 0EE.**  
**Tel: 01-437 1002 Ext. 50.**

# SALE ELECTRONIC GAMES



**NOW £40 OFF**

## ATARI T.V. GAME

THE GAME WITH 50 CARTRIDGES  
RRP £129.95 (inc VAT)

**OUR PRICE**  
**£78.22 + VAT**  
(£89.95 inc VAT)

The Atari is supplied with a free mains adaptor, a pair of paddles, a pair of joysticks and a combat cartridge and is the most popular television game on the market and has a range of over 40 different cartridges. In addition to the standard Atari range we also now stock the new Activision cartridges which are currently on special offer reduced from £18.95 to **£16.95 inc. VAT**

### ATARI CARTRIDGES

20% OFF R.R.P.  
Atari Soccer £29.95  
**NOW £23.95**  
Activision Dragster £18.95  
**NOW £14.95**  
Activision Boxing £18.95  
**NOW £14.95**

**ATARI OWNERS CLUB** — Why not join our **FREE** Silica Atari Owners Club and receive our bi-monthly newsletter with special offers and details of the latest new cartridge releases. Telephone us with your name and address and we will add your name to our computer mailing list.

## MATTEL INTELLIVISION

**NOW £50 OFF**

THE ULTIMATE T.V. GAME  
RRP £229.95 (inc VAT)

**OUR PRICE**  
**£156.48 + VAT**  
(£179.95 inc VAT)

6 NEW CARTRIDGES JUST RELEASED  
**ASTROSMASH • SNAFU • BOWLING**  
**SPACE ARMADA • BOXING**  
**TRIPLE ACTION**

All 19 current cartridges — the six new ones above now retail at £19.95 — Silica special offer price **£17.95 inc VAT**

The Mattel Intellivision is the most advanced T.V. game in the world with a range of over 25 different cartridges all at our special offer price of £17.95. This game uses a 16-bit microprocessor giving 16 colours and three-part harmony sound. The picture quality is incredible with 3D effects and realistic animation. An add-on keyboard will be available in the Spring 1982 to convert the Mattel into a full home computer with 16K RAM which will be fully expandable and programmable in Microsoft Basic. Other accessories will be added later in the year. The normal price of the Intellivision — free soccer cartridge is £229.95 but our special offer price is £179.95 inc. VAT saving you £50.00

**MATTEL OWNERS CLUB** — Why not join our Mattel Owners Club and receive our regular newsletters containing details of all the latest cartridge releases. Telephone us with your name and addresses and we will add your name to our computer mailing list.  
**FREE 16 PAGE CARTRIDGE CATALOGUE** — If you are interested in owning a Mattel, we now have available a 16 page catalogue describing the latest six cartridges to be released, as well as a new Mattel colour leaflet with brief descriptions of all 25 cartridges. Telephone us for further details.

## T.V. GAME CARTRIDGES

We specialise in the whole range of T.V. games and sell cartridges for the following games: **ATARI • MATTEL • ACETRONIC • PHILIPS • DATABASE • ROWTRON • INTERTON • TELENG**. Let us know if you own any of these games and we will let you have details of the range of cartridges available.

Attention INTERTON & ACETRONIC owners: We have over 75 assorted used cartridges in stock all with 1 year guarantee — **SPECIAL OFFER £8.95 each**

We also have a number of secondhand games and cartridges

## HAND-HELD GAMES EARTH INVADERS



**NOW £8 OFF**

These invaders are a breed of creature hitherto unknown to man. They cannot be killed by traditional methods — they must be buried. The battle is conducted in a maze where squads of aliens chase home troops. The only way of eliminating them is by digging holes and burying them.

RRP £26.95 **NOW £18.95 inc. VAT**

## ELECTRONIC CHESS

Liquid crystal battery chess computer with 100 200 hrs battery life and two levels of play. Comes with separate chess board and pieces.

**NOW £5 OFF**  
RRP £24.95  
**SALE PRICE**  
**£19.95**  
(inc. VAT)

## GRADUATE CHESS

A de luxe version of the electronic chess set with integral chess board. The ideal portable chess set — see illustration.

**NOW**  
**£29.95**  
INC VAT

## FIDELITY MINI-SENSORY CHESS COMPUTER

The very first chess computer of its price to offer a portable computer with integral sensory board. Battery (6 hrs) or mains operated. This is a modular game and additional plug-in modules are planned for 1982 for advanced chess, popular openings, greatest master games, draughts and fevers.

**MINI-SENSORY COMPUTER WITH STANDARD CHESS MODULE** WAS £54.50 **NOW £49.95 INC VAT**

Silica Shop are one of the country's leading specialists in Chess Computers and now stock a range of more than 20 Chess Computers, including Challenger 7, 10, voice, Sensory 8 and Sensory Voice, Diplomat System 3, Morphy, Great Game Machine, Voice Champion, and the new Scicys Mark V.

## PAC MAN 2

Pac Man 2 is based on the latest pub game. It is a two colour game of strategy, tactical pursuit and destruction pitting Pac Man against the large Ghosts. The object of the game is for Pac Man to attain as high a score as possible by capturing and destroying Ghosts, Bugs and Energizers without being himself destroyed by the Ghosts. Pac Man 2 incorporates the most modern and complex status displays ever produced and is now on release for the first in the UK offering an ideal present.

RRP £34.95 **NOW £24.95 inc VAT**

## SPACE INVADERS

Based on one of the most popular arcade games, Space Invaders packs in lots of action with multi-shaped brilliant LED vessels including attack ships, bombs, defenders, missile rockets and a 3-arm force cannon, plus exciting electronic sound effects. The attack ships attempt to bomb the ground defenders as they are moving. You manoeuvre the missile rockets, avoiding alien bombs, and destroy the invader force as quickly as you can. Progressive degree of difficulty. Includes automatic digital scoring. For ages 6 to adult.

RRP £24.95 **NOW £16.95 inc VAT**

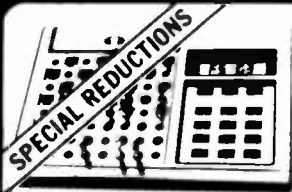

**SPECIAL REDUCTIONS**

**LESS THAN 1/2 PRICE**

**COLOUR CARTRIDGE T.V. GAME**  
5mm Programmable T.V. game  
4 cartridges  
main transformer  
**NOW £43.50 OFF**  
RRP £73  
**SALE PRICE £29.50** (inc. VAT)

**SCOOP PURCHASE 1/2 PRICE**

**BACKGAMMON COMPUTER**  
Backgammon computer with integral sensory board.  
WAS £99.95  
**NOW £48.95** inc. VAT

**CALL THE PRICE OF 2 — THE AFFORDABLE ANSWER**  
The Post Office certified telephone answering machine

Sorry darling I will be late home — Love John. The Call Jotter 1 brings the affordable answer at the amazing price of £69 (or £99 for the Call Jotter 2 with built in remote recall facilities). These amazing telephone answering machines are Post Office Certified and guaranteed for one year. They make a thoughtful gift for home or business use.

Call Jotter 3 illustrated  
RWINTAPE 138 **NOW £69.00** inc. VAT

**NOW £75 OFF**

**RADOFIN TELETEXT**  
This new model incorporates...

**ADD-ON ADAPTOR**  
WAS £199 inc. VAT  
**SALE PRICE £124** inc. VAT

**FOR FREE BROCHURES — TEL: 01-301 1111**

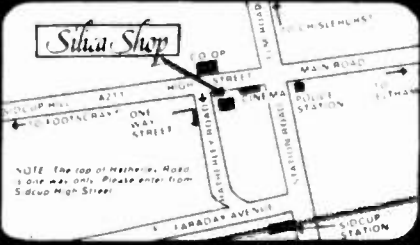

**SILICA SHOP LIMITED** HE0482  
14 The Mews, Hatherley Road, Sidcup, Kent DA14 4DX  
Telephone 01 301 1111 or 01 309 1111

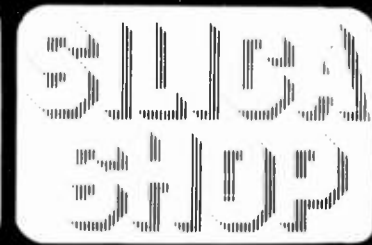

Step-by-step fully illustrated assembly and fitting instructions are included together with circuit descriptions. Highest quality components are used throughout.

# Sparkrite

BRANDEADING ELECTRONICS

NOW AVAILABLE IN KIT FORM

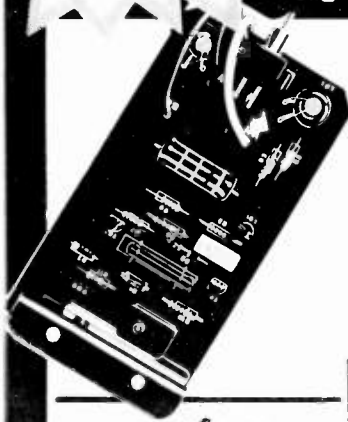

## SX1000 Electronic Ignition

- Inductive Discharge
- Extended coil energy storage circuit
- Contact breaker driven
- Three position changeover switch
- Over 65 components to assemble
- Patented clip-to-coil fitting
- Fits all 12v neg. earth vehicles

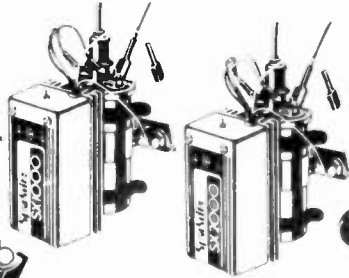

## MAGIDICE Electronic Dice

- Not an auto item but great fun for the family
- Total random selection
- Triggered by waving of hand over dice
- Bleeps and flashes during a 4 second tumble sequence
- Throw displayed for 10 seconds
- Auto display of last throw 1 second in 5
- Muting and Off switch on base
- Hours of continuous use from PP7 battery
- Over 100 components to assemble
- Supplied in superb presentation gift box

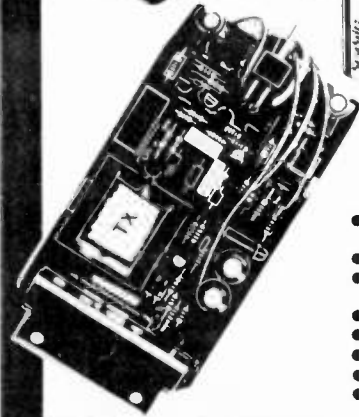
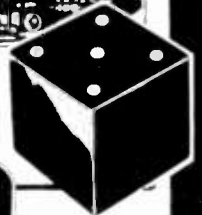
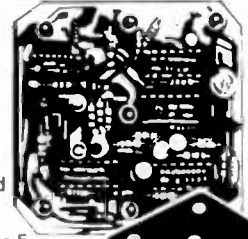

## SX2000 Electronic Ignition

- The brandleading system on the market today
- Unique Reactive Discharge
- Combined Inductive and Capacitive Discharge
- Contact breaker driven
- Three position changeover switch
- Over 130 components to assemble
- Patented clip-to-coil fitting
- Fits all 12v neg. earth vehicles

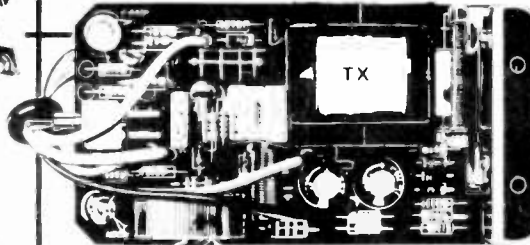

## TX2002 Electronic Ignition

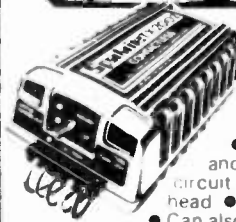

- The ultimate system • Switchable contactless • Three position switch with Auxiliary back-up inductive circuit
- Reactive Discharge Combined capacitive and inductive • Extended coil energy storage circuit • Magnetic contactless distributor triggerhead • Distributor triggerhead adaptors included
- Can also be triggered by existing contact breakers
- Die cast waterproof case with clip-to-coil fitting • Fits majority of 4 and 6 cylinder 12v neg. earth vehicles
- Over 150 components to assemble

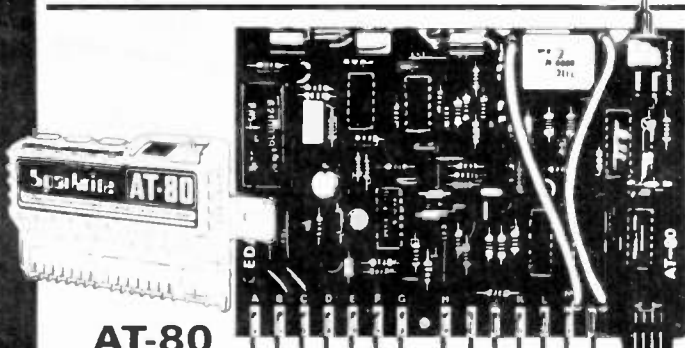

## AT-80 Electronic Car Security System

- Arms doors, boot, bonnet and has security loop to protect fog/spot lamps, radio/tape, CB equipment
- Programmable personal code entry system
- Armed and disarmed from outside vehicle using a special magnetic key fob against a windscreen sensor pad adhered to the inside of the screen
- Fits all 12V neg. earth vehicles
- Over 250 components to assemble

## VOYAGER Car Drive Computer

- A most sophisticated accessory • Utilises a single chip mask programmed microprocessor incorporating a unique programme designed by EDA Sparkrite Ltd
- Affords 12 functions centred on Fuel, Speed, Distance and Time
- Visual and Audible alarms warning of Excess Speed, Frost/Ice, Lights-left on
- Facility to operate LOG and TRIP functions independently or synchronously
- Large 10mm high 400ft-L fluorescent display with auto intensity
- Unique speed and fuel transducers giving a programmed accuracy of + or - 1%
- Large LOG & TRIP memories 2,000 miles, 180 gallons, 100 hours
- Full Imperial and Metric calibrations
- Over 300 components to assemble
- A real challenge for the electronics enthusiast!

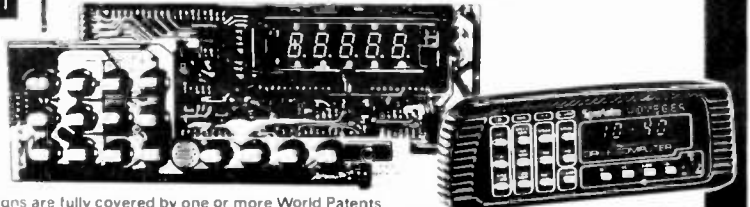

All EDA SPARKRITE products and designs are fully covered by one or more World Patents

EDA SPARKRITE LIMITED 82 Bath Street, Walsall, West Midlands, WS1 3DE England. Tel: (0922) 614791

	SELF ASSEMBLY KIT	READY BUILT UNITS
SX 1000	£12.95	£25.90
SX 2000	£19.95	£39.90
TX 2002	£29.95	£59.90
AT. 80	£29.95	£59.90
VOYAGER	£59.95	£119.90
MAGIDICE	£9.95	£19.90

PRICES INC. VAT POSTAGE & PACKING

NAME \_\_\_\_\_ HE482  
ADDRESS \_\_\_\_\_

I ENCLOSE CHEQUE(S)/POSTAL ORDERS FOR

£ \_\_\_\_\_ KIT REF. \_\_\_\_\_

CHEQUE NO \_\_\_\_\_  
24 hr. Answerphone  
PHONE YOUR ORDER WITH ACCESS/BARCLAYCARD  
SEND ONLY SAE IF BROCHURE IS REQUIRED  
Allow 28 days for delivery

BRANDEADING BRITISH ELECTRONICS  
CUT OUT THE COUPON NOW!