

# hobbies

five shillings

# 1968 annual

THE NEWEST AND BEST IDEAS FOR EVERY HOBBIEIST



PLANS FOR JET & RADIO CONTROL AIRCRAFT  
by JOHN CHINN

MODEL ENGINES by PETER CHINN

RADIO CONTROL by TONY DOWDESWELL

PHOTOGRAPHY by A. E. STANLEY

PLANS FOR A 11ft. RUNABOUT  
by P. W. BLANDFORD

D.I.Y. HOME DECORATING  
by D. G. JOHNSON



Instructions for making a fine 'CHALET' DOLL'S HOUSE with FREE plan inside - worth 5/-  
PLUS:- Reference catalogue containing items of interest to all HOBBIEISTS, MODELLERS, HANDYMEN, and CRAFTSMEN.



**SPECIAL FEATURE**

**SIR FRANCIS CHICHESTER'S EPIC LOG**

AS TOLD TO THE SUNDAY TIMES



hobbies 1968 annual

# selection from hobbies ltd 1968



The Hobbies Tool Kit suitable for father or son. See page 100.



The Hobbies 'Celebrity' bungalow type Doll's House. See page 67.



The 'A1' fretsaw machine by Hobbies. See page 90.



The Hobbies 'Marvel' fretsaw machine with electric motor. See page 90.



Hobbies 'A1' fretwork tool set. See page 88.



The Hobbies model Swiss Church with musical movement and lighting. See page 82.



Assorted Hobbies tools for the hobbist and craftsman. See pages 102-103.



# hobbies annual



# 1968

IT'S A HOBBY IN ITSELF!

There's reading enough in the new Hobbies Annual to keep you absorbed and enthralled right through the year. Pick it up in six months' or a year's time and we guarantee you'll still find something fresh and new.

It's bubbling over with adventurous ideas and, most important, the complete know-how to help you put even the most ambitious plan into practice without a hitch.

Hobbies are for pleasure and the 1968 Hobbies Annual is jam-packed with enough pleasure to keep an army of hobbyists happy for a hundred years. It's very much a family affair too. There are hobbies galore for the junior hobbyist, the hardened expert and even Miss and Mrs Hobbyist.

Browse through the fabulous colour section covering a truly colourful range of merchandise. Pick the brains of the specialists from an even more extensive selection of articles. (Order by post from your armchair or pop round to your nearest Hobbies Ltd. shop). You'll be amazed at the scope, presentation and value that Hobbies Annual offers the hobbyist. Escape right now into the fascinating world of Hobbies. It's as good as a holiday!



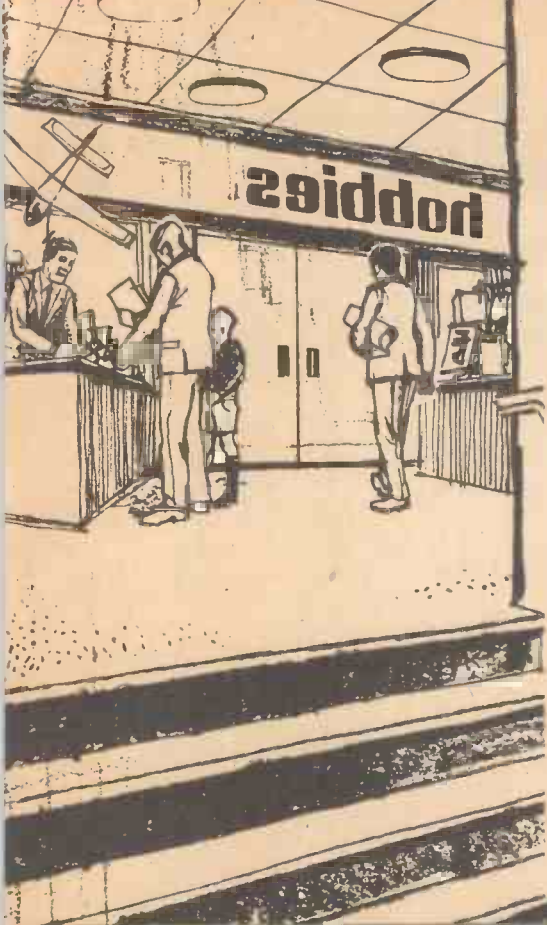

# hobbies

## AT YOUR SERVICE

Visit any of Hobbies Ltd. Branches in the towns listed below or refer to Page 158 for a selection of Hobbies Stockists.

**Head Office: DEREHAM, NORFOLK (Tel: 2193)**

**London Office: 81 PICCADILLY, W.1 (Tel: HYDe Park 4641)**

### LONDON

78a New Oxford Street, W.C.1  
Tel: MUSEum 2975 (E/C Sat.)

### LONDON

87 Old Broad Street, E.C.2.  
Tel: LONDON Wall 4375 (E/C Sat.)

### LONDON

81 Streatham Hill, S.W.2.  
Tel: TULse Hill 8796 (E/C Wed.)

### LONDON

151 High Street, Walthamstow, E.17.  
Tel: COPpermill 3928 (E/C Wed.)

### BIRMINGHAM

18 Moor Street, Ringway.  
Tel: MIDland 0219 (E/C. Wed.)

### BRISTOL

65 Fairfax Street, Bristol, 1.  
Tel: 23744 (E/C Wed.)

### GLASGOW

328-330 Argyle Street, Glasgow, C.2.  
Tel: CENTral 5042 (E/C Tues.)

### HULL

42 Savile Street, Hull.  
Tel: 23854 (E/C Thurs.)

### LEEDS

10 Queen Victoria Street, Leeds.  
Tel: 28639 (E/C Wed.)

### LEICESTER

25 Charles Street, Leicester.  
Tel: 24830 (E/C Thurs.)

## MAIL ORDER SERVICE

### hobbies by mail

It's the clever way to enjoy hobbying. All the many hundreds of items in the Catalogue can be ordered and purchased from your own fireside and delivered quickly and safely to your front door. There's an order form at the back of the Catalogue so take advantage of this super service—nothing's easier!

### pay as you hobby

#### CREDIT SALES

For the larger purchases (£2 and over) you may spread payment over 9 months and we make an additional charge for extra clerical work and interest. EVERY TRANSACTION IS TREATED WITH STRICTEST CONFIDENCE—Full details on the order form.

#### HIRE PURCHASE

Hire Purchase facilities also available on all articles £25 and over. Write for details of this scheme.

## hobbies cover the world

Our service spans the world, for 'hobbies' are truly international. Here are a few words of guidance for our overseas friends.

All prices include British Purchase Tax where applicable, but this tax does not apply to orders from abroad.

Where overseas instructions are concerned we quote corrected prices and carriage for all merchandise sent to an overseas address. Customers are requested to state method of transport to be used, i.e. sea freight, air freight.

If you are ordering from abroad, payment should preferably be made by International Money Order, payable to HOBBIES LIMITED, DEREHAM.

Payment in this fashion will ensure speed of despatch for your order and will give you full value of the amount in question.

We regret that C.O.D and credit facilities cannot be arranged outside the United Kingdom.

## advice section

When ordering, follow these helpful hints, to ensure full satisfaction and a quick delivery.

**NAME AND ADDRESS**—Enter your name and address in BLOCK CAPITALS for quick identification.

**CATALOGUE NUMBERS**—Identify your requirements by quoting the PAGE NO. and the ITEM NUMBER. The Catalogue Item number is the one nearest to the Cash price figures.



# your hobbies line up for 1968

## articles

Camping .....	27
D-I-Y Decorating .....	39
Holiday Travel .....	29
Model Engines .....	52
Photography .....	60
Radio Control .....	56
Sir Francis Chichester .....	15
Transfers .....	38

## things to make

Boat .....	22
Doll's House .....	32
Jetex Model Aircraft .....	48
Radio Controlled Model Aircraft .....	42

## merchandise sections

Boat & Canoe Plans .....	152
Carpentry Tools .....	100
Doll's Houses & Toys .....	65
Fretwork Kits & Tools .....	81
Marquetry Kits .....	92
Model Aeroplanes .....	121
Model Boats .....	129
Model Engines .....	134
Model Car Racing .....	112
Model Railways .....	118
Plastic Kits .....	150
Power Tools .....	104, 154
Radio Control Equipment .....	137
Scientist & Engineer Kits .....	142
Timber & Wood .....	110

## the hobbies aim

We are here to help you; we want to help you. We want to take the routine tasks out of your hobby and leave you all the creative enjoyment. Nowhere in the world is there a larger pool of expert knowledge on hobbies than in our files and we have specialists on hand to cover every facet of 'making things at home'.

Whatever you want or whatever you want to know about your hobby—ask us, please.

### MANCHESTER

10 Piccadilly, Manchester, 1.  
Tel: CENTRAL 1787 (E/C Wed.)

### SHEFFIELD

4 St. Paul's Parade, Sheffield, 1.  
Tel: 26071 (E/C Thurs.)

### SOUTHAMPTON

134 High Street, (Below Bar).  
Tel. 25947 (E/C Wed.)

**DESCRIPTION**—Enter the first few words that are used to start the description in the Annual.

**CASH PRICE & CARRIAGE COSTS** for Cash Orders—Be sure to complete these, so that you can easily work out total costs. Enter at the bottom the total of the money sent.

**DEPOSIT & CARRIAGE COSTS** for Credit Customers—Enter the Deposit and Carriage figures in the columns provided and be sure to complete the details listed on the back of the Order.

**CASH OR CREDIT**—It speeds delivery if you order cash purchases on a separate Order Form to Credit Purchases.

**METHOD OF PAYMENT**—All orders should be accompanied by a remittance, either Cheque, Postal Order, Money Order or Bank Transfer, made out to HOBBIES LIMITED. Treasury Notes must always be sent by Registered Post.

**CORRESPONDENCE**—Should not be written on the order, but on a separate sheet of paper.

**CARRIAGE AND POSTAGE**—HOBBIES pay carriage or postage on all orders over £5, otherwise postage is extra and should be sent with your order.

**CONDITIONS OF SALE**—Prices quoted are those ruling at the time of going to press, but if circumstances arise, beyond our control, they may be altered without notice.

**DELIVERIES**—Any damage must be reported immediately to the Carriers and to this Office.

**GUARANTEE**—We guarantee to refund your money or exchange any item, with which you are not completely satisfied, provided that the goods are returned within 7 days.

### 5 STAR LAY-AWAY SCHEME

- ★ Select from a full range of merchandise and NOT at the LAST minute.
- ★ Pay whatever deposit YOU can afford.
- ★ Pay over whatever PERIOD you want.
- ★ At whatever AMOUNT you want.
- ★ We DELIVER to your home when you have COMPLETED - FREE if over £5, or at normal carriage rates if under.

### GET THE GIFT IDEA

What fun to receive a Hobbies Gift Voucher. Then treat your best friend to one next time. A Hobbies Gift Voucher for any amount can be used for purchases by mail or at any one of Hobbies Ltd. Shops. Contact us or one of our shops for full details of this sensible gift idea.



(ORDER FORM  
INSIDE  
BACK COVER)



WHY DON'T YOU COLLECT  
OLD MASTERS?

# COLLECTOR'S CHOICE

A NEW PRESENTATION BY

*Art Master*  
OF CHELSEA

- CC1 "Cherry Ripe" by Millais
- CC2 "The Morning Walk" by Gainsborough
- CC3 "A Girl With A Kitten" by Perroneau
- CC4 "The Red Boy" by Lawrence
- CC5 "Miss Murray" by Lawrence
- CC6 "The Laughing Cavalier" by Hals

Each set contains: 1 Artist's Board (18" x 14"),  
1 Check Sheet, 1 Palette, 29 Paints, 1 Square-  
tipped Brush, 1 Fine-point Brush and a hand-made  
gilded Frame.

For leaflet write to: Uniray (U.K.) Ltd.,  
Commerce Rd., Brentford, Middx.

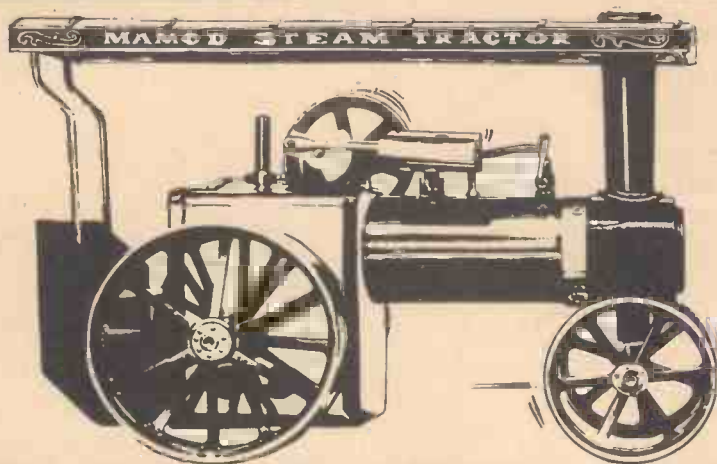

# WANT TO BE AN ENGINE DRIVER?

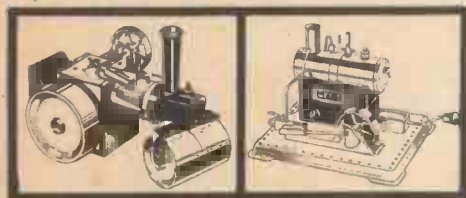

Then have fun driving a Mamod Steam Model. The traction engine and the road roller can actually be steered as they go. There are stationary engines, too, for powering Mamod miniature working machines and Meccano models. Precision engineered, Mamod models are safe as well as fun. Prices from 35/9 to 111/9 at leading toy and sports shops.

**Mamod** STEAM MODELS mean a world of fun for you

MANUFACTURED BY MALINS (ENGINEERS) LTD., THORNS ROAD, QUARRY BANK, BRIERLEY HILL, STAFFS



# MODELS IN Solarbo Balsa

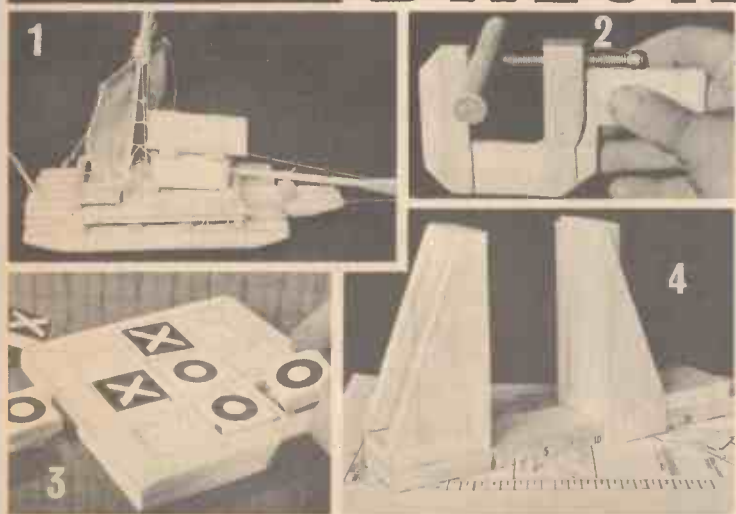

Balsa is not just for making model aircraft... It is ideal for boats, the construction of lineside models and model buildings... demonstration and layout models... architectural models... woodcarving... puppet making... scientific models... teaching apparatus... novelties... in fact there is no end to what Balsa can be used to make; (even full size aircraft and boats). Just remember always to use SOLARBO Balsa—specially selected and graded for modelling use... and the best Balsa there is! Your "Hobbies" shop has it in stock.

Balsa Models shown are the Kon Tiki (1), Micrometer (2), Noughts-and-Crosses puzzle (3), Circumference Measure (4) and Slide Rule (5). Plans for these—and many other Novelty, Scientific, Mathematical and other models—are available direct from Solarbo (see list below). Plans include complete pictorial instructions for cutting out parts required, assembly and finishing. All can be built from standard Solarbo Balsa sheet, strip and block sizes.

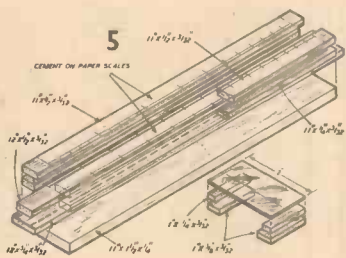

## PLANS...

Prepared basically for School use, these plans include many subjects of general interest and use (e.g. the Slide Rule).

PLAN PRICES - any 4... 1/-  
any 12... 2/6

Plans are post free, but please include a SELF-ADDRESSED ENVELOPE (foolscap size or larger) for speedy return of plans ordered.

### ART AND CRAFT

- WITCH (Matchbox holder)
- OWL & COOLIES (Calendar)
- SPRAY OF FLOWERS
- GIRAFFE (Matchbox holder)
- SAILOR (Calendar)
- BIRD MODELS (Calendar)
- GUARDSMAN (Calendar)
- WASP (Matchbox holder)
- PENGUINS (Matchbox holder)
- BUNNY (Matchbox holder)
- SAMBO (Calendar)
- NOAH'S ARK
- FISH (Calendar)

### BIBLICAL

- BIBLICAL HOUSE

### PUZZLES, ETC.

- O-X-O PUZZLE
- CROSSWORD PUZZLE
- TOWER OF HANOI

### HISTORIC

- PUNISHMENT THRU' THE AGES (special set of 4)

- KON-TIKI RAFT
- NORMAN CASTLE

### SCIENTIFIC

- TWO-STROKE ENGINE
- TEMPERATURE CONVERTER (°F to °C & vice versa)

### MATHEMATICAL

- CIRCUMFERENCE MEASURER
- SLIDE RULE\*
- UNIT COUNTER
- MAGIC SQUARES
- EGYPTIAN COMPUTER
- CUBES
- MODEL ACRE & HOUSES
- CLINOMETER
- MICROMETER

\*Special kit of parts including printed balsa scales 3/6 (post free) or 30/- doz. (post 1/6).

## SAVES YOU TIME! MONEY! EFFORT!

### Builders' and Decorators' Reference Book

Plan the job thoroughly before work commences and you will cut out waste of time and effort. This means money saved! Builders' and Decorators' Reference Book gives all the facts, figures and data needed by the Master Builder and Tradesman—keen practical householders will find it invaluable, too. Written by 19 specialists, it covers every branch of building work including the latest techniques and developments. It is the accepted reference work in the trade. Thousands of copies are in use and now you can examine it for a week without cost. Send no money—just post coupon to-day.

### OVER 1,700 PAGES

1,470 Diagrams, Explanatory Drawings, Photographs.

50 Main Sections



### Covers every building activity

Inspection - Estimating - Shoring - Materials - Surveying, Levelling, Setting-out - Excavations & Foundations - Damp-proof Courses & Water-proofing - Brickwork & Masonry - Scaffolding - Flues - Timbers - Floors & Partitions - Cradling & Bracketing - Roofs - The Steel Square - Windows - Doors - Glazing - Plastering - Internal Wall Finishes, Joinery, Painting & Decorating - Water Supply, Solid Fuel Appliances, Water Heating - Progress & Development, etc.

SEE IT - USE IT ON

## FREE TRIAL

WITHOUT OBLIGATION TO PURCHASE

Buckingham Press Ltd., Headington Hill Hall, Oxford.

If under 21 your father must fill up this coupon.

Please send Builders' & Decorators' Reference Book without obligation to buy. If you accept this application I will post 6/- deposit 8 days after receipt of book, then 10/- monthly for 12 months, paying 126/- in all—or return the book. Cash price in 8 days 120/-.

Free Trial applies G.B. For Ireland send cash price (refundable if title returned in 8 days).

Full Name ..... (Block Letters) (Mr., Mrs., Miss)

Address .....

Occupation .....

Signature..... (Mr., Mrs., Miss) (BR 3004)

Tick V where applicable

The address on left is—

My Property	<input type="checkbox"/>
Rented unfurnished	<input type="checkbox"/>
Parents' Home	<input type="checkbox"/>
Furnished Accom.	<input type="checkbox"/>
Temporary Address	<input type="checkbox"/>

## SUPERCAST

### RUBBER AND PLASTIC MOULDS FOR PLASTER CASTING

- ◆ DECORATIVE
- ◆ PROFITABLE
- ◆ EDUCATIONAL

NEW 1968 RANGE NOW AVAILABLE FOR CHILDRENS MODELS - GARDEN ORNAMENTS PLAQUES AND FIGURES FOR INTERIOR DECORATION

Also introducing

### SUPERWOOD NEW INSTANT MODELLING MATERIAL

Just Add Water! Dries into Real Wood

1/6 per pack

Ideal for Home and School

SUPERCAST  
31  
BLANKET  
ROW,  
HULL

CUT OUT AND POST TODAY

Please supply by return:  
YOUR LATEST SUPERCAST/SUPERWOOD  
ILLUSTRATED LISTS. I enclose STAMPS value 8d.

NAME .....

ADDRESS .....

(Hob./A) .....

# Solarbo

COMMERCE WAY,  
LANCING,  
SUSSEX.  
LIMITED



- VIPKITS. Famous cars in kit form.
- MOTORS. Super-power RX 1000 for maximum speed and reliability.
- CHICANE. The latest addition to VIPTRAK sections.



—Get this fully descriptive VIP Brochure today from your local stockist or write direct to:

**VICTORY INDUSTRIES (Raceways) LTD.**  
Raceway Works, Woodbridge Meadows, Guildford, Surrey.

# DO YOU WANT TO BE A GRAND PRIX DRIVER ?

Put your VIP Racing Cars on the VIP-TRAK, take up your VARISPEED Controllers and you're away. Skill at the controllers governs each car's performance and determines the winner. VIP Cars have been proved on the world's club tracks for outstanding speed, road holding and reliability.

Get your VIP Raceway Set NOW—and start building up your favourite Grand Prix circuit.



# EARN EXTRA CASH!

## WHILE YOU FOLLOW THE MOST FASCINATING HOBBY OF ALL—

THE ADANA '5/3'  
£9-15-0

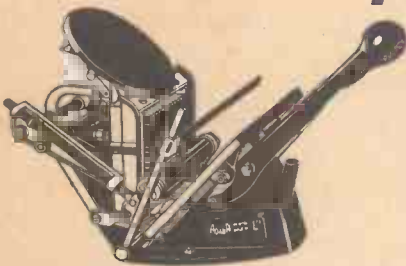

**REAL PRINTING MACHINES  
SOLD DIRECT TO YOU—  
AT FACTORY PRICES  
NO MIDDLEMANS PROFITS—  
SHEER, SOLID  
VALUE FOR MONEY!**

All over the world ambitious men and women are earning *EXTRA CASH* while they enjoy what has been called "the world's most interesting hobby." Adana Printing Machines enable you to "get into print," and produce first-class work easily and quickly. Everybody is a customer for printed material, such as greetings cards, leaflets, bills, notepaper, invitations, tickets etc.—in fact the demand increases with the increasing supply. Your next door neighbour, your nearest church, local businesses, shops—all are constant users of print, and it would surprise you to know how many would welcome the help of a Home Printer with an ADANA.

### FREE

*Send at once for sample of type and details of work! There is no obligation, but you will be let into the secret of this wonderful hobby and how ADANA users have built themselves up very profitable spare-time connections.*

THE ADANA '8/5'  
£25-10-0

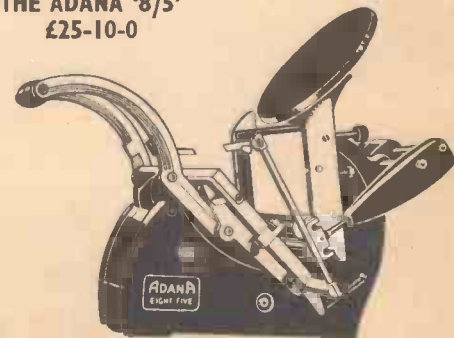

**ADANA (PRINTING MACHINES) LTD. (DEPT. H.O.10) 15/19 CHURCH ST. TWICKENHAM, MDX.**

Callers Welcome—Mon. to Fri. 9 a.m.—5.30 p.m. Sat. 9 a.m.—4 p.m. (E.C. Tues. 1 p.m.)  
London Branch: 8 Gray's Inn Rd., W.C.1. Mon. to Fri. 9 a.m.—5.30 p.m. Sat. 9 a.m.—12.30 p.m.



# ALL AROUND THE HOUSE

## and outside too!

### MOTORISTS!



David's **ISOPON** makes dented bodywork as good as new.



David's **ISOPON** plugs leaking radiators effectively and saves you Pounds.



David's **ISOPON** fills gaps in metal or glass fibre bodywork and does a perfect job.



David's **ISOPON** is acid resistant, seals leaking batteries.



David's **ISOPON** sets hard as steel. Is a boon for all motor cycle repairs.



David's **ISOPON** is petrol resistant, mends leaking petrol tanks.

### HANDYMEN (and WOMEN)!



David's **ISOPON** repairs broken roof tiles, seals leaking chimney stacks.



David's **ISOPON** fills cracks in wash basins invisibly and permanently.

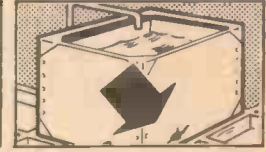

David's **ISOPON** plugs leaking water tanks.



David's **ISOPON** seals leaks in greenhouses.



David's **ISOPON** repairs corroded guttering and even replaces missing pieces.



David's **ISOPON** mends broken garden tools.



David's **ISOPON** seals leaks in washing machines.



David's **ISOPON** repairs broken ornaments, china, plastic handles.



David's **ISOPON** can be dyed or painted to make any repair absolutely invisible.

### AQUANAUTS!



David's **ISOPON** mends, bonds and seals above or below the waterline.



David's **ISOPON** plugs wood, steel, aluminium and glass fibre hulls.

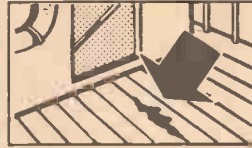

David's **ISOPON** seals leaking decks.

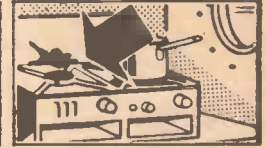

David's **ISOPON** makes cabin and galley fittings ship-shape.

David's **ISOPON** fills better, bonds firmer, seals tighter.

A kit of David's **ISOPON** goes a long way. Does a thousand repair and filling jobs. David's **ISOPON** spreads like butter, hardens like steel and is so easy to use. David's **ISOPON** is the polyester glass fibre repair kit that does the job with metal, wood, hard plastic, concrete—and does it to last.

ASK FOR David's **ISOPON**

by name at your local motor accessory, hardware, do-it-yourself store or ships' chandler.

David's **ISOPON** UNIVERSAL KIT



This versatile kit contains 10 different items, all of which are very useful for the 'Do-it-Yourself' enthusiast.

18/6

David's **ISOPON** SENIOR KIT



Contains 1 lb paste, perforated sheet metal, glass fibre, applicator.

12/6

also available  
**MINI KIT** 5/6  
**JUNIOR KIT** 8/6  
**HOUSE & CAR REPAIR KIT** 16/-

NEW David's **ISOPON** REFILL 'A'

Contains 1/2 lb Resin. Hardener, Glass fibre mat, and a very important 'Special Instruction Leaflet' giving details of how to use David's **ISOPON** as a waterproof

Economy kit adhesive, how to bridge holes, how to make your own Filler Paste, and how to add a pigment. Really a repair kit in itself! 10/-

Send now for our FREE 64 page booklet describing over 150 actual repairs successfully tackled with David's **ISOPON**.

NAME.....  
 ADDRESS.....  
 HA

W. DAVID & SONS LIMITED  
 Derbyshire House · St Chad's St · London · WC1

# Positively Unbelievable 15



**PU-15 POLYURETHANE  
CLEAR VARNISH**

One pack. No catalyst. Just brush on. Interior grades—gloss, matt and, now available, satin—for floors, stairs and any interior wood, lino, rubber, cement. Unaffected by dilute acids and boiling water. Exterior grade (gloss only) for all exterior woodwork—boats, red cedar, doors, cement, concrete. Strengthened with ultra violet barrier for exterior durability.

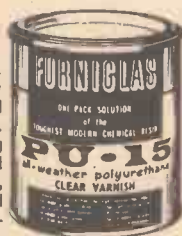

**POLYURETHANE  
FRENCH POLISH**



Furniglas Ltd., have now perfected a "French Polish" version of their one pack Polyurethane Varnish. This Polyurethane French Polish gives the perfect-polished wood appearance of professionally hand polished furniture plus polyurethane strength and durability. A pad charged with this polish slides over the surface as easily as Furniglas' famous No. 1 Home French Polish.

**Also WIDE RANGE OF  
FADELESS WOOD DYES  
and POLYURETHANE GRAIN FILLER**  
which can be used  
under PU.15 Varnish and French Polish

**INFORMATION FROM FURNIGLAS.**

If you care to send us a stamped addressed envelope, we will be only too pleased to advise you on any aspect of wood finishing, including such points as interior and exterior varnishing, furniture surface repair and brush care.

**FURNIGLAS LIMITED**  
136-138 GREAT NORTH ROAD HATFIELD HERTS

TEL: HATFIELD 5358

*Metal Stampers, Toolmakers*

# ROMSIDE

**MFG CO LTD**

Brooklands Approach, North St. Romford



for the  
**ROMSIDE SERIES of  
Metal Dolls House Fittings** *trade only supplied*

*A complete range obtainable from model and  
Handicraft shops and all Hobbies Ltd. Branches*



## Develop your own films Make your own prints

With this set you can develop your films and make prints from the negatives. Contains adjustable developing tank (for size 120, 127 and 20- or 36-exposure 35 mm. films), contact printer (mains operated), three dishes, two forceps, two film clips, 10 oz. measure, two stirring rods, water circulator, six print clips, three masks, 250 cc. Unitol Film Developer, "468" developer (for paper),

250 gram Fixadon (fixer for films and paper) and the 104-page "Home Photography" book.

No. 4 Outfit £6. 0. 0  
(15 watt pygmy lamp 2/2 extra)  
Other outfits from £2. 2. 0  
At your photographic dealers, or send for descriptive leaflet to

**JOHNSONS**  
OF HENDON LTD

Hendon Way, London, NW9



# HOBBIES EVERYWHERE

sell

## PECO STREAMLINE

### MODEL RAILWAY FLEXIBLE TRACKAGE SYSTEMS IN N, 009, 00/HO, & O GAUGES

Peco Streamline now provides the finest track service ever to the Railway modeller, with complete flexible trackage systems in N, OO-9, OO/HO and O gauges. Each system is scientifically designed to accept practically all popular makes of model trains, and beautifully modelled to contain the finest detail. The tied sleeper-strip base is moulded in unbreakable

plastic, completely flexible for easy laying. But Peco Streamline does not stop at trackwork—there are a host of trackside accessories; point motors, ballast inlays, buffer stops etc., all of which you can find, along with all the other Peco Products, in the new fully illustrated Peco Catalogue. On sale, price 3/- at all model shops, or price 3/6 direct from

THE PRITCHARD PATENT PRODUCT COMPANY LIMITED, SEATON, DEVON

## THE HOME JEWELLER

1/-



\* We also supply **SHELLCRAFT materials**  
(Instruction book 'HOW TO MAKE SHELL FIGURES' 2/6  
or complete Shell Outfit 15/-)

**RAWSON'S CRAFT SHOP**  
113 HUMBER ROAD  
LONDON SE3

*'Turn your leisure into profitable pleasure'*

This 75 page book explains and lists all the many materials for this fascinating hobby which we supply.

**YOU** can make your own jewellery so easily including: **Silver/Gold Rings**  
**Brooches - Earrings**  
**Necklets - Bracelets etc. etc.**  
*With real Swiss Marcasites Brilliants  
Limoges and GEMSTONES etc. etc.*

**CUT HERE**

Please send by return

Tick which required

<b>THE 'HOME JEWELLER'</b>	1/-
<b>HOW TO MAKE SHELL FIGURES</b>	2/6
<b>SHELLCRAFT PACK</b>	15/-

NAME .....

ADDRESS .....

(HOB/A)

*We supply the world over with shells and jewellery components.*

# JUST LIKE THE REAL THING!

OVER 250 KITS TO CHOOSE FROM

Here's hours of pleasure building exact and detailed models with Airfix Construction Kits. They cover an immense field of interests from historical ships to the latest cars. There are 19 different series and the scale is constant in each. All are planned with an eye for detail which will delight every model maker. Prices are extraordinarily modest.



SERIES 3 AIRCRAFT 1/72 SCALE 5/-



SERIES 5 AIRCRAFT 1/72 SCALE 8/6



SERIES 1 ARMOURD FIGHTING VEHICLES 2/3



SERIES 8 HISTORICAL SHIPS 1/600 SCALE 16/6



SERIES 1 WW 1 AIRCRAFT 1/72 SCALE 2/3



SERIES 1 WW 2 AIRCRAFT 1/72 SCALE 3/3



SERIES 2 AIRCRAFT 1/72 SCALE 3/6



SERIES C SKYKINGS 1/144 SCALE 7/-



SERIES 2 MODERN CARS 1/32 SCALE 3/6

YOU'VE  
GOT  
IT MADE  
WITH



CONSTANT SCALE CONSTRUCTION KITS

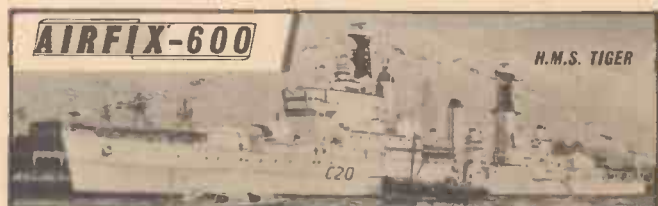

SERIES 3 FAMOUS SHIPS 1/600 SCALE 5/-



# hobbies books

Here's a selection of best-selling books from Britain's top publishers—guaranteed satisfaction or full money refund.



**New!**

**MAIL  
ORDER  
ONLY**

"The Veneer Craftsman's Manual"—96 pages. Crammed with know-how on veneering and marquetry. Only 2/6 post free. Complete Buyer's Guide, Catalogue, and Price List on **TIMBER — PLYWOOD — INLAYS — BANDINGS — CABINET HARDWARE — HAND AND POWER TOOLS.** Twelve most popular veneers 4" x 3" only 1/6d.

**THE ART VENEERS COMPANY LTD**

12 Station Estate, Woodford, London, E.18.

**The World's Largest Source  
of Rare and Exotic Veneers**

## 'TOP OF THE TOOLS'

for **Hobbyist  
and Handyman**

## JUNIOR THORLITE

The rubber-faced hammer for use in house, workshop, garage and garden.

This versatile soft-faced hammer is ideally suited for operations where damage to the work must be avoided. It is essential for shaping metals, assembling all kinds of woodwork, use on chisels, tile-laying, easing doors, windows, and tight bolts, freeing jammed lawnmower blades, car maintenance and dozens more light hammering jobs.

The JUNIOR THORLITE comprises a light alloy head, fitted with one hard and one soft rubber faces 1½" diameter, extremely durable yet easily replaced by hand when worn out. Replacement faces, Ref. 612HF (hard) and Ref. 612SF (soft) are 1s. 6d. each. The hammer has a strong ash handle and weighs approx. 10 ozs.

Obtainable from Halfords Branches and most good Tool dealers or, in case of difficulty, direct from makers, post paid against remittance of list price.

A complete range of THOR soft hammers is available with faces of copper, aluminium, rawhide, rubber, nylon and plastics. Send for details.



**THOR HAMMER**

COMPANY LIMITED

HIGHLANDS ROAD, SHIRLEY, BIRMINGHAM



Ref. J612

**7/6**

LIST PRICE

### 1 NEWNES COMPLETE PRACTICAL WOODWORKING

Spent many hours of profitable pleasure: home carpentry, joinery, cabinet making, turning, veneering, inlaying and finishing—all in one superb, clearly illustrated guide. 970 illustrations.

NEWNES 35/- (37/6 by post)

### 2 RADIO CONTROLLED MODELS

Contents include steering control gear, receivers, transmitters, control box, tuned reeds, model actuators, tuning transmitting aeriels and details for model battleship, aircraft, etc. Fully illustrated.

NEWNES 12/6 (13/8 by post)

### 3 MODEL CAR COLLECTING

By Brian Jewell, Secretary of the Model and Replica Car Society. Accent on mass-produced miniatures and methods of authentic conversion into individual replicas. Contains special register of makes, clubs and societies.

TEMPLE PRESS

15/- (16/2 by post)

### 4 MORE SIMPLE RADIO CIRCUITS

Includes: 2-Station radio and amplifier. Transistorised converter, double triode receiver, beginners 3-transistor reflex, modern 3-valve TRF, 2-transistor portable, 4-valve superhet, etc. Fully illustrated.

NEWNES 3/6 (4/2 by post)

### 5 QUESTIONS & ANSWERS ON RADIO AND TELEVISION

Fundamentals of electricity, sound and radio waves, practical modern techniques. Operation of valves and transistors, basic circuit arrangement and stage by stage working of receivers.

NEWNES 8/6 (9/6 by post)

In the same series at the same price:

### 6 QUESTIONS & ANSWERS ON TRANSISTORS

### 7 QUESTIONS & ANSWERS ON ELECTRONICS

### 8 EXPLORING PUPPETRY

The first really comprehensive work on this subject. Contents include: Shadow, glove, string and rod puppets, marionettes, peep-shows, toy theatres, masks, stages and notes on available materials and suppliers, films and scripts, etc. Packed with how-to-do-it illustrations—some in full colour.

MILLS & BOON

42/- (44/- by post)

### 9 THE WINEMAKER'S COMPANION

An essential reference work for the serious winemaker. Many recipes, also basic ingredients, processes and equipment. Wine ailments, serving, cellar-craft, keeping records, entering competitions—even how to contact other wine-makers.

MILLS & BOON

25/- (26/2 by post)

### 10 COLLECTING RECORDS

Most young people collect records and this book will go a long way to increasing their awareness of the vast range of music offered on discs. Although the accent is on classical music, there are sections on light music, jazz, humour and mood music.

BATSFORD 18/- (19/2 by post)

### 11 COIN COLLECTING FOR AMATEURS

Touch a coin and you touch history. Here's sound advice—from an acknowledged expert—on obtaining, housing and cleaning coins, also notes on how to avoid forgeries and overcharging, etc. An invaluable handbook for the beginner.

MULLER 16/- (17/2 by post)

### 12 PAINTING AND DRAWING FOR EVERYONE

A 62-page, 10" x 13" book in full colour—for only 15/-! This is a unique instruction book for all the thousands of would-be artists who just need that little basic 'know how' to get them started. There are even full-colour reproductions of classical and modern paintings to spur you on.

ODHAMS 15/- (16/6 by post)

From your bookseller, or to order by post, write reference numbers of books required in the boxes, fill in the coupon and send, with your remittance to:

**THE RECREATIONAL BOOK CENTRE · COLT HOUSE  
BIRCHANGER · BISHOP'S STORTFORD · HERTS.**

CUT HERE

<input type="checkbox"/>	<input type="checkbox"/>	<input type="checkbox"/>	<input type="checkbox"/>	<input type="checkbox"/>	<input type="checkbox"/>
--------------------------	--------------------------	--------------------------	--------------------------	--------------------------	--------------------------

**FREE!** Tick this box and attach 3d. postage stamp to receive our complete catalogue of hobbies and handicrafts books by return post. (If ordering books, catalogue will be sent automatically.)

NAME .....

ADDRESS .....

HA/1

For  
EVERY HOME

Decorative, Delightful, Distinctive . . .

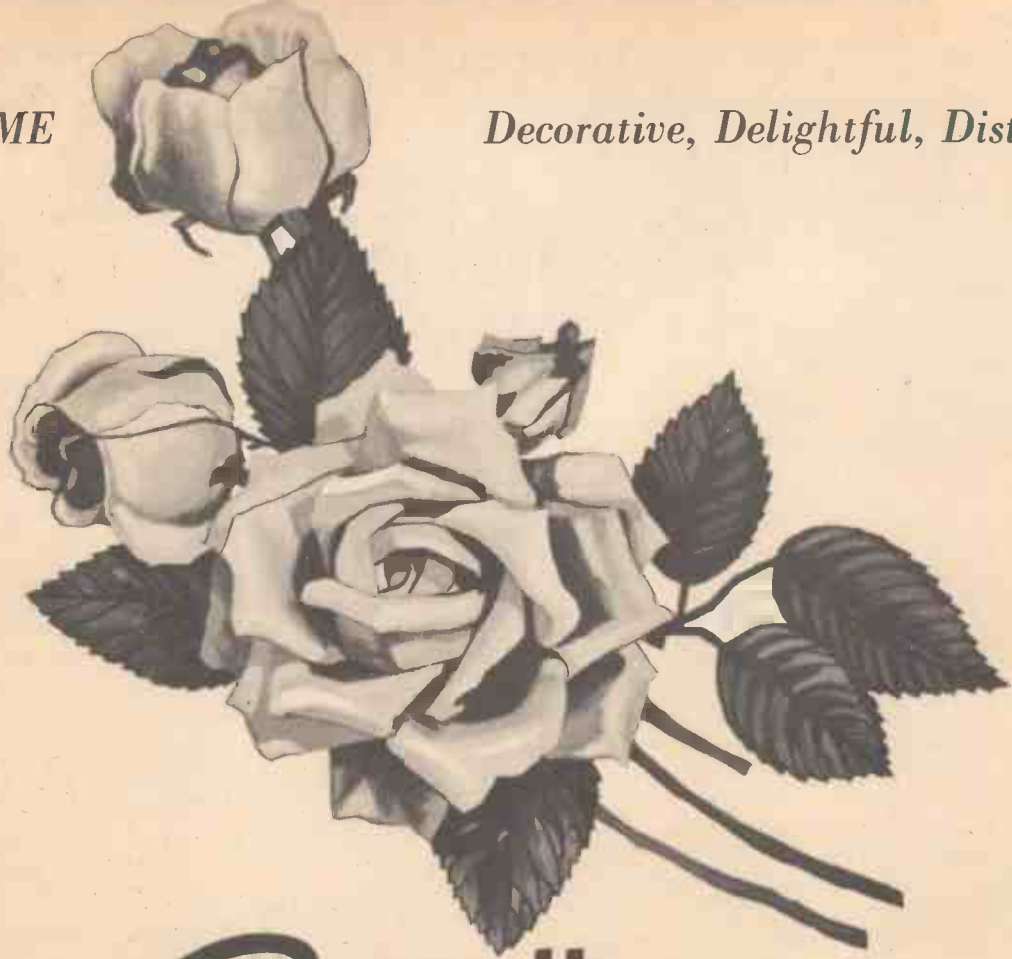

. . . it's a **Decorettes** transfer

It takes a Decorette transfer, a drop of water and a few seconds to transform any room and many items in it. The attractively designed rose above is just one of a hundred equally appealing Decorettes transfers; available from hobby, handicraft, wallpaper shops and department stores.

. . . and there's one for every room in your home

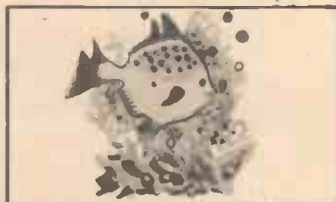

**Decorettes**

Decorettes Ltd Queens House  
Holly Road Twickenham Middlesex  
01-892 9159 (3 lines)



# QUICKSTART

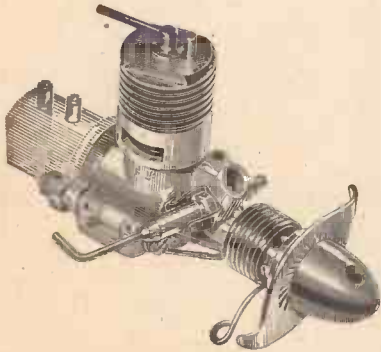

**MODEL AERO & MARINE  
ENGINES, ALSO ACCESSORIES**

*See them at your local model shop.*

*Every one tested and guaranteed for one year.*

Manufactured by

**DAVIES CHARLTON LTD.**  
HILLS MEADOW, DOUGLAS, ISLE OF MAN.

## The Sensational Hand Tool! ABRAFILE ROUND FILES

*Just bend them Cold to  
the shape you require!*

The amazing soft core parallel round file that makes it a joy to work convex or concave surfaces, around bends, inside pipes, tubular work etc. Helically cut teeth prevent clogging even when used for soft metals. Wonderful for all classes of work METALS, PLASTIC, WOOD, MARBLE etc.

Made in diameters of:  
3/32", 1/8", 5/32", 3/16", 7/32", 1/4"  
1/4" 1/8 1/10 2/- 2/3  
Also available in tapered form.

**HAVE YOU TRIED THE ABRAFILE  
TENSION FILE?**

Cuts any  
intricate  
shape

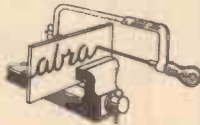

**FROM IRONMONGERS AND  
HOBBIES SHOPS EVERYWHERE**

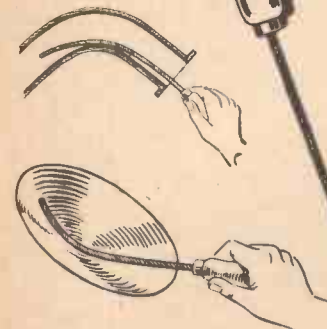

*And of course, the Inquisitive*

**MOUSETAIL**

For those  
awkward little  
places



It gets everywhere! 1/16" dia, 3 1/2" long. 6d.

or send stamp for leaflet describing all ABRAFILE Products to

**ABRASIVE TOOLS LTD. (Dept. HO)**

**ABRIUM WORKS · COLNE RD · TWICKENHAM MIDDXX**

**NEW!**



**How to make  
a sumptuous  
rug in only  
10 evenings...**

... send for a free copy of the full-colour Merryweave Rug-Book and discover an exciting new rug-making system. Beautiful designs or rich self-colours, d-e-e-p 100% pure wool pile, 'tread-on-air' foam latex backing, top-quality stencilled canvas... and the unique Merryweave Hi-Speed Rugmaker. So much *easier*... faster... more enjoyable. So rewarding when your friends admire the lovely rug you've made. Find out more. Post coupon now for your free rug-book and wool samples.

**A complete  
Merryweave  
Outfit,  
including  
Rugmaker  
and full  
instructions,  
costs less than  
most other kits.**



**You get  
better value  
for your  
money with  
Merryweave-  
and if you  
wish Easy  
Terms are  
available.**

**MERRYWEAVE**

Andrew Merryfield Limited  
Department HSA/302  
29 Wrights Lane, W.8.

Please send me the Merryweave Rug-book  
and wool samples FREE

name.....

address.....

BLOCK LETTERS



**2 oz Tin**  
Gloss finish  
36 wonder-  
ful colours



**1/2 oz Tinlet**  
36 Gloss  
and 12 matt  
colours

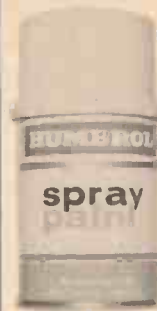

**4 oz Aerosol**  
18 shades  
**Giant 16 oz.**  
Aerosol  
11 shades



## Ship shape & Humbrol fashion!

It's the finish which adds that final touch of perfection to your models? HUMBROL ENAMELS, matt or gloss are used by modellers throughout the world.

Quick drying and in a wide range of inter-mixable colours, HUMBROL ENAMELS will meet your most exacting requirements.

They are available in the useful 1/2 oz. tinlet and in larger sizes. Additions to this range are the 4 oz. and 16 oz. aerosols. Now fitted with a

NEW 'Soft Spray' head to give greater control in application.

HUMBROL supply a complete range of modelling products including Britfix adhesives, dopes, varnishes and polyurethane gloss and satin finish in 4 oz. and 16 oz. aerosols—Look for them all at your nearest model shop.

\*N.B. HUMBROL ENAMELS are non-toxic, absolutely safe for children's toys.

# HUMBROL

# enamel

Humbrol · Hull · Yorkshire



# sir francis chichester's own story



THE LONELIEST PLACE  
IN THE WORLD—

as told to  
THE SUNDAY  
TIMES



I am, on the whole, reasonably satisfied with the first half of my round-the-world voyage. I failed to achieve my target of Plymouth to Sydney in the clipper average of 100 days, which was naturally disappointing. But my time of 107 days was respectable even for the big clippers, and at one point I was level with the Cutty Sark's best time, 5,000 miles out of London. I have made mistakes, largely caused through rashness and inexperience, and I have been humbled to discover that wherever I thought I could cut a corner on the route followed by the old-time clipper captains, particularly in going too near to South Africa, they were right and I was wrong.

By and large, I have had reasonable luck, or rather I got most of my bad luck in one crushing instalment—with the failure of my self-steering gear. As against this, I had the satisfaction of jury-rigging a substitute self-steering gear which worked and got me here. And Gipsy Moth IV and I have nearly doubled the record distance for a single-handed

voyage, in a time near the average of the fastest sailing ships ever built. I can't really complain.

As I write this, four days after reaching Sydney, I am at the lowest physical and mental ebb that I've ever been in my life. I weigh 10 stone against my normal 11 stone 4lb. I feel so emaciated and wizened up that I thought on the boat I had lost nearer 40 lb.

As I was beating up the coast to Sydney, I was near the end of my rope, physically. Off Port Kembla it took me two hours to set the working jib in place of the storm jib, hoist the mainsail, unreef the mizzen and trim the ship—which would normally have taken me twenty minutes. I had to stop every few minutes to rest and get my breath back. But the excitement, the nearness of my family and the welcome I could feel waiting for me kept me going to Sydney.

Now I can afford to be tired and I have sunk through a level of exhaustion I have never experienced before. I am too tired even to sleep properly. My bedroom

heaves in my sleep worse than the boat ever did. Last night, my wife tells me I was clawing the wall in my sleep and calling out, 'Where's the halyard, I can't find the halyard.'

I landed in a state of depression, partly physical, no doubt, and partly feeling the gloom I always experience at the end of a venture, when it's over, and I can no longer correct my mistakes. But now I'm beginning to eat again and I can feel my spirit coming back by degrees, and I think I will be physically and mentally fit to sail for the Horn in twenty-five days time, on schedule.

I have been heartened by a letter I had from an oldtime sailing-ship master living here in Sydney, Captain Charles Jagoe. The 100 days 'average time' for the clippers was arrived at partly by guesswork, and partly because it was a nice round number. Captain Jagoe tells me the true average for the clippers was nearer 127 days, and that 100 days is, in fact, an average of the fastest voyages ever made, a quite unreasonable target.

So I haven't failed so badly as I thought. Captain Jagoe wrote to me: "Any professional sailor knows that only a fool would attempt what you have done. What a glorious bloody fool you must be."

My first and silliest mistake was to leave behind at home my navigational tables covering the whole area of the globe from 40 degrees north to 40 degrees south. It was a stupid thing to do. I had to work out every sun-sight the long way with logarithms—about 20 minutes of solid mental effort a day. That doesn't sound much, but it cut alarmingly into my slender resources of mental energy, always a scarce commodity for a semi-exhausted man. And reciting the logarithms as I worked them out started me talking to myself, a disturbing feeling which added to loneliness, so I had to put a sharp stop to it.

I made a serious miscalculation when I thought I could sail closer to the Trade Winds than the clippers could. On the Solent, Gipsy Moth IV would get within 40 degrees of the apparent wind. But when I tried it at sea in the Trade Winds, every 'rocker' wave I hit would knock a knot off my speed, and four waves in a row would stop me in the water and put me in irons (a sailing ship is 'in irons' when she has lost way for steering and cannot turn her sails to catch the wind).

Through my impertinence in trying to improve on the clippers, I had to put up with this wearying stop-go for most of the Trade Winds—for 5,000 miles.

After that, through inexperience, I got myself into a big high pressure zone south-west of South Africa and day after day I was held up with light winds and flukey airs. The Cutty Sark on a similar voyage had gone well down south and was already in the Roaring Forties. I was the impertinent young man trying to improve on the old masters.

If I was doing this voyage again I'd have a different boat. I asked for something not more than nine tons displacement and she came out 11½ tons. I could have driven a smaller boat harder and made a faster time.

Gipsy Moth IV needs a crew of three—a man to navigate, an elephant to move the tiller and a three-foot-six-inch chimpanzee with arms eight feet long to get about below and work some of the gear. The keel seems too short. She broaches-to on the crest of a wave. Once when we were taking a bad beating off South Africa, she was carried forward sideways-on by a wave at thirty knots with her mast five degrees off the water. That would give any yachtsman a lot to think about—another few degrees and she would have rolled right over.

Captain Jagoe, who is an old Cape Horner, says she's much too unbuoyant in the stern. She's uncomfortable and unkindly. But she's beautiful in her pictures,

and my wife, Sheila, keeps reminding me that she's brought me here faster and further than any man has gone alone in a boat before.

I suspect that much of the dislike I feel for Gipsy Moth IV has been caused by the fact that she has handed me a lot of punishment in the past 107 days. Perhaps there will be more love in the love-hate relationship by the time I've finished my shore leave and got some of my strength back.

The southern ocean between South Africa and Australia must be the loneliest place in the world, or at any rate the loneliest place I've been in. I have, of course, often been alone on the North Atlantic, and far from land. But the North Atlantic is stuffed with spirits; whenever I go there I feel I have for company the bones of drowned sailormen—something has been left behind by the people who have been that way before me. But in the Southern Ocean I felt utterly alone; few ships have been that way and somehow they've left nothing behind.

I felt cut off from the human race, the living and the dead. It is a dreary ocean. On the whole voyage I did not see a fish in the water—only flying fish and a pathetic baby an inch and a half long which came aboard one night. Perhaps he was making a lonely voyage, too.

Loneliness, and the fear that goes with it, came at unexpected times. When the boat was going normally, every minute was full of work and things to do and any spare moments I tried to fill with sleep. But when we were becalmed and I had to force myself to work, or when the weather made work on deck impossible, loneliness would hit me. I often had the feeling of a man frustrated in love, longing for what was beyond impassable barriers. At times I was sad about my wife and family. Suppose they were ill or had an accident and I was not there to comfort them and look after them.

I had some bad nights and here is one recorded in my log:

*MONDAY, NOVEMBER 28th, 23.35—Had a talk with Sheila on long distance. I couldn't hear much of what she said, but she said she could hear me all right.*

*TUESDAY, NOVEMBER 29th, 07.50—I had a bad night. Couldn't sleep for some time. Around two o'clock, thoroughly rattled by the RJXT (radio telephone) and its prospects. I felt it was all too much, and I could not stand it and could easily go mad with it. All this is weak nonsense I know; but that's how I felt when I was twisting about trying to clear my brain of all the thoughts and images attacking it. I must try to be tolerant with the demands being made for air photography, telephone talks, etc., etc. I felt quite het up and exhausted last night after the radio telephone session. The gale blowing and seas striking the boat while I phoned made me nervy.*

Of course, I had no newspapers. But I read over and over again the out-of-date newspapers I brought aboard with me, mainly *The Observer* and *The Sunday Times*. You get a strange feeling of depth and solidity and understanding when you really read old newspapers, far away in time and distance from the events they are talking about.

I could have picked up the news broadcasts on my radio, but somehow I couldn't bring myself to listen to them. I felt there was no point in hearing what was going on in the world because I couldn't do anything about it; the news would only have made me feel more lonely and frustrated.

Nor could I get any comfort from music. I'm very fond of music. Before I left, my son, Giles, prepared me a tape with some of the things I like—Tchaikovsky's *Nutcracker Suite*, *Rhapsody in Blue*, Dvorak's *New World Symphony*, Beethoven's *Empereur Concerto*. I put it on, one fine night, off Africa. It was so pure, so beautiful, I felt sad and lonely and far from home. I can't explain it; it was one of the worst moments of the voyage. I turned my beautiful music off and I never played it again.

I've thought a lot about this, since I suppose that when you set off on a venture like this you shut off a lot of the things that make you a human being. You turn yourself into a machine for a particular purpose. And something that reminds you that you are a human being like everyone else is unbearably sad. A man does not listen to music when he is trying to run a four-minute mile.

The food problem of a single-handed long-distance sailor seems to me insoluble. I just could not eat as much as I should have. It started when I was a few days out and I began to get the feeling that Gipsy Moth IV and I were alone in our little world. I knew exactly what provisions I had aboard and I felt unnatural, like a squirrel with a store of nuts for the winter. I love food, but man is by nature a hunter and a gatherer, and deep in all of us there is an excitement about wondering and not knowing what providence is going to set on the table next.

Somehow, when all you are going to eat for the next three months is stored down below in little bottles and jars and bags, a lot of the zest goes out of being alive. I always managed to get a good breakfast. I had planned to make myself cakes and roasts out of nuts and powdered milk and so on, but in the event I did not use my oven more than once or twice except for baking bread. If only I had had a Chinese cook, or someone to dine with.

Towards the end, when I was getting very worried about my weight, I tried to force myself to eat nuts, honey, cheese, but it was hard work. I think much of my loss of weight and energy was caused by my inability to eat, but try as I might I



# THE ROUTE HOME

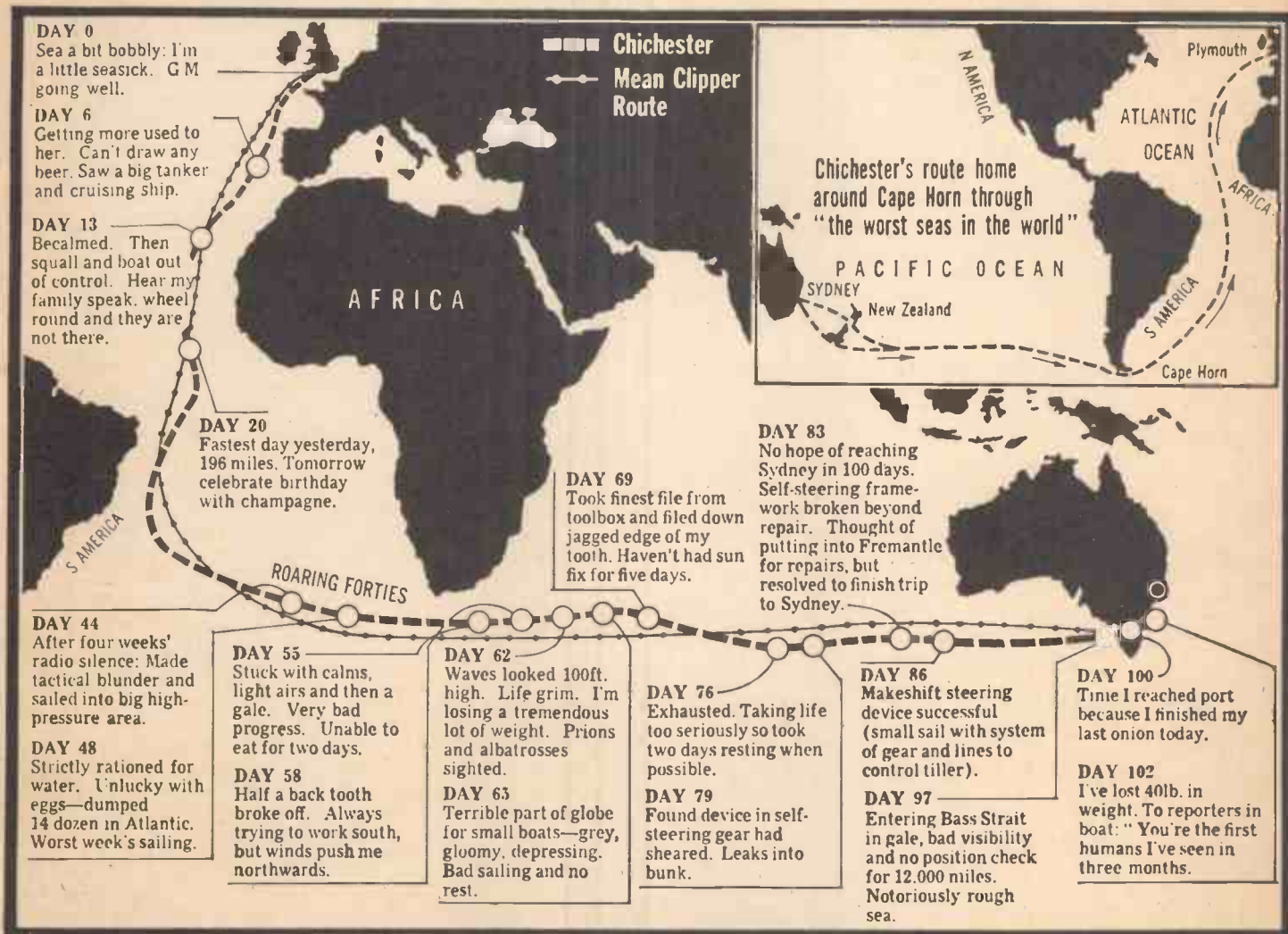

couldn't get another mouthful down.

On the other hand, when drink is your friend, it can be a very good friend indeed, as I've found on this voyage. In fact, one of my difficulties was that I could never drink enough, and if I did there was always a deck crisis immediately afterwards which demanded everything I had in the way of nervous and physical efficiency. Normally, I didn't take a drink before sundown, and it was something to look forward to all day—in fact all I had to look forward to. I found that a drink—gin, brandy and rum were my favourite spirits this voyage—released my inhibitions and gave me something like mental relief from the incessant hammering of the sea.

On a few occasions, regrettably too few, I was able to find time to have three or four stiff drinks, which in my strained and emaciated condition made me pleasantly tight. I paid for it afterwards, of course, in extra weariness, but the mental relief was well worth it.

I wouldn't like to face the second half of this voyage without a good supply of my

favourite booze on board.

This entry in my log reminds me of the help a drink gave me in the bad hours after the self-steering failed:

*TUESDAY, NOVEMBER 15th, 12.15—Came to a full stop. Went aft for a minor repair to the self-steering gear and found the steel frame holding the top of the steering blade broken in half. Dropped sails as fast as I could to take the strain off. Then I unshipped the blade and got it aboard before the rest of the frame bust off and I lost it. Now I am enjoying a brandy hot and my brain is turning in tight circles looking for the best course of action. I'm not really crestfallen, I guess I have been expecting this all along.*

*14.30—I hoisted the storm jib and played with tiller lines until I got the boat reluctantly to steer herself. Not the best course, but could be worse. How I shall get her to steer on any heading that is not nearly abeam I cannot think at present. I'll have some lunch and try again with more sail, etc. I have hopes of the mizzen, of course. This is a pretty strong wind, 37 knots.*

This entry hardly conveys the complexity of my emotions when the self-steering went. I decided that the only course was to put in at Fremantle. The project was too much for me, I gave up. It was a relief, in a way, that I had a large brandy, relaxed, lay down and went to sleep. When I woke up I was deeply depressed. It would take me at least a month to reach Fremantle if I could only sail the boat when I was not sleeping, eating, navigating, sail-shifting and so on. The boat must be made to sail herself somehow. All day I worked hard with tiller lines, shock cord and balancing of sails to make the boat self-steering.

That night I left her steering herself but awoke to find her headed west instead of north-east. Headed the wrong way, sails aback, she stuck firmly to that course. That gave me the missing clue. I deliberately backed one of my sails and harnessed it to the tiller.

It worked, the boat steered herself. All next day I worked with blocks and tackles and line to make it a more efficient system. Every day I improved my makeshift system

until I was sometimes making a good 160 miles a day, and my primitive rig brought me 2,750 miles to my destination—only 200 short of Plymouth to New York.

When I knew it would work, a kind of elation came over me. I thought, I am a sailor. Something has gone wrong, and I am all alone, but I am getting around the obstacle by myself. The excitement of the whole enterprise came back stronger than before. I forgot about Fremantle and the fact that I had mentally given in and altered course for Cape Leewin.

Of course the voyage wasn't all fight and disappointment and exhaustion, although often it seemed so at the time. Here is one of those nights that nearly make it all worthwhile:

*THURSDAY, NOVEMBER 17th—This sudden nightfall is one of the bad features of the tropics. I love those long Northern twilights. But there is magic in the evening. The horizon looks a straight line, and the departing sun suffuses some clouds with orange glow. The moon is on its back above the sun's exit. This is about the first time this voyage that I have been sentimental.*

*Sequel: celebration hangovers are not so good at 2.00 a.m. if one has to get in sail in a sharp squall. A squall of wind had me out of my bunk with no time for any pants.*

I saw relatively little of Australia until I put into Sydney. My landfall was a long featureless dark stain on the horizon, hardly visible through the murk. I saw the loom of the light on Cape Otway, but I never saw the light itself.

The people here well realise the ordeal ahead of us and they're determined that we will be as handily equipped for it as possible.

## **I'M RACING THE WEATHER TO THE HORN**

I am now 543 miles from the Horn. My position at zero hours today was 54.04 South, 82.20 West. I have a light easterly wind. I am excited by the prospect of Cape Horn ahead and impatient to reach it before the mild weather packs up.

I had my first position fix today from the sun for three days. It was important to know how accurate my dead reckoning had been. I was three miles in error in distance and 2½ miles out in direction after 390 miles. This called for a celebration and I drew a pint of Whitbread from the keg in my keel. It tastes better every day.

The weather changes quickly to extremes. On Tuesday night I had to turn downwind and run. I was wondering how far I could run south before getting among the icebergs, but four hours later I was able to head across the wind. Everything below deck was dripping or running wet. Next night it was calm or light airs and I was up nearly all night trimming the sail or

coaxing the self-steering gear to work. I counted that I had set or dropped 12 sails in the past 24 hours.

My engine is O.K. Providence was on my side and laid on a calm sea. I crawled under the cockpit behind the motor and, by using a mirror, was able to see the inaccessible starboard side of the motor. It was very claustrophobic alone at sea with my feet above my head. This is a long story but I succeeded in locating and fixing the trouble. The engine is now charging the batteries perfectly.

The other night I was working on deck handling the tackle of my trisail, and I was holding an inspection lamp in my hand because all the electric lights had failed. I was startled by something fluttering in my face. It was soft and warm, at least not cold like rope or gear. It was a Mother Carey's Chicken (stormy petrel) dazzled by the light. It fitted snugly into my hand when I picked it up. It is the most wild creature I know, but it is soft, delicate and lovable. I put it in a safe corner until after work.

Then I placed it on the after-deck from which I knew it would be able to fly off. In the morning I was sad to find it in the cockpit dead. It must have returned to the cockpit.

## **HOW I BEAT THE HORN**

I feel as though I have wakened from a nightmare. Wild horses could not drag me down to Cape Horn and that sinister Southern Ocean again in a small boat.

My overwhelming impression of the past week is one of fear. There is something nightmarish about deep breaking seas and screaming winds; I had a feeling of helplessness before the power of the waves rolling down on top of me. It all has ten times the impact when alone.

However, my passage of the Horn is mercifully over and I now have time to put together some account of my strategy.

My position at 22.00 GMT on Thursday was 51.56 South and 55.01 West, and for the first time in 50 days I am absolutely certain that this position is correct. I have had the unusual experience of getting a reliable position check on the island of Cape Horn itself!

I am about 110 miles east of Port Stanley in the Falkland Islands; at last the sun is shining, the skies have cleared and the seas have abated.

I am physically exhausted, just about at the end of my rope after a week with practically no sleep whatever. However, my low physical state is to some extent offset by a good mental condition, practically bordering on elation at times, at the thought of the warm blue seas ahead.

I am no singer, but a few minutes ago I actually caught myself humming a few bars from the Eton Boating Song—the bit about 'Jolly good boating weather.'

Quite a change from a few days ago!

Physical exhaustion led me to my one major mistake which could have led to disaster and I shall own up to it straight away. On Monday night, I was about 50 miles beyond the Horn with, as I thought, the worst of the danger past.

I allowed myself to doze off below in my cabin and I quickly fell into the nightmare-filled sleep of complete exhaustion in a violently pitching boat. But I forgot in my tiredness to switch on my off-course indicator which warns me if Gipsy Moth IV has deviated from her compass heading.

Sure enough she did. She turned a full 130 degrees off course and covered a good 20 miles south and west—directly towards the islands south of Cape Horn and the icebergs of the Antarctic continent.

Something about the motion of the boat seemed wrong even in my fatigue-drugged sleep and when I saw the compass I was wide awake in a second and got her back on her course as fast as I could.

Needless to say, I did not shut my eyes for a second for hours, after this unpleasant discovery.

But now my situation is very different. A very cheering message from my wife and another from my son Giles urging me not to relax—advice I intend to take as far as I can.

And H.M.S. Protector gave me some great news: no icebergs this year on the route I want to follow. So I have sailed east of the Falklands instead of to the West as I had planned because of the ice menace. This means I shall be following right along the Clipper Way, and now that I am clear of the Falkland Islands, I shall be sailing into the middle of the broad South Atlantic.

Looking back, I see that, apart from the test of endurance involved, my principal problems in making the passage of the Horn were navigational. As I approached the Horn the weather got steadily worse and for three days I could not get a fix on either the sun or the stars and had to rely completely on dead reckoning.

The magnetic compass is not much use in this part of the world so near the South Pole and there are huge deviations because of magnetic storms.

Remember, I was steering for the relatively narrow Drake Passage stuffed with islands and I had seen no land since Sydney Heads fifty days before. I had a nagging fear that I might have a persistent error in my calculations—something wrong with my sextant perhaps.

The rising westerly gale was fair for my passage of the Horn but it equally put any possibility of heaving to and waiting for daylight out of the question. With that wind and sea I would have gone just about as fast backwards as forwards.

If my calculations were out to the north



I was on the islands of Patagonia and if I was really further south I was on the Diego Ramirez group or the South Shetlands. In either case, I had a lee shore—the navigational hazard which seamen dread the most—and no chance of clawing my way off it.

I spent one of the most anxious nights of my life under my storm staysail and storm jib only. Every few minutes I peered ahead, but I doubt if I would have seen an island 300 yards away on that violent, pitch-black night.

Monday's dawn was a magnificent and terrifying sight. Across the heaving seas, with black clouds low overhead and bursts of rain, I made out, 30 miles to the North-East, the landfall I was looking for—Cape Horn Island itself. It was shrouded in rain, but as unmistakable as the Rock of Gibraltar. I hurried below to mark my position and make my log entry and I remember that I was strangely moved to notice that most of the rugged little islands of the Horn group bear the names of British ships and seamen—Beaufort,

Hall, Picton, Wollastan, Maxwell and many more, just as I suppose the reefs of these freezing waters are littered with many of the poor fellows' bones.

Although I have been navigating for many years, I will confess that I also felt a thrill at making my landfall so exactly. I have an unfailing sense of humility and amazement whenever I successfully put my trust in the mysterious and lifesaving art of navigation.

A few minutes later I was astonished to make out the grey shape of H.M.S. Protector wallowing in the heavy seas, waiting to meet me. Wind and sea were both rising so I took off my staysail and ran before the gale with only my spitfire jib, the smallest sail I have to keep her bow steady. Then I had a talk by radio with the Captain of the Protector and got the welcome news that there were no icebergs ahead.

Shortly afterwards I was even more astonished to see a tiny yellow plane come flying through the storm, practically skipping over the tops of the breaking

waves. It circled Gipsy Moth IV at not much more than the height of my masts, bouncing and pitching violently for twenty minutes or more before it turned and buzzed back towards the distant rock of Cape Horn. I thought 'the Horn seems to be getting quite crowded.' [This was the aircraft carrying Clifford Luton and Peter Beggin of the BBC and Murray Sayle of the Sunday Times.]

But the crowd did not last long. Protector kept company with me for about six hours and then steamed away to the north, leaving me alone once more.

I rounded the Horn in a real Cape Horner with driving rain and seas towering dangerously behind me. My wind-gauge stopped recording at sixty knots and I had no way of estimating the speed of the squalls—eighty knots, perhaps, or a hundred would not surprise me. My deck was being continually swept by freezing waves and my cockpit was flooded five times, taking more than fifteen minutes to drain the last time. Once the sea filled my seaboots before I could jump clear.

## CHICHESTER'S PATH ROUND THE HORN

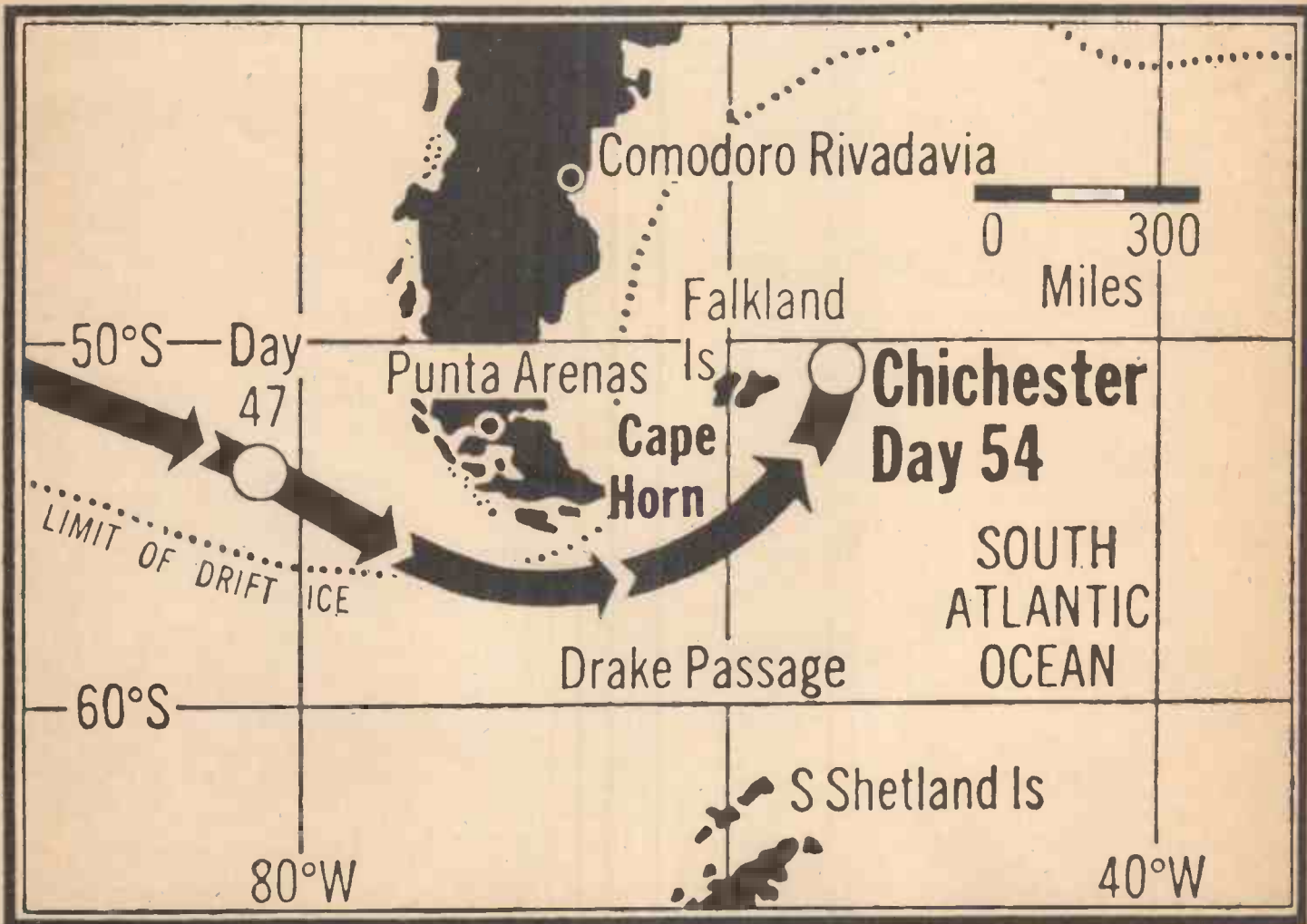

# CAPE HORN: DREAD & FASCINATION

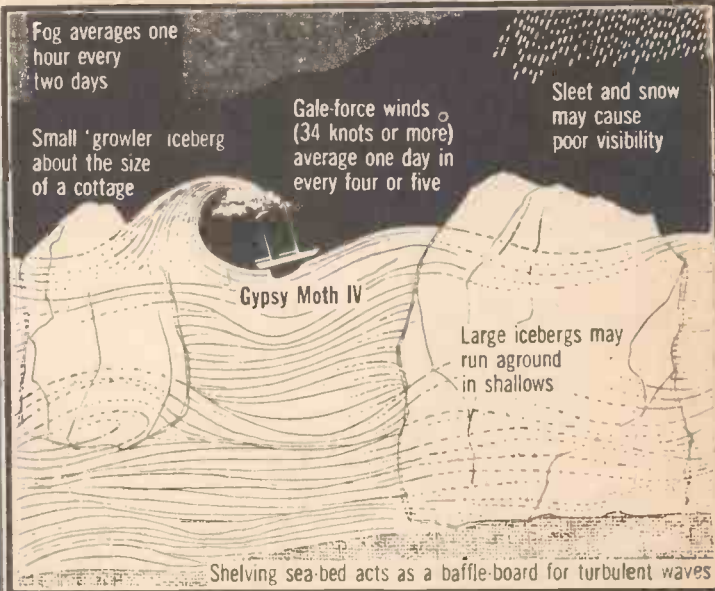
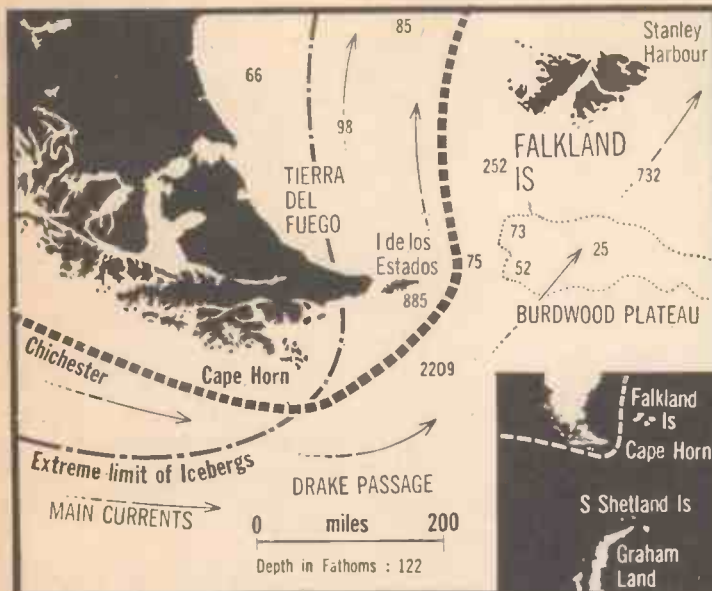

I do not think my feet have ever been so cold in my life.

My thoughts, when I had time to have any, were very much on the few people who had been that way before me in similar circumstances. I thought of Miles Smeeton and his brave wife Beryl, whose ketch was twice dismasted in the attempt. I also thought of that magnificent Argentine sailor, Vito Dumas, the first man to round the Horn alone, who came

by this way in the dead of winter of 1943.

Dumas has always been a hero of mine and so have the Smeetons. Now that I have done it myself my admiration for their feats has, if anything, increased and I would like to send my greetings to Dumas's compatriots now that I will be sailing for some weeks off the coast of Argentina.

© Francis Chichester and Times Newspapers Ltd., 1967.

*Francis Chichester*

## STORES FOR THE VOYAGE

**Biscuits:** 4 doz. pkts. Ryvita, 15½-lb. pkts. digestive, 15 pkts. ginger nut, 6 pkts. dark chocolate digestive, 4 pkts. cream crackers, 6 pkts. Kendal biscuits (survival).

**Barmene:** 3 screw-top jars. **Beer:** 1 barrel Whitbread. **Bread:** 8 small loaves. **Butter:** 3 lb. English fresh, 2 doz. tins. **Brandy:** 3 bottles.

**Cake:** 3½ lb. and 1 Dundee. **Cheese:** 8 lb. (3 lb. Cheddar, rest small Dutch midget), 8 tins Parmesan. **Candles:** 1 doz. **Chocolate:** 8 lb. **Chocolate drink:** 3 2-lb. tins Cadbury. **Chutney:** 6 jars Mango. **Curry:** 15 vegetable, 15 prawn. **Coffee:** 2 tins Pioneer.

**Eggs:** 156 fresh, 6 doz. powdered.

**Flour:** 24 lb. wholemeal wholly self-raising, 12 lb. wholemeal, partly self-raising. **Fruigrains:** 2 pkts. **Fruit, fresh:** 9 lb. apples, 28 grapefruit, 20 lemons, 20 oranges. **Fruit, dried:** 12 12-oz. pkts. bananas, 2 lb. currants, 9 lb. dates, 12 pkts. prunes, 12 pkts. raisins, 3 lb. sultanas. **Fruit, tinned:**

10 small grapefruit, 10 small Bartlett pears, 10 small pineapple.

**Garbina bags:** 1 pkt. **Garlic:** 12 bulbs. **GIN:** 6 bottles Squire's.

**Honey:** 12 jars (3 thin Acacia, 3 thin English, 3 thick New Zealand, 3 thick English) **Herbs:** 2 jars mixed.

**Jam:** 5 lb. blackcurrant and Swiss cherry, 2 lb. Golden Syrup.

**Lime juice:** 6 bottles Rose's.

**Matches:** 6 large boxes. **Marmalade:** 6 lbs. Rose's West Indian and Rose's Lime. **Milk:** 10 jars and 3 tins of Marvel.

**Nescafe:** 5 jars Continental. **Nuts:** 5 lb.—1 lb. almonds, 1 lb. walnuts, 1 lb. hazel nuts, 2 lb. brazil, 7½ lb. milled nuts (mixed, but no walnuts), 2 pkts. Nutter.

**Oil:** 4 26½-oz. bottles olive oil, 1 20-oz. tin olive oil, 2 bottles corn oil, 2 20-oz. tins maize oil.

**Pudding:** 6 tins treacle pudding, 2 Christmas puddings. **Pepper:** 4 oz.

**Red Currant Jelly:** 4 lbs. **Rum:** 4 bottles Bacardi. **Rice:** 10 lb. brown—5 lb. Patna, 5 lb. round.

**Salad Cream:** 5 large bottles. **Salt:** 1 tin Vegisalt. **Sardines:** 15 tins. **Salmon:** 14 small tins. **Sauces:** 6 pkts. mushroom mix, 6 pkts. onion, 6 pkts. tomato. **Sausalatas:** 24 small tins. **Soup:** 24 tins minestrone, 16 pea, 20 tomato, plus soup pkts. **Spaghetti:** 5 lb. **Sugar:** 10 lb. brown, 5 lb. lump.

**Tea:** 6 pkts. Earl Gray tea bags. **Tomato, tinned:** 6 small tins. **Tomato ketchup:** 6 bottles.

**Vegetables, fresh:** 5 lb. carrots, 20 lb. onions, 60 lb. potatoes—all hand-picked. **Vegetables, dried:** 15 pkts. onions, 16 pkts. lentils, 30 pkts. peas, 14 pkts. powdered potato.

**Wine:** Rudesheimer Rosengarten 1962, 2 bottles sherry.

**Yeast:** 30 1-oz. pkts. in a tin.



**sir  
francis  
chichester's**

**GIPSY  
MOTH IV**

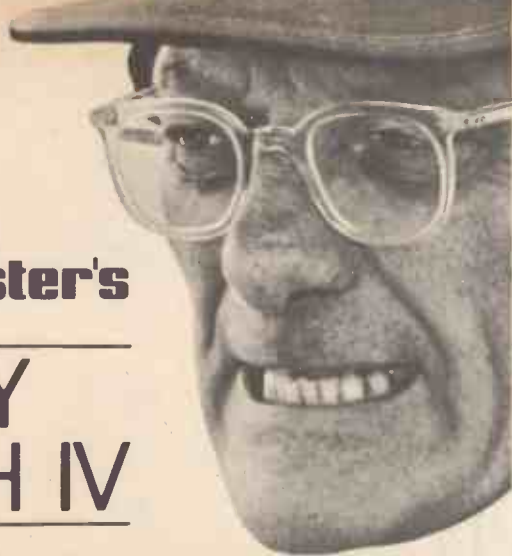

**A FULLY APPROVED MODEL EXCLUSIVE  
TO HOBBIES LIMITED**

A 26½ in. semi-scale working model of the famous 'Gipsy Moth IV' in which Sir Francis Chichester, the gallant lone navigator, fought and beat the treacherous oceans of the world. Designed with a view to simple adaptation to Radio Control.

Kit contains pre-cut parts, ready moulded plastic Hull and Cockpit, ready cut Sails, basic Fittings and cast Keel. Complete with log features from the *Sunday Times*.

**MBW. 230**.....Cash price **97/6** carriage 7/6 or deposit 13/- plus carriage and 8 monthly payments 13/-.



**hobbies**



*The  
Famous  
Danish*

**Billing Boats**

an excitingly varied range of kits  
with super-finished brass fittings

**FUTABA**

the best Radio Control Guidance  
System for boats and aircraft

Available at

**hobbies**

and other  
leading  
Model Shops

\*See Radio Control and Boat Sections

**Brookite Kites**

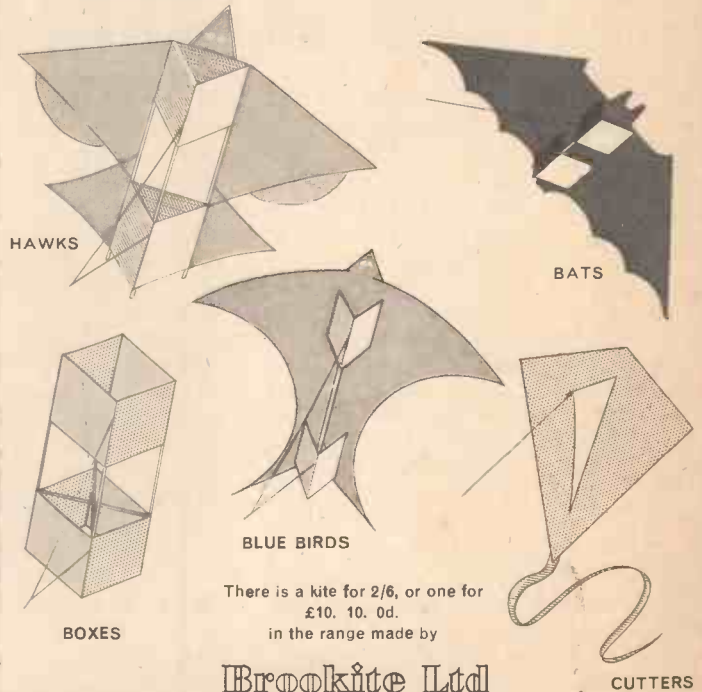

There is a kite for 2/6, or one for  
£10. 10. 0d.  
in the range made by

**Brookite Ltd**

Francis Terrace Junction Road London N19

Makers of good quality kites for over 50 years

"BROOKITES DO FLY"

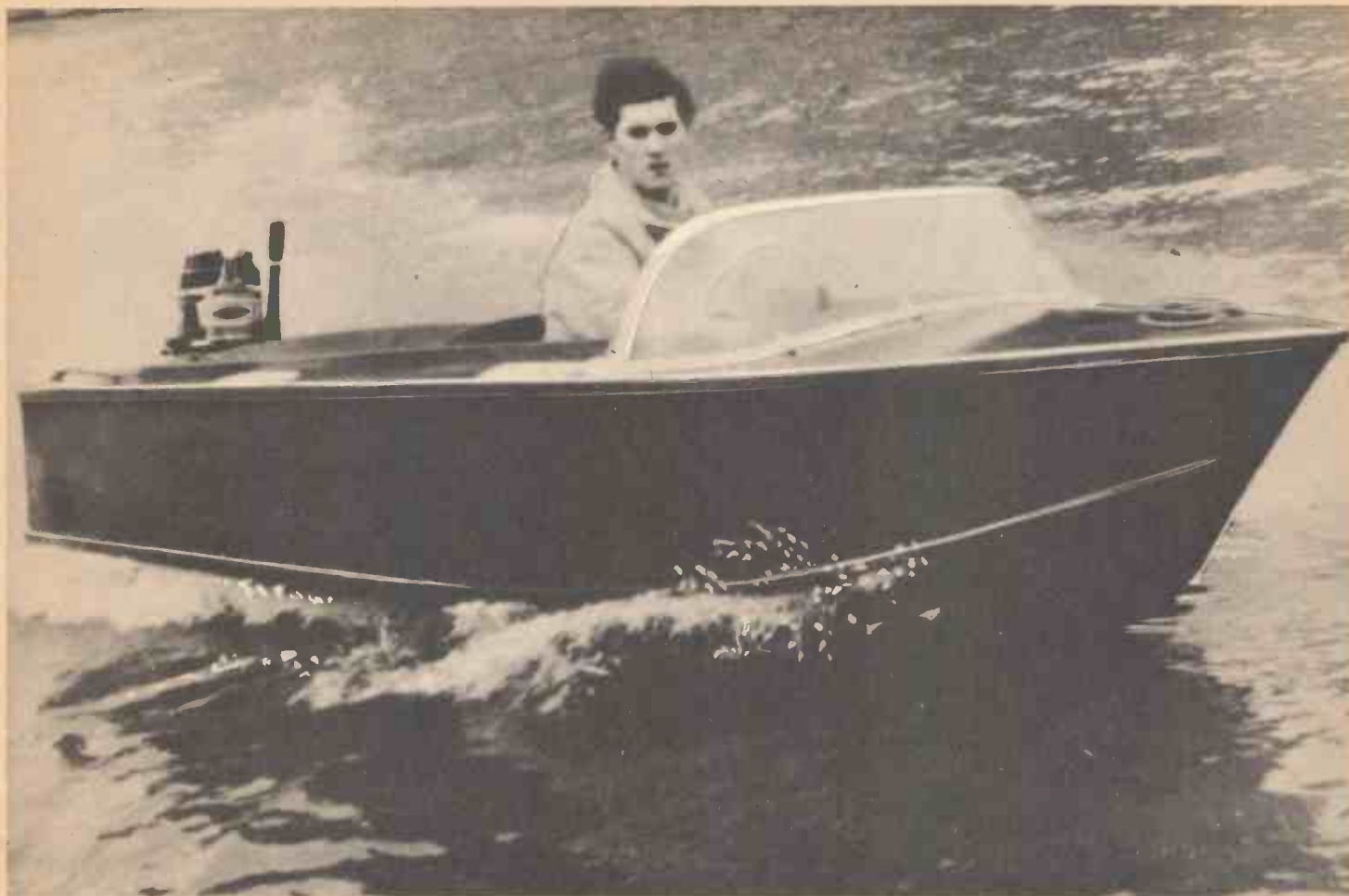

# build a bosun

by P.W. Blandford

Bosun is an easy-to-build plywood outboard runabout which has a hull-form suitable for pottering with a small motor or exhilarating planing with a motor between 10 and 40 hp. The boat can be completed in an open form for fishing or general use, or equipped as a comfortable family runabout with seats for four. The motor can be controlled from aft or with remote controls from the forward seat, using a car-type steering wheel.

The frames and some other parts have to be made, then the boat is assembled while fixed upside-down to the workshop floor. Except for this period, the boat can be moved about and stowed away between working sessions. All parts are joined with synthetic resin glue and either brass screws or barbed ring nails. Nails can be driven without drilling, except near edges, but for screws there should be a clearance hole in the top piece and an undersize hole in the lower piece. In most places the screw heads will pull in, but if not, the holes should be countersunk.

The three frames are made from overlapped strips. Their shapes can be set out on the floor (Fig. 4) using the table of 'off-

sets'. Notches should suit the sizes of the actual pieces of wood being used. Alternatively, use a full-size drawing (see note). The transom (Fig. 5) is similar to a frame, but a piece of plywood is fixed to the strips. The stem (Fig. 1) may have its forward edge partly bevelled (Fig. 2), but final shaping is done during assembly.

Mark out the floor (Fig. 3). Nail or screw the parts to the floor and fix temporary struts, if necessary, to hold them in position. Make the hog (A), tapering toward the stem. Draw a centre line on it, then bevel slightly, using the frames as a guide to angles. Fix with screws and glue to the frames, transom and stem. Fix the bottom stiffeners (D and E) (Fig. 6).

Spring a gunwale (C) into place. This will show any bevelling which has to be done in the notches. Mark the bevel of the end of the gunwale against the stem (Fig. 7), but do not cut the strip to length. Start by fixing both gunwales to the stem (Fig. 2 and 8), then spring them back and fix to frames before cutting to length and fixing to the transom. Fix the chines (B) in the same way.

All surfaces where the plywood fits have to be 'faired off' so that it lays flush. Check with a straight-edge, but test toward the stem with a strip of plywood to allow for the curve the skin will take on the bottom. The bevel on the chine increases forward until both panels will come in line on the stem.

For economy in cutting standard 8 ft. sheets of plywood, the sides are covered with a full-length piece from the transom and the bottom with a full-length piece from the stem. Cover the sides first. Put

*The finished boat planes with a 10 hp motor.*







The complete boat afloat. There is remote steering, windscreens, mooring cleats and steps on the side decks.

a sheet of plywood against the side so that it just overlaps gunwale and transom. Mark the shape of all framing on it. Cut it out, with a little to spare along the chine. Try it on the opposite side and use it as a pattern for marking that panel.

If screws are to be used, drill the panel for them at about 3 in. intervals. If nails are to be used, drive them part way. Apply glue—resin to framing and hardener to plywood, if a two-part type is used. Assemble by driving fastenings at a few key points, then at other positions fairly quickly.

Mark the forward side panels in the same way. The bottom will overlap the sides for most of the length, but toward the stem the angle increases in steepness and a change has to be made to a mitre. Allow for this by letting a little extra project when marking the panel (Fig. 9). Join a forward side panel to the long one with a plywood piece on the inside (Fig. 10). Glue and either screw or drive nails through and clench. When the glue has set, clean off the plywood flush with the chines, except for the forward mitre which should be trimmed with a chisel.

It is advisable to make a paper template of the forward part of a bottom panel. Mark and fit the mitre first. Aft of this the surplus may overhang the side, but mark and cut to the centre of the hog carefully. Fix both panels starting from their forward ends. Fastenings will have to be closer where the twist is greatest. Make up the length to the transom with joint covers similar to the sides. Level off the edges and fix the chine rubbers (I). These also act as spray deflectors when the boat is planing.

Level the plywood at the centre to take the keel (G). Fix this. Its forward end tapers to about  $\frac{1}{2}$  in. and is bevelled to take the

ends of the stem band (F), which is made up of two thicknesses, either rounded or flat to take a half-round brass strip (Fig. 2 and 11). The bottom rubbers (H) are glued and screwed through to the stiffeners (D and E). Bevel their forward ends. Well round the edges of all parts outside the hull. At this point it is advisable to give the hull at least one coat of paint.

Unfasten the boat from the floor and turn it over. Put a temporary strut across frame 2, then cut off all extensions, level the plywood along the gunwales and remove any surplus glue inside. Fix bottom board bearers (X) midway be-

tween frames 1, 2 and 3. The bottom boards (Q) are in four parts, stiffened below with strips, and divided along the centre. The forward pair follow the outline of the hull and extend a short distance through frame 1 (Fig. 12). Fix the risers for the seats (R and S).

The decking shown includes a well to take any standard outboard motor. The deck beams (M and O) are fixed to blocks on the gunwales and notched for other parts. To allow for deck joints, fill the spaces between the carlins (K) and the gunwales at each end (Fig. 13 and 14).

Fair off all top edges. Make the sides of the motor well and thicken their lower and forward edges. The lower edge slopes up at right-angles to the transom. Fit the other parts (Fig. 15). Drill  $\frac{3}{8}$  in. drain holes diagonally through the transom at the corners of the well. Holes will have to be cut in the sides to suit remote steering cables and any other motor attachments.

Make and fix the foredeck. The aft deck is made with side pieces notched to take a shaped piece over the well. (Fig. 16). Fix with glue and nails at about 2 in. intervals. Fix side decks in the same way. Level off edges. Put a rubbing strip (J) outside and a coaming (L) inside.

The seats (U and W) and their backs, are removable. Each seat extends a short distance over the risers and is on strips with notched ends (Fig. 17). The backs (T and V) rest in strips on the seats and the top of the front one is stiffened and supported between blocks on the coaming (Fig. 18).

Finish the boat with paint or varnish. Put a cleat on the foredeck and one at each corner of the aft deck for mooring

The hull immediately after turning over. The bottom has been painted and it is kept off the floor with temporary chocks. The extensions of the frames will be cut off and the plywood planed along the gunwales.

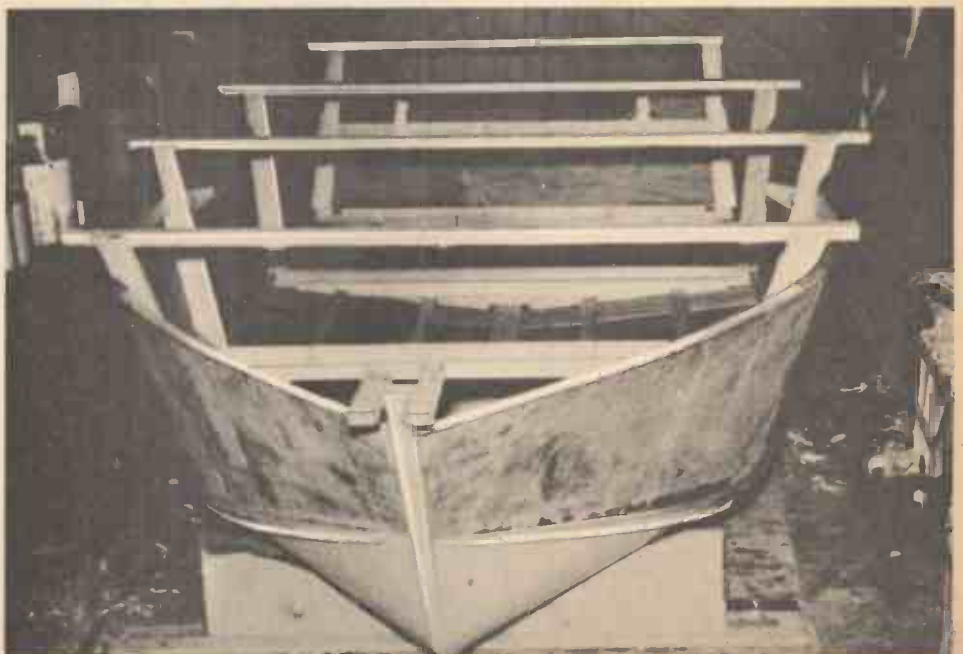

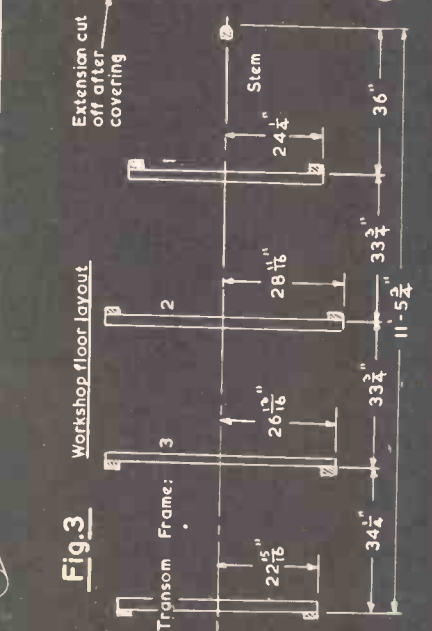
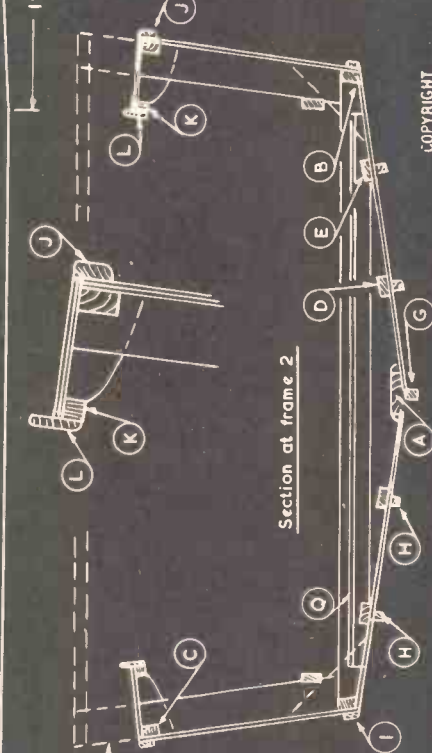
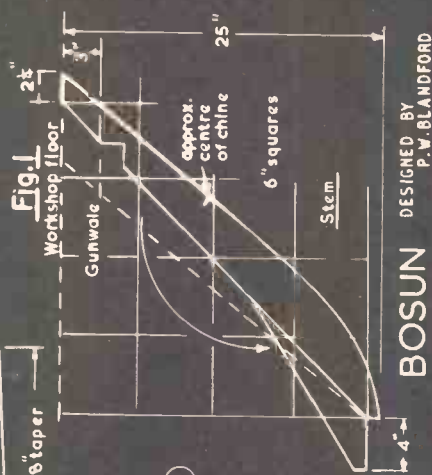
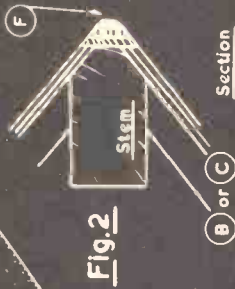
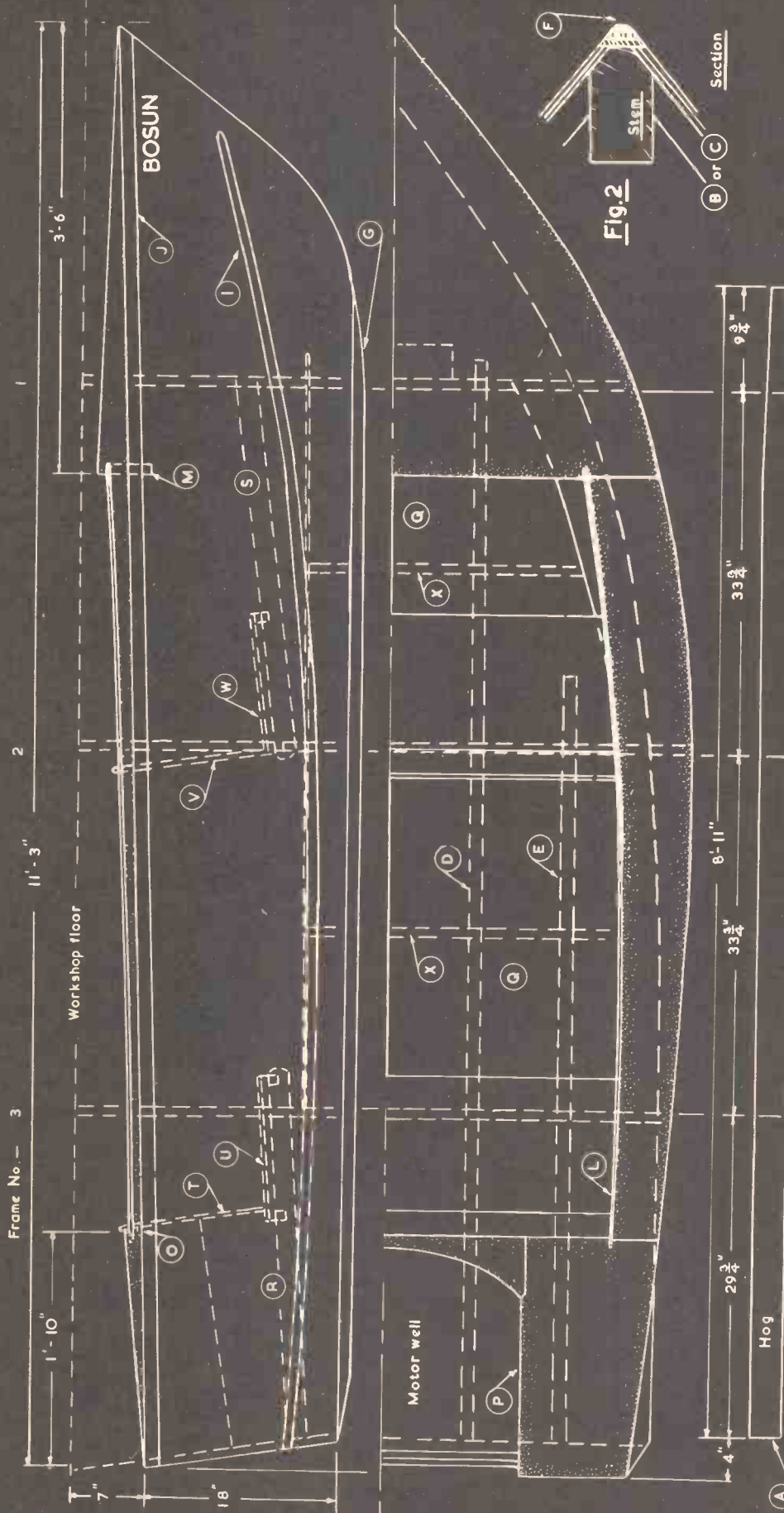

BOSUN DESIGNED BY P. V. BLANDFORD

COPYRIGHT



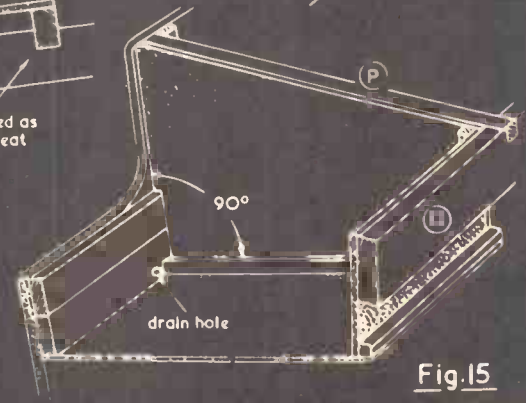
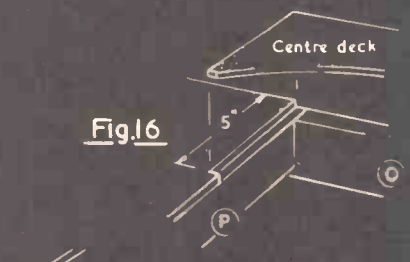
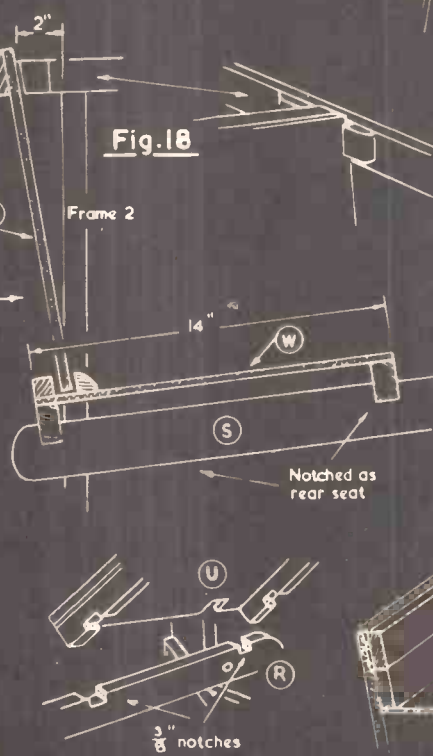
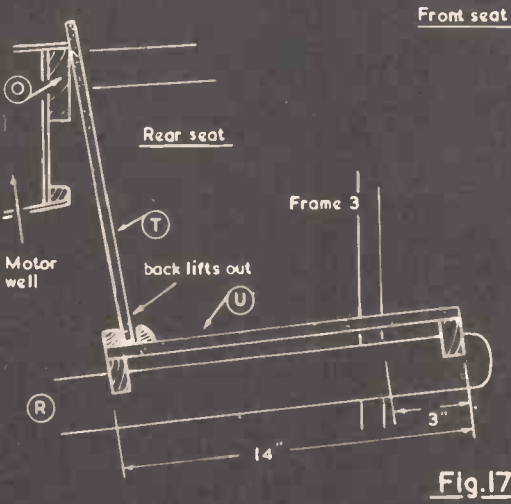
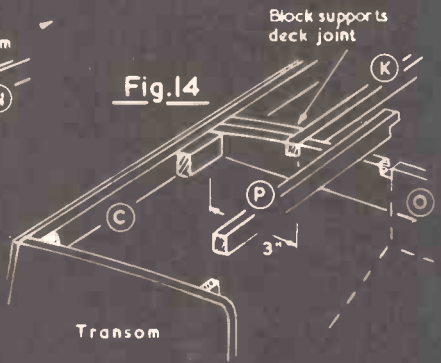
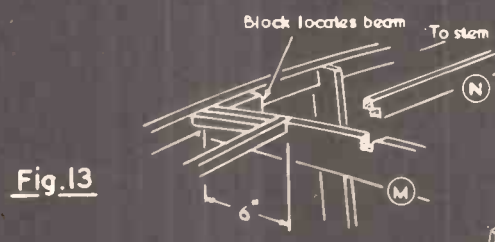
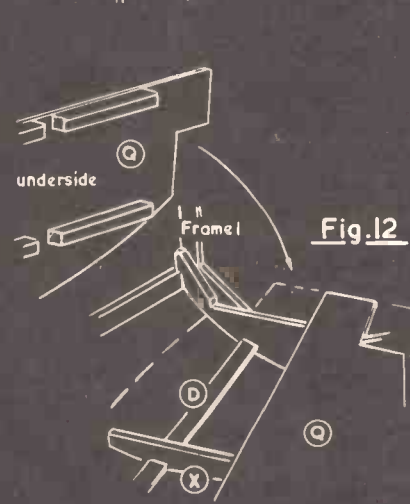
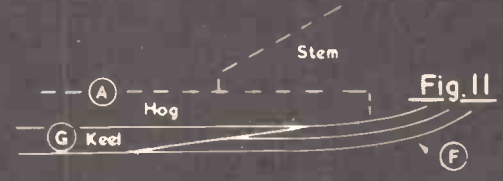
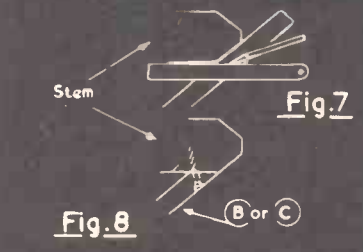
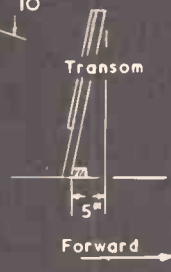
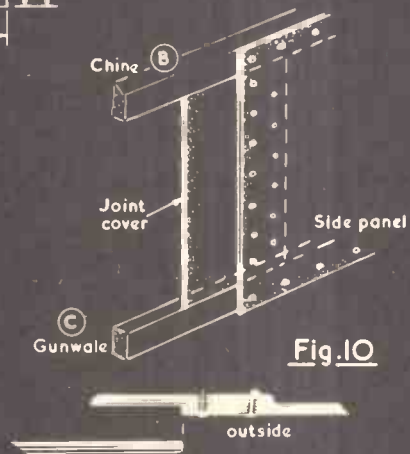
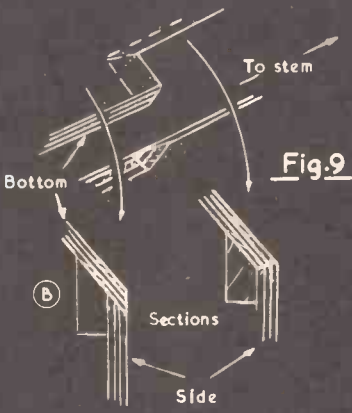
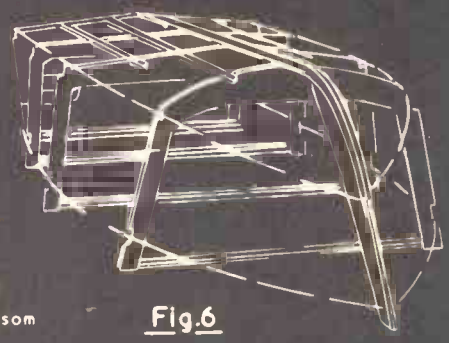
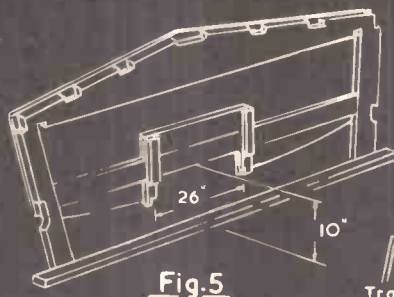
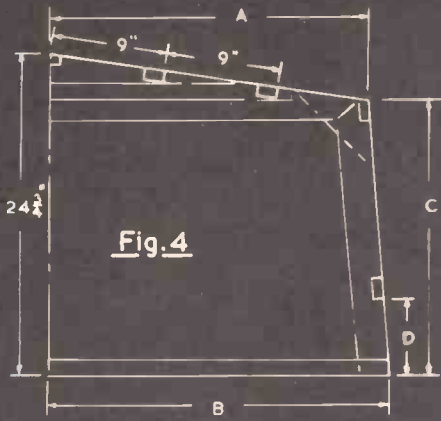

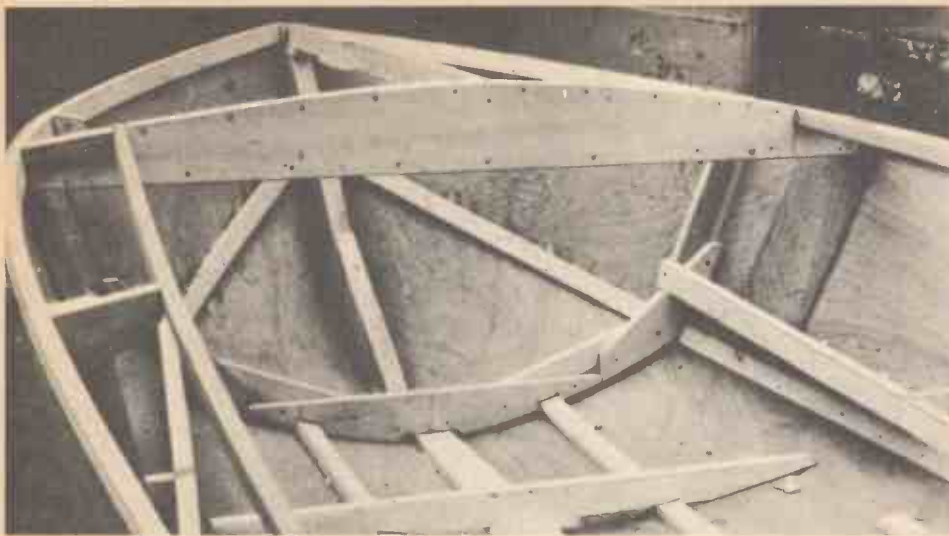

The forward part of the hull, showing the stem and frame 1. There is a bottom board bearer in position and the seat risers have been fixed. Deck framing is in place. Note the joint cover in the side just aft of frame 1.

ropes. Remote controls may be fitted according to the maker's instructions. Cushions may be made for the seats. A windscreens (46 in.) is a useful addition. For ordinary use a 4 hp outboard motor will be powerful enough. A 10 hp motor will make the boat plane, but for a heavy load, 15 hp is better and larger motors will give increased speed. There is space under the aft decking for fuel tanks and batteries. Bosun is not suitable for an inboard motor. Its weight is about 1 cwt.

#### KITS

Kits of materials and accessories can be obtained from Hobbies Ltd., Dereham, Norfolk. Ask for full details of contents and current prices.

HIRE PURCHASE FACILITIES  
ARE AVAILABLE

Note: A plan (BCW. 118) giving more information and showing the frames, transom, stem and other parts full-size, is available price 17/6, postage 1/- from Hobbies Ltd., Dereham, Norfolk.

#### Table of offsets (inches). See Fig. 4

Frame:	1	2	3	Transom
A	17 $\frac{1}{4}$	24 $\frac{1}{16}$	24 $\frac{3}{4}$	23 $\frac{5}{8}$
B	24 $\frac{1}{4}$	28 $\frac{11}{16}$	26 $\frac{13}{16}$	22 $\frac{11}{16}$
C	18 $\frac{3}{4}$	21 $\frac{3}{4}$	21 $\frac{3}{8}$	21 $\frac{1}{2}$
D	4	5	6	7

#### Materials required

All plywood should be marine quality—in Britain marked BSS 1088. Mahogany is the best wood for most parts, but Sitka spruce or yellow cedar are more easily bent for the chines and gunwales. Frames and many other parts can be made of parana pine.

Part	Number required	Length ft. in.	Width in.	Thickness in.
Stem	1	3 1	5	1 $\frac{1}{2}$
Frames and transom	1	3 1	5	1 $\frac{1}{2}$
from	3	4 2	4 $\frac{1}{8}$	$\frac{3}{8}$
"	3	2 0	3	$\frac{3}{8}$
"	8	4 0	2 $\frac{3}{8}$	$\frac{3}{8}$
"	3	4 0	1 $\frac{3}{8}$	$\frac{3}{8}$
"	4	5 10	2	1
A Hog	1	9 0	2 $\frac{1}{8}$	$\frac{3}{8}$
B Chines	2	12 0	1 $\frac{3}{8}$	$\frac{3}{8}$
C Gunwales	2	12 6	1 $\frac{3}{8}$	$\frac{3}{8}$
D Stiffeners, inner	2	8 6	1 $\frac{3}{8}$	$\frac{3}{8}$
E " outer	2	6 6	1 $\frac{3}{8}$	$\frac{3}{8}$
F Stem band	2	3 6	1 $\frac{3}{8}$	$\frac{1}{4}$
G Keel	1	9 3	1 $\frac{1}{2}$	1 $\frac{1}{2}$
H Bottom rubbers	2	8 6	$\frac{3}{8}$	$\frac{3}{8}$
"	2	6 6	$\frac{3}{8}$	$\frac{3}{8}$
I Chine rubbers	2	12 0	1 $\frac{1}{2}$	$\frac{3}{8}$
J Gunwale rubbers	2	12 6	1 $\frac{1}{2}$	$\frac{3}{8}$
K Carlins	2	7 0	$\frac{7}{8}$	$\frac{3}{8}$
L Coamings	2	7 0	2 $\frac{1}{2}$	$\frac{3}{8}$
M Foredeck beam	1	4 4	5	$\frac{3}{8}$
N " "	1	3 6	2	1
O Aft deck beam	1	4 4	3	$\frac{3}{8}$
P " " "	2	1 10	1 $\frac{3}{8}$	$\frac{3}{8}$
Q Bottom boards	2	3 2	22	$\frac{3}{8}$
"	2	2 11	22	plywood
"	12	1 6	$\frac{7}{8}$	plywood
R, S Risers	4	3 0	2	1
T, U, V, W Seats	4	4 0	14	plywood
"	5	4 0	1 $\frac{3}{8}$	$\frac{3}{8}$
"	4	4 0	$\frac{3}{8}$	$\frac{3}{8}$
X Bottom board bearers	2	3 9	2 $\frac{3}{8}$	$\frac{3}{8}$

Skin and deck will cut from 5 sheets 8 ft. x 4 ft. x  $\frac{1}{2}$  in. plywood.

Sundries

2 gross 1 $\frac{1}{2}$ " x 6 gauge brass screws or 1 $\frac{1}{2}$ " x 10 gauge barbed ring nails (framing).

6 gross  $\frac{3}{4}$ " x 4 gauge brass screws or  $\frac{3}{4}$ " x 12 gauge barbed ring nails (skin).

3 doz. 2" x 8 gauge brass screws (keel, framing).

About 3 lb. synthetic resin glue.

$\frac{1}{2}$  lb. stopping.

1 qt. varnish (decks and seats).

3 pints priming paint.

1 qt. undercoat paint.

1 qt. top coat paint.

The bottom being painted. Note the bottom and chine rubbers, tapered at their forward ends, and the keel blending into the stem band.



All of the internal structural work has been done. The motor well is complete and remote steering cables have been fitted. The next job is the making of the plywood deck.





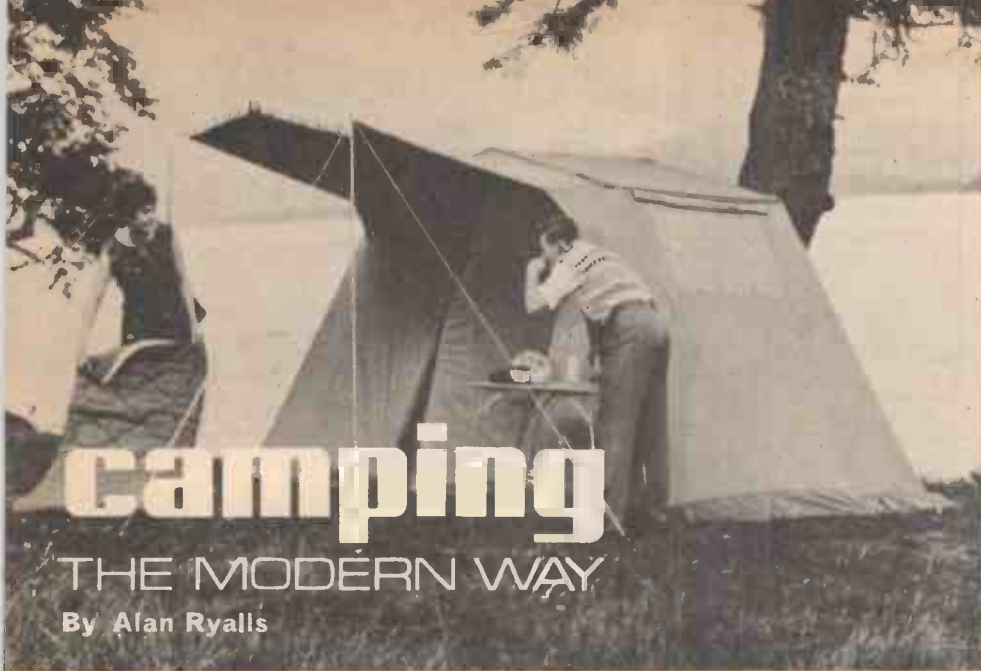

# camping

## THE MODERN WAY

By Alan Ryalls

Editor, 'Camping and Outdoor Life'

You don't have to be the tough, spartan, outdoor type to be a 1968 camper. Far from being the prerogative of the 'enthusiasts', camping is now a delight and recreation of families in all walks of life. Camping is the truly family pastime, and a typical camping site in Britain, or in fact anywhere in Europe, might see a milkman camping happily next to a Bank Manager, Solicitor or Teacher. Such is the comradeship of camping.

The 'enthusiasts' who travel light, with the barest essentials of life strapped to their backs, still persist, strong as ever, but the new wave of campers are the families. And it is the housewife, finding for herself a unique opportunity to relax, recreate and enjoy the luxury of a holiday in every sense of the word, who is the main influence in this latest trend to camping.

For the new camper here are a few hints on how to get in on the holiday of a lifetime, where freedom is at a maximum, cost a minimum and enjoyment a guarantee.

### The Tent

Your camping success is absolutely dependent on your choice of 'home'. Let us therefore take the success and popularity of the French frame tent as the personal recommendation of thousands of families like your own as their choice of ideal 'home'.

As its name implies, the frame tent is basically a large outer tent (anything up to 20' x 20') stretched over a jointed tubular frame of roof supports and 4, 6 or even more legs. Although they are large and heavy, frame tents are quite easy to pitch. The frame is set up with the roof structure completed (the poles are often spring-linked for easy erection) and the legs to half their full height. The canvas of the

outer tent is then spread over the frame, attached at the corners, and once the legs are extended to full height, the job is completed by pegging down the 2 dozen or so short rubber guy-lines which stabilise the tent. Storm guys allay any fears of high winds!

Frame tents are very sumptuously endowed, with one or more zipped doors, transparent picture windows probably canopied against the sun and rain and, almost certainly, some mosquito-netted ventilation as well, with a wind flap for bad weather protection. The kitchen area itself is usually of splash-proof, plasticised washable material which is not affected, as canvas is, when splashed with hot fat.

Choose your tent to suit your family size. Every frame tent has at least one sleeping tent suspended within it. This ingenious arrangement is entirely enclosed, with a sewn-in groundsheet extending several inches up the walls to ensure absolute waterproofness, even in an inch or two of water! 'Creepy crawlies', the imagined nightmare of so many campers, just do not exist!! But, for the unconvinced, the zipped doors and mosquito-netted windows are highly comforting.

The interior size and height of different tent designs does of course vary but all should have full standing room and be large enough for two full-size beds plus personal luggage. Check that your tent has sewn-in pockets to take personal items, cosmetics, etc., and that the ventilator has a flap to render the tent private and draughtproof. The best zipped doors are those which start near the roof, zip down to near floor level, along the bottom and back to the top on the other side of the door panel. When unzipped these can be thrown over the inner tent roof so that

the sleeping area can be used as living space.

The largest frame tents have 3 sleeping tents plus wardrobe hanging space, separate kitchen area and even a separate washing area as well as a large living room. Tents of this size however take some time to pitch and strike and are best used for long stays in one location rather than for touring with frequent changes of camp site.

Whether or not to buy a multi-bedroom tent for the family is, of course, a very personal matter. When the children are small, it is probably better to have a tent with a fairly large living space rather than be cramped and on top of one another all the time. By the time the children reach the age of 7 or 8 however, they are seeking some independence and, at this stage it is better to provide them with small sleeping tents of their own which can be pitched alongside the family tent. This gives them, and their parents, more privacy as well as the start of their own individual camping outfit.

### Sleeping Sweeter

We have considered at some length sleeping tents and the comfort and privacy they offer. Now how about the sleeping arrangements within them?

The first essential is to obtain good sleeping bags. The older types of down-filled bags are no longer favoured for family camping although they are still unbeatable for lightweight or mountain camping. Most campers now use convertible sleeping bags, oblong in shape, with a zip down one side and along the bottom. This enables them to be completely opened out for airing and for washing, but equally important, it allows two of them to be zipped together to form a double sleeping bag. They also convert into handy bed quilts for home use!

These bags usually have covers of gaily coloured cotton, terylene or nylon filled with man-made fibre. Washing is reasonably easy and they are extremely warm and comfortable. For added hygiene, and to save frequent washing, a nylon or cotton inner lining can be added just like the sheets of a normal bed.

The hard floor of the tent would not be the ideal start of a happy camping expedition. Use a modern camp bed, an air bed or a plastic foam mattress. The latter are warm and comfortable, their only disadvantage being their bulkiness when rolled. Air beds are the most compact and, in the last year or two, new types of box air mattresses, 5" or 6" deep and with a waffle-top like an ordinary bed mattress, have become increasingly popular. With an efficient bit of pumping, using a good pump, they are highly luxurious.

Today's campbeds are of the light steel or alloy-framed type, that come apart for packing, with a cover which may be simply

of canvas or which can incorporate an air bed or foam mattress. If there is no insulation of this kind, it is best to use a blanket or even a newspaper between your sleeping bag and the camp bed to provide insulation against the cold that can strike up from below.

Enough about sleeping? Well, not quite. There are small sleeping bags available at reasonable prices for junior, and for baby there are some really attractive folding camp cots, although a carry-cot would probably be adequate.

#### *Real Home Cooking*

Mobile gas stoves are pretty impressive these days, with 2 or 3 burner hot-plates, some incorporating a grill, and filled by bottled gas, butane or propane. For family camping it is cheapest to use the largest gas bottles you can carry. The most popular are the 10 lb. Calor Gas bottles and the 6 lb. Camping Gaz bottles. These are hired or purchased and then exchanged when empty. Camping Gaz\* is readily obtainable throughout Western Europe and Britain. Calor Gas is available at home, is not obtainable anywhere abroad. Camp cooking is no chore! Or it needn't be. Stand your stove on a cooking table at the correct height for seated cooking (better than home, this!) and with a draught and splash shield round three sides. Larder and shelves for pots, pans, vegetables, etc. can be fitted conveniently and tidily underneath. Non-stick cooking utensils are a boon to campers, so are plastic containers and special camp crockery available in unbreakable plastic. A simple box of expanded polystyrene with serviceable outer cover and washable inner-lining will make an effective and invaluable ice-box. With or without ice this will preserve perishable foods for a long time in extremes of climate and it is a handy way of housing them both in camp and 'on the road'.

#### *Other Aids to Happy Camping*

A folding table with chairs or stools of matching height is a must. There are many designs on the market, most with washable, heat and stain resistant tops, and some with individually adjustable legs

\*See page 79 for Camping Gaz

to ensure a level top on uneven ground. The best choice of folding chairs are those with a canvas back and no bar across the front to dig into the legs and the knees. Sets of table and stools are available, the table folding to form a case in which the stools can be packed for carrying.

For lighting you can use fluorescent tubes or ordinary lamps working from your car battery, similar lamps with long life batteries of their own and at least one type of fluorescent lamp that works from either. There are also some very good gas lamps fuelled like the cooking stoves (see page 79) and giving a very powerful light as well as some welcome heat on chilly evenings or at high altitude. Finally there are several types of small portable gas heaters for complete all-weather Camping Comfort.

Paraffin stoves and lamps are still available and work efficiently, but their smell and the problem of carrying extra fuel makes them unpopular with modern campers.

One essential that must be carefully attended to is the provision of proper toilet facilities. Hundreds of organised camp sites at home and abroad provide flush toilets, wash rooms with hot and cold water, showers, razor points, mirrors, etc. as well as rooms for washing and ironing. Some de-luxe camp sites even have recreation rooms, shops and other facilities too.

But some of the most beautiful camp sites throughout Britain and Ireland (particularly Ireland) are on farms or crofts with no facilities other than drinking water. If you want to enjoy these delectable spots you must be prepared to buy a toilet tent (rather like a small bathing tent) containing a modern hygienic chemical toilet, either of plastic or with a folding seat and plastic bucket. Scrupulous attention to personal hygiene is an essential part of good camping. See that the children wash their hands and scrub their nails regularly.

#### *Choosing Your Camp Site*

We have touched on camp sites and at this point a little advice on choosing an

actual place to pitch your tent may be helpful. It is very tempting to camp on an open headland facing magnificent seascapes. Remember though that wind is the biggest enemy of the camper and it is probably wiser to camp where there is some shelter from the prevailing wind. Don't camp under trees, however. Apart from the risk of falling branches, you will get drips of rain long after it has stopped raining. Also avoid those hollows that can turn into lakes in wet weather! In general, seek the high spot of the site, away from any area of bright green grass that could indicate swampy ground.

#### *Finding a Site*

There are no problems whatsoever about finding a camp site. The Camping Club of Great Britain and Ireland, 11 Grosvenor Place, London S.W.1, provides a list of over 2,500 camp sites throughout Great Britain for the use of its members, and there are lists of other sites obtainable from book stores and the motoring organisations.

Every country in Europe (apart from Albania) and many too in the Near-East and North Africa have well equipped camps. Their main National Tourist Offices in London all issue site lists, maps and other useful information to intending visitors.

Whichever country you prefer, and whatever doubts you may have had, you may be sure that once you have tried it, you will enjoy the hundreds of thousands who enthusiastically declare that this is the only type of holiday for them.

But wherever you camp, for your own enjoyment and that of others, do stick to the Country Code.

The Country Code says:

Guard against All Risk of Fire.

Fasten All Gates.

Keep Dogs Under Proper Control.

Keep to the Paths Across Farmland.

Avoid Damaging Fences, Hedges and Walls.

Leave No Litter.

Safeguard Water Supplies.

Protect Wild Life, Wild Plants and Trees.

Go Carefully on Country Roads.

Respect the Life of the Countryside.

#### *Guide to Cost of Main Camping Equipment*

Frame tents cost from £30-£140 (a good average price is £70):

Sleeping Bags cost from £4-£10 (a good average price is £6. 6s.).

Air Mattresses cost from £3-£5.

Foam Mattresses cost from £1-£3.

Campbeds cost from £1. 5s.-£4. 10s.

Twinburner gas stoves cost from £5-£8.

Cooking Tables cost from £4. 10s.-£10.

Ice Boxes cost from £2-£5.

Folding Tables cost from £3-£6.

Folding chairs cost from £1. 5s.-£3.

Lamps cost from £3-£5. 5s.

Toilet Tents cost from £5-£10.

Chemical Toilets cost from £4-£8.

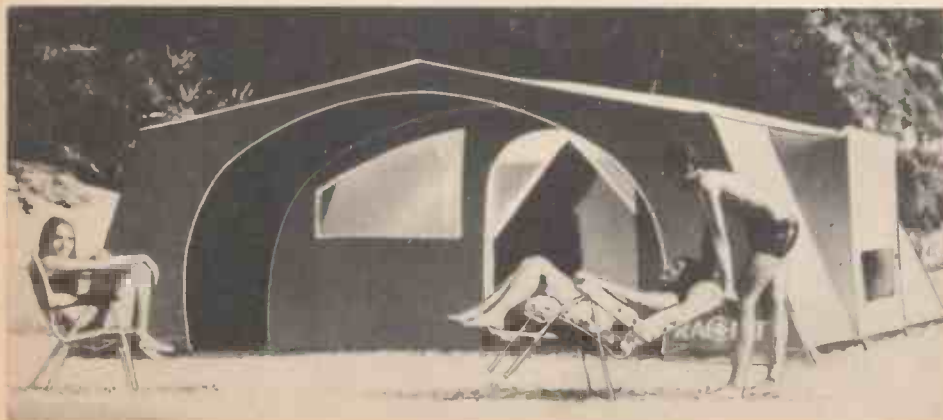



# a taste for adventure in holidays

BY TED APPLETON



*Diving is a favourite sport at the seaside.*

If you are interested in train spotting, brass rubbing, archaeology, bird watching, canoeing, angling, skin-diving, painting, water ski-ing, weight lifting, judo or ball-room dancing, there are tailor made holidays for you.

You won't find them in the brochures of the large tour operators. Dealing with tens of thousands of holiday-makers they are far too busy to provide specialist type holidays, so look in the holiday booklets published by largely non-commercial organisations like the Youth Hostels Association, the Central Council for Physical Recreation, the Ramblers Association, the Holiday Fellowship and Country Wide Holidays Association who aim to provide low cost activity type holidays for young people at home and abroad.

However, at this stage it would be fair to say many holidays offered by these organisations are more expensive than tour operators' package holidays. There are reasons for these sometimes higher prices. In the main, big tour operators like Cooks and Lunns deal in bulk, while activity type holidays are designed for

small groups—usually no more than fifteen to twenty persons with a fully qualified leader. This makes for easily handled friendly groups of young people who soon get to know each other, and because they share the same interests find themselves part of a happy group.

Because the party leaders are carefully chosen by the holiday organisers, the arrangements are ideal for teen-agers who may for the first time be holidaying away from their parents, who know their children are in safe hands. They can enjoy the outside activity they fancy and it will keep them fully occupied throughout the holiday.

The Youth Hostels Association (Home Tours Department), Trevelyan House, St. Albans, Herts., publish two holiday booklets. 'Adventure Holidays for Boys and Girls' are for those between 11 and 15 years, while 'Adventure '68' caters for anyone over 16 years of age. They also take people aged up to 40 on the 'Adventure '68' holidays, so parents who might share the same outdoor interests as their teen-age or younger children, and do not mind the simple dormitory type accom-

modation youth hostels provide, can holiday with them.

The holidays for boys and girls include walking tours—these are arranged for newcomers to country walking—in some of Britain's loveliest scenery including the Peak District, the Yorkshire Moors, Dales and Coast, Loch Lomond, Devon and Cornwall and Southern England. One of the Welsh holidays includes a walk to the very top of Snowdon to enjoy one of the grandest sights in our islands, with hills folding away into the distance.

Children with bicycles can take part in special tours organised by the YHA in conjunction with the Cyclists Touring Club. These cover the same areas as the walking holidays, but with time out to learn something about cycling and the upkeep of bicycles from the leader.

If walking and cycling sounds a bit tame, and hardly the activity you equate with 'adventure'—the same association have holidays for junior photographers showing them how to use their equipment when taking indoor and outdoor photographs to get the best results, and providing opportunities to develop and en-

large the pictures taken during the holiday.

A boy or girl who loves fishing should have plenty of fun fishing the waters of Yorkshire and Huntingdonshire with an expert to point out the best spots, helping to choose the right bait and offering tips on playing and landing fish.

Those who fancy canoeing, sailing, riding or bird watching are also catered for, while the initial thrill of putting on air bottles, goggles and breathing equipment before plunging overboard to explore, for the first time, the strange world beneath the sea is something to remember long after the holiday is over.

You can challenge the mountains on mountaineering holidays, which will show just how crafty and cruel a mountain can be, while if you have never been abroad and would like to see how people live in other lands you can join other boys and girls on walking holidays in Luxembourg, Germany or Switzerland.

These holidays are not expensive, about £8 to £13 for a week in England which includes accommodation, meals, instruction and equipment, and from £20 to £25 for up to two weeks on the Continent.

The 16 plus age groups can enjoy almost identical holidays—but with more exciting additional arrangements like gliding and caving, and for those interested in the arts, there is painting and sketching or brass rubbing which you will find quite absorbing and introduces you to history, heraldry and medieval art.

You can explore a waterway to discover rural industries which you never knew existed, or spend a week in the mountains on advanced map and compass reading.

And if the Continent beckons, the 16-35 age group will find YHA Travel, 29 John Adam Street, London W.C.2. have a series of eighty activity type holidays including walking in most European countries including Poland, Finland and Hungary, Pony-Trekking in Norway, Canoeing, collecting alpine flowers, alpine climbing, cycling in Czechoslovakia, Holland and Italy, holidays on islands, roughing it around Corsica for those who think they are really tough and want to get right away from civilisation for days on end, while the romantics can trundle in a gipsy caravan around Southern Ireland.

Holiday costs vary according to the kind of Continental arrangement booked, but some of the YHA Travel holidays cost as little as £26 for two weeks, though on average they are around £35. However as most of them take you to the lesser known corners of Europe, and in many cases include holidaymakers from other countries, especially Germany, in the groups, they give good holiday value.

The Central Council for Physical



*Putting the lessons to test.*

Recreation, 26 Park Crescent, London W.1., have sport holidays at special centres in different parts of England, Wales and Northern Ireland. Scotland has its own council with sports centres at Largs in Ayrshire and at Aviemore in Invernesshire.

These holidays—courses would perhaps be a more accurate description—are for people over 17 years of age, who wish to learn a new activity or to improve their standard of performance in one in which they already have some experience.

There's expert coaching, but if you do take part in one of these sport holidays you must attend all the coaching sessions, though you get plenty of free time too.

When it comes to choice, the list of sport holidays can only be called remarkable. There's hardly a sport not taken care

of. You can choose archery, football, fencing, fishing, judo, lawn tennis, rock climbing, swimming, diving, trampolining, table tennis, water-skiing, wrestling—find out what kind of athlete you are—polish up your ballroom dancing—and these are only a small sample of the many holidays to choose from.

Costs range from £11 to £20 a week, but inclusive of accommodation, all meals, use of equipment as well as expert tuition, they can hardly be called expensive, even though the accommodation is on the simple side with up to four people sharing a room.

Inexpensive is not a word to think of when considering the Continental holidays arranged by Ramblers Association Services, 124 Finchley Road, London N.W.3., who offer higher accommodation standards, usually in hotels and pensions





*If you like horses, learn to ride, this holiday.*

rather than hostels, and so appeal to older age groups who want something different and a touch of holiday adventure. They offer many holidays which are not only imaginative but exciting.

Their Railway Tour of Switzerland may cost around £70 for two weeks, but rail fans who have tried it consider it money well spent. Led by a railway enthusiast, the party travel on standard and narrow gauge railways, on funiculars and in cable cars; they visit the workshops of the Swiss Federal Railways, climb into signal boxes, explore the huge railway tunnels which burrow deep into the mountains, amassing information and impressions of one of the world's finest rail systems, which annually carry millions of travellers through some of Europe's most beautiful alpine scenery.

Horse lovers can have two weeks in Austria which includes visits to the famous Spanish Riding School in Vienna as well as to stud farms. The cost is around £59 but it is not expensive for what you get.

For anyone who likes the sea, and does not mind being cramped on a small Yugoslav sailing 'caique' there's a most adventurous holiday down the beautiful Dalmatian Coast, the vessel calling in at tiny little known islands and romantic ports, with plenty of time for bathing and sightseeing. At night, though there are comfortable bunks, most of the party prefer to sleep on deck beneath a velvet star studded sky. Costing around £65 for two weeks it's great fun with bathing trunks and bikinis standard dress. Even the Yugoslavian ship's cook who prepares scrumptious food in the tiny galley wears

this standard dress.

Erna Low Travel Service Ltd., 47 Old Brompton Road, London, S.W.7., publish a special brochure of holidays for Students, Teenagers and Unaccompanied Children. Though many are the normal centred arrangements, some have the added attraction of tuition in German, French, Italian or Spanish, yet still leaving you time to test your knowledge of languages when you are no longer sight-seeing or bathing.

The Holiday Fellowship, 142 Great North Way, Hendon, London N.W.4., appeal to the more mature, with special holidays for those who would like to try free-lance writing or perhaps painting and sketching. They also have holidays for amateur musicians who can bring their instruments with them and when it comes to dancing, ballroom, Scottish and old time dancing enthusiasts are catered for. They will also teach you to dance Latin-American steps.

For young holidaymakers they provide special house parties with social evenings, discussions, record sessions—everyone is asked to take his favourite record on holiday—mystery jaunts, while the holiday usually ends with a concert put on by the holidaymakers.

Provided you really look around, there seems no end to the special holidays likely to appeal to anyone who wants more than two weeks looking at the sea. As far more people want this kind of holiday the selection of arrangements is annually growing.

With holiday costs already tumbling, and when the new jumbo-jets come into service the possibility of further price cuts which will bring the Middle and Far East, Central and Southern Africa, America and Canada into the holiday price range of most of us, it is not unlikely that in ten years time activity holidays will include African safari trips, archeology in the Arabian Deserts and skin-diving for Spanish Treasure ships in the cool green waters of the Caribbean.

Until that time comes, there's a host of wonderful holidays nearer home at prices everyone can afford.



*Getting ready for training trips.*

# Hobbies

DESIGN SHEET

## THE 'CHALET' DOLL'S HOUSE FD 105



**CASCAMITE**  
**'ONE SHOT'**  
**THE TOP**  
**WOOD GLUE**

Built-in hardener for easy application. Gap filling. Heat resistant, waterproof. In 3½ oz., 7 oz., 18 oz. tins; from hobbies shops and ironmongers.

The Borden Chemical Co.  
(UK) Ltd.,  
Nth. Baddesley, Southampton

**PRICE**  
**5/-**

SIZE  
15 in. HIGH  
BASE 24 in. x 18 in.

A KIT OF MATERIALS FOR MAKING  
THIS DESIGN IS SUPPLIED BY HOBBIES  
LIMITED, DEREHAM, NORFOLK.

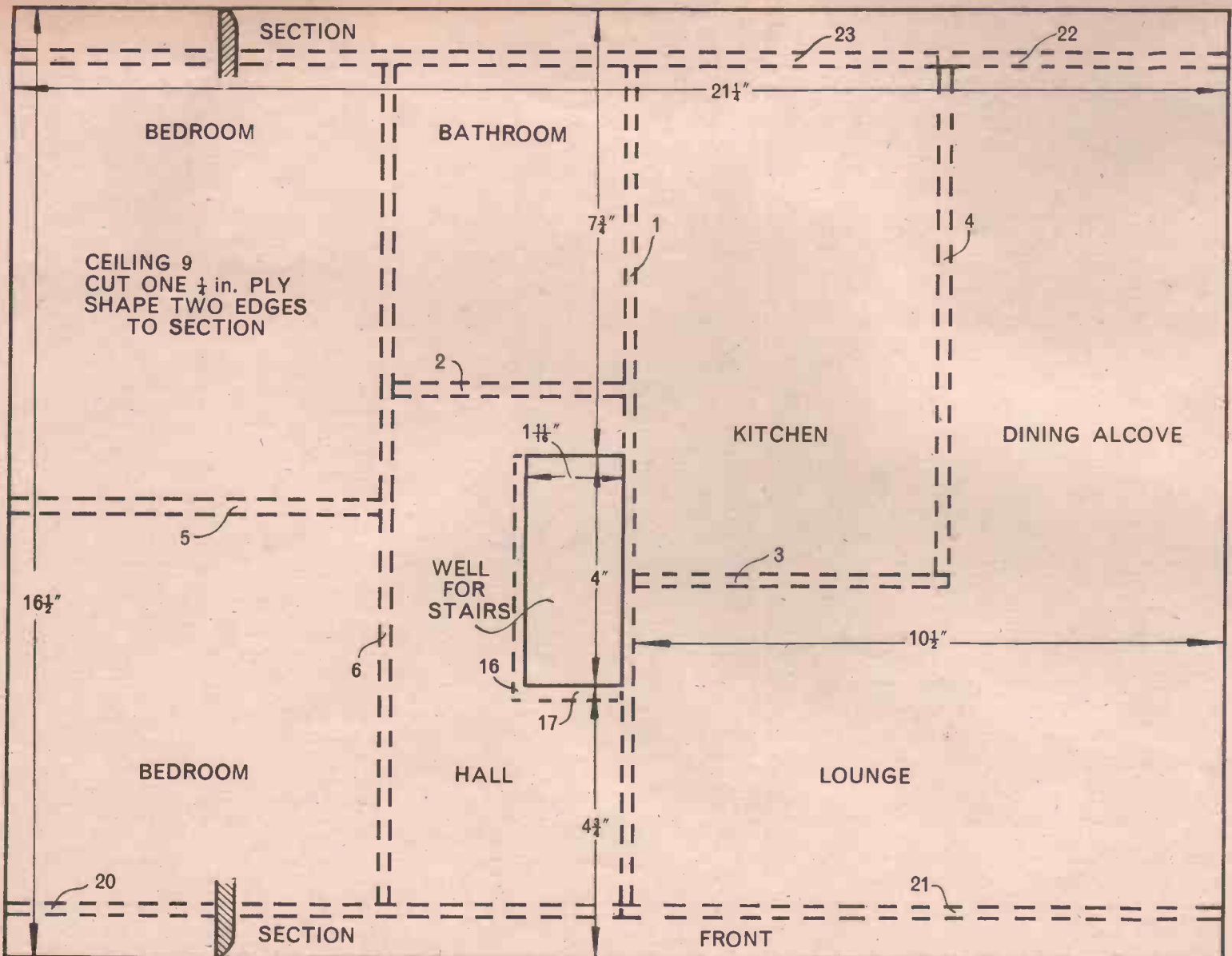
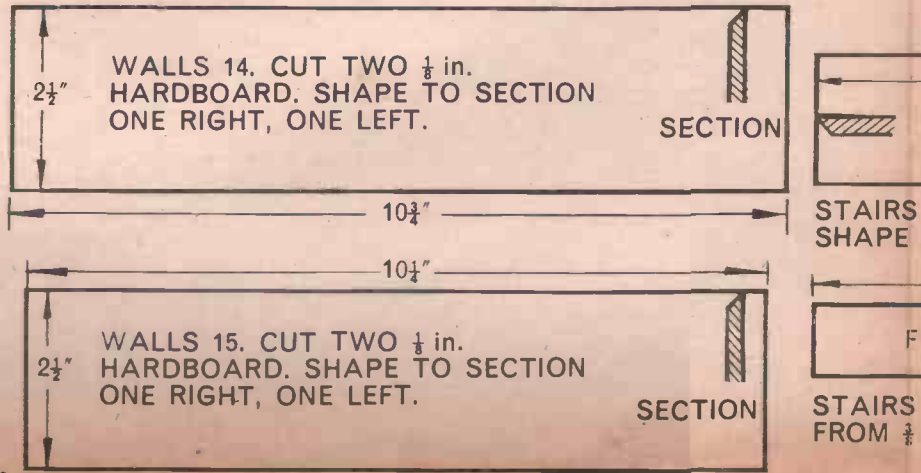
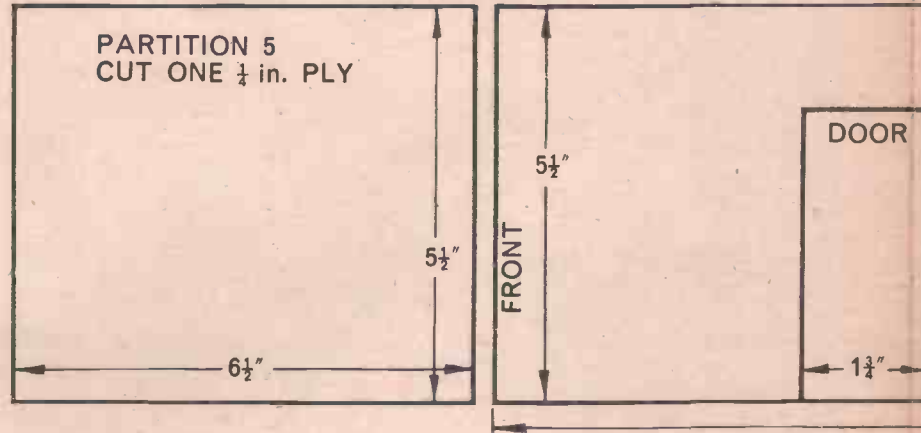
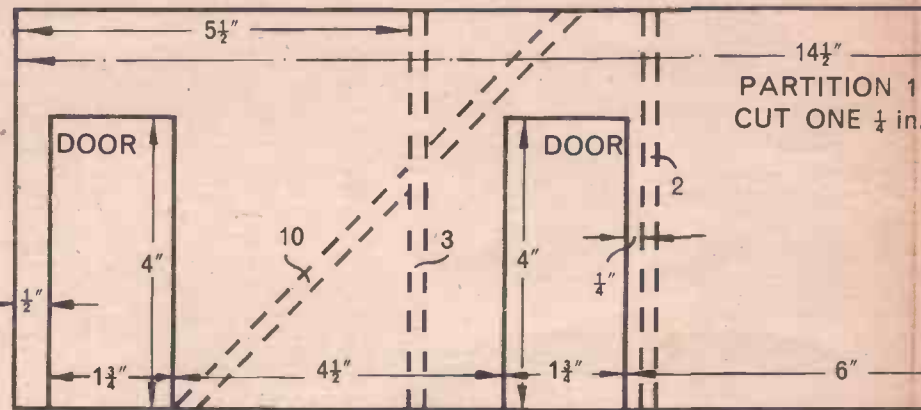



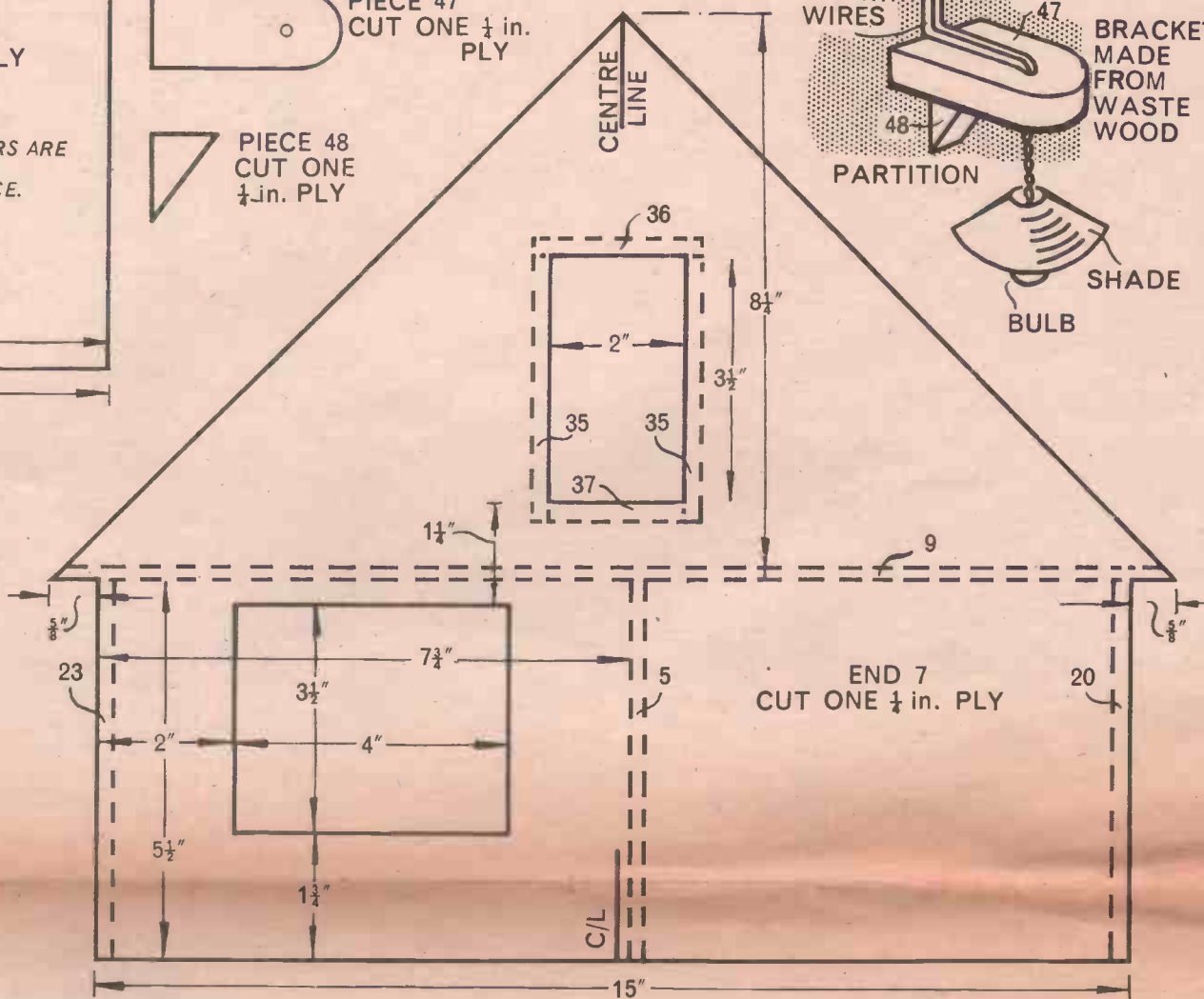
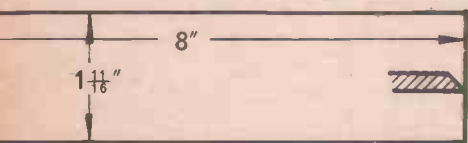
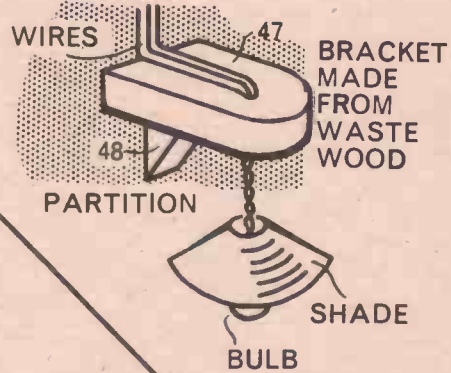
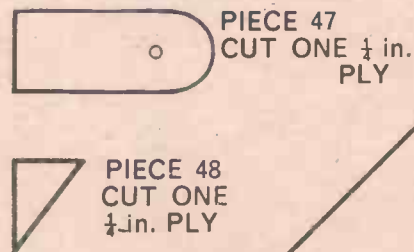
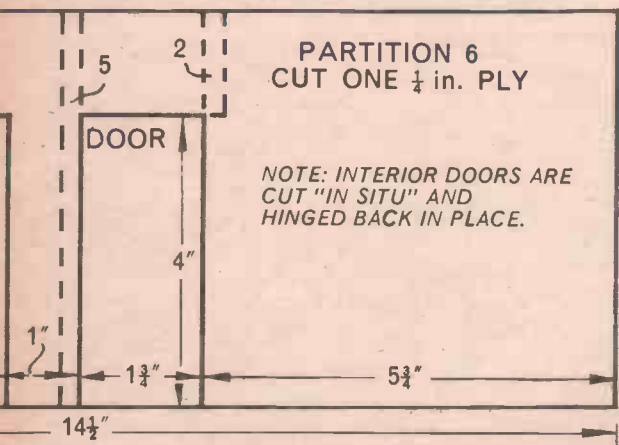
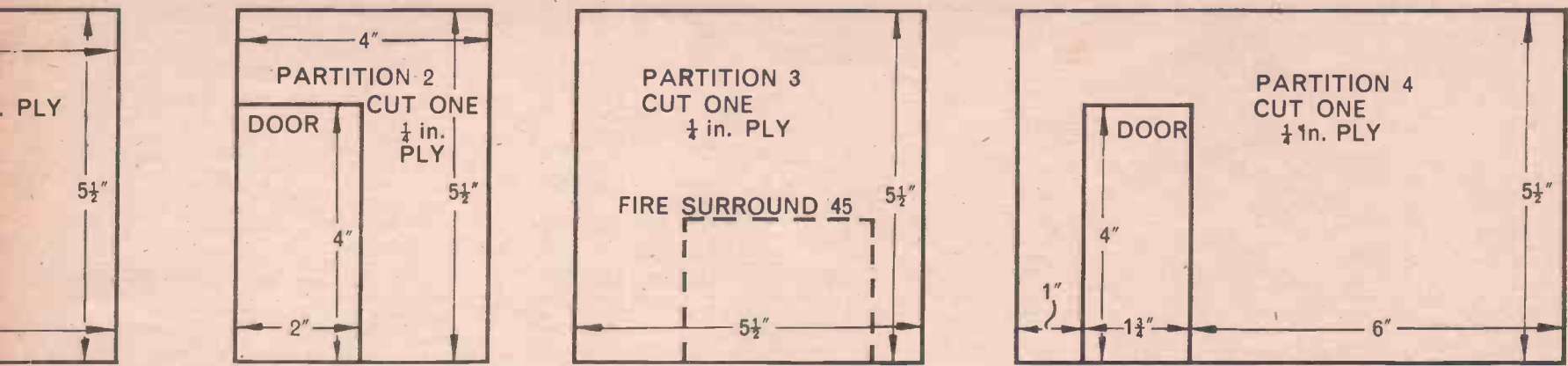

BASE 49  
CUT ONE 1/4 in. PLY  
24 in. x 18 in.

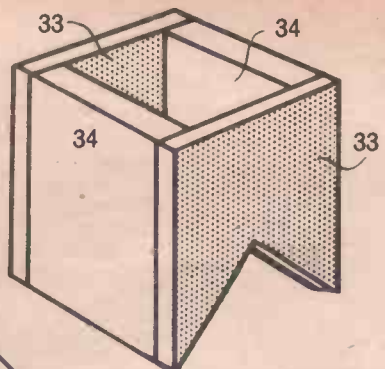
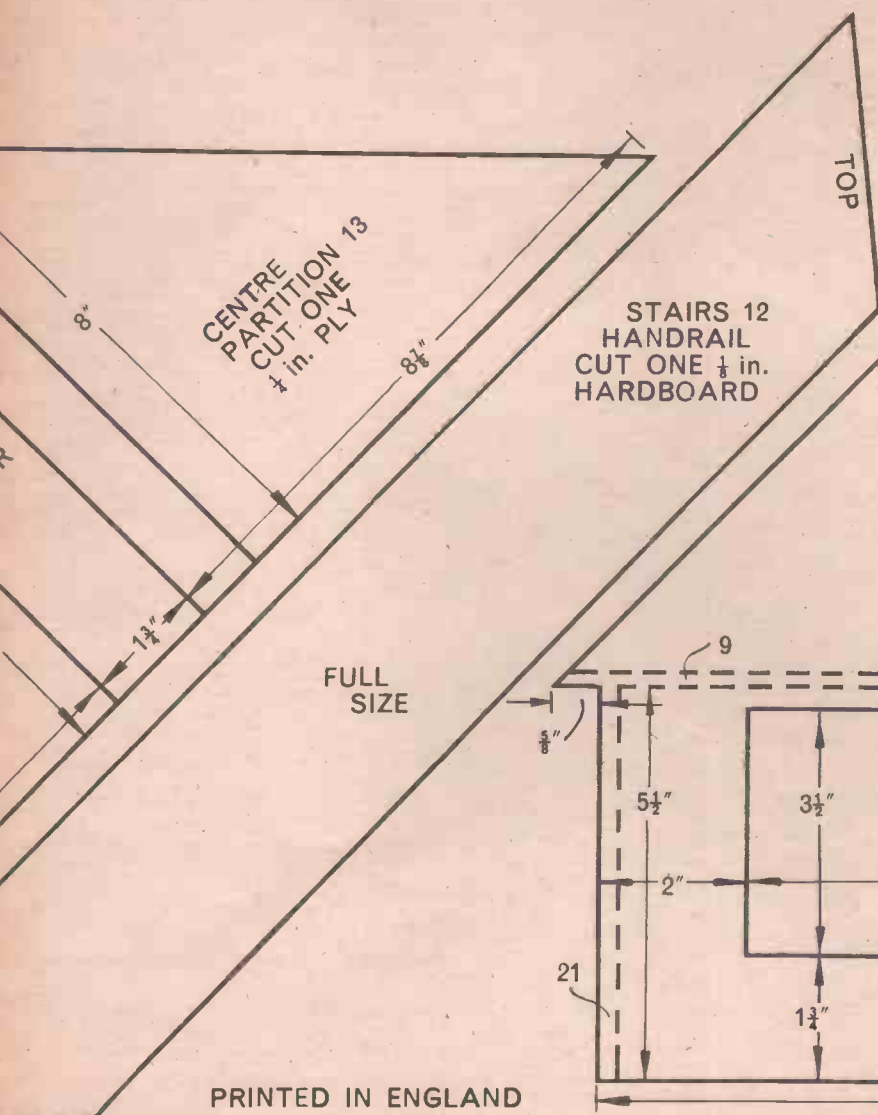

SKETCH SHOWING CONSTRUCTION OF CHIMNEY

END 8  
CUT ONE 1/4 in. PLY

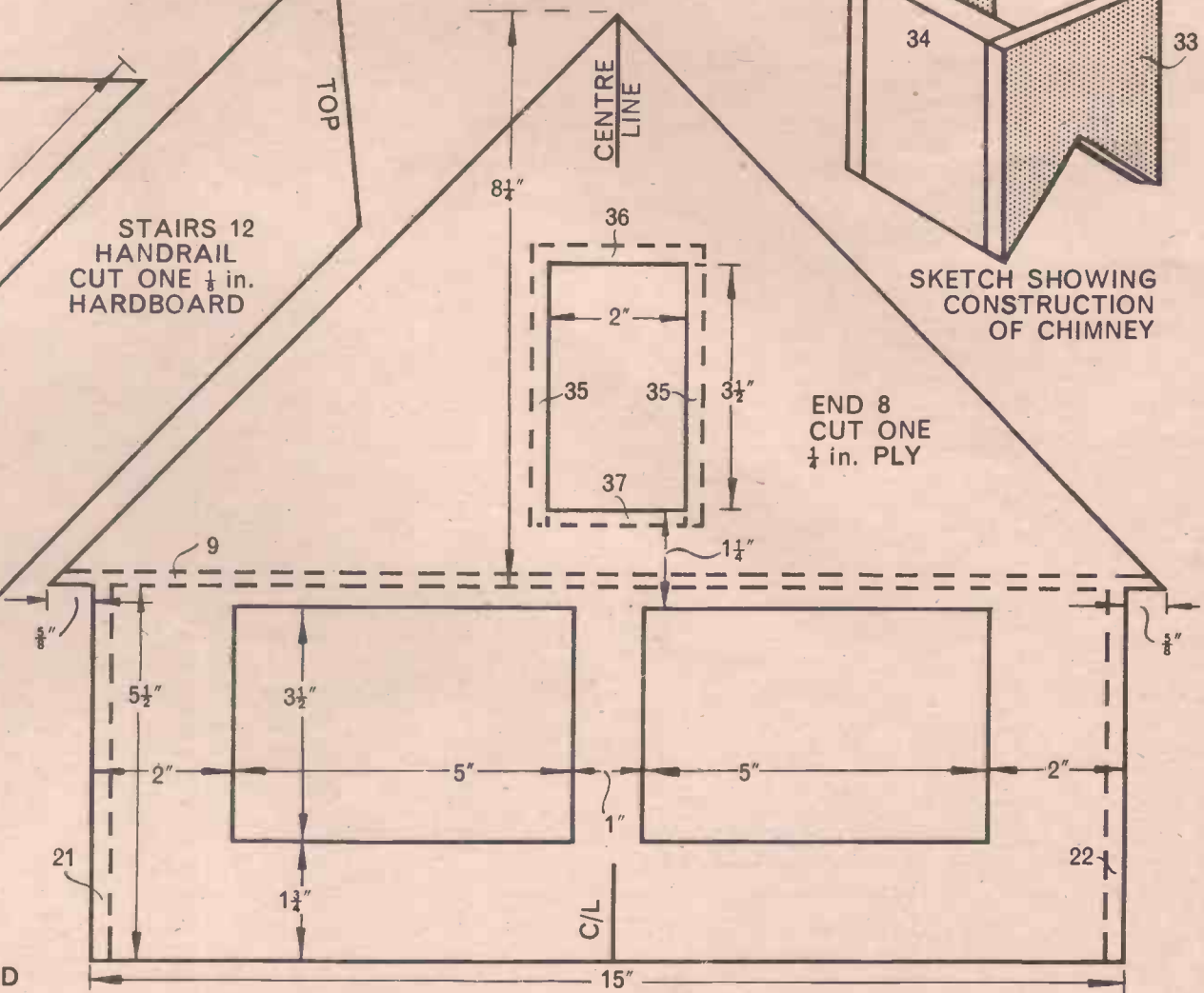

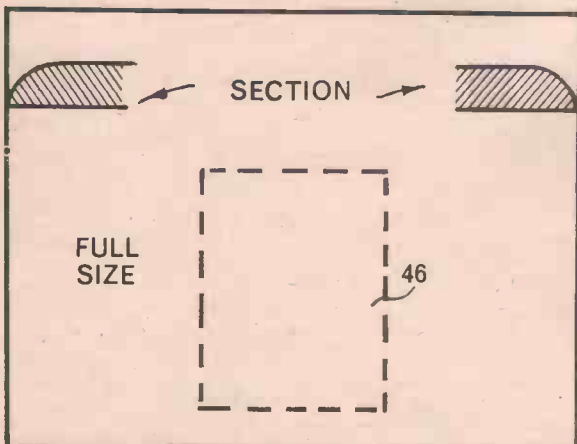
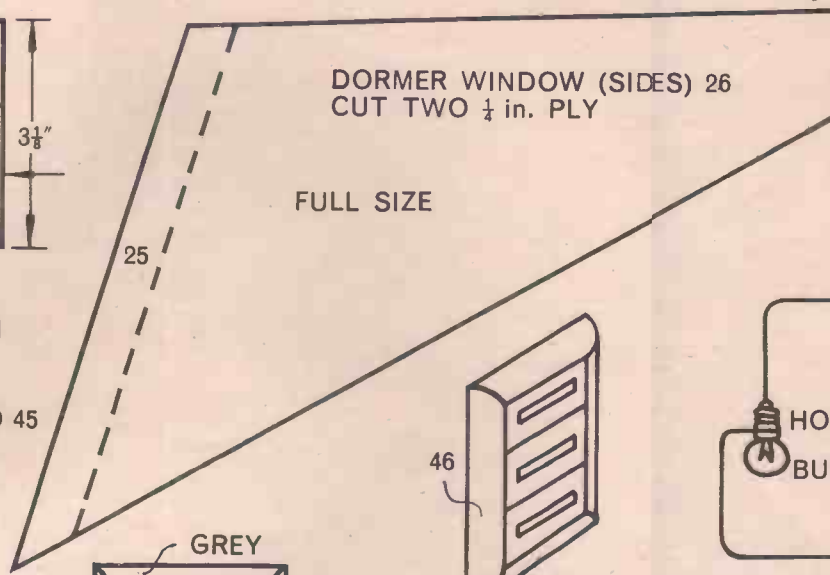
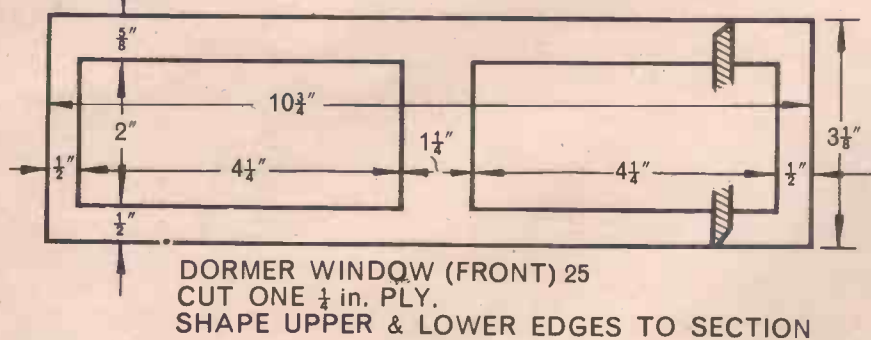
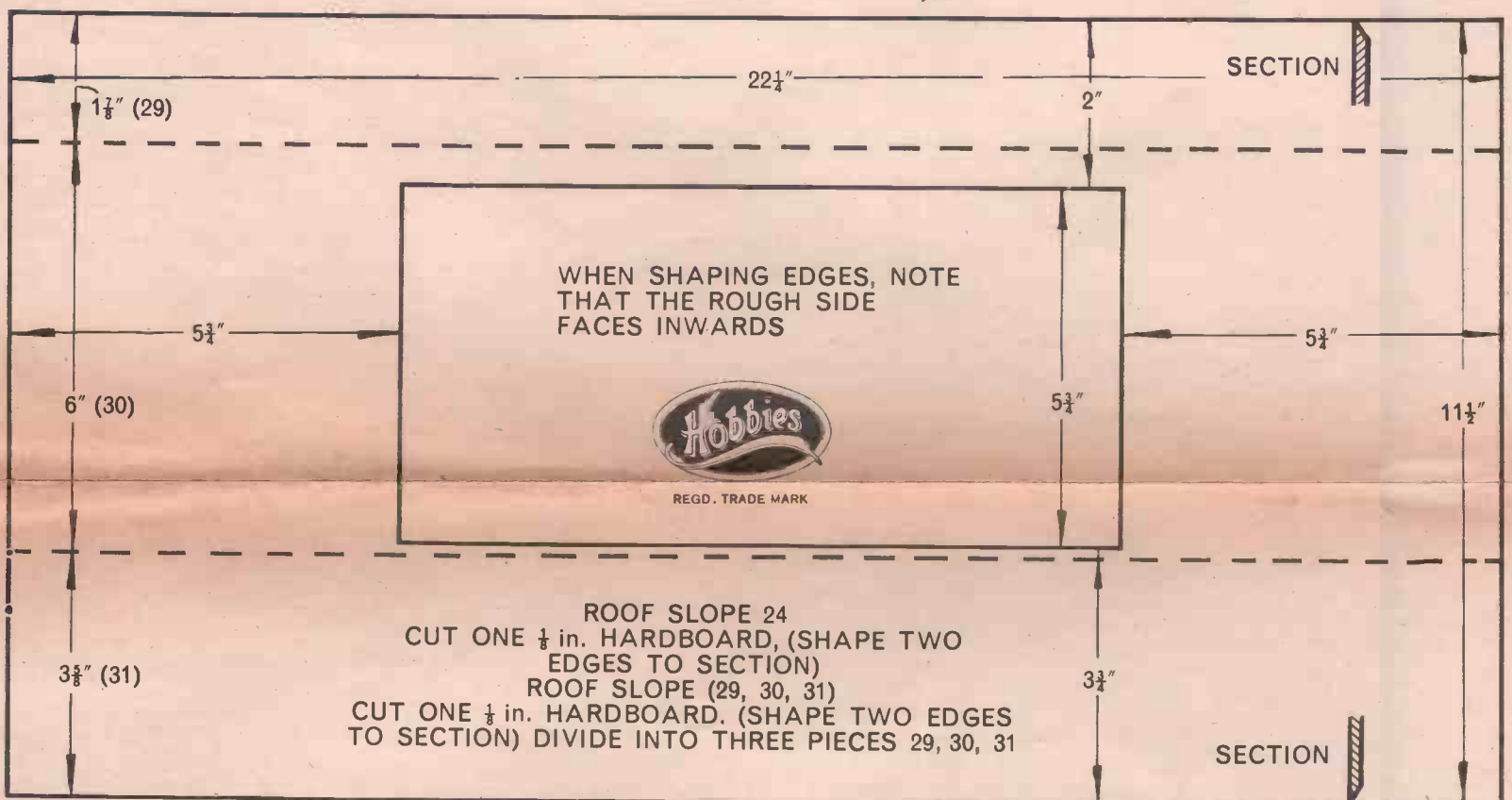
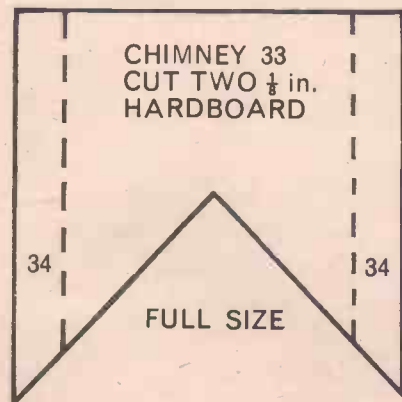
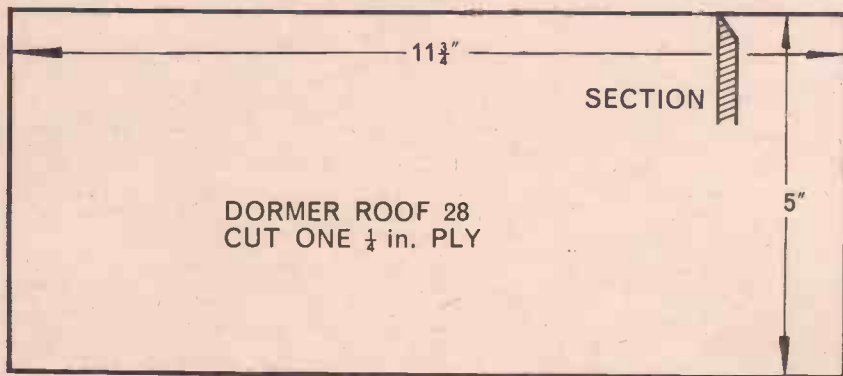
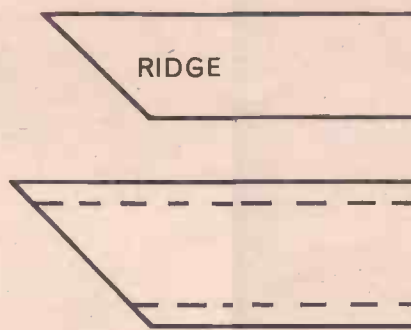
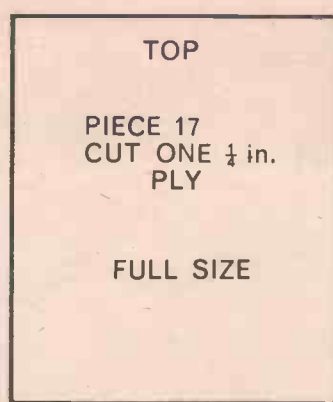
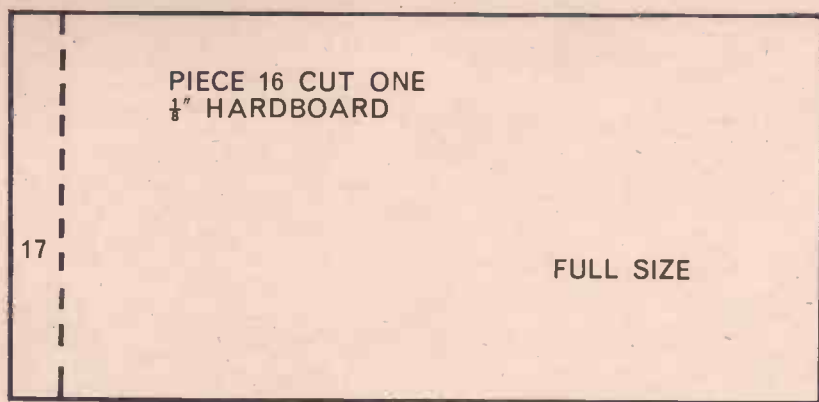

FIRE SURROUND 45 CUT ONE  $\frac{1}{4}$  in. PLY SHAPE TWO EDGES TO SECTION

ELECTRIC FIRE 46 CUT ONE  $\frac{1}{4}$  in. PLY SHAPE ALL EDGES AND PAINT AS SHOWN

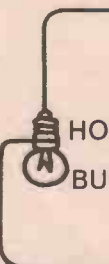
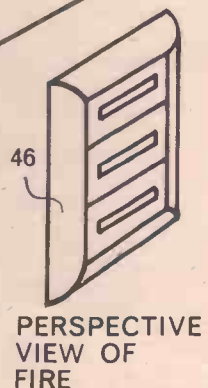
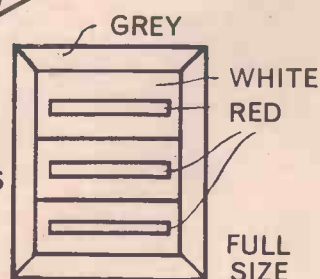

CAPPING PIECES 32 CUT FOUR  $\frac{1}{8}$  in. HARDBOARD THE PIECES ON THE HINGED SIDE SHOULD EACH BE CUT INTO THREE AS SHOWN IN FIG. 15 FULL SIZE



FULL SIZE

PIECES 18 CUT FOUR 1/4 in. PLY

FULL SIZE

PIECES 19 CUT FOUR 1/4 in. HARDBOARD

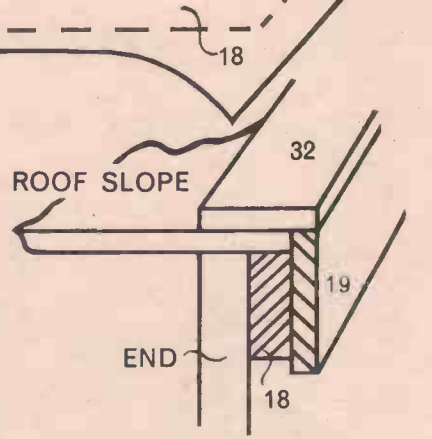
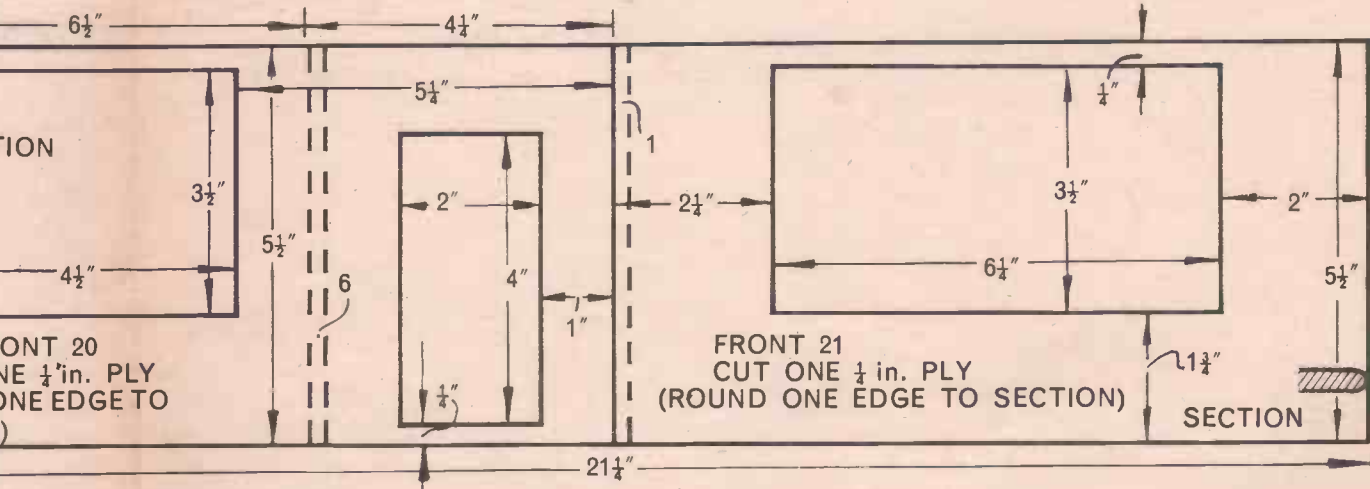

SECTION SHOWING RELATIVE POSITIONS OF PIECES 18, 19 & 32

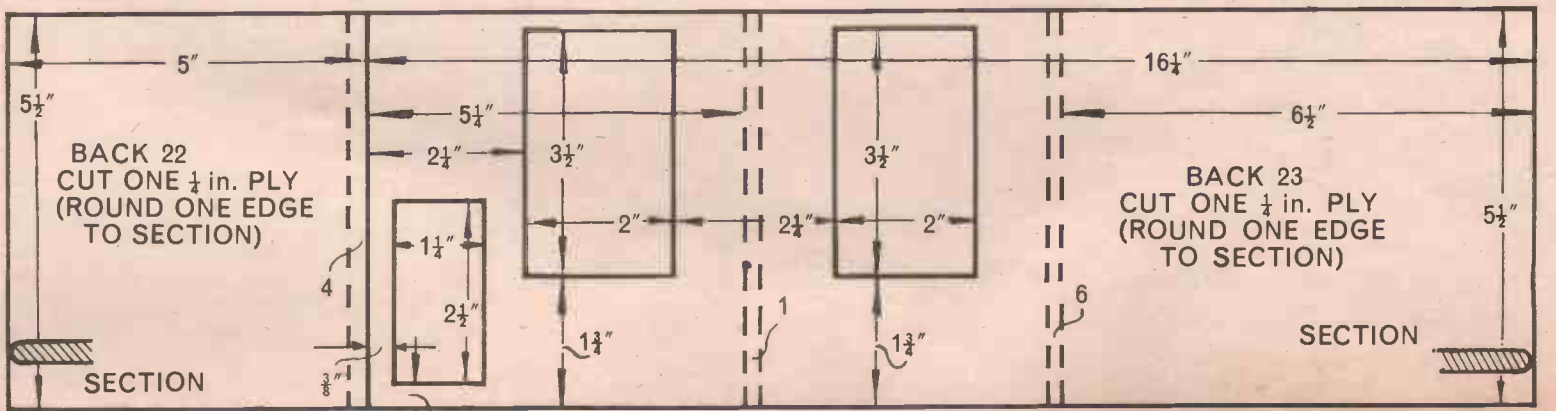
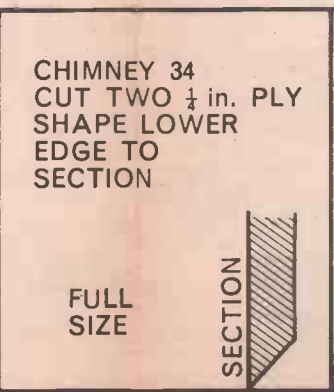

DORMER WINDOW 27 CUT ONE 1/4 in. PLY. CUT OVERSIZE & SHAPE TO FIT

FULL SIZE

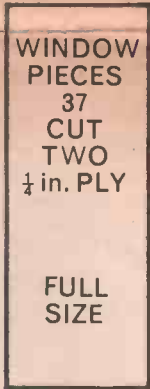
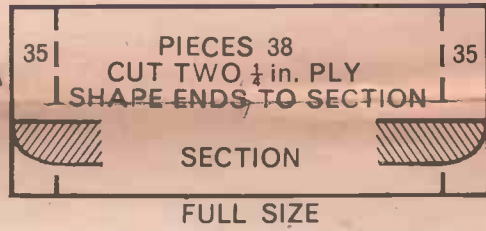

WIRE BARED, PASSED THRO' HOLDER, THEN TWISTED TO FORM A SMALL BLOB OR HOOK



WIRE BARED AND TWISTED ROUND OUTSIDE OF HOLDER

SKETCH SHOWING CONSTRUCTION OF END BEDROOM WINDOWS

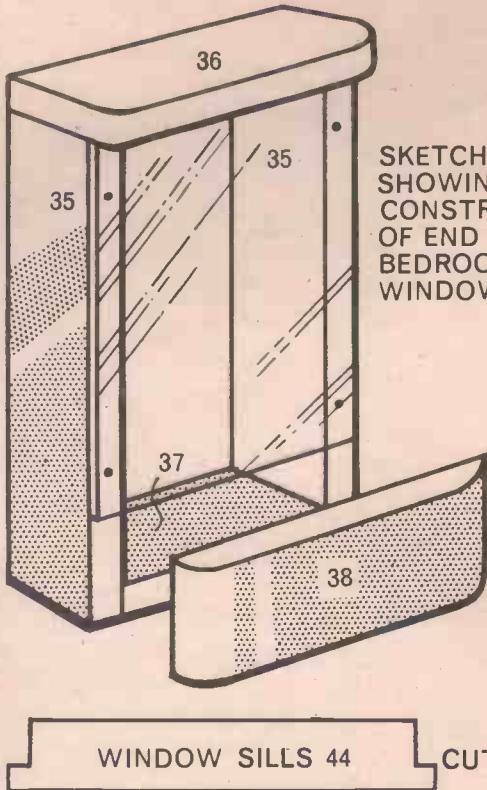

WIRING DIAGRAM

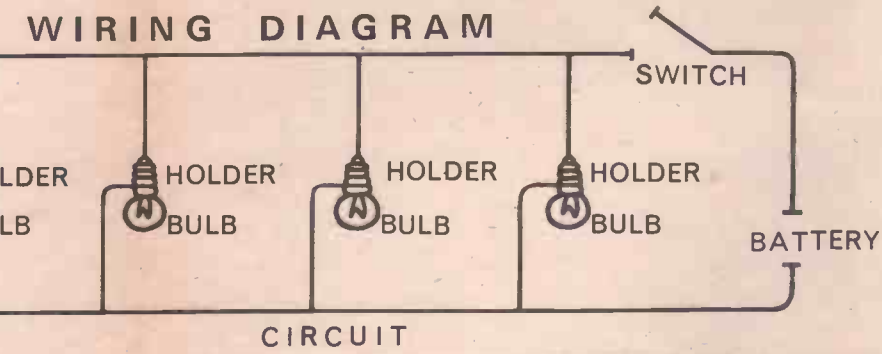

CIRCUIT

WINDOW SILL 43 CUT ONE 1/4 in. HARDBOARD

WINDOW SILLS 41 CUT TWO 1/4 in. HARDBOARD

FULL SIZE

WINDOW SILL 42 CUT ONE 1/4 in. HARDBOARD

WINDOW SILL 40 CUT ONE 1/4 in. HARDBOARD

WINDOW SILLS 39 CUT TWO 1/4 in. HARDBOARD

SECTION

IN THE INSTRUCTIONS.

# hobbies 'chalet' doll's house



by C. J. E. Mackrell

A 'Modern House' for the 'Modern Miss'.

#### MATERIALS FOR THE 'CHALET' DOLL'S HOUSE

Kit containing plywood, hardboard, triangular fillet, paint, glue, nails, exterior doors, hinges, screws, window material and paper for exterior and interior decoration. (Lighting system extra).

**FDW. 105**.....Cash price **87/6** carriage 9/- or deposit 13/- plus carriage and 8 monthly payments 11/6.

*Featuring: Large picture windows for a clear view of all rooms. 'Attic' bedrooms for extra play value. Opening front, back and roof. Provision for electric lighting.*

*By building it yourself you save labour costs and are sure of the very best value for your money.*

It would be difficult to imagine a more welcome present for a little girl, than a doll's house. There is a fascination about a well-furnished doll's house that appeals to everyone, and there's even greater enjoyment in building and decorating it oneself.

This 'Chalet' Doll's House is a popular type of modern home, and provides extra 'attic' bedrooms for *added* play value. It is designed for easy construction and all necessary measurements are clearly indicated on the Design Sheet. In fact,

the step-by-step instructions take you through every stage of building and you just cannot go wrong. Although it may appear a little difficult at first glance, each step is quite a simple operation, well within the scope of the average 'Dad'.

The house measures approximately 23" x 16" overall and stands on a base 24" x 18". The back, front and one side of the roof are hinged for easy access to the rooms, but the ceiling is fixed, giving scope for the provision of a permanent lighting system.

The plan includes a lounge, dining alcove, hall, kitchen, bathroom and two bedrooms. Stairs lead from the hall to two 'attic' rooms, one of which can be adapted for battery storage. The rooms are designed to take Hobbies wooden furniture sets (DHAW 801 to 805) which fit nicely into the space provided. Since





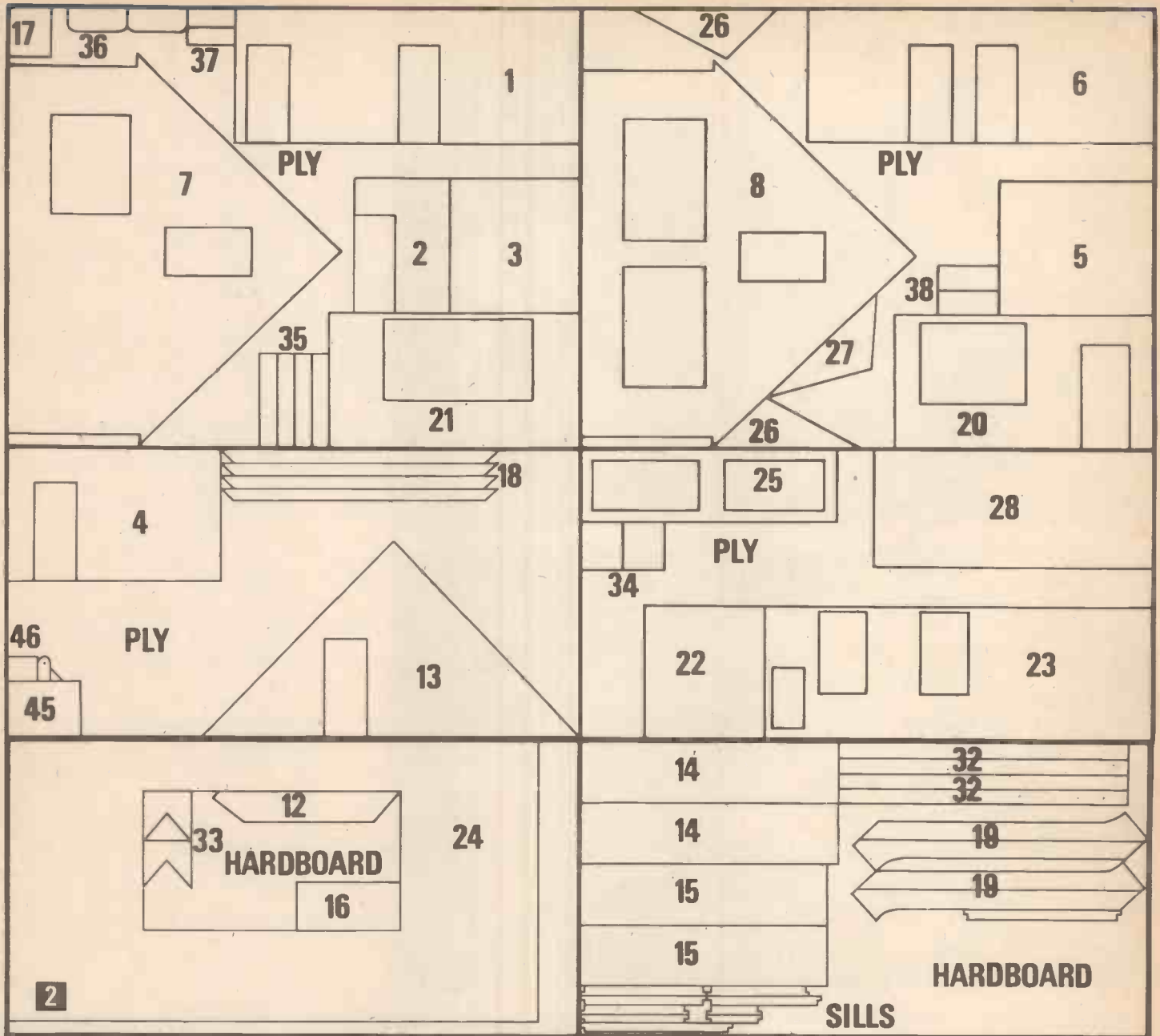

the house is designed for central heating, an electric fire replaces the traditional open grate.

Exterior doors are provided ready-made, but interior doors are cut from wood. The windows are constructed from clear acetate, making it possible to give wide 'picture windows' in keeping with the style of the house.

Cut all parts with a fretsaw, or use a fine tenon saw to cut some of the straight edges. When cutting the window, door and other openings, pass the fretsaw blade through a small hole drilled in the wastewood as shown in Fig.1. Pieces such as the roof slopes, which are shaped at the edges, should be cut slightly over size. Use glue liberally when assembling.

You can make the house from your own materials or you can buy Hobbies kit FDW. 105 which contains sufficient

plywood, hardboard, triangular fillet, paint, glue, nails, exterior doors, window material and paper for exterior and interior decoration. This includes imitation stone, parquet floor, ceiling, tile and special decorative papers for the inside of the rooms. A suggested colour scheme for paintwork, to tone with the embossed stone paper, is blue and white.

Read the instructions and study the diagrams carefully before starting. Ensure that you have a good idea of the sequence of cutting and assembling.

The design sheet shows the main parts with all necessary measurements and shows smaller pieces full size. The latter are clearly marked to avoid confusion. The material from which each part is to be cut is also indicated.

The first step is to draw out the various pieces of the house on to the appropriate

thicknesses of wood. Small parts shown full size can be traced and transferred by means of carbon paper. Arrange the pieces on the wood as shown in Fig. 2. If these parts are accounted for first, the positions of the rest will follow easily. Where possible, place pieces with straight edges adjacent to each other, making one cut do for two.

Make sure that all pieces have been accounted for before commencing cutting.

Cut out all pieces and clean up with glasspaper, removing whiskers from the cut edges. Give flat surfaces a light rub to remove any roughness. Commence assembly by glueing and pinning the parts together in the following order:

- A Fix piece 2 to piece 1, piece 3 to piece 1, and piece 4 to 3 as shown in Fig. 3.
- B Fix piece 6 to 5 (Fig. 4).

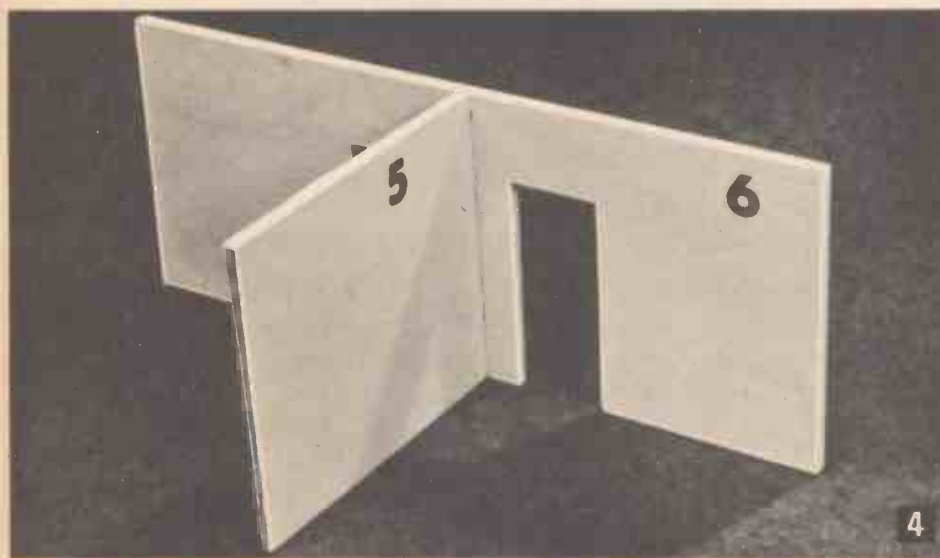
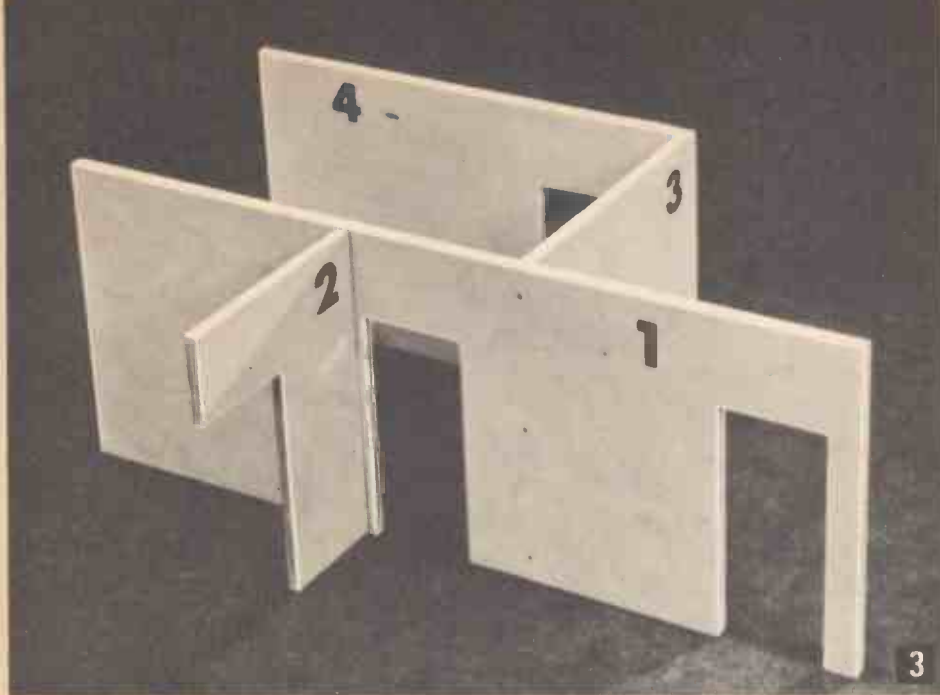

C Now join these two sections by fixing piece 2 to 6. The result should appear as the photograph in Fig. 5. Square-up the pieces and lay them on one side to dry.

D Take the two ends (7 and 8) and fix them to the ceiling (9). Make sure that the ends are the right way round as shown in Fig. 6, and that the ceiling is positioned correctly with the stairs' 'well' in the right place.

E Glue the partitions to the baseboard (49), allowing  $\frac{1}{4}$ " clearance for back and one end so that these will come flush with the edge of the baseboard when fixed. (Fig. 7). Turn over and strengthen with a few  $\frac{1}{2}$ " brass nails or countersunk screws.

F Now fix the ceiling and ends in position as in Fig. 8. Use the glue liberally and wipe off excess before dry. Strengthen with nails or screws where necessary.

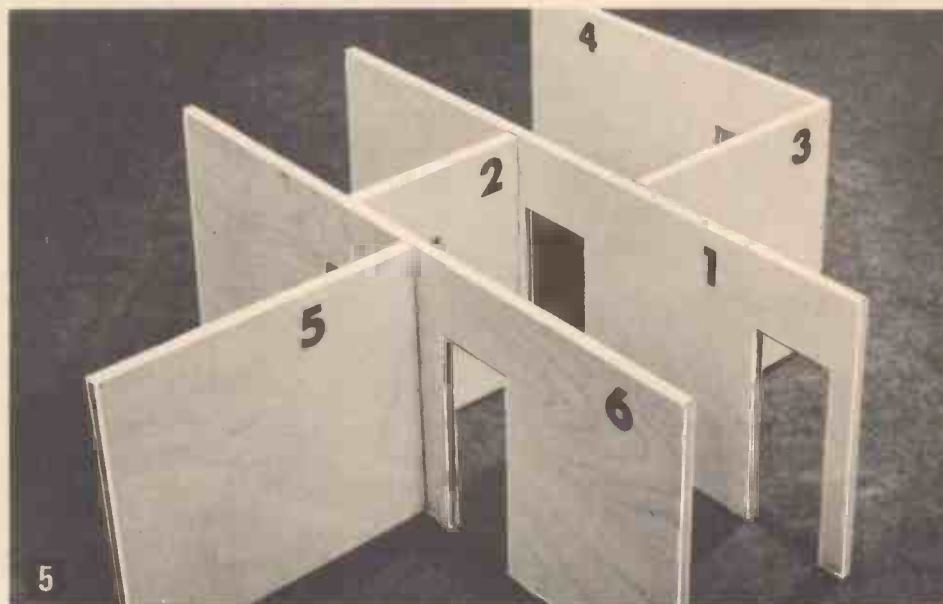

G Paint all edges of door openings, window openings and exposed edges of fronts and back—i.e. those which will not be covered with paper. Give an undercoat of matt white, finish off with high gloss white.

H Now paper the rooms, starting with the ceiling, which should be white, and continuing with the walls, using suitable decorative papers. Use tiled paper for bathroom and kitchen, bringing it about halfway up the walls and finishing with plain paper to match the ceiling.

Continue with the floors, using parquet for bedrooms, hall and lounge. The floors of both bathroom and kitchen will look attractive covered with tiles.

When papering, fit the paper into the corners and allow it to overlap windows, doors and outside edges, trimming off with a razor blade when dry. Break the razor blade in half lengthwise as it is safer and handier to use than the whole blade.

I Cut clear acetate to fit the window openings, allowing an overlap of about  $\frac{1}{4}$ " all round. Fix the acetate, on the inside, with  $\frac{1}{4}$ " brass nails. Start the nails with a burnishing awl and tap into place with a small pin hammer.

J Prepare interior doors for fixing. Insert  $\frac{1}{4}$ " brass nails to represent door knobs. Paint door and knobs, giving a matt undercoat and a gloss finishing coat. When dry fit in place with hinges of adhesive tape as in Fig. 9.

K Make up the stairs as shown in the photograph in Fig. 10, glueing short strips of  $\frac{3}{8}$ " triangular fillet (11) in place on piece 10 and adding hand-rail (12). Paint the stairs to match the colour scheme and glue in place in the hall as in Fig. 11. A strip of coloured



material, flock paper or wall paper may be glued in place to represent a stair carpet.

L Paint the fire surround (45) to match the colour scheme and glue in place on piece 3. A gas or electric fire should be simulated as suggested on the design sheet.

M Complete the construction of the attic rooms by fixing first the partition (13) and then the walls (14 and 15) which are  $2\frac{1}{2}$ " wide strips of  $\frac{1}{8}$ " hard-board cut to fit and shaped along the top. These may be strengthened by glueing blocks of waste wood at the back, as seen in Fig. 12. Add the pieces 16 and 17 at the top of the stairs.

N If electric lighting is to be used, then it should be inserted now. It is suggested that for economy you should use small units from sets specially made for doll's houses. Normally there are four units in each set and by using two sets, seven units can be allocated to the downstairs rooms and one to the attic bedroom, fixed to the partition wall on a small bracket made from waste wood. Other individual units can of course be utilised. Use two  $4\frac{1}{2}$  volt heavy duty batteries, running four lights from each battery, as shown in the wiring diagram on the design sheet. One switch for each circuit will suffice and both should be situated with the batteries. Fix the bulbs and shades by running wires along the attic floors, and passing them through holes drilled in appropriate positions as shown in the photograph in Fig. 12. Exposed wires should be lead to the sides, through the walls and along to the battery compartment. To avoid short circuits, when wiring the bulbs, it is advisable to test each unit individually before

Fix the bulbs and shades by running wires along the attic floors, and passing them through holes drilled in appropriate positions as shown in the photograph in Fig. 12. Exposed wires should be lead to the sides, through the walls and along to the battery compartment. To avoid short circuits, when wiring the bulbs, it is advisable to test each unit individually before

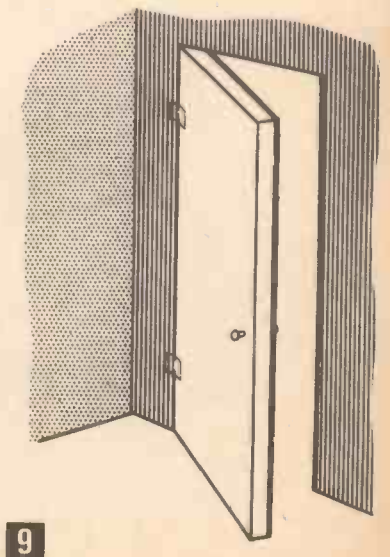
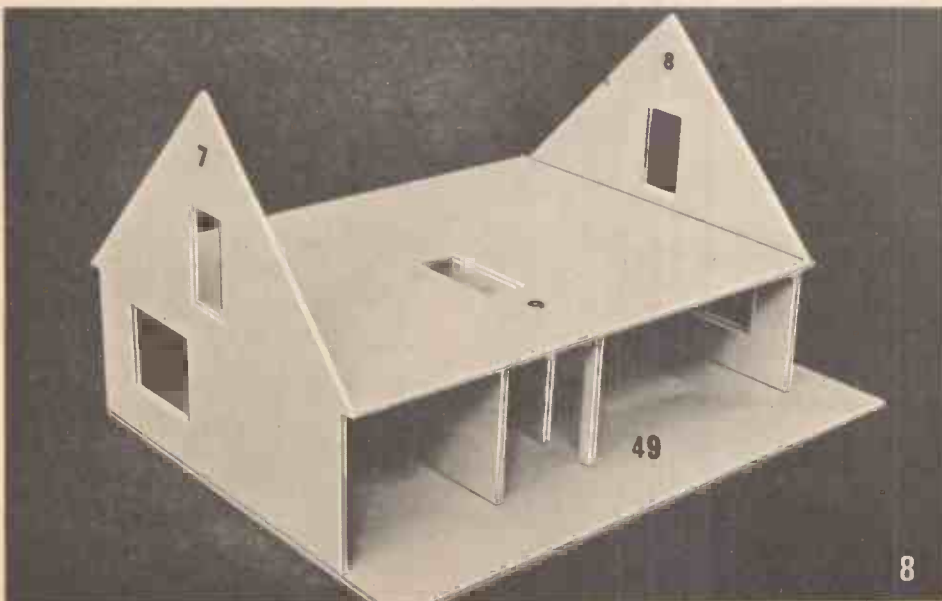
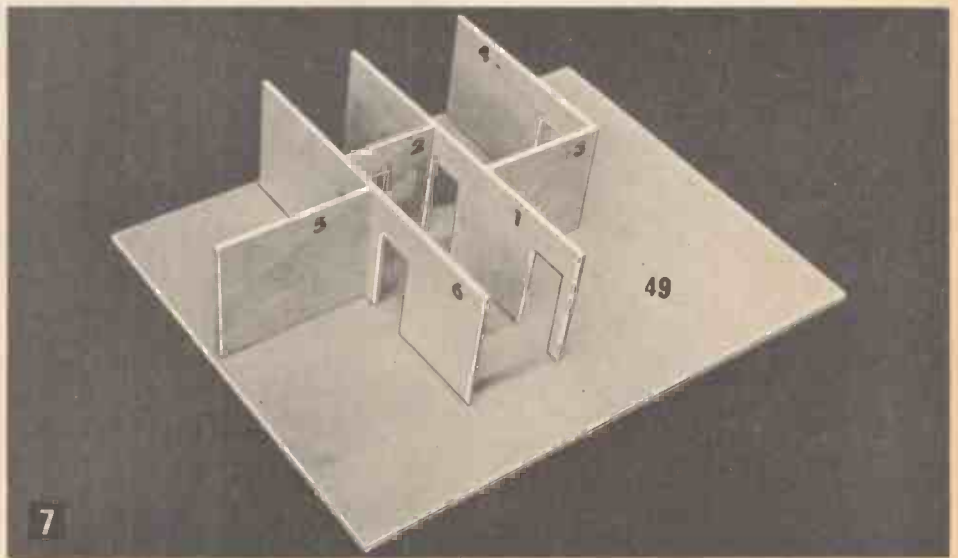
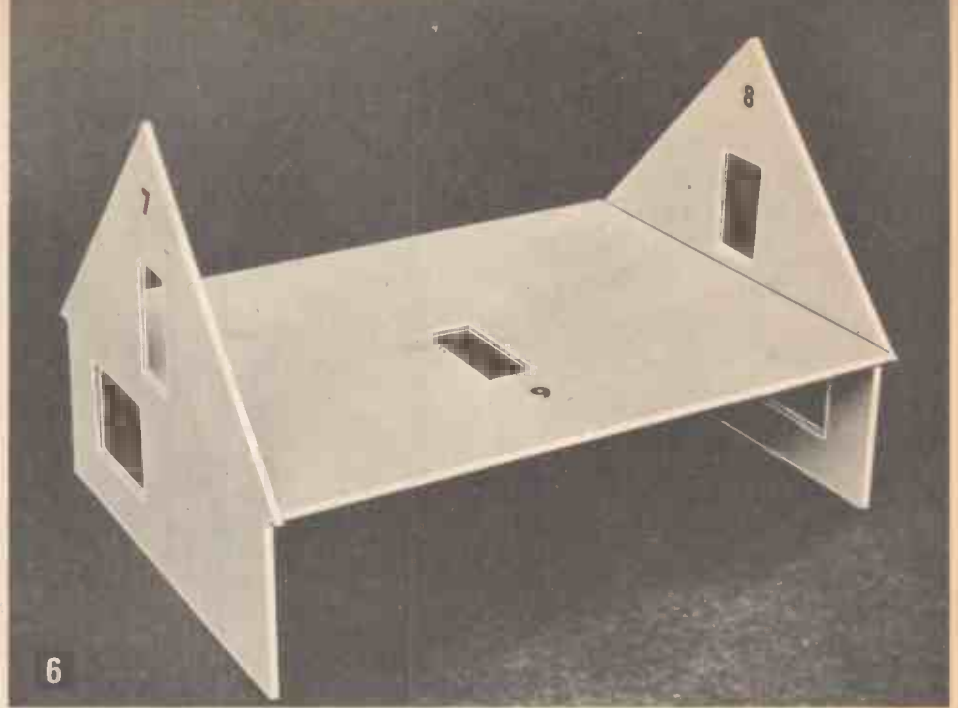

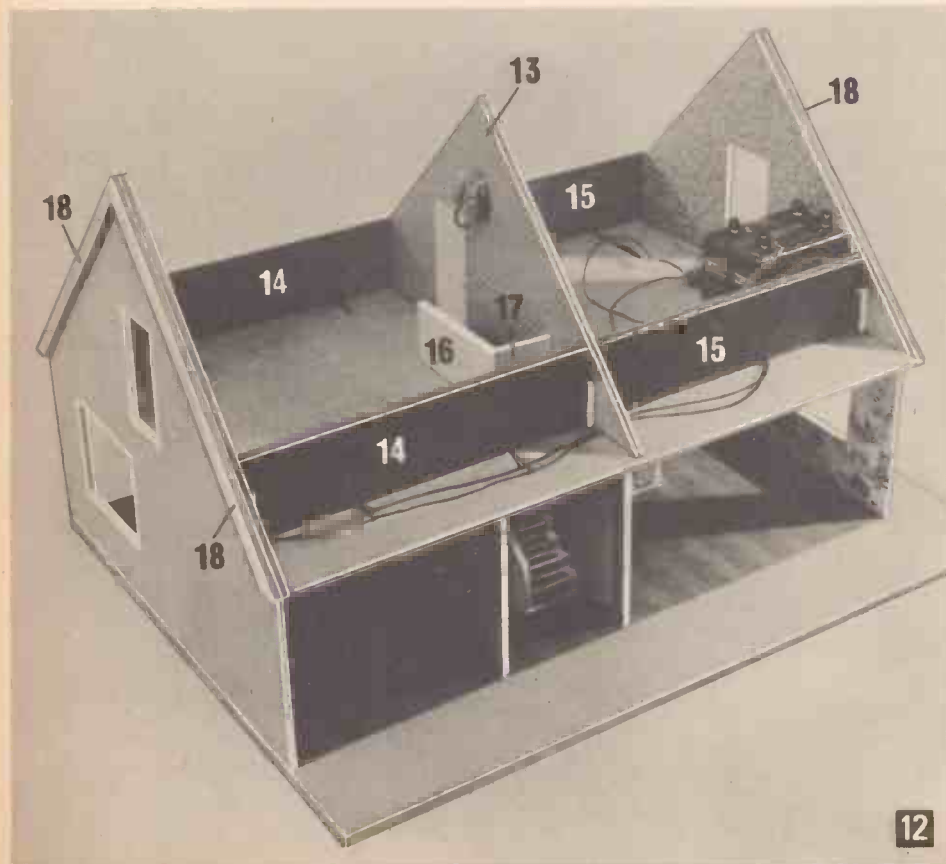
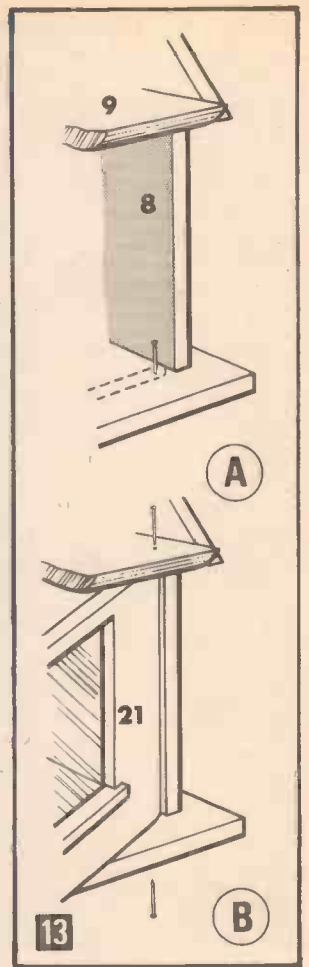
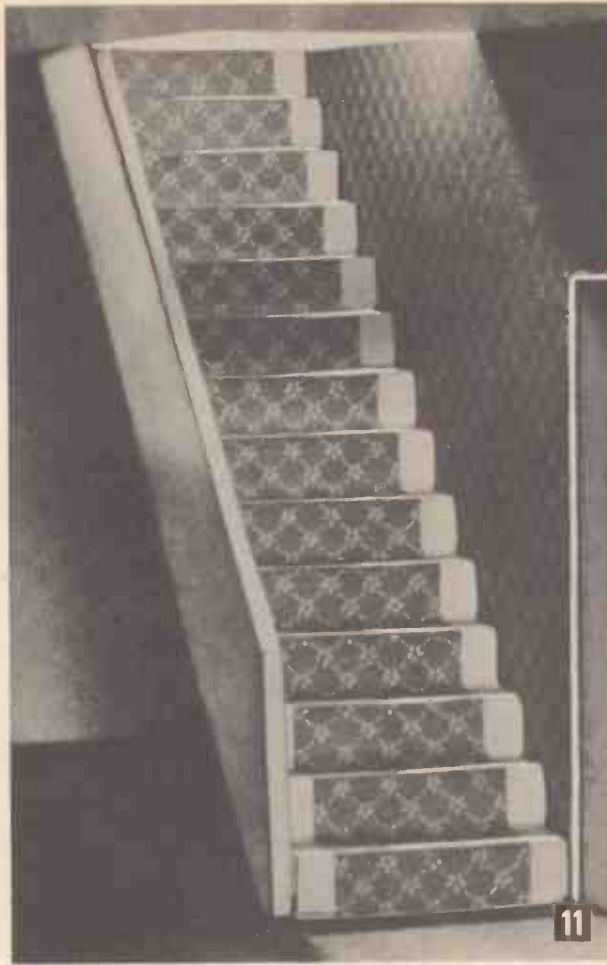
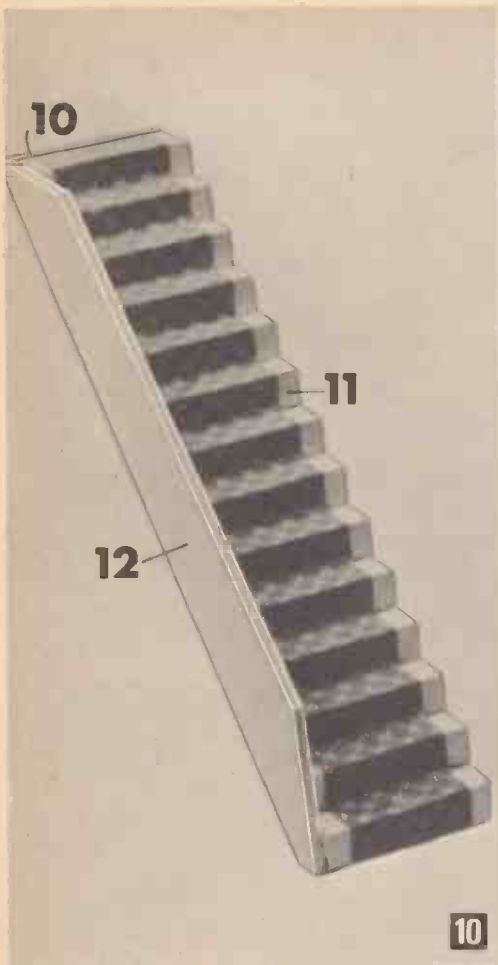

completing the circuit.

A more ambitious scheme could include modern lighting units, with separate switches to each room. Wire the units three or four to a battery and connect in parallel.

- O When the wiring is complete and the lights are working satisfactorily, finish-off the attic rooms. Paper the floor with parquet and the walls with decorative paper, covering the exposed wires where necessary. Fig. 12 shows the attic rooms, with wiring in position, but with floors uncovered.
- P Glue and pin piece 18 in position as seen in Fig. 12, following with piece 19. The sectional diagram on the design sheet shows the relative positions of 18 and 19.
- Q Paper both sides of the doors, which are in fact the front (20 and 21) and the back (22 and 23). Keep under heavy weights while the paste is drying, to prevent warping. Fix transparent acetate behind the windows, using  $\frac{1}{4}$ " brass fretnails, and pivot the doors in place with  $\frac{5}{8}$ " brass nails driven through the ceiling and floor into the doors as shown in Fig. 13.

To get the exact position drive a brass nail through as shown at A, then remove and drive from underneath as seen in B. Doors can be kept



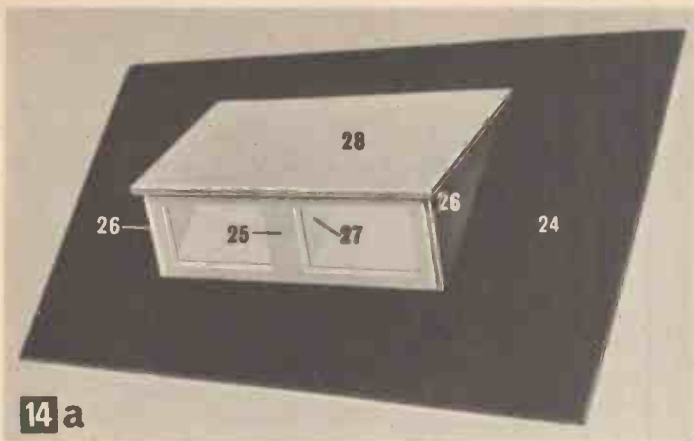

14 a

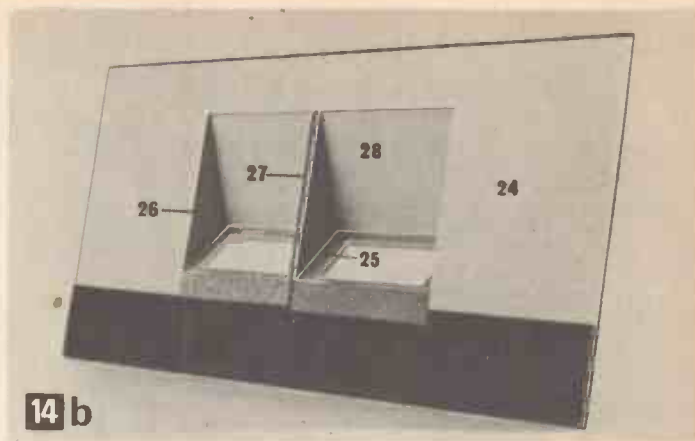

14 b

in position by hooks and eyes or may be left to swing free.

- R Make up the front roof slope (24) as shown in Fig. 14a. The dormer window is made up from pieces 25, 26, 27 and 28, with piece 28 shaped along the top edge and glued in place. Note that piece 27 when glued in position must come exactly opposite the centre partition (13). Cover the interior with Ceiling Paper and decorative wall-paper on the sides of the windows, as in Fig. 14b.

Fix transparent window material in position with  $\frac{1}{4}$ " brass nails. Make curtains, and fix before nailing the roof slope in place. The back roof slope is cut in three pieces (29, 30 and 31) and is positioned as shown in Fig. 15. Only the centre hinged portion (30) and the top portion need papering inside, and should be covered before hinging.

Small blocks of waste wood should be glued at the back to take the screws for the hinges. Fix capping pieces (32) to both roof slopes after shaping to allow roof to open. Finish by painting. Cover the entire roof with tile paper. Ridge tiles can be simulated by pasting a strip of roof tile paper lengthwise as shown.

- S Make up the chimney from pieces 33 and 34 and cover the outside with embossed stone paper. Paint the inside red and the edges buff or stone.
- T Paper the outside of the house with embossed stone, papering over the windows, and cutting out with a razor blade as previously described. Take care not to paste the windows or damage when cutting.
- U Make up the end bedroom windows from pieces 35, 36, 37 and 38 as shown by the diagram on the design sheet,

and finish with white paint.

Pin transparent acetate across the front and then glue them in the appropriate positions on the ends of the windows to match the bedrooms.

- V Cut the window sills, and paint them dark red and line with white to represent tiles. Glue them in place to the windows.
- W Paper the base (49) with mosaic tiles and fix the two metal entrance doors with small brass nails. These doors can be painted to match the colour scheme if necessary. Add curtains made from strips of thin material and complete the decor by finishing off the remaining pieces which have not yet been painted.

And there you have the very loveliest of doll's houses for the very loveliest of little girls.

15

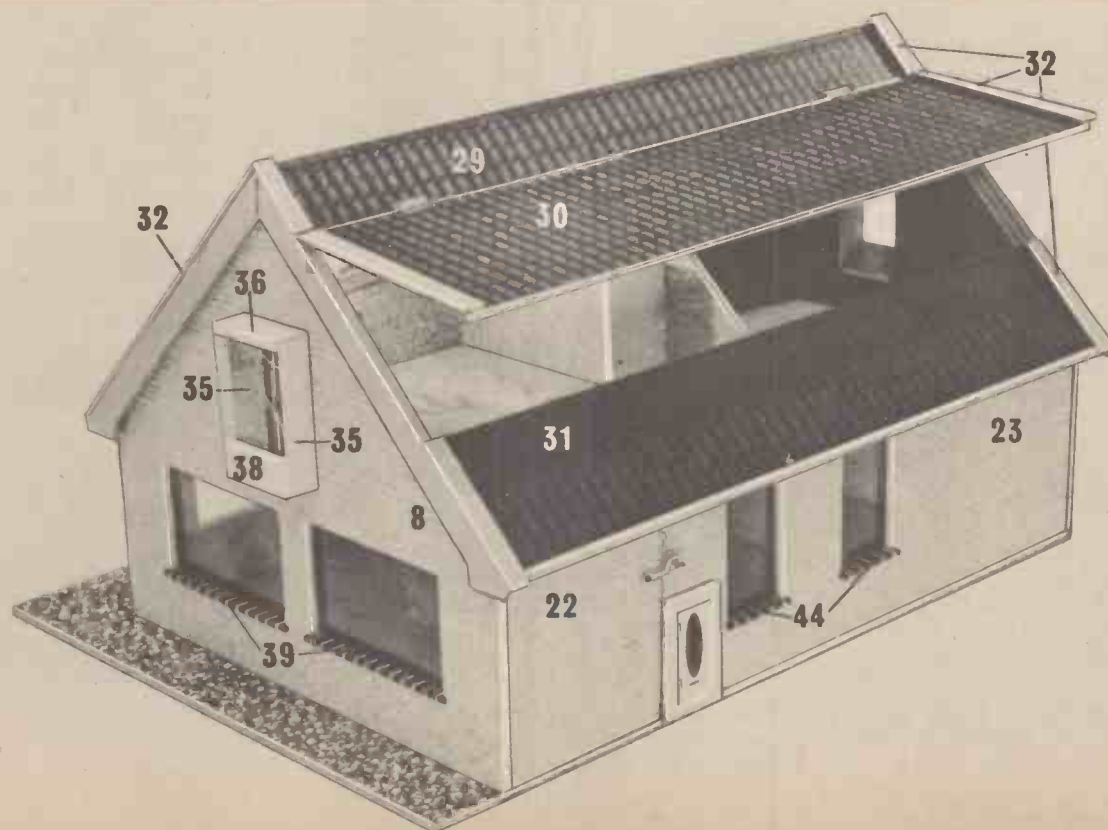

# Transfers add the personal touch



Transfers applied to a lampshade.

Mention transfers to most people and they immediately think of the hours they spent as children with scissors and rather gummy pictures of animals. But when transfers were invented two hundred years ago, they were taken more seriously as a pastime for fashionable ladies. In fact, there was even a word for the transfer craze—Decalomania—which swept through Europe in the 17th century.

You can now get a modern version of this permanent type of transfer; Decalomania is turning out to be very catching again today.

The transfers have a plastic coating which makes them washable and hard wearing. They are very simple to apply. Soak them in water for 30 seconds, slide off the backing sheet into position onto any sealed surface, wipe away excess moisture and leave to dry. You can use them in dozens of different ways to add sparkle and colour to your home. An enormous range of designs is available to suit every room and every sort of taste—cuddly nursery animals, delicate flower patterns, kitchen designs for tiles and canisters, sailing ships, etc.

Use transfers to brighten up a dull room. Apply gaily coloured vintage cars to a lampshade and repeat the design on a tiled fire-place surround. White painted furniture in a bedroom is enormously improved if you apply yellow roses to the top and drawers. And to give continuity to your efforts, apply the same yellow roses on lampshades, make-up jars and along a plain wooden pelmet.

For nurseries especially, transfers are a blessing. If you paint your own furniture and decorate it with toy animals, nursery rhyme characters or toy soldiers you can make a charming nursery for a fraction of the cost it would take to buy ready-made furniture.

Bathroom transfer designs include mosaic fish, sea-horses in two different sizes just right for finger plates and glass shower doors, seagulls and sailing ships. Apply them to tiles or straight onto walls so long as they are not distempred. Cosmetic jars, bottles for bath salts, etc., can all be given the hand-painted look in a matter of seconds.

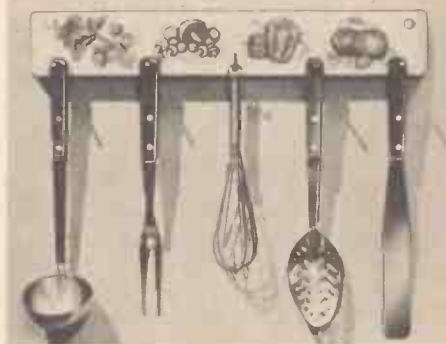

A decorated kitchen rack.

Transfers give the kitchen a face-lift too. There are gay modern fruit and vegetable designs, cooking utensils in line drawings and comical chefs which can be applied to tiles and cupboards or make bright washable decorations for plastic covered cookery books. And there is a very comprehensive sheet of canister names which can be applied to any type of tin, glass or plastic jar, just the thing for muddle-headed cooks who make a habit of putting sugar in the tea bin! Old kitchen trays can be made to look new with a coat of paint and a transfer.

Altogether, transfers can be a big help with modern life and the many ways in which you can use them help to give a personal touch to your home. So if you catch Decalomania, your family needn't worry. It's a disease that can have very pleasant complications! You catch it by visiting Hobbies Ltd shops, stockists, departmental and decorating shops. Or take a look at the Decorette transfers on page 107 of this annual.

Another range of transfers proving very popular is the Alphabet and Numeral

range. These are gold with black outlines and the sizes range from 1", 2", 3½" to 5", prices from 2d. to 1/-. These transfers are adhesive both sides. They are ideal for making shop signs on fronts and glass windows or doors, nameplates and office signs. Many people use them for house names and numbers.



Decorating crash helmets.

Amongst the younger set they are used to put their owner's name or initials on scooters, bicycles and crash helmets. And some Pop Groups even use them on front of their drums! Boat owners find them a very cheap and practical way of naming their boats. When the transfers are used outside it is a good idea to cover them with a protective coat of clear varnish to make them completely permanent.

For the county-proud, there is a range of full-colour county crest transfers. Based on original Heraldic designs all the main counties and areas of England, Scotland and Wales are available, including Chequered Flags, Union Jacks and a GB sign for motorists travelling overseas.

Each crest measures approximately three inches square and can be applied to any clean hard surface. The obvious use for them is on cars, scooters and motor-cycles, but they make very attractive decoration for place mats made from small off-cuts of hardboard. Use them on lampshades, fronts of bars or even beer glasses—provided you only give the glasses a quick rinse and don't soak them in water. Each County Crest costs 2/-.



Transfers made up into children's pictures.





An introduction to do-it-yourself painting and decorating by David Johnson Editor, 'Do it yourself' Magazine.

When you consider that at least one in five of all adults in this country follows some do-it-yourself activity, spending several pounds in painting and decorating materials every year, it becomes easy to appreciate that the turnover of the DIY Industry is about £450 million.

Over the past twelve years the man-in-the-street and his wife have come to appreciate that maintaining the home to a bright, modern standard provides not only a pleasurable hobby, but a most profitable one.

I said pleasurable one, and so it is if you approach the matter in a planned, sensible way and avoid bull-at-the-gate methods which lead to physical strain and disappointment.

As for the profit in it, look at these facts. Good, long lasting painting and decoration depends upon the amount of time spent in preparing the surfaces to be decorated, the choice of finishes and their application. When you ask for an estimate for having the work done, at least 75 per cent of the proposed charge is for labour. If you could be sure that the work done was of a high professional standard then there's something to be said for having the work done—if you can afford the present day high cost of labour.

But if you feel, as I do, that you can use exactly the same materials—or better ones—than the tradesman uses, if you can follow exactly similar techniques and are

prepared to spend the right amount of time on the job, then quite obviously, you should do-it-yourself.

The money saved will then provide the luxuries—or the things you can't make—which at present are out of reach.

It is unfortunately true that many house-

holders coming new to do-it-yourself think they can do all the vital work in maintaining their property 'on the cheap'. This is bad practice for it results in poor workmanship and blame is put on the products used, which is quite unfair.

The tools and materials available today are the products of manufacturers' expensive research programmes and are guaranteed to do the job if used correctly.

So at the start, buy the best equipment you can afford.

Supposing you decide to give a room a complete face-lift? What do you need, how do you set about it?

Here is your programme:

**FIRST.** Clear the room of all smaller furniture. Take down curtains, roll up carpet or cover with polythene sheeting. Put larger furniture in centre of room and cover with polythene dust sheet. Now, wearing overalls and head covering, tackle the ceiling by washing with warm water and a little detergent, using a large sponge. Wipe off excess water as you proceed to clean areas of about a square yard at a time.

Walls and paintwork come next. If faded wallpaper has to come off and does not respond to several wettings with water, use one of the patent wallpaper strippers. Now fill any cracks with a suitable filler. There are many on the market, but very good results, especially with fine hair cracks, have been reported on the use of a tile cement instead of a cellulose-based filler.



Use polythene for covering furniture and carpet.

When the ceiling is dry give it a first coat of emulsion paint, using a good quality roller, but use a 1 inch paintbrush for the corners. Allow to dry.

**NEXT DAY.** Apply second coat of emulsion paint to ceiling. Wash off all paintwork and dry with a leather. Any bad patches should be lightly sanded down or scraped to leave a feathered edge. Apply undercoat. When dry hang the wallpaper.

**FINALLY.** Finish wallpapering (or painting) walls and put on finishing coat of paint to all painted woodwork. Allow all painted surfaces to become completely dried before moving furniture back into position.

For a job of this kind what equipment and materials do you need?

First, you have got to be able to get near enough to your work so that it can be done in comfort. You cannot do a good job if you have to overreach on chairs or boxes. You can make do with a solid pair of steps, a stout scaffold board and a sturdy low table, but why not be a bit ambitious and buy (or hire) one of those excellent platform arrangements with lockable wheels which can be moved easily from one place to another?

So get your equipment ready; a large sponge, 2 buckets (one for rinsing the sponge), detergent, stripping knife, wall-paper stripper, scissors, paste, plumb line, wooden rule or straightedge, paper-hanger's folding table or one of those useful pasting machines which are so popular. If you intend hanging a ceiling paper take a careful look at the Skarsten ceiling paper holder—it makes the job extremely easy.

For painting you will need a 1 inch brush for the smaller areas and a 2 in. or 3 in. for larger surfaces. For ceilings and large areas of walls use a good quality roller outfit which includes a tray to contain the paint.

How much material will you require?

A roll of wallpaper measures 11 yds x 20 in. and this covers approximately 50 sq. ft. if the pattern is a simple one, i.e. you can cut about 5 lengths for a wall 6 feet between picture rail and skirting from one roll. Difficult patterns cover less area because of the waste in matching.

Using a plain or upright striped paper you can expect to cover the walls of an average 12 ft. by 10 ft. room with 5 rolls of paper.

For previously painted surfaces which

are in fairly good condition, i.e. which do not require burning off or stripping, the average covering capacity of paints is:

Emulsion paint. About 70 sq. ft. to a pint, one coat.

Undercoat (flat paint). About 70 sq. ft. to a pint, one coat.

Gloss or eggshell paint. About 100 sq. ft. to a pint, one coat.

To give a mirror-like finish to a flush door, for example (which involves two undercoats, each one carefully sanded with grade 0 glass paper) and two finishing coats of gloss paint (the first also very lightly sanded), you will need  $\frac{1}{2}$  pt. each of undercoat and gloss finish.

If you are using thixotropic (jelly) paints the spreading capacity is about one tenth less in area, but the thickness of the paint film you apply is slightly greater than ordinary paints.



A folding table, specially made for paper hanging.



Cutting in round the windows—the most difficult job!

### BRIEF HINTS

*Never* apply paint on a flaking or blistered surface, because the new paint will not adhere properly.

*Never* paint over dirt, grease or wax polish. Your new paint will have a poor gloss and take a long time to dry.

*Never* paint over wet surfaces, or flaking and blistering will result.

*Never* paint over old, thick, soft paint, or your new paint may blister.

*Never* ignore the skin that forms on the top of paint in already opened tins. If you can, remove it. If the skin becomes mixed in, strain the paint into another clean container.

*Never* sweep floors or dust just before, during, or just after painting. The dust will spread like fall-out to ruin your surface.

*Never* use dirty brushes, because your paint will be bitty.



Paint regularly and you will find your task of preparation easy. Leave it for any length of time and you will find your fingernails, knuckles and temper will become frayed and your holidays will have to be devoted to major painting jobs.

Read the instructions on a can of paint. The text has been carefully prepared and provides vital information.

If you are painting over wallpaper with emulsion or water paint, do a small trial area first. If the pattern on the paper stains through the paint, which is by no means impossible, then use a primer sealer. This will usually overcome the trouble. But remember that sealing the wallpaper will make it more difficult to remove at a later date.

Make sure new walls are completely dry before painting.

Do not apply paint too thickly. It may dry with a wrinkled or shrivelled surface.



Using the paper hanging brush.

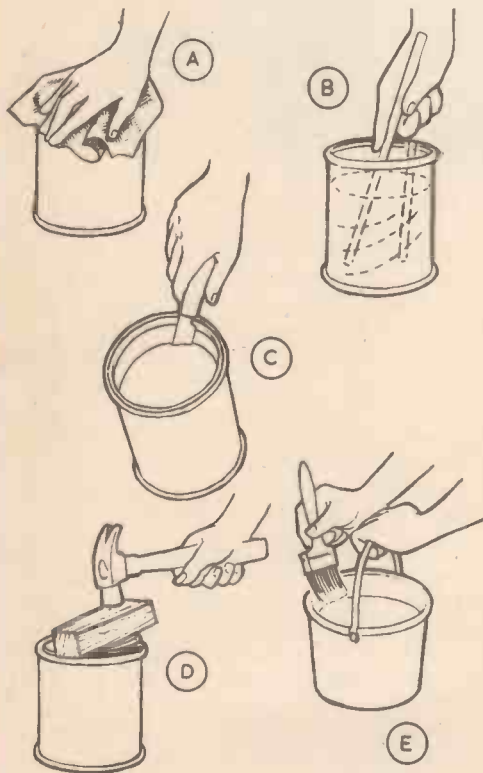

A. Always wipe the can before removing the lid.

B. Paint should be stirred with a lifting motion.

C. If the paint has formed a skin remove it by cutting round the edges. Don't try to work it into the paint.

D. Always close the lid tightly.

E. Wipe off excess paint this way to avoid drips and mess.

**A selection of scrapers.**

F. Wallpaper Stripper.

G. A stripper which can be used for filling also.

H. A Skarsten scraper.

I. and J. Paint strippers for mouldings.

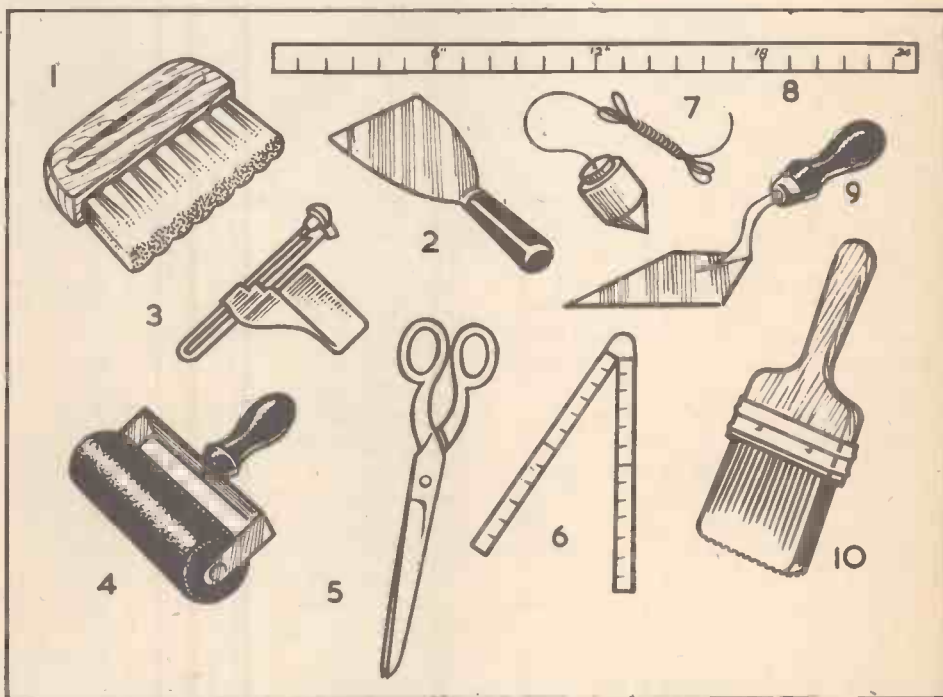

**Tools for Paperhanging.**

1. Paperhanger's brush.
2. Stripping Knife.
3. A Ridgeley paper trimmer.
4. A Roller for vinyl wall coverings.
5. Shears.
6. Folding rule.
7. Plumbline.
8. Straightedge.
9. Plaster filling trowel.
10. Pasting Brush.

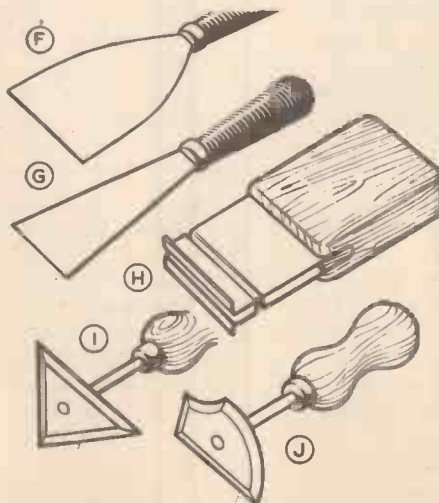

**hobbies**

# the 'graduate'

A FIRST RADIO CONTROLLED MODEL

BY  
JOHN I. CHINN



Why 'A First Radio Controlled Model'? We could have said 'A Beginner's Radio Controlled Model' or something similar, but this would be misleading in view of our firm belief that some previous experience of building and flying model aircraft is essential before tackling a Radio Controlled machine. The belief that Radio Control is a kind of secret formula for successfully flying any roughly constructed untrimmed aeroplane, is absolutely false. We have all seen the shockingly rough model which performs like a dream straight from the workbench. We forget, or never see, the many that are total failures.

Why build a model like this from a plan, when it is so much easier to build one of the many kit models, extensively prefabricated, which one sees advertised? This is a question that naturally springs to mind, and may only be answered in the light of some experience, by trying to determine the actual needs of the beginner. While many kit models on the market are first-class, one has to accept that these have to be commercially competitive, which inevitably means minimum cost, minimum materials, and minimum size. It really is quite amazing how the stock sizes of balsa wood govern the design of model aeroplanes! We then have to decide if all, or indeed any, of the available kit models measure up to those needs.

So, we forget all about the length of balsa, and try to decide what are the features most needed in the model, to help smooth the none-too-easy road to successful Radio Controlled Flying. A simple, basically stable, relatively slow-

flying design is essential; particularly to the 'lone' enthusiast without the benefit of expert advice. The model needs to be strong to survive the inevitable 'prangs' resulting from 'pilot error' etc., and should preferably have some form of 'breakaway' engine mounting to absorb much of the impact of a violent crash, and in so doing save the engine from serious damage. The engine mounting should be easily adaptable to any engine of suitable capacity that the builder might already own, and provide a means of adjusting the thrustline in any direction. The engine, tank, etc., must be easy to get at. The space available for the control installation should be large, and unobstructed, to allow a neat accessible set-up with almost any combination of single-channel radio equipment. In order to carry the higher payload of modern superhet receivers, motor driven servos, etc., which may be the choice of the builder, yet retain relatively docile flight characteristics, the model should be somewhat larger than most of the current popular kit models.

Well, our model seems to measure up to these requirements. As with most projects of this kind, some compromises have to be reached in order to retain an easily assembled structure. The wing section used, and the flat tailplane, are not ideal, but as the beginner is advised to fly only in very calm air conditions, the simplicity of constructing and covering these surfaces makes them the more sensible choice.

The model is strong, without being heavy. The prototype, during extensive

testing and various changes of engine and radio equipment, survived a number of 'prangs', the worst of which resulted in only a smashed engine mount and a cracked servo mount. Spare mounts are a worthwhile addition to your flying kit.

The following instructions should be studied in conjunction with the plans and photographic sequence, going through each stage in your mind, so that you have a full understanding of the job before you begin. When buying the balsa wood for this model, or in fact any model, particular attention should be paid to selecting the correct grades. Balsa wood varies in density, and therefore weight and strength also vary considerably. As an example, should very hard balsa be used in the construction of one half of a wing, and soft balsa in the other, one would have an unbalanced structure, with one wing weak and easily damaged. An extreme example perhaps, but it serves to illustrate that some degree of 'matching' is desirable.

We would advise the use of a good thick board, perfectly straight, and large enough to take the complete wing (48" x 12"), on which to build this model. A piece of three-quarter-inch 'Blockboard' is ideal. The usual simple hand tools such as pliers, fret or coping saw, drill brace and fine drills and a good balsa knife will be needed. Sandpaper in the finer grades, and one or two good 'square' blocks around which to wrap it, are essential. A box of dressmakers' pins is a good investment, as is a small oil stone with which to keep your knife blades razor-sharp.

Throughout the following stages of



construction, abbreviations will be used. These may be identified from being coupled with the full term at the first time of using.

Adhesives are most important. Where more time is required than that allowed by the fast-setting properties of ordinary cement, P.V.A. white adhesive such as Brltfix '55' is ideal, and in fact adds considerably to the strength of laminated balsa parts. For simplicity, the terms 'cement' and 'P.V.A.' will denote the joining of parts by smearing BOTH surfaces with the selected adhesive.

All material used in the construction is MEDIUM GRADE balsa, unless otherwise specified. Direction of wood grain is important, and should be as shown on the plans.

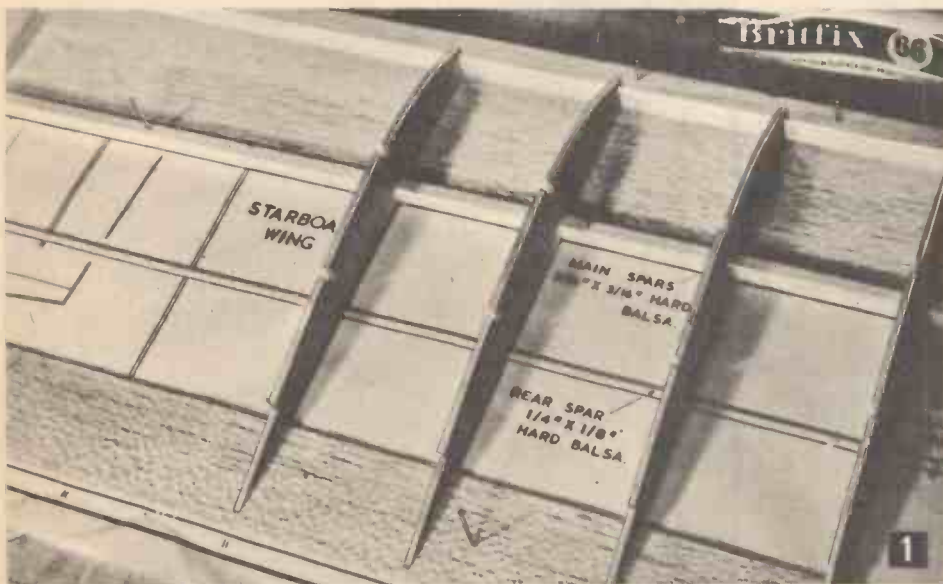

### The Wing

Cut out the separate starboard wing tip panel, and join accurately with the main panel, so that you have a full starboard wing plan identical to the port. It is a good idea to cover your plan with a sheet of thin polythene or waxed paper, to prevent the structure from sticking to the plan. Lay the full wing plan over your building board (BB), so that you may build the wing halves concurrently. Both wing halves are built in exactly the same manner. The following instructions describe the construction of one half.

#### Stage 1

Select three sheets of  $\frac{1}{16}$ " balsa, two for the leading edge (LE) top and bottom covering, and one for the trailing edge (TE) top and bottom. Cut the sheets at 22", leaving a balance of 14" from which the ribs will be cut. Cut the TE piece down the centre to give two pieces  $1\frac{1}{2}$ " in width. Cut one LE piece to  $2-9/16$ " in width for the bottom surface, leaving the remaining piece uncut.

You must now cut out twenty wing ribs, sixteen of them identical and four only

slightly different. The most accurate method for doing this is to cut one pattern exactly right from  $\frac{1}{16}$ " plywood. This pattern is then laid upon the balsa and held with the finger-tips, so that you are able to cut around it with a balsa knife, cutting the notches last. Repeat this process for all twenty ribs, stripping the surplus away from the four slightly smaller ribs afterwards.

Begin construction of the wing by pinning down the LE and TE lower sheets over the plan, checking with a rib that they are exactly the right distance apart. Select the  $\frac{3}{8}$ " x  $\frac{3}{8}$ " LE strip, and P.V.A. flush with the LE sheet front edge. Next P.V.A. the  $\frac{3}{16}$ " x  $\frac{3}{16}$ " lower main spar to the rear edge of the LE sheet. Again check with a rib that the strips are exactly

located, and then pin all firmly in position.

Now P.V.A. the ribs in position, working from the tips toward the centre. As the plan will now be partially obscured, the guide-lines beyond the wing outline will help you to align the ribs. Make sure that the ribs are straight, and also perpendicular. Use pins where required to secure the ribs until set. (See Fig. 1). Omit the  $\frac{1}{8}$ " root rib for the present.

#### Stage 2

The structure must now be temporarily removed from the plan. Trim off surplus wood projecting beyond tip rib, and sand flush. Both the LE strip, and the TE must

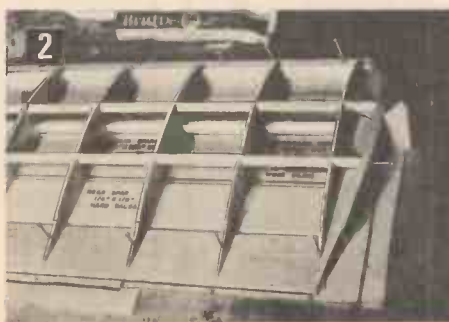

now be bevelled to follow the contour of the rib upper surfaces. This is best done by laying each edge in turn along the edge of the BB, and gently rubbing down with a sanding block, taking care not to damage or alter the shape of the ribs. Pin structure down to plan as before.

Cut tip-piece to pattern shown, from  $\frac{1}{8}$ " hard balsa. Bevel bottom edge of tip-piece at 45 degrees so that it will fit against tip rib, flush with the bottom edge, and project outward and upward at 45 degrees. Cement tip in position. You may cut a balsa wedge for retaining the tip at the correct angle until set. Select the upper  $\frac{3}{16}$ " x  $\frac{3}{16}$ " main spar, and the  $\frac{1}{4}$ " x  $\frac{1}{8}$ " rear spar, bevel the ends to fit neatly against the tip-piece, and P.V.A. or cement into the ribs. Make sure that the rear spar is flush with the rib upper surfaces, and main spar flush with the front portion of the ribs. (Fig. 2).

The  $\frac{1}{8}$ " root ribs should now be cut through, level with the front edge of the main spars. Using a template cut from balsa to the pattern on the plan, set up and cement in place the rear portion of this rib at the correct angle.

Trim tip-piece TE recess to the same level as the ribs. Take the matching piece of TE, mark on it in pencil the rib positions, so that you will know where to apply the adhesive. Check for fit along the ribs, and P.V.A. in place, using plenty of pins to secure it until set.

Cut the two dihedral braces from  $\frac{1}{16}$ " plywood, and cement firmly in position behind the LE strip and in front of the main spars of the STARBOARD wing. Cut to fit, and cement the remaining portion of the starboard root rib accurately in place. (Fig. 3).

Cut to fit, triangular pieces of  $\frac{1}{8}$ " balsa to fill gaps between tip-piece, tip rib, and top spars. Cut a small piece of  $\frac{3}{8}$ " x  $\frac{3}{8}$ " balsa to fit between LE strip and tip-piece. Allow adequate time for assembly to set hard.

#### Stage 3. (Starboard wing only)

Select LE top covering piece, and trim to  $2\frac{3}{4}$ " width. Trim level of recess in tip-piece so that it is to the same curvature as the ribs. Using the same procedure as with the TE, P.V.A. the LE covering in place. Plenty of pins along the LE and upper main spar will be needed to hold the sheet around the curvature of the ribs until set. Cut  $\frac{1}{16}$ " sheet fill-in pieces to fit the areas between the upper spars at the wing root, and cement in place. Allow to set.

#### Stage 4

Joining the wing panels together. You will need some thick books, a box, or something similar with which to support the outer end of the port wing, so that the underside of the tip rib is raised to a height of  $6\frac{3}{4}$ ". The root ribs should then meet flush with each other, and the di-

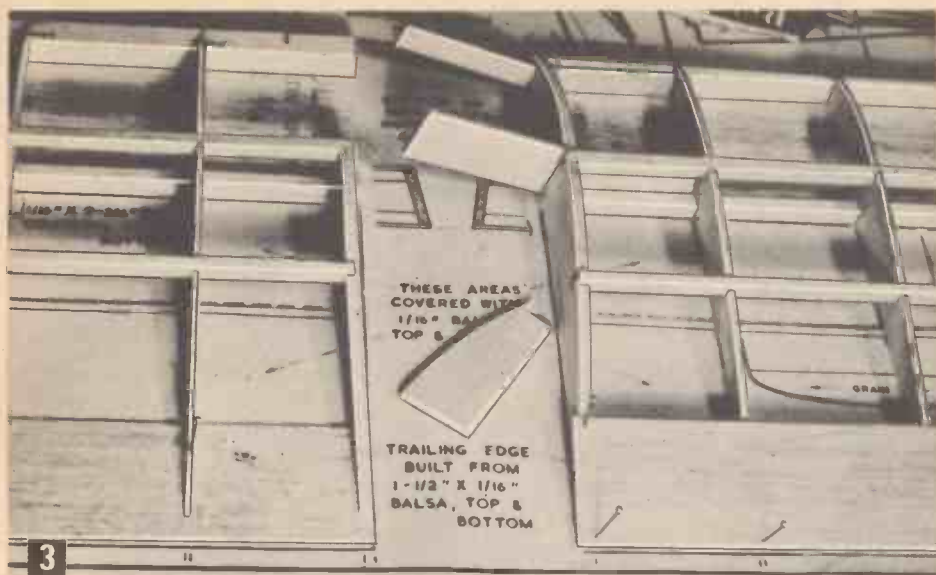

hedral braces should fit neatly in position in the port wing. Trim faces of root ribs, and ends of dihedral braces fractionally if needed to obtain a good joint. Liberally coat all surfaces to be joined, particularly the ply braces, with P.V.A. or cement and press firmly together, pinning as required. Scrape away all surplus cement while it is still soft, and allow structure to remain undisturbed until set. (See Fig. 4).

Remove wing from BB. Pin port side of wing down firmly. Repeat Stage Three covering sequence on the port wing, making a neat joint with the sheet covering already on the starboard wing. Allow to set hard.

Remove wing from BB. Cut  $\frac{1}{16}$ " sheet fill-in pieces to fit areas between root and first ribs on underside of wings, and cement in place. Round off the LE by careful carving and sanding, to the 'D' section shown on the plan. Sand all surfaces nicely smooth; particularly all junctions between spars, ribs, tips and sheeting. Give all external surfaces one liberally applied coat of clear dope, and sand smooth with 'flour' grade paper when dry.

#### The Tailplane

##### Stage 5

This component is very simple. The important point is to obtain the right grade of balsa. 'Quarter-grain' is the thing to look for. If your stockist cannot help you, look for a fairly light coloured sheet with a dark grain line, and a dappled cross-grain appearance. This particular cut is light, strong, and very resistant to distortion.

When cementing the two main parts together, scrape away all surplus cement that may squeeze from the joint, and pin the wood down to your BB so that it will set quite flat. When set, trim to correct length (17") and mark out the outline shape of the tailplane, taking measurements from the plan. Trim away surplus

wood, and cut two  $\frac{1}{2}$ " strips from this to form the tailplane tips. Using separate tips in this way, with the grain at right-angles to that of the main areas, helps to prevent any curving of the outer ends of the tailplane. Next P.V.A. the  $\frac{1}{8}$ " balsa centre stiffener ACCURATELY in position. This must also be cut with the grain at right-angles to the tailplane grain. When all is set hard, sand top surface down to the section illustrated in the side-view, leaving the TE no less than  $\frac{1}{16}$ " thick, and round-off the tips. Sand whole tailplane smooth, apply one coat of clear dope, and finally sand with 'flour' paper when dry.

#### The Fuselage. Study Figs. 5 to 9.

##### Stage 6

Bearing in mind the point of selecting similar grades of balsa for opposing like parts, cut out to the patterns provided, the fuselage sides and 'doubblers' 'H' and 'J'. These must then be accurately joined together to form a 'sandwich' with P.V.A. These 'sandwich' or laminated sides will be immensely strong when set, where the strength is needed, yet light where lightness is desirable. Make sure that you build a LEFT and RIGHT, and not two the same. Laid upon your BB, or somewhere else perfectly flat, and weighted down with books or whatever you have available, these should be left overnight to set hard. Formers 'A' and 'B' should be cut out next, and the like pairs stuck together with P.V.A. Again lay flat, weighted down overnight. Cut former 'C' as specified. Using  $\frac{1}{8}$ " x  $\frac{1}{2}$ " strip, build formers 'D', 'E', and 'F', pinning directly over the plans.

##### Stage 7

Cut out each of parts 'K', 'L', and 'M' accurately from the woods specified. Cut a pair of motor-mount bearers from  $\frac{1}{2}$ " x  $\frac{3}{16}$ " hardwood  $6\frac{1}{4}$ " in length. (This is a 'stock' size in most model shops). Take the pre-laminated formers 'A' and 'B',

and former 'C'; and sand all the edges smooth, making sure that the widths are correct. Check that the bearers are a neat fit in the former notches. Drill bearers at points shown on plan top view, to take  $\frac{3}{8}$ " x 8 b.a. brass bolts. As the heads of these bolts will be 'buried', you must 'lock' them in some way to prevent rotation when the nuts are tightened down. The simplest way to do this is to drive a pin into the bearer beside each bolt-head, bend it over to lie on the bolt-head, and solder it in position. Lay each bearer in turn upon the plan, and cement blocks 'K' and 'M' to them, checking that the gap left to take former 'A' is exactly right. Next cement pieces 'L' to these bearer/block assemblies, one left and one right hand, correctly aligned on all sides. Allow to set.

Check fit and alignment of bearer/blocks, laminated fuselage sides, and formers 'A' and 'B' with former 'C' pinned in place. The sides should be quite parallel, with the formers evenly touching.

##### Stage 8

Cement  $\frac{1}{4}$ " x  $\frac{1}{8}$ " longerons to inside edges of fuselage sides, from doubler 'H' to the tail, across the tailplane recess and former 'E' position. Fill in with a short piece across ends of side panels as shown.

Cement or P.V.A. bearer/block assemblies accurately in position on nose doublers, checking that formers 'A' and 'B' will fit accurately, and that the fuselage sides are perfectly in line when viewed from the sides. Take former 'A', and drill a series of  $\frac{1}{16}$ " holes at the points marked. Carefully bend the upper end of the nose-wheel leg to a right-angle to starboard, and then backward, so that it fits over the face of former 'A' between the holes you have drilled, and back under the starboard bearer. The leg must now be firmly 'sewn' to former 'A' with strong carpet thread or something similar, smearing plenty of cement around the leg, and the former face and back, before, during, and after 'sewing'. Sew as many loops as you can through each hole. Make it strong.

##### Stage 9

Cut from  $\frac{1}{8}$ " sheet balsa the parts for the fin and rudder. Cement the fin parts





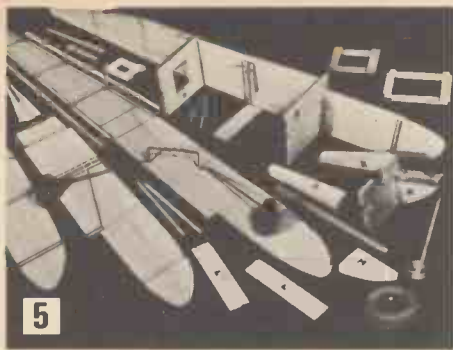

together as you did when making the tailplane. When set, sand all fin edges except the bottom to a half-round section. The rudder should be sanded to the tapered section shown on the plan. Cut out piece 'O', cutting the slot to fit the key-piece at the base of the fin. Remove formers 'D', 'E', and 'F' from the plan, and with your sanding-block bevel the edges as needed to fit the slope of the fuselage sides, bottom, etc. Check that former notches fit between longerons at correct former positions, which should be marked on the fuselage sides to aid final assembly.

#### Stage 10

Using plenty of cement at all joints, join fuselage sides with formers 'A', 'B', and

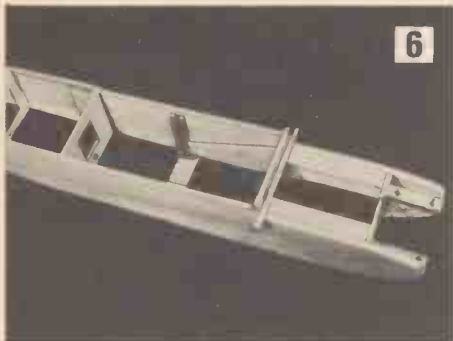

'C', paying particular attention to the positioning of former 'C'. Use plenty of elastic bands around the fuselage to hold it firmly together while settling. Before this assembly sets, cut the 'fuel tank floor' piece from  $\frac{1}{8}$ " balsa, absolutely 'square' to fit between pieces 'L' and formers 'A' and 'B' ( $1\frac{5}{8}$ " x  $3\frac{3}{4}$ "). Cementing this in place before the assembly sets, will ensure a correctly aligned fuselage.

Bend the rear undercarriage legs to shape from 14 s.w.g. piano wire, taking measurements from the half-scale diagram and plywood mounting pattern. Cut plywood mounting to an exact fit between fuselage sides, and drill similarly to former 'A'. Cement and sew wire to the ply mount, noting that the wire lays over the ply. It will be necessary to file or cut a small channel in each fuselage side to take the wire legs, and allow the ply U/C mounting to go up into place between the ends of fuselage doublers 'J'. Use plenty of cement around the legs when cementing the mount in place. Cut out and

cement in place the floor stiffener behind former 'B'. Also  $\frac{3}{8}$ " x  $1\frac{1}{4}$ " block flush with fuselage top, behind former 'C'. Allow assembly to set hard.

#### Stage 11

The fuselage sides now have to be curved to meet at the tail. It is a good idea to hold each side in turn in the steam from a kettle-spout, gently bending them toward one another so that they take a 'set'. But make sure that the bend comes in the right place, for the sides are quite straight from former 'E' to the ends. Place an elastic band around the extreme ends of the fuselage sides, and starting with former 'D' cement the remaining formers in place, finishing with a piece of  $\frac{1}{4}$ " x  $\frac{1}{8}$ " chamfered to a triangular section

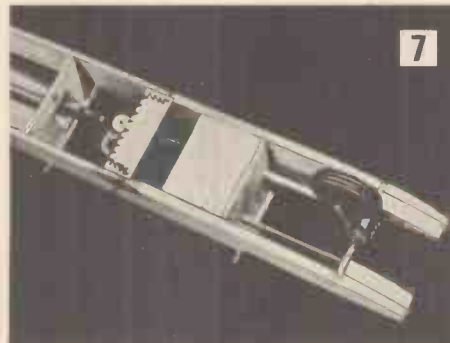

and cemented between the uprights at the tail end. Check alignment of the rear fuselage against the plans. Cement piece 'O' between the top longerons and former 'F'.

#### Stage 12

The structure of your model is now virtually complete, and there only remains the  $\frac{1}{16}$ " sheet covering to the fuselage top and bottom, and the addition of the fin and rudder, dowels, nose and tail blocks, etc. At this point however, it is advisable to decide upon the radio control installation layout. The plans and photographs show the original O.S. Minitron single-channel installation using a rubber-driven compound escapement. This installation has proved completely reliable, and represents a good simple type of control system, capable of extension to give throttle control, and offering 'selective' left-or-right rudder at a very reasonable cost. There are of course many other excellent single-channel R/C outfits avail-

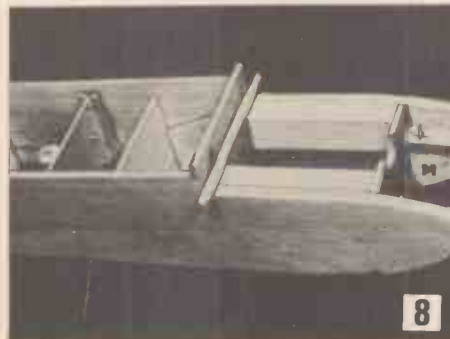

able, notably the British made R.C.S. and Macgregor sets, and the Japanese Futaba. All these makes offer a combination transmitter/receiver outfit, which with the addition of a good quality escapement, may be purchased for under twenty pounds.

In planning your layout, be guided by the installations shown in the photographs. (Figs. 11 & 12). The instructions supplied with your R/C outfit will provide all other essential information.

#### Stage 13

From  $\frac{3}{8}$ " balsa, cut a wedge-shaped block to fill the gap between the fuselage side panels at the extreme tail. Cut a 1" wide piece of  $\frac{1}{4}$ " balsa sheet to fit behind the bottom of former 'A', and cement in place. Form 'cabin' block from pieces of  $\frac{1}{4}$ " and  $\frac{1}{2}$ " balsa sheet cemented in position, and carved and sanded to shape when set. Before fitting this block, the forward  $\frac{1}{4}$ " dowel must be cemented in place. Accurately mark and cut holes in the fuselage sides to accept remaining dowels, which should then be cut to length and cemented firmly in position.

Cover top of fuselage from former 'C' to the tail with  $\frac{1}{16}$ " sheet balsa. P.V.A. is best for this job, as you will need time to apply adhesive to the sheet and the fuselage structure.

#### Stage 14

Make up the rudder push-rod as shown on the plan, to suit your installation. Bolt and cement a  $\frac{3}{4}$ " nylon control horn to the rudder. Cement the fin in position, making certain that it is upright, and perfectly aligned with the fuselage centre-line. Using nylon hinges as shown on the plan, secure the rudder to the fin. If you are using an escapement, then drill the fuselage tail-block to take the escapement-



rubber winding hook bearing, and the  $\frac{1}{8}$ " dowel stop. Cement brass bearing tube in position. Bend winding-crank from 18 s.w.g. wire, hook end first, then the crank AFTER passing it through the bearing. Cover the fuselage bottom with  $\frac{1}{16}$ " sheet balsa from former 'A' to former 'F'. Finally, carve and sand the 'V'-shaped bevel in the fuselage top, immediately behind the wing TE, to allow backward movement of the wing in the event of a 'prang'.

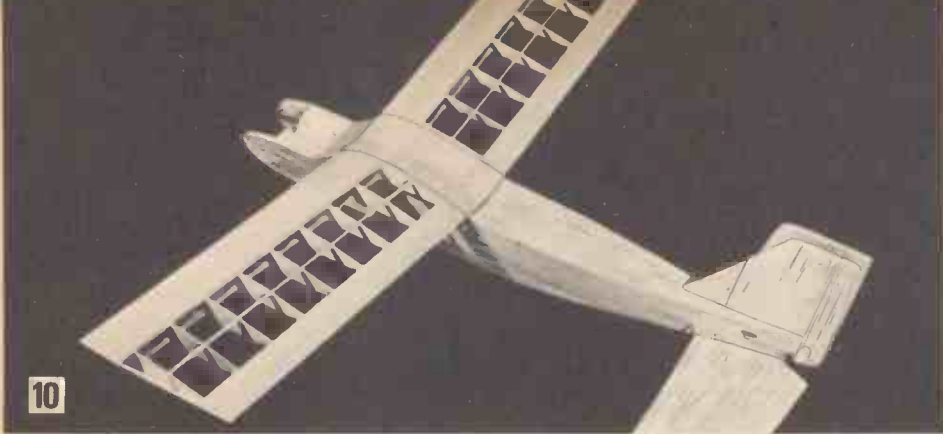

### Stage 15

Sand all fuselage edges smooth, and then entire fuselage surfaces until they are all even. Particular attention should be paid to the nose areas, using fairly rough grade paper to begin with. When you are satisfied, give whole structure two coats of clear dope, and finish with 'flour' paper. This completes the airframe. (See Fig. 10).

Using the method described in Stage Five of our Hi-Jet feature, the entire model must be covered. 'Heavy' grade 'Modelspan' tissue is quite suitable for the wings, and should be applied in exactly the manner described, except that gum should be applied only to the edges of the structure, and not all over the sheet areas.

The tailplane and fin should be covered as though they were open structures, using 'LIGHT' grade 'Modelspan', and making sure that the tissue grain runs in the same direction on each side of these components.

The fuselage is also covered with 'light' grade tissue, grain direction being unimportant in this case. When the tissue has dried out, at least three coats of clear dope must be applied to the fuselage and tail-unit. The wing will need four or five coats to 'fill' the heavier grade tissue. Wing and tailplane must be securely pinned down flat while the top surfaces are being doped, to avoid distortion. Apply several coats of clear dope to all exposed wood of nose area, and inside radio compartment.

Colour trimming, using coloured dopes or enamel, transfers, etc., should be added as desired, but in the interests of lightness, keep the paintwork to a minimum.

Finally the entire model should be treated with a coat of FUEL PROOFER to preserve the finish. 'Humbrol' Hot Fuel Proofer is ideal for this job.

### Stage 16

Cut the  $\frac{1}{8}$ " plywood engine mounting to fit the engine which you have selected, and drill the holes to accept the bearer bolts and engine mounting bolts. The engine must be bolted firmly in place, with two 'locked' nuts to each bolt.

The one-ounce capacity 'clunk' tank rests in the 'box' provided, and is secured by elastic bands stretched between the dowel pegs. Study the instructions provided with your engine, and practice starting the engine before taking that first trip to the flying ground.

Install your radio equipment neatly, following the manufacturer's instructions and advice. Pay particular attention to the neatness and strength of any soldered joints. Allow sufficient space for plastic or rubber foam packing around receiver and batteries. All snap-on type battery connectors should be secured with rubber bands. Control linkage and rudder should be free in operation, but without 'play'.

Check operation of control, and test according to the instructions provided with your R/C outfit. Remember that thorough checking before attempting to fly, is always the rule, even for very experienced R/C 'pilots'. To minimise the risk of losing the model in the event of radio failure, a smaller fuel tank may be used during the testing period. A 10 c.c. polythene bottle, with a threaded top of the same diameter as your 'clunk' tank, can be obtained from any helpful chemist.

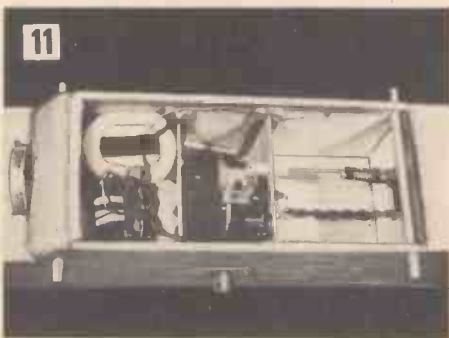

Before the first power flight, a series of glide tests should be carried out. Assuming that the model is balanced correctly, proceed with glide tests in the manner described in Stage Seven of our 'Hi-Jet' feature. If ballast is needed, small flat pieces of lead may be slipped over the bearer bolts, or secured within the fuselage tail.

When you are ready to attempt the first flight, check everything. Make sure that the wing and tailplane are held securely

in place, using several rubber bands each side and diagonally. When the engine is running, switch on the radio, and check again that control is absolutely right. Try to get the engine running at below full power for the first flight, and allow the model to take off if possible, as this is less hazardous than an erratic hand-launch. When the model leaves the ground, DO NOT attempt to turn it, just try to keep it headed into wind, climbing away from you, until you have become accustomed to its reactions to control. Make your first controlled turns fairly high up, remembering that little harm can come from temporary loss of control unless you hit the ground!

So the rest is up to you. Practice is essential, and fly only when conditions are suitable. Check, check, and CHECK again that everything is OK before you fly.

One final point. You must be licensed to operate an R/C model, and in your own interests you should be insured. The licence will cost you one pound for five years, the insurance as little as half-a-crown per year, subject to certain conditions. A radio-controlled model aeroplane can bring you much pleasure, it can also be lethal... Fly sensibly.

### MATERIALS AND ACCESSORIES LIST

- 8 pieces  $\frac{1}{8}$ " x 3" x 36" Medium balsa.
- 1 "  $\frac{1}{8}$ " x 3" x 36" " "
- 2 "  $\frac{1}{8}$ " x 3" x 36" Hard " "
- 2 "  $\frac{1}{16}$ " x 3" x 36" " " "
- 1 "  $\frac{1}{2}$ " x  $\frac{1}{8}$ " x 36" Medium " "
- 2 "  $\frac{3}{8}$ " x  $\frac{3}{8}$ " x 36" " " "
- 4 "  $\frac{3}{16}$ " x  $\frac{3}{16}$ " x 36" " " "
- 2 "  $\frac{1}{4}$ " x  $\frac{1}{8}$ " x 36" " " "
- 1 "  $\frac{3}{16}$ " x 3" x 36" Quarter-grain balsa.
- 1 "  $\frac{1}{2}$ " x 3" x 18" Medium balsa.
- 1 "  $\frac{1}{2}$ " x  $\frac{1}{2}$ " x 36" Hard balsa.
- 1 square foot of  $\frac{1}{8}$ " plywood, and 1 square foot of  $\frac{3}{8}$ " plywood.
- 1 piece hardwood  $\frac{1}{2}$ " x  $\frac{5}{16}$ " x 13".
- 1 piece of 14 s.w.g. and one of 18 s.w.g. piano wire.
- 1 foot each of  $\frac{1}{4}$ " and  $\frac{1}{8}$ " hardwood dowel.
- 1 'Enterprise' 2" nosewheel and leg, and a pair of  $1\frac{1}{2}$ " lightweight rubber-tyred wheels. One  $\frac{3}{4}$ " nylon control horn.
- 1 sheet of Heavyweight 'Modelspan' tissue, and 2 sheets Lightweight.
- Clear dope, thinners, nuts and bolts, fuel tank, cement and P.V.A. adhesive.

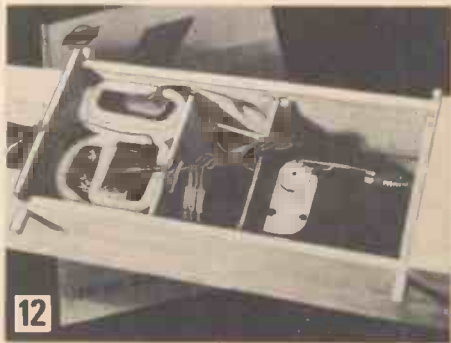







BY  
JOHN I. CHINN

A powerful, exciting, and modern means of propulsion like the Jetex 'PAA-Loader' unit, should surely have a number of models designed to suit it, but where are they? With 'Hi-Jet', we make a beginning to put this odd situation right. The plan, condensed to fit these pages, may make this model appear complicated; in fact, 'Hi-Jet' is simple to construct.

You will have to remove the plan pages from the Annual, and join them accurately to form the complete plan. The starboard wing panel should then be traced, which when turned over, will provide a working plan of the port wing panel. Use the same method with the tailplane outline, noting the centre-line (half-span  $5\frac{1}{2}$ ").

Abbreviations, initially coupled with the full term for identification, are used in the following instructions.

The term 'cement' will denote the joining of parts after smearing BOTH surfaces with balsa cement.

A rigid, flat building board ('BB') at least  $6" \times 30"$  is needed, on which to construct the model (an offcut of  $\frac{3}{4}"$  block-board would be ideal). A balsa-knife, with finely pointed blade (kept razor-sharp at all times), a sanding-block with various grades of fine glass and 'flour' paper, and finally two or three dozen pins, are the only 'tools' that you will need.

**Stage 2**

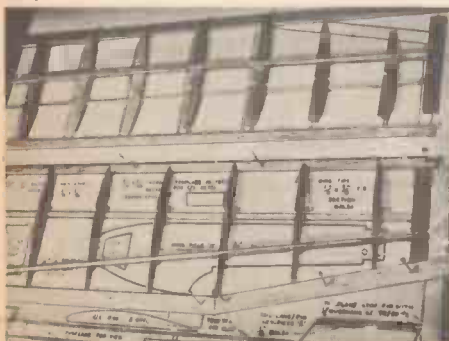

**Stage 1**

Trace side panel 'A' to thick outline, mark out and cut two from specified balsa. Repeat procedure with nose piece 'B', wing platform, fin parts, tailplane, and key-piece 'K'. Cement one side 'A' to piece 'B', and pin down to your BB. Cement fin parts together, and lay aside to set. Cut  $\frac{3}{8}" \times \frac{1}{8}"$  strips to length, cut fin slot through top strip, and cement strips along the edges of piece 'A'. Add short cross-piece and  $\frac{3}{8}"$  tail block. Pin all parts in position until set hard.

Cement the fin into slot in  $\frac{3}{8}" \times \frac{1}{8}"$  strip, and temporarily slide key-piece 'K' around top of fin to retain it in a perfectly horizontal position until set. Remove assembly from BB, lightly sand top and bottom strips flush with part 'B', cement second side 'A' in place, and again pin down to the BB until set.

**Stage 2**

In order to achieve uniform wing ribs, it is worthwhile to cut one W.1 from thin plywood to use as a template, cutting around

It when held by the finger-tips on the sheet balsa. W.2 and W.3 should be cut in pairs. Cover plans with thin polythene sheet to prevent structure from sticking to plans.

Pin Leading Edge (LE), lower spar, and Trailing Edge (TE) in position directly over plans. TE must be accurately jointed and cemented at outer W.1 rib positions. Cut tips accurately to fit, and cement between LE and TE. Cement all ribs over spar and between LE and TE, gently sanding as needed to achieve a snug fit without displacing the other parts. Check that all ribs are perpendicular, particularly the  $\frac{3}{32}"$  root ribs. When set, add top spars, cracking slightly at W.3 rib position, and tapering down underside to fit against lower spar in such a way that the top is on a level with the top of the tip piece. Add stiffening 'gussets' to complete the wing panels. Allow to set hard.

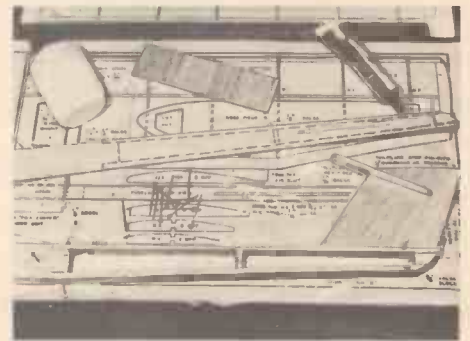

**Stage 1**

**Stage 3**

Perhaps the most tricky part of this aeroplane is the wing Centre-Section (CS). Cut a piece of  $\frac{3}{8}"$  balsa, absolutely 'square', to  $4" \times 1\frac{1}{4}"$ . The top surface must then be chamfered down from a line across the centre to a thickness of  $\frac{1}{4}"$  at the LE, as shown on the plan. Next, the block must be bevelled on both sides; this is best done by holding it flush with a good

**Stage 3**

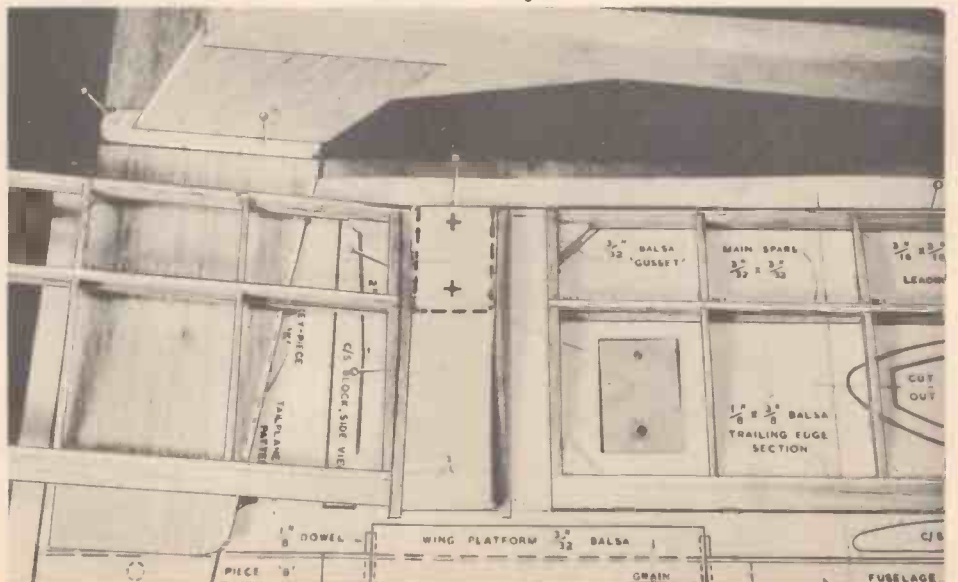



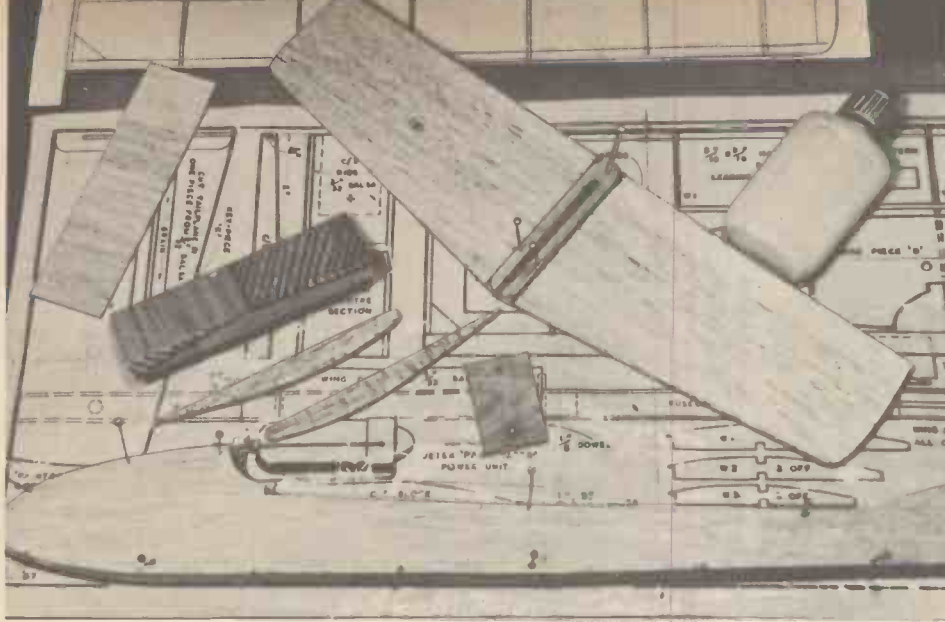

**Stages 1 to 4**

straight edge on your BB, and sanding to the correct angle with grade 1 sandpaper on a nice flat block. The angle should be checked at intervals with a template cut to the pattern given. A final check is made by placing the wing panels on either side of the block, and with thumb and forefinger tightly holding the root W.1 ribs against the CS block, the wing tips should automatically rise to 3" above the BB.

Cement CS ribs to block, and when set, carve TE half of block to follow curvature of ribs. Pin CS block to the BB, set up the wing panels with any suitable packing (books, small boxes, etc.) to a tip height of 3", and cement wing panels securely to the CS ribs. Pin together until set hard.

**Stage 4**

Carefully sand tailplane smooth, rounding off the LE, and tapering the TE down to about 1/32" thickness. Repeat process with fin. Cement key-piece 'K' to underside of tailplane, making certain that it is at 90 degrees to the TE.

Cement wing platform in position, making sure that it is at 90 degrees to the fuselage sides. Insert and cement the 1/8" dowels in the positions shown. Sand entire fuselage smooth, rounding-off all sharp edges. Sand wing surfaces smooth, so that all joints between ribs, LE, TE, and spars are quite flush. Brush a coat of Clear Dope, thinned 25% with Dope Thinners, over entire structure, and lay aside to dry.

**Stage 5**

Lightly sand entire structure with 'flour'-paper. Cut four panels of lightweight 'Modelspan' tissue 6" x 15". Cover each wing panel in turn, top surfaces first, in the following manner: Thoroughly dampen the front of an old newspaper with clean water. Fold the paper in half, with a tissue panel sandwiched between. Smear Clear Gum or Tissue Paste along LE, TE, tip, and a 1/4" strip of the CS area. Remove the

tissue panel, now evenly dampened, from the newspaper, and lay squarely over framework. Gently pull the tissue taut across the mid-point of panel, and press down to LE and TE. Repeat lengthwise between tip and CS, and then from each corner in turn. Smooth out all remaining wrinkles around edges, pressing tissue to gummed frame. Trim waste tissue to 1/4" all round, fold around and gum to underside of frame. Allow top surfaces to dry out before covering undersides. After covering undersides, waste tissue should be trimmed flush with all edges.

**Stage 6**

Your 'Hi-Jet' is now ready for final finishing. Avoid using coloured dope or enamel to decorate the model as this adds weight. The cockpit area may be painted on, but any other decoration is best done with contrasting coloured tissue 'shapes' doped on with thinned clear dope. When the wing has thoroughly dried out, two coats of thinned clear dope should be applied to the underside with a soft brush. While the wing dries out, a final coat of clear dope may be applied to the fuselage and tail assembly. Each half of the wing should now be pinned (pins angled around the outside) down to the BB, while the coats of dope are applied, to avoid any twisting. Allow each side to dry out thoroughly before removing from the BB.

**Airframe**

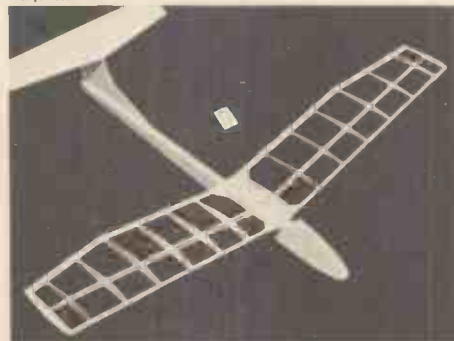

Cement tailplane to top of fin, and allow to set, again checking that they are at right-angles. Cut Jetex mount from ply, drill holes as shown to take the PAA-Loader mounting-clip, and bolt the clip in place with 8 b.a. bolts. The mount may then be cemented in position on the CS block. Bore a 1/4" hole from 'cabin top' down into ballast space in piece 'B' to allow the addition of lead shot for trimming the balance of the model.

**Stage 7**

Wait for a nice calm evening for your test flights. Mount the wing, using several thin rubber bands stretched between the dowels to hold it firmly. Fit the EMPTY Jetex unit, and check that the model balances fore and aft, at the point shown on the plan. Add small lead shot to ballast box if needed, and seal with Sellotape. Now repeatedly test-glide the model, launching into wind (however little) from shoulder height. Try to achieve a straight, smooth, evenly descending glide from a gentle launch. A steep glide may be corrected by removing ballast. A tendency toward stalling, in which the model 'floats' upward and then drops into a steep dive, may be corrected by adding ballast. When you are satisfied with the glide, try a power flight (one fuel pellet) launching gently as before. The model will most likely have a 'natural turn', circling under power as well as in the glide. Any turn correction is best made by cementing a small card tab to one wing (see plan),

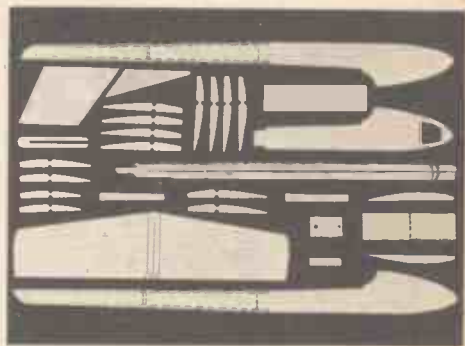

which may be bent up or down slightly to achieve the best flight path.

Good luck, don't burn your fingers, and don't set fire to the model!

**'HI-JET' MATERIALS LIST**

- 1 piece 1/16" x 3" x 36" Medium soft balsa.
- 1 " 3/8" x 3" x 12" " " "
- 2 " 3/32" x 3/32" x 36" hard balsa.
- 1 " 3/16" x 3/16" x 36" " "
- 1 " 1/8" x 3/8" x 36" hard balsa, trailing edge section.
- 2" of 1/8" dowel or plastic rod.
- 1 sheet of coloured lightweight 'Modelspan' tissue.
- 1 medium sized tube of balsa cement; also clear dope, thinners, gum or tissue paste, and a Jetex P.A.A.-Loader outfit.

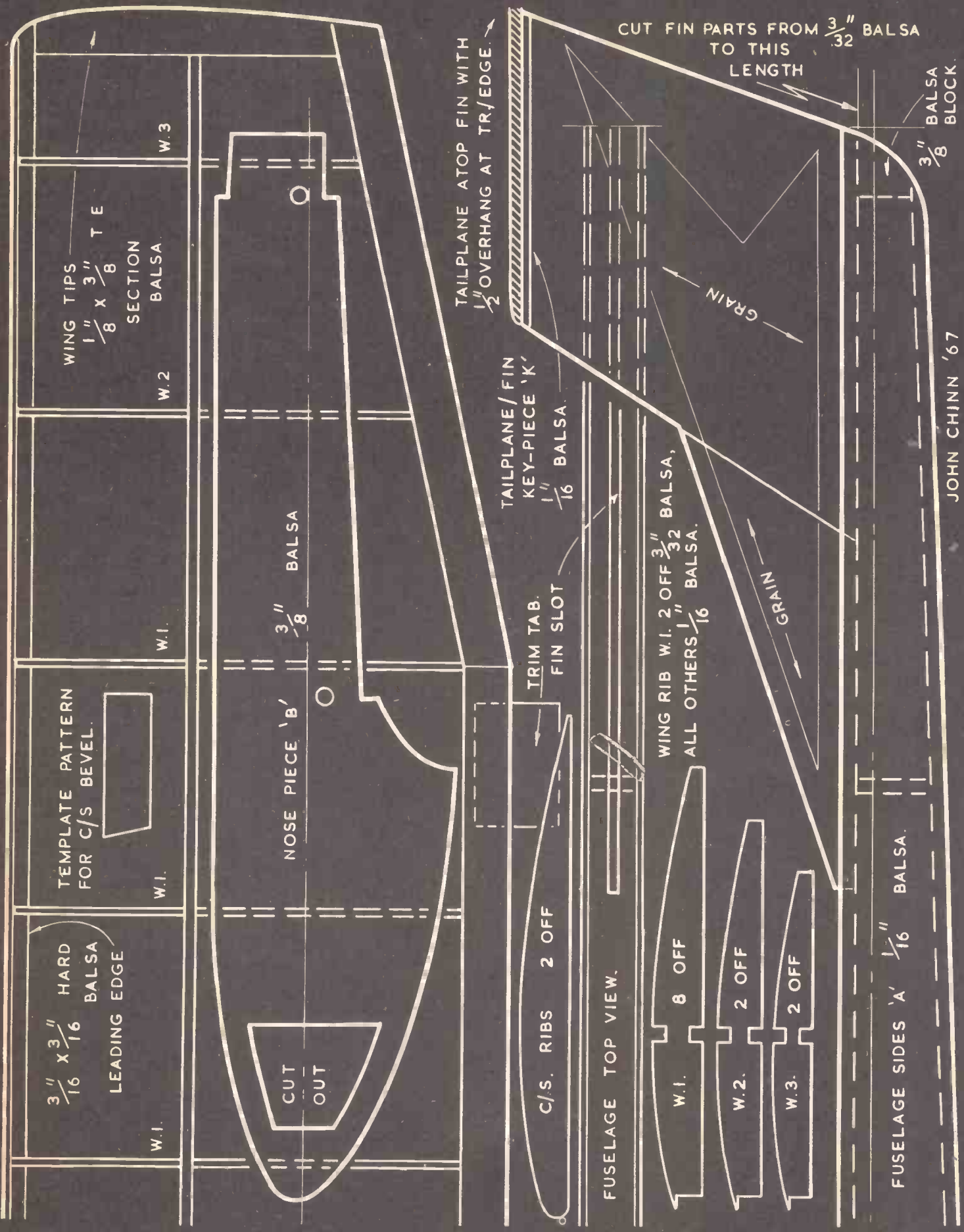

3" x 3/16 HARD BALS LEADING EDGE

TEMPLATE PATTERN FOR C/S BEVEL.

WING TIPS 1" x 3/8 T E SECTION BALS.

NOSE PIECE 'B' 3" / 8 BALS

CUT OUT

TAILPLANE ATOP FIN WITH 1/2" OVERHANG AT TR/EDGE

TAILPLANE/FIN KEY-PIECE 'K' 1/16 BALS

TRIM TAB. FIN SLOT

FUSELAGE TOP VIEW.

WING RIB W.1. 2 OFF 3/32 BALS, ALL OTHERS 1/16 BALS.

W.1. 8 OFF

W.2. 2 OFF

W.3. 2 OFF

FUSELAGE SIDES 'A' 1/16 BALS.

CUT FIN PARTS FROM 3/32 BALS TO THIS LENGTH

3" / 8 BALS BLOCK

JOHN CHJNN '67



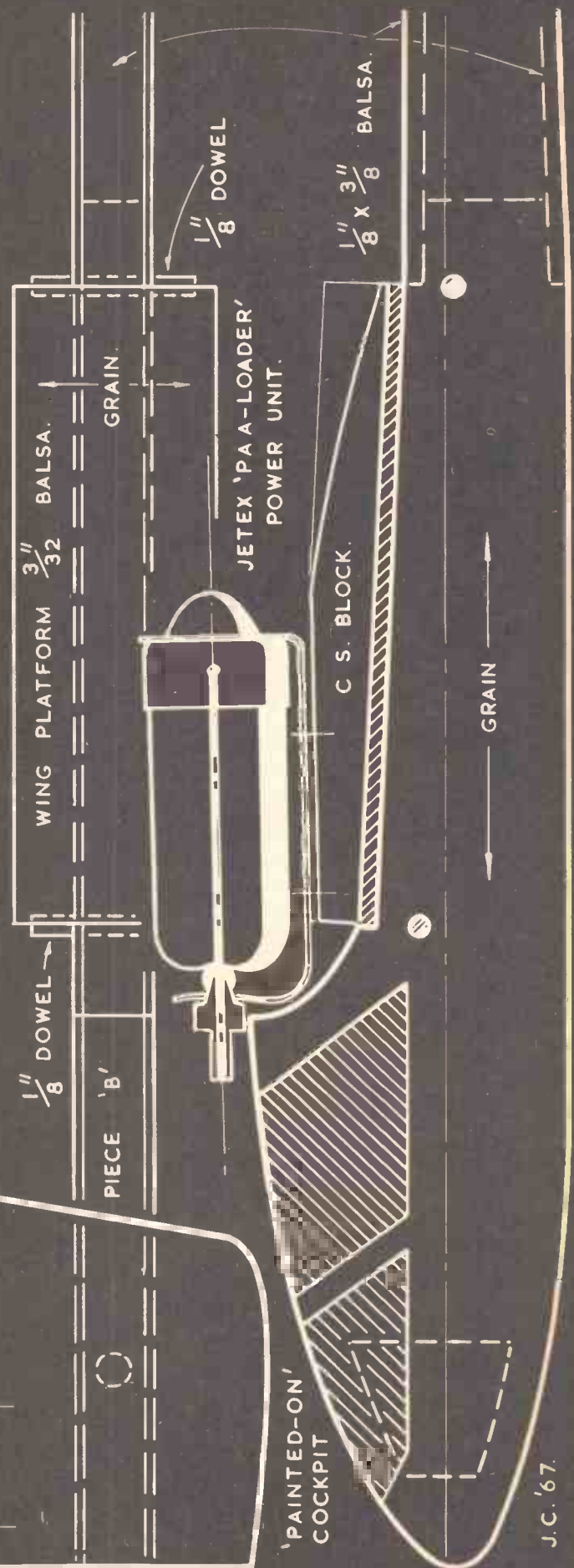
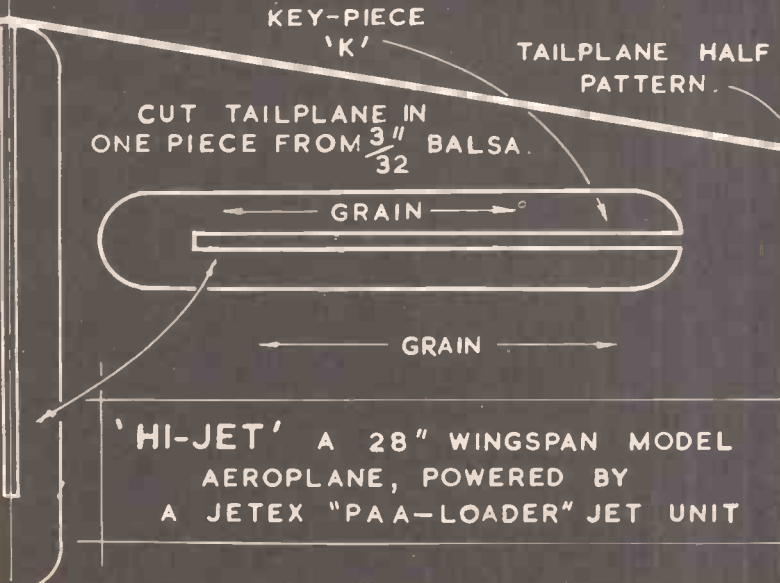
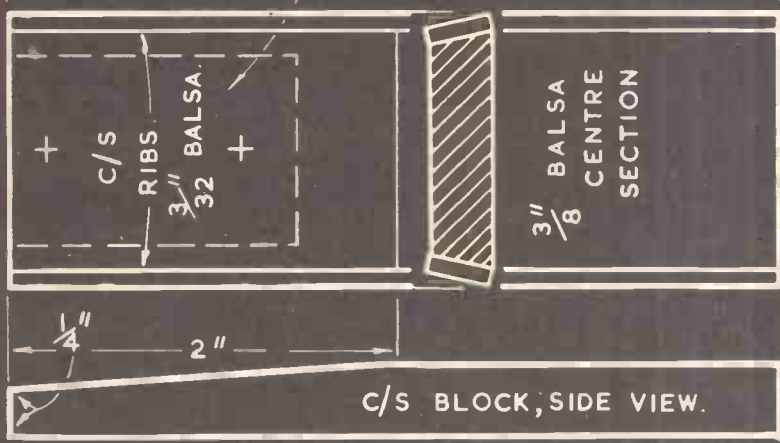
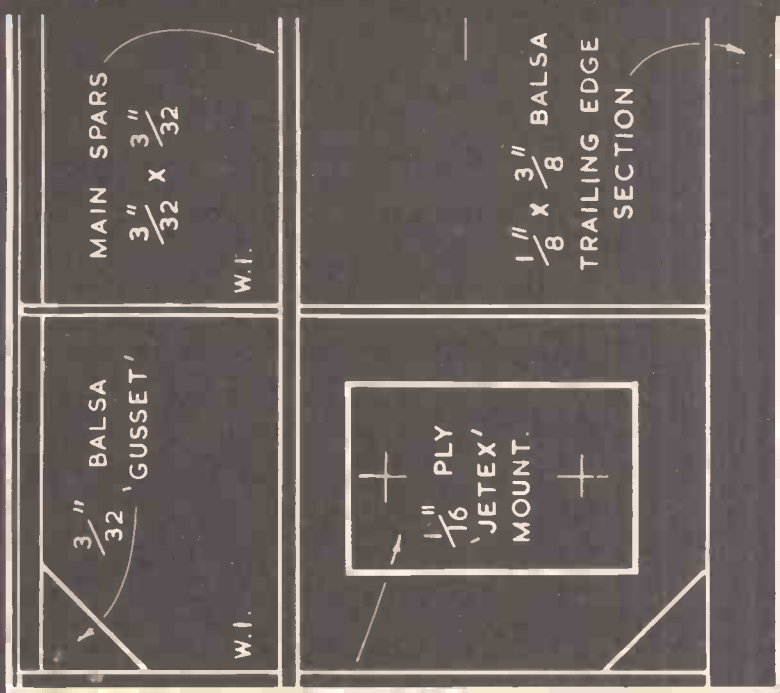

J.C.'67.

# AN INTRODUCTION TO model engines



BY  
PETER  
CHINN

*Grandfather of the modern model engine was the American 'Brown Junior' petrol engine, first model made in 1934.*

The manufacture of lightweight model aircraft engines on a commercial scale began in 1934 in Philadelphia, Pennsylvania, U.S.A. Here, William Brown began producing his famous 'Brown Junior' motor which, in prototype form during the previous two years, had demonstrated the practicability of such a power unit. At that time, most model planes were rubber-driven (a few were driven by compressed air) and the flight durations set up by models powered by Brown's engine were so incomparably superior, that contest organisers were obliged to establish a separate class for internal-combustion engined models.

Miniature engines for model aeroplanes (and boats) had been built long before Brown's engine, but very few of these could be purchased as ready-made products and none was so light and compact that it could be considered as a feasible alternative to strip rubber power, for the average model aeroplane enthusiast. By contrast, the Brown Junior opened up an immense new field of activity and one that is still developing and expanding, more than thirty years later.

Today, more than three hundred different types and sizes of model engines are being produced throughout the world: most of them in America, Japan and Great Britain, but also in many European countries, in Australia, Russia and

even in China. One American manufacturer turns out more than a million engines every year. New and improved models are constantly appearing. Sizes range from one-sixth of one cubic centimetre cylinder capacity to 10 c.c. (a few are even bigger but 10 c.c. is the recommended maximum size, in the interests of safety). The smallest weigh less than one ounce. The biggest and most powerful will develop as much as two horsepower.

All current model aircraft engines (and most model boat motors) are of the two-stroke type. The Brown Junior, and all other model two-strokes produced before

the war, were spark-ignition petrol engines. That is to say, they ran on a mixture of petrol and oil and were equipped with a spark-ignition system consisting of an induction-coil, condenser and battery which, by means of a contact-breaker

assembly, provided, at the sparking-plug, the means of igniting the fuel charge. In these respects, early model engines followed full-size practice. Two-stroke engines of the type used in some lightweight motor cycles, lawn-mowers and outboard motor-boats run on a petrol and oil fuel mixture and employ spark ignition either by coil-and-battery, or by a magneto. Motorcar engines are usually of the more complex four-stroke type but also use spark-ignition—usually with coil and battery.

The big disadvantage of spark ignition, for model aircraft engines, was the extra weight that had to be carried in the form of a battery and coil. Especially with the smaller size engines, the weight of this ignition equipment often equalled, or even exceeded, the weight of the engine itself. Another disadvantage was that the spark ignition system was a frequent source of starting difficulty, it being all too easy for the sparking-plug to get too 'wet' or for the contact-breaker points to 'oil up'.

By the nineteen-forties, therefore, model engineers were looking for ways of discarding the spark ignition system and

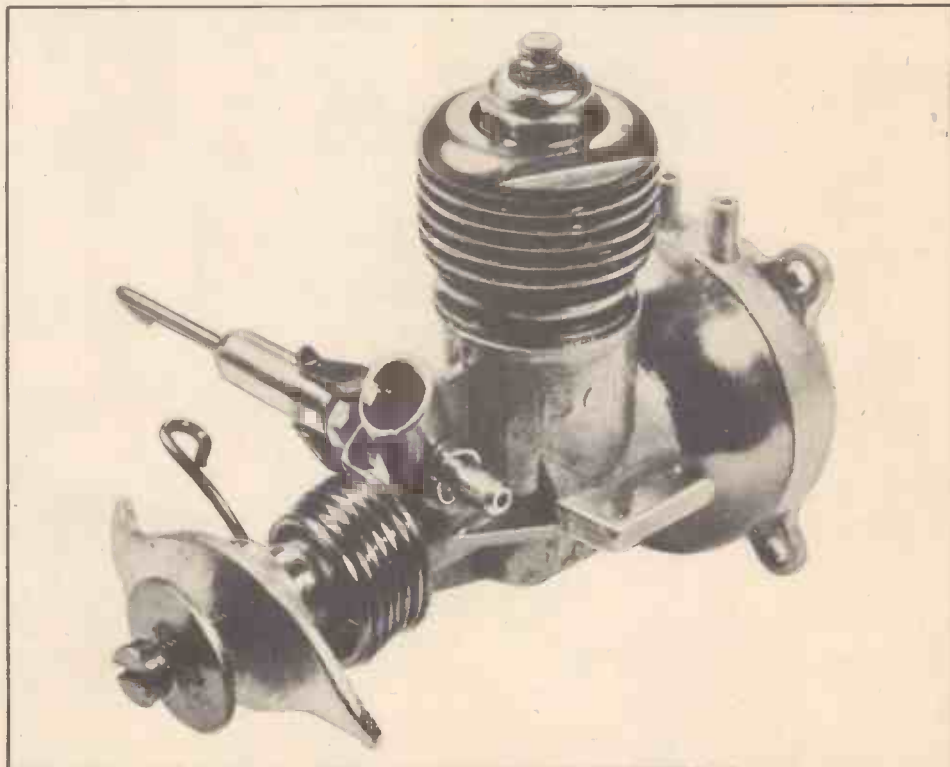

*One of the lowest-priced model engines is the 'D-C Bantam' 0.75 c.c. glow motor. Without the optional fuel tank at the rear, it costs only 45/9.*



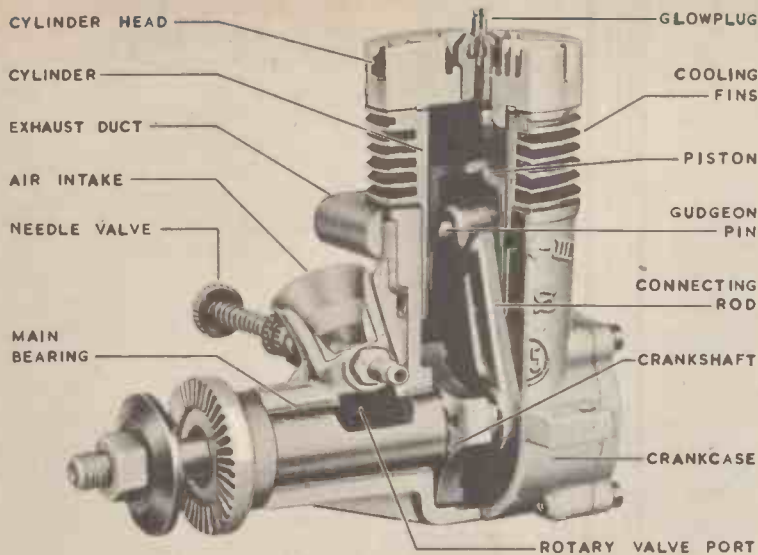

A cutaway drawing of a typical modern glowplug engine, showing the various component parts.



An interesting engine for model boats. This 'Fuji' 2.5 marine model has water-cooling and a separate rear driveshaft.

of achieving ignition by some simpler and less weighty means. The solution to the problem took two forms. The first, originated in Switzerland, was 'compression-ignition', the model 'diesel' as it is popularly known. The second, which originated in America, was the 'glowplug'. These two new developments were rapidly accepted by the model aeroplane fraternity and, today, all model aircraft engines, and nearly all model marine engines, are of the diesel or glowplug type.

Model diesels are not to be confused with the diesel engines used in lorries or diesel locomotives. Both are 'compression-ignition' engines but, in a full size diesel, there is no carburettor. Pure air is drawn into the cylinders and, as the piston rises, this air is highly compressed (two or three times as much compression as in a normal petrol engine) to raise it to a high temperature. Fuel-oil is then sprayed into the cylinder, under very high pressure, by means of a complex pump and injector-nozzle system and the heat of compression causes the fuel and air mixture to ignite automatically.

Such a complex fuel injection system would be much too costly to duplicate in a model engine and our miniature diesel therefore takes its fuel into the cylinder mixed with the air, via a simple carburettor, in the normal way. It is, however, highly compressed as in a full-size diesel and is automatically ignited in the same way, aided by a special fuel mixture. This fuel mixture contains an additive (usually ether) having a very low 'self-ignition temperature' which ensures easy starting.

The glow engine operates somewhat differently. In general, it resembles a conventional spark ignition two-stroke, but

without a contact breaker assembly. The glowplug, which replaces the standard sparking plug and may look quite similar externally, is fitted with a thin platinum wire element exposed to the interior of the cylinder. To start the engine, the glowplug element is energised by means of a 1½-2 volt battery and the bright red glow, thereby produced, ignites the fuel/air mixture as it is compressed by the rising piston. Once the engine is running, the glowplug filament continues to glow due to the heat of combustion and the battery leads are then removed. Consequently, the battery does not have to be carried in the model; it is merely connected to the engine for starting.

A special fuel is also required for glow engines, but is somewhat different from

model diesel fuel. Glow engine fuel contains methyl-alcohol (methanol) as its main constituent. This produces more power than petrol, but allows the engine to run cooler and is also less highly inflammable and thus safer to use. Because it will not mix with ordinary mineral type motor oils, castor-oil is used as the lubricant.

A simple glow engine fuel consists of 75 per cent methanol and 25 per cent castor-oil. However, for glowplug engines of under 2.5 c.c. capacity, it is often preferable to have a small proportion (5 to 10 per cent) of a suitable additive in the fuel, such as nitromethane or 2-nitropropane, to assist combustion. Many commercial glow fuel blends contain such additives. Glow engines are much more sensitive to variation in fuel blends than are diesels and special high-performance fuels containing very large proportions of nitromethane are sometimes used to achieve maximum performance. Generally, however, the newcomer to the hobby is well advised to use only the types of fuel recommended by the engine manufacturer.

There are, of course, various brands of model engine fuel on the market and there



The uses of model internal combustion engines are not confined to aircraft and boats. This scale model Westland SRN-S Hovercraft has two O.S. glowplug engines.

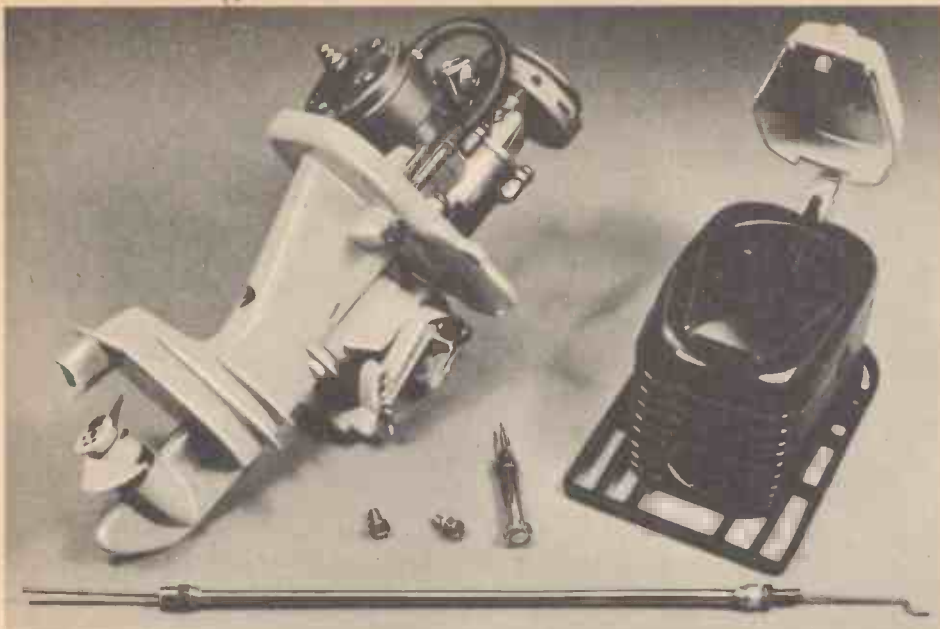

The very ingenious 'Fuji' 2.5 c.c. model outboard motor, showing the power unit casing removed. It has water cooling and built-in reduction gearing.

should be no difficulty in finding a blend to suit any model engine. Most commercial diesel fuels can be safely used in any type of variable-compression model diesel motor. Never try to use diesel fuel in a model glow engine, however. It may start the engine but it may also ruin it. Glow fuel in a diesel motor will not produce a start at all.

We have just mentioned 'variable compression model diesel'. All modern model diesels are of this type. They can be identified by the compression-screw in the top of the cylinder-head. When this screw (which is fitted with a lever or tommy-bar) is turned, the compression ratio of the engine is altered. This is achieved

by means of a 'contra-piston' positioned in the upper part of the cylinder. The contra-piston is a fairly tight fit in the cylinder and is forced downwards when the compression screw is turned in a clockwise direction and the compression ratio is thereby increased, since the space between the piston and contra-piston is reduced. If the compression screw is slackened, combustion pressure causes the contra-piston to rise again and so reduce compression.

The purpose of variable compression is to match the 'ignition timing' to the speed, fuel and cylinder temperature of the engine. As with any spark ignition engine, there is a precise point, relative to piston

travel, at which ignition should take place. In a car engine, this is controlled by the automatic advance and retard mechanism fitted to the distributor. The faster the engine is turning, the more advanced the ignition point has to be. This is because any fuel takes time to burn and for the gases, so produced, to expand. Therefore, when an engine is lightly loaded, to turn fast, power will be lost if maximum gas pressure on the piston does not begin until it is halfway down the cylinder.

Suppose, for example, that we have a 1 c.c. model diesel and we fit it with an airscrew of 8 in. diameter and 4 in. pitch. The maximum speed achieved will probably be in the region of 7,000 to 7,500 r.p.m. However, if we now fit a propeller of just 1 inch smaller diameter and pitch, revolutions will rise to about 11,000-11,500 r.p.m. and, unless compression is increased so that ignition is initiated a little earlier, it will be found that the engine will tend to mis-fire.

The compression control, therefore,



Another low-priced engine suitable for the beginner, the 'Fuji 099' glowplug motor of 1.6 c.c. capacity.

enables us to adjust the engine to suit different propeller sizes. It also enables us to compensate for different types of fuel. Some diesel fuels have additives which accelerate ignition and therefore require a different compression setting for any given load speed. The optimum compression setting is also affected by the running temperature of the motor. As an engine warms up from cold, the fuel mixture ignites sooner and a reduction in compression is then required or the engine will slow due to ignition taking place too early.

The choice of an engine obviously depends to a large extent on the types and sizes of model that one intends to build. Anyone who is new to the hobby of model aircraft will be well advised to start with a fairly small model and an engine to suit. The model should, whether free-flight or control-line, be of a type recommended for beginners' use. This will usually mean that it will be powered by a relatively small engine—probably of between 0.8 and 1.6 c.c. capacity. It is unwise to use a more



Preparing a radio controlled scale model for flight. This model which has all controls worked by radio including retractable undercarriage, is powered by a 10 c.c. McCoy glowplug engine developing over 1 horsepower.



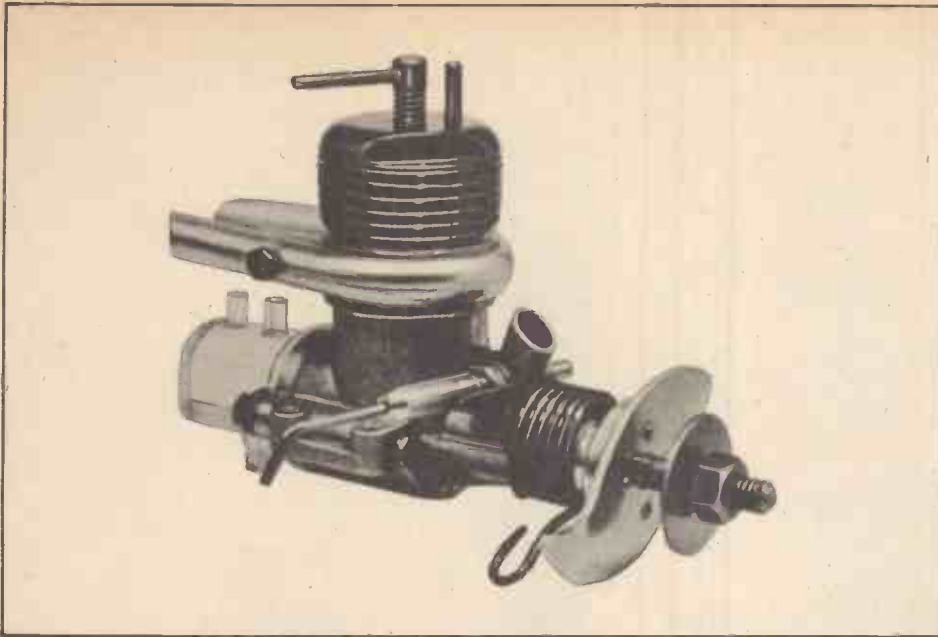

A beginner's type diesel motor, the 1 c.c. 'Davies-Charlton Spitfire', fitted with starter-spring, fuel tank and silencer.

powerful motor than is required to fly the model—especially in the case of free-flight models. The faster a model flies, the more sensitive it becomes to any maladjustment in the flying surfaces and if, as a result, the model crashes, the risk of damage is increased by the fact that the model hits the ground just that much harder.

Engines coming within this capacity group include the D-C 'Merlin', 'Spitfire' and 'Sabre' diesels, the Frog '80', '100' and '150' diesels, the D-C 'Bantam' glow-plug engine, the Cox 'Babe Bee', 'QZ', 'Medallion 049' and 'Medallion 09' glow-plug engines and the Fuji '049', '061' and '099' glowplug engines. Most of these are quite moderately priced, none are difficult to operate and all will give reliable, useful service, provided that one exercises a little care in looking after them.

Remember that the working parts of a model motor—piston, cylinder and all bearing surfaces—are finished to close tolerances. Normally, the rate of wear is such that hundreds—even thousands—of flights can be obtained before any part requires renewal. However, if the engine is abused and foreign matter of an abrasive nature is allowed to get inside, the life of these parts may be reduced to a few minutes.

If you crash the model and dirt gets into the air intake, exhaust or front bearing, the engine must be properly cleaned out by totally immersing it in petrol after brushing off excess dirt. It is helpful here if the engine can be partially dismantled. This is quite easy with some motors. Others, which may be difficult to take apart without special tools, are best left intact. In this case, concentrate on washing

out every particle of dirt by rinsing in two or three fresh lots of petrol, carefully rotating the shaft to ensure that the engine turns quite freely and smoothly. Lubricate the working parts by liberally injecting light machine oil into the air intake and through the exhaust ports, again rotating the shaft to distribute the lubricant.

When you have finished using your engine and especially if you are unlikely to be running it again for a while, it is always best if you allow the motor to run



The World's smallest model internal combustion engine. The remarkable little Cox 'Tee-Dee 010' motor has a piston diameter of less than  $\frac{1}{16}$  in., and weighs  $\frac{1}{2}$  oz.

itself dry of fuel. Raw fuel left in the crankcase or fuel tank may, in some cases, thicken or congeal and make the engine difficult to start.

Finally, a word about noise. Many people (not modellers!) find the high-pitched whine of a model engine somewhat disagreeable. Obviously, you should avoid running an engine in a residential area, but it is sometimes difficult, also, to find flying sites that are completely out of earshot of the general public. This problem, however, has now been eased by the introduction of exhaust silencers for model motors. Such silencers are now, obtainable for all British made engines and for most foreign motors as well. We would strongly recommend you to use one.

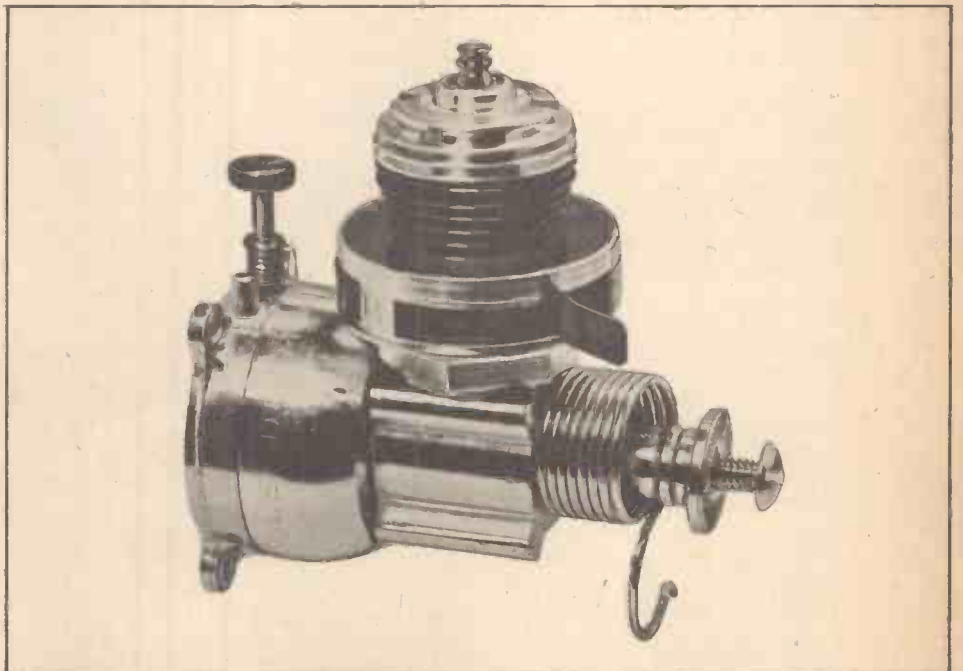

The Cox 'QZ' 0.8 c.c. motor, an improved version of the 'Babe-Bee', supplied complete with exhaust silencer.

# radio control

by Tony Dowdeswell



Scale-modelling expert Dennis Thumpston with his Bristol Monoplane, a radio control machine perfect in every scale detail.

One flick of the propeller, and the engine barks into life. A deft manipulation of the fuel mixture control, and the engine is set for maximum power. Control surfaces move, and then the muffled noise of the motor dies as the throttle is retarded and the model stands motionless, untrained.

The shiny machine moves forward slowly, turning at right angles down past the line of other models and modellers busy preparing their machines. Control surfaces move again as last minute checks are made . . . rudder, elevator, ailerons.

Fifty yards down wind now, and the model slows, and swings around to face the light breeze, coming to an abrupt halt as the brakes are applied. Suddenly, the engine screams and the model lurches forward, quickly reaching some 40 m.p.h. As the model speeds past, the pilot eases back on the control column and there is daylight between the wheel and the ground as the nose of the model

lifts, and the machine becomes airborne. Almost at once, the model is at 10 ft. altitude. Suddenly the wings gyrate around the fuselage, the model climbing away upside down.

The pilot of this radio-controlled model is an expert in an expert's field, the complete master of a highly-aerobatic precision-flying machine that he himself has created. This is radio control at its best—this could be you!

What is radio control? How does one become one of the elite band of enthusiasts known as radio-control modellers who operate their models all over the country?

Radio control, remote control as some people call it, is really nothing more than a switch—a remote switch if you like because there is no physical contact between the operator, and the object he controls. A radio signal is emitted from the transmitter held by the operator. This signal is picked up by a receiving device

installed inside the vehicle to be controlled, which then translates the signal into a command.

Actually it is a little more complicated than that, as might be imagined, so we will try to explain the operation of radio control by drawing a simple illustrative parallel.

A radio control transmitter is powered by a battery, and is an electronic device designed to be capable of translating battery power into a radio signal which is radiated in all directions from its aerial. The signal is nothing more than a form of energy radiating from the aerial. A simple parallel can be drawn with a bonfire which radiates heat in all directions, and as we know if we listened to our science lessons, heat too is a form of energy. The further away we go from the bonfire, the less intense the heat, and so also with a radio control transmitter—the further away from it we go, the weaker the signal becomes.





American Maynard Hill, with the model with which he set the World speed record for radio controlled model aircraft.

How then is this signal, this energy, used to control a model? Since the device designed to transmit the signal or energy is called a transmitter, it is not surprising to find that the device designed to receive the signal is called a receiver. This is an electronic device which can basically be divided into three separate consecutive functions. To begin with, the first part of the receiver is designed to sense the signal from the transmitter. The signal is picked up by means of an aerial, which is usually nothing more than a piece of thin flex, about three feet long. Having picked up the signal from the transmitter, the receiver then uses it as a trigger to produce an electric current within itself. This electric current can then be used to drive a control operating mechanism to steer a model aircraft or boat.

The simplest form of actuating mechan-

ism is called an escapement, which is an electro-mechanical device. Basically, this is a solenoid, an electro-magnet which is energised by the electric current produced by the receiver when it receives a signal. The escapement actuator is powered by a strip of rubber and the solenoid energy is used to move a cam, which in turn allows the actuating mechanism linked to the control surface to move, thereby affecting control.

So you see, radio control is really nothing more than a switch, except that unlike an electric light switch which you throw to turn off an electric light bulb, there is no physical movement involved. The turning on of the current to energise the escapement solenoid is done remotely—remote control if you like. This in fact is about the simplest form of radio control for models as practiced today. Although you can make your own, and indeed there was a time when you had to, this is no longer necessary and can put you at a distinct disadvantage. Today's radio control equipment requires no special knowledge of electronics to keep it functioning reliably and in fact, it would probably be true to say that the majority of radio control enthusiasts enjoying the hobby today have not a clue as to the detailed function of their equipment. To them, it is a means to an end, and as long as the equipment continues to do its job, they are perfectly happy. The equipment is simply a switch, a remote switch as we have already said.

Modern radio control equipment enjoys the benefit of full transistorisation. There was a time when radio control equipment was so heavy and bulky that transmitters could not be comfortably carried, and consequently had to be stood on the ground. The receivers were correspondingly large and consequently required large models to carry them.

Today's equipment is contrastingly compact and extremely lightweight. A good example of simple, modern, compact single-channel equipment is the Futaba FT-3A transmitter which measures only

$4\frac{3}{8}'' \times 2\frac{1}{2}'' \times 1\frac{1}{4}''$ , and operates off a small, inexpensive 12 volt battery. Matching this transmitter is the Futaba F4-LR receiver, which in its plastic case measures  $1\frac{1}{4}'' \times 1'' \times \frac{3}{4}''$ , less than twice the size of a postage stamp and weighs less than an ounce. It operates from two pen cell batteries, and can be used to drive an escapement such as the Futaba ML-2.

The Futaba FT-3A transmitter, F4-LR receiver, and Futaba ML-2 escapement



A typical aerobatic model is this 'Uplift' design built by Alan Whittaker, using Metz 10 radio.

can be combined to control a simple model aircraft, operating the rudder control. The actuator will move the rudder left and right for turns, and this is all that is required for a first attempt at radio control. In fact, it often proves too much for some beginners.

The type of model required for a first attempt is a simple 'stable' type. This usually involves a small machine with the wing on top of the fuselage, a high wing as we call it, such as the Schuco-Hegi Frechdax. This has a wing span of 44 in., and the details can be seen on page 128. In fact, it is not absolutely necessary to build a model—you can buy one ready made, complete with radio equipment and engine, ready to fly. Examples of the ready-to-fly model are the Futaba Cessna 210, Futaba Frontier I, or if you want something really swish, the Futaba Spitfire. However, the ready-to-fly model is never likely to eclipse the model kit; modellers will continue to build their own.

Why start with such simple equipment? Why use only one control? The answer is that even one simple control is as much as a beginner to radio control can handle. Even then he may over control the 'stability' out of his easy to fly stable model. If you think that one control would be rather tame, let us hastily add that it is possible with only rudder control to perform loops, rolls, wing-overs, spiral dives, Immelmans and split 'S's, plus even a few more. Many beginners have the wonderful vision of a four-engined Lancaster Bomber with all controls, working undercarriage, bomb doors, flaps, etc., which they insist will be their first radio control project. Such ideas are doomed to failure, and although multiple-engined models have been proved practical for the modeller with a vast experience, the immense cost alone really rules such models out.

Such then is the simple radio control



The start of a 'Goodyear Race' (radio controlled pylon racing), a new and thrilling spectacle in the R/C field.



G. Ford with his radio controlled Spitfire, always a popular scale subject.

model, but what comes next? What is the next step up in radio control?

To begin with, we must say that many modellers never go beyond the single channel stage. They are perfectly content with one control. In fact there are more single-channel radio-control operators than those who use multiple control,



The Futaba Frontier 1, which you buy literally ready-to-fly, complete with R/C equipment.

proving that a great deal of enjoyment can be had for a minimum of outlay.

Inevitably, a change to multiple controls involves an increase in cost. Multiple channels of control are derived in much the same way as the simple single-channel control. It remains nothing more than a switch, but this time it is selective. The transmitter, when keyed, transmits its signals in the same way. This in fact is an audio tone—simply a tone note, although you cannot hear it unless you use a piece of equipment designed to pick up the transmitter signals and relay them audibly. Each individual control then is represented in the transmitter by an individual tone note. These are transmitted to the receiver whenever a particular control is required. The receiver picks up the signal and feeds it to a device within itself, capable of differentiating between the individual tone notes. Thus filtered through this 'sorting' circuit, the signal is used to actuate the desired control.

A good illustration of how this works can be found in the tuning fork. Play a corresponding note on a piano, and the

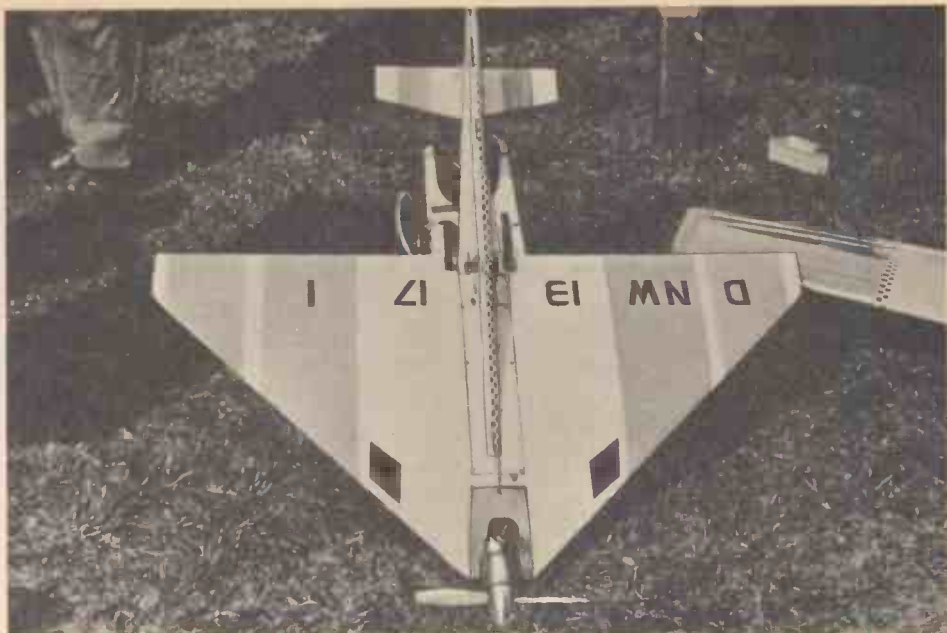

Fritz Bosch's 10 c.c. Rossi powered 'Speed Delta', unofficial World speed record holder, pictured at the first British R/C symposium at Weybridge.

tuning fork will resonate to it. In the receiver, the resonant filtering device can be either mechanical (tuned reed) or electronic (tuned filter). Both systems have their merits, and modern systems tend towards tuned filter (electronic).

Usually, with these more complex multiple-command systems comes the ability to operate more than one set of radio equipment (and therefore more than one model) together. Normally, the simple, inexpensive single-channel system is not capable of being operated more than one at a time without the systems interacting. This is due to their 'broad' tuning. However, the more complicated system usually employs a type of receiver which is capable of sensing signals on only one 'spot' in the radio control waveband, being insensitive to all others. Consequently a system using another 'spot' frequency can be operated at the same time without fear of inter-reaction.

Taking the Metz 10 as an example of modern 'multi channel' equipment as we call it, the transmitter is capable of sending signals capable of commanding rudder (left and right), elevator (up and down), aileron (left and right), throttle control for the engine (fast and slow), plus a trim control for the elevator. This represents what is called 'full house' controls i.e., a complete complement of controls offering comprehensive command of a model, with which it is possible to make a model completely aerobatic with few limitations.

The main problem for anyone breaking into multi-channel radio control is the cost. However, perusal of pages 137-141 will give a good idea of relative costs.

Once having taken the plunge into

multi-channel radio control, even if he has to go without other things he may want, the radio control enthusiast can look forward to a tremendous amount of enjoyment. The type of equipment he has bought no longer ties him to the stable type of single-channel model. There are in fact few limitations to the type of model subject he can choose. Most multi fliers tend to standardise on models with a low wing and a tricycle undercarriage, an example of which is the Schuco-Hegi Syncom Pioneer. These machines are capable of every aerobatic manoeuvre 'in the book' and then probably a few that nobody has ever dared to write down. Such models usually have a wing span of about 5-6 ft. They might weigh anything from 5½ to 8½ lb. and can be powered by engines ranging from 6-10 c.c. capacity. Obviously, the larger the engine capacity, the more spritely the model performance.



The 'Limbo' event, where a model is flown between two stakes and under a wire crosspiece which is progressively lowered!



Expensive as these multi-channel radio control systems may sound, there are some which offer more and better control—and are correspondingly more expensive. These are called 'proportional' control systems, and, as the name implies, offer fully-proportional control. In other words, when you move the control column a certain distance, the control surface follows exactly. It is, in fact, the nearest simulation to actually sitting in the pilot's seat yet offered to the radio control hobbyist. Examples of these complex systems are the Metz Digiprop and the Simprop, each offering seven independent simultaneously-operating, fully-proportional controls for the operation of rudder, elevator, ailerons and throttle, plus such extras as wing flaps, retracting undercarriage and bomb dropping.

Once having acquired one of these proportional systems, the modeller steps into a realm hitherto unknown in the radio control hobby, for it is only in the last two



An aerobatic competition-type model with a realistic appearance, by Derek Brunt, about to make a flight in a National Championships Competition. With Metz 10 radio equipment.



An expert in action. Frank den Bergh at the 1966 British National Model Aircraft Championships.

years that proportional control systems have proved reliable enough. His only limitations are his own modelling ability. For the modeller with the greatest ability,

the goal may be an accurate scale model of virtually any type of full size aircraft. Others may concentrate on aerobatic performance, perfecting a standard schedule of manoeuvres to a height of perfection which will bring high placings in contests held each year throughout the country.

Others may choose the latest type of contest which is rapidly gaining favour. This is pylon racing, where a number of models are raced around a narrow triangular course over a number of laps. Usually, the models are built as replicas of the famous Goodyear racers which performed in the Goodyear air races in U.S.A. during the late 1940's. To say that the excitement of such races is tremendous would even be an understatement.

Finally, radio control modelling is a precise science practised all over the world—for example Maynard Hill of America holds the World Speed Record at 140.28 m.p.h. whilst Geoff Brooke-Smith of South Africa holds the duration record for R/C gliders at 11 hrs. 33 mins. 28 secs. This incidentally is an absolute record for all model aeroplanes.

Men like these are experts who have had long experience in flying R/C models in all sorts of conditions, but most will readily admit that they started with simple and cheap single/three channel equipment. They had many hours of fun building up to the skill and knowledge required to fly the modern high-performance radio control models—which is where we came in!

Good flying!

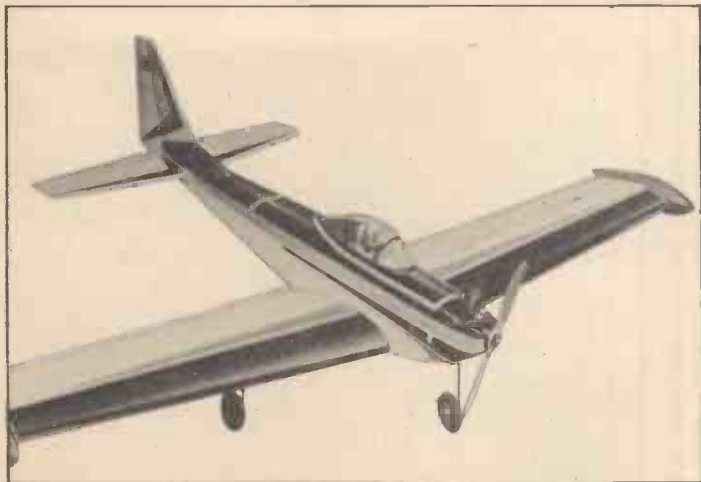

The 65 in. span 'Pioneer' by Schuco-Hegl. An ideal beginner's model, but very versatile, powered by a 6-10 c.c. motor.

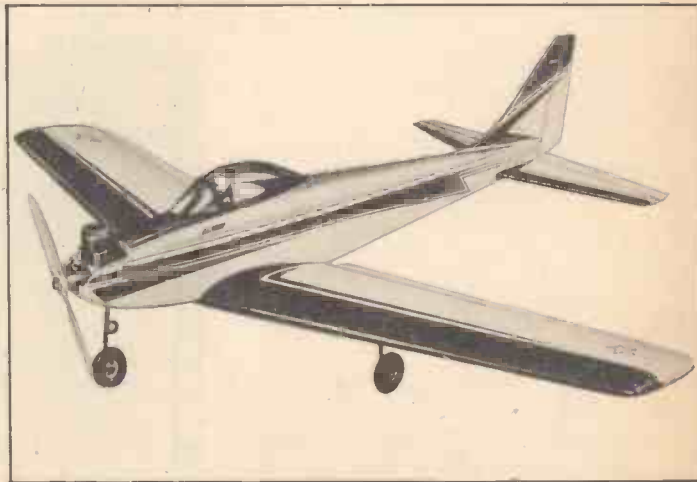

The Schuco-Hegl 65 in. span 'Syncom'. A low wing R/C model with a complete complement of controls, it is fully aerobatic and uses a 6-10 c.c. motor.

# taking photographs of your models

by A. E. STANLEY

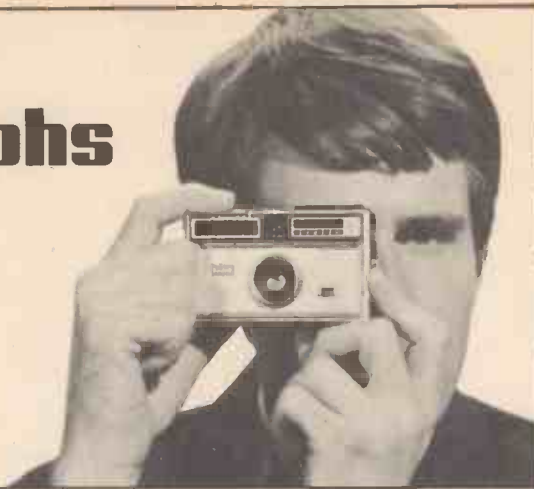

You've finished your model, and quite rightly, you are very proud of your success. After all, a great deal of careful work went into the making of it.

Naturally you want to let your friends and relations know all about it. This is easy enough if your model is, say, a 12-inch cabin cruiser. You can take that around with you to show them.

But you can't take a dinghy or a full-scale model railway on a bus. The bus people don't like it!

So you must find other ways of showing your model to friends. By far the easiest way is to show them a photograph. A photograph has the added advantage that you can send it to distant places where you could not conveniently take even a small model.

This article deals with the equipment you will need for simple photography, and how to get the best results from pictures both indoors and out of doors.

## EQUIPMENT

### Cameras

Obviously you need a camera. The question is what sort of camera, and how much should you pay for it?

Well, like everything else, you get exactly what you pay for. A camera costing a few pounds will produce perfectly satisfactory results. Such a camera, however, has certain limitations. It may have only one shutter speed, or it may not be synchronized for flash—that is you cannot take straightforward flash pictures. Also, it will probably be of the fixed-focus type, in other words it will record sharp detail of everything beyond about five feet. Subjects closer than that will be unsharp, so you could not take a close-up of a small model.

As you pay more for your camera, so you get extra refinements. A faster lens, so you can take pictures on duller days. A shutter synchronized for flash, so you can take flash pictures. And a focusing lens, that is one where the camera-to-subject distance is marked on a scale, and any object at the distance set on this scale

will be pin-sharp. The scale will possibly go down to  $2\frac{1}{2}$  or 3 feet, and you will probably be able to get close-up lenses to get as close as 9 inches.

Another point to consider is what size picture you want the camera to take. Do you want a roll-film camera, taking 127 or 120 roll film, or a miniature camera taking 35 mm film?

Probably the answer here depends on the use to which you intend to put your camera. If you just want to take a picture very occasionally, then a camera taking a roll of eight or twelve exposures, or a twelve exposure Kodapak cartridge, is the obvious answer.

But if you intend to use the camera not only for model pictures, but also for pictures on your holidays, etc., it might be better to go for one of the wide range of 35 mm cameras. Some of these take a cartridge of 12 or 20 exposures which can be loaded quite safely in bright sunlight.

Others take a cassette of 20 or 36 exposures which has to be loaded in the shade.

The question of choice of film is dealt with later.

What else will you need by way of equipment?

### Close-up lenses

Close-up lenses are always useful to have. Even if your model is, say, a 5-foot wing span aircraft, you may want to take a close-up detail shot. And, of course, you may not always make large-scale models.

So, if your camera will take close-up lenses, these would be a good investment.

Close-up lenses are graded according to their magnifying strength. A +1 close-up lens will enable you to take pictures with a fixed-focus camera as close as about 3 feet, and a focusing camera as close as about 2 feet.

With a focusing camera, a +2 close-up lens brings the near-focus down to between  $1\frac{1}{2}$  feet and 1 foot, while with a +3 close-up lens you can get as close as  $9\frac{1}{2}$  inches.

Your local photographic dealer is the best chap to advise you on this. But if you are thinking of buying a camera, it might be as well to talk over this aspect of close-up work before you decide which camera to buy.

### Lighting

If you are taking pictures indoors, you may need some form of lighting to boost that which already exists. Of course, you may be able to use daylight coming in through a window, but if your model is, say, a railway track along the side of a room, you will almost certainly need photographic light-sources. The room light will not be bright enough in the vast majority of cases. There are exceptions, and these depend mainly on the film used. We will talk about this later on.

There are two sources of high-intensity photographic light generally available to the amateur. These are flash and photo-flood.

A flash unit consists briefly of a



Taken with a telephoto lens at a distance of fifteen feet.



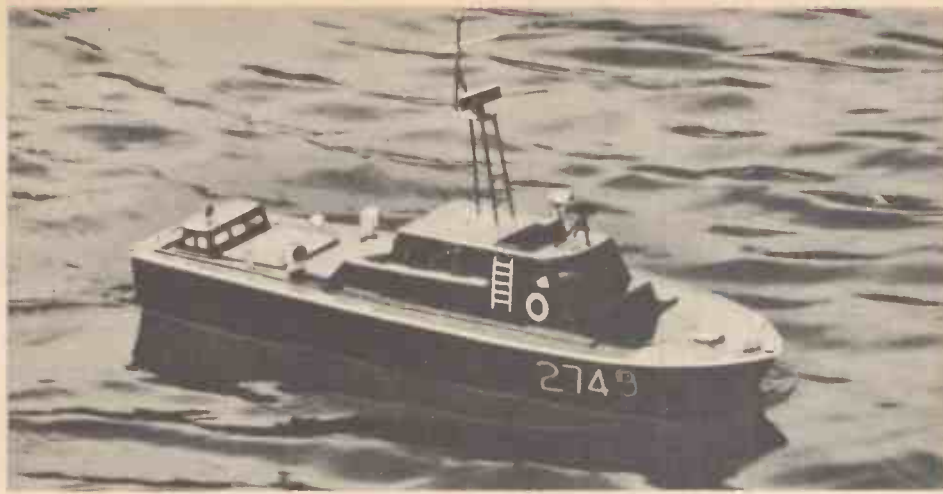

Taken with a standard lens at a distance of six feet.

housing for the battery, on which is mounted a reflector. The flashbulb is inserted into the socket in front of the reflector, and when the circuit is completed, usually through contacts in the camera shutter mechanism, the flashbulb is fired, giving a very brief, very brilliant light.

A photoflood lamp can be either a high-intensity lamp used in a reflector, or what is called a reflector-photoflood, because this type has the reflector coated on to the inside of the lamp, and so can be used without any additional reflector. These lamps operate on mains voltage.

#### Films

The first question you have to decide is whether you want to use black-and-white, or colour films. And don't jump to the conclusion that black-and-white is necessarily cheaper than colour. Your black-and-white film may cost less in the first place, but by the time you have paid for processing and enprints, this can work out dearer per print than a 36-exposure colour film costs per transparency!

Again, the answer depends on what use you want to make of your results.

If you want a number of prints to send to friends, then black-and-white prints are going to be far cheaper, even though colour prints may look nicer.

On the other hand, if you want pictures to look at in your own home, colour transparencies are much more satisfying.

#### Black-and-white films

These fall into two main classes—medium speed for general outdoor brightness conditions, and fast speed for dull days or poor lighting. For example, if you are taking a model cruiser on a park lake, you will probably do so on a bright sunny day. So you can use a medium-speed film such as 'Verichrome' Pan or 'Plus X' Pan.

On the other hand, if you are taking a model indoors by light coming through

a window, you may well need to use a fast film such as 'Tri-X' Pan. With this class of film you can usually take snapshot exposures by room lighting only, provided this is reasonably bright.

These films you can process yourself at home, provided you can load the film into a processing tank in total darkness. Then you can do the processing in any lighting conditions.

#### Colour films

Colour films fall into two classes. First, the colour reversal films. These are the films which give you transparencies. You can either hold these up to the light, or look at them through a viewer, or project them on to a large screen.

Certain of these reversal films you can process yourself, but you must have a dark-room suitably equipped in order to do so.

The other kind of colour films are the colour negative films—that is, those from which you get colour prints. Certain of these films you can also process yourself in a properly equipped dark-room.

#### TAKING CLOSE-UPS

Before we deal with the actual taking of the photographs, let us first of all talk about the use of close-up lenses in rather more detail.

There are two main objects in using close-up lenses. Obviously, the foremost is to enable you to get a sharp picture with the camera closer to your subject. But why should you want to get closer? Well, suppose you have built a 'Britannia' Class 7P6F locomotive. This is going to look very lost if the nearest you can get a sharp picture is, say, from 5 feet away. Not only will it be very small in the picture, but it will be so small that you will not be able to see any detail.

With suitable close-up lenses you can take the model from about one-and-a-half feet away, and fill the picture area with the subject, showing all the details.

These, then, are the two reasons for

using close-up lenses—to get near to the subject, and to get bigger pictures full of detail as a result of getting closer.

But there is one point to watch when using an ordinary camera for close-ups. The normal camera has a viewfinder usually on the top of the camera. When you look through the viewfinder, you do not see exactly the same picture as the lens 'sees'. At normal subject-to-camera distances (if over 5-6 feet) the difference is too small to matter (Fig. 1).

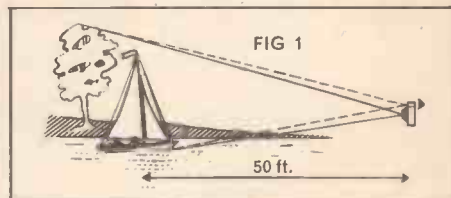

When you come to close-up work, the difference between what you see in the viewfinder and what the lens 'sees' is vastly different (Fig. 2), and you are liable to cut off the top of your subject.

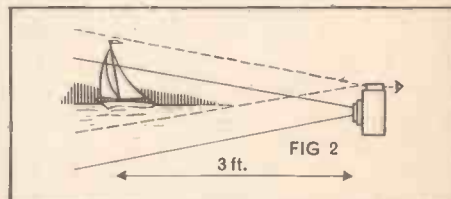

This difference is known as parallax, and the diagram shows exactly what happens. You can see that the closer you get to the subject the more you are likely to cut off when looking at the subject through the viewfinder.

So how do you overcome the problem? It's quite easy, really. One way is shown in Fig. 3. You place a ruler along the bottom of the camera, and point the ruler just below the centre of the model. Then keeping the camera quite still, you let the ruler fall away, and take your picture.

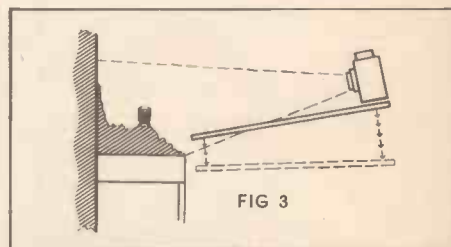

If you can stand your camera on something rigid, you can view both the camera and the model from the side and top, and check that the lens is pointing at the model.

Of course, if the viewfinder is on the side you will have to make similar allowances in a sideways direction. Always remember that to avoid cut-off you tilt the camera towards the viewfinder.

## TAKING MODELS INDOORS

### Available light

The easiest way to take a model is to place it near a window, and utilize the sunshine coming in through the window (Fig. 4).

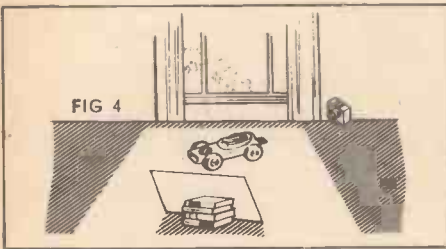

Avoid any bars on the window which might cast awkward shadows across your model, and also make sure the camera is not in sunlight. Otherwise you could get the sun shining into the lens, and this could easily spoil your picture by producing lens flare.

If you have a very large picture window, and you cannot get the camera out of the sunshine, use a lens hood to shield the camera lens. Alternatively, get a friend to hold a book to one side of the camera in such a position that the shadow of the book falls across the camera lens. But make sure the book is well outside the field of view of the camera.

You may not like the strong side lighting produced by this kind of picture. If so, you can reduce the shadow side by using a reflector, as in Figure 4.

This can be anything from a sheet of white cardboard to an aluminium tray, but a sheet of white card gives a softer result than a polished tray.

Whatever reflector you use, be sure it is white if you are using colour film. Otherwise you could get a colour 'cast' on your film, e.g. a blue board would reflect blue light, and your model would look bluish on the side nearest the reflector.

The use of a reflector would make no

difference to the exposure which would be just the same if there were no reflector present.

You can also take a picture indoors by ordinary room lighting after dark. Use a fast high-speed film, either black-and-white or colour. But to do this, you will need a camera with a fast lens, one having an aperture of at least f/3.5 for average room lighting.

Alternatively, if your camera is a simple one either having no marked aperture or f/numbers, or possibly f/8, f/11 or f/16, you can take a picture indoors by available room lighting provided your camera has a 'B' shutter setting.

'B' stands for 'brief time exposure', and on this setting the camera shutter is open while you hold the release button down, and closes when you let the button come up.

Obviously the camera must be kept perfectly still while you are doing this exposure, so you cannot hold the camera in your hand.

Stand the camera on a firm surface—a coffee table is ideal—then, holding the camera firmly pressed on to the table with one hand, gently press the shutter release button with a finger of the other hand until the exposure has been made. Then release the shutter button, and then the pressure on the camera.

### Flashlight

Lighting by flashbulb is probably the easiest way to take pictures indoors. This is because all the guesswork in exposure has been removed by the exposure details tabulated in the film instruction leaflet or on the flashbulb carton.

Exposures are given in one of two systems. The first is a straightforward flash-to-subject distance at any selected aperture and 1/30 second shutter speed. These figures are also for use with the simpler non-adjustable type of camera, or the camera with limited adjustments.

The other system, guide numbers, is

more for use with fully adjustable cameras. It looks complicated at first but in fact the guide number system is simplicity itself, and very useful.

The guide number for any particular flashbulb is related to the speed of the film and is the product of the lens aperture number (or f-number) multiplied by the flash-to-subject distance in feet. So,

Guide number = aperture × flash-to-subject distance in feet

or

Aperture = guide number ÷ flash-to-subject distance in feet

or

Flash-to-subject distance in feet = guide number ÷ aperture.

Let's see how this works out in practice. You want to take a photograph of a 'Strike Force 10' model railway set. Your camera is loaded with 'Kodachrome' II which has a film speed of ASA 25, and you intend using AG1B flashbulbs. From the film instructions we read that this film has a guide number of 72 at 1/30 second shutter speed.

The camera aperture selected is f/8, so dividing the guide number (72) by the selected aperture (8) we get 9. So the flash-to-subject distance must be 9 feet.

Note that this is the flash-to-subject distance, and not necessarily the camera-to-subject distance. You may well want to use the camera much closer than 9 feet—you certainly would in this case.

The answer is to get an extension lead for your flash unit, and then you can position the camera quite independently of the flash.

Now suppose you are taking a picture of a six-foot model aircraft. Using the same film, flashbulb and shutter speed, the guide number is still 72. From 9 feet you can get the whole of the model in the picture. All you want to know is the aperture to use at 1/30 second shutter speed.

The aperture to use is the guide number (72) divided by the flash-to-subject distance in feet (9). So you would need to set the camera aperture to f/8.

An extension lead to enable you to use the flash off the camera will prove very useful if you are taking small models which you need to take close up.

The easiest way to use flash is to have a single flash unit fired from the camera. Using the first example given above, the relative positions of the camera, flash and model would be as in Fig. 5a.

Because flash produces such strong shadows, a much better picture can be made if you soften these shadows with a reflector. A sheet of white card is ideal for this purpose (Fig. 5b). Make sure the card reflector is outside the field of view of the camera.



The same boat from a different angle.



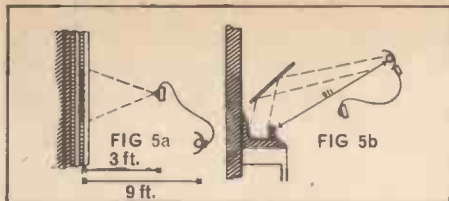

Before we leave flash, we ought to mention two special techniques.

The first is for those of you who have a simple camera which is not synchronized for flash, that is it has no flash contacts, but which nevertheless has a 'B' shutter setting. Get a friend in to help you.

Have everything set up neatly, with the camera on a firm surface. You operate the camera while your friend operates the flash unit. Make sure he has the flash at the right distance, and pointing in the right direction. Holding the camera firmly on the surface with one hand, gently press the shutter release with a finger of the other hand. At the same time you say: 'Open-flash-close'.

When you say 'Open' your friend is alerted. When you say 'Flash' he fires the flash. And when you say 'Close', you gently release the shutter button. Do not say the words too quickly—pause between each to give yourselves time to do the operations in an easy, unhurried manner.

This method of exposure is known as the open-flash method.

The other special technique concerns moving subjects such as a railway engine or a racing car on a track. The latter can move quite fast, while even the former moves too fast to enable a 1/30 second exposure to be made without the risk of subject movement on the photograph.

There are two ways to take this kind of picture. One is to adopt the system used in cinema or television to follow a moving subject with the camera—by 'panning'. This means that you hold your camera steady to your eye and follow the model so as to keep it in the viewfinder, swinging your body from the hips. When you think you have the model in the right place, press the shutter release and take a flash picture. Continue the swinging movement after you have taken the picture, as this ensures even movement.

With a little practice you will find this is quite easy to do, and the fact that the background will be blurred will give a realistic impression of speed to your model.

The other way to take a moving model is to use an electronic flash unit. These are rather more expensive than the ordinary flashbulb unit, but you may be able to borrow one from a photographic friend.

With these units, the flash duration is very short, and even the fastest-moving model can be taken with no risk of subject movement. But remember that even if you 'pan' the shot, the background as

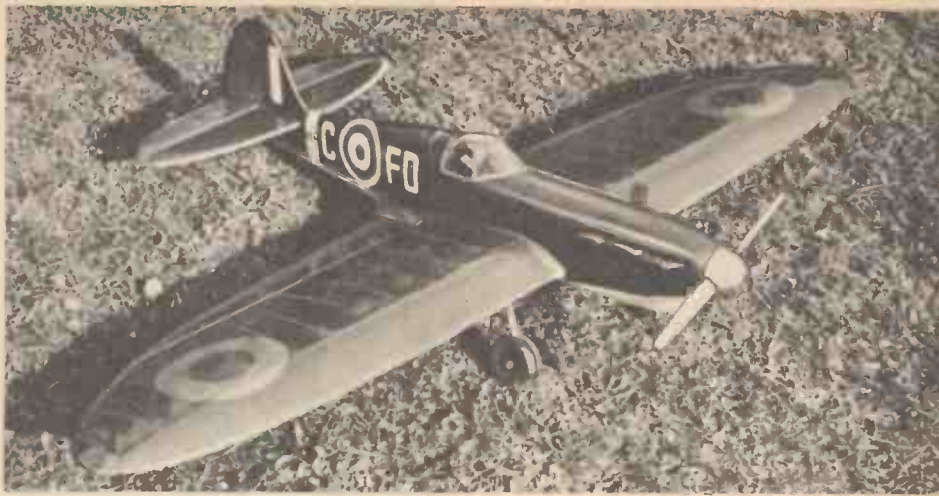

Taken on a dull day using flash high up off camera to simulate sunshine.

well as the model will be sharp with electronic flash.

Just before we leave flash, there are one or two precautions, which are really only common sense anyway.

Never fire flashbulbs in an explosive atmosphere. For example, some adhesives give off a flammable vapour, and it would be as unwise to fire a flashbulb in a small closed room where such an adhesive has been used as it would be to strike a match.

Flashbulbs get very hot when they are fired, and retain their heat for some seconds. Take care when handling freshly fired bulbs—they may be very hot, and could burn.

And, of course, do not look closely at a flashbulb when it is fired, and do not fire it close to anyone's face. Like looking at the sun, you or they will not be able to see very much for some time afterwards!

Finally, when using flash with reversal colour film, always use blue flashbulbs and daylight-type colour film. If your camera is loaded with artificial-light film (Type A), you must use a filter ('Wratten' No. 85) to convert it to daylight use.

#### Photoflood

We said earlier that there are two types of photoflood lamps—those which need a reflector, and those which have their own built-in reflector. Whichever you use, the method of taking pictures is the same.

With reversal colour film you must use artificial-light film (Type A). If you use daylight film, you will need to use the conversion filters recommended by the manufacturer of the film in question.

With one photoflood lamp, you just set the lamp to illuminate the subject, and make your exposure according to the information given by the lamp manufacturer.

If you want to reduce the intensity of the shadows, use a white card reflector, the same as we suggested for flash.

With two photoflood lamps you are much better able to balance the light from each lamp, and so control the shadows.

One lamp is placed to one side of and fairly close to the subject. This lamp gives 'contour' lighting, and is the main light. The other lamp is placed behind and slightly above the camera. This lamp provides 'fill-in' light, and serves to soften the shadows (Fig. 6). You can position the two lamps until the lighting suits you.

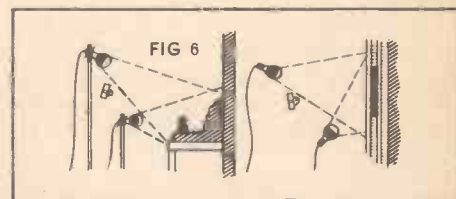

Remember that it is the lamp-to-subject distance of the main light which determines the exposure. For the purposes of exposure, you ignore the fill-in light, as it should be far enough away just to soften the shadows. If the fill-in light is so close that it alters the exposure, it will also be close enough to cast its own distinct shadows, which is not what you want.

So far we have dealt with single models. But suppose you want to photograph a railway layout running along a wall. You can, of course, photograph it in small sections, using one lamp to light each section as you do it.

But a far more satisfactory way of taking such a photograph is by 'painting' it with light.

Sounds fascinating, doesn't it? Well, in fact, it is rather. You will need someone to help you, and you will need your photoflood lamp on a length of cable sufficient to reach comfortably from one side of the room to the other, with some to spare.

Set your camera up so that it will photograph the whole of the layout. Have the

camera on a tripod or some firm surface, and set the shutter to 'B'. If you have one, use a cable release to operate the shutter. The exposure will be a long one—possibly up to a minute—and a cable release will considerably lessen the chances of camera movement.

Now while the exposure is being made, your friend walks up and down the room *without pausing*, shining the lamp all the time on to the layout (Fig. 7). He must take care, especially on the turns, to keep the lamp pointing towards the layout and away from the camera lens.

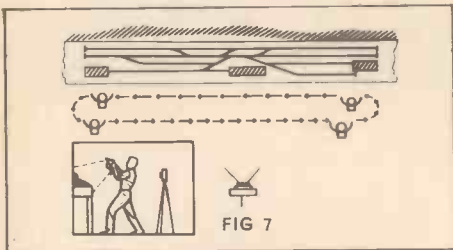

So what you do is to open the shutter on 'B', and your friend starts walking in front of the camera, shining the lamp away from the camera on to the layout. Provided he does not stop walking, but walks at a brisk, even pace, he will not record on the photograph. When there has been sufficient exposure, close the shutter, and your friend can stop his 'painting'.

Exposure is usually a matter of trial and error, as there are so many variables—mainly the speed of the walker. But a good starting point is 10–15 times the normal exposure, based on the lamp-to-subject distance.

This technique is excellent for taking the interiors of doll's houses, so as to give shadowless lighting. Only in this case, the camera will be close to the subject, while you keep the lamp behind and above the camera.

This is equally good lighting for tabletop photography, where you don't want harsh shadows. Where you want a light high up to simulate sunshine, just hold the lamp still.

#### To get better pictures

The best of model pictures can be spoiled by a newspaper included in the foreground, or a jacket draped over a chair in the background.

It is so very easy to miss things like that when you are so intent on the model itself. The eye tends not to see other things, to dismiss them as part of the foreground or the background. But the camera is not so kind—it reveals all, often with disastrous results to our pictures.

So before you actually press the shutter release button, have a last, long look through the viewfinder. Ask yourself, 'Is the foreground clear of clutter?' Then 'Is the background clear of clutter?' If the



Taken in sunshine.

answer to both questions is 'Yes', go ahead and take the picture.

But the extra time taken in clearing the clutter is time very well spent.

Keep the exposure as short as you can. Holding the camera in your hand, you cannot do so satisfactorily for longer than 1/30 second. Even then you must squeeze the shutter release very gently. If you jerk or stab at the shutter release, you will jerk the camera, and the picture will be unsharp and fuzzy.

If you have to use a brief time exposure, set the camera on a tripod if you can. If not, steady the camera on a firm surface, a table, for example, but not on a pile of books. Preferably use a cable release to fire the shutter.



Taken on a dull day by available light.

### TAKING MODELS OUTDOORS

Sunny days are best for outdoor shots on black-and-white film. The pictures come out crisp and contrasty. If you want to reduce shadows, use the same reflector technique that we suggested for flash.

The best position for the sun is to have it shining over one shoulder. But be sure your shadow is not included in the picture.

For colour films, a hazy or slightly overcast day is better. This lighting softens the shadows and reduces the contrast. On a bright sunny day, you can wait till the sun goes behind a cloud, and then

take your picture.

Avoid the period just after sunrise and just before sunset when taking colour pictures. Pictures at this time tend to have a reddish glow the same as the sky.

If the weather is very dull, you can use flash for outdoor pictures. In this case ignore the daylight, and follow the advice given for flash indoors.

Of course, the same points we made earlier about close-ups, parallax, etc., apply equally well when taking pictures out-of-doors.

But before you take any picture, check the foreground and the background and remove any clutter and bits of paper, wood, and so on. This is just as important out-of-doors as it is indoors.

And be sure, when you check the background, that your subject is clear of obstructions such as posts. A four-inch post appearing to grow out of a model yacht can ruin the best of pictures!

Don't be content just to take pictures of your models on, say, the lawn. If it is a radio-controlled boat, take it to a local park lake and photograph it speeding along. Use the panning technique mentioned earlier, and make sure you exclude any people who may be in the background.

Model railway trains can be taken in motion by panning, just the same.

With model aircraft you can suspend them from a tree by nylon thread. Anchor the tail by a further thread. You can then take the picture with the prop revolving, and produce a most realistic 'in flight' picture.

Make sure that no part of the tree is included in the picture.

Doubtless you will think of other ways to improve your pictures. We hope this article has helped you to a good start on the right road to first-class model pictures.





1



2

# sewing machines & projectors

*The ideal gift for a lucky little girl!*

*Sew just like mother, with this carefully designed machine.*

*Fine for making: DOLL'S DRESSES. SCARVES. TEA COSIES. TABLE RUNNERS. PRAM SETS.*

**1 'LITTLE BETTY'** by MISS DEBUTANTE. Size 11½ in. x 6 in. x 6½ in. An attractive hand-operated machine constructed from metal and plastic. Superbly finished in two-tone blue, and supplied with table clamp. Adjustable thread tension.

**TYW.108** ..... Cash price **35/6** carriage 4/6

**2 'COUNTESS' (30/760)** by VULCAN. Size 4¼ in. x 6¾ in. x 11½ in. A real sewing machine, the 'Countess' is in heavy alloy with nickel-plated working parts. Firm chain stitch and adjustable thread tension. Specially designed arm for circular sewing. Complete with detachable sewing table and illustrated book of instructions.

**TYW.101** ..... Cash price **63/11** carriage 4/6 or deposit 9/6 plus carriage and 8 monthly payments 8/6.

**3 MINOR** by VULCAN. Size 6½ in. x 3 in. x 4¾ in. A sturdily constructed metal machine supplied with table clamp. Attractive red finish. Adjustable thread tension.

**TYW.109** ..... Cash price **34/11** carriage 4/6

*Many happy hours of filming fun in your own home. Every child will be fascinated with these super toy projectors. By Chad Valley.*

**4 'STINGRAY' GIVE-A-SHOW PROJECTOR (G.346R).** A battery-driven plastic projector that will show pictures in colour up to 5 ft. square. Contains 112 colour slides showing 16 complete stories based on Gerry Anderson's exciting T.V. series. Also projects other 35 mm. transparencies. Batteries not supplied.

**TYW.144** ..... Cash price **32/6** carriage 4/6

**5 'GIVE-A-SHOW' PROJECTOR (G.343R).** A battery-driven plastic projector that will show pictures in colour up to 5 ft. square. Supplied with 56 colour slides giving eight favourite shows including 'Popeye' and 'Andy Pandy'. Will also take 35 mm. transparencies. Batteries not supplied.

**TYW.143** ..... Cash price **21/-** carriage 3/-

**6 'EASY SHOW' MOVIE PROJECTOR (G.337R).** A battery-driven movie projector supplied with three 8 mm. film cartridges giving 6,000 motion picture frames. No threading, no re-winding, just snap in a cartridge and turn the handle. Children can easily load and operate without help. Films include 'LASSIE', 'THREE STOOGES' and 'THE MUNSTERS'. Batteries not supplied.

**TYW.145** ..... Cash price **55/-** carriage 3/- or deposit 6/- plus carriage and 8 monthly payments 7/6.



3



4



5



6



# for and

MAXIMUM PLAY  
VALUE FOR MINIMUM  
OUTLAY!

## fort, farm and service stations

### 'READY-TO-ASSEMBLE' KITS.

*All the models on this page have the difficult construction work already completed and are literally 'ready-to-assemble' together. Strongly constructed from wood and/or hardboard, these kits can give hours of playtime pleasure. In each 'Hobbies' kit materials for finishing such as decorative papers and enamels are included.*



**[1] MODEL FORT (RTA.9)** by HOBBIES. A strong and authentic fort designed to give hours of wonderful play-value. With working draw-bridge, ramps, battlements, towers – even dungeons for the prisoners! (The base is hinged for storage of soldiers and knights.) Size 21 in. x 17 in. x 17 in. high. Complete with assortment of toy figures.

**FDW.715** ..... Cash price **85/-** carriage 6/- or deposit 10/- plus carriage and 8 monthly payments 11/6.



**[2] POPLAR FARM (RTA.11)** by HOBBIES. A complete farm unit in one, for all animal-loving children. Layout includes farmhouse, barn, cowshed, stable, pigsty, paddock, stockyard, pond and trees. Baseboard measures 24 in. x 18 in.

**FDW.716** ..... Cash price **67/6** carriage 6/- or deposit 9/- plus carriage and 8 monthly payments 9/-.



**[3] 'BRIDGEWAY' Motorway Service Station (RTA.20)** by HOBBIES. A spectacular up-to-the-minute design for a Motorway Service Station which will be the pride of all young lads. Includes showrooms, servicing bay, forecourts, roof park, cafe, etc. Size 24 in. x 20 in. x 7 in. high. Kit also contains two sets of pumps and hoist (not cars).

**FDW.719** ..... Cash price **59/6** carriage 4/6 or deposit 7/6 plus carriage and 8 monthly payments 8/-.

**[4] SERVICE STATION (RTA.8)** by HOBBIES. This magnificent model garage is up to date in design and styling. Just right for the modern youngster who loves 'playing cars'. There is a workshop, showroom, office, glazed forecourt, toilets, and cafe with spacious car park. Base measures 24 in. x 18 in. Kit also contains pumps (not cars).

**FDW.717** ..... Cash price **75/-** carriage 4/6 or deposit 10/- plus carriage and 8 monthly payments 10/-.



# lads lasses



# dolls houses



1

## 'READY-TO-ASSEMBLE' KITS.

Like the models on the opposite page, these doll's houses have all the difficult work already completed. They are sturdily constructed from wood and/or hardboard. Each kit contains materials for finishing, such as papers and enamels. The completed kit will give hours of playtime pleasure.

**1 'DREAMHOLME' DOLL'S HOUSE (RTA.14)** by HOBBIES. A superb doll's house with ultra-modern features such as panelled doors, glazed windows, shrubs, etc. 5 rooms and openings back and front, plus roof trap-door for battery storage, etc. Size 36 in. x 24 in. x 18 in. high.

**DHW.267** ..... Cash price **217/6** carriage free or deposit 29/- and 8 monthly payments 29/-.

**2 'LINDY' PLAY HOUSE (RTA.12)** by HOBBIES. A strongly constructed play house with 3 floor levels, standing 2 ft. 9 in. when completed. Sliding doors give an overall width of 2 ft. 4 in. Decorating materials included - no furniture. Size 15 in. x 19 in. x 33 in. high.

**DHW.212** ..... Cash price **67/6** carriage 7/6 or deposit 9/- plus carriage and 8 monthly payments 9/-.

**3 'CELEBRITY' DOLL'S HOUSE (RTA.7)** by HOBBIES. This model bungalow-type residence has everything - even the kitchen garden. Flat roof lifts off for easy access to the 5 main rooms. Car port, sun trap, service area, etc. Size 36 in. x 24 in. x 8 in. high.

**DHW.245** ..... Cash price **105/-** carriage free or deposit 14/- and 8 monthly payments 14/-.

**4 'CARLISLE' DOLL'S HOUSE** by KAYS. A complete doll's house that can be put together in 60 seconds. No nails, screws or glue required and packs flat when not in use. Easy access to 6 rooms from back. Completely decorated. Size 24 in. x 16 in. x 17 in. high.

**DHW.234** ..... Cash price **105/-** carriage free or deposit 14/- and 8 monthly payments 14/-.

**5 'ROYAL' DOLL'S HOUSE (RTA.6)** by HOBBIES. Elegant, modern-style house with picture windows. 6 rooms to furnish through double-door opening at back. All parts are pre-cut and all necessary decorating materials included. Size 26 in. x 12 in. x 19 in. high.

**DHW.256** ..... Cash price **127/6** carriage free or deposit 17/- and 8 monthly payments 17/-.



2



3



4



5

# hobbies

# doll's house papers

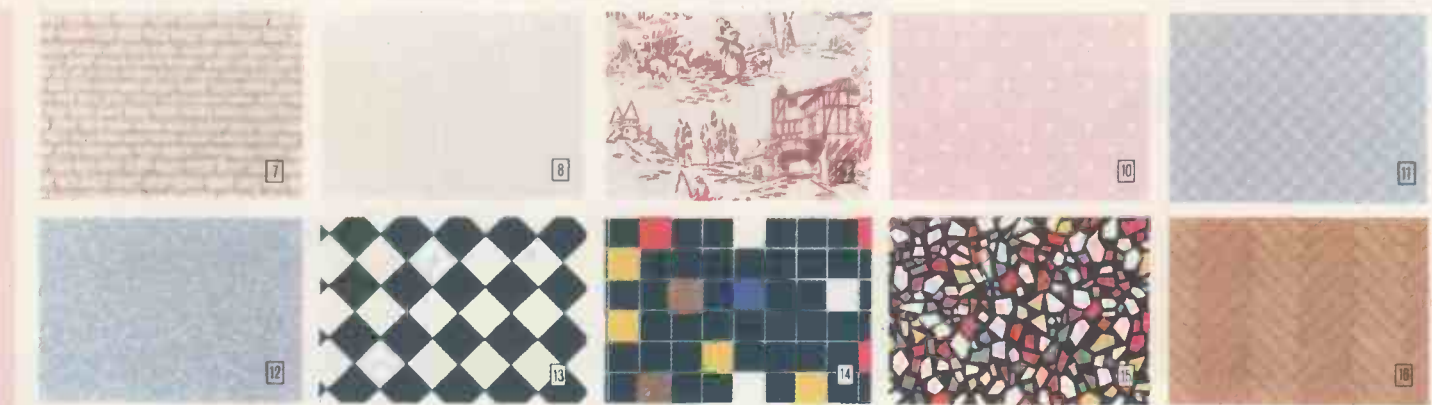

## SPECIALLY SELECTED MINIATURE PATTERNS FOR DOLLS' HOUSES, FORTS, FARMS AND GARAGES.

Use these papers for decorating the new Doll's House you are making - or give your daughter a dozen assorted sheets and let her redecorate her Doll's house while you are doing a mansize job in your own home.

All are expertly printed in appropriate colours by a well-known wallpaper manufacturer. In Sheets 22 in. x 30 in.

**MINIMUM QUANTITY** six assorted sheets to your own choice. Postage on six sheets 1/4.

**EXTERIOR PATTERNS** - For outside walls, roofs, etc.

- 1 **DHAW.140** Bright Red Brick
- 2 **DHAW.141** Natural Brick
- 3 **DHAW.142** Red Pantile
- 4 **DHAW.143** Green Pantile
- 5 **DHAW.144** Fort Paper - Stone Colour
- 6 **DHAW.145** Grey Slate Roof

Cash price **9d** per sheet.

- 7 **DHAW.159** Embossed Stone
- Cash price **1/-** per sheet.

**INTERIOR PATTERNS** - For inside walls and ceilings.

- 8 White Embossed Paper. A dual purpose paper with smooth side suitable for ceilings and rough side suitable for rough cast.  
**DHAW.131** ..... Cash price **1/-** per sheet
- 9 A new paper in modern trend, depicting country scenes. Maroon on White Ground.  
**DHAW.132** ..... Cash price **1/-** per sheet
- 10 Attractive Pink with small White Dot.  
**DHAW.133** ..... Cash price **1/-** per sheet

- 11 Pale Grey Background with neat White Pattern.  
**DHAW.134** ..... Cash price **1/-** per sheet

- 12 Pale Blue with White and Gold Flecks.  
**DHAW.135** ..... Cash price **1/-** per sheet

**TILE AND FLOOR** - Suitable for interior floors, bathroom and kitchen walls and exterior paving.

- 13 Black and White Tiles - a striking paper for bathroom or kitchen floors.  
**DHAW.160** ..... Cash price **9d.** per sheet

- 14 Multi-coloured Tiles, with Red, Yellow, Blue, Gold, Black and White squares - most attractive for entrance halls and effective as outdoor paving.  
**DHAW.162** ..... Cash price **1/-** per sheet

- 15 Mosaic Tile. Red, Yellow, Grey and White on Black Background - particularly suitable for outdoor effects.  
**DHAW.161** ..... Cash price **9d.** per sheet

- 16 Parquet Floor in Light Oak Colour.  
**DHAW.146** ..... Cash price **9d.** per sheet

## SUPER QUALITY DEEP PILE FLOCK PAPER

- 17 Green or Red. The thickness and high quality of this flock paper make it specially suitable for Doll's House carpets, rugs, staircarpets and of course the green is excellent for lawns. It can be used too for covering Doll's House furniture, or for lining trinket boxes. Green or Red. Size 22 in. x 30 in. When ordering state catalogue number and colour.  
**DHAW.171** ..... Cash price **5/9** per sheet

- 18 Green or Red. Size 22 in. x 15 in.  
**DHAW.172** ..... Cash price **3/-** per sheet

★ **REX** - Cellulose Adhesive.

For paperhanging, sizing or stripping. A smooth paste specially selected for fixing Doll's House papers. Handy size bag contains sufficient powder to make 1/2 gallon of paste. Soluble in cold water.

- DHAW.181** ..... Cash price **1/4** postage 4d.  
★ Not illustrated.

# hobbies





# DOLLS HOUSE FURNITURE

NOW - SEE ALL THE WONDERFUL FURNITURE YOU CAN GET FOR THE DOLL'S HOUSE.

Choose from wooden sets, with painted or varnished finishes, showing the natural wood grain, or high grade plastic sets containing every detail imaginable.

**DOLL'S HOUSE FURNITURE (WOOD)** by HOBBIES. A completely new range of wooden furniture sets, designed specifically to furnish Hobbies' range of Dolls' Houses. Sturdy, but light in weight, built to last and will provide many hours of enjoyment. Painted or varnished finishes.

- 1 DHAW.805 'Bathroom' Set -3 piece.
  - 2 DHAW.801 'Bedroom' Set -3 piece.
  - 3 DHAW.802 'Dining Room' Set -4 piece.
  - 4 DHAW.804 'Kitchen' Set -5 piece.
  - 5 DHAW.803 'Lounge' Set -4 piece.
- Cash price **7/11** each set ..... Postage 1/4

## ROOM FURNITURE SETS (in Plastic)

**JENNY'S HOME** Furniture Sets by ROVEX INDUSTRIES.

Modern furniture in self-coloured high grade plastic. Beautifully modelled with details carefully reproduced. Perfect reproductions!

- 6 'DINING ROOM' (JH. 1). Containing 3-leaf table, 4 upright chairs, sideboard and standard lamp.
- DHA.901 ..... Cash price **17/11** postage 1/4

- 7 'BEDROOM' (JH. 3). Containing double bed, dressing table, wardrobe (with coat hangers) and bedroom stool.
- DHA.903 ..... Cash price **17/11** postage 1/4

- 8 'LIVING ROOM' (JH. 2). Containing wing settee, 2 wing chairs, bookcase, low easy chair, T.V. set, coffee table and standard lamp.
- DHA.902 ..... Cash price **17/11** postage 1/6

- 9 'KITCHEN' (JH. 4). Containing sink unit, kitchen table, 2 utility chairs and cooker.
- DHA.904 ..... Cash price **17/11** postage 2/-

- 10 'BATHROOM' (JH. 5). Containing bath, bathroom stool, mat, washbasin and W.C.
- DHA.905 ..... Cash price **12/11** postage 1/4

- 11 'NURSERY' (JH. 6). Containing droppside cot, playpen, baby's bath and stand, Noah's Ark and rocking horse.
- DHA.906 ..... Cash price **12/11** postage 1/2

- 12 'PLAYTIME' (JH. 7). Containing see-saw, garden swing and chute.
- DHA.907 ..... Cash price **12/11** postage 1/-

- 13 'GARDEN SHED' (JH. 8). Containing Workbench and tools, lawn mower, garden roller, wheelbarrow and tools.
- DHA.908 ..... Cash price **15/6** postage 1/2
- Doll's Houses are shown on pages 67 and 84.*

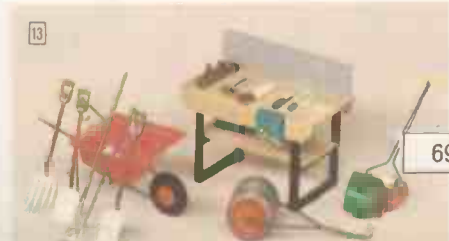
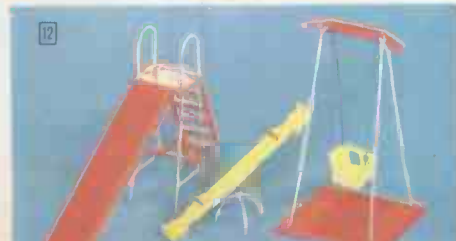
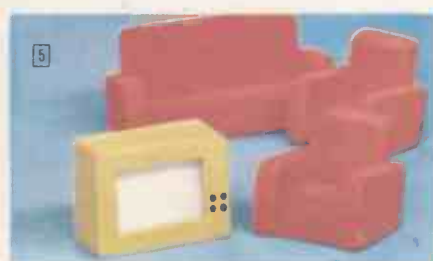
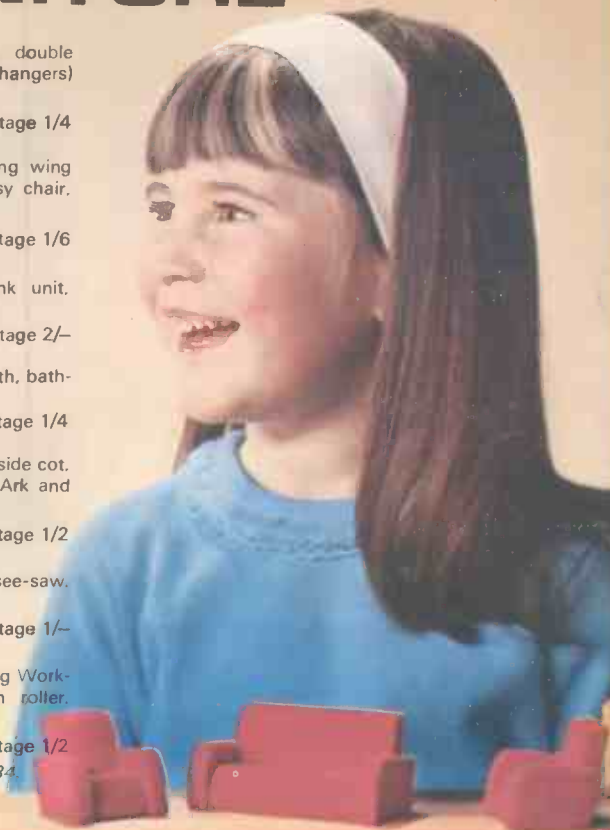

# SPIROGRAPH



Top educational awards in Great Britain and America

*Spirograph is the outcome of a life-long search to find a simple key to the patterns and designs known previously only to mathematicians and never before fully explored in a multiple combination of colours.*

*After many experiments with complicated mechanisms, the startling simplicity of this invention was visualized just after three years ago and it was immediately apparent that this 'new use of the wheel' would interest all the world.*

*By the correct choice of materials, tooling and manufacturing methods, the highest degree of engineering precision that was specified for the 1742 involute gear teeth and the 463 jugged holes of the Spirograph components has become a reality at a price in easy reach of everyone.*

The **SPIROGRAPH** set contains eighteen gear wheels, two gear rings, two gear racks, box of special pins, four coloured ball-point pens, unbreakable tray, paper back, baseboard, pattern sheets and instructions.

**PN.701** ..... Cash price **35/6** postage 4/6

**SPIROTOT**, from the makers of the award-winning Spirograph, is a creative drawing toy enabling 3-7 year olds to create bold, elementary, coloured patterns. Fully complete with paper, pens and instructions.

**PN.702** ..... Cash price **14/6** postage 2/-

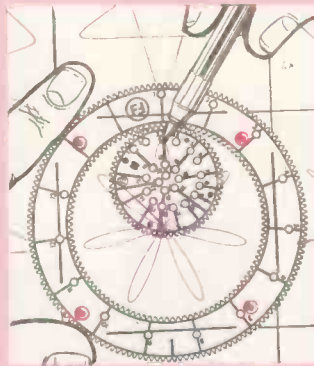

## 1. How do you use SPIROGRAPH?

- You hold the pen yourself and you actually draw the pattern.
- Fasten a ring to the paper and baseboard with the special pins.
- Put the point of a pen in a hole in a wheel.
- Move the wheel with the pen and keep the teeth in contact.

## 2. What is SPIROGRAPH?

SPIROGRAPH is a new invention for drawing coloured designs and patterns.

## 3. Why is SPIROGRAPH attractive?

- Because it appeals to young and old alike, and because it is easy to use.
- Children from five or six years old can draw with SPIROGRAPH.

## 4. Why is SPIROGRAPH educational?

- Because it is based on mathematical principles it teaches the effect of simple ratios.
- For those particularly interested it shows the nature, scope and artistic possibilities of the epicyclic curve.
- It teaches hand control and sensitivity of touch and is essentially a creative activity with inexhaustible possibilities.

## 5. How long will SPIROGRAPH last?

- Nothing can go wrong or break in normal usage and you will find that the initial sweetness of the gears improves with continuous use.
- The unbreakable tray and gears are moulded in polystyrene supplied by SHELL.
- Your set will last a lifetime.



## Draw with SPIROGRAPH

A simple and fascinating way to make a million marvellous patterns







# GUNS

## PRESENTATION KITS

Authentic full-size replicas of famous guns, firing repeater caps. Really outstanding workmanship and finish. Complete in every detail. Will be the pride of every boy.

**1 OUTLAW 'MINIATURE' (PS/M)** by B.C.M. A novel set of Miniature Antique Firearms. Supplied with spare bullets, Oil and Cleaning Brush. Contains 1 'Cadet' Gun, 1 'Pistolet' Pistol, 1 'Pirate' Pistol.  
**TYW.125** ..... Cash price **13/6** postage 1/4

**2 OUTLAW 'KID' Mk.II (PS/KII)** by B.C.M. A matching pair of Hand Guns attractively presented in rigid box with loose lid. Contents are fitted into a red imitation velvet plastic platform. Case contains 1 pair of Silver 'Kid' Guns, 1 Container of Oil, 1 Cleaning Brush.  
**TYW.126** ..... Cash price **14/-** postage 1/9

**3 OUTLAW 'AUTOMATIC' (PS/Auto)** by B.C.M. A realistic cased set of Automatic Pistols of authentic modern design - Roll Cap and Single Shot Bullet Firing. Contains 1 Full-size Automatic, 1 Miniature Automatic, 6 Plastic Bullets, Oil and Cleaning Brush.  
**TYW.124** ..... Cash price **16/1** postage 2/-

**4 OUTLAW 'MUSTANG' (PS/MG)** by B.C.M. Presentation Case containing Matching Pair of Reproduction 'Colt' cap 'n' ball percussion Pistols. 1 Container of Oil and 1 Cleaning Brush.  
**TYW.127** ..... Cash price **17/6** carriage 2/6

**5 OUTLAW 'APACHE' (PS/A)** by B.C.M. An attractive Presentation Case of Matched Guns, Badge and Cleaning/Oiling Equipment. Contents are set into imitation red velvet platform and contained in rigid box with hinged lid. Case contains 1 pair of 'Apache' Guns, 1 Sheriff Badge, 1 Bottle of Oil and 1 Cleaning Brush.  
**TYW.123** ..... Cash price **25/6** carriage 3/-

**6 F.N. PATROL RIFLE (173)** by CRESCENT TOYS. Length 31 in. A military rifle fitted with a lever-operated die-cast metal mechanism. Has steel barrel and plastic simulated 'wood grain' butt and stock. Fires full roll of caps. Detachable magazine, complete with Shoulder Strap.  
**TYW.177** ..... Cash price **22/11** carriage 2/6

**7 DE LUXE SHERIFF SET (741)**. Just the set for the local junior sheriff. Set contains Sharpshooter Rifle, Frontier Ace Gun and Holster, Belt, Handcuffs and Sheriff's Star.  
**TYW.178** ..... Cash price **40/6** carriage 4/6 or deposit 8/6 plus carriage and 8 monthly payments 5/-

**8 'MATT HELM' ELIMINATOR SET (756)** by CRESCENT TOYS. Intelligence Counter Espionage. A Secret Agent toy with push-on Telescopic Sight, push-on Subsonic Silencer, push-on Long Range Extension Barrel.  
**TYW.175** ..... Cash price **15/11** postage 2/-

**9 'LONE RANGER' HOLSTER SET (192)** by CRESCENT TOYS. A fine double holster set designed in realistic style. Complete with Guns, Belt and 'Lone Ranger' Mask.  
**TYW.176** ..... Cash price **21/6** carriage 2/6

*No caps supplied with these sets due to postal restrictions. Caps may be purchased locally.*

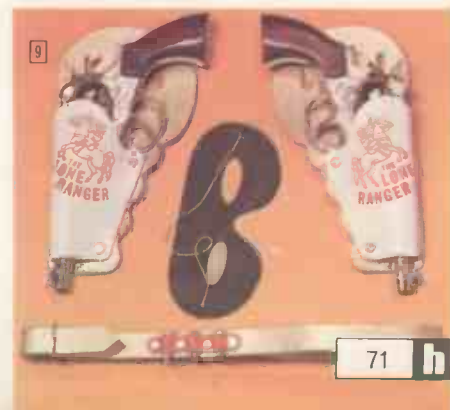



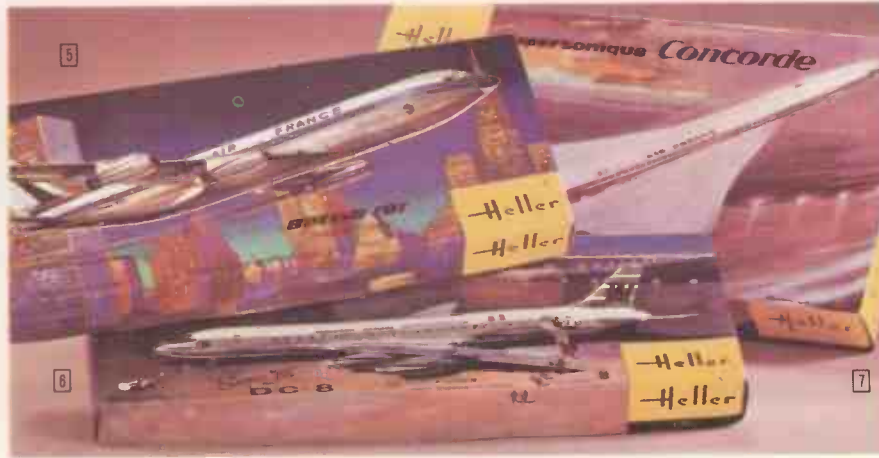
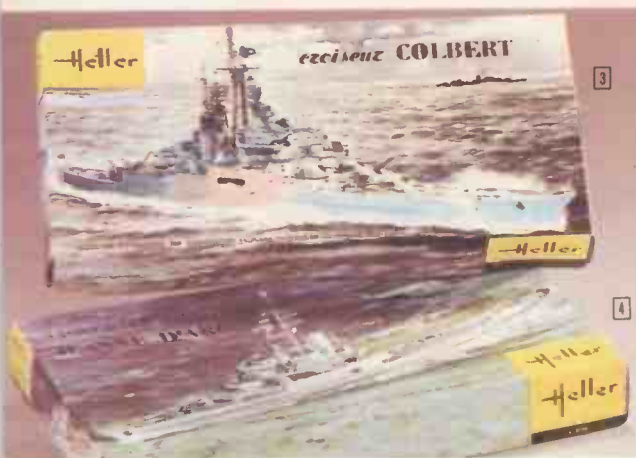

# PLASTIC MODELS

An exciting NEW range of Models to add to your collection.

*These beautifully boxed model kits are the last word in perfection. Complete to the last detail they will really try your skill and give hours of pleasure in building. Be the first to make up these superb models specially imported from France.*

*Complete instructions, in English, included in each kit.*

**1 'CLEMENCEAU' AIRCRAFT CARRIER** by HELLER. A 1/430 scale model - 25½ in. long. A magnificent model complete with coloured transfers. Made in France.

**PMW.138** ..... Cash price **49/6** carriage 4/6 or deposit 7/6 plus carriage and 8 monthly payments 6/6.

**2 'FOCH' AIRCRAFT CARRIER** by HELLER. Another 1/430 scale carrier with similar hull, but completely different superstructure. 25½ in. long. Complete with transfers. Made in France.

**PMW.139** ..... Cash price **49/6** carriage 4/6 or deposit 7/6 plus carriage and 8 monthly payments 6/6.

**3 'COLBERT' CRUISER** by HELLER. A fine 1/400 scale model of the 8,500 ton cruiser. Length 18 in. 200 pieces of intricate detail make up this splendid ship. Complete with transfers. Made in France.

**PMW.140** ..... Cash price **25/-** carriage 2/6

**4 'JEANNE-D'ARC' HELICOPTER CARRIER** by HELLER. A 17½ in. model of striking appearance. Complete with helicopters. Made in France.

**PMW.141** ..... Cash price **25/-** carriage 2/6

**5 'BOEING 707' (L.700)** by HELLER. A 15½ in. span model of the famous intercontinental plane. Scale 1/125. 66 pieces in all. Complete with coloured transfers and stand. Made in France.

**PMW.142** ..... Cash price **19/11** postage 1/6

**6 'DOUGLAS DC-8' (L.705)** by HELLER. A 14 in. span model of another intercontinental 'Super Jet'. 1/125 scale. A feature of this kit is the self coloured white plastic for the fuselage. With coloured transfers. Made in France.

**PMW.143** ..... Cash price **19/11** postage 1/6

**7 'CONCORDE' (L.855)** by HELLER. A 10 in. span model of this supersonic plane. 1/100 scale. In white plastic with black stand. Kit includes coloured transfers. Made in France.

**PMW.144** ..... Cash price **25/-** carriage 2/6

**8 'MIRAGE IV' (L.830)** by HELLER. A 1/50 scale bomber of 9 in. span. A highly detailed model with 149 pieces and stand. Complete with coloured transfers. Made in France.

**PMW.145** ..... Cash price **25/-** carriage 2/6

**9 'CARAVELLE' (L.300)** by HELLER. A sleek 14 in. span model. 1/100 scale. Complete with stand and coloured transfers. Made in France.

**PMW.146** ..... Cash price **13/9** postage 1/2

**10 'TRIDENT' (L.105)** by HELLER. A 7 in. span model. 1/50 scale. With stand and coloured transfers. Made in France.

**PMW.147** ..... Cash price **13/9** postage 1/2

**11 'RENAULT 16'** by HELLER. 8½ in. long. A highly detailed model of this popular car. Made in France.

**PMW.148** ..... Cash price **25/-** carriage 2/6

*For suitable cements see page 109.*



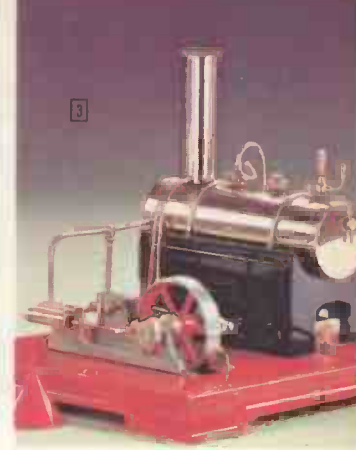
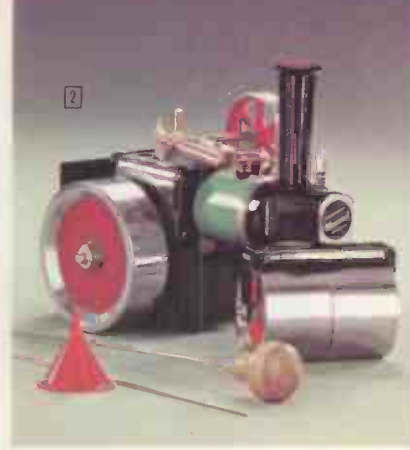

# Mamod steam engines

FULL STEAM AHEAD to hours of fun with MAMOD steam models. Precision engineered to operate alone, with miniature tools or with your own models and boats.

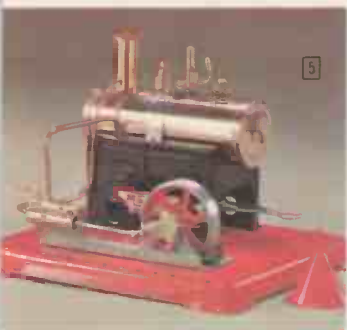

## MAMOD WORKING MODELS

Utilise the 'power' of your steam engines for driving one or more of these inexpensive machine tools.

**8 MINIATURE LINESHAFT** by MALINS. Enables several models to be connected for driving from a model steam engine, clockwork or electric motor. Shaft and pulleys fit Meccano.  
**MS.123** ..... Cash price **17/11** postage 1/9

**9 MODEL POWER PRESS** by MALINS. This model is fitted with a 1 3/8 in. diameter red-spoked flywheel. Easily driven by one of the smaller engines.  
**MS.124** ..... Cash price **9/11** postage 1/-

**10 MODEL POWER HAMMER** by MALINS. 1 3/8 in. diameter spoked flywheel, an ideal accessory for even the smallest engine.  
**MS.125** ..... Cash price **9/11** postage 10d.

**11 MINIATURE POLISHING MACHINE** by MALINS. Fitted with two 1 1/4 in. diameter felt polishing wheels.  
**MS.126** ..... Cash price **8/11** postage 8d.

**12 MINIATURE GRINDING MACHINE** by MALINS. Fitted with two 3/4 in. diameter Arcorundum grinding wheels.  
**MS.127** ..... Cash price **8/11** postage 8d.



**1 TRACTION ENGINE (TE.1)** by MALINS. A precision model powered by a very efficient steam unit. Fitted with speed regulator and towing eye. The canopy can be removed to allow tractor to be used as an open type unit. Extension steering rod supplied for easy manoeuvring.  
**MS.110** ..... Cash price **113/3** carriage free or deposit 15/6 and 8 monthly payments 15/-.

**2 STEAM ROLLER (SR.1)** by MALINS. This super quality model will travel approx. a third of a mile in a ten minute run. Boiler fittings include safety valve and whistle. Fired by a vaporising spirit lamp. Steam exhausted up chimney for added realism. Supplied with extension steering rods.  
**MS.111** ..... Cash price **99/9** carriage 4/6 or deposit 12/6 plus carriage and 8 monthly payments 13/6.

**3 SUPERHEATED TWIN CYLINDER STEAM ENGINE (SE.3)** by MALINS. This perfect Power Unit for model propulsion, has twin oscillating cylinders, coupled to 2 1/2 in. diameter flywheel. Boiler fittings include stop cock, whistle and water level end plug. Detachable chimney for storage purposes.  
**MS.112** ..... Cash price **108/3** carriage free or deposit 14/- and 8 monthly payments 14/6.

**4 MARINE STEAM ENGINE (ME.1)** by MALINS. A very lively power unit for boats of about 24 in. length. Simple installation, direct drive gives maximum efficiency with 15 minutes fast steaming to a filling.  
**MS.119** ..... Cash price **56/3** carriage 3/- or deposit 7/6 plus carriage and 8 monthly payments 7/6.

**5 SUPERHEATED STEAM ENGINE (SE.2)** by MALINS. A great favourite with model makers. Superheated steam pipe for greater efficiency. 2 in. diameter spoked flywheel and separate driving pulley. Boiler fittings include whistle and speed regulator.  
**MS.113** ..... Cash price **68/9** carriage 4/6 or deposit 10/6 plus carriage and 8 monthly payments 9/-.

**6 STEAM ENGINE (SE.1)** by MALINS. This model has the same specifications as the SE.2, but is fitted with a smaller boiler without the whistle and speed regulator.  
**MS.114** ..... Cash price **56/3** carriage 4/6 or deposit 7/6 plus carriage and 8 monthly payments 7/6.

**7 MINOR No. 2 STEAM ENGINE** by MALINS. Exceptional power and performance for such a moderate price. Brass balanced crank gives particularly smooth action at high speeds. Capable of driving a series of MAMOD working models.  
**MS.115** ..... Cash price **46/3** carriage 3/- or deposit 7/6 plus carriage and 8 monthly payments 6/-.

# radio control boats and cars



## THE IDEAL INTRODUCTION TO RADIO CONTROL

The cars and boats illustrated are beautifully constructed from colourful moulded plastic. Each model comes complete with motor, pre-tuned radio and transmitter – the only extras needed are the batteries. Allow five minutes for fixing, and you're off! "Right on the Beam!"

## ABSOLUTELY NO PREVIOUS EXPERIENCE OF RADIO CONTROL NECESSARY

1 'CRUISER' (202) by ELGI. Length 25 in. A really ambitious Cabin Cruiser which is absolutely up-to-date in every detail. Constructed from tough durable plastic and beautifully coloured. Complete with electric motor, two-channel filter radio, and transmitter pre-tuned to give left and right SELECTIVE control. Made in Italy.

RCW.262 . . . . Cash price **£29 7 6** carriage free or deposit 81/- and 8 monthly payments 78/-.

★'CRUISER' (204) by ELGI. As above, but with added forward and reverse control. Made in Italy.

RCW.264 . . . . Cash price **£36 0 6** carriage free or deposit 96/6 and 8 monthly payments 96/-.

2 'FLORIDA' (201) by ELGI. Length 19 in. Similar construction and high standard of workmanship as the 'CRUISER'. Complete with single-channel radio control equipment giving rudder control. Made in Italy.

RCW.263 . . . . Cash price **£19 17 6** carriage free or deposit 53/- and 8 monthly payments 53/-.

3 FIAT 850 (101) by ELGI. 12½ in. long. A less expensive, but equally fascinating, radio-controlled model. Operating on two channels this car will steer left or right up to a range of 100 yds. A slower car for beginners. Made in Italy.

RCW.253 . . . . Cash price **£15 5 6** carriage free or deposit 42/6 and 8 monthly payments 40/6.

4 FERRARI BERLINETTA 250 LE MANS (102) by ELGI. 13½ in. long. ½ scale. One of the most famous creations of the FERRARI GROUP. Operating on three channels this car will perform almost any manoeuvre. It will stop, start and steer left or right. Range 100 yds. Made in Italy.

RCW.254 . . . . Cash price **£26 2 6** carriage free or deposit 71/- and 8 monthly payments 69/6.

★FERRARI BERLINETTA 250 LE MANS (401). DE LUXE PLASTIC CONSTRUCTION KIT. ½ scale, 13½ in. long. Contains all parts including spoked chrome wheels and many chrome parts. Suitable for radio control as above. Note: Kit does not contain motor. Made in Italy.

RCW.256 . . . . Cash price **£6 15 3** carriage free or deposit 18/- and 8 monthly payments 18/-.

★FERRARI COMPLEMENTARY RADIO-CONTROL KIT (301). Specifically designed for motoring and radio-controlling the above kit. Includes special suppressed electric motor, completely built receiver and transmitter. Complete with all wiring. Made in Italy.

RCW.257 . . . . Cash price **£18 12 6** carriage free or deposit 51/- and 8 monthly payments 49/6.

★FERRARI BERLINETTA 250 LE MANS (103) by ELGI. 13½ in. long. ½ scale. In racing colours. Operating on three channels, but having the extra function of REVERSE. Similar to RCW.254. Made in Italy.

RCW.255 . . . . Cash price **£32 12 11** carriage free or deposit 87/- and 8 monthly payments 87/-.

★ Not illustrated.



# INDOOR

# GAMES



With the accent on good clean family entertainment, Waddington's Games offer hours of fascinating fun.

Without leaving the comfort of your home, you can now enjoy the thrills and spills of the racetrack, or the excitement and bustle of world travel. These are but two of the wide range of games which offer so much in both entertainment and educational values.

**1 CHESSMEN** by WADDINGTON. A quality chess set designed to appeal to the boy wanting something a little different, although still within his budget. These beautifully moulded chessmen are weighted and have felt bases.

**GMW.141** ..... Cash price **41/6** carriage 2/6 or deposit 6/- plus carriage and 8 monthly payments 5/6.

**2 TOTOPOLY** by WADDINGTON. All the thrills of owning a racing stable. Buy, train and race your own horses and collect huge sums of money if you win. For 2-6 players.

**GMW.104** ..... Cash price **39/6** carriage 4/6

**3 RAILROADER** by WADDINGTON. The scene is the 'Wild West'. Be the first to lay a railway track and run your train from Junction City to Buffalo Creek - fraught with hazards of Indians and derailments. 104 pieces of real track. For 2-4 players.

**GMW.102** ..... Cash price **33/11** carriage 4/6

**4 GO** by WADDINGTON. The world is on the move! Cover the globe from Cape Town to Cairo - Moscow to Madagascar, in an exciting search for adventure and souvenirs. But beware of 'Customs' difficulties and travel hazards. For 2-6 players.

**GMW.103** ..... Cash price **30/11** carriage 4/6

**5 CLUEDO** by WADDINGTON. Within the walls of Tudor Close, murder most foul has been committed - but by whom? All members are suspect. An exciting game of detection for 2-6 players.

**GMW.107** ..... Cash price **29/2** carriage 3/-

**8 MONOPOLY** by WADDINGTON. A most realistic game of big business and property deals. All the thrills and hazards of being a big business tycoon. For 2-6 players.

**GMW.106** ..... Cash price **29/2** carriage 3/-

**7 MINE A MILLION** by WADDINGTON. An entirely new kind of trading game in which each player owns a mining company. Transport your ore by lorry, barges or ships, but keep an eye on your Business rivals. For 2-6 players.

**GMW.142** ..... Cash price **29/2** carriage 4/6

**8 RISK** by WADDINGTON. The winner of this absorbing game rules the world, with armies stationed all over the globe. An interesting mixture of chance and tactical skill. For 3-6 players.

**GMW.105** ..... Cash price **30/11** carriage 4/6

**9 FORMULA 1** by WADDINGTON. A thrill-packed racing game with all the risks and excitement of racing at 100 m.p.h. + in a Grand Prix. No longer is the player governed by the luck of the dice - each "driver" sets his own pace.

**GMW.111** ..... Cash price **26/9** carriage 3/-

**10 DON'T MISS THE BOAT** by WADDINGTON. A hilarious game for everyone. Even the younger children will delight in the ever changing situations in trying to 'jump' their men into the boat. For 2-4 players.

**GMW.143** ..... Cash price **13/-** carriage 4/6

**11 TABLE SOCCER** by WADDINGTON. All the excitement of the 'World Cup'. Tension and tactics are as varied as in the big game itself. Attractively printed 'pitch' with polythene goals. For 2 players.

**GMW.115** ..... Cash price **13/-** carriage 2/6

**12 CRIBBAGE** by WADDINGTON. An absorbing game that requires rather more skill than usual. Varied scoring combinations call for a fairly high degree of concentration. Ideal for older children and adults. For 2-4 players.

**GMW.120** ..... Cash price **11/11** postage 1/6

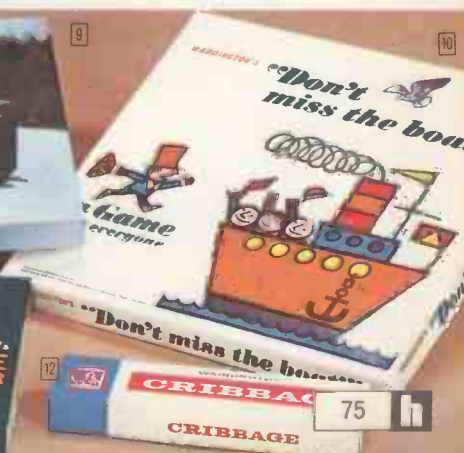
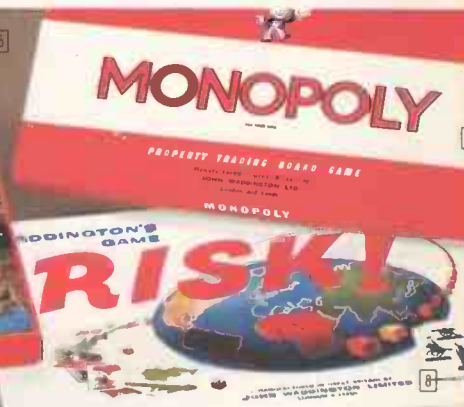
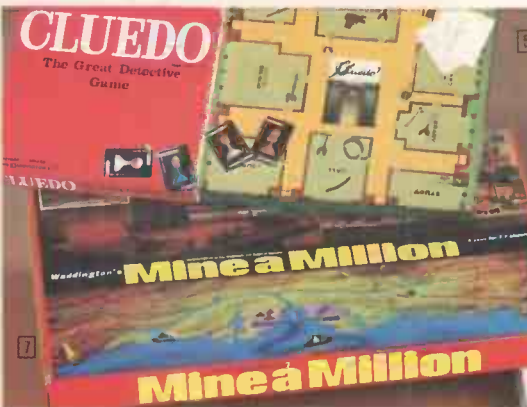
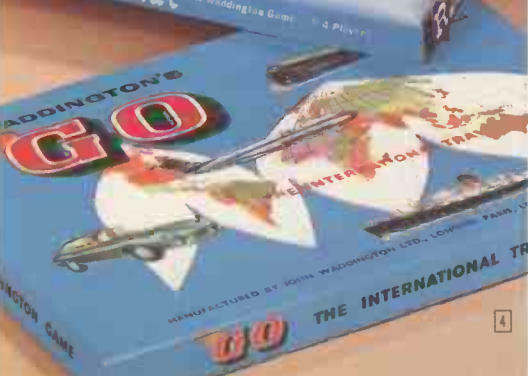
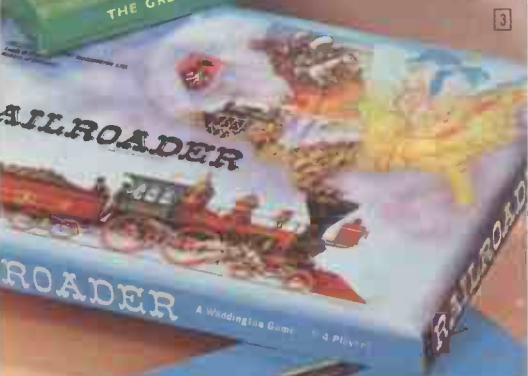
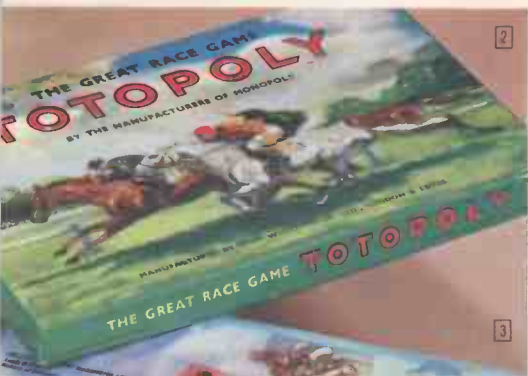
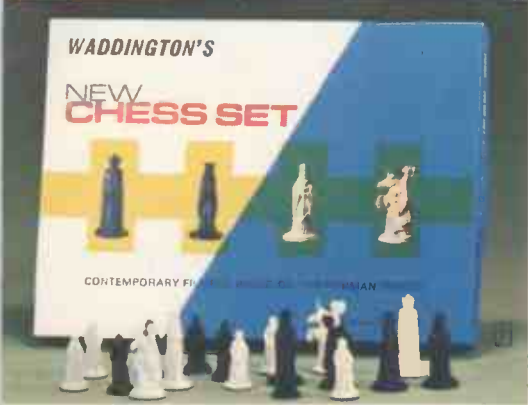





# FOR THE ARTIST

## HIGH QUALITY SETS OF UNIVERSAL APPEAL

A selection of popular paints and instruments which are unbeatable for price and quality. For the younger age group 'Pencil Craft' will fascinate for hours.

For the serious artist or student the water colours, oils and instruments are all that can be desired.

**1 OIL COLOURS (1002) by PAGE.** An attractive set in metal presentation box containing 11 tubes of oil colours, 1 bottle of turpentine, 1 bottle of linseed oil, 3 assorted brushes, palette and instruction leaflet.

**HPW.211** ..... Cash price **22/6** carriage 4/6

**2 STUDENTS' WATER COLOURS (8930/8C) by PAGE.** A smart metal presentation box containing 30 square pans of colour, 8 tubes, mixing palette and two brushes.

**HPW.212** ..... Cash price **16/6** carriage 3/-

**3 DRAWING INSTRUMENTS (4101) JAGUAR BRAND.** A really first class set of instruments in smart lined case. Contains spring bows and compasses for ink or pencil, dividers, drawing pens, extension bar and interchangeable points, pens, etc., for compasses, 10 instruments in all, with spare leads. Made in West Germany.

**HPW.213** ..... Cash price **69/6** postage 2/- or deposit 11/6 plus postage and 8 monthly payments 9/-.

**4 DRAWING INSTRUMENTS (4305) JAGUAR BRAND.** A less expensive set in lined case. Contains spring bows, compasses with interchangeable points, dividers, drawing pen, extension bar and spare leads. 9 instruments in all. Made in West Germany.

**HPW.214** ..... Cash price **32/6** postage 1/6

**5 ARTIST BRUSHES.** Assorted sizes of Artist Brushes suitable for Water Colour, and recommended for model painting with HUMBROL enamel.

**HDW.121** Brushes Nos. 1 and 2  
Cash price **6d.** each

**HDW.122** Brushes Nos. 3 and 4  
Cash price **9d.** each

**HDW.123** Brushes Nos. 5 and 6  
Cash price **1/-** each

**HDW.124** Brushes Nos. 7 and 8  
Cash price **1/3** each

Please state cat. number and brush number when ordering. Postage free when ordered with other goods.

## COLOURING BY NUMBERS

With the new popular colour-view pencils.

**6 PENCIL CRAFT (7009/12) by TOWER PRESS.** A series of nine designs, including Favourite Scenes, Landscapes, Boats and Children. Each contains 12 colour-view pencils and nine art prints numbered and ready to colour. Large full colour box, size 14 3/4 in. x 14 3/4 in. x 1 1/2 in.

**HPW.215** ..... Cash price **14/11** carriage 2/6

**7 PENCIL CRAFT (7010/8) by TOWER PRESS.** A series of six designs, including Cottages, Favourite Scenes, Wild Life and Harbours. Each contains 8 colour-view pencils and six art prints numbered and ready to colour. Brilliant full colour box 13 1/2 in. x 9 5/8 in. x 3/4 in.

**HPW.216** ..... Cash price **9/11** postage 1/4







# PAINTING BY NUMBERS

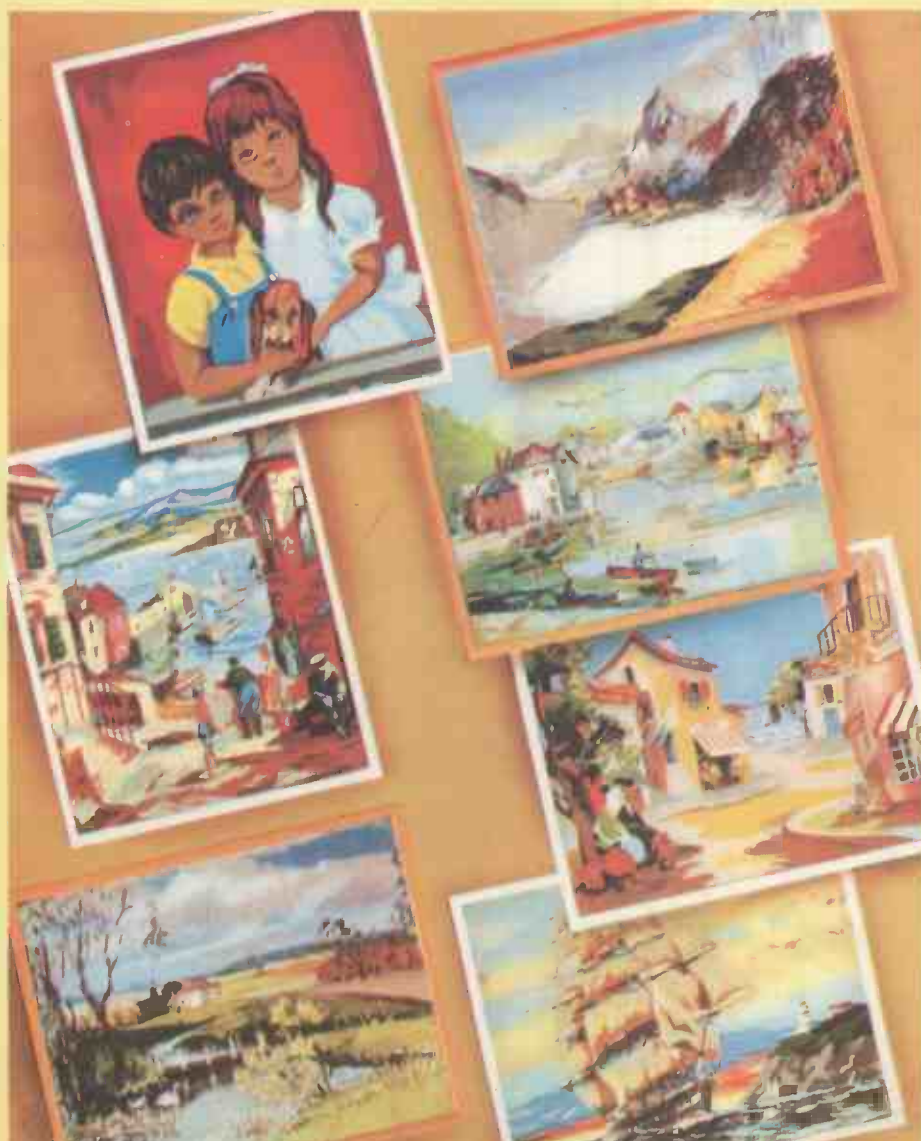

LEARN TO PAINT THE EASY WAY!

A CHOICE OF 12 SETS, EACH WITH ITS OWN ELEGANT WHITE FRAME. ADD CHARM AND BEAUTY TO YOUR HOME.

*Yes — you really can produce professional paintings right from the start with 'painting by numbers'. It is an absorbing hobby which may well reveal unsuspected artistic ability. Each set contains one 'Artists' Board and check sheet 18 in. by 14 in., Palette of 28 oil paints, genuine sable brush, full instructions and made to measure frame.*

A choice of 12 sets by Artmaster. Size 18 in. by 14 in.

Cash price **22/6** each . . . . . carriage 4/6 each.

- PNW.114** FIELD OF CORN (AM38)
- PNW.115** THE STREAM UNDER THE BRIDGE (AM31)
- PNW.116** SPANISH DANCERS (AM8)
- PNW.117** AUTUMN COLT (AM19)
- PNW.118** OUR PUPPY (AM37)
- PNW.119** ALPINE VILLAGE (AM36)
- PNW.120** ST. IVES (AM3)
- PNW.121** CORNISH RIVIERA (AM29)
- PNW.122** SWAN BY THE LITTLE BRIDGE (AM35)
- PNW.123** ON THE RIVIERA (AM22)
- PNW.124** HOMEWARD BOUND (AM10)
- PNW.125** SPRING FOAL (AM6)





# car accessories

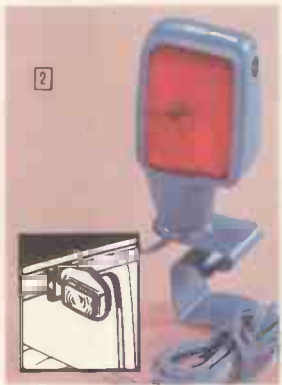

*HOBBIES' range of car accessories are carefully selected and are sure to appeal to the family motorist. For a small outlay you can now quickly add a touch of style and at the same time increase the value of your motor car. IDEAL GIFTS FOR EVERY OCCASION.*

**1 CAR SAFETY BELT** by ROMAC. A lap/diagonal type belt with 3-point fitting with 2-WAY RELEASE. Features slimline buckle with exclusive twin action for release with either hand. Pillar parking for convenient storage. 100% nylon webbing for strength, smartness and comfort. Approved by British Standards Institute to BS.3254. Complete with fitting instructions.  
**CA.117** ..... Cash price **65/-** postage free or deposit 10/- and 8 monthly payments 8/6.

**2 'PARK-LITE' (PL.1500)** by RAYDYOT. A new and completely universal Parking Lamp made largely from plastics. The special clip allows adjustment for off or near side fitting and will fit cars with either sliding or winding windows. Complies with M.O.T. regulations. Grey finish. Complete with 12-volt Bulb and 5 ft. of twin cable.  
**CA.101** ..... Cash price **12/6** postage free

**3 'REVERSING LAMP' SET (BP.10)** by RAYDYOT. Set comprises 12-volt Lamp, 12-volt Switch and Warning Lamp Panel. Complete with fitting instructions, sufficient cable and terminals for installation on all cars.  
**CA.102** ..... Cash price **48/-** postage free or deposit 5/6 and 8 monthly payments 6/6.

**4 QUARTZ-IODINE FOG LAMP (DL.81).** Chrome and enamel finish. With specially finished amber reflector with fluted lens and additional bulb shield to ensure an exceptionally wide 'cut-off' amber beam with minimum back glare. Complete with 10 ft. cable, cable connector, flick switch and full instructions. Specifications as for DL.80 driving lamp.  
**CA.104** ..... Cash price **70/-** postage free or deposit 12/- and 8 monthly payments 9/-.

**5 QUARTZ-IODINE DRIVING LAMP (DL.80)** by RAYDYOT. Chrome and enamel finish. Fitted with the latest 12-v. 55-w. Mazda Quartz-Iodine bulb for twice the light density and the life of the normal bulb. Gives an intensely white beam. Complete with 10 ft. cable, cable connector, flick switch and full instructions. 5 1/4 in. shallow reflector. Total depth 3 1/2 in. Only 1 1/2 in. from fixing centre to back of lamp.  
**CA.103** ..... Cash price **70/-** postage free or deposit 12/- and 8 monthly payments 9/-.

**6 CAR RADIO AERIAL (KL.2502).** Extension 15 in. to 38 in. Precision made for high fidelity performance and long life. Rigid rattle-free construction. Universal fitting, easily installed. Made in Canada.  
**CA.111** ..... Cash price **27/6** postage free  
**7 CAR RADIO AERIAL (KL.2503).** As above, but extension 22 in. to 56 in.  
**CA.112** ..... Cash price **34/-** postage free

**8 'MAJOR' BATTERY CHARGER** by DAVENSET. A robust compact unit with maximum output of 5 amperes. Ideal for charging the 6-volt or 12-volt heavy duty batteries of cars, commercial and farm vehicles. Attractively finished in blue hammer durable stove enamel. Double fused for safety. 4 ft. of three-core double-insulated mains cable. 8 ft. of twin output lead complete with battery clips. Tested to industrial standards to withstand 2,000 volts.  
**CA.121** ..... Cash price **97/6** postage free or deposit 13/- and 8 monthly payments 13/-.

**9 TURTLE WAX 'HARD SHELL' PACK.** Contains one Turtle Wax Liquid, 10 oz. - Protects against Sun, Rain, Snow, Ice, Dew and Salt Spray; and one Zip Wax Car Wash, 20 oz. - The Car Wash adds Turtle Wax as it washes, all in one simple operation.  
**CA.124** ..... Cash price **23/6** postage free

# hobbies



# picnic & camping

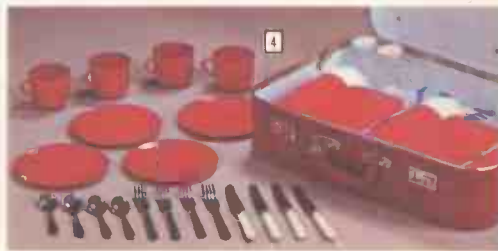
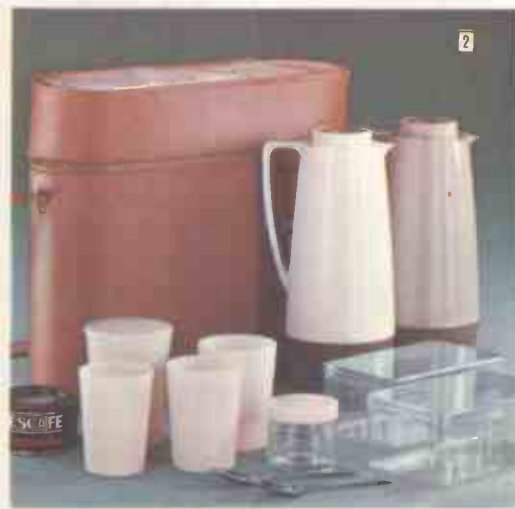

## JUST THE THING FOR THE FAMILY'S DAY OUT

Choose from these popular gifts to make travelling and picnicking easier. Vacuum flasks or jugs for really hot or cold refreshing drinks.

**1 TRAVEL REFRESHMENT CASE (241/2)** by ISOVAC. A completely new idea to make travelling more pleasant. Now you can have freshly made coffee - on the spot. Simulated Hide Case contains 1-16 fl. oz. Flask for Hot Water, 1-16 fl. oz. Flask for Milk, 1 Snack Box, 2 Teaspoons, 1 Sugar Jar.

**CPW.101** ..... Cash price **74/6** carriage 4/6 or deposit 9/6 plus carriage and 8 monthly payments 10/-.

**2 TRAVEL REFRESHMENT CASE (241/3)** by ISOVAC. Simulated Hide Case containing 1-16 fl. oz. JUG for Hot Water, 1-16 fl. oz. JUG for Milk, 2 Beakers (nested), 2 Snack Boxes, 1 Sugar Jar and 2 Teaspoons.

**CPW.102** ..... Cash price **121/-** carriage free or deposit 17/- and 8 monthly payments 16/-.

**3 'POPULAR' PICNIC CASE (141/82)** by ISOVAC. FOUR-PERSON SET. Size 16 in. x 14 in. x 5 in. A plastic-covered moulded fibre-board Picnic Case in attractive two-tone finish - light in weight but strong. The Flasks supplied are in superior plastic materials and are fitted with 'easy-lock' stoppers. Sheffield stainless-steel cutlery. Containing: 2-16 fl. oz. Plastic Flasks, 4 Cups and Plates, 2 Food Containers, 1 Sugar Jar, 1 Milk Bottle, 1 Knife and Fork, 4 Teaspoons and 1 Table Cover. Colour to match case.

**CPW.103** ..... Cash price **110/6** carriage free or deposit 16/6 and 8 monthly payments 14/6.

**4 'POPULAR' PICNIC CASE (141/83)** by ISOVAC. FOUR-PERSON SET. Size 20 in. x 14 in. x 5 in. Containing 3-16 fl. oz. Plastic Flasks, 4 Cups and Plates, 2 Food Containers, 2 Sugar Jars, 2 Milk Bottles, 1 Knife and Fork, 4 Teaspoons and 1 Table Cover. Colour to match case.

**CPW.104** ..... Cash price **130/6** carriage free or deposit 17/- and 8 monthly payments 17/6.

Here's the modern way to go picnicking or camping. Absolutely clean, and simplicity itself - instant heat or light from a butane gas cartridge.

**5 BLEUET S.200 (with Stabiliser)** by GAZ. Size assembled: 8½ in. high. 6½ in. dia., weight: 1 lb. An efficient lightweight stove using the Cartridge 200. Burns approximately 3 hours on one cartridge. Cartridge extra.

**CP.121** ..... Cash price **39/11** carriage 2/6.

**6 DE LUXE SUPER BLEUET** by GAZ. Size (closed): 9 in. x 9 in. x 5 in. Weight (Stove and Case only): 3½ lb. Consists of Super Bleuete Stove in a metal carrying case which when opened acts as an efficient windshield. Room for 2 spare cartridges. Cartridge extra.

**CP.122** ..... Cash price **75/-** carriage 4/6 or deposit 10/- plus carriage and 8 monthly payments 10/-.

**7 LOTUS** by GAZ. Overall size 5 in. x 11 in. x 9½ in. Working area 6½ in. x 9 in. A unique appliance. The only cartridge-fuelled stove with a burner and a working area sufficient for large pots or a pressure cooker. Burning time with Cartridge 400 approx. 5 hours. Cartridge extra.

**CP.123** ..... Cash price **132/6** carriage free or deposit 19/- and 8 monthly payments 17/6.

**8 LUMOGAZ 'C.400' LANTERN** by GAZ. A first-class portable lantern giving equivalent of 75-80 watt output. Operated by a Cartridge 400 lasting 13 hours approx. Supplied with Stabiliser. Cartridge extra.

**CP.124** ..... Cash price **72/6** carriage 4/6 or deposit 11/- plus carriage and 8 monthly payments 9/6.

Cartridges may be obtained at your local 'HOBBIES' Shop or nearest Stockist.





# do-it-yourself HOME DECORATING

## TRADESMEN'S TOOLS FOR THE DO-IT-YOURSELF ENTHUSIAST.

By investing in one or more of the 'High Quality' outfits illustrated, the handyman can save precious time and money on all paint and papering jobs around the house.

**1 DISTEMPERING AND WALLPAPERING OUTFIT (DWO.2)** by HARRIS. Contains one each of the following items: 1 in. and 2 in. paint brushes, 5 in. distemper brush, 7 in. nylon paperhanging brush, paperhangers' seam roller and 3 in. stripping knife. Beautifully presented in the new 'Tidibox'.

**HDW.126** ..... Cash price **56/3** postage free or deposit 7/6 and 8 monthly payments 7/6.

**2 WALLPAPER OUTFIT (984)** by HARRIS. Contains one each of the following items: 3 in. standard stripping knife, nylon seam roller, 7 in. nylon paperhanging brush and two packets of wallpaper adhesive. This comprehensive set includes everything needed for doing a first class wallpapering job.

**HDW.127** ..... Cash price **27/-** postage free

**3 PAINTING OUTFIT (P.O.2)** by HARRIS. Contains one each of the following items: ½ in., 1 in., 1½ in. and 2 in. paint brushes, 3 in. stripping knife, combination shave hook and paint brush cleaner. You will take a pride in doing-it-yourself with these high quality, craftsmen's tools.

**HDW.128** ..... Cash price **30/6** postage free

**4 DECORATORS' KIT (215)** by FOOTPRINT. An ideal combination set for the home decorator. Contains: 2½ in. stripping knife, 4½ in. putty knife and universal shave hook.

**CTW.481** ..... Cash price **21/-** postage free

**5 PAINTING OUTFIT (983)** by HARRIS. Contains one each of the following items: ½ in., 1 in., 1½ in., 2 in. paint brushes, 3 in. standard stripping knife. An inexpensive outfit which will give a 'Professional' look to your decorating.

**HDW.129** ..... Cash price **23/-** postage free

**6 WOOL PILE ROLLER OUTFIT (425)** by HARRIS. 7 in. paint roller with detachable washable wool pile fabric sleeve and cellulosed hardwood extension handle (13 in. long). Suitable for distemper, emulsion or gloss paint. Complete with paint tray - apply paint with ease and economy.

**HDW.130** ..... Cash price **27/6** carriage free

**7 PAINT BRUSHES** by HARRIS. 'The paint brush with a name to its handle'.

**HDW.107** Brushes ¼ in. ... Cash price **2/6** each postage 4d.

**HDW.108** Brushes ½ in. ... Cash price **2/9** each postage 4d.

**HDW.109** Brushes ¾ in. ... Cash price **2/11** each postage 4d.

**HDW.101** Brushes 1 in. ... Cash price **3/3** each postage 4d.

**HDW.102** Brushes 1½ in. ... Cash price **4/9** each postage 6d.

**HDW.103** Brushes 2 in. ... Cash price **7/11** each postage 6d.

**HDW.104** Brushes 2½ in. ... Cash price **9/11** each postage 6d.

**HDW.105** Brushes 3 in. ... Cash price **13/6** each postage 8d.

**HDW.106** Brushes 4 in. ... Cash price **17/6** each postage 10d.

**hobbies**



# fretwork

## easy-to-make musical novelties

exciting musical boxes  
suitable for making  
up as gifts

**1 MUSICAL SWISS PICTURE.** 12½ in. by 8 in. This delightful 3D picture brings the romantic charm of the Swiss scene to your home. The attractive chalet overlooks the lake and mountains with colourful flowers and rocks in the foreground. When the cord is pulled the picture 'comes to life'. The windows light up and music is heard coming from the house. Complete with Musical Movement.

**FDW. 101.**.....Cash price **53/6** carriage 4/6 or deposit 8/- plus carriage and 8 monthly payments 7/-.

**2 MUSICAL T.V. CIGARETTE OR TRINKET BOX.** 8½ in. wide. A miniature T.V. console with drawers for cigarettes or trinkets. Opening lower drawer actuates music, ballerina and screen lighting. Kit of materials including wood, acetate, knobs, etc. Complete with musical movement.

**FDW. 102.**.....Cash price **53/6** carriage 4/6 or deposit 8/- plus carriage and 8 monthly payments 7/-.

**3 PIXIE HOUSE MONEY BOX.** 7 in. high. Plays a tune as you save a penny. It has a delightful little balcony, windows with shutters, a decorative roof, flower-strewn trellis, toadstools and figures. Kit of materials, including design, wood, veneer etc. Complete with musical movement.

**FDW. 3340.**.....Cash price **30/6** carriage 3/-

**4 TREASURE CHEST TRINKET BOX.** 4½ in. box. A charming reproduction of a pirate's treasure chest with metal hinges and clasps. Music plays when the box is opened. Kit of design, wood, chain, anchor, stain, etc. Complete with Musical Movement.

**FDW. 3312.**.....Cash price **32/6** carriage 3/-

**5 SWISS CHALET.** 6½ in. wide. This musical box in the form of a Swiss Chalet holds about 25 cigarettes and plays a tune when the hinged roof is raised. Kit of design with instructions, wood, hinges, etc. Complete with musical movement.

**FDW. 3152.**.....Cash price **28/-** postage 2/-

**6 LOG CABIN MUSICAL CLOCK.** 9½ in. wide. A sensational novelty. Pull the cord, music starts and windows light up. Kit of all materials, special mechanism to work the Musical Movement. Complete with 30-hour clock and musical movement.

**FDW. 267.**.....Cash price **67/9** carriage 4/6 or deposit 11/6 plus carriage and 8 monthly payments 9/-.



8 MONTHLY  
PAYMENTS OF

**7/-**

1

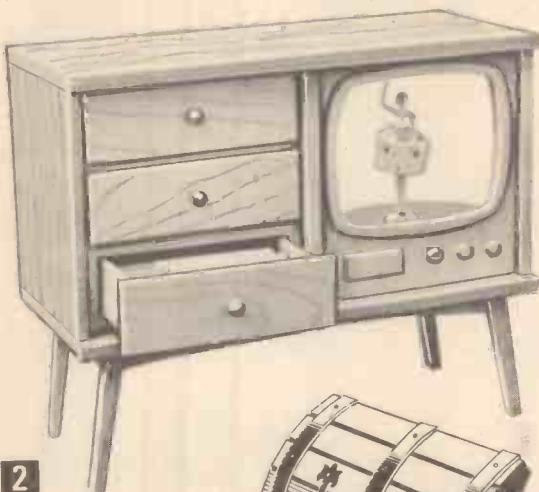

2



3

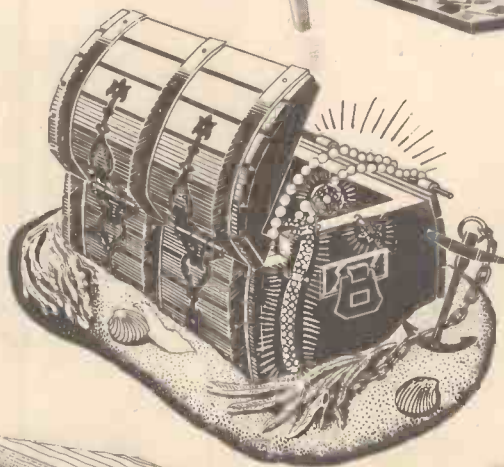

4

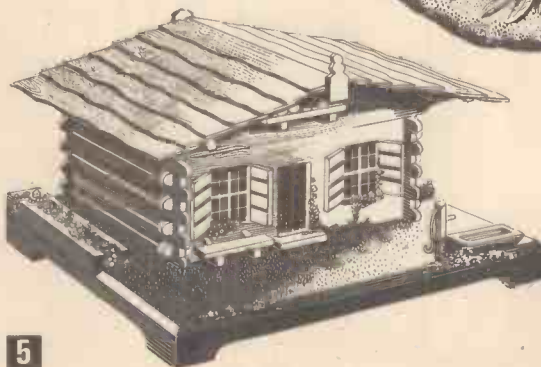

5



6

# hobbies



1

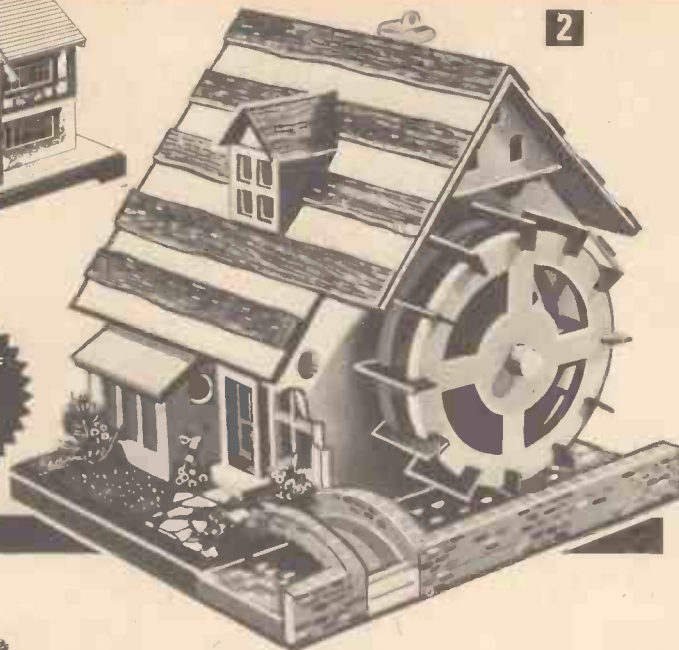

2

8 MONTHLY  
PAYMENTS OF  
**7/6**



3

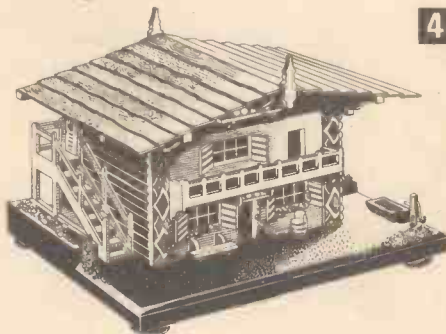

4

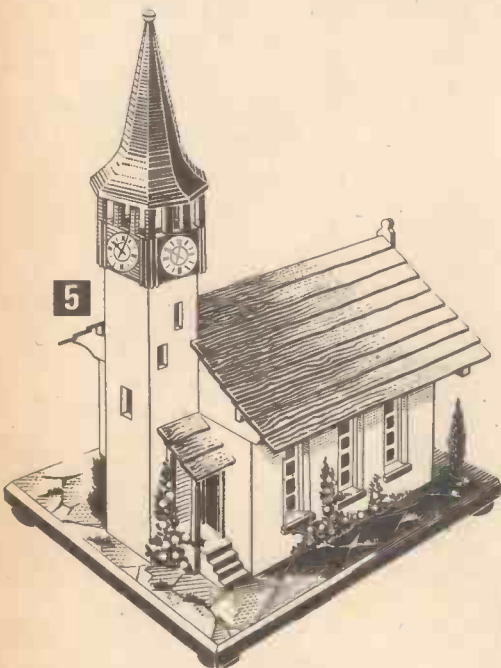

5



6

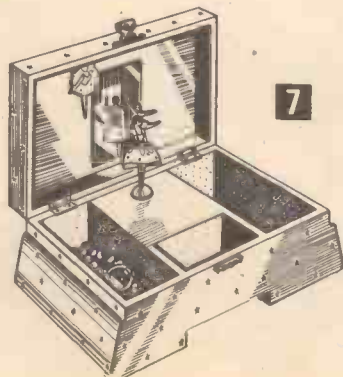

7

# fretwork

## easy-to-make musical novelties

**1 INN SAVINGS BOX.** 7½ ins. wide. An old-time half-timbered English tavern. Plays a tune when a coin is dropped in the slot. Kit of materials, includes design and instructions. Complete with suitable musical movement.

**FDW. 3222.** ..... Cash price **35/6** carriage 3/-

**2 WATER WHEEL.** 6½ ins. square. A fascinating model. Lift the lid and the windows light up, the paddle wheel revolves and a tune plays. Kit includes wood, hinges, enamels, glue, pea bulbs, wiring flex, etc. Complete with musical movement.

**FDW. 265.** ..... Cash price **57/6** carriage 4/6 or deposit 9/- plus carriage and 8 monthly payments 7/6.

**3 SMALL CHURCH.** 5½ ins. long. Holds about 30 cigarettes. Ideal too, as a Lady's Trinket box. Kit of materials includes design, wood, stripwood, knob, wire, hinges, etc. Complete with musical movement.

**FDW. 3364.** ..... Cash price **30/6** carriage 3/-

**4 2-STOREY SWISS CHALET.** 9 ins. wide. With cut-out balcony and stairs at side. Holds 50 cigarettes. Kit of design with instructions, wood, beading, hinges, paint, stain, glue, plastic wood, etc. Complete with musical movement.

**FDW. 255.** ..... Cash price **45/-** carriage 4/6 or deposit 6/- plus carriage and 8 monthly payments 6/-.

**5 SWISS CHURCH.** 12½ ins. high. Windows and clock faces light up, and music plays when you lift the hinged roof. The kit contains all materials, paint, glue, pea bulbs, clock faces, bell, printed windows etc. Complete with musical movement.

**FDW. 256.** ..... Cash price **55/-** carriage 4/6 or Deposit 6/- plus carriage and 8 monthly payments 7/6.

**6 BALLERINA CIGARETTE BOX.** 9½ ins. wide. A charming ballerina scene is incorporated in this delightful musical box which can be used for cigarettes or trinkets. Lift the lid and the Ballerina dances to tuneful music. Holds 50 cigarettes. Kit of materials including design, wood, veneer, mirrors, paint, glue, etc. Complete with musical movement.

**FDW. 257.** ..... Cash price **55/-** carriage 4/6 or deposit 6/- plus carriage and 8 monthly payments 7/6.

**7 BALLERINA TRINKET BOX.** 9 ins. wide. The ballerina doll pirouettes round and round to soft music when the lid of the box is raised. Useful, too, as a cigarette box. Kit of design, wood, mirror, hinges, 'flock' paper, etc. Complete with musical movement.

**FDW. 3380.** ..... Cash price **43/3** carriage 4/6 or deposit 8/- plus carriage and 8 monthly payments 5/6.

*All Musical Box designs on Pages 81 and 82, may be purchased separately. Price 2/6. FDW 3152, FDW 3222, FDW 3340, FDW 3364, FDW 3380, FDW 3312. Price 5/-.* **FDW 102, FDW 255, FDW 256, FDW 257, FDW 265, FDW 267, FDW 101.**  
Postage 3d. each extra.

# hobbies



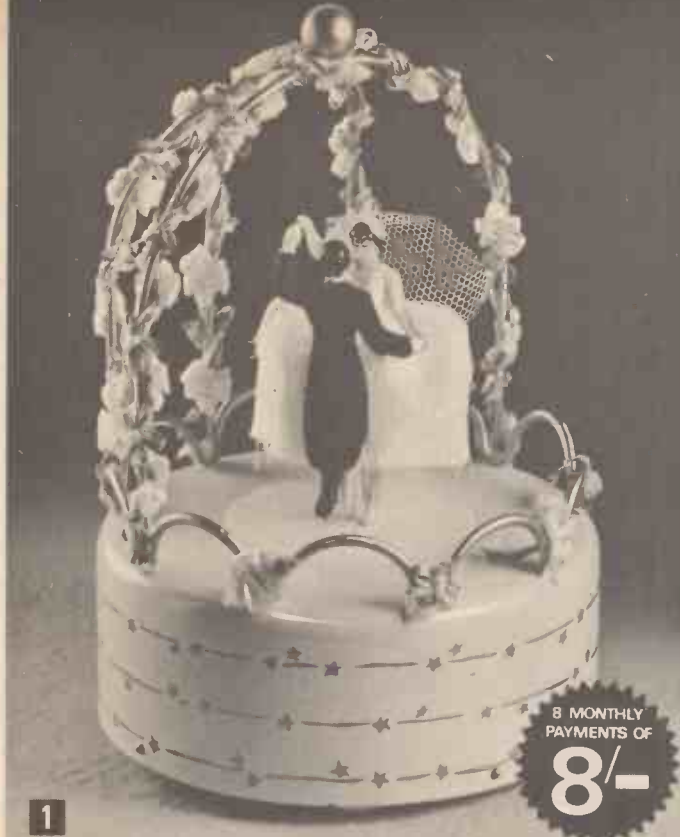

1

8 MONTHLY  
PAYMENTS OF

8/-

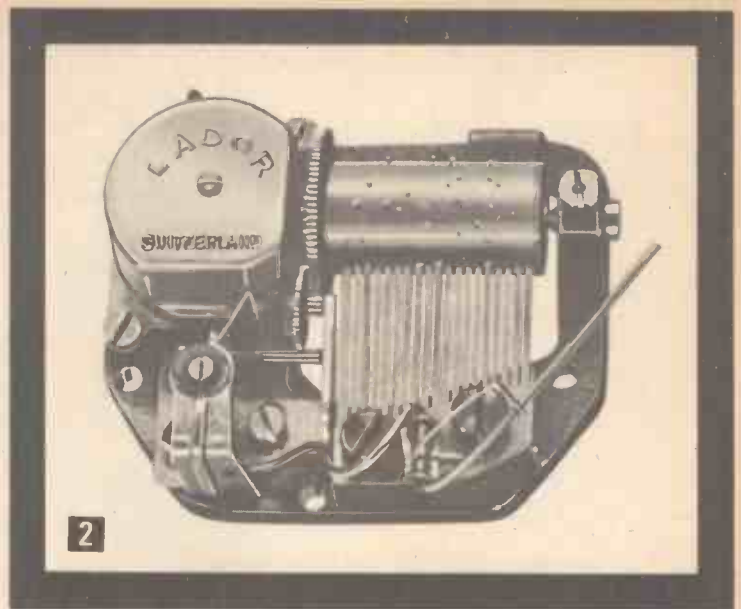

2

## HIGH-QUALITY musical movements

*These delicately-precisioned movements are acknowledged to be the best that money can buy. Made by experienced craftsmen to a standard which defies competition. When you are designing your own musical project you should use one of these movements to be sure of satisfaction and reliability.*

**1 BRIDE AND GROOM.** 5 ins. high. A ready made Swiss musical novelty with beautifully modelled rose covered arch on decorated and enamelled metal base and archwork, with Bride and Groom dancing to Lohengrin's Wedding March. A superb gift and sentimental keepsake for weddings and anniversaries.

FMW. 106. . . . . Cash price 59/6 postage 1/6 or deposit 7/6 plus postage and 8 monthly payments 8/-.

**2 SWISS MUSICAL MOVEMENT** (Single tune). Size 2 ins. by 1½ ins. by 1 in. A spring-wound movement, for Cigarette Boxes, etc., which plays a tune when the lid is lifted.

*Choice of 6 Tunes.*  
'Brahms Lullaby', 'Silent Night', 'Some Enchanted Evening', 'Swedish Rhapsody', 'Blue Danube', 'Greensleeves'.

FMW. 101. . . . . Cash price 15/11 postage 6d.

**3 SWISS MUSICAL MOVEMENT.** (Coin Trigger Action, single tune). Size 2 ins. by 2½ ins. by 1½ ins. Ideal for use in money boxes. Plays a tune only when a coin is inserted.

*Choice of 2 Tunes.*  
'Teddy Bears' Picnic', 'Happy Wanderer'.

FMW. 102. . . . . Cash price 17/11 postage 6d.

**4 SWISS MUSICAL MOVEMENT.** (Hand turn, single tune). Size 1½ ins. by 1½ ins. by 3½ ins. Turn the handle (backwards or forwards makes no difference) to play a tune. As used in the toy Barrel Organ Kit. Suitable for toys and novelties.

*Choice of 2 Tunes.*  
'Clementine' 'Here we go round the Mulberry Bush'

FMW. 103. . . . . Cash price 14/11 postage 6d.

**5 SWISS 'BALLERINA' MUSICAL MOVEMENT** (Single tune). This is the Movement fitted to Ballerina Cigarette or Trinket Boxes. The Ballerina, exquisitely dressed and beautifully modelled, 'dances' realistically as the music plays. In the dancing position, the overall height of the movement is 3½ ins. An ingenious mechanism allows the Ballerina to fold horizontally when the lid of the box is closed; the movement and the Ballerina then occupy a space only 3 ins. by 1½ ins. by 1½ ins. high.

*Choice of 2 Tunes.*  
'Swan Lake', 'I could have danced all night'.

FMW. 104. . . . . Cash price 24/11 postage 10d.



5

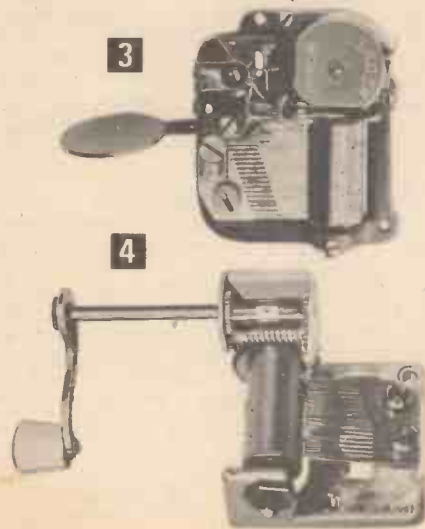

3

4

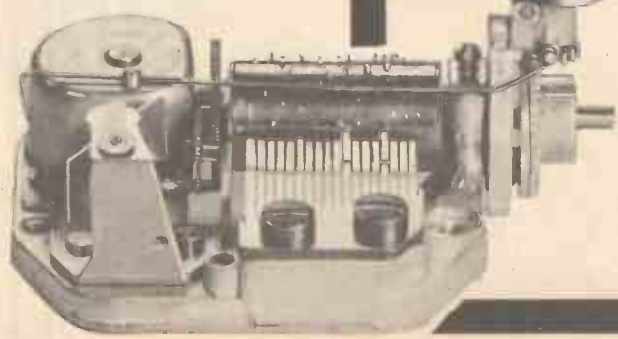

# good value doll's houses for you to make

Enjoy the thrill of making one of these perfect doll's houses for your daughter.



1

**1 JUNIOR PLAYHOUSE.** 22 ins. high by 13 ins. wide (23 ins. wide with doors open). A low-priced house with two large rooms giving good play value for the young child. It features attractive half timbering with opening windows. The front opens in two sliding sections. Kit comprises plywood, hardboard, windows, doors, papers, paint and glue, etc.

**FDW. 103.** ..... Cash price **49/6** carriage 7/6 or deposit 7/- plus carriage and 8 monthly payments 6/6.

**2 DOLL'S BUNGALOW.** Base 24 ins. by 18 ins. A sturdy design with good play value. Opening windows for realism, lift-off roof for easy access to rooms. Ornamental shutters are a feature of this design. Plan provides for entrance hall, lounge, kitchen, bedroom, and bedroom or bathroom. Kit comprises plywood, hardboard, windows, doors, papers, paint and glue, etc.

**FDW. 3643.** ..... Cash price **66/-** carriage 9/- or deposit 11/- plus carriage and 8 monthly payments 8/6.



2

**3 LARGE TUDOR DOLL'S HOUSE,** 24 ins. wide by 24 ins. high. An attractive model of a typical half-timbered Tudor House. Access is provided to the spacious interior by a double-door hinged front. The design sheet contains patterns of parts, including staircase and details for building. The kit of materials contains panels of plywood, material for staircase, sheets of card for the roof, set of windows and doors in painted metal ready for fixing, four metal fireplaces and sufficient brick, tile, floor and wallpaper.

**FDW. 237.** ..... Cash price **109/-** carriage free or deposit 15/- plus carriage and 8 monthly payments 14/6.

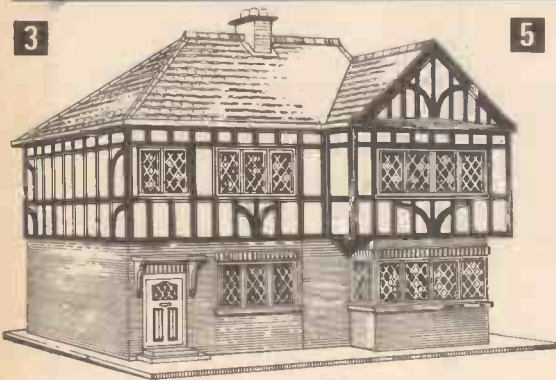

3

5



**4 DOLL'S HOUSE.** 17 ins. long. The front is hinged to reveal four rooms, a hall and landing. Four double and one single metal 'open and close' windows, a door, staircase and two chimneys are included in the kit, as well as the design, panels of plywood, wood, stripwood, hinges, catches and covering paper for outside and inside the house.

**FDW. 2910.** ..... Cash price **73/6** carriage 9/- or deposit 12/- plus carriage and 8 monthly payments 9/6.

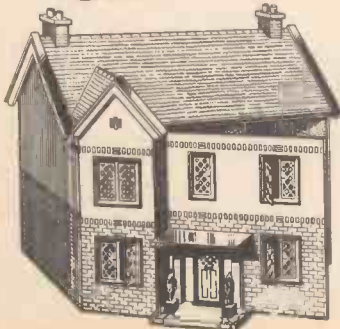

4

All designs on this page may be purchased separately:  
Price 5/- **FDW 103, FDW 254, FDW 2910, FDW 3643, FDW 237.**  
Postage 3d. extra.

**5 BIG VALUE DOLL'S HOUSE.** 18 ins. wide by 20 ins. high. This is an ideal project for the keen handyman. Easy to make from low-cost Kit, and a few simple tools. Sturdy hardboard—carefully contrived—ensures a rigid construction. There is one large room downstairs with hall (no staircase) and kitchen. Upstairs there is one large bedroom and bathroom. The back of the house is left open to facilitate furnishing. The kit includes a large design sheet of patterns, building instructions, selected hardboard panels, gaily-coloured papers for covering outside and inside the house, ready-to-fit metal door, windows, etc.

**FDW. 254.** ..... Cash price **55/-** carriage 7/6 or deposit 6/- plus carriage and 8 monthly payments 7/6.

Make up these authentic models for the children



# fretwork

easily made  
life-like  
models



1



2



3



4

**1 MODEL SERVICE STATION.** Base 24 ins. by 18 ins. Hours of pleasure are in store for the boy who has this model garage. Cars filling up at the pumps, running up the ramp into the main entrance for servicing, gleaming new models on view in the spacious showroom windows. The Kit comprises design with instructions, plywood panels, wood, stripwood, beading, dowel rod, ball feet, transparent material for windows, garage posters and petrol pumps, etc. Cars not included.

**FDW. 3129.....** Cash price **52/6** carriage 7/6 or deposit 7/- plus carriage and 8 monthly payments 7/-.

**2 FORT WYOMING.** 24 ins. by 24 ins. An exciting replica of a U.S. Cavalry Fort which is ideal for playing 'Cowboys and Indians'. Wonderful play value. Kit of wood, special bamboo and reeded hardboards to give 'logging' effect, hinges, glue, enamels, etc. Cavalry not included.

**FDW. 3569.....** Cash price **29/11** carriage 6/-

**3 LARGE MODEL FARM.** Base 24 ins. by 18 ins. With Farmhouse, barn with loft, stables, cowshed and dairy. Kit includes design, instructions, plywood, stripwood, fillet, round rod, hinges, screws, glue, transparent acetate, stone and roof papers, and green 'Flock' paper, plus an assortment of animals.

**FDW. 249.....** Cash price **57/6** carriage 7/6 or deposit 9/- plus carriage and 8 monthly payments 7/6.

**4 MODEL FORT WITH KEEP.** Base 24 in. by 18 in. by 9½ in. high. An easy-to-make toy with plenty of play-value. The walls are provided with inner platforms for Sentries. The kit contains design, instructions, selected plywood, fort paper, screw eyes, chain, hinges, screws and flock paper. Complete with Soldiers.

**FDW. 3274.....** Cash price **37/6** carriage 6/-

See page 106 for suitable paints.

# fretwork

## easily made life-like models

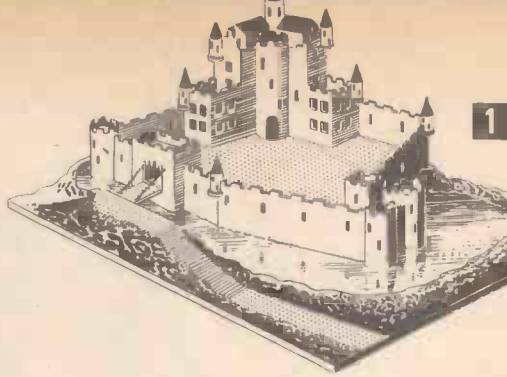

### 1 FORT WITH MOAT AND DRAWBRIDGE.

Base 20 ins. by 15 ins. This imposing model incorporates everything a boy looks for in a model Fort. The kit for making it includes design with instructions, selected plywood, stripwood, round rod, fillet strip, with tubes for round turrets, chain for drawbridge, fort paper, etc. Complete with set of Knights.

FDW. 260..... Cash price 35/- carriage 6/-

2 LARGE MODEL FORT. A superb model nearly 3 ft. long by 2 ft. 3 in. wide. Dismantles and packs away in the Keep for easy storage. Any handyman can make it. Kit comprises design, instructions, plywood, stripwood, round rod, fort paper, etc. Complete with Toy Soldiers.

FDW. 248..... Cash price 62/6 carriage 10/6 or deposit 11/- plus carriage and 8 monthly payments 8/-.

3 MODEL ZOO. 31 in. wide by 22 in. deep by 10 in. high. An authentic design modelled on the Mappin terrace of London Zoo. A toy to delight the heart of any youngster. Kit contains all materials including plywood, paint, glue, brick paper, etc. Complete with set of Animals.

FDW. 262..... Cash price 62/6 carriage 6/- or deposit 11/- plus carriage and 8 monthly payments 8/-.

4 GARAGE AND SERVICE STATION. Base 20 ins. by 15 ins. This grand model provides for showrooms, parking, servicing and other facilities with a ramp to give access to the flat roof. Kit contains design, instructions, wood and materials, together with an 'Island' petrol pump set, miniature posters and a special servicing ramp which is operated by a handle for lifting and lowering the cars. Cars are not included in the kit.

FDW. 258..... Cash price 35/- carriage 6/-

5 'TWINPLAY' MOTEL. Base 24 ins. by 18 ins. 26½ ins. high. Combines a Doll's House for girls or a Service Station for boys. Kit contains all wood and materials, adhesive, paints, decorative papers, petrol pumps, windows, doors, design and full instructions Cars not included.

FDW. 269..... Cash price 79/11 carriage 10/6 or deposit 12/- plus 8 monthly payments 10/6.

All designs on Pages 85 and 86 may be purchased separately. Price 2/6. FDW 3569, FDW 3274. Price 5/- FDW 3129, FDW 249, FDW 258, FDW 260 FDW 269, FDW 248, FDW 262.

Postage 3d. extra.

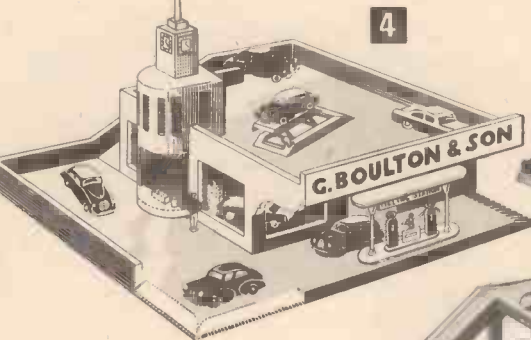
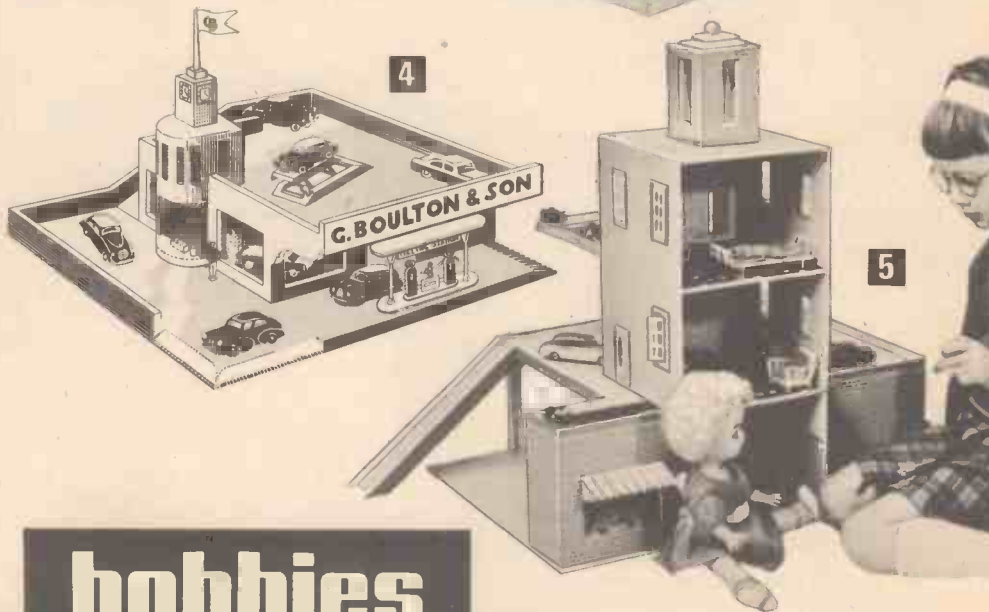
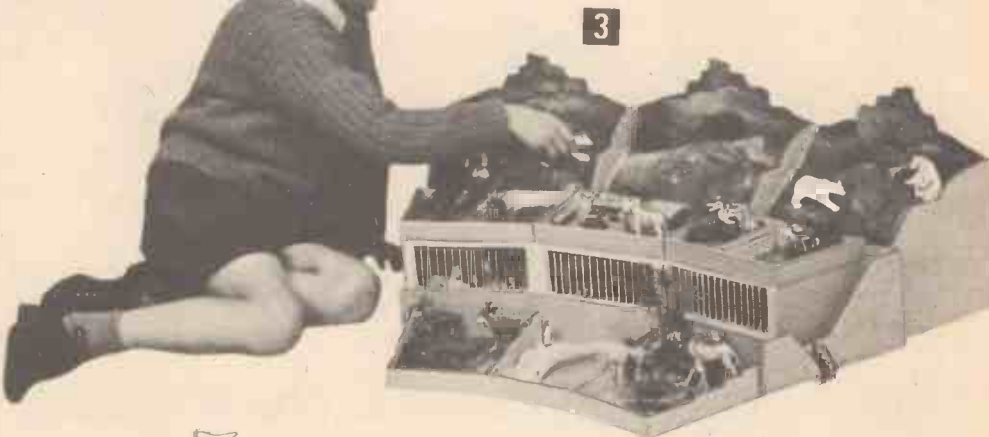
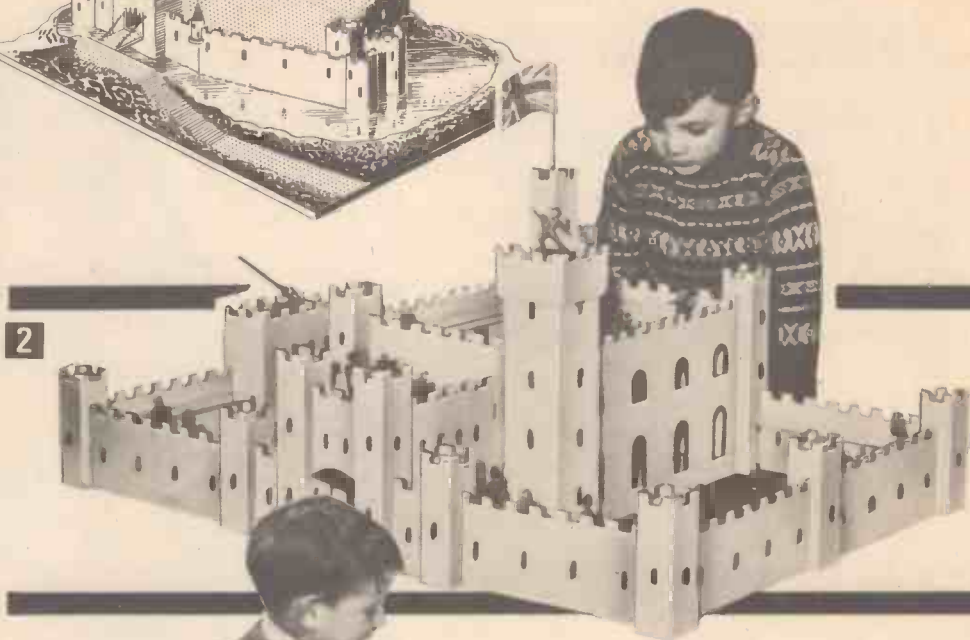

# hobbies



# make your own musical instruments

for solo work, or family fun



## SPANISH GUITAR KIT

**GUITAR.** 3 ft. long. A FULL-SIZED INSTRUMENT OF HIGH QUALITY AND TONE FOR BEAT GROUPS, SOLO WORK OR FOR FAMILY FUN. Whether you want a guitar on which to strum a few chords for your own entertainment or an authentic instrument ready to take its place in any group, this is the design for you. Thousands have been made up—with complete satisfaction. It's a full size instrument representing a high quality which would cost you considerably more ready made. Yet only a few simple tools, plus a Hobbies kit, are required. With the fully explained instructions the work is not difficult—just average care and patience is needed. Kit comprises plan and instructions, selected plywood and other wood, a semi-shaped neck, bridge, pegs, strings (nylon or wire—state which required), fretwire, tutor, pearl acetate, screws, etc.

**FDW. 3209.**..... Cash price 65/- carriage 6/- or deposit 14/- plus carriage and 8 monthly payments 8/-.

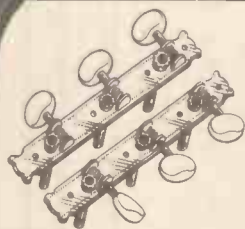
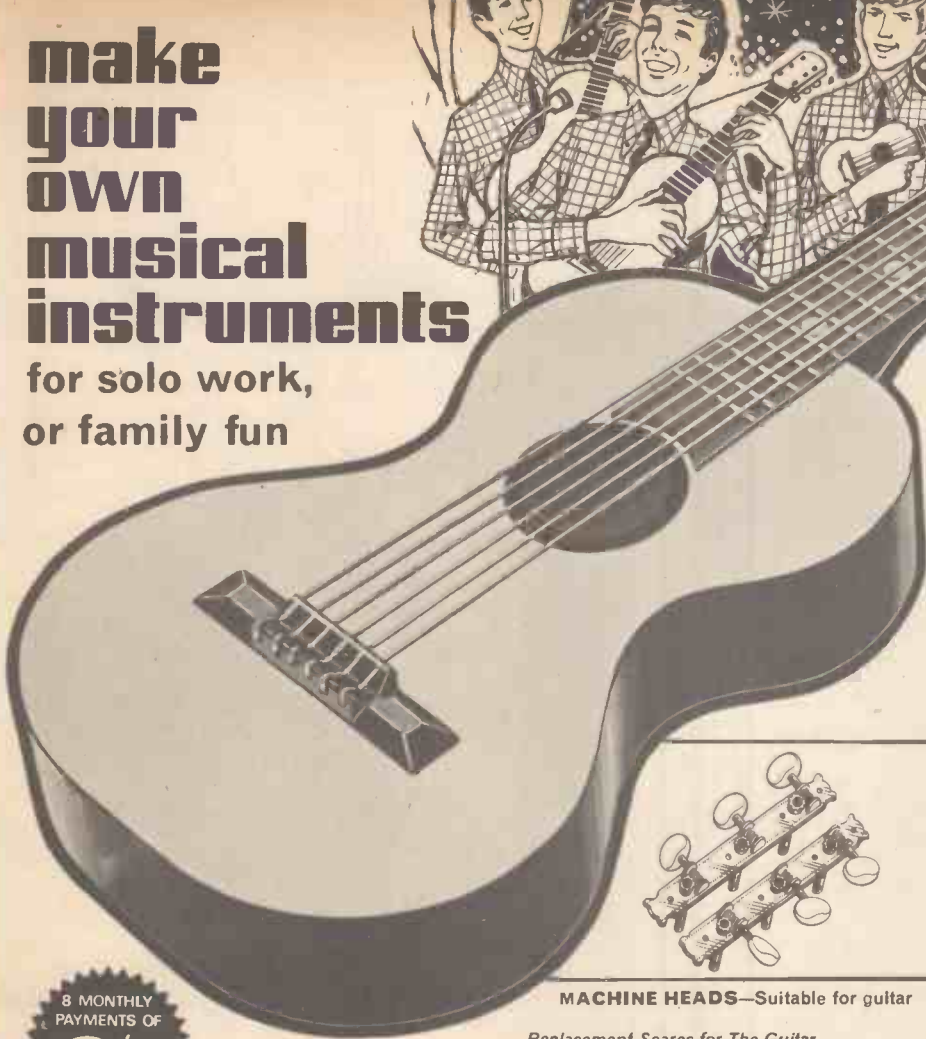

**MACHINE HEADS**—Suitable for guitar

### Replacement Spares for The Guitar

<b>FDW. 3209</b>	Plan and Instructions	5/-
<b>FDAW 10</b>	Pegs (set of 6)	7/9
<b>FDAW 11</b>	Fretwire (40 ins.)	2/6
<b>FDAW 12</b>	Strings—Nylon	10/3



<b>FDW 13</b>	Strings—Wire	10/3
<b>FDW 14</b>	Machine Heads	15/9
<b>FDW 15</b>	Set of six bushes for machine heads	5/3
<b>FDW 16</b>	Tutor	2/-
<b>FDW 17</b>	Tutor	3/-

Postage 6d. extra to all prices.

8 MONTHLY PAYMENTS OF **8/-**



## doll's dropside cot

**DOLL'S DROPSIDE COT** with real castors. 24 ins. long by 14 ins. wide by 21 ins high. Just like a full size child's cot. The frame is made of stripwood and dowelling, with both ends panelled. Construction is quite straightforward and simple. Kit includes design with instructions, wood, stripwood, round rod, brackets, webbing and screws. Complete with dropside fittings and castors.

**FDW. 3082.**..... Cash price 45/- carriage 6/- or deposit 6/- plus carriage and 8 monthly payments 6/-.



**hobbies**



# fretwork tool sets

8 MONTHLY  
PAYMENTS OF  
**10/-**



*Specially selected tools for making Doll's Houses, Novelties, Toys, Musical Boxes, Models, etc. in wood.*

**1 HOBBIES A3 OUTFIT.** Contains a 16 in. lever hand-frame, a superior cutting plate and cramp, metal plane, a large glasspaper block, a special fretwork hammer, rule, rapid action drill, spare blades and drill bits. Also designs and an instruction book, plus a leaflet of simplified instructions with pattern.

**FSW.101.** ..... Cash price **75/-** carriage 6/- or deposit 10/- plus carriage and 8 monthly payments of 10/-.

**2 HOBBIES A1 OUTFIT.** Finest quality tools. An ideal presentation outfit. Contains a 14 in. lever handframe, drill with bits, cutting plate with cramp, sawblades, hammer, glasspaper block, small plane, illustrated handbook and designs. There is also a handy instruction leaflet with pattern.

**FSW.102.** ..... Cash price **47/6** carriage 4/6 or deposit 5/- plus carriage and 8 monthly payments of 6/6.

**3 HOBBIES CROWN OUTFIT.** Suitable for the young beginner. Outfit contains a 12 in. hand-frame, cutting plate with cramp, sawblades, drill and bit, glasspaper block, a design, handbook of instructions and a beginner's simplified instruction leaflet.

**FSW.103.** ..... Cash price **32/6** carriage 4/6



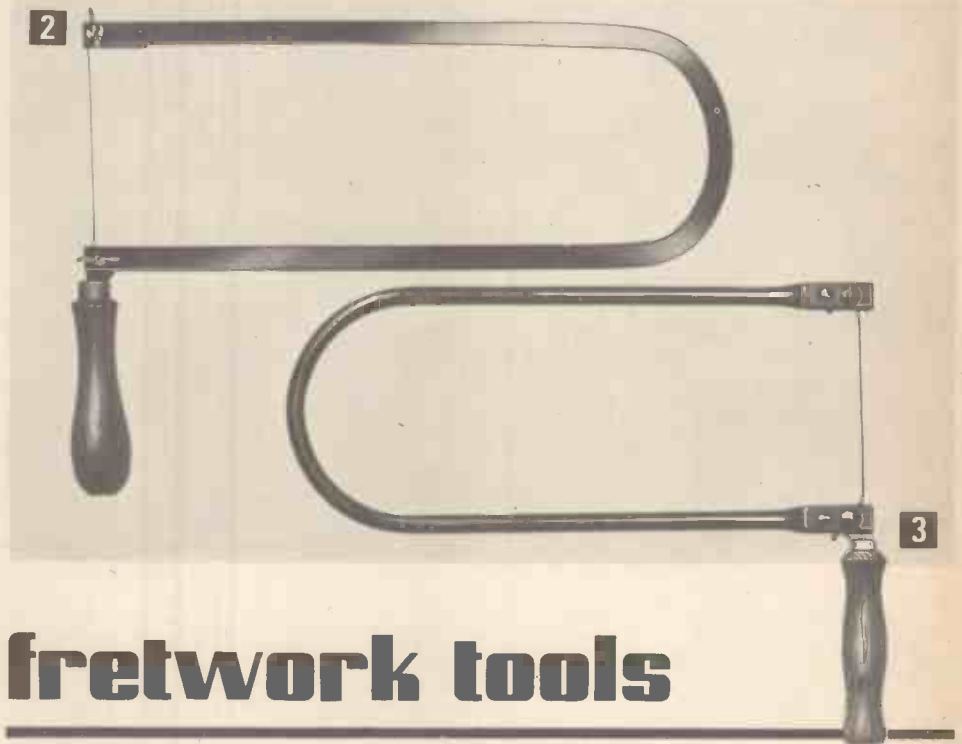
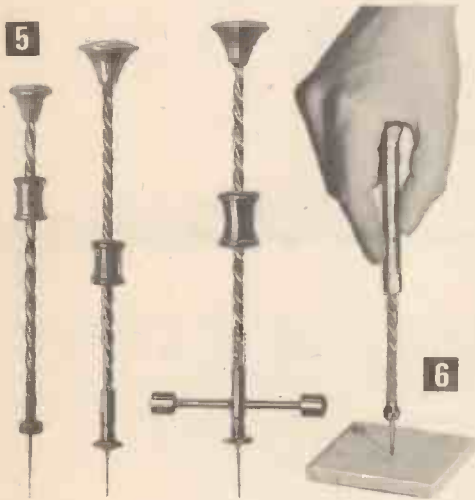
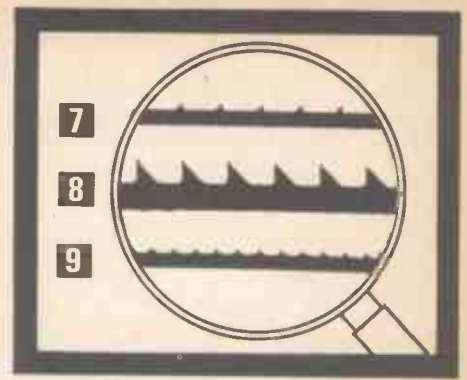
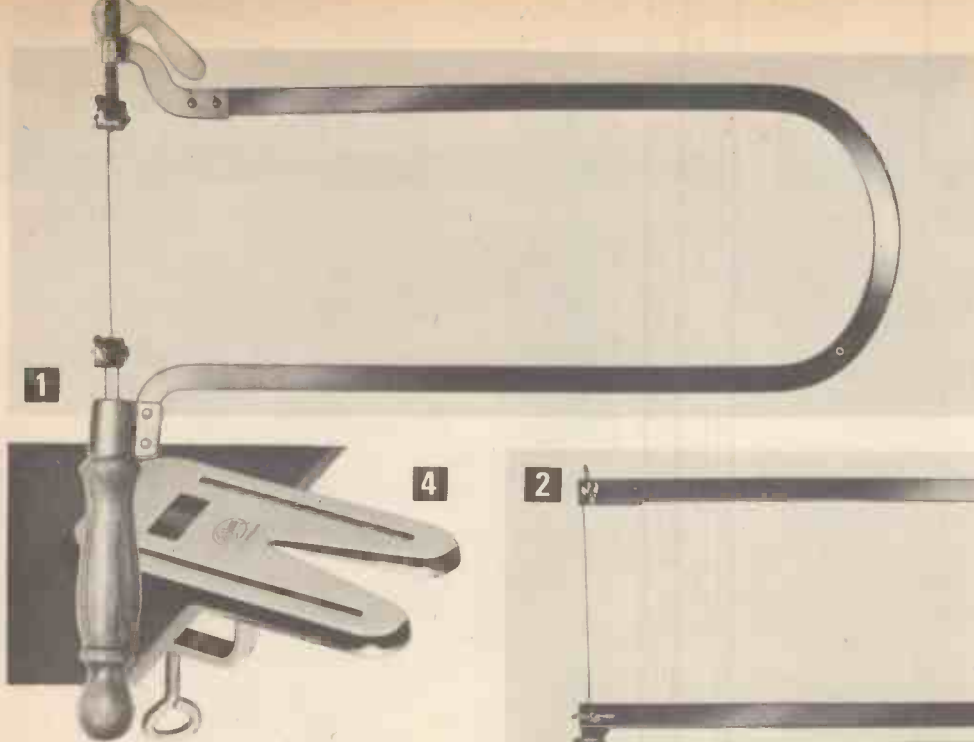

## fretwork tools

**1** **HOBBIES LEVER FRETSAW FRAME.** Good quality Sheffield Steel. A simple lever instantaneously tensions the sawblade. Moreover, the long screw in the handle enables the tensioning of the saw to be regulated, at the same time making it possible to use shortened sawblades instead of throwing them away.

**FTW.101**, 14 in. Frame. Cash price **17/6** carriage 3/-

**FTW.102**, 18 in. Frame. Cash price **19/6** carriage 3/-

**2** **HOBBIES JUNIOR FRETSAW FRAME.** Sheffield Steel for maximum tension. Polished wood handle. Not a toy, but a real handyman's or fretworker's tool.

**FTW.103**, 9 in. Frame. Cash price **9/11** postage 1/6

**FTW.104**, 12 in. Frame. Cash price **10/6** postage 1/6

**3** **HOBBIES, LIGHTWEIGHT FRETSAW FRAME.** Tubular metal, plastic coated for protection against corrosion. Well finished, with polished wood handle. Made in West Germany.

**FTW.105**, 11 in. Frame. Cash price **6/9** postage 1/3

**4** **HOBBIES PRESSED STEEL CUTTING PLATE.** 6 ins. by 4 ins. This is undoubtedly the most satisfactory cutting plate on the market. Easily fixed to bench or table by a strong steel cramp provided.

**FTW.125**.....Cash price **5/11** postage 10d.

**5** **HOBBIES FRETWORK DRILLS.** These drills work on the well-known Archimedean principle. The drill rotates rapidly as the barrel on the stem is worked up and down, and it is very quick and easy to bore holes through ordinary fretwood with any of these drills. In the 'Rapid Action' a ratchet device is provided which allows the drill to revolve continuously in the cutting direction. Each drill supplied with spare points.

**FTW.121**, Junior Drill. Cash price **6/-** postage 6d.

**FTW.122**, Simplex Drill. Cash price **8/6** postage 8d.

**FTW.123**, Rapid Action. Cash price **11/6** postage 10d.

**6** **HOBBIES PUSH DRILL.** A real handy tool. Takes standard fretwork drill points. Strong, all metal construction for lasting service. 7 ins. long. Ideal for Craft work. Supplied with Drill Point. Made in West Germany.

**FTW.124**.....Cash price **3/6** postage 4d.

**7** **HOBBIES 'YELLOW LABEL' FRETSAW BLADES.** Strong, sharp, long-lasting. Made from finest quality tempered Sheffield Steel. Non-set teeth for clean and accurate cutting. Suitable for cutting wood, perspex and similar plastics. 5 ins. long, to fit all Hobbies Handframes and Fret Machines.

**FTW.110**, Grades 0, (fine), and 1....Cash price **1/3** doz., postage 4d.

**FTW.111**, Grades 2 and 3. Cash price **1/6** doz., postage 4d.

**FTW.112**, Grades 4, 5 and 6. Cash price **1/9** doz., postage 4d.  
Please specify grade required.

**8** **HOBBIES 'HEAVY' FRETSAW BLADES.** Heavy-duty Fretsaws for cutting thick wood. Particularly suitable for industrial machines.

**FTW.113**.....Cash price **2/-** doz., postage 4d.

**9** **HOBBIES 'METAL CUTTING' FRETSAW BLADES.** For sheet metal, copper, brass and other alloys.

**FTW.114**, Grades Fine or Medium. Cash price **1/6** doz., postage 4d.

Please specify grade required.

**SPARE DRILL POINTS.** A container of 1 doz. assorted Drill Points. *Not illustrated.*

**FTAW.101**.....Cash price **3/-** postage 4d.

# hobbies fretsaw machines

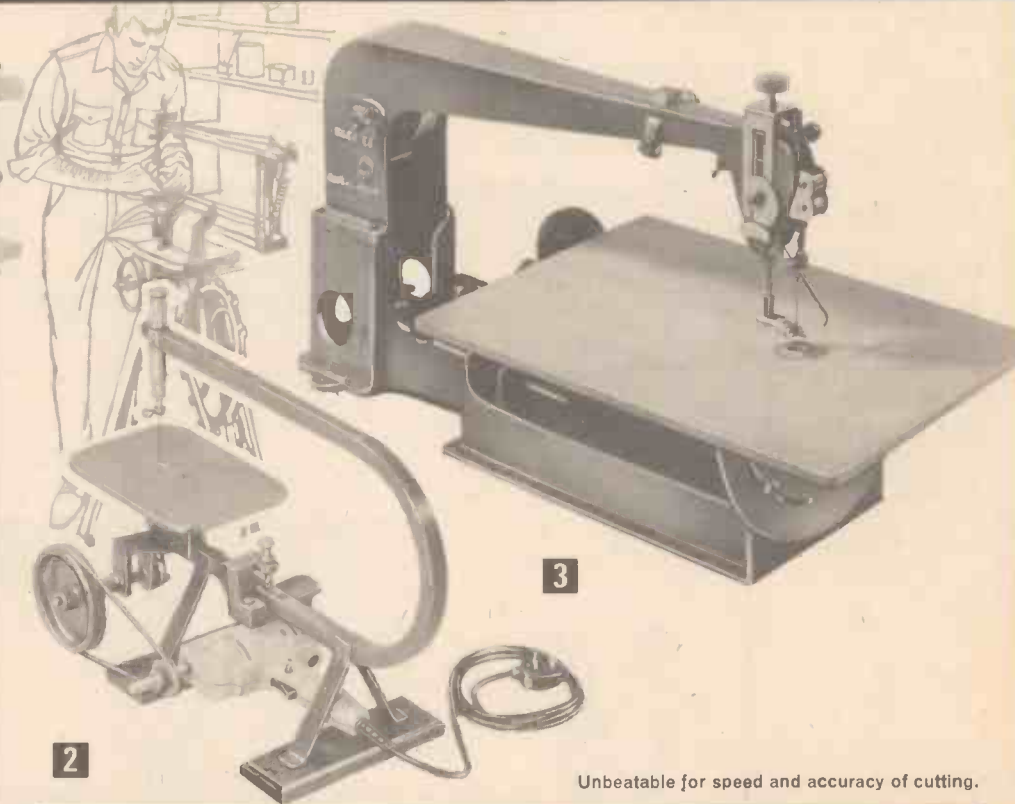

Double your output and halve your labour with a treadle or power machine. The length of arm allows longer work to be cut and considerably eases the cutting of wood, metal perspex, etc. If cut from both ends, work up to 36 ins. long can be manipulated.

Our technical staff will be pleased to advise you on any fixing, cutting or conversion problem.

**1 THE 'A1' FRETSAW MACHINE** Provides a happy hobby for any craftsman. A strong, rigid machine, with 8 ins. diameter table and a tray for small tools. Cuts wood up to 1 in. thick. The wooden arms may be adjusted to ensure accurate cutting by the saw blade. The Hobbies saw clamps hold the finest blade; correct tension is easily obtained by the special lever action on the top arm. The table—2 ft. 4 ins. from the floor—can be tilted for bevel cutting, and work up to 19 ins. behind the saw can be manipulated, or double that length if cut from both ends. Weight 37 lb. Spare parts are always available if needed.

**FMCW. 102**..... Cash price **259/6** carriage free or deposit 35/6 plus 8 monthly payments 34/6.

**2 THE 'MARVEL' FRETSAW MACHINE WITH MOTOR.** Complete with the famous Black & Decker Power Driver 5/16 in. Drill. A bench fretsaw for LIGHT fretcutting by the amateur. Cuts wood to about 3/8 ins. thick by means of spring-loaded saw action. 17 ins. between sawblade and back of frame. Vertical stroke. Saw stroke averages 700 per minute, metal table, 8 ins. by 6 ins.

**FMCW. 103** Cash price **£15 10 6** carriage free or deposit 40/6 plus 8 monthly payments 41/6.

**3 THE 'MARVEL' FRETSAW MACHINE WITHOUT MOTOR AND CONVERSION KIT.** For the D.I.Y. enthusiast who prefers to fit his own fractional horsepower motor or power drill. All other details are as above. Not illustrated.

**FMCW. 104**..... Cash price **150/-** carriage free or Deposit 20/- plus 8 monthly payments 20/-.

**4 THE 'ANCHOR MAJOR' FRETSAW MACHINE.** A heavy duty machine built and recommended for continuous hard work in workshop or factory. Cuts wood, metal, leather, perspex, etc. Suitable for cutting printers blocks and for the manufacture of Jigsaw Puzzles. The blade is driven at both ends by a flexible band working over ball-bearing pulleys, made to oscillate by means of the 'Anchor' movement.

Features include 24 ins. clearance behind sawblade, special saw tensioning device, Piston-type Dust Blower and metal table 24 ins. by 16 ins. The speed is approximately 1,000 saw strokes per minute.

**FMCW. 105** Without motor, with tilting table as illustrated. Cash price **£69 19 6** carriage free or deposit 186/6 and 8 monthly payments 186/6.

**4 THE 'GEM' FRETSAW MACHINE.** A sturdy machine built with an all-steel frame for strength and rigidity. The metal arms are U-shaped, and the blade is held in special Hobbies clamps which grip securely. The 7 ins. diameter table is non-tilting and is 2 ft. 3 ins. from the floor. The treading is easy and the tray provides a holder for small tools. Weight 26 lb.

**FMCW. 101**..... Cash price **179/6** carriage free or deposit 23/6 plus 8 monthly payments 24/-.



# craft tools

A range of tools for the Craftsman, Home Hobbyist and Handyman. You can select from this range with confidence. Well finished and presented, they make ideal gift sets.

**1 'MAJOR' CRAFT TOOL KIT** by MULTICRAFT. Containing precision knife with interchanging blades, multi-purpose saw and blades, abrafiles, chisels, gouges, keyhole saw blade, whittling blade and honing stone. In beechwood presentation case size 9 ins. by 4½ ins.

**HTW. 181**.....Cash price **55/-** carriage 3/- or deposit 6/- plus carriage and 8 monthly payments 7/6.

**2 'CADET' CRAFT TOOL KIT** by MULTICRAFT. Ideal for the young hobbyist. In wood display case size 7 ins. by 5½ ins. Contains precision knife with assorted blades, chisels, keyhole saw, saw frame, abrafiles, hacksaw blade and sharpening stone.

**HTW. 182**.....Cash price **40/-** postage 2/-.

**3 VICE (V6)** by UNIVICE. Has 2 in. wide jaws, opening to 2 ins. Cast metal body with strong steel jaws.

**HTW. 212**.....Cash price **12/6** carriage 4/6.

**4 VICE (V2)** by UNIVICE. Has 1½ in. wide jaws, opening to 1½ ins. Soundly made in cast metal to clamp on to table.

**HTW. 211**.....Cash price **7/6** carriage 3/-.

**5 'KING KLIK' RIVETING KIT.** Instant action. A quality tool with working parts of tempered steel. Complete with rivets, back-up plates and drill. Gives a near professional job. Perfect fastenings of metal to metal, wood, plastic, leather and canvas.

**HTW. 221**.....Cash price **39/-** carriage 3/-.

**6 'POCKET' CRAFT TOOL KIT** by MULTICRAFT. All tools in this set fit the one handle. Contains precision cutter, blades, chisels, saw frame, abrafiles and hacksaw blade. In strong plastic case.

**HTW. 183**.....Cash price **30/-** postage 1/-.

**7 'CRAFT TOOL'** by SWANN MORTON. Complete with two blades.

**HTW. 201**.....Cash price **2/6** postage 6d.

**8 'UNITOOL'** by SWANN MORTON. A pocket set consisting of three heavy duty blades nested into a mansize handle.

**HTW. 202**.....Cash price **5/-** postage 6d.

**9 'PRECISION CUTTER'** by MULTICRAFT. As featured in the Multicraft Kits. Complete with four pak-a-way blades and pocket clip.

**HTW. 203**.....Cash price **7/6** postage 6d.

**10 'SAW-KNIFE' SET** by STANLEY. For cutting and trimming. Comfortable alloy handle. Complete with a wood cutting saw blade, metal cutting saw blade and three assorted blades.

**HT. 231**.....Cash price **7/6** postage 1/-.

**11 'CRAFTSMAN KIT' (62 CK)** by BURGESS. Engraving tool operates off mains voltage 230/250. Vibrates at 100 strokes a second. Engraves on metal, glass, porcelain, wood, leather, etc. Includes 20 attachments for leather work, wood carving, line cutting, etc., also oil stone. All complete in strong steel presentation case.

**HTW. 171**.....Cash price **157/6** carriage free or deposit 21/- and 8 monthly payments 21/-.

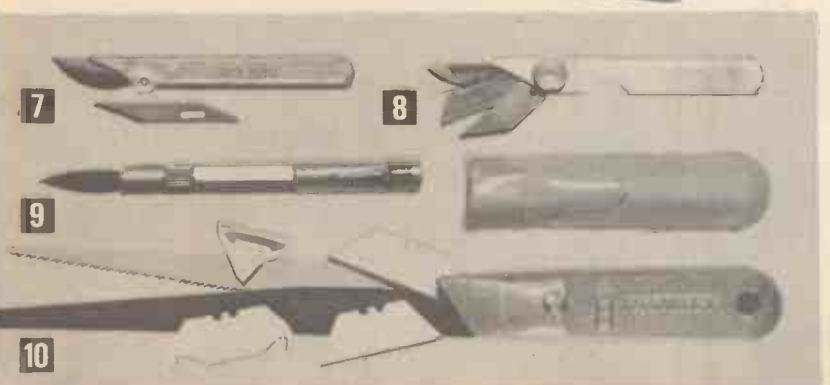
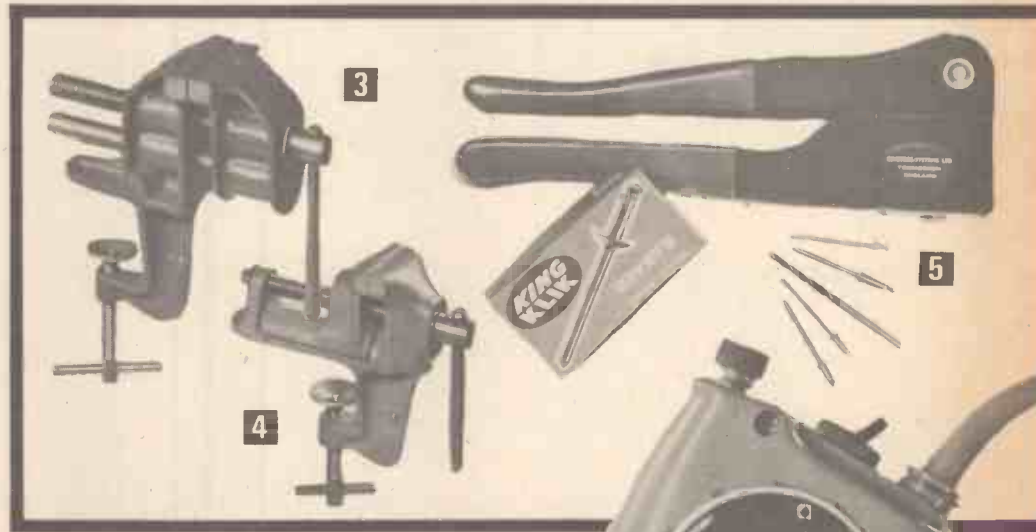
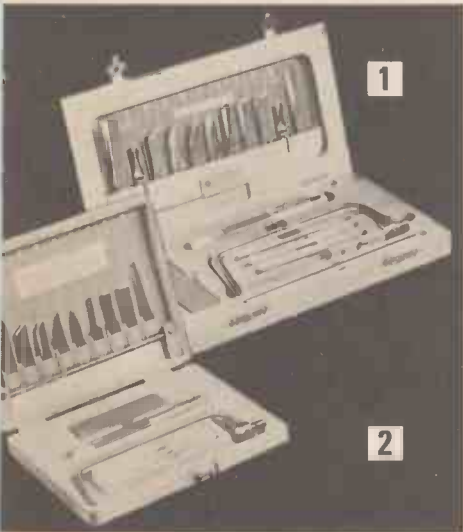

8 MONTHLY  
PAYMENTS OF  
**21/-**

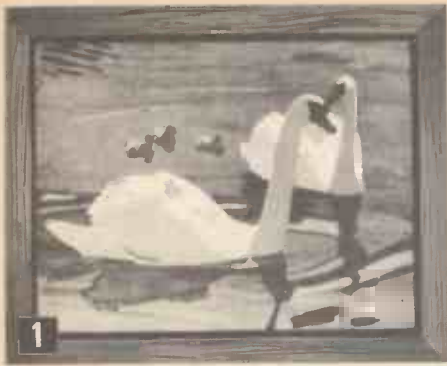

# hobbies

## marquetry kits



FOR MAKING ATTRACTIVE PICTURES IN NATURAL WOOD VENEERS.

An easy and absorbing craft for Modern Home Decoration.

Baseboard printed with detailed line guide of the design.

Yellow carbon paper for printing on dark veneers.

Rare and exotic veneers, craftsmen selected.

Every wood named and numbered to match design.

Border Mount and Fillet Border veneers cut from consecutive leaves for perfect match.

Glass paper and full working instructions for easy assembly.

### NEWCOMER SERIES by ART VENEERS.

Two kits specially designed for the newcomer to this fascinating craft. Each kit contains all necessary materials to complete these attractive pictures in rare and exotic natural wood veneers. Size including borders, 10 in. by 8 in.

1 MKW. 282 SWANS AND CYGNETS (403)

2 MKW. 284 SAIL ON THE LAKE (406)

Cash price 15/9 each.....carriage 4/6

3 HERSTMONCEUX CASTLE (407) by ART VENEERS.

A real challenge to the marquetry expert. This picture of a famous beauty spot is sufficiently detailed to give the experienced worker hours of pleasure. Size including borders, 10 in. by 8 in.

MKW. 285..... Cash price 15/9 carriage 4/6.

4 WOLSELEY SIDDELEY 1910 (409) by ART VENEERS.

An excellent reproduction in veneers of a real veteran. If you are interested in old cars you will enjoy making this picture of an 'old timer'. Size including borders, 10 in. by 8 in.

MKW. 286..... Cash price 15/9 carriage 4/6.

### MARQUETRY PICTURES by HOMECRAFT

Each set contains veneers (with some to spare), cement, glasspaper, instructions and printed baseboard 10 in. by 8 in.

5 MKW. 183 EVENING CALM (IC). Picture 8½ in. by 7½ in.

6 MKW. 184 STILL WATERS (ID). Picture 8 in. by 7½ in.

Cash price 15/9 each.....carriage 3/-

Two pictures chosen to give matching scenes. Each kit contains instructions, carbon-backed guide print, enlarging or reducing grid, printed baseboard, lettered veneers, spare veneers, glasspaper, yellow carbon paper, marquetry cement. Size with borders 10 in. by 8 in.

7 MKW. 201 RED ROOFS (3A)

8 MKW. 204 MORDIFORD (3D)

Cash price 15/9 each.....carriage 3/-

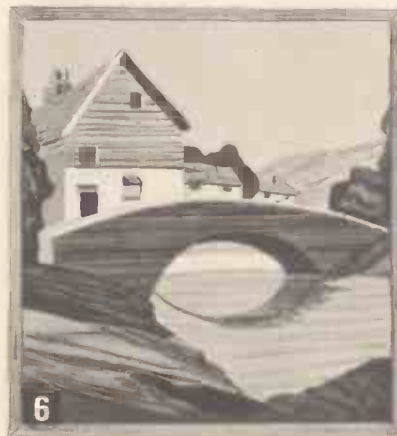





## exhibition pictures



**EXHIBITION PICTURES** by ART VENEERS  
First class pictures for the enthusiast. Suitable for home decoration or exhibitions, these larger examples give sufficient fine work for both requirements. Size 15 ins. by 13 ins.

- 9** MKW. 301 GODSHILL VILLAGE (501)
- 10** MKW. 305 SUMMER ROSES (505)
- 11** MKW. 306 YE OLDE CURIOSITY SHOP (506)
- 12** MKW. 302 ALPINE SCENE (502)
- 13** MKW. 303 DEVON COTTAGE (503)
- 14** MKW. 304 THE CAT & FIDDLE (504)

Cash price **31/6** each.....carriage 4/6

**15** **THE FAVOURITE.** A favourite in more senses than one. This fine head is a real 'winner'. Size

22 ins. by 14 ins., including borders. Kit of veneers and design. Baseboard not included.

**MKW. 321**.....Cash price **32/6** carriage 4/6.

**16** **MEDITERRANEAN SCENE.** Size 36 ins. by 15 ins. An extra large picture giving a panoramic view of a Mediterranean village. Kit contains design, instructions, and 38 colourful wood veneers. Baseboard not included.

**MKW. 322**.....Cash price **44/-** carriage 4/6 or deposit 8/6 plus carriage and 8 monthly payments 5/6.



# continental SERIES



## 'CONTINENTAL SERIES' by ATLAS

These six continental scenes are pleasing subjects for marquetry pictures. The carefully selected veneers are specially chosen for their artistic effect and give a colourful impression of the actual scene.

Each kit contains all first quality veneers numbered for easy selection, including border strips, carbon paper, fine grade glasspaper, design sheet and easy-to-follow instructions. The picture measures 10½ ins. by 8½ ins. with borders.

- 1 MKW. 101 'CHILLON' (501)
- 2 MKW. 104 'WETTERHORN' (504)
- 3 MKW. 105 'PIAZZA' (505)
- 4 MKW. 106 'MEZZINA' (506)
- 5 MKW. 102 'MUHLE' (502)
- 6 MKW. 103 'THAL' (503)

Cash price 13/6 each.....carriage 3/-

## 'OUTDOOR SERIES' by ATLAS

The four pictures in this series focus attention upon birds, animals and fish. The choice veneers not only portray the background scene, but highlight effectively the picture subject.

Each kit contains similar materials of the same high quality as the Continental Series. The picture, with border, is 10½ ins. by 8½ ins.

- 7 MKW. 121 KINGFISHER (201)
- 8 MKW. 122 LEAPING FISH (202)
- 9 MKW. 123 PLOUGHING (203)
- 10 MKW. 124 EAGLE (205)

Cash price 14/6 each.....carriage 3/-

See page 91 for Craft Knives.

# outdoor SERIES





## marquetry pictures



11



12

### MARQUETRY KITS by HOMECRAFT

These pictures offer larger sizes and differing proportions. Their carefully designed details make a special appeal to the eye. Each kit contains a splendid selection of veneers, together with carbon-backed guide print, glasspaper, instructions and printed baseboard giving overall size 15 ins. by 13 ins.

#### 11 MKW. 222 TRANQUILLITY (2B)

Size of picture 12 ins. by 10½ ins. Kit includes picture moulding.

#### 12 MKW. 223 THE MILL BRIDGE (2C)

Size of picture 14 ins. by 10½ ins.

Cash price 28/6 each.....carriage 4/6

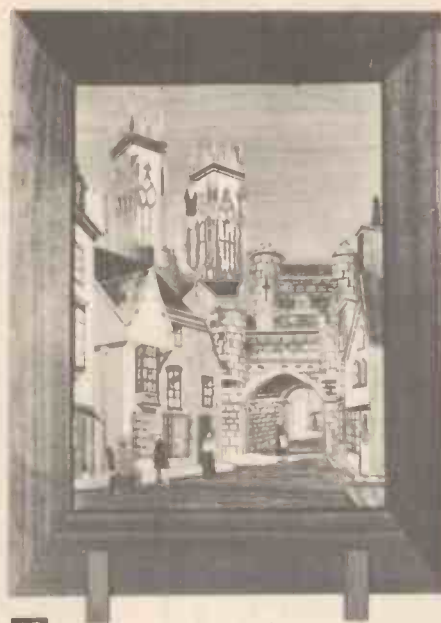

13



15

### 13 FIRESCREEN PICTURE 'BOOTHAM BAR' YORK in 1829, (66)

An intricate picture that will afford pleasurable pride in making this superb example of marquetry art. A real challenge to all marquetry craftsmen. Kit contains carbon-backed guide print, pack of 29 selected veneers, borders: baseboard and feet not included. Size including borders 23 ins. by 18 ins.

MKW. 241.....Cash price 35/- carriage 4/6



14



16

### FIRESCREEN KITS by ATLAS

Three subjects that are sure to appeal to the marquetry enthusiast and their large size makes them particularly suitable for firescreens. Each kit contains ¾ in. printed baseboard, numbered veneers, framing, firescreen feet, glasspaper, screws, marquetry cement and full instructions. Size 23½ ins. by 18 ins.

14 MKW. 141 SHIP AHOY (601)

15 MKW. 142 LEAPING FISH (602)

16 MKW. 143 GLENCASTLE (603)

Cash price 52/6 each.....carriage 6/- or deposit 7/- plus carriage and 8 monthly payments 7/-.

# leatherwork kits



1

Here's an opportunity for profitable leisure—practical kits that can be quite easily assembled—all parts are supplied cut out, punched and ready for stitching etc. They make very acceptable gifts for your family and friends.

### CANADIAN LEATHER MOCCASIN KITS.

The modern footwear for carefree leisure. A range of genuine Canadian leather moccasins, tanned and cut to shape in Canada, shipped in bulk, assembled and boxed in England. Available in two types of leather and a full range of sizes.

'BULLHIDE' MOCCASIN KITS. Made from natural grain bullhide, ankle fitting and can be worn in or out of doors. The leather being unstretched, moulds itself naturally to the feet, making really comfortable footwear.

All styles are suitable for children, women or men.

1 RANGER STYLE with flexible insole.

LCW. 101 sizes 3, 4 and 5.....cash price 37/6

LCW. 106 sizes 6, 7, 8, 9, 10, 11, 12 and 13.

Cash price 39/11..... Postage 2/3 extra per kit.

2 BOB-ABOUTS. With tartan cushioned insole and red laces. In FOUR sizes covering children's 8's to 2's.

LCW. 121 sizes 8-9, 10-11, 12-13, 1-2.

Cash price 29/11..... Postage 2/3 extra.

3 'COWHIDE' MOCCASIN KITS. Cut from finest Canadian top grain cowhide, these bone-coloured moccasins have gay tartan foam-rubber insoles, firmly fixed in position.

MO-CUBS. For women and children.

LCW. 132 sizes 3, 4 and 5..... Cash price 29/11

LCW. 133 sizes 6 and 7..... Cash price 32/6

Postage 2/3 extra. When ordering please state catalogue No. and size.



2

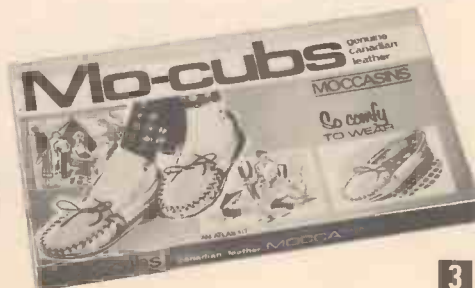

3



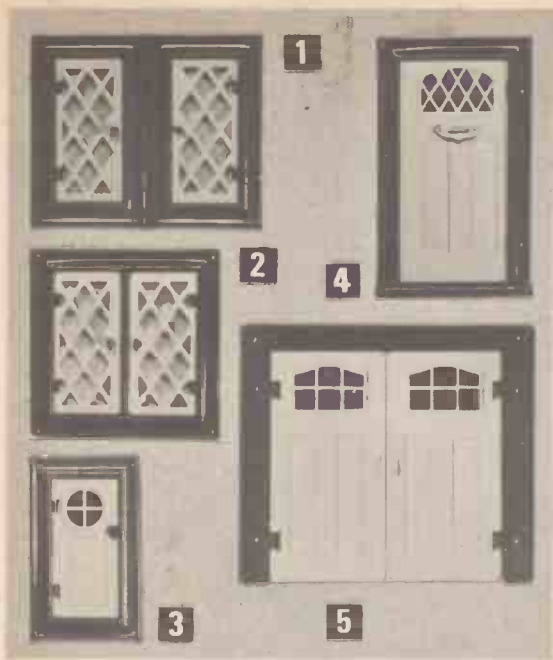

# doll's house fittings

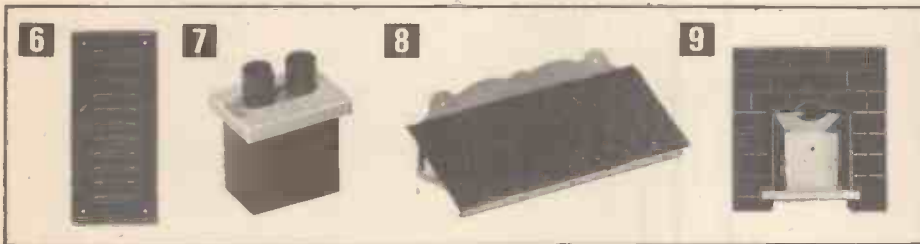
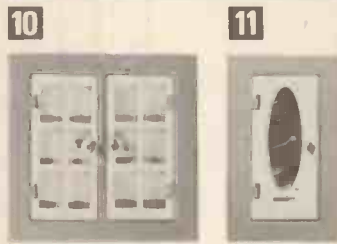

Metal or plastic fittings which are suitable for Old World or Modern Doll's Houses and similar toys. There are sizes to suit your every requirement.

**METAL WINDOWS AND DOORS.** A pleasing 'leaded' type, finished in cream and green enamel and glazed in transparent plastic. Holes drilled ready for fixing.

★ Single light window (1L) 3½ ins. by 2 ins.  
**DHAW. 201.**..... Cash price 9d postage 4d.

1 Two single light window (2LC) 3½ ins. by 3½ ins.  
**DHAW. 202.**..... Cash price 1/6 postage 4d.

★ Three single light window (3L) 3½ ins. by 5½ ins.  
**DHAW. 203.**..... Cash price 1/11 postage 4d.

2 Double light window (2L) 3½ ins. by 3½ ins.  
**DHAW. 204.**..... Cash price 1/3 postage 4d.

★ Two double light window (4L) 3½ ins. by 6½ ins.  
**DHAW. 205.**..... Cash price 2/3 postage 4d.

★ Three double light window (6L) 3½ ins. by 9½ ins.  
**DHAW. 206.**..... Cash price 4/- postage 6d.

3 Door with circular fanlight (1L) 3½ ins. by 2 ins.  
**DHAW. 207.**..... Cash price 1/- postage 4d.

4 Door with leaded fanlight (2L) 4¾ ins. by 2½ ins.  
**DHAW. 208.**..... Cash price 2/3 postage 4d.

5 Double garage doors. 4½ ins. by 5 ins.  
**DHAW. 209.**..... Cash price 4/- postage 6d.

### SHUTTER, CHIMNEY, ETC.

6 Shutter (Red) 3½ ins. by 1½ ins.  
**DHAW. 210.**..... Cash price 6d postage 4d.

7 Chimney (Red and Cream), fits any angle roof.  
**DHAW. 211.**..... Cash price 1/6 postage 4d.

8 Porch (Red Tiled) 3½ ins. by 1½ ins.  
**DHAW. 212.**..... Cash price 1/3 postage 4d.

9 Fire surround (Green, Red or Cream) 2½ ins. by 2½ ins. wide.  
**DHAW. 213.**..... Cash price 1/- postage 4d.

### 'EASIFIT' WINDOWS AND DOOR

*Specially designed for hardboard constructions. Fixed in a jiffy by means of metal tabs.*

★ Window (EF/1). An 'open and close' single light glazed metal window, finished in yellow and white. 3½ ins. by 2 ins.  
**DHAW. 251.**..... Cash price 9d postage 4d.

10 Window (EF/2). A double light window measuring 3½ ins. by 3½ ins. Yellow and White.  
**DHAW. 252.**..... Cash price 1/3 postage 4d.

11 Door (EF/10). A smart door with coloured glazing. 3½ ins. by 2 ins.  
**DHAW. 253.**..... Cash price 1/- postage 4d.

**'HOBBIHOLME' PLASTIC WINDOWS AND DOORS.** A modern type designed for the larger house and finished in strong rigid plastic. Made in Western Germany.

★ Single casement windows, cream, 5½ ins. by 3½ ins.  
**DHAW. 231.**..... Cash price 3/9 postage 6d.

12 Double casement window, cream. 7 ins. by 3½ ins.  
**DHAW. 232.**..... Cash price 3/11 postage 6d.

13 Picture window, cream, with Window Boxes and coloured Flowers. 6 ins. by 3½ ins.  
**DHAW. 233.**..... Cash price 5/3 postage 6d.

★ Picture window with Window Boxes but without flowers. 6 ins. by 3½ ins.  
**DHAW. 234.**..... Cash price 4/3 postage 6d.

★ Plain door in Eau-de-nil and Cream. 6 ins. by 3½ ins.  
**DHAW. 235.**..... Cash price 4/11 postage 6d.

14 Glazed door in Eau-de-nil and Cream. 6 ins. by 3½ ins.  
**DHAW. 236.**..... Cash price 5/3 postage 6d.

15 Interior door, pivoted for easy movement, amber colour. 5½ ins. by 2½ ins.  
**DHAW. 237.**..... Cash price 1/9 postage 6d.

16 **TRANSPARENT MATERIAL (Acetate Sheet)**  
 Essential for garage showrooms, picture windows, curved windows and photo frames. Also useful for novelties such as chalet and church music boxes.

•010 Thick, 36 ins. by 24 ins.  
**DHAW. 261.**..... Cash price 9/- postage 10d.

•010 Thick, 18 ins. by 24 ins.  
**DHAW. 262.**..... Cash price 5/- postage 8d.

•010 Thick, 18 ins. by 12 ins.  
**DHAW. 263.**..... Cash price 2/9 postage 6d.

•010 Thick, 9 ins. by 12 ins.  
**DHAW. 264.**..... Cash price 1/6 postage 4d.

•020 Thick, 54 ins. by 24 ins.  
**DHAW. 265.**..... Cash price 27/6 postage 1/2.

•020 Thick, 27 ins. by 24 ins.  
**DHAW. 266.**..... Cash price 14/6 postage 1/2.

•020 Thick, 27 ins. by 12 ins.  
**DHAW. 267.**..... Cash price 7/6 postage 8d.

•020 Thick, 13½ ins. by 12 ins.  
**DHAW. 268.**..... Cash price 4/- postage 6d.

★ Not Illustrated.

# hobbies



**1 'HOBBIES' LIGHTING SET.** A boxed set of larger fittings specially selected for Doll's Houses, Service Stations, Model Railways, Model Theatres, etc., providing all you need except battery and bulbs. Contains six bulb holders, two switches, six yards of insulated wire and full instructions with wiring diagram.

DHAW. 283.....Cash price 9/6 postage 10d.

**2 'WARDIE' LIGHT-UP SET** by B. J. WARD. With coloured shades to give real-life lighting to the Doll's House, Railway, Model Aerodrome, etc. Set contains 4 lamps, 4 holders, 4 shades, 4 ceiling roses, wire and battery clips. No tools or soldering required. Works off 4½ volt battery. Complete with full instructions. Battery not included.

DHAW. 282.....Cash price 5/1 postage 6d.

A range of authentic miniatures which will give a distinctive and realistic appearance to all Doll's Houses.

**ELECTRIC LAMPS.** Stylish and colourful additions to the Doll's House. Each unit is complete with flex, 2-pin plug and bulb, ready to plug into a Battery Cap (775). With brightly coloured plastic shades and polished gold finish metal bases. Not for mains use. Made In West Germany.

**3 CEILING PENDANT 3/LIGHT.** (728). 2 ins. deep.

DHAW. 295..... Cash price 9/9 postage 6d.

**4 CEILING PENDANT LAMP (727A).** 1½ ins. deep.

DHAW. 291..... Cash price 6/9 postage 6d.

**5 CEILING PENDANT LAMP (690).** 2 ins. deep.

DHAW. 292..... Cash price 6/9 postage 6d.

**6 WALL LAMP.** (716). 1½ ins. deep.

DHAW. 294..... Cash price 5/9 postage 6d.

**ELECTRIC BELL, BULB HOLDERS, SWITCHES, PLUGS ETC.** Perfect reproductions of the real thing. These miniatures will double the play value of the Doll's House. Can also be incorporated into Garages, Service Stations etc. Not for mains use.

**7 NEON STRIP LIGHT.** (717). 2 ins. long.

DHAW. 293.....Cash price 6/3 postage 4d.

**8 BULB HOLDER.** (732). 1½ ins. dia. to take flash lamp bulb.

DHAW. 311..... Cash price 9d postage 4d.

**9 ON/OFF SWITCH.** (730). 1½ ins. dia.

DHAW. 312..... Cash price 1/6 postage 4d.

**10 PLASTIC COVERED WIRE.** In coils of 6 yards.

DHAW. 313..... Cash price 1/- postage 4d.

**11 ON-OFF SWITCH.** (762). ¾ in. dia. Made in West Germany.

DHAW. 314..... Cash price 1/- postage 4d.

**12 PLUG (764)** to fit Sockets 315 and 316.

DHAW. 319.....Cash price 6d. postage 4d.

**13 SOCKET.** (763/4). ¾ in. dia. socket. Made in West Germany.

DHAW. 315..... Cash price 1/- postage 4d.

**14 SOCKET AND SWITCH (882/764).** 1½ ins. deep. A switched socket complete with plug. Made in West Germany.

DHAW. 316..... Cash price 1/6 postage 4d.

**15 BATTERY CAP.** (775) with two 2-pin sockets, to fit on top of a 4.5 volt flat battery. Made in West Germany.

DHAW. 317..... Cash price 1/6 postage 4d.

**16 PEA BULB WITH HOLDER (733)** ¾ in. dia. Not suitable for bulb holder 311. Empire made.

DHAW. 285..... Cash price 1/- postage 4d.

**17 ELECTRIC BELL AND BELL PUSH.** (781/766). 1½ ins. dia. clear ringing bell with ¾ in. dia. push. Made in West Germany.

DHAW. 318 (BELL)... Cash price 6/3 postage 6d.

DHAW. 320 (PUSH).. Cash Price 1/- postage 6d.

# 'hobbilite'

## DOLLS HOUSE ELECTRIC LIGHT FITTINGS



4



5



6



7



8



9

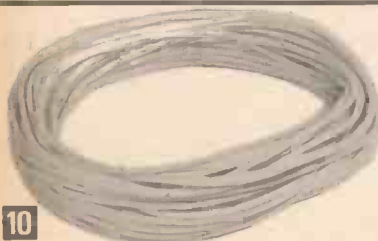

10



11



13

12



14

15



16



17



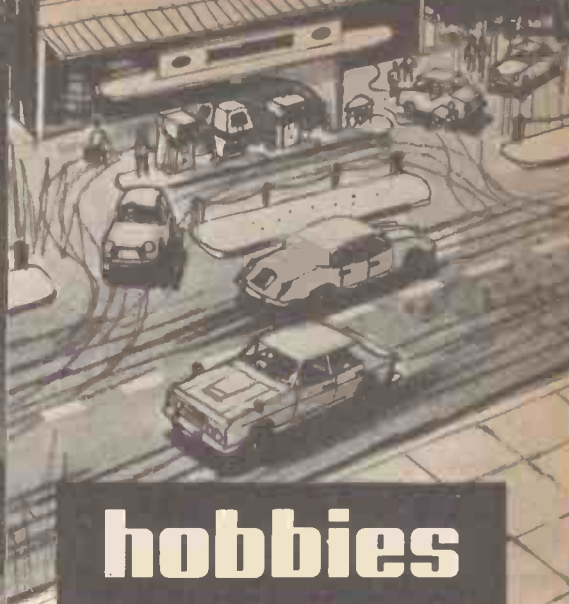

# hobbies

## garage accessories

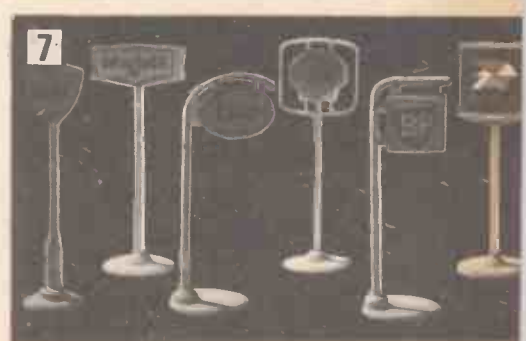
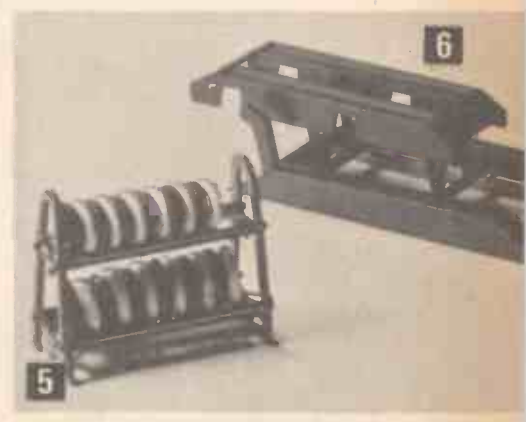
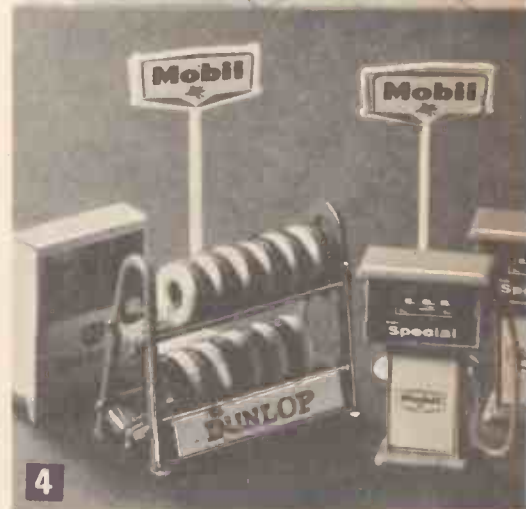

### MODEL GARAGE ACCESSORIES

These miniature models give the finishing touches to a Service Station or Model Garage. All are minutely detailed and appropriately coloured.

**1 GARAGE FORECOURT SET** (K. 70) by B. J. WARD. Another boxed outfit for the Service Station. With two modern pumps, tyre rack and oil cabinet.

KAW. 122..... Cash price 8/3 postage 1/-.

**2 PETROL PUMPS, ESSO, BP and FINA.** by B. J. WARD. Modern style pumps in bright metal and plastic, each with flexible hose.

KAW. 101.... Cash price (each) 1/6 postage 6d.

**3 OIL CABINETS, CASTROL, ESSO and BP** by B. J. WARD. 1½ ins. high. Each with working shutter.

KAW. 103.... Cash price (each) 1/6 postage 8d.

**4 GARAGE EQUIPMENT SET** by B. J. WARD. An attractively boxed set of useful accessories for the Model Garage or Service Station. Contains two

modern Petrol Pumps, two Petrol Standard signs, an Oil Cabinet and a Tyre Rack with Tyres.

KAW. 121..... Cash price 9/6 postage 1/2.

**5 TYRE RACK** by B. J. WARD. Complete with 12 large and 12 small tyres. 2½ ins. wide by 2 ins. high.

KAW. 104..... Cash price 3/3 postage 6d.

**6 CAR RAMP** by B. J. WARD. Lever raises cars for servicing. 4 ins. long by 2 ins. wide. 1 in. wheel base.

KAW. 105..... Cash price 2/6 postage 6d.

**7 PETROL STANDARD SIGNS, ESSO, BP and FINA** by B. J. WARD. Popular signs, correctly styled and coloured.

KAW. 102.... Cash price (each) 9d. postage 4d.

**MINIATURE GARAGE POSTERS AND SIGNS.** A large packet of assorted posters for decorating garage and service station walls. *Not illustrated.*

KAW. 106..... Cash price 1/6 postage 4d.

# carpentry tool kits

This range of kits includes sets suitable for the beginner, the young carpenter, the home handyman and the professional craftsman.

**1 THE 'RUTLAND' by STANLEY.** A set of Stanley and other tools specially selected for the amateur and beginner. Contains Bench Plane, 6 ft. 'Pull-Push' Rule, Hammer 10 oz., Wood Handle Screwdriver 4 in., Flared Tip; Plastic Handle Screwdriver 3 in., Cabinet Tip, Try Square 6 in., Trimming Knife with 5 blades, Junior Hacksaw, Hand Drill, Twist Drills  $\frac{3}{8}$ ,  $\frac{1}{2}$  and  $\frac{5}{8}$  in., Mallet 4 In., Panel Saw 20 in., 10 point, Tenon Saw 10 in., Marking Gauge, Pair Insulated Combination Pliers, Bradawl, Ash Handled Firmer Chisels  $\frac{1}{2}$  and  $\frac{3}{4}$  in., Pin Punch.

**CTKW. 103.**..... Cash price **£9 12 0** carriage free or deposit 26/6 and 8 monthly payments 25/6.

**2 THE 'DO-IT-YOURSELF' by STANLEY.** A comprehensive selection of 17 Stanley and other first class tools in a strong wooden case suitable for carrying or fixing to a wall. Contains Plane, Push Drill, Hammer, 16 oz., Block Plane, Ratchet Brace 8 in. sweep, Screwdriver 3 in., Screwdriver 4 in., Try Square 6 in. (Rosewood Stock), Slip Joint Pliers, Panel Saw 20 in. 10 point, Marking Gauge, Chisel  $\frac{1}{2}$  in. bevel edge, Boxwood Folding Rule 2 ft., Auger

Bits  $\frac{1}{8}$ ,  $\frac{3}{8}$  and  $\frac{1}{2}$  in. and book 'How to Work with Tools and Wood'. Case measures 26 $\frac{1}{2}$  ins., by 4 $\frac{1}{2}$  ins. by 13 ins.

**CTKW. 102.**..... Cash price **£15 18 0** carriage free or deposit 41/- and 8 monthly payments 42/6.

**3 THE 'CRAFTSMAN' by STANLEY.** A strong wooden case of 31 Stanley and other top quality tools for the discerning craftsman. Contains Smooth Plane, 'Universal' Brace 10 in. sweep, Hand Drill, Hammer 20 oz., Vice, Trimming Knife, Shaper-plane, Screwdriver 4 ins., Screwdriver 6 ins., Low Angle Block Plane, Honing Gauge, Try Square 6 ins. (Rosewood Stock), Bevel 7 $\frac{1}{2}$  ins. (Rosewood Stock), Marking Gauge, Slip Joint Pliers, Boxwood Folding Rule 2 ft., Panel Saw 22 ins., 10 point, Back Saw 12 ins., Chisels  $\frac{1}{2}$ ,  $\frac{3}{4}$  and  $\frac{1}{2}$  in. bevel edge, Mallet 4 Ins., Junior Hacksaw, Auger Bits,  $\frac{1}{8}$ ,  $\frac{3}{8}$  and  $\frac{1}{2}$  in., Twist Drills,  $\frac{3}{8}$ ,  $\frac{1}{2}$  and  $\frac{5}{8}$  in., Carpenter's Pencil and Book 'How to Work with Tools and Wood'. The case, which measures 30 $\frac{1}{2}$  ins. by 6 $\frac{1}{2}$  ins. by 15 $\frac{1}{2}$  ins., is suitable for carrying or fixing to a wall.

**CTKW. 101.**..... Cash price **£29 19 0** carriage free or deposit 71/- and 8 monthly payments 81/-.

**4 HOBBIES TOOL KIT (1).** Suitable for the young beginner. These are REAL tools—not toys.

Contains a 10 in. Handsaw (a real saw in miniature), Sheffield Steel Chisel, Cabinet Screwdriver, Carpenter's Hammer, Bradawl, all-steel Plane with adjustable blade, and a 12 in. Rule. In strong cardboard box, measuring 15 ins. by 9 ins.

**CTKW. 111.**..... Cash price **27/6** carriage 4/6.

**5 HOBBIES TOOL KIT (3).** A set of useful tools suitable for the young carpenter. Contains a 12 in. Handsaw of lasting quality, Carpenter's Chisel with polished wood handle, strong Steel Pincers, Cabinet Screwdriver, Gimlet, Bradawl, Carpenter's Hammer, 2 ft. Boxwood Folding Rule, and an all metal Plane 5 $\frac{1}{2}$  ins. long with adjustable blade. A most attractive set in strong cardboard box 17 ins. by 10 ins.

**CTKW. 112.**..... Cash price **47/6** carriage 4/6 or deposit 5/- plus carriage and 8 monthly payments 6/6.

**6 HOBBIES TOOL KIT (4).** Suitable for father or son, these workmanlike tools can be used for carpentry projects and for jobs about the house. Kit contains Handsaw, Plane, Backsaw, Chisel, two Screwdrivers, Gimlet, Square, Bradawl, Hammer, Panel Pins, Pincers, Mallet, Boxwood Folding Rule, Keyhole Saw, Fretsaw Frame and spare blades, and a Handbook on Home Carpentry. Packed in an attractive box, size 21 ins. by 7 ins.

**CTKW. 113.**..... Cash price **87/6** carriage 6/- or deposit 13/- and 8 monthly payments 11/6.

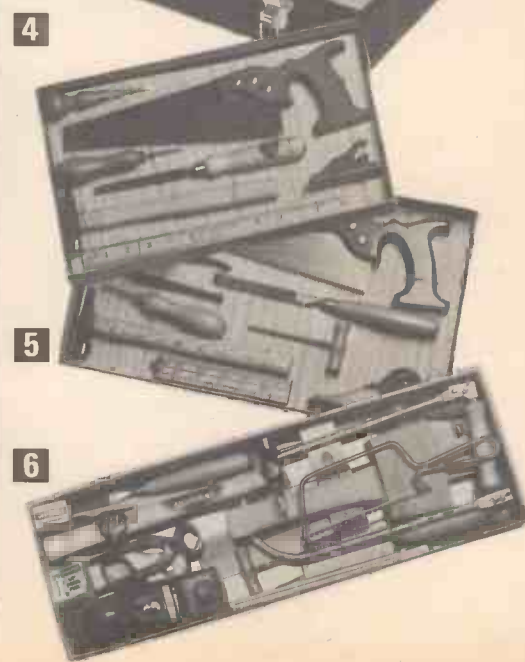

8 MONTHLY PAYMENTS OF **81/-**



# carpentry tools

For the carpenter and handyman.

**1 HAND TOOL SET** (139) by SURFORM. A useful set of tools comprised of a Standard Plane, Standard File, Block Plane, Round File, Fine Cut Flat Blade and a Half Round Blade.

CTW. 201.....Cash price **68/-** carriage 4/6 or deposit 7/6 plus carriage and 8 monthly payments 8/6.

★ **STANDARD FILE** (101) by SURFORM. Will work Mild Steel, Aluminium, Brass, Copper, Lead, Wood, Hardboard, Plastic Tiles, Perspex, Laminated Plastics, Fibre Glass, etc. Complete with standard cut blade.

CTW. 202.....Cash price **16/-** postage 1/6.

★ **STANDARD PLANE** (107) by SURFORM. Complete with standard cut blade.

CTW. 204.....Cash price **19/9** postage 2/-.

★ **PLANERFILE** (122) by SURFORM. A dual-purpose tool which can be used either with the handle up for planing or down for filing. Complete with standard cut blade.

CTW. 203.....Cash price **21/-** carriage 2/6.

★ **BLOCK PLANE** (111) by SURFORM. For quick, one-handed smoothing.

CTW. 205.....Cash price **11/6** postage 1/4.



**1**

**2 DOUBLE PINION ENCLOSED GEAR HAND DRILL** (5803) by STANLEY. Length 13 in., with three-jaw  $\frac{1}{8}$  in. chuck. Finished in matt black enamel with yellow gear wheel.

CT. 402.....Cash price **43/-** carriage 4/6 or deposit 7/6 plus carriage and 8 monthly payments 5/6.

**3 ENGINEER'S BREAST DRILL** (748A) by STANLEY. Length 18 in. With enclosed gears—two speed. Three-jaw chuck holds parallel shank drills. Ball race. Smooth operating. Chuck capacity  $0\frac{1}{2}$  in.

CT. 401.....Cash price **78/6** carriage 6/- or deposit 14/- plus carriage and 8 monthly payments 10/-.

**4 SINGLE PINION HAND DRILL** (103) by STANLEY. Length 12 in., with  $\frac{1}{2}$  in. chuck capacity. Fitted with three-jaw chuck and sintered metal pinion. Iron frame and gearwheel.

CT. 403.....Cash price **21/-** carriage 4/6.

**5 SET OF TWIST DRILLS** by HOBBIES. Containing nine drills,  $\frac{1}{8}$  in. to  $\frac{3}{8}$  in. (graduated in  $\frac{1}{16}$ ths). Made in West Germany.

CTW. 404.....Cash price **7/6** postage 6d.

**6 SET OF SOLID CENTRE AUGER BITS** (926) by FOOTPRINT. A pack of six bits. Set comprises one each  $\frac{1}{2}$  in.,  $\frac{3}{8}$  in.,  $\frac{1}{2}$  in.,  $\frac{3}{4}$  in.,  $1\frac{1}{2}$  in.,  $2\frac{1}{2}$  in.

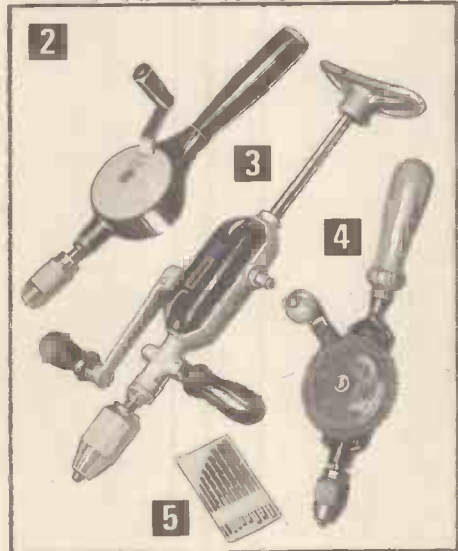

**2**

**3**

**4**

**5**

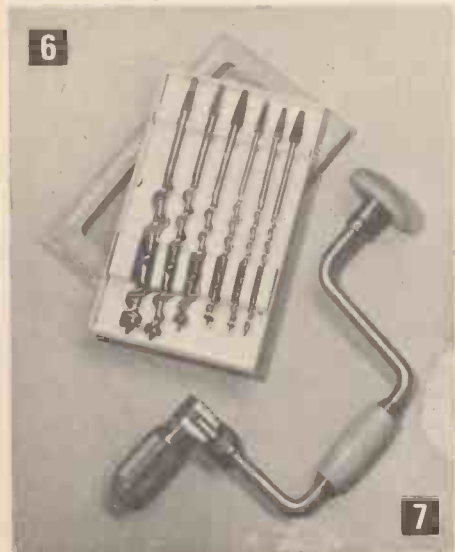

**6**

**7**



**8**

**9**



CTW. 407.....Cash price **41/9** carriage 2/6 or deposit 6/- plus carriage and 8 monthly payments 5/6.

**7 RATCHET BRACE** (78) by STANLEY. Open type twelve point ratchet. Alligator jaws. Ball-bearing head. Holds all standard square taper shank bits and parallel shank drills from  $\frac{3}{32}$  in. to  $\frac{1}{2}$  in., inclusive. Nickel plated.

CT. 406.....Cash price **30/-** carriage 4/6.

★ **ROUND FILE** (124A) by SURFORM. A 10 in. file suitable for many difficult shaping jobs.

CTW. 486.....Cash price **11/-** postage 1/6.

**8 'YANKEE' SPIRAL RATCHET SCREWDRIVER** (135A) by STANLEY. Length with bit  $13\frac{1}{2}$  in. Can be adapted to take drill points. With  $\frac{1}{16}$  in.,  $\frac{1}{8}$  in. and  $\frac{3}{16}$  in. bits for slotted screws.

CT. 409.....Cash price **37/6** postage 1/6.

**9 SMOOTHING PLANE** (4) by STANLEY. Length  $9\frac{1}{2}$  in., with 2 in. wide cutter. Fully adjustable.

CT. 416.....Cash price **49/6** carriage 4/6 or deposit 7/6 plus carriage and 8 monthly payments 6/6.

★ **BLOCK PLANE** (130) by STANLEY. Length 8 in., with  $1\frac{1}{2}$  in. wide cutter adjustable by hand only. A useful plane with two cutter positions, for ordinary and for bull nose work.

CT. 417.....Cash price **22/-** carriage 4/6.

**10 CHISEL SET** (455) by FOOTPRINT. A set of four, all purpose, general duty, Firmer Wood Chisels. Sizes  $\frac{1}{2}$  in.,  $\frac{1}{2}$  in.,  $\frac{3}{4}$  in., and 1 in.

CTW. 412.....Cash price **30/-** carriage 4/6.

★ **BLOCK PLANE** (102) by STANLEY. Length  $5\frac{1}{2}$  in., with  $1\frac{3}{4}$  in. wide cutter adjustable by hand only. A low price tool of the highest quality.

CT. 419.....Cash price **12/-** postage 1/9.

★ *Not Illustrated.*



**10**



**hobbies**

# hobbies



**1 ALL STEEL CORNER CRAMP** by HOBBIES. A picture Frame Cramp made from steel and practically unbreakable. Will take work up to 2½ ins. wide. A very serviceable cramp for the Handyman. CTW. 504.....Cash price **15/6** carriage 3/-.



**2 MITRE-CUTTING TOOL & CORNER CRAMP** by HOBBIES. Takes all the guesswork out of cutting mitres on moulding and similar work up to 4 ins. wide by about 1 in. thick. The wood is held fast on a perfectly flat bed, and the tenon saw is gripped between the blades of the saw guide at an angle of 45 degrees. Can also be used as a cramp for gluing up mitred corners. Not intended for 'deep' contemporary mouldings.

CTW. 501.....Cash price **59/6** carriage 4/6 or deposit 7/6 plus carriage and 8 monthly payments 8/-.

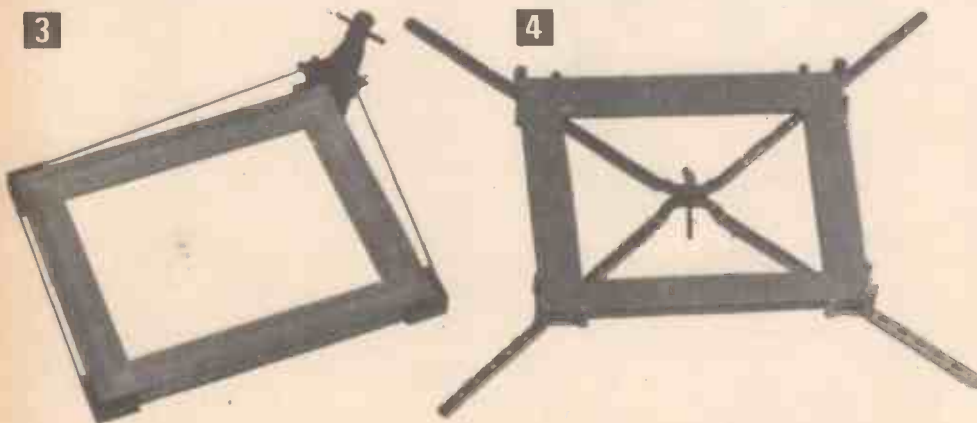

**3 THE 'ELWOOD' MULTI-PURPOSE CRAMP.** An essential tool for the Do-it-Yourself workshop. Cramps anything, anywhere! For Cabinets, Picture Frames, Chairs, Tables, Stools, Furniture, etc. Precision engineered to ensure accurate cornering of woods, metals, plastics, etc. Complete with cramping tool, three corner angles with detachable Base-Plates and 6 ft. of Bonding Wire.

CTW. 503.....Cash price **32/6** carriage 2/6.

**4 FOUR-CORNER PICTURE FRAMING CRAMP** by HOBBIES. A real 'time-saving tool! You can cramp and glue all four corners of a picture frame at once. Fit the frame into the four corner brackets and turn the centre screw to apply equal pressure to the four corners. Takes any size frame from 11 ins. by 9 ins. to 40 ins. by 30 ins.

CTW. 502.....Cash price **97/6** carriage 6/- or deposit 13/- plus carriage and 8 monthly payments 13/-.

**5 WOOD MITRE BLOCK** by HOBBIES. A 9 in. mitre-cutting block with right angle and 45 degree slots. Made from first quality Beech.

CTW. 505.....Cash price **3/6** postage 1/9.

**6 WOOD MITRE BOX** by HOBBIES. Ensures accurate cutting of right angles and 45 degree mitres. 9 ins. long. Made from first quality Beech.

CTW. 506.....Cash price **6/3** carriage 3/-.

**7 ALL-STEEL CRAMPS** by HOBBIES. Every worker in wood needs these cramps. For holding work together after gluing they are just the thing.

CTW. 508.....Cash price **2/3** postage 8d.

CTW. 509.....Cash price **2/6** postage 10d.

CTW. 510.....Cash price **2/9** postage 10d.

CTW. 528.....Cash price **3/-** postage 1/-.

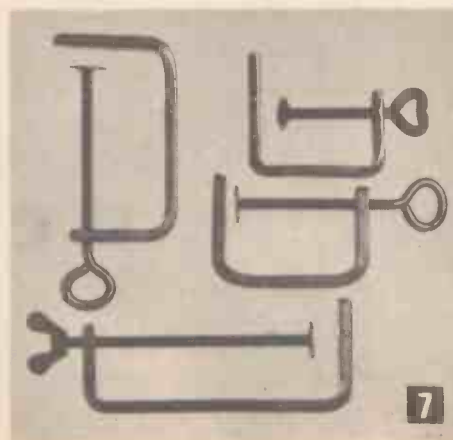





8

**8 VICE** (5702) by STANLEY. Aluminium body—genuinely portable. Jaws hold work vertically or horizontally. Double guide-rods give added stability. Oval clamping pad ensures a firm hold on clamping surface. Offset clamp allows easy fixing to front and side of bench and can be used as a 'G' cramp. Jaw width 5 ins., depth 5½ ins., capacity 3½ ins.

CTW. 413.....Cash price 34/6 carriage 4/6.

**9 WOOD Mallet** by HOBBIES. A dependable 5 in. hardwood mallet for the carpenter, home handyman or camper.

CTW. 522.....Cash price 6/6 carriage 3/-.

**10 WOOD MARKING GAUGE** by HOBBIES. A good quality hardwood marking gauge, 9 ins. long. A necessary tool for accurate marking.

CTW. 525.....Cash price 4/6 postage 1/-.

**11 JOINER'S SQUARE** by HOBBIES. A well made square with 6 in. metal blade and 5 in. hardwood Stock.

CTW. 526.....Cash price 5/11 postage 1/-.



10

**12 'PUSH PULL' RULE** (1206) by STANLEY. Length 6 ft. Die-cast case. Measures 2 ins. across the base for accurate inside measurements. Flexible steel blade. Bold black figures on a white background. 'True-zero' hook slides on studs to compensate for its own thickness. Feet and inches on upper edge, inches on lower edge. 16 ft. jolt-centre markings. Chromium plate case.

CT. 427.....Cash price 8/9 postage 10d.

**13 PADSAW** by FOOTPRINT. Length 13 ins. overall. With polished hardwood handle. For cutting straight or irregular shapes in plywood, hardboard and timber up to 2 ins. thick. Blade retracts into handle when not in use. Can be used with hacksaw blade for cutting metal.

CTW. 551.....Cash price 8/- postage 1/-.

**14 TOOL RACK** (12). Length 20 ins., with 12 clips.

CTW. 572.....Cash price 5/11 postage 1/-.

**15 COPING SAW** by HOBBIES. A special design with clamps which allow the blade to be turned to any angle in the frame. The 'pin-end' blade is 6½ ins. long.

CTW. 553.....Cash price 8/6 postage 1/2.



11

**16 'WARRINGTON' CROSS PEIN PIN HAMMER** (CP. 3½) by STANLEY. Specially suitable for the fretworker and modelmaker. Weight 3½ ozs.

CTW. 425.....Cash price 9/6 postage 1/-.

**17 'STEELMASTER' HAMMER** (ST. 1½) by STANLEY. With forged 'locked on' head, high grade alloy steel, polished finish. Alloy tubular handle, chromium plated. Shock absorbing contoured composition rubber grip. Designed for driving and drawing nails and carries the STANLEY guarantee. Weight 16 ozs.

CTW. 422.....Cash price 34/6 carriage 3/-.

**18 BACK SAW** by HOBBIES. A small saw with 6 in. blade for cutting beadings or for model making. The finely spaced teeth leave practically no burr.

CTW. 552.....Cash price 4/6 postage 10d.

**19 HANDSAW**. A 26 in. saw with steel blade and break-resistant 'Propathene' plastic handle. A saw with a comfortable grip for effortless work.

CTW. 531.....Cash price 16/6 carriage 3/-.

**20 TENON SAW**. A well made 12 in. saw with wide steel blade for deep cutting. With comfortable break-resistant 'Propathene' plastic handle.

CTW. 541.....Cash price 13/6 postage 2/3.

# carpentry tools

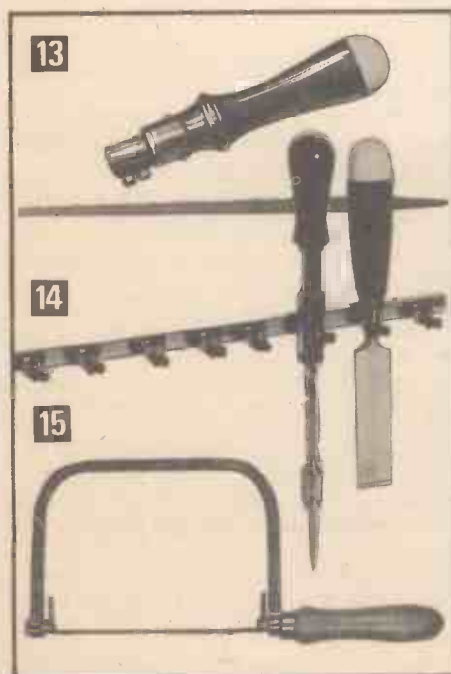

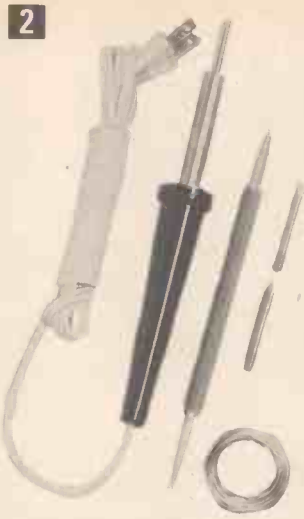

# power tools

For the home handyman.

*Ideal gifts for the Model-maker, Radio, T.V. and Do-it-Yourself enthusiast. Invaluable for home or workshop use.*

**1 SOLDERING GUN KIT (1225K)** by BURGESS. Comprises complete Gun, 6 in. Extension Barrel for deep work, Chisel Tip, Solder and a Double-ended Probe for holding delicate work. Operates off mains voltage 230/250.

**HTW. 102.**.....Cash price **79/6** carriage 4/6 or deposit 11/6 plus carriage and 8 monthly payments 10/6.

**2 SOLDERING IRON KIT (SP25 PK).** Comprises the SP25 Iron, two spare Tips, double-ended Soldering Aid and Solder. 23 watts, 230 volts.

**HTW. 115.**.....Cash price **38/-** postage 1/-.

**3 SOLDERING IRON (SP25).** Latest addition to the Weller range. 8 ins. overall, lightweight, highly efficient, of stainless steel construction with cool plastic handle. 23 watts, 230/250 volts.

**HTW. 114.**.....Cash price **29/-** postage 1/-.

**4 AUTOMATIC BLOWLAMP (Valtock '2000').** Burns methylated spirit, completely automatic and absolutely safe. Ideal for the small job of plumbing, paint stripping, glass bending, etc.

**HTW. 151.**.....Cash price **17/6** postage 1/-.

**5 AUTOMATIC BLOWLAMP (Valtock Major).** This lamp is a craftsman's tool and can last a lifetime. Supplied with a flame shield which is screwed on to the jet when a broad flame is required.

**HTW. 152.**.....Cash price **30/-** postage 1/6.

**6 SOLDERING GUN (1225)** by BURGESS. Instant heat in 5 seconds. Pre-focused light illuminates delicate wiring when soldering. Only the tip is heated—no wasted power—thus running costs are low. Well balanced to give easy control. Operates off mains voltage 230/250.

**HTW. 101.**.....Cash price **57/6** carriage 4/6 or deposit 9/- plus carriage and 8 monthly payments 7/6.

**7 SOLDERING GUN (8200d)** by WELLER. Heat and spotlight come on instantly when trigger is pulled. Dual heat gives high and low soldering temperatures. Robustly constructed. Operates off mains voltage 230/250.

**HTW. 111.**.....Cash price **57/6** carriage 4/6 or deposit 9/- plus carriage and 8 monthly payments 7/6.

**8 SOLDERING GUN KIT—HEAVY DUTY (8250D PK)** by WELLER. A robust gun for the professional. Twin spotlights, complete with Soldering Tip, Cutting Tip, Smoothing Tip, tip-changing Wrench and Solder. In a plastic case.



8 MONTHLY PAYMENTS OF **9/6**





10



11

# and accessories

275 watts. Operates off mains voltage 230/250.

**HTW. 113.**.....Cash price **105/-** carriage free or deposit 14/- and 8 monthly payments 14/-.

**9 SOLDERING GUN KIT (8200D PK)** by WELLER. Comprises 8200D Gun, two spare soldering Tips, tip-changing Wrench, Flux Brush, Solder and a double-ended soldering Aid. Operates off mains voltage 230/250.

**HTW. 112.**.....Cash price **72/6** carriage 4/6 or deposit 11/- plus carriage and 8 monthly payments 9/6.

**10 NEW POWER JIG-SAW (572)** by DREMEL. A large capacity De-luxe model with 15 in. throat which can operate safely on a 5 amp. lighting circuit. Fitted with heavy duty blades, capable of handling all kinds of wood up to 1½ ins. thick, copper up to 18 gauge, aluminium up to ½ in. and mild steel up to ⅜ in. Does NOT take fretsaw blades.

Complete with spring loaded blade guard, adjustable tilting table, positive locking and constant tension on saw blade, 8 in. square cutting table, power take off, disc sanding attachment, 240 volt A.C. motor, 3 sanding discs, 4 saw blades, flexible shaft attachment, 12 piece accessory set (drills, small buffing and grinding wheels, polishing brushes etc.), large grinding wheel, wire brush wheel and polishing compound. *Blades available, write for details.*

**PT. 101.**.....Cash price **£29 17 6** carriage free or deposit 81/- and 8 monthly payments 79/6.

**11 PORTABLE SAW ATTACHMENT (D984)** by BLACK and DECKER. Zips through wood up to 1½ ins. thick. Accurate sawing is easy with adjustable depth and angle of cut. A guide ensures exact rip cutting. Complete with combination rip and cross-cut blade.

**PTW. 121.**.....Cash price **59/6** carriage 4/6 or deposit 7/6 plus carriage and 8 monthly payments 8/-.

**12 POWER DRIVER ⅝ in. DRILL** by BLACK and DECKER. The advanced Power Driver ⅝ in. Drill is made on the new, registered 'Clamshell' principle. 'Clamshell' construction gives improved alignment and maximum motor efficiency.

In addition, perfect balance, light weight, a full grip side handle and precision engineer's chuck make this a tough machine you will be proud to own.

**PTW. 111** .....Cash price **110/-** carriage free or deposit 16/- and 8 monthly payments 14/6.

**13 ELECTRIC BANDSAW (BBS10)** by BURGESS. Length 21½ ins., width 12 ins., height 21 ins. A newly-styled precision tool capable of cutting anything from steel to foam rubber. Deals effectively with hard and soft woods, chipboard, hardboard, plastic, perspex, hard and foam rubber, leather, moulded fibre glass, asbestos, thermoplastic

tiling, soft alloys (up to 2½ ins. thick), brass, copper, mild steel (up to 1 in. thick) and fabrics and materials such as felt.

Complete with 10 in. square tilting table, adjustable fence, self-ventilating high torque self-lubricating electric motor (225-250v.) and shock absorbing rubber feet.

A portable power saw robust enough to be in constant use in industry, yet sufficiently inexpensive for the Do-it-yourself enthusiast.

**PTW. 102.**.....Cash price **£26 10 0** carriage free or deposit 76/- and 8 monthly payments 70/-.

★ **BANDSAW BLADES.** For use with the PTW. 102 Burgess bandsaw.

★ **GENERAL PURPOSE (B.90)** 14 t.p.i. For cutting metals from ⅜ in. to 2½ ins. thick. This blade can also be used for cutting wood, plastics, hardboards etc.

★ **WOOD CUTTING (B.91)** 8 t.p.i. For cutting all woods.

★ **MEDIUM-TOOTH METAL CUTTING (B.92)** 24 t.p.i. For cutting metals and alloys from 18 s.w.g. to 16 s.w.g.

★ **FINE-TOOTH METAL CUTTING (B.93)** 32 t.p.i. For cutting metals and alloys from 32 s.w.g. to 17 s.w.g.

**PTAW. 501.**.....Cash price **8/6** each, postage 6d.

★ *All blades are available but not illustrated.*



12

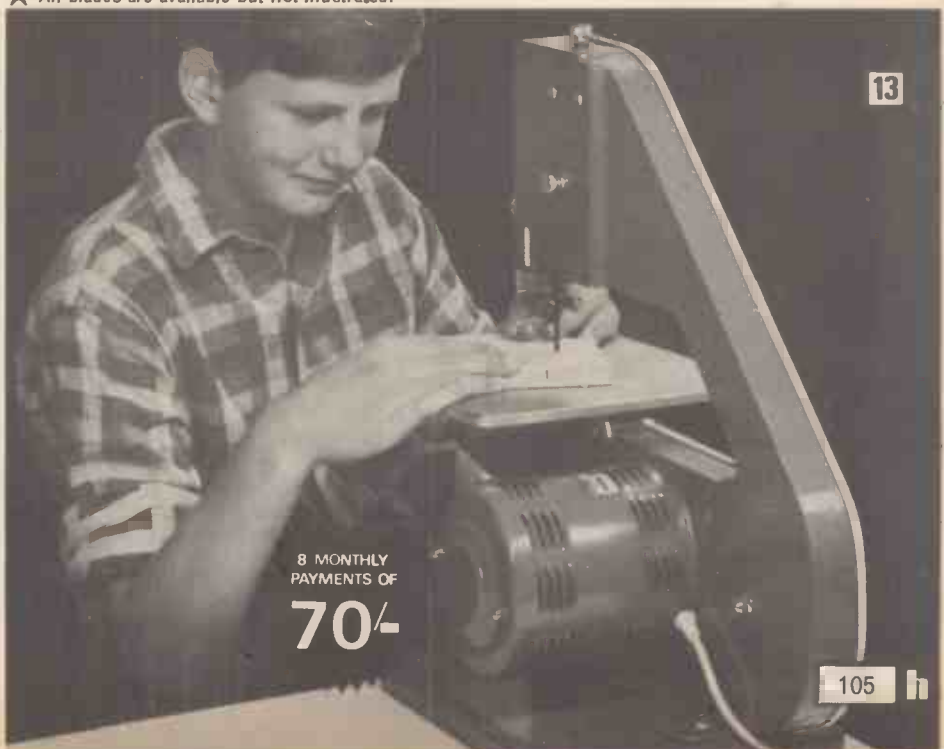

13

8 MONTHLY  
PAYMENTS OF

**70/-**

105

h

# paints & accessories for modellers

Unsurpassed for quality and simplicity in use they are the ideal paints for the modeller and handyman. Can be used with confidence on all surfaces, Resistant to petrol, oil and water. Unequalled for model boats. All shades are lead-free and non-toxic.

**1 ONE HOUR ENAMEL** by HUMBROL, in 36 gloss colours and 12 matt colours.

- |                     |                    |
|---------------------|--------------------|
| <b>Gloss</b>        | <b>Gloss</b>       |
| (1) Eau-de-Nil      | (13) Sky Blue      |
| (2) Emerald         | (14) French Blue   |
| (3) Brunswick Green | (15) Midnight Blue |
| (4) Light Grey      | (16) Gold          |
| (5) Dark Grey       | (17) Flesh         |
| (6) Pale Cream      | (18) Orange        |
| (7) Light Buff      | (19) Bright Red    |
| (8) Yellow          | (20) Crimson       |
| (9) Tan             | (21) Black         |
| (10) Service Brown  | (22) White         |
| (11) Silver         | (35) Gloss Varnish |
| (12) Copper         | (36) Fern Green    |

- |                         |                     |
|-------------------------|---------------------|
| <b>Gloss</b>            | <b>Matt</b>         |
| (37) Spring Green       | (23) Duck Egg Blue  |
| (38) Lime               | (24) Trainer Yellow |
| (39) Pearl              | (25) Blue           |
| (40) Granite            | (26) Khaki          |
| (41) Ivory              | (27) Sea Grey       |
| (42) Primrose           | (28) Sky            |
| (43) Mushroom           | (29) Dark Earth     |
| (44) Pink               | (30) Dark Green     |
| (45) Spring Lilac       | (31) Slate Grey     |
| (46) Clover             | (32) Red            |
| (47) Sea Blue           | (33) Black          |
| (48) Mediterranean Blue | (34) White          |

HPW. 101— $\frac{1}{2}$  oz. tinlets..... Cash price 10d each.

(HPW. 102—(12) Copper & (16) Gold..... Cash price 1/3 each) (Postage 4d. each or 1/- for 6 tins).

**2** HPW. 103—2 oz. tinlets... Cash price 2/- each.

(HPW. 104—(12) Copper & (16) Gold..... Cash price 3/3 each) (Postage 8d. each or 2/6 for 6 tins).

**3 AEROSOL SPRAY PAINTS** by HUMBROL. A speedy efficient method of painting. In a range of 18 colours. No brush—no fuss.

- |                     |                    |
|---------------------|--------------------|
| (2) Emerald         | (15) Midnight Blue |
| (3) Brunswick Green | (16) Gold          |
| (10) Brown          | (19) Bright Red    |
| (11) Silver         | (21) Black         |
| (14) French Blue    | (22) White         |
| (36) Fern Green     | (42) Primrose      |
| (37) Spring Green   | (43) Mushroom      |
| (40) Granite        | (44) Pink          |
| (41) Ivory          | (47) Sea Blue      |

HPW. 201—4 oz. size..... Cash price 4/11 each, postage 1/- (Carriage on 6 tins 4/6).

**4 EXCELENE OIL** by HUMBROL. A crystal clear lubricating oil which cleans and protects. In 5 oz. tins with flexible plastic spout.

HPW. 322..... Cash price 1/6 postage 1/-.

**5 LINSEED OIL** by HUMBROL. Excellent for preserving and beautifying all woods in their natural state and restoring shine to varnished furniture. 4 oz.

HPW. 321..... Cash price 1/6 postage 10d.

**6 JET PAK SPRAY GUN** by HUMBROL. Fully self contained and completely portable. Self powered by the 14 oz. Gas Power Unit which is quite harmless (Replacement Power Units available at 10/6 each and Glass Containers 1/6 each).

HPW. 311..... Cash price 29/6 carriage 3/-

**7 PRESENTATION KIT** by HUMBROL. An attractive gift pack containing six  $\frac{1}{2}$  oz. tinlets assorted colours. With helpful colour mixing chart. Ideal for the model maker and do-it-yourself enthusiast.

HPW. 303..... Cash price 5/- postage 1/-.

**8 ENAMEL MINI-KIT** by HUMBROL. Contains six phials of enamel in Yellow, Blue, Red, Green, White and Black. Fitted into a moulded plastic mixing palette with blending instructions.

HPW. 301..... Cash price 2/6 postage 6d.

**9 FLUORESCENT MINI-KIT** by HUMBROL. Contains six phials—four fluorescent colours plus base white and clear sealer. Excellent for fishing tackle and floats, safety signs, displays, vehicles etc.

HPW. 302..... Cash price 3/6 postage 6d.

See new colour chart—available free on request.



# hobbies



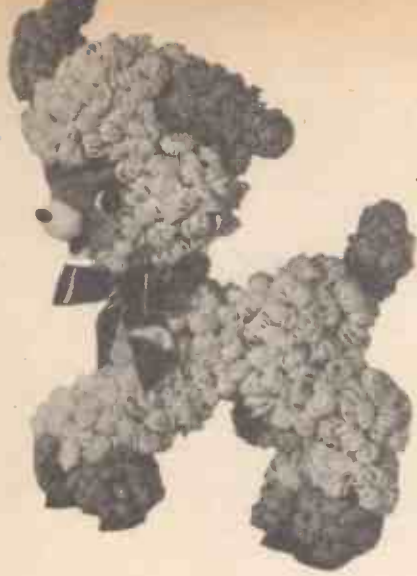

- 212 Kittens and puppies (6)
- 213 Blue bunny with duck (2)
- 221 Pink and blue lambs (2)
- 223 Fuzzy kittens (4)
- 236 Large pink teddy with drum
- 237 Toy Soldiers (6)
- 239 Donkey and chicks (2)
- 243 Sleepy pink teddy in bootie
- 244 Cuddly golden puppy
- 245 Frolicking animals (4)
- 249 Pink and blue teddies and basket
- 251 Yellow dressed teddy
- 257 Fairground toy animals (2)
- 260 Circus train (2)
- 262 Pink pixie on yellow flower
- 423 Small toy animals (9)
- 424 Playtime animals (5)
- 426 Space travel (9)
- 427 Horrifics (17)
- 428 Cowboys and Indians (4)
- 935 Zebras (4)
- 2001 Pink and blue bunnies (2)
- 2002 Blue teddy in bootie
- 2003 Pink circus elephant
- 2004 Pink and blue teddies (2)

- 145 Red roses (3)
- 147 Budgerigars (4)
- 150 Horse studies (6)
- 154 ½" gold and black letters and numerals
- 165 Pin-up girls (8)
- 169 Black poodles (4)
- 170 Outdoor girls (6)
- 173 Butterflies (8)
- 319 Mosaic fish (4)
- 330 ½" gold and black canister set
- 340 Gold fruit designs (4)
- 366B Small fruit stands (4)
- 367 Vegetable selection (4)
- 368 Happy chef (11)
- 369 Kitchen variety (4)
- 401 Busy penguins (4)
- 404 Small tropical fish (4)
- 407 Black and white swans (4)
- 409 Colourful swans (4)
- 410 Small sea horses (6)
- 412 Pink fish on blue coral
- 413 Pink and blue fish on coral (4)
- 414 Seagulls in flight (8)
- 420 Seagulls off shore
- 495 Railway engines (6)
- 500 Small veteran cars (8)
- 501 Large veteran cars (4)
- 540A Large pink rose
- 540B Small pink roses (4)
- 542 Large yellow rose
- 543 Small yellow roses (4)
- 4002 Large tropical fish

# decorative transfers

These distinctive transfers by **DECORETTES** are designed by noted artists to assist in making your home beautiful, distinctive and charming. Each design may be bought separately, but there are several matching sets which allow for complete accessory or room decoration, such as a Nursery, Bathroom or Kitchen.

Use transfers for pictures, mirrors, plaques, trays, lampshades, kitchen canisters, decorative vases and glass jars, scooters and crash helmets, coat racks, furniture, name plates, boats, table mats, tiles, etc., etc.

**STANDARD DESIGNS.** Size of sheet 8½ in. by 6½ in.

## NURSERY, TOYS, ETC.

- 196 Cuddly toys (4)
- 203 Nursery Rhymes (6)
- 205 Boy and girl teddies (2)
- 206 Boy and girl teddies (6)
- 210 Fawn and bunnies
- 211 Yellow bunny with duck

## GENERAL

- 100 Basket of flowers
- 101 Posies and floral baskets (4)
- 102 Red roses (6)
- 103 Red roses (10)
- 105 Floral bouquet
- 108 Pink roses and sprays (8)
- 114 Red rose and buds
- 115 Red roses and buds (4)
- 116 Yellow roses (6)
- 117 Floral sprays (6)
- 128 Carnation assortment (7)
- 129 Chrysanthemum assortment (5)
- 130 Rose set (35)
- 134 Gold and black galleons (6)
- 135 Large galleon
- 135IF Corn and carrots (2)
- 136 Ships of sail (6)
- 137B Large red geranium
- 137C Small red geraniums (2)
- 139 Racing yachts (4)

**GAW. 391** ..... Cash price 2/6 each postage 4d on one, 6d on four.

**EXTRA LARGE DESIGNS.** Size of sheet 13½ in. by 8½ in.

- 135A Galleon
- 138 Yellow roses (8)
- 171 Gold, black and pink canister set
- 195C Puppy sitting amongst flowers
- 195D Puppy peeping through flowers
- 195E Rabbit with flute
- 200 Large toy soldiers (3)
- 408 Little boy blue
- 411 Pink teddy and chicks
- 416 Toy orchestra (3)
- 418 Teddy bear in flower basket and lamb
- 419 Yellow teddy—away to bed
- 450 Old woman who lived in a shoe
- 503 Blue teddy and chicks
- 504 Pink bambi and blue bear
- 506 Blue giraffe and pink bunny
- 507 Twin lambs
- 508 Woolly lamb with pink ears
- 509 Bunny with flowers
- 510 Blue bunny with balloons
- 516 Blue bear with bubble pipe
- 517 Blue and white lamb
- 520 Sea horses (2)
- 529 Chinese set: red, black and gold (11)
- 530 Gold, black and white butterflies (6)
- 531 Gold decor (30)
- 545 Rose bouquet
- 546 Mixed floral designs (12)

**GAW. 392** ..... Cash price 4/11 each postage 6d each.

When ordering please quote serial number followed by transfer number e.g. **GAW. 391/196.**



# hobbies

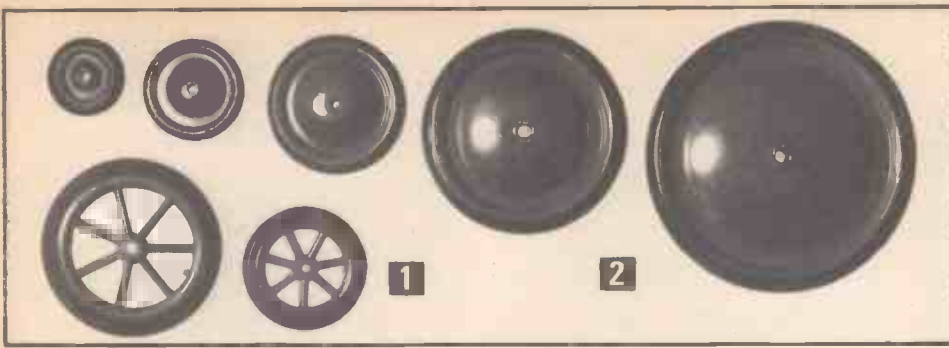

**SEAGRASS**

- GAW. 611 Natural..... Cash price **2/11** per hank
  - GAW. 612 Green..... Cash price **3/3** per hank
  - GAW. 613 Red..... Cash price **3/3** per hank
  - GAW. 614 Bi-colour Natural/Green Cash price **3/6** per hank.
  - GAW. 615 Bi-colour Natural/Red Cash price **3/6** per hank.
- For the above, carriage is 2/- on one hank. 4/6 on two. When ordering with Stool Set no extra carriage needed.

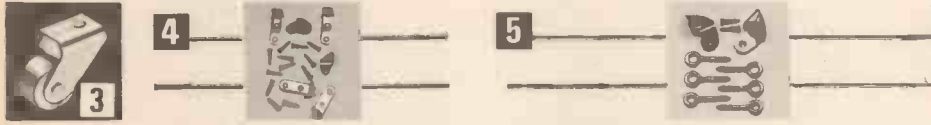

# fittings FOR THE DO-IT-YOURSELF HANDYMAN

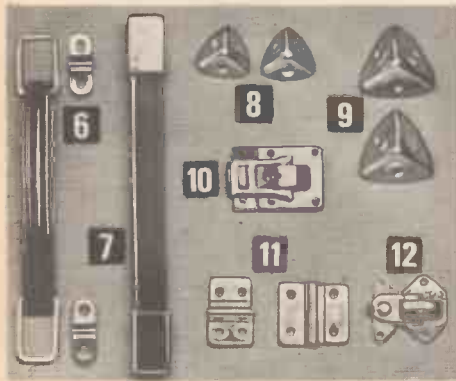

**1 PLASTIC WHEELS.** These spoked wheels are very strong and durable. Fitted with rubber tyres. In bright red finish.

- GAW. 717 4 ins.....Cash price **2/-** postage 8d.
- GAW. 718 6 ins.....Cash price **3/6** postage 1/-.

**2 RUBBER-TYRED WHEELS.** Built for strength and long life. Steel Discs fitted with rubber tyres. In bright red finish.

- GAW. 701 2 ins.....Cash price **1/-** postage 4d.
- GAW. 702 3 ins.....Cash price **1/6** postage 6d.
- GAW. 703 4 ins.....Cash price **2/9** postage 8d.
- GAW. 704 6 ins.....Cash price **5/-** postage 1/4.
- GAW. 705 8 ins.....Cash price **7/6** postage 2/-.

**3 DOLLS COT CASTORS.** In sets of four with fixing screws. 3/4 in. dia.

- GAW. 727.....Cash price **3/6** postage 8d.

**4 DOLLS COT FITTINGS.** The real thing in miniature. Comprises two 18 in. steel rods with top and bottom brackets, catches and screws. With full instructions.

- GAW. 728.....Cash price **5/6** postage 1/-.

**5 FULL SIZE COT FITTINGS.** For Baby's Cot. Set includes two rods 36 ins. long, six heavy-duty screw eyes (four plain and two threaded for rods) and two gravity catches.

- GAW. 729..... Cash price **8/6** carriage 3/-.

*Attache Case Fittings. These are strong and reliable accessories. Can be attached to fibre or leather cases by the use of bifurcated rivets or to wooden cases or boxes by the use of screws.*

**6** Handle in Metal. Finished in brown shade to give appearance of leather.

- GAW. 731.....Cash price **1/-** postage 6d.

**7** Handle in plastic. In pleasing modern style. Flexible steel core. In Black or Brown.

- GAW. 732.....Cash price **2/6** postage 6d.

**8** Corners. In nickel plate finish. 3/4 in. sides. Set of four.

- GAW. 735..... Cash price **1/-** postage 4d.

**9** Corners. In nickel plate finish. 1 in. sides. Set of four.

- GAW. 736.....Cash price **1/3** postage 6d.

**10** Lock. In nickel plate finish. Size 2 ins. by 1 1/2 ins. with key.

- GAW. 733.....Cash price **1/6** postage 6d.

**11** Hinges. In nickel plate finish. Per pair.

- GAW. 737 1 in.....Cash price **6d** postage 4d.

- GAW. 738 1 1/2 ins.....Cash price **9d** postage 4d.

**12** Clasp. In nickel plate finish.

- GAW. 734.....Cash price **6d** postage 4d.

**13 PICTURE FRAME MOULDINGS IN CONTEMPORARY STYLES** by HOBBIES.

All in 3 ft. lengths, and in good quality ramin.

- GAW. 621 (style a) 3/4 in. wide.

Cash price **1/6**

- GAW. 622 (style a) 1/2 in. wide.

Cash price **1/9**

- a. GAW. 623 (style a) 3/4 in. wide.

Cash price **1/11**

- b. GAW. 624 (Embossed b) 1/2 in. wide.

Cash price **1/9**

- c. GAW. 625 (style c) 3/4 in. wide.

Cash price **1/9**

- d. GAW. 626 (style d) 1/4 in. wide.

Cash price **1/11**

- e. GAW. 627 (style e) 3/4 in. wide.

Cash price **3/11**

- f. GAW. 628 (style f) 1/2 in. wide.

Cash price **1/9**

Carriage 3/- extra up to 12 lengths, and 4/6 extra up to 24 lengths.

# hobbies

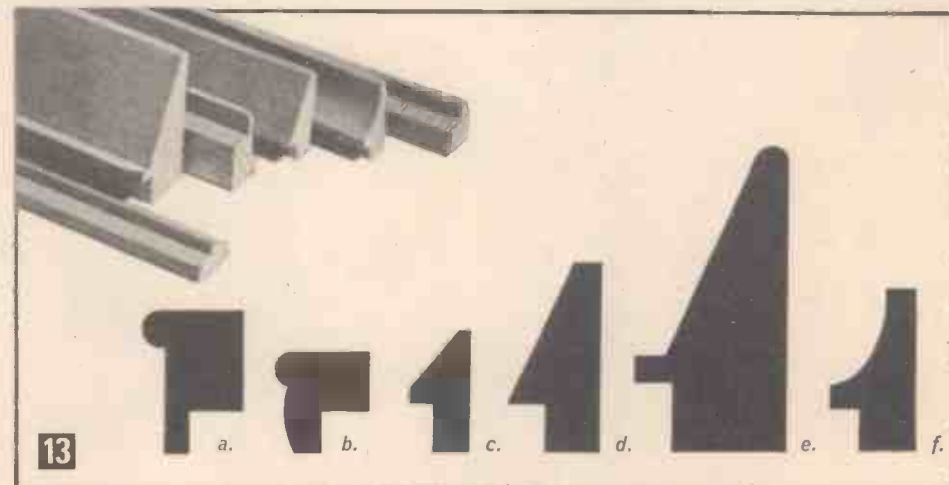





Beautifully made in selected hardwood these sets are ready to assemble. Illustrated instruction leaflet is included. Needs the addition of Seagrass to complete, about two hanks for each stool.

**14 SET 'A'**. Square shape, size 12 ins. by 12 ins. and 12 ins. high.

**GAW. 601**..... Cash price **14/3** carriage 4/6



**14**

**HIGH GRADE STOOL SETS**

**15 SET 'B'**. Oblong shape, size 12 ins. by 15 ins. and 12 ins. high.

**GAW. 602**..... Cash price **16/3** carriage 4/6



**15**

**16 SET 'C'**. In Contemporary style, size 12 ins. by 15 ins. and 12 ins. high.

**GAW. 603**..... Cash price **18/3** carriage 4/6



**16**

**GLUES, CEMENTS FOR MODELLERS AND HANDYMEN**

'**CROID**' clear liquid glue—strong and tacky—ideal for wood, leather and model making.

**GAW. 491**.. Cash price **1/11** per tube, postage 6d.

Croid Aero glue for joinery and cabinet work.

**GAW. 492** 4 oz. tin.. Cash price **1/6** postage 10d.

**GAW. 493** 8 oz. tin... Cash price **2/4** postage 1/2

**GAW. 494** 16 oz. tin.. Cash price **4/-** postage 2/-

Croid Universal Glue—a modern glue—ready for use.

**GAW. 495** 8 oz. tin.. Cash price **2/10** postage 1/2

Cascamite powdered resin glue. For all wood gluing. Very strong and waterproof.

**GAW. 501** 3½ oz. tin.. Cash price **2/9** postage 8d.

**GAW. 502** 7 oz. tin... Cash price **4/6** postage 1/2

**GAW. 503** 18 oz. tin.. Cash price **9/6** carriage 3/-

'**EVO-STIK**' Impact adhesive—a strong and durable water and oilproof bond between plastic and plastic, leather and wood, rubber and metal, etc.

**GAW. 481** small tube..... Cash price **1/11** postage 6d.

**GAW. 482** large tube..... Cash price **3/9** postage 10d.

**GAW. 483** ½ pint tin..... Cash price **4/3** postage 1/6

**GAW. 484** ¼ pint tin..... Cash price **7/-** carriage 3/-

'**ARALDITE**' an adhesive of immense strength for joining metal, glass, wood, etc. A two tube pack of adhesive and hardener.

**GAW. 511** per pack... Cash price **6/-** postage 6d.

'**AEROLITE 306**' essentially a wood-to-wood adhesive. Ideal for boat building. Gap-filling, economical and easy to use.

**GAW. 512** per pack.... Cash price **6/-** postage 2/3

**BOSTIK No. 1** clear adhesive. For indoor uses, Plastic, felt, glass, wood.

**GAW. 521** Cash price **1/11** per tube, postage 6d.



**17 BRITFIX Balsa CEMENT (66)**

**GAW. 538** ½ oz. tube Cash price **8d.** postage 4d.

**GAW. 539** 1 oz. tube Cash price **1/2** postage 4d.

**GAW. 540** 2 oz. tube Cash price **1/10** postage 6d.

**BRITFIX POLYSTYRENE CEMENT (77)**  
For Plastic models.

**GAW. 541** ½ oz. tube Cash price **8d.** postage 4d.

**GAW. 542** 1 oz. tube Cash price **1/2** postage 6d.



**18 ISOPON**. Glassfibre Packs. Save costly repair bills! Repairs almost anything, including car bodies, mudguards, burst pipes, tanks, sinks and kettles. Spreads easily and hardens like steel. Complete instructions with all Kits.

★ **MINI-KIT**. Contains Isopon paste and hardener, glass fibre, mixing rod and voucher for free booklet.

**GAW. 741**..... Cash price **5/6** postage 10d.

★ **JUNIOR KIT**. Contains ½ lb. Isopon and hardener, glass fibre, sheet Zinc, leaflet and voucher for free booklet.

**GAW. 742**..... Cash price **7/6** postage 1/6

**19 HOUSE & CAR REPAIR KIT**. Contains resin, inert filler, glass fibre, bristle brush, etc. Ideal for small laminating jobs and making paste to suit your own special requirements.

**GAW. 743**..... Cash price **15/-** carriage 3/-

**19 UNIVERSAL REPAIR KIT**. Finest on the British market. Contains nine different items, including Isopon paste, resin, inert filler, equivalent to 2 lb. Isopon super. Plus glass fibre too.

**GAW. 744**..... Cash price **18/6** carriage 3/-

★ *Not illustrated.*



# hobbies selected balsa,

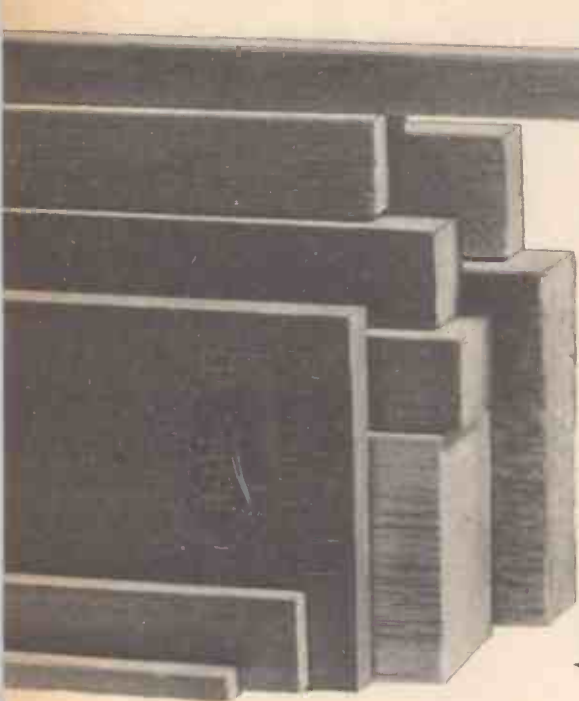

Balsa and selected woods for all purpose D.I.Y.

**1 Balsa Bundle.** A handy assortment for the beginner. Balsa strip and sheet up to about 8 ins. long, useful on many jobs.

**GAW. 241**.....Cash price **1/6** postage 6d. (postage 10d. on 3 bundles).

**2 Balsa Wood.** Specially selected and graded for model aircraft use . . . and for all modelling jobs. The best balsa you can buy. In 36 in. lengths.

## STRIP

<b>GAW. 101</b>	$\frac{1}{8}$ in square	2½d.	<b>GAW. 111</b>	$\frac{1}{2} \times \frac{1}{2}$ in.	4½d.
<b>GAW. 102</b>	$\frac{1}{8} \times \frac{1}{2}$ in.	2½d.	<b>GAW. 112</b>	$\frac{1}{2} \times \frac{1}{2}$ in.	5½d.
<b>GAW. 103</b>	$\frac{1}{8} \times \frac{3}{8}$ in.	3d.	<b>GAW. 113</b>	$\frac{3}{8}$ in. square	4½d.
<b>GAW. 104</b>	$\frac{1}{8} \times \frac{1}{2}$ in.	3½d.	<b>GAW. 114</b>	$\frac{3}{8} \times \frac{3}{8}$ in.	5d.
<b>GAW. 105</b>	$\frac{1}{8} \times \frac{3}{8}$ in.	4d.	<b>GAW. 115</b>	$\frac{1}{2}$ in. square	5½d.
<b>GAW. 106</b>	$\frac{1}{8} \times \frac{1}{2}$ in.	4½d.	<b>GAW. 116</b>	$\frac{1}{2} \times \frac{1}{2}$ in.	7d.
<b>GAW. 107</b>	$\frac{3}{8}$ in. square	3d.	<b>GAW. 117</b>	$\frac{3}{8}$ in. square	8d.
<b>GAW. 108</b>	$\frac{3}{8} \times \frac{1}{2}$ in.	3½d.	<b>GAW. 118</b>	$\frac{1}{2}$ in. square	1/-
<b>GAW. 109</b>	$\frac{3}{8} \times \frac{1}{2}$ in.	4½d.	<b>GAW. 119</b>	$\frac{1}{2} \times 1$ in.	1/8
<b>GAW. 110</b>	$\frac{1}{2}$ in. square	3½d.	<b>GAW. 120</b>	$\frac{1}{2}$ in. square	2/-

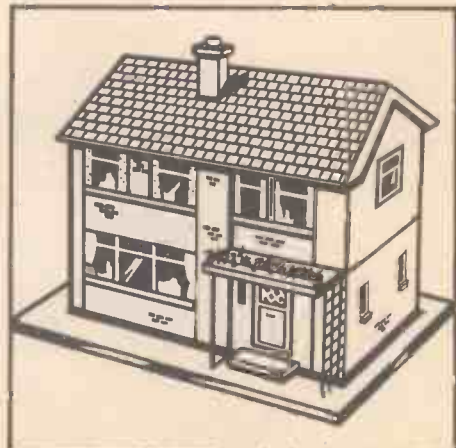
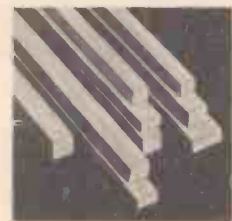
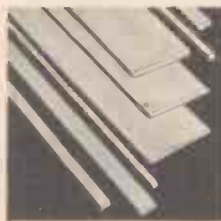



# hardwoods and dowels

SHEET		
GAW. 141	$\frac{1}{8} \times 2$ ins.	11d.
GAW. 142	$\frac{1}{8} \times 3$ ins.	1/6
GAW. 143	$\frac{1}{8} \times 4$ ins.	1/10
GAW. 144	$\frac{1}{8} \times 2$ ins.	11d.
GAW. 145	$\frac{1}{8} \times 3$ ins.	1/7
GAW. 146	$\frac{1}{8} \times 4$ ins.	2/-
GAW. 147	$\frac{1}{8} \times 2$ ins.	1/1
GAW. 148	$\frac{1}{8} \times 3$ ins.	1/10
GAW. 149	$\frac{1}{8} \times 4$ ins.	2/5
GAW. 150	$\frac{1}{8} \times 2$ ins.	1/2
GAW. 151	$\frac{1}{8} \times 3$ ins.	1/11
GAW. 152	$\frac{1}{8} \times 4$ ins.	2/9
GAW. 153	$\frac{1}{8} \times 2$ ins.	1/5
GAW. 154	$\frac{1}{8} \times 3$ ins.	2/2
GAW. 155	$\frac{1}{8} \times 4$ ins.	3/1
GAW. 156	$\frac{1}{8} \times 2$ ins.	1/6
GAW. 157	$\frac{1}{8} \times 3$ ins.	2/6
GAW. 158	$\frac{1}{8} \times 4$ ins.	3/6
GAW. 159	$\frac{1}{8} \times 2$ ins.	1/10
GAW. 160	$\frac{1}{8} \times 3$ ins.	2/11
GAW. 161	$\frac{1}{8} \times 4$ ins.	4/1
GAW. 162	$\frac{1}{8} \times 2$ ins.	2/3
GAW. 163	$\frac{1}{8} \times 3$ ins.	3/7
GAW. 164	$\frac{1}{8} \times 4$ ins.	4/9

BLOCK		
GAW. 181	1 in. square	2/9
GAW. 182	1 x 1½ ins.	4/3
GAW. 183	1 x 2 ins.	5/3
GAW. 184	1 x 2½ ins.	6/3
GAW. 185	1 x 3 ins.	7/9
GAW. 186	1½ ins. square	5/6
GAW. 187	1½ x 2 ins.	7/-
GAW. 188	1½ x 2½ ins.	7/9
GAW. 189	1½ x 3 ins.	9/9
GAW. 190	2 ins. square	8/3
GAW. 191	2 x 2½ ins.	10/-
GAW. 192	2 x 3 ins.	12/3

FILLET		
GAW. 201	$\frac{1}{8} \times \frac{1}{8}$ in.	8d.
GAW. 202	$\frac{1}{8} \times \frac{1}{4}$ in.	8d.
GAW. 203	$\frac{1}{8} \times \frac{1}{2}$ in.	9d.
GAW. 204	$\frac{1}{8} \times \frac{3}{4}$ in.	10d.

GAW. 205	$\frac{1}{4} \times \frac{1}{2}$ in.	1/-
GAW. 206	$\frac{1}{4} \times 1$ in.	1/4

MOULDING		
GAW. 221	$\frac{1}{2}$ in.	8d.
GAW. 222	$\frac{3}{4}$ in.	1/-
GAW. 223	$\frac{1}{2}$ in.	1/2

**3 OBECHI WOOD.** A soft textured hardwood, ideal for model making and for countless other woodwork projects.

STRIP		
GAW. 261	$\frac{1}{2}$ in. square	4d.
GAW. 262	$\frac{1}{2} \times \frac{1}{2}$ in.	6d.
GAW. 263	$\frac{1}{2} \times \frac{3}{4}$ in.	7d.
GAW. 264	$\frac{1}{2} \times \frac{1}{2}$ in.	8d.
GAW. 265	$\frac{3}{4}$ in. square	7d.
GAW. 266	$\frac{1}{2}$ in. square	8d.
GAW. 267	$\frac{1}{2} \times \frac{1}{2}$ in.	11d.
GAW. 268	$\frac{3}{4}$ in. square	1/-
GAW. 269	$\frac{1}{2}$ in. square	1/6

SHEET		
GAW. 281	$\frac{1}{8} \times 3$ ins.	1/8
GAW. 282	$\frac{1}{8} \times 4$ ins.	2/1
GAW. 283	$\frac{1}{8} \times 3$ ins.	2/-
GAW. 284	$\frac{1}{8} \times 3$ ins.	2/1
GAW. 285	$\frac{1}{8} \times 4$ ins.	3/-
GAW. 286	$\frac{1}{8} \times 3$ ins.	2/3
GAW. 287	$\frac{1}{8} \times 3$ ins.	2/6
GAW. 288	$\frac{1}{8} \times 4$ ins.	3/7
GAW. 289	$\frac{1}{8} \times 3$ ins.	3/3
GAW. 290	$\frac{1}{8} \times 4$ ins.	4/6
GAW. 291	$\frac{1}{8} \times 3$ ins.	4/-
GAW. 292	$\frac{1}{8} \times 4$ ins.	5/3

**4 SPRUCE.** Specially recommended for model boat building. A clean close grained softwood, light in weight and flexible in use.

STRIP		
GAW. 321	$\frac{1}{4} \times \frac{1}{4}$ in.	5d.
GAW. 322	$\frac{1}{4} \times \frac{1}{2}$ in.	7d.
GAW. 323	$\frac{1}{4} \times \frac{1}{2}$ in.	8½d.

GAW. 324	$\frac{3}{8} \times \frac{3}{8}$ in.	7½d.
GAW. 325	$\frac{1}{2} \times \frac{1}{2}$ in.	8½d.

SHEET		
GAW. 341	$\frac{1}{8} \times 3$ ins.	1/10
GAW. 342	$\frac{1}{8} \times 3$ ins.	2/3
GAW. 343	$\frac{1}{8} \times 3$ ins.	2/6
GAW. 344	$\frac{1}{8} \times 3$ ins.	3/-
GAW. 345	$\frac{1}{8} \times 3$ ins.	3/6

**5 HARDWOOD STRIP.** For carpentry and cabinet making. These sizes are useful for the handyman.

GAW. 301	$\frac{1}{2} \times 1$ in.	1/6
GAW. 302	$\frac{3}{4} \times \frac{3}{4}$ in.	1/9
GAW. 303	$\frac{3}{4} \times 1$ in.	2/-
GAW. 304	1 x 1 in.	2/6
GAW. 305	$\frac{3}{4} \times 1\frac{1}{2}$ ins.	2/9

**6 HARDWOOD DOWELS.** Ideal for all woodwork and modelling jobs. There is almost no limit to their usefulness. In 36 in. lengths.

GAW. 311	$\frac{1}{8}$ in.	3d.
GAW. 312	$\frac{1}{4}$ in.	4d.
GAW. 313	$\frac{3}{8}$ in.	5d.
GAW. 314	$\frac{1}{2}$ in.	6d.
GAW. 315	$\frac{5}{8}$ in.	7d.
GAW. 316	$\frac{3}{4}$ in.	9d.
GAW. 318	$\frac{1}{2}$ in.	1/-
GAW. 319	$\frac{3}{4}$ in.	1/3
GAW. 320	$\frac{1}{2}$ in.	1/6
GAW. 317	1 in.	2/-

\*POSTAGE and Packing 3/- extra on any quantity of Balsa, Obechi, Hardwood Strip, Spruce and Dowels. It is uneconomic to send small quantities through the post and customers are advised to request their entire requirements when placing their order.



4

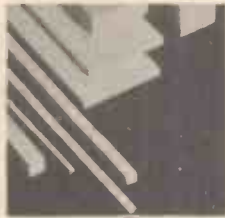

5

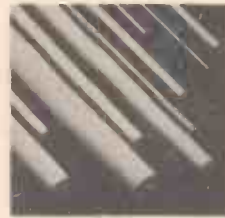

6

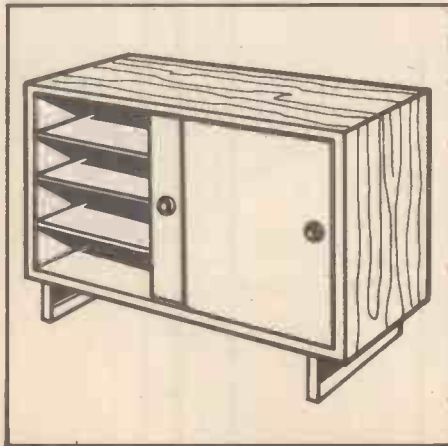
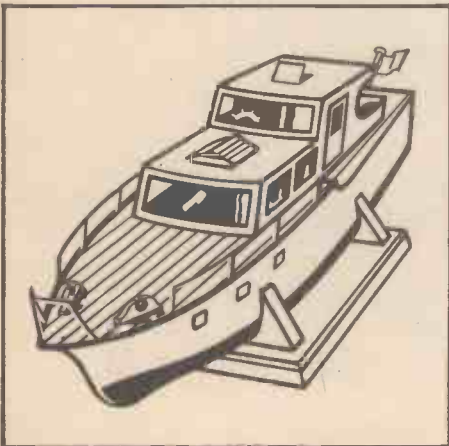

# model car racing



## 1/32nd scale HOME SETS

Enjoy the thrills, the tricky bends, the chicanes, the open throttle and the fantastic speeds along the straight. Watch out for spills too, the race can be lost even on the last lap. This is real excitement. You re-live the thrills of Grand Prix racing with miniature Electric Motor Racing. Hobbies offer you sets to suit every pocket. All sets on these pages operate off 12 volts D.C. with power unit or batteries.

**1 MODEL RACING SET, SCALEXTRIC '31'** by TRIANG. With flyover to give equal length to both lanes. An excellent two lane set as a basis upon which to build a replica of one of the famous full size racing circuits. Easily extended by adding extra track and accessories. Set contains 1 C/85 BRM Formula 1 car, 1 C/86 Porsche Formula 1 car, 6 Crash Barriers, 12 Banking Wedges, 2 Bridge Pillars, 2 Hand Throttles (A/256) and 12 ft. 6 ins. of Track to make three alternative layouts.

**SCR. 102**.....Cash price **101/6** carriage free or deposit 17/6 plus and 8 monthly payments 13/-.

**MODEL RACING SET, SCALEXTRIC '30'** by TRIANG. With SKID CHICANE for added thrills. Learn to race model cars with this super two-lane set comprising 1 C/85 BRM Formula 1 car, 1 C/86 Porsche Formula 1 car, 2 Hand Throttles (A/256), 8 Banking Wedges, 4 Crash Barriers, 1

SKID CHICANE and 6 ft. 9 ins. of Track to make two alternative layouts. This set can be gradually extended to a super figure 8, eight-lanes circuit, by adding additional track sections.

**SCR. 101**.....Cash price **81/3** carriage 4/6 or deposit 13/6 plus carriage and 8 monthly payments 8/- . Not illustrated.

**2 MODEL RACING SET, SCALEXTRIC '50'** by TRIANG. With Lap Counter, Flyover and two of the latest Formula 1 cars. The feature of this set is the Lap Counter, which counts up to 15 laps for the two cars on this 2 Lane Circuit. It is a simple matter to count any number of laps by noting when the counter passes 15. The set contains 1 C/81 Cooper Formula 1 car, 1 C/82 Lotus Formula 1 car, 1 LAP COUNTER, 2 Fly-over Bridge Supports, 6 Crash Barriers, 12 Banking Wedges, 2 Hand Throttles (A/256) and 16 ft. 8 ins. of Track to make three alternative layouts.

**SCR. 104**.....Cash price **149/3** carriage free or deposit 22/6 and 8 monthly payments 19/6.

**3 MODEL RACING SET, SCALEXTRIC '80'** by TRIANG. Super Excitement for All the Family. With 4 Lanes, 4 Cars and 4 Hand Throttles, this set solves the problem of whose turn it is to drive. It is complete family 'Grand Prix Motor Racing in one set.

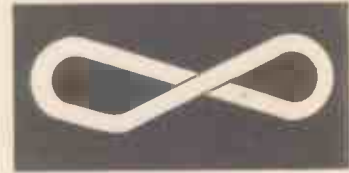

4

The contents comprise 1 each C/81 Cooper Formula 1 Cars, Red and White; 1 each C/82 Lotus Formula 1 Cars, Green and Blue; 10 Crash Barriers, 16 Banking Wedges, 36 Lane Clips, 4 Hand Throttles (A/256), 2 Power Boost Connectors and 29 ft. of two Lane Track to make two alternative 4 lane circuits or two lane circuits when only two are racing.

**SCR. 105**.....Cash price **£12 15 6** carriage free or deposit 38/- and 8 monthly payments 33/6.

**4 MODEL RACING SET '65' by SCALEXTRIC.** Super excitement with the Penalty Chicane, large Figure-Eight circuit and two famous sports cars. The set includes 1 C/74 Austin Healey 3,000, 1 C/75 Mercedes 190 SL, 2 Fly-over Bridge Supports, 1 Penalty Chicane, 6 Crash Barriers, 13 Banking Wedges, 1 Start/Finish Banner, 2 Hand Throttles (A/256) and 19 ft. of track to make alternative layouts.

**SCR. 106**.....Cash price **179/11** carriage free or deposit 24/- and 8 monthly payments 24/-.



1



2

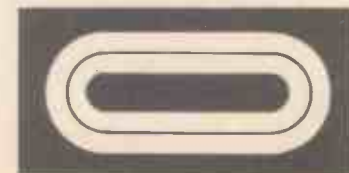

3



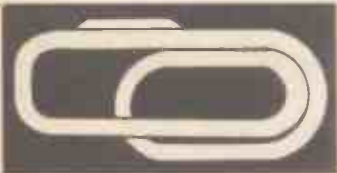

5



6

**5 MODEL RACING SET '90' by SCALEXTRIC.**  
A fabulous circuit on which can be held either Grand Prix or Sports Car Race Meetings. The set comprises: 1 C/81 Cooper, 1 C/82 Lotus, 1 C/74 Austin Healey, 1 C/75 Mercedes, 2 Hand Throttles, 1 pair of Change-overs, 1 Pit Stop Set, 1 Lap Counter, 1 Skid Chicane, 2 Bridge Supports, 14 Crash Barriers, 22 Banking Wedges, 1 Start/Finish Banner and 32 ft 6 ins. of Track to make three alternative layouts.

**SCR. 108.**.....Cash price **£15 8 0** carriage free or deposit 41/6 and 8 monthly payments 41/-.

**7 MODEL RACING SET '45' by SCALEXTRIC.**  
Brings Mini Car racing into your own home with the added thrills of a Right-Angle crossing. Contents of set-2 C/76 Mini-Coopers: 1 red and 1 green, 8 Crash Barriers, 8 Banking Wedges, 2 Hand Throttles (A/256) and 14 ft. of Track which makes an exciting and fast circuit.

**SCR. 110.**.....Cash price **141/3** carriage free or deposit 21/6 and 8 monthly payments of 18/6.

**9 'SMOOTHFLOW' POWER UNIT 'SF 240' by MINIMODELS.** A 12 volt D.C. unit with a 2.5 amp output for maximum efficiency of small electric motors. Ideal too, for the operation of low voltage electrical equipment in the home. Automatic overload cut-out switches off current in the event of an overload or short circuit. Current automatically restored when overload has been corrected. Perfectly safe—no direct connection between the mains input and the 12 volt output. For use with A.C. mains only and suitable for all Scalextric Home Sets.

**SCR. 377.**.....Cash price **42/6** carriage 4/6 or deposit 7/-, plus carriage and 8 monthly payments 5/6.

**6 MODEL RACING SET '40' by SCALEXTRIC.**  
The family can join in the fun by operating the Blow-Out unit whilst the cars are being raced. Set contains 1 C/81 Cooper Formula 1 car, 1 C/82 Lotus Formula 1 car, 2 Hand Throttles (A/256), 1 Blow-Out, 6 Crash Barriers, 12 Banking Wedges, 2 Bridge Pillars and 12 ft. 6 ins. of Track to make three alternative layouts.

**SCR. 109.**.....Cash price **138/9** carriage free or deposit 18/6 and 8 monthly payments of 18/6.

**8 JAMES BOND '007' SET by SCALEXTRIC.**  
A fantastic Car Chase Set with special operating cars and a circuit packed with untold thrills. Contents of Set include 1 special 007 Aston Martin G.T., 1 special Mercedes 190 SL Sports, 2 Hand Throttles, 4 Straw Bales, 8 Oil Drums, 6 Banking Wedges, 10 Marker Cones, and 18 ft. 8 ins. of Track which includes various chicanes and rightangle crossing.

**SCR. 111.**.....Cash price **£11 2 9** carriage free or deposit 31/- and 8 monthly payments 29/6.



9

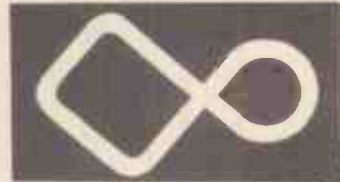

8

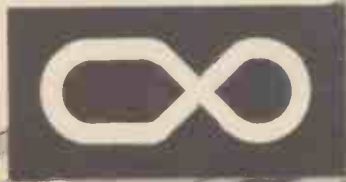
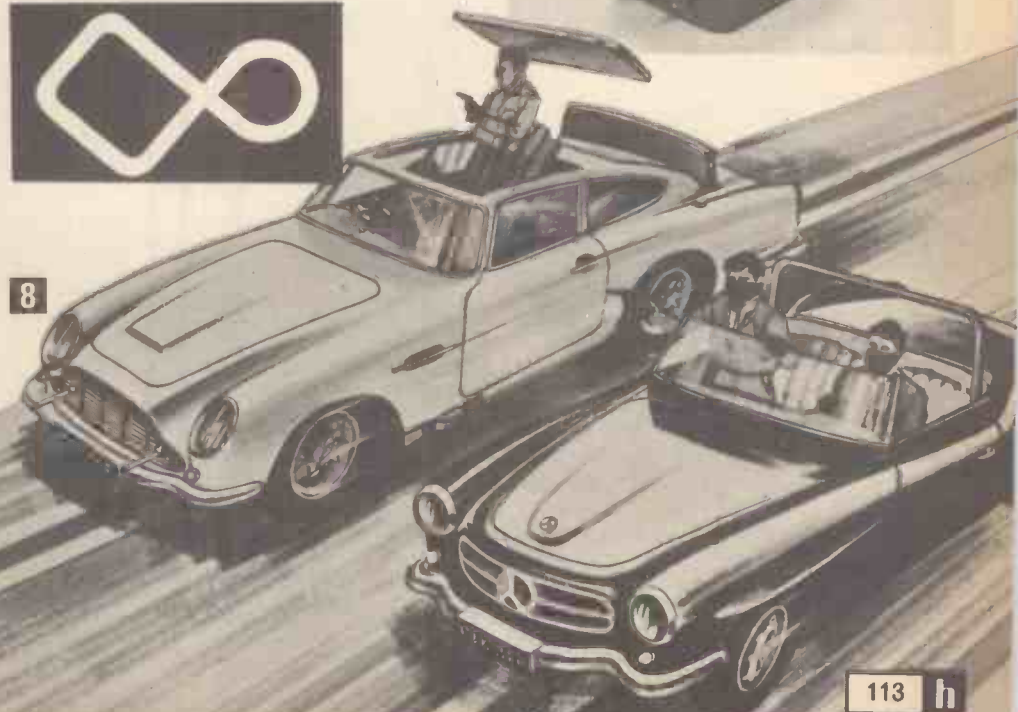

7

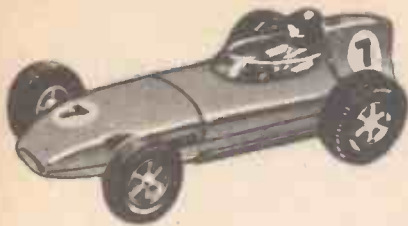
**1****2****4****3****5**

## racing models

### by SCALEXTRIC

A grand selection of 1/32nd scale model race cars, with every detail carefully represented to give an exact miniature of the real thing. Each car is ready to drive on the race circuit and includes soft rubber tyres, driver and complete maintenance instructions.

**1** LOTUS GRAND PRIX (C/54). Yellow.

SCR. 474.....Cash price **30/2** postage 10d.

**2** BENTLEY 1929 (C/64). Vintage Road Racer. Green.

SCR. 476.....Cash price **46/4** postage 10d. or deposit 7/- plus postage and 8 monthly payments 6/-.

**3** ALFA ROMEO 1933 (C/65). Vintage Road Racer. Blue.

SCR. 477.....Cash price **46/4** postage 10d. or deposit 7/- plus postage and 8 monthly payments 6/-.

**4** ASTON MARTIN G.T. (C/68). With Sunshine roof. Red or green.

SCR. 145.....Cash price **30/2** postage 10d.

**5** FERRARI G.T. (C/69). Red or blue.

SCR. 146.....Cash price **30/2** postage 10d.

**6** AUSTIN HEALEY 3000 SPORTS (C/74). Red or green.

SCR. 147.....Cash price **30/2** postage 10d.

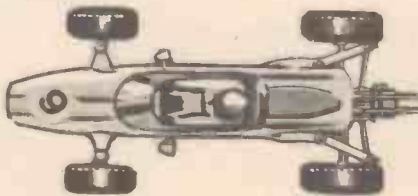
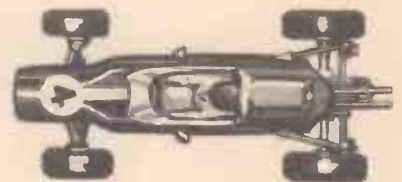
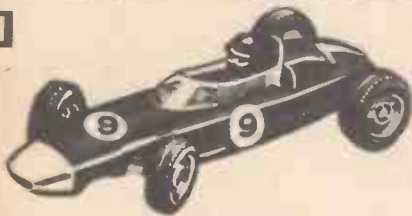
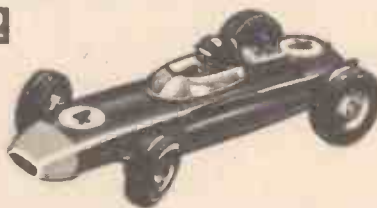
**8****9****10****11****12****13****14****15****16**

## hobbies

**7** MERCEDES 190 SL SPORTS (C/75). White or blue.

SCR. 148.....Cash price **30/2** postage 10d.

**8** AUSTIN MINI-COOPER (C/76). Red or green.

SCR. 478.....Cash price **23/2** postage 6d.

**9** COOPER FORMULA 1 (C/81). White or red.

SCR. 143.....Cash price **23/2** postage 6d.

**10** LOTUS FORMULA 1 (C/82). Blue or green.

SCR. 144.....Cash price **23/2** postage 6d.

**11** B.R.M. FORMULA 1 (C/85). Green.

SCR. 141.....Cash price **19/-** postage 6d.

**12** PORSCHE FORMULA 1 (C/86). Red.

SCR. 142.....Cash price **19/-** postage 6d.

**13** GO-KART (K/1). Red or blue.

SCR. 512.....Cash price **25/8** postage 1/-

**14** TYPHOON COMBINATION (B/1). Red or blue.

SCR. 472.....Cash price **30/2** postage 10d.

**15** HURRICANE COMBINATION (B/2). Green or yellow.

SCR. 473.....Cash price **30/2** postage 10d.

**16** CONTROLLER (A/256). This Hand Throttle is for use with all vehicles illustrated on this page.

SCR. 412.....Cash price **8/10** postage 6d.



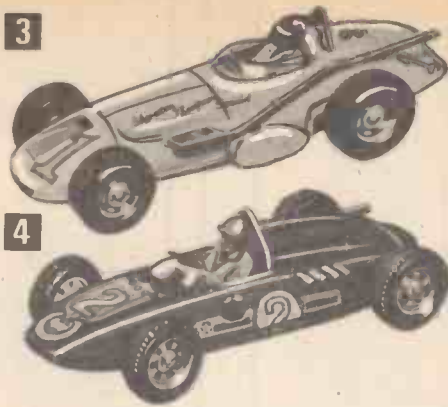

## race tuned cars

by **SCALEXTRIC**

'RACE TUNED' Cars have been especially designed for the advanced Scalextric driver who needs more speed, instantaneous acceleration and perfect braking power. In addition to being super fast, 'RACE TUNED' Cars are fitted with a new forward-mounting guide flag for greater stability, and soft tight-grip tyres to eliminate wheel spin and really hug the track.

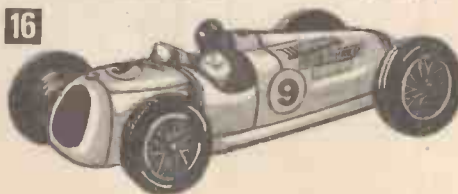
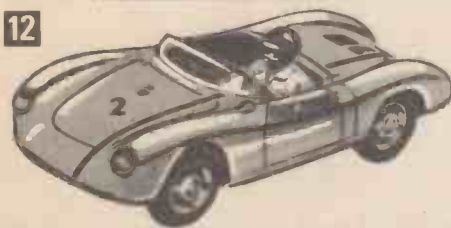
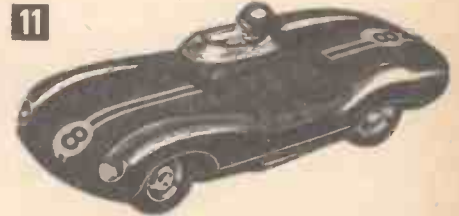

- 1 FORD GRAND TOURING (C/77).** Red or white.  
SCR. 479.....Cash price **30/2** postage 8d.
- 2 A.C. COBRA SPORTS (C/78).** Red or green.  
SCR. 480.....Cash price **30/2** postage 8d.
- 3 OFFENHAUSER FRONT ENGINE (C/79).** White or blue.  
SCR. 481.....Cash price **30/2** postage 8d.
- 4 OFFENHAUSER REAR ENGINE (C/80).** Red or yellow.  
SCR. 482.....Cash price **30/2** postage 8d.
- 5 SUNBEAM TIGER SPORTS (C/83).** Yellow.  
SCR. 483.....Cash price **33/6** postage 8d.
- 6 TRIUMPH TR.4A SPORTS (C/84).** Blue.  
SCR. 484.....Cash price **33/6** postage 8d.
- 7 VANWALL GRAND PRIX (C/87).** Green.  
SCR. 485.....Cash price **36/-** postage 10d.
- 8 COOPER GRAND PRIX (C/88).** Red.  
SCR. 486.....Cash price **36/-** postage 10d.
- 9 B.R.M. GRAND PRIX (C/89).** Green.  
SCR. 487.....Cash price **36/-** postage 10d.
- 10 FERRARI GRAND PRIX (C/90).** Red.

- SCR. 488.....Cash price **36/-** postage 10d.
- 11 'D' TYPE JAGUAR COMPETITION (C/91).** Green.  
SCR. 489.....Cash price **36/-** postage 10d.
- 12 PORSCHE COMPETITION (C/92).** White.  
SCR. 490.....Cash price **36/-** postage 10d.
- 13 AUSTIN HEALEY SPORTS (C/93).** Red.  
SCR. 491.....Cash price **36/-** postage 10d.
- 14 MERCEDES SPORTS (C/94).** White.  
SCR. 492.....Cash price **36/-** postage 10d.
- 15 BUGATTI 1934 VINTAGE GRAND PRIX (C/95).** Blue.  
SCR. 493.....Cash price **46/4** postage 1/- or deposit 7/- plus postage and 8 monthly payments 6/-.
- 16 AUTO-UNION 1936 VINTAGE GRAND PRIX (C/96).** White.  
SCR. 494.....Cash price **46/4** postage 1/- or deposit 7/- plus postage and 8 monthly payments 6/-.
- 17 RACE-TUNED HAND CONTROLLER (A/262).** This controller is only for use with the race-tuned cars illustrated on this page.  
SCR. 470.....Cash price **20/-** postage 10d.



1



2

4

3

## RACE CAR ACCESSORIES

**1 TRACK EXTENSION PACK, SCALEXTRIC (HP/1)** by TRIANG. LARGER LAYOUTS. GREATER REALISM. This set enables you to enlarge your Scalextric layout and at the same time brings your circuit to life by adding trackside figures and accessories. Suitable for use with the following sets 30, 31, 33 and 50. Pack contains, 1 Hump Back Bridge, 2 Change-over Tracks, 2 Straights 'B', 1 Start/Finish Banner, 1 Starter on Rostrum, 2 Paling Sections with Flagpoles, 1 Gate Unit, 6 Hurdles, 1 Pit Accessories Set, 1 Track Officials & Pit Crew Set, 1 Vendors and Spectators Set, 1 Sheet Official Flags, 1 Sheet Decorative Flags.

**SCR. 372**..... Cash price **61/3** carriage 2/6 or deposit 9/3 plus carriage and 8 monthly payments 8/-.

**2 LONG CHICANE SET, SCALEXTRIC (PT/76)** by TRIANG. Take care not to collide with your opponent as you come into the chicane. This 'long' hazard makes racing doubly exciting. Comprises 3 pieces of track to give a total length of 41½ ins.

**SCR. 373**..... Cash price **14/11** carriage 3/-.

**3 TRACKSIDE ACCESSORY PACK, SCALEXTRIC (HP/2)** by TRIANG. Give a real racing atmosphere to your circuit with these trackside additions. Pack contains 1 Start/Finish Banner, 6 Crash Barriers, 12 Straw Bale Obstacles, 12 Oil Drum Obstacles, 3 Track Borders (straight 'C'), 12 Lane Clips, 1 Pit Accessories Set, 1 Sheet Official Flags, 1 Sheet Decorative Flags and 1 Track Cleaner.

**SCR. 371**..... Cash price **20/6** postage 1/6.

**4 CONTROL CENTRE KIT, SCALEXTRIC (K/703)** by TRIANG. Bring realism to your racing circuit by adding this ready-to-assemble scale model Control Centre. An all plastic kit with a wealth of detail including opening windows and doors, stairways, flag staff, window boxes and clock tower with four faces. Paints not included.

**SCR. 375**..... Cash price **18/1** carriage 4/6.

**5 TRACK LIGHTING SET, SCALEXTRIC (A/239)** by TRIANG. A fully authentic set complete with 2 track lights which may be raised, lowered or rotated on lamp standard, 2 lamps with suction pads for fixing to ceiling or building, track light cable with connectors and 12 ft. of lead for connecting to a 12 volt D.C. power supply.

**SCR. 374**..... Cash price **30/6** postage 1/-.

**6 TWIN AUTO-SCREAMS, SCALEXTRIC (A/257)** by TRIANG. Engine screaming, the flag drops and they're away—roaring round the circuit. The fourth dimension—true to life engine screams mean racing plus 4D realism.

A simple attachment fits to the Hand Throttle giving independent fingertip control of each car's engine scream, whether it is stationary or moving.

**SCR. 376**..... Cash price **33/6** postage 1/2.

### 7 'SCALEXTRIC' CONSTRUCT-IT-YOURSELF CAR KITS

1/32nd scale. 'RACE TUNED' MOTOR, super-charged for speed. TWO REAR AXLE ASSEMBLIES, giving alternative high or low ratio gearing. SELF-CENTRING FORWARD-MOUNTED GUIDE FLAG, for super fast cornering. INDIVIDUALLY DESIGNED CHASSIS/UNDERPAN, giving balanced centre of gravity for perfect road holding. PLATED PARTS, for super detail finish. SPECIAL SUPER-GRIP TYRES, for rapid acceleration and instant braking power. Complete with STEP BY STEP INSTRUCTIONAL MANUAL. For use with 'Race Tuned' hand controller only.

**SCR. 551**..... A.C. 'COBRA' SPORTS (CK/1)

**SCR. 552**..... PORSCHE 904 G.T.S. (CK/2)

Cash price **28/3** each, postage 1/4.

5

6



7







8

9



10

11



**STEP UP THE PACE OF THE RACE!** Specially Imported to give you the chance of owning a team of 'thorough-bred' race cars. Tuned to give top competition performance.

Cars made from these ready-to-assemble kits are sure to be the envy of your club mates. **SPEED** with thrills. All approved for commercial tracks. All operate off 12 volts D.C.

**8 LOTUS 33 GP FORMULA 1**, 1/32nd scale Model Racing Car Kit (3208) by MONOGRAM. An authentic ready-to-assemble model scaled from the actual Grand Prix racing Lotus. Kit contains new Tiger Super X88 motor, slim-line brass chassis, brass swing pick-up, Tiger traction tyres, steel rear axle carrier, self aligning Oilite bearings, one piece red plastic body, precision gears, aluminium wheels and chromed plastic parts. Designed for realism, engineered for speed.

**SCR. 281**..... Cash price **91/-** postage 1/4 or deposit 13/- plus postage and 8 monthly payments 12/-.

**9 FERRARI GP FORMULA 1**, 1/32nd scale Model Racing Car Kit (3209) by MONOGRAM. An authentic ready-to-assemble model scaled from the actual Grand Prix racing Ferrari. Similar specification to 3208.

**SCR. 282**..... Cash price **91/-** postage 1/4 or deposit 13/- plus postage and 8 monthly payments 12/-.

**10 FERRARI 330 P/LM**, 1/32nd scale Model Racing Car Kit (3211) by MONOGRAM. Authentic model of the rear engined Ferrari so well known on the race track. Specification as for 3210. Red plastic body.

**SCR. 284**..... Cash price **91/-** postage 1/4 or deposit 13/- plus postage and 8 monthly payments 12/-.

**11 FORD GT**, 1/32nd scale Model Racing Car Kit (3210) by MONOGRAM. A high performing new racing breed. Model scaled from original Ford GT raced at Le Mans. Kit features Tiger Super X110 motor for high performance, swing pick-up chassis, one-piece high impact body, blue and white, regulation tyres with sidewall detail and easy to modify brass chassis. Engineered for 'GO'.

**SCR. 283**..... Cash price **91/-** postage 1/4 or deposit 13/- plus postage and 8 monthly payments 12/-.

## AMERICAN HIGH PERFORMANCE RACE CAR KITS

**12 CHAPARRAL**, 1/24th scale Slot Racer (14000) by COX. A detailed model of Jim Hall's Chaparral. A really unbeatable ready-to-assemble kit to build a racer unmatched for performance. Contents include die-cast magnesium chassis, accurately detailed and machined magnesium wheels, quickly removable motor, super sensitive swinging arm pick-up, new formula racing tyres, crash resistant sprung front axle, etc. White plastic body.

**SCR. 302**..... Cash price **90/-** postage 1/4 or deposit 12/- and 8 monthly payments 12/-.

**13 B.R.M. FORMULA 1**, 1/24th scale Slot Racer (9200) by COX. A high quality competition car with monocoque construction. A superbly detailed ready-to-assemble kit containing Hi Speed Competition 1 Motor, lightweight magnesium wheels, Dunlop tyres, cast magnesium chassis, exclusive spring loaded swinging arm, crash resistant sprung front axle and precision machined crown gears. British racing green.

**SCR. 301**..... Cash price **80/-** postage 1/4 or deposit 12/- and 8 monthly payments 10/6.



12



13

8 MONTHLY PAYMENTS OF **12/-**



1

8 MONTHLY PAYMENTS OF

**14/6**



2

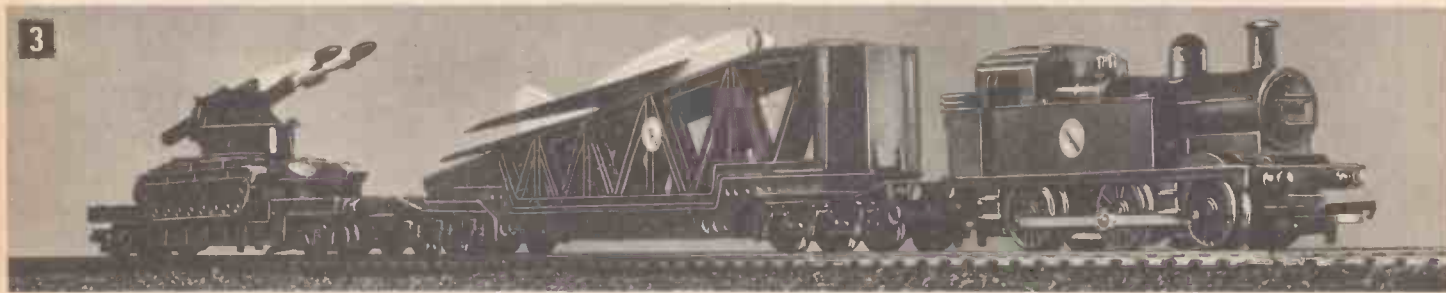

3



4



5

**1 THE 'BLUE PULLMAN' ELECTRIC PASSENGER TRAIN SET (RS.52)** by TRIANG. A Three Car set consisting of a Diesel Pullman Motor Car Type 2 with seating, Pullman Parlour Car Type 6 with seating, tables and imitation lamps, together with a Diesel Pullman Motor Car Type 2 with seating but non-powered. A large Oval of Super 4 Track approx. 46 ins. by 32 ins., with automatic Uncoupling Ramp and Power Clip completes the set. Operates off 12 volts D.C.

**MR. 105**.....Cash price **110/2** carriage free or deposit 16/- plus carriage and 8 monthly payments 14/6.

**2 'THE FREIGHT MASTER' ELECTRIC GOODS TRAIN SET (RS.51)** by TRIANG, with seven trucks. A powerful and realistic A1A-A1A Brush Type 2 Diesel Electric Locomotive in green livery, together with Horse Box, Cattle Wagon, United Dairies Milk Wagon, 'Triang' Container Wagon, Three Containers Wagon with removable containers, Goods Wagon with drop sides and E.R. Brake Van. Complete with a large Oval of Super 4 Track, approx. 44 ins. by 30 ins., including auto-

matic uncoupling device. Operates off 12 volts D.C.  
**MR. 118**.....Cash price **112/3** carriage free or deposit 15/- and 8 monthly payments 15/-.

**3 STRIKE FORCE 10 SET (RS.16)** by TRIANG. A complete Train equipped for air and ground warfare. Contains Synchromoking Locomotive, Catapult Plane Launching Car with catapulting plane which flies up to 20 ft. and CLIP-FIT launching trigger, Assault Tank Transporter with twin missile firing tank and a 36 ins. by 30 ins. Oval of Track with automatic Uncoupler. Detachment of 12 Battle Space Commandos included. Operates off 12 volts D.C.

**MR. 144**.....Cash price **102/3** carriage free or deposit 15/- and 8 monthly payments 13/6.

**4 'THE MIDLANDER' ELECTRIC PASSENGER TRAIN SET (RS.8)** by TRIANG. A fine example of a local railway. Consists of a powerful 0-6-0, Class 3F Locomotive with Crew and Tender, in maroon livery, together with a Composite Corridor Coach with seating plus a Brake 2nd Coach, and an Oval of tough Super 4 Track approx. 37 ins. by

31 ins., with Power Clip and Ramp for automatic Uncoupling. Operates off 12 volts D.C.

**MR. 103**.....Cash price **97/5** carriage 4/6 or deposit 13/- plus carriage and 8 monthly payments 13/-.

**5 'INTER-CITY EXPRESS' ELECTRIC PASSENGER TRAIN SET (RS.9)** by TRIANG. Contains a Co-Co English Electric Type 3 Diesel Electric Locomotive with Magnadhesion, in green livery, together with two Pullman 1st Class Cars and Pullman Brake 2nd Car, all complete with interior seating, tables and imitation table lamps plus a Large Oval of Super 4 Track with Uncoupler. Operates off 12 volts D.C.

**MR. 104**.....Cash price **129/2** carriage free or deposit 20/- plus carriage and 8 monthly payments 17/-.



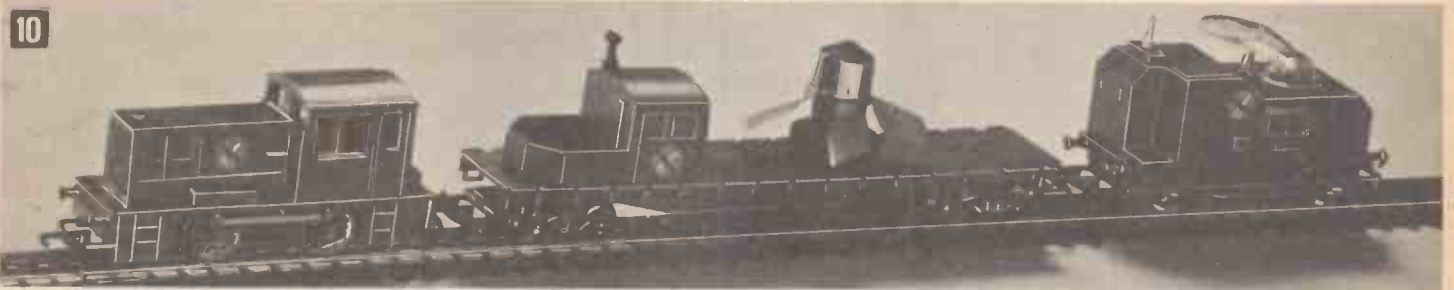
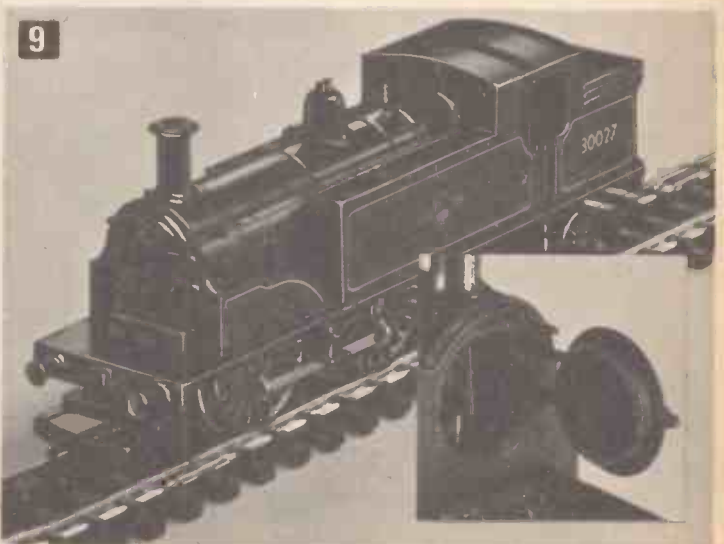
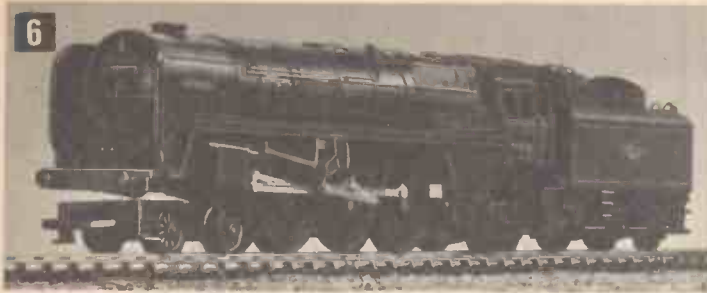

**6** **LOCOMOTIVE 'BRITANNIA' CLASS 7P6F** (R.259S) by TRIANG. This beautifully detailed model is finished in Green Livery and is complete with crew, R.35 tender and Walschaerts Valve Gear. For operation on 12 volt D.C.

MR. 201..... Cash price **87/2** postage 2/3 or deposit 12/6 plus postage and 8 monthly payments 11/6.

**7** **DIESEL ELECTRIC LOCOMOTIVE A1A-A1A BRUSH TYPE 2** (R.357) by TRIANG. A powerful electric locomotive finished in blue and white. Incorporates a wealth of authentic detail. Just like the real thing. Operates off 12 volts D.C.

MR. 212.....Cash price **50/9** postage 1/4 or deposit 8/6 plus postage and 8 monthly payments 6/6.

**8** **R.T.A. LOCOMOTIVE KIT 'PRINCESS ELIZABETH'** (R.386) by TRIANG. This 'ready to assemble' kit with over 40 separate parts gives you the added satisfaction of assembling a locomotive which is identical to a factory finished one. A screwdriver is included, but no gluing, soldering or painting is required. Finished in green livery. Complete with crew, tender and full instructions. Operates off 12 volts D.C.

MR. 203..... Cash price **53/10** postage 2/- or deposit 8/6 plus postage and 8 monthly payments 7/-.

**R. T. A. ELECTRIC LOCOMOTIVE 'ELECTRA' KIT CLASS EM2** (R.388) by TRIANG. A complete 'ready to assemble' Kit with over 50 parts enabling you to build a model indistinguishable from a factory-made one. The locomotive is finished in blue livery and is complete with working pantograph. Kit also includes screwdriver and full working instructions. Can be used with coaches R.727 and R.728. Operates off 12 volts D.C. *Not illustrated.*

MR. 211..... Cash price **59/3** postage 1/9 or deposit 7/6 plus postage and 8 monthly payments 8/-.

**9** **TANK LOCOMOTIVE M7 CLASS** (R. 754) by TRIANG. Fitted with hinged smoke-box door that opens to show boiler tube detail. Cab has realistic glowing firebox which adds an authentic touch to night operations. Space in cab to stand driver and fireman. Complete with crew.

MR. 204..... Cash price **50/9** postage 2/- or deposit 8/6 plus postage and 8 monthly payments 6/6.

**10** **SATELLITE SET** (RS. 17) by TRIANG. Complete train with Spy Satellite Launcher and Radar Tracking Command Car hauled by Diesel Locomotive. Pre-wound launch mechanism boosts spinning satellite into air on spy mission as rail car passes over trackside trigger! The revolving radar scanner on the Command Car tracks spy satellite or enemy planes! Flashing dome shows all systems at GO!

MR. 145..... Cash price **97/6** carriage 4/6 or deposit 13/- plus carriage and 8 monthly payments 13/-.

**hobbies**

# model railways

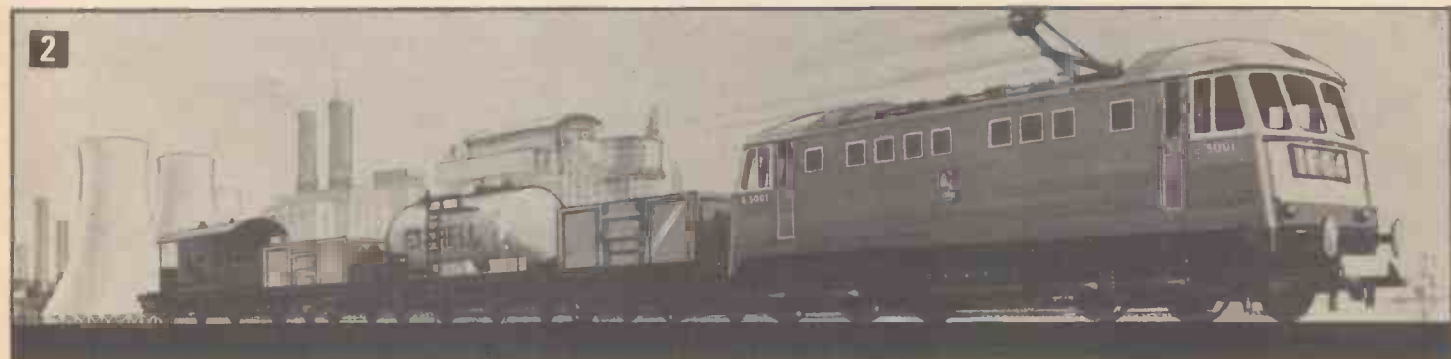

**'N' GAUGE** Micromodel electric trains. TRACK gauge 9 mm. Scale 1-160. Faithful replicas incorporating superb detail for such small size.

**VALUABLE SPACE SAVING**—The 'N' gauge layout saves up to one quarter the size of an equivalent 00 gauge layout. Features include: Current pick up from all wheels. Rubber tyred wheels for powerful traction. Gimbal point bearings for extra free running. Powerful low consumption D.C. Motor for battery operation, Robust Automatic Couplings. Weighted rolling stock for great stability.

**1 PASSENGER SET (1).** Contains B.R. BO-BO Electric Locomotive Class A.L.6, 1 Blue Brake Second Coach, 1 Blue Composite Coach, 8 curved Track including Terminal, 4 Straight Track and 1 Battery Controller. Track forms oval 21 ins. X 15 ins. Made in Italy.

**MR. 122**.....Cash price **79/11** carriage 6/- or deposit 12/- plus carriage and 8 monthly payments 10/6.

**2 GOODS SET (2).** Contains B.R. BO-BO Electric Locomotive Class A.L.6, 2 Mineral Wagons, 1 B.P. Tank Wagon, 1 Brake Van, 8 Curved Track including Terminal, 4 Straight Track and one Battery Con-

troller. Track forms oval 21 ins X 15 ins. Made in Italy.

**MR. 123**.....Cash price **79/11** carriage 6/- or deposit 12/- plus postage and 8 monthly payments 10/6.

## HAMMANT & MORGAN ELECTRICAL EQUIPMENT

*Acknowledged to be the best that money can buy.*

These units carry a twelve month guarantee and conform to the Toys (Safety) Regulations 1966. They are fitted with the approved C.E.E. 15 type transformers.

**3 THE 'CLIPPER' VARIABLE RESISTANCE UNIT.** The latest CLIPPER with New Appearance and Features. Now increased to 1½ amps output. A safe and foolproof Power-control Unit, protected by Automatic Self-Setting Overload Cut-out.

Input 200-240v. A.C. mains. Three outputs: 12v. D.C. controlled; 12v D.C. and 16v A.C. uncontrolled. Uncontrolled outputs are not suitable for common-return operation.

With High/Low Resistance Switch and Pulse-Power Switch for perfect control of all motors up to 1½ amps rating. Up-to-date in appearance, reliability and performance.

**MR. 232**.....Cash price **58/6** carriage 4/6 or deposit 10/- plus carriage and 8 monthly payments 7/6.

**4 THE 'VICTOR' POWER UNIT.** More power for your 12v. D.C. Motors! More Speed! A Super Power Unit operating from 200-240v A.C. Output 12v. D.C. at 2½ amps. Protected by thermal cut-out.

**MR. 231**.....Cash price **45/-** carriage 4/6 or deposit 6/- plus carriage and 8 monthly payments 6/-.

**5 THE 'DUETTE' VARIABLE RESISTANCE UNIT.** The famous H & M Duel Control Unit. Two completely independent 1 amp Power-control Circuits, suitable for common-return operation. Protected by Automatic Self-setting Overload Cut-outs. Foolproof and safe. Input 200-240v A.C. mains. Outputs: Two 12v D.C. Independent Controlled. 12v D.C. and 16v A.C. Uncontrolled Outputs, alternative to controlled outputs. With High/Low Resistance Switches and Pulse-Power Switches for perfect control of all motors up to 1 amp rating. Total Output 2 amps.

**MR. 233**.....Cash price **81/-** carriage 4/6 or deposit 13/- plus carriage and 8 monthly payments 10/6.



# model aircraft

**ACROBATIC MONOPLANE** by HOBBIES. An Electric powered Pylon-Racer. (4 U2 batteries in base). Ideal for indoor or outdoor training. Fully aerobatic—loops—dives—flies inverted—lands and takes off. Full control of motor speed by wire cable held in one hand—elevator control (up and down movement) with other hand. Hours of fun learning to fly—just like a real pilot! Made in Japan.

**MAW. 111**.....Cash price **82/6** carriage 6/- or deposit 11/- plus carriage and 8 monthly payments 11/-.

**ACROBATIC BI-PLANE** by HOBBIES. Same specification as above, but with Bi-Plane model instead of Monoplane. Batteries extra.

**MAW. 112**.....Cash price **82/6** carriage 6/- or deposit 11/- plus carriage and 8 monthly payments 11/-.

## hobbies

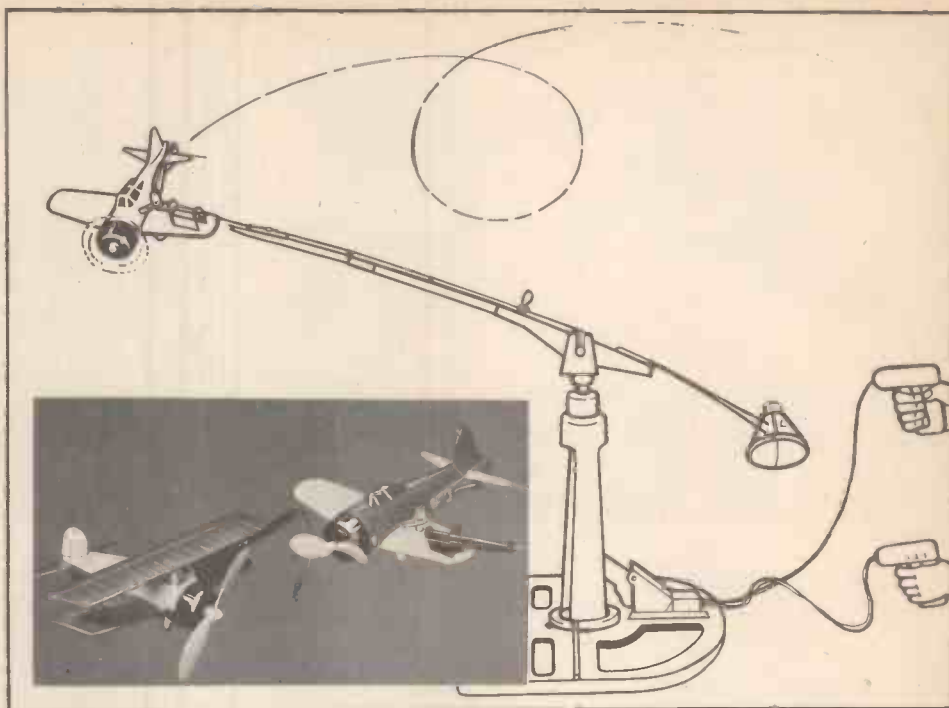

## control line



## by a.a.hales

*READY-TO-FLY models for those who are keen to fly, but lack the time to build. Each plane is complete with instructions, engine, control handle and line. Packed in attractive 'window' box. Flight tested by the manufacturers and ready to fly. Made in America.*

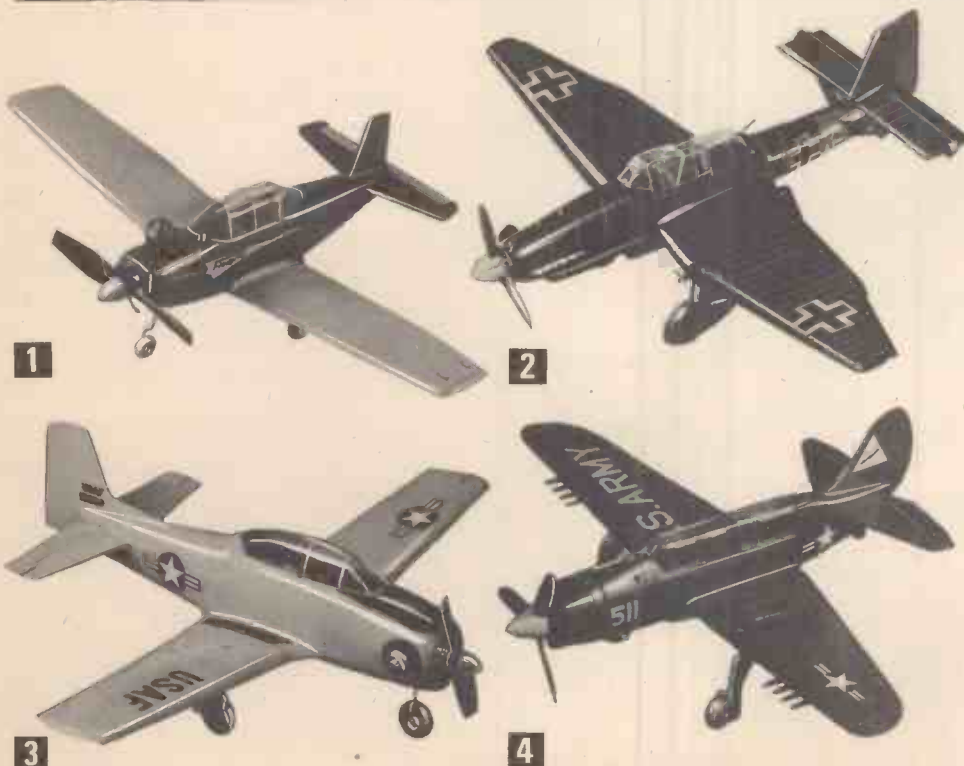

**1 'FLEDGLING'** Mk. 2 A 16 in. span control line model finished in tough blue and cream plastic. Can be flown from grass or any other reasonably flat surface. Powered by an easy starting engine which is already installed in the plane.

**MA. 461**.....Cash price **94/-** carriage 4/6 or deposit 13/- plus carriage and 8 monthly payments 12/6.

**2 JU87d 'STUKA'**. 23½ in. wing span. For Diving—Stunting—Racing—Looping and Flight Training. This accurate scale model control line plane bristles with armament, drops a bomb in flight, fascinates viewers with a close-up look at a once formidable adversary. Gauge shows fuel in tank! Machine gun swivels. A complete and exciting model.

**MA. 463**.....Cash price **152/-** carriage free or deposit 22/- and 8 monthly payments 20/-.

**3 'T-28' ADVANCED TRAINER**. 18½ in. span. Authentic design in trainer yellow. With tricycle landing gear, sponge rubber tyres, spring starter, control handle and line.

**MA. 465**.....Cash price **135/-** carriage free or deposit 18/- and 8 monthly payments 18/-.

**4 'A-25' BOMBER**. 20 in. span. A power World War II U.S. Dive Bomber. Releases a 4 in. bomb in flight by means of third line. Features include underwing rockets, spring wire landing gear, sponge rubber tyres, three blade prop., with spinner and spring starter. Control handle and all flying lines.

**MA. 466**.....Cash price **152/-** carriage free or deposit 22/- and 8 monthly payments 20/-.

# jetex models

with space age power  
for speed and thrills

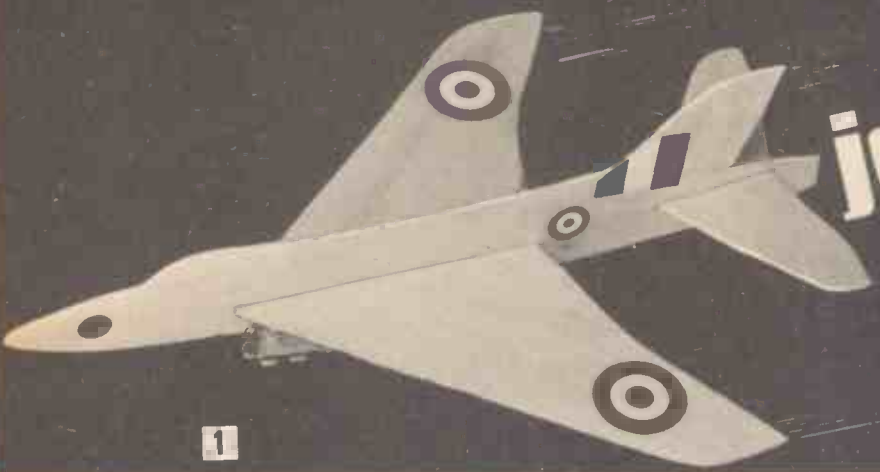

1



2

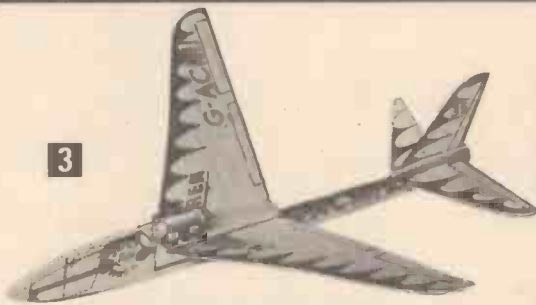

3



4



5



6



7

Driven by the famous JETEX power units which literally 'jet-propel' models at fantastic speeds. Motors are driven by solid, gas-producing fuel with a controlled rate of burning. They are absolutely safe and there is no risk of explosion when used with JETEX motors. Fuel and wicks are supplied in each kit.

**JETEX 'TAILORED' AIRCRAFT KITS.** Specially made with all the difficult jobs done for you. All parts are pre-cut and ready for cementing. These models are excellent flyers and the simplest of all to assemble. Their sturdy all-balsa construction will withstand the inevitable knocks of 'Flying for Fun'!

**1 SWIFT.** Length 14 ins., span 10½ ins., weight ½ oz. Complete with Jetex 50C motor.

MJW.502.....Cash price **10/9** postage 1/-.

**2 JAVELIN.** Length 14 ins., span 12 ins., weight ½ oz., complete with Jetex 50C motor.

MJW. 501.....Cash price **10/11** postage 1/-.

**3 WREN.** Ready to fly. An attractive 12 ins. span model complete with the powerful Jetex Atom 35 motor. Capable of climbing to 300 ft. and gliding for ¾ mile.

MJW. 503.....Cash price **13/3** postage 1/-.

Remember to order extra fuel and wicks for your motor!

**JETEX CARS AND BOATS.** Ready made models which are expertly moulded from tough durable plastic. They are complete with motor, fuel and wicks, and are ready for a speed trial.

**4 RACING CAR.** 6 ins long. The fastest car for its size in the world! With special box which can be used as a pylon base. Follow the instructions and see the car whiz round at 40 m.p.h. Complete with wire bridle, full instructions and Jetex 50C motor.

MJW. 504.....Cash price **18/3** postage 1/-.

**5 SPEED BOAT.** 7 ins. long. A FAST and UNSINKABLE boat which will rise up on its stern step like a real speed boat. Capable of speeds up to 20 m.p.h. With movable rudder and 'Atom 35' motor.

MJW. 505.....Cash price **15/9** postage 1/-.

**6 JET CAR.** 9½ ins. long. A NEW and fast record breaking car of up-to-date design. Ready to run including pylon box, wire bridle, 50C motor, wick, fuel and accessories.

MJW. 506.....Cash price **17/9** postage 1/-.

**7 JET HYDROPLANE.** 7½ ins. long. Another NEW design. See this little boat skim along the water. A real winner! Complete with Jetex 50C motor, pilot, fuel and accessories.

MJW. 507.....Cash price **12/9** postage 8d.

## how jetex motors work

Solid Fuel Charge (4) is ignited by the Plastic Igniter Wick (2), the coiled end of which is held against the face of the charge by a Gauze Disc (3). The gas is compressed in the main case (8) and forces its way out through the jet at supersonic speed, producing thrust. The end cap (5) is held by spring (9), and acts as a safety valve. If the jet were to clog, the gas escapes via the end cap.

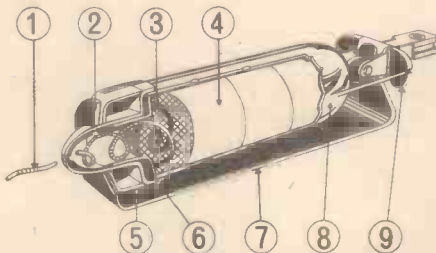

1. External igniter wick.
2. Internal igniter wick.
3. Wire gauze disc.
4. Fuel pellets.
5. End Cap.
6. Sealing washer and flame shield.
7. Mounting clip.
8. Main Case.
9. Safety clip spring



# jetex

power outfits  
and  
accessories

## JETEX POWER OUTFITS AND ACCESSORIES

Essential when making jet aircraft and other models to your own design.

**1 ATOM 35.** Outfit contains the smallest jet motor in the world. Ideal for small 'chuck' glider. Thrust  $\frac{3}{4}$  oz.— $\frac{1}{2}$  oz. Duration 7-8 secs. Complete with fuel, igniter wick and instructions.

MJW. 508..... Cash price 5/- postage 6d.

**2 JETEX 50C.** Contains motor, fuel, igniter wick and instructions. The 50C is the standard jet motor as fitted to the Jetex model aircraft kits. It is fitted with exhaust deflector ring to prevent damage to model. Thrust  $\frac{3}{4}$  oz.— $\frac{1}{2}$  oz. Duration 7 secs. per pellet. Use two pellets for 14 sec. duration.

MJW. 509..... Cash price 6/9 postage 6d.

**3 PAA-LOADER.** The new super augmented jet motor is contained in this outfit. Complete with fuel, igniter wick and all accessories. Easy to fit new style snap-in clip—will not shake out. Thrust  $1\frac{1}{2}$  oz.—2 oz. Duration 7 secs. per pellet. Use up to three pellets for maximum duration.

MJW. 510..... Cash price 17/3 postage 1/-.

**4 SCORPION.** An outfit with the largest jet motor—ideal for use with contest models. Complete with augments tube, fuel, igniter wick and all accessories. Motor develops over 5 oz. thrust with augments tube. Duration 7-9 secs.

MJW. 511..... Cash price 36/3 postage 1/2.

### JETEX FUEL

**5 Atom 35.** Per carton of 8 pellets

MJW. 519..... Cash price 1/-

**Jetex 50C.** Per carton of 20 pellets. *Not illustrated.*

MJW. 520..... Cash price 2/-

**PAA Loader** Per carton of 14 pellets. *Not illustrated.*

MJW. 521..... Cash price 2/3

**Scorpion.** Per carton of 10 pellets. *Not illustrated.*

MJW. 522..... Cash price 3/6

Postage 6d. extra on each carton.

**6 Jetex Igniter Wick** for all motors.

MJW. 523..... Cash price 1/- Per tin, postage 4d.

Send for free leaflet giving complete range of JETEX models and accessories.



# hobbies



1



2

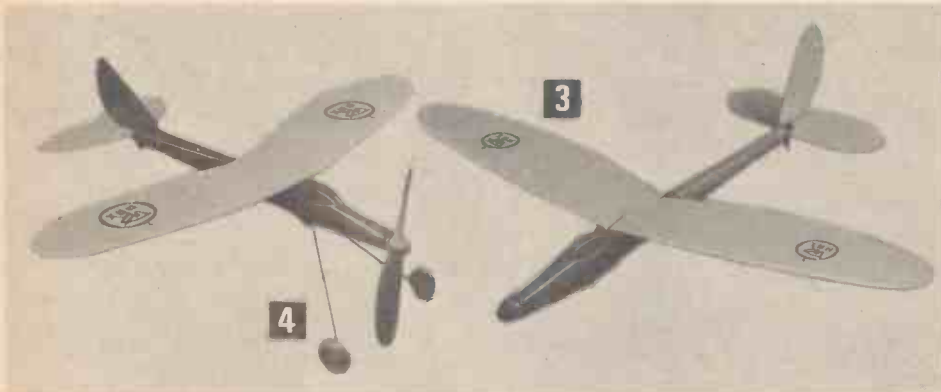

3

4



5

6

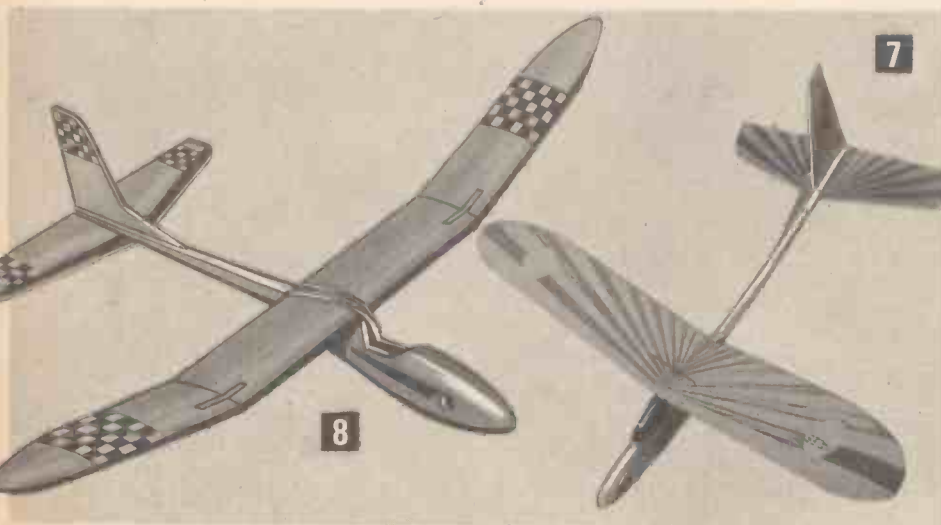

7

8

# model aircraft

by a.a.hales

## 'PAX' READY-TO-FLY MODELS

Smart all plastic models which are 'ready-to-fly' in seconds. All parts are self coloured and each model is complete. Wings and tail surfaces are tightly stretched plastic skin. Made in West Germany.

1 'PAX 22'. A 16 in. span Catapult glider. Red fuselage. Complete with Catapult.

MA. 425.....Cash price 15/9 postage 1/-.

2 'PAX 9'. A 23½ in. span towline glider. With towline, reel and launching instructions. Red and Yellow fuselage.

MA. 141.....Cash price 28/- postage 1/6.

3 'PAX 14'. A 29½ in. span Soarer. Fuselage Red and Cream. Complete with towline, reel and launching instructions.

MA. 424.....Cash price 35/6 postage 1/6.

4 'PAX 7'. 18 in. span. Rubber powered. Fuselage Red. Complete with pilot, rubber motor, propeller, undercarriage and wheels.

MA. 423.....Cash price 23/- postage 1/2.

5 'PAX 8'. 23½ in. span. Rubber powered. Fuselage Yellow and Red. Complete with pilot, rubber motor, propeller, undercarriage and wheels.

MA. 421.....Cash price 33/- postage 1/6.

6 'PAX 17'. 29½ in. span. Rubber powered. Red and Cream fuselage. Complete with pilot, rubber motor, propeller, undercarriage and wheels.

MA. 422.....Cash price 43/- postage 1/6 or deposit 7/6 plus postage and 8 monthly payments 5/6.

## BALSA KITS

7 FROG 'CLIPPER 26' SAILPLANE. 26 in. wing-span. Pre-shaped all Balsa parts. No cutting or trimming. For Catapult launching, hand launching or slope soaring. Complete kit, only plns and cement needed.

MA. 123.....Cash price 12/6 postage 1/-.

8 FROG 'SUPER CLIPPER' ONE-METRE SAILPLANE. 39 in. wing-span. Semi-scale appearance. Capable of long soaring flights. Similar to 'Clipper 26'. Quick and easy to build.

MA. 124.....Cash price 16/6 postage 1/6.



# model aircraft

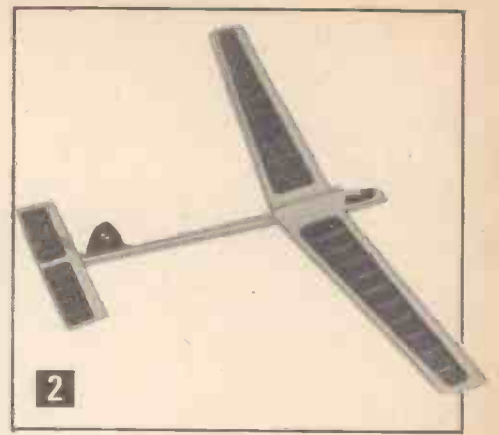

1

1 'VEROSONIC' by VERON. A 46in. span streamlined soaring contest glider. This design, if carefully built, is quite capable of consistent contest durations of three to four minutes in still air from a standard F.A.I. line length of 328 feet. Kit contains everything you need to fly. Complies to F.A.I. ruling.

MA. 103.....Cash price 18/7 postage 1/6.

2 'PHOENIX' by VERON. A graceful Open Class 60 in. span soarer, capable of really first class competition performances. No cutting out—no shaping! Just glue it, sand it and cover it. Kit contains full shaped Balsa halves, spindled boom halves, shaped and slotted leading edges, shaped and slotted trailing edges, die-cut wing and tail ribs, and transparent moulded cockpit.

MA. 104.....Cash price 43/11 carriage 2/6 or deposit 5/- plus carriage and 8 monthly payments 6/-.

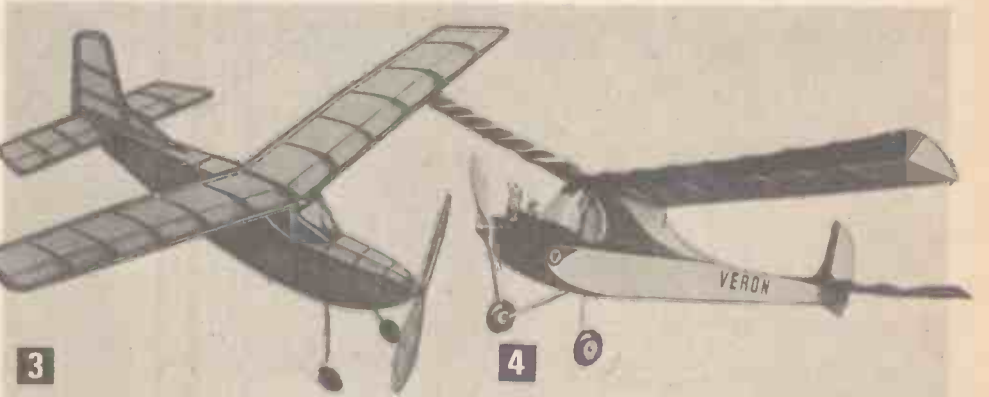

3

4

3 'RASCAL' by VERON. A 24 in. span lightweight duration model. A slick little cabin job. Excellent performance. Easy to build and fly. Complete with rubber and ready carved propeller.

MA. 181.....Cash price 9/9 postage 1/-.

4 'CARDINAL' by VERON. A grand little 35 in. span plane with outstanding performance. Modernistic in appearance and a 'good-looker'—here you have just the model for those who wish to make a start in powered flight. Suitable for small diesel and glow plug motors up to and including 1 c.c. Can be fitted with a small modern transistorised radio unit.

MA. 241.....Cash price 23/7 postage 1/9.

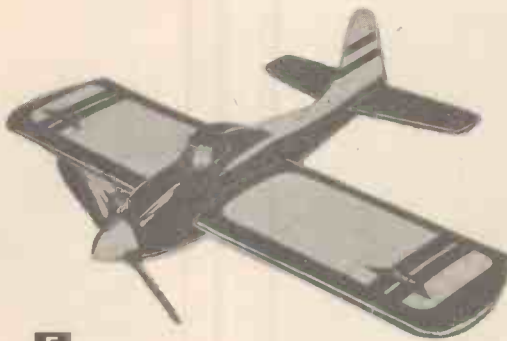

5

6

5 'BEE-BUG' by VERON. A 22 in. span lightweight stunt model. It's snappy, fast and easy to control. Designed expressly for small diesel motors of .5 c.c. to 1 c.c. Kit complete with metal spinner and tank parts.

MA. 491.....Cash price 19/8 postage 1/6.

6 'SPITFIRE' F.22 by VERON. A 27½ in. span replica of Britain's finest fighter. Flies at speeds in excess of 60 m.p.h.! Combined flap and elevator control for super manoeuvrability. For Diesel motors of 1.3 c.c. to 3.0 c.c. or Glow-plug 1.5 c.c. to 5.0 c.c.

MA. 493.....Cash price 42/2 carriage 2/6 or deposit 7/- plus carriage and 8 monthly payments 5/6.



7

8

7 'ROBOT' by VERON. A 45 in. span international radio trainer. Easy to build, inherently stable, robust and dependable. An all weather model for single channel radio control. Kit contains a host of features such as bendproof dural undercarriage, crash resistant leading edges, sponge rubber wheels, etc. For 1.49 cc. to 2.49 diesel or glow plug motors.

MA. 342.....cash price 98/6 carriage 4/6 or deposit 14/- plus carriage and 8 monthly payments 13/-.

8 'STUNTER' by VERON. A 30 in. span control-line stunter with thrilling performance with 1 to 1.49 c.c. Diesel or Glow-plug motors. Weight 13 oz. A highly pre-fabricated kit complete with undercarriage, light Balloon Wheels, plastic spinner and step-by-step instructions.

MA. 494.....Cash price 36/1 carriage 2/6.

# hobbies

The last word in Model Aircraft!

Experience the thrill of being the 'pilot'. These construction kits are designed to help you get the utmost enjoyment from your hobby. Made in West Germany.



# radio control glider kits

BY  
SCHUCO-HEGI

## GLIDERS

1 'SPASSVOGEL' (325). 51 in. span. 1-2 channel R/C Soarer or can be used free flight. Prefab kit.

MAW. 161.....Cash price 57/6 carriage 3/- or deposit 9/- plus carriage and 8 monthly payments 7/6.

2 'PASCHA' (330). 64 in. span. 1-2 channel R/C Soarer. Good performance. Prefab kit.

MAW. 160.....Cash price 76/3 carriage 4/6 or deposit 11/- plus carriage and 8 monthly payments 10/-.

3 'BERGFALKE' (150). 92 in. span Slope Soarer with an excellent performance record. Fully prefab kit features 'knock off' wings. Suitable for 1-3 channel R/C.

MAW. 156.....Cash price 159/6 carriage free or deposit 19/6 and 8 monthly payments 21/6.

4 'K8B' (151). 72 in. span. Semi-scale Slope Soarer suitable for 1-3 channel R/C. Features plug-in wings. Fully prefab kit.

MAW. 151.....Cash price 117/- carriage free or deposit 16/6 and 8 monthly payments 15/6.

5 'SB7' (153). 92 in. span. Semi-scale model featuring Styrofoam cores. Suitable for 4-6 channel R/C. Good performance.

MAW. 157.....Cash price 162/6 carriage free or deposit 23/- and 8 monthly payments 21/6.

6 'ALI' (340). 89 in. span. 'Full House' R/C Slope Soarer. Quick-build prefab kit. Suitable for 4-6 channel R/C.

MAW. 155.....Cash price 182/6 carriage free or deposit 23/- and 8 monthly payments 24/6.

7 'MOTORSPATZ' (152). 81 in. span. Power assisted Glider suitable for .8-1.5 c.c. engines and 1-3 channel R/C. Prefab kit.

MAW. 158.....Cash price 147/6 carriage free or deposit 19/- and 8 monthly payments 18/6.

8 'TWEN' (326). 56 in. span. Beginners model for 1-2 channel R/C. Quick-build kit.

MAW. 149.....Cash price 75/- carriage 4/6 or deposit 10/- plus carriage and 8 monthly payments 10/-.

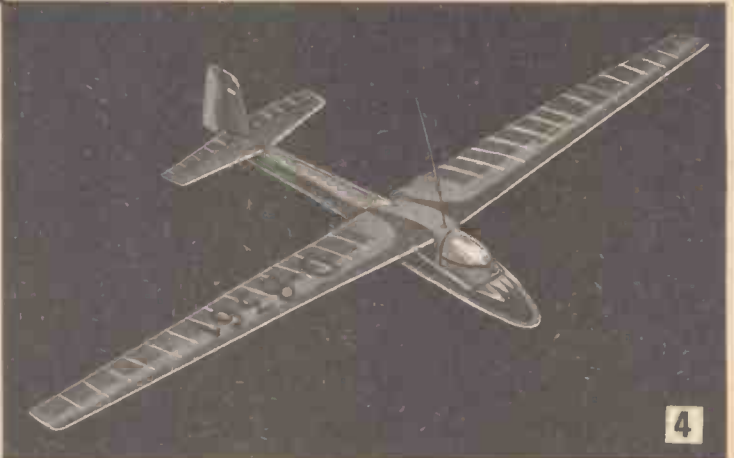
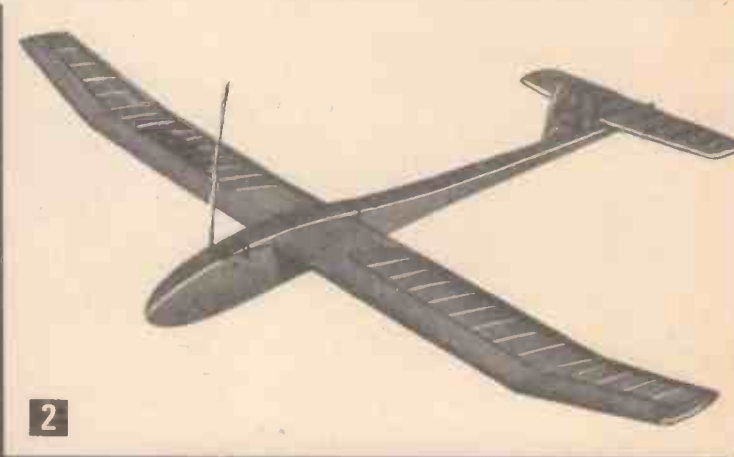
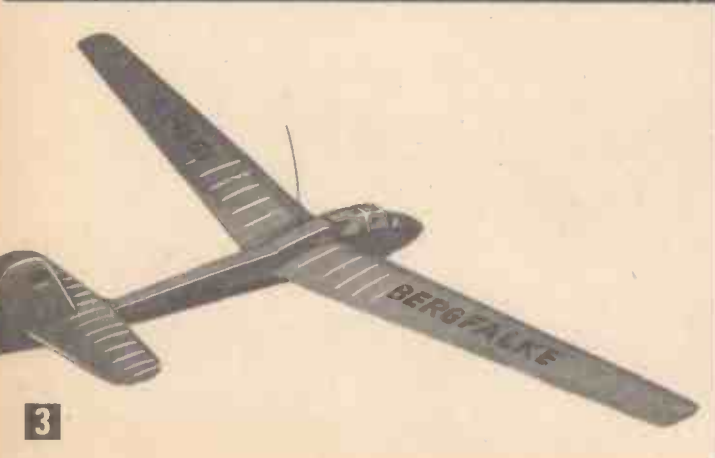
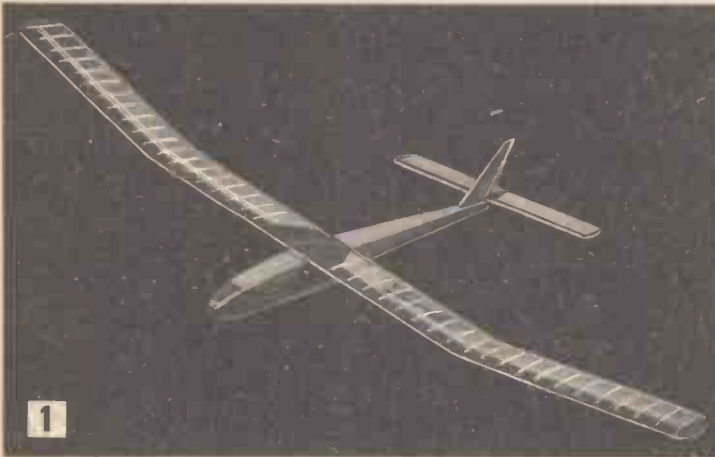



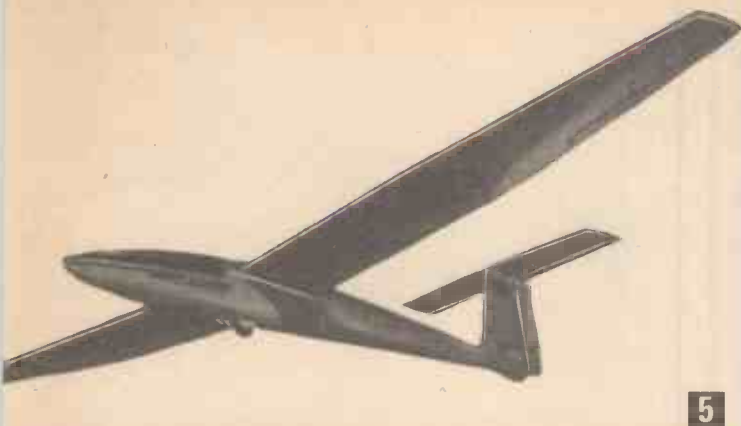

5

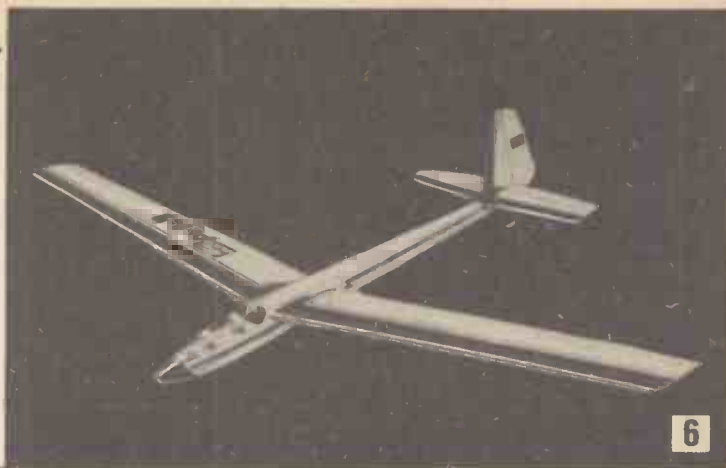

6



7

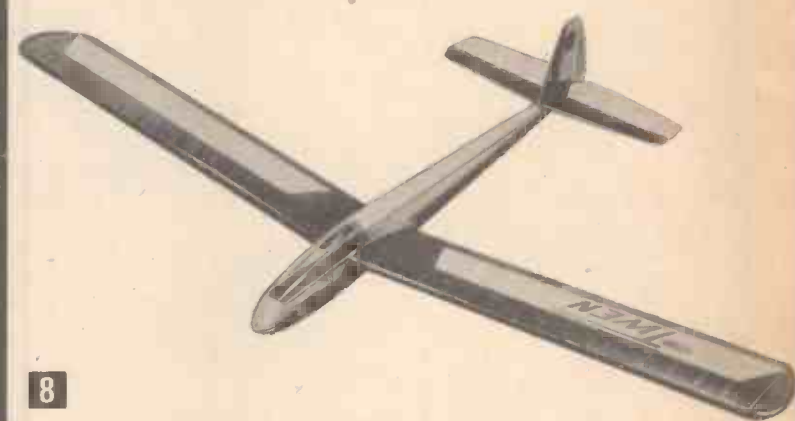

8

# radio control power kits BY SCHUCO-HEGI

1 'FOKKER D VIII' (90). Semi-scale 50 in. span model of the famous 1917 Parasol Monoplane. Fully prefab kit. For 3.5-7.5 c.c. engines. For 3-6 channel R/C.

MAW. 145..... Cash price 146/- carriage free or deposit 17/6 and 8 monthly payments 18/6.



1

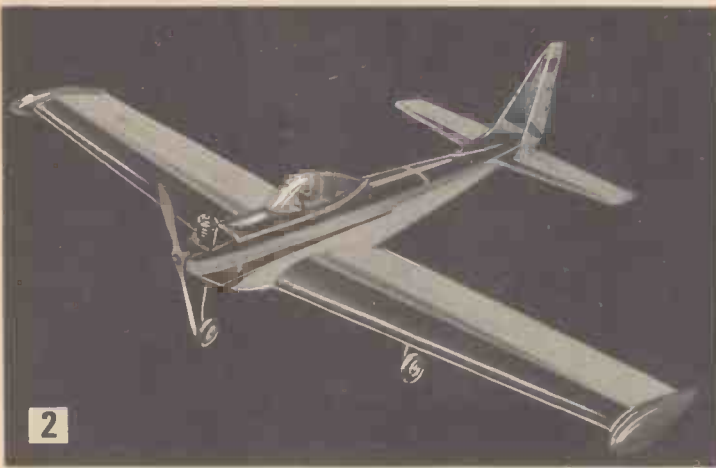

2



3



4



5

## radio control power kits

**2** 'PIONEER' (133). 65 in. span. A new ultra-fast assembly kit containing Styrofoam wings completely planked with Balsa. Steerable nose wheel. New type Plastic Fuselage. Wing tanks. Can be assembled in 24 hours. Suitable for 5-10 c.c. engines, and 8-10 channel or 4 function proportional. Makes a good beginner's model, but will go 'Through the Book' when suitably powered.

MAW. 146. .... Cash price **£14 3 0** carriage free or deposit 42/6 and 8 monthly payments 43/6.

★ 'PIONEER' WING KIT (133/2). 65 in. span. Complete. Styrofoam wings ready planked. Not illustrated.

MAW. 147. .... Cash price **162/6** carriage 3/6 or deposit 23/- plus carriage and 8 monthly payments 21/6.

**3** 'SYNCOM' (132). 65 in. span 'Full House' multi or proportional equipment, Styrofoam wing and fuselage core. Fully prefab kit. Flies like a dream. Easy to land. Quick-build kit. Suitable for 5-10 c.c. engines.

MAW. 165. .... Cash price **£16 5 6** carriage free or deposit 42/6 and 8 monthly payments 43/6.

**4** 'TELSTAR' (130). 65 in. span 'Full House' multi or proportional trainer. Styrofoam wings and fuselage core. Fully prefab kit. Easy to build and fly. Suitable for 5-10 c.c. engines.

MAW. 166. .... Cash price **£14 5 0** carriage free or deposit 38/- and 8 monthly payments 38/-.

**5** 'AUSTER AIGLET' TRAINER (101). 48 in. span. Quick-build kit. Suitable for single channel radio control and engines of 2.5 c.c. Easy to fly.

MAW. 381. .... Cash price **96/6** carriage 3/6 or deposit 12/- plus carriage and 8 monthly payments 13/-.

**6** 'STARLET' (103). 42 in. span. Low wing, 1-3 channel R/C. Suitable for .8-2 c.c. engines. Completely 'stuntable'. Fully prefab kit.

MAW. 148. .... Cash price **145/-** carriage 4/6 or deposit 20/- plus carriage and 8 monthly payments 18/-.

**7** 'FRECHDAX' (104). 44 in. span single channel trainer. Suitable for .8-2 c.c. engines. Fully prefab kit. Ideal for beginners.

MAW. 169. .... Cash price **85/6** carriage 4/6 or deposit 10/6 plus carriage and 8 monthly payments 11/6.

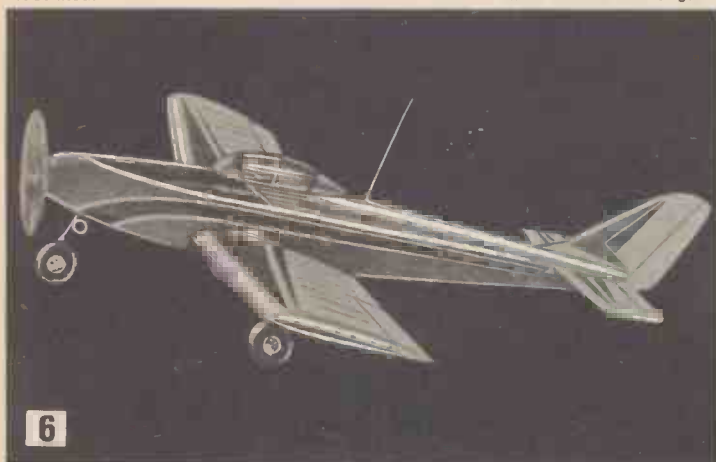

6



7

See page 138 for Ready-to-fly R/C Aircraft



# model boat kits BY SCHUCO-HEGI

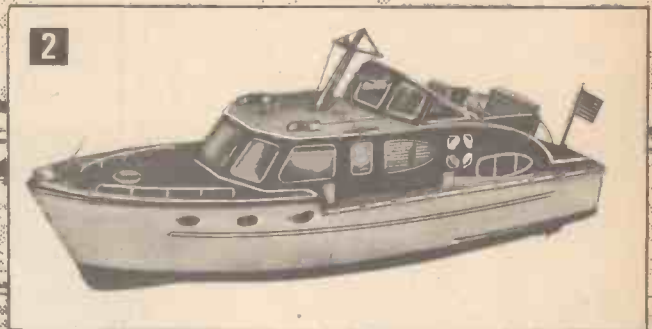
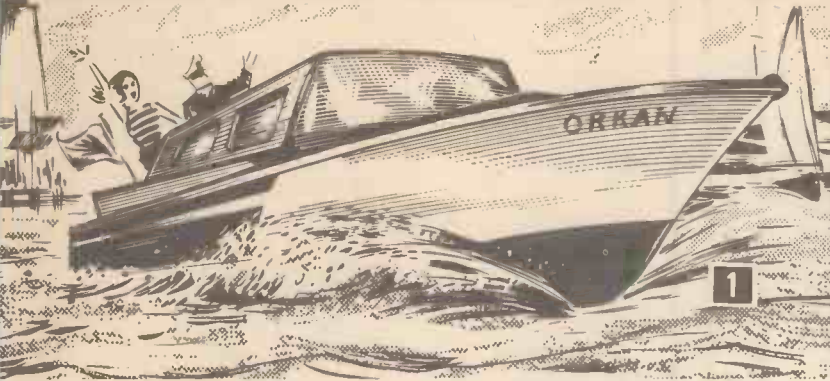

**THE MOST PRE-FABRICATED BOAT KITS AVAILABLE FOR FREE RUNNING OR R/C**

**1 'ORKAN' SPORT RACING CRUISER (511).** Length 30 in. Beam 14 in. Ready formed Hull. All parts die-cut. Suitable for electric power or 3.5-5 c.c. motors. 1-6 channel R/C.

**MBW. 255.** Cash price **223/9** carriage free or deposit 32/6 and 8 monthly payments 29/6.

**2 'CATALINA' (510).** Length 36 in. Beam 10 in. Kit contains ready formed polypropylene Hull, die cut parts and grained Deck. Suitable for twin electric motors or 2.5-5 c.c. engines. Ideal for Radio Control 1-6 channels.

**MBW. 253.** Cash price **195/3** carriage free or deposit 26/- and 8 monthly payments 26/-.

**'CATALINA' FITTINGS SET (510/1).** Not illustrated.

**MBW. 254.** Cash price **63/3** carriage 3/- or deposit 8/6 plus carriage and 8 monthly payments 8/6.

**3 'U-25' U-BOAT (515).** Length 43 in. A working model for Radio Control only. For electric power (twin motors). Will dive, surface and steer. Kit is fully pre-fabricated.

**MBW. 251.** Cash price **186/-** carriage free or deposit 27/- and 8 monthly payments 24/6.

**'U-25' FITTINGS SET (515/1).** Not illustrated.

**MBW. 252.** Cash price **62/9** carriage 3/- or deposit 11/- plus carriage and 8 monthly payments 8/-.

**4 'SAMARA' (514).** Length 26 in. Beam 7 in. A scale model of a Chriscraft Fisherman. Ready formed Hull, die-cut parts. Complete with fittings. Suitable for electric motor or 1.5-3.5 c.c. engines. 1-6 channel R/C can be used.

**MBW. 245.** Cash price **154/6** carriage free or deposit 21/6 and 8 monthly payments 20/6.

**5 'FAIRPLAY V' TUG (513).** Length 30 in. Beam 8 in. Scale model of this famous Hamburg Tug. Kit includes ready formed Hull and superstructure. Accessory parts die-cut. Suitable for electric power or 1.5 c.c. motors and 1-6 channel R/C.

**MBW. 256.** Cash price **183/3** carriage free or deposit 24/- and 8 monthly payments 24/6.

**'FAIRPLAY' FITTINGS SET (513/1).** Not illustrated.

**MBW. 257.** Cash price **97/6** carriage free or deposit 13/- and 8 monthly payments 13/-.

**6 'POLICE BOAT' (516).** Length 24 in. Ready formed Hull. For electric power or 1 c.c. engines. Suitable for 1-4 channel R/C. Ideal for beginners.

Simple and rapid construction.

**MBW. 242.** Cash price **99/9** carriage 6/- or deposit 12/- plus carriage and 8 monthly payments 13/6.

**'POLICE BOAT' FITTINGS SET (516/1).** Not illustrated.

**MBW. 243.** Cash price **28/9** carriage 3/-

**7 'BERMUDA' (533).** A 19 in. Cabin Cruiser. Pre-formed plastic hull and all parts pre-cut. Includes all fittings. For electric powered outboard motor. Ideal for single channel R/C.

**MBW. 244.** Cash price **57/-** carriage 4/6 or deposit 8/6 plus carriage and 8 monthly payments 7/6.

Made in West Germany

**hobbies**



A comprehensive range of boat kits specially imported from Denmark. These kits are ready-to-assemble, with die-cut parts for easy construction. Many parts are printed to simulate planking or to facilitate painting. They can be made up purely for decoration or in some cases can be fitted with a suitable motor and radio control. The fittings, which are sold separately as sets, are beautifully made and add the finishing touches to the boats. Fittings sets contain such items as brass parts including lanterns, lights, rails, vents, boats, propellers, capstans, bills, anchors, guns, etc., and other pre-shaped accessories.  
★ Not illustrated.

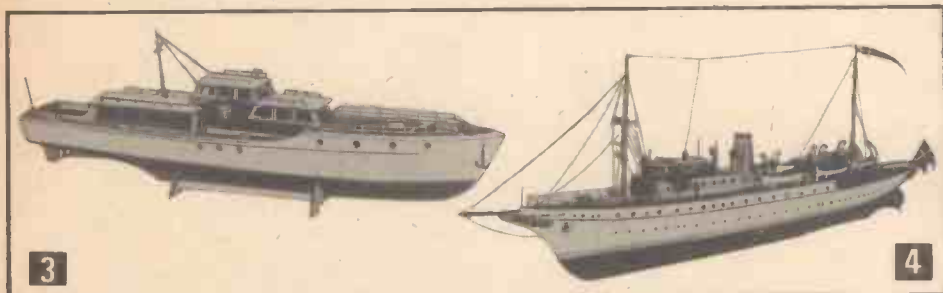

# model

**1** 'ZWARTE ZEE' by BILLING. Length 31 ins. A scale model of a powerful tug. Clean lines and a wealth of detail. A real collector's model. Can be fitted with a motor. Suitable for radio control.

MB. 185..... Cash price **101/6** carriage free or deposit 13/6 and 8 monthly payments 13/6.

★ FITTINGS SET

MB. 186..... Cash price **113/6** carriage free or deposit 16/- and 8 monthly payments 15/-.

**2** 'NORWEGIAN LION' by BILLING. Length 40 ins. One of the largest battleships of it's time, with 70 cannons. A beautiful ship, rich in detail. For the demanding model maker.

MB. 205..... Cash price **155/-** carriage free or deposit 22/- and 8 monthly payments 20/6.

★ FITTINGS SET

MB. 206..... Cash price **£16 6 6** carriage free or deposit 48/- and 8 monthly payments 43/-.

**3** 'NEPTUN' by BILLING. Length 34 ins. An attractive motor yacht which will afford great pleasure in construction and use. Can be fitted with diesel or electric motor. Suitable for radio control.

MB. 183..... Cash price **79/11** carriage 4/6 or deposit 12/- plus carriage and 8 monthly payments 10/6.



★ FITTINGS SET

MB. 184..... Cash price **99/6** postage 1/4 or deposit 15/6 plus postage and 8 monthly payments 13/-.

**4** 'DANNEBROG' by BILLING. Length 30 ins. The Royal Family's Boat. Elegant and rich in tradition. An easy-to-build model. Can be fitted with electric motor.

MB. 193..... Cash price **66/-** carriage 4/6 or deposit 11/- plus carriage and 8 monthly payments 8/6.

★ FITTINGS SET

MB. 194..... Cash price **113/9** carriage free or deposit 16/6 and 8 monthly payments 15/-.

★ STANCHION SET

MB. 195..... Cash price **60/6** postage 6d. or deposit 8/6 plus postage and 8 monthly payments 8/-.

**5** 'LILLA DAN' by BILLING. Length overall 27 ins. An exact replica of a beautiful training ship. Learn about sailing ships as you build.

MB. 197..... Cash price **73/9** carriage 4/6 or deposit 12/6 plus carriage and 8 monthly payments 9/6.

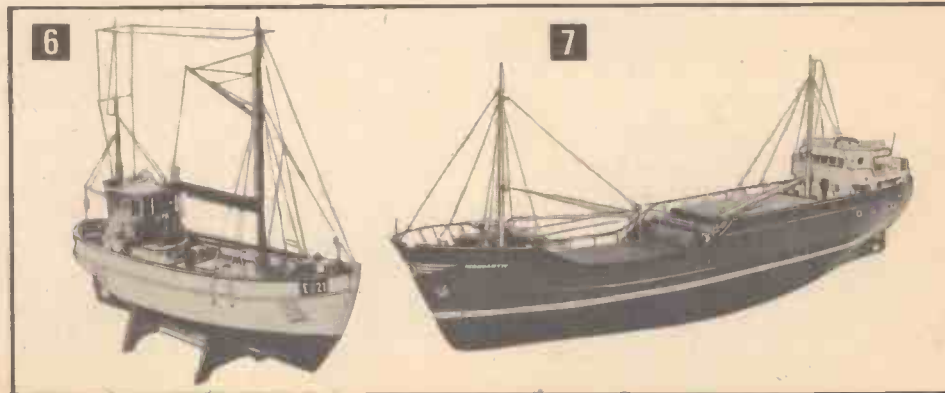

★ FITTINGS SET

MB. 198..... Cash price **87/3** postage 1/4 or deposit 12/6 plus postage and 8 monthly payments 11/6.

**6** 'NORDS KUTTER' by BILLING. Length 21 ins. A beginner's model of a 45 ton cutter which is out on the fishing banks in all weathers.

MB. 181..... Cash price **60/6** carriage 4/6 or deposit 8/6 plus carriage and 8 monthly payments 8/-.

★ FITTINGS SET

MB. 182..... Cash price **80/3** postage 1/4 or deposit 12/6 plus postage and 8 monthly payments 10/6.

**7** 'MERCANTIC' by BILLING. Length 38½ ins. A modern coaster. Easy to build and suitable for radio control.

MB. 187..... Cash price **106/6** carriage free or deposit 16/- and 8 monthly payments 14/-.

★ FITTINGS SET

MB. 188..... Cash price **127/9** carriage free or deposit 21/6 and 8 monthly payments 16/6.





8 MONTHLY  
PAYMENTS OF  
**23/6**

# boat kits

**1** 'HUNTSMAN' by VERON. Length 42 ins. A scale model of a Fairley Marine high speed cruiser. Takes a large water cooled diesel from 3.5 c.c. to 10 c.c. or a 12 volt electric motor. This is a really fine model, perfect in every way. Ideal for radio control—single or multi-channel. Kit contains one piece hardwood keel, all hardwood prefabricated parts, ready slotted ply formers, preshaped window and cabin structure, rudder and plastic fittings.

**MB. 149.**.....Cash price **177/4** carriage free or deposit 25/- and 8 monthly payments 23/6.

**2** 'DEEP SEA TRAWLER' by VERON. Length 30 ins. The pride of the fleet! Based on a Brooke-Marine design. Suitable for water cooled diesels up to 8 c.c., or 6 to 9 volt electric motors. Ideal for single channel lightweight radio control. Kit contains fully shaped balsa base, die-cut ply decking and superstructure, plastic parts and fittings, brass rudder and shaped funnel.

**MB. 147.**.....Cash price **109/8** carriage 4/6 or deposit 16/- plus carriage and 8 monthly payments 14/6.

**3** 'CARIBBEAN COASTER' by VERON. Length 32 ins. A fine construction kit for a modern motor vessel. For small water cooled diesels up to 1 c.c.



or electric motors from 6 to 12 volts. Ideal for single channel lightweight radio control. Kit contains pre-shaped hull parts, die-cut plywood cabin structure, decking and gunwales. Ready made funnel, rudder, ventilators and plastic fittings.

**MB. 148.**.....Cash price **123/7** carriage free or deposit 16/6 and 8 monthly payments 16/6.

**4** 'RIVER POLICE PATROL LAUNCH' by VERON. Length 26 ins. An accurate replica of the real thing. For use with water cooled diesels up to 1 c.c. or electric motors up to 6 volts. Kit contains ready shaped balsa and ply parts, printed parts, panelling, metal rudder, celluloid fittings, plan and instructions.

**MB. 145.**.....Cash price **58/5** carriage 4/6 or deposit 10/- plus carriage and 8 monthly payments 7/6.

**5** 'VOSPER' by VERON. Length 28 ins. A fine scale model of a Rescue/Target-towing Launch. Ideal for lightweight radio control! Suitable for 1 c.c. water cooled diesels or up to 6 volt electric motors. Kit contains accurate die-cast balsa and ply parts, plastic moulded ventilators, brass rudder and accessories.

**MB. 146.**.....Cash price **82/6** carriage 4/6 or deposit 11/- plus carriage and 8 monthly payments 11/-.



**6** 'SKEETER' by VERON. Length 12 ins. A slick little speedboat with simplified balsa and ply construction. Designed for small electric motors. Kit contains all pre-shaped balsa and ply parts, propeller, shaft, tube and rudder gear.

**MB. 142.**.....Cash price **14/7** postage 1/4.

**7** 'SKIPPER' by VERON. Length 12 ins. A completely prefabricated kit for a cabin cruiser. Preshaped balsa and die-cut ply parts, includes rudder and prop shaft. For small electric motors.

**MB. 143.**.....Cash price **19/8** postage 1/4.

**8** 'VICEROY' by VERON. Length 20 ins. A Classic Cabin Cruiser. Suitable for small water cooled diesels 5 to 1 c.c. or up to 6 volt electric motors. Robust block balsa and ply prefabrication with die-cut ply deck and cabin structure.

**MB. 144.**.....Cash price **37/3** carriage 4/6.

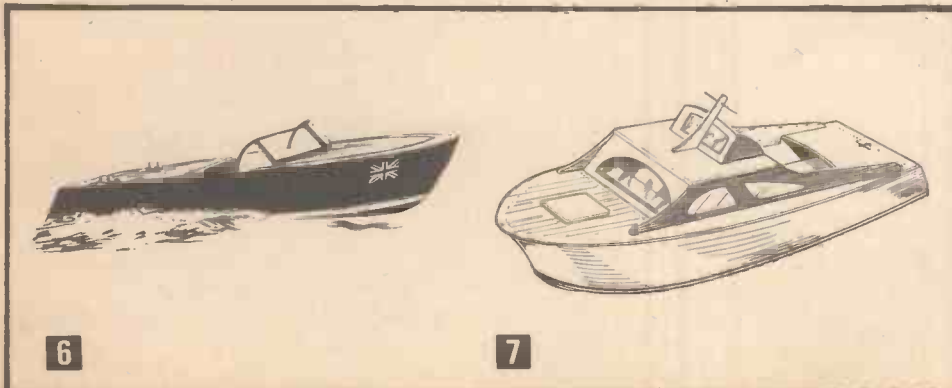

# hobbies

# marinecraft galleon kits

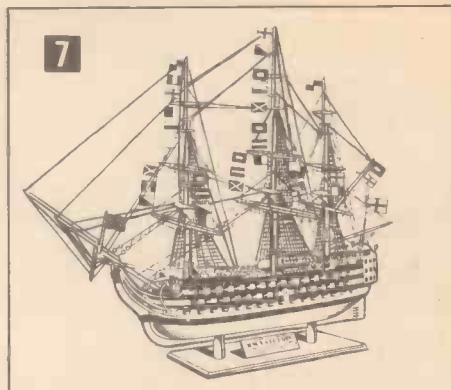
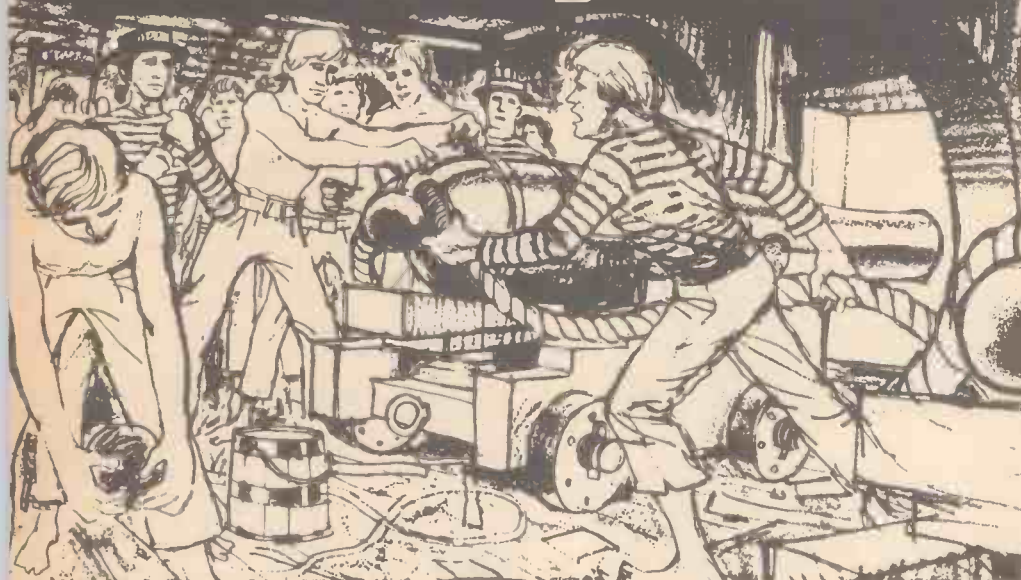

by **a.a.hales**

## MARINECRAFT GALLEON KITS

All shaped parts from best quality wood. These superb kits are complete to the finest detail possible. Each contains shaped hull and keel, coloured panels, sails and flags, plus a full size plan and complete set of fittings. Particular attention has been given to ease of construction, enabling the modeller to make a really first class model.

The beginner is advised to start with 'The Bounty' or 'Mayflower'.

- 1 BOUNTY.** Length 13 in.  
MB. 163..... Cash price **17/6** postage 2/3
- 2 CUTTY SARK.** Length 17 in.  
MB. 165..... Cash price **24/3** postage 2/3
- 3 GOLDEN HIND.** Length 24 in.  
MB. 167..... Cash price **38/3** carriage 4/6
- 4 MAYFLOWER.** Length 13 in.  
MB. 164..... Cash price **20/9** postage 2/3
- 5 SANTA MARIA.** Length 19 in.  
MB. 166..... Cash price **29/9** carriage 3/-
- 6 ARK ROYAL.** Length 19 in.  
MB. 168..... Cash price **40/6** carriage 4/6 or deposit 4/6 plus postage and 8 monthly payments 5/6.
- 7 VICTORY.** Length 20 in.  
MB. 169..... Cash price **40/6** carriage 3/- or deposit 4/6 plus postage and 8 monthly payments 5/6.

## MINIATURE GALLEON KITS

These small galleons are identical to the large series, except that dead-eyes are not used and crow's nest, anchors, etc. are in plastic. Not illustrated.

- BOUNTY.** Length 6½ in.  
MB. 170..... Cash price **8/-** postage 1/-
- CUTTY SARK.** Length 8½ in.  
MB. 171..... Cash price **8/-** postage 1/-
- MAYFLOWER.** Length 6½ in.  
MB. 172..... Cash price **8/9** postage 1/-
- SANTA MARIA.** Length 9½ in.  
MB. 173..... Cash price **10/3** postage 1/-
- GOLDEN HIND.** Length 12 in.  
MB. 174..... Cash price **10/9** postage 1/2
- ARK ROYAL.** Length 9½ in.  
MB. 175..... Cash price **10/9** postage 1/2
- VICTORY.** Length 10 in.  
MB. 176..... Cash price **10/9** postage 1/2

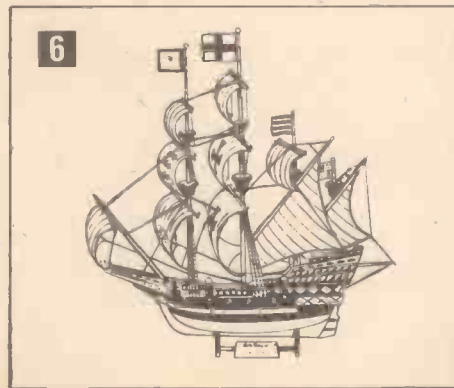
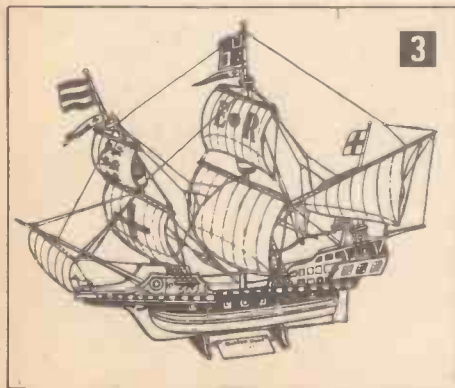
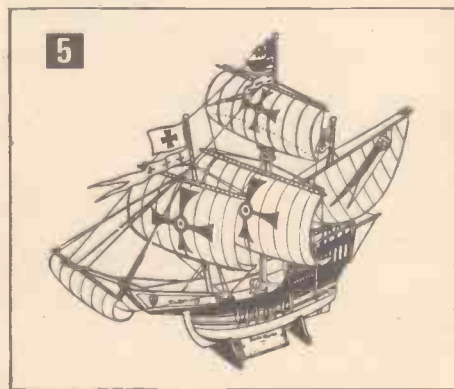
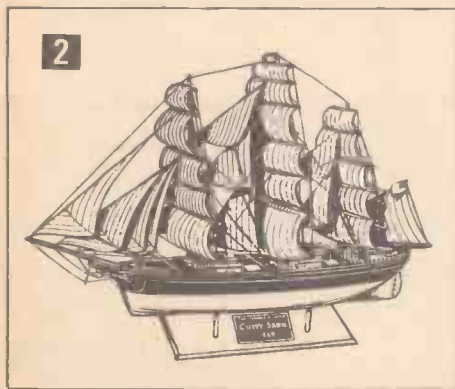
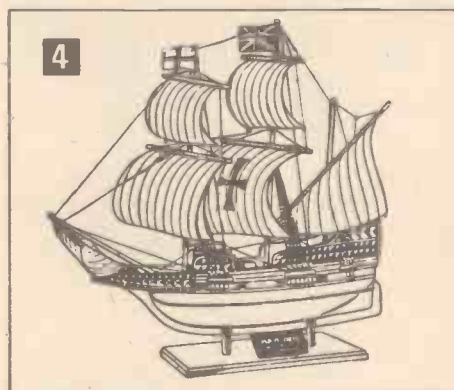
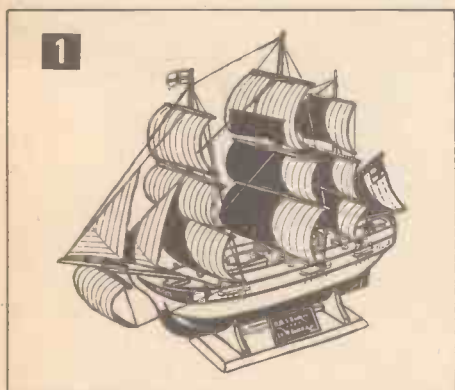



# model boats

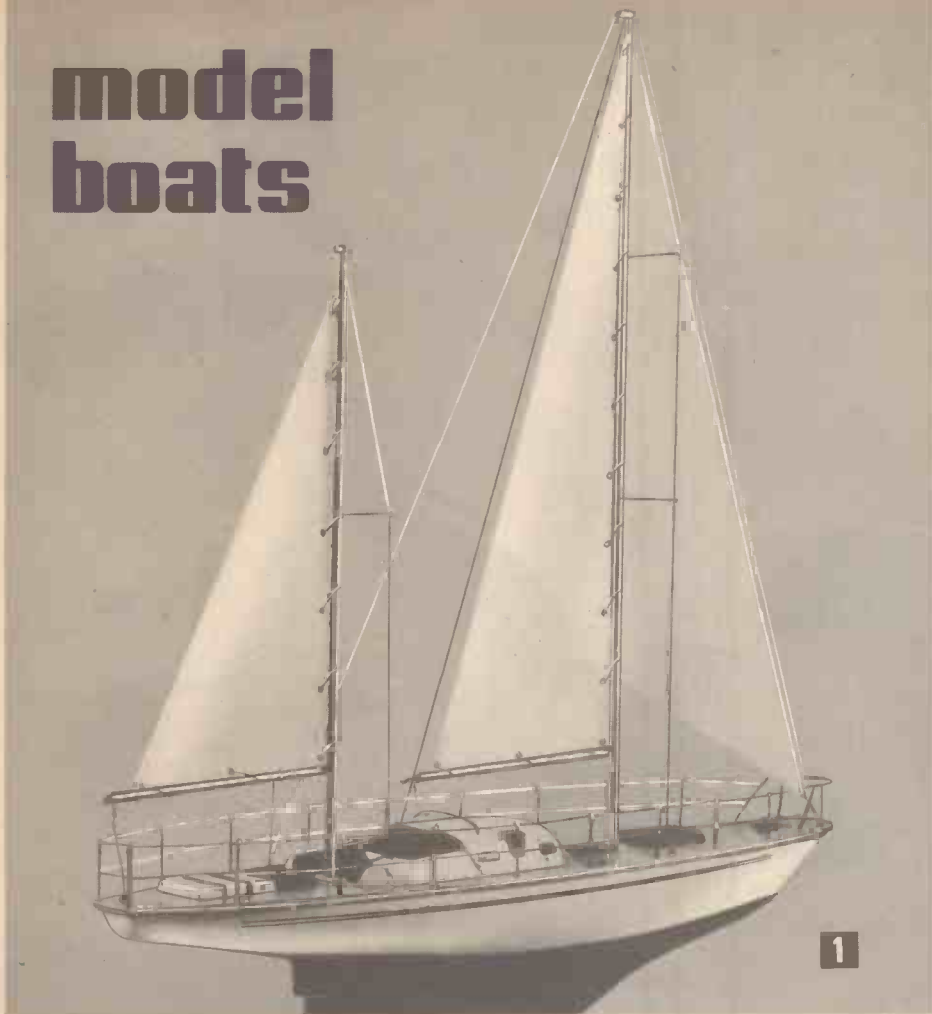

**1 'GIPSY MOTH IV' A FULLY APPROVED MODEL EXCLUSIVE TO HOBBIES LTD.**

A 26½ in. semi-scale working model of the famous boat in which Sir Francis Chichester, the gallant lone navigator, fought and beat the treacherous oceans of the world. Designed with a view to simple adaptation to Radio Control.

Kit contains pre-cut parts, ready moulded plastic Hull and Cockpit, ready cut Sails, basic Fittings and cast Keel. Complete with log features from the *Sunday Times*.

**MBW. 230**.....Cash price **97/6** carriage 7/6 or deposit 13/- plus carriage and 8 monthly payments 13/-.

**2 'BERMUDA PRINCESS' by HOBBIES.** Length 42 in., beam 15 in. A semi-scale model of the 'Constellation'. Moulded fibre glass Cabin Tops and Hull. All parts pre-cut from marine ply. Deck pre-patterned. Performs excellently when powered with 5 c.c. to 25 c.c. motor. Ideal for all Radio Control units. For expert or beginner.

**MBW. 229**.....Cash price **£17 19 6** carriage free or deposit 47/6 plus 8 monthly payments 48/-.

**3 'MEFA II' HOVERCRAFT by A. A. HALES.** Length 13 in. Suitable for all ages from 8 years. Ready-formed plastic parts. Can be used over the floor, asphalt or water. Hovering ability unlimited. Suitable for engines up to 1 c.c. Speed up to 16 knots.

**MB. 234**.....Cash price **29/6** carriage 2/6.

**4 'EAGLE' HOVERCRAFT by A. A. HALES.** Length 13 in. Easy to make and drive. Switch on and it soars fast on its air cushion. Ready made plastic parts. High quality 3v. electric motor included. Use over floors or similar surfaces. Batteries extra.

**MB. 233**.....Cash price **22/6** carriage 2/6.

**5 'WINDY II' YACHT by A. A. HALES.** Length 16½ in. Quick and easy to build. Scandinavian semi-scale design. Genuine glazed Terylene Sails. All parts die-cut. Lead Keel. Complete with rigging, fittings and pictorial step-by-step assembly instructions.

**MB. 178**.....Cash price **30/-** carriage 2/6.



# model engines

## 'DAVIES CHARLTON'

**1** 'DART' .5 cc DIESEL. Suitable for free flight and scale models up to 42 in. span. Suitable prop: MEW. 601.

MEW. 101..... Cash price **76/3** postage 10d or deposit 11/- plus postage and 8 monthly payments 20/-.



**2** 'BANTAM DE-LUXE' .75 cc GLOW. Complete with prop. MEW. 601.

MEW. 103..... Cash price **57/6** postage 10d or deposit 9/- plus postage and 8 monthly payments 7/6.

'MERLIN 9' .76 cc. DIESEL. Suitable prop: MEW. 602.

MEW. 104..... Cash price **60/6** postage 1/- or deposit 8/6 plus postage and 8 monthly payments 8/-.

'MERLIN' .76 cc. DIESEL. Marine version.  
MEW. 112..... Cash price **81/3** postage 1/6 or deposit 13/- plus postage and 8 monthly payments 10/6. Not illustrated.

'DART' .5 cc DIESEL. Marine version.

MEW. 111..... Cash price **96/6** postage 1/6 or deposit 12/- plus postage and 8 monthly payments 13/-.

'BANTAM' .75 cc GLOW. Suitable prop: MEW. 601.

MEW. 102..... Cash price **45/9** postage 10d or deposit 7/- plus postage and 8 monthly payments 6/-.

**3** 'MERLIN SUPER' .76 cc. DIESEL. Suitable prop: MEW. 602.

MEW. 105..... Cash price **65/11** postage 1/- or deposit 11/- plus postage and 8 monthly payments 8/6.

**4** 'SPITFIRE' 1 cc. DIESEL. Suitable prop: MEW. 603.

MEW. 106..... Cash price **71/9** postage 1/- or deposit 10/6 plus postage and 8 monthly payments 9/6.

**5** 'SPITFIRE' 1 cc. DIESEL. Marine version.

MEW. 113..... Cash price **91/6** postage 1/6 or deposit 14/- plus postage and 8 monthly payments 12/-.



**6** 'SABRE' 1.49 cc. DIESEL. Suitable prop: MEW. 603.

MEW. 107..... Cash price **76/3** postage 1/- or deposit 11/- plus postage and 8 monthly payments 10/-.



**7** 'SABRE' 1.49 cc. DIESEL. Marine version.

MEW. 114..... Cash price **96/6** postage 1/6 or deposit 12/- plus postage and 8 monthly payments 13/-.



**8** 'QUICKSTART' PROPELLERS

5½" x 3½"  
MEW. 601..... Cash price **1/6** postage 4d. 6" x 4"

MEW. 602..... Cash price **1/9** postage 4d. Not illustrated. 7" x 4"

MEW. 603..... Cash price **2/6** postage 4d. Not illustrated.

SILENCERS (Not illustrated).

MERLIN SILENCER/MANIFOLD.

MEW. 115..... Cash price **8/9** postage 6d.

SABRE/SPITFIRE SILENCER/MANIFOLD.

MEW. 116..... Cash price **8/9** postage 6d.

DART SILENCER/MANIFOLD.

MEW. 117..... Cash price **12/-** postage 6d.

'QUICKSTART' GLOW PLUGS. (Not illustrated)

SHORT REACH (.8 cc.) 1½v. (EG.98).

MEW. 118..... Cash price **5/6** postage 6d.

LONG REACH (LARGE) 1½v. (EG.99).

MEW. 119..... Cash price **6/6** postage 6d.

LONG REACH (PERFORMANCE) 2v. (EG.200).

MEW. 120..... Cash price **9/9** postage 6d.

GLOW PLUG CLIPS (Not illustrated).

QUICKCLIP CONNECTOR (WITH LEAD).

MEW. 123..... Cash price **5/6** postage 6d.

GLOWCLIP CONNECTOR (CLIP ONLY).

MEW. 124..... Cash price **3/3** postage 6d.

K11 KWIKKLIP (A. METAL).

MEW. 125..... Cash price **3/3** postage 6d.

K1 KWIKKLIP (PLASTIC).

MEW. 126..... Cash price **4/3** postage 6d.



# model engines FUJI

These model aero and marine engines are designed and built by experts. They are individually tested and guaranteed against defect. Precision engineered throughout to last a modelling lifetime.

FUJI for VALUE+ PERFORMANCE—Made in Japan.



1

1 -049 GLOW (FU.1). Easy to start. Complete with tank.

MEW. 135.....Cash price 59/- postage 1/6 or deposit 7/- plus postage and 8 monthly payments 8/-.

-061 GLOW (FU.2). As -049 but more powerful. With tank.

MEW. 136.....Cash price 59/- postage 1/6 or deposit 7/- plus postage and 8 monthly payments 8/-.



2

2 -099 GLOW (FU.3). Complete with integral tank.

MEW. 137.....Cash price 64/- postage 1/6 or deposit 9/6 plus postage and 8 monthly payments 8/6.

-099 R/C VERSION (FU.4).

MEW. 138.....Cash price 76/3 postage 1/6 or deposit 11/- plus postage and 8 monthly payments 10/-.



3

3 -099S (FU.13). Complete new version. No tank, but a hot motor.

MEW. 139.....Cash price 82/6 postage 1/6 or deposit 11/- plus postage and 8 monthly payments 11/-.

-099 W/C R/C VERSION (FW.19).

MEW. 152.....Cash price 135/9 postage free or deposit 18/- and 8 monthly payments 18/-.



4

4 -099S W/C R/C VERSION (FW.26).

MEW. 153.....Cash price 153/6 postage free or deposit 20/- and 8 monthly payments 20/-.



5

5 -12 GLOW (FU.14). High performance easy starting -27 BHP motor.

MEW. 140.....Cash price 82/6 postage 1/2 or deposit 11/- plus postage and 8 monthly payments 11/-.



6

6 -15 GLOW (FU.5). A good all-round motor with easy-to-handle settings.

MEW. 141.....Cash price 98/11 postage 1/2 or deposit 12/- plus postage and 8 monthly payments 13/-.

-15 R/C VERSION (FU.6).

MEW. 143.....Cash price 122/- postage free or deposit 18/6 and 8 monthly payments 16/-.

-15 W/C R/C VERSION (FW.21).

MEW. 155.....Cash price 169/9 postage free or deposit 24/- and 8 monthly payments 22/6.



7

7 -19 GLOW (FU.7). A good solid motor that will last a modelling lifetime.

MEW. 144.....Cash price 116/9 postage free or deposit 16/- and 8 monthly payments 15/6.

-19 R/C VERSION (FU.8).

MEW. 145.....Cash price 149/6 postage free or deposit 19/6 and 8 monthly payments 20/-.

-19 WATERCOOLED R/C VERSION (FW.23).

MEW. 159.....Cash price 194/3 postage free or deposit 25/- and 8 monthly payments 26/-.

-29 GLOW (FU.9). -65 BHP at 16,000 r.p.m. Easy starter.

MEW. 146.....Cash price 137/3 postage free or deposit 17/- and 8 monthly payments 18/6.

-29 R/C VERSION (FU.10).

MEW. 147.....Cash price 174/- postage free or deposit 25/- and 8 monthly payments 23/-.

-29 WATERCOOLED R/C VERSION COMPLETE.

MEW. 134.....Cash price 229/- postage free or deposit 31/- and 8 monthly payments 30/6.



8

8 -35 GLOW (FU.11). -7 BHP at 15,000 r.p.m. Good solid easy-to-handle motor.

MEW. 148.....Cash price 141/6 postage free or deposit 16/- and 8 monthly payments 18/-.



9

9 -35 R/C VERSION (FU.12).

MEW. 149.....Cash price 178/- postage free or deposit 21/- and 8 monthly payments 24/-.

-35 WATERCOOLED R/C VERSION (FW.25).

MEW. 161.....Cash price 229/3 postage free or deposit 31/- and 8 monthly payments 30/6.

# hobbies

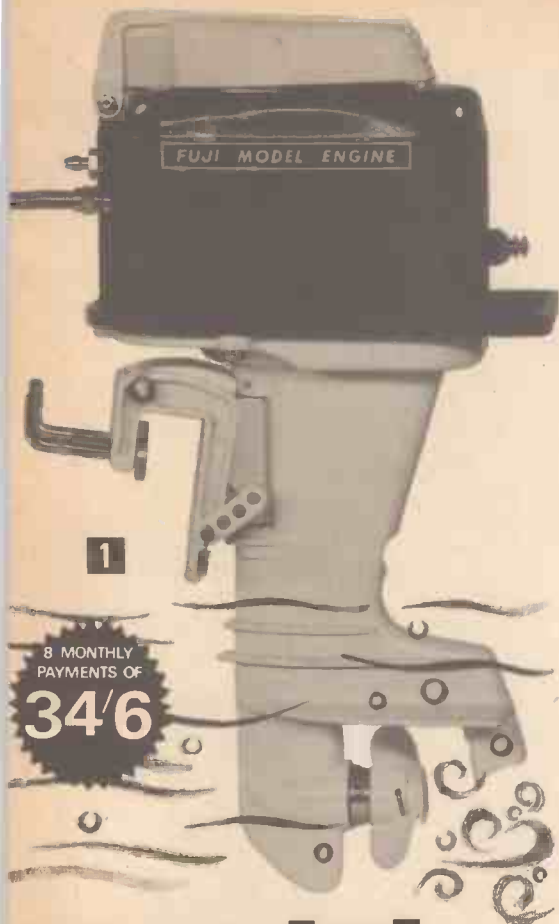

1

8 MONTHLY  
PAYMENTS OF  
**34/6**

# model engines FUJI

**1** '15 OUTBOARD (FW.17). A glow motor that has everything the real full-size outboards have. Easy to start. Fitted with R/C throttle.

ME. 151.....Cash price **257/6** postage free or deposit 33/- and 8 monthly payments 34/6.



2

**2** '061 OUTBOARD (FW.16). A novel way to propel boats of up to 24". Including integral tank and flywheel.  
ME. 150.....Cash price **118/-** postage free. or deposit 17/- and 8 monthly payments 15/6.

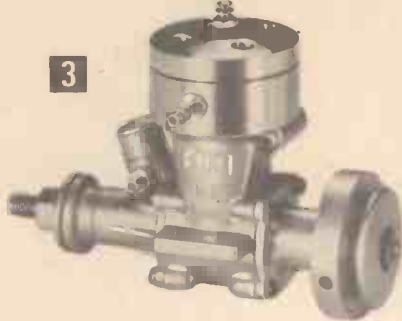

3

**3** '15S SPECIAL MARINE UNIT (FW.27). Fitted with rear flywheel for very easy starting. Please note this glow motor has been developed over 12 months with the help of many top boat enthusiasts. WITHOUT BALLRACE.

ME. 157.....Cash price **194/3** postage free or deposit 25/- and 8 monthly payments 26/-.

'15S SPECIAL MARINE UNIT (FW.28) WITH BALLRACE.

ME. 156.....Cash price **230/3** postage free or deposit 32/- and 8 monthly payments 30/6. Not illustrated.



4



5

**FUJI SILENCERS.** Everyone is amazed at the value of these expansion type silencers.

**4** 'A' Type for most engines from '049-099 (FU.50).  
MEW. 162.....Cash price **17/3** postage 8d.

**5** 'B' Type for most engines from '15-35 size (FU.51).

MEW. 163.....Cash price **23/3** postage 8d.

**FUJI GLOW PLUGS (Short Reach).**

Type 'A' ('049-099) 3v. (FU.40). Not illustrated.

MEW. 164.....Cash price **3/6** postage 8d.

Type 'B' ('15-35) 3v. (FU.41). Not illustrated.

MEW. 165.....Cash price **3/6** postage 8d.

by **a.a.hales**

**6** 'COX' 'PEE WEE' '327 cc GLOW. Made in U.S.A.

ME. 121.....Cash price **53/3** postage 6d. or deposit 8/- plus postage and 8 monthly payments 7/-.



7

**7** 'COX' 'BABE BEE' '819 cc GLOW. Rear Needle valve. Integral tank carburettor. Made in U.S.A.

ME. 122.....Cash price **53/3** postage 8d or deposit 8/- plus postage and 8 monthly payments 7/-.

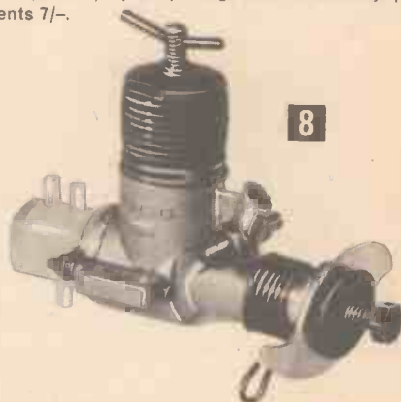

8

**8** 'FROG 100' '99 cc DIESEL.

ME. 131.....Cash price **60/6** postage 1/- or deposit 8/6 plus postage and 8 monthly payments 8/-.

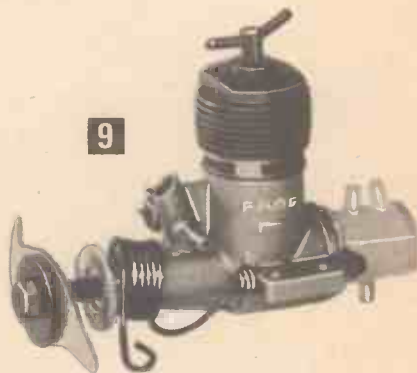

9

**9** 'FROG 150' '149 cc DIESEL. Suitable for 1/2A Team Racing and small stunt models.

ME. 132.....Cash price **66/-** postage 1/2 or deposit 11/- plus postage and 8 monthly payments 8/6.

**hobbies**



6



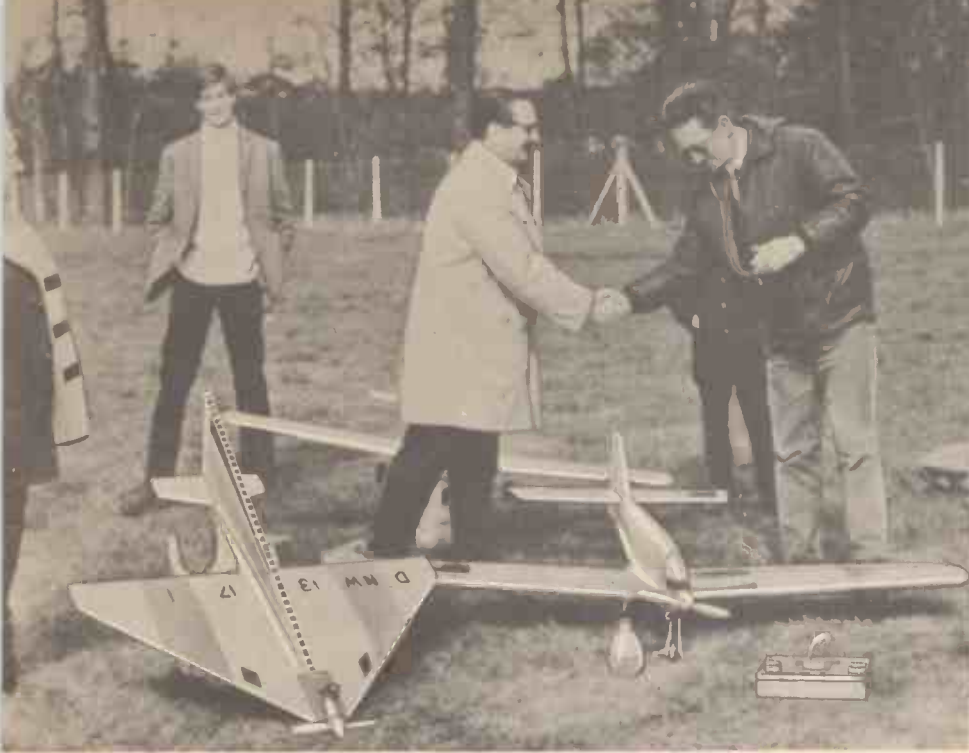

Mr. J. Trupp, Chairman of Hobbies Ltd., congratulating Fritz Bosch on 'unofficially' breaking the world speed record with his Delta model at the Weybridge Symposium 1967.



H.P. facilities are available for this equipment. Details on application to: Sales Division, Hobbies Ltd., Dereham, Norfolk.

# simprop for success

THE LAST WORD IN RADIO CONTROL EQUIPMENT. Made in West Germany

## 1 DIGI 4

The four-function Superhet, tri-simultaneous system is the most reliable outfit ever offered to the modelling fraternity. The development time of three years, including thousands of hours in the air by leading flyers all over the world, ensures that you are buying the most 'PROVEN' equipment available.

### WILL LAST A LIFETIME!

#### Technical Data:

Tx	Rx	Servos
12 volt Deac	4.8 v Deac Pack	4.8 volt
Output 600 m W	Sensitivity 3 m V	4 lb. thrust
Drain 125 m A	Weight 5½ oz.	Weight 2 oz.
Lightweight	Drain 280 m A	Drain 60 m A
Out of sight range	with 4 Servos in operation	

Digi/Analogue system. Twelve frequencies available. State left or right stick. Unit is ready wired, complete with Deac Pack, Tx, Rx and four Servos in Attache Case Pack.

RCW. 421... Cash price £282 17 9 carriage free



## 2 DIGI 7+1

This is a 7+1 function fully digital system, Superhet tri-simultaneous and proportional. The Rx employs micro-circuitry in the Decoder section for extreme reliability.

Chosen by eleven leading European flyers for the International in Corsica (1967).

#### Technical Data:

Tx	Rx
12 volt Deac	4.8 v Deac Pack
Output 800 m W	Sensitivity 1 m V
Drain 125 m A	Weight 4 oz.
Lightweight	Drain 25 m A
Out of sight range	Size only 3" x 2¼" x 1"

Servos  
Drain 25 m A  
4.8 v working  
4.2 lb. thrust  
Weight 2 oz.

Please state frequency required and left or right stick. 12 frequencies available.

Unit is complete with Tx, Rx, Servos, Deac Pack, Ready wired, charging lead, etc. Packed in Attache Case.

RCW. 423 with 7 Servos... Cash price £363 11 6 carriage free.

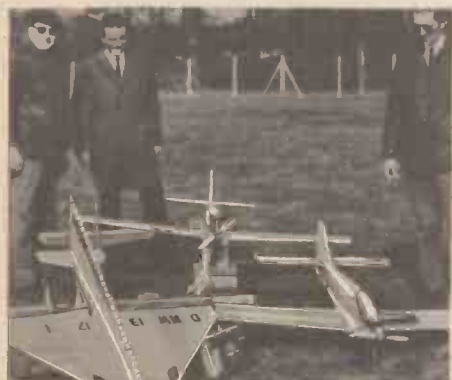

Fritz Bosch and the German Flying team. Demonstrating proof of Simprop superiority at Weybridge 1967 Symposium, where they dominated the show.



# radio control

## RADIO CONTROLLED AIRCRAFT by FUTABA Made In Japan

**1** 'CESSNA' 210. 29 In. span Radio Controlled ready to fly. Just fit in engine, fix wings and tail-plane in position, insert batteries and you are ready to go. Includes Transmitter, Receiver and Escapement built-in. Gives Rudder-only control. This is a stable little model provided it is not flown in rough weather. With a little practice will give a lot of fun. Enjoy the thrill now.

MAW. 441..... Cash price **£19 17 6** carriage free or deposit 53/- and 8 monthly payments 53/-.

'CESSNA' 210. 29 in. span, ready finished in Styrofoam, fast-assembly kit. Can be ready to fly in one hour. Suitable for S/C Radio Control and engines of up to .5 c.c. Please note Escapement is included and is 'built-in' the fuselage. Ideal gift. Not illustrated.

MAW. 442..... Cash price **139/6** carriage free or deposit 19/- and 8 monthly payments 18/6.

**2** 'FRONTIER 1'. Ready to fly 44 in. Styrofoam model, complete with Enya engine, Tx and Rx and Servos, giving rudder and engine control. Flies like a dream and with a little practice will do stunts such as loops, wing overs, etc. Engine throttle can be controlled at will to bring the model in to land at any time.

Three versions are available as follows:

Complete as above with Superhet Transmitter (FT-5C) and Receiver (F6-STR), also two servos (FE-3B and FR-3B).

MAW. 438..... Cash price **£57 10 0** carriage free or deposit 152/6 and 8 monthly payments 153/-.

Complete as described, but with Standard Transmitter (FT-3A) and Receiver (F3-27R), plus two Servos (FE-3B and FR-3B).

MAW. 439..... Cash price **£46 7 6** carriage free or deposit 125/- and 8 monthly payments 123/6.

Ready to assemble kit, without Engine, Servos, Transmitter or Receiver. Can be built in one hour.

MAW. 435..... Cash price **199/6** carriage free or deposit 27/6 and 8 monthly payments 26/6.

**3** 'SPITFIRE'. Styrofoam 36 in. span. Has motor and Aileron Control. Enya .05 engine included. Complete and ready to fly, with Superhet Rx (F3-27R), Servo and Escapement (FR-3B and ME-2S) and Transmitter (FT-3A).

MAW. 436..... Cash price **£45 0 0** carriage free or deposit 120/- and 8 monthly payments 120/-.

Please note: Spare parts are available for Cessna 210, Frontier 1 and Spitfire.

## ACCESSORIES

**MICRO PLUG & SOCKET (SP-7)**. 7 pin. Not illustrated.

RCW. 233..... Cash price **7/11** postage 1/-.

**MICRO PLUG & SOCKET (SP-3)**. 3 pin. Not illustrated.

RCW. 234..... Cash price **5/3** postage 8d.

**WIRING HARNESS FOR F4-LR RECEIVER (LR-BSS)**. Not illustrated.

RCW. 232..... Cash price **18/11** postage 6d.

**AERIAL FOR TxFT-3A**. Not illustrated.

RCW. 224..... Cash price **21/-** postage 8d.

**4 BATTERY BOX FOR TWO PENCELLS (BB2)**.

RCW. 225..... Cash price **4/-** postage 4d.

**5 BATTERY BOX FOR THREE PENCELLS (BB3)**.

RCW. 226..... Cash price **5/6** postage 4d.

**6 BATTERY BOX FOR FOUR PENCELLS (BB4)**.

RCW. 227..... Cash price **6/9** postage 4d.

**RELAY 9 VOLT, 400 OHM.**

RCW. 228..... Cash price **22/6** postage 1/6





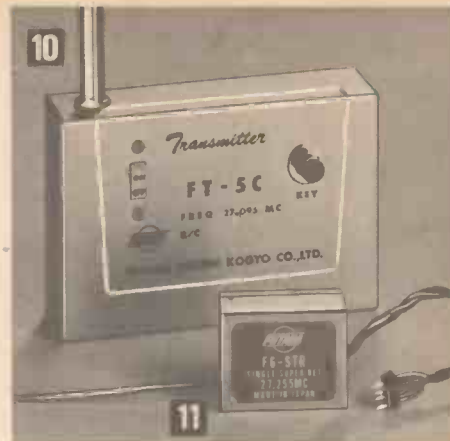
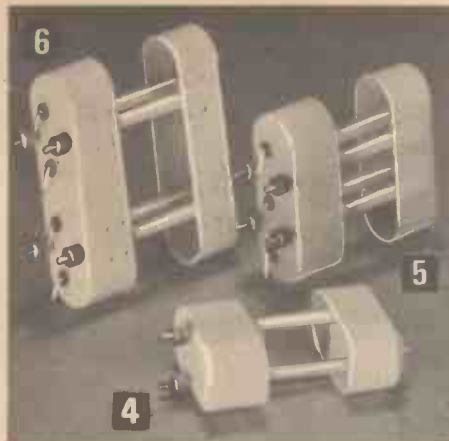

# equipment BY FUTABA

**7 FT-3A TRANSMITTER.** S/C Tone, tuned 27 Mc/s crystal, 12 volt working (dry batteries), 150 m.w. output. Good range, suitable for most receivers (except Superhet).

**RCW. 201.**.....Cash price **165/-** carriage free or deposit 22/- and 8 monthly payments 22/-.

**8 F4-LR RECEIVER.** Relayless type, 3 volt working for most escapements (ML-2A ideal), 3 pin Plug and Socket included. Smaller than a Matchbox. Use Transmitter FT-3A with this Receiver.

**RCW. 211.**.....Cash price **159/6** carriage free or deposit 23/6 and 8 monthly payments 21/-.

**9 F3-27R RECEIVER.** With relay (to work with FR-3B high speed servo and/or FE-3B engine control servo), 9 volt operation. Very reliable. When used with FT-3A Transmitter, 700 yd. range. With FT-5C Transmitter, 1200 yds. range. Matchbox size. As above.

**RCW. 214.**.....Cash price **165/-** carriage free or deposit 22/- and 8 monthly payments 22/-.

**10 FT-5C SUPERHET TRANSMITTER.** S/C Tone available on 7 spot frequencies. Out of sight range, when used with F6-STR Rx. 10 m.w. output. Tone frequency 600 cp/s, 12 volt working.

**RCW. 203.**.....Cash price **£15 15 0** carriage free or deposit 50/- and 8 monthly payments 41/-.

**11 F6-STR SUPERHET RELAY RECEIVER.** 9 volt working to operate with FR-3B servo and/or FE-3B engine servo. Available on 7 spot frequencies. Matchbox size. For use with FT-5C Tx and usually sold in matched Rx and Tx.

**RCW. 213.**.....Cash price **£13 12 6** carriage free or deposit 35/- and 8 monthly payments 36/6.

**12 FT-5E SUPERHET STICK TYPE TRANSMITTER.** 12 volt working. Out of sight range. Has unique directional stick control, 'Quick Blip' button. Has output meter which indicates battery strength. De Luxe.

**RCW. 215.**.....Cash price **£22 5 0** carriage free or deposit 58/- and 8 monthly payments 59/6.

**13 ML-2A COMPOUND RUBBER ESCAPEMENT.** For use with F4-LR Rx. Gives selective Rudder Control for aircraft only.

**RCW. 231.**.....Cash price **45/-** postage 6d or deposit 6/- plus postage and 8 monthly payments 6/-.

**ME-2S COMPOUND RUBBER ESCAPEMENT.** For engine control. Will work in conjunction with other servos and escapements. Not illustrated.

**RCW. 230.**.....Cash price **45/-** postage 6d or deposit 6/- plus postage and 8 monthly payments 6/-.

**14 FR-3B HIGH SPEED SERVO** (for relay Rx only). Low drain gives reliable left and right rudder control. For Aircraft and Boats. Provision for Third Control in conjunction with FE-3B or ME-2S. Recommended for use with Rx F6-STR or F3-27R.

**RCW. 221.**.....Cash price **108/-** carriage free or deposit 13/6 and 8 monthly payments 14/6.

**15 FE-3B ENGINE CONTROL SERVO.** Low drain, must be used with Rudder Servos to give selective 'Slow' and 'Fast' on 'Quick Blip' signal.

**RCW. 223.**.....Cash price **76/9** postage 8d or deposit 12/- plus postage and 8 monthly payments 10/-.



# hobbies

# Metz

## the quality name in radio control

Made in West Germany.

**1 R/C GIFT SET (191/13).** Complete (except for batteries) and ready wired. Gives selective Rudder Control or if used for Boats will give progressive Rudder Control. Range 1,000 yd. Simple to install. Needs no radio knowledge to work. 6 volt Deac required for Receiver. 2 U2 cells for Transmitter.

RCW. 351.....Cash price **£37 16 6** carriage free

**2 METZ 3 CHANNEL SYSTEM (Tx 192/1, Rx 192/2SL, Servo 195/3 and Servo 190/1ST).** Complete outfit, ready wired, giving selective Rudder Control (Joystick) and progressive Engine Control (Button). This unit has absolute reliability and will last a lifetime. Can be built up to 5 Channel by 'Plug-in' units. One 6 volt Deac for Rx and Servos, 4 U2 cells for Transmitter are extra. Note this unit is completely electronic, with tuned filters and transistor switches. (No relays).

RCW. 312.....Cash price **£59 9 0** carriage free

**3 METZ 10/6 CHANNEL.** Tuned filter Superhet (5 frequencies). This unit has proved itself over the last four years to be the most sophisticated and reliable of its type. Completely electronic throughout. The unit is tri-simultaneous and has 'easy-to-fly' Pilot Sticks for the Main Controls and four Buttons for Trim Controls. Features 'Plug-in' crystals for ease of frequency change. Ready wired.

Tx 195/1, Rx 195/2, Servos (3) 195/3=6 Channel.

RCW. 359...Cash price **£118 19 6** carriage free

Tx 195/1, Rx 195/2, Adaptor 195/4, Servos (5) 195/3=10 Channel.

RCW. 360...Cash price **£149 7 6** carriage free

### METZ MECATRON DIGIPROP SYSTEM

The new Metz Digiprop System is a sensational and outstanding development and a top-level pro-



duct in respect of technology, functioning and value for your money. Unbeatably small, light and inexpensive basic set-up (Transmitter: 6 channels; Receiver: 2 channels).

Novel, simple extension of the transmitter with two electronic plug-in units (4 channels each). Sensational: Receiver made up of Superhet unit and up to 7 fully identical and interchangeable Duo Amplifier Stages (2 channels each).

With this truly proportional R/C with 14 channels working on the digital principle the servos follow the movement of the joystick uniformly. And yet further exclusive advantages: Extremely selective receiver due to the piezo-electric fixed frequency filters; simple extension due to the self-arresting safety plug-in connection of the Duo Controllers; simultaneous operation of up to 12 systems on the 12 standard frequencies; lightning-fast replacement of control crystals. Due to the truly functional design the transmitter is easy to hold.

Please refer to the Metz Mecatron Leaflet for exact technical data.

**4 MECATRON DIGIPROP TRANSMITTER (196/1).** Basic unit equipped with 6 channels.

RCW. 337...Cash price **£73 15 0** carriage free

**5 MECATRON DIGIPROP SUPERHET RECEIVER (196/2).**

RCW. 338...Cash price **£29 19 0** carriage free

**6 FAIL-SAFE ATTACHMENT (196-8).** (Optional use).

RCW. 345..... Available soon, price on request.

**7 MECATRON DIGIPROP DUO AMPLIFIER STAGE (196/3).**

RCW. 339.....Cash price **£17 0 6** carriage free

**8 DIGIPROP SERVO (196/4).**

RCW. 340.....Cash price **117/-** carriage free



★ **SEGMENT FOR AILERON DRIVE (196/40).** Including mounting for direct fitting of servo 196/4.

RCW. 341.....Cash price **22/6** postage 6d.

★ **TRANSMITTER EXTENSION STAGE 1 (196/6).** For 4 channels with cross controller (two-way trimming), neutralising in one plane and stable in other.

RCW. 342.....Cash price **272/6** carriage free

★ **TRANSMITTER EXTENSION STAGE 11 (196/5).** For 4 channels with two-way stick.

RCW. 343.....Cash price **272/6** carriage free

★ **INDICATING INSTRUMENT (196/7).** For transmitter for supervision of battery voltage.

RCW. 344.....Cash price **89/-** postage 1/-

★ **SPECIAL CONNECTING CABLE (196/9).** For engine throttle servo in conjunction with fail-safe attachment.

RCW. 346..... Available soon, price on request.

★ **TWELVE DIFFERENT TRANSMITTER CRYSTALS (196/21-32).** For MECATRON Digiprop system, Channels 2, 4, 9, 12, 14, 17, 19, 22, 24, 27 and 30 of the standard 10 kc/s frequency screen in the 27 Mc/s band.

RCW. 341.....Cash price **49/-** (each) postage 6d.

★ **TWELVE DIFFERENT RECEIVER CRYSTALS (196/41-52).**

RCW. 348.....Cash price **49/-** (each) postage 6d.

★ Not illustrated.

H.P. Facilities are available for equipment over £25. Details on application to: Sales Division, Hobbies Limited, Dereham, Norfolk.

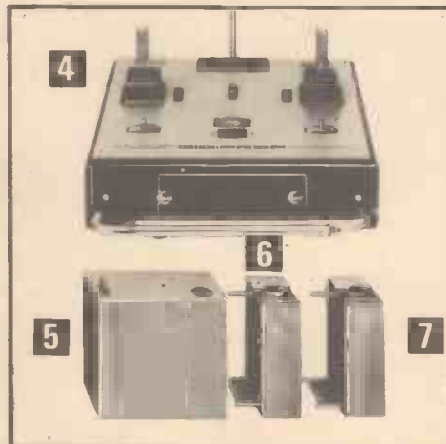



# ELGI radio control equipment

1



2



3



4



## ELGI R/C UNITS

These are short range (400 yd.) equipment. Made specially for Model Boats and Cars, etc. **NOT SUITABLE FOR AIRCRAFT.** Made in Italy.

**1 SINGLE CHANNEL SUPEREGEN TONE (302).** Complete Unit. Needs no wiring, and is pre-tuned. Transmitter, Receiver, Servo, Battery Box, Switch and Wiring. Batteries not included.

RCW. 416. . . . . Cash price **269/9** carriage free or deposit 39/6 and 8 monthly payments 35/6.

**2 TWO CHANNEL TUNED FILTER SUPEREGEN (301).** Specification as above. Complete.

RCW. 415. . . . . Cash price **£18 12 6** carriage free or deposit 49/6 and 8 monthly payments 49/6.

**THREE CHANNEL TUNED FILTER SUPEREGEN (304).** Complete with Transmitter, Receiver, Servo, Battery Box, Switch and Wiring. Ready to go. Batteries not included. Not Illustrated.

RCW. 414. . . . . Cash price **£22 6 3** carriage free or deposit 59/6 and 8 monthly payments 59/6.

**ELGI CAR KITS**—To make up into the model Ferrari illustrated in colour on page 74.

**3 FERRARI BERLINETTA 250 LE MANS (401).** De Luxe plastic construction kit. 1/12 scale. 13½ in. long. Contains all parts including spoked chrome wheels and many chrome parts. Suitable for radio control as above. Note: kit does not contain motor. Made in Italy.

RCW. 256. . . . . Cash price **135/3** carriage free or deposit 18/- and 8 monthly payments 18/-.

**4 FERRARI COMPLEMENTARY RADIO-CONTROL KIT.** Specifically designed for motoring and radio-controlling the above kit. Includes special suppressed electric motor, completely built receiver, transmitter. Complete with all wiring. Made in Italy.

RCW. 257. . . . . Cash price **£18 12 6** carriage free or deposit 51/- and 8 monthly payments 49/6.

# the future scientist



1

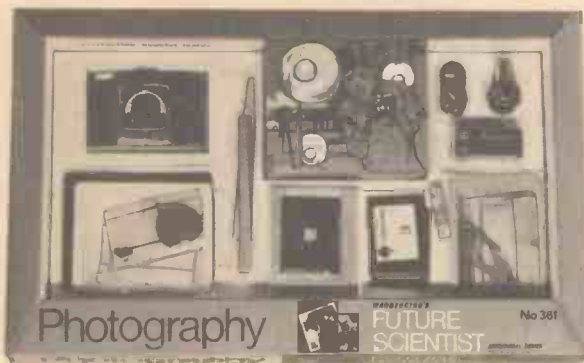

2



3



4



5



6

'Future Scientist' introduce a range of kits in the fields of Photography, Radio Engineering and Propulsion. Every effort is made to introduce science and physics as a fascinating hobby. Simple-to-follow instructions make these sets 'Ready-to-Assemble' working models that will bring fun and pleasure to the home.

**1 'RADIO-ELECTRONICS' SET (343).** Here is a more advanced kit for young radio enthusiasts. When erected it forms a most realistic inclined control panel, to which many components are fitted. The panel can be wired up in several ways to give germanium and transistor radio receivers, amplifiers and minipower transmitters. The kit includes a Solar cell which turns daylight or artificial light into electricity-sufficient to energise the circuit. Complete with battery and well written Instruction manual.

**YSW. 238.** ..... Cash price **72/9** carriage 4/6 or deposit 11/- plus carriage and 8 monthly payments 9/6.

**2 'PHOTOGRAPHY' SET (361).** All the equipment and materials necessary for the amateur photographer to take, develop and print his own

photographs, are available in this kit. The camera has a focusing ring for distance setting, instantaneous or time shutter releases and special aperture settings. Trays for developing and printing are provided together with the necessary chemicals, thermometer, printing masks, frame, etc. etc. Detailed instructions leaflet also provided. Complete with a roll of 120 film, for your first 16 pictures.

**YSW. 231.** ..... Cash price **54/6** carriage 4/6 or deposit 9/- plus carriage and 8 monthly payments 7/-.

**3 'PHOTOGRAPHY' SET (261).** This kit is ideal for someone who already owns a camera. It contains all the materials and chemicals necessary for equipping a darkroom and for developing and printing negatives.

**YSW. 232.** ..... Cash price **30/6** carriage 3/-

**4 'PROPULSION' SET (36).** This battery operated racing car and steam jet propelled boat can be assembled by children, who will learn, at the same time, something of the principles of propulsion and energy.

**YSW. 235.** ..... Cash price **15/7** postage 1/6

**5 'PERSONAL RADIO' SET (41).** Here is a pocket size radio kit that can be assembled in 5 minutes. The radio will provide good standard broadcast band reception, and will give hours of listening fun. Fitted within a playing card packet, it comes complete with battery, earphone, and full assembly instructions.

**YSW. 236.** ..... Cash price **41/6** postage 1/6 or deposit 6/- plus carriage and 8 monthly payments 5/6.

**6 'AUTORADIO' SET (243).** A detailed model car can be assembled from plastic parts and then fitted with a working transistorized radio. The radio is pre-assembled and receives standard broadcast band stations. Complete with battery, earphone and instructions.

**YSW. 237.** ..... Cash price **52/3** carriage 3/- or deposit 7/- plus carriage and 8 monthly payments 7/-.

## hobbies





# the future scientist

The Canadian 'Future Scientist Kits' have built up an international reputation in the past few years and are now available for the first time, in this country. This is a very timely debut in view of the increasing interest in Science. These kits have been extensively tested and will give full value and educational satisfaction to their users. They contain full explanatory manuals, easy to handle components and are attractively presented.

**1 THE 'MICROSCIENCE' KIT (21).** A beginners set which includes an easily assembled, single objective microscope, magnification 150x. Also included are glass slides, glass tubes, etc., together with Brine Shrimp eggs and Shrimp food for experiments.

**YSW. 171.....** Cash price 28/6 postage 1/6

**2 THE 'MICROSCIENCE' KIT (221).** A similar set for beginners, but with additional instruments, test tubes and liquid tray. A specially written manual of instructions will give hours of pleasure. Included are all ingredients for hatching, rearing and observing Brine Shrimps.

**YSW. 172.....** Cash price 33/- carriage 3/-

**3 THE 'MICROSCIENCE' KIT (222).** Contains a 3-turret microscope with 3 magnifications 100x—200x—300x. With this set the young scientist can study, in great detail, biological specimens, coins, stamps, natural and synthetic fibres and a host of other fascinating objects.

**YSW. 173.....** Cash price 40/11 carriage 3/- or deposit 8/6 plus carriage and 8 monthly payments 5/-.

**4 THE 'MICROSCIENCE' KIT (322).** A full size precision-built triple-lens microscope with magnifications 100x—200x—300x brings this set into the Senior Student Class. There is a full range of dis-



8 MONTHLY  
PAYMENTS OF  
**9/6**

secting tools, equipment for making micro-slides, a bee specimen for immediate dissection and Brine Shrimp eggs for the study of living creatures. Full instruction manual provided.

**YSW. 174.....** Cash price 71/9 carriage 4/6 or deposit 10/6 plus carriage and 8 monthly payments 9/6.

Newest hobbies Innovation for 1968 are 3-D Scenic Kits, the kits that 'come alive'. Beautifully presented, brimful of authentic detailed parts and full construction materials, experience the pleasure of building-up, painting and then displaying a novel and unique living picture.

**5 3-D SCENIC KIT 'SEA LAB'.**

Full colour background depicting underwater sea life. Authentic 6" Scuba diver, 6" sea-tow, 9" mako shark, green sea turtle, moray eel and various coral

reef life, sea grunt, angel fish, rock with hole, etc. Simulated wood frame 12" x 19". A plastic kit with fully sculptured vacuum-formed base, paints, brush, glue and full instructions. Attractive full colour sealed package. Made in Canada.

**YS. 177.....** Cash price 38/11 carriage 4/6

**6 3-D SCENIC KIT 'MOON SURVEY'.**

Authentic with full colour curved background—simulated wood frame 12" x 19". A plastic kit with fully sculptured vacuum-formed base, robot controlled 'Moon Beetle' with movable arms and T.V. Camera. Senior Astronaut with Survey Scope, 6" tall. Junior Astronaut with Radar Antenna, 6" tall. Paints, brush and glue included. Instruction book. Attractive full colour sealed package. Made in Canada.

**YS. 178.....** Cash price 38/11 carriage 4/6





# the future scientist and chemist

Chemistry is one of the oldest of the sciences but is also one of the most modern. Thousands of everyday articles we see and use, the food we eat and the clothes we wear, all have been created with the aid of the science of Chemistry. These kits will give a good understanding of the subject and a lot of fun completing the experiments.



**1 'CHEMISTRY' SET (311).** Another of the 'Future Scientist' series. The kit contains a wide selection of chemicals and top quality equipment necessary for a first-class chemical laboratory. Materials and experiments have been selected with a special regard to safety. In the instruction booklet there is also a special section on chemical magic.

**YSW. 201**..... Cash price **40/3** carriage 4/6 or deposit 8/6 plus carriage and 8 monthly payments 5/-.

**2 'CHEMISTRY' SET (W13)** by KAY. An excellent low priced beginner's set containing a bunsen burner, rubber tubing, flask, a good supply of chemicals, test tubes, filter funnel, paraffin burner etc., together with book of instructions.

**YSW. 211**..... Cash price **22/6** carriage 3/-

**3 'CHEMISTRY' SET (W14)** by KAY. Contains an ample supply of chemicals, paraffin and bunsen burners, flask, test tube holder, brush, pipette, asbestos, tube stand, funnel and glass tubing etc. A new book of instructions and experiments completes the set.

**YSW. 212**..... Cash price **32/6** carriage 4/6

**4 'CHEMISTRY' SET (W15)** by KAY. A very popular set containing the new detachable sloping rack for tubes of chemicals. Contents also include test tubes, brush, holder, stand, tripod, gauze, U-tube, pipette, paraffin and bunsen burners, flask, funnel, filter papers. Full instructions given.

**YSW. 213**..... Cash price **50/-** carriage 4/6 or deposit 8/- plus carriage and 8 monthly payments 6/6.

**5 'CHEMISTRY' SET (W16)** by KAY. This fine set includes the popular and new style test tube rack, flasks, test tubes, bunsen burner and tubing. In addition it includes a 'U' tube, pipette, brush, holder, filter papers, tripod and gauze. A splendid new book of Instructions has been specially written by a science master.

**YSW. 214**..... Cash price **79/11** carriage 4/6 or deposit 12/- plus carriage and 8 monthly payments 10/6.

To add to our range of scientific and mechanical engineering hobby kits, we introduce a range of 'Magnetricity' Kits. These kits explore the marvels and mysteries of Magnetism and Electricity. Completely safe, for all electric power needed can be supplied by a small 4.5 volt pocket battery.

**6 'MAGNET-TRICITY' SET (W9)** by KAY. An advanced set which includes all the previously mentioned items plus electric motor, pliers, clips, electromagnet, galvanometer, copper, aluminium and carbon rods, soft iron core, solenoid, etc., etc. A comprehensive manual of experiments, written by an experienced Science Master, is included. Battery extra.

**YSW. 183**..... Cash price **95/-** carriage 4/6 or deposit 14/- plus carriage and 8 monthly payments 12/6.

**7 'MAGNET-TRICITY' SET (W8)** by KAY. Another fine set for experiments. Full of additional chemicals and apparatus for developing your knowledge of physics. Included are a fire alarm system, elements for making and testing batteries, etc., etc. Instruction book. Battery extra.

**YSW. 182**..... Cash price **59/11** carriage 4/6 or deposit 8/- plus carriage and 8 monthly payments 8/-.

**8 'MAGNET-TRICITY' SET (W7)** by KAY. A beginner's set containing everything necessary to start your experiments in these fields. A powerful magnet, compass, rheostat, morse tapper, electrodes and tubes of chemicals. A 48 page book of explanations and experiments is included. Battery extra.

**YSW. 181**..... Cash price **37/6** carriage 3/-







3

8 MONTHLY  
PAYMENTS OF  
**13/-**

# the young micro-biologist

*Hobbies introduce a range of compact, strong, accurately engineered microscopes with rack focusing for sharp definition. Black lacquered and plated. Good optical systems which show cells, cell structure and cell division. Easy tilting for comfortable working. Not a toy, but a precision instrument suitable for the amateur botanist, entomologist, biologist, chemist and science student. Full instructions with each instrument.*

*These microscopes of Japanese origin, have been fully tested by a laboratory expert, and are claimed to be superior to similar types on the market. Presented in a high quality box with red 'velvet' insets.*



**1 'HOBBIES MICROSCOPE' (3)** with 3-objective turret. Magnifications 100 x, 200 x, 300 x. Illumination by plane mirror alone or in conjunction with built-in batteries. Handy switch in base. Height 8 3/8 ins. Base 4 1/2 ins. x 2 1/2 ins. Stage 2 3/4 ins. square. Complete with specimen slide and spare slides. Batteries are not included.

**YSW. 122**..... Cash price **75/-** carriage 3/- or deposit 10/- plus carriage and 8 monthly payments 10/-.

**2 'HOBBIES MICROSCOPE' (2)** with a swivelling 3-objective turret. Magnifications 50 x, 100 x, 200 x. Illumination by plane mirror. Height 6 1/2 ins. Base 2 3/4 ins. x 3 3/4 ins. square. Complete with specimen slide and spare slides.

**YSW. 121**..... Cash price **47/6** carriage 3/- or deposit 5/- plus carriage and 8 monthly payments 6/6.

**3 'HOBBIES MICROSCOPE' (4)** with 3-objective turret. Magnifications 150 x, 300 x, 750 x. Illumination by plane mirror or built-in batteries. Reversal of the mirror automatically switches on powerful spotlight. Height 8 3/8 ins. Base 4 1/2 ins. x 2 1/2 ins. Stage 2 3/4 ins. square. Complete with specimen slide and spare slides. Batteries extra.

**YSW. 123**..... Cash price **95/-** carriage 4/6 or deposit 10/- plus carriage and 8 monthly payments 13/-.

**4 MICROSCOPY SLIDES by N.B.S.**

*Commence using your microscope right away with these specially selected sets of slides. They bring you a new vision of things invisible to the naked eye. A fascinating and absorbing study. Each set is packed neatly in a box with grooved mounts.*

**SETS OF TWELVE SLIDES**

**GENERAL MICROSCOPY SET 12/A/One.** Containing twelve different slides of insects, algae, fibres, etc.

**YSW. 131**..... Cash price **18/6** postage 8d.

**INSECT PARTS SET 12/B/Three.** Contains twelve different slides of insect parts.

**YSW. 132**..... Cash price **12/6** postage 8d.

**RAT HISTOLOGY SET 12/H.** Twelve different slides showing smears from different parts of the body.

**YSW. 133**..... Cash price **15/-** postage 8d.

**SETS OF SIX SLIDES**

A selection of sets each containing six different slides packed in a box with grooved mounts. Cash price 12/6 each, postage 8d. each.

- YSW. 134 MARINE ORGANISMS (SET 6/K)**
- YSW. 135 FRESHWATER ORGANISMS (SET 6/L)**
- YSW. 136 FRESHWATER ALGAE (SET 6/M)**
- YSW. 137 DIATOMS Strewn Slides (SET 6/Q)**
- YSW. 138 BIOLOGY—including Volvox, Spirogyra, Wool, Plankton, Hydra, Navicula. (SET 6/V)**

Send for our FREE catalogue of MICROSLIDES, MICROSLIDE SETS, MICROSCOPICAL REAGENTS AND APPARATUS. Postage 4d.

Freshwater Algae  
Textile Fibres and Starch Mounts  
Anthropod Parts  
Non Aquatic Insects  
Pond and Stream Life  
Botanical Slides

Marine Life  
Spiders  
Diatom Mounts

# PHILIPS young engineer

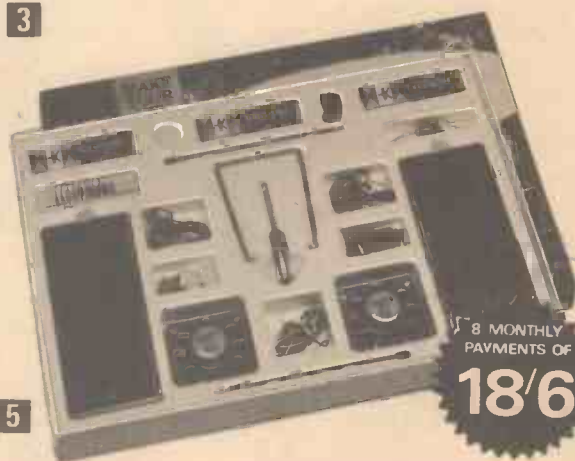
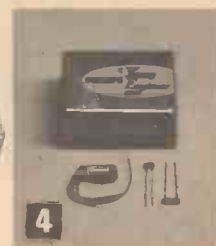
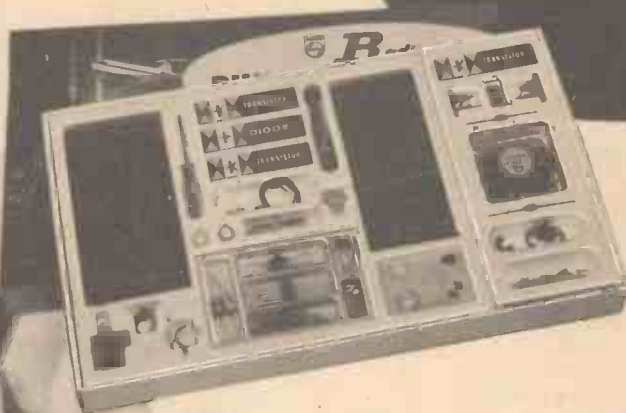
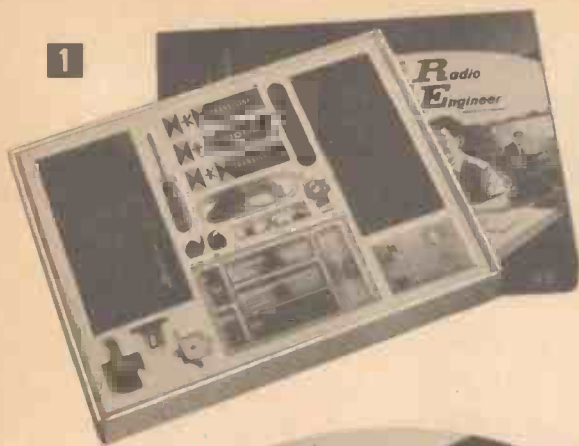

8 MONTHLY  
PAYMENTS OF  
**18/6**

## 'THE YOUNG ENGINEER'

The World of Radio Engineering & Telephony.

Here is a range of superb Radio Engineering Kits, that enable boys aged 10 to 16, without any previous electrical experience, to make efficient radios. A 3 colour instruction manual explains how radio works as well as giving full assembly instructions. Completely safe as they are battery operated and there is no 'Mains' connection.

**1** 'RADIO ENGINEER' SET (RE.1) by PHILIPS. All you need to build an efficient 2 transistor, medium wave radio. Complete with its own earphone and stylish cabinet. Battery (not included) is a 9 volt Vidor (VT 7) or Ever Ready (PP 7).

YSW. 105..... Cash price **113/-** carriage free or deposit 15/6 and 8 monthly payments 15/-.

**2** 'RADIO ENGINEER' SET (RE.1A) by PHILIPS. An 'add-to' set that builds up your first set (RE.1) from a 2 transistor set to the 3 transistor medium wave set (RE.2) with its own loudspeaker. Can only be used in conjunction with the (RE.1) set and not alone.

YSW. 106..... Cash price **39/6** postage 1/2.

**3** 'RADIO ENGINEER' SET (RE.2) by PHILIPS. With this kit you have the advantage of loudspeaker listening. With a full 3 transistor assembly, this set gives you a bigger selection of medium wave stations and a variety of experiments you can carry out. The only extra needed is a 9 volt battery.

YSW. 107..... Cash price **144/-** carriage free or deposit 19/- and 8 monthly payments 18/-.

**4** 'RADIO ENGINEER' LONG WAVE CONVERSION KIT (YE. 1000) by PHILIPS. A special kit to convert your sets from medium wave to long wave reception (not switchable).

YSW. 108..... Cash price **10/9** postage 6d.

## ANOTHER NEW ADDITION TO THE RANGE!

The Interphone Engineer Kit.

It's new—it's fun—this handsomely styled Intercom set. Designed for boys aged 10 to 16, it is ideal for sending messages from one room to another. The manual supplied gives easy-to-follow instructions for building this high quality and powerful intercom set, that also doubles as a home or office phone or baby alarm.

**5** 'INTERPHONE ENGINEER' SET (IE. 2000) by PHILIPS. This powerful transistorised set comes complete with all components for two receiver/transmitter sets, complete with loudspeakers, dummy aeriols, etc. Extras required are 4 Ever Ready (U. 7) batteries.

YSW. 109..... Cash price **139/6** carriage free or deposit 19/6 and 8 monthly payments 18/6.



6



7



8

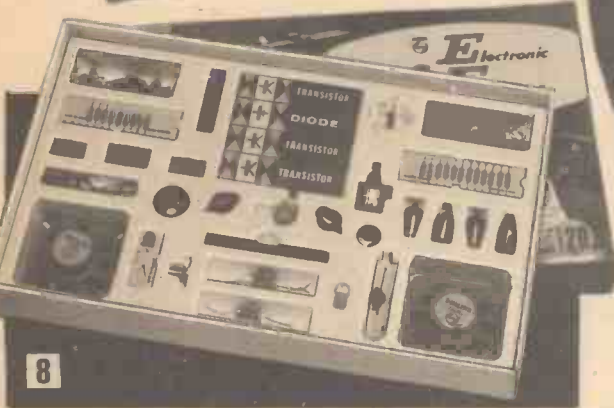

8 MONTHLY  
PAYMENTS OF  
**27/-**



The World of **Electronics** and **Mechanical Engineering**.

*Electronics provide the key to the world of tomorrow. NOW even if you have no electrical knowledge at all—your family and friends will be surprised how quickly you learn about circuits and how to make them work.*

*Absolutely safe because there's no connection to mains. No previous electrical experience needed.*

*No soldering or special tools required—just a small screwdriver and penknife.*

*Constructive, instructive, fascinating—super.*

**6 'ELECTRONIC ENGINEER' SET (EE. 8)** by PHILIPS. The beginner's basic kit that makes 8 working models. These include two radio receivers burglar alarm, automatic night light, etc., etc. The 72 page instruction book gives detailed working plans and the theory that makes these models function. Operates off two Ever Ready 1289 batteries (not included).

**YSW. 101**.....Cash price **109/6** carriage free or deposit 15/6 and 8 monthly payments 14/6.

**7 'ELECTRONIC ENGINEER' SET (A. 20)** by PHILIPS. The supplementary kit that expands the basic kit (EE. 8) with a further 13 working models. It takes the beginner to more advanced yet simply described, practical circuits and plans. This (A. 20) set cannot be used by itself but only in conjunction with the basic (EE. 8) set.

**YSW. 102**.....Cash price **72/6** carriage 3/- or deposit 11/- plus carriage and 8 monthly payments 9/6.

**8 'ELECTRONIC ENGINEER' SET (EE. 20)** by PHILIPS. **NEW.** This great new kit—equivalent to the (EE. 8) set and (A. 20) set combined, contains all you need, complete in a single box, to make no less than 21 thrilling models. The only extras needed are a screwdriver, a penknife and two 1289 batteries.

**YSW. 103**.....Cash price **175/6** carriage free or deposit 26/6 and 8 monthly payments 23/-.

**AND NOW A COMPLETELY NEW ADDITION TO THIS RANGE—THE 'POWERED' MECHANICAL ENGINEER KIT.**

This kit teaches the principles of mechanics and the use of 5 different kinds of 'Power'.

The high-precision electric motor provided, powers many exciting models.

Electricity (9 volt battery) powers several electric cars, tractors, cranes, etc.

Spring tension and gravity is the motive force behind 5 more models.

Compressed air, as from a bicycle inner tube, has been used to drive 3 models.

Water pressure provides the force to turn a miniature turbine.

**9 'MECHANICAL ENGINEER' SET (ME. 1200)** by PHILIPS. Designed for boys between the ages of 11 and 17. It is a kit with over 600 components enabling you to make as many mechanical constructions as you like. The instruction book not only teaches about mechanics but gives simply detailed instructions for more than 41 models and at least 70 assemblies. Complete in a stout wooden box with specially moulded interior container.

**YSW. 104**.....Cash price **£10 3 6** carriage free or deposit 28/- and 8 monthly payments 27/-.

# PHILIPS young engineer kits

1



2

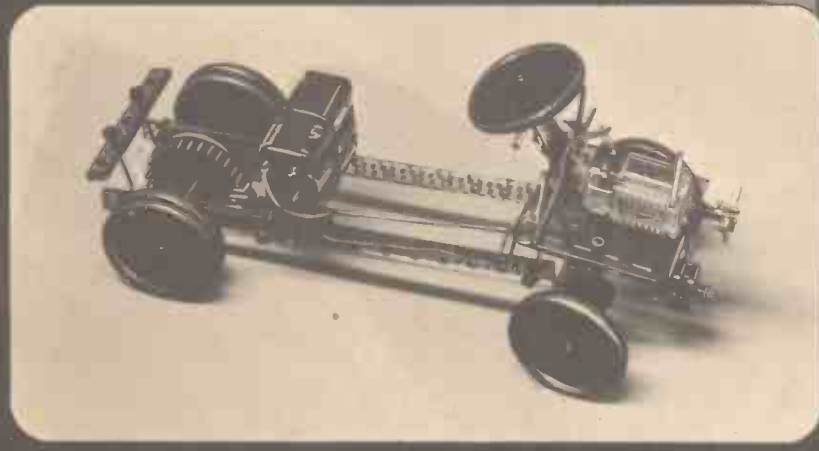

**1 RADIO ENGINEER SET (RE.1108). FOR BOYS AGED 10 AND OVER.** A two-waveband transistor Radio with full 3 transistor assembly, this receiver gives a large selection of medium and longwave stations. Putting it together will bring loads of fun and knowledge about the techniques of radio engineering. Complete with simple instructions. The only extras needed are batteries.

**YSW. 110.....** Cash price **155/-** carriage free or deposit 22/- and 8 monthly payments 20/6.

**2 MECHANICAL ENGINEER KIT (ME.1201). FOR BOYS AGED 11 AND OVER.** Uses simple basic materials—collets, springs, clamps, pins, plates and wheels. Plans for 25 working models including cars, trucks, cranes and windmills. Batteries extra.

**YSW. 111.....** Cash price **139/6** carriage free or deposit 18/- and 8 monthly payments 20/-.

**SPARE PARTS SERVICE**

All Philips spares are available at Hobbies Limited shops, stockists or direct from Hobbies Limited, Dereham, Norfolk. When ordering by post, please indicate Number, Colour and any other relevant details. Spares lists with prices are available on request.

**hobbies**





8 MONTHLY  
PAYMENTS OF  
**12/-**

# the constructional engineer

BY MECCANO

*MECCANO—the oldest and best known of all construction kits—is as popular today as it was in Grandad's day.*

*But with a difference—for Meccano has progressed with the times. Great new 'theme sets' set the scene, in a series of special kits, for hundreds of working models.*

**1 THE 'HIGHWAY VEHICLES' SET (3).** Build motorways complete with bridges, cafes, filling stations. Race along them with sports cars, lorries, tankers. Lots of other working models—mobile crane, fork-lift truck, tank, gunboat, etc. Full instructions are included for 56 working models and you will be able to make many others yourself.  
**YS. 261.**..... Cash price **43/-** carriage 4/6 or deposit 7/6 plus carriage and 8 monthly payments 5/6.

**2 THE 'AIRPORT SERVICE' SET (4).** Make your own airport. Build a monoplane, observer plane, helicopter. A petrol tank for refuelling. A saloon car, jeep, mobile crane, etc. Instructions for 72 working models.  
**YS. 262.**..... Cash price **67/9** carriage 4/6 or deposit 9/- plus carriage and 8 monthly payments 9/-.

**3 THE 'SITE ENGINEER'S' SET (5).** You're all set for building skyscrapers, office blocks, etc., with the tipper, builder's crane, excavator, and shooting brake. Plus fire engine, power press, fork-lift truck, etc. Instructions for 88 working models.  
**YS. 263.**..... Cash price **91/6** carriage 6/- or deposit 14/- plus carriage and 8 monthly payments 12/-.

**4 THE 'OCEAN TERMINAL' SET (6).** Build a busy dockside scene. Set sail in an aircraft carrier, complete with helicopter. Shunt freight with a dockyard loco. Load goods on to ships with a dockside crane. Instructions for 104 working models.  
**YS. 264.**..... Cash price **112/-** carriage free or deposit 14/6 and 8 monthly payments 15/-.

**5 THE 'MOUNTAIN ENGINEER'S' SET (7).** Build a funicular railway and cable car. A helicopter for rescue work. An estate car to carry equipment. Minibus and single deck bus to carry the men and many other exciting models. Instructions for 120 working models.  
**YS. 265.**..... Cash price **153/-** carriage free or deposit 19/6 and 8 monthly payments 20/6.

**6 THE 'BREAKDOWN CREW' SET (8).** All the excitement of a derailment—re-created by Meccano. Loco, railway service crane, police patrol car, TV camera, breakdown lorry, elevated platform vehicle and many more true-to-life models. Instructions for 136 working models.  
**YS. 266.**..... Cash price **266/-** carriage free or deposit 35/6 and 8 monthly payments 35/6.

*Plus—Meccano Conversion Kits that give you more scope for bigger and better model making by converting your existing set into the next larger one.*

**7 CONVERSION KIT (3A).** Converts No. 3 set into a No. 4 set.  
**YS. 271.**..... Cash price **29/6** carriage 4/6

**8 CONVERSION KIT (4A).** Converts No. 4 set into a No. 5 set.  
**YS. 272.**..... Cash price **35/-** carriage 4/6



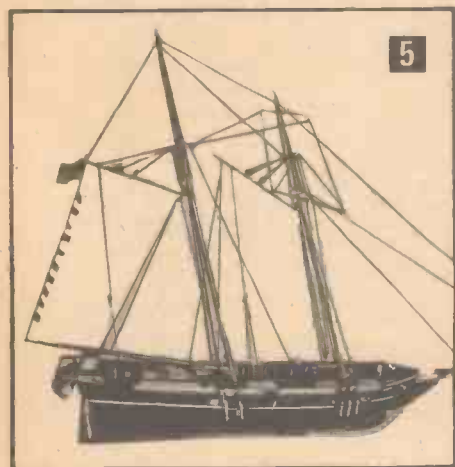
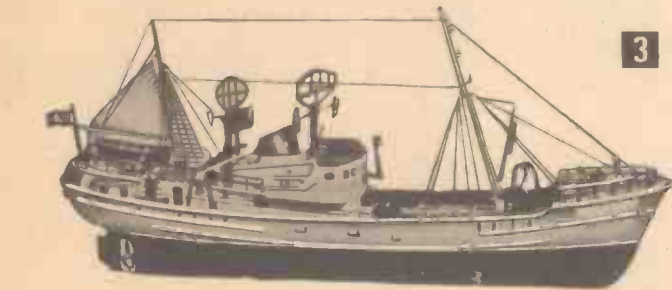
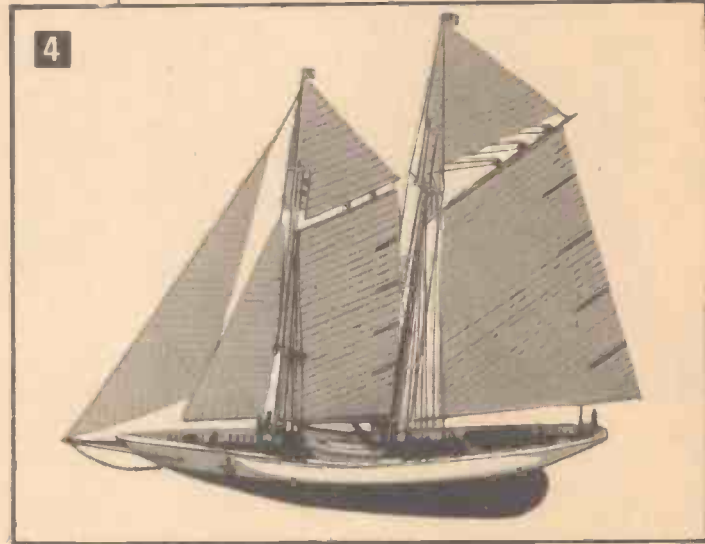
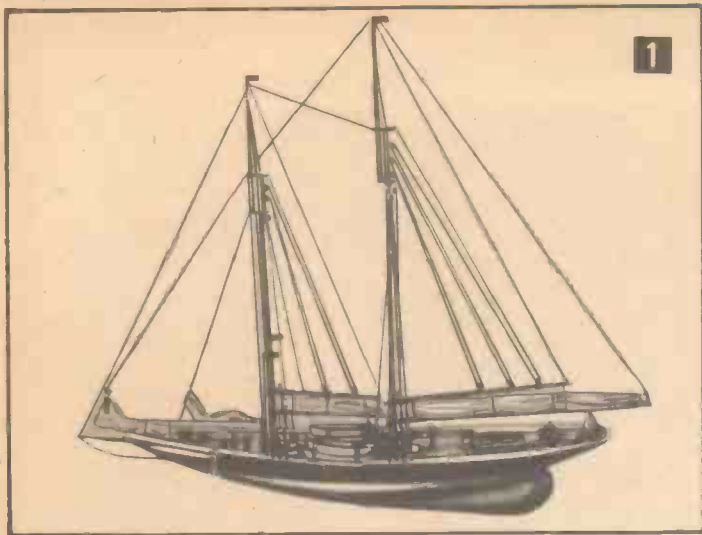

# PYRO collector's famous ships

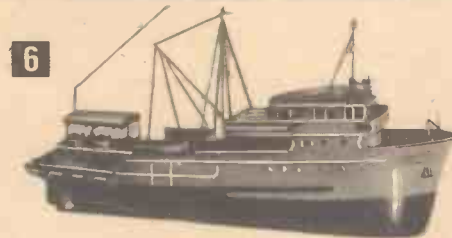

by a.a.hales

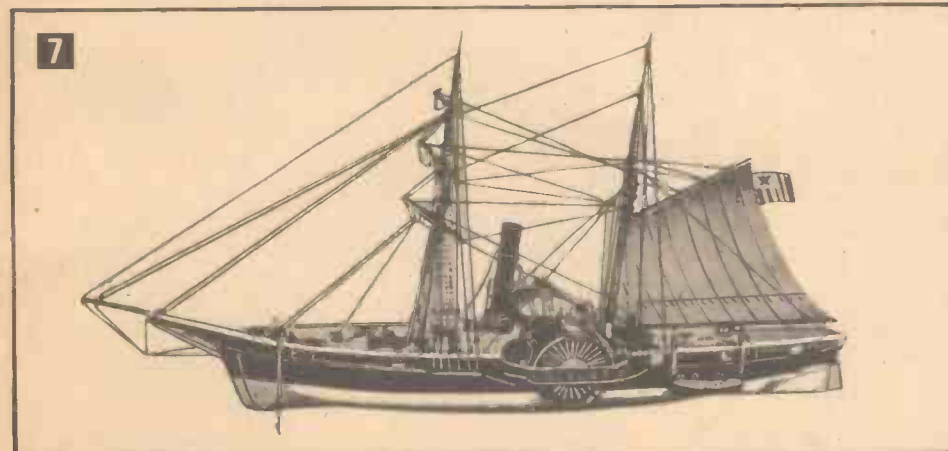

*These fine plastic hobby kits are the last word in perfection. Every detail is carefully moulded to give an exact representation of the real thing, and will give hours of relaxing pleasure to build.*

**EVERY KIT A COLLECTOR'S ITEM.**

Cash price **38/-** each, postage 6/-.

**1** PM.157 FISHING SCHOONER (C206). 'The Gertrude L. Thebaud'. Length 20 in. overall.

**2** PM.158 DIESEL TUG BOAT (C207). 'The Despatch No. 9'. Length 14 in.

**3** PM.159 RUSSIAN FISHING TRAWLER (C247). Length 17 in.

**4** PM.160 AMERICAN CUP RACER (C328). Length 20 in. overall.

**5** PM.161 WAR SCHOONER (C373). 'The Independence'. Length 19 in. overall.

**6** PM.162 JAPANESE FISHING BOAT (C374). Length 15 in.

**7** PM.163 CIVIL WAR BLOCKADE RUNNER (C375). Length 19 in. overall.



# PYRO famous historic firearms

by a.a.hales

These exciting plastic kits are full size replicas of historic pistols and guns, copied exactly from the original museum pieces.

Cash price 12/9 each, carriage 2/6.

- 1 P.M. 168... WESTERN '44' PISTOL (C200)  
14 in. model.
- 2 P.M. 169... 'BUCCANEER' ANTIQUE PISTOL  
(C201) 10½ in. model.
- 3 P.M. 170... 'PRIVATEER' ANTIQUE PISTOL  
(C202) 10½ in. model.
- 4 P.M. 171... 'YORKTOWN' ANTIQUE PISTOL  
(C203) 14 in. model.
- 5 P.M. 172... 'BUNKERHILL' ANTIQUE PISTOL  
(C204) 14 in. model.
- 6 P.M. 173 CIVIL WAR NAVY '36' PISTOL (C208)  
14 in. model.
- 7 P.M. 174... DERRINGER '41' & PEPPERBOX 45  
PISTOLS (C224). Derringer 5½ in. Pepperbox 8½ in.  
models.
- 8 P.M. 175 FRENCH WHEELOCK PISTOL (C225)  
14 in. model.
- 9 P.M. 176 MIQUELET PISTOL (C227) 21 in. model.
- 10 P.M. 177 PAIR OF DUELLING PISTOLS (C229)  
10 in. models.
- 11 P.M. 178. DUTCH FLINTLOCK PISTOL (C230)  
14 in. model.
- 12 P.M. 179. PEACEMAKER '45' PISTOL (C231)  
11 in. model.
- 13 KENTUCKY RIFLE (C195) length 4 ft. 5 in.
- P.M. 180..... Cash price 40/- carriage 6/- or  
deposit 8/3 plus pstg. and 8 monthly payments 5/-.
- 14 WESTERN SADDLE GUN (C197) length 40 in.  
P.M. 181..... Cash price 30/- carriage 6/-.
- 15 BLUNDERBUS (C228) length 18½ in.  
P.M. 182..... Cash price 15/9 carriage 2/6





★**PBK 26.** Fast single seater with shorter cockpit and rockered keel. 14 ft. long, 26 in. Beam, 39 in. Cockpit, draught 4 in. Normal maximum load 400 lb.

**BCW. 108.** .....Cash price **14/-** postage 1/-  
**CANOE (Rigid—plywood skins)**

★**PBK 16.** Flat bottomed two-seater, safe and robust. 16 ft. long, 32 in. Beam, 7 ft. Cockpit, draught 5 in. Normal maximum load 700 lb.

**BCW. 104.** .....Cash price **14/-** postage 1/-

★**PBK 23.** Single seater with V Bottom and hard chine section. Roomy and stable, may be left afloat. 14 ft. 6 in. long, 26 in. Beam, 48 in. Cockpit, draught 4 in. Normal maximum load 400 lb.

**BCW. 106.** .....Cash price **14/-** postage 1/-

**CANOE (Folding)**

★**PBK 24.** A short single seater similar to PBK 10, but with a longer cockpit—packs into one bag. 11 ft. long, 28 in. Beam, 55 in. Cockpit, draught 4 in. Normal maximum load 300 lb.

**BCW. 107.** .....Cash price **14/-** postage 1/-

**DINGHIES**

② **WENSUM,** 11 ft. × 56 in. double chine plywood

## A COMPREHENSIVE SELECTION OF PLANS FOR

All these plans have been designed by P. W. Blandford, Associate of the Royal Institute of Naval Architects, and contain plenty of illustrations, detailed instructions and a complete materials list. Frames, transom, stem and other shaped parts are shown full size.

**CANOE (Rigid—fabric covered)**

★**PBK 10.** The shortest satisfactory canoe, carrying a man and camping kit. 11 ft. long, 28 in. Beam, 48 in. Cockpit, draught 5 in. Normal maximum load 300 lb.

**BCW. 101.** .....Cash price **12/6** postage 10d.

① **PBK 14.** Roomy single for the big man or a two-seater for adult and child. A popular tourer. 14 ft. long, 29 in. Beam, 76 in. Cockpit, draught 5 in. Normal maximum load 500 lb.

**BCW. 102.** .....Cash price **14/-** postage 1/-

★**PBK 15.** Fast touring single seater. Safe and stable. The adult enthusiast's canoe. 14 ft. 6 in. long, 26 in. Beam, 48 in. Cockpit, draught 4 in. Normal maximum load 400 lb.

**BCW. 103.** .....Cash price **14/-** postage 1/-

★**PBK 20.** Stable and seaworthy two-seater, with sufficient beam to carry an efficient sail plan. Very roomy tourer. 15 ft. long, 32 in. Beam, 7 ft. Cockpit, draught 6 in. Normal maximum load 600 lb.

**BCW. 105.** .....Cash price **14/-** postage 1/-

sailing boat. Basic boat is an open dinghy with a gunter rig of about 66 sq. ft. Weight complete approx. 220 lb. {Draught of hull only 6 in., with centre-board down about 30 in. Sailing gear easily removed. Suitable for sailing by crew of two or will carry four for general use.

**BCW. 111.** .....Cash price **17/6** postage 1/2.

③ **GOBLIN.** 9 ft. 10 in. × 54 in., plywood pram dinghy of special form, light enough to be easily lifted on to a car roof. Easy quick construction. Good foredeck, and buoyancy built in under side benches. Weight complete 120 lb. Sail area 52 sq. ft., in a single lug sail. Good racing performance. Sail numbers are issued.

**BCW. 112.** .....Cash price **16/-** postage 1/9.

★**GREMLIN.** 7 ft. 7 in. × 46 in. Plywood pram dinghy. The longest hull that can be cut from standard 8 ft. plywood sheet. The bottom is a single sheet, split at one end and sprung to give V forward and curve aft. Can be carried single handed.

**BCW. 113.** .....Cash price **15/-** postage 1/2.

④ **PETE.** 6 ft. × 44 in. flat bottom pram dinghy. The cheapest and simplest practical boat. Can be built from one plywood sheet. Details of simple sailing gear included. Will carry two adults or three children. Ideal for angling.

**BCW. 114.** .....Cash price **11/-** postage 1/-



2



3



4



**5 CORRIB.** 10 ft. x 54 in. single chine V-bottomed boat, general purpose dinghy for rowing or outboard motor (3 h.p. is adequate). Simple construction. A fine family boat.

**BCW. 115.**.....Cash price **13/6** postage 1/-.

**6 VENTURER.** 11 ft. x 54 in. double chine fast outboard boat. Two versions included. Basic design is camping cruiser adaptable to sleep two on air beds under canvas cover. Runabout version also described. 4 h.p. motor is adequate for general purpose. Will plane with upwards of 10 h.p. Not adaptable to sailing, easily rowed, seats four.

**BCW. 116.**.....Cash price **17/6** postage 1/2.

**7 CURLEW.** 9 ft. x 4 ft. robust car top boat for sailing, outboard motor and rowing. Plywood skinned, simple and cheap to build. Ideal for exciting solo sailing or will carry up to four persons.

**BCW. 117.**.....Cash price **17/6** postage 1/2.

★**BOSUN.** An 11 ft. x 4 ft. 7 in. single chine runabout. Same overall size as Venturer, but with single instead of double chines, giving slightly higher speeds. Plywood skin. Comfortable seating for four. Will plane at 17 m.p.h. with a 10 h.p. outboard motor



## CANOEES, DINGHIES & POWER BOATS

and crew of two. Weight 180 lb. (See page 22).

**BCW. 118.**.....Cash price **17/6** postage 1/-.

★**SIREN.** 11 ft. 6 in. x 4 ft. 6 in. Basically a lengthened Goblin able to take larger rig. Easy quick construction. Weight 140 lb., sail area (gunter rig) 66 sq. ft. Fine performance with crew of one or two. Easily carried on roof of car.

**BCW. 119.**.....Cash price **20/-** postage 1/2.

★**TARPON.** 14 ft. x 5 ft. 6 in. double chine plywood seaworthy hull. A safe, roomy non-planing boat. Suitable for rowing, 5 h.p. outboard motor or sailing with gunter sloop rig. Sail area 106 sq. ft. For inland use it is possible to arrange permanent shelter for two bunks, with room for two more to sleep under cover in the cockpit.

**BCW. 120.**.....Cash price **36/-** postage 1/2.

### CRUISER

**8 NOMAD.** 16 ft. x 6 ft. 2½ in. double chine cabin cruiser. Full size bunks for two with room for two more on air beds in the cockpit. Cabin space for cooker, toilet and ample lockers. Performs well with outboard motor of 4-10 h.p. and will plane with 18 h.p. Weight 6 cwt. complete. Easily towed and launched from a trailer. Draught 12 in., 8 ft. long cabin with 47 in. headroom—34 in. over bunks.

**BCW. 121.**.....Cash price **45/-** postage 1/9.

★ Not illustrated.

### KITS

We offer kits containing all the necessary wood, fastenings, etc. for all the Dinghies and Power Boats, but not for the Canoes.

For details of H.P. facilities, complete specifications, prices of kits, sails, etc., write to: Hobbies Limited, Dereham, Norfolk. (Sales Division).



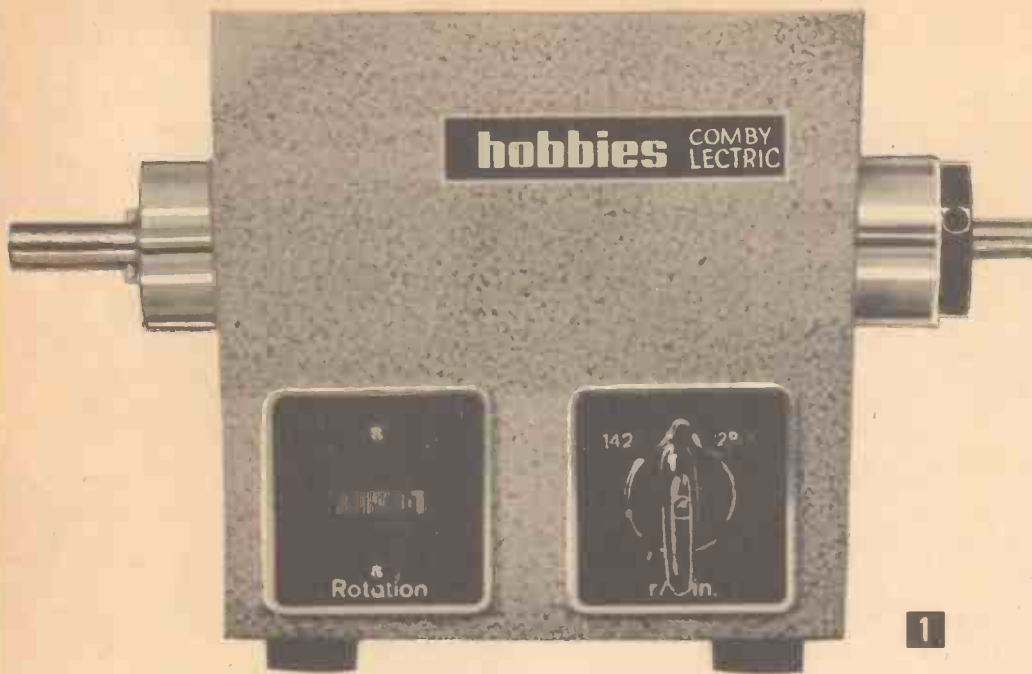

1

# hobbies comby lectric

POWER TOOLS



## THE NEW HOBBIES COMBY-LECTRIC MULTIPURPOSE COMBINATION POWER TOOL

PROGRESS · PRECISION · PERFECTION

*The superior multipurpose combination power pack and accessories for sawing, planing, grinding, drilling, and turning.*

*Extremely sturdy and quiet motor—no wearing parts.*

IDEAL FOR HOME HANDYMEN, SCHOOLS, INSTITUTIONS, CARPENTERS, FARMERS and INDUSTRIAL USERS.

There is nothing on the market to compare with the workmanship and presentation of these high quality tools.

**UNCONDITIONALLY GUARANTEED FOR THREE YEARS AGAINST DEFECTS IN WORKMANSHIP**

Note that many parts are interchangeable and to avoid duplication have been omitted from some kits.

Kits and accessories may be purchased separately and added to the motor unit or may be obtained as a COMPLETE COMPREHENSIVE KIT.

**1 BASIC UNIT: MOTOR.** A completely original and unique power pack of 3 h.p. (squirrel-cage rotor, no carbon brushes, no troublesome gear parts). Double insulated throughout. 210/240 volt A.C. 50 cycles. COMPLETE TECHNICAL DATA AVAILABLE. (Consists of parts 120, 1201, 121 and 127).

**CEW. 0.** . . . . . Cash price **£27 17 6** carriage free or credit sale, deposit 73/- and 8 monthly payments 74/6.

**COMPLETE COMPREHENSIVE KIT** containing Basic Unit (Motor) CEW. 0 and kits CEW. 1, 2, 3, 4 and 5. Complete.

**CEW. 0/1/2/3/4/5** Cash price **£67 10 0** carriage free or credit sale, deposit 180/- and 8 monthly payments 180/-.

As above, but containing CEW. 0 and kits CEW. 1, 2a (larger table), 3, 4 and 5. Complete.

**CEW. 0/1/2a/3/4/5.** Cash price **£73 10 0** carriage free or credit sale, deposit 196/- and 8 monthly payments 196/-.

If credit sale facilities are insufficient to meet your requirements HIRE PURCHASE arrangements are available for longer periods, on orders of £25 and over. Write for details.

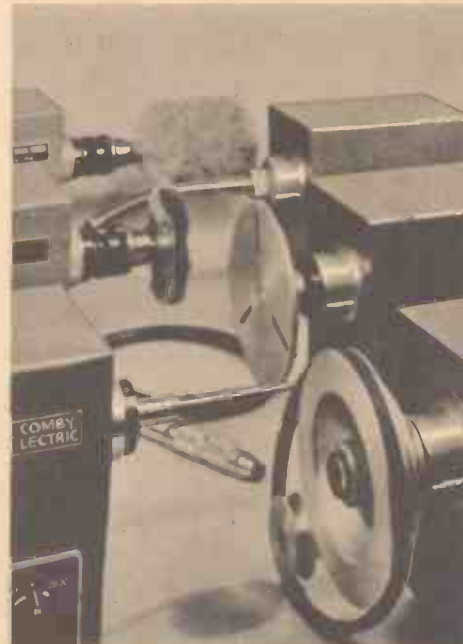



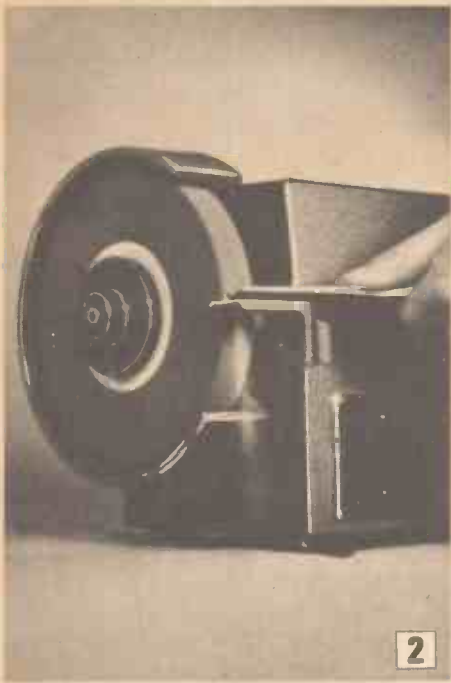

2

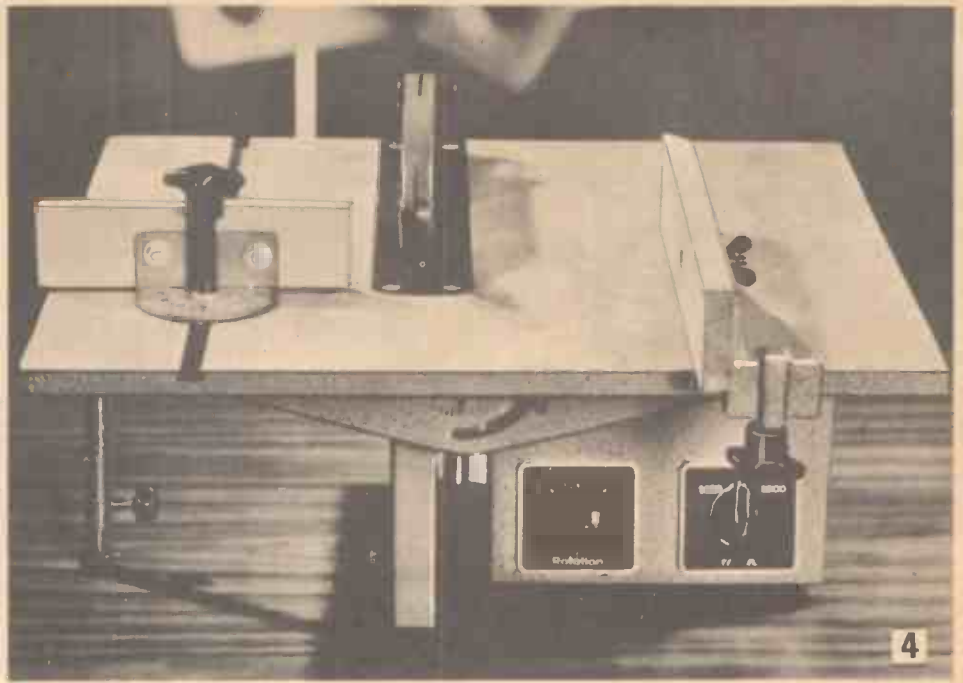

4

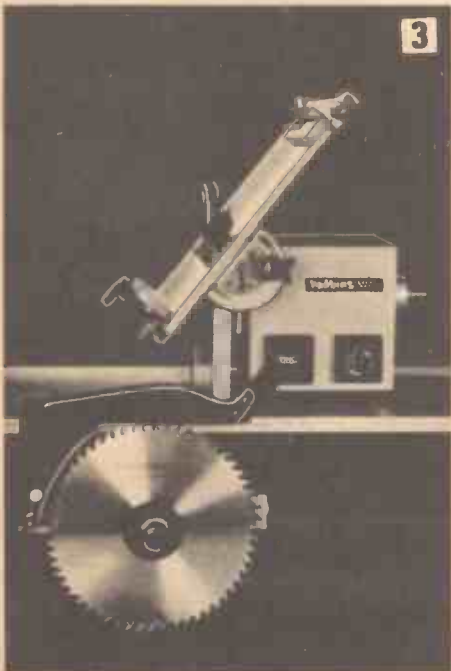

3



5a

**2 GRINDING ATTACHMENT KIT WZ.** An up-to-date tool of industrial design for sharpening drills and cutting tools. (Consists of parts 122, 136 and 137).

**CEW. 1**.....Cash price **75/-** carriage 4/6 or credit sale, deposit 10/- plus carriage and 8 monthly payments 10/-.

**3 CIRCULAR SAW BENCH KIT TK1.** (If part 122 of Kit CEW. 1 already exists). Table size 13 in. by 14 in. approx. (320x360 mm.). Adjustable in height and tilting up to 45°. With accurately guided stops for longitudinal and angular cuts. (Consists of parts 123, 124, 125, 126 and 147).

**CEW. 2**.....Cash price **£16 19 6** carriage free or credit sale, deposit 47/6 and 8 monthly payments 45/-.

**4 CIRCULAR SAW BENCH KIT TK 2.** (If part 122 of kit CEW. 1 already exists). With large table size 16 in. by 18 in. approx. (400x430 mm.). Specifications as above. (Consists of parts 123, 124, 1251, 1261 and 147).

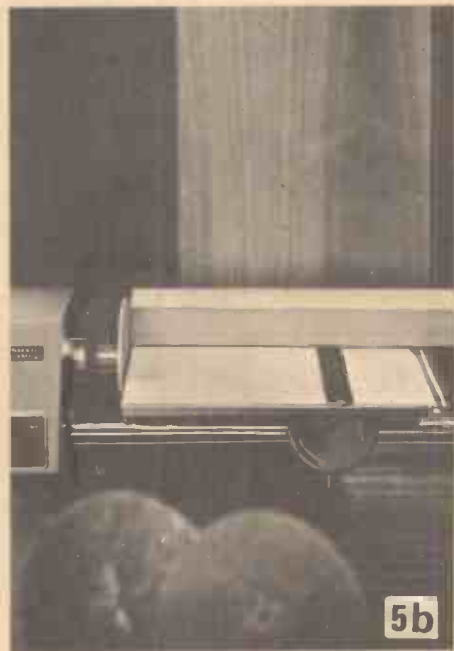

5b

**CEW. 2a**.....Cash price **£23 5 0** carriage free or credit sale, deposit 62/- and 8 monthly payments 62/-.

**5 DISC GRINDING KIT TS.** (If part 130 of kit CEW. 4 already exists). For smoothing and finish-grinding wood, metal and plastic. Can be used with the drilling table as shown at 5A or with circular saw table as at 5B. Includes self adhesive grinding tapes. (Consists of parts 1291, 138, 139, 1331, 155 and 140).

**CEW. 3**.....Cash price **62/6** carriage 4/6 or credit sale, deposit 11/- plus carriage and 8 monthly payments 8/-.

**6 TABLE DRILL PRESS KIT TB.** For precision drilling in handicrafts and industry. Special conical shaft connection ensures accuracy and smooth running. Easy running gear-wheel drive. Large cast-iron base-plate. (Consists of parts 128, 129, 130, 131, 1311 and 132).

**CEW. 4**.....Cash price **265/-** carriage free or credit sale, deposit 34/- and 8 monthly payments 35/6.



6

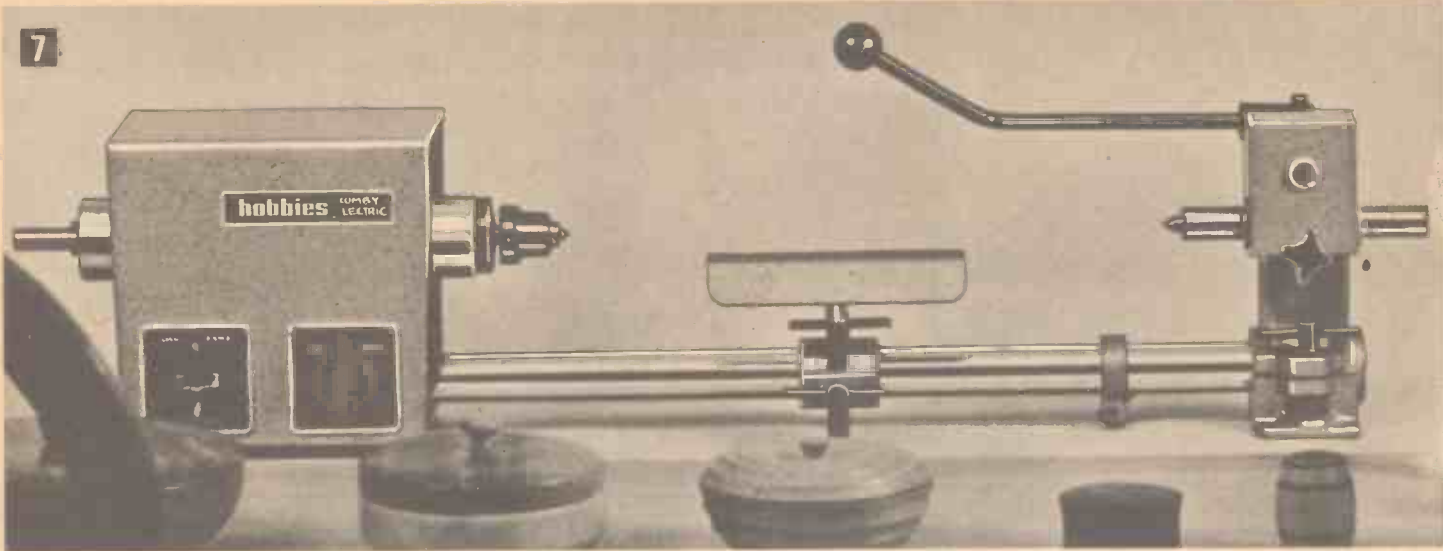

**7 WOOD TURNING LATHE KIT DBL.** (If parts 129, 131 and 1311 of kit CEW. 4 already exist). For work up to 5½ in. approx. (140 mm.) diameter, 16 in. to 36 in. approx. (400 to 900 mm.) in length. Universally adjustable chisel support, centre running on ball bearing, three prong chuck. Complete with turning chisel. (Consists of parts 133, 134 and 135).

**CEW. 5.** ..... Cash price **47/6** carriage 4/6 or credit sale, deposit 5/- plus carriage and 8 monthly payments 6/6.



**8 FACE PLATE ATTACHMENT KIT DBQ.** (If parts 133 and 134 of kit CEW. 5 already exist). For turning bowls, plates, trays, etc., up to 12½ in. approx. (320 mm.) diameter. Extremely easy to handle. Complete with face plate, containing screws and adjustable support bracket. (Consists of parts 141, 142 and 143).

**CEW. 6.** ..... Cash price **99/-** carriage 4/6 or credit sale, deposit 11/- plus carriage and 8 monthly payments 13/6.



**9 PLANING ATTACHMENT AM. 120.** Gives neat, smooth surfaces and cutting edges to your work. Masked planing shaft—perfectly safe. Parallel stop adjustable laterally. Tilting both sides to 45° for mitring. Clear scale graduation for exact adjustment. Cutting depth accurately regulated 0-4 mm. (Consists of AM. 120 and 162).

**CEW. 7.** ..... Cash price **£37 2 6** carriage free or credit sale, deposit 99/- and 8 monthly payments 99/-.

**10 TAPE GRINDING ACCESSORY GB.45.** With endless grinding tapes 2 in. approx. (45 mm.) wide and 32 in. approx. (800 mm.) long. Can be used vertically and horizontally. Attached to the cylindrical motor shaft. (Consists of GB. 45 and 451).

**CEW. 8.** ..... Cash price **£16 17 6** carriage free or credit sale, deposit 45/- and 8 monthly payments 45/-.





# accessories

CAT. No. CEW/	Description	Cash Price	Post-age	or		CAT. No. CEW/	Description	Cash Price	Post-age	or	
				Deposit + Postage	And 8 Monthly Payments					Deposit + Postage	And 8 Monthly Payments
				Deposit						Deposit	
001	Combination cemented-carbide stone drill 6 mm.	7/6	6d.	—	—	206	12 abrasive-paper discs, 125 mm. dia., for wood	5/6	8d.	—	—
003	Carbide-tipped disc, suitable for rubber plate, for removing paint	19/-	6d.	—	—	207	12 abrasive-paper discs, 125 mm. dia., for metal	5/9	10d.	—	—
004	Steel wire pot brush, 55 mm. dia., coarse—with shank	10/6	1/3	—	—	208	Genuine lambskin polishing cap, 125 mm. dia.	9/8	8d.	—	—
120	Motor for 210/240 v. A.C. 50 cycles	581/9	—	77/6	77/6	209	Fixing pin for grinding wheel (211)	6/3	6d.	—	—
121	Inside hexagon spanner SW.5	2/6	10d.	—	—	210	Wood rasping device, with shank	16/6	1/-	—	—
122	Front-hole spanner for flange	13/3	10d.	—	—	211	Grinding wheel, 75 mm. dia., 12 mm. wide.	5/6	1/6	—	—
123	Traverse with splitting wedge and hand guard	49/6	2/6	7/-	6/6	212	Collets 2-35/3-0/3-5/4-0/5-0/6-0 mm. dia.	33/-	1/6	—	—
124	Wood saw-blade, 225 mm. dia., with flange	59/6	1/6	7/6	8/-	213	Wood drilling and countersink set, consisting of 5 parts	16/6	1/-	—	—
125	Saw bench 320x360 mm. with guard plate	213/3	—	28/6	28/6	214	Twist drill set WS for wood, 9 parts, 1-5 mm.	6/9	1/-	—	—
126	Adjustable longitudinal stop	23/6	3/-	—	—	215	Twist drill set HSS for metal, 9 parts, 1-5 mm.	21/6	1/-	—	—
127	Pull-off ring for conical shaft end	5/6	6d.	—	—	216	Twist drill set WS for wood, 13 parts, 1-7 mm.	11/6	1/-	—	—
128	Gear-wheel rim drill-chuck P 12 S 2-12 mm. with spanner	54/6	2/6	5/6	7/6	217	Twist drill set HSS for metal, 13 parts, 1-7 mm.	40/-	1/6	8/-	5/-
129	Guide column, 30 mm. dia., 720 mm. long	26/3	2/-	—	—	218	Twist Drill set WS for wood, 19 parts, 1-10 mm.	28/6	1/6	—	—
130	Drilling table, 170x200 mm.	29/-	2/6	—	—	219	Twist drill set HSS for metal, 19 parts, 1-10 mm.	91/3	1/6	13/-	12/-
131	Tailstock with operating lever	125/3	—	18/-	16/6	220	Additional drill-chuck 0-13 mm.	18/-	2/-	—	—
132	Base plate	49/6	4/6	7/-	6/6	221	10 part set of ROTO tools for milling, grinding, etc., for flexible shafts (shank 3 mm. dia.)	34/-	2/6	—	—
133	Adjustable turning-tool support	27/-	2/-	—	—	222	5 part set of chamfer tools and rasp for table drill-press and flexible work-shafts	38/-	2/6	—	—
134	Turning tool	14/9	1/-	—	—	223	Knife and scissor grinder with shank	10/6	1/-	—	—
135	Carrier pin	9/3	6d.	—	—	224	Rubber plate, 125 mm. dia., with shank, for attaching abrasive-paper discs and lambskin polishing cap	6/9	8d.	—	—
136	Protective hood with support	29/-	1/-	—	—	225	Steel-wire round brush, 75 mm. dia., coarse—with shank	6/6	8d.	—	—
137	Carborundum grinding-wheel 150 mm. dia., with flange	41/-	3/-	5/-	5/6	226	Keyhole-saw set, 7 saw blades for holes of 25-62 mm. dia., with shank	18/-	1/-	—	—
138	Grinding disc, 140 mm. dia.	19/3	6d.	—	—	227	Rasping disc, fine, with shank	19/9	1/6	—	—
139	5 self adhesive grinding strips (Granulation 40/60/80/100/120/)	6/9	6d.	—	—	228	Dovetailing and tenoning ruler for TK.1	33/-	2/-	—	—
140	Reduction ring for fitting traverse	6/9	1/6	—	—	229	Dovetailing and tenoning ruler for TK.2	41/-	2/-	9/-	5/-
141	Plane plate, 140 mm. dia.	26/3	3/-	—	—	451	Spare tapes, endless, 45x800 mm. per piece. (Various granulations 60-200)	6/9	10d.	—	—
142	Adjustable support bracket	78/-	5/-	13/6	10/-	1201	Table attachment with screws	3/-	8d.	—	—
143	Centering screw	5/6	6d.	—	—	1251	Large saw bench 400x430 mm., with guard plate	344/-	—	45/-	45/-
144	HOBBY-shaft, 3 1/2 ft. long, connection to drill head part 128, with manual chuck 0-6 mm.	108/9	—	15/-	14/6	1261	Adjustable longitudinal stop	31/9	2/6	—	—
145	Technicians' precision-shaft, 4 ft. long, connection directly to conical motor axis	332/9	—	44/6	44/-	1281	Gear-wheel rim drill-chuck P 13, 1-13 mm., with spanner	68/6	4/6	10/-	9/-
146	Heavy-load shaft, 4 1/2 ft. long, connection to drill head part 128	206/3	—	28/6	27/6	1282	Quick-acting chuck, Su 12 S, 2-12 mm., without spanner	78/6	4/6	14/-	10/-
147	Angle/transverse cutting template	35/6	1/-	—	—	1291	Short guide-column, 30 mm. dia., 400 mm. long	18/-	1/-	—	—
148	Variable grooving saw, groove adjustment 0-13 mm., with flange	206/3	—	28/6	27/6	1292	Extended guide column, 1250 mm. long, may also be used instead of part 129 (particularly for wood-turning)	52/3	2/6	7/-	7/-
150	Fine cutting saw blade for wood, 220 mm. dia., 80 teeth	39/-	2/-	—	—	1311	Adjusting ring for guide column	5/6	6d.	—	—
151	Saw-blade flange, complete	20/9	1/6	—	—	1331	Column support for grinding table	19/-	1/-	—	—
154	V-belt pulley 40 mm. dia., cylindrical bore 14 mm. profile 6	11/-	1/-	—	—	1341	Cutting-off tool for wood-turning	17/9	1/-	—	—
155	Fitting pin for grinding table	5/-	6d.	—	—						
156	V-belt pulley 50 mm. dia., cylindrical bore 14 mm. profile 10	19/3	2/-	—	—						
157	V-belt pulley 100 mm. dia., conical bore B 12 profile 10	38/6	2/6	—	—						
159	Reduction gear 1:4 with gear wheel rim drill-chuck 0-10 mm., and spanner, for drilling steel	200/6	—	24/6	27/-						
161	Mounting support for flexible work-shafts, suitable for guide columns parts No. 129/1291/1292	19/3	1/-	—	—						
162	Spare V-belt, endless, 10x560 mm.	6/-	10d.	—	—						
163	Spare V-belt, endless, 10x670 mm.	6/-	10d.	—	—						
164	Spare knives for planing shaft (set=2 pieces) per piece	44/-	2/6	5/-	6/-						
201	Quick cutting saw blade for wood, 220 mm. dia.	39/-	2/-	—	—						
202/3	Circular saw blade SS, 200 mm. dia., for brass, copper and aluminium	132/-	—	18/6	17/6						
204	Circular saw blade CV, 200 mm. dia., for plastic	104/6	—	13/6	14/-						
205	Circular saw blade SS, 200 mm. dia., for iron	179/-	—	23/-	24/-						

Note: Drilling, milling, grinding, polishing, brushing and smoothing tools are all 6 mm., shank dia., unless otherwise stated.

When ordering please prefix each Cat. No. with CEW.

# traders section

YOUR HOBBIES,  
HANDICRAFTS &  
MODELLING  
REQUIREMENTS MAY BE  
PURCHASED AT  
THESE SHOPS

**BIRMINGHAM, 4** Tel: Midland 0219

**HOBBIES LTD.**  
18 MOOR ST., RINGWAY  
(Facing Moor St. Stn.)

Model Boats, Aircraft, Radio Control. All Hobbies Kits, Designs, Accessories, Sports Goods, Games. Something for all the family.

**BRISTOL, 1** Tel: 23744

**HOBBIES LTD.**  
65 FAIRFAX STREET  
(Next door to Woolworths)

Model Aircraft, Boat and Yacht Kits and accessories. Radio-Control units and accessories. Selective range of Plastic Kits.

**CO. DURHAM** Tel: 5068

**MACKAY'S DO IT YOURSELF STORE**  
80-86 FREDERICK STREET  
SOUTH SHIELDS

Plywood, Timber, Hardboard, Formica, White-wood Furniture, Tiles, Doors, Tools, Mouldings, Paints, Stains.

**DURHAM CITY** Tel: 4627

**THE MODEL SHOP**  
92 CLAYPATH

Model Railway Specialists, High Class Equipment for all Hobbies and Handicrafts. Flower Arrangement Accessories.

**GLASGOW, C.2.** Tel: Central 5042

**HOBBIES LTD.**  
328-330 ARGYLE STREET  
(Near Central Stn.)

Complete range of Model Aircraft Kits and accessories. Official Triang & Scalextric service agents. All leading makes slot car racing equipment.

**HARROW** Tel: 0387

**THE MODEL SHOP**  
31 ST. ANNES ROAD

Phone, write or visit us for your model requirements. We have the most varied stock of model equipment in the South.

**HULL** Tel: 23854

**HOBBIES LTD.**  
42 SAVILLE STREET  
(Opp. City Hall In Sq.)

Modellers requirements in stock, including Model Railways, Aircraft and Boats. The shop for that extra special present!

**HULL** Tel: 408953

**SHORT WAVE (HULL)**  
24A NEWLAND AVENUE

THE NORTH EAST RADIO CENTRE. All your requirements for Radio Control and Amateur Radio. Specialists in Model Boats, Aircraft and Slot Car Racing.

**LEEDS, 1** Tel: 28639

**HOBBIES LTD.**  
10 QUEEN VICTORIA STREET  
(Nr. Mecca Dance Hall)

Model Aircraft, Boats, Engines & Accessories, Model Roadways, Railways, Radio Control. Full range of Plastic Kits. Meccano. Everything for the Modeller.

**LEICESTER** Tel: 24830

**HOBBIES LTD.**  
25 CHARLES STREET  
(Opp. Safeway Supermarket)

LEICESTER'S MODEL BOAT SPECIALISTS. Hobbies Kits, Designs & Accessories. All makes Slot Car Racing. Official Triang & Scalextric agents.

**LIVERPOOL** Tel: Royal 7562

**LUCAS'S (HOBBIES) LTD.**  
7 TARLETON STREET

Stockists of Model Aeroplanes, Ships & Cars, Model Trains, Scalextric, Airfix & Champion Sets. Chemistry Sets & Apparatus, Steam Engines.

**LONDON, E.17** Tel: Coppermill 3928

**BATEMAN'S**  
151 HIGH ST., WALTHAMSTOW

Main Stockists: Triang Railways, Scalextric, Minic, Airfix, Lone Star, Frog, Monogram, B.S.A., Webley, Diana, Revell. 'Club Book' kept all year round.

**LONDON, E.C.2** Tel: London Wall 4375

**HOBBIES LTD.**  
87 OLD BROAD STREET  
(Nr. Liverpool St. Tube Stn.)

*London's Model Boat Centre*

R/C Equipment. Full range of Boat Kits. Accessories.

**LONDON, S.E.13** Tel: Lee Green 2637

**LEWISHAM MODEL CENTRE**  
45 LEE HIGH ROAD

Stockists of: Model Boats, Planes, Railways, Cars, Radio-Control, Engines & Accessories. Repairs & Remagnetising specialists. Mail Order a pleasure.

**LONDON, S.W.2** Tel: Tulse Hill 8796

**HOBBIES LTD.**

81 STREATHAM HILL, STREATHAM  
(Opposite Rank Bowl)

Specialists in Model Railways, Model Aircraft, Model Boats, Model Car Racing, etc.

**LONDON, W.C.1** Tel: Museum 2975

**HOBBIES LTD.**

78a NEW OXFORD STREET  
(Nr. Totl. Court Rd., Tube Stn.)

Large selection of: Balsa Wood, Diesel Engines, Electric Motors, Model Boat and Aircraft Accessories.

**MANCHESTER** Tel: CEN 1787

**HOBBIES LTD.**

10 PICCADILLY

(Same road as Piccadilly Stn.)

*Manchester's Premier Model Shop*

The obvious shop for your toy and modelling requirements.

**MANCHESTER 4** Tel: BLA 6924

**ALLEN SCOTT (MODELS) LTD.**  
54 SHUDEHILL

Radio-Control & Model Specialists. Backed by our 24 hour Mail Order & After Sales Service.

**NORWICH** Tel: 21959

**LANGLEY'S**  
20/21 ROYAL ARCADE

Scalextric, Triang/Hornby, Airfix, Monogram, A.M.T., Revell, Pyro, Inpact, Aurora & Hawk Kits. Tamiya, Monogram, Cox & Airfix Slot Racing. Many Accessories.

**NORWICH** Tel: 26525

**WILLIMENT'S LTD.**  
86 ST. BENEDICTS

Model Race Cars, Aircraft, Boats, Railways & D.I.Y.

**NOTTINGHAM** Tel: 46823

**C. HALL & SONS LTD.**  
D.I.Y. Suppliers  
126-8 DERBY ROAD

Black & Decker, Stanley, Marples, Wolf Tools. Plywood, Hardboard, Timber, Mouldings. Contemporary & Queen Anne Legs. 5s., 10s. offcut parcels.

**OXFORD** Tel: 42407

**HOWES MODEL SHOP**  
9-10 BROAD STREET

Largest stock in the Midlands. Model Aircraft, Railways, Cars, Boats, Radio Control. Run by Modellers for Modellers. Mail Orders by Return.

**READING** Tel: 50074

**G. SLEEP LTD.**  
22/24 KING'S ROAD

Large Stocks of Hobbies, Handicrafts and Do-It-Yourself Goods. Write or Phone us for all your requirements.

**ROCHESTER** Tel: Medway 45616

**WOODCRAFTS**  
10/12 VICTORIA STREET

Everything for the Handyman, Home Decorator and hobbies enthusiast. The shop with a thousand lines. Always try us first.

**SHEFFIELD, 1** Tel: 26071

**HOBBIES LTD.**  
4 ST. PAULS PARADE  
(Nr. Peace Gardens—Town Hall)

Everything for your hobby. Boats—Aircraft. All spares carried.

**SOUTHAMPTON** Tel: 25947

**HOBBIES LTD.**  
134 HIGH STREET  
(Below Bar)

Come and see our range of tools, toys, kits, etc. Let us solve your gift problems.

**ST. HELENS** Tel: 23039

**MODEL SHOP**  
113 DUKE STREET

Stockists of leading makes of Constructional Kits, Models and accessories for Aircraft, Railways, Boats and Slot Racing Cars.



# index

## a

Acetate	
Clear	97
Adhesives	
Various	109
Aircraft	
Acrobatic	121
Control Line	121, 125
Engines	134-136
Jetex	122
Jetex Article	48-51
Plastic Kits	72
R/C Article	42-47
R/C Models	126-128
Ready to Fly	124
Sailplanes	124, 125
Artist's Materials	
Brushes	76
Oil Colours	76
Water Colours	76

## b

Back Saw	103
Ballerina	
Musical Boxes	81, 82
Musical Movements	83
Balsa Wood	110, 111
Bandsaw, Electric	105
Battery Charger	78
Belt, Safety	78
Bits, Auger	101
Blades	
Bandsaw	105
Fretsaw	89
Block Plane	101
Blowlamps	104
Boats	
Model Kits	129-133
Plans	152, 153
Radio Control	74
Runabout Article	22-26
Brace, Ratchet	101
Breast Drill	101
Bride and Groom Musical Novelty	83

## c

Camping	
Article	27, 28
Equipment	79
Canoe Plans	152
Carpentry	
Tools	100-103
Kits	100
Car Accessories	78
Car Racing	112-117
Cars, Radio Control	74, 141
Castors, Doll's Cot	108
Chalet Doll's House Instructions	32-37
Charger, Battery	78
Chemistry Sets	144
Chichester Story	15-20
Chisel Set	101
Circular Saws	155
Comby Lectric Power Pack	154
Control Line Aircraft	121
Controllers, Race Car	115
Constructional Engineer Kits	149
Cot	
Doll's	87
Fittings	108
Craft	
Kits	91
Tools	91
Cutting Plate, Fretwork	89

## d

Decorettes	
Article	38
Transfers	107
Decorating	
Article	39-41
Kits	80
Designs, Fretwork	81-87
Dinghy Plans	152, 153
Disc Grinder	155
Distemping Outfit	80
Doll's Bungalow Kit	84
Doll's House Kits	67, 84
Dolls House	
Accessories	97
Chalet Instructions	32-37
Doors	97
Electrical Fittings	98
Furniture	69
Playhouse	67, 84
Wallpaper	68
Windows	97
Doll's Cot	
Castors	108
Fittings	108
Kit	87
Do-It-Yourself Home Decorating Kits	80
Dowel Rod	111
Drawing Instruments	76
Drills	
Breast	101
Fretwork	89
Hand	101
Points	89
Power Driver	105
Press	155
Twist	101

## e

Electric	
Bandsaw	105
Drill	105
Power Pack	154
Power Tools	154-157
Electrical	
Engineer Sets	147
Fittings, Doll's House	97, 98
Enamel	106
Engines, Model	
Article	52-55
Cox	136
Davies Charlton	134
Frog	136
Fuji	135, 136
Jetex	123
Steam	73
Engineer	
Electronic	147
Interphone	146
Mechanical	147, 148
Radio	146, 148
Engraving Kit	91
Equipment, R/C	137-141
Escapements, R/C	139

## f

Farm Kit, Fretwork	85
Farm Kit, Ready to Assemble	66
Frescreens, Marquetry	95
Firearms Kits, Plastic	151
Fitting, D/H Electric	98
Fluorescent Paint	106
Fort Kits	
Fretwork	85, 86
Ready to Assemble	66
Fretsaw	
Blades, Frames	89
Machines	90

Fretwork	
Cutting Plate	89
Designs	32, 81-87
Drills	89
Kits	32, 81-87
Musical Movements	83
Sets	88
Fuel, Jetex	123
Furniture, Dolls House	69
Futaba R/C Equipment	138, 139

## g

Galleon Kits	132
Games, Indoor	75
Garage	
Model Garage Accessories	99
Kits, Fretwork	85, 86
Ready to Assemble	66
Gaz Picnic Equipment	79
Gipsy Moth IV	
Article	15-20
Model	21, 133
Glues, Various	109
Grinder	
Disc	155
Tape	156
Guitar	
Kit, Tutor, Accessories	87
Guns	
Toy	71
Soldering	104

## h

Hammers	103
Handsaw	103
Hardwood Strip	111
Home Decorating	
Article	39-41
Kits	80
Hovercraft	133
Humbrol Paints	106

## i

Indoor Games	75
Instruments, Drawing	76
Interphone Set	146
Irons, Soldering	104
Isonon Kits	109

## j

Jetex	
Aeroplane Article	48-51
Fuel	123
Models	122
Power Units	123
Wicks	123
Jigsaw, Powered	105

## k

Kits	
Fretwork	32, 81-87
Plastic-Heller	72
Knives, Handicraft	91

## l

Lathes	156
Leatherwork Moccasins	96
Lights, Motoring	78
Lighting Sets, D/H	98
Linseed Oil	106
Locomotive Models	119



Machines, Fretwork	90
Magnetism	144
Mallet—Wood	102
Mamod Steam Engines	73
Marking Gauge	102
Marquetry	
Frescreens	95
Kits	92-95
Meccano	149
Mechanical Engineer	147, 148
Metz R/C Equipment	140
Microscopes	145
Microscience Kits	143
Microscopy	
Sets	145
Slides	145
Mitre Block	102
Mitre Box	102
Moccasin Kits	96
Model Aircraft	121-128
Control Line	121, 125
R/C Models	126-128
Ready to Fly	124
Sailplanes	124, 125
Model Boats	129-133
Billing	130
Galleons	132
Gipsy Moth IV	21, 133
Hovercraft	133
Radio Control	129
Veron	131
Model Car Racing	112-117
Accessories	116
Controllers	114, 115
Model Engines	134-136
Article	52-55
Models	
Fretwork	81-87
Ships, Plastic	72, 150
Model Railways	118-120
Locomotives	119
Power Units	120
Resistance Units	120
Train Sets	118, 119
Musical	
Movements	83
Novelties	81, 82

## O

Obechi Wood	110, 111
Oil Cabinets, Model Garage	99
Oils	106
Oil Colours, Artists	76

## P

Padsaw	103
Painting by Numbers	77
Paint	
Brushes—Artist's	76
Brushes—Decorating	80
Models	106
Outfits	76
Oil Colours	76
Roller	80
Spray	106
Water Colours	76
Parking Light—Motorists	78
Pencil Craft	76
Petrol Pumps, Model	99
Photography	
Article	60-64
Sets	142
Picnic Equipment	79
Picture Frame Moulding	108

Pictures, Marquetry	92-95
Planes	101
Planing Machine	156
Plans, Fretwork	32, 81-87
Boats	152, 153
Canoes	152, 153
Dinghies	152, 153
Plastic Kits	
Aircraft	72
Firearms	151
Ships	72, 150
Playhouse, Dolls	67, 84
Polish—Car	78
Power Tools	104, 105, 154-157
Power Pack—'Comby'	154
Tools—'Comby'	154-157
Jigsaw	105
Power Unit—Jetex	123
Presentation Kits—Guns	71
Projectors	65
Propulsion Set	142
Push Drill—Fretwork	89

## R

Race Cars and Accessories	112-117
Radio Aerial, car	78
Radio Control	
Aeroplane Article	42-47
Aircraft	126-128
Boats	74, 129
Cars	74, 141
Article	56-59
Radio Control Equipment	137-141
Elgi	74, 141
Futaba	138, 139
Metz	140
Simprom	137
Radio Electronic Sets	142
Radio Engineer Sets	146, 148
Railways, Models	118-120
Ready to Assemble	
Doll's Houses	67
Farm	66
Fort	66
Service Station	66
Receivers, R/C	138, 141
Reversing Lamp	78
Rifles—Toys	71
Rule, Push/Pull	103
Runabout—'Bosun' Article	22-26

## S

Safety Belt	78
Saw	
Back	103
Bandsaw	105
Circular	155
Knife Set	91
Power	105
Scenic Kits, 3D	143
Screwdriver—Ratchet	101
Sea Grass	108
Service Station	
Accessories	99
Kits	66, 85, 86
Servos, R/C	139, 141
Sewing Machines	65
Ships—Plastic Kits	72, 150
Simprom R/C Equipment	137
Slot Car Racing	112-117
Smoothing Plane	101
Soldering Guns, Irons	104
Spirograph	70
Spray Paints	106
Steam Engines	73
Stool Sets	109
Surform	101
Swiss Musical Movements	83
Switches, Miniature	98

## T

Tape Grinder	156
Tenon Saw	103
Tool Rack	103
Tools	
Carpentry	100-103
Craft	91
Fretwork Sets	88
Hand-set	101
Kits	100
Power	104, 105, 154-157
Train Sets	118, 119
Transfers	
Decorettes	107
Decorettes Article	38
Transmitters, R/C	138, 141
Travel	
Article	29-31
Refreshment Cases	79
Tutor—Guitar	87

## U

Units R/C	141
-----------	-----

## V

Varnish	106
Vices	
Carpentry	103
Craft	91

## W

Wallpaper—Doll's House	68
Wallpapering Outfits	80
Water Colours—Artists	76
Wheels—Various	108
Wicks—Jetex	123
Wood—Various	110, 111

## Y

Young Scientist Kits	
Chemistry Sets	144
Electronic Engineer	147
Interphone Engineer	146
Magnetism	144
Meccano	149
Mechanical Engineer	147, 148
Microscience	143
Microscopes	145
Microscopy Set	145
Microscopy Slides	145
Photography	142
Propulsion	142
Radio	142
Radio Electronics	142
Radio Engineer	146, 148
Scenic Kits, 3D	143

## Z

Zoo Fretwork Kit	86
------------------	----



# MAIL ORDER TO HOBBIES LIMITED, DEREHAM, NORFOLK



<b>ACCOUNT REFERENCE NUMBER</b> <small>(For Credit Customers Only)</small>		<b>Important. Please tick squares that apply</b>	<input checked="" type="checkbox"/>
<b>FULL NAME</b>	<small>STATE IF MR/MRS/MISS</small>	<b>Full Cash/Carriage Enclosed</b>	<input type="checkbox"/>
<b>ADDRESS</b>		<b>Deposit/Carriage Enclosed</b>	<input type="checkbox"/>
<b>TOWN</b>	<b>COUNTY</b>	<b>New Customer</b>	<input type="checkbox"/>

**1968 ANNUAL**

**Credit Terms are only available to Residents in England, Scotland and Wales**

**New Credit Account—To Open An Account Please Complete Details Overleaf and Enclose Deposit**

Page No.	Catalogue No.	Amount Required	ARTICLE	Price Each	Carriage Each	CASH		CREDIT	
						Total Cash	Total Carriage	Deposit	Carriage
<b>TOTAL</b>									

**FOR OFFICE USE ONLY**

**Enclosed Full Cash Payment**      **Enclosed Full Credit Payment**

A	B	C	D	E	£		£	
---	---	---	---	---	---	--	---	--

# MAIL ORDER TO HOBBIES LIMITED, DEREHAM, NORFOLK



<b>ACCOUNT REFERENCE NUMBER</b> <small>(For Credit Customers Only)</small>		<b>Important. Please tick squares that apply</b>	<input checked="" type="checkbox"/>
<b>FULL NAME</b>	<small>STATE IF MR/MRS/MISS</small>	<b>Full Cash/Carriage Enclosed</b>	<input type="checkbox"/>
<b>ADDRESS</b>		<b>Deposit/Carriage Enclosed</b>	<input type="checkbox"/>
<b>TOWN</b>	<b>COUNTY</b>	<b>New Customer</b>	<input type="checkbox"/>

**1968 ANNUAL**

**Credit Terms are only available to Residents in England, Scotland and Wales**

**New Credit Account—To Open An Account Please Complete Details Overleaf and Enclose Deposit**

Page No.	Catalogue No.	Amount Required	ARTICLE	Price Each	Carriage Each	CASH		CREDIT	
						Total Cash	Total Carriage	Deposit	Carriage
<b>TOTAL</b>									

**FOR OFFICE USE ONLY**

**Enclosed Full Cash Payment**      **Enclosed Full Credit Payment**

A	B	C	D	E	£		£	
---	---	---	---	---	---	--	---	--

# HOBBIES LIMITED, DEREHAM, NORFOLK

## CONFIDENTIAL APPLICATION TO OPEN CREDIT ACCOUNT (HEAD OFFICE RECORDS ONLY)

IF YOU HAVE NOT HAD A PREVIOUS ACCOUNT — PLEASE COMPLETE THIS FORM AND RETURN TO US WITH THE FULL DEPOSIT. CREDIT TERMS ARE ONLY AVAILABLE TO RESIDENTS IN ENGLAND, SCOTLAND AND WALES

I AM OVER 21 AND MARRIED/SINGLE/WIDOWED/HOUSEHOLDER/OWNER/IN APARTMENTS  
(PLEASE DELETE WHICHEVER DOES NOT APPLY)

SURNAME  
(BLOCK CAPITALS)

MR  
MRS  
MISS

CHRISTIAN  
NAMES  
IN FULL

FULL POSTAL ADDRESS  
(BLOCK CAPITALS)

HOW LONG AT  
THIS ADDRESS

EMPLOYERS NAME AND ADDRESS  
(NO ENQUIRIES MADE)

OCCUPATION  
(HUSBAND'S IF MARRIED)

HOW LONG IN  
PRESENT EMPLOYMENT

IF UNDER 2 YEARS AT PRESENT ADDRESS,  
PLEASE GIVE PREVIOUS ADDRESS

ORDERS OVER £15 KINDLY SUBMIT NAMES AND ADDRESSES OF TWO REFERENCES  
i.e.: TRADESMEN OR BANK

1.

2.

DATE:

SIGNATURE:

# HOBBIES LIMITED, DEREHAM, NORFOLK

## CONFIDENTIAL APPLICATION TO OPEN CREDIT ACCOUNT (HEAD OFFICE RECORDS ONLY)

IF YOU HAVE NOT HAD A PREVIOUS ACCOUNT — PLEASE COMPLETE THIS FORM AND RETURN TO US WITH THE FULL DEPOSIT. CREDIT TERMS ARE ONLY AVAILABLE TO RESIDENTS IN ENGLAND, SCOTLAND AND WALES

I AM OVER 21 AND MARRIED/SINGLE/WIDOWED/HOUSEHOLDER/OWNER/IN APARTMENTS  
(PLEASE DELETE WHICHEVER DOES NOT APPLY)

SURNAME  
(BLOCK CAPITALS)

MR  
MRS  
MISS

CHRISTIAN  
NAMES  
IN FULL

FULL POSTAL ADDRESS  
(BLOCK CAPITALS)

HOW LONG AT  
THIS ADDRESS

EMPLOYERS NAME AND ADDRESS  
(NO ENQUIRIES MADE)

OCCUPATION  
(HUSBAND'S IF MARRIED)

HOW LONG IN  
PRESENT EMPLOYMENT

IF UNDER 2 YEARS AT PRESENT ADDRESS,  
PLEASE GIVE PREVIOUS ADDRESS

ORDERS OVER £15 KINDLY SUBMIT NAMES AND ADDRESSES OF TWO REFERENCES  
i.e.: TRADESMEN OR BANK

1.

2.

DATE:

SIGNATURE:



# her first home in miniature

This charming Doll's House is designed with every feature to delight the young girl.

- ★ Large picture windows for a clear view of all rooms.
- ★ 'Attic' bedrooms for extra play value.
- ★ Opens front, back and roof.
- ★ Provision for electric lighting.

It's fun to build it yourself and you'll save money too. We offer a FREE PLAN with this 1968 Hobbies Annual! See the editorial article in the front of the Annual for complete instructions on how to build the Hobbies 'Chalet' Doll's House (FDW, 105). Size 24" X 18" base.



# Croid



Polystik is also in PolyB



Universal, a cold liquid glue with a strong tack, for wood, card and many other materials.



Aero - The Craftsman's hot glue that needs no glue pot.

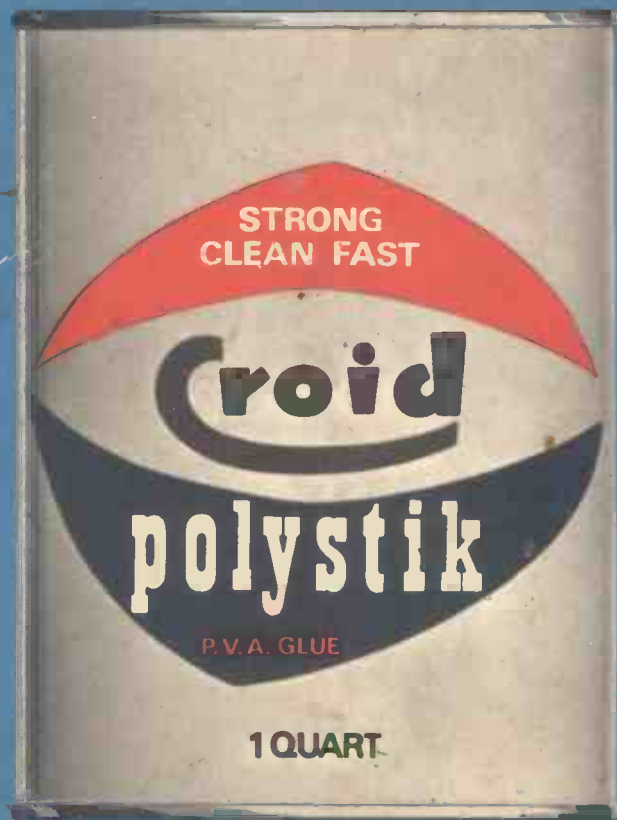

## FOR STRONG CLEAN WOOD JOINTS -

Polystik P.V.A. glue is the woodworkers' handiest for speed, convenience and strength.

- Instantly ready for use from the can
- Spreads easily, economically
- Grips fast, cuts cramping time
- Non-staining
- Non-flammable.

Croid make the best of all glues. Other favourites are illustrated.

**CROID LIMITED** · BERKSHIRE HOUSE · 168/173 HIGH HOLBORN · LONDON WC1  
*A division of B.G.C. (Marketing) Limited*



Croid Clear Liquid, strong, non-flam glue for all making and mending