

15th NOVEMBER 1961

VOL. 133

NUMBER 3440

THE ORIGINAL
'DO-IT-YOURSELF'
MAGAZINE

HOBBIES *weekly*

FOR ALL
HOME CRAFTSMEN

★ *FREE design inside
for this novelty*

Also in this issue:

HOW TO MAKE A
SILHOUETTOGRAPH

COLLECTORS' CLUB
—LATEST STAMPS

I-TRANSISTOR TAPE
RECORDER FEEDER

IT'S FUN WITH
A LAND YACHT

PATTERNS FOR A
FREESAW PROJECT

CHEMISTRY AND
ANGLING

ETC. ETC.



PERPETUAL CALENDAR



Up-to-the-minute ideas

Practical designs

Pleasant and profitable things to make

World Radio History

5^D

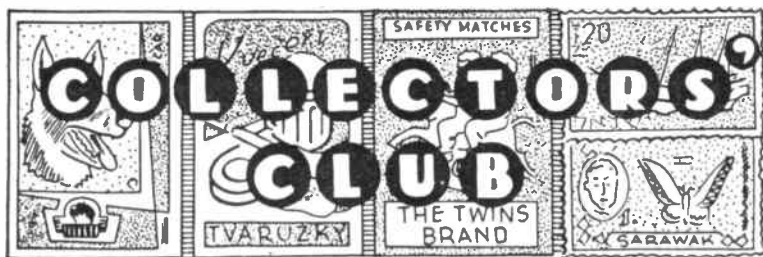

THE Cretan civilization that existed over a period of three thousand years paved the way for European civilization. While it preceded the latter by many centuries it was actually the source of the ideals of universal and human co-operation.

MINOAN ART FROM GREECE

Already in 3000 B.C. there was prosperity and a flourishing organization on the island. From 1500 B.C. the seat of this civilization moved to Greece where were the great centres of civilization, Minoan Crete and Mycenae. The newcomers poured fresh blood into those civilizations and soon evolved that notable civilization which was Ancient Greece.

The set of stamps now released bears some characteristic examples of Minoan art. The vases are decorated with a wondrous combination of many colours and the harmonious designs of the

Kamareos period. No other civilization has produced vases of similar quality. The vases inspired by the naturalistic tendency of the 2nd millennium came out a little later. Plants, flowers and seaweed delight and fill us with the joy of nature. It is decorative art enlivened by the breath of nature.

But the real glory of Cretan art is seen in the wall-paintings of the palaces and mansions — vivid, bright colours, inspired and daring designs, themes representing all aspects of life and nature. Garden and wild flowers are depicted as well as animals, sea-animals and birds.

Religious and other rites are illustrated in the most vivid colours. The presence of women in all social gatherings is also characteristic of Minoan Crete which was ahead of other civilizations in that respect too.

Such was Minoan art, examples of which are illustrated in the present set of stamps seen below on the left.

* * *

ECUADOR

WE have just received two Ecuadorian covers depicting animals and lepidoptera.

* * *



SWITZERLAND

In replacement of the 3, 5, and 10fr. stamps of the 'Symbolic Motifs' set 1938, three equivalent stamps were issued on 18th September, plus a new 20fr. value mainly intended for the pre-payment of postage on airmail items and parcels for abroad. The stamps show the four Evangelists with their attributes, drawn after fifteenth century wood-carvings from St. Oswald's church in Zug, which are now the property of the Swiss National Museum in Zurich.



FIJI

The first of the new designs from Fiji, the 8d. value, was released on 1st August. It depicts the exotic hibiscus flower, accepted today as symbolic of the beautiful South Sea Islands.

* * *

SWEDEN

Two new stamps appeared on 22nd September, in commemoration of the 300-year jubilee of the regulation, prescribing that copies of Swedish printed works should be handed over to the Royal Library.

FROM NETHERLANDS NEW GUINEA



A series of charity stamps from Netherlands New Guinea was released on 15th September and includes four values, each stamp depicting an indigenous weevil, together with its host-plant, in their natural colours

How to make a Silhouettograph

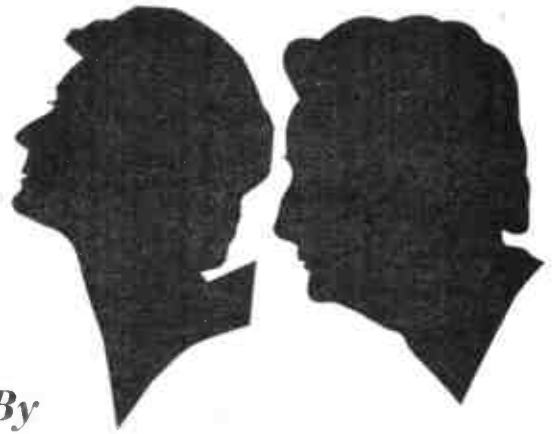
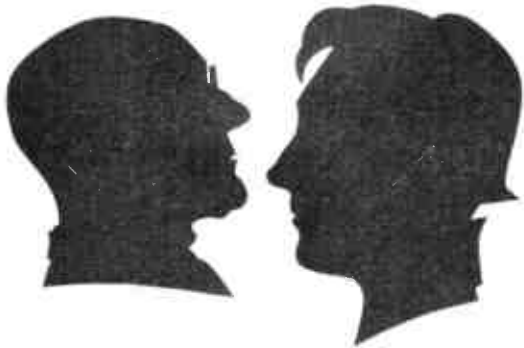

By
**A. E.
Ward**

THE jet black profile portraits called silhouettes were named after their originator, an eighteenth century French government official, who earned fame through bringing about drastic savings in the public expenditure of his country. It has been slyly suggested that Silhouette devised the method in order to save the expense of having likenesses painted by professionals.

The vogue for silhouette cutting continued into the nineteenth century, and became a popular folk art which survives today as an absorbing children's pastime. Unfortunately everybody is not gifted with the skill needed to produce recognizable outlines, so, perhaps, many adults are reluctant to pursue the art as a

hobby. If you are not greatly talented artistically, but would find pleasure in making acceptable pictures of your friends, why not cheat a little, and make a silhouette machine, or 'silhouettograph'.

The machine is based upon the principle whereby levers can transmit movements accurately, and alter the magnitude of motions. Build the base of the apparatus by firmly attaching a wooden pillar measuring $1\frac{1}{2}$ in. by $1\frac{1}{2}$ in. by 10 in. to a baseboard measuring $\frac{1}{2}$ in. by 8 in. by 8 in., using long screws. Saw off one end of a small cotton bobbin to obtain an object which will form the basis of a two-way swivel mounting for the lever. (See diagram A.)

Use a long screw to secure the cotton reel to the top of the pillar. The screw should first be fitted with a small washer, as illustrated, and it will be advisable to insert a little glass or metal tube into the wide hole in the wood, in order to ensure that the screw fits snugly, but not too tightly. A coffee tin lid will serve as a convenient large washer to interpose between the swivel and the upper part of the pillar.

Fit a pair of eyelet screws, well spaced apart, into the top of the rotatable lever mounting. The apertures of the eyelets should be just sufficient to receive a length of $\frac{1}{4}$ in. dowel (or a piece of penholder) reasonably tightly. Obtain a 1 yd. length of $\frac{1}{2}$ in. dowel, and bore a neat $\frac{1}{4}$ in. diameter hole clean across the middle from a point 10 in. or 12 in. from one end. Employ a $1\frac{1}{2}$ in. long rod of $\frac{1}{4}$ in. dowel as a tight spindle to hold the lever firmly between the metal eyelets. It should now be possible to swing around the lever like a telescope upon its stand. Take care to avoid any loose fittings which might cause wobbling.

Diagram B illustrates the 'stylus' of the machine, and the assembly consists of a 5 in. long glass or metal tube bound to the 'short' arm of the lever with Sellotape, and of adequate internal diameter to permit free movement of a pencil to and fro within it. Tension must be applied to the blunt end of the pencil, and this is achieved by means of a small rubber band looped around a drawing pin below the level of the tube, and pressing into a slot which is cut into the pencil.

Using the machine

These details may be easily recognized in the diagram. It now remains for you to insert a steel knitting needle securely into the end of the 'long' arm of the lever. A hole may be bored into the wood, using a red hot nail barely less in diameter than the steel rod.

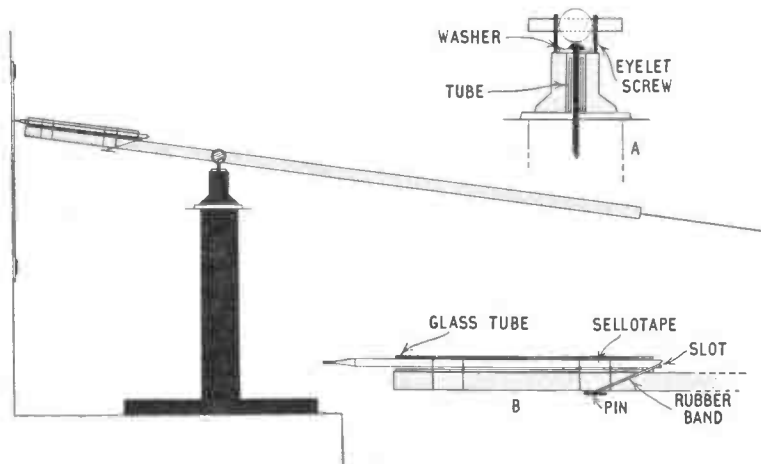

● Continued on page 101

1-Transistor Tape Recorder Feeder

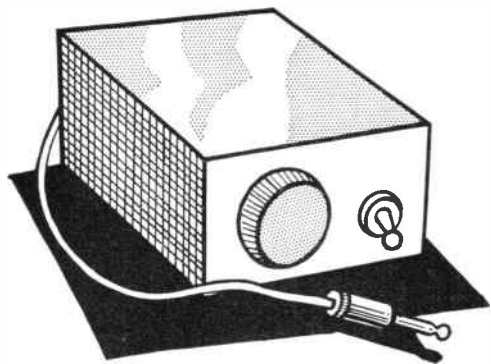

By
'Radio Mech'

A GOOD deal of interest can be obtained by recording programmes from the radio, and the feeder described here is intended for this purpose. It is, of course, possible to make recordings of radio programmes by placing the tape recorder microphone near the radio receiver loudspeaker. This is very straightforward, but has the disadvantage that some distortion is introduced by the loudspeaker, and microphone.

To avoid this difficulty, a tuning unit can be employed to feed the tape recorder direct, without any loudspeaker or microphone being in circuit. Recordings of very good quality are obtainable in this way.

The feeder unit described here has a single transistor, and this will give enough output in very many parts of the country. The feeder is not intended for reception of overseas or very distant stations, but can easily provide a strong enough signal from local stations.

The circuit is shown in Fig. 1, and is intended for an OC71 transistor. Other kinds of audio frequency transistors will work instead, and can be used if to hand. A small dry battery of 3V. to 9V. provides current, and will have a very long life. The voltage is not important,

and 3V. or 4.5V. may easily give enough volume in some localities. More than 9V. should not be used.

Any ordinary medium wave tuning coil is satisfactory. A coil can be wound with 32 s.w.g. enamelled wire, on a 1 in. diameter former, if preferred. Referring to Fig. 1, 40 turns of the wire are wound on, side by side, between points 1 and 2. A space of about $\frac{1}{8}$ in. is then left, and 75 turns are wound on, also side by side, between points 3 and 4. The wire ends can be left long enough to reach the various components.

Assembly

The diode should be of good quality, either new, or tested. The resistor values should be reasonably near those given. The condenser values are, however, much less critical. In the $5\mu\text{F}$ position, anything from $2\mu\text{F}$ to $8\mu\text{F}$ may be used. The $50\mu\text{F}$ condenser could equally well be $25\mu\text{F}$ or $100\mu\text{F}$. Both these condensers are low voltage, miniature transistor type components. The $0.1\mu\text{F}$ condenser is a normal paper type, of about 150V. to 250V. or so rating.

All the parts are mounted on a small insulated baseboard, as shown in Fig. 2. A small panel holds the switch, and $0.0005\mu\text{F}$ tuning condenser. At the other

end of the baseboard, a twin socket strip is screwed.

The coil tags in Fig. 2 are numbered to agree with Fig. 1. If a ready made coil is used, the tags may be in different positions. If so, simply connect the tuned winding (3 and 4) to the tuning condenser, and the aerial coupling winding (1 and 2) to aerial and earth circuits.

Small transistor type condensers usually have a rim near the positive end, as shown, or the condenser will bear positive and negative markings. Wire these items as in Fig. 2. The $0.1\mu\text{F}$ condenser, and all resistors, may be wired in either way round.

In the diagrams, C shows the transistor Collector, B the Base, and E the Emitter wires. With the OC71 transistor, a red dot marks the Collector, as in Fig. 2. Leave the wires their full length, and make the soldered joints quickly, with a really hot iron, so that the transistor itself is not heated. It should not be necessary to keep the iron in contact with the joint for longer than a second or so. Cored solder is most convenient for all joints, and it is applied to the joint at the same time as the heated iron.

Lengthy heating of the other components should also be avoided, especially when wiring in the diode.

The screened lead is best kept reasonably short, and reaches from the feeder to the tape recorder. The correct type of jack plug should be obtained, so that this can be inserted in the microphone or radio tuner socket of the recorder. The centre, insulated lead in the screened cable passes to the tip of the jack plug, while the woven metal braiding forms the stem, or outer, connection. At the feeder end, the lead is held by a small clip, as shown. The braiding is pulled to one side for 1 in. or so, and the strands twisted together, and soldered to a lead going to the earth circuit. The inner, insulated lead is connected to the $0.1\mu\text{F}$ condenser.

The battery may be a miniature transistor receiver type, or a torch or flashlamp battery can be used. The battery leads must be joined up in the correct polarity. Receiver batteries have the polarity marked on them. Flashlamp batteries are not usually marked in this way, but the zinc case is negative.

The battery voltage can be chosen to suit the volume required, as mentioned.

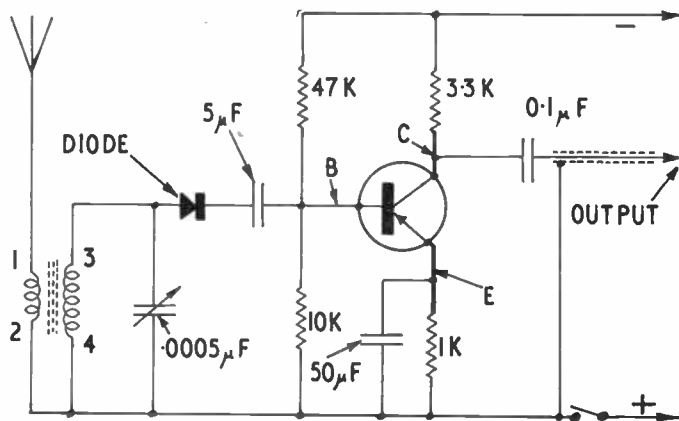

Fig. 1
Feeder
Circuit

There is no point in using a 9V. battery if a 4.5V. or 3V. battery will suffice, because this is likely to increase background noise. A clip is cut to hold the battery in place.

Using the feeder

If the recorder has a socket marked for use with a radio tuner, this will probably prove best. If there are alternative microphone input sockets, try these to find which is most satisfactory.

If the recorder has a switch giving 'straight through' operation, the radio programme can be checked by listening with the recorder loudspeaker. This also allows tuning to be adjusted. If there is no provision for working in this way, the best solution is to listen to the signal obtained, by connecting phones across the jack plug.

When the station is correctly tuned in, the recording level is adjusted by means of the tape recorder volume control, exactly as when recording from a microphone. Some recorders are so made that the signal can be heard on the loudspeaker, while being recorded, and this is a convenient method.

In most cases no earth will be necessary. If one is available, it can be taken to the E socket of the feeder. An earth may be worthwhile in some localities, to reduce interference, or improve signal strength.

An aerial is required, but the type of aerial necessary will depend on the strength of the local station, and the

Fig. 2—Parts and Wiring Plan

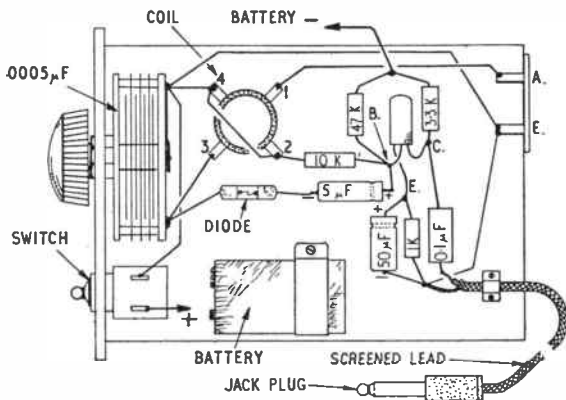

sensitivity of the recorder. In many areas, a simple or temporary indoor aerial will be sufficient. Elsewhere, an outdoor aerial may be needed. An elaborate aerial is not likely to prove necessary, so the wire can be of any reasonable length, supported by two or three insulators.

Use as receiver

The feeder can be used as a 1-transistor receiver, and can give very good headphone reception. If the unit is to be employed for this purpose only, omit the 3.3K resistor, 0.1µF condenser, and screened lead and jack plug. The phones are then connected from the transistor collector C to battery nega-

tive. Two terminals or sockets can be provided for this purpose.

If the feeder is normally used with a tape recorder, but is occasionally used for headphone listening, simply connect the phones to the tip, and stem of the jack plug. This is most readily done by connecting the phones to a spare socket, into which the plug is inserted. It is then possible to remove or connect the phones at once.

A small case to take the feeder can be made from thin wood. Clearance holes for the jack plug and lead, and aerial and earth socket plugs, should be provided. The completed unit can then be inserted in the case from the front.

● Continued from page 99

A SILHOUETTOGRAPH

Stand a small table against a wall, and clamp the base of the apparatus to the table top, in such a manner that the pencil point only projects about a ¼ in. beyond the end of the glass tube, and is pressing up against the wall when the lever is horizontal. Take care to protect your wall from scribble marks. Next you must secure a sheet of drawing paper to the wall, so that its middle is roughly in line with the stylus tip. Perhaps you will be able to improvise an arrangement in which the paper is pinned to a vertically held board. Such a board should be hard, to prevent the pencil jabbing into the paper. A house brick will serve very well to keep the apparatus steady if you lack a clamp. Let your first volunteer sit in a chair with one side of his face towards the machine. Adjust the sitter's position until the steel rod 'tracer' is pressing lightly against his throat.

It will be advantageous if you can squeeze yourself between the table and your friend before you begin drawing. Gently and steadily move the steel tracer

over your subject's throat, chin, mouth, nose, and forehead. When you reach the hair, merely trace the general outline. Try and include some detail of the clothes your sitter is wearing. Soon you will learn to operate the machine quickly and accurately. The little profile traced by the stylus will be inverted, and may lack certain minute but vital parts. Remove the paper, and place it against a sheet of black paper. Ask your friend to pose, sideways on, while you cut out the profile and refer to your friend's features to help you improve any part of the outline not satisfactorily sketched by the machine. Finish off the portrait gracefully at the base of the neck.

Mount the completed picture tastefully upon a white background, adding the name of the person represented, and the date. With some thought and practice, you will be able to mount white silhouettes upon black cardboard and to vary the shapes of your backgrounds. Try a broad elliptical setting. Many variations are possible, including

the use of coloured materials. When you have acquired facility in this art, you will wish to compile a gallery of portraits illustrating all your friends and members of the family. An album compiled in this manner would be a treasured possession in years to come.

It is surprising how expressive the portraits can be. The minutest exaggeration of a single feature, or whether you cut the hair in deep or shallow curves, will prove subtle devices for infusing some genuine character into your cut paper studies. When mounting the pictures, a slight upward or downward tilt of the profile can improve the general effect. Youthful and more elderly persons will be seen to have characteristic outlines which betray the ages of the sitters.

As a 'side-show' attraction at a fete or bazaar, a silhouette cutter will do good trade.

★★★★★★★★★★★★★★★★★★★★
 ★ How to make a cart trailer for a ★
 ★ bicycle will be described in next ★
 ★ week's issue, together with other ★
 ★ interesting and worthwhile pro- ★
 ★ jects. Make sure of your copy. ★
 ★★★★★★★★★★★★★★★★★★★★★★

CHEMISTRY AT HOME

THE upkeep of wooden sheds is expensive if paint is used. Where a black finish is not objected to tar is well worth consideration, as it is so cheaply obtained at the gas works. Normally, it is heated and applied warm. As a protective coating it can be much improved by the incorporation of $\frac{1}{4}$ lb. of tallow and $1\frac{1}{2}$ pints of kerosene to a gallon.

RECIPES FOR HOBBIES AND IN THE HOME

By L. A. Fantozzi

Choose a dry spell for the job. Heat up the tar over a small outdoor fire and when nicely thinned stir in the tallow. Lift the vessel from the fire and stir in the kerosene. The preparation is equally good for reproofing a felted roof but after application scatter dry sand over the coating.

The tar brush may be cleaned with kerosene. A further tip is that if a brush has hardened with old tar, creosote is the best medium for softening it again. Simply stand the brush in creosote and when thoroughly soft, remove it and rinse in kerosene.

CASTING COMPOSITION

A composition which gives a good hard cast and is superior to plaster of Paris may be made from zinc oxide and zinc chloride. The zinc oxide should first be heated strongly, cooled and at once temporarily stored in a well-closed bottle until required. The zinc oxide should be mixed with half its volume of a 55 per cent weight in volume solution of zinc chloride, taking care to eliminate any air bubbles. When the mass begins to thicken pour into the mould and leave until hard. A coloured composition may be obtained by previously mixing ferric oxide (for red), manganese dioxide (for black) or chromium sesquioxide (for green) with the zinc oxide.

TOOTH POWDER

An old fashioned tooth powder which is

gentle but efficient and antiseptic may be made from camphor and precipitated chalk. One part of camphor and eight of chalk are needed, both by weight. First moisten the camphor with a few drops of ethyl alcohol or iso-propyl alcohol and then powder it. Let the alcohol dry off and then grind the powdered camphor with the chalk. Pass the powder through a coffee strainer and regrind any residue in the strainer, again sieving.

CAMPHORATED OIL

This is easily made for winter use by warming 40 c.c. of olive oil and then dissolving in it 10 grams of camphor. Allow it to cool and bottle it.

MOTH REPELLENT

Naphthalene or p-dichlorobenzene are the repellents usually used, but their smell is objectionable to some people. A more fragrant repellent may be based on camphor and tincture of tolu. You will first need to make a rough mould, such as will produce a disc with a central hole. A 1 in. length of $1\frac{1}{2}$ in. internal diameter metal tubing, or a suitable tin the bottom of which has been cut off, will serve admirably. Press a disc of modelling clay and a short metal rod upright in the middle.

The ingredients are made up in the proportions of 2 grams of camphor, 5 grams of white wax (bleached beeswax) 3 grams of spermaceti, 3 c.c. of oil of almonds and 0.25 cc. of tincture of tolu. Melt the wax, spermaceti and oil at as low a heat as possible in a water bath or double boiler, add the camphor, and, when this has dissolved, remove the vessel from the bath and stir in the tincture of tolu. Pour into the mould and allow to set and grow quite cold.

Remove from the mould, thread a loop of tape through the central hole and hang up in the wardrobe.

SILVERING BONE

An unusual finish on bone is one of silver. The bone must first be degreased. If grease is apparent to the eye or finger, a preliminary boiling in water should be carried out. Let the water grow cold, skim off the fat, remove the bone and let it dry thoroughly. Soak the bone in benzine to remove any further traces of fat, remove, allow to dry off, and soak in a 4 per cent weight in volume solution of quinol. Transfer the bone to a 2 per cent

weight in volume solution of silver nitrate. Silver is formed on the bone. When no more action seems to be taking place, remove and rinse the article. Let it dry and then buff up bright.

If desired, this silvered bone can form the basis of a means of electro-plating bone, for the silver provides a surface for deposition.

STRENGTHENING GUM

Gum arabic may be made to yield a more adhesive mucilage by the addition of aluminium sulphate. Put 75 grams of gum arabic in 175 c.c. of water and leave until dissolved. An occasional shake helps. To this add a solution of 2 grams of aluminium sulphate in 20 c.c. of water, followed by 2 grams of phenol as a preservative. Caution: solid phenol should not be handled, for it causes blisters; use a spatula when weighing it. Another way of preventing mould formation is to place a piece of camphor in the gum instead of using phenol.

SOLIDIFIED METHYLATED SPIRIT

Camperos who dislike carrying methylated spirit for priming pressure stoves will appreciate a solid form. Proprietary solid primers are expensive, whereas this is extremely cheap.

Put 100 c.c. of methylated spirit, 3 grams of dry soap shavings and 0.2 gram of shellac into a dry tin standing in a pan. While stirring with a thermometer, pour hot water into the pan until the temperature of the mixture in the tin stands at about 60 degrees Centigrade (140 degrees Fahrenheit). If you register a temperature much higher than this, causing the spirit to boil, remove the tin and allow to cool somewhat.

Stir until the solids have dissolved. The solution may then be poured into a warmed screw-capped jar, a press lid tin, or into moulds of glass tubes set upright in modelling clay, and allowed to set. Which you choose is a matter of convenience of carriage. Using a jar or tin you can carry plenty. If tube moulds are used, the resulting sticks may be accommodated in old push-up cosmetic tubes, and are suitable for weekend camps. In either case a piece of the fuel is cut, placed in the priming cup and lit in the usual way.

PAPER-TO-WOOD MOUNTANT

Engravings, prints and photographs should be stuck to wood by means of a special mounting composition. Into a screw-capped bottle put 100 c.c. of methylated spirit, 25 grams each of Venetian turpentine and sandarac, 6.4 grams of mastic and 12.5 grams of rosin. Screw on the cap and shake occasionally until the solids have dispersed. Brush on to the wood and press home the paper.

Instructions for making

A PERPETUAL CALENDAR



A PERPETUAL Calendar is a happy choice for a gift which extends its personal thought throughout the year. The date is changed daily by means of the neat calendar pads supplied by Hobbies Ltd.

Our model illustrated is 8 in. wide by 5½ in. high by 3¾ in. deep, and as you can see, has a novel theme — that of a man holding on to his dog by means of a chain and with the wording 'Never be late for a date'. It is intended to be stood on a mantelshelf, sideboard, or other flat surface, or alternatively can be fixed to a wall with the provision of a suitable backing block at the top.

The figure of the man in a hurry is in the shape of an overlay and the model dog is of the terrier type, fashioned in metal and very nicely finished. This is also contained in Hobbies kit.

All the parts required are shown full size on the design sheet. These should be traced and transferred by carbon paper on to their appropriate thickness of wood, then cut out neatly with a fretsaw and cleaned up ready for assembly. Incidentally, the lettering is intended to be cut out from the back panel. Those who are handy with a paint brush can, however, add the words in hand lettering rather than cut them out. It is a matter of personal choice.

The figure of the man (piece 7) is glued in the position shown by dotted lines to the back (piece 1). To piece 1 can next be added pieces 4, 5 and 6 which make up the holder for the calendar pads.

Piece 1 is then glued to piece 2 and a strengthening piece of triangular fillet (piece 3) is glued along at the back.

At this stage, clean up the work thoroughly and add the finish, which will

★★★★★★★★★★★★★★★★★★★★
 ★ Hobbies Kit No. 3440 for making ★
 ★ this novel Perpetual Calendar ★
 ★ contains all wood and accessories ★
 ★ including chain, date pad, orna- ★
 ★ mental dog, etc. Kits price 9/11 ★
 ★ from branches or by post (2/- ★
 ★ extra) from Hobbies Ltd, Dere- ★
 ★ ham, Norfolk ★
 ★★★★★★★★★★★★★★★★★★★★★

be by painting to colours of choice. The clothing on the man can be represented by a suitable piece of cloth glued on as indicated in the main illustration. The hands, boots and facial features will be painted on to the wood. A screweye is inserted into the man's hand and to this is attached one end of a piece of link chain. The other end of the chain is attached to a piece of cord round the dog's neck, and should of course be of suitable length. The dog stands firmly on its four legs and is positioned as shown in piece 2. Small holes can be made where the paws fit into piece 2 to make a firmer setting.

A Trumps Indicator

CARD players will appreciate a simple trumps indicator which is both novel in appearance and easy to use. The card box itself will form the basis of the gadget, but its function as a storage place for the cards will remain unaltered.

You will need one pip of each suit cut out of old playing cards, a paper fastener, a strip of Sellotape and a little arrow cut out of cardboard. Use the paper fastener to fix the arrow pointer to the middle of the card box back. The colour of the arrow should contrast well with the colour of the box.

Glue the four pips, in the proper order, at the four corners of the box, around the pointer. It now remains to fix the strip of Sellotape over the 'prongs' of the paper fastener, inside the box. The tape will prevent damage to the cards when they are returned to the box. (A.E.W.)

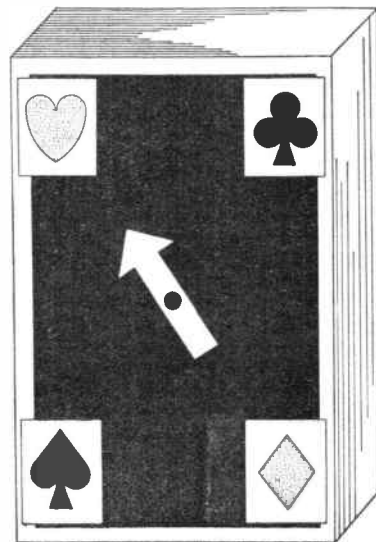

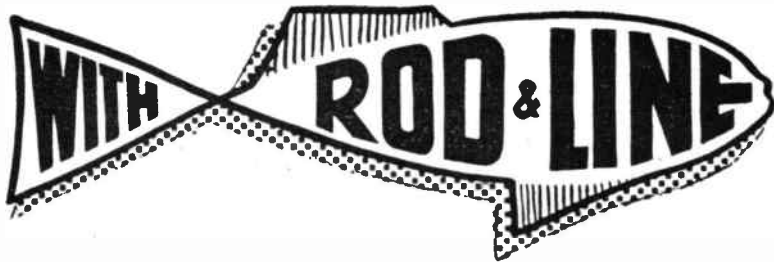

IN fly fishing for chub you can, in addition to using flies, both artificial and natural, use plastic lures. Bait fishing makes use of shot to get your bait down to the bottom and is useful when you find long stretches of bushy banks where it would be impossible to cast a fly. Here your float tackle can be guided under the overhanging foliage.

CATCHING THE FOXY CHUB—2

By 'Kingfisher'

Your trout rod is just the thing when casting a fly for chub. Your flies should be what are known as the Palmer type; that is, they have a bushy body which is made by taking the hackle right along the shank of the hook and finishing near the bend. Although chub will take the flies tied small, as for trout, they much prefer the aforementioned type. I tie my own flies and have found that a black hackle ribbed with orange tinsel and with a further couple of turns of orange-coloured hackle at the eye is a very successful pattern for these fish. Some chub flies have a bit of white kid tied in at the tail but I dispense with this and put on a couple of turns of silver tinsel instead.

You should cast the fly down and across and don't worry about the 'wake' which the fly will set up as it comes across the current. With trout this would be fatal to your sport but chub don't seem to mind it. Trout know that a tiny fly hasn't the strength to swim across the current, just as the chub knows that a much larger fly will be able to make its way across a similar stream.

My method is to fish one fly only at all times. The reason for this is two-fold. When a chub is hooked it will make for its holt of tree roots and any flies swinging loose will be snagged up, with a break as the result. Your chub is left with a fly in its lip, a length of your cast attached to it and the whole lot anchored off a snag by another fly. If your fish isn't strong enough to break away then it will

die a slow and miserable death. The second reason is that there is no need to risk losing your tackle by being too greedy.

There are, of course, many other dressings for Palmer flies and it is interesting to experiment in making up your own. There's a good deal of satisfaction in creating a pattern of your own and taking fish with it. The bluebottle is a good natural fly to use, as also is almost any large fly, but they take some catching when you are wanting them.

Regarding plastic lures, the maggot can be cast in exactly the same manner as the fly but you require a rather different technique for caterpillars and tadpoles. The caterpillar should be cast down and across and here I would recommend putting your threadline reel on the fly rod. You can then let off quite a length of line as your caterpillar goes downstream. Every few yards check the line so that the caterpillar lifts and swings in the current and send it along under the bushes where chub expect such insects to come from. You can use a light float on the line if you wish but I dispense with this.

The tadpoles are yet another proposition and these should be fished close in as they are usually found in shallower water and near weeds. Your chub would look with suspicion on any tadpole swimming serenely about in midstream and away from its fellows because it knows that tadpoles just don't behave in such a manner.

FOUR BOOKS ON THINGS TO DO

HOBBIES AND HANDICRAFTS — Many popular hobbies such as book-binding, pewter work, leatherwork, photography, etc. are fully covered, and very well illustrated. Readers of *Hobbies Weekly* will be particularly interested in the section devoted to fretwork.

MODEL MAKING AND CARPENTRY — A constructive and thoroughly practical introduction to these popular hobbies, which is especially valuable for the beginner. How to make typical projects in this field is adequately described and illustrated.

ABOUT THE HOME — Explains a host of really useful jobs and repairs from

Let the current take it along a little way and then hold it so that it gets a lift up and the flow of water will make the thin tail wiggle very realistically. If you use your fly line and reel carry out the same tactics and don't put weight on the line or cast to get it out. Whichever tackle you use remember to fish the tadpole near weeds and always in the shallower water. All these lures have been personally tried out and found to be good but you must remember that it is an artificial with no life so that you must impart the movements which are expected by the fish. If you don't get fish don't blame the lure. Rather you should go out and make a study of the creatures you are trying to copy, watch their movements and when you have learnt how to give your artificial similar movements then you'll start catching fish.

In spinning your tackle should be light and your spinning rod brought into use. Your lure should be on a swivelled trace and you must put a small half-moon lead on the line above the top swivel to prevent line kink. Your lure should be a small blue and silver Devon, a small trout spoon or any small lure and you will find a quill minnow an excellent lure for chub. For this type of fishing I use a spool which carries a line of 3 lb. B.S. only. Heavier lines can put the fish down and in any case are not required for chub.

I can also recommend plug fishing for chub but I have never yet seen plugs small enough in the tackle shops so I make my own. The information I've given in the past will serve for plugs for chub as all you need to do is make them much smaller. I find that the plugs should be the type that will sink easily and this is allowed for when making them up but they don't want to plummet down like a stone. A quicker turn of the reel handle will take them well down if you have got the weight right. Make a few up of slightly different weights and then take them to the water and try them out.

mending a fuse to the simple upholstering of furniture. With these instructions, spare time can be put to really good use, and money on repair jobs saved into the bargain.

OUTDOOR PASTIMES — Camping, walking, cycling, bird watching, and fishing are among the ever-popular open-air pastimes described in this handbook. A description of basic equipment for each particular pursuit, and how to get the best out of your pastime, are very valuable features.

All the above books are published by Ward Lock & Co. Ltd, price 4s. 6d. each.

**BUILD YOUR OWN SUPER
MODELS WITH REAL
BRICKS AND CEMENT!**

Real bricks, real cement and a wide range of models to build with them. Designed to O-Gauge Scale by architects to look exactly true to life. Roofs, windows, doors, plans, full instructions—everything's complete. You can make permanent models or dismantle them and re-use bricks and other components. Kit "A"—20/6 Kit "B"—27/11

Kit "C"—53/6

CONTEMPORARY
BRICKPLAYER

WIN A PRIZE! £21.0.0 £10.10.0 £5.5.0

also consolation prizes are offered in the BRICKPLAYER contest

At good toyshops, hobby shops, departmental stores. Leaflet on request, together with name and address of nearest stockist if required.

J. W. SPEAR & SONS LTD., (Dept.HW) Enfield, Middlesex



THERE'S MORE THAN A TOOLCHEST IN THIS TIN

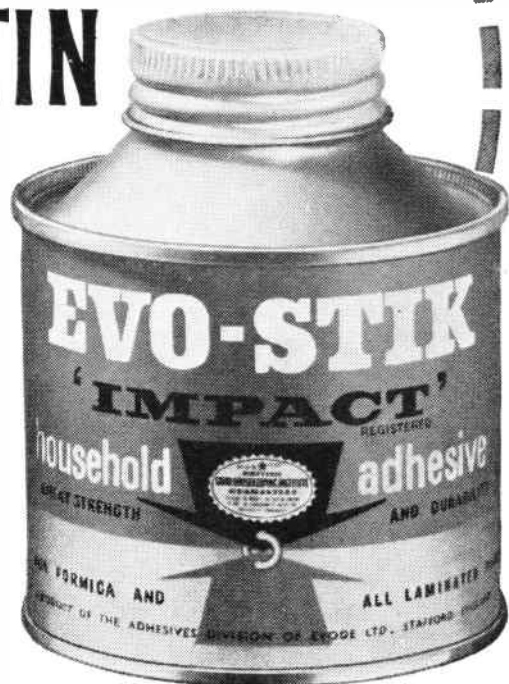

... THERE'S THE STRENGTH
OF A HERD OF WILD ELEPHANTS

EVO-STIK IS MANUFACTURED BY THE INDUSTRIAL ADHESIVES DIVN OF EVOGLU LIMITED, COMMON RD, STAFFORD. STAFFORD 2241 (8 lines).

with an invisible ease and economy which makes most tools and fixing methods "old-fashioned"

You can say "thanks" to modern research and scientists for Evo-Stik 'Impact' Adhesive. The amazing new "toolchest in a tin" which permanently fixes almost anything to anything. And with a power which wild elephants couldn't separate.

Demand for this new scientific method of fixing means that hundreds of thousands of gallons of Evo-Stik 'Impact' Adhesive go to important British industries. And millions of gallons go to industries throughout the world.

Now, demands from home-users just like you mean that all this fixing power; all this "know-how", powering international industry is available to you. Here are some examples . . .



SURFACES THAT SHINE

Decorative wall-boards and laminated plastics fix to almost any surface, be it plaster, metal or wood. And although they can be screwed, nailed or pinned, few builders would care to spoil such fine surfaces. Instead, manufacturers invariably recommend fixing with Evo-Stik 'Impact' Adhesive. And it is mainly due to the speed, economy and amazing strength of Evo-Stik that 75 million square feet of these materials are fixed each year.

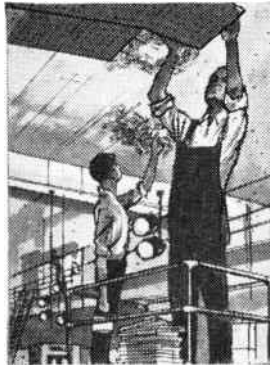

CEILINGS THAT SEAL SOUND

Only a few years ago industrial installations of Acoustic Tiles were laboriously and expensively fixed with screws and bolts. Often with a maximum speed of around 30 tiles an hour. Demand was low due to high installation cost. But to-day; two workers using Evo-Stik 'Impact' Adhesive install up to 300 tiles an hour. Result; new ceilings that silence sound; and new acoustic materials, shapes and decorative effects; through the speed of Evo-Stik.



CARS THAT LAST LONGER

Many of the component parts of motor vehicles such as draught excluders, foam rubber weather seals, etc., are under permanent atmospheric attack. Metal fixings used to hold these parts in position were constantly attacked by rust and corrosion. New fixing methods, resistant to atmospheric attack yet with all the strength of steel rivets and bolts were needed. Evo-Stik 'Impact' Adhesive answered this vital problem, throughout the motor industry.



DO THAT JOB YOURSELF

Because Evo-Stik is in your Ironmongers right now all these latest industrial joining techniques are being applied in the home. No wonder people say it's taken the "do" out of "do-it-yourself". Within seconds of applying Evo-Stik 'Impact' Adhesive you have a permanent, waterproof, and heat resistant bond. And Evo-Stik is efficient with practically every material you can think of. It's a toolchest in itself. Keep a tin handy.



TINS 7/- AND 4/3. TUBES 1/9



'IMPACT'
EVO-STIK
ADHESIVE

is a Registered Trade Mark

Remember . . . a small deposit secures any article.

LONDON OFFICE: 450/52 EDGWARE ROAD, W.2. AMB 2425 (5 lines). Associated Company in Eire: Evode Industries Limited, Swords, Co. Dublin. Swords 331

DOLLS' HOUSES OF DISTINCTION

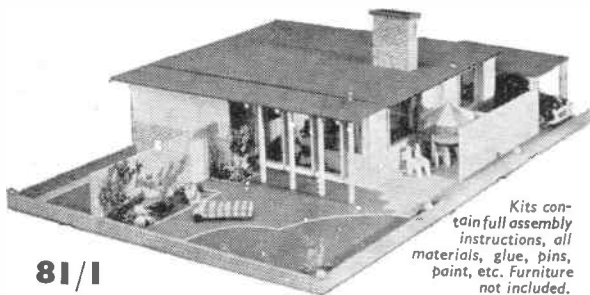

Kits contain full assembly instructions, all materials, glue, pins, paint, etc. Furniture not included.

81/1

THE 'CELEBRITY'—RTA 7

Size 36 in. x 24 in. Five main rooms including lounge with dining recess. Gardens, car port, service area, sun trap, etc. Flat roof lifts off for easy access to each room.

ALL PARTS PRE-CUT

ALL READY TO PUT TOGETHER

For the 'Royal' and 'Celebrity' Dolls' Houses, Hobbies have prepared kits with all parts cut to size and shape, ready for you to put together and finish. These are ideal for the man who wants to make a really excellent Doll's House — in a hurry!

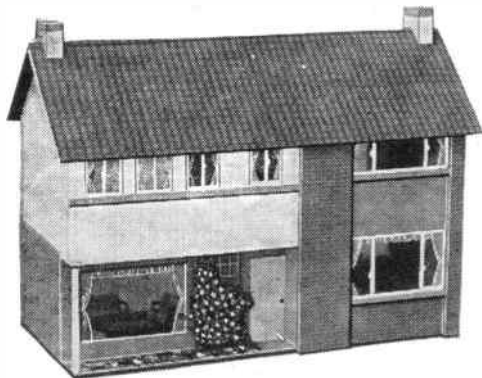

THE 'ROYAL'—RTA 6

Size 26 in. x 12 in. x 19 in. high. Double door opening at back. Modern lounge, hall entrance, kitchen/dining room, 2 bedrooms, bathroom and landing.

99/11

TO HOBBIES LTD (DEPT. 992), DEREHAM, NORFOLK
 PLEASE SEND KIT No. RTA.....
 NAME
 ADDRESS.....

 P.O. or cheque for.....enclosed

MANY MODELS from ONE TIN!



Pyruma, plastic and ready to use from its tin, can be fashioned into the widest variety of models imaginable. Buildings for your model railway set, houses, ship models, animals and figures, ashtrays and plaques — all of which when set or baked to stone-hardness can be finished in natural colours. Get the Pyruma Model Instruction book — see Coupon — and start making things like those shown below.

SANKEY'S PYRUMA PLASTIC CEMENT

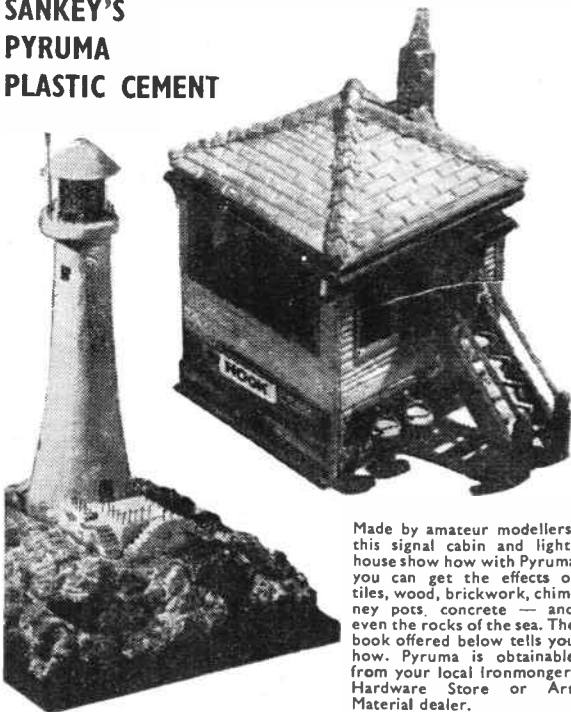

Made by amateur modellers, this signal cabin and lighthouse show how with Pyruma you can get the effects of tiles, wood, brickwork, chimney pots, concrete — and even the rocks of the sea. The book offered below tells you how. Pyruma is obtainable from your local Ironmonger, Hardware Store or Art Material dealer.

POST THIS BOOKLET COUPON TO-DAY

To J. H. SANKEY & SON, LTD (Dept. HW),
 ILFORD, ESSEX
 I enclose P.O. 6d. (not stamps) for a copy of Pyruma Modelling Instruction Booklet, post free to:

NAME

ADDRESS.....

(BLOCK LETTERS PLEASE)

Fun in the breeze with...

A LAND YACHT

A LAND YACHT which will provide hours of amusement whenever there is a breeze blowing is surprisingly easy to make. Besides the wood for the base, the main requirements are two pairs of wheels with axles, a broomstick, a cane and a sack.

The platform A is wedge-shaped, and made of $\frac{3}{4}$ in. thick wood. The one illustrated is 33 in. long, 15 in. wide at the

By

A. Liston

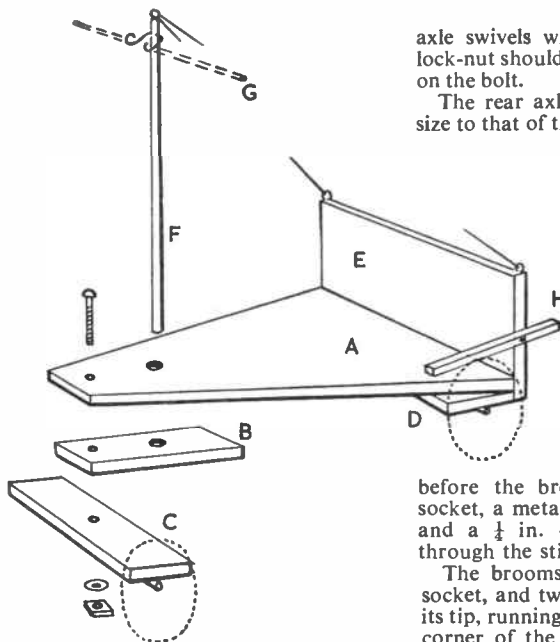

axle swivels without any 'play' and a lock-nut should then be screwed in place on the bolt.

The rear axle beam D, is of similar size to that of the front, and with wheels attached, it is screwed to the underside of the platform, flush with its rear edge. The back plate E is 15 in. wide and 9 in. high, and is screwed to both sections A and D. For extra rigidity, L-shaped metal brackets may also be used here.

A hole large enough to take the broomstick mast is drilled through sections A and B, 6 in. from the front, but before the broomstick is glued in its socket, a metal eye is screwed to its tip and a $\frac{1}{4}$ in. diameter hole is drilled through the stick, 3 in. from the top.

The broomstick is then glued in its socket, and two cords tied to the eye at its tip, running to hooks screwed to each corner of the backplate. If the wheels used have all been of the same size, it will be noted that the mast is raked slightly; this is intentional, and gives a more pleasing appearance.

The sail is made from a sack, which is opened out by cutting down the seam at one side and along the bottom. A 2 ft. wide and 3 ft. high piece of sackcloth is tied along its upper edge to a 24 in. long spar G, for which a cane or piece of $\frac{1}{2}$ in. diameter dowel rod can be used. The spar is wired or tied to the mast through the hole previously drilled.

A length of cord is tied to each lower corner of the sail. These cords are held in the hands and should not be tied to the framework, so that in the event of a strong gust, they can be released quickly.

A simple brake H, is made by screwing

a strip of 1 in. by 1 in. wood to the backplate, so that when the end of the strip is pressed down, it bears on the tyre.

Steering is done with the feet, as the illustration shows, and the angle of the sail is controlled by the cords held in the hands. It is best to try out the yacht in a steady breeze, rather than in a gusty wind, until one has become accustomed to the way it handles. Choose an open space with a hard surface, such as a playground, and not a roadway. Under the right conditions, you will find that land yachts can be surprisingly speedy.

EMBOSSING CHRISTMAS CARDS

WE have just had the opportunity of examining and experimenting with the Embossed Christmas Card Outfit, which represents excellent value for an outlay of only 12s. 6d. (including postage). It embodies a highly successful process which enables the amateur to make individual greetings cards bearing an embossed and very professional finish in silver or gold. This new approach to the making of 'personal' Christmas cards will be appreciated by our readers.

Four rubber stamps bearing Christmas motifs and an ink roller are included in the outfit, which contains enough materials (card, ink, decorations, adhesive, etc) for producing at least fifty cards according to size and shape, in an endless variety of patterns. The application is quite simple and users can confidently 'go into production' after a few trial runs in the handling of the rubber stamps.

Enquiries concerning these outfits should be sent to The Embossprint Company, 146 Fleet Street, London, E.C.4.

rear, tapering to 5 in. at the front. But these widths may be altered to suit the length of axles available.

A strengthening strip B of $\frac{3}{4}$ in. thick wood, 5 in. wide and 18 in. long, is screwed to the underside of the front of section A. The axle beam C, also of $\frac{3}{4}$ in. thick wood, is 5 in. wide and 15 in. long.

A hole for the 3 in. long bolt on which the axle pivots is drilled through sections A, B and C, and after the wheels and axle have been attached to the axle beam, passing behind the hole drilled for the bolt, the front wheel assembly is completed.

The nut should be tightened until the

THE WEBB COMPOUND ENGINES

THE first four-cylinder 0-8-0 Compound Coal engine designed by Mr F. W. Webb for the London & North-Western Railway, left the Crewe erecting shop in August 1901.

been previously provided with larger boilers by George Whale in 1906-07, and were known as Class 'F'. The original 0-8-0 'B' class engine No. 1881 was never rebuilt or modified and she

two inside low-pressure 20½ in. by 24 in. stroke. Ratio 1·87. Wheels, diameter 4 ft. 5½ in. Boiler heating surface, tubes 1,630 sq. ft., firebox 123 sq. ft., total 1,753 sq. ft. Working pressure 200 lb.

per sq. in. Grate area 20·5 sq. ft. Centre line of boiler from rails 7 ft. 10½ in. Height to top of chimney 13 ft. 0¼ in. Wheelbase 17 ft. 3 in. equally divided.

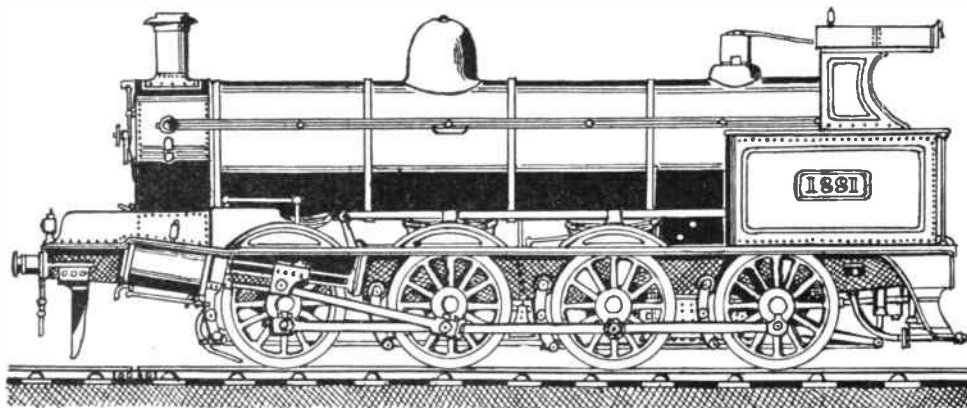

London & North-Western Railway No. 1881 F. W. WEBB'S first eight wheels coupled 4 cyl. compound coal engine. Crewe No. 4155, Aug. 1901

This engine No. 1881 (Crewe No. 4155) was followed by a further nine of the class in September of the same year. These were numbered 1882-1890, and their Crewe works numbers were 4156-4164. In December a further ten were built, Nos. 1891-1900, Crewe Nos. 4185-4194, all in the same order. These first twenty engines of 1901 were put to work on the heavy coal and mineral traffic of the line, and proved at the time quite capable of these duties. After a short period, however, it was found that there was a concentration of weight at the front end, and in 1904 George Whale subsequently modified several of the class by adding a pony truck. As thus modified they were known as Class 'E', whilst the original engines were Class 'B'.

Construction of the Class 'B' engines was continued by Mr Webb and Mr Whale from March 1902 up till August 1904, when the last of the class, No. 1543, Crewe No. 4411 was built. This engine was one of many of the class which were finally converted to the large boiler 'G1' class superheater 'simple' type by Mr C. J. Bowen-Cooke, No. 1543 (as L.M.S. No. 8952) being converted in February 1924. Several of the 2-8-0 'E' class also came in for this conversion.

In January 1923 the L.M. & S.R. took over sixteen L. & N.W.R. Crewe Compound 2-8-0 engines, which were numbered L.M.S. 9600-15. Nos. 9600-09 being Class 'E', whilst Nos. 9610-16 had

finally finished her working days as L.M.S. No. 8900, being withdrawn in her original condition in 1928. In 1925 she was specially painted in her original L. & N.W.R. livery and number for the L.N.E.R. Centenary at Darlington and this was the last L.N.W.R. engine to be so treated.

The Crewe engine diagram No. 28 gives the following details of the original '1881' 'B' class: cylinders (four), two outside high-pressure 15 in. by 24 in. stroke,

Weight engine in working order, on leading wheels 14 tons 4 cwt., on driving wheels 17 tons 10 cwt. (all four cylinders actuated the second axle), on intermediate wheels 14 tons 4 cwt., and on trailing coupled wheels 9 tons 10 cwt., total 55 tons 8 cwt. The tenders were of the standard Webb pattern with wooden frames, having six wheels of 3 ft. 9 in. diameter, tank capacity of 2,000 gallons coal space of 5 tons, and weighing full 26 tons 12 cwt. (A.J.R.)



A READER'S CONTEMPORARY CABINET

DETAILS of modifications which have been made to Hobbies Design No. 3144 for a Contemporary Bedside Cabinet have been passed to us by Paul Pickering of Bedford. In particular, the door has been made to hinge downwards instead of at the side, and held up by cabinet stays. This, of course, facilitates removal of contents in some instances and is a personal preference. Mr Pickering used shellac varnish with wax polish to produce a light finish.

The Hobbies kit for this project which is ideal as a bedside cabinet and measures 27 in. high by 18 in. wide, costs 72s. carriage free from branches and Hobbies Ltd., Dereham, Norfolk.

NEWSPRINT MARQUETRY

YOU will probably have seen many examples of marquetry pictures made by using a variety of wood veneers glued on to a wood base. Here we describe a similar method but our material is much cheaper and easier to work for it is nothing more than newsprint. While the process itself is something like making and assembling a jig-saw you also have the fun of deciding the shape.

We first prepare a line drawing on a reasonably large sheet of drawing paper. You may use white paper but tinted pastel paper can be used to better advantage since it will make a suitable

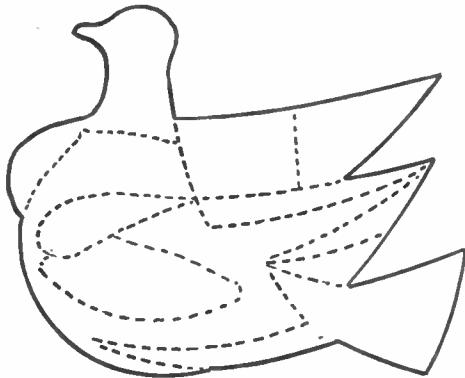

background. The main requirements of the drawings are only the outline plus any distinctive details it is necessary to incorporate and the drawing itself can be either an animal or a pictorial scene.

Having prepared the basic drawing on a sheet of paper, which will ultimately bear the finished picture, we make a tracing on transparent tracing paper. We then have to decide how to treat various parts of our sketch by sticking on newsprint, some light in tone and some much darker.

Here we must mention that when we use the term newsprint we mean black and white printing from newspapers and magazines. From experiment we find that the ordinary newspaper is not to be recommended since the paper is pulpy and too absorbent for perfect adhesion. You will find that magazines which are printed on better quality paper are much better to handle and the parts will stick to the base without trouble if a good adhesive is used.

Collect a few magazines, cutting out and grading columns of typescript, pictures and items into their respective

tones as near as possible. You will discover that the advertisements are as good as anything since they often bear illustrations or drawings, and portions of these can be used effectively for detail work. Moreover, the characters are usually much larger and make quite distinctive features for the construction. You may also require some strips of unprinted paper which can be taken from the margins.

It is advisable to cut some of the typescript on the diagonal when the lines of print will appear at an angle on the

required. Cut out the newsprint to the prepared shape with scissors so that there is no trace of the carbon line, testing for size before sticking into position. Any trimming should be done at this stage. Then apply a little adhesive to the back of the cut-out portion and attach to the base paper. And we continue to make tracings of different parts, cutting out and fitting together in the same way until the picture is completed.

In some cases the fragments may overlap but those on the surface must be accurately cut for neat pictures. More-

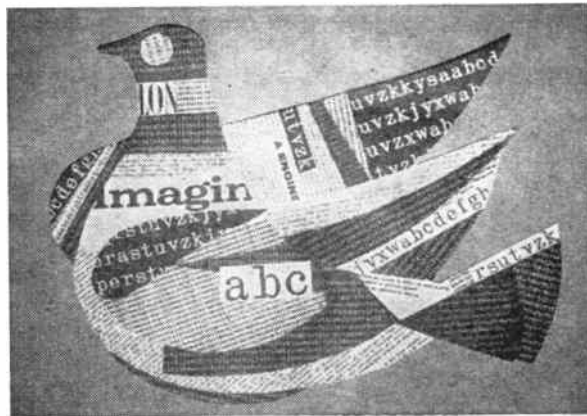

picture. In brief, you require as large a variety of newsprint as you can get, vertical, horizontal and diagonal typescript, pictures, bold lettering and textures all graded into tones ranging from black to white.

With the material and drawing ready to hand it is only a matter of assembling the picture and for this you will require a pair of scissors, some carbon paper, and some adhesive.

In the illustration you will see the completed assembly of a picture of a duck while the diagram shows the preliminary treatment. In the latter you will see that we first sketch an outline and the dotted lines indicate how to divide the shape into sections for the wings, tail, etc. It is sometimes a help to mark those sections where dark tones are desired by means of a few pencil lines or shading to give some idea.

Assuming we start with the neck and head of our duck we select an appropriate piece of newsprint, place this on the table with a piece of carbon paper on top. Now place your tracing on top of this, marking out the shape of the part

over, if one piece does not meet with your approval — in terms of tones — you may replace with another and it is quite a simple matter to make alterations before sticking on to the paper.

We have not made a background for our illustration since pastel paper was used but no doubt you will realise that if one is required it must be the first item to be attached, hence our earlier suggestion of tinted papers. Birds flying in the sky can be added by cutting V shapes and sticking these on at an angle and no doubt you will think of other additions.

If you also use scraps of coloured typescript or coloured advertisements from the magazines you will be able to add touches of colour here and there. Ships, yachts, and the like make good pictures while you can make some really novel animal pictures. So you may mix black and white newsprint with colour or endeavour to make coloured pictures, which are a little more difficult but very fascinating. And as there are no set rules we think the addition of tiny details with water-colour can be permitted.

(A.B.)



HUMBROL'S HANDY IN THE HOME... TOO!

Handy tinlets by Humbrol give you an attractive range of 34 intermixable colours. No undercoat needed, dries in an hour without brushmarks. Also available is Humbrol radiant Décor, the luxury paint to give your home the daring, different '61 look. Décor comes to you in 22 wonderful colours. Use Humbrol paints for every household and handicraft purpose.

Humbrol is available in handy tinlets price 9d. each and 2oz. tins at 1/6 each at all Hobbies Ltd., Branches

HUMBROL ONE-HOUR ENAMEL in the Décor range of colours



Humbrol One Hour Enamel, in a range of glorious Décor colours, is the ideal paint for those round-the-house jobs. It's so easy-flowing and it withstands the worst the weather can do. Décor colours at your local paintshop 1/4 pt. 3/-; 1/2 pt. 5/3.

KEEP HUMBROL HANDY

THE HUMBROL OIL COMPANY LTD, MARFLEET, HULL

HEAR ALL CONTINENTS With H.A.C. Short-Wave Receivers

Suppliers for over 18 years of radio S-W Receivers of quality.

One-Valve Kit, Price 25/- Two-Valve Kit, Price 50/-
Improved designs with Denco coils. All kits complete with all components, accessories and full instructions. Before ordering, call and inspect a demonstration receiver, or send stamped addressed envelope for descriptive catalogue.

'H.A.C.' Short-Wave Products (Dept. 22), 44 Old Bond Street, London, W.1.

THE 'MARVEL' BENCH MOTOR- DRIVEN SAW

To meet modern needs. Just plug in and switch on from any house lighting point. For either A.C. or D.C. mains. With 230-250 volt motor, flex, switch, etc.

£13 10 0

(without motor
£5 10 0)

Easy Payments
1 Available

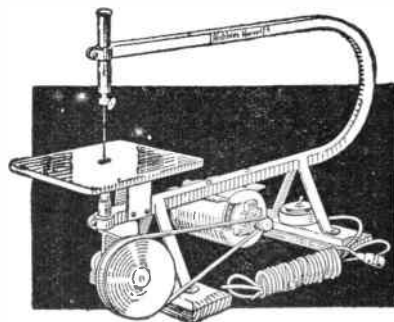

HOBBIES LTD (Dept. 992), DEREHAM, NORFOLK

LET 'Plasticine'



HELP YOU DO-IT-YOURSELF Regd. Trade Mark
Special Trial Offer. We will send 4 lb. 'Plasticine' (any colour) with booklet 'Plasticine Modelling for Amateurs' Post free: 10/- U.K. only.

Harbutt's Plasticine Ltd, Bathampton, Bath

THE BENCH FOR YOU!

With a bench like this you can work to your heart's content. Perfectly rigid, but can be easily taken apart if space is required. Best selected timber, complete with hardwood vice with twin screws. Easy payments £2 down and 6 monthly payments of 18s. 3d. Ask for agreement form.

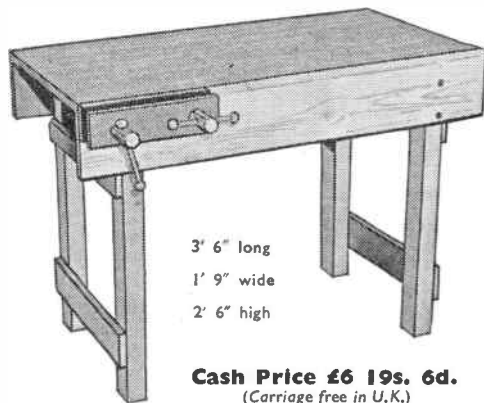

From Branches or direct from:
HOBBIES LTD (Dept. 992), DEREHAM, NORFOLK

...ab evenly on the paper...
...to know if you could...
...to go over the wallpan...
...wish to make some plan...
...on the sum...
...mitter? (R.F. — Wolverhampton.)
...Channel 10 would

Replies to Readers

...to charge a 12V. battery, as...
...was made by fixing...
...board over a stou

Quick-setting Cement

AS I am in need of a very hard quick-setting cement, I had thought of using that such as dentists use for filling teeth (the white type), and would be most grateful if you could let me have the formula. (D.P. — Bolton.)

AHARD and quick-setting dental cement of the white type can be produced when needed by mixing zinc oxide with half its bulk of silica and then grinding this with enough zinc chloride solution of specific gravity 1.260 to form a thin paste. This sets rapidly, and must thus be used at once. The zinc chloride solution need not be made up freshly each time, but may be kept as a stock in a closed bottle.

Removing Tar

THE wings and sides of my car are spattered with tar; is there a way of removing this without damaging the paint work? (A.D. — Birmingham.)

SPONGING with either paraffin or Smethylated spirit will remove the tar provided this has not dried out too hard. They are highly efficient with fresh or fairly fresh tar. We recommend the use of these first. If the tar has become very hard and resistant, rub with creosote (by means of a rag tied to a stick, for contact with the hands will produce blisters).

Grinding a Glass Stopper

IHAVE an old decanter, but the stopper does not fit as it is slightly on the large side; can you tell me how to reduce it slightly in diameter? (N.L. — Nottingham.)

PRESUMABLY the decanter and stopper are of glass, in which case the only feasible way of reducing the diameter of the stopper is by grinding. If a lathe is available, the stopper can be held in a chuck, and the grinding accomplished by applying a coarse carborundum stone to the conical surface, whilst keeping the whole well lubricated with water. In the absence of a lathe, the best plan is to make a conical hole in a piece of wood, and to use coarse carborundum grinding powder and water, and rotate the stopper in the conical hole until sufficient has been ground away to suit your purpose.

A Water Resister

CAN you tell me, please, the name of a chemical or powder which when rubbed on the hand resists water? (E.G. — Poole.)

THE substance referred to is lycopodium powder. When rubbed on the hand it forms a water-resistant 'glove'. It is obtainable from laboratory furnishers.

Water Divining

ISHOULD like to know how to become a water diviner. (H.L. — Swindon.)

THE art of 'dowsing' or water-divining by means of a rod, is of immemorial antiquity. The rod normally used is a forked twig of hazel or willow. The two ends of the fork are held tightly, one in each hand with the single end pointing horizontally outwards. When near or over water (subterranean), the twig twitches and pulls vigorously downwards, if the holder possesses the unknown power of 'divination'. There is no known reason for the power — it cannot be learnt; either you have it, or you do not. Trial will soon show if a person has this super normal perceptive power — as real but

as obscure as the homing instinct in pigeons.

Is It Gold?

IHAVE a small ornament which I believe to be gold, although not stamped. Is there a method by which I can find this out at home? (T.G. — Bradford.)

YOU should buy a little strong nitric acid from a chemist, and apply a small drop to a hidden part of the ornament with a glass rod drawn out to a fine point, or with the edge of a glass stopper. If the nitric acid spot shows no change in colour in half a minute, the ornament is gold. With brass and other alloys resembling gold, the nitric acid spot immediately becomes green, fizzes and then turns blue. The carat number cannot be determined by the nitric acid method of course. This is beyond home determination and is a matter for a goldsmith.

Home-made Stain

IHAVE five rooms and wish to stain the floors about 3 ft. wide all round. Would it be cheaper to make my own stain (T.J. — Salford.)

THE cheapest stain is permanganate of potash in water. This darkens the wood but needs several applications. The next cheapest is dark oak powder stain, soluble in water. A packet of this costs but a few pence and is enough for a quart of water. Apply it hot and make sure you have enough to treat each floor at one application, as it may prove difficult to mix a second lot to exactly the same tint.

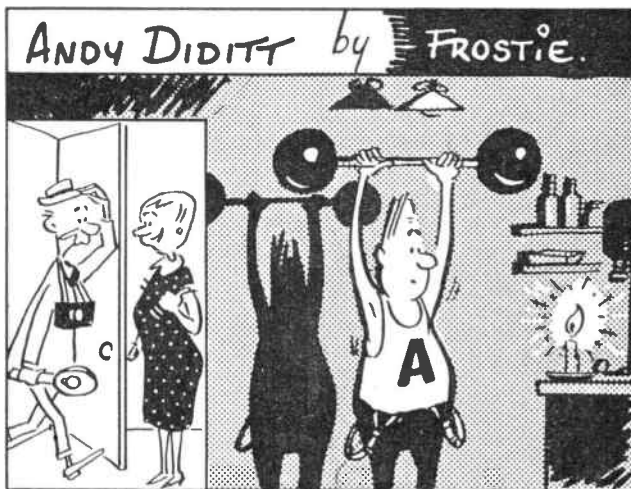

"GO RIGHT THROUGH, MR. WEST — ANDY'S IN THE DARKROOM DOING SOME DEVELOPING."

BRASS, COPPER DURAL, ALUMINIUM, BRONZE

ROD, BAR, SHEET, TUBE, STRIP, WIRE
3,000 STANDARD STOCK SIZES

No Quantity too small List on Application

H. ROLLET & Co. Ltd.

6 CHESHAM PLACE, LONDON, S.W.1

Also at

Liverpool, Manchester, Leeds, Birmingham

LEARN

RADIO & T/V SERVICING for your OWN BUSINESS/HOBBY

● by a new exciting no-maths system, using practical equipment recently introduced to this country
FREE Brochure from:—

RADIOSTRUCTOR

DEPT. 681, READING, BERKS.

15/11/61

HOMEWORKERS required to make up and machine simple household goods. Experience unnecessary. Good pay. Regular work. S.A.E. for details to Dept. 28, Arnold, 10 Shelley Road, Worthing, Sussex.

100 DIFFERENT stamps free! Request 4d. upwards discount approvals. — Bush, 53 Newlyn Way, Parkstone, Dorset.

ENJOY WRITING? Then write for Profit. Send for 'Writers' Handbook' (free) detailing countless opportunities for beginner or experienced. — Writers' Ring (HW), 5 Edmund Street, Birmingham.

MAKING YOUR HOBBY MAKE MONEY

HOW, WHY any handicraft can make money for you — everything you should know.

40 pages of experience — 5/6 from

G. SEALE

Regent House, 26 Queen's Rd., Coventry

PRINT YOUR OWN CHRISTMAS CARDS

Many design combinations in shining embossed silver and gold + multi-coloured metallic stars, crescents, etc., gold transfer foil for drawing—coloured paper for 50 cards—printing materials for 100s. Fascinating—simple—unique. Complete outfit only 12/6 P.O. including postage from THE EMBOSPRINT COMPANY LTD, Fleet Street, London, E.C.4.

MAKE FRIENDS ANYWHERE (17-70). Join our Unique Club. — S.A.E. for details. — Personal Column Ltd., Falcon House, Burnley, Lancs.

REMUNERATIVE, RELAXING. Paint designs on paper. Flowers, Abstracts. Anything YOU wish. Exceptional opportunities, beginners, others. Read exciting 'PROFIT-ABLE ART' (free). Popular Art (HW), Clun, Shropshire.

WILL PAY worthwhile for one or more compass lens combination, sandwich type, stamped 'Made in England'. New, used. — Alexei Zardetzke, 340 Bowery, New York 12, New York, U.S.A.

There was a young man from Penzance — who hadn't a clue how to dance!

but he sent for our book — and in no time—just look!

—he's made an amazing advance!

Can't afford private lessons? Learn ballroom dancing at home! Send for exciting booklet. "Dance Escort" — FREE to readers of 'Hobbies Weekly' — which explains the dynamic SURE STEP system.

Send name and address to: ESCORT DANCE INSTRUCTORS

Studio H33, Harrogate

(or Rock 'n' Roll Course—send 4/6 p.o.)
or Old Time 8/6, or Cha, Cha Course 5/6
or Escort's complete Ceili Course 6/6.

MAKE interesting new friends, ages 17-70. — Join V.C.C. 34 Honeywell, London, S.W.11.

BUYING OR SELLING?

Classified advertisements on this page are accepted at a cost of 6d. per word prepaid. Use of a Box No. is 1/- extra. Send P.O. with advertisement to *Hobbies Weekly*, Advert. Dept., Dereham, Norfolk. Rates for display advertising on application.

Enjoy the thrill of enlarging your own photos and become expert operating this super

'AGISCOPE' ENLARGER

IT'S YOURS
FOR ONLY 15/-

dep.
then 4 monthly
payments of 30/-

Here is the most modern enlarger everyone can operate at a price everyone can afford.

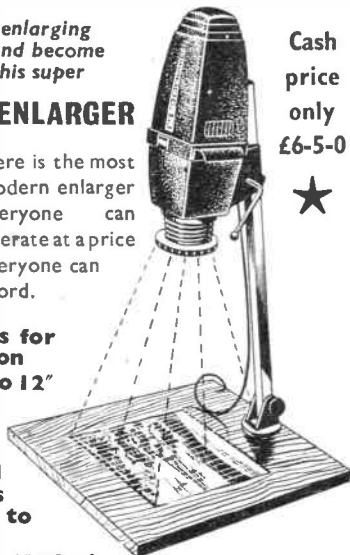

Cash price only
£6-5-0



- ★ Coated lenses for high definition
- ★ Enlarges up to 12" square on baseboard
- ★ 6 aluminium masks for all popular sizes from 35mm. to 2 1/4 x 3 1/4
- ★ Baseboard of 3/4" Block Board ensures freedom from warping
- ★ Non-rust aluminum column
- ★ Folds easily for storing

SMALLEY PHOTOGRAPHIC

(Dept. H), 221 DAWES ROAD, LONDON, S.W.6.

MARQUETRY IN FULL COLOUR

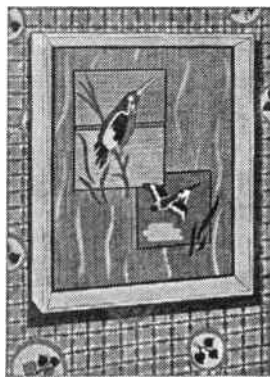

HH/5 Kingfishers

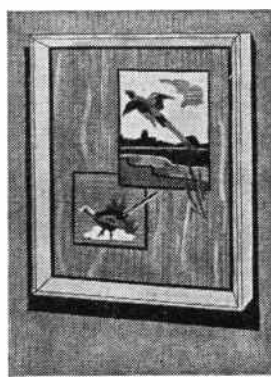

HH/6 Pheasants

12/6 each
(post 2/-)

Each kit contains baseboard size 10 in. by 8 in., selected oak veneer (printed) for the background, brilliant coloured veneers, carbon paper, guide print, cement, glasspaper, moulding, instructions. They make a perfect pair.

HOBBIES LTD (DEPT. a92) DEREHAM, NORFOLK

PIPE RACK PATTERNS

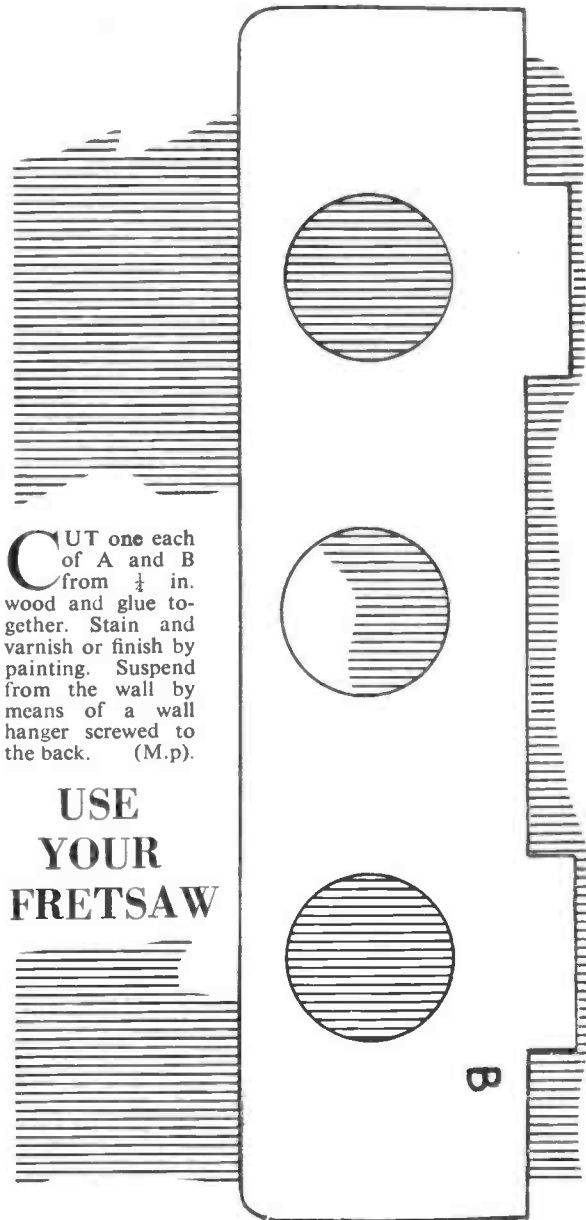

CUT one each of A and B from $\frac{1}{4}$ in. wood and glue together. Stain and varnish or finish by painting. Suspend from the wall by means of a wall hanger screwed to the back. (M.p.)

**USE
YOUR
FRETSAW**

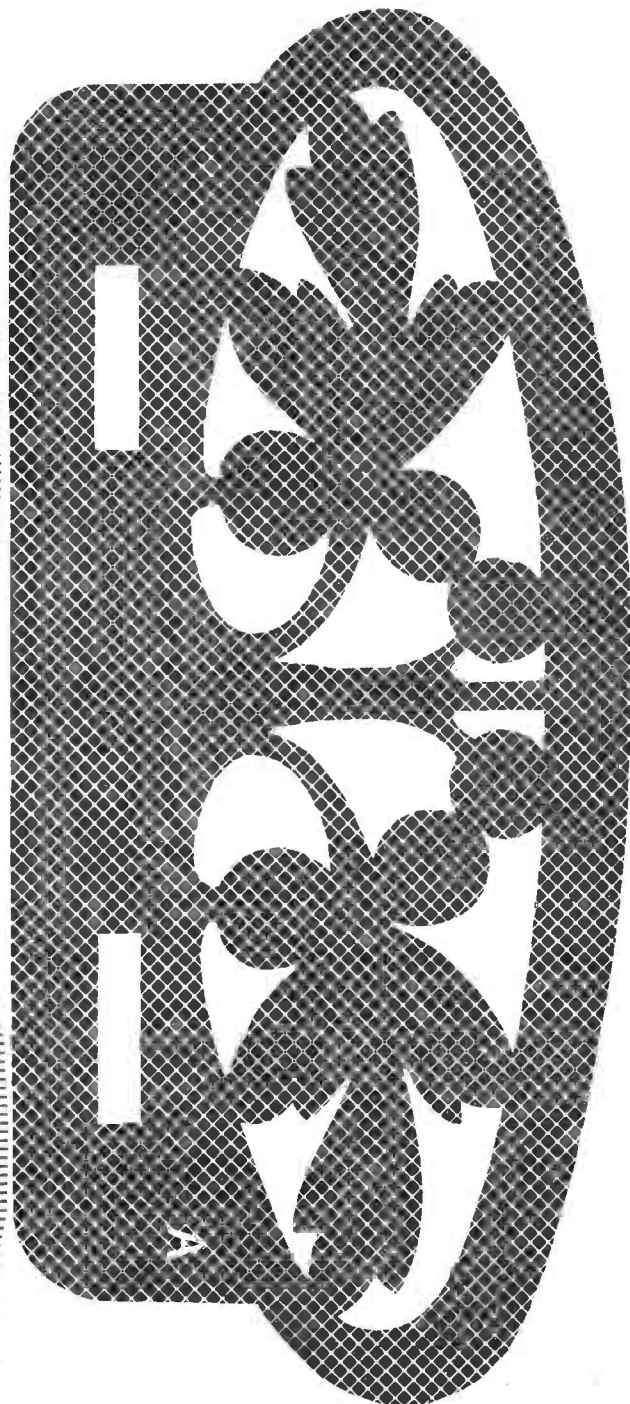

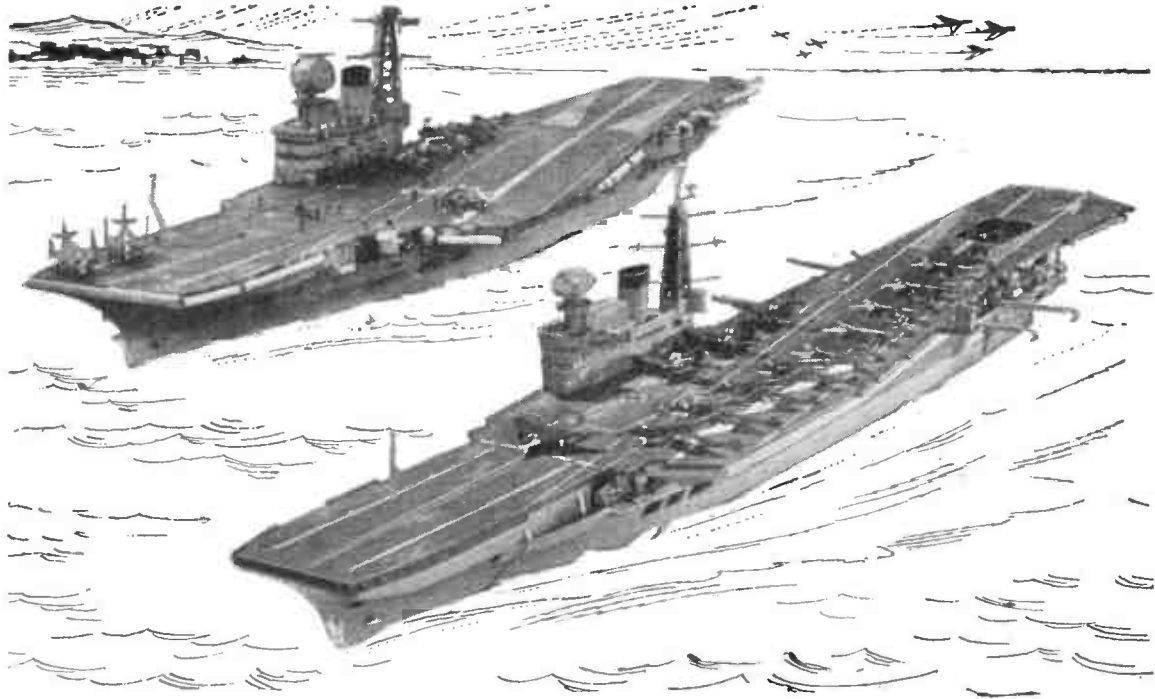

Just like the real thing!

Believe it or not, the nearer one is the Airfix model of H.M.S. "Victorious", 1/600th scale (Kit 6/-). Behind it is a picture of the real thing.

That's how wonderfully realistic Airfix models are. Close attention to every detail gives them their faithful-to-the-original look—makes them true collector's pieces. And every Airfix series is to a constant scale. This means Airfix models look proportionally right, one against another, because they *are* right! You can't beat Airfix for realism—or value.

AIRFIX

Constant Scale Construction Kits

From Model & Hobby Shops, Toy Shops, and F. W. Woolworth

There are over 140 Airfix models from 2/- to 10/6.

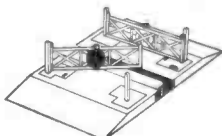

TRACKSIDE SERIES
Level Crossing 2/-

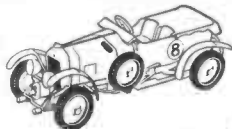

VINTAGE CARS
1930 Bentley 2/-



MODEL FIGURES
Lifeguard 2/-

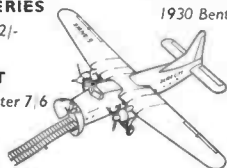

AIRCRAFT
Bristol Superfreighter 7.6

STOP PRESS!

Latest Airfix Production



NEW 'SKYKING' SERIES

Fantastic value! Amazing detail! The first two in this new 1/144 scale series are:

De Havilland 'Comet' 4B (wing span 9 inches)
— 45 part kit . . . 4/6

Sud-Aviation SE210 'Caravelle' (wing span 9 3/8 inches)
— 44 part kit . . . 3/6

Also New Austin-Healey 'Sprite', the second in the new Modern Car series

— 52 part kit . . . 2/-

NEVER BE
LATE FOR
A DATE

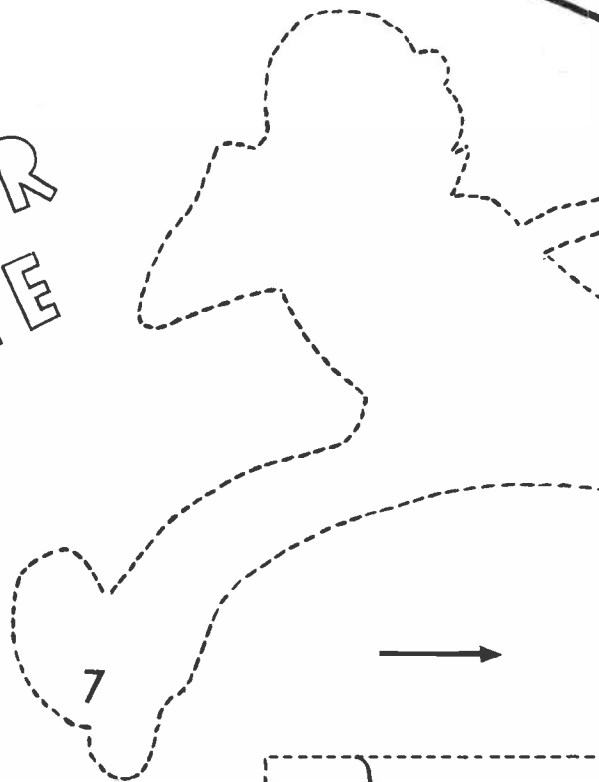

7



4

PIECE 1.
CUT ONE
1/4 in.

3

1



4

5

6

5

6



PIECE 2.
CUT ONE
1/4 in.

NOVEL PERPETUAL CALENDAR



SIZE:
8 ins. WIDE
5½ ins. HIGH

A KIT OF MATERIALS FOR MAKING THIS DESIGN IS SUPPLIED BY HOBBIES LIMITED, DEREHAM, NORFOLK. PRICE ON APPLICATION.

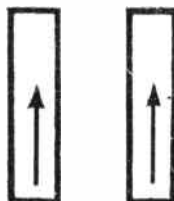
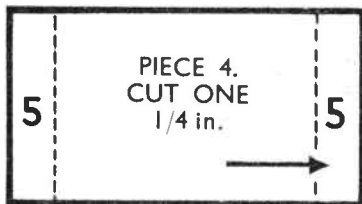

PIECES 5.
CUT ONE
OF EACH
1/4 in.

THE WORLD'S STRONGEST GLUES

Stick it with—
Croid POLYSTIK



A white P.V.A. adhesive, clean to use, non-staining, fast-drying and strong. For joinery and cabinet work. In easy-spread polythene bottle: 2/6d and 5/-.

BUY CROID FROM YOUR LOCAL HOBBIES BRANCH



DOG

PIECE 2.
CUT ONE
1/4 in.

PIECE 3. CUT ONE FROM TRIANGULAR FILLET.

NOTE.—Cut to the outside
of thick lines.



PIECE 7.
CUT ONE
1/4 in. AND PAINT.

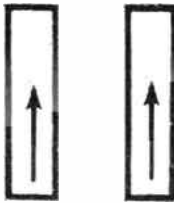

PIECES 5.
CUT ONE
OF EACH
1/4 in.

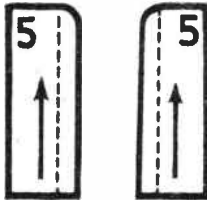

PIECES 6.
CUT ONE
OF EACH
1/4 in.



Stick it with -
Croid POLYSTIK

A white P.V.A. adhesive, clean to use, non-staining, fast-drying and strong. For joinery and cabinet work. In easy-spread polythene bottle: 2/6d and 5/-.

BUY CROID FROM YOUR LOCAL HOBBIES BRANCH

THE ARROWS
INDICATE DIRECTION
OF GRAIN OF WOOD.

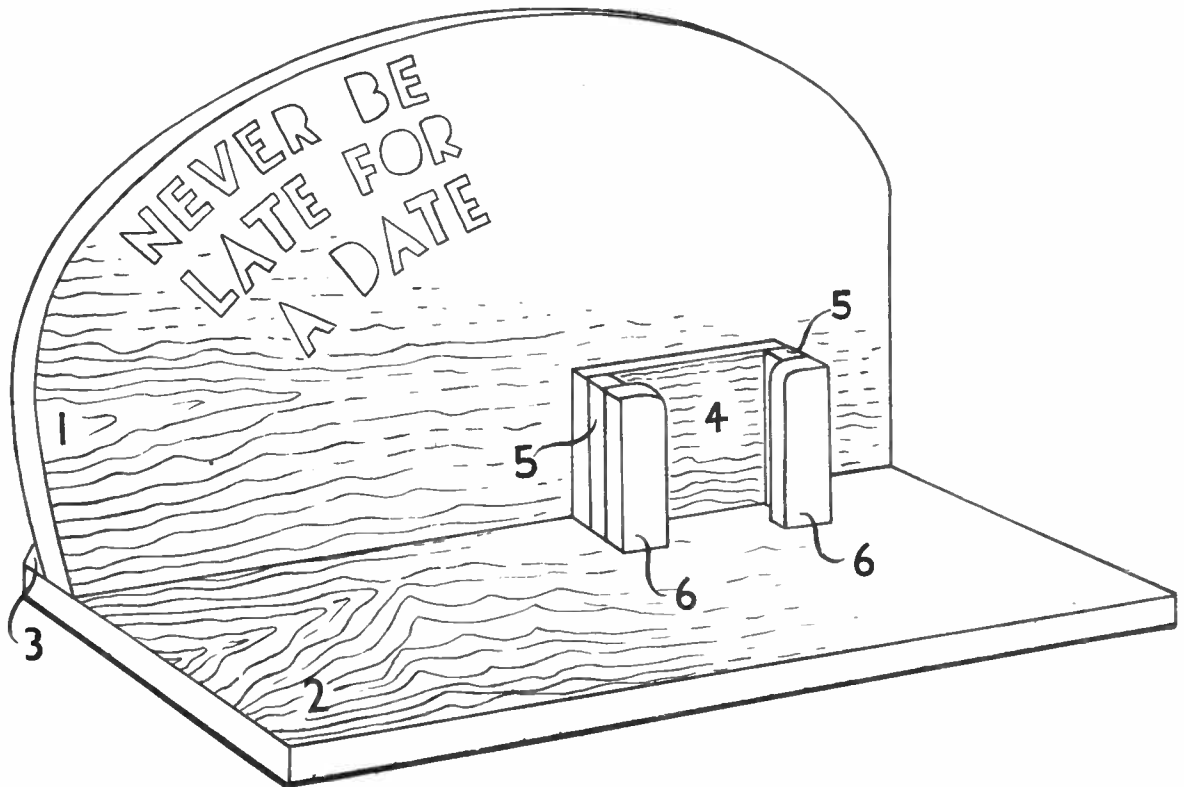

PRINTED IN ENGLAND.