

31st MAY 1961

VOL. 132

NUMBER 3416

THE ORIGINAL
'DO-IT-YOURSELF'
MAGAZINE

HOBBIES *weekly*

FOR ALL
HOME CRAFTSMEN

BRITAIN'S NUCLEAR SUBMARINE

'DREADNOUGHT'



Also in this issue:

ENLARGING FOR
THE BEST PRINTS

COLLECTORS' CLUB

MAKING A HOME
SHOWERBATH

START OF SERIES
ON DIVING

H.T. ELIMINATOR

SUMMER FISH
WORTH CATCHING

GARDENING HINTS
AND A PLAYPIT

ETC. ETC.

Free Plan to make this model

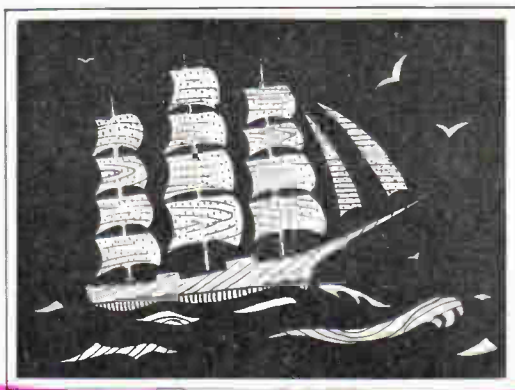

Instructions
for making

**Novel
Marquetry
Pictures**



Up-to-the-minute ideas

Practical designs

Pleasant and profitable things to make

World Radio History

5^D



THE Postal Administration of Netherlands New-Guinea issued two special stamps on 5th April, on the occasion of the opening of the New Guinea Council. The same design has been used for both stamps (25 cents bluish green, 30 cents wine red), and features the new Council House at Hollandia.



These stamps will be available for a period of three months. They will be valid until 31st December 1962.

NEW ISSUES AND FACTS

On 11th January Mauritius issued a set to commemorate the Sesquicentenary of the Post Office under British Administration. The issue consists of four values — 10, 20, 35 cents, and 1 rupee. The design, which is common to all four values, includes the Annigoni portrait of the Queen with the St. Edward's Crown, and a portrait of King George III by Sir Thomas Lawrence. Permission to reproduce the Lawrence portrait of George III was kindly given by the City of Coventry, who own the original. It is believed that this is the first occasion that the portrait has been used on a postage stamp.

The early stamps of Mauritius are one of the greatest prizes of the collector, and worth thousands of pounds. The famous

2d. deep blue of 1847 is now listed at £6,000 mint and £5,000 used.

Mauritius is in the Indian Ocean about 530 miles east of Madagascar. It is 39 miles long and 29 miles wide, with an area of 720 square miles. Surrounded by coral reefs, it is a rugged, hilly mass of volcanic origin, the chief heights being Black River Peak (2,711 ft.) and Pieter Both (2,676 ft.), with valleys of great fertility.

Pieter Both is depicted on the 50 cent stamp of 1950 — 2s. mint.

Sugar is the chief export, and to this commodity the island owes its prosperity. Tropical fruits, vanilla plants, and hemp are grown, most of the inhabitants being engaged in agriculture. There are about 120 miles of railways. Port Louis, the capital, with a population of 66,460, has the only good harbour. It is an important link on the sea route to India.

Stamps of 1953 are: 4 cent — Sugar Factory — (2d. mint). 10 cent — Transporting Cane — (5d. mint). 2 rupee, 50 cent — Port Louis — (5s. mint).

Mauritius was discovered by the Portuguese in 1505, but they soon abandoned it. The Dutch occupied the island in 1598 and gave it its present name in honour of Prince Maurice of Orange-Nassau. The Dutch left in 1710, and five years later the French established a settlement there.

The British conquered Mauritius in 1810. In literature it is famous as the scene of the French novelist Bernardin de Saint-Pierre's story entitled 'Paul and Virginia'. The 20 cent stamp of 1950 depicts a scene from the novel.

Mauritius was once the home of the dodo, a bird which became extinct in about the year 1700, shown on the 12 cent stamp of 1950 (8d. mint).



Allan Nichols

'I would like a pen friend from anywhere in the world', says ALLAN NICHOLS of 2 Oaklands West, Alnmouth Road, Alnwick, Northumberland. 'My hobbies are swimming, fretwork, marquetry, and collecting cigarette packets.'

'Friends' Wanted

CRAIG PELTON of 37 Robert Avenue, Broadview Gardens, Brisbane, Australia, collects stamps, and brewery labels. He has many items for exchange.

W. D. A. SAMARASINGHE, 141 Main Street, Bandarawela, Ceylon, has received many letters from pen friends. 'But I would like many more friends', he writes. 'I have many stamps and cards for exchange.'

MRS JOYCE WEIR has sent some interesting news of her family — 'My daughters are both Girl Guides. Barbara, aged 11, has gained her "Second Class". Judy, aged 15, is a "First Class" Guide, and has been working hard for one year to gain the "Queen's Guide" badge, which she gets next October. My son is 8 in November, and is joining the Cubs in February.' Write to — 13 Oman Road, Kaiti, Gisborne, New Zealand.

MRS RUE E. M'CUILLING of 12 Abbott Street, Gisborne, New Zealand — a good friend of Mrs Weir — would like friends from all over the world.

CHARLES JEFFERYS of 'The Gardens', Crathorne Hall, Crathorne, Yarm-on-Tees, Yorkshire, collects stamps, match labels, and coins.

'I have not got many friends, and would like readers to write to me', says DAVID A. MULLETT, 37 Station Road, Rotherham, Yorkshire. 'I collect stamps.'

If you want a friend from Ghana write to A. D. HAGAN, Post Office Box 73, Tarkwa. He collects stamps, labels, and cards.

ENLARGING—THE TEST STRIP

TO obtain a true perspective effect a print needs to be viewed from a certain distance. This distance is determined by the focal length of the camera lens with which the exposure was made.

In many cases this is too short a range for the human eye to deal with satisfactorily. For instance, a camera with a 2 in. focus lens will produce pictures which must be viewed from a distance of 2 in.

By K. Baxter

Enlarging is the answer to this problem. It is also the key to top-quality prints, opening the door to almost unlimited opportunities. Yet this aspect of photography is not difficult if the correct technique is applied. To this end the value of the test strip cannot be over-emphasized.

The test strip has many uses, but its principal one is in determining the right exposure for the subsequent enlargement. The minutes taken to produce it will be saved many times in the long run — as will a considerable amount of printing paper.

Start by selecting a normal negative, that is, one with highlights, shadows, and a fairly full range of tones. Place the negative in position in the enlarger, emulsion side facing the paper holder. Switch on the white light and adjust the lamphouse assembly on its column so that the approximate size you wish the finished print to be is reached. Then

focus the lens. Stop down half-way if you have a lens of variable aperture.

Range of tones

When you are satisfied that the image is correctly aligned, switch off the white light and insert a 1½ in. strip of printing paper in the masking frame. Use a strip from a sheet of the type and grade of

A square of stiff, opaque cardboard of a suitable size and a timing clock are the only other items required. The work can be carried out by olive-green or lime-green safelight, so reading the clock will not be difficult.

The exposures are made at two-second intervals and really accurate timing is all-important. You will find it advisable

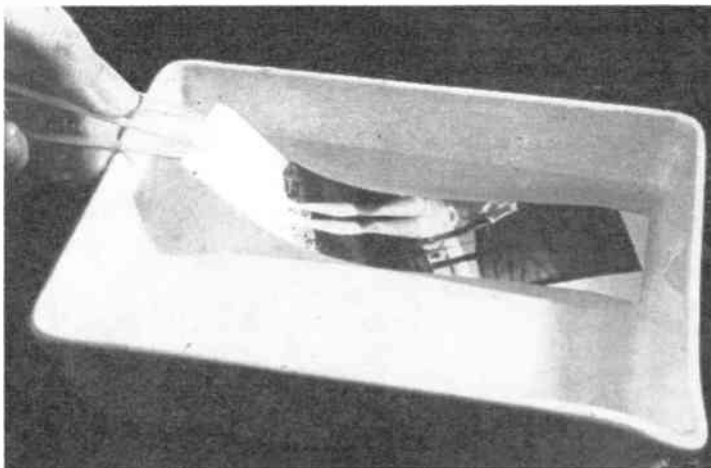

Developing the test strip. Note the five areas of varying intensity

paper you normally work with and from which you will produce the enlargement. Ensure that the strip is located to cover a picture area with a wide range of tones. It should be held firmly in place so as to allow no movement at all.

to pick up the piece of card before switching on the enlarger light. Expose the entire test strip for 2 seconds and switch off the enlarger lamp. Then, mentally divide the strip into five approximately equal sections and cover up the first one with the opaque card. Expose the rest of the strip for a further 2 seconds.

Repeat this procedure until the final section of the strip is covered and exposures of 2, 4, 6, 8, and 10 seconds have been made. The test strip is then ready for developing. This should be carried out under exactly the same conditions as will be employed for the final print.

A typical developer for bromide papers consists of: Metol 1.1, Hydroquinone 8.5, Sodium sulphite, anhyd. 38, Sodium carbonate, anhyd. 32, Potassium bromide 1.4, water to make 1,000 c.c. All quantities are in grams per 1,000 c.c. of water. Dissolve the chemicals in the order given, using about three-quarters of the water at not more than 125°F. When mixing is complete, add the rest of the water. For use, dilute 1 part to 1 part water.

Develop the test strip for 2 minutes exactly. Do not be tempted to remove it

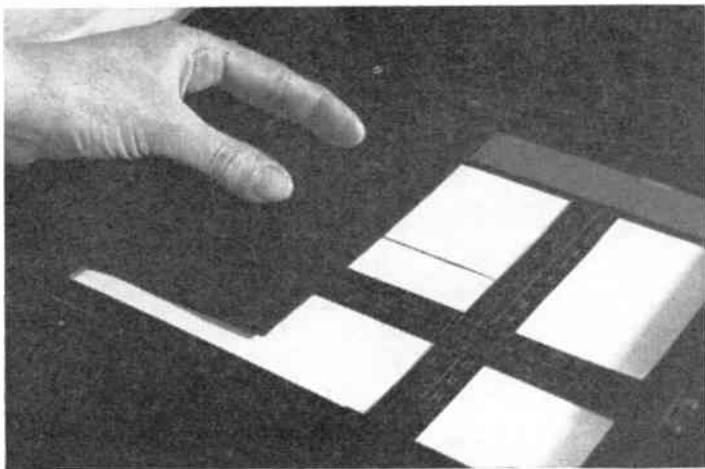

Covering part of the test strip while making the exposure

before this time has elapsed, even if it appears that at the end of 2 minutes all areas of the strip will be too dark. Likewise, do not over-develop. Any deviation from the recommended time will destroy the value of the test strip.

Rinse thoroughly

When development is complete, the strip should be thoroughly rinsed in clean water. Alternatively, immerse the strip in an acid stop bath and agitate for about 5 seconds. A $\frac{1}{2}$ oz. of glacial acetic acid to 2 $\frac{1}{2}$ pints of water makes a suitable bath. This has several advantages over a water rinse: the risk of stains is lessened, the action of the developer is immediately stopped, and the life of the fixing bath is extended.

After rinsing, transfer to the fixing bath. A suitable fixer comprises: Hypo, anhyd. 3 $\frac{1}{4}$ oz., Potassium metabisulphite $\frac{1}{2}$ oz., water to make 20 oz. Dissolve the

hypo in cold water. When it is thoroughly mixed add the potassium metabisulphite.

Place the strip face down in the fixing bath and keep it moving for about 20 seconds to ensure the solution reaches all parts of the strip. Fix for 10 minutes, then wash in clear water.

In the case of a finished print washing should be continued for at least half an hour. But for the test strip a few minutes is sufficient. In both instances the best results will be obtained if all solutions and water are of a constant temperature. 65°F is satisfactory.

Examine the test strip under a good white light. From the five varying densities one should indicate the correct exposure. This can be readily determined by a simple test. Carefully inspect the highlights of the print. If the sky plays an important part in the picture, that will indicate the right exposure. Simi-

larly, a white building, provided it is the centre of interest, will determine the section of the strip which has been correctly exposed.

If none of the five areas seems exactly right, consider if two of them together are nearly so. Should this be the case an exposure time half-way between these two should prove satisfactory.

In the event of all the test strip areas being too light, it is advisable to make another strip, stepping up the exposure times. Start with 8 seconds, increase to 16, then 32, and finally 64.

When you have selected the correct exposure you are all set to make the enlargement. Follow the exact procedure by which you have produced the test strip and you can be sure of getting a satisfactory print. But remember that after fixing, the print should be washed for at least half an hour in running water.

MAKE A SHOWER FOR THE BATH

A SHOWER bath tones up the system more thoroughly than the normal bath and is therefore to be preferred. There is also the question of economy in heating costs to be considered.

You can fit a shower to your existing bath quite easily. Do remember that any fittings or screws you use should be of the non-rust, non-corrosive type, for the unit will be suspended over clouds of steam.

The first step is to screw to the ceiling a square of $\frac{3}{4}$ in. plywood. This will provide a base on to which affix the fittings required. Make the sides of this square of ply about 6 in. greater than the width of the bath and do remember to

use resin-bonded, waterproof plywood. Your dealer will advise you on this.

The plywood is fitted to the ceiling with about eight countersunk screws and to make a firm fixing these screws must go into the actual ceiling joists behind the plaster. To find the position of the joists, tap the ceiling lightly with a hammer. A dull echo will reveal the presence of a joist; a hollow echo means you are tapping between joists.

Next, curtain track must be fitted, to follow the square of the plywood ceiling piece. Most of you will know how to fit curtain track but remember to have the two free ends just passing one another, as shown in the drawing. This will ensure that there is no gap when the plastic curtains are pulled together.

The square of curtain track should have sides approximately equal to the width of the bath, so that when the curtains are draped they hang just inside the sides of the bath.

You will need to purchase the rose and hose that supplies the water from the suspended position over the bath. You will need a unit that finishes with twin tube ends to be separately affixed to the hot and cold taps. The

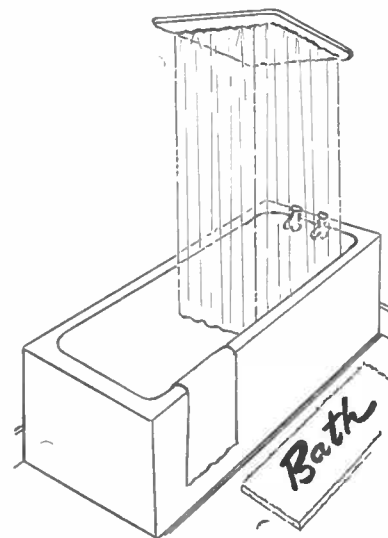

flow from these taps is controlled and mixed so as to give the desired temperature for the shower.

The rose end of the hose is kept in place by being suspended from a hook or a more permanent job can be made by affixing it to an angle bracket as shown in the drawing.

It only remains to enlist the aid of your wife to make up the plastic curtains. The hem at the top and bottom of the curtain can be formed by using a plastic adhesive. If a sewn hem is preferred, enclose the hem portion in lengths of tape first and sew through the tape and plastic sheeting together. If you attempt to sew the plastic together without any backing it may rip at the first pull. (E.C.)

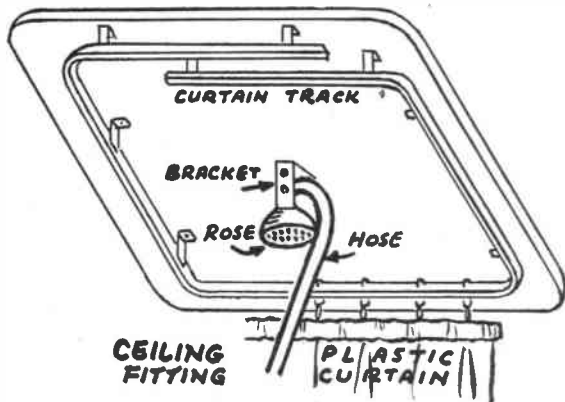

BATTERY ELIMINATORS

BATTERY-OPERATED receivers may be run from A.C. mains, by adding a unit which delivers suitable voltages. Such a unit is present in popular Mains/Battery portables. As a result, they can be run from batteries when no mains are available, as when they are taken out of doors, or on holiday. But when mains supplies can be used, advantage can be taken of this to save batteries. During the winter, for example, it may never be necessary to take the receiver away from the house, so mains running can then be adopted.

By 'Radio Mech'

Non-portable, or old type battery sets can also be run from the mains in the same way. Many old receivers can be usefully employed in this manner, and running costs are very small indeed, compared with the cost of batteries.

The usual battery receiver of fairly modern type requires about 90V. for

voltage should lie between 1.25V. and 1.4V. For continuous mains running, 1.3V. is recommended.

If the filament voltage falls outside these limits, the life of the valves will be much reduced. Actually, it is not difficult to maintain a suitable voltage. But if the need for a fairly exact filament voltage is overlooked, valves may be quickly damaged.

The H.T. voltage is much less critical. The older type of 2V. valve can receive up to 150V., and will work well with 90V. or less. For a receiver equipped with such valves, a H.T. supply of about 120V. will usually do very well.

For small, modern sets, simply provide a H.T. voltage of about the same figure as the battery used — generally 67½V., or 90V.

batteries to mains, or back again, merely by changing connections from the batteries to the mains unit. No wiring changes are required in the receiver itself.

H.T. circuit

Fig. 1 shows a suitable circuit for obtaining the H.T. supply. The transformer has a 200/250V. primary. Its secondary is rated at 90V., 120V., or whatever H.T. voltage is wanted. The rectifier is similarly a 90V. or 120V. type. The resistor is about 1,000 to 5,000 ohms. About 2,000 ohms will normally do very well, but the value can be changed if it is found that the output voltage from the unit needs to be increased or reduced a little.

A twin smoothing condenser, which consists of two condensers in a single case, is convenient. Separate condensers

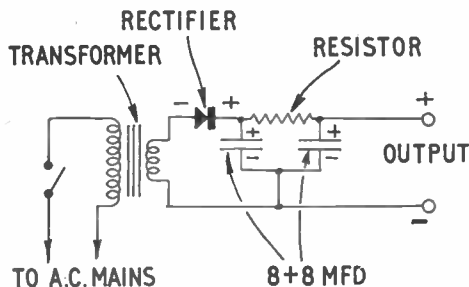

Fig. 1—Circuit of H.T. eliminator

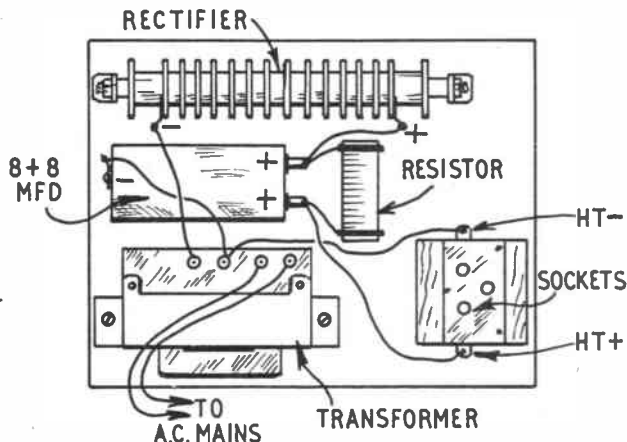

Fig. 2—Eliminator wiring plan

H.T., and 1½V. for filaments. It is most convenient to deal with the H.T. and L.T. parts of the mains-operated eliminator separately.

Older sets may require 120V. H.T., and 2V. for filaments, to replace a large H.T. battery, and 2V. accumulator. If so, the eliminator circuit can be arranged to suit. In a few cases, grid bias may also be needed.

Essential points

In order that the battery set will give long and trouble free service, when used with its mains unit it is essential that the filament voltage be correct. With the oldertype of 2V. valve, the actual filament voltage must lie between 1.8V. and 2.2V. For the modern 1.4V. valves, normally run from a 1½V. dry battery, the actual

Eliminator construction

If necessary, the whole eliminator can be built in a small case of the same dimensions as the original batteries. This is handy for small portables and similar receivers.

When more space is available, building is a little simplified by using a larger case, or even mounting the necessary parts on a simple wooden baseboard. This can be accommodated in most sets of other than miniature or portable type.

The eliminator unit should be fitted with a socket which will take the receiver battery plug or plugs. It is sometimes feasible to take this socket from an old battery. If the receiver has separate H.T. and L.T. leads, provide the eliminator with separate sockets and terminals.

It will then be possible to transfer from

will give exactly the same results. The capacity is of little importance, and can be about 8μF to 32μF. It is not necessary for both to be of the same capacity. Condensers rated at 150V. will suffice, but condensers rated at 250V., 350V., or more, as used in mains sets, are equally satisfactory.

Building details

Fig. 2 shows a suitable layout of parts, on a small wooden baseboard. Most 90V. batteries have a 2-socket or 3-socket strip, to take the receiver plug. The socket strip from an old battery can be mounted on strips of wood. Carefully note which sockets of the strip provide positive and negative connections, so that all will be in order when the receiver plug is inserted.

If the receiver has a combined H.T./L.T. battery, be sure to use the correct sockets for the high tension supply. For old type sets, mount two H.T. plug sockets on a strip of insulating material.

The transformer may have tags, or coloured leads. Follow the markings, or maker's connecting instructions, which will show primary and secondary.

Take twin flex leads of suitable length from the transformer primary. A lead-through type of switch can be added in this mains lead, for on/off switching. Fit a mains plug to suit the socket from which current is drawn.

If two separate condensers are used, wire both negative tags together, and to H.T. negative. Rectifiers vary considerably in shape and size, but this is of no importance, provided it is for the voltage required.

To test the circuit, connect a H.T. voltmeter to the output sockets, plug into the mains, and switch on. The meter should indicate roughly the voltage required. The reading will probably be somewhat high, due to the fact that little current is being taken.

After this test, the receiver can be connected. As the circuit so far given provides H.T. only, the usual L.T. dry battery or accumulator is retained for

filaments. With the receiver switched on and working, the eliminator output should be about the voltage intended. With sets normally run from a 120V. battery, some 10V. or so either way will make little difference. If the set usually has a $67\frac{1}{2}$ V. or 90V. battery, anything within about 5V. of this figure will be suitable.

Voltage correction

The exact voltage obtained depends on the current drawn by the receiver. For example, it might be 120V. with a 4-valve receiver, but rise to 140V. or so, with a 2-valve receiver.

For this reason it may be necessary to correct the output, especially when using small, home-constructed 1- or 2-valve receivers. This is easily done by changing the value of the resistor.

Most average receivers will use roughly 10mA H.T. current. With this current flowing, each 1,000 ohms of resistor value will drop 10V. Should it be found, for example, that the H.T. voltage is 20V. higher than required, then the value of the resistor should be increased by 2,000 ohms, or a 2,000 ohm resistor should be added in series with the present resistor.

A change of this kind will allow several receivers to be run or tested from one eliminator. For example, if the H.T. obtained is normally 120V., this can be reduced to 90V., or less, if necessary for a different receiver.

As mains circuits are taken to the eliminator unit, this should be constructed in an enclosed case, if the receiver has no back. No bare joints or bare connections should be left in the primary wiring.

If it is desired to obtain H.T. alone from the mains, the circuit need be only that in Figs. 1 and 2. This is particularly useful when accumulators are used for filament supply, and these are to be charged fairly regularly, to keep them in good condition.

When both H.T. and L.T. batteries are to be eliminated, a low voltage secondary will be necessary. It is then most convenient to use a transformer with two secondaries — one for H.T., and one for L.T. Typical transformers of this kind have 120V. 40mA. and 5/0/5V. outputs, for the old 2V. valve type of receiver; or 90V. 15mA. and 6/0/6V. outputs, for modern 'all dry' type receivers. Details of the filament part of the circuit will be given in another article.

The 'Houdini Band' Trick

THE great escapologist Harry Houdini used to boast that no prison in the world could hold him. You can illustrate the amazing feats of this remarkable man, using no other prop than a brightly coloured rubber band which you can manipulate upon your fingers. Follow the directions closely and rehearse the trick well, until it can be done smoothly and smartly, before demonstrating the effect to a friend.

Obtain a small rubber band and loop it upon the index finger, 1, of your left hand. Pull the band upwards behind the middle finger, 2, then over the same finger, downwards, and finally loop it back upon the index finger. It is im-

portant to follow these instructions exactly. The band upon your fingers should now appear as in the diagram.

Grip the tip of your index finger with your right hand at point X. At this stage assume to yourself that you have effectively trapped the band upon your index finger. Yet it will be a simple matter to permit the band to escape. Whilst still firmly gripping point X merely flex your middle finger and let part of the band slip off the fingertip. There will be a sudden 'flip' as the band is seen to snap upwards on to the outstretched middle finger.

Introduce the trick by stating that you have in your possession a well trained rubber band which you have named

Houdini. Place the band upon your fingers and request your assistant to trap it upon your index finger by gripping the fingertip tightly. Stress that the band is now imprisoned upon your index finger. In conclusion state that the band will escape. Snap the fingers of your right hand, flex your left middle finger and watch the look of astonishment upon the face of your friend as the rubber band leaps free. (A.E.W.)

Sticking Ball Catches

ALL catches have a very annoying way of sticking when they have been fitted to doors for some time. The ball has a tendency to rust or tarnish slightly, making it difficult for it to revolve freely, and consequently the door will not open smoothly.

This can be remedied by mixing a little vaseline with a small amount of very fine grade abrasive such as emery, carborundum or oil-stone powder, and applying it to the ball and just inside the ball housing.

It will keep the ball bright, shiny, and trouble-free for many years. (F.A.F.)

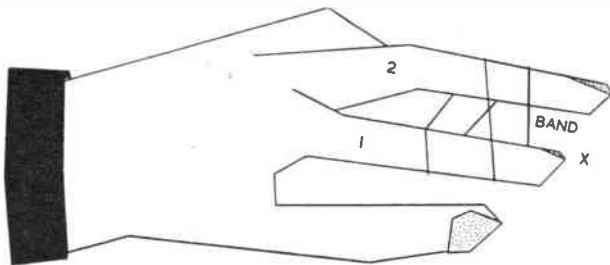

Nuclear Submarine 'Dreadnought'

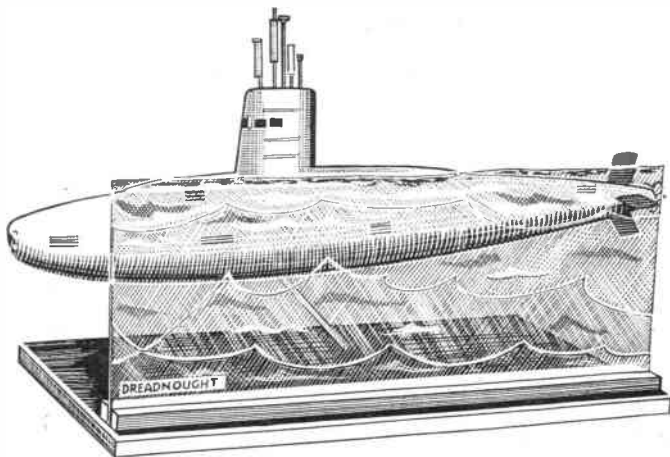

P R I M A R I L Y intended as a submarine hunter-killer, H.M.S. *Dreadnought*, Britain's first nuclear submarine, was designed to undertake patrols of particularly long endurance at high speeds under water and ice.

She was launched by H.M. the Queen at the Barrow-in-Furness shipyard of Vickers-Armstrongs on October 21st, 1960. With a length of 266 ft. and a beam of 32 ft., there is accommodation for 11 officers and 77 ratings.

Our model of *Dreadnought* is 9 in. long, 3 in. wide, and 5 in. high. As can be seen from the illustration, it is intended as a standing model depicting the submarine in the process of travelling under water. This impression is created by a transparent foreground formed by acetate sheeting suitably cut and decorated to represent the ocean. The submarine itself can be set to simulate a diving, surfacing or level-keel action.

Most of the parts are shown full size on the design sheet. These should be traced and transferred to their appropriate thicknesses of wood by means of carbon paper, and cut out neatly with the fretsaw. Measurements are given for

the base (piece 10) and strips (11) which are also marked off on to the wood and cut out.

The first part of assembly is to make up the submarine. Piece 1 is glued between the two pieces 2. After the glue has set, the hull is shaped with a sharp knife and glasspaper, as indicated on the design sheet and in the finished illustration. Next add the rudders and hydroplane, consisting of four pieces (3) which are shaped to section as shown, and glued in the positions indicated on the finished illustration.

The next stage is to add the propeller (piece 4). Fig. 1 shows how it is fixed in place with the addition of a nose cap suitably shaped from waste wood.

Now add the periscope and snort etc, on top of the conning tower. These instruments consist of pieces 5, 6, 7, 8 and 9, fashioned from wire and $\frac{1}{8}$ in. wood and positioned as shown on the design sheet. Small holes are drilled in the conning tower to take the wires.

At this stage, the submarine should be painted. Give an overall flat coat of grey after thoroughly rubbing down. Details as indicated in the finished illustration

★
★ KIT FOR ONLY 6/11 ★
★ Hobbies Kit No. 3416 contains all ★
★ panels of wood, transparent material, ★
★ wire etc, for making this model of ★
★ the 'Dreadnought'. Kits price 6/11 ★
★ from branches etc or by post from ★
★ Hobbies Ltd, Dereham, Norfolk ★
★ (post 1/6 extra). ★
★

can be added in black.

To give an underwater effect, the submarine will be located behind an 'aqua-window'. This is made up from four sections of transparent acetate sheeting, pieces A, B, C and D. These are cut to the shapes and sizes shown on the design sheet, where an indication of colouring is also given. The prototype was finished in Humbrol matt paint. These four pieces of acetate sheeting are pinned together between the two strips (11) in the order shown in Fig. 2.

The top edges of the base (piece 10) can be bevelled to give a neat appearance. To this base add the 'aqua-window' by gluing in the position shown by dotted lines on the design sheet. The base itself can now be painted in colours to represent the sea bed.

The submarine is located by means of a single wire support drilled underneath the hull and into the base. Insert the wire underneath the submarine according to the angle of viewing required. The submarine can be set pointing up or down or on a level keel.

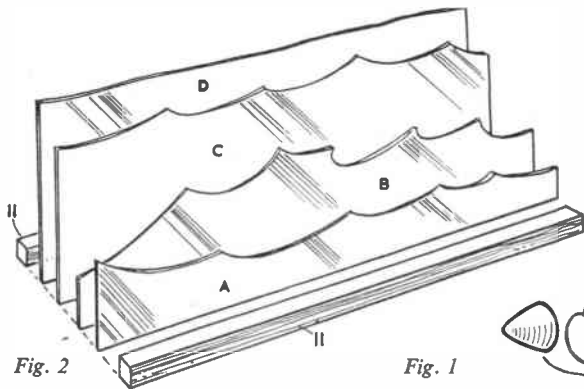

Fig. 2

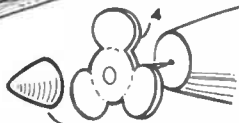

Fig. 1

MAKE FROM WASTE WOOD

Next week's issue will contain details for making a paddling catamaran for use on your holidays. Make sure of your copy.

ADDING DIGNITY TO YOUR ENTRY

ALTHOUGH the ability to dive is not directly connected with swimming skill and, in theory at least, the only necessary swimming is the ability to return to the edge of the bath, a good diver should certainly be a proficient swimmer, and have complete confidence in the water.

Diving is a most fascinating and exhilarating sport. There are several reasons for wanting to do it, and different degrees of proficiency can be aimed at. The most obvious reason for wanting to dive is the ability to enter the

water in a more dignified way than just climbing down the steps!

One may also delight in the style and grace of an expert diver, and although championship standards may be beyond most of us, if only because of the necessarily long hours spent in practice, a considerable degree of proficiency is possible for anyone who is prepared to take diving seriously.

Since any confident swimmer can easily make some sort of a head-first entry into the water, there is an unfortunate tendency to be satisfied with this, and always making a 'dive' which has force and confidence, but is sadly lacking in 'style'. To acquire the latter elusive quality, the matter of diving must be taken step by step, paying careful attention to detail.



The sitting dive

face, and push off downwards with your bent leg. As soon as your legs leave the side, try to straighten them out.

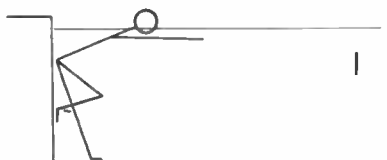

1

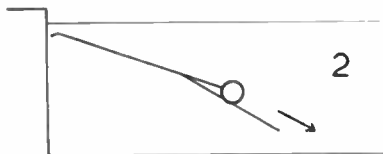

2

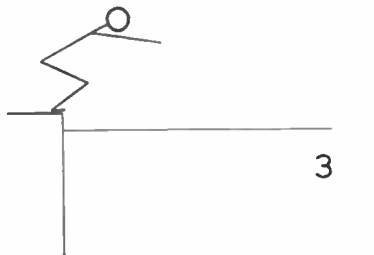

3

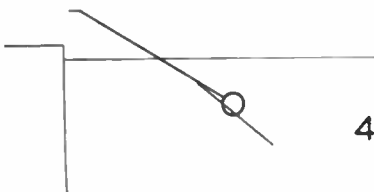

4

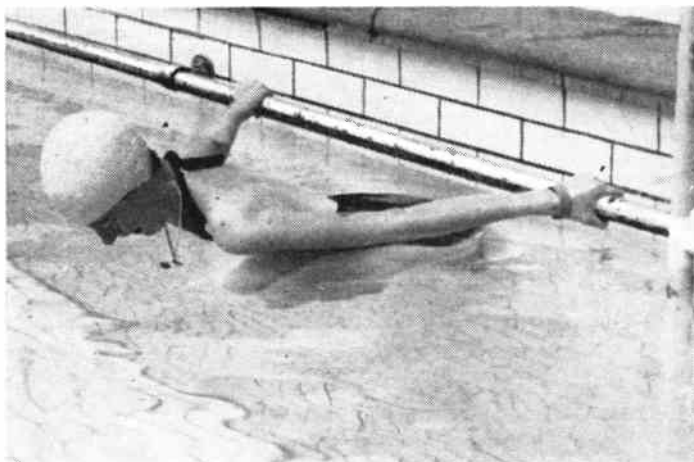

Pushing down into deep water

How to start

The first essential in learning to dive is to be able to push down into the water easily and cleanly at a depth of 3 ft. to 4 ft., according to your height. Ideally the water should be about chest high to begin with.

Stand with your back to the bath side and leaning against it. Bend one leg so that the sole of your foot presses on the side, and bend down with arms forward and straight, so that the inside of them touches your ears (Fig. 1). The hands should be together, palms downwards. Now take a deep breath, submerge your

You should attempt to reach the bottom with your hands (Fig. 2), and glide along it before rising to the surface. The whole movement must be practised until you are able to do so. As with all underwater work, your eyes should be kept open.

Once you can do this easily, it is a good plan to move up the bath and try in deeper water. Here, of course, you will be unable to stand on the bottom, and you should take up a position as in the photograph by grasping the bar or trough with your hands behind you, and drawing both feet up as high as

possible. You should then simultaneously duck your head, swing your arms in front of you, and push with your legs and feet. If you direct your head and arms downwards you should eventually be able to push down to the bottom at the deep end.

The object of these exercises is to enable you to push down easily and neatly to any reasonable depth, and to feel quite confident under water. Since you will probably not know just how well you are doing it, it is useful to have a friend to watch and criticize; it is, of course, more fun to take it in turns to do this.

Entering from the side

Having become quite accustomed to pushing down head first into the water, the next stage is to enter from the side of the bath. This is the 'sitting dive'. You should take up the position shown in the photograph by sitting on the edge at about 5 ft. deep and placing your feet

together on the bar or the edge of the trough. Open your knees and bend over so that your outstretched arms point downwards and your head is between them. Then lean slowly forwards until you topple into the water, remembering to keep your head between your arms, and giving a final push with your feet as you straighten your legs. If you go 'flat' it probably means that you have attempted to look up at the last moment.

Again aim for the bottom of the bath, and when you reach it your body should be in a straight line. By flattening your hands slightly when they contact the bottom, you will be able to glide along it, and you can then either raise your head and continue your progress to the surface, or place your feet on the bottom and kick up. This dive should finally be practised at the deep end of the bath.

When doing these elementary dives always aim at going deep and not trying to come up too soon. This will stand you

in good stead when you come to learn the more difficult dives, giving you complete confidence under the water.

The crouch dive is just one stage removed from the sitting dive, and only differs in that one crouches rather than sits, and is, of course, somewhat higher above the water. From now on all practice should be done at the deep end. For this entry you should stand on the side of the bath with the toes just overlapping the edge. Bend down and bend the knees to assume a crouching position (Fig. 3). Again stretch your arms in front, and gradually lean over until you topple into the water, straightening out as you enter (Fig. 4). The final push with your feet should be given just as in the case of the sitting dive.

This again must be practised until you can do it with ease and confidence. Always remember to keep your head well down and avoid the tendency to look up, or you will go in 'flat'. (P.R.C.)

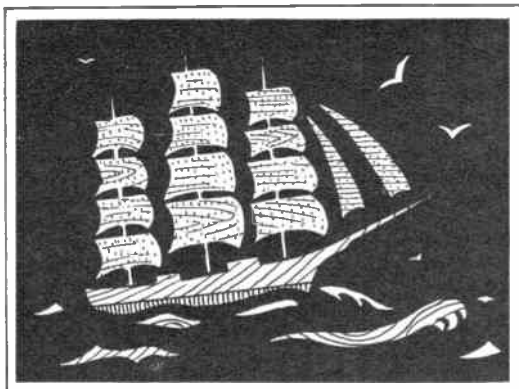

NOVEL PICTURES IN MARQUETRY

By

A. Liston

cardboard the same size as the glass. The edges are bound with passe-partout tape or coloured plastic adhesive tape. A simple cardboard flap with a hole in it (C) is glued to the backing to hang the picture.

Landscapes, especially Alpine scenes, can also be done in this way, so long as

PICTURES made from a pattern of wood veneers, or marquetry as it is called, are very attractive, but it is difficult for beginners to cut the pieces accurately for a complicated design. Here is an easy way to make a marquetry-type picture where pieces of veneer in simple shapes are used to build up a complicated design.

The requirements are a piece of glass, black paint, cardboard, binding tape, a selection of mixed pieces of veneer, and a piece of adhesive plastic sheeting in any design or colour.

First, the outline of the design chosen is drawn in pencil on the paper backing of the plastic sheeting. The example shown here is of a clipper. The outline may be intricate and detailed, and may consist of several separate pieces. These are cut out, the backing paper peeled off, and the shapes pressed firmly to the back surface of the glass.

The back of the glass, on which the shapes are stuck, is then painted black.

It is best to give the glass two coats to get a good dense finish. When the paint is dry, the shapes are peeled off, leaving the outline of the picture in clear glass, as seen at A.

The picture is then filled in with strips and squares of veneer, choosing the shades and markings carefully. The edges need not be cut to the shape showing on the front of the picture, as the paint will mask the edges (B).

The veneers must be held in place with an adhesive, making sure that it does not show through on the clear glass area.

The backing of the picture is a piece of

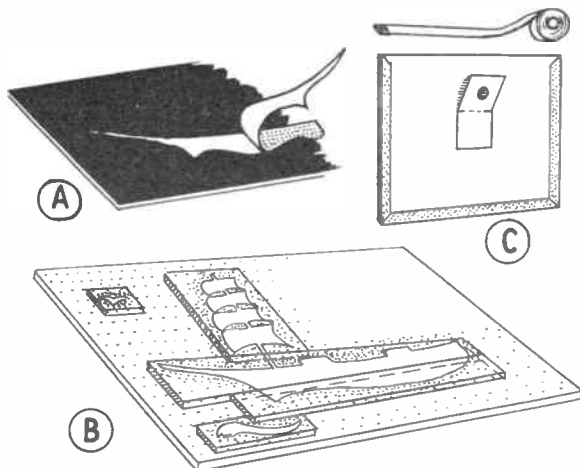

the foreground contains a large object such as a house or tree. Side views of merchant vessels of today also make good subjects.

Summer Fish Worth Catching

SUMMER is the time for spending holidays by the river. Never was there a better excuse for going off with rod and line than in the sunny days from June to the end of September.

Now, let us glance briefly at the prospects and deal with the kinds of fish which are most likely to afford good sport. We'll take them in this order — barbel, bream, tench, carp, chub, roach and dace. Perch also, but these fish provide better fun in October.

The barbel 'swims' in summer usually have their quota of keen anglers pegged at favourite spots, while punts are occupied on the larger rivers at weir-pools. These fish attain heavy weights, and fight hard, giving grand sport, but unfortunately they are not widely distributed. Really good barbel rivers are few — the Thames, Hampshire Avon, Lea, Kennet, and a few of the Yorkshire streams are the principal ones.

Strong tackle is required, and a fairly large goose quill float or a tapered cork pattern. Hooks, sizes Nos. 4 to 6 'crystal'. Baits include lobworms, maggots, cheese paste. Lobworms are mostly used, and the 'swim' to be fished should get a preliminary ground-baiting of the same. To make a proper job of it, dump as many lobs in the swim as you can afford.

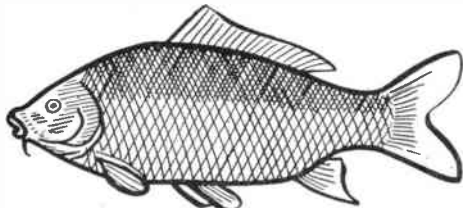

CARP

In swift water, groundbait with a mixture of clay and bran kneaded into balls, with a handful of worms in the middle. The current gradually washes away the clay and bran, releasing the worms to tempt the fish to 'come on the feed'. Barbel are hefty fish, and you do get a good run for your trouble if the fish are in the mood for feeding.

Bream and tench

Bream like warm weather conditions. They have a habit of flitting to and fro in shoals. It is possible in some streams and drains to trace their movements by the discoloration of the water, caused by their feeding on the bottom and rooting in the mud. They may also be seen 'priming' on the surface. When they are settled for a time, the angler may enjoy really good sport of a thrilling character

where the fish in the shoal run to a fair size — say, 2 lb. to 4 lb. Bream are well distributed in many parts of this country, particularly in the Fenlands, and the Broads of Norfolk. Sluggish streams and drains, lakes, reservoirs and ponds, canals, and meres, all provide the bream with a suitable home.

Take an old towel

Bream are usually coated thickly with slime, so much so that it is wise to take a cloth or old towel with you to keep wiping your hands after unhooking a captured fish. Some regular bream-fishers don their oldest clothes or wear waterproof aprons when fishing.

Use No. 9 or 10 'crystal' hooks mounted on a 2-yard nylon or gut cast; the float may be a porcupine or goose-quill. Bait with lobs, red, marsh, and brandling worms, paste, creed wheat, stewed barley, wasp grub, and similar baits. For ground-baiting a swim use bread and bran mixed and kneaded into balls, or potato and bread, and brewer's grains. Do not overdo the ground-baiting.

Bream bite cautiously, and may at times blow the baited hook from their mouths the instant they feel the resistance of the line. Occasionally they rise with the bait and this causes the float to lie flat on the surface. Wait until it moves and slides away in a sidelong movement under the water, then strike. Hooked bream plunge heavily and bore deep; but mostly a bream gives in if brought to the surface and kept there. When fishing such waters as shallow lakes and Broads, or drains and canals, go to work quietly and keep well out of sight.

The tench is another summer fish affording sport on hot days, or rather mornings, for in tropical-like weather, with blazing sunshine, they do not stir much in the noontide hours. Early morn, just after dawn, and late evening are the best times.

Tench chiefly haunt weedy ponds, meres, lakes and canals. They are fickle in their feeding habits, and at times the angler may wait days before getting a good hour's sport. On rare occasions they come on the feed eagerly, and then the angler makes a catch worth boasting about. It is possible to collect thirty or more fish at a standing. And among them may be fish of 2 lb. and 3 lb. or over. June, July and August are the best months to fish for them. Like bream their bodies are covered with slime and it is as well to take an old towel with you to keep your hands clean.

Baits include worms, slugs, snails, maggots, wasp-grubs and sweet paste. Ground-bait, when you think it will be helpful, with soaked bread and bran in which a few small worms are placed. The fish root on the bottom feeding on the worms in the ground-bait, and when you see tiny bubbles rising up from the baited spot, quietly drop in your bait and hope for the best. Probably in a while the float will 'bob' and then slant away in a leisurely movement. Wait until the tip disappears under water, then strike. Remember a big tench is a powerful fighter, so see to it that your tackle is

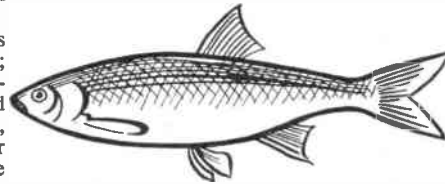

DACE

strong. Do not forget your landing-net; you may need it. Fish your bait well on the bottom, but if getting little response try it at mid-water or even just under the surface, and between the two depths. Keep very quiet and take cover, if possible, behind a clump of reeds or rushes.

The same remarks will do for carp as well as tench, but you can vary the baits with small par-boiled potatoes, green peas, boiled wheat, sweet paste made with honey or brown sugar.

Chub, roach and dace

The chub is a popular summer quarry. A sturdy fighter, yet a shy and wary fish. A grasshopper, caterpillar, wasp-grub, a ripe cherry or a strawberry, a worm, maggot, cube of banana, strip of macaroni, slug, and flies natural or artificial — all will attract the summer chub, and be received with a kind of 'Welcome, little stranger!' appreciation. Chub like tree-shaded streams, and lurk under willows and alders.

Roach and dace are taken in June, July and onwards with the usual tackle and such baits as maggots, bread-crust, small red worms, creed wheat, wasp grubs, hempseed and paste. Like chub, they will also rise to flies on summer evenings. A cast of three small black artificials fished with fly-rod and suitable line, the flies being mounted on 3x gut or nylon tapering down to 4x, will do nicely. Dace in particular delight to feed on surface flies in summer-time, and they provide good sport on the fine tackle employed. (E.)

Making toys, models and novelties is a paying pastime, and with a machine you can double your output right from the start. In fact you have a factory in the home.

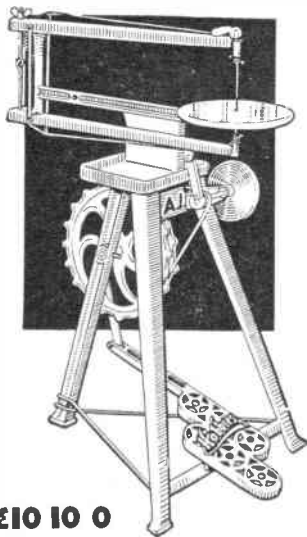

£10 10 0

'A.1.' TREADLE SAW

A sturdy machine with cast metal legs, metal table, wooden arms, special saw tension action, etc. Easy to treadle, smooth running and rigid. Provides a factory at home for the handyman — a machine for profit and pleasure.

THE 'MARVEL' BENCH MOTOR-DRIVEN SAW

To meet modern needs. Just plug in and switch on from any house lighting point. For either A.C. or D.C. mains, with 230/250 volt motor, flex, switch, etc.

£13 10 0

Also a Bench Machine without motor for **£5 10 0**.

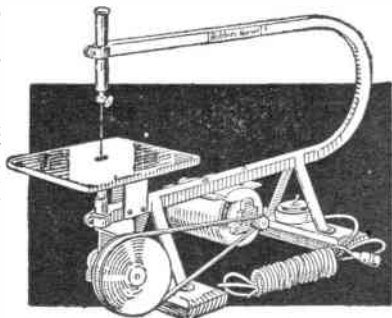

EASY PAYMENTS

A system is now in operation whereby a machine can be despatched carriage paid after the initial down payment, and subject to the completion of a simple form of Agreement. The slight additional cost over cash price is to cover extra clerical work, books, interest charges, etc. *It is impossible for us to allow this system to apply in any part of Ireland, or anywhere outside Great Britain.*

Agreement Forms are obtainable at any Hobbies Branch, where machines may be seen, and money paid each month. Or, you can do the business through Hobbies Head Office at Dereham, Norfolk, sending your instalments there.

Send for full details

Hobbies Ltd (Dept. 99) DEREHAM NORFOLK

ARCOY PRODUCTS



make ideal tools for the handyman

ARCOY RABBETTER

For use with any Portable Drill. A boon for all workers in wood. It rebates for panelling, etc. It slots for drawers. It strips for laths. It tongues, grooves and fillets.

PRICE £2.2.6

Moulding cutters for use with rabbetter **£1.3.6** each.



ARCOY POWER PLANE

Combines the handiness of the normal smoothing plane with the efficiency of the planing machine. Will never split wood, lift fibres or tear. Depth of cut adjustable from 0- $\frac{1}{8}$ in.

PRICE £14.15.9

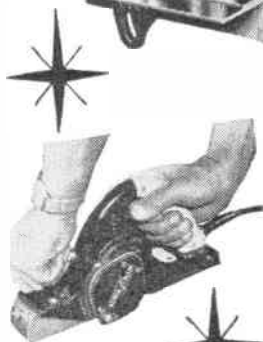

ARCOY DOVETAILER

With the aid of any $\frac{1}{2}$ in. capacity power tool you can produce joints at $\frac{3}{8}$ in. pitch in timber up to 9 in. in width in any combination of thicknesses from $\frac{1}{8}$ in. to 1 in. in five minutes!

PRICE £6.6.3

Housing Joint Attachment

PRICE £1.11.9

Multi-Pitch Attachment

PRICE £2.16.6

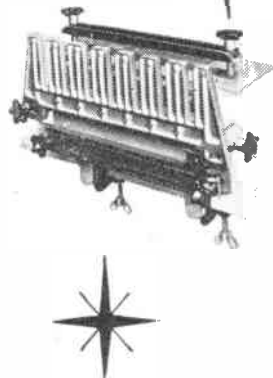

If you have any difficulty in obtaining Arcoy Products write for the name of your nearest stockist to:
ARCOY PRODUCTS, KNOWSLEY RD, BOOTLE, LIVERPOOL 20

NAME

ADDRESS

TOWN COUNTY

PLEASE COMPLETE IN BLOCK CAPITALS H.W. M31



THESE NOTES REFER CHIEFLY TO MIDLAND GARDENS. DUE ALLOWANCE SHOULD BE MADE FOR CHANGE OF LATITUDE.

It is quite safe to put out tender bedding plants now. There is no longer any fear of damage from frost, and if plants are watered well shortly before lifting and kept moist for a few days they will soon become established.

It is very important to keep up with your spraying programme this month. Spray regularly against greenfly, black spot, and mildew.

Now is the time to start staking tall herbaceous and bedding plants. The plants will then grow naturally around the stakes, and will not look so artificial when the flowers are in full bloom.

Suggestions for work during the month

- Sow seeds of perennials and biennials such as delphinium, lychnis, aubretia, hollyhocks, aquilegia, etc.
- Protect fruit against birds.
- Thin out annuals drastically.
- Thin out gooseberries.
- Peg strawberry runners into pots.
- Mulch blackberries, loganberries, raspberries, etc, during wet weather.
- Lawn clippings are ideal for mulching.
- Summer prune red and white currants. (Cut back young side shoots).
- Plant out celery, outdoor tomatoes, ridge cucumbers, and gourds.
- Transplant brassicas.
- Earth up potatoes.
- Stake runner beans.
- Continue to sow radish, carrot, lettuce, and turnip for succession.

- In the warm greenhouse**
- Take cuttings of fuchsias and begonias.
- Feed pot plants in the 'bud' stage.
- Provide humidity during hot weather.
- Pinch back laterals of cucumbers.
- In the cool house**
- Pot up cinerarias to provide early plants.
- Sow seeds of calceolarias and prim. malacoides.
- Feed tomatoes, cucumbers, and fuchsias.
- Increase water for cacti and succulents.
- Transplant small seedlings.
- Inspect for mealy-bugs.
- In the cold greenhouse**
- Feed and fumigate as for cool house.
- Ventilate and provide shade. (M.h.)

MORE TANGRAM PUZZLES

FEW geometrical puzzles are as absorbing or as capable of infinite variation as the four thousand years old Chinese game of Tangrams. The necessary apparatus comprises seven shapes which may be assembled to form a square, as illustrated in the plan. Copy the diagram on to black cardboard.

Suitable dimensions will be 4 in. by 4 in. Cut out the pieces, using sharp scissors. For a permanent puzzle the parts can be cut from plywood. Usually the object of the puzzle 'game' is to put together the pieces to resemble human beings in various poses, wild animals and familiar

objects. *All the seven pieces must be employed for each construction and no part must be permitted to overlap another.* Bearing these rules in mind, can you duplicate the six silhouettes shown. (A.E.W.)

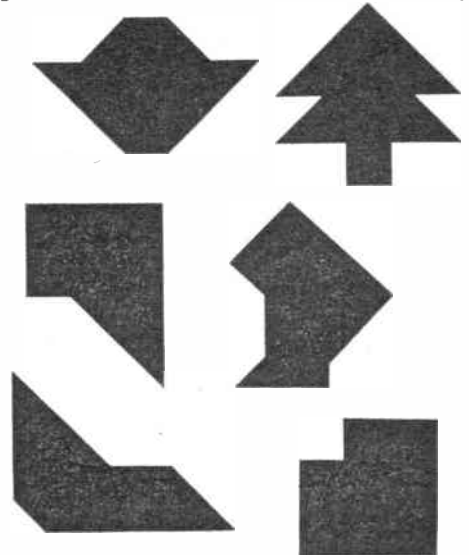
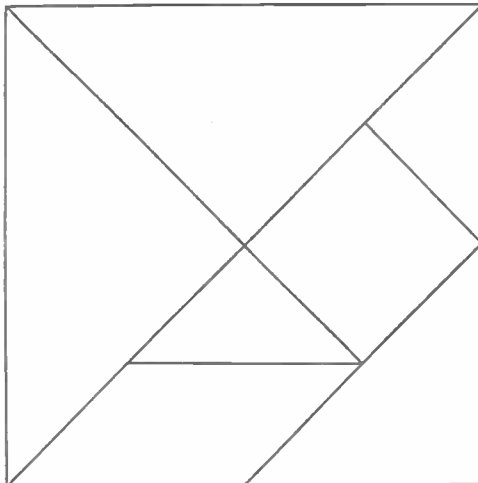

MAKE A GARDEN PLAYPIT

CHILDREN are rarely happier than when at the seaside, where they keep themselves occupied with buckets and spades for hours on end.

Playing with sand is the great attraction, and there is no reason why this pleasure should be theirs for only a week or so of the year. A sandpit in the garden will give untold interest to small children, keep them from mischief and danger, and prove a great boon to a harassed housewife. It is quite simple to construct, and the materials cost little.

A location should be chosen within sight of the house, so that an occasional glance through the window will confirm that the children are playing happily.

On sloping ground the site may be excavated, and drained from the lower end, but where the ground is flat it is best to build up retaining walls. In any event it will be necessary to line the sides and bottom with stones, concrete blocks or cement, and although the resulting pit need not be watertight, it should be constructed so as to retain the sand. The pit itself may be of any shape to suit the location.

Line it with large stones, giving a natural effect resembling seashore rocks. Large stones as used for rockery construction are admirable for this purpose. Crazy-paving stones also look well, and are easy to handle. Concrete blocks give an artificial appearance, and some would object to the too formal effect in their gardens.

Retaining walls

The retaining walls should not be vertical, but should slope outwards as shown in the sketch. This will tend to throw the sand inwards and allow easier shovelling; also the walls will be less liable to be dislodged by outside pressure.

It is not strictly necessary to cement the stones in position, but unless this is done, there may be a tendency for soil to filter through, and make the sand dirty. The bottom of the pit should be as smooth as possible, so that the spade will not encounter projections.

A form of drainage is necessary, otherwise the pit will become waterlogged after rain. A good method of arranging drainage is to lay a piece of tube in position and build the wall over this. In sloping gardens this tube should be at the lowest side. To trap escaping sand, the pipe outlet should lie over a shallow trough, into which the drainage water will run and the sand fall to the

SLOPING SIDES OF CRAZY PAVING STONES OR CONCRETE

STONE STEPS

STONE SEAT

GRASS BANK SUPPORTING SIDE WALLS

SMOOTH CONCRETE BOTTOM

DRAIN FROM LOWEST POINT WITH SANDTRAP

bottom, from where it can be returned to the pit.

Gentle slope

In excavating the pit the shovelled earth should be piled around the sides to form sloping banks against which the walls will lie. If a gentle slope is arranged on the outside, the banks may be sown with grass seed. This will bind the soil, and enable the mower to be run over it.

At a point conveniently near a pathway, stone steps should be built from large stones or concrete blocks, and inside the pit a large boulder will give a seashore effect, and could form a seat. The sand may be kept clean by occasional hosing, but it is wise to keep the site as far as possible from trees to avoid fouling from falling leaves.

Children will love this sandpit, and will play in it for hours on end.

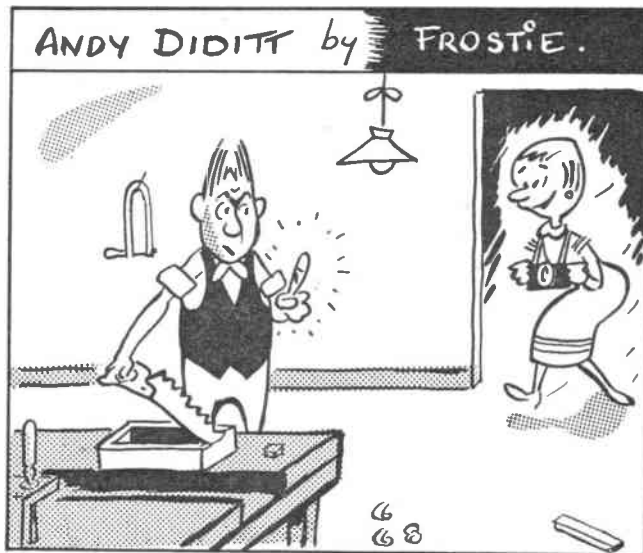

"CUT YOUR FINGER, ANDY? - GOOD, I'VE JUST PUT A NEW COLOUR FILM IN MY CAMERA."

TABLE TOPS FOR MODERN FURNITURE

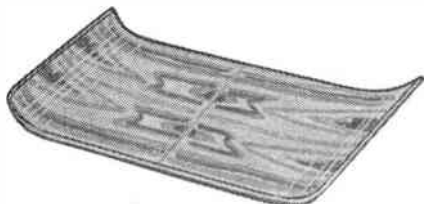

CURVED ENDS

In Oak, Sapele or Walnut. Veneered one side on strong plywood, $\frac{3}{4}$ in. thick.
Size: 26 x 15 in.

Price **29/3** each (Post 2/6)

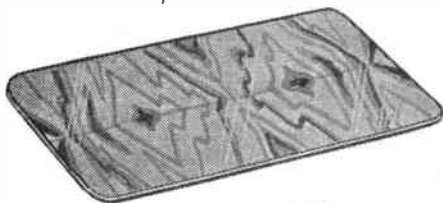

Veneered both sides in Oak, Sapele or Walnut.
Two useful sizes: 20 x 20 in. and 30 x 15 in.

Price **18/6** each (Post 2/-)

HOBBIES Ltd (Dept. 99), Dereham, Norfolk

HEAR ALL CONTINENTS With H.A.C. Short-Wave Receivers

Suppliers for over 18 years of radio S-W Receivers of quality.

One-Valve kit, Price **25/-**

Two-Valve Kit, Price **50/-**

Improved designs with Denco coils. All kits complete with all components, accessories and full instructions. Before ordering, call and inspect a demonstration receiver, or send stamped addressed envelope for descriptive catalogue.

'H.A.C.' Short-Wave Products (Dept. 22), 11 Old Bond Street, London, W.1.

CONTEMPORARY LEGS

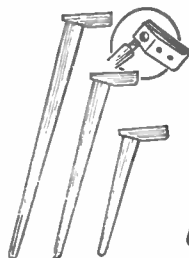

PLAIN BEECH

No. 580 9 in. 2/- each

No. 581 15 in. 2/6 each

No. 582 20 in. 3/- each

No. 583 29 in. 5/6 each

(Postage: 3 or 4 Legs 1/6 extra)

FERRULED BEECH

No. 590 6 in. 2/9 each No. 593 15 in. 3/6 each

No. 591 9 in. 3/- each No. 594 18 in. 3/9 each

No. 592 12 in. 3/3 each No. 595 20 in. 4/- each

(Postage: 3 or 4 Legs 1/6 extra)

Ferrules are of Brass securely fitted.

EBONIZED FERRULED BEECH

No. 600 With metal block and brass ferrule

One size only 18 in. 5/3 each

(Postage: 3 or 4 Legs 1/6 extra)

HOBBIES Ltd, (Dept. 99), Dereham, Norfolk

BUILD your town electric guitar in one hour. Screwdriver only required. Thin line cutaway full-size body. Reinforced neck, built-in Vox pick-up and controls, 9 gns., plus 5/- carriage or 20/- and eight payments of 23/-. — Musicland, 88 Broadway, Bexleyheath, Kent.

GET YOUR FREE COPY of 'Write for Profit', the most interesting little book you've ever read. For beginner or experienced. — WRITER'S RING (HW), 5 Edmund Street, Birmingham, 3.

PROFITABLE LEISURE. Learn to draw/paint flowers, birds, doodles, etc. Waiting markets. Profitable. Fascinating. Exciting. Booklet, specimens, free. — Popular Art Services (HW), Clun, Shropshire.

100 DIFFERENT stamps free! Request 1d. upwards discount approvals. — Bush, 53 Newlyn Way, Parkstone, Dorset.

PERSONS (either sex). Soft toy assembling in spare-time. The ideal profitable pastime. Everything supplied. Details s.a.e. Dept. H.W., Cuddycraft Supplies, East Road, London, N.1.

LEARN RADIO & ELECTRONICS the NEW Practical Way! Very latest system of experimenting with and building radio apparatus — 'as you learn'. FREE Brochure from: Dept. H.W.10, Radiostructor, 40 Russell Street, Reading, Berks.

LEARN RADIO & T.V. SERVICING for your OWN BUSINESS/HOBBY

● by a new exciting no-maths system, using practical equipment recently introduced to this country
FREE Brochure from:—

RADIOSTRUCTOR

DEPT. G81, READING, BERKS.

31/5/61

YOU DON'T NEED A TRIP TO THE ANDES to get the finest Chinchillas for breeding. Contact us today for full details of this profitable hobby or business. Write to the British Chinchilla Breeders Co-operative Ltd. (Dept. H.W.), 23 Brazenose Street, Manchester 2, for full details.

KEYS to Success 5/6. Money in Scrap 3/- Profit from Sawdust 2/9. Wealth from Waste 2/9, 112 Odd Businesses 2/9. — B. Watts, 81 Bassett Street, Woodgate, Leicester, England.

GRAT FREE GIFT OFFER of 52 Stamps of Gt. Britain. Sent per return to approval applicants enclosing postage. — Yulwontmor Stamps (Dept. H), 54 Compton Avenue, Leagrave, Luton.

BUYING OR SELLING?

Classified advertisements on this page are accepted at a cost of 6d. per word prepaid. Use of a Box No. is 1/- extra. Send P.O. with advertisement to *Hobbies Weekly*, Advert. Dept. Dereham, Norfolk. Rates for display advertising on application.

EARN EXTRA MONEY with your sewing machine by making cushion covers. Regular work guaranteed. — Apply Dept. 28, Arnold Company, 10 Shelley Road, Worthing, Sussex.

IF you have taken a lot of care in making a musical box, be sure to make it worthy by including the best Swiss movement — a REUGE. Prices from 13/9. Wide range includes a charming Dancing Ballerina. Many tunes to choose from. Send for details in free booklet 'Profitable Leisure'. — HOBBIES LTD, DEREHAM, NORFOLK.

GRIMSBY

DO YOU KNOW?

HOBBIES LTD. have a branch at

88 VICTORIA STREET

where the manager and staff are always willing to give you the benefit of their experience with any of your handicraft problems. Why not pay a visit?

HANDY 'REMINDER' PAD

HOW often have you gone away on holiday and forgotten to take something you wanted? The easiest way to remember everything is to jot it down when you think of it, then on the last day before your holidays you can read through your notes and make sure that you have done everything you intended.

All you need is a piece of $\frac{1}{4}$ in. plywood, cut with a fretsaw to the shape shown. Fix a wall hanger to the back and a small pad to the front, and hang it up in the kitchen. A small pencil may be suspended as shown. (M.p.)

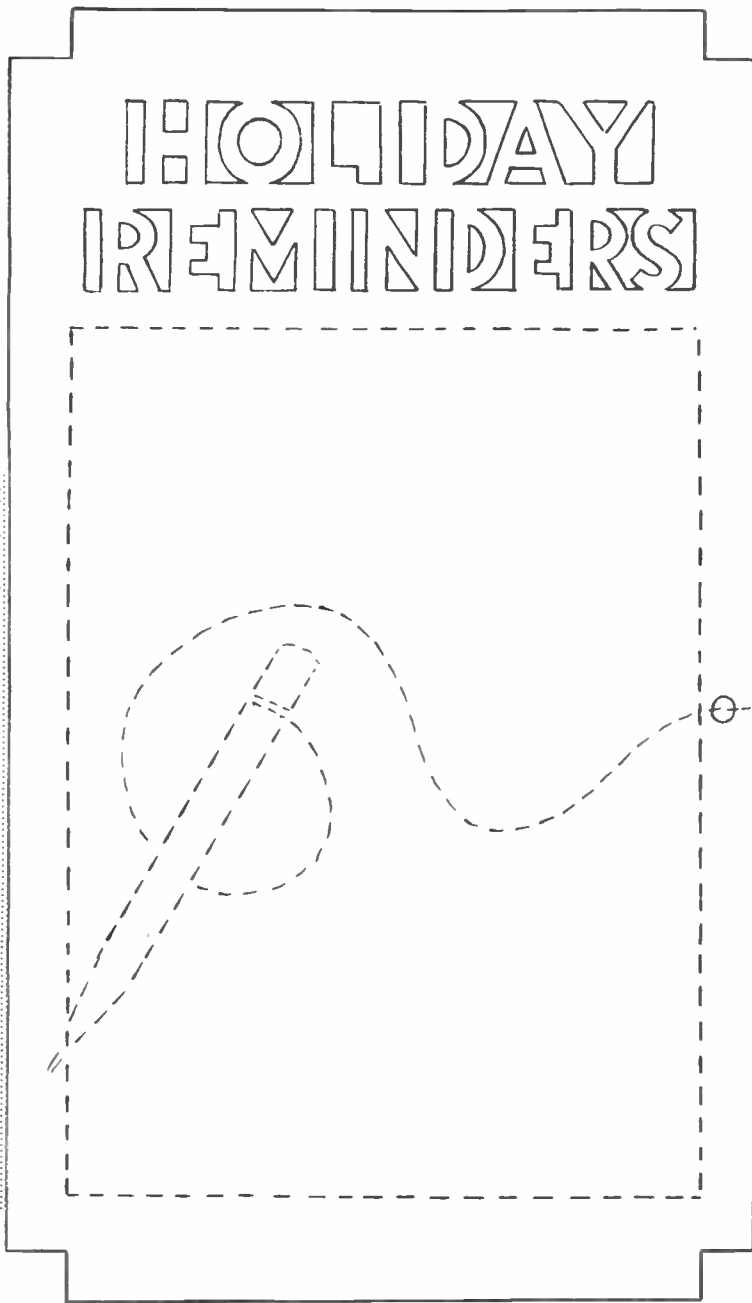

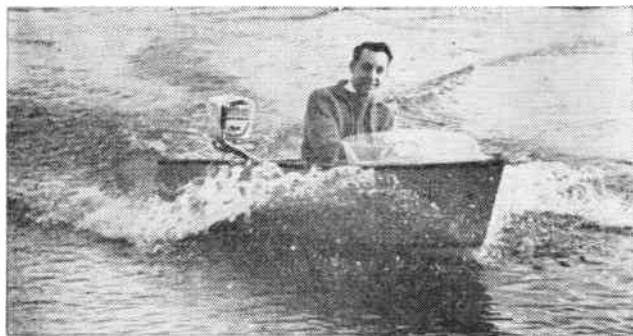

RUNABOUT 'ZIP'

Length 7 ft. 8½ in. Beam 2 ft. 10½ in.
Weight 80 lb. (without motor)

A kit designed especially for the beginner to make as an inexpensive introduction to water craft. Skinned with oil-tempered hardboard and suitable for a small h.p. outboard engine. Will carry an adult and one or two children. Steering by wheel and/or motor.

COMPLETE KIT OF MATERIALS FOR BUILDING 'ZIP'

includes PARANA PINE, MAHOGANY MARINE PLYWOOD, OIL-TEMPERED HARDBOARD, STRIPWOOD, BEADING, PERSPEX, BOWDEN CABLE, SCREWS, GLUE, FULL-SIZE PLAN, etc. (not paint and varnish). CASH PRICE

£19. 19. 0

(plus 30/- part carriage & pkg.)

KIT EASY PAYMENT TERMS—£5 down (plus 30/- part carriage and packing) and 6 monthly payments of **£2.13.0**.
Total E.P. price **£20.18.0** (plus 30/- part carriage and packing).

FULL-SIZE PLANS AVAILABLE SEPARATELY, 16/6 (post 9d. extra)

Kits from branches, etc., or
direct from the factory

HOBBIES LTD. (DEPT. 99), DEREHAM, NORFOLK

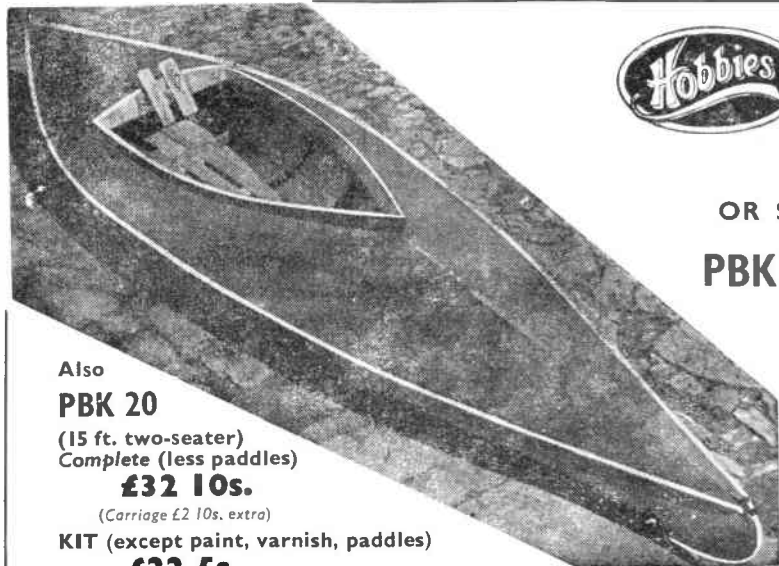

CANOES

FULLY FINISHED CRAFT
OR SPECIALLY PREPARED KITS

PBK 10 (11 ft. single-seater, as illustrated)

Complete (less paddles)

£24 5s.

(Carriage £2 extra)

KIT (except paint, varnish, paddles)

£15 10s.

(Carriage 15s. extra)

Double-bladed paddles

47s. 6d.

(Carriage 2s. 6d. extra)

Also

PBK 20

(15 ft. two-seater)
Complete (less paddles)

£32 10s.

(Carriage £2 10s. extra)

KIT (except paint, varnish, paddles)

£22 5s.

(Carriage 20s. extra)

Easy payments available.

Send for Agreement Form.

HOBBIES LTD (Dept. 99), Dereham, Norfolk

PIECES 2. CUT TWO 1/2 in.

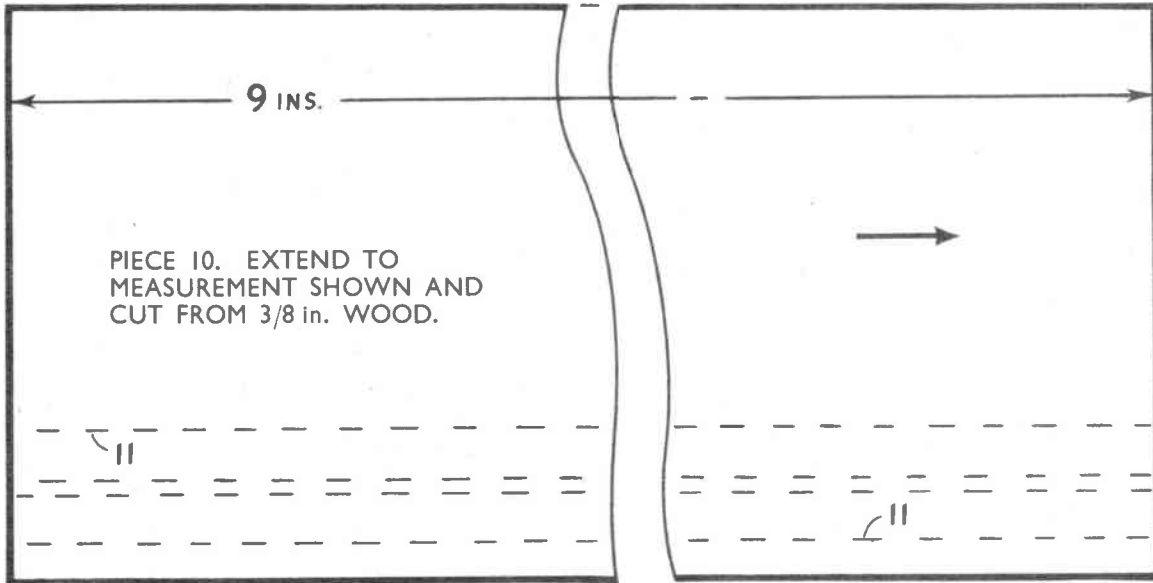

PIECES 3. CUT TWO OF EACH 1/8 in. SHAPE TO SECTION.

PIECE 4. CUT ONE 1/8 in.

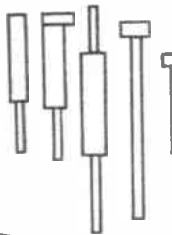

PIECES 5, 6, 7, 8 AND 9. MADE FROM WIRE AND 1/8 in. WOOD. FOR FURTHER DETAILS SEE CONSTRUCTION OF PIECES ON CONNING TOWER.

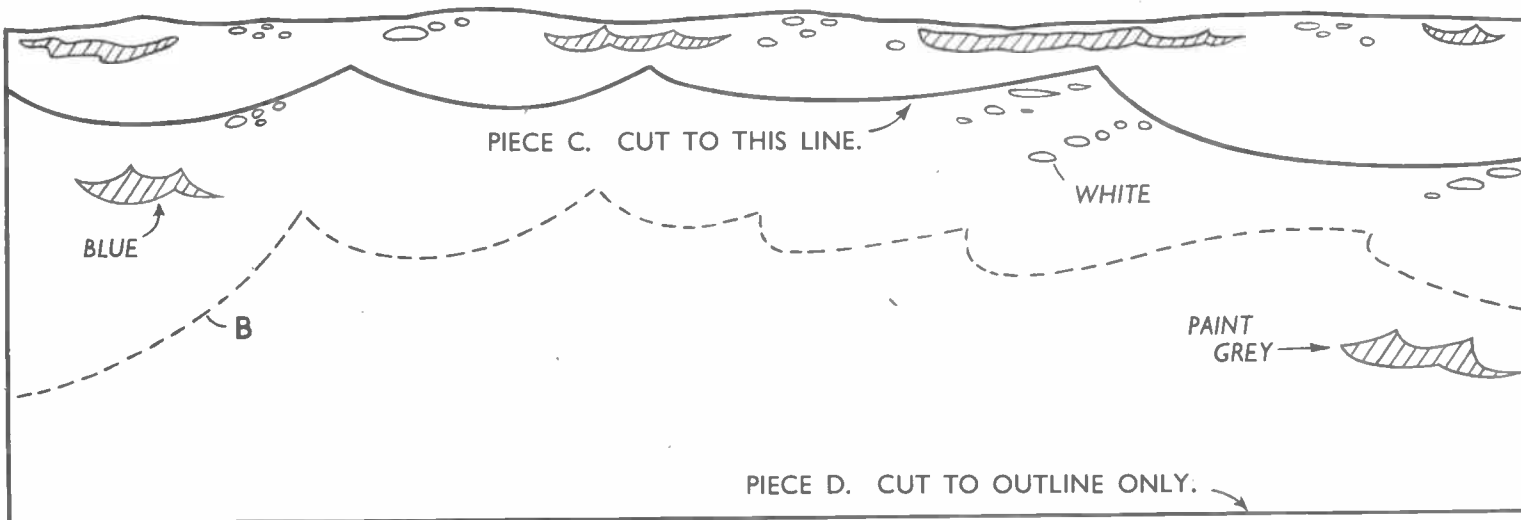
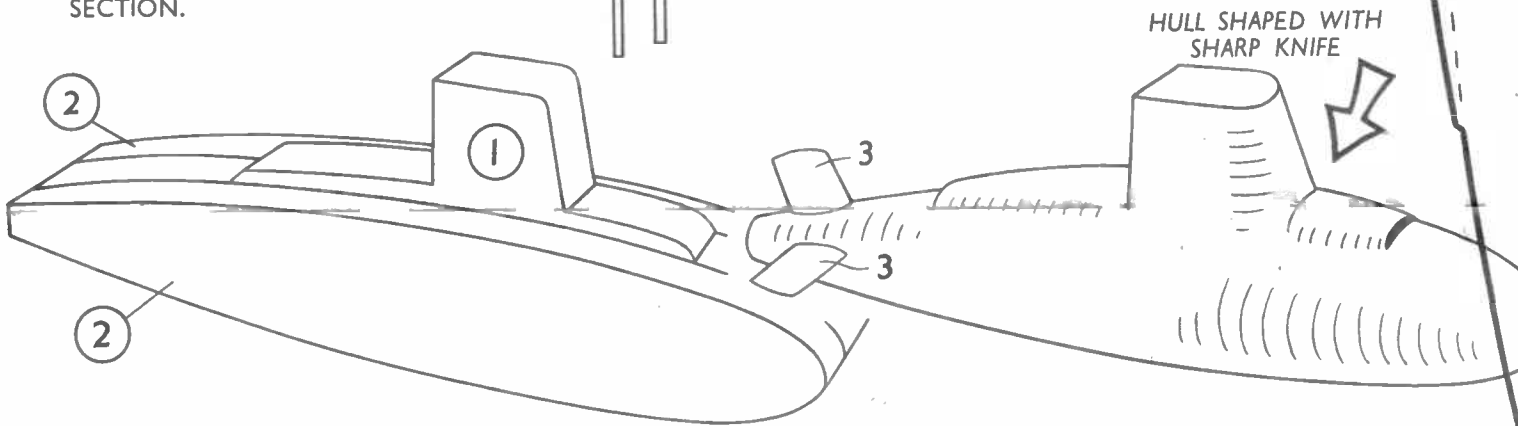

MODEL NUCLEAR SUBMARINE 'DREADNOUGHT'

SIZE: 9 ins. BY 3 ins. BY 5 ins. HIGH.

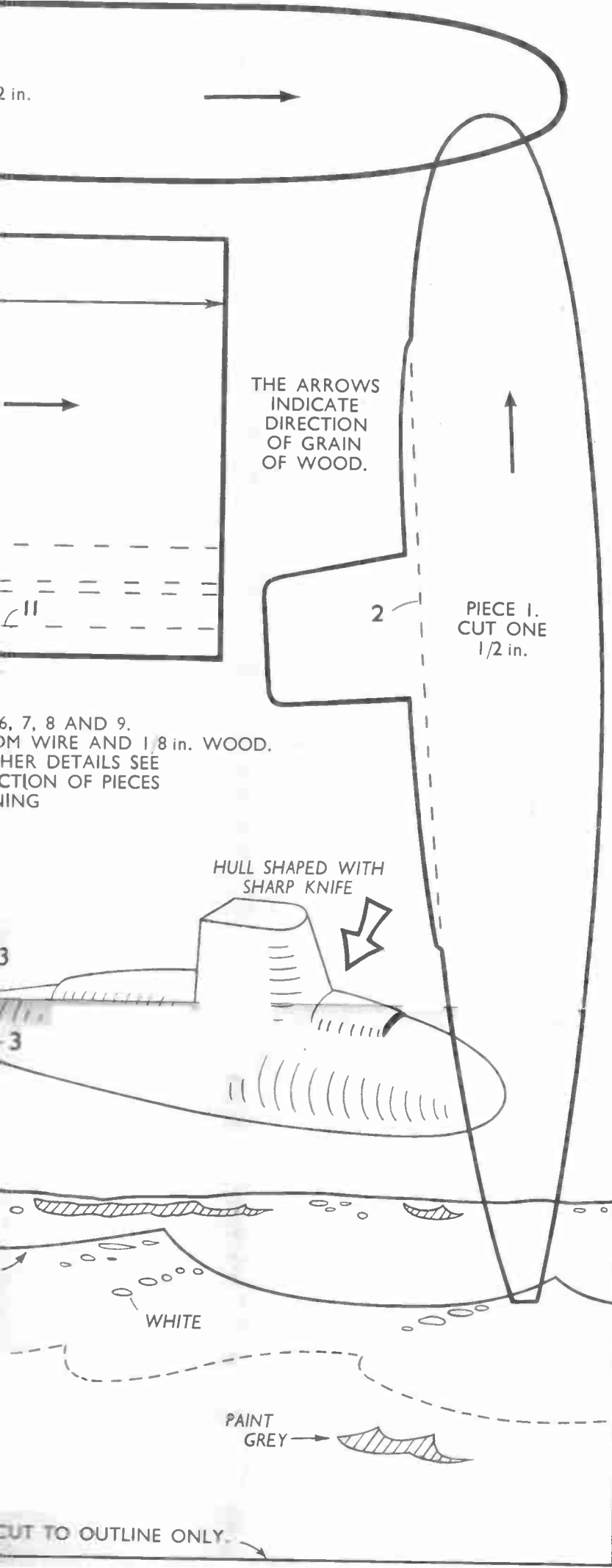
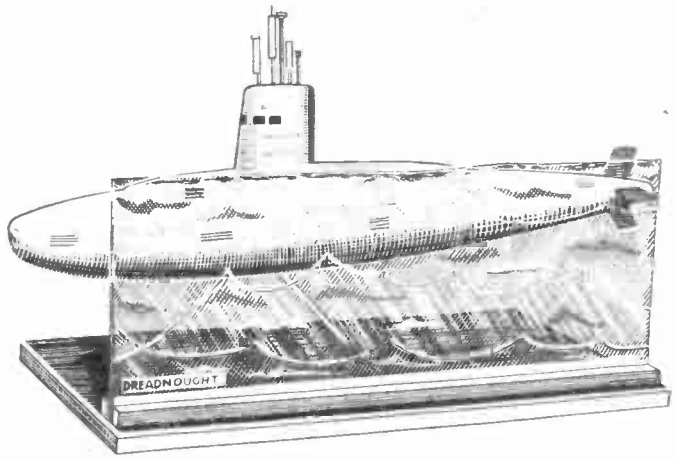

A KIT OF MATERIALS FOR MAKING THIS DESIGN IS SUPPLIED BY HOBBIES LIMITED, DEREHAM, NORFOLK. PRICE ON APPLICATION.

THE WORLD'S STRONGEST GLUES

Stick it with-

Croid POLYSTIK

A white P.V.A. adhesive, clean to use, non-staining, fast-drying and strong. For joinery and cabinet work. In easy-spread polythene bottle: 2/6d and 5/-.

BUY CROID FROM YOUR LOCAL HOBBIES BRANCH

DETAIL SHOWING POSITION OF PARTS ON CONNING TOWER.

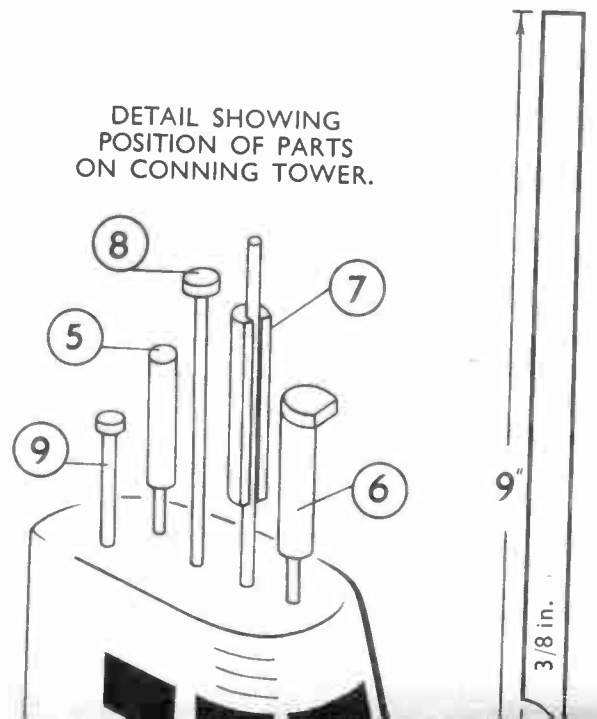

PIECE 10. EXTEND TO MEASUREMENT SHOWN AND CUT FROM 3/8 in. WOOD.

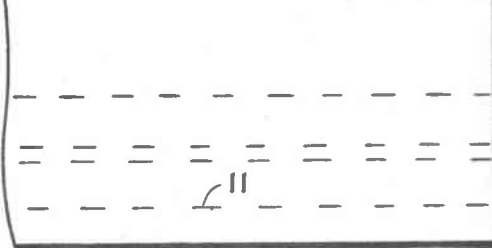
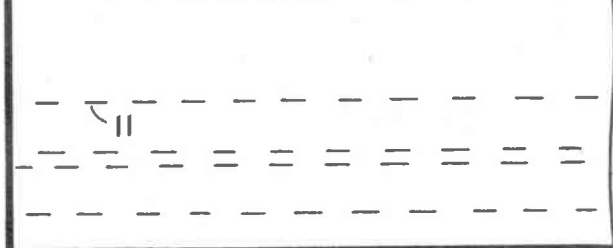

DIRECTION OF GRAIN OF WOOD.

2



PIECES 3. CUT TWO OF EACH 1/8 in. SHAPE TO SECTION.



PIECE 4. CUT ONE 1/8 in.

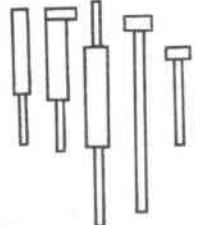

PIECES 5, 6, 7, 8 AND 9. MADE FROM WIRE AND 1/8 in. WOOD. FOR FURTHER DETAILS SEE CONSTRUCTION OF PIECES ON CONNING TOWER.

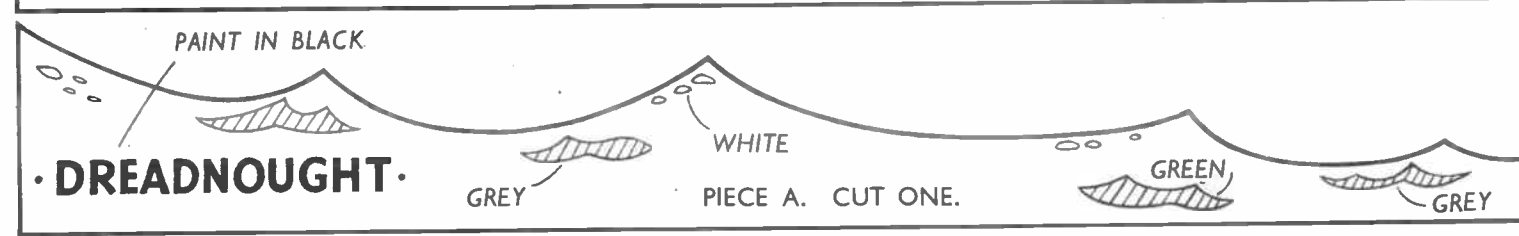
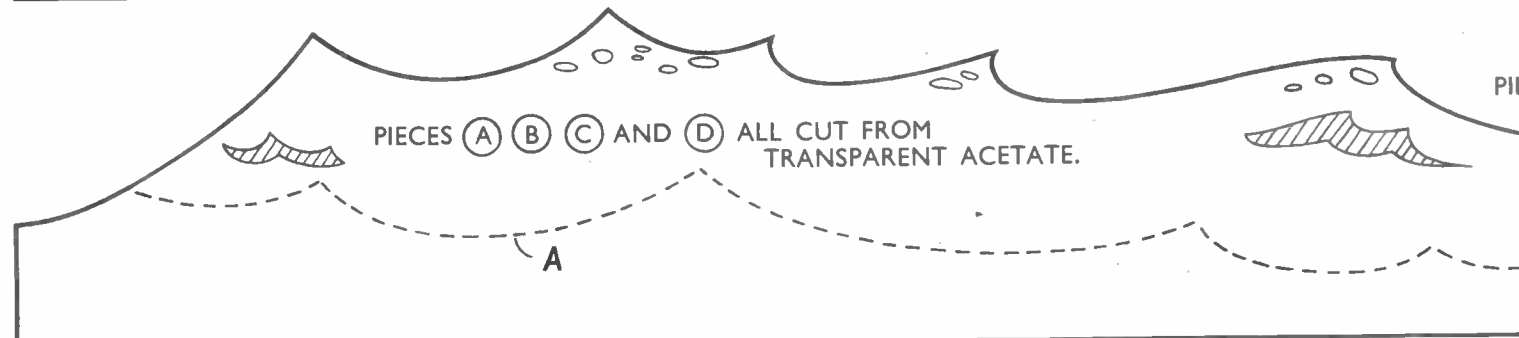
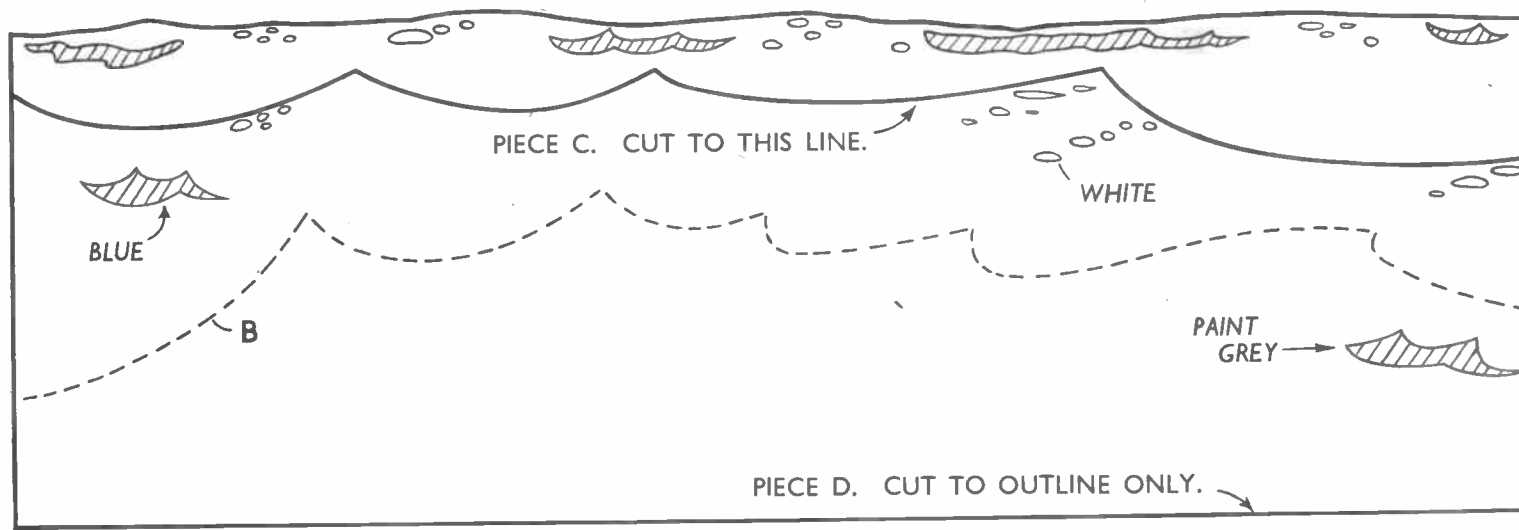
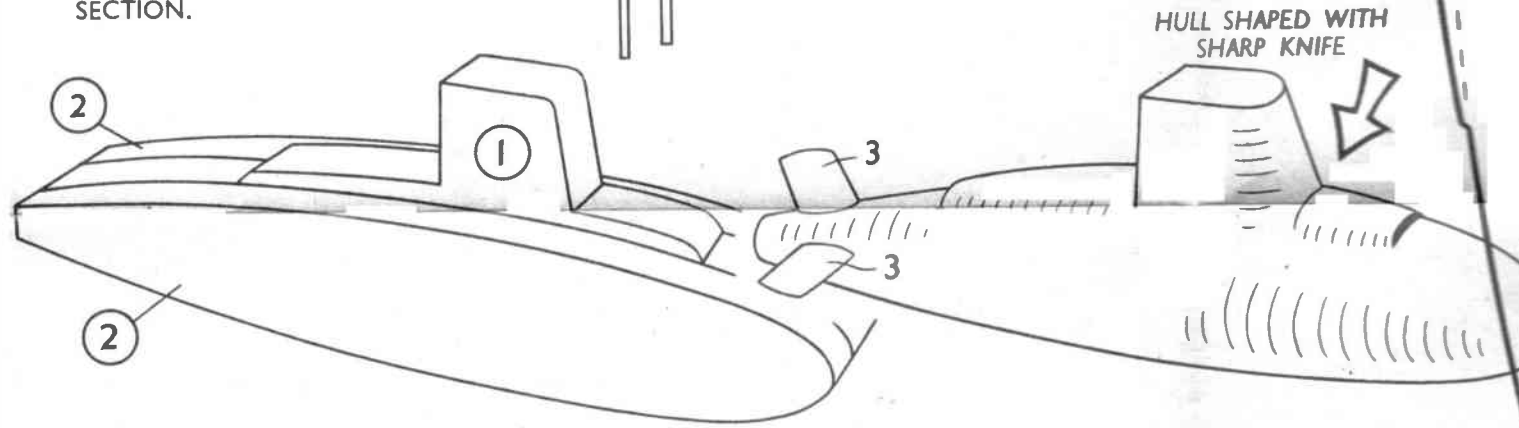

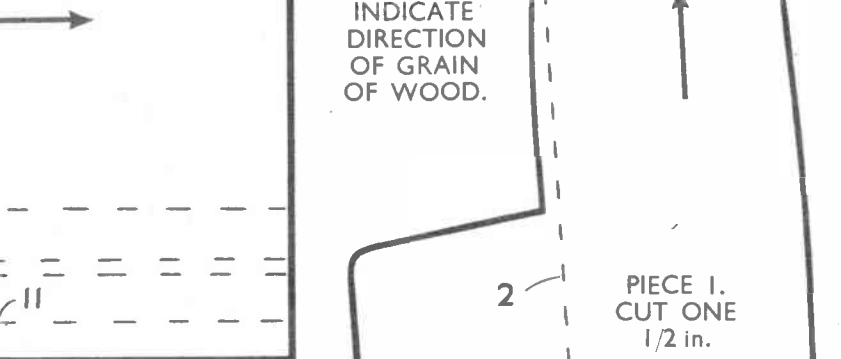

5, 7, 8 AND 9.
 M WIRE AND 1/8 in. WOOD.
 HER DETAILS SEE
 SECTION OF PIECES
 ING

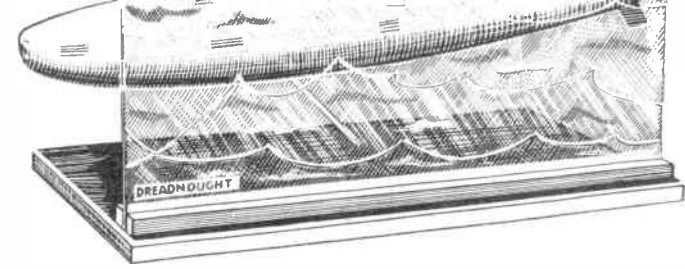
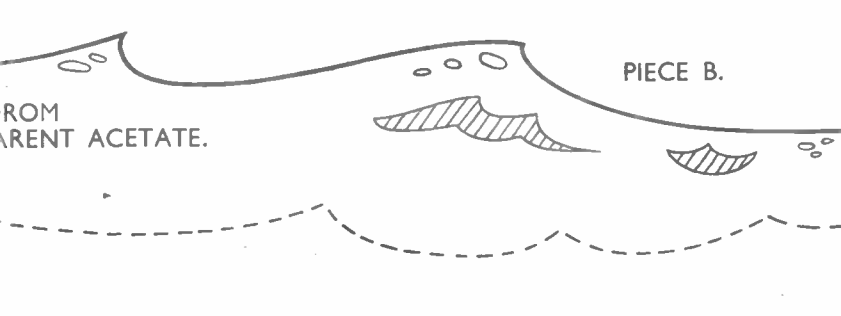
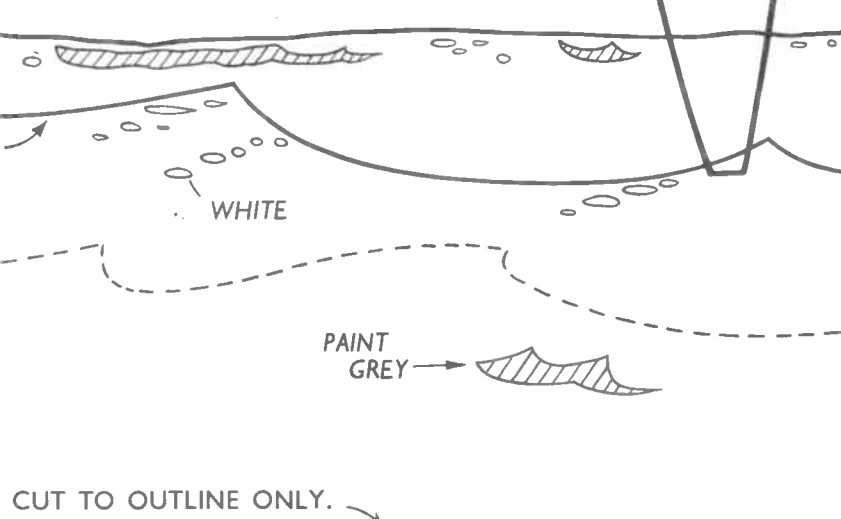
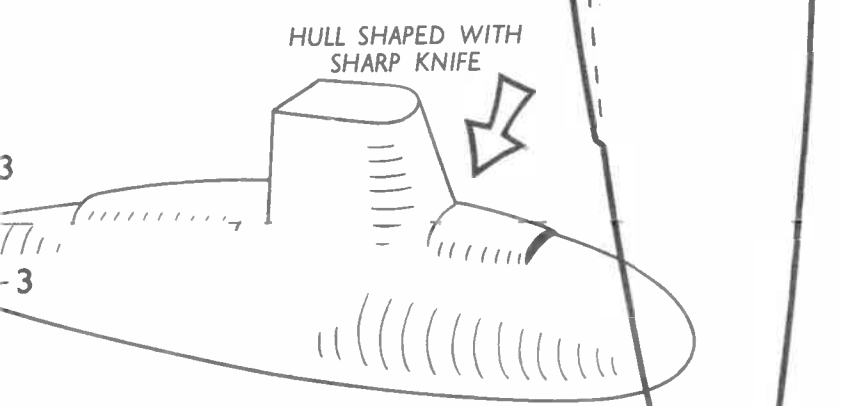

A KIT OF MATERIALS FOR MAKING THIS DESIGN IS SUPPLIED BY HOBBIES LIMITED, DEREHAM, NORFOLK. PRICE ON APPLICATION.

THE WORLD'S STRONGEST GLUES

Stick it with -

Croid POLYSTIK

A white P.V.A. adhesive, clean to use, non-staining, fast-drying and strong. For joinery and cabinet work. In easy-spread polythene bottle: 2/6d and 5/-.
 BUY CROID FROM YOUR LOCAL HOBBIES BRANCH

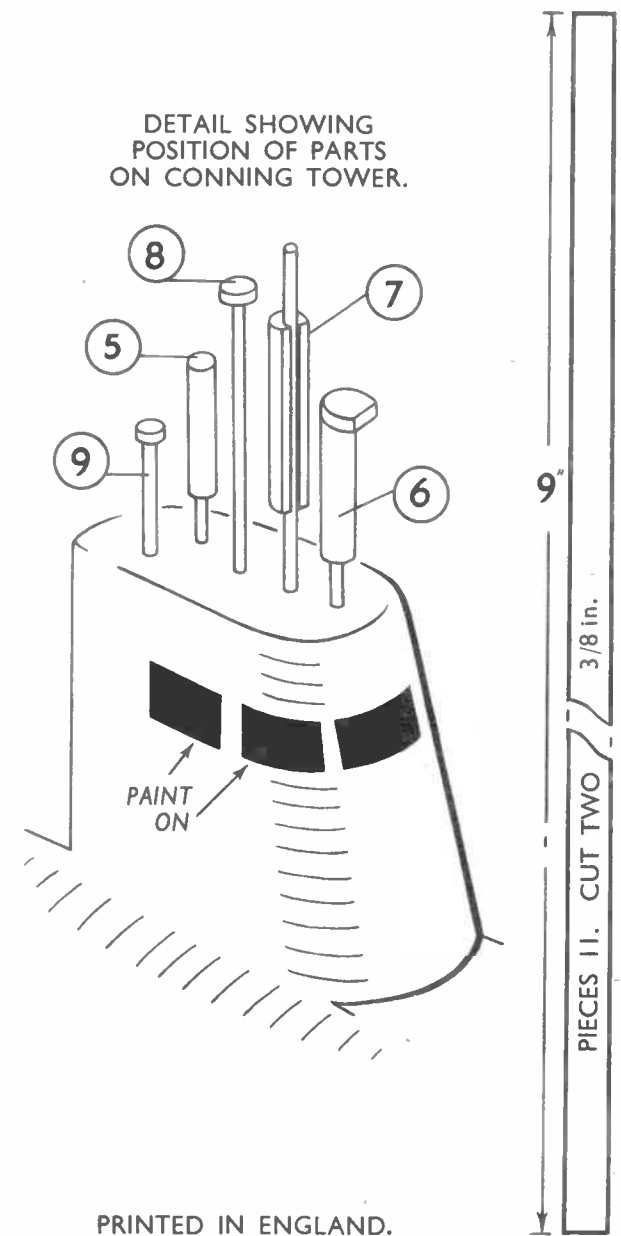

PRINTED IN ENGLAND.