

6th DECEMBER 1961

VOL. 133

NUMBER 3443

THE ORIGINAL
'DO-IT-YOURSELF'
MAGAZINE

HOBBIES *weekly*

FOR ALL
HOME CRAFTSMEN

Instructions for making . . .

Also in this issue :

PROJECTS FOR
CHRISTMAS

A HANDSOME
PADDED STOOL

COLLECTORS' CLUB
LATEST STAMPS

TWO-TRANSISTOR
POCKET RADIO

CHRISTMAS WITH
THE STARS

PATTERNS FOR
FRETSAW JOB

ETC. ETC.

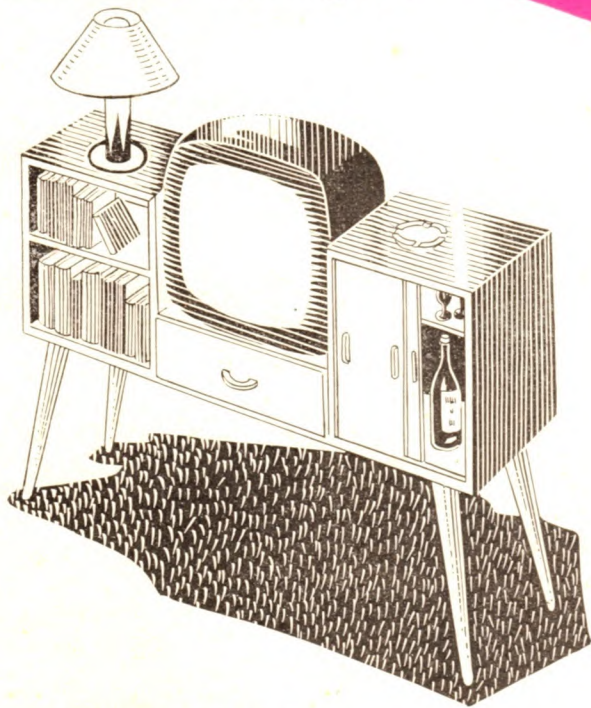

MODERN TV SETTING



Up-to-the-minute ideas

Practical designs

Pleasant and profitable things to make

5^D



WITH its azure-blue sky and bright sunshine, its enchanting seashores and picturesque landscapes, its ancient monuments, its wonderful climate and traditional hospitality, Greece is the ideal place for the tourist who would combine the pleasures of a wonderful and healthful holiday resort with the benefits of a cultural pilgrimage to the country which gave birth to humanism and elevated art to heights of perfection.

NEW STAMPS FROM GREECE

To extol the beauty of the Greek landscape and the majesty of the ancient Greek monuments and to offer an invitation of hospitality to all those who long to know Greece, the General Direction of Greek Posts issued a set of 17 tourist stamps with choice designs depicting representative landscapes and ancient monuments.

Lepta 10 — Castoria

Castoria is a beautiful town in Northern Greece, built on the ruins of the old town founded in the 6th century A.D. by the Byzantine emperor Justinian on a promontory in Lake Orestias.

Old patrician houses with richly painted and carved woodwork ornamentation (17th-19th centuries) lend picturesqueness to the town. There are also 72 very old churches, wonderful examples of Byzantine architecture and painting, all of historical importance.

Lepta 20 — The 'Meteora'

Near the small town of Kalambaka, in Thessaly, a number of gigantic vertical rocks tower majestically over the plain. Their strange shapes and bare majesty make them one of the most beautiful and fantastic landscapes in Greece. On the tops of these rocks pious monks set up monasteries in the 15th and 16th centuries A.D. and called them 'Meteora', to imply (the Greek meaning of the word) 'suspended between sky and earth'. Of the 24 monasteries on the summits, only 4 are inhabited today.

Lepta 50 — Hydra

The picturesque and historically interesting little island of Hydra is a long narrow rocky stretch of land towering over the deep blue waters of the Saronic Gulf. In its capital, which is called after the island, there are many beautiful spots, such as a charming little port with stone steps leading to the upper quarters of the town, windmills, old churches, monasteries and rich patrician houses — the homes of its sea captains (18th-19th cent. A.D.) — wonderfully furnished and abounding in old heirlooms.

In 1821 the heroic seamen of Hydra offered their ships and substantial funds for the Greek War of Independence.

Lepta 70 — Athens

The Parthenon, built on the highest part of the Acropolis, is the most important creation of ancient Greek architecture and a symbol of the perfection that marked the classical spirit of the age of Pericles — 5th century B.C. — the 'Golden Age' of Greek history. It was built during the period 447-438 B.C. by the architects Ictinus and Callicrates.

The composition and sculpture of its ornate decorations were the work of the great Phidias, who was also the coordinator of the whole plan.

An eternal symbol of aesthetic perfection, this temple was dedicated to the goddess Athena, the Patroness of Athens. Of Doric order, the temple was made of marble extracted from Mt. Pendeli. Its length is 69.51 m. and its width 30.87 m. Although partly ruined today — largely due to the bombardment by Morozini in 1687 — it still fills the visitor with admiration and awe.

Lepta 80 — Mykonos

Mykonos is one of the most picturesque of the Cyclades islands in the Aegean Sea. Mykonos town (Hora), with its port, resembles a mythical town with a nautical character. The innumerable little Byzantine churches and its picturesque houses, snow-white and always freshly white-washed, with their external wooden staircases and flower-pots of basil (basilicum) on their window-sills, with their looms, by means of which the island girls weave wonderful brightly coloured textile fabrics, charm the visitor with their originality.

The famed wheat-grinding windmills of Mykonos on the heights of the town are real jewels.

Drachma 1 — Salonica

Salonica, the capital of Northern Greece, was founded in 316 B.C. by Cassander, who named the town after his wife, a sister of Alexander the Great.

The Apostle Paul preached Christianity in Salonica; hence the town is considered the gateway through which Christianity spread over Europe. The city is a vast museum of Byzantine architecture packed with Christian monuments, built mostly during the 14th century.

At the bend of the seaside avenue stands the mediaeval 'White Tower', which has come to be the symbol of the town.

Drachmae 1.50 — Olympia

Olympia was one of the brightest jewels of the miracle that was Ancient Greece. Situated in the Peloponnese, it lies in a peaceful valley thickly wooded with pines and intersected by the rivers Alfios and Cladeos.

Olympia was not a town but a great sanctuary where Olympian Zeus and the goddess Hera were worshipped.

A number of huge pillars of Doric order, the ruins of Hera's temple, bear witness to its former grandeur.

Apart from the exquisite landscape with its two rivers and verdant Cronus Hill there are the ruins of a considerable number of shrines, gymnasiums, sculptors' workshops. The Museum contains unique sculptural masterpieces, such as



Praxiteles' Hermes, Paoneus' Victory, Apollo and many other art treasures. At the Stadium the well-known Olympic Games of the ancient Greeks took place.

Drachmae 2.50 — Knossos

Knossos is a picturesque spot near Heraklion, Crete. A town flourished there in very ancient times (3rd-1st millennium B.C.), and it was the kingdom of Minos, the prehistoric ruler of the seas. It was the first spark of European civilization, the Minoan.

Today the visitor will see the restored ruins of Minos' palace, unearthed in 1900 by the British archaeologist Evans.

The many-storeyed palace was the centre of a big tree-surrounded town without protective walls. Built in the 19th century B.C. it was destroyed by earthquake and rebuilt in the 17th century B.C. Its complex architecture, its lordly chambers and staircases, its perfect baths with their drainage system, its masterly wall paintings, statuettes, precious jewels and carved vases, all compel admiration. (To be concluded next week.)

Labels in Circulation

AUSTRALIAN 'NEW WILD LIFE'



A further selection of match labels currently in circulation, being numbers 11-20 in the Australian 'New Wild Life' series

THE LATEST FROM RUSSIA

HERE'S the latest list of new stamps from Russia.

A 4 Kopeks pictorial (illustrated) appeared on 14th July, to continue the 'Capitals of Autonomous Republics' set. This stamp depicts CHEBOCKSARI — capital of CHUVASH ASSR.

A multicoloured commemorative (illustrated) released on 25th July, marking the '40th Anniversary of the People's Republic of Mongolia,' depicts the

People's Hural Building — the Government of MPR.

S. I. VAVILOV, who was president of the Academy of Sciences for many years, was depicted on a special stamp on 25th July.

On the same day a 4 Kopeks value appeared marking the 100th Anniversary of the Birth of VAZHA PSHAVELA — Georgian poet. And a 6 Kopeks value honouring the 'World Youth Forum,' held in Moscow in 1961.

The Fifth International Biochemical Congress, held in Moscow in 1961, was commemorated on a 6 Kopeks stamp on 31st July.

The following stamps were released on

8th August.

VIIth Soviet Trade Union's Games — an athlete appears at left, the emblem of the games at right — 6 Kopeks.

200th Anniversary of Birth of A. D. ZAHAROV — Russian architect — 4 Kopeks.

20th Anniversary of Defence of Brest's Fortress — 4 Kopeks.

15th Anniversary of International Union of Students — 6 Kopeks.

40th Anniversary of First Soviet Stamps — 2, 4, 6 and 10 Kopeks, depicting various stamps pertaining to the growth of the Soviet Union.

The Second Flight of Man in Space' — the 4 Kopeks value shows a pilot at the cockpit of Sputnik Vessel — the 6 Kopeks depicts H. S. TITOV and Sputnik 'East II.' These last two stamps are also illustrated.

* * *

NORWAY

In connection with the 100th anniversary of the birth of FRIDTJOF NANSEN, 2 special stamps appeared on 10th October.

* * *

CZECHOSLOVAKIA

To mark the 'International Trade Fair' at BRNO from the 10th to the 24th September, 3 special stamps appeared. Designs are: 30 h. blue and yellow-green — Map of Europe. 60 h. green and pink — Boring Machine. 1 k. brown, violet and blue — International Scientific Symposia.





ANYONE can place a few Christmas cards on the mantelshelf and fool themselves that the room is decorated for the festive season. It's not very ambitious, is it?

With this in mind, I thought I would try and find some individual touches for Christmas decorations says Ed Capper. And who are more individualistic than

stage and screen stars? Here are their suggestions.

You may like to know that each and all of these celebrities send sincere good wishes to all Hobbies readers.

DAVID HUGHES

CHRISTMAS trees are a 'must' for any Christmas decoration. But, they can take up quite a lot of space. If you trim off the back of a small tree, making it semi-circular in fact, then place it in a pot and stand it on the mantelshelf in front of the mirror, the result is fascinating. The effect is that of a whole tree in three dimension. What's more, the number of lights and decorations on the tree is doubled due to the reflection in the mirror. And of course, it does not stick out into the room.

MORECAMBE AND WISE

WE make our own Christmas tree. We get a block of wood and cover it with coloured paper, tied round with a bow. We drill a hole in the centre of the block and into it push seven lengths of strong wire and wedge them tight. After that we bend the wire at intervals on all but one that we leave for the main stem and over the bent wires we drape our Christmas cards. It never fails to bring a lot of favourable comment from our friends — both of them!

JOE LOSS

I THINK the most colourful part of Christmas decorations should be the 'eats'. I favour a tray filled with snacks that guests can take at any time during the evening. Colour should be the keynote of such a tray. Fill it with a mixture of cheese and fruit. Bright red apples, golden russets, amber pears and black grapes, together with creamy cheeses like Camembert, sharp blue and mild, red-wrapped Gouda.

Some pears and apples could be cut into wedges for easy finger eating. It is best to dip them in lemon juice to prevent browning and replace them on the tray so that they look whole again. Guests will take a wedge expecting to have to eat, out of politeness, a piece of apple turning brown through exposure and will be pleasantly surprised to find it white and wholesome and with a fascinating taste of lemon.

HARRY SECOMBE

I THINK one should try and get some life into Christmas decorations. One of the nicest ways is to include some novel presentation of Christmas cards. Have you ever thought of hanging a tablecloth on the stair wall and pinning on the cards, as they arrive. I find a pocket handkerchief sufficient for the cards I receive, but you may be luckier!

Another idea I employ is to hang tapes



Harry Secombe's card display

on the banisters and pin the cards on them from top to bottom.

After Christmas, I keep the cards and use the gayest of them for next year's labels on presents and for decorating boxes, or give them to children to cut out and remount to make their own cards. Orphanages or hospitals are grateful for them, too.

DEREK ROY

MY wife, Sue, is the brains in our home and she always makes her own decorations. The Christmas table is her speciality. She wires small pieces of evergreen, cut to shape, to make very attractive, miniature trees. Sometimes, she makes a tree from an 18 in. square of small mesh wire netting, folded into a cone shape. She fastens the top and sides by hooking the wire ends together. Then she cuts the base level (with my secateurs I'm sorry to say!) and fills the centre with damp moss, fixing pieces of evergreen into the mesh.

We find that this decoration stays fresh and green right through until the New Year.

LENNY THE LION

MY old man (Terry Hall, to you!) comes out with one or two good ideas for Christmas decoration. But don't tell him I said so; that man gets awfully swell-headed!

He gets a red polythene bucket and then makes up a spiral from strong wire which he stands in the bucket. From the spiral he hangs sprays of holly and mistletoe and finishes it off with a bright red, ribbon bow, tied to the top. Across the mouth of the bucket he places wire mesh into which he sticks other sprigs of evergreen.

KEN DODD

I RECOMMEND hanging a kissing ring in the hall or over a doorway,

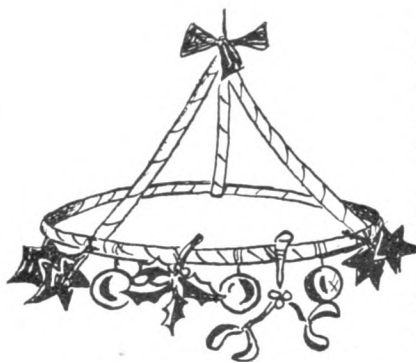

Ken Dodd's kissing ring

(Actually, I've got to employ some artificial means to get any girl to kiss me!) I make my ring from a hoop of wire as the foundation. Holly, ivy, mistletoe and laurel should then be wired evenly around the ring. Colourful glass balls and little red satin bows tied on, give an extra sparkle. Then cut three equal lengths of red ribbon, attach one end of each piece to the ring and knot the other ends together, to suspend it. Make sure there is an oversize sprig of mistletoe in the centre.

LESTER FERGUSON

THROW an American party. Have hamburgers and cheese, cream cakes

and of course, 'coke'. Don't waste money on things that only the minority of your guests may like such as olives, gherkins and suchlike. Order your drinks on sale or return basis (yes, it can be done) and why not hire the glasses to save having to buy extra for the occasion.

Don't serve food too late as some guests may not have eaten before the party and nothing will produce yawns quicker than an empty tummy. And, always serve something hot, even if it is only coffee. The best drink at a party is of course a nice bowl of steaming hot punch. It is not expensive to make. Any wine merchant will give you advice.

STAN STENNETT

ITHINK windows are most important in the Christmas decoration scheme. Pelmetts can be edged with fronds of fir, tinsel tassels and clusters of baubles, with green garlands hanging down the side. Closed curtains can be scattered with Christmas tree decorations to complement the pelmetts. If there is no need to close the curtains, hang large glass balls from nylon thread at different heights over the window surface.

Also stick small blobs of cotton wool all over the window panes to represent a snow storm. A novel touch is to add miniature snow drifts with the cotton wool, to the corners of the panes.

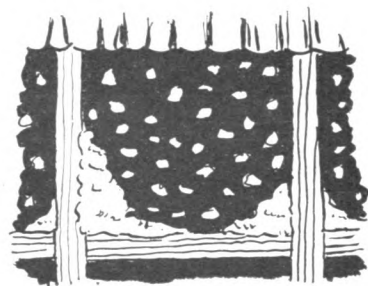

Stan Stennett's window scene

JESS CONRAD

IGENERALLY try to make up some novel decorations for Christmas. I was particularly proud of an oversize spray of mistletoe I made up, from a small tree branch and with leaves made up from cardboard, covered with green crepe paper. They were held to the branch ends with drawing pins. The 'berries' were table tennis balls, held in place by piercing them right through with a needle and holding with cotton.

Naturally, no one could fail to see it as they entered the room but to really over-exaggerate its function, I cut out a large 'X' from cardboard and pinned it to the floor right under the suspended mistletoe. I can assure you, it was a most popular decoration.

MAKE SOME 'CANDLE' LOGS

A GLITTERING 'Christmas' log' makes a pretty table decoration and gives a festive air to the home. These can be bought, but they are by no means cheap. However they are quite easy to make and will give a great deal of fun in doing so.

The basic material is a log about 8 in. long, the sort of branch that sometimes has to be pruned from a fruit tree, and an assortment of pine cones. These can be picked up from the ground on one's country rambles.

The ideal thickness for a log of this length is about 3 in. but since one is restricted to the material available, no definite size can be laid down. A thicker log can be sawn down its length to make two half logs. This will produce a flat base, so that no further support is needed. Since the sawn ends of the log will probably be quite rough, having been cut with a coarse saw, they should be trimmed off neatly with a tenon saw. It is easier to do this when the log has dried out.

It will usually be found that the log will rest more easily in one position than any other, and it should be assisted to do so without rolling by sticking small pieces of wood or cork to it, close to

where it contacts the surface on which it is resting.

A hole for the candle should be drilled

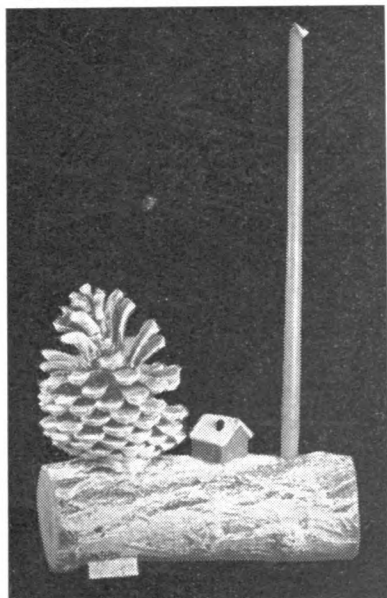

in the log, and the size should be so that the candle is a fairly tight fit (it can be trimmed down if necessary). The hole must be drilled vertically into the log when in its resting position, and may be either at the end or in the centre, according to the design of the finished article. Two or more candles may be fixed if preferred.

Pine cones should be stuck on to the log. Ordinary tube glue is usually too thin for this, since the surfaces are very rough, but plaster, or some types of fire-clay cement can be used.

The log and cones should then be roughly painted with flat white paint, to represent snow. 'Glitter' can then be added by brushing gum over the required parts, and sprinkling the powder over them. If this is performed over a sheet of paper, the excess can be shaken off and used again.

The decorative effect of the log can be improved by sticking on small Christmas-cake ornaments. Holly leaves and berries, or ribbon bows can also be added, according to personal taste. (P.R.C.)

A HANDSOME PADDED STOOL

THIS useful stool is easily constructed by the home handyman. It consists, quite simply, of a shallow box, padded and covered, set on four shaped legs.

The legs are the cabriole type (Hobbies No. 560, 6 in. high) and cost 9s. per set of four (postage 1s. 6d. extra) from Hobbies Ltd, Dereham, Norfolk or from any branch or Hobbies trader.

The side view and end view in Fig. 1 show the main sizes and the arrange-

The bottom should be fixed before gluing and screwing the legs in place as shown in Fig. 3. The wings of the legs are drilled and counter sunk and the floor is also drilled to take a long screw running down into the leg.

Now fix the top, after bevelling the edge as shown in Fig. 2. The legs are finished by staining and polishing or varnishing.

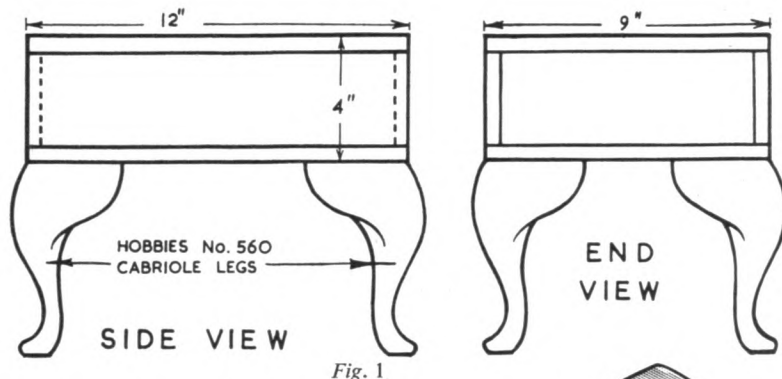
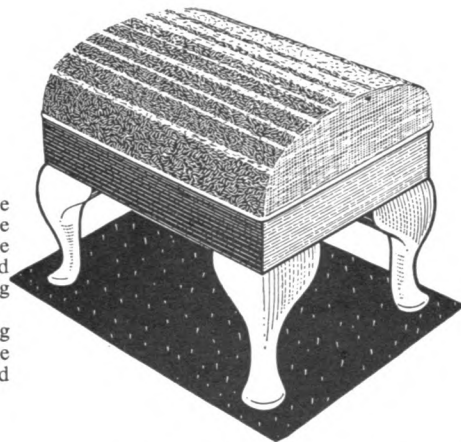

ment of the parts. All joints are butted and screwed together for maximum strength. The diagram in Fig. 2 shows how the ends go between the sides, with the bottom and top in their respective positions.

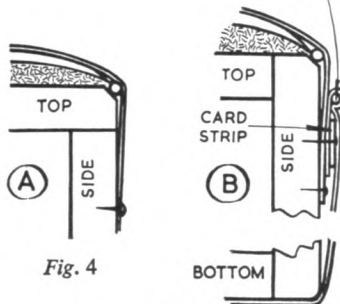
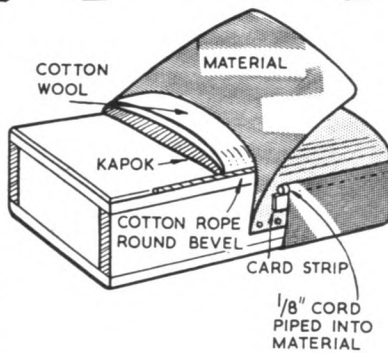
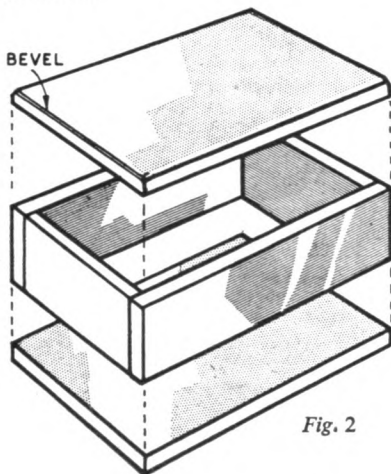

The stool is now ready for covering and the method is shown in Fig. 4. A piece of rope or cord is first glued round the bevelled edge and a wad of kapok or cotton wool placed on the top. It should be shaped to a feather edge all round.

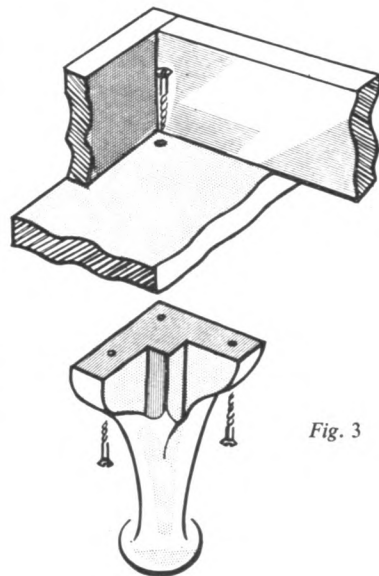

Cover with suitable material, bringing it halfway down the sides as indicated at A in Fig. 4. The material should be fastened all round with upholstery pins.

The sides are now finished off with a piece of piped material. A narrow strip of card is taken around underneath the piping and secured with large headed tacks. The material is now taken underneath between the legs and secured there by tacks. Finish off round the legs by doubling under and gluing with a suitable adhesive. (M.h.)

full industrial strength

CASCAMITE 'ONE-SHOT' RESIN GLUE

waterproof and heat resistant

Table-tops, worktops and kitchen cabinets . . . bathroom panels and fittings . . . wherever you need strong, waterproof and heat-resistant bonds, use CASCAMITE "One Shot"—the resin glue that has proved its worth in the furniture, joinery, boatbuilding and many other industries. With CASCAMITE "One Shot" you have ample time to position your work before the glue begins to set.

for permanently bonding WOOD
HARDBOARD · FORMICA · WARERITE
FABLONITE and other plastic lam-
inates. Also for model making and
general repairs.

3½-oz. tin 2/6d.
7-oz. tin 4/-d.
18-oz. tin 8/6d.



CASCO 'CONTACT' INSTANT ADHESIVE

For practically everything that needs to be stuck instantly, without pressure. Ideal for handicrafts. In a handy hang-up pack. Tubes 1/- and 1/9d.

MANUFACTURED BY LEICESTER, LOVELL & CO. LTD., NORTH BADDESLEY SOUTHAMPTON



141

Thrill to the rhythm of STEAM—

Get a

Mamod

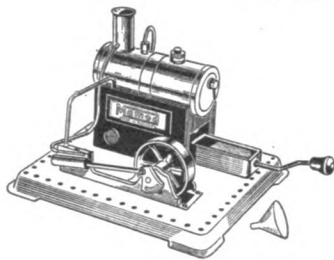

A real, working steam powered engine to operate other models or to work on its own. Thrill to the hiss and puff of steam, the flash of moving pistons and the smooth rhythm of the revolving flywheel. Absolutely safe, beautifully made and smartly finished, a MAMOD steam engine is a possession you'll always be proud to own and to show your friends.

Manufactured by

MALINS (ENGINEERS) LTD, 25-31 CAMDEN STREET, BIRMINGHAM 1

Telephone : CEN. 6175-6

Grams.: MAMOD, BIRMINGHAM

155

MODERN LAYOUT FOR THE T.V.

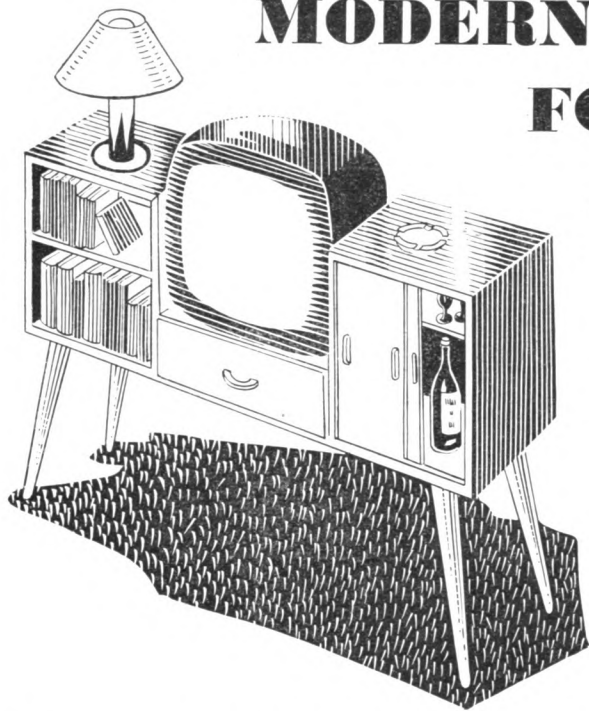

Details for making an attractive 'sideboard' with the television a central feature

WARERITE PANELS
 Warerite panels, size 36 in. by 24 in. are available from Hobbies Ltd, at the reduced price of 26s. (post free). Specifications are:
MORESCO — Scarlet, Lemon, Sky Blue, Ivory
FLORAL — Brown, Lotus Pink, Blue
Royale, Gold Dust on White, Zig-Zag White, Blue-Grey Check
 Other 36 in. by 24 in. Warerite panels are available at 30s. post free. They are:
TESSUTO — Primrose, Coral Pink, Biscuit, Pearl Grey, Azure Blue
WOODPRINTS — Australian Walnut, Sapele Mahogany.

THIS attractive piece of furniture comprises bookcases, cabinet with sliding doors, and a drawer for odds and ends. There is nothing difficult about the construction and it can be confidently tackled by the handyman. The tops of the various pieces are further enhanced by the addition of Warerite, which provides a first class, hard wearing and easy-to-clean surface.

To ensure a suitably strong base for the television set, $\frac{3}{8}$ in. wood should be used where possible. The backs of the cabinets and the bottom of the drawer can be of lighter material however, $\frac{1}{4}$ in. plywood or $\frac{1}{8}$ in. hardboard being quite

suitable. The main piece is strengthened by a piece of 1 in. by 2 in. along the whole length.

Study the diagrams carefully before commencing work. The front view and side view in Fig. 1 show the main construction and overall measurements. The aperture for the television should be checked against your own set before commencing work and any necessary alteration made in the measurements.

The main piece, seen in Fig. 2, will be about 61 in. long and 11 $\frac{1}{2}$ in. wide. The strengthening piece is glued and

screwed centrally as shown.

Build up the cabinets as detailed in Fig. 3, supporting the shelves with triangular fillet glued underneath. Note that the backs of the cabinets come level with the sides at the top. The position of the channel moulding for the sliding doors is also shown in Fig. 3.

Fig. 4 shows the addition of the sliding doors and the tops. The doors may be faced plywood, hardboard or glass and should run smoothly in the channel. If you do not wish to buy the special channel moulding you can use three pieces of $\frac{1}{4}$ in. by $\frac{1}{4}$ in. strip glued and nailed in place. Short strips of wood are

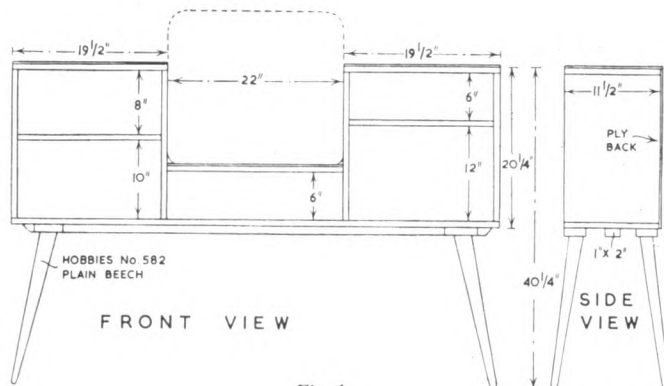

Fig. 1

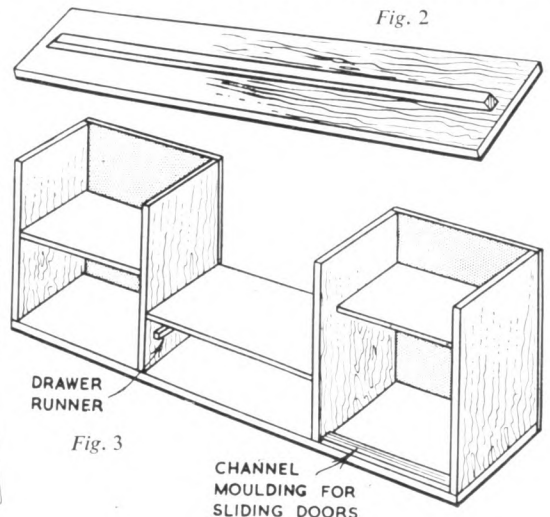

Fig. 3

glued and nailed in place. Short strips of wood are glued on to form handles.

The make-up of the drawer is shown in Fig. 5. The back and front are held

panel being the most economical size. It is fixed in the usual way, instructions being supplied with the Warerite when it is purchased. The plastic handle and the Warerite can be obtained direct

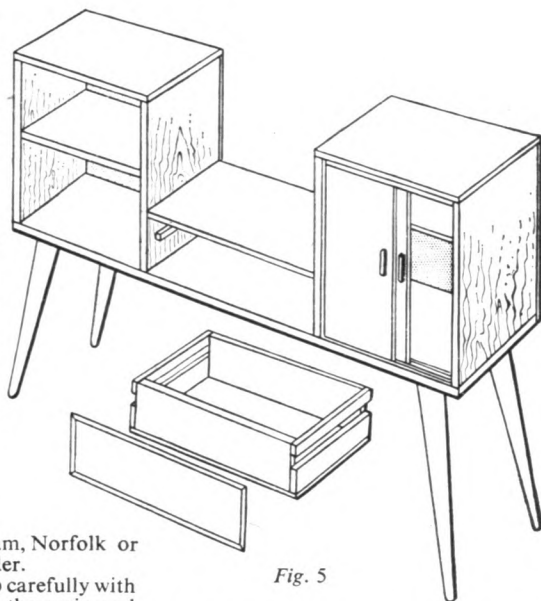

Fig. 4

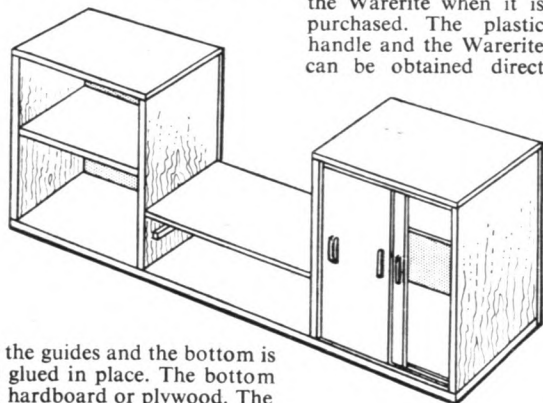

Fig. 5

together by the guides and the bottom is pinned and glued in place. The bottom can be $\frac{1}{2}$ in. hardboard or plywood. The drawer front is now covered with a piece of $\frac{1}{4}$ in. wood which will overlap about $\frac{3}{8}$ in. all round. This piece can be chamfered all round to enhance the appearance. A Hobbies No. 711 plastic handle will complete the drawer, and runners are glued in appropriate positions indicated in Fig. 3.

The tops of the cabinets are now covered with Warerite, a 36 in. by 24 in.

from Hobbies Ltd, Dereham, Norfolk or through any branch or trader.

Finish off by cleaning up carefully with fine grade glasspaper. Fill the grain and stain ready for polishing or varnishing.

The legs are Hobbies No. 582 plain beech, 20 in. high and cost 11s. per set of four, complete with block. Postage and packing will be 1s. 9d. extra. Plain

ferruled legs of the same length cost 14s. 6d. per set, and ebonized legs with ferrules and glides 20s. Plain legs will of course be stained and varnished to tone with the rest of the cabinet. (M.h.)

GRAND XMAS GIFTS

FOR
THE
LAD



AND
HIS
DAD

These fine presentation sets of Hobbies famous tools will prove ideal gifts throughout the year for any lad or adult interested in woodwork, modelling, etc.

Available from all Hobbies branches, stockists, etc., or send coupon today for immediate delivery.

Hobbies have other outfits costing up to 70/-, suitable for all occasions and all pockets.

YOU MUST HAVE HOBBIES 1962 ANNUAL
180 pages crammed with woodworking projects, toys, novelties, furniture, etc. Free designs for making a grand model Zoo and a Whistling Bird Novelty Cigarette Box with each issue. Only 2/- from newsagents, etc., or by post 6d. extra.



THE POPULAR 'A.1.'
The set most beginners demand. **42/-**



THE 'CHALLENGE'
Represents real value. Contains 12 in. handframe saw, steel cutting table, bradawl, spare saw blades, design and working instructions.

14/6 (post 2/-)



FREE Ask for 20-page booklet of Hobbies tools and gift sets.

THE 'CROWN'
With strong hand-frame, spare saws, cutting table, drill, instruction book, glasspaper block and design. **27/6** (post 2/3)

To Hobbies Ltd., Dept. 993, Dereham, Norfolk.
Please send free 20-page booklet, name of stockist and items indicated.

- 'A.1.' Outfit 42/- (post free)
 'Crown' Outfit 27/6 (post 2/3)
 'Challenge' Outfit 14/6 (post 2/-)
 Hobbies 1962 Annual 2/6 (post free)

Name

Address

CHRISTMAS CUT-OUTS

ENLARGE BY 'SQUARE' METHOD

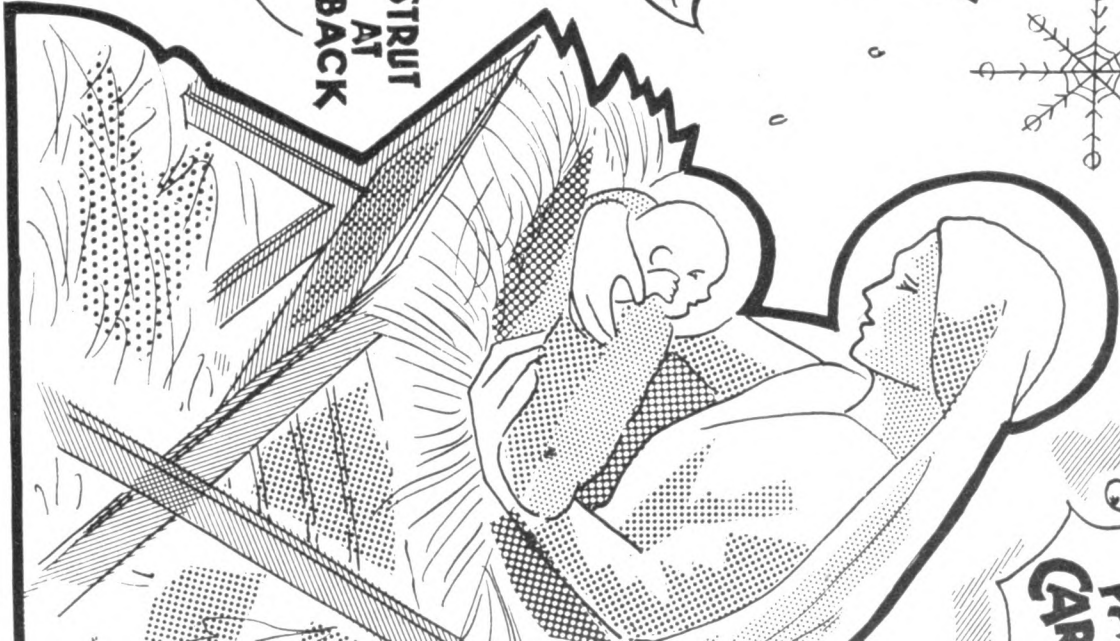
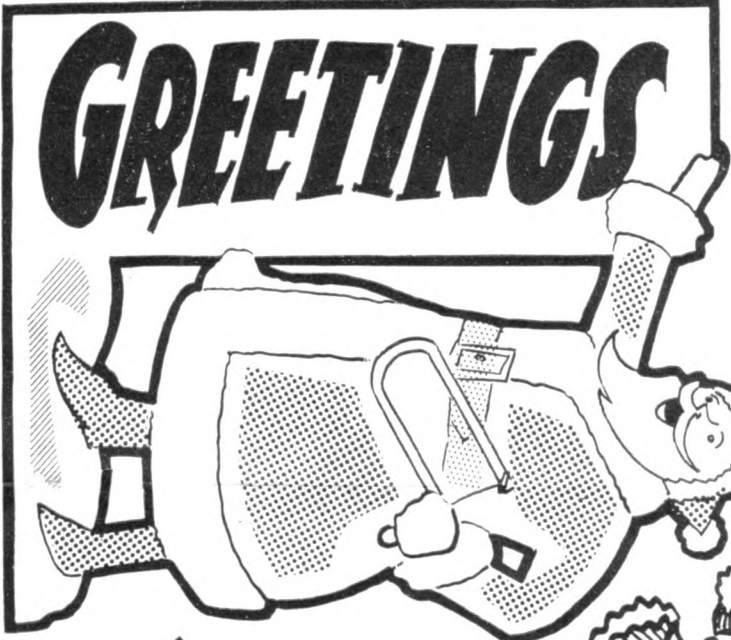
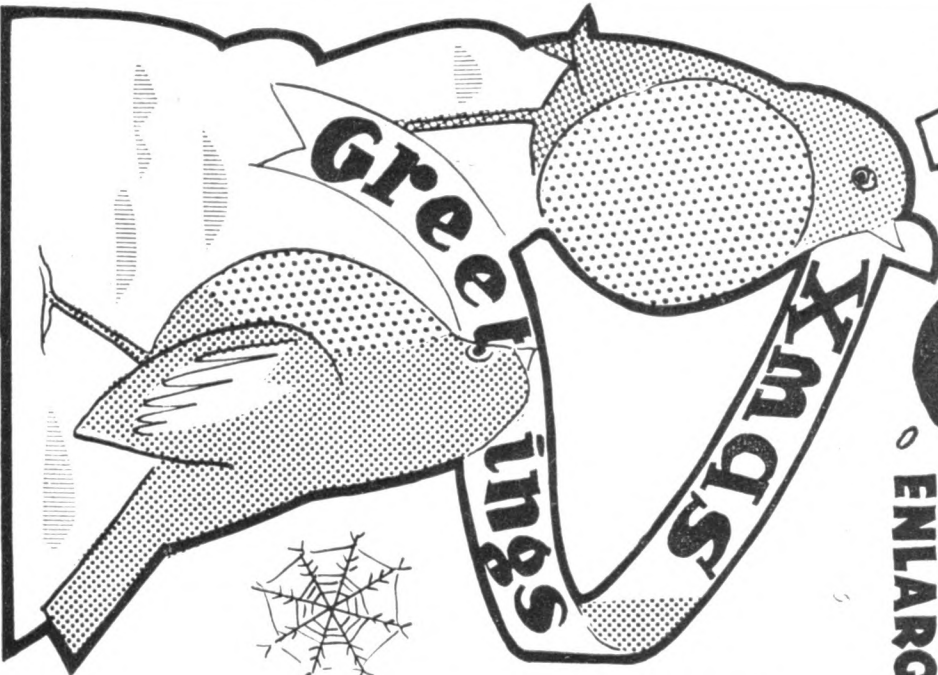

FOR LAWN DECORATION - TA
 DISPLAY ETC. CUT FROM
 WOOD OR STOUT CAR

PA
 CAR

CHRISTMAS CUT-OUTS

ENLARGE BY 'SQUARE' METHOD

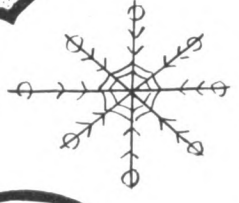
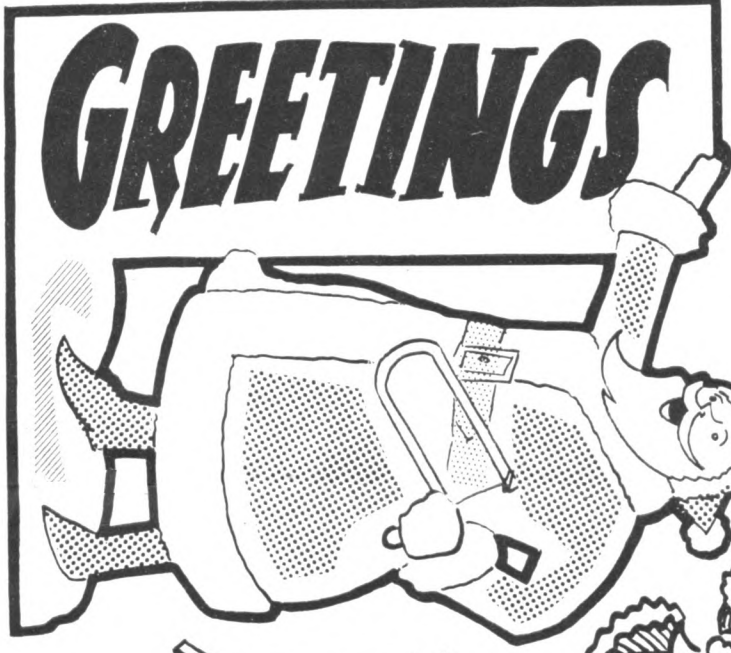
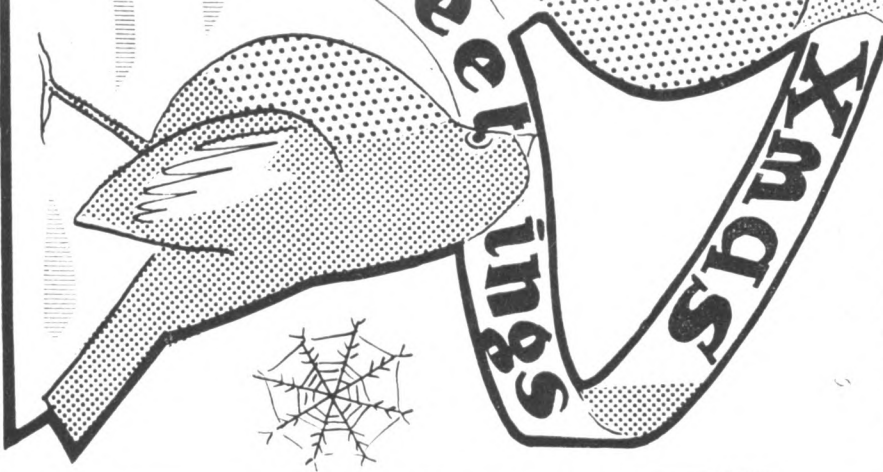

FOR LAWN DECORATION - TABLE
DISPLAY ETC. CUT FROM
WOOD OR STOUT CARD

PAINT
CAREFULLY

WITH CHRISTMAS IN MIND...



THINKING of Christmas? Wondering what to buy for a youngster? If you live in a town where there is a Hobbies branch the answer is obvious. Go and choose from the hundreds of appealing gifts on display.

Our picture shows Mr C. Owen (on left) ready to welcome Sheffield customers at the branch at 4 St. Paul's Parade. His window is chock full of gift sugges-

tions calculated to delight youngsters of all ages — and, indeed, adults as well.

This service and wide selection is typical of all Hobbies branches and for the stay-at-home customer there is always a large range of goods to select from, all illustrated in Hobbies 1962 Annual. Order now and make sure you get them in time for Christmas.

Other Hobbies Branches are at :

LONDON

78a New Oxford Street, W.C.1
Telephone: MUSeum 2975

87 Old Broad Street, E.C.2
Telephone: LONdon Wall 4375J

81 Streatham Hill, S.W.2
Telephone: TUlse Hill 8796

151 High Street, Walthamstow, E.17
Telephone: COPpermill 3928

Also at LONDON AIRPORT
The Model Aircraft Shop (Hobbies Ltd)
Queen's Buildings, Roof Gardens
Central London Airport
Hounslow, Middlesex

GLASGOW

328-330 Argyle Street, Glasgow, C.2
Telephone: CENtral 5042

MANCHESTER

10 Piccadilly, Manchester, 1
Telephone: CENtral 1787

BIRMINGHAM

18 Moor Street, Ringway
Telephone: MIDland 0219

LEEDS

10 Queen Victoria Street
Telephone: 28639

HULL

42 Savile Street
Telephone: 32959

SOUTHAMPTON

134 High Street (Below Bar)
Telephone: 25947

BRISTOL

65 Fairfax Street, Bristol, 1
Telephone: 23744

NEWCASTLE

42 Dean St, Newcastle-on-Tyne, 1
(continuation of Grey Street)
Telephone: 21465

EXETER

9 North Street
Telephone: 76661

DESIGNED to give an excellent performance, the 18 in. Bowman model yacht, which has an overall height of 30 in., will be the pride of all boys and their fathers. It is available as a very well prepared kit which has simply to be assembled and finished, and requires no previous experience of modelling to make up into a really super craft.

BOWMAN GULL MODEL YACHT IN KIT FORM

The hull is already machined, shaped and hollowed, with a rebate to take the special steel keel. Masts are drilled and sails come complete with rigging cords attached. An easy to follow plan and full instructions are also included, together with all fittings, glue, paint and marine varnish.

The Gull Kit in its attractive box will make an excellent gift for a lad, who will enjoy the natural pleasure and pride of a do-it-yourself achievement with a really super working model as a result.



These Bowman Gull model yacht kits are available from all branches of Hobbies Ltd, price only 28s. 6d., or can be obtained through the post (1s. 9d. extra) from Hobbies Ltd, Dereham, Norfolk.

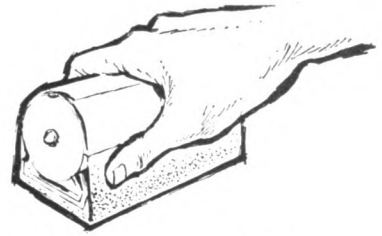
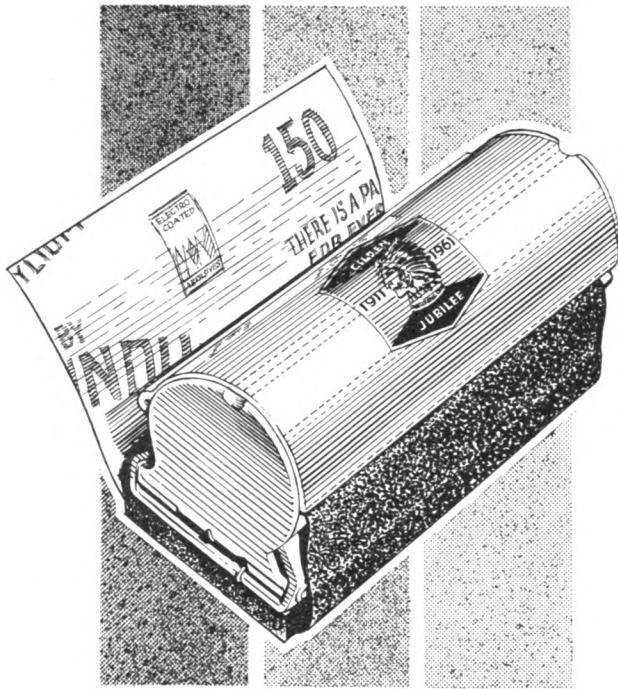

For the professional or amateur handyman here is a device that was really needed. It makes sand papering easier, quicker, more economical and gives a better result too—it uses all the abrasive paper uniformly. A steel cylindrical container holds a roll of abrasive paper which is withdrawn through a slot and folds round the resilient rubber base where it is firmly held by fingers and thumb—the rubber base enables the abrasive to make a better all-over contact.

As each portion is used to the limit, the roll is pulled out just the width of the base again—no waste in time or material.

the new **SLIK** sander



**GIVE IT, IN THE NEW
ATTRACTIVE
GIFT PACK
THIS CHRISTMAS**

From Ironmongers, Hardware
and Do-it-Yourself Shops.



THE
CARBORUNDUM
COMPANY LTD
TRAFFORD PARK
MANCHESTER 17

For radio fans

2 - TRANSISTOR POCKET SET

By 'Radio Mech'

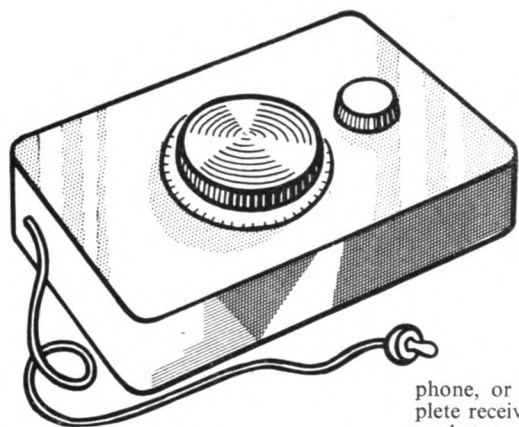

YOU can build this receiver in a ready-made plastic box, or in a case made from thin wood. Or even a strong cardboard box could be used. A box about 3 in. by 5 in. by 1 in. thick (inside measurements) will easily hold the components, so that the finished set really is of pocket size. Dimensions

phone, or personal earpiece, the complete receiver can easily be taken in the pocket anywhere. But if maximum portability is not important, an ordinary pair of headphones may be preferred.

The set runs from a 9V. transistor radio battery, which will have a very long life. Any of the usual 9V. transistor batteries will be suitable, and they are easily obtained at any radio shop.

0C45 and various similar R.F. types. A cheap White Spot transistor was found to work reasonably well here, though reaction was somewhat weak.

The second transistor is an A.F. (audio frequency) one, and 0C71, 0C72, Red/Yellow Spot, Green/Yellow Spot, and similar types were found satisfactory. A very cheap surplus Red Spot worked fairly well here.

Transistors of named manufacture, obtained from the maker, will be of at least a certain efficiency.

Surplus transistors, however, vary greatly, and some work less well than others.

Two popular types of transistors are shown in Fig. 2. The Mullard transistors 'A' have a spot near the Collector lead C, other leads being for Base B, and Emitter E as indicated. Red/Yellow Spot and similar transistors have a larger space between two wires, as at 'B' and this allows Collector, Base and Emitter leads to be identified.

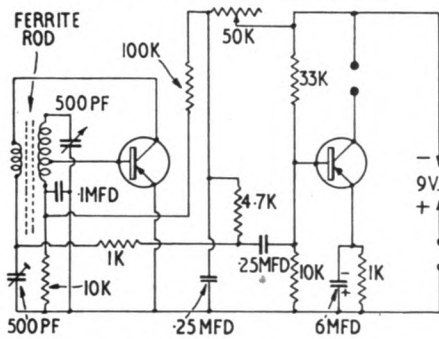

Fig. 1—The receiver circuit

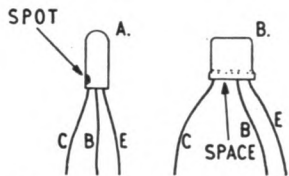

Fig. 2—Transistor connections

may be changed to some extent, to suit a plastic lunch box or trinket box, and these are strong and light.

The circuit uses two transistors, and gives good headphone volume, without any external aerial or earth. For listening, a small 'personal' earpiece, as sold for transistor sets, can be used, or a single earpiece of usual type, or a pair of headphones. The earpiece or headphones should be of medium impedance type, for best results, though most ordinary headphones will be satisfactory. With a single

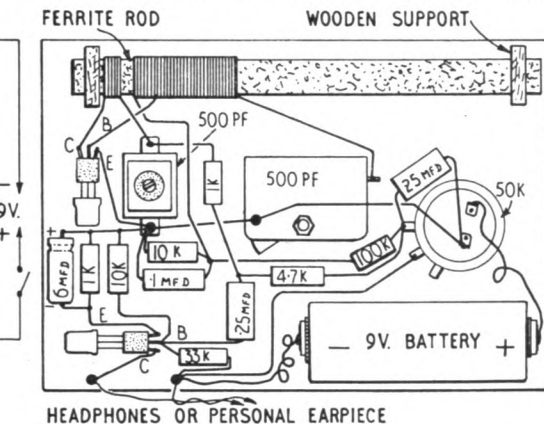

Fig. 3—Complete wiring plan of the receiver

Circuit details

The receiver has a home-wound ferrite rod for medium waves, with a feedback winding which gives a great increase in sensitivity. The 50K potentiometer acts as on/off switch and sensitivity control, the remaining knob being for tuning.

A single amplifying stage follows, and this results in really good phone volume, from local stations. In most localities, some more distant stations should be heard at reasonable volume.

The first transistor must be a R.F. (radio frequency) type, or reaction will not be obtained. Transistors of good manufacture are now quite low in cost and will generally give better results than very cheap, surplus transistors. Typical transistors for the first stage are the

Transistors and holders

Holders are shown for the transistors, and these have tiny sockets into which the transistor leads are inserted. This allows the transistors to be easily changed, or alternative ones tried, and avoids danger of damaging the transistors due to overheating while soldering.

Insulated sleeving should be placed over the transistor leads, before fitting them in their holders, and each of the three wires should be pressed well in.

It is also in order to solder the transistors directly into circuit, if preferred. If so, leave them until last, and make the joints quickly. It should not be necessary to keep the soldering iron in contact with the joint more than two or three seconds, and lengthy heating will damage the transistors.



A NEW RANGE OF JOHNSON DO-IT-YOURSELF OUTFITS

Here's excitement! The new Johnson range of "Do-it-yourself" outfits makes it so easy to develop and print your films at home.

These outfits contain everything you need. They range from sets for the beginner, to outfits for the more advanced enthusiast. And full instructions go with every outfit.

Prices from £1-17-6 to £5-12-6.



FOR CONFIDENCE
IN PHOTOGRAPHY

MAKE A GIFT TO LAST ALL THE YEAR ROUND

*by making sure that they get
a regular supply by post of*
'HOBBIES WEEKLY'

1 year 30/-; 6 mths. 15/-; 3 mths. 7/6 including postage.

TO THE PUBLISHERS 'Hobbies Weekly'
DEREHAM, NORFOLK

Please send a copy of 'Hobbies Weekly' every Wednesday
for a period of.....months to

Name

Address

for which I enclose.....

The recipient to be informed that this gift is from:

Name

Address

(ALL IN BLOCK LETTERS PLEASE)

MANY MODELS from ONE TIN!



Pyruma, plastic and ready to use from its tin, can be fashioned into the widest variety of models imaginable. Buildings for your model railway set, houses, ship models, animals and figures, ashtrays and plaques — all of which when set or baked to stone-hardness can be finished in natural colours. Get the Pyruma Model Instruction book — see Coupon — and start making things like those shown below.

SANKEY'S PYRUMA PLASTIC CEMENT

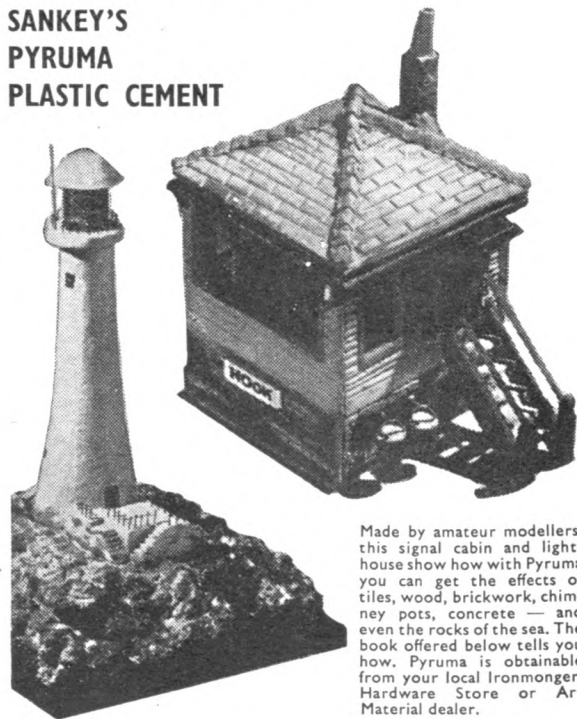

Made by amateur modellers this signal cabin and lighthouse show how with Pyruma you can get the effects of tiles, wood, brickwork, chimney pots, concrete — and even the rocks of the sea. The book offered below tells you how. Pyruma is obtainable from your local Ironmonger, Hardware Store or Art Material dealer.

POST THIS BOOKLET COUPON TO-DAY

To J. H. SANKEY & SON, LTD (Dept. HW),
ILFORD, ESSEX

I enclose P.O. 6d. (not stamps) for a copy of Pyruma
Modelling Instruction Booklet, post free to:

NAME

ADDRESS

(BLOCK LETTERS PLEASE)

Receiver construction

Fig. 3 shows all connections and components. The tuning condenser is fixed centrally to the panel. The best possible condenser to use here is a miniature air-spaced model, as intended for such receivers. This will actually have a capacity of about 350pF to 400pF, which is sufficient. The usual type of 500pF air spaced condenser will require a larger case. For low cost with small size, a reaction type condenser can be fitted.

The other 500pF condenser is a trimmer or padder, which can be adjusted with a screwdriver, when first testing the set. A small bolt holds it to the panel.

The ferrite rod is about 5 in. long and $\frac{3}{8}$ in. in diameter, but does not need to be this exact size. If it is much smaller, a few extra turns should be put on the windings.

Both windings are of 26 S. W. G. cotton-covered wire. Winding begins about $\frac{1}{2}$ in. from one end of the rod. Leave an end long enough to reach Collector tag C, and wind on 8 turns side by side, leaving a further end to reach the 500pF trimmer. Spots of sealing-wax will hold the coil ends, so winding does not come undone.

A space of $\frac{3}{8}$ in. should be left, and the larger winding is commenced, leaving an end about 2 in. long. This lead goes to 10K, 0-1 μ F, and 100K components. Wind on 8 turns, and form a loop long enough to reach the transistor holder Base tag B. Continue winding, putting on 44 more turns, secure the wire, and leave the end long enough to reach to the fixed plates tag of the tuning condenser. All turns in both windings must be in the same direction.

The rod is fitted in holes in two small wooden supports, which are cemented to the panel. The two transistor holders can also be cemented down. Some of the 26 S. W. G. wire, with thin sleeving, will be satisfactory for wiring up, though in most places the wire ends of the resistors and condensers will reach the connecting points.

All joints should be soldered. This will prove to be quite easy if the iron is hot enough, and clean, and leads are bright and clean. Apply a radio type cored solder, and the iron, to the joint simultaneously, and remove the iron immediately the joint is made.

Note that the moving plates (frame) of the tuning condenser are wired to the bolt holding the 500pF trimmer. This point also goes to one of the back tags of the sensitivity control (50K), as these two

 * The free design in next week's *
 * issue will be for making a hand- *
 * some pair of fire bellows — *
 * practical and decorative. Make *
 * sure of your copy. *

back tags form the on/off switch.

Battery leads are made from thin flex. The battery must never be connected in the wrong way round. Positive and negative press-button clips can be obtained, and will only fit on the battery in the proper way.

Two small terminals are fitted near the second transistor, for phone connections, which are made from thin flex. 'Crystal' ear-pieces, such as are available as surplus from some deaf-aids, cannot function with this receiver. If the earpiece or phone leads have polarity marked, take positive to the Collector C, and negative to battery negative.

It should usually be possible to build the receiver on the lid of the box. Thin knobs will be most suitable, and the spindle of the sensitivity control will probably need to be sawn short, so that the knob does not project. If so, this should be done first. If possible, grip the end of the spindle in a vice, when it can be easily cut with a hack-saw. A paper scale, subsequently covered with celluloid, should be fixed below the tuning knob.

After checking all connections, the transistors can be inserted in their holders, taking care that the Collector, Base and Emitter leads are in the correct sockets, as in Fig. 3, and that no leads touch each other. The phones and battery should then be connected, and the receiver switched on. The 50K control is turned about half way, and the tuning condenser set about half open. The 500pF trimmer is then screwed slowly down until there is a sudden increase in background noise.

It should then be possible to tune in the local station easily, and adjust sen-

COMPONENTS
 Resistors: Two 1K (brown/black/red),
 Two 10K (brown/black/orange),
 100K (brown/black/yellow),
 4-7K (yellow/purple/red),
 33K (orange/orange/orange).
 Small 50K volume control with on/off switch.
 Knob.
 500pF or similar tuning condenser with knob.
 500pF pre-set condenser.
 Fixed condensers: 0-1 μ F, two 0-25 μ F, 6 μ F 6V.
 or similar.
 Two transistor holders. R.F. transistor. A.F. transistor.
 Ferrite rod and 26 SWG cotton covered wire.
 Length 1 mm. sleeving. Battery clips, etc.
 Medium impedance headphones, or personal phone.

sitivity with the 50K control knob. For maximum sensitivity to weak signals, adjust the control so that the receiver is almost oscillating, when turned through a station. Some final re-adjustment of the 500pF trimmer may be needed, so that this result can be obtained over the whole tuning range.

If enough reaction is not possible, the detector transistor may not be suitable or in good condition. Such a transistor may still work perfectly in the second (amplifier) position.

The set should be placed flat, and if volume from a particular station is too low, the receiver should be turned, to make use of the directional effects of the ferrite rod. The sensitivity control must be operated in exactly the same way as the reaction control in simple valve sets.

The set cannot work properly in a screened locality. That is, inside a metal dwelling, caravan, or car. If it is wanted in such circumstances, a *short* external aerial can be used, connected to the tuning condenser fixed plates tag.

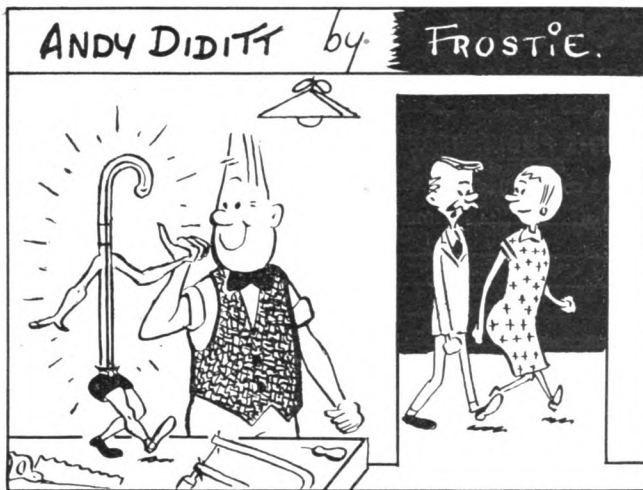

"I'D LIKE TO SEE WHAT'S SO NEW ABOUT THIS WALKING STICK ANDY'S MAKING."

AN EVER-WELCOME GIFT

Making toys, models and novelties is a paying pastime, and with a machine you can double your output right from the start. In fact you have a factory in the home.

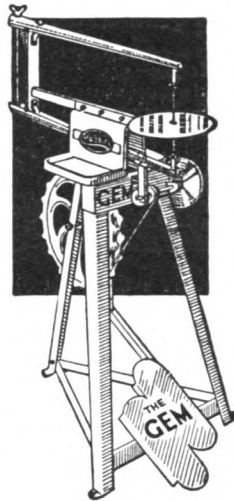
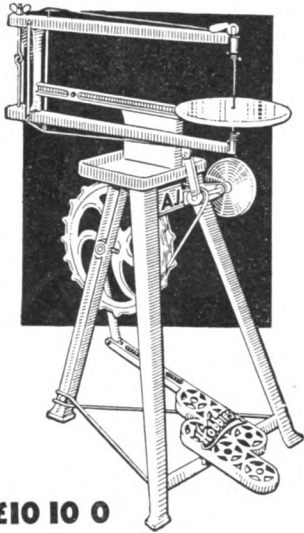

£10 10 0

THE 'GEM'
£6 12 6

'A.I.' TREADLE SAW
A sturdy machine with cast metal legs, metal table, wooden arms, special saw tension action, etc. Easy to treadle, smooth running and rigid. Provides a factory at home for the handyman — a machine for profit and pleasure.

A lighter machine with pressed metal legs, but easy running and a reliable worker. Sound value and a machine for all kinds of work. Spare blades, instructions, and designs are included with each.

THE 'MARVEL' BENCH MOTOR-DRIVEN SAW
To meet modern needs. Just plug in and switch on from any house lighting point. For either A.C. or D.C. mains, with 230/250 volt motor, flex, switch etc.

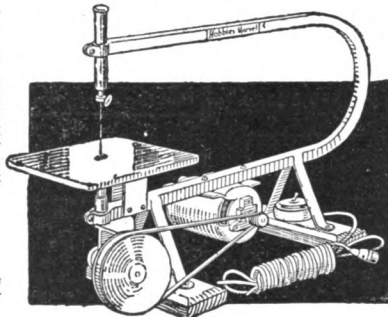

£13 10 0

Also a Bench Machine without motor for £5 10 0.

EASY PAYMENTS

A system is now in operation whereby a machine can be despatched carriage paid after the initial down payment and subject to the completion of a simple form of Agreement. The slight additional cost over cash price is to cover extra clerical work, books, interest charges, etc. *It is impossible for us to allow this system to apply in any part of Ireland, or anywhere outside Great Britain.*

Agreement Forms are obtainable at any Hobbies Branch, where machines may be seen, and money paid each month. Or, you can do the business through Hobbies Head Office at Dereham, Norfolk, sending your instalments there.

Hobbies Ltd (Dept. 993) DEREHAM NORFOLK

IN TIME FOR CHRISTMAS

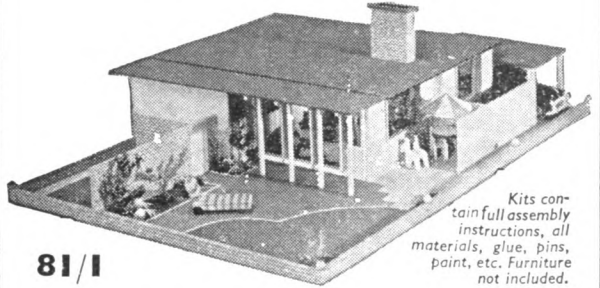

Kits contain full assembly instructions, all materials, glue, pins, paint, etc. Furniture not included.

81/1

THE 'CELEBRITY'—RTA 7

Size 36 in. x 24 in. Five main rooms including lounge with dining recess. Gardens, car port, service area, sun trap, etc. Flat roof lifts off for easy access to each room.

ALL PARTS PRE-CUT

ALL READY TO PUT TOGETHER

For the 'Royal' and 'Celebrity' Doll's Houses, Hobbies have prepared kits with all parts cut to size and shape, ready for you to put together and finish. These are ideal for the man who wants to make a really excellent Doll's House — in a hurry!

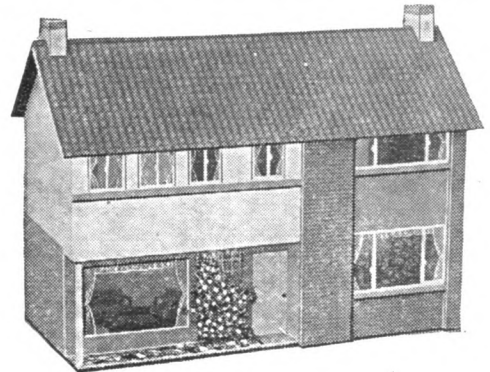

THE 'ROYAL'—RTA 6

Size 26 in. x 12 in. x 19 in. high. Double door opening at back. Modern lounge, hall entrance, kitchen/dining room, 2 bedrooms, bathroom and landing. **99/11**

TO HOBBIES LTD (DEPT. 993), DEREHAM, NORFOLK

PLEASE SEND KIT No. RTA.....

NAME

ADDRESS.....

P.O. or cheque for..... enclosed

NEW Angles

on OLD favourites

from these Books bulging with BRIGHT IDEAS

Any volume in this most interesting range of books, each dealing with a different aspect of gummed paper-craft, will show you a wealth of ideas, the way to carry them out, and give hours of intense enjoyment.

Each is the key to an economical hobby that is rich in variety, ranging from the making of a charming picture to framing it delightfully — from three dimensional models to wall decorations, from paper sculpture to charming flower studies.



Other books by FREDERICK T. DAY

Coloured Paper Decoration ..	7/6
Coloured Papercraft for Schools ..	7/6
Coloured Papercraft for Infants' Schools ..	6/-
Lampshade and Parchment Craft ..	8/6
Decorative Flower and Leafmaking ..	8/6
Gummed Strip and Paper Modelling ..	7/6
Paper Sculpture for Schools ..	7/6

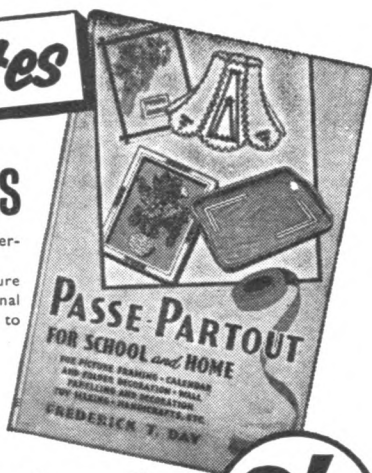

8/6

SAMUEL JONES & CO. LTD.

STATIONERY MILL, CAMBERWELL, LONDON, S.E.5. RODNEY: 5064

All books obtainable from:
Newnes & Pearson Ltd.
Tower House, Southampton St., Strand, W.C.1.
Ask your stationer to show you the Butterfly range of handcraft materials.

54 page Edition WHERE'S THAT CAR FROM?

Price 1/- (Postage 4d.)

Entirely new! Brief Guide to
INN SIGNS

Price 1/6 (Postage 4d.)

Of all Booksellers
or

RALEIGH PRESS, Exmouth, Devon

MAKING YOUR HOBBY MAKE MONEY

HOW, WHY any handicraft can make money
for you — everything you should know.

40 pages of experience — 5/6 from

G. SEALE

Regent House, 26 Queen's Rd., Coventry

IT'S EXCITING. IT'S PROFITABLE.
Flower painting can bring extra income.
Previous experience unnecessary. Waiting markets.
Inexhaustible demand. Details free.
Popular Art Services (HW), Clun, Salop.

PERSONAL COLUMN LTD, Falcon
House, Burnley, Lancs. Pen Friend — all
hobbies. Correspondents in almost every country.
All ages. S.A.E. for details.

HOMEWORKERS required to make up and
machine simple household goods. Experience
unnecessary. Good pay. Regular work. S.A.E. for
details to Dept. 28, Arnold, 10 Shelley Road,
Worthing, Sussex.

LEARN

RADIO & T/V SERVICING

for your OWN BUSINESS/HOBBY

● by a new exciting no-maths system, using practical
equipment recently introduced to this country
FREE Brochure from:—

RADIOSTRUCTOR

DEPT. G81, READING, BERKS. 6/12/61

100 DIFFERENT stamps free! Request 1d.
upwards discount approvals. — Bush,
53 Newlyn Way, Parkstone, Dorset.

ENJOY WRITING? Then write for Profit.
Send for 'Writers' Handbook' (free) detailing
countless opportunities for beginner or experienced.
— Writers' Ring (HW), 5 Edmund
Street, Birmingham.

WILL PAY WORTHWHILE for one or
more compass lens combination, sandwich
type, stamped Made in England. New, used. —
Alexei Zardetzke, 340 Bowery, New York 12,
New York, U.S.A.

WANT AN EXTRA INCOME? Then get
'Money-making Made Easy'; the book that
contains dozens of part-time business ideas, each
one fully explained. 2/11 post free, from —
Joughin, Room 8, 62 Dale Street, Liverpool 2.

STAMP ENCYCLOPAEDIA — 100
SPICTORIALS FREE! Request 7d. Appro-
vals. — A. Bateman, 1099 York Road,
Seacroft, Leeds 14. (Postage 6d.)

PRINT YOUR OWN CHRISTMAS CARDS

Many design combinations in shining embossed
silver and gold + multi-coloured metallic stars,
crescents, etc., gold transfer foil for drawing —
coloured paper for 50 cards — printing materials
for 100s. Fascinating — simple — unique. Com-
plete outfit only 12/6 P.O. including postage
from **THE EMBOSSPRINT COMPANY LTD,**
Fleet Street, London, E.C.4.

STOP SMOKING

You can overcome the Smoking habit in **3 days**
or **money back.** Safe, pleasant, permanent. The
only scientific way. **No will power necessary.**
'Conquered the habit in 2½ days' — F.C. 'Within 2
days I was free.' — W.G. Complete Course 7/6
Details 2½d. Sent under plain cover.
**NATURE REMEDIES, (H156), 28 Dean Road,
London, N.W.2. Established 1928**

NEW! Chemistry sets for boys. Harmless;
entertaining; instructive. £1 post free. —
Storer (Dept. H.W.), 67 Clopton Road, Sheldon,
Birmingham 33.

FREE Money Making Magazine. Send 6d.
stamp. — TEM, 124-H Newport St, Bolton.

MAKE YOUR OWN table tennis table.
We can supply all the materials required to
make a really first-class job. In fact, everything
down to the last screw. Complete kit including
plans sent carriage paid for £12/10/0. Plans sold
separately 10/-. — Edrank Trading Co. Ltd,
66A Susans Road, Eastbourne, Sussex.

GARAGES FOR THREE TOY CARS

THIS toy is intended to hold three MATCHBOX cars. All parts are cut from $\frac{1}{8}$ in. plywood. Cut one of each of pieces C, D and E with a fret-saw. Cut two each of A and two each of B to the widths shown. The doors F and the uprights G are cut as indicated.

Assemble the garage as detailed in the sketch. The pieces A form the ends, pieces B the interior partitions and piece C the back. The uprights G are glued to the partitions and the doors hinged in place with small pieces of tape. Finish by cleaning up and painting. (M.p.)

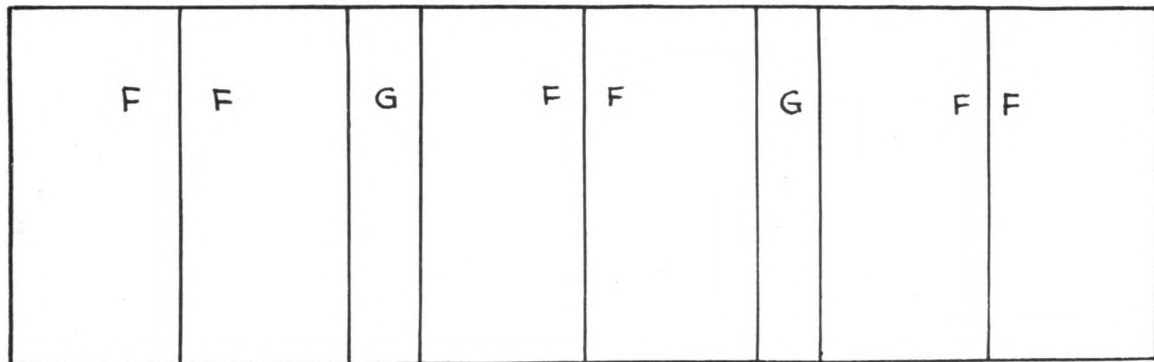
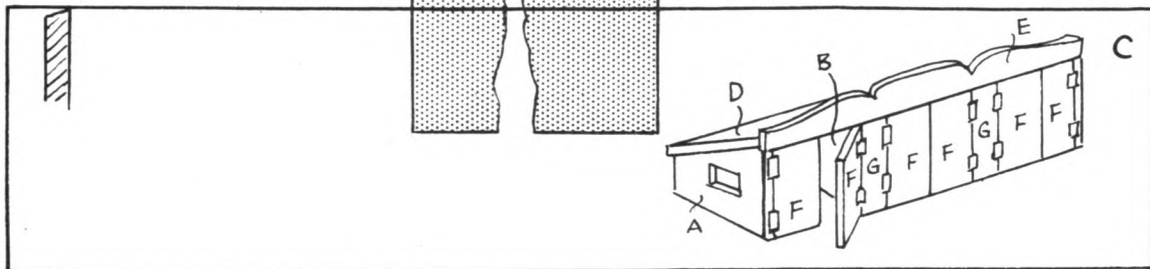
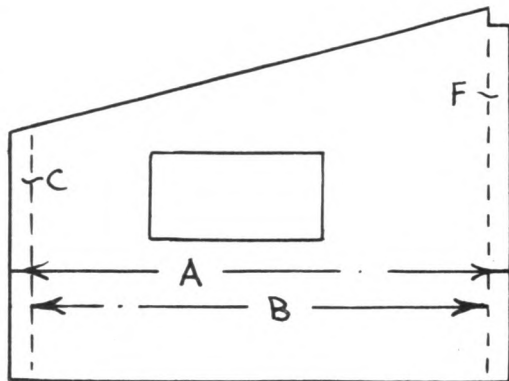
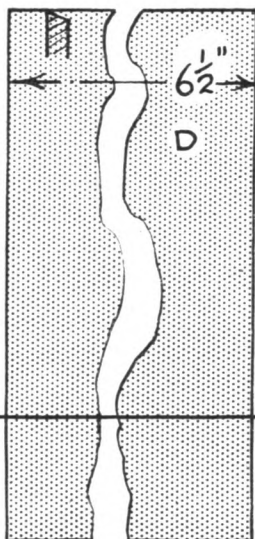

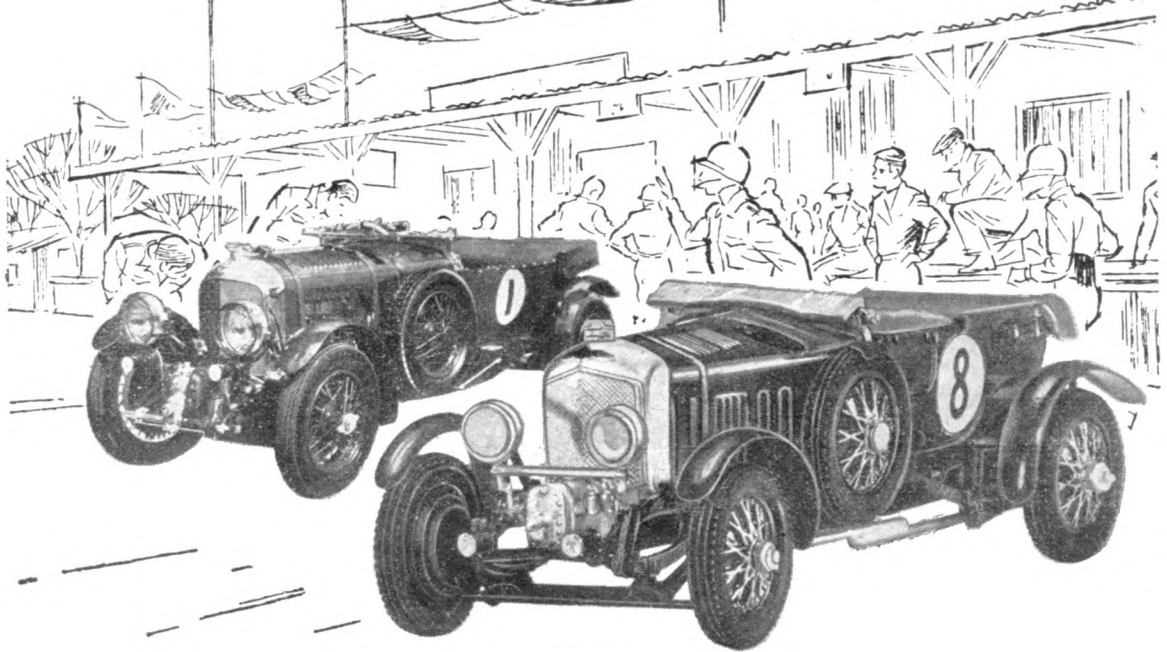

Just like the real thing!

Believe it or not, the nearer one is the Airfix model of the 1930 Bentley, 1/32nd scale (Kit 2/-). Behind it is a picture of the real thing.

That's how wonderfully realistic Airfix models are! Close attention to every detail gives them their faithful-to-the-original look—makes them true collector's pieces. And every Airfix series is to a constant scale. This means Airfix models look proportionally right, one against another, because they *are* right! You can't beat Airfix for realism—or value.

AIRFIX

Constant Scale Construction Kits

From Model & Hobby Shops, Toy Shops and F. W. Woolworth

There are over 140 Airfix models from 2/- to 10/6.

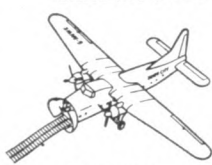

AIRCRAFT

Bristol Superfreighter 7/6

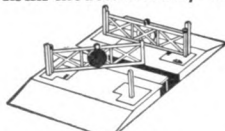

TRACKSIDE SERIES

Level Crossing 2/-



MODEL FIGURES

Lifeguard 2/-

BRITISH WARSHIPS

H.M.S. Cossack 2/-

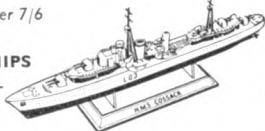

C.160

STOP PRESS!

Latest Airfix Production



NEW 'SKYKING' SERIES

Fantastic value! Amazing detail! The first two in this new 1/144 scale series are:

De Havilland 'Comet' 4B (wing span 9 inches)
— 45 part kit . . . 4/6

Sud-Aviation SE210 'Caravelle' (wing span 9 3/8 inches)
— 44 part kit . . . 3/6

Also New Austin-Healey 'Sprite', the second in the new Modern Car series
— 52 part kit . . . 2/-