

27th JULY 1960

VOL. 130

NUMBER 3372

THE ORIGINAL  
'DO-IT-YOURSELF'  
MAGAZINE

# HOBBIES *weekly*

FOR ALL  
HOME CRAFTSMEN

## FREE Design Supplement

Also in this issue:

MAKE A TWO-  
VALVE AMPLIFIER

COLLECTORS' CLUB

A STAGE FOR  
MARIONETTES

GARDENING HINTS  
FOR AUGUST

ORIENTAL WALL  
BRACKET PLANS

NOVELTIES AND  
USUAL FEATURES

ETC. ETC.

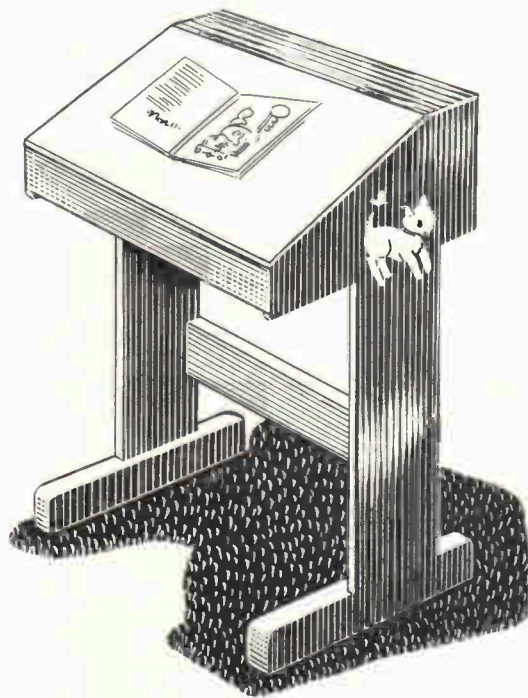

**IDEAL  
FOR THE  
YOUNG  
CHILD  
—AND A  
PROJECT  
FOR ALL  
PARENTS**

## CHILD'S DESK



*Up-to-the-minute ideas*

*Practical designs*

*Pleasant and profitable things to make*

World Radio History

**5<sup>p</sup>**



### TIP OF THE WEEK

**T**HE 1950 Canterbury Centennial stamps of New Zealand (below) are increasing in value — see illustrations. So get this set before it's too late. Also the 1958 Health set depicting Life Brigade Cadets and the 1953 Coronation issue. And don't forget the 1953 pictorials showing the Queen and the Duke of Edinburgh. These stamps were issued to mark the first visit to New Zealand of a British Sovereign.



### PEN FRIENDS

**GEORGE PENTELOW** of Tydd Manor, Tydd St. Giles, Wisbech, Cambridgeshire, has a large collection of beer labels. His cousin, who keeps a pub in the village, collects bottle openers.

**CLIVE RANDALL** of 42 Windsor Road, Willesden Green, London, W.2, collects stamps, match labels, postcards, etc.

**MR R. J. WIID** of Spring Street, Richmond, Cape, South Africa, would like stamp exchanges with readers.



A smile from Yugoslavia

*Dragan Gojkovic of Pula, 1 Maja 51, Yugoslavia, collects stamps, labels, and cigar bands. He would like pen friends in England.*

**A**FTER collecting post cards for twenty years I find cards depicting bridges the most interesting.

Fifty years ago covered wooden bridges were so common that card manufacturers didn't think a card of a barn-like bridge would sell. Travellers were more interested in sending cards home of their hotel with an 'X' mark to locate their room, or a card of the railway station, or one of the many corny comics that flooded the market.

The two oldest covered bridges in the world are in Switzerland at Lwyern, one was built in 1333 and the other in 1408.

Do not include the Bridge of Sighs in Venice or the Old Shop Bridge in Florence in your collection. These are not covered bridges in the same sense of the word.

### Know your Bridges

Recently an American sent me a card on which he wrote — 'This is the only covered bridge we have in Cincinnati, it's covered with rust.'

A true collector is not just content with saving as many cards of any given subject but tries to find out as much as he can about that subject. I have many books on bridges. It is interesting to know why some were covered, how they were built, the stories and legends connected with them and the people who built them.

Many bridges were built of wood because wood was more plentiful than other materials. They were covered to protect the floors from the elements.

All bridges pictured on cards have an interesting story connected with them. So learn all you can about these historic landmarks, and your collection will take on a new meaning. (R.L.C.)

SAVANNAH RIVER BRIDGE, ON THE COASTAL HIGHWAY, SAVANNAH, GA 197



*The Savannah River Bridge is the main bridge on the Atlantic Coastal Highway connecting Georgia with South Carolina, just on the outskirts of Savannah.*

# MAKING THE CHILD'S DESK

IT is an exciting time for children when they first attend school. A new life opens out before them and they soon thoroughly enter into the excitement of mixing with other children of their own age, and become enthusiastic in their lessons, elementary though they may be at the beginning.

Invariably these children like to carry their enthusiasm back into the home again at the end of the day, to show mother just what he or she can do. This design for a child's desk will help much towards this end as it provides working conditions similar to those in the school-room. The desk has a hinged lid and allows generous space for books and other writing equipment. It is 24 in. high and 16½ in. wide, being thus suitable for a child from four years old and upwards. Construction throughout is quite simple from ¼ in. plywood and ¾ in. and ½ in. wood.

If working from a Hobbies kit, which contains all the materials necessary, pieces A, M, I, and J should be arranged on plywood panels for economical cutting, as shown in Fig. 1. Piece J will

be cut from one panel and piece M from the other. Piece F is cut from a Hobbies LD12 panel (size 18 in. by 3 in. by ¾ in.) and pieces C, D, E, and G are cut from three MD8 panels (16 in. by 3 in. by ½ in.). Pieces B, H, K, and L are cut from stripwood, and pieces G, which are 16 in. long and ½ in. square are cut from the waste wood from pieces E and C. If using your own materials, pieces C and D can be cut as one piece, the overall measurement being 16 in. by 5½ in.

All the necessary dimensions and makeup of the desk are shown on the design sheet. Mark and draw out the pieces on their appropriate thicknesses of wood, and cut them out neatly. Note that halving joints are used for the lid framing.

The first stage in construction is to assemble pieces A, B, C, D, E, and F. Butt joints are used, as shown on the design sheet, together with gluing and pinning.

Continue by inserting rails G and H. H is a length of 1 in. by ¾ in. stripwood cut to fit between the sides A.

Now fix the floor J and the top strip I. The floor measures 16 in. by 11 in., and is fixed underneath to pieces G.

The framing for the lid is halved together, and the hinge edge is chamfered to butt neatly against piece H when the lid is in place. Note that the framing goes *inside* the desk between the sides. The lid M is now fixed to the frame. It goes flush at the chamfered edge and overlaps at the sides and front. Hinges are recessed so as to fit snugly.

It is not thought necessary to provide wells for ink containers, which are hardly ever used in these days of ball-point and fountain pens. A container for these, together with crayons, etc. can be made from stripwood and fixed to the top of the desk. A piece of stripwood can also be fixed along the leading edge of the desk top to prevent books falling

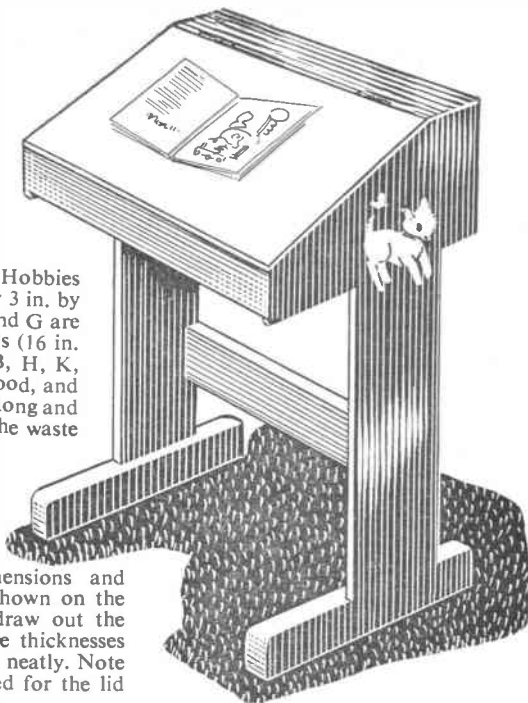

off, if thought necessary.

Clean up thoroughly, taking particular care to round off all sharp edges before applying the finish. If painting, best results are obtained after filling the grain. Alternatively, a nice finish is

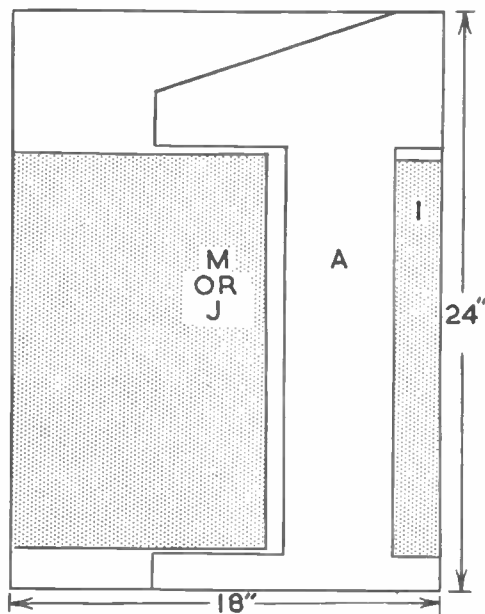

Fig. 1—Showing how to space out the pieces on Hobbies standard plywood panels

## A Kit for 25/8

**Hobbies Kit No. 3372 for making the Child's Desk contains all wood and fittings, including transfer. Available from branches, etc. price 25/8 or from Hobbies Ltd., Dereham, Norfolk (post 3/6 extra)**

obtained by rubbing over all woodwork thoroughly with linseed oil or staining and giving a final coat of varnish. The addition of transfers to each side, as shown in the finished illustration, gives an attractive touch to the desk. These transfers are included in Hobbies kit of materials.



**P**LASTER boards or  $\frac{1}{2}$  in. thick hardboard is used for lining the framework of the attic room. The latter is preferable, although more expensive. Plaster boards, unless finished with their proper coating of plaster, tend to be soft; nail and screw fixings tend to sink under their surface.

The lining is done in three stages; first, the ceiling, then the sloping rafter fronts, and finally the short upright grounds. There is a reason for this; the tops of the lower sheets abut under, giving extra support to the boards and preventing any sag.

The ceiling boards are nailed to the underside of the lockables, as shown in Fig. 1. First, however, a word about the lockables. They are originally fitted at a height of around 4 ft. above the original joint level. Obviously, they will be in the way in this position, and will need to be raised.



The lining of the sloping rafters and the short grounds is shown in the diagrammatical drawing in Fig. 2. The tops of the boards covering the rafters

will tuck under the ceiling boards, whilst the boards covering the grounds will tuck under the rafter boards. Any joins in the boards must be made down

## 5—LINING AND FITMENTS

The important point to remember is that the new and higher lockables must be fitted before the lower position is removed. There is no need to fit entirely new lockables in the higher position. If the existing ones are removed carefully, they can be re-used in the higher position.

They will be shorter in length in the new position, and will need trimming. Proceed as follows; cut and fix the first higher lockable with a new length of timber, then remove the old lockable, trim it to use across the next pair of rafters, remove the lower lockable, and proceed as before.



Fig. 3 MOCK FIREPLACE

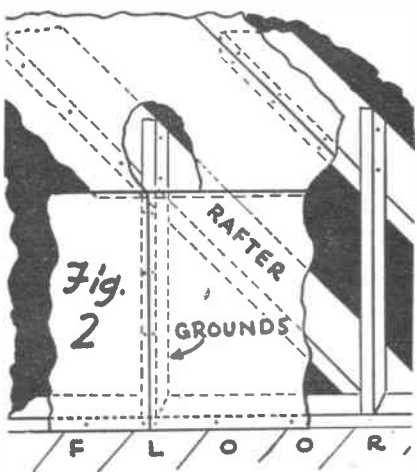

Fig. 2

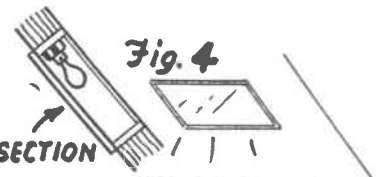

Fig. 4

SECTION



BED LIGHT

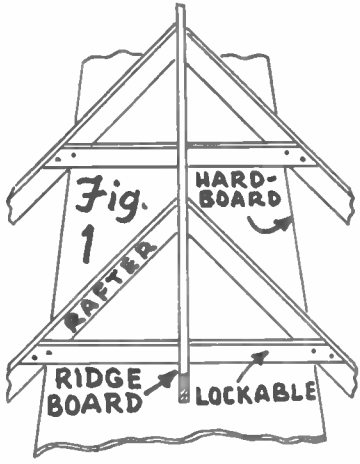

Fig. 1

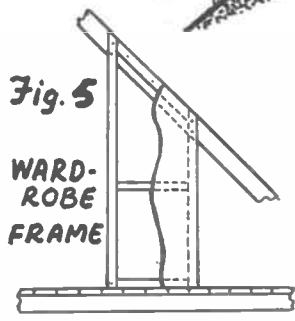

Fig. 5

WARD-ROBE FRAME

the centre line of any framing. At this stage, plan and fix any electric wiring that can be safely concealed behind the lining. Also, it is wise to spare a thought for any built-in furniture you may wish to include in the room, and to leave out any lining boards where necessary.

The inclusion of a skirting board around the room is optional, but it is easily fixed by screwing through into any framing. If you intend to wallpaper the finished lining, any gaps in the joining of the boards should be filled in with wood filler. If you prefer to paint the finished room, the joins can be covered with half-round moulding.

Opportunities abound for building in fitments in the finished room. The work is simple, for the majority of framing needed is already in existence. It is made

● Continued on page 293



**A** NEW craft which should prove very popular with men and women and indeed children, has been introduced by Atlas Handicrafts. Called mosaistry, it is a means of making pictures similar to painting by numbers, but in this instance using small chippings of natural stone in a range of colours to obtain the desired effect.

Various subjects are obtainable in the form of kits, which contain all the materials necessary, including a printed baseboard, ready mitred strips for framing, various shades of stone chippings adhesive, tweezers for placing the stones, brushes and varnish.

# MOSAISTRY PICTURES IN STONE

Working to the outline of the picture which is already printed on the baseboard, the various areas are covered with the adhesive and then the designated shades of chippings are applied either individually with the use of tweezers, or in the case of a big area en masse. For instance, when working to a thin outline, the stones are picked up one by one and set in place close together. If a comparatively large area such as a background has to be covered, much time can be saved by spreading the adhesive over the surface and then waiting for the adhesive to harden before removing any surplus chippings.

Kits contain a very generous supply of the materials — in fact, much more than are needed for the particular picture one is working on. The chippings are graded upwards from very small, so sorting out the size required in order to fit into a particular space is quite simple.

The subject we worked on, entitled 'Bonzo', was completed in an attractive range of coloured stones, and by following the instructions carefully, 100% success should be obtained with each outfit even by the youngest of workers.

The mosaics set firmly in the transparent adhesive and when the picture is completed it is given an overall covering of varnish which enhances the tones of



the various colours of chippings. The finished picture is intended for hanging on a wall, but for the ambitious, a good idea is to let it into a plaster wall and after having 'made good', decorate the wall with a suitable background. This treatment would add a very contemporary touch to any 'special' room.

There are two sizes of picture available, with different subjects to choose from. The 12 in. x 7 in. kit costs 13s. 11d. and the 18 in. x 11 in. kit is 19s. 11d. Kits are available from Hobbies branches and craft shops etc. and an illustrated folder F19 is free on request to Atlas Handicrafts, Spring Alley, Manchester 4.

● Continued from page 292

## BUILDING AN EXTRA ROOM

even simpler if the fittings are planned before the lining of the walls is completed.

Another matter to be decided is the treatment for the brick gable or end wall, which will almost certainly occupy one wall of the room. It can, of course, be hidden by erecting framework from the rafters to the floor, and then lining. It will, however, add at least £5 to the cost of the room.

Much better to leave the brick wall on show. An easy treatment is shown in Fig. 3. A mock fireplace has been made up and fitted with Rawlplugs and screws to the wall. The sides and mantelshelf are made from 6 in. by 1 in. planed deal, whilst the front is hardboard. Cross supports should be fitted to prevent the hardboard sheet from billowing. The front can be painted or papered with a gay, contemporary wallpaper.

Particularly pleasing is imitation Cotswold stone walling paper (Crown, 15/-piece).

The brickwork on show will almost certainly need some dressing. There will be lumps of mortar or gaps everywhere. The lumps must be knocked off and the gaps filled in and pointed with either mortar or a weak mixture of six parts of sand and one of cement. A stronger mixture is unnecessary, as the wall is not exposed to outside elements.

A novelty is a built-in reading light, sited over the position a bed or bureau is to occupy, as shown in Fig. 4. A gap in the lining is left between a pair of rafters. A backboard of plywood or hardboard is fitted to battens, nailed lengthways down the rafters. It should be painted white to reflect the light.

A sheet of Perspex is fitted to the

front of the rafters and held in place with a timber framing. The lampholder is fitted to the inside of the rafter. Care should be taken to include some ventilation to the fittings, so that the hot air can escape. A row of small holes can be drilled along the top edge of the Perspex for this purpose.

Wardrobes and cupboards are quite easy to fix. They will, however, project a little into the room, as shown in Fig. 5. The grounds are used for the back framing; only front framing will need to be added.

It is advisable also to box in the well opening of the trap door. This is easily done by building up a three-sided rectangle around it, 4 ft. high, from 2 in. by 1 in. framing, held to the floor with angle brackets and the framing finally covered with hardboard. The fourth and open end of the enclosure, where you enter the room, can be protected with a swing gate.

# FLOWERS AND LANTERNS

**I**N the making up of sprays and posies of flowers remember the aids that may be obtained from paper lace and doyleys and the application of corrugated material as a base holder in the holes of which the stems may be 'stuck'.

This series of articles deals with only the first and intermediate stages of paper sculpture and does not take into account the wide variety of floral decorations which may be obtained by the expert working in a studio for his living. Much may be learned, however, from the exercises given and the rest comes through practice and ability.

Illustration 'A' has been prepared for intermediate students, and in three phases shows how a beautiful flower head may be obtained. This involves the usual thick, dark and dotted lines, scoring, moulding or bending, serrating,

tration B) may be obtained by long cuts with a single scored line and a fold as shown. Stems may be made from wire or some strong material. Master pieces may be cut and used in some cases as stencils where several motifs are required.

---

*By F. T. Day*

---

Actual flowers might be studied in advance with some advantage. Quite a good deal of the leaves and petal motifs or components may be cut out of suitable material freehand and the curling and fashioning with the fingers follows. A simple expedient is to fold the paper in half and cut out the actual shape required. When opened out, this gives the

edges of the scallops rolled nicely with the aid of a ruler. Notice how all these tools have their value and must be ready at hand when working on paper sculpture.

Continuing with the marguerite, which is now almost complete, the edges of the cut-out segment are now pulled up together and the final result is a serrated and moulded flower head similar to the traditional marguerite. This is some variation on a flower style but is really a combination of the instructions already covered and embraces the cone, rolling, and the half-cut or scored line.

The beauty of floral decoration or vase motifs is that the flowers may be changed, added or taken away and thus kept new and stylish. They may be handled, as they are quite strong. At all times, they may be used for a window

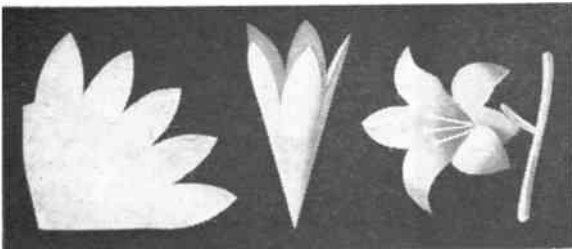

(A)—Making a flower head

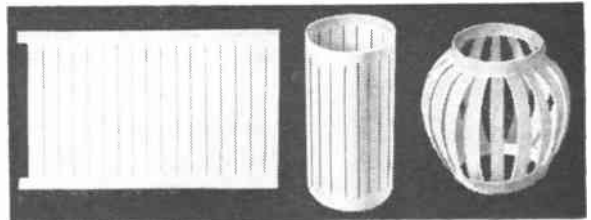

(C)—Stages in lantern making

of edges, and adhesive joints. The bell or trumpet of the bloom is shown with serrated and scalloped edges and the two edges are drawn together and stuck permanently to form the centre motif of the flower. Stamens are added and these may be pins or wire or stiff card suitably cut and treated. The finished result is really lovely and represents the true flower grown in the garden or park. Care, neatness and clean fingers are essential, as nothing looks worse than dirty and fingermarked work.

Long daffodil leaves and stems (illus-

tration B) may be obtained by long cuts with a single scored line and a fold as shown. Stems may be made from wire or some strong material. Master pieces may be cut and used in some cases as stencils where several motifs are required. The half lines are bent as usual and the

decoration or as a frame for some other motif and they thus become the props of many a scheme of decoration. A good length of wire is an advantage as this may be used from time to time to suit various forms of decoration.

Take every advantage of coloured papers which are available for coloured paper craft work. The glossy paper will give the highlights and the matt the subdued effects, while the tints and tones will give intermediate results. Hand tinting may be carried out, and much can be done with coloured matt poster papers.

Bouquets of flowers may be composed in all one style or two varied kinds of flowers or leaves. Oak leaves may be used for merit motifs and awards. Where two different kinds of flowers and leaves are used in a motif the first type may consist of a shape cut out, say, from a flat piece of card or thick paper. A centre hole is always essential and this may be made with a thong punch or scissors. The circle of paper obtained for the petal will need scalloping or serrating. In figures A and B two different types of flowers and their make-up are shown.

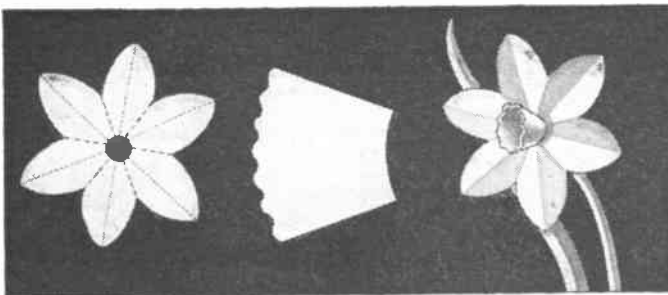

(B)—Daffodil leaves and stems

● Continued on page 295



# A Trick to fool your Friends

**H**ERE are instructions for making and performing an unusual trick which will give you a reputation for possessing a pair of X-ray eyes. The apparatus comprises a little cardboard box containing a wooden cube, each side of which has a different colour painted upon it.

You begin by passing the box to your audience with a request that somebody takes out the cube and replaces it in the box, with a colour of their own choice uppermost. While this is being done you have turned your back. When the box has been closed again, you take it into your hands, behind your back, and turn to face your audience. As you do so, you raise the box to your forehead and appear to concentrate deeply. After a suitable pause, you announce the selected colour and receive your applause.

Make the box from fairly thin, good quality, cardboard. A convenient length for the sides of the box is 2 in., and the sides of the lid should be  $\frac{1}{8}$  in. greater than this. Copy out the patterns in Fig. 1 upon the cardboard, and cut out both pieces, using sharp scissors. Score along the edges of the sides and tabs, using a ruler and penknife, before commencing to assemble the box and lid. Balsa cement will be found to be a satisfactory quick-acting adhesive when sticking the tabs in place.

The dimensions of the wooden cube must be slightly less than those of the box, so that the cube will fit snugly into its container. Paint circular patches of different colours upon the sides of the cube. Alternatively you may stick discs of coloured paper to the cube.

When you have completed your apparatus you will want to learn the secret method by which you may discover the hidden colour. The vital moment in the performance of the trick is when you receive the box into your hands, behind your back. As you turn to face your audience, remove the lid of the box and replace it to one side of the now exposed cube (see Fig. 2). Now, as you bring the box up to your forehead, glimpse the colour, which should be facing towards you. Do not hurry this move.

Pause awhile before you announce the colour. Remember you are suppose to have X-ray eyes and intimate that the experiment is very difficult. A magician must be ninety per cent an actor.

When you announce the chosen colour, take the lid of the box in your right hand and lift it clear as you bring down the box in your left hand with a neat

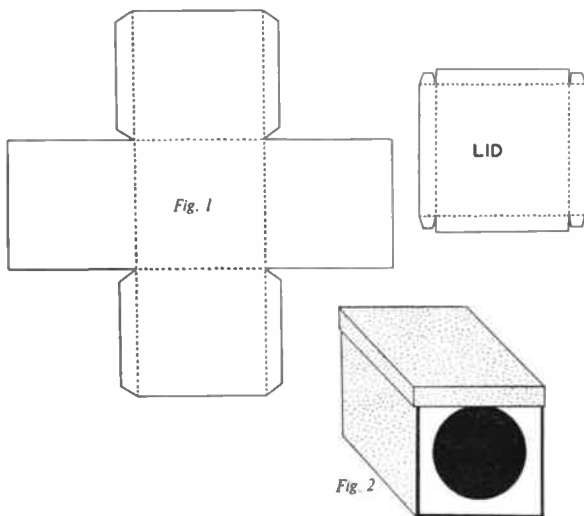

sweeping gesture, which must conceal the fact that you 'pivot' the box upright. Do this smoothly in order to create the impression that you have merely lifted the cover of the box to check your divination.

Mental mysteries are usually best performed as if they were genuine scientific experiments, but do not be too serious in your presentation, otherwise you may be embarrassed should your secret be detected.

● Continued from page 294

## PAPER SCULPTURE LANTERNS

These two different styles give a first-class vase display. Note that the stamen of the flower should be suitably treated with colour. Laurel leaves have many uses and this style should also be worked out.

Illustrated in Fig. C is the display unit called the lantern, and this may be used for decoration inside or outside the house. It falls into place in this chapter dealing with floral decoration, as both flowers and lanterns may well form part of a decorative room scheme.

The exercise is fairly simple. There are two variations of one form used together, one a rectangle of thick paper, white or coloured for decorative outdoor effect — the paper being rolled into a plain tube — and the other a rectangle of paper that is cut and afterwards rolled, the former supporting and holding the shape of the latter.

It is worth while remembering here that when lanterns are required for outdoor use, the best paper to use is a water-

proof paper to resist damp and rain; such a paper as flint or gelatine is ideal.

Ruling should be carefully carried out in order to produce first-class lanterns so that a set square and ruler with pencil are the first essentials to good execution. Phase one of our illustration shows the paper ruled out; the horizontal lines are half scored and the upright or vertical lines are cut right through the paper. Phase two of the picture shows the rolled and joined cylinder. The tube is then pressed into shape, shown in phase three, thus forming the lantern shape. Note that two additional strong bands are required for the top and bottom to give strength and style. An additional cylinder of paper or tube may be placed down the middle of the lantern and affixed into position to complete the job.

In serious display work, the lantern may be used for windows and other important forms of decoration. It has indeed many uses and much appeal, especially when worked out in colour.

For plenty of volume

# MAKE THIS TWO-VALVE AMPLIFIER

THIS amplifier runs from A.C. mains, and has two valves, plus a valve rectifier. It will give plenty of volume, when used with a gramophone pick-up, radio tuner, etc. A suitable radio unit, which can be plugged in for the reception of broadcast programmes, will be described next week.

High tension and heater currents for the valves are drawn from a mains transformer. This is only very slightly more expensive than the simpler circuits which take H.T. current directly from the mains circuit, and has the great advantage that the transformer isolates the amplifier from direct contact with the mains. The metal chassis, pick-up, radio tuner, or other items in contact with the amplifier cannot be alive with mains current, and it is for this reason that the transformer type of power circuit is recommended.

The circuit is shown in Fig. 1, and the parts needed are given in the component list. The values of the large condensers are not critical. The amplifier has a volume control, combined with switch. In the output circuit, the speaker matching transformer is fitted in the amplifier, and any 2 ohm or 3 ohm permanent magnet moving coil speaker can be connected to the speaker sockets on the amplifier. To handle the full output which the amplifier can give, a reasonably large speaker (6, 8 or 10 in.) may be used, fitted in a cabinet. If a suitable speaker, with transformer permanently fixed to it, should be to hand, this can be used, if the transformer in the amplifier is omitted. The two speaker sockets on the amplifier are then wired to the valve anode and H.T. line. It should then be

By  
*'Radio Mech'*

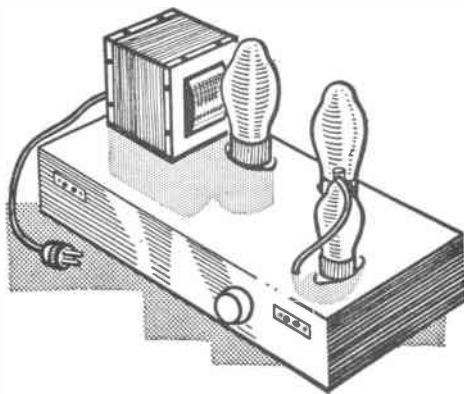

remembered that high tension voltage will be present in the loudspeaker leads from the amplifier, so these must be properly insulated. (The speaker circuit is isolated from the high tension circuit when the output transformer is fitted in the amplifier.)

### Chassis and valves

Fig. 2 shows the top of the chassis, and the positions in which the valves are

inserted, when the amplifier is finished equivalent valves with other numbers can be used instead, though the valves shown are easily obtainable, and inexpensive. Instead of the 6X5, a 6X5/G, 6X5/GT, CV572, EZ35, or U70 can be fitted. For the 6V6 holder, a 6V6/G, 6V6/GT, CV509, or CV511 may be inserted. In the 6J7 position, a 6J7/G or 6J7/GT, CV1935, CV1937, or Z63 may be used. These various valves are the

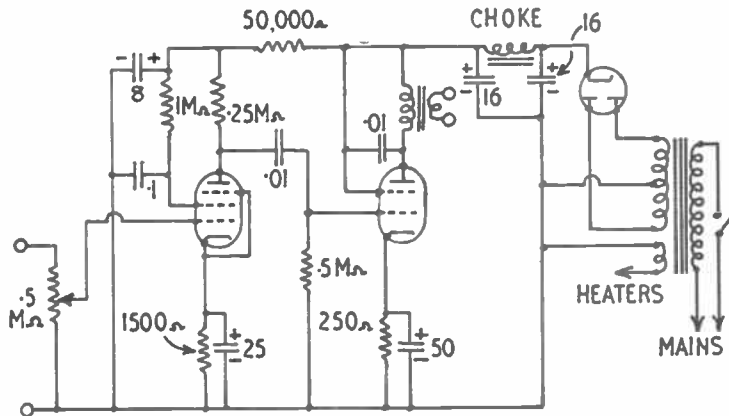

Fig. 1—Amplifier circuit

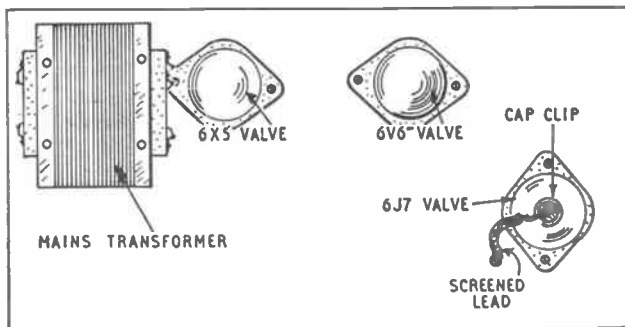

Fig. 2—Positions for the valves

same electrically.

There are only a few connections on top of the chassis. A screened lead passes down from the 6J7 top cap, and is connected to the centre (slider) tag of the volume control. Leads from the mains transformer tags also pass through the chassis. The tags will be marked, so that connecting points can be identified. Some mains transformers have tags which project through a hole in the chassis, and the connections will then come directly below.

It is simplest to use a ready-made aluminium chassis, and this can be about 5½ in. by 11 in. by 2 in. deep. Holes for the valveholders can be made



with a washer-cutter, metal-cutting fret-saw, or by drilling rings of small holes. Small holes, to secure the various parts, can be drilled by marking their positions through the fixing holes of the items themselves.

Larger holes must be made for the sockets of the input and speaker strips, so that these do not touch the chassis. At the back of the amplifier, a 3-way socket is used for chassis, heater, and H.T. circuits to the radio unit. If the amplifier is to be used alone, for record-playing, this power outlet socket is not needed.

### Amplifier wiring plan

Fig. 3 should be followed when wiring up the amplifier. When bolting down the three valve holders, place them so that the slots face in the direction shown. All the points marked E are joints made to the chassis, the

quite easy if a cored-solder, and really hot iron, are used, and all tags, etc. are really clean and bright.

The primary of the output transformer is connected to the same valve-holder tags as the one  $\cdot 01$ mfd. condenser. The secondary, which is of stout enamel wire, goes to the speaker output sockets. One fixing bolt is used as earth return to the chassis, as described.

When wiring in the mains transformer, take a length of good quality twin flex, and connect one lead to the transformer primary. The other lead in the twin flex goes to one switch tag on the back of the volume control, marked S in Fig. 3. A lead passes from the other switch tag to the second primary tag on the mains transformer. Most transformers have tags marked for about 200, 230, and 250V. If so, connect to those tags which are suitable for the house voltage. (This can be found by

COMPONENTS LIST	
Resistors:	250 ohm 1-watt. 1,500 ohm, 50,000 ohm, $\cdot 25$ megohm, $\cdot 5$ megohm, 1 megohm, all $\frac{1}{2}$ -watt. 5 megohm volume control with switch. Knob.
Condensers:	$\cdot 01$ mfd mica. $\cdot 01$ mfd paper. $\cdot 1$ mfd 250V. 8mfd 350V. Two 16mfd 350V. 25mfd. 25V. 50mfd 50V.
6J7, 6V6 and 6X5 valves. Three octal holders. 45:1 speaker transformer. Mains transformer; 250/0/250V. 60mA, 6.3V. 2 amp. 60mA smoothing choke. 1 yd. screened wire. Chassis. Two 2-way sockets. 6BA nuts and bolts, etc.	

which is wired to the volume control.

It is not absolutely essential to use screened connections, but doing so prevents mains hum or instability due to this lead. Hum due to pick-up in the input circuit can easily be identified, because it will get louder as the volume control is turned towards maximum, but will cease as soon as the plugs are pulled out of the input sockets of the amplifier. Radio unit

This can be of any suitable type — that is, with a 6.3V. heater valve. If a 3-pin plug which will only fit one way is not used, chassis, heater and H.T. positive leads from the radio unit must be carefully marked, so that they are not wrongly connected at the amplifier.

The amplifier power section will give  $\cdot 3$  amp heater current, and 10mA H.T. current, and this can be remembered if a radio unit other than that described in a previous issue is to be used.

If the speaker output transformer is fitted to the speaker, as mentioned, the amplifier should not be switched on unless the speaker is connected, or the 6V6 valve may be damaged. If this transformer is included in the amplifier, as in Fig. 3, no harm will arise if the amplifier should be switched on with the speaker disconnected.

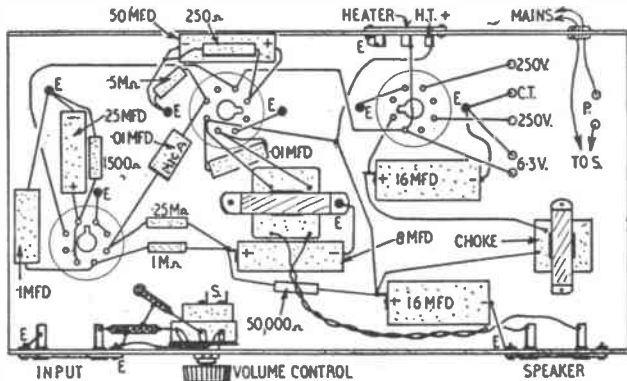

Fig. 3—Amplifier wiring plan

bolts also serving to hold valve holders, socket strips, or other items. It is best to use tags at these points, especially where several leads go to one earth return, and the bolts holding them to the chassis should be really tight.

The outer braiding of the 6J7 cap is earthed, together with a short piece of screening from the volume control to input socket, as in Fig. 3. The screening should run to within  $\frac{1}{2}$  in. or so of the end of the connection, but must not touch the inner, insulated wire. Earthing leads are soldered to the braiding, and to a tag bolted to the front of the chassis.

The five large condensers have positive and negative ends, and the negative tags or leads go to the chassis. Metal clips can be made, to hold these condensers.

Insulated wire should be used for all connections. In most places the wire ends of the resistors will be long enough to reach various connecting points, and insulated sleeving should be cut and placed over these wires. All the joints should be soldered, and this will be

looking at a house bulb.)

The mains transformer has two secondaries. One delivers 6.3V. for the valve heaters. This is connected to heaters, heater output circuit socket, and chassis, as in Fig. 3. The other secondary delivers 250V. high tension. There are two 250V. tags, with a centre tap. This centre tap is marked C.T. in Fig. 3, and is connected to the chassis. On some transformers the centre tap is marked 0-volts, or 0V.

Check all the connections carefully against Fig. 3, to make sure that the amplifier will work correctly at once. See that there is no possibility of valve-holder tags or other joints touching the chassis, or each other.

### Pick-up connections

Most gramophone pick-up record players will already have a screened lead from the pick-up. The outer, screened braiding of this lead is taken to the earthed input socket. The inner, insulated lead goes to the other socket,

## ★ LEARN ★ RADIO & T/V SERVICING for your OWN BUSINESS/HOBBY

● by a new exciting no-maths. system, using practical equipment, recently introduced to this country.

FREE Brochure from :—  
**RADIOSTRUCTOR**  
DEPT. G81, 46, MARKET PLACE,  
READING, BERKS. 27/7

# WITH ROD & LINE

**W**ITH more and more anglers looking towards the sea and its possibilities for fishing, perhaps a few remarks will be found helpful.

First of all don't let the fact that you have no actual sea fishing tackle as such deter you. Lots of sea fish can be taken on river tackle, and I often use such equipment myself. At times I find myself at a spot within easy reach of the sea, but the fact that my sea rods are back home does not prevent me going along to fish if the river is not offering good sport.

## TRY THE SEA FOR A CHANGE *By 'Kingfisher'*

First thing to appreciate is the fact that sea fish live mainly on each other — 'the sprat for the mackerel' in a manner of speaking. It will be realized, then, that sea fish have to chase their prey as a general rule, so if you do not have something live, such as shrimp or prawn, on the hook, then you must have movement to simulate life.

Take your spinning rod with you on your summer holidays, as it is during this part of the year that mackerel are to be found close in-shore. Try fly fishing for them, and you'll have some good fun. You don't have to think in terms of trout flies in this case.

Here I propose to explain how a very simple fly for mackerel fishing can be made at home. These flies I use myself, and fish other than mackerel will take them at times. I usually tie them on a size No. 1 sea hook which is eyed, of course.

The only things required are a few coloured feathers, some small diameter coloured plastic tubing, and waterproof cement. The plastic tubing will be found at shops which deal in do-it-yourself materials. The colour schemes you can use are dictated by your own fancy, but a good one I have found is made as follows: cut off a short piece of

white tube and slide this over the point of the hook and up to the eye. The length should be such that with one end of the tube up to the eye of the hook, the other end will terminate just before a point opposite the hook point. In other words, assuming the length of the hook from eye to bend is 1 in., then the tube should be round about half that length.

This tubing will be a very slack fit on the hook shank in order to attach the feathers. These you can either buy already coloured or to make it less costly, you can get some white hackle feathers about 2 in. in length and dye them yourself, using one of the many dyes on the market to-day which are suitable for nylon fabrics. These particular dyes appear to have a more intense, almost fluorescent quality.

The feathers are washed in a detergent to remove all the natural grease, and are then immersed in the hot dye, made up according to the instructions. They should be laid out to dry, and the surplus dye should be washed out by thorough rinsing in clean cold water until the latter shows no trace of colouration from the dye.

## Peeps at Nature

### THE LOBSTER

**A**LTHOUGH the lobster habitually lives in the deeper waters around our coasts, it may sometimes be found in deep rock-pools near low-water level. The living lobster is blue in colour and, as is well known, is heavily armoured. It grows between moults of its hard covering. It is a scavenger, living on live or dead matter found on the sea bed. This it holds in its large claws and tears to pieces with its jaws.

Whilst able to walk quite quickly on the sandy bottom, when alarmed the lobster can travel backwards by flicking its tail and abdomen. The eggs hatch

At the quill end of the feather you will notice there is a small amount of fluffy fibres which should be pulled off. With this particular fly I use two orange feathers and a black. Don't ask why, as I cannot tell you beyond that I think orange and black a good colour combination, and what is more important, it appears to please the fish, too, judging by the number I have taken on these colours.

The nozzle of the cement tube is now placed against the end of the tube nearest the bend, and a little cement is squeezed out, which will be forced up inside the tube. The quills of the feathers are then pushed inside the tube until they come up to the eye end, so that they are right through, and when set the cement will hold the lot firmly in position. To make doubly sure, although I have had no trouble in the past, I now take a few turns of whipping silk round the end of the tube nearest the eye, tie off and smear with a touch of cement, and the fly is ready for use.

In practice, I usually fish from a boat with these. A small amount of lead is put on the line about 1 ft. or so above the fly which will then pull the latter well down below the surface. The job now is to keep that fly moving, so that it looks alive. You can ignore the fact that the ends of the feathers protrude well beyond the point of the hook. They are so soft, and the fish take with such a rush, that the hook point will not be prevented by the feathers from getting a good hold.

Once you have tried this method you will get so much pleasure and fish, that you will become a confirmed practitioner of this form of the sport.

out into shrimp-like larvae, which live for six months at the surface of the open sea before they change into miniature lobsters, sink to the bottom, and make their way shorewards. (P.R.C.)

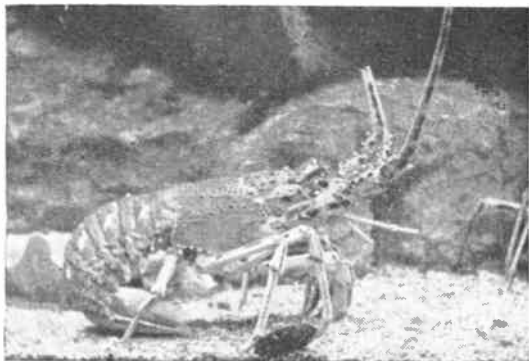

**BUYING OR SELLING?**

Classified advertisements on this page are accepted at a cost of 6d. per word prepaid. Use of a Box No. is 1/- extra. Send P.O. with advertisement to *Hobbies Weekly*, Advert. Dept., Dereham, Norfolk. Rates for display advertising on application.

**100 STAMPS FREE** — request 4d., 4d., 1d. etc. discount approvals. — Croft, Pigdown, Hever, Edenbridge, Kent.

**PERSONS** (either sex). Soft toy assembling. The ideal profitable pastime. Experience unnecessary. Everything supplied. Apply, enclosing s.a.e. Dept. H. W. Cuddycraft Supplies, East Road, London, N.1.

**KUKLOS ANNUAL**. Indispensable cyclists' handbook. Tours, resthouses, money-saving hints. 3/- post free. — Burrow, Publishers, 2 Imperial House, Cheltenham.

**100 DIFFERENT stamps free!** Request 4d. upwards discount approvals. — Bush, 53 Newlyn Way, Parkstone, Dorset.

**MODELS**. You can make lasting stone-hard models with Sankey's Pyrama Plastic Cement. Supplied in tins by Ironmongers, Hardwaremen and Builders' Merchants. Ask for instruction leaflet.

Further reduced  
Brand  
New  
**ILLUSTRIOUSLY QUILTED "QUILTERFOAM"**  
**SLEEPING BAGS** ONLY 19/11 POST 6/6 2/6



Slip into it—soft and comfy—enjoy restful sleep throughout night. No blankets, no sheets, everything in one including special padding for a beautiful soft mattress effect. Light as a feather, it rolls up to a tiny lightweight size. 19/11, post 2/6. Even finished in heavy quality strong material. Really hardwearing. Not a blanket with outer, but genuinely quilted. Refund guaranteed.

10/-, bal. 10/-, bal. 18 fort- nightly p a y - m e n t s 8 oz. 7/1. Plus DUCK carr.

**PRICE OFFER!** **10/-**

The **RIGHT LIEUTENANT** Genuine **NEW TENT**



Waterproofed 1960 Tents of 8 oz. **WHITE DUCK**. Galeproof. Brand new surplus to export order. **DON'T CONFUSE** with Tents made from drab material never meant for tentage. This is real thing, withstands anything even in our climate. Approx. 7 ft. 6in. x 6ft. x 6ft., 3ft. walls. Cash £5/19/6, carr. 6/-, complete ready to erect, incl. valise. 'Willesden Green 42'-ex. Ridge pole if req. 7/6 Fly-sheet 39/6 Rubberised Groundsheet 19/6. These essentials sent on appro. Refund guaranteed. **LISTS, TENTS.**

Headquarter & General Supply Ltd.  
(HOBW/15) 196-200 Coldharbour Lane  
Loughboro Junc., London, S.E.5. Open Sat.

**AGENTS WANTED**

Large private Christmas Card Company has few vacancies for agents (spare time). Tremendous scope and excellent profit. to be made by keen agents: wide range of best selling designs; reasonable prices. Write for further details without obligation to: **GARRICK CARD CO. DEPT. 6, AVENHAM STREET, PRESTON, Lancs.**

**WORKERS** with sewing machines required for making cushion covers. Regular work guaranteed. Apply enclosing s.a.e., Dept. 28, Arnold Trading, 10 Shelley Road, Worthing, Sussex.

**PEN PROFIT**. If you like writing send for 'Writers' Guide' (free). Thousands of words to interest beginner or experienced. Typewriter unnecessary under our system. Writers' Ring (H.W.), 5 Edmund Street, Birmingham 3.

**DO YOU DOODLE?** Then you have creative ability. Read 'MAKE ART PAY' (sent free). This fascinating booklet shows how doodling can be turned to profitable artistry, quickly, easily **VALLEY FEATURES**, Castle Gallery, Clun, Shropshire.

**WHEELS** (Hardwood and Rubber Tyred Metal.) Cot, Pram and Doll's house Fittings and Papers, Beads, Transfers, Prints and other accessories. Stamp for new lists. (Trade supplied.) New address — **JOYDEN CO., 91 Peplins Way, Brookmans Park, Herts.**

**LEARN RADIO & ELECTRONICS** the NEW Practical Way! Very latest system of experimenting with and building radio apparatus — 'as you learn'. FREE Brochure from: Dept. H.W.10, Radiostructor, 40 Russell Street, Reading, Berks.

**PUBLICATION DATE—AUGUST 1ST**

Make sure of your copy of

**HOBBIES 1961 ANNUAL**

Enlarged to 180 pages—and still only 2/-

Two free plans with each copy, for making

**TOY FORT** (with moat and drawbridge)

**MUSICAL BOX** (The Old Woman who lived in a Shoe)

Hundreds of exciting projects for all ages

From Hobbies branches, stockists, newsagents, bookstalls, etc, or send NOW for your copy by post (6d. extra)

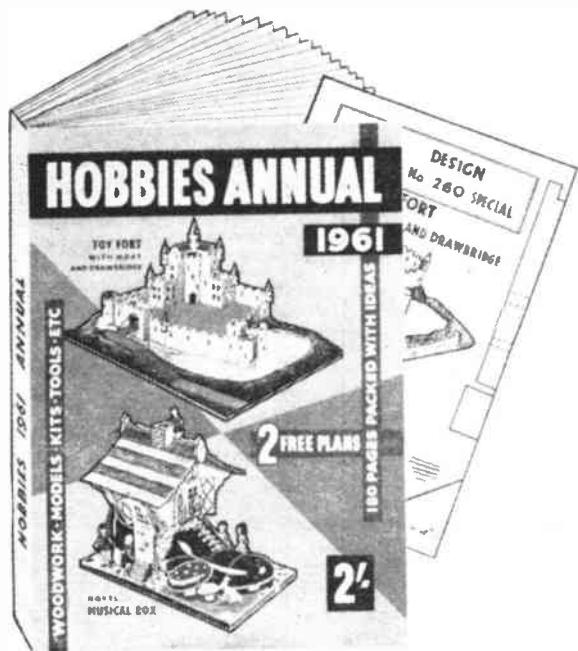

To Hobbie. Ltd., Dept. 99, Dereham, Norfolk

Please send.....copy/copies Hobbies 1961 Annual containing two free plans

Name.....

Address.....

.....

.....

P.O. for.....enclosed



# A Simple-to-make Marionette Stage

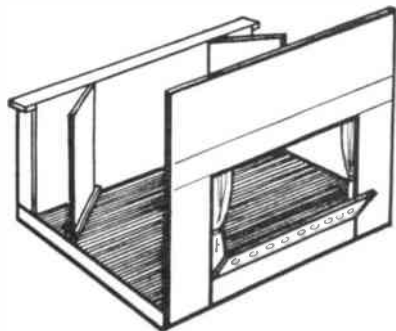

**A** REASONABLE stage on which to work your papier mâché marionette can be made from wooden packing cases. The writer was fortunate in obtaining a large wooden case made of  $\frac{1}{2}$  in. wood, and measuring 3 ft. 9 in. by 2 ft. 6 in. by 2 ft. 6 in. for a shilling. Only half of this case was used

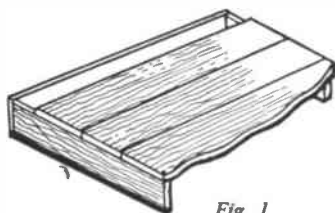

Fig. 1

in the making of the stage illustrated, so with the cost of the hardboard for the back the total price was about six shillings.

The stage stands 3 ft. 9 in. high, and is 3 ft. 9 in. long and 2 ft. deep. The proscenium measures 2 ft. 5 in. by 2 ft., which is a workable size for 15 in. to 18 in. puppets.

The packing case was carefully taken apart, and two pieces each 3 in. by 2 ft. and two pieces each 3 in. by 3 ft. 9 in. were nailed into a rectangle. Three boards (two at 8 in. by 3 ft. 9 in. and one at 6 in. by 3 ft. 9 in.) were nailed on this rectangle, leaving a 3 in. gap at the rear (Fig. 1).

Three other boards, each approximately 8 in. by 3 ft. 9 in., were nailed together to form the proscenium arch. The space above the cross member was filled in with patterned curtaining, but hardboard could have been used. The stage curtains were fitted to a curtain rail behind the cross member.

The framework for the back, which also forms the rest for the operators, was made of two pieces each 3 in. by

2 ft. 6 in., and two pieces each 3 in. by 3 ft. 9 in. The two shorter pieces were fitted into the 3 in. gap at the back of the stage boards at each side, and one of the longer pieces nailed across them. The

*By G. A. Edmonds*

other long piece was cut to fit between the uprights at stage level. On this framework was nailed hardboard cut to size (see Fig. 2).

Two 5 in. lengths of 1 in. square block were screwed half way along both sides of the stage to form the wings and

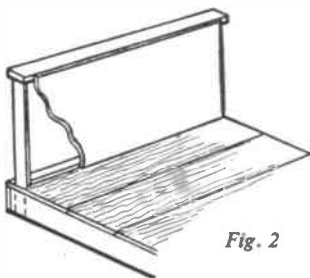

Fig. 2

to hold the scenery. They were fitted diagonally, pointing towards the back of the stage. The following is the procedure used to fit them.

The back block of each pair is fitted first, and an 18 in. lath is screwed to the centre of the front edge. A length of hardboard is placed against it, and the remaining block is screwed to the floor as tightly as possible to the hardboard. In this way the hardboard is adequately supported and is detachable (see Fig. 3).

There must be no support across the top of the stage because this will impede the operation of the marionettes.

## Lighting

Stage lighting is desirable, but is not a necessity. Should the puppeteer wish to add this refinement, then there is no need for over-complication.

An overhead batten bracketed at an angle to the rear of the proscenium arch and above the curtain rail, and a batten for the footlight which is fitted at an angle to the front base of the stage, should be sufficient.

White, red, blue, and green lights,

repeated in that order until there are sufficient of each colour to take the power load, are socketed along both battens. Each colour group is wired separately in parallel so that, at the most, four switches are needed for each batten. This can be reduced to only four switches in all if the same colours from both battens are wired to the same switch.

The rubber-covered flex from the mains can be connected to a distributor point, but this can be replaced by a master switch, so that the stage can be blacked-out in one movement when required. All the switches must be mounted on the same board, and this board fixed to the back framework for

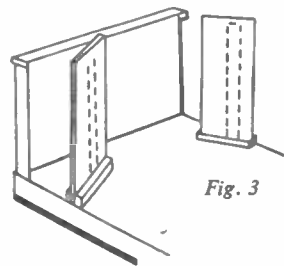

Fig. 3

easy access.

It would be wise to fit fuses, or at least one to the master switch.

## 'The Autocar' Handbook

by J. R. Singham, Ph.D., B.Sc.(Eng.), A.M.I.Mech.E.

**A** NEW issue of this popular handbook is now available. This is the twenty-second edition, and has been completely re-written so as to include all the latest improvements in the modern car.

'The Autocar' Handbook has been the recognized guide for over fifty years for the owner-driver who wants a clear picture of how his car works. The simple semi-technical language, together with over 200 clear cut illustrations, make this an important handbook for the motorist who wants to get the best out of his car and to be able to recognize maladjustments before damage is done.

Published by Iliffe & Sons Ltd, Dorset House, Stamford Street, London, S.E.1, and costs 12/6.

# FULL SIZE CHILD'S COT

4 ft. x 2 ft.

Drop-sided with lift-out webbing mattress. Collapsible for easy storage. Easy to make by the handyman from the Kit supplied which contains selected planed wood, dowel rod, webbing, drop-side fittings, hinges, and screws.



KIT No.  
3202

**63/6**  
(post free)

Drop-side fittings, available separately, price 7/9 a set, postage 1/6 extra.

Obtainable from all Hobbies Branches or Stockists, or direct by post from Dept. 99

**HOBBIES LTD., DEREHAM, NORFOLK**

## APPARATUS & CHEMICALS

For your experiments. Let us help you equip a **HOME LABORATORY**

Beakers, Crucibles, Flasks, Funnels  
Gas Jars, Test Tubes, etc.

Booklets:

(including postage)

'Experiments' 1/2  
'Formulas' 1/2  
'Home Chemistry' 2/10  
New edition



Send 3d. Stamp for latest PRICE LIST

**A. N. BECK & SONS (Dept. H.W.)**

68 Stoke Newington High Street, London, N.16

## WOOD BENCH VICE

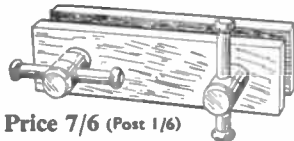

Price 7/6 (Post 1/6)

A strong hardwood vice which can be screwed to the work bench. A real serviceable tool, well made, and fitted with hardwood screws. 12 in. long.

From branches or:  
**HOBBIES LTD.,**  
Dereham, Norfolk

## HEAR ALL CONTINENTS With H.A.C. Short-Wave Receivers

Suppliers for over 18 years of radio S-W Receivers of quality.

One-Valve Kit, Price 25/- Two-Valve Kit, Price 50/-

Improved designs with Denco coils. All kits complete with all components, accessories and full instructions. Before ordering, call and inspect a demonstration receiver, or send stamped addressed envelope for descriptive catalogue.

'H.A.C.' Short-Wave Products (Dept. 22), 11 Old Bond Street, London, W.1.



## CONTEMPORARY BOOKCASE

43 in. high 36 in. wide



Of pleasing design with its side panels and top of sapele veneer. Will add distinction to the modern home. Easily made by the handyman with a few simple tools, and a Hobbies Kit No. 3348. All wood fittings, including veneered plywood for the decorative panels, screw-in veneer, design sheet with instructions, etc.

PRICE 82s. 6d. Carr. paid.

To **HOBBIES LTD., (Dept. 99)**  
**DEREHAM, NORFOLK**

Please send me Kit No. 3348.

Name .....

Address .....

P.O./Cheque for 82s. 6d. enclosed.



THESE NOTES REFER CHIEFLY TO MIDLAND GARDENS. DUE ALLOWANCE SHOULD BE MADE FOR CHANGE OF LATITUDE.

## Outside

**D**URING this holiday month provision must be made for watering of greenhouse and indoor plants. If your neighbour is helping out while you are away you should sink as many pots in the garden as possible to save him extra work. Choose a shady spot and they will need little attention for several days.

Transplant early sown biennials as growth increases. Perennials such as polyanthus, pansy, viola, etc, may also be pricked out.

Trim lavender and disbud dahlias. Inspect dahlias for earwigs, and spray against aphids.

**ROCK GARDEN** — Start replenishing pockets which are looking washed out. Soil should not be too rich. Add a little lime for lime loving plants. Renew slug bait.

**FRUIT GARDEN** — Pay attention to

wall fruits this month. Train in new growth required for next year and cut back unwanted growth. Remove canes of loganberries and raspberries that have finished fruiting. Tie in new growth.

**VEGETABLE GARDEN** — Continue to sow carrots, lettuce and radish for succession. Make a second sowing of spring cabbage. Spray potatoes and tomatoes against blight. Stop outdoor tomatoes at three or four trusses. Earth up celery and leeks. Celery should be earthed up a little at a time, leaving a few days between each earthing.

**Inside — warm house**

**C**ONTINUE to feed cucumbers. Top dress where necessary. Take cuttings of soft wooded plants as required. Harden off foliage and flowering plants when required for indoors.

**Cool house**

**F**EED tomatoes and top dress where possible. Strike cuttings, especially

of zonal pelargoniums (geraniums) and regal pelargoniums. Sow schizanthus and other annuals required for blooming inside next spring. Pot up bulbs for winter flowering and plunge in ashes or peat in a cool dark place. Set bulbs of daffodils and narcissus. Watering of cacti may be reduced towards the end of the month and conophytums should be watered from 1st August onwards.

**Cold house**

**A**S for cool house, take cuttings, pot A on and feed as required.

**General**

**C**ONTINUE to hoe and clean up C where possible. Take away weeds which are likely to seed and compost them. (M.h)

## Make an amazing Candle See-Saw

**R**EGULAR as clockwork, this candle see-saw will ride up and down as it burns away at both ends. The effect is pretty, as well as unusual, and is well worth the expenditure of a penny candle.

end. Do not mind about this, but proceed to light the suspended candle at both ends.

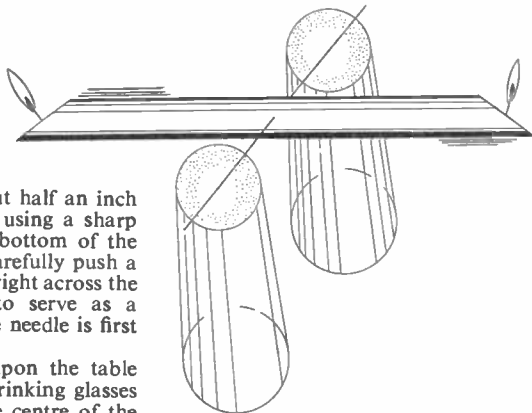

Neatly trim away about half an inch of the base of a candle, using a sharp penknife, until only the bottom of the wick is exposed. Then, carefully push a slim steel knitting needle right across the middle of the candle, to serve as a spindle. It will help if the needle is first heated slightly.

Spread a newspaper upon the table and place two inverted drinking glasses three inches apart, in the centre of the paper. Suspend the candle between the glass 'pillars' by resting the spindle ends upon the glasses.

The candle will probably dip at one

To begin with the candle will hardly move, whilst the molten wax drips copiously off each end. Slowly the candle will assume a horizontal position as its balance becomes automatically adjusted.

After a while a rhythmic see-sawing motion will commence as drops of wax fall, alternately, off each end and the candle's centre of gravity is constantly displaced to alternate sides of the spindle.

The swinging tempo will increase and then die down, and, finally, the last of the melted wax will fall in an untidy heap upon the paper. When your demonstration is over, blow out the flame and save the wax, in the newspaper, as a fire-lighter. Try arranging your display in a darkened room. (A.E.W.)

Next week's issue will include details for making a seaside bathing raft. Make sure of your copy.



# ORIENTAL WALL BRACKET

**T**HIS oriental wall bracket consists of two pieces, A and B, each cut from  $\frac{1}{4}$  in. wood or plywood. The shelf B slots into piece A. Clean up, paint, and fix to the wall by means of a small hanger. (M.p)

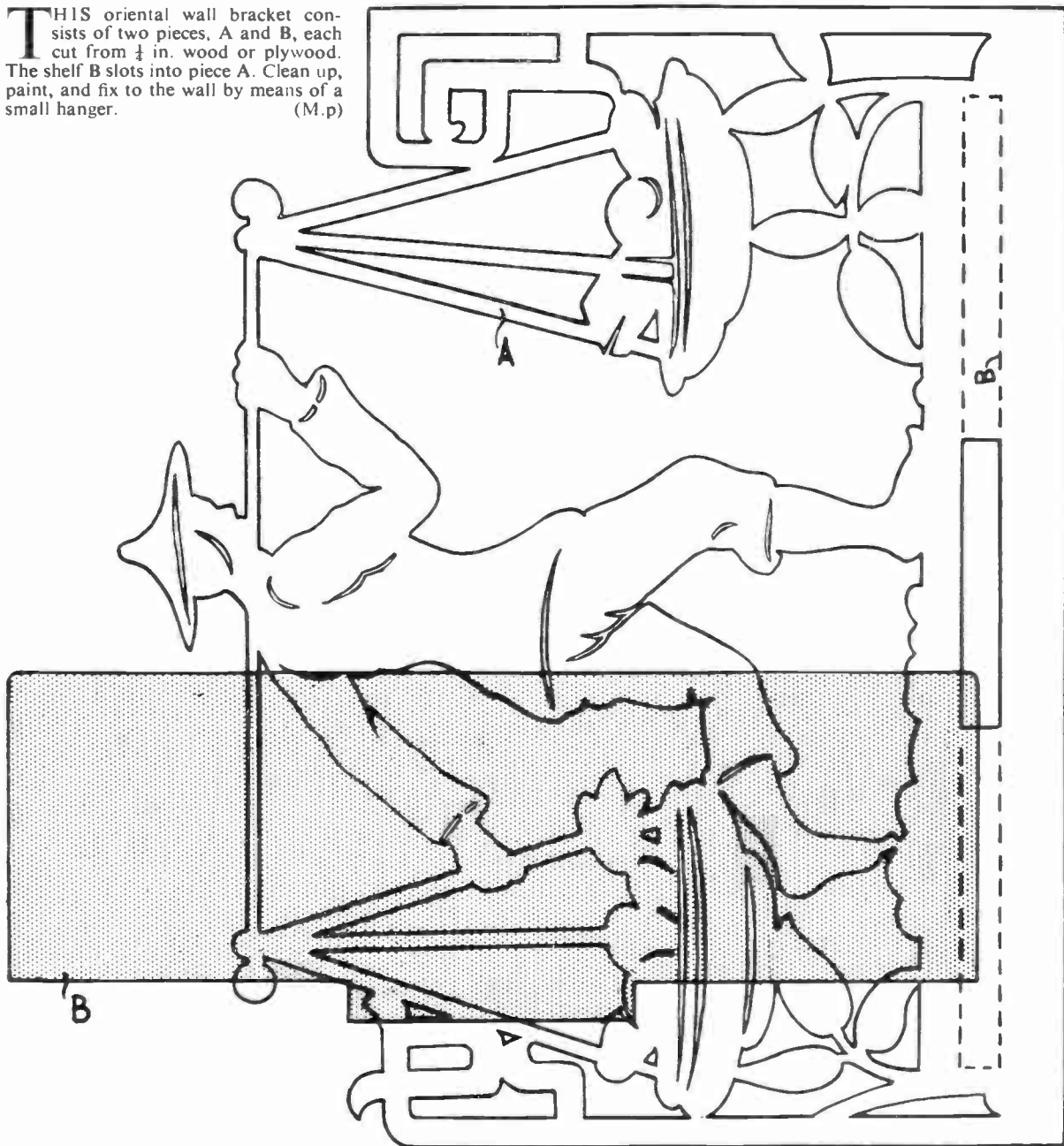

303

Printed by BALDING & MANSELL, LTD., London and Wisbech, and Published for the Proprietors, HOBBIES LTD., by HORACE MARSHALL & SON, LTD., Temple House, Tallis Street, E.C.4. Sole Agents for Australia and New Zealand: Gordon & Gotch (A'sia) Ltd. For South Africa: Central News Agency Ltd. Registered for transmission by Canadian Magazine Post.

READER'S REPLY  
HW JULY 1960



Copyright photograph by permission of British Railways

# Just like the real thing!

Airfix kits are not just models — they're exact replicas, each series to a constant scale.

Airfix 00 gauge Signal Box. 2/-.

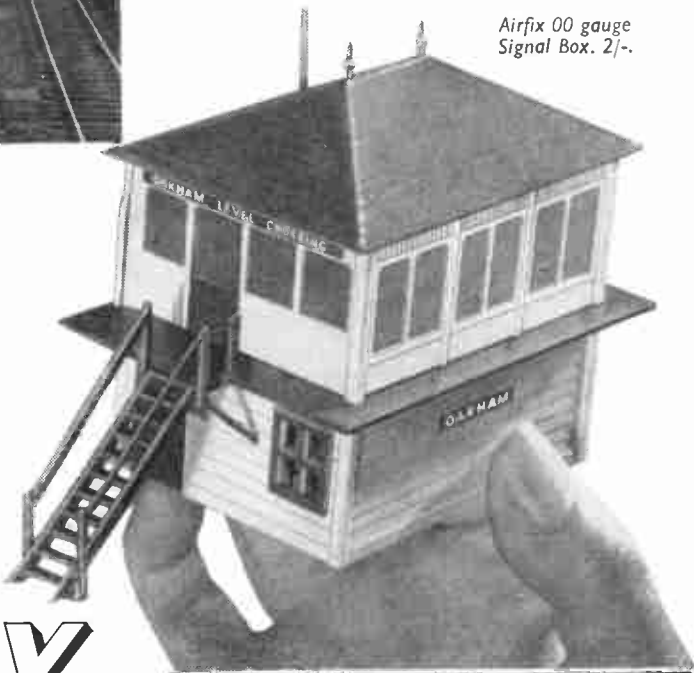

There are models galore in the Airfix range! Aircraft from fighters to bombers (all to the same 1/72nd scale), 00 gauge railway accessories, vintage cars, historical ships. Airfix value is unbeatable — ask your dealer for the latest list.

Nearly 100 kits from 2/- to 10.6d.

# AIRFIX

THE WORLD'S GREATEST VALUE IN CONSTRUCTION KITS

From Model and Hobby Shops, Toy Shops and F. W. Woolworth



### AIRCRAFT

Bristol Superfreighter 7/6d.

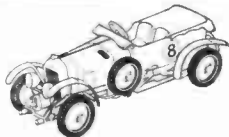

### VINTAGE CARS

1930 Bentley 2/-



### OIL TANKER

NOW — 00 GAUGE ROLLING STOCK FROM AIRFIX! First off are the true-to-life Oil Tanker illustrated, and an equally perfect Presflo Cement Wagon. Both are typical of Airfix unbeatable value and accuracy. 2/-.  
ALSO NEW: 00 gauge Locoshed with opening doors. 3/-.

### MODEL FIGURES

Life-guard 2/-



### HISTORICAL SHIPS

H.M.S. Victory 2/-