

29th JUNE 1960

VOL. 130

NUMBER 3368

THE ORIGINAL
'DO-IT-YOURSELF'
MAGAZINE

HOBBIES *weekly*

FOR ALL
HOME CRAFTSMEN

FREE plan
to make
musical
model

ST.
CLEMENT
DANES

Also in this issue:

BUILDING AN
EXTRA ROOM

MATCH HINTS
FOR ANGLERS

COLLECTORS' CLUB

PAPIER MÂCHÉ
MARIONETTES

GARDENING NOTES
FOR JULY

BALLOON NOVELTY

ETC. ETC.

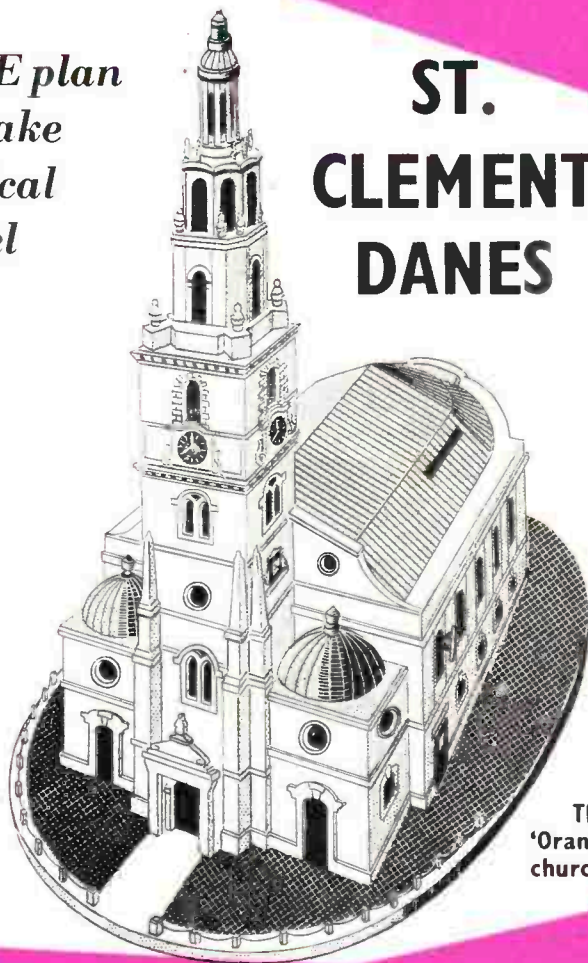

The famous
'Oranges & Lemons'
church in the Strand



Up-to-the-minute ideas

Practical designs

Pleasing and profitable things to make

World Radio History

5^D



COLLECTORS seeking a specialized field should consider the 1867 stamps of Austria. There were two principal printings, popularly known as 'coarse beard' for the first, and 'fine beard' for the second. These stamps have an interesting background.

For some time prior to 1867, Hungary had been attempting without success to obtain the right to self-government. Finally, in that year, the right to become a self-governing state within the Empire was granted. This included an inde-

SOME EARLY AUSTRIAN STAMPS

pendent postal system. As no facilities were available and considerable time was necessary for the creation of these, certain temporary arrangements were made.

It was agreed to issue a stamp suitable for both Austria and Hungary. The previous issue of 1863 was not to be used, as it showed the word 'Kreuzer' and the double eagle, both of which were Austrian and not Hungarian. The new stamp was to use the abbreviation 'Kr.' and the head of the Emperor Franz Josef. Stamps were to be produced in Vienna and supplied to Hungary. The die was engraved by Tautenhayn. The designer is not known. The emperor's head was copied from a photograph.

The first five values, 2, 3, 5, 10 and 15 Kr., were ordered 25th May and issued on 1st June 1867. The 25 and 50 Kr. values were issued at a later date. These were primarily for use on money orders, which were just being introduced. The series of stamps was valid in Hungary until 30th June 1871, when Hungary was able to produce its own stamps, and in Austria until 31st October 1884.

Coarse and sharp

The manner of producing these stamps is the cause of many interesting and perplexing problems. In the original printings there was an underlay of soft felt which served the purpose of making more prominent the centre medallion

showing the head of the emperor. The softness of the material permitted the paper, which was also soft and coarse, to take more ink and produce the so-called coarse printings.

As time elapsed, the underlay became flatter and firmer. This, coupled with the usage of a thinner, harder paper, resulted in an entirely different type of printing which was sharper and clearer, with finer lines, and is the 'fine beard' in contrast to the earlier stamps. However, there are so many variations in printing results, and also so many transitional stages, that it becomes a frequent problem to differentiate clearly the stages of printing. The stamps frequently give the impression of arising from entirely different plates, which is not so.

The stamps were printed in sheets of 400 with four panes of 100 each. Undivided sheets have never been dis-



COLLECTING autographed photographs of TV stars is very popular. The latest addition to my collection, says R.L.C., has just arrived from David Lutyens, I.T.N. news reader

covered, which makes the setting up of an entire sheet impossible to this date. Plating of the issue has been attempted by a number of collectors.

The number of perforations that exist is large, as a result of the imperfect perforating machines. This necessitated the frequent switching of a sheet from one machine to another, and caused combination perforations.

The pins in the machines frequently loosened, causing many irregular and missed perforations. Originally the stamps were sheet perforations, but later many were line perforations.

A rare item

The rarest item in existence is the 3 Kr. colour error resulting from the insertion of a 3 Kr. cliché in a plate setting of the 5 Kr. stamp. A number of sheets was issued before the error was discovered, but only about six copies of the 3 Kr. red are known. These are all used and emanate from the southern district of Hungary. The known cancellations are Beskerek, Kecskemet, Detta, and Bruckenuau. The date is probably 1847, late September and early October.

Actual plate flaws are very rare. Usually those thought to be flaws are merely the result of the many printing peculiarities.

The paper is watermarked with the word BRIEF-MARKEN across the sheet, and many copies can be found with an entire letter of the watermark on it. In 1883 the lettering of the watermark was altered somewhat, and such stamps are much more difficult to find.

The number of cancellations on this issue is tremendous, and offers a fertile field for the interested collector, as there are about 20,000 different in existence.



ALL of us have wished, at some time or other, that we had a spare room in the house. A room to accommodate the occasional guest; a den or workshop for father; a games room or one that could be used as a quiet retreat for the children to do their homework.

There is a solution — to transform what is more or less wasted space, under the roof, into a light and airy room. It is a job well within the scope of the average handyman, and in this series of articles we shall deal with all aspects of the building, from enlarging the trap door, three different types of loft ladders, and right through to building the actual room, windows, and ventilation.

Its uses

First, you must decide the purpose for which the room is required, i.e. what the local authorities call a 'habitable room'; that is, a room intended for living or sleeping in, or just a room intended for

1—REGULATIONS AND COSTS

occasional use or storage or anything else except living or sleeping in.

All local councils have regulations controlling the building of a habitable room. These deal with air space, etc, and exact details should be ascertained. There must for instance, be a window, or windows, which give a total glass area equal to not less than one-twelfth of the floor area.

Of these windows, a part equal to not less than one-twentieth of the floor area must be capable of being opened. The

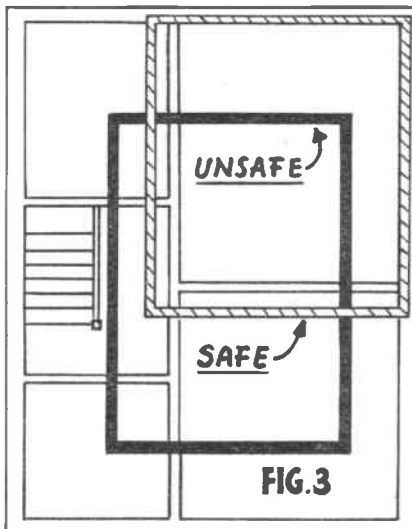

FIG.3

top of the windows must not be less than 5 ft. 9 in. above the floor.

The floor joists must be capable of carrying any loads which might reasonably be imposed on them, and if there is no fireplace or air-brick, ventilation must be provided.

In London, another regulation is that skylights, dormer windows, etc, must not be more than half the area of the roof unless metal frames or reinforced glass are used. Measurements are also laid down for loft ladders.

Mostly, you will find local councils very helpful. They will have no objections to rooms, other than habitable rooms, provided no structural alterations are envisaged. All of them, however, will insist on rough plans, particularly for a habitable room.

Know your roof

The next step is to get really acquainted with your roof construction.

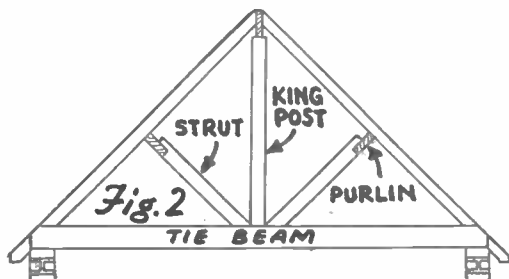
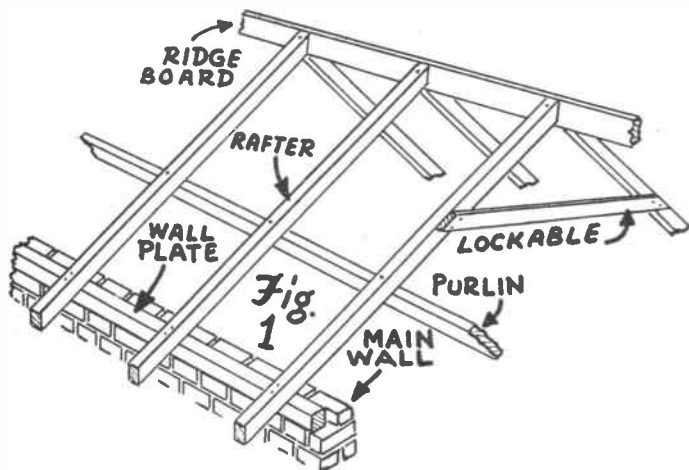

All the main timber work is shown in Figs. 1 and 2. All of them may not be found in your roof. Some you may not be familiar with, such as the wall plate, which is timber laid along the top course of the brickwork, and to which is affixed the rafters. If you take the drawings with you when you inspect the attic, you will soon identify the others.

If you have what is called a gable end roof, as in Fig. 1, there will not be any impediments of structure traversing the

space wherein you can build a room. The twin purlins will have their ends seated in the opposite gable walls, and are themselves a suitable support. The exception will be a long roof, when a central support of king post and struts may be found. Even here, it will be found that there is sufficient space on either side of the king post support to build a suitable room.

The modern 'semi-detached' will probably have a hip roof, that is, a roof that slopes on three sides, as opposed to the two sloping and one straight of the gable end roof.

Roof supports cannot be tampered with. The exception is the lockables, which can be raised if necessary. This will be explained in a later article.

Study well the available space, having regard to any cold water tank that may be present. Tanks can be moved, but it is far better to plan your room to leave the tanks undisturbed.

Decide on your window or windows; whether they must traverse a solid brick wall, or go through the rafters to form an attractive dormer window. Both can easily be built.

Strength of joists

The floor joists of an attic room must be capable of carrying any loads which might reasonably be imposed on them. This is obvious, for with the present joists, probably of not more than 4 by 2 in. in size, it would be dangerous to walk across them, let alone build on

them. So be careful when making your initial inspection. The new joists to be fitted will need to be 7 by 1½ in. stock-size sawn timber. And they will have to rest on supports consisting of the tops of internal or external wall, or both.

We now see that the siting of the proposed room depends on two main factors, i.e. the positioning of the roof supports and the internal walls. Fig. 3 shows a simple plan of the main and internal walls of a typical semi-detached house. A safe structure is shown by the shaded rectangle, whilst an unsafe structure is indicated by the heavy black rectangle.

It will be seen that the safe structure can overhang the internal wall tops, but not by more than 9 in. Also, other positions for siting the room can be identified. The point to remember is that the new fitted joists must rest on the tops of internal or main walls.

It may be that the joists will have to be fitted much longer than the actual size the finished room will occupy, but this cannot be avoided.

Some schools of thought contend that it is perfectly safe, and cheaper, to fit the new 7 by 1½ in. joists alternatively alongside the existing joists, and that the 4 by 2 in. existing joists in between can be brought up level by 'topping them up' with 3 by 2 in. timber. Before you decide on this method, however, it is wise to have a word with your Borough Surveyor to see if he approves.

Costs

You cannot build an attic room for next to nothing. On the other hand the work can be done on the instalment system; buying and fitting parts when you can afford them. The cost must be weighed against the added convenience and extra value added to the property.

A small room of, say, 10 ft. by 9 ft. proportions of the non-habitable type will cost up to £40. A habitable room of, say, 20 ft. by 12 ft., complete with windows can cost up to £150. The main cost will go in purchasing the new and stronger joists required. They will be laid alongside the existing joists or around 14 in. apart. You can, therefore, see just how many you will require, and in what length in order to obtain an estimate from your local dealer.

Tongued and grooved boards should also be used for the actual floor itself and here again, these are expensive. They will probably be 6 in. in width, so it is comparatively easy to calculate just how many boards you will need.

A point to remember here. Obviously, the floor will not need to be laid right over the joists and into the sharp angle formed by the rafters and the wall plate. This part of the floor would always be useless. Nothing could be placed there; you could not crouch, let alone walk on this part of the floor. Estimate, therefore, the amount of flooring needed to reach a line approximately 4 ft. away from the sharp angle.

Next: Trapdoor and Loft Ladder.

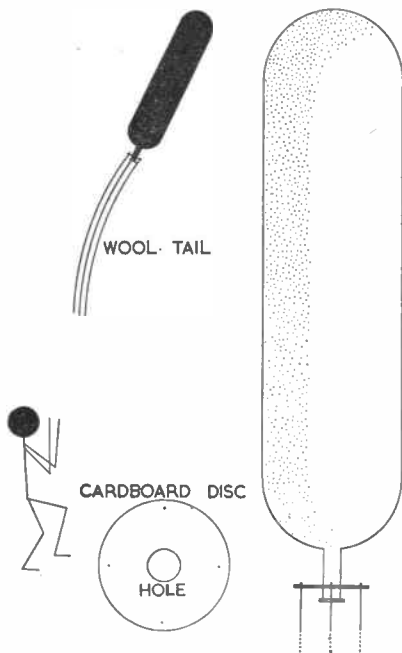

Have lots of fun with this Balloon Rocket

WHEN you blow up a rubber balloon and then release it, the toy will rush wildly about as the air escapes through its neck. The balloon is propelled by the force of re-action, or 'recoil', produced by the violent action of the escaping air. This is the principle by which rockets and jet aeroplanes work. By fixing a simple device on to the neck of a balloon its crazy antics in flight can be controlled. The balloon rocket described here is a novel toy, absolutely harmless, and bearing but a faint resemblance to more warlike playthings.

You will need a twopenny 'sausage' balloon, together with a 1½ in. diameter disc cut out of stout cardboard, and four yards of lightweight coloured wool. Make a ¼ in. diameter hole in the centre of the disc. This may be done, using a six-inch nail, or a cork borer. Make four

little holes, evenly spaced, around the disc, as illustrated. Cut the wool into four one yard strands and tie these to the disc by threading them through the little holes. This arrangement will provide a tail for the balloon, which will provide the 'drag' needed to keep the toy moving on course.

Insert the neck of the balloon through the hole in the tailpiece and inflate your 'rocket'. Hold the toy steady in your left hand, pointing upwards, whilst pressing your right thumb over the opening in the balloon's neck. When the balloon rocket is released it should soar upwards until it is deflated. You may need to adjust the weight of the tail by lengthening or shortening the woollen strands. It will be found that the balloon rocket works best in absolutely calm air, or inside a large room which has a high ceiling.

(A.E.W.)

MAKING AND USING CONCRETE

THE home handyman is often called upon to carry out jobs requiring the use of concrete in making garden paths, slabs, bases for sheds and garages, drive-ins for cars, etc. The making of good concrete is quite simple and the necessary materials are readily obtainable. Concrete is a combination of Portland cement, sand, and aggregate, which when mixed in specified proportions with water, sets into a hard, dense, solid material. First of all let us consider the various materials separately.

Portland cement is obtainable in bags, each weighing 1 cwt., from any builder or builders' merchant. Ironmongers and hardware stores sometimes sell cement in smaller quantities, but it is more expensive this way. The cement must be perfectly dry before it is suitable for making concrete, because once it becomes damp it loses its cementing properties. A damp atmosphere can even 'air set' exposed cement, so keep your supply stored in a dry place until it is required for use. Because cement is so difficult to keep bone dry for long

periods, it pays to purchase your supplies as you require them.

Clean pit or river sand are the best types to use for making concrete. Don't attempt to use sea-shore sand, as this is unsuitable because of its high salt content. To test a load of sand to ensure that it is clean, rub some between your hands. If this stains your hands, then the sand is dirty and will require washing

By K. Finlay

before use. Dirty sand prevents the concrete binding together properly.

The aggregate can be stone chippings, broken brick, ballast, pebbles, etc. The maximum size of the aggregate varies according to the job being done. For instance, 2 in. aggregate is normal for foundation work and garage slabs, whereas $\frac{3}{4}$ in. should be the maximum size for use on making paths and paving slabs. As with sand, it is necessary for the aggregate to be clean.

The water used for mixing with the ingredients should be clean and free from impurities likely to affect the setting properties of the concrete. Tap water may be used with confidence.

The final quality of concrete depends largely on the proper proportioning of the ingredients. The principle of proportioning is shown diagrammatically in Fig. 1, where the voids formed by the aggregate are filled up by the sand and their voids are in turn filled up by the cement. When properly done the final result is a dense, homogeneous mass of solid concrete. The proportioning of

concrete is normally referred to as a ratio of the three basic ingredients, e.g. a 1:2:4 mix. This really means that this particular mix is made up from 1 part of cement, 2 parts of sand, and 4 parts of aggregate. The amounts may be measured out either by weight or by volume. The handyman, however, will find that measurement by volume is the easier method for small jobs, and an ordinary bucket may be used for measuring the quantities. The accompanying table gives suggested mixes for the principal jobs the home handyman is likely to encounter.

The mixing of concrete should be done on a hard, clean surface; a concreted yard is ideal. To ensure a thorough mixing, it is best to mix the ingredients dry several times until the colour becomes uniform. After this, add just the right amount of water to make a workable mix. If insufficient water is used the cement will not set properly, and if too much water is added the resulting concrete will be weak and crumbly. A simple test is to take a handful of mixed concrete and squeeze it in your hand. If the proper amount of water has been used, then the squeezed concrete should retain its shape and become moist on the surface without dripping.

Once the concrete has been mixed, it should be placed in its final position without undue delay. When ordinary Portland cement is used the initial set normally takes place about half an hour after mixing, so it is essential that it is in position by that time.

If you are laying a concrete path or base for a shed, then some temporary formwork must be prepared beforehand to keep the concrete in position until it sets. The illustrations at Figs. 2 and 3 show the simple formwork necessary for these jobs. The top edges of the formwork should be properly levelled off to correspond with the finished surface of the path or base.

When placing concrete in position care should be taken to prevent the aggregate falling to the bottom and leaving a weak mix on the surface. Once the mixed concrete has been shovelled into the formwork, it should be tamped down with a wooden tamper to its proper level, using the formwork as a guide.

Concrete becomes hard as a result of a chemical action which is set up between the cement and the water. It is important, therefore, that the mixing water is not allowed to dry out too quickly before the concrete has had a chance to set hard, otherwise the concrete will be weak. During hot weather, therefore, the surface of the concrete should be

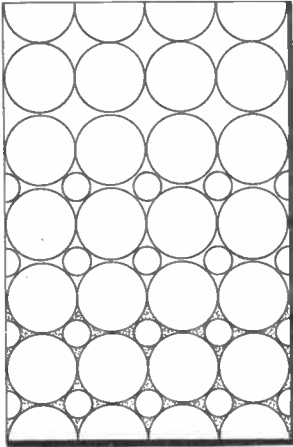

Fig. 1

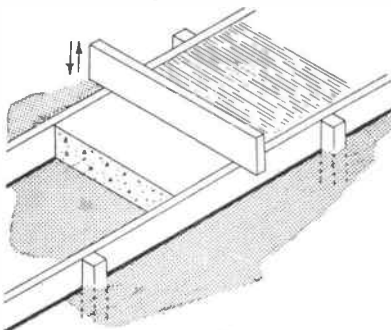

Fig. 2

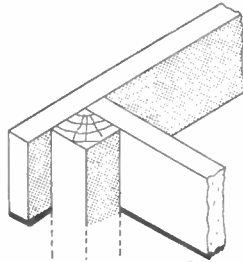
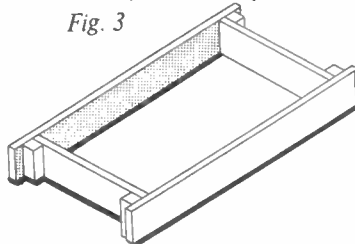

Fig. 3



protected with some suitable material like wet sacking, straw, paper, etc. This is known as curing.

Concreting jobs should, if possible, be carried out in one operation without any interruptions. If, however, this is not convenient, then the end of the first portion should be left rough in order to form a 'key' for the subsequent portion. Before placing new concrete against a stopped end, soak with water first and ensure that there is no dirt or other foreign matter present which will reduce the bond at the joint.

Finally, if you are not too keen on the normal greyish appearance of ordinary concrete then why not colour your con-

crete? This can be done in two ways. Firstly, the concrete can be painted with special paint once it has hardened. Secondly, dyes can be added at the mix-

ing stage so that the colouring is produced throughout the full mass of the concrete. The latter method, of course, is the more lasting.

TABLE OF MIXES

Class of Work Description of Job	Cement (Loose) Bucket	Sand (damp) Bucket	Aggregate Bucket	Approx. Amount of Water Bucket
Unimportant work, foundations for sheds, small concrete walls	1	3	6	½ to ¾
Ordinary concrete work, bases, walls, slabs, etc ..	1	2	4	½ to ¾
Watertight concrete, floors, garden paths, steps, flagging stones, etc	1	2	3	½ to ¾
Work of thin sections, fence posts, precast work ..	1	1½	2	½

Some Hints for Match Anglers

TO hope for the best results when match fishing, likely tactics should be thought out beforehand. To lay plans it is necessary to know, first, the kinds of fish available in the water pegged for the contest; secondly, the average depth and type of water — fast, slow, or medium; thirdly, the condition of the water — low and bright, or stained as the result of showers, or high and muddy following a storm of heavy rain up river. Such variations of water affect one's chances, and the competitor must adjust his tackle, baits, and methods accordingly.

Speed is a great factor. To facilitate this, see that you have all your essential needs close at hand. Fix the keep-net handy to your peg, and seat-basket, or your stance if standing or kneeling to your task, in order that you can drop your fish into it without having to move far. Obviate hauling the keep-net out of the water each time you land a fish. This wastes time, and is liable to disturb the swim and so scare off the fish into deep water or into your neighbour's 'pitch'.

If your keep-net is low owing to a steepish bank, it is a good idea to add a sort of muslin funnel — or a short length of tubular netting — to the top ring of the net. You can then slide your captures down this 'chute' to their temporary prison without disturbing the net, and making undue commotion.

Always use the best baits, and as fresh as possible. This also applies to ground bait. Worms and maggots must be lively; 'weary' baits are not attractive to fish. Throw your ground bait in the swim sparingly, and without undue splashing.

For match fishing, maggots (or gentles, if you prefer their other name), take some beating as hook baits. Use the bigger ones for the hook; the smaller ones can be

scattered in the swim from time to time. Coloured and uncoloured maggots may be included in the kit at a contest, ready for a change-over if you feel this would be helpful. If the water is 'pea-soupy' then worms will probably be most effective. If chub are in the swim, use a tiny cube of cheese paste. Breadcrust cubes are tempting to roach. Creed-wheat and stewed barley are also attractive at times. In a match of limited duration, it is advisable to take a choice of varied baits.

Use light tackle for match fishing. The lighter you fish the better your chances. You just cannot afford to use clumsy and

heavy tackle. Don't waste your breath in grousing about your particular swim — make the best of it. Don't keep your eye on your neighbour's activities — you may well miss a bite. Keep several spare casts made up with hooks of different sizes. Carry your box of split shot in a handy pocket to facilitate quick changing over from light to heavier tackle.

And a final note: When returning the catch after the weigh-in, don't just sling the fish back into the water. Place them in your landing-net, lower it into the swim, and allow the captives to go free. Then you are not liable to injure them.

(E.)

● Continued from page 223

MAKE SIMPLE MARIONETTES

been done the lower arms and hands can be formed.

When the body has been completed the whole should be carefully lifted by the pad of newspaper and put in a safe place to dry for at least three days in the summer, and at least a week in the winter. From now on the marionette must not be moved until the drying is completed. When this stage is reached the excess string should be cut off, except at the point where the head joins the shoulders and at the hands.

The back and the front of the head are made separately. Two milk straws are placed between the two halves of the head diagonally from just above the temples to cross at the neck (Fig. 5). When the head is dry these straws are cut off close to the head. They become

the tunnels through which the strings left at the shoulders are threaded. When the head is attached to the body the strings are knotted immediately above the head and sufficient is left to be attached to the puppet strings later.

When the body is dry it may be found that the joints are stuck. These may be loosened by moving them to and fro, and a little application of oil will help to keep them supple. Should the clearance at the joints not allow for proper movement, then the papier mâché may be shaped with a small file. Finally, all the rough edges may be smoothed away with a fine file or with glasspaper.

Dressing the marionette will be described in another article.

MAKE SIMPLE MARIONETTES

TELEVISION is fast making the public, and particularly the young viewers, puppet conscious. For many years teachers have recognized the value to children of puppet-making, in that it gives unbounded possibilities in the teaching of all branches of English and arts and crafts.

The making of glove puppets is relatively easy, but it is likely that the complexity of a fully-articulated marionette will deter many would-be enthusiasts. The method outlined here will produce realistic and workable marionettes in a very short time.

Papier mâché may be easily made by soaking newspaper torn into very small pieces overnight, then rubbing the soaked newspaper on a scrubbing-board until it is reduced to a grey pulp. When the excess water is squeezed out of the pulp it is mixed with cold water paste powder, which can be used either dry or mixed with water.

positions marked in Fig. 2. The string is cut into the appropriate lengths and is forced into these cuts, as shown in Fig. 3. These strings are not knotted at the slots, because the wet papier mâché is likely to tighten the strings and thus distort the frame.

By G. Edmonds

Sufficient string is left at the top of the frame to take the head, which is attached later. Elsewhere a certain amount of string is left to allow for adjustments

place of storage, where it will dry.

As will be seen in Fig. 4, the torso is made in two halves to enable the puppet to bend at the waist. The top, or chest, is worked first.

A lump of well-kneaded papier mâché is flattened into a rough V-shape and is placed beneath the centre and arm strings. A wetted gummed strip, with gummed side up, is placed under the centre strings at the waist. Half of the strip protrudes, to be fixed into the pelvic shape later. Another wetted gummed strip is stuck upon the first to form a sandwich of gummed strip and strings. This sandwich process is used throughout to strengthen the join and to

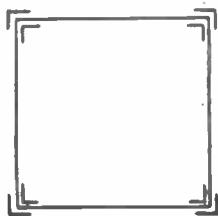

Fig. 1—Gummed strips at corners

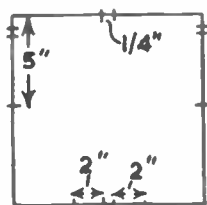

Fig. 2—Scissor cuts for stringing

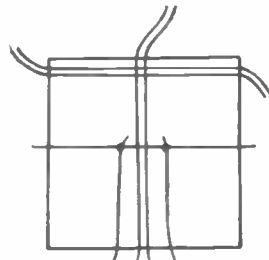

Fig. 3—Note arm strings are extra long counteract the unnatural body movements liable to occur if the strings alone are used.

MATERIALS	
Heavy cardboard.	4 strips, each 14 in. by 1 in.
Gummed strip.	18 pieces, each 3 in. by 1/2 in. Some extra for frame corners.
String.	10 ft. (approximately).
Papier mâché.	4 handfuls for the head and the body.
Newspaper.	A thick wad on which to build the puppet.

A square is formed from the four strips of heavy card, joined by gummed strip both inside and outside, as in Fig. 1. Scissor cuts halfway through the width of the card are made at the

when making the puppet, particularly at either end of the arm strings, for the arms will be longer than the width of the frame allows.

The thick pad of newspaper is placed beneath the frame, both to provide a surface upon which to build the puppet and to enable the work to be moved safely from the working bench to a

Similar sandwiches are made at the junction of the upper arms and shoulders. These are pushed into the papier mâché horizontally and parallel to the line of the shoulder (see Fig. 4). The joins are done this way to ensure that the arms fall to the sides of the puppet.

When the joining sandwiches for the upper torso are completed, more papier mâché is applied over the strings and the sandwiches until the chest is formed with the connecting string running through it.

The same procedure is followed for the pelvis and for the limbs; that is, the back is applied below the strings; the sandwiches are made at the appropriate places; and the papier mâché to form the front of the chest is placed above it. Gentle pressure upon the front will ensure that the strings and the sandwiches are firmly welded to the body when it is dry.

The arms are left to the last. The space on either side of the torso is not sufficient for the length of the arms, so, when the upper arms are made, the strings are removed from the notches and placed in the position shown by the dotted lines in Fig. 4. When this has

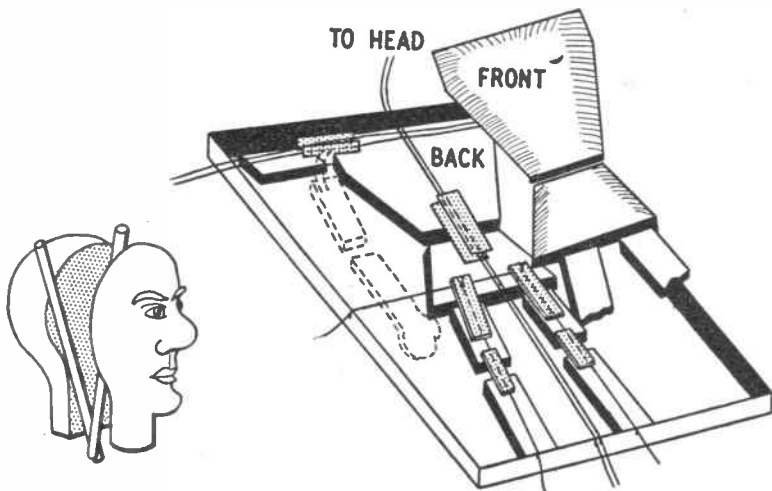

Fig. 4—The puppet in two halves

Fig. 5—Position of straws within head

● Continued on page 222

ST. CLEMENT DANES

THE church of St. Clement Danes has stood sentinel over the streams of London traffic on its ancient island site in the centre of the Strand for many centuries. Its famous peal of bells ringing out the old nursery rhyme of 'Oranges and lemons, the bells of St. Clement's' are known throughout the world. This then is the setting for our model, which has been designed as a musical money box.

It can be used for personal savings or

high. The money saved can be collected by removing a panel from underneath which is ordinarily fixed in position by sticking brown paper over it.

St. Clement Danes is now known, of course, as the church of the Royal Air Force because of the part this Service played in rebuilding the church following its partial destruction by enemy air action in 1941. The original church dedicated to St. Clement has stood just outside the old walls of the City of

present form, and reconsecration by the Bishop of London in the presence of H.M. the Queen and other members of the royal family, on 19th October 1958.

As can be seen from the finished illustration, a finely detailed model can be made of this famous old church, and if the instructions are carefully followed in conjunction with the diagrams, the work should not prove too difficult. Careful fretcutting and attention to detail and finish is, of course, necessary to obtain the best results, and it is suggested that the worker should first of all read through the instructions carefully in order to get a thorough working knowledge of the makeup of the model.

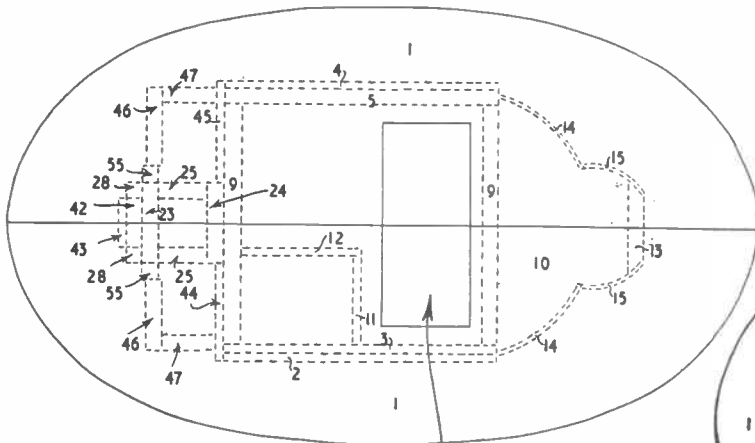

Fig. 1

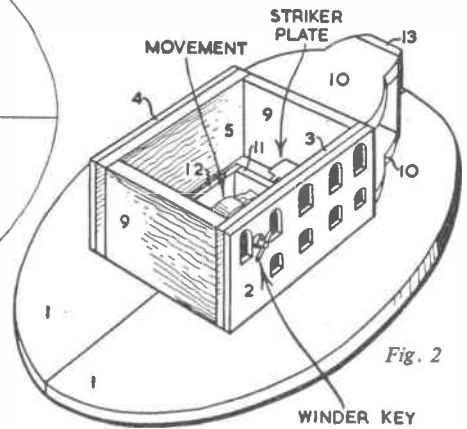

Fig. 2

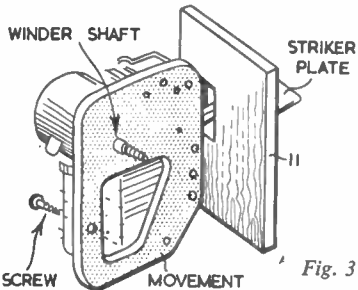

Fig. 3

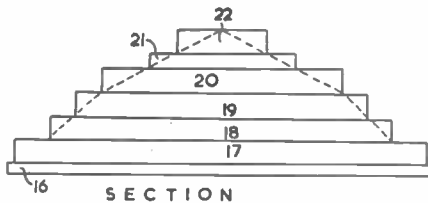

Fig. 4

London since the ninth century. William the Conqueror rebuilt the church and it was again rebuilt in the Middle Ages. No trace of these buildings remains today except the stump of the mediaeval tower which is now encased in the present church.

St. Clement's escaped the ravages of the Great Fire of London in 1666. In 1680, however, it was found unsafe and had to be pulled down, but Christopher Wren created a new St. Clement Danes and his church stood on its island site in the middle of the Strand for over 250 years. Then came the bomb damage during the last war, the rebuilding in its

On the special large design sheet all parts which go towards the building of the church are shown full size. When cutting pieces 14 and 15 from thin ply, allow extra on the sides for later trimming to fit. If you are working from a Hobbies kit you will notice that the base is made up from two pieces, but workers using their own materials can make it from one complete oval.

Trace the various pieces from the design sheet and transfer them to their appropriate thicknesses of wood by means of carbon paper. Make sure that all parts have been accounted for on the wood before cutting them out with the fretsaw. Then clean them up well with glasspaper.

Commence by making the base as shown in Fig. 1. The two pieces of $\frac{1}{4}$ in. wood are butted and glued together, and the rectangular portion in the centre is removed by the fretsaw with a slanting cut, as shown. This is the piece which will be removed from underneath the model in order to collect the coins which

would be ideally suited for church or other charity appeals, and in this instance the subject would encourage patrons to give generously.

The action is that when a coin is inserted in a slot provided in the roof of the church, it triggers off the musical movement, which obviously in this case has to be the tune of 'Oranges and Lemons'. The tune is played over once for each coin inserted. The church stands on a base $11\frac{1}{2}$ in. by $6\frac{1}{2}$ in. and is $9\frac{1}{2}$ in.

have been saved. Fig. 1 also shows by dotted lines the positions of various parts as they are glued on to the base. Working from Figs. 1 and 2, build up the side walls and the ends of the main body of the church. Note that the side walls are of double thickness, pieces 2 and 4, which have the windows cut out, being overlays on pieces 3 and 5.

Before adding the side wall consisting of pieces 4 and 5, the musical movement must be fixed to the interior of the church. Insert the striker plate through the hole in piece 11, as shown in Fig. 3, and screw the movement to piece 3, locating the winder shaft through the hole provided in the side. Finish off the musical movement compartment by gluing piece 12 in position (Fig. 2), and then add the second side of the church.

The roof consists of one each of pieces 16 to 22 inclusive. The sizes of these are taken from the design sheet, which clearly shows the contours of the various pieces and the provision of a

fret pins, and thus can easily be prised off if and when necessary.

Fig. 6 shows the addition of further sections of the building. The tower (pieces 23, 24, and 25) is glued centrally to the front (Fig. 6) and shaped portions

Hobbies Kit No. 3368 for making the model of St. Clement Danes includes all panels of wood in required thicknesses. Kits from branches, etc, price 15/-, or from Hobbies Ltd, Dereham, Norfolk (post 1/6 extra).

The tune 'Oranges and Lemons' is on Hobbies No. 2 Musical movement price 16/- (by post 6d. extra). This is the special coin-operated movement necessary for this particular model.

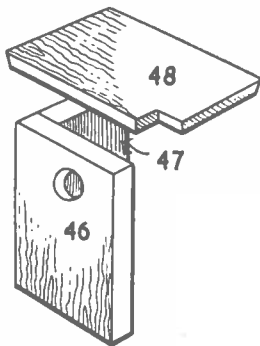

Fig. 7

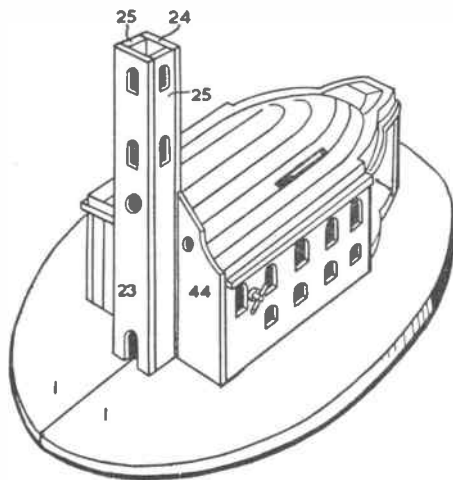

Fig. 6

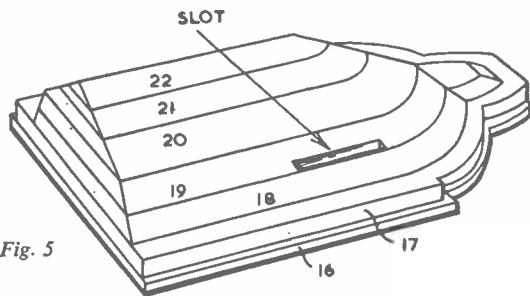

Fig. 5

slot for the coin entry in pieces 16, 17, 18, and 19. Fig. 4 gives a section showing how these pieces are glued one on top of the other in order to build up the roof. When the glue is thoroughly set, shape away the roof with a knife or rasp to the section shown on the design sheet, which will then give the two slopes indicated by dotted lines on Fig. 4. After shaping, the roof should appear as seen in Fig. 5.

Next glue thin plywood sides (pieces 14 and 15) round pieces 10 to form the back of the church.

Before finally adding the roof, make sure that the musical movement is working satisfactorily, and that it starts when a coin is dropped on the striker plate.

It may be that in course of time adjustments will have to be made to the movement, such as cleaning, etc. It is, therefore, not advisable permanently to fix the roof in position by gluing. It can be added quite satisfactorily with four

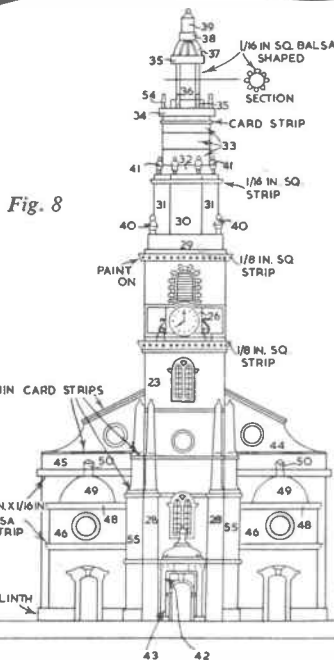

Fig. 8

44 and 45 are glued on either side. The front 'wings' each consist of three pieces, namely 46, 47, and 48, which are glued together, as shown in Fig. 7. This is the left-hand wing, and it will be noted that there is also a right-hand wing. These can now be added to the front on either side of the tower.

Continue by adding the rest of the tower, building up pieces 29, 30, and 31, and so on, as seen in Fig. 8. Then glue on the four clock faces. Other details, such as buttresses, main and side door entrance, cupolas, pieces 49, etc, are also added, as shown in Fig. 8. Thin card should be used for the plinth which goes all round the church, and also for the trim to the buttresses.

For finish, the whole church can be painted a pale grey with the roof a dark grey. The doors can be dark brown, the window openings black, with other detail painted on to various pieces as suggested on the design sheet. The posts (52 and 53), connected by cord, add a final touch to the front boundary, as seen in the finished illustration.



THESE NOTES REFER CHIEFLY TO MIDLAND GARDENS. DUE ALLOWANCE SHOULD BE MADE FOR CHANGE OF LATITUDE.

Outside

BEDDING plants are now beginning to bloom and many will be at their best towards the end of the month. Pay attention to staking, placing supports as inconspicuously as possible. Lupins, forget-me-nots, pansies, etc, may be sown in the open, to be transplanted in the autumn. Layer border carnations and set pipings of pinks.

Feed roses to encourage second flush of flowers. Bud roses this month.

ROCK GARDEN — Continue to take cuttings where practicable. Transplant cuttings previously rooted. Keep well watered until established. Renew slug bait.

FRUIT GARDEN — Summer prune trained trees. Clean up strawberry bed, burn straw and dead leaves. Remove unwanted runners. Thin apples to prevent overcrowding.

VEGETABLE GARDEN — Continue to sow carrots, lettuce, and radish for succession. Plant out brassicas and make

first sowing of spring cabbage. Spray potatoes against blight. Start early in the month and continue at fortnightly intervals. Tomatoes should also be protected by spraying if planted near potatoes.

Continue to hoe and weed regularly. Hoeing not only kills weeds, but provides a dust mulch which will conserve moisture.

Inside — warm house

PAY special attention to shade and watering. Ventilation is important at this time of the year. Pick off dead and decaying leaves. Feed plants which show signs of starvation.

Cool house

CONTINUE to feed tomatoes and cucumbers. A first sowing of schizanthus may be made at the end of the month. Make a further sowing of prim. malacoides.

Cactii and succulents will now be growing well, and must be watered regularly. Give a good soaking and allow to dry before watering again. They may be lightly sprayed during very hot weather.

Cold house

MUCH the same as cool house. **F**eed tomatoes, etc. Pinch back side growths of cucumbers and do not allow the plants to be overburdened. Fumigate regularly. Pelargoniums which have finished flowering should be laid outside on their sides for three weeks to rest them. No water should be given at all. They are then planted (in the pots) in a trench. Take a few cuttings and then cut back the plants as required. Water them and leave until the end of August.

General

FRAMES will most likely be empty now, and this is a good time to scrub down and repaint. Pots may be scrubbed and stored for future use. (M.h)

Make a Vivarium for young Frogs

YEAR by year young naturalists enjoy watching the thrilling change of frog and toad tadpoles into miniature amphibians, but usually they are disappointed to find that the little creatures die soon after their transformation. The main trouble is the difficulty of feeding the tiny insect eaters. As soon as the remaining stub of tadpole tail has been absorbed into the body and all its available nourishment has been utilized by the animal, other sources of food become essential. Green fly and black fly provide a satisfactory solution to the diet problem, and a plentiful supply will keep the little frogs and toads content.

You should not keep your tadpoles in a jam jar. It is far better to provide a shallow baking dish where you can place an island or two of stones in the water. About eight weeks after hatching from the spawn the little frogs and toads will possess four legs and will need to make frequent trips to the surface of the water in order to take gulps of air, for now they will be breathing with their newly-developed lungs. Soon the young amphibians will begin to climb

out of the water on to the rock islands. Now will be the time to make a vivarium to house them.

Obtain a large goldfish bowl and cover the bottom with a layer of clean silver sand. Pour in a little water to make a partial swamp. Scoop away some of the sand to create a pond, and place in it a well-scrubbed and attractive-looking stone or two. Pull out a few small, finely leaved, fern plants from between the cracks in an old damp and shady wall and plant these within the bowl by pressing their roots down into the sand.

Place two or three frogs or toads into the bowl, and then shake a rose leaf which is infected with green fly over the entrance. Soon your pets will become used to their new home, and will commence hunting the insects. Black fly will usually be found upon a bean plant. If you have little frogs these will be most active, jumping about from rock, to sand, to damp glass wall with amazing vitality. You will be able to watch the quaint breathing movements of your frogs and toads, and count the minute toes upon their feet, and observe the queer snicker of their abnormally long

and sticky-tipped tongues as they lash out and snatch up the luckless aphids. Toads will be less excitable. You may be able to notice how the bulging eyes press inwards to assist in swallowing the proportionally bulky morsels of live insect food.

If there are ants upon the rose leaf, herding the greenfly and protecting them, in order to 'milk' them of their sugary sap, or 'dew', you may shake one of them into the bowl with the green ant 'cows'. To a tiny frog an angry ant must appear as a fierce wild beast, but observe how neatly the hungry frog traps and devours the ant. You will learn much of the wonder and ferocity of nature whilst you keep your pets under observation. Keep your bowl covered with a piece of perforated zinc, bent down round the edges, and place your pets in a cool and shady place. When you have enjoyed watching the little amphibians for a week or two it will be best to release them and let them fend for themselves, as it will require much patience and skill to rear them up to full adult maturity.

(A.E.W.)

BUYING OR SELLING?

Classified advertisements on this page are accepted at a cost of 6d. per word prepaid. Use of a Box No. is 1/- extra. Send P.O. with advertisement to *Hobbies Weekly*, Advert. Dept., Dereham, Norfolk. Rates for display advertising on application.

KUKLOS ANNUAL. Indispensable cyclists' handbook. Tours, resthouses, money-saving hints. 3/- post free. — Burrow, Publishers, 2 Imperial House, Cheltenham.

100 DIFFERENT stamps free! Request 1d. upwards discount approvals. — Bush, 53 Newlyn Way, Parkstone, Dorset.

MODELS. You can make lasting stone-hard models with Sankey's Pyrama Plastic Cement. Supplied in tins by Ironmongers, Hardwaremen and Builders' Merchants. Ask for instruction leaflet.

WORKERS with sewing machines required for making cushion covers. Regular work guaranteed. Apply enclosing s.a.e., Dept. 28, Arnold Trading, 10 Shelley Road, Worthing, Sussex.

PEN PROFIT. If you like writing send for 'Writers' Guide' (free). Thousands of words to interest beginner or experienced. Typewriter unnecessary under our system. Writers' Ring (H.W.), 5 Edmund Street, Birmingham 3.

MOSAIC PUBLICATIONS present the brilliant new **MOSAIC BUSINESS MANUAL**. This attractively PRINTED Manual is divided into two sections. Successful MAIL ORDER TRADING and SPARE TIME EMPLOYMENT — both containing lots of inspiring ideas; all guaranteed workable. Write for your copy today — only 5/6 including postage. Satisfaction guaranteed, to — Mosaic Publications (Dept. H.W.1.), 124 Newport Street, Bolton.

DO YOU DOODLE? Then you have creative ability. Read "Make Art Pay" (sent free). This fascinating booklet shows how doodling can be turned to profitable artistry, quickly, easily and with ready sale through us. **CLUN VALEY FEATURES**, Castle Gallery, Clun, Shropshire.

Further reduced

Brand New LUXURIOUSLY QUILTED 'QUILTERFOAM' SLEEPING BAGS
Slip into it — soft and comfy — enjoy restful sleep throughout night. No blankets, no sheets, everything in one including special padding for a beautiful soft mattress effect. Light as a feather, it rolls up to a tiny lightweight size. 19/11, post 2/6. Even finished in heavy quality strong material. Really hardwearing. Not a blanket with outer, but genuinely quilted. Refund guaranteed.



Sent for 10/-, bal. **1/2 PRICE OFFER!** The FLIGHT LIEUTENANT Genuine NEW TENTS
18 fortnightly payments 8oz. 7/1. Plus DUCK carr.

Waterproofed 1960 Tents of 8 oz. WHITE Duck. Galeproof. Brand new surplus to export order. DON'T CONFUSE with Tents made from drab material never meant for tentage. This is real thing, withstands anything even in our climate. Approx. 7 ft. 6in. x 6ft. x 6ft., 3ft. walls. Cash £5/19/6, carr. 6/- complete ready to erect, incl. valise. 'Willesden' Green 42/- ex. Ridgepole if req. 7/6 Fly-sheet 39/6 Rubberised Groundsheet 19/6. These essentials sent on appro. Refund guaranteed. LISTS, TENTS.



Headquarter & General Supply Ltd. (HOBV/11) 196-200 Coldharbour Lane Loughboro Junc., London, S.E.S. Open Sat.

LEARN RADIO & ELECTRONICS the NEW Practical Way! Very latest system of experimenting with and building radio apparatus — 'as you learn'. FREE Brochure from: Dept. H.W.10, Radiostructor, 40 Russell Street, Reading, Berks.

WHEELS (Hardwood and Rubber Tyred Metal). Cot, Pram and Doll's house Fittings and Papers, Beads, Transfers, Prints and other accessories. Stamp for new lists. (Trade supplied.) New address — JOYDEN CO., 91 Peplins Way, Brookmans Park, Herts.

FREE SEEDS go to our happy members all over the British Isles, and parents are joining too. Satisfaction Guaranteed. Subscription 2/6. Send your postal order now to — **YOUNG GARDENERS' CLUB OF GREAT BRITAIN**, 9 Newnham Road, Wood Green, London, N.22.

★ LEARN ★ RADIO & T/V SERVICING for your OWN BUSINESS/HOBBY

● by a new exciting no-maths. system, using practical equipment, recently introduced to this country.

FREE Brochure from : —
RADIOSTRUCTOR
DEPT. G81, 46, MARKET PLACE,
READING, BERKS. 29/6

AGENTS WANTED

Large private Christmas Card Company has few vacancies for agents (spare time). Tremendous scope and excellent profits to be made by keen agents; wide range of best selling designs; reasonable prices. Write for further details without obligation to: **GARRICK CARD CO. DEPT. 6, AVENHAM STREET, PRESTON, Lancs.**

GLASGOW

DO YOU KNOW?

HOBBIES LTD. have a branch at 326 ARGYLE STREET where the manager and staff are always willing to give you the benefit of their experience with any of your handicraft problems. Why not pay a visit?

APPARATUS & CHEMICALS

For your experiments. Let us help you equip a **HOME LABORATORY**

Beakers, Crucibles, Flasks, Funnels
Gas Jars, Test Tubes, etc.

Booklets:

(including postage)

'Experiments' 1/2
'Formulas' 1/2
'Home Chemistry' 2/10

New edition

Send 3d. Stamp for latest PRICE LIST

A. N. BECK & SONS (Dept. H.W.)

60 Stoke Newington High Street, London, N.16



HEAR ALL CONTINENTS With H.A.C. Short-Wave Receivers

Suppliers for over 18 years of radio S-W Receivers of quality.
One-Valve Kit, Price 25/- **Two-Valve Kit, Price 50/-**
Improved designs with Denco coils. All kits complete with all components, accessories and full instructions. Before ordering, call and inspect a demonstration receiver, or send stamped addressed envelope for descriptive catalogue.
'H.A.C.' Short-Wave Products (Dept. 22), 11 Old Bond Street, London, W.1.

A HANDY GLASSPAPER BLOCK

A wooden block with special handle which holds glass-paper taut and always in place. In two sizes, 3in., price 1/9 (post 6d.); 5in., price 3/- (post 9d.).

HOBBIES LTD., DEREHAM Norfolk, and all Branches



Hints on Riverside Camping

BOATING and camping are pastimes that seem to go together naturally. Even if one owns a cabin cruiser, it is always handy to have camping gear on board, in case there is more crew than there is sleeping accommodation for.

The type of equipment required depends on the craft being used. Canoeists, for example, should use similar equipment to cyclists. In case of larger craft, such as punts, dinghies, and cabin cruisers, more spacious camping equipment can be used, since there is more storage space.

By G. Gompers

However, whatever the equipment used there are a few simple rules to observe for the camper's personal comfort and safety. Observe the high flood mark, as shown by the bits of dead grass, leaves, and mud along the brush on the water front, and camp well above it. Do not camp under trees with dead limbs. Rather camp in the open where your tent will dry quickly after rain and dew, and where there is no danger of falling trees.

When on a camping tour, the boatman should always get an early start, so he can reach his prospective camping site in time to have plenty of daylight for setting up his tent. As far as canoeists are concerned, the luxuries of a fixed camp are out of the question, for everything has to be stored away in some part of the canoe, and bulk and weight are a chief consideration. A canoeist would be well advised, in planning a tour, to jot down beforehand those items which are really necessary and, taking into consideration the space available, and the conditions likely to be encountered, to make necessary adjustments.

The choice of a site is rather a tricky question, as often there is hostility to campers by some navigation authorities. This is often caused by local vandals giving campers a bad name. It is surely no coincidence that an area where local vandalism is at its worst is where the anti-camping rules are the strongest. I am referring in particular to the River Wey, my own particular territory.

Some country folk, fortunately in the minority, are fond of telling you what tremendous harm is done by Londoners when they get into the country. However, I have found, as far as the riverside goes (and I know of more than one

navigation officer who would support my opinion), that the greatest amount of damage is done by youths from the nearby towns. The Londoner, or anyone from a big city, is quite often too much a genuine country lover to be really vandalistic, whatever damage might be done out of sheer thoughtlessness. Be that as it may, campers get the blame — and are banned. Consequently, on more than one piece of riverside common land there is a forbidding notice: 'CAMPING STRICTLY PROHIBITED.'

There is a tendency among boat campers to regard islands as no man's land; and certainly if one camps on one he is almost sure of a trouble-free repose — free from intruders, both human and animal. But river islands are owned by someone, or they are under some navigation authority, and if there are 'NO CAMPING' signs on the banks, you can be sure that they refer to islands as well, with similar penalties involved for offenders.

Although legally it is permissible to camp at night on tow paths, for obvious reasons they should be avoided. Often, especially from the point of view of privacy, the opposite side to the tow path is preferable. After a certain number of feet from the banks, and well beyond the tow path, quite often the ground ceases to be common land and becomes private property. There is no hard and fixed rule about this, as many of our rivers and tributaries run through large stretches of common land.

The laws about camping on common

land are fairly simple. Generally the only common land you cannot camp on has signs all over the place to that effect. But it is not always easy to tell common land from private property. For example, a park might seem to be common land, yet I can think of at least one riverside park, very much frequented by the public, but which is very much private property. To be on safe ground, it is always best to get permission to camp from some responsible person; or (as in most cases of privately-owned land) from the farmer.

The advantages of camping by the river, whether boating or not, are many. When pitching the tent, it should be placed as near the water's edge as possible, for convenience of washing and the morning dip. One of the great disadvantages (although it is not always the case) can be the lack of any decent fresh water supply. Many riverside campers have found themselves very much in the position of the ancient mariner in Coleridge's poem, with: 'Water, water, everywhere, nor any drop to drink'. Many campers, including the writer, feel a little squeamish about drinking river water, or even water from a fast-flowing stream, however clear it may be, even if it has been boiled or put through some home-made purifier. Canoeists, when selecting a site for camping, should, therefore, try and choose a spot near to a fresh-water supply; those who are touring in large boats can conveniently carry a substantial supply of fresh water.

THE prickly pear represents the popular conception of a cactus, and the name can be applied to a number of related species. The name actually refers to the fruit, which is pear-shaped and covered with a prickly skin. When this is removed, the fruit of many species is edible and is sold in the markets of countries in which the plant grows freely. Although growing readily in Africa, from whence it has been imported, this cactus is a native of the American continent, in common with almost all cacti.

The flat 'pads' are in reality the stems, and the spines modified leaves. The plant is adapted for living in desert areas with only a small annual rainfall, and is, therefore, able to survive long periods of drought. Since the pads can easily be detached, and each is capable of rooting and forming a fresh plant, this cactus will spread rapidly under suitable conditions, as has happened in Australia. (P.R.C.)

PRICKLY PEAR

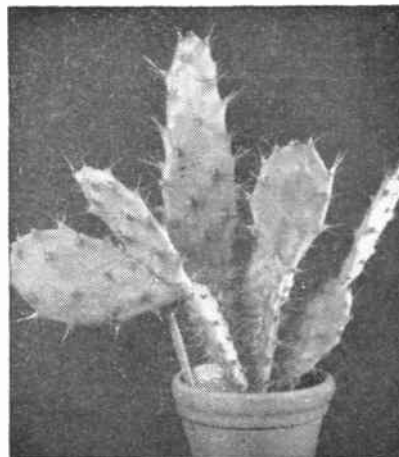

Single seat and two seat CANOES

COMPLETE AND READY
FOR THE WATER — OR
IN KIT FORM TO MAKE
YOURSELF

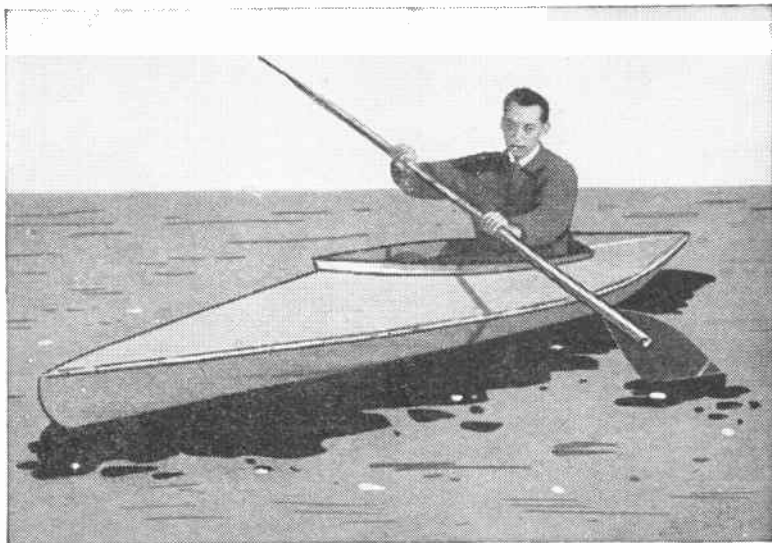

THE PBK 10 SINGLE SEATER

These popular craft are designed by that well-known authority, P. W. Blandford. With canvas skins, they are propelled by double-bladed paddles and are thoroughly at home on lake, river or canal — or even on the sea in experienced hands. They are offered as complete canoes, or as specially prepared kits, which include full building instructions. Easy terms are available, subject to the completion of a simple form of Agreement.

PBK 10

Single seat — 11 ft. long
28 in. beam — load 300 lb.

COMPLETE CANOE (without paddles)
CASH PRICE £24.5.0 (part p. & p. £2 extra),
or EASY PAYMENTS £6 DOWN (plus £2
part p. & p.) & 6 monthly payments of £3.4.8.

COMPLETE KIT (except paint and
varnish and without paddles)
CASH PRICE £15.10.0 (part p. & p. 15/- extra)
or EASY PAYMENTS £4 DOWN (plus 15/-
part p. & p.) and 6 monthly payments of £2.0.9.

DOUBLE-BLADED PADDLES, 47/6 Complete (part p. & p. 2/6 extra)

PBK 20

Two seater — 15 ft. long
32 in. beam — load 700 lb.

COMPLETE CANOE (without paddles)
CASH PRICE £32.10.0 (part p. & p. £2.10.0
extra), or EASY PAYMENTS £8 DOWN
(plus £2.10.0 part p. & p.) & 6 monthly pay-
ments of £4.6.9.

COMPLETE KIT (except paint and
varnish and without paddles)
CASH PRICE £22.5.0 (part p. & p. 20/- extra)
or EASY PAYMENTS £5.10.0 DOWN
(plus 20/- part p. & p.) & 6 monthly payments
of £2.19.4.

(DEPT. 99)

DEREHAM



NORFOLK

Budgerigar

OUR FRIEND, the

THE original budgerigar was green. By selection and breeding this has been split into its component colours, i.e. blue and yellow. Thus we now have three basic colours, blue, green, and yellow. But, as can be expected, green is the predominant colour.

The three colours each have light, medium, and dark shades. Fig. 1 shows the 'tree', and the names of the three classes in each group. These colour varieties do not all breed true to colour: for example, if we mate an olive green with a mauve, we get young all of which are olive green (Fig. 2). Similarly, if we breed a light green with a sky blue we get young of light green. This is because the green is dominant.

However, in their own group, if we mate a light with a dark we get offspring of a medium shade, as shown in the two examples in Fig. 3.

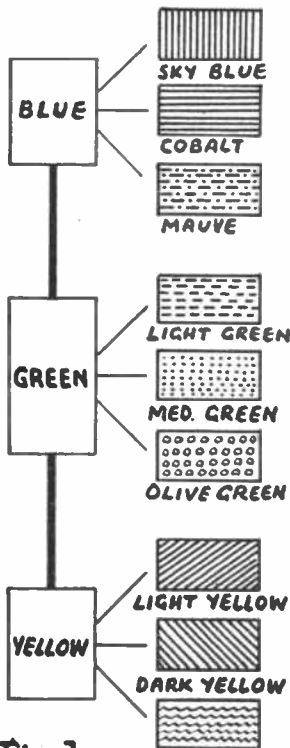

Fig. 1. The Family Tree.

It takes the second or third generation to produce colours more or less similar to the pair that are breeding. An example is shown at Fig. 4. The light green mated with the sky blue first produce young of light green. However, the young of the match if mated again with a sky blue can be expected to produce a brood half of which are light green, and half sky blue.

4—BREEDING FOR COLOUR

In the blue class, the mauve is rather a misnomer for the colour is more of a pinkish-grey, and somewhat disappointing to anyone rather intrigued by the title.

If you have an aviary and propose to try breeding for colour, it is best to 'ring' the young bird's legs as soon as they leave the nest, or to separate those birds which you propose to use for breeding a new colour.



FIG. 2. GREEN DOMINANT

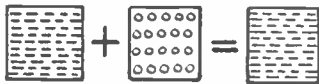

FIG. 3. LIGHT and DARK PRODUCE MEDIUM



FIG. 4. SECOND GENERATION PRODUCES EQUAL NUMBERS



Budgerigars are, on the whole, healthy, robust creatures. They are, however, susceptible to minor ailments, and a few of more serious nature.

1. ENTERITIS. — This is characterised by a general air of lassitude and diarrhoea. The bird sits on its perch looking very dejected, its head under its wing, and its feathers fluffed out. If left unattended the disease can be fatal. The cause is usually through feeding the bird with tit-bits such as potato, cake, etc, containing too much starch. Enteritis can also be part of a general chill.

Warmth and rest is the treatment. The bird should be placed near a fire with all but the front of the cage covered with a cloth. A little powdered bismuth carbonate should be sprinkled on its feed.

2. EGG-BINDING. — Occurs mainly to hens when they are allowed to mate in cold weather, such as at the beginning and end of the year. Here, prevention is better than cure. Cod liver oil should also be added to their feed during the mating season.

The treatment is the same as for enteritis. In an emergency, the bird should be wrapped in a warm towel, and held near the fire. The egg will normally be laid under these conditions. Whilst some people advocate holding the bird over a jug of hot water, this can be dangerous, as the steam may give the bird a chill.

3. OVERGROWN BEAK AND CLAWS. — These should be cut periodically with a nail clipper, care being taken not to cut too short.

4. FITS. — During hot weather, particularly where birds are in cages at windows, and being subject to the hot sun, they take fits. Here again, prevention is better than cure; the cage should not be placed in hot sunshine.

The treatment is to cover the cage completely with a dark cloth, and the bird left quietly to recover. Sudden noises or movement should be avoided. After a few hours the cloth can gradually be removed, when usually the bird has completely recovered.

Instructions for building a portable 2-valve radio will be given in next week's issue. Also, making back-rests for comfort on the beach, patterns, and other feature articles. Make sure of your copy.

Pattern for a Pencil Holder

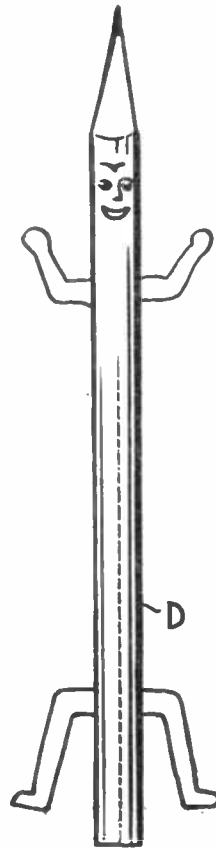
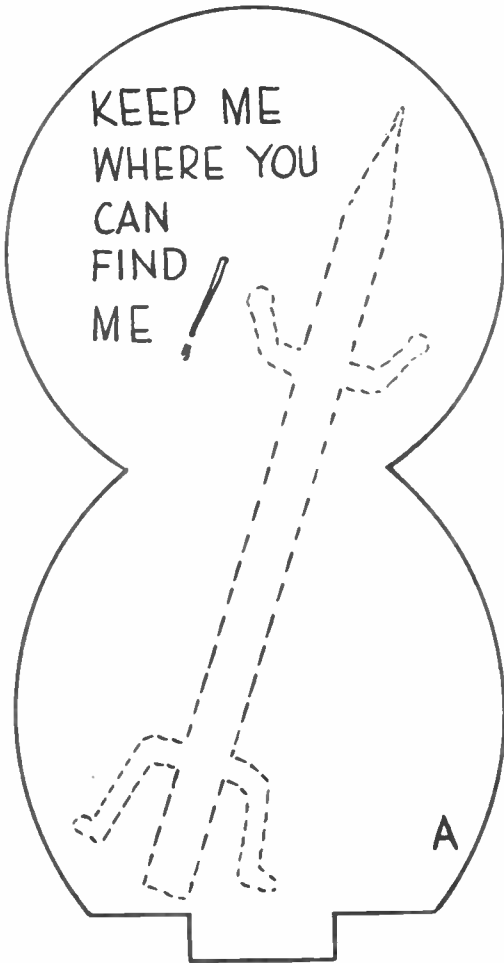

CUT one of each piece A, B, and C from $\frac{1}{4}$ in. wood, using a fretsaw. Be careful to hold the saw upright while cutting.

Clean up with glasspaper and glue the pieces together, as shown in the sketch. This view, showing the back of the holder, indicates the position of each piece. The overlay D is cut from $\frac{1}{4}$ in. wood and is glued to the front of piece A.

Paint with glossy enamel and paint in the wording on the front with a contrasting colour. (M.p)

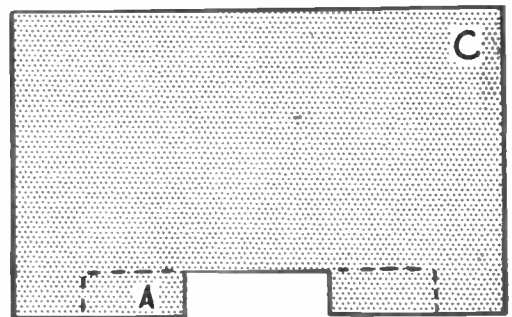
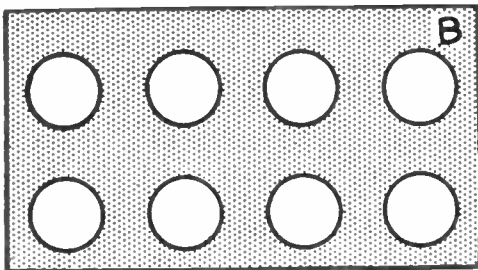
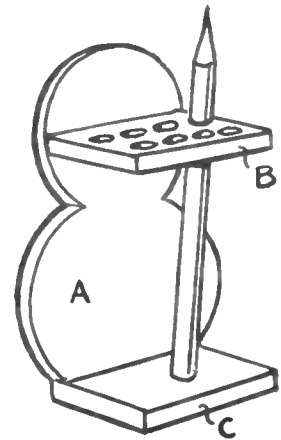



DESIGN No. 3368

THE ST. CLEMENT DANES MUSICAL OFFERTORY OR MONEY BOX

(SPECIALLY SUITABLE FOR CHURCH
RENOVATION FUNDS, ETC.)

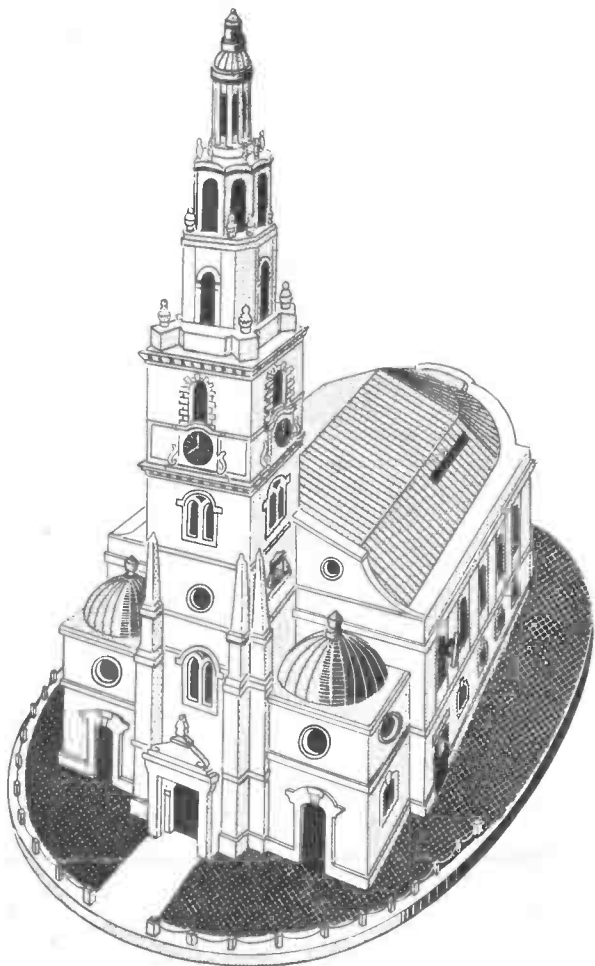

SIZE $9\frac{3}{4}$ ins. HIGH
BASE
 $11\frac{1}{2}$ ins. BY $6\frac{3}{4}$ ins.

POSTS 52.
CUT EIGHTEEN
FROM $1/16$ in. sq.
BALSA STRIP.

PIECES 1. CUT TWO
 $1/4$ in.

THE ARROWS INDICATE
DIRECTION OF GRAIN
OF WOOD.

REMOVE THIS PA

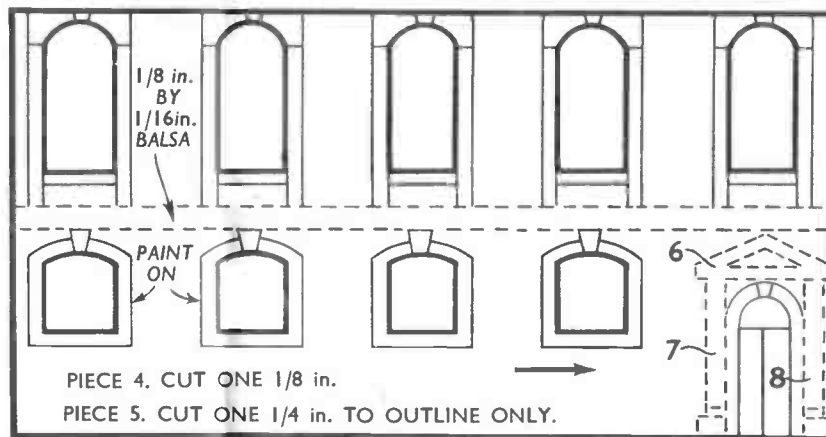

NOTE. TRACE OR CUT TO THE OUTSIDE OF ALL THICK L

PIECES 9. CUT TWO $1/4$ in.

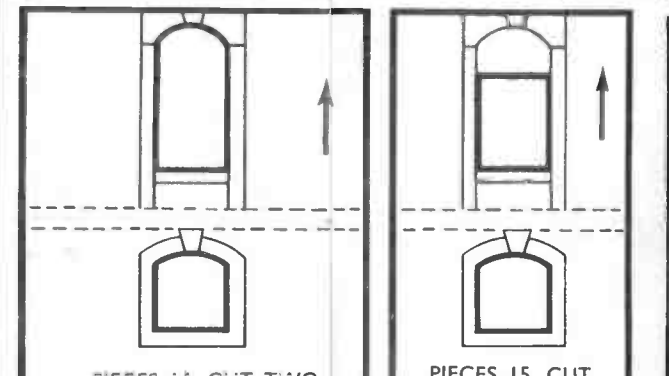
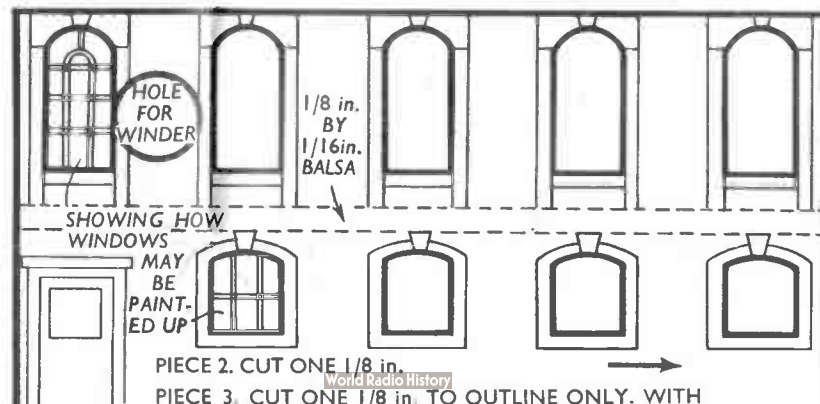

ARROWS INDICATE
DIRECTION OF GRAIN
WOOD.



REMOVE THIS PANEL.

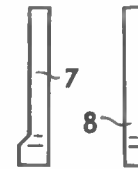

PIECES 7 AND 8.
CUT ONE OF
EACH 1/8 in.

PIECES 41.
CUT EIGHT.
1/8 in.
ROUND OFF.



PIECES 10. CUT TWO
1/4 in.

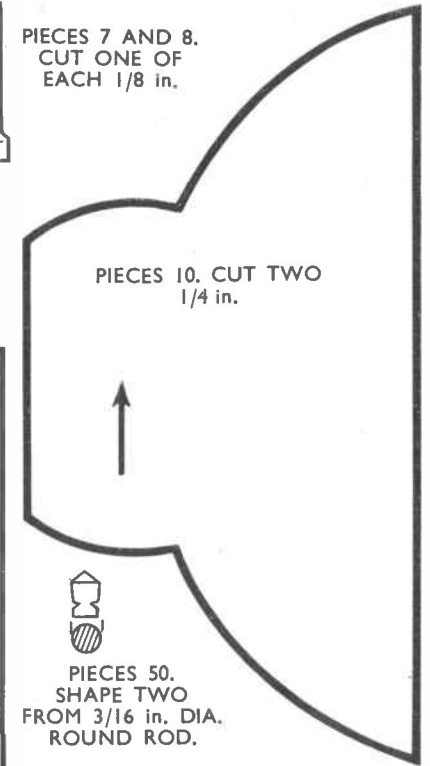

PIECE 13.
CUT ONE 1/4 in.
SHAPE EDGES
TO SECTION.

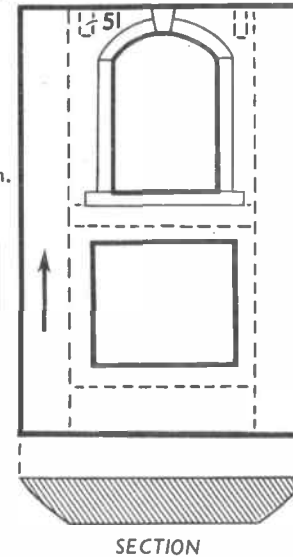

PIECES 50.
SHAPE TWO
FROM 3/16 in. DIA.
ROUND ROD.

POSTS 53.
CUT FOUR 1/8 in.

NOTE. TRACE OR CUT TO THE OUTSIDE OF ALL THICK LINES.

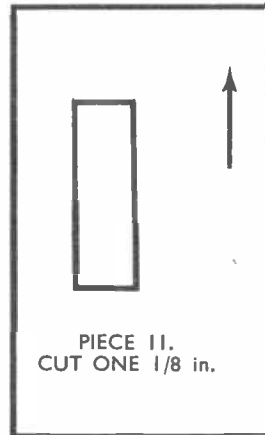

PIECE 11.
CUT ONE 1/8 in.

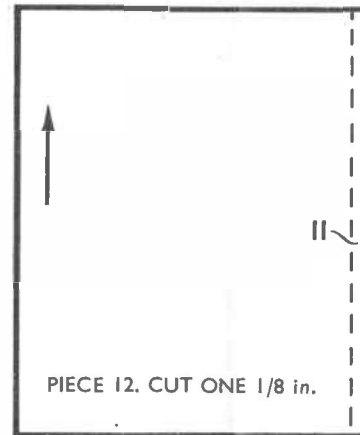

PIECE 12. CUT ONE 1/8 in.

PIECES 9. CUT TWO 1/4 in.

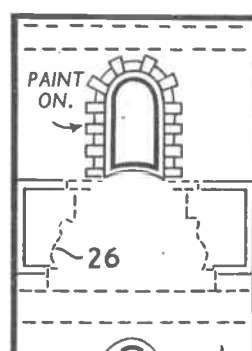
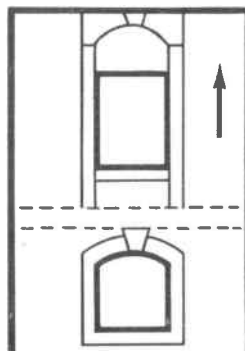
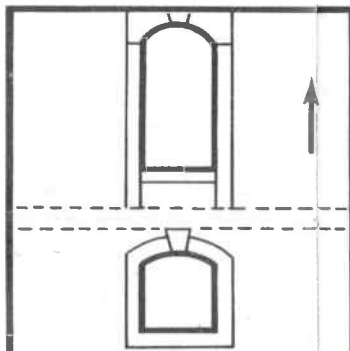

PAINT
ON.

26

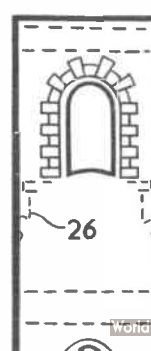

26

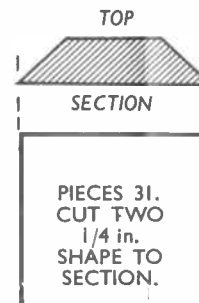

PIECES 31.
CUT TWO
1/4 in.
SHAPE TO
SECTION.

30

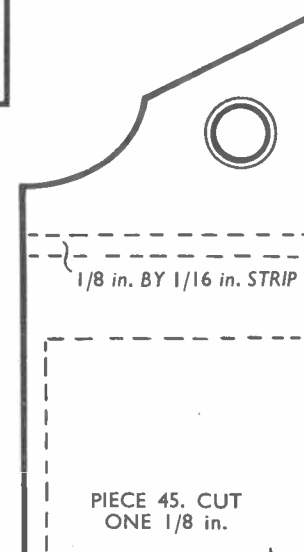

PIECE 45. CUT
ONE 1/8 in.

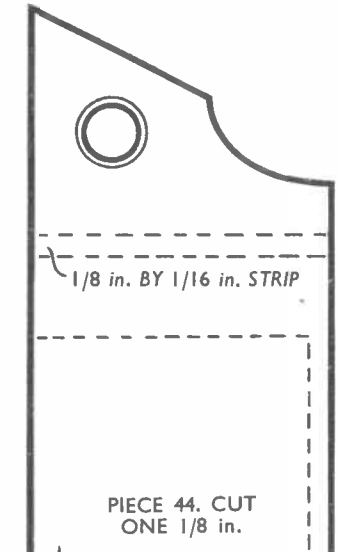

PIECE 44. CUT
ONE 1/8 in.

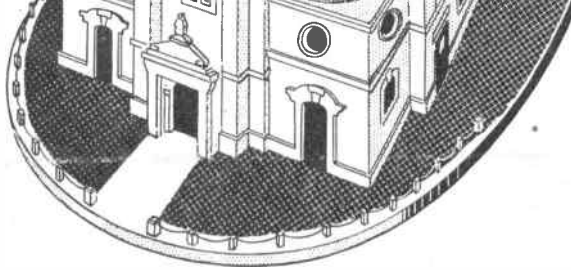

A KIT OF MATERIALS FOR MAKING THIS DESIGN IS SUPPLIED BY HOBBIES LIMITED, DEREHAM, NORFOLK PRICE ON APPLICATION

THE WORLD'S STRONGEST GLUES
Stick it with-
Croid
UNIVERSAL

A cold glue of great strength—for wood, leather, cardboard, plastic, etc. Made to B.S. specifications. Large tube 1/2d, 8 oz. tin 2/10d, 1 lb. tin 4/6d.

BUY CROID FROM YOUR LOCAL HOBBIES BRANCH



CLOCK FACES 26. CUT FOUR 1/8 in. DETAIL SHOULD BE PAINTED ON.

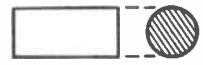

PIECE 36. CUT ONE FROM 1/4 in. DIA. ROUND ROD.

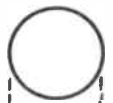

PIECE 37. CUT ONE 1/4 in. ROUND OFF TO SECTION.



PIECES 40. CUT FOUR 1/8 in. AND ROUND OFF.

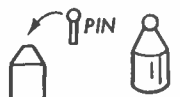

PIECE 39. CUT ONE FROM 3/16 in. DIA. ROUND ROD.



PIECE 6. CUT ONE 1/8 in.

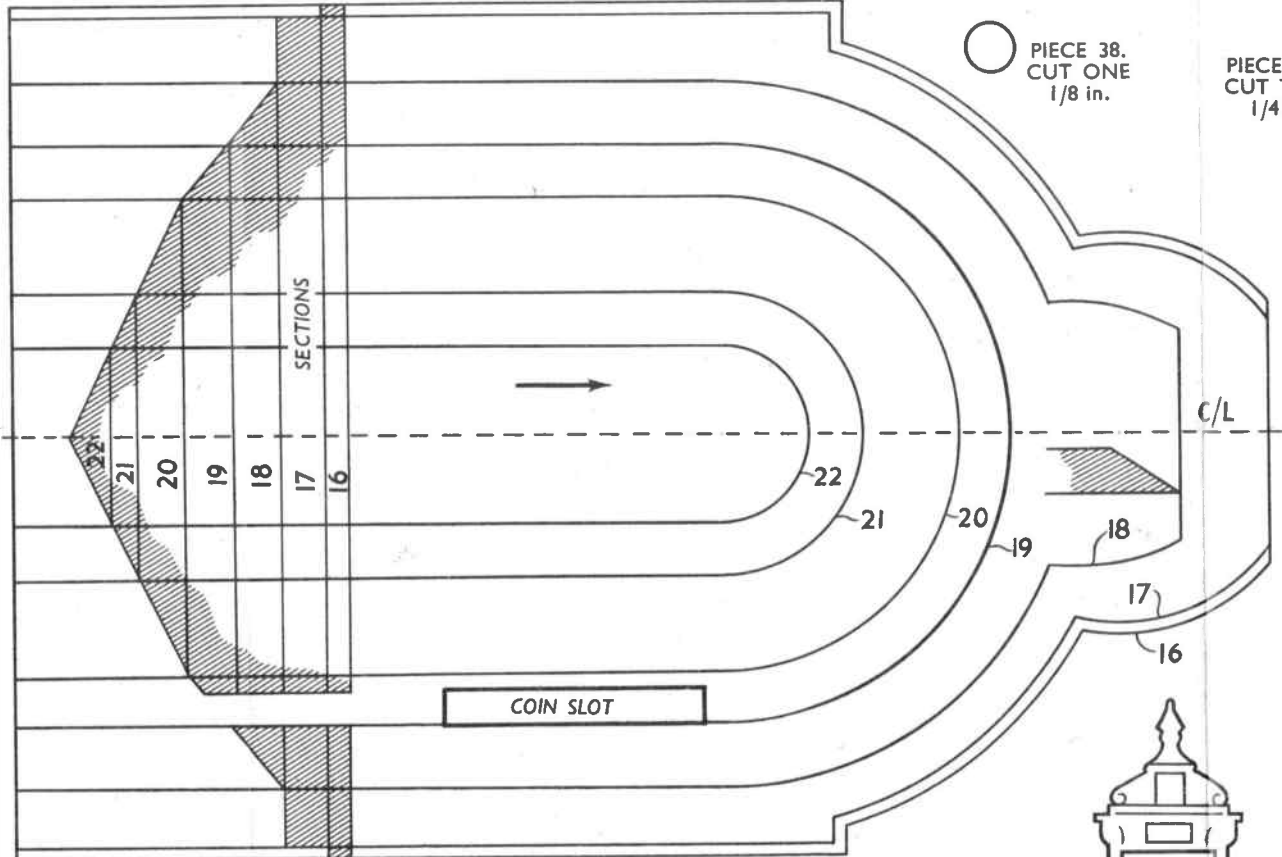
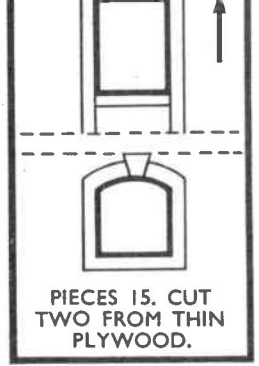
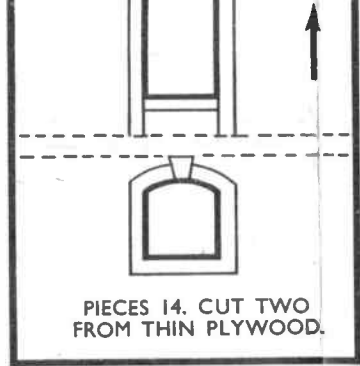
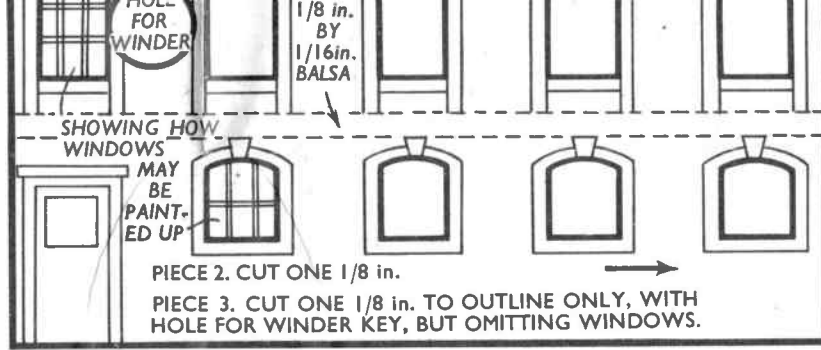

PIECES 16 and 21. CUT ONE OF EACH 1/8 in.

PIECES 17, 18, 19, 20, AND 22. CUT ONE OF EACH 1/4 in.

THE COIN SLOT IS CUT IN PIECES 16, 17, 18, AND 19.

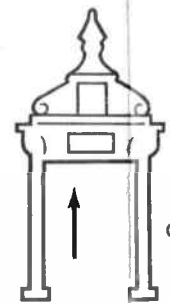
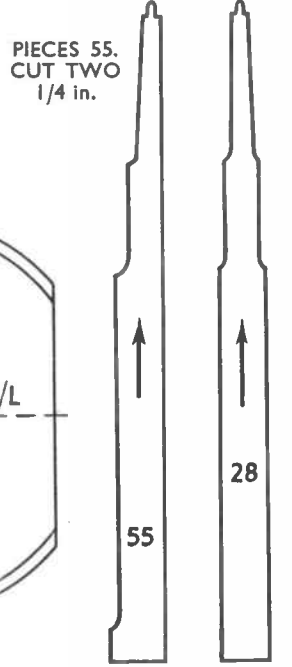

PIECES 54. SHAPE EIGHT FROM 1/16 in. sq. BALSA.

PRINTED IN ENGLAND.

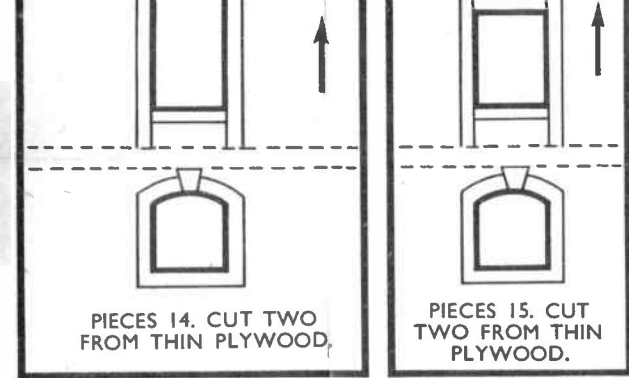

PIECES 14. CUT TWO FROM THIN PLYWOOD.

PIECES 15. CUT TWO FROM THIN PLYWOOD.

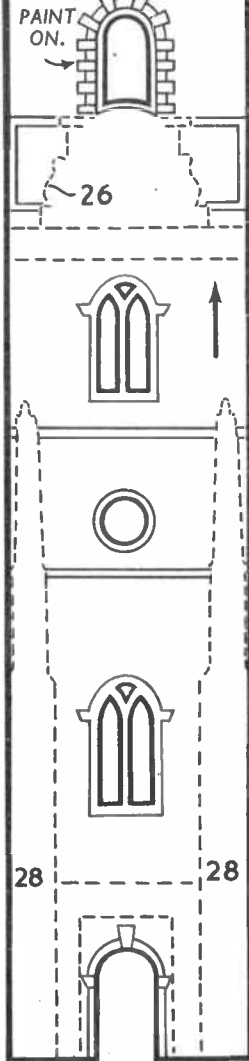

PIECE 23. CUT ONE 1/4 in.
PIECE 24. CUT ONE 1/4 in. OMITTING DOOR AND TWO LOWER WINDOWS.

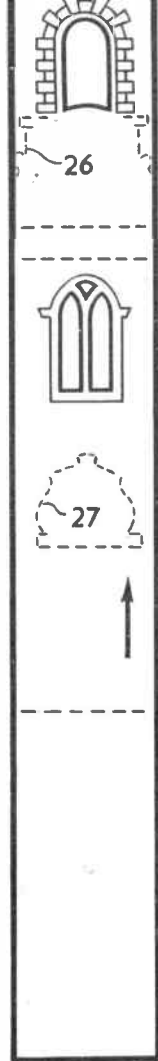

PIECES 25. CUT TWO. 1/4 in. (THE SUNDIAL IS ON ONE SIDE ONLY.)

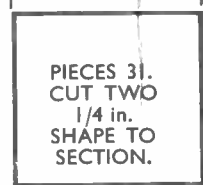

PIECES 31. CUT TWO 1/4 in. SHAPE TO SECTION.

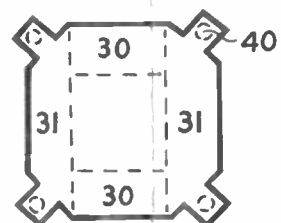

PIECE 29. CUT ONE 1/4 in.

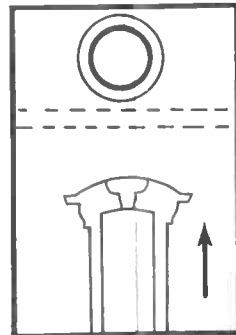

PIECES 46. CUT TWO 1/4 in.

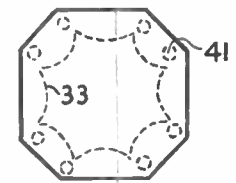

PIECE 32. CUT ONE 1/8 in.

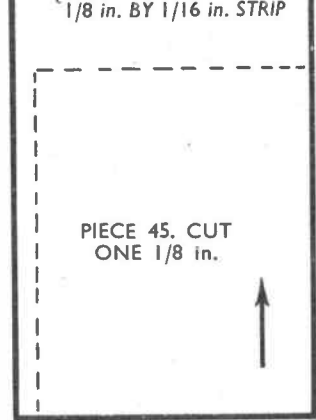

PIECE 45. CUT ONE 1/8 in.

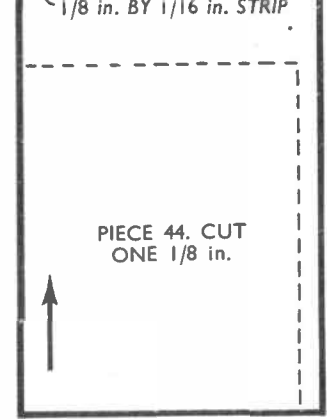

PIECE 44. CUT ONE 1/8 in.

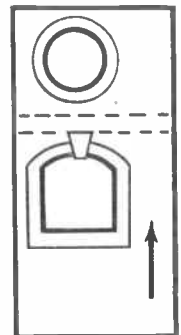

PIECES 47. CUT TWO 1/4 in.

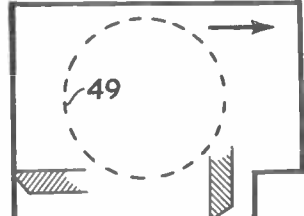

PIECES 48. CUT TWO 1/8 in. CHAMFER TWO EDGES TO SECTION.

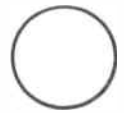

PIECES 35. CUT TWO 1/8 in.

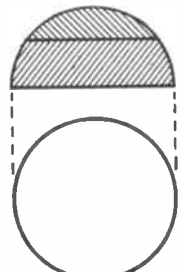

PIECES 49. CUT FOUR 1/4 in. AND GLUE TOGETHER IN PAIRS.

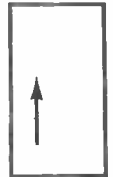

PIECES 30. CUT TWO 1/4 in.

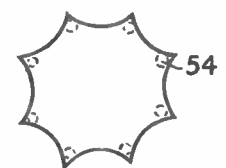

PIECE 54. CUT ONE 1/8 in.

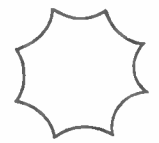

PIECES 33. CUT THREE 1/4 in.

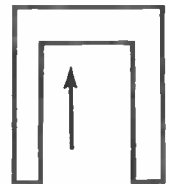

PIECE 42. CUT ONE 1/4 in.

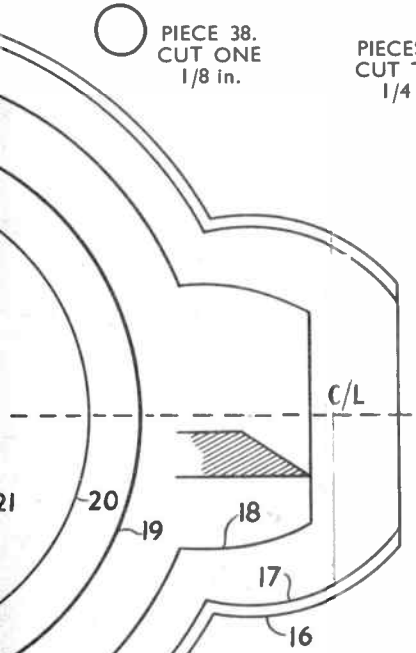

PIECE 38. CUT ONE 1/8 in.

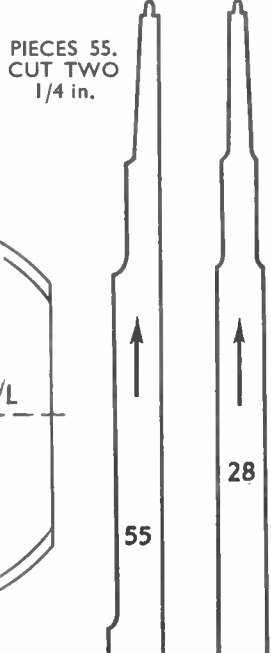

PIECES 28. CUT TWO 1/4 in.

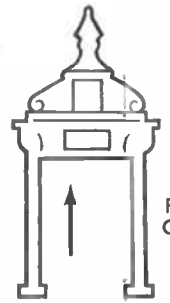

PIECE 43. CUT ONE 1/8 in.



SUNDIAL 27. CUT ONE 1/8 in.

PIECE 51. CUT ONE 1/8 in.



PRINTED IN ENGLAND.