

HOBBIES WEEKLY

MARCH 11th 1959

VOL. 127

NUMBER 3306

IN THIS ISSUE,

	Page
Pair of 'Galleon' Candlesticks	369
'Decorette' Nameplates	370
Making up the 'Galleon' Candlesticks	371
Free-Standing Fitment for a Four-Poster	372
Sundial for a South Wall	373
Chemistry in the Home	374
Movable Bookshelves	375
Mainly for Modellers	376
Cutting Film in the Dark	378
Easter Eggshell Gardens	378
Collectors' Club	380
Alone — or in Company?	382
Patterns for Egg Novelty for Easter	383



All correspondence should be addressed to the Editor, Hobbies Weekly, Dereham, Norfolk

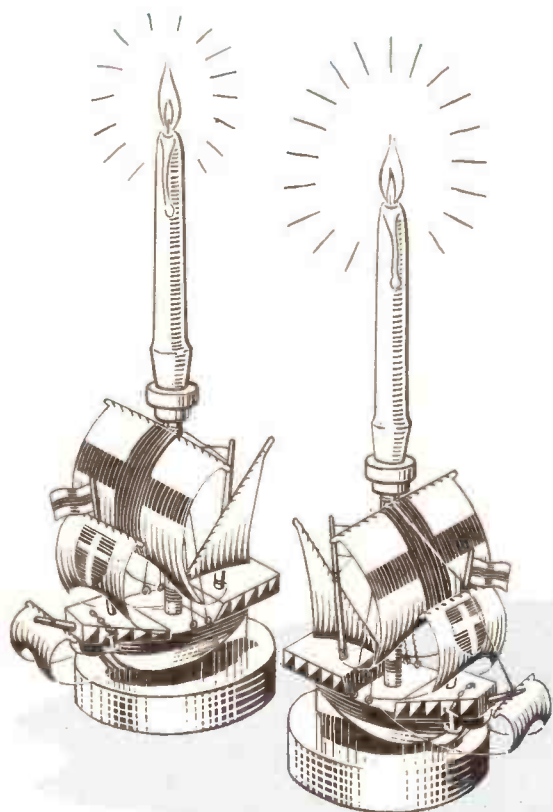

*For charm and novelty
in the home*

PAIR OF 'GALLEON' CANDLESTICKS

*Make them from
FREE design and full
instructions inside*

369

FOR ALL HOME CRAFTSMEN
Over 60 years of 'Do-it-Yourself'

World Radio History

4¹/₂^D

'Decorette' Nameplates

WITH the advent of alphabet transfers, such as 'Decorette' No. 154, the lettering of nameplates is much simplified. Most of us, at some time or another, need a nameplate, perhaps for the house, or to title a model, and not everyone can claim to paint lettering with any chance of fair comparison with professional work. This is where transfer letters prove to be invaluable.

shown in Fig. 2. This strip, by the way, should be previously cut along line (C), and the lower portion, not being wanted, thrown away. It is then pinned to the board or plate, as shown in Fig. 2.

Remove paper backing of the transfer letter and press down firmly to the board. Adjust with the tweezers, if the letter is not positioned truly straight. All the letters completed, the paper guide can be removed, and the nameplate set aside to dry for an hour or so.

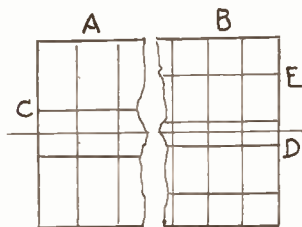

Fig. 1

Even with these, however, to produce the best results some kind of guide to ensure alignment of the letters is necessary, and by carefully reading the following tips, a good job will result.

Applying the letters

Dealing with a house nameplate, as an example, cut a strip of paper about as long as the plate, and the same width. Down the centre draw two lines, $\frac{1}{4}$ in. apart, that being the length of the transfer letters to be used, as at (A) in Fig. 1. Divide into $\frac{1}{2}$ in. divisions by cross lines, and pencil in the name chosen, one letter in each division. An exception to this rule may be made with letters (I) and (J), these being much narrower. A space of $\frac{1}{2}$ in. will suffice.

Provide a saucer of water, and two pieces of absorbent material, one piece on which to lay the letters when removed from the water and absorb the surplus, the other piece (which should be damped) for wiping over the board or plate, previous to applying the letters. Cut the necessary letters from the transfer sheet, allowing very little surplus paper each side of the letter, and none at all at the top. Dip the letters, two or three at a time, in the water for a few seconds, then remove and place on the material for a minute or two for surplus water to drain off.

Wipe the plate with the damp cloth and pick up each letter in turn. A pair of tweezers will come in handy for this. Now slide the paper backing still on the transfer, about half-way off, then position the letter on the plate, with its top edge touching the paper strip, as

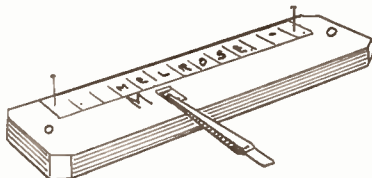

Fig. 2

If the name consists of two or more words, and a double line of lettering is necessary, mark out the guide strips as in (B), Fig. 1. Here two lines are drawn down the centre $\frac{1}{4}$ in. apart, and above and below these lines, $\frac{1}{2}$ in. apart for the lettering. Divide as before into $\frac{1}{2}$ in. vertical divisions. The bottom line of lettering must be affixed first, so cut along line (D) and remove the surplus below it. Position the strip on the plate as before, and fix on the letters. Then cut the second and top line of letters to complete.

The plate will, of course, have been previously painted or varnished, but a point to notice is that as the letters are provided with a black edging, do not use a dark colour of paint, or stain, or the edging will scarcely be perceptible. A light colour must be used; if stain is to be applied, then a light oak will suit nicely.

Alphabet in gold

With the alphabet mentioned, the makers include a second alphabet, this being in gold only. As the letters are $\frac{1}{2}$ in. long, not $\frac{1}{4}$ in., the lined spaces for them must, naturally, be $\frac{1}{2}$ in. also to suit. Incidentally, with these gold letters, a dark stained or ebonised plate is suitable, as it shows up the lettering to advantage.

A double sheet of Decorette alphabet and numerals is obtainable from branches or Hobbies Ltd., Dereham, Norfolk, price 2/3 (post 3d. extra), together with free illustrated leaflet showing a large range of other transfers.

(W. J. E.)

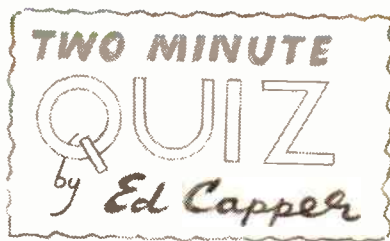

1



JOINING
TWO LENGTHS OF WOOD,
LIKE THIS IS - what?

2



IS THIS TOOL
FOR TIRED BRICKLAYERS?

3



NAME
THE LEAD
WORK AT
BASE OF
CHIMNEY
STACK

4



NAME THE JOINT

5

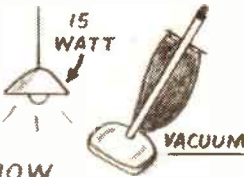

FOR HOW
MANY HOURS WILL THESE
TWO RUN ON ONE UNIT
OF ELECTRICITY?

ANSWERS ON PAGE 377

MAKING UP THE 'GALLEON' CANDLESTICKS

WHETHER for decorative effect or for practical use, this pair of galleon candlesticks would be a welcome addition to any home.

The colourful ship models are incorporated in the candlesticks, and in fact, the crow's nests of the mainmasts provide the holders for the candles. The candlesticks, which are 5½ ins. high, are an identical pair, and would make suitable ornamentation for the mantelpiece,

writing bureau or sideboard. With candles lit they would provide an added attraction for the party table.

All the parts which go towards the make-up of one candlestick are shown full size on the design sheet and will, of course, be repeated for the second holder. Enough materials to make the pair are included in Hobbies kit.

Trace and mark out the various pieces from the design sheet, and transfer them to their appropriate thicknesses of wood by means of carbon paper. Next cut them out with the fretsaw, and clean up well with glasspaper.

Make a start in assembly with the hull of the galleon. Piece B, which is cut as shown in Fig. 1, is shaped by rounding off the underside as shown in Fig. 2, and in the section on the design sheet. This piece B is glued on the side of piece C as shown in Fig. 3, and the second piece B is similarly shaped and glued on the opposite side of piece C.

Shape pieces D and E according to the sections on the design sheet, and glue them to the hull section (Fig. 4). Drill holes in the approximate positions shown to take the various masts.

Hobbies Kit No. 3306 contains sufficient wood, parchment for sails, chain, anchors, etc., for making a pair of Galleon Candlesticks. Price 5/4 from branches or Hobbies Ltd., Dereham, Norfolk (post 1/6 extra).

parent cement.

The hull can now be glued on to its base (A), ensuring that the ship stands upright. Cut the sails from parchment and paint them in the colourings suggested on the design sheet. The woodwork can be painted to taste. It is suggested that the base be black with the lower half of the hull white, and the upper half medium brown. Decks can be painted buff and lined in pencil to represent planking, while the masts and spars can be plain varnished. The decoration on the sides of the bulwarks (see main illustration) can be alternate white and green or white and blue triangles. Attach the small anchors which are provided in Hobbies kit by means of a small length of chain pinned to piece E.

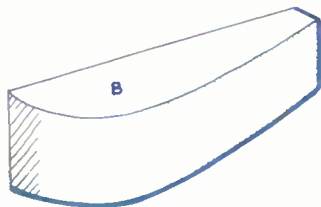

Fig. 1



Fig. 2

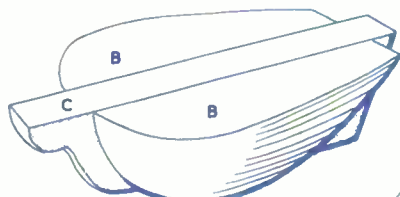

Fig. 3

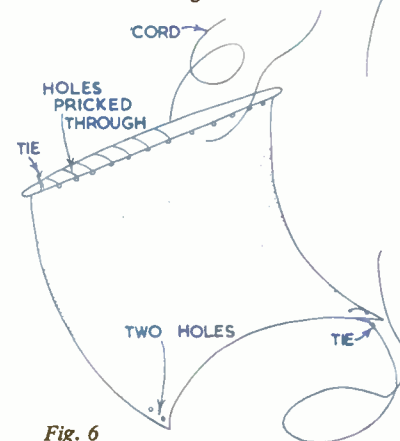

Fig. 6

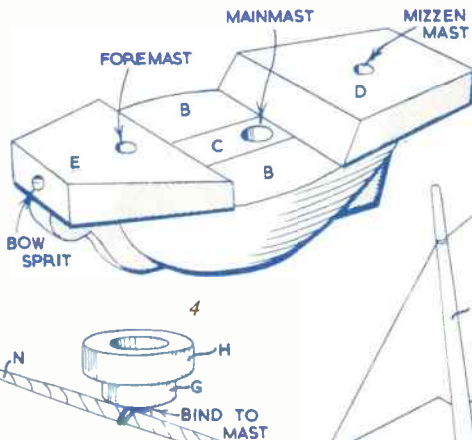

Fig. 7

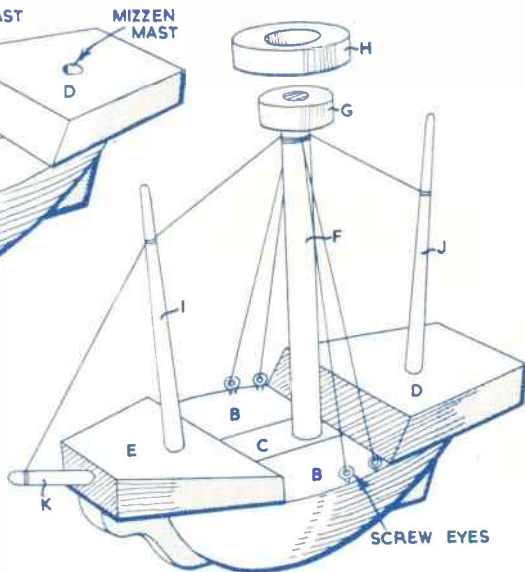

Fig. 5

Now glue the masts and pieces G and H in place. Note that the diameter of the inner circle of piece H should be adjusted to suit the size of candle which will be used, and which will be held in piece H.

Continue by adding the screweyes and attaching the standing rigging, as seen in Fig. 5. The rigging is simply wound round the masts in the appropriate places shown in Fig. 5 and tied off, finally securing with a dab of trans-

When all the paint is dry, the sails should be laced as shown in Fig. 6, which also shows how cords are attached at the bottom corners. Attach the sails by binding to the mast as seen in Fig. 7. To hold the sails in a realistic fashion, attach cords from the lower corners to appropriate places on the decks, screweyes or masts and give a billowing effect to the sails before fixing.

SUNDIAL FOR A SOUTH WALL

THE sundial is probably one of the oldest instruments made by man for measuring time, consisting of two parts only, a graduated scale indicating the hours and a stile, or gnomon, which casts the shadows. There is no mechanism to go wrong and the following will help you to construct a sundial for attaching to the south wall of your home.

You will need a piece of $\frac{3}{4}$ in. wood measuring 12 ins. by 12 ins. and although you may use plywood it is perhaps better to use the solid material if available. If plywood is used it is essential

FIG 1 TOE OF STILE

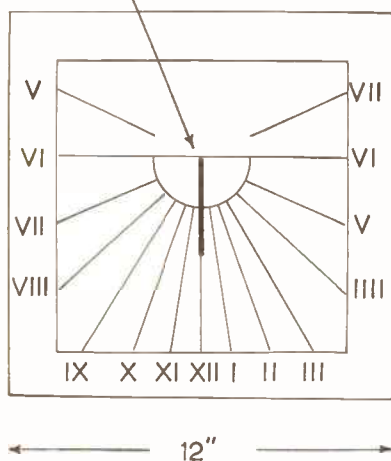

that it is thoroughly painted for protection against the weather, as there is always the risk that the cement may be softened allowing the layers to peel. Since also the sundial will be exposed to a great deal of sunlight we have to guard against any blistering of the paint. You are therefore recommended to prepare the wood ready for the stile, giving a thorough priming on the back, front and edges with aluminium paint, then two coats white paint and a finishing coat of gloss paint.

Before you can paint in the markings, or apply the paint, a slot must be cut with your fretsaw for fixing a stile and reference should now be made to Figs. 2A and 2B. This stile is made from a triangular piece of tin, or copper and the angle of 52° should be noted. You may use wood if adequate precautions are taken for preservation against the weather but any warping would affect the time recording and it is preferable to use sheet metal.

To the normal height of the metal stile add the width of the wood panel plus $\frac{1}{2}$ in. to act as a bracket. The latter portion is cut in the centre, drilled for screws, one-half turned to the left and

By H. Mann

the other to the right after pushing through the prepared slot and is then screwed to the back of the panel. The stile is painted black. It is most important that the basic angle is exactly 52° at the toe and Fig. 2B shows a suggestion for the ultimate shaping of the stile as often used. When fitting to the dial the toe is situated in the centre as shown in Fig. 1.

The next step is the marking of the dial in accordance with the specimen shown in Fig. 1. Your own dial will be considerably enlarged but you should have no difficulty in transferring the markings proportionately, using ruler and pencil. When this has been completed

On the 11th February clocks are $14\frac{1}{2}$ minutes before sundials; on the 2nd November they are $16\frac{1}{2}$ minutes after and it is only on 15th April, 15th June, 1st November and 24th December that they are alike! So you may check on any of these dates. This difference in the two methods of time measurement is caused by the elliptical orbit of the earth, combined with the inclination of its axis to the plane of the Ecliptic, causing the day by the dial to be sometimes half a minute more or less than 24 hours, which, when combined for several days, amounts to the aforementioned differences.

You should verify the position of the wall where the sundial is to be fixed by means of a compass, adjusting where necessary until it faces due south. It is hung with the toe of the stile pointing upwards as in Fig. 1 and you will find it a distinct advantage to arrange the fitting at noon when the cast shadow will fall directly down the 12 o'clock mark. You must also remember that when

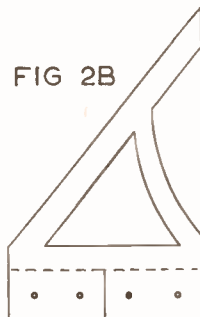
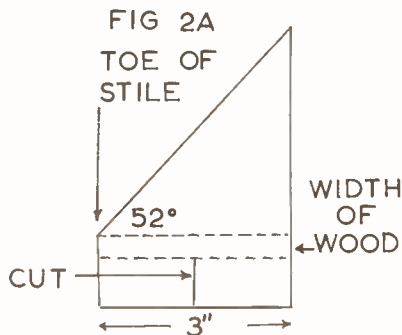

the lines and figures may be painted black or gold at your discretion. For the straight lines you may use the aid of a ruler and a lining brush or by using masking tape, stripping the latter away when the paint has dried.

Earlier we mentioned that this sundial is designed for a south wall and it should be noted that the slightest alteration will affect the time reading. It is accepted that the sun reaches its highest point at noon (ordinary time) and it follows that the period between sunrise and noon and the latter and sunset should be the same. Now the time shown on sundials is known as Apparent Time and that measured by clocks is termed Mean Time and we find a considerable difference between the two, so if your sundial does not agree with your watch it does not mean that it is wrong. Let us see how we may check the sundial.

Summer Time is in operation the sundial will only show the time as 11 a.m. and during this period true noon is at 1 p.m. It is possible to fix a sundial on other than a south wall but that will necessitate some adjustment of the markings involving many calculations.

At Seaton Ross in Yorkshire there is a large sundial occupying almost the entire wall of a cottage and at Walton in the same county is another marvel of calculation which records the time from all sides.

While the measurements shown in the diagrams are for a panel 1ft. square with a stile 3 ins. at the base, you may modify these to your own dimensions but remember that the two must be reduced or enlarged equally. If you only make a 6 in. dial, your stile must be $1\frac{1}{2}$ ins. For practical purposes you will find the dimensions given to be most suitable.

CHEMISTRY IN THE HOME

WHAT is the chemical difference between iron and steel? Merely the amount of carbon each contains. Pure iron, which is seldom met with, consists of iron alone. Commercial iron contains a variable amount. Carbon hardens iron. When the metal contains up to 2.5 per cent it is classed as steel (the proportion is generally 0.2 to 1.5 per cent). If the proportion is higher than 2.5 per cent, we have cast iron. The higher proportion of carbon has made the metal brittle, hence carbon content has to be carefully controlled. The addition of other metals produces steels for special purposes.

That iron contains carbon can be shown by pouring some dilute sulphuric acid on to some clean iron panel pins in a flask or large test tube. Warm the acid/iron mixture by immersion in hot water. (No flame, since inflammable hydrogen is given off). The acid attacks and begins to dissolve the metal, evolving bubbles of hydrogen. When action stops you will note black flecks floating in the solution. These consist of carbon, which is unattacked by the acid.

It is an interesting experiment to see what happens when iron rusts under controlled conditions. Loosely wrap some small iron nails (panel pins are very suitable) in a piece of wet cotton gauze. Tie the package to the end of a glass rod and put it in a test tube inverted in a beaker of water (Fig. 1).

Note what happens in the next few days. The water rises slowly and then remains stationary. Keeping the mouth of the tube under water, remove the rod and nails, close the tube mouth with your thumb, take it out of the water, and turn it right way up. Light a spill, remove your thumb and plunge the lighted spill into the tube. It will go out. This shows that the oxygen has been removed from the air, leaving nitrogen, which does not support combustion. On opening the gauze you will find the nails have rusted. Therefore oxygen is necessary for iron to rust.

A striking confirmation of this is easily obtained using two test tubes. Boil some water for a few minutes to drive out dissolved air. Nearly fill a test tube with water, drop in some nails and then run a thin layer of oil on to the surface of the water. The oil prevents the water redissolving air. In another test tube put some unboiled water and some nails. After a time you will see that the

nails in the boiled water have not rusted, whereas those in the unboiled water have.

It would seem from this that water plays no part in rusting. Let us test this. In a screw top jar put some iron nails and a small crucible containing calcium chloride. Insert a rubber disc in the screw top to make an airtight seal. The nails do not rust despite there being oxygen present in the air in the jar. The calcium chloride withdraws water vapour from air. Consequently, the air in the jar

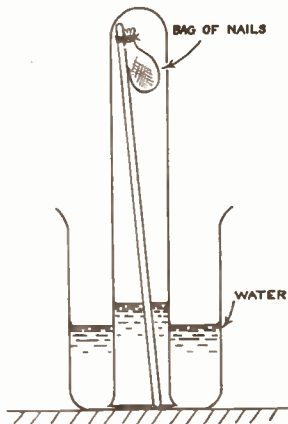

Fig. 1—Controlled rusting of iron

is dry. This experiment shows that water is needed for iron to rust.

Empty the jar and this time put in nails and some sodium hydroxide solution contained in a crucible and screw up tight. There is air in this jar and water in the form of sodium hydroxide solution. Yet you will be puzzled to note that no rusting occurs. This seemingly contradictory fact is easily explained when we remember that sodium hydroxide solution eagerly absorbs carbon dioxide from air. This finally shows us that for iron to rust the essentials are water vapour, oxygen and carbon dioxide.

The curious effects of heat on the metal are well worth examining. Take a piece of clock spring — about $\frac{3}{16}$ in. by 4 in. — and heat it to redness. Let it cool rather slowly, achieved by gradually raising it out of the flame. When it is quite cold you will find the spring has lost its characteristic property and can be bent at will into any shape and that it

Experiments with Iron

will retain that shape. If you file a piece of the untreated spring you will find it is very hard, whereas the treated spring is soft. This softening by heat is known as annealing.

Now heat the spring once more to redness, but this time quench it in cold water. Bend the metal sharply. It will snap. Quick cooling has made it brittle. Try to file it. It has become so hard that you cannot do so. This is steel hardening.

It will be clear from these two experiments that the form of iron we know as steel must be heated in some special way if it is to have rigidity, strength and hardness. Tempering is the name given to this process.

Straighten the steel hardened in the last experiment. Polish it bright with wet emery cloth. Lay it on a piece of sheet

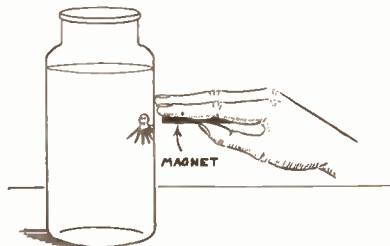

Fig. 2—The obedient octopus

iron and heat it slowly and evenly over a flame. The colour of the steel begins to change. First it is yellow, then orange, then blue. At the blue stage drop it into cold water. Remove it and bend it. It will have become a true spring once more and neither be too soft nor too hard when tested with the file.

By quenching at other colour stages, steels of varying degrees of hardness for specific purposes are obtained.

We all know of iron's magnetic properties. Here is an amusing variation. Put some iron filings into a bottle of water. Bring a magnet in contact with the glass near the filings and draw the magnet up the side of the bottle. The filings, despite the thickness of glass between, will climb with the magnet. On removing the magnet they fall back to the bottom. By cutting an octopus out of tinplate and using this instead of the filings you can amuse your friends by 'raising a monster from the deep' (Fig. 2). Colour the water with a little blue dye, conceal a small bar magnet under your fingers, and the trick has all the appearance of magic!

MOVABLE BOOKSHELVES

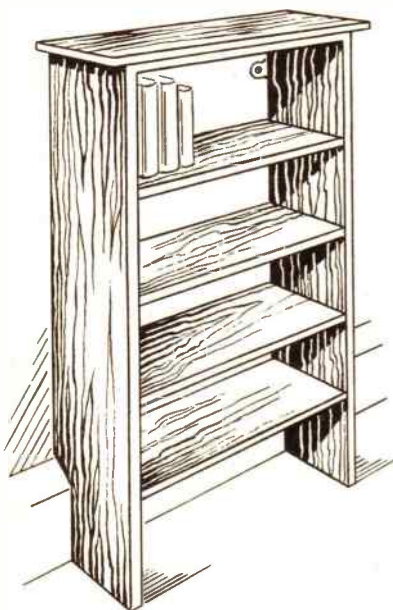

MOVABLE bookshelves that take little wall space can be easily constructed. With four shelves of various heights, books of many sizes can be accommodated, and the article still makes an attractive piece of furniture suitable for any room.

Apart from the extra top which requires a piece of five-ply wood, 25ins. by 10ins., the bookshelves are made of 9ins. by $\frac{3}{4}$ in. white pine or some other similar wood. 16ft. 9ins. will be required. In addition, a quantity of 2in. ovalbrad nails, a very small amount of putty, and two small glass plates are needed.

Allow for skirting

The two sides are first sawn from the white pine. These will each be 4ft. long. As the finished article will go right against the wall, a portion at the back must be cut out to allow for the skirting board of the room. As the heights and widths of skirtings vary in different houses, the cutting must be made accordingly. In the case of the illustra-

Next week — instructions for making a contemporary Standard Lamp incorporating a table, bookshelf and plantholder. MAKE SURE OF YOUR COPY

tion shown, the edge of the side was measured up 11ins., and $1\frac{3}{4}$ ins. further in from the edge another upward measurement was made of 9ins., and a slanting line drawn from the 11ins. mark down to the 9ins. mark. This piece is sawn out, leaving the sides shaped as in Fig. 1.

From the remaining white pine cut five lengths of 21ins. each, as in Fig. 2, to be used for the top and four shelves.

Fill nail holes

Taking one of the lengths, nail this against the extreme top of the side but on the inside. Use three 2ins. nails and nail from the outside of the side into the top. It is advisable to use ovalbrad nails, and after driving them in, place a small carpenter's punch and hammer it down on to the nails. This will sink them below the wood surface. The hole made is filled with putty, and when stained will be nearly invisible.

While nailing it is wise to place a box or some support under the far end or leg part of the side, as this takes the weight, holds the wood more level, and helps take the strain.

After securing the top to both sides, measure the places for the shelves. The first open space will be 7ins. Clearly mark this and then $\frac{3}{4}$ in., where the first shelf will be placed. From here measure down 7ins. to the second shelf and another $\frac{3}{4}$ in. The third space down should be $8\frac{3}{4}$ ins. Again mark the $\frac{3}{4}$ in. for the third shelf. The fourth space will be 9 $\frac{3}{4}$ ins., and then $\frac{3}{4}$ in. for the fourth shelf. The opening, below the bottom of this shelf mark, should be 11 $\frac{3}{4}$ ins.

Adding the shelves

It is best to nail in the last or fourth

shelf next, where the $\frac{3}{4}$ in. markings are made just above the 11 $\frac{3}{4}$ ins. When this shelf is secured in the same manner as the top, the box or support will no longer be necessary. The other two shelves are now nailed into place at the $\frac{3}{4}$ in. markings. The appearance will be as in Fig. 4.

The extra top to add attractiveness is next prepared. For this the five-ply wood measuring 25ins. by 10ins. is used as in Fig. 3. The two corners along one 25ins. edge should be rounded slightly with a plane and smoothed off with glasspaper. The edge between these two corners and the sides should also be smoothed or rounded.

Keeping the extra top flush at the back, make certain it overlaps equally on each side. Nail this top with four nails each side, so that the nails go down into the sides, but be careful to avoid the nails coming in from the side.

Choice of finish

There now remains the staining of the wood. A choice can be made of mahogany or oak. If preferred, a mahogany powder is purchased, mixed with water, and applied with a brush, covering every particle of the wood. Any surplus stain is removed with a cloth.

In the case of oak, black enamel is thinned with turpentine and the same procedure taken. If a glossy surface is desired, the wood can then be varnished.

Lastly, the shelves are 'tied' to the wall. The small glass plates are screwed to the backs of the sides 2ins. below the lower edge of the top. The section to be attached to the wall protrudes towards the centre as seen in Fig. 4. Finlay screw to plugs in the wall. (H.M.)

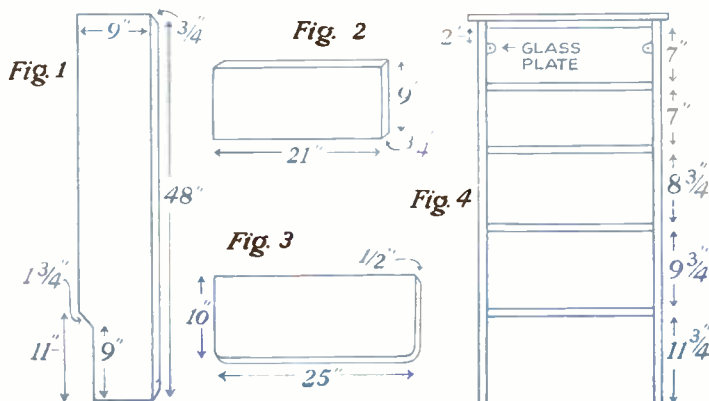

MAINLY *for* MODELLERS

THOSE of our readers who are building from our kit a more detailed model of the 'Mayflower' will by this time have completed the model according to instructions in previous articles and have it ready to commence the rigging in an authentic manner. Before forwarding this last article on the 'Mayflower', which completes the series, I have been comparing several rigging plans of various models

through the bulkhead, or deck, at an angle to allow it to be secured to the heel of the bowsprit.

Add the following stays as indicated, forestay (2), mizzen stay (3) main topmast stay (4) fore topmast stay (5) mizzen spar stay and bridle (6). Next add the gammoning of the bowsprit (10) following on with the backstays. The backstays are only shown on one side of the model for clarity, they must be

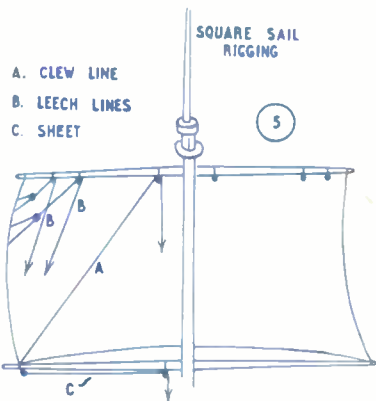
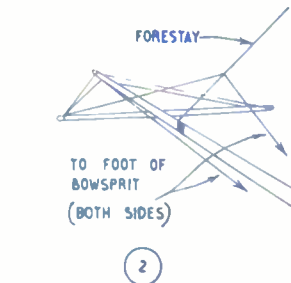
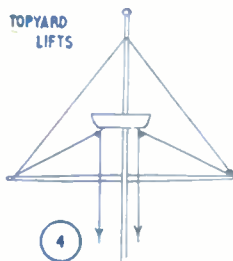
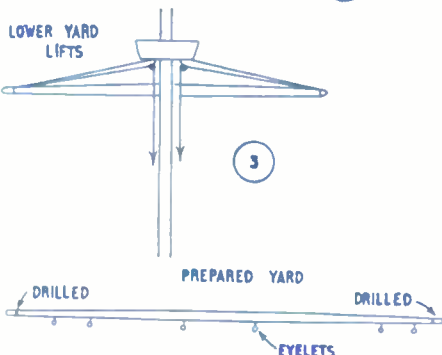
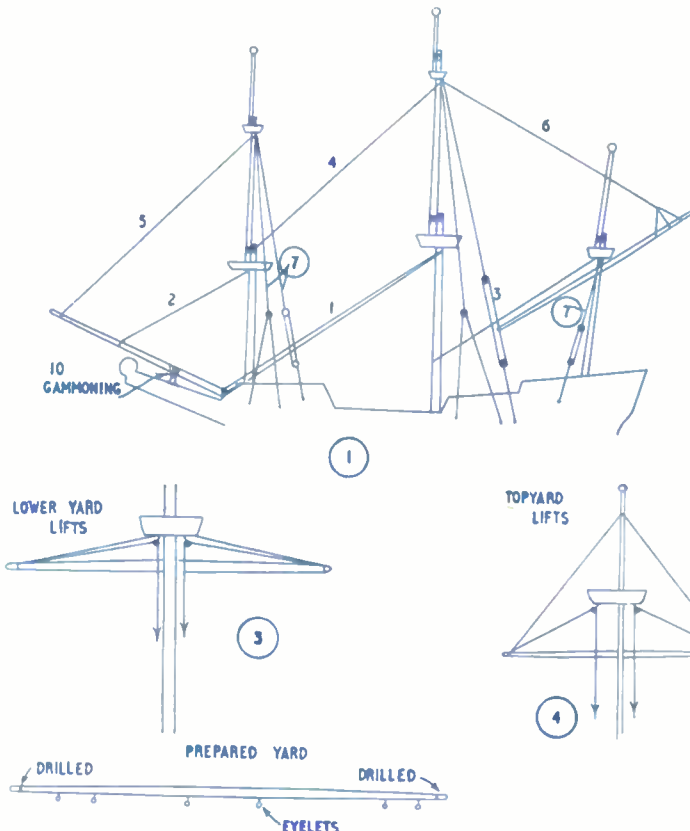

of this famous little ship and of various writers on details of the period.

In Fig. 1 we have the plan of the standing rigging. Having made your shrouds in the manner outlined in the kit instructions or in one of the ways I have suggested in earlier articles, erect them in position on the model and proceed in the following manner.

Commence with the mainstay. This is a double stay, passing on each side of the foremast, it is led from the mainmast top, passes through two holes drilled

erected on each side of the model (see Figs. 1 and 2)

Our model being of small scale and being fitted with sails, we cannot show every line of the running rigging and will show the lines that will give our model that authentic look without the appearance of being over-rigged.

The lines we will show are the following: lifts, braces, tacks, buntlines, sheets, clew lines and leech lines.

Our rigging cord for the standing rigging being black, as I have stressed in

RIGGING THE 'MAYFLOWER'

By 'Whipstaff'

previous articles, we use natural coloured cord of approximately half the size of the cord used for the standing rigging, thus, if the standing rigging has been made from the cord supplied in the kit, use natural colour sewing thread, as used for sewing on buttons.

To make the following instructions clear, the standing end of a rope is the end that is permanently fixed, the running end is that which is led through the various blocks and used to control the sails.

Commence with the lower yard lifts, as in Fig. 3. The standing end is fastened to a tiny eyelet, made from a bank or lill pin, under the top, taken through a

similar eyelet at the end of the yard, back through the eyelet under the top and down to the foot of the mast and secured to the bitts. If you have not fitted bitts secure it to a small eyelet in the deck, for the main mast. For the foremast it can, if more convenient to get at, be secured to the forecastle rails. Where shown only on the port side, they must be duplicated on the starboard side.

This applies to all the running rigging unless otherwise stated.

The next to be fitted are the topmast yard lifts; see Fig. 4. Secure the standing end to the topmast, just below where you will attach the flag (that is, just above the cap), take to the eyelet at the end of the yard, back up to the first eyelet and down to the deck as before, to the fore-castle rail or bitts for the fore topmast lifts and to the bitts or eyelet at the foot of the mast for the main topmast lifts.

The mizzen lifts, brails and sheet can be rigged easily from Fig. 5. The sheets, clew lines and leech lines of all square

as shown in Fig. 6. There are two for the foresail and mainsail.

The topsails have only one buntline, cemented to the foot of the sail in the centre and taken up over the fore side of the sail, through an eyelet at the top and down to the bitts.

The clew lines are secured to the end of the yard as shown in Fig. 7 and the running end taken through the corner of the sail, the hole drilled in the end of the yard, along to the eyelet in the yard nearest to the mast and down to the

The sheets for the foresail and main-sail are secured to the lower corners of the sails and secured to eyelets on the outside of the hull as shown. For the topsails they are secured to the corner of the sail, taken through the hole in the end of the yard, along to the eyelet nearest the mast and down to belay to eyelets in the deck just inside the bulwarks.

The mizzen brails and clew line belay to either the bitts or poop rail, whichever you find more convenient. The tacks go from the corner of the sail to the outside of the hull as shown in Fig. 8. The braces are again for clearness shown on one

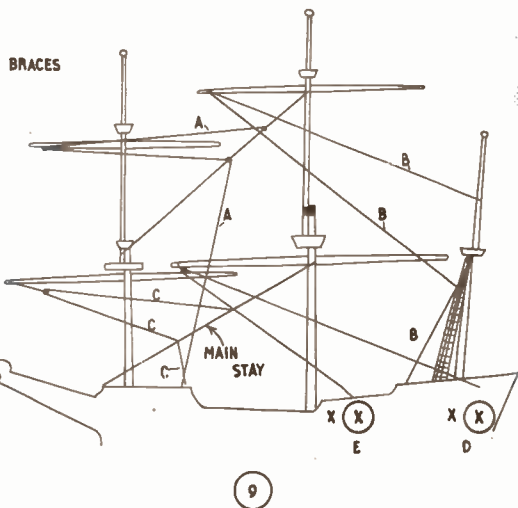
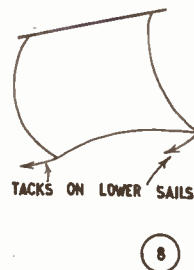
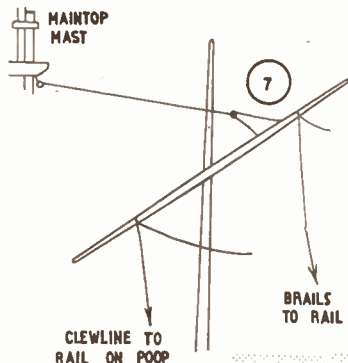
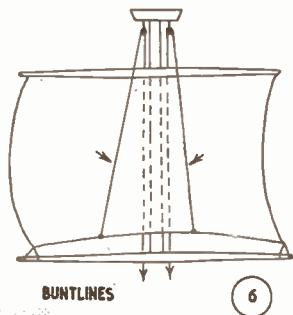

- A Fore topyard brace
 - B Main topyard brace
 - C Foreyard brace
 - D Mainmast sheet points.
 - E Foremast sheet points.
 - X Standing end, through lower corner of sail to X running end.
- } Shown one side only.
} Repeat on other side of model.

sails are shown in the sketch, again to be shown on both sides of the sail. These lines are aft, on the rear side of the sail.

Now add the buntlines to each square sail. The standing end is attached to the foot of the sail with quick drying cement, carried up over the fore side of the sail, through a small eyelet under the cap and down to the bitts at the foot of the mast;

forecastle rails or bitts for the foremast and to the bitts or eyelet in the deck for the main mast.

The leech lines come next. The standing end is cemented to the inside (rear or aft side) of the sail, taken up to the eyelet in the yard and taken down to the deck, they are belayed or secured to eyelets let into the deck just inside the bulwarks.

side of the model only. Repeat on the starboard side.

The foretopmast brace has its standing end secured to the main topmast stay, is led through the end of the yard, back to the main topmast stay and down to the fore-castle rail. The main topmast brace has the standing end secured to the mizzen mast above the top, is taken to the end of the yard, back to the fore shroud of the mizzen mast and down to belay on the poop deck rails.

The foreyard and mainyard braces have their positions shown in Fig. 9. In the case of the main yard brace the standing end is secured to an eyelet in the outside of the hull and the running end belays to the quarter deck rails.

Although much simplified, as is necessary with such a small scale model, it is sufficient to give an authentic picture of the rigging of these splendid little vessels.

If you have not added rails to the various decks (i.e. poop, fore-castle or quarter deck), where the running rigging lines belay to these rails, they can in all cases be secured to eyelets let into the edge of the deck where the rails would otherwise be.

ANSWERS TO TWO-MINUTE QUIZ (see page 370)

1. It is called 'scarfing'; 2. It could be, for it is known as a brick bolster; 3. Stepped flashing; 4. A loose tongue joint; 5. A 15 watt lamp will run for 66 hours whilst a vacuum cleaner will run for approximately 4 hours.

CUTTING FILM IN THE DARK

MANY photographers who use plate cameras are likely at one time or another to encounter the difficulties of cutting panchromatic film with sufficient accuracy to fit plate-holders. As the operation must be performed in total darkness, it is not always easy to ensure that the film will remain motionless in the desired position as it is being cut. There is, in addition, always the danger of scratching the emulsion, and perhaps of leaving ugly finger-prints on the film as it is being handled.

To overcome these difficulties, the simple little box was made, as illustrated on this page, which makes the operation almost automatic.

This box consists of a shallow wooden frame made of hardwood, just the size of the film to be cut. It has two doors or flaps, which together measure a fraction of an inch less than the interior measurement of the box. The flaps are attached to the frame by leather hinges, stuck on with quick-drying adhesive.

Boxed flat film is usually interleaved with black paper to protect the emulsion. In the dark, a sheet of film together with its protecting paper may be taken from the pack without difficulty and placed face downwards in the frame, the paper protector being between the emulsion

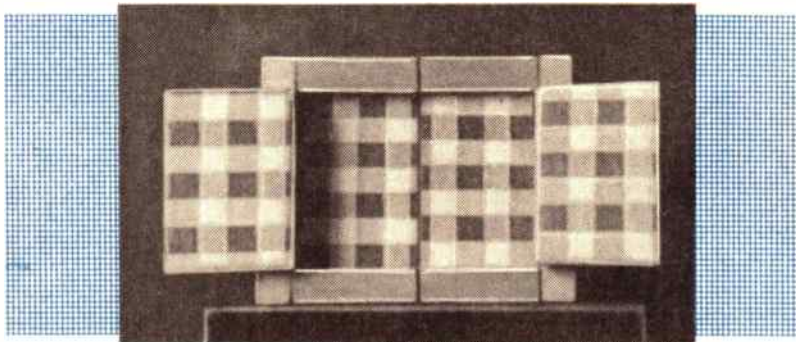

and the floor of the box. The flaps are then closed and held firmly down with the left thumb and fingers, thus securely holding the film in position and motionless on all sides.

A sharp, short-bladed stencil-cutting knife is held in the right hand. A short stiff blade of this type enables adequate pressure to be used to ensure a good, clean cut of both film and paper. The narrow gap between the flaps acts as a guide for the knife in the dark.

After cutting, the doors are opened and the two pieces of film with their

paper protectors are easily removed and placed in proper order in a light-tight box. My practice is to place them emulsion side upwards. From start to finish it is not necessary to touch the emulsion side of the film.

My own box was designed to enable me to cut film into halves. As can be seen from the photograph, the doors are of equal size. But by using two or more boxes with appropriately-sized doors, film of any size can be cut to fit any size of plate-holder.

(C.O.H.)

Easter Eggshell Gardens

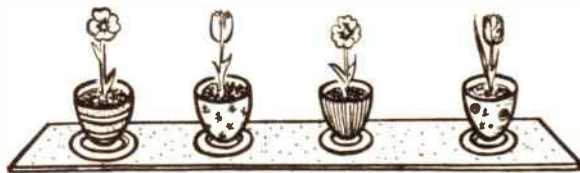

EGGSHELL gardens take about half an hour to make, cost only a few pence, and look delightfully gay and expensive.

As a gift for Easter most people would certainly appreciate one.

To make one garden, take two eggshells and make them into four half shells. The edges must be made perfectly smooth by gently breaking off a tiny piece at a time.

Now paint them on the outside with gold paint and on the inside with silver paint. If you are clever at painting with oil paint, the outside shell may be decorated with any design you care for,

which will give the garden a more finished look, but this is not entirely necessary, and may be dispensed with.

The eggshells will naturally not stand up on their rounded ends, so cut four circles of cardboard, each measuring about 2ins. in diameter and paint two with silver and two with gold paint. In the centre of each put half a teaspoon of soft plaster (the kind used for filling in cracks on walls) and set the eggshell firmly on it before it dries. Put a contrasting coloured shell on each round of cardboard.

Now take a strip of plywood, hardwood or even very strong cardboard,

measuring 12ins. long and 3ins. wide and paint it green or brown, whichever you fancy. When thoroughly dry, set the four circles of cardboard at equal distances on it by means of plastic wood. Put a small quantity of this where required, and press the circle on it before the plastic wood hardens.

Now gently fill each shell with bird gravel (a small quantity may be obtained from a pet store), and place in each shell a single flower. Fresh flowers may be used, in which case a little water must be poured over the gravel, but everlasting flowers are the most suitable for planting. Most florists will supply them.

Cut the stem of the flower until it measures 2ins. or 3ins. long, and force it well into the gravel. Then add a few tiny green leaves to enhance the single flower. These may be cut from green crêpe paper and attached to thin wire, or, if preferred, some artificial moss may be used instead.

If the eggshell garden is required for a window sill, it should be made a few inches longer.

(D.D.)



makes you an expert... *easily!*

It's not difficult to be an expert with the BRITFIX/HUMBROL combination... tried to the qualities which the Handyman needs... tested to the requirements of the do-it-yourself man. And—more than ever—produced to give that 'professional' look... That's the way with H.O.C.—you can see-it-yourself when you do-it-yourself!

FOR WORKING IN WOOD OR PLASTICS

Humbrol Art Oil Enamel, a 4-hour lacquer enamel which dries with a brilliant finish. Is most suitable for the handyman about the house, being ideal for touching up all decorative household and workshop utensils.



BRITFIX TISSUE PASTE.

A specially prepared paste for aeroplane tissue providing exceptional adhesion and non-staining qualities.



BRITFIX CEMENT.

The finest all-purpose adhesive made. Transparent, water and heat proof, BRITFIX CEMENT combines rapid drying with the utmost tenacity.

BRITFIX PLASTIC POLYSTYRENE CEMENT.

A high quality polystyrene adhesive, combining quick drying with excellent adhesion. An ideal companion to Enamel



BRITFIX COLOUR DOPES, fast drying, clean and bright, smooth and easy to work with.



HUMBROL INTERMIXABLE PAINTING KIT.

Humbrol Art Oil Enamel Kit—6 intermixable colours in capsule form. An economical method of application for the Handicraft Worker.



the choice of the expert!

Send to-day for FREE Humbrol Colour Card,

THE HUMBER OIL CO. LTD., MARFLEET, HULL.



ICEBERGS are chips from the great glaciers. The calving of icebergs, as the breaking-off of blocks from the parent glacier is called, is produced by the action of the tide. Upward and downward pressure, exerted by water at the rise and fall of the tides, on submerged portions of the glacier front, forces off a strip of ice, which floats away as a berg.

Icebergs—By R.L.C.

There are few more fascinating spectacles in nature than a procession of these stately giants floating along in the ocean. Those seen in the North Atlantic, by ships passing to and from U.S.A. and Canada, represent the wastage from the glaciers of Greenland. Here we find one of the world's largest glaciers — the 'Humboldt' — discovered by Dr. E. K. Kane in 1853. It is 60 miles in length and has a perpendicular face of 300ft. It is

said that the Humboldt is responsible for half a million icebergs every year.

The bergs from Greenland are carried down towards the middle of the Atlantic by the Labrador current. They travel down the coast of Labrador, passing Newfoundland, until they reach the warm waters of the Gulf Stream, when they disappear — melt completely away. It is only the largest bergs that reach the middle of the Atlantic before they disappear.

During certain seasons of the year one can cross to New York or Canada and be sure of seeing many icebergs. The fascination about them lies in their curious shapes and designs and beautiful colouring. No two icebergs appear exactly alike in size and shape. Some look like an Arab's tent as they glide along. Others resemble castles, cathedrals, yachts, animals, etc.

Some of the pinnacles of a large berg rise nearly 1,000ft. above the water, while the base may occupy an area of 10 or 12 acres. Seen through a powerful

glass, one may detect waterfalls upon these islands of ice, all kinds of arctic birds and, perhaps, a few seals.

Colour tones

Then the colours are almost beyond description. The stately pinnacles glisten in the sun like powdered glass. At times the berg is pure white, at others it looks greenish. This latter tone is caused by reflection of light upon masses of ice under water, thrown back upon the exposed surface. The shadow side, away from the sunlight, is a beautiful blue, traceable to the reflection from the sky.

Crews from ships in the Arctic regions are often forced to land upon a berg to renew their supply of fresh water. This is exciting work. Not only do these men get water from the bergs, but they often find seals upon them, and occasionally come face to face with a Polar bear.



Doll collecting is popular

THROUGHOUT the world the collecting of dolls by children and adults has reached large proportions.

When English manufacturers discovered that their dolls were being bought by collectors at home and abroad, they organised the 'Doll Collectors' Club of Great Britain'.

English collectors usually choose foreign dolls. Many school teachers belong to this group. The dolls are taken into the classroom where, they illustrate costumes, customs, history and many other subjects to the children.

Some enthusiasts collect antique dolls. It takes an expert to identify the country and date of origin. Antique dolls are mostly valuable. American collectors make regular trips to England and Con-

tinents, buying dolls for their collection.

The very old dolls have no identifying marks pointing to their origins. Among these are the 'Crèche' figures, papier mâché, waxes, some fine unmarked bisques, porcelain and parians and woodens. The so-called 'Queen Anne' is much sought after. The French Fashion Lady doll is also in demand.

During the years before 1800, dolls were rarely marked. A few fine porcelain dolls made in old noted manufactories bore, under the glaze, the firm's trademark. To discover such a prize is a major event.

Doll collector readers of *Hobbies Weekly* who seek pen-friendships with fellow collectors should send their requests to the Editor, Dereham, Norfolk, enclosing stamp for reply.

APPARATUS & CHEMICALS

For your experiments. Let us help you equip a HOME LABORATORY

Beakers, Crucibles, Flasks, Funnels
Gas Jars, Test Tubes, etc.

Booklets:
(including postage)

'Experiments' 1/2
'Formulas' 1/2
'Home Chemistry' 2/10
New edition

Send 3d. Stamp for latest PRICE LIST

A. N. BECK & SONS (Dept. H.W.)
60 Stoke Newington High Street, London, N.16



HEAR ALL CONTINENTS

With H.A.C. Short-Wave Receivers

Suppliers for over 18 years of Radio S-W Receivers of quality.

One-Valve Kit, Price 25/- Two-Valve Kit, Price 50/-
Improved designs with Denco coils. All kits complete with all components, accessories and full instructions. Before ordering, call and inspect a demonstration receiver, or send stamped addressed envelope for descriptive catalogue.

'H.A.C.' Short-Wave Products (Dept. 22), 11 Old Bond Street, London, W.1.



WOOD
MITRE
BLOCK

Price 3/3
(post 1/-)

This 9in. block is handy for cutting mitres on any small work — moulding, edgings, etc. Made of selected hardwood with right angle and 45° slots for the small tenon saw

From branches or:

HOBBIES LTD., DEREHAM, NORFOLK

HOW TO STOP SMOKING

and permanently overcome that ceaseless craving for tobacco. Save money, safeguard health. Send stamp for details of the world-famous inexpensive Stanley Treatment for tobacco habit.

THE STANLEY INSTITUTE LTD Dept. 30
12 Bridewell Place, London E.C.4

10,000 FORMULAS. Trade secrets, recipes, processes. Remarkable 900 page book. Only few available. Money back guarantee. 27/6 p. pd. — S. P. Ltd., 28(H.B.) Dean Road, London, N.W.2.

MAKE A MUSICAL BOX for as little as 21/- . New kits and tunes available. Movements 13/- post free. Please send 3d. stamp for free illustrated catalogue. — The Swissrock Co., Dept. B, 202 Tulse Hill, London, S.W.2.

WHEELS (Hardwood and Rubber Tyred Metal). Cot, Pram and Doll's House Fittings and Papers, Beads, Transfers, Prints and other accessories. Stamp for new lists. (Trade supplied.) New address — JOYDEN CO., 91 Peplins Way, Brookmans Park, Herts.

FREE stamp album and 20 stamps. Request approvals, enclosing 6d. Additional gifts given. — Beeze, 8 Langland Villas, Mumbles, Swansea.

KUKLOS ANNUAL. Indispensable cyclists' handbook. Tours, resthouses, money-saving hints, 3/- post free. — Burrow, Publishers, 2 Imperial House, Cheltenham.

100 DIFFERENT stamps free! Request ¼d. upwards discount approvals. — Bush, 53 Newlyn Way, Parkstone, Dorset.

BOYS book of crystal sets, 2/6, post 3d. — B Fuller, 72 Leeds Rd., Shipley, Yorks.

Sent for 10/- bal. **1/2 PRICE OFFER!** SENT FOR 10/-
18 fortnightly payments 7/6.
The FLIGHT LIEUTENANT
Genuine NEW WATERPROOF 3oz. DUCK TENT
Waterproof 1959 Tents of real 8 oz. WHITE Duck.
Galproof Brand new, surplus to export order. DON'T CONFUSE with Tents made from drab material never meant for centage. This is real thing, withstands anything even in our climate. Approx. 7ft. 6in. / 6ft. x 6ft., 3ft. walls. Cash £5/17/6, carr 8/- complete ready to erect, incl. valise. Willsend Green 42/- extra. Ridge pole if required 7/6. Fly-sheet 37/6. Rubberised Ground Sheet 19/6. LISTS, TENTS, MARQUEES, ETC. TERMS.

£5-17-6 CARR 8/-

GREAT HALF PRICE OFFER!
"Matahari"
FOLDING CAMP BEDS
CASH PRICE 27/6
CARR. ETC. 3/6

Makes Camping Holidays a Joy!
Genuine 18 oz. rot proof green duck canvas, withstands 30 stone strain. BRAND NEW, famous lightweight, tremendously strong beds fold to practically nothing in size for easy transport. Full 6 ft. length, normal width. This represents the finest camping bargain. Half price of other types. Lightweight rustless strong steel. Lasts years. Ideal as occasional bed for visitors. Makes up like divan. 27/6, post 3/6. Three for 89/6, including post.
Headquarter & General Supplies Ltd.
(HOBW/53) 196-200 Coldharbour Lane
Loughboro Junc., London, S.E.5 Open Sat.

STICK TO SECCOTINE



Sole Manufacturers —

McCAW, STEVENSON & ORR LTD., BELFAST

A new book which will give you a wealth of novel suggestions

CERAMIC PAINTING MADE EASY

by Gertrud Derendinger

68 pages, large format (8½" x 12"), with illustrations of 216 hand-painted ceramic objects and 26 pages of designs. Retail price 20/-. The text contains in a concentrated form, numerous practical hints showing how to avoid mistakes which would otherwise appear only after firing. The book is particularly remarkable for the variety of its contents. A gay series of elegant animal and flower motifs alternates with modern abstract designs. This work, which has also appeared in German, French and Italian, is already achieving large sales in 19 countries. Obtainable in all good Ceramic Supply Shops or direct from the publisher. (On advance payment, post-free dispatch from the publisher.)

R.I.A. Publisher, Wynigenstr. 15, Burgdorf, Switzerland

MAKE EXTRA MONEY AT HOME

Are you earning enough? If not, you can add to your income by conducting a spare time agency for FREEMAN'S OF LONDON. Generous commission on everything your family and friends purchase from the 4,000 item all-on-weekly instalments. Catalogue obtainable from Dept. 258A, FREEMAN'S (LONDON, S.W.9) LTD., Lavender House, London, S.W.9.

MODELS. You can make lasting stone-hard models with Sankey's Pyrama Plastic Cement. Supplied in tins by Ironmongers, Hardwaremen and Builders' Merchants. Ask for instruction leaflet.

STAMPS FREE — Empire Packet including Pictorials and Victorians with approvals. — Robert J. Peck, 7A Kemp Road, Bournemouth.

PHOTO-CARDS SHIPPING. Famous liners, etc. Send 1/6 list; specimen. — Elder, 38 Westview Rd., Barrow-in-Furness.

KEYS CUT — by return. Latch type; Yale, Union, Etas, Regal, Legge, etc. — Send 1/6, S.A.E. and duplicate. Keep this address. — Chippy Store, Station Street, Sunderland, Durham.

STAMPS FREE — Empire packet including S.Q.E. 11, Pictorials, etc. Request famous discount approvals. Enclose 3d. stamp. — Victorian Stamp Services, 32 Victoria Rd., Rathgar, Dublin.

LIMITED Stamp Offer — unsorted World Mission lots 5/- and 10/- post free. — L. S. Buckett, 10 Hinkler Road, Southampton.

MEN/WOMEN with spare time, required for new simple weaving work. For details, send S.A.E. — Dept. 4, Weava Products, 10 Shelley Rd., Worthing.

SOUVENIR MAKERS — we supply transfers for your goods. Mottoes, crests, town names, etc. Large range. List and samples 1/-. — (Dept. H), Axon, Jersey, C.I.

ALONE—OR IN COMPANY?

THE hiker planning a holiday on foot is exercised in mind, whether to go alone or in company. Much, of course, depends upon one's temperament, individuality, inclinations, and preferences. Yet it is a question that is important, for on the issue may depend the joy or disappointment of the outing.

World-famous writers have voiced their opinions. Some are in favour of a tramping holiday spent alone, and favour a solitary tramp, with no one to talk to, unless it be a doggy pal. Take R. L. Stevenson, alone as he loved to travel, or with a dumb companion, as related in his *Travels with a Donkey*, when his companion was Modestine, the wayward donkey; R.L.S. was altogether exceptional — he travelled with the spirit of adventure inspiring him. 'I have been after adventure all my life, a pure dispassionate adventure such as befel early and heroic adventurers' was his ardent desire, and on most of his way-side travels his wish was gratified. How he would have felt with a companion to share it is doubtful. Hazlitt, too, believed that solitariness was essential to the enjoyment of a walking tour.

There are other writers who share the sentiments of the man who declared: 'Give me a companion by the way, if it be only to remark "how the shadows lengthen as the sun declines".'

There are certain advantages in having a friend and companion on the road. I remember tramping over difficult

ground — miles of rough going, and never a soul, save a lonely hill shepherd to be seen, not a cottage or other dwelling. In places it was a case of scrambling down precipitous crags, for I was taking a bee line across country. On finally arriving at a small house the kindly person who provided a meal for me said, with a shake of her head, 'Ye shouldna have come alane. Suppose ye had slippit and broken your leg! And never a body to find ye for hours!'

It certainly was no 'one man's job' and it made me think—for the element of

By A. Sharp

risk was great. Lonely the road might be, but not so lonely as being quite 'on your own' should a mishap befall you. It is wise to have a pal!

But, your companion must be of the right spirit — one who has the love of hiking in his heart, cheerful, light-hearted, and optimistic, always ready with a smile, even if it does 'rain cats and dogs'.

The importance of choosing a pal is not to be dismissed with a shrug of the shoulders. The right type of companion cannot be over emphasised.

There is much pleasant fun to be obtained by a tramp in quiet places. Or,

on the other hand, with a company of enthusiastic ramblers, and to this end you must join a tramping club. One thing, by the way, weekend ramblers should bear in mind, choose a knowledgeable leader, and obey his instructions. Hill climbing can be dangerous. Keep with your party, and do not ramble off by yourself when exploring some beauty spot, and then keep the party waiting, before the homeward start can be made.

Precepts for lonely ramblers:

(a) Travel lightly, the less of a load the better. (b) Keep to the sheep tracks and footpaths as much as possible. (c) 'ware potholes and peat bogs! (d) Don't endeavour to cross strange ground without aid of map and compass. (e) Don't allow yourself to get belated in the midst of a lonely moor at night-fall! (f) If tramping alone carry a whistle, which can be used to attract attention in case of accident.

Remember: don't leave litter about. Perhaps one ought to apologise for this hackneyed phrase, for the matter has been preached and propounded by voice and pen and printed notice for years, yet litter fiends still prowl abroad, defiling the countryside as they pass, giving no thought to wayfarers who follow. Please do not regard a beautiful little trout stream as a dumping ground for empty sardine tins, etc. In brief, think of the beauty of the countryside — and acquire country manners!

GLORIOUS DEVON

MAYBE you are thinking of exploring the delights of Devon this year. The author of 'A Pedagogue at Play' refers to his love of the county in this manner: 'I wonder what it is exactly that delights the heart of even an alien who crosses its border, and makes him feel at once that he is in a new world. Perhaps it is the beautiful red soil . . . perhaps it is the wondrous growth of carnations, rhododendrons, azaleas, and camelias, that lead so precarious an existence elsewhere . . . perhaps it is the cream . . .'

But he goes on to think that it is partly due to the recollection that the visitor holiday-making in Devon is in a land immortalised by many famous books, and partly the expectation of a kindlier and heartier welcome, and greater comfort and happiness, than have been experienced on visits to other countries; and 'in this expectation you will not be deceived.'

Bitten by the Wanderbug?

Then you've the explorer's urge to hit the trail. Sometimes you know where you're going — sometimes you just want to see what lies beyond the next hill or round the bend of the road.

And why not? — Young people have always been adventurous — the only difference today is that it is so very much easier. Yes, it really is! Nearly 300 friendly youth hostels in England and Wales wait to welcome you on your travels. A comfortable bed, three-course supper and breakfast, and the comradeship of young people of your own age — all for 6/6 a night if you're under 16 (8/- if you're older). It's even cheaper if you cook your own meals.



Don't
delay
Post
to-day

To Y.H.A. Trevelyan House, St. Albans, Herts. 592/HW

Please send me 'Going Places' and details of Y.H.A. membership.

Name

Address

.....

EGG NOVELTY FOR EASTER

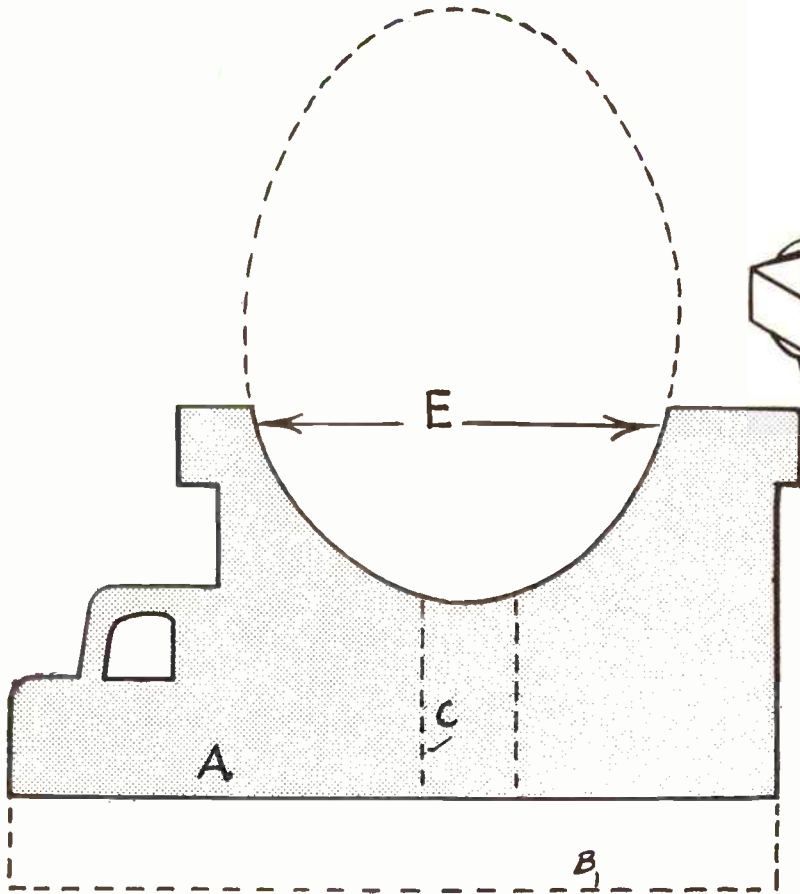

A 'DOUBLE GIFT' FOR A CHILD

THIS easter egg 'transporter' is made from $\frac{1}{8}$ in. wood and is cut out with a fretsaw. Glue piece (A) to piece (B) and glue one piece (C) on each side of (A).

The measurement (E) and the shape of pieces (C) must be adjusted slightly, according to the size of egg used.

The wheels are drilled to take round-head screws, by which they are pivoted to piece (B). Wheels could be cut from $\frac{1}{2}$ in. diameter round rod instead of $\frac{1}{8}$ in. wood.

Paint the transporter in bright colours and line the doors, windscreen and radiator in black. Finish by tying the egg in place with a piece of brightly coloured ribbon. (M.p.)

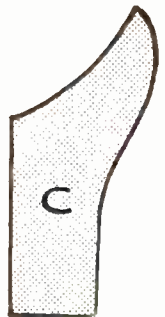
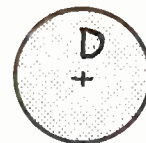
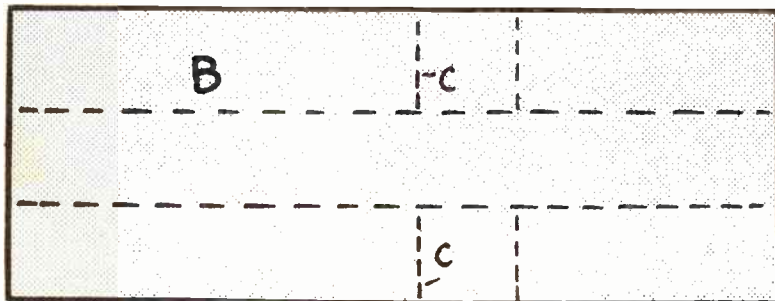

LADY'S SEWING 'COMPANION'

ALSO FOR
USE AS
A SMALL
TABLE



MAKE IT FROM
DESIGN No. 3278

A well-designed piece of furniture in contemporary style to hold all sewing and mending materials, etc. When closed it serves as a handy occasional table.

Today's value is in the region of £9 but a big saving can be made by working with Hobbies Kit No. 3278, price 65/-. This contains all planed wood panels, contemporary legs which are simple to fit, hinges, etc. Kits from all Hobbies branches, etc., or post free (see coupon).

Send for details of other furniture kits which will save you pounds.

To HOBBIES LTD., Dept. 99, DEREHAM, Norfolk

Please send details of furniture kits and Kit No. 3278 for Lady's Sewing Companion, price 65/-.

Name

Address



SPEED YOUR WORK

with POLYSTIK P.V.A. adhesive

Use Polystik P.V.A. for everything. Polystik is strong. Polystik is reliable. And Polystik will save you time.

READY TO USE No stirring, no heating, you can use Polystik straight out of the bottle or jar.

QUICK SPREADING Flows onto your work from bottle or brush — you get an even film.

FAST DRYING Polystik grips in a few seconds. Cuts down cramping time. Minimises delays.

Croid POLYSTIK
Polythene bottles 2/6, 28 oz. jars 12/6

CROID LTD., IMPERIAL HOUSE, KINGSWAY, LONDON, W.C.2

For wood,
card,
plastic,
leather,
metal, etc.

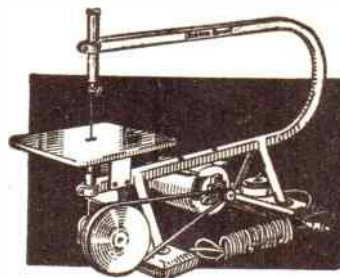

£12 - 5 - 0

TREADLE OR MOTOR FRETSAWS

Whatever the handyman or craftsman is cutting or making, one of Hobbies Fretmachines will help with the job. For toy making, fretwork, model making, it provides easy and speedy cutting in all kinds of material. A pleasure to use, a factory for output, a lifetime of service.

Obtainable at any Hobbies Branch or good class ironmonger or hardware stores. Or carriage paid U.K. from:

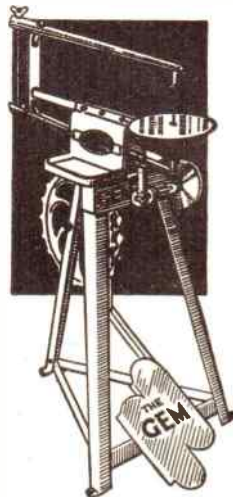

£5 - 17 - 6

HOBBIES LIMITED, DEREHAM, NORFOLK

NOTE:—PATTERNS FOR ONE GALLEON ONLY ARE SHOWN. DUPLICATE TO MAKE THE PAIR.

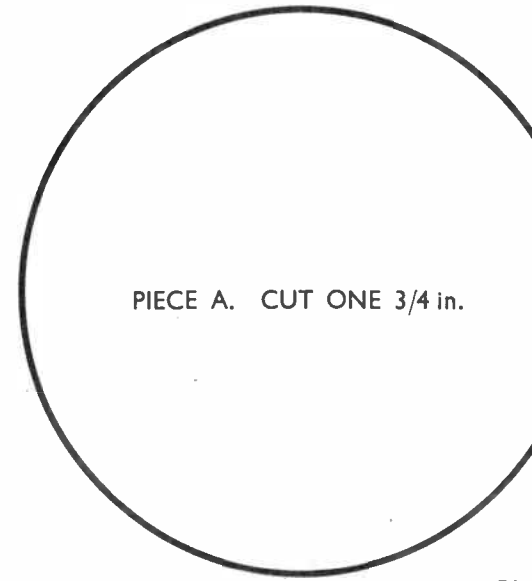
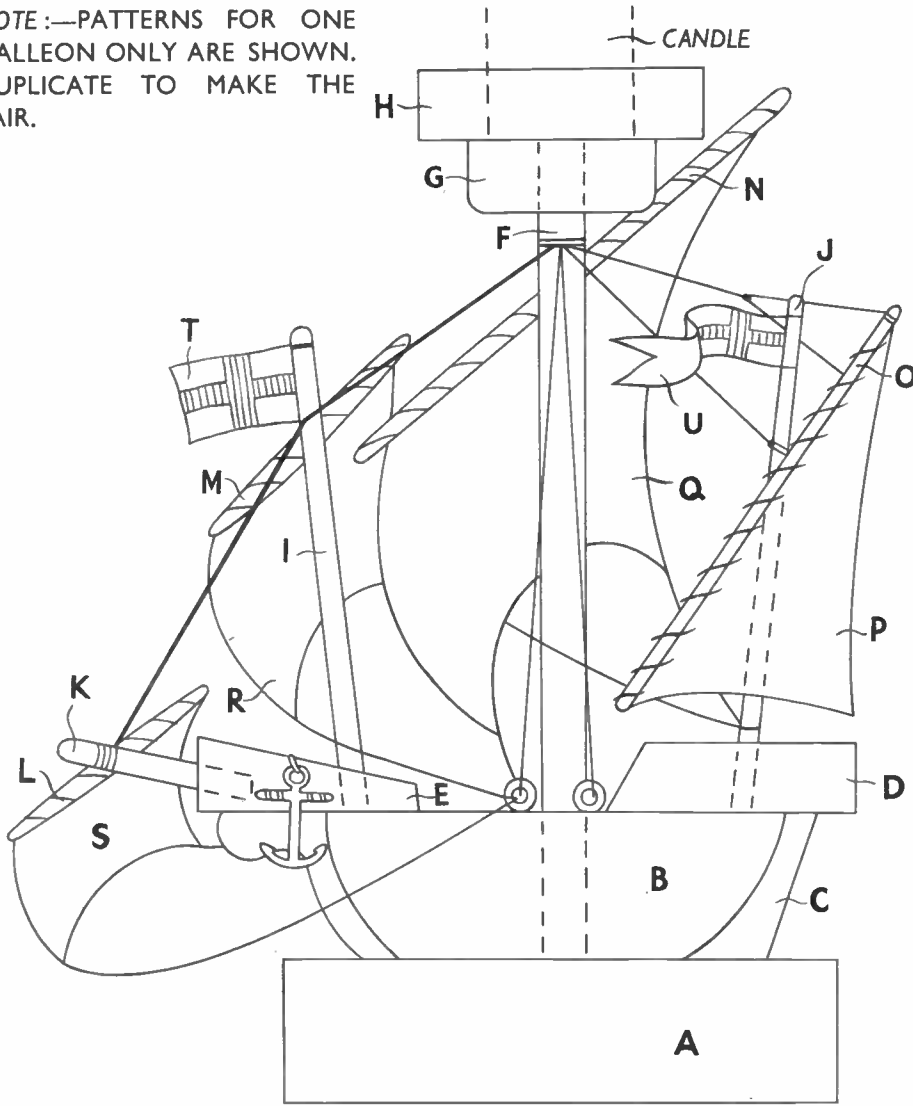

PIECE A. CUT ONE 3/4 in.



SPAR L. SHAPE ONE.

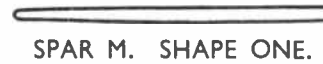

SPAR M. SHAPE ONE.

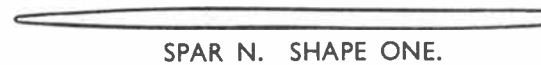

SPAR N. SHAPE ONE.



SPAR O. SHAPE ONE.

ALL SPARS ARE SHAPED FROM 1/8 in. ROUND ROD.

SPAR N

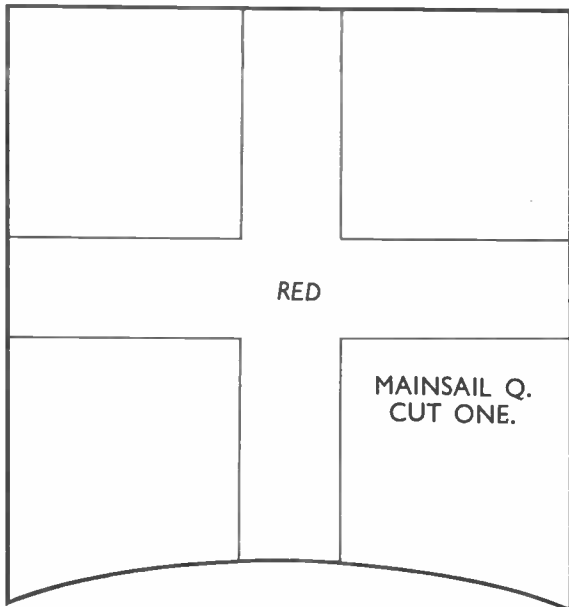

SPAR M

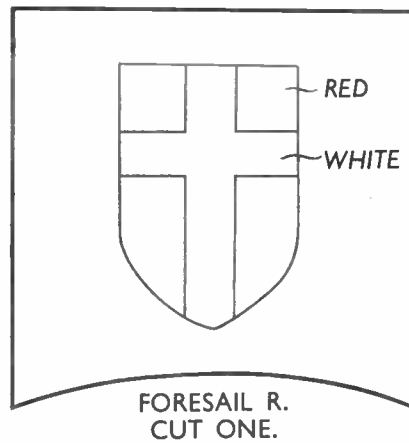

RED

MAINSAIL Q.
CUT ONE.

RED

WHITE

FORESAIL R.
CUT ONE.

WRAP
AROUND
MAST

WHITE

RED



PENNANT U. CUT ONE
FROM PARCHMENT.

WRAP
AROUND
MAST

WHITE

RED



WRAP
AROUND
MAST

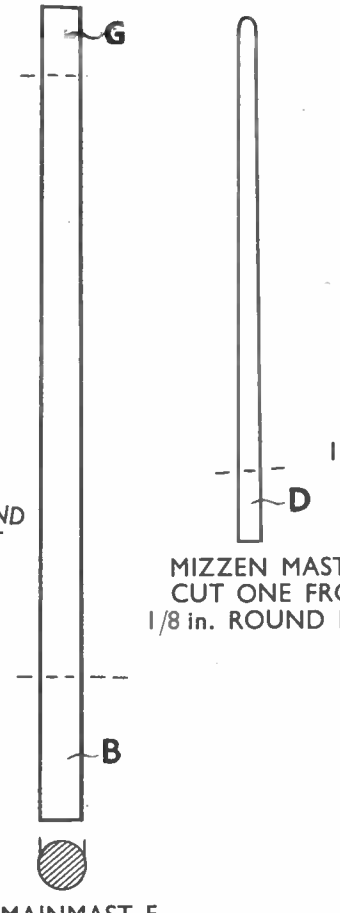

MIZZEN MAST
CUT ONE FROM
1/8 in. ROUND ROD

SPAR L

SPRITSAIL S.
CUT ONE.

SPAR O



DESIGN

No. 3306

A PAIR OF GALLEON CANDLESTICKS

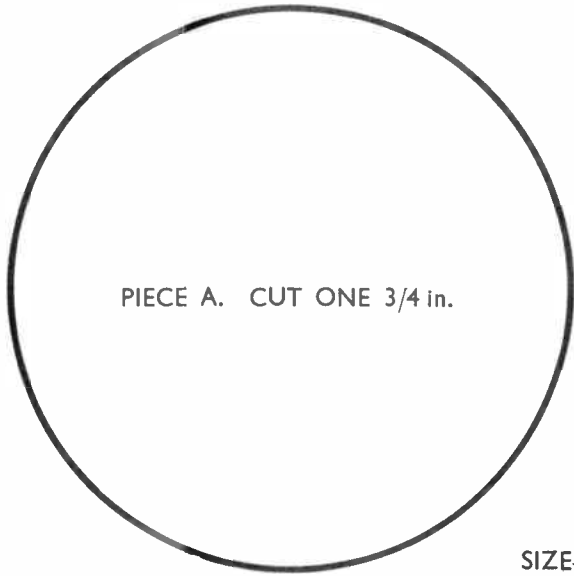

PIECE A. CUT ONE 3/4 in.

SIZE—
5 1/2 ins. HIGH
(WITHOUT
CANDLE).



SPAR L. SHAPE ONE.



SPAR M. SHAPE ONE.



SPAR N. SHAPE ONE.



SPAR O. SHAPE ONE.

ALL SPARS ARE SHAPED
FROM 1/8 in. ROUND ROD.

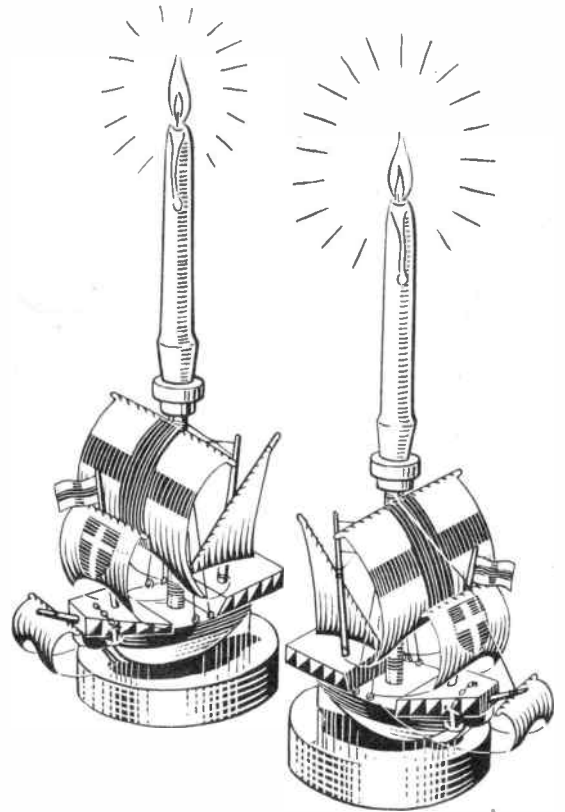

PANELS OF WOOD REQUIRED
FOR THIS DESIGN

One GD6 One GDI2

A KIT OF MATERIALS FOR MAKING THIS
DESIGN IS SUPPLIED BY HOBBIES LIMITED
DEREHAM, NORFOLK.
PRICE ON APPLICATION.

O

P

D

M

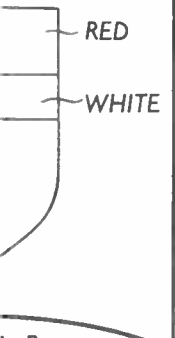

L R.
NE.

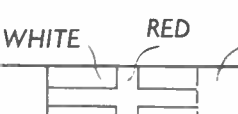

NT U. CUT ONE
1 PARCHMENT.



E. CUT ONE

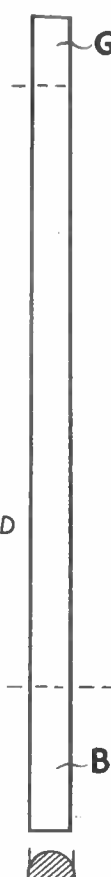

MAINMAST E



MIZZEN MAST J.
CUT ONE FROM
1/8 in. ROUND ROD.

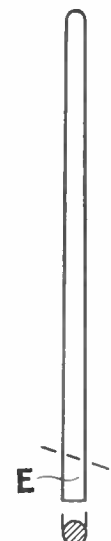

FOREMAST I.
CUT ONE FROM
1/8 in. ROUND ROD.

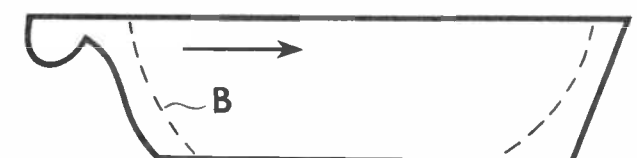

PIECE C. CUT ONE 3/8 in.

FINEST VALUE EVER! The **HUMBROL**
Economy kit

Perfect for small jobs. Contains 8 intermixable Art Oil Enamels (including gold and silver), thinners and flattening agent, plus brush, palettes, colour guide and mixing instructions.



only **3'-**

MADE BY THE HUMBER OIL CO. LTD. • MARFLEET • HULL



World Radio History

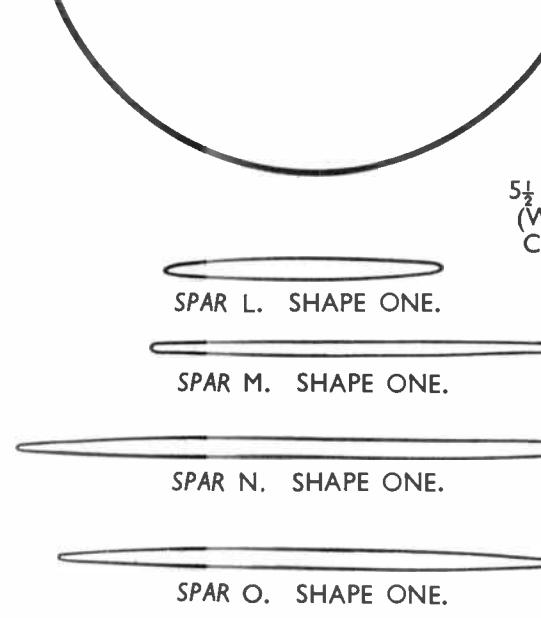
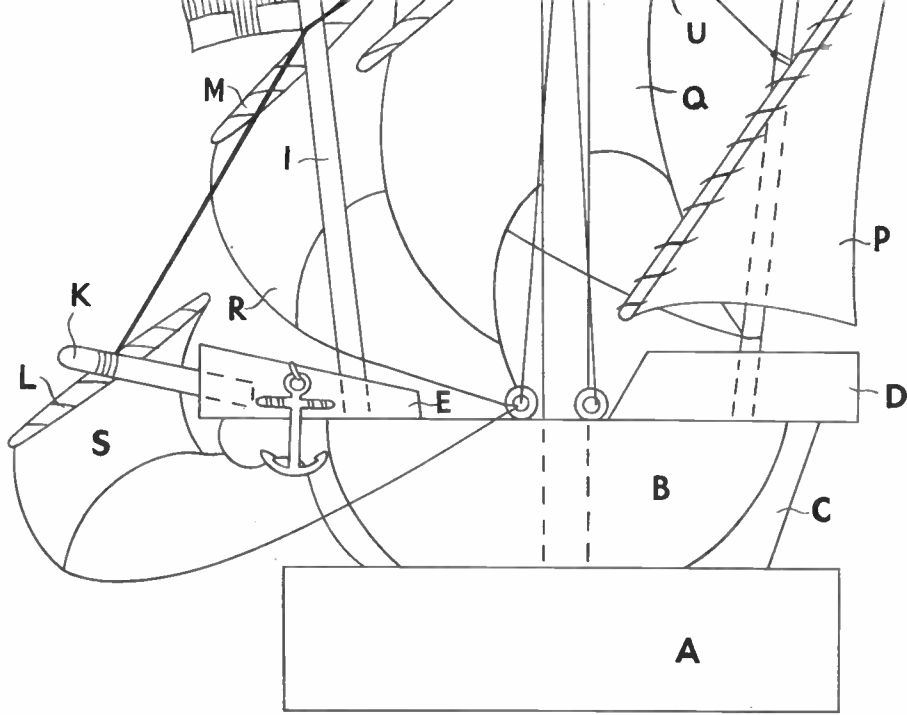

SPAR L. SHAPE ONE.
 SPAR M. SHAPE ONE.
 SPAR N. SHAPE ONE.
 SPAR O. SHAPE ONE.
 ALL SPARS ARE SHAPED FROM 1/8 in. ROUND ROD.

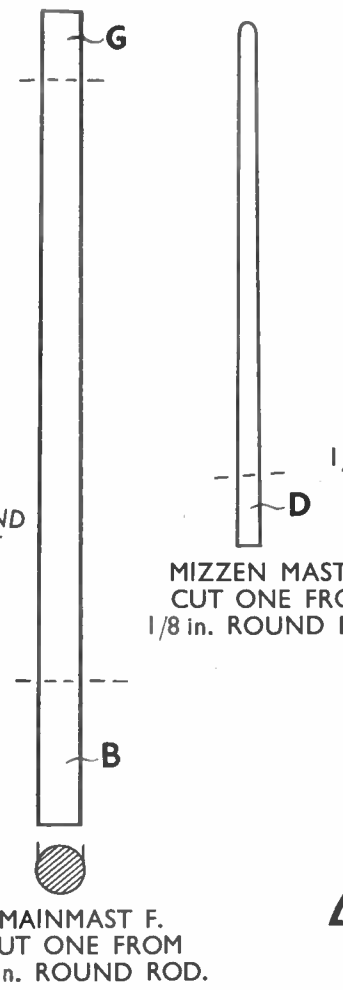
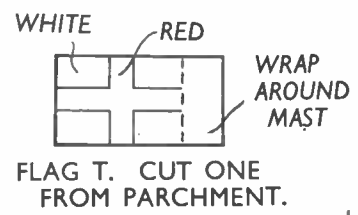
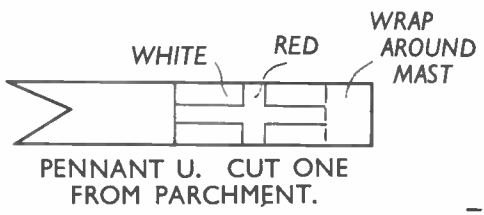
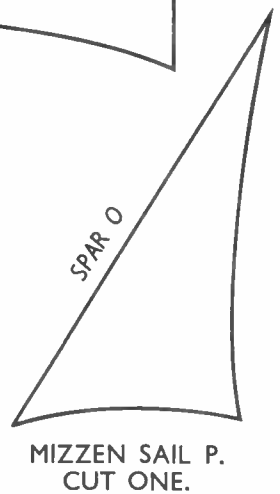
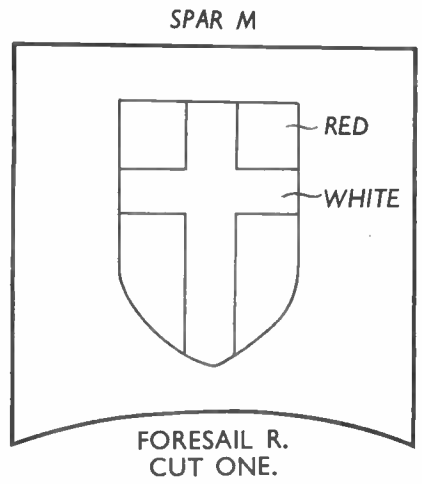
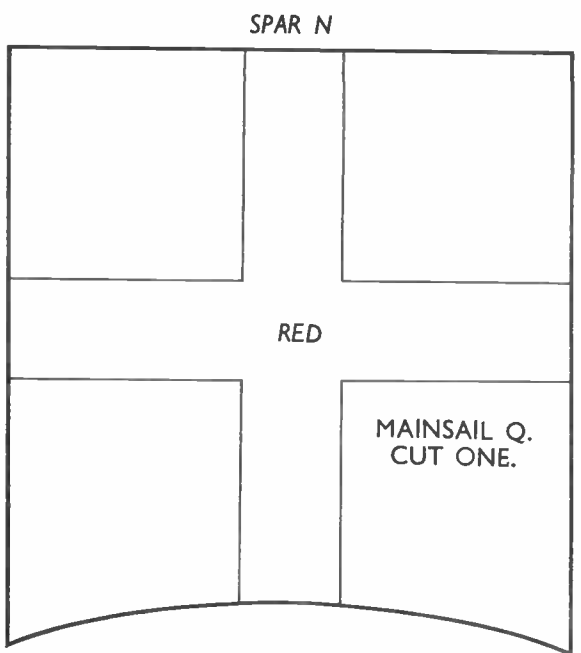

SAILS ARE CUT FROM PARCHMENT.

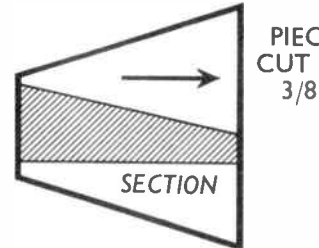
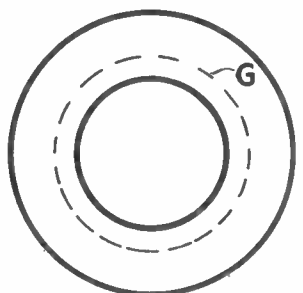
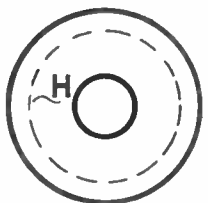

SIZE—
5½ ins. HIGH
(WITHOUT
CANDLE).

SPAR L. SHAPE ONE.

SPAR M. SHAPE ONE.

SPAR N. SHAPE ONE.

SPAR O. SHAPE ONE.

ALL SPARS ARE SHAPED
FROM 1/8 in. ROUND ROD.

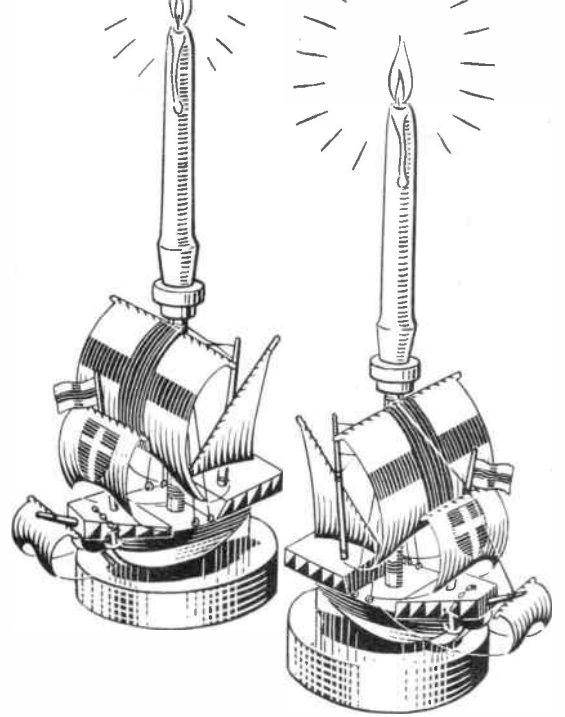

PANELS OF WOOD REQUIRED
FOR THIS DESIGN

One GD6 One GDI2

A KIT OF MATERIALS FOR MAKING THIS
DESIGN IS SUPPLIED BY HOBBIES LIMITED
DEREHAM, NORFOLK.
PRICE ON APPLICATION.

FINEST VALUE EVER! **The HUMBROL**
Economy kit

Perfect for small jobs. Contains 8
intermixable Art
Oil Enamels
(including gold
and silver),
thinners and
flattening agent,
plus brush,
palettes, colour
guide and mixing
instructions.



only
3' -

MADE BY THE HUMBER OIL CO. LTD. · MARFLEET · HULL

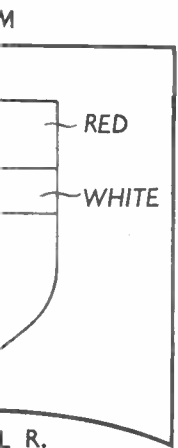

RED
WHITE

WRAP
AROUND
MAST

WHITE RED

WRAP
AROUND
MAST

PIECE U. CUT ONE
FROM PARCHMENT.

WHITE RED

WRAP
AROUND
MAST

PIECE T. CUT ONE
FROM PARCHMENT.

PIECE H.
CUT ONE
3/8 in.



MAINMAST F.
CUT ONE FROM
1/4 in. ROUND ROD.

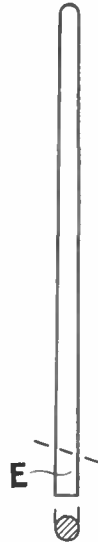

FOREMAST I.
CUT ONE FROM
1/8 in. ROUND ROD.



MIZZEN MAST J.
CUT ONE FROM
1/8 in. ROUND ROD.

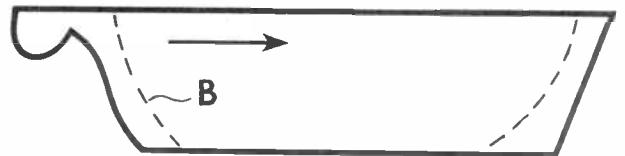

PIECE C. CUT ONE 3/8 in.

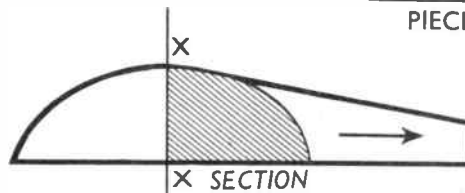

PIECES B. CUT TWO 3/4 in.

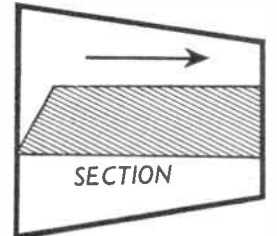

PIECE D. CUT ONE
3/8 in.

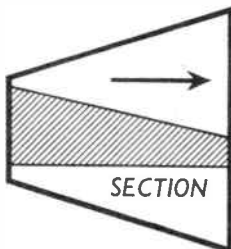

PIECE E.
CUT ONE
3/8 in.



BOWSPRIT K.
CUT ONE FROM
1/8 in. ROUND ROD.

THE ARROWS
INDICATE DIRECTION
OF GRAIN
OF WOOD.