

HOBBIES WEEKLY

FEBRUARY 18th 1959

VOL. 127

NUMBER 3303

IN THIS ISSUE

	Page
'Barrel' for Biscuits	321
Finishing Touch for Carpentry	323
A Midget Mains Set	324
Novelties for the Home	326
Cork Compressor for the Lab.	327
Bulb Bowls from Old Records	327
Patterns for Inlay Fingerplates	328
Collectors' Club	330
Work-Box Fittings	330
Finding the Ring by Arithmetic	332
Mainly for Modellers	334
Patterns for Cut-out Bookmarkers	335



All correspondence should be addressed to the Editor, Hobbies Weekly, Dereham, Norfolk

MAKE THIS
ATTRACTIVE

'BARREL' FOR BISCUITS

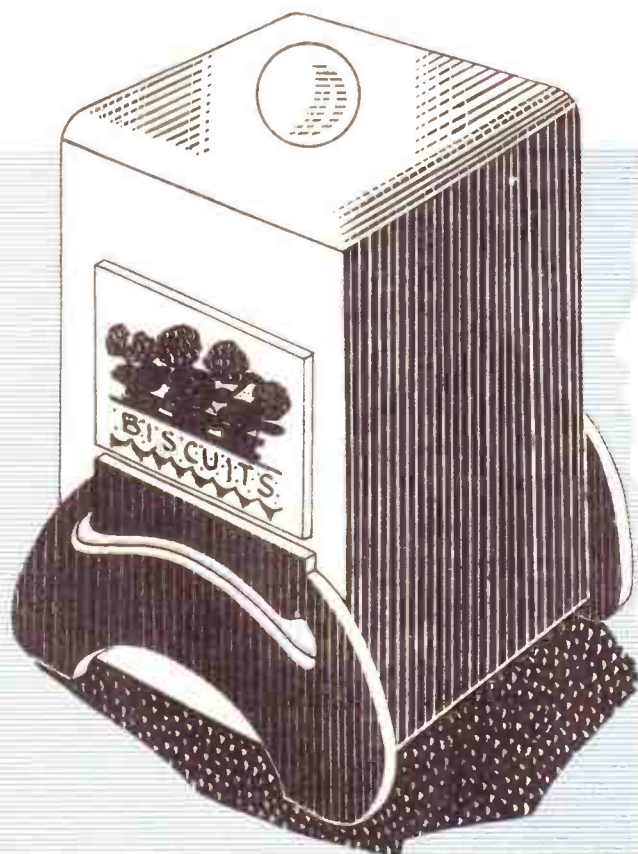

THE feature of this attractive biscuit container is the decorative transfer on the front. The colourful pots of red geraniums, and the word BISCUITS neatly printed, give the finishing touch to a useful article which will be appreciated in every home.

Full Instructions
inside

321

FOR ALL HOME CRAFTSMEN
Over 60 years of 'Do-it-Yourself'

World Radio History

4¹/₂^D

MAKING UP THE BISCUIT 'BARREL'

(Illustrated on front page)

THE diagram in Fig. 1 shows the general construction and the overall dimensions of the biscuit barrel. Note that recesses are cut in piece (A) to take the lin. light brass hinges.

Fig. 2 shows the lid ready to be hinged with the Hobbies No. 22 knob already in place. Drill a hole to take the shank and trim off the shank to fit flush.

Pieces (A) and (B) are cut from $\frac{1}{4}$ in. wood and pieces (C) and (D) from $\frac{1}{8}$ in. The edges of the lid (D) are nicely rounded before fitting.

Assemble the box as shown in Fig. 1, using glue only. Wipe off the excess before the glue has time to dry.

The decorative feet, shown full size in Fig. 3 are traced and cut from $\frac{1}{8}$ in. wood and are glued to the front and the back (pieces A). These pieces should be cut with a fretsaw and cleaned up with glasspaper before fixing.

The overlay to take the decorative transfer measures $3\frac{1}{2}$ ins. by $2\frac{1}{2}$ ins. and is also cut from $\frac{1}{8}$ in. wood, being glued to the front of the barrel.

The whole assembly is now thoroughly cleaned and the grain filled. Glasspaper smooth and give two coats of plastic

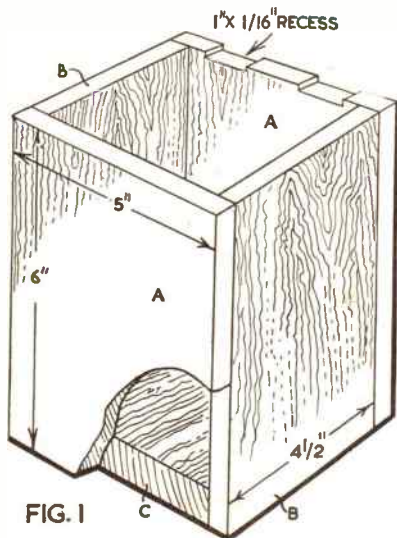

FIG. 1

enamel paint. The inside may be painted or lined with metallic paper, which may be purchased locally. All other materials required can be obtained from branches or by post from Hobbies Ltd., Dereham, Norfolk.

Other projects

The sheet of transfers, 12 in all, gives decoration for biscuits, bread, tea, flour, etc., and in subsequent issues we shall give designs for making other suitable containers, and using applicable transfers. One sheet, No. 300A, costs $\frac{2}{3}$ (post 3d).

The wood required is in convenient panels, two Q4 price $\frac{1}{6}$ each, one Q2 price $\frac{1}{3}$, one ND8 price $\frac{1}{4}$. Postage $\frac{1}{6}$ on the four panels. The ball knob

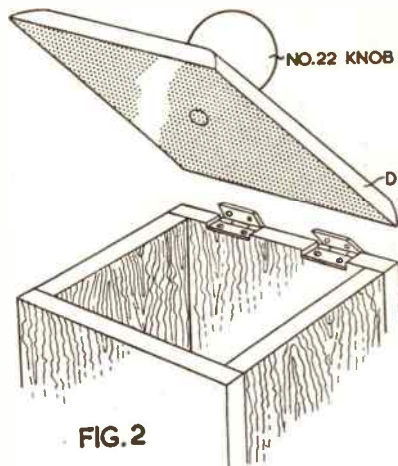

FIG. 2

costs 6d, postage 6d, and the lin. hinges 4d. per pair, postage 3d. If the items are ordered together allow a total of $\frac{1}{6}$ postage. (M.H.)

SAWREY, IN LAKELAND

ONE of the places to be visited by young booklovers is Sawrey in the Lake District, where the famous author, Beatrix Potter, lived for many years. Beatrix was also known as Mrs. William Heelis, and was the creator of those utterly delightful children's books Peter Rabbit, Jemima Puddleduck, Mrs. Tiggy Winkle, Ginger and Pickles, and many other animal friends.

Hawkshead is also associated with this well known writer, whose death is reported to have occurred in the latter part of 1943, and who has placed children — and many grown-ups for that matter — under a debt of gratitude for her lovely illustrated stories.

Of a retiring disposition, she was happy and contented to realise how much genuine pleasure and joy her work gave to so many people of all ages.

Visitors of all parts will, undoubtedly, revel in making this corner of the Lakeland countryside a place of pilgrimage, to the memory of the talented author who certainly aroused many unforgettable memories by her writings, especially to the younger folk. She showed her great love for animals by her deeds and actions. In her will, she included, among other matters, a ban on hunting by otter hounds and harriers over all her Troutbeck property in Cumberland. (A.S.)

TRACE THIS HALF AND TRANSFER WITH CARBON PAPER

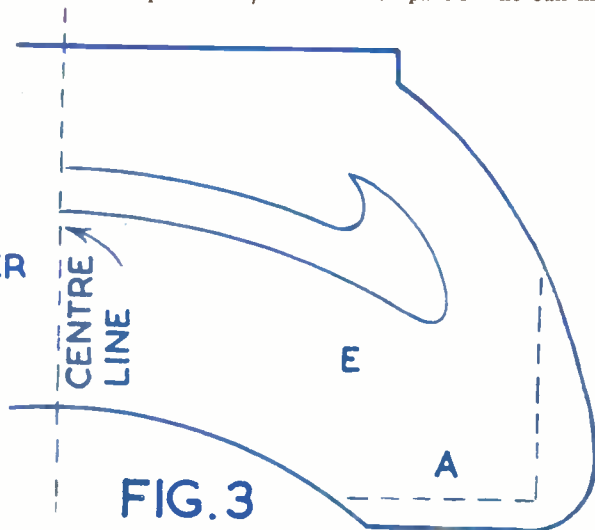

FIG. 3

Finishing Touch for Carpentry

PLAIN wood, ply and hardboard used in the construction of furniture and model making by the handicraft worker in the home may be considerably improved by adding a finishing surface of wood veneer. The work is simple, very decorative and amply repays for the small cost and extra work involved.

Grained veneers produced from choice woods may be combined on to wood surfaces by the aid of thin glue kraft tape which is used to hold the veneer pattern, when made up, in position. The charming patterns and designs seen on modern furniture are produced by carefully joining up pieces of veneer. The veneers are strong although thin in substance and stand a fair amount of handling. A perfect fit is essential for good finished work. Anything from border patterns to the most intricate veneer styles may be made up with a little practice. All work must lie absolutely flat and even.

Glue and veneer tape

Having selected the wood veneers, and having made up the design, lay a strip of well moistened veneer kraft tape firmly over all joints or component pieces. Glue is used to combine made up veneer pattern to wood surfaces, but in the case of metal surface decoration, it is, as a rule, done by making undercut edges to the pieces. The glue holds the veneer firmly down to the wood surface and the veneer tape prevents any separation of the pieces which go to make up the inlay.

When the work is completely hard and dry the final process of cleaning or sanding takes place.

The tape is easily removed by an application of fine abrasive or glasspaper applied to the surface.

As sanding down can disturb the more delicate designs, the tape must be easily removed and if there is some resistance to this work, the tape should be dampened, so that it may be removed without damaging the veneers at their joints.

In the wood, furniture and veneer trades, the patterns in veneer work become more and more complicated. The work is assisted by the use of transparent tape so that the veneer joints and the actual pattern may be seen during the operation.

Home-made mosaics from thin wood

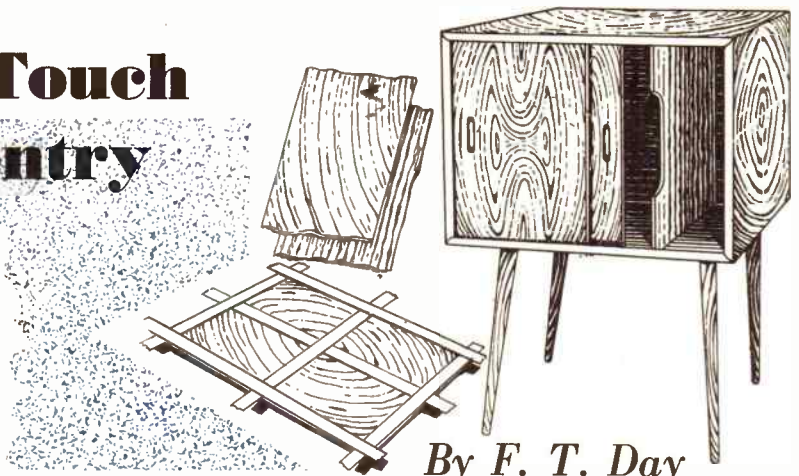

By F. T. Day

Illustrating the use of four pieces of veneer to make up a pattern

or ply, even hardboard itself, may be suitably tinted, coloured or stained, thus producing veneers for surface treatment

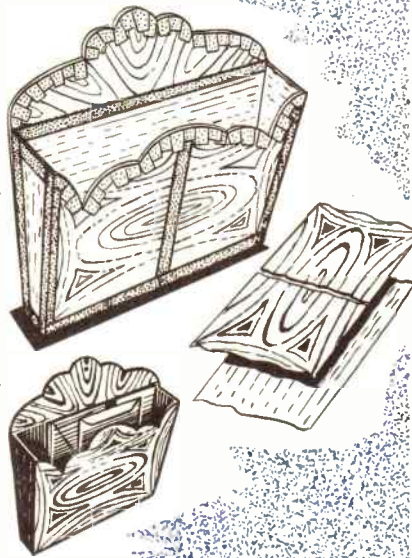

Veneers held in pattern position by glued tape

to woodwork. Where an inferior wood has been used in furniture making for the home, it may be considerably improved by some form of improvised veneer treatment in this way. Veneer treated surfaces may be finished with a coating of varnish or cellulose to harden and make glossy.

Wood veneer papers

It is possible to obtain Japanese real-wood veneers in sheet form 20ins. by

30ins. and English Imitation Wood Grain papers in a similar size and in roll form for larger work. Such grains as walnut, oak, cedar, etc., are available. These papers may be pasted down to wood surfaces, the paper itself being cut into veneer patterns to suit the style of the room or to taste. The real-wood veneer paper is actual wood fibres laminated on to a kraft base material so that it is very strong. It pastes well and may be cut with scissors. Attractive patterns may be made up in the form of draughtboard style patterns where the grain is laid to run against each piece applied. Wood grain or wood veneer paper will stand varnishing or cellulose treatment so that the surface may be hardened and made more durable.

Veneer may be made up from imitation mother of pearl, ivory tortoiseshell and thin metal materials. Suitable adhesive will stick all of these materials to wood surfaces.

Various projects

Handicraft workers commencing veneer work for the first time may select some piece of work similar to a small occasional coffee table, record holder cabinet, or a letter rack. Where such pieces are made up from inexpensive wood or hardboard, they may be suitably treated either with actual veneers of wood, or veneer papers of the kind described. Having decided upon the veneer design, the pieces are cut suitably to size to cover the area to be treated. All the pieces are at this stage held together or joined up in the pattern ready for gluing down to surface. The tape is removed after the veneer has been glued and dried out, other treatment following.

Build this 5-valver

A MIDGET MAINS SET

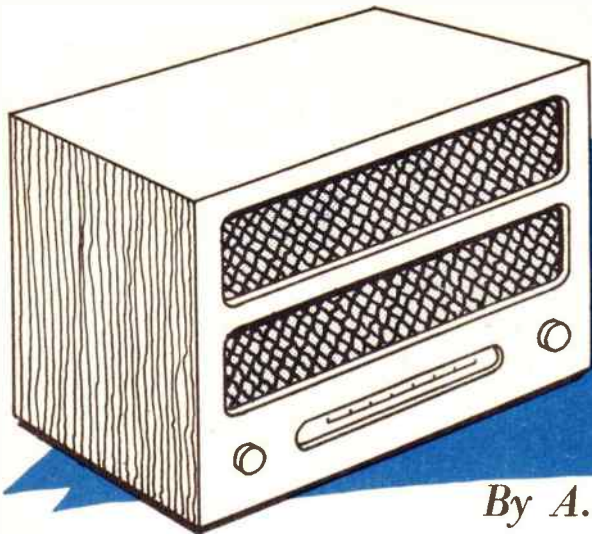

By A. Fraser

HERE is a small, powerful, yet inexpensive mains set which anyone with some experience in radio construction can build without much difficulty.

It is a five-valve superhet using modern midget valves and the size, including cabinet, amounts to only 8ins. by 5½ins. by 5ins. Obviously a very handy little set, easily transportable from room to room as desired. It incorporates a frame aerial, so that an ordinary aerial can be dispensed with where this is not to hand.

In power it is equivalent to the usual commercial five-valve superhet, but costs much less than half — actually about £5.

Constructors should not be deterred by the fact that it is a superhet type of set. These are not much more difficult to build than the ordinary T.R.F. design. Even if you possess no signal generator for alignment, pre-aligned intermediate frequency transformers are available, which makes a signal generator unnecessary.

Construction is simplified by making the set single waveband only (the choice of which band is left to the reader). However, dual waveband could be incorporated, but this would involve more work and expense, and should be avoided by the novice.

The first thing to do is to make the chassis (20 to 24 gauge aluminium will do). A sheet should be sawn out as in Fig. 1(a). This is shown flat. When the cut-outs are made it is bent along the dotted lines. It is best held between wooden boards and cramps for this bending process. Fig. 1(b) shows the completed chassis.

All the valve holders are B7G except the fourth one, which is B9A. Use a fretsaw for these if you haven't a proper cutter. Incidentally, the sheet aluminium should be clean and free from grease, etc. Petrol and cloth will see to this.

The components list is given and many of these can be bought cheaply from firms dealing with manufacturer's surplus. One or two firms are mentioned

but there are others just as good. The condenser C12, owing to the restricted space, should be a small type, which will cost a few pence more.

The aerial and oscillator coils could be made cheaply at home, if you have

COMPONENTS LIST

Valves. 6BE6, 6BA6, 6AT6, 6BW6, 6X4. (a). Twin gang tuning condenser. (Small type, with trimmer). (a). Heater transformer. 6.3 volt, 2 amp. (b). Output transformer. (Small type, to match 3 ohms). (b). Loudspeaker (Elac, 3½ins.). I.F.T.'s (465 kcs. midget, pre-aligned). (c). Valve holders (4 B7G, 1 B9A). Volume control/switch. (.5 meg. single pole). Osmor frame aerial QFA1. Osmor oscillator QO8. C14, 16, (32-32 mfd. 350 v). C15, (25 mfd. 25 volt working). C3, C4, C10, C11, (.0001). C5 (470 pfd.) C6, C7, C8, C9, (.1 mfd.). C12, C13, C17, (.01). C18, (.005). C19, (.001 mfd. 500 v). R1 (1 meg), R2 (22K), R3 (120), R4 (10K), R5 (15K), R6 (68), R8 (50K), R9 (220K), R10 (220K), R11 (10 meg), R12 (.5 meg), R13 (220). R14 (2.2 k, wire wound, 5 watt). R15 (120, 2 watt). R16 (2.2 meg). Drive drum, 2½ins. diam. Drive spindle. Tag strips (2), grommets (5), solder tags.

(a) T.R.S., 70 Brigstock Rd., Thornton Heath, Surrey.
(b) Radio Supply Co., Mande St., Leeds 2.
(c) Clyde Radio, 24-26 Hampstead Rd., London, N.W.1.

the experience. The volume control/switch (R6) could be a midget type, if desired, but would cost more.

Lastly, the tuning condenser (C1, C2) should be a type that has trimmers attached, and be of midget size. The I.F.T.'s should be small types, pre-aligned, if you have no signal generator.

The system of tag connections of the I.F.T.'s should be studied to see if they correspond with the wiring scheme. Different makes have different connections. With surplus types, having no explanatory leaflet, carefully remove the can and identify the leads, making a note of these before replacing the can. Owing to different systems, the reader may have to alter the connections (as shown in the wiring diagram) of the I.F.T. tags.

The chassis being ready, mount the valve holders on it seeing that they are oriented in the correct position (see

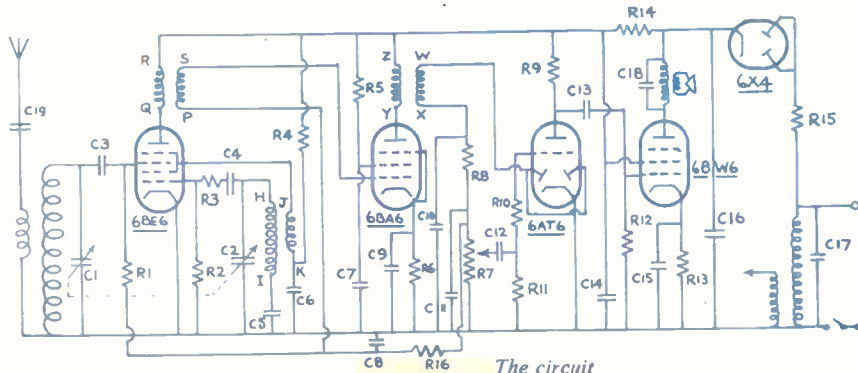

The circuit

Fig. 2 of one underneath chassis view). Don't forget soldering tags where necessary.

Add the I.F.T.'s, again in their correct positions from the point of view of tag connections. The tags or pins or wires of the I.F.T.'s should not touch the sides of the holes from which they issue.

Next, mount the volume control. This should be done by first making a support made of a square of aluminium, bent at the bottom to make a flange. Two holes through this flange enable the support to be bolted to the chassis deck.

A $\frac{1}{16}$ " hole in the centre of the support allows the volume control spindle to pass through and the nut fixed to hold it (see Fig. 3).

The spindle of the control will have to be extended to pass through the hole opposite in the side of the chassis. This is done with a spindle coupler and a length of $\frac{1}{16}$ " tubing or rod. Take care the screws of the coupler do not foul the tags of the valveholder below.

Now add the smoothing condenser (C14,16), and fix in the oscillator coil, L2. Finish the underchassis for the time being by adding any extra solder tags and tag strips where necessary, and the grommets (rubber) where these are shown (A, B, C, D, E).

Turn the chassis over and start on the upper deck fittings. First, fix the heater transformer as shown, using bolts and nuts, not forgetting the solder tag (see Fig. 4).

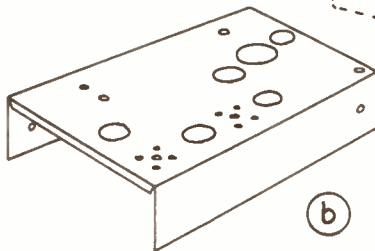
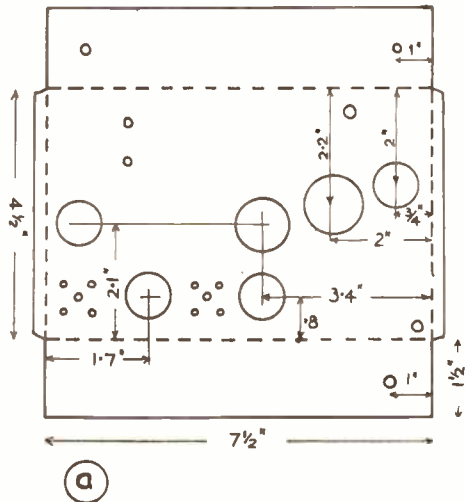

Fig. 1

Next, the output transformer must be mounted. This could be fixed as the heater transformer is, but to preclude any interaction (causing hum) between them, mount the output transformer on a screen made of aluminium and fixed to the deck by bolts through a flanged base. (Compare volume control support.) Bolt the transformer to this screen, as shown in Figs. 4 and 5.

The tuning condenser is fixed now. There are different systems of fixing according to the make. Some condensers are provided with bottom feet, others with front side screw holes for fixing to a support plate similar to the one just made for the output transformer support. One must fix the condenser accordingly. The position is seen in Figs. 4 and 5. When fixed, with drive drum in position, the drum should just overhang the chassis side (front runner).

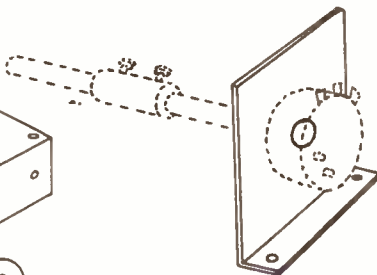

Fig. 3

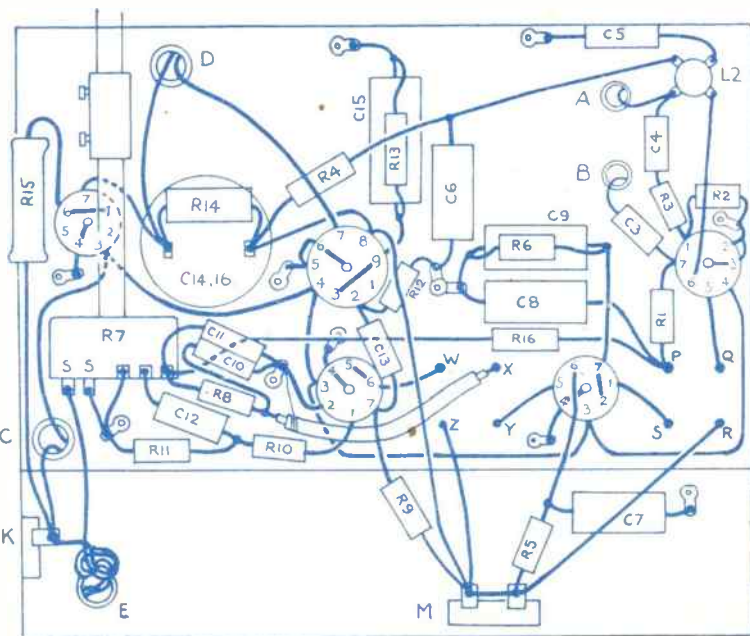

Fig. 2

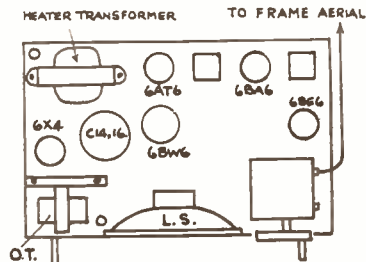

Fig. 4

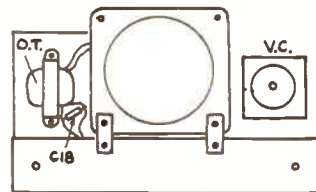

Fig. 5

In next week's issue A. Fraser will give detailed instructions for wiring this receiver.

Add a note of realism

NOVELTIES FOR THE HOME

WITHIN a few days I have seen three very novel and attractive additions to three different living rooms, and since the ideas are themselves well worth copying — to say nothing of the fact that they may set you thinking of fresh ones — I will describe them.

My first innovation concerns the very popular and equally common tropical

To my way of thinking, my friend had achieved a truly original addition to that particular tank, and one which lifted it way out of the ordinary. You can either buy such small model ships and their crews, or you can make them, according to your tastes. Or, perhaps, you may now have other ideas for your own tank. But it must be admitted that a little

virtual landscape, and named it 'The Painted Desert'.

Using a home made 'tray' as his platform (about 4ft. long, 2ft. wide and some 3ins. deep) which fits precisely into an alcove in his lounge above

By J. Thompson

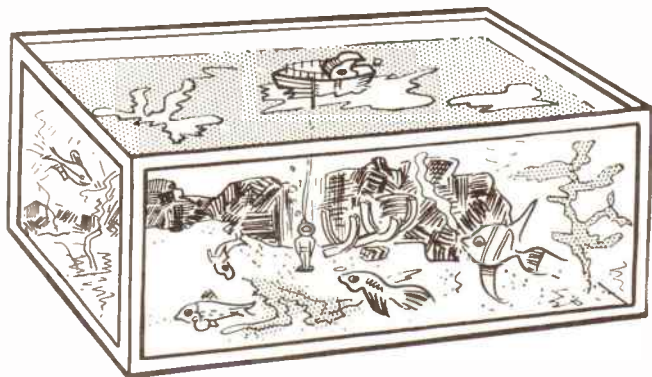

fish tank.

The tank — a medium sized one — was, of course, lit up, and there was the usual sandy bed with various green plants growing therein. Additionally, there were one or two small rocks lodged in the sand, and a much larger one in the form of a reef at the back of the tank. Several types of fish were lazily swimming about — and I can already hear you saying that so far I have described nothing out of the ordinary.

But wait a moment. Just in front of that reef, and in fact leaning drunkenly against it and plain for all to see, was a small scale model of an ocean going freighter, its plates rusting and apparently barnacled, whilst a gaping hole in the bows, and well below the water line, spoke of the reason for its sinking. And clambering up the side of the doomed vessel, and again to scale, was the tiny model of a deep sea diver, his life and air lines reaching up the tank to the surface, on which a small salvage vessel floated, with two tiny members of its crew standing by the ladder hanging over the vessel's side and into the water.

Next week's free design is for a 'Kennel Money Box' complete with dog.
MAKE SURE OF YOUR COPY



variety, undoubtedly, adds spice to this hobby.

The painted desert

My second illustration should surely appeal to gardening enthusiasts. This, however, is a form of indoor gardening — but taken a great deal further to depict the type of desert scene which we have come to know via the medium of Wild West books and films. For this particular friend of mine is keenly interested in cacti plants — but in a corner of his lounge he has built a

suspended above the tray, sheds a bluish light over the scene — giving, when the room light is switched off, a truly realistic impression of moonlight over the desert.

Indoor aviary

My third friend is a cage bird enthusiast — but not for him the ordinary cage and stand. As he explained to me, he not only likes budgerigars, he likes all manner of tropical birds, many of which can and do live amicably together in close confinement. But he cannot

indulge in an outdoor aviary — for the good and sufficient reason that he lives in a top floor town flat, with no garden facilities available to him.

Being something of a handyman, he has made for himself what is virtually, for want of a better term, a 'wallcase'. This is sturdy but quite light — being 4ft. long, 3ft. high by 1ft. deep. It comprises a tastefully made wooden frame with wooden floor and a glass back the whole length and height. Glass is fitted 1ft. only up the front and the sides, the rest being enclosed by fine mesh wire. The whole case is hung from the picture rail on two serviceable chains — just as a picture might be — the base of the case being some 5ft. above floor level.

All the necessary paraphernalia of the average birdcage has been incorporated in the 'wallcase', so that there are an adequate number of small feeding and drinking bowls, and, of course, perches. Half-a-dozen birds of various types and

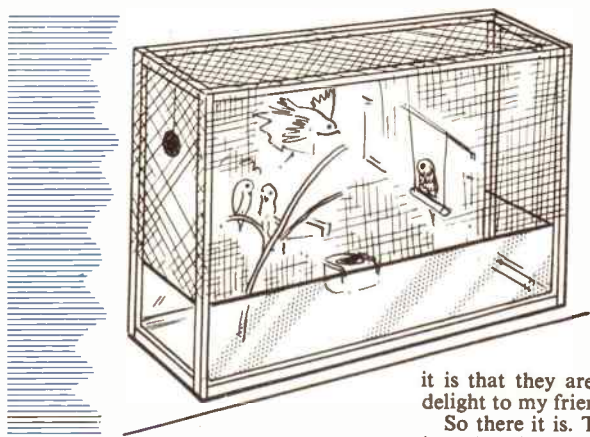

origin occupy this indoor aviary, and no one could deny that they seem supremely content with their lot. Certain

it is that they are a constant source of delight to my friend and his family.

So there it is. Three people who have introduced something of the 'novel' into their hobbies — and who have, as a result, found an increased interest for their leisure hours. (H.G.)

Cork Compressor for the Lab.

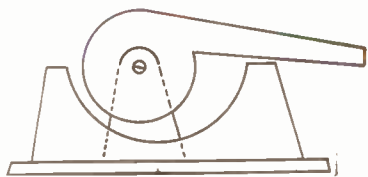

BEFORE a cork is used it should invariably be rolled in order to soften it and compress it. This not only puts it into a condition in which it makes a much better fit in the tube or bottle for which it is intended, but it also prevents a great deal of the risk of the tube or bottle neck splitting.

New corks (and old dried-up ones) are hard and unyielding until they have been rolled when they become much softer and more like the texture of rubber. The dangers of glass being split by an unrolled cork are not at all to be despised. The writer was once engaged in fitting a large cork and delivery tube into a stout hard-glass boiling tube and being in something of a hurry didn't bother to soften the cork. As a result the tube shattered, both hands came together forcibly and the one holding the cork was badly cut. Since then, it has become habitual to roll all corks.

The diagram is self-explanatory. The dimensions are not at all critical but all the wood used should be fairly substantial, perhaps about an inch in thickness. The diameter of the wheel portion is about 4ins. and although it is shown made in one piece the handle may, if desired, be screwed on to the outer face

as a separate member. Do not smooth either the edge of the wheel or the curved top of the fixed part. Both edges should be rough as the saw leaves them so that the cork will be gripped the more easily and firmly.

The wheel part is fixed to its supporting bracket by means of a large stout screw which should also be a good fit in the hole in the wheel. It is important to make a good job of this bearing so that there is little or no play in it and the minimum amount of wobble in the wheel itself.

The remainder of the joints between the various parts of the device should be made with glue and screws to ensure that

the whole thing is quite rigid and strong. The curved channel between the wheel and the stationary part should be about 1½ins. in width tapering to ¾in. at the smaller end.

In use, the handle is pushed upwards and backwards, the cork is inserted as far down the curved channel as it will go and then the handle is again pulled forwards and downwards. The cork is thereby carried along the channel towards the narrow end rotating as it proceeds and therefore getting more and more squashed and thus more compressed and softened. Reverse the motion of the handle and remove the cork. (H.G.)

Bulb Bowls from Old Records

MANY people hope to have beautiful hyacinths, daffodils and crocuses in the house in the spring. Often, however, one gets the fibre and bulbs — only to find that one hasn't enough bulb-bowls. However, here is an easy way to counter this lack.

All you need is some old records (even broken ones will do), plenty of really hot water, rubber gloves and some patience. Having boiled some water, tip it into the sink, put on some really reliable waterproof gloves and immerse a record in the water. As it gets soft and pliable, bend it into the shape of a bowl, fluting the edges at the same time.

When it gets cold and set you have a handy fluted, black bowl, complete with drainage hole, for your bulbs. (P.C.)





Inlay FINGER

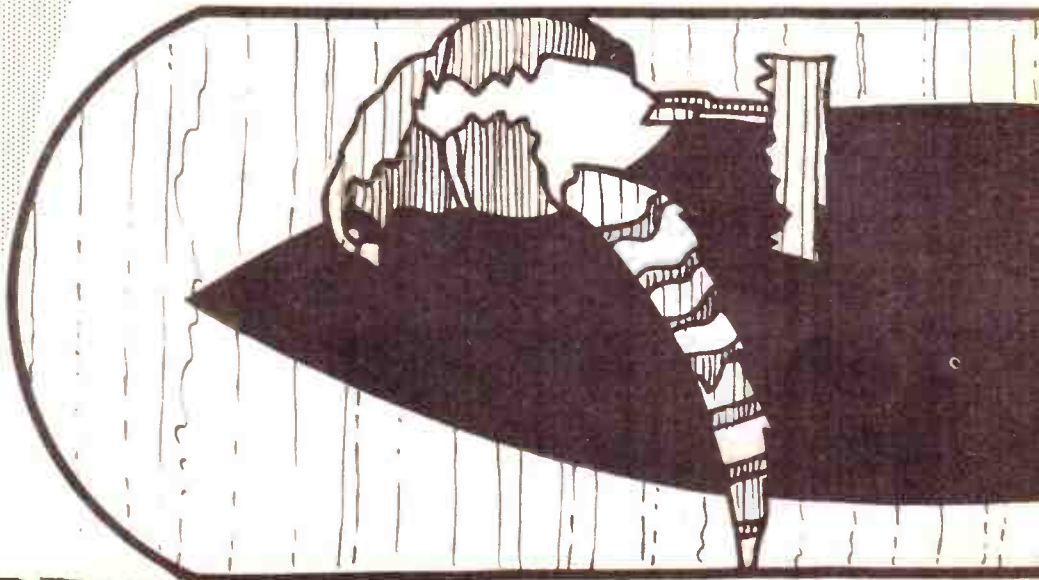
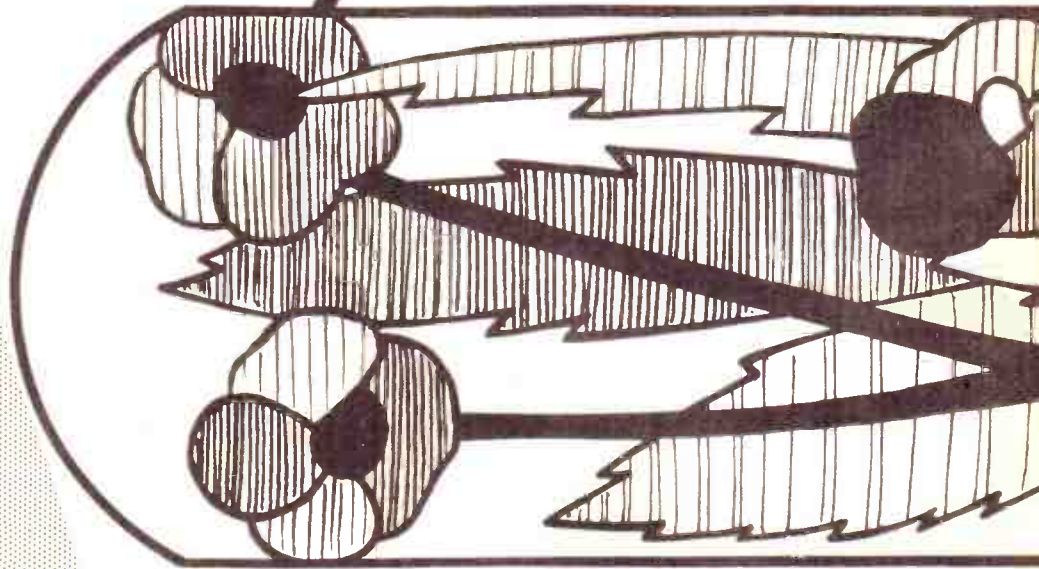

RPLATES

TELEVISION

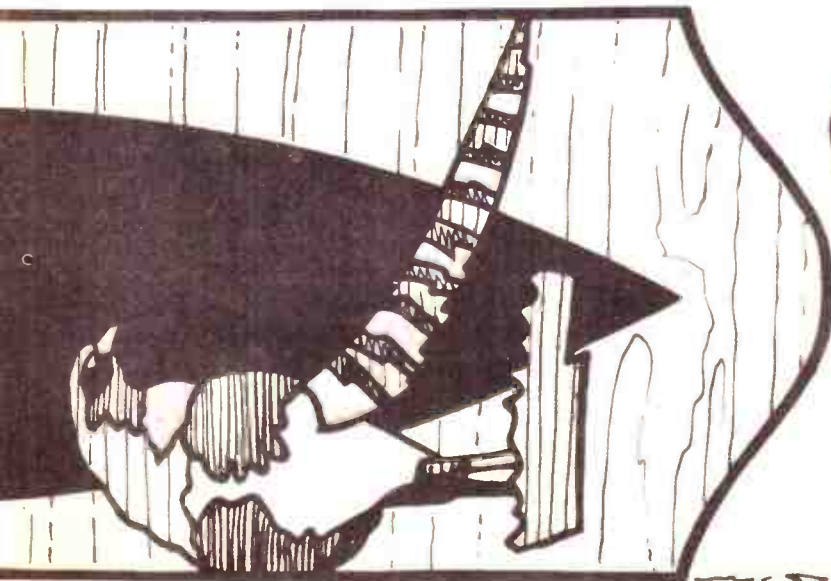
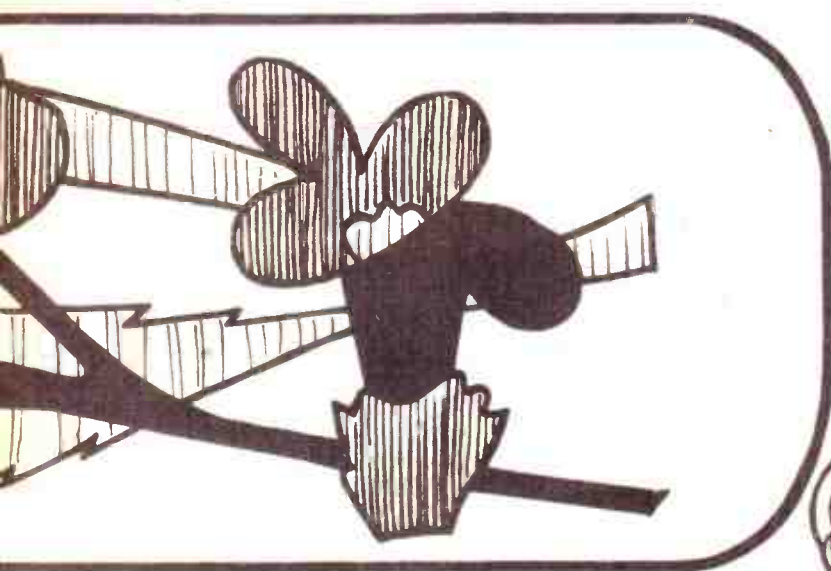

MAKE
FROM
Hobbies
INLAY
PANELS



OF all the little wild creatures none is quite so easy to make friends with as the red squirrel. Watch him pop out as you enter the woods and greet you with a challenging bark, for all the world like an excitable little dog. And, like the little dog, his subsequent conduct depends on how you treat him.

If you pass by and ignore him, or jeer at him, he will scold shrilly as long as he can see you. But if you sit quietly and assume a friendly, interested manner he, too, will become quiet and seek closer acquaintance with you.

RED SQUIRRELS

— By R.L.C.

His movements are pretty and amusing. See him dart up the tree trunk and run along the branches 'trying to get a better view of you. Then, having found the nearest and best one for this purpose, he will advance along it in spasmodic jerks, flicking his bushy tail and chattering nervously to bolster up his courage. As soon as he finds himself partly screened by the foliage he will suddenly become silent and sit watching you, thinking he is entirely concealed.

When he is satisfied that you are harmless and well disposed, see him scurry

back along the branch and down the trunk in sharp dashes, now on this side, now on that, with loud and defiant barking.

Having reached the ground, his first act will probably be to scamper off to

another tree at top speed. But if you keep still, his natural curiosity and friendliness will get the better of him. He'll come closer, hopping around the spot where you are sitting, making swift dashes between tree stumps and occasionally stopping to sit up and peer out at you with his black, shining eyes.

Whether he stays with you now or not depends upon how you really feel towards him in your heart, for the red squirrel is a quick and sure judge of character and motives.

If you love him and wouldn't hurt a hair of his russet coat, he'll very soon know it, and will approach fearlessly — even with affection. If, on the other hand, you are only curious to see what he will do if you humour him, he'll simply play around until his curiosity is satisfied, then disappear.

Those who learn to know and love the red squirrel will find him a jolly, entertaining little fellow.

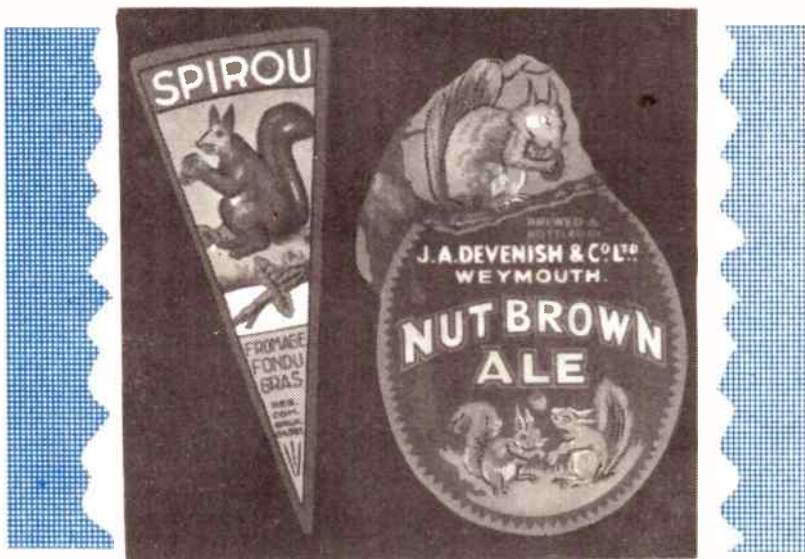

Work-Box Fittings

IN Victorian times, no lady's worktable was complete without a variety of shuttles for use in connection with her tatting. This occupation was as popular then as jumper knitting is today.

Tatting shuttles are much sought after by collectors of work-box fittings. They range from plain specimens in bone to those in elaborate fretted gold, often inlaid with enamels or decorated in a design carried out in mother-o'-pearl.

Silk-winders — flat sheets of ivory,

grooved at either end to hold skeins of embroidery silk — have become rare.

Decorated to match with the ornamentation of the box to which they belonged, these winders were made in great variety. Some represented scenes and landscapes engraved on metal. Others contained delicately painted floral designs. Many were made in Tonbridge ware, that ingenious method of wood inlay so much in favour 100 years ago. It seems incredible that the

introduction of carded silks resulted in many fine specimens being condemned to the rubbish heap.

Every work-box contained at least one emery cushion. Many and various were the forms which this indispensable accessory assumed.

The common form of a strawberry, crocheted in crimson silk or wool and punctuated with beads of steel or gold to represent the seeds is among the most delightful. Some cushions were made in the form of a velvet pouf set within a tiny ivory basket. Little steel pails with a

● Continued on page 332



**You Can Make
a Modern
Table in
One Evening
with these legs**



**FOR ALL
CONTEMPORARY
FURNITURE**

A coffee table, TV table, footstool, etc. . . . all can be made in quick time with these Contemporary style legs. Beautifully turned in Scandinavian beech, they can be left in their natural colour, or stained. Each leg is threaded at one end to screw into a hardwood block (see inset) which, in turn, is screwed to the underside of a piece of plywood or suitable material which forms the table top. Simple . . . and a perfect job. The legs are obtainable in three sizes:—10 ins. 2/3 each, 15 ins. 2/6 each and 20 ins. 3/- each. Postage on 3 or 4 legs 1/6 extra. Legs from branches or:

HOBBIES LTD, Dept 99, Dereham, Norfolk

MODELS FOR BOYS

No. 251 Spl.
TUG 'CLIMAX'
16ins. long

53/6



**Make them with a
Hobbies Kit**

No. 253 Spl.
**TRAWLER
'ANGLIAN'**
18ins. long

54/6

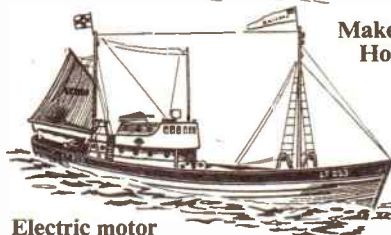

**Electric motor
and propeller
included**

No. 3206
**'EMPRESS
OF
BRITAIN'**
24ins. long
56/5

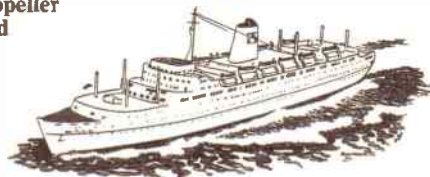

Hobbies Ltd, Dept 99, Dereham, Norfolk

**10/- 'GOLD MINE' 10/-
PARCEL OF STAMPS**

Contains sets, Mixed lots, Approval sheets, Album leaves, etc. *Hundreds of satisfied customers.*
Rec.—'Please send me a Gold Mine (I have had one and found it excellent value)'—T.R.T., Coventry
BELFIELDS (Dept. H)
STOUR HILL, QUARRY BANK, STAFFS.
Postal Business Only C.W.O. Post Extra

**FULLY TRANSISTORIZED!
PORTABLE TAPE RECORDER**

NOW a brand new EXPENSIVELY TRANSISTORIZED tape recorder and play back machine AT EVERYBODY'S PRICE. Complete outfit ready to record and play back. £11. 19. 6., carr. 5/-.



No more to buy. Records anything — music, outdoor sound effects, sing-songs, parties, ideal reporters, dictating, etc. Permanent recordings or tape can be used again and again. Further 3 in. spools obtained anywhere. With standard batteries (cost 1/8d. — months of normal use), you can record outdoors — anywhere! Perfect reproduction. Variable speed 1 1/2 to 3 1/2. Portable. Written guarantee. Or sent for £4 bal. 18 fnlt. payts. 10/10d. LISTS. GUITARS, WATCHES, RINGS, CABINETS, JEWELLERY, and MANY WONDERFUL BARGAINS. TERMS.

Headquarter & General Supplies Ltd.
(HOBW/50), 196-200 Coldharbour Lane
Loughboro Junc., London, S.E.5 Open Sat.

100 DIFFERENT stamps free! Request 1d upwards discount approvals. — Bush 53 Newlyn Way, Parkstone, Dorset.

I went to a dance to find a girl friend—
—but my dancing didn't make girls 'friendly'!



Now I'm no longer lonely—
—the girls know my steps are sure!

Can't afford private lessons? Learn ballroom dancing at home! Send for exciting booklet 'Dance Escort'—FREE to readers of *Hobbies*—which explains the dynamic SURE STEP system. Just send name & address to:
ESCORT DANCE INSTRUCTORS
Studio H.19 Harrogate
(or Rock'n'Roll Course—send 4/6 P.O.)

BUYING OR SELLING?

Classified advertisements on this page are accepted at a cost of 6d. per word prepaid. Use of a Box No. is 1/- extra. Send P.O. with advertisement to *Hobbies Weekly*, Advert. Dept., Dereham, Norfolk. Rates for display advertising on application.

**BRASS, COPPER, DURAL,
ALUMINIUM, BRONZE**

ROD, BAR, SHEET, TUBE, STRIP, WIRE
3,000 STANDARD STOCK SIZES
No Quantity too small List on Application
H. ROLLET & Co. Ltd.
6 CHESHAM PLACE, LONDON, S.W.1
Also at
Liverpool, Manchester, Leeds, Birmingham

**Completely new 54 page Edition
WHERE'S THAT CAR FROM?**

Price 1/- (Postage 4d.)

Of all Booksellers
or

RALEIGH PRESS, Exmouth, Devon

STAMPS FREE — Empire Packet including Spictorials and Victorians with approvals. — Robert J. Peck, 7A Kemp Road, Bournemouth.

MAKE A MUSICAL BOX for as little as 21/- . New kits and tunes available. Movements 13/- post free. Please send 3d. stamp for free illustrated catalogue. — The Swidcross Co., Dept. B, 202 Tulse Hill, London, S.W.2.

100 FREE including Giants, Triangles. Request Approvals. Postage. — Salter, 42 North Road, Rotherham.

Finding the Ring by Arithmetic

At some time or other you may have played a game where you are asked to think of a number, double it, add three and so on — a kind of mental arithmetic game for rapid thinking, but by applying a rigid formula we can make such a game into a really cunning trick.

Here the trick is to reveal a hidden ring, indicating not only the person but the particular hand and finger where it is worn, and the only apparatus required is some kind of a ring. A curtain ring will do, or, in an emergency, you may be able to fashion one from a piece of string. It should be noted that the more persons there are present the more baffling this trick appears, but first of all let us describe the presentation.

Appoint a leader

Showing the ring held in your fingers you ask some member of the group before you to act as leader, saying that you hope he is fairly good at arithmetic. Arrange the group so that they can be numbered off from left to right, doing this while the leader is standing with you facing the group. This must be remembered, for it plays an important part in obtaining a correct solution. Number off all the persons taking part in the game, say, ten or fifteen, and then present the ring to the leader, asking him to place it on someone's finger — on either hand and any finger, but making a note of these details for his own reference, that is (1) the number of the person, (2) the left or right hand, and (3) the number of the finger, counting the thumb as 1, all this being done while you are out of the room or your back is turned.

When the ring has been placed and you are recalled, the leader is asked to do some simple calculations on the paper provided for his notes, revealing only the final answer to you.

The leader is asked to multiply the number of the person having the ring by 2, add 3 and then multiply that total by 5. If the right hand bears the ring he is asked to add 8, but if on the left hand add 9. The resulting total is now multiplied by 10, the number of the finger bearing the ring added and finally 2 added. You will now see why the leader is previously asked to make a note of the exact whereabouts of the ring by the prepared number codes for person, hand and finger.

When this little piece of arithmetic is completed you have merely to subtract 222 and the remainder provides the answer to the location of the hidden ring.

This will, perhaps, be best explained

by an example and we shall assume that the ring has been placed on the fourth person's second finger of the left hand. This is the calculation the leader would make on your instructions.

Number of person	4
Multiply by 2	8
Add 3	11
Multiply by 5	55
Add 9 for the left hand	64
Multiply by 10	640
Finger number 2 add 2	642
Add 2	644

The final number is revealed to you by the leader and from this you mentally and silently subtract 222, giving a remainder of 422. Taking the reading from the right of this number, the 2 indicates the finger, the next 2 indicates the hand, and the 4 represents the number of the person. Here it is for clarity:—

4 2 2
PERSON HAND FINGER

This is the order of reading every time, and it should be noted that the middle figure will be either 1 or 2, the former indicating the right hand and the latter the left, while the other numbers will vary according to the number of the selected person and the finger chosen. Remember that in both hands the thumb counts figure 1 and the others numbered consecutively up to 5.

In reading out the solution you may omit the person's number entirely, using the name and saying something like this, 'I think I am correct in saying that the ring is to be found on the second finger of John's left hand.'

The calculations will prove similar for a number of players but in our illustration the fourth player was selected, the final answer becoming 644, but you may

ask what would happen if the fifteenth person held the ring. Here the procedure is exactly the same but as an experiment make calculations for this fifteenth player, holding the ring on the fourth finger of the left hand.

By 'Mystifier'

You will find that the answer here is 1746 and after subtracting 222 we have a remainder of 1524. It will be seen that in this instance the first two figures give the person number quite correctly.

As with other tricks with numbers, and as we have shown before, you can make modifications to the mystification of your friends. Let us start at the beginning again and after doubling the person number we added 3. For a change we could add 4, or some other number, and what do you think would happen? If you added 4 in the second step it would mean that instead of making the compensating number 222, which we finally subtract, some alteration would be required. The correct compensating number if 4 were added would be 272, and perhaps you may like to try with adding 1 or 2, prepare calculations for different hands, etc., and see if you can detect the proper number to subtract. You will probably find that an alteration of 1 makes a difference of 50 in the compensating figure, but be careful not to use too many of these modifications when performing the trick or you may not give the correct solution. The exercise is mentioned merely to show that modifications are always possible. And do not forget to keep the secret.

● Continued from page 330

Work-Box Fittings

silken emery cushion fixed within were made to accord with the scissors, bodkin, and embroidery punches, with the handles of wrought steel that found so much favour among Victorian seamstresses.

Collectors who specialise in these small articles of the work-box often restrict their researches to one particular branch of their manufacture, limiting themselves either to the ivories or to the objects in steel, bone or silver.

Much ingenuity and craftsmanship were brought to bear upon the pin-box or tray. Small trays for pins, little eight-sided bowls, made from pierced sheets of pearl or ivory, fastened together with minute lacings of ribbon, found a place

within most work-boxes. Occasionally these were formed of a thick cardboard, pierced to form a lacy pattern or painted with sprays of tiny blossoms.

But perhaps the most elaborate of all were the needle-cases of steel, silver-gilt and mother-of-pearl, that found a place at the top of the work-box. These were minutely patterned, the owner's initials often being worked into the engraved ornament with rich effect. The case itself frequently took the form of a human or animal figure, the designer's skill being directed towards circumventing the join at the centre in such a way that it would pass unnoticed.

Made this yet?
BED-TRAY
 or
BOOK-REST

Kit contains all
 wood and fittings

From branches:

LONDON
 78a New Oxford Street, W.C.1
 (Phone MUSEUM 2975)
 87 Old Broad Street, E.C.2
 (Phone LONDON Wall 4375)
 81 Streatham Hill, S.W.2
 (Phone TULse Hill 8796)
 151 High Street, Walthamstow, E.17
 (Phone COPpermill 3928)
GLASGOW—326 Argyle Street
 (Phone CENTral 5042)
MANCHESTER—10 Piccadilly
 (Phone CENTral 1787)

or direct (post free)

HOBBIES LTD (Dept 99) Dereham, Norfolk

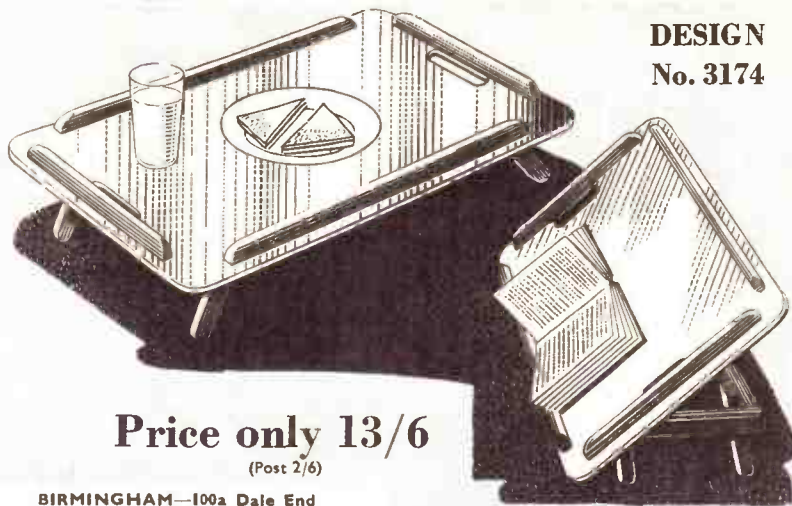

DESIGN
 No. 3174

Price only 13/6
 (Post 2/6)

BIRMINGHAM—100a Dale End
 (Phone CENTral 5483)
SHEFFIELD—4 St. Paul's Parade
 (Phone 26071)
LEEDS—10 Queen Victoria Street
 (Phone 28639)
HULL—179 Ferensway
 (Phone 32959)
GRIMSBY—88 Victoria Street
 (Phone 4186)

BRISTOL—65 Fairfax Street
 (Phone 23744)
NEWCASTLE—42 Dean Street
 Newcastle-on-Tyne 1 (Phone 21465)
SOUTHAMPTON—134 High St.
 (Below Bar) Phone 25947

ALL-STEEL CORNER CRAMP



Price
 11/9
 (post 1/3)

A Picture Frame Cramp made from steel and practically unbreakable. It is well made and finished and will take work up to 2 1/2 in. wide. For ordinary moulding it is a very serviceable article. From branches or:—

HOBBIES LTD, DEREHAM, NORFOLK

BE TALLER

In 12 days or money back. New gland and spinal discovery increases height 2 to 5 inches. 'I have gained 4 1/2 inches in height. My weight increased from 9-stone 4-lb. to 10-stone 3 1/2-lb.'—P.D. 'Increased 3 inches.'—H.G. Guaranteed harmless. Full course 10/6 (or \$1.50). Air mail 16/3. Details 2d. Sent under plain cover. J. H. MORLEY, 28 (H/189) Dean Rd. London, N.W.2. Practical Courses, all subjects. List free.

LET

'Plasticine'
 HELP YOU DO-IT-YOURSELF Regd. Trade Mark
 Harbutt's Plasticine Ltd, Bathampton, Bath

Refix loose or broken
 tiles with

fixatile



TILE FIXING CEMENT

fixes loose or broken tiles round fireplaces and on kitchen and bathroom walls. Resists heat.

In tins from ironmongers and hardware retailers.

**PURIMACHOS, LTD. ST. PHILIPS
 BRISTOL 2.**

MAINLY *for* MODELLERS

TO the model maker the problem of rigging cord becomes more important the further he progresses in his chosen hobby. Many materials are pressed into service, but eventually, to the modeller who reaches the pleasant field of scale model making, ready-made materials seldom enable one to get every piece of rigging to scale.

For the beginners our title means exactly what it says, rope is rope when purchased, but as soon as it is in service on ship board, it becomes cordage. All rigging is known as cordage.

The first thing we must make note of in relation to the rigging of ships and models, is that all rope is measured by the circumference, not the diameter. To find the diameter of a cord you contemplate using, use the following method.

Finding the diameter

Take a piece of dowel ($\frac{1}{4}$ in. or $\frac{3}{16}$ in.) will do, and mark 1in. on this as in Fig. 1. Wind your cord around it between these two marks, the number of turns will give you the diameter, for example, 25 turns in the inch will mean your cord is $1/25$ in. thick, the circumference will, therefore, be approximately $3/25$ in.

To the two scales to which I work for scale models, that is $\frac{1}{4}$ in. to the foot, and the standard museum scale for period models of $\frac{1}{8}$ in. to the foot, a rope that is $3\frac{1}{2}$ ins. in circumference on the prototype will be $1/96$ in. and $1/48$ in. in diameter on the model, respectively.

In making a rope, three or more strands, are used, each strand being made of three or more yarns.

On early ships the rope was made of hemp, usually tarred; late in the 19th century manilla was introduced and also wire.

Ropes are made with twist either right-hand or left-hand, and some of the heavier ropes are twisted round a centre core.

In order to make this clearer to the reader, in Fig. 2 we have examples of right- and left-handed ropes, (A) is hawser-laid rope, (B) shroud laid rope and (C) cable laid rope.

In four stranded rope the strands are wound around a heart or centre rope. This is to make the strands tie evenly, if there were no heart, the rope would have a hollow centre.

On large scale models the keen model maker can enhance the value and interest of his model by following full

size practice, serving and parcelling the various cords in the rigging. This we will consider in a later article.

For the modeller to scale, it is a

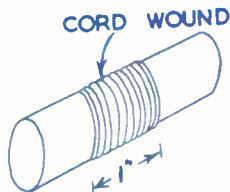

FIG. 1.

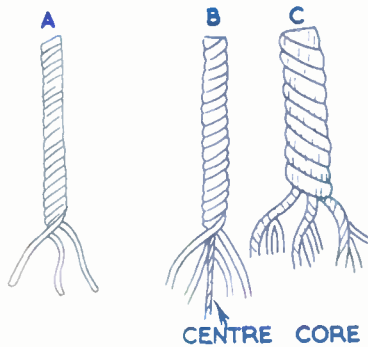

FIG. 2.

'must' to make his own rope in miniature, and we will discuss ways to do so in this series. All full scale rope was made in a rope walk, and this method can be used by making a miniature rope walk.

Book to read

Tape Recording as a Pastime

by Ian Arnison & Douglas Gardner.
TAPE recorders are being used in rapidly increasing numbers and are now an established source of pleasure to countless enthusiasts. There is more to it, however, than merely playing back the voices of friends and the family, and this book throws an authoritative and most welcome light upon the hitherto little explored territory which lies beyond the first and obvious use of the tape recorder.

Technicalities are dealt with in

SHIP'S CORDAGE

By 'Whipstaff'

As a point of interest and maybe help to those who cannot make or do not wish to make their own rigging cord, here is a list of commercial sewing threads that were used to rig a $1/48$ in. scale model of a 17th century ship to give as near possible scale rigging, all standing rigging being black and running rigging being natural colour, not white.

Shrouds and stays

For the shrouds the thread had to be wound into rope, the foremast shrouds were made of three strands of No. 35 linen thread, the main shrouds of three strands of No. 30 thread, and the mizzen of three strands of No. 60 thread. The method of simply twisting these will be given in a later article.

The stays are made of three strands of the shroud ropes already made, twisted together in the same way.

If fitting tackle falls, they are made of No. 30, 35 and 60 thread for their respective masts, single strands being used.

The shrouds in the topmasts were made from the linen thread in the following sizes:—foretopmast No. 30, maintopmast No. 35 and mizzen topmast No. 60, single strands.

For running rigging, on mainyard use No. 30 linen thread, maintopyard No. 60, maintopgallant No. 70, foreyard No. 35, foretopgallant sail yard No. 70, and foretopsail No. 60. On the mizzen yard No. 35, mizzen topsail yard No. 70, spritsail yard No. 60, and sprit topsail yard No. 70.

While not being completely to scale, these sizes are very close to actual scale size, and as such give the correct appearance to the rigging as viewed on the model.

CUT-OUT BOOKMARKERS

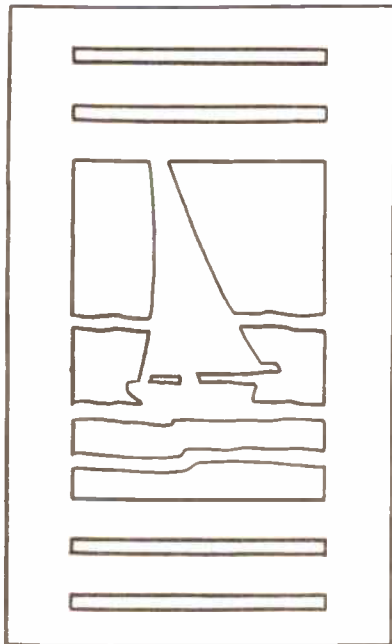
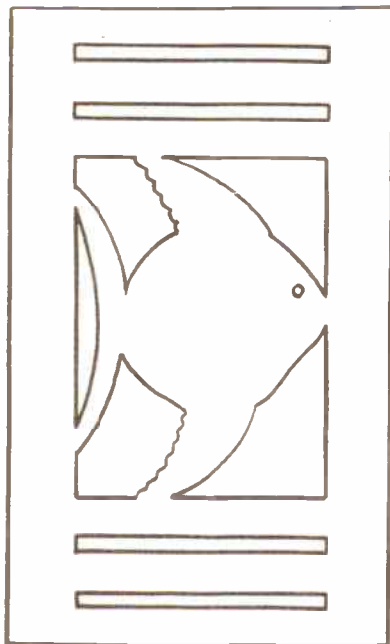

CUT OUT THESE USEFUL GIFTS WITH A FRETSAW

THE four designs shown on this page are cut from thin plywood. Tape five or six pieces together and cut with a fine-grade fretsaw. Spare ones may be given to friends as presents.

Insert the ribbon as shown at the top right-hand side of the page. The coloured ribbon makes a background for the picture.

Cut-outs may be left plain, or may be painted with plastic enamel. (M.p)

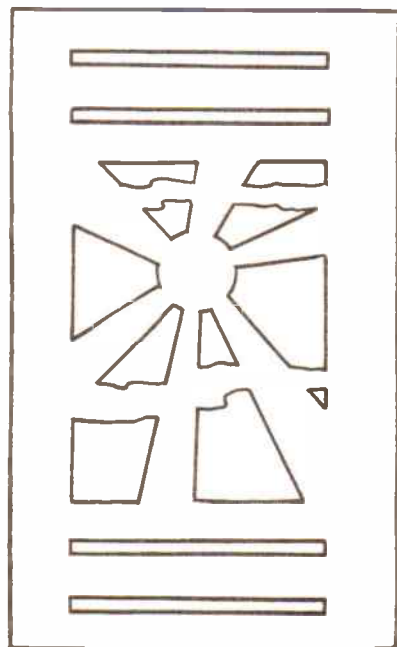
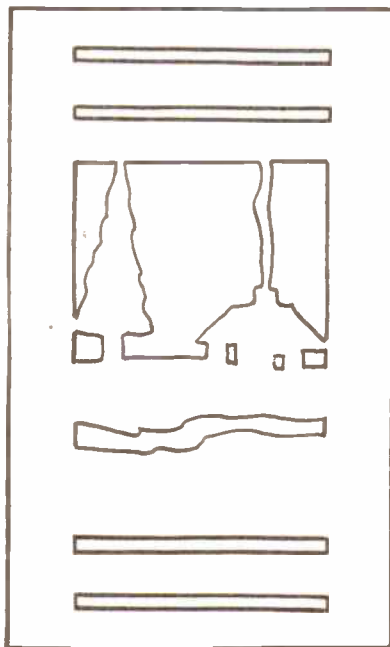



KITS WHICH WILL MAKE GRAND GIFTS FOR ALL MEMBERS OF THE FAMILY

Gifts made by yourself have that 'personal' touch which make them all the more appreciated. Here are a few kit suggestions from Hobbies which will delight both giver and receiver. Many more ideas in Hobbies free 20-page booklet. Send for one today and save yourself £££'s.

KITS CONTAIN ALL MATERIALS AND FULL INSTRUCTIONS FOR MAKING WITH A FEW SIMPLE TOOLS.

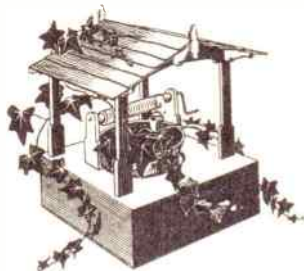

'OLD WELL' PLANT HOLDER

Kit No. 3248

10/3 (post 1/6)

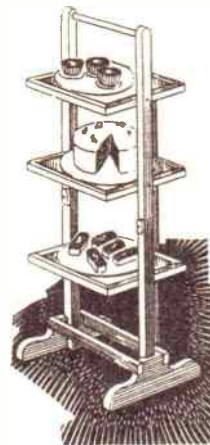

FOLDING CAKE STAND
Kit No. 3226. All wood, hardboard, etc.

20/- (post 1/9)



**'LIGHTHOUSE
ELECTRIC LAMP'**

Kit No. 3252. Lampfittings, printed window material, etc.

22/6 (post 1/9)

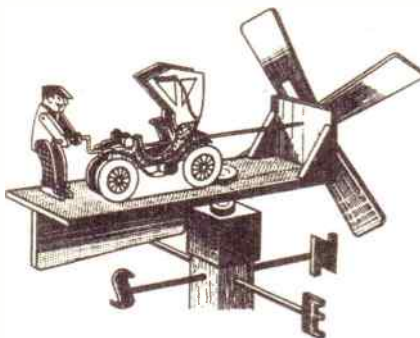

NOVEL WINDVANE

Kit No. 3258. Wood, wire, steel, etc.

16/- (post 2/-)

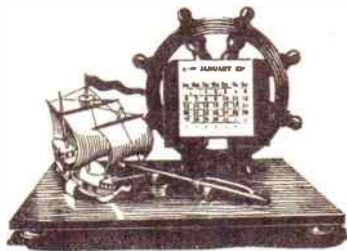

GALLEON CALENDAR **5/9** (Post 1/-)
No. 3188 Graceful and practical.

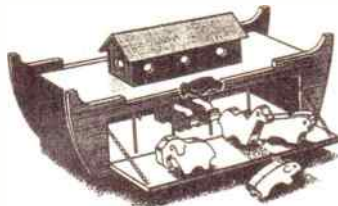

NOAH'S ARK
No. 3270. With animals.

13/11 (post 1/6)



**AUTOMATIC
CIGARETTE BOX**
No. 3272. Open the
drawer for a cigarette.

5/6 (post 1/-)

**GET STARTED ON SOME
OF THESE RIGHT AWAY!**

To Hobbies Ltd., Dept. 99, Dereham,
Norfolk.
Please send free copy of 'Profitable Leisure'
and

KIT NO.....

Name.....

Address.....

P.O. for..... Orders totalling 30/- and
enclosed. over, post free