

23rd DECEMBER 1959

VOL. 129

NUMBER 3341

THE ORIGINAL
'DO-IT-YOURSELF'
MAGAZINE

HOBBIES *weekly*

FOR ALL
HOME CRAFTSMEN

*Instructions
for making . . .*

Also in this issue:

FLYING THE
'HOBBY CLIPPER'

COLLECTORS' CLUB

MAKING AN
ELECTRIC PUPPET

SCENERY FOR A
PUPPET THEATRE

LAST-MINUTE
'STOCKING' TOYS

MAKE A CRYSTAL
DIODE RADIO

MODELLING NOTES
AND CHEMISTRY

ETC. ETC.

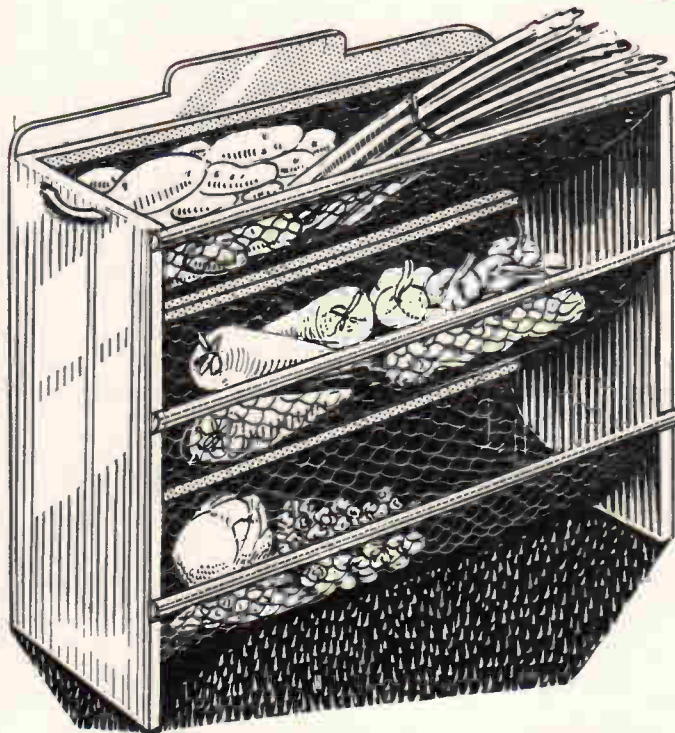

VEGETABLE RACK



Up-to-the-minute ideas

Practical designs

Pleasant and profitable things to make

5^p



MR R. Hayes Hamilton, manager of the Flanders Hotel, Ocean City, U.S.A., collects hotel service plates. His collection of over 400 plates is probably the only one of its kind in existence.

He has written more than 800 letters to hotels, large and small, in each American state, as well as Canada and Mexico, asking for plates. He has been

rewarded by having fifty per cent satisfactory replies.

Each plate in his collection is individual. Some bear the picture of the hotel, or at least the name of the hotel represented. Three hundred persons answered his request and apologized that they had no service plates or name plates in their hotels. Some asked if they could

HE COLLECTS HOTEL PLATES

have specimens specially made and designed for this unique collection.

The plates, incidentally, include the world's finest china — Minton, Wedgwood, Royal Worcester, Doulton Ware and many others. They range in value from £1 to £50 a piece. Probably the most distinctive as well as expensive piece of the entire collection is from the Netherlands Plaza Hotel in Cincinnati, Ohio; the centre of this plate is a sterling silver inlaid crest on black ebony china.

An hotel in Casper, Wyo., asked to be excused from sending a plate since their

service plates cost about £40 each!

A large golden lustre plate represents a hotel in Alaska. In the centre is the picture in gold of an Alaskan dog.

One section of the collection, which encircles the entire Hamilton dining room, is devoted exclusively to the National Parks, and so far, Yellowstone, Glacier, Yosemite, Zion, Grand Canyon, Banff, as well as McKinley National Park in Alaska are represented.

Another section is given over to Canada, showing plates from the famous Manoir Richelieu in Murray Bay, the Château Fontenac, the Royal York, Banff, and Lake Louise, and a complete collection featuring each of the Canadian Pacific Hotels.

While not strictly a hotel plate, perhaps the most attractive one is from the President's private car of the Pennsylvania Railroad.

In connection with guest plates, Mr Hamilton has had some amusing experiences. In 1952 one of the guests, in fact the right hand man to the Mayor of the nearby city of Philadelphia, asked if he might add a plate commemorating this great city. An order was forthwith put in through the Mayor's office to have a special plate made up with the city seal of Philadelphia on it in blue and gold. A few days later this contribution arrived: not only one plate but two plates, engraved beautifully — not dinner plates but automobile license plates! This time the Mayor was contacted by phone and told that china plates, not upper or lower plates nor auto plates, were wanted! The plate was finally received along with a golden key to the city of Philadelphia. (R.L.C.)



Latest American match covers

Brandy Snaps for TV. Snacks

WINTER parties beside the fire or on 'sledging' nights seem to call for something gay yet warming, something grandmother kept in her cupboard as an extra tit-bit to keep out the cold.

Here, then, are some recipes for warming up our winter parties —

BRANDY SNAPS

- 2 oz. butter or margarine
- 2 oz. brown sugar
- 2 tablespoons golden syrup
- $\frac{1}{2}$ teaspoon ground ginger
- 2 oz. plain flour

Warm butter, sugar, golden syrup and ground ginger in a basin in a warm oven until the butter is melted. Mix this well. Add the flour to the warmed mixture. Grease a baking tray and drop the mixture in spoonfuls upon it. Leave room between each spoonful for spreading. Bake in a moderate oven (Reg. 4) for fifteen minutes. When cooked, allow the snaps to cool very slightly, then roll each

snap quickly round the handle of a wooden spoon. The brandy snaps will have a crisp and pleasing crackle when eaten.

Parkin is another old favourite, and is a good selling line for cake stalls at sales of work.

Though it varies a little in different parts of the country, I do not think that you can beat the old north country recipe. It is very nourishing and sustaining for cold winter weather.

PARKIN

- 2 lb. treacle
- 2 lb. medium oatmeal
- $\frac{1}{2}$ oz. mixed spice
- 6 oz. margarine or lard
- citron or mixed peel

Melt butter and treacle in a saucepan. Add dry ingredients and beat well. Cover with a cloth and allow to stand all night. Bake in a well greased tin in a slow oven (Reg. 3) for $1\frac{1}{2}$ to 2 hours. Allow to get quite cold before turning out. (G.K.)

Instructions for making

A VEGETABLE RACK

VEGETABLES should be kept in an open rack so that air can circulate round them freely. In a closed cupboard the stagnant air gives ideal conditions for mould growths, causing fruit and vegetables to deteriorate quickly. An illustration of the rack described here is shown on the front page.

They need not look untidy if the right kind of rack is made. As shown in the details, wire netting is the ideal material

for the curved racks. It is light and strong and is easily fixed in position with large-headed tacks.

Fig. 1 shows the main measurements. Note that the racks are spaced to give a clearance of 12 in. The back (C) is a piece of $\frac{1}{4}$ in. hardboard 3 ft. by 3 ft. 3 in., and is shaped at the top to improve the appearance. The sides (A) are cut from $\frac{3}{4}$ in. wood, and the rails (B) are pieces of 1 in. square stripwood 36 in. long.

The rails are slotted into the ends as shown in Fig. 2. Three methods of fixing are shown in Fig. 3. Note that at B the rail is secured by an angle plate in position 1 or 2. Continue by pinning the back (C) in place as shown in Fig. 4.

The wire netting, which should be about 1 in. mesh, is secured by tacks as shown in Fig. 5. Cover the front and back rails with $\frac{3}{4}$ in. No. 35 round beading, which costs 10½d. per 3 ft. length,

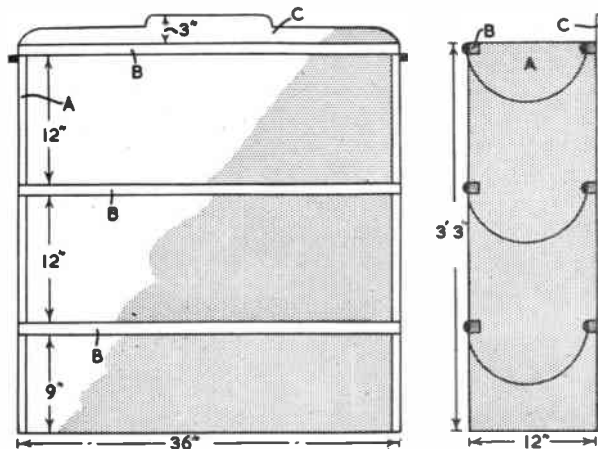

Fig. 1

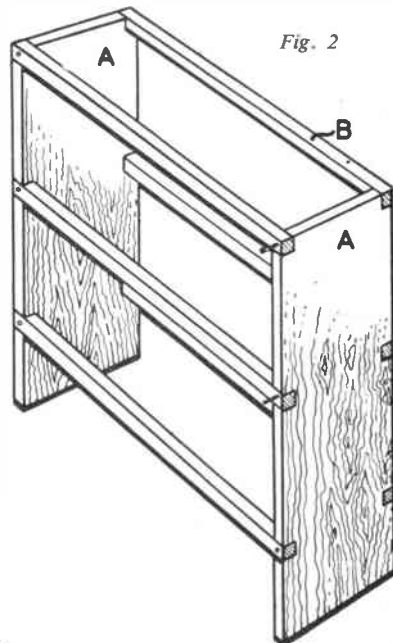

Fig. 2

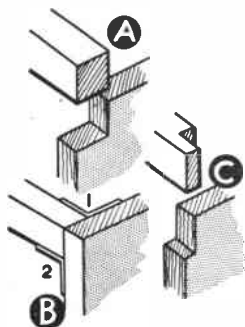

Fig. 3

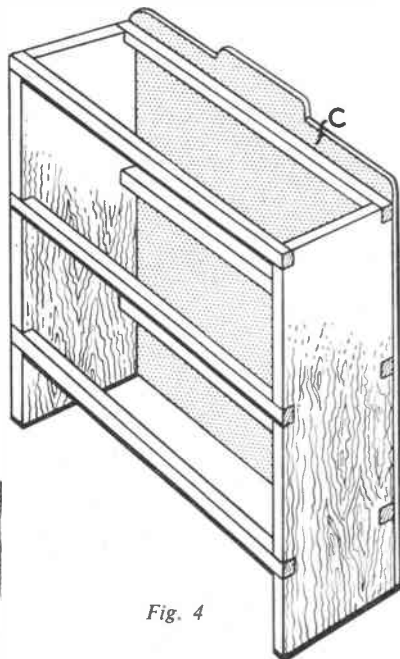
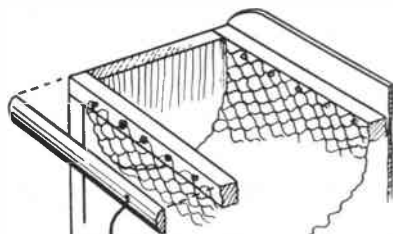

Fig. 4



No. 35. Fig. 5

from branches, or from Hobbies Ltd, Dereham, Norfolk. (Postage and packing 1s. 6d. for any quantity.)

Clean up all parts thoroughly with glasspaper and give one undercoat. Finish off with two top coats of high gloss paint, applying it sparingly to the netting.

If the rack is to be moved at all, a pair of Hobbies No. 711 plastic handles could be screwed to the sides. The handles are 3½ in. long in cream or black and cost 1s. per pair, post 4½d. (M.h.)

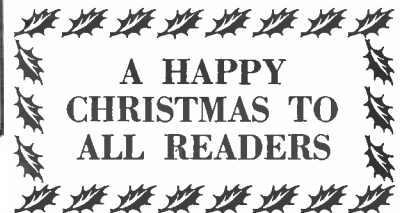

A HAPPY
CHRISTMAS TO
ALL READERS

FLYING THE 'HOBBY CLIPPER'

PREPARING the Hobby Clipper for flight brings us immediately to the make-up of the rubber motor. This consists of eight strands of $\frac{1}{4}$ in. flat rubber strip (obtainable from model supply stores) each strand being 25 in. long. The motor is therefore made up from a single length of rubber 16 ft. long which is first tied with a reef knot into one long loop.

By G. Allen

Before installation the motor must be 'pre-tensioned'; that is, made up into a form of plaited skein so that when it is wound up and allowed to run down, it will ravel up on itself and remain suspended evenly between the propeller hook and the rear peg. Otherwise the motor would 'sag' or 'bunch' in the fuselage at varying positions and would upset the trim of the model.

The sketch will help in indicating how this tensioning is carried out, but before doing this the loop of rubber must be lubricated so that the resulting twisted strands will slide over each other evenly during winding. Lubricant can be obtained in tubes, or it can be made by mixing one part of soft soap with two parts of glycerine. Rub this gently on the surface of the rubber, but do not apply too much; a thin smearing is sufficient.



Method of winding the motor, showing how the rubber is 'stretched' from the fuselage during winding.

Now fold the loop into two (i.e. four strands), make sure the ends are even and then put the two loops at one end over a hook in the wall or over a similar anchorage — Step 1. Bend a small hook on the end of a 3 in. length of 18 SWG piano wire, bend over the point of the wire at the opposite end and insert this tightly in the chuck of a handbrace so that the crooked end fits under the jaws of the chuck — Step 2. Engage the free loops of the rubber in the handbrace hood and wind on 60 turns on the rubber in an anti-clockwise direction. Remove the rubber from the winder and hold the loops tightly. Then crook your finger over the middle of the motor and insert the free loops over the wall hook — Step 3. Pull the whole motor several times until it 'skeins' itself evenly, then remove it from the hook and wind a rubber band round the free loops at the end.

Before fitting the motor it is necessary to drill the motor-peg plates at the rear of the fuselage as indicated on the drawing. Use a $\frac{1}{8}$ in. diameter twist-drill and then fit a piece of birch dowel which should protrude at each side of the fuselage for about $\frac{1}{4}$ in.

Remove the peg and thread the motor down the fuselage from the nose until the loops at the end are over the motor-peg holes and then manoeuvre the peg



Launch the model smoothly with nose pointing downwards.

clutch of the freewheel, wind a few turns on the motor by hand and let the propeller run down so that the motor is suspended between hook and peg. Check the model for alignment and launch the model from shoulder height with a smooth follow-through action and with the nose pointing slightly downwards. If the model noses into the ground at a steep angle, move the wing forward $\frac{1}{8}$ in.

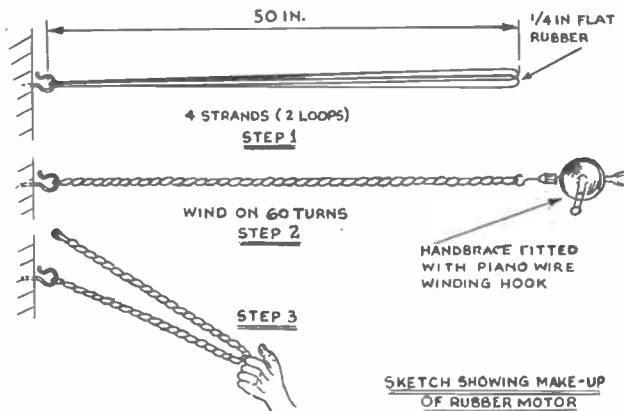

in place. To facilitate this operation it will be necessary to cut away a panel of the tissue covering underneath the fuselage adjacent to the peg position. Fix the free loops of the motor over the propeller shaft hook (which must be covered with a piece of cycle valve tubing) and the model is ready for testing.

Choose a very calm day. Engage the

at a time until the model glides smoothly and lands on its wheels. Should the model's glide-path curve upward after the launch and then dip into the ground, move the wing backward $\frac{1}{8}$ in.

When a reasonable glide results, mark the wing position. You can now try the model with a few turns on the

Continued on page 205

Alek Tron, the Electric Puppet

YOU will enjoy making up Alek Tron, the novel electric puppet whose merry antics will delight the younger members of the family. The toy is activated by a simple electromagnet, which is concealed beneath a little stage, above which Alek is suspended, upon a rubber band, from a miniature 'gallows' made of bent wire.

Obtain a small, strong cardboard box with a deep lid, measuring about 4 in. long by 3 in. wide, to serve as a stage. Next, cut out a piece of $\frac{1}{2}$ in. thick wood to fit neatly inside the bottom of the box.

Make the electro-magnet by winding 200 turns of fairly thin insulated copper wire upon a 2 in. long iron nail. Drive the wire-wound nail firmly into the wooden block, near one end of the cardboard box. When the lid is placed upon the box, the head of the nail should be just beneath the cardboard.

The little gallows is fashioned from a 1 ft. length of very stout wire. Bend the wire as illustrated, using pliers. In order to mount the gallows above the stage, first bore a hole into the wooden block at the opposite end to the electro-magnet, and then make a small hole in the box lid, exactly above the hole in the block. Now it will be an easy matter to place the lid upon the box and then to fix the gallows in place, via the two holes.

A simple switch can be made, using $\frac{1}{2}$ in. wide metal strips cut from an old tin lid, and a block of wood about 3 in. long. Cut out two metal strips, one $2\frac{1}{2}$ in. in length and the other 1 in. long. Bore a

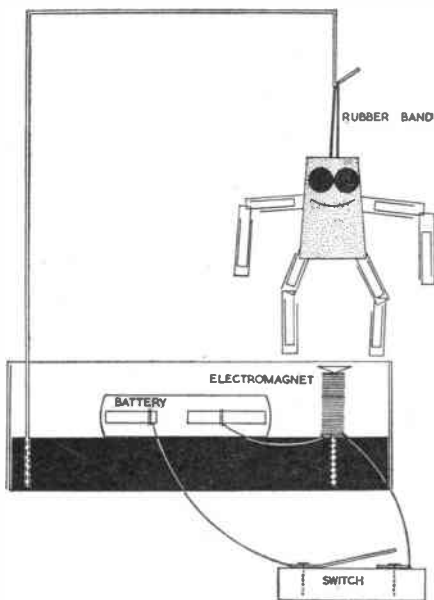

tiny hole through each strip, to which copper wires can be attached. Nail one end of the $2\frac{1}{2}$ in. long strip to the base block and nail the 1 in. long strip to the base, so that when the free end of the longer strip is pressed, it will make contact with the shorter strip.

Alek Tron himself is made from a large cork. Paint eyes and a mouth upon the cork, using bright poster colours, and insert the end of a red-top match

into the centre of the face to make a comic nose. The jointed legs and arms are formed from pairs of large paper clips, linked together. The limbs are inserted into appropriate positions in the body. Finally, you may like to make large hands and boots for Alek out of coloured paper and glue them into place, and you may care to provide a paper guitar that you can pin across the body and which Alek can be made to 'strum' as he dances.

Press one end of a short rubber band into the head of the figure, using the end of a matchstick.

Assemble the toy as follows. Join one of the wires from the electro-magnet to a $4\frac{1}{2}$ volt torch battery, and attach the other wire from the electro-magnet to one of the metal strips on the switch. Complete the wiring by joining up the battery to the second metal strip on the switch, using a length of copper wire. Do not forget to scrape away the insulation from the wires before making the contacts.

Tuck the battery neatly into the box, then fit on the lid and erect the wire gallows. Suspend Alek Tron from the end of the gallows by means of the rubber band. The puppet's feet should be just clear of the stage. Now watch Alek dance as you press the switch and the hidden electro-magnet attracts the wire legs and makes them swing. The figure will also bounce up and down a little when agitated, owing to the effect of the rubber band. A few minor adjustments may be necessary to make the toy perform satisfactorily. (A.E.W.)

● Continued from page 204

Flying the 'Hobby' Clipper

motor. The motor will take approximately 600 turns but these must not be wound on right away. The motor must be 'run in' gradually and the model must be adjusted between test flights.

Apply about 150 turns (the number of turns on the winder will vary, of course, according to its gear ratio) and launch the model facing the wind, if any, from shoulder high, exactly as before. It should climb fairly easily and should not turn in either direction. Correct any tendency to stall by clipping a very thin piece of balsa strip between the top of the noseblock and the fuselage — giving down-thrust.

Increase the turns gradually until a steep climbing turn results, which will carry the model to a considerable height. The model should then glide at a very

flat angle with the freewheel working smoothly. If the model turns too steeply, resulting in either a series of fast circuits with little increase in altitude or a roll into the ground, clip thin packing between the noseblock and the fuselage on the side to which the model turns — giving side-thrust. Increase the amount of packing necessary to give sufficient down-thrust or side-thrust, or a combination of both, as you increase the number of turns to full power.

If it is found that your model does not glide as flat and smoothly as it should, after the power has run out, place a thin strip of packing under the trailing edge of the tailplane. If this is necessary it is possible that you will also have to increase the down-thrust on the propeller shaft because the tailplane adjustment

will affect the model under power. On the other hand, if the model tends to stall on the glide, place similar packing under the leading edge of the tailplane and remove some of the propeller's down-thrust.

After flying, remove the rubber motor, release the tensioning turns, wash it in cold water and after drying it, store it in an airtight tin half filled with French chalk.

Next week's free Design will describe three interesting fretwork projects — especially for our younger readers.

MODELS WITH D.C. MAINS

IN some parts of the country direct current mains are still provided, and a transformer cannot be used to step down the voltage for the model. There are, however, other means of operating models, though they are rather different from those used with A.C. mains.

Occasionally model builders who have learnt that a resistance will drop a high voltage to a lower one decide that this could be a good way to run a model. Such a resistance circuit would work with both D.C. and A.C. mains, but it should never be used, because of the danger of shocks.

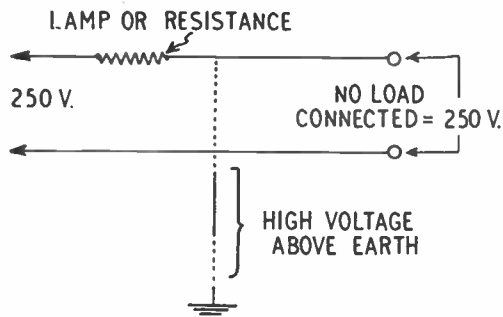

Fig. 23—To show why dropping resistors are not used

The two most important reasons why a resistance dropper circuit is unsafe, with both A.C. and D.C., will become clear from Fig. 23. It can be supposed that a 6 volt motor is to be run, and that the correct lamp or resistance has been fitted to drop the 250 volt mains voltage to 6 volts. In these circumstances, with the motor connected and switched on, it will run normally. But the voltage drop in the lamp or resistance only arises because current is flowing to the motor. When the motor is disconnected, or switched off by a switch wired to it, no current flows. There is then no voltage drop in the lamp or resistor, and the full 250 volt mains voltage appears at the switch or connections to the motor, instead of 6 volts. A direct mains shock will thus be experienced if these leads, etc., are touched.

The second danger arises because one side of the circuit will be at high voltage above earth. This means that a shock can be experienced if only one lead or connection is touched, the current passing down through the body and the person's feet, to earth. This can happen even if the person is standing on a floor which he considers insulated from earth.

For these reasons, voltage dropping

circuits should never be used with model motors, lamps, or any similar items.

Accumulator charging

D.C. mains offer an extremely simple way of charging an accumulator, which can in turn be used to work a model. This is particularly to be recommended when an adult will see to the accumulator charging.

To charge from D.C. mains, it is only necessary to wire the accumulator in series with a lamp, as shown in Fig. 24. The charging rate depends on the lamp wattage and exact mains voltage. With 200/250 volt mains, the rates obtained with various lamps will be approximately as follows:

- 60 watt lamp = $\frac{1}{4}$ amp.
- 100 watt lamp = $\frac{1}{2}$ amp.
- 200 watt lamp = 1 amp.

It should be possible to arrange that the lamp serves some useful purpose. There is no need to charge the accumulator in one continuous period, if it is more convenient to do so a few hours at a time, when the lamp is used. Any 2, 4, 6 or 12 volt accumulator can be connected.

The polarity shown in Fig. 24 must be observed, but the lamp can be either side the accumulator. It is best to have

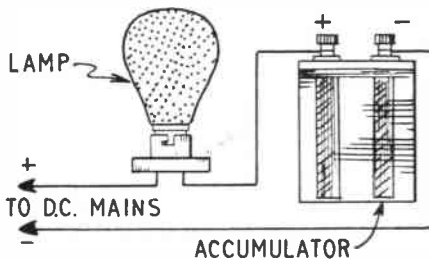

Fig. 24—D.C. Mains charging circuit

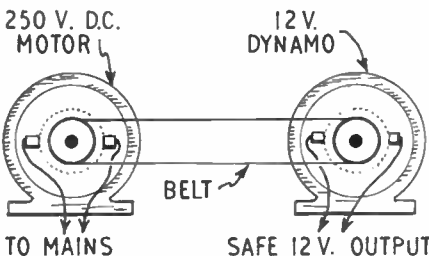

Fig. 25—How a rotary converter works

the accumulator at that side of the circuit which is at lowest voltage above earth, and this will not be the negative connection, in some areas.

A closed cupboard or other safe place should be chosen for charging. The circuit must be completely disconnected from the mains, before touching the battery. This is most easily done by employing a stand or table lamp, fed from a plug inserted in a wall socket. The

By 'Modeller'

accumulator should be connected up before this plug is inserted. It should also be withdrawn when testing the accumulator to see if it is charged. When charged, it is disconnected and removed to the model.

Such a charging circuit should not be used where it may be touched by children. The mains plug should always be withdrawn before handling the accumulator in any way. With these precautions, its simplicity makes it a useful method, with D.C. mains.

Rotary converters

It will have been seen that if a train or other model is to be run from D.C. mains, some safe method of reducing the voltage is needed. A rotary converter is one means of doing this.

The way in which a rotary converter works will become clear from Fig. 25. This actual arrangement was, in fact, often used in the past. A 200/250 volt motor is run from the mains, and in Fig. 25 it is shown driving a low voltage dynamo, which gives a 12 volt output. There is no direct electrical connection between the mains and dynamo output circuits, so no danger of shocks exists. In addition, the output voltage does not rise to a high and dangerous figure, when no current is taken.

The modern type of converter has both the 'motor' and 'dynamo' sections built upon a common spindle, so that it resembles a kind of double-ended electric motor or dynamo, as shown in Fig. 26. Here, the motor part is shown at the left, with mains connections to the high voltage brushes. At the right is the 'dynamo' commutator, with a low voltage output from its brushes.

The converter (which is sometimes termed a rotary transformer) should be totally enclosed in a wooden box, to avoid damage and prevent the mains leads being touched. A number of small

ventilation holes should be drilled in the case. If the box is stout, this will help reduce the noise made by the convertor running. Ex-service convertors are occasionally fitted in metal or wooden cases.

A mains type switch should be added in the mains lead, to switch off the unit when current is not required. Such convertors should not be wired to A.C. mains, with which an ordinary transformer can be used. The last two in this series dealt with ways of running models from a transformer, with A.C. mains.

The brushes may need to be cleaned occasionally, but glasspaper or other abrasives should not be used unless essential. Careful cleaning with a cloth moistened with petrol should be sufficient. The brushes and other running parts should not be disturbed unnecessarily, or the bedding-down of the brushes on the commutator may be upset.

If the output from the convertor is too great for the model, the voltage can be reduced by adding a small resistance

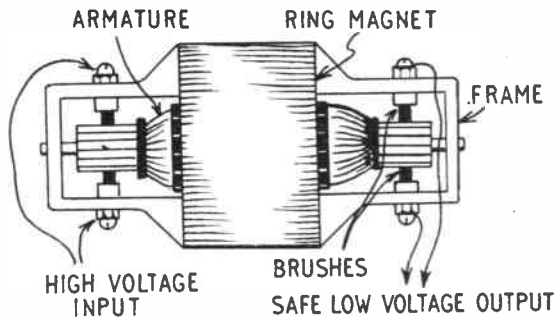

Fig. 26—A rotary convertor

controller, exactly as with a battery or transformer. Most ex-service convertors give an output of about 12 volts or 24 volts, when run in this way.

Other models

The remaining articles in this series will show how to build items such as bells, buzzers, trips, shocking coils, etc.,

and arrange charging and electroplating circuits. Most of these can be run from batteries, which are often preferred for small children, because of their complete safety.

NEXT—

Buzzers, Bells and Shocking Coils

Peeps at nature

Sea-Lions and the Grey Seal

MOST people are familiar with the performing 'seals' of the circus. These 'seals' are really sea-lions. The sea-lion, unlike the seal, can turn its back flippers outwards and use them to support itself on land. This makes the sea-lion somewhat more mobile than the seal when out of the water.

Sea-lions are the largest members of the 'eared' seals. They are found on the Pacific coast of America. The variety we are most familiar with is the Californian sea-lion. They feed on fish, crustacea, molluscs, and sea birds.

The bull sea-lion keeps a harem and

during the breeding season there are pitched battles between rival males.

Sea-lions come on to land to bask in the sun and also to breed. The young have to be pushed into the water by their mothers and have to be taught to swim.

The true seals differ from the sea-lions in several ways. Their hind limbs extend backwards and cannot be turned forwards for movement on land, so that the animal has to jerk itself along with far greater difficulty than the sea-lion has. Seals swim more in a fish-like manner, using the back flippers as a fin, and do not use their front flippers as paddles. They have no external ear.



The British grey seal

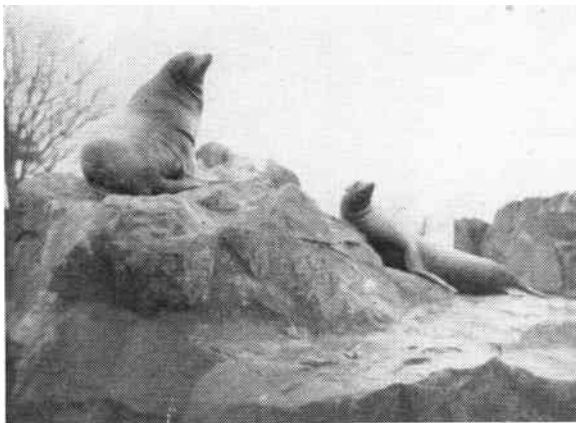

Sea-lions basking on the rocks

Of the two species found in British waters the grey seal is more 'common' than the common seal, since the latter prefers sandy to rocky coasts. The grey seal, distinguished by its longer snout (the common is almost snub-nosed), frequents our rocky western coasts. It feeds on fish and is particularly partial to salmon. It is a very intelligent, curious animal, and will 'stand up' in the water to observe passing boats. The young, or 'pups', are born usually in caves.

The seal is, of course, an excellent swimmer and is able to remain submerged for quite long periods; sometimes up to twenty minutes. (P.R.C.)

SCENERY AND PRODUCTION

THE puppet theatre offers almost unlimited scope for the scenic artist. The small scale of the marionette stage makes possible even more elaborate sets than are used on the 'live' stage. Generally speaking, three main types of scenery are used: the backcloth, or back scene; wings, or side scenes; and standing units, or 'floor pieces'. In order to explain their use and construction I have designed a stock scene incorporating the different units.

Fig. 1 shows the designer's first rough sketch for the proposed scene. Although

help you. Apply your paint in large flat 'washes' according to the colour key, with the paint reasonably thick. Do not be afraid if your effort looks crude, a backcloth is always flattered when seen under lighting at stage distance.

By C. C. Somerville

General rules for painting backcloths are: avoid small details, and keep the horizon line low. Small details are always lost, and tend to make the scene look cluttered. Remember always that it is

the puppets and the play which are most important, the scenery is merely to set the locale and indicate the mood.

The wings or side screens were also dealt with previously. The two wings used in this set are profile wings, and are cut from $\frac{1}{2}$ in. plywood to the design shown in Fig. 3. They also are painted in poster colours in the same manner as the backcloth.

Standing Units — a modern name for the more usual 'set pieces' used on the 'live' stage, can consist of rocks, trees, bushes, walls and many other things. They may be fitted with wooden bases, or screwed by means of an angle bracket to the stage floor. They must stand very

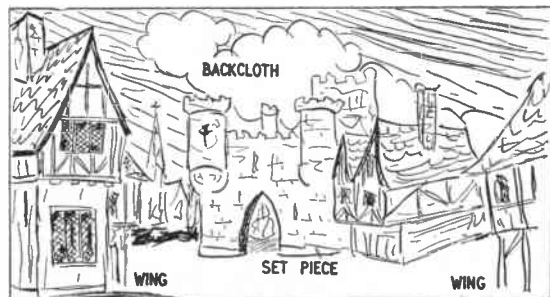

Fig. 1—Rough sketch for proposed Stage Set

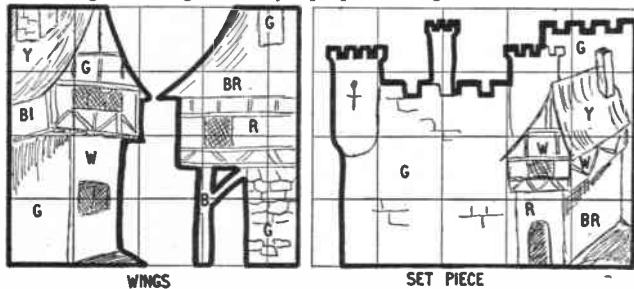

Fig. 3—Wings & Set Piece. Each square represents 6 in. x 6 in. Cut to centre of thick black line.

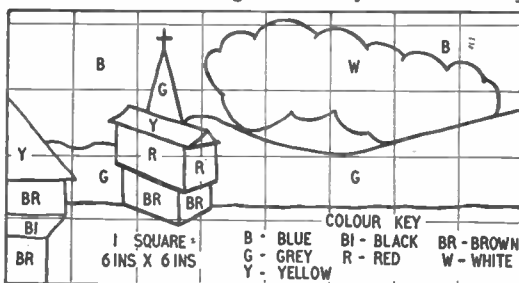

Fig. 2—Backcloth design

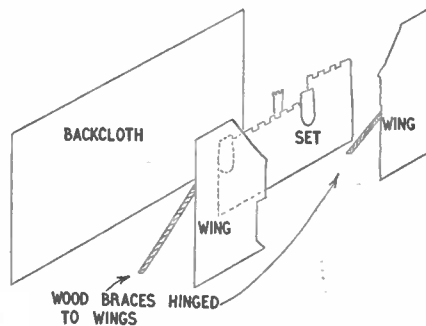

Fig. 4—Position of scenic units

every play requires its own individual scenery, you will find that a 'Street Scene' is useful in many plays.

The construction and method of hanging the backcloth were discussed in a previous article; it remains to paint it. Unbleached calico is excellent for a backcloth, and takes paint well. Either oil or poster colours may be used. Personally I prefer poster colours, which are easy to apply, look fresh under stage lighting, and do not crack when the cloth is rolled for storage. Buy your colours in jars; tubes are uneconomical, since you have such a large area to cover.

First sketch in the outline in either charcoal or black crayon. The backcloth has been 'squared off' in Fig. 2 to

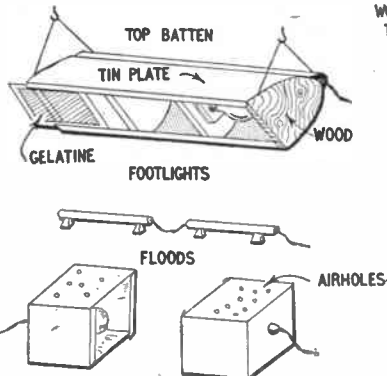

Fig. 5—Lighting units

securely on the stage, so that they are not easily shaken or knocked over by an unexpected collision with a passing marionette.

The castle in our 'Street Set' is of course a standing unit. It is cut from $\frac{1}{2}$ in. plywood according to the design in Fig. 3, painted, and then mounted on small metal angle brackets to enable it to be screwed to the stage.

The complete scene showing methods of support can be seen in Fig. 4. It now remains to light our setting to make us ready for the show. The lighting system to be shown is based upon the widely

used 'three colour system', and is an adaptation of the one in my own theatre.

The main lighting units are shown in Fig. 5, and consist of a top batten — supported above the proscenium — footlights and two floodlights in the wings. The top batten consists of three

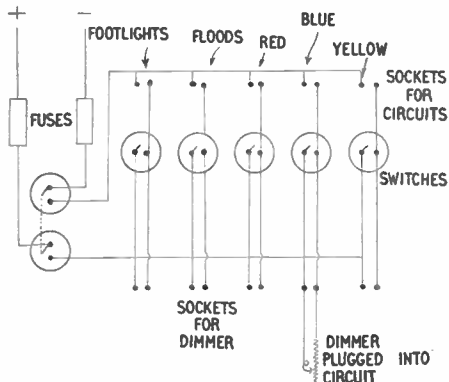

Fig. 6—Layout for the Switchboard

lamps coloured red, yellow and blue. Each lamp is 100 watts. The footlights are plain and consist of two strip lights. The two floodlights can be constructed by any tinsmith, but my own are merely 100 watt bulbs mounted in biscuit tins. Sheets of coloured gelatine are fitted into slots at the front of the tins. Coloured gelatine, or a stronger non-inflammable material, 'Cinemoid', can be obtained from any theatrical supplier.

There remains the question of dimmers and the switchboard. Dimmers, large rheostats, are used to enable you to fade from one effect to another. Ideally, of course, every circuit should have its own dimmer, but it is possible to economize here by having only one dimmer, and arranging a series of plugs on the switchboard so that any circuit can be put on the dimmer as required. It would be too

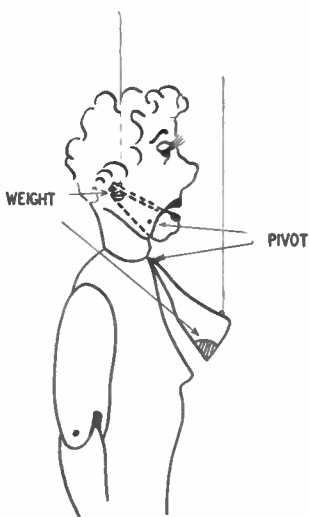

Fig. 7—Prima Donna with moving mouth and heaving bosom

lengthy to describe such a switchboard here, but the layout is illustrated in Fig. 6. The general idea is that beneath each switch a plug socket is provided in parallel. The dimmer is plugged into this to operate that particular circuit, thus shorting the switch, which should remain in the off position.

If you feel that all this is beyond you, then I cannot urge you too strongly to call in an electrician to avoid trouble.

The theatre and puppets being complete, there remains the fascinating question of production. This means that every action, every stage position, every movement, every effect of lighting and sound accompaniment and the various dialogues, will have to be planned and rehearsed to ensure a smooth running show.

Opera, ballet, drama, and vaudeville

may be successfully presented as puppet entertainment, but I would always recommend a variety show as a first attempt. Remember that the puppet can burlesque and satirize the live performer to a fine degree. Special stringing of the puppets can achieve a host of startling and amusing effects. An extra string to the hinged chest of the puppet prima donna enables the puppeteer to give her bosom a hefty heave as she



Fig. 8—Strong man

reaches her top notes. Fig. 7 illustrates this, while in Fig. 8 you can see how hooks are fitted to puppet strong man's hands to enable him to perform. With a little thought and ingenuity, many similar feats may be arranged.

With your puppets made, your show planned, and your music chosen, you are in a position to rehearse the show. When everything runs smoothly, and not before, you can invite your first audience.

Make this Toy Magnifier

YOU can make a simple magnifier in ten minutes, using a drop of clear water as a miniature lens. The materials needed are a 3 in. length of $\frac{1}{2}$ in. diameter dowel, a drawing pin, a metal jam jar cover, and a $1\frac{1}{2}$ in. diameter disc of black paper.

From the thin metal jar cover, cut out a 2 in. diameter circle, with a $\frac{1}{2}$ in. square side bracket, using an old pair of scissors. Glue the black paper disc to the middle of the round metal lens mount. Bend the bracket through ninety degrees, then use the drawing pin to secure the lens mount to the dowel rod, which will serve as a handle.

Use a large darning needle, or thin steel knitting needle, to bore a clean hole

through the centre of the black paper and the lens mount. Dip a matchstick into clear cold water and use it to place a drop of water over the small hole, on the same side as the black paper. The drop of water, because of surface tension, will form itself into a round flat lens.

You may use this little magnifier to inspect minute details on postage stamps, and other objects may be viewed, such as the heads of insects. Observe that a fatter lens gives greater magnification and that as the water molecules evaporate the lens becomes thinner, with consequent loss of enlarging power.

When replacing a lens make sure that the lens mount is perfectly dry.

(A.E.W.)

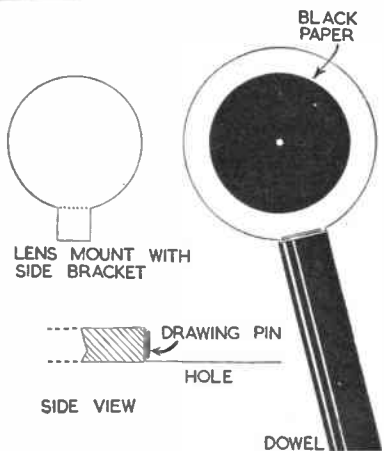

DECEMBER

DECEMBER

4
23

LAST MINUTE

BASES
1/2 IN.

YELLOW

WHEELS
FROM
1/2 IN.
WOOD

CUT FROM
1/2 IN.
WOOD

RED

RED

BLUE

PINK

WHITE

GREEN

RIDE A CO
TO BANB
TO SEE A
RIDE ON

THE STOCKING FILLERS.

HEELS CUT FROM 1/2 IN. WOOD

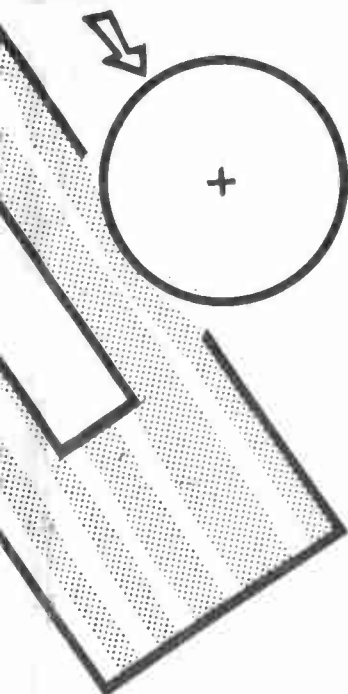

CUT FROM 1/2 IN.

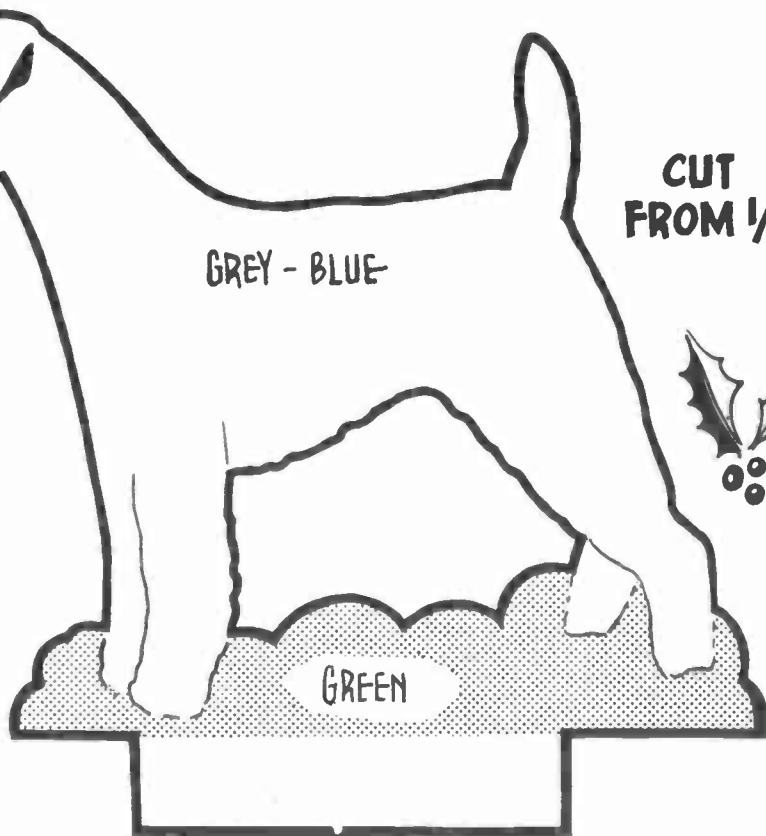

SCREW EYE

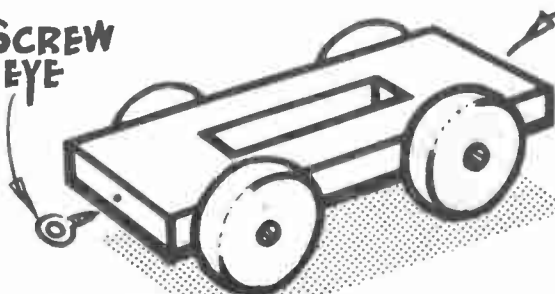

MAKE UP OF BASE

SEE A COCK-HORSE
SEE A BANBURY CROSS
SEE A FINE LADY
SEE A WHITE HORSE.

MAKE A CRYSTAL DIODE RECEIVER

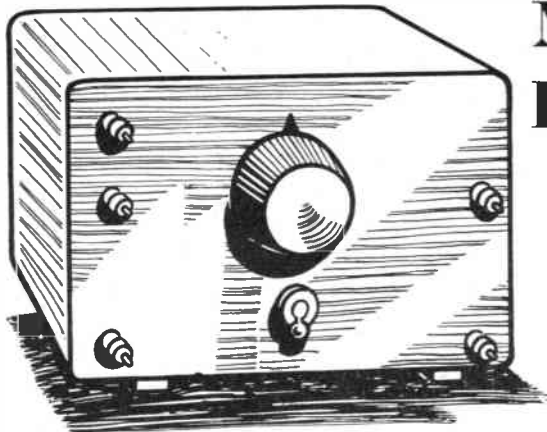

Described
by
*'Radio
Mech'*

EVEN if you have never built a receiver before, you will be able to construct this one quite easily. Not many parts are needed — a permanent crystal diode detector, an on/off switch, a cardboard or Paxolin tube and wire to wind the coil, five terminals or sockets, wood for panel and cabinet, and a tuning condenser with knob. This condenser is .0005 μ F and an air-spaced condenser gives slightly better results than the solid dielectric type, though the latter can be used.

A pair of medium or high impedance headphones having a resistance of about

room.

The set is built on the panel, and all wiring is shown in Fig. 1. Drill five small holes for the terminals or sockets. The switch goes through a hole, and is fixed with a nut. Some condensers are also held with a nut. Others need small screws or bolts to hold them to the panel. A set-screw holds the tuning knob on the condenser spindle.

In Fig. 1 P and P are the two terminals to which the phones are connected when the set is finished. M shows the moving plates connection of the tuning condenser, and F shows the fixed

30 more turns, anchoring the end 3 by again passing it through two small holes.

If the set is wanted to tune medium waves only (about 200 to 550 metres) take end 3 straight to the earth terminal, and omit the switch.

About 240 turns are needed for long waves, so three strong cardboard discs X about 1 $\frac{3}{4}$ in. in diameter are cut to fit the tube, and are glued on with about $\frac{1}{4}$ in. space between them. Some 34 S.W.G. silk covered or similar wire is then anchored by means of the same holes as end 3. This gives lead 4, which is twisted together with end 3, both going to the switch. About 120 turns are then wound between the first and second cardboard washers. The wire is then carried over to the second space, and another 120 turns or so put on. The wire is then anchored, leaving lead 5, which goes to the earth terminal.

The coil is fixed by a screw each end, with small blocks of wood to keep it just clear of the panel. Loop 2 goes to terminal A.2. All the turns throughout the whole coil must be wound on in the same direction.

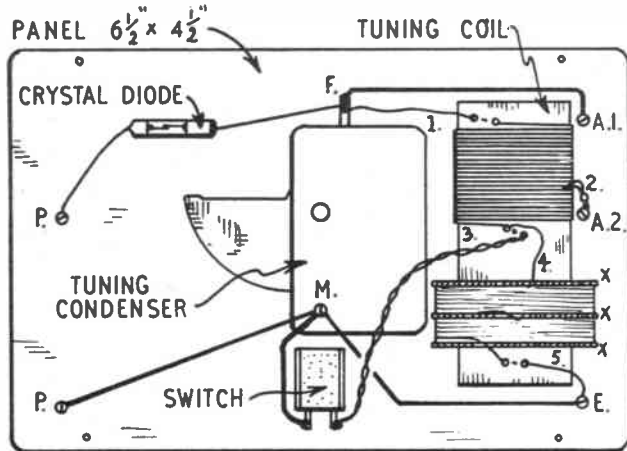

Fig. 1—Complete wiring plan

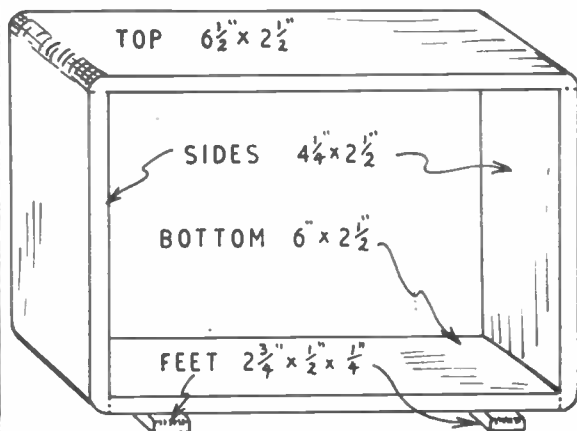

Fig. 2—How to make the cabinet

500 to 4,000 ohms will also be needed for listening, and wire for an aerial and earth. The earth can go to a metal spike or rod in the ground, or to a cold water pipe. An outdoor aerial made by supporting 30 ft. to 60 ft. or so of 7/22 S.W.G. wire on insulators will give best volume, but an indoor aerial is often good enough, and this can be made from thin insulated wire, perhaps hidden by the picture rail along two walls of the

plates tag or terminal.

A home wound coil

An insulated tube about 1 $\frac{1}{4}$ in. in diameter and 3 in. long will do for the coil. Some 32 S.W.G. enamelled or similar wire is anchored by passing it through two small holes, leaving lead 1 a few inches long, to take to F. Wind on 50 turns evenly side by side, and make the loop 2, about 1 $\frac{1}{2}$ in. long. Then wind on

A ready-made tuning coil can be used instead. The maker's leaflet will then show which are the various connections.

To use the set, connect up phones as described. The receiver earth lead is taken to the terminal marked E. If the aerial is rather short, take it to terminal A.1. But with a long aerial use terminal A.2 instead, because this will give sharper tuning. The set covers about 200

● Continued on page 213

House improvements with

GOVERNMENT GRANTS

GIVEN correct circumstances local Councils will not refuse to make you a grant towards improving your home. But you must get your application approved before any work is commenced.

These grants are called Standard Grants and cover installing a bath or shower in a bathroom, a wash-hand basin, a water closet, a hot water supply or a food store.

The local Council will approve your application if you have a freehold or hold a lease with at least 15 years to run and the house will be reasonably fit to live in for 15 years after the work has been done and will be kept as a house for that period.

By E. Capper

Grants are only made for houses built before 1945, or if your house has been made by the conversion of a larger house, built before 1945, and the conversion carried out by the end of 1958.

A tenant cannot apply, but only the owner or a leaseholder with 15 years to run. If you are the owner you must get the tenant's permission in writing before applying for a grant.

If you desire to install all five standard improvements you can claim £155 or half the cost of the work if less. Individual grants are reduced by £25 if there is already a bath or shower, £5 for a wash-hand basin, £40 for a water-closet, £75 for a hot water supply and £10 for a food store.

If you have to disturb, say, the existing W.C. in order to enable other improvements to be made you can get a grant for the W.C. provided the local Council is satisfied that it was not possible to do the work without disturbance.

You can apply for a grant to put in any of the standard improvements but if you do you must have the rest of the improvements already installed. The local Council will send you an application form, but remember there is a long waiting list so you must expect some delay before approval is given to your application.

You can continue to live in the house after the improvements have been made or you can let it. If the latter, the rent you can charge will be limited for the next 10 years unless you choose to repay the grant within that period. If the house is rent-controlled, you can charge the Rent Act limit plus an annual sum

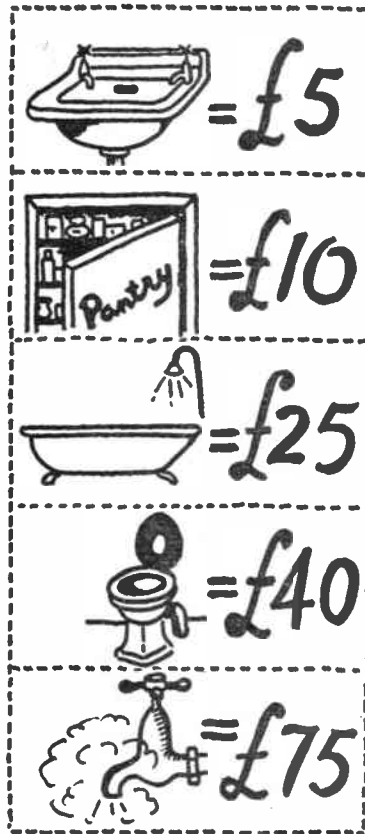

amounting to 8 per cent of your share of the cost of the improvements. This outlay can include improvements other than those for which you are given a grant, so long as the additional improvements are allowed under the Rent Act.

If the house is not rent-controlled, you

may ask the local Council to fix the rent. It cannot be lower than the rent you would have been able to charge had the house been rent-controlled. You can repay the grant any time you like and after that the limit on the rent of a decontrolled house disappears.

If you repay you need not repay the whole of the grant but only a proportion of it, plus compound interest. This will depend on how soon you repay within 10 years of receiving same. For instance, if you repay after 3 years, the proportion will be seven-tenths of the grant and so on.

Do remember that on no account should the work be started until the local Council has approved your application or you will be disqualified. Make sure it is the right approval; planning permission is not the same as grant approval.

Finally, you may not sell the house to a new owner for his own occupation (unless he is a member of your family) within a period of three years from the completion of the improvements. If you do you will be required to repay the proportionate amount of the grant outstanding.

Grants other than Standard Grants, called Discretionary Grants, can be made by the local Council. They are made to help owners to modernize houses by carrying out more extensive work than is covered by Standard Grants or by converting into flats a large house which is too big for a single family under present conditions.

For these, grants up to £400 can be obtained. There are however many conditions on which the local Council must first be satisfied and it would be wise first to get professional advice and then, if satisfactory, to approach your Council with the proposed scheme.

● Continued from page 212

Crystal Diode Receiver

to 550 metres (medium waves) with the switch closed, and about 1,000 to 2,000 metres (long waves) with the switch open.

A strong cabinet can be made from $\frac{1}{2}$ in. thick wood, as shown in Fig. 2. The meeting surfaces can be smeared with glue, and the parts held together with panel pins. A back will strengthen the cabinet, and should be $6\frac{1}{2}$ in. by $4\frac{1}{2}$ in. When the glue is dry round the corners and edges, smooth off with glasspaper,

and varnish or stain.

If a sheet of ebonite or paxolin is used for the panel, this will not need varnishing. If wood is used, it is best sanded and varnished before mounting the condenser and other parts. Varnished items should be left undisturbed in a dust-free room until dry. Four small screws driven through holes drilled in the panel hold the panel and cabinet together.

Mainly for Modellers

FOR most of our ship models the flags are usually made from the parchment supplied for making the sails. I have frequently advocated the making of fabric sails to improve our models, and now suggest that readers may like to fashion their flags from silk. I usually use a thin silk which can be painted in ordinary artist's colours or poster colour if placed upon blotting paper; this absorbs the surplus fluid and prevents the paint running.

RANDOM NOTES by 'Whipstaff'

Now, however, there are special fabric paints available, which enable fine detail to be added, and a few tubes are a good investment for the regular model maker.

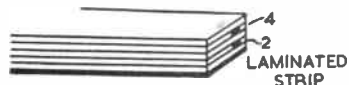

Fig. 1



Fig. 2

When cutting out the flag a little balsam cement run along the edges will prevent fraying and enable the flag to be curled into the required shape.

Double blocks

In many of our models we need double blocks, and for average or large scale Fig. 1 shows a method used by modellers abroad of building up laminated blocks.

Besides adding strength to these small parts, the tedious drilling of two holes in each block is avoided. This is an undoubted advantage if a large number is required. If waterproof glue is used, these blocks are useful on actual sailing models.

For an example as to method we will take the oval double block. This is built up of five laminations. Numbers two and four are in two parts, thus forming the holes right along the length of the strip. The thickness of each lamination will depend on the scale. For $\frac{1}{4}$ in. scale (that is where $\frac{1}{4}$ in. equals 1 ft.) I use $\frac{3}{32}$ in. thickness, the strips being equal in width to the length of the blocks required. They must be glued and left clamped together until the glue has set, then rounded on all four corners to give the shape of the block. Each block is cut off and grooved across the surfaces and top and bottom to take the stropping (see Fig. 1).

Dowels and mouldings

Small mouldings and small dowels are often a problem to ship modellers. In all ships, sail and steam, we find mouldings required. Some model makers stick a piece of cord or build up these mouldings with a plastic material. These methods are quite suitable for small scale models, but where we are working to a scale of $\frac{1}{8}$ in. or $\frac{1}{4}$ in. to the foot a more efficient way is to make our mouldings from stripwood. Very small dowels and treenails can be made from bamboo strip, which gives an added strength. To make dowels, all we need is a steel plate drilled with various size holes (Fig. 2). My plate was made by a metal worker friend and ranges from $\frac{3}{32}$ in. to $\frac{1}{8}$ in. in sizes of dowel produced. I find it better to plane the edges of the stripwood and point the end. It is then tapped through the appropriate hole to form a perfect dowel. Small sizes can be pulled through with a pair of pliers. To tap these through usually results in several breakages.

For mouldings, a thin steel plate can be made as in Fig. 2. For small mouldings I use strong tinsplate cut from a large cigarette or tobacco tin. A pilot hole is drilled for each moulding, and the holes shaped to the required moulding design with needle files.

Any modeller can make either plate quite simply, given an ordinary hand drill and the right sizes in drill bits to cover the required range.

TWO MINUTE

QUIZ

by Ed Capper

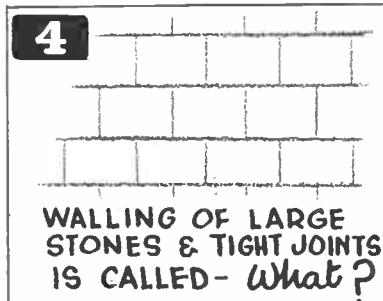
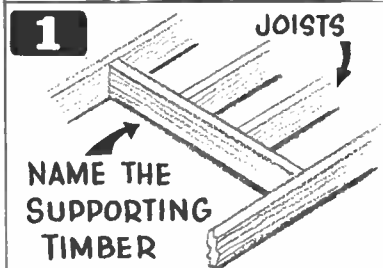

ANSWERS ON PAGE 216

THE BEST CHOICE

FOR
THE
LAD



AND
HIS
DAD

These fine presentation sets of Hobbies famous tools will prove ideal gifts throughout the year for any lad or adult interested in woodwork, modelling, etc.

Available from all Hobbies branches, stockists, etc., or send coupon today for immediate delivery.

Hobbies have other outfits costing up to 65/-, suitable for all occasions and all pockets.

YOU MUST HAVE HOBBIES 1960 ANNUAL
168 pages crammed with woodworking projects, toys, novelties, furniture, etc. Free designs for making Ballerina Musical Cigarette Box and Model Garage with each issue. Only 2/- from newsagents, etc., or by post 6d. extra.



THE 'CHALLENGE'
Represents real value. Contains 12 in. handframe, saw, steel cutting table, bradawl, spare saw blades, design and working instructions.

13/6 (post 1/6)



THE POPULAR 'A.1'

The set most beginners demand.

38/6



FREE Ask for 20-page booklet of Hobbies tools and gift sets.

THE 'CROWN'
With strong hand-frame, spare saws, cutting table, drill, instruction book, glasspaper block and design. **25/-** (post 1/9)

To Hobbies Ltd., Dept. 993, Dereham, Norfolk.
Please send free 20-page booklet, name of stockist and items indicated.

- 'A.1' Outfit 38/6 (post free)
- 'Crown' Outfit 25/- (post 1/9)
- 'Challenge' Outfit 13/6 (post 1/6)
- Hobbies 1960 Annual 2/6 (post free)

Name

Address

*The Ideal Target Rifle
for the Young Shot*

Webley



'JUNIOR' AIR RIFLE

Semi-bead Foresight
14" Machine-cut Rifled barrel
Wheel adjustable Rear Sight

WEBLEY & SCOTT LTD., Established 1790
34 Park Lane, Handsworth, Birmingham 21

YOU CAN BECOME A HANDICRAFTS INSTRUCTOR

EXPERIENCE NOT ESSENTIAL

Men who enjoy making things in wood or metal can turn their hobby into a permanent and interesting Career. Short hours, long holidays and security in a job you would really enjoy, can be yours if you become a Handicrafts instructor. Let us send details of the easiest and quickest way to get the necessary qualification.

We guarantee "NO PASS—NO FEE"

If you would like to know about our unique method of preparing you for one of these appointments, write today, and we will send you our informative 144 page Handbook—free and without obligation. Mark your letters "Handicrafts Instructor".

**BRITISH INSTITUTE OF
ENGINEERING TECHNOLOGY**

BIET

595 College House, Wright's Lane
Kensington, London, W.8

33rd NATIONAL SCHOOLBOY'S OWN EXHIBITION NOW AT NATIONAL HALL OLYMPIA

28th DECEMBER 1959 — 9th JANUARY 1960
9 a.m. to 7 p.m. Daily except Sunday. Admission 1/6

**come early—
room for everyone — every day**

Fun, thrills, displays, sports arena,
competitions and valuable prizes
for boys and girls of all ages.

BETTER THAN EVER — AT OLYMPIA !

CHEMISTRY

AT HOME

SALICYLIC acid and sodium salicylate are two common and cheap chemicals. Some interesting and instructive experiments can be carried out with them, using the simplest apparatus.

SALICYLATES

An important test for the acid and its soluble salts is the purple colouration given with ferric chloride solution. Add a few drops of ferric chloride solution to a solution of either, when the colouration will be obtained.

In separate test tubes put a little phenol solution and resorcinol solution, and to each add a few drops of ferric chloride solution. Both give a purple colouration, too. How are we to differentiate between these reactions? To the test tube containing the purple liquid produced with salicylic acid or sodium salicylate add a drop or two of lactic acid. The colour is unchanged. Now do the same with the phenol and resorcinol reaction products. Both become yellow-green.

The purple colouration with salicylic acid and its salts depends on the formation of the intensely coloured salt ferric salicylate. It is of interest to prepare a specimen.

Dissolve 2.66 grams of ferric chloride and 4.8 grams of sodium salicylate each in 20 c.c. of water. Mix the solutions. A purple-brown sludgy precipitate appears. Filter this off, preferably with the aid of a filter pump, and wash on the filter with two small lots of water. Note that the wash waters run through coloured, owing to the slight solubility of the substance. Transfer filter paper and residue to an evaporating dish and allow it to dry in a warm room or in a not too hot oven. The ferric salicylate is obtained as a purplish-black, microcrystalline powder.

Another colour reaction for salicylic acid and its soluble salts is that with copper sulphate. To a solution of the acid or of sodium salicylate add a few drops of copper sulphate solution. A fine grass-green colouration appears. This is most striking when the order of addition is reversed. Put some copper sulphate solution into a test tube and dilute it until it is a middle sky-blue. Now add the solution of the acid or of

its sodium salt. The blue at once changes to green. This test is sensitive enough to detect one part of salicylic acid in 2,000 parts of water.

The colour is due to the formation of copper salicylate. The isolation of this salt is interesting in that the salt itself undergoes a colour change in the solid state. As it is fairly soluble in water we must work with strong solutions, for it is then precipitated.

Finely powder 2.5 grams of copper sulphate, dissolve it in 10 c.c. of water and add a solution of 3.2 grams of sodium salicylate in 10 c.c. of water. The copper salicylate appears as a fine green precipitate. Filter it off. It now

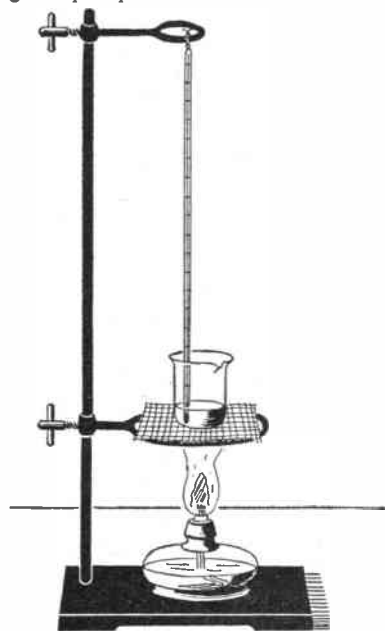

Purifying copper salicylate by recrystallisation

undergoes a startling change to light blue.

When the mother liquor ceases to drip from the funnel, transfer the copper salicylate to a small beaker and add small quantities of warm water, keeping the temperature at about 50 degrees Centigrade (see diagram). When the whole of the solid has dissolved, let the solution cool. Note that the solution is

green. Tufts of small pale blue needles crystallize out. Let the whole stand overnight in a cool place for maximum crystallization to take place. Drain off the liquid and dry the crystals of copper salicylate on a porous brick.

Lead salicylate, though fairly soluble in hot water, is only slightly soluble in cold. Hence it may be isolated by precipitation and purified by solution in hot water.

Dissolve 6.4 grams of sodium salicylate and 7.58 grams of lead acetate each in 35 c.c. of water and then mix the solutions. The mixture at once turns to a thin white cream owing to the precipitation of lead salicylate. Filter off the lead salt, preferably with the aid of a filter pump. Boil up 200 c.c. of water and remove the flame. Into this stir the lead salicylate. After a few moments' stirring, filter the solution hot. As the filtrate cools, colourless needles crystallize out. These are lead salicylate. After standing overnight in a cool place, decant the mother liquor and dry the crystals on a porous brick.

From these experiments it might be thought that insolubility or sparing solubility in cold water is the rule with salicylates. The opposite is true. This may be seen by adding a little sodium salicylate solution to solutions of calcium chloride, strontium nitrate, nickel sulphate, cobalt chloride, magnesium sulphate, zinc sulphate, ammonium chloride and potassium nitrate. In no case does a precipitate form. Therefore, to obtain salicylates of these metals, precipitation through double decomposition cannot be relied upon. Neutralization of the free acid by a suitable compound of the metal and crystallization must be adopted.

Calcium salicylate, for instance, may be prepared by stirring 6.9 grams of salicylic acid into 80 c.c. of boiling water and adding gradually 3 grams of calcium carbonate in the form of precipitated chalk. Effervescence occurs owing to carbon dioxide evolution. When all the chalk has been added you will find the mixture is neutral to litmus paper.

Filter the solution hot from the excess of calcium carbonate. Let the filtrate stand overnight. Drain off the mother liquor from the white crystals of calcium salicylate which have been deposited. Generally, these crystals stick to the beaker bottom. They may be loosened by gently warming the beaker on wire gauze. Let them dry on a porous brick.

QUIZ ANSWERS (see page 214).

1. A trimmer. It is used to hold joint ends through the ceiling or a floor opening.
2. Rebate Joint.
3. Wall tie. Strips of metal used as a tie in cavity walls.
4. Ashlar walling.
5. Damp proof course.

★ LEARN ★ RADIO & T/V SERVICING for your OWN BUSINESS/HOBBY

● by a new exciting no-maths. system, using practical equipment, recently introduced to this country.

FREE Brochure from :—

RADIOSTRUCTOR

DEPT. G81, 46, MARKET PLACE,
READING, BERKS, 23/12

BUILD YOUR OWN HI-FI at home! At last, for reasonable cost — the chance to make your own quality HI-FI audio equipment and to gain the knowledge to service and maintain it. FREE brochure from — Dept. HW20, Radiostructor, 46 Market Place, Reading, Berks.

FREE G.B. High Value and 10 Q.E. Mint Pictorials plus 100 different on requesting Approvals. — P. E. Bentham, 40 Little Glen Road, Glen Parva, Leicester.

1-VALVE S.W. Receiver, ready built, reception guaranteed, cash with order, 35/-. Phones and batteries extra. — Midland Electrical, 9 Gaveston Road, Leamington Spa.

LOOK! 100 Free including loads of Pictorials, plus further gifts each time you request my cheap approvals. 3d. Postage. — Salter, 42 North Road, Rotherham.

REFUND IF NOT WORTH 50% MORE.

Amazing Portable TRANSISTOR RADIO

ADVANCE 1960
SENSATION!

ONLY
£6.19.6
INCLUDES BATTERIES
OR SENT FOR 40/-



Your personal set wherever you are. Genuine Transistor, only 6" x 4" x 1 1/2", weight 15 ozs. Fits pocket yet has wonderful qualities reproduction & volume. Built-in Aerial & Speaker. Additional booster Aerial FREE! As pleasing as its big brothers. Finger tip control & selection of stations. Runs on 2 batteries obtainable everywhere 7d. each giving months normal use. Ultra modern case — delightful pastel shades. Guaranteed. £6.19.6 — 3/9 p & p, or 40/- dep. bal. 14 ftnly. pyts. 8/8 + p & p. Carrying case & Slings sent on approx. 12/6 ex. & Batteries 1/6 inc. post. LISTS GUITARS, RINGS, WATCHES, etc. (Easy terms available on most lines) STATE REQUIREMENTS.

H EADQUARTER & **G** ENERAL SUPPLIES LTD.

(HOBW/ENG/94) 196-200 Coldharbour Lane,
Loughboro Junc., London, S.E.5. Open Sat.

100 DIFFERENT stamps free! Request 3d. upwards discount approvals. — Bush, 53 Newlyn Way, Parkstone, Dorset

STAMPS FREE — Empire Packet including Pictorials and Victorians with approvals. — Robert J. Peck, 7A Kemp Road, Bournemouth.

LEARN RADIO and **ELECTRONICS** the NEW practical way! Very latest system of experimenting with and building radio apparatus — 'as you learn'. FREE brochure from — Dept. HW10, Radiostructor, 46 Market Place, Reading, Berks.

HOBBIES BRANCHES

LONDON

78a New Oxford Street, W.C.1
(Phone MUSEUM 2975)
87 Old Broad Street, E.C.2
(LONDON Wall 4375)
81 Streatham Hill, S.W.2
(TULSE Hill 8796)

151 High St., Walthamstow, E.17
GLASGOW — 326 Argyle Street
MANCHESTER — 10 Piccadilly
BIRMINGHAM — 100a Dale End
SHEFFIELD — 4 St. Paul's Parade
LEEDS — 10 Queen Victoria Street
HULL — 179 Ferensway
SOUTHAMPTON — 134 High St.
BRISTOL — 65 Fairfax Street
NEWCASTLE — 42 Dean Street,
Newcastle-on-Tyne 1
GRIMSBY — 88 Victoria Street

MAKE A MUSICAL BOX for as little as 21/-. New kits and tunes available. Movements 13/-. post free. Please send 3d. stamp for free illustrated catalogue. — The Swisscross Co., Dept. B., 202 Tulse Hill, London, S.W.2.

EXTRA CHEQUES from writing. Send for 'Ideas for Writers' (free). Scores of suggestions for beginners and others. Typewriter unnecessary. — Writers' Ring, (H.W.), 5 Edmund Street, Birmingham 3.

Completely new 54 page Edition

WHERE'S THAT CAR FROM?

Price 1/- (Postage 4d.)

Of all Booksellers

or

RALEIGH PRESS, EXMOUTH, DEVON



with

Hobbies
kits &
outfits

Hobbies kits for novel musical boxes are extremely popular for making up as gifts and for sale. Kits include materials and full instructions for making with a few simple tools. Musical movements are extra. Make your choice of tune from list below.

GET A KIT NOW!

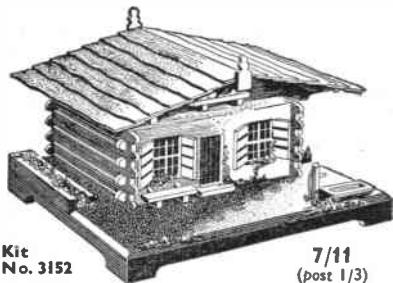

Kit
No. 3152

7/11
(post 1/3)

SWISS CHALET. Lift the lid to offer a cigarette and it plays a tune.

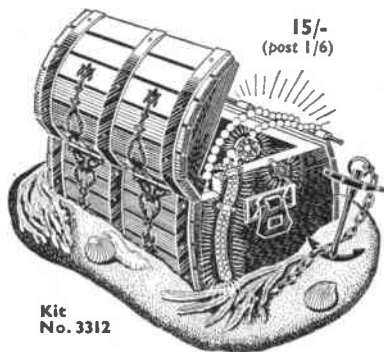

Kit
No. 3312

TREASURE CHEST. Kit includes wood, anchor, chain, metal fittings, etc.

Fit your box with one of these tunes
No. 1 movement 14/11 (post 6d.)

- B Kiss Me Honey-Honey
- C The Knick-Knack Song
- D Anniversary Song
- N The Bridge on the River Kwai
(Col. Bogey)
- O On the Street where you Live
- P Ave Maria de Gounod

15/-
(post 1/6)

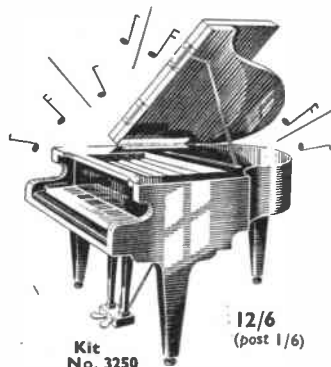

Kit
No. 3250

12/6
(post 1/6)

GRAND PIANO. Kit includes printed keyboard.

Other models detailed in free Booklet

To Hobbies Ltd, Dept. 993, Dereham, Norfolk.
Please send free copy of 'Profitable Leisure' and items detailed.

Kit No.

Musical Movement.

Name.

Address.

P.O. for enclosed.

MAKING A FLANNELGRAPH

THERE is something magical about a flannelgraph upon which pictures and diagrams can be made to grow and diminish with the charm of a cartoon film, running in slow motion. Despite its odd name, the principle of the flannelgraph is quite simple. It consists of a board, covered with some fluffy material, to which pictures backed with pieces of lint or felt can be made to adhere, owing to the interlocking of the coarse fibres. A good teacher, using a flannelgraph to illustrate the various stages of his discourse, will always be sure of an attentive audience.

eight inches in length. Secure these, to form a stout frame behind the board, using short screws. The blanket material will now be held firmly in place and the screw heads should present a tidy and regular appearance around the front of the apparatus. Make the framework stronger by knocking in corrugated fasteners to grip the ends of the battens together. If it is desired to hang the completed flannelgraph upon hooks fixed to a wall or blackboard, a pair of eyelet screws should be mounted in the batten frame.

It would be a good idea to provide eyelets along one long and one short side, in order that the board may be hung upright or sideways, as the occasion demands. Also, it might be useful to make the flannelgraph with a softer material as base, like Essex board, so that large pictures and maps can be pinned on, if required. Instead of the old blanket a large piece of lint may be preferred. Ideally, the surface is covered with black material, sold by educational suppliers for the purpose. Having made up the flannelgraph, you will need to make

Teachers and demonstrators of technical subjects will be able to prepare diagrams in small sections, which can be assembled upon the board as the discourse progresses. Lecturers in first aid will find the flannelgraph valuable for illustrating the correct positions of bones and the body organs. The parts of the diagrams are first drawn upon thin cardboard, then cut out with sharp scissors and backed with lint, or, alternatively, shapes may be cut out of coloured blotting paper which will, by themselves, adhere to the rough surface. In a similar manner, diagrams of engines, machinery and electrical circuits are built up.

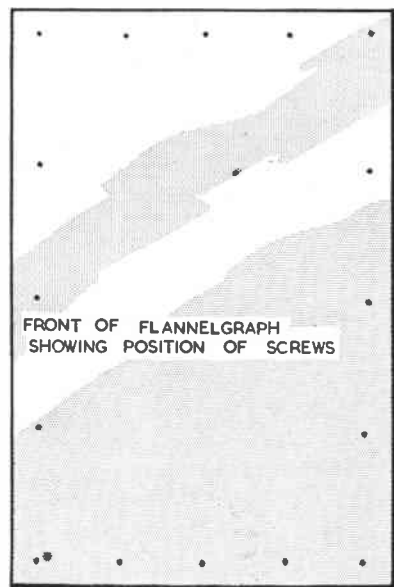
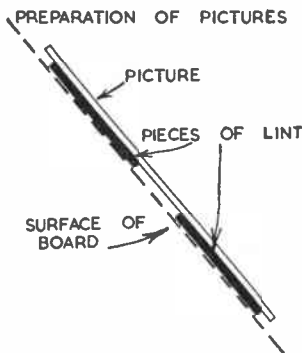
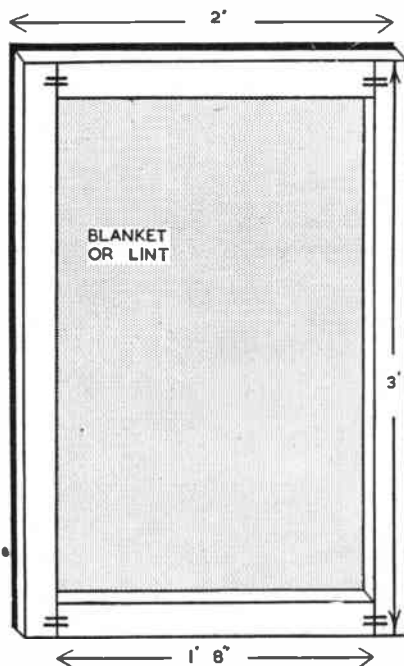

A flannelgraph of useful dimensions can be constructed, using a piece of hardboard, measuring three feet by two. Obtain a large piece of an old plain coloured blanket, which will completely cover the hardboard, with a margin of three or four inches all round. Roughly secure the blanket to the hardboard by stretching the material carefully and fixing the margins in place behind the board, using strips of Sellotape. This is a temporary arrangement, until battens of 2ins. by $\frac{3}{4}$ in. timber can be screwed on to the back of the board to hold the material taut and prevent the hardboard from warping.

Cut four battens, two measuring three feet long and two measuring one foot

sets of pictures and dissected diagrams to use upon it.

Characters from Bible stories and pictures depicting historical modes of dress, buildings and implements are cut out of magazines and old children's picture books, which are easily obtainable. Glue one or two pieces of lint to the back of each picture. To mount the pictures, press them gently against the fluffy surface of the flannelgraph. Sets of pictures, relating to a great variety of subjects, can be prepared and stored in large envelopes. The envelopes are labelled and placed in a cardboard box, like cards in an index system. In this way, a valuable collection of illustrative material can be amassed.

Smaller versions of the flannelgraph will serve as fascinating toys. Children will love putting together words and numbers from figures cut out of blotting paper and making up pictures of farms and towns by sticking on the appropriate 'picture units'. Blotting paper shapes may need 'roughing up' by rubbing with glasspaper. Numerous uses for the apparatus will occur to youth leaders and games coaches will find the flannelgraph useful for the planning of tactics. The author has used a flannelgraph to play the well-known TV quiz game 'Criss Cross Quiz'. Blotting paper noughts and crosses were placed upon the board whenever a contestant scored a point. (A.E.W.)

DECORATIVE BRACKET

AN ATTRACTIVE PROJECT FOR THE FRETSAW

CUT one each of pieces A, B and C from $\frac{1}{4}$ in. wood using a fine grade fretsaw. Piece B is the top and C the back. All three are glued together as

shown by the section.

Clean up all pieces with glasspaper and give a light rub with stain before applying a final coat of clear varnish. (M.p.)

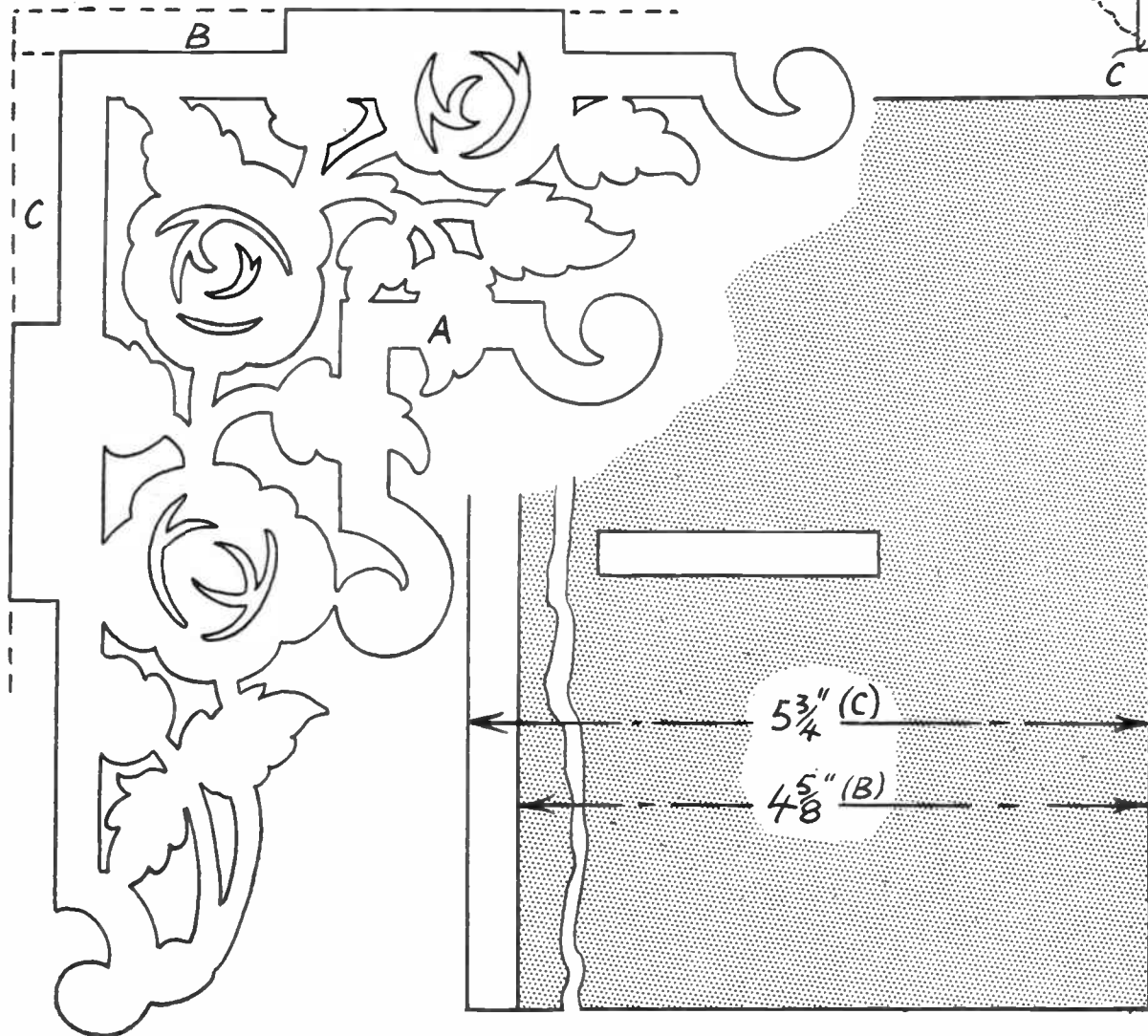
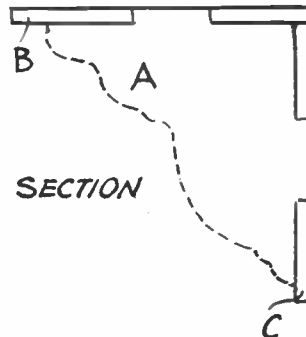



KIT No. 3308

Contemporary Plant Stand

27/6

(post 2/9)

Although simple in construction, this **Contemporary Plant Stand** makes an elegant showpiece in the modern home. Trough measures 30 in. by 7 in. Supported on 15 in. contemporary style legs, giving

an overall height of 21 in. Kit contains design and instructions, panels of wood, and four 'screw-in' legs.



KITS FOR MODERN FURNITURE

Finest quality materials from which the handyman can make attractive contemporary furniture for the home, and save pounds!

Obtainable from all Hobbies Branches or Stockists, or by post from Dereham, Norfolk.



Kit No. 3268

Plant-Holder Table

This **Modern Table** with its intriguing little plant holder will appeal to all lovers of contemporary furniture. Size 24 in. by 18 in. by 20 in. high. Kit contains design with instructions, selected plywood and other wood, three 'screw-in' legs, and screws.

24/9

(post 2/9)

THESE KITS

Record Cabinet/Bookcase

Planned so that anyone who can handle simple woodwork tools can make a really good job of this **Record Cabinet and Bookcase**. A handsome cabinet 34 in. high, 20 in. wide and 13 in. deep to accommodate over 200 records and a quantity of books.

65/-

(post free)

Kit contains planed wood, plywood, four contemporary style 'screw-in' legs, hinges, beading, ball catches, cabinet stays, handles, etc.



Kit No. 3266



Kit No. 3278. This **Lady's Sewing Companion** is a really worthwhile job for the handyman. 30 in. wide, 17½ in. deep, 20 in. high. A handy table when closed. Kit contains selected planed wood, hardboard, beech rails, screws, corner plates, and four 'screw-in' contemporary legs.

65/-

(post free)

SAVE POUNDS

**Kit No. 3262
Marquetry
Firescreen**

This **Marquetry Firescreen** depicts a colourful bird with outstretched wings against a background of foliage. Overall size of the screen is 28 in. high by 18½ in. wide. Kit contains hardboard, planed wood, moulding, wood balls for feet, round rod, and selected veneers for marquetry picture.

15/-

(post 2/-)

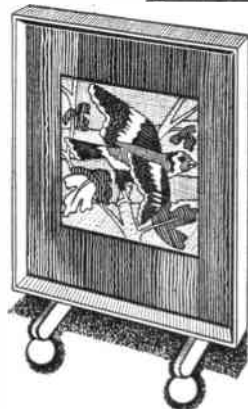

**To HOBBIES Ltd. (Dept. 99)
Dereham, Norfolk**

Please send me free booklet showing other kits available and

Kit No.

Name

Address

P.O. or Cheque for enclosed.