

HOBBIES WEEKLY

NOVEMBER 5th 1958

VOL. 127

NUMBER 3288

IN THIS ISSUE

	Page
Toy Fire Engine	81
Popularity of Colour Photographs	82
Aircraft Spotting	83
Cuttlefish Holder for the Bird Cage	84
Adding a Transistor	85
Flattening Sheet Metal	86
Mainly for Modellers	87
An Ideal Nail Box	88
Gauging Air Pressure	89
Making a Pantograph	90
These will make Novel Book-ends	90
Protect your Milk Bottles	92
Collectors' Club	95
Patterns for Making a Spill Holder	



All correspondence should be addressed to the Editor, Hobbies Weekly, Dereham, Norfolk

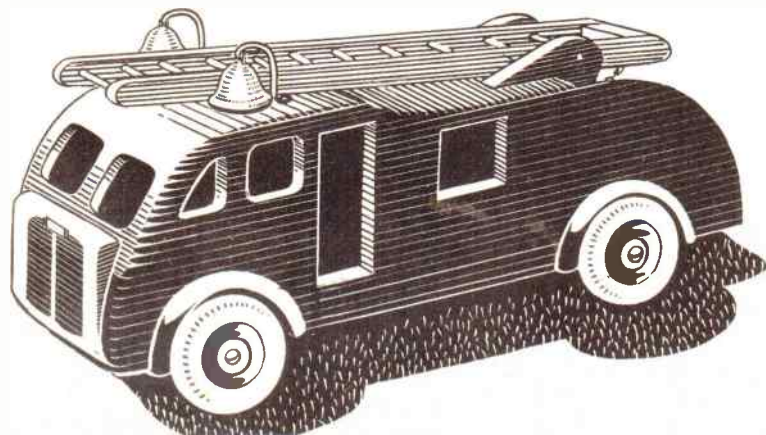

★ *FREE design
inside*

*Make this
exciting
model for
a child's
Christmas
Stocking*

TOY FIRE ENGINE

THIS gaily coloured fire engine will be a firm favourite as a gift for children. Designed as a pull-along toy, it has two fire bells and a ladder which can be raised and lowered, a fixed position being provided for by means of a chain. Of modern design and robust but simple construction, this model will provide hours of pleasure for youngsters.

Most of the parts which go to the make-up of the engine are shown full size on the design sheet, and these should

be traced and transferred by means of carbon paper to the appropriate thicknesses of wood. For pieces 5, 6 and 7, measurements only are shown, and these should be drawn out direct on to the wood. It will be noticed that piece 2 is broken away and will, of course, have to be extended to the full measurement of 11½ ins. Cut out all the parts neatly with a fretsaw, and clean up thoroughly preparatory to assembly.

Fig. 1 shows how the various parts are

glued to the floor (piece 2). Glue on pieces 3, 4 and 6 in positions shown by the dotted lines on the design sheet. All parts can, incidentally, be further secured by pinning.

Add one of the sides (1) and continue by gluing pieces 5, 7, 8, 9 and 10 before adding the second side (1). Note that pieces 8, 9 and 10 can be shaped *after* they have been glued in position. Pieces 9 and 10 will conform to the outline of piece 1, and piece 8 will project to form

81

FOR ALL HOME CRAFTSMEN
Over 60 years of 'Do-it-Yourself'

World Radio History

4 1/2^D
2

the radiator of the engine. Now fix the two axles (12) and the wings (11) in the positions shown on the design sheet and indicated on the illustration of the finished model.

Pieces 13 are brackets from which will be suspended the ladder. Glue them in place $1\frac{1}{2}$ ins. apart.

Next make up the ladder as seen in Figs. 2 and 3. This consists of two pieces of $\frac{3}{8}$ in. by $\frac{1}{4}$ in. stripwood 10 ins. long and staves of $\frac{1}{4}$ in. round rod spaced approximately $\frac{1}{2}$ in. apart. Note from Fig. 3 that the lower end of the ladder is blocked by a piece of $\frac{3}{8}$ in. by $\frac{1}{4}$ in.

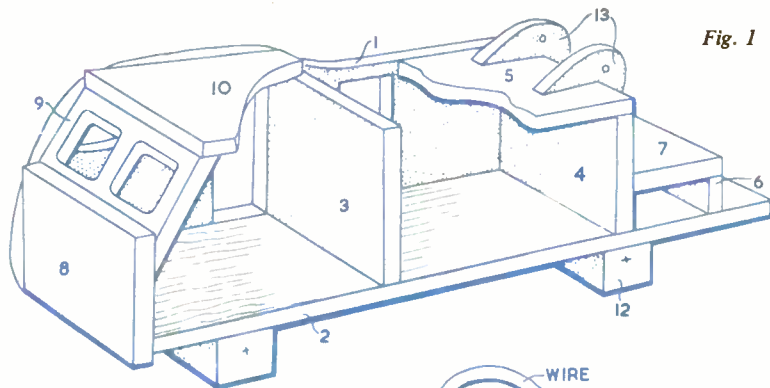
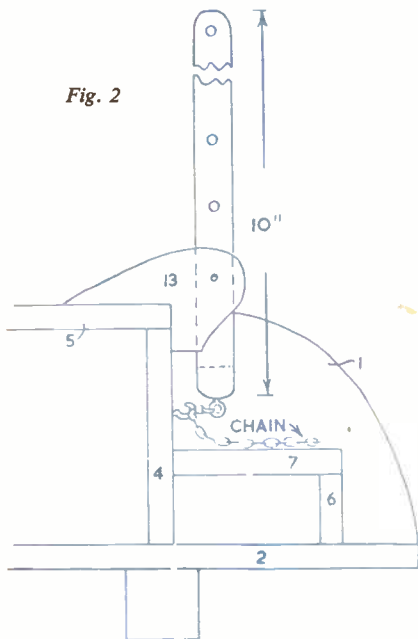

Fig. 1

Fig. 2



stripwood into which a screweye is inserted from underneath. To ensure that the staves are parallel, drill both sides of the ladder together. The staves are inserted into the drilled holes and glued in position. The overall width of the ladder when made up should be $1\frac{1}{2}$ ins.

The ladder is now pivoted in between pieces 13 by means of two roundhead screws. The chain for locating the ladder is fixed as shown in Figs. 2 and 3, an opened-out screweye being inserted in piece 4 to maintain the chain in place.

Bells can be attached to the roof by pieces of wire shaped like a ship's davit, as seen in Fig. 4, where alternative ways of fixing are indicated.

Before adding the wheels, the toy should be painted. For a first-class finish, rub down well, fill the grain and give two or three coats of bright red paint, rubbing down in between coats.

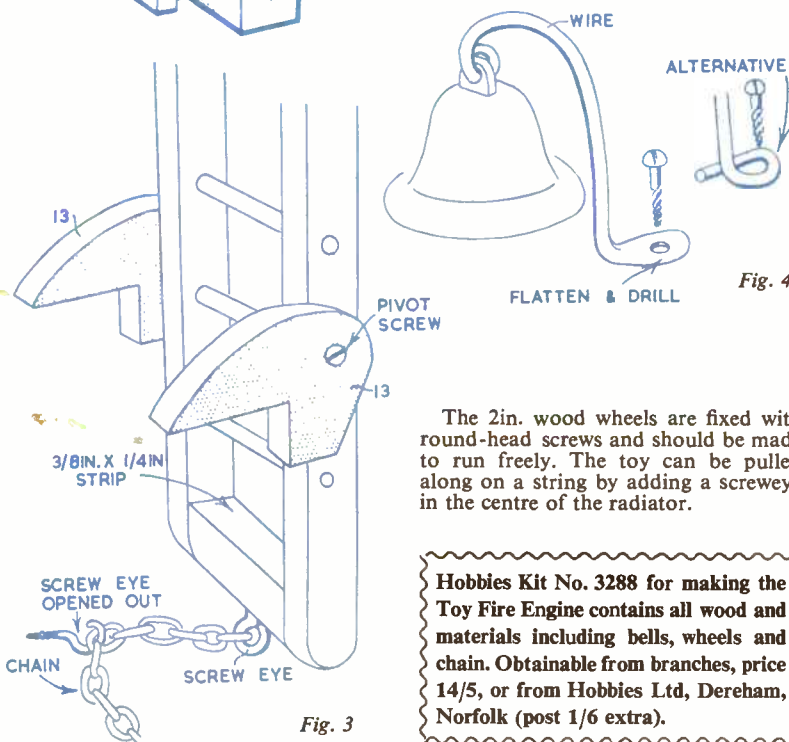

Fig. 3

The 2 in. wood wheels are fixed with round-head screws and should be made to run freely. The toy can be pulled along on a string by adding a screweye in the centre of the radiator.

Hobbies Kit No. 3288 for making the Toy Fire Engine contains all wood and materials including bells, wheels and chain. Obtainable from branches, price 14/5, or from Hobbies Ltd, Dereham, Norfolk (post 1/6 extra).

Popularity of Colour Photos

BRITAIN'S millions of amateur photographers are becoming more and more colour conscious. This is shown by a recent report which says for every 22 snaps in black-and-white taken in 1955, one was in colour. In 1957 the ratio was one in seven. This year the proportion is in the region of one colour shot to five in black-and-white.

Britain's photographic industry reckons to give pretty good service — but how about this? Amateur photographers in America who want a quick

look at the results of their colour snaps can now, by arrangement with U.S. photo dealers, take their colour films personally to the processing laboratory and receive them back ready for viewing in only 75 minutes!

DID YOU SPOT IT?

Many readers have kindly written to the Editor pointing out a mistake which appeared in E.D. Capper's Two-Minute Quiz in our issue of October 1st. In Fig. 3, the style of brickwork was given in the answers as of English bond, but as readers have so correctly pointed out, it was Flemish style.

AIRCRAFT SPOTTING

MOUNT the picture on stiff cardboard and cut out the various pieces with a sharp modelling knife. Then fit the pieces together to form a picture of a well-known civil light transport aeroplane.

The manufacturers of this aircraft also design and manufacture the engines, two of which are used each of 380 h.p. The name of the manufacturers is renowned throughout the aviation world because they have produced many outstanding civil and military aircraft during the past forty years.

The aeroplane which is the subject of our quiz this time is now operating all over the world in a variety of roles and more than 470 have been built. It is a most versatile aircraft and the production of it has been grouped into series (1 to 6), each series of machines having special features of their own.

Standard models have accommodation for 8 to 11 passengers and a crew of two consisting of pilot and co-pilot/radio operator. Dual controls are fitted. If the rear cabin bulkhead is removed together with the toilet compartment it is possible to accommodate a ninth passenger. If, in addition, the bulkhead aft of the vestibule is removed, 11 passengers can be seated in comfort.

Variants of the aircraft include those designed for survey work, ambulance

duties, and those which meet the requirements of the modern businessman who wants to 'get there in a hurry' — the executive transport, designed as a flying office-cum-cocktail lounge. Several of the aircraft can also be used by the up-to-date farmer for 'pest control', particularly in the dense tropical parts of the world. Duties of these aircraft include crop-spraying with toxic substances and the spreading of fertilizers.

There is also a military version in service with the Royal Air Force and 13 'sea' versions in service with the Royal Navy.

The two latest types are the Series 5 with more powerful engines, giving a 20% increase in payload compared with Series 1, and the Series 6, which is the same as the Series 5 but with a special executive interior.

The aeroplane has an all-metal stressed skin construction throughout, *i.e.* all surfaces including wings and tail are covered with smooth panels of aluminium alloy.

Have you completed and identified the aeroplane? (G.A.)

Answer next week

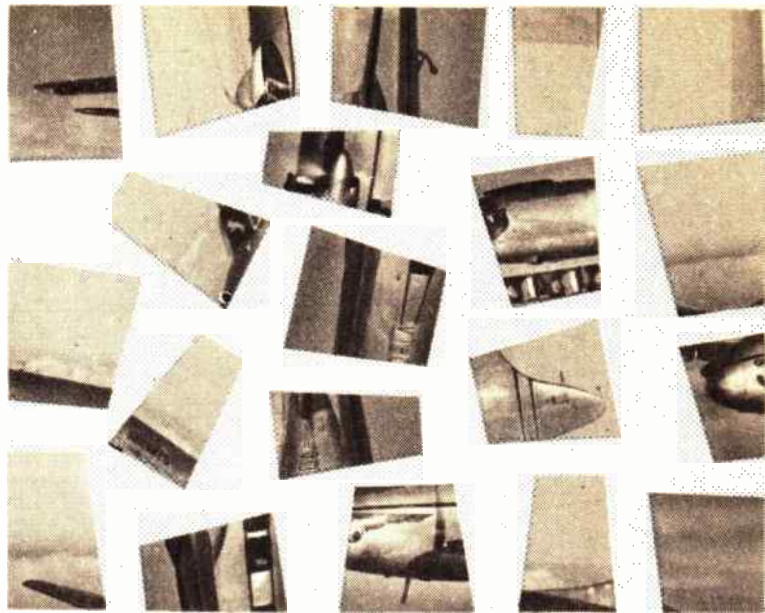

Cuttlefish Holder for the Bird Cage

MOST cage bird enthusiasts like to give their pets cuttlefish. It is in fact very good for them on account of the calcium which it contains. It is not hygienic for the cuttlefish bone to be left lying about in the cage to collect the dirt from the floor.

Pushing the bone between the bars of the cage is not a satisfactory way of offering it, and it is here that the neat little holder will be found extremely useful.

It is simply a spring clip capable of holding a small piece of cuttlefish bone and fixed in an appropriate position in the cage where the bird can get at it easily.

The spring clip can be obtained from a stationer for a few pence, and its size will depend to a certain extent on the size of the cage. A large clip and chunk

of bone would look out of place in a small cage, and it is also better to give the bird smaller pieces but more often.

There are many different kinds of spring clips which can be used and the type (A) with curved jaws will hold the

bone with a more secure grip. Do not choose a clip which is liable to make the bone slide out and close with a snap — there is a possibility that the bird might get a foot or even its head caught.

To fix the clip to the side of the cage it must first be screwed or bolted to a block of wood, and this in turn is screwed to the cage wires. Details of the method of fixing the clip are shown at (B).

Fix the block on to the side of the cage by screwing a metal plate over the wires as shown at (C). A piece of brass sheet large enough to engage three or four wires will need two round-headed screws to hold the block in place.

The block should be left in its natural state and not painted. There is a possibility that the bird will peck at it and some paints can be poisonous. (A.F.T.)

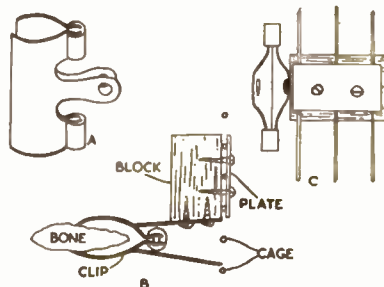

ADDING A TRANSISTOR

A CRYSTAL set can easily be converted into a transistor receiver, and will then give better volume. It is also quite simple to add a further transistor to a 1-transistor receiver, which will often allow a loudspeaker to be used.

The symbol employed to show a transistor, in radio circuits, is given in Fig. 1. The Emitter is an arrow, the Collector a straight line, and the Base a flat plate. Provided this is remembered, any transistor circuit can be followed without much difficulty.

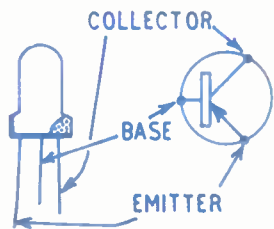

Fig. 1—Transistor connections

Fig. 1 also shows the actual connections for the low-cost and popular 'Red Spot' transistor, which has three wires issuing from its base. The Collector lead is marked by a red dot on the case. The Base lead comes next, centrally placed, and the Emitter wire is at the left. 'White Spot' transistors have the same connections, except that the dot is white. With other makes of transistor, the manufacturer's data should be followed, because wrong connections can damage the transistor.

The wires should be left full length, and not bent very near the transistor. If they are taken to three small terminals on a strip of insulating material, other connections can be taken to the terminals, when wiring up a receiver.

Converting a crystal set

An ordinary crystal set consists of coil, tuning condenser, detector, and phones. If a transistor is added to this, volume is much improved, and only a small battery is necessary, in addition to the transistor.

A circuit for this is shown in Fig. 2. Base goes to detector, Emitter goes to earth and battery positive, and Collector goes to phones, the second phone lead (negative) being taken to battery negative. The set can be switched off by disconnecting the phones or battery. Or an on/off switch can be placed in one battery lead, for this purpose.

For best results, detector negative

must go to the transistor. Crystal diodes often have polarity marked. If not, leads to the detector should be temporarily reversed, to find which way round is best.

By 'Radio Mech'

As with the other circuits, a $1\frac{1}{2}$ V, 3 V or $4\frac{1}{2}$ V dry battery is used. Current drain is low, and the battery will have a long life. Torch cells are suitable, the zinc case being negative. There is little point in using a very high voltage for phones. But when a speaker is to be used, the battery voltage may be increased to the maximum allowed for the transistor, though not very much is gained by using more than $4\frac{1}{2}$ V or 6 V.

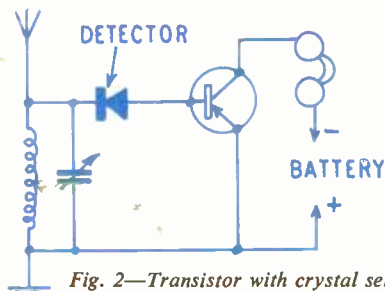

Fig. 2—Transistor with crystal set

The battery must never be connected the wrong way round, as this can immediately damage the transistor.

Transistor detector

A White Spot transistor will also function as detector, the Base being taken directly to the tuning coil. Some Red Spot transistors will also work well in this way.

Volume can usually be improved somewhat by using a tapping on the coil, as shown in Fig. 3. The best position for this tapping varies with individual transistors, but it is usually satisfactory if about one-third to one-quarter the total number of turns from the earthed end of the coil. That is, say, 20 turns up, on a 60 turn coil.

If a coil is to be wound, it is worth while providing a further tapping for the aerial, and a suitable winding for medium waves is shown in Fig. 4, 28 S.W.G. to 30 S.W.G. wire being used. If an insulated tube or former of different diameter is to hand, this will usually be satisfactory. But smaller tubes will require a few more turns,

while fewer turns are required on a former of larger diameter.

The coil is tuned with the usual $0.0005\mu\text{F}$ variable condenser, an air-spaced condenser being recommended if possible. The circuits can equally well give dual-wave reception, if dual-wave coils are fitted, or if the converted crystal set tunes long waves in addition to medium waves.

Volume control

With a single transistor, a volume control is not necessary unless a very good aerial and earth are used, when signals can be too loud for comfort with headphones.

A circuit for volume control is shown in Fig. 5. This also applies a negative voltage to the Base, through the 100,000 ohm resistor, which can give some increase in amplification. When the circuit is used with a crystal set, 'X' (one outer tag of the volume control) is taken to the detector. 'Y' is taken to earth, which will usually be the other headphone terminal on the crystal set. Battery positive is also joined to this terminal.

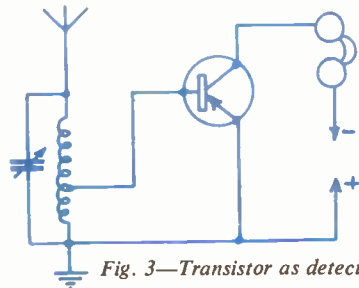

Fig. 3—Transistor as detector

The circuit can be simplified by omitting the 100K resistor and $8\mu\text{F}$ condenser, wiring the volume control slider (centre tag) directly to the transistor Base, other connections being as explained. This will give volume control in the same way, but will not give the slight increase in amplification mentioned.

For two transistors

The circuit in Fig. 5 can also be employed to add a second transistor to 1-transistor receivers such as those in Figs. 2 and 3. In this case 'X' is taken to battery negative and 'Y' is connected to the Collector of the first transistor. The same battery is, of course, used for both transistors, the positive points and negative points in Figs. 2 or 3 being joined to the same points in Fig. 5.

The 'Output' terminals can be taken

MAINLY *for* MODELLERS

WE now come to what our readers will find of real interest, the rigging. I say this because for the first time since commencing our series of ship modelling articles some years ago, we are about to follow the rigging plan of an early European ship other than the usual British models, and the usual Santa Maria model.

For rigging cord we have several to pick from and each of us will make his own choice. My suggestions are fine dark coloured fishing line for the standing rigging and nylon surgical thread for the running rigging. As some of our readers may not be within reach of a wholesale surgical supply firm, the alternative to nylon thread is fine natural sewing thread and those who prefer to do so, may use black button thread for the standing rigging in place of the fishing line.

All rigging cord should have the

Those readers, who like myself, are continually engaged on ship models may like to make a set of small weights for this purpose. Mine were made in the following manner, and I find that six of these usually stretch all my rigging cord for one model in two stages.

Take a piece of waste timber 1in. thick and with a $\frac{3}{4}$ in. wood bit, drill six holes $\frac{3}{4}$ in. deep in the block of wood,



LEAD WEIGHT
Fig. 1



MASTHEAD PLATFORM
MAINMAST & FOREMAST
Fig. 2



MASTHEAD
MIZZEN MAST
Fig. 2



MAST CAPS
CARVE TO
SHAPE
Fig. 3

BRACES AND STANDING RIGGING

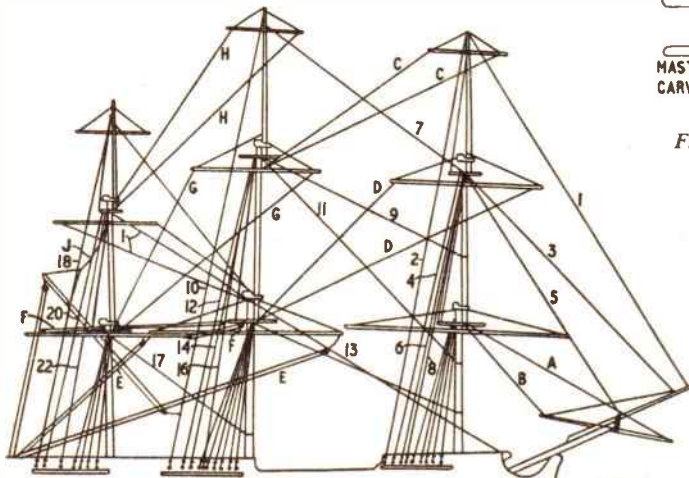

SHROUDS & BACKSTAYS EACH SIDE OF MODEL OTHER STAYS SINGLE LINES
BACKSTAYS EVEN NUMBERS
BRACES, TO BE SHOWN BOTH SIDES OF MODEL, FIT AS SHOWN ON PLAN. LETTERED LINES

MODEL OF A MODEL — 3

By 'Whipstaff'

The masts are now prepared, while the cord is left to stretch, and the sizes are as follows:—mainmast 2ins., foremast 1 $\frac{1}{2}$ ins., mizzen 1 $\frac{1}{4}$ ins. These sizes allow for $\frac{1}{4}$ in. to insert and glue into the decks.

Main topmast 1 $\frac{1}{4}$ ins., fore top mast 1 $\frac{1}{8}$ ins., mizzen topmast 1 $\frac{1}{8}$ ins., main topgallant mast 1 $\frac{1}{2}$ ins., fore topgallant mast 1 $\frac{1}{2}$ ins., mizzen topgallant mast 1 $\frac{1}{8}$ ins.

The lower mast is taken from $\frac{1}{4}$ in. dowel, and all upper masts are shaped from $\frac{1}{8}$ in. dowel.

The mast head platforms (Fig. 2) are best made from thin white celluloid. If

RUNNING RIGGING Fig. 5

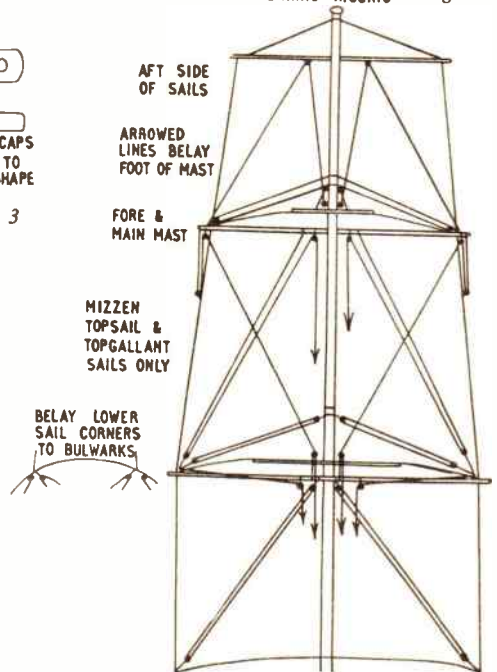

AFT SIDE
OF SAILS

ARROWED
LINES BELAY
FOOT OF MAST

FORE &
MAIN MAST

MIZZEN
TOPSAIL &
TOPGALLANT
SAILS ONLY

BELAY LOWER
SAIL CORNERS
TO BULWARKS

stretch taken out before use, otherwise our rigging will tend to sag when the model has stood for some time.

To do this the cord is cut into useable lengths and suspended from a hook with a weight at the lower end. They can be suspended in bundles and left for a couple of days.

line with soot by smoking over a candle flame to avoid the lead sticking to the wood and fill with molten lead. Any waste lead such as a piece of waste lead pipe or similar, will serve, and have some screw hooks ready to stick in the centre immediately, as the lead sets very quickly. See Fig. 1.

this is not available, use 1/32in. plywood and paint white.

The mast caps are distinctive, and size can be taken from the rigging plan. Carve these as in Fig. 3. As you will notice, their distinctive shape is one of the recognisable continental features. Use holly if possible or plastic.

For the various yards use the following measurements:—mainyard $2\frac{1}{8}$ ins., foreyard $1\frac{3}{8}$ ins., mizzenyard $1\frac{3}{8}$ ins., main topyard $1\frac{1}{8}$ ins., fore topyard $1\frac{1}{8}$ ins., mizzen topyard $1\frac{1}{8}$ ins., main topgallant yard $1\frac{1}{8}$ ins., fore topgallant yard $1\frac{5}{16}$ in., mizzen topgallant yard $1\frac{5}{16}$ in.

There are six shrouds each side of the main mast, five for the foremast and four for the mizzen. The ratlines (or ladders) are left out of the rigging plan for the sake of clarity, but you must add these in fine black cotton, building up on a card in the usual kit manner, spacing them approximately $\frac{3}{32}$ in. apart.

The bowsprit shown in Fig. 4 is now made up and added, and then the standing rigging is added from the plan. Follow these numbered lines carefully. They are from an authentic French rigging plan. The braces are added, and in the plan these are the lines lettered.

In Fig. 5 is given the plan of one mast, in the usual manner of these models. The sails can be left off, and in this case only the lifts, etc., will be shown. These are numbered.

If any reader would like to add sail, by all means do so, in which case the shape can be taken from the sail plan (Fig. 6).

Those who like miniatures can fashion the dead-eyes and blocks from plastic knitting needles as described in an

earlier article, $\frac{1}{8}$ in. for the dead-eyes of the shrouds and under $\frac{1}{16}$ in. for the blocks. Very tiny beads can be used for the blocks, and I have used them very successfully for miniature work.

Most of these prisoner of war models were mounted on stands decorated with beautiful marquetry designs, some even in straw marquetry taken from the prisoners' beds. Those of our readers who are expert in marquetry can use any geometrical design they wish, but for

wood dowel, the holes for the dowel being drilled in $\frac{1}{8}$ in. deep and pieces of dowel glued in. The holes for the square strip can be cut in with an X-acto knife, and pieces cut off the stripwood to glue in, either as square shapes or diamond shapes. A quarter of a suggested design is shown in Fig. 7.

Make the stand 8 ins. by 3 ins., and

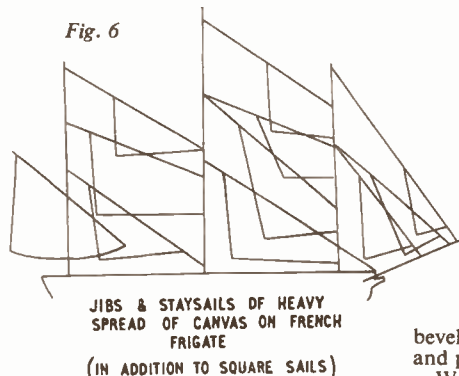

SIMPLIFIED SUGGESTED INLAYS
FOR STAND

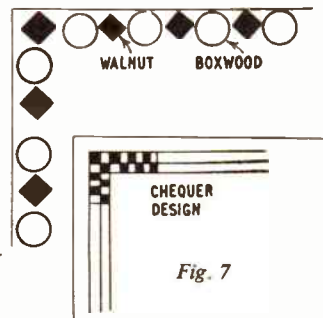

the average modeller I suggest a simplified pattern. This can be inlaid by using walnut square stripwood and box-

bevel all edges. Smooth after inlaying, and polish nicely.

We have now completed what to me was a model of great interest, and I hope it will also give our readers many enjoyable hours in the building.

An Ideal Nail Box

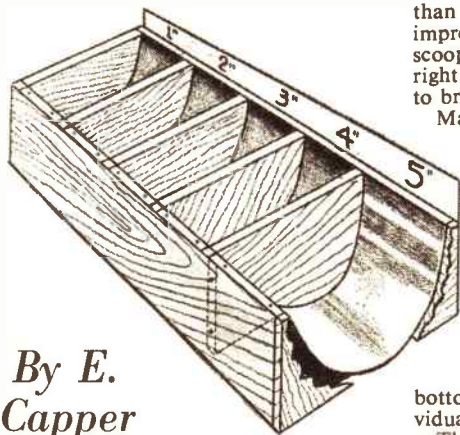

By E.
Capper

UNDOUBTEDLY, the most-used container in the workshop is the nail box. Yet how many appreciate this and construct a decent container instead of managing with a toffee tin or a jar?

The grocer's cash till has rounded bottoms to the compartments for easy retrieving of the change. What better

than to follow his example with this improved nail box, thus enabling one to scoop out the nails easily and quickly right to the last couple, saying goodbye to broken finger nails and splinters?

Make up a simple rectangular shaped box of $\frac{1}{2}$ in. deal, approximately 21 ins. by 9 ins. by 4 ins. deep. Screw it together firmly for it will have to do a lot of work.

To make the rounded-bottom divisions, one can proceed in one of two ways. The box can be divided with right-angled pieces of timber, cut to fit snugly across the inside dimensions (see dotted lines), the sheet metal curved

bottom pieces being then fitted individually into each division.

The second and better method is to cut a piece of metal to form a one-piece bottom and to cut rounded division pieces to fit down on to the bottom piece. To make these division pieces scribe and cut two circles of $\frac{1}{2}$ in. deal to 8 ins. diameter. Then saw each circle in half. To fit, punch holes in the bottom metal piece and screw through to the arc of the division pieces.

The front and back edges of the metal

bottom piece are turned back and fitted to the top edges of the front and back piece of the box. Punch holes through the metal and screw to hold in place.

When spacing out the divisions allow a width of $\frac{1}{8}$ in. more than the length of the nails to occupy each separate compartment.

The optional size indicator is simply a strip of $1\frac{1}{2}$ in. metal screwed to the back of the box and the nail sizes painted on.

Uses of 'Impact' Adhesive

THE many household uses to which Evo-stik 'Impact' adhesive can be put are summarised in an eight-page booklet issued by Evode Ltd. The booklet gives hints and suggestions on bonding laminated plastic to table tops, fixing acoustic and ceramic tiles, repairing toys and jewellery, invisible mending of fabrics and furniture, making lampshades, and many other jobs. Evo-stik 528 is an all-purpose adhesive which will bond practically any materials, either to themselves or to each other.

The booklet is obtainable free from Evode Ltd, 82 Victoria Street, London, S.W.1.

GAUGING AIR PRESSURE

YOU will have read about the famous experiment with the Magdeburg Hemispheres. Now try it on a small scale yourself. Two gas jars, the rims of which are well coated with vaseline are ideal for the experiment. If you haven't gas jars any two jars or tumblers the mouths of which fit together perfectly may serve the purpose. Hold them mouth downwards for a short time over a Bunsen flame and then place them together, rim to rim. Allow the air inside the jars to cool. It will contract and the pressure inside the jars will be less than the external air pressure and you will find it difficult to pull the jars apart (Fig. 1).

Apparatus required: Two gas jars, vaseline, Bunsen burner, candle, large tin can — petrol can or workman's tin bottle.

Repeat the experiment by placing a lighted candle in one of the jars and then place them together vertically. The candle slowly dies out as it consumes the oxygen. The pressure inside the jars is again reduced below the air pressure outside and it is again difficult to part the jars (Fig. 2).

Fill a gas jar or tumbler with water, place a piece of blotting paper across the mouth of the jar, and press it firmly against the rim. Invert the jar, and you will find that the pressure of the air not only keeps the water in the jar, but actually compresses it, so that the outer surface of the blotting paper becomes concave (Fig. 3).

The air pressure inside a large tin can, such as a petrol can or a workman's tin bottle, may be reduced by boiling a little water in the can.

When steam is issuing freely remove the flame and screw up the cap tightly or push in a rubber bung. The water vapour inside the can cools and condenses and the inside pressure is greatly reduced. The air pressure of 14.7 lb. on every square inch of the outside of the bottle crushes it as though it were made of paper (Fig. 4).

Measuring the pressure

Fig. 5 illustrates a rough method of measuring the pressure or weight of the air with a rubber suction cap. Caps of

varying sizes can usually be obtained from cheap stores. Holes can be made in the stems of the cups for the ring (A), by using a red hot piece of iron. The diameters of the cups should be measured, their surface area calculated from the formula πr^2 , and then each is used with the spring balance as shown. The lower surface of the suction cup should be moistened and pressed firmly against a perfectly smooth surface. The pull on the spring balance should be steady, uniform, and at right angles to the surfaces to which the cup is attached and a watchful eye must be kept on the indicator.

Apparatus required: Rubber suction caps of various sizes, spring balance, strong metal ring, scale pan, weights.

The results should be tabulated thus:

Diameter of Suction Cap	Surface Area of cap	Reading of balance when cap leaves surface	Pressure of air per sq. in. of Suction Cap
Average pressure of air per sq. in. =			

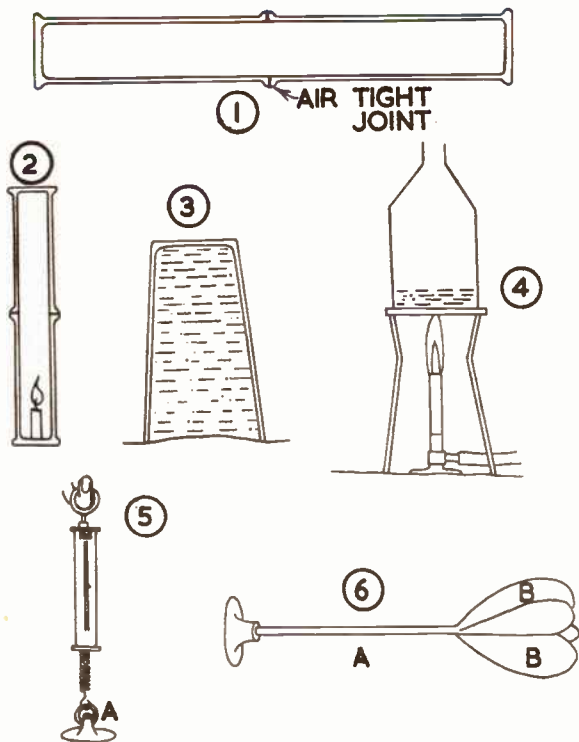

The same apparatus may be used to show that the pressure of the air is the same in all directions by placing the cup against a vertical surface and against a horizontal surface with the suction cap uppermost. In the latter case a scale pan and weight may be used and this is more satisfactory than a spring balance.

Air pressure darts

Air pressure darts made with rubber suction cups are great fun and much less dangerous and destructive than the usual darts. An ordinary circular flat piece of wood marked out and enamelled makes an ideal dart board. The darts are made as shown in Fig. 6.

Suction caps about $\frac{1}{2}$ in. in diameter are most suitable, and if the stem of the cup has no hole into which the piece of dowelling (A) can be fixed, one can be made with a piece of red hot iron. (B, B) are vanes made of cardboard and fixed into saw cuts made in (A). The suction cup should be dipped into water from time to time when it is being thrown against the dart board.

(T.A.T.)

For copying or enlarging

MAKING A PANTOGRAPH

A PANTOGRAPH is a simple instrument enabling us to make copies of drawings, cartoons or maps directly on to separate sheets of paper without requiring the use of transparent tracing or carbon paper. Moreover, by adjusting this instrument we may make our copies larger, smaller, or the same size as the original according to our requirements.

You can make one of these useful accessories from $\frac{1}{2}$ in. stripwood $\frac{1}{8}$ in. thick. Four pieces of stripwood each 14ins. long are required, rounded off at the ends. You may make the pieces a little shorter or longer, but not less than about 12ins. Small screw-hooks or eyes hinge the pieces in two places, so that they may be removed for adjustment, while a wooden peg forms a permanent pivot.

The diagram shows more detail of the arrangement of the few parts. (A D) and (D C), (F B) and (B E) are two pairs of strips, being hinged at (D) and (B) respectively. At (D) a small wooden peg holds the two together, or you may use a small rivet, while at (B) we prepare a longer pointed stick which also acts as a stylus. Screw-eyes hold the strips together at (X) and (Y). The pantograph is secured to the drawing board at (A) by means of a pushpin, while a pencil is inserted at (C) to produce the drawing.

Drill first

The necessary holes for these joints should be made with a very fine drill to avoid splitting the stripwood, and then enlarged where necessary, as for example at (C) for the fitting of the pencil.

This pantograph can be considerably modified by making a series of holes an equal distance apart in each strip to

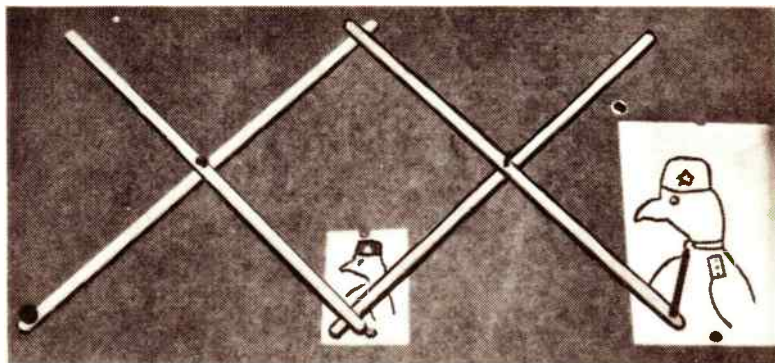

Showing the pantograph in operation with the enlarged drawing on the right.

accept the screw-eyes. This permits the hinging at (X) and (Y) to be changed to similar numbered holes, and the sides of the parallelogram (DX-BY) may be made equal to, longer than or shorter than the sides (BX-DY). Note that the larger (DX) is to (DY) the greater will be the movements of the pencil at point (C) to those of the stylus (B). This stylus is actually the short peg, and may be made from a toothpick or similar piece of material, but the point must not be too sharp, or it will catch in the paper. If the copy is to be larger than the original, the pencil is always inserted at (C), with the stylus at (B), when the original picture must also be fixed in position on the right.

Operation of the pantograph is quite simple. The original drawing or map is fixed centrally on the drawing board and held in position by drawing pins. The

stylus is placed over this drawing, and the pantograph anchored to the board by a pushpin at point (A). A sharp pointed pencil is now inserted at (C), underneath which is placed a sheet of plain paper for the copy drawing.

To make the copy hold the pencil by the right hand, but allowing the eyes to concentrate on the original where the stylus traces the shape. You may either make continuous lines or short marks, filling in the drawing by freehand.

(S.H.L.)

LADY FAYRE

T HIS new set will appeal to the older child and adults. The figurines that are made from the rubber moulds are all authentic costumes from varying periods.

The set contains all materials, moulding powder, moulds, paints, brushes, flock for the application to the base of the models, and plaque pins for inserting in the back of the wall miniatures. It retails at 22/6 in the U.K. and is manufactured by Seamer Products (Sculptorcraft) Ltd.

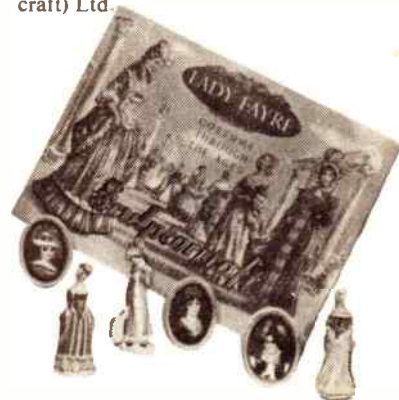
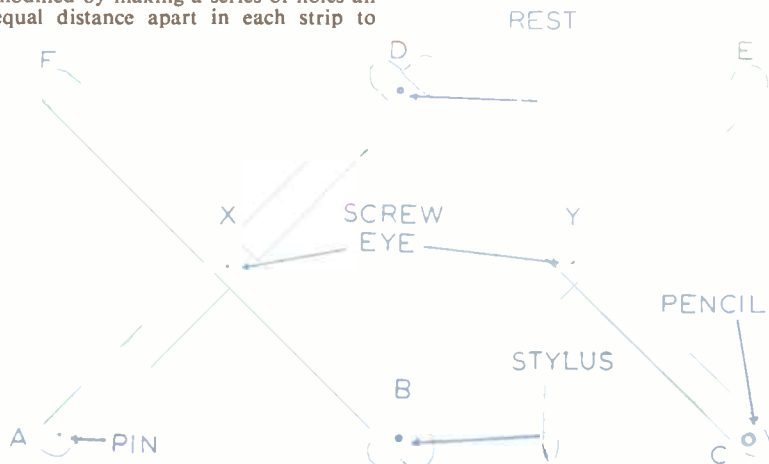

These will make Novel Book-ends

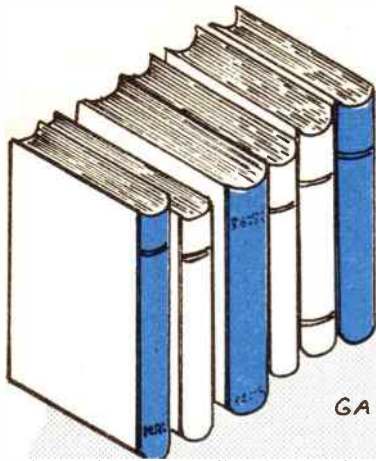

By Finlay Kerr

HERE is a way in which you can make your books stand upright without any visible means of support, as illustrated. This is sure to attract attention from your friends and visitors. The secret is to make a set of book-ends resembling ordinary books and which have metal supports at the bottom.

The first thing to do is to obtain two old books which have hard covers that are in good condition. The size of the chosen books is not very important and will depend upon your own requirements. Remove all the pages until you are left only with the covers.

The next step is to make wooden blocks to fit into the covers. These blocks should be made exactly the same size as the torn out pages. Use a good softwood and shape the narrow sides with a round and a recess to resemble the shape of pages, as shown in Fig. 1.

After this, score some gauge marks with your marking gauge along the top surface to look like the edges of the pages.

The metal supports at the bases are made from any light gauge sheet metal. Note from Fig. 2 that the fixed ends are turned up the sides of the wood blocks and nailed through the sides. Don't attempt to nail the supports from the underside. The metal being thin is almost certain to leave the heads of the fixing nails projecting a little which could scratch polished furniture when in use. A projection of about 3ins. beyond the inner face of the blocks is quite satisfactory for the metal supports.

Finally, glue the stiff covers over the blocks and the book-ends are ready for use.

GAUGE LINES

Fig. 1

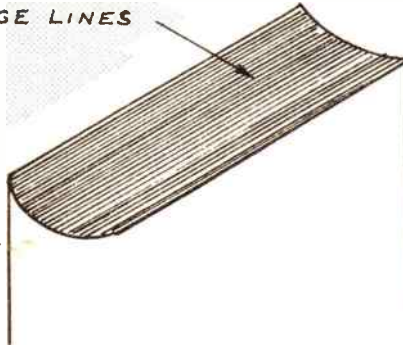

SHEET METAL

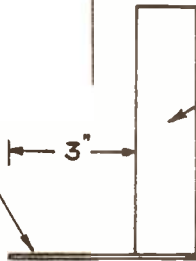

WOOD BLOCK.

NAIL HERE

Fig. 2

Protect your Milk Bottles

As a rule too little care is taken with regard to milk bottles, be they full ones left by the milkman, or empties awaiting collection. It is unhygienic, uneconomical and, sometimes, dangerous to leave bottles of milk lying unheeded on the doorstep, maybe in the full glare of the sun.

Here is an idea which will tidy up the disposal of the bottles. It provides a covered box-shelf for the full bottles and a separate rack for holding the inverted empties. In addition, as will be seen from the illustration, provision is made for a clip to hold the household's order for the milkman.

The illustrations are self-explanatory and both articles can be quickly made up by the average handyman. Dimensions will, of course, depend upon personal requirements, but the box should be made high enough to just take the bottles, thus thwarting any effort by our

feathered friends, the tits, to get at the contents under the metal foil caps.

Use a 3in. by 1in. piece of board for the rack and mark out for 3/4in. dowels. Fix to the wall with 3in. by 3in. metal brackets. The box-shelf should be plugged to the wall. Be sure and fix this in the shade. The two articles and fittings can be painted to match the house paint. (P.P.)

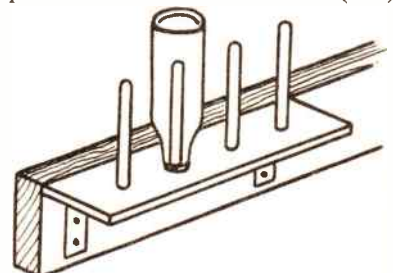
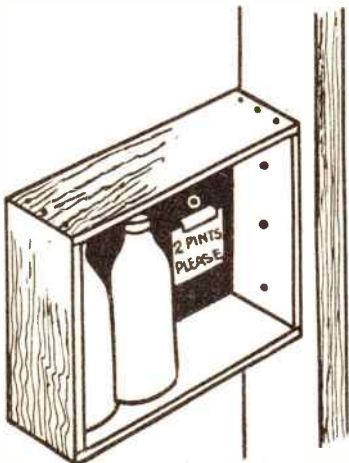



It won't move!

CERTOFIX liquid glue can cope with all general repairs. It unites wood, glass, metal and almost all substances. It is clean in use; its joints are stronger than the materials it unites.

Sold at all Woolworth Stores

CERTOFIX

WILL Really FIX IT!

The best tools you can lay hands on

"YANKEE" HANDYMAN PUSH DRILL

A simple push action automatically turns drill point into wood, plastic, plaster, or wallboard for screws, brads, nails, etc. No splintering. Magazine handle holds four drill points—room for four more.

21/- complete with 4 drill points.

STANLEY VICE



A new portable vice at an amazingly low price. Body of cast aluminium gives lightness combined with great strength. Clamped to table or workbench it holds work rigidly—either horizontally or vertically.

25/-

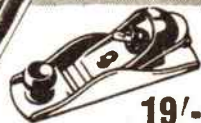

STANLEY BLOCK PLANE

19/-

There are many uses for the Stanley 220 Block Plane. Particularly useful for cutting against the grain and smoothing up ends. 7" long. 1 1/2" cutter.

STANLEY

STANLEY WORKS (G.B.) LTD., RUTLAND ROAD, SHEFFIELD, 3.

SW60



with



Hobbies kits for novel musical boxes are extremely popular for making up as gifts and for sale. Kits include materials and full instructions for making with a few simple tools. Musical movements are extra. Make your choice of tune from list below.

GET A KIT NOW!

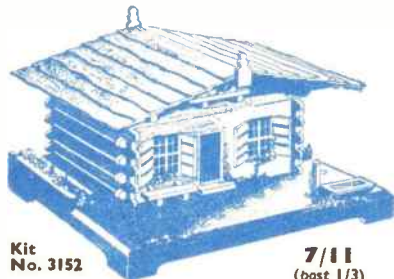

Kit No. 3152

7/11
(post 1/3)

SWISS CHALET. Lift the lid to offer a cigarette and it plays a tune. Fit with Musical Movement No. 1.



Kit No. 3222

11/6
(post 1/6)

MUSICAL TAVERN. A savings box which plays a tune when you insert a coin. Fit with Musical Movement No. 2.

- Fit your box with one of these tunes
- No. 1 Movement. 15/6 (post 6d.)
 - C Swedish Rhapsody
 - D Silent Night
 - E Brahms' Lullaby
 - Y Anniversary Waltz
 - No. 2 Movement. 16/9 (post 6d.)
 - R Happy Wanderer
 - S Teddy Bears' Picnic



Kit No. 3250

12/6
(post 1/6)

GRAND PIANO. Kit includes printed keyboard. Fit with Musical Movement No. 1.

Other models detailed in free Booklet

To Hobbies Ltd., Dept. 992, Dereham, Norfolk.
Please send free copy of Profitable Leisure and items detailed.

Kit No.

Musical Movement.

Name

Address

P.O. for. enclosed



YOUR 'Salute to the Fallen' in stamps and labels should be carefully planned. Many minor themes will automatically suggest themselves. But concentrate on the main idea — Armistice Day.

Decorate the album cover with any of the following: A large poppy or wreath of poppies, a picture of the Cenotaph, a soldier, sailor or airman or all three, a large V similar to the one depicted on a 1957 Chinese match label (see illustrations).

ARMISTICE

— By R.L.C.

Introductory notes are important — nice read thus:

'On Remembrance Sunday when we commemorate those who died in the two world wars H.M. the Queen leads the nation's homage at the Cenotaph, as her father and grandfather did before her. The same familiar services are held in the great cities and on the village greens. The same blood-red poppies remind us of those Flanders fields where a generation died.

The veterans with their rows of medals recall lost comrades. Beside them their sons and daughters remember the battlefields of the Second World War.

This annual service of Remembrance

Remember



Poppy Day

should ever remind us that the most urgent task in the world today is to ensure that our children never have to go to war as we, their fathers, did.

This album is dedicated to those who gave their lives that we might live in Peace and Freedom.'

The illustrations show a few of the many items available for depicting this noble story. The armed forces are well represented on stamps and match labels.

But don't forget organisations like the Red Cross — Czech. match labels

1956, set of 10, 2/6d. mint. French patriots who continued to fight after the Germans had overrun their country — French stamp 1946, 10 cent black and blue, 1d. mint. Malta, the island which won the George Cross — stamps 1938, ½d. green, 2d. used. Falkland Islands stamp of 1954, ½d. black and green — Ship — 2d. mint. Those who fought at home, like the postwomen of both wars depicted on cigarette cards issued by W. H. J. Woods Ltd.

Think of the stars who sang songs to the troops, many of whom are depicted on various cigarette cards.

Conclude your album to date by illustrating the actual Remembrance Service. You will experience no difficulty here. For example that famous hymn:

O God, our Help in ages past,
Our Hope for years to come,
Our Shelter from the stormy blast,
And our Eternal Home.

Stamps: Italy 1923, 20 cent orange and green — Christ and His disciples — 1/6d. mint. Malta 1951, 1d. green — Virgin Mary — 6d. mint. 1954, 3d. violet — St. John's Co-Cathedral — 9d. mint.

WE WILL REMEMBER THEM.



John Peel's Caldbeck

IN the snug parlour of a house in the little village of Caldbeck, in Cumberland, two friends, John Peel and John Woodcock Graves, sat one evening exchanging stories of hunting the fox, and the up-shot of all their talk was the composition of that well known song 'D'ye ken John Peel?'

Peel, the hero of the song, was a Caldbeck man, whilst his chum Graves was born at Wigtown, a Cumberland village, and for some years resided at Cockermouth. Peel was a hardy Cumberland yeoman, who, on a limited income, managed to hunt with his own pack of hounds, which included the

famous Ranter, Ringwood and Bellman true, and his followers were the farmers who dwelt in the Skiddaw country at the time. His favourite sport was hunting the hill foxes.

Visitors to the Lake District enjoy exploring the little village of Caldbeck with its grey stone cottages, and the house where the famous song of 'John Peel' was written, and the old inn where Peel and his friends foregathered on many a winter's evening after a day scrambling over the rough fellsides in pursuit of the hill foxes. There they still sing the old song that rendered Peel famous for all time. (A.S.)



For REPAIRING FIREPLACES

**IN THE BLUE
and
WHITE TIN**

PRICES

1 lb. 1/9
2 lb. 2/9



PURIMACHOS LTD

ST. PHILIPS · BRISTOL 2



**WOOD
MITRE
BLOCK**

Price 3/3
(post 1/-)

This 9in. block is handy for cutting mitres on any small work — moulding, edgings, etc. Made of selected hardwood with right angle and 45° slots for the small tenon saw. From branches or:

HOBBIES LTD., DEREHAM, NORFOLK

You simply pour out these

NOVELTIES

with NEW LIQUID PLASTIC

Here's the hobby to make your spare time pay dividends. You simply choose your mould and pour out beautiful castings. We supply everything, including instructions. Wonderful results achieved — wonderfully quickly!

Start right away—no training needed. Send 6d. stamp for exciting book and market details. No obligation.

QUALITY PLASTICS LTD.

Dept. H30, Brentwood, Essex



HEAR ALL CONTINENTS With H.A.C. Short-Wave Receivers

Suppliers for over 18 years of radio S-W Receivers of quality.

One-Valve Kit, Price 25/- Two-Valve Kit, Price 50/-

Improved designs with Denco coils. All kits complete with all components, accessories and full instructions. Before ordering, call and inspect a demonstration receiver, or send stamped addressed envelope for descriptive catalogue.

'H.A.C.' Short-Wave Products (Dept. 22), 11 Old Bond Street, London, W.1.

Modelling with Balsa

written by one of the world's leading authorities on models and modelling —

RON WARRING

A complete guide to the making of working models in that inexpensive and easily worked material—balsa wood.

The opening chapters describe marking-out, cutting, shaping and assembling techniques, with a full description of the range of simple tools needed for the modeller's workshop.

The remainder of the book is devoted to plans of many different models, from boats and aeroplanes to model railway accessories, each complete with full-size patterns and profusely illustrated with step-by-step diagrams covering all assembly stages.

8s. 6d.



STANLEY PAUL

178-202 Great Portland Street, London, W.1

APPARATUS & CHEMICALS

For your experiments. Let us help you equip a
HOME LABORATORY

Beakers, Crucibles, Flasks, Funnels,
Gas Jars, Test Tubes, etc.

Booklets:
(including postage)

'Experiments' 1/2
'Formulas' 1/2
'Home Chemistry' 2/10
New edition

Send 3d. Stamp for latest PRICE LIST

A. N. BECK & SONS (Dept. H.W.)

60 Stoke Newington High Street, London, N.16



BRANCHES: LONDON

78a New Oxford St., W.C.1
(Phone MUSEUM 2975)
87 Old Broad Street, E.C.2
81 Streatham Hill, S.W.2

GLASGOW
326 Argyle Street

MANCHESTER
10 Piccadilly

Head Office & Factories—**HOBBIES LTD, DEREHAM, Norfolk**

BIRMINGHAM
100a Dale End, Birmingham 4
SHEFFIELD
4 St. Paul's Parade
LEEDS

10 Queen Victoria Street
HULL

10 Paragon Square
SOUTHAMPTON
134 High St. (Below Bar)

BRISTOL

65 Fairfax Street

NEWCASTLE

42 Dean Street

GRIMSBY

88 Victoria Street

A certain young fellow named Moore...



tried dancing, but fell on the floor!

So—a man of resource—



he took ESCORT'S quick Course



—And now he's got partners galore!

Can't afford private lessons? Learn ballroom dancing at home! Send for exciting FREE booklet "Dance Escort" which explains the miraculous SURE STEP system. Cut out this advt., enclose 3d. stamp, name and address and post to: **ESCORT DANCE INSTRUCTORS** Studio H15 Harrogate or Rock'n'Roll Course—send 4/6 P.O.

HOW TO STOP SMOKING

and permanently overcome that ceaseless craving for tobacco. Save money, safeguard health. Send stamp for details of the world-famous inexpensive Stanley Treatment for tobacco habit.

THE STANLEY INSTITUTE LTD Dept. 30
12 Bridewell Place, London E.C.4

WHEELS (Hardwood and Rubber Tyred metal), Cot, Pram and Doll's House Fittings and Papers, Beads, Transfers, Prints and other accessories. Stamp for new lists. (Trade supplied.) New address. — **JOYDEN CO.**, 91 Peplins Way, Brookmans Park, Herts.

MODELS. You can make lasting stone-hard models with Sankey's Pyruma Plastic Cement. Supplied in tins by Ironmongers, Hardwaremen and Builders' Merchants. Ask for instruction leaflet.

'PAINTSPRAYING' HANDBOOK. Covers Car, Industrial & Flock Spraying. 3/3, post 4d. Catalogue of our Cellulose and Paints and all Allied Sundries 3d. — **Leonard Brooks Ltd.**, 81 Oak Road, Harold Wood, Essex.

FULLY TRANSISTORIZED

The VOXETTE TAPE RECORDER

NOW a brand new EXPENSIVELY TRANSISTORIZED tape recorder and play back machine AT EVERYBODY'S PRICE. Complete outfit ready to record and play back. £11. 19. 6., carr. 5/-.



No more to buy. Records anything — music, outdoor sound effects, sing-songs, parties. Ideal reporters, dictating, etc. Permanent recordings or tape can be used again and again. Further 3 in. spools obtained anywhere. With standard batteries (cost 1/8d. — months of normal use) you can record outdoors — anywhere! Perfect reproduction. Portable. Written guarantee. Or sent for £4, bal. 18 ftnly. payts. 10/10d. LISTS. GUITARS, WATCHES, RINGS, CABINETS, JEWELLERY, etc. TERMS.

Headquarter & General Supplies Ltd. (HOBW/36) 196-200 Coldharbour Lane Loughboro Junc., London, S.E.5. Open Sat.

BECOME CHIROPODIST MASSEUR. Postal Schools (Dept. 27), 48A Abbey Street, Accrington.

100 DIFFERENT stamps free! Request 3d. upwards, discount approvals. — Bush, 53 Newlyn Way, Parkstone, Dorset.

CLUB PRINTING AND DUPLICATING. Samples and prices 3d. — Bernard Salmon, 107 Shearer Road, Buckland, Portsmouth.

MUSICAL MOVEMENTS. The largest selection of tunes in England. — Richardson & Forder, 5 Chapel Place, London, N.17.

MAKE A MUSICAL BOX for as little as 21/-. New kits and tunes available. Movements 13/- post free. Please send 3d. stamp for free illustrated catalogue. — **The Swisscross Co.**, Dept. B., 202 Tulse Hill, London, S.W.2.

STOP SMOKING in 3 days or money back. Safe, pleasant, permanent. The only scientific way. No Will Power necessary. 'Conquered the habit in 2 1/2 days'.—F.C. 'Within 2 days I was free from the tobacco habit'.—W.G. 'Was a smoker for 2 years and broke the habit in 2 days'.—F.N. 'I used to smoke 20 a day... now I have no desire to smoke'.—J.M. Recommended by 'Health and Efficiency Magazine'. Complete course 7/6 (or \$1.00 bill). Details 3d. stamp. Sent under plain cover. **NATURE REMEDIES, 28 (H/185) Dean Road, London, N.W.2.** Established 1928

SAVE THIRTY SHILLINGS!

ELECTRIC DRILL ACCESSORY KITS

Sanding Discs — Backing Pad — Lambswool Bonnet — Grinding, Buffing and Wire Wheels with Arbor — Masonry Drill and Wallplugs — 3 Drills for Wood — 3 Drills for Metal — Postage Paid — 24/6 — (Usually 54/6). — Lists Free.

BARKERS, 70 WEST STREET, LEEDS 1

OLYMPIC Games stamp and 10 beautiful pictorials free! Five Continents represented. Send 3d. postage requesting bargain approvals. — **Greenwood (HA), 9 Moor View Road, Sheffield 8.**

MEN-WOMEN with spare time, required for new simple weaving work. For details send S.A.E. — (Dept. 4), Weava Products, 10 Shelley Road, Worthing.

BOYS — Build a sailing catamaran. Send for illustrated leaflet. Plans 12/6 per set. Stamp to — **J. B. Marine Products, West Coker, Yeovil.**

MAKE your own Electric Blanket. Complete Kit 15/6. Full instructions. Leaflet free. — **W. Hancox, 29 Rowlands Crescent, Solihull, Warwickshire.**

STAMPS FREE — Empire Packet including Pictorials and Victorians with approvals. — **Robert J. Peck, 7A Kemp Road, Bournemouth.**

KUKLOS ANNUAL. Indispensable cyclists' handbook. Tours, resthouses, money-saving hints. 3/- post free. — **Burrow, Publishers, 2 Imperial House, Cheltenham.**

YOU CAN BUILD 'DEREHAM'

A Sturdy 10ft Dinghy

Design by
P. W. Blandford

For river or sea — oars or outboard motor — carries three persons and kit — light enough for two to lift. A detailed drawing showing the main frames, transom, stern and other parts full size for easy working. Costs only 8/6, and full building instructions are given free.

A project

for the winter months ahead

Write to: The Editor,

HOBBIES WEEKLY, DEREHAM, NORFOLK

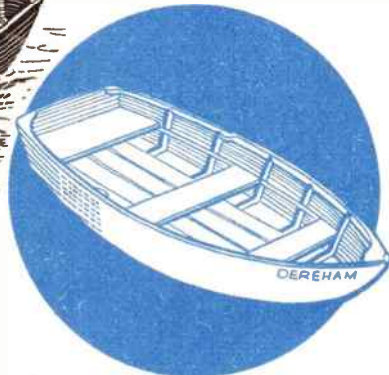

MAKE A SPILL HOLDER

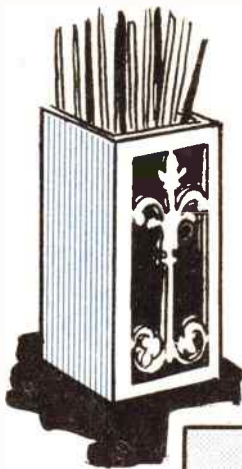
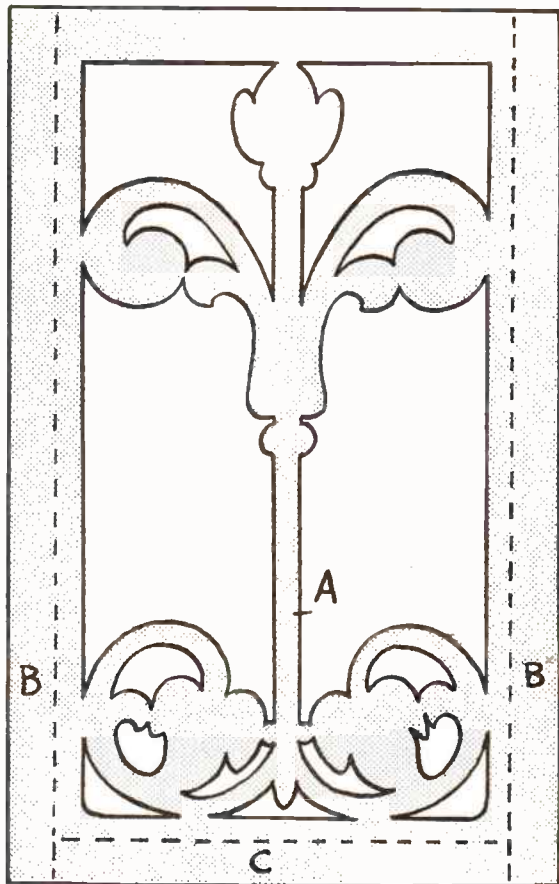

THIS is a small project for the beginner in fretwork. It is made from $\frac{1}{4}$ in. wood, glued together, and may be finished by staining and varnishing or painting.

Cut two pieces (A), two pieces (B) and one piece (C). The patterns are easily transferred to wood by means of carbon paper.

Cut out the interior frets first, in pieces (A), and then cut round the outline. Use a fine-grade fretsaw for all cutting.

Note that the bottom (C) goes between the sides (B) and the back and front (A). The fretted portions of pieces (A) may be backed with cloth or coloured paper. (M.p.)

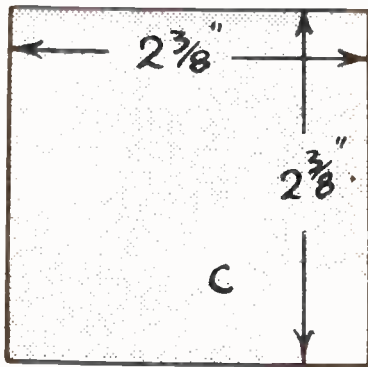
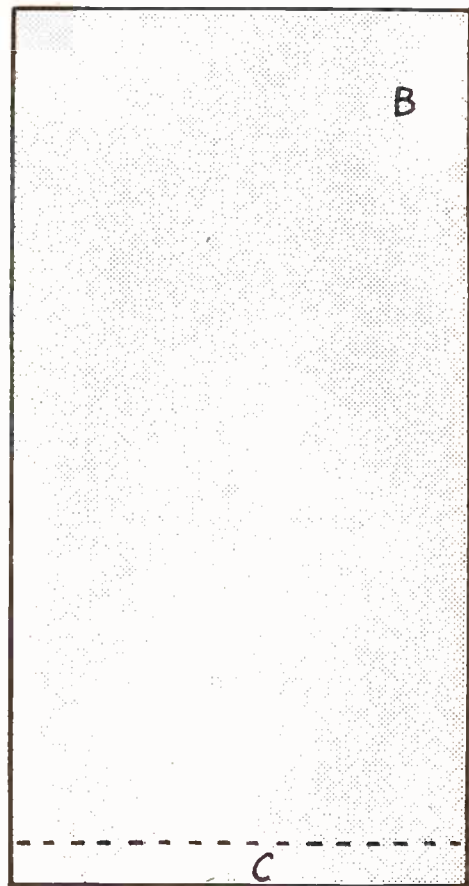

*Use
Your
Fretsaw*



All the care and artistry which go into the creation of a model or the execution of home craftsmanship can be marred unless correct materials are used. Valspar products not only guard against this risk but produce a finish that enhances even the most skilled hobbyist's work.

VALSPAR
2-4 HOUR LACQUER
 AND
WOOD STAIN • CLEAR VARNISH

- ★ Dries in 2-4 Hours.
- ★ Proof against boiling water, petrol, oil, alcohol, etc.
- ★ Can be applied to all surfaces.

Write for a free copy of the Valspar Handbook

GODDASS, WALL & CO. LTD. 179/185 (A.C. 11) Gt. Portland St. London W.1
 Please send me a free copy of the Valspar Handbook giving full details of how to use Valspar paints

NAME
 BLOCK CAPITALS
 ADDRESS

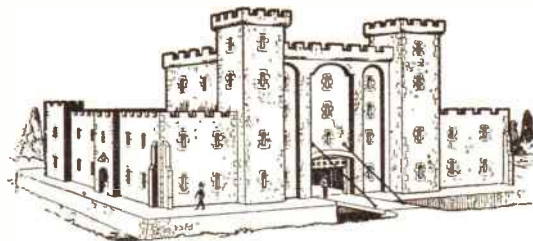

GIFTS

Kit No. 3274
GRAND MODEL FORT
 Base 19ins. x 13ins.
28/6
 (post 3/3)

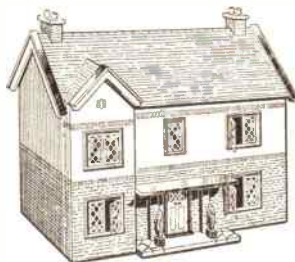

FOR

Kit No. 2910
DOLL'S HOUSE
 17ins. wide.
 Four rooms, hall, landing.
65/-

GIRLS

Kit No. 254 Spcl.
DOLL'S HOUSE
 Rigid hardboard construction.
 Open back.
47/11



AND

BOYS

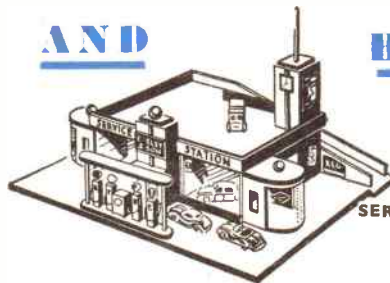

Kit No. 3129.
SERVICE STATION
 Very modern.
 Base 24ins. x 18ins.
43/11

To Hobbies Ltd., Dept. 992, Dereham, Norfolk.
 Please send free booklet illustrating kits available and kit indicated here.

Kit No.....

Name

Address

P.O. for..... enclosed. (Orders value 30/- and over, post free)

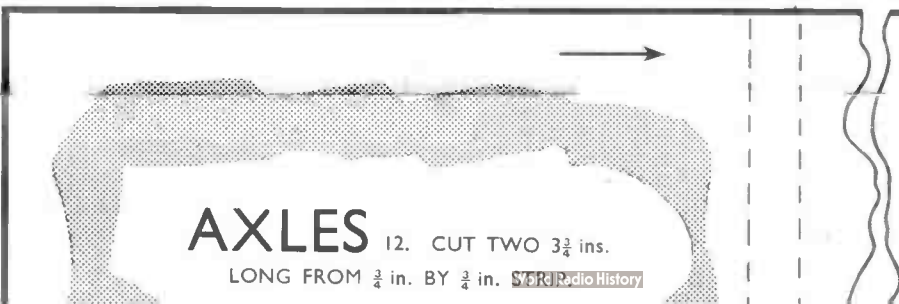
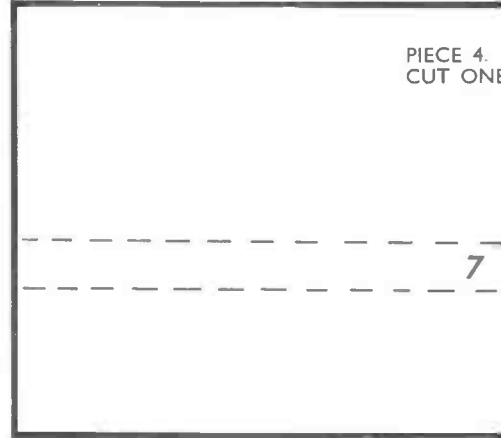
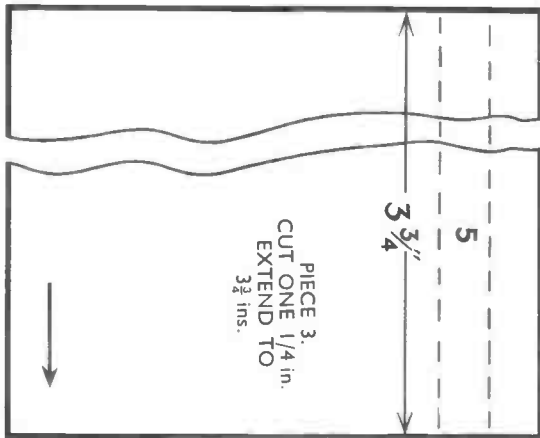
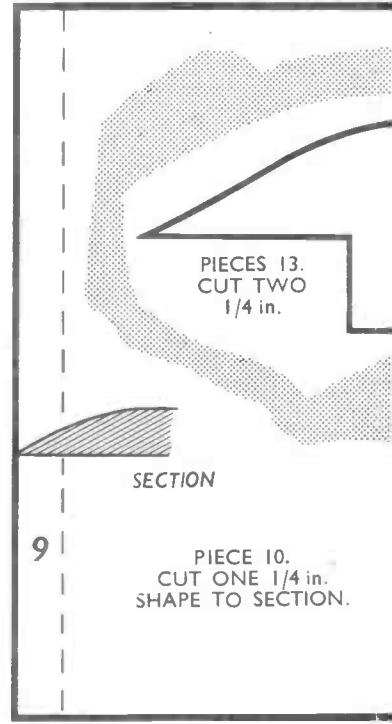
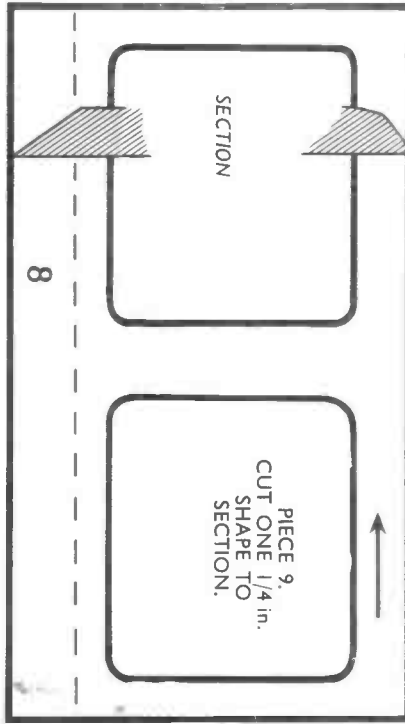
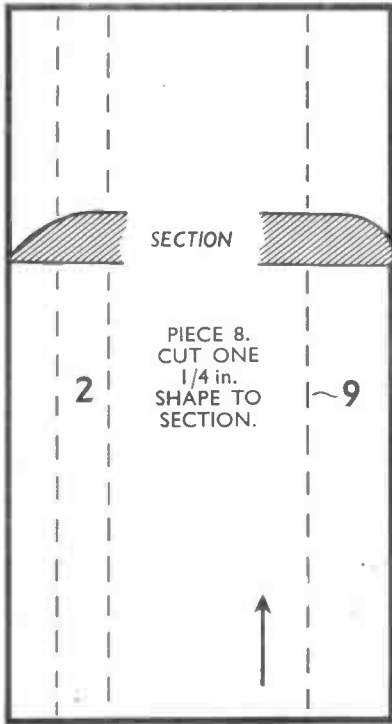

FLOOR 2.
CUT ONE 1/4 in.
EXTEND TO
11 3/4 ins.



DESIGN

No. 3288

TOY FIRE ENGINE

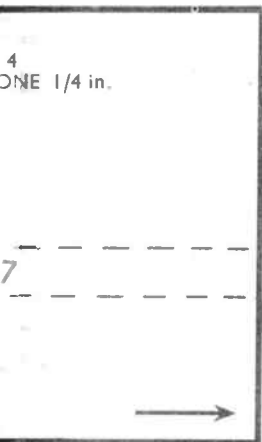
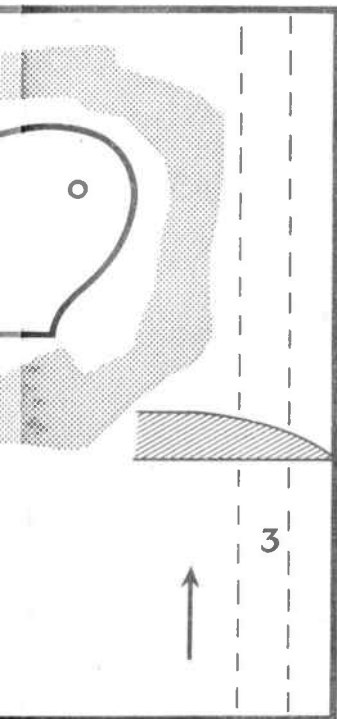
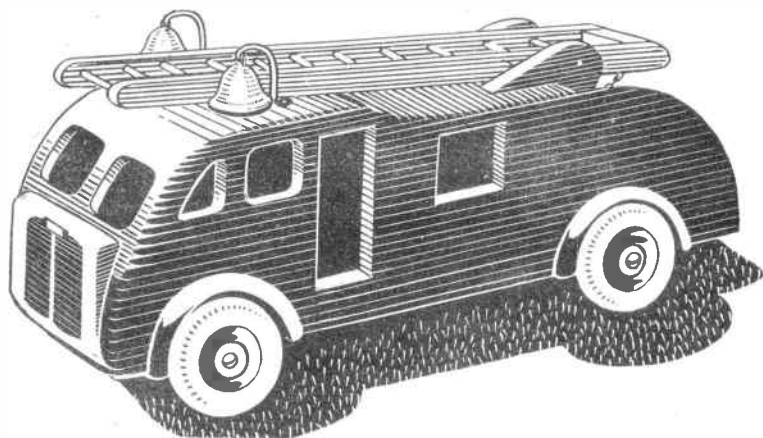

SIZE
12 ins. LONG
5 ins. WIDE.

PIECE 5. CUT
ONE 1/4 in.

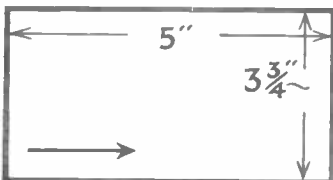

PANELS OF WOOD REQUIRED
FOR THIS DESIGN

THREE H.4

A KIT OF MATERIALS FOR MAKING THIS DESIGN
IS SUPPLIED BY HOBBIES LIMITED
DEREHAM, NORFOLK.
PRICE ON APPLICATION.

Use **CASCAMITE**
'One Shot'
Resin Glue



for all Model Making

- Mixed & use cold
- Waterproof type
- Gap-filling and non-staining

Obtainable in:
3 1/2-oz.; 7-oz.
and 18-oz. tins.

Stocked by: Ironmongers, Builders' Merchants, etc.

Manufactured by:

LEICESTER, LOVELL & CO. LTD. North Baddesley, Southampton

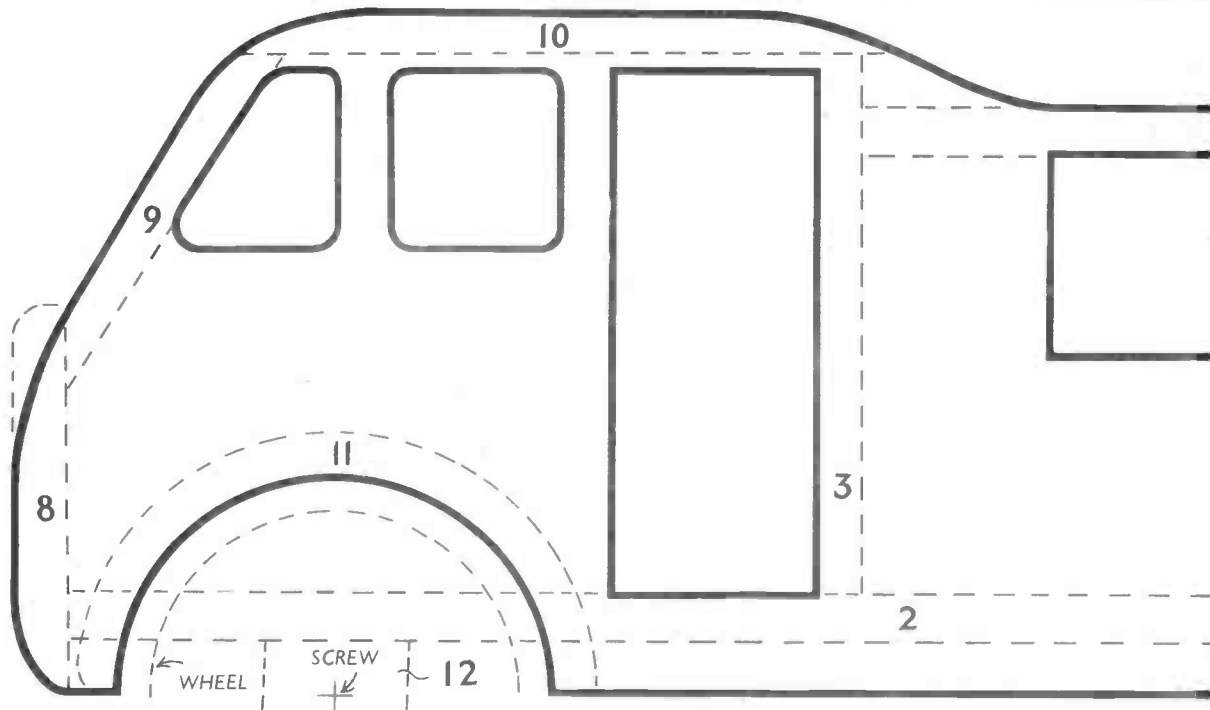
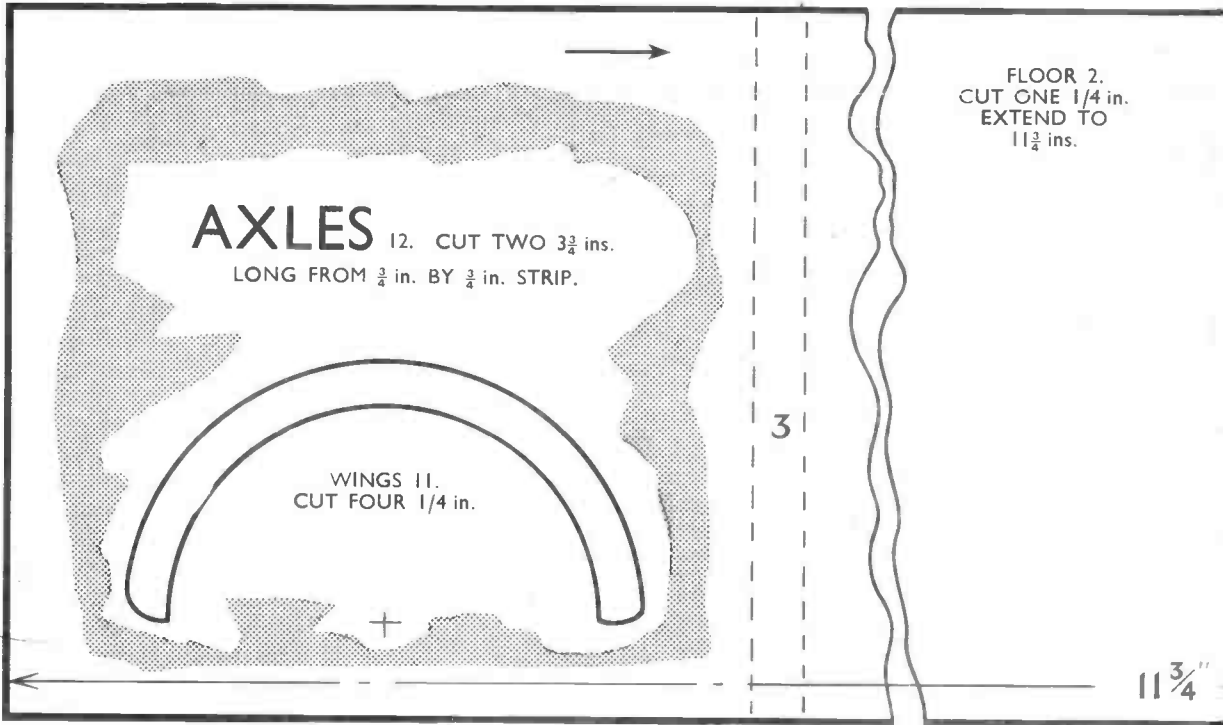

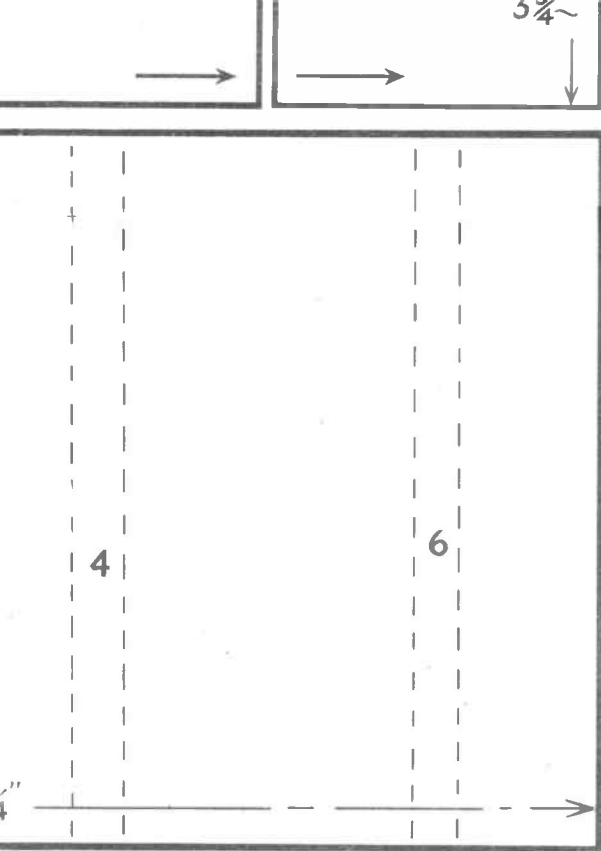

Use **CASCAMITE**
 'One Shot'
 Resin Glue



for all Model Making

- Mixed & use cold
- Waterproof type
- Gap-filling and non-staining

Obtainable in:
 3½-oz.; 7-oz.
 and 18-oz tins.

Stocked by: Ironmongers, Builders' Merchants, etc.

Manufactured by:

LEICESTER, LOVELL & CO. LTD. North Baddesley, Southampton

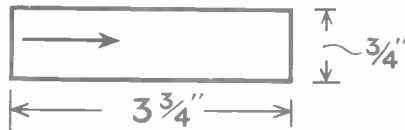

PIECE 6.
 CUT ONE 1/4 in.

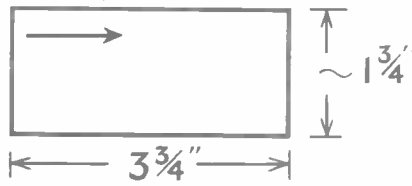

PIECE 7.
 CUT ONE 1/4 in.

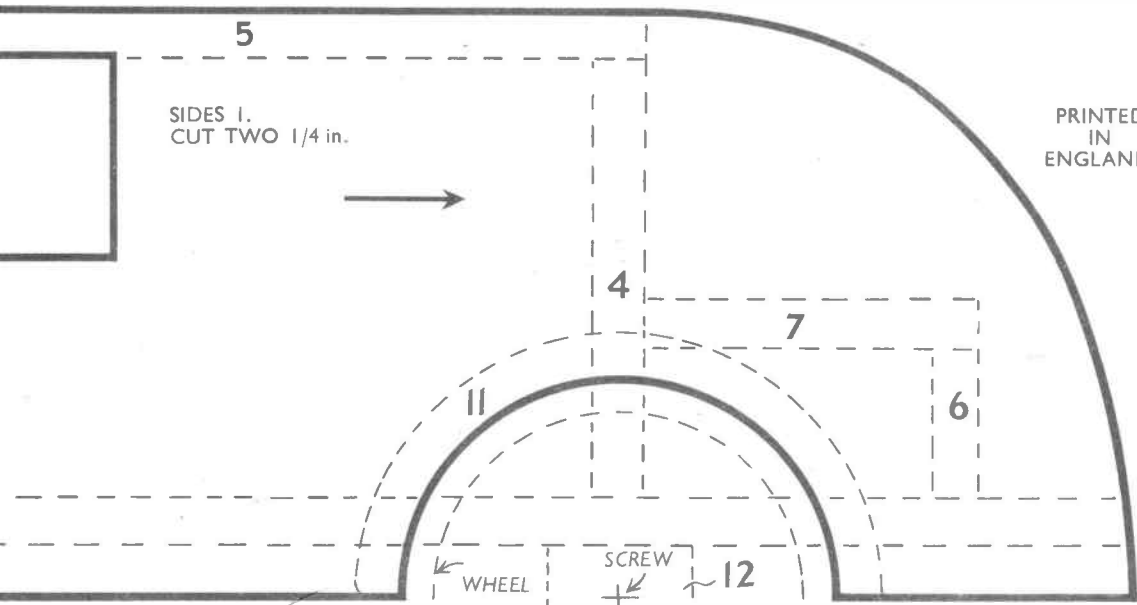

PRINTED
 IN
 ENGLAND.