

# HOBBIES WEEKLY

FEBRUARY 19th 1958

VOL. 125

NUMBER 3251

IN THIS ISSUE

	Page
Make a Sturdy Garden Swing	337
'Chair' Plant Stand	338
Transistor Amplifier	339
Why not grow a Citrus Tree?	340
Making Sliding Doors	341
Chemistry in the Home	342
Swiss Chalet	343
Solution to Jig-Quiz No. 7	343
Patterns for 'The Corner' Garage	344
Collectors' Club	346
Concocting New Wines	348
Patterns for 'Bird' Jigsaw Puzzle	351



All correspondence should be addressed to the Editor, Hobbies Weekly, Dereham, Norfolk

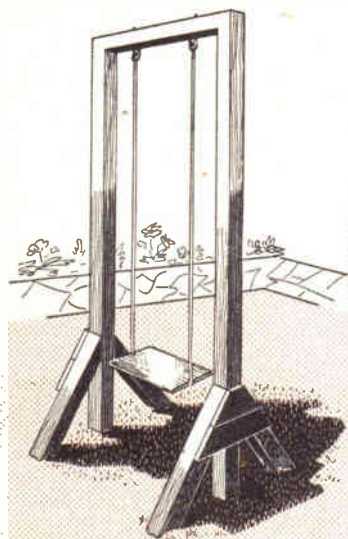

## MAKE A STURDY GARDEN SWING



*A design that  
will last for  
years and suit  
children of all ages*

**S**PRING TIME will be swing time if you start work right now ready for the light evenings. Children love to have a smart swing in the garden and it is an easy job for the handyman to tackle. If well treated with wood preservative it will last for many years. It is of sturdy construction and will allay any fears of sudden collapse so common with makeshift swings.

The uprights, struts and crossbar are made from 3in. square wood, oak if possible. Select timber that is free from shakes. The posts are 8 ft. 6ins. long and the crossbar 3ft. 6ins. The four struts are 4ft. 6ins. long and are cut to fit as shown in Figs. 1 and 2. The easiest way to find the correct angle is to lay the upright post on the floor and place the struts underneath in the correct positions. They

are splayed out to a width of 3ft. 7ins. The bottom brace of  $\frac{1}{2}$ in. wood, 3ins. wide, is laid underneath and the struts then marked off for cutting.

The crossbar is fitted into the posts as shown by the detail in Fig. 3. The joints should be treated with a wood preservative such as Cuprinol and could also be painted with red lead for extra protection. Fix in position with a  $\frac{1}{2}$ in. diameter dowel as shown in Fig. 3.

All parts should be treated with preservative before assembling, paying special attention to joints and end grain. Nail the struts to the uprights, and secure the braces in position. Strengthening pieces of  $\frac{1}{2}$ in. wood 6ins. wide are pinned in place over the joint between uprights and struts as shown in Fig. 4. These pieces are broken away to show

337

FOR ALL HOME CRAFTSMEN  
Over 60 years of 'Do-it-Yourself'

World Radio History

4  $\frac{1}{2}$  <sup>D</sup>

the strut fitting snugly against the upright.

Let the posts into the ground to a depth of about 2ft. 6ins. and fill the holes with rubble well rammed down. Pack rubble and earth together, ramming every few inches. There is no need for cement if this job is done properly.

The ropes are fixed to the cross bar by means of bolts turned at the ends as shown in Fig. 5. Use long bolts and cut off the heads with a hacksaw. Heat and turn to the required shape. Chain links or eyelets with the ropes attached are

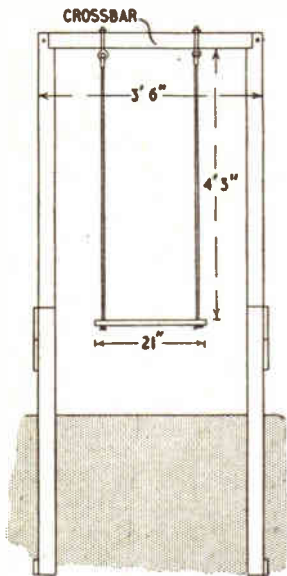

Fig. 1

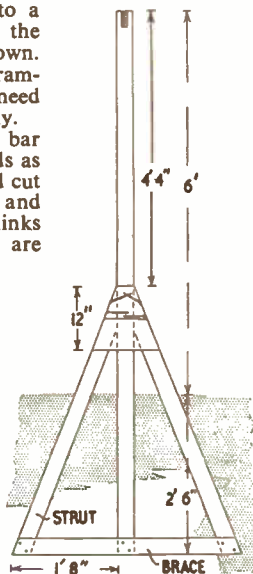

Fig. 2

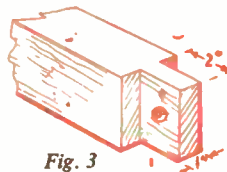

Fig. 3

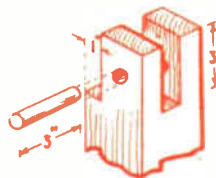

Fig. 4

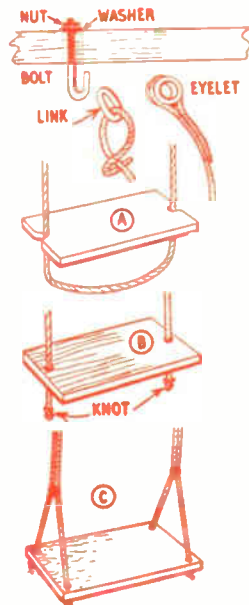

Fig. 5

now slipped over the hooks formed in the bolts and the nuts tightened, thus drawing the hooks up to the underside of the crossbar.

The seat is cut from  $\frac{3}{4}$ in. thick hardwood, and measures 21ins. by 10ins. It may be attached to the ropes by either of the methods shown in Fig. 5. For small children, method (C) gives a better

balance and is probably the safest. Older children, however, can get a much higher swing with the other methods of seating and in the case of (A) the seat can be removed in wet weather.

Finish off by painting all the woodwork dark green, leaving the seat in the natural wood, but giving two or three coats of brush polish. (M.h.)



**T**HAT disused child's metal chair with torn canvas seat can be turned into an attractive plant stand.

## 'Chair' Plant Stand

The collapsible metal frame is painted a jade green after removal of the canvas. Three lengths of rope or thick cord are hung up for convenience and painted the same green. When the frame and cords are thoroughly dry, the cords are tied across the frame with equal spaces between in place of the old canvas seat (Fig. 1). They hold out the frame and partially take away the appearance of a chair.

The plant box is constructed from any wood to hand about 16ins. long 5ins. wide and 5ins. deep. It is painted the same jade green as the metal support.

When dry the box will hold four small sized flower pots. As the box is not watertight each flower must be stood in a small container. Short plastic covers of old powder boxes will prove very successful.

The box with the four flowering or

climbing plants will lie quite firmly on the three stretched cords. The metal back is useful for training the ivy stem. (H.M.)



For increased volume

# TRANSISTOR AMPLIFIER

THIS is the simplest form of transistor amplifier that it is possible to construct, yet one which gives a useful increase in signal strength. It is intended for use in conjunction with a crystal set, to improve volume. Under average reception conditions, really loud headphone results can be expected. In unfavourable circumstances, where a crystal set scarcely gives enough volume for comfortable reception, the transistor amplifier can increase this to a suitable

By F. G. Rayer

level. When conditions are very favourable (e.g., a good aerial and earth are possible, and a major BBC station is not more than 10 to 20 miles away) then a loudspeaker can be operated at low volume.

The circuit is shown in Fig. 1, and employs a junction type A.F. amplifier transistor. The cheap type of transistor, which is easily obtainable, will function quite well, if in good condition.

A small signal is applied to the 'input' terminals. This small current flows from the base element of the transistor to the emitter. In doing so, it allows a larger

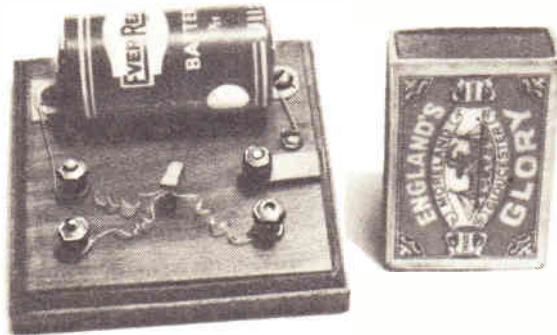

The amplifier compared in size with a matchbox

side of the baseboard, by drilling out for this. If a thin ebonite panel or base is used, this will not be possible, but four small feet can then be screwed or glued to each corner of the base.

The four terminals are positioned as in Fig. 2. In addition, three small wood-screws (or short bolts) are required to hold the battery brackets, and take the switch connection.

The switch is made from a small strip of brass or other metal, with a hole drilled at one end so that it can be pivoted upon the one output terminal, as shown. When turned back, this strip bears upon the screw which is connected to battery negative. This is the 'On' position. Washers will help to give free movement without looseness.

Any  $1\frac{1}{2}$  V. torch cell is suitable as the

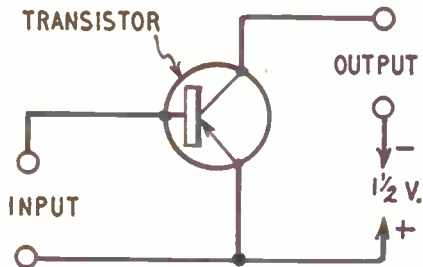

Fig. 1—The amplifier circuit

current to flow from the collector. This larger current is obtained from the battery, and passes through the headphones. A more powerful signal is available at the 'output' terminals, than was applied to the transistor, so that amplification has taken place. A switch is added in one battery lead, to stop current flowing when the amplifier is not in use.

A small wooden or ebonite baseboard about 3ins. square is large enough. If of wood, it should be varnished before use. Bolts, with nuts and terminal heads, provide for external connections. The bolt heads can be sunk into the under-

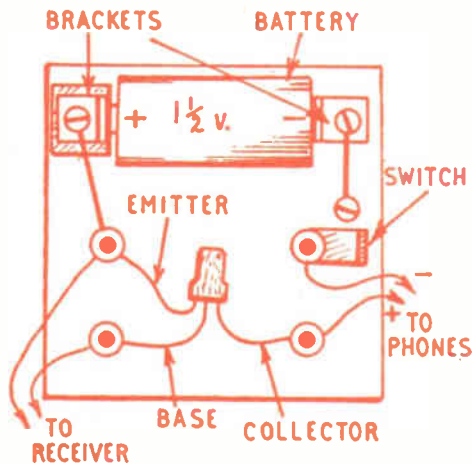

Fig. 2—Wiring diagram

The three leads emerging from the transistor should be left their full length. The collector is usually indicated by a red dot, and goes to one output terminal. The base lead is centrally placed, and is taken to one input terminal. Finally, the emitter lead goes to the other input terminal, and battery positive. It is absolutely essential that these three leads be correctly connected.

battery, its size not being of any importance. The two brackets, which are cut from thin metal, are screwed down with a suitable distance between them to accommodate the battery.

As it is important that the battery is always inserted in such a way as to give the correct polarity, a strip of cardboard, with a hole just large enough to clear the centre contact of the battery, is fixed

under the left hand bracket. This can be seen in Fig. 2. When the battery is correctly inserted, its brass cap (which is positive) passes through this hole, touching the bracket. But if the battery is inserted the wrong way round, the card prevents contact between the bottom of the cell (which is negative) and the bracket.

Trying to use the amplifier with the battery connected in the wrong polarity can immediately destroy the transistor. There is, however, no reason why a 3V. (2 cell) battery should not be used, if a little extra volume is required. The brackets will then have to be far enough apart to accommodate the two cells.

The current taken is very small, so that even pen torch cells will last a long time. The circuit should always be broken, by means of the switch, before disconnecting either of the leads going to the input terminals of the unit.

#### Connecting the receiver

The usual headphones are disconnected from the crystal set, and two

leads taken from these terminals, to the input terminals of the amplifier. For proper results, the crystal detector has to be connected in such a way that a negative voltage is applied to the transistor base. If a crystal diode is used in the crystal set, it may have positive (red) and negative (black) markings. If so, the red end is taken to the crystal set tuning coil, and the black end to the base input terminal in Fig. 2.

With catwhisker detectors, or diodes with no polarity marked, the correct connection for the detector is that which gives best volume. The two leads to the detector should thus be reversed, if this is found to give more satisfactory results. Alternatively, a crystal diode can be fitted instead, and this is best.

#### Phones or speaker

The usual phones can be connected to the amplifier, and will be satisfactory. Best results will be obtained if the phones are not of extremely high resistance, but phones of even 4,000 ohms will operate quite well.

If a speaker is to be tried, it should be of the sensitive type intended for use with small battery receivers. A midgeet speaker is not recommended, however, or volume will be reduced. The usual matching transformer has to be included in circuit, with its primary connected to the amplifier, and secondary to the speaker speech coil.

Unless the original crystal set is used in favourable circumstances, so that speech is clearly audible with phones laid on the table, it is not recommended that a speaker be obtained, since full volume cannot be expected. The amplifier is primarily intended for loud headphone reception. Even when a speaker can be used, volume from it will not equal that of a valve receiver, as a single transistor cannot give anything like so much amplification or power output.

Though purchasing a speaker may thus lead to disappointment, there is, of course, no reason why one, if already to hand, should not be tried. It is most likely to be successful in quiet surroundings.

## Why not grow a Citrus Tree?

**A** MINIATURE citrus-grove can be raised from pips and will thrive as satisfactorily as an indoor garden. The tiny trees flourish from the moment they appear and seem to be entirely free from fads and fancies.

Apart from a small quantity of potting compost and the earthenware pots that can be bought from any nurseryman for a few pence, this fascinating hobby will cost you absolutely nothing. Your day-to-day household shopping will give you all that you need.

There seems to be no special time of year for starting citrus trees indoors, except of course that the fruit from which to obtain your pips must be in season. Seville oranges are on sale in England during January and February only. Sweet oranges, grapefruit and lemons seem now to be in the shops nearly all the year round. You will need, though, to watch your grapefruit. Delicious as are the seedless ones for eating, they are useless for your special purpose.

The first step towards your citrus grove is as simple as the rest.

#### Orange Pips

When you are making marmalade or clearing fruit plates after a meal, select the plumpset, juiciest-looking pips and place three or four in a circle round a 3in pot filled with compost. Make sure the soil is well damped and stand your pot in a saucer away from frost, should there be any.

You will have to wait five or six weeks before anything appears, but don't be as

impatient as I was, and, concluding that nothing is going to happen, plant a different kind of pip in the same pot. I certainly have regretted my haste ever since, for now I don't know which of my trees is a Seville and which an ordinary sweet orange.

#### Good Germination

Twice a week put a little, not too much water in each saucer, letting it soak upwards until the top soil looks dark and moist. Place your pots in front of a window two or three weeks after planting. When the first shoot appears it will be quite hefty and should unfold within a few days. Five shoots resulted from the six orange pips I planted and all the grapefruit and lemon germinated.

After a few months you will need to watch the root growth. As soon as this begins to creep through the hole at the bottom of your pot, transplant to a somewhat larger one, say 4½ins. to 5ins. Before doing this, decide how many trees you wish to keep eventually and select the most promising of your seedlings.

Carefully done, the transplanting should not affect the trees at all. In fact the only thing to which they seem allergic is a direct draught. This makes the leaves curl up at once. A coal fire, the warmth of a hot water radiator troubles them not at all, provided they have plenty to drink.

Moisten the leaves occasionally with a sprinkler. An ordinary medicine bottle with a perforated plastic top such as many women use for damping down the

weekly wash will do admirably.

At about 10 months the little trees will have several leaves apiece; their stems, hardly big enough yet to be called trunks, will be straight and sturdy. The tallest of mine at this age measured 9ins. The smallest just over 4ins.

Some weeks ago one of them had what was almost a tragic adventure. It seemed to be rather 'leggy' and thinking it needed more light, I took it down to the greenhouse. Fortunately I paid it a visit next morning. Overnight some unknown enemy had eaten away the tender tip of the main stem, devoured one entire leaf and started to breakfast off another.

After a frantic but unsuccessful hunt for the offender, I took the injured tree upstairs, quite expecting it to droop, possibly die off altogether. Amazingly enough it survived and but for one scarred leaf and an abrupt end to the main stem, seemed none the worse.

#### Hardy Plants

Within a few days a new growth was apparent at the base of the nibbled leaf. From this a healthy stem developed, put out leaves and after a few weeks topped the original stem by more than 4ins. A leaf grew just below the scarred tip and although the tree will always have a slightly one-sided appearance, it seems not a whit the worse for its adventure.

The hardness of these little trees is definitely in their favour. They cause so little anxiety and demand next to no attention. (J.M.)

# MAKING SLIDING DOORS

**S**LIDING doors are great space-savers — needed in these accommodation-starved days of small flats. They can be made by (a) running in wood channels, (b) with wheel roller-bearings or (c) the acme of perfection, on ball-bearings.

One important factor applies to all methods. There must be sufficient width across the cupboard rails, top and bottom, to carry the width needed for the two doors and their guide channels to operate. As an example, with doors of 1in. width, you would need rails of approximately 4ins. wide, except if you are using ball-bearing runners, as will be explained later.

In Fig. 1 is illustrated the simplest form of mechanism. The doors overlap when closed, so when constructing them, make each approximately 1in. wider than half the width of the cupboard space which they are to fill. For example, if the cupboard opening is 2ft. across, each door should be 13ins. wide and not 12ins., to allow for the overlap.

Hardboard or 3-ply is sufficient, without supporting battening for doors up to 4 square feet. Over this, it is best to

support the outside edge of the hardboard.

The doors run in grooves formed of  $\frac{1}{2}$ in. quartering moulding, with a separating piece down the middle. The separating piece is kept to a minimum width dimension that can be firmly fixed with small panel pins.

Make the doors an easy fit, without sloppiness, in the grooves and note that any handles used must be fixed at the far ends, when doors are closed.

Doors running on ball-bearings are, of course, more difficult to construct (see Fig. 2). You must have facilities for bending metal, although you could probably get the sheet metal or aluminium needed, shaped by a plumber for a few shillings.

The metal is shaped in a sharp-angled 'U' shape to make a channel. A length is then affixed to each door, top and bottom. Along the cupboard rails, again top and bottom, and along the whole length, similar channelling is laid, formed of larger dimensions that allow it to slide freely along the door channelling. In between the channelling are placed ball-bearings of a diameter

sufficient to make the bearing entirely on the balls and not on the channelling.

The balls must be controlled from gathering all at one end when the doors are in motion by keeping them in a limited field by the insertion of stop pins inside the well of the channelling. These stop pins are simply the sawn-off shanks of round nails, driven into the wood through holes drilled through the channelling. Their height must be kept slightly below the ball height to prevent fouling. The end balls on the channelling are prevented from falling out by cutting and turning up the ends of the channelling. You will need approximately one ball for each 3in. run of channelling used.

The channelling is held in place with countersunk-head wood screws, through holes drilled in the channelling. It is important that the screw heads, when driven home, do not protrude above the level of the channelling, to stop the free progress of the balls, or are not screwed home below the level of the channelling to form a dimple in which a ball could rest.

Doors running on ball-bearings, fitted properly, should have the advantage of finger-tip control and silence when operating. Apart from this, they need no guide rails of quartering moulding, and can, therefore, be used with much narrower cupboard rails. Two things to remember; work backwards when calculating the width of the doors you make by finding the minimum diameter ball-bearing you will need, add on the width to be taken up by the channelling, and make your door width approximately  $\frac{1}{2}$ in. wider than this total dimension. Secondly, remember to allow for the ball mechanism on the top and bottom of the doors, plus the channelling on the cupboard rails, when determining the height of the doors.

The third method you can employ is to use wheels as roller bearings (see Fig. 3). Thick washers are ideal. Even better are Meccano wheels, with the hubs turned off on a lathe, but with the rubber tyres retained.

You will need one wheel near each top and bottom corner of each door — or four wheels in all for each door. A housing must be gouged out in which the wheels rotate, held on an axle made from the sawn-off shank of a round nail, as shown. Here again, allow the wheel to rotate freely without sloppiness, and fix it so that only approximately  $\frac{1}{2}$ in. of its circumference protrudes. As in the first scheme, fit guides and separators of moulding and strip wood. (E.C.)

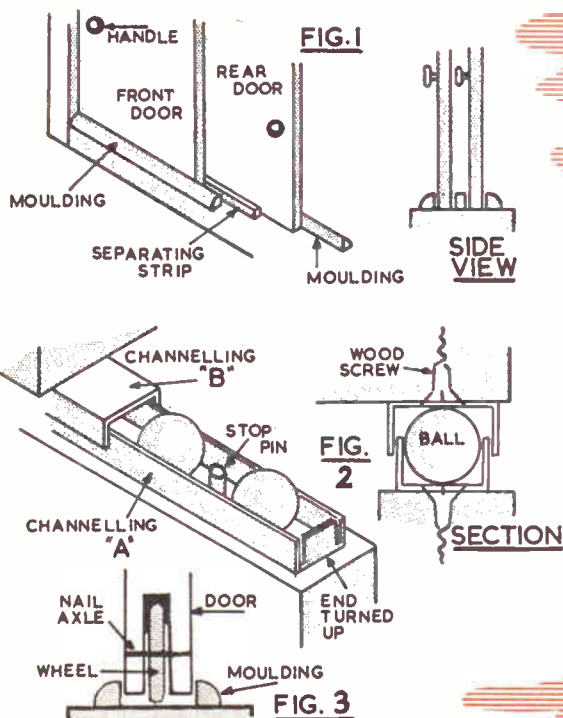

# CHEMISTRY IN THE HOME

READERS who use a Leclanché cell to provide current for their electric doorbells will be familiar with sal ammoniac, for a strong solution of it forms an essential part of the cell. Chemists know it as ammonium chloride and we know from this that it is a salt formed from ammonia and hydrochloric acid.

Dip a glass rod in strong ammonia and another in strong hydrochloric acid. Bring them close together. The vapours mix and white fumes of ammonium chloride appear. This is the basis of the trick. If you wish to try it out, put a few drops of strong ammonia (ammonium hydroxide) in the bottom of a jam jar and a few drops of strong hydrochloric acid on the bottom of an inverted saucer. Keep them a few feet apart, so that the trick does not work before you are ready for it! Light a cigarette and state that you will from the other side of the room make the smoke enter the closed jar.

Turn the saucer over, place it on the jar and quickly throw a cloth over the whole. Stroll over to the other side of the room, puff your cigarette and then stroll back to the jar. Remove the cloth and the jar will be full of smoke!

Ammonium chloride has many uses in the laboratory. One of them is as a

lime). Make a mixture of equal volumes of ammonium chloride and calcium hydroxide and put it in tube (A) and heat it.

Ammonia is rapidly given off, passes into tube (B) (which serves to condense a little water formed in the reaction), and then into tube (C). You may wonder why the ammonia does not fall out of the inverted tube (C). It does not do so

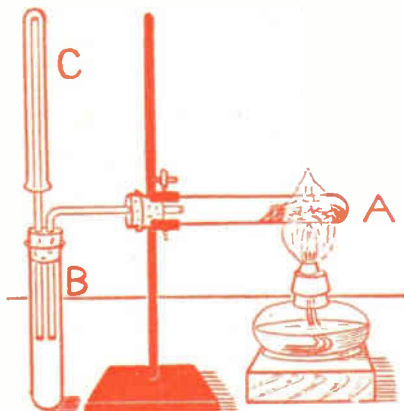

Fig. 1—Making ammonia

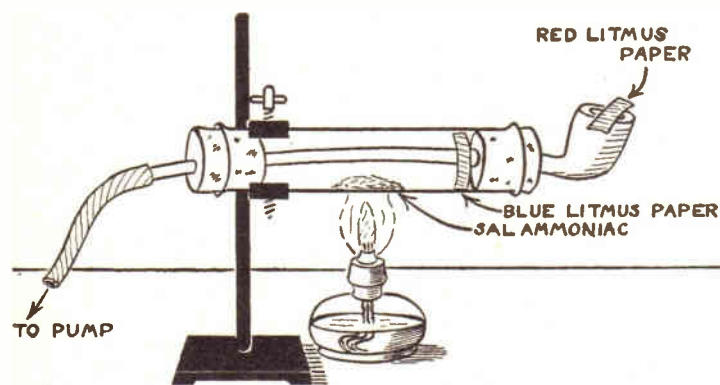

Fig. 3—Finding out why sal ammoniac sublimes

source of ammonia gas. The simple apparatus shown in Fig. 1 will serve for its experimental production. Ammonia may be liberated from the salt by heating it with dry calcium hydroxide slacked

because it is lighter than air and so 'stays put'. Hold a damp red litmus paper about an inch below the mouth of tube (C). When it turns blue the tube is full.

This tube of gas will serve to show how

## Experiments with Sal Ammoniac

soluble ammonia is in water. Dip the mouth of the tube below the surface of some water in a beaker. The water will rush up the tube, because it dissolves the ammonia so avidly. Ordinary household ammonia is simply a solution of the gas in water.

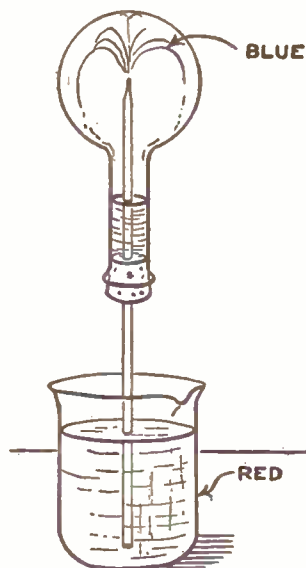

Fig. 2—The magic ammonia fountain

A variation of this experiment provides a spectacular trick. Replace test tube (C) by a flask. When it is full fit a cork carrying a glass tube drawn out to a jet at one end (Fig. 2) and dip the wider end of the tube in a beaker of water which has been coloured with red litmus. This time the water rushes up the tube and emerges in the flask as a blue fountain. The change from red to blue is striking. This change, of course, is due to ammonia being an alkaline substance, litmus always being blue in the presence of an alkali if it is soluble in water.

Heat some ammonium chloride in a dry test tube. You will see that it does not melt, but passes direct into the gaseous state and then condenses back to a solid on the cool part higher up the tube. This is an example of true sublimation — passage direct from solid to gas without melting and solidifying without passing through a liquid state. This property serves to purify ammonium

chloride from non-volatile impurities.

A simple experiment using a clay pipe will show us more of what happens here. A long stemmed pipe is best to use. Pass its stem through two corks fixed in a glass tube as shown in Fig. 3. In the glass tube place some ammonium chloride and also a slip of blue litmus paper. On the pipe bowl rests a slip of red litmus paper. Connect the pipe stem by means of a rubber tube with a bicycle pump. Heat the glass tube until the salt sublimes. Now pump a slow stream of air through the pipe stem. The red litmus paper on the bowl turns blue, showing ammonia to be issuing, whereas the blue litmus paper in the glass tube turns red showing hydrochloric acid is being evolved.

Therefore ammonia splits up into the two gases when it is heated and this accounts for its subliming when it is heated. By using our special apparatus we have partially prevented them recombining and so detected their presence. Ammonia diffuses more rapidly through porous clay than hydrochloric acid and so we were able to separate them. This splitting into ammonia and hydrochloric acid on heating explains why sal ammoniac is used in some soldering fluxes. The liberated acid cleans the metal.

It was mentioned at the beginning of this article that ammonium chloride is used in dry batteries. It is interesting to make a small experimental cell to show this. You will need to make a cylinder of sheet zinc by soldering or you can clean out a zinc case from an exhausted battery. Make a dry mixture of equal

parts by weight of ammonium chloride, manganese dioxide, charcoal, plain flour and zinc chloride and three parts of plaster of Paris. In a mortar work in enough water to make a thick paste and pack this into the zinc case. Press in a carbon rod from an old battery and leave the whole for a couple of days. Now connect wires from the casing and from the carbon rod to a 1.5 volt bulb. The bulb will light up.

Ammonium chloride unites with many other chlorides to form double salts. A typical example is with copper chloride. Copper ammonium chloride, as this double salt is called, is easily made by

mixing solutions of 8.25 grams of copper chloride and 2.67 grams of ammonium chloride and then evaporating to the crystallisation point by boiling the mixture in an evaporating basin over wire gauze. The crystallisation point is determined by taking up a drop on a glass rod now and again and noting if it crystallises rapidly. When this is so, let the solution cool. Crystals then form. Lovely blue-green crystals of copper ammonium chloride separate. Let the whole stand overnight, pour off the mother liquor and dry the crystals between filter paper or on a clean porous tile.



**H**OBBIES LTD. regret that despite the most rigorous checking, a mistake crept into their design for the Swiss Chalet Musical Cigarette Box (No. 255 Special) pictured here. The positioning of the slot of pieces (10) was wrongly given on the design sheet, and we warmly thank the many readers

## SWISS CHALET

who wrote pointing out the error, which has been put right on subsequent printings. For the benefit of those who are making up this delightful model we give here the corrected outline of pieces 10 (not to scale).



Incidentally, the kit for this two-storey chalet, which is an excellent exercise in fretcutting and modelling, contains paint, glue, plastic wood, etc., besides the wood panels and materials for making. Kits are obtainable from branches and stockists or from Hobbies Ltd., Dereham, Norfolk, (19/11 post free). Musical movements, of which there is a choice of over 20 tunes, are 18/3 extra.

## Solution to Jig-Quiz No. 7

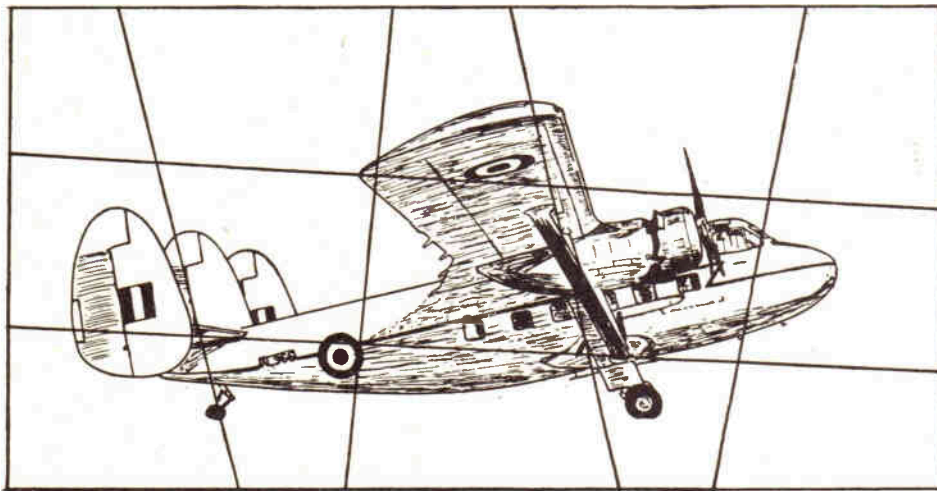

The aircraft featured in our jig-quiz last week was the Scottish Aviation Twin Pioneer, and those of you who

have been lucky enough to visit recent Farnborough Air Shows will, no doubt, have seen this machine performing those

incredibly short take-offs and landings. Incidentally the aircraft from which the Twin Pioneer was evolved is the Prestwick Pioneer.

TOY  
DUN-ON  
ZOO

# "THE CORNER"

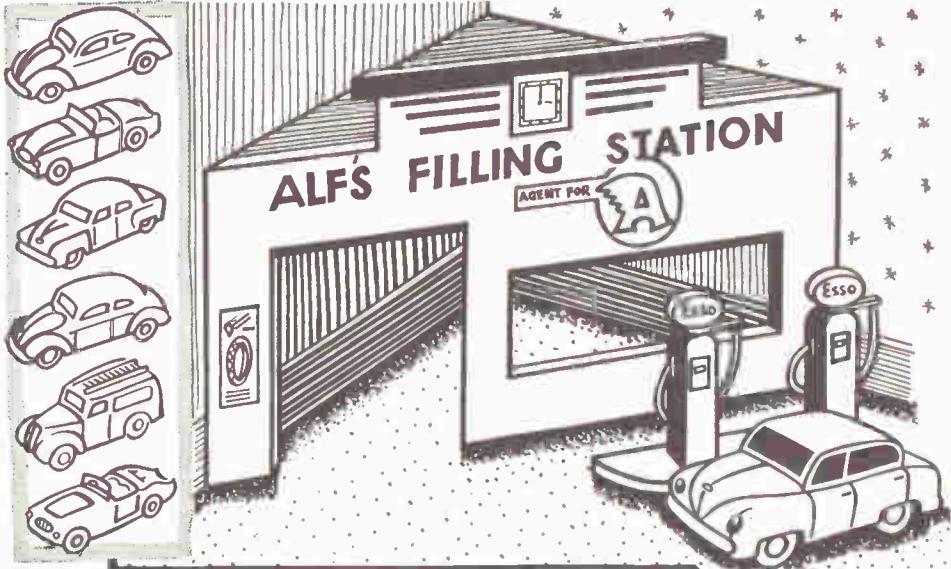

FITS  
CORNER  
YOU

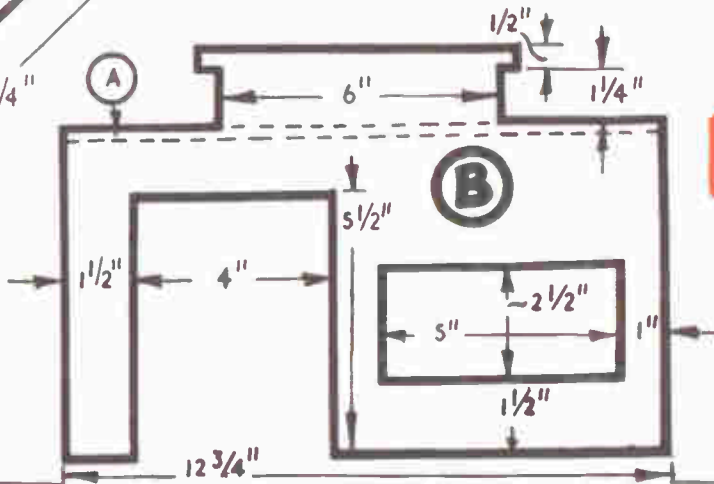
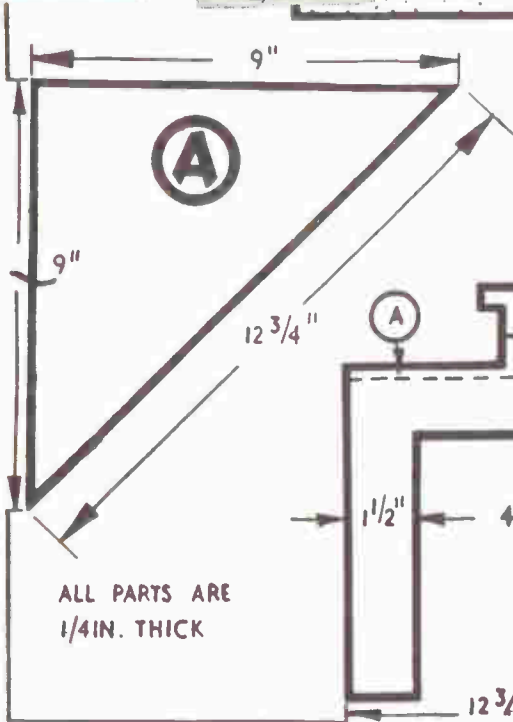

ALL PARTS ARE  
1/4 IN. THICK





# ER// GARAGE

for the  
young  
Mechanic

PIECES A & B CAN  
BE HINGED TO ALLOW  
GARAGE TO FOLD FLAT.

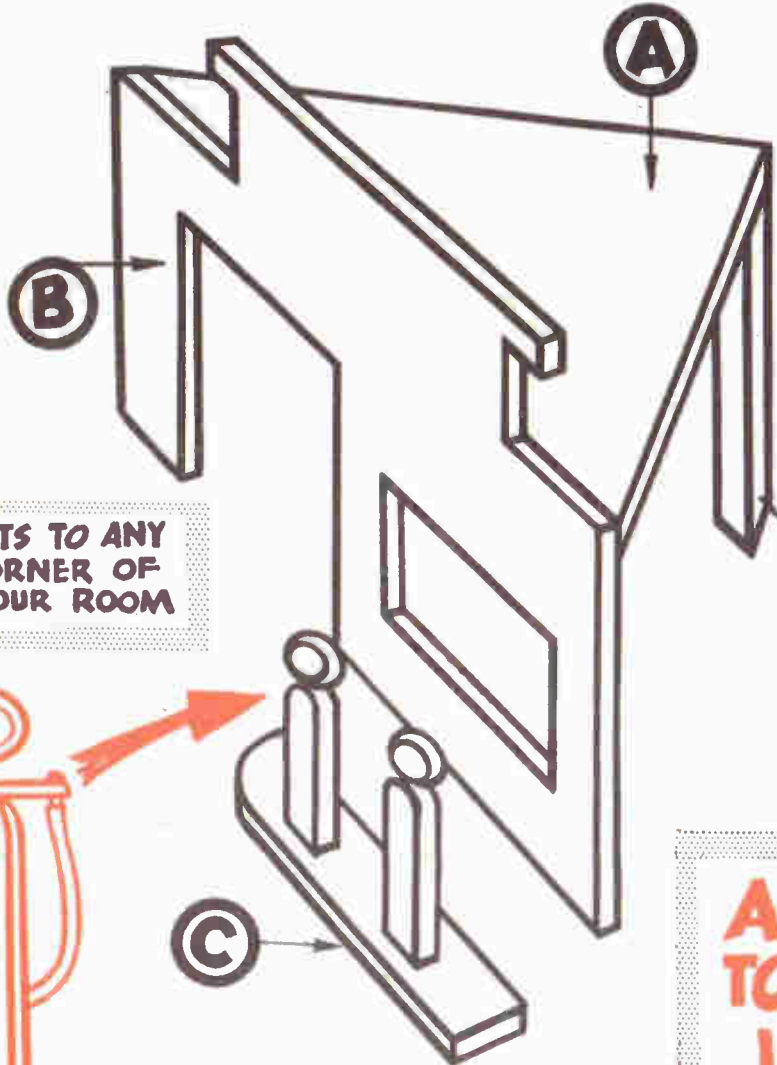

FITS TO ANY  
CORNER OF  
YOUR ROOM

CAN BE MADE  
FROM TWO  
HOBBIES J4  
PANELS

HOBBIES  
TRIANGULAR  
FILLET



PETROL PUMP  
(ACTUAL SIZE)  
CAN BE PURCHASED FROM  
HOBBIES LTD., DEREHAM, NORFOLK.

A GARAGE  
TO CUT OUT  
IN UNDER  
1 HOUR



WHEN an object, no matter how prosaic or utilitarian its purpose, happens to be one which is habitually carried about the person, it is certain that ingenuity will soon set to work to convert it into as great a thing of beauty as is humanly possible.

This holds good in the case of the eighteenth-century snuff-box, which from a simple box of horn or pewter grew into a gem-studded enamel-encrusted wonder, whose richness strove hard to blind the eye of the observer to the rather unseemly habit which it served.

The evolution of the snuff-box is an interesting one, and presents to the collector unrivalled opportunities, since the snuff-taking habit, enduring, as it did, over the reigns of Queen Ann and the Georges (a period when craftsmanship, both English and French, was at an extraordinarily high degree of excellence), held its sway over all classes of the community, from the peasant to the aristocrat.

#### A wide field

Hence the different varieties of snuff-box offer a wide field for research, while as regards workmanship, one can in them discern in miniature some of the finest efforts of the carvers, enamellers, silversmiths and metal-workers of the day.

The early snuff-boxes of horn, as soon as they emerged from the simpler stage, were decorated by means of stamped designs, the most popular of which took the form of hunting scenes, pictures of dogs and horses, or of a mythological figure. Later came designs that were either moulded or cut in the horn, a species of impressed decoration being much favoured, since it suited itself well to the pliant character of the material.

In the snuff-boxes formed of the baser metals, such as pewter, brass, and iron (for even this heavy substance was not infrequently brought into use in this connection), the engraved decoration shows the Dutch influence to a very large extent, for it was about this time that English

taste was so much influenced by that of the Netherlands in regard to metal-work of all kinds. In France, however, the vogue of the snuff-box was leading the wealthy into paths of extravagance, the man of commerce deeming the box of chased or tinted gold as necessary to his well-being as to that of the courtier whose beruffled wrists seemed to demand some exquisite example of the jeweller's craft in order that their elegance might be suitably brought into play.

## SNUFF BOXES

By R. L. Cantwell

The majority of the French snuff-boxes show some form of enamelled decoration mostly in dark blue, a favourite tone at this period in matters of ornament. The central medallion was frequently occupied by a miniature, either of some notable personage of the day or of the donor. As a snuff-box was often given as a *gage d'amour*, many a man carried a specimen on which were enamelled the features of his lady. If he happened to be of years unsuitable to such a display of sentiment, the picture would be rather of an impersonal nature, and take the form of a replica of some famous picture, or of a graceful group specially designed to accord with the box's form.

Engine-turning, a form of decoration much in favour in the eighteenth century for the embellishment of watches and lockets, appears on the lids of many of the snuff-boxes of the same period, no matter to what nationality they belong.

*Czech 'Holiday' set of match labels costs 9d. from the Hon. Secretary League of Hobbyists*



The china factories were as busy as the jewellers in producing wonders of beauty in snuff-boxes. Gold boxes inset with Wedgwood plaques yield nothing in merit to those of costlier type, while Sevres likewise turned out delicate plaques for similar use. Finely-cut cameos presented still another form of snuff-box ornament, these, for the most part, being based on classical designs. At the same time the enamel factories of Battersea and Bilston were deriving a flourishing trade from the enamelled snuff-boxes, that were as dainty in character as the patch-boxes for which they were already famous.

#### Presentation pieces

Little pictures, surrounded by mottoes, form a usual type of decoration in these enamelled boxes, groups of tiny flowers on a delicately tinted ground dividing the honours with them in regard to daintiness and beauty.

The fashion of presenting to public men a testimonial in the form of a handsome snuff-box naturally gave a great impetus to the industry, but since such boxes seldom pass out of the family of the recipient, the collector has small hope of being able to add such specimens to his collection. Snuff-boxes were, however, very largely used as presents from one friend to another, and one often comes across specimens inscribed with lines that testify to the feeling that has inspired them. There seems to have been in a gift of this nature something as intimate as that sentiment which we now connect with the gift of a watch, the fact that the little box was destined to be carried on the person of the recipient probably aiding in its creation.

Most of us have in our possession one or two old family snuff-boxes which we may make the nucleus of a collection. Though we cannot aspire to specialise in more elaborate examples, we can yet form a group of real interest and beauty from among those of minor pretensions.

As a hobby the collection of snuff-boxes offers great opportunities to those whose inclination is towards the development of beauty within the home. Arranged under the lid of glass-topped tables, or on shelves, the boxes cannot fail to prove decorative in an extraordinary degree. Posed on black velvet, their 'points' will be thrown into relief and their design displayed to the best possible advantages.

## Want to be a PRESS PHOTOGRAPHER?

Photography involves a lot more than just aiming a camera and pressing a button. Any successful photographer, professional or amateur, will tell you that to do the job properly you must know how to develop and print photographs yourself. If YOU want to be a photographer, you can start training NOW! Do it the easy and inexpensive way by buying one of the range of Johnson Home Photography Outfits. There is one to suit every pocket.

Print your own snaps with the **JUNIOR PRINTING PACK**. It costs only 13/3 and includes everything you need for making perfect prints.



from your Local dealer.

**JOHNSONS**  
OF HENDON LTD.

# YOU can make- and save- MONEY

by learning-as-you-do it:-

## RADIO & T/V building & servicing OR DOMESTIC ELECTRICAL APPLIANCE REPAIR

Our Courses (which include equipment) will teach you how to earn EXTRA £.s.d. by repairing and servicing domestic radio and television receivers and home electrical equipment.

- **FREE BOOK**
- will be sent to you
- on request, without obligation,
- giving details of our interesting & lucrative
- Do-It-Yourself Courses



# EMI INSTITUTES

Associated with  
**"HIS MASTER'S VOICE"**  
Columbia, Etc., Etc.

### POST TODAY

E.M.I. Institutes, Dept. 31X, London, W.4

Name \_\_\_\_\_ Age \_\_\_\_\_  
(if under 21)

Address \_\_\_\_\_

I am interested in the following subject(s) \_\_\_\_\_

IC 121

19-2-58

## APPARATUS & CHEMICALS

For your experiments. Let us help you equip a  
**HOME LABORATORY**

Beakers, Crucibles, Flasks, Funnels,  
Gas Jars, Test Tubes, etc.

Booklets:  
(including postage)

'Experiments' 1/2  
'Formulas' 1/2  
'Home Chemistry' 2/9  
New edition



Send 3d. Stamp for latest **PRICE LIST**

**A. N. BECK & SONS (Dept. H.W.)**  
60 Stoke Newington High Street, London, N.16

# BE TALLER

in 12 days or money back. New gland and spinal discovery increases height 2 to 5 inches. 'I have gained 4 1/2 inches in height. My weight increased from 9-stone 4-lb. to 10-stone 3 1/2-lb.'—P.D. 'Increased 3 inches.'—H.G. Guaranteed harmless. Full course 10/- (or \$1.50). Air mail 16/3. Details 2d. Sent under plain cover. J. H. MORLEY, 28 (H/177) Dean Rd., London, N.W.2. Practical Courses, all subjects. List free.

## KITS for OLD TIME SHIPS

Hobbies range of Ship Models includes Elizabeth Jonas, Cutty Sark, Victory, Mayflower, etc. Complete kits of wood, sail material, guns, pulleys, cord, etc., with full-size patterns of parts and planed wood ready to cut out, shape and construct. A fascinating pastime.

Ask for free illustrated list at Hobbies Branches or from Hobbies Limited, Dept. 99, Dereham, Norfolk.

DECORATE YOUR HANDICRAFTS WITH

# Decorettes



### SIMPLE-TO-APPLY TRANSFERS

Brighten up a firescreen or a table lamp with Decorettes' penguin (he'd be a great favourite on the nursery wall.) Choose from over 60 designs. 2/6d. at Hobbies and Handicraft Shops.

**SPECIAL OFFER** open until June 1st 1958. Send a 6d. postal order (1/6d. for overseas readers) for sample Decorette worth 2/6d.



Name \_\_\_\_\_

Address \_\_\_\_\_  
(BLOCK CAPITALS PLEASE)

DECORETTES LTD., Dept. H4, Garrick House, Carrington Street, W.1



# POPULAR KITS...

No. 3188

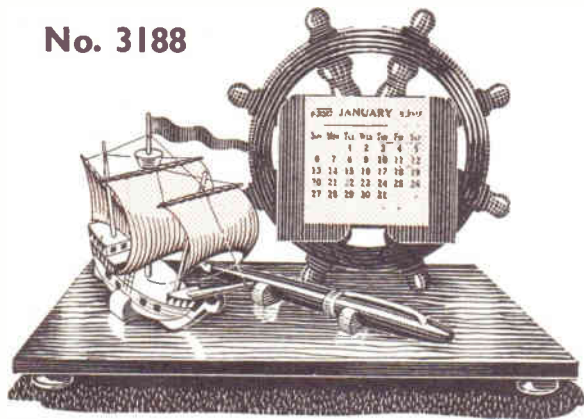

'Galleon' Perpetual Calendar with pen rack. Ideal for a desk. Kit includes wood, parchment, perpetual calendar set ... 5/9  
**...with novel appeal**

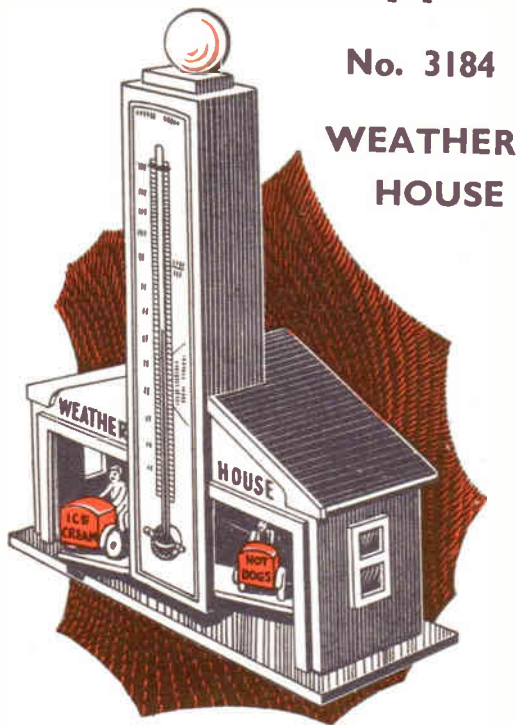

No. 3184

**WEATHER  
HOUSE**

Foretells the weather ahead. Kit includes wood, gut, thermometer, etc. ... 8/1

Kits from branches or  
**HOBBIES LTD** (Dept 99) Dereham Norfolk

# News

**for all 'do-it-yourselfers'!**



THE **X-acto**

'1001' Knife

**SUPER-SHARP ALL-PURPOSE  
KNIFE WITH SPARE BLADE**

FOR ONLY **1/6**

Whether you're laying lino or model-building, pruning the roses or simply sharpening the office pencils, you'll do it better with the '1001' Knife.

Each X-acto '1001' has a carefully balanced steel handle—easy to grasp—and reversible blade, with another 'spare' in the handle—all for only 1/6. Spare blades are 3 for 1/-. Get an X-acto '1001' knife—from all good model shops and ironmongers.

**Other X-acto  
precision tools**

For greater accuracy there's a whole range of X-acto interchangeable blade knives—three weights of handle with a blade for every cutting job. Also plane, sander and modellers' tool sets. All precision-built for precision work, and so reasonable in price.

**More skill at your fingertips with  
TRIX**

# X-acto

**HANDYMAN KNIVES AND TOOLS**

**TRIX LTD. 5 CONDUIT ST. LONDON W.1.**

# YOU CAN BUILD 'DEREHAM'

A Sturdy 10ft Dinghy

Designed by  
P. W. Blandford

For river or sea — oars or outboard motor — carries three persons and kit — light enough for two to lift. A detailed drawing showing the main frames, transom, stern and other parts full size for easy working costs only 8/6, and full building instructions are given free.

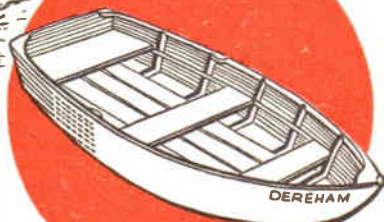

Get started on yours to-day

Write to: The Editor,  
HOBBIES WEEKLY, DEREHAM, NORFOLK

I went to a dance to find a girl friend — but my dancing didn't make girls 'friendly'!

— till a pal told me the secret of Escort' Sure Step System

Now I'm no longer lonely — — the girls know my steps are sure!

Learn ballroom dancing at home! Send for exciting FREE booklet "Dance Escort", which explains the miraculous SURE STEP system. Cut out this advt., enclose 3d. stamp, name and address, and post to:

**ESCORT DANCE INSTRUCTORS**  
Studio H5, Harrogate

or Rock'n' Roll Course, send 4/6 P.O.

**PURE WOOL SWEDISH RED CROSS SLEEPING BAGS**

Brand new Government stock. Completely zipped full length on one side and especially zipped across the chest and around the head, which is held rigid with flexible stays that fold flat when packed. They must have cost £4 to make. These famous sleeping bags, comfortable to an amazing degree, are without doubt the finest model ever made and we offer them at a cost of less than the wool content! Send for one and see for yourself, on money back guarantee. Only 18/11, post etc., 3/1. Folds up neatly for easy transportation. Full length and width, accommodates any size person. Send quickly or callers welcome. LISTS.

ONLY 18/11 POST ETC. 3/1

TENTS, BINOCULARS, WATCHES, ETC. TERMS

COMPLETE TRANSMITTING AND RECEIVING APPARATUS FOR TWO PERSONS.

From a few yards to a mile. Normal telephone strength. No batteries or electricity — it just works! Send 12/11, post 2/1. Ready for use in 5 mins. Lists, Binoculars, Watches, Tents, Terms.

**AMAZING GOVERNMENT SURPLUS NEW TELEPHONE INTERCOM MOBILE OR STATIC ONLY 12/11 POST ETC. 2/1**

Headquarter & General Supplies Ltd.  
(HOBW/99) 196-200 Coldharbour Lane  
Loughboro Junc., London, S.E.5 Open Sat.

## HOBBIES BRANCHES LONDON

78a New Oxford Street, W.C.1  
(Phone MUSEUM 2975)

87 Old Broad Street, E.C.2  
(LONDON Wall 4375)

81 Streatham Hill, S.W.2  
(TULSe Hill 8796)

GLASGOW—326 Argyle Street  
(Phone CENTRAL 5042)

MANCHESTER—10 Piccadilly  
(Phone CENTRAL 1787)

BIRMINGHAM—100a Dale End

SHEFFIELD—4 St. Paul's Parade  
(Phone 26071)

LEEDS—10 Queen Victoria Street  
(Phone 28439)

HULL—10 Paragon Square

SOUTHAMPTON—134 High St.  
(Below Bar)

BRISTOL—65 Fairfax Street

NEWCASTLE—42 Dean Street  
Newcastle-on-Tyne 1

GRIMSBY—88 Victoria Street

STAMPS FREE — Empire Packet including Pictorials and Victorians with approvals. — Robert J. Peck, 7A Kemp Road, Bournemouth.

MAKE a MUSICAL BOX for as little as 21/6. New kits and tunes available. Movements 14/9 post free. Please send 3d. stamp for free illustrated catalogue. — The Swisscross Co., Dept. B., 116 Winifred Road, Coulsdon, Surrey.

15/6 CRYSTAL RADIO kit. Easy-to-build with only a screwdriver and pliers. Post free — send 15/6 P.O. ALSO — 1 and 2 valve kits, headphones, etc. — send stamped addressed envelope for complete list to — Gardner's Radio, Dept. HC7, 13 Gainford Gardens, Manchester, 10.

## BRASS, COPPER, DURAL, ALUMINIUM, BRONZE

ROD, BAR, SHEET, TUBE, STRIP, WIRE  
3,000 STANDARD STOCK SIZES

No Quantity too small List on Application

H. ROLLET & Co. Ltd.  
6 CHESHAM PLACE, LONDON, S.W.1  
Also at  
Liverpool, Manchester, Leeds, Birmingham

100 DIFFERENT stamps free! Request 4d. mixed if you wish. State your choice and an excellent selection will be sent for you to look through, plus a discount on your purchase.

'PAINTSPRAYING' HANDBOOK. Covers Car, Industrial & Flock Spraying. 3/6, post 4d. Catalogue of our Cellulose and Paints and all Allied Sundries 3d. — Leonard Brooks Ltd., 81 Oak Road, Harold Wood, Essex.

LEARN it as you do it — we provide practical equipment combined with instruction in Radio, Television, Electricity, Mechanics, Chemistry, Photography, etc. Write for full details to E.M.I. Institutes, Dept. HW47, London, W.4.

75 DIFFERENT stamps free with approvals 4½d. postage. — Salter, 42 North Road, East Dene, Rotherham.

BECOME trained chiropodist. Quick postal, practical. — GRADUATE SCHOOLS, 48A Abbey Street, Accrington.

## BRITISH COLONIAL

Stamps on approval are our speciality, foreign or mixed if you wish. State your choice and an excellent selection will be sent for you to look through, plus a discount on your purchase.

Free to all new applicants enclosing 6d. for return postage  
British Colonial's FACE value 15/-  
LINDSEY STAMPS (H), 85 LEGSBY AVE., GRIMSBY

# 'BIRD' JIGSAW PUZZLE

**T**HE pattern is traced and transferred to wood by means of carbon paper. Use  $\frac{3}{8}$  in. or  $\frac{1}{2}$  in. plywood and cut out with a fine grade fretsaw.

Clean up the pieces with glasspaper and paint the birds in bright colours with quick drying enamel. The background is coloured pale blue. Alterna-

tively paint the birds and background before cutting, but in either case do not allow the paint to run down the edges. There is no need to worry about being realistic with the colours for the birds; use bright colours to please the children. (M.p.)

**A JOB FOR  
THE  
FRETSAW**

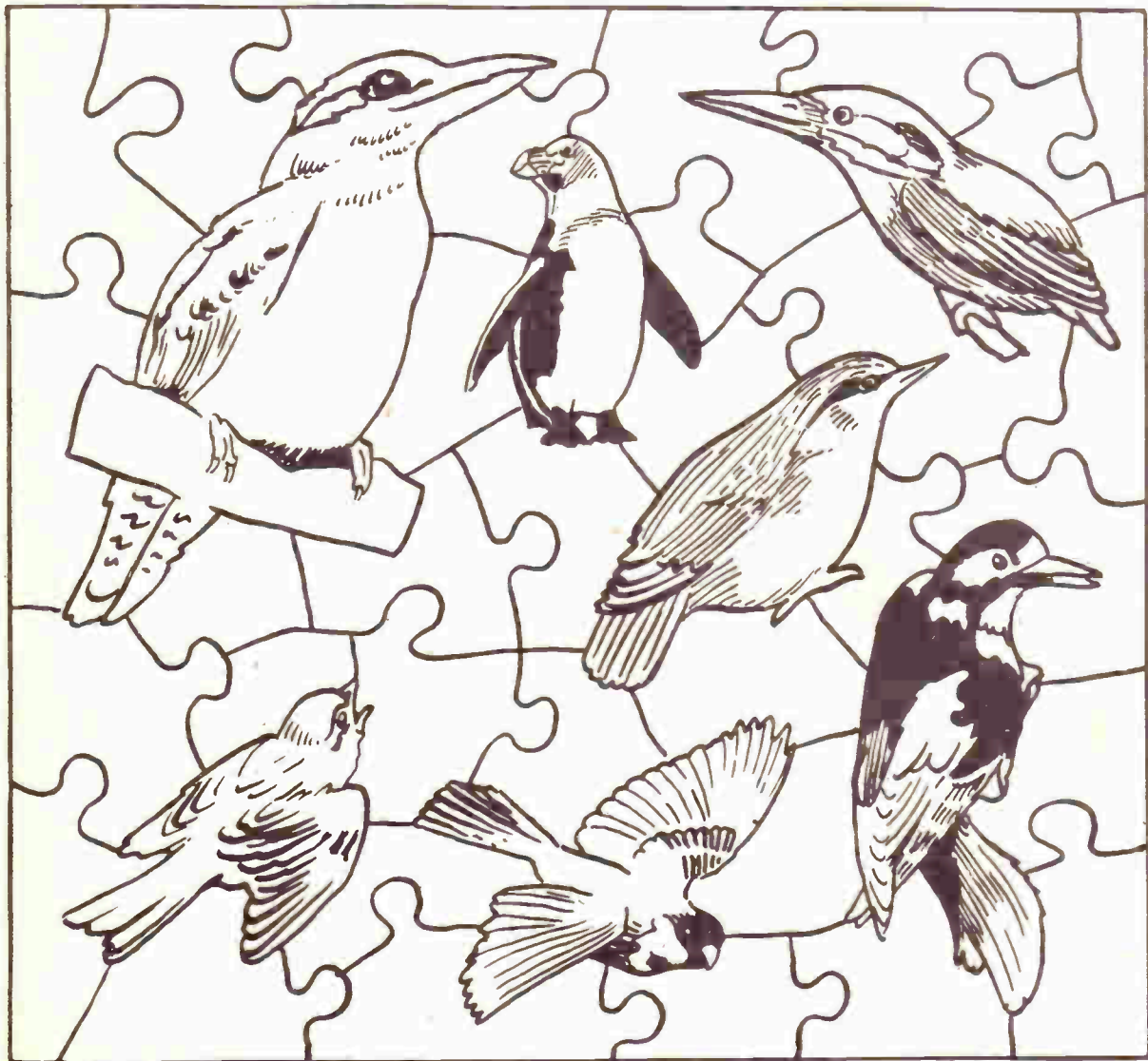

# OUT of the BLUE

## SUPER AIRCRAFT KITS

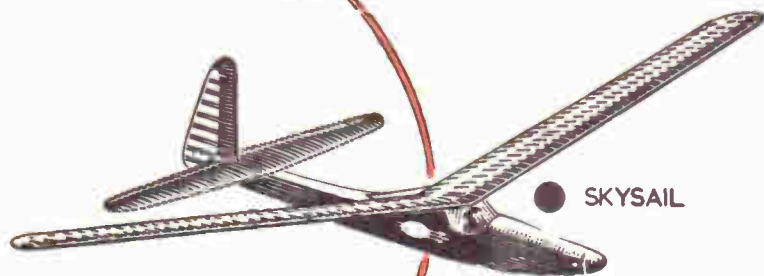

● SKYSAIL

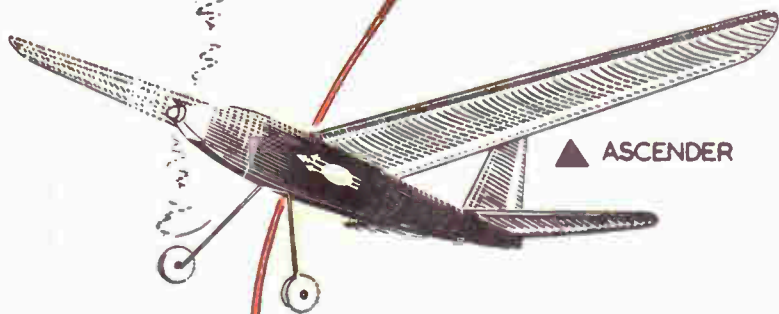

▲ ASCENDER

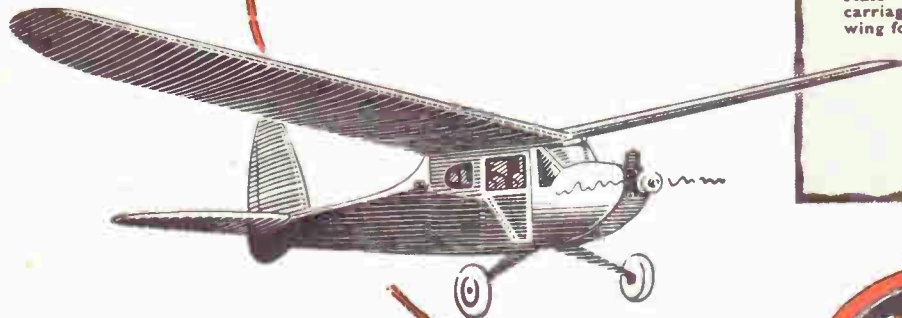

★ CHAMPION

### EXCLUSIVE FEATURES

These kits introduced by Hobbies have many important exclusive features. Designed to give top performance in their various classes. All sheet parts are die cut and there are super detail plans. Easy to build and fly.

● SKYSAIL — A 36in. wing span glider for tow launching. 'Wingsaver' tow hook—printed dummy pilot — anti-warp wing bracing — jig-lock fuselage alignment.

6/6

▲ ASCENDER — A 30in. wing span rubber duration model. Adjustable pitch propeller with replaceable blades — fixed tail surfaces for positive trimming — anti-torque automatic-action rudder.

10/11

★ CHAMPION—  
A 36in. wing span free flight power model. Suitable for .5, .75, .8 and 1 c.c. motors. Opening cabin door and complete cabin details — scale type light alloy undercarriage — optional polyhedral wing for high power.

18/6

DESIGNED FOR  
THE NOVICE  
AND EXPERT



From all Hobbies branches and model shops, or

**HOBBIES LTD. (Dept. 99), DEREHAM, NORFOLK**