

HOBBIES WEEKLY

OCTOBER 23rd 1957

VOL. 125

NUMBER 3234

IN THIS ISSUE

	Page
Tea Clipper	65
Tiny Tot's Counting Toy	67
A Guy Fawkes Party	68
Cinema at Home	70
A.C. and D.C. Electricity	71
Interesting Locos—No. 3	71
Make this Neat Table	72
Novelty Easel Picture Holder	73
Money-Saving Recipes	74
Useful Workshop Gadget	76
Is This Your Problem?	78
Pattern for Counting Toy for Tiny Tots	79



All correspondence should be addressed to the Editor, Hobbies Weekly, Dereham, Norfolk

THE famous breed of ships, the Tea Clippers, will always be associated with the spirit of adventure and romance of the seas. Products of the finest standard that British shipbuilders could put into their work, they were used on the China run with the express purpose of bringing to England as speedily as possible the early season's tea from the east.

Having to meet the challenge of steam, which was then coming into use as a means of propulsion, it is obvious that

19th-Century

TEA CLIPPER

these craft of the 'Cutty Sark' era had to be built with the accent on trimness and speed in order to successfully compete in the race home with their goods. Many are the tales told of these famous craft, and our Tea Clipper is designed as a typical ship of that era which were

racing the seas in the second half of the 19th century. It is shown without sails, so as to emphasise the picturesque rigging. It is 22ins. long, and the hull is built up on the bread and butter principle, that is cutting out and working up step by step from the bottom.

65

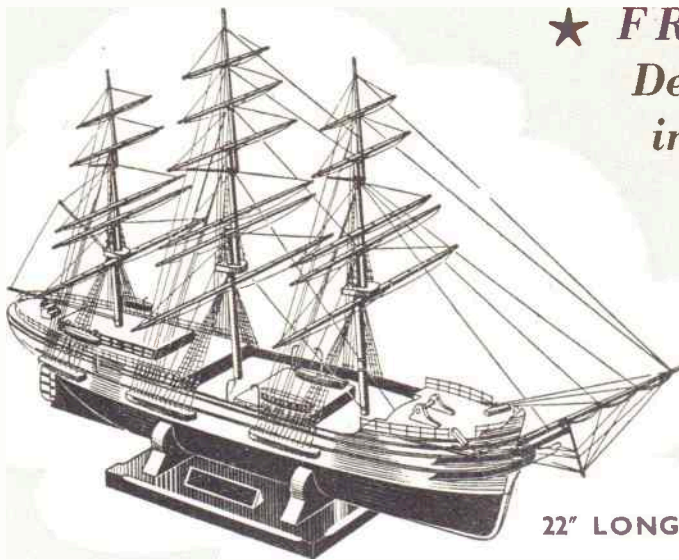

★ *FREE
Design
inside*

22" LONG

With care and a deal of patience there is no reason why the average handyman should not make a good job of this striking model.

Make a start by tracing and transferring by carbon paper to the appropriate thicknesses of wood all the various pieces detailed on the design sheet. Arrange all the shapes so as to ensure that they can be cut from the panels of wood with ease. Cut them out with a

FOR ALL HOME CRAFTSMEN
Over 60 years of 'Do-it-Yourself'

World Radio History

4 1/2 D

fretsaw, keeping as accurately to the outlines as possible, and clean them up with glasspaper preparatory to assembly.

It will be seen that the keel as shown on the design sheet consists of two pieces which are joined together at (X). This applies to models being made from Hobbies Kits, but workers who are using their own wood and materials can, of course, make the keel in one piece. The hull consists of the keel (1) and six pieces 2 which are glued 3 on each side of the keel. The deck (3) is then glued on top and pieces 4, 5, 10 and 11 are added as indicated in Fig. 1. Allow the glue to dry thoroughly and then shape this portion now completed to the section shown on the design sheet. These lines coincide with the vertical lines similarly numbered on Fig. 1, and show the

Kit for 25/6

Kit No. 3234 contains all the wood, rod, wire, nameplate and materials for making this 19th-Century Tea Clipper. Price only 25/6 post free from branches and Hobbies Ltd, Dereham, Norfolk.

shape at which to aim at those given points. Shaping can best be done with a rasp, Surform tool or modelling knife, finishing with glasspaper.

The next step is to add pieces 6 and 7 which are glued in place as shown in Figs. 1 and 3. Continue by making up

the small assembly at the bow consisting of pieces 8 and 9. When completed, glue this section to piece 11 (Fig. 3). Two pieces 12 made from thin card are now glued to the deck (3) and the addition of piece 13 completes the bow. Shape this off to conform with the general outline.

The wheel assembly consists of pieces 14, 15 and 16 and is next made up and glued to piece 5 (Fig. 1). The decorative pieces 17 are also furnished from thin card and added at the bow, being glued at the figurehead and hull as seen in Fig. 2, and in the illustration of the finished model.

At this stage make up the base consisting of two pieces 18 and one piece 19. The cradle (18) may need a slight alteration in outline to suit individual shaping of the hull.

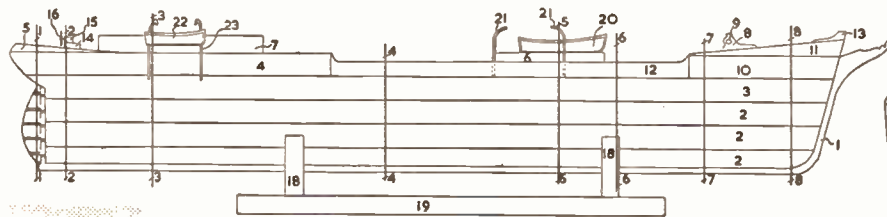

FIG. 1

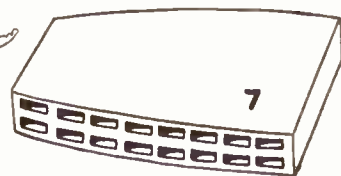

FIG. 4

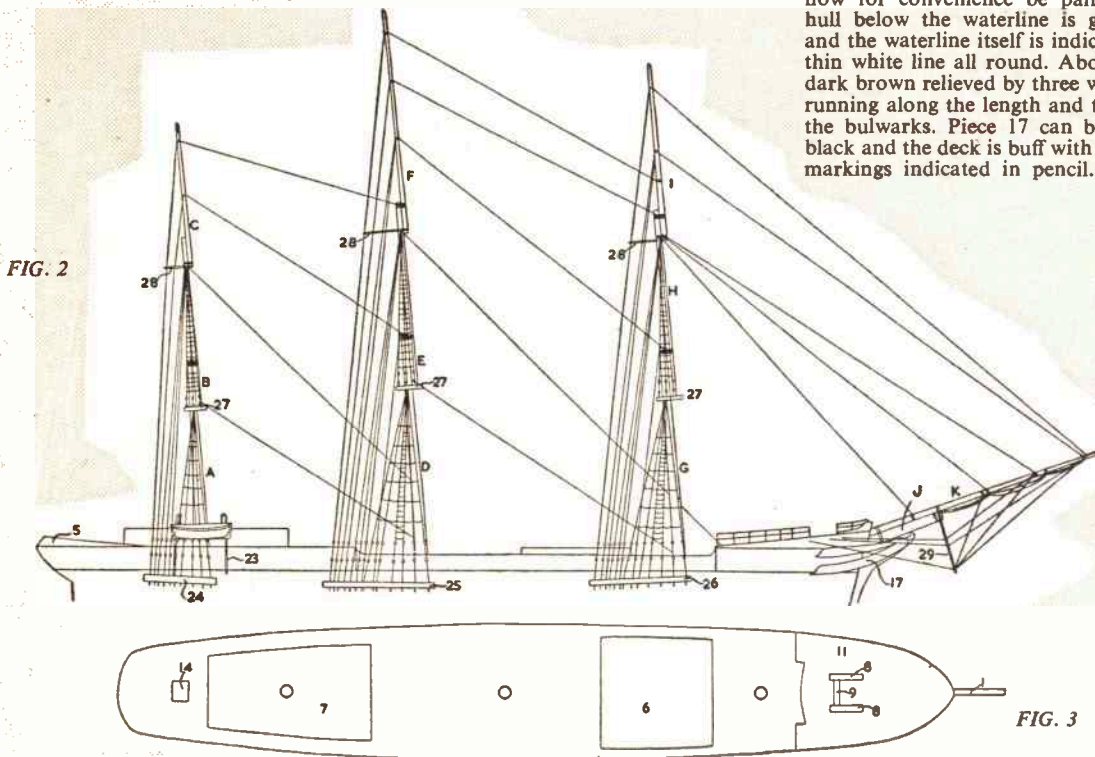

FIG. 2

The model thus far completed should now for convenience be painted. The hull below the waterline is grey-green and the waterline itself is indicated by a thin white line all round. Above this is dark brown relieved by three white lines running along the length and the top of the bulwarks. Piece 17 can be painted black and the deck is buff with the plank markings indicated in pencil. Pieces 6

and 7 are coloured medium brown and the lights are blue and white (Fig. 4).

When the paint is completely dry, continue assembly with the masts and rigging. The masts are made up as shown in Fig. 5, being glued and lashed with cord. The channels (24, 25 and 26) are next glued in their positions as shown in Fig. 2. Now step the masts in the appropriate holes provided in the deck and carry on with the standing rigging as seen in Fig. 2. For this use medium cord as supplied in Hobbies Kits. The bowsprit (J) is let into a hole drilled in the bow and (K) is lashed on the top side of (J). Rigging should be tied to the masts and bowsprit and attached to the deck by small staples made from beheaded fretpins. A touch of glue will give added strength to the knots.

The shrouds are threaded through and fixed to the channels and ratlines (ladders) are made from thin cord. Deadeyes consist of blobs of glue which can be painted brown. Note that pieces 28, which are cut from wire, may vary in length according to the exact set of the masts. Fig. 6 should also be consulted when the bowsprit is being rigged.

Handrails are made up from beheaded fret pins and thin cord as seen in Fig. 7. They are inserted in the deck around the bow and stern (see illustration of finished model). Davits are made from wire and inserted in their deck or hull positions. The boats (22) are suspended from davits (23) by means of thin cord, while boats (20) are glued to piece 6. It may be easier to paint the boats before fixing in their appropriate positions. They should be light brown with white tops to represent canvas covers.

The spars are lettered and shown full size on the design sheet. They are shaped from $\frac{1}{8}$ in. round rod. Lash them to the masts and attach lines of thin cord as indicated in Fig. 8. Note that (AA) and (BB) are made from wire and lashed to



FIG. 5

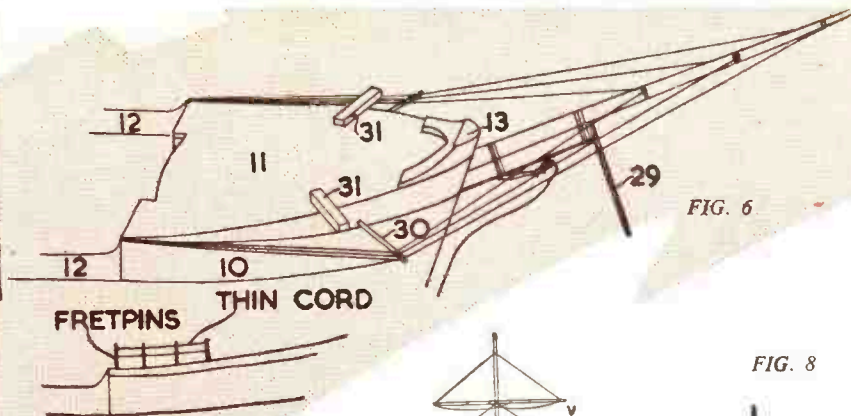

FIG. 6

FIG. 7

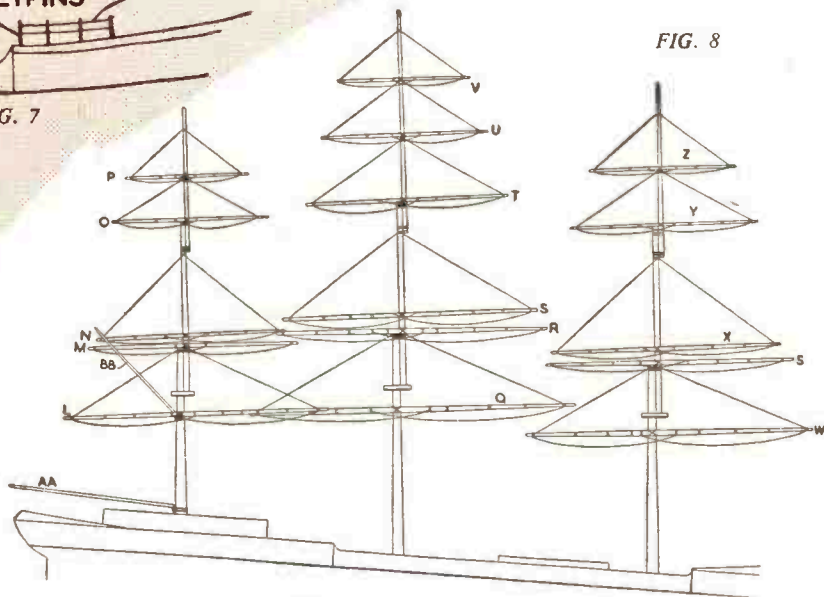
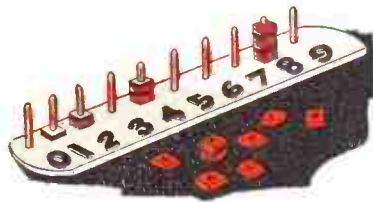

FIG. 8

the mizzen mast. Spar lashings can be represented by cord or by painting. Spars, bowsprit, masts, etc., can all be given a coat of brush polish followed by clear varnish to give a golden brown

natural colour. Complete the model by painting the stand black and adding a nameplate made from a piece of triangular fillet, and the metal engraving supplied in the kit.

Tiny Tot's Counting Toy



FULL-SIZE PATTERNS ON PAGE 79

THIS toy is invaluable for teaching young children to count. The appropriate number of counters is placed on each peg, enabling a good

grasp of the connection between figures and actual numbers.

The baseboard is cut from $\frac{1}{4}$ in. wood, $14\frac{1}{2}$ ins. long and 3 ins. wide. Drill holes at $1\frac{1}{4}$ in. intervals to take the $3\frac{1}{2}$ in. long pegs of $\frac{1}{8}$ in. diameter round rod. The pegs are glued in place.

The figures are cut from $\frac{1}{4}$ in. wood as shown at (A) and these are glued opposite the pegs. Make the counters from $\frac{1}{4}$ in. wood, drilling $\frac{1}{8}$ in. holes, so that they will slip easily over the pegs. Three different shapes are indicated for the counters. It is a matter of personal choice which design is used.

The whole toy should be painted in bright colours with plastic enamel paint. (M.p.)

Bang up to date

A GUY FAWKES PARTY

YOU will want a bonfire on November 5th, of course. You will also want it to burn brightly. So give it a good start.

The best way is to fill an old, wooden box with paper, scraps of wastelinoleum, cardboard, that scrap of roofing felt, that 'gone-hard' paint you were going to get rid of—in short, all easily combustible materials. On top you can pile the old mattress, the garden rubbish, the old magazines and other stuff that burns slowly.

A few don'ts. If the fire goes low, don't re-ignite it with petrol. It will cause a nasty explosion. Paraffin can be used but even here sprinkle it on the fire from a safe distance.

By E. Capper

Don't build a fire on or near sandstone. This stone has a porous, damp content. Excessive heat causes terrific pressure inside the stone. It won't explode like petrol but it can be quite dangerous.

Don't build the fire on a concrete path, especially if you know the path is not thick. The fire will crack it in all directions. The best site for the fire is on a waste piece of the garden but near a hard path if possible, so that you can feel the warmth of it without getting your feet damp. Naturally you will not be foolish enough to have a fire near a wooden fence or shed.

Illumination

Even a large bonfire gives limited illumination. And the instructions on fireworks are written in very small type.

If you are able to do the job, fix up an electric light in the garden by running an extension from the house. You don't need a bright light—a 40 watt lamp is sufficient. Don't, of course, fix it if the night is wet. It could be dangerous.

A 'jolly' effect is obtained with Christmas tree fairy lights, strung along the garden line. The kiddies will love it.

Hide a few fireworks in its body. Not the explosive type, of course. Use the 'effect' type, such as Roman Candle, Snowstorm, etc.

If you can dress the guy with some old clothes and a hat, so much the better. Use a funny mask for the face. An old pair of stuffed gloves make realistic 'hands'. Put a sparkler in each finger as a novelty.

Do have the guy really standing up in the fire to take his punishment. Wire it round an iron stake if you have one. If not use a thick wooden stake.

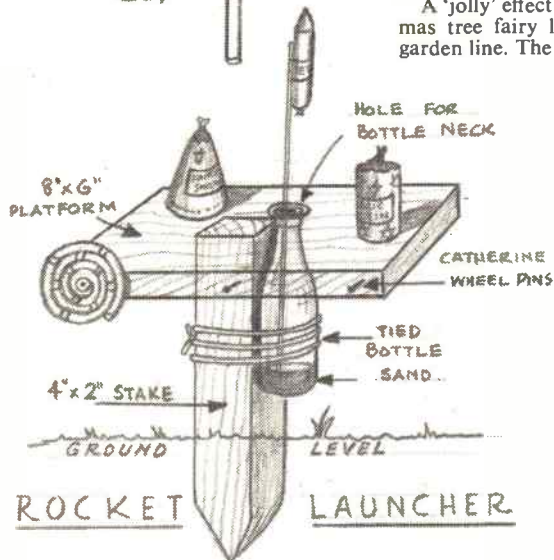
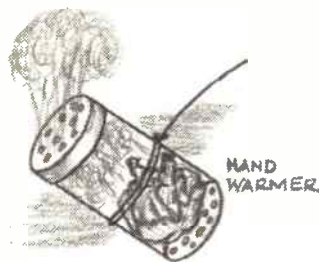

The guy

Take a little trouble over the construction of your guy. Make up a body of old sacking. Don't fill it with straw but rather use slow-burning materials such as sawdust. Your local sawmills will be only too glad to give you a sackful. You can sprinkle a few drops of paraffin in with the filling as you progress. After all, you don't want to put the guy on the fire and then see all your efforts burn away in a matter of minutes.

Always a good laugh is the guy that is so unconcerned about his impending demise that he smokes nonchalantly. Get a length of old tubing—the longer, the better. Bend it as shown in the drawing. Open the mouth of the tube to form a pipe-bowl with a cone-shaped piece of wood knocked with a hammer. Smoke will come from the guy's pipe almost as soon as the guy is put on the fire.

Fireworks

It cannot be said too often; follow the instructions on the firework. If it tells you to stand back, then do stand well back.

A 'safety lighter' for fireworks can easily be made by drilling the end of a bamboo cane to take a wax taper (see drawing).

Also worth the few minutes trouble of making is a rocket launcher. A

4in. by 2in. stake is driven into the ground. Across the top is nailed a wooden platform, say 8ins. by 6ins. In this platform has been drilled a hole to allow the neck of a bottle, tied around the stake, to protrude through. A layer of sand in the bottom of the bottle keeps the rocket base firm before launching.

The platform is also used for setting off 'effect' fireworks, but not, repeat not, the big bangers, the squibs and other types liable to explode. The platform also keeps the fire-work bottoms dry. You cannot afford the failures of damp fireworks. They are expensive enough.

The platform is again useful for firing catherine wheels. We have all learnt, with regret, that nothing removes paint from a door faster than a revolving hot catherine wheel.

A barbecue

It is all very well for mother to bring out a tray holding glasses of lemonade and cakes. It's not very exciting, is it?

Further, it is not very ambitious to push a few potatoes into the fire and hope for the best. Why not a miniature barbecue?

A turning spit is easily constructed of a scrap length of ½in. diameter wire. Form a handle at one end as shown in the drawing. Hold the spit between two piles of bricks on each end of the fire. Allow the wire to revolve freely by separating the two top bricks at each end by two pieces of wood with the wire traversing a gap between the wood (see detail 'A').

On the spit thread slices of bread, sausages, rolled slices of bacon, onions, etc, as shown. There will be no absence of volunteers to turn the spit.

For roast chestnuts and potatoes make up a simple oven of bricks and place in position before you light the fire. Start all your cooking, when the smoke and smuts and flames from the fire have died down and that large, glowing pile of white-hot embers remain. A word of caution. Do prick with a fork any eatables that are covered with a skin, such as the chestnuts and sausages, before cooking. And do have the salt cruet handy.

Hand warmers

The children will love these hand-warmers. They are simply cocoa tins, with small holes punched in the lid and bottom. Inside is stuffed a piece of

smouldering rag. The tin soon warms up to a pleasant heat.

Around the tin tie a length of string. When the heat shows signs of diminishing, hold the end of the string and whirl the tin around in the air. It will soon re-ignite the rag. At the same time, streams of smoke will pour from the punched holes to the kiddies' delight.

Safety

Keep a bucket of sand or water handy. Do not place it where it is liable to get knocked over. Make sure rockets are directed to go up into the air away from where your guests are assembled. See the fire is completely burnt out before you return indoors. Better to be safe than sorry!

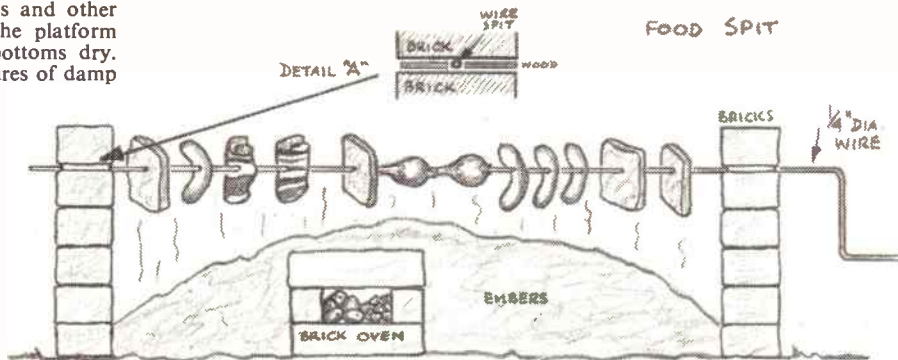

● Continued from page 70

A Cinema at Home

picture size to be expected with a measured 'throw', that is, the distance between projector lens and screen in the room. This will enable you to settle upon the size of screen wanted. The white sheet serves remarkably well if it is kept taut (and clean!), but sheets of blotting-paper pasted together are better, if less durable.

Proper screens are not expensive, however, and the average handyman can always make a good one from plywood or hardboard, painting the surface with white oxide or aluminium paint. White screens are best for the largest audience, sitting all round the room, and they also show colour films to best advantage. Silver screens give more luminous black-and-white image, but distort the picture slightly for those seated well to each side. Glass-beaded screens are best of all, but also the most expensive.

Now for the films to show. Both projectors and screens may be purchased second-hand at much less than cost prices new, and so may films. If, however, caution is necessary when buying the former, it is doubly necessary for the latter, indeed, to buy second hand films (usually ex library copies) without experience, is to court disaster. They are sure to prove scratched, dirty, incomplete, with torn sprocket holes and countless joins and constantly-snapping, brittle patches.

Short films, like cartoons and sports productions, are inexpensive to buy new, and for the rest, it is worth patronising a good lending library, postal or otherwise. These have fixed hire rates on the basis of so much per reel per day or week-end. As a rule these rates are moderate, but it is worth studying half-a-dozen catalogues to pick the firm offering the best terms.

With the projector installed on a firm surface, fitted according to the maker's instructions, a film threaded in, the motor already oiled and warmed up on a trial run, and the screen adjusted — only an audience is required now.

Whatever the audience, rig up screen and projector before they settle in their chairs, and always have a trial run beforehand. Appoint a trusted assistant to operate the house-lights, and keep a torch handy to check the machine as it runs. Most models will give at least half-an-hour's uninterrupted showing, but it is wise to become adept at speedy reel-changing to avoid family impatience at the blank patches in an evening's entertainment. A little experience will result in a most professional show, and it never pays to give an audience of children anything less.

A home cinema will give years of pleasure, and far from displacing visits to the commercial cinema, may make them more critically enjoyable.

...Have Fun This Winter



DESPITE the attractions of the orthodox cinema, there is no more enjoyable hobby-cum-entertainment than showing films in one's own home. The delights of the home cinema are far superior, say most enthusiasts, to those even of T.V., for home-projected films provide something more than that form of passive entertainment and, more important, *you* have control over what is to be seen.

Every autumn and winter many thousands of people run their own little cinema shows in the living room: thousands more would do so if they realised not only the fun involved but the simplicity of the hobby. If one spends a lot of time indoors during the dark evenings, or lives, maybe, in the country far from cinemas and theatres, or above all, if there are children in the house, then the home cinema is a *must*. The expenditure of time and money need not be large, far less than that spent on T.V. in fact.

Different gauges

To begin with, here are a few basic facts. Films shown publicly in cinemas are on 35 mm., or standard gauge film, whereas home films are invariably on sub-standard stock, which may be 8, 9.5 or 16 mm. wide. Although most home films are confined to silent ones (at first, anyway), both 9.5 and 16 mm. sound films are available, the latter of an exceptionally high standard of fidelity and reproduction.

Films may be hired at very moderate rates from a wide selection of film libraries up and down the country, some of which specialise in certain gauges, while others cater for all three. 8 mm. is, naturally, minute film, tiny ribbons of pictures, with a single line of sprocket-holes along one side, to enable the film to be pulled through the projector at a fixed speed by the mechanism. 9.5 mm. film has also only a single line of sprocket-holes, this time in the centre of the strip, in between each separate picture or frame. 16 mm. has one line of sprocket-holes along one side like 8 mm. film if it is sound, but a double line, one each side, if it is silent.

What are the respective merits of these different gauges, leaving aside for the moment any question of projector cost? Being the smallest and most compact, 8 mm. film has obvious advantages apart from the lowest cost for purchase or hire, but it also gives the smallest

With a

picture size. On 8 mm. you can borrow a good selection of documentary films, a rather meagre selection of drama films, a fair selection under the ever-popular heading of comedy, and plenty of good cartoons. Colour Kodachrome films are also available sometimes. This gauge was introduced by the famous firm of Kodak, and had its heyday before the war, but nowadays it seems to have lost a good deal of its popularity to the other gauges, particularly 9.5 mm. Probably the slow flow of new films of this size and the shrinking of many 8 mm. libraries may have something to do with this, but it remains a good gauge, and the small size in no way limits the clarity of the pictures on the screen.

Probably the most popular gauge at the moment, 9.5 mm., is of French origin, introduced by the firm of Pathé, and organised in this country today by Pathéscope, Ltd., who concentrate much of their activities on the filming side. In passing, it should be mentioned that many people are influenced as to the gauge they adopt by its amateur ciné possibilities in the films available (including colour), and the relative cheapness of the ciné cameras. On 9.5 mm. you can see an interesting range of drama films of Continental origin, including French films of various dates and many German pre-Hitler UFA films, some of them very well worth seeing today. Comedy on 9.5 mm. is extensive, but a little weak, being confined, apart from the ever-present and ever-enjoyable Charlie Chaplin films and a handful of others, to short, second-rate American comic films of the 'twenties. As for documentary, 9.5 mm. has some interesting films to offer, and a very large range of cartoons, including innumerable Mickey Mouse and Disney Silly Symphonies. The 9.5 mm. sound range, however, being of more recent origin, has less to offer.

16 mm. is the gauge beloved of schools, film societies, and study groups, and is even used commercially on occasions. On 16 mm. sound stock you can obtain most of the world's famous films, as well as almost anything seen week by week at the cinema. On silent

CINEMA AT HOME



stock there are available many of the old screen classics, but the cost of their hire puts them beyond the reach of most home users. Nevertheless, 16 mm. films offer by far the largest range in black-and-white and colour, with the added advantage that a great many films of

By D. Gunston

general interest, or instructional value, may be borrowed, completely free of charge, from Government Departments, large industrial concerns, holiday resorts and the like. The 16 mm. user has the best of the world at his disposal, but, of course, both his initial and running costs are higher.

Price range

Projectors vary enormously in cost, performance and range. As a rule, a good 8 mm. projector will cost between £20 and £50. A 9.5 mm. sound projector sells at around £75-80, but silent machines are available for under £20, and one model is available at around £7 hand-driven, and £13 motor-driven, and it gives very good results. In the 16 mm. field the silent machines work out at about £45-50, and the sound models tail away at £200 or so upwards. However, a silent model on one or other of the two smaller gauges need not involve the expenditure of more than £30-40, although it goes without saying that for long life and first-rate performance, the better models are the finer investment.

So much for the projector, and master apparatus, the next need is a screen.

This may range from a household sheet fastened with drawing-pins to a glass-beaded screen costing several pounds. When the make of projector is decided upon, the dealer or manufacturer will give information on the

● Continued on page 69

A.C. and D.C. ELECTRICITY

IN the last article in this series you were shown how to make a model dynamo supplying either A.C. or D.C. A dynamo generating A.C. is usually called an alternator, and where electricity is to be sent long distances across country it is generated by alternators, usually at voltages ranging from 2,000 to 11,000 volts. Not only is

be connected to a 3.5 volt A.C. or D.C. supply which can be obtained from the dynamo described in the last article. The lamp (C) will light up. The terminals (A) and (B) are connected through the lamp (C) in parallel to the terminals (D) and (E) which are connected as illustrated by about 6ft. of very thin wire to the lamp (F) which will not

more costly over long distances.

The apparatus illustrated in Fig. 2 illustrates why alternating current is now distributed by the Electricity Boards.

The 3.5 volts A.C. supply is connected to the terminals (A) and (B). The lamp (C) lights up, and the terminals (D) and (E) are connected to the 3 volt terminals of a bell transformer.

This transformer increases the voltage and reduces proportionately the strength of the current. The high voltage is transmitted from the transformer through the thin wires, now able to convey the weak current to another bell transformer where it is changed again into a form suitable for lighting the lamp (F) as brilliantly as the lamp (C). If you try this experiment with D.C. it will not

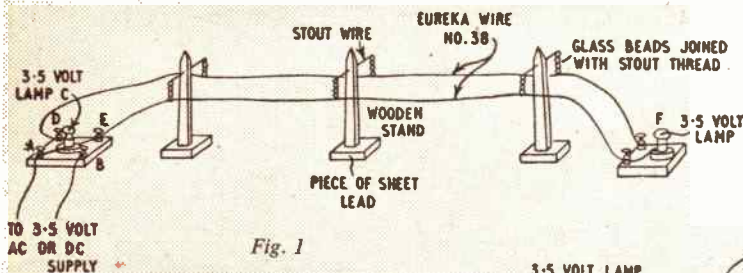

Fig. 1

such a high-voltage current dangerous to life, but it is quite unsuitable for such purposes as heating and lighting. It is necessary to reduce the high voltage to one which is safe and suitable. For this purpose transformers are used.

The diagrams illustrate a model for demonstrating the transmission of electric power and show how the voltage of alternating current may be changed by means of transformers.

Using the apparatus illustrated in Fig. 1, the terminals (A) and (B) should

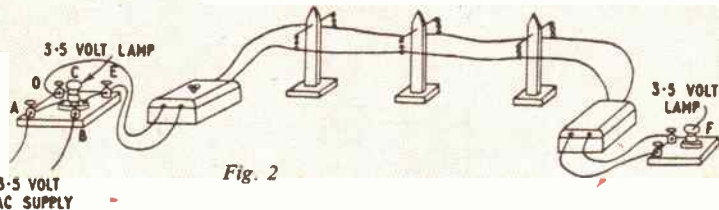

Fig. 2

light up at all or only very dimly.

The electrical energy has been consumed in the thin transmitting wires. To avoid this, the lamp (F) must be connected to (C) by means of thicker wires, which are of course very much

work, for the voltage of D.C. cannot be transformed in this way.

This exercise illustrates how vast quantities of electric power can be transmitted over great distances through comparatively thin cables. (T.A.T.)

Interesting Locos - No. 3

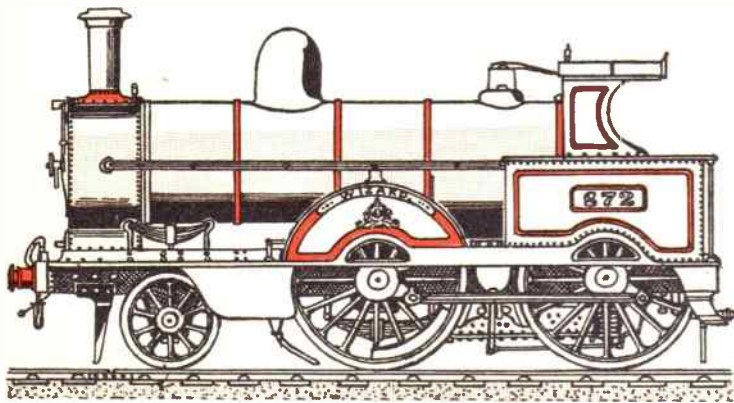

OUR illustration shows one of the most notable locomotive classes to run in this country. The class engine No. 2175 *Precedent* was erected at Crewe in December 1874 by Mr F. W. Webb, the locomotive superintendent

for the principal express work on the London and North Western Railway.

Precedent was followed by a further 69 sisters and Mr Webb later replaced the 96 engines of the 2-4-0 'Newton' class (first designed by John Rams-

bottom in 1866) by 'Precedents', making a total in the class of 166. Notable engines were No. 790 *Hardwicke* which, during the race to Scotland in 1888 ran the 10 a.m. ex Euston between Crewe and Carlisle and on one trip covered the 90 miles from Preston to Carlisle in exactly 90 minutes having a gradient of no less than 1 in 75 to climb between Tebay and Shap Summit. This famous engine is now preserved at Crewe.

No. 955 *Charles Dickens* was well known by every habitual traveller between London and Manchester, running every day for many years between these two cities and back, a total distance of 366½ miles.

The engine shown in our drawing, No. 872 *Wizard*, was built at Crewe in June 1877 and was the 2,053rd engine to be built at the famous works.

Leading details—Wheels, leading, diameter 3ft. 9ins., coupled, 6ft. 9ins. Cylinders, 17ins. by 24ins. Total heating surface 1,083.6 sq. ft. Boiler pressure 150 lb. per sq. in. Total weight (with tender) 57½ tons. (A.J.R.)

For the kitchen

MAKE THIS NEAT TABLE

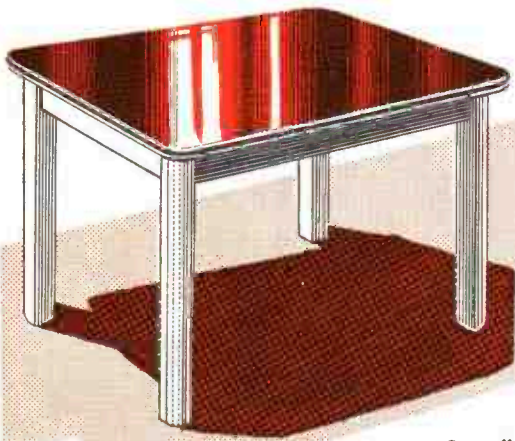

The best effect is obtained by painting, so that the choice of wood is not important. Soft wood is easily worked and should be used in preference to hard wood such as oak.

Overall measurements are shown in Fig. 1 and these can be increased if necessary. The height will, of course, remain the same.

The legs are cut from 2in. by 2in. material and are rounded as shown in the illustrations. The height should be increased if the table is to be used by a tall person. The rails are 2½ins. by ½in. and are tenoned into the legs as shown in the exploded view in Fig. 2 and in Fig. 5. Notice that the tenons are

also mitred.

Fig. 3 shows how to set out the leg for the mortise. Bore away as much wood as possible with a brace and bit and then finish off with a sharp chisel. The mortises will, of course, meet in the centre.

Fig. 4 shows the rail in position in the leg and the dotted lines indicate the tenon. In this diagram the fixing dowel is also shown. Panel pins may be used instead of dowels, but they should be punched home and filled with plastic wood.

The top may consist of one large piece of ½in. or ¾in. plywood if obtainable. Alternatively make from two or three pieces of ½in. wood. These should be

● Continued on page 73

THE appearance of your kitchen will be greatly improved by the addition of this plastic-covered table. The covering is easy to fix and the construction of the table itself presents no difficulties to the average handyman. There are so many shades of material to choose from that it is possible to match any colour scheme.

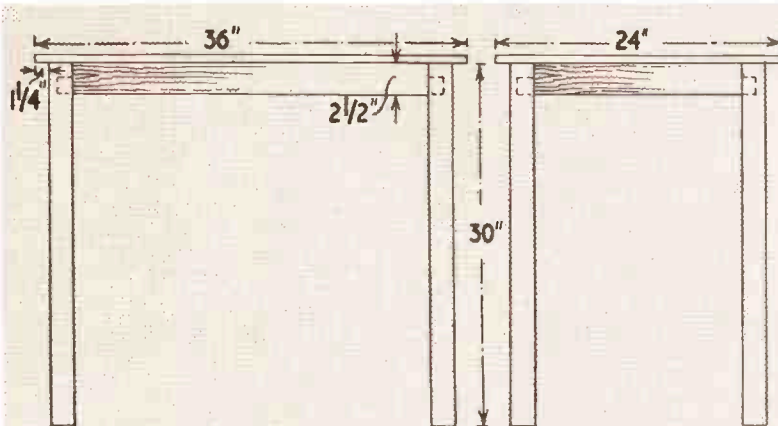

Fig. 1

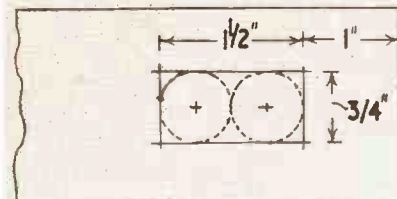

Fig. 3

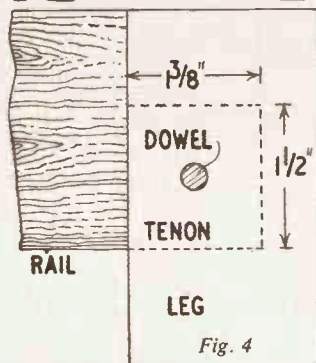

Fig. 4

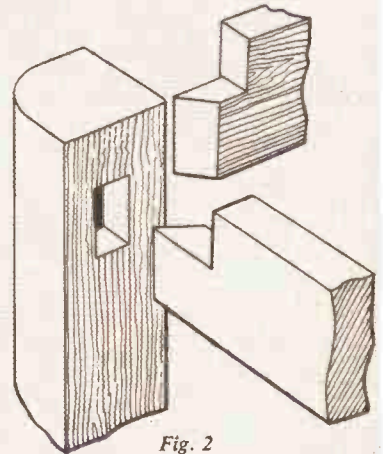

Fig. 2

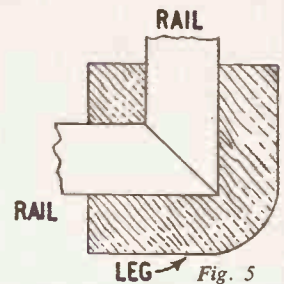

Fig. 5

NOVELTY EASEL PICTURE HOLDER



AN easel is more often considered as part of an artist's equipment, or as a stand for the school blackboard, but when made in miniature form it provides a useful means of displaying small pictures or photographs. These novelties can be easily made from plywood and although the one shown is intended for the popular size photographs of 3½ ins. by 2½ ins. it will require slight modification for adapting to hold any size of picture.

By

S. H. Longbottom

Take a piece of plywood measuring 4½ ins. by 3 ins., marking out as in Fig. 1 where the thick lines represent the shape on ½ in. squares. The shape is cut out with the fret saw, and being in one piece there are no joints to make. You may cut out two or three easels at the same time by cramping the sheets of wood together, thus making a set.

You will also require a further strip of plywood measuring ½ in. by 3½ ins. for a leg and this can be made from a small strip of waste material. Clean up all the edges with fine glasspaper, rounding off the tops of the three legs as shown.

Referring to the enlarged Fig. 2 you will see that the leg is hinged to the easel quite simply by means of a piece of linen strip glued to the horizontal part of the easel and the top of the leg. Use good glue for this purpose along with reasonably strong, linen tape for the hinge.

We also require a stay to prevent the leg from slipping when the easel is

erected for holding pictures. This is achieved by gluing one end of a short strip of tape to the centre leg of the easel and the other end to the hinged leg, at a point approximately halfway down.

When the easel has been fitted with the leg you may either give the whole a coat of paint or stain. A black finish gives an attractive appearance, causing the pictures with much lighter tones to stand

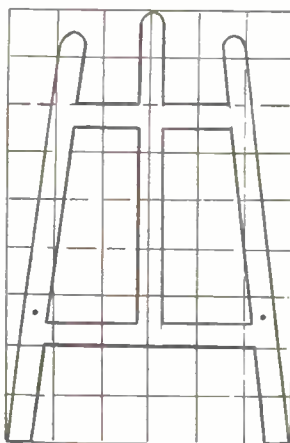

1/2" SQUARES Fig. 1

out in contrast, and where sets are proposed they should all be finished to match. You may, of course, finish with a suitable stain to suit the wood.

The picture is glued on to a piece of stiff cardboard and left under pressure until quite dry when it can be trimmed to size with a sharp knife. Should there be any tendency for the mounted picture

to warp this can be countered by pasting a piece of plain paper on the reverse side.

Small holes should be made in the two outer legs and small pegs, made from thin dowelling, inserted for supporting the picture on the easel.

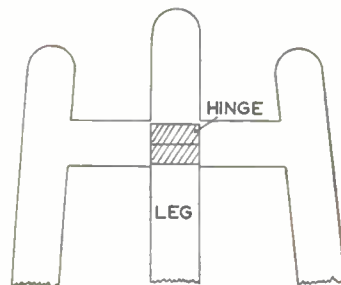

Fig. 2

While the foregoing provides the basic information necessary for making ideal novelty picture easels, you may like to 'glaze' your pictures, binding with passe partout.

To avoid the difficulties of cutting small pieces of glass you are recommended to glaze the miniature pictures with thin sheet celluloid. This material, usually obtainable from good arts and crafts shops in small sheets, is cheap, and very suitable for this type of work. Moreover, there is no possibility of breakage should the easel or picture be knocked over. A piece of card, the same size as the picture is required, along with a piece of celluloid of the same size. The three are bound together on all sides with strips of passe partout binding tape, making a complete miniature picture.

● Continued from page 72

Neat Kitchen Table

glued and butted together before nailing or screwing to the legs and rails. The screws must be countersunk and the nails punched well home. Fill with plastic wood and glasspaper flat.

The top may be covered with Formica, Waverite or Marleyfilm. The latter can be obtained from Hobbies Ltd., Dereham, Norfolk, price 3/- per ft. run, one yard wide, postage 6d. per foot extra.

After covering the top, in accordance with the makers' instructions, the edges can be finished off with a special metal and plastic beading which can be obtained locally for the purpose.

Clean up all the woodwork and paint with plastic enamel. Remember that thin coats should be given and that a high-gloss finish is obtained by rubbing down between coats with silicon carbide paper used wet. (M.h.)

MONEY-SAVING RECIPES

WITH a few chemicals and everyday vessels the handyman can save a surprising amount of money by making up his own products — and even make some by selling to friends and workmates. A small laboratory at home with its greater facilities enormously increases the number of products which can be made. This is especially the case where small quantities have to be weighed or where glass vessels must be used for heating. Naturally, in these recipes as many methods as possible are included which call only for ordinary domestic facilities.

To clean a felt hat

Simply buy an ounce of magnesia (magnesium oxide) from a dispensing chemist, make this into a thin creamy paste with benzine (inflammable) and brush it *lightly* on to the hat. Leave it until it is quite dry. Then brush off the magnesia with a dry brush. It will usually remove all oily stains and generally renovate the appearance of the hat.

Preventing window condensation

This nuisance is easy to prevent. In a dry bottle put an eggcupful of methylated spirit and three eggcupfuls of glycerine. Cork the bottle and shake until an even solution is obtained. Soak a piece of chamois leather or car sponge in the mixture and rub all over the glass. The window or windscreen must be dry or dried before applying the anti-condensation liquid. This mixture may also be used on house or shop windows.

A cheaper preparation for shop and domestic use calls for less of the rather dear glycerine. Shred with a knife 4 ounces of ordinary yellow bar soap and dissolve this in 12 fluid ounces of hot water. Stir in 2 fluid ounces of glycerine and allow to cool. Apply a little to the window and wipe all over with a soft cloth as if you were polishing. A fine film remains which prevents steaming up.

Neither of the above is a permanent treatment. Renewal is necessary from time to time, and, naturally after window cleaning. Ventilation is the real answer to window steaming, but the products dealt with are a good compromise where ventilation is not practicable.

Tailor's chalk

The lady of the house may welcome some of this. Mix well $\frac{1}{2}$ ounce of Castile soap powder, and $2\frac{1}{2}$ ounces each of

French chalk and pipeclay (both in a fine powder). When you are satisfied that a homogeneous mixture has been arrived at, work in enough water to give a stiff paste. Mould between the palms into round discs and set aside to dry. This gives a white chalk.

Gloss finish for leather

This preparation can be used for glazing new leather or touching up worn leather. It must be freshly made before use, for, as it contains egg white and milk, it will deteriorate if kept.

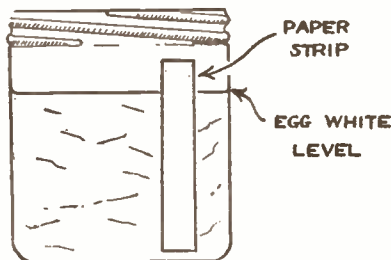

Fig. 1—Measure for making gloss leather finish

This recipe is most easily made up by using the metric system, but, since it will doubtless be of interest to a wide number of readers who have no such facilities, a more cumbersome yet everyday method is given. You will need a small wide-mouthed cylindrical glass jar to serve as a measure. Gum a strip of paper up the side as shown in Fig. 1. Separate the white from an egg and put it into the jar. Make a pencil mark to show its volume. Put the egg white into a jug and then pour in seven times its

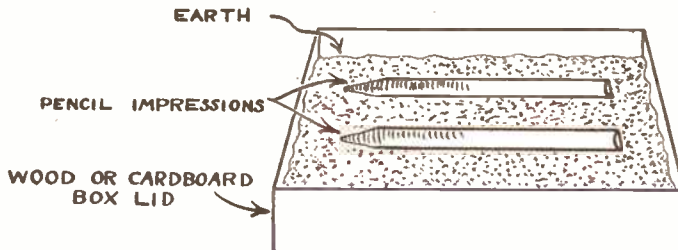

Fig. 2—Simple casting moulds

volume of cold water, using the jar as a measure.

Whip the egg white with the water by means of a fork. This will separate membranes and these can be removed by straining through cloth. Again using the jar as a measure, add one-third of a

volume of milk. Stir well and the preparation is ready for use. Spray or brush the liquid on to the leather and allow to dry.

If it does not spread evenly, sponge the leather first with soapy water, then with plain warm water and allow to dry before again applying the gloss producing liquid.

Celluloid to wood adhesive

This preparation may also be used if you wish to stick celluloid to tin. It is easily made from shellac, spirit of camphor and methylated spirit. Into a dry, screw-top bottle pour $\frac{1}{2}$ fluid ounce of spirit of camphor and 1 fluid ounce of meths. Add $\frac{1}{2}$ ounce of shellac and replace the screw top. Leave aside with an occasional shake until the shellac has dissolved, when the adhesive is ready for use. It will keep indefinitely, provided the screw-top is tight enough to prevent evaporation. Coat the two surfaces evenly, press together and leave until firm.

Celluloid to celluloid bonding fluid

A broken celluloid article can be mended, or two pieces of this plastic can be stuck together, simply by making use of its known property of softening in contact with alcohol and ether. Mix 3 volumes of methylated spirit and 4 volumes of ether. Paint this fluid over the surfaces until they soften and then press together, bind or weight down, and leave aside for a full day.

The bonding fluid is highly inflammable and so must be made and used in flame-free conditions. In this connection an electric fire also constitutes a flame! The red hot element will ignite the vapour just as easily.

Jewellery polishing powder

Plated ware, as well as metal jewellery, will polish up well with this preparation. You will need some precipitated chalk and very finely powdered ferric oxide ('jewellers' rouge'). Mix equal volumes

● Continued on page 76



R.A.F. NEW WATERPROOF BACK PACKS



One large FULLY ZIPPED Compartment. One ditto same size back to back, 4 Buttoned off separate side by side super imposed Pockets. 2 strong adjustable webbing back straps with easy release press studs. Made of genuine R.A.F. 100 per cent. waterproof material, all brand new. Ideal for Motor Cyclists, Hikers, Fishermen and 100 other uses. 4/11 only, post etc. 1/1. A fraction of original cost. Send immediately.

4/11 POST ETC. 1/1
NO MORE TO PAY

Complete transmitting and Receiving apparatus for two persons.

From a few yards to a mile. Normal telephone strength. No batteries or electricity - it just works! Send 12/11, post 2/1. Ready for use in 5 mins. Lists, Binoculars, Watches, Tents, Terms.

HEADQUARTER & GENERAL SUPPLIES LTD.
(HOBW/82), 196-200 Coldharbour Lane Loughboro Junc., London, S.E.3 Open Sat.

CHOOSE free stamps from approvals every time you receive them. Send postage. — Orr, 17 Linthorpe Grove, Willerby, Hull.

FREE — 100 World Stamps; enclose postage for approvals. — J. Gledhill, 85 Paddock Lane, Halifax.

MATCHBOX crystal receiver parts and instructions 3/6. Reception guaranteed. — Write BCM/ALEXSTONE, London, W.C.1.

SCIENTIFIC and Technical Supplies (Nottm.) Ltd. Apparatus, chemicals, sets, special Christmas offers, experimental books, illustrated Catalogue; send 3d. — Dept. H.9, Wellington Circus, Nottingham.

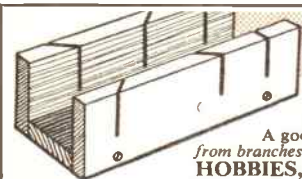

WOOD MITRE BOX

Made of selected hardwood with slots for 45° and right-angle cutting. Size 9ins. long. 5/6

A good tool at a modest price
from branches or: —
HOBBIES, DEREHAM, NORFOLK



BRANCHES: LONDON
78a New Oxford St., W.C.1
(Phone MUSEUM 2975)
87 Old Broad Street, E.C.2
81 Streatham Hill, S.W.2

GLASGOW
326 Argyle Street
MANCHESTER
10 Piccadilly

Head Office & Factories — **HOBBIES LTD., DEREHAM, NORFOLK**

BIRMINGHAM
100a Dale End, Birmingham 4
SHEFFIELD
4 St. Paul's Parade
LEEDS
10 Queen Victoria Street
HULL
10 Paragon Square
SOUTHAMPTON
134 High St. (Below Bar)
BRISTOL
65 Fairfax Street
NEWCASTLE
42 Dean Street
GRIMSBY
88 Victoria Street

RUSSIA 1956 Sports. This beautifully, fascinatingly coloured set offered **FREE** to approval applicants enclosing 3d. postage. — Yulwontmor Stamps (Dept. H6), 29 Layton Avenue, Mansfield, Notts.

MAKE A MUSICAL BOX for as little as 21/6. New kits and tunes available. Movements 14/9 post free. Please send 3d. stamp for free illustrated catalogue. — The Swisscross Co., Dept. B., 116 Winifred Road, Coulsdon, Surrey.

WHEELS (Hardwood and Rubber Tyred Metal). Cot, Pram and Doll's House Fittings and Papers. Beads, Transfers, Prints and other accessories. Stamp for new lists. (Trade supplied.) New address — **JOYDEN CO.**, 91 Peplins Way, Brookmans Park, Herts.

LEARN it as you do it — we provide practical equipment combined with instruction in Radio, Television, Electricity, Mechanics, Chemistry, Photography, etc. — Write for full details to E.M.I. Institutes, Dept. HW47, London, W.4.

STAMPS FREE — Empire Packet including 50 Pictures and Victorians with approvals. — Robert J. Peck, 7A Kemp Road, Bournemouth.

GENUINE Swiss Musical Movements. The best and largest selection of tunes in the country, lowest prices 16/3 each. Genuine Thorens Movements, 22/9 each. All guaranteed. P & P. 9d. extra on all orders. — Richardson & Forder, HW, 5 Chapel Place, White Hart Lane, London, N.17.

MODELS. You can make lasting stone-hard models with Sankey's Pyruma Plastic Cement. Supplied in tins by Ironmongers, Hardwaremen and Builders' Merchants. Ask for instruction leaflet.

'PAINTSPRAYING' HANDBOOK. Covers Car, Industrial & Flock Spraying, 3/6, post 4d. Catalogue of our Cellulose and Paints and all Allied Sundries 3d. — Leonard Brooks Ltd., 81 Oak Road, Harold Wood, Essex.

FRETWORKERS — over 200% profit can be obtained making my quick selling Xmas line. 2/- P.O. for full particulars to — L. Foster, 19 Roseland Ave., Brierfield, Nelson, Lancs.



So one night I sat down and wrote off for details of Escort's Sure Step system



Now I never put a foot wrong —



Learn ballroom dancing at home! Send for exciting **FREE** booklet, 'Dance Escort', which explains the Sure Step system. Cut out this advt. and post with name, address and 3d stamp to: **ESCORT DANCE INSTRUCTORS** Studio H1, Harrogate

HOW TO STOP SMOKING

and permanently overcome that ceaseless craving for tobacco. Save money, safeguard health. Send stamp for details of the world-famous inexpensive Stanley Treatment for tobacco habit

THE STANLEY INSTITUTE LTD (Dept. 30)
12 Bridewell Place, London E.C.4

CASTING moulds for lead soldiers, animals, etc. Catalogue 4d. Sample mould 6/6. — G. Rhead, Bacton, Stowmarket, Suffolk.

KUKLOS ANNUAL. Indispensable cyclist's handbook. Tours, resthouses, money-saving hints, 2/10, post free. — Burrow, Publishers, 2 Imperial House, Cheltenham.

FREE! Two beautiful sets Q.E. II Colonials. Request approvals, 3d. postage. — Fildes, 4 Hawarden Ave., Whalley Range, Manchester 16

BECOME trained chiropodist. Quick postal practical. — **GRADUATE SCHOOLS**, 48a Abbey Street, Accrington.

100 DIFFERENT stamps free! Request 4d. upwards discount approvals. — Bush, 53 Newlyn Way, Parkstone, Dorset.



COT FITTINGS (full size)

The fellow handy with tools can make quite easily a drop-side Cot using these fittings. The set comprises two bright steel rods 36ins. long, six heavy-duty screweyes (four plain and two threaded for rods) and two catches. Price 7/- Set. From branches or: — Cot Design 3202 1/3

HOBBIES LTD., Dept. 99, Dereham, Norfolk

HEAR ALL CONTINENTS With H.A.C. Short-Wave Receivers

Suppliers for over 18 years of radio S-W Receivers of quality. One-Valve Kit, Price 25/- Two-Valve Kit, Price 50/- Improved designs with Denco coils. All kits complete with all components, accessories and full instructions. Before ordering, call and inspect a demonstration receiver, or send stamped addressed envelope for descriptive catalogue. 'H.A.C.' Short-Wave Products (Dept. 22), 11 Old Bond Street, London, W.1.

USEFUL WORKSHOP GADGET

THIS is a simple to make, but very useful article for the workshop, with which it becomes an easy matter to strike large circles and arcs accurately. Woodworkers will appreciate this, where curved edges and table tops are concerned. A further use is for the benefit of lamp shade makers, as the gadget is primarily designed to accurately pencil a pattern for any diameter of rings and variety of slopes.

Materials required are a couple of planed wood laths of $\frac{1}{2}$ in. by 1 in. section and 5 ft. to 6 ft. in length, plus a sliding point (easily made) and a few inches of $\frac{1}{4}$ in. dowel rod with which to make the necessary pegs mentioned in the article.

From each lath cut off a 1 ft. 6 in. length. The long laths, shown in Fig. 1a should have a pencilled line run down their middle on which a series of $\frac{1}{4}$ in. holes are bored, starting at $\frac{1}{2}$ in. from

(B) across the parts (A) at the bottom, with pegs through the holes; the pegs being short lengths of the dowel rod. The distance between should be the

By W. J. Ellson

same as the diameter of the lower ring of the shade. A second bar is then fitted across higher up, set to the diameter of the top ring of the shade, the distance between these bars being that of the height of shade required.

bottom end sharpened to a point and fitted with a couple of nuts, the upper one of which should be of the wing variety for ease of adjustment. The distance bars can now be removed, and a pencil point placed in the holes of part (A), first in the lower hole and then when that arc is struck moved to the upper hole for the upper arc.

With the aid of the lower distance

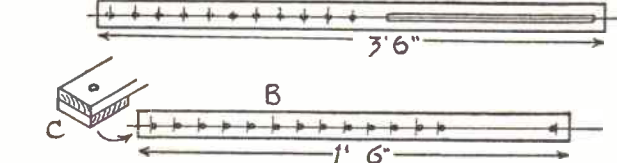
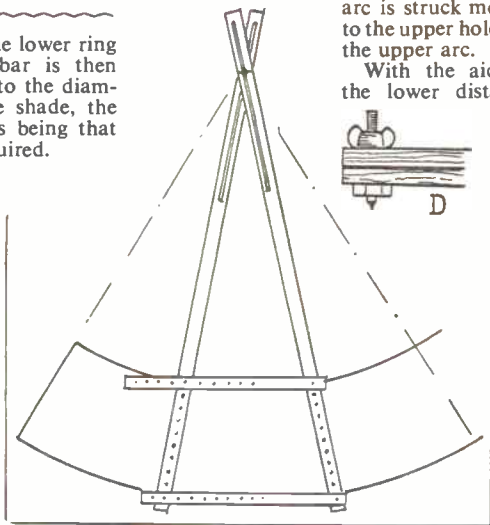

Fig. 1

Fig. 2



one end. These are accurately marked off 1 in. apart. About 10 such holes should suit most requirements. Higher up, a $\frac{1}{2}$ in. slot 1 ft. 6 ins. long should be carefully sawn out. If the lengths of these laths exceed that given, the slot could well be cut some 6 ins. longer.

The shorter lengths of lath, shown at B, are divided into 1 in. divisions, as for (A) and similar holes bored. These are for spacing parts (A) a certain definite distance apart, when setting the gadget for describing the curves for lamp shades. To ensure a reasonable degree of accuracy, the right end hole is not bored on the cross line, but against it, while the rest are similarly treated but touch the cross lines on the opposite sides. The drawing, which like (A) is not to scale, shows this. For lamp shade work, only distances from 5 ins. to 14 ins. are really necessary, so the intermediate spaces and holes are not wanted — hence the unbored space. It may in some cases be of advantage to thicken the left end of parts (B) with a short piece of lath glued underneath as at (C).

To use the gadget for setting out a lamp shade pattern, fix one distance bar

Where the parts (A) cross, pass through a sliding point. This is shown at D, in Fig. 2 and is a $\frac{1}{4}$ in. steel bolt, its

bar, measure off the distance already set on the lower arc, $3\frac{1}{4}$ times to finish the pattern. This will allow for overlap.

Continued from page 74

Money-saving Recipes

of the powders and keep in a wide-mouthed jar. For use, you may mix it to a thin paste with either water, meths., or household ammonia. With a soft cloth rub the paste all over the article and let it dry on. With another soft cloth rub off the powder and use a brush to remove it from crevices or other places not reachable by the cloth. Finish off the polishing with a soft chamois leather.

Stove polish

Cast iron kitchen ranges will quickly shine if you use plumbago powder. Damp a woollen cloth and dip it in the powder. Rub the range well all over and polish up with a dry cloth. An excellent shine will result. Plumbago powder can also be used to give the shiny black

finish to wood, if you happen to need this.

Low-melting point alloy

For making seals, small parts for models, or casting medal replicas, a really low-melting alloy is a boon. This one will melt in a vessel surrounded by boiling water! To make a stock of it, weigh out 1 part of cadmium, 6 parts of lead and 7 parts of bismuth. Melt the lead in a small tin over a flame, add the bismuth and then the cadmium. Stir well and cast into convenient short rods by pouring into moulds made by pressing a pencil into damp earth contained in a box lid (Fig. 2). When required for use, partially sink a tin into boiling water and drop in some of the alloy, when it will rapidly melt. (L.A.F.)

Replies to Readers

Is this YOUR Problem?

Canoe Storage and Transport

HAVE you any useful hints as to storage, transport of canoes, etc. that might prove useful to me? (C.L.—Port Elizabeth).

A CANVAS canoe is best stored under cover—a common method is to hang it from the roof of the garage in two slings. Inverted on a rack is a good way. Keep the cockpit open to ventilate inside. The canoe may be carried short distances or wheeled on trolley. It will travel the right way up on a car roof rack, preferably of the type consisting of two crossbars. Lashing down to the crossbars is usually sufficient, but other ropes may be put at the ends.

Cobblers' Wax

WILL you please tell me how to make cobbler's brown wax for making brown threads for sewing boots and shoes by hand? (A.T.—Warwick).

FOR a brown cobbler's wax melt together two ounces beeswax, ½ ounce Japan wax and 7½ ounces paraffin wax. Stir in enough raw umber to give the desired depth of shade. This gives a yellowish brown; for tan, use burnt umber. Oil soluble brown is also a good colouring matter to use in place of the umber, but it is difficult to obtain in small quantities from laboratory furnishers. This is melted in with the waxes in sufficient quantity to colour.

Torches for Pageants

IHAVE been asked to produce a torch (such as used in the Olympic Games) for a Boy Scouts' pageant and would like to know if you can supply me with details how to make one. Also which type of fuel would be safe as well as effective? (A.C.—East Finchley).

TORCHES of the flaming variety can be made by paraffin soaked rags, wired around a branch of wood, but the best material to use is obtainable from a ropemaker and is called flax tow. Alternatively, any piece of old thick rope would do providing it is not too tightly plaited. If sticks are to be used, the top portion which will be near the flame must be protected by tin to prevent the wood burning, and around this is wired the flax tow. These ends are inserted into a quantity of paraffin for several hours to allow the material to become thoroughly impregnated, and when lit they will last for a considerable time. An

objection to the use of cotton wool is that it does not last very long when lit, but you can choose your material depending upon the length of time the lighting is required.

Reclaiming Rubber

HOW can I melt rubber? (C.C.—Grimsby).

THERE is no way of melting the ordinary rubber we meet with in everyday life. As soon as the softening point is reached by heating, the rubber begins to decompose and does not return to its original texture on cooling.

Painting Brickwork

IHAVE a red brick fireplace which up to now has been polished with Cardinal red polish, but which for a change I would like to paint. Assuming I have to remove all traces of polish, will sugar soap answer the purpose. Having done that, what paint do you suggest I use? (R.E.—Neath).

SUGAR soap may not take out all the grease and wax from the polish. We suggest you use one of the new solvents such as Polyclens. Ordinary household paint may be used, but it may be advisable to seal the pores with petrifying liquid.

Warped Racquet

IWISH to straighten a tennis racquet which has warped. Could you please tell me a way of doing this? (R.M.—Wanstead).

THE re-straightening of a warped tennis racquet frame is a task with considerable uncertainty of success. Probably the best method of attempting it is firstly to remove all the strings and scrape off the varnish from the frame. Next get a really strong piece of board or the like, on to which the racquet can be secured. Clamp the handle firmly to the board in such a way that the racquet frame is clear of the board; next insert blocks of wood of such heights that the frame when clamped down on to them will become level and true with the centre line of the handle. Clamping can be achieved by means of short

*** Draught Excluder ***

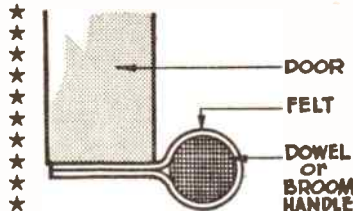

This easily made draught excluder works quite efficiently over uncarpeted floors. The 'open' ends of the felt can be taken under and tacked to the other side of the door for easier fixing.

pieces of sufficiently strong wood drawn down by screws close to each side of the frame. Adjust the number and position of the clamps until the frame is really flat and true as this is most important. Clamp first those parts of the frame which are most nearly flat. Now pour boiling water over the frame and then direct a stream of steam from a kettle of boiling water on to the frame, especially on the strained parts, that is to say, those parts which were the hardest to pull down with the clamps. Tighten all clamps again and repeat this treatment for three or four times and leave the frame in a damp place for several days. Next slacken but do not remove the clamps on the frame, and if it appears to have yielded to this treatment, all is well, if not, repeat the treatment. When the frame is thus sufficiently flattened, rub it with fine sandpaper and apply a coat of quick drying varnish and immediately complete the job by restringing the racquet in the normal way, and as far as possible with the frame clamped flat on the board.

Quick-setting Cement

AS I am in need of a very hard quick-setting cement, I had thought of using that such as dentists use for filling teeth (the white type), and would be most grateful if you could let me have the formula for same. (T.S.—Liversedge).

AHARD and quick-setting dental cement of the white type can be produced when needed by mixing zinc oxide with half its bulk of silica and then grinding this with enough zinc chloride solution of specific gravity 1.260 to form a thin paste. This sets rapidly and must thus be used at once. The zinc chloride solution need not be made up freshly each time, but may be kept as a stock solution in a closed bottle.

 * How to make a charming model of *
 * the Nativity Scene will be described *
 * in next week's issue. Make sure of *
 * your copy. *

See page 67

Counting Toy for Tiny Tots

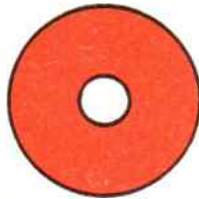
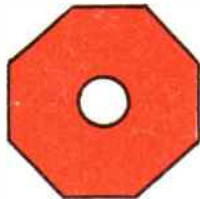
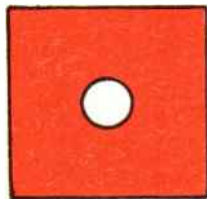
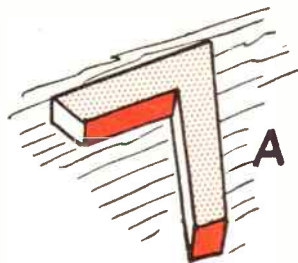
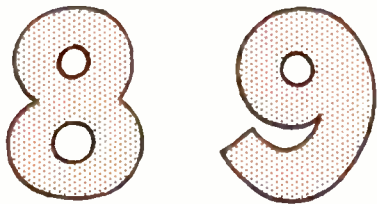
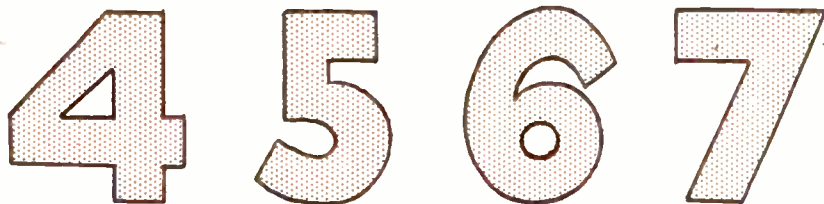
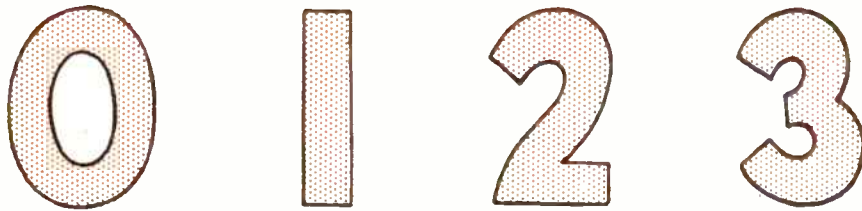

79

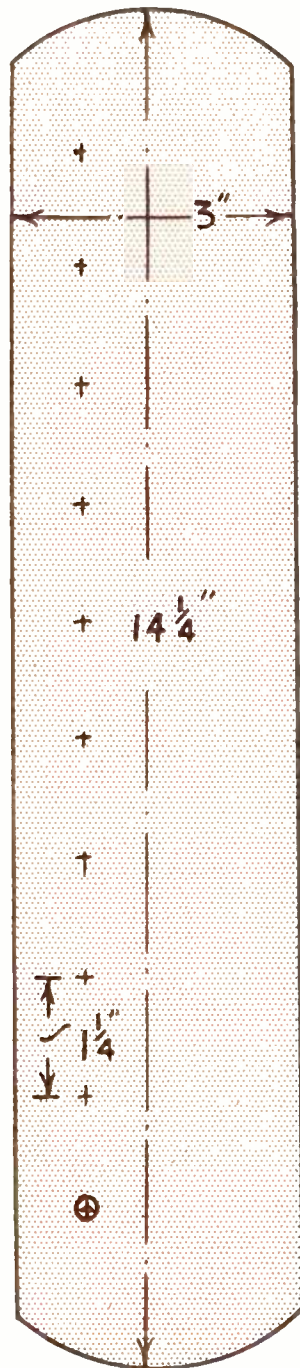

SOMETHING FOR THE HOME?

Kits of materials with full details of construction

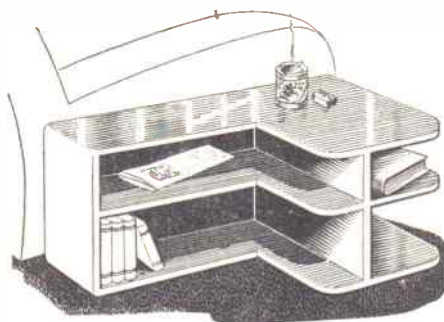

FIRESIDE TABLE/BOOKCASE No. 3200 68/9
Selected wood panels, etc.

Make it with a Kit from

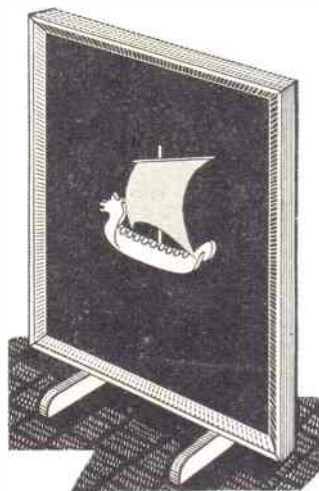

VIKING FIRESCREEN No. 3208
With ship in semi-relief.
13/6

Hobbies Kits make it easy for the average handyman to complete a fine piece of furniture for the home. They have that individual touch which gives the maker a pride of achievement.

Kits obtainable from branches or direct (post free).

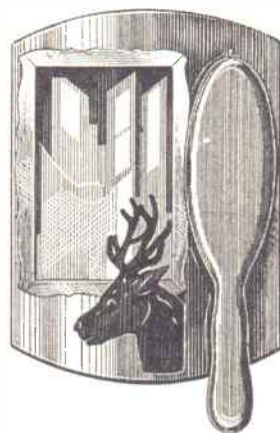

BRUSH SET No. 3080 10/6
With mirror, brush, etc.

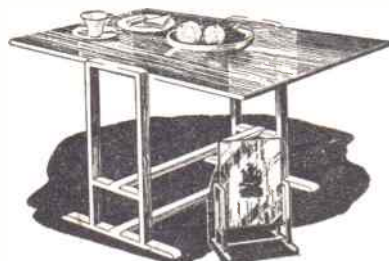

TABLE AND FIRESCREEN No. 3050
A dual-purpose kit.
37/6

★ ★ ★ ★ ★ ★ ★ ★ ★ ★
★ Dozens of similar projects ★
★ detailed in ★
★ **HOBBIES 1958** ★
★ **ANNUAL** ★
★ on sale at branches, news- ★
★ agents, etc. price only 2/-, or ★
★ post free 2/3. ★
★ 168 pages packed with 'do- ★
★ it-yourself' ideas for the ★
★ handyman. Send for free ★
★ booklet 'Profitable Leisure' ★
★ ★ ★ ★ ★ ★ ★ ★ ★ ★



CONTEMPORARY TABLE No. 3212
With special screw-in legs. Made in an evening.
29/6

To Hobbies Ltd., Dept 991,
Dereham, Norfolk.
Please send free 20-page
booklet and items marked X.

Kit No.
 Hobbies 1958 Annual.
P.O. for enclosed.

Name

Address



DESIGN No. 3234

MODEL 19th CENTURY TEA CLIPPER

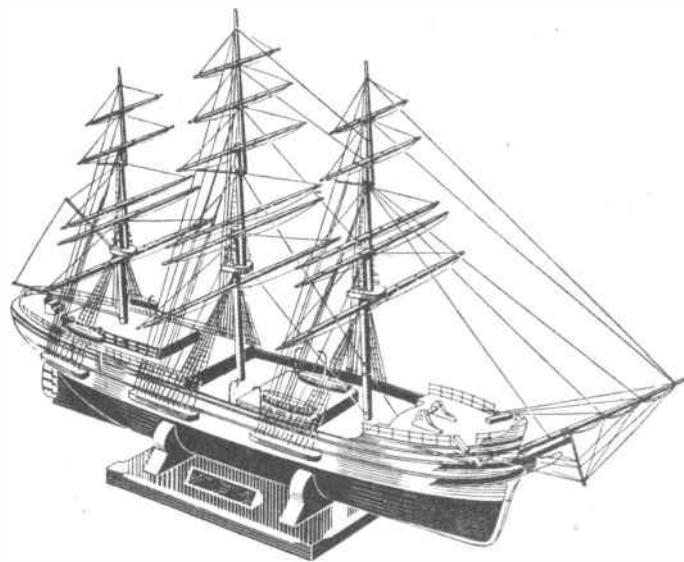

SIZE
22½ ins. LONG.

SCALE
¾ in. : 10 ft.

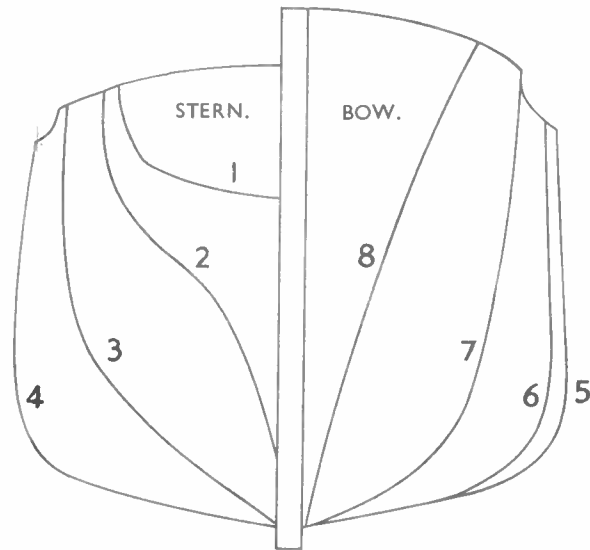

SECTIONS SHOWING SHAPING
OF HULL
(SEE INSTRUCTIONS).



PIECE 14. CUT ONE 1/8 in.



PIECE 15. CUT ONE 1/8 in.



WHEEL 16.
CUT ONE FROM
THIN CARD AND PAINT.

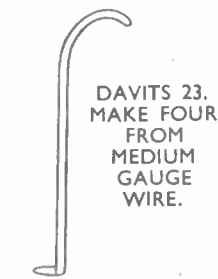

DAVITS 23.
MAKE FOUR
FROM
MEDIUM
GAUGE
WIRE.

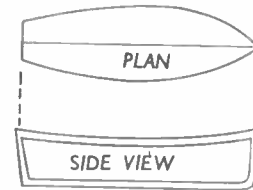

BOATS 22. CUT TWO 3/8 in.



DAVITS 21.
MAKE
FOUR
FROM
MEDIUM
GAUGE
WIRE.

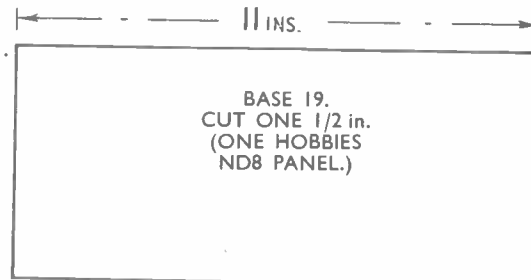

BASE 19.
CUT ONE 1/2 in.
(ONE HOBBIES
ND8 PANEL.)

WASTE
FOR
TRIM

BULWARKS 12.

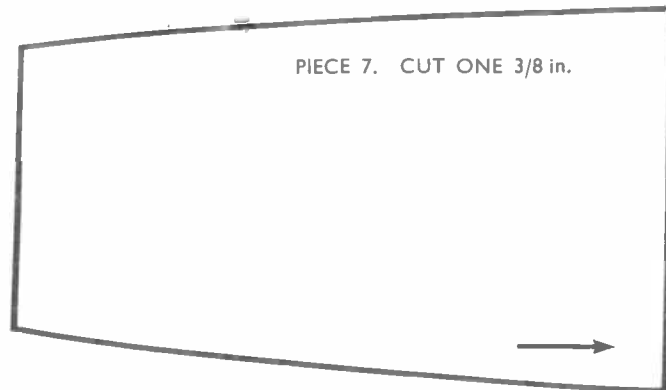

PIECE 7. CUT ONE 3/8 in.

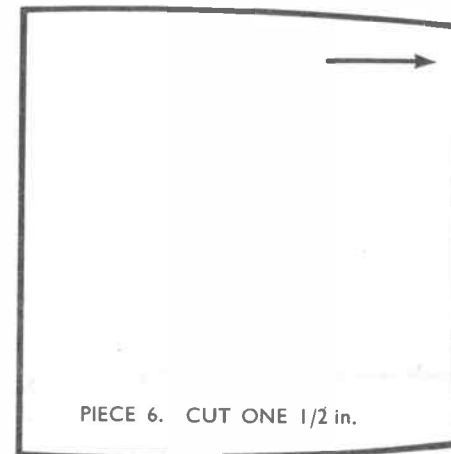

PIECE 6. CUT ONE 1/2 in.

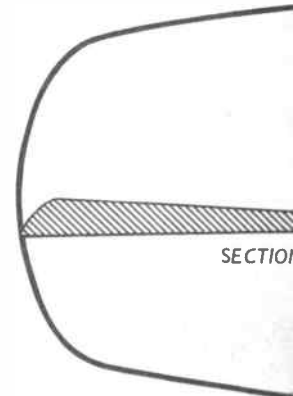

DECK 5. CUT ONE 1/4 in.

Use **CASCAMITE** 'One Shot' Resin Glue

for all Model Making

- Mixed & use cold
- Waterproof type
- Gap-filling and non-staining



Obtainable in:
3½-oz., 7-oz.
and 18-oz. tins.

Stocked by: Ironmongers, Builders' Merchants, etc.

Manufactured by:

LEICESTER, LOVELL & CO. LTD. North Baddesley, Southampton

DAVITS 23. MAKE FOUR FROM MEDIUM GAUGE WIRE.

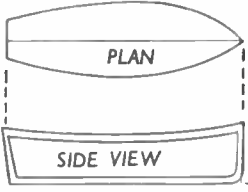

BOATS 22. CUT TWO 3/8 in.

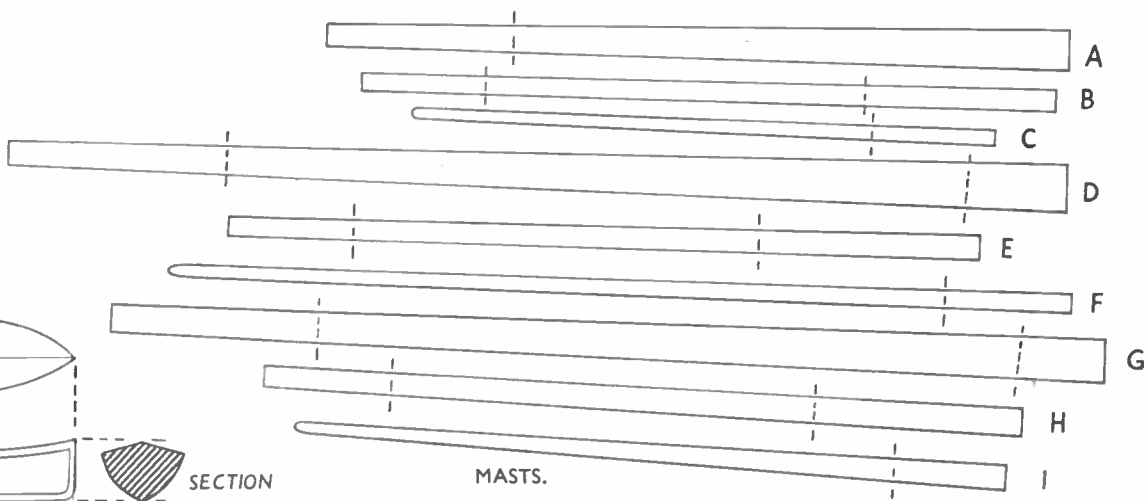

SHAPE SPARS AND MASTS FROM 1/4 in., 3/16 in. OR 1/8 in. ROUND ROD.

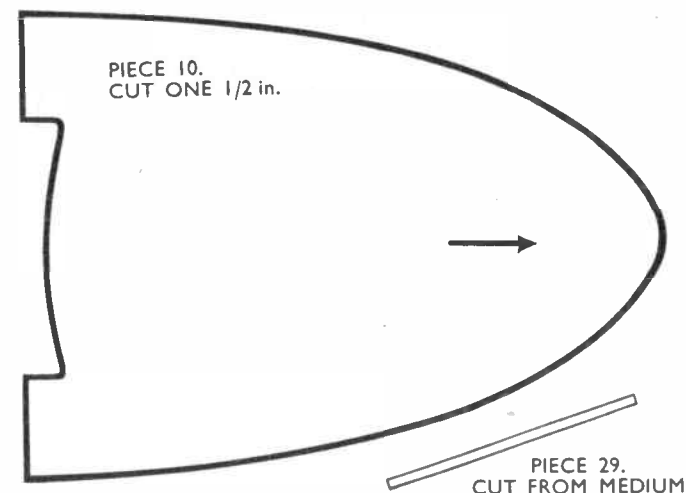

BOATS 21. MAKE FOUR FROM MEDIUM GAUGE WIRE.

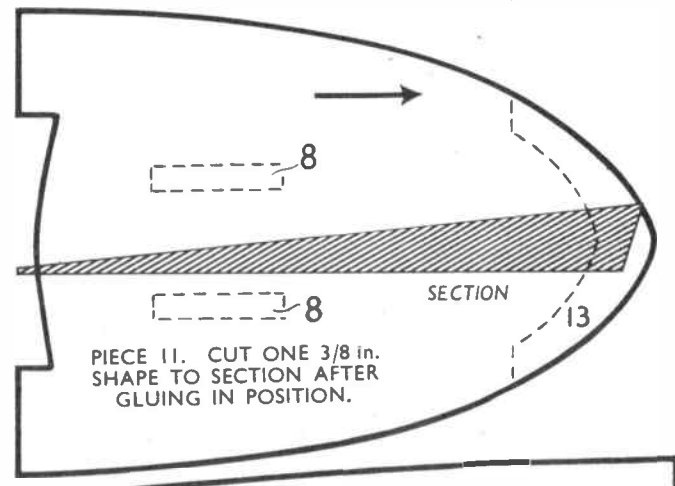
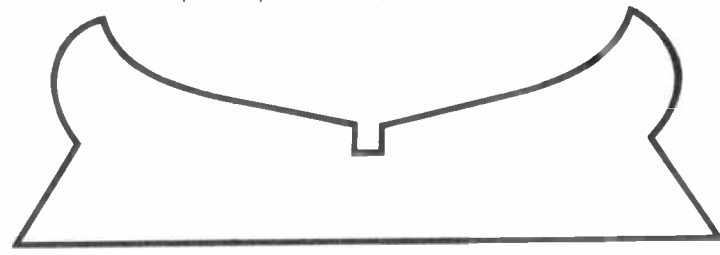
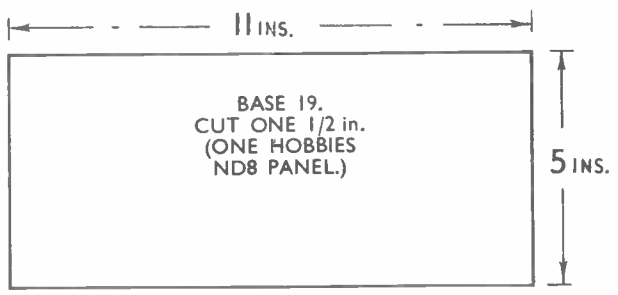

BULWARKS 12. CUT TWO FROM THIN CARD.

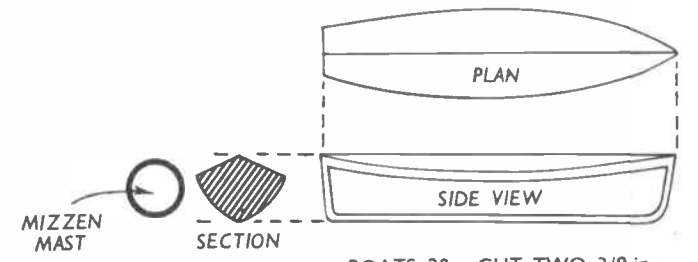
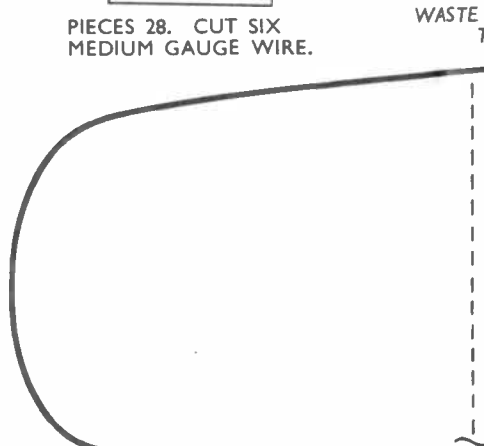
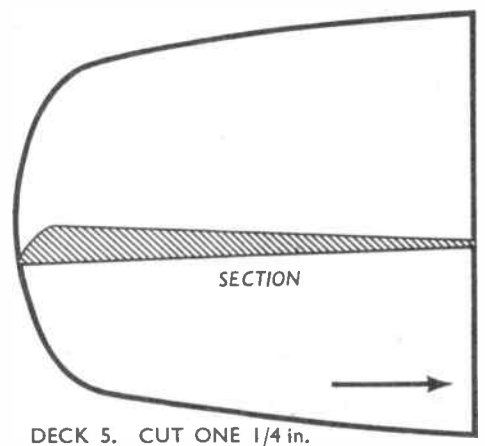
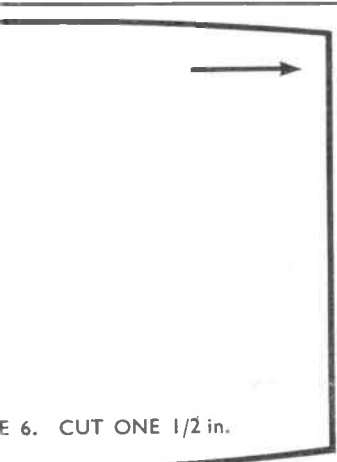

BOATS 20. CUT TWO 3/8 in. AND SHAPE.

Resin Glue

for all Model Making

- Mixed & use cold
- Waterproof type
- Gap-filling and non-staining



Obtainable in:
3½-oz., 7-oz.
and 18-oz. tins.

Stocked by: Ironmongers, Builders' Merchants, etc.

Manufactured by:

LEICESTER, LOVELL & CO. LTD. North Baddesley, Southampton

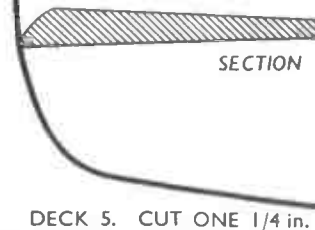
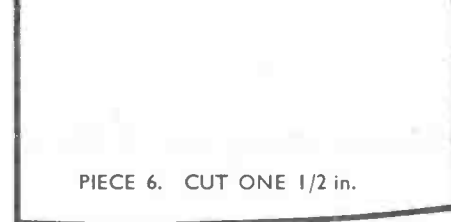

PIECES 30.
CUT TWO
FROM
MEDIUM
GAUGE
WIRE.



PIECES 17.
CUT TWO
FROM
THIN CARD.

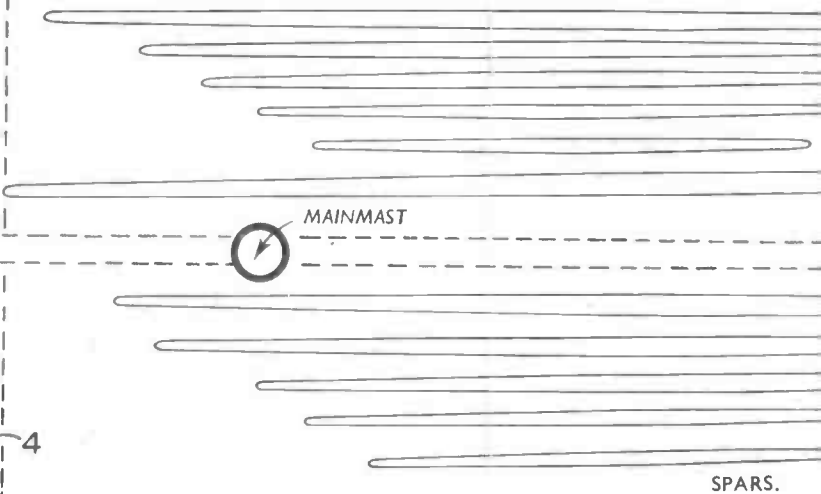

A KIT OF MATERIALS FOR MAKING THIS DESIGN
IS SUPPLIED BY HOBBIES LIMITED, DEREHAM, NORFOLK.
PRICE ON APPLICATION.



CHANNELS 24.
CUT TWO 1/8 in.

THE ARROWS
INDICATE DIRECTION
OF GRAIN OF WOOD.

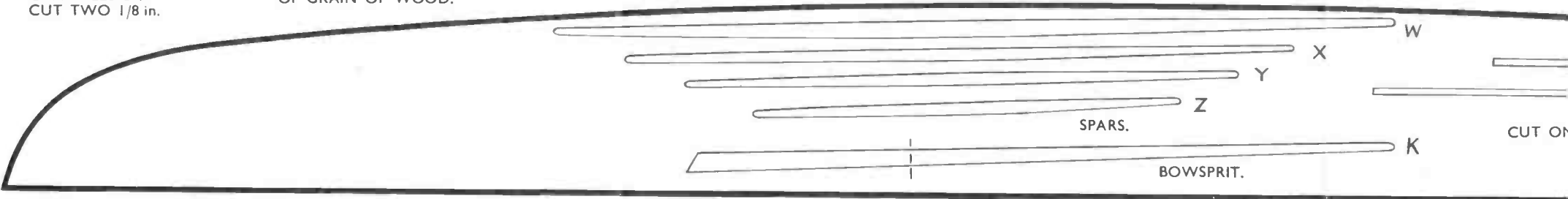

KEEL 1. CUT ONE 1/8 in. (MAY BE CUT IN TWO PIECES, JOINING AT X.)

HULL 2. CUT TWO 3/8 in. AND FOUR 1/2 in.

PIECES 31. CUT TWO

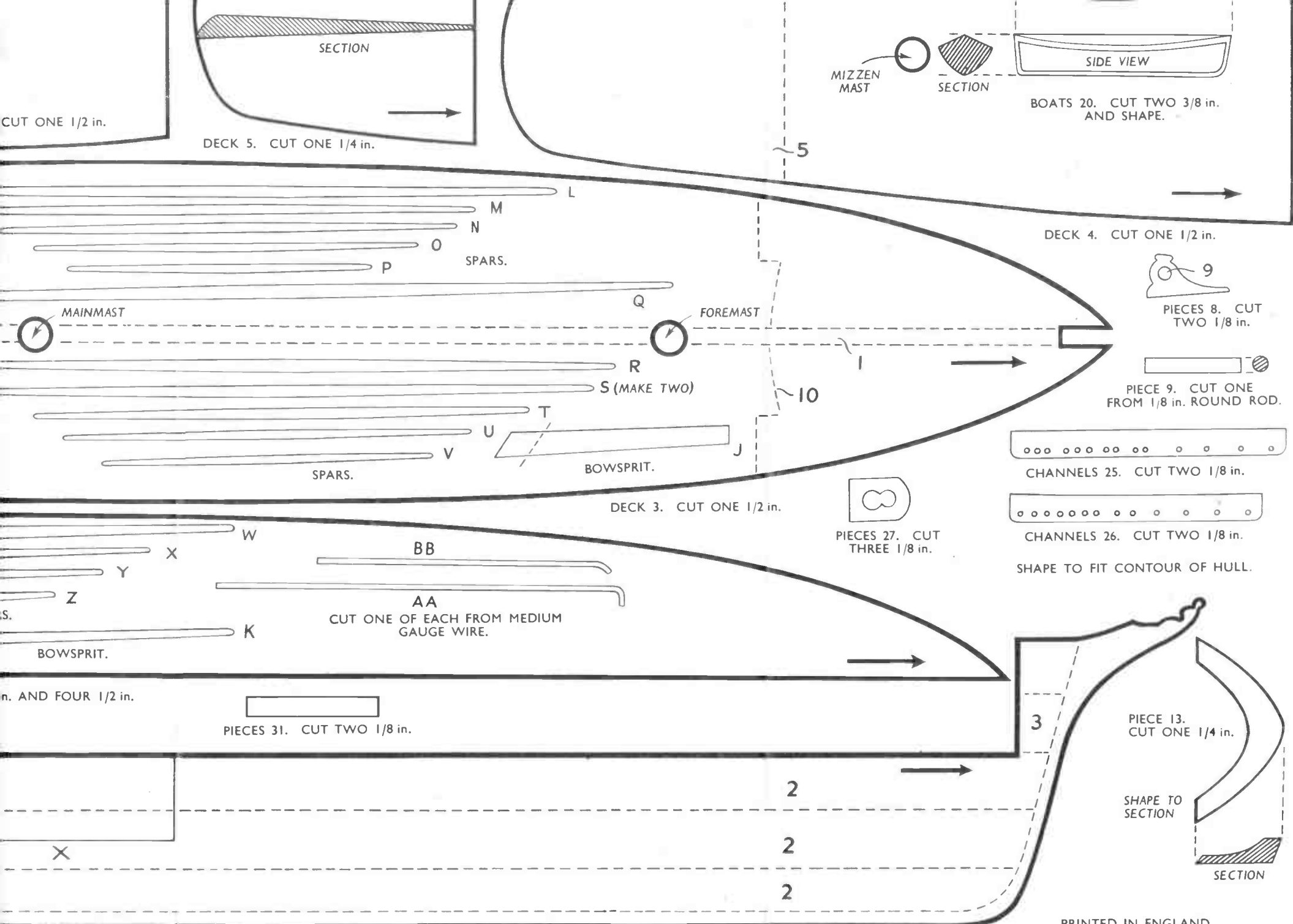

CUT ONE 1/2 in.

DECK 5. CUT ONE 1/4 in.



MIZZEN MAST

SECTION



SIDE VIEW

BOATS 20. CUT TWO 3/8 in. AND SHAPE.

5

DECK 4. CUT ONE 1/2 in.



9

PIECES 8. CUT TWO 1/8 in.



PIECE 9. CUT ONE FROM 1/8 in. ROUND ROD.

MAINMAST

FOREMAST

SPARS.

BOWSPRIT.

SPARS.

DECK 3. CUT ONE 1/2 in.



PIECES 27. CUT THREE 1/8 in.



CHANNELS 25. CUT TWO 1/8 in.

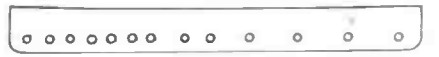

CHANNELS 26. CUT TWO 1/8 in.

SHAPE TO FIT CONTOUR OF HULL.

AA
CUT ONE OF EACH FROM MEDIUM GAUGE WIRE.

PIECES 31. CUT TWO 1/8 in.

PIECE 13. CUT ONE 1/4 in.

SHAPE TO SECTION

SECTION

PRINTED IN ENGLAND.