

HOBBIES WEEKLY

IN THIS ISSUE

	Page
A Small Cabinet -	257
Radio Valve Equivalents -	258
Science Experiments -	259
Electric Motor Drives -	260
Home Cine Troubles -	262
Cane Flower Pot Holder -	263
Open-Casting at Home -	264
Easily-made Photo Frame -	265
Useful Toast Rack -	265
Kitchen Plate Rack -	266
Try this New Line in Marquetry -	266
Listen to their Song in Winter -	268
Patterns for Useful Toast Rack -	271



FEBRUARY 1st 1956

VOL. 121

NUMBER 3144

★ *Ideal for the Lounge or Bedside*

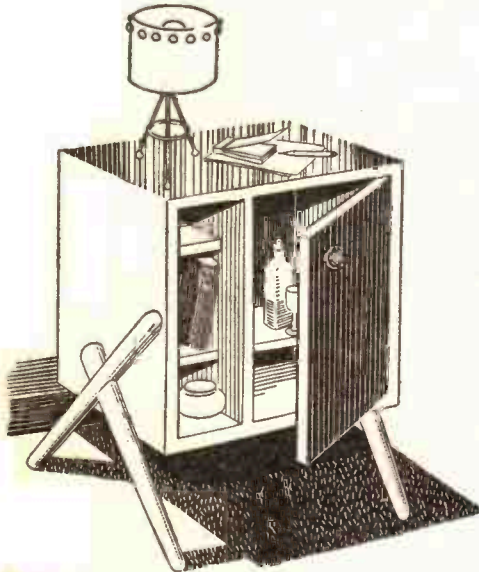

*Make it
from the
FREE
Design
inside*

the dowel joint illustrated on the design sheet, where also can be seen other methods of jointing. The worker will choose the method according to his capabilities. The joint at (B) is the most difficult kind to make, but it gives a much neater and more professional look to the article.

For the amateur, however, it is recommended that the dowelling method should be undertaken. With reasonable care this gives a very satisfactory and strong union.

It will be realised that if joints (A) or (B) are used in conjunction with Hobbies panels, the measurement of the sides will have to be reduced to give an

A SMALL CABINET

THIS small cabinet is a handy piece of furniture for any room in the house. Designed as a companion to Hobbies Design No. 3114, the contemporary cabinet for cocktails, etc., it can serve many useful purposes in the lounge. As a bedside cabinet it is ideal.

Cut out all the pieces of wood according to the measurements given on the design sheet. Notice that the shelf (5) runs through the two compartments and

is halved into the upright partition (4) as shown in the detail.

It will be noted that alternative joints are given for fixing the top, bottom and sides of the cabinet. If desired, the parts can be butted together for simplicity, and secured by pins or screws. In this case, of course, the holes would be filled with a suitable woodfiller before finishing.

The step further from the butt joint is

overall length of 17½ ins. in order to get them both out of Hobbies 36 ins. panels.

Clean up the bottom and top pieces (1 and 2) and sides (3) and plane them square and true. Then prepare them for dowelling. It will be seen that dowel holes must also be made to take pieces (5) and (6). The shelving (5 and 6) and partition (4) can now be prepared for dowelling in the same manner.

● **Continued on page 259**

All correspondence should be addressed to The Editor, Hobbies Weekly, Dereham, Norfolk

*For Modellers, Fretworkers
and Home Craftsmen*



PAGE 257

Radio Valve Equivalents

BECAUSE different manufacturers use their own numbering methods, valves of exactly similar type may be marked in dissimilar ways. The Services also developed various systems, so that a single valve may easily have half-a-dozen different code numberings. As a result, confusion is easy and in building or repairing a set a constructor may not know that he actually has a suitable valve to hand.

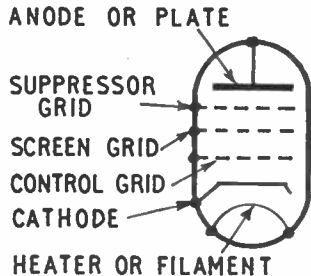

Fig. 1—A Pentode

It is convenient to know the electrodes, since a theoretical circuit can then be followed, or a valve readily wired in. A pentode is shown in Fig. 1. The heater or filament is between two pins, and lit by battery, transformer or mains-dropper circuit. If a voltmeter test shows no continuity between these pins, the valve is useless. No cathode is present in battery valves, electron emission being straight from the filament.

The control grid always goes to the tuned circuit, L.F. coupling, or other source of signal to be amplified. The screen grid goes to H.T. positive, often via a resistor to drop the voltage. The suppressor grid is usually wired to filament or cathode; in low-frequency valves this connection is often made inside the valve, when it will be shown as such. The anode goes to loud-speaker or other output circuit.

Screen Grid valves have no suppressor grid. In output types, such valves are known as Tetrodes. Any tetrode can replace any pentode of comparative type, in standard output circuits. Triodes only have filament, control grid and anode (plus cathode in mains valves). These three kinds, Triode, Screen Grid (or Tetrode) and Pentode are found in practically any receiver.

In mains sets a rectifier may be found, and will have heater or cathode, and one or two anodes. Old battery sets of powerful type may have push-pull output valves—these are two triode or pentode assemblies in a single glass bulb. Superhets will have a double-

diode-triode. This is a triode with two small extra anodes or diodes. Finally there is the frequency-changer, complicated in appearance, but really consisting of two valves, such as a triode and pentode, in a single bulb.

Valve makers take care not to use numberings which would indicate a different valve by another manufacturer. Because of this there is no need to indicate the maker's name. For example, the Brimar 1T4, Mullard DF91, Mazda 1F3 and Osram W17 are all the same, but it is only necessary to say that the 1T4, DF91, 1F3 and W17 are equivalents. Similarly, there are Army Receiving, Navy Receiving, R.A.F. and Common Valve Service numbers, marked AR, NR, RAF/VR and CV. (The Common Valve numberings was an attempt to produce some kind of order in Service numbers.) For example, all the following refer to the same valve—VR22, NR42, AR6 and CV1304. This happens to be a popular 2-volt triode L.F. valve. Its commercial equivalents are—LP2, P220, K30G, PM2A, 220PA. Any of these nine valves could thus replace the others in a circuit.

A large number of modern valves of octal type end with 'G' or 'GT'. This only shows a Glass or Glass Tubular bulb. For example, a 6V6, 6V6G, and 6V6GT are all the same, except for the bulb size. Any could replace the others unless space is very cramped.

Before considering other types, the valve bases in Fig. 2 should be studied. As is usual, pins are shown as if the valve (or holder) is being looked at

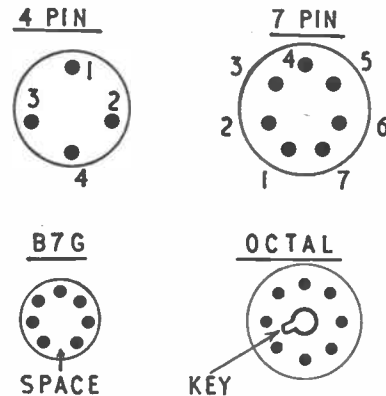

Fig. 2—Most-used bases

from the underside. The 4-pin English base was used for years for 2-volt valves, and still exists. The 7-pin English base is also often found. The B7G, or 7-pin Glass type is employed for miniature valves, while the Octal type is among the most widely-used of all. Pins of the B7G valves are counted clockwise from the space; those of Octal valves are similarly counted from the key-way. (F.G.R.)

Keep this list of valve equivalents, connections and types, for future reference

POPULAR OLD 2-VOLT TYPES
 LP2, as given. Detector: HL2, PM1HL, K30C, 210HF, CV1303, AR4.

Amplifier: LP2, also 210LF, L210, PM1LF, K30B, L210, CV1307, AR9, VR21.

Triode Output: PM2A, K30G, P220, 220PA, CV3620.

Pins: 1, Anode; 2 and 3, Filament; 4, Grid. Pentode Output: PM22A, K70B, PEN220, KT2, PT2, 220PT, 220HPT, CV3647.

Pins: 1 to 4, as for Triodes; Centre pin, Screen Grid.

Screen Grid Valves: VP215, VP210, SP215, SP210, SP2, CV1028.

R.F. Pentodes: 210VPT, VP21, W21, Z21, CV1332, ARP13, NR41, VR83.

Pins of both types: 1, Screen Grid, 2 and 3, Filament; 4, Control Grid; Top Cap, Anode.

ALL-DRY MINIATURES

1T4, DF91, 1F3, W17. Pins: 1, Filament Negative; 2, Anode; 3, S.G.; 4, unused; 5, wired to 1; 6, Control Grid; 7, Filament Positive.

1S5, DAF91, 1FD9, ZD17. Pins: 1, Filament Negative; 2, unused; 3, Diode; 4, S.G.; 5, Anode; 6, Grid; 7, Filament Positive.

1S4, DL91. Output: 1 and 5, Filament Negative; 2 and 6, Anode; 3, Control Grid; 4, S.G.; 7, Filament Positive.

3S4, DL92, 1P10, as for 1S4 except 3 V filament. Pins: 1, Filament Negative; 5, Centre-tap; 7, Filament Positive. Must have filament sections wired in parallel for 1-4 V.

POPULAR OCTALS

6K7, EF39, KTW63. Pins: 2 and 7, Heater; 3, Anode; 4, S.G.; 5, Suppressor Grid; 8, Cathode; 1, Metal Shell, when present; Top Cap, Control Grid.

6J7, Z63, KTZ63. Pins as for 6K7. 6V6 output. Pins: 2 and 7, Heater; 3, Anode; 4, S.G.; 5, Control Grid; 8, Cathode.

6X5, EZ35, U70, Rectifier. Pins: 2 and 7, Heater; 3, Anode; 5, Anode; 8, Cathode.

6K8, ECH35, X65, Frequency Changer. Pins: 1, Shell; 2 and 7, Heater; 3, Anode; 4, S.G.; 5, Triode Grid; 6, Triode Anode; 8, Cathode; Top Cap, Control Grid.

7-PIN ENGLISH

7A2, AC/PEN, PEN4VA, MKT4, A70B, MP/PEN. Output Pentode. Pins: 1 and 7, Filament; 2, Cathode; 3, Anode; 5, Control Grid; 6, S.G.

8D2, same as 6J7, but pins are: 1 and 7, Heater; 2, Cathode; 3, S.G.; 5, Anode; 6, Suppressor Grid; Top Cap, Control Grid. SP13C, C50B and 13SPA are equivalents.

OTHER POPULAR EQUIVALENTS

6Q7—EBC33, DH63. 5Z4—U50, GZ30. 1N5—DF33, Z14. 1CS—DL35, N14. 9D2—VP13C, VP1322.

In all, these valves probably constitute over 75% of those used in all home-constructed equipment, and they are also much used by receiver and amplifier manufacturers.

SCIENCE EXPERIMENTS

Why Water Pipes Burst

Required:—Bottle; pieces of cork; glass tube.

HALF fill the bottle (Fig. 5) with small pieces of ice and then completely fill it with water, so that when the cork and glass tube are pushed into the neck of the bottle, the water rises well up the glass tube. Mark the position of the water level in the glass tube by using a paper indicator. Allow the bottle to stand in a warm place and note what happens as the ice melts.

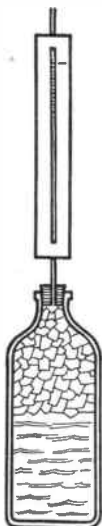

Fig. 5

When all the ice has melted there is considerable contraction in volume before the water begins to increase in volume, as it warms up the temperature of the air surrounding the bottle. Eleven volumes of ice become ten volumes of water.

In the next experiment you will investigate the great force exerted when water changes into ice, and the volume change takes place in the reverse direction from liquid to solid.

Smashing the Bottle

Required:—Strong glass bottle with screw cap; ice; salt; small wooden box.

FILL the glass bottle (Fig. 6) completely with water and screw on the cap, taking care that no air is trapped above the water.

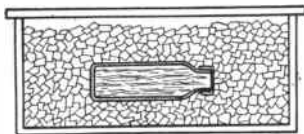

Fig. 6

Place a layer of small pieces of ice on the bottom of the wooden box and lay the bottle of water on the ice. Cover the bottle with similar pieces of ice and scatter a little common salt over the ice. A mixture of ice and common salt will produce a temperature as low as -22°C . and this will rapidly freeze the water in the bottle. Place a piece of wood over the box to prevent accidents from flying

glass. Leave the box in a sink, so that any water from the melting ice may drain away. In a short time you will hear a loud crack as the bottle bursts and you will find it shattered.

You may be able to obtain an iron bottle with a screw-top for this experiment. These bottles can be burst in this way just as easily.

It is, therefore, obvious that if we wish to prevent the water in pipes from freezing and thus increasing in volume and bursting the pipes, we must prevent this water from losing heat to surrounding ice-cold air. In other words we must clothe them as we clothe ourselves, and the next experiment shows how effective this is.

Loss of Heat

Required:—Two cylindrical tins of equal size with lids having small holes in them; cotton wool; cotton; two thermometers.

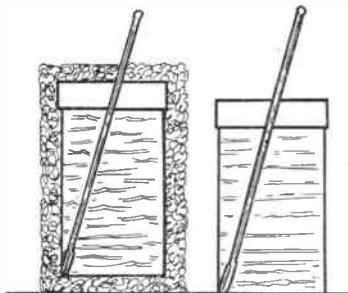

Fig. 7

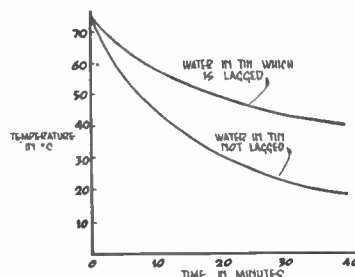

Fig. 8

WRAP some cotton wool loosely round one of the tins (Fig. 7) and fix it in position with cotton. Pour equal quantities of hot water into each tin, replace the lids and place the thermometers through the holes in the lids.

Read the temperatures indicated by the thermometers at intervals of one minute and note them down. Make graphs of the rate of cooling in both tins and from the steeper curve (Fig. 8) you will see that the water in the tin which is not wrapped, or lagged, as we say, loses heat much more rapidly to the surrounding air.

Further experiments on this theme will be described in a future issue of 'Hobbies Weekly'. Order a regular copy from your newsagent and be sure of enjoying all the exciting articles which are in store.

● Continued from page 257

A Small Cabinet

The back consists of three pieces (7), glued and dowelled together and planed down to an overall depth of $17\frac{1}{2}$ ins. This section forms the complete back which goes between the two ends. The length of the back is, therefore, 15 ins.

To assemble, put together the shelving and partitions, back, ends and top and bottom in that order. In all cases, use glue to secure in addition to the dowelling.

The legs are made as shown on the design sheet, being halved and glued together. These legs will come out of the spare wood from the shelving panel if Hobbies materials are being used. About four countersunk screws will hold the legs securely to the sides.

The door should be made up as shown in the detail on the design sheet. It is of $\frac{1}{2}$ in. wood with $\frac{1}{2}$ in. wood battens

glued and screwed in place for strengthening. After recessing for the hinges, fix the door as shown. Two small blocks are glued in the positions indicated to act

Buy a Kit

Kit No. 3144 contains all the wood and accessories needed to make this delightful cabinet. From branches or Hobbies Ltd, Dereham, Norfolk, price 73/- post free.

as door stops, and a ball catch for fastening can also be added if required.

Before the addition of the handle, finish off the woodwork as required. This can be by staining and polishing, or by merely rubbing with linseed oil and wax polishing. In both cases the grain will have to be filled with a proprietary brand of woodfiller.

ELECTRIC MOTOR DRIVES

WHERE high-speed performance is not required, an electrical motor is the ideal power plant for a power boat. Installation is generally reasonably straightforward, but there are a number of basic factors to be considered as affecting the future running of the model.

There are three main ways of aligning motor and propeller shaft. The stern

is operating at a speed very much below that at which it develops maximum efficiency.

With most miniature electric motors of this size, torque is roughly proportional to the current. Thus at lower speeds we get higher torque from the motor at the expense of a higher current drain, and vice versa, the overall conditions at either point being

It is not necessary to resort to gearing to get this reduction drive. Simple belt drive systems work quite well on small models, using two pulleys of widely different diameters connected with a rubber band as the belt (F). The band should not be excessively tight, just tight enough to prevent slip. By taking off a double belt drive a single motor can be used to drive twin screws (G), although to get opposite hand rotation of these screws one of the bands would have to be crossed. A particular advantage of a twin drive is that it takes side loads off the motor spindle but, of course, only one half of the available torque is transmitted to each shaft (less transmission losses).

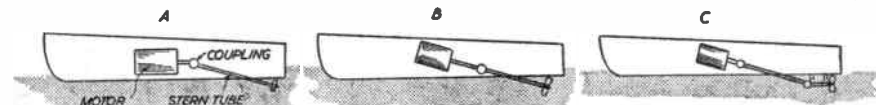

tube and propeller shaft is nearly always raked down at an angle. If the motor is mounted horizontally in the hull (A)—usually the simplest and most direct method—some form of flexible coupling is necessary between motor and propeller shaft. If motor and shaft are in

similar, in theory. But apart from the fact that in practice the efficiency of such motors is lower at low speeds, operating the motor in a region of high current drain is poor practice. For one thing it gives a greater demand on the battery, and for another brush wear is considerably increased, especially in motors with metal brushes.

Thus it is better practice to operate the motor through a reduction gear as in (E) instead of (D), improving both brush and battery life and working at a higher motor efficiency. There is also less danger of stalling the motor completely since the margin between working torque and available maximum torque (when stalled) is much higher.

Flexible Couplings

Flexible couplings, or universal joints as they are sometimes called, present few problems with small, low-powered models. It is quite easy to crank the end of the drive shaft (H) to engage a similar cranked end on the propeller shaft (J). The minimum crank angle in each case should be 35 degrees, although the optimum angle will depend on the difference in alignment of the two shafts.

It is important that both cranks be quite smooth, since their motion is that

By R. H. Warring

exact alignment a fixed coupling could be used (B), but since exact alignment is tedious to achieve, here again it usually pays to employ some form of flexible coupling. The installation will be that little bit more efficient, however, because the coupling does not have to operate through any definite angle.

A further alternative is shown in (C) where the propeller shaft is brought out horizontal to avoid any upthrust on the hull. Either of the systems (A) or (B) do, in fact, produce a nose-down force when the propeller is driving, usually cancelled out in practice by the tendency for most hulls to nose up when driven through the water.

Most Efficient Drive

Layout (C) gives the most efficient drive and may be advantageous where the trim of the hull is critical, but this really only applies to high-speed work. Thus it is a fact that some high-speed planning hulls perform best with horizontal thrust, but this can be considered unnecessary on any displacement type of hull—which covers the complete range of electric-powered model boats.

Nearly all model electric motors run at quite high speed when lightly loaded. With some the free running speed is as high as 10,000 r.p.m. Coupled direct to a marine propeller, speed is dragged down to a very low figure when the boat is in the water, with the result that the motor

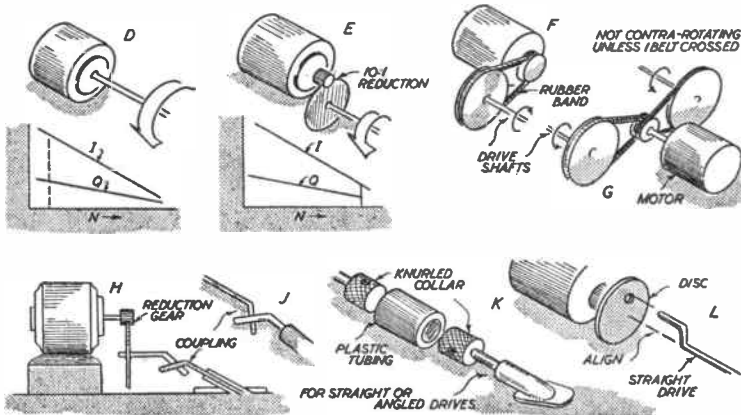

And since even relatively crude gears are quite efficient mechanically, the same high torque as before can be produced (at a much lower speed) through the reduction gearing. Thus everything is in favour of a geared-down drive rather than a straight drive. Where the free running speed of the motor is of the order of 8,000 to 10,000 r.p.m., a suitable reduction ratio would be 10:1.

of sliding, one over the other. By careful positioning they can be used to drive through angles of up to 30 degrees, although the smaller the angle the higher the efficiency of the transmission. There will come a critical angle, depending on the bend angles and the workmanship of the assembly, where the two shafts will tend to bind and lock at certain positions. It is as well to

check this by experiment and then adopt a final angle at least 10 degrees less than this.

A more positive job of flexible coupling is done by fitting knurled collars to each shaft and connecting with a short length of stiff plastic or rubber tubing (K). Again such a coupling can work through quite high angles, although it is

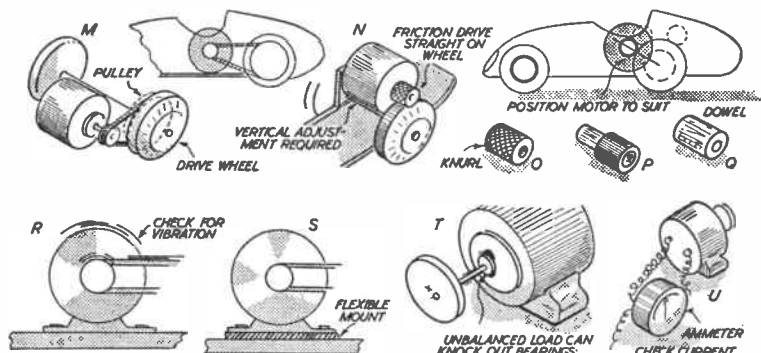

most efficient straight. It pays to increase the length of the tubing with increasing angle of drive, provided it does not become so long that the tubing develops a definite helical twist under load.

So effective is this form of coupling that it can be used to transmit the power from internal combustion engines operating at 15,000 r.p.m. or more to a screw shaft. It is certainly more than adequate for all electric motor power transmission requirements as regards durability and consistency. Standard couplings of this type are available commercially and save the bother of making them up. But basically they are so simple that they can readily be fashioned from scrap materials.

Positive Drive

Another very simple form of coupling suitable for 'straight' drives is that shown in (L). The motor shaft is fitted with a metal or fibre disc, in which is drilled a hole. The end of the propeller shaft is cranked to engage in this hole and the drive is positive with enough fore and aft movement to take care of quite appreciable misalignment, if necessary. This is a particularly good method if, for any reason (e.g., for smooth running) the motor is to be fitted with a flywheel. The flywheel in this case becomes the disc of the coupling.

A final word about the other end of the propeller shaft. Since the thrust is forwards or up the stern tube, provision should be made at the propeller end to take care of this thrust rather than let the boss of the propeller ride up against the end of the stern tube of the whole shaft to have a considerable 'float'. Another 'marine' problem is what is the best material for the propeller shaft. Steel wire shafts running in

brass stern tubes is common practice and some commercial shafts are flash copper plated to improve their corrosion resistance. Neither are particularly satisfactory for continuous operation in salt water, however. Failing bronze wire for the shaft, or some similar non-rusting metal, provision for withdrawing the shaft periodically for cleaning is good

can be altered. Wear on the tyre is quite appreciable, so that after a period of operating, the drive will slip, calling for readjustment. Rubber-tyred wheels, too, are necessary for good traction and no-slip drive, the friction drive itself being a brass collar suitably knurled (O).

This particular drive described worked so well when first tried, that other types of collars were tried to see just how crude the system could become and still work. A plain collar with a tightly fitting rubber sleeve (P) worked as well, whilst even a plain length of dowel forced on to the motor shaft gave reasonable results (Q). The latter would have been improved by fitting with a rubber sleeve.

Eliminating Vibration

There are few problems associated with stationary mounting of electric motors. When a motor is bolted down to a baseboard it sometimes happens, however, that it is extremely noisy.

The cause is nearly always bad vibration. Model motor armatures are not accurately balanced, and so every motor will tend to vibrate when running, and the higher the speed of operation, the more noticeable this effect. Lower operating speeds are, therefore, preferred. Check also that the driven load is reasonably balanced; or if vibration persists, try a flexible mount by sandwiching sheet rubber between the motor mounting lugs and the baseboard (S).

On small motors in particular a badly unbalanced load driven for any period at high speeds can knock out the bearings and quickly ruin the motor. This is particularly true of motors with thermo-plastic mouldings, for the casing, the bearings being metal bushes pressed into the ends of the casing. Whilst the bushings may remain a close fit on the shaft, it is quite common to have these work loose in the casing itself to the extent that a quite fantastic end play soon develops on the shaft.

It is strongly recommended that to get the best out of any electric motor it should be operated at recommended optimum conditions, which can largely be boiled down to operating at optimum current drain. Temporary installation of an ammeter in the motor circuit is, therefore, good practice, both after initial installation and for periodic checks.

Finally a word about another sort of trouble—radio and television interference. Some small motors are free from this (mainly split field series wound types), others are notoriously bad. In many cases a complete cure can be effected (on D.C. motors, at least), by connecting a .01 microfarad condenser straight across the two terminals. Performance is not affected and the small cost of such miniature condensers (about one shilling from any radio stores) is well worth a try out, at least.

design practice. Otherwise the best that can be done is to keep the shaft extremely well lubricated and make it initially a fairly loose running fit in the stern tube bearings.

Rust quickly results in an appreciable dimensional increase and consequent seizure with small clearances. Provided this seizure is only light, the rust can be broken down by turning the shaft. Strong rusting up calls for more drastic action, such as flooding the stern tube with penetrating oil and a rust-solvent, such as Plus Gas Formula A.

Electric drives for other moving models present different problems. Battery size limits the size of a model car, for instance, which can be made as a self-contained unit. Since this normally results in a fair size of car, and a reasonably complicated model, geared drives are to be preferred. To squeeze in a motor in a small car model fed from an external battery (e.g., operating on a rail track), simplified drives may be preferred.

A pulley drive (M) will work quite well, if carefully installed, but is not as satisfactory as a straight friction drive on to one of the wheels (N). About the only advantage of the former is that it can be completely enclosed, whereas the drive pulley in (N) may have to protrude through the side of the body.

Negligible Slip

With friction drive straight on to the wheel a step-down gear ratio is achieved (which is necessary for similar reasons to those previously described) and, provided the contact pressure is correctly adjusted, slip is negligible. It is very necessary, however, to be able to adjust the position of the motor in a radial (up and down) sense, so that this pressure

HOME CINE TROUBLES

By H. A. Robinson

FAULTS that spoil home cine shows can sometimes be very mystifying to the beginner. Here are some of the troubles that may arise, their cause, and how to cure them.

Weak-looking picture. Often due to the screen being too near some very light area, as when the screen comes close up under the ceiling in a small room (Fig. 1). The light from the picture shines on this area and then is reflected back in a diffused state, thus weakening the blacks and making the whole projection look wishy-washy. The cure is to drape the offending area with something dark or so reset the screen that it has a complete surround of blackness. Generally speaking the best projection is always secured in a dark-toned room.

Hazy picture not due to reflections. The trouble here is a dirty lens. If a projector has been lying by for some time the lens glasses get filmed over and smeary. This must be remedied by wiping the lens with a soft cloth that has

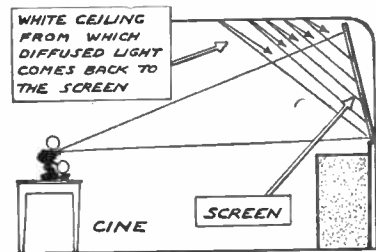

Fig. 1

been dipped in methylated spirits. Chamois leather that has been well softened up is an excellent cleaning material. On no account must anything hard be used for the wiping, or the glass will develop minute scratches which can destroy fine definition in the screen picture.

Rough edges to the picture. The mountain-like and unsightly projections that sometimes appear round the perimeter of the picture are really fluff, etc., that has collected in the gate. The mask here should be well cleaned out with a camel hair brush and the 'mountains' will disappear.

Occasional flashes of white on the screen. This means that you have scraped off too much emulsion when making splices. The only cure is to search out the offending joints, break them and remake with a shorter cleaned-off area. Only the actual area that is to be covered with cement need be scraped clean of emulsion.

Areas of very poor definition. These are given by the screen not being tightly stretched and bulging in places. The cure is to tighten up, so that a perfectly flat surface is produced.

Uneven illumination. Here the lamp has got out of position. If a dark area is at the bottom, the lamp is too low, while if the dark patch is at the top, the lamp is too high. Should a cloudy area appear in the middle, then the lamp is too near or too far back from its correct position.

Now some mechanical faults that can take place in the picture itself. It is

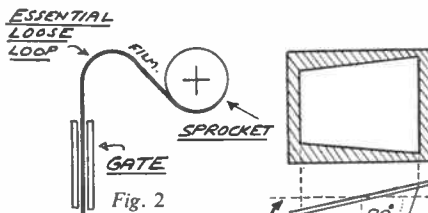

Fig. 2

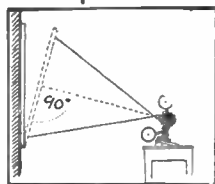

Fig. 4

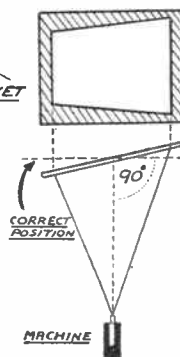

Fig. 3

stopping. This comes about when sprocket holes have become broken. Cut out the bad lengths and rejoin. Sprocket holes can be patched so as to do their work, but unless the few pictures concerned are very important, it is better to cut and rejoin.

(3) **Continuous jumping**, and a sense of heavy going. This is caused by the loss of the 'top loop', or by having threaded-up with a much too small top loop. In threading, the film comes from the top sprocket roller and then arches loosely before entering the gate (Fig. 2), which ensures that there is always enough film to allow for the next downward drag of the claw. If this top loop is too small, if only slightly, the downward drag just tightens the film up and causes the jerking. This trouble can damage a film badly, for it imposes a too great strain on the sprocket holes, the claw tearing at them instead of merely pulling the film down. The loss of the top loop can be through too tight threading to start with, or it can be gradually lost through occasional slipping. If in any doubt, always stop and check for a good top loop.

Ghost Image

Another fault that can appear in the picture itself is the *ghost image*. Here the light areas of the scene all seem to have a dragged down and elongated look. It is due to the shutter having become badly timed. The film passes through the gate with a stop-start action, becoming absolutely stationary for a brief space of time at each frame. The downward movement to the next frame is hidden from the eye by the shutter momentarily plunging the screen in darkness.

'Ghost' is caused by the shutter closing just a shade too late, and allowing the eye to see a little of the downward motion. The cure lies in setting the shutter to close a trifle earlier. Adjustment can be effected by trial and error, but the point to bear in mind is that the shutter blade must be positioned to cut off all light the smallest fraction of time before the film starts to descend.

And here is another picture trouble, the one where it *looks smaller at one side*. Or, perhaps, it looks bigger at the top than the bottom, or vice versa. In all cases the fault is that the screen is not at a true 90 degrees to a line from the cine (Figs. 3 and 4). If a side looks smaller, rectify by taking the screen at that side outward a little (Fig. 3). If the bottom is too small it generally means that the machine has been pointed too

● Continued on page 263

important that you should be able to identify them.

First a *jumping or jerky picture*. Distinction must be made between pictures which jump as a whole and those that jump inside their frame, the frame itself remaining stationary. Pictures that jump as a whole mean that the projector is not on a rock-steady support or that the lens tube is loose. A picture that shakes within the frame means that the trouble is in the mechanism of the cine. The first kind of shakiness can be dealt with in whatever is the most obvious way to secure rigidity in the stand, but jumping within the frame may come from any one of several causes.

(1) **An occasional jump.** This is without doubt due to having made your splices too thick. The only real cure is to break the splices when time permits, scrape them down and remake thinner, keeping them under good pressure as the cement dries out.

(2) **Jumping with a sense of action**

Cane Flower Pot Holder

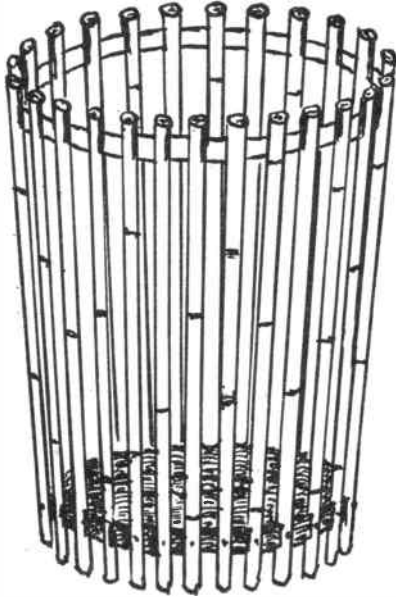

For this plant holder quite thin canes can be used, those between $\frac{1}{4}$ in. and $\frac{3}{8}$ in. being most suitable. As the size of the holder is increased, so must both the canes and baseboard be thicker in proportion.

The canes are all cut to exactly 6 ins. long and you will need 25 of these. A notch is cut half way through the cane near the end of each as shown in the diagram. Make the notch $\frac{3}{8}$ in. wide to

By A. F. Taylor

fit into the baseboard tightly and about $\frac{3}{8}$ in. from the end of the cane. A fretsaw will make a neat job of this. Drill a small hole in the centre of the notch, so that the cane can be fixed to the baseboard with a fine panel pin.

The other end of the cane is slotted, so that a metal band can be slipped in to hold the canes in position at the top of the stand. It should be sufficient if the slot is cut about $\frac{3}{8}$ in. deep and the width will depend on the type of band used. An ordinary hacksaw blade will usually be found just right to make this slot.

Various metals may be used for the band—brass, copper or even tinplate being quite suitable. About 18 ins. of $\frac{3}{8}$ in. to $\frac{1}{2}$ in. material will allow the ends to overlap about $\frac{1}{2}$ in., and these are secured with a rivet, or they may be soldered.

The canes are first secured to the base, and if the slots were cut exactly, a panel pin through each will hold them tight, but a spot of glue can be applied for extra security if needed. Next slip the

band in the slots at the top and push down as far as it will go. This can be secured in several ways, the easiest being to glue wooden plugs into some or all of the canes, and finish off flush when dry.

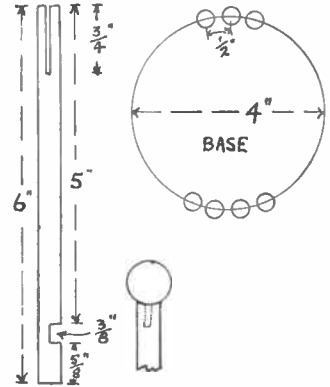

If you possess a lathe, plain or ornamental balls with a short stem can be turned and glued in. Another method is to plug some of the holes, and then cut a narrow ring of ply about $\frac{1}{2}$ in. to $\frac{3}{4}$ in. wide and glue on top.

The canes may be left in their natural state and given a coat of varnish to preserve them from damp, but they would look much more attractive if given two coats of gay cellulose or enamel. A tin lid which will just fit in the bottom of the holder is an advantage, as it will keep the drainage from the pot away from the woodwork.

Provided the metal band in the top is stout enough, wire or chain may be attached and the holder hung up with a trailing plant draping over the sides.

BAMBOO cane work is one of those Victorian crafts which, after a lapse of popularity is coming into its own again. In those olden times many useful articles were made of this material, especially of furniture such as chairs and occasional tables.

Today, on account of the attractive finishes which can be given to it in the form of cellulose and enamels, bamboo craft is being practised by increasing numbers of handymen. A little inspection of existing articles will show the ease with which it can be worked and turned to useful account for the adornment of our homes.

Variety of Designs

The flower pot holder can be made in a variety of sizes, as well as in numerous designs to suit individual tastes. This article shows you how to make a plain circular stand in what is probably the most popular plant size to take a 4 $\frac{1}{2}$ ins. pot.

Choose good quality clean straight cane and if carefully made it will stand quite rough treatment and last a long time. If it becomes at all shabby, a new coat of enamel will soon give it a new lease of life.

Cut a base of hardwood 4 ins. diameter and $\frac{3}{8}$ in. thick, and set out round the circumference 25 equal parts at a distance of $\frac{1}{2}$ in. between each. These will mark the positions at which the canes are to be fixed.

Continued from page 262

Curing Home Cine Troubles

sharply upwards to get everything in, and that the screen is not at 90 degrees in the vertical plane. Should it be impossible to put the machine at a higher level, then the screen must be tilted forward (Fig. 4) till the picture becomes a true rectangle. It is seldom that the reverse trouble takes place, but if it did, the reverse remedy would have to be employed.

Now for one last trouble you may find, this time again mechanical. It is when

the film keeps snapping below the gate. Here the trouble is in the bottom 'take up'. This has to feed the film on to the lower spool at a varying rate as the diameter of the film on the spool gets greater. It is done by a slip-friction arrangement and breakages mean that there is not sufficient slip in the bottom spool, thus a too great pull is put on the film. The cure lies in adjusting the 'take up' so that it just winds on the film without any marked pull being exerted.

Simple and cheap

OPEN-CASTING AT HOME

IN this article the emphasis will be on simplicity and cheapness, especially the latter, so none of the equipment described is very elaborate and can mostly be obtained or made without cost. Even so, quite a high quality finished article will be the result if a certain amount of care is taken.

The requirements for home-casting are: a flat baseboard known as the 'ramming-board'; a wooden box up to

removal from the moulding-sand. This applies equally to home-made wooden patterns.

In foundries it is usual for a mould to be made of two parts, the upper part known as a 'cope' and the lower or 'drag'. In simple home casting, however, only one box, the latter, is used, which gives us the term 'open casting'.

To make the mould the box framework is placed on the ramming board to

over, so that the pattern may be gently removed, after this thoroughly dry the mould by playing the flame from a bunsen-burner on to the sand for about ten minutes.

As the melting point of lead is only 327°C., it can be easily melted on an ordinary gas ring. The same method can also be used for melting most alloys. When alloy or lead is quite liquid, i.e., easy to stir, hold the tin firmly with the



Fig. 1—Ramming down the moulding sand around the pattern which has been previously dusted with 'parting-powder'. The easily-made sprinkler in the foreground is for moistening the sand. Note strips of wood inside box

12ins. square and 4ins. deep, without a bottom (small strips of wood should be fixed on the inside to prevent the moulding sand from falling out when the mould is inverted); moulding sand, which is easily obtained from any foundry, together with the special 'parting-powder'. Before using to make a mould, the sand should be moistened, so that if a quantity is compressed in the fist it may be broken cleanly. This last point is extremely important, as it is virtually impossible to obtain a good mould with sand that is either too dry or too wet.

The only other items needed are the lead or alloy, which latter can usually be obtained from a garage in the form of scrap pistons, etc. The melting tin may be a large cocoa-tin or something similar. Grippers are used to hold the tin while pouring the molten lead or alloy into the mould. Lastly, a steel rod for stirring the melting alloy and some blocks of hardwood with which to ram down the sand round the pattern.

The pattern may be any small household article such as a tea-strainer rest or ashtray, or it may be made from a block of wood to your own design and painted with a high-gloss paint for a surface equal to that of a metal object. To be suitable for moulding, a pattern must have its sides sloping inwards for easy

form the 'drag'. The pattern is then placed on the ramming board and lightly dusted with the parting-powder to form a thin dry layer between the previously dampened sand and the pattern, so that they will not stick together. The moulding sand is placed around the pattern beginning at the edges of the box and working inwards, firmly ramming it down with the hardwood blocks until the box is completely filled. Level off the sand to the top of the box with a straight edge.

The 'drag' is now carefully turned

J. C. M. here describes how perfect castings can be made in your own kitchen by a very simple method.

grippers and pour it into the mould. It is essential that the mould be on a level surface and if possible, the molten lead or alloy should be poured on to a flat surface in the mould itself. Do not overfill the mould.

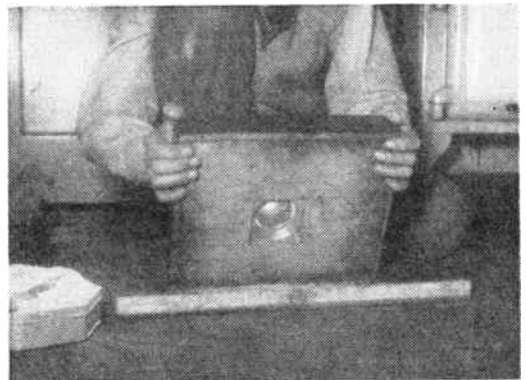

Fig. 2—Turning over the 'drag' so that pattern is uppermost

When the mould is completely filled, allow it to stand for 10 minutes without disturbing, after this, holes should be pierced around the casting to assist its cooling. A short while later the casting may be removed from the mould and put on one side to cool, but do not stand it on a cold surface, as there is still some danger of it cracking.

The casting, when quite cold, may be cleaned up with a small file, emery-cloth and metal polish. If a reasonable amount of care is taken with the process, perfect articles will result.

Cheap and practical

Easily-made Photo Frame

THE photo frame described here will take a post card size print and is of very simple construction. It looks well in any hardwood and can be made from scrap pieces left over from some bigger project. Made in mahogany and finished by french polishing, the results are quite pleasing.

a guide. During this operation keep the block well pressed against the side of the base. Note that the grooves are not continued on to the ends, but automatically run off to nothing at the beginning of the curve.

Glasspaper Well

Glasspaper all the pieces well before assembly. The uprights are secured to the base as shown in Fig. 1, using glue



*Described
by
I. J. Steele*

and 1½ ins. by No. 6 woodscrews (one per upright). The distance apart of the inside edges of the uprights should be 3¼ ins.

Take Care in Screwing

Drill a small hole or use a bradawl when starting the screw in the uprights and take care not to split the upright when driving the screw. It is advisable to assemble dry (i.e., without glue) in the first instance, then take to pieces, apply glue and reassemble.

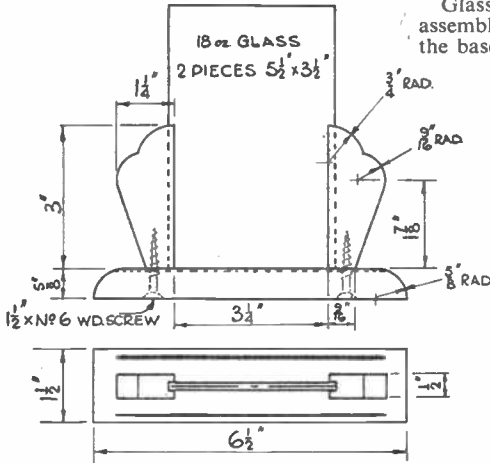

Fig. 1

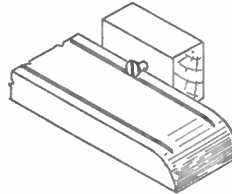

Fig. 2

The uprights are made from ½ in. thick wood. Draw out their shape (Fig. 1), using ruler and compasses, on to a piece of stiff cardboard. Cut out and use as a template for marking the shape on to the wood. Cut the wood to shape with a fretsaw and finish carefully with a smooth rasp and glasspaper. Time spent in getting a really smooth surface amply repays itself in the superior finish obtained when polishing.

Ensure Squareness

Form the groove for the glass by means of a tenon saw and chisel. The groove should be a full ½ in. deep and ⅜ in. wide if 18 ounce glass is used. Finally, make sure that the small end of the upright is quite square both to the face and the straight edge of the upright, as the truth of the final assembly depends on this.

The base is made from ¾ in. thick wood. Plane to size and round off the ends as shown again using a rasp and glasspaper to finish. Form the decorative grooves ⅜ in. from each edge by means of a woodscrew partly screwed into a block of wood as shown in Fig. 2. The head of the screw should project ⅜ in., and when rubbed up and down the base, it will score lines perfectly parallel to the edges, the screw head acting as a cutter and the wood block as

Useful Toast Rack

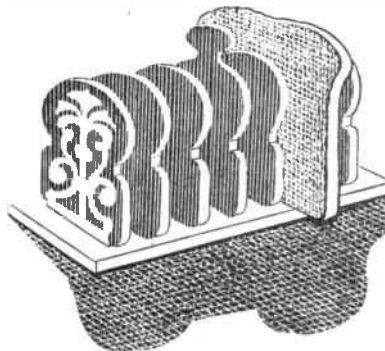

attention to the mortises in the base (piece A).

When tracing the parts you should transfer one of piece (B), six of piece (C) and two of the overlay (D), of which only half is shown. Note that (B) is the

Use your fretsaw

to cut out the

Patterns on page 271

THE small design shown on our pattern page is intended as an exercise in fretwork for the young beginner. It can easily be undertaken by boys of eleven and upwards. When polished or painted it makes a useful gift for mother, besides being good practice for fretcutting.

The main pieces are cut from ½ in. wood, well cleaned with glasspaper before assembling. Pay particular at-

same shape as (C) except for the knob on the top. Cut the overlays from ¼ in. or ⅜ in. wood and glue them on the end pieces (C).

To finish the rack, give several applications of clear lacquer or lightly stain and polish. Plastic enamel paint can be applied if preferred, and looks very well if a pastel shade is used. (M.p.)

Make it yourself

KITCHEN PLATE RACK

THERE are many small items such as the one shown here, which can save labour in the kitchen. Other articles we have in mind are a towel rail, saucepan rack and vegetable rack. These will be published in future issues of *Hobbies Weekly*.

The picture of the finished article shows that the plates are held upright by lengths of round rod let into the base. The distance apart of the rods can be varied between 1in. and 1½ins., but it will be more economical to keep to the larger measurement, because of the amount of round rod required.

Centre left open

The centre of the rack is left open to allow for drainage and to prevent warping. A hook of some kind may be fixed to one end to allow the rack to be hung up out of the way when not required.

Make the base from 2ins. by ½in. wood to the dimensions shown in Fig. 1. The ends are halved together and

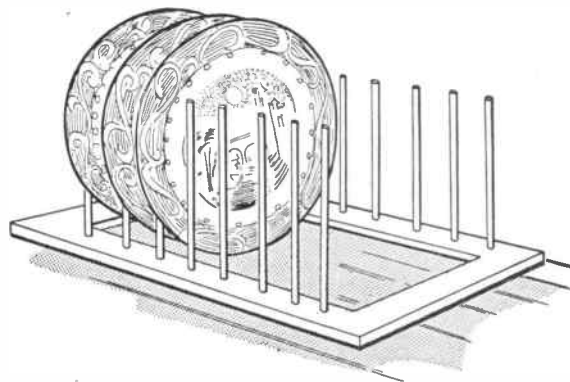

secured by countersunk screws, and the heads filled with plastic wood or putty. A detail of the halving joint is shown in Fig. 2.

First mark out the ends of the four pieces. The measurements are shown in Fig. 2. Cut away the waste wood with a

tenon saw, making sure that the saw kerf is on the waste side of the mark each time.

When the base has been prepared, paint the joints and assemble, driving the screws home to tighten up the joints while the paint is still wet.

Space dowels equally

The next step is to mark out the positions of the upright dowels. Space them out equally along the sides and bore holes in the positions marked. The uprights should be of ½in. diameter round rod about 10ins. long.

When the uprights have been glued in place, the whole assembly should be cleaned up and painted. Give at least four coats and make sure that each coat is dry before applying the next. If the rods are slightly loose and require glue, it is essential to use one which is waterproof. (M.h.)

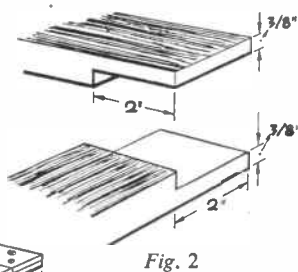
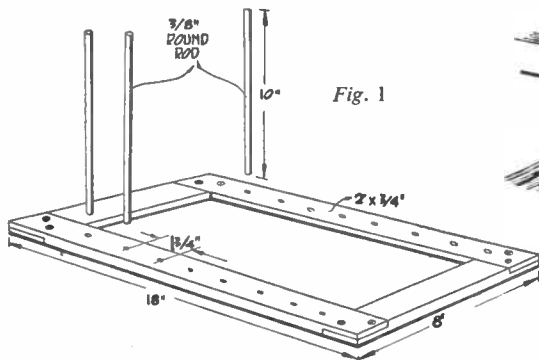

Try this new line in Marquetry

HERE is a new line in marquetry. Any map can be made in this medium. In the following instructions, the map of England has been taken as an example. The counties are cut out of contrasting veneers and mounted on a sheet of plywood.

A paper (not linen) map is required as a pattern. This should be about 12ins. by 8ins. The counties should be clearly defined in contrasting colours. An old school atlas should contain the very thing.

Cut round the coastline with a pair of scissors, leaving about a ¼in. of 'sea'. Dissect the map along the county boundaries with a razor blade. Cut out the Isle of Man, Isle of Wight and small portions of Scotland, Ireland and France

depicted in white.

Sort the counties into colours. There are normally five: red, yellow, brown, green and purple. Select six contrasting veneers. Stick Scotland, etc., on to the palest. On each of the remaining five, stick a batch of counties.

Cut out the pieces, using a fine fret-saw blade. Write the name of each county in pencil on the underside and soak off the coloured paper.

Cut a piece of 5-ply, large enough to take the map, with a 1in. margin all round. Glasspaper to a smooth finish. Assemble the pieces on the plywood sheet, using another map as a 'key'.

You should now have before you a map of England in low relief. Starting at

the top and working downwards, fix each piece firmly in position with balsa cement. Leave overnight to set.

If the top piece is not correctly orientated, the map will be slightly askew. This may now be corrected by squaring-up the edges of the plywood board. Leave sufficient margin for a narrow moulding, which should be fixed with balsa cement and panel pins. Finish with a clear varnish.

Mercator's Projection of the World makes a striking marquetry map. But it requires a considerable amount of skill and care in assembling. The five main land masses and numerous islands call for accurate spacing and orientation. (L.H.)

**YOURS for only
16/- down**

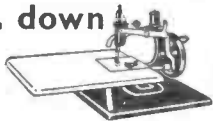

Save time and work on sewing jobs with this excellent 'Essex' Miniature Sewing Machine. Beautifully finished with chromium plate. Supplied with clamp for fixing firmly to table. 6 months' guarantee. Cash **£4.17.6** or **16/-** deposit and 6 monthly payments of **16.6**. Electric model available A.C./D.C. with foot control **£10.3.4** or **31/-** down and 6 monthly payments of **32/-**. Protective carrying case **18/4** extra. Send for leaflet today.

**ELECTRIC PAINT
SPRAYER**



**for 4/-
deposit**

Cash **75/-**. Or **4/-** deposit and 6 monthly payments of **13/6**. Paints easily, evenly, twice as fast as the Burgess Electric Sprayer. Sprays paint, varnish, etc. Complete with sturdy glass container, flex, nozzles for ceiling spraying and extra nozzle discs for different liquids. A.C. mains - state your actual voltage. Fully guaranteed. Also Horvell Electric Paint Stripper **30/-** cash, or **4/-** deposit and 3 monthly payments of **10/-**. Leaflets free.

**LOOK! THE BASIS OF
A MAGNIFICENT
HOME WORKSHOP
for only
6/- deposit**
Wolf Cub
1/4" DRILL



Here's the most compact, powerful and fully guaranteed $\frac{1}{4}$ " electric drill ever offered at such a popular price — the **WOLF CUB**. Sturdy, efficient and reliable, it's the first step to owning a complete home workshop, and the power unit for all Wolf Cub Sets. Drilling capacity: Mild Steel $\frac{1}{4}$ in.; Hard Wood $\frac{3}{8}$ in.; with 210 watts input on full load. Complete with $\frac{1}{4}$ in. three-jaw chuck and Allen key and 5ft. of cable. T.V. suppressed. State voltage. Cash price for Drill is **£5.9.6** or only **6/-** deposit and 6 monthly payments of **19.6**. **ALSO** Sanding and Polishing Kit (drill, discs, etc.): **£6.10.6** or **19/-** deposit and 6 monthly payments of **21/-**. Saw Kit (including drill): **£9.17.0** or **20/-** deposit and 8 monthly payments of **25/-**. Fretwork Kit (including drill): **£10.10.6** or **21/-** deposit and 8 monthly payments of **26/6**. Lathe Kit (Drill and Tools): **£10.10.6** or **21/-** deposit and 8 monthly payments of **26/6**. Home Workshop Outfit (drill, saw, lathe, sanding and polishing kits): **£16.17.6** or **40/-** deposit and 8 monthly payments of **41/6**. No. 5 Saw Set: **£3.1.6** or **4/-** deposit and 6 monthly payments of **10/6**. No. 10 Bench Planer Set: **£3.13.6** or **6/-** deposit and 6 monthly payments of **12/6**. No. 8 Fretsaw Set: **£3.15.0** or **10/-** deposit and 6 monthly payments of **12/6**. Send at once for full details, including a profusely illustrated and informative leaflet.

THE MOST VERSATILE TOOL EVER!

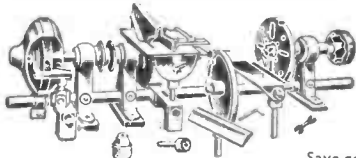

**PICADOR
PUP**

**ONLY £6.15.0
OR 25/- deposit and
6 monthly paym'ts of £1**

Save ground space with this modern multi-purpose tool. PICADOR PUP comprises a wood turning lathe, a rise and fall, fully tilting circular saw, a hooded grindstone with drill sharpening attachment, together with sanding and drilling attachments also. It GRINDS, including Twist Drill Grinding, TURNS, SAWs wood, plastics or soft metals. SANDS and DRILLS. PICADOR PUP is small, compact, hardy and motor driven. Only **£6.15.0** cash or **25/-** deposit and six monthly payments of **£1**. Extra cradle providing for drive by $\frac{1}{2}$ " drill. Price **23/-**. 3" four-jaw Chuck suitable for the above **£3** cash or **16/-** deposit and three monthly payments of **16/6**. ALSO Picador Rotosaw, Price **33/-**. Spare blades available, **8/6** each. Send 4d. for Illustrated Brochure.

BARGAIN DISTRIBUTORS

(Dept. 124), 5 Silver Street, Luton

NEW!

EXPERIMENTAL KITS

LEARN THE PRACTICAL WAY

Here is home study of the most effective kind under expert tutors. There is no better way of studying for an examination for a career in industry or starting a new hobby. Our Practical courses comprise the most modern methods of postal tuition, combined with a practical kit of parts (which is supplied upon enrolment and remains your property).

COURSES FROM 15/- A MONTH

COURSES WITH KITS INCLUDE : Radio, Television, Mechanics, Electricity, Chemistry, Photography, Carpentry; also Draughtsmanship, Commercial Art, Amateur S.W. Radio, Languages, etc.

EMI INSTITUTES
The only Postal College which is part of
a world-wide Industrial Organisation.

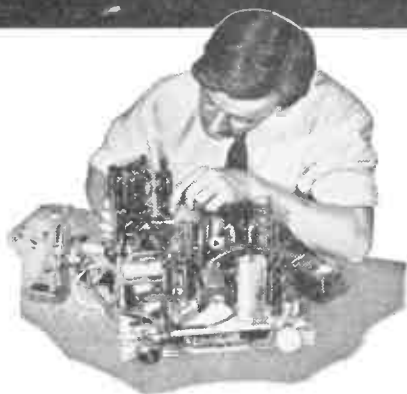

POST THIS COUPON TODAY

E.M.I. INSTITUTES, Dept. 31X, Grove Park Road, London, W.4. Please send me your free book.

Subject(s) of Interest

NAME

ADDRESS

1/2/56 IC.51



LISTEN TO THEIR SONG IN WINTER

THE bird-watcher in winter cannot fail to be interested in looking for the many species that visit Britain's woods, marshes, and hedgerows.

The Bramblings or Bramble-finches in the young trees in the plantations are worth noting. They come from Norway to enjoy the ripe beech-nuts and other food, so if you live near a beech wood that is a likely spot to see them. The Brambling often mixes with the flocks of bachelor finches, such as the Chaffinch. You may easily distinguish between the two. The Brambling is recognised by the white patch just above the tail, displayed when the bird is flying.

Foreign goldcrests journey across the North Sea to spend winter here, travelling 300 miles or more. If you live within reach of fir woods you may see the wee bird. It is recognised by its small size and the crest or crown of golden-yellow on the head bounded on either side by a black streak. There are white bars on the wings, plainly visible in flight. A flock of goldcrests fill the winter copse with eager shrill call-notes as they quest for food; 'tsit, tsit, tsit' echoes their needlelike efforts. Most of them return overseas in spring, but some will stay and breed here.

'Gipsy migrants'

Also, while among the firs and conifers look out for the Cross-bills, members of the finch family. These handsome, 'parrot-like' birds come to Britain from parts of Scandinavia during winter months. Keep a special watch for them as they are worth seeing. Crossbills have beak tips that overlap, enabling them to extract seeds from the pine cones, their special diet, to obtain which they often hang upside down like tits. The male is handsome, with bright red plumage, and the female has greenish-yellow feathers. They wander about the countryside a lot, 'here today, gone tomorrow'. Some people refer to them as 'gipsy migrants' owing to their wandering habits.

The pretty redwing is another winter visitor—a lovely bird with a ruddy

patch of feathers on the flanks—a notable feature as the bird expands its wings to fly up from the ground. The wings are *not* red, as one might surmise from its name. Sometimes, on a mild day, the redwing warbles a sweet low song.

Then we have the field-fares from Norway. These are the biggest members of the thrush family, very handsome, with auburn mantle and general plumage of grey and buff, black and white in contrasting shades. You may watch for these fine birds and hear their characteristic 'chak-chak-chak' as they flit about the winter meadows in flocks, or see them resting on the grass, with pickets posted.

Bird watchers are reminded of the winter habits of our feathered friends.

By A. Sharp

Still another interesting winter bird is the Snow-bunting, which on arrival in this country is of sober mottled plumage, but as winter develops changes its feathering to a much lighter colour, often pure white. But you have to visit the moors and hilly countryside to come across these pretty creatures.

A further visitor to our hedgerows and coppices is the pretty little Siskin, a bird which roams about in small flocks, haunting the alders by the riverside, where they feed on the kernels of the catkins. It is a pleasure, indeed, to watch a party flickering about the black boughs and naked twigs like bright greeny-olive and yellow canaries, their gay colouring showing up in contrast. The cocks are very striking with their gold-banded wings, yellow rumps, and greenish backs. As they flutter about the trees they utter snatches of linnet-like notes ending in a rather drawn-out 'tsy-e-e'. Siskins are erratic visitors, some years

fairly plentiful, other seasons scarce. It is a red-letter entry for your diary when you see a party of these gay-hued birds on a winter day.

Although the number of birds that indulge in winter song can be counted on your fingers, they are worth notice. The warbling of a bird at such a time is one of the most delightful sounds that fall upon the ear of a bird-lover. Here are the most noticeable winter singers—Misselthrush, Song Thrush, Starling, Robin, Wren, Dipper or Water Ouzel (a bird of the streamside), and occasionally the hedgesparrow. Of course, many other birds utter their call-notes, and goldfinches twitter sweetly as they wander about the banks where seeded heads of weeds provide food. There are the calls of tits in the garden and orchard, where they inspect every tree and fruit-bush for scraps to eat.

But real song is scarce during winter. The Robin will give good measure, and so will the Dipper, but you will need to go to the hillside stream to hear him, for he is a bird of the wilderness. The Dipper tunes in to the metallic flow of the rock-strewn beck, raising his notes above the gurgle and splash of the fretting water.

In mid-winter, too, you will at times hear the Misselthrush or Stormcock singing from the uppermost boughs of the tall elm tree, defying the wintry wind. It takes a lot to dishearten him from throwing forth his clarion notes, just as the Starling on the chimney-pot defies the blast and chitters and whistles in rain and sleet, frost and snow. The little Wren, too, is a persistent winter songster, and will sing undismayed.

BE YOUR OWN BOSS

114 tested ways of earning a second income at home with little or no capital. Packed with money-making information on how to start a business of your own. Many earning £5-£20 weekly. Money back if not delighted. Only 5/6 from
PRACTICAL COURSES, 28 (H13) Dean Road, London, N.W.2

SAVE MONEY!



ALL
ITEMS
POST FREE

WITH WOLF
ELECTRIC TOOLS

YOURS
FOR
ONLY **5/-** dep

& 7 monthly payments of 17/6 Cash £5.9.6
The 1/4" Drill is the most compact and powerful, fully guaranteed electric drill ever marketed at a popular price.

WOODTURNING LATHE

Consists of Wolf Cub 1/4" Drill, Bench Clamp, Drill-stand, Base Set, Drill-stand Pillar Set, Lathe Set, Woodworking Tool Set. Send for Complete Price Lists.

FOR ONLY
£1.0.0. deposit
and 9 mnth. pay.
£1.5.0.
Cash Price £10.10.6

A COMPLETE PAINTING KIT FOR ONLY £1 DEPOSIT

and 9 monthly payments of £1 or cash £9. Kit comprises: (1) Electric SANDER POLISHER (A.C. mains only), (2) Electric SPRAY GUN. Variable Spraying 2 containers (for thick and thin paints). Spray cellulose, synthetic paints and distemper, etc. (A.C. mains only), (3) PAINT SCRAPER will remove many coats of paint with ease. A.C./D.C. state exact voltage required. Individual items: SANDER POLISHER: £3.15.0 or £1 dep. and 3 monthly payments of £1. SPRAY GUN: £3.15.0 or £1 deposit and 3 monthly payments of £1. SCRAPER: £1.10.0 or 4/- deposit and 3 monthly payments of 10/-. All items POST FREE.



FREE with the above Kit a parcel of wood off-cuts consisting of: 2.12 mm. 9-ply boards 12in. x 17in. and one obeche board 7 1/2in. x 9in. x 3/4in. Don't miss this Free offer; it is worth 10/- to you.

JOHN RYSDALE (Dept. H6), COLYTON, DEVON



SAVE MONEY

with

VALSPAR

REG. NO. 402880

2-4 HOUR LACQUER High-Gloss WOOD STAIN or CLEAR - VARNISH

Paint, Stain or Varnish whitewood furniture with Valspar which produces a brilliant, smooth finish, proof against boiling water, alcohol, petrol, oil and grease.

No knotting, priming or undercoating required — easily applied coat-over-coat. Dries in 2-4 hours.



GOODLASS, WALL & CO., LTD. 179/185 (CD2) Great Portland Street, London, W.1

Please send me a free copy of the Valspar Handbook giving full details of all Valspar Paints.

NAME _____
BLOCK CAPITALS

ADDRESS _____

APPARATUS & CHEMICALS

For your experiments. Let us help you equip a
HOME LABORATORY

Beakers, Crucibles, Flasks, Funnels,
Gas Jars, Test Tubes, etc.

Booklets:

'Experiments' 10 1/2d.

'Formulas' 10 1/2d.

'Home Chemistry' 2/3d.



Send 2 1/2d. stamp for latest PRICE LIST

BECK (Dept. H.W.)

60 Stoke Newington High Street, London, N.16

WATCH AND CLOCK REPAIR OUTFIT



The complete Outfit for cleaning and repairing. Comprises: Illustrated explanatory booklet, eye-glass, tweezers, screwdrivers, oil, dusting powder, oilers, also illustrated catalogue, tools and materials.

Plus P. & P. 6d. extra C.O.D. if required

12/9

The above with additional luminous compounds, jewellers' rouge, dial brush, jewels.

Plus P. & P. 6d. extra. C.O.D. if required.

21/-

ASSEMBLE YOUR OWN JEWELLERY

Selection of unset earrings, pendants, rings, brooches and stones, etc., at fraction of cost.

Send S.A.E. now for big illustrated free catalogue. Money back guarantee

THE BOLSTER INSTRUMENT CO. (Dept. HB51)
GOVETT AVENUE, SHEPPERTON, MDDX.

MODELS. You can make lasting stone-hard models with Sankey's Pyrama Plastic Cement. Supplied in tins by Ironmongers, Hardwaremen and Builders' Merchants. Ask for instruction leaflet.

AMERICAN MAGAZINES. One year's 'Popular Mechanics' 30/- 'Homecraftsman' 16/6; 'Homecraft' 18/-. Full list from Willen Ltd. (Dept. 57), 101 Fleet Street, London, E.C.4.

KUKLOS ANNUAL. Indispensable cyclist's handbook. Tours, resthouses, money-saving hints, 2/10, post free.—Burrow, Publishers, 2 Imperial House, Cheltenham.

TOY CASTING Moulds. Soldiers, sailors, Airmen, etc. 1,000 varieties from 3/- each. Rubber moulding compound for flexible moulds, granulated ready for use, 8/6 per lb. Aluminium moulds for plaster work. S.A.E. for list. Catalogue 9d.—F. W. Nuthall, 69 St. Mark's Road, Hanwell, London, W.7.

ACCESSORIES

Telephone Handset Mouldings—P.O. Type—12/6 per set

Single Pin—2-way plugs—4/6 each.

Set of Transmitter Parts—10/6 each.

Set of Receiver Parts—10/6 each.

Twin Tinsel Flex—tagged each end, approx. 6ft. lengths—1/- each.

Oak Switches—10/6 each. Kelog Keys—S.H.—10/6 each.

Other accessories—Price on application with stamped addressed envelope.

'ONLY' COMPONENTS LTD
Llanerch-y-Mor, Holywell, Flintshire

'PAINTSPRAYING' HANDBOOK (1954 Ed.). Covers Car, Industrial & Flock Spraying. 3/6, post free, including catalogue of our Cellulose and Synthetic Paints and all Allied Sundries and Plant Hire.—Leonard Brooks Ltd., 81 Oak Road, Harold Wood, Essex.

400 STAMPS free. Genuine. S.A.E. for approvals. Details—W. H. Self, 36 Fairfield, Boro Green, Kent.

DO-IT-YOURSELF BOOKS. List free.—D.S.P. Ltd., 28(H) Dean Road, London, N.W.2

THE 'ROYAL CHARLES'

is the latest design in Hobbies wide range of models of famous old-time galleons. Obtain your design FREE with

HOBBIES 1956 HANDBOOK

Now on sale (2/-) at newsagents, etc., or 2/3 post free from Hobbies Ltd., Dept. 99, Dereham, Norfolk

SPECIAL OFFER

12 Assorted Acid-Sharpended Files from 4" to 14", all shapes (including at least one Millenicut or Dreadnought file) for 12/6d. post free.

These files have been specially sharpened by a chemical process for use on Wood, Brass, Alloys, Leather, etc., and are indispensable to the Modelmaker, Handyman, Leatherworker, etc.

PHOENIX FILE CO.

22 EAST UNION STREET, OLD TRAFFORD, MANCHESTER 16

* GREAT CAMPING OFFER *



RIDGE TENT SENT FOR 4/-

BRAND NEW de luxe 'Safety' Tent. All colours. Complete. Ideal Cyclists, Campers. Length 7 ft. 3 in. sleeping base x 4 ft. 6 in. wide x 3 ft. 6 in. high x 12 in. walls, all approx. Weight 3½ lb. £2 15s. or 4/- deposit and 6/- monthly. With fly-sheet £4 2s. 6d. or 10/- deposit and 9/9 monthly. Both carr. 1/6. Don't delay, send now.

GERMAN PRISMEX BINOCULARS

6 LENSES x 40 mm COATED LENSES. Popular Squat Model CASH PRICE 69/6



For wide field viewing, finest value for German Prismex Binoculars. 5½" x 4½". Bending Bar for eye adjustment, centre focus. Splendid magnification, 3D viewing. Clear Bloomed lenses, wide angle. Sports and holiday use, day and night lenses. Lightweight model. With case lanyard and leather straps. Send 2/6 for pack. & reg., etc. 7 days approx., if satis. send 4/6. then 8 pays. 9/- in 8 months. CASH 69/6. LISTS, TERMS.

HEADQUARTER & GENERAL SUPPLIES LTD.

(HOBW/91), 196-200 Coldharbour Lane, Loughboro Junc., London, S.E.5. Open Sat.

STAMPS FREE—Empire Packet including Pictorials and Victorians with approvals.—Robert J. Peck, 7A Kemp Road, Bournemouth.

SWISS MUSICAL Mechanism for cigarette boxes, etc., 18/- post free. S.A.E. for illustration and list of tunes available.—Dept. HW., Metwood Accessories, Church St., Wolverton, Bucks. (Trade supplied.)

£5 to £20 weekly earned at home running your own Mail Order business. Complete Course 5/6.—Courses, 28(HB) Dean Road, London, N.W.2.

GENUINE Swiss Musical Movements. The best and largest selection of tunes in the country, lowest prices 16/3 each. Genuine Thorens Movements 21/- each. All Guaranteed. P. & P. 9d. extra on all orders.—Richardson & Forder, 5 Chapel Place, White Hart Lane, London, N.17.

LEARN it as you do it—we provide practical equipment combined with instruction in Radio, Television, Electricity, Mechanics, Chemistry, Photography, etc.—Write for full details to E.M.I. Institutes, Dept. HW. 47, London, W.4.

ACID-SHARPENED FILES. One dozen assorted specially sharpened files, all types and cuts; ideal for modelmakers, etc. 12/6 post free.—Phoenix File Co., 22 East Union St., Manchester.

100 DIFFERENT stamps free! Request ¼d. upwards discount approvals.—Bush, 53 Newlyn Way, Parkstone, Dorset.

HOW TO STOP SMOKING

and permanently overcome that ceaseless craving for tobacco. Save money, safeguard health. Send stamp for details of the world-famous inexpensive Stanley Treatment for tobacco habit

THE STANLEY INSTITUTE LTD (Dept 30)
12 Bridewell Place, London, E.C.4

50 FREE stamps to all applicants enclosing 2½d. stamp requesting approvals. Various other free gifts given.—Beeze, 8 Langland Villas, Mumbles, Swansea.

50 STAMPS free to all approval applicants enclosing 2½d. stamp.—Cliffe West, 61 Wynyard Rd., Sheffield, 6.

LOVELY Belgian Congo flowers. Super free gift to approval applicants enclosing postage.—Yulwontmor Stamps (Dept. H5), 29 Layton Avenue, Mansfield.

PRINCESS ELIZABETH album gratis approvals, postage.—Neave, 5 Surrendale Place, Paddington, W.9.

STAMP approvals, colonial and foreign. Priced 1d. upwards, state requirements.—Hall, 80 Broadway Grove, Bromyard Rd., Worcester.

WOOD screws, plated, #in. No. 8 counter-sunk; 2/9 gross, post paid; reduction quantities.—Hindle, 25 Brixton Hill, London, S.W.2.

HEAR ALL CONTINENTS With H.A.C. Short-Wave Receivers.

Suppliers for over 18 years of Radio S-W Receivers of quality. One-Valve Kit, Price 25/- Two-Valve Kit, Price 50/-

Improved designs with Denco coils. All kits complete with all components, accessories and full instructions. Before ordering, call and inspect a demonstration receiver, or send stamped addressed envelope for descriptive catalogue.

'H.A.C.' Short-Wave Products (Dept. 22), 11 Old Bond Street, London, W.1



MANCHESTER
10 Piccadilly
(Phone CENTRAL 1787)
BIRMINGHAM
100a Dale End, Birmingham 4
SHEFFIELD
4 St. Paul's Parade
(Phone 26071)
LEEDS

10 Queen Victoria Street
(Phone 28639)

HULL

10 Paragon Square
(Phone 32959)

SOUTHAMPTON
134 High St. (Below Bar)

BRISTOL

30 Narrow Wine Street
(Phone 23744)

GLASGOW

326 Argyle Street
(Phone CENTRAL 5042)

Head Office & Factories—HOBBIES LTD., DEREHAM, NORFOLK

See page 265

USEFUL TOAST RACK

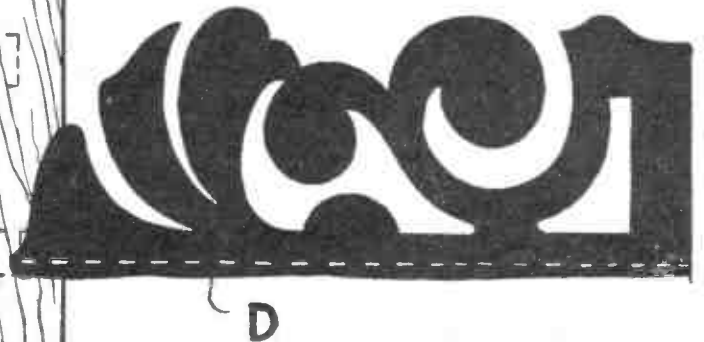
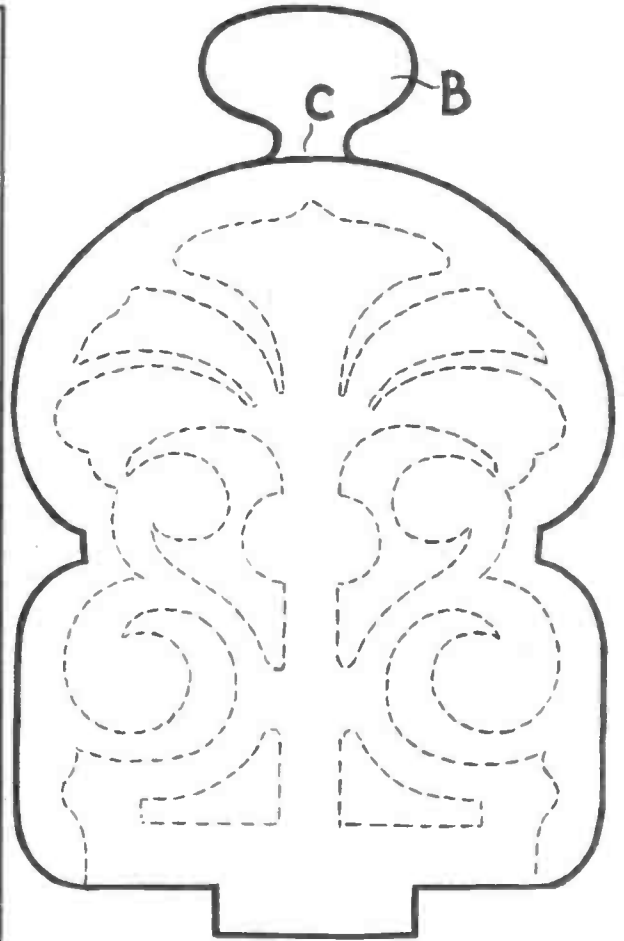
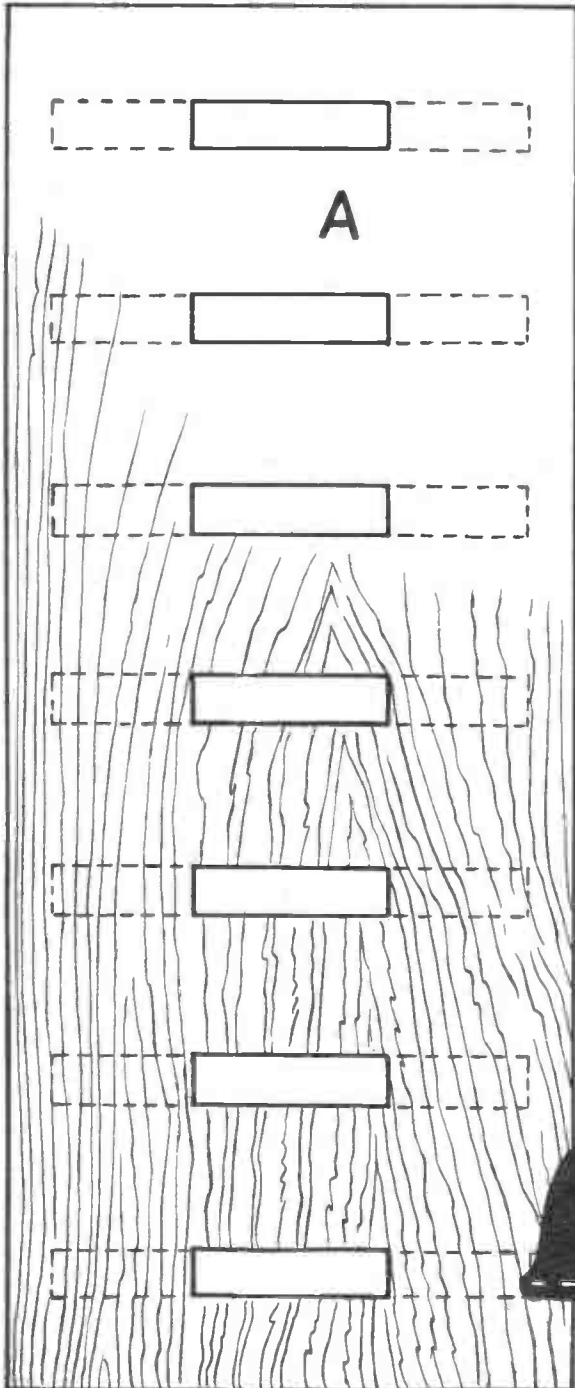

*Make it
or Mend it—
you can't go wrong*

MAKE MODELS



Mend anything from crockery to cricket bats with Rawlplug DUROFIX, the colourless cellulose adhesive that's heatproof and waterproof. Strong, almost invisible join—for good!

RAWLPLUG DUROFIX

Tubes from 9d Tins from 2/9

MEND MODELS

Mend or model with Rawlplug Plastic Wood—pliable as putty, yet when dry—it's wood! You can saw, plane, sand-paper, paint or polish. Moulds to any shape; strong, weatherproof.



RAWLPLUG PLASTIC WOOD

Tubes 1/- Tins from 2/3

DRILL BRICK

Drill brick, tile cement, etc., with astonishing ease and speed with Rawlplug DURIUUM-tipped Masonry Drills. Can be used in hand or suitable electric drills; ideal for making holes for Rawlplugs

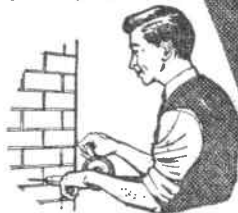

RAWLPLUG DURIUUM-tipped DRILLS

B520

FROM YOUR IRONMONGER OR HARDWARE STORES **THE RAWLPLUG CO. LTD · LONDON · S.W.7**

THE 'ASPDEN' TAPE DECK

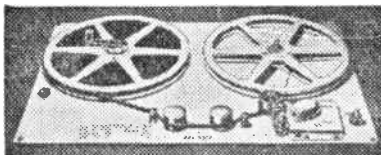

Model No. 721 (assembled). **YOURS FOR 10/- DEP.** plus 5/- P. & P. and 6 monthly payments of 3/6. **CASH £9/17/6.** Model No. 521 (assembled). **7/- DEP.** plus 5/- P. & P. 6 monthly payments of 3/6. **CASH £8/17/6.**

They are also available in kit form at £8/10/- and £7/10/- respectively or on our easy terms. Specifications. Model 521 7in. x 11in. 5in. Reels. Model 721 10 1/2in. x 11in. 7in. Reels. High Impedance Record/Replay heads 2,800 ohms at 1K Gap. .0004in. at 50 Kc/s. 60 v. High Impedance Erase Head 10,000 ohms at 50 K. Gap. .0025in. Erase Volts at 50K.80/90. Both heads are latest type, low capacity moulded with Ferroxcube core. 2 speeds are obtainable 3 1/2in. and 7 1/2in. per sec. Frequency Response at 3 1/2in. per sec. approx. 50/6,000 c.p.s. and at 7 1/2in. per sec. 30/12,000 c.p.s. A detachable handle is supplied for hand rewinding. Model 721 panel is drilled for a rewind motor should the user wish to fit one. Drive. Rubber belt from a constant speed motor to a perfectly balanced flywheel, giving constant tape speed, without "wow" and "flutter", throughout the full length of tape. The motor is suitable for 100/250 volts 50 cycles mains.

STANLEY TOOLS TRIMMING KNIFE

Supplied with five double ended razor-sharp spare blades in handle. Ideal for lino, cardboard, sheet material. Heavy duty and hooked blades also available.

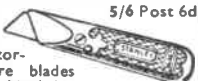

5/6 Post 6d

"YANKEE" HANDYMAN PUSH DRILL

For small holes—all you have to do is push! 19/3 Post 1/- Complete with 4 spare bits in magazine type handle.



THE "I & G" UNIVERSAL SAW

No vibration, robust, light. Will fit any electric hand drill. Complete with attachment and two extra saw blades. Will Jig saw. Cross cut, Rip saws. Hack saw, etc.



YOURS FOR ONLY 5/- Deposit

plus 2/- p. & p. and 6 monthly payments of 8/3. **CASH 4/6.**

LAFCO COMPOUNDS LTD (Dept. HW6)
3 Corbetts Passage, Rotherhithe New Road, London, S.E.16

*BEFORE YOU DECORATE
FILL THAT CRACK
WITH—*

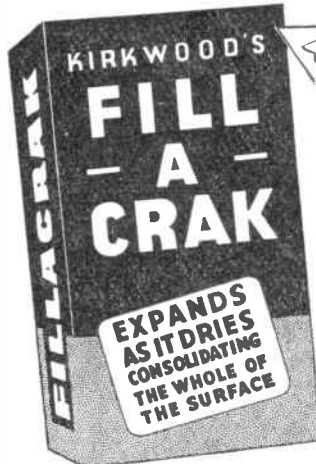

THE FILLER THAT WON'T FALL OUT

Time spent on "making good" the cracks in walls and ceilings will more than repay you in the professional look that it gives to the finished job. **FILL-A-CRAK** is the ideal filler for an amateur—it is easily mixed, easy to apply and **EXPANDS AS IT DRIES**—consolidating the whole surface and ensuring a firm and lasting repair. Use **FILL-A-CRAK**, too, for filling dents, old nail holes, etc. in woodwork before painting.

On sale at all good Decorators' Shops and Ironmongers

KIRKWOOD, CRAIG & CO. LTD.

8TH AVENUE WORKS, MANOR PARK, LONDON, E.12.

Printed by **BALDING & MANSSELL, LTD.**, London and Wisbech, and Published for the Proprietors, **HOBBIES LTD.**, by **HORACE MARSHALL & SON, LTD.**, Temple House, Tallis Street, E.C.4. Sole Agents for Australia and New Zealand: **Gordon & Gotch (A'sia) Ltd.** For South Africa: Central News Agency Ltd. Registered for transmission by Canadian Magazine Post.

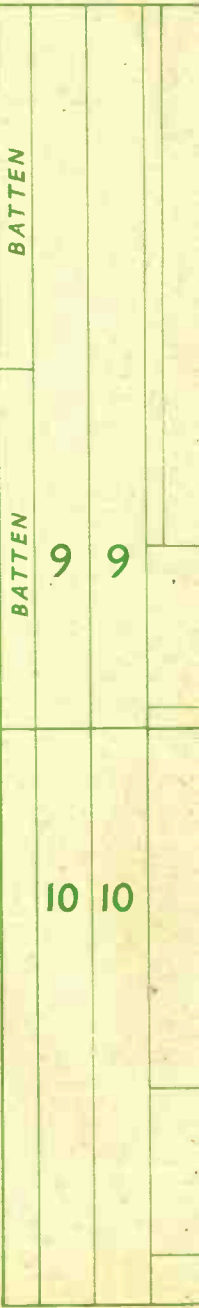
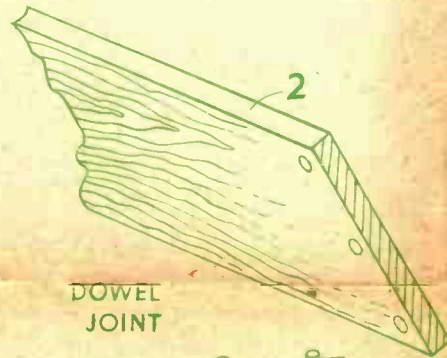
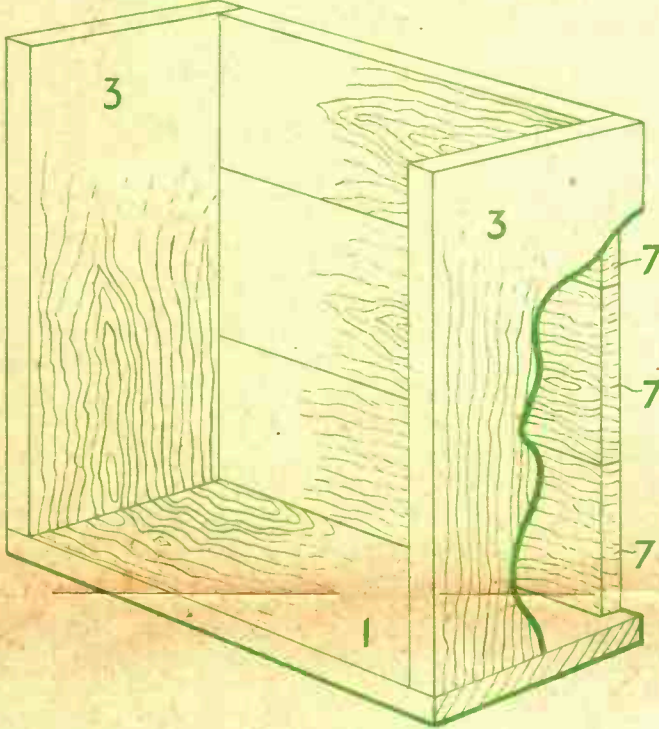
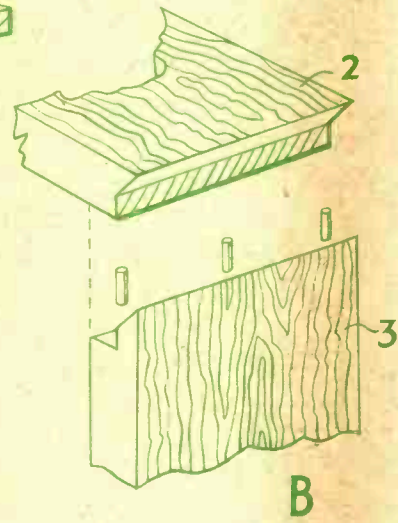
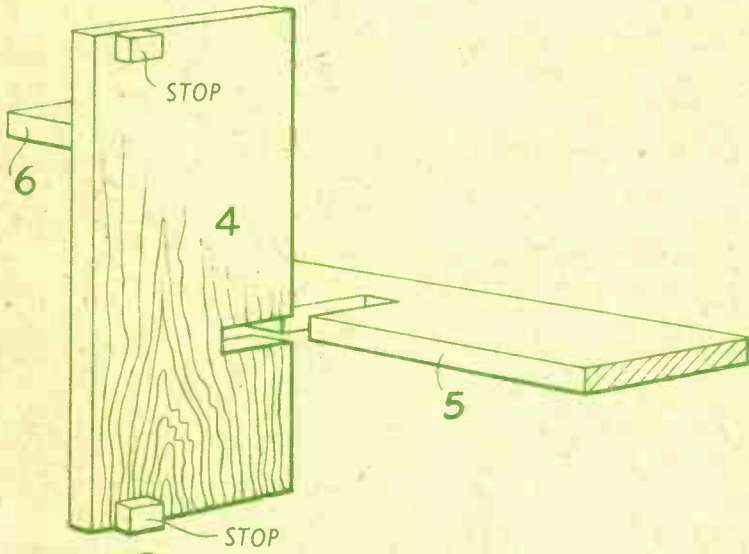
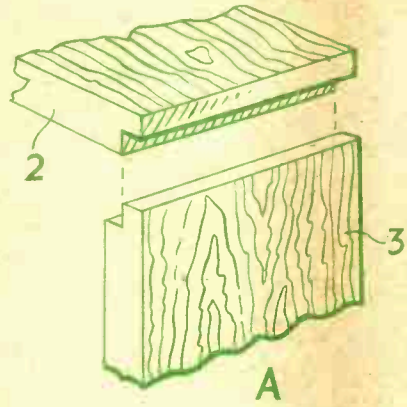

DOWEL JOINT

DETAIL SHOWING LAYOUT OF PARTS ON PANEL.

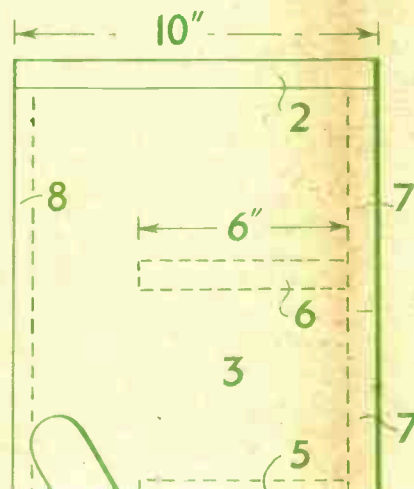
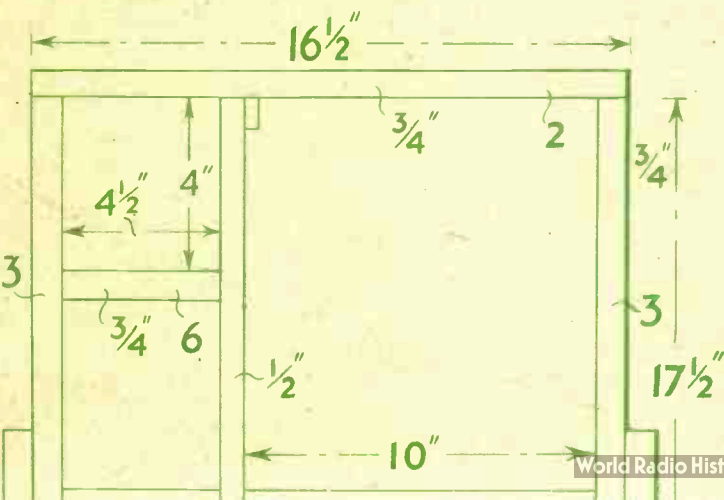
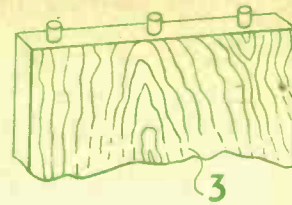



DESIGN

No. 3144

SMALL CABINET FOR BEDSIDE OR LOUNGE

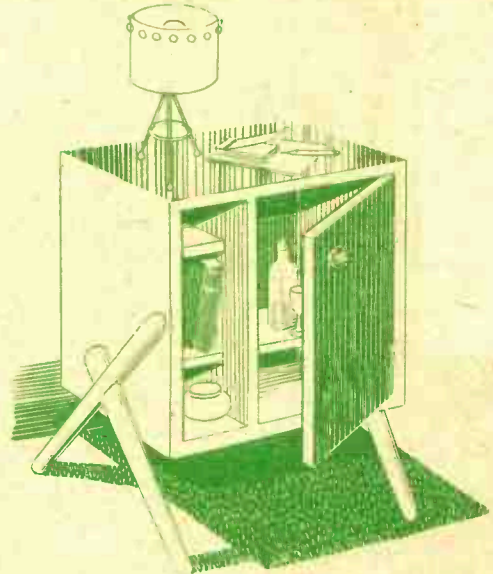

COMPANION DESIGN TO DESIGN No. 3114. CONTEMPORARY CABINET FOR COCKTAILS, ETC.

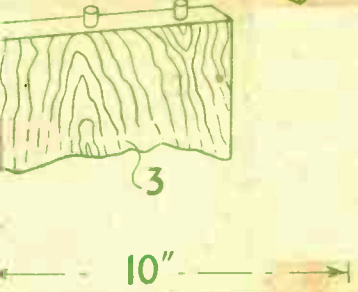
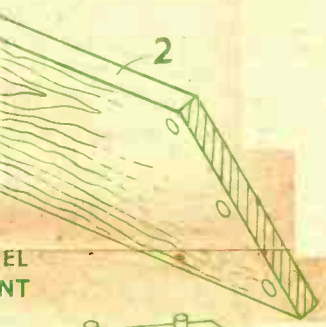
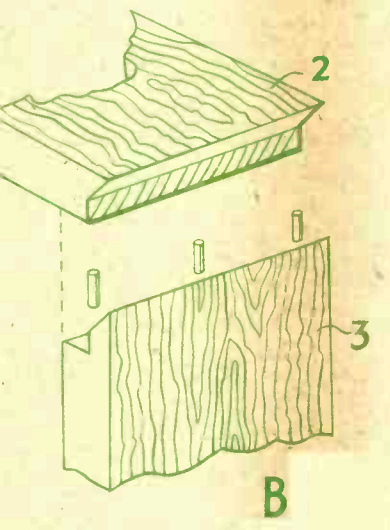
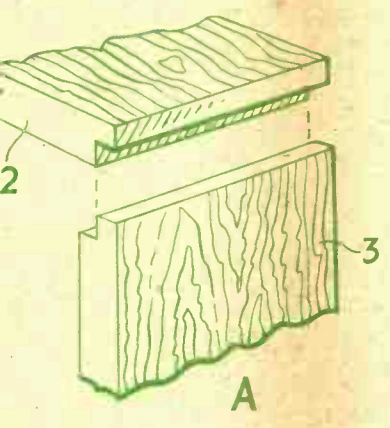
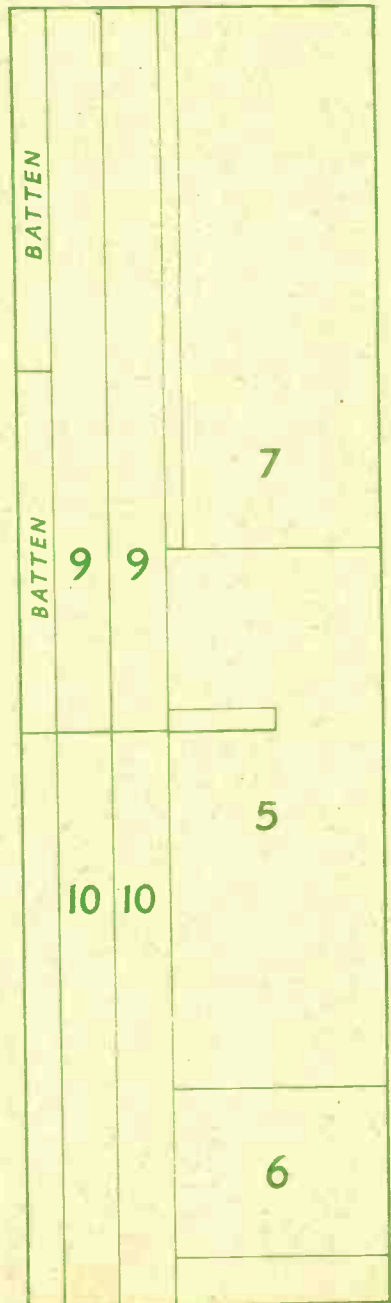

DETAIL SHOWING LAYOUT OF PARTS ON PANEL.

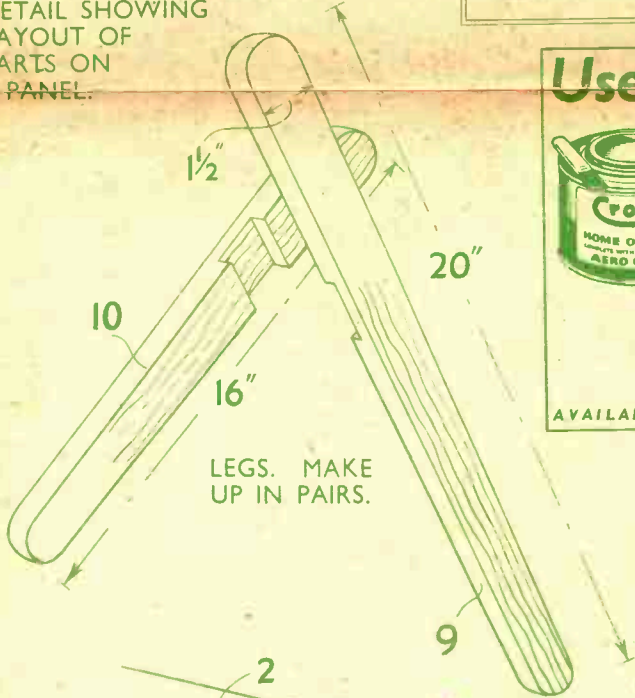

MATERIALS REQUIRED

WOODS

- Three pieces 36ins. x 10ins. x 3/4in. (Hobbies S12)
- One piece 36ins. x 10ins. x 1/2in. (Hobbies S8)
- One piece 36ins. x 6ins. x 3/4in. (Hobbies R12)

FITTINGS

- Two pieces 3/8in. dia. round rod—18ins. long
- One pair 2ins. x 1/2in. heavy brass hinges
- One 1 3/4in. dia. metal handle (Hobbies No. 712)

A complete kit of the above materials can be obtained from **HOBBIES LTD., DEREHAM, NORFOLK**

Use



Croid AERO

IT'S DESIGNED FOR THE JOB

This pure hot animal glue of great strength needs no mixing or preparation. The Home Outfit consists of 8 oz. tin Croid Aero Glue — Hot Water Container — Handy Brush — 4/- complete.

AVAILABLE FROM ALL BRANCHES OF HOBBIES LTD

SIZE 27 1/2 ins. HIGH. 18 ins. WIDE.

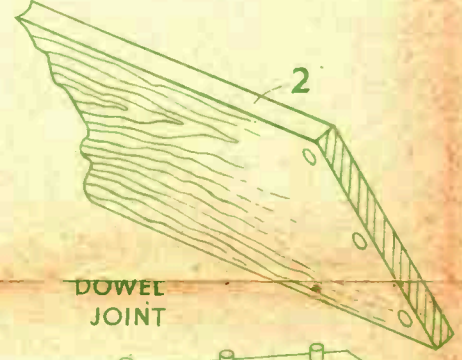
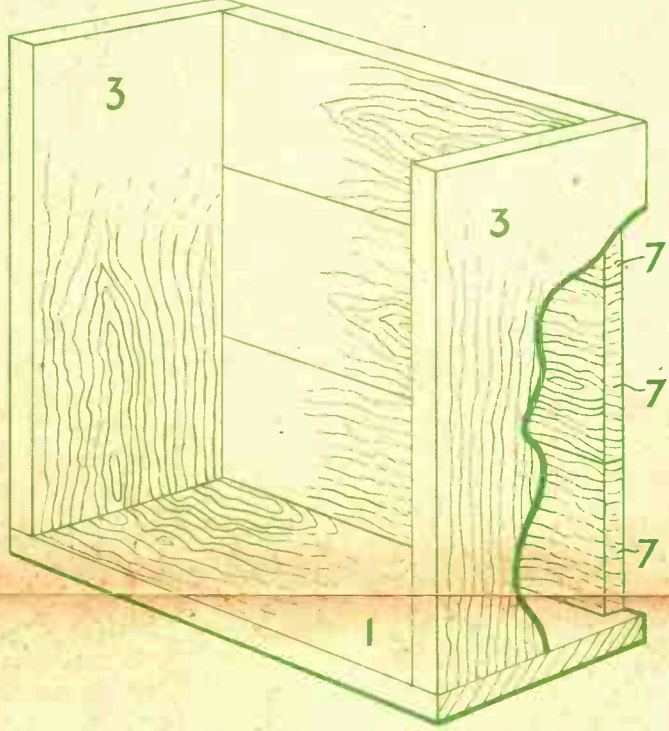
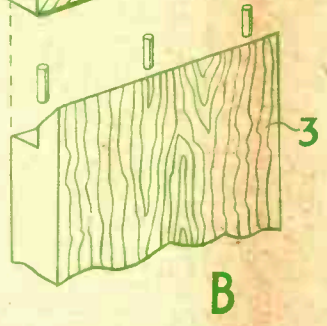
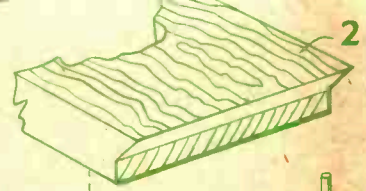

DOWEL JOINT

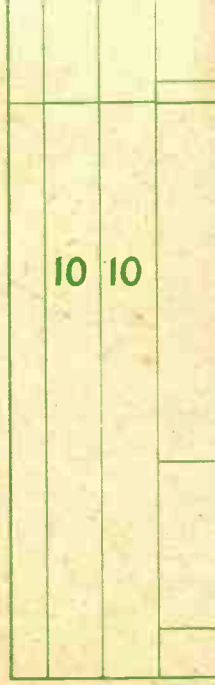
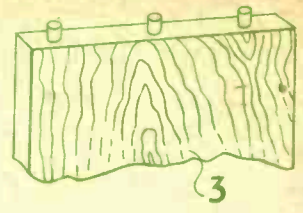

DETAIL SHOWING LAYOUT OF PARTS ON PANEL.

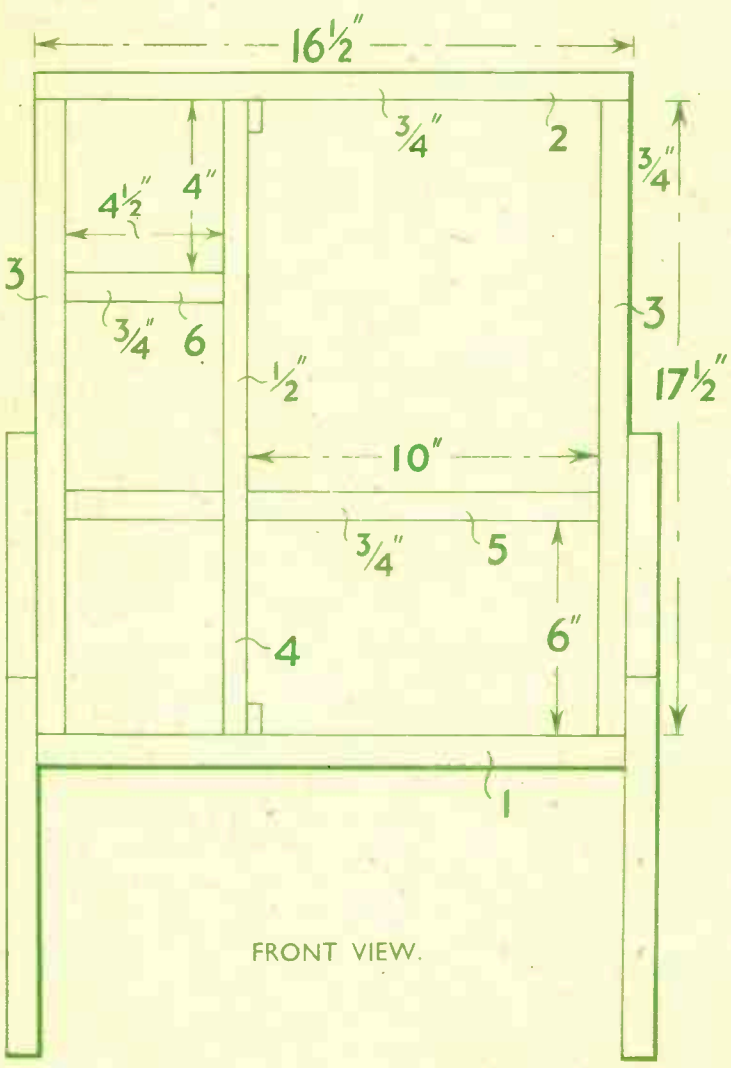

FRONT VIEW.

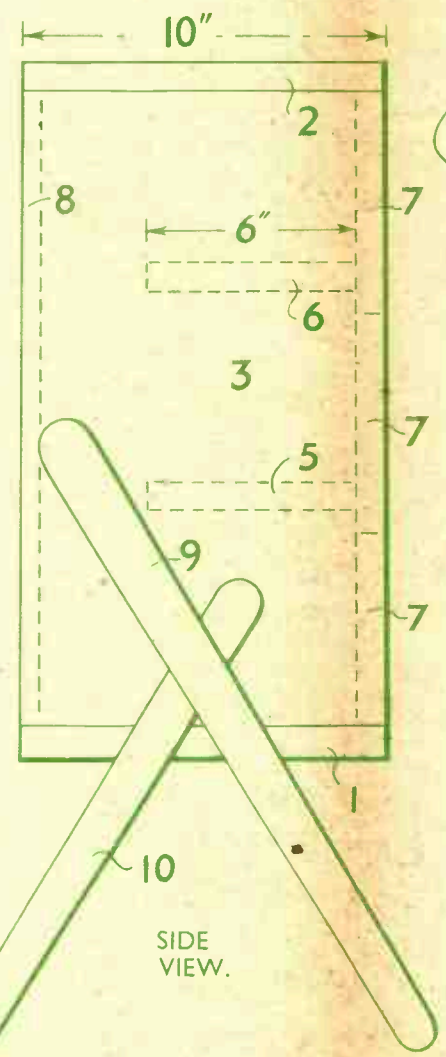

SIDE VIEW.

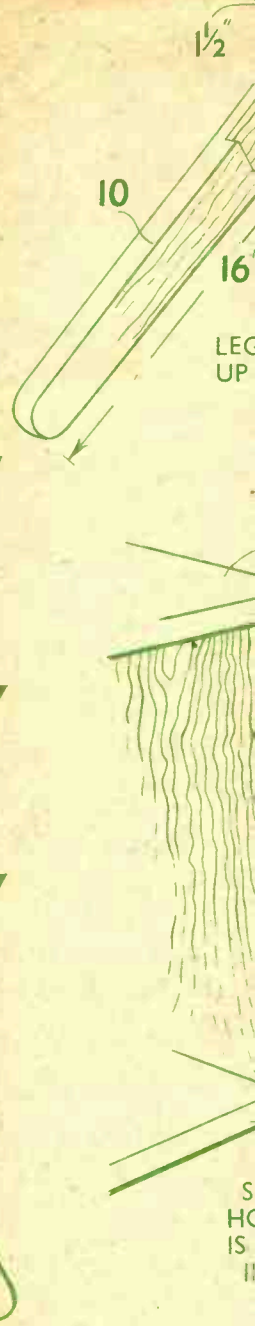

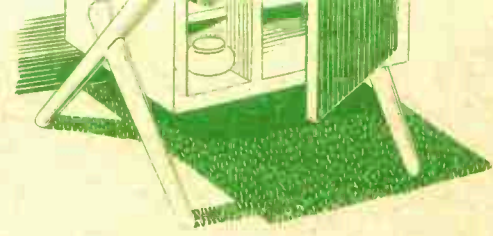
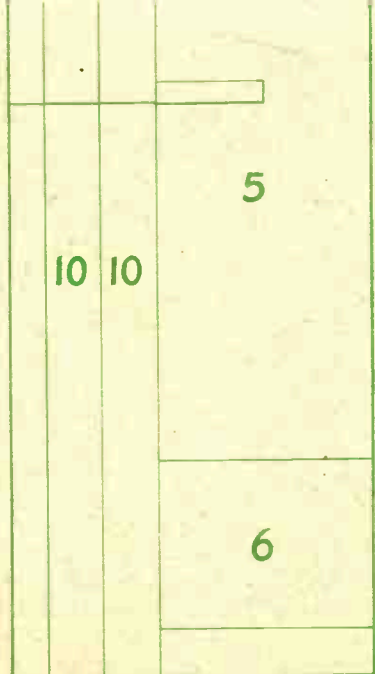
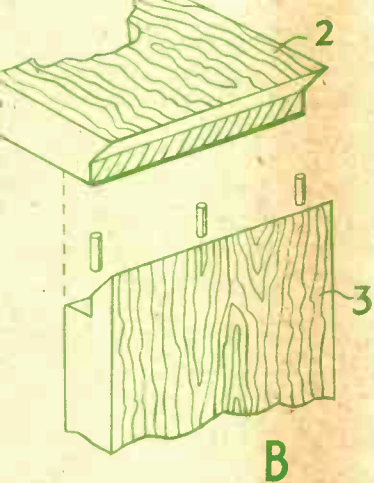

COMPANION DESIGN TO DESIGN No. 3114.
CONTEMPORARY CABINET FOR COCKTAILS, ETC.

MATERIALS REQUIRED

WOODS
 Three pieces 36ins. x 10ins. x 3/4in. (Hobbies S12)
 One piece 36ins. x 10ins. x 1/2in. (Hobbies S8)
 One piece 36ins. x 6ins. x 3/4in. (Hobbies R12)

FITTINGS
 Two pieces 3/8in. dia. round rod — 18ins. long
 One pair 2ins. x 1/2in. heavy brass hinges
 One 1 3/4in. dia. metal handle (Hobbies No. 712)

A complete kit of the above materials can be obtained from
HOBBIES LTD., DEREHAM, NORFOLK

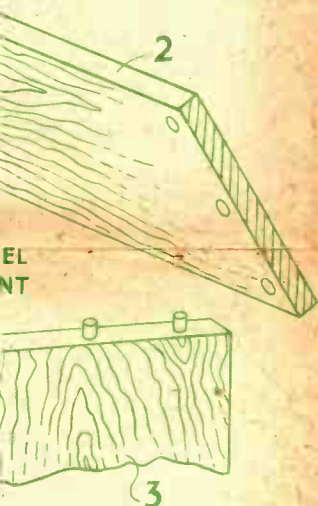

DETAIL SHOWING LAYOUT OF PARTS ON PANEL.

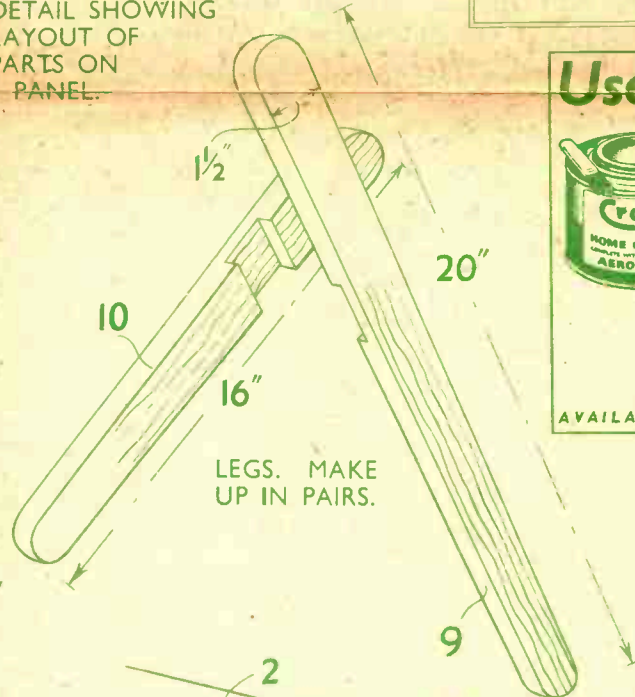

Use

Croid AERO

IT'S DESIGNED FOR THE JOB

This pure hot animal glue of great strength needs no mixing or preparation. The Home Outfit consists of 8 oz. tin Croid Aero Glue — Hot Water Container — Handy Brush — 4/- complete.

AVAILABLE FROM ALL BRANCHES OF HOBBIES LTD

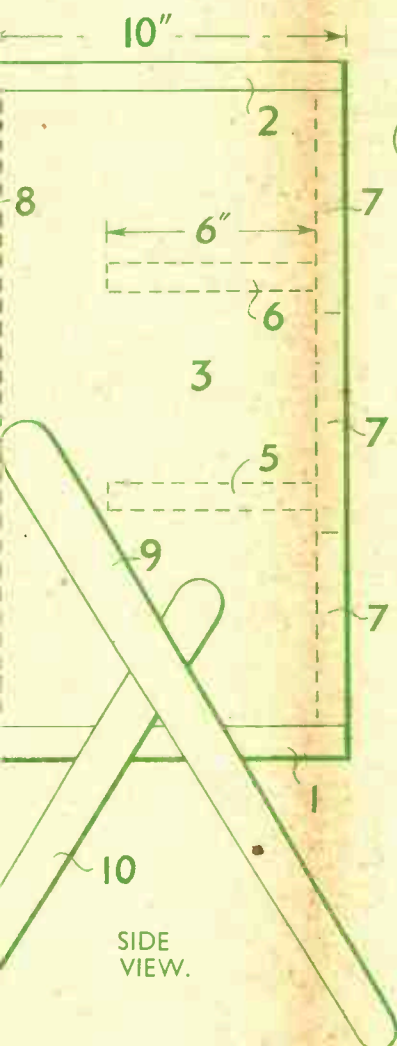

SIDE VIEW.



SHOWING HOW DOOR IS HINGED IN PLACE.

SIZE 27 1/2 ins. HIGH.
18 ins. WIDE.

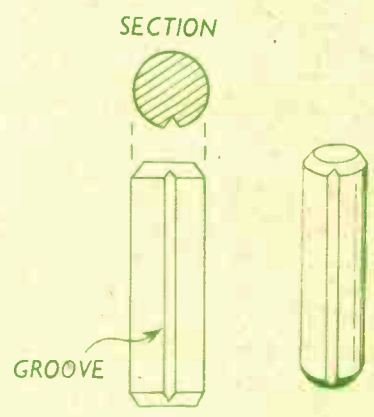

DOWELS. CUT FROM 3/8 in. ROUND ROD.

PRINTED IN ENGLAND.