

HOBBIES WEEKLY

IN THIS ISSUE

Perpetual Cut-Out Calendars	Page
Joining Flat Boards	129
Using the Mortise Chisel	130
A Fern or Vine Stand	131
A Radio Cabinet	132
'Traffic Lights' Ball and Cup Game	133
Cycle Lamp Maintenance	134
Make an Extending Fireside Curb	134
'Table Top' Pictures	135
Colouring Brass	136
Model Garage Lighting	137
Books to Read	138
Gifts for Christmas	140
Patterns for Extending Fireside Curb	143



DECEMBER 7th 1955

VOL. 121

NUMBER 3136

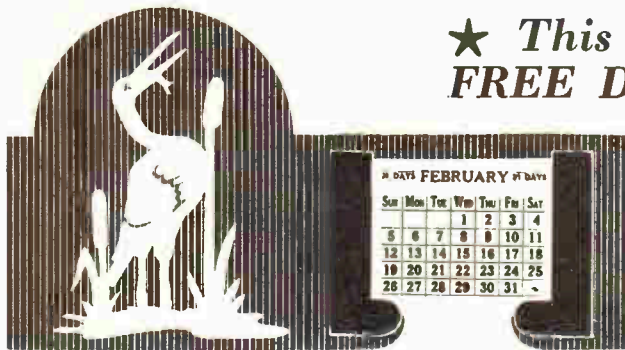

★ *This Week's
FREE Design*



Make
Gifts
with

price 1/3. They consist of seven white plastic printed sheets.

The backing pieces for the calendars are of 1/4 in. wood. Cut the backing piece to the required shape and also cut out the pieces for the calendar holder, gluing these in position. At the same time, cut out and glue the strut at the back.

Trace Overlay

Next trace the design overlay to the 1/4 in. wood and cut out, carefully cleaning up ready to glue to the backing piece. Before this gluing is done, however, it is best to paint the backing piece in the desired finished colour. We suggest

PERPETUAL CUT-OUT CALENDARS

THREE delightful subjects for perpetual calendars are given with this week's free design sheet. Two of them—The Heron and Lamb—are illustrated here, and the third takes the form of a cathedral.

They would make ideal Christmas presents for friends, and if making up several of these calendars, the worker could cut together up to four overlays,

which are of 1/4 in. wood, to save time. For beginners it is suggested that the Lamb design should be undertaken as being the simplest, as in this case there are no interior frets to be cut.

All the necessary materials are contained in the kit, but for those who desire to use their own wood, perpetual calendars (No. 6161) can be obtained from Hobbies Ltd., Dereham,

black, as if the overlays are left in their natural colour, this will show the work to the best advantage.

Do not paint the whole of the backing piece, as parts of it would have to be scraped away later to provide a key when gluing the overlay in position. It is preferable to lay the overlay on the backing piece and mark round the

● Continued on page 131

All correspondence should be addressed to The Editor, Hobbies Weekly, Dereham, Norfolk

For Modellers, Fretworkers
and Home Craftsmen

World Radio History

4^D

PAGE 129

JOINING FLAT BOARDS

THESE diagrams and instructions are for the guidance of the newcomer to carpentry and woodwork. When constructing tables or cabinets, in fact, anything with a large flat surface, the problem of how to make the top arises.

The solution would appear to be the use of a wide board, wide enough to

used, spreading it over both edges to be joined. Put the edges together and rub backwards and forwards, pressing down all the time until the glue holds. The boards are then cramped tightly together until the glue sets. Place them on a flat surface and if they are inclined to

buckle, put on weights or cramps on the other side to keep them flat.

Thicker boards need rather different treatment, and for these the dowel joint will be the best method to adopt. The diagram in Fig. 3 shows how the dowels are spaced. Obviously, the centres of the holes should be accurately marked before drilling, and the drill kept perfectly upright all the time. For accurate marking the boards should be placed together in line at the ends and squared across. Centres can be lightly punched to start the drill.

Dowel pegs are made from round rod cut into short lengths and tapered only slightly for about $\frac{1}{16}$ in. at each end. A groove is then made as shown in the inset Fig. 3. This allows air and excess glue to escape.

Another method is to use a tongue and groove, but this is only practicable if you have a suitable plane or planes for making the joints. Tools for this purpose are usually called matching planes. The diagram in Fig. 4 shows how the joint is made up.

There is also the loose tongue method. In this case a groove is made in both pieces of wood with a plough plane. A loose tongue is cut from plywood and inserted in the grooves as shown in Fig. 5. In both cases the boards must be cramped securely together while the glue is drying.

Having completed the top, the next step is to fit it in position. An article in a future edition of Hobbies Weekly will deal with this problem. (M.h.)

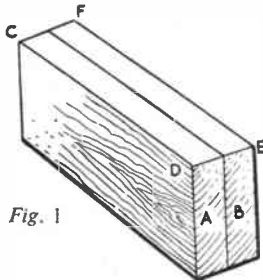

Fig. 1

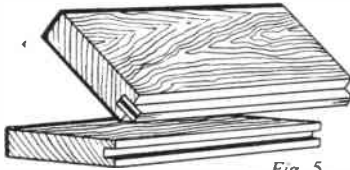

Fig. 5

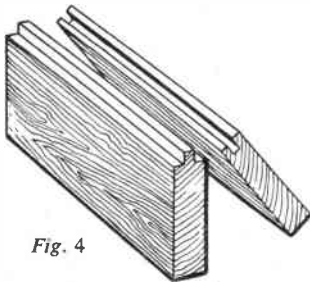

Fig. 4

make the top in one piece. This, however, is not the case, because even if it were possible to obtain wood of sufficient width, it would probably warp hopelessly.

The usual practice is not to use one piece, but to make the tops from pieces of narrow board, say, 5ins. or 6ins. wide. These are glued and cramped together in various ways to give a top of the required size. It is just as strong and less liable to warp and twist than a top made from one piece.

Where the wood is thin, say, $\frac{1}{2}$ in. or $\frac{3}{4}$ in., the boards can be glued and butted together. First put the boards together by pairs in a vice and plane them true, as in Fig. 1. Note the positions of the boards and how they will be glued together in Fig. 2. Hot glue should be

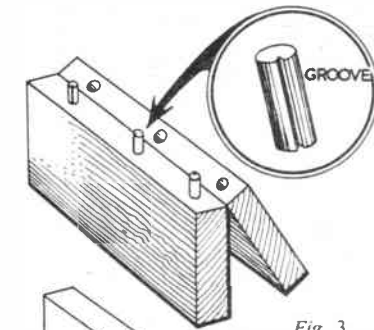

Fig. 3

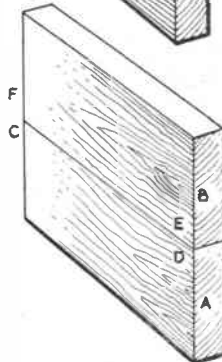

Fig. 2

Using the Mortise Chisel

WHEN chopping a mortise, great care must be taken, to ensure that the mortise chisel remains vertical when viewed from the end of the wood. If the chisel is allowed to tilt, the rail bearing the tenon will be thrown out of line, and if, for example, a framed door is being made, the whole frame will be twisted.

Any slope of the chisel will be immediately obvious if you stand directly in line with the wood. Thus, if the wood runs parallel with the front of the bench, as is usually the case, it is necessary to stand at the end of the bench. This also ensures that the mortise is resting on the most solid part of the bench, i.e., over the legs.

It is only necessary to give the chisel one blow each time: each additional blow is less effective than the last. Make a series of cuts the full length of the mortise, delivering one blow each

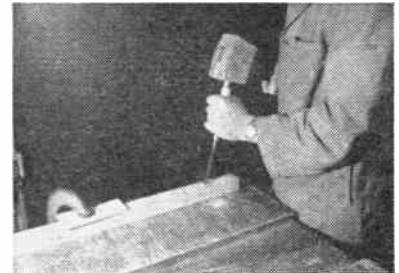

time, remove all loose wood, and repeat the procedure.

The wood may be held in the vice or secured to the bench with a G clamp. If it is put in the vice, make sure that the mortise is over the centre of the vice, and also that the top of the wood is flush with the bench. This provides a surer grip and eliminates any splitting tendency. (K.B.)

A Fern or Vine Stand

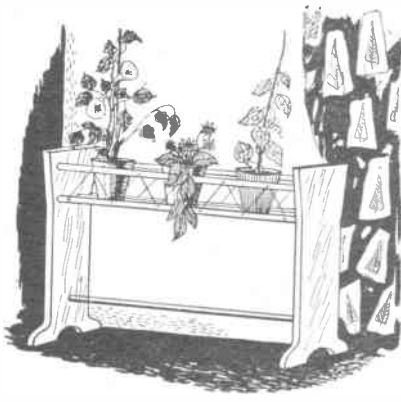

larger ferns and trailing vines really require a stand for themselves.

Illustrated is a simply constructed stand which can be made to suit individual requirements. Since there are so many types and widths of flower-pots, measurements have not been given for the building of this stand. However, when measuring up for construction purposes use, if possible, flower-pots which are of the same width and size. This greatly enhances the look of the stand. It also tends to simplify building operations.

$\frac{1}{4}$ in. rods, of which six are needed altogether, are sturdy enough to support most vine and fern pots. As can be seen from the illustration five are used for keeping the pots in place, while one is required for the bottom of the stand.

The holes in the rods are $\frac{1}{8}$ in. in diameter and these are drilled $\frac{3}{8}$ ins. apart along the length of the rods. Care must be taken when drilling to ensure a zig-zag effect is produced when corded. End pieces should be carefully marked

THERE is such a variety of indoor plants these days, that it becomes quite a problem to know where to place them around the home. The smaller cacti can always be placed in an alcove or on a window ledge, but the



END PIECE



RODS GLUED & HOLED INTO END PIECE

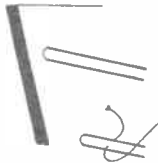

STRINGING CORD KNOTTED ON THE INSIDE

Continued from page 129

Perpetual Calendars

outline with pencil. Then paint the backing piece, taking the colour slightly over the pencilled lines. Where applicable, the interior frets should also have been marked, of course, and these are painted in the same way. Use good enamel paint.

Allow the work to dry and rub down in the usual way before applying a further coat. One or two more coats can be given with advantage.

With the overlay all ready for fixing, lightly scrape away excess paint near the edges of the outline and glue the overlay in position, placing it under suitable weights until dry.

As with all fretwork articles of this nature, the finished appearance depends entirely on the care the maker puts into the work. It is particularly applicable to

THREE FOR 7/11

Kit No. 3136 for making these three calendars can be obtained from branches or Hobbies Ltd., Dereham, Norfolk, price 7/11 post free. This includes three No. 6161 perpetual calendar sets.

the fretcutting involved with the overlays, and to the painting of the backing board. Care should also be taken to see that the holder for the calendar set is made neatly and positioned correctly at the foot of the calendar. These points should always be given extra attention and will well repay the effort.

and holed, rods glued and inserted and cramps used if the reader possesses a set.

Since most modern furniture is finished in two or three tones, one way of introducing a colour note is to use a coloured cord. Many colours, including yellow, red, green and black may be bought at hardware stores. A suggested finish would be yellow cord with white rods with the end pieces a warm buff shade. Needless to say enamel paint will enhance the finished article. (J.M.)

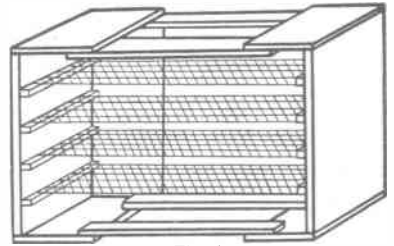

Fig. 1

A RACK FOR STORING FRUIT

STORING fruit is always a problem if space is limited. Moreover, storage racks are expensive to purchase. But the problem can easily be solved with some wire netting and a few wooden boxes.

Remove the lid from a box, and cut the box in half (Fig. 1). Then lengthen by nailing wooden strips across.

All that remains to be done is to make the racks, which are formed with the wire netting. Nail the netting over one of the side supports, and under the other (Fig. 2). Be careful to stretch the netting, so that the shelf is taut.

The mesh of the network should be small, otherwise the fruit may fall through. A small wooden strip at the back of the shelf will also prevent fruit falling. However, this is not necessary if the rack is placed in front of a wall.

If you decide to paint the storage-rack, give it a coat before the wire shelves are fixed. It is not necessary to paint the netting.

Racks may be made to stand one on top of another, but they should be nailed together, to prevent them falling off. (F.G.)

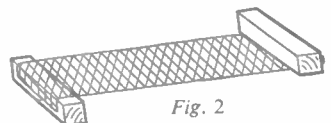
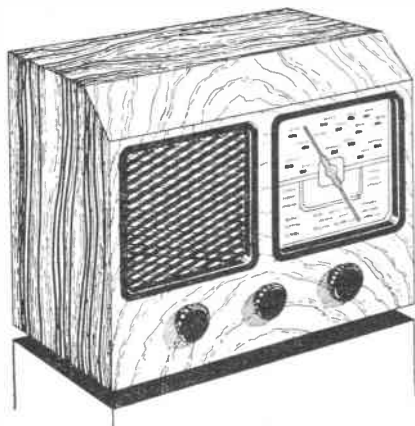

Fig. 2

To house your Superhet—make . . .

A RADIO CABINET



WHEN one has built a radio set, the next problem is how to house it in a suitable fashion. Too often a perfectly good set (from a functional point of view) is spoiled by being placed in a cabinet that is badly designed and constructed. One is confronted with a cabinet with that all too familiar amateur 'home-made' appearance.

There is no reason why one should be satisfied with this sort of thing. The cabinet described here, for instance, is relatively inexpensive, and certainly easy to build. A balanced frontal design is achieved by the use of two identical factory made escutcheons which cover the dial and loudspeaker cut-outs.

This not only improves the design, but gives a professional touch to the cabinet. The completed job has a most pleasing appearance.

The design should suit any conventional chassis. No dimensions are given, as it is quite simple to determine these to fit the particular chassis to be enclosed. A little measuring up of the existing chassis is all that is needed to work out the cabinet dimensions.

The position of the spindle of the main tuning condenser is important, as this will be the pointer centre and consequently the centre of the indicator dial cut-out.

The dimensions should start from this focal point.

The actual design is intended to accommodate an ordinary superhet set with the usual tuner, volume, and wave-change controls, but there is no reason why a straight T.R.F. set should not be suited to the design.

The first thing to do is to saw out the base of the cabinet. This should be $\frac{3}{8}$ in.

or $\frac{1}{2}$ in. thick and can be of any wood, although plywood is recommended. The kind of wood used for this and the other parts is unimportant, as it will be covered with veneer later.

It will be noticed that the base board (B) is narrower than the width of the side (E). This is to enable the front panel (F) to be recessed between the sides.

By A. Fraser

The ends of the base board should be squared off accurately and carefully.

Next, cut out the sides of the cabinet. The shape is shown in Fig. 1. The angle and width of the cut-off portion is a matter of taste. Some may like it bigger or smaller, or, perhaps, at a steeper angle.

The thickness of the wood for all parts of the cabinet except the base should be $\frac{1}{2}$ in. and plywood is again suggested.

When the sides have been cut out, strips are fixed to the top, as seen in Fig. 2 (S,S). These should be about $\frac{3}{8}$ in. wide by $\frac{1}{2}$ in. deep, and can be glued, nailed, or screwed.

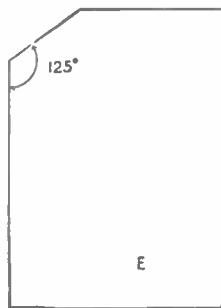

Fig. 1

They should be $\frac{1}{4}$ in. from the top edges as they are to support the boards at the top of the cabinet.

Note that the strips do not come right to the edges of the side. This is to allow for the front and back panels.

The top of the cabinet (T, Fig. 3) can now be cut out. Again see that the ends and edges are true. The width extends from the back of the cabinet to commencement of the slope on the side.

Next, deal with the front panel (F). Saw out the rectangle to the correct size. This can be calculated from the length of the base and the height of the sides as far as the slope.

When the panel has been cut the

positions of the cut-outs for the loudspeaker and dial must be drawn on the wood. For this, place the bakelite escutcheons face down on the board in the desired positions and draw round with a pencil. The actual cut-out should be $\frac{1}{4}$ in. smaller on all sides than this outline to allow the escutcheon sufficient overlap.

When satisfied on this point, saw out shapes with a fretsaw. The escutcheons should be tested in the cut-outs to ensure a satisfactory fit.

The piece (L) forming the sloping part of the front or top has yet to be sawn, but this is not done until the cabinet has been assembled.

First join the sides to the base board. Glue, and fine nails or screws will effect this. The heads of nails or screws should be countersunk slightly below the level of the surface of the side (E), so that the subsequent veneering process can be successful.

The front of the cabinet is attached similarly. Glue and pins or screws will secure it efficiently. Fine panel pins (P,P, Fig. 3) nailed into the sides from the inside of the cut-out portions will secure the upper part of the front.

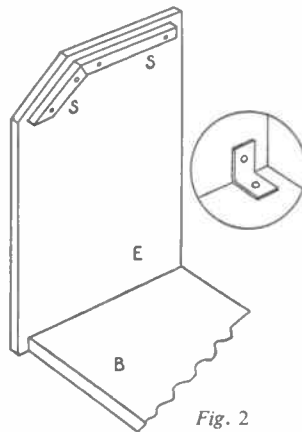

Fig. 2

The top (T) can then be fixed with glue, and again using fine pins or screws into the strip wood for added strength.

As the cabinet is mostly assembled, accurate measurements can be taken for the sloping section. It will be seen that the long edges of this piece (L) will have to be chamfered, if it is to fit properly into the recess. Fig. 3 shows the piece (L) about to be fitted into position. When a satisfactory fit is obtained, glue all edges of (L) and fix into position.

● Continued on next page

'TRAFFIC LIGHTS' BALL AND CUP GAME

EASILY made in an evening, this novel ball game will provide hours of fun. The idea is to flick a table tennis ball from the spring projector

(Fig. 1) into one of the numbered cups on the play board to score.

The ball is placed into the holder on the spring and is given the correct

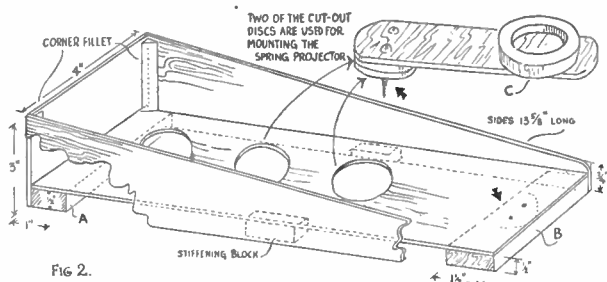
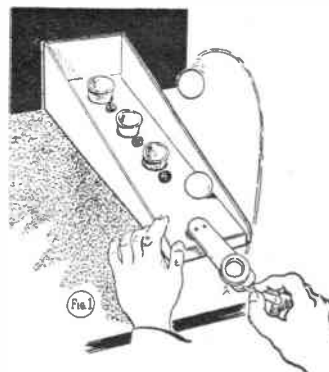

Fig. 2.

amount of 'flick' with the finger or 'plucker' to project the ball towards the cups. Coloured egg-cups are placed in each of the three holes cut in the board, and are arranged as traffic lights; red, amber and green. Own rules of play may be adopted, but a good idea is to allow each player so many attempts each

●Continued on page 140

●Continued from previous page

Making a Radio Cabinet

One or two fine pins nailed into (S) will secure the job.

When all is dry and firm, veneering can be started. The kind of veneer is a matter of taste, though walnut is a popular choice.

The sides should be veneered first, and here a plain vertical stripe grain pattern is, perhaps, best. Until the glue is dry, weights should be employed to press the veneer quite flat to the side.

craft knife is handy for this. Always cut the pieces of veneer larger than is required and trim off when fixed).

Next, do the top (T) in the same way, again trimming off with the knife. A grain pattern running lengthwise is suggested here.

Great consideration must be given to the pattern of the grain on the front, as this can add considerably to the beauty of the cabinet. A piece of veneer should be chosen which is excitingly variegated and yet symmetrical (i.e., balanced from side to side). A lop-sided pattern will spoil the effect.

When the glue of the front veneering is dry, trim off, and then lay face down on a hardwood board or smooth piece of aluminium in order to cut out the dial and loudspeaker shapes without splitting the veneer. One can, of course, cut out the escutcheon shapes in the veneer before gluing, but accuracy is not so easy to achieve.

Lastly, the sloping portion of the front can then be veneered and trimmed off.

Ventilation Holes

One need hardly say that before all this veneering process the wood surfaces of the cabinet must first of all be glasspapered to remove all excrescences, especially at the joinings, so that a perfectly level surface is provided on which to glue the veneer.

Only the removable back of the cabinet remains to be cut. This can be of 1/4 in. plywood. If a mains set is to be

used, then ventilation holes must be provided in the back. Small metal slip catches (Fig. 4) hold the back in place.

The holes in the front through which the control spindles pass must be carefully positioned, and drilled 3/8 in. or 1/2 in. diameter.

The finish to the cabinet is left to the reader. If it is to be stained and polished, glasspaper down, then glue-size, then rub down again. Do this twice and a really smooth surface is ready for treatment.

However, the virgin wood simply waxed to produce a satin finish is highly recommended.

Finishing Touches

Lastly, the dial and loudspeaker surrounds, or escutcheons, are fixed in. The best way to do this is to use Durofix or plastic wood. Lay the cabinet face down while the adhesive is setting, so as to press the surrounds flat up against the cabinet front.

After this, all that remains is to drill holes through the base board for the screws which hold the chassis down. Then fix on four rubber feet to raise the cabinet about 1/4 in.

A bronze metal fret is suggested for the loudspeaker aperture.

The dial and pointer and the two escutcheons can be obtained from Osmor Radio Products, 418 Brighton Road, South Croydon, Surrey.

Note that in Fig. 2 the inset shows an alternative method of fixing the base to the sides. This is useful where the sides are already veneered plywood and one does not want to spoil it by driving nails through into the baseboard.

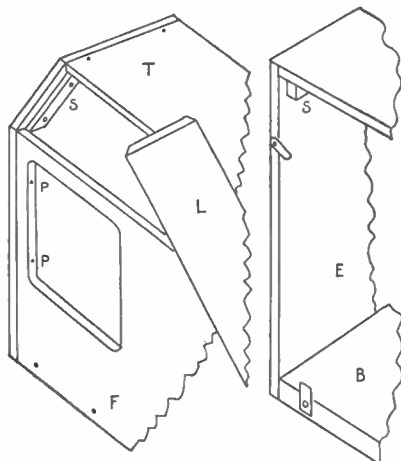

Fig. 3

Fig. 4

When dry, trim off the projecting edges to bring the veneering flush with edges of the sides. A razor blade or

Cycle Lamp Maintenance

MODERN battery-operated cycle lamps are usually very dependable and require the minimum of attention. When, however, it is out of commission for a while, the battery slowly deteriorates and the activating chemicals cause corrosion. Difficulty is then experienced in removing the battery.

If it cannot be removed by pressing up through the hole provided in the bottom end of the lamp body, a thin bladed knife should be inserted between the battery and the inner sides of the lamp and worked around to break down the corrosive deposits. In severe cases, the lamp should be stripped of its glass, bulb and reflector, and any other movable components, and placed in hot water for a few minutes, after which the battery can usually be easily removed. Needless to say, the lamp must be thoroughly dried before re-assembling.

Poor Contacts

A weak or flickering light is usually indicative of poor contacts, either on the bulb, battery electrodes or switch gear, and a dressing with fine emery paper may prove effective. Very often after installing a new battery the lamp fails to light, possibly because the top contact strip of the battery fails to make contact with the switch when it is in the 'On' position. A little experimenting in bending the contact strip will soon rectify the trouble.

The correct choice of bulbs is very important, as one-cell lamps such as are used for rear-lamps will require a bulb of 1.5 volt rating, while for two-cell units a bulb of 2.5 voltage will be required. In the latter instance a slightly larger rated bulb of 3.5 voltage can be used. If a two-cell battery is nearly exhausted, it is useful to remember that in an emergency a 1.5 volt bulb can be used.



Cyclists can help a great deal in the campaign to keep death off the roads by ensuring that their lighting systems are functioning to the maximum. Some useful advice on maintenance is given here by

E. S. Brown



Dynamo lighting sets are far more powerful than those that are battery operated, and their great advantage lies in the fact that apart from occasional bulb replacements, the initial cost is the final one. There is some slight objection to the increased friction caused through the magnetic fields of the dynamo, but as the average output is only of the order of 3 watts or so, the drag is negligible. In fact, far more drag and friction can be caused through the cycle being maladjusted and insufficiently

lubricated than could ever be caused by installing a lighting dynamo.

Correct Alignment

The dynamo should be installed and correctly aligned so that the friction drive is parallel to the wall of the tyre in the vertical plane, and ensuring that the drive makes an all-over contact, otherwise a flickering light will result.

Most dynamos use the earth return principle on their wiring systems, and weak and dim lights may indicate that rust has formed on the earthing point between dynamo and machine. The usual procedure for earthing is to scrape the enamel away on the tube where the dynamo is installed, either beneath the mounting brackets, or on a point where a bolt will be tightened to make the necessary contact. If rusting has occurred here the metal should be cleaned with emery paper, then lightly smeared with petroleum jelly before re-installing.

It is not advisable to take the dynamo apart, as being of the permanent magnet type, they will quickly lose some of the magnetism with the withdrawal of the armature, resulting in a loss of efficiency and output.

With the relatively more powerful headlamp of the dynamo set, care should be taken in obtaining the correct alignment and focusing. Broadly speaking, the headlamp should be adjusted so

● **Continued on page 136**

Make an Extending Fireside Curb

THE illustration shows an easy project for the amateur handyman. You can 'do it yourself' with a minimum of outlay and work.

The curb is extending, and can be modified to suit almost any fireplace. The extending pieces are held in place by two plain pegs made from dowel rod. Just place them in position and the curb is held firmly at the desired length.

If, however, you are using it in a permanent position, then the extending arms can be fixed with screws. Frequently curbs are lined with metal. This is desirable if it is near the fire, but if the wood is over 12ins. from the grate, scorching is not likely to occur.

Make the curb in two L-shaped pieces from 3ins. by 2ins. wood joined together at the corners as in the illustrations (page 143). If you can tackle a secret halving and mitre joint, so much the better, but the one shown is quite

Patterns
are on
page 143

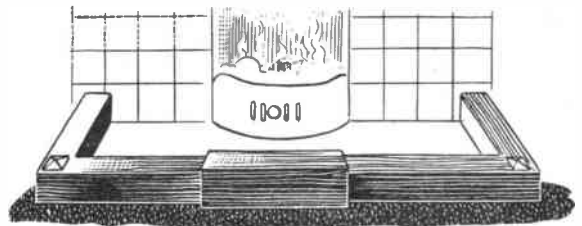

strong enough. Secure the corners with dowels as shown in the diagram in the lower right-hand corner.

Make up the box portion from four pieces of $\frac{1}{2}$ in. wood glued and pinned together. Note the strengthening cross-piece in the centre. Remember to bore a hole at each end for taking the dowel pegs. They should be on the inside of the curb, facing the fireplace.

Two wood ornaments are shaped as

shown in the full-size drawing at the top of the page. They are glued in position on the corners of the curb.

Finish off by staining and wax polishing. Five or six applications of polish will be necessary and each coat except the last should be polished with a duster and then rubbed with fine glass-paper. The final coat of polish should be lightly applied and given a brisk rub with a duster.

(M.p.)

'TABLE TOP' PICTURES

IF a 'table top' item is photographed from a high viewpoint, the effect is to dwarf its size and generally produce an appearance of smallness and insignificance.

This is but one point that should be known when taking pictures of handicrafts and the like, and it was made very obvious to me recently when getting some pictures of an African carved elephant for reproduction.

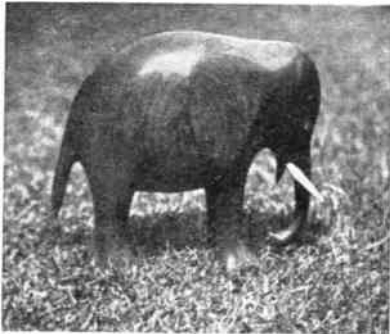

'True-to-life' result given by midway viewpoint. Note realistic effect produced by the grass

Up to the time of its becoming my model I had always viewed this piece of native craftsmanship from the depths of an armchair, and so with an upward line of sight, as its home was a mantel-piece. From this low view point the beast could look definitely ponderous, so the reduction in apparent size in my first photograph (taken from a high view point) was most startling and disconcerting.

Before I had finished with the elephant other principles of viewpoints (and lighting) had made themselves obvious, and as they apply equally to all table top items a few words about them may be helpful to any attempting this class of photography.

True to Life

Taking at a level of about midway up, the model's size, which would be about equivalent to the eye level of a person standing beside a real elephant, gave the most true to life result, while with the lens virtually at 'ground' level a great boosting in size was produced.

When deciding from what angle to take a table top subject the question, then, should be asked as to what is the purpose of the picture. Is it to make the item look like something miniature that can be picked up in the hand, or is the aim to get away from this? Is it wished to stress the fact that the item is a

By H. A. Robinson

hand-made and diminutive article or do you want the observer to exclaim 'It looks just real—for a moment I thought it was real!'

The range also influences the result. To get rather well back, obtain a pin-sharp negative and then enlarge gives a most pleasing 'drawing'. Also a very small stop and long exposure bring about the best rendering of detail.

Importance of Lighting

Having equal importance with camera height for getting the impression desired comes the lighting. Three-quarters frontal lighting brings up well the texture of the material from which the item is made. Indeed, with a very small stop and long exposure (which



The dwarfing effect of a high viewpoint

always, seem to 'bite' in detail better than a short exposure with large stop) the texture detail can be made to come out to an exceptionally strong degree.

Thus if one wishes to show the texture, use lighting of this kind. But if it is desired to subdue the texture, then toning-down can be obtained by using more back light than front. Carried to extremes this would give only a silhouette, but there is a mid-way line where texture is subdued and yet general form retained.

Side lighting, while it gives relief, if too directly side and strong shows up defects in a surface. For example an apparently perfectly flat area of, say, tin will, under a strong side light, seem to be almost buckled and denied. At the very least all impression of extreme flatness will have gone. Any actual flaw stands out prominently in a quite untruthful manner.

Setting a table-top item in an appropriate surround helps if it is wished to get away from the 'toy' appearance. Placing the elephant on grass demonstrates this point. The grass, which was

really quite short, gives the appearance of the rough 'flooring' of the elephant's natural home rather well.

All the photographs illustrated were taken at a stop of about $f/32$ and an exposure of 7 seconds. A film speeded 29 Scheiner was used, the time being mid-day August and the light bright.

A spectacle lens acted quite well as a 'magnifier' and by the use of one any camera that, perhaps, will not give pictures sharp nearer than, say, 7ft. or 8ft. can be made to take in good definition items only 2ft. or 3ft. away. Elastic bands hold the spectacle lens quite well in position.

Sharp Definition

Using a spectacle lens this way, however, gives only a limited depth that things are in focus. Note how quickly the grass gets fuzzy behind the elephant. And so to find the exact point on which a camera with a spectacle lens will focus, the back must be taken off and a piece of ground-glass or tissue paper put over the opening. What is in front of the camera will be seen and a few tests with some bright object will

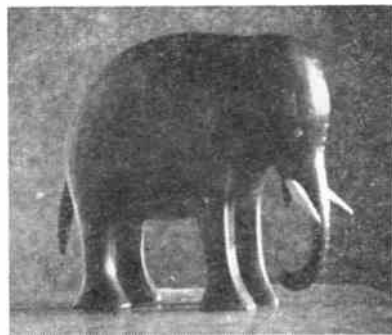

Apparent increase in size given by a low viewpoint

soon establish the point of sharp definition.

Once the point of sharp focus has been found no further tests will ever be necessary, as it will always remain the same and the point where to place future items can always be measured out with a ruler.

Ensure Rigidity

The spectacle glass method is an excellent help in taking table-top items with fixed focus cameras.

When taking table-top items with dragged out exposures everything must be very rigid, the camera being on a perfectly solid support, for even the most minute movement of either subject or camera destroys definition.

COLOURING BRASS

FOR models, instruments, and other small constructions brass is a justifiably popular metal with amateur craftsmen. Its ease of working is an advantage, but the fact that it has a colour so different from the usual white metals, undoubtedly explains its main attraction. This attraction of colour is a potent factor in the finish of an object, and to have a choice of colour should appeal to all metal-workers. By the use of various baths it is possible to obtain a wide range of shades. Individual taste, or suitability to the object can turn out a distinctive finish.

The methods are essentially chemical in principle and consist of producing a thin surface layer of certain chemical compounds on the metal. It is the thinness which gives the effect, just as does an oil film on water. The requirements for the formulas given in this article are easily obtainable from a pharmacist or laboratory furnisher.

Pre-treatment, as in electro-plating, is necessary, so as to operate on a completely clean surface. Grease, whether apparent or not, should be removed by swabbing with benzene, changing the rag frequently. The metal should not be touched with the bare hands after this, or the usual grease film from the skin may cause a patchy result.

Acid Pickle

Follow up degreasing by rubbing bright with fine pumice and water, rinse, polish with whiting and water and finally rinse again. Immediately before immersion in the bath dip for a few moments in an acid pickle consisting of 1 volume of strong nitric acid and 10 volumes water. Rinse and place in the bath. When the colour appears, remove, rinse well with water and allow to dry, either in the air or in sawdust. To preserve the colour a very thin coating of lacquer is usual. A little bleached shellac dissolved in methylated spirit or clear cellulose lacquer thinned with amyl acetate are both very suitable.

For the baths glass vessels (beakers for hot liquids) are best, though enamel can serve. Bare metal vessels should not be used.

Gold, green or blue-green. Dissolve 1½ ounces sodium hydroxide (caustic soda) in 25 fluid ounces of cold water. In this solution dissolve 1 ounce lactose, bring to the boil and simmer for 15 minutes, making up any water lost by evaporation. Remove the flame and add 1 ounce by weight of a cold saturated solution of copper sulphate. This latter

is made by adding small portions of powdered copper sulphate to boiling water until no more will dissolve, allowing to cool overnight and pouring off from the crystals which will have formed.

Following this addition, a red precipitate of cuprous oxide appears and settles in the cooling bath. The colour sequence in the bath begins with gold, passes to green, then to yellow and finally blue-green. By longer treatment iridescent effects are obtained.

Warm Bath

This bath must be operated warm. For quick results a temperature of 75 degrees Centigrade may be used, but the colours sometimes tend to be uneven. Remove the work at one minute intervals for inspection. Though needing longer immersion, a temperature of about 56 degrees Centigrade ensures more even results.

Black. Dissolve 1 ounce copper carbonate in 7½ fluid ounces ammonium hydroxide of specific gravity 0.88 and then stir in 1½ fluid ounces water. The colour usually appears in two to three minutes. The brass should be kept on the move in the bath.

Brown. Age the brass in moist sand, then polish with a dry brush.

Blue. Immerse in a strong solution of sodium thiosulphate ('hypo').

Grey. This is the end point of several colour changes. In 40 fluid ounces of water dissolve 2 ounces copper sulphate, 2 ounces sodium thiosulphate and 1 ounce potassium hydrogen tartrate ('cream of tartar'). On immersion, the metal first develops a rose shade which changes to blue. Remove the work and dissolve in the solution 2 ounces of ferrous ammonium sulphate and a further 2 ounces of sodium thiosulphate. Re-enter the brass. It will now revert to yellow, pass to rose, blue,

back to yellow, finally the grey appears. **Iridescent.** Dissolve 0.5 gram each of potassium hydrogen tartrate and copper sulphate in 25 c.c. of water. To this add a solution of 1.3 grams sodium thiosulphate in 1500 c.c. of water.

Copper reddish tone. Dissolve 30 grams potassium hydrogen tartrate in 700 c.c. water. To this add the liquid obtained by thoroughly stirring 15 grams stannous chloride with 65 c.c. water. Heat to boiling, remove the flame, allow the precipitate to settle, and pour off the clear liquid. Stir this slowly into a solution of 90 grams sodium thiosulphate in 130 c.c. water, and then heat to boiling. Immerse the brass in the boiling liquid.

Moiré. Dissolve 10 ounces of copper sulphate in 20 fluid ounces of boiling water. The bath is used at the boil. A small clean iron nail must be kept in the bath during the whole of the time the metal is being treated.

Colour Enriched

Orange. Deepening the colour of brass enriches its appearance. To produce the orange finish first measure out 20 fluid ounces of water. Put 2 ounces sodium hydroxide in a rubber stoppered bottle, pour on about 4 fluid ounces of the water and shake occasionally until dissolved. Then add 4 ounces copper carbonate and stir or shake until dissolved. This solution is then diluted with the remaining water. On immersion, the brass first deepens to gold and then passes to orange.

Carmine red oxide finish. If the work is left in the last bath the orange gives place to the carmine red colouration.

Brownish-yellow with red iridescence. This beautiful finish calls for a bath made by dissolving 10 grams each of nickel sulphate and potassium chlorate in 500 c.c. water and stirring into this 4 grams nickel carbonate. (L.A.F.)

● Continued from page 134

Cycle Lamp Maintenance

that the beam strikes the road surface approximately 30ft. in front of the machine. The focus should be adjusted so that the beam is not too concentrated, but tends to open out and illuminate a 10ft. frontal area at the point where the beam meets the road surface.

When replacing bulbs, use only those specially designed for use with dynamos, and more especially of the rating as recommended by the makers of the lighting set. Without exception, the

headlamp bulb is always of a higher rating than that of the rear-lamp, and if the balance is upset by using replacement bulbs of a different rating, either the bulbs will burn out or the light will be weak and dim. When replacing bulbs, always remember to reinstall the cork or rubber weather sealing ring between the front glass and the reflector. Failure to do so, will badly tarnish the reflector and greatly reduce the powers of illumination.

Easy to fix

Model Garage Lighting

WHAT could add more to the pleasure of owning the popular Service Station described in the Oct 19th issue of *Hobbies Weekly* than full electric lighting?

You need not be an electrician to complete a satisfactory wiring system to give not only illumination to the outside, but to the inside as well. The diagram here deals mainly with illumination, but it is a simple matter to add more lights to the existing layout.

There are no actual structural alterations to make, but it will be necessary to fix the parts of the garage securely to the base. This can be done by using glue, and also running pins or screws through from underneath. Stand the pieces in position, mark round them, then drill through in convenient positions and countersink for all the screws.

The battery is housed in the ramp at the back of the garage as shown in Fig. 1. There is no need to make elaborate joints in the wiring, paper clips are quite suitable for the connections to the battery. They can be slipped on and off at will.

The switch is situated at the back of

How to wire your Service Station for illumination

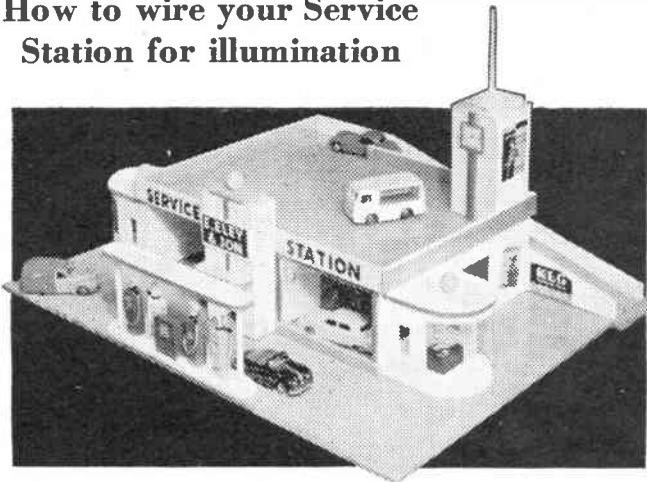

from the battery and the other lead from the switch will connect to the bulbs through the bulb holders.

The holders can be purchased from Hobbies Ltd., Dereham, Norfolk, price

The bulbs are connected in parallel; that is all the threaded portions together and all the bases together. The lead is then carried back to the battery as shown in Fig. 2.

The best battery to use is the double cell type shown in Fig. 1. Larger heavy duty batteries could be used, but it might be necessary to provide separate accommodation.

For the outside illumination, bulb holders should be screwed to the top of the two 'wings', taking the place of the ball ornaments. Drill two holes to take

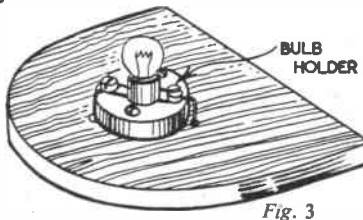
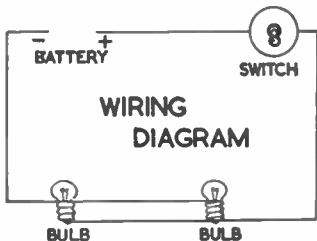
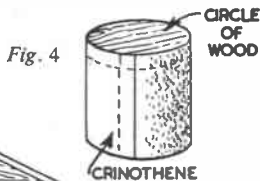
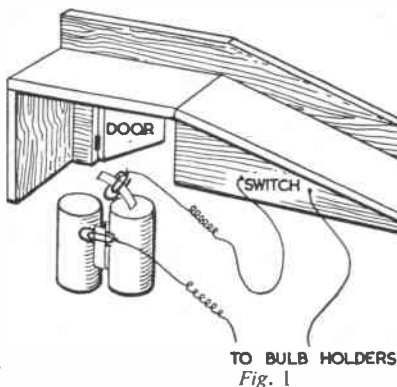

9d. each and the switches 1/6 each. Sets of six holders, two switches and six yards of wire cost 8/1. If you examine them you will find that the wire is connected to two screws. One screw leads to the threaded portion of the bulb and the other to the base, thus making the circuit.

POPULAR CHOICE

The design for model garage (illustrated above), given in the Oct. 19th issue of *'Hobbies Weekly'* proved to be very popular and thousands of parents and boys are making it up. The full kit, including petrol pumps, can be obtained from branches or post free from Hobbies Ltd., Dereham, price 39/-.

the wires as shown in Fig. 3. Further holes may be drilled at convenient points to connect up with other bulb holders as required.

To finish off, the bulbs should be covered with Crinothene. Cut a circle of $\frac{1}{4}$ in. wood, the same diameter as the holder, and glue the Crinothene round as shown in Fig. 4. For bulbs inside the garage, use white or coloured paper glued round the outside of the bulb holder. (M.h.)

the ramp where it is easily to hand. Lead one wire from the battery direct to the switch as shown. The remaining lead

Books to Read!

A review of interesting books for craftsmen which have been recently published. Obtainable through newsagents or book-sellers or direct from the publishers mentioned.

Woodworking

by J. S. Chappell

THIS complete guide for the wood-worker contains detailed instruction in the use and care of woodworking tools and all necessary equipment. It explains the nature of wood and covers the conversion, seasoning and storing of timbers, of which it supplies a comprehensive catalogue. There are instructions for the cutting of all kinds of joints and other aspects of woodwork are fully covered. The making up of different categories of projects are also clearly described in this profusely illustrated book which can be recommended for its comprehensive treatment of a subject with so many aspects.

Published by Cassell & Co. Ltd., 37/38 St. Andrew's Hill, London, E.C.4—Price 15/-.

The Four-Masted Barque

by Edward Bowness

THIS book goes fully through the whole process of building scale models of four-masted barques. It covers the whole subject of these colourful sailing boats, and everything is explained in detail from the point of view of the ship modeller. A 'must' for modellers who have a leaning towards and love for barques.

Published by Percival Marshall & Co. Ltd., 19-20 Noel Street, London, W.1—Price 9/6.

Hamsters

by C. F. Snow

ALTHOUGH the golden hamster is a comparative newcomer to England, it has quickly established itself as an endearing pet. It is a most attractive, entertaining and mischievous little animal, giving constant joy and amusement to its owner. Expert advice is given on everything you will want to know about this pet.

Published by W. & G. Foyle Ltd., 119-125 Charing Cross Road, London, W.C.2—Price 2/6.

Wooden Toys for Boys

HERE are instructions, including scale diagrams and assembly details, for making 14 fascinating toys, and lots of information which will be valuable in making many others. It explains that equipment need not be large, nor expensive, for making up toys to delight children—as a matter of fact,

cotton reels are a basic material for many of those described.

Published by The Studio Ltd., 66 Chandos Place, London, W.C.2—Price 5/-.

Young Collectors' Book

HOW many young collectors know the number and type of birds' eggs which they are allowed to take, providing they have obtained the permission of the owner of the property on which the eggs are found? This list is detailed—an example of the careful thought which has gone into the compilation of this book in its various chapters on different collecting hobbies. Wild flowers, coins, cigarette cards, and cheese labels are among other subjects which are dealt with very fully, and so as to ensure the maximum interest.

Published by Burke Publishing Co. Ltd., 55 Britton Street, Clerkenwell Road, London, E.C.1—Price 7/6.

Leathercrafts

by J. F. B. Parkes and S. P. Judge

THIS well-produced volume contains a valuable aid and instruction for the specialist in school, college or industry, for the craft instructor and for all those who take pleasure in working leather as a hobby. From the history of leather through the ages, tools are discussed, general instructions given, and significant details of accessories, techniques and designing explained. Excellent designs in full size should enable the beginner to make up attractive articles in this medium.

Published by Longmans, Green & Co. Ltd., 6 and 7 Clifford Street, London, W.1—Price 21/-.

THREE handbooks in the Popular Handicrafts series—on basketry, weaving and lampshades—have also been received.

Published by Link House Publications, Link House, Store Street, London, W.C.1 and priced at 1/6 each, they contain really useful information for those interested in these particular hobbies.

THE Micromodels book, priced at 2/9, goes thoroughly into the fascinating hobby of making models in card. The recommendations born of experience will be a great aid to workers in this medium.

Modelled Portrait Heads

by T. B. Huxley-Jones

MODELLED sculpture is an art which many people would like to practise. They, no less than the sculpture student, will find in this book an extraordinarily clear explanation of the processes of working 'in the round'. The work of building up accurately in clay, the basic forms of the bony structure of faces, and the addition of the particular features which convey the character of the sitter, are clarified step by step. Casting and finishing plaster replicas are also fully described.

Published by The Studio Ltd., 66 Chandos Place, London, W.C.2—Price 18/-.

How to Draw Ships, Vol. 2

by Peter F. Anson

THE author, who has made an extensive study of the subject, shows how to draw all kinds of craft, from rowing boats and sailing ships, to passenger-carrying liners and warships. Not only will the reader learn to draw ships, but he will learn a great deal about the ships themselves, so that this book has a two fold appeal.

Published by The Studio Ltd., 66 Chandos Place, London, W.C.2—Price 5/-.

YOU MUST HAVE THE Micromodels BOOK

MAKING Authentic Models of Historic Buildings, Locomotives, Ships, Aeroplanes, Trams, Cars, etc. is the Hobby for a Lifetime. Using card, model making is a tidy fireside hobby. This new book

'MAKING MODELS IN CARD'

with full-colour cover and 32 pages and 40 illustrations of valuable Hints & Tips and Stimulating Ideas, is being sold at the actual cost of production to tell you how to make Micromodel Museum Pieces at small cost. A Hobby that challenges and rewards your skill. **MICROMODELS LTD** 3 (H) Racquet Ct., Fleet St., London, E.C.4

2/9

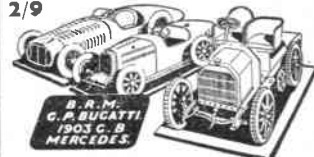

The Handyman's PERFECT PAINT

Here is a perfect answer for the home handyman's painting problems—easy-to-use Robbialac Lacquer. This versatile finish dries dust-free in 2-4 hours and overnight sets to a diamond hard glass-like gloss that resists steam and hard wear. It leaves no brushmarks and is the ideal finish for the amateur painter who aims at a professional job. It is sold in handy $\frac{1}{8}$, $\frac{1}{4}$, $\frac{1}{2}$ and 1 pint tins and is available in 24 brilliant colours plus black, white and silver. Ask for it at any good paint shop, cycle shop, ironmonger or hardware dealer.



FREE: Put a 'factory finish' on your handiwork. For a free Instructional Leaflet send 13d. stamp to: Dept. 6L12 Jenson & Nicholson Ltd., Carpenters Road, London, E.15

ROBBIALAC LACQUER

JENSON & NICHOLSON LTD., CARPENTERS ROAD, LONDON, E.15

Wolf Cub ELECTRIC DRILL for only 6/- deposit



This Electric Drill is the power unit for ALL Cub equipment. Drilling capacity: Mild Steel $\frac{1}{2}$ in., Hard Wood $\frac{1}{2}$ in., with 210 watts input on full load. Complete with $\frac{1}{2}$ in. three-aw chuck and Allen key and 5 feet of cable. TV suppressed. State voltage. Cash price £5.9.6 or 6/- deposit and 6 monthly payments of 19/6. Also **SANDING AND POLISHING KIT** (complete with drill, discs, lambswool bonnet, etc., £6.10.6 or 19/- deposit and 6 monthly payments of 21/-). **LATHE KIT** (complete with drill and tools) £10.10.6 or 21/- deposit and 8 monthly payments of £1.6.6. **WOLF HOME WORKSHOP OUTFIT** (comprising drill, saw, lathe, sanding and polishing kits) £16.17.6 or 40/- deposit and 8 monthly payments of £2.1.6.

Send for illustrated Brochure of the complete WOLF Cub range of tools and see how you can build up your own sets.

ELECTRIC PAINT SPRAYER 4/- deposit



Cash 75/-. Or 4/- deposit and 6 monthly payments of 13/6. Paint easily, evenly, twice as fast with the Burgess Electric Sprayer. Sprays paint, varnish, etc. Complete with sturdy glass container, flex, nozzles for ceiling spraying and extra nozzle discs for different liquids. A.C. mains—state your actual voltage. Fully guaranteed. Also Horvell Electric Paint Stripper 30/- cash, or 4/- deposit and 3 monthly payments of 10/-. Leaflets free.

YOURS for only 15/- down!



Save time and work on sewing jobs with this excellent 'Essex' Miniature Sewing Machine. Beautifully finished with chromium plate. Supplied with clamp for fixing firmly to table. 6 months' guarantee. Cash price £4.17.6 or 16/- deposit and 6 monthly payments of 16/6. Electric model available A.C./D.C. with foot control £10.3.4, or 31/- down and 6 monthly payments of 32/-. Protective carrying case 18/4 extra. Send for leaflet today.

BARGAIN DISTRIBUTORS
(Dept. 124), 5 Silver Street, Luton

NEW- for you!

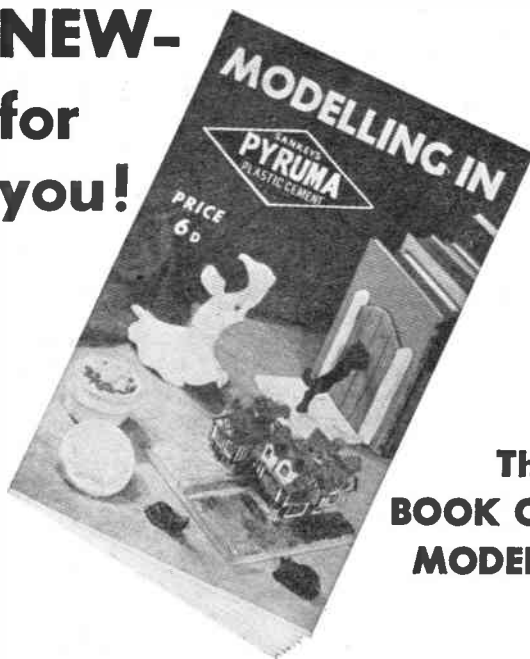

This BOOK OF MODELS

MODELS of every kind from one plastic ready-to-use material—PYRUMA! This book with new methods—new ideas—shows you how to acquire simple skill in making many types of permanent models listed below. And pages in full colour show how your models of animals, buildings, figures, etc., can be painted in natural tints.



Pyruma is supplied, plastic and ready for immediate use, in air-tight tins, obtainable from your local Ironmonger, Hobbies shop or Art material dealer, from 1/6d. upwards. Finished Pyruma Models can be baked or air dried to stone hardness ready for colouring after simple treatment. Send 6d. P.O. (not in stamps) with the coupon below for the book which shows how to make **MODEL RAILWAYS, STATIONS, SIGNAL CABINS, FARM COTTAGES, SHIPS, FIGURES, ANIMALS, ASH-TRAYS, BOOK-ENDS, MODEL FURNITURE, PLAQUES, RELIEF MAPS, ETC.**

COUPON

To: **J.H. SANKEY & SON, L^{TD}**

Estd. 1857

Dept. HW, ILFORD, ESSEX

Enclosed 6d. P.O. (not stamps) for PYRUMA MODELLING INSTRUCTION BOOK addressed to:

NAME (Block letters)

ADDRESS

Easy to make

GIFTS FOR CHRISTMAS

By S. H. Longbottom

A FIRESCREEN is not beyond the ability of any resourceful handyman. A panel, approximately 24ins. by 20ins., of hardboard, fibre-board or plywood is required. The choice between veneered or plain board which may be finished by painting depends on the amount you are prepared to spend.

If hardboard is used it is better to glue and pin a frame 2ins. by $\frac{1}{4}$ in. wood to the back of the board followed by a piece of beading at the edges. The feet are 6ins. long, $1\frac{1}{4}$ ins. thick, rounded and with a notch cut out to accept the panel. Many handicrafts shops sell these feet ready prepared, but it is always wise to hollow the bases slightly to prevent a wobble on uneven tiles.

The whole screen may be painted to any required shade, and a transfer applied for decoration. Some may prefer to give it a coating of plastic paint.

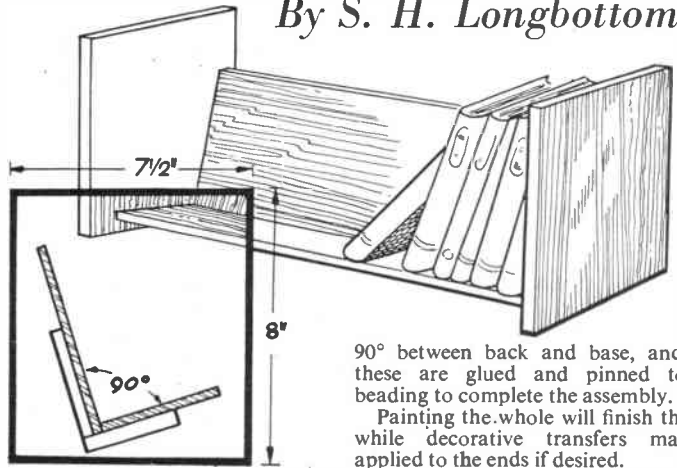

90° between back and base, and that these are glued and pinned to the beading to complete the assembly.

Painting the whole will finish the job, while decorative transfers may be applied to the ends if desired.

Continued from page 133

Ball and Cup Game

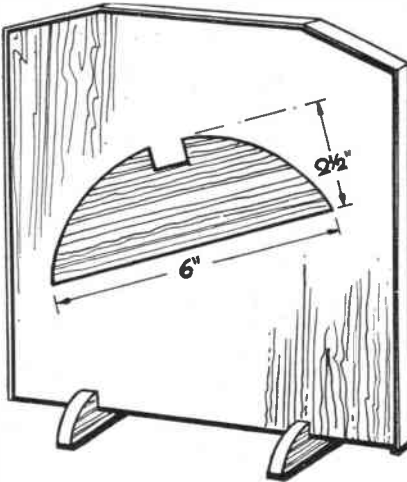

after getting the ball into the green cup for 'go'.

Fig. 2 shows the simple construction. The play-board (Fig. 3), the two sloping sides, and the end are cut from plywood. Mark out the three circles with a compass and drill a fine hole in each outline. Cut out with the fretsaw. Mount the board on two wood strips (A) and (B), and glue and nail the sides and end to it, adding strips and corner fillets for extra support. Cut out the projector (Fig. 4) from plywood, so that the grain runs across the width, to give it the necessary 'spring'.

Mount Centrally

The ball-holder (C) is cut with the fretsaw from $\frac{1}{4}$ in. plywood, or is made up of two cut from $\frac{1}{4}$ in. wood and glued together. Glue and pin this to one end of the projector. Take two of the discs cut from the board and place them under the other end of the spring projector. Drill two holes right through. This assembly is now screwed to the front end of the play board. Ensure that it is mounted centrally.

Clean up all the surfaces with glass-paper, and give the whole board two coats of enamel paint. Cheap plastic egg-cups are placed in the holes, and each is given a number. A ball 'fired' too strongly can be bounced back to the player by the addition of a large sheet of cardboard to the end of the play board. One or two balls complete the game.

(T.S.R.)

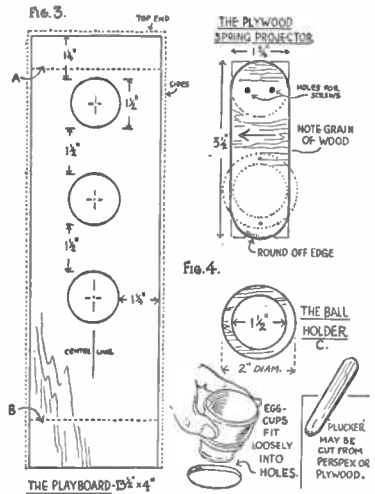

New Eyelet Kit for Leather Workers

To make eyelet holes for leather belts and bags, and for fixing on materials where lacing is required, is an easy matter with the new Dura-Bac kit. This consists of rust-proof metal eyelets which are neatly and firmly fixed into the material with the aid of an ingenious little tool. The kit costs only 1/3 and a variety of eyelet colours are obtainable.

NEW!

EXPERIMENTAL KITS

LEARN THE PRACTICAL WAY

Here is home study of the most effective kind under expert tutors. There is no better way of studying for an examination, starting a new hobby or for a career in industry. These special courses comprise the most modern methods of postal tuition, combined with a Practical Kit of parts (which remains your property).



COURSES FROM 15/- A MONTH

COURSES WITH PRACTICAL EQUIPMENT INCLUDE: Radio, Television, Mechanics, Electricity, Chemistry, Photography, Carpentry; also Draughtsmanship, Commercial Art, Amateur S.W. Radio, Languages, etc.

POST THIS COUPON TODAY

For FREE brochure write: E.M.I. INSTITUTES, Dept. 31X, Grove Park Road, London, W.4.
 SUBJECT(S) OF INTEREST.....
 NAME.....
 ADDRESS.....
 7/12/55..... IC5IA

**E.M.I.
INSTITUTES**

The only Postal College which is part of a world-wide Industrial Organisation

THE ROYAL AIR FORCE invites 1,000 boys to train for KEY TECHNICAL POSTS

If you are between 15 and 17½ the R.A.F. can offer you the chance of a lifetime: to begin a technical or administrative career *now*. In a few years' time, you could be a skilled man. Those accepted will train as—
Aircraft Apprentices: age 15-17 (exceptionally 17½) in the aircraft, armament, radio, electrical and instrument trades.
Administrative Apprentices: age 16-17 (exceptionally 15½-17½) in supply, accounting and secretarial duties.
Boy Entrants: age 15½-16½ (exceptionally 15) to be mechanics in radar, armament, engine and other trades, also telegraphists and cooks.

This valuable training *will not cost your parents a penny*. You get good pay, good holidays, plenty of sport. Post the coupon for full details.

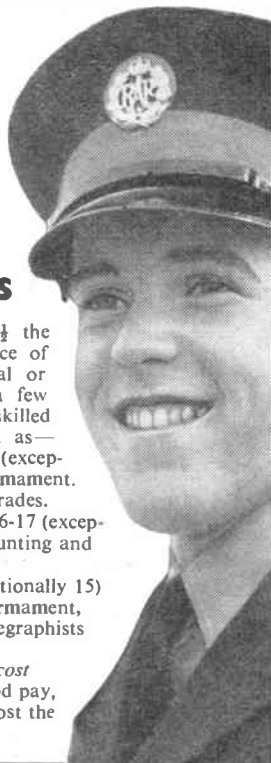

TO: R.A.F. (H.S.245), VICTORY HOUSE, LONDON, W.C.2.
I am between 15 and 17½. Please send me the illustrated booklet "Highway for Youth" and details of Apprenticeship scheme.

NAME.....
 ADDRESS.....
 (Applicants from British Isles only)

POST THIS COUPON BEFORE DECEMBER 20—OR YOU MAY BE TOO LATE

MAKE BETTER MODELS with this fine **X-acto TOOL CHEST**



YOURS FOR ONLY **6/3** DEPOSIT plus 2/6 post & packing and 6 monthly payments of 15/- CASH £4. 7. 6

All robust accurately made tools: 3 knives, 23 cutting tools, spokeshave, plane, stripper and steel rule — in magnificent moulded cabinet

Write now to:

LAFCO COMPOUNDS LTD (Dept. H.W.4)
 3 Corbetts Passage, Rotherhithe New Road, London, S.E.16

WATCH AND CLOCK REPAIR OUTFIT



The complete Outfit for cleaning and repairing. Comprises: Illustrated explanatory booklet, eye-glass, tweezers, screwdrivers, oil, dusting powder, oilers, also illustrated catalogue, tools and materials.
 Plus P. & P. 6d, extra C.O.D. if required **12/9**
 The above with additional luminous compounds, jewellers' rouge, dial brush, jewels. Plus P. & P. 6d, extra. C.O.D. if required. **21/-**

ASSEMBLE YOUR OWN JEWELLERY

Selection of unset earrings, pendants, rings, brooches and stones, etc., at fraction of cost. Send S.A.E. now for big illustrated free catalogue. Money back guarantee

THE BOLSTER INSTRUMENT CO. (Dept. HB49)
 GOVETT AVENUE, SHEPPERTON, MDDX.

HEAR ALL CONTINENTS With H.A.C. Short-Wave Receivers

Suppliers for over 18 years of Radio S-W Receivers of quality.
 One-Valve Kit, Price **25/-**. Two-Valve Kit, Price **50/-**
 Improved designs with Denco coils. All kits complete with all components, accessories and full instructions. Before ordering, call and inspect a demonstration receiver, or send stamped addressed envelope for descriptive catalogue.

'H.A.C.' Short-Wave Products (Dept. 22), 11 Old Bond Street, London, W.1



**PURE PLATINUM PLATED
FILM STAR WATCH
SIMULATION DIAMOND SET**

Setting closely resembles fine White Diamonds. Set on the four quarters is a choice of sapphire, ruby or emerald coloured stones. Accurate pin-lever jewelled movement.

Comp. guar. £4.19.6 on cordette, 21/- extra for dainty bracelet. Luminous dial 6/6 extra. Sent for 3/6 dep. If satis. pay 18 fortnightly pmts. 6/- Offered for the first time in England.

**Pure Platinum Plated
GENTS CALENDAR WATCH**

SENT FOR ONLY
3/6 DEPOSIT
CASH PRICE £4 19 6



For the first time you can own this wrist watch, genuinely plated with pure unadulterated Platinum. With calendar dial that keeps you informed of date. Automatic action changes date every 24 hours. Real pin-lever movement, shock and dust resistant. Neat flat case. Comp. guar. £4.19.6 on strap, or 21/- ex. for bracelet. Luminous dial 6/6 ext. 3/6 dep. If satisfactory, 18 fortnightly payments 6/-. LISTS. TERMS. Open Sat. 1 p.m. Wed.

HEADQUARTER & GENERAL SUPPLIES LTD.

(HOBW/82), 196-200 Coldharbour Lane, Loughborough Junc., London, S.E.5.

VIBRO-ARC

**ELECTRIC METAL
ENGRAVING TOOL**

Engraves, etches, marks, writes... on

Brass, Copper, Silver, Nickel, Aluminium, Chromium, Hardened Steel



TEEBEE MANUFACTURING CO. LTD.
Dept. V51, 205 Hook Road, Chessington, Surrey.

ONLY
10/-

POST FREE
Complete with instructions for use. Additional 12 engraving points 2/6, post free. Operates from 4 or 6-volt Accumulator or Mains Transformer. Suitable for Name Plates, Dog Collars, Cutlery, Tools, etc.

A GRAND BOOK FOR ALL THE FAMILY. The "Kaylee Year Book of Bright Ideas". A really helpful guide to home planning, decoration, Hobbies, toys, etc. Showing famous Kaylee Transfers in brilliant colours, and most effective uses. From "Hobbies" stockists or direct.

KAYLEE TRANSFERS Postage 3d.
LTD. (HW), Long Eaton, Nottingham.

BUILD your own T/V and learn about its operation, maintenance and servicing. Qualified engineer-tutor available whilst you are learning and building. Free Brochure from—E.M.I. Institutes, Dept. HW58, London, W.4. (Associated with H.M.V.)

Genuine Swiss Musical Movements. Owing to large purchase now reduced to 14/6 each. Genuine Thorens Movement, all guaranteed, 19/3 each. P. & P. 9d. extra on all orders.—Richardson & Forder, 5 Chapel Place, White Hart Lane, London, N.17.

200 STAMPS free. Genuine. S.A.E. for approvals. Details.—W. H. Self, 36 Fairfield, Boro Green, Kent.

'PROFITABLE HOBBIES', America's leading monthly. Year's subscription 28/6, specimen 3/6. Full list American magazines free—Hobson, 79 Southbrook Road, Exeter.

PLYWOOD; large sizes, 14 lbs. 10/- delivered (Express) C.W.O.—H. Leader (1920), Gosford St., Middlesbrough.

DO-IT-YOURSELF BOOKS. List free.—S.P. Ltd., 28 (H) Dean Road, London, N.W.2.

MODELS. You can make lasting stone-hard models with Sankey's Pyruma Plastic Cement. Supplied in tins by Ironmongers, Hardwaremen and Builders' Merchants. Ask for instruction leaflet.

SWISS MUSICAL Mechanism for cigarette boxes, etc., 16/6 post free. S.A.E. for illustration and list of tunes available.—Dept. HW., Metwood Accessories, Church St., Wolverton, Bucks. (Trade supplied.)

CHINA repairing. This fascinating and profitable hobby can be learnt successfully and inexpensively at home. Particulars from—The Chelsea Studio, 10 Blacklands T'ce, S.W.3.

100 DIFFERENT stamps free! Request 1/d. upwards discount approvals.—Bush, 53 Newlyn Way, Parkstone, Dorset.

CASTING moulds for lead soldiers, animals, Cowboys, Indians, etc. Illustrated catalogue 4d. Sample mould 6/6.—G. Rhead, Bacton, Stowmarket, Suffolk.

25 QUEEN ELIZABETH stamps absolutely free to approval applicants enclosing postage.—Yulwontrom Stamps (Dept. H5), 29 Layton Avenue, Mansfield, Notts.

50 STAMPS free to all approval applicants enclosing 2/d. stamp.—Cliffe West (M4), 61 Wynyard Road, Sheffield, 6.

TRY the approval service which offers free gift and bonus scheme. Details and sample selection by return.—Paragon Stamp Co., 138 Oakley Rd., Shirley, Southampton.

COIN Collectors! S.A.E. for list of inexpensive coins.—Box No. 15, Hobbies Weekly, Dereham, Norfolk.

ALL model makers requisites. Plans for dolls' houses, forts, galleons, garages, etc.; model aircraft, marquetry, fretwork, plywood. Hobbies stockist. S.A.E. for enquiries.—Handicrafts, 441 Seven Sisters Road, London, N.15.

STAMPS—500 different 5/-. Sample 100, 1/3.—Tom Clarke, 46 Carysfort Ave., Blackrock, Dublin.

CHRISTMAS DECORATIONS, ETC. Everlasting Flowers/Grasses/Ferns, Foliage/Artificial, 3/- per bunch. Post 6d. Ass'd. Colours and types. The five kinds, 14/6 c.p. Tinsel ribbon, Glitter Gilt, Silver foils, etc. **WREATH OR BOUQUET-MAKING OUTFITS,** Instructions and designs, 20/- each. Combined, 30/- c.p. Instructions and designs 2/6. Book 'Making Floristry Your Business' 6/6. Stamp, list all materials.—Station Nurseries (H), Oakengates, Salop.

PYGMY TREE-GROWING OUTFIT, 17/6 c.p. 6 Trees, 6 Cuttings, 6 Pkts. Seeds, 18 Growing Pots, Compost, Cuttings, Powder, Instructions. **MINIATURE-GARDEN OUTFIT,** 20/- c.p. 5 Growing Trees, Container (10"x8") and Tray, Sunk Flower Centre, Pool, Fish House, Rocks, Compost, Instructions. **BOOK 'Jap Minigardens & Pygmy Trees',** 2/10 c.p. Instructions Leaflets 9d. Stamp, list all materials.—Station Nurseries (H), Oakengates, Salop.

£5 to £20 weekly earned at home running your own Mail Order business. Complete Course 5/6.—Courses, 28(HB) Dean Road, London, N.W.2.

SHORTHAND in 1 week. Test lesson, 2/d. Stamp.—Dutton's (HB/SV), 93 Gt. Russell St., London, W.C.1.

AMERICAN MAGAZINE Subscriptions. One Year Popular Mechanics 30/-. Popular Science 43/-. Homecraftsman 16/6. Homecraft 18/-. Deltagram 12/6. Free booklet quoting others.—Willen Ltd. (Dept. 57), 101 Fleet St., London, E.C.4.

TOY CASTING MOULDS. Soldiers, sailors, fairmen, etc. 1,000 varieties from 3/- each. Rubber moulding compound for flexible moulds, granulated ready for use, 8/6 per lb. Aluminium moulds for plaster work. S.A.E. for list. Catalogue 9d.—F. W. Nuthall, 69 St. Mark's Road, Hanwell, London, W.7.

**OUR LADS
BRITAIN'S
FIRST
ROCKET
SPACE SHIP**



SENT FOR
2/6 Deposit

Actually holds 4 boys
A romantic ten thousand miles an hour trip to the Moon. Adventure for brave young pioneers to be first there. Attractive coloured wind, rain, and element resisting material, definitely not plastic. Silver tipped. With Aerial. Large enough for four boys. Stands indoors or out-doors. Height 5' 3". Sent for 2/6 dep. Bal. 6 mthly. pmts. 5/4. Cash 29/11, post etc. 1/6.

**THE NEW INTERPLANETARY
SPACE SUIT** Only 12/11



Be an interplanetary Commando Officer. Wear this metallic blue Space Suit and pressure helmet. Be the first Earth Man to Jupiter. Can also be worn over outdoor clothing, guaranteed waterproof. For boys aged 4 to 12. Waisted and adjustable, visor on helmet. Lightning flashes on breast panel. State age for size. 12/11 post 1/6. LISTS, TERMS. Open Saturday 1 p.m. Wednesday.

HEADQUARTER & GENERAL SUPPLIES LTD.

Dept. HOBW/81, 196/200, Coldharbour Lane, Loughborough Junction, London, S.E.5.

MAKE A RADIO SET

NO SOLDERING—only a screwdriver and pliers needed. FULL-SIZE plans and building instructions for 8 sets, 2/6 post free.

CRYSTAL RADIO KITS. "Varicoil", coil tuned, 10/6; "Popular", condenser tuned, 17/6; "Twin", very selective, 21/-; "Major", works well anywhere, 21/-.

EXPERIMENTAL KIT No. 1, builds all 4 crystal sets above, 27/6.

"BASIC", a very simple 1 valve set, 35/- with valve and batteries.

"NEW ECONOMY 1", receives scores of stations, 52/6 with valve and batteries.

"NEW ECONOMY 2", works with loud-speaker, 82/6 with valves and batteries.

"PREFECT" 1-VALVE LOUDSPEAKER set, £3 with mains type valve and batteries.

Prices include postage and packing. Send S.A.E. for list—or send 2/6 P.O. for easy to follow building instructions for all sets.

BLANCHARD'S, DEPT. RH,
13 Gainford Gardens, Manchester, 10

STOP SMOKING in 3 days or money back. Safe, pleasant, permanent. The only scientific way. No Will Power necessary. 'Conquered the habit in 2 1/2 days'.—F.C. 'Within 2 days I was free from the tobacco habit'.—W.G. 'Was a smoker for 2 years and broke the habit in 2 days'.—F.N. 'I used to smoke 20 a day... now I have no desire to smoke'.—J.M. Recommended by 'Health and Efficiency Magazine'. Complete course 6/6 (or \$1.00 bill). Details 1/d. stamp. Sent under plain cover. **NATURE REMEDIES,** 28 (H/150) Dean Road, London, N.W.2. Established 1923

PLYWOOD—HARDBOARD—at amazing low prices. Send S.A.E. for samples and prices to—N. Gerver, 10 Mare Street, Hackney, London, E.8.

'PAINTSPRAYING' HANDBOOK (1954 Ed.). Covers Car, Industrial & Flock Spraying, 3/6, post free, including catalogue of our Cellulose and Synthetic Paints and all Allied Sundries and Plant Hire.—Leonard Brooks Ltd., 81 Oak Road, Harold Wood, Essex.

STAMPS FREE—Empire Packet including S.Pictorials and Victorians with approvals.—Robert J. Peck, 7A Kemp Road, Bournemouth.

Extending Fireside Curb

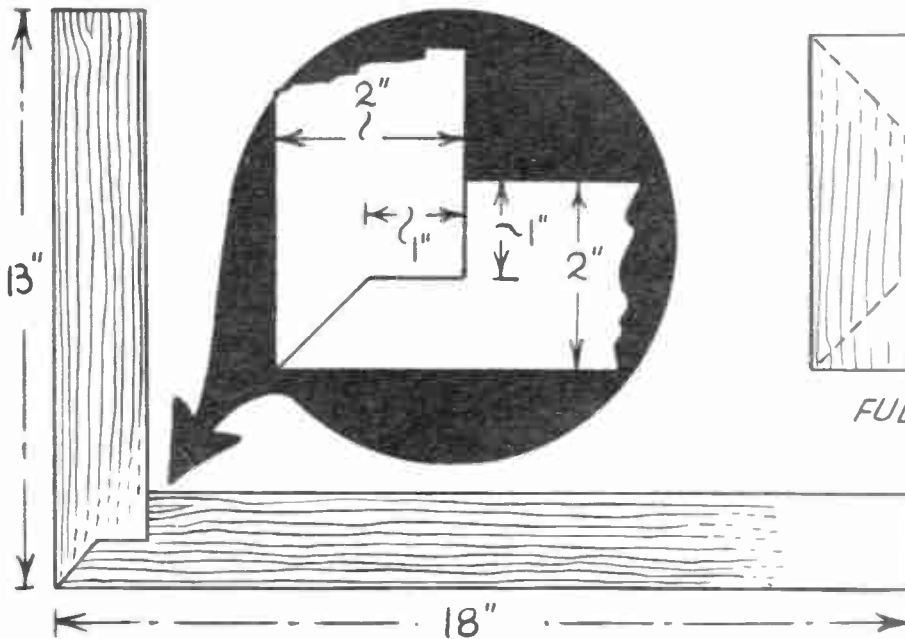

☆☆☆☆☆☆☆☆☆☆
☆☆ See page ☆☆☆
☆☆ 134 ☆☆☆
☆☆☆☆☆☆☆☆☆☆

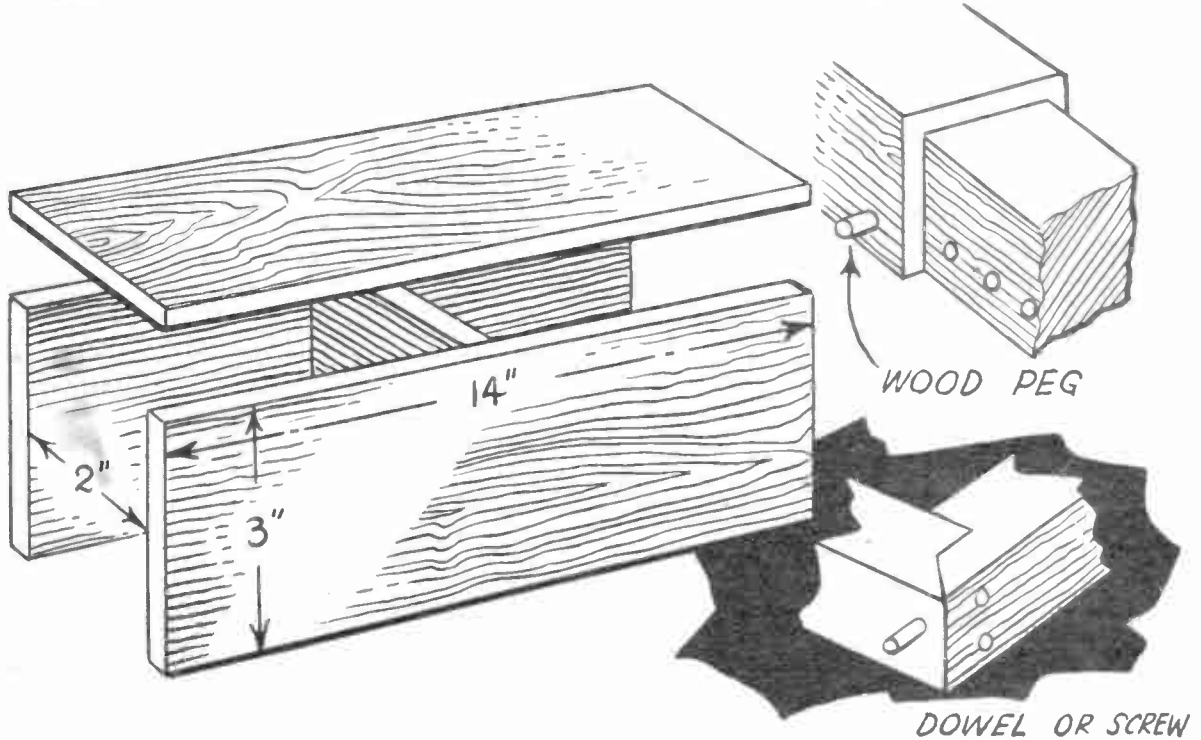

IT'S FAR QUICKER WITH RAWLPLUGS!



FASTEST EVER MASONRY DRILLING

Even when you've tried a Durium-tipped Masonry Drill you'll find it hard to believe that brick, stone and tile can be drilled with such speed and ease! You can use Durium-tipped Drills in a hand brace or electric drill. Sizes from $\frac{5}{32}$ " to 1" diameter.

There is nothing just as good; look for the name DURIMUM on the shank.



RAWLPLUG

DURIUM-tipped DRILLS FROM YOUR IRONMONGER OR HARDWARE DEALER

THE RAWLPLUG COMPANY LTD. LONDON. S.W.7

WHEN YOU'RE FIXING SCREWS in brick, tiles, stone, etc., the world famous Rawlplug is still far and away the quickest way. Quickest and the easiest, and the safest way too! Get a Rawlplug Outfit for your toolkit. It contains all you need—Rawlplugs, Rawltool, screws and 16-page 'Hints on Fixing'. Popular Outfit 2/6d: larger sizes 6/- and 9/6d.

SPEEDFIX
SELF-ADHESIVE Tape
All sizes from 6" a roll

A boon to the Keen model maker!

SPRAY GUN

For Cellulose, Lacquer, etc.
No. 3 Spray Gun. Complete with Air Bulb, Connector, Container & Guaranteed Spray Unit, 8/6
No. 2 Spray Gun for use with motor tyre pump 7/6
Giving a perfect finish using coloured or clear cellulose lacquer or any paint. Cellulose ready for spraying is available in any quantity from 2 oz.

All P. & P. free. From leading Model Shops, or direct from:

CELSPRAY LTD. (Dept. H.1)
Beechwood Rise, Watford.
Tel.: Watford 6284



The sparkling enamel PAINT IN TUBES!

Handy, Economical

STARLON in handy, economical tubes is just right for all small or multi-coloured painting jobs, cycles, prams, etc.

- No wasteful 'left-overs'
- Easy to apply
- Quick drying
- No brush marks
- Brilliant lasting finish



1/-
IN 14
LOVELY
COLOURS
Trade Enquiries
welcomed by
the makers

See STARLINE
on INDEPENDENT
TELEVISION
'DO-IT-YOURSELF'
presented by
W. P. Matthew
London, Sat., Dec. 10th
at 5.20 p.m.

Starlon

PLASTIC ENAMEL PAINT

From Paint, Domestic, Handicraft Shops and the big Stores

STARLINE, SOUTHEND-ON-SEA, ESSEX

SIZE— 6½ in.
W
3½ in.
HI



PIECE 4. CUT ONE
1 8 in.

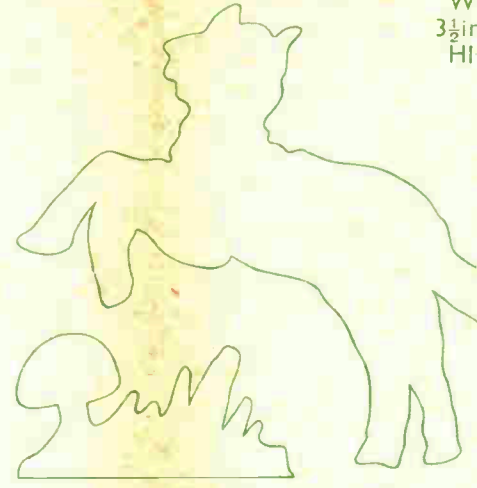

PIECES 6. CUT ONE
OF EACH 1/8 in.

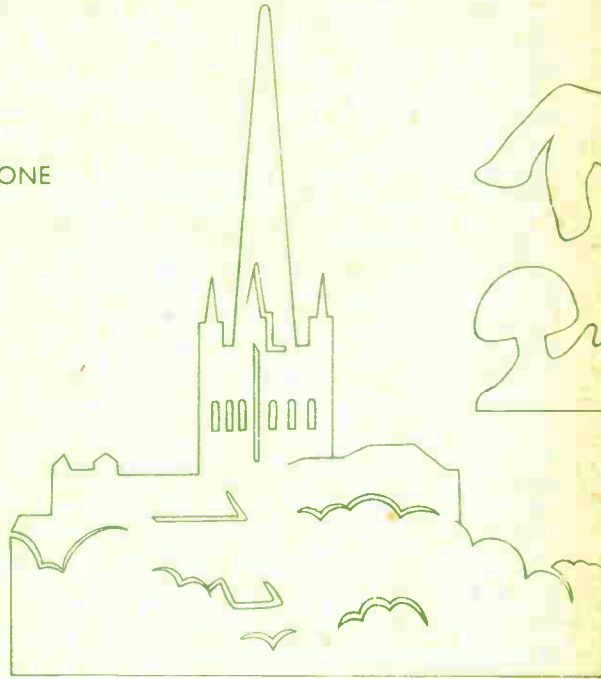

PIECE 5. CUT ONE 1 8 in.

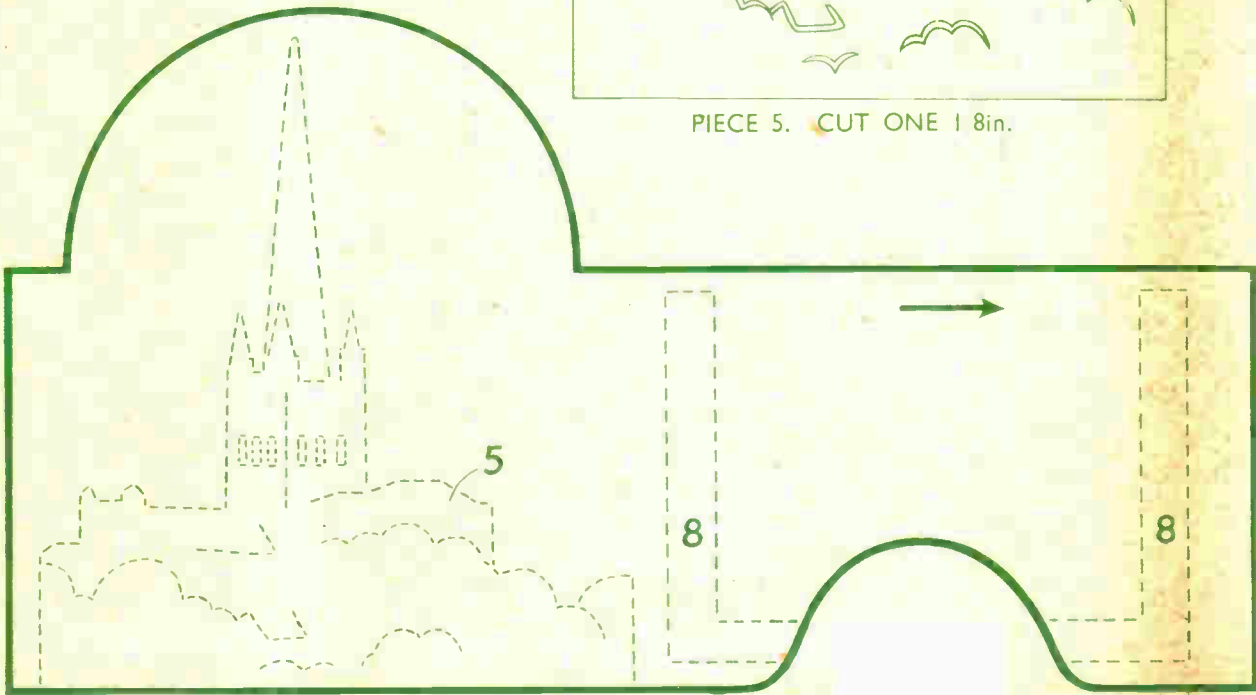

PIECE 1. CUT ONE 1 4 in.

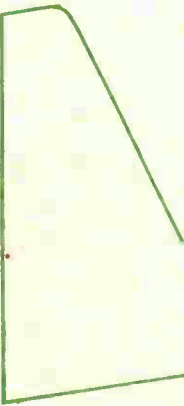

STRUT. CUT
1 4 in. (ONE
EACH CALEND

NOTE THE PA
ARE FOR ON

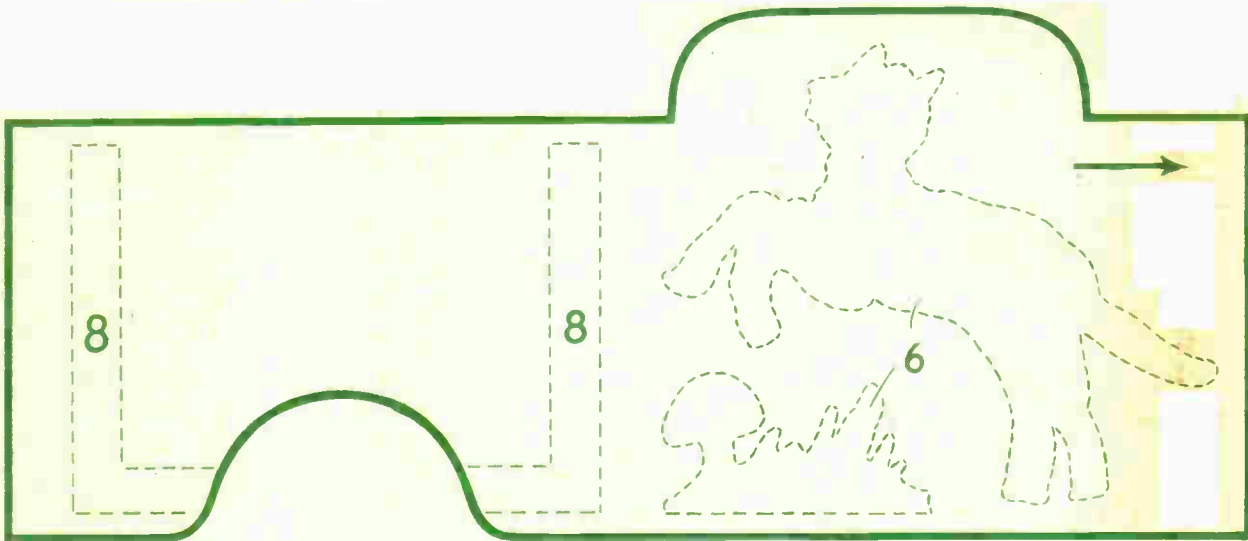

PIECE 2. CUT ONE 1 4 in.

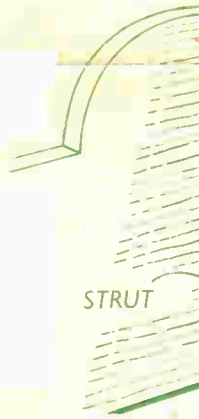

STRUT

SHOWING HO
STRUT IS GLU
ON THE BACK
OF THE CALEND



THE ARROWS INDICATE
DIRECTION OF
GRAIN OF WOOD.

SIZE—6½ ins.
WIDE.
3½ ins.
HIGH.



DESIGN

No.
3136

PERPETUAL CUT-OUT CALENDARS



PIECES 6. CUT ONE OF EACH 1/8 in.



ONE 1/8 in.

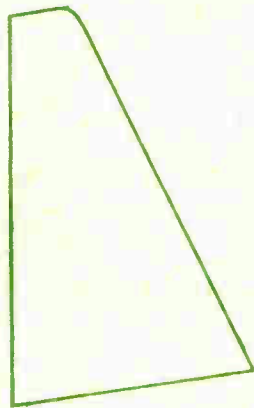

STRUT. CUT ONE 1/4 in. (ONE FOR EACH CALENDAR).

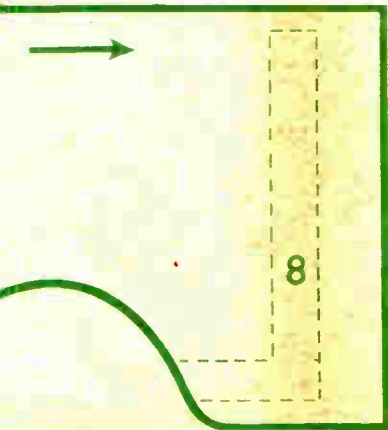

8

NOTE THE PANELS SHOWN ARE FOR ONE CALENDAR ONLY.

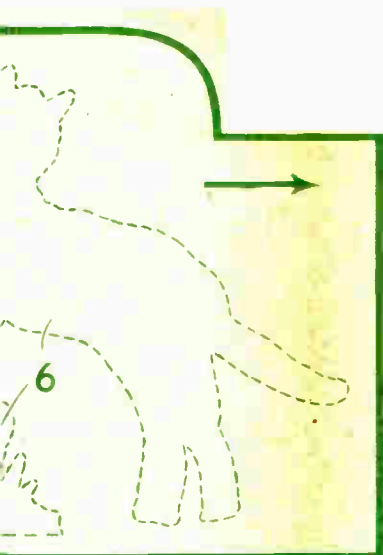

PIECE 2. CUT ONE 1/4 in.

THE ARROWS INDICATE DIRECTION OF GRAIN OF WOOD.

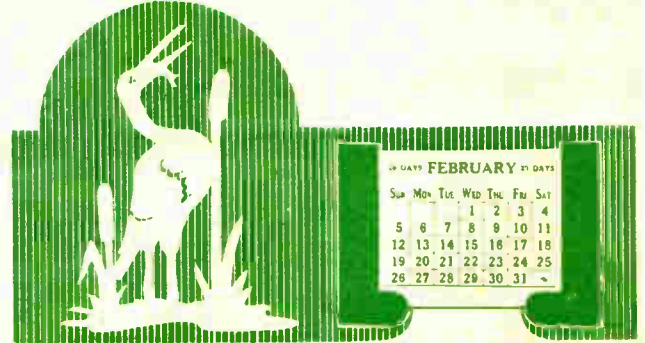

PANELS OF WOOD REQUIRED FOR THIS DESIGN

ONE G2

ONE G4

A complete kit of the above materials can be obtained from **HOBBIES LTD., DEREHAM, NORFOLK**

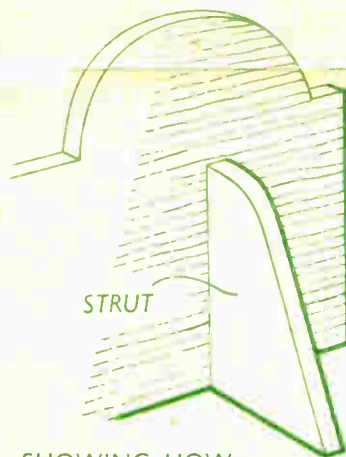

SHOWING HOW STRUT IS GLUED ON THE BACK OF THE CALENDAR.

Glue it with **Croid**

LIQUID GLUES OF QUALITY

UNIVERSAL GLUE for use cold straight from the Tube 1/-, or Tin 2 6d.

AERO GLUE for quicker setting, in the Home Outfit 4/-, or in Tins from 1/3d. each.

POLYSTIK PVA ADHESIVE a new adhesive in Polythene bottle at 2 6d.

The world's strongest glue is available from all branches of Hobbies Ltd.



CALENDAR CARDS SLIP IN HERE.

SKETCH SHOWING HOW CALENDAR HOLDER IS MADE UP.

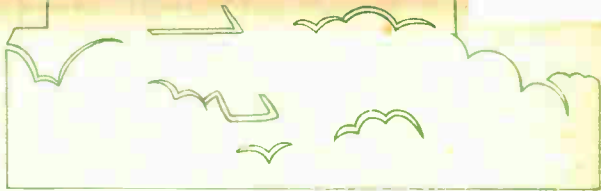

PIECE 5. CUT ONE 1 8in.

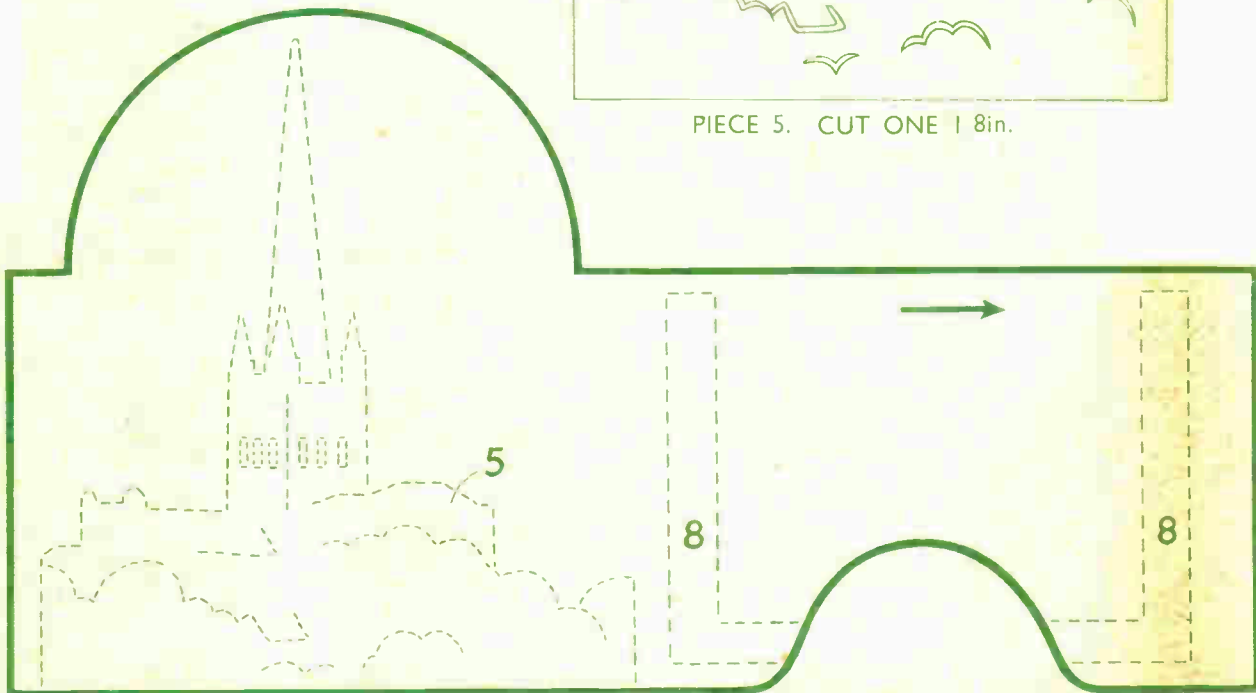

PIECE 1. CUT ONE 1 4in.

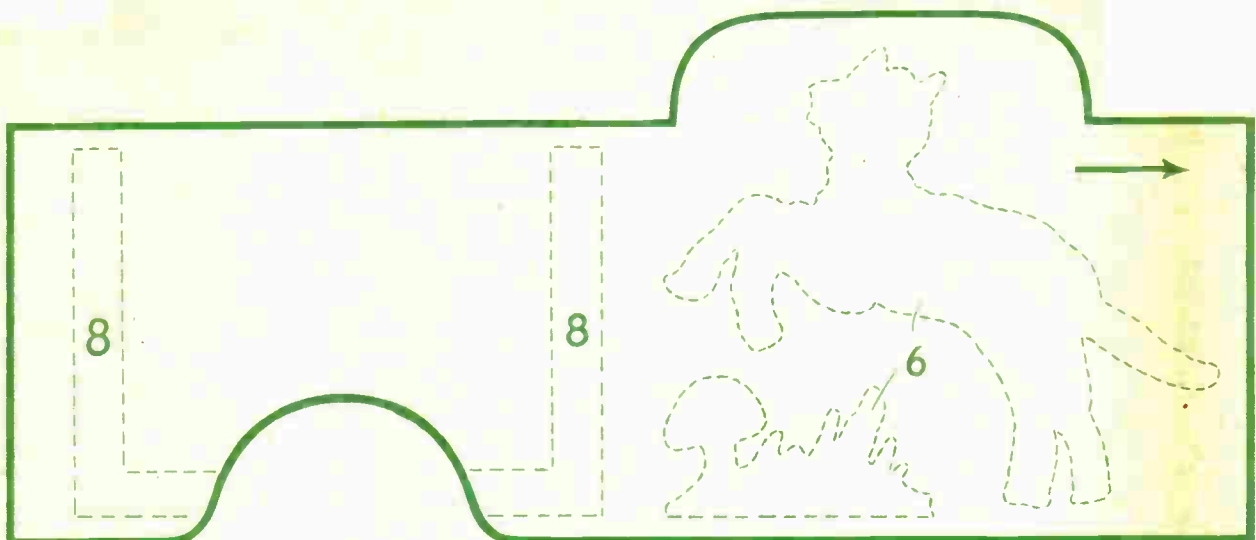

PIECE 2. CUT ONE 1 4in.

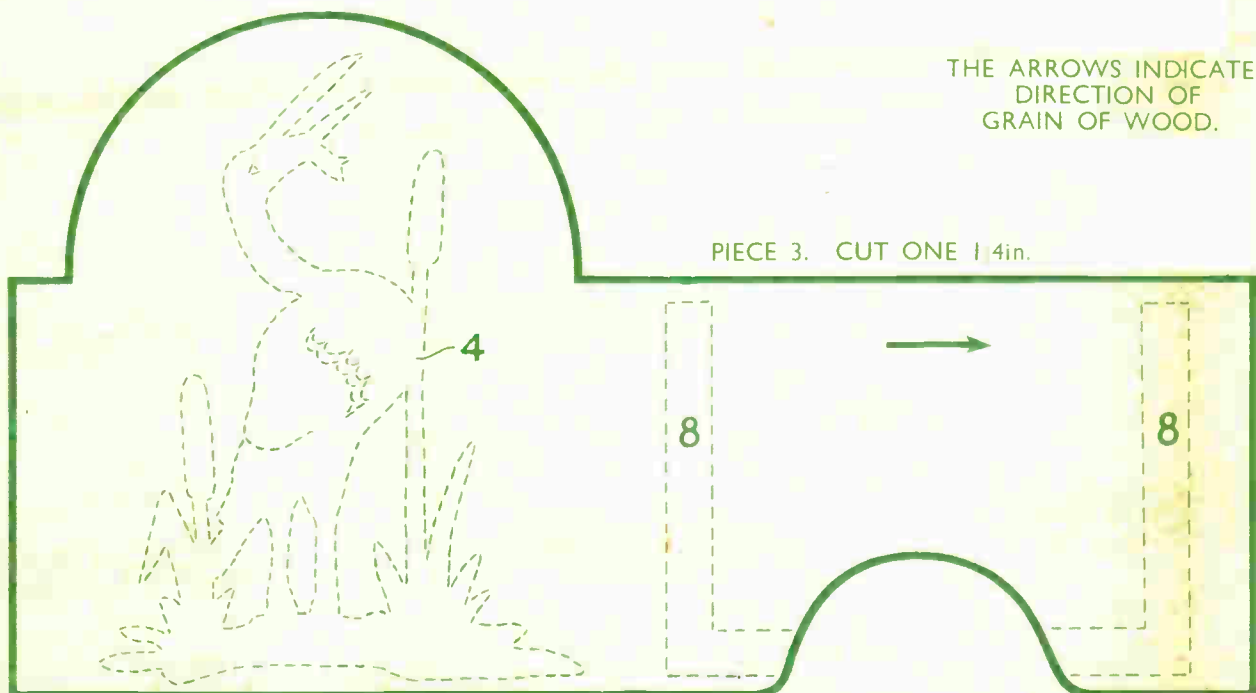

PIECE 3. CUT ONE 1 4in.

THE ARROWS INDICATE DIRECTION OF GRAIN OF WOOD.

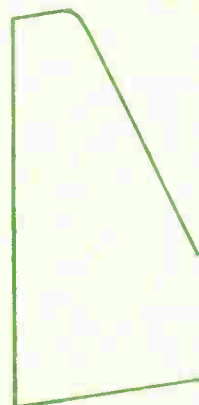

STRUT. CUT ONE 1 4in. (ONE FOR EACH CALENDAR)

NOTE - THE PAIRS OF STRUTS ARE FOR ONE CALENDAR



STRUT

SHOWING HOW STRUT IS GLUED ON THE BACK OF THE CALENDAR



ONE 1 8in.

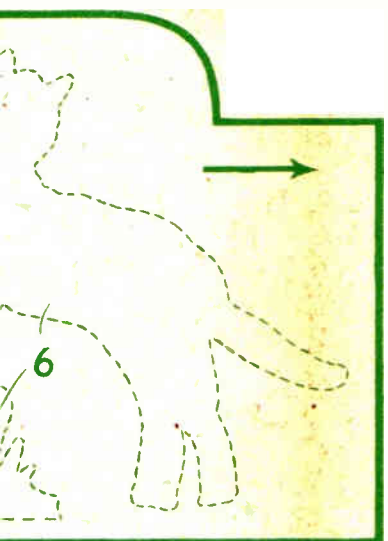
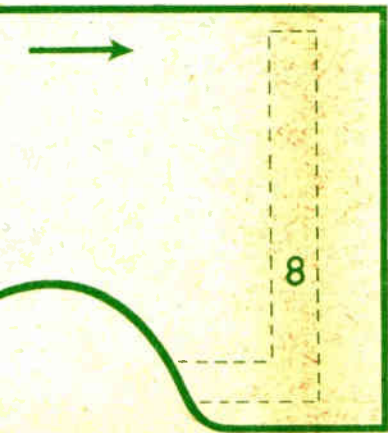

PIECE 2. CUT ONE 1/4in.

THE ARROWS INDICATE DIRECTION OF GRAIN OF WOOD.

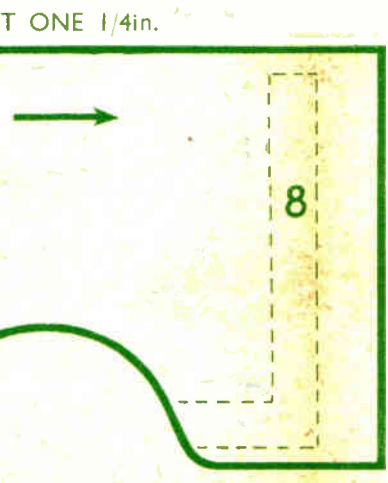

CUT ONE 1/4in.



STRUT. CUT ONE 1/4in. (ONE FOR EACH CALENDAR).

NOTE THE PANELS SHOWN ARE FOR ONE CALENDAR ONLY.

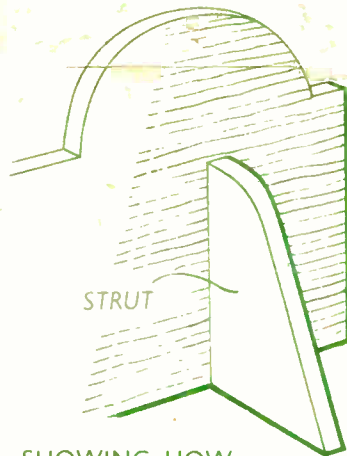

SHOWING HOW STRUT IS GLUED ON THE BACK OF THE CALENDAR.

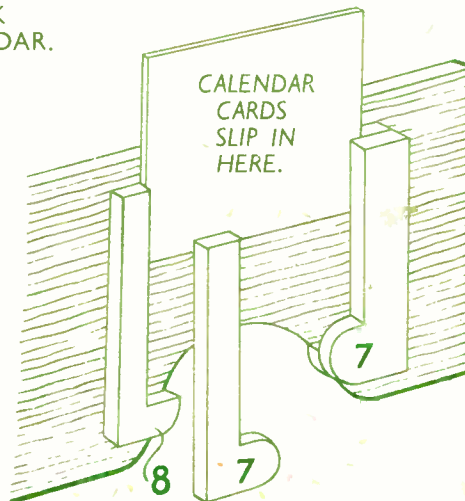

CALENDAR CARDS SLIP IN HERE.

SKETCH SHOWING HOW CALENDAR HOLDER IS MADE UP.

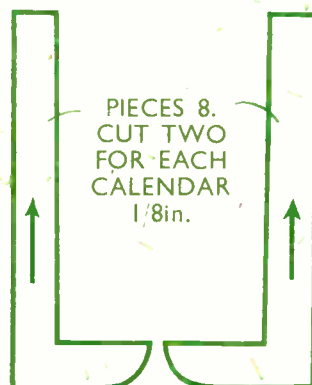

PIECES 8. CUT TWO FOR EACH CALENDAR 1/8in.

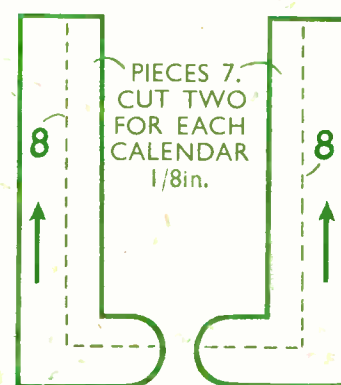

PIECES 7. CUT TWO FOR EACH CALENDAR 1/8in.

PRINTED IN ENGLAND.

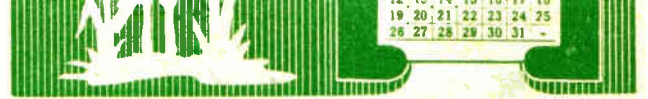

PANELS OF WOOD REQUIRED FOR THIS DESIGN

ONE G2

ONE G4

A complete kit of the above materials can be obtained from HOBBIES LTD., DEREHAM, NORFOLK

Glue it with **Croid**

LIQUID GLUES OF QUALITY

UNIVERSAL GLUE for use cold straight from the Tube 1/-, or Tin 2/6d.

AERO GLUE for quicker setting, in the Home Outfit 4/-, or in Tins from 1/3d. each.

POLYSTIK PVA ADHESIVE a new adhesive in Polythene bottle at 2'6d.

The world's strongest glue is available from all branches of Hobbies Ltd.