

HOBBIES WEEKLY

IN THIS ISSUE

	Page
A Cabinet in Contemporary Style	209
Making a Multiple Retort Stand	210
Amateur Boat Building	211
Replies of Interest	212
A Serviceable Attaché Case	213
An Old-Time Stool	214
Have You Tried These Balts?	215
A Shelter from the Wind	215
The Shipmodeller's Corner	216
A Useful Spirit Lamp	217
A Sailing Model Viking Ship	217
Making Panoramic Pictures	218
Patterns for the Model Viking Ship	223



JULY 6th 1955

VOL. 120

NUMBER 3114

The subject for this week's FREE Design Sheet is a pleasing piece of furniture for the home

THIS fine piece of furniture in the contemporary style can easily be made up at home by the average handyman, with careful studying of the design sheet and following the instructions closely.

With an open section in the centre and two outside sections with doors, it can be used as a cocktail cabinet, or for more general purposes such as a side-board. If the worker uses Hobbies standard panels, it will be found that measurements have been worked out which give but the minimum of waste.

Cut out all the pieces of wood according to the measurements given on the design sheet. It will be noticed that the shelving consists of one piece of wood which runs right through the three compartments, and is halved into

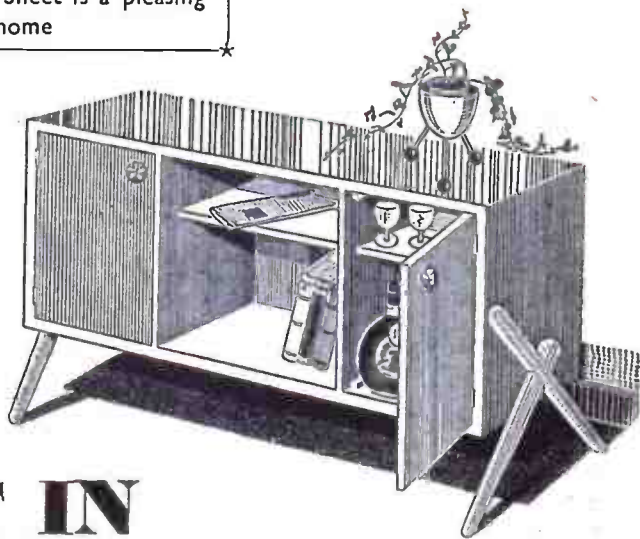

A CABINET IN CONTEMPORARY STYLE

the central upright partitions.

Another point of which to take note is that alternative joints are given for the top, bottom and sides of the cabinet. These parts can be butted together for simplicity, in which case the dimensions given on the design sheet will be

followed. Other methods of jointing, however, are given in Figs. A and B on the design sheet. B is the more difficult joint to make, but will give a much neater and more professional look to the finished article. It will be realised that if joints A or B are used in conjunction

with Hobbies panels, the measurement of the sides will have to be reduced to give an *overall* length of 17½ ins. in order to get them both out of Hobbies 36 ins. panels.

Clean up the bottom and top pieces
● Continued on page 210

All correspondence should be addressed to The Editor, Hobbies Weekly, Dereham, Norfolk

For Modellers, Fretworkers
and Home Craftsmen

4^D

Making a Multiple Retort Stand

IN our article, *An Easy-to-Make Retort Stand*, mention was made of the multiple stand now in use in many laboratories. Such a stand calls for a superstructure of vertical and horizontal steel rods and its cost, with

the unoccupied fittings. The convenience and compactness is self-evident.

The two verticals are screwed to a shelf above the bench, but if a shelf is not already there or is impracticable, a length of wood of the same width as the

down adjustment of the horizontals, the latter being secured by wing nuts and bolts at either end. A slot in each horizontal provides lateral movement of clamps, rings and funnel supports.

Provision is also made for further fittings on the verticals. The funnel support at the left can be swung to the

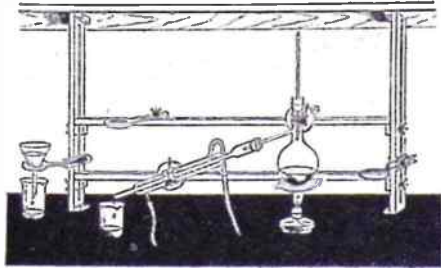

Fig. 1

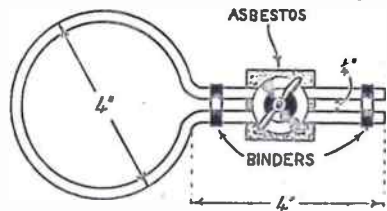

Fig. 3

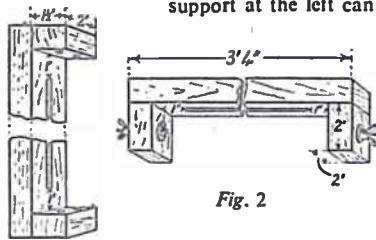

Fig. 2

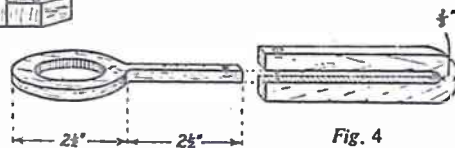

Fig. 4

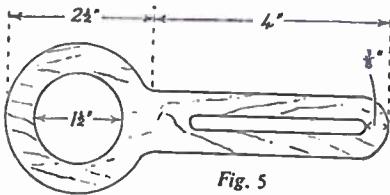

Fig. 5

clamps, bosses and rings, runs into many pounds.

Fig. 1 shows a substitute which costs only a few shillings. The operations shown in progress would need three retort stands and a further two to hold

verticals can be screwed across the corners made rigid by two triangles of wood at the back edges. The lower ends of the verticals are screwed to the bench.

The slots in the verticals allow up and

side of the vertical if the bench space at the front is needed. The unoccupied ring on the right vertical can be used to heat an odd beaker.

● Continued on page 212

● Continued from page 209

Contemporary Cabinet

(1 and 2) and sides (3), and plane them square and true. Then prepare them for dowelling as shown in the diagram on the design sheet. From this it will be noticed that dowel holes must also be made to take pieces 5 and 6.

The shelving (5) and partitions (4) can now be prepared for dowelling in the same manner.

The back consists of three pieces (6) glued and dowelled together and planed down to an overall depth of 17 1/2 ins. This section forms the complete back which goes between the two ends. The length of the back is, therefore, 33 1/2 ins.

To assemble, first put together the shelving and partitions, back, ends and

top and bottom in that order. In all cases use glue to secure, in addition to the dowelling.

The legs are made as shown on the design sheet, being halved and glued together. These legs will come out of the spare wood from the shelving panel if

YOU CAN BUY A KIT
For making this cabinet you can buy kit No. 3114, containing wood, knobs, hinges, round rod and strip-wood, from any Hobbies branch, or post free from Hobbies Ltd., Dereham, Norfolk, price 107/9.

Hobbies materials are being used. About four countersunk screws will hold the legs securely to the sides. For preference, screw from the inside after having drilled holes to take the screws.

The doors should be made up as shown in the detail on the design sheet. These are of 1/2 in. wood with 1 in. by 1 1/2 ins. battens glued and screwed in place for strengthening. After recessing for the hinges, fix the doors as shown on the design sheet. Four small blocks are glued in the positions indicated to act as door stops, and ball catches for fastenings can also be added if required.

Before the addition of the knobs, finish off the woodwork as required. This can be by staining and polishing, or by merely rubbing with linseed oil and wax polishing. In both cases the grain will have to be filled with a proprietary brand of woodfiller.

AMATEUR BOAT BUILDING

By R. H. Warring

THE motor-boat is for the lazy man, the sailing enthusiast will say. Personally, for getting on the water at every suitable opportunity and being independent of winds and tides (to a large extent), give me a boat which has an assured method of propulsion all the time. The main difficulty, particularly as far as the younger enthusiasts are concerned, is cost.

Speaking of 'new' prices, the cheapest motor for powering a small craft will cost about £25. It is an outboard motor, of course, but forget any previous ideas you may have had put into your head about outboards being unreliable, difficult to start and giving only low power. A good outboard will slog away all day at full throttle, if necessary, as long as there is enough fuel in the tank. Starting is merely 'knack', which is simply another way of saying that you have to practice until you have got the hang of it. As to low power, well, you can buy a 25 horse-power outboard in this country, if you wanted to, and that is powerful enough to drive a 14ft. hull at some twenty knots!

The £25 outboard will develop just about 1 horse-power. That will push a small dinghy along at about walking pace, or a little better. A 4 horse-power outboard, which about doubles the price, will drive a 13ft. runabout at 8-10 m.p.h.—fast enough for most purposes, even on a tidal river. You can use low power on quite large boats on inland waterways with little or no tide. On a tideway, or if you contemplate popping out to sea for a short trip when the weather is fine, you want about double the speed of the tide at full throttle, to be on the safe side. Even then you would arrange to go 'with' the tide each way—it saves a lot of petrol on a longish trip!

Not for the Amateur

Forget ideas about speedboats. A 25 h.p. outboard engine would certainly push a 14ft. hull along at a fair clip, but you would need a planing hull to take full advantage of that power. With an ordinary displacement hull the more power you apply the more the nose tends to rise—not necessarily dangerous, but not very efficient, or pretty, either. Speedboats are a class unto themselves. Amateur enthusiasts do build them, but for sport, not for fun. For the same total cost you could probably build a small cabin cruiser.

Yes, even a cabin cruiser can have outboard power. A 14 to 15-footer will just about give you a two-berth cabin and 4 to 5 horse-power will be ample to



Even a cabin cruiser can be outboard powered. Such an arrangement just about halves the cost of the motor unit. This 14-footer can sleep two

drive her. Total material costs would work out to between £90 and £100, exclusive of the motor. A suitable outboard would add about another £50. A comparable inboard motor (with the extra trouble of fitting the engine), more likely twice that figure. From there you can go on up. A 20-footer £150 to £200, plus engine—and now we are getting out of the realms of amateur boat building again.

Too expensive? Far too much for most of us. You could probably buy a second-hand boat, complete with engine, for less. The only thing is it might not be so much of a bargain in the long run—and in any case we are concerned with being our own boat builders.

Outboards are widely used by amateur enthusiasts because they are the cheapest form of marine engine—and also the simplest to fit. Buying second-hand you can again cut the price, but you may unwittingly be buying trouble. The best bargains in this respect are re-built engines with a manufacturer's guarantee (or similar) against mechanical defect. You can usually get these about a third less than new price and be assured of a reliable power plant.

With this in mind you can probably produce a powered dinghy for about £50 complete. If you want to be on the safe side and start with everything new, then about £100 should cover everything. It may seem a lot in one sum, but split it up amongst a group and it becomes less formidable. Remember,

too, that you need not buy the motor until you have completed the boat. And if you plump for a 'general purpose' small craft you might even think it best to wait until next year before you fit her with 'power'.

However you decide to go about it, do not be tempted into trying to make a business of the whole thing. For instance, you may think that you could start with a small boat, use her for a while and then sell at a substantial profit to finance construction of a larger craft, and so on. You may be lucky and bring it off, but the chances are that you won't. Boats, and particularly small craft, have a rather 'indefinite' re-sale value, especially if home built. A man who knew boats would probably not offer more than the cost of the materials in her for an amateur-built craft.

Your Own Skipper

If you tackle boat building, it must be purely for the fun of it—and the satisfaction of creating from lengths of timber and sheets of ply a presentable, seaworthy craft, of which you are the owner. Ownership means a lot. It is just as much fun on a nice day to fiddle about doing odd jobs with the boat moored to the quay—or even just sitting in her—as it is to be chugging or sailing up and down the stream. You will not envy the other fellow his larger, impressive yacht whilst you are your own skipper.



Query About Gramophone

I HAVE a 1938 Collaro gramophone working off a 240 volts A.C. mains. I wish to modify it and in so doing, fix an indicator light in the circuit which lights up when current is switched on. Could you please inform me of the correct circuit? (F.A.—Morden.)

IT is only necessary to wire the indicator lamp in parallel with the motor, so that it will light when the motor is switched on. Any small mains-voltage lamp would do. If required, a holder or panel fitment for the bulb may be purchased from a radio or electrical shop, or from a supplier of such items, such as Bulgin & Co., Bye-Pass Rd., Barking, Essex. A twin-flex connection from bulb-holder to motor circuit would then be satisfactory.

Repolishing Perspex

I HAVE a quantity of sheet Perspex to make up into photo frames, cigarette boxes, etc. Would be glad of information regarding method of reglazing cut edges, repolishing scratched surfaces, etc.—whether butt jointing with Perspex cement is strong enough. (H.C.—Lyminster.)

A CUT edge of Perspex is repolished by breaking it down with successively finer abrasives—glasspaper followed by brass polish and finally silver polish, or the two grades of polish supplied by the makers. The makers' cement is strong enough for small articles. Surround the joint with adhesive tape to prevent surplus adhesive marking the surface. Roughen the jointing surfaces slightly—they will become clear again as they fill with adhesive.

Liquid Paraffin Stain

IS there any way of removing liquid paraffin stain from a carpet? (E.H.—Watford.)

LIQUID paraffin requires treatment with a dry cleaner, followed by a detergent. First remove as much as possible of the paraffin by placing absorbent paper above and below the stain and ironing with a hot iron. Place another sheet of absorbent paper beneath the stain and rub the stain from the edge inward with a cloth soaked

with dry cleaner (either a proprietary such as Thawpit, or benzene, or carbon tetrachloride—benzene is inflammable). Blot the stain and rub again with the rag which has been re-charged with dry cleaner. Continue the treatment until the maximum effect is obtained. Complete removal is usual. Finish by applying a lukewarm solution of a household detergent, blotting between applications. A rub over with lukewarm water should be given last.

Paint for Rubberised Canvas

PLEASE tell me how I could make some black paint for rubberised canvas, as I cannot buy any anywhere? (P.J.—Reading.)

ORDINARY paint is unsuitable for rubber, as it will cause perishing. You should be able to get black tyre paint from a car sundries firm, such as Halfords, and this is quite cheap and preferable to making your own. It is

possible to thin Bostik adhesive with petrol and use this as a paint on rubber. Alternatively, use a black pigment such as lampblack, with a little rubber solution, thoroughly mixed with petrol.

Scratches on Furniture

I HAVE a light walnut bedroom suite which has been scratched on the surface, and I would be glad if you could tell me what to use to cover these marks. (M.J.—Leeds.)

IF the scratches are not too deep or many (in which case repolishing is the only remedy), try filling them with varnish, laid in the scratches with a fine brush. This can be effective sometimes. Rub over after a few days with furniture polish.

Creeping Carpet

I HAVE a carpet with a felt underlay which persists in creeping along the polished floor. Can you advise the type of glue to use to stick the felt to the floor? (F.S.—W. Bromwich.)

THERE is a proprietary preparation called 'Bateman's Rubber Paste' which should suit your purpose satisfactorily. It can be spread over the felt underlay, and prevents the slipping you complain about. A tin would be needed for such a job, and costs 4/6. You can obtain it from handicraft dealers and possibly from a local ironmonger.

Continued from page 210

A Multiple Retort Stand

The stand is shown in its simplest form. Further horizontals and their rings and clamps could be turned out according to need.

The clamps shown holding the flask and condenser, and the ring on the right vertical, are of the same forms and dimensions given in the article *An Easy-to-Make Retort Stand*. Details need, therefore, only be given for the verticals, horizontals, funnel supports and for the ring beneath the flask.

In Fig. 2 are details of the verticals and horizontals, wood 2ins. by 1in. being used. The height of the verticals will depend on the height of the shelf. This will probably be in the region of 2ft. 8ins. The slots in both verticals and horizontals are 1/2in. wide.

The ring for the horizontals (Fig. 3) is bent from 1/2in. or 3/4in. iron wire. The two binders consist of sections cut from suitable diameter metal tubing and pressed into ovals. 1 1/2ins. squares of 1/2in. thick asbestos millboard are positioned on each side of the horizontal to protect the wood from heat. Washers are inserted on the wing nut

and bolt. Fig. 4 shows the construction of the swivel funnel support depicted on the left vertical in Fig. 1. The ring is 2 1/2ins. in diameter, and with a 1 1/2ins. diameter hole. It is cut from 1/2in. wood. The slide shown to the right of Fig. 4 calls for 3/4in. thick wood, 4ins. long and 1in. wide. The slot is 1/2in. wide. A screw passes through slide and ring and so provides the swivel motion, and a wing nut and bolt through slide and vertical gives any desired adjustment in the two planes.

Lastly we have the simple funnel support for the horizontals (Fig. 5). For this, 1/2in. wood is needed. The slide end is 1 1/2in. wide. A 3ins. by 1/2in. slot gives ample adjustment. When not in use, this support can be turned out of the way by loosening its wing nut and sliding it round so that it rests along the horizontal.

As with the single retort stand described in our former article, the finish can well consist of aluminium paint for the woodwork and ferrous metal parts, and shellac lacquer for the brasswork. (L.A.F.)

EASY TO MAKE

A Serviceable Attaché Case

A SMALL case such as this is useful for a variety of purposes, and the sizes may be altered to suit the particular need for which it is required. It is of little use making a case to a set size only to find that it is too small to accommodate the articles it is intended to carry. If it is required for general purposes, however, the sizes given will probably be found suitable.

Construction

The lid and the container part of the case are made in one piece, and plywood is fixed to the top and bottom, making a totally enclosed box. Then the two sections are sawn apart. This method ensures a perfect fit of the lid.

Two pieces of wood will be required, each 26ins. by 4 1/2ins. by 1/2in. Prepare these to 4 1/2ins. wide and 1/2in. thick, and place them in the vice together for the marking out, which is shown in Fig. 1. Each line is squared right round. The wastewood is then sawn away, giving the two sides and two ends of the case.

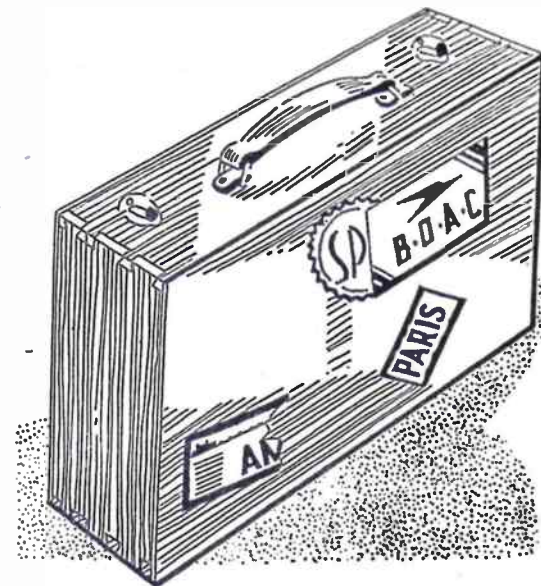

By Kenneth Blackburn

for sawing. Remove the wastewood from between the tails with a tenon saw and a bevel-edged chisel. A coping saw may be used to remove some of the waste, thus reducing the amount of chiselling.

The corresponding pins for each set

with a very sharp pencil or a compass-point (see Fig. 3). Remember that the face sides should be on the inside of the finished case. Put identifying numbers on corresponding pins and tails, or you may be faced with a jig-saw problem later on.

Square the lines down with a try-square to the shoulder-lines, and shade in the wastewood: Saw down these lines on the waste side and remove the waste with a coping saw and chisel. After fitting the joints, clean up the inner surfaces with a smoothing plane and glasspaper before gluing the case together. Test for square immediately after assembly.

The plywood top and bottom are cut to a size 1/4in. bigger than the case, and secured with 1/2in. panel pins. A steel plane is used for trimming the plywood flush with the case. The whole outer surface is also cleaned up, planing to the centre of the wood to avoid splitting the dovetails.

Test with Try-Square

Two lines are now gauged right round the case 1/4in. apart in the centre of the wide pins. The lid and lower part are separated by sawing with a panel saw between these two lines. The edges of both parts are carefully planed to the gauge lines with a smoothing plane. The two parts should be tested together. If they do not meet perfectly, test the edges with a try-square: you will probably find that the plane has not been held square.

A pair of 1in. brass hinges are used. They must, of course, be recessed into the wood so that no space is left when

Continued on page 214

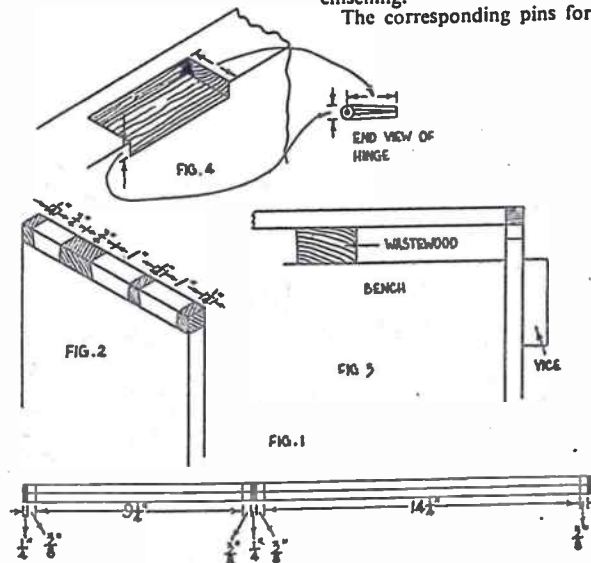

The dovetails are now marked on the shorter pieces (see Fig. 2). Notice how one socket is made wider than the others in order to provide sufficient for one pin of normal width on the lid and one on the lower part, with 1/2in. extra

of tails are marked by placing the longer piece in the vice so that its end is level with a piece of wastewood placed on the bench. This provides a firm base on which to hold the wood down firmly while marking round the tails

An Old-Time Stool

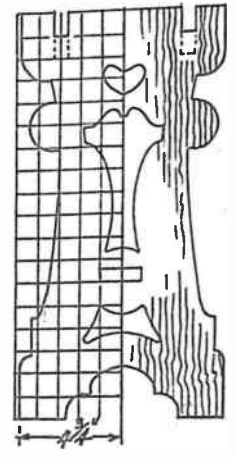
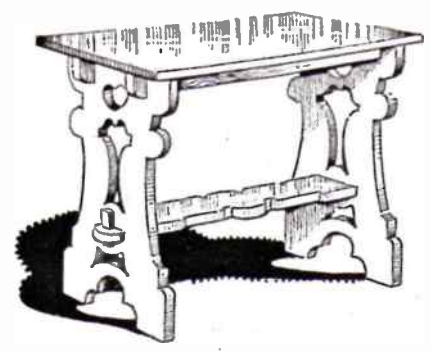

Fig. 1

draw over the lines to complete the whole end. Carbon paper may be put between the two sheets to get a solid line on which to cut.

This done, use the fretsaw for the cutting, then take this cut-out as a template for marking out the second leg or end. The two rails (A) in Fig. 2 are plain in outline, but the slots must be carefully set 17ins. apart as shown. The lower rail (B) has its outline shaping carried out in much the same way as that adopted for the legs. Note the length of

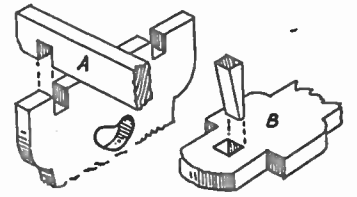

Fig. 3

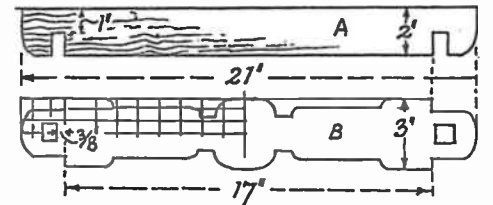

Fig. 2

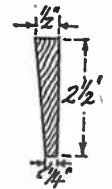

Fig. 4

THE stool shown in our illustration has a somewhat old-time appearance, and would look well if made up in oak. But if this wood is considered too hard for cutting, then Spanish chestnut or any similar fancy wood may be used. Wood should be not less than 3/4 in. thick, and all the cutting should be done with a coarse fretsaw.

The construction of the stool is shown in Figs. 2, 3 and 4. In the top edges of the two legs there are slots into which fit a pair of rails (A). The method of cutting the slots and fitting the rails to them is shown in Fig. 3. At a distance of 6ins. up from the bottom of the legs are cut mortises 2ins. long by 3/8 in. wide to receive the tenons on the ends of the cross-rail (B). This rail is connected and fastened in the old-time method of wedging, the wedges being inserted through holes made near the ends of the rail, as seen in Fig. 4.

How to Begin

First make the legs by enlarging the pattern shown in Fig. 1. On one of the boards measuring 18ins. by 10ins., mark and rule in the centre line down its length and then set out a series of 1in. squares as shown. Through these squares draw the outline, following each square of the diagram carefully.

Draw in the mortise for the cross-rail (B), and also the three frets to be cut out. Some workers may, perhaps, prefer to leave out the latter frets altogether.

Now make a tracing on thin paper of this half of the design, adding the centre line as well. Turn the tracing over and place the centre lines together, and then

17ins. again, and also the space of 3/8 in. near the hole for the wedges. This clearance allows for the wedges to be knocked into place after the rail has been inserted.

The wedges pull the parts tightly together. They must be carefully marked out and cut according to Fig. 4, but trial wedges may be made before deciding the true taper required for them. The top of each wedge may be chamfered on three sides for appearance sake if desired.

Making the Top

The top of the stool is a plain oblong of wood 22ins. by 10 1/2 ins. and the edges may be planed to a wide chamfer if desired to lighten its appearance. Countersunk screws will hold the top securely to the rails, or glued angle blocks may be put underneath. Fill the screw-heads with a suitable filler before the actual wood finish is applied. After all surfaces have been cleaned off, a dark stain may be added, finished with either wax polish or varnish. (S.W.C.)

the sizes shown.

When the hinge is screwed into this recess, the centre of the hinge pivot should be level with the outer surface of the wood, and the knuckle should be flush with the edge of the wood.

A dark stain and a few coats of french polish applied with a brush provide a durable finish. The handle and clasps are easily obtainable, and are fixed after the last coat of polish is thoroughly dry.

Continued from page 213

A Serviceable Attaché Case

the lid is closed. The simplest way of doing this is to let the full thickness of the hinge into the lid. Square across a line about 2ins. from each end of the lid, and then a further 1in. These lines show the positions of the hinges. The gauge is set from the hinge as shown in Fig. 4 to mark the width and depth of the recess. This marking must be done accurately if the lid is to close properly. If anything, set the gauge a trifle bare of

Have You Tried These Baits?

asks Arthur Sharp

FISH of all species are for the most part omnivorous creatures, and will feed readily enough, when hunger-driven, on anything edible that comes floating downstream or can be rooted up from the gravel and mud, or sucked in from the water-weeds.

Surface flies, insects, etc., are also greedily scooped up, for fish are always on the watch for grubs, caterpillars, and larvae, that fall from the boughs of trees and shrubs. Many—perhaps most—anglers seem to stick faithfully to certain popular baits, some half-dozen or so, and do not look beyond these, which include various kinds of worms, maggots, pastes, hemp, breadcrust, creed wheat, and so on. The great majority of anglers only fish these baits, overlooking the numerous lures and natural edible titbits that may well prove attractive to the fish.

During the summer season such baits are always worth a trial. Grasshoppers are 'good medicine' for trout, chub and grayling. So are beetles, as the fern-beetle, the common water or 'diver' beetle, the garden beetle, and others. The ladybird is another likely one for summer fishing. And the common cockroach, which can be caught in a beetle-trap, is often a killer.

An old Angler's Secret

An old angler used to get good trout in a stream just below an ancient corn mill, which, up to a few years ago, was still working by water power. One day his secret was discovered. He often helped the miller, and noticed that many cockroaches—the old mill was simply alive with them—found their way, unwittingly, into the water and were carried down into the mill race and thence into the pool below, where fat trout cruised around on the lookout for such food. The wise angler took his cue from this happy discovery, and many a nice fish was brought to the landing-net as a result!

Many kinds of fish, including trout, chub, tench, carp, and perch will not disdain such baits as snails, slugs, frogs, dock grubs, chafer grubs, wasp grubs, and many other larvae turned up by the fork when you are gardening. One successful bait for trout in spring is the small grub or larva, white, with a brown head, and about 1in. long—sometimes referred to as a 'false' centipede—found among grass roots in gardens. A mint bed that has run wild will often yield many similar grubs if you shake out the roots as you dig them up.

By digging up the roots of dock

plants, dandelions, and other similar plants, a fattish creamy-white grub with segmented body and brownish head that is hard and crusty may frequently be found; if lucky half-a-dozen from the roots of a single plant may reward you. Impale the grub on the hook, which is pushed through the body below the head, and leave point and barb bare. This is irresistible to trout.

Strange Tastes

Many fish acquire strange or unsuspected tastes. Trout readily take scraps of meat, cubes of fat mutton or pork. Macaroni is a titbit that chub are fond of. Carp like a parboiled potato, about the size of a walnut. Boil the potato in its skin, but peel before use.

Cold Yorkshire pudding, cut into small cubes, has proved successful in chub-fishing. Pieces of ham, small strips of tripe, of bacon rind, and raw meat have all been used with success at times. Trout have been caught on a small hook baited with a wood louse. Caddis larvae also tempt trout and other fish, as roach and dace. Dragonflies, butterflies, moths, crane-flies ('daddy-long-legs'), bluebottle flies, and hairy caterpillars are other lures fished in a natural manner that various kinds of

fish gladly accept. Many species of fish, especially chub, roach and dace, can be tempted with ripe fruits. When elderberries are nice and juicy, roach and dace fall for them. A strip cut from a mellow pear will prove attractive to chub; so, too, will a cube of banana.

Dead Sparrows for Pike

In old angling literature one finds references to the fondness of pike for rats and voles, for dead sparrows—the 'deader the better' says the old angler—and baby mice. One curious pike lure used evidently with some success in the past and is mentioned in ancient angling works, is the tip of a calf's tail, with a short length of leather bootlace attached. This strange device, attached to a simple tackle with fairly large hooks, is said to be very attractive to big pike.

As to artificial lures, they are legion. Many pages of fishing tackle catalogues are needed to accommodate them. Yet most of them appear to attract fish in due season.

In all truth, baits that will attract fish are exceedingly numerous; the old angler was right when he said: 'The trouble is to find out what *not* to use rather than what *can* be used.' Fish will on occasion take anything that promises to be edible, and strange and unusual baits tried as a last resource have been highly successful—at times.

A Shelter from the Wind

By Victor Sutton

IT is not always possible to have a complete tent in the garden for the summer days, but the handyman can make up this useful screen as illustrated.

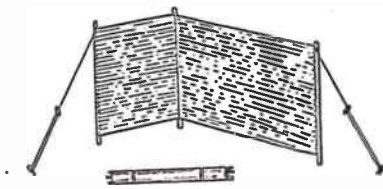

It can be made with hessian, blind cloth or a similar material. Firms who supply tents sometimes sell special canvas in cut lengths.

You will require three uprights of wood about 7ft. high and about 2ins.

square. The ends should be cut so that they can be forced into the lawn. The material is fitted to the supports with felt tacks which have suitable large heads. It is best to have one full length, about 6ft., and the shorter length 4ft.

Hardwood Pegs

The arrangement of a few guy-ropes fitted in the same way as one would adjust a tent can be fitted to suit the angle and position. Pegs can be made from short pieces of stout hardwood.

This shelter can be rolled up as shown and secured with a couple of straps. If wet, allow it to dry in the sun before rolling up, or the fabric will be ruined by mildew.

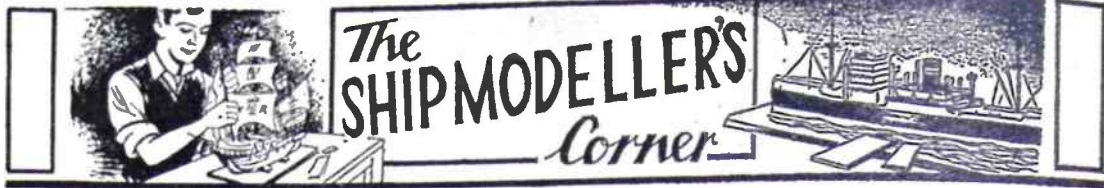

IN approaching this model, one of the finest in our range of Old Time Ship Models, I first decided to collect all the information I could about the period and the original ship. Much research has been done since the kit was first designed some years ago and we are always unearthing new facts about naval architecture and individual ships. In this model we find we are up against the fact that there were several ships called the 'Royal Prince', 'Royal Charles', etc., some being built under another name before being renamed the 'Royal Prince' or 'Royal Charles'.

THE 'ROYAL PRINCE' Part I—Building the Hull By 'Whipstaff'

The 'Prince' was a first rate, a vessel designed by Phineas Pett and was launched at Chatham in 1670. She was flagship during the battle of Solebay, carrying the flag of the Lord High Admiral. At that time this office was held by the Duke of York. Carrying a crew of 700 men under war conditions, she was armed with 26 forty-two pounders on the lower gun deck, 28 whole culverins (eighteen-

lengths and not in one continuous plank. Make cross-cuts on the lines, staggering them to avoid an unseamanlike effect. Now give the decks a generous coat of artist's oil colour, burnt umber, then rub off the paint with a cloth. This will give the decks a warm, natural colour and the colour remaining in the cuts of the planking will give a realistic effect of the actual caulking between the planks.

The Wales

Having our hull complete, we now add the wales as in Fig. 3 (our sketch is not to scale, but foreshortened to save space). The wales are cut from wood $\frac{1}{4}$ in. thick and $\frac{1}{4}$ in. wide and are glued and pinned along the hull in the positions shown.

The next operation is to mark the porthole positions. To do this I use a pair of dividers to mark out the exact centre of each porthole, the porthole next being marked on the hull in pencil as in Fig. 4.

Now comes an interesting piece of work; in order to give our hull an

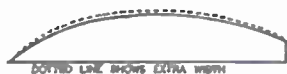

Fig. 1

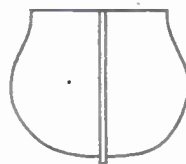

Fig. 5



Fig. 4



Fig. 3

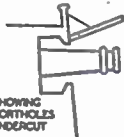

Fig. 6

pounders) on the middle gun deck, and 28 demiculverins (nine-pounders) on the upper gun deck. On the quarter deck were 10 sakers (six-pounders). The poop was armed with 4 three-pounders. She carried three boats and nine anchors. Her dimensions were: Length of keel 131ft., breadth of beam 45-8ft., depth of hold 19ft. Her tonnage was 1,463 tons burthen and her draught 21-5ft.

And now to our model. Commence by cutting hull pieces A and C $\frac{1}{4}$ in. wider and piece B $\frac{1}{4}$ in. wider as in Fig. 1. This will allow us to carve the hull to the correct shape, showing the tumblehome as in Fig. 2, which shows the midship section. The remaining parts of the hull can now be added as in the kit instructions; first the upper decks and finally the bulwarks.

In order to have the finished model as perfect as possible, I would suggest you line the decks in the same manner as was done on my own last two models of the ship. With a metal straight edge and a razor blade cut in the lines of the planks after first giving the decks two coats of shellac and allowing it to dry. Do not forget that the planks were laid in

A USEFUL SPIRIT LAMP

By A. F. Taylor

TO be able to solder different metals in a satisfactory manner is one of the greatest assets for the handyman to possess. There are so many jobs always cropping up in the home and workshop which need this attention.

The good old-fashioned soldering iron is still a very useful tool, but it has some serious drawbacks. It must be used near a fire or gas burner, as it cools very quickly, and it must be cleaned quite frequently to keep it in good working order.

An improvement on this is the electric iron which keeps clean, but it must be used near to a lamp holder or plug socket.

For work anywhere and under most conditions there is really nothing to beat a good spirit lamp, especially if it is fitted with a blowpipe attachment. By this means a very considerable amount of heat can be obtained, and what is very important it can be directed on to the exact spot where it is required.

Simple Construction

The subject of this article is a very efficient spirit lamp; it is simple to construct and if carefully made will give years of useful service. The body of the lamp which holds a supply of methylated spirit can be made from a large variety of articles and provided the lid or cap fits tightly it does not much matter what you use.

A glass jar with a metal screw cap is, perhaps, the ideal choice, as it allows the amount of the spirit to be observed at any time, and it is also very easy to fill up. Small metal cans with a push-in tin lid may also be used with equal success.

The size of the container will depend on the work which is to be done, but it is not advisable to have it too big, and something to hold about a quarter of a pint will be ample for most purposes.

Drill or pinch a hole in the top of the cap and file it so that a length of brass tube can be fitted in tightly, and then soldered to make the joint airtight. A piece about $\frac{1}{4}$ in. diameter and 3 ins. long should have 2 ins. projecting at the top, and it is a good idea to have a row of small holes round the top, as this sometimes helps to make the flame more efficient.

For the blowpipe attachment quite thin tube may be used— $\frac{1}{16}$ in. to $\frac{1}{8}$ in. being suitable. To make the end tapered, cut a V-shape slot as shown at (A), and carefully nip the tube together to form the end (B). If a needle is placed in the

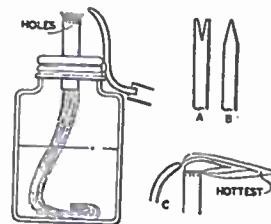

end as it is being closed, a much neater job will result. Solder the joint to make it tight. The V slot may be cut on both sides of the tube if a smaller hole is needed, but in this case, there will be two joints to solder.

Experiment will show the best position for the blowpipe, and it can be

wired to the cap while this is being carried out. When the best place is found it should be soldered firmly to the cap.

Adjusting the Air Pressure

About 18 ins. of rubber tube connects the end of the blowpipe tube with the mouth and the amount of air pressure can be adjusted by blowing until the flame is the correct size for the work in hand. An oil lamp wick can be used for the jar tube and this should not be packed in too tightly. Half fill the container with methylated spirit and try it out.

It is possible with correct air supply to create a very hot flame and a lot of useful work can be done with it. The temperature of the flame varies considerably according to the part that is used; the hottest spot is indicated at (C).

A Sailing Model Viking Ship

FULL-SIZE
PATTERNS
ARE ON
PAGE 223

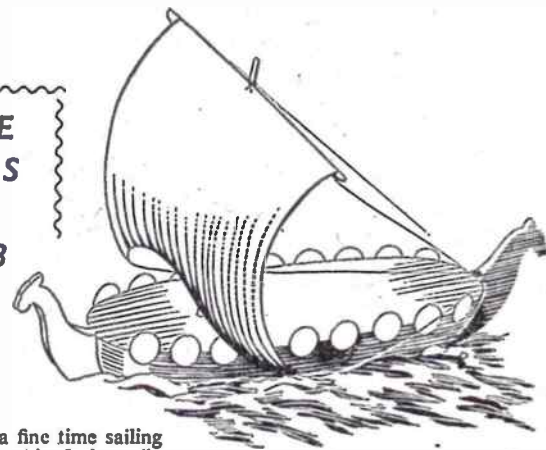

BOYS will have a fine time sailing this little Viking ship. It is easily constructed and will give endless hours of fun.

Cut out the hull pieces (A) and (B) from $\frac{1}{4}$ in. wood and the centre keel portion (C) from $\frac{1}{8}$ in. or $\frac{1}{16}$ in. wood. Shape the hull pieces to the sections shown on the patterns and glue one on each side of the centre keel portion (C). Use waterproof glue for this job. Screw two weights to the keel, sufficiently heavy enough to keep the boat on an even keel.

Give the ship two or three coats of

paint and then glue the shields along the sides. They should be about $\frac{1}{4}$ in. diameter and can be cut from thin card.

Step the mast in the hole provided, shaping it from $\frac{1}{4}$ in. wood, and make the sail from thin cloth. Sew the sail to the spar which should be tied to the mast. Insert a pin or screw-eye to the deck for attaching the running lines from the sail.

Try the little ship on the water and you will be delighted with its performance. (M.p.)

MAKING PANORAMIC PICTURES

By H. A. Robinson

FROM time to time you have probably come across very extended subjects, like scenes looking away over a wide expanse of country, that just will not go on a single snap. Also you have found that if you go far enough back to get everything in the picture the principal part becomes so small and distant as to be useless.

Such scenes can, however, often be taken quite well fairly near in by making a panoramic series of slightly overlapping prints and mounting these later

plainest of foregrounds and with the line of country you want some little distance away.

Thus, looking out on to a wide expanse of countryside from elevated ground is good for then there generally is no foreground at all. Looking over water is very satisfactory, too.

But much depends on the nature of the foreground, for often coarse grass and the like can be made to connect up

without much trouble even if it is not along the perfectly correct line of joining. The middle and far distance must join correctly, however.

Panoramas can be made up of two or three snaps. Often as not two snaps cover the subject, and, of course, this works out cheaper than with three exposures. But it is a case where it is best not to spoil the ship for a ha'porth of tar. So if three shots are needed on some really splendid scene, do not begrudge the third piece of film.

The sketch shows how panorama

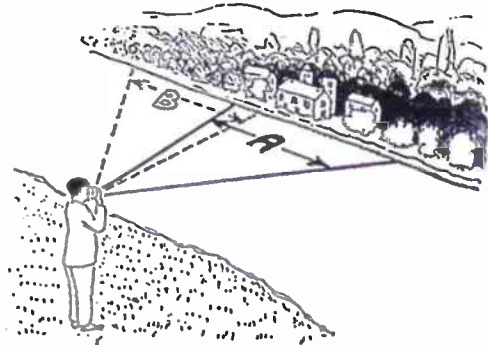

The method of taking overlapping photographs

as a connected length.

The results obtained this way are very pleasing, giving a sense of space and width, just as do the wide-screen cinema films. Indeed, you seem, as with the films, to get better into the pictures. Unfortunately, not all scenes can be taken by this overlapping method—but some respond very well. The wide-expanse subjects that do not take too well are those where there are also numerous near-in features like trees, fences and hedges. Scenes that take the easiest, and the best, are those with the



These three prints make up the completed panorama shown below. In this case the picture was made by considerable overlapping of the prints. The scene is on the outskirts of Berlin

pictures are taken. By looking through the finder you see whether the scene will be well covered with two or three shots. If two, sight one picture taking, say, the right of the subject (A). Note some feature on the extreme left edge of the finder that just comes in. Now swing the camera, getting this feature in on the

Continued on page 220



The all-British board with a 1001 uses

KITCHEN FITMENTS
WALL PANNELLING
BATH PANELS
STAIR CASING
FLUSH DOORS
HOBBIES
CABINETS
SHELVING

TOYS
PARTITIONS
PELMETS
CUPBOARDS
FURNITURE
CEILING PANNELLING

CELOTEX
FIVE-STAR HARDBOARD

Celotex Five-Star Hardboard has all the advantages and none of the imperfections of natural wood being a tough, dense, grainless, splinter-proof material of exceptional strength and rigidity. It is made in large size sheets in $\frac{1}{2}$ " and $\frac{3}{8}$ " thicknesses from clean, refined wood fibres and is easily worked with standard wood-working tools. The attractive rich brown surface can be easily decorated when required. There's a use for Celotex Five-Star Hardboard everywhere. Further details, samples and name of your nearest distributor will be gladly sent on request.

Ask for it by name. Every sheet carries a FIVE-STAR label

Made in Great Britain with all-British materials by
CELOTEX LIMITED
 North Circular Road, Stonebridge Park, London, N.W.10
 Telephone: ELGar 5717 (10 lines)

opposite side of the finder (right) and snap again (B)—not forgetting, of course, to wind on in between!

When three snaps seem necessary, snap the centre one first and then make two more pictures, one to either side. With three pictures you can often allow a little more overlap, which is all to the good.

When you have got the prints, examine the overlapping strip well for the best line of cutting. Sometimes a fraction of an inch to one side or the other will make all the difference between a satisfactory join or otherwise. There is generally one very best line of joining.

Cut with Razor Blade

The prints can be overlapped, but the best junction is made by accurately overlapping the similar parts, then pressing down with a steel rule and cutting with a safety razor blade through both prints. In mounting, the two cut edges can now be brought accurately up to one another and not overlapped at all.

The most ideal way to get panorama pictures is to be able to travel *parallel* to the scene and then take succeeding shots so that the picture ends just overlap. An excellent example of this would be going along the coast in a boat and covering a required length with a sequence of snaps.

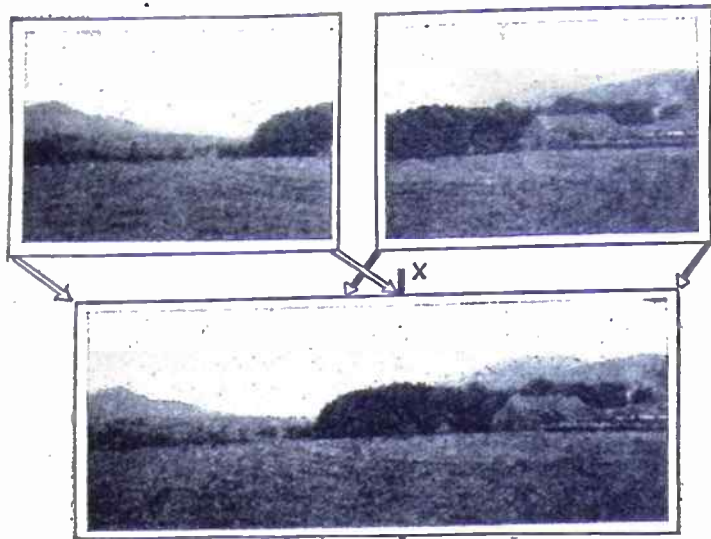

A two-print panorama. The arrows show how the pictures overlap

The 'drawing' this way is very true. With the swinging method there may be a tendency for the ends of the scenes to look as though they were receding. But only in very exacting cases is this

noticeable as, perhaps, where a road runs straight across the field of vision in the middle distance. With fairly distant hills and other expanses this effect is never noticeable.



Ewhurst, Sussex

You'll soon grow up!

And when you're older, you'll treasure those wonderful photographs of holiday Faces and Places which might soon have been forgotten.

Make sure of a well-packed album of exciting snaps by using Ilford films. They fit all popular cameras and you simply can't go wrong—you'll get a good picture every time.

ILFORD FILMS FOR FACES AND PLACES

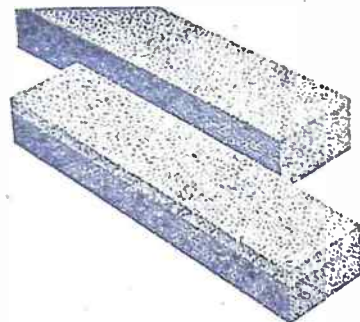

1. FOR CHISELS AND PLANE IRONS

Flat stones suitable for sharpening any flat-bladed tool, and for outside-bevelled gouges. In coarse or fine grits of silicon carbide or ALOXITE (aluminium oxide). Combination (coarse and fine) stones also available.

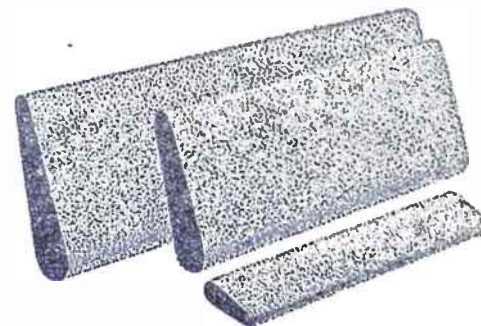

2. FOR GOUGES WITH INSIDE BEVEL

Slipstones of various sizes, in silicon carbide or ALOXITE (aluminium oxide), for all tools that need sharpening on an inside curve.

Sharpening Stones by CARBORUNDUM

3. FOR SHARPENING GIMLETS

Bore a hole with gimlet in hard wood. Fill hole with silicon carbide grain by CARBORUNDUM (120 to 180 grit). Work gimlet in hole with a little oil. Then repeat in a second hole, without oil.

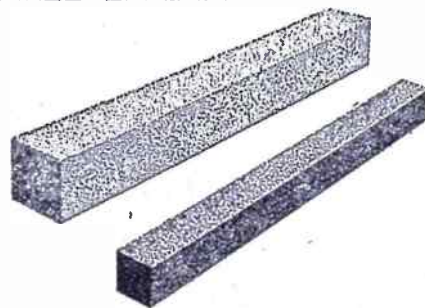

4. FOR SHARPENING AUGER BITS

Small stones like these are ideal for sharpening auger bits and other small tools. Auger bits should be sharpened so that the bevel is on the upper side of the cutting blades.

Write for pamphlet, 'The Art of Sharpening' to Dept. H, The Carborundum Company Limited. Responsible organisations may borrow an entertaining 16 mm. sound film, in colour, called 'Here's How', on the same subject, from the same address.
THE CARBORUNDUM CO. LTD. TRAFFORD PARK MANCHESTER 17

5. FOR SMALL OR INACCESSIBLE SHARPENING JOBS

CARBORUNDUM make a complete range of small sticks of different section and different grit sizes, for every small sharpening job.



SOLD BY TOOLSHOPS AND GOOD
HARDWARE STORES EVERYWHERE
THERE'S A PRODUCT BY
CARBORUNDUM
FOR EVERY SHARPENING JOB



Get WISE!

GET THE 1955 MAMMOTH 10/- ONLY

GADGETS ANNUAL

AND FIND OUT
HOW TO MAKE

OVER 350 NOVEL AND PRACTICAL DEVICES AND GADGETS FOR CARAVAN - HOME - WORKSHOP - OFFICE - HOBBY - MAGIC - PUZZLES - TOYS - GIFTS - MODELS - MONEY SAYING IDEAS - SALEABLE INVENTIONS.

● THIS MASSIVE VOLUME — PRINTED ON SOLID CARD — PROFUSELY ILLUSTRATED — AND BEAUTIFULLY BOUND ON PATENT OPEN-FLAT HINGES — IS LITERALLY PACKED WITH INGENUOUS IDEAS.

The radio and over 60 famous journals have praised this WONDERFUL annual, and The Sunday Graphic said: "This is the very book thousands have been waiting for." The Sunday Dispatch was equally enthusiastic.

● GET YOUR PERSONAL COPY TODAY! The price is 10/- only, post paid. Send to: HOME MADE GADGETS MAGAZINE 26 Swan House, Kingsbury, London, N.W.9.

● NOTE: We now have a stock of the famous "SEVENACE" seven-in-one combination pocket knife—26/- only. It has two blades, gimlet, all-purpose punch, corkscrew, screwdriver, and all-purpose saw! A HAND-MADE LUXURY KNIFE.

BUILD your own T/V and learn about its operation, maintenance and servicing. Qualified engineer-tor available whilst you are learning and building. Free Brochure from—E.M.I. Institutes, Dept. HW.58, London, W.4. (Associated with H.M.V.)

£5 to £20 weekly earned at home running your own Mail Order business. Complete Course 5/6.—Courses, 28(HB) Dean Road, London, N.W.2.

MODELS. You can make lasting stone-hard models with Sankey's Pyruma Plastic Cement. Supplied in tins by Ironmongers, Hardwaremen and Builders' Merchants. Ask for instruction leaflet.

GENUINE SWISS Musical Movements

Limited Quantity 17/- each, plus 9d. post/pkg.

Richardson & Forder, 5 Chapel Place, White Hart Lane, London, N.17

HEAR ALL CONTINENTS With H.A.C. Short-Wave Receivers.

Suppliers for over 18 years of Radio S-W. Receivers of quality One-Valve Kit, Price 25/- . Two-Valve Kit, Price 50/- Improved designs with Denco coils. All kits complete with all components, accessories and full instructions. Before ordering, call and inspect a demonstration receiver, or send stamped addressed envelope for descriptive catalogue.

'H.A.C.' Short-Wave Products (Dept. 22), 11 Old Bond Street, London, W.1

MAGIC Jumping Card and wonderful Catalogue 1/-.—Dellampsey, 363 Sandycombe, Kew Gardens, Surrey.

STOP SMOKING!! Quick Guaranteed remedy. Free Testing Sample!—Triumph Remedies (113), Exeter.

'PAINTSPRAYING' HANDBOOK (1954) Ed.). Covers Car, Industrial & Flock Spraying. 3/6, post free, including catalogue of our Cellulose and Synthetic Paints and all Allied Sundries and Plant Hire.—Leonard Brooks Ltd., 81 Oak Road, Harold Wood, Essex.

EARN £££'s WEEKLY in Sparetime. Hundreds of tested ways. Details free.—S.P. Ltd., 28(11B) Dean Rd., London, N.W.2.

SWISS MUSICAL Mechanism for cigarette Xboxes, etc., 18/- post free. S.A.E. for illustration and list of tunes available.—Dept. HW, Metwood Accessories, Church St., Wolverton, Bucks. (Trade supplied.)

AMERICAN MAGAZINE Subscriptions. One year Popular Mechanics 32/- . Popular Science 31/6. Homecraftsman 16/6. Homecraft 18/- . Deltagram 10/6. Free booklet quoting others.—Willen Ltd. (Dept. 57), 101 Fleet St., London, E.C.4.

PLYWOOD: large sizes, 14 lbs. 10/- delivered (Express) C.W.O.—H. Leader (1920), Gosford St., MidJesbrough.

A MODEL-MAKER'S 'MUST'!

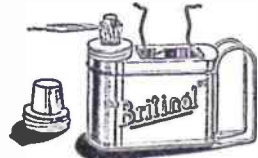

The 'BRITINOL' Spirit Blowlamp Gives a 2—4 inch flame from methylated spirit, is ideal for all soldering jobs, and heats a small iron rapidly. Completely automatic in action, no pumping necessary. Price 7/- from Hobbies or Halfords shops, or in case of difficulty, from: **BI-METALS (Britinol) LTD.,** St. Mary's Works, Bridge Road, London, N.9

TOY CASTING MOULDS. Soldiers, sailors, Airmen, etc. 1,000 varieties from 3/- each. Rubber moulding compound for flexible moulds, granulated ready for use. 8/6 per lb. Aluminium moulds for plaster work. S.A.E. for list. Catalogue 9d.—F. W. Nuthall, 69 St. Mark's Road, Hanwell, London, W.7.

STAMPS FREE—Empire Packet including Spictorials and Victorians with approvals.—Robert J. Peck, 7A Kemp Road, Bournemouth.

DOLL'S HOUSE fittings and papers. Send S.A.E. for list. Doll's House plan, special, send 2/6. Trade supplied.—Zimplan, 88 Ware Road, Hoddesdon.

AMATEUR WOODWORKERS—why not turn your hobby into substantial income? S.A.E. for full particulars.—Good-Woodcrafts, Cross Street, Leamington Spa.

* GREAT CAMPING OFFER *



BRAND NEW de luxe 'Safety' Tent. All colours. Complete. Ideal Cyclists, Campers. Length 7 ft. 3 in. sleeping base x 4 ft. 6 in. wide x 3 ft. 6 in. high x 12 in. walls, all approx. Weight 3 1/2 lb. £2.15s. or 4/- deposit and 6/- monthly. With fly-sheet £4 2s. 6d. or 10/- deposit and 9/3 monthly. Both carr. 1/6. Don't delay, send now.

GERMAN PRISMEX BINOCULARS

6 LENSES x 40 mm.
COATED LENSES
Popular Squat Model
NO DEPOSIT



Cash Price 69/6

These 6 lenses x 40 mm. for wide field viewing represent the finest value for German Prismex Binoculars. Size 5 1/2" x 4 1/4", Bending Bar for eye adjustment, with centre focus. Splendid magnification with real 3D viewing. Clear Bloomed lenses, wide angle. Ideal for sports and holiday use, day and night lenses. Lightweight model. With case lanyard and leather straps. NO DEPOSIT. Send only 2/6 for packing & reg., etc. 7 days approval, if satisfactory send 4/6, then 8 payments of 9/- within 8 months. CASH PRICE 69/6. SEND FOR LIEBERMAN & GORTZ CATALOGUE CONTAINING EVERY KNOWN BINOCULAR MAGNIFICATION, LISTS, TERMS. Herdarter & General Supplies Ltd. HOBWX/59, 196/200 Coldharbour Lane, Loughboro June, London, S.E.5. Open Sat., 1 p.m. Wed.

PERFORATION gauge and 50 stamps, free to all approval applicants enclosing 2jd. stamp.—Cliffie West (H8), 61 Wynyard Rd., Sheffield, 6.

TRANSFER graining paper—oaks, walnuts; samples 1/-; complete range, 3/-; roll, 16/10.—H. Decano Co., 20 Clarendon Rd., Jersey.

MARQUETRY Bargain Parcel. 20 different fine veneers, approx. 8 sq. ft. 5/-; p.p. 1/-.—Kirby's, 322 Denman St., Nottingham.

100 DIFFERENT stamps free! Request 3d. upwards discount approvals, wants lists welcomed.—Bush, 53 Newlyn Way, Parkstone, Dorset.

AERIAL rods—interlocking copper plated 12in. lengths, 3d. each; 2/6 doz. R1125 receivers, 6/- post. 2/6. Last remaining few.—Vi-Rad, 6 Twyford Rd., Eastleigh, Hants.

PLYWOOD — HARDBOARD — at amazing low prices. Send S.A.E. for samples and prices to — N. Gerver, 10 Mare Street, Hackney, London, E.8.

PRIVATE CHRISTMAS GREETING CARDS: Agents (either sex) wanted. Sample Book of beautiful designs free to enterprising and reliable applicants. Generous Commission. Also useful means of raising funds for any schema. No outlay. Write Box 544, Williams's Advertisement Offices, Bradford.

KITS for OLD TIME SHIPS

Hobbies range of Ship Models includes Elizabeth Jonas, Cutty Sark, Victory, Mayflower, etc. Complete kits of wood, sail material, guns, pulleys, cord, etc., with full-size patterns of parts and planned wood ready to cut out, shape and construct. A fascinating pastime.

Kits for models 7ins, long and upwards. Ask for free illustrated lists of Hobbies Branches or from Hobbies Limited, Dept. 99, Dereham, Norfolk.

SEE PAGE 217

Patterns for the Model Viking Ship

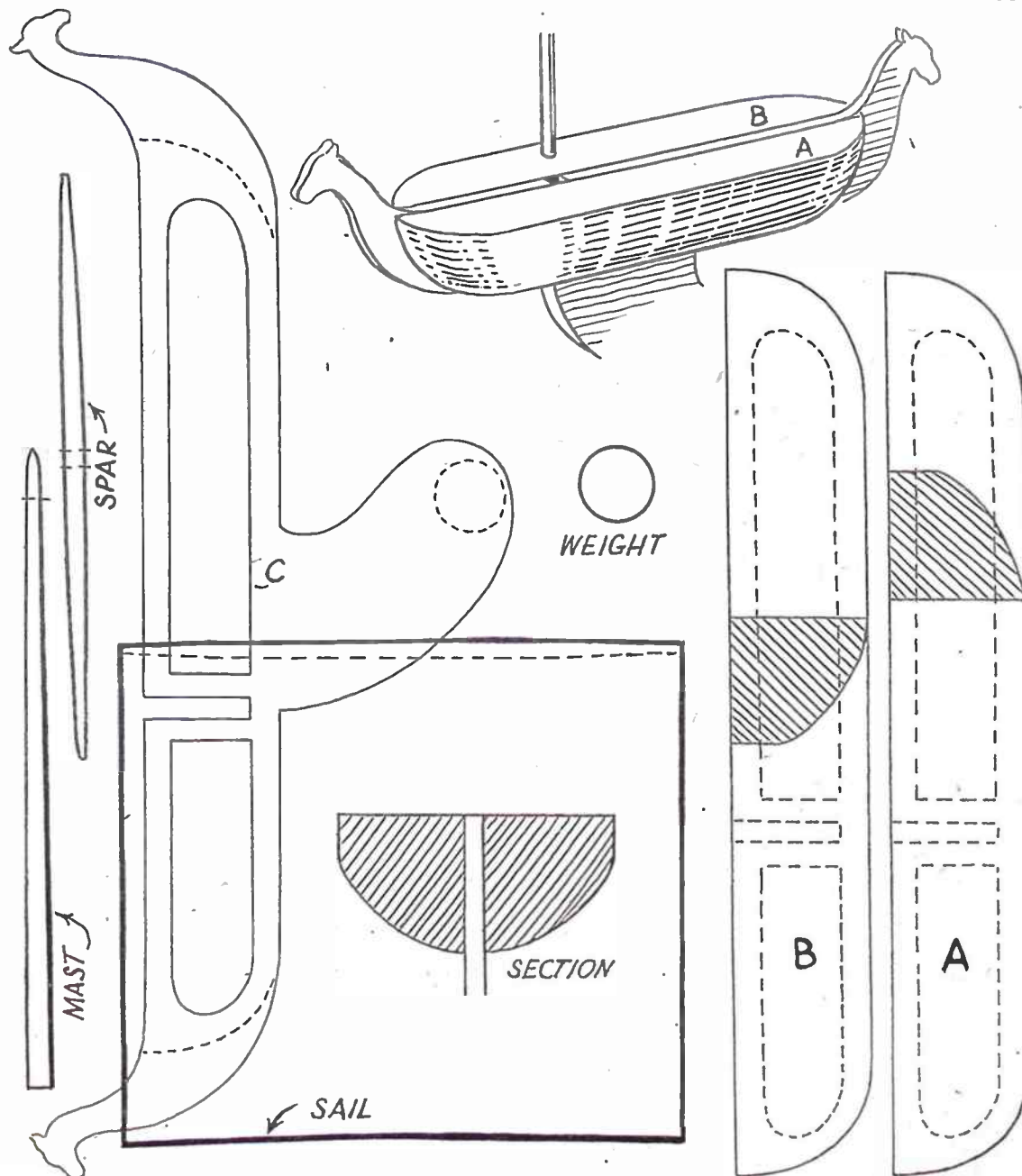



*Proof
against
Boiling
Water*

VALSPAR
MADE IN GREAT BRITAIN

2-4 Hour LACQUER • VARNISH • WOOD STAIN

- ★ NO KNOTTING PRIMING OR UNDERCOATING REQUIRED
- ★ DRIES IN 2-4 HOURS
- ★ SUITABLE FOR ALL SURFACES—EVEN TILES
- ★ EASILY APPLIED, EASY TO KEEP CLEAN



Write for booklet and name of stockist to the Sole Manufacturers U.K.

GOODLASS, WALL & CO., LTD.

179/185, (AC7) Gt. Portland St. W.1 Est. 1840

NEW! EXPERIMENTAL KITS

LEARN THE PRACTICAL WAY

Here is home study of the most effective kind under expert tutors. There is no better way of studying for an examination, starting a new hobby or for a career in industry. These special courses comprise the most modern methods of postal tuition, combined with a Practical Kit of parts (which remains your property).

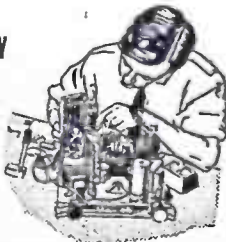

COURSES FROM 15/- A MONTH

COURSES WITH PRACTICAL EQUIPMENT INCLUDE: Radio, Television, Mechanics, Electricity, Chemistry, Photography, Carpentry; also Draughtsmanship, Commercial Art, Amateur S.W. Radio, Languages, etc.

POST THIS COUPON TODAY

For FREE brochure write: E.M.I. INSTITUTES, Dept. 31X, Grove Park Road, London, W.4.

SUBJECT(S) OF INTEREST _____

NAME _____

ADDRESS _____

6/7/55

ICSLA

**E.M.I.
INSTITUTES**

The only Postal
Colleges which is
part of a world-wide
Industrial Organisation

ELECTRIC PAINT STRIPPER

4/-
DEPOSIT
4 monthly
payments of
7/6
Cash price 30/-



Old paint peels off like magic with the Horvell electric paint stripper. Easy, even strokes remove paint, varnish, etc. Four-sided blade for angles and corners. A.C./D.C. mains - state voltage. P. & P. 1/- Extra flex 1/- yd. Spare element 5/6.
Leaflet free

ELECTRIC PAINT SPRAYER

For 4/-
deposit



Cash 75/- Or 4/- deposit and 6 monthly payments of 13/6

Paint easily, evenly, twice as fast with the Burgess Electric Sprayer. Sprays paint, varnish, etc. Complete with sturdy glass container, flex, nozzles for ceiling spraying and extra nozzle disc for different liquids. A.C. mains - state your actual voltage. Fully guaranteed Leaflet free

BATHROOM SCALE BARGAIN



★ FOR 5/- ONLY

★ and 6 monthly payments of 13/- (or Cash Price 69/6)
WATCH Your WEIGHT every day with this streamlined Bathroom Scale. Magnified dial easy to read. Weighs accurately from 1lb. to 18st. Lovely white enamel finish. Non-slip rubber mat. All mechanism enclosed, 2 years' guarantee. Cash 69/6, or 5/- dep. and 6 monthly payments of 13/6.

PHILISHAVE

14 DAYS' FREE TRIAL



Try the wonderful Philishave Electric Dry Shaver FREE for 14 days. Send only 5/- deposit (returnable if not satisfied). Two shaving heads with two 6-bladed cutters have unique rotary action which genuinely shaves - doesn't just nip at the hairs. Result - better quicker shave. Operates 110/250 volts. A.C./D.C. 67-9.3 cash less your deposit. Or 5/- deposit can be first payment, followed by 8 monthly payments of 11-12 months guarantee. Brochure of this & other shavers free.

BARGAIN DISTRIBUTORS
(Dept. 124), 5 Silver Street, Luton

HURRY! HURRY! HURRY!

Get your kits NOW for these grand working models

15 in. Model Yacht
Kit No. 3104

(all fittings, including sails)

Sails perfectly and a real bargain for

14/3



20in. Motor Launch
Kit No. 3096

(including motor and propeller unit)

36/6



Obtain your kit now from your Hobbies branch or stockist or direct, post free, from:

HOBBIES LTD. (Dept. 99)
Dereham, Norfolk

CONTEMPORARY CABINET

(FOR COCKTAILS OR GENERAL PURPOSES)

SIZE 36½ ins. LONG (OVERALL)
27 ins. HIGH.

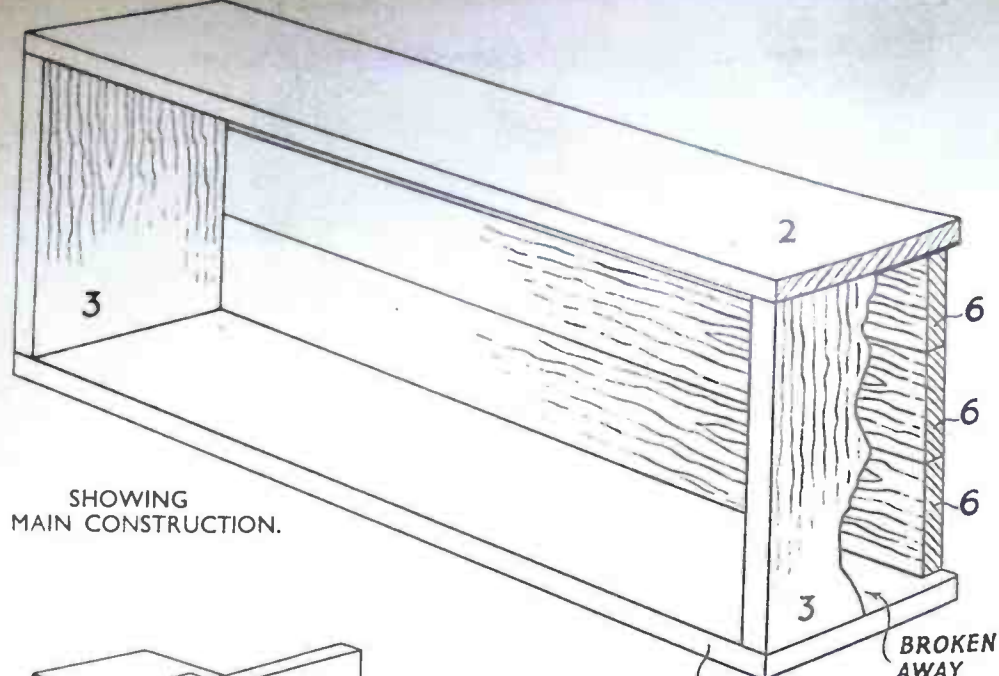
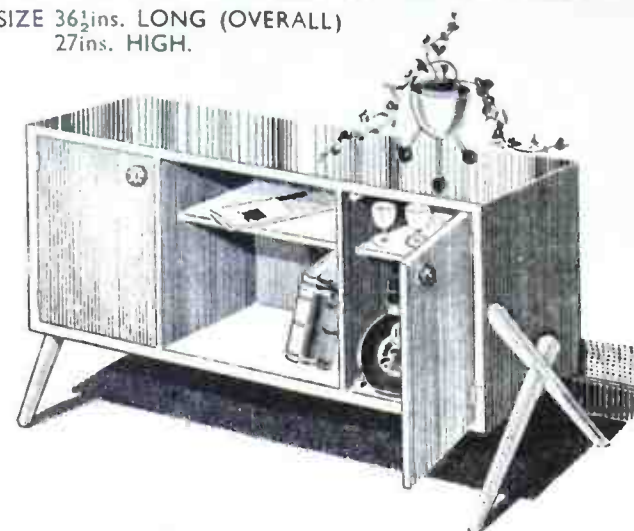

SHOWING MAIN CONSTRUCTION.

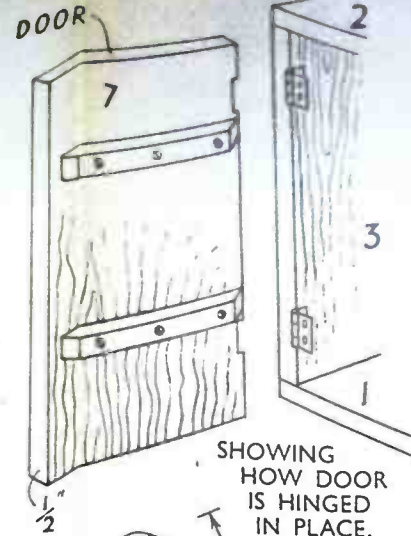

SHOWING HOW DOOR IS HINGED IN PLACE.

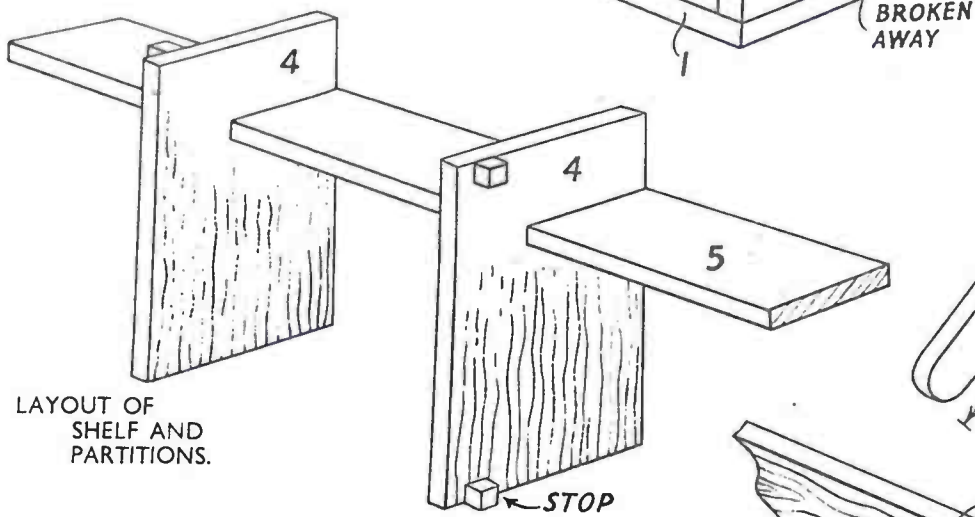

LAYOUT OF SHELF AND PARTITIONS.

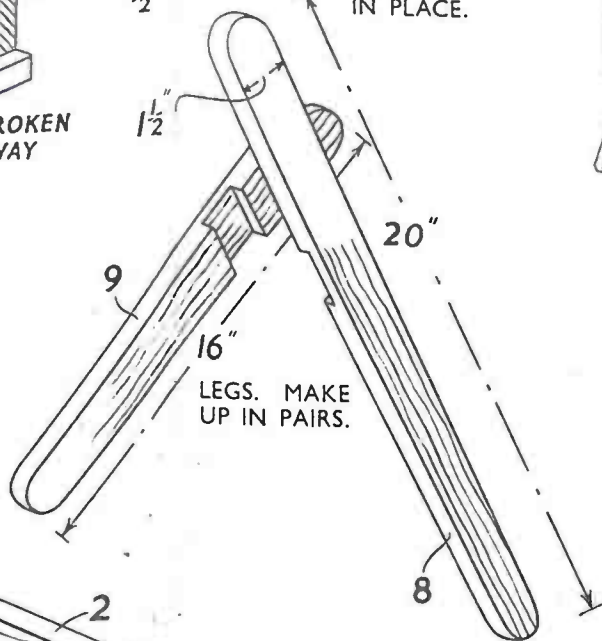

LEGS. MAKE UP IN PAIRS.

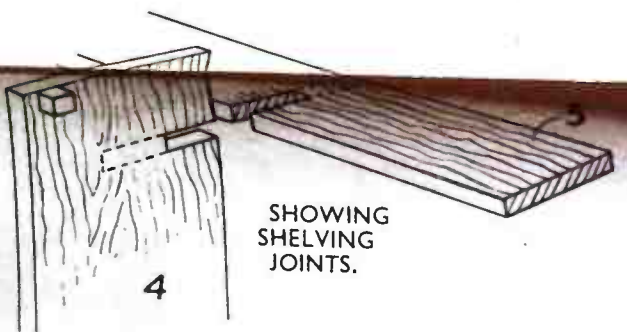
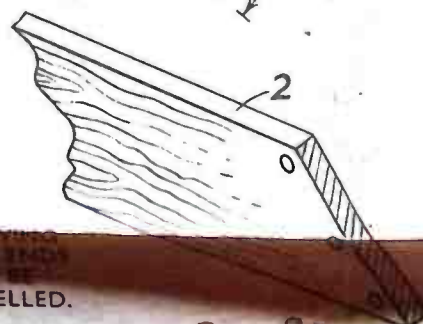

SHOWING SHELVING JOINTS.

SHOWING HOW LEGS CAN BE DOWELLED.

THE ARROWS INDICATE DIRECTION OF GRAIN OF WOOD.

GROOVE

DOWELS. CUT FROM 3/8 in. ROUND ROD.

Materials required for this Design:—

WOOD
 Four pieces 36ins. x 10ins. x 3/4in. (Hobbies S12)
 Two pieces 36ins. x 10ins. x 1/2in. (Hobbies S8)
 Three pieces 36ins. x 6ins. x 1/2in. (Hobbies R8)

STRIPWOOD
 Four pieces 1in. x 1/2in. x 12ins. long
 Two pieces 3/8in. diameter round rod, 18ins. long
 Two pairs of 2ins. x 1/2in. heavy brass hinges
 Two 1 3/4in. diameter metal handles (Hobbies No. 712)

A complete kit of the above materials can be obtained from **HOBBIES LTD., DEREHAM, NORFOLK**

Did You Know

. . . That details of hundreds of designs and kits, chosen from among the best of those produced during the past few years, are given in . . .

HOBBIES Annual HANDBOOK

In addition, there is an extensive editorial section full of "how-to-make" articles, a large FREE Design, and a comprehensive catalogue of tools and materials.

The Handbook is published each year, and is obtainable from newsagents or Hobbies stockists and Branches, or by post from Hobbies Ltd., Dereham, Norfolk.

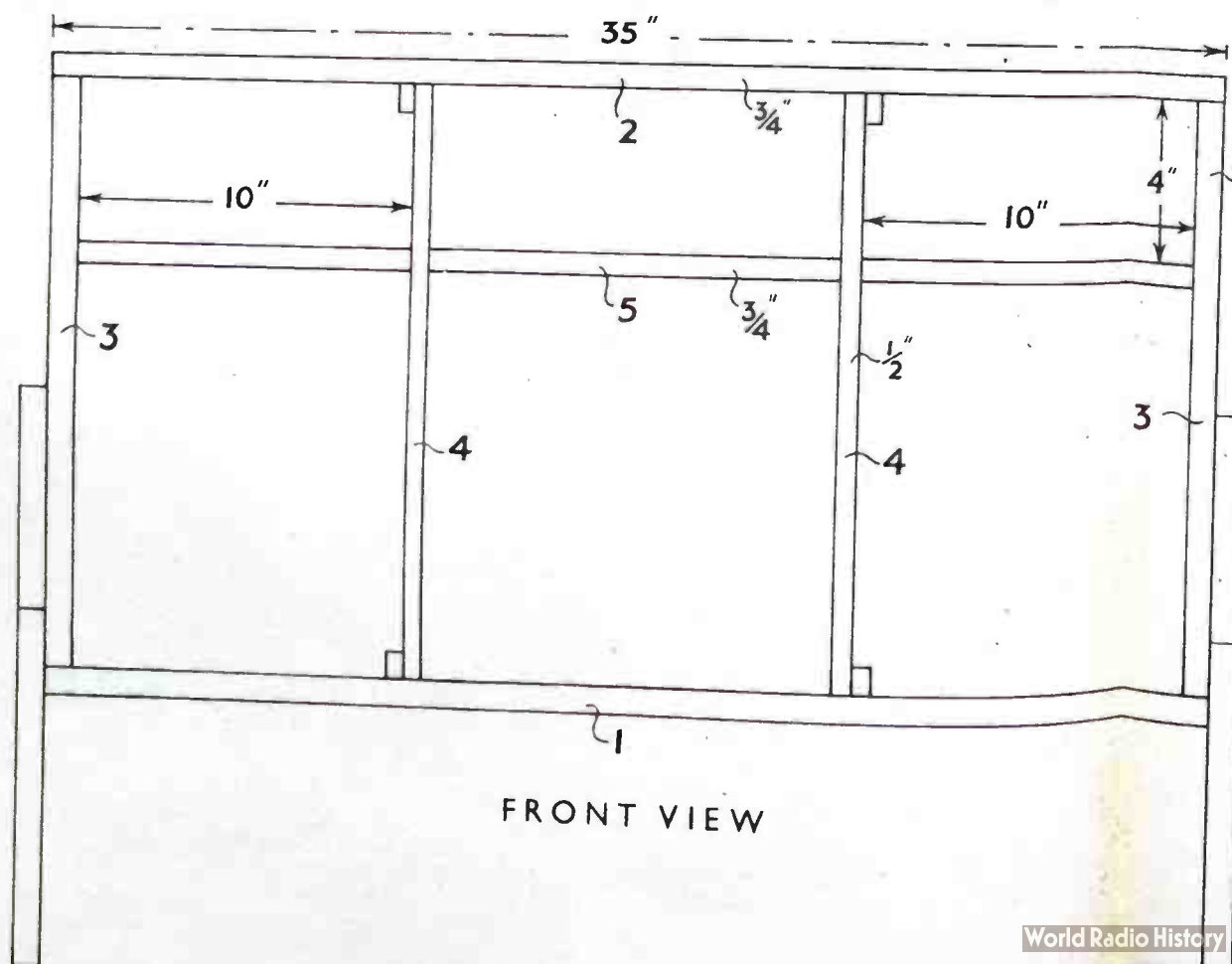

FRONT VIEW

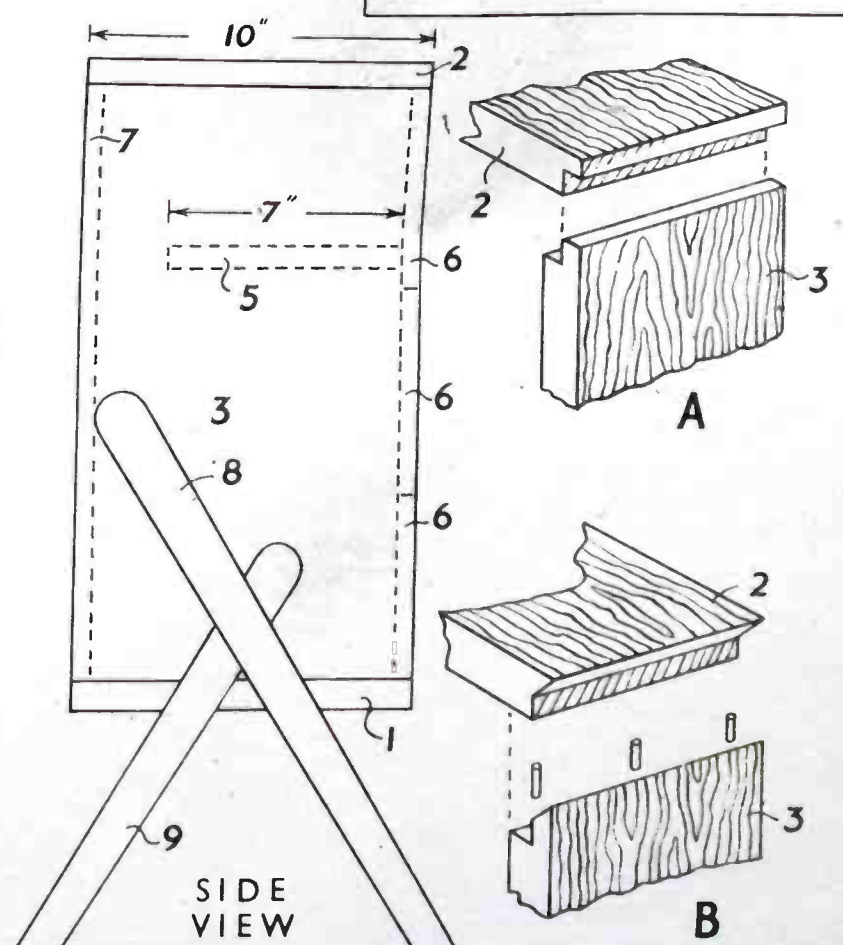

SIDE VIEW



*Proof
against
Boiling
Water*

VALSPAR

2-4 Hour LACQUER · VARNISH · WOOD STAIN

- ★ NO KNOTTING PRIMING OR UNDERCOATING REQUIRED
- ★ DRIES IN 2-4 HOURS
- ★ SUITABLE FOR ALL SURFACES—EVEN TILES
- ★ EASILY APPLIED, EASY TO KEEP CLEAN



Write for booklet and name of stockist to the Sale Manufacturers U.K.
GOODLASS, WALL & CO., LTD.
 179/185, (A27) Gt. Portland St. W.1 Est. 1840

ELECTRIC PAINT STRIPPER

4/- DEPOSIT
4 monthly payments of 7/6
Cash price 30/-

Old paint peels off like magic, with the Morvell electric paint stripper. Easy, even strokes remove paint, varnish, etc. Four-sided blade for angles and corners. A.C./D.C. mains - state voltage. P. & P. 1/- Extra flex 1/- a yd. Spare element 5/6.
Leaflet free

ELECTRIC PAINT SPRAYER

for 4/- deposit

Cash 75/- Or 4/- deposit and 6 monthly payments of 13/6

Paint easily, evenly, twice as fast with the Burgess Electric Sprayer. Sprays paint, varnish, etc. Complete with sturdy glass container, flex, nozzles for ceiling spraying and extra nozzle discs for different liquids. A.C. mains - state your actual voltage. Fully guaranteed Leaflet free

BATHROOM SCALE BARGAIN

★ FOR 5/-

★ and 6 monthly payments of 13/- (or Cash Price 69/6)
WATCH YOUR WEIGHT every day with this streamlined Bathroom Scale. Magnified dial easy to read. Weighs accurately from 1lb. to 18st. Lovely white enamel finish. Non-slip rubber mat. All mechanism enclosed. 2 years' guarantee. Cash 69/6, or 5/- dep. and 6 monthly payments of 13/-.

PHILISHAVE

14 DAYS' FREE TRIAL

Try the wonderful Philishave Electric Dry Shaver FREE for 14 days. Send only 5/- deposit (returnable if not satisfied). Two shaving heads with two 6-bladed cutters have unique rotary action which genuinely shaves - doesn't just nip at the hairs. Result - better quicker shave. Operates 110/250 volts. A.C./D.C. 67-9/- cash less your deposit. Or 5/- deposit can be first payment, followed by 8 monthly payments of £1.12 months' guarantee. Brochure of this & other shavers free.

BARGAIN DISTRIBUTORS
(Dept. 124), 5 Silver Street, Luton

NEW! EXPERIMENTAL KITS

LEARN THE PRACTICAL WAY

Here is home study of the most effective kind under expert tutors. There is no better way of studying for an examination, starting a new hobby or for a career in industry. These special courses comprise the most modern methods of postal tuition, combined with a Practical Kit of parts (which remains your property).

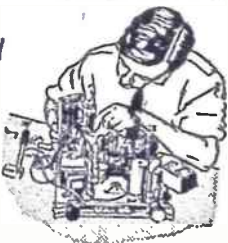

COURSES FROM 15/- A MONTH

COURSES WITH PRACTICAL EQUIPMENT INCLUDE: Radio, Television, Mechanics, Electricity, Chemistry, Photography, Carpentry; also Draughtsmanship, Commercial Art, Amateur S.W. Radio, Languages, etc.

POST THIS COUPON TODAY

For FREE brochure write: E.M.I. INSTITUTES, Dept. 31X, Grove Park Road, London, W.4.
 SUBJECT(S) OF INTEREST _____
 NAME _____
 ADDRESS _____
 6/7/55

E.M.I. INSTITUTES
The only Postal College which is part of a world-wide Industrial Organisation

HURRY! HURRY! HURRY!

Get your kits NOW for these grand working models

15 in. Model Yacht Kit No. 3104

(all fittings, including sails)

Sails perfectly and a real bargain for

14/3



20in. Motor Launch Kit No. 3096

(including motor and propeller unit)

36/6



Obtain your kit now from your Hobbies branch or stockist or direct, post free, from:

HOBBIES LTD. (Dept. 99)
 Dereham, Norfolk