

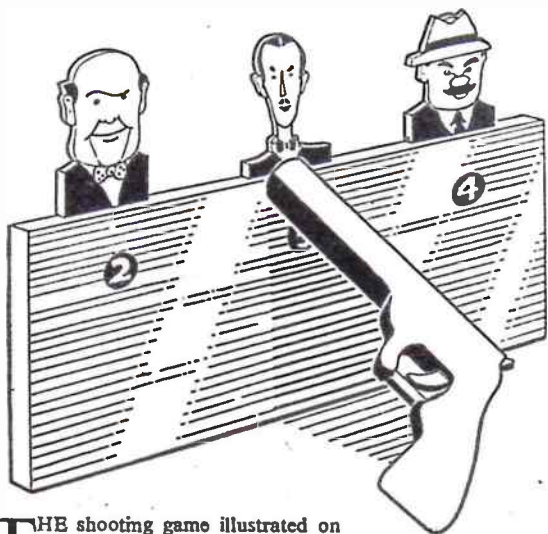

A Design Sheet  
for a model  
Trinity House  
Lightship is  
**FREE INSIDE**

VOL. 114

NUMBER 2946



*Elastic bands are the  
missiles with this novel*

# 'SHOOTING GALLERY'

Easy to make—  
silent in action—  
and lots of fun!  
Make yours right  
away.

in the trigger. Now place the second side in position and drive home the pin which forms the trigger pivot. This side can be screwed in position to enable you to get at the trigger in the event of this being fractured. To complete the pistol it can be rounded off where desired, and should either be varnished, or given a coat of jet black paint.

**T**HE shooting game illustrated on this page has one advantage that should appeal to all parents. It is that, unlike the usual cap type, this pistol is not a noisy toy, being constructed to fire elastic bands. To lessen the possibility of the gun being fired at members of the family, patterns are provided for a shooting gallery. The faces are hinged, so that when hit, they fall back and disappear behind the wall.

### The Pistol

You will see from the full size patterns provided on page 47 that the pistol is made up of two sides, a centre piece which fits exactly between the sides, and a trigger. The thickness of the wood used is not important, 3/4 in. or 1/2 in. wood will suit. When all the parts

have been cut out with a fretsaw, glue or pin the centre piece to one of the sides

Full-size patterns for the Gun are on page 47. See next page for details of the figures.

in the position shown by the dotted lines. The next step is to mark on this side the position of the trigger pivot and to drill a hole through the trigger so that it will move easily. A pin should be knocked home through this side so as to protrude through the hole

### Firing the Gun

To load the pistol, place the elastic band over the muzzle, bring it back and stretch over the gun just above the trigger piece as shown in Fig. 1. When the gun is fired, the top of the trigger lifts and releases the rubber band.

### The Shooting Gallery

This is constructed from a piece of

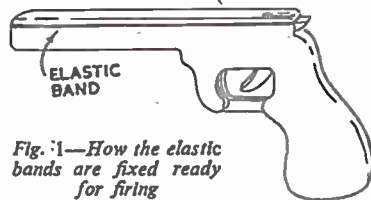

Fig. 1—How the elastic bands are fixed ready for firing

All correspondence should be addressed to The Editor, Hobbies Weekly, Dereham, Norfolk.

THE MAGAZINE FOR MODELLERS,  
HANDYMEN AND HOME CRAFTSMEN



wood measuring 12ins. by 5ins. and about  $\frac{1}{4}$ in. thick. It can be made to stand upright by fixing a piece of wood at the back, as shown in Fig. 2. The actual targets are full size and should be traced off direct on to  $\frac{1}{4}$ in. wood. The method of hinging should not be too stiff, so that the figures will fall back easily when hit with the elastic band. The wall may be painted a bright colour, and the scoring numbers cut out and pasted underneath the figures. (341)

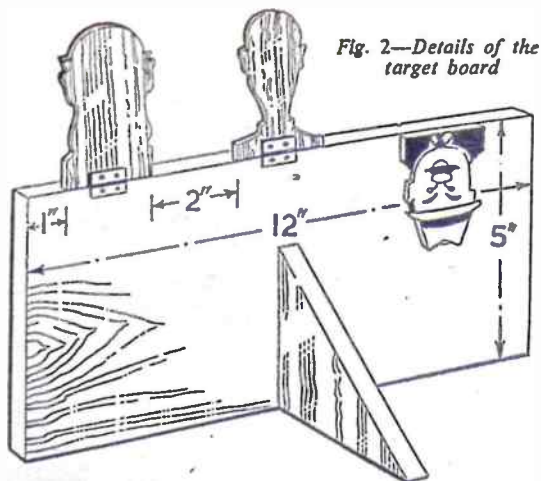

Fig. 2—Details of the target board

Fig. 3 (below)—Full-size drawings of the three 'targets' ready for tracing off on to the wood



## ★ Be Sure You Read This

READERS who are making, or intend to make, the electric chandelier published in our issue of March 12th, should take careful note of the following.

Unfortunately a diagrammatical error has occurred and shows in Fig. 3 the bulbs wired in series. To use this wiring, the reader would have to obtain 60 volt bulbs, and these are not, in fact, generally available.

To use ordinary 230-250 volt bulbs the wiring must, of course, be in parallel as in our amended drawing herewith. This error is very much regretted, and to

those who have progressed to the stage of wiring—and found, perhaps, that they can get nothing but a dull red glow from the four bulbs—we offer our sincere apologies, trusting that the extra time involved in rewiring will be well repaid by the trouble-free working of the finished chandelier.

One further point. The article implies that switching off the room light is sufficient precaution before removing the ceiling rose, but, in the case of indifferently wired houses, this may not be so. Before fixing the chandelier, therefore, be on the safe side, and switch off at the mains.

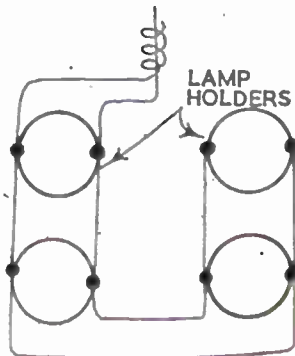

## Where space is limited, make A CABINET TYPE WRITING DESK

THIS is a handy writing desk for a small room. It is fitted on the surface of a wall, or even inset in the wall, if facilities are available, and thus takes up the minimum of space. Three small drawers are provided at the top of the cabinet, which can be opened separately. The front is hinged so that it folds down to a horizontal position, when it forms a suitable writing surface. Convenient shelf and compartment space is provided in the interior for writing materials, etc.

### The Basic Cabinet

Construction of the basic cabinet is shown in Fig. 1. Main material sizes are listed in Fig. 3, whilst Fig. 2 gives a front and side elevation of the completed assembly.

Top, sides and bottom should be cut from  $\frac{1}{4}$ in. material. The type of joints used are left to the individual. Plain butt joints will be adequate if properly made and well glued. Small corner

blocks between the bottom and the sides and the top shelf will help. Rigidity is, in any case, afforded by the fitting of the back panel, which can be pinned or screwed to the sides.

### Shelves and Partitions

Once the main cabinet parts have been cut out and properly assembled, the interior shelves and partitions can be added. The cabinet is divided into an upper and lower compartment by the addition of the top shelf. This is the full width of the side so that the drawer assembly actually projects  $\frac{1}{4}$ in. This accounts for the thickness of the hinged front, fitted later. The lower shelf, vertical frame and the partitions are set back  $\frac{1}{4}$ in. to clear the writing surface to the back of the hinged front.

It is particularly important that the top shelf and the drawer verticals be fitted accurately, otherwise trouble will probably result when fitting the drawers. The drawers themselves are simple assemblies from  $\frac{1}{4}$ in. material—Fig. 4. Again more elaborate construction can be used, if desired, or even different

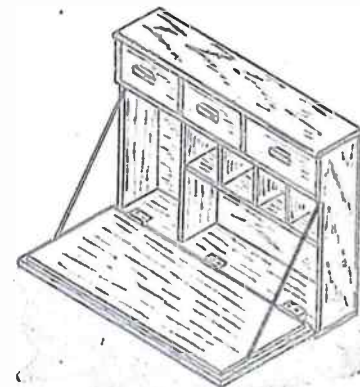

material thicknesses, working to the same outside dimensions. These give  $\frac{1}{4}$ in. vertical clearance for the drawers when in position and no horizontal clearance. Drawer width can be relieved slightly to provide this latter clearance later.

### The Front

The front is a panel of  $\frac{1}{4}$ in. material with a good grained face. This is the main part of the finished cabinet which will show, and careful, initial selection of the wood is important. It must be cut absolutely true to line up with the rest of the cabinet. On the inner face of

(Continued on page 39)

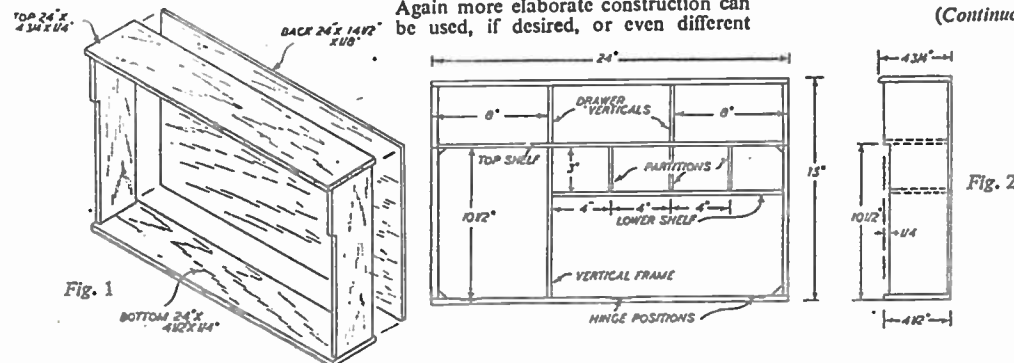

Fig. 1

Fig. 2

Fig. 3

Fig. 4



# Notes for the photographer on recognising and PREVENTING CAMERA 'SHAKE'

WHEN you come across a print that looks fuzzy amongst a batch that are quite sharp it is probable that the trouble is 'shake', or, to give it its full name, 'camera-shake'.

This fault is rather subtle and can reveal itself as anything from a snap that does not look quite as sharp as it should to a hopelessly blurred picture. There is one way, however, that you can always tell 'camera-shake' from any

shutters, too, when they are released, go off like a pistol, which again is bad. So insidious, and so easily will it come about that professionals, pressmen and others will go to the greatest pains to ensure a steady camera—even though the shutters they are working with slip over with no suggestion of vibration. So in doing everything possible to guard against shake we must not consider ourselves as being too faddy. Even

lot of things. A telegraph pole or tree will do, or, perhaps, a lamp-post or standing motor truck is handy. Anything will do as long as it is rigid and in roughly the right position for your taking.

## At Any Level

Working this way means that the camera can be held at any level desired and the ordinary waist-height finders comfortably used—that is, those that one looks down at for sighting.

Often, however, one has to use a camera right out in the open with no support of any kind available—then it has to be held in the hand. But much here can be done to stop shake.

The position taken should be firm with the feet slightly apart. At the exact moment of making the exposure the breath must be held, and the trigger squeezed rather than pressed. This can be effected in all box cameras and many of the other types by placing a finger at some point below the instrument to counterbalance the downward pressure of the thumb, which moves the trigger. Practice this method of releasing when the camera is empty and it will be found that in time a very smooth action can be secured. At all costs anything in the nature of a jabbing action must be avoided, for it is this which results in a shaken picture.

Even in the open, sometimes a semi-support can be used. Thus the camera can be held to the top of a walking stick which only has its end resting on the ground—that is, in no other way fixed. The stick and camera are held with one hand and the release effected with the other. A camera can be steadied in a similar way on, say, the seat of a cycle—the machine leaning against you, or a steadying effect can be obtained by pressing the instrument against one's own hip—the feet being placed well apart. In this latter position it will be found it is quite easy to look down into a waist-level finder.

## Using the Sling

Some cameras are supplied with a sling which goes over the back of the neck, the camera then, in effect, hanging in front of the body. It is then held against the pull of the strap and great firmness can be secured. The efficiency of a sling in giving steadiness is very marked but has to be experienced to be fully appreciated.

The sling, hip, or supports of the walking stick type cannot be used with cameras that have eye-level finders only,

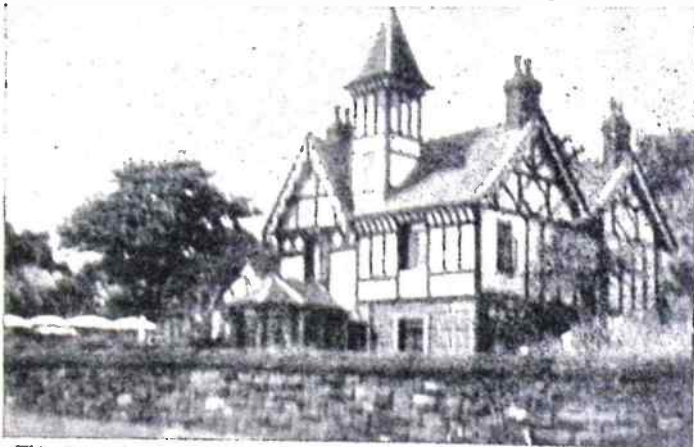

This picture has been spoiled by 'Shake'. In places the 'sideways dragged' effect is obvious

other cause of poor definition and that is by the image having a 'dragged sideways' appearance. Lack of good definition can be caused by a number of conditions—poor focusing, a dirty lens or a film that for some reason has become buckled. But all these show a general softening of detail, not that sideways drag. Even if the blur of a shaken exposure is slight, the characteristic can be picked out by using a microscope.

## What is 'Shake'?

'Camera-shake' is exactly what the term implies. The camera has been given a jolt or shake at the very instant that the lens was open and so the image on the film (for a very real picture appears there—like a scene at the cinema) has slipped sideways during the time that the light was acting—hence the dragged impression.

It is a pity, but the shutters on some of the less expensive cameras are stiff in action and need a good pressure to operate them, a condition which invites a jolt at the crucial moment. Some

though just passable as a contact print, a shaken snap is quite useless for making an enlargement from, and it is becoming popular to have P.C. (post-card) enlargements, made from your 'best snaps'.

To prevent any danger of shake the camera must be perfectly rigid as the exposure is being made, and the ideal condition is to have the camera resting on something solid and firm, say, a wall or the top of a gate-post. But gate-posts and walls are not always just where you want them—indeed, they seldom are—and so other ideas must be adopted to secure the necessary rigidity. The old-time tripod, of course, did all that was required, but now-a-days few snapshotters want to be burdened with these things. In any case, there are many places where you just cannot set up a tripod—as at the ropes on sports day for instance.

A good substitute for an actual support for a camera is to press the instrument sideways against some firm object as you work the trigger. This means you can enlist the aid of quite a

but a novel way to use an instrument so fitted is to raise the left arm and crook it to rather less than a right-angle at the elbow so that the forearm comes across the face—much the action that would be adopted in shielding the eyes. On this support the camera is placed and the exposure made with an antinous release. Quite long exposures can be given using this idea, but, of course, it is only possible with an instrument having a cable release. It also needs a fairly big camera but it is remarkable how firm the arm can be held in the position described.

## Don't Tense Muscles

In all ways of taking, it is a great fault to tense the muscles too much—as this causes a kind of internal muscular vibration. While firmness of stance is aimed for, any fierce muscular tension should be avoided like the plague.

Finally, as will be quite understood, a major point in avoiding shake is to know, and know well, your own camera. Every type of instrument has its own characteristics and spending time getting the feel of it when unloaded is time well spent. Shutters all differ in smoothness of action, and it will be found that one of the smoothest is the 'Compur'—but this is only fitted to fairly expensive cameras. The smoother the shutter action the greater the liberties that can be taken with regard to supports. The higher the shutter speed the greater

liberties also. Thus the operator with a shutter working at 1/500 second could take chances that one having a shutter giving 1/25 second could not. And most box cameras and fixed speed cameras give only a standard 25th second. But

whatever the speed of the shutter or type of release, keep a weather eye open for the possibility of shake and do all that is feasible under the circumstances to avoid it. (351)



A picture of the same scene taken with a rigidly held camera. The detail is now quite sharp

## WORKSHOP NOTES AND HINTS (5)

# A PIVOTING LIGHT

THE average workshop of an amateur is often a shed lit by a single light, so that whilst some parts of the work are well lit—perhaps too brightly, much of the shed remains in deep shadow. Even the fitting of a second fixed light does not improve matters much, owing to the fact that the light has to be hung from a low roof.

The arrangement to be described, however, has proved quite successful in overcoming the disadvantages just mentioned and is seen rigged up at very small cost in time and materials. It is simply a light at the end of a swinging, bent-down arm (a) which will swing round to b, for example. The length of the arm and amount of dip will depend, obviously, on the size of the shed and its height.

Three methods are illustrated, though these merely touch the many ways of making the pivot. Very simple is a 36in. (or so) length of lin. (approx.) strap metal, bent as shown at c, about 3ins. from each end. A simple wooden

slat with a wedge shape block screwed on is shown at d. One end of the flex is taken to the nearest electrical point and the other has a lamp adaptor. The flex is so arranged that it has some ample 'play' when the pivot is turned. Through the wedge a hole is bored to take a coach screw which secures the pivot, via a washer, to the rafter of the shed. The pivot should turn easily without being too sloppy.

At e we see a slightly more elaborate version. Here, two light wooden arms are permanently attached to a small

block at the lamp end, but are fastened with a bolt and wing nut to the main block which, in turn, is held, as in the other cases, to a rafter by means of a coach screw. This beam can be moved round not only in a circle but also up and down. (315)

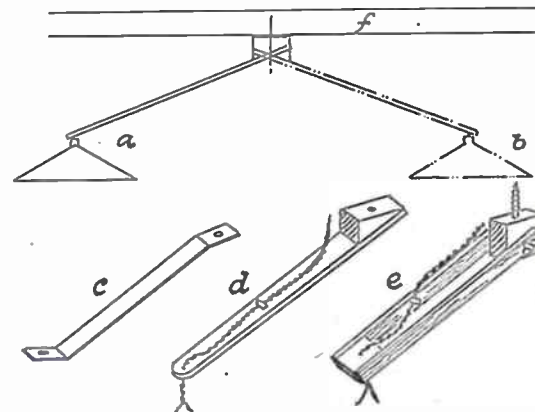

Details of the light



# A beginner's model of a TRINITY HOUSE LIGHTSHIP

**T**HIS model of an up-to-date Trinity House light vessel has been specially designed for the beginner. Construction has been simplified throughout, and detail, while adequate, has been kept to a minimum. Experienced model makers are not precluded from making the model, of course, as they will be quite able to add extra detail as required.

## Acknowledgments

The original from which this model was devised was built by Messrs. Philip & Son Ltd., of Dartmouth, Devon, to whom we are indebted for the loan of plans and photographs. We should also like to acknowledge the help extended to us by the Trinity House authorities. The scale of the vessel is  $\frac{1}{4}$  in. to the foot, but those who wish to model it to another scale could easily do so by re-scaling the design sheet. Some who made the lifeboat published recently may like to make the lightship to the same scale (4 mm. to the foot) so that the two can be used together in some sort of layout, and they will find that making the lightship to this scale will enlarge it to ap-

*This striking model is the subject of Design Sheet No. 2946, given free with this issue. A complete kit of wood, wire, etc., for making the model can be obtained from Hobbles Branches, or post free from Hobbles Ltd., Dereham, Norfolk, price 5/4, including tax.*

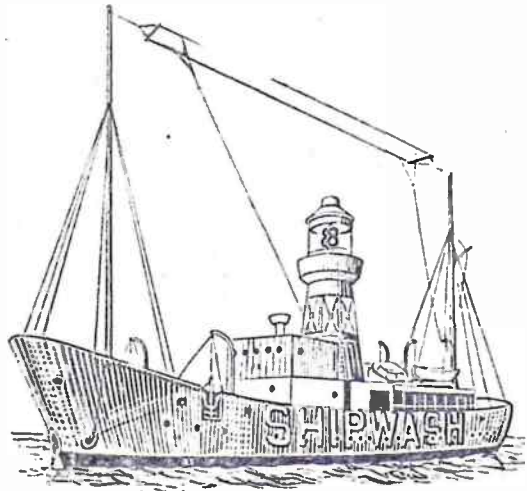

parts and letter each according to its number on the design sheet. In this way you will avoid confusion later when assembling the craft.

The first step in assembly is shown in Fig. 1. Glue pieces 1, 2, 3, 5 and 6 together 'bread and butter' fashion, and when the glue is perfectly dry, shape the whole as shown by the dotted lines and three shaded half sections in Fig. 1. The shaded portions represent the shape of one half of the hull at the points shown.

Pieces 4, 7, 8, 9, 10 and 11, which form the main upper deck and bridge, are then glued together as seen in the side view of the vessel on the design

will be found on the design sheet. Around this completed unit is wrapped a piece of transparent material (see design sheet) which is glued and pinned in position. Before sealing the lamp chamber, however, the interior should be painted. All fittings should be a light grey with the lamps themselves painted silver. To complete the lamp-house, pieces 12 and 13 are shaped and glued into position on its top, and piece 17 shaped and glued to its underneath.

## The Light Support Tower

The supporting tower is made next, and consists of pieces 18, 19 and 20. The edges of pieces 18 and 19 are shaped to conform with the slope of the sides of piece 20, and this can be easily followed from the sketch on the design sheet. To cover the tower, a piece of thin notepaper is required. Smear the edge with glue and attach the paper to the edge of the tower support as shown in Fig. 2. When dry, wrap the tower completely in the paper (Fig. 3). Pull as tightly as possible, smear the remaining edge with glue and hold in place with elastic bands until quite dry, when the top and bottom edges are trimmed off with a sharp razor blade.

The support is now glued on the upper deck (7) in the position shown by the dotted lines on the design sheet, and the lamp-house can then be glued on top of the support to complete the assembly.

Now comes the task of making the various deck fittings. Begin with the davits (21) which are made from medium thickness wire bent to shape and inserted in small holes drilled in the positions shown on the design sheet. Four will be found on the upper deck and two on that part of the deck formed by piece 5.

To support the two lifeboats, the

small blocks (22) are glued into position on the upper deck (7), and then pieces 23 are shaped as the lifeboats. This shaping can be readily accomplished with a sharp penknife. When finished, glue the boats to the supporting pieces and run thin pieces of thread from the bow and stern of each to the davits (see side view). A spot of Durofix will secure the thread in position.

Next shape up pieces 24 which form the raft supports. They are glued in position with the feather edges facing outwards. Then shape the rafts and glue these into position also. Fig. 4 shows a raft ready to glue into position on one of the supports.

## Making the Anchors

To make the anchors, use thin card, cutting the shapes out carefully. When ready, they are glued into the recesses provided near the gunwale and suspended from the forward davits by pieces of thin cord glued in position (see side view). When riding at anchor, only the anchor in the extreme point of the bow (see main illustration) is used, and the two side anchors are normally used only to ride out bad weather. For this reason they are stored where shown, and to keep their chains clear of the water they are secured near the top of the gunwale as seen in the side view. For our purposes they can be fixed permanently in this position by means of a small piece of pin driven into the side of the craft and bent round the chain, or by a spot of glue. In the real model, of course, they are made so that

they can be freed at a moment's notice.

To make the anchor chains, pieces of thin cord are recommended, or better still, pieces of thin chain such as that used in small jewellery and for holding crucifixes, etc. The piece in the bow of the vessel is not fixed until the completed model is glued to its baseboard when the short length of chain is let into a small hole drilled in the baseboard and permanently secured.

To rig the vessel, start by making the masts from  $\frac{1}{16}$  in. round rod tapered as shown on the design sheet. The main mast has a spar made of medium wire let in it as shown. Rigging thread is of thin cord and the main lines are taken to the positions shown in Fig. 5. To fix the lines in their positions the modeller can either make small eyes from fret pins and drive these into the

masts are tied round the masts and finally secured with a thin coat of Durofix or similar. Details of the wireless aerial can be seen in the side view.

## Painting

To paint the model, it should first be gone over entirely with light battleship grey. Certain parts of the superstructure, such as the lower part of the upper deck, the lettering on the sides of the vessel, and the rafts are then given a coat of white, and other details, such as port-holes, imitation girders on the lamp-house support, the davits and anchor chain holes picked out in black. Below the water line the vessel is painted red.

When dry, mount the completed model on the baseboard (26). This can either be brush polished, or stained and polished, with the edges painted black,

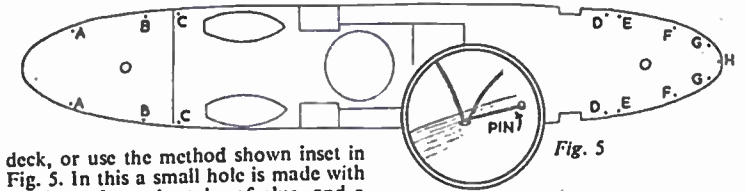

deck, or use the method shown inset in Fig. 5. In this a small hole is made with a prickler from the tube of glue, and a blob of glue is run into the hole. Before the glue dries, the cord is pressed into the hole with a pin, as shown, and left to dry. When quite firm, the main rigging line is led away to the required position and the unwanted end of the thread glued to the deck is cut away with a razor blade. Lines to the

or an imitation sea can be built up with plaster of paris, etc., and painted blue with the caps of the waves picked out in white. Alternatively, the cellophane and glue type of imitation sea described for our models of the 'Discovery' and the lifeboat, both published recently, can be used.

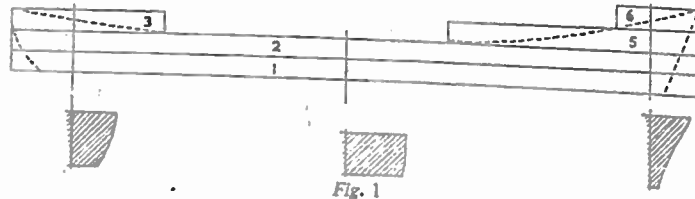

Fig. 1



Fig. 2



Fig. 3



Fig. 4

proximately two and a half times its present size—or approximately 21ins. long.

$\frac{1}{16}$  in. and  $\frac{1}{8}$  in. wood is used throughout, and all parts have been numbered as far as possible in the order of assembly. Begin by tracing the pattern parts on the various thicknesses of wood, using carbon paper between the design sheet and the wood. Then cut out the

sheet. When firm, clean up and glue the whole assembly on to the main deck (piece 2) in the position shown by the dotted lines on the design sheet.

Now concentrate on making the light tower. Begin by gluing the two pieces 14, and pieces 15 and 16, together. On the dowel piece 15 are secured the small pieces of card 16, which represent the actual lamps. A detail of these parts

## CABINET WRITING DESK

(Continued from page 35)

the front is glued a slightly smaller rectangular piece of thinner material to provide the writing surface. The main object here is to provide a really smooth surface, slightly raised from the 'writing desk' itself. Slightly thinner material than  $\frac{1}{16}$  in. could be used and the surface covered with blotting paper. Suitable corner clips could be incorporated so that the blotting paper sheets can readily be renewed. The action of the hinged front is shown in Fig. 6. The hinge fitting as shown is a compromise one, and could be improved. It is, however, the simplest to fit, so that the front and bottom are flush with the front closed. The hinge is attached to the front in end grain wood, but this is acceptable since there is little or no load on this side of the hinge. It will not do, however, if the wood used for the front is of poor quality.

The front is held in a truly horizontal position by suitable stops. Lengths of plated chain will do, secured to the inside of the front and the inside of the cabinet. Alternatively, sliding metal fittings can be

used. Chain is the simplest solution and quite pleasing in appearance.

Small handles are fitted to each drawer, as indicated in the heading drawing, and some form of catch or lock is necessary to hold the front up in the closed position. A lock would be preferable to a catch, but if the latter is used a small handle must also be fitted to the front so that it can be pulled open. For finishing, treat as any other item of furniture and stain and polish to suit.

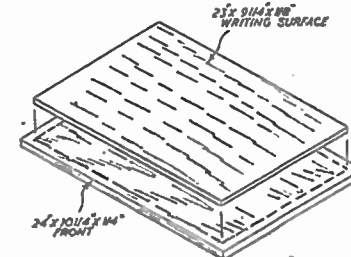

Fig. 5

If the fitment is made for a child's room, then a painted finish will probably be acceptable. It is generally easier to get a good finish with paint or lacquer than polishing, unless expert in the latter. Preferably, of course, all paint-work should be applied by means of a spray gun.

The interior may be elaborated somewhat from that shown. Individual compartments can be fitted out to hold bottles of ink, pens, and so on. A row or four or five screw eyes on the back inside the main compartment would be useful for holding keys, etc. Other details of this nature will suggest themselves after the main work is completed. (357)

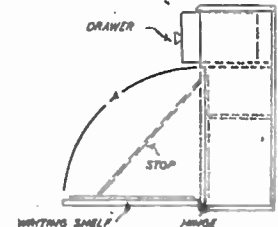
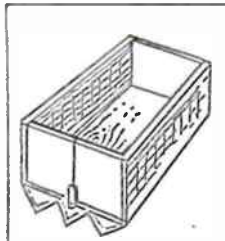

Fig. 6



# Building a Locomotive Shed

TO CONCLUDE OUR TOY TRAIN SERIES



TURN UPSIDE DOWN AND USE AS A BOX

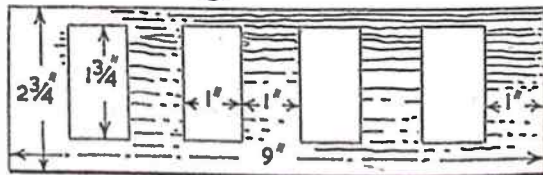
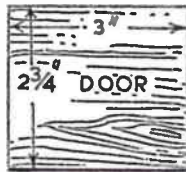
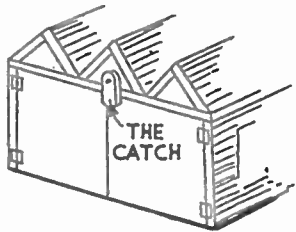
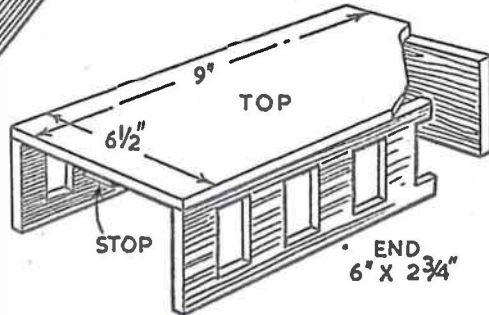
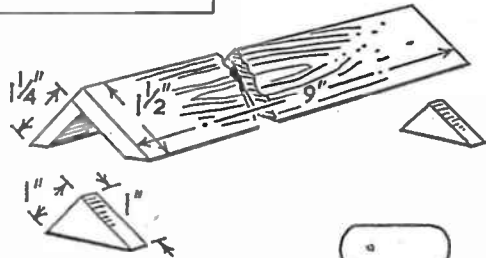
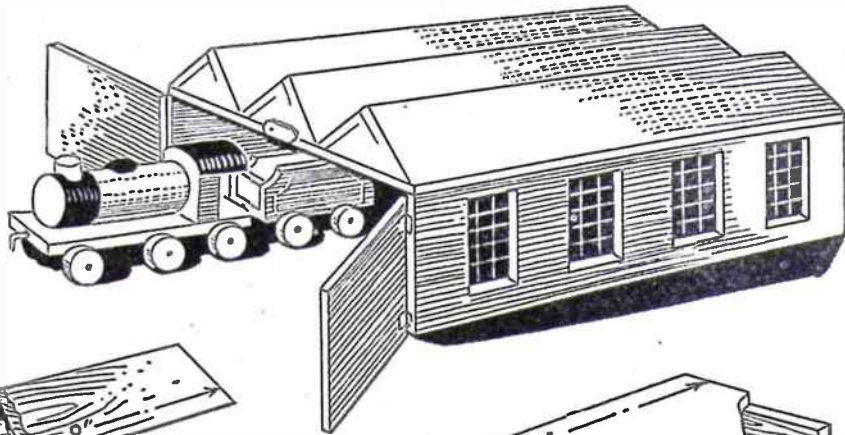

## Construction

The box forming the main part of the shed is drawn with the top and side cut away to show how the end goes between them. The end measures 6 ins. by 2 3/4 ins. Cut the windows out or mark their positions for painting on. The roof is formed from three gables made from strips as shown on the left of the sheet. These must be chamfered to fit flat on the top.

## The Doors

The two doors are secured by small brass hinges, or alternatively by pieces of tape glued on. To prevent them swinging too far inwards a stop should be glued a little way in under the top. Screw the catch to the outside as shown so as to prevent either of the doors opening when it is pulled down.

To make it more realistic you can glue or pin transparent celluloid inside the windows after painting the bars of the windows in black or white. Colour the shed inside and out with enamel. We suggest brick-red for the walls and a darker red for the tiles or dark grey to represent slates.

## Our Wish

We hope you have enjoyed making these little toys, and that you will by now have completed a lengthy train for your youngsters. (353)

Watch for a grand new series for a garage and a multitude of different vehicles.

# All about making CONCRETE SLABS FOR THE GARDEN PATH

THERE is, no doubt, that a well kept path can make or mar an otherwise attractive garden. Nothing detracts from the beauty of a well filled flower bed so much as an untidy weed-filled path. We plan our gardens with the best intentions, laying down gravel paths with correct drainage, only to find that weeds seem to grow overnight. Weedkiller is expensive and

however, do not make such a rigid job as the former method. The hook can be made from a piece of wire bent to shape. Screw the hook to the end of the frame and insert another screw to form a fastening.

## Mixing the Concrete

The proportions generally recommended are one of cement to three of sand, but on paths that are not likely to bear heavy traffic a slightly weaker mix may be employed, say, four or four-and-a-half to one. Mix the sand and cement thoroughly before adding water. Make a stiff mixture that will remain in shape after the frames have been removed. Experiment with a

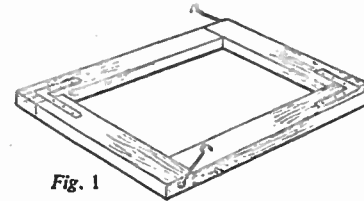

Fig. 1

hoeing is laborious, so why not make your garden paths labour saving?

By casting your own paving slabs and laying an attractive path you can spend more time on the flowers and vegetables where a little hoeing will do far more good. You will always have a tidy path into the bargain.

## Materials

Do not imagine that this is going to involve you in unwarranted expense, because it is not. Although cement has gone up in price recently you will find that the cost in this direction is almost negligible. Your local Builder's Merchant will let you have a cwt. bag at the current price. A cubic yard of sand and a few pieces of wood will complete the other materials. When you have decided upon the size of slab required you must make a small frame as shown in the diagrams. We suggest a useful size of about 12 ins. by 9 ins. or 15 ins. by 10 ins. and about 1 1/2 ins. deep. A glance at Fig. 1 will show how the frame is constructed. Remember that the inside measurement will be the size of the slab required. Four pieces of wood are needed, these being joined together in pairs. The best method is shown in Fig. 2 and this entails making an angle half-lap joint as detailed in the inset. There is nothing difficult about this joint if it is marked out beforehand. The waste wood can be cut away with a hand or tenon saw and the pieces screwed together. The second method, which is more of a make-shift, but involves less work, is to use two flat angle plates as shown in Fig. 3. These,

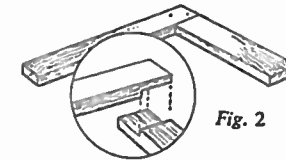

Fig. 2

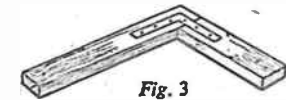
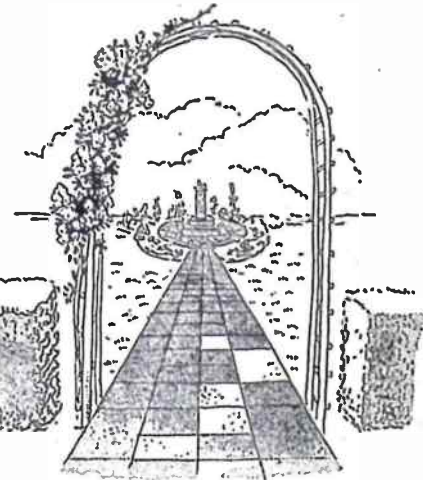

Fig. 3

small quantity at first until you get the right consistency.

## Making the Slabs

A flat surface is needed for this operation, and if a shed floor or work bench is not available you can overcome the difficulty by levelling the path itself. Get it reasonably level with a spade and see that it is fairly firm. Lay out sheets of newspaper and assemble your frame on the newspapers as in Fig. 4. Fill the cavity with concrete and trowel smooth as indicated. If a proper trowel is not available a smooth piece of hardwood will do almost as well. Do not trowel too much or you will bring excessive moisture and cement to the surface. Gently undo the hooks at each end and draw the frames carefully away as shown in Fig. 5. They should be drawn away cornerwise so as not to damage the slab. Now move the frame on to another sheet of paper and continue casting. In this manner a dozen or two slabs can be made in an evening, using only the one frame. Keep them damp



for a few days by covering with sacks.

## Laying the Path

If the path is to be labour saving you will need to cement the slabs together as they are laid, but to give an artistic appearance the cement joint should not extend to the surface. You will then have a ridge into which soil can be brushed, but which will not allow the

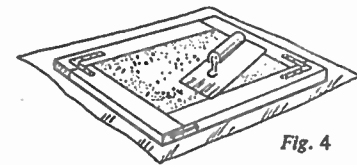

Fig. 4

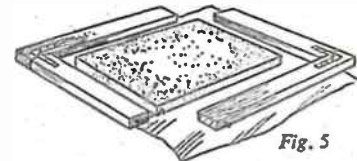

Fig. 5

growth of weeds. By using half-slabs to make a pattern you can design a pleasing path similar to the one shown in our illustration. For making half slabs it will be necessary to make an extra frame or, alternatively, to put a bar across the middle of the existing frame. In this case only one half-slab can be made at a time, because the bar must be offset a little to allow for its thickness.

## Firm Foundation

Prepare the path before laying, and pay particular attention to getting it firm. Arrange the slabs so as to form a pleasing pattern and you will be more than pleased with the result. (354)



# Full details for making A MODEL OLD-TIME SHOP

HERE is a splendid addition to our model town, of which previous subjects have been: The Old Curiosity Shop (13.9.50), The Village Smithy (17.10.51), The Galled Inn (31.10.51) and its Extension (7.11.51) and the Stage Coach (21.11.51). (Back numbers are available). The present project can, of course, be made as a separate model in its own right, and though we have chosen a draper's shop, other trades can be chosen. The name on the present model is quite fictitious, but the design, whilst much simplified, is based on an actual old-time shop.

## Making the Front

The Front (1) is cut from a 7ins. by 5½ins. piece of ½in. plywood. Only the three windows near the top are cut right out, though, as described later, the door (X) can, *optionally*, be cut out. Mark out all the other lines in pencil. The Sides (2) of which two are required, are cut in ½in. ply 7ins. by 6ins. The Base (3)—one required—is in ½in. plywood. 6ins. by 5½ins. and the Roof (4)—one required—is cut from ½in. ply, 6ins. by 5½ins. The whole is tacked together, simple box fashion, with the roof ½in. down from the top, as shown, and strengthened, internally, with glue blocks. Before assembling the carcass,

however, the front had better be completed.

Lay out the Bracket (5) and cut it from ½in. softwood or use the 'sand-

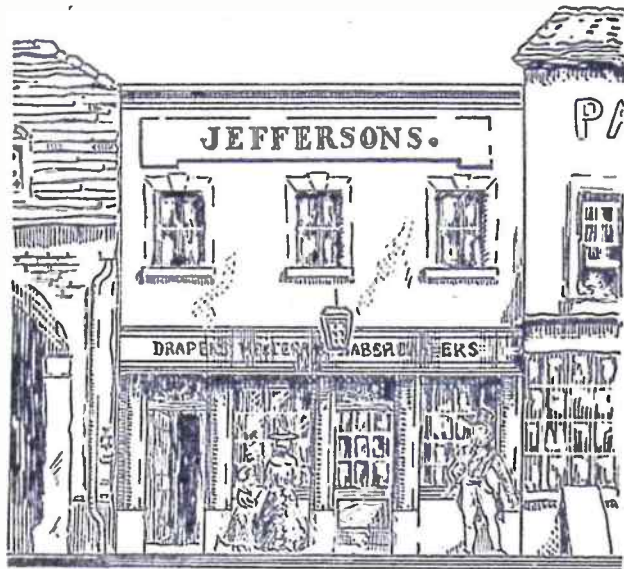

wich' method shown in the diagram. The middle part is a plain ½in. wide strip. The gap is afterwards hidden by the Fascia Strip (6). Nail the bracket from behind, to the front, 2½ins. up from the base. Part 7 (five required) is just a 2½in. length of ½in. square stripwood. These can be seen in the 'Constructional Detail' and also in 'Section Through P-P': (Note that Part 8, an ½in. piece of ½in. square stripwood—five required—comes in front of Part 7, at the base). Glue Parts 7 and 8 in position and fit in Part 9, which is a 7½in. length of ½in. dowel with a flattened part glasspapered on it. (See diagram to the left of the 'Constructional Detail'). Five of Part 9 are required.

Now cut out a cardboard template for Part 10 (Shelf) and mark off and cut out six pieces from ½in. wood. These are fitted in the bow window bays of the front piece (the 1½ins. wide part), in sets of three; one at the bottom, one at the top, immediately under the Bracket (5) and the other with its upper side 1½ins. from the base.

## The Name Panel

Cut out the Jefferson panel in thin ply (½in. thick is enough, or cardboard will serve) and mount in position. Make window sills from ½in. by ½in. stripwood for the upper windows,

Along the whole length of top glue a piece of ½in. moulding of the type shown.

Put in the two Steps (Part 14) and Dummy Door and Window (Part 17) cut from 2½ins. by ½in. by ½in. material. Optionally the Keystones over the upper windows can be cut from thin card and glued on. At this stage the work will appear as in the photo, and the front can be fastened to the carcass.

The Chimney Stack is a simple 2ins. by 1in. by ½in. block with ½in. by ½in. stripwood round the top and ½in. diameter dowel chimneys.

## Clean and Paint

At this stage the model might be cleaned up and painted. There are other parts to go on, but it is as well to put these on after, clear of the risk of paint splashes, sawdust, and the like. As hinted in the notes describing previous models, the model should look old and mellowed without appearing derelict. Glasspaper well, dubbing over

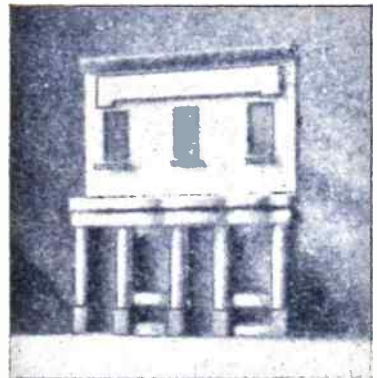

Showing the front assembled

sharp angled corners. A dent or two in the Pillars (Part 9) would be in keeping with the aged look required, whilst a slight bulge or two on the upper front (made with a smear of plastic wood or plaster applied to a roughened base) would be a good thing. Give the model first, a coat of size and then a coat of any light-coloured paint. Then apply the final coat of cream paint to all parts of the front except the Door (X) and Window (Y), the Parts 8 and the insides of the yet unfinished bow windows. The sides can be covered with doll's house brick paper, though this is not really necessary if the model is to take its place in a row with others.

The back of the Bow Window (Part 13) is cut from a piece of post-card, the exact size being obtained by actual test. It is curved inwards. You can draw some merchandise on it, as in the sketch, if desired, although a few indefinite dabs of water colour will

suffice. On the floor of the Bow Window (the middle of the three Part 10 pieces) put a shapeless lump of plastic wood, coloured, to suggest merchandise. Part 12 (shown conventionally broken in the 'Constructional Detail') is a piece of thin transparent plastic, 2½ins. long and with a width determined by actual test. It is bent

The Fascia (Part 6) is of thin card glued on, the lettering being painted on first. The Lamp (optional) is shaped from a ½in. length of ½in. square dowel. The upper windows can be 'glazed' with plastic sheet and have paper curtains. As has been pointed out in conjunction with previous models in this series, in the final stages, few

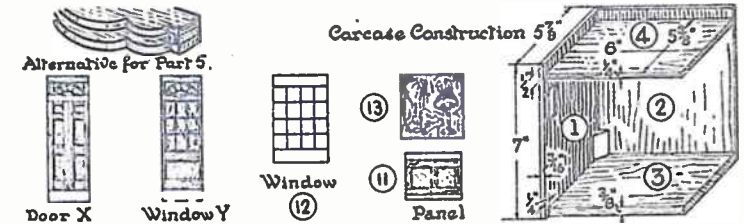

## Some more helpful details

round the front of Parts 10 and can be tacked to them with very small pins. Before applying in place, rule window bars on it with indian ink. Over the lower part is pasted a piece of paper (or very thin wood veneer) painted or ruled to represent a panel (Part 11).

Strips of card, ½in. wide are glued round Part 12 (the Window) immediately over the edges of Parts 10 (i.e. six strips for the two windows).

The Door (X) and Window (Y) can be drawn on thick paper, coloured to represent natural wood, and pasted into place, or they can be built up from pieces of wood veneer. In the sketch, the door is shown open, and this certainly adds a touch of life to the street scene. One can debate whether to show a closed door, a door drawn permanently open, or a door that, being cut out and hinged, actually opens. Considerations of space prevent giving large detailed diagrams of Door (X) and Window (Y), but from any well stocked Public Library, one can get books dealing with Georgian or Regency architecture.

readers will follow, in exact detail, the printed instructions, but add personal touches of their own, which is as it should be.

A coat of clear varnish will prevent dust and grime working in. Use artists' picture varnish, not copal. (308)



The completed model

## It all Started as a Joke!

A LADY living in Richmond, Virginia, U.S.A., married a man whose surname was Fant, and whose initials, by a humorous chance, were L. E. Finding herself thus called Mrs. L. E. Fant, she saw the funny side of it—but not before her friends and neighbours did. They ragged her and teased her unmercifully about her new name, with its suggestion of ungainly fatness, that she decided to turn the circumstances to good account. She did so by devising herself an original hobby; she was called 'elephant', so why not start collecting objects either derived from

them, or model elephants of various kinds! Her sense of humour rewarded her, for she now has a most remarkable collection of elephant pieces, amassed over years from all over the world. In addition to model elephants in china, glass, wood, ivory, metal, plastic, cloth, paper, rubber and many other materials, she has a great many items from these animals themselves in her collection. Pieces of ivory, fragments of tusks, a hair from an elephant's tail, bits of elephant's skin, toe-nails, elephant harness, a mahout's good, and so on. And it all started as a joke. (280)

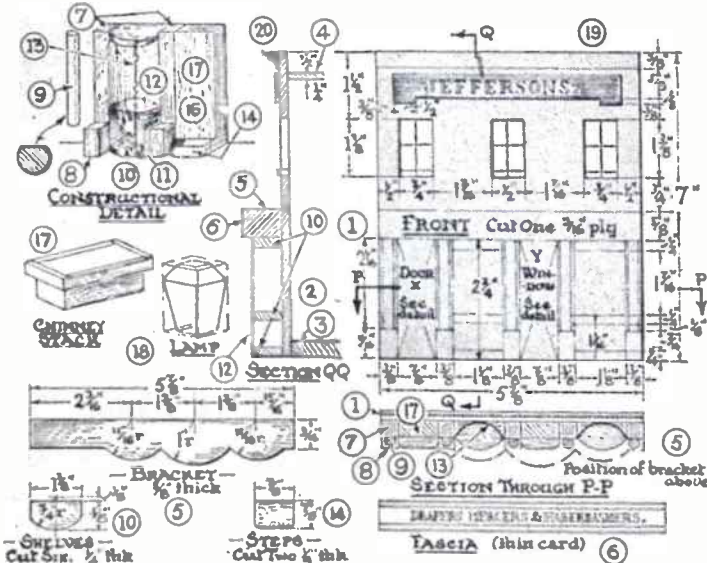

These drawings will assist the modeller



# DESIGNING AND BUILDING MODEL RAILWAYS

By E. F. Carter

in Fig. 13. This may seem to be an

IN all probability, most readers will have tried at one time or another to effect a realistic-looking layout by using 'standard' turnouts of certain given radii. In such cases, the track may have been accurately and carefully laid, and yet the finished job looks—somehow—all wrong, without giving any hint as to why it should do so.

### Prime Cause of Failure

One of the prime causes for such failures, and for this lack of track realism is that points and crossings are usually joined together as purchased, without first treating them in such a way that all unnecessary track between the units is eliminated.

When purchased, ready-made turnouts and crossings have anything up to 3ins. of plain 'lead' track left at each end (Fig. 10), and if points are joined end to end in this condition—as they would be in goods yards and other cramped spaces—the cumulative effect of these ends is to increase the overall length of the set-piece without providing any additional running facilities.

Let us take as an example two turnouts fitted back-to-back, as shown in Fig. 11. If the 'lead' portions (shown shaded) are allowed to remain in place, it will be found impossible to get the 'between-track' distance (X) sufficiently small to allow of the accommodation of several roads in a given width of layout area. By cutting off (Y) and (Z) or parts thereof, the tracks are automatically closed up to something like Fig. 12, and, moreover, the overall length of the two turnouts is reduced materially from (A, Fig. 11) to (A1, Fig. 12); which is a further advantage when one is trying to get the maximum accommodation of sidings into a restricted space area.

By careful manipulation along these lines it is possible to easily make a station yard layout more compact and realistic without going to the expense of purchasing special triple or compound points, which in itself is an asset, to say nothing of the amount of effort saved.

All trackwork should be 'tailored to measure', for there is no more certain way of achieving the unrealistic than by merely fitting together sundry turnouts and track parts which happen to be ready to hand when 'the spirit moves'.

Before purchasing any points or crossings, it is very essential that the maximum radius permissible on the layout is first worked out, so that the turnouts fit sweetly into the curved track without producing any mixed radius curves similar to those depicted

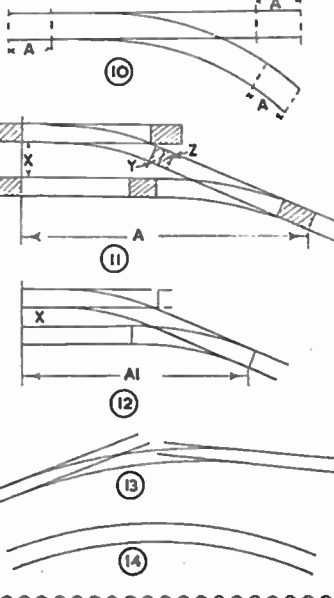

unnecessary warning, but the writer has seen many layouts—particularly in 'OO' scale, where the track has been laid to mixed radius, and a futile attempt has been made to effect a cure by bending the ends of the mis-matching sections of curve—with appalling results.

### 'Dog-Legs'

Talking of curves brings to mind the matter of 'dog-legs' and other irregularities in curved track. In Fig. 14 is shown a truly-curved length of track. 'Dog-legged' track is usually caused by the lack of fishplates or by fishplates which have not been tightly clenched to the rail ends.

On curved track, fishplates are particularly vital, as they retain the rail-ends in correct curved alignment, whilst at the same time providing the additional support needed at the rail-ends to preserve a constant radius curve without either projections away from or flattening into the track gauge.

### The Reward

Careful attention to such seeming trivialities will be rewarded amply by sweet and trouble-free running at the later stages of construction, when the reader will rightly be looking for some fun—by way of running rolling stock—on his model line. (335)

## Replies of Interest

### Tiled Surrounds

PLEASE give me some information on the materials used for the making of tiled surrounds for fireplaces. (D.T.—Brighton).

THE surrounds of tiled fireplaces are generally made of tiles which are themselves made of clay earth, glazed and baked in a kiln. The tiles are usually laid out in position face-downwards on a flat surface, and then coated with a layer of cement concrete about 1in. thick. When dry and set, the whole slab is raised and set in place with tile cement or with plaster of paris.

### Producing Oxygen

I WOULD like to know if there is another way of producing oxygen than

by electricity or vacuum and water. (C.S.—Manor Park).

THE easiest way for you to prepare oxygen is to heat a mixture of three parts of powdered potassium chlorate and one part of manganese dioxide, both by weight. The manganese dioxide must be the ordinary laboratory quality, not the type used in dry batteries, which latter, containing carbon, would explode when heated with potassium chlorate. Other simple ways are to heat any one of the following:—red lead, lead dioxide, potassium nitrate, sodium nitrate, potassium permanganate, also by warming hydrogen peroxide, though this method is expensive. A method which needs no heating is to drop water slowly on to sodium peroxide. Wet sodium peroxide should be kept away from organic matter such as paper, wood, etc., as it usually sets these on fire.

**Micromodels**  
BUILD YOUR OWN MICRO MUSEUM  
Amazingly realistic three dimensional volumetric models.  
Railway, Engineering, Architectural, Maritime, etc., subjects. Cost pence. Often sell for pounds. Send stamped addressed envelope for 100 model catalogue. Micromodels Ltd., 3 (H) Racquet Court, London, E.C.4.

### BE TALLER

1 Guarantee to increase your height in 12 days or return your money. New discovery increases height 2 to 5 inches. "Gained 4 1/2 inches in my height. My weight increased from 9 stone 4 lb. to 10 stone 8 1/2 lb."—P.D., Whitham. "I have increased in stature from 5 feet 1 inch to 5 feet 4 inches, a matter of 3 inches."—H.C., Chesterfield. "My increase is 2 inches and I really do feel ALIVE."—E.T. Guaranteed harmless. Full course, 10/-. Details 1/6d. stamp. Sent under plain cover.

### Be a Master of JU-JITSU

Amazing new methods show you how to "get tough" and make any attacker helpless with lightning speed — or money back. The Morley Rapid Ju-Jitsu Course teaches you all the knock-out blows, shows you how to throw a stronger man helpless to the ground, gives absolute mastery. Develops body, gives self-confidence. You can acquire this devastating weapon in a few weeks. Both sexes. Complete system 10/- (\$1.50). Details 1/6d. Powerful arms course 2/9. Powerful chest 2/9. J. J. MORLEY (H/69), Terry House, Naphill, High Wycombe, England. Established 1936

**MANCHESTER**  
10 Piccadilly  
(Phone CENTRAL 1787)  
**BIRMINGHAM**  
14 Bull Ring  
**SHEFFIELD**  
4 St. Paul's Parade  
(Phone 24071)  
**LEEDS**  
10 Queen Victoria Street  
(Phone 28439)  
**HULL**  
10 Paragon Square  
**SOUTHAMPTON**  
25 Bernard Street  
**BRISTOL**  
30 Narrow Wine Street  
(Phone 23744)  
**BRANCHES**  
**LONDON**  
78a New Oxford St., W.C.1  
(Phone MUSEUM 2975)  
87 Old Broad Street, E.C.2  
(LONDON Wall 4375)  
117 Walworth Road, S.E.17  
(RODNEY 5509)  
**GLASGOW**  
326 Argyle Street  
(Phone CENTRAL 5042)  
Head Office & Factories—HOBBIES LTD., DEREHAM, NORFOLK

**J. WOTTON (Dept. H.)**  
140 HOLLINGS ROAD, BRADFORD, YORKS.  
**ALL TYPES OF MOULDS**  
3/- each  
TOYS, ORNAMENTS, PLAQUES, ETC.  
New 1952 Illustrated Catalogue. Send 6d. stamps, refunded on first order over 10/-

### KITS for OLD TIME SHIPS

Hobbies range of Ship Models includes Elizabeth Jonas, Cutty Sark, Victory, Mayflower, etc. Complete kits of wood, sail material, guns, pulleys, cord, etc., with full size patterns of parts and planed wood ready to cut out, shape and construct. A fascinating pastime. Kits for models 7ins. and upwards.  
Ask for free illustrated lists at Hobbies Branches or from Hobbies Limited, Dept. 89, Dereham, Norfolk.

## FLEXIMOULD

FOR PLASTER CASTING  
WALL PLAQUES, FIGURES, GARDEN ORNAMENTS, BOOK-ENDS, ETC. MADE IN YOUR OWN HOME. THE ALL-FAMILY HOBBY THAT ADDS POUNDS TO YOUR INCOME.  
Write for **FLEXIMOULD ILLUSTRATED LEAFLET** to **DOHM LTD. (DEPT. H)**  
167 VICTORIA ST., LONDON, S.W.1

### The Model Stadium

HIRE PURCHASE SPECIALISTS  
can now extend their facilities and offer Lathes and other Woodworking machines on weekly terms, from 15/- Dep. Also Gaiety Electric Locos at 12/6 Dep.  
BUY FROM THE ONLY ESTABLISHED H.P. FIRM for Model Aircraft Goods, Diesels, Radio Control Units and Kits.  
NO DEPOSIT is required after satisfactory completion of First Purchase.  
5 Village Way East, Rayners Lane—Harrow, Middx.  
2 mins. Rayners Lane Station. S.A.E. enquiries please. Tel.: Pinner 6459

## TOOLS FOR THE HANDYMAN

**TOOLCLIP**  
For holding any handled tool. Spring steel. Holed for hanging. 7/6d. each

**BENCH STOP**  
3 1/2 ins. by 2 ins. — Spring loaded 6/6

**STEEL CUTTING TABLE**  
With clamp for easy fixing to bench. 6 ins. by 4 ins., strong and light. 3/6

**SINGLE HANDED SCREWDRIVER**  
5 ins. long. Ideal for small work. 1/9

**MODEL MAKER'S BENCH VICE No. 1**  
Strong, light and rigid, 3 in. opening. 6/9

**FRETWORK HAMMER**  
5 ins. long. Strong and light for small work. 1/5





**SANKEY'S**  
**PYRUMA**  
PLASTIC CEMENT

**for a house — or a horse!**

From rough, rugged stone to smooth animal muscles—any surface, any shape can be easily modelled, moulded or cut from plastic, ready-to-use PYRUMA. Baked or air-dried to stone-hardness, your Pyruma models can be painted or enamelled in realistic colours, as instructed in the Illustrated Book offered below. Send for it today and learn how to make model—

HOUSES, BUILDINGS FOR MODEL RAILWAYS, DOCKS AND AIRPORTS, SHIPS, MODEL FURNITURE, ANIMALS, FIGURES, RELIEF MAPS, Etc., as well as utility objects such as ASHTRAYS, BOOKENDS, MENU HOLDERS, PAPER WEIGHTS, ORNAMENTS AND DECORATIVE OBJECTS.

NO SKILL OR SPECIAL TOOLS REQUIRED.

inexpensive, PYRUMA is obtainable from Ironmongers, Art-material Shops and Hobbies Stores.

4d. brings book from: DEPT. H.W.

**J. H. SANKEY & SON, L.P.**  
ILFORD ESSEX

Choose  
a Lathe  
that will  
last a  
lifetime

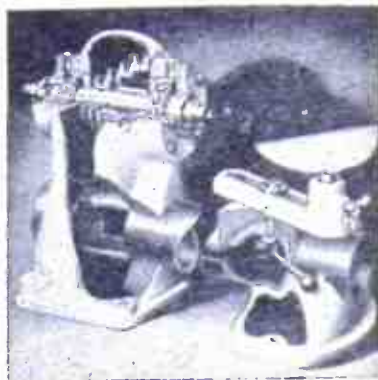

Here you see a sectioned view of the ML8. 4 in. x 30 in. Woodworking Lathe—the Complete Woodworker. Note the one-piece headstock unit with totally enclosed drive; angular contact ball bearings for years of hard work at speeds up to 2850 r.p.m.; accurate threads and register diameter at each end of the spindle for chucks, faceplates, etc.; plunger indexing mechanism giving 24 fixed positions to spindle; quick action lever control to slides; bed of heavy gauge seamless drawn steel tube. See your Tool Merchant for complete details.

**MYFORD**

ENGINEERING CO. LTD. BEESTON, NOTTINGHAM

**YOU CAN BECOME A HANDICRAFTS INSTRUCTOR**

EXPERIENCE NOT ESSENTIAL

Men who enjoy making things in wood or metal can turn their hobby into a permanent and interesting Career. Short hours, long holidays, and security in a job you would really enjoy, can be yours if you become a Handicrafts instructor. Let us send details of the easiest and quickest way to get the necessary qualification.

We guarantee **"NO PASS—NO FEE"**

If you would like to know about our unique method of preparing you for one of these appointments, write today, and we will send you our informative 144 page Handbook—free and without obligation. Mark your letters "Handicrafts Instructor".

BRITISH INSTITUTE OF ENGINEERING TECHNOLOGY **BIET**

595 Shakespeare House  
Stratford Place, London, W.1

**'Handicrafts'**  
NEW LIQUID PLASTIC

Make your spare time profitable pouring beautiful castings at home. We supply everything including ready-made moulds and show you how. Amazingly simple. Rapid production. Immediate results. Also other Novel Plastics. Good proposition for both women and men and younger generation. Send 2jd. stamp for exciting Book and Market details. No obligation.

QUALITY PLASTICS LTD.

Dept. H.7.  
BRENTWOOD,  
ESSEX.

Tommy Trump says:—"Smoke

**DOUBLE ACE**

The **ACE** of cigarettes"

10 for 1/3½ THEY WIN ON POINTS!

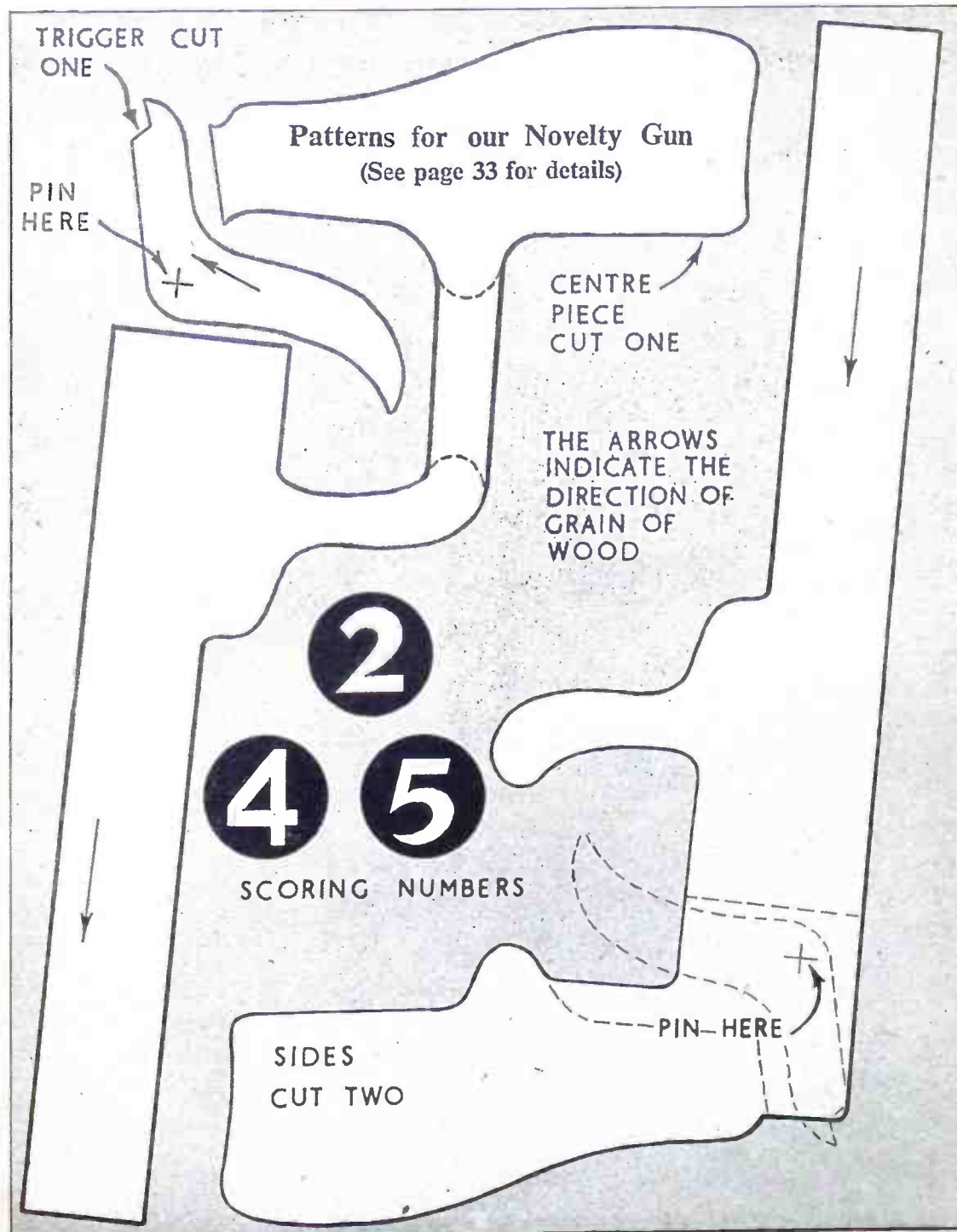





## For pleasure and profit

With a Hobbies Outfit you can make models that will please—models that will earn you spare-time cash. A splendid hobby. Patterns are provided for hundreds of things to make—toys, models, fretwork. With a few odd pieces of wood, or the kit provided, you can turn out lots of things; for gifts or even to sell. Any Hobbies Outfit provides all the tools.

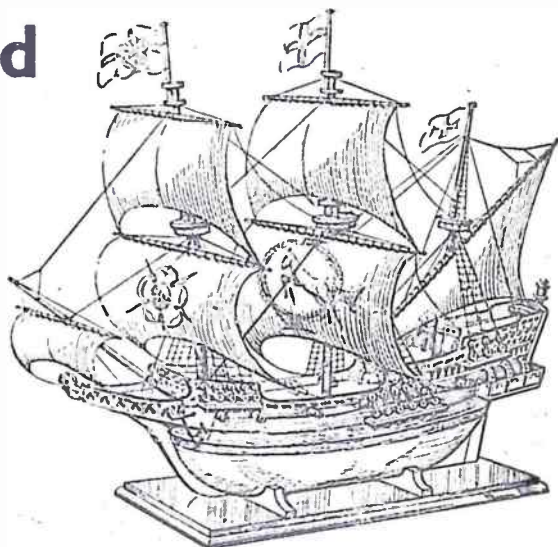
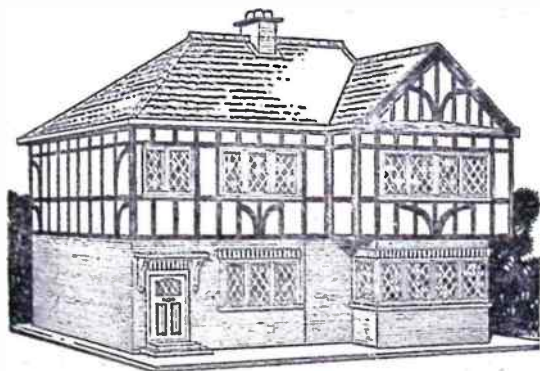

**Complete Tool Sets**  
**Full-size Patterns**  
**Kits of Materials**

*Ask for Hobbies at any stores, Ironmongers or Hobbies own branches. Free illustrated leaflets from Hobbies Ltd., Dereham, Norfolk.*

*Father and Son  
find Hobbies fun!*



Printed by BALDING & MANSSELL, LTD., London and Wisbech, and Published for the Proprietors, HOBBIES LTD., by HORACE MARSHALL & SON, LTD., Temple House, Tallis Street, E.C.4. Sole Agents for Australia and New Zealand: Gordon & Gotch (A'sia) Ltd. For South Africa: Central News Agency Ltd. Registered for transmission by Canadian Magazine Post.