

# Hobbies

## WEEKLY

### CONTENTS

	Page
The Christmas Wishing Well	145
Replies of Interest	- 146
Using Tin Cans in the Kitchen	147
Make this Sledge	- 148
Pull-along Dromedary	149
A.C. Mains Amplifier	- 150
Smart Wayside Station	152
Easily-made Easels	- 153
A Puppet Theatre	- 154
Seed Container from Scrap	156

December 5th, 1951

Price Fourpence

Vol. 113 No. 2927

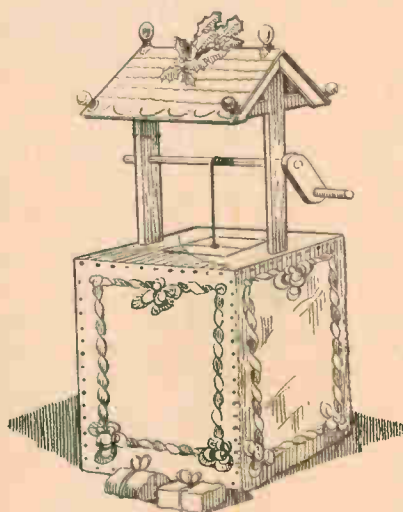

**G**REAT fun can be given the kiddies at a Christmas party by having a 'Wishing Well' to distribute small gifts. This well is simple to make up and is made from a light wood framework covered with cheap gay-coloured material draped and pinned round.

#### Card Covering

Covering the top of the wood frame is a square of stoutish card. This is nailed firmly to the top all round (see Fig. 1). In the middle of this square of card is a trap-door, formed by cutting out a square and dividing it along its centre. Both the flaps are reinserted in their cut-out square and are hinged along one edge by means of strips of linen tape or gummed paper.

Cut from each flap a semi-circular hole for the 'chain' which passes over the

## Prepare for the 25th with THE CHRISTMAS WISHING WELL

windlass and down to the 'well' below. In the underside corners of the opening round the flaps, glue small squares of card to prevent the flaps from falling through. Beneath the little hood above the well is formed a simple windlass from which hangs the chain, this latter consisting of stout cord to which is attached a hook of wire, and a weight.

The gifts are tied up in parcel form with string, with one or two loops formed in the knot so that they can be easily picked up by the hook.

Each recipient of a parcel is led to the wishing well and has a wish. The cord and hook are passed down into the well,

make up, as the wood need be only light section stuff, and for draping round the framework a yard or two of some cheap material will answer well. The roof or hood of the well can be made of card of similar thickness to the cover of the well.

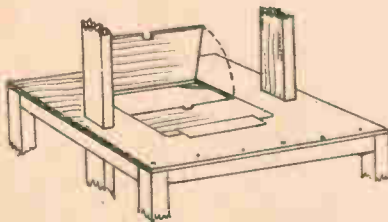

Fig. 1—The cardboard top

one of the parcels is hooked and brought up by turning the handle and windlass.

This novelty should cost very little to

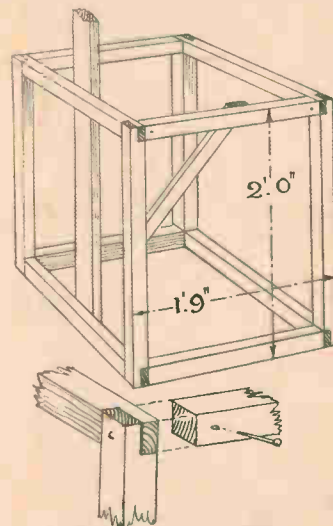

Fig. 2—The framework

All correspondence should be addressed to The Editor, Hobbies Weekly, Dereham, Norfolk.

The card can be painted or stained as desired, and the whole made gay and attractive with holly or twisted crêpe paper.

The suggested sizes for the framework are given in Fig. 2, together with the simple construction. Two complete frames are made, the four pieces of wood being halved together and nailed strongly. On each frame there should be a cross brace to hold it square. The frames are held together by side rails fitted and nailed in between them, the nails being inserted from the sides as seen in Fig. 2. Nailing should be done wherever possible to make a substantially strong framework, but there is no need to be over-accurate in such a case as this, for the whole structure is, of course, only temporary, and will be knocked apart later on.

To form the roof of the well, two uprights of wood about 3ins. by ½in. in section and about 4ft. long are cut off and shaped at the top. The formation of one of the ends is shown in Fig. 3, with suitable measurements suggested, and in

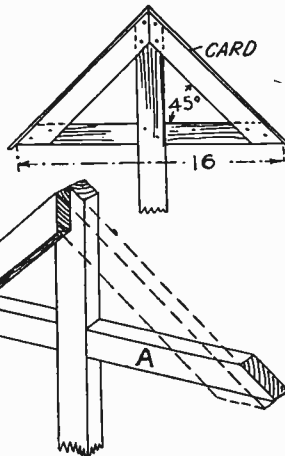

Figs. 3 and 4—Details of the roof supports

Fig. 4 the method of construction is given, all parts being simply cut from light section stuff with the tenon saw.

The top cross arm should be half-lapped into the upright, the sloping pieces being easily nailed on. The card covering forming the roof should overhang the ends of the frame slightly.

### The Windlass

This is formed from a piece of round rod about ¾in. or 1in. in diameter, with a crank at one end made from stoutish wood cut to the shape shown in the sketch. A short piece of the rod forms the handle, which is let into a hole in the crank in a similar way to the end of the cross piece forming the winding drum. Holes for the cross piece mentioned are made in the side uprights at a convenient height either for an adult or a youngster to use the crank. The latter, too, needs to be carefully thought out before it is cut.

The finished well should be decorated with holly and paper chains, and one or two small electric bulbs added where possible, to make a brilliant centre piece to the room. (157)

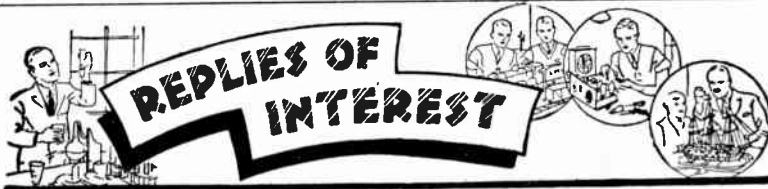

### Colouring Bottles

**I** WISH to decorate the interior of an old 'dimple' whiskey bottle which I am converting into a table lamp. I tried dye and gelatine but it just drained away out of the bottle. I have also tried gold enamel but the same thing happened. Perhaps you could tell me how to coat the inside of the bottle. (R.S.—Upton-on-Severn).

**P**ROBABLY the best way to colour the interior of a bottle is to use any fairly quick-drying enamel of a cellulose or synthetic nature, such as for example, Jap-Lac. First make sure the inside of the bottle is absolutely clean and dry, then pour the enamel into the bottle and turn it about in various directions so that the colour flows evenly over the surface. Pour out all surplus enamel and if need be, keep moving the bottle to keep the enamel flowing so that the whole surface is covered. Drying can generally be hastened by warming the bottle beforehand to a comfortable warmth to the touch. If necessary, a smaller second coat of enamel can be applied until a 'solid' colour is attained.

### Graining

**P**LEASE give me a tip on graining. What is put in the graining colour when graining a door, to stop the colour

from running together. (J.M.—Farnworth). **Y**OU may be using the graining colour too thin, but more probably applying it much too thickly, to cause it to run. Try the following, supposing it is oak graining you are attempting. For light work, two parts raw umber, ground in oil, one part ochre, one part putty and one part driers. Work up well together with equal parts turpentine and linseed oil. Brush out very thinly on the work and grain while still wet. For dark oak, burnt umber is worked to a paste with gold size and terebene, and thinned down with boiled oil and turpentine. As before, brush out very thinly.

### D.C. Only

**I** HAVE a R.A.F. motor generator Type M. Ref. 10K/11852. The input voltage is 24 V. 3 amps, output voltage 200 V. 50 MA and 13 V. 1.8 amp. I have tried it off 250 V. A.C. 50 cycles, but it refuses to work on this voltage. It has three sets of carbon brushes. Could you give me any information whether it is A.C. or D.C., and if it is possible to change it to 250 V. 5 amps 50 cycles? (J.A.G.—Newstead Colliery).

**U**NFORTUNATELY it appears you have a generator of the type with a ring magnet, and suitable for use from direct current only. A motor with a

permanent field magnet cannot operate from A.C. It would be possible to convert your mains supply to D.C. by using a rectifier circuit, but unless you could obtain a cheap, second-hand rectifier of suitable voltage and current capacity, this would probably prove more expensive than a new motor suitable for use directly from the A.C. supply. It is suggested you write to Clydesdale Supply Co., 2 Bridge Street, Glasgow, C.5 for their catalogue of ex-service motors and other equipment, as they can supply cheap ex-service motors suitable for A.C. mains.

### Noisy Water Tank

**P**LEASE advise me the most satisfactory method of silencing the water inlet of a large tank installed in my flat? The tank supplies the water system of the block, and operates with a ball float. It is particularly noisy late at night and interferes with sleep rather badly. (H.H.—Abergavenny).

**I**T is very difficult to silence the incoming water in a service tank. One way is to enclose the valve and water outlet part in a large tube extended well down below the water level. The top of this tube should be closed to exclude dust, but must not be air-tight. Another plan is to arrange a perfectly clean wooden 'shoot' for the water to run down—but this wooden device must be cleaned at frequent intervals. As the tank supplies the whole block, it might be better to induce the landlord to deal with the matter, and install a new 'silent' system, of which various makes are on the market.

# Some clever suggestions for USING TIN CANS IN THE KITCHEN

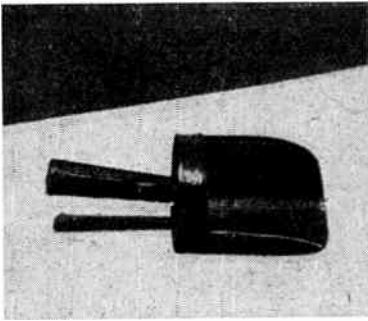

A well made scoop

IN these days when the cost of materials is ever soaring, it is up to enterprising homecraftsmen to use as much salvage and scrap material as possible. Tin cans, so often thrown away, can form the raw material of quite useful kitchen equipment as the drawings and photographs show. These tin can projects are no flimsy collapse-at-a-touch models, but are intended for hard wear and use in the house.

## Useful Gift

The canisters rack would make quite a useful gift or something to sell at a Bazaar. So far as the tin cans are concerned, there is 'nothing to it', as the cans are just ordinary tins about 3ins. diameter and 5ins. or so high, with lids. They are thoroughly cleaned and then painted with enamels, the paint, possibly, being sprayed on if the apparatus is handy. Pastel shades are generally favoured and a contrasting colour for the lid and bottom strip lends distinction. Paint all over in, say, light leaf green. When absolutely dry, wrap a piece of paper all round a tin so that a band, say,  $\frac{1}{2}$ in. wide is left showing. This part is sprayed or otherwise painted with a contrasting paint, the paper acting as a mask. To prevent possible smudging, the paper had best be left until the paint is

dry. A rubber band will easily hold it.

The words TEA, COFFEE, COCOA, etc., can be stencilled on. Stencil alphabets can be obtained in waxed card quite cheaply at art-supplies shops. The letters can be about  $\frac{1}{4}$ in. high. Should the canister sets be made up in quantity, however, it will save time and ensure more neatness if complete words such as TEA are made into one stencil, rather than applied as separate letters.

Fig. 1 shows a suggested form of wooden rack, but it will be appreciated that the size of the rack must be suited

to the size of the tins. Bigger tins (for rice, sage, etc.) will, obviously, require a bigger rack. The rack is gaily painted to match the canisters. In the photo, only one of a set of three canisters is shown. On the right we see a sugar (or flour, etc.) dredger detailed in Fig. 2. This is, preferably, made from a tin having a domed lid.

The holes in the top can be punched with a nail (from the inside, leaving the burrs outwards, otherwise the holes will

(Continued foot of page 148)

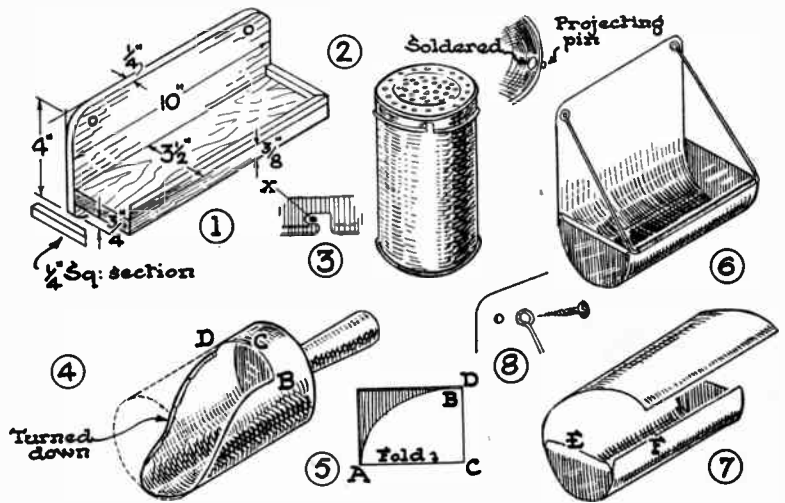

How the articles are made

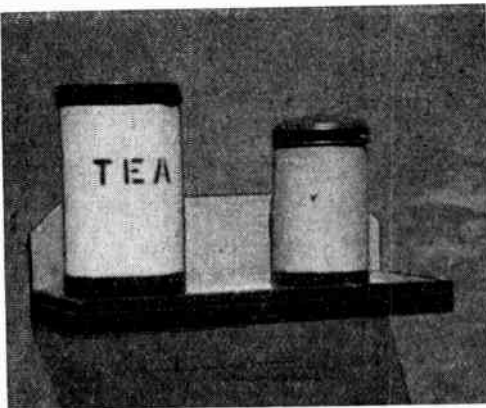

A tea container and sugar dredger

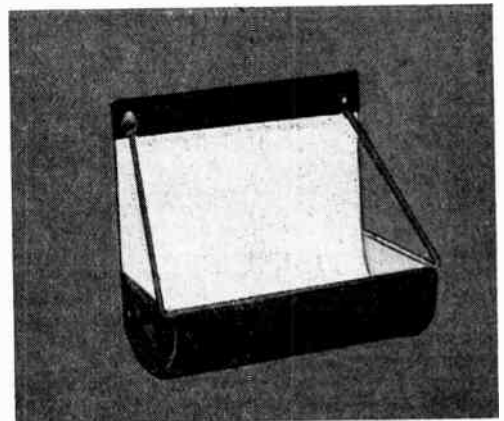

Handy wall bracket



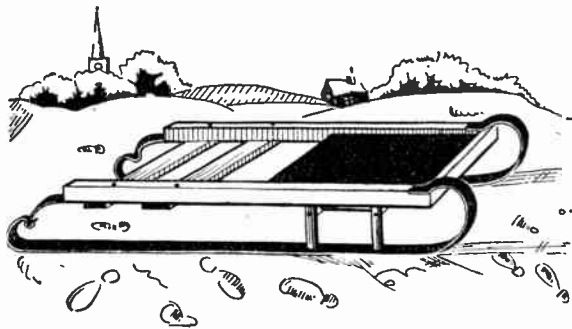

# Be ready for the snow— MAKE THIS £5 SLEDGE for 5/-

**T**HE meteorologists (weather forecasters to you) prophesy more snow between now and Easter. Do not let it catch you sledgeless! Half-an-hour's sorting over stock at the local junk-shop rewarded me with a second-hand 17in. hardwood rubbing-board (as used on wash day) for 1/-; a pair of rusty old pram springs, 2/6; three broken broom handles, 6d.; six 3in. bolts with twin washers and nuts, 6d.; twenty slender flat-topped screws from 2ins. to 3ins., 6d.; and an odd 3ft. length of 2ins. by 1in. batten thrown in free. With these I had all the parts necessary to make a first-class sleigh for the very modest outlay of a few shillings.

## Two Hours' Work

A couple of hours' work with brace-and-bit, saw, screwdriver and pliers resulted in as fine a racing sledge as can be bought for a fiver anywhere outside Switzerland. Stream-lined, rigid and strong enough to carry an adult. Lighter, livelier and faster than most readymade jobs. On the local sledging-slope it proved an easy winner in a varied field of professional and home-made models.

Timed with stopwatch over a measured quarter-mile with a gradient of 1 in 4 it clocked 30 seconds, or 30 m.p.h. Twice the speed you cycle, four times faster than you run and about eight times faster than average walking pace. It is a real flyer!

## Countersink Screws

Countersink runner-screw heads. If unable to do this, hammer them as nearly flush as possible. Any slight

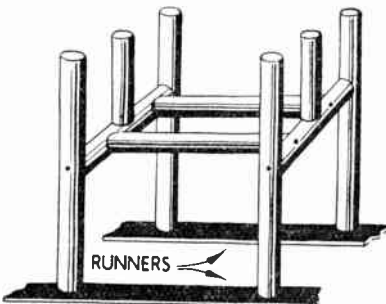

projection will wear down level during the first few runs. You will probably find the springs already drilled (as I did) so position chassis and bodywork to take advantage of the holes.

Do not deviate from the under-

carriage design. The result of experiment, it combines lightness and ease of construction with maximum strength and rigidity.

If you fancy that the greater leverage of a handbar gives better guidance control than footwork or front bend grip, fit a piece of broom handle across the bow. A refinement would be a 3in. length of gas-mask concertina tubing (as sold for cycle grips) on each end.

## How to Ride

If this is your first sleigh start in the sitting position, using the model in reverse with reins tied to a foot-rest fitted across the runner bends. This method should be used, too, for young juniors to give them confidence. When preparing to start a run do not lie down and rely on pushing off with your feet. This gives a dead start from stop take off. Crouch, take a grip on each front bend, flex the arms by bending the elbows and get off to a speedy start by taking a flying dive. If you are a beginner achieve this by easy stages on short gently falling slopes.

## Avoid Obstacles

An important point. Ensure there is no obstacle at the end of the run. Finally, a length of plaited electric-line flex makes a better towing and guiding rope than clothes-line. (132)

## Tin Cans in the Kitchen—(Continued from page 147)

soon get clogged up), but a much neater job is made with a proper punch. With a drilling machine, of course, the holes can be drilled. A 'bayonet catch' is needed (one each side would be even better). Fig. 3 shows the inverted L-shaped slot to cut in the lid. This lid should have a wired or pressed rim, as shown in Fig. 2, so that the projecting part of the L-slot corresponds with the rim stiffening and is thus strong. If two catches are used do not forget that if one faces left, the other must face right. With the lid in position mark out the place for the pin (x). Make a small hole in the body of the can and insert from inside, a short thick brass nail. A touch of solder will fix it. The part of the nail outside the can is then cut and filed away, so that only  $\frac{1}{16}$  in. or so projects.

The kitchen scoop (Fig. 4) comes in useful for flour, etc. To mark off the

requisite shape, take a piece of folded paper, in length (i.e. from A to C) about three-quarters of the length of the tin and in width (i.e. the folded width BC) a little less than a quarter of the circumference of the tin. Sketch out a smooth curve, as shown, and cut along it. The opened-out paper template thus obtained can be laid on the tin and marked off with a sharp nail, etc.

## The Handle

The handle can be made up from tin plate, but probably the simplest method for the beginner would be to use, say, a shaving stick tin, a wooden handle from a discarded Bradawl, or the like, a piece of broomstick whittled to shape, or something similar. It is best to cut the curved part a bit over size so that raw thin edges can be turned over in segments, as in the sketch. When painted,

they are not so obvious as in the drawing.

The wall bracket (Fig. 6) is very useful in the kitchen or bathroom, especially for taking spent matchsticks and the like. Fig. 7 shows how the cutting is started. In this sketch the 'waste' halves of the ends have already been removed. As in the case of the kitchen scoop, all rough edges are turned down as along (E).

## Stiff Wire

The stiff wire that can be seen is actually shaped like a square U, the long edge (F) being turned down over it. The looped ends are left free until it is desired to attach the bracket to a wall. Then a round-headed screw is inserted through the loop in the end of the wire, through the hole in the metal and so into the wall (Fig. 8). (162)

# How to make a mechanical PULL-ALONG DROMEDARY

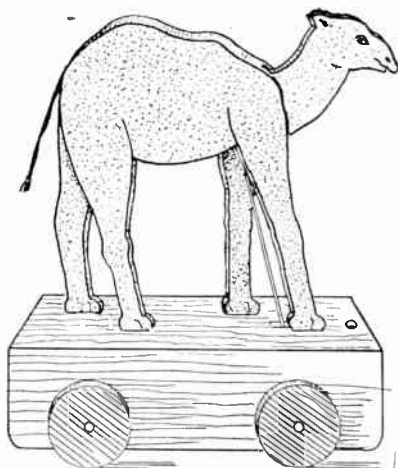

THESE mechanical toys are very popular with children, especially when they include animals which move. In the example chosen for this article, the animal is a dromedary, whose head nods as the toy is drawn along. The mechanical movement to effect this is very simple and easily made, and the result should prove an attractive gift for a youngster.

## The Platform

The platform is shown in plan and elevation at Fig. 1. Make it from  $\frac{3}{4}$  in. deal. Cut the platform to dimensions given, and on a centre line, at the distance from the fore end shown, cut the slot (A) about  $\frac{1}{4}$  in. wide. The sides of the platform, cut to length and width, have holes for the axles of the wheels bored in the positions indicated in the diagram. As the axles are pieces of  $\frac{3}{8}$  in. round rod, the holes will, of course, be bored to suit. Make the inside of these holes smooth with glasspaper to better ensure the smooth running of the wheels. A strip of the glasspaper rolled round a pencil will do this job.

At this stage, the dromedary should be cut out. The parts for this are shown, drawn over 1 in. squares, in Fig. 2. Two body parts are cut from  $\frac{1}{4}$  in. or  $\frac{3}{8}$  in. wood, and are glued to a middle piece, the head, a separate item, swinging in the space between. Pin the pattern to the wood, and with carbon paper beneath, trace the outline of the body, including the front fore and back legs only. Now make a tracing for the second part, this time including the rear legs. Where marked by a tiny circle, drill a hole for

the pivot on which the head will swing. The pivot suggested here can be a small wire nail, and as a very free movement is essential, make these holes an easy fit over the pivots.

The intermediate body piece is shown shaded, and should be traced on to  $\frac{3}{8}$  in. wood, not less. Now glue the two sides to this, and leave for awhile for the glue to get hard. It may be added, that the tenons, shown attached to the feet of the dromedary, should be  $\frac{1}{4}$  in. long and  $\frac{3}{8}$  in. deep, and care should be taken, when tracing the patterns to the wood, to set them with the grain of the wood running vertical. The head of the animal can now be traced and cut out, in similar wood to the intermediate body piece, but should be glasspapered down to  $\frac{1}{8}$  in. to ensure it moving freely when in place. A small hole, a tight fit for the pivot, is bored where shown, and at the rear edge, where indicated in the drawing, a tiny screw eye is driven in.

The head is now fitted in, and the pivot nail pushed through, when it

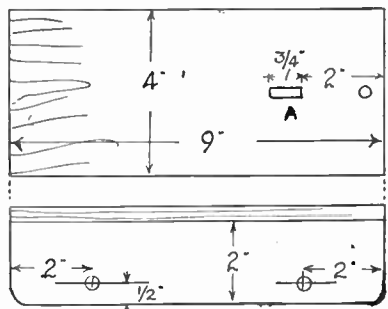

Fig. 1

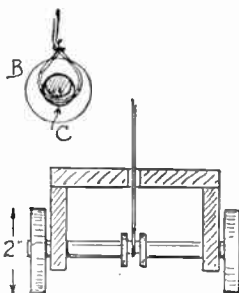

Fig. 3

should drop to its limit, which it will do if the holes in the body part of the dromedary are large enough. Place the animal on the platform, as near central as possible, and where the tenons contact the wood, run a pencil round to mark

their positions. Cut these out and glue the animal in place. The sides of the platform are then screwed to the underneath, one side permanently, the other, which will have to be removed in order to fit the axles and wheels, only partly screwed down.

## Simple Mechanism

A front view of the platform is given in Fig. 3, to show the simple mechanism for working the head. First cut the two axles, about 5 ins. long. The wheels are 2 ins. diameter, at least that size is suggested, but up to 3 ins. diameter could be substituted. The wheels could be cut from  $\frac{3}{8}$  in. wood and bored centrally to fit the axles. As a general practice, it is really better to buy wheels; they are usually more accurate than the home made kind, unless a lathe is available for turning them.

In the centre of the front axle cut a groove across,  $\frac{1}{4}$  in. wide and  $\frac{1}{8}$  in. deep; extend this each side upwards,  $\frac{1}{8}$  in. deep, then file smoothly the sharp corners. To explain this more clearly, the detail (C) shows the axle, the shape

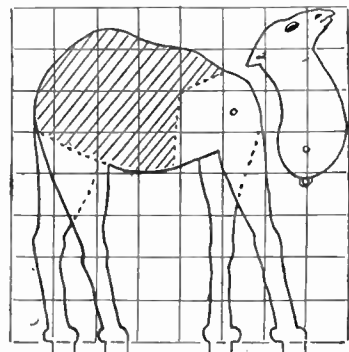

Fig. 2

of the part left, after grooving, being shaded. Cut two  $\frac{3}{8}$  in. discs of thin fretwood, as at (B) and bore to fit the axle. Glue these on either side of the grooved portion. On both axles glue one wheel, and push through the axle holes.

A short length of wire is now required. One end of this is bent to a hook shape and is then linked to the screw eye, a job more easily done before the head is fitted in position. Draw the wire down through the slot in the platform and loop it round the grooved part of the front axle (the

(Continued foot of page 151)







# A SMART WAYSIDE STATION

FOR THE TOY TRAIN SET

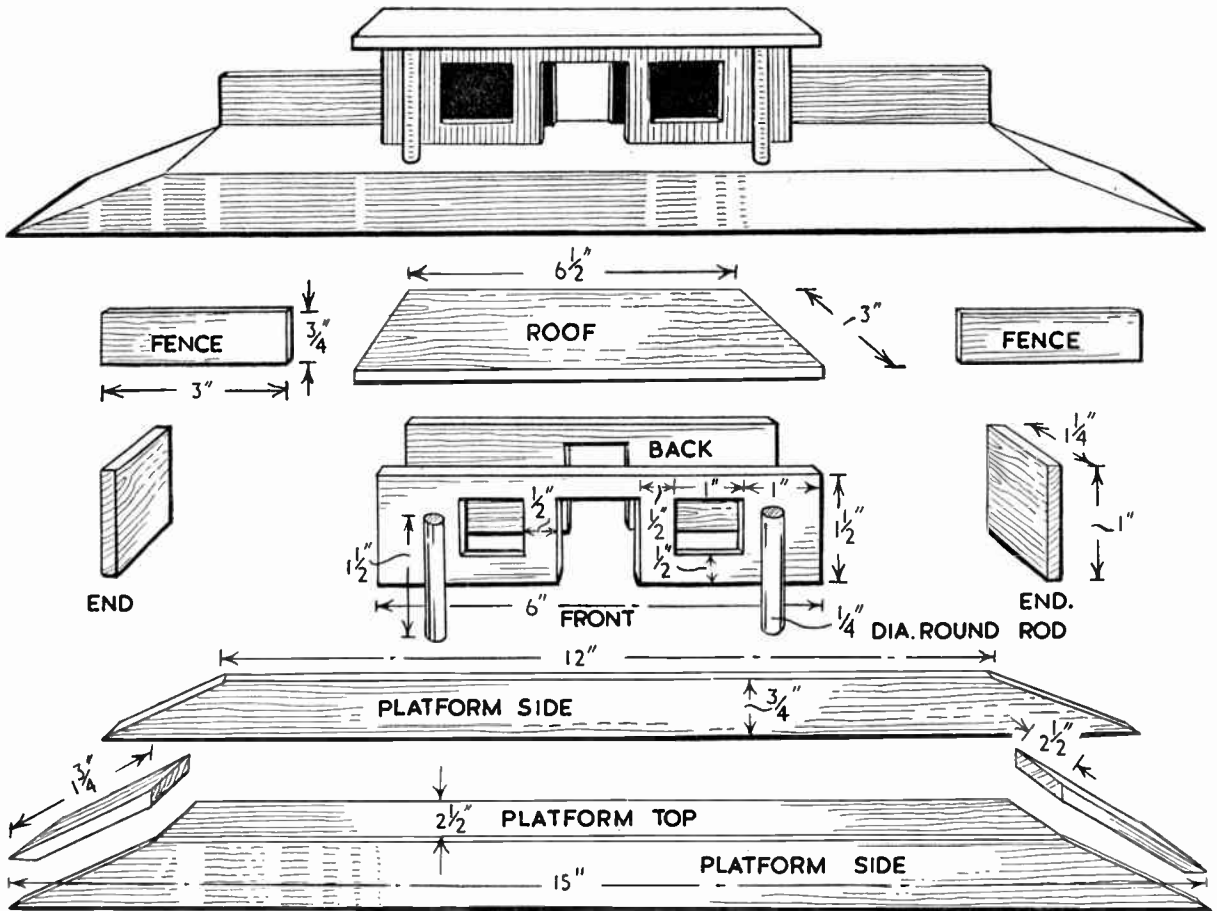

**C**ONTINUING our Toy Train Series, we give this week a small wayside station or halt. As with the other articles in this series the details have been modified so as to give a good-looking toy that can be made up in an evening. The picture at the top of the page shows that it is of modern design, incorporating a flat roof, imitation display windows and a through entrance.

The 'exploded' diagram shows the parts in their relative positions, with all necessary measurements included. This, however, is not necessarily the order of construction. We suggest that the platform is made up first and the booking office glued in place afterwards.

The platform sides are identical and measure 15ins. overall in length. The top edge is 12ins. as shown and height approximately  $\frac{3}{4}$ in. The piece that goes

between, or the platform top as we have called it, measures 12ins. long by  $2\frac{1}{2}$ ins. wide. The sloping ends are chamfered and fitted after the sides and top have been glued together. All these pieces are cut from  $\frac{1}{4}$ in. wood.

### The Station Building

This is made in the form of a box; back, front and two ends. The ends go between the back and front and should be pinned as well as glued. Make all these from  $\frac{1}{4}$ in. wood. The roof, which can be  $\frac{1}{2}$ in. wood or stout card is next glued in place and the whole fixed, by gluing, to the platform. Note that the back may have the display windows omitted if desired. Now glue the two upright columns,  $\frac{1}{4}$ in. dowels, in place and pin from under the platform and also through the roof. An alternative method if the roof is of wood, is to cut a  $\frac{1}{4}$ in. diameter hole in roof and platform and

let the dowel in. This would make a stronger finish, but you would have to make the dowel correspondingly longer. The railings or fence is now added along the back of the platform and the toy is ready for painting.

The platform itself can be painted stone or grey to represent concrete, and the edges painted white as in actual practice. The roof of the station building will be dark grey—slate grey, while the walls will be red. The columns and fences will be bright green and this can also be used to paint the edge of the roof. Cellophane can be stuck behind the window openings and display goods stuck to the back of this. The goods can be represented by a coloured advert cut from a periodical or catalogue. If you find that the first coat of paint raises the grain of the wood, glasspaper smooth before applying the second. (168)



# Full details of two EASILY-MADE EASELS

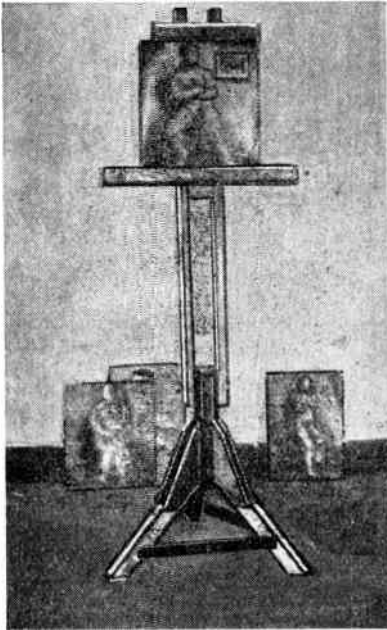

**P**AINTING in oils is becoming an increasingly popular hobby, and for this branch of art an easel is not a luxury but an essential, since it is necessary not only to hold up the work at a convenient height, but to be able to tilt the painting forwards, to throw off annoying reflections in the wet paint. For the amateur poster artist an easel is also useful.

Granted, however, that only a proportion of our readers will be directly interested in painting it is useful to have instructions for making an artist's easel, since the handyman with an eye to business, may make up an easel or two speculatively or to order, to sell at a profit, either through a local art supplies shop or, privately, to artists themselves. Again, the reader may have a friend or relation interested in art. The sturdy three-legged base can also be taken a photographer's battery of lights for indoor work.

## Years of Service

The easel designed by the writer of this article has been in hard use for many years and readers can go ahead with its making in perfect confidence, that it is a thoroughly practical article and not at all difficult or complicated to make. Most of the parts consist of ready-planed wood

which needs only a touch up with a smoothing plane. The sections mentioned in the text and diagrams are given as a *guide only* and need not be followed slavishly. Common deal can be used, though for a really 'super' job, oak or beech can be used.

Start off with the pillar (B) which is of 3in. square section wood, 14ins. long. The wood is planed to the section shown in the bottom right-hand corner of the diagrams. The three legs are each about 16ins. long of 1½ins. square stuff, cut off at an angle of 45 degrees each end as seen in the detail at the bottom left. The three legs are screwed to the pillar, as shown in the diagrams, using, in each case, a long screw, well countersunk and inserting a glue block under each (F).

## Secure Legs

It is most imperative to secure these legs well, as considerable strain is put upon them in use. The screw and the glue block just mentioned are merely to position the legs whilst extra brackets are applied. A block of wood, 1½ins. square in section and 5ins. long (D) is bevelled at 45 degrees each end and screwed with a couple of screws to the pillar, its lower end bedding down well against the sloping leg. Brackets (E) of ½in. plywood are screwed on as shown in the diagrams. These have not been

dimensioned, as the shape is easily taken off the actual job. Make a cardboard template first. Braces of ¾in. by ¾in. strip iron are made and applied at the bottom as shown in the sketches and photograph, holes being drilled in the iron at each end, to take a round-headed screw.

Make sure that the legs unit thus made does not wobble when placed on a flat surface. The most difficult part of the job is now done, and the easel will rapidly take shape as two lengths of 1½ins. by 1in. section wood, 5ft. long are added. A ¾in. hole is drilled just inside each end of the uprights and a similar hole drilled near the top of the pillar. Through the bottom of the pillar goes a ¾in. diameter bolt 6ins. long, with a wing nut and washer. At the top goes a similar bolt.

The upper and lower rails (J) and (H) are much alike except that (J) is upside down compared with (H), and (J) is 12ins. long, whilst (H) is 20ins. Each rail is, in section, like a letter L, made up of three strips nailed and glued together. Permanently attached to each rail is a slider block (K), 6ins. by 3ins. by 1½ins. The clamp plate (L) is not attached permanently but a ¼in. diameter bolt, 3ins. long, with a washer and wing nut, is arranged as shown, so that when tightened up from behind, the rails can be held in any desired position. A circular clamp plate is suggested, since circular pieces of plywood are often to be had cheaply at woodworkers stores,

(Continued foot of page 156)

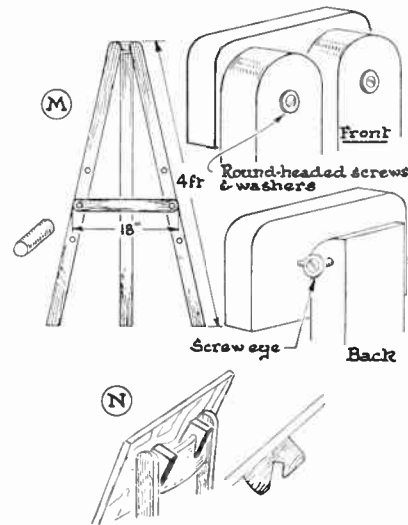
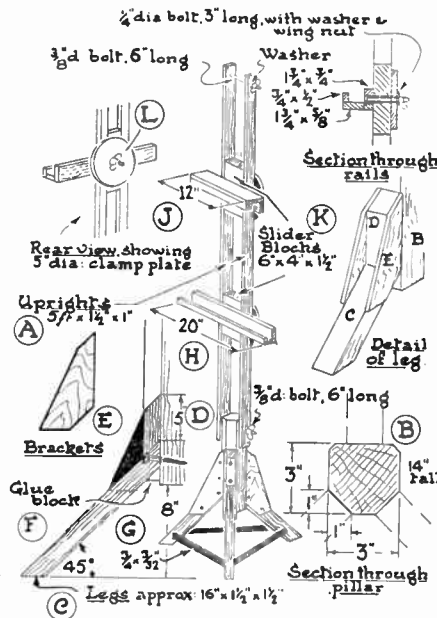

Constructional details

The second type

# Complete instructions for the making of A PUPPET THEATRE

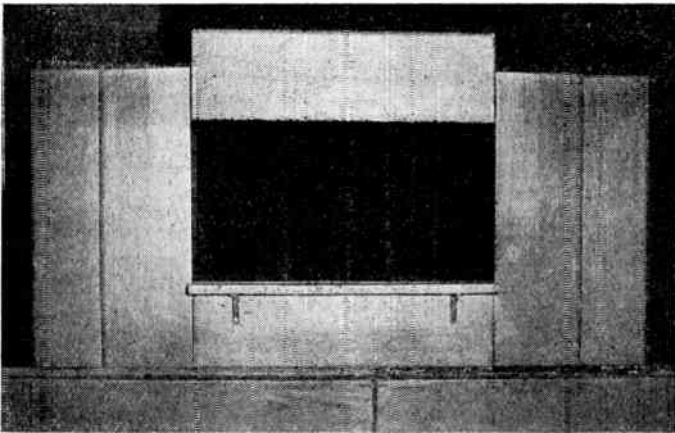

**P**UPPETRY is an absorbing business and, apart from the fun of operating the little figures, much pleasure can be derived from their construction, and the construction of the various accessories. This article deals with the making of a puppet theatre, and later we hope to deal with other aspects of the hobby.

The front of the theatre (Fig. 1) is constructed of six pieces of wood, 2ft. 5ins. long, 8ins. wide and  $\frac{3}{4}$ in. thick. Proceed in the following manner.

Place four of the pieces to make the top, bottom and two of the sides, on a table. Make the stage opening the correct size. Next, take two strips of wood approximately  $1\frac{1}{2}$ ins. wide and  $\frac{3}{4}$ in. thick, place these across the pieces at the

FIG. 1

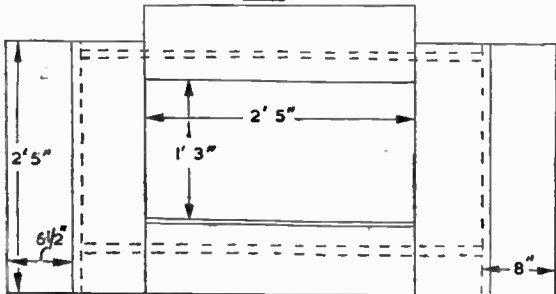

top and bottom, and cut so that each strip is 2ins. shorter than the combined lengths of the boards when they are in position. Screw these pieces on to the boards as shown by the dotted lines in Fig. 1.

Before fastening the bottom strip it is advisable to read the notes on lighting, as the foot-lights are fastened to it. The remaining two boards should be screwed on to each side, leaving a  $1\frac{1}{2}$ in. overlap as shown by the vertical dotted lines in Fig. 1.

The apron stage shown in Figs. 1 and 2 must be screwed to the front by means of two angle brackets.

Figs. 2 and 3 show the method of mounting the three boards on each side at the back. Each one must be joined by two hinges so that, when completed, the three boards will close up concertina fashion. The top of the first board, i.e. the one which joins on behind the front of the theatre, must be cut away to allow room for the front curtain rails, which are mounted on the top batten. The top edges of the first and third boards must be drilled with holes into which can be fitted the thin battens holding the side curtains, backcloths, etc. Fig. 4 will show how this is done. By this means side curtains, backcloths, etc., can be moved into any desired position.

A double angle iron, Fig. 5, must be screwed on to the back of the second

angled metal hooks screwed into each end. These hooks slip into the holes drilled in the top of the boards.

The front of the theatre may be painted any desired colour while the three hinged boards on each side must be given a coat of dead black.

The diagrams show some of the different scenes which can be mounted on the battens. These scenes must be of such a length that approximately 3ins. to 4ins. clearance is left between the bottom of the cut-out and the table on which the theatre is placed. For example, the trunks of the trees, or the bottom of the arches, should be about 4ins. from the theatre floor. This allows the operator of the puppet free hand and arm movement.

The traverse curtains (or 'tabs') can be used as wings and, when drawn, enable scenery to be changed behind, whilst a scene or play is acted in front of them.

## Notes

1. The four holes for back-cloths in Fig. 4 are useful for storing back-cloths not in use when the puppet show is over.
2. The particular theatre described was made from a wooden bench taken from a disused air-raid shelter.

FIG. 2

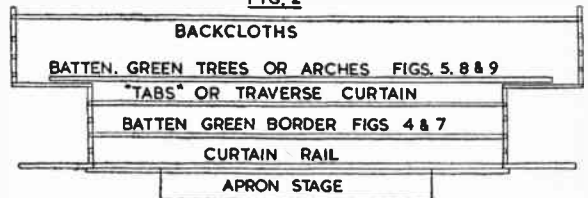

board, Fig. 3. Larger battens supporting the tree scene and arches, Fig. 8 and Fig. 9, or any other 'cut-outs', can be dropped into these when they are required.

Cut a hole in the first board on each side (Fig. 3) sufficiently large in size to allow light from the floodlights placed outside to shine through.

Mount the front curtain rails on the top batten shown in Fig. 3. Two pulleys are required, on one side and one on the other. Fig. 6 shows how the cord is attached.

The battens shown in Figs. 2 and 4 must be of suitable length and have right-

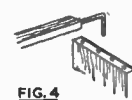
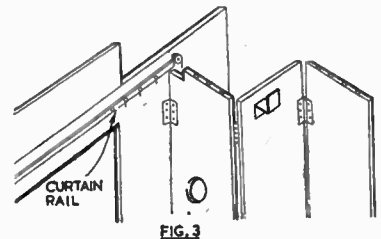

FIG. 4

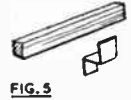

FIG. 5

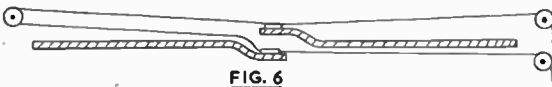

FIG. 6



FIG. 7

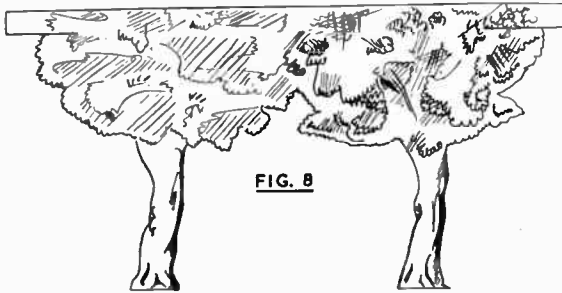

FIG. 8

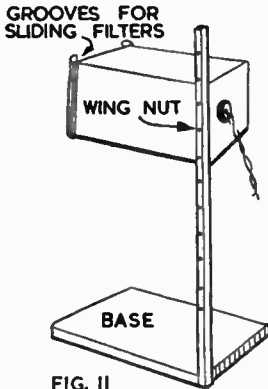

FIG. 11

3. The border of leaves blends with a tree scene. Similar borders should be made to fit other scenes.
4. The 'cut-outs' can be made from three-ply wood from a tea-chest.

### Wiring Notes

The lighting of the theatre can be divided into two parts. The overhead lights and floodlights use full mains voltage, whilst the side and foot-lights step down the voltage through a 12-volt transformer so that smaller bulbs may be used. This is shown in the wiring diagrams.

Overhead lights can be constructed as follows: Cut out four end pieces of wood in a roughly semi-circular shape and join each two together with a sheet of tinplate. Lamps must be long enough and wide enough to allow the easy fitting of the bulbs. Allow sufficient tinplate at each side to make a groove into which can be slid coloured filters and fit a small end stop to one of the semi-circular wooden pieces. Cut out a hole at one end of each lamp to permit a bulb socket to be inserted. Near the apex of the

bends, drill small holes to take small bolts with wing nuts. Bend a suitable iron strip into a U shape, so that the lamp will fit in the jaws of the U. Drill holes at the top of the U and along base. Screw base of U to back of theatre and put bolts through the lamp and tops of the U and screw on nuts. This lamp is adjustable for angle by loosening wing nuts (see Fig. 10).

### Side Lights

Side lights consist of motor car single filament headlamp bulbs. Sockets for these are screwed on to the side of the theatre.

Footlights are flash lamp bulbs (2v.) connected in series and the holders are screwed on to the bottom batten shown as a dotted line in Fig. 1. It is important that this batten should be low enough to allow these bulbs to be mounted so that they do not show from the front of the theatre.

Floodlights can be made from any suitable round tins or can be made by bending tinplate round a suitable square wooden base and soldering the ends of the tinplate together. Cut a hole in the base for the bulb socket and a small hole at the side near the base to take a bolt and

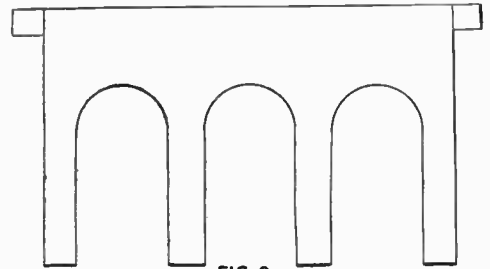

FIG. 9

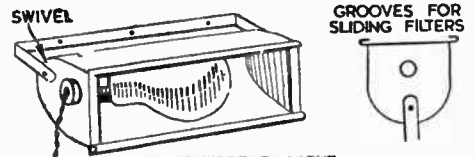
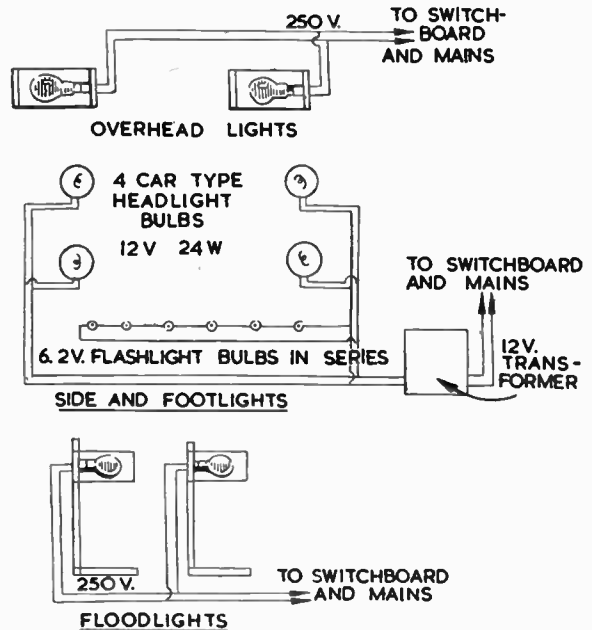

FIG. 10 OVERHEAD LIGHT

wing nut. The stand should be made from a suitable flat piece of wood to form the base. The upright should be mounted at the corner of the base and drilled along its length. Fasten the wing nut on the lamp through any hole and tighten.

This lamp is adjustable for height by using any hole in the upright and for angle by tipping lamp before tightening the wing nut. If filters are required it is better to use the square lamp and make grooves in tinplate as for the overhead lights. This lamp can be used to shine through the hole cut in the first board (Fig. 3) or used inside the theatre at any desired height and angle. (126)



Wiring details



# The amateur gardener can make this SEED CONTAINER FROM SCRAP

**A**T odd times garden seeds are gathered from the plants, and pushed into paper bags of various sizes, with the intention of labelling some time in the future. Not only is this untidy, but often the seeds get mixed, and some remain unlabelled. This can be remedied by collecting a little scrap

The materials required are a number of matchboxes, sufficient to cover the varieties of seeds to be kept; cardboard or wood for the base and top; secotine and paper clips of the variety having two prongs which push in and bend over at the back. The matchboxes are fixed on top of each other or side to side, leaving the ends free so that the insides may be pulled out like a series of drawers. So first we work out a design to cover our seeds.

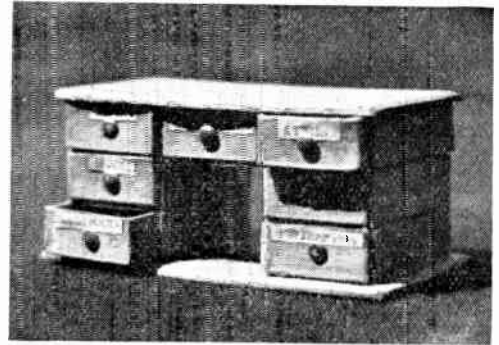

The finished box

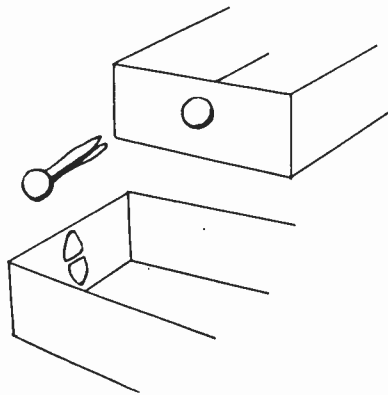

How the 'handles' are made

material and devoting half an hour to making a neat container, which may be in the form of a desk or chest of drawers, each drawer being neatly labelled for further reference.

## The Base

Having decided the area these boxes will occupy on the base, we mark it out, and cut the base about  $\frac{1}{2}$ in. bigger all round from the card or wood. The edge is bevelled with sandpaper, and the boxes are built up on this base. The top layer of boxes can be stuck on the underside of the top of the desk, which should be  $\frac{1}{2}$ in. bigger all round the boxes. Bevel the top. The two sections can then be stuck together.

Each 'drawer' must be taken out and a slit made in one end of each, to insert a small paper clip of the type mentioned. This makes the handle for ease of opening and closing. The slit must be very carefully made as the matchbox wood splits

easily. Perhaps the best way is to use the corner of a razor blade. Above each handle a typed or printed label is stuck, bearing the name of the plant.

## Increasing the Size

If desired, the number of compartments may be increased by doubling the depth of the boxes, so that the drawers pull out from the back as well as the front. Such containers as these can easily be made by the children, and their uses can be extended to other things than garden seeds. They are, for instance, admirable for keeping tiny screws and pins for model making. (182)

## Easily-Made Easels—(Continued from page 153)

being off-cuts, one presumes. A 5in. square would do equally well, of course, with just a little taken off the corners.

In actual use, the easel soon gets streaked with paint, and if the easel is for one's own use no special finish need be given. If made up for sale or a gift, however, a smart appearance is required, and this can be obtained by good glass-papering and possibly a coat of light oak varnish if deal has been used.

## Another Type

Another type of easel (M) more suited to outdoor sketching in watercolour can be very easily and cheaply made chiefly from tiler's 'furring' battens (obtained rough but smoothed up afterwards). Three 4ft. lengths and one 18in. length are required. Such wood has a nominal 2ins. by 1in. section. A piece of hardwood about 5ins. by 2ins. by  $\frac{3}{4}$ in. has its corners taken off and to this, at the front, the tops of two of the long laths (ends rounded off) are screwed. Drill the holes first, to avoid splitting the wood. The screw should pass freely through the hole in the batten. The

diagram shows a very simple way of hinging—more effective, for this purpose, than employing a regular hinge. Two screw eyes are used.

A pair of  $\frac{3}{8}$ in. diameter holes are drilled in the ends of the shorter piece of lath that acts as a shelf. Three pairs of holes are drilled in the front legs as shown. By means of dowel pegs, the shelf can be set at three different heights. If the shelf is taken right off, the whole easel is easily transportable and can be tied up with a piece of tape or, more workmanlike, a small strap provided.

To prevent slipping on smooth floors (if used indoors) rubber ferrules (as used on walking sticks and crutches) can be applied to the feet (which can be suitably tapered down at the ends).

Fig. N shows a way of clipping a small drawing board to the back of a chair. Only the general idea can be shown, as chair backs differ in design. The artist, of course, sits in reverse position on the chair, facing the back.

No instructions need be given for making the usual 'blackboard and

easel' for children's use, as few, if any, readers will need details for this very simple job. What, it is hoped, will be useful, however, is information of blackboard paint. Ordinary black paint is not suitable. True, special blackboard paint can be obtained in paint shops but there are occasions when blackboards are being made in quantity and it will pay to make up one's own blackboard paint.

## Recommended

The writer can thoroughly recommend the following formula which he has successfully used for many years. The basis is 'drop black'—a sooty-looking black powder which, if not in stock at a local paint dealers, might be obtained to order. It is used a good deal by theatrical scene painters. This is made into a paint-like mixture by adding turpentine. A small quantity of gold size is then added, together with a little fine carborundum powder. The whole should be applied as soon as made.

Before applying the special paint, coat the blackboard with one or two coats of ordinary black paint. (161)

# MISCELLANEOUS ADVERTISEMENTS

**PLYWOOD** offcuts. Birch and Gaboon in various thicknesses. Handy sized parcels for the cabinet, toy, model maker, and all handicrafts. Parcels made up in £1 and 10/- lots. Carriage paid. Send P.O. to—Reeves, Plywood and Timber Merchant, 33 Front Street, Monkseaton, Whitley Bay. Tel. W.B. 4677. Parcels are now dispatched on day of receiving order.

**AMERICA'S** famous hobby magazines. One year's supply Popular Mechanics, 32/-; Popular Science, 28/6; Homecraftsman, 16/6; Popular Homecraft, 18/-. Free booklet listing all others sent on request.—Willen Ltd., Dept. 37, 101 Fleet Street, London, E.C.4.

**EARN £££s** Weekly with '114 Ways to be Your Own Boss', 5/6 only. Money back if dissatisfied.—Stebbing Publications Ltd., Naphill, High Wycombe.

**HOME** Watch and Clock Repair Outfit. Includes watchmaker's magnifying eyeglass, tweezers, screwdrivers, oilers, oil, brush, dusting powder, plus illustrated explanatory book. Watch and clock repairing simplified. In container, 12/9 inclusive.—D. Bolster (Dept. H.), 5A Station Parade, Ashford, Middx.

**LONELY?** Then write the Secretary, U.C.C.—5 B.B. Hay St., Braughing, Herts. Genuine. Est. 1905.

**HAVE** you got your Junero Riveting Jig yet? From all Hobby shops or Post free from Junero Ltd., Stirling Corner, Boreham Wood, Herts.

**STAMPS** Free—Empire Packet including Pictorials and Victorians free to approval applicants.—Robert J. Peck, 7A Kemp Road, Bournemouth, Hants.

**WHEELS** for Toys, etc., in Hardwood, Plastic and Rubber Tyred Metal. Doll's House fittings and papers. Doll's cot and pram fittings. Decorative Transfers. Beads for Counting Frames and other toy accessories. Fine Art Pictures for Jig-Saws, etc. Stamp for lists. Trade supplied.—Joyden Toy Co., 193 Chase Side, London, N.14.

**HOMEWORKERS** required, either sex, light Assembly, part or full time. S.A.E.—Esprey, Box 18, 41 Wade Street, Lichfield.

**NOVEL** calendar designs painted on plywood (or cutting out, with date cards.) Inexpensive gifts. Profitable to sell. Sample, 2/-; half dozen, 11/-, including postage.—Clever (H.W.), 50 Windsor Road, London, N.W.2.

**CONJURING** and Magic. New tricks and Pocket Novelties every month. Lists, 4d.—Roboati, Magician, 363 Sandycombe, Kew Gardens.

**MALTA** 3d. to 3d., 1/6 per set. Other Br. Colonials in stock. Terms cash. S.A.E.—Distribution Supplies, 54 Leopold St., Leeds, 7.

**50** Free stamps including pictorials to all applicants enclosing 23d. and requesting approvals. Medium and Junior. Postal only.—Beeze, 116 Newton Road, Mumbles, Swansea.

**INTERESTING** work available for all in spare time. Experience unnecessary. Send S.A.E. for details to—'Leathaweave' Co., Dist. 37, 2 Tudor Road, Leicester.

**KUKLOS** Annual. Indispensable cyclists' handbook. 1951 edition. Tours, resthouses, money saving hints. 2/9, post free.—Burrow Publishers, 2 Imperial House, Cheltenham.

**START** making money at home whole or spare time on production of Slippers and useful Leather Goods. Material Provided. Write for rates of pay and full details.—Dept. X, Grange Co., 2 Curzon Street, Leicester.

**PERSPEX.** Flat, Clear and Coloured. Cut to sizes and shapes.—Henry Moat & Son, Ltd., Atom Works, Newcastle, 1.

**ATTENTION** Homeworkers! Martin's Mail Order Services require clerical homeworkers and envelope makers. Excellent prospects, and regular work assured. Send only 13d. S.A.E. for particulars to—M.M.O.S. (Regd.), Dept. HW/HWK., 43 Marina Road, Prestwick, Ayrshire

**100,000** Government Surplus Bargains. Sample parcels (guaranteed containing at least 15/- worth assorted electrical and other useful items) in handy wooden box, 5/-, post 1/8. Hand Lamps, 4 1/2" high x 3" wide, complete with battery (standard 3v twin cell), bulb and carrying handle, 2/11, post 8d. Aluminium rivets, approx. 1lb. assorted, 2/6, post 6d. Transformers, heavy duty, 230/12v 10 amps., 25/-, post 1/8. 230v A.C./D.C. electric motors, continuous rating, ideal models and light workshop use, 20/-, post 1/8. Hundreds of other bargains for the handyman. Send 3d. stamp for catalogue. Money back guarantee.—Miliigan's, 24 Harford Street, Liverpool, 3.

**CRYSTAL** set kits—15/-. Amazing reception.—Buckle, 77 Horrington Road, Bury St. Edmunds.

**FREE**—100 Foreign stamps including British Colonials, to all approval applicants. Send now. Do not delay your application for your free gift and an approval selection.—Sheldrake, Harwen House, New Cross Rd., Guildford, Surrey.

**FRENCH** polishing is simple if you use Everyman's French Polish. Easy to apply, no skill required. Try this amazing new invention. Send 3/9 for trial size to—Palmer, Manufacturing Chemists, Dept. D., 39 Seaton Place, London, N.W.1.

**CHRISTMAS**—Complete pictorial set free. Issued in Hungary, commemorating the Festive Season. Enclose 23d. Request approvals.—H. B. Watson, 85 Larkwood Rd., Chingford, London, E.4.

**PACKET** free. All pictorial commemoratives, including high values. Request approvals. 3d. postage please.—E. W. Compton, S.C.A., 93 Manor Place, London, S.E.17.

**PHOTOGRAPHERS**—assemble your own exposure meter. Kit of parts for sensitive photo-electric model, 27/6.—Lucas, 22 Hengrove Rd., Bristol, 4.

**10** Magnificent Large Jungle Scenes Free. Approvals. Postage.—Mousley Stamps, Heanor, Derbyshire.

**STAMP** outfits! Album, hinges, detector, Magnifier, tweezers, stamps, etc., 10/- each. Larger sizes, 15/-, 25/-. Free gifts to all approval applicants.—Hawkins, 247 Rotherhithe New Rd., S.E.16.

**DIAMONDS,** Triangulars. 23d. for approvals.—Ardson, 3 Glenbank Road, Londonderry, N.I.

**STAMPS FREE!!** Twenty unique (23d.).—S.G. H. Barnett, Limington, Somerset.

**SPERM** whale teeth; approx. 3ins. to 8ins. long. Suitable for carving; can be highly polished. Price, 50 for 25/-, 100 for 45/-, post free.—Chr. Salvesen & Co., Leith, Scotland.

**SPARE-TIME** homeworkers wanted. 13d. Stamp for details.—Rapid Publications, 63 Lewin St., Middlewich.

**BE INDEPENDENT**—£5 weekly guaranteed. Running your own mail order business. Astounding opportunity. Complete course with full instructions, 3/6 only.—B. Duffield, BCM/NEWDALE, London, W.C.1.

**TRICKS!** Jokes! Be popular at Christmas. Send stamped addressed envelope for free list.—Morgan-Hughes, 29 Penylan Road, Newport, Mon.

**PENNY** Black and Sir Rowland Hill on stamp of Cuba free. Request approvals, enclosing 23d. stamp.—Hubert Rajski, 211 Thornes Road, Wakefield.

**MANY** have already secured the valuable 1840 Penny Black free. Easily available to all. Request details, approvals and gift stamp set.—S. R. Giddings, Linden Lea, Coombwood Drive, Thundersley, Essex.

**WORLD** stamps, 25% discount, 23d. stamp.—Brain, Marsh Lane, Taplow.

**CASTING** moulds for lead soldiers, animals, etc. Sample mould, 4/-. Handbook and catalogue, 2/6.—G. F. Rhead, Hartest, Bury St. Edmunds.

**INTRODUCTIONS.** Pen friends, companionship or marriage. V.C.C., 34 Honeywell Road, London, S.W.11.

**STAMPS**—superb selection sent post free on 10 days' approval. Good discount. List of books free.—Gem Stamp Co., 514 Fairfax Drive, Westcliff, Essex.

**LOVELY** leather, at low prices for handicrafts, Slippers, clothing repairs.—Cowling, Free-school Lane, Leicester.

**PERSPEX**—clear offcuts in 1/4", 3/8" and 1/2". All useful sizes. Bargain parcels, 10/- and £1. C.W.O. (refunded if dissatisfied).—R.L.R. Plastics, Wembley Park, Middlesex.

**HOMEWORKERS** required by few reliable firms; genuine offers made. Please send S.A.E. for complete details.—Robertson, 73 Barone Rd., Rothsay, Scotland.

**E.C.G.** waterproof varnish, colourless. For fishing rods, models, etc. Small size bottle, 1/3, post free.—E. C. Griffiths, 75 Orchard St., Weston-super-Mare.

**10 CANADA** free. Send 3d. stamp for discount approvals.—Bernard E. Sherwood (5/H), 11 Philip Road, Ipswich.

**SPARE-TIME** workers urgently needed for our Export orders. Good pay. Write—Empire Co., 117 Nottingham Road, Loughborough.

**CIGARETTE** cards—complete your Part Sets. Send P.O. 1/6 and Wants List.—T. Verity, 193 Sandford Road, Bradford, Yorks.

**20 BRITISH** Colonials, free with approvals. Postage.—W. E. Tucker, 6 Higher Church St., Barnstaple, Devon.

**GENUINELY** interested persons required to undertake light, clean assembly work in their own homes. Good rates of payment.—Dept. P/918, Universal Products, 5 Cornhill, Lincoln.

(Continued foot of page 158)

## HOBBIES BRANCHES

### LONDON

78a New Oxford St., W.C.1

(Phone MUSEum 2975)

87 Old Broad Street, E.C.2

(LONDON Wall 4375)

117 Walworth Road, S.E.17

(RODney 5509)

GLASGOW—326 Argyle Street

(Phone CENTral 5042)

MANCHESTER—10 Piccadilly

(Phone CENTral 1787)

BIRMINGHAM—14 Bull Ring

SHEFFIELD—4 St. Paul's Parade

(Phone 26071)

LEEDS—10 Queen Victoria Street

(Phone 28639)

HULL—10 Paragon Square

SOUTHAMPTON—25 Bernard St.

BRISTOL—30 Narrow Wine Street

(Phone 23744)

**Earn Money Making OSCAR ELEPHANT**

No mechanism—yet walks down any incline in lifelike manner. Simple to make from odd wood. Sells on sight. Patterns, instructions, 3/6 from Dept. HW/D



6, Cedar House, Erlanger Rd., London, S.E.14

## IMPORTANT ANNOUNCEMENT

Customers old and new are advised that the well-known

**'DUREX' Cellulose TAPE**

will in future be known as

**"SCOTCH BOY" TAPE**

★ ★ ★

the name of the manufacturing company

**DUREX ABRASIVES LTD.**

has been changed to the

**MINNESOTA MINING & MANUFACTURING CO. LTD.**

to which all future communications should be addressed.



MINNESOTA MINING & MANUFACTURING COMPANY LTD.

Arden Road, Adderley Park, Birmingham, 8

## PUPPETS

Kits of parts to make two Fully Jointed 12 inch puppets with controls.



**15/6** post free  
Send stamped addressed envelope for illustrated list of complete puppets and books

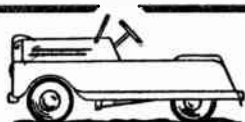

## PEDAL MOTOR CAR

Any amateur can make this strong smart modern pedal car for children 2 to 5. Plan and instructions with list of available metal parts

**2/6** post free

**ZIMPLAN**

88 WARE ROAD  
HODDESDON, HERTS

## Miscellaneous Advertisements—(Continued from page 157)

**GRAND** discount selections of Foreign and Colonial stamps. Free gift with each selection.—Ramsey, 28 Conduit Road, Sheffield.

**HYPNOTISM**—astounding new methods now enable anyone to acquire this marvellous power quickly and easily. Complete course, 5/- only. Details free.—BCM-NEWDALE (H), Monomark House, London, W.C.1.

**900 SHEETS**; six attractive colour pictures per sheet. Suitable calendars, jigsaws, 45/- per 100. Send 1/- P.O. sample sheet. Tinplate wheels, 2ins. x 1/2 in., 2/- doz.; 15/6 gross, post free.—T.B.S. Ltd., 34 Hayes St., Hayes, Bromley, Kent.

**LORRY** kits, 4 mm. and 7 mm. scale. Also large range of spare parts from which to build to your own design. Send for fully illustrated catalogue. Price 1/-.—Wilson's Lorrys Ltd., 6 Gt. Winchester St., London, E.C.2.

**SPARE** time homeworkers, either sex, urgently required. Clean work; good pay. Write—Area 343, 88 Rutland St., Leicester.

**SPECIAL** offer. Constructional plans. Model Railway station, 1/6. Kaleidoscope, 1/6. P.O. to—10 Audries, Kirby Rd., Walton-on-Naze.

**MODELS.** You can make lasting stone-hard models with Sankey's Pyrama Plastic Cement. Supplied in tins by Ironmongers, Hardwaremen and Builders' Merchants. Ask for instruction leaflet.

**LEARN** Shorthand by January 9th. (1 hour's study nightly). 1st lesson, 23d. stamp.—Duttons (Dept. H.B.), 92 Gt. Russell St., London, W.C.1.

**DUPLEX** self-adhesive transfers for decorating fancy goods, trays, plastics, etc. List and samples, 3d.—H. Axon Harrison, Jersey.

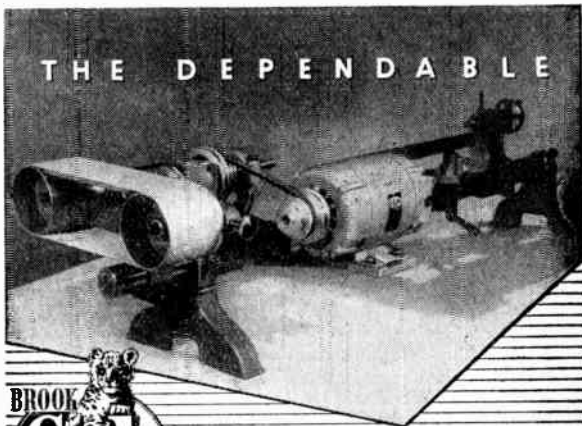

**"FRACTIONAL"**

The Coronet Tool Company of Derby, makers of the lathe shown in our illustration, fit Brook 'Cub' Motors

A sound machine with a reliable driving unit—The one motor is easily interchangeable for driving the lathe and all its attachments.



EMRESS WORKS Huddersfield

I.H.M.148

## SPECIAL MOULDS

Some new lines for the Craftworker

Sets of moulds for Cake Decorations, Christmas Novelties and Brooch Making at 12/6 for a set of 8 moulds. Plaster moulds for all types of Ornaments and Plaques made for 6/6. Dolls Masks and Faces, 3 sizes, set 15/6. Dolls Heads, 25/- for mould. 150 Toy Making moulds at 3/- each. New Father Christmas and Snowman, 2 1/2 in. flexible moulds, 12/6. Buy direct and save money. New catalogue illustrated 9d. post free. All moulds are made of strong aluminium or vinimould. They are made to last. 4 sample moulds of Toy Soldiers or Sailors, 12/- post free.

**COCK OF THE NORTH MOULDS**  
140 HOLLINGS ROAD, BRADFORD

**DOLL'S** house fittings and papers; send S.A.E. for list. Doll's house plan special; send 2/6. Trade supplied.—Zimplan, 88 Ware Road, Hoddesdon.

**BLUSHING**, shyness, nerves, self-consciousness. Tears ended. Details under plain cover, 13d.—Stebbing Treatment, 28 (HB) Dean Road, London, N.W.2.

**£5** to £20 weekly earned at home running your own Mail Order business. Details, 13d.—Stebbing Publications Ltd. (HB), Naphill, High Wycombe.

**PLYWOOD** offcuts, in 5/- and 10/- parcels, post free. Money-back guarantee.—Ezedraw, 21 Spring Grove Rd., Kidderminster.

**HOMEWORKERS** required; full/part time. S.A.E. for particulars.—Vocational Services, 105 Burkes Rd., Beaconsfield, Bucks.



# MAKE MONEY-making casts with **VINAMOLD**

The **ORIGINAL** Flexible Mould

For pleasure or profit and without previous experience you can mass produce any object from a chessman to a large statue with 'Vinamold'. It is easy to work, gives excellent results, and can be used over and over again. 'Vinamold' has been used with complete success for years by leading industries, including all the big film studios. Trade enquiries are invited.



Write for full details and instructions to:—

**Vinyl Products Limited (Dept. H1), Butter Hill, Carshalton**

# WEBLEY AIR PISTOLS



Marvellously accurate for target practice. No licence required to purchase for use on enclosed premises.

Senior Mark I Webley Air Rifle  
Junior Mark II WEBLEY & SCOTT LTD.  
Write for List. 166 WEAMAN STREET, BIRMINGHAM, ENG.

## Airborne supply!

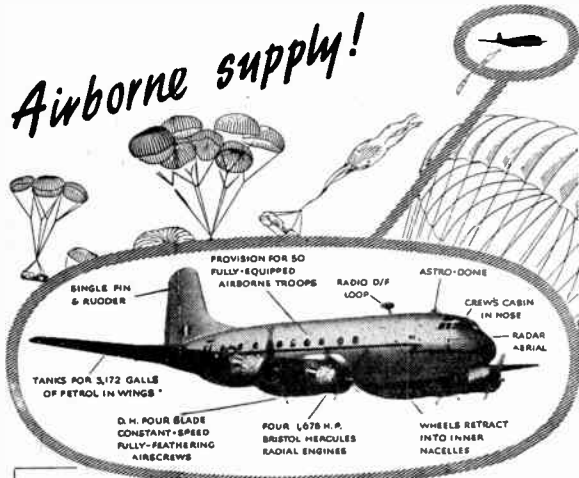

### HANDLEY PAGE HASTINGS

R.A.F. Transport Command's latest aircraft. Crew of 5, capacity for 50 troops. Four 1675 h.p. Bristol Hercules engines. Maximum speed: 354 m.p.h. Range: 2,000 miles. Wing span 113 ft.

There may be 50 lives depending on the brains and skill of the men who fly and maintain this aircraft, so naturally they must be pretty smart. That's why the Royal Air Force is always on the look-out for suitable boys to join their Apprenticeship Scheme. These boys get a flying start to a thrilling career at one of the R.A.F.'s fine residential schools, without cost to their parents and with good pay to spend. In this way the R.A.F. gives them the right kind of start for their future as key men in the finest air force in the world.

If you are over 14 this coupon brings you free a 26-page illustrated book about thrilling careers in the R.A.F. If you are 12 to 14 it brings you full details about the A.T.C.

TO: ROYAL AIR FORCE (H.5.56B), VICTORY HOUSE, LONDON, W.C.2



NAME.....  
ADDRESS.....  
.....AGE.....  
DATE OF BIRTH.....



how about some  
**Seelastik?**

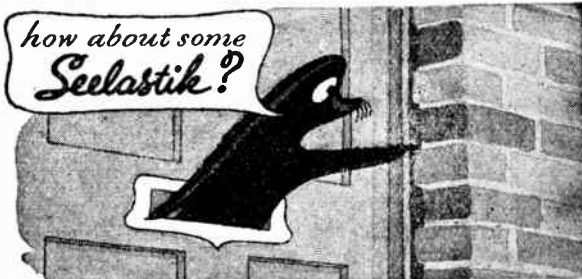

Every time this door slams a little more of the mortar or putty drops out. Why? Because it sets hard and shrinks and does not really stick.

They should have used Seelastik.

Seelastik forms a watertight, airtight seal and remains flexible and elastic when set; it sticks tenaciously even to highly polished surfaces, such as glass, as well as to any combination of brick, cement, stone, plaster, wood, metal, tiles, glazed earthenware...

A Seelastik seal costs ¼d. to 1½d. a foot, depending on its width. It is light-coloured, and can be painted 24 hours after it is put on.

You can buy Seelastik — packed in handy cartridges, and applied by the Expandite gun (50/- with two nozzles) — or in 2/- and 3/- tubes, which are self-contained sealing tools.

# Seelastik

SEALS THE GAP

EXPANDITE LTD., CUNARD ROAD, LONDON, N.W.10



## F. W. NUTHALL

Toymakers' Casting Moulds

Moulds: deep-cut and ordinary type Aeroplanes, Soldiers, Farm and Wild Animals, Cars, etc. Stamped envelope for full list Illustrated Catalogue 9d.

Sample mould 3/6d.

## PLASTERCRAFT

ALUMINIUM MOULDS  
BROOCH MASKS  
GARDEN ORNAMENTS  
WALL PLAQUES  
BOOK ENDS AND ORNAMENTS  
CAKE DECORATIONS

### BEAUTIFULLY DRESSED DOLLS

WALK, TALK, SIT AND GO TO SLEEP

		NON-WALKERS	
21 ins. Tall	35/-	21 ins. Tall	61 8 0
22 ins. Tall	38/-	22 ins. Tall	61 10 0
23 ins. Tall	42 2 0	23 ins. Tall	61 15 0
25 ins. Tall	42 15 0	25 ins. Tall	62 5 6
27 ins. Tall	64 0 0	27 ins. Tall	63 7 6
30 ins. Tall	64 10 0	30 ins. Tall	64 0 0

### BEAUTIFUL BABY DOLLS

CRY AND GO TO SLEEP

21 ins. Tall	32/-
18 ins. Tall	25/-
14 ins. Tall	16/-

DOLL MOULDS SUPPLIED

69 ST. MARKS ROAD, HANWELL, LONDON, W.7

The Bennett College

Which will be YOUR door  
five years from now?



How you can get the extra  
education you need for a  
**BETTER PAID JOB...**

**ONE OF THE CROWD?** Or someone who counts? It's for you to decide which you will be in future years. There is only one sure way to go ahead, and that is to train and study for a better position. The purpose of a Bennett College Course is to fit you for your chosen career, to bring your training by well-organised stages to the standard required by the examination which you have in view.

**The Turning-Point of your Career**

Thousands of men now holding well-paid positions point to the day they enrolled with the College as the turning-point in their careers. You (yes, you, sir!) will get "out of the rut" by becoming a Bennett College trained man. Then you'll have your own Tutor. You'll study in your own home. At your own pace. What is more, The Bennett College guarantees to provide you with tuition until you have passed the examination for which you enrolled.

**WHICH OF THESE CAREERS IS YOURS**

- |   |  |                         |
|---|--|-------------------------|
| Accountancy Exams.                        | Diesel Engines   | Radio Service Eng.      |
| Aviation (Eng. and Wire)                  | Draughtsmanship Engineering. All Branches, Subjects and Exams. | Salesmanship            |
| Building, Architecture and Clerk of Works | Gen. Cert. of Education Exam.                                  | Secretarial Exams.      |
| Carpentry and Joinery                     | Jigs, Tools and Fixtures                                       | Shorthand (Pitman's)    |
| Chemistry                                 | Journalism   | Short Tech. Courses     |
| Civil Service                             | Languages  | Telecommunications      |
| All Commercial Subjects                   | Mathematics  | Television and Wireless |
| Commercial Art                            | Mining All Subjects  | Works Managers          |

AND MANY OTHER COURSES

Knock at the door of The  
**BENNETT COLLEGE**

WE WILL OPEN THE DOOR TO OPPORTUNITY

**THIS COUPON SENT TODAY**

can change your whole life...

To the Governor,  
Dept. D.62  
The Bennett College, Sheffield, England

I would like to have (at no cost) your prospectus and particulars of

NAME \_\_\_\_\_

ADDRESS \_\_\_\_\_

AGE (if under 21) \_\_\_\_\_

TEAR OUT

**YOU CAN START ON A BENNETT COURSE FOR ONLY 30/-**  
and monthly instalments of 15/-

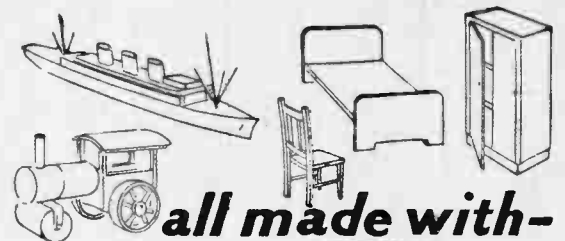

all made with-

**Croid**

THE MODERN GLUE



**Aero Glue.** The strongest glue in the world.  
**Universal Glue.** Cold glue ready for use from tube or tin.  
**Waterproof Cement.** Specially prepared for balsa wood.  
**Whyte Paste.** For paper work and photo-mounting, etc.

CROID LTD.,  
IMPERIAL HOUSE  
KINGSWAY, LONDON, W.C.2

Add realism to your  
**Model Railway!**

WITH 'OO' GAUGE

**PLATFORM ACCESSORIES**



This set of intriguing platform accessories is just what you need to add realism to your model railway.

Die cast and hand painted in bright colours, this set, No. 7, is 'OO' Gauge scale, and consists of a four-wheel porter's trolley, bicycle, chocolate machine, three milk-churns and weighing-machine. Price 2/6 complete set, including post and packing. Send now for this set.

We have a complete range of 'OO' Gauge model railway accessories. Send stamped addressed envelope for descriptive list.

TRADE ENQUIRIES ALSO INVITED

**R.B.N.CO**  
(DEPT. H) 180, BROADHURST GDNS., WEST HAMPSTEAD,  
TELEPHONE: MAIDA VALE 1070 LONDON, N.W.6

Printed by BALDING & MANSELL, LTD., London and Wisbech, and Published for the Proprietors, HOBBS LTD., by HORACE MARSHALL & SON, LTD., Temple House, Tallis Street, E.C.4. Sole Agents for Australia and New Zealand: Gordon & Gotch (A'sia) Ltd. For South Africa: Central News, Agency Ltd. Registered for transmission by Canadian Magazine Post.



# Hobbies

## WEEKLY

### CONTENTS

	Page
Lanterns for Christmas	161
'Ring and String'	
Conjuring	- - 163
Inflating small Balloons	164
Table Lamp	- - - 165
Colouring Lamp Bulbs	166
More Fun with Light	- 167
Low-Built Tea Trolley	168
A Ship in a Bottle	- - 169
Replies of Interest	- - 170
Shipmodeller's Corner	171
A Perpetual Calendar	172
Simple Curtain Fitment	173
Dock-side Crane	- - 174
<b>DESIGN SHEET FOR A PERPETUAL CALENDAR</b>	

December 12th, 1951

Price Fourpence

Vol. 113 No 2928

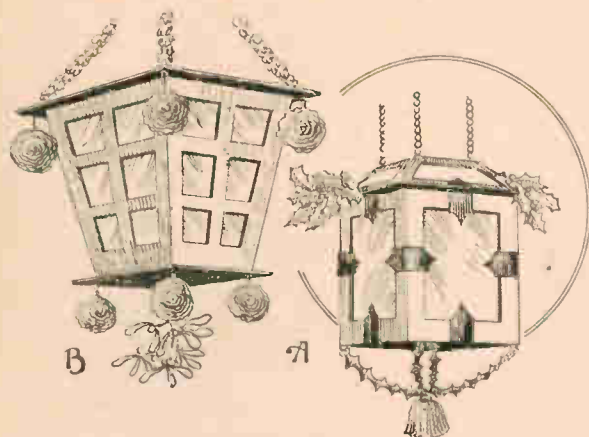

Fig. 1—The lanterns in use

**D**URING the season of good will when everyone endeavours to throw off, at least for a while, the worries of everyday life, the home can be made cheerful and bright by the introduction of paper lanterns. They can be easily and cheaply made at home from a few sheets of thin card and some gaily coloured paper, plus, of course, a little ingenuity and patience. A few scraps of tin and wire are also required, and a pot of paste and a wide paste brush.

#### Old Cardboard Suitable

Old boxes and packing board will be found suitable for the making up, as faults in colour, etc., are all covered with the coloured paper. A few decorative pom-poms, some holly, and a length or two of paper chain; some paper flowers, too, perhaps, all go to make for brightness, and improve the appearance of the lanterns. Small candles used to be the

luminant years ago, with always the fear of fire. Nowadays, however, little electric bulbs take their places and are easily wired up and fitted from the mains or from a battery.

#### General Instructions for Making

We show in Fig. 1 two suggestions for lanterns, to which are added some of the decorations previously mentioned. The lantern marked (A) is, perhaps, the simpler of the two to make up, and at Fig. 2 is shown the piece of card measuring 18ins. by 13½ins. from which all four sides as well as the bottom and top can be cut.

By making the whole from one sheet, a very stiff framework will result. Draw out the given pattern as shown, full size on the card, following carefully the measurements given, and noting the dotted lines which indicate where the card has later to be lightly scored with a pocket knife or safety razor blade prior

*Help festivities by making paper*

## LANTERNS FOR CHRISTMAS

to angling up into a perfect square.

Note should be made of the narrow border strips which act as gluing tabs after the frame has been bent. Glue or strong paste may be used as the fixative. If it is desired to make more than one of each lantern, then the cut-out pattern can be laid on a sheet of card and a pencil line drawn round, template-wise, to produce the second pattern. The gluing tabs should be ½in. wide, and cut at the ends to 45 degrees to make a neat glued joint at the angles.

It will be found that ordinary wire paper clips can be used to great advantage to hold the card in place until the glue has hardened.

The top to the lantern is shown in detail at Fig. 3. Cut four sides like this, ignoring the dotted strips, and paste paper down the angles as shown in Fig. 4. A stiffish paper is needed here. If desired, and if sufficient card can be got large enough, two of the sides can be cut together, which would save time in joining the two angles instead of the four. The dotted strips in this case will be used in fastening each pair of sides which will be angled up as previously

All correspondence should be addressed to The Editor, Hobbies Weekly, Dereham, Norfolk.



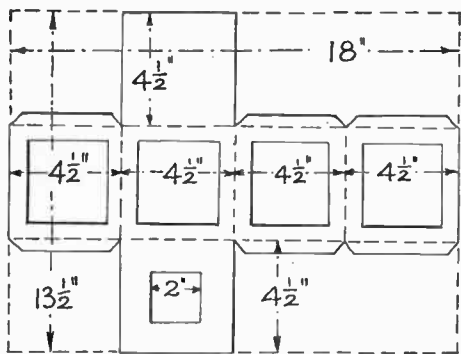

Fig. 2

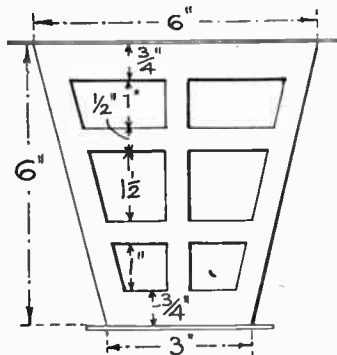

Fig. 6

mentioned for the side frames of the lantern.

At Fig. 5 we show how the lantern will look when built up and glued together, and with the shaped top attached. To hide the extreme plainness of the lantern, the sides may be covered all over with thin coloured paper, open parts as well, so that the light inside will be nicely diffused. The shaped and shaded pieces shown in Fig. 5 are of gold or silver gummed paper, or a stiffer paper of some contrasting colour may be quite satisfactory. The small circled diagram shows how these latter additions may be glued or pasted round the angle of the two sides.

For our second lantern, that shown at (B) in Fig. 1 we have adapted a rather different shape and one with more character in the cut-out openings in the sides. Looking at Fig. 6 we see the outline design of one of the sides, and all measurements are here again included to complete the draughting out on to a

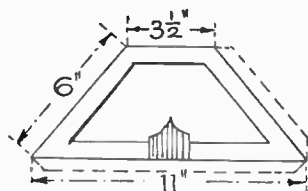

Fig. 3

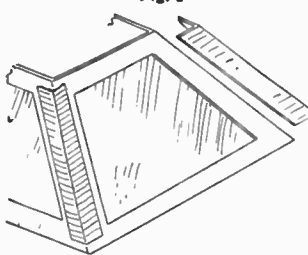

Fig. 4

piece of card measuring 6ins. square. Cut round the outline to get the exact shape, and also cut out the six openings, all cutting being done with knife or razor blade.

Having got the one side done as a template, lay it on a sheet of card measuring 15ins. by 14ins. in the position shown as (X) in Fig. 7. Go all round the outline, and the outline of each opening, with a pencil, then shift the template to one side so that two long sides meet, and repeat the process of marking round the outlines. Carry on the process until four distinct outlines result, just as seen in Fig. 7, only here the interior work is not shown. Gluing tabs may be included and drawn on, if desired, in a similar manner to our previous lantern for fixing the top and floor.

#### A Plain Square

The top of the lantern being flat is just a plain piece measuring 6 3/4ins. square, and this can be got from the waste card as shown in Fig. 7. Proceed to do all the cutting both of the complete outline and the interior openings of all four sides. Next, score lightly with knife or razor blade the lines dividing each panel, and then bend up carefully and glue each angle with strips to strengthen these parts where they have been cut partly through. Now cut the top square and also a 4in. square of card for the floor, see Fig. 6. These two pieces are attached by separate gluing strips glued to the faces of the lantern and along

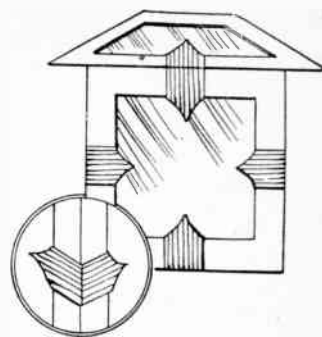

Fig. 5

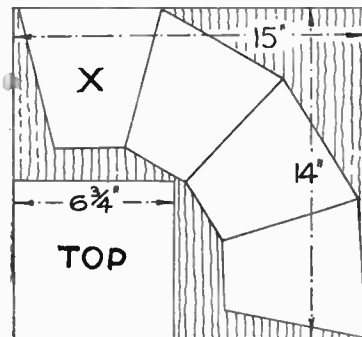

Fig. 7

underneath the top and on the upper surface of the floor piece. Some stiffening strips should also be added inside the lantern to the floor and top, as sufficient strength must be given here to take the weight of the lantern and the electric bulb when it is suspended.

Choose some gaily coloured paper for covering the sides of the lantern and the top and floor. A hole should be cut in the centre of the top of the lantern to receive a small bulb, while a hole must be made in the centre of the floor to facilitate handling the bulb. It would make for good effect if two sides of the lantern had one colour and two another—it all helps the finished gay effect.

#### Remember the Effects

When the lanterns are hung and safely suspended, do not forget to add the pom-poms and other decorative effects. Wire should be used to suspend the lanterns, and twisted paper or paper chains used for effectively hiding the wire. (165)



#### HEAD OFFICE AND FACTORY—DEREHAM, NORFOLK.

Branches at LONDON—78a New Oxford St., W.C.1 (Phone MUSEum 2975); 87 Old Broad Street, E.C.2 (London Wall 4375); 117 Walworth Road, S.E.17 (RODney 5509). GLASGOW—326 Argyle Street (Phone CENTral 5042). MANCHESTER—10 Piccadilly (Phone CENTral 1787). BIRMINGHAM—14 Bull Ring. SHEFFIELD—4 St. Paul's Parade (Phone 26071). LEEDS—10 Queen Victoria Street (Phone 28639). HULL—10 Paragon Square. SOUTHAMPTON—25 Bernard Street. BRISTOL—30 Narrow Wine Street (Phone 23744).

# Give a show at Christmas with this 'RING AND STRING' CONJURING

**T**HERE are very few men and boys who are not interested in conjuring tricks and who would like to perform before friends at social gatherings or to have a few pocket tricks to interest companions at odd moments. For these, the following selection—all from the repertoire of a professional entertainer—should be useful, as they can be done with very little preparation and at negligible cost. Yet the following warning cannot be given too often: practice these tricks, however simple they may seem, well in advance of public showing. Do not merely hastily read the instructions five minutes before you hope to astound your friends.

As the title of this article suggests, all these tricks are done with a ring and a string, mostly, and the first can be done anywhere with any piece of string and any ring.

## Thumbs Up!

A friend is asked to put 'thumbs up' vertically, and a loop of string (not too short) with a ring, is slipped over his thumbs as shown in Fig. 1. The problem is for the conjurer to remove the ring without taking the string off the friend's thumbs.

Here is how. Take the string at (X) in your left hand by crooking the tip of the first finger in it (Fig. 1 shows how the set-up appears to you) and (Y) in your right, the ring being well to the right. Draw (X) downwards over (Y) whilst moving (Y) upwards and leftwards, so that the loop that was (Y) can be slipped over the friend's thumb on your left (Fig. 2). Now move the ring to the left and, taking the string at (Z) (BEHIND, i.e. TO THE RIGHT OF THE RING), slip the loop that was (Z) over the friend's thumb on your left. There will be three turns of the string on your friend's thumb. Now take the ring in the right hand and release your left finger which has been holding the other loop down. A gentle pull and off comes the ring, leaving the string loop over the thumbs as before.

This, of course, is just a clever 'manipulation'. The next trick, however, is a bit of pukka conjuring.

## On a Shoe String

The magician exhibits what appears to be a ring threaded on a black boot lace. A cotton reel is then slipped over the lace as shown in Fig. 7. It would seem that the ring prevents the removal of the reel if the two free ends of the lace are held by a friend. Yet with a light tug, off

come the ring and reel, leaving the looped boot lace intact, and which can be thoroughly examined.

Here is the secret. First thread the lace fairly as at Fig. 5. Then tie a piece of black cotton lightly round at point (P) just above the ring. Now thread end (B) back through the ring, as in Fig. 6. If a black lace and black cotton have been used, it is very difficult, on casual showing, to detect what has really been

The performer gets someone to tie his wrists with string, somewhat as in Fig. 8 but without the ring. Provided the performer's wrists are not injured, the cord or string may be tied quite tightly. A slip of card can be slipped under the knots so that sealing wax can be used to seal the knots without burning the performer's wrists. Have red sealing wax for the right wrist and green for the left. (Actually this has nothing what-

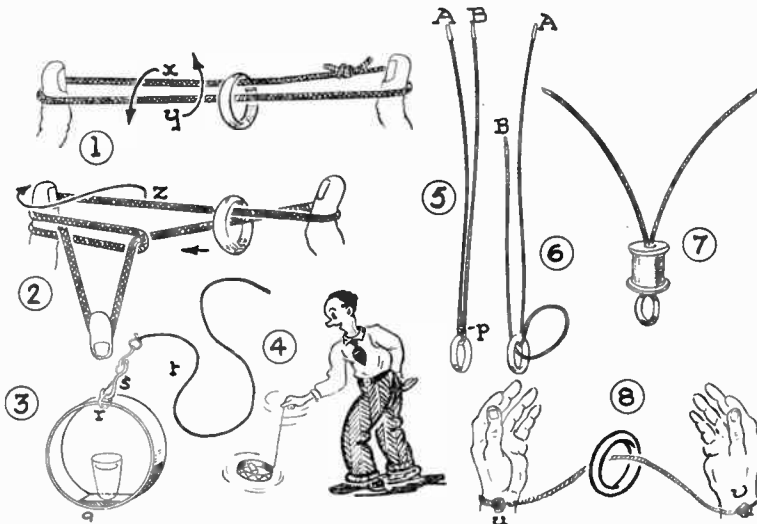

These drawings will assist the performer

done and the lace appears to be threaded fairly through the ring (the friend having, indeed, no reason to suspect otherwise). A slight tug on the ring breaks the cotton, and in holding up the lace for inspection, opportunity is taken of drawing the hands all it casually, as if to stretch it to its full length but in reality to remove any small strand of black cotton that might remain. Experiment is needed beforehand to ascertain just how tightly to tie the cotton.

Until you are quite sure that you can 'pull this off' (in more than one sense of the word!) the reel and ring can be covered with a large handkerchief.

As this trick cannot be repeated immediately (nor should any trick be repeated twice running), go on to another. Quite a good one may be entitled: *ON AND OFF*.

Admittedly this makes use, in part, of a rather well known trick, but that is where the catch comes in. Smart lads who know 'how it is done' may easily be baffled by the new twist now given it.

ever to do with the mechanics of the trick, but it plays an extremely psychologically important part in hoodwinking the audience). In view of what finally happens, all this 'bunkum' with the two different sealing waxes usually prevents anyone thinking of identifying the seals by impressing with a signet ring, etc.

## Quite Impossible

The performer defies anyone to slip the bonds off his wrists. This is quite impossible unless the performer has very unusual hands. Make sure this point is understood by the audience.

A plastic bangle is now shown and can be examined. Yet, after a quick turning of his back, the performer shows that the bangle is now on the string, as in Fig. 8. The secret is simple. The performer has a duplicate bangle already on the wrist, up his sleeve, out of sight. As soon as his back is turned, he puts the original bangle in a breast pocket and lets the other bangle slip down.

(Continued foot of page 164)

# Hydrogen and coal gas used for INFLATING SMALL BALLOONS

LETting go small hydrogen and coal gas balloons and seeing how many of the labels attached to them are returned is amusing—as long as one does not mind never seeing again at least four out of every five of the labels. The balloons please children—especially at parties, and, provided they are kept away from flames, they are quite harmless.

## Two Methods

The two methods of balloon inflation described in this article have both been used frequently and are both reliable with reasonable care.

Fig. 1 shows the method of filling a balloon with hydrogen gas. The generator bottle which contains  $\frac{1}{2}$  lb. of cut up zinc can be any narrow-necked bottle which will take the rubber bung shown. Some 1pt. sized detergent bottles are ideal. The long glass tube and single-holed rubber bung can be ordered for you through any friendly chemist. The glass tubing will only go safely through the rubber bung when wet. The tubing should be heated in the gas, being twisted all the time until it is plastic, and then bent as shown. These bends trap acid spray. The upper end of the tubing can be rendered free of sharp edges by a period of gentle heating.

## Gas-Tight Joint

Grease the top inch of the rod, and with thin twine tie the balloon neck over the greased portion. It is essential that this joint is absolutely gas-tight.

Pour from a kitchen measure  $\frac{1}{2}$  pt. of water into the 1pt. sized generating bottle. Now, with great care to avoid spilling or splashing, add a  $\frac{1}{4}$  pt. of strong spirit of salt.

It must be emphasised that this

chemical, which must be kept in glass, is highly dangerous if splashed in the eyes. Splashes washed off the skin immediately are quite harmless. Goggles or glasses are a good precaution for inexperienced people handling acid.

Only spirit of salt (hydrochloric acid) should be used. Sulphuric acid will generate the hydrogen, but the heat also liberated may crack the bottle. The other common acid, nitric acid, is quite unsuitable.

As soon as the acid has been added, insert the rubber bung and keep finger pressure on it, or the gas will leak. You will see that acid spray which would weigh down and corrode the balloon is trapped by contact with



Fig. 1

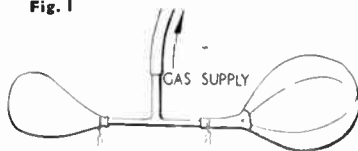

Fig. 2

the glass in the bends of the tubing. This is the only reason long tubing is employed. Within ten minutes the balloon should be sufficiently inflated. Balloons to be released in the open rise rapidly and burst if overfull.

Grip the balloon firmly over the twine and slide it off the tube. There will be a hiss of escaping gas from the generator bottle. The bung can now be taken off and the acid emptied away, and the bottle

swilled with plenty of water. This will save the zinc from being eaten away unnecessarily by the acid. Use thin twine to tie the balloon again, and cut your small label from thin cartridge paper. Replies are very erratic. Try a day with a good wind and remember rain weighs the balloons down.

## Second Way

The second method shown in Fig. 2 is simple and less dangerous. The essential apparatus is a 'T' shaped tube capable of joining in a gas-tight manner with gas copper tubing, a football bladder, and the balloon to be inflated.

When the gas is turned on, it will be seen that while the football bladder rapidly inflates, the balloon remains scarcely larger than a crab apple. Lack of pressure makes unaided house-gas normally useless for balloon filling. With this simple apparatus and two operators balloons can be rapidly filled.

Pinch the supply tube, press on the bladder, forcing the gas into the balloon. Pinch the neck of the balloon. Release the supply of gas again, and allow the football bladder to reinflate. Stop the gas, force more from the bladder into the balloon, and repeat as often as necessary. Balloons 18 ins. in diameter can be blown up in a minute or two.

The 'T' piece can be conveniently made out of 1ft. length of  $\frac{1}{4}$  in. copper tube. Saw off 4 ins. File with a rat-tailed file at the centre of the larger piece of tube, and round the end of the shorter piece, as shown in the third diagram. Solder the two parts of the T piece together.

Do not smoke, and on no account fill the balloons near a fire or any naked flame, and the process is safe and amusing. (134)

## 'Ring and String' Conjuring—(Continued from page 163)

But that is only a beginning. Showing that the knots are intact and sealed, the performer goes behind a screen or into a corner and in a very short space of time emerges with the string off his wrists, the loops remaining knotted and sealed as before. Here again the secret is absurdly easy. The performer, when out of sight, merely cuts the loops with a pair of scissors he has in a pocket. He conceals the cut string and pulls out a duplicate string, looped and knotted and sealed!

Lastly, an effect you can do as well on a public stage as in a small room, and which forms a useful interlude in any conjuring or juggling show.

A flat stiff ring, about 18-24 ins. diameter and about 3 ins. deep of metal,

thick card, plastic, etc., is made (Fig. 3). There is a small platform *q* of wood and a ring *r* to which a dog lead swivel *s*, or something similar, is attached. A yard or so of strong thin cord *t* is attached. Fig. 4 shows how, by moving one hand in small circles, the ring may be spun horizontally to the ground.

When you have practised this (no real skill required: just a very simple knack) stand a squat heavy tumbler on the platform and spin as before. Though it looks amazing, it is actually centrifugal force which keeps the tumbler in place. (The Rotor, of fun-fair fame works on the same principle). The glass can now be filled with coloured water and spun round horizontally without spilling a drop, which seems to require unusual

skill. The only real skill needed is in showmanship to convince the audience that it is real skill!

Practice this on a garden lawn and, at first, with a tin can, etc., instead of a glass tumbler. The attachment at *r* must be very strong, particularly if you wish, by way of variety, to stand the glass of water on its platform and after a few pendulum-like motions, whirl the apparatus at full arm's length round vertically. There is no skill whatever in this, but since, in the event of anything 'giving' there is likely to be a bad accident with a glass of water flying through the air, it is best to keep to the demonstration as shown in Fig. 4, which is perfectly safe and extremely effective. (160)



# Making a well-designed TABLE LAMP

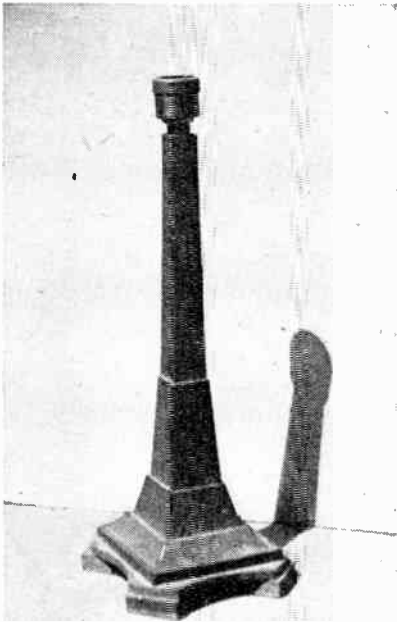

**T**HE electric table lamp standard which forms the subject of this present article is no gimcrack 'novelty' but an honest-to-goodness project: work on which the craftsman can lavish care, as it is well proportioned and designed and offers plenty of opportunities for careful setting out and craftsmanship.

Oak is about the best possible wood for this model. Plain deal is hardly suitable, both as regards appearance and working qualities.

The photograph shows the appearance of the finished model (less, of course, the shade), whilst Fig. 1 shows the general assembly. The part 11 $\frac{5}{8}$  ins. long, marked (A) in Fig. 1, is cut from one solid piece. The first shaping of this piece is shown in Fig. 5. Part (B) (of Fig. 1) is just a 4 in. square of  $\frac{3}{8}$  in. wood. Part (C) (of Fig. 1) is further detailed in Fig. 4, and consists of a curved cross-shaped piece of  $\frac{1}{4}$  in. wood (not ply). Lastly, part (D) (of Fig. 1) consists of the parts shown in Fig. 3 these parts forming an X-shaped foot.

All the parts are screwed together, and throughout the column runs a hole to take the flex. Making this hole is the only tricky part of the job. One could start off with a block of wood 3 $\frac{1}{2}$  ins. square and 11 $\frac{5}{8}$  ins. long, as in Fig. 5, and merely bore a hole right through, working from both ends. This is perfectly pos-

sible, and advanced workers with a good kit of tools will probably prefer this direct method. It is difficult, however, to prevent the drill from 'wandering' off the centre, so it may prove better to build up the column from four pieces of wood, 1 $\frac{1}{2}$  ins. square, with an inner corner bevelled off as shown in Fig. 6, and glue them all together. If well done, it is very difficult to detect the joins in the finished article, provided the four smaller pieces come from the same plank with no marked differences of tone.

Assuming, then, that we have either a solid or a built-up column, we can proceed to shape it up as shown in Fig. 5. The parts are square. Naturally, care is needed in the setting out and the cutting, and really sharp broad chisels are needed. Take care to get all the shoulders square and sharp. Having reached the stage shown in Fig. 5, proceed to the stage shown in Fig. 1. Take care not to damage the sharp edges of the bevelled base.

(By the way, to save wood, it is possible to make the bevelled sub-base—the 3 $\frac{1}{2}$  in. square by  $\frac{1}{2}$  in. thick, piece—as a separate unit).

Fig. 4 shows how to set out part (C). On a sheet of paper or thin card, set out centre lines *a* and *b* at right angles to each other. Draw a circle, *j*, 4 $\frac{1}{2}$  ins. radius. From points *c*, *d*, *e*, *f*, draw part circles, *g*, etc., at 2 $\frac{1}{2}$  ins. radius. From the main centre draw a circle, *h*, at 3 ins. radius. This will give the shape (shown shaded) required, cut from  $\frac{3}{8}$  in. wood.

The X-shaped foot (part D) is made up of parts shown in Fig. 3. First make two parts exactly alike, as shown by the lower of the two sketches and then, from one, cut a 1 $\frac{1}{2}$  ins. wide gap. The assembly is shown in Fig. 2, screws and glue being used to hold the parts.

The lamp holder is of a special type as shown in Fig. 7. It is as well to secure

this *in advance* so as to make sure that it is obtainable and that you have made the central hole of suitable diameter—to take the metal tube in a good fit. Shades can be bought ready made, but most readers will probably content themselves with buying just the wire frame part and making the rest themselves. There are several booklets on sale at the handicraft shops on this subject. (173)

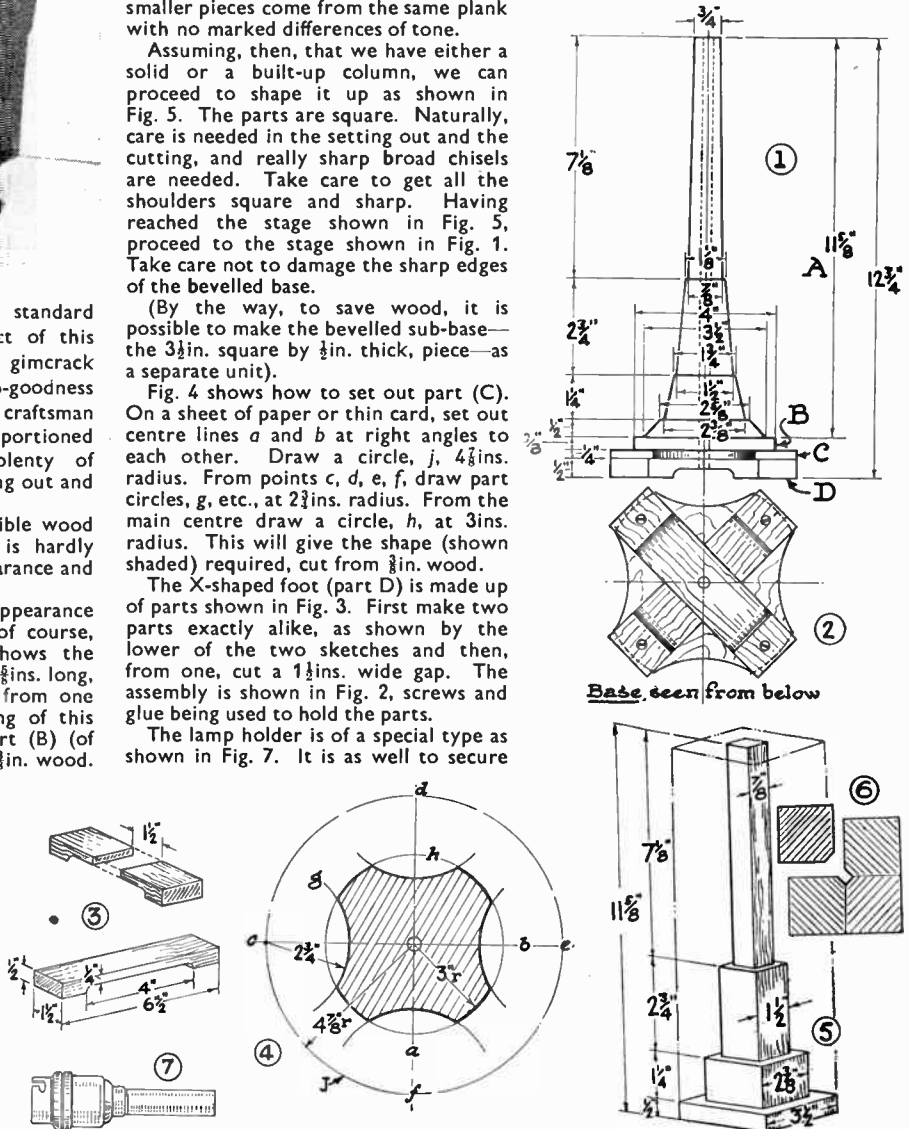

All the necessary constructional details are given in these drawings

# Useful methods of COLOURING LAMP BULBS

**C**HRISTMAS is the season when the question invariably arises as to how electric bulbs can be coloured. Tinted lights do definitely help decorations schemes and give an artistic and seasonable appearance entirely their own. Thus, quite apart from Christmas tree illuminations it is good to have coloured lights in the hall, on landings and in other suitable places.

As coloured bulbs are not used much during the year (except by photographers) it is better to have these with

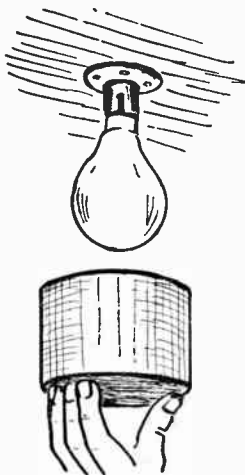

Dealing with a bulb in a fixed holder

a not too permanent covering so that when the festive season is over they can be cleaned up and put back for domestic use.

Ordinary oil paints, no matter how bright in appearance, are quite useless for colouring clear glass electric lamps, as these pigments are not transparent. For bulb-colouring the paints must retain their hues when a light shows through them. The standard paints just look black.

## Lamp Lacquer

An easy way to put on colour is with 'electric lamp lacquer'. A half pint of this, which is a shellac preparation to which an aniline or other dye has been added, will do quite a large number of bulbs. The shade of the colour, too, can be easily altered if desired by the putting in of more dye, while with the primary colours an entirely different colour can be obtained by introducing the necessary complement. Thus, if the

lacquer is yellow, a green can be obtained by adding an amount of blue dye and this blending is the best way of producing say a chain of lights each with a different colour. When mixing tints yourself avoid getting the final shade too dark. Colour takes off quite a lot of light and on the whole it is better to keep the tint fairly light, which gives a general effect of brightness.

## Clean the Bulbs First

The bulbs to be treated must first be well cleaned with methylated spirits to remove all grease and then be polished with a clean piece of rag.

Pour the lacquer into a receptacle that will take the whole bulb, remembering that as it is lowered in, any liquid in the container will rise up the sides. Consequently there must be plenty of room for this to happen without the mixture pouring out over the top. Indeed, it is best to make a few experiments with water to find out just how much liquid is necessary to come up to the top of the glass when a bulb is inserted, the water then being poured away and the same amount of lacquer put in.

Now plug the bulb to be treated into some suitable holder that will allow of its being dipped in the lacquer while



Quick way of colouring small battery-run bulbs

alight (for the colouring is done with the lamp burning). This can be effected by using a loose flex or some holder from which the lamp hangs straight down and which has no interfering shade.

## Before it's too Hot

After the lamp has been switched on it must at once be put into the lacquer before it gets too hot. When a fixed holder is being used and the container, holding the shellac, is brought up under the bulb and raised steadily but fairly quickly till the glass is completely covered, this being important, as we do not want a ring of 'no colour' round the top.

The immersion need not be prolonged, and once the bulb is completely covered the container is lowered and held beneath for a moment to catch any drops

that may come down after it. Drying takes place very quickly, however, on account of the heat generated by the bulb.

When it is desired to return the lamps once more to clear glass after the festivities, all that is necessary is to plunge them into methylated spirits for a few moments and wipe off the lacquer (which becomes softened) with a wad of rag.

Another solution that gives a transparent colour to glass is amyacetate, into which a dye of one sort or another has been put. The various coloured inks on the market will do quite well to give the tints. With this method the bulbs can be immersed cold, but the dipping again is but a matter of seconds as the acetate grips the glass at once.

## A Good Base

Canada Balsam, too, can be used as a base to make colours adhere to glass. This ingredient is heat proof. Indeed, the more heat to which it is subjected the harder it becomes. The balsam can be painted on first, the bulb then being given a coat of transparent oil paint (this being bought at any artists' colour-man's as transparent pigment) or the colour can be mixed with the base and the two applied together. Canada Balsam does not lend itself so well to the covering of the bulbs by 'dipping' the painting on of the solution seeming necessary to get a good coat. However, the method has its advantages, and Canada Balsam can be obtained at most chemists.

## Temporary Measure

As a temporary measure for very small bulbs, the handiness of the various coloured cellophanes that are now on the market should not be overlooked. These are a comparatively recent addition to our range of wrapping and fancy papers but they have almost replaced the older tissue papers and they have the advantage of retaining their colour when viewed by transmitted light. That is, a red cellophane will send out a bright red light when looked at with a lamp behind. Ordinary tissue paper, no matter how brightly coloured, just looks mottled grey.

Cellophane wrapped round a bulb, therefore, gives to the bulb its colour, and this method of colouring can be quite well used for small low-powered lamps. Thus for colouring a Christmas tree chain of 3.5 watt units the method is ideal. (181)

# For the experimenter — MORE FUN WITH LIGHT

**A** SERIOUS student of this subject soon finds need of a Ray Box, and even the casual experimenter will discover that thirty minutes' work is amply repaid by results.

A Ray Box is a source of light suitably enclosed so as to give a parallel beam. A purchased instrument includes lens to keep the beam from diverging, but the model shown is quite efficient without this refinement.

The source is an eight volt bulb working at .3 amps. and driven by a grid bias battery. The two vertical sides and front are made from ply, the top from card and the rear from a piece of  $\frac{1}{4}$  in. wood. Bulb holders are easily obtainable and the overall length depends upon the length of the bulb when screwed in its holder. Two holes are drilled through the thicker end for the flex. Provided the four sides making the base are true, there is no need to fit a sixth side, in fact it is useful to lift the instrument to give more light when handling mirrors in a darkened room.

The beam from the instrument will diverge slightly so two more pieces of card are required. One of these should have a single vertical slit ( $\frac{1}{8}$  in.) and the other, four or five slits parallel. By standing one of these cards in the path of the ray a reasonably straight beam can be obtained.

The box should be laid on a flat surface on a sheet of white paper. This enables the ray to be seen. A mirror set in the path of the ray soon demonstrates reflection and by changing the single slit for the multiple one an ingenious pattern is formed. Place another mirror at an angle to the first for some remarkable results!

## Refraction

If you are fortunate enough to possess a glass block then refraction of light can be directly observed. The beam, striking the block at an angle, is bent and emerges parallel to its original course. Pass the beam across the corner of the block and notice the double bending.

The path of light through a periscope (see last article) can also be demonstrated with a Ray Box. Suitably raised so that the beam enters one opening, light can be seen emerging from the opposite end.

You have probably observed how the amount of light from different sources varies. An electric bulb working from the mains gives more light than, say, a candle or a match. It is possible to measure the amount of light given out and the

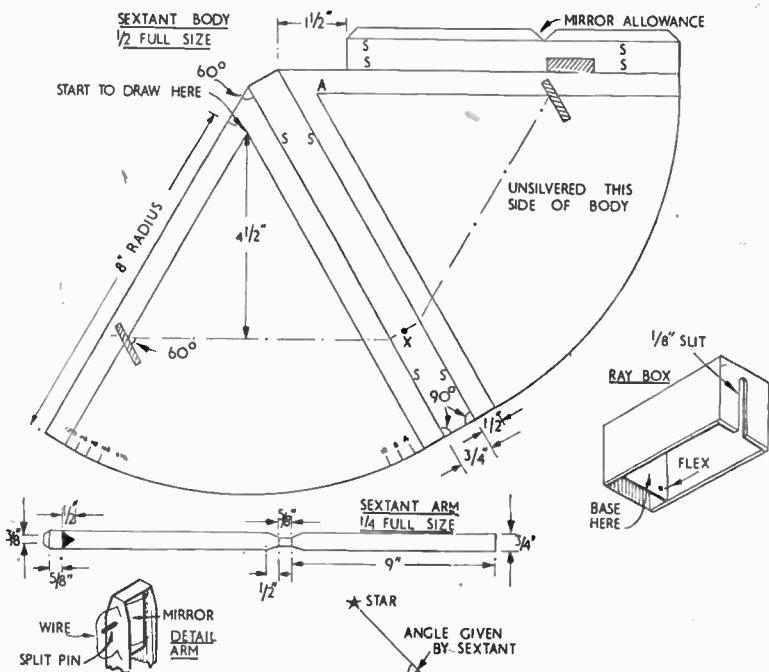

Details for making the instruments described in this article

instrument which does it is called a Photometer.

In such a way as the unit of length is the foot, so the unit of light is the candle power. This is the light given off by a special candle—spermiceti, six to the pound weight and burning 120 grains per hour. Nowadays scientists use a far more accurate method, being the light from freezing platinum (1755°C.). This gives 60 candle power for every square centimetre of surface.

But let us be content to compare various sources of light. To make a photometer, all that is needed is a piece of fairly opaque paper about 10ins. square. Onto the centre of this drop a few spots of hot candle grease and smear (carefully!) into a small circle.

When the grease has set hold the paper up to the light. Notice how light passes easily through the spot and not through the paper. This is our photometer.

Supposing we wish to discover how many ordinary candles give the same light as a torch. Set the paper vertically on a flat surface and place the torch about 18ins. away, pointing at the grease spot. Darken the room and 18ins. from the other side of the paper set up the candles.

Light from the torch will come through

the grease spot making it bright. Light from the candles will shine on the paper, making it bright. Add candles until both spot and paper are equally bright. That number of candles is equal in light to the torch.

Notice, by the way, that when the torch shines alone on the grease spot, the spot on that side appears dark. This is because the light is going through the spot and does not illuminate it.

## Making a Sextant

Finally, the construction of another optical instrument—the Sextant. This is used to find the position of a ship at sea, but it can also be used to find the angle of elevation of a church spire or some other building. The sailor sights at the sun or star which he knows will be in a certain position at a certain time. The angle he finds enables him to state the position of the ship.

Use fairly stout card for the model. Copy the diagrams onto it. If your compass will not extend 8 ins., a piece of card fixed at one end with a drawing pin and marked to length can be a guide for your pencil. Take care with both measuring

(Continued foot of page 168)



# For the bedridden — a LOW-BUILT TEA TROLLEY

THE trolley described was made for a bedridden person, and designed of dimensions to bring the top shelf practically level with the bed, convenient for a person sitting up. The timber for the legs and rails was agba, but obéchi (which seems fairly plentiful at present) would do as well. Oak, if it were available, would be the timber of choice.

Agba squares, finished to a fraction over  $1\frac{1}{2}$  ins. square in section and 4ft. long, were purchased from one of 'Hobbies' advertisers, who also supplied some 6mm. plywood in panels 29ins. by

giving two rails 4ft. long and a feather of waste. The cutting was done on a small power saw bench, but would present no difficulty in hand sawing. A rebate was worked on the lower edge of all rails, to take in the 6mm. plywood tray bottom, and leaving  $\frac{3}{8}$  in. full depth of rail at the outside. Simple mortise and tenon joints were used, with a  $\frac{3}{8}$  in. shoulder at the lower edge of the rail, finishing a little above the rebate level. The tenons were  $\frac{1}{8}$  in. thick, though, strictly according to rule, the thickness should have been no more than  $\frac{1}{2}$  in. But a  $\frac{1}{8}$  in. chisel is so much handier that the larger size was used.

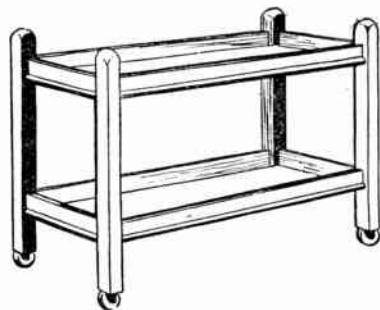

were fixed. The latter were glued here and there, and pinned down with  $\frac{3}{8}$  in. pins while the job was in cramps. Next the bead strips were glued and pinned on.

## The Castors

The castors used were of the type in which a steel spring shell is first inserted into a  $\frac{3}{8}$  in. hole bored up the leg. Into this shell the stem of the castor was inserted, and driven down with a punch to pass the spring neck of the shell, so holding it firmly in place. This is probably the easiest castor to fix; and when properly used is very satisfactory.

## Finishing

The trolley was stained with a solution of Vandyke crystals in water, the lighter (plywood) parts being coloured down first as near as possible to the agba. A very dilute stain was then rubbed over the agba parts. Two coats of clear hard varnish were given, this finish being more durable for such a piece of furniture than french polish. (140)

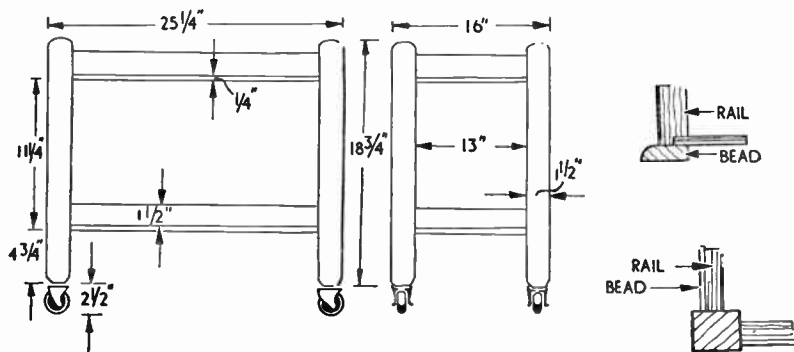

Drawings giving necessary dimensions and constructional details

16ins. The agba lengths were ripped down to furnish legs  $1\frac{1}{2}$  ins. square, leaving pieces which were used for the bead strips after moulding with a  $\frac{3}{8}$  in. 'hollow' plane. Practically none of the timber was wasted.

The rails were  $1\frac{1}{2}$  ins. by  $\frac{3}{8}$  in., and were ripped from one of the agba squares,

The job was assembled the narrow way first, as usual, glued up and cramped. Next day the long rails were put in, and the tray bottoms fixed at the same time, on account of their usefulness in getting the job square. A pair of bar cramps were put on and the frame pulled up to the rails before the ply bottoms

## More Fun with Light—(Continued from page 167)

and cutting out for the accuracy of the instrument depends upon it.

The lines (S) should be scored for bending and the shaded parts cut out. When folded the main body should form a triangle with a curved base. Notice particularly that the 60 degrees have been marked up to 120 degrees. The reason for this will be given presently.

Two mirrors are needed. The first slots into the main body and measures 1 in. by  $1\frac{1}{2}$  ins. Divide the  $1\frac{1}{2}$  in. length in half with a pencil line and scrape all the silvering from one side of this line. This gives a half silvered mirror.

The other mirror fits in the folded arm. It measures 1 in. by  $\frac{1}{2}$  in. and is held in place by wire as shown. A small strip of paper can be glued across to hold it

firmly. Before fixing this mirror insert two paper fasteners of the split pin variety to act as hinges.

Fix the arm into the main body by easing the pins into the holes marked ('A'). The mirror should face the cut-away portion. Glue the body and hold with elastic bands until dry.

With the arm at zero degrees and looking through the small hole (X), two pictures can be seen. One straight through the unsilvered part of the mirror the other a reflection from two mirrors. Pointed towards the horizon two horizons should be seen side by side. It is unlikely that the instrument will be so accurate as to have these dead level but they should be reasonably so. Now,

keeping the horizon in straight view, move the arm until the instrument shows you a star (or a church spire, etc.). A glance at the scale will then reveal the angle this makes with the earth and a diagram can be drawn. The horizon, incidentally, can very well be a window level with your eye when measuring buildings.

Regarding the 120 degree scale. A mirror and your Ray Box will soon make this clear.

Set your mirror on a pencil line and mark the reflected ray. Now turn the mirror slightly about its centre. For every 1 degree the mirror moves, the ray moves 2. Hence a fact which makes our Sextant doubly sensitive. (141)

# The art of modelling A SHIP IN A BOTTLE

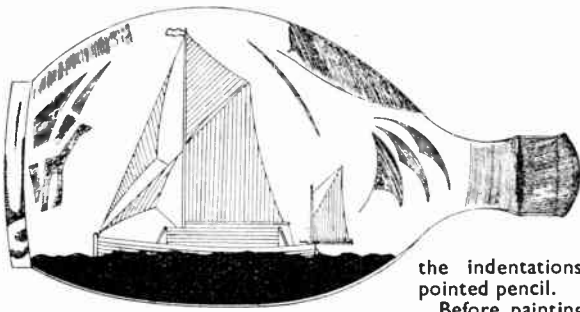

**N**O doubt, like the majority of us, you have frequently tried to puzzle out how the ship gets into the bottle. Really it is quite simple, and if you care to work along with me on the attractive little model depicted in the accompanying illustrations, the mystery will be solved for you, too.

Most schoolboys—if they do not carry these things in their pockets—have access to a sharp penknife, a sheet of fine sandpaper, a suitable bottle, plasticine, a few scraps of wood, used match-sticks, a remnant of linen, reel of thread, card of fuse wire, tube of liquid glue, and two or three tubes of artists' colours, which are all that are necessary to pursue this fascinating hobby.

## Make the Sea First

It is not sufficient just to hack away merrily at a piece of wood in the vain hope that it will eventually assume the correct shape. Nor is there anything half so discouraging as to discover that you have left insufficient room within the bottle to step the masts. So the first thing to do is to put the 'sea' in first. Pack the plasticine in a little at a time on the end of a curved stick, and ram it well into the corners before finally moulding the surface to represent the kind of seascape you prefer. Breaking waves can be reproduced most realistically by tipping the crests with Chinese white.

Now draw carefully the profile of your intended model to just below the waterline on the two sides of a piece of wood—yellow pine for preference, but almost any clean grained wood will do—and the deck plan on the top surface. Carve the hull to shape and bore the requisite number of holes right through for the masts. Smaller ones at the stem and on either side of the masts will also be required to take the bowsprit and standing rigging, if any. Hollow out shallow slots on the underside of the hull opposite all these holes.

The latter ensure that the threads run more easily when drawn through the hull. Where required, deck structures are best represented with fragments of an old cigar box, while the deck planking may be reproduced with

the indentations of a sharp, chisel-pointed pencil.

Before painting, first ensure that the hull is as finely finished as you can make it. Any attempt to camouflage shoddy woodwork with a coat of paint will be all too obvious to the practised eye. When it is quite dry, complete the finishing touch with a coat of varnish.

Several pieces of straight grained pine are now required for the masts. Match-sticks will suffice for the bowsprit and crossrees of square-riggers and the booms and gaffs of fore-and-afters. Fine

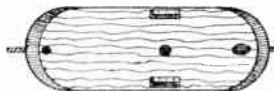

Plan of a finished hull

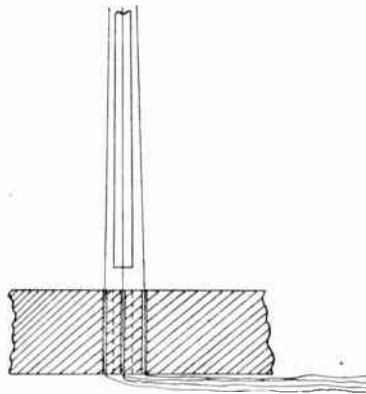

HOLE THROUGH HULL FOR MAST SHOWN DOTTED.

Showing how the rigging runs through the hull

down all the spars to proportion, otherwise the general effect will be spoiled. Apply a coat of varnish to the natural wood.

Split the heel of each of the masts and glue in separate pieces of thread. Mark and cut the sails out of a piece of linen. Remember, fore-and-afters have the bolt ropes sewn in position on the port side of the sails only. Bellying sails are most effectively reproduced by dyeing and starching the cloth or by the addition of a coat of thin oil paint, followed by a coat of varnish.

Before attempting to insert the model

in the bottle, step the masts—having first passed the threads attached to the bottom of each through the holes in the hull—and secure the standing rigging and spars to the masts. The latter can be satisfactorily hinged by pinning to the masts with fuse wire. Pass the opposite ends of the rigging through the holes provided in the hull—a groove at the end of the bowsprit, and another at the forefoot, carries the forestay aft. To avoid unnecessary confusion later, colour the threads on the port hand red and those to starboard green. Number the threads from stem to stern by tying the appropriate number of knots in each. Bend on the sails.

## Inserting the Ship

Having adjusted all the parts to produce the maximum effect, lay the masts, etc., pointing aft along the deck ready for stepping inside the bottle. Retain the ends of the threads through the neck of the bottle and settle the model firmly in the plasticine. Then hold a

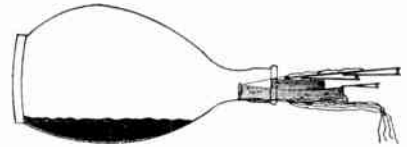

Placing the completed craft in position

piece of shaped wood against the stern to prevent it from shifting and haul on the threads controlling the masts. When they are standing proudly, haul on the threads leading to the rigging to port and starboard in turn, ensuring that all is taut and shipshape before snipping off the surplus and sinking the ends beneath the waves. Set the spars at the correct angle with the aid of a knitting needle, and secure the ends of the various sheets comprising the running rigging on deck with a spot of glue. Belly the sails to your own satisfaction, and see that all pennants, etc., stream on the wind forrard. It is only on powered ships, steaming into the wind, that they stream aft.

When all is snug within, clean the neck of the bottle and, if you feel so inclined, print details of the ship's history on a piece of paper. Varnish the paper, wrap it round the stopper and cork the bottle.

(Continued foot of page 170)

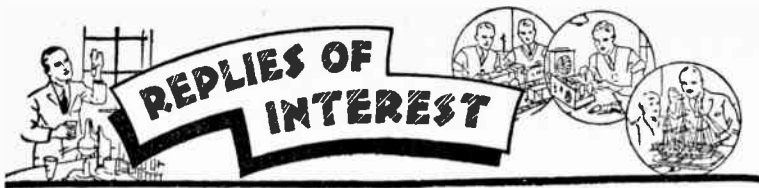

### Stain Before Stopping

**I** HAVE recently built a cabinet from light oak and had to use a little plastic wood. I now wish to polish in the following manner. Stain with permanganate of potash (three teaspoons in one jam jar of water) then coat with shellac, sandpaper, then again shellac, sandpaper and then polish with white polish. I have experimented and found that the medium dark colour of the polishing does not hide the plastic wood which appears quite light below the polish. Can you advise me if it is possible to treat the plastic wood before staining and polishing, to avoid this difference of colours? (N.F.—Sevenoaks).

**T**HE safest practice is to stain before stopping the holes, then to colour the stopping to match. We suggest you employ coloured plastic wood, oak or mahogany, as stain does not penetrate the plastic wood well. This can be obtained from most stores, and you could use a separate stain then to match the plastic wood, instead of vice versa. If you particularly wish to use the permanganate stain, then apply this to the wood, then colour a stopping of putty and white lead with dry colouring matter to match the tint.

### Transfers

**I** HAVE been trying to make transfers such as used on metal work, bicycles, etc. During various experiments I have come to the conclusion that the paper on which the design is painted wrong way round, must be non-absorbent. To prevent this I have coated the paper with shellac and used methylated spirit for removing the paper after the design has been put in place with gold size. This method has brought limited success, but I should like to know if I am experimenting along the right lines. (J.R.B.—Peterhead).

**I**T is very difficult to assess the reasons for your partial success with transfers, without knowing all the details. Fundamentally, the transfer ink can be made with materials that are not soluble in water, but will soften upon the application of gentle heat, such inks being largely bonded with varnish or shellac or

resin. These transfers are printed on slightly greased paper, are laid with heat and removed by wetting the paper. Possibly you could apply your design colours to a greased paper; only slightly greased, of course. Still another method is to use soluble paper for your base and simply wash it away.

### Improving a Model Destroyer

**S**INCE painting the hull of a model destroyer, I have decided to represent the out strokes of the plating of the hull, by sticking on thin strips of paper (cartridge or detail paper). The whole will be given further coats of paint, the final coat being cellulose or enamel finish. Is it possible for you to suggest a waterproof adhesive which will stick paper to paint? (L.B.—Derby).

**Y**OU can readily attain the desired result by sticking on the strips of paper with either (a) ordinary paint such as you have already applied to the model boat hull, (b) by using shellac varnish or french polish, coating both the hull and the paper with either of these materials, or (c) you can use cellulose finish for the purpose, especially if you intend using this material for the finish coats. In all cases the paper should be coated with paint on the side to be applied to the hull and after the paper has been pressed firmly into contact, apply a coat of paint (not too thickly) to the exposed side of the paper.

### Correct Soldering

**I** HAVE a Primus stove which caught fire, with the result that all the soldered joints have become loosened. I have used solder but failed to seal it properly. It may be that I am not doing the job correctly as I have never used solder before. I would be glad if you could give me some advice. (E.G.—Galway).

**T**O ensure a good soldered joint proceed as follows. Remove the old solder and clean the joint with file and emery cloth. Heat the soldering iron until a green flame rises and see the tip is

properly tinned. If not, file the tip, dip into the flux and then rub it over with solder until it is completely coated. Do not let the flame play on the tip, but only on the body of the iron. Fix the broken parts to be soldered together if possible—a binding of iron wire may do this, or else hold securely in close contact. Melt a little solder in a tin lid, or hold the heated iron on the solder, when a blob of the latter will adhere to it, and apply to the joint, rubbing it along until the solder runs. The flux should, of course, be applied to the joint beforehand. The solder should then run into the joint freely. The metal must be warm or the solder will not adhere, but the heated iron will warm the metal enough for that. The main points to observe are to get a clean joint beforehand and not to over-heat the iron.

### Precautions Against Warping

**I** AM considering building the framework of a fairly large article in the near future. However, I do not wish to assemble this framework for some considerable time. The joints being cut accurately, I should be interested to know whether it is your opinion that they will lose their accuracy and fit over a long period through not being assembled. (D.M.—Bexley).

**T**O leave such framework apart for a long period is a risky business, unless precautions are taken. The period may not affect the close fitting of the actual joints, but the parts themselves may well twist, especially if the wood is none too well seasoned, and present a troublesome problem when assembling. The best action to take is to lay the lengths side by side, and clamp them up together, all the lot, letting them rest in a dry room. At intervals loosen the cramps and give the wood pieces a quarter turn before cramping up again. This should ensure, as far as possible, the parts not warping, nor twisting, unless the period is unduly lengthened.

### Liming Oak

**H**AVING completed the construction of an oak firescreen, I should like to lime it. Can you give me instructions? (E.R.B.—London, N.4).

**A**SPECIAL preparation called limed-oak filler is now universally used to gain this effect. It is quite simple to apply, being in the form of a paste, and is worked over the article after it has been stained and part finished.

### A Ship in a Bottle—(Continued from page 169)

Your monogram stamped in sealing wax puts the finishing touch to this operation.

Never on any account include such extraneous details as distant coastlines,

rocky eminences and lighthouses. For surely, the whole purpose of bottling a ship in this fashion is to create the illusion of boundless sea and sky. And a ship at sea is the essence of loneliness.

Set on a suitable stand, this little world of your own creation will be a source of joy and inspiration to you— for ever revealing fresh angles of beauty to your appreciative eye. (187)





# The SHIPMODELLER'S Corner



**I**N making our ship models, we frequently require small mouldings. In some cases we require to groove small strips of wood. As an example, on my present model the main wale is half-round, with a groove running down the centre. As it is only  $\frac{1}{16}$  in. in measurement, a way had to be found to groove a strip of this size down the exact centre, and this was accomplished by use of a home-made grooving tool.

So, first, I am going to describe three home-made tools for making

## More Home-made Tools for the Shipmodeller

By 'Whipstaff'

adjusted to cut the depth desired, and the nuts tightened. It is now used in the

same manner as a beading plane, a piece of wood padding being placed between the hacksaw blade and the block sufficiently thick to bring the cutter the required distance in from the edge of the work.

We many times in our modelling have to place small parts in position in places that appear to be inaccessible, especially those of us who delight to mystify our friends by building up a scenic model of a ship in a bottle or other container. For example, we

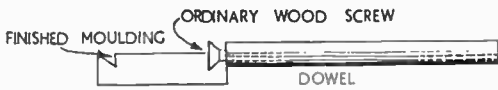

①

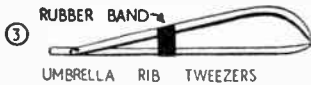

③

beadings and mouldings. They can be used for many other model maker's problems where mouldings are required.

The first is a very simple tool, where the mouldings are of reasonably large size. It consists simply of an ordinary wood screw, of suitable size for the moulding required, screwed into a dowel handle and used by drawing along the edge of a panel of wood, the screw cuts a channel in the same way as a carpenter's cutting gauge as shown in Fig. 1. After cutting the groove, smooth it with a folded piece of glass-paper, cut off the strip from the edge of the panel with your fretsaw and glasspaper to the finished shape as in Fig. 1.

Another more permanent grooving tool is made by making the cutter of a piece of old hacksaw blade, fitted to a block with a metal adjustable depth gauge.

First, as in Fig. 2, take a block of wood 4ins. by 2ins. by 1in., on the centre line of the 4ins. by 2ins. face drill two holes 2ins. apart to take the nut and bolt assembly. Cut a 4in. piece of angle iron, or make from a flat piece of metal, the guide shown in the sketch. Drill two holes in the one face, again 2ins. apart, and cut a slot down to these with your hacksaw.

The piece of hacksaw is now held between the guide and the block,

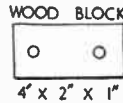

4" x 2" x 1"

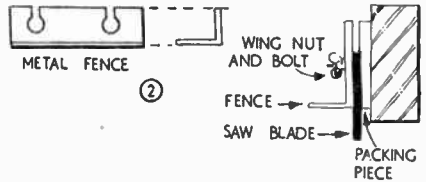

②



HOME MADE VICE

④

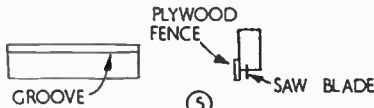

GROOVE

⑤

might like to put a lighthouse or other small building at the far end of our bottle. Here, then, is a simple tool that will do the job for us. It consists merely of a piece of umbrella rib cut off above the hinged joint. Bend the two ends slightly to make them meet as with a pair of tweezers and slip on a rubber band. The small fitting can be released by drawing the rubber band towards you when you have placed the fitting to your satisfaction (see Fig. 3).

Another problem we are continually faced with is the drilling and finishing of small parts, dowel, spars, etc., and to facilitate this work, make a home-made holder as in Fig. 4. This vice consists of a piece of wood 1½ins. by 9ins. and 1in. thick. The upper edge is cut into convenient notches and the lower edge screwed to a base plate made of 1in. wood, a suitable size being 9ins. by 6ins. This will hold many of your small parts while you drill and finish them.

Next, here is the tool I used for grooving the main wale of my own model. It is useful for making very small mouldings, and can be made in various sizes.

Take a small block of wood and groove it to take a small piece of hacksaw blade. Be sure to leave the blade projecting sufficiently to cut only the depth required, and make the

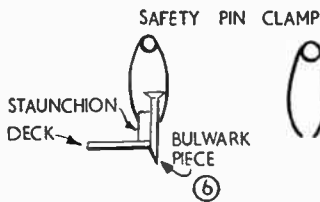

STANCHION DECK

BULWARK PIECE

⑥

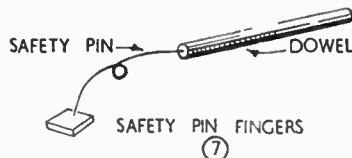

SAFETY PIN

SAFETY PIN FINGERS

⑦

MODEL SAW FOR SMALL WORK

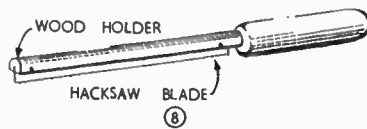

WOOD HOLDER

HACKSAW BLADE

⑧

(Continued foot of page 172)

# Full instructions for making up our design for A PERPETUAL CALENDAR

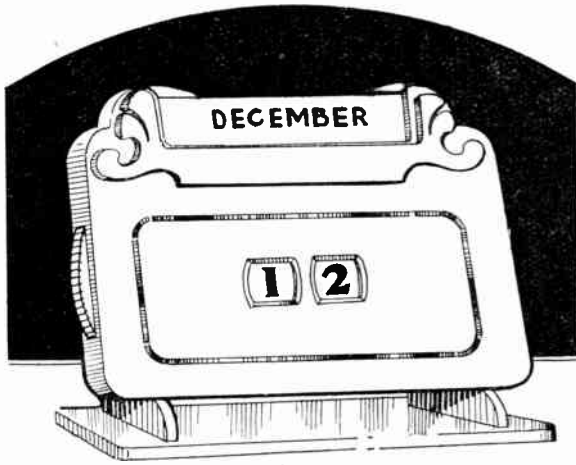

Made from Design No. 2928

**A** CALENDAR is always an acceptable gift for the new year, and it is even more acceptable when it is of the perpetual type, and will last a lifetime. The calendar illustrated is not difficult to make, and neither should it take very long. It should not be hurried, however, and extra care should be taken in executing the necessary lettering.

To commence construction, trace the pattern pieces on to the required wood. Now cut the back, the inner front, the three lower spacing pieces and the two discs (B) and (C). These parts should now be assembled as shown by the dotted lines on the front of the design sheet, and the whole, when finished, should appear as Fig. 1.

## The Two Discs

Next turn your attention to the two discs. Cut them carefully, and do not forget the shallow curves to be filed round the edge of each to give it a milled effect and facilitate turning. Clean

the discs up thoroughly and then draw and paint in the necessary numerals. Any good black paint can be used, but make sure that it is not too thin or it will run and spoil the whole work.

While you wait for the discs to dry, you can proceed to cut the front, the overlay if you intend to use it, and the parts for the stand. Take care in cutting the openings in the front, and make a neat job of the chamfering.

When the front and overlay, if used, have been properly cleaned up, the overlay can be glued in place, and the whole front laid aside to dry.

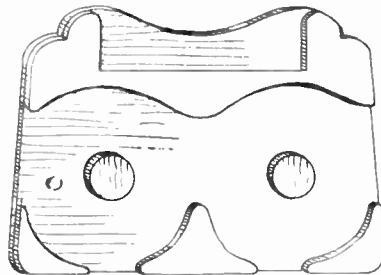

Fig. 1

Now proceed with the stand. Glass-paper the parts thoroughly, and then glue the tenons (A) into their respective mortises on the base piece. The stand can now also be put aside to harden.

When the painting on the two discs is

quite dry, place them in position on the two centres originally glued to the back of the calendar. Make sure that they turn evenly and easily, and then put the front in position securing it with a thin coating of glue, and, possibly, four fret screws placed one in each corner. Only small screws should be used, to avoid splitting the wood.

The calendar itself can now be glued in position on the upright supports and the whole thing placed aside to harden thoroughly. While waiting, the worker can turn his attention to making the necessary month cards. These should be

## Materials Supplied

A kit containing the necessary wood for making this novel calendar can be obtained from Hobbies Branches or post free from Hobbies Ltd., Dereham, Norfolk, price 3/10d. including tax.

cut from good quality white card and lettered with care. A little pains taken in transferring the lettering from the design to the cards, and neatly finishing them, will be amply repaid, as the completed article will look much more professional. It is optional whether the worker uses twelve cards with the months on one side only, or six cards with a month on each side. If fairly thick card is used it will be found that the space provided in the calendar will not hold more than six, but if a thinner Bristol board is used there is plenty of space for twelve.

## Good Quality Finish

All that remains is to paint the calendar and we would suggest a good quality enamel or cellulose finish, or the worker may prefer stain and polish. Whichever finish he uses he should be quite certain to keep the paint from the faces of the circular discs, so that they show up quite plainly in the centre of the calendar.

## Shipmodeller's Corner—(Continued from page 171)

groove the distance from the edge of the block to correspond with the distance the groove is to be cut in your moulding. A strip of thin plywood nailed to the edge will serve as a fence and enable the groove to be cut parallel with the edge of the wood (see Fig. 5).

During the building of any model it is often difficult to keep small parts in position while the glue hardens; say, for example, you are adding stanchions to the inside of bulwarks. To overcome this difficulty make a number of small

clamps, as in Fig. 6. These are simply ordinary safety pins, cut off at the head and point and bent to the shape shown in the sketch. This type of clamp is also very useful if you do miniature modelling of any kind.

A safety pin can also be used for making a useful gadget for picking up small parts and for holding them while you paint them before putting them in position on your model.

Cut off the head and mount the pin in a dowel handle. The head end is inserted in the dowel, leaving the

point for use (Fig. 7).

A small model saw for cutting off small beadings and mouldings can be easily made by taking a strip of  $\frac{1}{8}$  in. by  $\frac{1}{4}$  in. stripwood and grooving the centre of one face. In this groove insert a hacksaw blade and hold it firmly in position by screws passing through the holes at each end of the blade. The back of the wood holder can now be rounded for appearance's sake. At one end, glue on two pieces of  $\frac{1}{4}$  in. wood and round off to form a comfortable handle (Fig. 8). (122)

# Here is a mechanical but SIMPLE CURTAIN FITMENT



**W**ITH this arrangement, easily fitted up, the window curtains can be opened and closed by the pulling of a cord. The whole business is very simple, and most handy to the housewife. A pelmet is added, which hides the apparatus from view, and adds a lot to the finished appearance of the curtains. Construction is of wood, and three-ply, and needs very little of either to complete.

## Box-like Structure

The whole affair is contained within a box-like structure, shown in Fig. 1, consisting of a back part (A) which is screwed to the window frame, and a front piece (B) which constitutes the pelmet and hides the 'works' as we may say. The length of (A) should be about 2ins. longer than the width of the window frame. As shown in the drawing, it consists of two pieces of wood, say,  $\frac{1}{2}$ in. thick stuff, glued and nailed together, L shaped, with end pieces of similar wood, also glued and nailed on.

To enable the curtains to slide easily, a spring curtain rod is fitted to (A) with sufficient rings slipped over it. The rod is stretched between screw hooks, driven in the back piece of (A) about 1in. from each end, and about the same down from the top. Three small pulleys are required, over which the cords, which open or close the curtains, run, and here those small curtain rollers, which can be bought at any stores quite cheaply, will serve well. One pulley is fitted to the left side and two to the right side.

They are suspended from screw hooks, driven in the top part of piece (A) as near as possible to the spring rod and outside its ends, not inside. The detail sketch, Fig. 2, will help to make this point clear—it is really quite simple. Part (A) can then be screwed across the window frame, and is ready for the curtain arrangement to be fitted in. This is shown diagrammatically at Fig. 3, three rings only being shown to each curtain, for simplicity's sake, though actually several more will be needed, but

the housewife will probably decide about that.

A good length of thin strong cord will be needed, and two boxwood acorns to fit the cord ends. Starting from the right side draw the cord over a pulley, thread it through the rings and tie it to ring (D) the last ring on the left curtain. Continue with the cord through the remaining rings, then over the pulley, then tie again, this time to ring (E) the last ring on the right curtain. Now pass the cord over the last pulley. The curtain rings against the hooks are dropped over them to prevent their shifting along the rod. Now on pulling one cord the rings (D) and (E) will draw apart, and pulling the other cord will draw them together.

Trim off any surplus cord, and to the ends fit the boxwood acorns as a finish. The curtains can then be attached to the rings, preferably with the special pins

round-headed screw. Above these holes bore additional holes, this time big enough to let the head of the screws pass. Connect the two holes with a slot, as in detail (C).

## Fitting

Fitting is just a matter of screwing the pelmet on, through the small holes. It can then be removed by sliding it down until the screw heads come under the large holes, when it can be lifted off. The position of these screw holes should be ascertained before the moulding is applied, so that the latter can be pinned on without covering them. An alternative design for the pelmet is shown in Fig. 4. Here the ornamentation consists of a narrow moulding along the top and simple fretwood overlays glued where shown. The outline is easy to follow, and the fretwood ornaments should present no difficulty.

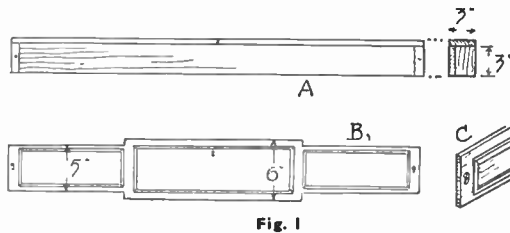

Fig. 1

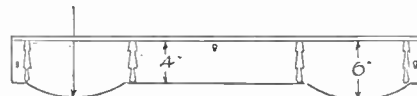

Fig. 4

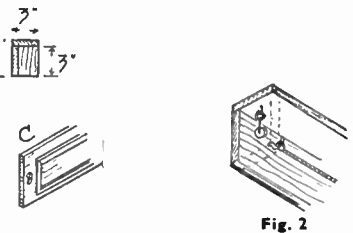

Fig. 2

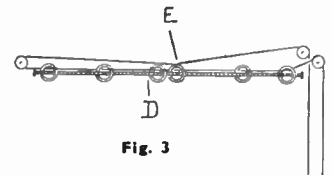

Fig. 3

made for such a purpose, and enabling the curtains to be easily removed for washing, without disturbing the arrangement of the rings.

## The Pelmet Front

The pelmet front can now be made, though it should be understood that it is optional. It is worth adding, however, as it makes such an artistic finish to the whole.

A simple design for this is shown at (B) in Fig. 1. It is made to the same length as part (A) and can be cut from three-ply, or, perhaps, a good quality hardboard, would do. The design can be pencilled on the wood. The panelled effect is obtained by gluing and pinning on either narrow moulding or just plain wood strips. Both should be neatly mitred at the corners. To fit it to the back part, at each end and in the centre, bore a hole large enough to admit a stout brass

Finish is largely a matter of taste. Just as a suggestion, enamel in pleasing pastel shades would look nice. It might be as well to paint the back part (A) as well as the pelmet portion. This should be done, of course, before the rings and pulleys are fitted in position. (152)

## DOLL'S HOUSE KITS

Hobbies can supply many splendid doll's house kits, including a low-priced Doll's House 1ft. 5ins. wide (Kit 2910) price 45/10, a Modern House, 1ft. 8ins. wide (Kit 2666), price 51/4; a Bungalow, 1ft. 9ins. wide (Kit 2792), price 56/2; a beautiful Tudor House, 2ft. wide (Kit 237 Special), price 72/9; and a magnificent 8-roomed Georgian House 2ft. 3ins. wide (Kit 244 Special), price 94/8. All prices include tax.

HOBBIES LTD., DEPT. 99,  
DEREHAM, NORFOLK



# Small boys will want this DOCK-SIDE CRANE

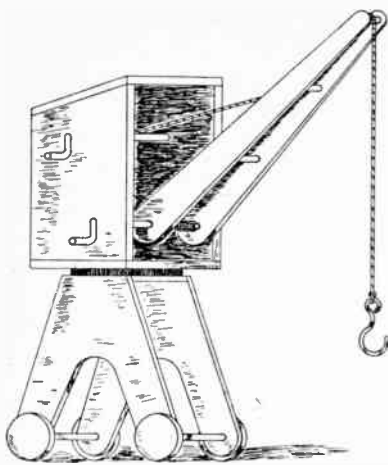

Fig. 1—The finished model

Of all the mechanical marvels to be seen on a visit to the docks, probably the most fascinating are the giant cranes which trundle along the tracks under their own power and dip their hooks into the holds of ships from all the seven seas. Perched in their eyrie, clear above the distractions of the work-a-day bustle, the crane drivers can command the whole romantic panorama spread before their gaze.

You, too, can achieve the dizzy heights at the controls of one of these huge cranes, at least, in imagination. All you have to do is to work along with me on the model depicted in the accompanying illustrations.

## Not Complicated

The tools and materials required to make it are easily come by. They are a saw, chisel, file, drill, pliers, pencil, ruler, compass, sheet of medium glass-paper, discarded soap box, short length of dowelling rod, nails, screw, reel of stout thread, short length of stiff wire, glue and paint.

Having acquired these items, let us now commence with the carriage. This necessitates two pieces of wood roughly 5ins. square by  $\frac{1}{2}$ in. thick, from which must be cut two side pieces to resemble the shape shown in Fig. 2. First, draw a centre-line across each piece of wood, and, bisecting the top of each of these centre-lines at right angles, another line  $2\frac{1}{2}$ ins. long. Still on the centre-line, at a distance of  $2\frac{1}{2}$ ins. down from the top line, inscribe a circle with  $\frac{3}{8}$ in. radius. Then, equi-distant from the centre-line, inscribe two more circles with  $\frac{3}{8}$ in. radius 4ins. apart and  $4\frac{1}{2}$ ins. down from the top line. Draw in the connecting lines between the top side and the outside of each of the two bottom circles and the outsides of the circle on the centre-

line with the inside of each of the two bottom circles.

To erect, set up the two side pieces in position 2ins. apart and glue a piece of wood  $2\frac{1}{2}$ ins. square by  $\frac{1}{2}$ in. thick across the top. Two pieces of  $\frac{3}{8}$ in. diameter dowelling rod 2in. long, glued in position across the inside of the carriage with centres the same as those of the two bottom circles of the side pieces, make rigid the whole. Complete the structure by nailing four wheels 1in. diameter by  $\frac{1}{2}$ in. thick on the centre of each foot. (Fig. 1).

The driver's control cabin consists of the floor 4ins. square by  $\frac{1}{2}$ in. thick, the back 5ins. long by  $3\frac{1}{2}$ ins. wide by  $\frac{1}{2}$ in. thick, two sides cut to size and shape, and drilled, out of  $\frac{1}{2}$ in. thick board (Fig. 3), and the roof 5ins. square by  $\frac{1}{2}$ in. thick. Set up the two sides in position  $3\frac{1}{2}$ ins. apart and glue in the back. Mount the cabin-walls-unit on the floor and secure with glue. Leave off the roof temporarily.

On a centre-line,  $11\frac{1}{2}$ ins. apart, inscribe two circles—one  $\frac{1}{2}$ in. radius and the other  $\frac{1}{4}$ in. radius. Draw in the lines connecting the outside of these two circles and cut two off (Fig. 4). Drill a  $\frac{3}{8}$ in. diameter hole in each on the same centre as the  $\frac{1}{2}$ in. radius.

To erect, set up the two arms in position 1in. apart and glue a piece of  $\frac{3}{8}$ in. diameter dowelling rod between them on the same centre as the  $\frac{1}{2}$ in. radii, a second  $3\frac{1}{2}$ ins. along the centre-line and a third another  $3\frac{1}{2}$ ins. along.

Set up the lifting arm in position with the  $\frac{3}{8}$ in. diameter holes in line with those in the bottom front corners of the cabin. Place a piece of  $\frac{3}{8}$ in. diameter dowelling rod—each 1in. long and previously drilled along its length to take the heavy gauge wire—one on each side of the lifting-arm and one between the sides of same. Insert a length of wire through the lined-up holes to the opposite side of the cabin and bend over to secure. Bend the other end to the shape of a handle (Fig. 4). It is important to ensure that the length of dowelling rod between the sides of the lifting-arm

is a tight fit on the wire-handle. Tie the end of a length of thread to this rod and wind on the amount required. Attach a hook made from the heavy gauge wire to the opposite end and pass over the top runner.

Another piece of  $\frac{3}{8}$ in. diameter dowelling rod, also drilled to take a piece of wire along its length, should now be lined up with the holes in the top rear corners of the cabin sides. Insert a length of wire, as before, turn over one end to secure and form the opposite end into a wire handle. Here, again, it is important to ensure that the dowelling rod is a tight fit on the wire-handle. Tie the end of another length of thread to this rod and, again, wind on the amount required. Attach the other end to the dowelling rod connecting the sides of the lifting-arm below the top runner.

Cut a washer 2ins. diameter by  $\frac{1}{2}$ in. thick from a piece of wood and drill

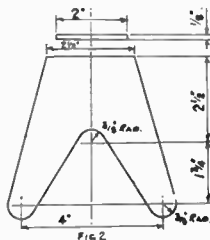

FIG. 2

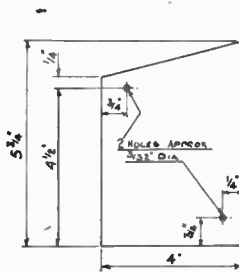

FIG. 3

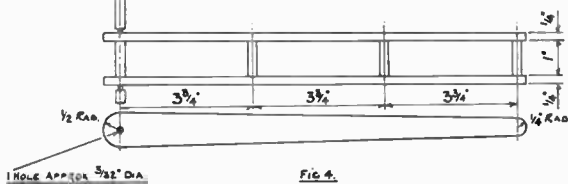

FIG. 4

More helpful drawings

centrally to revolve freely beneath the head of a suitable screw. Insert this between top of carriage and floor of cabin. Secure by screwing down from inside the cabin, and ensure that the latter also revolves freely. Glue on the roof.

You will, of course, have carefully sandpapered all the parts smooth before assembly. All that remains to be done now is to give your model a finishing coat of paint. Suppose we make the wheels and washer black, the carriage and lifting-arm green, and the control cabin post-office-red?

Properly constructed, the model is fully mobile, and should give hours of interest.

(190)

# GIVE YOURSELF A GRAND CHRISTMAS PRESENT

You cannot fail to appreciate a Hobbies A1 Fretwork Outfit, as illustrated. With it, you can make splendid models, working toys, novelties, and hundreds of articles of use in the home. And not only can you make them — you can sell them, too, and build up a steady demand for your work as others are already doing. If you lack ideas, Hobbies publish hundreds of designs to help you make saleable goods, and *Hobbies Weekly* is always a goldmine of ideas. **Get your Outfit today, enjoy a really happy Christmas—**

**YOURS FOR ONLY**

**31/-**



## —And a Prosperous New Year!



Hobbies Outfits range in price from 10/6 to 56/-, and all contain sturdy tools and sufficient to make a start. Get yours from good class stores, ironmongers, Hobbies Branches, or post free from Hobbies Ltd., Dept. 99, Dereham, Norfolk.

FREE ILLUSTRATED LEAFLETS ON REQUEST.

SHIPS  
GALLEONS  
LOCOS  
ARCHITECTURAL  
SUBJECTS  
ENGINEERING  
MOVING TOYS  
ETC.



Building Micromodel replicas of beautiful Mechanical, Architectural, and other Subjects has become a serious cult. On special cards, units readily shaped and assembled models authentic in every detail. Cost a few pence, often sell for guineas. Send stamped addressed envelope for Illustrated 100 Model Catalogue. **MICROMODELS LTD., 3 (H) Racquet Court, London, E.C.4**

"ABADAN" Oil-well Refinery and Tanker (2/-)

ENJOY MAKING  
**PLASTER FIGURES**  
WITH  
**FLEXIMOULD**



No experience is required to cast religious figures, wall plaques, ash trays, garden ornaments, candlesticks, book-ends, vases, coats-of-arms, articles for window display, cake decorations, cameos and animals, etc. Make a profitable business with this pastime.

Write today for free details of

**'FLEXIMOULD' to**

**DOHM LTD. (DEPT. H)**

**167 VICTORIA ST., LONDON, S.W.1**

## Is This Saw in Your Kit?

You can cut almost anything in wood with this Coping Saw. The blade is 6½ ins. long and can be turned to cut at any angle. No tool-kit is complete without one. Get yours NOW.

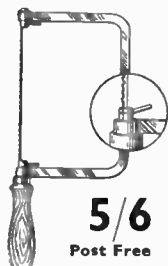

**5/6**  
Post Free

Buy from any Hobbies Branch or post free from Hobbies Ltd., Dept. 99, Dereham, Norfolk

## THE BOLSTER HOME WATCH AND CLOCK REPAIR OUTFIT



These precision jewellers' instruments include watchmaker's magnifying eyeglass, finest watch tweezers, set watchmaker's screwdrivers, watch and clock oil, oilers, dusting powder, clock brush, plus illustrated instructional manual for the amateur. In container 12/6 post free.

Senior Outfit includes everything above, plus watch jewels luminous compounds, dial renewer, jewellers rouge, explanatory book. Price 21/- post free.

**BOLSTER INSTRUMENT Co. (Dept. H.W.), 5a Station Parade, Ashford, Middx.**

## H.A.C. SHORT-WAVE EQUIPMENT

Suppliers for over 18 years of Radio S.W. Receivers of quality.

One Valve Kit, Price 25/- Two Valve Kit, Price 50/-

Improved designs with Denco coils. All kits complete with all components, accessories and full instructions. Before ordering, call and inspect a demonstration receiver, or send stamped addressed envelope for descriptive catalogue.

**'H. A. C.' Short Wave Products, (Dept. 22.)**  
11 Old Bond Street, London, W.1



CHARLE ATLAS twice won the title "The most perfectly Developed Man"

# Will You Give Me 7 Days to PROVE I Can Make YOU a New Man?

DO you want big, smashing, sledge-hammer muscles all over your body? Husky, broad shoulders? A deep, powerful chest? All the pep and vigour of a "hard as nails" athlete? Give me just 7 days—one short week. That's all I need to give you the PROOF that I can make you a New Man—give you a real he-man build, massive shoulders, biceps, and glowing health that resists sickness, ends pimples, constipation and other troubles. Once I was a soft, skinny, 7-stone weakling! Then I discovered "Dynamic-Tension." It gave me the body that twice won for me the title "The World's Most Perfectly-Developed Man!" And what my amazing system did for me—it can do for YOU, too.



## CHARLES ATLAS

(Dept. 102/Z) 2 Dean St., London, W.1

### Send for 48-page FREE Book

Make me PROVE in just 7 days that I CAN give you the big, smashing muscles—powerful shoulders. Take the first step TO-DAY. Post the coupon for YOUR Free Copy of "Everlasting Health and Strength". Do it Now! Address to CHARLES ATLAS (Dept. 102/Z), 2, Dean Street, London, W.1.



I want the proof that your system of "Dynamic-Tension" will make me a New Man. Send me your book, "Everlasting Health and Strength" FREE and details of your amazing 7-Day Trial Offer.

Name.....  
 (Please print or write clearly)

Address.....

For wood, card, plastic, leather, metal etc.

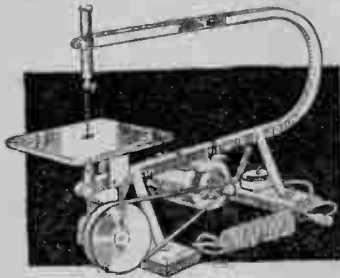

## TREADLE OR MOTOR FRETSAWS

Whatever the handyman or craftsman is cutting or making one of Hobbies Fretmachines will help with the job. For toy making, fretwork, model making, it provides easy and speedy cutting in all kinds of material. A pleasure to use, a factory for output, a lifetime of service. FROM

80/- to £11-2-6

Obtainable at any Hobbies Branch or good class ironmonger or hardware stores. Or carriage paid U.K. from:

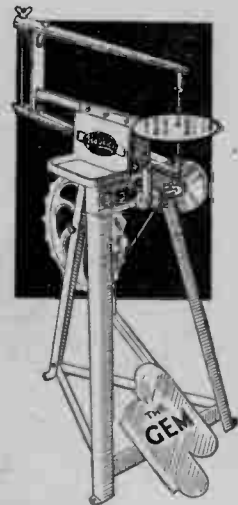

HOBBIES LIMITED, DEREHAM, NORFOLK

## The acid-free cored solder for every handyman

This new, non-resin cored solder is an indispensable addition to every home workshop, replacing stick solder and fluid and paste fluxes. It contains two cores of Arax Flux, a flux so fast that Arax Multicore Solder can even be used for soldering blued spring steel without pre-cleaning. Flux continuity is assured, there is no waste, and no extra flux is required. The flux residue can be easily washed off with water.



SIZE 8 CARTON 5/- EACH



A COMPLETE RANGE OF MULTICORE SOLDERS IN THIS SINGLE HANDY KIT  
 The Multicore 2 - Solder Kit contains two specifications of Arax Multicore for metal soldering and two specifications of Arax Multicore for electrical and radio work.

MULTICORE SOLDERS LTD  
 MELLIER HOUSE ABERMARLE ST., LONDON, W.1 REGent 1411

Printed by BALDING & MANSELL, LTD., London and Wisbech, and Published for the Proprietors, HOBBIES LTD., by HORACE MARSHALL & SON, LTD., Temple House, Tallis Street, E.C.4. Sole Agents for Australia and New Zealand: Gordon & Gotch (A'sia) Ltd. For South Africa: Central News Agency Ltd. Registered for transmission by Canadian Magazine Post.



# Hobbies

## WEEKLY

### CONTENTS

	Page
Make your own Christmas Tree	177
Fishing Game	178
A Puppet Shadow Show	179
Removing Spots and Stains	180
Conjuring for Christmas	181
Keeping Sea-Anemones	182
Colours in Black and White	183
Table-Top Garden	184
Your Cycle in Winter	185
Deceptive Dovetails	186
Household Tool Tray	187
Home Chemistry	188

December 19th, 1951

Price Fourpence

Vol. 113 No. 2929

*Now is the time to*

## MAKE YOUR OWN CHRISTMAS TREE

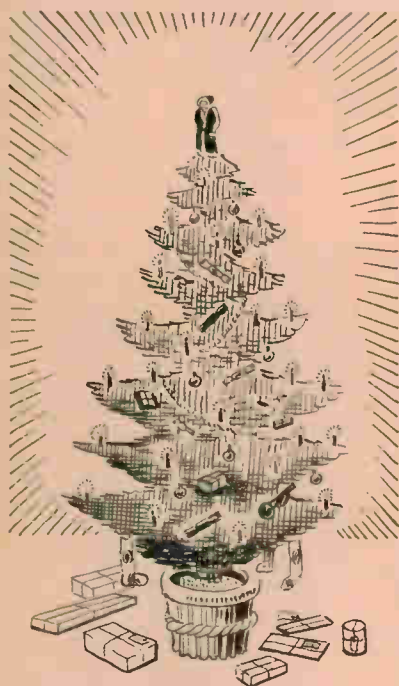

a hedgerow. The most useful are ash, willow or sycamore, but any branch that resembles the one in (A) of the instructions will do. Please obtain permission to cut the branch if you have nothing in your own garden. The branch should be about 6ft. to 7ft. high and strong enough to take the weight of the green stuff which is afterwards tied in place.

The branch is planted securely in an old bucket and held in place with damp sand or soil. The soil must be thoroughly rammed to hold the branch upright. We now have the skeleton of the tree and the next thing is to procure an armful of evergreen branches. Any evergreen will do, but the most suitable is ivy; not the young clinging shoots, but the larger branches that are found, usually trying their best to strangle, on old and decaying trees. The ivy is tied to the main branch as shown at (B). Commence at the bottom and tie securely wherever possible and try to give the tree a pyramidal shape as shown in the drawing of the finished thing.

When you have finished tying, you may snip off the ends of the original branch and trim up the ivy until the whole has a neat and tidy appearance. The extreme tip must also be cut off to take the Father Christmas which is the main decorative feature of the tree. The bucket should be covered with crêpe

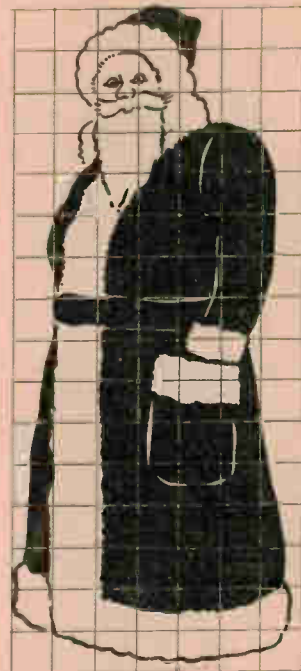

The figure of 'Father Christmas', ruled in 1in. squares, which adorns the top of the tree

**E**VEN those living in the country have difficulty in obtaining a fair-sized Christmas Tree. Suitable trees are sold in the markets in good time for Christmas, but they are usually very small indeed and the price out of all proportion to their size. We would like to give a few suggestions, which have been tried successfully many times, on making a Christmas Tree from materials which are easily obtainable for those living in the country or small towns.

The first essential is a branch cut from

All correspondence should be addressed to *The Editor, Hobbies Weekly, Dereham, Norfolk.*

paper which can be bought at most multiple stores.

### Making 'Father Christmas'

You will need a piece of  $\frac{3}{8}$  in. or  $\frac{1}{2}$  in. wood, upon which you should mark out a rectangle 16 ins. by 7 ins. Divide this into 1 in. squares and draw in the figure as shown. The drawing shown here is one quarter full size. Cut round the outline with a fretsaw and clean up with glasspaper. The figure will be painted bright red and white, with a touch of pink for the face.

A small rectangular box must now be glued to the back of the 'Father Christmas'. The dimensions are shown in the diagram (C). The material need not be more than  $\frac{1}{4}$  in. thick. The twigs on the branch will stop the figure from slipping down.

### Trimming the Tree

The main feature of a Christmas Tree is the lighting and this was achieved by using small cake candles. The method of fixing is to use ordinary pipe cleaners as illustrated in (D). Wrap the cleaner tightly round the candle as shown and then twist the other end round a suitable branch. Two dozen of these will make a grand display, but they must not be left alight for too long and take care to place them so that they will not set fire to the tree. Another method of lighting is to use a string of bulbs which may be bought specially for the purpose. If these are to be used in connection

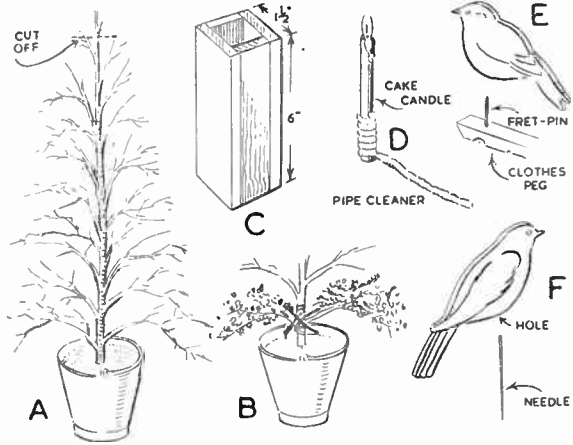

The construction explained

with the mains you must be sure to comply with the instructions of the makers when making your connections.

Many small articles of decoration may be purchased, but since these are rather expensive you may like to make do with only a few of these and make the rest yourself. We have shown cut-out birds in our illustrations, but this method can be applied to butterflies and flowers. Coloured pictures should be pasted down to  $\frac{1}{4}$  in. wood and cut out with a fretsaw.

The sketch at (E) shows how the cut-out can be fixed to the tree by

means of a clothes peg. Separate the two halves of the peg, drill a small hole through one half and drive in a fretpin or a small screw to which the cut-out is fixed.

The second method is to bore a hole in the cut-out itself and fix to a sewing needle. The eye is broken off and the point is pushed into a convenient twig on the tree.

Other decorations can be made from paper, buttons, etc., but you will find that the candles and cut-outs, together with a few coloured glass bulbs will be all that is required. (193)

## The youngsters will enjoy this FISHING GAME

HERE is a new 'slant' on a popular idea—one that will be a sure winner at any party, indoors (or out, if we look ahead). In the form illustrated in the diagram, *t* represents a cut-out plywood fish, for which a squared-up pattern is provided. Glued to it is a small block *s* whose only purpose is to provide sufficient thickness of wood for a screw eye *r* to be driven in. If the fish is cut from  $\frac{3}{8}$  in. wood instead of  $\frac{1}{8}$  in., the extra block will not be needed. On the other hand, shape *t* is not essential. A wooden block would do just as well, or one can use bottles with a screw eye driven in the cork.

The fishing rods consist of walking sticks, garden canes, plasterers' laths or anything suitable (for a permanent job,  $\frac{1}{2}$  in. dowel rods could be provided). But here is the tricky part of the whole business. Instead of the hook *q* (of bent wire) being fastened directly to the end of the string, a heavy iron nut *p* is interposed, as shown. If the reader will try the effect of 'fishing' (i.e. trying to

engage the hook in the screw eye) with, and without the iron nut (*p*) he will see that the addition of the nut makes the job much more tantalising. Without the nut, the job is quite 'tame'. With the nut the slightest movement of the hand, however, causes the line to swing like a pendulum, and even if the hand is kept dead still, the pendulum will swing, as Galileo of old found out in his famous experiment.

Provide about six rods and six 'fishes'. At a yard or so from the fishes (placed on the floor), place a line of chairs, backs facing the fishes, one for each player, who can either sit astride or kneel on the seat of the chair. The rod must be held by the handle at all times. For a permanent game, the nuts can be replaced by cast lead weights. The first person to catch a fish wins the game and possibly a prize. Practical experiment will determine how large to make the hooks, eyes and how far away to place the chairs. Avoid the extremes of making the game either too easy or too difficult. (179)

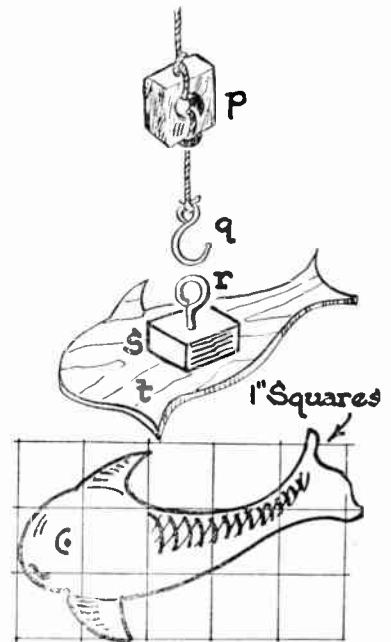

# It isn't hard to give A PUPPET SHADOW SHOW

**P**UPPET shows, using glove puppets or stringed marionettes are very popular just now and those readers who wisely preserve back numbers of *Hobbies Weekly*, together with the indexes, will find, in them, details on how to make such puppets.

To provide for variety in a long show, however, *shadow puppets* are also used. In many ways these are easier to manipulate, being semi-mechanical. It must be distinctly understood that though definite patterns and a definite 'gag' are

same performance is gone through with the manager. On being asked why he cannot eat the soup, the diner calmly declares that there is nothing wrong with it except that he has no spoon! The restaurant staff collapse in a heap!

One feature claimed by the writer as original is the way in which the arm of the diner points downwards and also beckons.

The first thing to do is to lay out the



Fig. 1

one man has a pointed nose, one a square nose, one a bulbous nose. One waiter has very long feet. Note the relative heights of the figures.

Brass paper fasteners or bifurcated rivets will secure the parts together. They should move quite freely. Place small washers between the parts. In the case of the diner figure, one arm goes at either side of the body (see Fig. 3, B and C). Strips of wood about  $\frac{7}{8}$  in. by  $\frac{3}{8}$  in. section are glued to the cut-outs as in Fig. 3. The strips are roughly 12 ins. long.

Fig. 3 shows how thin stiff wires are attached to the ends of the moving parts. The ends of the wires can be taken in large loops round the sticks. In Fig. 3, by the way, to avoid confusion, (B) and (C) have been shown with one wire each. Actually there would be two on each, (B) including, also (C), and, of course, (C) including (B), the loops being arranged one above the other. By moving either (B) or (C), the arm appears to be either pointing to the soup or beckoning.

The shadow of the wires will also be seen on the screen, but professionals make no attempt to disguise this (though it could be done).

## Makeshift 'Theatre'

For a temporary makeshift 'theatre', the arrangement shown at Fig. 4 takes some beating. The rectangle a, b, c, d, represents an open doorway covered with a tightly stretched sheet and so masked (with cardboard or thick brown paper, etc.) so that an opening e is left—about 24 ins. by 18 ins., though this dimension can vary a bit. If you have a suitable picture frame (f) to mask the opening, so much the better.

At a suitable height a shelf l is fixed across (inside the 'theatre'). This has some lumps of clay (g, h, j, k) on it, into which the sticks from the cut-outs can be placed when the hands are required to move other puppets, especially if one is working alone. Other arrangements for supporting the puppets will, of course, suggest themselves. One can, for example, bore holes in the shelf or use blocks of wood, but clay, if available in fair-size lumps, is very adaptable.

(Continued foot of page 180)

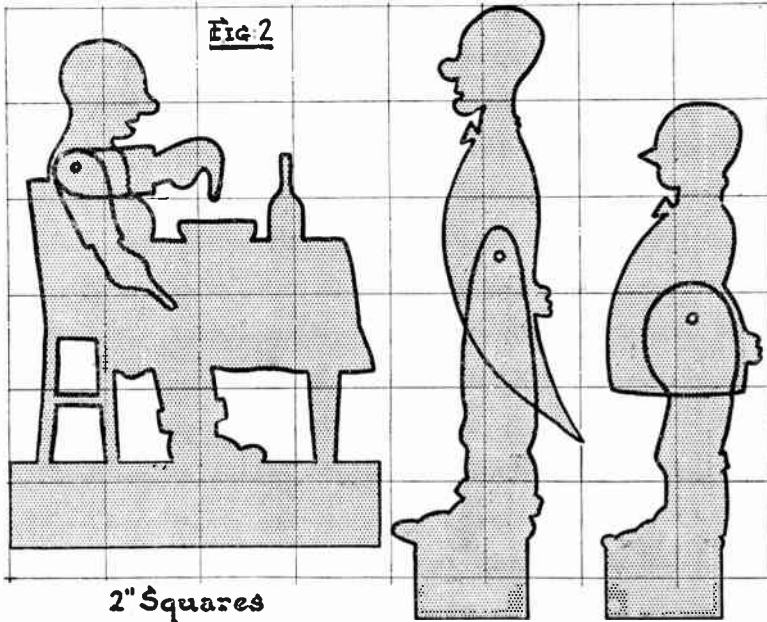

given in this article, they are to be taken as an *example only*—typical of the many that the amateur entertainer can devise for himself, possibly with the aid of the comic papers. The particular 'gag' has been chosen, not for its freshness but for its suitability.

The *finale* of the shadow play is shown in Fig. 1. At first, only the diner is seen. He calls to a waiter and points to his soup (the arm actually moving) declaring that he cannot eat it. The waiter, bowing, and swinging his tray, says he will call the head waiter. The head waiter also bows to the customer, and on hearing that the diner cannot eat his soup, says he will call the manager. The

figures full size and then cut them out of thin cardboard (if for casual use) or of thin plywood or thin plastic if the manipulator is to give several shows and the 'props' are due for hard wear owing to constant use and packing. Note that the diner figure is in three parts: one main body and table part and two arms. The other figures are in two parts. Owing to shortage of space, the waiter with a tray (see Fig. 1) has not been detailed but can easily be adapted from the other waiter figure. He can be in three parts: as for the head waiter, plus an arm with a tray.

No great drawing skill is required. Exaggerate all the features. Note that



# Useful tips to know about REMOVING SPOTS AND STAINS

It is wise to get rid of spots and stains as soon as possible after they are noticed. Keep this list for easy reference in one of your cupboards on the door.

Grease and oil on carpets, linen and upholstery are the worst disasters to happen in any home. Take up the surplus with blotting paper. Cover stain with clean blotting paper, press with a warm iron, moving paper as it discolours. Rub with benzine or carbon tetrachloride, making a large ring first to prevent spreading. For hair oil on chair backs, spread with a thick paste of french chalk and carbon tetrachloride, leave to dry, then brush off. In the case of candle grease, scrape off all the grease and then treat as above.

## Careful Treatment

Grease on polished wood needs careful treatment. Wash with warm water and vinegar. Allow candle drips to cool before removing. Wash well. In the case of grease on wallpaper, cover marks with french chalk, leave for some hours, then brush off. Repeat if necessary.

We sometimes let cod liver oil run on carpets, upholstery or linen. Treat this at once with carbon tetrachloride before washing or applying heat to avoid smell remaining.

Heat marks are an eye-sore and very difficult to overcome. In the case of scorch (not an actual burn) make 2ozs. of fuller's earth, 2ozs. of soda,  $\frac{1}{2}$  pint of vinegar, one onion peeled and sliced. Boil for 10 minutes. Strain. Keep in a well corked bottle. Spread over scorch, allow to dry, brush off, and repeat if necessary.

In the case of polished wood and for a hotplate mark on a table, mix up 1 pint of linseed oil with  $\frac{1}{2}$  pint of turpentine. Keep in a bottle. Rub on mark, leave an hour, then polish off. Repeat if necessary.

In the case of a fire burn mark on a brick fire-place, scrub well, and treat with undiluted vinegar.

Tea, coffee and cocoa stains can be removed as follows. On carpet, linen and upholstery you should wash or sponge with 1 pint of water containing 1 teaspoonful of borax, or with a warm solution of peroxide of hydrogen (10 vol), 1 teaspoonful to 6 teaspoonfuls

Blacklead is something we often get where we shouldn't. On carpets, treat whilst fresh, or it is unlikely that it can be moved. Rub with carbon tetrachloride, wash afterwards with warm, soapy water.

Rust is one of those things we are always grappling with. In the case of linen (ironmould), use a proprietary cleaner. Wash well. In the case of metals, rub oxidized metals with sweet oil (almond or olive). Work oil into ornamentation with brush. Leave overnight and then polish off. Where you have verdigris on ornamental copper, wash with 1oz. of citric acid dissolved in 1 pint of water. Brush in. Rinse and polish.

## Discoloured Piano Keys

Discolouration. In the case of piano keys, treat with a thick paste of whiting and lemon juice. Allow to dry and then polish with a soft cloth. Gilt frames may be treated with a wash of onion water. Rinse, then polish with a soft duster.

We often have to deal with hard water marks in a 'furred' kettle. You should boil up with 1 tablespoonful of vinegar. For bad cases repeat several times. Marks inside glasses may be treated as follows. For lines which may appear in water carafes and flower vases, steep in warm vinegar and water and rub with a stick with a soft rag attached. For the mark below the cold water tap in the bathroom, rub with warm vinegar. Repeat until deposit softens and moves.

Paint drops in many bad places on carpets, linen, upholstery and wood. Treat as follows:—linseed oil paints, rub with turpentine; cellulose paints, rub with petrol or benzine; and varnish, rub with methylated spirit. (192)

\* \* \* \* \*

*The Editor and Staff of*  
**HOBBIES WEEKLY**  
*wish all readers a really*  
**HAPPY CHRISTMAS**  
\* \* \* \* \*

of warm water. In the case of metals, ivory and polished wood, wipe off at once to prevent rust or liquid being absorbed. This will stain brown if left in contact with coffee.

## Soot Stains

Soot is one thing we hate to get on the carpets, furnishings or upholstery. First, take up as much as you can, using a suction cleaner if possible, then rub any marks that are left with carbon tetrachloride. Blow off with a bicycle pump or bellows. Do not brush.

## Puppet Shadow Show—(Continued from page 179)

The height of the opening (e) and, consequently, the shelf, l, is adjusted to suit the performer's convenience. He should take care not to let his head bob up and its shadow be seen through the opening, e. This can often be ensured by remaining seated. The figures should be pressed as close to the screen as possible, to ensure clear-cut shadows. The light should be immediately behind the figures.

As hinted at the beginning of this article, the foregoing is merely typical of what can be done. Extra movements can be given to the figures by having more joints and more wires, but, within reason, the more simple the figures, the better the show 'goes over'. As the

whole thing is 'make believe', complete realism serves no useful purpose, even

were it possible.

(175)

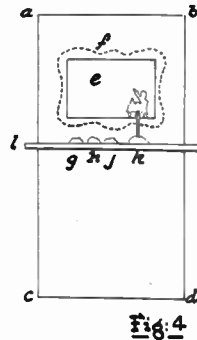
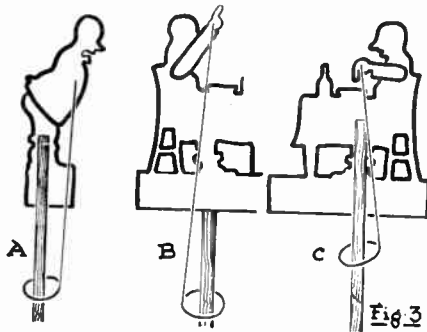

# More instructions on CONJURING FOR CHRISTMAS

**A** CONJURER is the 'lion' of any party and many a professional or semi-professional conjurer made a start by entertaining friends at a party. Conjuring apparatus is usually rather expensive, and despite what the advertisements lead one to think, the tricks do not work themselves, just because their owner knows the secret.

Here are some tricks requiring, in two cases, no apparatus at all, and, in the others, apparatus that can be made by any woodworker of average skill at negligible cost.

## The Perplexing Pencil

The conjurer holds a full-length pencil or fountain pen upright in one hand between the thumb and first finger and drapes the lot with a handkerchief. The shape of pencil can be seen clearly through the handkerchief. The performer, with his free hand, turns back the sleeve of the other hand holding the pencil. Taking the tip of the tent-like handkerchief, the performer whips it away. The pencil, whose shape is clearly seen up to the very end, has quite vanished.

Fig. 1, of course, gives the game away. As soon as the handkerchief is thrown over the hand, the first finger of this hand is extended, as shown in the diagram, whilst the pencil is allowed to slip down the sleeve. The drawing back of the sleeve after this, is a bit of bluff, but it is useful afterwards, since when the sleeve is pulled down again after the trick, the pencil is allowed to slip back in to hand, unseen, and under cover of

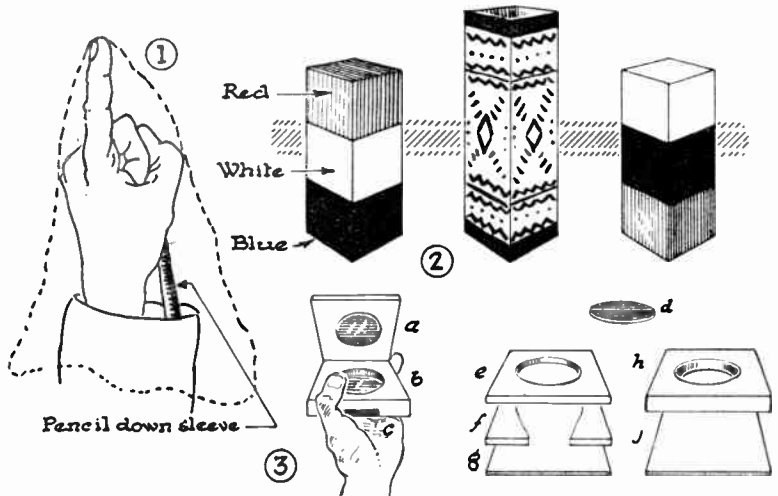

Some of the tricks explained

putting the handkerchief in the pocket, the pencil is put there, too.

## The Baffling Blocks

Three wooden cubes of 1 in. sides are shown. Their tops and bottoms are painted black, but the other sides are, respectively, painted red, white and blue. There is also an open-ended cardboard cover made to slip over the pile of cubes. This is gaily decorated as hinted in the sketch.

The tube is stood on a table and into it are dropped the blocks, first blue, then white and lastly, red. Yet when the cover is lifted, the red, the last to be placed in, is at the bottom, apparently having passed through the other two blocks. Yet such a thing ('matter through matter') is not possible.

Or is it? The process is repeated twice more. In each case one block sinks through others.

The secret is in the use of a fourth cube which is painted black top and bottom, with one pair of sides red and one pair blue, so that if placed corner-wise to the audi-

ence, the cube appears red or blue. This block is already in the tube, red sides facing the front. The other cubes are dropped in as just mentioned: blue-white-red (make it quite clear that the red is on top), but in lifting off showing now, the order red (fake block) at bottom—blue-white, the red, top (genuine), block is retained in the tube. As the tube is of card, one merely presses, with the hand, where the top block is. This red block is allowed to slip down to the bottom of the tube, being checked from coming right out by a finger tip across the bottom.

The trick is apparently repeated. The blue block is dropped in, then the white and then the red (actually the trick block). When the tube is lifted (with the top—fake blue block in it) the white has gone to the top and the red to the bottom.

Again the trick block is allowed to slide to the bottom but this time the tube is turned, secretly, so that the blue sides are outwards. The performer drops in the red one first, then white, then blue. When the tube is lifted (with the top cube) a further change is seen, the blue block having sunk from top to bottom. The genuine blue block is now left in the tube. By means of suitable misdirection, the faked block is picked up and hidden in the hand whilst the genuine blue block is allowed to fall from the tube and mingle with the others so that cubes and cover may be examined.

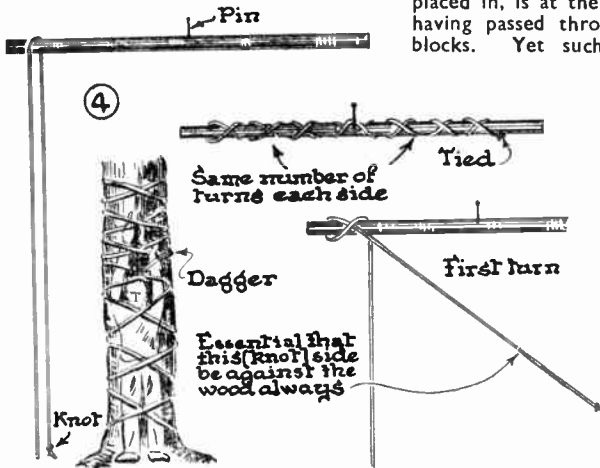

The cord tricks

(Continued foot of page 182)

# If you have an aquarium you should try KEEPING SEA-ANEMONES

It is surprising how many people who, until they have made one themselves, imagine that the making and upkeep of an aquarium is boring in the extreme. But, of course, it is not. In fact, the danger is that once you have been bitten by the collecting bug, as it were, you will become too enthusiastic and want to cram more interesting specimens into your aquarium than you have room for.

Briefly, then, an aquarium is a vessel in which fresh and sea-water animals and plants are kept. Beautiful sea-anemones (pronounced a-nem-o-nees) are probably the most popular items among amateur aquarium-keepers, and in some cases they have been kept alive by the care and devotion of their owners for fifty years or more.

Many people imagine that because sea-anemones look like flowers they are plants. Actually they are animals which live on rocks or in the sea. They are all sorts of colours, such as cream, brown, orange, and crimson. Surrounding the mouth at the top of each small animal is a wonderful fringe of thread-like feelers.

In the water the sea-anemones spread these feelers, which are really tentacles, to catch their food. This is probably because they have neither eyes nor ears and so cannot see or hear their victims' approach.

If, as I hope by now, your enthusiasm has been sufficiently roused to make you want to own an aquarium of your own, you can make a start by obtaining a large glass bowl 1ft. or more across and fairly deep. Place a few attractively-marked stones in the bottom, also some shells, a piece of coral if you can manage it, some green seaweed which looks like grass, and fill the bowl with sea-water to within a few inches of the top. The latter should not be obtained from close in to the shore as it is unlikely that it will be pure.

Now to stock your aquarium. If you live close to the sea, this will prove an easy task. But if you live some way off do not worry. Packed in damp seaweed the evening before you return home your captures will travel well enough. The best place to seek sea-anemones and similar small animals is in rock pools left behind by the receding tide. On the dry

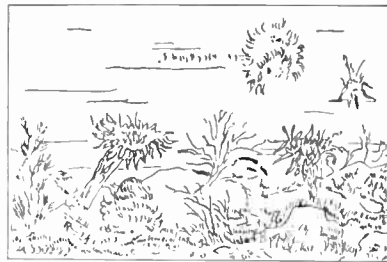

rocks they look like blobs of coloured jelly, but they are far more attractive when put into water again.

Finally, overfeeding will surely kill your specimens. A small piece of fresh raw meat, about the size of a pin-head dropped into the mouths of the large anemones once a month is ample. The small ones obtain their food from the water. Change the latter every six weeks. Remove a cupful of water daily and pour it back into the bowl. The air bubbles thus created keep your captures healthy. Place your aquarium in a warm spot in winter and keep cool in summer. (186)

## Conjuring for Christmas—(Continued from page 181)

### The Prize Trick

The illusionist shows a flat box about 3ins. square of the type shown in Fig. 3. It consists, apparently, of two slabs of wood, hinged along one side and bearing, in each half, a circular well about 1½ins. diameter. The performer should look out, at junk shops, etc., for a large medal (or fake one up) so that there is some excuse for this curious box being used. The medal, taken out of box, plays no further part in the trick. One can patter, however, about winning medals for conjuring.

With this box, however, a coin will disappear or be changed for another. Unknown to the audience there is a disc *d* of metal, for preference, which fits snugly into either of the wells in *a* or *b*. As the wells are painted black, the disc, also dead black, is not seen, and, in any case, the box is not handed out for inspection. There is also a slot *c* by means of which a coin placed in the well of *b* can be slipped out secretly into the hand. The construction of each half of the box is shown, the parts *e*, *f*, *g* and *h*, *j* being glued together. Parts *g* and *j* are quite thin.

The box can be manipulated in various ways. For example, a duplicate coin can be placed in the well of *a* and covered by the disc *d* (the box being

held open so that each part is flat. A borrowed coin is placed in *b*. In closing the box, the coin in *b* is tilted out into the hand, whilst the disc and coin in the well of *a* now fall into the well of *b*. Merely to change one coin for another, there is no need to slip the first coin out, but it is often useful to obtain possession of the coin (usually marked by its owner) and to exhibit a duplicate. The amateur conjurer will find plenty of uses for this box. A useful topical 'gag' is to say that the box was made to contain a Festival 5/- piece.

### All of a Twist

The performer takes a walking stick, magic wand, broomstick, etc., and sticks a large pin in the centre. A piece of cord is draped over as shown in Fig. 4, and twisted round the rod, being finally tied. Yet when the pin is removed, the cord drops off.

The trick works itself and is quite easy when one has the idea. Two things are essential. One 'end' or half of the cord must be in contact with the wood all the time. So that there is no doubt about this, there is a knot at one end. Then there must be an equal number of turns on each side of the pin. Try this out with one or two twists before going on to a larger number.

This simple trick can be made the basis of a spectacular stage or outdoor stunt. A 'victim' of a bandit, etc., attack (an assistant) is tied to a tree, as shown, with a dagger (Scout knife) over the head. The procedure is exactly the same as for the drawing-room rod and pin version, the dagger taking the place of the pin. When the dagger is removed, the ropes fall away and the assistant walks free. Make sure, by previous practice, how long the assistant can keep his hands over his head (a tiring position). He can, alternatively, be tied to a post with his hands behind him. One of his thumbs can take the part of the pin. As soon as he slips the ropes from his thumb he can release himself. If you have a girl assistant, there is scope here for a comedy sketch featuring the village maiden and the wicked squire. Comedy conjuring is all the rage! (159)

### CLEANING A WATCH

If your watch is dirty, open the back, then cut a piece of blotter to fit the inside. Soak the blotter in petrol and place it in your watch. Leave it like this overnight and in the morning it will be going again.



# Things you should know about photographing COLOURS IN BLACK AND WHITE

**M**OST amateurs sooner or later come across a type of snap that is disappointing. It looks well-made, and the negative seemed clean and bright; but the picture in some strange way does not suggest the original. Areas that should have been light have come out dark, and others that were, without doubt, quite dark, appear far too light.

All this is because ordinary films (in addition to not showing actual colours) do not reproduce tones correctly. In most cases these false tones pass unnoticed, but occasionally, as for instance when there is a lot of greenery about, they suddenly force themselves to the fore with unpleasant results

was made with an ordinary film from a colour-card bearing in small rectangles the colours as shown. The first thing we note is that the four corner rectangles brown, crimson, terra cotta and chocolate have all come out very black, and would, therefore, appear the same shade in a photograph, although we would never mistake, say, brown and crimson in an actual scene. At the other end of the scale, light blue has reproduced almost as white and deep blue is only a grey, but strangely enough mid-green, which to the eye seems lighter than deep blue, has come out much darker.

A general comparison of the rectangles makes it clear that all colour round

not sufficiently advanced for this, let us consider just how a knowledge of the manner in which colours reproduce can be used to help in the obtaining of better pictures.

The first thing to do is to get a clear idea of which colours come out dark and which light. This really only means that you should be able to recognise that colours fall into the two big groups of reds and blues—greens being composite colours form a group apart, but normally come out too dark, a point which should always be borne in mind.

The thing, then, is to apply this knowledge to the arranging of your pictures and not have, say, a subject against a background of the same group of colouring, but to try and contrast it with a tint of the opposite grouping if possible.

We recently saw a snap of a brown dog. It was good as far as focus and exposure were concerned, but the background was of red brick, with the result that owing to the similar reproducing powers of brown and red, it was impossible almost to tell where the dog ended and the wall began, although to the eye the animal stood out well. Against a blue, grey or other light-reproducing background, the photograph would have been excellent. This is the type of error we can learn to avoid.

Remembering and applying the colour laws are not as hard as it might at first seem, indeed after getting the groupings in mind one seems automatically to arrange and adjust items to agree with these.

A useful accessory to carry with your camera to help with this tone business is a small rectangle of blue glass. Viewing a scene through this gives a much better idea of how it will appear in black and white, the various colours taking on more the relative tones they will in the final prints. Examining the picture to be taken for a few minutes through the glass, puts you in a position to be able to make helpful adjustments, for instance, to prevent persons in clothes that come out the same tone from standing too close or one in front of the other.

Inaccuracies in colour-rendering also always become worse if the picture is under-exposed, and less noticeable as the exposure is increased beyond the normal. Therefore, if you are taking anything in which colour plays a big part, as is the case with, say, a Scout in uniform, always give as long an exposure as possible. Finally, the better illuminated the subject is, the less effect of false tones there will be in the final picture. (172)

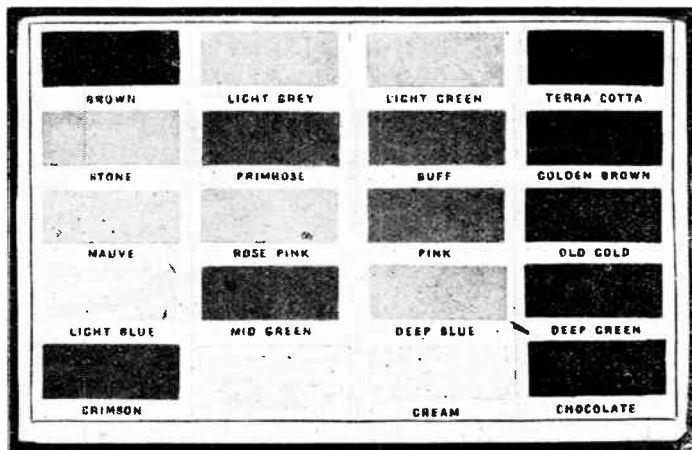

The colour chart

'Tone' must not be confused with actual colour, and it is the upsetting of the relative tones rather than the absence of colours that makes us often feel that something is wrong somewhere. Thus, two pieces of cloth, say, a light blue and light green, may lie side by side. If of about the same depth of colour they will appear to the eye to be of similar tone, and should the pieces reproduce in a snap as only slightly differing shades, the result will seem pretty true to life; but if they reproduce as vastly differing shades, then their rendering will seem unreal, and this is what often happens.

In making ordinary snaps, unless we want to go into the study of 'filters', very little can be done to help remedy this defect in the camera itself, but we can do quite a lot, if we get a rough idea of how various colours reproduce, by the arranging of our subjects against suitable backgrounds, etc.

Take a look at the photograph—this

about the red end of the spectrum come out dark (i.e. they do not affect the film greatly), and those in the neighbourhood of the blue end come out very light. In short, the reds appear to come out too dark and blues too light.

And this is exactly what does happen when using the ordinary film, and the small effect reds have on the film gives us at once the reason why we can safely develop in a red light.

'Panchromatic' films are an attempt to equalise things out, and are so made that they are more sensitive to red tints and less sensitive to blues, hence with this film we get more shades of tone at both ends of the scale, with a truer result throughout the whole picture.

A result somewhat similar can be obtained when using an ordinary film by taking through a filter, a coloured piece of glass that goes before the lens while snapping and which reduces the activity of certain rays. But supposing you are



# Making ornaments for a TABLE-TOP GARDEN

**M**ANY readers must have seen and admired those Japanese 'table-top' gardens illustrated above, which consist of a bowl of cactii or other miniature plants embellished with a miniature pagoda, bridge spanning a 'pool' (actually a piece of mirror), a Japanese temple, and so on. So far as the actual gardening aspect is concerned, the reader is referred to gardening books that can be obtained, for example, at the public library, or to advice to be obtained from the nurserymen who sell the cactus, etc., plants. (An article on growing dwarf trees appeared in our issue of October 18th, 1950). This present article is concerned with the making of the accessories, which are not always easy to come by and not particularly cheap when found.

It is not intended that all the five articles here described need be made. Indeed, unless the miniature garden is fairly large, only two or three embellishments will be needed. The figure (19) is, admittedly, difficult to make, but the bridge is fairly easy (7). Dimensions have been given, taken from the original models (of real oriental origin), but these need not be strictly adhered to, since, in scale, the various pieces are not related to each other and are not, in any case, related to the size of the plants.

As regards materials, one can use (among other things), wood, plastics or one of the modelling materials which are frequently advertised in *Hobbies Weekly*. These latter can be modelled like clay, but set quite hard. Wood will suffice if well enamelled afterwards, as a cactus garden is usually kept on the dry side, but plastics are, perhaps, better. The following notes, however, can be taken as hints rather than as specific instructions.

## Archway (Fig. 1)

The wire seen projecting at the base is merely for pushing into the soil to prevent the archway overturning. If the model is made in modelling clay, it is a wise idea to carry this wire right up one pillar, across the top, down the other leg and across the base again (i.e. in the form of a squarish P). This will reinforce the model, which is otherwise extremely likely to snap across the thin pillars.

For wood or plastics, however, the

construction can be as at Fig. 2. When thus assembled, a piece can be cut from the upper bar and a keystone shaped piece put in as at Fig. 3. Round off all square edges. Fig. 5 shows a section through the top bar and Figs. 4 and 6 show details, respectively, of the arch centre and the base of the pillars. Remember always, in these models, to avoid a mechanical, mass-produced look. It is for this reason that the artist has drawn everything freehand (as for

off. Paint in brown with the top rail green.

## Temple (Fig. 11)

This can be made up of separate parts as indicated in Fig. 13 and the roof afterwards carved. Fig. 14 shows a cross-section through the roof and Fig. 15 shows how an extra 'wave' has been added with plastic modelling material. The steps which lead up to a door are well shown in Fig. 16. A view



example, Fig. 9) rather than with mechanical drawing instruments. The articles, when finished, should look as though they were made of china. Gay enamel paints are used. The archway is painted red and black, with a touch of gold on the 'Keystone'.

## Bridge (Fig. 7)

This is easily made by cutting two sides as in Fig. 9 (preferably not in plywood) and then assembling as in Fig. 8. As the extreme left of Fig. 7 shows, the footway of the bridge is corrugated (actually it would be made of bamboo poles). Fig. 10 hints that the rails and posts should be well rounded

of the back is shown in Fig. 12. The central part of Fig. 13 is not mounted exactly in the centre of the base but more to the rear, giving more space at the front where the steps are. All corners are well rounded off. The model is painted green with all the edges and the door picked out in gold.

## Pagoda (Fig. 17)

Carving this is something like carving a chessman. Its total height when

(Continued foot of page 185)

# All about the care of YOUR CYCLE IN WINTER

**W**INTER is not exactly the season when we look forward to long, happy touring projects, and there are those who put away their bicycles until the brighter spring days are with us again.

Certainly, if you are not disposed to use your machine at this period of the year it is advisable to store it properly in some suitable place where it will not be a nuisance at any time to other members of the household; people have a tendency to come into contact with the pedals if the cycle is left in a lobby or other small room which has to be used.

You can 'dismember' the machine and pack it away in a big cupboard or corner of the attic, or other dry room indoors that is not much used; or in an outdoor shed, provided it is not a wet or damp place. Whatever you decide upon, do not forget that damp and rust can work havoc with your spick-and-span machine. Therefore choose an airy dry place for storage, and inspect the cycle periodically. Damp air will rust the bright plated parts if it is left in a more or less open spot. If you cannot do anything else about it, be sure and cover it over with some waterproof material—an old groundsheet or mackintosh or piece of waterproof canvas, etc.

## Anti-Rust Treatment

Before storing give all bright parts, wheels, spokes, handlebars, chain-wheel, pedals and cranks, brakes and levers, and every part liable to ravages of damp and rust, a thin coat of vaseline. Put the chain wheel in a paraffin bath—an old shallow tin will do; cover chain with the oil.

If you do not 'dismember' the machine before storing, hang it up, if possible suspended from hooks, in order to take the weight off the tyres; these should be kept inflated, and covered over.

## Re-enamelling

When you dismember your bicycle it affords a good opportunity for a spot of enamelling. This will not only give the machine a gayer and 'newer' appearance, but also go a long way to preserving it from rust.

Strip off the old, cracked enamel, where such is found. If the enamel is still in fair condition all over the frame, you need only wash it down with turpentine or petrol (watch out if using the latter, not to have a naked light, or a lighted cigarette, near it). Be sure and get all grease well cleared off the parts to be enamelled. Any bare places must be touched up with a spot or two of enamel and allowed to dry.

Then, with a suitable camel-hair brush, apply one coat all over—rather thin. Allow to dry hard, and give a second coat. Use only the best enamel. When this has dried thoroughly, smooth down with fine glasspaper or fine pumice stone in water and a piece of cloth. Again apply a final coat of enamel or a 'Transparent Finish', working the brush with horizontal and then perpendicular strokes, applying the stuff with the brush evenly and smoothly over the entire surface.

It is, of course, better to hang up the frame in a suitable position clear of the floor while doing this work. When the third and final coat is set really hard wash the frame down with clean cold water and window-leather. After use, all brushes should be cleaned with turps and then stored in a suitable receptacle, with the bristles covered with water, until required at some future date.

## To Store or not to Store?

The question often arises as winter comes on—shall I store my machine away or not? It all depends upon how you are placed. Perhaps you have but

little time—days are so short and weather so uncertain—for cycling runs in winter. Yet, if you take your beloved mount to pieces you may well regret it, when a week-end of fine sunny days happens to tempt you out-of-doors into the countryside.

Therefore, many keen cyclists prefer to keep the machine ready for immediate use. It is such a bother to re-assemble a dismembered bike if such a chance of a week-end run crops up.

If you feel that way, by all means keep your steed ready; but you can give it a protective coat of vaseline, without taking it to pieces. Keep tyres blown up, and your lamps ready in case you suddenly find yourself able to take an opportunity for a spin.

## Protecting a Cycle in Use

What steps can be taken to protect a shiny new machine when regularly using it during the winter. You will probably ride it during all weathers, if you are among those who do not 'lay up' their mounts for the cold months.

First, beware of the demon rust, therefore watch the edges and corners of all chromium plating. If signs of wear of the plating appears apply vaseline. Indeed, you may keep a thin smearing of vaseline on all bright parts, except, of course, the rims, which come into contact with the brake blocks.

For winter, a gear-case is perhaps the best protection for the chain; otherwise give it an application of graphite grease; but do not overdo it. Wipe off all surplus, for a thin film of the grease will be quite sufficient. Keep all bearings nicely adjusted, and pack them with a light grease, or keep them well oiled. A packing with grease in all the bearings will preserve them from rust, and yet permit of free running. See that your free-wheel is also lubricated. (183)

## Table-Top Garden—(Continued from page 184)

finished is about 2ins., but is more convenient if one takes a stick of wood (or plastic),  $\frac{3}{8}$ in. square in section and works on the upper part, using the lower part as a handle, and then cutting off the modelled portion when finished. The pagoda is coloured red and black.

## Japanese Lady (Fig. 19)

This is for the experienced modeller, of course, but is quite a possible project, for, after all, one is not undertaking something to be shown at the Royal Academy. Fuller details as to dress, etc., can be obtained from such books as

'Peoples of All Nations' (usually to be seen in a public library). The wire at the bottom is, obviously, continued to form the sunshade handle.

The kimono is painted red and green; the face and hands are light yellow and the hair, black. The sunshade has concentric rings of red, yellow and green.

After the labour of carving this, the reader may like to cast others from it in lead, plaster, or one of the new materials often advertised in these pages. Indeed, especially if one could supply everything—the plants, bowls and ornaments,

quite a useful little private business could be done in supplying oriental gardens. (177)

## BETTER PLANING

When you are working with a metal plane it is sometimes found that it is difficult to work, especially on poorly grained wood. Add a little sweet oil or linseed oil to the bottom of the plane and it not only works easier, but cuts the wood considerably better.



# Tips you might like to know on DECEPTIVE DOVETAILS

**T**HE dovetail is a very useful joint which every woodworker should be able to cut neatly. Details are given in all good books on woodwork and need not be repeated here, since this article is concerned with 'odd' aspects of this joint.

Mention, however, might be made of a very useful little gadget which, so far as the writer is aware, cannot be bought ready-made but which, constructed in ten minutes or so, saves, over the years, many hours of work in marking out dovetails. It is simply a piece of  $\frac{3}{8}$  in. plywood (plastic or even metal might be better) of the size indicated in Fig. 1 (it must be cut accurately). A strip of  $\frac{3}{4}$  in. by  $\frac{1}{2}$  in. wood is glued dead parallel to each side of the top and when dry, the strips are trimmed off as in Fig. 2. Fig. 3 shows the template in use, marking out dovetails at the correct slope.

The principle of the dovetailed joint is that its wedge form together with its shoulder prevents any movement in the direction of its length. In Fig. 6 it would appear that the only way to separate the parts is to lift the top part up vertically. But this is not possible, as the joint is also dovetailed the other way. Is such a joint possible?

Fig. 7 shows the secret. The joint is thus a bit of a catch, and might well be made up, partly as an exercise in careful marking out and cutting, and also as something with which to mystify friends.

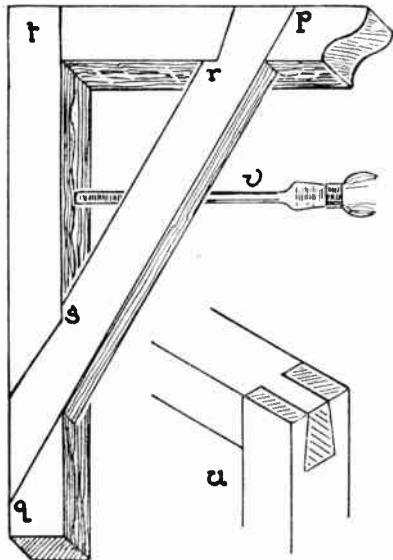

The woodwork 'teaser' explained

Make a fairly large joint at first so as to make sure of the principle. Afterwards make a pocket edition.

It might appear that this sort of thing, amusing as it is, has no practical use. Fig. 8, however, shows a shouldered dovetailed housing, used, among other purposes in high-class cabinet work, for connecting fixed shelves to divisions. This bears a very close resemblance to Fig. 7. Fig. 5 is a more simple form known as a Common Housed Dovetailing. This is quite easily cut in a machine at a factory, but it should be remembered that this joint was, for many generations before the coming of machinery, carefully cut by hand, as was the type of work shown in Fig. 8. Think of that when you are cutting a simple line of 'through' dovetailing, used in boxes, pedestals and the like.

Fig. 9 again seems an impossibility.

How can there be dovetails in contrary directions? This paradox is again illustrated, but in a simpler form at Fig. 14. The secret is given away in Fig. 13. It will be seen that the joint is not a true dovetail at all and that the two parts slide apart when moved diagonally. It is a good idea to make such a joint, using two different kinds of wood, one dark and the other light.

Figs. 11 and 12 explain the secret of Fig. 9 which works on exactly the same principle as Fig. 13. The model in this case, however, is a real box made up of four sides, with a top and bottom. Normally, the top would go on after the manner of Fig. 10, concealing the edges of the sides. The arrangement shown in Figs. 9 and 11, however, is adopted so as to make it clear to the puzzled beholder

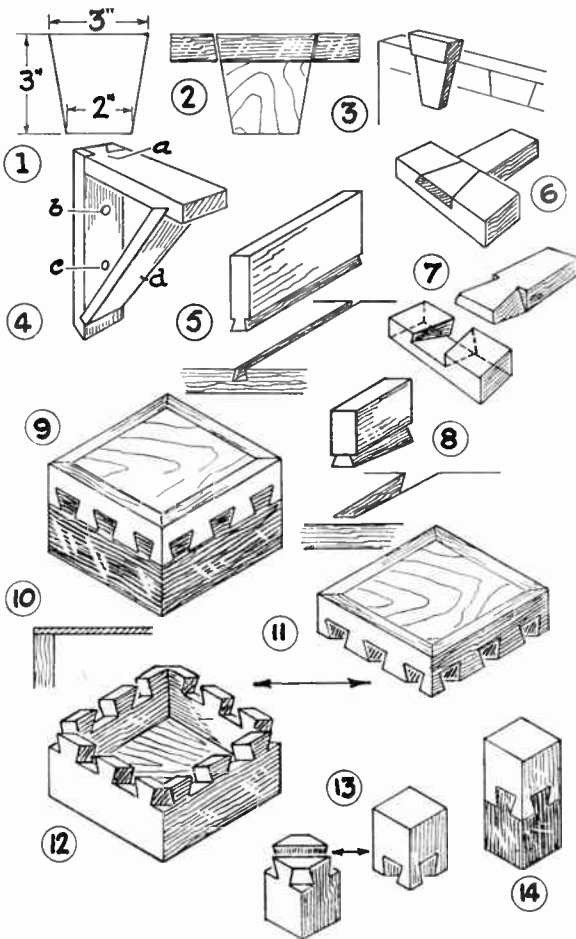

that the sides really do consist of four pieces and that the whole job is not just one solid block with imitation joints incised on the edges.

It is perfectly possible to make a box after the style of Fig. 9, though the simple model (Fig. 14) is, naturally, easier. A good hardwood (oak) is to be preferred, especially if the model is to be repeatedly taken apart to show 'how it is done'.

Fig. 4 shows a woodwork 'teaser' of another kind. Wanting a pair of large brackets to put up a shelf, a woodworker made a pair of the type shown. He made a really nice job of it, with a well fitting dovetail at a and holes at b and c for the screws for attaching to the wall. But, well-made though the joint was, the

(Continued foot of page 187)

# Making a useful household TOOL TRAY

**T**HE tool tray and rack shown in the illustration, Fig. 1, will be found most useful when doing household jobs or for simple gardening repairs, etc. The article can be handled conveniently and taken from place to place as required. It is 17ins. long and 13ins. wide.

The length, incidentally, is somewhat governed by the length of the handsaw which is fitted to and held flat against the middle upright of the tray, as shown in the illustration Fig. 2. The saw shown has a 12in. blade, but a saw having a 10in. blade would be useful, and, perhaps, quite sufficient for any ordinary

upright partition will take the saw on the one side, and on the other there is a rack for such frequently used tools as screwdriver, chisel, square, etc., as seen in Figs. 2 and 3 respectively.

A sound idea of the construction of the tray is given in Fig. 4, with all the necessary measurements for setting out. The floor (A) measures 17ins. long by 13ins. wide, and as it will be most unlikely that a board this width will be forthcoming, the floor should be made up in two or three widths. These boards, after being planed up, fitted accurately and glue jointed, may be held well together by cross battens at the ends (see Fig. 4). The battens should be 13ins. long by 1½ins. wide, and fixed with countersunk screws. They serve the useful purpose of feet to raise the floor

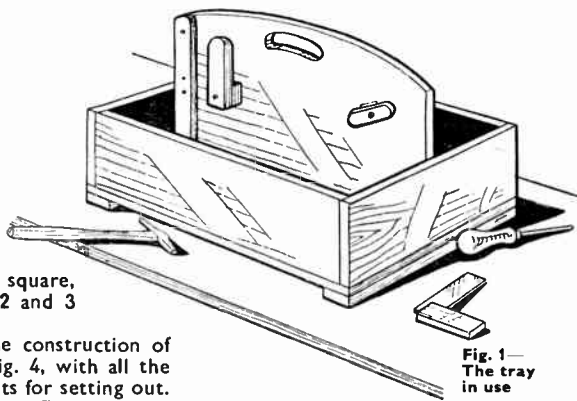

Fig. 1—  
The tray  
in use

Looking at Fig. 1 it will be noted that the saw is held in a simple rack. This consists of a piece of ¾in. or ½in. stuff 5ins. long as (F), with a block at the lower end screwed to it (see detail Fig. 5). At the handle end the saw is held by a turnbuckle (H) or button arrangement which keeps it firmly in place in the rack. Cut the handhole in the partition 4ins. long. Use the fretsaw for this work, of course.

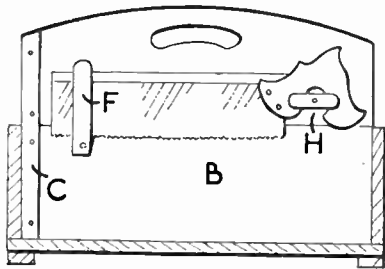

Fig. 2—The middle upright with saw in place

household jobs. Therefore, a tray 15ins. long and, say, 9ins. wide would be quite as convenient as the larger one shown here.

The tray itself is intended to take the majority of the smaller tools, with, perhaps, a cross partition in one of the side trays for nails, screws, etc. The

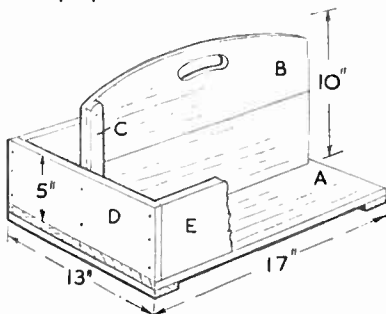

Fig. 4—Details of construction

off the damp ground or grass when the tray is used out of doors.

Wood ½in. thick is used for most parts of the tray, only the pieces (C), (F), (G) and (H) being of thinner wood ¼in. or ⅜in. thick. The partition (B) measures 16ins. long and 10ins. wide, and this member again is made up of two pieces held together by the narrow battens (C) as seen in Figs. 2 and 3. Note the section of the partition in the latter figure, how the pieces (C) are put on—one each side and at the ends. The top of the partition is cut to a slight curve with the fretsaw and afterwards cleaned with coarse and fine glasspaper.

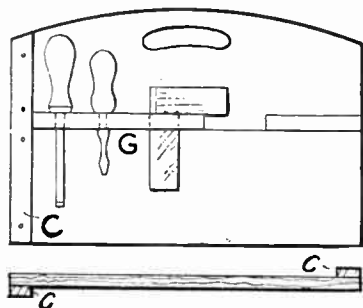

Fig. 3—The upright reversed

## The Rack

The rack for the tools on the opposite side to the saw is made as (G) in Fig. 3 and 5. Stuff ½in. for the front of the rack with ¾in. or ½in. blocks each end to hold it clear. Note how the sides (D) and (E) of the tray are fixed together, and as an added fixing put four triangular blocks in each inside corner. Screw on the floor and clean round the edges, and after this insert the upright partition and put screws into this through the ends.

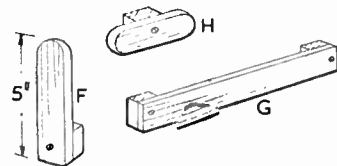

Fig. 5—The various fittings

Round off the edges of the sides and ends of the tray, and glasspaper them to make them safe for handling. The same applies to the exposed edges of the partition and its handhole. Clean up the woodwork at completion and either paint or use some kind of wood preservative. Stain and varnish would make a suitable finish. (174)

## Deceptive Dovetails—(Continued from page 186)

bracket was not a success. Can you see why?

**Answer.** The brace (d) prevents a screwdriver getting at holes b and c! An alternative form of bracket is shown herewith which allows a screwdriver to

be used. The thickness of the wood should be quite 1in.—preferably more, so that it can rest snugly against the wall. The bracing diagonal strip is only half or a third of the thickness of the main bracket. This, of course, allows a long-

bladed screwdriver (v) to be applied.

From p to q on the diagonal bracing is a straight run through, the dovetail shoulders being made at r and s. The best form for a joint at t is shown at detail u. (174)

# Experiments with boracic powder in HOME CHEMISTRY

**B**ORACIC powder is chemically known as boric acid, and is useful for many more purposes than drawing septic wounds. Some enamels and certain kinds of glass need it. It is also used as a flux in steel and iron working.

Even candle snuffers went out of fashion because of boric acid. In the days of long ago a candle wick did not burn away as quickly as the wax. It stood up straight as a Guardsman and gave a long smoky flame. When it outgrew its strength it collapsed and showered down greasy wick carbon. The only remedy was to crop the wick frequently.

And then it was discovered that if the wick were impregnated with a dilute solution of boric acid mixed with sulphuric acid, it curled outwards from the flame and burned away at the same speed as the wax.

Boric acid is not very soluble in cold water. Drop a pinch of it (note what a greasy texture it has) into a test tube, add a few ccs. of cold water and shake. Much of the acid will remain undissolved. Now boil the water, when it will readily dissolve. On cooling most of it will crystallise out.

## A Useful Test

It is also soluble in alcohol and this leads us to a useful test for boric acid. Dissolve a pinch in a few ccs. of methylated spirit, pour it out on to a tin lid and set fire to it. The meths. will burn with a green flame, instead of the usual blue.

Another test for boric acid may be done by mixing four parts of it with one part of powdered fluor spar (calcium fluoride) either by weight or volume. Make a small loop in a piece of thin iron wire and hold the loop in the bunsen or spirit lamp flame until it is red hot.

Then dip the loop into the mixture and heat it once more in the flame. You will see green flickers which are due to the formation of the gas boron trifluoride.

Boron trioxide is easily prepared from boric acid by heating it. Place some boric acid on a clean tin lid and heat it. It will quickly begin to swell up and give off steam. As the reaction proceeds it forms large glassy bubbles, alternately expanding and collapsing to a pasty mass.

If you dip an iron nail into the hot paste and draw it up, you will find the paste will produce long silky threads which harden and become brittle on cooling.

When no more bubbling takes place,

let the paste cool and then crack it off the lid. You will be left with a brittle glassy mass of boron trioxide. Keep it in a well-corked bottle, for otherwise it will absorb atmospheric moisture and become opaque.

As its name suggests, boric acid contains the element boron. Not only does boron form an acid, however, but it can also act as a base. For instance, it

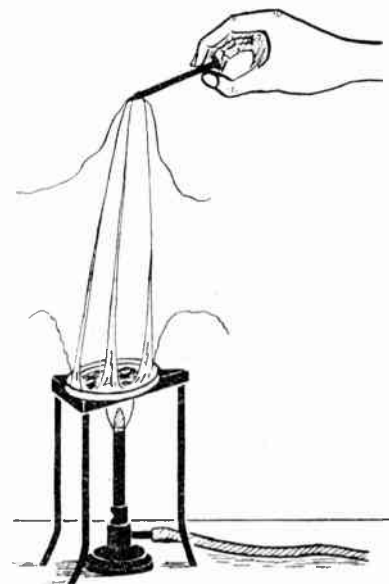

Preparing boron trioxide

forms a white compound with phosphoric acid called boron phosphate. This is insoluble in water.

To prepare boron phosphate, take about as much powdered boric acid as will lie on a half crown piece and mix it to a paste with phosphoric acid. Add a few ccs. of water to thin it down and then evaporate the mixture to dryness in an evaporating basin on wire gauze.

You will be left with a white residue containing boron phosphate. We now have to separate this from soluble matter by mixing it with water and filtering it off.

Boron phosphate, however, often forms a milk-like colloidal solution and passes through a filter paper. Therefore, if on mixing the residue with water the boron phosphate does not separate in an easily-filtered granular form, note the rough volume of the colloidal solution and add to it an equal bulk of a saturated solution of common salt. In a few hours the boron phosphate will separate and you will then be able to filter it off.

Wash it with cold water on the filter and then dry it in the oven.

Boric acid has the remarkable property of combining with salicylic acid and sodium salicylate to form a little known organic compound called sodium borondisalicylate.

## Means of Weighing

To make sodium borondisalicylate you will need to weigh out 1.03 grams of boric acid, 4.6 grams of salicylic acid and 5.33 grams of sodium salicylate. If you have no means of weighing you can solve the problem in the following way.

Take a flat-bottomed glass phial of  $\frac{1}{2}$  in. internal diameter and about 3 ins. long. Gum a narrow strip of paper along it and carefully graduate it by making marks  $\frac{1}{16}$  in. apart. Grind your boric acid, salicylic acid and sodium salicylate finely.

Drop a little boric acid into the phial and tap the bottom of the phial on the bench until the acid packs down no further. Repeat the process until the boric acid is level with the  $\frac{1}{16}$  in. mark. This will give you roughly 1.03 grams.

Measure out the salicylic acid in the same way until it reaches the  $2\frac{1}{16}$  ins. mark (4.6 grams) and the sodium salicylate to the  $2\frac{1}{2}$  ins. mark (5.33 grams).

Dissolve the three substances in boiling water (about 100ccs.) and evaporate the solution until the surface is covered with a white film. Then allow it to cool. The solution sets to a moist, almost solid white mass of sodium borondisalicylate.

Beat up this mass to a paste and spread it on a clean porous tile to drain out the mother liquor. When it is dry, purify it by redissolving it in water and evaporating and draining it again. You will thus obtain the compound as a pearly crystalline powder.

## Making Talcum Powder

Boric acid is an ingredient of talcum powder, so if you feel inclined to turn your chemistry to domestic use, here is a recipe for talcum powder:

Talc (French chalk) ...	95 parts.
Boric acid ...	2 parts.
Magnesium carbonate ...	3 parts.

The ingredients can be measured by weight or volume. Add a few drops of any available perfume if desired, and mix thoroughly. (169)

Remember the advertisement pages of Hobbies Weekly—they are worthy of your attention.



**20** BRITISH Colonials, free with approvals. Postage.—W. E. Tucker, 6 Higher Church St., Barnstaple, Devon.

**G**ENUINELY interested persons required to undertake light, clean assembly work in their own homes. Good rates of payment.—Dept. P/918, Universal Products, 5 Cornhill, Lincoln.

**W**ORLD stamps, 25% discount. 2½d. stamp.—Brain, Marsh Lane, Taplow.

**C**ASTING moulds for lead soldiers, animals, etc. Sample mould, 4/-. Handbook and catalogue, 2/6.—G. F. Rhead, Harrest, Bury St. Edmunds.

**I**NTRODUCTIONS. Pen friends, companionship or marriage.—V.C.C., 34 Honeywell Road, London, S.W.11.

**S**TAMPS—superb selection sent post free on 10 days' approval. Good discount. List of books free.—Gem Stamp Co., 514 Fairfax Drive, Westcliff, Essex.

**L**OVELY leather at low prices, for handicrafts, slippers, clothing repairs.—Cowling, Free-school Lane, Leicester.

**P**ERSPEX—clear offcuts in ¼ in., ½ in. and 1 in. All useful sizes. Bargain parcels, 10/- and £1. C.W.O. (refunded if dissatisfied).—R.L.R. Plastics, Wembley Park, Middlesex.

**A**N interesting hobby. Collect stamps and while you circle the globe, acquire historical and geographical knowledge. Send 2½d. for our approvals. Good stamps at most attractive prices.—Willott & Carville, 69 St. Vincent Crescent, Glasgow, C.3.

**F**REE—stamps catalogued 5/- to applicants for ½d. approvals.—Cox, 17 Stoneleigh Park Road, Ewell.

**N**ICOTEXIT—the guaranteed smoking deterrent. Stops you smoking immediately. C.O.D. price 5/6 per bottle from—The Nicotexit Co. (MP), 62 High Street, Croydon.

**S**TAMPS FREE!! Twenty unused (2½d.).—S.G. H. Barnett, Limington, Somerset.

**I**NTERESTING work available for all in spare-time. Experience unnecessary. Send S.A.E. for details to—'Leatheweave' Co. (Dist. 37), 2 Tudor Rd., Leicester.

**100** FREE stamps including Pictorials and Triangulars to all applicants for my discount approvals, enclosing 2½d. stamp. (Stamps from 8 for 1d.).—W. B. Hughes, 32 Cendle Terrace, Cwm, Ebbw Vale, Monmouthshire.

**50** FOREIGN stamps. Genuine approval applicants.—Sheldrake, Harwen House, Newcross Road, Guildford.

**3** BEAUTIFUL Hungarian animal stamps free. Request approvals and enclose stamped addressed envelope.—Jeffreys, 2 Bay View, Craigavon, Port Talbot.

**S**TAMPS—exceptional value. Colonial and Foreign approvals. Discount. 2½d. stamp.—J. Whitty, 37 North Side, Streatham Common, London, S.W.16.

**1,000** assorted stamps—5/-; 500—2/9; 250—1/9; all post free. Terrific value!—Newdale Stamps, BCM/NEWDALE, London, W.C.1.

**S**TUPENDOUS offer. Complete set Hungary Post-riders, free to approval applicants.—W. Standen, Claremont, Heckmondwike, Yorkshire.

**S**PARE-TIME homeworkers, either sex, urgently required. Clean work, good pay. Write—Area 343, 88 Rutland St., Leicester.

**S**PECIAL offer. Constructional plans. Model Railway station, 1/6. Kaleidoscope, 1/6. P.O. to—10 Audries, Kirby Rd., Walton-on-Naze.

**R**OYAL visit set free. Discount approvals, 2½d. postage.—M. Matson, 306 London Road, Staines, Middx.

**B**E a hypnotist in seven days. Anyone now learn the amazing secrets of hypnotism, personal magnetism and auto-suggestion, quickly and easily. Send immediately for our new course and learn the thrill of being able to control and influence others. Complete course, 5/-, post free. Further details free.—BCM-Newdale (HH), Monomark House, London, W.C.1.

**'PERSONAL'**—the fascinating magazine. Crammed with pen friend addresses, personal advertisements, etc. Specimen, 1/-.—Woolf's Publicity, 7 Princes Street, Hanover Square, London, W.1.

**P**UBLICATION of books, booklets, pamphlets, business brochures. Publicity/distribution services. Commercial printing.—Scrivener Press, 7 Princes Street, Hanover Square, London, W.1.

**M**AKE your own Xmas cards and calendars, from brilliantly coloured leaflets of British Birds, 7ins. by 5ins., by well-known artists. 1/- per doz. assorted, post free. Sample, 2½d. stamp.—Vawser & Wiles (London) Ltd., 356 Kilburn High Road, N.W.6.

**E.C.G.** waterproof varnish. For fishing rods, models, etc. Small size bottle, 1/3, post free.—E. C. Griffiths, 75 Orchard St., Weston-super-Mare.

**C**RYSTAL sets. All parts complete with building and operating instructions. Satisfactory reception guaranteed. For midget set, 3/6. Descriptive list, 1½d.—Atestone Co., Hillworth, London, Glos.

**M**ODEL fort for Christmas. Special easiplan, 12/3, post free.—Las, 59 Queen Adelaide Court, London, S.E.20.

**B**E STRONG! Astounding new methods develop muscles like magic in only 15 minutes daily—without apparatus. Results in one week guaranteed. Complete course, 6/6 only. Details free.—BCM-NEWDALE, Monomark House, London, W.C.1.

**X**MAS offers. 1,100 stamps mounted in album, £3. 7/6 parcel, delightful album, 1,000 hinges and 250 stamps. 1/6 packets, 150 whole world, 100 British Empire, 100 Austria, 100 Hungary, 100 Japan, 50 Bulgaria, Special 100 Sweden, 2/-.—W. E. Tucker, 6 Higher Church St., Barnstaple, Devon.

**B**RITISH Empire and foreign stamps specially selected from fine collection. 30 worth-while specimens for 2/3, grand value. Request approvals.—D. Foster, 84 London Road, Guildford.

**20** WORLD free. Send 2½d. for super discount approvals.—Freeman, 14 Oldhill Place, London, N.16.

**F**RENCH polishing is simple if you use Everyman's French Polish. Easy to apply, no skill required. Try this amazing new invention. Send 3/9 for trial size to—Palmer Manufacturing Chemists, Dept. D., 39 Seaton Place, London, N.W.1.

**P**ACKET FREE. All pictorial commemoratives, including high values. Request approvals. 3d. postage, please.—E. W. Compton, S.C.A., 93 Manor Place, London, S.E.17.

**C**HRISTMAS—Complete pictorial set free. Issued in Hungary, commemorating the Festive Season. Enclose 2½d. request approvals.—H. B. Watson, 85 Larkwood Rd., Chingford, London, E.4.

**P**HOTOGRAPHERS. Assemble your own exposure meter. Kit of parts for sensitive photo-electric model, 27/6.—Lucas, 22 Hengrove Rd., Bristol, 4.

**S**TAMP outfits! Album, hinges, detector, Magnifier, tweezers, stamps, etc., 10/- each. Larger sizes, 15/-, 25/-. Free gifts to all approval applicants.—Hawkins, 247 Rotherhithe New Rd., S.E.16.

**P**LYWOOD offcuts, in 5/- and 10/- parcels, post free. Money-back guarantee.—Ezedraw, 21 Spring Grove Rd., Kidderminster.

**H**OMEWORKERS required; full/part time. S.A.E. for particulars.—Vocational Services 105 Burkes Rd., Beaconsfield, Bucks.

**M**ODELS. You can make lasting stone-hard models with Sankey's Pyrum Plastic Cement. Supplied in tins by Ironmongers, Hardwaremen and Builders' Merchants. Ask for instruction leaflet.

**D**UPLEX self-adhesive transfers for decorating fancy goods, trays, plastics, etc. List and samples, 3d.—H. Axon Harrison, Jersey.

**D**OLL'S house fittings and papers; send S.A.E. for list. Doll's house plan special; send 2/6. Trade supplied.—Zimplan, 88 Ware Road, Hoddeston.

**L**ORRY Kits, 4 mm. and 7 mm. scale. Also large range of spare parts from which to build to your own design. Send for fully illustrated catalogue—Price 1/-.—Wilson's Lorries Ltd., 6 Great Winchester Street, London, E.C.2.

**P**LYWOOD offcuts. Birch and Gaboon in various thicknesses. Handy sized parcels for the cabinet, toy, model maker, and all handicrafts. Parcels made up in £1 and 10/- lots. Carriage paid. Send P.O. to—Reeves, Plywood and Timber Merchant, 33 Front Street, Monkseaton, Whitley Bay, Tel. W.B. 4677. Parcels are now despatched on day of receiving order.

**B**LUSHING, shyness, nerves, self-consciousness, fears, ended. Details under plain cover, 1½d.—Stebbing Treatment, 28 (HB) Dean Road, London, N.W.2.

(Continued, foot of page 190)

## HOBBIES BRANCHES

### LONDON

78a New Oxford St., W.C.1

(Phone MUSEum 2975)

87 Old Broad Street, E.C.2

(London Wall 4375)

117 Walworth Road, S.E.17

(RODney 5509)

GLASGOW—326 Argyle Street

(Phone CENTral 5042)

MANCHESTER—10 Piccadilly

(Phone CENTral 1787)

BIRMINGHAM—14 Bull Ring

SHEFFIELD—4 St. Paul's Parade

(Phone 26071)

LEEDS—10 Queen Victoria Street

(Phone 28639)

HULL—10 Paragon Square

SOUTHAMPTON—25 Bernard St.

BRISTOL—30 Narrow Wine Street

(Phone 23744)

MAKE THIS YOUR MOST EXCITING XMAS EVER with



with **JOHN WAYNE** in 'NEW FRONTIER' **ROD CAMERON** in 'THE PLUNDERERS' **WILLIAM ELLIOT** in 'THE GALLANT LEGION' **RUSSELL HAYDEN** in 'HOSTILE COUNTRY'

Extra films from huge list 1/- each. **BOB STEELE**: 'SIX GUN MAN'. **TEX RITTER**: 'WHISPERING SKULL'. **HOPALONG CASSIDY**: 'SUNSET TRAIL'. **RUSSELL HAYDEN**: 'NORTH OF THE BORDER'. **LAUREL & HARDY**: 'WAY OUT WEST'. **BUSTER CRABBE**: 'WILD HORSE PHANTOM'. 'TROOPING OF THE COLOUR'. 'FUN AT THE ZOO'. 'BRITISH BIRDS'. 'TEST MATCH THRILLS'.

2/6 each. **DAN DARE**: 'SPACESHIP TO VENUS'. **DAN DARE**: 'MEKONTA'. **JOHN WAYNE**: 'FIGHTING KENTUCKIAN'. 'ROCKETSHIP X.M. MOON'. **RANDOLPH TURPIN**: 'THE TURPIN TRIUMPH'. **BRUCE CABOT**: 'TRANS-CONTINENT EXPRESS'. 'FESTIVAL OF BRITAIN'. From all good stores and toy shops OR DIRECT, post and packing 1/- extra. C.O.D. 1/- extra. FROM **FILM STIPS, EDLESBORO, DUNSTABLE, Beds.**

**SHIPS  
GALLEONS  
LOCOS  
ARCHITECTURAL  
SUBJECTS  
ENGINEERING  
MOVING TOYS  
ETC.**

**Micromodels**  
TRADE MARK



**"ABADAN" Oil-well  
Refinery and Tanker  
(2/-)**

Building Micromodel replicas of beautiful Mechanical, Architectural, and other Subjects has become a serious cult. On special cards, units readily shaped and assembled models authentic in every detail. Cost a few pence, often sell for guineas. Send stamped addressed envelope for Illustrated 100 Model Catalogue **MICROMODELS LTD., 3 (H) Racquet Court, London, E.C.4**

## PICTORIAL APPROVALS

Fine selection of STAMPS including BRITISH COLONIAL NEW ISSUES, VICTORIES, SILVER WEDDINGS and magnificent MINT FOREIGN PICTORIALS on approval.  
*Generous Discount — Post Free.*  
**L. E. THOMPSON, 2, Western Gdns., London, W.5**

# BE TALLER

I Guarantee to increase your height in 12 days or return your money. New gland and spinal discovery increases height 2 to 5 inches.  
'I have gained 4½ inches in height. My weight increased from 9-stone 4-lb. to 10-stone 3½-lb.'—P.D. 'I have increased a matter of 3 inches.'—H.G., Chesterfield. Guaranteed harmless. Full Course 10/- post free, Air Mail 15/-. Details free for 1½d. stamp. Sent under plain cover. **J. H. MORLEY (H/86), Terry House, Naphill, High Wycombe, England. Est. 1936**  
**114 WAYS TO BE YOUR OWN BOSS.** 114 tested ways of earning £5-£20 weekly with little or no capital, 5/6.

### Miscellaneous Advertisements—(Continued from page 189)

**£5 to £20 weekly earned at home** running your own Mail Order business. Details, 1½d.—Stebbing Publications Ltd. (HB), Naphill, High Wycombe.  
**AMERICA'S famous hobby magazines.** One Year's supply Popular Mechanics, 32/-; Popular Science, 28/6; Homecraftsman, 16/6; Popular Homecraft, 18/-. Free booklet listing all others sent on request.—Willen Ltd. (Dept. 57), 101 Fleet Street, London, E.C.4.  
**EARN £5-£20 weekly** dealing in stamps. Booklet, testimonials, 1½d.—M. Stebbing, Terry, Naphill, High Wycombe.  
**HOME Watch and Clock Repair Outfit.** Includes watchmaker's magnifying eyeglass, tweezers, screwdrivers, oils, oil brush, dusting powder, plus illustrated explanatory book. Watch and clock repairing simplified. In container, 12/9 inclusive.—D. Bolster (Dept. H.), 5a Station Parade, Ashford, Middx.  
**HAVE you got your Juneero Riveting Jig yet?** From all hobby shops or Post free from Juneero Ltd., Stirling Corner, Boreham Wood, Herts.  
**STAMPS Free—Empire Packet** including Pictorials and Victorians free to approval applicants.—Robert J. Peck, 7A Kemp Road, Bournemouth, Hants.

**WHEELS for Toys, etc., in Hardwood, Plastic and Rubber Tyred Metal.** Doll's house fittings and papers. Doll's cot and pram fittings. Decorative Transfers. Beads for Counting Frames and other toy accessories. Fine Art Pictures for Jig-Saws, etc. Stamp for lists. Trade Supplied.—Joyden Toy Co., 193 Chase Side, London, N.14.  
**HOMEWORKERS required, either sex, light** Assembler, part or full time. S.A.E.—Esprey, Box 18, 41 Wade Street, Lichfield.  
**NOVEL calendar designs** painted on plywood for cutting out, with date cards. Inexpensive gifts—profitable to sell. Sample, 2/-; half dozen, 11/-, including postage.—Cleaver (H.W.), 50 Windsor Road, London, N.W.2.  
**CONJURING and Magic.** New Tricks and Pocket Novelties every month. Lists, 4d.—Roboati, Magician, 363 Sandycroft, Kew Gardens.  
**START making money** at home whole or spare time on production of Slippers and useful Leather Goods. Material Provided. Write for rates of pay and full details.—Dept. X., Grange Co., 2 Curzon Street, Leicester.  
**KUKLOS Annual.** Indispensable cyclists' handbook, 1951 edition. Tours, resthouses, money saving hints, 2/9, post free.—Burrow, Publishers, 2 Imperial House, Cheltenham.

## TOOLS FOR THE HANDYMAN

**TOOL CLIP**  
For holding any handled tool. Spring steel. Holed for hanging.  
7d. each

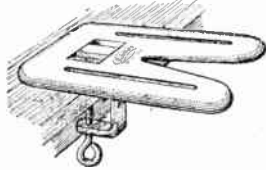

**BENCH STOP**  
3½ ins. by 2 ins. — Spring loaded top.  
6/-



**STEEL CUTTING TABLE**  
With clamp for easy fixing to bench. 6 ins. by 4 ins., strong and light. 3/-

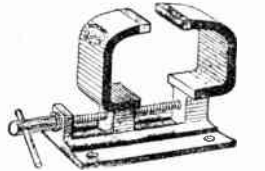

**SINGLE HANDED SCREWDRIVER**  
5 ins. long. Ideal for small work.  
1/8



**MODEL MAKER'S BENCH VICE**  
Strong, light and rigid, 3 in. opening.  
6/3



Obtainable from Hobbies Branches in London, Glasgow, Manchester, Birmingham, Leeds, Sheffield, Hull, Southampton, Bristol and ironmongers everywhere. Or post free from Dept. 99, Hobbies Ltd., Dereham, Norfolk.

**FRETWORK HAMMER**  
5 ins. long. Strong and light for small work.  
1/4



## TWO GRAND SETS OF DESIGNS

**1** A packet of accurate designs for a splendid set of miniature models of 8 ships of the Royal Navy complete with a Naval base with berths for the ships, and all buildings. Price 1/6  
**2** A set of designs for Famous Aircraft of the 1939-45 War. Worthwhile souvenirs, including the Spitfire, Blenheim, Wellington, and 5 others. Price 1/-  
*Obtainable post free from*  
**HOBBIES LTD., DEPT. 99, DEREHAM, NORFOLK**

**LONELY?** Then write the Secretary, U.C.C.—5 B.B. Hay St., Braughing, Herts. Genuine. Est. 1905.  
**ATTENTION Homeworkers!** Martin's Mail Order Services require clerical Homeworkers and envelope-makers. Excellent prospects and regular work assured. Send only 1½d. S.A.E. for particulars to—M.M.O.S. (Regd.), Dept. HW/HWK, 43 Marina Road, Prestwick, Ayrshire.  
**10 Magnificent Large Jungle Scenes Free!** Approvals, Postage.—Mousley Stamps, Heanor, Derbyshire.  
**100,000** Government Surplus Bargains. Sample parcels (guaranteed containing at least 15/- worth assorted electrical and other useful items) in handy wooden box, 5/-, post 1/8. Hand lamps, 4½" high x 3" wide, complete with battery (standard 3v. twin cell) bulb and carrying handle, 2/11, post 8d. Aluminium rivets, approx. 1 lb. assorted, 2/6, post 6d. Transformers, heavy duty, 230/12v., 10 amps., 25/-, post 1/8. 230v. A.C./D.C. electric motors, continuous rating, ideal models and light workshop use, 20/-, post 1/8. Hundreds of other bargains for the handyman. Send 3d. stamp for catalogue. Money back guarantee.—Milligan's, 24 Harford Street, Liverpool, 3.

how about some  
**Seelastik?**



Every time this door slams a little more of the mortar or putty drops out. Why? Because it sets hard and shrinks and does not really stick.

They should have used Seelastik.

Seelastik forms a watertight, airtight seal and remains flexible and elastic when set; it sticks tenaciously even to highly polished surfaces, such as glass, as well as to any combination of brick, cement, stone, plaster, wood, metal, tiles, glazed earthenware . . .

A Seelastik seal costs ¼d. to 1¼d. a foot, depending on its width. It is light-coloured, and can be painted 24 hours after it is put on.

You can buy Seelastik — packed in handy cartridges, and applied by the Expandite gun (50/- with two nozzles) — or in 2/- and 3/- tubes, which are self-contained sealing tools.

**Seelastik** SEALS THE GAP 

EXPANDITE LTD., CUNARD ROAD, LONDON, N.W.10

**GOOD NEWS FOR THE HANDYMAN**  
*Special Double Christmas Number*

POPULAR  
**Handicrafts**

Patterns and designs for widest range of handicraft products ever produced.

2/- from your newspaper or 2/3d.

H. BURT, LINK HOUSE, 24 STORE STREET, LONDON, W.C.1

ENJOY MAKING  
**PLASTER FIGURES**  
WITH  
**FLEXIMOULD**

No experience is required to cast religious figures, wall plaques, ash trays, garden ornaments, candlesticks, book-ends, vases, coats-of-arms, articles for window display, cake decorations, cameos and animals, etc. Make a profitable business with this pastime.

Write today for free details of  
**'FLEXIMOULD'** to  
**DOHM LTD. (DEPT. H)**

167 VICTORIA ST., LONDON, S.W.1



# MYFORD

extend the Season's Greetings  
to all readers of 'Hobbies'  
everywhere

We sincerely hope that your Christmas will be one of Happiness and Good Cheer; and that Peace and Prosperity will follow in 1952 together with unlimited Success in your particular hobby.

**MYFORD ENGINEERING CO., LTD.**

(makers of the ML8 Woodworking Lathe)

BEESTON : NOTTINGHAM

Add realism to your  
**Model Railway!**

WITH 'OO' GAUGE

**PLATFORM ACCESSORIES**



This set of intriguing platform accessories is just what you need to add realism to your model railway.

Die cast and hand painted in bright colours, this set, No. 7, is 'OO' Gauge scale, and consists of a four-wheel porter's trolley, bicycle, chocolate machine, three milk-churns and weighing-machine. Price 2/6 complete set, including post and packing. Send now for this set.

We have a complete range of 'OO' Gauge model railway accessories. Send stamped addressed envelope for descriptive list.

TRADE ENQUIRIES ALSO INVITED

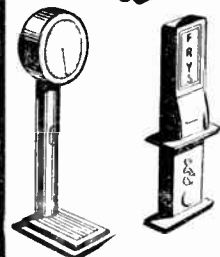

**R.B.N.CO**

(DEPT. H) 180, BROADHURST GDNS., WEST HAMPSHEAD,  
TELEPHONE: MAIDA VALE 1070 LONDON, N.W.6





**"LOOK!**  
*an Electric*  
**TABLE SAW**  
*for £4.0.9!"*

**-and all because I've got a**  
**Wolf Cub**  
**ELECTRIC DRILL**

I bought this wonderful Wolf Cub  $\frac{1}{4}$ " electric drill for only £5. 10. 0—the sturdiest, most powerful and compact machine I have ever used. Even more astounding was my discovery that by adding a few parts which cost me £4. 0. 9, I became the proud possessor of a complete saw kit as well.

**"NEXT ILL HAVE A**

**LATHE SET for £2.8.0"**



I intend to add a few more parts to give me a powerful Lathe kit. Then with the Drilling, Grinding and Polishing Set I shall own a complete Wolf Cub Home Constructor Outfit.

*and that's not all the Wonderful Wolf Cub story!*

Write today for this fully illustrated descriptive folder. Read all about the greatest value for money ever offered in Home Workshop and Handyman tools. Copy free on request.

**KILL RADIO INTERFERENCE**



**FIT A**  
**SURATEL**  
**SUPPRESSOR**

Specially designed for use with Wolf Cub Drills. Supplied ready to attach to "Cab" lead. Conforms fully with official regulations. Only 23 6.

Television Suppressors also available for fitting by Wolf Service Engineers. 8 6 inclusive.

\* Prices and descriptions subject to alteration without notice.

**WOLF ELECTRIC TOOLS LTD.**

**PIONEER WORKS, HANGER LANE, LONDON, W.5**

Telephone: PER 56114. BRANCHES: BIRMINGHAM · MANCHESTER · LEEDS · BRISTOL · GLASGOW

**One plastic material**  
**MAKES MANY PERMANENT**  
**MODELS**

and utility objects, from simple instructions in illustrated Booklet—please read below.

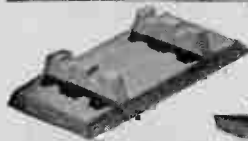

**ONLY 4<sup>D</sup>**  
**IN STAMPS**  
**BRINGS BOOK**

... showing how such models as those above, and many others, can be made, without skill or special tools, from Sankey's PYRUMA Plastic Cement. Ready for immediate use in its plastic state, Pyruma sets or bakes to stone-hardness, and can be painted or enamelled in all colours according to instructions.

Pyruma is inexpensive, and easily obtainable in tins from Ironmongers, Art Material Dealers and Hobbies Shops. Send 4d. in stamps for illustrated Instruction Book.



**J H SANKEY & SON, L<sup>TD</sup>**

ILFORD

Est 1857

ESSEX



**THE SCHOOLBOYS' EXHIBITION**  
**IS COMING AGAIN IN JANUARY**

If you have a camera and are likely to be in London during the holidays come and learn how you can develop your own films and make your own prints. Practical demonstrations—at which you can help—will be given all day long. You will be allowed to do some of the work yourself under the guidance of photographic experts.

**HORTICULTURAL HALL**  
**WESTMINSTER, S.W.**

Opens Dec. 31. Closes Jan. 12

Come and bring your friends to help in the demonstrations organized by

**JOHNSONS OF HENDON LTD. & KODAK LTD.**

Printed by **BALDING & MANSELL, LTD.**, London and Wisbech, and Published for the Proprietors, **HOBBIES LTD.**, by **HORACE MARSHALL & SON, LTD.**, Temple House, Tallis Street, E.C.4. Sole Agents for Australia and New Zealand: **Gordon & Gotch (A'sia) Ltd.** For South Africa: **Central News Agency Ltd.** Registered for transmission by Canadian Magazine Post.

# Hobbies

## WEEKLY

### CONTENTS

	Page
Model Milk Delivery Van	193
Vegetable Rack	195
Novel Windvane	196
How to Tint Photographs	197
Tea Caddy	198
Planning an Exhibition	199
Shipmodeller's Corner	200
Use your Camera More	201
Two Decorative Spill Holders	203
Model a Cow	205
<b>DESIGN FOR AUTOMATIC TEA CADDY</b>	

December 26th, 1951

Price Fourpence

Vol. 113 No. 2930

## How to make a MODEL MILK DELIVERY VAN

**T**HERE are, about our towns and cities, an ever increasing number of electrically-driven delivery vans. They are being used by the baker, the dairyman, the grocer and many more who have extensive in-town deliveries. It is upon such a modern form of van that our little toy is based, and in Fig. 1 we show its simple lines and its attractive appearance.

It is made entirely of wood, a few pieces of planed deal and some prepared fretwood being all that is needed, with a set of four 1½ in. diameter wheels, such as are sold by Hobbies at 1/- the set.

### Built for Strength

The little van is built for strength, and capable of taking the rough handling it will, no doubt, receive. The construction of the toy is straightforward, while the amount of fretcutting will not be found to tax the skill of even the youngest amateur.

The length of the toy overall is 7½ ins., its height 4½ ins., and its width 3½ ins. In Fig. 1 will be seen its general construction, and all parts have been lettered clearly, making for ease in assembly.

The floor (A) is a plain oblong piece

measuring 7 ins. long, 2½ ins. wide, and ½ in. thick. The front edge of this piece must be planed or rasped to a slight angle to meet the front (D) of the van, and this angle is seen in Fig. 2. To the long edges of the floor the two sides (B) will be attached, and in Fig. 3 is given a diagram with all measurements clearly indicated for enlarging to full size on paper or direct on to the ½ in. wood. Note from this figure that the floor

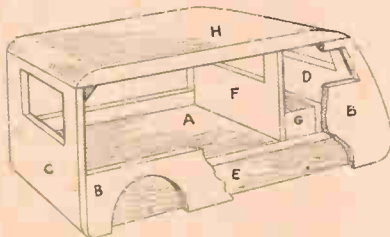
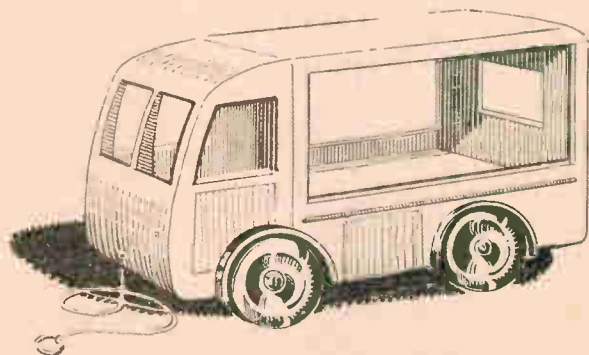

Fig. 1

stands down ½ in. from the top edge of the back part of the sides, where screws or nails are introduced as an extra fixing to the glue.



Next, draw out the back of the van, piece (C). This is a plain oblong 3½ ins. long by 2½ ins. wide of ½ in. wood. Cut a window in this piece about 1½ ins. wide by 1 in. high. Glue and nail the pieces to the floor and to the lower edges of the sides (B), as seen in Figs. 1 and 2. Now, to stiffen the sides (B) and to form a backing to the wheels, cut and glue in the two pieces (E), a full-size pattern for which may be outlined and cut from the diagram Fig. 4. Note where the holes will be bored for the screws of the wheels.

The next piece to cut and fit will be piece (F), which is the cross-partition or back to the driver's seat. This piece is 2½ ins. square and ½ in. thick, and a window will be cut in it the same size as that in piece (C). The position of piece (F) is seen in the side diagram Fig. 3 and in Figs. 1 and 2. One or two wire nails or screws should be run up through the floor into this piece to ensure strength.

### Driver's Seat

The driver's seat (G) is 2½ ins. long and about ½ in. wide and ¾ in. deep, and can be made up from some odd pieces of

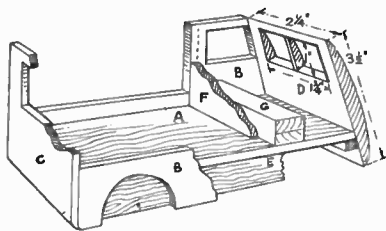

Fig. 2

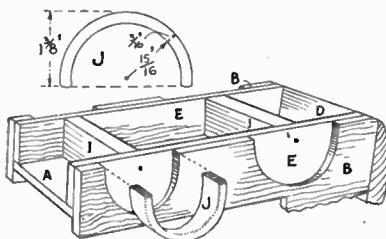

Fig. 5

deal glued together. The roof (H) of the van measures  $6\frac{1}{2}$  ins. long and  $2\frac{1}{2}$  ins. wide and is of deal or any other soft wood  $\frac{3}{8}$  in. thick.

The simple shaping of this piece is done with the rasp and file and finished off with coarse and fine glasspaper. It is glued to the back (C), and to the partition (F), into which one or two fine nails may be driven.

The main front of the van (D) needs some little care in shaping and fixing. Its overall size and the size of the open panels facing the driver's seat are given in Fig. 2, and it can be gathered from this diagram how the piece fits the edge of the roof and the floor below where it is glued, a stiffening fillet of wood being glued along inside as shown. The main van itself is now almost finished, but it will be found at this juncture that the whole can be strengthened in places liable to strain or fracture by the addition of angular or square fillets of wood, say,  $\frac{1}{2}$  in. or so square.

The two cross axles (I) will next be added, and these may be of deal  $1\frac{1}{2}$  ins.

long by  $1\frac{1}{2}$  ins. wide and  $\frac{3}{8}$  in. thick. They should be cut to fit tightly between the inner pieces (E), and the worker should see that they come central with the holes which have been previously bored for the screws.

We now come to the mudguards (J), of which there are four all of the same size and shape. Wood  $\frac{3}{8}$  in. thick is suggested for these, and each is cut from wood  $2\frac{1}{2}$  ins. by  $1\frac{1}{2}$  ins. as shown in the enlarged detail in Fig. 5. The main diagram here is of the underside of the van showing the axles and one of the mudguards ready to be put into place on piece (E), and in the curved recess in piece (B).

Set out the two arcs of the circle, noting the radius and the thickness of the guards— $\frac{3}{8}$  in. Use rasp and file for the edge shaping, but do the necessary finishing after the four pieces have been glued in place. It will be found that the mudguards are a little delicate to handle until they have finally been glued into their recesses.

It only remains now to clean up all the

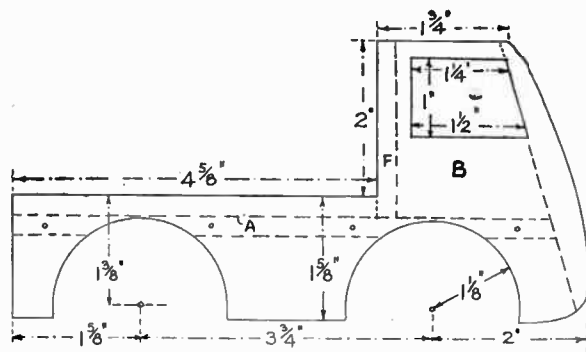

Fig. 3

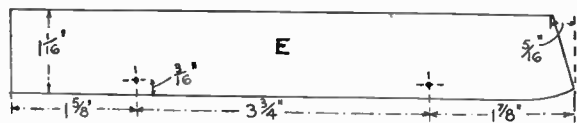

Fig. 4

woodwork preparatory to painting or enamelling the toy. Use fine glasspaper for the final rubbing, and then give two coats of paint or one coat of paint and one enamel. Keep to bright colours for the sides and floor of the van, with light grey, perhaps, for the roof outside and inside. Inside the driver's cab, too, might be grey, with black for the recesses into which the wheels will go after all the paintwork is completed. The mudguards should also be black. The wheels may be coloured up gaily or just black enamelled. Four 1 in. round-head screws are best for the wheels, and will run in deeply enough to make a sound fixing. Thin celluloid washers about  $\frac{1}{2}$  in. in diameter should be put on the screws between the wheels and the sides (E). Leave ample freedom for the wheels to revolve.

A steering column and wheel can be added, if desired, and pieces of stoutish celluloid, held in place by fillets, added in the front to represent the wind-screen. (209)

### Vegetable Rack—(Continued from page 195)

strips well to remove it, and possibly splinters, which might enter the hands when rummaging about for vegetables.

The containers are now nailed or screwed to the sides of the framework, on the guide lines already squared across. Fix them accurately to the lines, or the whole rack may stand somewhat uneven and be a bit wobbly, and see that the back of each container is level with the back edges of the side frames and not sticking out, or they will come in the way of the diagonal backbrace to be afterwards nailed over.

Nail a strip of wood across the bottom battens of the rack, as in Fig. 1, and along the top a board of wood, 6 ins.

wide, and long enough to overhang the ends by 1 in. This is nailed or screwed to the top battens, and should, preferably, be about  $\frac{3}{8}$  in. thick, if likely to hold a heavy saucepan. The diagonal brace, seen in the front view of the rack, should be cut from wood about  $\frac{3}{8}$  in. thick, and 2 ins. to 3 ins. wide. It is firmly nailed to the side frames at top and bottom, and any projecting corners sawn off.

This practically completes the rack. If the shelf is required more to hold vegetables than kitchen utensils, a rim of thinner wood can be nailed round to transform it to a shallow tray. Strips of  $\frac{3}{8}$  in. by 2 in. wood nailed all round to the

edges would serve nicely. (206)

#### CUTTING LIST

Straight uprights (2)—3ft. by 2 ins. by  $\frac{3}{8}$  in.  
Sloping uprights (2)—3ft. 3 ins. by 2 ins. by  $\frac{3}{8}$  in.  
Shelf—2ft. by 6 ins. by  $\frac{3}{8}$  in.  
Diagonal brace—3ft. 6 ins. by 3 ins. by  $\frac{3}{8}$  in.  
Bottom crossbar—1ft. 10 ins. by 2 ins. by  $\frac{3}{8}$  in.

For side battens— $\frac{3}{8}$  in. by 2 ins. by 3ft. 6 ins. run.  
Container ends— $\frac{3}{8}$  in. by 8 ins. by 4ft. 6 ins. run.  
Container sides from box wood or odd lengths of thin matchboarding.



# Making a useful VEGETABLE RACK

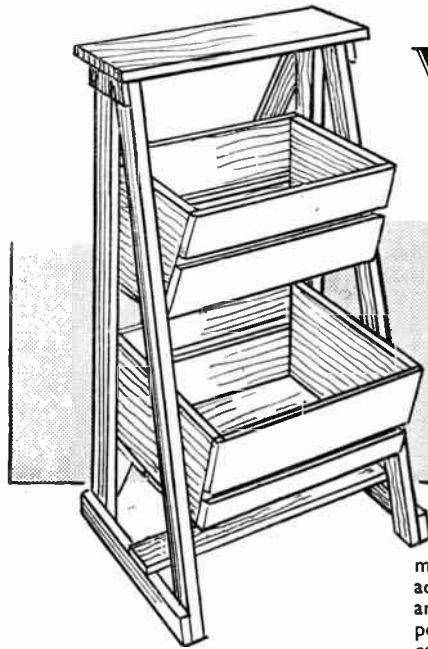

the rack can also be used, either to hold saucepans and similar kitchen utensils, or, if provided with a rim, as an extra receptacle for such vegetables as marrows, cucumbers, etc. No large quantity of timber is necessary for its construction, and what there is can be deal, and in some instances, just common box wood.

A side and front elevation of the framework are given in Fig. 1. Make up each side frame first. Wood of  $\frac{5}{8}$  in. by 2 in. section will do, or thicker stuff if available, held together by cross battens of the same.

Take the straight upright members of each frame and square lines across for the top and bottom battens and the vegetable containers, the position of the latter parts being indicated by dotted lines across. The sloping members are then cut to length, nailed to the bottom batten with one nail only at first, then swung forward to touch the straight ones and there nailed as well. Add two more nails at top and bottom to make a strong joint.

At this stage the two vegetable containers can be made. The sides of

these are shown in Fig. 2. All could be cut from  $\frac{5}{8}$  in. or  $\frac{3}{4}$  in. deal board, or if economy is desired, they might well be cut from the stout ends of a decent fruit or grocer's box. Some of these boxes, especially those for the transport of apples, are made of quite good timber. The sides and bottoms of these containers can be cut from any suitable wood available. No need to be too particular over the matter, or utilise a quality of wood possibly needed for something a bit more artistic, say.

The sides of one of the boxes mentioned above might be brought into use, or even a stout plywood. The strips need not touch, a space of anything up to 1 in. between each strip will not matter in the least. If you can obtain a few odd ends of thin matchboarding, this would suit best of all, perhaps, especially if sawn into strips which would make a small quantity go a long way.

It is important that these strips be all cut to the same length so that both containers will measure the same. Nail the strips to the ends firmly, as in detail Fig. 3. If any roughness is present, it would be as well to glasspaper the

(Continued foot of page 194)

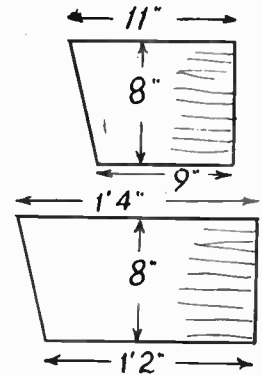

Fig. 2—The sides of the containers

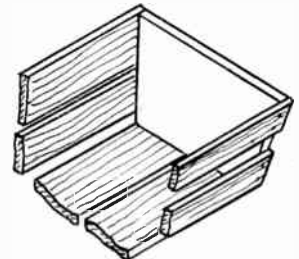

Fig. 3—How the containers are made up

**T**HIS would prove a useful article in any kitchen, and having a generous capacity would hold a week's supply of vegetables. Two containers are provided, a large one for potatoes, as being the vegetable most used in the average household, and a smaller one for greens, onions, etc. A shelf at the top of

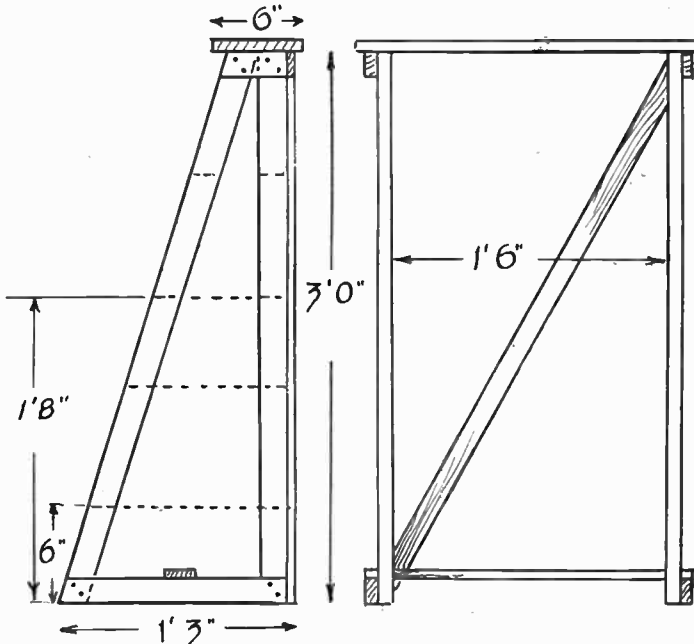
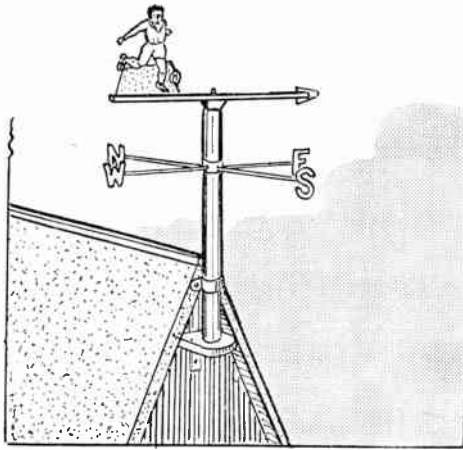

Fig. 1—Side and end views with dimensions

# A footballer is featured on this NOVEL WINDVANE



**A** WINDVANE is a useful article to erect in the garden, as it is of interest to learn which direction the wind may be blowing. Designs of windvanes are, of course, legion, and the pattern, which is the subject of this article, employs a sporting motif—a footballer, as the actual moving vane. It would, perhaps, be no difficult matter for some readers to incorporate a tennis player or batsman as a substitute for the footballer, or in fact, any other sportsman as may be preferred.

The arrow shown in Fig. 1 is cut to the length given from a piece of hardwood,

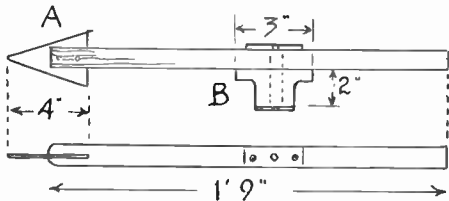

Fig. 1

1in. square section or thereabouts. A strip of oak or beech would suit, or almost any hardwood in fact. At one end the arrow point, which can be cut from sheet metal, is to be fitted in. Slit down the wood with a fine tenon saw for a depth of 2ins., push the arrow point in, and drill a pair of holes through both wood and metal, in which screws can be driven to fix the point in securely. At this stage, the figure of the footballer must be cut out, and fitted to the arrow shaft.

This is shown in Fig. 2 drawn over 1in. squares, except at the top where  $\frac{1}{2}$ in.

only is added. This makes the height of the figure just  $7\frac{1}{2}$ ins. Copy the squares full size on to thin paper, and draw the figure carefully over. Fasten to a piece of thin sheet metal, tinplate would serve, and trace the figure through carbon paper to the metal. Note that a  $\frac{1}{2}$ in. wide strip of the metal is added at the bottom of the drawing, which is afterwards bent outwards, and pierced, for fixing to the shaft.

Cut the figure out with a metal fretsaw blade, or if of tinplate, an old pair of scissors. Those parts of the figure which are not cut out, being incorporated in the lower background portion, should be scratched in, otherwise the carbon paper copy may be rubbed away during the cutting out process. Fix the figure to the end portion of the shaft with small brass roundheaded screws, pretty close to the end opposite the arrow point. Now balance the shaft on the finger, and at the point of balance drill a hole, the size of the metal pivot, on which it is to swing. This pivot should be about 7ins. long and  $\frac{1}{2}$ in. diameter, and can be a piece of iron, steel or brass rod.

A pair of brass plates will be required, one over the hole at the top, which will be 2ins. long, and one underneath block (B) which is  $1\frac{1}{2}$ ins. long. Drill the plates at their centres with suitable pivot

wind direction, copy the letters in Fig. 3 on thin paper, and gum to sheet metal, again tinplate if nothing stiffer is available. Cut the letters out, and soak in warm water to remove the paper pattern. Dry the letters, and flatten out with a hammer on a hardwood block if at

(Continued foot of page 197)

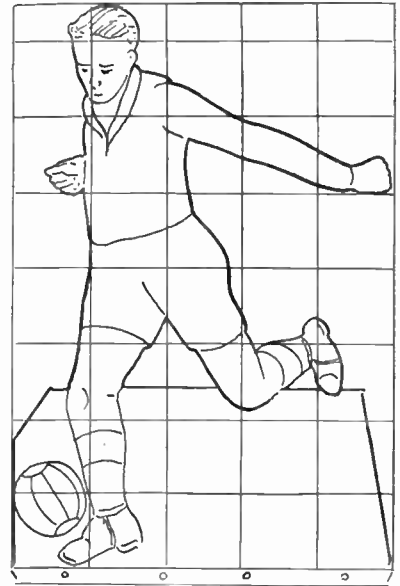

Fig. 2

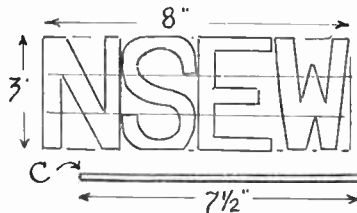

Fig. 3

holes; and screw holes also at each end. Cut block (B) to the shape from a 1in. thick piece of hardwood. Glue it under the pivot hole in the shaft. Screw the top plate over the pivot hole, and if fairly long screws are used, say,  $1\frac{1}{2}$ in. ones, these screws will penetrate through the shaft and into the block, strengthening the glued joint. Screw the second plate under the block, and see the holes in all three are in true alignment. Remove both plates, and widen the hole in the shaft by working a larger drill through. Then rescrew the plates on.

For the cardinal points, to indicate the

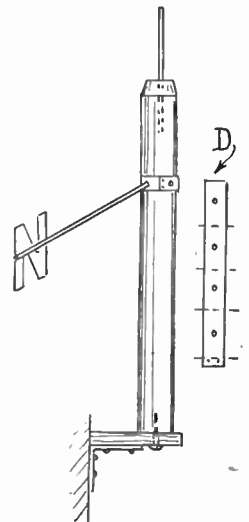

Fig. 4

# Improve your prints by learning HOW TO TINT PHOTOGRAPHS

**P**HOTOGRAPH colouring or tinting is a most absorbing and interesting hobby, and can transform the most mediocre picture into a subject of compelling interest.

The process is extremely simple and inexpensive. In fact, a small box of photo tints costing a few shillings, will, on account of the concentrated nature of the colouring, process many dozens of photographs.

Suitable photo tints made by the leading photographic manufacturers can be purchased from any photographic suppliers for a modest sum. A very convenient box of tints containing all the essential colours, and complete with brush, is sold by Messrs. Johnsons of Hendon. The price at the time of writing is 5/-.

## Small Prints Unsuitable

Generally speaking, prints of smaller size than post-card are not very suitable for colouring, due to the more intricate work required for the smaller sizes. Glossy prints also should not be used, as the glazed surface tends to make the colours run. The most suitable surface is known as semi-matt which provides an excellent base for colouring. Black and white prints, although they can be coloured, are not always so effective as those which have been sepia toned. These have a softer graduation which blends unobtrusively with the colouring.

If the reader has not the means to undertake the enlarging of his small photograph negatives, any chemist or

photofinishing agent will undertake this for him at a reasonable charge. Be careful to specify the size, not smaller than post-card, with a semi-matt and sepia finish.

The photograph is prepared for tinting by soaking in warm—not hot—water for approximately 15 minutes to soften the emulsion. It is then removed from the water, allowed to drain and placed upon a smooth hard surface, such as a sheet of glass or a flat enamelled plate. A sheet of clean blotting paper is then applied to the print emulsion to absorb any surplus water, and the photograph is then ready for colouring.

The tints are very highly concentrated, and need considerable dilution for use. The best method is to put a small amount of water in a saucer or similar, then pass the brush into the tints and allow a few drops to fall into the water, afterwards thoroughly mixing. Do not make the mistake of applying the colours too strongly, or of using extreme contrasts of colour. The best and most natural effects are obtained by using the least possible amount of colouring for the particular subject in hand.

The colouring is applied evenly on the photograph and any surplus absorbed with clean dry blotting paper. Should the colour be insufficient or lack depth, several applications should be made until the results are satisfactory.



The necessary equipment laid out ready to begin

The photograph should be treated in sections, that is, flesh tints such as the face, neck, arms, etc., should be completed before commencing on other parts of the photograph.

Where coloured portraiture is attempted, the background colouring should be kept at a minimum to focus attention on the subject of the photograph.

Upon the completion of the colouring, a final application of blotting paper is made to the print, which is then placed aside to dry. When the print is dry, any curling can be removed by holding firmly between the fingers at the diagonal corners, and passing over a straight edge, emulsion side uppermost. A table edge is ideal for this purpose. The photograph can then be left between the leaves of a heavy book for a few hours to flatten permanently. (166)

## Novel Windvane—(Continued from page 196)

all distorted during the cutting out. The arms, to which the letters are to be fixed, are cut to the length shown at (C) from stiff brass rod, and one is soldered to the end of each rod. It is a good idea here to flatten 2ins. of each rod, where the letters will come, to ensure a closer soldered joint.

The pillar of the windvane, Fig. 4, is a short length of round wood rod, say, 1½ins. diameter. The length must be calculated to suit the building it is to be attached to. A piece of curtain pole would suit nicely for the pillar. At the top end a hole is drilled 3ins. deep, a tight fit for the pivot, which is then driven in. Bevel off the top edge a little, as in the diagram. A few inches down from the top, a metal band is to be pinned round, into which the arms of the cardinal letters are to be fixed. A strip of fairly stout metal, say, 1in. wide will serve, long enough to embrace the pillar, with a little over to overlap.

Ignoring the overlap, divide the strip into four equal parts and in the centre of each part drill a hole the diameter of the rod used for the arms, as at (D). Drill smaller screw holes at each end of the strip, and bend it round the pillar and fix it with the screws. Now, as shown in the drawing, continue the rod holes in the band partly in the pillar as well, drive the arms in, in their correct order, of course, and solder each arm to the metal band.

Fixing the windvane is a simple matter, and in some cases may be left to the ingenuity of the reader. A good place is to the end of a shed or other building in the garden. Such a fitting is shown in the general view of the windvane, and may be copied and amended to suit individual cases. A suitably sized base piece of wood is fixed to the end of the building with a metal bracket. To this the pillar is secured with a single screw, as in Fig. 4.

A little higher up a metal band is attached, the ends of which are bent outwards and screwed to the roof ends. The pillar can then be turned until the letters on the arms point to their correct cardinal points of the compass, and there the bottom screw is tightened, and a nail driven through the metal band into the pillar to prevent any further rotation. Place a large metal washer on the pivot, then slip the shaft of the windvane over. Oil it, and see it is able to rotate freely.

The woodwork should receive two or more coats of paint, and the metal work be enamelled. The vane should be painted to suit the figure, the background being green, face, knees and hands a light brown, also the boots. Features can be put in with black paint and a fine brush. Shorts and shirt coloured to choice, perhaps to suit that of a favourite football team. The back of the figure could be enamelled to suit the other metal parts. (202)



# A novelty automatic TEA CADDY

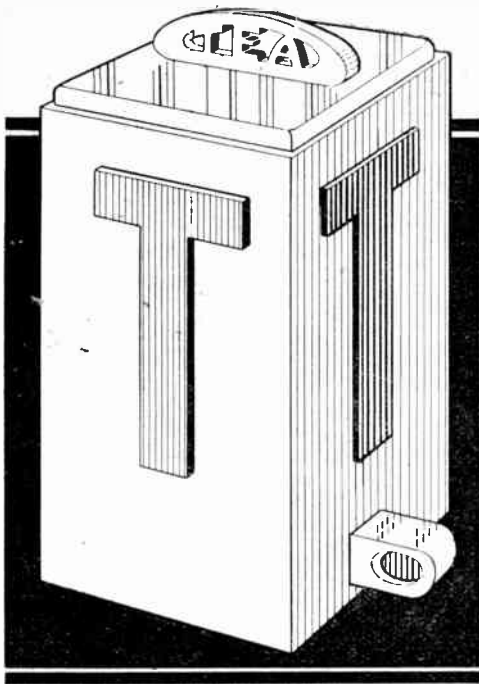

This novel tea caddy is the subject of this week's free Design Sheet, No. 2930, and would be ideal to make up as a present, or for sale. A parcel of materials for making the caddy can be obtained from Hobbies Branches or post free from Hobbies Ltd., Dereham, Norfolk, price 6/9, including tax.

It has often been said that tea is the Englishman's national drink, and this is one of the reasons why we feel that the tea caddy described here will be welcomed by fretworkers as a useful article to make up, especially as many homes have no proper receptacle for their tea ration.

And this is no ordinary tea caddy. Not only does it store the leaves, but, by means of the plunger in the front of the case, it can be made to dispense its contents—a spoonful at a time.

## Straightforward

At first sight, such a gadget might be thought to be complicated from the point of view of construction, but this is not so. Construction is straightforward, and the caddy, once made, is strong and foolproof.

The pieces on the design sheet have been numbered as nearly as possible in the order of cutting out and assembly, and, as soon as the parts have been traced off to the necessary wood, a start can be made.

First cut the two side pieces (A) and one of the pieces (B) (the back), and glue them together so that the piece (B) goes between the two pieces (A). The glued joints can be strengthened by fret-pins or small countersunk screws. Next cut out and glue the floor (C) in position as shown by the dotted lines on the design sheet, and this will hold the assembled three sides square.

Now cut the pieces (D) and chamfer them as indicated in the section on the design sheet and as in Fig. 1. When gluing them into position note that the lower edges are flush with the opening at the front of the floor (C). It is important that they should be glued in position thus, if the caddy is to dispense an accurate teaspoonful each time the plunger is worked.

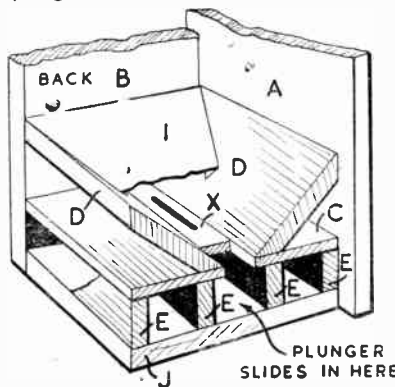
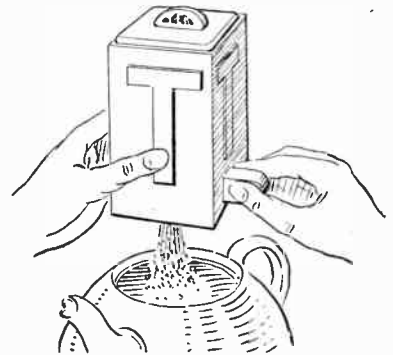

Fig. 1—Showing the assembly of the vital parts of the caddy

The false bottom of the caddy is now built up with the pieces (E) which are glued to the underside of the floor and to the sides (A) in the position shown by the dotted lines on the design sheet and as seen in Fig. 1.

To make the plunger, cut the pieces (F), (G), and (H) and glue them together as shown in the detail on the design sheet. The plunger is now inserted in the slot as indicated in Fig. 1. The floor (J) should be held temporarily in place while the plunger is inserted. Slide the plunger in until its rectangular opening coincides exactly with the opening in the floor (C). Now put a round-headed screw or fret-pin through the slot in the floor (C) at the point marked (X), and this will ensure that the plunger when pulled out, stops in the exact position to receive tea from the container.

Once this job has been satisfactorily accomplished, the worker can proceed with the piece (I), which is cut from thin card. Card is used for convenience, as such a piece made from wood would be complicated to chamfer exactly. In using card there is also the advantage



How the novelty works. The plunger is pulled out and then pushed in again, when a spoonful of tea is allowed to drop into the teapot

that, in the event of having to get to the plunger at any time, the card can be torn away, the repair effected, and a new piece of card put in place.

When the card has been cut to shape and bent according to the dotted lines, it should be glued into position as shown in Fig. 1. This drawing, of course, shows the card cut away, but in actual fact the narrow end of the card extends right to the edge of the opening in the floor. Thus, with the two pieces (D) the card piece ensures that tea must slide easily through the rectangular opening whenever the position of the plunger will allow it.

The second piece (B) (the front) can now be glued into position, and the floor (J) can also be put on. The floor should not be glued, but should be secured to the pieces (E) with countersunk screws.

(Continued foot of page 199)

# Notes for clubs on PLANNING AN EXHIBITION

**D**URING the last nine months I have been closely connected with many exhibitions, trade and otherwise. I find that there is much on which we can improve in our arrangements, and this short article might help readers.

Many struggling hobby and model clubs feel that they cannot put on a show all on their own, although they want to get known so that they can increase in membership and interest. If you feel this way, try to contact the British Legion, the R.A.F. Association or any well established organisation. Just a small show will start you off, and the fact that you have assisted will build up much goodwill. You should remember that all local organisations represent some part of the family circle. Father may be in the Horticultural Society, John is in the Scouts and mother in the Women's Institute, just to mention a few links in the chain. Get in on these lines and you will find that half the problems are solved.

## Avoid Clashing Dates

I know it is difficult, but try and avoid the same date as other functions. You cannot succeed by clashing with them. Never make up your minds suddenly. Let it be a good show in nine month's time rather than a hurried show in nine weeks' time. Recently I have heard genuine grouses about this and I am fully sympathetic. We do not make good models in a couple of Saturday afternoons. Get a note in the local paper of the proposed date, with the heading 'Local Secretaries Please Note'.

Now I come to the question of collection of models. If you borrow these, you must transport them. If you

do not, the answer will be 'No' next time. Make a list of all the models to be collected. You must contact those who want to exhibit. Ask if they want transport and encourage as many as you can to trundle their boats and such items round on a borrowed hand-truck. It is slow but very sure and definitely safer where boats are concerned. If you have boats with super structures, try and make these to take off. A simple sling to fit under the hull with two long handles will help splendidly.

Helping in a recent exhibition I went around with a friend in a large two-ton furniture van. We had fifteen calls in about twelve different areas. Try finding all these places in a strange world and see how long it takes. Not only this, at least five had taken their models in. Here was sheer waste of time on somebody's part. In other cases the models were in use till two days after the show opened. This should have all been arranged first. You will never get free use of a transport like this when you waste the driver's time.

## Let Them Know

You must let those taking part know when they can get into the hall to arrange the lay-outs, set up their pet models and adjust the various scenic features. You will have to have someone on duty to help unload the goods. You cannot expect a van-driver to handle 6ft. long battleships by himself.

If you know that sets of models are coming in from a group or society, have the courtesy to appoint a lad solely responsible for the tables on which these should rest previous to setting them up. Avoid the 'Dump it there attitude' of which I have been painfully aware in the last few months. In all my

nine major exhibitions of the last six years I have had a treasurer, exhibition manager (myself), tables and forms officer, publicity officer, a young poster artist to make out tickets and instructions at a minute's notice, besides my normal committee. And then, most important, some kind person with the teapot. I do wish clubs would think this one out. I went for six hours on a Sunday recently, missed my dinner and came home without so much as a cup of tea. I am not surprised that some shows get such little support.

## No 'Spare' Needed

Spare people shuffling around are useless and will only annoy exhibitors. I like children very much, but have them in their place. At the time of fixing up the show my view is that they should not be there. Let an exhibitor see a youngster pushing his locomotive along the floor and you most certainly will hear about it; or maybe you won't, and that is worse—you will lose his support for good.

There are many things needed at an exhibition and the Secretary should see that they are available. Drawing pins, a small hand-saw, pliers, small nails, a piece of chalk, card for tickets wanted urgently, thin string, thin wire and an assortment of nails. Blocks for fixing up boats which may not have a stand, and an assortment of stripwood should be handy. Realise that many very busy people are giving up their time to help your show with their models. You cannot expect them to do more than this.

Lastly, send all exhibitors a programme and then you will not find people worrying you to know when it is open. (199)

## Tea Caddy—(Continued from page 198)

This is to enable the worker to get to the plunger at any time without difficulty. Note, too, that the rectangular opening in the floor (J) is not central, and be sure to fix it in position in the right way; i.e., the opening should be nearer the back of the caddy than the front.

The main work of construction is now finished, and the worker can proceed to make the lid. This is made from the piece (K), which is chamfered to section as shown on the design sheet, and piece (L), which is glued to the underside of (K). The handle (M) should be neatly fretted out, so that the word 'Tea' is easily readable, and glued into the

mortise on the top of the lid.

The work of construction is completed by cutting the overlays (N) and gluing them firmly into position on each side of the caddy.

When the article has been thoroughly cleaned up, the rest is really a matter for the individual choice of the craftsman. Some will, naturally, prefer stain and polish, while others, with an eye to existing colour schemes in their homes, will wish to enamel or cellulose the caddy. In either case it would look effective if the overlays, and possibly the handle, were made darker than the remainder of the article.

A word of warning. Do not stain or

paint the inside of the caddy, as there would be a danger of contaminating its contents later. Instead, leave it plain wood, or alternatively glue in a lining of tinfoil, if available, or a good quality stiff paper.

Readers will be glad to know that an Index to Hobbies Weekly Vol. 112 (covering issues from April 18th. to September 26th. 1951) is available, price 1/- post free. There are also red linen binding cases price 4/6 each post free.



# The SHIPMODELLER'S Corner



**I**n ship model making there are many fittings that are the better for being turned to shape, and the work is much simplified by the use of home-made tools and accessories for use with your Hobbies lathe.

All the accessories dealt with throughout this article, with the exception of two (which I had made to my specification by a friendly toolmaker) I have actually made and have continually in use. Those of our readers who are lucky enough to possess a Hobbies lathe will find that they widen the scope of the work which can be undertaken on this most useful home-worker's machine.

Always when beginning to use a lathe, the first difficulty to arise is how to centre the work correctly. With square or octagonal work it is quite simple as Fig. 1 shows, but with round stock it is not so easy.

To deal with this problem in a practical manner, we need a centre-square, and this is quite easily made from a piece of  $\frac{3}{8}$  in. fretwood or

## Lathe Accessories for the Shipmodeller

By 'Whipstaff'

plywood. It pays to make two or three of different sizes, as all work is not the same size (see Fig. 2). (A) and (B) are dowel pins equidistant from (C), the working edge.

In use the pins are brought into contact with the curved surface of the work, and by drawing two or more lines across the face of the stock, the exact centre is found at the intersection of the lines, Fig. 3.

In all model making and woodwork we often require half-round beading of a particular size, and this is most simply made by gluing two strips of wood of the necessary size together,

with a strip of paper between to facilitate separating them after turning in the lathe.

The usual difficulty here, as in all cases where a long thin piece of stock has to be turned, is to support the work and prevent it from bending under the pressure of the turning tool. This has to be done by supporting the work in one or two places. For stock up to 6 ins. long a single support in the centre would suffice. I find, however, that such lengths are better turned by use of the tailstock described later.

For longer pieces I made two supports as in Fig. 4. These consist of a base piece of  $\frac{1}{2}$  in. plywood, with the

centre fretted out to take the locking bolt in the lathe bed, the upright of the same material, glued and screwed in the centre of the front edge of the base piece.

A strengthening block of 1 in. by 1 in. wood is glued into the angle of the two pieces, as shown in Fig. 4, sketch B.

The completed assembly is now mounted in the lathe bed, and a hole  $\frac{1}{8}$  in. larger than the stock you are going to use is drilled through the upright in direct line with the lathe centre.

I have three of these assemblies in use, to take  $\frac{1}{2}$  in.,  $\frac{3}{4}$  in. and  $\frac{1}{2}$  in. stock. All square stock should have the corners planed off to make the initial turning easier.

In turning tiny stanchions and guns, etc., I found it simplified the work to make a special tailstock similar to our supporting rest above, but with this difference; in place of the strengthening block of 1 in. by 1 in. wood, a cube of wood is glued in the angle of the two pieces. The upper surface of this block must be level with the lower edge of the hole drilled to take the stock. In the case of a hole to take  $\frac{1}{2}$  in. stock, your cube will be 1  $\frac{1}{2}$  ins. by 1  $\frac{1}{2}$  ins. by 1  $\frac{1}{2}$  ins.

In the back of the upright piece and slightly below the upper surface of the block, drive in a 1  $\frac{1}{2}$  in. nail to form a tool rest. Using this tailstock in conjunction with the drill chuck of our lathe, you will find it possible to turn even the very small scale stanchions, etc.

Accessories of which you cannot have too many, are chucks of various kinds suitable for the different kinds of work.

Owners of Hobbies lathes who are lucky enough to possess all the accessories supplied by Hobbies Ltd., plain, spur, and screw centres, bell and drill chuck, will know how useful such accessories can be. Many can be made at home quite simply.

If you are not a metal worker, perhaps you can find a friend who is (as I did myself), and persuade him to make the first two items for you.

No. 1, Fig. 5, is a most useful item. It is a bell chuck to hold work up to 1 in. in diameter. The one supplied is for work up to 1  $\frac{1}{2}$  ins. If the measurements in the sketch are adhered to, you will have a chuck whose weight makes it turn

(Continued foot of page 202)

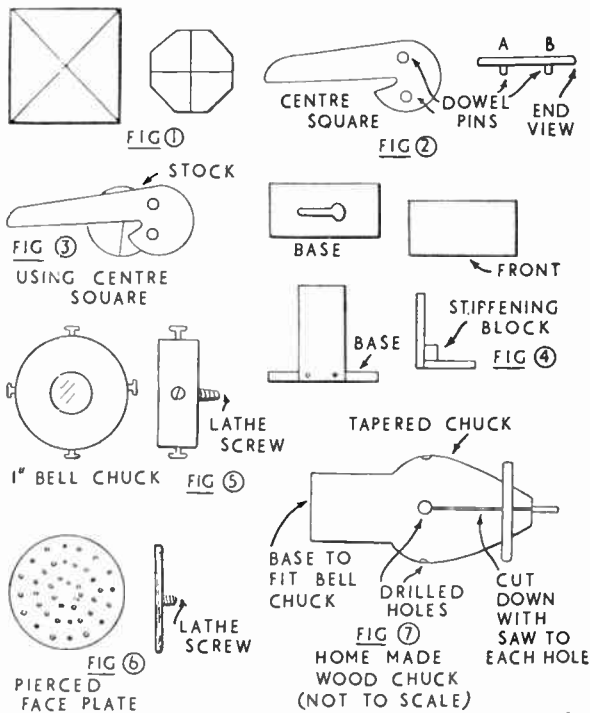



# Why you should USE YOUR CAMERA MORE

**T**HIS article is specially written for the benefit of the many thousands of amateur photographers who think of using their camera only when they are going for their summer holidays, or, perhaps, when they have arranged to go on a ramble on a bank holiday or at a weekend. For the rest of the year that wonderful piece of apparatus, which may have cost anything from one guinea to ten, or even more, is allowed to remain idle and, in many cases, completely forgotten.

There are hundreds of opportunities occurring in the lives of all of us throughout every year when, if the camera is handy, we can secure some excellent snaps of scenes, or records of events, that will give us untold enjoyment and

making a few snaps? An hour or two spent in a ramble would put your mind in better trim for that particular sticky bit of studying. Why not take the camera to the football or cricket field on one or two occasions, even if it is only used for taking a snap or two of your colleagues?

## An Experience

Let me give you just one experience of my own which happened forty years ago. I was asked to join a small party of friends who were going on a ramble through a very charming piece of the country. I agreed to go and to carry my  $\frac{1}{2}$  plate camera. Six exposures were made, including two woodland scenes. From these two I made enlargements which were subsequently framed and have had a prominent place on my walls ever since. They have given me pleasure and enjoyment all those years; and here is the historical and interesting sequel — those woodland paths no longer exist, for they are now streets of houses.

If you read the photographic articles which appeared in the December 20th, 1950 and January 17th, 1951 issues of *Hobbies Weekly* you must

have been surprised and impressed to learn that photography is playing such an important part in our lives and in so many different spheres. It is because of this universal recognition of the value of photography that I appeal to readers to make more use of their cameras and to become experts. It may be that an opportunity may soon present itself whereby you will be able to put such knowledge to practical use in a remunerative job. Those of you who are likely to be called up for National Service will find large photographic establishments in all branches, with openings that offer good opportunities.

Let us consider ways and means of becoming keener and more interested in using the camera. First, you should join the local camera club, for quite a lot of valuable help can be gained at these societies where, in most instances, practical demonstrations or lectures are given weekly by really qualified men.

There are also regular rambles and excursions where you will have the valuable assistance willingly given by the 'older hands' on the vital queries of exposure, what to take and what to avoid. The benefits of membership are good value for the small fee required, and the large majority of advanced workers will acknowledge that it was the influence of the club members and the knowledge gained by the demonstrations that made them so.

Perhaps you feel that you are not old enough to join such a community, that you are still at school and your evenings are taken up with homework. That is quite a reasonable excuse, but you can do something in the nature of giving help to and getting help from others. Possibly two or three of your companions have cameras. Get together and arrange an outing. This could be to the open country or to a nearby village or town, or possibly along a river bank for a mile or so. But wherever it happens to be, let photography be the subject of conversation and be sure to discuss together the exposure time, and the most favourable position from which to make the exposure, not forgetting to study the lighting from all angles. Listen to, and take part in, the discussions, for it is surprising how mutually helpful these can be, and you have the advantage of hearing the other chap's point of view.

## First Step

If such a meeting has been made possible, you have made the initial move towards forming a camera club. We will presume that you and your friends belong to the same school, are, perhaps, in the same form. It is just likely that there are several other fellows in the school who have cameras. Right. Go to one of the masters — probably the science master — see if he would be interested in helping you to form a school camera club, and if he favours the idea, then the first step to take is to call a meeting of everyone in the school who has a camera or is interested in some way or other in photography.

The master should be invited to take the chair at this meeting and the items to be discussed should include dates of meetings and times, membership fees and the appointment of secretary, etc. Questions will be asked about where the meetings can be held and whether there is a room that can be used as a dark-room. Usually the master can help in finding such accommodation.



A pleasing hillside scene

pleasure in the future. Some of them will be of events that may never recur.

Let every reader ask himself why he has a camera? If you bought it yourself, then you must have had a reason for doing so. If it was given to you by a relative or friend, then there must have been a motive attending such a gift. It is up to you to fulfil the purpose you had in mind when buying or receiving the camera, and it is for the purpose of helping you to make use of it from January to December this coming year that this article is appearing.

## Excuses

All the excuses that are running through your mind are common to us all. There are the old stagers such as:— 'I am no photographer'. 'I have not got the time'. 'I am still at school and all my time is devoted to studying'. 'I go in for other sports such as football and cricket'. But how much time is taken in

Then comes the question of dark-room apparatus; dishes, lamp, measures, developing tank, etc. This is seldom as difficult as it seems, for usually some member has a brother who used to go in for photography and he will lend you some of the things. Others can be bought out of the club fees, and others can be borrowed when required from the school laboratory. The secretary should try to arrange a programme of interesting items for the meetings, and he will be well advised to have a few moments with the secretary of the local adult society, with the idea of getting him and some of his members to give a few short talks on the elementary side of the hobby.

### Success Assured

These are but a few hints relative to the formation of a society for you and your pals, and there is no reason why it should not be just as successful as the school cricket or football clubs. There is not the slightest doubt that it will put each of its members on the track of obtaining a greater percentage of successful negatives.

It is time now to give a little thought to 'individual' help, for if one wishes to assist a group or society he must have had some experience relating to the subject. In this connection let us consider the errors which seem to be 'common' to most beginners. I was recently invited to visit the exhibition of photographs entered for a fairly popular competition. The first prints to be noticed were the prize winners, and most of these were, obviously, by advanced workers. But they were not outstanding, either in the selection of subject or technique, and if some of the less experienced competitors had been a little more careful it is possible that their entries would have found a place 'on the line'.

Why will the horizons in seascapes run uphill? Simply because the amateurs who produce such effects will not use a

little commonsense when trimming the print or when actually taking the scene. There is an old rule which says: 'Do not have two or more points of interest in your print'. Of course, every picture is made up of items or details and usually one or more of these is bigger than the others, but—and this is the meaning implied in the rule—all the details, both large and small, must combine to make the picture, the eye must not be diverted from the general effect by two or more outstanding and overpowering items.

Another rule said: 'A fake is permissible if it cannot be proved to be a fake'. Many attempts are made to give moonlight or night effects. Some are very nice in their way but one has to be so very careful about the lighting; one example at this exhibition simply shouted that it was a fake. It was, obviously, taken at midday against the light, given a faulty exposure, and a grossly over-exposed enlargement made. The result showed, not moonlight as suggested by the title, but patches of glaring sunlight.

Finally, about mounting. Why leave paste marks on the print? They can be easily removed with a pad of cotton wool and some clean water.

### A Final Word

No more about errors because I want to give a final word of advice to the keen amateur. When you have a few minutes to spare on a Saturday morning just take the camera and go down to the

market place or shopping district of your neighbourhood. Try to imagine that you have been asked by an editor to



A riverside view

write and illustrate with photographs a brief description of the busy thoroughfare. You will perch yourself in a suitable doorway where a good comprehensive and representative view of the busy spot can be obtained, carefully estimate the distance between you and the nearest object, observe the light and calculate the exposure time. Remember that a fast exposure is necessary because of the constant movement going on, therefore a large stop may be necessary.

Take two or three shots, varying the angle of view, and try to be absolutely absorbed with the job and quite unconscious of anyone or anything. Having got what you want and arrived home, sit down and write out your 'copy', and when you have made the prints. See if they well illustrate your story. You will then have had your first lesson at photographic reporting. (198)

### Shipmodeller's Corner—(Continued from page 200)

absolutely true. This is most essential, as we require it to hold our home-made wood chucks, to be described later in our article. This bell chuck must be of metal.

No. 2, Fig. 6, is a pierced face plate made from a piece of  $\frac{1}{2}$  in. steel, and has a screw shank, threaded to fit the Hobbies face plate, brazed to the back face. This enables you to screw this face plate in position on the existing face plate of your lathe. This face plate is now drilled with  $\frac{1}{8}$  in. holes spaced equidistant over the plate, to enable work to be attached to the plate with small screws, put in from the back. For face turning it is a very versatile tool. Mast tops, etc., are turned easily.

And now as an example, let us proceed to make a small wood chuck. These can be of varied types and sizes and are very useful for turning capstans, small wheels and knobs, etc., also for using up small pieces of dowel for guns, etc.

Take a piece of hardwood—beech is suitable—2 ins. long and  $1\frac{1}{2}$  ins. square, mount it between centres in your lathe, and turn down to form a cylinder  $1\frac{1}{2}$  ins. in diameter. You will, of course, have outside and inside calipers to ensure correct work.

Next turn down one end to  $1\frac{1}{2}$  in. diameter for  $\frac{1}{2}$  in. along the length of the cylinder. This enables the chuck to be mounted in our  $1\frac{1}{2}$  in. bell chuck.

We now drill down the exact centre

of the wide end to a depth of  $1\frac{1}{2}$  in. and then turn down the chuck to a tapered shape as in the sketch Fig. 7, the end diameter to be  $\frac{1}{8}$  in. in diameter.

While in the lathe, drill four equidistant holes around the circumference and  $\frac{1}{2}$  in. from the end. Finally cut down to these holes with a tenon or dovetail saw.

You will need a washer with an internal diameter to fit over your chuck. This can be metal or cut from  $\frac{1}{2}$  in. plywood. In use we mount this chuck in our bell chuck, place our work in the jaws of our wood chuck and push back our washer tightly. This ensures the jaws gripping the work firmly. (145)

(To be continued)

# Gifts from odd wood — TWO DECORATIVE SPILL HOLDERS

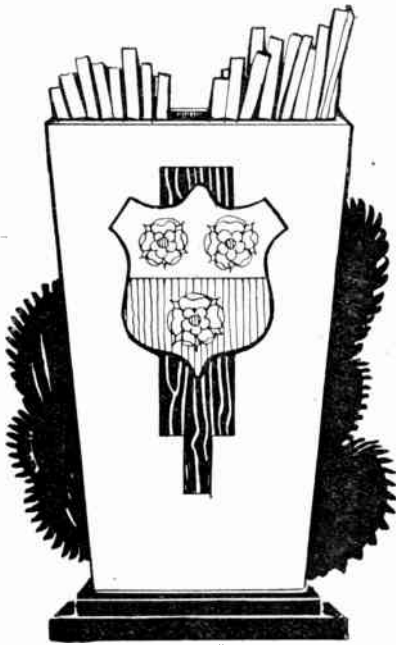

Fig. 1—The first design

**M**ANY useful gifts can be made from some odd pieces of fret-wood, and we show two simple ones here in the form of spill holders. The fretsaw enters largely into the making of these, and as can be seen from the illustrations on this page, the actual finish and decoration to be afterwards applied to the wood makes them attractive.

## Making a Start

We will deal first with the holder shown at Fig. 1. This has two shaped pieces—front and back, as (A) in Fig. 2, the measurements being clearly given for marking out on the wood or on to a sheet of paper. Note all wood is  $\frac{1}{8}$  in. thick excepting the base which is  $\frac{1}{2}$  in. thick. Note from the diagram that the two sides (B) go in between the front and back. These side pieces are plain oblongs measuring 5 ins. by  $1\frac{1}{2}$  ins. When the four pieces are cut, glue them together, making neatly fitting butt joints, and then rub down all four side surfaces so as to make the joints almost invisible.

The top and bottom should then be rubbed down flush and the bottom surface properly levelled off so that it fits the upper surface of the base piece

(D). The base is made up of the two pieces (D) and (E); (D) measuring  $2\frac{1}{2}$  ins. by  $2\frac{1}{2}$  ins., and (E)  $3\frac{1}{2}$  ins. by  $2\frac{1}{2}$  ins. Cut these two pieces and glue them together, taking care that a  $\frac{1}{4}$  in. margin is kept at the sides and an  $\frac{1}{8}$  in. margin at back and front. Then on top of these two pieces a third piece (C) is glued, over which the completed 'box' must be glued, exactly as seen in the cut-away diagram Fig. 3.

The measurements of (C) should be about  $1\frac{1}{2}$  ins. by  $1\frac{1}{2}$  ins. but the size should be checked direct from the opening at the foot of the 'box' so as to make a tight fit. Coat the edges of piece (C) with glue, and press the box over this.

## Simple Decoration

The simple decoration shown on the

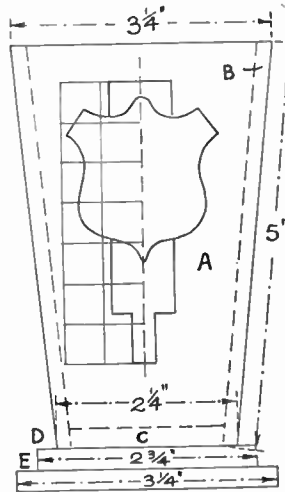

Fig. 2—Measurements for the first article

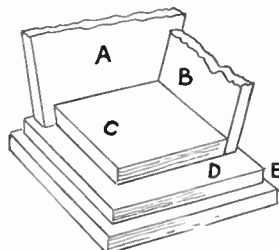

Fig. 3—How the holder is built up

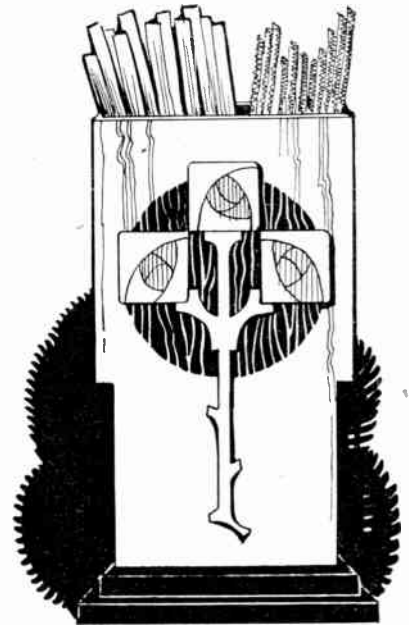

Fig. 4—The second holder

front of the box consists of two overlays, the back one taking the form of the complete outline, the front one being just the shield. The enlargement for the overlays can be made by drawing out on paper the fourteen  $\frac{1}{2}$  in. squares shown in Fig. 2 and following the outline given through each square. The half outline should be traced and transferred to the wood which should be  $\frac{1}{8}$  in. in thickness. A town arms or crest could be painted on the shield and afterwards given a coat of clear varnish. The back overlay may be darkened with stain to show up the shield. The finish to the wood should suit the kind of wood used. Oak may be stained and waxed, or a white wood just plain varnished.

## The Second Design

The second design, that shown in Fig. 4, consists of a plain upright box made up of two pieces (E) and two pieces (F)—see the front view Fig. 5 and the sectional detail Fig. 6. In the latter diagram can be seen the simple construction, while Fig. 5 gives the necessary measurements.

The front and back of the box are shaped quite simply, and between these two pieces the sides (F) are glued. Pieces (F) are 5 ins. long by  $1\frac{1}{2}$  ins. wide

(Continued on page 204)



**Decorative Spill Holders—(Continued from page 203)**

and  $\frac{3}{16}$  in. thick. To thicken out the top of the box at the sides, two pieces as (G)  $3\frac{1}{2}$  ins. long by  $1\frac{1}{8}$  ins. by  $\frac{3}{16}$  in. are glued to

of the centre line, and then sticking down the pattern to the three pieces of thin wood.

**Final Stages**

These pieces of wood must be pinned together in the waste corners, and the design then cut with a fine fretsaw. The pieces are finally glued carefully in their respective positions to make up the

colour scheme indicated. Another way of treating the design would be to cut it as an ordinary overlay and mount this on the circle which should have been previously drawn in and stained with heavy stain. The roses in the design can have their petals in paint or indian ink.

The base designs would look well stained black and then varnished or coated with ordinary polish. (197)

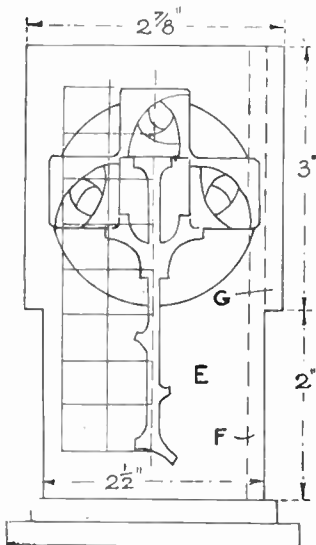

Fig. 5—Dimensions of the second design

(F) as seen in Fig. 6. The base of this box is made up similarly to our first design, with an added piece, perhaps, put down inside the box and glued to the top

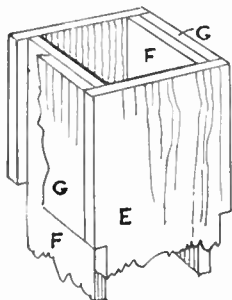
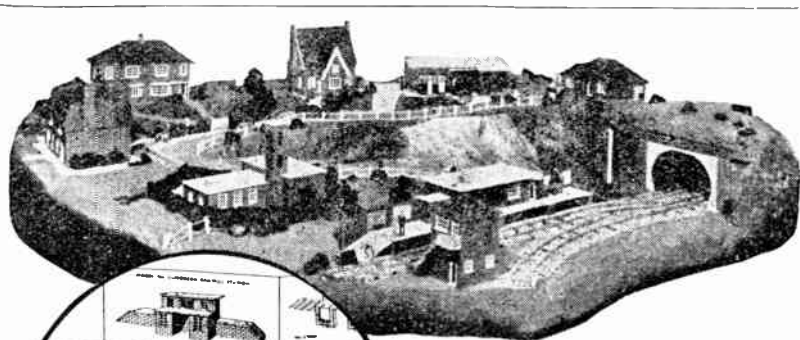

Fig. 6—Constructional details

member of the base.

**Overlay**

The side faces of the box should be glasspapered clean and then some thought given to the overlay on the front. There are one or two ways of carrying out a good colour scheme. An attractive one would be an inlay in, say, three woods, the darkened parts shown in the sketch Fig. 4, giving a clue as to the shade or colour. To do this, an enlargement must first be made from the squared half of the design in Fig. 5. The squares here are shown to scale  $\frac{1}{2}$  in. and, therefore, sixteen  $\frac{1}{4}$  in. squares must be drawn on a paper pattern, and the completed outline made by transferring the half design to the other side



**Build this Realistic Model Village with**

**BRICKPLAYER**

**Bricks and Mortar Building Kit and Accessories**

**ENTER FOR THE BRICKPLAYER COMPETITION**

Prizes of £10 10s., £5 5s., and £3 3s. and a number of consolation prizes of Brickplayer Accessories will be awarded for winning models.

Write for full details.

The Brickplayer Kit contains miniature bricks in all required shapes, mortar, roofing, metal windows and doors, plans and instruction booklet. All models are architect designed to 'O' gauge scale. Buildings can be permanent or dismantled by merely soaking in water, and the bricks used again and again.

Brickplayer Kits at 28/6 and 52/6 and Accessories are available from good toyshops and stores.

If your dealer cannot supply, write for address of nearest stockist to:

**J. W. SPEAR & SONS LIMITED**

Dept. "H", Enfield, Middlesex

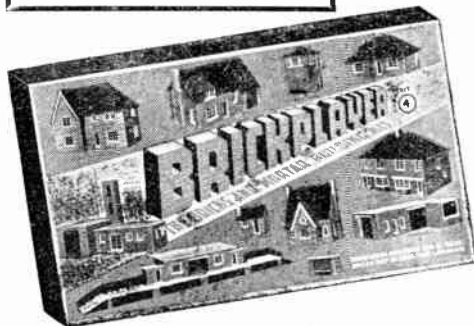

**YOUR IDEAL CHRISTMAS GIFT**

# For a change—let's MODEL A COW

**W**HITTLING or carving in wood is quite a popular hobby in the U.S.A. and would be even more popular over here if hobbyists would get rid of the idea that the carved figure should, necessarily, be a work of (academic) art for which a high degree of art training and craftsmanship is required. In whittling, a good deal of the effect lies in the grotesque shaping and cutting, so that readers can go ahead with this project, safe in the assurance that even if it is somewhat 'out', it will probably look all the better for it!

## A Caricature

Even 'serious' art students, however, might make this model—a caricature, of course—since by exaggerating the animal's anatomy (the hips, flat muzzle,

reference: common deal is useless); in modelling clay (ordinary potters clay or Plasticine, etc.); cast in plaster or in plastic, etc., from a clay model; made in Pyruma and left to harden. By using leathery, half dry clay, one can carve it as opposed to modelling it in a plastic way. One can carve in chalk, alabaster or use terracotta. One can also carve in soap, using a couple of large bars of yellow laundry soap stuck together. Even if made in wood, it is an advantage to make a clay model first.

We should first make a set of templates. First draw out, full size, the

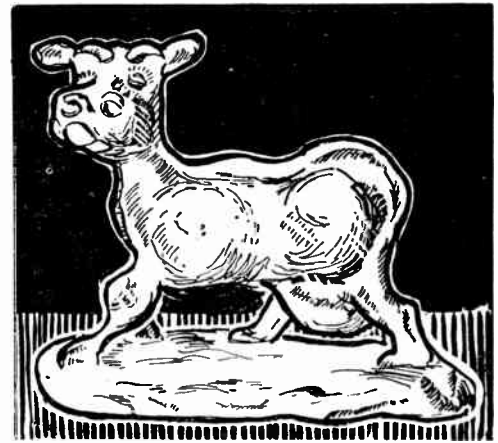
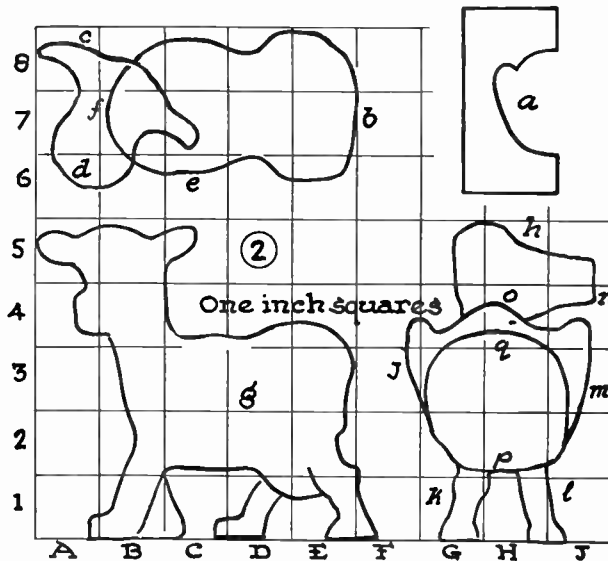

Fig. 1

needs strengthening. With clay, of course, modelling is started by means of a dumpling shape for the body; a small



large eyes, knobby knees, etc.), one is made aware of the characteristics of the cow, and even serious drawings often have that element of a little exaggeration of characteristic parts.

This model cow has specially been designed by the writer and can be freely made up for personal use by amateur makers, though commercial rights are reserved. It is impossible to show the complete effect in simple drawings but enough has been shown to indicate the quaint effect.

The model can be made up in several ways, among them: carved from a solid block of wood (white pine for pre-

squared diagram (Fig. 2), ignoring the top right-hand shape *a*. Now trace off on to thin card, various templates. These are (1) the complete shape *b, c, d, e*; (2) *b, e, f*; (3) complete shape *g*; (4) complete shape *h, j, k, l, m, n*; (5) *o, j, p, m*; (6) *p, q*. Other shapes may be traced off if required. It is an advantage to have two templates for each part: the main profile shape, as at *g* and such half-templates as at *a* (which represents on a smaller scale half of shape *o, j, p, m*). The use of these templates will readily be apparent when modelling starts.

If clay is used, a stiff wire core is needed as in Fig. 8. The neck, especially,

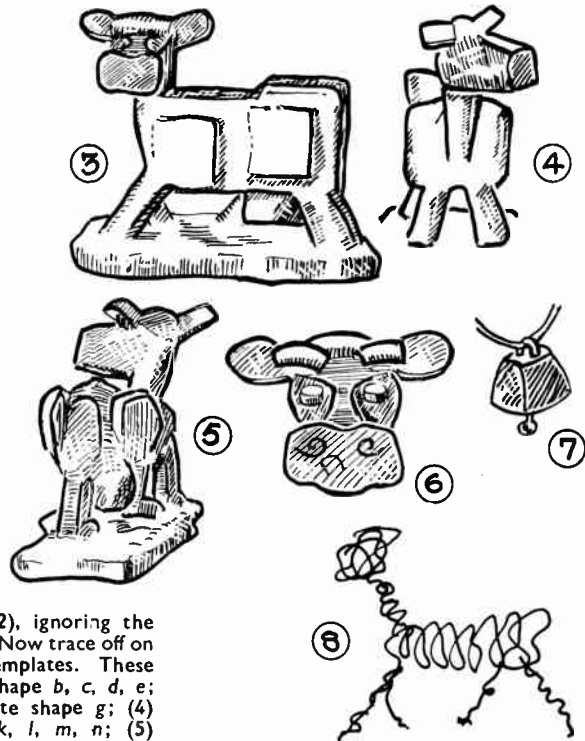

pear shape for the head, etc., and so adding or taking small pieces. Remember always, whatever the medium used, rough out the main forms before attending to details, i.e. reach the stages shown in Figs. 1, 9, 10, 11. Work all over the model, 'advancing' it

(Continued foot of page 206)

**ENJOY MAKING  
PLASTER FIGURES  
WITH  
FLEXIMOULD**



No experience is required to cast religious figures, wall plaques, ash trays, garden ornaments, candlesticks, book-ends, vases, coats-of-arms, articles for window display, cake decorations, cameos and animals, etc. Make a profitable business with this pastime.

Write today for free details of  
**'FLEXIMOULD' to  
DOHM LTD. (DEPT. H)  
167 VICTORIA ST., LONDON, S.W.1**

**STOP SMOKING**

only scientific way. **No Will Power necessary.** You can overcome the smoking habit in 3 days or money back. Safe, pleasant, permanent. The "Conquered the habit in 2 1/2 days. Am delighted".—F.C. "Within 2 days I was free from the tobacco habit".—W.G. "Was a smoker for 2 years and broke the habit in 2 days".—F.N. "I haven't smoked a cigarette for 5 weeks".—J.E. "I used to smoke 20 a day . . . now I have no desire to smoke".—J.M. Recommended by "Health and Efficiency Magazine". Complete course 6/6. Details 1d. stamp. Sent under plain cover.—**STEBBINGS, 28 (H/103), Dean Road, London, N.W.2. Established 1928**

**EARN £££'s WEEKLY**

**114 WAYS TO BE YOUR OWN BOSS**

114 tested ways of earning a second income at home, with little or no capital. Many are earning £5-£20 weekly. Money back if not delighted. Post free, only 5/6. Details 1d. Catalogue of Money-making Hobby Books and courses, 2d. **STEBBING PUBLICATIONS LTD., 28 (H/103), Dean Road, London, N.W.2**

**H.A.C. SHORT-WAVE EQUIPMENT**

Suppliers for over 18 years of Radio S.W. Receivers of quality.

One Valve Kit, Price 25/- Two Valve Kit, Price 50/-

Improved designs with Denco coils. All kits complete with all components, accessories and full instructions. Before ordering, call and inspect a demonstration receiver, or send stamped addressed envelope for descriptive catalogue.

**'H.A.C.' Short Wave Products, (Dept. 22.)  
11 Old Bond Street, London, W.1**

**Model a Cow—(Continued from page 205)**  
all together as an artist would say; i.e. do a bit of the ears, then a bit of the tail, then a bit of the hooves, etc. Do not complete the ears entirely and start on the tail and then the hooves. If you are using potter's clay and, as is likely, are spending several sessions on the job, keep the model wrapped in a damp rag and in an airtight box, and if you intend to cast from it, do not keep it too long exposed to the air as, when the clay dries out, cracks will develop.

Note that the horns are shown flat against the forehead. If made to stand up, as in nature, they would, at least in clay, snap off.

There is not space in this article to deal with casting techniques, but at any public library you can borrow a book on the subject, e.g. *Modelling*, by Maria Petrie. Suffice it to say that one cannot, with a model of this kind, have a simple two-piece mould of the type used for casting lead soldiers in quantity, as the model contains many 'undercuts' that would lock a simple mould, although an

expert could make a mould in six or more pieces. The best proposition is to make a 'lost' mould (described in books of the type mentioned), though by this process, the original clay model is destroyed and only one cast can be made.

One can also try the new flexible moulds and moulding powders frequently advertised in our columns.

In carving from wood, the material is first roughed out with a saw (a coping saw for the leg openings), then chisels, and finally a sharp penknife, though some modellers make use of cutters mounted on the end of a flexible drive on the

dentist's drill principle.

The diagrams show all that is necessary but if further details are required one can see pictures of cows in children's books or one can observe from nature.

A model cow cast in lead or plastic can be obtained from a toy shop and used as a guide but do not aim at a realistic carving.

A cow bell can be shown slung round the cow's neck. This gives a quaint touch (Fig. 7). It has been omitted from the main diagrams, however, in order that basic structure can be shown, rather than details. (170)



206

**A VALUABLE ADDITION  
TO YOUR "OO" LAYOUT**



**LARGE  
GOODS STATION**

**OTHER "LINESIDE"  
KITS INCLUDE**

- Large Signal Cabin 3/8
- Water Towers (2 types in one kit) 2/9
- Country Station 5/6
- Platforms . . . . . 3/8
- Footbridge . . . . . 2/9
- (Postage 1 kit 6d. 2 or more 10d.)

Here is another fine example by Modelcraft from their range of kits produced specially for the "OO" enthusiast. The inclusion of these excellent models adds great realism to lay-outs at very moderate costs. Kit contents include printed card and wood parts, brick and tiling papers, etc. etc., to build complete model. **6/5** Inc. P/Tax.

**BE SURE YOU CHOOSE A "LINESIDE" KIT BY**

**MODEL-CRAFT**

**77 (F.) GROSVENOR ROAD, LONDON, S.W.1**



**THE BOLSTER HOME WATCH AND  
CLOCK REPAIR OUTFIT**

These precision jewellers' instruments include watchmaker's magnifying eyeglass, finest watch tweezers, set watchmaker's screwdrivers, watch and clock oil, oilers, dusting powder, clock brush, plus illustrated instructional manual for the amateur. In container 12/6 post free.

Senior Outfit includes everything above, plus watch jewels luminous compounds, dial renewer, jewellers rouge, explanatory book. Price 21/- post free.

**BOLSTER INSTRUMENT Co. (Dept. H.W.), 5a Station Parade, Ashford, Middx**



# MASTER

## "OO" SCALE HAND FINISHED RAILWAY ACCESSORIES

MODELS

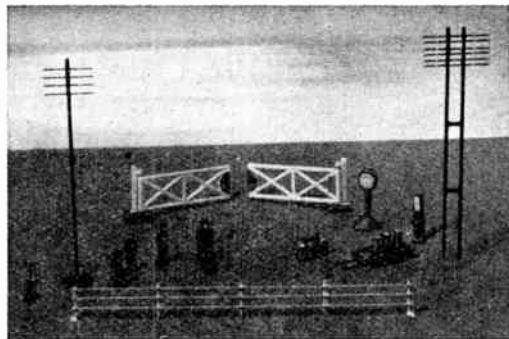
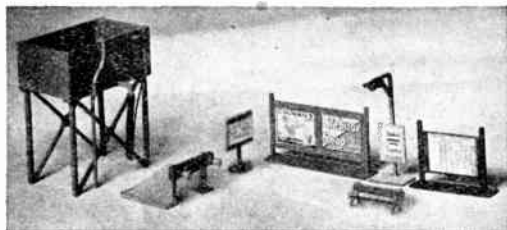

LSA	Lamp and advertisement ... ..	1/10
TP	4-arm Telegraph Pole, without base ... ..	5½d.
TPB	4-arm Telegraph Pole, with base ... ..	8½d.
TPD	6-arm Telegraph Pole, without base ... ..	10d.
LCG	Level Crossing Gates, boxed pair ... ..	3/6
BS1	Buffer Stop, with buffers ... ..	2/-
BS2	Buffer Stop, without buffers, with lamp ... ..	2/-
SG & SM	Single Seats, grey and green ... ..	6d.
No. 6	Double Seats, boxed sets of 2 seats ... ..	2/-
No. 7	Platform Accessories. Boxed set 7 pieces ... ..	2/-
No. 8	Milk Churns. Set of 1 doz. ... ..	1/6
No. 10	Railway Equipment. Boxed set 4 pieces ... ..	2/-
H1, H2, H3	Hoardings ... ..	1/-, 1/7 & 1/-
T1, T3	Timetables ... ..	1/- & 1/7
T4	Train Departure Board ... ..	1/7
Sets A, B, C & V	Track Signs ... ..	2/9, 1/10, 1/10 & 2/9
F6	6 in. Fencing, with base ... ..	9½d.
F12	12 in. Fencing, without base ... ..	1/4½

	Packets of Imitation Coal ... ..	6d.
WT	Water Tower ... ..	6/6
No. 1	Railway Staff. Boxed set 5 figures ... ..	2/-
No. 2	Passengers ... ..	2/-
No. 3	Assorted Figures. ... ..	2/-
No. 4	Seated Figures. ... ..	2/-
No. 5	Seated Figures. ... ..	2/-
No. 1	Freight Series. 6 Girders ... ..	1/6
No. 2	2 Cable Drums ... ..	2/-
No. 12	Electric Trolley with Trailer ... ..	2/9
No. 15	2 Telephone Booths ... ..	2/-

STOCKED BY HOBBIES BRANCHES

WATERLOO 6416/7

SOLE DISTRIBUTORS :

**B. J. WARD LTD, 130 WESTMINSTER BRIDGE ROAD, LONDON, S.E.1**

**SHIPS**

**GALLEONS**

**LOCOS**

**ARCHITECTURAL SUBJECTS**

**ENGINEERING**

**MOVING TOYS**

**ETC.**

**"ABADAN" Oil-well Refinery and Tanker (2/-)**

Building Micromodel replicas of beautiful Mechanical, Architectural, and other Subjects has become a serious cult. On special cards, units readily shaped and assembled models authentic in every detail. Cost a few pence, often sell for guineas. Send stamped addressed envelope for Illustrated 100 Model Catalogue. **MICROMODELS LTD., 3 (H) Racquet Court, London, E.C.4**

**HAND GENERATORS**

L.T. Voltage, 5.3 v. 2.6 amp; H.T. Voltage, 320 v. 60 m/amp, at 120 R.P.M.  
New and complete. Post & packing 1/8 **18/6**

**NEW AND PERFECT Ex-Govt. SIGNAL LAMPS**

for day or night use. 3½ in. lamp. Morse key, viewfinder, mirror reflector, fully wired. In strong waterproof case. Swivel base, metal screw-in stand. Adaptable as car, motor cycle, workshop, studio spotlight. Complete with spare parts, tin and coloured discs. Ideal Scout troops, boys' clubs, signalling instruction, etc. Special spare bulbs, 2/6 Post & packing 1/8 **13/6**

Send for New 1952 Free Illustrated Catalogue  
**PRIDE & CLARKE LTD. (Dept. H.)**  
STOCKWELL ROAD, LONDON, S.W.9 **BRIxton 6251**

Tommy Trump says:— "Smoke

# DOUBLE ACE

*The ACE of cigarettes"*

**10 for 1/3½** THEY WIN ON POINTS!



*British  
made*

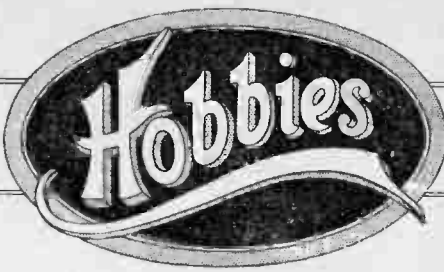

*Fretwork  
Outfits*

## For pleasure and profit

With a Hobbies Outfit you can make models that will please—models that will earn you spare-time cash. A splendid hobby. Patterns are provided for hundreds of things to make—toys, models, fretwork. With a few odd pieces of wood, or the kit provided, you can turn out lots of things; for gifts or even to sell. Any Hobbies Outfit provides all the tools.

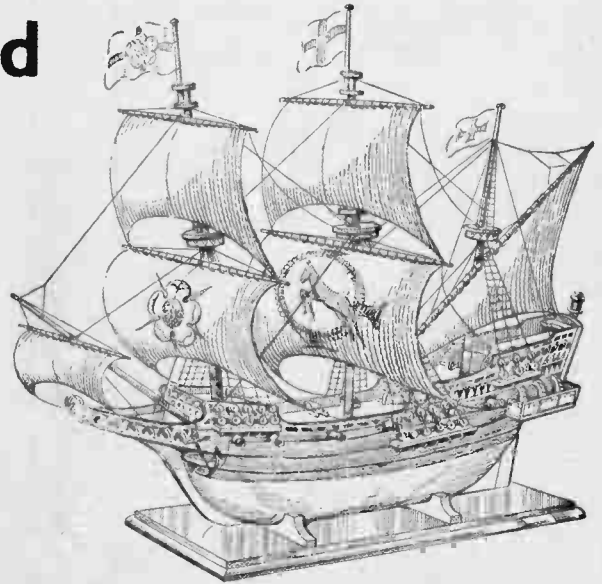
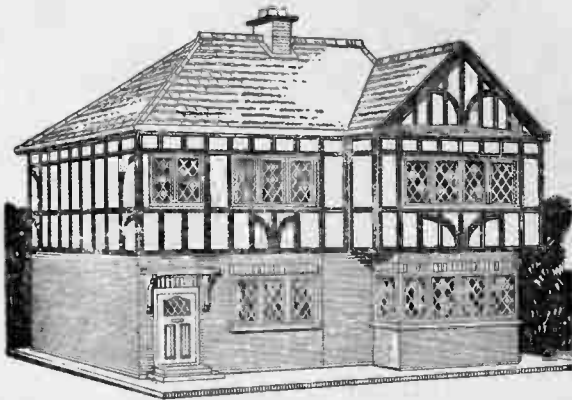

**Complete Tool Sets  
Full-size Patterns  
Kits of Materials**

*Ask for Hobbies at any stores, ironmongers or  
Hobbies own branches. Free Illustrated leaflets  
from Hobbies Ltd., Dereham, Norfolk.*

*Father and Son  
find Hobbies fun!*

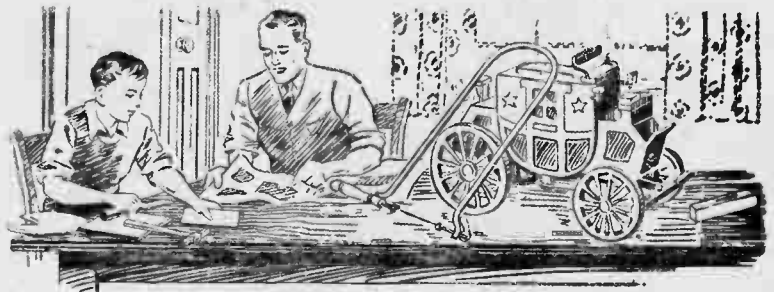

Printed by BALDING & MANSELL, LTD., London and Wisbech, and Published for the Proprietors, HOBBIES LTD., by HORACE MARSHALL & SON, LTD., Temple House, Tallis Street, E.C.4. Sole Agents for Australia and New Zealand: Gordon & Gotch (A'sia) Ltd. For South Africa: Central News Agency Ltd. Registered for transmission by Canadian Magazine Post.