

Hobbies

WEEKLY

CONTENTS

	Page
Tyrolese Chair - - -	33
Have Fun with a Raft -	35
Plate Draining Rack -	36
Two Spill Holders - -	37
Papier Mâché - - -	38
A Wheelbarrow Runway	38
Re-covering a 3-piece	
Suite	39
Hints for the Handyman	40
Child's Stool & Toy Box	41
Matters of Interest -	42
Tie your own Fishing	
files	42
Framework for Tables	43
Camera Overhaul - -	44
Notes about Chisels -	45

DESIGN SHEET FOR A
GYPSY CARAVAN

May 2nd, 1951

Price Fourpence

Vol. 112 No. 2896

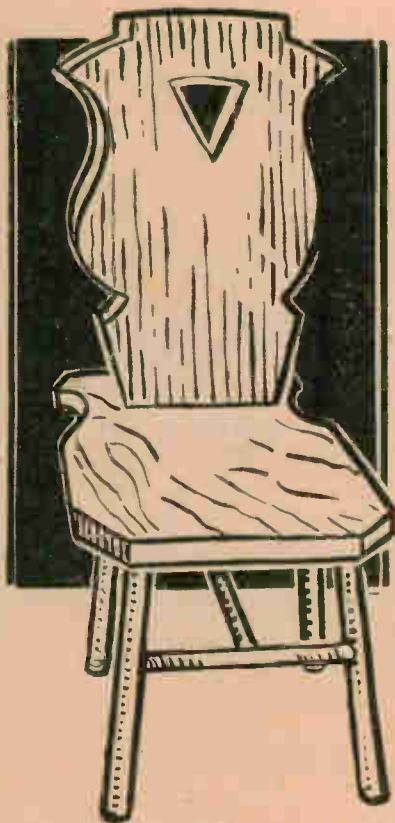

Fig. 1

THE attractive and unusual chair shown in Fig. 1 is based upon one which the writer sketched in a chalet at the top of a Tyrolese mountain. It was one of a dozen or so, all made for hard use as well as ornament. It would make an excellent ornament, however, for use in an English hall or drawingroom corner, or, perhaps, some readers would like to make it up for use in a Scout 'Den' as a special chair of honour.

You can make this ATTRACTIVE TYROLESE CHAIR

The construction is somewhat out of the usual. As can be seen from the drawings, the seat part (Fig. 5) has a slot at the rear through which passes the back (Fig. 2). The back tapers and comes to rest in the seat slot. In the back is another, smaller, slot, the top of which comes to the level of the underside of the seat. A wedge (Fig. 8) is driven in this slot and so holds the back in place. The lower end of the tapering back rests against a rail between two back legs (Fig. 10).

The seat is in two parts: the decorative part visible in Fig. 1, and another bottom (seen in Figs. 10 and 11) into which the legs are inserted. The two parts (seat and under-bottom) are afterwards screwed together. The legs can be either turned, as in the familiar kitchen chair, or made of square section, as in Fig. 13.

Variations

In the usual how-to-make article, all dimensions are given, but this is not possible, or rather, not practical in the present case since, within reasonably wide limits, the size and shape can vary and readers may have suitable pieces of wood they can employ without being tied down to hard and fast dimensions. We will first describe a standard method of construction and design and then describe some alternatives and easier forms of working.

The wood should be quite substantial; 1in. or so thick for the seat and about $\frac{3}{4}$ in. for the back. Ordinary deal is not very satisfactory. Pitch pine would be ideal, as would oak (though the latter would be harder to work).

As regards dimensions, those of an ordinary kitchen chair can be taken for a guide. It looks much more decorative if the seat is made rather low and the back rather high, but if this is carried to excess, the chair will not be comfortable or dignified to sit on, and there will be a danger of the chair falling over backwards.

The seat, then, will be approximately 15ins. square and the back will be about 2ft. 3ins. long, but it is important to cut the back rather longer than needed and then trim off afterwards, if necessary.

It is best to cut the seat first as a plain square and the back as a plain keystone shape, as shown in Fig. 3. The slot is then cut in the back of the seat, taking care not to get it too near the edge. The most practical way of making this slot will be to bore out a line of $\frac{3}{4}$ in. holes and then neaten off with a chisel. Note, from Fig. 6, which represents a section through b-b of Fig. 5, that the holes are not to be bored nor the slot made vertically downwards through the seat, but at a slight slant (do not overdo this). The ends of the slot also slope to accommodate the sloping sides of the

All correspondence should be addressed to The Editor, Hobbies Weekly, Dereham, Norfolk.

Now slip the back in the seat slot and enlarge this slot (if necessary) a little at a time so that the lower end of the back presses against the back rail of the chair legs. The back should extend to about 2ins. below the rail. If it extends more, the excess can be cut off.

The position of the slot for the wedge can now be marked in the back. Mark it first, directly off the job, making line p flush with the underside of the seat. Now take out the back. Push line p up 1/2 in. or so and then mark out a slot for the wedge, which you proceed to cut. When the wedge is driven in, the fact that line p is a little above its true position will cause the back to be pulled down tightly into the slot. Take great care not to overdo the wedge driving, however, as the wood may split. Rather, knock out the

wedge and enlarge the seat slot a little.

Shaping the Back and Seat

If all is satisfactory, the seat and back may now be shaped. Chalk a centre line down each piece. Chalk out the shape on one side of the centre line. Use this to form a paper template (Fig. 9) which will enable you to cut each part perfectly symmetrically.

A bowsaw is needed for the shaping, followed by spokeshave and chisel work. The triangular hole in the back can be omitted if too difficult to cut. Indeed, the back can be carved but only in a shallow way. If too 'knobbly' the back of the chair will be uneasy to rest against.

Though adding to the effect, the shaped rear of the seat, seen in greater detail in Fig. 4, can be omitted and made somewhat similar to the front.

Before screwing the underbottom firmly to the seat, a 'way' (see Fig. 12) must be made for the wedge.

In fitting up, see that the lower end of the back rests against the chair rail, as the

(Continued foot of page 36)

Details of the back, seat and keystone

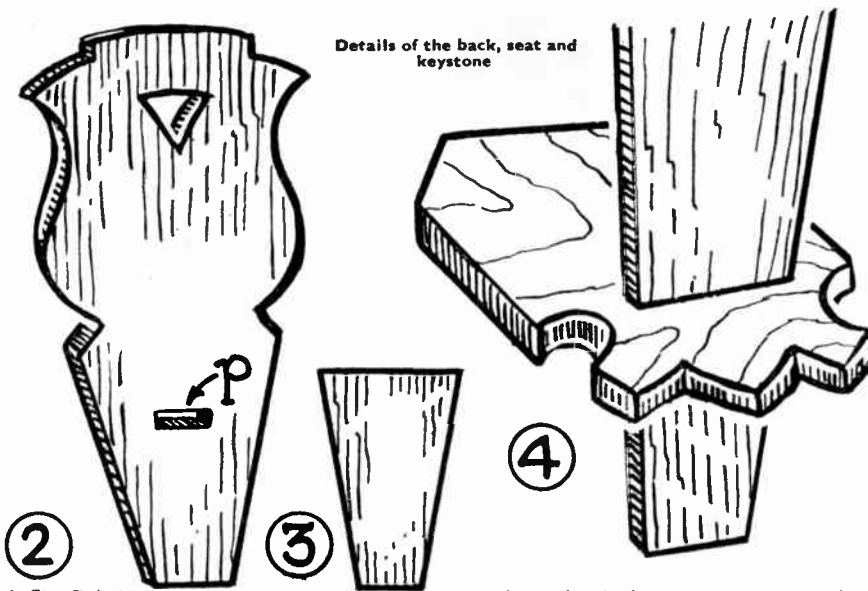

back Fig. 7 (which represents a section through a-a of Fig. 5. It is best, temporarily, to leave the slot rather under required length until the chair legs have been fitted. The fitting of the wedge will also come later.

The underbottom can be of ordinary deal and as thick as possible. It is so proportioned as to come 1in. or 2ins. inside the front and sides, and within 1in. of the slot, of the seat. The legs can well be taken from an old broken down kitchen chair if one has no facilities for turning them. Alternatively, one can make them of, say, 1 1/2 in. square-section stuff, finished off at the bottom and rounded off at the top, as shown in Fig. 13.

Holes are drilled in the underbottom (not too near the edges, for fear of

splitting out) to take the legs, bearing in mind that the legs point outwards and not vertically downwards. Study a kitchen chair. The ends of the legs should, at this stage, fit slightly loosely in their holes. They are afterwards secured very tightly by a method known as 'Fox Tail Wedging', described in due course.

Temporary Fastening

By means of a couple of screws, temporarily fasten the underbottom to the seat and assemble the legs. In addition to the four legs, there are three rails; doweled or tenoned as the case demands, one at the back and front and another connecting them, a method immediately familiar to anyone who has ever looked twice at a chair.

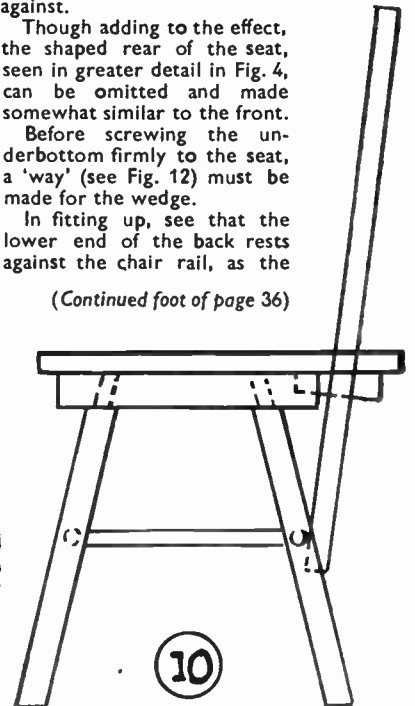
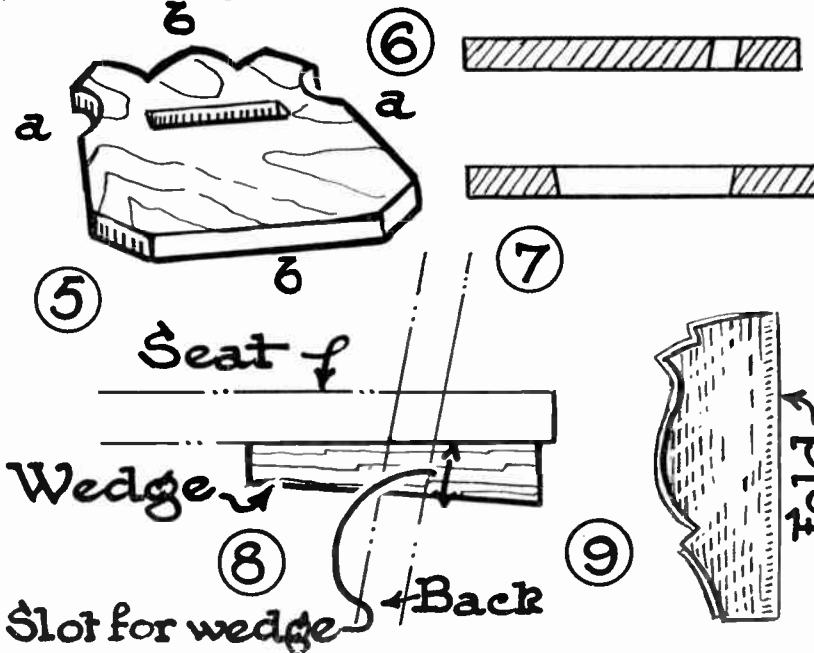

More working drawings to help the constructor

Concluding our article— HAVE FUN WITH A RAFT

A PETROL TIN RAFT

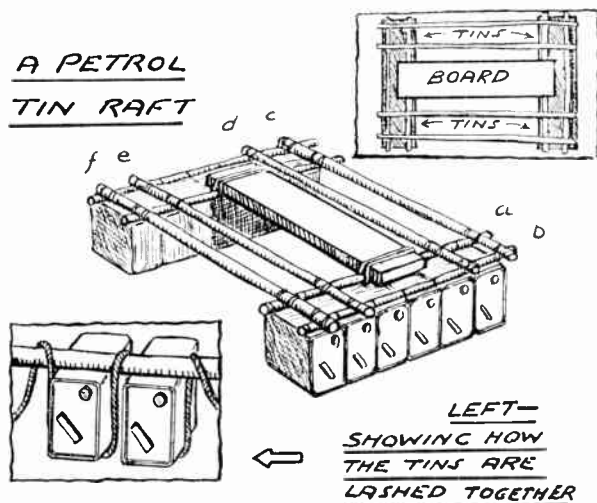

Fig. 1

CONTINUING our description of various rafts which you might try making during the holidays, the next one is a really good proposition. It is constructed with standard petrol tins and will carry quite a big person well out of the water. If the tins are only required for a limited time, as, say, during a camp, it might be possible to borrow these from a nearby garage, especially if the firm concerned has done any of your transporting. With reasonable care, the tins are not in any way damaged by incorporating them in the craft.

Twelve Tins Required

Twelve tins are required and these are laid out in two rows of six each, with their filling caps towards the top. All the caps, incidentally, must be securely screwed down. Two spars (A and B) Fig. 1 are then required to go along the full length of the upper sides and four more as (C), (D), (E) and (F) to go at right angles. These spars must be firmly lashed together into the framework shown before dealing with the tins, the square lashing again being used at all points of intersection.

Now take six of the tins and lash them under one of the ends as shown by the inset sketch. A continuous piece of cord is used, and is taken alternately under a tin and over a spar. The tins must be pulled as tightly together as possible so as to form, as nearly as they can, a solid block. And to get this ideal condition it might be found advisable to take a horizontal lashing round a complete set, passing the cord through the handles which, as well as anything else, will prevent any tendency it might have to ride up.

Finally, lash a board (or boards) across

is known as a 'sausage' raft. This was often used by the army some years ago for the taking of pioneers across streams to carry lines, etc. for later and more permanent means of crossing.

In this case, the idea is to make watertight bundles of straw which float quite well, and which, in numbers, are capable of supporting a tidy weight. A sausage raft of 18ft. by 15ft. will carry 24 cwt. The army variety made use of six tarpaulins, each of which was filled with straw and rolled into a tube, the ends being turned well in to give absolute watertightness. The more straw that was pressed into the bundle, the greater was the buoyancy.

When completed, the rolls were laid side by side and tightly bound together by a figure-eight lashing, this going transversely down the whole set. Normally, six sausages were used. Upon this base was then fitted a framework of sufficient strength to support the load, this in its turn being lashed in position. A well-made raft of this type would stay afloat indefinitely.

A simple form of this passenger-carrier can be constructed with six ordinary groundsheets and even using these smaller pieces of material sufficient buoyancy can be obtained to carry two

the centre, as shown, to give the passenger a riding position. In this type of raft, the longer the longitudinal spars, the more stable the whole arrangement will be; but, of course, they must not be so long as to introduce any undue springiness.

With a space left between the central boards and longitudinal spars, paddling this kind of vessel is quite possible, the paddle being used between these two parts.

The last improvised carrier to be mentioned is that which quite officially

small boys. The groundsheets must, of course, be in good condition, or the water will seep through and the straw inside become just a soggy mass with virtually no power of floating.

Construction is exactly as for the bigger article, but being smaller, greater care must be taken in turning in the ends to give the necessary watertightness. The top frame can be quite simple, consisting only of four main

MAKE SURE OF YOUR NEXT WEEK'S COPY

In our next issue, we are publishing an article describing the making of a two-seater stability canoe. It is not expensive to make, and should prove extremely popular.

spars and two diagonals with a single board only, if desired, for the passenger to sit upon. Again the rolls should be lashed tightly side by side with the figure-eight lashing.

The success of this raft lies to a large extent in having plenty of strong cord to hand so that an extra binding can be put in here and there if it seems necessary. Indeed, the success of all raft-building is in the main dependent upon having plenty of rope to hand, but chain stores

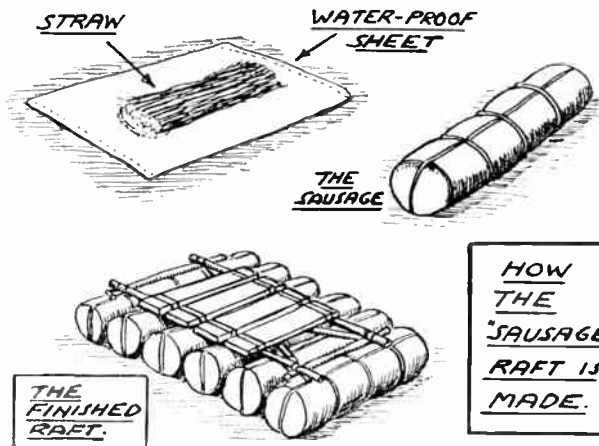

Fig. 2

are now offering quite good lengths of thin rope at a really low price, and in any case it is worth a few shillings to make a good craft which will probably give many hours of enjoyment.

Tip To Remember

One final word. Make your rafts as near the water in which they are to float as possible, as while they are perfectly firm when supported by the water, many are not easy to carry without disturbing the lashings. If there is any lifting to be done, get as many persons to help as feasible, so that they can all take the weight of various parts together.

The housewife will appreciate this useful PLATE DRAINING RACK

A PLATE draining rack is a useful piece of apparatus to have over the draining board in the kitchen, but there are many kitchens or kitchenettes too small to allow the usual type of rack to be fitted.

It is for such places that the folding plate rack described in this article was designed. When in use it extends to only 14ins. from the wall, and may be folded back when not wanted and then projects about 4ins.

The hinges can be fitted so that it will fold back either to the right or to the left to fit whatever space is available. It is made with two tiers to take different sized plates, but if space is not available for this, one tier may be omitted without impairing its efficiency.

Teak is the ideal wood for making the rack, but as some difficulty may be experienced in getting this, almost any other kind of close-grained hardwood is quite suitable.

For the corner pieces, cut four lengths of 1in. square wood 23½ins. long. Next cut the four short bars 5ins. long and 1in. square and cut a ½in. tenon on the end of each. These are fitted into mortises cut in the corner pieces 1in. from each end as shown in Fig. 2. Make these joints a good fit, for although they may be glued in, it shows better workmanship to make a professional joint, besides being much stronger.

While the joints of the two end sections are drying we can cut and fit up

the rack portion. Six bars are needed—two of these have holes drilled right through, while the remaining four are only drilled halfway. Seven ¼in. diameter holes are drilled in each piece 1½ins. apart.

Cut fourteen ¼in. dowel rods 20½ins. long and fit up the two sides as shown in Fig. 1, gluing the rods securely into the bars. The centre bar is fixed so that there is a space of 8ins. on one side and 10½ins. on the other. The position of this bar can, of course, be altered to take different sized plates if required.

When quite dry, all the woodwork should be given two or three coats of good oil paint, allowing each coat to harden thoroughly before applying the next.

The next job will be to fit the hinges—four on the top bars and four on the bottom. Fig. 3 shows the positions of the hinges, which fold to the left when out of use. (A) shows the rack opened out for use, (B) is half closed, and (C)

shows it folded back out of use. If it is wanted to fold in the opposite direction the hinges must be put on the other sides of the bars.

Good strong hinges are necessary in order to carry the weight of several plates and the best for the purpose are either ¼in. steel tee hinges or straight bar hinges.

The method of fixing the rack to the wall is an important point and should be really well done as we cannot afford to break many plates these days. Four strong brass mirror plates would provide a satisfactory means. Another way is to drill the ends of the corner pieces and screw to the wall, but if this method is favoured it would be best to make each end another 1in. longer when making up the framework.

Unless the rack is screwed into woodwork the wall should be well plugged first. The rack could be made to fold back closer to the wall by fixing a block of wood between the rack and the wall on the right hand side as shown in (C), Fig. 3, or to the left side if it folds in the opposite direction. (201)

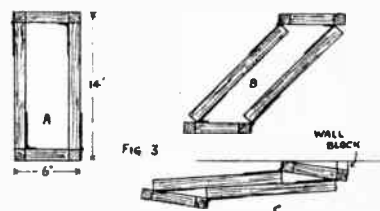
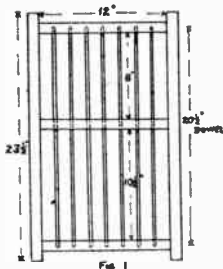

Attractive Tyrolese Chair—(Continued from page 34)

'mechanics' of the chair depend on this. Indeed, this back rail can be made larger and stronger than the front rail. When all is assembled, a screw may be put through the wedge into the under part of the seat to prevent the wedge, and incidentally the back, coming loose.

Finally, a word about foxtail wedging. A sawcut is made in the ends of the legs, as shown in Fig. 14, and a thin wedge inserted. In the present case we can assemble the legs and underbottom exactly as though we are making a stool (Fig. 11), and add the seat proper,

afterwards. The ends of the legs (see Fig. 11) will show through the holes and the wedges can easily be hammered in and trimmed off if necessary. Glue is also used in addition. It is possible, however, to fit the underbottom to the seat so that the holes are 'stopped'. Some glue is put in the hole, a leg with the wedge is inserted (Fig. 14) and the leg given a sharp tap with a mallet which expands the end of the leg and makes a very tight joint. Do not

overdo the wedging, as either the wood will split or else the leg fail to 'take' well in the hole.

The reader-constructor who has reached the final stages will need no further advice on the minor matters of finishing off. (223)

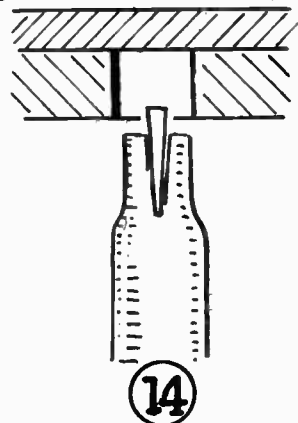
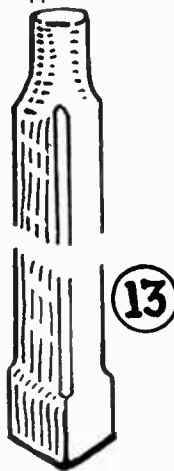
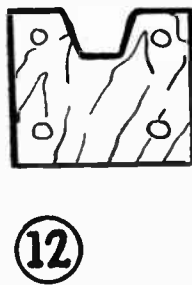
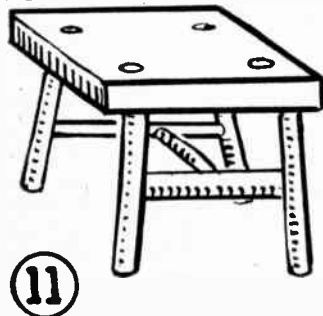

The underbottom, a suggested pattern for the legs, and details of the method of wedging

Ornamental—and useful—are these TWO SPILL HOLDERS

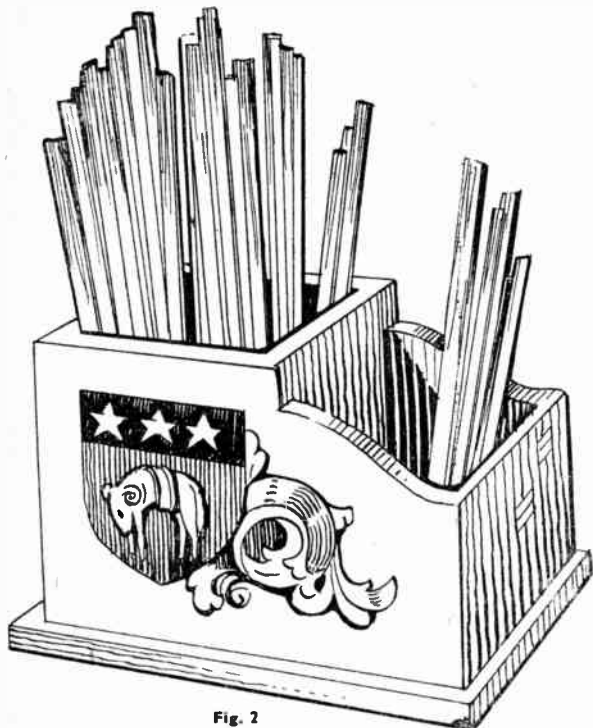

Fig. 2

THE ordinary wood spill is still much in evidence, and, especially since the economy campaign of the late war, is still much used and appreciated. It is a useful substitute for matches, and, in a great many shops these days, ornamental and decorative holders are to be seen which will take bundles of gaily coloured thin wood spills.

These spills, which may be bought

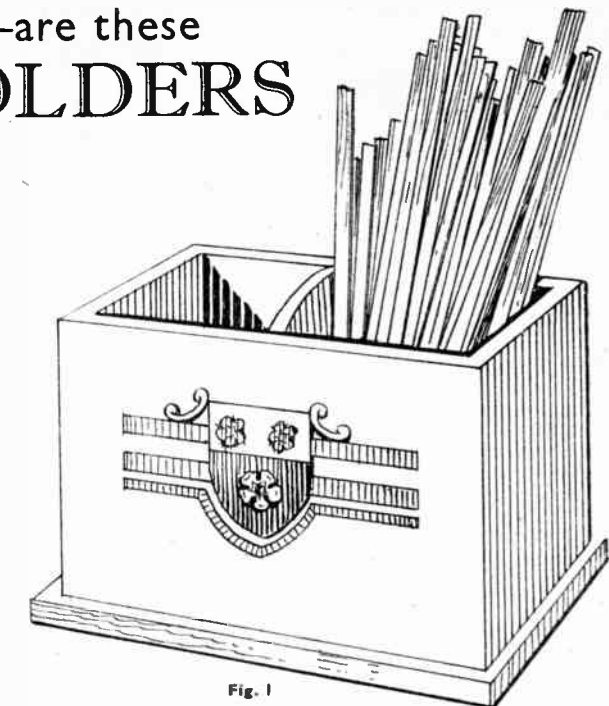

Fig. 1

quite cheaply, are in themselves quite a decorative feature of a room, and, when placed in a convenient holder or vase, present quite a good effect.

We are giving here, two suggestions for spill holders which may be made up from some odd pieces of $\frac{1}{4}$ in. or $\frac{3}{8}$ in. wood.

The simplest form of holder would seem to be a tall open-ended oblong box, set on a base, which latter might be weighted so that it stands firm upon mantelpiece or sideboard.

The Two Designs

In the illustrations Figs. 1 and 2, two

forms of ornamental holders are shown, and each is decorated with coloured overlay shields on which may be painted such emblems as the arms of cities or towns or those which appear on certain flags of the empire. We have chosen as an example here the arms of Southampton (Fig. 1) and Leeds (Fig. 2).

Correct and authentic outlines, with the colouring of any particular coat of arms, can be obtained from the town clerk's office, and these can be copied on to the shield to any desired size.

To make the holders shown here, we shall require only a few pieces of odd wood, cut square, glued up, and put on a suitable base. In Figs. 3 and 4 the general construction is shown. There are two pieces cut as (A), for front and back, all the necessary measurements

(Continued foot of page 44)

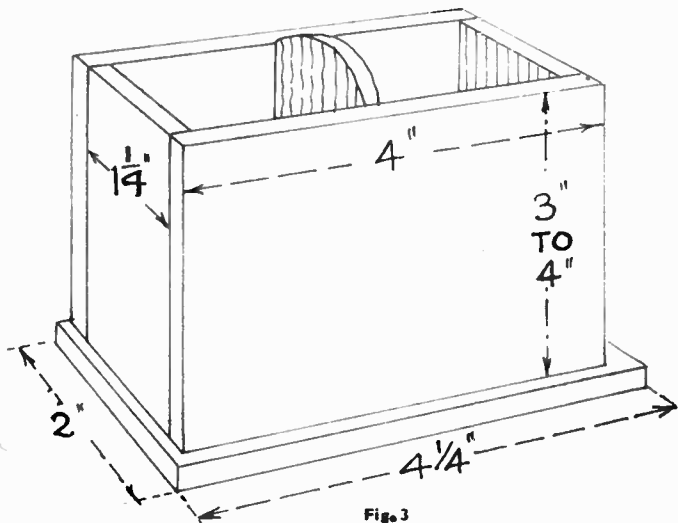

Fig. 3

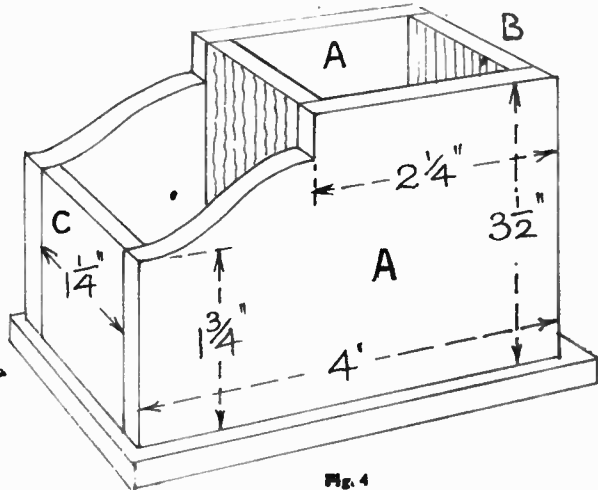

Fig. 4

Hints on making — and using — PAPIER MÂCHÉ

FROM time to time we get enquiries from readers who want to know how to make papier mâché. It may be that they are undertaking scenic work with a model railway, and require something a little stronger than the usual crumpled brown paper for hills, or that they wish to mould such things as small trays, bulb bowls, etc., for which papier mâché is admirable.

There are several ways of making papier mâché, some of the finished preparations containing extra hardening substances such as plaster of paris, others being little else but paper and wallpaper paste—or ordinary flour paste. In all cases, the chief requirement is an abundant supply of old newspapers.

Two methods of preparing papier mâché are described here, and the reader can take his choice according to the job he has in mind.

The First Method

For method one, shred a quantity of paper as finely as possible, and when you have a sufficient quantity for your purpose, place in a dish or basin and pour in boiling water until the paper is covered. Leave the paper to soak for an hour or two—the longer the better.

While you wait, prepare a quantity of paste. It should not be thin, but of the consistency of cream. When the shredded paper is thoroughly soaked, knead it with the fingers, until it is reduced to pulp. Now squeeze out all the excess water and add a little paste to the pulp, being sure to mix it well. Do this part of the job well, for the better you mix your ingredients, the better will the finished product be.

After thorough mixing, the papier mâché is ready for use.

Method Two

Method two is a little more complicated, and gives a rather harder product. Tear up the paper as before, and place in a saucepan until the latter is three-quarters full. Then add hot water until the saucepan is full, and boil the mixture gently for three or four hours.

When you find that the paper has disappeared and left a porridge-like mass in its place, take the saucepan off the stove and add a mixture of one part size and one part paste. The product should then comprise equal parts of pulp, paste and size.

Now add plaster of paris until the mixture becomes stodgy, like mortar. The papier mâché is then ready and should be used warm.

The product described in method two is eminently suited for scenic work in railway modelling, making ideal hills, etc. Hills, incidentally, should not be built up in papier mâché right from the baseboard, as this is extravagant. Instead, build a suitable rough framework

of builders' laths, and apply the papier mâché to this. Tin-tacks can be driven into the wood if it is found necessary to give the papier mâché a 'key'.

Numerous ornamental articles can be made from papier mâché, but when deciding what article you propose to reproduce, bear in mind that the papier mâché casts are made from the inside surfaces of the moulds.

For this reason, you must select an article which will permit the cast to be easily extracted when set. Shallow trays, bulb bowls, and ornamental flower pots are usually the easiest to reproduce.

To prevent the cast from sticking to the chosen mould, line the inside with dry paper. If you do not do this, you are almost bound to have trouble in extracting the cast.

Take a quantity of the prepared papier mâché and spread it evenly over the surfaces of the mould, to a thickness of $\frac{1}{8}$ in. or $\frac{1}{4}$ in. A large spoon will be found useful for getting a nice smooth surface. This task completed, leave the work for at least 24 hours to set. Some

varieties of papier mâché dry more quickly than others, but, in any case, it pays to let the work dry thoroughly. In the case of small, movable articles, the drying process can be finished off in a moderately warm oven.

As soon as you are satisfied that it is quite dry, extract the cast from the mould and strip off the paper lining which you will find sticking to it. Trim all the edges with a razor blade, and glasspaper the surfaces until you have a thoroughly smooth job.

The work can now be painted and decorated according to taste. Whatever the colour scheme, give the finished article a coat of good shellac. Apart from adding to its appearance, the shellac will render the article waterproof and greatly prolong its lease of life.

Properly made, papier mâché is strong and will stand a lot of abuse. It will not break if dropped, and will last for years. It cannot be said to be weatherproof, however, so should not be used out of doors. (236)

A Wheelbarrow Runway

WHEN moving soil from a flower bed or border to another part of the garden, or for the operation of manuring, a wheelbarrow has to be brought into use. It often happens that there is an ornamental edging to the flower bed consisting of

amount to bevel the ends will depend on the height of the bridge.

For the two supporting blocks fairly substantial pieces of wood will be needed, especially if the wheelbarrow is a heavy one. Blocks of 2ins. by 4ins. will be enough for light work, but it would be better to use 3ins. by 6ins. and make a stronger and more satisfactory job.

Carefully cut the blocks to shape; no measurements can be given as the necessary angles will depend on the height of the bridge.

When fixing the planks on to the blocks use plenty of fairly large screws. As there will be a very considerable strain when the wheelbarrow is on top, it would be advisable to fix a bolt to the inner end of each block, sinking each head into the plank to make a smooth runway.

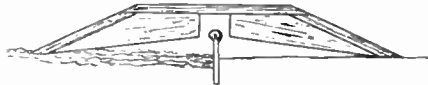

The runway

tiles, concrete edging or brickwork. Sometimes there is a narrow grass edging about 9ins. wide.

Under these circumstances it is not possible to get the wheelbarrow over them without doing damage.

The bridge runway described here overcomes this difficulty and makes the job quite easy. It can be made from odd scraps of any type of rough wood.

A rough guide is given regarding measurements but these may be altered to suit local conditions. For the main runway the writer used 6in. wide boards with a thickness of $1\frac{1}{2}$ ins.

Before making up the gadget measure the height of your garden edging so as to allow for sufficient clearance. In most cases $4\frac{1}{2}$ ins. to 6ins. should be sufficient for this.

The top plank was cut 18ins. long and the two side ones $10\frac{1}{2}$ ins. each, which when bevelled off at the ends, gave an overall length of about 36ins. The exact

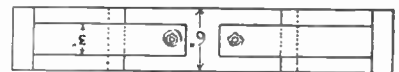
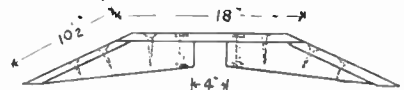

General dimensions

If the bridge has to be made larger than the 36ins. given in this article, or if a very heavy wheelbarrow is used, it would be much better to use two blocks at each end for support. These could be fixed to the edges of the planks instead of running along the centres. (386)

A worth while job for the handyman is RE-COVERING A 3-PIECE SUITE

RE-COVERING a suite is a job that can be undertaken by the average handyman, and is, from an economical point of view, well worth while.

As a commencement, carefully strip off the old material at the back of one chair, also the sides of the arms, or perhaps one arm will be sufficient. This will reveal how the stuff is tacked to the framework, and be of immense help during the course of the work. The second chair should then have its back and side material removed, ready for the re-covering to be done.

Do a portion at a time, and, if in any doubt, refer to the partially stripped

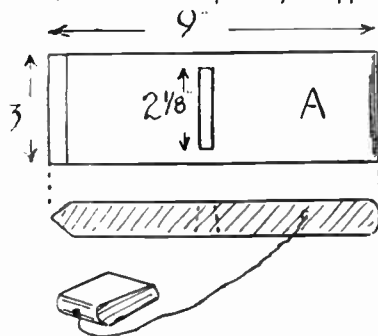

Fig. 1—The tools for the job

first chair for information. It will be found in some suites that the second stuffing is not covered with calico, but only by the outer covering, so care must be taken, when stripping the old stuff off, and putting on the new, to disturb it as little as possible. Do the arms first, one at a time.

Start with an Arm

Starting with one arm, remove all tacks, lay the chair on one side, then carefully draw the old material away. Damage it as little as possible, as when flattened out it may prove a useful guide to cutting the new stuff. Do not cut it too closely, however, but leave enough to grip with when drawing it across the frame. Tack the stuff to the arm rail with one or two tacks only, draw it through the frame, between the arm and seat, and tack again.

It will be seen that the material has to be snipped in some parts to clear portions of the frame, and an examination of the old covering will help here.

Now draw the material tight, and tack in place as you go, both to the under framework, and top part of the arms. In front of the arms there is usually a separate piece of material, called a facing strip, padded with cotton wool. This will also be replaced. The second arm can now be attempted, and in both cases a careful examination of

the first chair will help a lot both as regards the tucking through of the stuff, and finish of the front.

The second stage is re-covering the seat. Here an examination of the springs is advisable, as it is a waste of time to recover and expect a comfortable seat if the springs are weak, or the webbing sagged. Strip off the old canvas cover at the bottom, and note the condition of the springs, and webbing. A broken spring must, of course, be replaced. If the webbing has sagged, then it should be removed, and a new webbing put on.

For this job, a tool is necessary for stretching the webbing. One can be bought, of course, but a good one can easily be made of hardwood, to the pattern shown at (A) Fig. 1. The slot in it is cut wedge-shaped, and a hardwood wedge to fit it is made, and attached to

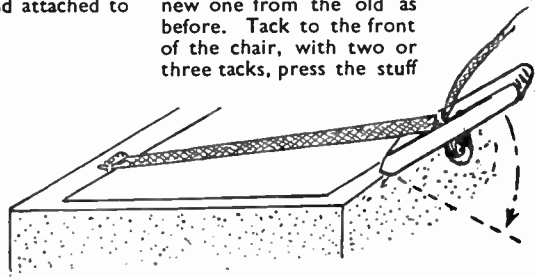

Fig. 2—Strainer and webbing in position

the stretcher with a length of cord, as depicted in the diagram. Push the springs out of the way, and tack the new webbing

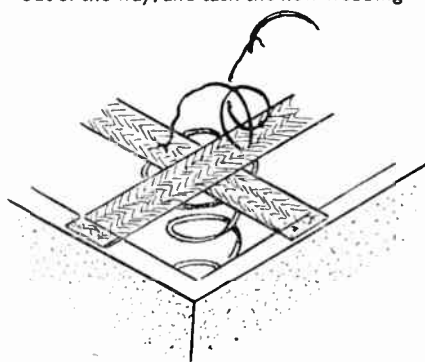

Fig. 3—Sewing the springs to the webbing

to the frame, first with three tacks, then, after doubling over the end of webbing, two more tacks, the latter two through the double thickness.

Push the webbing through the slot in the stretcher and insert the wedge in the loop. This will prevent the webbing slipping out. With the strainer and webbing in the position shown in Fig. 2, press strainer down until the webbing is as taut as possible, keeping it so until it is tacked to the frame again. Note that the cross bands of webbing are interweaved with the first bands tacked on, just like a

darning job, in fact. When the new webbing is all fixed, push the springs beneath it and sew them to it with upholsterers' twine.

For the sewing job, a special half circle needle, like that shown at (B) will be required. With this, threaded with a long length of twine, push the point through the webbing, against the top ring of the spring, and bring it out through the webbing again, the opposite side of the spring. Here tie off, then, without cutting the twine, make two more stitches through spring and webbing, knotting each, and finally tie off and knot the last one. The detail sketch, Fig. 3, will help to explain this. The seat should then be reasonably shapely, and springy to sit upon.

Strip off the seat covering, and cut the new one from the old as before. Tack to the front of the chair, with two or three tacks, press the stuff

over the seat, and between it, and the back, and there tack similarly. Tack to the sides, and note, when pushing the material between seat and arm stuffing, how it has to be snipped at the corners to clear the framework. Now finish the tacking, pressing the hands firmly over the material as you draw it tight.

The front of the chair will probably have a cover strip along and this will need to be replaced, as with the arms.

The Back

Now for the back. Strip all tacks away, then lay the chair flat on its back, and carefully draw the old material off. The new covering can then be lightly tacked to the top back of the rail, pushed between the stuffing of the back, and seat, and there be tacked. Now push between seat and arms, snip as necessary at the corners, and tack to the framework behind. Draw the material tight, and tack all round. Smooth out any creases as you proceed, and make the whole as shapely as possible.

It may be found that the old material has, in some parts, been lengthened by strips of calico sewn to it to save stuff. The new coverings should, also, be so treated, as any material now bought is rather expensive, and there is no sense in using it for those portions hidden in the framework, where calico will suffice.

(Continued foot of page 40)

An "old hand" gives two HINTS FOR THE HANDYMAN

Sharpening Lawn Mower Blades

TO do this job really satisfactorily, the cylinder bearing the cutting blades has to be taken out and mounted between centres on a lathe. A separately

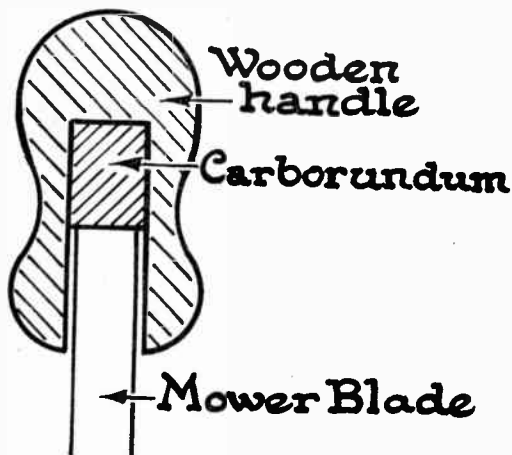

Fitting the carborundum stone

driven grinding wheel is used to traverse the whole length of the blades whilst the cylinder is slowly turned. Naturally this demands special equipment beyond the means of the average home mechanic.

Good Makeshift

A good makeshift, however, useful when one wants to get on with lawn mowing during, say, a bank-holiday week-end and cannot wait a week or so for an engineer-sharpened job, is as follows.

Take off the driving wheels and reverse the driving sprocket and pawls from one side to the other and replace the wheels so that the cylinder, with its blades, turns backwards when the mower is pushed forwards. Smear the blades with medium valve-grinding paste, or a mixture of emery powder and oil (or vaseline and carborundum powder). Adjust the blades to rub

against the shearing iron. Run the mower rapidly along a smooth garden path a few times and the blades will become very sharp. Then return the wheels, etc. to their proper position.

Better Method

A better method is to use a special carborundum stone, normally available at tool-merchants', and mount it between two pieces of wood, or one shaped piece, as in the sketch. This is used to true up the blades. A certain amount of energy and patience is needed.

Place a piece of brown paper between the blade cylinder and bottom blade. Rotate the cylinder slowly by hand. If it cuts the paper cleanly into pieces, the blades are sharp and properly adjusted. (222)

Emergency Measures

A TWO-FOOT rule is one of the first tools ever bought by the hobbyist and some workmen are never without one in the workshop. But there are often occasions we are without a ruler, as for example, when working on an allotment. It is then useful to know that the human foot is usually a foot long (more or less: it depends on your size, of course).

It is a good idea to measure across the rake head so that this can be used as a measure when setting out distances between rows of seeds, etc. Even more certain is to file marks at a distance of 6ins., 12ins. and 24ins. from the end of the rake handle.

Easily remembered are: a halfpenny has a diameter of 1in. and three pennies weigh approximately 1oz. A brick, with its mortar is about 9ins. long.

Whilst you are at it, measure the following, and remember them:

The span of your thumb and first finger, and the span of your thumb and little finger; the length of the nail joint on the first finger; the length of your pace. (222)

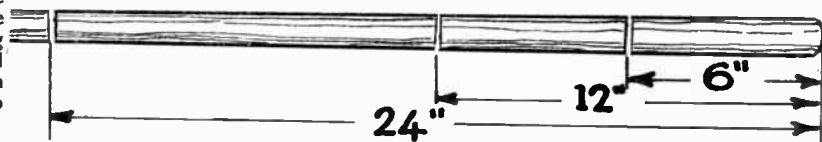
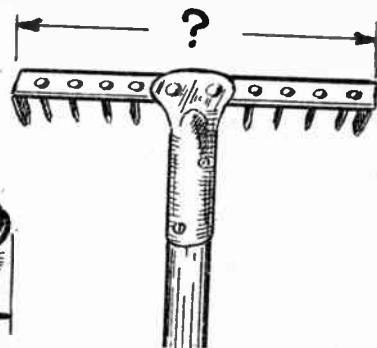

Re-covering a 3-piece Suite—(Continued from page 39)

As, during the process of the work, pieces of the stuffing may fall out, these must be carefully replaced. To keep it in place, it will be seen that loops of twine have been made, under which the stuffing has been pushed. These loops can be made of use in those parts where a little more stuffing may be introduced to shape up the work nicely. In some parts, a layer of cotton wool will be handy to puff out portions which have been flattened by long use.

This practically completes the work,

as the settee can be re-covered by the same sequence as followed for the chairs—it is really only an elongated arm chair, after all.

Suites which have their tacked edges hidden by cording, will need to have this replaced, of course, but sewing it in position, is not difficult, either with a cording needle, or even the curved one already mentioned.

The final job is to re-cover the backs and sides of the suite, and then tack on the banding, or gimp. The former, must,

of course, be a matching banding, and the studs for tacking must be suitable to it. For gimp, it is usual to fix with small black nails, known as gimp pins, as these are almost invisible in use.

Estimating

In case a difficulty arises when ordering the material, to estimate the quantity required, it is best to state the pattern of the suite, and let the shop people, with their greater experience, advise you on the subject. (211)

It is not hard to make this CHILD'S STOOL AND TOY BOX

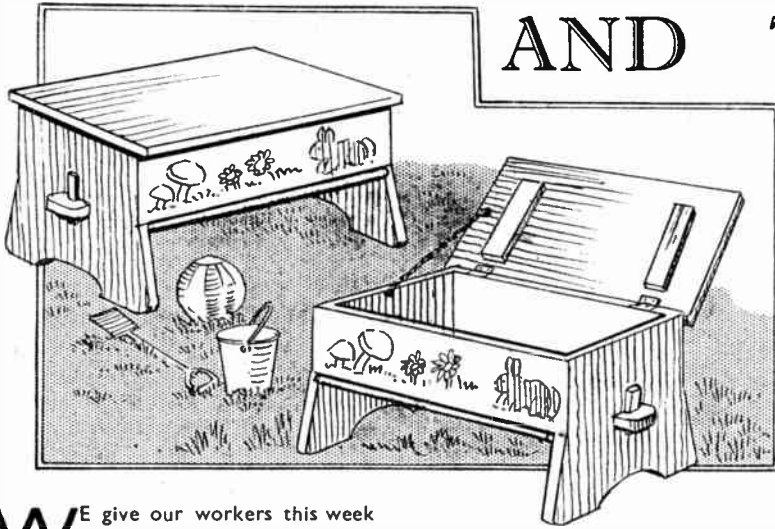

mark round it, keeping close into the corners and to the cut edges. Cut round this again and treat the mortise similarly.

Next, mark out the floor piece. Take Fig. 2 as a guide for this, and it will be seen that it is rectangular in shape and with tenons each end projecting $1\frac{1}{2}$ ins., each shaped as shown with the fretsaw. See that the lines of the ends of the board are square with the sides, and, in cutting, take particular care to get a square edge and an even and straight cut with neat corners.

Two square holes will be cut for the wedges, the holes being, of course, kept $\frac{1}{2}$ in. or rather less, away from the long cut edges of the floor. Make the holes $\frac{1}{2}$ in. long and about $\frac{1}{4}$ in. wide.

The Wedges

Make two hardwood wedges about 2 ins. long by $\frac{1}{2}$ in. by $\frac{1}{2}$ in. with a slight taper towards one end as shown in Fig. 2. Place the ends of the stool over the tenons and drive in the wedges until all three pieces are rigid and firmly held together.

Next, cut two pieces to form the sides of the box. These are quite plain, and cut with square ends with either tenon saw or hand saw. Note the dimensions of the sides in Fig. 1. Fit them in place on the floor and into the recesses in the ends, and see that they lie even with the top of the ends. Bore three holes in each end of the boards as Fig. 1, countersink them, and drive in flat-headed screws, the heads of which might be filled with plastic wood or putty. One or two screws can also be driven up into the sides through the floor. This will stiffen up the whole stool and box.

WE give our workers this week details of a sturdy box seat which would answer splendidly or the garden or for the nursery.

By virtue of the fact that it has sides and a floor, the strength is more than double that of an ordinary open stool, and the usefulness of the box itself is obvious. The stool should be made of hard wood such as beech, oak or spanish chestnut, but good selected pine or deal would do equally as well if well worked and strongly put together.

The ends of the stool, the lid and the floor are all $\frac{1}{2}$ in. thick. They should not be less, in fact, wood $\frac{3}{4}$ in. or even $\frac{1}{2}$ in. would be preferable for those parts. If one of the harder varieties of wood can be got, then the lid and the floor might be $\frac{3}{4}$ in. thick. The strengthening battens on the inside face of the lid are $\frac{1}{2}$ in.

a dividing line in pencil down the centre. If wood 10 ins. wide cannot be obtained, then two pieces of 5 in. stuff should be planed up and glued together. Next, set off 4 ins. each side of the centre line, and run lines down parallel with the centre line for a length of $5\frac{1}{2}$ ins., where a break is made the thickness of the floor.

From here the 'legs' spread outwards to the full width of 5 ins. each side of the centre line, the extreme points being rounded and cut with the fretsaw. In marking out the mortise in the centre of the piece, run a line across the wood where the break occurs, set down $\frac{1}{2}$ in. below this, and draw a line parallel with it. The width of the tenon is 2 ins., so that 1 in. requires to be marked out each side of the centre line. The setting out is clearly seen in Fig. 1.

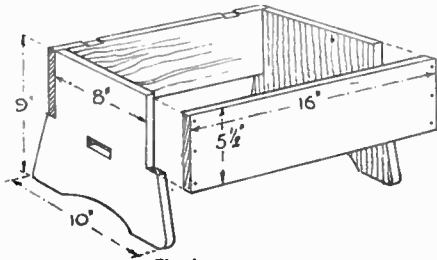

Fig. 1

The strength of the stool depends much upon the manner of fixing and the neatness of fitting the floor tenons, which are shaped and wedged—the best and strongest form of joint for this particular job. Of course, the simplest way of fixing the floor would be to screw it through from the ends and then add gluing fillets along underneath.

Commencing Work

Commencing construction with the two ends of the stool, first square up a board 9 ins. long and 10 ins. wide and run

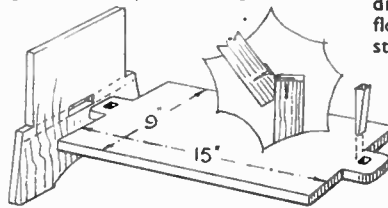

Fig. 2

A word of advice may here be given. In setting out any object of a symmetrical nature, such as the ends of the stool, and where sloping or curved lines occur on two edges of a piece, always work from a given central line, taking care to set out all working dimensions from this line.

Saw out the mortise slot with the fretsaw and cut away the curved portion between the 'feet' immediately below this. Trim up, if necessary, with rasp and file and finish with glasspaper.

Now lay the finished end upon the second piece of end wood and neatly

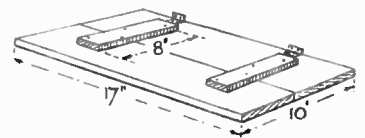

Fig. 3

Plane off any unevenness along the sides and ends, and then form shallow sinkings for the flaps of the hinges as seen on the rear side in Fig. 1. To do this accurately and neatly lay the hinge in place on the top edge of the side and mark a line at the edges of the hinge with a chisel or steel scriber. Then cut down and clean out the wood to the depth of the knuckle of the hinge.

Preparing the Lid

Next, prepare the lid, which is a plain piece of wood 17 ins. by 10 ins.

(Continued foot of page 43)

MATTERS of INTEREST



Matching Up

I HAVE some pieces of mahogany which I wish to match up with dark oak. I have tried treating the wood with a green aniline dye, with no success, and would be grateful if you can provide me with a solution to this problem. (R.S.—Belper).

IT is no easy matter to match up mahogany, with its reddish tint, with dark oak, but perhaps if the mahogany were bleached it might be done. We suggest you wash the wood with a solution of 1oz. oxalic acid to 1 pint of water to bleach. Several washes may be necessary to get the right effect; then clear off with clean water and wash over with brown vinegar to kill the bleach. Be careful to avoid getting acid on hands or clothes. Glasspaper when dry, then try the stain. The result may be satis-

factory, but a preliminary test would be wise on a small piece of the wood, as the process can only be suggested as experimental.

Traffic Indicator

WITH regard to the wiring instructions for the traffic indicator—if I complete the wiring as instructed, then all the bulbs will burn at the same time. A satisfactory circuit can be obtained by the use of two or three single pole switches, but I should be obliged if a circuit of only one switch could be supplied. (A.W.B.—Plymouth).

IF the bulbs are wired in parallel, they will, of course, light together. The amber bulbs may be given separate connections and the amber-with-red sequence obtained by the switch arm bridging two contact studs, in this

particular position. If other forms of switching are desired, it is suggested one of the multi-contact switches such as used for wavechanging in all-wave radio receivers, be employed, as it is not easy for the amateur to make a switch with many contacts which will, nevertheless, give good contact.

'Fitzroy Barometer'

I WOULD much appreciate a revising of the formula for a 'storm-glass' or 'Fitzroy barometer' for weather forecasting. (D.S.A.—Castle Bromwich).

THE usual formula for the storm glass is camphor gum in absolute alcohol; we have no knowledge of the formula you put forward. Normally the glass is closed at the top, but there is an air space above the liquid to allow for expansion. Saltpetre is generally known as nitre, whereas nitrates are salts of nitric acid. The 'storm glass' is not a reliable instrument, and is not particularly responsive to weather changes, but is rather more responsive to temperature changes. Extreme cleanliness and purity of the solution is highly desirable.

Tie Your Own Fishing Flies

THE fly fishing season is now in full swing. Artificial flies are one of the more expensive items, because of the wide variety needed, but the art of tying one's own flies is simply learned, and the fingers soon become deft and quick. A wide variety can soon be made, and the material required is easily found.

A selection of eyed hooks of different sizes must be bought, and also a tin of bees-wax, and fine silk of several colours. For the body of the flies there will be needed cock and hen feathers from tail and body, feathers of a starling, and some snippings of hare, rabbit, and mole fur.

Binding the Body

Commence by stripping one of the large tail feathers, scraping off the sheen with a blunt knife. With the resulting quill strand, begin to bind the body from the rail or hook end, of the hook. Secure the thin end of the quill with a piece of silk, binding the end of the piece under the quill as it is twisted round the hook towards the eye. As the quill is thus twisted it will be seen that the familiar striped effect now rings the body. When it has been worked about three-quarters of the way towards the eye bind in the base end of a colourful cock's feather.

Continue binding the quill and feather until the neck of the hook, just before the eye, is reached. Complete the binding with a small piece of silk, tying in the end of the quill.

Cut off the hackle, which now stands out around the neck of the hook, to the desired length (about $\frac{1}{2}$ in.) all round

with scissors. Bees-wax should be rubbed on to the binding silk at either end, or may be applied to the silk before work is commenced. Its purpose is to waterproof the silk.

Other Varieties

This method can be used with a variety of feathers, and some fine colourings can be worked with quills from a peacock's feather, if this can be obtained. Feathers from a number of breeds of hen and cock are successful, and also those from the well-marked starling.

The body can be varied by binding in snippings of fur from the animals mentioned earlier. Bind them beneath the quill as it is twisted round the hook, and trim them to an even length when the tying is complete. This gives a solid body which holds air: the fly used for dry-fly fishing.

The larger hooks should be used for tying flies for use in the evening when the light is not so good, and these flies should be tied with lighter-coloured feathers so that this will show up in the poor light. Use the smallest hooks and darker feathers for daylight flies. Colours of the more successful flies can be noted, and the feathers picked and flies made accordingly. Suitable feathers can soon be chosen to make copies of the familiar Olive and Blue Duns, March Brown, Speckled Yellow, and others.

The outlay for making one's own flies is extremely small, and the art is soon learned. Many anglers will not use bought flies, and it is possible that the slight variety which is introduced by the tying of one's own fly is appreciated by fish. Certainly it is a useful art, and one which brings a glowing reward in the summer months. (232)

Model Gypsy Caravan

This week's design sheet (No. 2896) is of a really attractive model gypsy caravan which any model maker should be proud to construct. For making the model we supply wood and necessary material 11.6 inc. tax, post free.

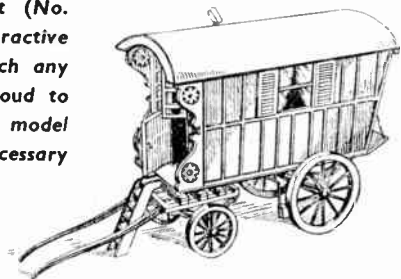

Good practice with a saw is this FRAMEWORK FOR TABLES

THE components of this basic framework to carry a tabletop are so designed that they lock together. The whole assembly, in fact, is perfectly rigid without any glued joints, let alone screws or nails. Accurate workmanship is the key to success and the construction is an excellent exercise in working with a saw.

Simple Interlocking

The assembly consists simply of two side beams and two end beams which lock into one another, as shown. The legs are cut from solid stock to identical length and then slotted in a cruciform at the top to fit around the X-joint of the basic beam members. A fairly generous leg section is desirable, and so each leg is tapered off towards the foot by reducing the dimensions to one half at the lower end.

This method of assembly should be suitable for almost any size of table, from a small card table, upwards. The one fixed dimension is the length of the leg. According to best standards the top of a table should be 30ins. from ground level. This figure is achieved if the length of the leg is made equal to 30ins. less the thickness of the material which is to be used for the tabletop.

Roughly speaking, the cross beam should be 1.5 times the depth of the

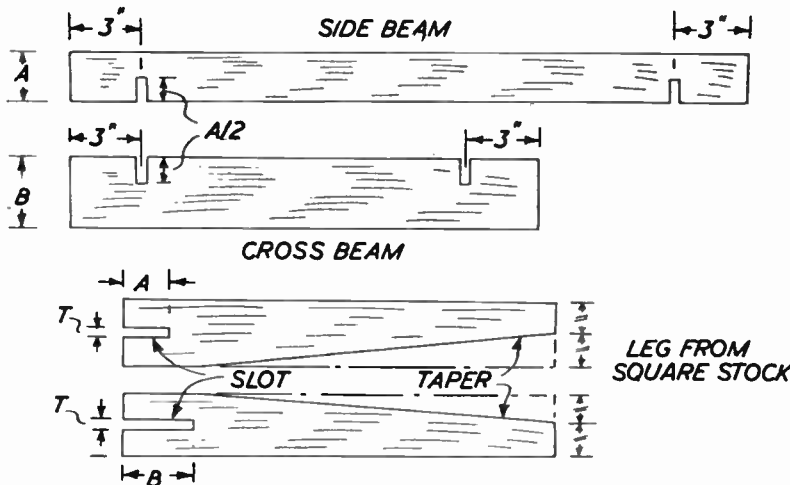
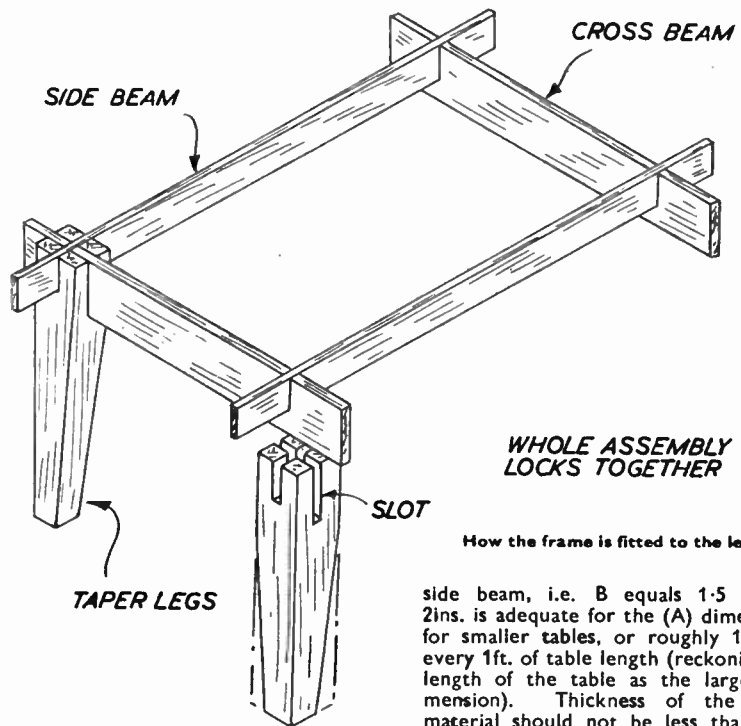

side beam, i.e. B equals 1.5 by A. 2ins. is adequate for the (A) dimensions for smaller tables, or roughly 1in. for every 1ft. of table length (reckoning the length of the table as the largest dimension). Thickness of the beam material should not be less than 3/4in., with 1/2in. stock preferred for all tables of 3ft. length and over. The square section table leg needs to be roughly the same as the (A) dimension.

Glue the joints

Where this method is used to construct a table, all the joints should, of course, eventually be glued to give a permanent assembly. The table top is then laid over the main frames and similarly glued or dowelled in place. The tabletop should extend to the full length and width of the side and cross beams, respectively. Using relatively thin material for the table top, or where the overall length exceeds about 3ft., it would be as well to introduce one or more cross braces in the main frame to give support to the top. These need only to be about one half of the (A) dimension in depth and can be slotted into the side frames. (212)

Child's Stool and Toy Box—(Continued from page 41)

seen in Fig. 3. If this full width cannot be got in one piece then two pieces should be planed up, glue jointed, and cramped together, being afterwards stiffened by adding two narrow battens about 2ins. wide and nailed or preferably screwed as shown in the completed lid, which is ready for fixing as in Fig. 3.

To get the correct position of the lid on the box, lay it on the top of this, and see that an equal margin is allowed all

round. Then mark off in pencil where the hinges should come on the underside of the lid.

It would be a good plan at this juncture to make the chamfer on the under side of the lid so that when this is thrown open it stands at a convenient angle, as seen in the right-hand sketch of the completed stool, and also in the enlarged detail incorporated in Fig. 2. Hold the lid in place and mark off in

pencil where the chamfer is to be planed off, and then made smooth with glasspaper.

Having marked the position of the hinges just above the chamfer, proceed to screw them on. Then hold the lid upright or slightly backwards, and screw the remaining hinge flaps to the sides and, of course, in the recesses. (228)

Now is the time for CAMERA OVERHAUL

WITH holidays 'in the air', now is the time to overhaul your camera. It will be a pity if your negatives are marred by fluff on the lens, spasmodic working of the shutter, pin holes in the bellows, etc. The whole job can be done in an evening.

First, dust all over the outside of the instrument. Then dust the inside. A sable hair brush, as used by artists is very useful here.

Practically every reader knows that old static electricity experiment of rubbing a piece of ebonite on a coat sleeve and picking up tiny pieces of dry tissue paper. In the same way, if you rub or stroke the brush on your sleeve (which must be quite dry) a few times you can generate enough static electricity to attract particles of dust from awkward corners.

The lens must be well polished. An old silk handkerchief is useful here. Some lenses are difficult to get at. An easy way to do the job is to take a small wooden golf tee and cover the concave top with a little cotton wool and silk. Hold the tee against the lens and twirl between the fingers. In no circumstances should the lens be removed by an amateur.

Another warning here! Do not oil the shutter. Oil will pick up dirt, with disastrous results. Usually, by working the shutter several times, stiffness is taken out. It is not wise to tamper with the shutter mechanism, but small screws holding the camera carcass together

might well be tightened with a watchmaker's screwdriver. If they are rather loose, apply a touch of celluloid cement on each.

Though most cameras take roll film, there are still people who use plates or film packs. The slides of these sometimes tend to bind. A little paraffin wax applied to the offending spot will usually cure matters.

After much use, the bellows of a folding camera tend to crack and the light leaking in spoils many an otherwise good snapshot. If the bellows are in a very bad way it is possible to have new bellows fitted, but for small repairs black sticking plaster (black adhesive tape) is useful. Rubber cement (black rubber cement if you can get it) is useful for painting along worn folds.

For freshening up leather bellows and camera leatherwork generally, black boot polish may be used. Apply sparingly and make sure that all surplus is wiped off. Sometimes the leather is so worn that a brown undersurface shows. This can be stained black with the dye sold by bootsellers for staining leather shoes.

The following formula is of a compound used by experts for freshening up leather bellows and camera bodies generally. For a single private job it may be rather a bother to gather all the ingredients, but some readers may like to work up a spare-time business of renovating cameras.

Sperm Oil ...	1 oz.
Acetic Acid ...	1 dram

Glycerine ...	1 dram
Oil of Turpentine ...	$\frac{1}{2}$ oz.
Water to ...	5 ozs.

Add the mixture slowly to the white of an egg, beating up well, and then add 1 oz. of methylated spirit and about 30 grains of black aniline dye.

Some camera bellows are made of cloth, and a renovator for these may be made up as follows:—

Methylated Spirits ...	4 ozs.
Shellac ...	1 oz.
Oxalic Acid (poison) ...	$\frac{1}{8}$ oz.

Shake until dissolved and then add 1 oz. of linseed oil. If the bellows are black give them a preliminary coating of indan ink dissolved in a little water, and a trace of Prussian blue to kill the brownness. When quite dry, apply the reviver, using a pad of cotton-wool. Remove the surplus by brisk brushing.

It is quite possible that many readers will make the first extensive use of their cameras on a seaside holiday. It is as well to remember that the salt sea air can play havoc with a camera. Even if you have a leather or canvas case, it is a wise plan to wrap a valuable camera in an oilskin bag—of the type used to hold toilet articles. Metal parts can be very lightly smeared with vaseline.

One last word: take care not to twist or bend the front of a folding camera as it is opened. Many people wonder why their cameras never produce pictures in proper focus, and fail to realise that the front (which forms the bellows rest) is bent. (364)

Two Spill Holders—(Continued from page 37)

being given, one end piece (B) measuring $3\frac{1}{2}$ ins. by $1\frac{1}{2}$ ins., and one end (C), which is $1\frac{1}{2}$ ins. by $1\frac{1}{2}$ ins. Both pieces are 'let in' between the pieces (A).

The great thing to remember is accuracy and correctness in the setting out on the wood. The rest is done with the fretsaw and glasspaper. It might be advisable to set out the shapes of the various pieces on paper, so that if a number of the holders are wanted later on, the patterns are available.

When the four pieces have been cut and glued together—and checked with a try square or set square—each face should be rubbed smooth on a sheet of glasspaper previously been glued or pinned to a piece of perfectly flat board. Finished like this, the glued joints should be hardly noticeable.

The top edges of the holder may be either left square or be rounded off on the glasspaper board. Providing the glue is of good quality and the joints are carefully made, there should be no need to insert fret pins to further strengthen the joints. If, however, pins are driven in, the heads should be filed off and the surfaces glasspapered down so that practically nothing of the pin is seen.

The bases consist of one thickness of wood as shown or could be built up

from two or more pieces glued together.

If the bases are to be weighted, then a square of wood should be cut from the centre of the piece, and a corresponding shape of lead let in, a further layer of wood being glued over to make a neat finish at the bottom.

The middle partition in the first

Ways with Screws

Those who encounter any difficulty driving screws into any hard woods should rub the thread of the screw on a piece of soap, so that soap adheres to the thread of the screw. It is much easier then to drive the screw in; soap will not stain.

A tip worth remembering is: for any outdoor jobs always use brass screws. These will not rust and can be withdrawn easily after any length of exposure, to the weather.

design (Fig. 1) can be of thinner wood if desired, and a carved top could be formed to it to give an added effect. The sharp edges of the base pieces should be lightly glasspapered off.

The shields and their surrounding decoration can be painted on with ordinary water-colour or poster paint, or even oil paint. A good effect could be got by painting the decorative parts and then cutting the shields from, say, $\frac{1}{4}$ in. wood, and gluing them in place afterwards, following on with the painting of the arms as chosen.

Oil paint or enamel, the latter for preference, would make for a better job than water paint as the surface can then be wiped clean should it become dirty with handling.

The finish to the wood of the holders must, of course, be applied before the shields are put on. If the holders are of oak, then it should be stained to the depth required and rubbed up with wax, a soft brush being used for this. If mahogany has been used, then french polish would be appropriate as a finish. A whitewood holder would be best just lightly varnished. In the sketches of the finished articles, the town arms of Southampton and Leeds is shown in Figs. 1 and 2 respectively. (224)

Young craftsmen will appreciate these NOTES ABOUT CHISELS

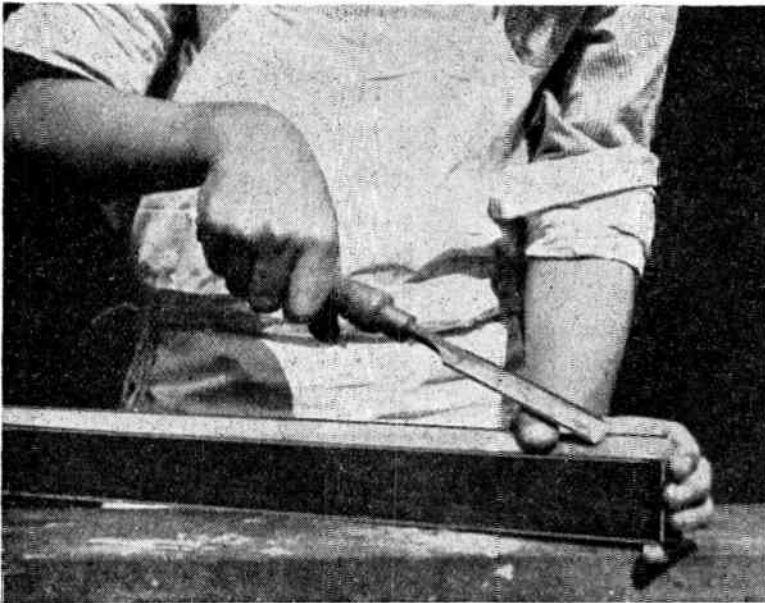

How not to use a chisel!

AN oilstone is an inseparable adjunct to the use of chisels, and one should learn to sharpen a chisel as soon as one starts to learn to chisel.

As regards an oilstone, one that is rough one side and fine on the other is best suited to the amateur. A wooden box with a cover should be made to contain it and protect it from damage and dust. Quite a simple affair will do. The illustration herewith will show the

idea. The depth (X) will be half that of the thickness of the oilstone. The smaller sketch shows how the box and cover can be made as one and then carefully sawn in half.

Novel Idea

A quite novel idea, however, is to tack a piece of rubber on the bottom of the box so that, when in use, the box will not "skid" off the bench. The

rubber was taken from old rubber soles. Oil should always be wiped off the oilstone after use and not allowed to soak in.

Final Stage

The final stage of sharpening is to remove the 'wire' edge that forms. Usually the chisel is just stropped on the palm of the hand, but one can glue a piece of leather to a strip of wood, as shown. The leather is treated with razor-strop paste.

As regards the actual process of chiselling, a very wise maxim is: *Keep both hands behind the cutting edge.* The photograph shows how NOT to do it. If the chisel slips, as is very likely, the operator will get a very nasty gash in the fingers. He should have rested one end of the job against the bench stop, or something similar, and put both hands behind the cutting edge. Then all would be perfectly safe.

Easier Cutting Angle

When paring with a chisel, most readers must have noticed that it is easier to work with the chisel held diagonally, than it is to work pushing the chisel forward in the ordinary way. Why is this?

The cutting angle (x), of a chisel is 30 degrees. If it were made less, it would certainly cut better, but not for long. The 'thin' edge would soon crumble. If we use a chisel along line (AA), however, we find that it is the same as using a chisel with a cutting edge of angle (y). Angle (y) is less than angle (x), and so the chisel cuts better. This is somewhat similar to cycling up a steep hill by zig-zagging from one side of the road to the other. (222)

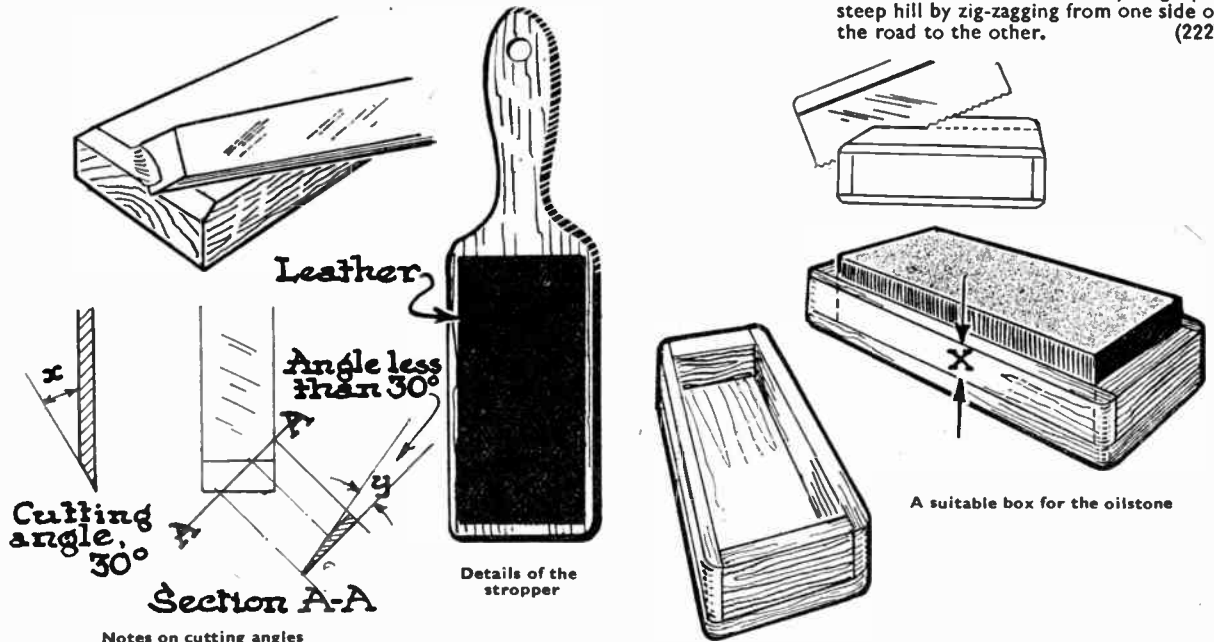

Notes on cutting angles

For all kinds
of woodwork

HOBBIES FRETSAWS

Not only in fretwork and model making but in a hundred and one woodwork, composition plastic, leather or metal sheet jobs you'll find a fretframe handy. And the best blade for any is the saw which is made here by Hobbies from good steel and the experience of forty years of manufacture. Every dozen is distinctly labelled.

IN 3 GRADES

Blue Label 1/- per doz.

Yellow Label 1/3 "

Metal Cutting 1/4 "

Obtainable from Ironmongers' Stores and Hobbies Branches, or by post from **HOBBIES LTD., DEREHAM, NORFOLK**



PUPPETS

Kits of parts to make two Fully Jointed 12 inch puppets with controls.

15/6 post free

Send stamped addressed envelope for illustrated list of complete puppets and books



PEDAL MOTOR CAR

Any amateur can make this strong smart modern pedal car for children 2 to 5. Plan and instructions with list of available metal parts

2/6 post free

ZIMPLAN

88 WARE ROAD
HODDESDON, HERTS

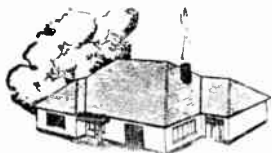

TURN YOUR SPARE-TIME INTO CASH
Men and women wanted to make Bennett Model Bungalows at Home.

Fascinating, simple, well paid work

No selling involved.

Send penny stamped addressed envelope for full details.

BENNETT MODELS,

Duncan Road, Richmond, Surrey

FRETWORK HANDFRAMES

—for the fretworker, model maker and handyman. Made by Hobbies. In various

sizes. Details and prices on application at any Branch of Hobbies Ltd. or

HOBBIES LTD., DEREHAM, NORFOLK

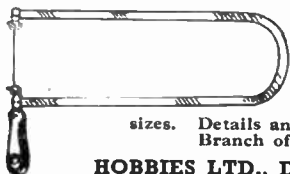

YOU CAN BECOME A HANDICRAFTS INSTRUCTOR

EXPERIENCE NOT ESSENTIAL

Men who enjoy making things in wood or metal can turn their hobby into a permanent and interesting Career. Short hours, long holidays, and security in a job you would really enjoy, can be yours if you become a Handicrafts instructor. Let us send details of the easiest and quickest way to get the necessary qualification.

**We definitely guarantee
"NO PASS—NO FEE"**

If you would like to know about our unique method of preparing you for one of these appointments, write today, and we will send you our informative 176 page Handbook—free and without obligation. Mark your letters "Handicrafts Instructor".

BRITISH INSTITUTE OF ENGINEERING TECHNOLOGY

BIET

595 Shakespeare House
Stratford Place, London, W.1

SHIPS
GALLEONS
LOCOS
HISTORIC &
ARCHITECTURAL
SUBJECTS
ENGINEERING
MOVING
TOYS
ETC.

Micromodels

TRADE MARK

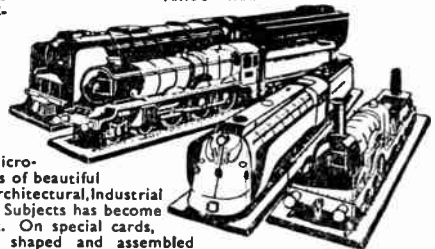

Assembling Micro-model replicas of beautiful Mechanical, Architectural, Industrial and Maritime Subjects has become a serious cult. On special cards, units readily shaped and assembled models authentic in every detail. Cost a few pence, often sell for guineas. Send 1d. stamp for illustrated Descriptive Catalogue.

MICROMODELS LTD., 6 (H) Racquet Court, London, E.C.4



THE BOLSTER HOME WATCH AND CLOCK REPAIR OUTFIT

These precision jewellers instruments include watchmaker's magnifying eyeglass, finest watch tweezers, set watchmaker's screwdrivers, watch and clock oil, oilers, dusting powder, clock brush, plus illustrated instructional manual for the amateur. In container 12/6 post free.

Senior Outfit includes everything above, plus watch jewels luminous compounds, dial renewer, jewellers rouge, explanatory book. Price 21/- post free.

BOLSTER INSTRUMENT Co. (Dept. H.W.), 5a Station Parade, Ashford, Middx.

ORIGINAL AND BEAUTIFUL DESIGNS

for Wall Plaques made at home. P.O. 6/6 inc. PT will bring you outfit comprising board, paint, design in natural colours and full instructions, post free.

Send to **R. S. NAPIER & CO.**

Central Chambers, Market Place, Pontefract, Yorks.



MANCHESTER

10 Piccadilly
(Phone CENTRAL 1787)

BIRMINGHAM

14 Bull Ring
SHEFFIELD
4 St. Paul's Parade

LEEDS

10 Queen Victoria Street
(Phone 28639)

HULL

10 Paragon Square
SOUTHAMPTON
25 Bernard Street

BRISTOL

30 Narrow Wine Street
(Phone 437-4)

BRANCHES

LONDON

78a New Oxford St., W.C.1
(Phone MUSEUM 2975)
87 Old Broad Street, E.C.2
(LONDON WALL 4375)
117 Waltham Road, S.E.17

GLASGOW

326 Argyle Street
(Phone CENTRAL 5042)

Head Office & Factories—**HOBBIES LTD., DEREHAM, NORFOLK**

the strong point
of every hobby...



Aero Glue. The strongest glue in the world.
Universal Glue. Cold glue ready for use from tube or tin.
Waterproof Cement. Specially prepared for balsa wood.
Whyte Paste. For paperwork and photo-mounting, etc.

CROID LTD., IMPERIAL HOUSE, KINGSWAY, LONDON, W.C.2

EXTRA CASH IN SPARE TIME



A fascinating way of earning extra cash in spare time from odd pieces of lead. Small Outlay—Large Profits. Sample mould 3/6d. Casting moulds, deep-cut and ordinary type Aeroplanes, Soldiers, Farm and Wild Animals, Cars, etc. Stamped envelope for full list Illustrated Catalogue 9d.

MASTERCRAFT MOULDS
 69, ST. MARKS ROAD, HANWELL, LONDON, W.7

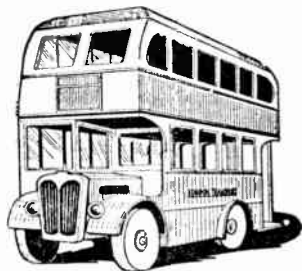

You can make them all

A splendid hobby. Patterns are provided for hundreds of things to make—toys, models, fretwork. With a few odd pieces of wood, or the kit provided, you can turn out lots of things; for gifts or even to sell. Any Hobbies Outfit provides all the tools—from 10/6 to 56/-.



Complete Tool Sets
Full-size Patterns
Kits of Materials

Ask for Hobbies at any stores, ironmongers or Hobbies own branches. Free illustrated leaflets from Hobbies Ltd., Dereham, Norfolk.

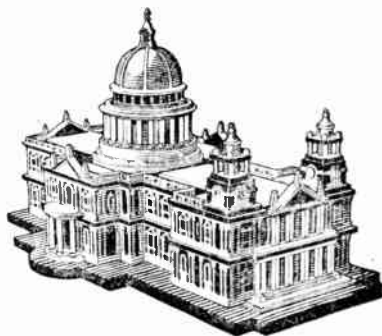

British
made

Hobbies

Fretwork
Outfits

FOR FACES & PLACES



ILFORD

SELOCHROME

FILM

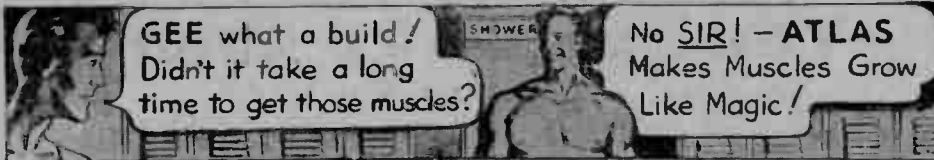

CHARLES ATLAS twice won the title "The most perfectly Developed Man"

Will You Give Me 7 Days to PROVE I Can Make YOU a New Man?

DO you want big, smashing, sledge-hammer muscles all over your body? Husky, broad shoulders? A deep, powerful chest? All the pep and vigour of a "hard as nails" athlete?

Give me just 7 days—one short week. That's all I need to give you the PROOF that I can make you a New Man—give you a real he-man build and glowing health that resists sickness, ends pimples, constipation and other troubles.

Once I was a soft, skinny, 7-stone weakling. Then I discovered "Dynamic-Tension". It gave me the body that twice won for me the title "The World's Most Perfectly Developed Man!" and what my amazing system did for me—it can do for YOU, too.

Send for 48-page FREE Book

Make me PROVE in just 7 days that I CAN give you the big, smashing muscles—powerful shoulders—deep chest—and glowing, all round health you have always wanted. Take the first step TO-DAY. Post the coupon for YOUR Free copy of "Everlasting Health and Strength". Do it NOW! Address to CHARLES ATLAS (Dept. 102/Q), 2, Dean Street, London, W.1.



I want the proof that your system of "Dynamic-Tension" will make me a New Man. Send me your book, Everlasting Health and Strength FREE and details of your amazing 7-day Trial Offer.

CHARLES ATLAS (Dept. 102/Q), 2, Dean Street, London, W.1.

Name (Please print or write clearly)

Address



Hobbies

WEEKLY

CONTENTS

	Page
A Stability Two-Seater Canoe	49
A Bunny Cart	52
Dove Cote	53
Removing Stains	54
A Magnetic Voltmeter	55
A Model Liner	56
Making Boards Wider	57
Doll's House Fireplaces	58
Plywood Photo Album	59
Keep your Camera Clean	60
Bunny Cart Patterns	63

May 9th, 1951

Price Fourpence

Vol. 112 No. 2897

OUR readers have often asked for a two-seater canoe, and here we present one which should serve their purpose admirably.

The canoe is specially designed to resist capsizing—an inherent drawback to the ordinary canoe—and with the aid of the instructions the amateur woodworker should have no difficulty in producing a seaworthy boat which will give years of hard service.

STAGE I

Preparation

Assemble your materials first. Only the best are good enough for boat building and a few shillings extra spent on good materials will make all the difference to the life of your boat. Take particular care over the selection of timber, and make sure that it is straight and reasonably free from knots, especially near the edges. If possible, have the timber cut and planed to size before purchase.

It is usual to build craft of this type upside down on a base plank, and this must be straight, otherwise the boat will not be symmetrical. The ends of this plank have to be cut off at an angle of approximately 60 degrees, with a length of 15ft. 6ins. on the upper side. If the plank is exactly 2ins. thick, this will mean a length of 15ft. 8ins. on the under side,

i.e. the ends slope outwards 1in.

Support the base plank on trestles or boxes and mark off the centre. Then mark every 2ft. towards each end, which should leave a space of 1ft. 9ins. at the ends. These marks are intended as guides for the bulkheads and should be numbered 1 to 7. It is advisable to nail the plank to the supports and, if possible, the supports to the floor.

The two end bulkheads have to be raised $\frac{3}{4}$ in., and in order to achieve this a length of 3ins. by $\frac{3}{4}$ in. scrap timber should be nailed along the base plank over each end mark. The length is

unimportant, but 12ins. is as handy as any (see Fig. 10).

STAGE II

Bulkheads

The boat is the same at both ends and, therefore, bulkheads 1, 2 and 3 are the same as 7, 6 and 5, except for the coaming slots. These are $\frac{3}{4}$ in. wide and 1in. deep, except the centre slot on No. 2, which is shaped to take the V of both coaming and coaming strip. This should be cut when fitting the coaming strip, in order to obtain an accurate fit.

Nos. 1, 2, 6 and 7 are made of plywood stiffened with $\frac{3}{4}$ in. frames, and it is advisable to cut out the plywood shapes first and use these as guides for making the frames. Screw the plywood to the frames with $\frac{3}{4}$ in. screws. Plywood is not used for 3, 4 and 5, and in this case it is best to cut out the shapes in thick cardboard first. To make sure the bulkheads are accurate, mark off two centre lines at right angles as shown in Fig. 7, and use these to lay off the measurements.

The top of Nos. 1 and 7 curves downward 1in. on each side and $1\frac{1}{2}$ ins.

What you've been waiting for— A STABILITY TWO-SEATER CANOE



All correspondence should be addressed to The Editor, Hobbies Weekly, Dereham, Norfolk.

on Nos. 2, 4 and 6. Dotted lines show where the $\frac{3}{8}$ in. frames fit. These are of 2 in. strip for the top and sides of Nos. 1 and 7, and 4 ins. across the bottom. All the others have 3 ins. at the top, sides and bottom. Screw the plywood on to the frames before cutting away for the $1\frac{1}{2}$ ins. by $\frac{1}{2}$ in. and 1 in. by $\frac{3}{8}$ in. strips.

As Nos. 3, 4 and 5 bulkheads do not have plywood, $\frac{3}{8}$ in. screws are required. The top cross members of 3 and 5 are temporary pieces which will be removed later.

All the bulkheads, except No. 4 require the side and bottom edges bevelled slightly to allow the wooden strips to fit properly. This is approximately $\frac{1}{8}$ in., $\frac{1}{4}$ in. and $\frac{3}{8}$ in. towards each end of the boat. Check by holding gunwale and chine strips loosely in position beforehand. Nos. 3 and 6 bulkheads should be positioned with their wooden frames facing the centre of the boat in order to support the floorboards.

Position the bulkheads on the appropriate marks on the base plank and support them with a 6 in. length of

1 in. by $1\frac{1}{2}$ ins. nailed closely at each side across the base plank. Make sure they are exactly at right angles across the plank (see Fig. 10).

STAGE III

Stem and Stern Posts (18 ins. by 2 ins. by 2 ins.)

These must be planed to a wedge shape so that one of the 2 in. sides is reduced to $\frac{1}{2}$ in. in the centre. Draw a pencil line $\frac{3}{8}$ in. from each edge and continue these over the ends back to the corners on the opposite side, so that the planing can be carried out accurately (see Fig. 9).

One end of each post must now be cut off at an angle of 60 degrees. Mark 1 in. from the end along the $\frac{1}{2}$ in. edge and continue the line back to both corners on the opposite side to ensure an accurate saw cut.

The posts should now be lightly nailed to the sloping ends of the base plank and projecting $11\frac{3}{4}$ ins. vertically above it. Use a long nail and leave the head projecting so that it can be withdrawn later with the aid of a pair of

strip in line with the slope of the bulkheads and give the whole a coat of priming paint.

STAGE VI

Skin (3 mm. plywood or canvas)

If plywood is used, work from one end and trim the edges of the sheets after they have been glued and screwed in position. Where two sheets join, the seam must be backed up on the inside with a strip of $\frac{1}{2}$ in. plywood, 6 ins. wide.

To fit a canvas skin, stretch the centre along the keelson, tack it at the ends and then at 9 in. intervals. Stretch the sides downwards and tack along the side of the chine strip, working from the centre. Special care is needed to make a neat job at the ends. The canvas can either be folded without cutting or carefully cut so that each side overlaps the stem and stern posts by 1 in. or so and then the whole covered by a 6 in. wide strip of fabric. Use plenty of glue or Bostik. If waterproof canvas is not available, use ordinary canvas and treat with size.

Next, fit the keel and the chine

FIG 1

LENGTH 15' 10" BEAM 2' 4"

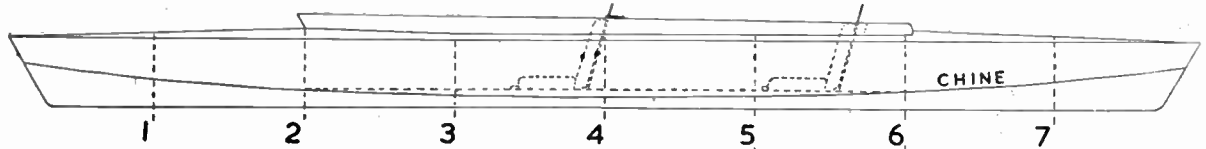
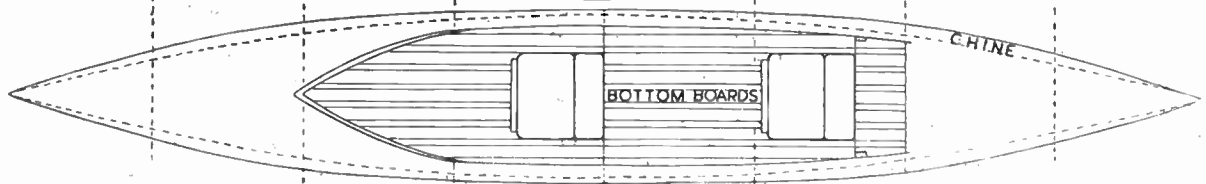

FIG 2



Side and plan views of the craft

MATERIALS REQUIRED

- 1 base plank—16ft. by 3 ins. by 2 ins. Must be straight.
- 2 pieces—12 ins. by 3 ins. by $\frac{3}{8}$ in. Scrap timber.
- 14 pieces—6 ins. by $1\frac{1}{2}$ ins. by 1 in. Scrap timber.
- 1 sheet—36 ins. by 30 ins., 3 mm. ($\frac{1}{8}$ in.). Marine plywood for bulkheads.
- 6—16ft. lengths of $1\frac{1}{2}$ ins. by $\frac{1}{2}$ in. strip. Red deal, cedar or spruce.
- 10—16ft. lengths of 1 in. by $\frac{3}{8}$ in. strip plus 40ft. for odd lengths. Red deal, cedar or spruce.
- 140ft. of 2 ins. by $\frac{3}{8}$ in. strip. Red deal, cedar or spruce.
- 30ft. of 3 ins. by $\frac{3}{8}$ in. strip. Red deal, cedar or spruce.
- 20ft. of 4 ins. by $\frac{3}{8}$ in. strip. Red deal, cedar or spruce.
- 2—18 in. lengths of 2 ins. by 2 ins. For stem and stern posts. Red deal, cedar or spruce.
- 30ft. of 16oz. waterproof canvas, 48 ins. wide.
- $\frac{3}{16}$ lb. $\frac{3}{8}$ in. rustless tacks.
- $\frac{1}{2}$ gross $\frac{3}{8}$ in. No. 6 countersunk brass screws.
- $\frac{1}{2}$ gross $\frac{3}{8}$ in. No. 6 countersunk brass screws.
- $1\frac{1}{2}$ gross 1 in. No. 6 countersunk brass screws.
- $\frac{1}{2}$ gross $1\frac{1}{2}$ ins. No. 8 countersunk brass screws.
- $\frac{1}{2}$ pint primer paint.
- $\frac{1}{2}$ pint undercoat paint.
- $\frac{1}{2}$ pint finishing paint.
- Putty, glasspaper, marine glue.

pincers (see Fig. 10).

STAGE IV

Keelson (16ft. by $1\frac{1}{2}$ ins. by $\frac{3}{8}$ in.)

This is secured in the centre slot of each bulkhead by a $1\frac{1}{2}$ in. screw and at the stem and stern posts by glue and two screws. Allow a few inches overlap at each end and trim to shape later on. When screwing strips to bulkheads, make sure screws go into solid timber, and always work from the centre.

STAGE V

Gunwale and Chine Strips (16ft. by $1\frac{1}{2}$ ins. by $\frac{3}{8}$ in.)

Fit both gunwale strips next. The ends of these should fit snugly on to the stem and stern posts and be secured in the same way as the keelson. Ends can be trimmed later.

The chine strips are fitted in the same way, and then the intermediate strips. One 1 in. screw at each point is sufficient for the latter, but all ends must be glued in addition.

Now trim the ends of all strips flush with the stem and stern posts and round off neatly. Bevel the edge of the chine

rubbers over the canvas with 1 in. screws, and finish the ends off neatly. The upper corner of the chine rubber is rounded slightly but not the lower one (see Fig. 3), and this is best done before fitting. If the boat is likely to be dragged up and down beaches or river banks it is advisable to fit a bilge keel on each side of the bottom. 6ft. of 1 in. by $\frac{3}{8}$ in. strip will do for these (see Fig. 3).

The boat can now be removed from the base plank and turned over.

STAGE VII

Deck (canvas or plywood)

First, bevel the edge of the gunwale strip to suit the slope of the deck. Now, cut off the stem and stern posts level with the gunwale strip, and then remove the temporary cross members from bulkheads 3 and 5. Next, fit the coaming strip. This is 1 in. by $\frac{3}{8}$ in. strip, secured by 1 in. screws to each bulkhead at the slots. Cut the centre slot in No. 2 bulkhead and shape it carefully to take the bevelled ends of both coaming and strip.

The deck strips should now be fitted, and these are 2 ins. by $\frac{3}{8}$ in., secured along the centre and at 2 in. intervals

towards the sides. Fit two together at each side to make a solid deck, and shape to the curve of the boat, after securing. The remainder of the woodwork should be given a coat of primer, and the canvas can then be drawn up the sides, working from the centre again, and tacked along the gunwale strip. Cut away the surplus at deck level and fit separate pieces over the ends and sides of the deck, the edges being turned down $\frac{3}{4}$ in. and tacked along the gunwale and coaming strips.

To make the canvas turn neatly over the edges of the deck, it is advisable to fit small packing pieces between the ends of the deck strips.

STAGE VIII

Finishing

Fit the gunwale rubber, making sure that it covers the edges of the deck canvas. Round off corners before fitting.

Now, fit the coaming. This consists of $\frac{3}{4}$ in. timber, 4 ins. wide at the front, sloping to 2 ins. at the rear and rounded off, and an 18 in. piece across the rear with the upper edge curved to match the deck. Very careful fitting is required, particularly at the forward end in order to obtain a neat joint. Screw to the coaming strip with 1 in. screws and round off the upper edges of all three

pieces before fitting. The upper edge of No. 4 bulkhead will also be improved by rounding off.

The bottom boards are made up of 2 in. by $\frac{3}{4}$ in. strip, the first one down the centre and the others at 1 in. intervals towards the side. The outer strips must be shaped to fit the curve of the boat. The bottom boards should be made up in two 4 ft. sections with cross battens secured underneath 6 ins. from each end. These boards are supported on the cross members of the bulkheads, but an additional strip will be needed across the centre bulkhead to provide more surface.

The seat rests are also made up of 2 in. by $\frac{3}{4}$ in. strip, as shown in Fig. 8. The lower ends are held in position by a 1 in. by $\frac{3}{4}$ in. strip screwed across the floorboards, and cushions can also be held in position by similar strips. The upper end of the front seat rest is supported by the centre bulkhead, but 1 in. by $\frac{3}{4}$ in. blocks screwed to the coaming are required for the back seat rest. Cut the cross member to fit snugly on these. The back seat is placed 8 ins. forward of No. 6 bulkhead in order to give the craft a reasonable trim under load.

Primer should now be applied to the remainder of the bare woodwork,

except, possibly, the coaming, which looks better varnished. Finish off the whole with two coats of good paint of the desired colour, and fix a strong screw eye to each end for mooring purposes.

HELPFUL HINTS

With such a light craft, the weight must be evenly distributed, and, therefore, the timber on each side should be as nearly as possible of equal weight. It is also essential to keep the boat absolutely straight during building, otherwise the balance will be upset.

When using wood screws, it is advisable to drill a hole in the top piece of timber the same size as the shank of the screw and use a prickler to enter the screw in the wood underneath. This makes a solid joint without splitting. With No. 6 screws a $\frac{3}{4}$ in. hole will be suitable and these must be countersunk slightly with a countersinking bit.

If the canvas skin ever becomes torn, fix a neat patch on both inside and outside with marine glue.

When the boat is finished, try it out on sheltered water first and, if possible, have it tested by an expert.

If you cannot swim, be sure to learn before you take up canoeing! (240)

FIG. 3 CENTRE SECTION

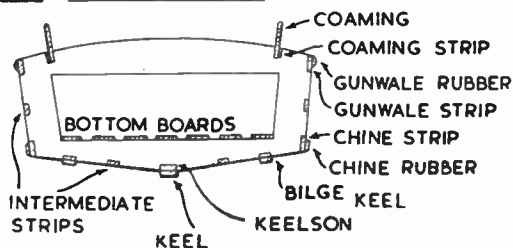

FIG. 4 BULKHEAD 1 AND 7

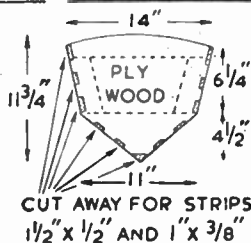

FIG. 5 BULKHEAD 2 AND 6

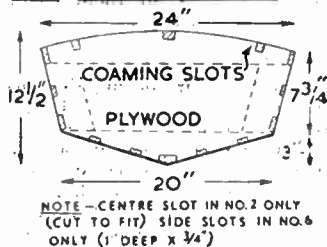

FIG. 6 BULKHEAD 3 AND 5

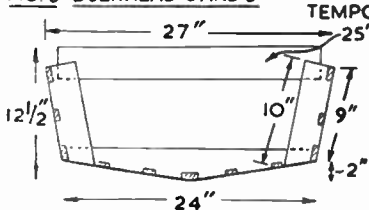

FIG. 7 BULKHEAD 4 (CENTRE)

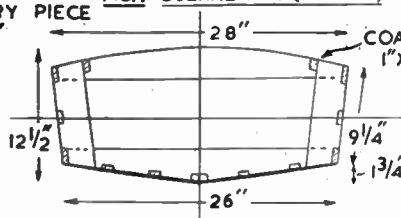

FIG. 8 FRONT SEAT REST

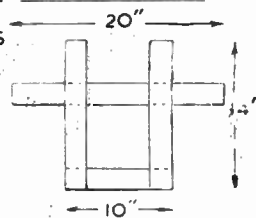

FIG. 9 STEM OR STERN POSTS

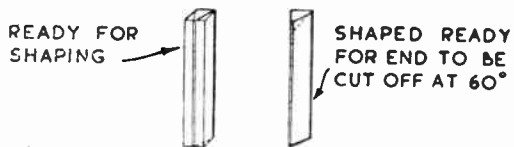
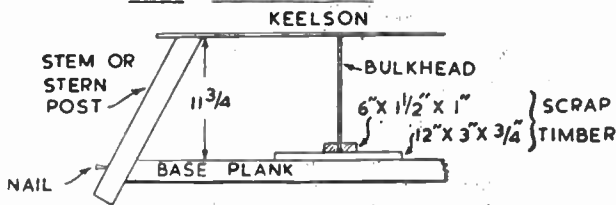

FIG. 10 END ASSEMBLY



More drawings to help the constructor

Tell your friends that they, too, can get Hobbies Weekly now

Please the youngster by making A BUNNY CART

THIS week we are giving another toy for the father of the family to make up. It is illustrated in Fig. 1, and when made up and painted or enamelled, it makes a particularly attractive toy.

Very little wood is required to make it. Some pieces of $\frac{1}{4}$ in. and some $\frac{1}{2}$ in. or $\frac{3}{4}$ in. stuff will be wanted, and all can be cut with the fretsaw and put together with glue and nails or screws. The toy is 10 ins. long when complete, and stands 7 ins. high. The finished effect, of course, depends largely upon the final cleaning up and painting, and the choice of colours used.

The cart, including the shafts, consists wholly of $\frac{1}{4}$ in. wood, while $\frac{1}{2}$ in. or $\frac{3}{4}$ in. stuff is used for the rabbit. Two 4 in. diameter wheels give the cart balance and weight.

As there are several shaped parts in the toy which require actual patterns, we have included in this issue a page devoted to the shaped pieces. It will only be necessary, therefore, to stick the patterns down direct to the wood and proceed to cut them out with a medium grade fretsaw.

The Cart

Commence by making the cart, and the main floor (A) should be the first part put in hand. We have not been able to find room on our pattern sheet to include this floor full-size, but it is simple in outline and we have shown a diagram of it in Fig. 2 with all the necessary measurements for draughting it out on the wood direct.

If several of the toys are to be made, then it would be a good plan to make a

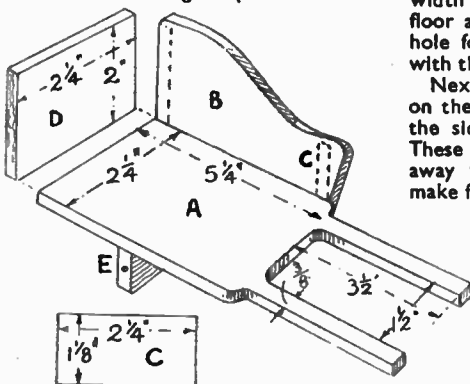

Fig. 2

tracing of the full-size outline for future use. The same applies to the outline of the various parts which comprise the rabbit.

Having set out the floor, cut it from a piece of $\frac{1}{4}$ in. wood and glasspaper it up clean. Next, make the two sides (B) from the full-size pattern given. Cut one side from the $\frac{1}{4}$ in. wood, clean it up,

and use it as a template for outlining the second side.

Prick off on to the wood the dotted lines of (A), which will act as a guide

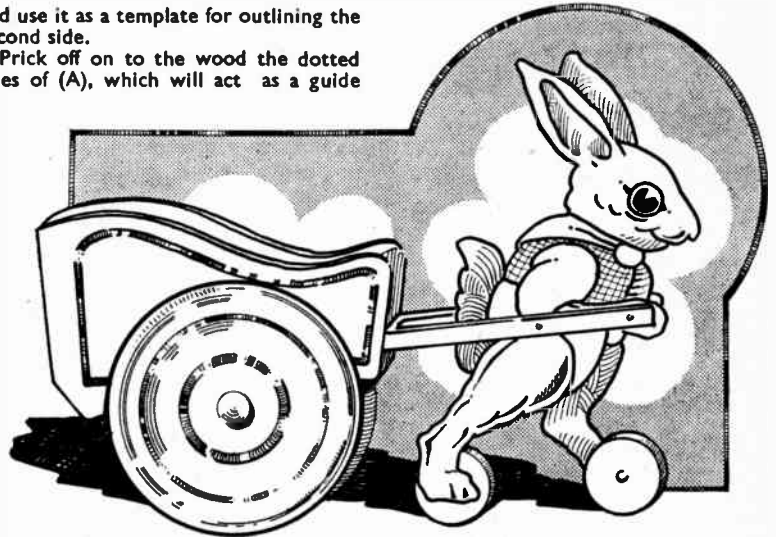

Fig. 1

when the floor is glued and nailed on. The other dotted lines as (C) and (D), and the axle bar (E) should also be similarly indicated, and the hole should be drilled in the axle bar to carry the wheel retaining screw through into the axle.

Glue the sides to the floor and then prepare the two pieces (C) and (D) from the measurements given in Fig. 2. Cut these out neatly, and glue and nail them to the sides.

The axle bar (E) may be of $\frac{1}{4}$ in. wood, but a spare piece of $\frac{1}{2}$ in. stuff would give better support for the wheels. The size of the piece is: length $2\frac{1}{2}$ ins., width 1 in. Glue and screw it to the floor and to the sides and see that the hole for the axle screw comes central with the piece.

Next cut two discs of $\frac{1}{4}$ in. wood, as (F) on the pattern sheet, and glue them to the sides over the holes in the sides. These discs will keep the wheels well away from the sides of the cart and make for free running.

The Rabbit

This is in itself an interesting item, and it should also be simple to make. Wood $\frac{1}{4}$ in. thick is best for it, but if a few pieces of $\frac{3}{4}$ in. stuff are available, then they may be used instead. All five parts constituting the figure are given on the pattern sheet, and it should be an easy matter to stick the patterns down to the wood and cut them round with the fretsaw. Care should be taken to hold the fret frame perfectly upright so as to get a square edge on the wood during cutting. One only will be wanted of piece (H), while both front legs—(I) and back legs (J) are given ready for cutting.

The markings on the body piece should be traced off on thin paper from the patterns before cutting is commenced. Then, when the pieces are cut, the markings can be added to the wood surface ready for painting. It would be well, perhaps, to give all the parts a coat of cream or buff paint after they have been glued up in their respective places as shown by the dotted lines on the patterns, these dotted lines, of course, being added from the tracing before the gluing up is commenced.

The other markings can be drawn in when the figure of the rabbit is done and the first coat of paint laid on. Put one or two long fret pins ($\frac{1}{4}$ in.) into the legs to make a firm fixing into the body.

Two wheels as (G) on the pattern sheet will be cut from $\frac{1}{4}$ in. wood, cleaned up and screwed to the inside surfaces of the hind legs. Allow these wheels free movement so that the finished toy runs smoothly. Paint the rabbit in bright colours, say, light brown for the body part, and get some white or cream portions on the head and legs.

See page 63 for patterns

To complete the toy, get two long round-head screws and run them through the cart wheels and well into the cross axle. Thin metal washers inserted between the discs on the axle bar and the wheels would make for better running. The large wheels are best bought ready-turned and varnished and can be obtained from any good wood turners or from stockists who deal in goods for the toymaker. The cart should be painted in bright colours.

The rabbit is nailed inside the shafts, two nails being driven through from the outside.

(238)

How to make an attractive DOVE COTE

THERE are few sights in a garden more attractive than a flock of doves wheeling against the sky, but such birds demand a home worthy of their appearance. The dove-cote described here, with its nest boxes and gabled roofs, looks extremely well if finished in white enamel and mounted on a post of reasonable height.

But in addition to being a cote of good proportions, the design is eminently a 'practical' one. Bird-fanciers will note with approval the removable sides which mean that the inside is readily accessible for cleaning, and the generous degree of roof overhang to give reasonable weather protection.

1/2 in. Preferred

Timber of 1/2 in. thickness can be used for the construction, though 3/4 in. wood is preferable. The latter measurement has been used as the basis in working out the details given below, and readers using 1/2 in. thick timber are advised to check overall measurements at frequent intervals to ensure correct fitting and finished sizes.

The two fixed ends are the first to be made, these measuring 2ft. 2ins. square. As it will be necessary to joint the edges of boards to get the required width, waterproof glue must be used for the assembly. Alternatively, battens can be

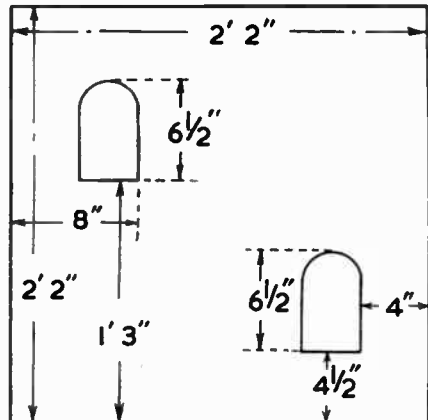

Fig. 1

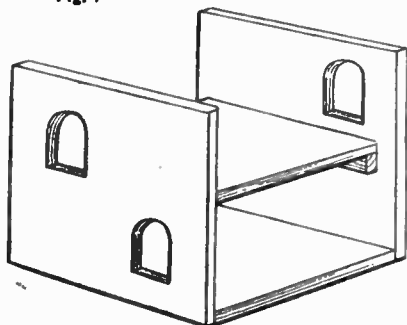

Fig. 2

screwed across the boards on the inside but these must be kept clear of the nest box openings.

Two arched openings measuring 6 1/2 ins. by 4 ins. are cut in each end, the shape and position of these being clearly shown on drawing (Fig. 1). The shapings can be cut with a keyhole saw by first drilling a small hole in the waste wood.

A floor support is then screwed across the inside face of each end, this being of 1 in. by 1/2 in. material, 2ft. 0 1/2 ins. long. Each is fastened into place so that its top edge is at 1ft. 0 1/2 in. from the bottom edge of the side.

The base and floor are both 2ft. 0 1/2 in. long, the former being 2ft. 2ins. and the latter 2ft. 0 1/2 in. long. Screws are driven through the bottoms of the sides into the ends of the base, while the floor rests on top of the supporting battens. It should be noted that the sides are so arranged that the upper door openings are on opposite sides of the cote (see Fig. 2).

Movable Sides

Both movable sides measure 2ft. 0 1/2 in. long by 2ft. 1 1/2 in. high, each having two nest box openings of the same size

as before. The bottom edges of these movable sides rest on the baseboard, and the position of the openings must be adjusted so that they match up with those on the fixed sides. The movable sides are held in place by two small metal turn-buttons on each edge, while to prevent the top edge from falling inwards a 1 in. by 1/2 in. batten is screwed between the fixed sides, level with their top edges. These battens are shown in Fig. 3.

An extra length of 1 in. by 1/2 in. batten, slightly chamfered on one edge, is glued and screwed to the lower edge of each movable side so as to cover the edge of the baseboard. This is shown on the perspective sketch.

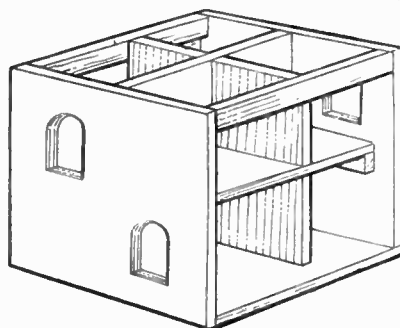
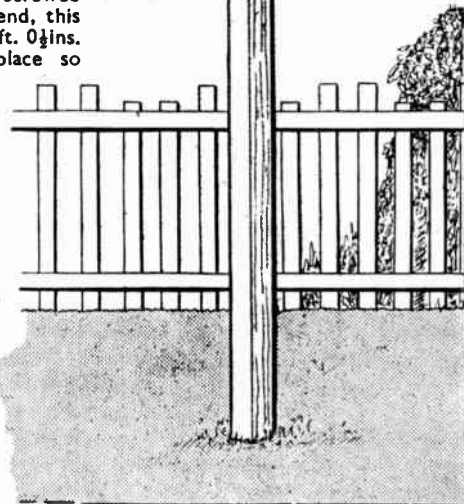

Fig. 3



At this stage the alighting boards can be fixed. Each is of exactly the same shape and size as the door opening, and is glued and screwed into place from inside the cote so that its top surface is about 1/2 in. below the bottom of the door opening.

The top and bottom floors of the cote are then divided up into nesting compartments. For each floor, two partition pieces are needed, both 2ft. 0 1/2 in.

(Continued foot of page 54)

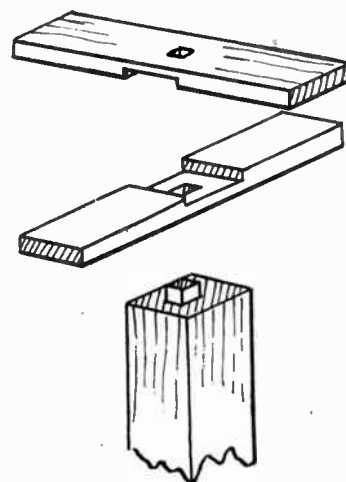

Fig. 4

Things the handyman should know about REMOVING STAINS

THE hobbyist is often regarded as the handy-man about the house and is thus frequently called upon for help when stains have to be removed from household linen, and from furniture. The remedies are mostly of a simple nature and the following notes might be of service for reference purposes.

Treat the stain as soon as is possible. The longer the delay the greater is the chance of the stain becoming permanently set.

Where more than one remedy is suggested, choose the one for which the materials are at hand.

Tea Stain

Soak the material in a fairly strong solution of borax until the stain has disappeared. This may take anything from ten minutes to a couple of days.

Alternatively, the stain can be smeared with glycerine, left for two hours and then washed.

Coffee Stain

Rub in glycerine, leave for a little time and then wash. Repeat the process until the stain has gone.

Cocoa

Never wash a cocoa stain with soap as this will only fix it into the fabric.

(1) Lay the material over a large basin and pour boiling borax water through the affected patch.

(2) Put Cream of Tartar over the stain and tie the material into a little bag with the stain on the inside. Dip the bag into boiling water, leave for a little time and then rinse.

Fruit Stains

For fresh stains either:

(1) Lay the material over a basin and pour boiling water on to it, or

(2) Cover the stain with powdered starch and brush this off when it is dry. If any of the stain remains, moisten it with a little water and repeat the starch treatment.

If the stain is stale, cover it with a paste of common salt dissolved in a very little lemon juice. Wait until the paste is dry and then wash off. This treatment should be used on white materials only.

Very stubborn stains can be treated with a solution of chloride of lime.

Medicine Stain

Cover with a paste of fuller's earth and ammonia solution. Wash off when dry.

Blood Stain

Soak in lukewarm salt water. Change the salt solution every hour and then wash with soap and water.

When it is impossible to soak the material, sponge it with a dilute solution of ammonia.

Ink Stain

Cover the stain with a paste of either milk and salt or lemon juice and salt, and then wash with soap and water. Lemon juice and salt is more effective on woodwork.

White materials can be treated by pouring a solution of oxalic acid on to the stain. Stretch the material over a basin to do this.

Grass Stain

Treat 'whites' with a weak solution of ammonia.

For other materials, cover the stain with glycerine, leave for an hour and then rinse in warm water.

Grease Stain

Either (1) wash in a solution of borax and water, or (2) cover the stain with french chalk and then hold it over a hot iron. Finally, rub the chalk off with a linen rag.

Tar Stain

Sponge with a clean rag dipped in petrol. The important thing to remember is to start on the outside of the stain and work to the centre.

Ironmould

Stretch the material over a basin of boiling water and then drop on to the stain a few drops of a solution made by dissolving salt in lemon juice. Dip the material into the hot water; raise it up and apply a little weak ammonia solution. Finish by rinsing.

Egg Stain

Soak in cold water and then wash with soap and hot water.

Vinegar Stain

Sponge with a dilute solution of ammonia and then dab with a little chloroform.

Ink Stains on Wood

Where possible, plane off the shallow stains. Cover any deep-seated stains with a creamy paste of chloride of lime and water. Add to this a little acetic acid and then wash off.

Other methods are (1) sponging with a hot solution of oxalic acid and (2) treating with a mixture of Milton and acetic acid.

Removing ink from a polished surface needs a little more care. First, rub the stain well with soap and water, and then with a little dilute ammonia solution. Next, cover the area with a thin cream of chloride of lime and finally swab it with a 50 per cent solution of acetic acid. When all the ink has disappeared, wash the chemicals away and allow the wood to dry.

Later on it will be necessary to re-stain the cleaned surface, taking care to match the stain with the existing polish.

(251)

Dove Cote—(Continued from page 53)

long. A 'cross-check' joint is cut in the centre of each so that they fit together, and they are then glued and screwed into place. It will be necessary to take a 1in. by ½in. strip from the top corners of the upper cross partition so as to fit round the batten there.

With these partitions installed, the cote, with its movable slides taken away, will appear as in Fig. 3.

The top of the cote is closed in by a panel measuring 2ft. 6ins. square, but before this can be fixed the gable ends of the roof must be fastened to it. These gable ends are simply triangles of wood with a base of 2ft. 6ins. and a height of 9ins. They are glued and screwed at each end of the top so that their outer faces are flush with the ends, and then the composite top is screwed on to the edges of the fixed ends of the cote.

The roofing boards stretch from gable to gable, extending 6ins. beyond them at each end. A similar overhang is left at the bottom of the roof.

This latter must be covered with roofing felt or a similar substance, all overlapping edges being treated with a waterproofing solution. A batten is fastened to the underside of the overhang at each end (as shown on the sketch of the finished cote), while a V-shaped section is cut from the underside of a square strip so that it can fit along the apex of the roof to serve as a 'ridge roll'.

The Supporting Pole

Wood 4ins. square can be used for the supporting pole, while two strips of 4ins. by 1in. will be needed for the supporting arms at the top.

The two supporting arms, both 1ft. 6ins. long, are joined across the centre by means of a cross-check joint, but the two pieces should not be fastened together until a 1in. square mortise has been cut through the centre of the joint. The top of the post should be cut down to form a 1in. square tenon, as in Fig. 4, and then the cross-arm can be finally fixed into place. Screws are then driven through the underside of these arms into the base of the cote.

The cote should be between 8ft. and 10ft. above ground level, and the post should be sunk into the ground for at least 2ft. 6ins. That part of the post which is below ground level should be creosoted, and the pole kept firmly in place with well-rammed earth and small stones.

(219)

Test your batteries and wiring with A MAGNETIC VOLTMETER

TO test batteries and electrical circuits, a voltmeter is very useful. With it, the condition of a battery can be seen at once; wiring, etc. can also be tested for short circuits or breakages, and it is possible to make up an efficient meter from oddments.

Actually, this meter can also be used to measure amps., and for other purposes, as will be explained. An examination of Fig. 1 will make the method of working clear.

To simplify construction, the pointer returns to zero (the centre position) under its own weight. It is attached to a pivot which has a magnetised needle secured in a crossways position. Above this the magnet is fixed. The wires from this magnet go to two terminals, and to the circuit being tested.

When current flows, one end of the needle is attracted and the other repulsed, thereby moving the pointer. As the extent of this movement depends upon the current flowing, the voltage can be read off against the scale. If the

these dents. A small bracket (B) is bolted or soldered to the bearing bracket so that the whole can be mounted inside the case with a small screw at the back.

For the pivot (C) use a $\frac{1}{2}$ in. length of fine needle, or a pin with the head cut off. File the blunt end to a sharp point.

For the pointer (E) use a length of thin copper wire, or a stout bristle. Loop or glue it to the pivot.

Magnetising the Needle

(D) is a piece of steel needle about $\frac{1}{2}$ in. long. It must be magnetised by stroking from end to end with a permanent magnet, or by putting one end against an electro-magnet and applying current from a battery several times. After this, it will pick up small bits of tin or iron, and it is fixed at right angles to the pointer, as shown. A touch of pitch or sealing-wax can be used here, or a turn or two of glued cotton.

The pivot should then be slipped into the dents in the bearing. If it does not turn absolutely freely, bend the arms of

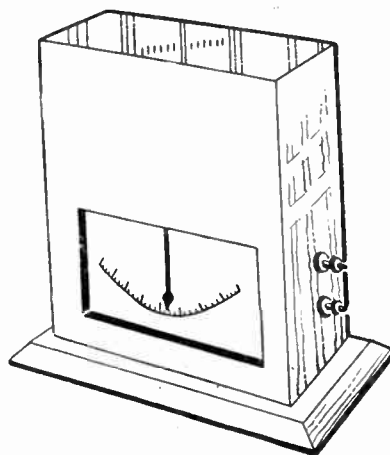

the pointer.

A small bolt is used for the core of the magnet. Two strong cardboard washers are placed on this to form a spool on which the wire is wound. The finished magnet is mounted on a bracket (see Fig. 2).

For measuring small batteries up to about 6 volts about 200 turns of 32 to 36 S.W.G. wire can be put on. If it is desired to measure up to about 20 volts or so, use 500 turns of 40 S.W.G. wire. For voltages up to 100 or more (e.g. wireless batteries) use a resistor of about 2,000 to 6,000 ohms in series with one lead.

For current measurements (as a charging meter) use about 30 turns of 16 S.W.G. wire for 1 amp., with 15 turns 14 S.W.G. wire for bigger currents.

Calibrating the Meter

A new battery in proper condition can provide calibration. Grid Bias batteries haveappings each 1.5 volts. Flash-lamp batteries can have the card stripped off, disclosing the individual cells. Each of these is 1.5 volts. It is, therefore, only necessary to connect different voltages—say, 1.5, 3, 4.5, 6, 7.5, 9, and so on—and mark the scale according to the movement of the pointer. The intermediate markings can be filled in by eye.

(Continued foot of page 58)

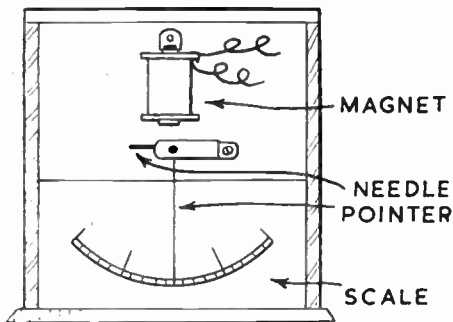

Fig. 1—Front view, showing layout of parts

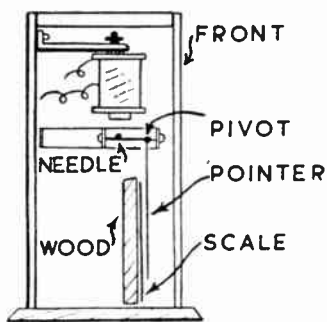

Fig. 2—Side view

polarity of the supply is reversed the pointer moves the other way.

The Meter Case

This is made up from thin wood and is about 3 ins. high by 2 $\frac{1}{2}$ ins. wide by 1 in. deep. The base is slightly larger and a window 1 $\frac{1}{2}$ ins. by 2 ins. is cut near the bottom of the front. The other pieces can be tacked or glued together, but the front should be attached by means of four small screws.

A piece of wood about 1 $\frac{1}{2}$ ins. high is fixed inside, at the bottom, to hold the scale close up against the pointer, as shown in Fig. 2. Fix two terminals on one side of the case, marking 'Plus' and 'Minus'.

The Pointer

Fig. 3 will enable the most critical part of the meter to be made up easily. (A) is a strip of thin metal about 1 $\frac{1}{2}$ ins. long. Make a small depression near each end by placing the strip on a piece of wood and using a sharp-pointed nail as punch. When the strip is bent as shown, the ends of the pivot (C) rest in

the bearing out a trifle.

Screw the bracket to the back of the case and arrange the scale so that the pointer does not touch it.

The Magnet

By using different thicknesses of wire, and a suitable number of turns, any desired voltage or current reading can be obtained. Adjusting the distance between the end of the magnet and the needle will also alter the voltage necessary to move the pointer a given distance, as will altering the weight of

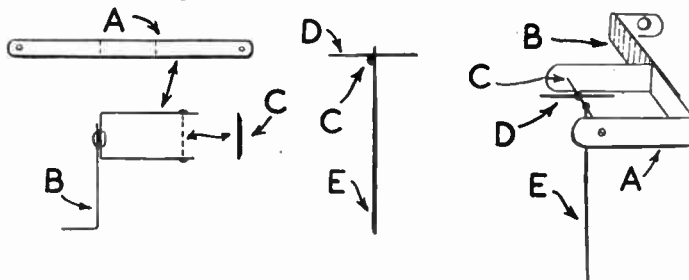

Fig. 3—Details of the important parts

Make your boy A MODEL LINER

SOON we shall be thinking of seaside holidays, and the children will be getting out their buckets, spades and boats. The younger child wants its boat to 'sail' equally well on the sands as in the water, and the small model sailing boats with their deep keels give little satisfaction to such a youngster.

The model liner described can be easily made from available materials, has a fair amount of detail and will stand up to many rough 'voyages', whether on the sands, in the sea or on a pond.

The Hull

This is built up from pieces of $\frac{3}{4}$ in. thick wood, and is 18ins. long by 4ins. wide. First cut out a template from stiff paper the shape of the boat. This is best done by drawing half of the plan on the paper, folding along the centre line and tracing the other half.

Using the template, mark off the shape of the hull on two pieces of wood, $\frac{3}{4}$ in. thick by 18ins. long by 4ins. wide, and cut accordingly (Fig. 1). The hull is completed by cutting two sections from wood $\frac{3}{4}$ in. thick by 4ins. by 4ins., one to fit the bow and the other the stern (Fig. 2).

All sections are now cramped together, holes drilled through the two top sections, countersunk, and the whole screwed together temporarily with 2in. screws. Complete the shaping of the hull with files and glasspaper, the bottom edges to be bevelled off.

These sections must now be taken

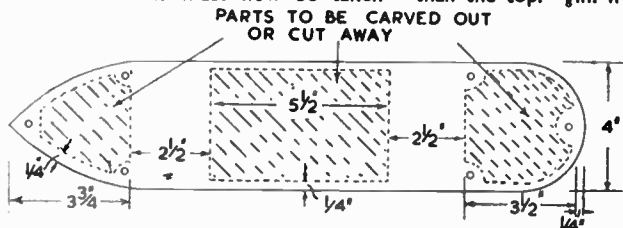

Fig. 1

apart. The bottom one is carved out, leaving $\frac{1}{4}$ in. thickness of wood on the bottom and all round the sides, and $\frac{1}{4}$ in. around the screw holes. The middle section has holes cut right through, as shown in Fig. 1. The top sections are now carved out. In each case $\frac{1}{4}$ in. thickness of wood is left on top, $\frac{1}{4}$ in. round the sides and $\frac{1}{4}$ in. round the screw holes (see Fig. 2).

All sections are now finally glued and screwed together, using a good waterproof glue. Fill in screw holes with plastic wood and set aside to dry.

The Superstructure

This must be constructed to be as light as possible. From wood $\frac{1}{4}$ in. thick and $\frac{3}{4}$ in. wide, make a frame 6ins. long by 4ins. wide. Nail and glue this together,

and cover with the thinnest available plywood. Drill two fine holes vertically in each of the four sides for nailing to the main deck later.

The two funnels are made from 1in. diameter wood, and are each 2ins. high. The base of each one is cut at a slight angle, to give the necessary slope to the funnel when fixed to the deck. In a piece of wood $\frac{3}{4}$ in. thick by 1 $\frac{1}{4}$ ins. wide and 6ins. long, drill two holes to take thin screws about 1 $\frac{1}{4}$ ins. long. These holes must be bored on the centre line 1 $\frac{1}{4}$ ins. from one end (the stern) and 2ins. from the other (the bow), and countersunk on the underside. Screw and glue the funnels to this strip, both pointing towards the stern.

This strip of wood, complete with funnels, is now nailed and glued to the boat deck, using two fine steel pins at each end. It must be exactly in the centre of the boat, with the funnel 2ins. from the front of the bridge facing foremost.

The bridge is made from a piece of wood $\frac{3}{4}$ in. wide, $\frac{1}{4}$ in. thick and 4ins. long. The front edge is chamfered off slightly, the base being a little wider than the top. $\frac{1}{4}$ in. from each end drill

two fine holes to take steel pins $\frac{1}{4}$ ins. long to form stanchions. Fix the bridge at the front of the boat deck as shown, and the whole superstructure can then be glued and nailed to the main deck.

Masts

The masts can be made from dowel rod about $\frac{1}{8}$ in. in diameter. They are 8ins. long, and slightly tapered at the top end. $\frac{1}{4}$ in. from the top of each mast, drill a hole about $\frac{1}{8}$ in. in diameter, and drill another $\frac{1}{4}$ in. below and at right angles to the first one. These are for fine string, representing the rigging, to pass through.

Now drill two holes in the main deck in the position as shown on the plan, to take the base of the masts. The holes must slope in the same direction as the funnels. Glue and fix the masts in position.

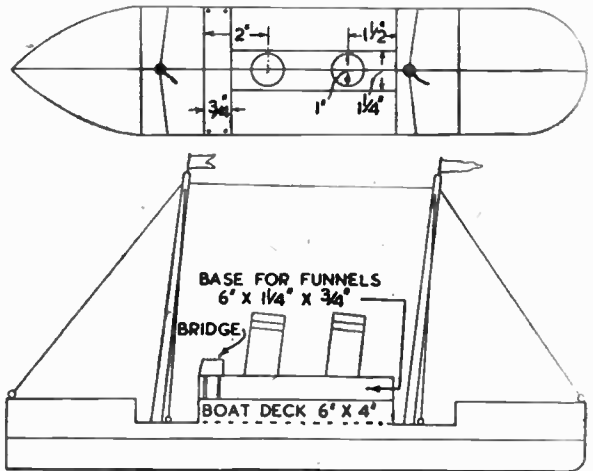

Plan and side views

The boat is now ready for painting, but first test it in a bath of water for floating. If exactly the same amount of wood has been cut away each side of the centre line, the boat should rest in the water on an 'even keel'. If not, adjustments can be made by screwing a small lead weight underneath the hull, in a suitable position to create a balance.

All the woodwork should be given a coat of priming paint, and any cracks filled in. The hull should be painted in two colours, grey below the water line and red above. The deck can be painted white, and the funnels red with a black band $\frac{1}{4}$ in. wide painted round them

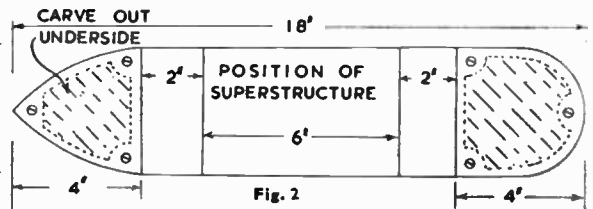

Fig. 2

$\frac{1}{4}$ in. from the top. The masts can be stained brown.

The Rigging

A screw eye is fitted in the front of the bow of the boat; one in the stern and one each side of the masts. A towing string is attached to the front eye. A piece of fine string is also tied to this eye, passed through one of the holes in the top of the forward mast, then through the rear mast and made fast to the eye in the rear of the boat. A piece of string is tied to the screw eye at each side of the mast, passed through one of the holes in the top of the mast and made fast to the other screw eye. Finally two small flags made from coloured material are fixed to the masthead with long pins, and the ship is ready for her 'Maiden Voyage'. (231)

Here are some helpful tips on MAKING BOARDS WIDER

UNTIL the invention of plywood and laminated board, a drawback to wood was that it did not grow to give large wide sheets. The widest boards were much more expensive than narrower ones, and very liable to warping, so that to make a wide sur-

worker. But it is quite easy to make a quite serviceable clamp for gluing boards together. This, as shown in the diagram, consists of a stout flat length of hard wood, of fair thickness (say, 1in.) and as wide as possible. At one end is a fixed block, firmly screwed on. At the other end, one half of a pair of wedges is screwed on. By means of suitable packing, the whole is assembled as in the sketch, and the wedge driven in tightly.

advantage to have a long shooting plane here, but an ordinary jack plane set not too coarsely will serve for many purposes. A small smoothing plane is not suitable.

It is an advantage if one face of the board is planed flat and smooth so that a try-square can be applied to the edge being planed, to make sure that it is square. This done, the abutting edge of the next piece is similarly planed. The two pieces are then placed one over the other, and viewed as in the photo. One can then see if any 'daylight' is showing or, by swivelling the top board on the lower, note whether there is any catching. Work with the plane until both edges are in good contact. Mark one or two ticks across the wood (as seen in the photo) to identify each pair of abutting edges. Proceed with as many pieces of wood as are to be joined.

Warm the Surfaces

It is an advantage to warm the surfaces now to be glued. One board is put in the vice, glued on edge and the other facing surface similarly glued. The two edges are rubbed together (i.e. the upper, free, board rubbed along the lower, fixed, board until the glue drags. The clamp is then applied (it should have been set, approximately, in advance). It is particularly important to apply a straight edge, as in the photo, to ensure that the boards are quite flat.

Leave for 12 Hours

The work should be left for twelve hours or so. Thin boards need not be clamped. After being rubbed they can be placed against a sloping board, as shown in the third photograph. A piece of newspaper should be placed behind the boards to prevent the possibility of the boards sticking to the back support. (222)

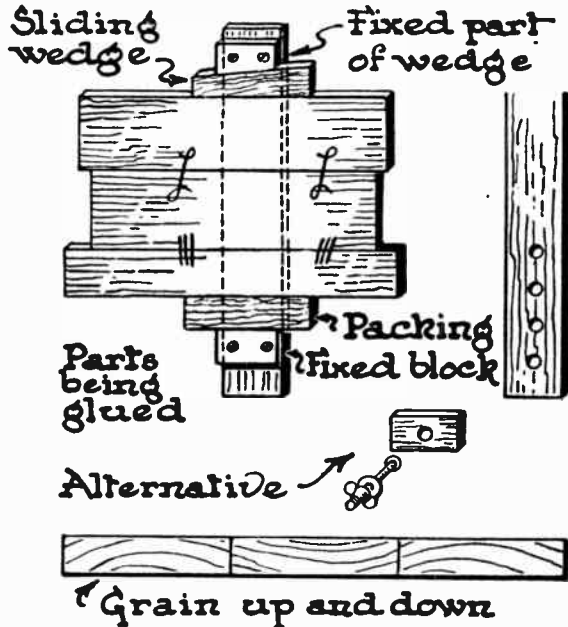

These drawings show how the home-made clamp is used—and the way to lay the wood to help prevent warping

face, several boards have to be glued together, edge to edge.

This is not a very difficult job, even for the amateur of limited tool kit. In one of the photos a steel sash clamp is shown—a necessity to an advanced

worker, we arrange them so that in each piece, the grain goes up and then down, alternately, as seen in the diagram. This helps to prevent warping.

The first piece is clamped in the vice and has its edge 'shot'. It is a great

Instead of the lower block being fixed, it is possible to make a series of, say, $\frac{1}{2}$ in. holes down the centre of the lower part of the wooden board, 2ins. or so apart, and make a similar hole in the lower block. This adjustable lower block is then fixed, in a suitable position, to the board by means of a $\frac{1}{2}$ in. bolt and wing nut.

Arranging the Wood

Having selected our pieces of wood to make a wide



Making sure the edges are square

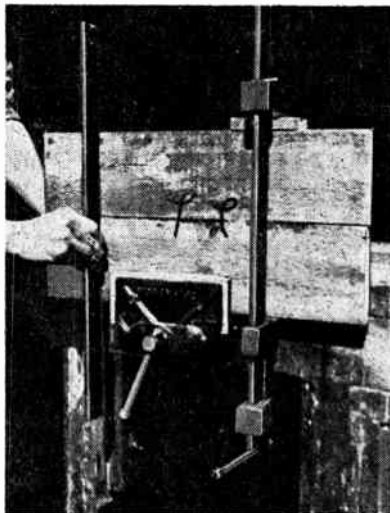

Applying a straight edge



Method of sealing with thin boards

A few pieces of wood makes these DOLL'S HOUSE FIREPLACES

In many homes during spring or early summer, old fireplaces are pulled out and replaced with modern grates with tile surrounds. How delighted a small girl would be to have miniature grates fitted in her doll's house to match the new ones in her home. With a few pieces of wood some realistic grates can be built and easily fitted into the rooms of the doll's house.

Chimney Breast

If there are no chimney breasts in the doll's house, obtain a piece of wood 1 in. thick and 5 ins. wide. Cut off a length to fit between floor and ceiling. At one end, cut out a hole 1 1/2 ins. wide and 2 3/4 ins. high to form the fireplace. Cut a small piece of wood to fit the hole and shape as shown to form the fire back. Glue this into the back of the opening and fix the breast into position. Paint the inside of the grate and the fire back black, and cover the breast with imitation wallpaper to match the room.

If the doll's house is fitted with chimney breasts but fireplace openings are not provided, stick a piece of matt black paper on to the breast to represent a fire-place.

Hearth

From a length of wood 3/8 in. thick, cut a piece 4 ins. long by 1 1/2 ins. wide. After glasspapering, round off the edges and score with a sharp knife to represent tiles, perhaps copying the markings from an existing grate. Now paint the hearth, using pastel shades to match the colour scheme of the room, and, when dry, fix in position. Fill in with wood the small hole now formed at the bottom of the fireplace.

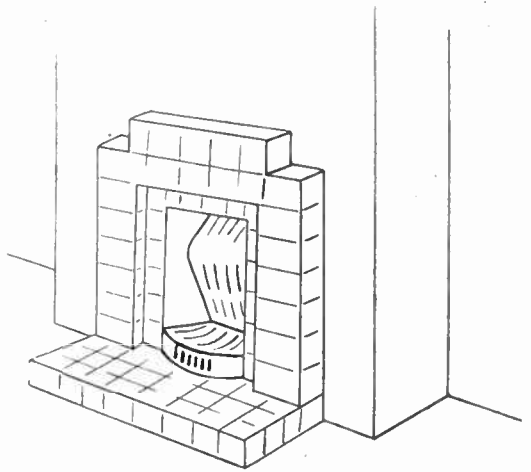

A fireplace and chimney breast in position

Tile Surround

This is made from pieces of plywood 3/8 in. thick. Cut two pieces 4 ins. by 3 ins., and in one cut a hole in the bottom edge 2 3/4 ins. wide by 2 3/4 ins. high, while in the other, cut a similar hole 1 1/2 ins. wide by 2 ins. high, to fit the fireplace.

Glue these two pieces together, and, when dry, cut away the corners at the top for 1/2 in., to form a design. Clean up with glasspaper and round off the edges.

Now, carefully score face of the wood, as was done for the hearth, and paint; some of the 'tiles' being stippled in a darker shade to form a pattern. Finally, glue the completed surround to the chimney breast.

Fret and Basket

Shape a piece of wood to fit into the fireplace and curve the front to form the 'fret'. Carve out a depression to form the basket and paint the inside surface black. The front should be painted to match the tiles, and small black lines marked on it to represent the ventilation holes.

The shape of the surrounds should be varied to suit different rooms, and alternative designs are shown. Use a smaller surround, about 3 ins. by 3 ins. for bedrooms, while in a large lounge the width can be increased. The sizes suggested are all to a scale of approximately 1 in. to a foot. (204)

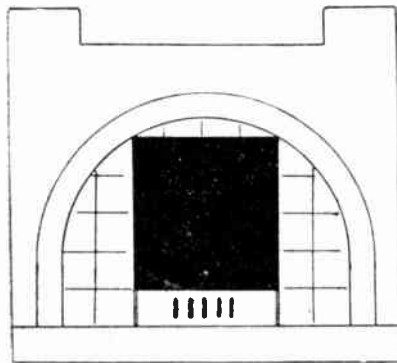

Alternative design for drawing room

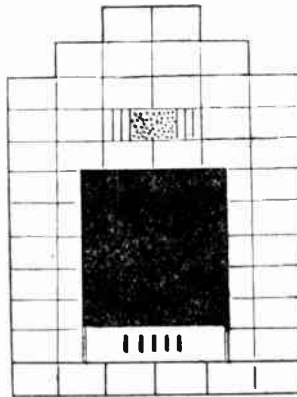

Design for bedroom

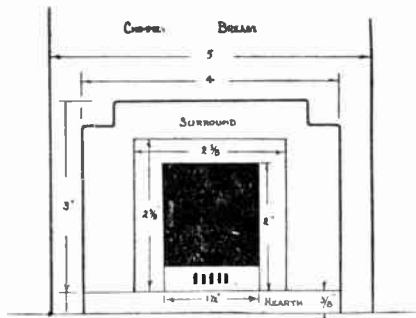

Main dimensions for a complete fireplace

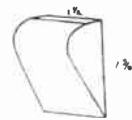
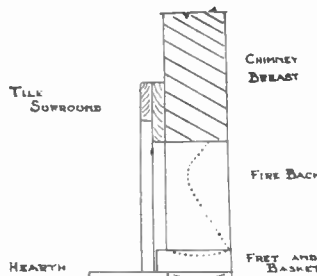

A Magnetic Voltmeter—(Continued from page 55)

If used for measuring amps., connect in series with a circuit where a known current is flowing. A battery and bulb will do. A 6 watt, 6 volt bulb will pass 1 amp., and so on. (To find current

passing, divide the wattage by the voltage). Some bulbs have the consumption (in amps.) marked on them.

Fill in intermediate markings as before. The pointer will move one way

for 'Charge' and the other for 'Discharge' and may be marked accordingly.

The meter will not read alternating current, but is always ready for checking direct current, when made up. (227)

For lasting service, make a PLYWOOD PHOTO ALBUM

A BOOK with wood 'binding' and covers is still a comparative novelty and is quite an interesting project to make. The size we are describing, 10ins. by 8ins. is particularly suitable for a photo album although, of course, the dimensions can be varied to produce a similar book for any other purpose.

It is possible, for example, to produce a pocket notebook by this method, and in one instance where this was done, all the pages themselves were of extremely thin ply (itself scarcely thicker than paper). The book we are describing,

however, uses ordinary paper pages bound in place with decorative cord.

About the thinnest plywood made at the present time is 0.4 mm. Unfortunately, this is very difficult to obtain. Expense, and excessive thickness, precludes the use of 0.8 mm. ply which is in fairly ready supply.

$\frac{3}{8}$ in. by $\frac{7}{8}$ in. stock. This binding block, however, must be drilled and slotted and the paper pages incorporated before securing in place—Figs. 2 and 5.

Details of this slotting are given in Fig. 5. A groove is cut along the bottom to take the full thickness of the binding cord used. Four holes are drilled

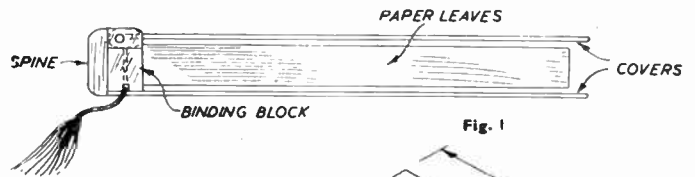

Fig. 1

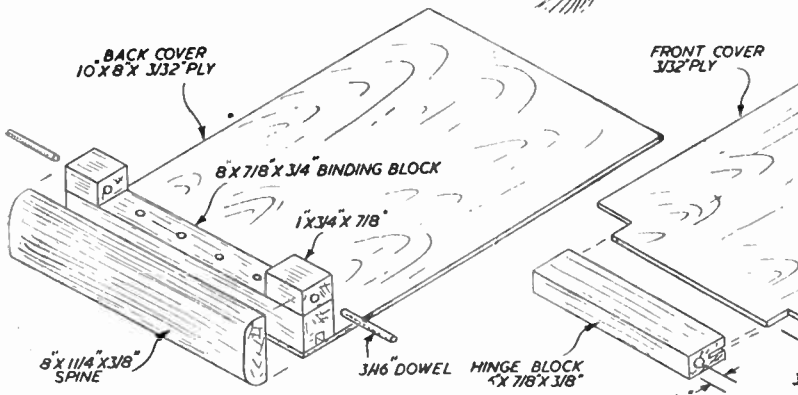

Fig. 2

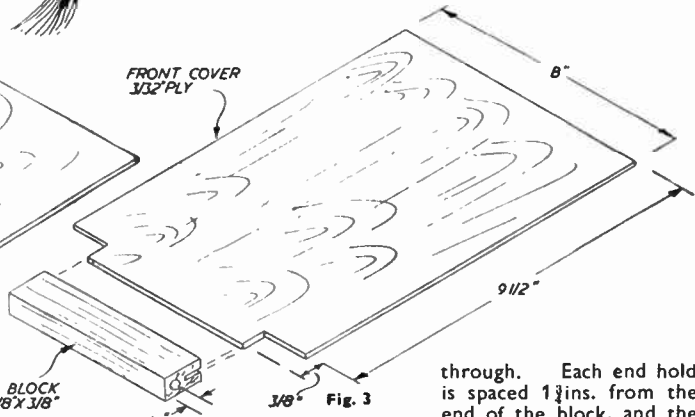

Fig. 3

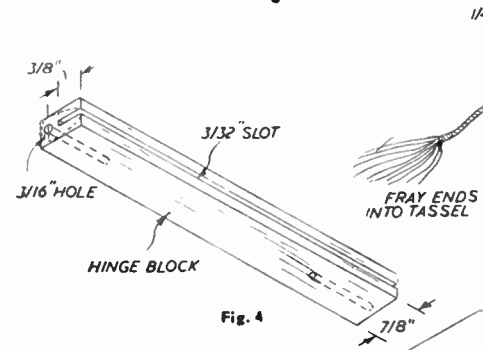

Fig. 4

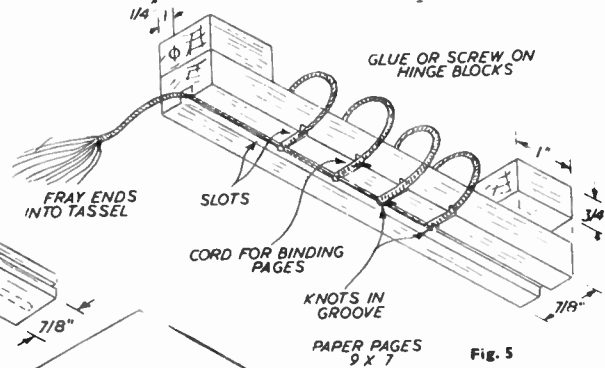

Fig. 5

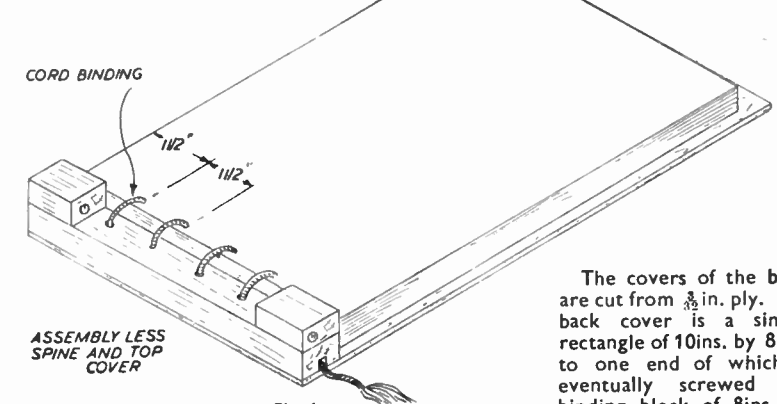

Fig. 6

through. Each end hold is spaced $1\frac{1}{2}$ ins. from the end of the block, and the hole adjacent to it a further $1\frac{1}{2}$ ins. distant.

The paper pages are cut to 9ins. by 7ins. size and punched through with four holes to correspond with the holes drilled in the binding block—Fig. 6. These pages are then bound to the binding block, using a single length of cord, making off each knot in the groove, as shown in Fig. 6. The spare end of the cord is then led out of the end of the binding block and frayed out into a decorative tassel.

The two small hinge blocks can then be mounted on the binding block, gluing in place and screwing through from the bottom (groove) of the binding block. The assembly is then glued and screwed to the ply back cover, as in Fig. 6.

The front cover is also cut from $\frac{3}{8}$ in. ply, 8ins. wide as before, but only $9\frac{1}{2}$ ins. long. The ends are cut to a tongue shape, as shown in Fig. 3, the length of the tongue being exactly 6ins. This fits into a corresponding slot cut in the 6ins. by $\frac{7}{8}$ in. by $\frac{3}{8}$ in. hinge block, which is rounded and tapered off in cross section—Fig. 4.

The front cover with hinge block attached rests on top of the binding

The covers of the book are cut from $\frac{3}{8}$ in. ply. The back cover is a simple rectangle of 10ins. by 8ins., to one end of which is eventually screwed the binding block of 8ins. by

(Continued foot of page 60)

An expert tells you why you should KEEP YOUR CAMERA CLEAN

TAKE a look at the snapshot on this page and you will see at once that there is something wrong with it. The whites seem to have an emanation around them like the 'electric man' in the film of that name. A sort of ghostly mistiness.

This print was handed to me some time ago by a worried amateur who wanted to know if I could possibly give him any idea of what had gone amiss. At first I suspected 'halation', that is a spread of the highlights caused by rays going through the film and, striking the back of the celluloid, being reflected forward again in a diffused state.

With the material being used, however, I came to the conclusion that this could hardly be the case. Asking for the camera, I looked for, and found, the root of the trouble—a dirty lens. It was not dirty in parts only, but smeared from edge to edge with that grease that glass always appears to collect when standing by. This, then, was causing 'light scatter' which, in its turn, was giving the misty highlights as shown.

The lens, therefore, was carefully cleaned with a soft cloth, moistened in methylated spirit—and the next film put through the camera was all that could be desired in the way of sparkle and sharpness.

Now, this simple experience shows the great need for the utmost cleanliness in the camera if the very best pictures are to be obtained. Here the lens was so dirty that even the most untutored could see that the instrument was not doing its job properly, but less obviously dirty glass can still spoil the brightness of the pictures to a greater or lesser degree. So periodically, therefore, go over both sides of your lens with a piece of very soft cloth or chamois leather softened still further in methylated spirit, to make sure that the surfaces (which do the work of ray refraction) are keen and bright.

This cleaning process must be carefully done, as optical glass is soft and soon scratches. There must be nothing like a scouring action and the material must not be applied to the glass until it is thoroughly softened in the spirit. If this is quite pure and contains no suggestion of water, it will dry off automatically without any vigorous wiping.



This picture shows the effect of 'light scatter' due to a dirty lens

Other Causes of Trouble

But other forms of camera dirtiness can cause trouble. I can well remember, as a beginner, being bothered with hundreds of little black dots on my prints. They were unsightly and caused much mystification. Approaching an expert I was told that it was dust inside the camera that was producing these. To my then layman mind it seemed that dust should make white dots if anything.

It was dust, however. Dust that had settled on the film and prevented a minute circle under each grain from getting any exposure, even when the lens was open. Thus, in the developer each of these came out as a tiny circle of clear gelatine, which, of course, printed in the positive as black dots.

So, as well as always watching that the lens is perfectly clean, see to it that the inside of the camera is quite clear from particles of dust. In the case of a robust and fair-sized box camera, the smallest nozzle on the vacuum cleaner will do the

clearing out in excellent style. With very small and bellowed cameras, it is best to go over the interior with a camel hair brush (as from an artist's paint-box) that has been dampened and then pressed well out. This, it will be found, collects and brings away grains of dust without in any way damping the material below. The end of the brush, of course, should be continually kept wiped with a clean bit of cloth.

'Telegraph lines' are long horizontal scratches on a film and are caused by grit inside the body which has worked its way into the winding gear and between the layers of the film as it is rolled up. These horizontal lines are caused by something rather harder than dust and are made worse by giving the roll that extra turn when taking it out just before sealing, to make sure that everything is tight.

Sand will cause these lines, as well as any grains of a more gritty type. So do please treat sand as 'dirt' as far as your camera is concerned. Sand is a very real enemy when at the seaside, and it can very easily get into an instrument if especial care is not taken. As well as causing 'telegraph lines', a grain between the leaves of a shutter can ruin it, or with the coarser, single-disc type, slow it down to an unusable degree, if not causing an actual jam.

Cameras should never be put down on the sand, and photography on the shore should be cut out entirely if sand is being driven by the wind. Even under the best of conditions when taking snaps on the beach, make a point of listening to the shutter action to make sure it is working properly. Also, get into the habit of shaking out the case before replacing the camera, to be certain that no grains have crept in.

It will be seen that the need for scrupulous cleanliness in the taking apparatus itself is a very real one. Cleanliness is needed right throughout the whole process of making a print, but, while it is constantly stressed in regard to dishes, your hands, benches, etc. you do not hear so often about it in connection with the camera. But its need here is as great as elsewhere, indeed, perhaps more, for it is in the camera that the foundation of the whole picture is laid. (235)

Plywood Photo Album—(Continued from page 59)

block and between the two smaller hinge blocks integral with the lower assembly. It is then pinned in place with two lengths of $\frac{3}{8}$ in. dowel to act as a hinge. The dowel should be a loose fit in the hinge block attached to the front cover and glued in the holes in the smaller hinge blocks. Check that the front cover hinge block is sufficiently rounded to allow the cover to be

opened fully.

Finally, the spine is added, cut and shaped from a piece 8 ins. by $1\frac{1}{2}$ ins. by $\frac{3}{8}$ in. This is simply glued in place. Countersunk woodscrews can be used to strengthen this joint but the holes must be filled and covered. Alternatively, the spine can be dowelled to the binding block assembly.

The 'book' can then be left with its

natural wood finish, varnished or stained and polished, according to individual taste. In any subsequent treatment, however, make sure that the pages themselves are first adequately protected. A final decorative touch is to fret out a motif or title from thin ply, preferably in a wood of contrasting colour and then glue this to the outer cover. (216)

MISCELLANEOUS ADVERTISEMENTS

The advertisements are inserted at the rate of 4d. per word prepaid. Name and address are counted, but initials or groups, such as E.P.S. or £1/11/6 are accepted as one word. Postal Order and Stamps must accompany the order and advertisements will be inserted in the earliest issue. Announcements of freework goods or those shown in Hobbies Handbook are not accepted. The charge for use of a Box No. is 1/- extra. Orders can be sent either to Hobbies Weekly, Advert. Dept., Dereham, Norfolk, or Temple House, Tallis St., London, E.C.4

MAKE money. Ply outfits, 3/-, 5/- and 10/- parcels.—Mayco (D), 117 Station Rd., Sutton Coldfield.

YOU can french polish. No skill required. By using everyman's french polish. Easy to apply, instant results. Try this amazing invention. Send 3/9 for trial size.—Palmer Manufacturing Chemists, 39 Seaton Place, London, N.W.1.

CRAFTSMEN wanted. Profitable homework. S.A.E.—D.2. Biltex, Chiswick.

INTRODUCTIONS. Pen friends, companionship or marriage.—V.C.C., 34 Honeywell Road, London, S.W.11.

RADIO experimenters. Build your own experimental crystal set. Excellent results. Performance at least equal to factory-made model. No batteries required. Complete set with instructions and highly sensitive headphones for only 15/6 post free, from—Enterprises, BCM/IGLN, London, W.C.1.

STAMPS. 25—1d.; 100—4d. S.A.E. approval Sbooks. Free Gifts.—Pavely, 12 Leeder Close, Coventry.

MEN and women beginners wanted for interesting spare-time work. Apply with S.A.E. for details to—Leatheweave Co. (Dist. 37), 2 Tudor Road, Leicester.

STAMPS FREE!! Twenty unused (2½d.).—S.G. H. Barnett, Limington, Somerset.

BRITISH Empire approvals, ¾d. upwards trial selection.—Dowe, 149 Nottley Road, Braintree, Essex.

FREE—stamps catalogued 5/- to applicants for ¾d. approvals.—Cox, 17 Stoneleigh Park Road Ewell.

PERSONS are wanted for spare time work, making up fancy goods at home. Experience unnecessary. Write for details—Dept. 918, Universal Products, 5 Cornhill, Lincoln.

PLYWOOD Offcuts. Birch and Gaboon in various thicknesses. Handy sized parcels for the cabinet, toy, model maker and all handicrafts. Parcels made up in £1 and 10/- lots. Carriage paid, send P.O. to—Reeves, Plywood and Timber Merchant, 33 Front Street, Monkseaton, Whitley Bay. Tel. W.B. 4677. Parcels are now despatched on the day of receiving order.

LUSHING, shyness, nerves, self-consciousness, fears, ended. Details under plain cover, 1d.—Stebbing Treatment, 28 (HB) Dean Road, London, N.W.2.

BE Taller in 14 days or money back. Details, 1d.—Stebbing System, 28 (HB) Dean Road, London, N.W.2.

EARN £5 to £20 Weekly dealing in stamps. Booklet, testimonials, 1d.—M. Stebbing, Terry, Naphill, High Wycombe.

LOOK! ALL at 3/-. Metal Die Cast Moulds for Toy making. Soldiers, planes, sailors, ships and farmyard stock, etc. All new lines. Pick where you like—3/- each mould. New illustrated catalogue, price 6d. post free.—Robin Hood Moulds (Dept. H), 140 Hollings Road, Bradford, Yorks.

P.C. Secures 3 a 1d. approvals.—Jeffreys, 2 Bay View, Craigavon, Port Talbot.

MODEL Makers and Handymen. Bumper set of Lists, books, plans and samples, 2/6.—Sutton Models, Billericay.

PERSONS willing to devote few hours per week to clean interesting work. Excellent pay.—Dept. 11, Chas & Co., Albert Street, Loughborough.

TABLE Tennis, complete, ply top, £9.—Box No. 55, Hobbies Weekly, Dereham, Norfolk.

EARN Money French Polishing. Complete course, other wood finishes, formula for manufacturing polishes and stains for only 5/- post free. BCM/MERCIA, London, W.C.1.

HAVE you got your Juneroo Riveting jig yet? From all Hobby shops or post free from—Juneroo Ltd., Stirling Corner, Boreham Wood, Herts.

SEND 3/6 for full-size patterns and instructions for making profitable novelty toy.—Dept. H., 6 Cedra House, Erlanger Road, London, S.E.14.

BUILD your own circular saw bench; shaft, bearings, plates and locknut, suitable for saws up to 10ins., 29/9, post free. Saws, pulleys, belts, motors, etc., available. S.A.E. for list. Stamps to your specification.—Sullivan, 19 Allen Road, Wednesbury.

40 DIFFERENT stamps free, including Silver Wedding, U.P.U., Victory, Silver Jubilee, Coronation, Pakistan, etc. Send 3d. postage and request approvals.—J. F. Smith, 39 Manor Park, London, S.E.13.

AMERICAN Magazines post free for one year. Popular Mechanics, 32/-; Popular Science, 28/6; Mechanix Illustrated, 22/6; Popular Homecraft, 18/- Stamp for full list of others.—Willen Ltd. (Dept. 57), 101 Fleet Street, London, E.C.4.

PLYWOOD Birch, Grade III, 30" x 6½" x ½", 24 for 15/-. Sanded Lagos Mahogany, 13" x 8" x ½", 18 for 12/-. 36 for 20/-. Solid Brownish Mahogany, 1½" x 1½", P.A.R., 24" long, 8 for 15/6; 36" long, 5 for 15/6. Immediate delivery C.O.D. List, 1d. S.A.E. Dept. H.J.D.D. Storage, East Dulwich, S.E.22.

MODELS. You can make lasting stone-hard models with Sankey's Pyruma Plastic Cement. Supplied in tins by Ironmongers, Hardwaremen and Builders' Merchants. Ask for instruction leaflet.

DUPLEX Self-adhesive Transfers for decorating fancy goods, trays, plastics, etc. List and samples, 3d.—H. Axon Harrison, Iersej.

£5 to £20 weekly earned at home, running your own Mail Order business. Details, 1d.—Stebbing Publications Ltd. (HB), Naphill, High Wycombe.

STAMPS Free. Empire Packet including Pictorials and Victorians free to approval applicants.—Robert J. Peck, 7A Kemp Road, Bournemouth, Hants.

MAKE your own Jig-saw Puzzles. Fine Art Pictures, various reproductions and sizes. Also suitable for framing. Stamp for full list.—Joyden Toy Co., 193 Chase Side, London, N.14.

HARDWOOD Ball Beads. ¾in. diameter, suitable for children's Counting Frames, etc. 5/3 per hundred, plus 1/9 P.T.—Joyden Toy Co., 193 Chase Side, London, N.14.

MADE big money so can you. Enclose envelope.—H. Wamsteker, Box 34, Wynberg, Cape, Africa.

PLYWOOD Offcut parcels. Nothing under 12" x 12" x ½in. 15 sq. ft. parcels, 7/6, post paid. Immediate despatch.—Breezcraft Ltd., 113 High Street, Staines, 3461/12.

PRESSED Metal Wheels. 1½ins., 1/3. 2ins., 1/9 per dozen. Or in stove enamel finish, red, green, or blue at 6d. per dozen extra. Tax included. Post paid.—The Joyden Toy Co., 193 Chase Side, London, N.14.

HARDWOOD Wheels. 2ins., 1/-; 3ins., 2/- per set of four. Tax included. Post paid. Other sizes available.—The Joyden Toy Co., 193 Chase Side, London, N.14.

DOLL'S House fittings and papers; send S.A.E. for list. Doll's house plan special; send 2/6. Trade supplied.—Zimplan, 88 Ware Road, Hoddesdon.

LORRY Kits, 4 mm. and 1 mm. scale. Also large range of spare parts from which to build to your own design. Send for fully illustrated catalogue price 1/-.—Wilson's Lorries Ltd., 6 Gt. Winchester Street, London, E.C.2.

USE spare time on profitable homework making fancy goods. Write for free booklet.—(Area 544), 54 Southgate Street, Leicester.

HOME Watch and Clock Repair Outfit. Includes watchmaker's magnifying eyeglass, tweezers, screwdrivers, oilers, oil, brush, dusting powder, plus illustrated explanatory book. Watch and clock repairing simplified. In container, 12/9 inclusive.—D. Bolster (Dept. H.), 5a Station Parade, Ashford, Middx.

LONELY? Then write Secretary, U.C.C.—15B.B. Hay St., Braughing, Herts. Genuine. Est. 1905.

IN Spite of the shortage there is still plenty of Juneroo material available at all Hobby shops.

HOMEWORKERS required, either sex, light assembly, part or full time, s.a.e.—Esprey, Box 18, 41 Wade Street, Lichfield.

LUMINOUS Paint, 2/- per tin.—Box No. 44, Hobbies Weekly, Dereham, Norfolk.

100,000 Government Surplus Bargains. Heavy duty transformers, 230v./12v., 10 amps, 25/-, post 1/6. Immersion heaters, 230v. A.C./D.C. 850 watt., flange fitting, easy to fix, 15/-, post 1/-. Spirit levels, 2/11, post 6d. Perspex cleaning/polishing kits, containing Nos. 1, 2 and 3 cleaners, 3/9, post 1/-. Huge stocks of switches, resistances, condensers, boxes (wood or metal), motors, generators and other useful items for all handymen at fraction of cost. Send 3d. stamp for new illustrated list just published. Money back guarantee.—Milligan's, 24 Harford Street, Liverpool, 3.



YOU can build this GARAGE

WITH BRICKPLAYER

BRICK & MORTAR BUILDING KIT

It enables you to build Houses, Inns, Railway Stations, Sign Boxes, or from your own imagination. All railway models will fit 'O' gauge scale. Buildings can be permanent, or dismantled by merely soaking in water and the bricks used again and again.

BRICKPLAYER KITS AT 28/6 AND 52/6 ARE AVAILABLE FROM GOOD TOYSHOPS, HOBBY SHOPS, AND DEPARTMENTAL STORES.

ACCESSORY PACKS

No.	Contents	Price
100	100 Full size Bricks	3/-
101	52 ½-Bricks and 72 ¾-Bricks	3/-
102	Gable and Peak Bricks	3/-
111	Capping and Roof Tiling	2/6
112	Concrete Roofing	2/6
114	Bag of Brickplayer Cement	1/3
115	Roofing Cement	9d.
8107	2 Bay Windows with 31 Splay Bricks	3/9

METAL WINDOW AND DOOR FRAMES

F1 F2 F3 F4 F6 F8 F10
8½d. 6½d. 7½d. 5d. 4d. 6d. 7½d.
8108 Sheets of Glazing, 1½" x 6" (Plastic) 1½d.
If your dealer cannot supply, write for address of nearest stockist to:

J. W. SPEAR & SONS LTD.
(Dept. H) ENFIELD MIDDLESEX

YOU CAN BECOME A HANDICRAFTS INSTRUCTOR

EXPERIENCE NOT ESSENTIAL

Men who enjoy making things in wood or metal can turn their hobby into a permanent and interesting Career. Short hours, long holidays, and security in a job you would really enjoy, can be yours if you become a Handicrafts instructor. Let us send details of the easiest and quickest way to get the necessary qualification.

**We definitely guarantee
"NO PASS—NO FEE"**

If you would like to know about our unique method of preparing you for one of these appointments, write today, and we will send you our informative 176 page Handbook—free and without obligation. Mark your letters "Handicrafts Instructor".

**BRITISH INSTITUTE OF
ENGINEERING TECHNOLOGY**

395 Shakespeare House
Stratford Place, London, W.1

BIET

Is This Saw in Your Kit?

You can cut almost anything in wood with this Coping Saw. The blade is 6½ ins. long and can be turned to cut at any angle. No tool-kit is complete without one. Get yours NOW.

Buy from any Hobbies Branch, or direct from Hobbies Ltd., Dereham

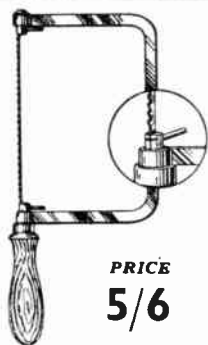

PRICE
5/6

WEBLEY AIR PISTOLS

Marvellously accurate for target practice. No licence required to purchase for use on enclosed premises.

Senior Mark I
Junior Webley Air Rifle
Write for List. **WEBLEY & SCOTT LTD.**
166 WEAMAN STREET, BIRMINGHAM, ENG.



EVERY CAR THAT PASSES YOU WILL FIND THE INDEX MARK ALPHABETICALLY ARRANGED IN WHERE'S THAT CAR FROM ?

Price 6d.

from all Booksellers or from the Publishers (1d. postage)

RALEIGH PRESS, EXMOUTH

ORIGINAL AND BEAUTIFUL DESIGNS

for Wall Plaques made at home. P.O. 6/6 inc. PT will bring you outfit comprising board, paint, design in natural colours and full instructions, post free.

Send to **R. S. NAPIER & CO.**

Central Chambers, Market Place, Pontefract, Yorks.

GRIPS the SCREW AND DRIVES IT HOME INTO THAT AWKWARD SPOT!

SO QUICK, SO EASY! A LITTLE MIRACLE!

This new precision driver GRIPS the smallest grub screw or large wooden screw firmly, instantly—and drives it quickly home into any awkward spot. Saves time & labour.

ORDER TODAY ONLY 3/6 POST-PAID

MAILEX SUPPLY COMPANY (H)
70 POYNTERS ROAD, DUNSTABLE, BEDS.



MANCHESTER
10 Piccadilly
(Phone CENtral 1787)

BIRMINGHAM
14 Bull Ring

SHEFFIELD
4 St. Paul's Parade

LEEDS
10 Queen Victoria Street
(Phone 28039)

HULL
10 Paragon Square

SOUTHAMPTON
25 Bernard Street

BRISTOL
30 Narrow Wine Street
(Phone 23744)

Head Office & Factories—**HOBBIES LTD. DEREHAM, NORFOLK**

DANCE IN 30 MINUTES OR MONEY BACK



Amazing new method enables you to master all the popular modern ballroom dances with the Morley Rapid Course in Ballroom Dancing or money back. No experience, no music, no teacher or partner necessary—the Morley Rapid Course tells you everything. In a few days you are dancing with confidence. G.B. (Buxton) writes: 'I can dance as well, if not better than anyone in the dance hall I visit twice a week.' Keep fit—have fun—get self-confidence—be popular. Complete Course only 10/- (or \$1.50) Booklet 1d.

Tap Dancing Course. 12 lessons, 64 photos. 2/9

114 Ways To Be Your Own Boss, with little or no capital. 5/6

JOHN D. MORLEY (Dancing) (HB/9), Terry House, Naphill, High Wycombe. (Established 1936)

For wood,
card,
plastic,
leather,
metal etc.

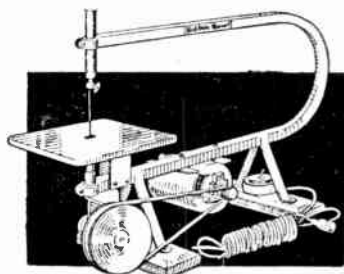

TREADLE OR MOTOR FRETSAWS

Whatever the handyman or craftsman is cutting or making, one of Hobbies Fretmachines will help with the job. For toy making, fretwork, model making, it provides easy and speedy cutting in all kinds of material. A pleasure to use, a factory for output, a lifetime of service.

FROM

80/- to £11 - 2 - 6

Ask to try one at any Hobbies Branch or good class ironmonger or hardware stores. Or free illustrated leaflets on request to:



HOBBIES LIMITED,

DEREHAM, NORFOLK.

See page 52

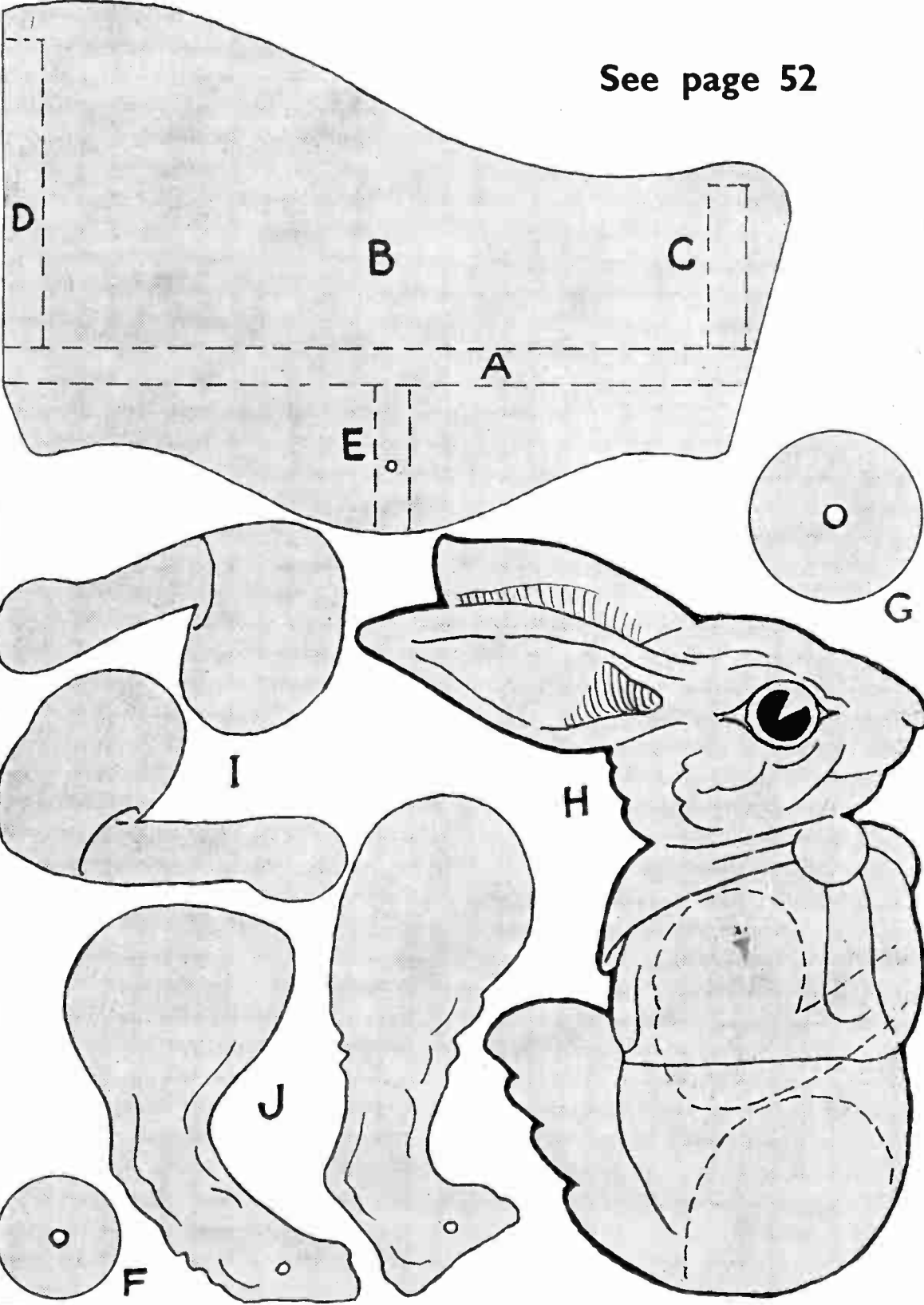

STUDY
AT
HOME

IN YOUR
SPARE
TIME

THE BENNETT COLLEGE

*will set you on the right
course for success*

You make sure of planned progress in the career of your choice when you let the most progressive, most successful Correspondence College In the world coach you through the post. By friendly, individual training we equip you with the specialized knowledge you must have for a well-paid key position. Make the first move TODAY—post the coupon below!

**ALL TEXT BOOKS ARE
FREE!**

to Students of The Bennett College Ltd., we send as many volumes as the subject demands and they become your personal property.



IS YOUR CAREER HERE ? IF NOT, WRITE FOR FREE ADVICE

- | | | |
|----------------------|----------------------|----------------------|
| Accountancy Exams. | Engineering. | Radio Service En- |
| Agriculture | All branches. Sub- | gineering |
| Applied Mechanics | jects and Exams. | Radio (Short Wave) |
| Auctioneers and | General Certificate | Road Making and |
| Estate Agents | of Education | Maintenance |
| Aviation (Engineer- | Examinations | Salesmanship |
| ing and Wireless) | General Education | Sanitation |
| Blue Prints | G.P.O. Eng. Dept. | School Attendance |
| Boilers | Heating and Venti- | Officer |
| Book-keeping. Ac- | lating | Secretarial Exams. |
| countancy, and | Institute of Muni- | Sheet Metal Work |
| Modern Business | cipal Engineers | Shipbuilding |
| Methods | Journalism | Shorthand(Pitman's) |
| Builders' Quantities | Languages | Short Story Writing |
| Building, Architec- | Mathematics | Speaking in Public |
| ture, and Clerk of | Metallurgy | Structural Engineer- |
| Works (A.R.I.B.A. | Mining. All Subjects | ing |
| Exams.) | Mining. Electrical | Surveying (R.I.C.S. |
| Carpentry and | Engineering | Exams.) |
| Joinery | Motor Engineering | Teachers of Handi- |
| Chemistry | Naval Architecture | crafts |
| Civil Engineering | Plastics | Telecommuni- |
| Civil Service | Play Writing | cations (City and |
| All Commercial | Plumbing | Guilds) |
| Subjects | Police, Special | Television |
| Commercial Art | Course | Transport Inst. |
| Common Prelim. | Preceptors, | Examinations |
| E.J.E.B. | College of | Viewers, Gaugers |
| Concrete and Struc- | Press Tool Work | Inspectors |
| tural Engineering | Pumps and Pumping | Weights and Mea- |
| Diessl Engines | Machinery | sures Inspectors |
| Draughtsmanship. | Quantity Surveying | Wireless Telegraphy |
| Electrical or | —Inst. of Quantity | and Telephony |
| Mechanical | Surveyors Exams. | Works Managers |

COUPON. CUT THIS OUT

IF YOU ATTEND TO THIS NOW
IT MAY MAKE A WONDERFUL
DIFFERENCE TO YOUR FUTURE.



To DEPT. 62
THE BENNETT COLLEGE LTD.
SHEFFIELD

Please send me (free of charge)

Particulars of..... (Cross out line
which does not
apply.)

Your private advice

about

PLEASE WRITE IN BLOCK LETTERS

Name

Address

MASK...MAKE...



MEND...WITH



Sellotape



Whatever your hobby, Sellotape is your greatest ally. For masking paintwork, holding parts while gluing, protecting plans—and a thousand other useful jobs—it's Sellotape every time. It sticks at a touch without moistening. It fits evenly on a curving surface. There's coloured Sellotape for easy indexing, for recognition tags, and decorating. You just can't do without it. Get some today—and remember, if it doesn't SAY Sellotape—it isn't!

Stocked by all
Stationers



G & G

Hobbies

WEEKLY

CONTENTS

	Page
Transportable Book Case	65
Pocket Radio Set	67
Cigarette Ash Holder	68
Outdoor Food Safe	69
Easier Gardening	71
Pinhole Camera	72
Garden Deck Chair	73
A Screen and Occasional Table	74
Matters of Interest	75
Making Lantern Slides	76

DESIGN SHEET FOR
GRUMB TRAY AND
SCRAPER

May 16th, 1951

Price Fourpence

Vol. 112 No. 2898

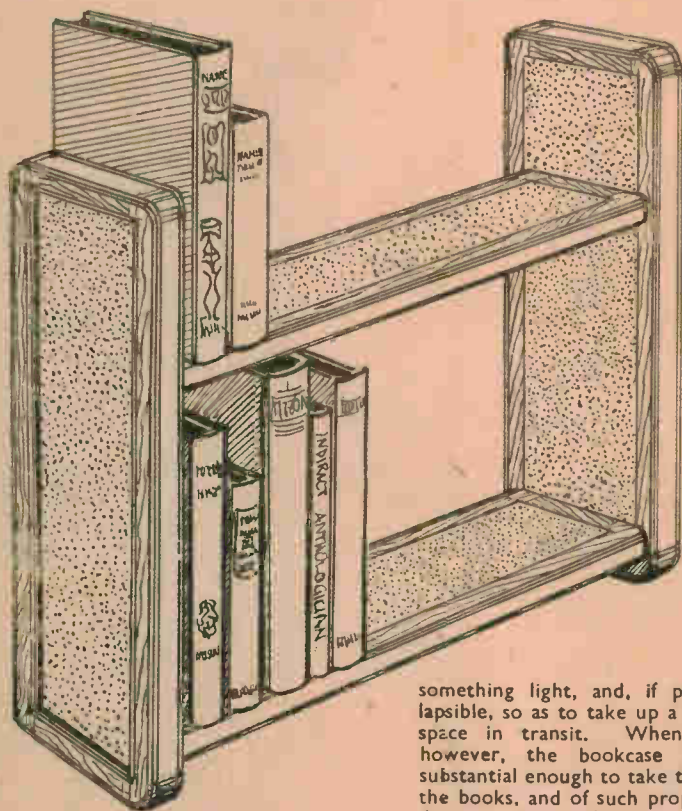

Complete details for making a **TRANSPORTABLE BOOK CASE**

ends 18½ ins. high and 6 ins. wide hold two shelves between them, each 23 ins. long by 5½ ins. wide. The units are frameworks rebated on the inner edges to carry panels of ¼ in. thick hardboard; the shelves are panelled on top only, while end units are covered both sides.

Commence construction with the shelves. The timber should be oak for preference, but ash or even elm (without knots) might serve. Cut (for each shelf) two pieces 24 ins. long (½ in. extra each end), 1 in. thick by 1½ ins. wide for the main members, and three cross pieces 5½ ins. long. Mark off the cross pieces for the tenon joints while clamped together in a vice. Cut the tenons half the thickness of the wood, and note that the end cross pieces have haunched tenons (B in Fig. 1). Plane the middle cross piece down by ¼ in. in thickness to allow for the hardboard panel.

Now cramp the long members together in a vice, and mark the positions of the mortices. Gauge the thickness from the upper edge (½ in. mortice for ½ in. tenon) and chop out the mortices to a depth of ⅝ in. with a ¼ in. firmer chisel. Keep everything nice and square to avoid twists in the finished frames.

Try the frameworks together, paring the tenons down carefully if they are too thick, or clearing out mortices as required, until a smooth fit is obtained. Take care, with the end haunched tenons, not to burst out the end grain when levering out waste from the

something light, and, if possible, collapsible, so as to take up a minimum of space in transit. When assembled, however, the bookcase had to be substantial enough to take the weight of the books, and of such proportions and design as not to offend the critical eye of passing art students! The design was evolved after some experiment with models, and suited all these conditions admirably, with the added advantage of being economical in timber. As reclaimed oak was used in combination with a few pieces of ¼ in. hardboard, it turned out at a total cost of under ten shillings.

Four Sections

The bookcase consists of four flat units which are held together with ¼ in. coachbolts arranged out of sight. Two

THE bookcase described here was made for a student teacher who had just commenced her college course and discovered that there was nowhere in the study to accommodate the mass of books in current use.

A bookcase to hold some thirty or forty books, while not large as bookcases go, can be a fairly cumbersome piece of furniture when it comes to making a move; at holiday time, or to another study.

It would be an advantage to make

All correspondence should be addressed to The Editor, Hobbies Weekly, Dereham, Norfolk.

mortices. The $\frac{1}{2}$ in. extra length should, therefore, not be cut off until the frames are glued and set together. When the frame joints fit together well, take the frames apart and run a $\frac{1}{4}$ in. by $\frac{1}{4}$ in. rebate on the inner edges, noting that on the long members the rebate is stopped at the ends (see (A) Fig. 2). A $\frac{3}{8}$ in. chisel may be used to clean out these stopped ends where the rebating plane cannot reach.

Round off the outer edges of the shelf members, excluding the ends, as these have to fit square against the end units (see section through shelf rail, Fig. 2).

End Units

The end units are made in much the same manner, except that they are double panelled; the outer panel being set in a $\frac{1}{8}$ in. by $\frac{1}{4}$ in. rebate, so that there is $\frac{1}{8}$ in. of wood protruding above the panel. This is rounded off to give a

Round off the outer edges, and take off the corners. Then, run the rebates, $\frac{1}{8}$ in. by $\frac{1}{4}$ in. inside, and $\frac{1}{8}$ in. by $\frac{1}{8}$ in. outside, using the chisel for the stopped ends as required.

After cleaning up with glasspaper, the four frameworks should be glued, cramping up with sash cramps as required. See that the units are quite flat, otherwise the bookcase will not stand correctly.

Panelling

Any polishing of the framework is best completed before the panels are fixed (see Finish below).

For the panelling, obtain the necessary $\frac{1}{4}$ in. hardboard, as high a quality as possible. Masonite $\frac{1}{4}$ in. hardboard is ideal, but there are a variety of makes to choose from, and possibly your local builder or ironmonger will have something which, while not quite up to the hardness you would like (appearing like

below the surface about every 4 ins. or so. Glue and nail the inside panels on the end units, but, before fixing the outside panels, bore the $\frac{1}{4}$ in. holes through and drive home the bolts, covering the heads with plastic wood to fill the gaps.

The bolt holes in the shelf ends are made $\frac{1}{8}$ in. diameter for extra clearance and ease of assembly. These holes must be accurately registered and drilled square so that the bookcase will stand level when assembled. If it is desired to make the bookcase a permanent structure, substitute three 2 in. screws for each pair of bolts.

The bookcase is assembled and dismantled by means of the bolts. Provide a small spanner, but never screw the nuts up too tight and pull the bolt heads further into the wood cross members. They should be screwed just firm enough to prevent any wobble. In transit, the bolts should be protected by placing thick wood washers over them, and screwing the nuts lightly in place.

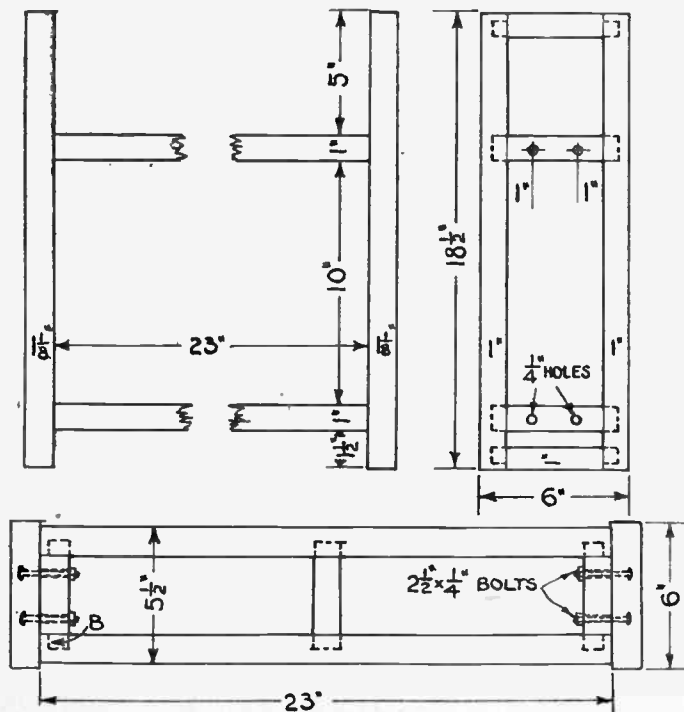

Fig. 1—Front, end and plan of frameworks (rebates not shown)

pleasing effect. The main members are 1 in. by $1\frac{1}{2}$ ins.; this time the $1\frac{1}{2}$ ins. measurement is the thickness as can be seen from the front elevation, Fig. 1.

There are four cross pieces in each end unit to be tenoned. The two end ones are haunched as before. The other two are positioned on the levels of the shelves—i.e. the lower shelf is $1\frac{1}{2}$ ins. from the bottom, and there is 10 ins. between the shelves. $\frac{1}{4}$ in. holes are bored 1 in. from the tenon shoulders of the inner cross pieces to take the $2\frac{1}{2}$ ins. by $\frac{1}{4}$ in. diameter coach bolts which hold the units together. The bolt heads must be let into the wood so that the outer panel will fit snug over them (see sect on through bolt fastening, Fig. 3).

pressed cardboard), may well serve the purpose as the panels are small and well supported.

Mark out and cut the panels to a dead fit. Better to cut them $\frac{1}{16}$ in. larger all round and plane carefully down to size than to have to fill any ugly gaps with plastic wood afterwards.

Now glue in the shelf panels, driving and punching some $\frac{1}{4}$ in. panel pins

CRUMB TRAY & SCRAPER

Material for this week's Design (No. 2898) is supplied for 5/1 including tax; post free.

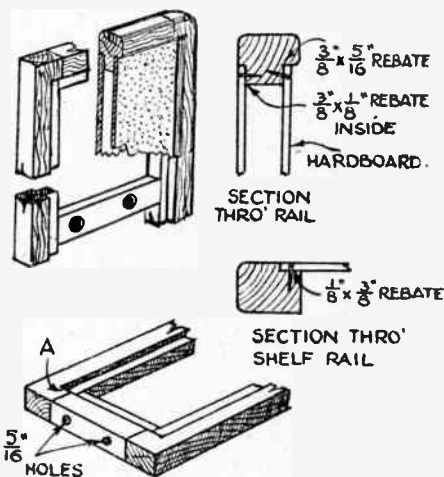

Fig. 2—Constructional details



Fig. 3—Method of fastening

Finish

A most pleasing finish may be obtained as follows: fill the wood grain with suitable paste filler; if oak, use light oak filler, or 'golden oak', and french polish, before fixing the panels. Alternatively, wax polish.

Give the panels two light-coloured priming coats of paint before fixing, with a light glasspapering between. Fix; drive panel pins, and fill the punch holes with plastic wood. Give a coat or two of flat cream undercoating. Finish the panels, taking care to keep off the polished wood, with a coat of high gloss enamel cream. It is suggested, as an alternative, that a maroon or brighter red would be a stimulating colour to blend well with the polished oak. (246)

Don't be 'out of touch' — build a POCKET RADIO SET

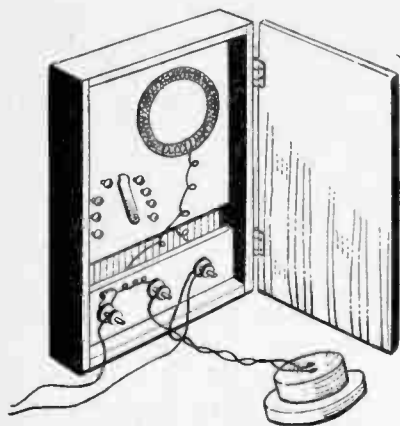

THIS receiver is a crystal set and does not require any batteries or valves. It is only necessary that an aerial and earth be connected, and a pair of headphones. (Or a single earpiece on a length of twin flex, if preferred). Once made up, it can be used indefinitely, as the crystal will last for years.

Even if all the parts have to be bought, the cost need not exceed a few shillings and good volume is obtainable up to a range of 100 miles or more from one of the usual stations.

The Containing Case

This is made in the form of a shallow

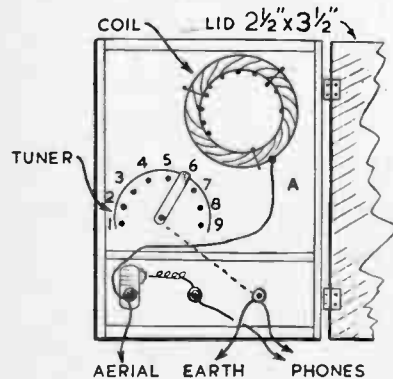

wooden box with lid. For top and bottom $\frac{1}{2}$ in. thick wood is most convenient. Both these pieces are $2\frac{1}{2}$ ins. by $\frac{3}{4}$ in. For the sides, $\frac{1}{8}$ in. plywood can be used, cutting two pieces $\frac{3}{4}$ in. by $3\frac{1}{2}$ ins. The back will then be $2\frac{1}{2}$ ins. by $3\frac{1}{2}$ ins. as will the lid. The latter may be fixed on two small hinges. In addition, a strip about $\frac{3}{4}$ in. wide and $2\frac{1}{2}$ ins. long will be required to hold the three terminals, and a piece $2\frac{1}{2}$ ins. by $2\frac{1}{2}$ ins. for the coil and tuner.

Reference to the diagrams will help in building the case, and none of the dimensions are in any way critical. If a

small box is to hand, it can be used.

Winding the Coil

The coil has a number of tappings to permit tuning to be carried out. To wind it, any wire between about 26 S.W.G. and 36 S.W.G. can be used, and the wire may be enamel, silk, or cotton covered. If wire is being bought, some 32 S.W.G. is, perhaps, most convenient and only a few pennyporth will be necessary.

Take some small, smooth object about 1 in. to $1\frac{1}{4}$ ins. in diameter and begin to wind the wire on this. Hold the beginning (A) in Fig. 2) with one finger and wind on thirty turns in a pile. Now make a loop about 2 ins. long by twisting the wire, and wind on ten turns. After that make a second loop, wind on ten more turns, and make a third loop. Continue in this way until there are eight loops. Then wind on a final ten turns and cut off the wire, leaving end 'B'.

Carefully slip the coil off the former, holding it securely, and bind it round and round with cotton. When the cotton is tied a kind of wire ring with many turns will be left, and there will be no danger of this coming undone. All turns must be in the same direction, and there should be about ten turns between each of the tappings which have been made.

Carefully scrape each tapping and ends (A) and (B) to remove the insulation. Do not fracture the wire. Fig. 2 shows the finished coil.

The Tuner

This is shown in Figs. 1 and 3. It consists of a metal strip, cut from tin or brass, which can be turned to make contact with any one of nine small, round-headed bolts. (Or brass, push-through paper fasteners can be used here, instead of bolts).

Arrange the nine contacts in a semi-

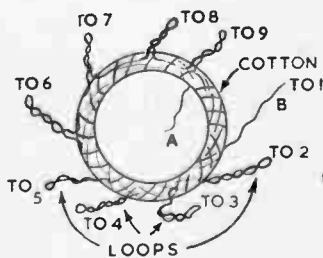

Fig. 2—The coil

circle and pivot the strip at the centre, as shown in Fig. 3.

The coil should now be fixed in place, holding it in position by cotton loops passed through small holes made in the piece of wood. Then make nine small holes and take end (B) down through one, and each loop through another.

Take each loop across to one of the nine contacts and twist it round tightly. End (B) also goes to the last contact.

End (A) is attached to the Aerial terminal, and the moving arm to the Earth terminal. It will thus be seen that by turning the arm round the studs, any number of coil turns from thirty up to 110 can be selected, and this enables different stations to be tuned in.

Other Details

As shown in Fig. 3 (B), a small clip can be cut from metal to hold the crystal down. A spiral of thin copper wire is used for the whisker, and three terminals or bolts are required for phone, aerial and earth connections.

Check connections, which should be as follows: Aerial terminal to (A) on coil. Centre terminal to catswhisker and phone. Second phone lead to terminal which also forms Earth connection. This terminal also goes to tuner strip. End (B), and each coil loop, to a separate

WRITING ON WOOD

Sometimes in model work it is necessary to write on wood in ink. To prevent the ink running, rub some powdered resin well into the wood.

contact screw on the tuner semicircle.

If cut as described, the two pieces of wood should fit in the case and they may be glued in position.

Using the Receiver

The earth lead should go to a metal object buried in the ground. Loudest volume will be obtained from a high outside aerial, but an indoor aerial will give sufficient volume in some parts of the country. Ordinary high-resistance headphones, such as made for crystal and other sets, should be used.

Adjust the whisker so that its point is resting on a sensitive spot on the crystal. Signals should then be heard and by turning the tuning strip the desired station can be brought up to maximum volume. Some spots on the crystal will not give such loud results as

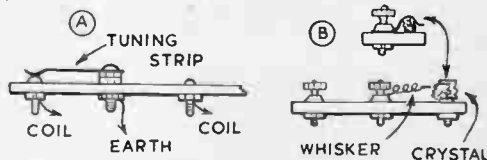
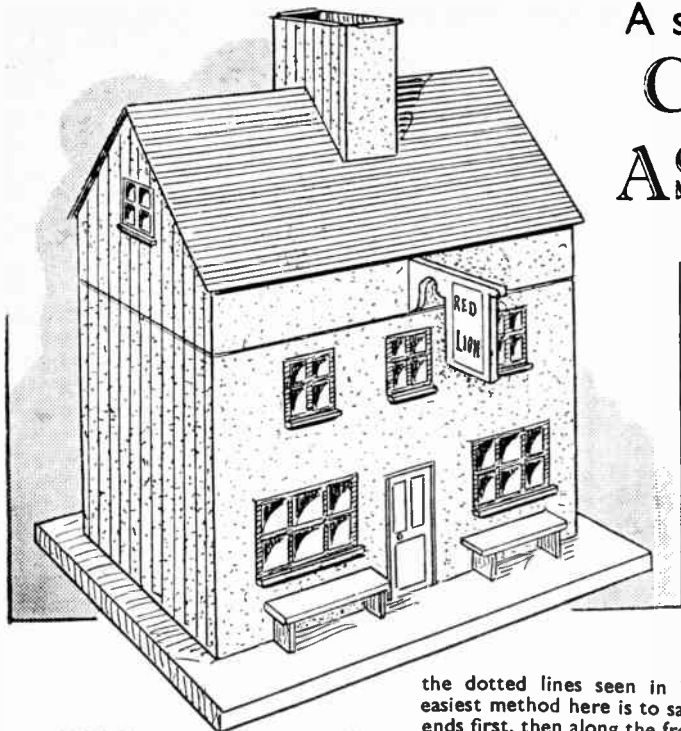

Fig. 3—Details of the tuner and the holders for the whisker and crystal

others, so the catswhisker may be moved about until satisfactory volume is obtained.

Out of doors, a large nail pushed in damp soil will form an earth. The top strand of a wire fence, or a length of wire hung up as convenient, may be used for the aerial. (229)

A simple-to-make novelty CIGARETTE ASH HOLDER



THIS little novelty is just the thing to hold cigarette ends, and used matchsticks, both being dropped down the chimney of the model house. The house itself is based on a common type of country inn, and is quite an attractive little article itself. Any scrap

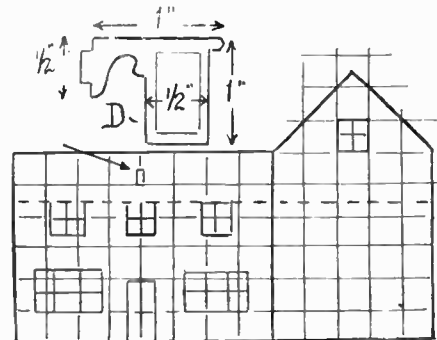

Fig. 1—The front and a side drawn over $\frac{1}{16}$ in. squares

pieces of fretwood might usefully be employed in the making, and provide a pleasant job of work.

The front, and a side of the house are shown in Fig. 1, drawn over $\frac{1}{16}$ in. squares, as a guide to marking out the windows, and the door. Both sides are alike, but the back, which as far as dimensions are concerned, is obviously a replica of the front, has only a door, and need not show any windows at all. It is important to note that the slope of the roof is an accurate 45 degrees, and this must be ensured for the chimney stack to fit neatly on. Cut the four parts and glue and nail them together.

When the glue is hard, with a tenon saw cut the house into two parts along

the dotted lines seen in Fig. 1. The easiest method here is to saw across the ends first, then along the front and back. The upper part will form the lid, enabling the cigarette ends, etc. being emptied away. Rub the sawn edges of both on glasspaper to smooth them. Where marked with an arrow, cut out a $\frac{1}{16}$ in. long mortise slot to receive the bracket of the hanging sign later. Cut four strips of the fretwood, $\frac{1}{16}$ in. wide, and glue and nail these strips to the inside of the lid as a rim, letting them

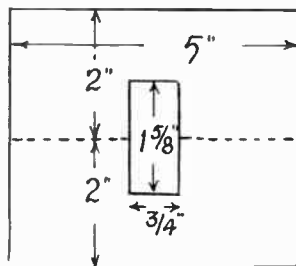

Fig. 2—Dimensions for the roof

protrude downwards just $\frac{1}{16}$ in., as in detail (A) in Fig. 3. The lid should then fit on closely.

The roof, Fig. 2, is made up from tinplate, and any empty food tin will provide this material. In the centre cut out the opening shown for the chimney stack. A cold chisel, laying the tin on a block of wood, will do this easily enough. Bend the tin along the dotted lines until it fits the slope of the roof, then punch a few holes near the edges and fix to the house with nails or round-headed brass screws. The edges all round will look much neater if bent over and hammered down, about an $\frac{1}{16}$ in. no more, a job to be done, of course,

while the tin is still in the flat.

The chimney stack (B) Fig. 3, is best drawn on thin paper and gummed to a suitable piece of the tinplate. The flanges, at sides, top and bottom, are a full $\frac{1}{16}$ in. and added afterwards. Bend these flanges out at right angles, and then bend the stack along the dotted lines. Place the tin in warm water to soften the gum and enable the pattern to be stripped off the tinplate. Dry the latter, and solder the corner joint, making the stack to the shape depicted at (C). Place it over the hole, cut in the roof, and there solder it in position.

The hanging sign (D) in Fig. 1 is cut to the dimensions given, the tenon being made to fit the mortise in the front of the lift-off roof of the model. Glue it in place. The model can now be glued to a base.

The Base

Any suitable piece of wood, fretwood or deal can be cut to serve as a base for the model. Its dimensions should be large enough to extend beyond the model house $\frac{1}{16}$ in. at sides and back, and 1 in. at front. If wood, thicker than $\frac{1}{16}$ in.

(Continued foot of page 70)

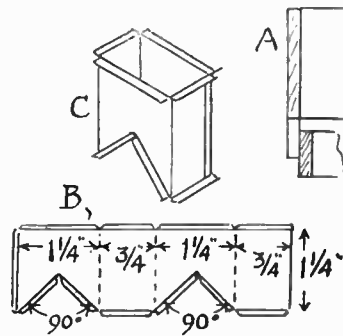

Fig. 3—The chimney stack

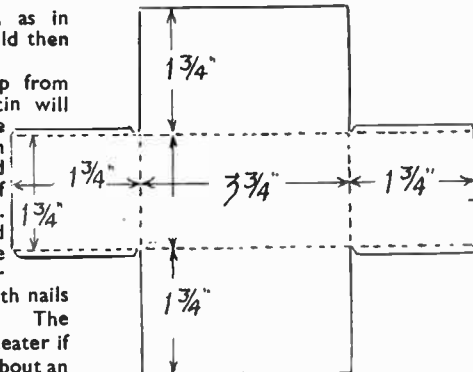

Fig. 4—The fireproof interior

A useful article these days is an OUTDOOR FOOD SAFE

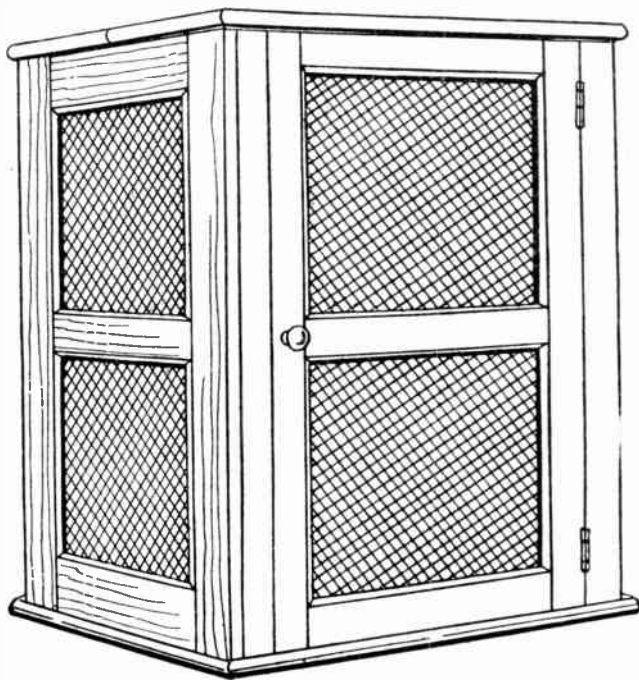

Fig. 1—The completed safe

WE have had a request from a reader who wishes to make an outdoor food cupboard to hang on a wall, and here are some practical details.

He has already got a pair of wide, flat iron brackets which can be used for the fixing of the cupboard, and in addition to these, he will, no doubt, require a pair of stout wall hooks also. These are knocked

(Fig. 2) shows the general construction and gives the clear measurements inside, which should be useful when it comes to fitting the shelf. The floor and the top, identical in size, are made up and may be put in hand first.

Each is made of two pieces of match-boarding, tongued and grooved together and glued with waterproof glue. The edges are planed off; that is, the tongue will be taken off one piece and

into the mortar joints of the wall, and the cupboard then screwed to the projecting ends which are holed to receive the screws.

A really useful type of cupboard is shown in Fig. 1, and it has purposely been made simple in construction to suit the young craftsman and the home worker. The overall size is, height 24½ ins., width 17 ins., and depth 11 ins.; ¾ in. matchboard is used for all parts.

The plan

the groove planed away in the other, as shown in the enlarged detail in Fig. 2. The full width, when planed up with edges rounded off and glasspapered, should be 11 ins. or rather more, so as to give a fair margin when the side frames and the door are in place.

If it is necessary to strengthen the pieces, two cross battens 1½ ins. wide and ¾ in. thick can be nailed so that they come just within the side frames under the top piece, and in a similar position, only underneath, for the floor piece. This may not, however, be necessary, as the pieces should be held well together by the side frames.

The method of making the side frames is shown in Fig. 3. Two long rails 23 ins. by 1½ ins., a top and bottom rail each 10 ins. long by 2½ ins. wide and a middle rail also 10 ins. long but 1½ ins. in width are required.

The Halving Joints

Each piece is prepared at the ends for the halving joints, which are considered the most suitable and simple to

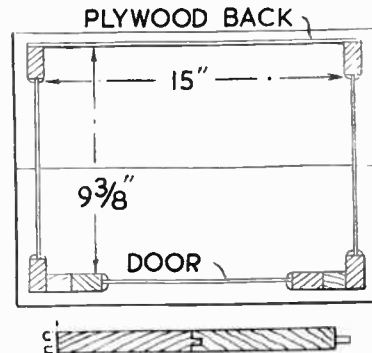

Fig. 2—Plan showing general construction

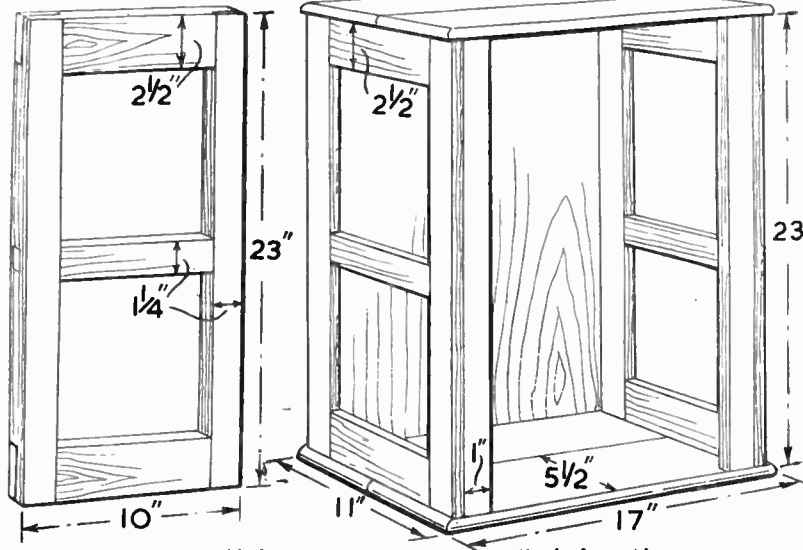

Fig. 3—How to make the side frames

Fig. 4—Assembly

make in a case such as this, and, to stiffen up the frame, a cross rail is halved in the centre to the two upright rails. This cross rail, incidentally, will take the small fillet of wood, say, ¾ in. wide by ¾ in. thick, which will form the end support for the shelf.

Measure off for the shelving carefully, and draw the cross lines with a try square or set square, afterwards cutting them across and downwards with a small tenon saw. Clean out the sinkings in the middles of the long upright rails with a ½ in. chisel, and, when fitting all the rails together (before actually fixing them) see that they lie flush and square and that the ends are even. Put two screws into each halving, and, if glue is used, be sparing with it and get a good close joint.

The Carcase

Make up both frames alike and take the precaution of seeing, when they are finally screwed to the top and floor, that the long rails show their complete

length from outside, as the sketch (Fig. 1) indicates.

The next step is the cutting and fixing of the two door side rails, which will be screwed between the top and floor and to the front edges of the side frames. These rails are 23ins. long, 1in. wide and $\frac{3}{8}$ in. thick, and their positions are indicated in the plan (Fig. 2) and again in Fig. 4.

The back may consist of plywood about $\frac{3}{8}$ in. thick, or any good type of hardboard which can be painted. Take the measurements direct from the partly made-up cupboard, and be sure to get the angles perfect right angles, so that when the piece is screwed on, the whole framed piece is brought to a true shape and square.

The door is made up exactly like the side frames, and is shown in Fig. 5. The measurements can be taken from this figure, and the joints again made as before, and as shown in the enlarged detail in the circle.

The panels of the sides and door are filled either with perforated zinc or

wire gauze of small mesh. If neither of these materials can be obtained, then butter-muslin—a kind of loosely-woven cloth can be used and would suit the case admirably. The actual fixing is done, as shown in Fig. 6, by means of quarter-round beading or ordinary $\frac{3}{4}$ in. square stripwood.

CUTTING LIST

- 4 Boards—18ins. long, 7ins. wide, tongued and grooved.
 - 6 Pieces—23ins. long, 1 $\frac{1}{2}$ ins. wide, $\frac{3}{8}$ in. thick.
 - 2 Pieces—10ins. long, 1 $\frac{1}{2}$ ins. wide, $\frac{3}{8}$ in. thick.
 - 3 Pieces—13ins. long, 1 $\frac{1}{2}$ ins. wide, $\frac{3}{8}$ in. thick.
 - 4 Pieces—10ins. long, 2 $\frac{1}{2}$ ins. wide, $\frac{3}{8}$ in. thick.
 - 2 Pieces—23ins. long, 1in. wide, $\frac{3}{8}$ in. thick.
 - 2 Pieces—15ins. long, 4 $\frac{1}{2}$ ins. wide, $\frac{3}{8}$ in. thick.
 - 1 Piece—Plywood (or other), 23ins. by 16 $\frac{1}{2}$ ins.
 - One Pair Brass Hinges, 1 $\frac{1}{2}$ ins.
 - One Knob Handle.
 - 16 Pieces Beading, 9ins. long.—
 - 8 Pieces Beading, 10ins. long.—
 - 16 Pieces Beading, 8ins. long.—
 - 8 Pieces Beading 11ins. long.—
- These lengths should be checked direct from the made up cupboard frames.

Strips of this material are first of all cut square to the various lengths required and the ends then mitred with either the fretsaw or a fine-tooth tenon saw. The beading or filleting must be cut accurately to fit round

inside each of the openings, fine brass wire nails being used in the fixing. First, of course, nail round, say, the four outside strips of each panel as (A), Fig. 6, then insert the panels of zinc or wire gauze and follow with the inside strips (B). Like this the panels are well held between the fillets.

If, however, butter-muslin is used, then a rather different procedure is followed. The beading (A) will be put round as suggested and the muslin then cut rather on the large side for each panel. A little waterproof glue can then be brushed on the inside face of the filleting and the muslin laid up to it. This holds the muslin in place while the other four strips to each panel are nailed in, the strips being pushed well up against the forward beading to make a secure fastening.

If there should be any spare $\frac{3}{8}$ in. wood that could be cut into suitable strips, say, $\frac{3}{8}$ in. wide, then these strips would answer as good stiffening pieces for nailing round inside the cupboard between the floor and the upright panels. The top of the cupboard could be similarly treated inside.

A pair of 1 $\frac{1}{2}$ in. brass hinges should be screwed to the right-hand rail of the door, shallow recesses being cut to allow the flaps to fit flush. Similar recesses should be cut in the side rail of the cupboard, and, when the hinges are fixed, their knuckles should project slightly to allow clearance for the door opening.

We give a cutting list of wood required for making the cupboard, and this will be found most useful when preparing the rails, etc.

Good, straight-grained deal or pine would be most suitable, and this should be coated with lead priming paint, followed by two coats of good oil paint. The top should be covered with a piece of Ruberoid or roofing felt, closely tacked all round.

The cupboard should slope very slightly towards the front, and a fillet of wood could be laid across the iron wall brackets at the back for this purpose.

(225)

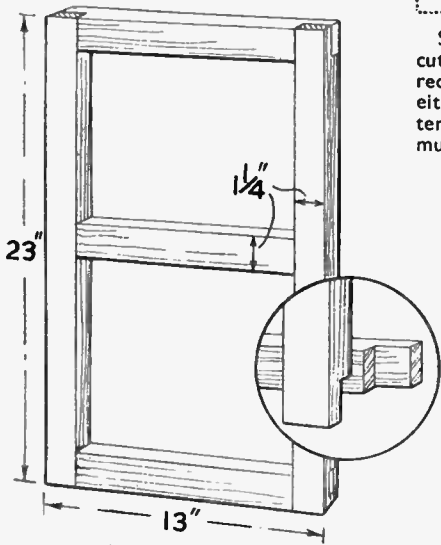

Fig. 5—Details of the door

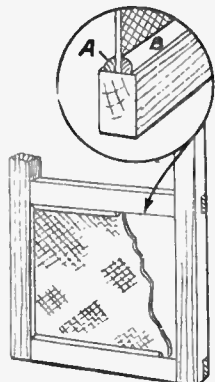

Fig. 6—Fixing the panels of perforated zinc

Cigarette Ash Holder—(Continued from page 68)

is used, a slight bevelling of the edges would improve its appearance a lot, but if bevelling does take place, the base should extend $\frac{3}{8}$ in. at sides and rear to allow for it.

The two small benches in front can be made of strips of the fretwood 1 $\frac{1}{2}$ ins. long and $\frac{3}{8}$ in. wide, supported on small bits of wood $\frac{3}{8}$ in. high. Clean up the work, and well glasspaper in readiness for the final painting. This can be a matter for personal choice. Just as a suggestion, the house might be painted cream colour, the roof red or slate, and the chimney stack red, or to match the house, as preferred. The woodwork, by which is meant the surrounds of doors and windows, and the seats, a nice green. The windows are painted in blue.

A slight addition of artistry can be provided by gluing slips of wood over the doors and under the windows, the

latter to represent window sills, of course. Any thin slips would do here, even pieces of matchstick. The sign can be painted in as the 'Red Lion' or, of course, any title chosen. If the reader has sufficient artistic talent to paint on the sign a lion rampant, all the better. Window surrounds can, of course, be just painted on, or if a better effect is desired, cut from very thin wood or card, and glued on. Other details, to add realism, can be put in as the reader's own experience and skill may suggest.

Inside the model, a metal tray must be provided into which the cigarette ends and burnt-out matches can fall, or a flare-up may result some time. For this cut out the pattern drawn in Fig. 4 and gum to the tinplate. Add the $\frac{3}{8}$ in. flanges shown to the sides and cut out. Bend along the dotted lines, and hammer the flanges over at rightangles. Then wash

off the paper pattern, dry the tin, and solder the flanges, the result being a deep tray, which should fit easily enough inside the model. The tray is best coated with enamel to prevent rust, and it would be an advantage to solder a piece of wire to it to enable it to be lifted out for emptying with ease. Alternatively, it could be fixed to the floor of the model with a couple of nails or screws, in which case the house portion would be tipped over for emptying, naturally.

Readers who may care to make the model, but lack sufficient spare wood for the job, will find that a panel of fretwood 7ins. by 14ins. will suffice for all, including the base, the panel being $\frac{3}{8}$ in. thick. It may be added that $\frac{3}{8}$ in. or $\frac{1}{2}$ in. wood can be used for the model, but not less, or more.

(239)

Some simple devices for EASIER GARDENING

THESE are busy times in the garden and a few simple, easily made devices will make work easier.

Digging, for example, is made less laborious if the spade is clean and free of encrusted mud. A proper spade-scraper is easily made and better in use than the odd piece of wood or crock casually picked up.

Fig. 1 shows a useful article having a metal blade and a wooden handle. Hardwood is preferred for the handle, though this is not essential. A saw kerf is made to take, in a tight fit, the blade made from sheet-iron or zinc (the nearest scrap-metal dump will provide material). When the blade is set in the handle, holes are drilled right through to take rivets. A third hole is provided so that the scraper can be hung up in the tool shed.

Fig. 2 shows a wooden spade scraper, approximately 7 ins. wide and 5 ins. deep of $\frac{1}{2}$ in. thick hardwood. Fig. 2a shows the first rough shaping. There is no need to make it a work of art, though, at the same time, one would like to see a revival of that old craftsmanship which thought that whatever was worth doing was worth doing well, and no tool or appliance was too lowly to be well

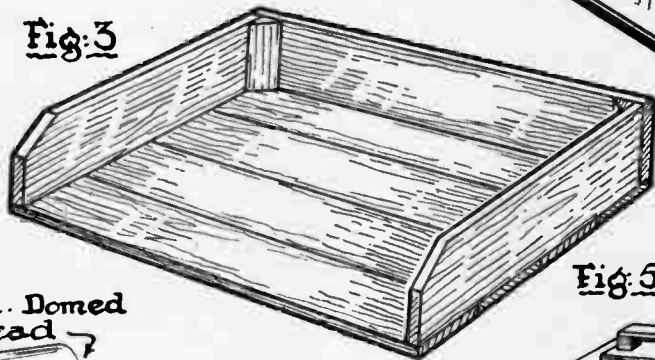
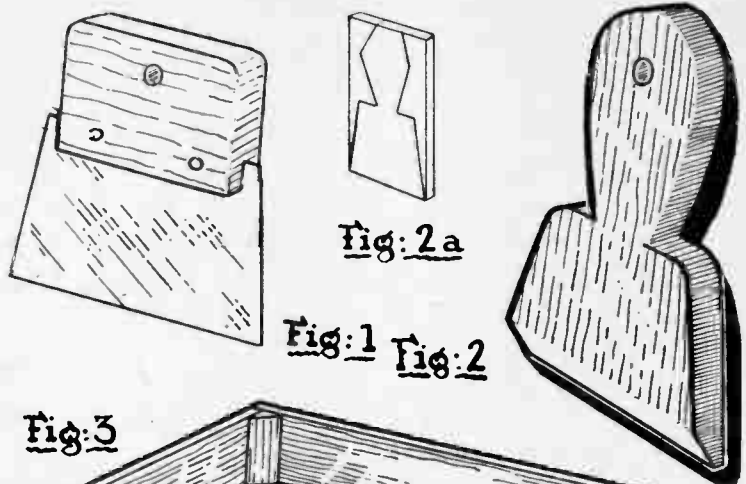

made and pleasant to handle.

Not many amateurs have a special potting shed, but all can make a portable potting bench or tray, as illustrated in Fig. 3. The size will depend on the timber available, but a tray 3 ft. long, 2 ft. deep and 6 ins. high is a useful size. The diagram shows how simply the whole affair is put together. It will last

many years longer if treated with a wood preservative. Do not, however, use creosote.

It is essential, in potting, to firm the earth in the pots or boxes, and a potting rammer, shown in Fig. 4 is as useful as it is simple: just a 1 ft. length of $1\frac{1}{2}$ ins. diameter rod tapered to $\frac{1}{2}$ in. diameter at the other end where the head is domed.

For firming the earth in seed boxes, the type of rammer shown in Fig. 5 is useful. Fig. 5a shows a handle of a 'more simple type. Such rammers can be of a size to press the whole

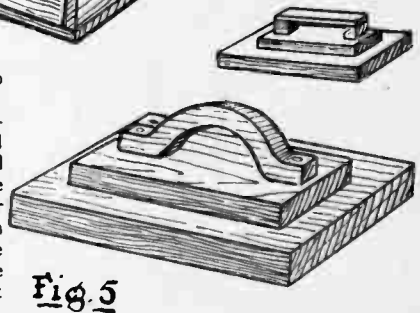

of a seed box at one operation.

The amateur gardener is often chronically short of small flower pots. At the same time, the dust-bin is usually overflowing with old tin cans. Yet quite useful flower pots can be made from such cans (Fig. 6). For a temporary job, first cut down both sides with tin snips (Fig. 6a). Fill with earth and bind with a turn of twisted wire (Fig. 6b). The seedling is planted, and when large enough is easily removed with the earth in a compact lump (Fig. 6c). The tin is then discarded.

For a more permanent job, melt asphalt in an old bucket, outdoors. Dip the tins in it after making necessary drainage holes in the bottom. Fill the tins with sand and quickly tip the sand out again, so that a layer is left on the inside. Then roll the tins in sand to coat the outsides.

(233)

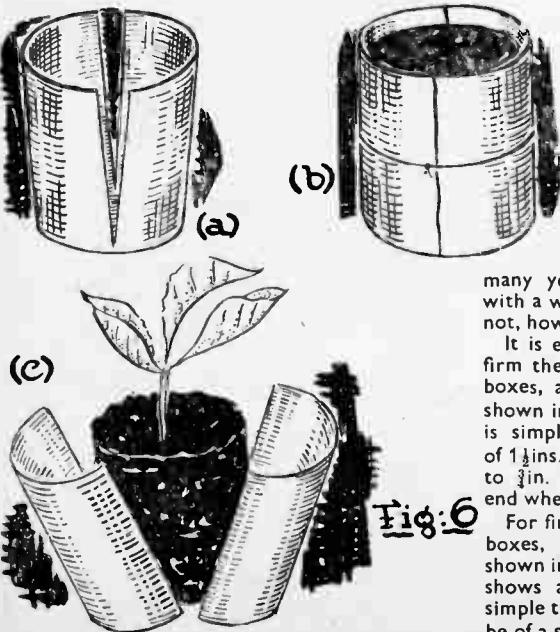

Fig:6

It isn't expensive to make a PINHOLE CAMERA

HERE is a method by which a perfectly workable camera can be made without any expense whatsoever. All that is required is a rectangular tin with a 'slip-on' lid about 4ins. by 3ins. and 3ins. deep, and some card. Of course, photographic plates will be needed upon which to make the pictures.

The precise size of the tin is not material, actually the larger the better, but if it is much bigger than the dimensions given, the camera becomes cumbersome for carrying about.

Taking the tin first of all, mark the centre of the base on the inside. This can be found near enough by drawing diagonals—the centre is where they cross. At this point we wish to pierce the smallest of holes possible through the tin. The smaller it is, the sharper will be the final picture.

The best way to make the hole is to tap a large darning needle on the intersection from the inside, the tin resting on a piece of wood. Turning to the outside it will be found that the tapping has made a very slight bulge, and, with a fine file, this should be rubbed down level.

Take the needle again and tap once more from the inside. Again a small bulge appears, and this must once more be filed down. Repeat the filing and tapping until the tin is the merest wafer. A slight press now will just send

the point of the needle through—and the 'pin-hole' is complete.

The great thing is that the hole must be, and, as far as possible, a true circle.

Now take the lid of the tin and cut a rectangle of thick card to fit inside the rim. From this, cut a rectangle $2\frac{3}{8}$ ins. by $3\frac{3}{8}$ ins., thus forming the collar (A).

Next cut a three-sided piece of card as (B), the measurements (a) and (b) agreeing with the outside width and length of the collar of card just made, the inside dimension being as shown.

Glue this on the collar (A) (as per C) leaving $\frac{1}{8}$ in. clear space right round the inside of the rectangular opening.

Cut another piece of thinner card the same size as the lid and glue it over the back. The gluing must be thoroughly done, and the whole should be put under heavy pressure while drying. The complete article should be a frame, as per (D), into which a standardized glass plate $3\frac{1}{2}$ ins. by $2\frac{1}{2}$ ins. will just slide as (E).

The interior of the box and the frame is finished with a dead black paint to prevent inside reflection. Take care, not to interfere with the pin-hole.

The camera is now complete. It is loaded by sliding into the frame an ordinary $3\frac{1}{2}$ ins. by $2\frac{1}{2}$ ins. plate and then fitting the frame into the lid (with the emulsion side of the plate toward the pin-hole), and then the lid on to the tin as per sketch (F).

This, of course, will be done in a dark

room and the pin-hole is covered with a piece of adhesive tape till the time for exposure arrives. The image forms on the plate by means of the pin-hole which, being very small, acts as a lens. A pin-hole has one very big advantage over a real lens. It is, that, irrespective of how the camera is placed, all objects will be in focus, no matter how near or how far away.

A fair idea of what will appear on the plate can be obtained by drawing two lines (as F), as sighting along from the point (T), these act as a view finder. The pin-hole remains covered with the piece of adhesive tape until the time of exposure. The adhesive tape is replaced again after the exposure.

The length of exposure required by a pin-hole camera limits the work that it is capable of doing, but if subjects are only attempted when long exposures are possible, good pictures can be obtained—the camera, of course, being left to stand on something very firm during the time of taking.

A fair example of exposure is 2 to 3 minutes on a well-lit subject, sun shining, during May to August, 10 a.m. to 5 p.m. For February to April and September to October double this time. A few experiments will soon give a clear idea on this point, however.

Developing and finishing is, of course, the same as with a plate exposed in any other camera. (243)

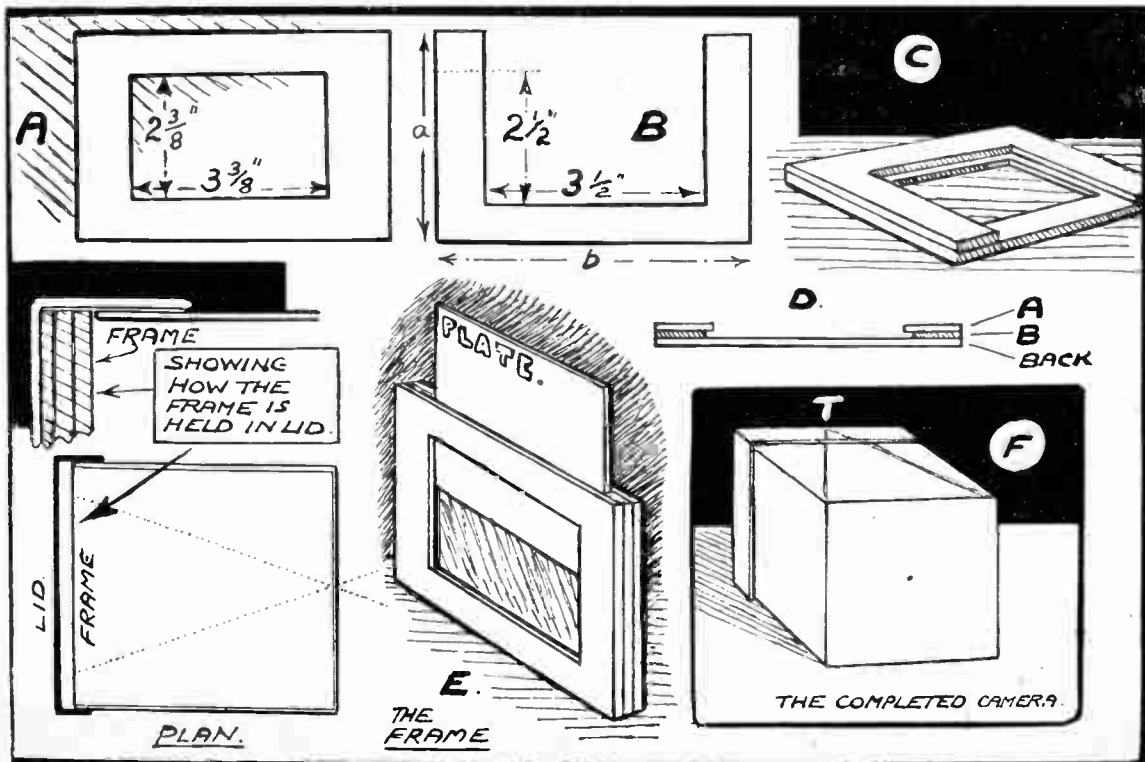

Enjoy the coming summer in a GARDEN DECK CHAIR

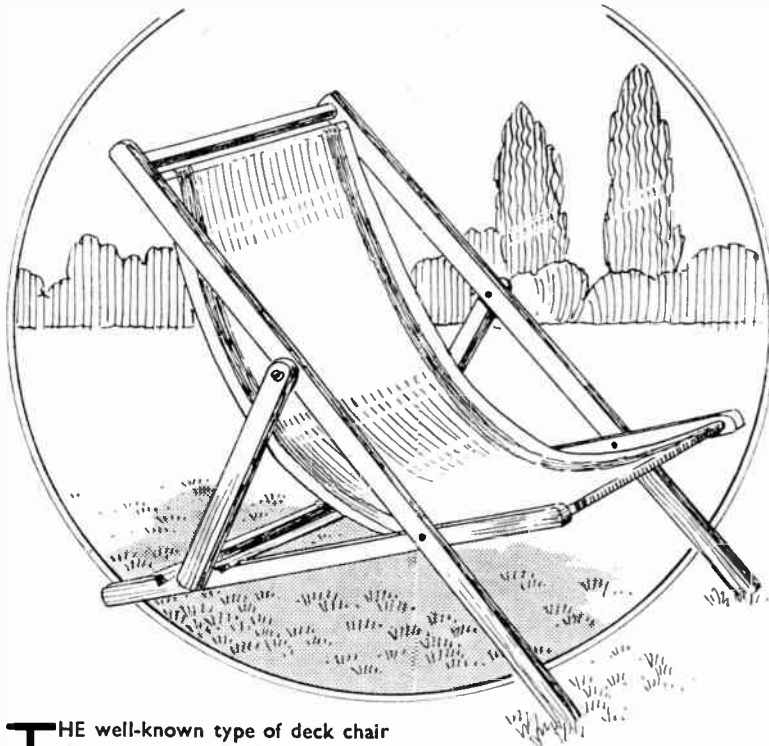

THE well-known type of deck chair always seen at the seaside, and which still seems the favourite for lawn or garden, is quite the easiest to construct. We are, therefore, giving here details for making one up as we believe many of our workers would prefer a home-made effort to the more costly shop-bought article. Such a chair is shown in our illustration.

The construction is, if anything, on the sturdy side and a chair so made will stand up to hard usage.

Briefly, its construction consists of the making up of three distinct frames.

These comprise the arm frame (A), the seat frame (B), and the support frame (C). Our choice of wood would lie between beech or birch, and either of these may be given a coat of varnish or spirit stain, or even ordinary oil paint.

A general side view of the made-up chair is given in Fig. 1, while Fig. 2 shows the appearance of the frames when

folded ready for storage. The diagram of rails and cross rails given in Fig. 3 will be used by the worker for cutting the various lengths of stuff after it has been planed up to the various sections—viz. $1\frac{1}{2}$ ins. by 1 in. and $1\frac{1}{2}$ ins. by $\frac{3}{4}$ in.

Each of the rails, etc., should be cut to the lengths given and the ends of the frame rails should be shaped and cleaned up neatly, as seen in the enlarged

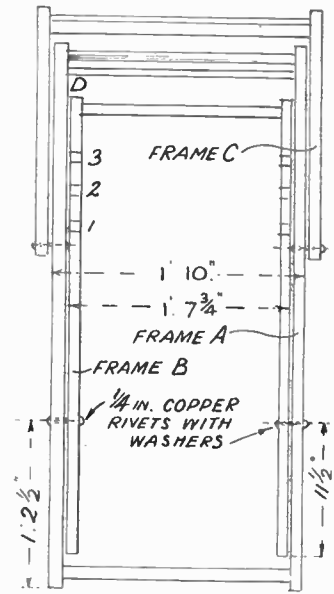

Fig. 2—Plan of frame

diagram Fig. 4. Section (E) in this diagram shows the rails which take the canvas.

If, however, some good straight—
(Continued foot of page 77)

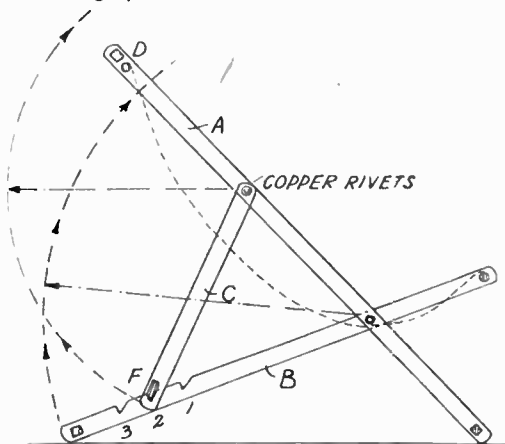

Fig. 1—Side elevation of frame

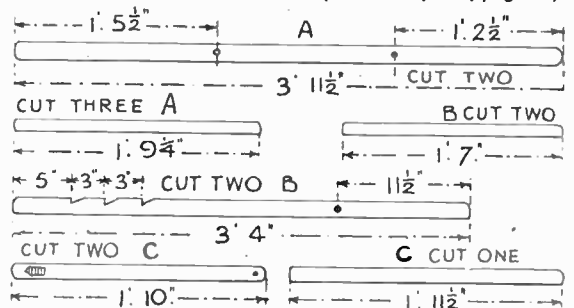

Fig. 3—Details of the various parts

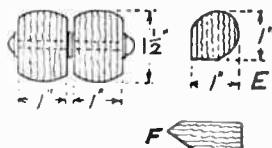

Fig. 4—Section of frames and rivets, rails (E) and supporting rail (F)

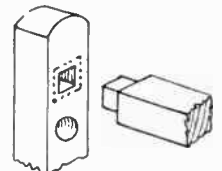
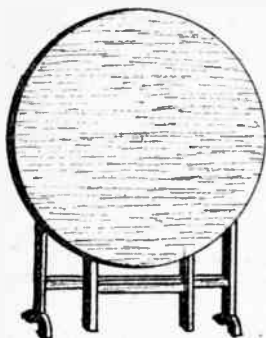

Fig. 5—Framing joint

You will have no difficulty in making A SCREEN AND OCCASIONAL TABLE



ARTICLES of furniture that can serve a dual purpose are much in demand these days, and are especially servicable in small houses and flats where there is need for economy of space. The fire screen and occasional table combination described on this page is an excellent example of space saving.

Besides being of use during the summer months as a fire screen it need not be put away when fires are wanted,

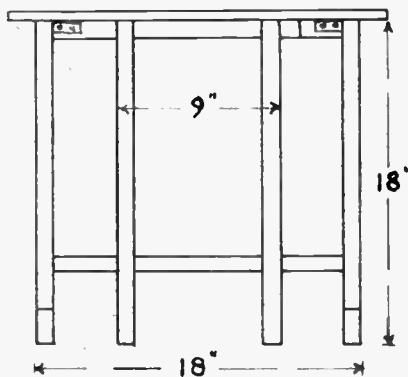

Fig. 1—Front view with latch top in place

as it can be quickly converted into a useful fireside table.

Simple Construction

Its construction is quite simple and well within the scope of the handyman. It should be made of wood to match the existing furniture in the room unless it is wanted as a present. Indeed, if well made it would form an ideal wedding or other present and be greatly appreciated.

Suitable woods for the purpose are oak or walnut, and, when stained, are capable of receiving a nice polish. Many other kinds of wood are quite as servicable and the final choice must be left to the maker.

The top, which is hinged to the leg framework, is made of plywood about $\frac{1}{2}$ in. or $\frac{3}{4}$ in. thick. A circular top of 21 ins. is shown in the sketches, but there are several other shapes that

could be used instead to produce a well balanced article. Six or eight sides, or a scalloped edge, are all suitable variations.

Cutting the Top

The best way of cutting the plywood for the top is with a coarse fretsaw, especially if the shape is circular or with a scalloped edge. Although this method is rather slow it prevents the wood from splitting and the extra time spent in doing it is well worth while. A fine tenon saw is, of course, much quicker, but it is not recommended for cutting plywood. The edge can then be smoothed and polished with medium and fine grades of glasspaper, doing the first stages on a wood block.

With the exception of the top bar, as shown in Figs. 3 and 4, and the two feet, all the framework is made up of wood 1 in. square. Start by making the main leg framework as shown in Fig. 4. Cut the top bar 18 ins. long, 2 ins. wide and

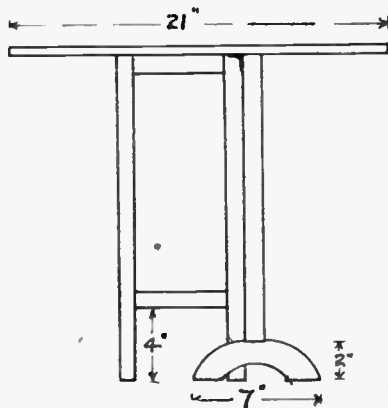

Fig. 2—Side view

1 in. thick. Reference to the diagram will show what to cut out of this piece—first a $\frac{1}{2}$ in. wide slot in each end to take the leg tenons, and also part of the front side to a depth of 1 in. for the moving leg to fit into.

This space is 10 ins. long, its exact position being $4\frac{1}{2}$ ins. from one end and $3\frac{1}{2}$ ins. from the other. The reason for the difference in these measurements will be seen when the moving leg is fitted—the extra 1 in. is needed to enable the arm to swing open and also to act as a stop.

The bottom rail is 17 ins. long and has a $\frac{1}{2}$ in. tenon cut on each end. Cut the two legs 17 ins. long and make a 1 in. tenon on the bottom, cut a mortise half way through for the bottom bar, and cut a halved joint on the top of each, as shown on Fig. 4.

Two shaped feet are needed for



fitting on to the main legs, to prevent it from falling over when used as a screen. If the table is having a circular top, then the feet can be semi-circular as shown, but if a six or eight sided top is decided on, then these will not be suitable. In order to be in harmony, the feet should be similar in shape to half the table top, but you can decide which you like best. The size of the feet is the same whatever type is decided on—7 ins. long, 2 ins. high and 1 in. thick.

Make all these joints a good tight fit. Glue the top bar and bottom rail into the two legs and then fit the two feet, making sure that the framework is square and quite upright in the feet.

The Movable Legs

Allow the glue to dry thoroughly while you make the movable legs. For this part, as shown in Fig. 5, we need two pieces 18 ins. long, the top bar 9 ins. long, and the bottom rail 8 ins. long. Tenons are cut on both ends of these two last pieces—a 1 in. tenon on the top bar and a $\frac{1}{2}$ in. tenon on the bottom rail.

Cut slots in the top of the legs for the top bar, and mortises for the bottom rail to a depth of $\frac{1}{2}$ in. Glue these up and put aside to dry thoroughly, then all the woodwork can be well glasspapered.

The hinges should be fixed next and a little care is needed to get these in their correct positions. Get the movable leg fitted first, after which the top can be

(Continued foot of page 75)

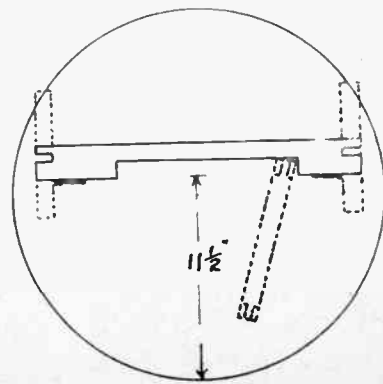

Fig. 3—Plan view, showing the top bar

MATTERS of INTEREST

work, employ a small brush for the purpose.

Arch for Aquarium

I WOULD like to make an arch with holes and a little fancy work on it to go in a 2ft. long aquarium. Please tell me what material to use, and the kind of paint which is waterproof. (L.C.T.—West Kensington).

PARTITIONS such as you suggest are not desirable in a small aquarium. To fix firmly would probably mean scratching the glass sides of the tank, and a scratch often means a breakage. If both edges of the arch are held away from the tank side, it would be better, but it is not easy to arrange. If it is an ornamental effect you desire, it would be more satisfactory to use artificial rocks, procurable from aquarists' suppliers, which could be arranged suitably to form an arch with holes. Here again, it is unwise to be too lavish in the use of rockwork; give the fish plenty of swimming room, in preference to a lot of interior decoration.

Removing Dye

CAN you tell me any method of removing the dye from 3-ply wood taken from tea chests, as it spoils the whole look of any subject made with it? (A.G.—Sandwich).

IT may be rather difficult to entirely remove the stains in the wood, especially as the cause is not known. About the safest method would be the oxalic acid treatment. For this, use a solution of 1oz. of oxalic acid to 1pt. of water, and apply only to the stained portions. Be careful not to get the stuff on hands or clothes. When the stains have been reduced as much as possible, wash well over with clear water, then with common vinegar. This may prove effective, but time must be given for the acid to take effect.

Sharpening and Setting a Circular Saw

WILL you inform me how to sharpen and set a 4in. circular saw? The saw is one of Hobbies manufacture and is worked in the Hobbies Bench Lathe. Could you tell me what speed is necessary for the lathe and the saw, and the type of electric motor which would be capable of driving them? (J.R.—Billinge).

FOR full information on how to sharpen a 4in. circular saw, the advice of any local carpenter or joiner should be sought. We would suggest running the saw at, say, 700 r.p.m., but this, naturally, depends on the class of work being done, and experience must be the guide. An $\frac{1}{8}$ th h.p. motor should be used, of a type to suit the local electricity supply; the suitable speed would be about 1,400 r.p.m. With a pulley 2½ins. diameter on the motor drive and a 5in. pulley on the outer end of the lathe spindle, the result would be about right.

Restoring Colour

MY bicycle is fitted with Bluemels' 'Featherweight' white mudguards. These have since turned rather yellow. I wonder if you could tell me how to restore them to their original whiteness? (J.M.S.—Neasden).

ASSUMING the mudguards are of a plastic material or coated with a cellulose finish, we suggest you en-

deavour to remove the discolouration by first washing with hot soda water, or with a solution of 'sugar soap'. A more drastic treatment (and more risky) is to use a clean rag dipped in Acetone and lightly wipe with this. The Acetone dissolves the cellulose, so use it very carefully. Also do this in the open air and away from any naked flame; fumes of Acetone are inflammable and toxic.

French Polishing

WHAT do I require for french polishing a single bedroom suite, whose surface has worn off? Do I have to glass-paper all the old surface? (N.P.—St. Leonards-on-Sea).

IF the old polish is worn and patchy in places, it is advisable to remove it with glasspaper, assisted by a cabinet scraper. If obstinate, employ a proprietary brand of varnish remover, and wash over with weak vinegar. It may then be necessary to re-stain the work, using a spirit soluble stain. Soak a handful of cotton wool with french polish, cover with a clean rag and twist tightly. Use this rubber all over the surface, employing a rotary motion until the wood begins to shine, and apply a spot or two of linseed oil to the rubber to prevent it sticking. Then finish off the surface with one or two coats of brown hard spirit varnish. A warm room is essential when varnishing, to prevent 'bloom'. If the rubber is difficult to get into the corners of the

Screen and Occasional Table—(Continued from page 74)

put on. Two 1in. brass hinges will be suitable for the leg, and the position of the top one is clearly shown in Fig. 4. A

space of 1in. is left behind the hinge to allow the leg to open fully, and this also acts as a stop to prevent it swinging out too far.

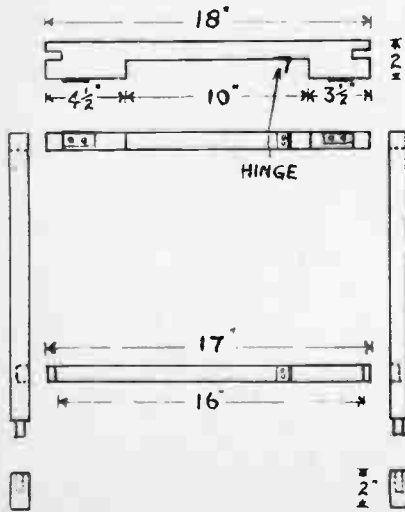

Fig. 4—Frame dimensions and joints

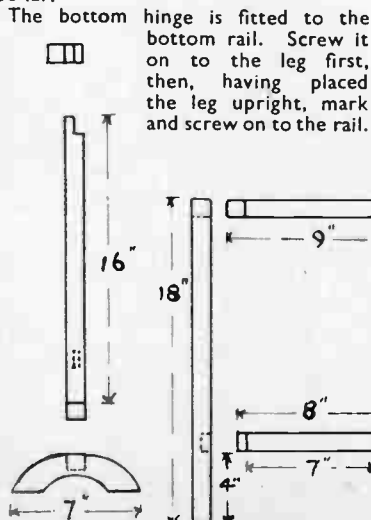

Fig. 5—Details of the movable legs

Now the top can be fitted, and two 1½in. or 2in. brass hinges will do the job nicely. The exact positions for these can be easily seen from Figs. 1 and 4.

Suggested Decoration

The top can be left plain or decorated in quite a variety of ways. A transfer could be fixed in the centre, or if the maker is also an artist, a neat design of flowers, the head of a dog, or even a local view, could be painted on in oil colours. Some very good work can be done with poster colours on to the natural wood. In both these cases the top should be well varnished afterwards to preserve the design.

The Best Way

The best way to finish the article is to take the hinges off and do each piece separately. Stain if necessary, and either wax polish or french polish, or if the top has been varnished the rest of the woodwork should also be done to match. (230)

Helpful advice on using and MAKING LANTERN SLIDES

ON many occasions during the last twenty years I have been asked to give talks on my experiences as an amateur photographer, and although at first I was somewhat diffident, and doubtful whether I could possibly interest any audience, I had the feeling that a chance had come my way of putting my knowledge of photography to a practical use, and, at the same time, of passing to other amateurs some useful hints of the 'Do's and Dont's' type, which, of course, were the outcome of my own failures and successes.

The first of these talks was given to a number of young folk, who were fellow guests at a guest house where we were holiday-making, and it was mostly concerned with picture-making. In order to bring home the chief points, several photographs of my own were handed round and discussed and criticised. The results of the initial efforts proved so successful that I have never regretted accepting the invitation and have never since turned down any requests for lectures—and every one has proved an evening's enjoyment for me.

Most Enjoyable

Undoubtedly, the most enjoyable and interesting type of lecture, and this is the right word, is that dealing with pictorial rather than the technical side. People do like to see landscapes, seascapes, interiors, etc., the sort of results that one brings back from one's summer holiday. But it is somewhat surprising to note that the questions which arise at the end of the talk are nearly all of a technical character, dealing with the brand of film, the stop used, and whether a filter was advocated.

When holiday-making, my camera is always with me, and, therefore, my collection of suitable negatives runs into some thousands, and it has been a simple job to select sufficient for a lecture on almost any beauty spot of Gt. Britain, and to make lantern slides for illustrating each subject by means of a 6ft. or even 12ft. enlargement thrown on a screen by a suitable lantern.

Lantern Slides. This brings us to the subject for this month's article, and it is hoped that it will find many readers keenly interested and ready to put into practice what is, unquestionably, a most fascinating branch of our hobby.

Simple Process

To those who have so far not made a slide or even given a thought to doing so, I would preface my remarks by saying that it is quite a simple process and as easy as the making of a contact or bromide print. In fact, if you select a negative which you know will give a good print, then you can be sure it will give you a good slide. It follows that

there must be plenty of detail and that this must be 'sharp'. Further, the negative must be quite free from blemishes, such as pinholes, scratches, finger impressions and stains, because any such markings will be reproduced on the slide and eventually magnified forty or possibly sixty times when focused on to the screen.

There are two standard sizes in lantern slides, $3\frac{1}{2} \times 3\frac{1}{2}$ and miniature 2×2 . Those of you who are using films giving negatives $3\frac{1}{2} \times 2\frac{1}{2}$ will require the former, unless it is intended to produce only part of the image in the slide.

All the leading manufacturers of sensitised material make lantern plates, which are retailed in packets of a dozen. As with papers, so with these plates there are various grades and speeds. It is advisable to commence with a well-known brand such as Ilford Special, normal grade, which is easy to manipulate and gives excellent gradation and quality in the image.

A darkroom is not necessary, but you must be able to do the work in a room where all white light can be shut off. This, of course, includes daylight. A kitchen or warm scullery can be converted into a very useful photographic department. Very often the light in these rooms is hanging from the ceiling, and, by means of a two-way connection, an orange bulb can be easily brought into use on the table and close to where the work is to be done.

Just imagine that you are with me in such a room and that it is your job to produce a perfect lantern slide by simply carrying out the instructions I am giving you.

The negative is one of medium density with splendid definition and free from all blemishes. By the way, all our negatives have been arranged in three regular groups for printing, i.e. dense, medium or normal, and thin. On

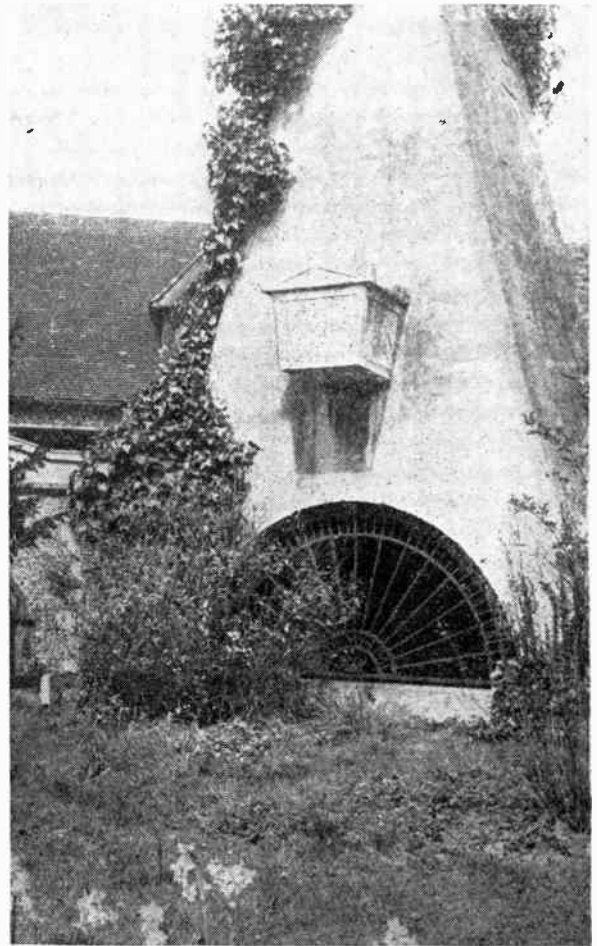

'Buried above Ground'.—A subject of local or topical interest, and typical of the type of slide which goes to the making of a successful lecture

the table is a printing frame for quarter plates, $4\frac{1}{2} \times 3\frac{1}{2}$. The first job is to see that the piece of glass in this is perfectly clean. Switch off the white light and put on the orange. Open the box of lantern plates, and remove the cover paper from the first small packet. You will find that it contains four plates in two pairs, with the film sides facing each other. Carefully remove one plate and be sure to rewrap the other three and return them to the box.

Now, place the negative on the glass in the frame with the film side uppermost, and then, on top of this, put the lantern plate so that the sensitised surface is in contact with the film negative. Fasten the back of the frame.

Exposure

The direction leaflet states that the exposure for an average negative with this brand of plates is approximately 2 seconds at a distance of 48ins. from a 15 watt lamp, and if that lamp is fitted

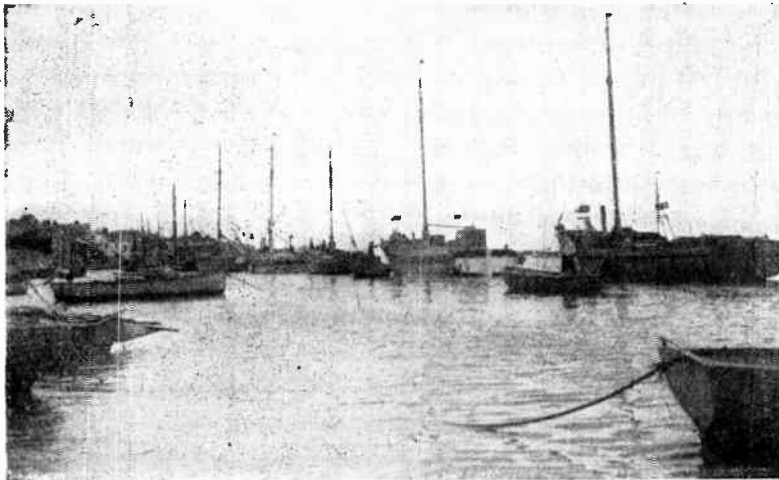

Fishing boats after their return with the day's catch. A typical subject for use in a lecture dealing with holidays

with a reflector this time must be halved. Let us assume that we are novices and we want to get some experience on this important question of exposure, so we propose making four exposures on the one plate in the same way as we sometimes do when making prints.

With a piece of card in hand we cover three quarters of the plate which is 48ins. from the light. Then we switch on the white light and *immediately* switch it off again, not allowing more than $\frac{1}{2}$ second. Another quarter of the plate is then uncovered, and the light switched on for 1 second. A third quarter is exposed for 1 second, and finally the last quarter is exposed for 1 second.

Four On One

On this one plate we now have four different exposures. The last quarter to be exposed only got 1 second, while the third quarter got 2, the second 3 and the first a total of $3\frac{1}{2}$ seconds. With these times, we should be able to find the correct time required for all normal negatives, using these plates at a distance of 48ins. from the light. You will thus have standardised all this part of the process.

Development is simple, and without going into the question of what is the best formula, I would advise that if you have a Johnson's M-Q Pactum, then mix its contents in 4ozs. of water and pro-

ceed by placing the exposed plate in a dish. Then pour the solution quickly and evenly over it. The image appears quickly, but allow it to continue for a couple of minutes before transferring the plate to the acid-fixing bath.

When completely fixed, it is possible to examine the plate by the white light and that section which gives all the detail without any signs of fog through over developing, or lack of depth in the blacks through under developing, should prove to be the part that received the correct exposure.

Give the slide about half an hour's washing in light running water and stand it in a place where it can dry without picking up dust. When dry, it should be mounted as soon as convenient. Mounting glasses can be bought at about 2/- per dozen, and binding strips at 2/6 per 200. If preferred, small strips $3\frac{1}{2}$ ins. long with titling space and spots, at 1/9 per 100, can be obtained. The latter are much preferred as, apart from titling, the space allows a reference number to be given to the slide, and the white spots indicate which way the slide is to be placed in the lantern. Be sure to see that the cover is quite clean before mounting.

If there are any readers who, having got so far, feel that their interest in or knowledge of photography is such that they should not attempt to give anything in the nature of a lecture, I would

earnestly advise them to dispel that idea. If you have a collection of negatives and can sort out thirty, forty, or as many as eighty, dealing with any subject such as holidays, camping, hiking, cycling, or concerning local views and interesting items to be found in your own neighbourhood, then you have the making of a jolly good lecture.

Perhaps some may argue that they could not face an audience and talk to them about any subject. Perhaps you have never tried? Anyway, if you can talk to your family or a friend about these negatives, then you can do so to any number of persons. My advice is 'Get going', and you will be surprised. It is one of the very best means of cultivating self-confidence. Everyone has some of this stored away, and the sooner it is developed the better for the individual.

The Illustrations

The two illustrations are typical of two different types of lectures. The one of the tomb is suggestive of 'local' points of interest, while the other is one that could be included in a holiday lecture. It is, of course, necessary to be able to tell the audience something about each slide as it is thrown on the screen. What you tell them might be in the form of an anecdote or personal experience, or of historical interest.

Just as a guide, when the tomb slide is being shown the audience is told that the local story about it is that it is the grave of a man buried (?) above ground. But the truth is that it is the work of a crank whose father is buried in the vault underneath. The coffin shaped stone through the centre of the obelisk gave rise to the local yarn.

The row of fishing boats in the holiday picture represents a present-day fleet and are the successors of sailing craft that have been operating from this town for over six hundred years. Some did excellent work at Dunkirk and one failed to return.

Get your slides and lecture ready, and then approach your Scout or Guide Troops, the local Y.P.A., the Church or Chapel social secretaries, etc. You should have no difficulty in booking a few dates for the autumn and winter sessions. Some associations are quite willing to pay your expenses, and to add a small fee, and they can usually provide the lantern. (248)

Garden Deck Chair—(Continued from page 73)

grained turned beech or other hardwood round rods can be obtained, then these might well be used. They should be let into the frame rails at each end and nailed to get a strong fixing.

Plane up the edges of the supporting rail as (F) in Fig. 4, and let the ends of this be tenoned into the long rails in a somewhat similar manner to the top rail of frame (A) as shown in Fig. 5.

All cross rails should have stub tenons $\frac{1}{2}$ in. in length cut at each end, and this means preparing the mortises to correspond in the adjacent members.

Notice, when gluing up the frames,

that clearances of $\frac{1}{16}$ in. are allowed between each (as Fig. 2). It might also be mentioned at this point that all the cross rails are positioned $\frac{1}{2}$ in. in from the extremities of the side rails. The canvas rail to the arm frame (A) is kept $\frac{1}{2}$ in. in from the outside rail. Extra strength will be gained after gluing if screws are driven through the side rails into the cross rails.

All frames swing on $\frac{1}{2}$ in. diameter copper rivets, or alternatively, iron bolts with nuts and washers. The washers should be inserted as shown in the detail in Fig. 4, and the copper rivets

burred over afterwards and made neat.

The seat canvas is 17ins. wide and should be secured with large-headed tacks to the two cross rails. The length of canvas required will be about 4ft.

A warning note in conclusion. In cutting down the triangular recesses in the two side rails of the seat frame, which take the shaped lower cross rail of the frame (C), do not cut them too deeply or the rails (B) will be greatly weakened. The three recesses are shown as 1, 2 and 3 in the diagrams Figs. 1 and 2. (237)

YOU CAN BECOME A HANDICRAFTS INSTRUCTOR

EXPERIENCE NOT ESSENTIAL

Men who enjoy making things in wood or metal can turn their hobby into a permanent and interesting Career. Short hours, long holidays, and security in a job you would really enjoy, can be yours if you become a Handicrafts instructor. Let us send details of the easiest and quickest way to get the necessary qualification.

**We definitely guarantee
"NO PASS—NO FEE"**

If you would like to know about our unique method of preparing you for one of these appointments, write today, and we will send you our informative 176 page Handbook—free and without obligation. Mark your letters "Handicrafts Instructor".

**BRITISH INSTITUTE OF
ENGINEERING TECHNOLOGY**

BIET

595 Shakespeare House
Stratford Place, London, W.1



THIS CINE VUWER

GIVES
PERFECT
CINEMA
SCREEN
PICTURIZA-
TION FOR
ALL STRIP
FILMS
2/9



ABOVE FILMS
AND VUWER 7/9
VUWER ONLY 2/9
FILMS ONLY 2/6 each
Post and packing 6d.

**FILM STRIPS
EDLESBORO
NR. DUNSTABLE**

Is This Saw in Your Kit?

You can cut almost anything in wood with this Coping Saw. The blade is 6½ ins. long and can be turned to cut at any angle. No tool-kit is complete without one. Get yours NOW.

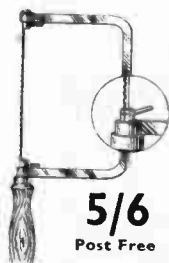

Buy from any Hobbies Branch, or direct from
Hobbies Ltd., Dereham



BRANCHES

LONDON

78a New Oxford St., W.C.1
(Phone MUSEum 2975)

87 Old Broad Street, E.C.2
(LONDON Wall 4375)

117 Walworth Road, S.E.17

GLASGOW

326 Argyle Street
(Phone CENTral 5042)

Head Office & Factories—HOBBIES LTD., DEREHAM, NORFOLK

MANCHESTER

10 Piccadilly
(Phone CENTral 1787)

BIRMINGHAM

14 Bull Ring

SHEFFIELD

4 St. Paul's Parade

LEEDS

30 Queen Victoria Street
(Phone 28639)

HULL

10 Paragon Square

SOUTHAMPTON

25 Bernard Street

BRISTOL

30 Narrow Wine Street
(Phone 23744)

BE TALLER

I Guarantee to increase your height in 12 days or return your money. New gland and spinal discovery increases height 2 to 5 inches.

'I have gained 4½ inches in height and feel fresher first thing in the morning. My weight increased from 9-stone 4-lb. to 10-stone 3½-lb.—P.D., Witham. 'Since taking your Course I have increased in stature from 5 feet 1 inch to 5 feet 4 inches, a matter of 3 inches.—H.G., Chesterfield. 'My increase is 2 inches and I really do feel ALIVE!—E.T.

Guaranteed harmless. Full Course 10/- post free, Air Mail 14/-. Details free for 1d. stamp. Sent under plain cover.

J. H. MORLEY

(H/83), TERRY HOUSE, NAPHILL, HIGH WYCOMBE, ENGLAND
Established 1936



THE BOLSTER HOME WATCH AND CLOCK REPAIR OUTFIT

These precision jewellers' instruments include watchmaker's magnifying eyeglass, finest watch tweezers, set watchmaker's screwdrivers, watch and clock oil, oilers, dusting powder, clock brush, plus illustrated instructional manual for the amateur. In container 12/6 post free.

Senior Outfit includes everything above, plus watch jewels luminous compounds, dial renewer, jewellers rouge, explanatory book. Price 21/- post free.

BOLSTER

INSTRUMENT Co. (Dept. H.W.), 5a Station Parade, Ashford, Middx.

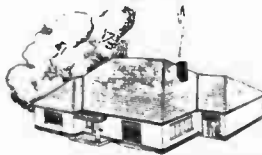

TURN YOUR

SPARE-TIME INTO CASH

**Men and women wanted to
make Bennett Model
Bungalows at Home.**

Fascinating, simple, well paid work

No selling involved.

Send penny stamped addressed envelope for full details.

BENNETT MODELS

Duncan Road, Richmond, Surrey

Tommy Trump says:— "You'll enjoy

DOUBLE ACE

The ACE of cigarettes"

10 for 1/3½ A CONSISTENT PERFORMER!

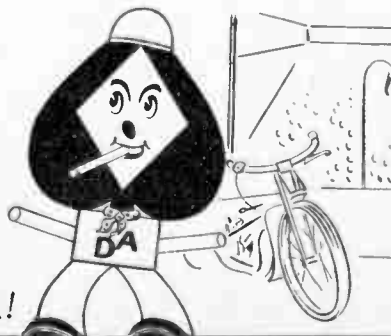



**FOR A
REAL
Professional
FINISH**

'FINISH' is the true test of craftsmanship. It's easy to impart a real professional 'finish' to woodwork and furniture you make at home with "COLRON" WOOD DYE—the finest stain for all practical purposes.

One coat of "COLRON" is all that is required to emphasise the natural beauty of the wood grain. No smears—no "overlap"—no trouble. Leave from two to three hours, burnish with rough dry cloth and you have a perfect base for french polishing or for waxing with "RONUK" FLOOR POLISH.

COLRON WOOD DYES

12 SHADES—ALL SIZES

Write for colour guide and full details to:

RONUK LTD. (Dept. 62) Portslade, Sussex

LOOK!! The AUTOMATIC MOWER HONE

★ SAFETY ★

SAFE · SIMPLE · QUICK



Blades sharpen themselves and are always sharp as new.

In four sizes 10" 12" 14" & 16"

PRICE 10/6 POST FREE

STATE LENGTH OF BLADES

Y.P.K. PRODUCTS COMPANY

688, Christchurch Road, Boscombe 3, Hants.

SEVEN GRAND HOBBY BOOKS!

- ALL ABOUT FRETWORK, by W. F. Chambers (formerly Editor, Hobbies Weekly) 2/6
- CIGARETTE CARD COLLECTING, by A. J. Cruse. All you want to know about this money-making hobby ... 2/6
- PEWTER RELIEF MODELLING, by Zita Dundas. How to make trays, jewellery, boxes, etc. 2/6
- ALL ABOUT SKETCHING, by Reg. Harrison. You, too, can become an artist! 2/6
- EASY HOME CHEMISTRY, by F. T. Oram, B.Sc. The book for the experimenter! 2/-
- PHOTOGRAPHY FOR PLEASURE and PROFIT, by Reg. Harrison. The hobby from A to Z. 2/-
- CANOEING TO-DAY, by P. W. Blandford. All about this great sport by Britain's leading canoeist 2/6

Every book packed with illustrations

by post add 3d.

VAWSER AND WILES (LONDON) LTD.
356 8 KILBURN HIGH ROAD, LONDON, N.W.6

**'KARLENITE'
PLASTIC MARBLE**

The entirely new Art Stone for casting Bookends, Ashtrays, Wall Vases, Statuettes, etc. 'KARLENITE' sets granite-hard with scintillating crystalline structure which very closely resembles marble or alabaster. It is enormously strong, highly resistant to heat, and impervious to water. Literally any type of natural 'veining' can be simulated in any colour and a wide range of pigments is available for this purpose.

**MAKE YOUR OWN
FLEXIBLE MOULDS**

with 'Elastomould' Synthetic Rubber Solution. By means of this simple technique, you can easily prepare permanent elastic moulds for repetition casting, plaques, bookends, etc., in quantities of thousands.

'Elastomould' will faithfully reproduce even the most minute details of ornamentation and surface texture.

It is incredibly simple to use and moulds can be prepared from any type of pattern including Wood, Metal, Plaster, Stone, Glass, Ivory, etc.

Such moulds are ideally suitable for casting in plaster, Cement and Karlenite.

Start your Own Business. Send 1s. for full details of this easy, fascinating and profitable hobby.

MONEY REFUNDED TO BONA FIDE ENQUIRERS

Dept. H.3, Karlena Art Stone Company, Ltd.,
55 Deansgate Arcade, Deansgate, Manchester, 3.

For wood,
card,
plastic,
leather
metal etc.

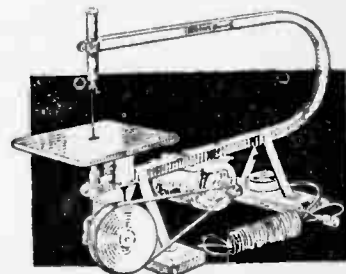

**TREADLE
OR MOTOR
FRETSAWS**

Whatever the handyman or craftsman is cutting or making, one of Hobbies Fretmachines will help with the job. For toy making, fretwork, model making, it provides easy and speedy cutting in all kinds of material. A pleasure to use, a factory for output, a lifetime of service. FROM

80/- to £11 - 2 - 6

Ask to try one at any Hobbies Branch or good class ironmonger or hardware stores. Or free illustrated leaflets on request to:

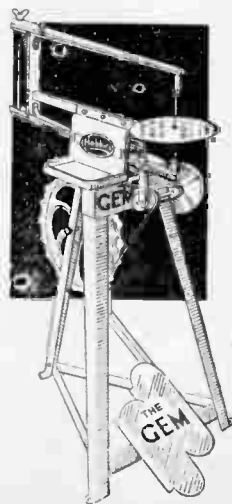

HOBBIES LIMITED, DEREHAM, NORFOLK



'Bunts' talks fast . . .

"We call him 'Bunts' because flags are made of bunting, see! And when the skipper wants signals hoisted to talk to another ship the flags fly fast—or the fur flies! Not that Bunts has to worry—he and his lads are a smart team. And you'd go a long way to find a cheerier bunch, too. I was lucky enough to be selected for Signalmen myself during my Seaman Boy training . . ."

BOYS AGED 15-16 years 3 months can enter the Seaman Branch of the Royal Navy. Higher pay—better prospects than ever. The Royal Navy needs the right Boys now.

Make the ROYAL NAVY your career

WRITE TODAY for details to:—D.N.R., Dept. V/37, Admiralty, London, S.W.1. (Applications from U.K. only.)

Name

Address

Age

Announcing

'LINESIDE' KITS

for 'OO' Gauge

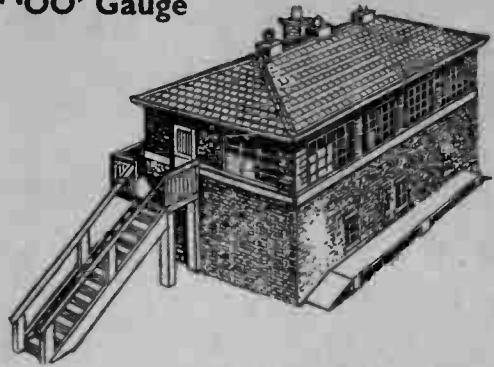

These kits contain plans, brick and tile building papers, printed card and wood parts and printed celluloid windows. Really authentic and detailed true-to-scale designs. The first off are:—

LARGE SIGNAL CABIN 3/8 COUNTRY STATION 5/6
WATER TOWERS 2/9 PLATFORMS 2/9
(2 types in 1 kit)

Postage: Single kit 6d.; 2 or more 10d.

★ The full Modelcraft List for 1951 gives details of over 600 plans, planbooks, kits and accessories for every branch of modelmaking. It costs 1/- post free and includes a 1/- refund voucher for use in buying Modelcraft goods.

MODEL-CRAFT LTD.

77 (F) GROSVENOR ROAD, LONDON, S.W.1.

One plastic material
MAKES MANY PERMANENT



MODELS

and utility objects, from simple instructions in illustrated Booklet—please read below.



ONLY 4^D
IN STAMPS
BRINGS BOOK



. . . showing how such models as those above, and many others, can be made, without skill or special tools, from Sankey's PYRUMA Plastic Cement. Ready for immediate use in its plastic state, Pyruma sets or bakes to stone-hardness, and can be painted or enamelled in all colours according to instructions.

Pyruma is inexpensive, and easily obtainable in tins from Ironmongers, Art Material Dealers and Hobbies Shops. Send 4d. in stamps for illustrated Instruction Book.



J. H. SANKEY & SON, L^D

ILFORD

Est. 1857

ESSEX

FOR AMATEUR PHOTOGRAPHERS

Unitol

CONCENTRATED LIQUID
FINE GRAIN DEVELOPER

After long research Johnsons are now able to present a ready-to-use, concentrated liquid fine grain developer. One ounce of Unitol, suitably diluted, is used once to develop one film and the solution is poured away. No trouble, no waste. Gives wonderful negatives. A simple calculator is also sold, giving developing times for all dilutions from 6 to 25. Unitol is ideal for the tank development of roll films.

225cc. (8-oz.) ... 3/6

570cc. (20-oz.) ... 6/6

Unitol Calculator ... 4d.

JOHNSONS OF HENDON

LONDON, N.W.4

EST. 1743



UNIVERSAL ADJUSTABLE TANK

For daylight development of roll films. Fitted with the new Roto-feed easy-loading feature and two-way agitation movement. Takes Nos. 16, 20 and 27 roll films, 36-exposure lengths of 35mm. film and 5ft. of 16mm. film.

PRICE 3/2/6

Hobbies

WEEKLY

CONTENTS

	Page
Automatic Cigarette Box	81
Portable Food Safe	- - 83
Bedside Cabinet	- - 84
Winding Tuning Coils	- 85
Simple Cutlery Box	- 86
Editor's Notebook	- - 87
Improving your Larder	88
Simple Electrical Work	89
Shipmodeller's Corner	90
Keeping a Nature Diary	91
French Colonials	- - 92
Patterns for Cigarette Box	95

May 23rd, 1951

Price Fourpence

Vol. 112 No. 2899

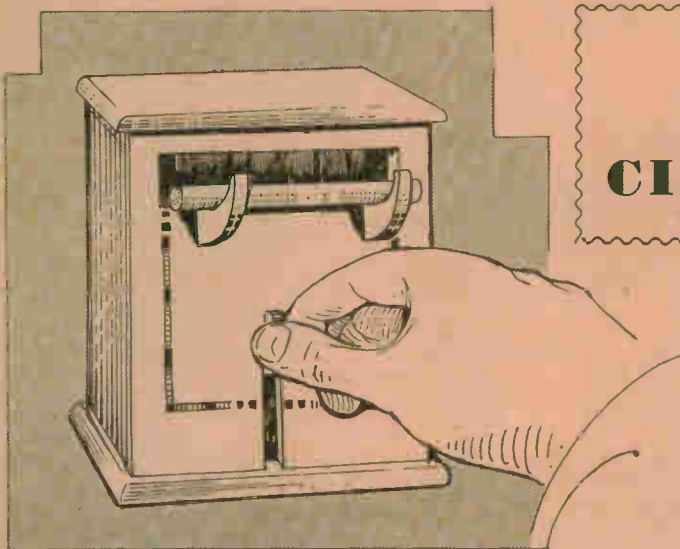

Fig. 1—The box in action

THE novelty cigarette box shown in operation at Fig. 1 is made up entirely of $\frac{3}{8}$ in. fretwood. It would look well in oak or mahogany, but any hard wood would be suitable.

The size of the box overall is height 5 ins., width 4 ins. and depth (front to back) about 3 ins.

Simple Device

It has a simple automatic device, whereby raising the projecting handle near the base of the box ejects a cigarette through the slot at the top. The cigarette comes to rest in the shaped arms each side, as seen in Fig. 1.

The sectional diagram (Fig. 2) gives a clear idea of the various parts of the box, and the simple mechanism at the front. The box is made up, and just behind the front (I) is arranged a compartment in which the sliding front (K) is held. At the bottom of this is a handle (M) for raising and lowering.

Behind this sliding front there is a sloping floor (H) on which rest the

cigarettes. These fall forward and down the sloping floor through an opening in the rear partition (G), until one cigarette rests upon the top of the moving front (K).

Directly the moving front is raised, the cigarette on top is carried up, the remainder being left in the compartment behind (G).

The action is again further demonstrated in the sectional diagrams Figs. 3 and 4, the former diagram shows the interior construction with sliding front (K) down, while in Fig. 4, the sliding front is in its raised position.

Construction

So much for the working of the novelty. We will continue now with a few hints on its construction and build-up. A simple box is first constructed, consisting of the floor (A), the top (B), two sides (C) and the back (J). We have included at the end of this article a full cutting list of parts with all the sizes given ready for the worker to set out the various sections of the work.

A Novelty AUTOMATIC CIGARETTE BOX

All the cutting may be done with the fretsaw, and, if a handframe is used, care should be taken to hold it vertical. Cut and glue up the parts of the box.

On the one-page pattern sheet included in this issue we have shown some of the parts which need particular cutting and shaping. Included here is the back (J) and the front (I) of the box. Both these pieces are identical in outline, the back (J) being quite plain, while the front has two slotted openings cut in it. The upper horizontal slot will have its lower edge chamfered as shown in the hatched section on the pattern sheet.

On this diagram is indicated by dotted lines where the shaped arms (L) are glued on. It also gives the position of the sides (C), which will glue between the front and back of the box. The front of the box will not be put on until the interior pieces are fitted and fixed.

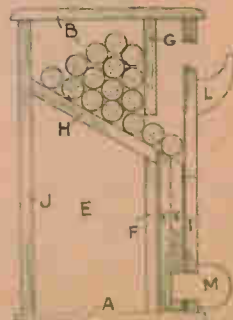

Fig. 2 Section showing how the box works

All correspondence should be addressed to The Editor, Hobbies Weekly, Dereham, Norfolk.

The two interior sides (D) are next cut, and glued inside the sides as seen in Fig. 5. The piece (E) will then be glued to the face of these pieces, thus forming the supports for the sloping floor (H).

The next piece to cut will be piece (F) (see cutting list and Fig. 2). The top edge of this piece must be carefully chamfered to the same slope as the

The sloping floor (H) is next made and the outline of this is given on the pattern sheet. The two long edges of the piece are chamfered, as shown in the section, to fit between the back (J) and the front of piece (F).

All the parts of the box are now assembled, with the exception, of course, of the front (I). Then proceed

and check the working of the sliding front to see that it runs easily and smoothly up and down.

It only remains to screw or glue the front to the ends and put the handle in place. The four edges of the box top (B) should be rounded and glasspapered smooth. The box will be filled with the cigarettes by dropping them through the slot in the front, then tilting the box so that they roll back into the rear compartment behind the inside partition (G). During this operation the sliding front must, of course, be in its down position to allow clearance for the cigarettes to fall back.

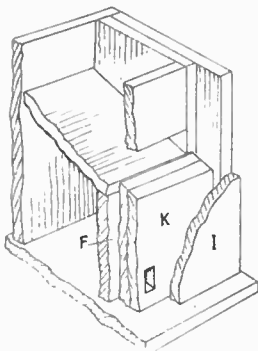

Fig. 3

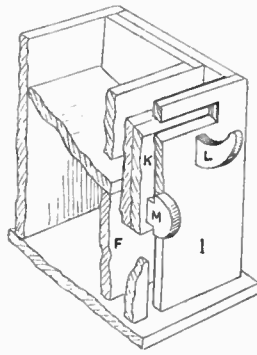

Fig. 4

Sectional drawings to help the constructor

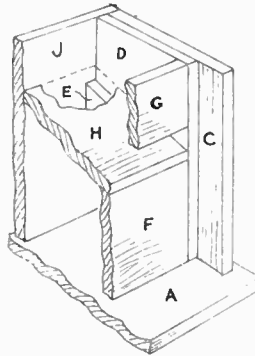

Fig. 5

supports (E). Now above (F) and in direct line with it is the upper front (G), its actual place being shown in Fig. 5, etc. It is simply a rectangular piece glued between the two inner sides (D).

with the moving inner front (K) which consists of two pieces glued together to the sizes given on the pattern sheet. First cut the two pieces to the full size shown, then glue them together face to face, afterwards chamfering one long edge to the section shown. Note that the mortise (M) must be cut in the one piece only—the front piece (see section, Fig. 2).

When this is done, cut and temporarily insert the tenon of the handle (M). Next, place the main front on the ends,

Finishing

The woodwork should be smoothed with fine glasspaper and finished to suit the variety of wood used. If oak, then it should be lightly stained and either polished or rubbed with linseed oil. If mahogany, then it may be varnished or french polished. A little applied decoration could be added to the front as desired. (270)

**Full size patterns
on page 95**

CUTTING LIST

	A	4½ ins. by 3 ins.
	B	4½ ins. by 3 ins.
Two	C	4½ ins. by 2½ ins.
Two	D	4½ ins. by 1½ ins.
Two	E	3½ ins. by 1½ ins.
	F	3½ ins. by 2½ ins.
	G	3½ ins. by 1½ ins.
	H	3½ ins. by 2½ ins.
	I	4½ ins. by 3½ ins.
	J	4½ ins. by 3½ ins.
Two	K	3½ ins. by 2½ ins.
Two	L	1 in. by ½ in.
	M	1 in. by ½ in.

Portable Food Safe—(Continued from page 83)

halved joints are definitely the easiest, as explained below and seen at Fig. 3.

The back of the safe consists of a frame 13½ ins. by 11 ins. (external measurements); the two side frames 12 ins. by 11 ins.; the bottom 12½ ins. by 12 ins., and the top 13½ ins. by 11 ins. The top is made 1 in. shorter than the bottom to allow space for the sliding door. This door is cut from 1 in. by ½ in. wood, and consists of a frame measuring 11½ ins. by 12 ins., but with the top piece made 1 in. longer at each side, to finish flush with the sides of the safe.

By fixing another strip of the 1 in. by ½ in. wood over this top piece (Fig. 3) a grip for the hand is provided, and the front of the door made up flush with the remainder of the front. To hold the door in position, four lengths of ½ in. by ½ in., or similar, are cut and fixed to the front edges of the side frames, as seen at Fig. 2.

The Collapsible Jointing

Use dowelling of ⅜ths or ½ in. diameter, and a bit to correspond. When boring the holes in the 1 in. by 1 in. wood, take care not to go more than half way through. Cut off the dowelling to pieces of just under 1 in., and glue them into one of each pair of holes. Then, when the glue is dry, they can be rubbed shorter with glasspaper, if necessary, to ensure that the flat surfaces of the

1 in. by 1 in. stuff fit up flush. Space the dowel joints carefully, to give maximum strength to the frames, and mark the sides so that the pieces are always assembled in the same position.

The Legs

The frame which forms the base is bored on the underneath side for the

CUTTING LIST		
No. of Pieces	Description	Size
2	Back	13½" x 11" x 1"
2	Back	11" x 11" x 1"
4	Sides	12" x 11" x 1"
4	Sides	11" x 11" x 1"
2	Bottom	13½" x 11" x 1"
2	Bottom	12½" x 11" x 1"
2	Top	13½" x 11" x 1"
2	Top	11" x 11" x 1"
2	Door (Top)	13½" x 11" x ½"
1	Door (Bottom)	11" x 11" x ½"
2	Door (Sides)	12" x 11" x ½"
4	Rebates	11" x 11" x ½"
4	Legs	12" x 11" x 1"

four legs, but these holes are set in a little from the edges to avoid the frame joints. Taper the bottom edges of the legs to a blunt point, so that when the safe is in use they can be pushed into the ground a little, to give it rigidity. Dowelling can be used for the collapsible leg joints, too, or alternatively, ½ in. can be marked off from the top edge of each, and this end carefully rounded to

the required diameter, to form the shoulder.

The Gauze

Cut five pieces of the perforated zinc; for the back, two sides and bottom, each piece 1 in. shorter in both directions than the frame it is to cover, and fix these down with neat staples. The piece for the door must be ½ in. shorter each side than the door frame, so that it is clear of the rebates. When covering the top frame with the sheet zinc, allow the zinc ½ in. longer on the back and two sides, so that it can be turned over the edges and fastened on the side surfaces of the frame, to give smooth edges along the top. It must, however, finish a little shorter than the front edge, to clear the sliding door. Take care that this edge is fastened down particularly well, and fix a strip of wood across the frame as shown, to support the sheet zinc in the middle.

Finishing Off

Finish off all collapsible joints thoroughly with glasspaper, so that they pull in and out smoothly; and if the whole of the woodwork is given a coat of clear varnish, this helps to protect the wood from damp when in use in the field. When packed up the various pieces can be held neatly together with a thin strap. (245)

Here are some hints on IMPROVING YOUR LARDER

THERE are many improvements you can make in your larder before the weather gets too warm. You usually have to get far more into it than it was originally built to hold, and this needs a little adjustment.

Give it a thorough clean out and a coat of whitewash to freshen it up. Then see that the window works properly and is giving proper ventilation.

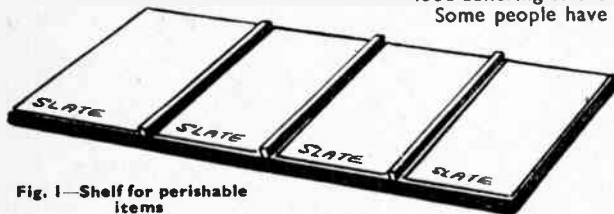

Fig. 1—Shelf for perishable items

A rod across the window, supported by small wire hooks, will be handy to hang various items of food and will keep them fresh.

Should you shift your larder in any replanning, remember that the North side of the house is the best, as it seldom gets the direct light of the sun. A small sunblind will also keep the larder temperature down. See that the window is covered on the inner frame with a square of perforated zinc, and if the window should face a direction in which it gets much heat, then arrange another zinc square at least 3 ins. removed from the first and this will also help to counteract the heat. Failing zinc, one can make a substitute with a piece of old lace curtain knocked up on a light wooden frame to fit in the window.

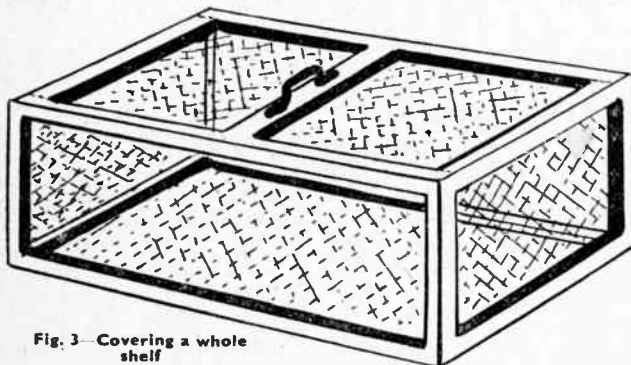

Fig. 3—Covering a whole shelf

On very hot days, soak this in cold water and replace it.

Tiles are the best material on which to keep perishable goods, but you may be able to obtain one of those large stone slabs used on the old-fashioned type of wash-stand. They are often found derelict outside a secondhand shop.

Have a spare shelf on which to keep a collection of spare enamel bowls, as these are handy to store left-over food which can be used for the next meal.

Have some covers made in muslin with beads on the corners.

If you have a deep shelf on which you keep perishable items, you may be able to line this with some old roofing slates of the grey type. Make small slat divisions as shown in sketch No. 1, and these can be taken out and thoroughly washed or discarded at any time should you wish. With this arrangement, there will be no chance of old oddments of food adhering to the shelves.

Some people have to store vegetables in the larder, and the handyman can knock up quite a useful sort of box for these with a cheese drum obtainable from the grocers.

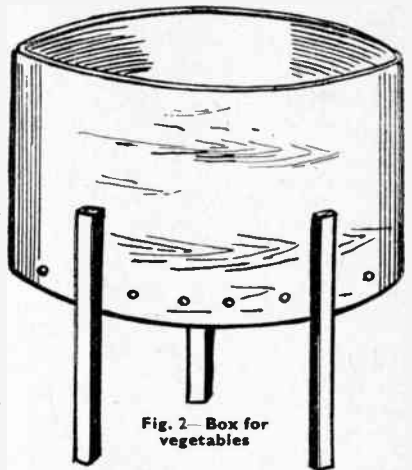

Fig. 2—Box for vegetables

Make some holes in the base, and fit three short square legs [as shown in sketch No. 2. This will store the vegetables and keep them well aired.

If you are overstocked with fats, then remember that an inverted flower-pot well soaked in cold water will retain the moisture for quite a time and keep the contents fresh.

In cleaning out a larder, it is unwise to use a disinfectant as this is bound to affect the foodstuffs when the larder is closed up.

If you have the space, it is a good plan to cover in the whole of one shelf as shown in sketch No. 3. By this means you can store quite an amount of foodstuffs, which can be taken out by opening up the lid at the front. It can be covered with close wire mesh or wire gauze.

top jar or bottle.

Always remember that milk, eggs and butter are inclined to absorb strong smells. So keep them away from herrings, apples and onions.

For a large family you often require a large covered section of your larder. In sketch No. 4 is shown a system by which a fully enclosed larder can be built within the existing larder. It is capable of taking a vast amount of foodstuffs and at the same time it gets the full advantage of the air currents. If the window is suitably placed, the interior larder can be built in position and holes drilled through the partitions so that the air circulates freely. A lift-up frame door can then be added to keep it clean.

(254)

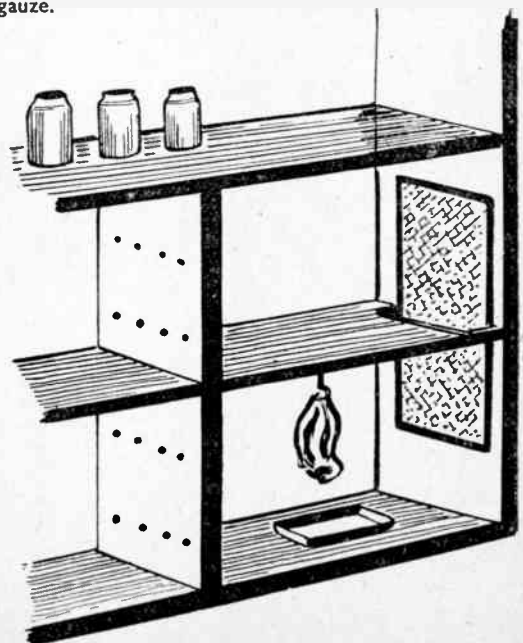
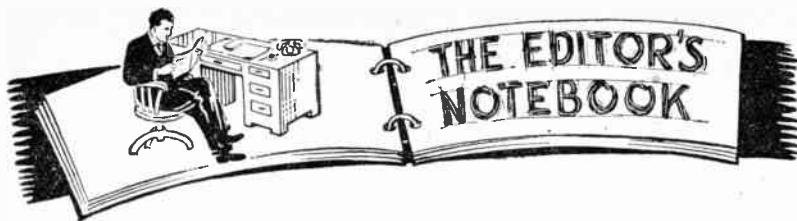

Fig. 4—Larder within a larder

Do not keep things wrapped in paper. Paper conducts heat, and will affect the foodstuffs in a very short time. Brown paper is the worst offender of all. Keep the bread fresh in the bin by lining the base with greaseproof paper. Sauce will keep better in hot weather if slightly warmed and then run into a screw-



A Larger St. Paul's

THE picture reproduced on this page, was sent to us recently by Mr. B. Morris, of Moss Side, Manchester, and shows a model of St. Paul's made by he and his son.

It was made from Hobbies design No. 240 Special—but with a difference. All the parts were redrawn, as all the measurements of Mr. Morris' model are double those of our design. Which makes the model approximately 34ins. long by 20ins. high.

The windows and segments of the dome, Mr. Morris tells us, were cut from thin Perspex and pieces No. 54 and 56 of the design from duralumin. The finished model is lit inside by three chandeliers of coloured lights, which, says Mr. Morris, give a wonderful effect.

* * *

Letter from the East

ANOTHER keen model maker is one of our overseas readers, Mr. Goh Peng Koon, of Singapore. He wrote us recently enclosing a photograph of himself and his post-war A1 machine: 'to prove', as he put it, 'that I am still proud of my work'.

Mr. Koon has known hard times, times which might have deterred many a modeller. Before the war he completed a lot of models, including that of Big Ben, the Coronation Coach, several old-time galleons, and many odd items such as dolls' houses and photograph frames. Unfortunately, most of this

work, and his pre-war A1 machine, were lost during the Japanese occupation.

'But', says Mr. Koon, concluding his letter, 'I am still happy that I manage to discover some of my best designs, such as Big Ben and the Coronation Coach, again'.

So are we, Mr. Koon, and we hope that such a situation will never again arise.

* * *

For Aeromodellers

THE 1951 Festival coincides with an exciting time for aeromodellers, for it sees a great expansion in British aeromodelling

activities. There are more than 50 major perpetual trophies to be contested during the Society of Model Aeronautical Engineers' calendar of events, compared with less than 30 last year.

The Contest Programme covers the whole of Great Britain, so that everyone will have an opportunity to see or take part in model flying at its best. It is in London, however, that the maximum interest will be centred; for it is here, at world-renowned Wembley Stadium, that the Festival of Britain National Model Flying Championships will be staged, the events to include speed trials, aerobatics or 'stunt' contests and team races. The great size of the Empire Stadium will permit up to six events to be carried on simultaneously, whilst the banked terraces will enable each of the audience to enjoy an unobstructed view of the contest arena.

By the time these notes appear in print, the first meeting on the 1951 calendar—the International meeting at Langley, Berks.—will be over, and three trophies will have been secured by enthusiasts, but there is still much to come. The next meeting is at the R.A.F. College, Cranwell, Lincs., on June 10th.

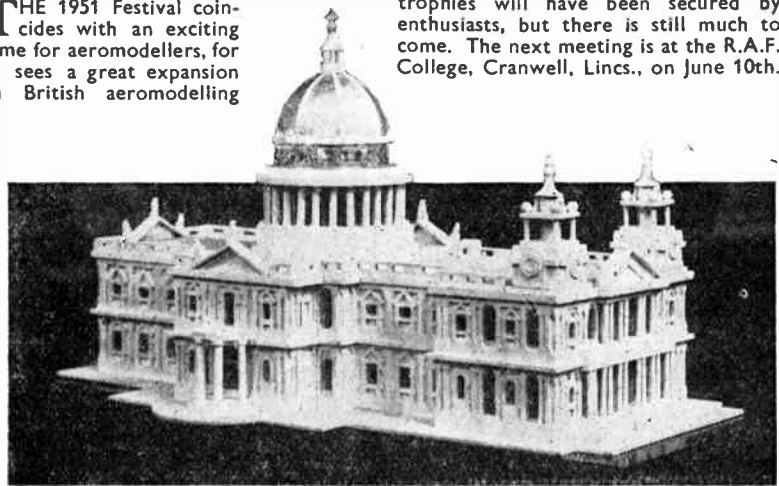

Mr. Morris' model of St. Paul's

Winding Tuning Coils—(Continued from page 85)

plates of reaction condenser, earth, and remaining wavechange switch contact.

Short Wave Coils

As excellent results can be obtained with even a simple one or two valve short wave set, details for winding S.W. coils should prove useful. Conditions here are rather different and the type of coil shown in Fig. 4 is generally suitable.

The aerial coupling winding should be of 26 to 32 S.W.G. insulated wire, turns side by side. The grid (tuned) winding is of 18 or 20 S.W.G. wire, each turn being spaced from its neighbour by approximately the diameter of the wire. Bare, tinned-copper wire is most convenient, here. The reaction winding is again of 26 to 32 S.W.G. insulated wire, turns side by side. A $\frac{1}{4}$ in. space is left between each winding.

Connections are as follows:—(A) to aerial. (B) to earth. (C) to fixed plates of tuning condenser. (D) to moving plates of tuning condenser. (E) to fixed plates

of reaction condenser. (F) to detector anode.

For a single coil a waverange of about 19 to 45 metres is most generally suitable. For this, use 3 turns for aerial coupling, 6 for grid winding, and 5 for reaction, on a 2in. diameter former. If the former is about $1\frac{1}{2}$ to $1\frac{3}{4}$ ins. in diameter, use 5, 8 and 7 turns respectively.

Assuming a former of about $1\frac{1}{4}$ ins. in diameter, 10 to 25 metres can be tuned by using 2, 5 and 4 turns respectively. The higher bands can be tuned by using 10, 22 and 15 turns, with 22 or 24 S.W.G. wire for the grid section. If larger tubes are used, it will be necessary to reduce the number of turns slightly; with tubes of smaller diameter, employ slightly more turns. However, the number of turns is not critical as there is usually no necessity that a certain waveband be tuned exactly. When the coil is in use it will soon be seen what wavelengths are being covered.

Modifying the Waveranges

If it is desired to tune any exact waverange, to suit a particular tuning dial, or for any other reason, this need not prove difficult. The more turns on the grid (tuned) section of a coil, the higher are the wavelengths to which it will tune. The wavelengths tuned can, therefore, be reduced by stripping off some turns.

The number of turns on the reaction winding should not be allowed to become too large, in proportion to the grid winding, or reaction will be fierce. On the other hand, too few turns will result in weak reaction.

With the aerial coupling winding, reducing the number of turns, or moving the winding away from the grid winding, will increase selectivity, but decrease volume. The spacing and number of turns suggested provide a useful compromise, and should not be changed to any great extent. (267)

Any amateur woodworker can make a SIMPLE CUTLERY BOX

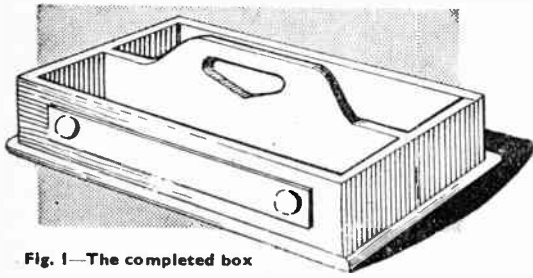

Fig. 1—The completed box

WE show at Fig. 1 a useful type of cutlery box or tray, and the diagrams and instructions given here should help the worker to make a sound and satisfactory job.

The measurements of the box on the outside, and not including the base, are 13ins. long by 8 $\frac{1}{2}$ ins. wide. There are two compartments each measuring 12 $\frac{1}{2}$ ins. by 3 $\frac{1}{2}$ ins. wide, and the full depth of 2 $\frac{1}{2}$ ins. is given for the cutlery.

These measurements will be found ample to take ordinary dinner knives which are generally 9 $\frac{1}{2}$ ins. long. Smaller knives will, of course, fill the other compartment, with forks, etc., included as necessary.

A Good Plan

It would be quite a good plan to have two distinct boxes, one to the dimensions shown here, and one on rather smaller lines, with, say, an 8ins. long centre partition for taking forks and spoons.

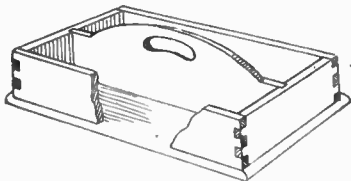

Fig. 3 Methods of jointing

Wood such as oak or mahogany should be used if possible, but a softer wood would answer quite well, and stuff $\frac{3}{8}$ in. thick should be used throughout.

It will be seen from the diagram Fig. 2 how simple is the construction of the box, but the parts will, nevertheless, need to be marked out with a certain amount of care to get the ends perfectly square. The cutting, too, should be carefully done.

The two long sides measure 13ins. long by 2 $\frac{1}{2}$ ins. wide, and the ends 8ins. long by 2 $\frac{1}{2}$ ins. If the sides and ends are to be lock-jointed together at the corners as in Fig. 3, then the ends must be $\frac{1}{2}$ in. longer, that is, 8 $\frac{1}{2}$ ins. long. This lock-joint makes a good strong joint and is much to be preferred to the plain butt joint shown in Fig. 2.

The method of setting out the joint is

shown in Fig. 4, and it must be remembered, when cutting with the fretsaw or the small-tooth tenon saw, to keep just to the outside of the drawn line so that a tight fit is assured when the parts are fitted and glued together.

When the lock-joints are finished and the box tested for squareness with a try square or set square, it should rest for a time until the glue has thoroughly hardened.

Some workers will decide, no doubt, to just drop the central partition in place between the ends of the box and nail or screw it, but the better and stronger method would be to house the

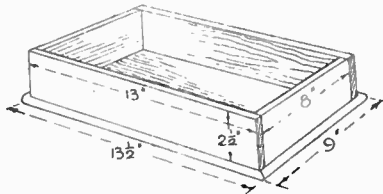

Fig. 2—The main dimensions

ends of the partition into the ends of the box as seen in Fig. 3. If you decide to do the housings, then they should be cut before the box is glued up.

Making the Housings

In making the housings, first mark in

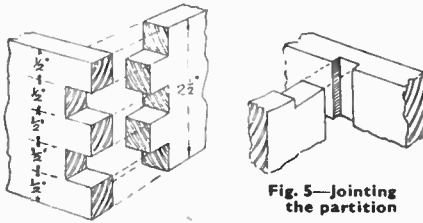

Fig. 4—Setting out the corner joints

pencil the centre line of each box end, and, on each side of this, set out $\frac{1}{8}$ in. which will make the finished recess $\frac{1}{4}$ in. wide to receive the partition. Cut down each side with the fine-tooth tenon saw to $\frac{1}{8}$ in. deep, keeping to the inside of the drawn line. Then the wood between these cuts can be cleaned out with a $\frac{1}{8}$ in. chisel.

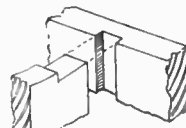

Fig. 5—Joining the partition

Now, mark out and cut the floor, the measurements being shown in Fig. 2. Clean off the cut edges and round them off slightly with rasp and file and smooth off with coarse and fine glasspaper. Lay the frame of the box on the floor, taking care to get equal width of margin all round. Lightly scribe or pencil a short line on each side to ensure the position, and then apply glue sparingly to the lower edges of the frame and press it home to the floor piece, keeping in mind the marks mentioned.

Two screws run up from the underside of the floor into each side and end will make a firm fixing.

Mark on the floor inside the box the position of the centre partition. This can be done by running a pencil line from the centre of each housing in the ends. Then bore three holes from the inside which will give the exact position for the screws after the partition has been glued to the floor and into the housings. The partition measures 12 $\frac{1}{2}$ ins. long, this length allowing for the $\frac{1}{8}$ in. deep recesses each end.

In Fig. 6 we give two outlines suitable for the shaping of the top edge. All that needs to be done is to choose one of the outlines, divide the wood into a number of 1in. squares and draw in the outline and the shape of the cut-out handle. Note that half only of each design is given, and it will be necessary to trace this off on to thin paper and transfer it over on to the wood on the second half of the centre line.

A coarse fretsaw can be used for the cutting, and when this is done, glasspaper the top edges and the hand-hole. Check the length between the housings before actually cutting the ends of the

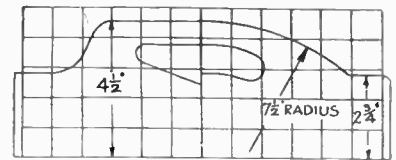

Fig. 6—Alternative designs for the handle

partition, so that a reasonable fit may result when the latter is glued up. When the glue has hardened, put in the screws. These must have countersunk heads, of course.

If it is thought that a little decoration would add to the attractiveness of the box, then a plain panel of, say, $\frac{1}{8}$ in. wood could be cut, and glued on as shown in Fig. 1. On this, two discs of similar thickness wood might be added at the ends of the panel.

The whole box should be varnished over, and two pieces of green baize carefully cut and fitted in to the floor with another, and, of course, larger piece, perhaps, glued underneath the floor.

(269)

KNIFE CLEANER

Owners of stained or rusty pocket knives or sheath knives should find a patch of firm soil and stab the knife into it up to the hilt. Rub it up and down several times and the stains and rust will disappear.

All you need to know about WINDING TUNING COILS

It is apparent that many radio constructors like to wind their own tuning coils because they are much cheaper than ready-made ones and for the added interest of undertaking this work. With a reel or so of wire, and a few insulated formers, quite a number of coils can be made at very low cost, and they are just as efficient as ready-made coils.

It is, therefore, proposed to set out full details for winding the most useful

Wind the turns on evenly, closely side by side, and finish off in the same way. By using extra nuts convenient terminal connections will be provided for wiring up.

The coil can be mounted by small brackets, or by cutting a disc or strip of wood which is a push fit inside the former. One bolt or terminal will be connected to the fixed plates terminal of the tuning condenser; the second, to the moving plates terminal of the condenser.

both long and medium waves, therefore, and this is particularly useful in valve sets.

The aerial condenser or tapping, or both, may be omitted, and good results obtained. The aerial will then be taken directly to the fixed plates terminal of the tuning condenser. However, in some areas interference may be troublesome and it will then be desirable to make a tapping on the coil, or use an aerial condenser, as described.

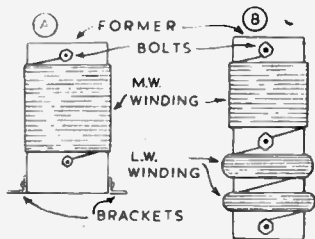

Fig. 1—Coils for crystal sets

type of coils, and the constructor should be able to undertake any of them without difficulty.

For Crystal Sets

The simplest type of crystal set coil is shown at (A) in Fig. 1, and consists of a single winding of insulated wire on a tube. Ready-made bakelite or paxolin tubes can be bought, or a tube can be made by wrapping glued brown paper or card round a suitable object, slipping off, and allowing to dry. Some household commodities will also be found to be in cardboard containers, and these can be used. With a card or paper tube insulation will be improved if the former is varnished before use.

The insulated wire may be enamelled, or silk or cotton covered.

Enamelled wire is cheapest and quite satisfactory. 32 S.W.G. enamelled wire can be used for both long and medium wave coils. If medium wave coils only are to be wound, rather thicker wire, such as 28 S.W.G. can be used, but this takes up rather too much space for long wave purposes (where many more turns are required).

The medium wave coil shown at (A) will require 80 turns of 32 S.W.G. wire, if the former is about 1½ ins. in diameter. If the former is larger, less turns will be needed, about 65 being suitable on a 1¾ in. former and 58 on a 1¾ in. former. A 2 in. diameter tube would need only about 48 turns.

To begin winding, scrape the end of the wire to remove the insulation and secure it with a small nut and bolt.

A Dual Range Coil

In many parts of the country the addition of long waves is worthwhile, and the coil shown at (B) will tune both medium and long waves. The medium wave section is put on exactly as already described.

The long wave winding consists of two piles, with 100 turns in each. The piles should be compact and tight, with about ¼ in. space between them. For the larger coil-formers, use only about 80 turns in each pile. The tube will need to be fairly long (2½ ins. minimum) and all turns must be in the same direction, as shown. To prevent the turns coming loose with handling it is a good plan to bind a layer of the well-known transparent adhesive tape round the windings.

Crystal Set Connections

Fig. 2 shows how the coil described

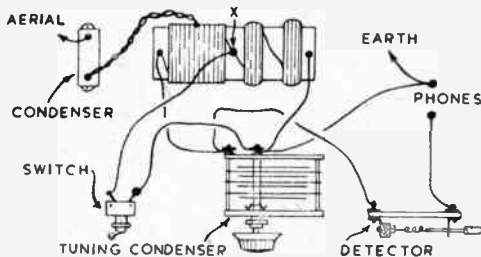

Fig. 2—A complete crystal set wiring plan

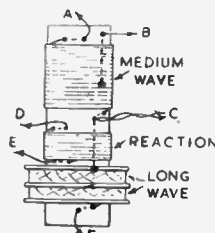

Fig. 3—A dual-wave coil with reaction winding

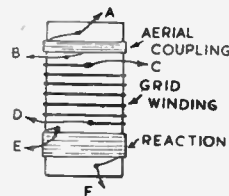

Fig. 4—An efficient form of short wave coil

can be wired into a crystal set, and how the wavechange switch is connected. The tuning condenser should be of the usual .0005 mfd. capacity, and any type of crystal detector can be used.

In this diagram the aerial is shown taken to a condenser, which goes to a tapping on the medium wave section of the coil. This increases selectivity (sharpness of tuning). For normal purposes the condenser may be about .0003 mfd. and the tapping be at about the centre of the M.W. section. The smaller the capacity of the condenser, the sharper will tuning become, especially on long waves. The nearer (X) the tapping is, the sharper will tuning on medium waves be (this will not influence L.W. results appreciably). By a suitable choice of condenser and tapping-point, the desired results may be obtained on

the top of the reaction winding and bottom of the M.W. winding.

Note that the beginning of the L.W. section is now taken inside the tube, and brought out with the bottom of the M.W. winding, at point (C), in order that this connection shall not interfere with the reaction section. The aerial tapping is about 2/3rds down the M.W. section, and the number of turns on the reaction winding is 2/3rds those on the M.W. winding.

Connections are:—(A) to fixed plates of tuning condenser. (B) to aerial or aerial condenser. (C) to one contact of wavechange switch. (D) to fixed plates of reaction condenser. (E) to detector anode. (F) to moving plates of tuning condenser, which also goes to moving

(Continued foot of page 87)

Made from a tea chest is this BEDSIDE CABINET

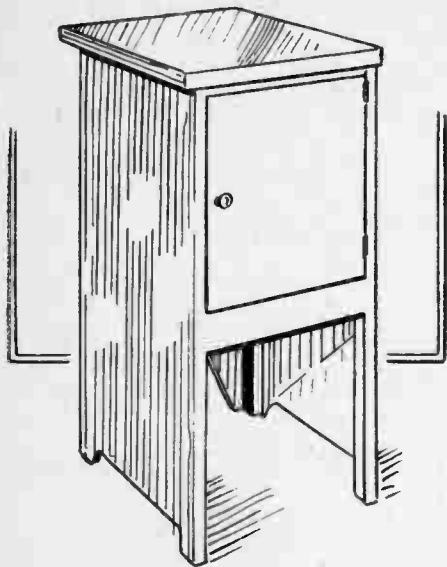

MANY useful articles can be made up from the plywood to be obtained from a tea chest, usually to be bought for a few shillings from the grocer. The quality of the wood is, it must be admitted, rather inferior, but a coating of paint or enamel works wonders in hiding defects. A useful bedside cabinet (illustrated) can easily be built with the wood, plus a few strips of deal, some of the latter being also obtained from the tea chest as well.

Cut out the corner fastenings, as close as possible, and several sheets of plywood are to hand. A front and side section of the cabinet are given in Fig. 1, with useful dimensions, though these can be amended to suit the sizes of panels you have to work with.

Saw out the sides of the cabinet, and shape up the bottom, choosing the best

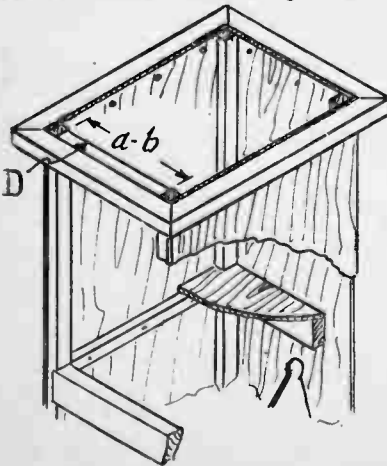

Fig. 2—Details of construction

panels for the purpose. At each edge, nail and glue strips of $\frac{3}{8}$ in. square deal, as at (A). Where shown, saw out grooves, $\frac{1}{8}$ in. deep and 2 ins. long, for the cross rails (B) at back and front. As it is desirable that the back of the cabinet should be level with the back edges of the sides, both the rear strips (A) should be glued in, not right up to the edges like the front strips, but about $\frac{1}{8}$ in. from the edge.

Now nail and glue strips of $\frac{3}{8}$ in. square wood across between the vertical strips, as shown at (C), the top edges of these being level with the top of the grooves cut for cross strips (B), as the plywood floor of the cabinet is fitted to these strips all round.

The Top

For the top, make up a frame of $\frac{1}{2}$ in. square wood, as can be seen in the detail of construction, Fig. 2. This should be mitred at

the corners, picture frame fashion, and needs to be truly square. Accurately cut mitres will ensure this. Strengthen the glued corner joints with nails, driven in askew, to hold the joint securely. Cut the crossbars (B) from $\frac{3}{8}$ in. by 2 in. wood, their exact length being carefully measured. First screw the sides to the inside edges of the top frame, the length of the crossbars will then be the measurement across the side strips (a-b), plus $\frac{1}{8}$ in. for the amount to enter the grooves.

Nail these bars across, using oval nails as the kind that can be more easily punched down afterwards. Now cut from the plywood a panel for the floor of the cabinet, its size being the distance between the plywood sides, and the full depth of the carcase, measured across crossbars (B). Cut out the corners to clear the side vertical strips, then nail it both to strips (B) and (C). The back of the cabinet, also of plywood, is cut to fit between the sides and long enough to reach from the top to bottom of the cabinet. It is nailed to the inner edge of the top frame, side strips and also to (B), as shown in Fig. 2, its lower part shaped up as at Fig. 1. Cut a strip of deal, say, $\frac{1}{2}$ in. thick, and long enough to reach across the side strips. It is 1 in. wide, and is glued and nailed to the inside edge of the top frame, at (D) in Fig. 2. It should project below this frame just $\frac{1}{8}$ in. as seen in the detail

CUTTING LIST

Strips (A) (4)—2ft. by $\frac{3}{8}$ in. by $\frac{3}{8}$ in.
 Strips (B) (2)— $\frac{3}{8}$ by 2 ins. by $\frac{3}{8}$ in.
 Strips (C) (2)—8 $\frac{7}{8}$ ins. by $\frac{3}{8}$ in. by $\frac{3}{8}$ in.
 Strips (D)— $\frac{1}{2}$ by 1 in. by $\frac{3}{8}$ in.
 Top frame (2)—1ft. 1 $\frac{1}{2}$ ins. by $\frac{1}{2}$ in. by $\frac{1}{2}$ in.
 Top frame (2)—11 ins. by $\frac{1}{2}$ in. by $\frac{1}{2}$ in.
 Door (2)—11 $\frac{1}{2}$ ins. by 1 in. by $\frac{3}{8}$ in.
 Door (2)— $\frac{1}{2}$ by 1 in. by $\frac{3}{8}$ in.
 Plywood panels from tea chest.
 * Measure carcase for actual length.

sketch. Now cut a panel of plywood, to the outside dimensions of the top frame. Level this frame all over, and nail and glue the plywood to it; it forms the actual top of the cabinet.

Go all over the work with a smoothing plane to leave the edges of plywood, and deal strips, quite smooth and level. Punch down nails, and fill up with plastic wood. No need to use large headed nails for fixing the plywood to the deal strips, except when fitting the crossbars (B). If panel pins or similar nails are employed, they will hold well, and make, with properly glued joints, a sound structure.

Good Surface Needed

A thorough rubbing all over with medium and then fine glasspaper will be necessary to make the surface good

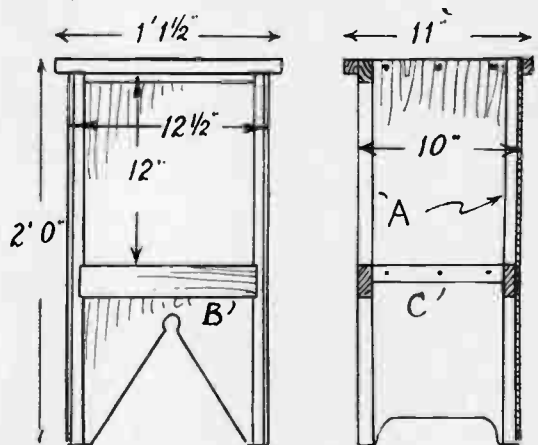

Fig. 1—Front and side views

enough for subsequent finishing. For the door of the cabinet, make a frame of

(Continued foot of page 89)

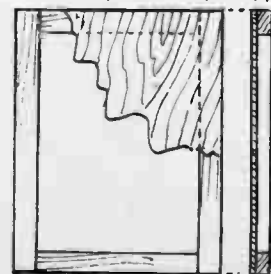
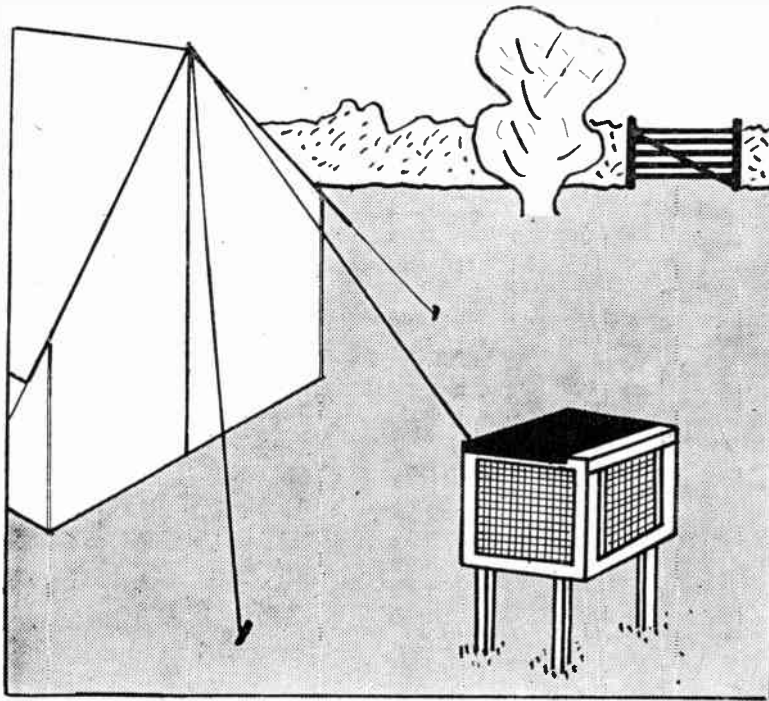

Fig. 4—The door frame

A 'must' for the camper is a PORTABLE FOOD SAFE



the same material. The collapsible joints holding the frames together are on the dowel principle, and the four short legs, of 1in. by 1in., also fit by dowelling. The door slides between rebates, which make it completely fly-proof.

The top can be covered with perforated zinc like the sides, but a piece of sheet zinc is to be preferred, since it then provides a useful little cutting table for the cook, as well as shade for the contents of the safe.

Perforated zinc can be obtained quite readily from any good ironmongers' or builders' merchant. It is usually sold from the roll, in a width of 3ft., at about 1/2 per square foot. Sheet zinc for the top can also be obtained from the same

HOT sunny days are the campers' delight, but they bring with them one difficulty—that of keeping foods such as butter and milk in good condition when away from home conveniences. Every old hand, of course, has his own favourite dodges, but the camper who is also a handyman can go one better by providing the party with a proper portable food safe.

The keyword of all campers' gadgets is, of course, utility. In addition to being efficient, they must be simple to operate and light in weight. And they must pack small. The portable safe shown here was therefore designed with all these objects in view.

Properly looked after it will give good service over many seasons, and its ingenious construction from wood and sheet zinc make it just the sort of thing where care and craftsmanship in its construction are amply repaid in the satisfaction derived from using it in the field.

As will be seen from the sketch, the construction consists of five simple frames of 1in. by 1in. wood, each covered with perforated zinc, and a sliding door of 1in. by 1/2in. stuff, also covered with

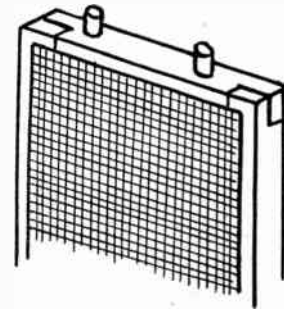
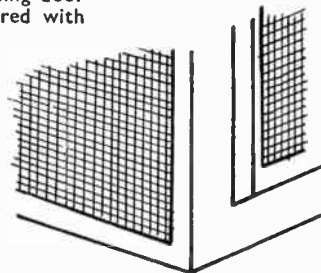

Fig. 1—The sides and top



source, at a similar price, but varying a little according to the gauge chosen. The actual minimum requirements are 5 sq. ft. of the perforated zinc and a piece 14 1/2 ins. by 12 ins. of sheeting for the top.

Construction

For making up the frames, either mortise and tenon, halved or mitred joints can be used, according to preference. The dimensions given in the cutting list allow for a lap-over, the width of the wood, on two of each set of four pieces. For the top joints of the frame which makes the door (which is a little different)

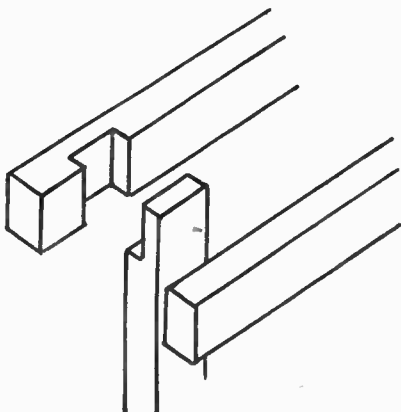

Fig. 2—Rebate for the door

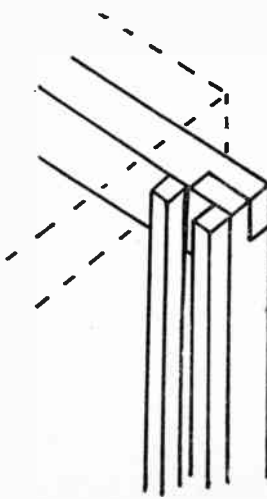

Fig. 3—The door top joints



Fig. 4—Details of the legs

Things the handyman should know about SIMPLE ELECTRICAL WORK

Cables & Connections

ELECTRICAL connections to domestic appliances are made with flexible cables which are described by the number of cores (or independent electrical conductors) which go to make them up, and the amount of current that they can carry with safety and the material which covers the cable and protects it from damage.

Cables can be described in the following manner:—

2 core, 5 amp., silk covered, or,
3 core, 10 amp., rubber covered
and so on.

The first of the cables referred to is that normally used for electric lighting pendants, while the second would be suitable for providing the connection to a small electric fire.

Which Cable?

The first consideration, then, in replacing a defective flexible cable is to discover the name of the particular cable which is needed for the job in hand, so that the correct cable can be obtained. The name is not always known and while an electrician would recognise the type and rating of a particular cable, an amateur may not readily do so.

A table is, therefore, included in this article which shows the kinds of cable used for the more usual type of repair and readers will, no doubt, recognise the particular cables with which they are familiar.

CABLES IN COMMON USE

Rating in amps.	Number of cores	Use	Covering
2	2	Table lamps, razors, electric bells	Silk or cotton covered—plastic
5	2	Lighting pendants, wireless set power connections (not A.C./D.C. sets), electric kettles.	Silk or cotton covered—plastic-metallic braid.
5	3	Fans, smoothing or soldering irons, electric fires (up to 750w.).	Silk or cotton covered—rubber covered.
10	3	Electric fires (1 kW—2 kW), large fans, small cookers.	Rubber covered.
15	3	Electric fires (3 kW), larger cookers.	Rubber covered.

Bedside Cabinet—(Continued from page 84)

fin. by 1in. wood to the size of the door opening. Quite a simple frame, with common halved corner joints will suffice, as in Fig. 3, though the more particular worker may prefer to use mortise and tenoned joints for the corners, as these do not show up when the door is opened. Try the frame for fit, and when satisfactory, cover its front surface with the plywood. Finish off with glasspaper, and hinge to the cabinet with a pair of 1½ins. brass butts. Fit a convenient cupboard fastener.

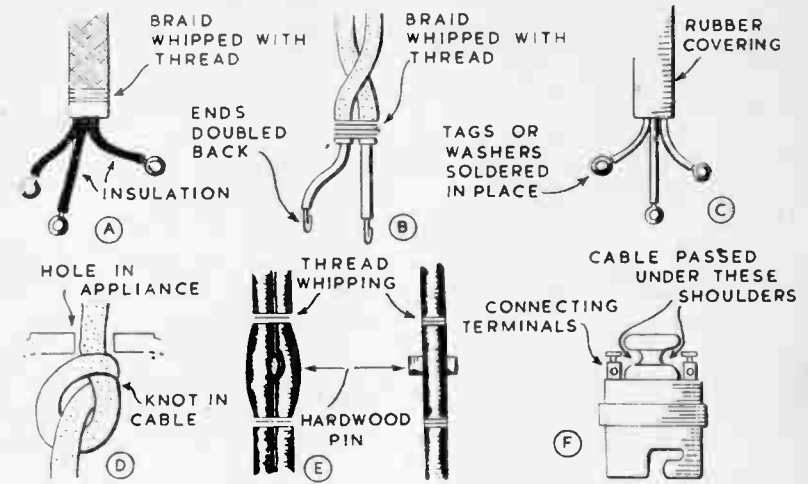

Connections

The accompanying sketch shows at (a) a typical three-core cable such as that used for connecting an electric fire to a supply point. The cable is covered with silk or cotton braid, which is cut back to a suitable degree—the braid end being whipped with thread to prevent unravelling. It will also be seen from the sketch that the insulation on each conductor is carried to a point as near as possible to the point of electrical connection. The connection itself may be either a metal tag or washer soldered to the end of the conductor. Soldering the

tag or washer to the conductor gives a greatly improved connection, which lasts exceptionally well and fully justifies the small amount of extra work involved.

The sketch (b) indicates the familiar two-core cable, such as that used for electric lighting pendants, while (c) shows a three-core rubber-covered cable which might be used for a vacuum cleaner connection.

Anchoring the Cable

Flexible connections must always be secured to the appliance, or fitting, in such a manner as to prevent mechanical stress or strain falling on the electrical connections.

There are several means by which cables are secured and the sketches (d), (e) and (f) show three of the more usual kinds. (d) is effected by making a knot in a cable which passes through an outlet hole in an appliance so that any mechanical strain falls on the knot instead of on the connections.

The sketch (e) shows an elaboration of the idea underlying (d), but in this case, a hardwood pin is used to take the strain. Yet another form of anchorage, usually found in bayonet type lamp-holders, is found in the sketch (f). (276)

(To be Continued)

IODINE STAINS

If you accidentally spill iodine over a table cloth, wallpaper or your clothes, buy some Hypo (as used in photography) from a chemist. Lightly rub over the stain with a cloth saturated in the hypo and the stain will soon disappear.

be necessary owing to the rather porous nature of the plywood. If stains and markings show, even after the glass-papering treatment, a finish of paint or enamel is, preferable, as likely to hide defects much better.

Perhaps the most suitable finish would be a priming coat, then undercoat, with a final one of enamel or enamel paint. Colour is, of course, a matter for personal choice, but white or chocolate brown, would suit as well as any if no matching effect is desired. (247)



The SHIPMODELLER'S Corner



IN commencing to add our running lines to our little model we must consider not only our small scale, but, the fact that our sails are of parchment. With parchment sails we must keep our rigging to those lines that are practical with the material we are using.

When we come in a later series to our larger models, those of us who desire to rig in complete detail will turn to sail

More about Elizabethan Rigging

by "Whipstaff"

the yard, up to an eyelet at the trestle-trees or upper mast cap, whichever is shown on your plan and down as before to the forecastle rail for the fore-topmast and eyelet in the deck for lift of the main-topmast yard.

In addition there are the halyards but we will leave these out on our smaller models.

The mizzen lift is shown in Fig. 2 and can be easily rigged by reference to the sketch, also brails and sheet. No vanes with sails.

Our next operation is to attach the sails to the yards, when the glue is set, stitch your sails to the yards using the 'chainstitch'; this will give a much more realistic finish.

When this operation is complete the yards can be glued and pinned in position.

Before doing so you will, of course, have prepared your yards as in Fig. 1 with eyelets and drilled at the ends.

Fig. 3 shows the bowsprit rigging for

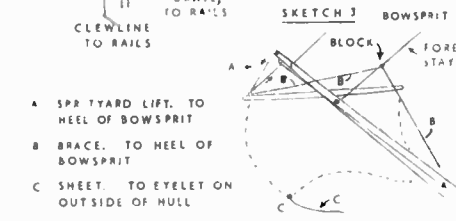
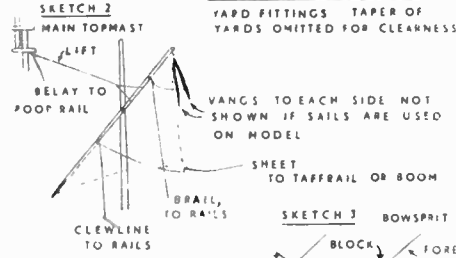
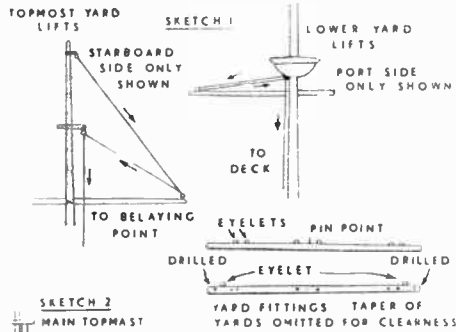

material that will allow us to do so. For the purpose of our small models we will portray only the following ropes.

LIFTS. These control the movement of the yards up and down the mast and also keep the yards horizontal.

BRACES. These are to control the fore and aft movements of the yards when the ship goes about.

TACK. These are the ropes for hauling the sail down to the rail and appear on the fore-sail, main-sail and mizzen only.

BUNT-LINES are for hauling up the middle of the sail when furling.

SHEETS. These are used for hauling the sail out to the end of the yard, and in the case of the foresail and main-sail, to hold the weather clew of the sail.

CLEW-LINES used when furling the sail.

LEECH-LINES. For hauling up the leech of the sail when furling. I have explained the use of these ropes because it not only adds to the interest of your model to know the purpose of each rope, but it will also assist you in obtaining the right atmosphere when you can approach your rigging from the angle of actual ship practice.

During the course of our rigging procedure I will refer from time to time to the standing end and the running end of each rope and to save repeating I will now explain the terms.

The standing end of the rope is that which is permanently fixed, the running end is that taken through the various blocks and used in controlling the sails.

We will now commence the actual work of rigging, using natural coloured thread, not white, and about 1/3 the size of that we used for our standing rigging.

Turn to Fig. 1 and commence with the lower yard lifts, the standing end is fastened to a tiny eyelet under the top, the cord is then taken through a similar eyelet at the end of the yard back through the eyelet under the top and down to the foot of the mast and secured to a block or eyelet in the deck. In actual practice it would be secured to a sampson post, a part which can be included in our larger models. In the case of the fore-yard it is belayed to the forecastle rail. In our drawing only the port side lines are shown, all lines must be duplicated on the starboard side of our model.

The topmast yard lifts are shown in Fig. 1 and in this case the standing end is secured at the flagpole just above the cap, taken to the eyelet at the end of

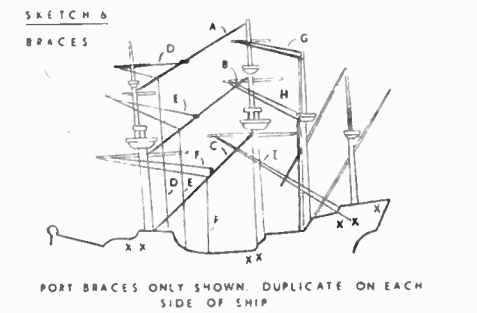
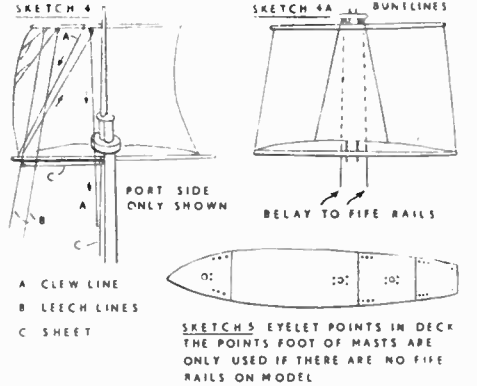

Key:
 (A) MAIN-TOPGALLANT STAY (B) MAIN-TOPMAST STAY (C) MAINSTAY (D) FORE-TOPGALLANT BRACE (E) FORE-YARD BRACE (F) FORE-YARD BRACE (G) MAIN-TOPGALLANT BRACE (H) MAIN-TOP-YARD BRACE (I) MAIN-YARD BRACE (X) POINTS ON HULL FOR LOWER SAIL SHEETS AND TACKS

the port side and must be repeated on the starboard side.

Now turn to Fig. 4. This shows the sheets, clew lines, lifts and leech lines of all square sails for the port side and must be duplicated on the starboard side. Fig. 4a shows the bunt-lines; where blocks are indicated use tiny eyelets at this scale.

Now commence with the buntline for the foresail. Glue the standing end to the foot of the sail about $\frac{1}{2}$ of the way along and carry up over the fore side of the sail, through the eyelet under the cap and down to the five rails at the foot of the mast. There are two as shown in the sketch. Repeat on the main-sail.

For the topsails there is only one to each sail and this is taken from the centre of the foot of the sail, up over the fore side of the sail and again through eyelet at the top and down to the five rail.

The clew lines come next. Secure the standing end to the yard as shown in Fig. 4. Take the running end through the corner of the sail, the hole in the end of the yard, up to the eyelet in the yard, nearest the mast and down to belay at the five rails. If there are no five rails on your model, belay it to the fore-castle rails for the foreyards and an eyelet in the deck at the foot of the mast for your main yards.

Follow now with the leech-lines. There are two to each side of the sail; glue the standing end to the inside

(aft) edge of the sail, take the running end up through the eyelet in the yard and down to belay at eyelets in the deck, just inside the bulwarks. See Fig. 5 for eyelet positions.

Finally take the sheets. These actually commence at the corner of the sail and can be tied with a small knot to the clew line, on a small model, taken through the hole in the end of the yard, along the yard to the eyelet in the yard, near the mast, and down, to belay to an eyelet in the deck, just inside the bulwarks, for all top sails. For the foresail and mainsail they are secured to eyelets in the outside of the hull, as shown on hull in Fig. 6.

Fig. 2 shows the necessary rigging for mizzen and bonaventure on our small ship. The vang's are not shown on a model carrying sail. Brails and clew line belay to either five rails or poop deck rails. If no sail is fitted add vangs secured to eyelets in the deck inside bulwarks.

The tacks for foresail and mainsail go from point of sail to outside of hull aft.

It only remains to add the braces. These again we will simplify, for our model. Study the sketch and commence with the fore-topgallant brace, secure the standing end to the main-topgallant stay, take the running end through the hole at the end of the yard, back to the fore-topgallant stay and down, to belay to the fore-castle rail. If your model has no deck rails in fore-castle, quarter deck or poop, use

eyelets, let into the edge of the deck.

Follow now with the fore-top-sail yard brace, secure the standing end to the main-topmast stay, through the end of the yard, back to the main-topmast stay and down to the fore-castle rail. Follow with mainyard brace.

Now, take the main topgallant brace, secure the standing end to the top of the mizzen mast up through the end of the maintopgallant yard, back to eyelet just below top of mizzen mast and down to belay at the poop deck rails.

The main-top-yard brace has the standing end secured to the mizzen mast above the doublings, up through the end of main-topmast yard, back to the fore shroud of the mizzen mast and down to belay on the poop deck rails.

Our main brace has its standing end secured to an eyelet in the outside of the hull, under the poop taffrail, goes through the end of the yard and belays to the quarter-deck rails.

Our model is now complete, and although we have much simplified the details of the rigging, those we have shown are authentic in their positions and our finished little vessel gives a realistic picture of the ships and rigging of this interesting period of our maritime history.

If following these instructions for our larger kits, substitute small blocks for the numerous eyelets shown for the small models. (284)

Helpful notes on KEEPING A NATURE DIARY

MOST naturalists keep a notebook of sorts, but it is a good idea to keep a really comprehensive diary throughout the year. In this, a lasting record can be kept concerning the subjects which interest most, and it also affords a useful basis for comparison with diaries of later years.

Start with a Notebook

The first notes for the diary should be made in the field in an ordinary notebook. These notes will serve as a basis for the lengthier entries to be made at leisure in the diary itself. The notes should always include references to the weather, wind, and time, as all these factors have a bearing on all plant and animal life. The rest of these short entries will deal with the particular subjects in hand, such as birds, animals, plants, and there will also be notes concerning any particularly unusual incidents which are observed. In the last category, for example, may come a note about a very early cuckoo record: the arrival of the migrant varies in different parts of the country. Birds nesting very early should be noted for comparison with future records.

The Full Diary

The diary should be kept in a large

exercise book, and is best divided into sections which afford two or three comprehensive entries each month. When the divisions have been made in accordance with the number of pages, cut the top right-hand corners so that the months can be marked, thus forming an index which can be turned to at will.

The diary should be kept as fully as possible, and should be written up slowly and in detail with the field notebook as a guide. Particular attention must be paid to time and weather. If the diary is scamped, it will be found that even a few months later any lack of detail in earlier entries will cause much heart-searching for the keen naturalist. Such detail as the appearance of eggs one by one in a nest, the flowering of a particular plant, arrival of migrant birds (to the day, if possible), birth of young to animals, and so on should be meticulous to make a good diary.

Month-by-Month Record

Quite a good idea, and one which can be followed as incidental to the diary, is to keep a record of a small piece of ground, or water for that matter, throughout the year. Half an acre forms a handy basis for this, and is sufficient to give the infinite changes which will be recorded through the seasons. In

addition to a written record, a pictorial record can be kept, the diary enlarging the pictures.

Take a series of twelve photographs at a certain time in each month, and from the same angle each time. The diary record should enlarge on these photographs, commenting in detail on the complete change of outer scene which they portray. The chosen piece should contain some trees, so that change in foliage will be shown, and possibly some obvious item, such as a small rookery, will serve a useful purpose in the diary and pictorial record. The greater the variety in the piece under observation the better will be both records.

Start Now

The nature diary itself should be started straight away while the interests of the early part of the year are fresh in the mind. There have been a number of unusual incidents all over the country this year: unusually active starling flocks, early snow falls and flooding, freak mild spells, early flowering spring flowers, and so on. Entries covering the months will vary considerably with the part of the country, but wherever one lives, the diary will be full of interest when it is glanced at in the distant months of next winter. (250)



FRENCH COLONIALS

IN the last stamp article in which we dealt with the stamps of the French Colonies, we described some of the interesting designs which come to us from them. This time we are going to continue with the same area, but it is not the designs which will demand our attention as showing methods of transport or methods of living, but the mistakes in designs, overprints and surcharges which are so frequently found on these stamps.

One Design—Many Regions

We are also going to draw your attention to certain regularities of design which occur on these stamps—that is to say, point out that one particular design does for many regions, the only distinguishing item being the name placed in a tablet prepared to receive it.

Unfortunately, we should need many illustrations to make all points clear, if we used one illustration for each point, so that you will have to look a little more carefully at the individual pictures. Take the first. Neglect for the minute the black 'N.C.E. 5' and two black lines' (yes, they are upside down) and look at

the sheet of 'Peace and Commerce' stamps is fed into the machine in order to receive the surcharge, naturally it must go in the correct way. If not, then the further printing will not be correct. In this case it was fed in upside down.

Now, it is difficult in this case to decide if it is upside down on purpose or by accident. Nowadays, when such a mistake occurs, the stamps so spoiled are destroyed. Should some of them escape destruction and be used, then you know what a 'find' that is, and the price of the mistake goes up tremendously.

Remember the 2½d. blue Silver Jubilee stamp of King George V. The catalogue value of one of these is now 1/9, but a few stamps were, by mistake, printed in Prussian Blue (or it would be more correct to say that some of the Prussian Blue printing got out and were used in error) and one of these used is catalogued at £160. So you see what happens to a mistake. The curious point about the New Caledonia stamp is that the type illustrated, with the surcharge inverted, is catalogued at a lower price than the correctly surcharged specimen.

Mistakes should not have occurred as most of the printing of the later French Colonial stamps was done at the Government Printing Works in Paris.

Our third illustration is of a stamp with an inverted centre. It comes from the French Somali Coast and was issued in 1903. Again it is worth less than the correctly printed stamp. Now, a real error of this sort (for example, the U.S.A. specimen of 1918, the 24c. stamp showing an aeroplane upside down) is catalogued at £850, whereas properly printed it is only 25/-. So you see why collectors are rather suspicious of the French Colonial 'errors'.

Number two is a genuine stamp, but in this case it looks far more like an illustration taken from a book. Actually it is an imperforate stamp. The wavy line which you see on the outside is printed on. Now, in the illustration you should be able to see some lines crossing at right angles. These are part of the water mark. It is what is called 'quadrille' paper. Some of the French stamps have it, and so do stamps from Ecuador. See if you can find a specimen, as, when once you have seen one, you will not forget the type.

Other curiosities that you can find in the French Colonials are different sized figures or letters in the surcharge. Then you may see what is called a type-set stamp. Such a stamp is one made up by a local printer. It would, of course, be an emergency that would require this. The outer frame of the stamp is made up of printers' stars, for instance. Then, perhaps, there is a frame of straight lines, and inside that is the name of the country and the value of the stamp.



1—'Peace and Commerce' surcharge inverted

2—Djibouti stamp on 'quadrille' paper

3—French Somali Coast stamp with inverted centre

4—'Tablet' type, double overprint

the printed stamp. You see two figures seated either side of a space. In this case the space contains the figures 40.

Now, such a design is used frequently for French Colonial issues, and, as this is the case, the design has a name. It is called the 'Peace and Commerce' type.

Black Surcharge

Now pay attention to the black surcharge, and this will give you the Colony in which the stamp was used. N.C.E. stands for Nouvelle Calédonie and the 5 means that the face value of the stamp has been changed from the original 40 centimes to 5. Remember that if there is no change in value, then the black letters will be called an overprint and not a surcharge.

We have already mentioned that the surcharge is the wrong way up. When

'Tablet' Type

The fourth illustration shows the next type, which is called 'Tablet' type. It should hardly be necessary to comment that the tablet is filled in with the name of the colony—in this case 'Nouvelle Calédonie et Dependances'. The first name we have written in full, although on the stamp it is abbreviated.

The specimen illustrated has a double overprint. The second is no doubt difficult to see, owing to the colour of the stamp. One overprint is in gold, the other black. Again the mistake is worth less than the correct specimen.

Mistake on Purpose?

It seems difficult to explain the unusual values of these stamps unless the mistakes were made on purpose to try to make philatelists pay more.

A Condominium

Lastly, we will mention the best example of a Condominium—an area which is administered by two governments. In this case, the two are Great Britain and France, and the area is the New Hebrides. The first issue of stamps from each government was in 1908. Gt. Britain overprinted the stamps of Fiji, and France used those of New Caledonia. In 1925, each currency was noted, so that we have stamps with values expressed in centimes and pence. For instance, ½d. and 5 cm. appear together. If the name of the area is given as Nouvelles Hebrides, then you put the stamp in the French Colonial section. If it has New Hebrides, then it will go as a British Colonial. (256)

MISCELLANEOUS ADVERTISEMENTS

The advertisements are inserted at the rate of 4d. per word prepaid. Name and address are counted, but initials or groups, such as E.P.S. or £1/11/6 are accepted as one word. Postal Order and Stamps must accompany the order and advertisements will be inserted in the earliest issue. Announcements of fretwork goods or those shown in Hobbies Handbook are not accepted. The charge for use of a Box No. is 1/- extra. Orders can be sent either to Hobbies Weekly, Advert. Dept., Dereham, Norfolk, or Temple House, Tallis St., London, E.C.4

CRAFTSMEN wanted. Profitable homework. S.A.E.—D 2, Biltex, Chiswick.

INTRODUCTIONS. Pen friends, companionship or marriage.—V.C.C., 34 Honeywell Road, London, S.E.11.

RADIO experimenters. Build your own experimental crystal set. Excellent results. Performance at least equal to factory-made model. No batteries required. Complete set with instructions, and highly sensitive headphones, for only 15/6, post free, from—Enterprises, BCM/JGLN, London, W.C.1.

STAMPS. 25—1d.; 100—4d. S.A.E. approval books, free gifts.—Pavely, 12 Leeder Close, Coventry.

MEN and women beginners wanted for interesting spare-time work. Apply with S.A.E. for details to—Leatheweave Co. (Dist. 37), 2 Tudor Road, Leicester.

BRITISH Empire approvals—1d. upwards trial selection.—Dowe, 149 Notley Road, Braintree, Essex.

FREE—stamps catalogued 5/- to applicants for 1/6 approvals.—Cox, 17 Stoneleigh Park Road, Ewell.

PERSONS are wanted for spare time work, making up fancy goods at home. Experience unnecessary. Write for details.—Dept. 918, Universal Products, 5 Cornhill, Lincoln.

OSCAR ELEPHANT has no mechanism, but he walks. Made quickly from odd wood for pleasure or profit. Patterns and instructions, 3/6.—Dept. HW, 6 Cedar House, Erlanger Road, London, S.E.14.

MECCANO! Meccano! Meccano! Electric motors, clockwork motors, outfits, transformers. Parts 1 to 219 in quantities. Send requirements and offers.—Pydar, Tredragon Rd., Mawgan Porth, Nr. Newquay, Cornwall.

STAMPS FREE! Twenty unused (2½d.).—G. H. Barnett, Limington, Somerset.

PEN PALS. International magazine. Interesting copy, sixpence.—Social World, 189 The Loaming, Motherwell.

SUCCESSFUL editor and author can help young writers into print—and profit. Details from Box 77, Hobbies Weekly, Dereham, Norfolk.

50 DIFFERENT stamps, including pictorials, free to applicants for approvals. Generous discounts.—Adams, Underbank, Station Road, Amersham, Bucks.

SPARE-TIME employment. Clerical, assembly, stonemaking, etc. 100 firms. "Spare-Timer" (1/-).—43 Douglas Avenue, Heanor, Derbyshire.

40 DIFFERENT stamps free, including Silver Wedding, U.P.U., Victory, Silver Jubilee, Coronation, Pakistan, etc. Send 3d. postage and request approvals.—J. F. Smith, 39 Manor Park, London, S.E.13.

RADIO. We stock a wide range of components and valves. Our 1951 Catalogue sent free upon request.—M. Watts & Co., 8 Baker Street, Weybridge, Surrey.

STAMPS. Triangulars, airmails, pictorials, S. value over 2/- free. Send 3d. requesting approvals.—Johnson, 7 Old Mill Lane, Forest Town, Mansfield.

WANTED. Bound volumes or loose copies "Magnet", "Gem", "Union Jack", "Boy's Friend Libraries", "Schoolboys Own Libraries", "Sexton Blakes", "Nelson Lees", "Chuckles", "Jester", etc.—W. C. Martin, 93 Hillside, London, N.W.10.

100 FIRMS urgently need reliable spare-time workers. Details 3/.—BCM/ROLY, London, W.C.1.

MODELS. You can make lasting stone-hard models with Sankey's Pyrama Plastic Cement. Supplied in tins by Ironmongers, Hardwaremen and Builders' Merchants. Ask for instruction leaflet.

LEARN Shorthand by June 23rd (1 hour's study nightly). 1st lesson 2½d. stamp.—Duttons (Dept. HB), 92 Gt. Russell St., London, W.C.1.

DUPLEX Self-adhesive Transfers for decorating fancy goods, trays, plastics, etc.; list and samples, 3d.—H. Axon Harrison, Jersey.

RUBBER Tyred Metal Disc Wheels finished in red, green or blue enamel. 2ins., 2½; 3ins., 3/- per set of four. Post Paid. Other sizes available up to 9ins.—The Joyden Toy Co., 193 Chase Side, London, N.14.

WHEELS for toys, and other accessories. Full list will be sent on application to—The Joyden Toy Co., 193 Chase Side, London, N.14.

DOLL'S House fittings and papers; send S.A.E. for list. Doll's house plan special; send 2/6. Trade supplied.—Zimplan, 88 Ware Road, Hoddesdon.

LORRY Kits, 4mm. and 7mm. scale. Also large range of spare parts from which to build to your own design. Send for fully illustrated catalogue, price 1/-.—Wilson's Lorries Ltd., 6 Gt. Winchester Street, London, E.C.2.

PLYWOOD Offcuts. Birch and Gaboon in various thicknesses. Handy sized parcels for the cabinet, toy, model maker and all handicrafts. Parcels made up in £1 and 10/- lots. Carriage paid, send P.O. to—Reeves, Plywood and Timber Merchant, 33 Front Street, Monkseaton, Whitley Bay. Tel. W.B. 4677. Parcels are now despatched on the day of receiving order.

BLUSHING, shyness, nerves, self-consciousness, fears, ended. Details under plain cover, 1d.—Stebbing Treatment, 28 (HB) Dean Road, London, N.W.2.

BE Taller in 14 days or money back. Details. 1d.—Stebbing's System, 28 (HB) Dean Road, London, N.W.2.

£5 to £20 weekly earned at home running your own Mail Order business. Details, 1d.—Stebbing Publications Ltd. (HB), Naphill, High Wycombe.

BRUSH on New-Een Composition and renew Band recolour your old leather Three Piece Suite for 12/6. Also for your car seating, etc. In Red, Green, Blue, Maroon, Leather shades. 12/6 pint or trial tin 3/6 post free.—New-Een (S), 101 King's Cross Road, London, W.C.1.

100,000 Government Surplus Bargains. Collapsible (2 piece) aerials, 8ft. fully extended, tubular copper plated steel throughout. 7/6, carriage 1/9; single 20 amp. switches, 9d., post 3d.; 3-bank switches (3 separate switches in one case), 3/-, post 4d.; 5-bank switches, 4/6, post 6d.; 16-bank switches, 7/11 post 1/-; 5-way junction boxes, 9d., post 3d.; 70 ohm variable resistances, 9d., post 3d. Hundreds of other bargains for the model maker and handyman. Money back guarantee. Send 3d. stamp for latest list of bargains.—Milligan's, 24 Harford Street, Liverpool, 3.

AMERICAN Magazines post free for one year. Popular Mechanics, 32/-; Popular Science, 28/6; Mechanix Illustrated, 22/6; Popular Homecraft 18/-. Stamp for full list of others.—Willen Ltd. (Dept. 57) 101 Fleet Street, London, E.C.4.

PLYWOOD Birch, Grade III, 30" x 6½" x ½" 24 for 15/-. Sanded Lagos Mahogany, 13" x 8" x ½", 18 for 12/-. 36 for 20/-. Solid Brownish Mahogany, 13" x 1½", P.A.R., 24" long, 8 for 15/6. 36" long, 5 for 15/6. Immediate delivery. C.O.D. List, 1d. S.A.E.—Dept. H, JDD, Storage, East Dulwich, London, S.E.22.

MAKE your own jig-saw Puzzles. Fine Art Pictures, various reproductions and sizes. Also suitable for framing. Stamp for full list.—Joyden Toy Co., 193 Chase Side, London, N.14.

HARDWOOD Ball Beads. ¾in. diameter, suitable for children's Counting Frames, etc. 5/3 per hundred, plus 1/9 P.T.—Joyden Toy Co., 193 Chase Side, London, N.14.

IMADE big money so can you. Enclose envelope.—H. Wamsteker, Box 34, Wynberg, Cape, Africa.

3/- PER Mould. One price only in catalogue. For Toy Soldiers, Sailors, Airmen, Ships, Planes, Farmyard and Zoo Animals, etc. Illustrated catalogue, 6d. each. Full list free.—Robin Hood Moulds, 140 Hollings Road, Bradford.

PLYWOOD Offcut parcels, nothing under 12" x 12" x ½in. 15 sq. ft. parcels, 7/6, post paid. Immediate despatch.—Breezcraft Ltd., 113 High Street, Staines, 3461/2.

LEARN Self-defence quickly or money back. Details of Wharton Course, 1d.—Stebbing Publications (H), 28 Dean Road, London, N.W.2.

USE spare time on profitable homework making fancy goods. Write for free booklet.—(Area 544), 54 Southgate Street, Leicester.

HOME Watch and Clock Repair Outfit. Includes watchmaker's magnifying eyeglass, tweezers, screwdrivers, oilers, oil, brush, dusting powder, plus illustrated explanatory book. Watch and clock repairing simplified. In container, 12/9 inclusive.—D. Bolster (Dept. H), 5a Station Parade, Ashford, Middx.

LOVELY? Then write Secretary U.C.C.—55B, Hay St., Braughing, Herts. Genuine. Est. 1905.

HOMEWORKERS required, either sex, light assembly, part or full time, s.a.e.—Esprey, Box 18, 41 Wade Street, Lichfield.

LUMINOUS Paint, 2/- per tin. Box 44, Hobbies Weekly, Dereham, Norfolk.

HAVE you got your Juneero Riveting Jig yet? From all Hobby shops or post free from—Juneero Ltd., Stirling Corner, Boreham Wood, Herts.

STAMPS Free. Empire packet including Pictorials and Victorians free to approval applicants.—Robert J. Peck, 7A Kemp Road, Bourne-mouth, Hants.

MODEL Makers and Handymen. Bumper set of lists, books, plans and samples, 2/6.—Sutton Models, Billericay.

PERSONS willing to devote few hours per week to clean interesting work. Excellent pay.—Dept. 11, Chas & Co., Albert Street, Loughborough.

TABLE Tennis, complete, ply top, £9.—Box No. 55, Hobbies Weekly, Dereham, Norfolk.

EARN Money French Polishing. Complete course, other wood finishers, formula for manufacturing polishes and stains for only 5/-, post free.—BCM/MERCIA, London, W.C.1.

HAVE you seen the new Juneero punching and riveting jig? Ask your Hobbies Shop.

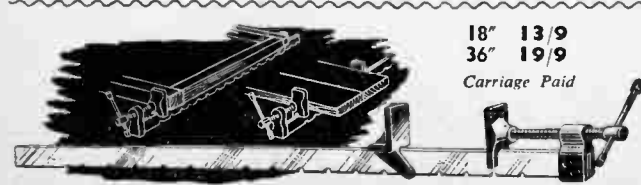

18" 13/9
36" 19/9
Carriage Paid

STRONG STEEL BAR CRAMPS

A strong well-made tool for the carpenter and handyman. Takes work up to 36ins. long. Easily adjusted to varying lengths as a sash clamp or for wide boards. Strong steel bar with square edges for rigidity.

At Hobbies Branches or from
HOBBIES LIMITED · DEREHAM · NORFOLK

YOU CAN BECOME A HANDICRAFTS INSTRUCTOR

EXPERIENCE NOT ESSENTIAL

Men who enjoy making things in wood or metal can turn their hobby into a permanent and interesting Career. Short hours, long holidays, and security in a job you would really enjoy, can be yours if you become a Handicrafts instructor. Let us send details of the easiest and quickest way to get the necessary qualification.

**We definitely guarantee
"NO PASS—NO FEE"**

If you would like to know about our unique method of preparing you for one of these appointments, write today, and we will send you our informative 176 page Handbook—free and without obligation. Mark your letters "Handicrafts Instructor".

**BRITISH INSTITUTE OF
ENGINEERING TECHNOLOGY** **BIET**

595 Shakespeare House
Stratford Place, London, W.1

STEEL BOXES



Ex-W.D. strong steel ammunition boxes. 19" x 7" x 7" inside size. Hinged lid, two carrying handles, perfect condition. Suitable for tools, etc. **5/3**
Post 1/3

SPONGE RUBBER SLABS
16" x 9" x 1" blue sponge or red crepe rubber. New ex-Gov. Limited quantity only. Worth treble. **4/9**
Post 10d.

RUBBERISED CANVAS

Superior quality, 3-ply grey, white backed, immensely strong, easy to sew or stick, waterproof and dustproof. **9/9**
Post 1/3 (yard)

ALL LEATHER TOOL BAGS
New Ex-W.D., light, durable. 14" x 6" x 6". Two leather handles, two snap locks with keys. Exceptional offer. **17/6**
Post 1/-

Illustrated Catalogue Free

PRIDE & CLARKE LTD., (Dept. P.W.)
STOCKWELL ROAD, LONDON, S.W.9. BR1xton 6251

DOES YOUR PIANO LIE IDLE?

LEARN MODERN SWING
THE APM WAY



FAST POSTAL METHOD (Guaranteed Tuition)

Treat written music as a mere pattern for a breath-taking SWING STYLE. Playing Dance Music has no life until you can SYNCOPATE. APM Students play Classics also.

Whether Beginner, Advanced or Somewhere Between, Talentless, Old, Lethargic or Keen

Send for interesting details without obligation

GEORGE ASHBURNHAM, APM (41a), 221 Acton Lane, London, W.4

KITS for OLD TIME SHIPS

Hobbies range of Ship Models includes Elizabeth Jonas, Cutty Sark, Victory, Mayflower, etc. Complete kit of wood, sail material, guns, pulleys, cord, etc., with full size pattern of parts and planed wood ready to cut out, shape and construct. A fascinating pastime.

Kits for models 12½ ins. long and upwards.

Ask for free illustrated lists at Hobbies Branches or from Hobbies Limited, Dereham, Norfolk.

A Handy Glasspaper Block

A wooden block with special handle which holds glasspaper taut and always in place. In two sizes, 3in., price 1/4; 5in., price 2/6, post free.

HOBBIES Ltd. DEREHAM
Norfolk, and all Branches



MANCHESTER
10 Piccadilly
(Phone CENTRAL 1787)

BIRMINGHAM
14 Bull Ring
SHEFFIELD
4 St. Paul's Parade

LEEDS
10 Queen Victoria Street
(Phone 28639)

HULL
10 Paragon Square

SOUTHAMPTON
25 Bernard Street

BRISTOL
30 Narrow Wine Street
(Phone 23744)

Head Office & Factories—HOBBIES LTD., DEREHAM, NORFOLK

EVERY CAR THAT PASSES YOU WILL FIND THE INDEX MARK ALPHABETICALLY ARRANGED IN WHERE'S THAT CAR FROM?

Price 6d.

from all Booksellers or from the Publishers (1d. postage)
RALEIGH PRESS, EXMOUTH



4 CANNON - 8 ROCKETS -
TOP SPEED - STILL SECRET

GLOSTER METEOR F.Mk.8

The latest version now with Fighter Command Squadrons. Single seat fighter with two Rolls-Royce Derwent 5 turbojet engines and armed with rockets or bombs as well as cannon.

Handling a plane like this calls for pretty smart people, so no wonder the Royal Air Force is always on the look-out for really bright boys. Under the R.A.F. Apprenticeship Scheme you can get a flying start on a thrilling career. At one of the R.A.F.'s fine residential Technical Schools, without cost to your parents and with good pocket money to spend, you can get the education and training that will fit you for your future as a key man in the finest air force in the world.

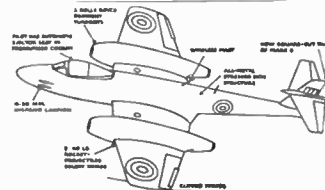

Opportunities for You in the R.A.F.

If you are over 14 this coupon brings you free a 26-page illustrated book about thrilling careers in the R.A.F. If you are 12 to 14 it brings you full details about the A.T.C. TO: R.A.F., (H.S.52) VICTORY HOUSE, LONDON, W.C.2.



NAME
ADDRESS
AGE
DATE OF BIRTH



Patterns for Novelty Cigarette Box

(See page 81)

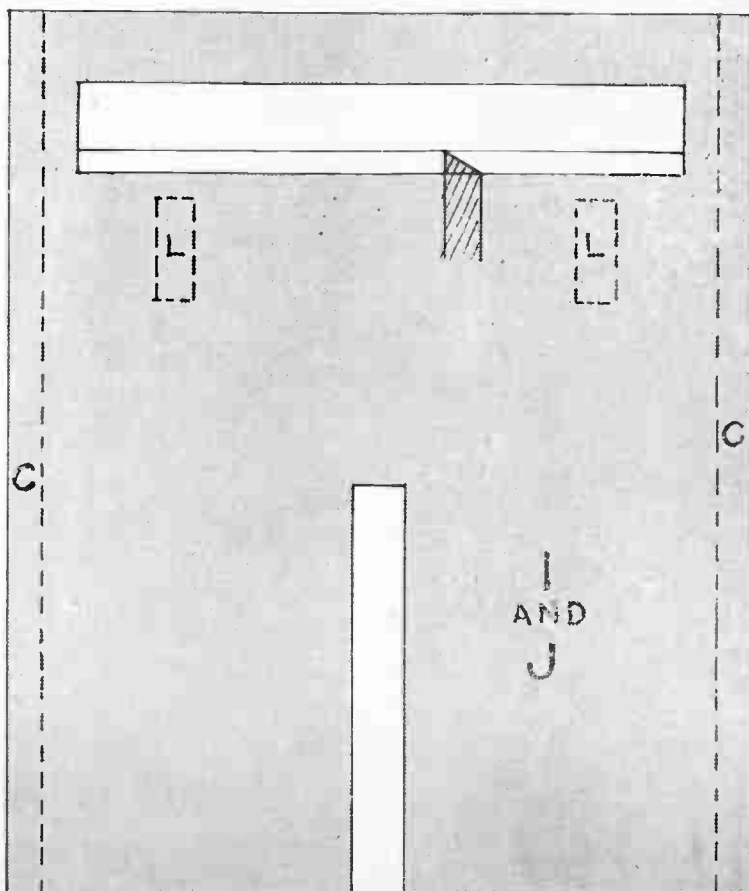
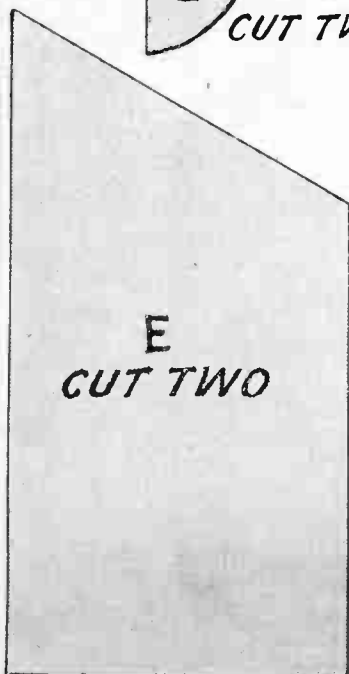
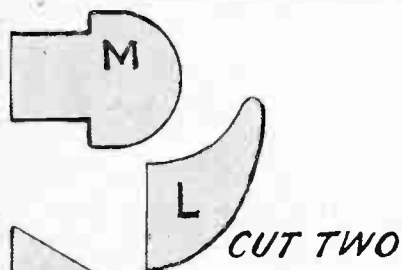
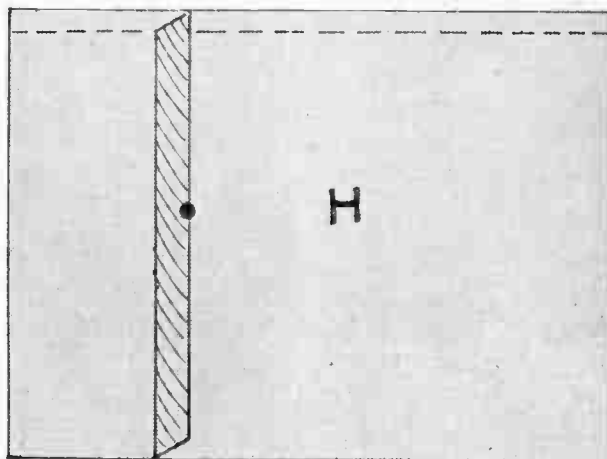
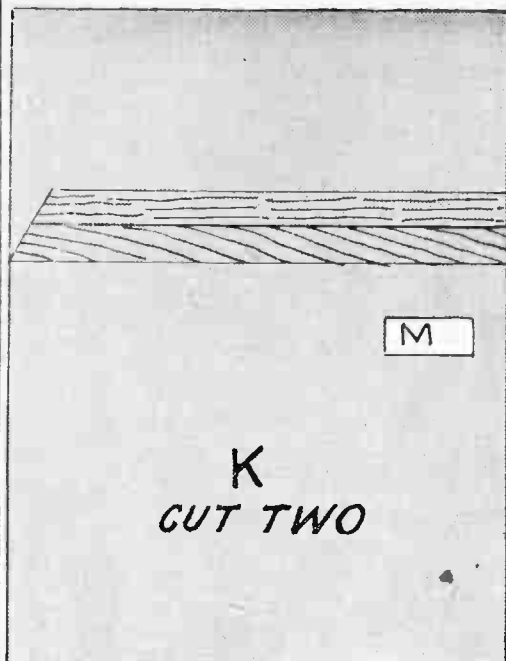

STUDY
AT
HOME

IN YOUR
SPARE
TIME

THE BENNETT COLLEGE

*will set you on the right
course for success*

You make sure of planned progress in the career of your choice when you let the most progressive, most successful Correspondence College in the world coach you through the post. By friendly, individual training we equip you with the specialized knowledge you must have for a well-paid key position. Make the first move TODAY—post the coupon below!

**ALL TEXT BOOKS ARE
FREE!**

to Students of The Bennett College Ltd., we send as many volumes as the subject demands and they become your personal property.



IS YOUR CAREER HERE?

IF NOT, WRITE FOR FREE ADVICE

- | | | |
|----------------------|-----------------------|----------------------|
| Accountancy Exams. | Engineering. | Radio Service |
| Agriculture | All branches. Sub- | Engineering |
| Applied Mechanics | jects and Exams. | Radio (Short Wave) |
| Auctioneers and | General Certificate | Road Making and |
| Estate Agents | of Education | Maintenance |
| Aviation (Engineer- | Examinations | Salesmanship |
| ing and Wireless) | General Education | Sanitation |
| Blue Prints | G.P.O. Eng. Dept. | School Attendance |
| Boilers | Heating and Ventila- | Officer |
| Book-keeping. Ac- | ating | Secretarial Exams. |
| countancy, and | Institute of Municip- | Sheet Metal Work |
| Modern Business | al Engineers | Shipbuilding |
| Methods | Journalism | Shorthand(Pirman's) |
| Builders' Quantities | Languages | Short Story Writing |
| Building, Architec- | Mathematics | Speaking in Public |
| ture, and Clerk of | Metallurgy | Structural Engineer- |
| Works (A.R.I.B.A. | Mining. All Subjects | ing |
| Exams.) | Mining. Electrical | Surveying (R.I.C.S. |
| Carpentry and | Engineering | Exams.) |
| Joinery | Motor Engineering | Teachers of Handi- |
| Chemistry | Naval Architecture | crafts |
| Civil Engineering | Plastics | Telecommuni- |
| Civil Service | Play Writing | cations (City and |
| All Commercial | Plumbing | Guilds) |
| Subjects | Police, Special | Television |
| Commercial Art | Course | Transport Inst. |
| Common Prelim. | Preceptors, | Examinations |
| E.J.E.B. | College of | Viewers, Gaugers |
| Concrete and Struc- | Press Tool Work | Inspectors |
| tural Engineering | Pumps and Pumping | Weights and Mea- |
| Diesel Engines | Machinery | sures Inspectors |
| Draughtsmanship. | Quantity Surveying | Wireless Telegraphy |
| Electrical or | —Inst of Quantity | and Telephony |
| Mechanical | Surveyors Exams. | Works Managers |

COUPON. CUT THIS OUT

IF YOU ATTEND TO THIS NOW
IT MAY MAKE A WONDERFUL
DIFFERENCE TO YOUR FUTURE.

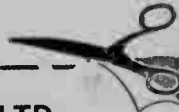

To Dept. 62
THE BENNETT COLLEGE LTD.
SHEFFIELD

Please send me (free of charge)

Particulars of..... (Cross out line
which does not
apply.)

Your private advice

about

PLEASE WRITE IN BLOCK LETTERS

Name

Address

State Age if under 21.....



For every purpose in the
small home workshop
use a BROOK 'CUB' 1/4 h.p.
motor. Single or split phase.

Electric Motors from 0-25
to 200 H.P.



IMPERIAL WORKS HULL DUNSTONFIELD I.H.M.14

The bristles won't come out!



Harris—the paint brush with a name to its handle



There are three ranges of Harris
Brushes: "Jurdor" (Red tipped handle) good.
"Standard" (Brown tipped handle) better; "Super" (Rosewood handle) best.

L. G. HARRIS & CO. LTD., STOKE PRIOR, WORCESTERSHIRE

CRC 26

Hobbies

WEEKLY

CONTENTS

	Page
Sectional Summer House	97
Simple Shoe Repairs	99
Rustic Arch	100
Improving your Snaps	101
Choosing a Site	102
Handy Moulding Cutter	103
Model Trestle Bridge	104
True-to-Scale Wheelbarrow	105
Work Table & Cabinet	107
Chemical Experiments	108
Matters of Interest	109
Model Road Signs	110

DESIGN SHEET FOR A
MOTOR CAR AND
TRAILER CARAVAN

May 30th, 1951

Price Fourpence

Vol. 112 No. 2900

How to build a SECTIONAL SUMMER HOUSE

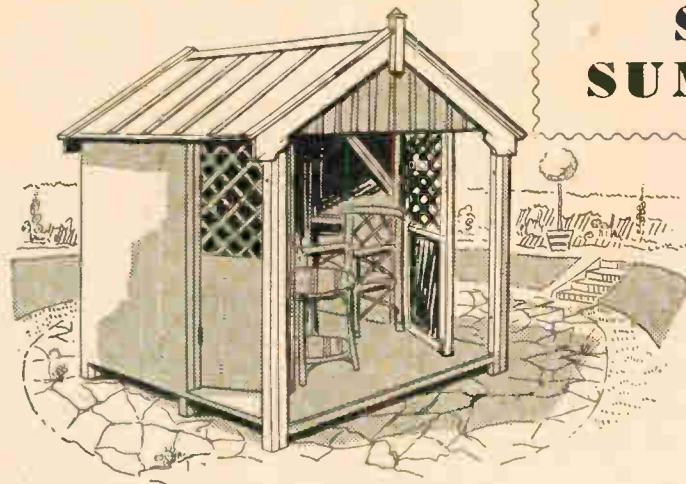

THE general appearance of any garden of reasonable proportions can be greatly improved by the judicious placing of an attractive summer house. Its usefulness, too, makes it well worth the labour expended in making.

The house shown in the illustration is designed to give the handyman the minimum amount of work, and uses inexpensive materials. It is made in complete sections, which are bolted together and can, therefore, be easily dismantled and packed flat if there is occasion to move.

Another special feature is the additional space provided by the extension of the roof. The two doors open outwards and can be fastened, by means of bolts, to the front uprights. You will appreciate that they provide additional shelter from the wind, and, at the same time, the lattice-work top is sufficiently open to provide light. No glass is needed in the doors, because when shut they are adequately protected from rain

by the roof extension. The illustration shows the doors partly open.

Constructing the Frames

The framework of the house is constructed entirely of 2ins. by 2ins. wood, and consists of three upright frames to which are bolted two side frames. Bolts should be about 5ins. long and $\frac{3}{16}$ in. to $\frac{1}{2}$ in. diameter. Stout washers should be threaded on before screwing the nuts in place. Study the diagram in Fig. 1 carefully and then proceed to make up the end and centre frames as shown in Fig. 2.

The back end frame is constructed exactly as shown, and the joints to be used are similar to those shown in Fig. 3, the centre frame. Note that piece (E) is halved completely in place in the back frame, while in piece (E) of the centre frame, the

halving joint is only $\frac{1}{2}$ in. deep. This is to allow the doors to fit between the uprights (A). The middle rail (B) is tenoned into the uprights (A) in the same manner as the bottom rail. In the centre frame, the middle rail (B) is omitted. The front frame has the middle rail (B) and also the struts (E) omitted.

The side frames are constructed as shown in Fig. 4 and it may be necessary, depending upon the covering used, to insert extra rails shown by the dotted lines. All rails are halved or tenoned together as shown in the details in Fig. 5.

The Doors

The next stage in the construction is to make and fit the doors. These can be made from 2in. by 1in. material halved or tenoned together as shown in Fig. 6. The bottom half can be covered in with asbestos sheet, plywood or 'Rubberoid'. The top is filled in as shown with lathes criss-crossed. As an alternative to

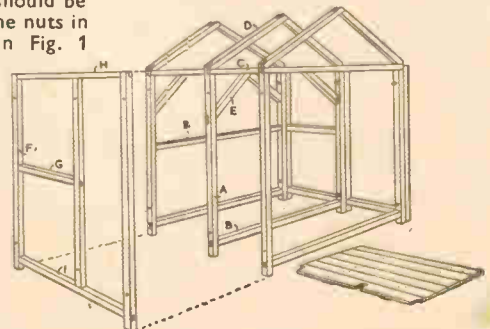

Fig. 1—Showing construction of the main framework

All correspondence should be addressed to The Editor, Hobbies Weekly, Dereham, Norfolk.

lathes, we suggest nailing 'Windowlite' in place. Cut the recesses for the hinges and also cut similar recesses in the appropriate positions on the uprights (A) of the centre frame.

The Roof

Two frames are required for the roof slopes, and these are constructed of 2ins. by 1in. material. The rails are halved or morticed and tenoned together, the exact dimensions being shown in Fig. 7. Remember that the top rails must be chamfered to fit snugly at

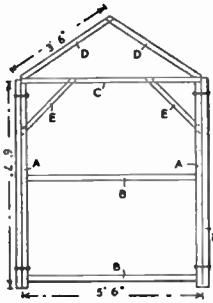

Fig. 2—Elevation of end frame, showing side bolted in position

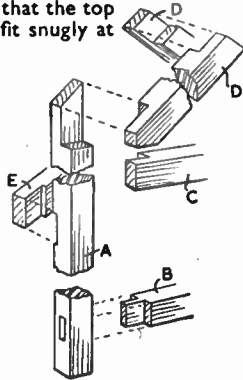

Fig. 3—Joints of the centre frames

rames are now put in position, and then the other side frame. Tighten up all the nuts and see that the structure is rigid. The roof slopes must now be bolted into place to complete the main assembly. Note that the top edges of the side frames may have to be chamfered slightly to take the roof slopes.

Covering the Roof

Rubberoid is the best material to use, and this should be tacked in place as shown in Fig. 8. The width of the 'Rubberoid' is 3ft. and this allows the roof to be covered in three strips as shown. Put

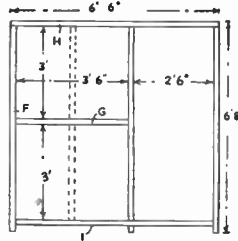

Fig. 4—Side frame construction

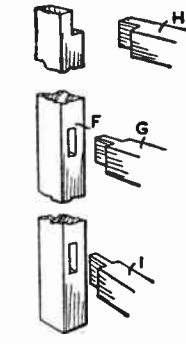

Fig. 5—Side frame jointing

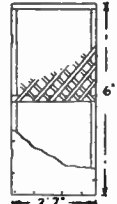

Fig. 6—The doors

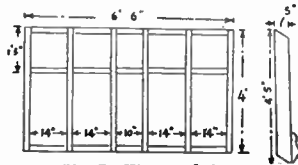

Fig. 7—The roof slopes

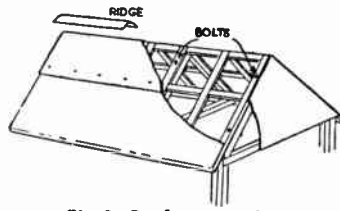

Fig. 8—Roof construction

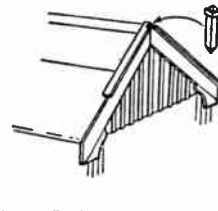

Fig. 9—Finishing the roof

the ridge when bolted to the frames. Finally, before assembly, cover the top of the front end frame with suitable material, as suggested in Fig. 8.

Assembling

You will need some help when fixing the frames together and the best method is to commence by bolting one end and one side frame loosely together. The remaining two upright

the top piece right over the ridge and overlap as much as possible. A narrow strip can be tacked in place to form extra protection. The shaped boards can now be screwed in place. These are shown in detail in Fig. 7. They are cut from 3/4in. to 1in. thick material. Narrow overlapping pieces are nailed to the top of these as shown in Fig. 9. The finial is shaped from 2ins. square wood and fixed in place where

shown, and the decorative strips pinned firmly in place.

Covering the Sides

We suggest the best material for this will be asbestos sheeting, but a cheaper though not so durable substitute would be 'Rubberoid' roofing felt. It should be neatly tacked in place, overlapping where possible.

The floorboards can be constructed in two pieces from 3/4in. boarding, battened underneath. They must be fitted round

the uprights as shown in Fig. 1.

If the summer house is to be placed against an existing wall it will be necessary to cement the bolts into the wall. Place the end frame in position and screw up the nuts to within 1/2in. Fill the space between house and wall with 'Secomastic' or similar material and screw up tight. Needless to say, the shaped boards must be omitted in this case.

Whatever the position, the house must be stood on a solid foundation. We suggest crazy paving as an attractive finish.

After completion, the adding of doors, lock and bolts, the whole of the woodwork can be treated with Cuprinol or creosote, or painted according to taste.

(275)

Simple Shoe Repairs—(Continued from page 99)

all round, but chiefly along the inner edge. Long nails (the special shoemakers' 'rivets') can afterwards be driven through the whole set of pieces.

When all are nailed in position, a good shape is obtained first with a rasp and then with a long strip of emery or glasspaper. Avoid bruising the leather of the upper part of the shoe. Finally, for appearance and to make the lot waterproof, you take a piece of cobblers' 'heel ball' (a black or brown wax), rub it over the exposed edges of the leather and then burnish well with a slightly warm heeling iron of the type illustrated in Fig. 5. This is not an expensive tool, but for an occasional job where it is not desired to invest in special tools, one could possibly make do with the handle of a large size old spoon or use a hammer head, etc.

Now place on that rubber heel and vow

to save yourself a lot of bother in future, by replacing rubber heels promptly.

A Special Awl

At leather-supplies stores one can purchase for 4/- or so a special awl which sews with a lock stitch and is very

FIXING MODEL WINDOWS

The model maker sometimes has a model which requires the use of glass for windows, etc., to look neat. Paint the edges of the glass, put a layer of plastic wood on and press in position on the model. Leave for a few hours to set, when it will be fixed firmly in place. Any surplus wood may be scraped off with a penknife.

useful for restitching, for example, broken backs of shoes or cracks at the toe end where the leather most creases. Although shoes have 'had it' when they reach the latter stage, an extra month or so of wear can be obtained, in dry weather, from neatly stitched and patched shoes.

Do not try, beyond sticking on new rubber soles and applying rubber heels, to mend ladies' shoes. Many have wooden heels and very thin soles, the repair of which is a trained man's job. Indeed, the purpose of this article is not to show you how to 'cheat' the shoe repairer of his due work but to indicate that, with a little care and small expense, one can save unnecessary bills. There will always be unpractical people who hardly know one end of a hammer from another—but not among *Hobbies* readers!

(221)

Don't be down at heel—do these SIMPLE SHOE REPAIRS

THE cost of shoe repairs is now so high that many a handyman must have considered doing some repairs himself. Many, of course, have made a specialised hobby of boot and shoe repairing and can do practically anything that a tradesman can do. But in this short article there is no space to cover such matters as re-soling boots and shoes but only to deal with such repairs as the inexperienced amateur can hope to accomplish with every prospect of success.

A Prejudice

Boot repairers have, quite understandably, a prejudice against stick-on or nail-on rubber soles, alleging that they tend to pull off the uppers and that there is nothing like walking on leather. Their real motive, one suspects, is that a comparatively inexpensive rubber sole lasts quite a long time and is easily replaced, again at small cost. If one always wears rubber soles one never, or

shoemaker's last, the stick-on type are, perhaps, more suitable, though care should be taken to see that they have half-a-dozen or more nails at the toe end, otherwise they will soon come off when the toe is stubbed against anything.

The Right Time

Especially with stick-on soles, the time to apply them is when the shoes are new and unworn, or immediately after they have been resoled. Follow the instructions on the packet carefully. Merely to rub the rubber cement over the sole, slap it on the leather and half-heartedly hold it down for ten minutes is NOT the way to make a lasting job. The cement has to be applied separately to both sole and leather and allowed to dry, first. The leather should first be roughened.

There is no real excuse for being down at heel. Rubber heels are quite cheap and easily applied. The circular ones seem to give the best wear. But occasionally they come off and though

steps, as shown (Fig. 3). The shoe is put on a suitable part of a three-footed last and the cutting done with a hacksaw. Not your best tenon saw, as you are practically certain to run into nails. Take care that each step is cut clean and square.

You may find that the shoe will wobble on the last, making the sawing difficult (as you will have to use one hand to steady the last). A very simple way to cure this is to take a long loop of rope (or leather strap), of such a size as to go round the instep of the shoe being mended to within a few inches of the floor. You place a foot in the lower end of the loop and press down. This holds the shoe well down on the last and enables both hands to be used for sawing. The last is placed on the corner of the bench or table. In Fig. 1 the strap is, for lack of space, shown conventionally broken.

When the steps have been cut out

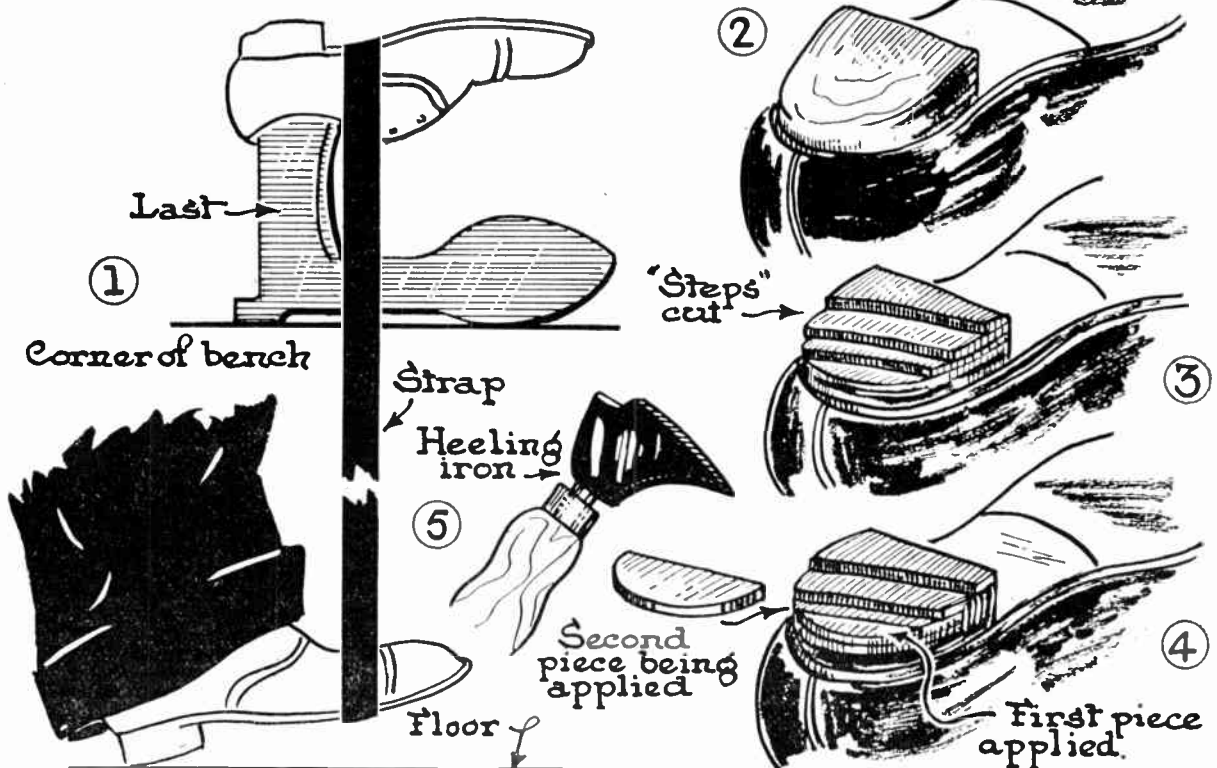

rarely, need have one's shoes resoled. As for pulling off the uppers, the present writer has worn rubber soles for the last thirty years and has never found them damage the shoe.

He prefers the nail-on type as holding much better. For ladies' shoes, however, or for those who do not possess a

we are always intending to spare a few moments to replace the missing heel, we tend to delay matters until the heel is quite worn. In the illustration (2) we see a rather bad specimen of this kind.

It is completely unnecessary to strip off the whole heel down to the worn level. Rather, it is cut down in a series of

the waste pieces being removed with pincers and an old screwdriver, they are replaced by scraps of new leather of the same thickness as the missing layers (Fig. 4). These pieces are roughly cut to shape before being nailed down. It is not necessary to nail these individual pieces

(Continued foot page 98)

Add decoration to your garden with a RUSTIC ARCH

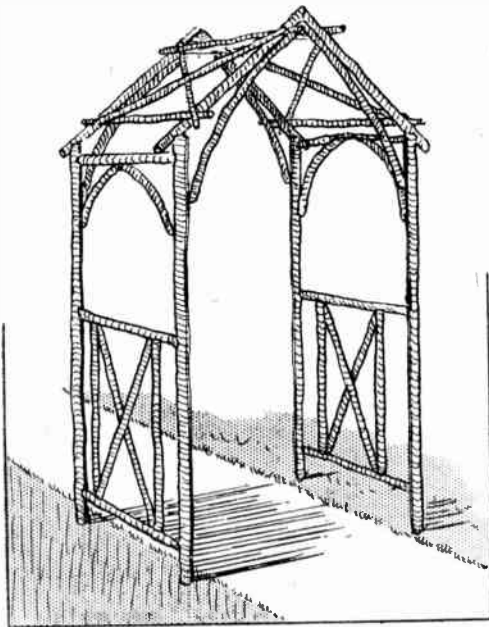

RUSTIC work always looks particularly well in the garden, and as it can be put together quite easily, and is inexpensive to make, is well worth the little trouble involved in the work. Wood for the purpose can usually be bought in the towns quite cheaply. In the country it may be merely a matter for cutting oneself. A little seasoning is desirable, though not imperative, and if some which has been drying out for firewood can be bought, all the better, perhaps.

Simple Entrance

A simple, but artistic, rustic arch is as drawn, and is just the article to bridge a path, or provide an entrance to the garden, or an object over which a climbing plant can wander. A front elevation is given in Fig. 1, and a side view in Fig. 2. It will be obvious that the dimensions of both can and, in some cases must, be amended to suit the actual conditions of a particular garden, especially the path portion, if the arch is intended to straddle it. In such a case the width should be just 12ins. more than the width of the path, so that sufficient space is available either side to embed the uprights into the ground.

The height given in Fig. 1 is from ground level, and when cutting the uprights, an extra 15ins. should be added for that portion entering the earth. For these uprights, wood of at least 2ins. diameter should be chosen, with slightly lesser material for the cross rails, etc., except the top front and rear cross pieces of the arch, which are cut from similar stuff to the uprights.

Each side should be put together first. Cut the uprights, and parts to be inserted in the ground should have the bark stripped off. Leave for a few days

for the stripped parts to dry, then soak them in creosote as a preventative against rot. Unless this is well done, the wood will rot at ground level, and down will come the arch at the first effort of any strong wind.

Cut the horizontal side rails. These, at their ends, are hollowed a little, to better fit against the uprights, as at (A) in Fig. 3. They are then joined across with a single long nail to each joint, as in the diagram. It will be wise here to make preliminary holes through the uprights with a gimlet, otherwise the wood may split. Take care to get each rail approximately correct as to height from ground level, and both sides alike. As some of the wood is likely to be far from truly straight, some judgment must be shown in fixing to get a symmetrical effect.

The vertical rods are fitted between similarly, and the diagonal ones cut from 1½ins. stuff, or thereabouts, and skew nailed in position. A little thoughtfulness in placing the diagonals in the right and most convenient position for skew nailing will save much labour

here. As the diagonals cross each other, a slight curve must be given to the wood by careful bending, unless the wood chosen has the necessary curve by nature's handiwork, of course.

Finish the sides with a carved piece of wood (naturally curved) in each angle, meeting together, approximately, in the middle of the top rail.

Top Pieces

Cut the pieces of wood required for the cross pieces at the top of the arch. These must be cut at their meeting ends in the centre at an angle of 60 degrees. They are then skew nailed together, as shown at (B) in Fig. 3. Place them, one on top of another, to get them both alike, then fix in that position with a short piece of 6ins. wide board firmly nailed behind each. The detail (B) explains this quite clearly. With the assistance of obliging friends, or members of the family, place the sides of the arch at their correct distance apart. To better ensure this, cut a length of spare wood to that distance, and hold it between the sides.

Place the top pieces across, and where they rest on the tops of the uprights, cut out a right-angled notch, so that a fit, as it were, is obtained. Now securely nail the top pieces across, with a long single nail to each joint.

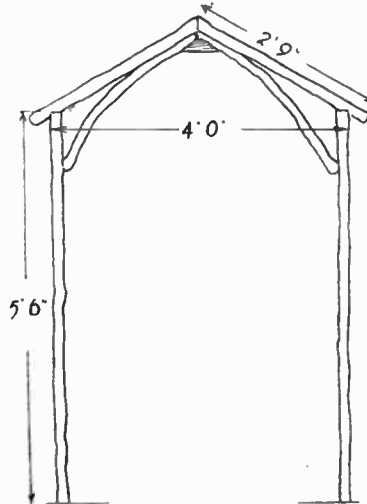

Fig. 1

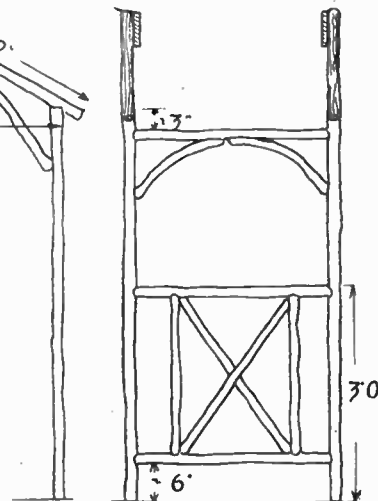

Fig. 2

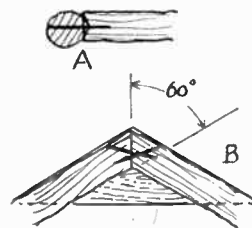

Fig. 3
100

The whole arch should now be carefully lifted up, and conveyed against the spot it is to occupy. Excavate a narrow trench, or a pair of holes if you like, for each side, 1ft. 6ins. deep. Drop a shovelful of small stones in the holes, and ram them down hard.

Drop the uprights in the holes, and shift, as may be necessary, until they are approximately vertical. The excavated earth should then be shovelled back, a

(Continued foot of page 103)

Two ways of IMPROVING YOUR SNAPS

DESCRIBED here are two simple ways in which you can improve the technical excellence of your snapshots this year, and put into them that little extra kick and richness which is generally only associated with the work of professionals.

Make this experiment. Look for some moments at an item a short distance away, say, a picture on the wall, or, if out of doors, a tree or house. Note the general brilliance and amount of detail you can see, and the contrast of

unwanted side rays—and this is all that is required (see diagram).

Lens hoods, as these short tubes are officially called, are easy to make. A hood is best obtained by considering it as part of a cone as shown, the smaller end being of such a size that it will just fit over the metal rim of the lens (or lens and filter as described in a moment).

To make a hood, take a sheet of cardette and, after painting both sides a matte (i.e. non-reflecting) black, roll it into a cone with an apex angle of about 50 degrees. Glue the overlapping edges

Apart from generally brightening a picture, a hood enables the rule of 'the sun at the back' to be ignored. Indeed, with a camera held level and having a hooded lens, it is possible to take pictures with 'King Sol' well round to the front, and, under certain conditions, with the old gentleman dead in front and apparently shining straight into the lens—a position which, without a hood, would give a semi-fogged picture, covered with flashes of light. A lens hood does not lengthen exposures.

If you have any doubts about the efficiency of the arrangement, let me say that pressmen, who always want the best, invariably use a hood for all their pictures, no matter what the lighting conditions. And you should use it for all your snaps. The more the front glass of a lens protrudes, the more essential is a hood. It is less important if the optic is hidden well away inside the front, as is the case with certain box cameras.

Makeshift 'Hooding'

Incidentally, a 'hooding' effect can be obtained without a hood by having the camera in the shade and taking out into sunlight. Cupping the hand or holding a

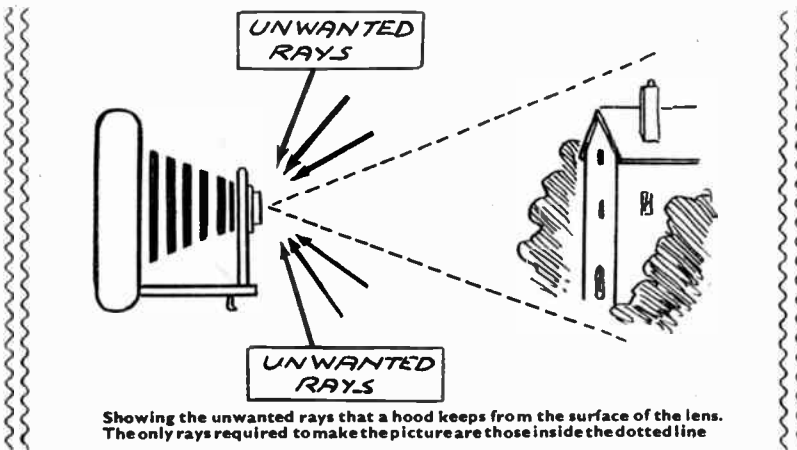

various parts. Now roll anything handy into a tube of about 2½ ins. diameter. A newspaper or piece of card will do, but if the material ensures that the inside surface of the tube is a dark tone, so much the better.

Brightening Effect

Hold the tube to the eye and again examine the picture, tree or house. You will at once see a brightening effect. It will be easier to examine the item, and detail will stand out in a bolder measure. Lines will be more defined and subtle graduations of light and shade just a trifle more pronounced.

Now the reason for this is that you have prevented all side light from impinging on the eye, the only rays now reaching the retina coming from the items in question. Thus, if out of doors, all glare from a broad expanse of sky above and, perhaps, a concrete road below is eliminated, while in a house the ceiling and surrounding light areas are cut out.

As with our eyes, so with the camera, and the tube which has just produced a brightening effect in the experiments will give to a camera the power of putting on the film a similarly bright picture.

Fortunately, to secure the improved effect the tube used on a camera need not be very long—1½-1¾ ins. being enough to shade the front surface of the glass in smaller cameras from the

well and temporarily secure with a paper clip. Put on one side till dry.

When ready, the cone must be cut carefully at (A) and (B), the end at (A) being of such a diameter that it will just (and only just) fit over the metal lens 'cell'. The best way to get the right diameter is to first cut out a line nearer the apex where the diameter is, obviously, too small and then work

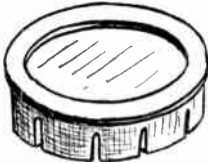

Filters can be bought in a spring clip like this to fit over the camera lens

forward, cutting a little at a time till a perfect fit is secured. The further end of the hood is cut to be parallel with the front of the camera.

For carrying, the hood so formed can be pressed flat, as it will open out and hold quite well when placed on the lens.

The hood is now complete, and the only point you have to watch is that it does not cut off any of the corners of the picture, but unless your lens is very 'wide-angled', 50 degrees will be all right.

If a hood is found to cut the corners (that is, produce areas of shade there in the prints) the only thing is to scrap it and shape another with a greater side slope.

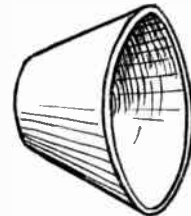
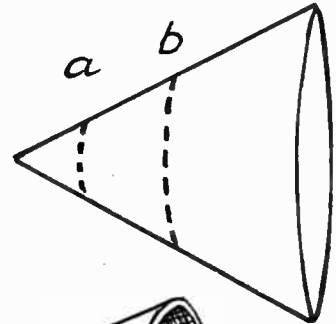

A simple method of making a lens hood

small piece of card above the lens as the trigger is pressed is also a help. These latter makeshifts are only possible if you are taking with the camera set up on a tripod, or some other firm base, and if the hands are free. The idea is the same in all cases—to keep unwanted rays from impinging obliquely on the front glass of the lens, and the last two methods, while not going right round the optic, cut off the rays from the sky, and most of the detrimental emanations come from here.

The second suggestion for better pictures this year is the consistent use of a very weak filter. Many beginners, I

(Continued foot of page 102)

Camping? Here's what you should know about CHOOSING A SITE

THERE is more in choosing a camping site than meets the eye, and considerable care should be given to this part of an alfresco holiday. If on a cycling tour, to start prospecting two hours before dusk is a good rule.

What to look for in a site is one of those things that can be expressed more forcibly by saying *what to avoid*—and it is surprising what a lot of factors are to be avoided if the pitch is to be really comfortable. The degree of perfection to be aimed for in a site will, of course, greatly depend on the length of stay. You can put up with conditions for one night only that would become intolerable if they had to be borne for a week.

What To Avoid

Here are some of the numerous things that must be avoided—and the reasons therefore.

Never pitch beside water—especially if of any size. A camp at the water's edge looks pretty, no doubt, but a certain amount of evening dampness always lies around ponds, lakes and rivers. Mists more readily collect here and most readers will recall evening rides when, after heat, every pond and pit is seen to be cloaked in a miniature fog, though the fields about are clear. As well as mists, water (especially if stagnant) also collects mosquitoes. So not for you the shady nook beside a babbling brook.

If a farmer has given you permission to wander round a bit and select a site, avoid like the plague fields in which there are animals. Cows, horses, and even sheep, are all curious, and although far enough away to start with, sooner or later will come clustering round the tent, get mixed up with the guy lines and probably cause tears if nothing worse.

Neglecting this rule of 'no animals', the writer had the experience of waking up early one summer morning to find the head of a prize bull well in through the door flaps! Luckily, on being 'shoo-ed' the heavy fellow decided to sheer off stern first instead of coming forward. The camp was a standing one

for several days, and for the next night the site was changed.

Avoid trees also, and never pitch directly under one. Trees look so protecting, but the best of them may drop branches during a wind, while the elm will drop a branch at any time, wind or calm. Trees are also bad during rain, for although they seem to give initial shelter they are infinitely worse than the actual rain when they start to 'drip'. Tall trees, however, can be used as a 'break' from a prevailing wind, if some considerable distance away. Woods themselves should be shunned on account of the flies close-packed trees always engender—particularly in hot weather.

With regard to the ground underneath the tent, look for good turf and avoid sand or gravel. There is no satisfactory grip for the pegs in the latter and sand or sandy compounds are the most uncomfortable terrains for sleeping. When on sand, also, grains of the stuff seem to get into everything.

No Depressions

Avoid, too, dells, gullies or other depressions, for they are always damp, even during fairly dry weather, while when it rains they can quickly become quagmires, and, in the case of heavy deluges, there may be the real danger of being flooded out.

Knowing now what to avoid in the choice of a pitch, what conditions should be looked for?

First, the ground ought to slope very gently for comfort and natural drainage. The gradient, if possible, should be with a bias towards the south or south-east, for in this way a maximum benefit will be obtained from the mid-day sun, while an easterly trend will make King Sol effective earlier on in the day, which is definitely a good thing.

If there is no consistent slope about but irregular rolls only, then set up the tent slightly, but only very slightly, off the summit of a roll so that all the advantages of the raised land is secured, together with a trifling tilt in the tent floor.

The spot (and this is very important)

should have complete privacy, being right out of sight from any nearby road, pathway or dwelling houses. A pitch screened by low but not too near bushes is the ideal thing. This point of privacy should be given especial attention if camping over a bank holiday, for a pitch that may seem quite secluded the night before can become the centre of a milling holiday throng by noon the next day—possibly much to your embarrassment.

Examine the Ground

Examine closely the actual few square feet of ground on which the tent will stand, and choose an area completely free from bumps. A foot or so this way or that will often make all the difference. A hummock in the wrong place can mean a sleepless night, and yet campers of several years' experience will often neglect this preliminary examination. A hummock, too, might turn out to be an ant-hill and once these pests are disturbed they swarm over everything in seeming millions—and they can sting also.

Reasonable nearness to a supply of drinking water is essential—particularly if you are pitching for several days. Having to carry drinking water too far can definitely spoil a camp. Supplies are usually obtained from some private house in the vicinity, although village pumps, wells, drinking fountains and springs recognised as fit for drinking can be pressed into service.

Make Sure It Is Fresh

Finally, look for a pitch that is absolutely fresh, not one that has been camped on by scores of previous predecessors. Ground, like everything else, can become 'sad' and stale with use. If there has been a lot of pitching on the same spot it may also be not too healthy, particularly if some of the residents have not been as careful as they might have been with wash water, food fragments and the like.

A new pitch every time, therefore, for 'sweetness', comfort and health, although, of course, ground does freshen up again after some long time. (272)

Improving Your Snapshots—(Continued from page 101)

find, panic when filters are mentioned and, imagining charts, queer index numbers and tricky exposures, say 'no thank you'.

Filter work in its 'advanced stages' can be intricate, certainly, but there is no reason why you should not take every snap with a pale yellow filter before the lens. This will not increase the exposure in the least and filters of this kind can be bought for a few shillings. They are in a spring collar and fit tightly over the existing lens cell—thus becoming in their turn the camera lens cell for the purpose of fitting a hood.

And why should one work with a slight filter? If you have seen, side by side, a picture taken with a filter and one taken without, the answer should be known. Pictures taken without tend to show skies, though cloud-flecked, as blank areas—and other bright expanses the same. Even with the weakest filter, however, the clouds show up, and what a difference that alone makes to any snap.

Other areas, too, take upon themselves a certain finer range of gradation which together give the whole scene just that little extra element of tonal values required to make a good picture.

Colour and gradation-correction by filters is a big subject, but there is no reason why the veriest beginner should not use the weak filter recommended with every success. Indeed, I have in mind an amateur who used one from the very start, and who, almost at once, was turning out pictures of near 'exhibition standard' as far as tonal and other effects were concerned.

There, then, are the two ideas for better pictures this year. If you do not feel like trying them both, at least give the lens hood a try. You will not be disappointed. (234)

A useful fitting for the workshop is this HANDY MOULDING CUTTER

It very often happens that, when making some piece of furniture, we should like to ornament it, but are prevented from doing so by not having a suitable moulding plane. These planes can be obtained in a very wide range of shapes and sizes, and to possess only a few could be quite expensive.

With the aid of the simple and also extremely useful little tool described here, almost any pattern of moulding can be cut. It is an easy tool to use, and there seems to be no limit to the kind of work it is capable of doing.

The tool consists of a strip of wood with a guide piece fastened at one end and having a slit cut along the remainder of its length. In this slot various cutters are placed and held in position by two thumb screws.

The method of using is similar to that of a marking or cutting gauge—just sliding it along the piece of wood while

keeping the guide piece pressed tight against the edge.

A piece of straight grained beech is the best wood to use, although many other kinds of hardwood such as walnut or oak are quite suitable. Cut a 6in. length of wood 1in. square and along the centre make a thin saw cut for a distance of $4\frac{1}{2}$ ins. as shown in Fig. 2.

Fig. 1 shows the position of the bolt holes which should be about $\frac{3}{8}$ in. diameter. The first hole is $1\frac{1}{8}$ ins. from the right end, and the others follow at intervals of 1in. The two bolts can be inserted into holes adjoining the cutters. It will be seen that the cutter has a wide range of movement and can be securely fixed in any desired position.

The guide piece is made $2\frac{1}{2}$ ins. long, 2ins. wide and $\frac{1}{2}$ in. thick, and fixed exactly at right angles to the slotted bar. It is necessary to get this fitted at right angles, as it helps to keep the cutter in the correct position and in alignment.

The cutters need not be larger than $1\frac{1}{2}$ ins. to 2ins. long, and Fig. 4 shows a few of the shapes that it is possible to make. (A), (B) and (C) are inside and outside curves which can be made in an assortment of widths and, also, the amount of curve may be varied from shallow to half-round.

For producing a 45 degrees bevel on the edge of a board, a cutter shaped like (F) is useful, and it is also possible to make this for other angles as well. Three well known types of mouldings are shown at (G), (H) and (J), while the reed cutter (K) is handy. The number of reeds and also their sizes may be varied to suit your needs.

Grooving can be carried out efficiently with different width cutters as shown at (L). Two or more cutters may be placed together to form a more complicated design, and there is really no limit to the patterns that can be produced.

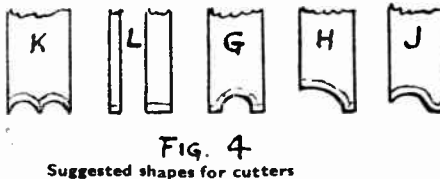
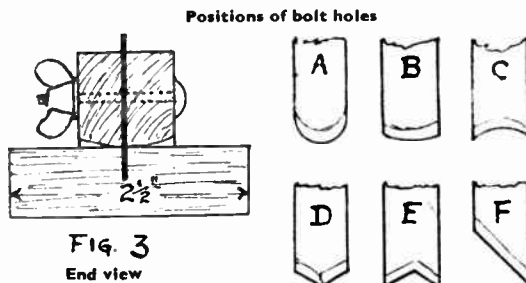
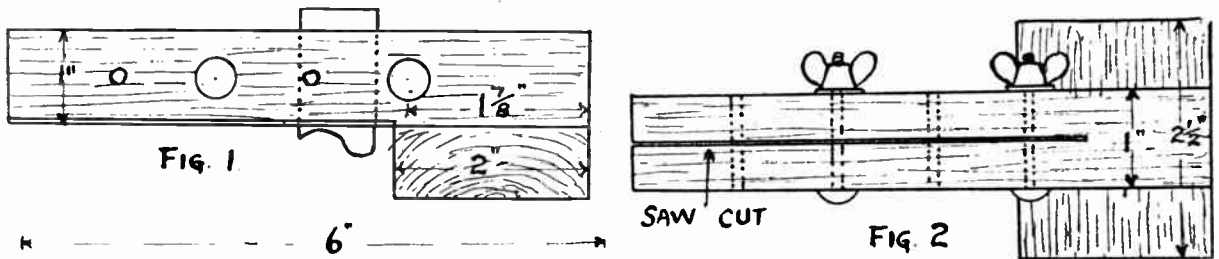

It is an advantage to have the underside of the slotted bar slightly rounded, as shown in the end view Fig. 3. This can easily be done with glasspaper on a block of wood.

Iron or steel bolts and thumb screws are best for the job, but brass ones may be used if you are unable to get the others.

The best method of making the cutters is to use the blade of an old hand saw. It is tough stuff and will keep its edge reasonably well, yet its mild temper allows it to be cut to the desired shapes with files.

How the saw cut is made

There are three methods of sharpening the cutter blades. They may be left square as filed up and used like a cabinet scraper, but better results will be obtained by sharpening either chisel shaped or tapered on both sides like a knife.

Care must be taken when using the tool to cut with the grain of the wood. Serious tearing may occur if you try to work against the grain. Different woods require different treatment; some will cut quite well with the tool held upright, while other woods may be worked at an angle similar to that of a plane. It may even be an advantage to round off the bottom of the tool more, so that the cutting angle can be increased.

A little practice on some odd scraps of wood will soon determine the best methods to adopt. (257)

Rustic Arch—(Continued from page 100)

little at a time, and be well rammed down, when the arch should stand reasonably firmly. A more secure fixing will result if a few small stones are added to the earth, and a good ramming given for each shovelful.

The curved arch pieces, shown in the front view, can then be chosen from

wood with a natural bend. These are skew nailed, and stiffen the whole structure a lot. Across the top, pieces of the wood are nailed at about 9ins. from the sides and tops and diagonals nailed to these to partly cover over the lot. As whatever climbing plant chosen will, in time, spread itself over these, no

further covering is necessary.

This completes the arch. It is not usual to varnish barked wood, but should it be decided to remove the bark, the wood should, after drying, be varnished, or creosoted, against the weather. (264)

When in camp, try this MODEL TRESTLE BRIDGE

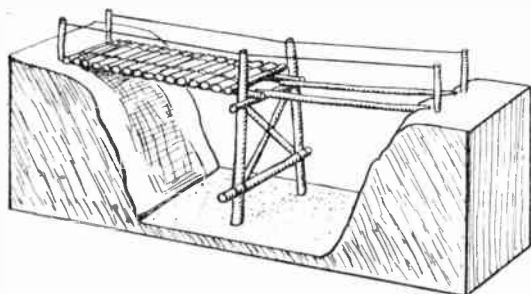

The model trestle bridge showing only half the deck covered, for demonstration purposes

MODEL bridges of the pioneer kind are extremely effective and are easy to put together. The building of such a miniature bridge is an ideal hobby for camp, as the main material required is suitably-cut sticks and twigs, which one can be quietly collecting during day trips about the countryside. The lashings can then be done at odd rest moments and the bridge be taken home in sections for final assembly and fitting on to a base.

A miniature rough timber bridge looks very well on an exhibition stall, while it can also be extremely useful for demonstration and training purposes.

There are, of course, many different types of bridge to choose from, but the ordinary trestle shown in the illustration is straightforward to make and satisfying as a finished model.

So as not to be too small, make the parts to fit nicely on a base 12ins. by 6ins. which will be about right. The trestle then will be 4 to 5ins. high and about 3ins. between the sides at the top.

First, it is best to collect quite a lot of stiff twigs, straight and up to a 1/2in. diameter. For the decking a good number of equal-diameter lengths will be required. The 'legs', 'transoms' and 'ledgers' (to give the proper names) of the trestle are of fairly heavy pieces, the full 1/2in., but the 'brace' pieces can be of less size and more agreeing to the decking.

Start building with the trestle. The general proportions are shown in the diagram. Both legs must slope in a little, and the

sections are lashed at their connecting points by fine twine of the 'kite cotton' variety. What is termed a 'square lashing' is employed. It starts with a clove hitch on the more vertical piece, just below the intersection. The twine, pulled tight, is then taken over the cross member and round the back of the vertical and again over the horizontal as shown, this path being followed for several turns. A finish is made by taking the end

through one of the turns and pulling tight.

From the general model-making point of view there is some considerable latitude in making a lashing, of course. That is to say, the look of the finished model will not suffer much if the lashings are not absolutely correct, but it is nice to get them as near correct as possible.

Having joined the ledgers, transom and legs, the whole frame is made rigid by the diagonals or braces. Fit one first and spring the other into position, but finishing, of course, with lashings at both ends and the middle.

twine as shown. The main spars are spaced so that they will just drop between the tops of the legs on the trestle.

For finally assembling the model we need a base 12ins. by 6ins., at either end of which is fitted a block. Over each block spread thick green or brown paper, crinkling it to look like a rough bank. The insides of the paper are brought forward to give a slope, but at the back and sides it is glued firmly to the wood.

If desired, a tougher job can be effected by using papier mâché here. The plastic mass is just lumped around the blocks and finished by sprinkling

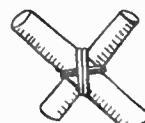
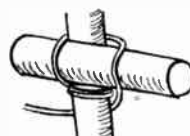
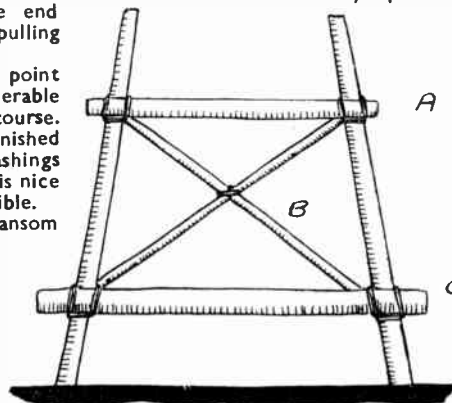

Making up the trestle; (a)—Transom. (b)—Brace. (c)—Ledger. Below; The square and cross lashing

DECK CROSS-PIECES

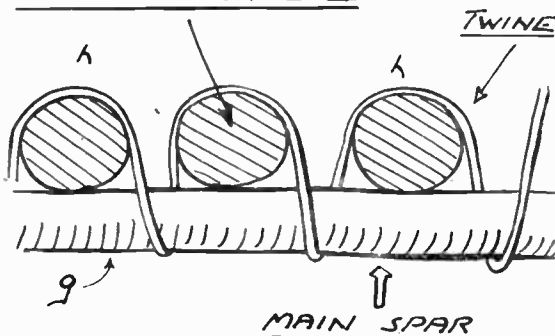

Lashing the cross-pieces of the deck to the main spar

with sand. It will dry hard and look like rock. The top of the base-board can be glue-painted and sprinkled with sand or painted to look like water.

For neatness, the sides and ends are painted a strong contrasting colour to give a good 'cross-sectional' impression.

The bridge can now be placed in position, and, in lieu of the correct anchorages at either end, niches can be made in the end blocks, and the main spars sunk in a little and secured by carefully inserted pins.

For demonstration purposes it is best to deck in only half of the bridge, the other half being left with the main spars showing as indicated. An additional refinement, if desired, is a hand rope which can run from the leg tops, rather extended, to uprights on the shore.

The wood of the bridge is, of course, left as it is, but a rather improved effect can be secured by polishing the bark.

(242)

When Painting Near Glass

After painting window frames it is often difficult to remove the paint from the glass. A good tip is to cut a piece of ordinary white soap into the form of a wedge, wet it and rub all round the glass near the frame. It will then be possible to paint freely without thoughts of splashes because as soon as the paint is dry, it will suffice to rub the glass with a soft cloth to remove both soap and paint.

The young 'gardener' will want this TRUE-TO-SCALE WHEELBARROW

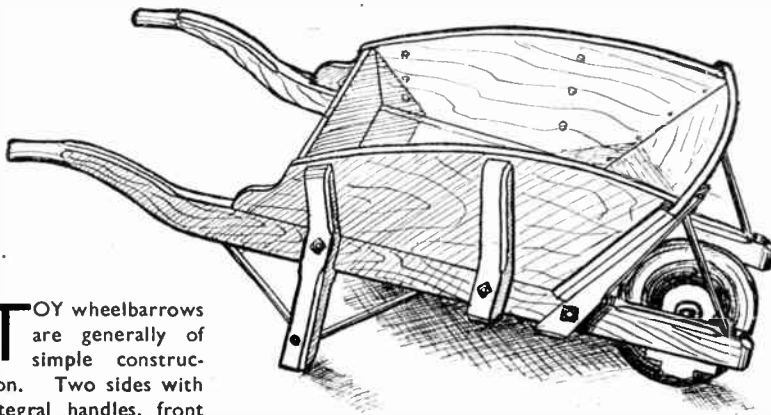

The average handyman will be able to heat up, flatten and shape the ends of the iron rods upon a small anvil, or, perhaps, a heavy vice top. If no forge is available for the heating, a good hot coal fire may serve. Get the metal almost white-hot, if possible, before hammering and shaping the rod ends.

Main Framework

Fig. 1 is a plan of the bed of the wheelbarrow. Two sides (S) are cut from 1½ in. thick hardwood (ash preferably) 2 ins. deep and 38 ins. long. Note the curved handles (Fig. 3) which will need to be cut out with a coping saw, or better, a power bandsaw.

The cross pieces (P) are cut from 1½ ins. by 1½ ins. material and are tenoned into the sides. Note from Fig. 2 that there is only one shoulder on the

TOY wheelbarrows are generally of simple construction. Two sides with integral handles, front and back boards, a bottom, and the wheel, constitute the usual shop article. They are expensive to buy, as they use up a fair amount of timber in wide boards. The simple construction allows of speedy assembly, but the wheelbarrow usually looks nothing more than a toy, and if it were enlarged to full size, its proportions would be seen gross and clumsy in many respects.

Here is a model which is a two-thirds scale replica of a gardener's wheelbarrow built by a country wheelwright. The truly realistic appearance amply justifies the more difficult construction than that of the average toy, and the

extra time and material involved. If two-thirds scale is considered too large, a one-third scale model may be produced by halving all the main measurements in the drawings, and adjusting the smaller measurements, such as board thicknesses, bolt diameters, etc., as required, and according to the nearest available material.

The construction is mostly straightforward woodworking. The only out-of-the-ordinary work is the blacksmithing involved in the making of the leg and front stays from ½ in. diameter iron rod, and the hacksawing and filing of the wheel bearings from pieces of iron.

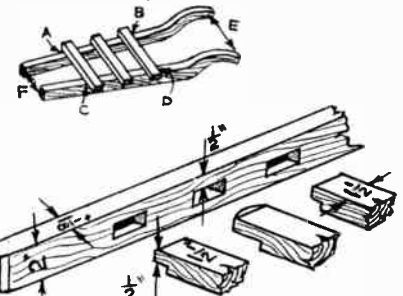

Fig. 2

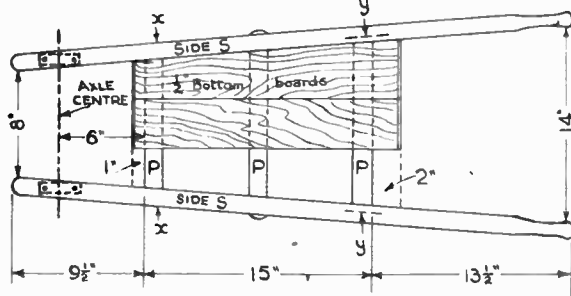

Fig. 1

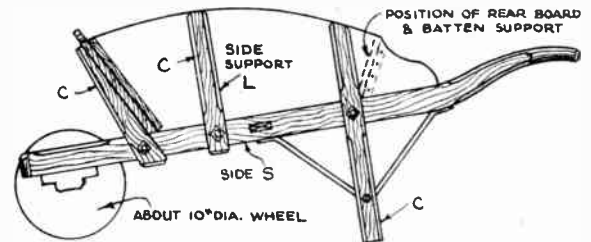

Fig. 3

tenons, and only the centre tenons go right through the sides and have decorated ends. The other tenons go half way into the sides.

Fig. 2 shows how the cross pieces and sides are placed for marking the joints. Widths (E) and (F) (14 ins. and 8 ins.) are set, while points (A), (B), (C), (D)—the outer edges of the mortice positions—are 'squared' up, using a strip of wood diagonally to test. Move one side back or forth until these points are squared, so that when the cross pieces are placed on top they will be parallel, and the sides are symmetrical in their taper.

Front and rear crosspieces are placed level with points (A), (B), (C), (D) and the centre piece measured from them. Mark the tenon positions under the cross-piece ends and the mortice positions on top of the sides. Square down the mortice positions and proceed to gauge the mortices as usual,

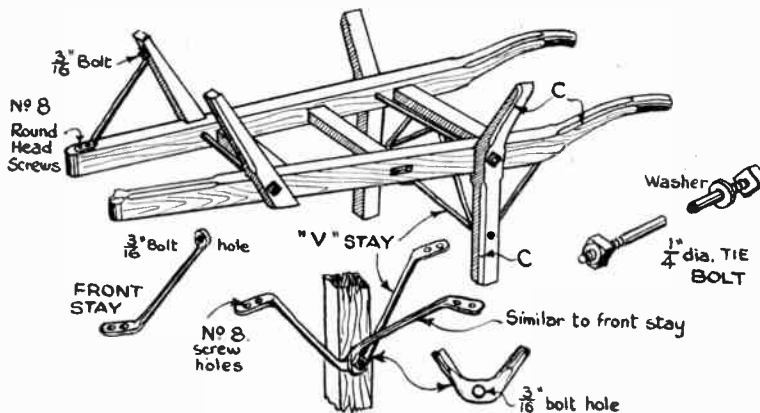

Fig. 4

allowing $\frac{1}{8}$ in. from the top of the sides for the thickness of the bottom boards.

When chopping out the mortices with a $\frac{1}{2}$ in. firmer chisel, remember that they are on a slight angle and not square cut with the face, otherwise the tenon shoulders (also on an angle) will not fit up to the sides correctly.

Before assembling the framework, round up the handles with a small spokeshave, file and glasspaper, and work the decorative chamfering as required. See Figs. 3 and 4

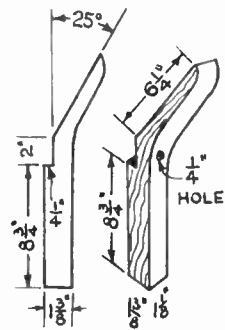

Fig. 5

at (C). Smooth up the pieces with plane and glasspaper and put together. Use a sash clamp to pull the frame together and put a nail through the long tenon—centre joint.

Legs and Front Supports

Cut out the legs and front supports as at Fig. 5 from $1\frac{1}{2}$ in. hardwood. Again a bandsaw is the ideal cutting instrument. Notice that the front supports must be bevelled so that the front board (Fig. 6) fits correctly against them. Either bevel face (A) or the face which fits against the side where the bolt goes through. Chamfer the parts (C, Fig. 4) and fix to the framework each with two nails (N, Fig. 5) and bolt the whole together with long $\frac{1}{2}$ in. tie rods passed through the sides, legs, and front supports as at Fig. 4.

Do not pull the bolts up too tight, or if the tenon joints are not a good fit the sides will tend to tilt inwards where there is no supporting shoulder on the crosspieces. One or two loud cracks as the bolts are tightened is a healthy sign that the joints are a good fit.

Next cut and fit the bottom boards from $\frac{1}{2}$ in. material as indicated at Fig. 1. Plywood, two $\frac{1}{4}$ in. thicknesses of hardboard or anything that will make up the thickness, and is strong enough, will do for the bottom boards. Cut them in three widths, chamfer the front and rear edges, and work a slight vee joint between the boards for the sake of appearance.

Front Board

Refer to Fig. 6. The front board is $9\frac{1}{2}$ ins. high at the centre and 9 ins. at the sides. It is bevelled at the bottom, where width (X) must be the same as the barrow width at the base of the front supports (Fig. 1). Two battens $\frac{1}{2}$ in. thick by $\frac{1}{2}$ in. are nailed down the edges of the front board as a support for the ends of the side boards. The battens are slightly bevelled on the inner edge. Screw the front board to the supports,

omitting a screw where the bolt goes through to hold the top end of the iron front stays.

Iron Stays

All the iron stays should next be made and fitted. If you do not feel up to making these, it is best to get a blacksmith to do the job. The flattened ends for the roundhead screws are $1\frac{1}{2}$ ins. long. The ends for the $\frac{3}{8}$ in. bolts are about $\frac{1}{2}$ in. diameter and thicker (see Fig. 4). The centre of the long leg stays is flattened for about an inch after

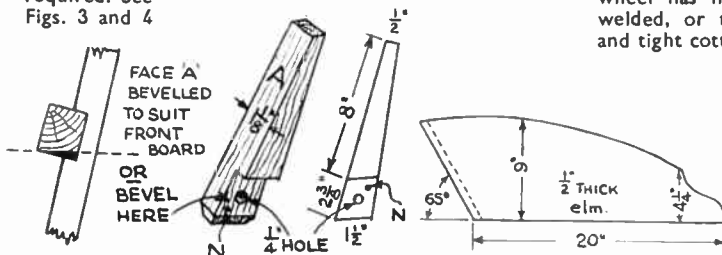

Fig. 6

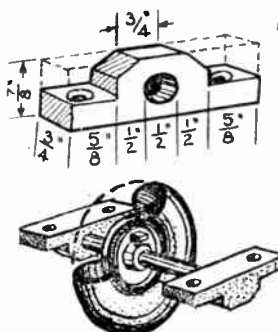
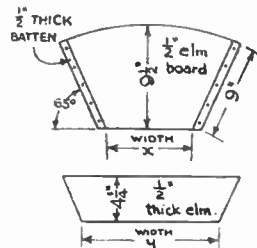

Fig. 7

bending to the V shape.

Drill the screw holes to take No. 8 size roundhead screws, and the bolt holes for $\frac{3}{8}$ in. bolts, after fitting the irons in their places. The lengths of the rod between the shaped ends must be carefully measured from the job.

Side Boards

Cut these to fit with bevelled lower edges. Carefully nail the front ends to the battens on the front board and screw to the leg tops from the inside. Cut the side supports (L, Fig. 3) to a similar shape as the leg tops, but longer, and fix with one $\frac{1}{4}$ in. bolt each at the lower end to the sides, and screw from the inside.

The rear board is cut with width (Y) at the bottom, bevelled, and screwed in place just behind the legs. See Fig. 3. Extra support for this board may be obtained with a small nailed batten if required.

Wheel and Bearings

This is, perhaps, the most difficult part of the model. The Dunlop 16 in. diameter pneumatic wheels used on the full-size wheelbarrows are difficult to match correctly with a wheel of 10 ins. diameter. The original model had to be fitted with a solid tyre pressed wheel

welded to the $\frac{1}{2}$ in. axle. Although not strictly to scale this did not detract from the appearance greatly. If you can obtain a pneumatic wheel about 10 ins. diameter, so much the better, and if it is a one-third scale model wheelbarrow it might be possible to obtain a 5 in. diameter model aeroplane or racing car pneumatic wheel which would serve the purpose.

Fig. 7 shows how the wheel is mounted on the $\frac{1}{2}$ in. axle and bearings. The full size wheels have a set screw which clamps on to the axle. If the model wheel has no set screw, it could be welded, or the hub could be drilled, and tight cotter pins passed through the

axle. Another way is to fix the axle tight into the bearing blocks and allow the wheel to turn on the axle, with a cotter and washer each side of the hub.

The iron bearing blocks (Fig. 7) entail plenty of work with the hacksaw and file, or grindstone. If you have not the time to spend on these it is suggested that thicker blocks of hardwood should be fashioned as bearings. The $\frac{1}{2}$ in. hole which is $\frac{1}{8}$ in. deep, has to be reamed out slightly larger to allow the axle to turn freely. Drill a $\frac{1}{8}$ in. oiling hole to the outside, upwards. The bearings are fixed with No. 12 countersink screws through the ends, underneath the sides as indicated in Fig. 1 by the broken lines

Finish

If you have used elm boards in the construction, with ash for the framework, one or two coats of clear varnish

A SUITABLE HACKSAW

If you happen to break a hacksaw blade, do not discard it. Take the best piece and fit into an old hand-frame, and you will find that you can use it for a considerable time in this way.

will set the wheelbarrow off well. If the wood is varied, or there are a number of large knots or other blemishes, perhaps paint will make a better finish—a bright green with red for the wheel centre? In any case, paint the inside with lead colour paint where the 'load' causes wear. Give one priming, one undercoat coloured, and one hard gloss finishing coat of paint, all, of course, after suitable glasspapering.

Finally, by increasing all the measurements by one-half, enthusiastic gardening readers will be able to produce a full-size barrow all ready for that latest crop of weeding that must ever be done on the allotment! (263)

Any needlewoman would appreciate a WORK TABLE AND CABINET

THE combined work table and cabinet described in this article is a useful and also attractive piece of furniture for the needlewoman. It has been designed to hold most of the tools and materials needed for needlework and general clothing repairs.

When closed the 24in. table top is a convenient size for working on, and, being circular, there are no corners for materials to catch on. Its height makes it ideal for use beside an easy chair and it is really surprising the amount of odds and ends it is capable of holding.

Neat Cupboard

The table top opens to disclose a neat little cupboard, on the inside of its doors being racks for scissors and pads for needles and pins, while the shelves are suitable for reels of cottons.

The work in hand can be placed in the well of the cabinet, while the small drawer underneath will hold more materials or tools.

The choice of wood is not an important matter, but as plywood is being used for the table top and the panels of the cabinet, oak or a similar texture hardwood would be best for the legs and bars. There are many other woods that are equally suitable, and it is a matter of personal choice which you use.

Cut the four legs 21ins. long and 1in. square—they can be left as shown in the drawing, or the part below the drawer can be slightly tapered towards the bottom, but do not do too much to this.

Tenon and mortise joints are used to fasten all the bars into the legs. All the bars are 12ins. long, plus a $\frac{3}{4}$ in. tenon on each end, making 12 $\frac{3}{4}$ ins. total length.

The top bars are 2ins. wide, and, with the exception of the back one, are $\frac{3}{4}$ in. thick. The back or hinge bar is made $\frac{7}{8}$ in. thick and is fitted level with the legs at the back so that when the hinges are fitted the table top will open up correctly. Cut the tenons 1 $\frac{1}{2}$ ins. wide on these top bars as shown in the drawings.

Six smaller bars will be needed for the bottom. One of these goes on top of the drawer in front and another in the back to match. It is these two bars that hold the ply bottom in position. Make the tenons the full width of the bar (1in.), while the thickness of all is $\frac{3}{4}$ in.

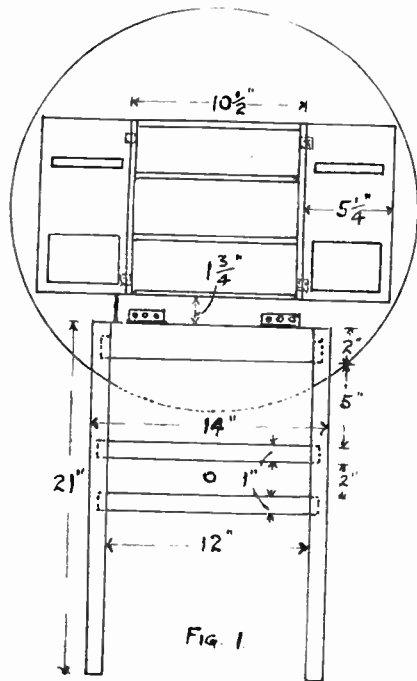
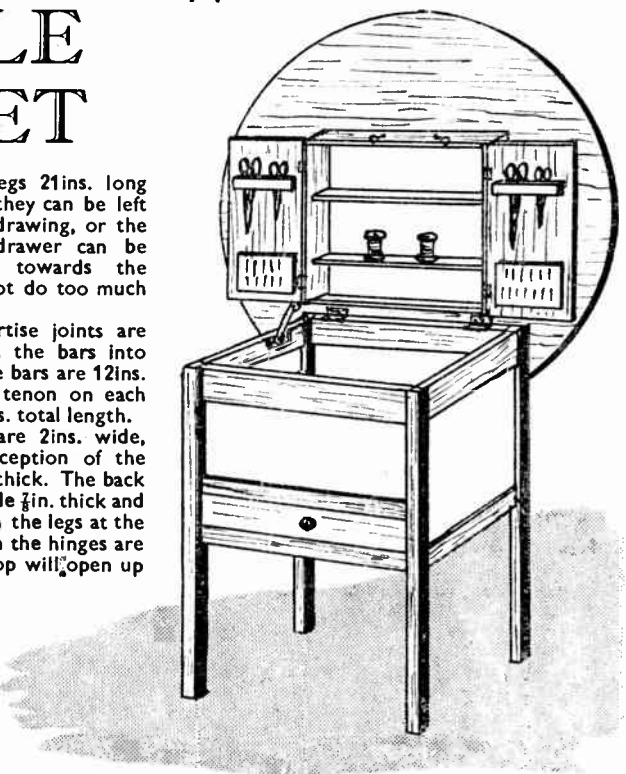

Fig. 1
Front and side elevations, giving dimensions:

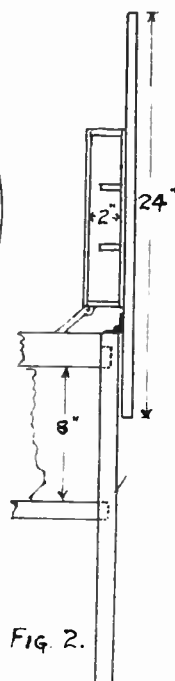

Fig. 2.

The exact positions for the bars is shown in Figs. 1 and 2. On the front and back, the first bar is fixed 5ins. down, and then a space of 2ins. is left for the drawer before fitting the bottom bar. On the two other sides the space between top and bottom bars is 8ins.

Having got all the tenons and mortises neatly cut and fitting nice and tight, we can prepare the four ply panels and cut the grooves for them to fit into. Assuming that we make the grooves $\frac{3}{8}$ in. deep the panels will be 12 $\frac{1}{2}$ ins. long, and the width of the front and back ones 5 $\frac{1}{2}$ ins., while the others will be 8 $\frac{1}{2}$ ins. Make the grooves in the centre of the bars, and in the legs,

to correspond. The exception to this will be the hinge bar which is $\frac{1}{8}$ in. wider than the others.

Before gluing all these parts together, the bottom of the cabinet must be cut out of plywood. Reference to Fig. 3 will show a $\frac{3}{8}$ in. ledge on the bars on which this base board can rest. Make the

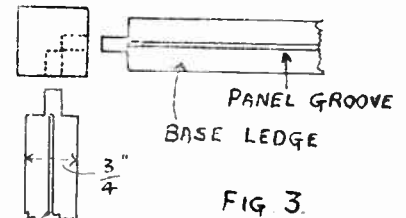

FIG. 3.

Constructing the base pieces of the cabinet

ply 13ins. square and cut a $\frac{1}{2}$ in. square from each corner to clear the legs.

Start assembling by gluing together the back legs, bars and panels. Next, the two sides can be fitted, then the plywood base placed in position, and finally the front portion glued in.

The Drawer

When the glue is nicely set, the drawer can be made. On to the two bottom side bars strips of $\frac{1}{2}$ in. wide wood are glued and tacked to form runners. Making the drawer should not present any difficulty. The easiest method is to cut the bottom of ply and fasten the front and sides on to this, but

(Continued foot of page 109)

Here are some more CHEMICAL EXPERIMENTS

HAVE you ever seen *black copper*? It is easily prepared by immersing zinc in copper sulphate solution. Pour some copper sulphate solution into a beaker. Test a few drops with potassium ferrocyanide solution. Red-brown copper ferrocyanide will be precipitated. Now put a piece of zinc into the beaker. The zinc gradually becomes covered with a spongy black powder, and in a few days the solution's blue colour will disappear.

When no trace of blue can be seen in the solution, test a few drops with potassium ferrocyanide solution. A white precipitate of zinc ferrocyanide falls. This proves that the copper has been completely withdrawn from the solution by the zinc and that zinc has entered the solution.

If you now remove the black powder from the rod, wash it and dry it, and then burnish a little of it between the

back of your thumb nail and a sheet of paper, you will find it assumes its natural coppery lustre.

COPPER OXIDE AND STARCH

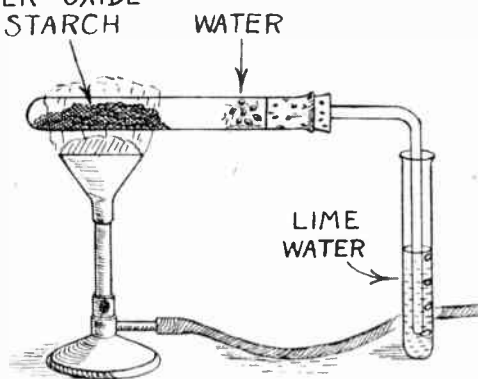

Fig. 1

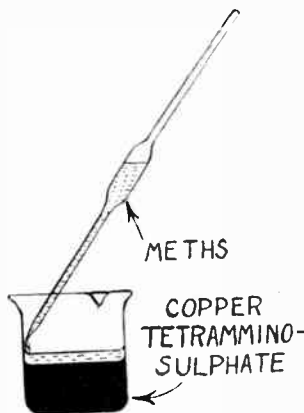

Fig. 2

back of your thumb nail and a sheet of paper, you will find it assumes its natural coppery lustre.

Now filter the colourless solution and evaporate to the crystallisation point. On cooling, large white crystals of zinc sulphate separate, which you can then remove and dry on a clean porous tile or brick for your chemical stock.

A Good Pigment

The copper ferrocyanide we produced in the last experiment is worth making on a larger scale, for it is a good pigment and known commercially as Hatchett's brown. Mix copper sulphate and potassium ferrocyanide solutions in a beaker with rapid stirring. Wash the precipitate by decantation several times, until the wash waters no longer give a white precipitate with barium chloride solution. Filter off and dry in the oven. If you grind this with glycerine you will produce a water colour of a warm red-brown tone.

This reaction may also be used for mineral dyeing on the small scale.

Basic copper carbonate is a most useful copper compound to have at hand, for copper oxide and soluble copper salts may be easily prepared from it.

Immerse a small square of white cotton in copper sulphate solution. Remove it, wring it out evenly, and then stir it round in a dilute solution of potassium ferrocyanide. The red-brown colour will then develop on the cotton. Wash the cloth well, dry it, and then gum it in your experiment book.

Basic copper carbonate is a most useful copper compound to have at hand, for copper oxide and soluble copper salts may be easily prepared from it.

Into a large beaker pour enough copper sulphate solution to fill the vessel to about one-fifth its depth. Add sodium carbonate solution gradually, and stir constantly. At a certain point, the blue precipitate formed evolves carbon dioxide and copious foaming occurs. Stir rapidly and when the effervescence subsides, add further portions of sodium carbonate until no more precipitate is formed.

Filter the precipitate, wash on the filter and dry filter paper and precipitate on a saucer in the oven. During the drying the precipitate often becomes green and more sandy in texture. This green form has the exact composition of the green copper ore, malachite.

To prepare a soluble copper salt from this basic carbonate you need merely add a dilute acid to a slight excess of it. It will effervesce, giving off carbon dioxide. When all action has ceased, filter the solution and evaporate. Try this with hydrochloric acid and evaporate to complete dryness. A yellow-brown mass of copper chloride will be left in the evaporating basin. Keep this in a tightly corked specimen tube, as it is very deliquescent.

To prepare a soluble copper salt from this basic carbonate you need merely add a dilute acid to a slight excess of it. It will effervesce, giving off carbon dioxide. When all action has ceased, filter the solution and evaporate. Try this with hydrochloric acid and evaporate to complete dryness. A yellow-brown mass of copper chloride will be left in the evaporating basin. Keep this in a tightly corked specimen tube, as it is very deliquescent.

Copper Oxide

To prepare copper oxide from the basic carbonate, heat it in a crucible. It will give off steam and carbon dioxide and become black. Since copper oxide is hygroscopic, it should be bottled while still slightly warm, so that it has no

chance to absorb atmospheric moisture.

Copper oxide is an important substance in organic chemistry, being used in the analysis of organic compounds. One easily performed experiment in this connection is to find out if starch contains carbon and hydrogen. If it does, and you heat it with copper oxide, the carbon and hydrogen will take oxygen from the oxide and form carbon dioxide and water.

First heat some copper oxide to ensure that it contains no moisture, then well mix it with one-fifth its bulk of powdered starch. Place it in a hard glass test tube fitted with a delivery tube dipping into lime water, as shown in Fig. 1.

Now heat the tube. A gas will bubble through the lime water and turn it milky, thus indicating carbon dioxide. The drops of colourless liquid which collect near the mouth of the test tube can be proved to be water by dusting on to them anhydrous copper sulphate (made by heating crystalline copper sulphate until it is uniformly white) which will turn blue. By means of this simple test you can also show the presence of carbon and hydrogen in many other compounds, such as tartaric, citric, tannic and oxalic acids, sugar and glucose.

Dissolving Paper

If you dissolve a little copper oxide in strong ammonia it forms a blue solution. Pour off the clear liquid. This has the curious property of dissolving paper and cotton. Drop in a few fragments of filter paper. They will first swell, then dissolve. Add some dilute hydrochloric acid. The cellulose of the paper will be precipitated again. By forcing the cellulose solution through fine holes into a bath of acid a kind of artificial silk was once made.

Lastly, let us make some copper tetramminosulphate. To strong copper sulphate solution add enough strong ammonia to produce a deep blue solution. With a pipette, carefully run on to the surface a layer of methylated spirit one centimetre thick, as shown in Fig. 2, and let the whole stand undisturbed for a few days. Long and beautiful sapphire-blue crystals slowly form. When they have ceased to grow, remove them and dry them at room temperature. Keep them in a tightly corked bottle. (253)

A BRASS POLISH

To polish brass, put a little salt in some vinegar and mix it. Then rub the mixture over the brass and wipe it off with a cloth.

MATTERS of INTEREST



Primer for Matchsticks

I HAVE built a model almost entirely of matchsticks. Can you advise me of a suitable primer to eliminate the porosity of the wood, to provide a suitable base for the various varnishes, matt paints, etc.? (J.G.S.—Culdrose).

ORDINARY size would be about the best filler you could use for such porous wood as matchsticks. It should be applied warm, but not hot, and two or more coats may be necessary.

Cleaning India Oilstones

I HAVE a coarse and a medium India oilstone, and have never used anything but mineral or lubricating oil on them. I wish to give them a clean up, and am considering using paraffin. Is this correct? (A.B.—Hounslow).

OPINIONS differ as to the best method of 'de-oiling' India oilstones, and even as to the desirability of doing so. Paraffin can be used, but apply it—or petrol—which is rather quicker in action, to the underside of the stone, the object being to cause as much old oil to exude and fall. Oilstones are absorbent and 'draw' the oil, hence, by keeping the solvent on the underside gravity tends to help clear the stone. Another plan is to put the stone in a strong solution of soda and cold water, and bring gradually to the boil, afterwards wash very thoroughly in clean, fairly hot water, while the stone is still warm.

Chess Board Squares

I WISH to make a chess board and would be glad to know which two types of wood to use for the squares, any assembly details, and what type of finish, e.g. polish, varnish, etc. (W.A.W.—Hull).

SUITABLE woods for a chess board are walnut, spanish mahogany, teak and sycamore or holly. Cut and plane in strips, 1½ ins. wide and 13 ins. long, and glue together, dark and light wood alternately. When set, cut and plane into strips crosswise, 1½ ins. wide, and then place together dark and light squares as in the usual board. Glue them to a foundation of wood, glue a ½ in. border all round, and glasspaper smooth.

Cloudy Aquarium

PLEASE give me some advice regarding an aquarium. Only two days after putting the fish in the tank, the water was cloudy. I have plenty of plants for the size of the tank, and also use an aerator. The fish are not overcrowded. As the water used was from the tap, there may be chalk in it. If so, can you tell me how to treat it, or the best method to overcome the trouble? (D.V.—Rochester).

ONE way of overcoming your difficulty, is to make a partial or complete change of water regularly. Daily changing of part of the tank water, say, a quarter or half of contents, replacing with fresh water will help. The trouble may be due to the water you are using; it may be well to try

50 per cent clean rain water, plus water taken from the domestic boiler supply or water that has been boiled. Water from a clean pond could be tried, or from a clear stream, but you would have to be very sure about the purity of such water before using it for an aquarium. It is usually possible to keep aquarium water pure and clear by partially changing water at intervals fairly frequently; by removal of sediment and excreta, and artificial aeration. Overcrowding must be avoided. Plants also are needed. As you seem to have complied with these requirements with your aquarium, it appears as though the tap water is the root of the trouble.

Repairing Bakelite Mouldings

PLEASE inform me whether bakelite mouldings can be repaired when they become broken. I have an expensive piece of equipment which has become shattered and will be rather difficult to stick. Please tell me if there is a solution or composition with which I can fill in the spaces, and at the same time build up the inside of the moulding to strengthen it. (T.H.—Stoke).

BAKELITE can be cemented by using the special bakelite cement made for the purpose; that known as 'Formite' Bakelite Cement A.P. should be suitable. Apply the cement to both surfaces to be united, allow to air-dry until sticky to the touch, then press the parts firmly together and stove for one hour at 270 degrees F. (132 degrees C.). Build up small units first, then unite them into the complete article. Small gaps can be filled in with the cement (after the main joining has been done), and stoved as before. An alternative filler is plastic wood, to which resin powder has been added; stove at a low heat (about 180 degrees F.) to cause the resin to fuse and run.

Work Table and Cabinet—(Continued from page 107)

if a more workmanlike job is wanted, the sides should be dovetailed into the front and back and the base grooved in.

Do not let the base show from the front—this can be overcome by cutting a rabbet half way along the drawer front to the thickness of the ply base. The front is 2 ins. wide and ½ in. thick, and the sides and back can be about ¾ in. thick. A brass knob, or one of the more modern type made from a strip of wood, puts a finishing touch to the drawer.

Select a nice flat piece of ¾ in. plywood for the table top and cut out a 24 ins. circle with a coarse fretsaw to prevent chipping the plywood. Well glasspaper both sides, and also the edges, to give a slightly rounded finish.

Strong brass 2 in. hinges are needed to fix the top to the cabinet. Draw a line across the centre of the table top, and 7 ins. from this a parallel line gives the position for the hinge centres. Put the hinges 10 ins. apart, measured from the outsides.

A lid stay should be carefully fitted to

hold the table top firmly when open. A rule joint stay or an auto type can be used, and it does not matter on which side it is fixed.

We are now ready to fit the cupboard on the inside of the table top lid, and this can either be built up on the lid, or made as a separate item and fixed afterwards, which is, perhaps, the easiest method.

Cut a piece of thin plywood 10½ ins. square, and round the edges of this, glue and tack four strips of wood 2 ins. wide and ¾ in. thick to form a case. The two 9¾ in. long strips which are fitted inside to form shelves will help to strengthen the case. Make these 1½ ins. wide to make room for the scissors when the door is closed.

The two doors are of ¾ in. plywood, fixed with two small brass hinges to each. When glued up and dry, the case is screwed on to the centre of the table top with four screws in the corners.

When the case is built up direct on to the table top, the ply back is omitted entirely and the four sides glued on

with dowel rod joints, three being used on each side. If the dowels are fitted accurately this will make a strong job.

Racks for Scissors

The doors are kept closed with brass side-hooks and eyes fastened on top. Inside the doors are racks to hold scissors. A 4 in. length of wood 1 in. wide and ½ in. thick will do for each. Before gluing on, cut two slots ½ in. to ¾ in. long and ¼ in. deep to fit the scissors. Fix these strips slightly higher than the top shelf so that the doors close easily.

Below each scissor rack fasten a pad to hold needles and pins. Cut a piece of cardboard about 4½ ins. long and 3 ins. wide and cover with velvet, turning the edges over about ½ in. and gluing on to the door.

The drawer can be partitioned off to hold various odds and ends if thought necessary.

The cabinet can be finished off by staining a nice shade of brown and then either french polishing or varnishing.

(261)

Improve your roadway lay-outs with MODEL ROAD SIGNS

MODEL roadways, whether made temporarily or as a permanent lay-out, can be greatly improved by realistic direction signs, while much greater interest is created if these bear local place names. The signs must be in proportion to other parts of the model, and often they have to be so small that the printing cannot be done by hand and

and, therefore, accurate focusing is essential. If possible, use a small stop and a corresponding long exposure.

Other signs can be copied in the same way, but if they are high up on a building or post, take care not to tilt the camera too much.

When photographing a signpost, however, it is essential to choose a type with the arms at right angles. Photograph it first with one arm pointing directly towards the camera, and then take

board can be painted green, while the posts are painted black and white. If the model is for use in connection with a permanent lay-out, a base will not be necessary.

The Signpost

The base for this must be 2ins. square and made from plywood $\frac{1}{8}$ in. thick. In the centre cut a hole $\frac{1}{4}$ in. square. The post is cut from hardwood $\frac{1}{4}$ in. square and 4ins. high. In the top of this make two saw cuts to take plywood arms

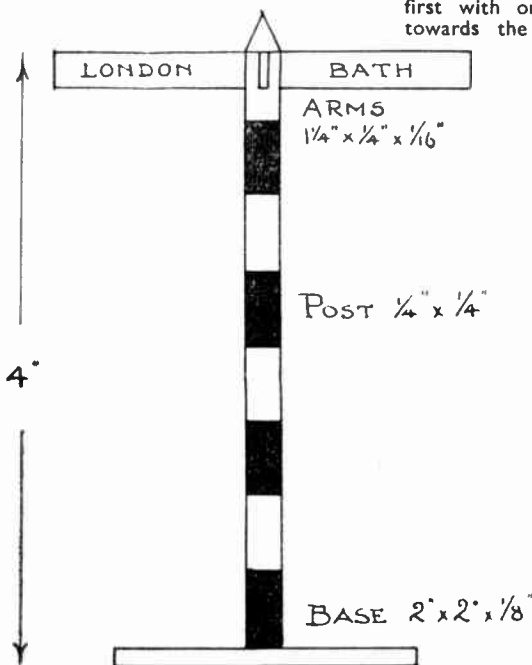

The ordinary village sign post

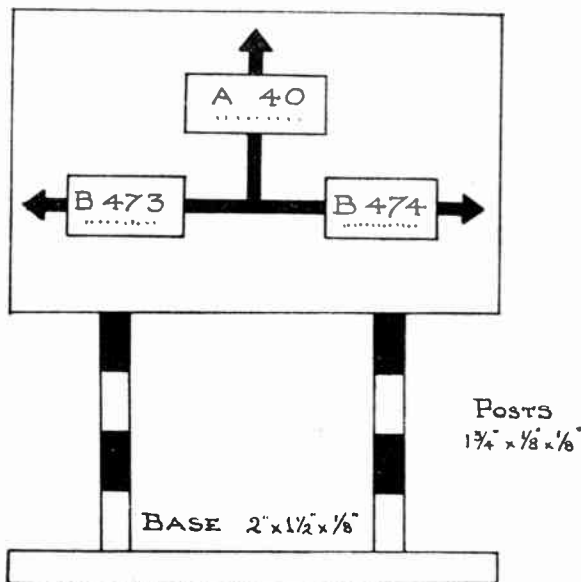

An 'advance direction' sign

is smaller than the tiniest stencil. Such difficulties can easily be overcome by the use of photography when making these little models.

Photographing Existing Signs

One of the easiest signs to model is the 'advance direction' type that is often found placed in the grass verge, a few yards before reaching a main crossing. Choose one which has black printing on a white ground, and, on a bright day, when no shadows fall across the sign, take a photograph of it so that it will appear about 2ins. long on the negative. If a miniature camera is used, then an enlargement will have to be made. The picture must be very sharp

other shots of the remaining sides of the arms. The number of photographs required will depend on whether the post is a two, three or four-way sign.

The Direction Sign

The photograph having been produced, trim the print until only the signboard remains. This should be glued to a piece of $\frac{1}{8}$ in. plywood cut to the same size. If the model is to be portable, then cut a base 2ins. long by $1\frac{1}{2}$ ins. wide from a piece of plywood $\frac{1}{8}$ in. thick. To this fix two uprights 1in. apart, cut from hardwood $\frac{1}{4}$ in. square. The uprights, $1\frac{3}{4}$ ins. high, should be slotted into the base and the signboard glued to them. When set, the base and back of the

$\frac{1}{8}$ in. thick. Each arm is made about $1\frac{1}{4}$ ins. long, but the exact size will depend on the length of the arms in the photograph. Fix the arms in position, and glue a square finial on top. Fix post to base, and the model can now be painted. When dry, glue place names on to the arms.

Other Signs

Many other signs with a local significance can be made, and such signs as appear on the local builder's yard, the coal yard, temporary 'Road up' notices, and others, will greatly add to model roadways, and are interesting to make, combining the art of photography with that of model making. (252)



THE BOLSTER HOME WATCH AND CLOCK REPAIR OUTFIT

These precision jewellers instruments include watchmaker's magnifying eyeglass, finest watch tweezers, set watchmaker's screwdrivers, watch and clock oil, oilers, dusting powder, clock brush, plus illustrated instructional manual for the amateur. In container 12/6 post free.

Senior Outfit includes everything above, plus watch jewels luminous compounds, dial renewer, jewellers rouge, explanatory book. Price 21/- post free.

BOLSTER INSTRUMENT Co. (Dept. H.W.), 5a Station Parade, Ashford, Middx.



TURN YOUR SPARE-TIME INTO CASH
Men and women wanted to make Bennett Model Bungalows at Home.

Fascinating, simple, well paid work

No selling involved.

Send stamped addressed envelope for full details.

BENNETT MODELS,
Duncan Road, Richmond, Surrey

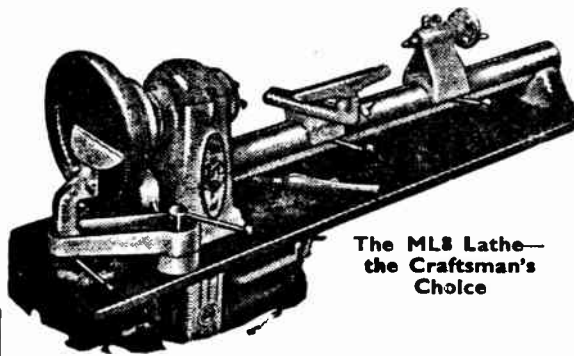

The ML8 Lathe—the Craftsman's Choice

MYFORD

For both the home craftsman and the professional expert, the ML8 Woodworking Lathe (8" swing x 30") incorporates the most modern, up-to-date features.

Extra attachments enable sawing, grooving, planing, rebating, sanding, grinding, polishing, metal and plastic turning. The illustration shows a mahogany bowl being turned on the Rear Turning Attachment.

The ML8 Lathe (also available on steel cabinet stand) is sold through all leading Tool Merchants.

Myford Engineering Co., Ltd.
Beeston - Nottingham

For all kinds of woodwork HOBBIES FRETSAWS

Not only in fretwork and model making but in a hundred and one woodwork, composition plastic, leather or metal sheet jobs you'll find a fretframe handy. And the best blade for any is the saw which is made here by Hobbies from good steel and the experience of forty years of manufacture. Every dozen is distinctly labelled.



IN 3 GRADES

Blue Label 1/- per doz.
Yellow Label 1/3 "
Metal Cutting 1/4 "

Obtainable from Ironmongers' Stores and Hobbies Branches, or by post (2½d. extra) from **HOBBIES LTD., DEREHAM, NORFOLK**



BRITFIX BALSA CEMENT

★ The ideal transparent cement for Balsa Ply Wood, Hard Woods, and Plastics, combining rapid drying with utmost tenacity.

Remember
STICK BY
BRITFIX

½oz. Tube 6d.
1oz. Tube 10d.
2½oz. Tube 1/6

THE HUMBER OIL Co. LTD., HULL

YOU CAN BECOME A HANDICRAFTS INSTRUCTOR

EXPERIENCE NOT ESSENTIAL

Men who enjoy making things in wood or metal can turn their hobby into a permanent and interesting Career. Short hours, long holidays, and security in a job you would really enjoy, can be yours if you become a Handicrafts instructor. Let us send details of the easiest and quickest way to get the necessary qualification.

**We definitely guarantee
"NO PASS—NO FEE"**

If you would like to know about our unique method of preparing you for one of these appointments, write today, and we will send you our informative 176 page Handbook—free and without obligation. Mark your letters "Handicrafts Instructor"

**BRITISH INSTITUTE OF
ENGINEERING TECHNOLOGY**

BIET

595 Shakespeare House
Stratford Place, London, W.1

STOP SMOKING

You can overcome the smoking habit in 3 days or money back. Safe, pleasant, permanent. The only scientific way. No Will Power necessary. "Conquered the habit in 2½ days. Am delighted".—F.C. "Within 2 days I was free from the tobacco habit".—W.G. "Was a smoker for 2 years and broke the habit in 2 days".—F.N. "I haven't smoked a cigarette for 5 weeks".—J.E. "I used to smoke 20 a day . . . now I have no desire to smoke".—J.M. Recommended by "Health and Efficiency Magazine". Complete course 6/6. Details 1d. stamp. Sent under plain cover.—**STEBBINGS, 28 (H/99), Dean Road, London, N.W.2. Established 1928**

MONEY-MAKING BOOKS

114 WAYS TO BE YOUR OWN BOSS—114 Tested ways of earning a second income at home with little or no capital 5/6
MONEY FROM MAIL ORDER—How to start and run a Mail Order business at home and earn pounds weekly 5/6
HOW I WRITE AND SELL THRILLERS—By the author of 73 successful thrillers 4/6
Catalogue of Money Making Books free.
STEBBING PUBLICATIONS LTD., 28 (H/99) Dean Road, London, N.W.2. Established 1928



BRANCHES LONDON

78a New Oxford St., W.C.1
(Phone MUSEum 2975)
87 Old Broad Street, E.C.2
(LONDON Wall 4375)
117 Walworth Road, S.E.17

GLASGOW

326 Argyle Street
(Phone CENTral 5042)

Head Office & Factories—**HOBBIES LTD., DEREHAM, NORFOLK**

MANCHESTER
10 Piccadilly
(Phone CENTral 1787)

BIRMINGHAM

14 Bull Ring
SHEFFIELD
4 St. Paul's Parade

LEEDS

10 Queen Victoria Street
(Phone 28039)

HULL

10 Paragon Square
SOUTHAMPTON
25 Bernard Street

BRISTOL

30 Narrow Wine Street
(Phone 23744)

*British
made*

Hobbies

*Fretwork
Outfits*

For pleasure and profit

With a Hobbies Outfit you can make models that will please—models that will earn you spare-time cash. A splendid hobby. Patterns are provided for hundreds of things to make—toys, models, fretwork. With a few odd pieces of wood, or the kit provided, you can turn out lots of things; for gifts or even to sell. Any Hobbies Outfit provides all the tools—from 10/6 to 56/-.

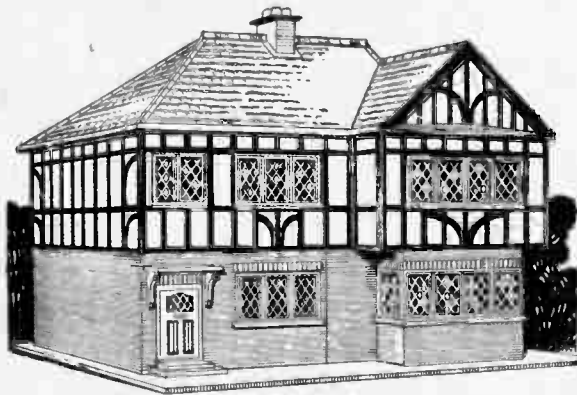
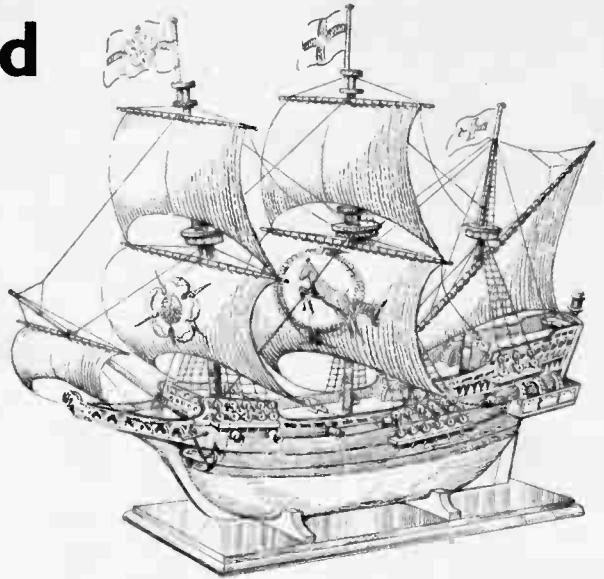

**Complete Tool Sets
Full-size Patterns
Kits of Materials**

*Ask for Hobbies at any stores, ironmongers or
Hobbies own branches. Free illustrated leaflets
from Hobbies Ltd., Dereham, Norfolk.*

*Father and Son
find Hobbies fun!*

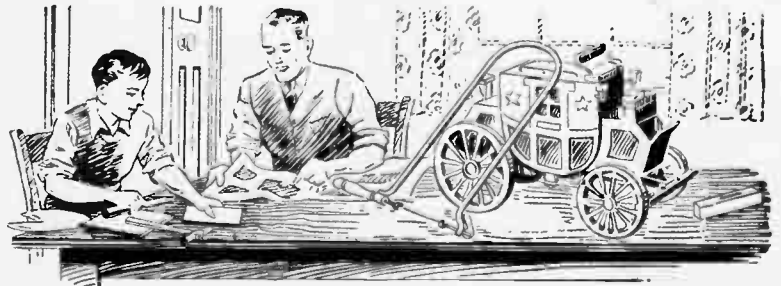

Printed by BALDING & MANSELL, LTD., London and Wisbech, and Published for the Proprietors, HOBBIES LTD., by HORACE MARSHALL & SON, LTD., Temple House, Tallis Street, E.C.4. Sole Agents for Australia and New Zealand : Gordon & Gotch (A'sia) Ltd. For South Africa : Central News Agency Ltd. Registered for transmission by Canadian Magazine Post