

# Hobbies

## WEEKLY

All correspondence should be addressed to The Editor, Hobbies Weekly, Dereham, Norfolk.

December 1st, 1948

Price Sixpence

Vol. 107 No. 2770

### A SMALL

# MANDOLELE

**A**S the name implies, this stringed musical instrument is a cross between a mandolin and a ukulele. Readers who are conversant with both types of instruments will know that the mandolin has a set of eight steel strings, two of each being tuned in unison to give four notes, such as G, D, A and E, the same as a violin is tuned; one can play melodies on it, using a celluloid plectrum to obtain a tremolo effect.

The ukulele differs in that it has four gut strings tuned A, D, F-sharp and B on a piano (and various other keys). One can only "vamp" or harmonize on the ukulele, a felt plectrum being used to stroke the strings.

The writer has combined both instruments by designing a special body and incorporating four steel mandolin strings, i.e., a half set.

These strings, tuned to ukulele pitch, results in a sweet-toned melodious type of ukulele—in fact, a mandolele!

#### The Construction

A photograph of the actual model made is provided to show the slender neat, and novel appearance of the finished work. Odds and ends of scrap material, such as thin cheese box wood, margarine box wood, celluloid sheeting, etc., are used, and despite the fact that deal, with the exception of the walnut pegs and fingerboard, is the nature of the timber throughout, the mandolele is surprisingly sonorous, with a satisfactory tonal quality.

A front and side elevation appears at Fig. 1 to give a clear impression of the work. The alphabetical letters indicate (A) the handle head, (B) peg holes, (C) nut, (D) frets, (E) handle

support bracket, (F) finger-board, (G) the body, (H) sound hole, (J) bridge and (K) a dragon emblem.

#### The Body

The body parts are prepared first. Back and front pieces are cut identical in size and shape from  $\frac{1}{8}$  in. wood, a 2 in. diameter sound hole being cut in the front piece which, incidentally, should be straight-grained and free from ugly knots.

It is advisable to gauge an  $\frac{1}{8}$  in. marginal line all round the edges, at the interior side of both shapes, then mark out the corner block positions (see Fig. 2). The blocks, when shaped and cut to length, are glued and pinned to the bottom, as shown, including the handle support blocking, further details of which are given at Fig. 3 (E).

#### The Handle

The handle has been designed to cut out unnecessary hard work in shaping from the solid. A piece of  $\frac{1}{2}$  in. thick wood 11  $\frac{1}{2}$  ins. long by 2  $\frac{1}{2}$  ins. wide is wanted.

The top shape (A, Fig. 2) is marked

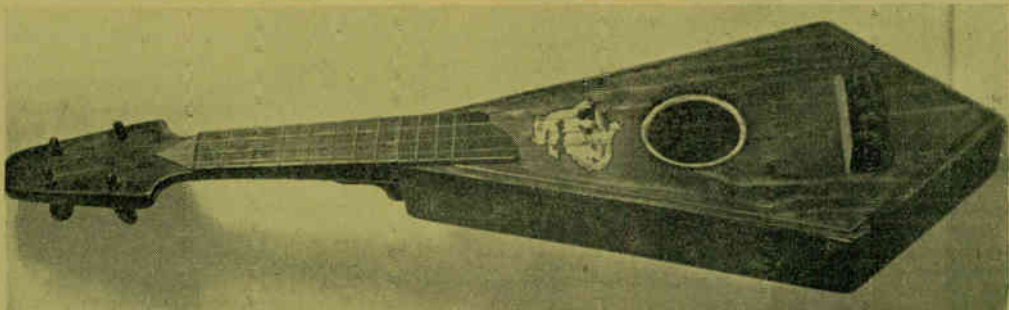

A Merry Christmas to all our Readers

out, then cut to shape with, preferably, a coarse fretsaw. Note, from the side view, that the head is 5ins. long and tapers to about  $\frac{1}{4}$ in. at the end; the peg holes are  $\frac{3}{16}$ in. in diameter.

Having checked the shoulder end as shown, the underside of the handle is rounded to the sections (Fig. 3) and then glued and screwed on top of the support blocking as indicated (E). It is imperative, of course, that the handle is truly in line with the body shape. If a central line is ruled down the surface of the handle and front body piece, the latter will, when set temporarily in position, enable you to look down the lines and draw the handle into alignment.

### The Side Pieces

When the top shape has been secured, the  $\frac{1}{8}$ in. thick side pieces

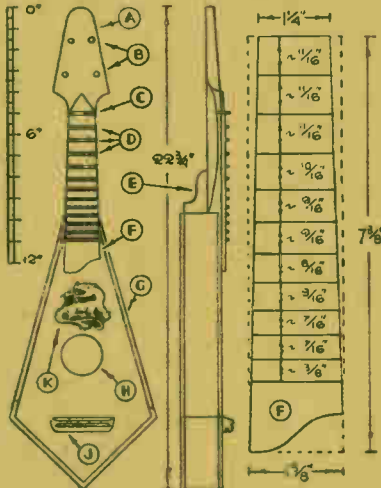

Fig. 1—Front and side elevation, with fingerboard shape and sizes

can be fitted and glued in place. Try to obtain neat mitre joints at the corners. When glued, the use of suitable clamps will hold the back and front firmly down on the side edges, otherwise thin panel pins or needle points may be used.

The nut is a piece of  $\frac{1}{16}$ in. thick celluloid or bone, cut to the size shown (C, Fig. 2). Make a kerf for it with a tenon saw at the neck, i.e., 5ins. down from the top of the head, the depth of the cut being  $\frac{1}{8}$ in. (see constructional details at Fig. 4), then fix in position.

### The Finger-board

Regarding the finger-board (F), an enlarged view is given at Fig. 1, together with the exact fret positions. The wood is  $\frac{1}{8}$ in. thick and should be planed true prior to shaping it to correspond with the handle.

The fret positions are marked off with a set-square, then saw cuts

made  $\frac{1}{16}$ in. deep. When cut to shape, the finger-board is adhered neatly over the handle and fore-end of the body, keeping its narrower end close against the nut.

It is better to make the finger-board from a hardwood like walnut or even mahogany. Deal is too soft, and besides, it needs to be stained, whereas walnut or mahogany can be left in the natural state.

### Bridge and Pegs

This also applies to the bridge (J) and pegs (B) as detailed at Fig. 3. The writer used whitewood in making the bridge and polished it ebony, and readers might care to follow this example.

Having shaped the bridge, make four knife nicks on the top edge  $\frac{1}{2}$ in. apart, then drill or pierce four holes at a slant through the groove in the

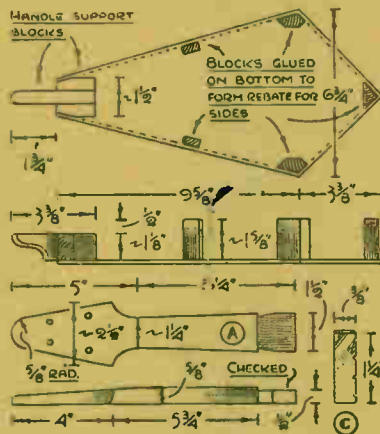

Fig. 2—Bottom with blocks in place handle shape and bone piece C

back for the insertion of the steel strings. The best way to anchor the strings is shown. The bridge may be

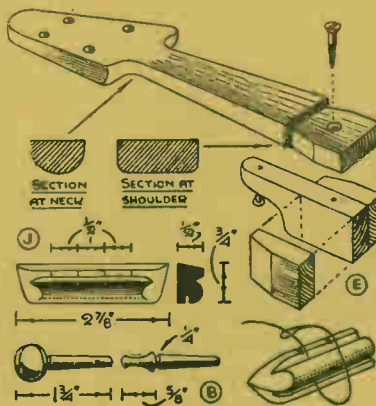

Fig. 3—Detail of handle at shoulder; piece J is bridge, B peg shape, etc.

adhered in position at this juncture.

### Finishing Details

If constructed from deal, the finger-board can be fitted with the frets, then stained mahogany, including the rest of the work, excepting the front side of the body. Normally, brass fret-wire is fitted to the finger-board, but as this wire is difficult to obtain, one can make use of  $\frac{1}{16}$ in. white celluloid.

Cut off  $1\frac{1}{2}$ ins. by  $\frac{1}{4}$ in. strips and glue them into the saw cuts. Level off the tops with a flat file and glasspaper. Projections at each side are cut flush and glasspapered, any sharpness at the ends being removed. The frets should project  $\frac{1}{16}$ in. high, whereas the nut projects  $\frac{1}{8}$ in. high.

Having stained the work as explained, apply a single coat of polish to the finger-board surface. The rest of the work is french polished in the usual way. The face of the mandolele should be kept in the white state and a coat of clear polish or varnish applied.

### Fretted Emblem

Before doing so, however, the decorative dragon emblem (K) should be painted on the wood in black and silver. Pencil it on first, fill in with silver paint, allow to dry, then use black paint for the foundation. A black ring encircles the sound hole and the edges could be lined black.

Allow the finished instrument to stand aside for a few days before fitting the strings which, reading from right to left, are:—

- 1st string, very thin wire.
- 2nd string, slightly thicker.
- 3rd string, silver covered.
- 4th string, similar, but thicker.

If the thick silver-covered 4th string is used, it must be tuned an octave lower than the other strings. If a 1st string is used in place of a 4th one, it may be tuned in conjunction with other strings as shown at Fig. 4.

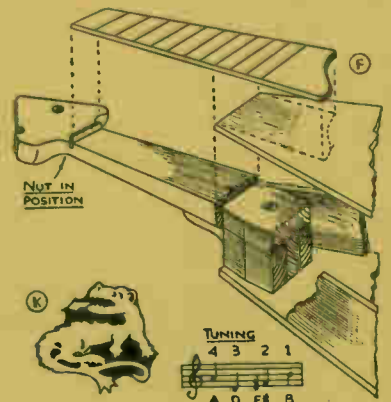

Fig. 4—Body detail at fingerboard, with emblem (K) and usual ukulele tuning

This issue contains special Supplements of Xmas Gifts Design Sheet and a Novelty Colour Calendar Picture

# Full instructions for building and completing a SIMPLE DOLL'S HOUSE

**F**EW presents are more pleasing to a young girl than a doll's house, and the one illustrated can be built for such a trivial sum that it is worth the little trouble to make it. It is of simple design so can be undertaken by almost any handy worker with confidence.

The foundation of the house is a grocer's box, the wooden type of course. One can generally be bought for a small sum, and should be about the following dimensions, 19ins. high, 12ins. wide, and 11ins. deep. Smaller or larger boxes could be used if the measurements given in the diagrams are suitably amended. The box, where necessary, should be smoothed with a vigorous rubbing all over with medium, and then fine glasspaper.

## A Suitable Box

It may be desirable to drive in a few more nails to the joints, to make a sound job. The boards for the top of the box, which will be the front of the doll's house later, should be glued edge to edge and kept flat with a weight on top, until the glue is hard. At the same time glue across the front  $\frac{3}{8}$ in. by  $\frac{1}{2}$ in. strips of wood, one each at the top and bottom, and one across the middle, as shown by the dotted lines in Fig. 3.

The box being smoothed, cut a middle floor for it, from any thin wood available. This floor should have an opening sawn at, as at A, Fig. 1, to provide access via the stairs to the bedroom. The diagram, Fig. 1, by the way, shows how the box is fitted up before the details are added, and has one side of it removed to reveal the interior more clearly. Fix

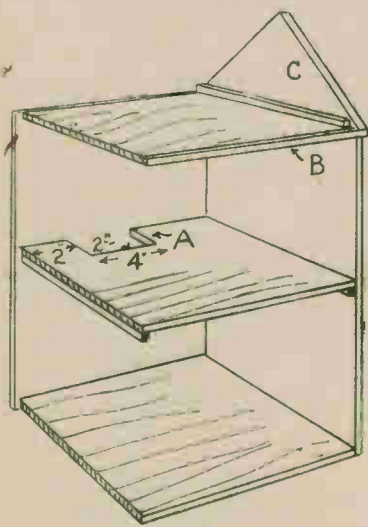
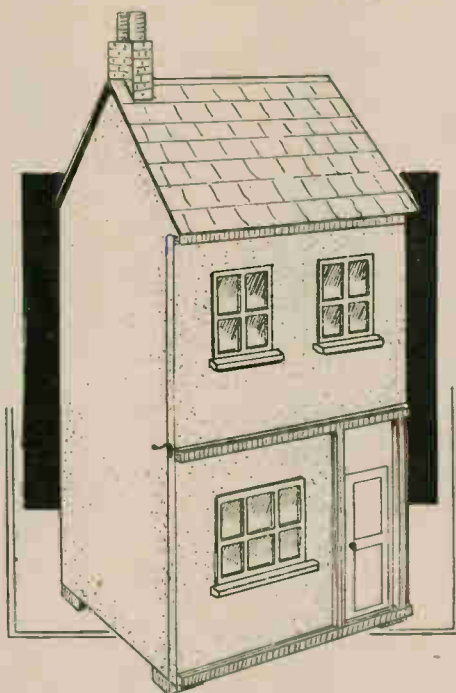

Fig. 1—General view of car case



the floor across the centre, gluing and nailing it to side fillets, as shown.

Across the front top edge of the box glue a strip of wood, B. This should be  $\frac{1}{2}$ in. wide and the same thickness of wood as the front of the box. To support the roof cut two triangular pieces of spare box wood and fix to the top of the box, as seen at C.

## Roof Supports

These should be the same length as the depth of the box, plus the strip, B, and have the sides cut to an angle of 45 degrees. They could be doweled in place, or just fixed there with side fillets, as in the diagram.

The next part is the stairs and details pertaining to them. There are several methods of making up

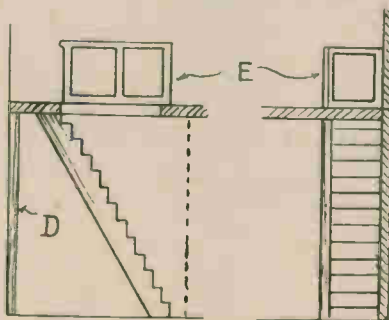

Fig. 2—Side and front view of stairs

doll's house stairs, and readers may choose their own, or adopt the following simple method. A front and side view of these stairs is given at Fig. 2.

## Stairs

For the stairs a 2in. wide strip of wood,  $\frac{3}{8}$ in. thick can be cut to fit between the two floors. This should be trimmed to 60 degrees, top and bottom, to bed down flat at the best angle. The diagram shows this. Now divide the strip into divisions of say  $\frac{3}{4}$ in. each, as near as possible, and cut down on these lines to make the stairs. Fix in the position shown with glue.

The stairs should be boxed in with a piece of thin wood, or stout cardboard, which should extend from the wall to a little beyond the stairs, to about where shown by the dotted line. It can be securely fixed in place by gluing it to the stairs and to a strip of wood, D, nailed to the wall.

## Handrails

Around the opening through the floor, some bannister rails should be fitted, as shown at E. These can be cut from fretwood and be fixed to the floor with glue and a few small nails. It will be found convenient to cut and fix these before fixing the floor in place. The rails will be fixed to the side and end of the opening, leaving the front open, of course. It may be added that the design of stairs shown is common to country cottages, and has been adopted here both for simplicity and room saving.

Two fireplaces can now be made from thin wood to the design shown at H, in Fig. 4. The method both of cutting to show a grate and the requisite projection is made clear in

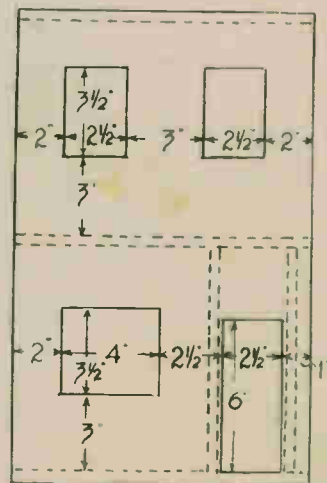

Fig. 3—How to mark and cut the main front

the drawing. These can be glued inside the house, in the centre of the left hand side. So far as the one is concerned that is made for the ground floor, it will be necessary to saw out a piece at the top to fit over the fillet on which the floor rests. This will be seen at once, when fixing in place.

### Mantel and Grate

The mantelpiece and side grate strips are cut from any scraps of fretwood lying about and glued and nailed in position. Some care should be taken to cut the fitting the right length to fit tightly between floor and ceiling. This must be measured from the box as exact distances cannot obviously be given.

Cut the roof from cardboard, preferably in one piece, which can be cut lightly across the centre and then bent to the angle of the end blocks. C. It should extend over the eaves and ends about  $\frac{1}{4}$  in., and can be glued and further strengthened with small nails. One or two angle blocks, cut to 45 degrees, might well be glued to the top of the box, say about where shown in Fig. 1, to fix the roof well down between the blocks.

The chimney stack is shown at I, and is cut from a solid piece of wood to dimensions given. Cut the bottom to 45 degrees, each way, to fit over the roof. The pots are pieces of  $\frac{1}{2}$  in. dowel rod, or wood planed to that diameter if the rod is not handy. They can be fixed in place by boring  $\frac{1}{2}$  in. holes in the stack, and then gluing the pots in the holes. Now glue the lot to the roof,  $\frac{1}{4}$  in. in from the left side.

### The Front Door

Now take the door in hand, which forms, of course, the front of the doll's house. This should have a strip  $\frac{1}{2}$  in. wide sawn off the top and should then cover the box comfortably, coming just underneath the added strip, B.

It will be convenient at this stage to fit it to the box, with hinges, to open. Take care to hinge properly so that the front closes up against strip B, and does not drop. It shows bad workmanship when a door sags to one side and spoils the job.

### Windows

Door and window openings can

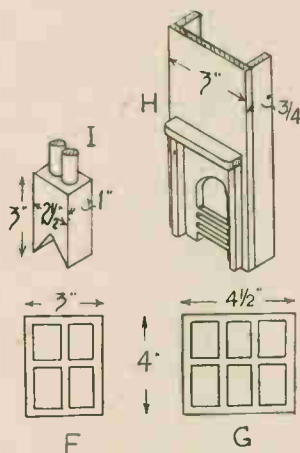

Fig. 4—Details of chimney stacks, fireplace and windows

now be sawn out of the front, as shown in Fig. 3, and narrow strips of wood glued each side of the door opening, reaching from the top to the middle strips glued across the front. The window overlays are shown at F and G, and are marked out and cut from thin fretwood. Being larger than their respective openings, they, when glued over, will form rebates behind for glass windows to be fitted in. Rhodoid, or any transparent material, can be fixed here in place of the glass, if preferred.

If the door opening is cut out with a fine fretsaw, the piece cut out can serve as the actual door. It should be fitted with small hinges.

To complete the work of construction, fix  $1\frac{1}{2}$  in. square squares of wood to the bottom of the doll's house, one at each corner. These will raise the house a little, just enough to allow the front to open and shut freely and not scrape the table or floor.

### Suitable Finish

The doll's house can be finished with suitable paper, both inside and out. The woodwork parts, doors, windows, etc. can be painted or enamelled any pleasing colour. Here there is scope for individual treatment, the main thing being to make a pleasing article, and if for a young child, there is no need to be too accurate about the details, such as the scale size of bricks and tiles for instance. A small catch should be fitted to the door and a strong hook fastener to close the front of the doll's house.

Those who would like to do a really economical job of decorating, can cover the interior walls with green wrapping paper, and the ceilings with white. Floors can be stained with any remains of oak or walnut stain handy. Outside, the roof and stack can be covered with paper, then stained with red ink. The bricks and tiles can be marked in in soft lead pencil, and a coat of clear varnish spread over the lot. The pots should also be stained red.

### Paper Covering

The walls can be coated, if reasonably smooth enough, with tinted distemper. If you have not any left over from a job, make up a little with powdered whiting, size, and water, and tint with a little dry colour to cream, pink, or green, as preferred.

Instead of painting, as suggested, you can now obtain, quite cheaply, sheets of brick, tile, and interior paper from Hobbies Ltd., who also have realistic fireplace surrounds in metal ready to nail in place.

### Repolishing a Table

**I** HAVE stripped all the polish from a dark oak Utility table, and wish to re-polish it light oak. At present the wood although thoroughly cleaned, is too dark, and I am undecided how to proceed. (B.L.—Wembley).

**N**OT an easy job, as the stain formerly used may have sunk in rather deep. Wash over the surface with oxalic acid, 1 ounce acid to a pint of water. Give it several applications and allow time for the acid to take effect. Then rinse with plenty of clean water and wipe over the surface with acetic acid or vinegar to stop the bleaching process, which otherwise may still continue. The wood can then be dealt with as usual.

### Perspex Cement

**C**OULD you give me any information on a strong cement for Perspex plastic glass and how to obtain it? (C.G.M.—Carlisle).

**T**HERE are several makes of Perspex Cement now on the market, and as those are listed under a number of different trade names, it is difficult to recommend a particular brand, as this may not be available in your locality. All of these cements are, however, very similar and there is little to choose between them.

You could make your own cement by shredding scraps of Perspex into Acetone until the mixture assumes the consistency of syrup. Put the acetone into a small bottle, shred the Perspex in a little at a time and

shake the bottle to dissolve the Perspex. Always keep the bottle tightly corked and never on any account bring it near a naked light. Acetone is highly inflammable and is very dangerous if handled near an open flame.

### Dissolving Perspex

**I**S there a means of dissolving Perspex into a malleable form for filling cracks and joints, etc., without losing its colour? (C.G.—Penrith).

**T**O fill cracks in Perspex or gaps between joints where coloured material has been used, you can, of course, make a very small quantity of cement by shredding scraps of Perspex of the colour required into Acetone.

# For the bedside light or watchstand you should make THE ELECTRIC OWL

HERE is a novelty which should appeal to our readers who like making up electrical novelties. It is a night light having a box container for a pocket flashlamp battery, whilst above it sits an owl whose eyes consist of electric bulbs. By switching over a little lever attached to the top of the box these bulbs light up and give sufficient illumination to tell the time by a watch which could be laid on the top of the box or hung from a small hook on the breast of the bird.

## The Box

The box is very easily made as the diagram Fig. 1 shows. The base is hinged to a frame, this frame having a top fixed permanently to it. The base piece is  $\frac{1}{2}$  in. thick, while the other parts of the box are  $\frac{3}{16}$  in. thick, and with a mortise cut in the top for the reception of the tenon on the owl upright and an opening for

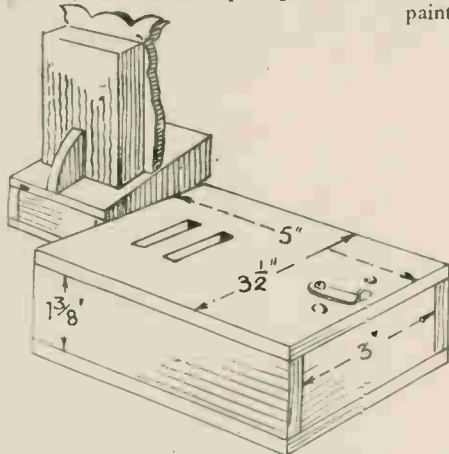

Fig. 1—General view of box base

the passage of the wires. The mortise is made 1 in. long and  $\frac{1}{2}$  in. wide. Cut the various pieces square and glue and pin them together with fine fret pins.

To hold the base securely to the box after the battery has been put in and linked up with the wiring connections, a brass hook and eye may be fitted or two screws may be run in which can easily be taken out and replaced when a new battery is installed.

A squared diagram of the owl is given in Fig. 2 and this will enable the worker to make his enlargement of the bird direct on to the wood. On a piece of  $\frac{1}{2}$  in. wood, therefore, measuring 5 ins. by 4 ins., run lines each way  $\frac{1}{4}$  in. apart.

Draw the outline and feathers of the bird by following each square carefully and cut round the outline with the fretsaw. Also cut the holes

where the eyes come, but before cutting them, obtain the bulbs and see they only just pass through. At a distance of  $\frac{1}{16}$  in. away from the owl upright, a second upright, A, is arranged and the threaded tail portion of the bulb must be screwed into this just as seen in the sectional diagram in Fig. 3.

A box-like casing is made of  $\frac{3}{16}$  in. or  $\frac{1}{2}$  in. wood to go behind the owl. In the diagram the back of the casing is shown as B, and the top of it as C. The back, C, could if desired be held in place by round-head screws, so that it can be easily removed in the case of any adjustments to the interior wiring, etc.

A complete view of the back casing is given in Fig. 4 and also shows the two connecting wires, B and C, which go on the switches below.

## Carved and Painted

The feathers, etc., on the front of the bird could be either carved in or painted on and afterwards varnished

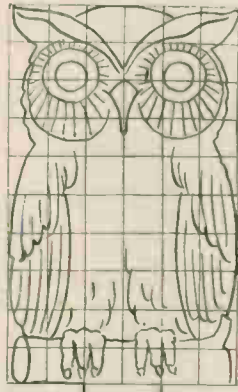
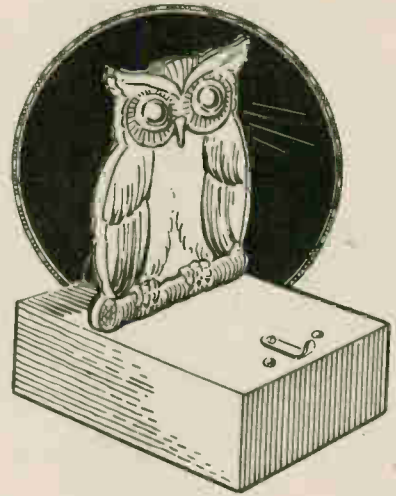

Fig. 2—The "bird" outlined for drawing

over. The cut outline should also be painted and varnished over. The two sides and the top of the back casing of the owl should be glued on after the owl upright has been fixed, like this, the three pieces can be measured for convenience and neat joints made.

The wiring and the battery connections are shown in the diagram Fig. 5. The battery will be laid in the box so that contact will be made between plus and minus brass



strips of the battery and the fittings, C and D, of the box. To the back of the casing and immediately between the eye holes is fixed a piece of thin brass as, A, in Fig. 5.

The bulbs screw into this and complete the contact with C. Two smaller holes should be made in the brass strip, one to take a small round-head screw for fixing the strip to the upright, the other to take the end of the wire which runs down to connection C. The bulbs in Fig. 5 are shown ready to be screwed into A.

To make contact with the extreme ends of the bulbs, two pieces of thin brass are bent up as at B in Fig. 5. These are about 1 in. long and are drilled at one end to take round-headed screws for fastening. Coiled round these screws are pieces of covered wire which should come together in the centre and

(Continued foot of page 112)

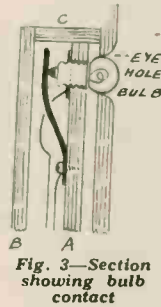

Fig. 3—Section showing bulb contact

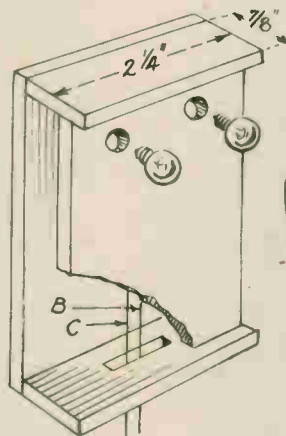

Fig. 4—The box with eyeballs

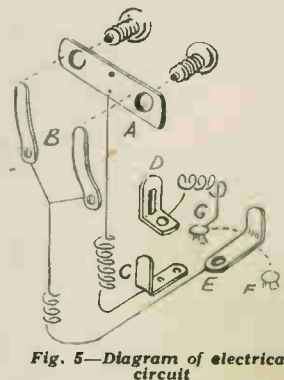
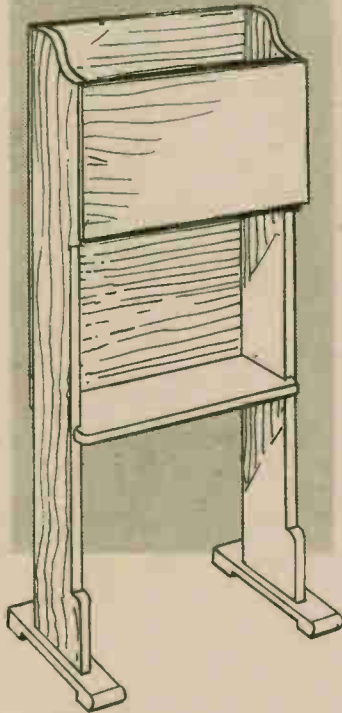

Fig. 5—Diagram of electrical circuit

# Very little wood is required to construct this handy PAPER AND BOOK RACK



**A** VERY useful article of furniture this, for holding papers and magazines, with a shelf for the library books. It occupies little space, being intended for standing against the wall, and prevents the untidy appearance of such articles lying about on chairs and table.

It is made of wood, any kind, and requires comparatively a short piece of board, say  $\frac{1}{2}$  in. thick, or  $\frac{3}{4}$  in.; 9 ins. wide and 4 ft. 6 ins. long. Though timber is so scarce nowadays, it is generally possible to find such a short board from a piece of unwanted shelving, or from something no longer in use.

A front elevation of the rack is given in Fig. 1, and a side elevation in Fig. 2. Prepare the ends first. Cut the two ends 4 ins. wide and plane up. At the top of each a strip of the wood,  $\frac{1}{2}$  in. wide and 10 ins. long is glued and nailed, as in Fig. 3, to widen the ends at these parts. Measure down the 8 ins. shown, and from there chisel out a groove across,  $\frac{1}{2}$  in. deep, for the bottom of the paper rack to enter. Now shape up the tops to the curve and round off the bottom ends of the glued-on strips.

The bottoms of the ends of the rack are to be sawn to form a pair of tenons for fitting to the feet, as at C, Fig. 4. Make these tenons 1 in. long, spaced 1 in. apart and as deep as the thickness

of the wood used. Now cut the groove across, also  $\frac{1}{2}$  in. deep for the book shelf to enter.

Cut a piece of the board for the bottom of the rack 5 ins. wide and 12  $\frac{1}{2}$  ins. long, and make it a close fit in the grooves. Cut a similar piece for the bookshelf, but 12  $\frac{3}{4}$  ins. long. This, being 5 ins. wide, will project beyond the front just 1 in.

For the remaining 4 ins. of the width cut a piece away each end  $\frac{1}{4}$  in. wide, for fitting in the grooves, as at B in Fig. 4. The shelf and bottom can now be glued and nailed to the ends of the rack. Use oval nails for this job, and punch them down below the surface, as they must be hidden with stopping afterwards.

## The Feet

The feet are shown in detail in Fig. 4, C. They are 9 in. lengths of the wood, about 1  $\frac{1}{2}$  ins. wide, with two inch lengths of the same stuff glued below, one at each end. The mortises for the ends to fit in are cut 2  $\frac{1}{2}$  ins. from the back edges, allowing the ends to be 2 ins. from the back edges and 3 ins. from the front. Make these mortises a nice fit for the tenons, then glue only will make a firm secure fixing. The front edges of the feet are neatly rounded off.

Between the angle formed by the vertical ends of the rack and the feet, pieces of 1 in. wide wood, 3 ins. long, are glued and nailed in front. These are clearly shown in the elevations. Round off their upper ends. Now take the whole rack in hand, glasspaper all over smoothly, especially the upper curved edges of the ends.

The sharp angles of the side projections of the book shelf are slightly rounded off with a file. See the back and front edges of the

bottom of the rack are quite level with the side edges of the ends so that the boards to be used for making the sides of the paper rack can bed down properly and make a close fit.

Boards for the back and front could be made from plywood, if any is to be got. Even tea chest plywood could be used if placed with the best side on view, for though it is of rather common quality a good rubbing down with glasspaper and a coat of stain and varnish will work wonders in covering up faults.

If no plywood is to be got, do not be tempted to use fretwood, supposing you are lucky enough to possess it, as any of the composition boards, now obtainable, will serve quite well and be good enough. Plywood substitute is quite suitable, in fact almost any of the wood substitute boards.

## Two Panels

One board covers the back from the top to the book shelf, making a back both for the rack and shelf as well. A second piece is needed across the front to complete the rack portion. Both should, for preference, be screwed on, using no glue, and for appearance sake, screws of the round-headed variety should be selected for the front board of the rack.

The completed rack could be stained oak or mahogany colour, then receive a coat of varnish which, when dry, should be lightly rubbed down with a piece of worn glasspaper, and be completed with a final coat of the varnish.

The bare expanse of the rack front could be improved by the fixing of a suitable transfer decoration. This, if added, should be applied before the final coat of varnish, as the latter will protect and improve its appearance.

An alternative finish, and one that suits deal, is a couple of coats of paint, with a finishing coat of clear copal varnish, or one coat of flat paint and then a coat of enamel.

Apply all finishing stain or colour with care, as this will make all the difference to the finished article.

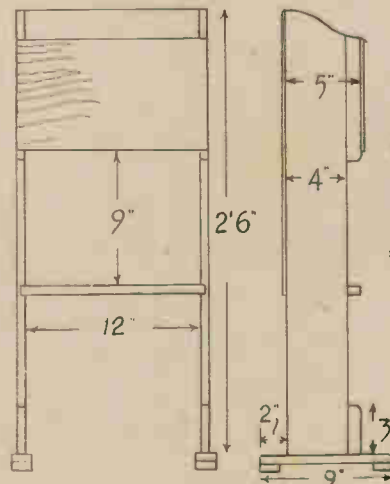

Fig. 1—Front view of rasp

Fig. 2—Side view

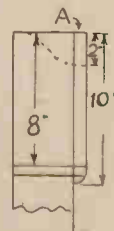

Fig. 3—Top shape of side

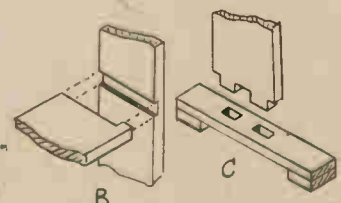

Fig. 4—Detail of various joints

# Quaint little toys can be made from our patterns of WALKING ANIMALS

**H**AVE you ever made a "walking" duck or rabbit? A design for these two popular novelties is provided in this issue (patterns on page 115), and needless to add, the toys are easily constructed, using a few pieces of wood, a fretsaw, and the usual handy tools about the home or workshop.

Wooden toys, with some form of action, always please the kiddies. The small rabbit, which the writer has devised, is a quaint realistic comical affair. It patters down a sloping board just like a real bunny, the large hind legs moving well up to the shorter fore legs and sending the wooden animal forward in short jumps, just like a real rabbit.

Regarding the duck, this is also fascinating to watch. It waddles down the board in a comical manner. Both novelties will amuse children for hours, and as only a few scrap pieces of wood are required, the toys are worth making as gifts.

## An Inclined Surface

An inclined surface, such as provided by a board of wood is needed to operate the toys, of course. The board should not be less than 6ins. wide and about 30ins. long. The surface—and this is important—must not be smooth, otherwise the toys will merely slide down.

## Accuracy Essential

Now, it should be explained at this stage that, although the novelties are simple to make and work easily, care is necessary in the construction. The edges of all shaped parts must be cut squarely—not at a slant.

For a brief second, you see, the body is tilted on the board. In that moment, it allows the legs to swing forward. If the supporting edge of the body is cut at a slant, the toy will be unbalanced and is apt to fall sidewise. This, however, is particularly the case when the body is cut from  $\frac{1}{2}$ in. wood, and the legs from  $\frac{1}{4}$ in. stuff. If you use this thickness of material and see that all edges are cut squarely, the toys will function without falling over sidewise.

It is better to use fairly thick wood, however, if possible. The body pieces are best cut from  $\frac{3}{4}$ in. or  $\frac{1}{2}$ in. wood, and the legs from  $\frac{1}{4}$ in. or  $\frac{3}{8}$ in. wood. This ensures a good "spread" in the width and toppling over on one side or the other is avoided.

## Making the Duck

The duck could be made first. Trace the outlines of the body on  $\frac{1}{2}$ in. or  $\frac{3}{4}$ in. wood, using a sharp pencil and duplicating paper. Be sure to indicate the exact position of the pivot holes,

this also applying to the leg piece, two of which need to be cut out from  $\frac{1}{4}$ in. or  $\frac{3}{8}$ in. wood. The legs must be exact copies.

When the parts are cut out and smoothed with glasspaper, obtain two  $\frac{1}{2}$ in. by 6in. roundhead brass screws and two  $\frac{3}{8}$ in. diameter brass washers. These screws are for  $\frac{1}{4}$ in. thick legs. If you use  $\frac{3}{8}$ in. legs, get  $\frac{1}{2}$ in. long screws.

Drill holes in the legs for the screws so the latter will be fairly free. If you bore  $\frac{1}{4}$ in. holes, there should be plenty of freedom. The pivot hole in the body is made with a fretwork drill.

The legs are pivoted on the sides

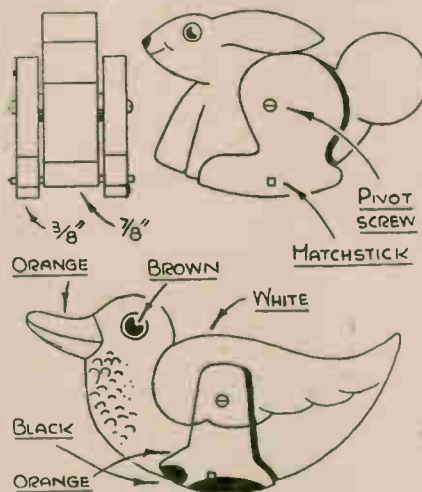

How rabbit is made, with colour details of the duck

of the body with the screws. A washer should be between each leg and the body. The legs are not screwed tightly against the body, but left fairly slack to swing easily. The legs are connected at the bottom by means of a length of  $\frac{1}{4}$ in. dowel or a piece of matchstick. Have the dowel or stick glued to the legs. Allow some slackness in the width between the legs so the legs swing freely.

Now test the novelty on an inclined board. A board, raised 6ins. at one end, gives sufficient incline to operate the toy. It should waddle down the board realistically. You will have to start it off, by the way, by rocking the body with the finger, or if the novelty is well made, it should start off on its own accord.

## The Rabbit

The rabbit is made up similarly to the duck. In the constructional view provided, it will be seen that the body is cut from  $\frac{3}{4}$ in. wood and the legs from  $\frac{3}{8}$ in. wood. There is no need to stick to these particular

thicknesses. If you have  $\frac{1}{2}$ in. or  $\frac{3}{4}$ in. wood, use it for the body. If you have  $\frac{3}{8}$ in. or  $\frac{1}{4}$ in. wood, use it for the legs.

Remember, however, that the thinner wood means a tendency to top-heaviness, with over-balance, if edges are cut at a slant. Do not, in any way, depart from the original shape of the body. The rabbit's tail, for instance, may strike you as being somewhat large. The tail is really a counter-balance. If you reduce it, there will be no backward swing and the toy will definitely not work. An 8in. incline is needed for the rabbit.

## Finishing the Novelties

Having made and tested the novelties, the next thing is to finish them. Generally, an oil paint or enamel is used. A drawback here is the length of time it takes for the finish to dry—and there is always some stickiness.

What is the best way to finish the toys? The best way, in the writer's opinion, is to use cellulose paint. The smoothed wood should be given a coat of flat paint which, when hard, is rubbed down with fine abrasive paper. This helps to seal the pores and leaves a smooth foundation for the finishing paint, which can be oil, enamel or cellulose paint.

Thin cellulose paint is the best stuff to use. The entire body of the duck is coloured white. Use a soft-haired enamel brush. When the application has dried (in about 20 minutes), it is rubbed down with 320-grade abrasive paper. The second coat is best rubbed on, like french polish. The rubber or pad consists of a ball of cotton wool covered with a piece of chamois leather.

The paint must be thin—1 part cellulose paint to 2 or 3 parts of thinners. The finish is rubbed on similar as french polish. It dries rapidly, however, and one must be quick, and also avoid rubbing too much in the one position. A smooth finish results, rather like the finish on pencils, if you take sufficient pains in the matter.

The legs of the duck need to be finished similarly, but with different colour, as shown. The outlines can be applied with a pencil brush, dipped in black cellulose paint.

Of course, if desired, you could apply the cellulose paint with a brush only. You must, however, have the first applications smoothed down with fine abrasive paper.

Regarding the bunny, it should be coloured light brown, with features and other details in black. Aim at simplicity.

# Get ready for the Christmas Party by knowing some GAMES WITH PAPER

IT is really surprising in how many ways those two simple materials, paper and cardboard, can help you to make a real success of your party. Thus it is sometimes necessary to pair off guests, as, say, for a competition or dance and to do this it is good to have ready a number of rectangles of stiff paper or cardette, each piece being roughly torn in halves by a jagged line. Old picture postcards would do admirably.

Keep the halves carefully apart and at the required time distribute the one set to the boys and the other to the girls. The fun then is for everyone to roam around and try to find their other half. For "breaking the ice" at the beginning of the proceedings this is an excellent scheme.

## Portrait Identity

The game of "silhouettes" is great sport. This means the collecting of a number of large-sized portraits of celebrities from periodicals, which you ink in solid. "Silhouettes" is played by pinning the pictures around the room, when everyone tries to identify as many as they can in a certain time, say five minutes. Have a few silhouettes that are fairly obvious and a number that take some puzzling out, Pictures of film stars and characters should certainly be included.

The same idea can be worked with advertisements. Collect about one dozen of the fairly well-known advertisements and then with a razor blade cut out all names or other identification marks. The winner is the person who can correctly name the biggest number of the advertisements in a given time.

For a sit-down game people like to have things to handle, and a letter puzzle can supply quite a few minutes of diversion. Draw the capital, as shown, on a post-card and then with several cards together cut out with a sharp blade and afterwards cut up along the dotted line. Keep the sets separate with a paper clip and hand one to each player at the correct time. The aim then is to build up the letter, the winner being the one who completes his first.

Fish-waiting is great sport. For this you require four fish, as shown, cut out of thin paper. Laid on the ground it will be found possible to waft these forward by sharply waving a stiff piece of card behind them. The game is, of course, a race, the winner being the person who first gets his fish from the starting line to some predetermined goal. Make some fish to go with your other paper preparations.

## Man on a String

A similar game is the "jumping man". To play this you must prepare two or three figures of men about lin. to 3ins. from fairly heavy card. About three-quarters of the way up bore a hole and thread through about 12 feet of knotless string.

If one end of the length is now fastened to a chair rung and the other held, it will be found possible to urge the figures by a slightly jerking motion. The "race" lies in two or more players trying to get the figure to the chair first *without the feet ever*

leaving the ground. It is quite possible and good fun.

Have also in your box of paper gadgets a few rectangles of plain white paper. These are for such games as telegrams, composite drawing, consequences, etc.

Another excellent "paper" game is to collect a number of fairly large-sized pictures of film stars (those found in film periodicals will do very



Advert and silhouette games

well) the caption being cut away. The games organiser pins a picture on the back of each guest, the person in question not knowing which celebrity they are carrying.

The aim is for everybody to try and find out whose picture is on their own back and to this end the players intermingle and may ask six questions of every other guest to which the answer must be only yes or no.

The first player to get the name of their own star wins. A small prize adds zest to the game and things may go on after the winner has been discovered to give second and third places.

## Recognition Game

Finally, make three fairly big "dunces" caps (really paper cones) with two eye-holes cut some way up from the rim. The hats are to go right over the head and face of an average-sized person so they must be quite large.

The game is in guessing who people are by their eyes alone. The victims sit enveloped in the cowl (in another room) with blankets or rugs coming up to the paper. The other guests are then allowed in one at a time and with, say, half a minute's look must say who the people are. Even if they know who is missing from the main room it is not too easy to say who is who of the cowed figures.

Well, there you get the idea of how useful paper can be in games, so start well in advance and have your box of surprises ready for when the great night arrives.

Remember that it is always advisable to work out a rough programme for your games, mixing them as much as possible. Do not have any last too long either, or the players will tire of them and become bored. Keep it all going with a swing.

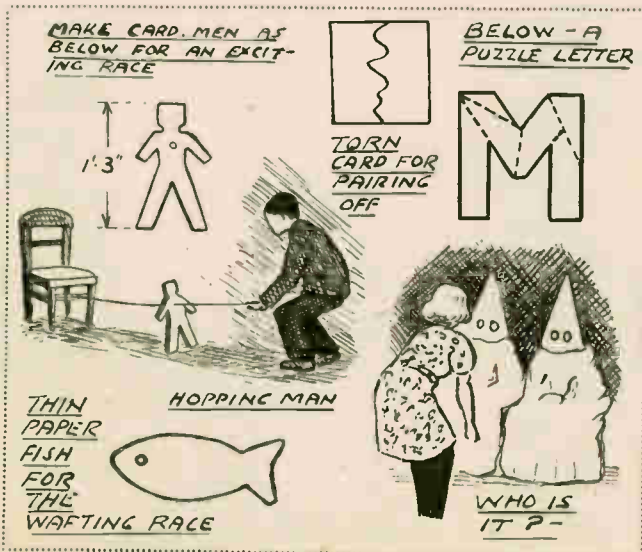



# Complete your radio set by putting it into A RECEIVER CABINET

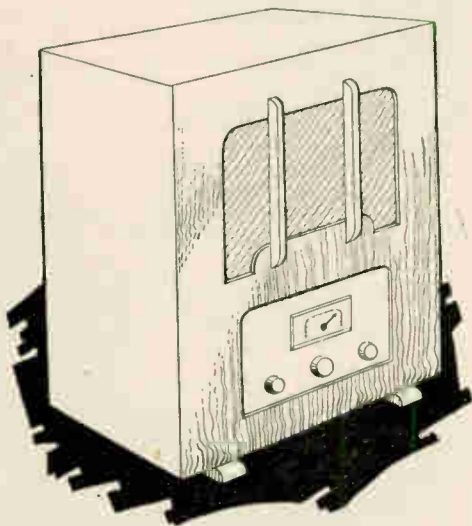

**T**HIS cabinet is so made that the receiver can be slipped in from the back and the panel of the receiver comes up behind a cut-out in the front of the cabinet. Therefore, almost any receiver can be accommodated and if it (or the control panel) is changed, the cabinet is not damaged or spoiled in any way.

Any ordinary loudspeaker can be used. Behind the speaker is a fairly large space with a shelf intended to hold the batteries used with a battery-operated receiver. With mains sets, this shelf is not needed.

The cabinet is quite straightforward, but has a modern and pleasing appearance. The radio constructor should find it well worth making to add the finishing touch to the set he has built.

## The Cabinet Front

Fig. 1 shows the shape and dimensions of the front of the cabinet.

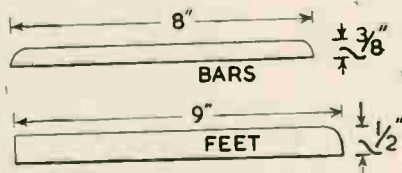

Fig. 2—Upright bars and feet

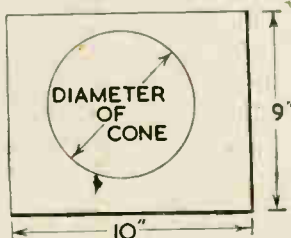

Fig. 3—Speaker baffle board

mensions of this. Mark the wood out carefully, using a compass set at 1 in. radius to draw the curved corners.

Good quality 3-ply is best, with the visible grain crossways if the wood allows this. Saw the two holes accurately and carefully, getting straight edges and smooth curves. When sawing is completed the edges should be glasspapered; fold the glasspaper round a block of wood so as to true up the straight edges.

## Bars and Feet

The upright bars add considerably to the appearance of the cabinet. Cut them from 1/4 in. thick wood to the size shown in Fig. 2. Scraps of wood of a contrasting colour (or which can be finished off with a different shade to that used on the rest of the cabinet) are preferable. Glasspaper them smooth.

The feet (see Fig. 2 also) can be made by cutting two lin. strips from a 1/4 in. thick piece of wood. The flat ends will be fixed level with the back of the cabinet so that the curved front ends project slightly. Drill three holes through each.

They can then be finished off with a dark varnish, being screwed to the bottom of the cabinet with countersunk screws when the cabinet is finished.

## Speaker Mounting

A piece of strong plywood is cut to the size shown in Fig. 3. The average moving-coil speaker is about 6 ins. in diameter across the cone, and this will require a 6 in. diameter hole. With smaller or larger speakers, adjust the size of the hole accordingly.

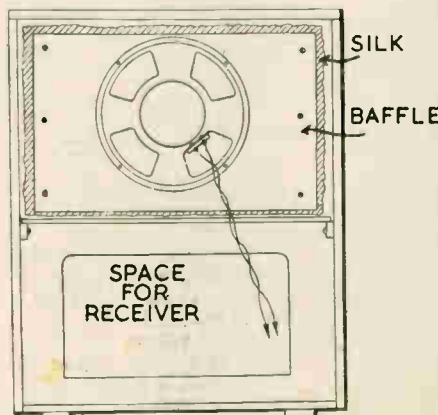

Fig. 4—Internal arrangement of cabinet

There is no need for the hole to be central. Actually, the batteries will probably go in easier if the speaker is a little to one side, and this will not harm reproduction in any way.

## Building the Cabinet

To make a strong job, 1/2 in. thick wood is recommended for top, bottom, and sides. With wood of this thickness, the top should be cut 12 ins. by 8 1/2 ins. Each side will be 16 ins. by 8 1/2 ins. and the bottom will be 11 ins. by 8 1/2 ins. If required, a shelf

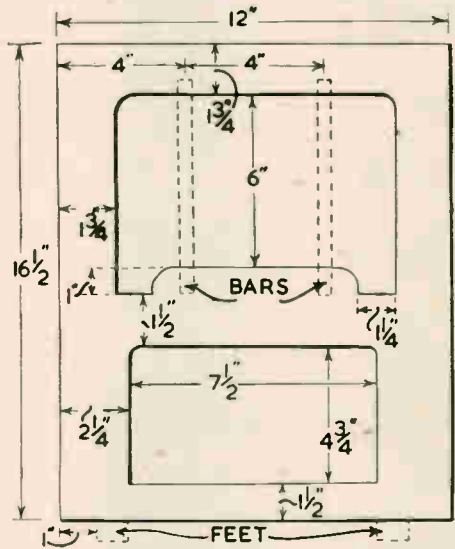

Fig. 1—Dimensions of front of cabinet

11 ins. by 8 ins. is cut from 3-ply.

Fig. 4 shows an internal view of the cabinet. Thin cabinet nails are used to secure the pieces together, and also to fix the front in position. The heads can be sunk slightly with a fine punch and the holes filled with plastic wood.

Do not fix the baffle, shelf or feet in place until after the cabinet has been thoroughly glasspapered and finished off with a medium glossy varnish. The feet should be a dark contrasting colour, and are screwed on from the bottom.

## Inside Bars

The two upright bars should then be fixed on. They are screwed from the inside, one countersunk wood-screw being used at each end. Do not use large screws. The position of the bars is shown in Fig. 1 and small holes should be drilled to start the screws.

A piece of silken material about 9 ins. by 10 ins. should be strained over the inside of the cabinet so as to completely cover the speaker hole.

(Continued foot of page 108)

# Any youngster will be delighted with a set of TOY BUILDING BRICKS

**M**OST children enjoy building something, and boxes of wood building blocks have long been a popular line in the shops. This is the kind of thing which any reader can well make himself for the amusement of his own children, and need cost nothing to make as any short ends of wood, useless for other purposes, can be utilised. Even if the reader has no such pieces of wood at home, a bag of these odd pieces can be bought cheaply at a timber yard.

As the set illustrated is primarily intended for a young child at the "kiddie" stage, let us say, the bricks are fairly large. Two lengths are suggested, one  $\frac{1}{2}$  in. long and the other twice that length—1  $\frac{1}{8}$  ins. long. If these are cut from  $\frac{1}{2}$  in. planed board, and first cut in strips  $\frac{1}{8}$  in. wide, the short bricks will be cubes, and can therefore be used any way.

A certain number of cubes, sawn diagonally across, are provided to finish the pointed gable ends of the buildings. All should be cut exactly to size as that fitting together becomes simple.

## Marking the Strips

The first stage, having the pieces of board, is to mark a  $\frac{1}{8}$  in. strip with the gauge. Cut off and plane to the gauge line. Then plane the edge of the rest line. Then plane the edge of the rest line of the piece and mark and saw off another strip. Collect a decent number of these strips, and then make up a cutting gauge for sawing the strips into bricks of both sizes.

Fig 1 (A) shows a plan view of the cutting gauge mentioned, with a detail sketch (B), showing its construction.

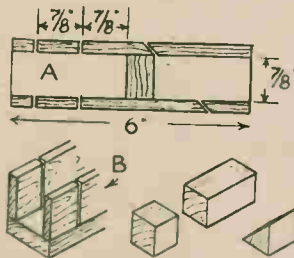

Fig. 1—Cutting trough and parts

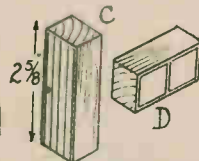

Fig. 2—Door, window and chimney blocks

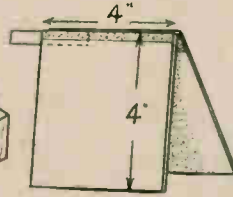
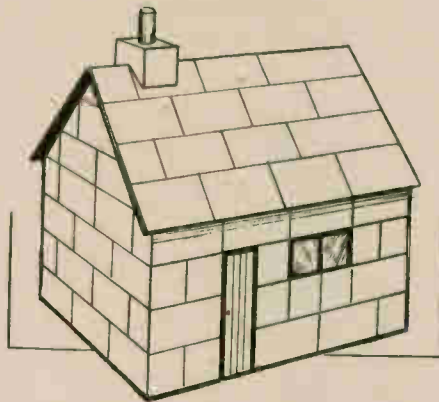

Fig. 3—A roof section



It is fairly obvious how the gauge is used. The strips are inserted and kept against the stop while being sawn across. Make a generous number of both sizes of bricks, as quite a number are required to build even a small house. The weakness of bought sets of bricks is invariably the insufficient number, causing some disappointment in "building" operations.

To gauge the cutting of the triangular blocks, set a bevel to 45 degrees, and mark the angle across the cutting gauge, seeing it exactly touches the stop, as shown at A. The triangular brick can then be accurately sawn, and should, if placed together in pairs, make a cube the same size as a small brick. The three sizes of bricks obtainable are shown, grouped together, in Fig. 1.

## Finish and Colour

No need to cut an abundance of the triangular blocks, a comparatively small number, say 12 to 18 will most likely be found sufficient. When cut,

the bricks should be carefully glass-papered smooth, a job quickly done if a sheet of medium glasspaper is pinned down to a flat board and the bricks rubbed gently on it, one by one.

Though in no way essential, a more pleasing article will result if the bricks are stained red or yellow, which can easily be done by dipping them in an aniline dye. In fact, if red is chosen, ordinary red ink could be used to colour them.

Fig. 2 shows other items, door, window, and chimney stack, necessary additions for building a model house. The door, C, is a strip of brick size, but as long as three small bricks, as shown. The door is defined by painting a border strip at sides and top. The space between can be painted any other colour and lined in pencil, vertically, to represent planking.

Item D shows a window. It is just large brick size, and outlined to show up the window panes, the latter being painted on a blue colour. Both window and door are, of course, solid blocks, and fit in with the bricks.

## Doors and Chimneys

Two doors should be provided and, say, an equal number of windows. One small brick, outlined and painted to represent a one-pane window, could be added, as many cottages include such a small window at the rear.

The chimney stack, E, two of which may well be included in the set, is a small brick with a piece cut out underneath to fit over the roof. Bore a  $\frac{1}{8}$  in. hole through the centre of the brick, and glue therein a round bit of wood to represent the chimney pot. Stain the pot red and the rest the same colour as the bricks, if it has been decided to colour them at all.

Roofs must now be made up to complete the set. It is suggested that the roofing be in two or three sections, to cover different sizes of model houses, as any kiddie will wish to work some variety in his building operations. Fig. 3 shows one section.

It is composed of two pieces of cardboard cut to the dimensions given. Lay them flat, edge to edge, and glue over the joint a piece of tape to act as hinge. When dry, close the two together and glue a second piece of tape over the joint on the outside. This will make a strong joint and enable the roof sections to close up for packing away with the bricks.

Colour the roofs with the red ink or dye, and line them with pencil to imitate tiles. When two are placed in position on the bricks, end to end, to prevent them sagging in the middle, glue a strip of thin card in one section, letting it stand out as in the diagram.

This end will go underneath the opposite roof section and support it. It should be added that the strip is doubled lengthwise and is glued to the section at the angle of the ridge, inside of course, then it can close up with the section when the latter is folded.

To hold bricks, etc. provide a small cardboard box, so that they can be safely put away after use.



# FRETWORK DESIGN No. 238 SPECIAL

SUPPLEMENT TO HOBBIES No. 2770. DEC. 1st, 1948.

## THREE XMAS DESIGNS - CALENDARS, CIGARETTE BOX AND PULL-ALONG TOY

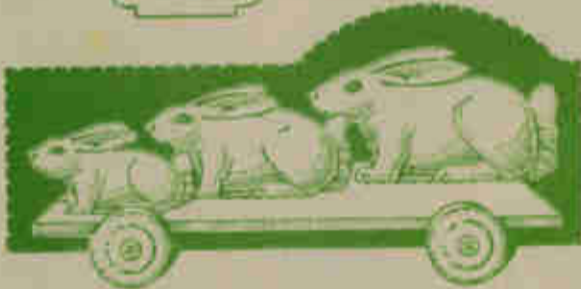

PANELS OF WOOD REQUIRED FOR THIS DESIGN

**TWO H4 ONE H3**

The price is shown in Hobbies Weekly, December 1st, 1948, but is subject to revision. See the current edition of Hobbies Handbook, or write for prices to Hobbies Limited, Dereham, Norfolk.

THE ARROWS INDICATE THE DIRECTION OF GRAIN OF WOOD.



COLOURED OTHER MATERIALS MAY BE STUCK TO LEAF WORK THREE CUTS

UPRIGHTS ON ENDS OF BOX.

CUT TWO OF EACH 1/4in.



LID/ TOP PIECE. HALF ONLY SHOWN. CUT ONE 1/4in. SHAPE TO SECTION.

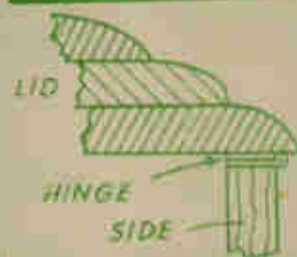

SIDE. CUT TWO 1/4in. DOTTED LINES SHOW POSITION OF OVERLAY WHICH IS OPTIONAL. SECTION SHOWING HOW HINGE IS FIXED.



LID. MIDDLE PIECE. HALF ONLY SHOWN. CUT ONE 1/4in. SHAPE TO SECTION.



FLOOR. HALF ONLY SHOWN. CUT ONE 1/4in.



LID. LOWER PIECE. HALF ONLY SHOWN. CUT ONE 1/4in. SHAPE TO SECTION.







PAPER OR  
SILK SHOULD  
BEHIND THE  
BACK OF THE  
CALENDARS.

NOTE:—SUFFICIENT WOOD IS PROVIDED  
IN THE KIT FOR TWO CALEN-  
DARS, ONE PULL-ALONG TOY  
AND CIGARETTE BOX.



CUT ONE  
1/4in.

AXLE.  
CUT FOUR 1/4in.  
AND GLUE TOGETHER  
IN PAIRS



NOTE.—This design sheet  
is only presented free  
with the current issue of  
Hobbies and not with  
back numbers. Further  
copies may be obtained.

CUT THE CALEN-  
DARS FROM  
3/16in. WOOD.



B

BASE.  
CUT ONE  
1/4in.



CIGARETTES  
OVERLAY.



CUT ONE  
1/4in.



HANDLE. CUT ONE 1/4in.



CUT ONE  
1/4in.

PRINTED IN ENGLAND.

# THREE SIMPLE GIFTS

**T**HIS enlarged sheet provides patterns for quite a number of useful little gifts which can be made from comparatively small pieces of wood  $\frac{3}{16}$ in. and  $\frac{1}{4}$ in. thick. Apart from the fretcutting involved, the only other work is painting or drawing the figurework of the animals concerned.

## Calendars

The three calendars each consist of a single piece of wood  $\frac{3}{16}$ in. thick, cut with a small amount of work and surmounted by a figure of a popular type of dog. The pattern can be pasted down for cutting, but a good plan is to trace off the dog shape and shading so that you may have it for reference when finishing the part later. The panels supplied are sufficient for two of the three shown.

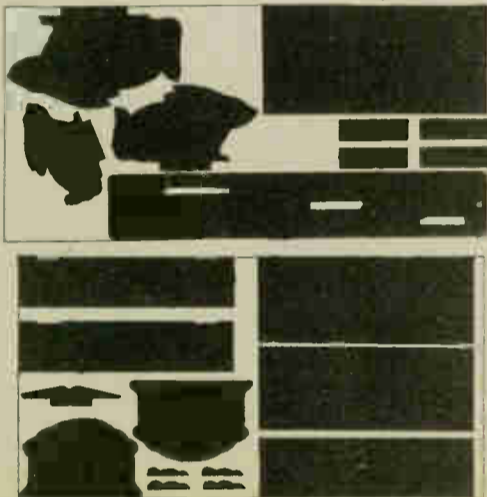

How the patterns are laid out on two of Hobbies Standard panels

The position of the calendar pad (obtainable from Hobbies Ltd. if necessary) is shown.

The pattern shows the dog silhouettes shaded and with feature lines marked on. This gives a sug-

gestion for the colour shadows and the lines which can be cut with a knife or carving tool. The painting of the dog can be done in appropriate colours in poster paint. The back of the fretted work can also be covered with gold or silver paper or some fancy material to add to its attractiveness.

## Cigarette Box

The cigarette box is cut from  $\frac{1}{4}$ in. wood, and the arrangement of pattern on wood is shown. The three parts forming the lid are drawn only half size on the Sheet, but it is a simple matter to mark out the complete rectangle. Each of these three pieces is  $6\frac{1}{2}$ ins. long, the parts being respectively  $3\frac{1}{2}$ ins.,  $2\frac{1}{2}$ ins., and  $1\frac{1}{2}$ ins. wide. The floor is glued between the two sides, and then the two ends glued on. The position is shown by the dotted lines on the pattern of the ends. Make a strong joint of the box frame, and see the sides are upright.

The lid is composed of three parts. The long edge of each piece is shaped nicely round as you see by the shaded section on the pieces concerned. This shaping will then be parallel to the shaped top of the ends, and give the attractive effect shown in the picture of the finished box. Glue the three pieces firmly together, then fit in the small handle by its tenon joint at A in the uppermost piece.

A recess to take the hinge is shown in one of the sides, and a section of its position is shown in the detail. Put the lid in place, and then raise it carefully. Mark on the underside where the hinge flange is to come as indicated by the recess in the side. Fix the hinge with tiny screws to the underside of the lid, and then holding it in place, fix the other flap to the top edge of the sides in the recess provided.

Take care in fitting this lid to see it does not bind, and that it lies flat when the box is closed.

Two ornamental upright strips are added to each end, being glued flush with the bottom and a little way inwards in order to come in line with the actual sides.

The decorative overlay of the word "Cigarettes" is cut from a piece of  $\frac{1}{16}$ in. wood, or plastic, or composition box and glued or nailed in the position shown. It is quite optional whether you have the box with plain sides or decorated as shown. Wood for that part is not included in the kit.

## Pull-along Toy

This simple toy of the three rabbits is easily constructed. A long base is provided with three openings, A, B, and C, to take the upright figures of the rabbits themselves. Under the base, axle bars are formed by gluing four pieces of  $\frac{1}{4}$ in. wood together in pairs. See these are firmly glued to each other, and then glue the solid block on edge to the underside of the base  $1\frac{1}{2}$ ins. inwards from each end.

The rabbit figures are also cut from  $\frac{1}{4}$ in. wood, and you can probably carve on them the rough shape of the animal itself. For that reason it is better to trace off the outline to cut, rather than paste the design pattern down. A penknife or carving tool can round off the bodies, ears, tail, etc., and you can just shade in with paint, the darker portions shown. Eyes, nose, ear lining can also be drawn in, and finished before standing the whole animal in place in its appropriate mortise in the base.

Four small wheels of  $1\frac{1}{2}$ ins. diameter are required, and they are screwed to the end of the axle bars, with, if possible, a small metal washer on each side to produce even running. A fancy cord tied through the hole at the front of the base, finishes the whole article satisfactorily.

# How to prepare, hang and colour the strings of FANCY XMAS LIGHTS

**T**HERE is, no doubt, that the use of strings of coloured lights are very popular for parties and similar occasions. Children welcome them with pleasure, especially when they are used in otherwise complete darkness, as when on a tree at Christmas.

Once made, a string of lights can be kept for use year after year as occasion demands, and it is the purpose of this article to describe how such lights may be connected up. Operation from batteries or mains is

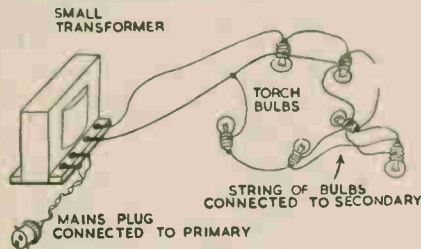

Fig. 1—Small bulbs in parallel

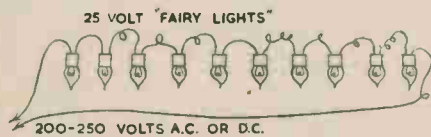

Fig. 3—The circuit for direct mains use

possible and the most convenient system should soon become apparent.

## Series and Parallel

Before going on to describe actual fittings it should be remembered that a number of bulbs may be connected in one or two ways, as Fig. 2 illustrates.

In series connection all the bulbs are wired in series. This means that the voltage required to work the full string will be the voltage of all the lamps added together. When bulbs are wired in this way it does not matter what their working voltage is.

For example, lamps of 6 volts working can be connected in series with 12 volt lamps, or even in series with 100 or 200 volt lamps, and so on. But all the lamps must pass the same current. If they do not, some may light weakly (or not at all), while others are too brilliant.

## Same Voltage Essential

In parallel connection the voltage of all the lamps should be the same but the current need not be the same. Fig. 2 shows how the different way of connecting exactly the same bulbs makes a totally different power supply necessary. 17.5 volts is needed in one case, with 3.5 volts in the other. But in the latter case, the

current consumption is five times as great.

## Transformer Operation

A mains transformer with a low voltage secondary (used for driving model motors, etc., or employed in radio sets), is ideal for supplying power to a string of lights in parallel. Such an arrangement is shown in Fig. 1.

The great advantage is that a high voltage is not connected to any of the lamps. If the transformer secondary is for 4 volts, torch bulbs may be used. The easiest manner of connecting is to take a length of twin flex and bare both strands at 2ft.

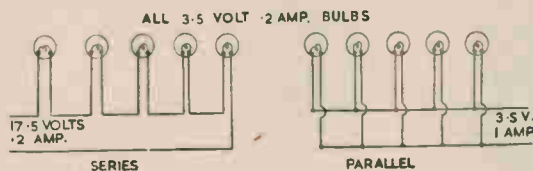

Fig. 2—Example of series and paralleled connection

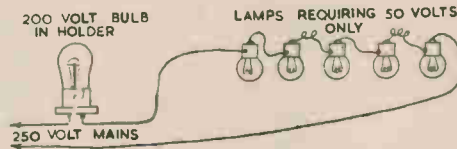

Fig. 4—Making use of a ballast bulb

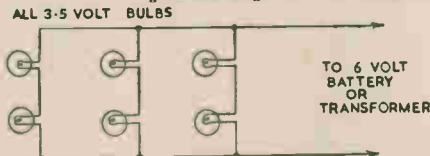

Fig. 5—Diagram of series-parallel connection

intervals. The bare places should only be about  $\frac{1}{4}$  in. long and the bulbs may be soldered directly to the wire.

As many bulbs as are desired may be added, provided that the total amperage does not exceed that of the transformer secondary (e.g.—10.2 amp. bulbs would be the maximum for a 2 amp. transformer). It must be remembered that transformers cannot be used on direct current mains.

## Series Lights

Fig. 3 shows a series circuit. This shows how bulbs are added until the necessary voltage is made up. Ten 25 volt lamps add up to 250 volts, which is suitable for 200 to 250 volt mains. Some shops can supply lamps specially made for this purpose.

If the small lamps do not add up to the mains voltage, then a large lamp may be used to rectify this, as in Fig. 4. It will be found that the total voltage is not critical, but the lamps

should add up to, or exceed, the mains voltage. For example, lamps adding up to, say, 270 volts, will be satisfactory on 240 to 250 volt mains, but lamps adding up to only, say, 200 volts, should not be used on 240 volts.

## Torch Bulbs, etc.

All sorts of bulbs may be used in Fig. 4. Car lamp bulbs are cheap. Nine 6 volt bulbs would add up to 54 volts; with a 200 volt main-electric bulb added; the whole could operate from 250 volts.

Any bulbs may be used provided they all pass the same current, as mentioned. If the current is not

known, it may be found by dividing the voltage of the bulb by the wattage. For example, a 6 volt 6 watt car amp will consume 1 amp. A 12 volt 6 watt lamp will consume  $\frac{1}{2}$  amp., and so on. Some manufacturers mark their torch bulbs, which are usually .2 or .3 amp., 2.5 or 3.5 volts.

## Series-Parallel

For battery or transformer operation it may be convenient to arrive at a certain voltage. Bulbs may then be connected in parallel in series of two or three, and so on. Fig. 5 illustrates this. If more bulbs were needed they would be added in pairs. Actually the two 3.5 volt bulbs will add up to 7 volts, but a 6 volt supply will be ample.

With a little thought almost any bulbs can be wired up to total approximately the voltage of any transformer or battery it is desired to use.

## Battery Operation

For battery operation, wiring is extremely simple, but the number of lights will be limited by the current taken. If an accumulator is handy this is most suitable, and a moderate-sized one will operate ten or a dozen small bulbs easily. It is usually most convenient to wire all the bulbs in parallel.

Bulbs should be chosen which consume a small current. Some cycle lamp bulbs for the rear light consume only .06 amp. Ten in parallel will then consume .6 amp., and this can be supplied by one of the larger cycle lamp dry batteries.

For shorter periods of use, ordinary torch bulbs can be used, but a dry battery will not last long when working several of these together.

(Continued on foot of page 109)

# You can get much fun if you make for yourself AN ELECTRIC BUZZER

**N**UMEROUS uses for this buzzer will immediately come to mind. It may be used instead of an electric bell; it can be used for practice in learning Morse, or used for signalling. With two buzzers connected at a distance, two-way communication can be arranged.

It will operate from any small dry battery and none of the constructional details is in any way critical.

## The Electro-Magnet

It is probably best to wind this first. An iron core is necessary and there are many ways of making this up. A piece sawn from an iron bolt about  $\frac{3}{8}$  in. in diameter is suitable, or a bundle of iron wires or iron nails with the heads removed can be used. The length should be between  $1\frac{1}{2}$  ins. and 2 ins.

Two cheeks about 1 in. in diameter are fitted to the core so as to make the bobbin shown in Fig. 2. They can be a tight fit, glue helping to hold them secure.

The bobbin is wound almost full with 22 to 26 S.W.G. wire. If enamel-covered wire is used, brown paper should be wound round the core between the cheeks before putting on the wire. The S.W.G. is not critical and for 2 to 3 volt operation 16 or 18 S.W.G. wire can be used. Put several layers of paper over the

completed winding. If the ends of the wire are taken to a battery, the core should become strongly magnetized.

A strap cut from tin secures the bobbin to a baseplate about  $2\frac{1}{2}$  ins. square. Two round-headed screws are best, as these can be tightened until the bobbin is firm.

The armature piece should be about  $\frac{1}{4}$  in. wide and  $1\frac{1}{2}$  ins. long and it is cut from thin sheet iron or a tin can. (As the latter is rather thin it should be doubled into two or three thicknesses). The armature is bolted or soldered to a springy strip—brass is best, but one thickness of tin can be used. This strip is then fixed to a bracket which is screwed to the base so that the armature comes about  $\frac{1}{8}$  in. from the magnet pole, as shown in Fig. 1.

A contact screw bears on the free end of the springy strip. This screw should be filed to a blunt point and it is fixed to its bracket by means of lock-nuts so that it can be adjusted easily. Its position will be seen from Fig. 1. The point of the screw will need to be at about the same height as the centre of the magnet.

## Adjusting and Using

One end of the magnet winding

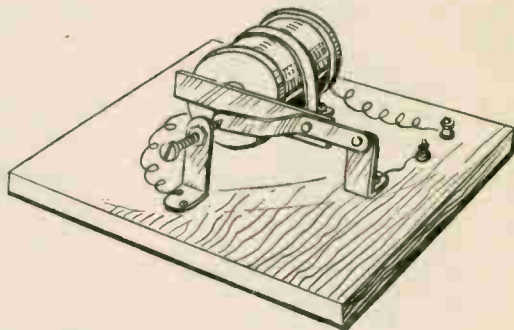

should be connected to the bracket holding the contact screw. The other end is taken to a screw or terminal from which flexible leads can be carried. A second screw or terminal is wired to the armature bracket.

The armature should bear back against the contact screw. Any note from a powerful high-pitched buzz to a low drone can be obtained by varying the distance between armature and magnet, and altering the strength with which the springy strip bears against the contact screw.

## For Signalling

For signalling, a Morse or tapper key must be wired in series with the battery. If the buzzer is used instead of a door-bell, the bell-push would be wired in the same way. A voltage of about 2 to 6 is most convenient.

The completed buzzer may be fixed inside a box or tin, the latter providing the greatest sound. If a suitably sized tin with a lid can be found, this may be screwed up where required with the buzzer inside, the leads passing through a small hole. If the whole is painted or enamelled, the final result will be quite as neat as can be desired.

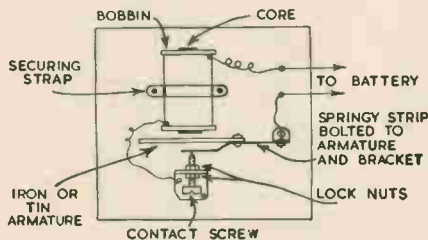

Fig. 1—Plan view of buzzer parts

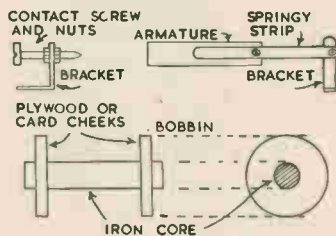

Fig. 2—Details of bobbin, etc.

## Receiver Cabinet (Continued from page 105)

Glue or pins will hold it secure and the squares of material made specially for this purpose are best from the point of view of appearance. A golden brown colour which tones with the cabinet should be chosen.

The speaker should now be screwed or bolted to the baffle board. Because of the vibration the screws should be really tight and washers may be added.

The baffle and speaker are now inserted in the cabinet and fixed by six or seven small woodscrews. Take care that the latter are not long enough to penetrate right through the front of the cabinet. The silk will now be held securely between the baffle and cabinet and will not

come loose or pucker into odd creases.

## The Shelf

This rests upon two strips approximately 8 ins. by  $\frac{1}{4}$  in. by  $\frac{1}{4}$  in. These strips are screwed on to the sides of the cabinet from the inside. Use three or four screws in each strip so that the weight of the batteries can be withstood.

It will be found most convenient to leave the shelf loose so that it can be lifted out when inserting the receiver into position.

## Receiver and Back

Four short screws driven through the receiver panel from the back will hold the panel tightly up against the

lower cut-out of the cabinet and prevent the set moving when in use.

If a back is made to exclude dust it should be 12 ins. by  $16\frac{1}{2}$  ins. It can be held in place by small catches or any other convenient means.

To prevent muffled or echo reproduction, the back should have a row or two of  $\frac{1}{2}$  in. or 1 in. diameter holes, to permit sound waves to escape. With mains receivers, one row of holes should be near the top, with a second row near the bottom, so as to permit a free circulation of air to reduce heating.

To allow aerial and earth to be connected easily, drill  $\frac{1}{8}$  in. holes in the back level with the aerial and earth terminals on the set.



# There is nothing really difficult in making A SIMPLE GYROSCOPE

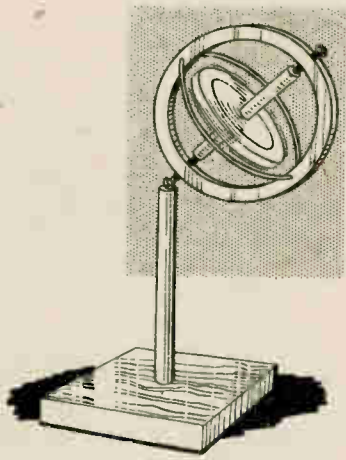

THE simple gyroscope shown herewith can be made almost entirely from scrap material, but if a little care is taken in the construction, the result will be an interesting and instructive toy.

Commence by making the wheel, A, Figs. 1 and 2. On a piece of 3/16in. wood—plywood if possible—draw a circle 2ins. in diameter. Use compasses to draw this article, as the mark made by the compass needle will indicate the exact centre and ensure that the wheel runs true. Cut the wheel out carefully with a fretsaw.

## Lead Rim

The wheel has now to have a lead rim cast around it. To do this, cut two more discs, B and C in Fig. 2, from 1/2in. wood, making them 1 1/2ins. in diameter. Drill a fine hole in each of the three discs, exactly at the centre mark left by the compasses, and taking great care to keep the drill vertical. Join the three discs together with a fine 1in. nail, the largest disc, A, between the two smaller discs, B and C, as shown in Fig. 2.

For the mould use two pieces of scrap wood. The upper piece, D,

Fig. 2, should be 1/2in. thick; the thickness of the lower piece, E, does not matter. Cut a hole 2 1/2ins. in diameter in D, then draw a circle 2 1/2ins. in diameter on E. Nail or screw the two pieces together, taking care that the hole in D, is exactly over the circle marked on E.

Now take the wheel and with a file or penknife, make four small notches at equal points around the edge of disc A. This will give the lead rim a grip and prevent it from turning round on the finished wheel. Use the nail in the discs to secure them in the mould, being careful that the point goes into the mark left by the compass needle. Do not hammer the nail down hard, as you will have to remove it again.

## Melting

Melt some scraps of lead in a ladle. If you have not got a ladle, a small tin fitted with a handle will do. Pour the lead carefully into the mould until it is level with the top disc, B, of the wheel. When cold, take the wheel from the mould and remove the nail and the discs, B and C, which may now be scrapped.

Next enlarge the centre hole in the wheel until it will take a piece of 1/4in. diameter dowel rod a tight fit. Cut the dowel rod 2ins. long and secure it with a touch of glue, taking care that the rod is vertical in the wheel. Test it by spinning between the fingers, and if there is any "play", correct it before the glue sets.

The pivots are gramophone needles inserted into each end of the dowel rod, point outward. Drill a hole first in the exact centre of each end of the rod and about 1/4in. deep. Grip the needle with pliers, being careful not to damage the point, and force it into the rod until only 1/4in. projects.

The gimbal ring, G, which carries the wheel, is cut from 1/4in. hardwood to the measurements given in Fig. 1. At two opposite points in the ring make 1/4in. diameter holes to take the pivot sockets.

For the sockets, get two 1/4in. by 1/4in. round headed brass Whitworth screws. Drill a very small hole in the end of each screw to take the pivot point. A fretwork drill will make these holes quite well, which need only be 1/32in. deep.

## Assembly

Enter the screws into the holes in the gimbal ring and drive them in with a screwdriver. If the holes are sufficiently tight, the screws will cut a thread in the wood as they go in, which will secure them and also allow for adjustment. Place the wheel in position and tighten the screws until it will spin freely, but without shake. A spot of oil on the pivots will help.

If desired, a guard ring to protect the wheel may be added. This is a

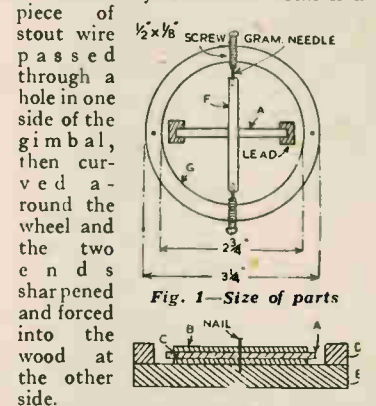

Fig. 1—Size of parts

Fig. 2—Section of wheel frame

The completed gyroscope should be painted in bright coloured enamels. A simple demonstration stand, as shown in the illustration, may be made from a piece of rod fixed in a wooden base 4ins. square.

To spin the top, take a piece of thin cord and give it a couple of turns round the dowel rod, then pull smartly. The top may then be placed on the stand at any angle and will remain in this position as long as the wheel continues to spin.

## Xmas Lights—(Continued from page 107)

With low-voltage operation there is no chance of shocks and any small holders may be used, or the bulbs can be soldered directly to the wire.

But with mains-operated lamps, care should be taken. Good twin-flex should be used and moulded insulated bulb holders. All joints should be secure so that they will not pull loose and no bare ends should be left which anyone might touch.

A switch can be added in the circuit at any convenient point. The

pear-shaped switches intended to include in the run of wiring are convenient as they do not require fixing down.

If the lamps are naked they should be coloured in a variety of hues. Thin paper, tissue, Cellophane, or coloured varnishes may be used. Bright reds, pinks, greens, yellows and light blues are best as dark, heavy colours are ineffective.

Where one large bulb is used, as in Fig. 4, this may be covered with

coloured paper and placed at the foot of the Xmas tree, or otherwise contribute to the effect. Remember that high wattage, high voltage lamps become hot after a period of use, so that paper should not be close to such bulbs.

Variety in the form of hanging lanterns, coloured paper shades, etc., are possible and quite simple to contrive. The handyman should be able to arrange something suitable without much difficulty.

# The amateur photographer should make this handy PHOTO PRINT GLAZER

**A** GLAZER and drier for prints is a very handy accessory for photographers to have. Here is how the amateur can make one for himself. Unlike most of its kind, the glazer described is constructed of wood. The prints, however, are squeegeed on to the usual chromium or stainless steel plate which, of course, does the actual glazing.

As will be seen by the sketch, the general idea is of a box with electric bulbs burning inside to give the necessary heat and with a plate holding the prints across the top, the latter being covered and held firmly by a canvas "apron".

## Non-Sticking

Prints will never stick to either stainless steel or chromium (as they often do to glass) and either type of plate will serve the purpose. But stainless steel is better in the long run, as in time chromium dressing is apt to get rubbed away, and prints certainly will stick to the metal below.

Stainless steel, being of the same material throughout, never loses its surface, no matter how much it is cleaned.

Both types of plate can be obtained through photographic dealers in several sizes. For the amateur, however, and for use in the wooden glazer described here (in which the plate is flat) the smallest size, 10ins. by 15ins. is the best.

The box is constructed from two end pieces, 16ins. by 6ins. (assuming a 10ins. by 15ins. plate is being used), two sides 9ins. by 6ins. and a base 15ins. by 16ins. Side and end pieces should be of  $\frac{1}{2}$ in. wood, but the base can be thinner. From the middle of each end-piece a circular hole is made to hold a standard electric bulb socket.

## Cross Strips

The most important sections of the box are the strips (A). These are shaped as (B) with a "step" (b) across each extremity to fit over the end pieces and a step (d)  $\frac{1}{2}$ in. wide down the whole length, and just the depth of a glazing plate.

The side steps should be dead flush with the top edges of the ends, and form with the ends a complete all-round support for the plate.

The strips (A) can be quite deep and are held in position by screws going into their ends from the side. The thin layers (g), however, should be continued over the ends and be held by sprigs as this makes it possible to use the plate for glazing purposes to the very end.

If all has gone well a perfectly flush

top should now be presented when the plate is in position, as shown in the "cut away" sketch.

## Apron Piece

The "apron" (T) can now be fitted. This is a length of fairly stout calico, 15ins. wide, and of sufficient length to wrap round from side to side, over the top of the box and plate, as indicated in the bottom right-hand diagram.

At one side the material is attached to the wood by a series of small screws going through a fold, but at the other a metal rod (h) passes through a tunnel of cloth formed by turning a short length back and stitching.

Another rod (k) (a length of old metal stair rod will do) is now attached by the two coil springs (p).

The second rod when pulled over catches under the two screws (m), things being arranged that when it is so caught the springs are under tension, thus holding the canvas tight.

Finally, two ordinary electric light sockets are fitted into the hole in the

glazing in general. The main factor when getting the prints on to the plate is to exclude every bit of air from between the surfaces. This is the idea of "squeegeeing", but even the squeegee has to be used correctly.

First the prints must be taken straight from the water and placed on to the plate (the very best thing is to float them on). They are then covered with a cloth, laying it on without creases or rucks. Now holding the cloth and plate together at one side take the squeegee and roll over the surface from the side you are holding, covering the whole area in as few strokes as possible.

## One Way Only

Always work the roller in the same direction, not first one way and then another. This is most important.

If the prints have not been in perfect contact with the plate you will know by seeing areas of dull emulsion surrounded by a general higher gloss. If the dull areas are very marked,

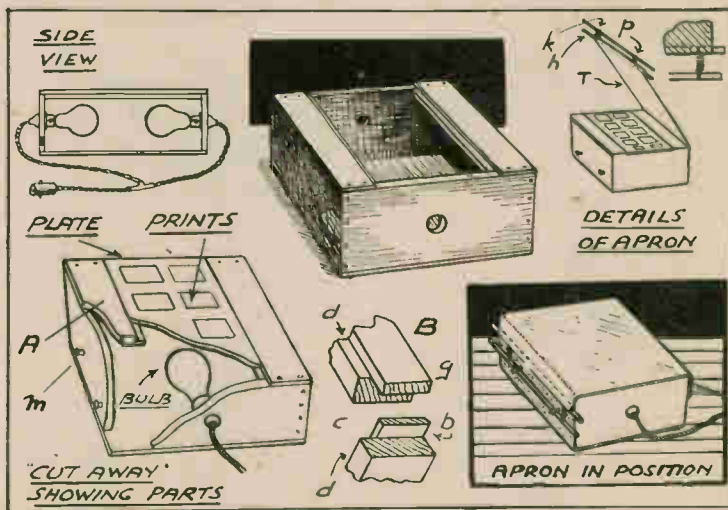

side (top left-hand sketch) and wired together so that they can be run off one household plug. The bulbs employed need not be of great power, 50 or 60 watts being sufficient.

## Procedure

To use the glazer, the plate is removed and the wet prints squeegeed on to its surface. It is now replaced and the apron brought over and clipped in position.

The lamps are then switched on and in a short time it will be found that the prints are perfectly dry and glazed. The box, of course, will get very warm, as well as the plate, but not dangerously so.

Now, just one or two points about

there has been definite air bubbles imprisoned.

In all cases of poor glazing the print can be re-soaked and the process done all over again. The plate itself should of course be kept well wiped, using some very soft material for the purpose. On no account use any cleaning preparation as neither stainless steel or chromium need these things.

**HOBBIES 1949 HANDBOOK**

68 Pages—Large Model Coach

Design—Colour Air Pictures

Price 1/- or Post Free 1/2

# A unique occasion marked a service of HOBBIES THANKSGIVING

**D**EREHAM, Norfolk, as most readers know, is the centre of industry where much of the popular tools, machines, and materials of Hobbies Ltd. are made. Dereham is, also, geographically, almost in the centre of Norfolk. During the late war this was certainly not an enviable position, for it was surrounded by airfields in a county which contained more acres of runways than any other part of the country. The railway was a centre of three radial lines serving the surrounding country, and the factories and offices of Hobbies Ltd. stand astride the main line.

The danger of enemy air attack was therefore obvious, particularly as virtually the whole output of the firm at that time was for important and essential Government requirements. Naturally, air raid warnings and civil defence activity had to be a part of the scheme of things, and equally naturally it was called into play as frequently throughout the war as anywhere in the country.

There were well over 1,000 alerts on the town sirens during the war—sometimes three and four a day. Work at first had to be stopped frequently, but a special system of localised danger warning soon reduced these periods and the 24-hour day and night shifts continued.

In spite of almost daily sound of bombs dropping in and around, however, the town was indeed fortunate in suffering little damage—although a wing to the house of the Managing Director was badly knocked about. Incendiaries strung out down through the station on one occasion, but almost miraculously nothing even fell on the acres of ground covered by factories and offices, and no single casualty was sustained by any of the personnel due to enemy action.

Such an escape was surely a great cause of thankfulness, and it was with this in mind that the Chairman of the Board of Directors, Mr. Richard Jewson, J.P., a former Lord Mayor of Norwich and President of the Timber Trades Federation, suggested a suitable service could be arranged, as a Thanksgiving Jubilee Service for the preservation of personnel and works from enemy attack. And it met with enthusiastic support from the whole of the employees on an occasion which will long be remembered by every one who took part. It was perhaps

the more appropriate as coinciding with the 50 years of progress of the firm and its Jubilee events which have already been mentioned in these pages.

## A Packed Church

Towards the end of September a special Thanksgiving Service for employees was held in the centuries-old Parish Church, and although it has a capacity of over 1,200, there were large numbers who could not get seats, but had to fill the back of the church and even the porch. The local band of the British Legion accompanied the singing, which was led by a mixed choir of works employees. A special form of service was printed and an outstanding feature was the hearty singing of the well-loved hymns. The service was conducted by the Vicar, Rev. Noel Boston, M.A., F.S.A., and ministers of the other denominations took part.

The Directors were present, as well as a number of the Urban and Rural District Councils. An inspiring and appropriate address was delivered by the Vicar who stressed the need for the spirit of service, that we might not waste the fruits of the sacrifice of those who had laid down their lives in the war.

## Tea and Entertainment

After the service the whole company went to the Vicarage meadow where an enormous marquee had been erected so that nearly 900 could sit down to tea. A tasty and sufficient meal was provided for all, with a range of substantial and dainty edibles. The scene of such numbers at one sitting enjoying the repast, was

an unforgettable sight and one which must have been sufficient recompense to the Directors for their thought and arrangements.

## Speeches

After tea, on behalf of the Chairman's brother, the Vice Chairman (Mr. Frank Jewson) expressed the hope that "something of the same kind may happen in another 50 years". He added, "Throughout the whole of the firm's existence the directors have had the loyal and unswerving support of the employees and without it the firm would not have been in existence today. The continuance of Government contracts after the war testified to the quality of the work done by all employees". There were three cheers for the Chairman, who had made a long journey to be present despite ill-health.

On behalf of the employees and pensioners of the firm (a number of whom were present), Mr. R. Moore, assistant engineer, thanked the Directors for their generous and enjoyable effort, and this was received with loud acclamation.

Afterwards a very enjoyable entertainment was provided for all sections. A Punch and Judy show enthralled the children, a first-class all-round B.B.C. entertainer (Mr. Bert Bradshaw) gave an excellent programme for the adults, and the British Legion Band rendered several items of music.

Altogether an outstanding occasion worthy of the great name of Hobbies, and one which will long be remembered by all those who enjoyed taking part.



Employees outside the huge marquee prior to the tea

# Some practical advice by an expert on KEEPING PET MICE

**H**ERE are a few interesting hints for those who keep pet mice, which will, undoubtedly, appeal to our younger readers. The pastime is inexpensive, and the ways of the little animals quite fascinating.

## Feeding

Be sure to have a regular feeding time. Many fanciers feed their pets once a day, in the evening. For adult mice, get good quality oats, with a little wheat added. For growing youngsters use Quaker Oats and/or coarse variety of oatmeal.

For seeds, provide them with best white millet and a little linseed. For soft food, use stale bread soaked in hot water. Squeeze out all surplus water and add a little milk, which must be fresh. Or you can use one or other of the foods for mice that are advertised.

Perhaps for your purpose it will be advisable to feed morning and evening. Morning meal, say, scalded bread and milk added to each doe nursing young, about 1in. cube of bread being sufficient for each doe; other stock is not fed in the morning.

## Evening Meal

For evening meal, give all stock the bread and milk, and to the adults also give whole oats; for the young ones Quaker Oats or oatmeal. Twice a week give just a few seeds of white millet to each mouse along with the oats, and once a week a little linseed.

Keep all feeding pots clean, and do not allow uneaten bread and milk to stay overlong in the cages, especially in hot weather.

If possible, keep your mice in a suitable shed or outhouse; if not possible, use an indoors room, preferably the attic or any spare room. It is better to have an outdoor mousery, but though almost any sort of outbuilding will do, it must be free from damp and draughts.

## Cages

A good size for an outside mousery is a wooden shed about 7ft. by 5ft. and 6ft. high, with a door at one end and a window to open at the other. It should be built well off the ground, on bricks, to allow air to pass under.

for the mice to pass in and out from run to compartment.

At the end of box bore two 1in. diameter holes and cover with perforated zinc from the inside. For the lid, make a frame to fit the opening at top of box, leaving the end pieces to overlap the width of the wood at each end, so they rest on the end of the box to hold lid in position. Cover the lid frame, from the inside, with perforated zinc. Give the inside of box a coat of distemper.

For a breeding cage the measurements should be about 14ins. by 8ins. by 6ins. high. Partition the nest



Besides these two practical presents, this week's enlarged design (No. 238 Spec.) contains patterns for three novel "doggy" Calendars. Wood for making Toy Rabbits, Cigarette Box and two Calendars is supplied with all date pads, wheels, hinges, etc. for 6/5 or 7/2 post free

## Designs for making 5 Xmas Presents

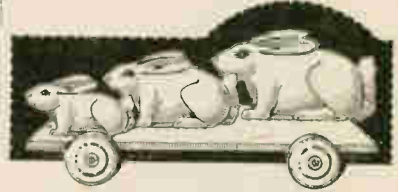

However, any small shed will be suitable provided it is dry and not draughty. You can easily make cages for your pets or you can buy them from makers who advertise in the papers.

Get a few empty boxes or packing cases. About 4ins. from the end of your box, inside, nail a piece of wood from side to side, but not quite the depth of the box, this to partition off a sleeping compartment. Allow a hole 3ins. square at bottom of partition

part off 4ins. by 8ins. and leave a hole for the mice to run from outer compartment to the nest. Sawdust should be laid down in the run, and soft sweet hay placed in the sleeping compartment. It does not matter if the mice eat some of the hay; indeed, it is good for them.

Whatever you do, be sure and keep your cages scrupulously clean. When cages have been used for some time, scrub them out with a little disinfectant in the water.

## Electric Owl—(Continued from page 101)

then lead down to the battery below. The diagram, Fig. 3, shows clearly the brass pieces and their wire connections.

Coming down now to the box where the battery is installed, it will first be advisable to remove the base from the hinges so the correct positions for the contact pieces may be ascertained and marked out. Lay the battery centrally on the inside of the base and note where the two pieces of strip brass come from it.

Next angle up two pieces of thin brass as C and D, Fig. 5. Each may be cut as D, so the battery strips may be pushed in and held tightly or they may be plain just for contact only as C. Put these two pieces on the base, and screw them in place, afterwards connecting one of them up with one of the wires from the bulbs, allowing a little spare wire for ease in handling.

Now take in hand the box portion, and to the top fix two brass studs. These may consist of ordinary paper clips, F and G, Fig. 5, just pushed through holes and turned down. The studs should be placed 1in. apart. Centrally with the studs and 1in. higher, screw on a lever formed of stout brass, shaped and turned up at one end as E, Fig. 5. This is the contact lever and to its fixing screw must be brought the other wire from the bulbs.

## The Lever Switch

By switching the lever from the "off" stud, F, on to stud, G, contact is made, the circuit completed, and both bulbs lighted. To hold the battery firmly in place, two small blocks of wood may be glued on, one each side of the battery, and small hooks run into the tops. Over the

battery stretch an elastic band, this will hold the battery steady and in place.

Those pieces of loose wire which allow for the opening and closing of the box, are coiled and laid near the battery, and the top box portion replaced and screwed to the base. Two coats of clear varnish should be given to all the wood parts including the base.

It should be noted that the size of the battery box is such that it will hold comfortably a double-cell dry battery such as is used for an ordinary cycle head lamp, or the smaller square flash-lamp battery. If the former is adopted for use, then some little modification of the contacts in the box must be made from that shown. That is, a flat contact strip will take the place of the angled piece, C, in Fig. 5.

# MISCELLANEOUS ADVERTISEMENTS

The advertisements are inserted at the rate of 3d. per word prepaid. Name and address are counted, but initials or groups, such as E.P.S. or £1/11/6 are accepted as one word. Postal Order and Stamps must accompany the order and advertisements will be inserted in the earliest issue. Announcements of fretwork goods or those shown in Hobbies Handbook are not accepted. Orders can be sent either to Hobbies Weekly, Advert. Dept., Dereham, Norfolk, or Temple House, Temple Avenue, London, E.C.4

**100** STAMPS free, enclose 3d. for approvals, state age and favourite countries, many free sets.—G. Roberts, 59 Gledhow Park Grove, Leeds 7.

**2** POLAR Flight giant pict. (cat. 1/3) — 9d. 5 Spanish American lge. Air pict. (cat. 1/7) — 1/-. List of packets, sets, singles free.—G. Pearce, Wheathill, Burwartron, B'north, Salop.

**STAMPS**—No free gift, but better value. Very big discount. Send postcard for approvals. — Pye, 30 Shenstone Avenue, Birmingham 32.

**40** DIFFERENT stamps free to all applicants for, my 3/4d. — 1/- approvals. Includes Mint Victory, used Coronation, Silver Jubilee, Ship, Pictorial, etc. etc.—J. F. Smith (Dept. H.), 60 Edison Rd., Welling, Kent.

**PLYWOOD.** We can supply sound plywood tea-chests 24ins. by 19ins. by 19ins., at 5/- each. Del. approx. 1/6 extra. Panels are ideal for model making, etc.—Universal, 91c, Mora Road, N.W.2. GLAdstone 9994.

**G**REAT free gift. Bahawalpur. Brilliant unused large Bicentenary Commemorative stamp in two colours (black and carmine) depicting head of the Ameer set against ornate oriental background. Printed in England early this year, it is already valued at over eight times its face value. This very beautiful Indian Native State stamp will grace any collection, and is given free, until supplies run out, together with four other interesting stamps, to all applicants for approvals that offer a wonderful selection of stamps at a fraction of catalogue value. Postage to —Richard Turnbull, 4 Gt. Bedford St., St. James's Square, Bath.

**I**NTERESTING approvals (Empire and foreign) sent on request.—Anderson, Lilac Cottage, Church Road, Bagshot, Surrey.

**M**ODEL Garage 19ins. by 15ins. made for a few shillings. Comprising garage with sliding door, pumps, oil cabinets, railings, trees, clock etc. all made in wood. Plan and instructions 1/6d postage free. — Westacott, 34 Aelybryn Rd., Cockett, Swansea.

**D**IGNIFY your correspondence — private notepaper 8ins. by 5ins. printed your address, 100 sheets 4/6d.—Soho Press, 38 Soho Street, Salford 5.

**B**ILLHEADS printed cheaply. 1000 lot 27/6d. post free. Send for sample.—Soho Press, 38 Soho St., Salford 5.

**A**RE you interested in moulds for lead toys and plastercraft? Lists and full instructions 3d.—"Moulds", 7 Hawthorn Terrace, Halifax.

**A**N EXPORT, Import Agency offers you an opportunity of establishing a small spare-time business. Home and overseas contacts provided. Free pamphlet on request (1d. stamp).—Wade, 68 Carlton-hill, London, N.W.8.

**H**AWAI calls to you! With the aid of my complete drawings and constructional data you can build a first-class Electric Hawaiian Guitar in a few winter evenings. 7/6 post free.—C. W. Cragg, 48 High St., Oakham, Rutland.

**I**NFINITE Calendar, 32pp. booklet giving by direct reading, the day of the week for any date from year 1753 onward. Special offer, 1/6d. post free from—J.G.S., 62 Beanfield Avenue, Coventry.

**STAMPS FREE !!** Twenty unused (2 3/4d.)—H. G. Barnett, Limington, Somerset.

**"MODERN Wood Toymaker"**, a new handbook with 180 effective designs and illustrations—2/6 posted.—Industries, 2 Waldegrave Park, Twickenham.

**"LEAD Toy Casting"**, a new book on hand-casting for the home worker, with 126 illustrations—2/6 posted, with complete catalogue of moulds.—Industries, 2 Waldegrave Park, Twickenham.

**50** SCALE Model Houses wanted. Firms or individuals with small scale Model Houses for sale, or who possess materials and facilities for making, detached and semis to 1/2in. and 3/4in. scale, from plans supplied, are invited to communicate with Box No. 234, Hobbies Weekly, Dereham, Norfolk.

**F**REE with approvals, 5 Russian Pictorials (Cat.) 4/10, send postage. 50 Spain 1/4, Denmark 1/1, 100 World 1/-, 100 British Colonials 1/8—Kirby, (S.T.A.L.), 96 Taunton Way, Stanmore, Middlesex.

**3** D. IN 1/- discount approvals. 3 Postage.—48 Ambra Vale East, Bristol 8.

**E**SSENTIAL for every workshop. "Ellcrist" hand bench grinder. All die cast. No oiling. Clamp or screw fixing. Early delivery.—R. W. Knowles, 71 High Street, Beckenham (S851) Kent.

**M**ATCHBOX radio set. With the aid of our instructions you can build a complete radio set in a match-box, using parts easily obtainable from your radio dealer. Incorporates the crystal-valve Radar Detector and requires no batteries. Tunes B.B.C. wavelengths. Full instructions, drawings, and theoretical circuit diagram, 2/9 post free.—John O'Beirne (H), 137 Cotham Brow, Bristol 6.

**F**REE—Beautiful set China 1948 Postal Centenary. Request discount approvals (2 3/4d.) — Williams, "Dunromyn", Castle Lane, Carisbrooke, I.O.W.

**PLYWOOD** off-cuts 3/16in. three-ply. Parcels from 10/-. Send stamped addressed envelope for bargain list.—Naylor, 204 Wolverhampton Street, Bilston.

**L**ATHES—have a proper one this time. Edwards & Drage (Tools) Ltd., can supply from stock, 5in. "Little John", "Atlas", "Halifax", "Rollo Elf", "Grindturn", "Willimott" & "Myford". Hire purchase arranged. Also "Coronet", "Centriz", "Gala" & "Hobbies". Send us your enquiries.—131 Magdalen Road, Exeter. 56134 and 67645.

**STAMPS**—Grand approval advertising packet. One only to each client. Containing Roosevelt Mourning Issue, Italian "Jet Bomber" Pictorial, Hitler, Mussolini and General Franco Portrait stamps. War and Victory, Unused Kenya, Dominica and Cayman Isles, together with 50 other different foreign and Colonial stamps. Catalogue value over 5/-, all guaranteed genuine. Send 6d. and request approvals, free gift list, etc.—W. O. Took, 2 Cowper Street, Hove, Sussex.

**STAMPS** unlimited. Special agent offers 25 free with super approvals. Postage 2 3/4d.—Jones, Messines Park, Londonderry.

**P**LASTICS. Catalin sheets, rods, cylinders and profiles. Perspex sheets and off-cuts, clear and coloured, glues, polishes, and transfers. Send stamped addressed envelope for details.—Eastern Plastics, Church St., Westbury, Wilts.

**C**IGARETTE card collecting. Fascinating hobby for young and old. Catalogue of sets and odds. 3d.—O'Neill, 68 Lavender Vale, Wallington

**P**ERSPEX products pay, so model in the latest medium. Kit comprises brooch pins, delicate coloured bases, handicraft wax (gold, ivory and pastel shades), stiletto, plans, etc. for six superb brooches, price 7/6d.—also cigarette/trinket box kit 6/11d., and artistic pink and clear toast rack set 7/11d. Postage and packing 7d. Perspex polish and cement available. Send for leaflet. — Plastics Home Products, 18 St. Mary's Rd., London, N.9.

**P**ETS, by Harper Cory. 48pp of practical tips on how to look after pets of all kinds, 61 illustrations. 1/6d. from booksellers, or post free 1/8d. from—Mayflower Publishing Co., Ltd., 17 Farringdon Street, E.C.4.



THE  
**'MOLE'**  
*Self-Grip*  
WRENCH

*From your regular  
Tool or Hardware Dealer*



**FOR THE PRACTICAL  
HANDYMAN & MECHANIC**



A multi-purpose tool that will lock on to the work and stay there as long as you want it!—how often have you wished for just that? Over half a million are already in use. You can use it as a vice, clamp, wrench and pliers.



**NO TOOL KIT IS COMPLETE  
WITHOUT IT**

**REDUCED  
PRICES 7" 10/6 10" 12/6**

**M · MOLE & SON LTD · BIRMINGHAM · 3**

**BOYS — MEN!**



*Give your  
varnishing &  
polishing that  
professional  
look!*

**10/6**

Here is a unique new woodworkers' Varnishing and Polishing kit produced by specialists for you. It contains 1 Jar Rustin's Stain, 1 Jar Varnish, 1 Jar French Polish, 1 Jar 'Kwiksol' Paint Remover, 1 Bottle Linseed Oil, 1 Bottle Thinners, 1 Bottle Methylated Spirit, 2 Sticks Wood Stopper, 1 Tin Woodfiller, 1 Polishing Rubber, 2 Sheets Glass Paper and Full Instructions. Complete from your local store or carriage paid 10/6d. Get your outfit to-day.

FROM  
ALL  
STORES

**A GRAND  
XMAS GIFT  
IDEA!**

OR  
CARR.  
PAID  
from

**Rustin's**  
WATERLOO RD. LONDON · NW2

**U.S.A. COMMS. PACKET FREE**



Send NOW to the Windsor Stamp Co. for this very lovely Packet of U.S.A. Commemorative Stamps—it will be sent to you ABSOLUTELY FREE to add interest and value to your very own collection. It contains, amongst others, the fine stamp illustrated, which was issued to commemorate the achievements of the UNITED STATES MERCHANT MARINE in Peace and War, and depicts an armed Liberty Ship unloading Cargo. In addition, this Free Packet contains an attractive large new stamp depicting THOMAS EDISON, commemorating the Centenary of the death of this famous inventor. AND ALSO yet another fine Army and Navy stamp issued during the war and showing a 90-Millimetre ANTI-AIRCRAFT GUN. Get all this wonderful packet ABSOLUTELY FREE—just write for U.S.A. COMMEMORATIVES PACKET FREE and Approvals, and enclose 3d. stamp for postage of Free Gift and Approvals to you.

**WINDSOR STAMP CO. (Dept. 12), Uckfield, Sussex**

The latest V & W book :

**CIGARETTE CARD CAVALCADE**

by A. J. Cruse

An ideal Xmas present for all interested in Cigarette cards.

180 pages. Coloured frontispiece. 28 pages of half-tone plates (illustrating 100 cartophilic rarities). Full cloth binding with five-colour jacket. 10/6 net.

**VAWSE & WILES (London) LTD.**

555, Lea Bridge Road, London, E.10



Whatever your soldering job, in your home or workshop, you will prefer to use Ersin Multicore Solder. No extra flux is required. Multicore is the simple and precision method of making sound soldered joints for all household purposes. Just apply it simultaneously with the soldering iron; the three cores automatically provide correct proportions of flux to solder.

**6**  
d.  
CARTON  
Shown above

WORKSHOP SIZES 4/10 - 6/9 each.

**MULTICORE SOLDERS LTD.**  
Mellier House, Albemarle Street, London, W.1  
Tel.: REGent 1411

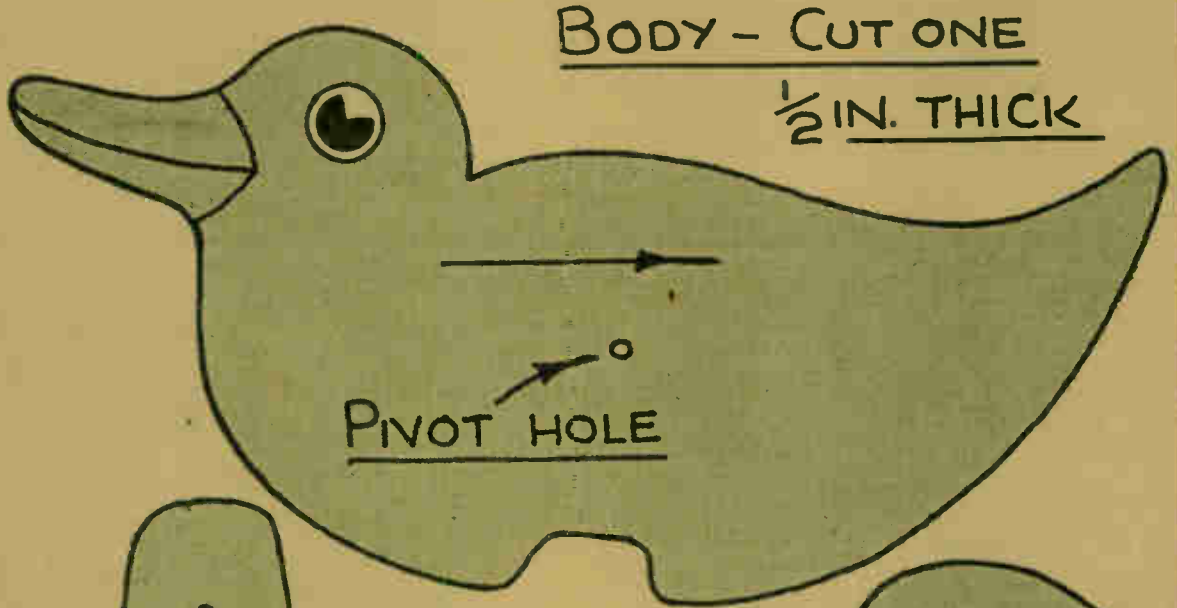

BODY - CUT ONE

1/2 IN. THICK

PIVOT HOLE

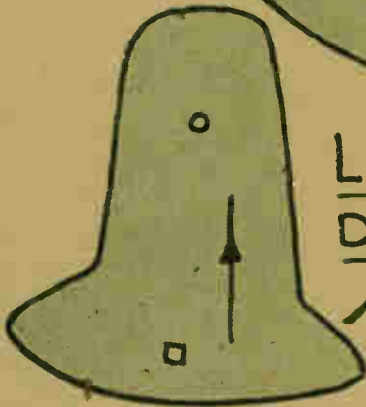

LEG OF DUCK

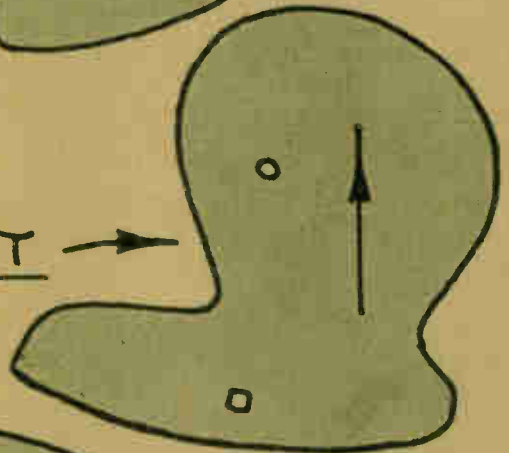

RABBIT LEG

BODY

CUT ONE FROM 1/2 IN. OR 7/8 IN. WOOD.

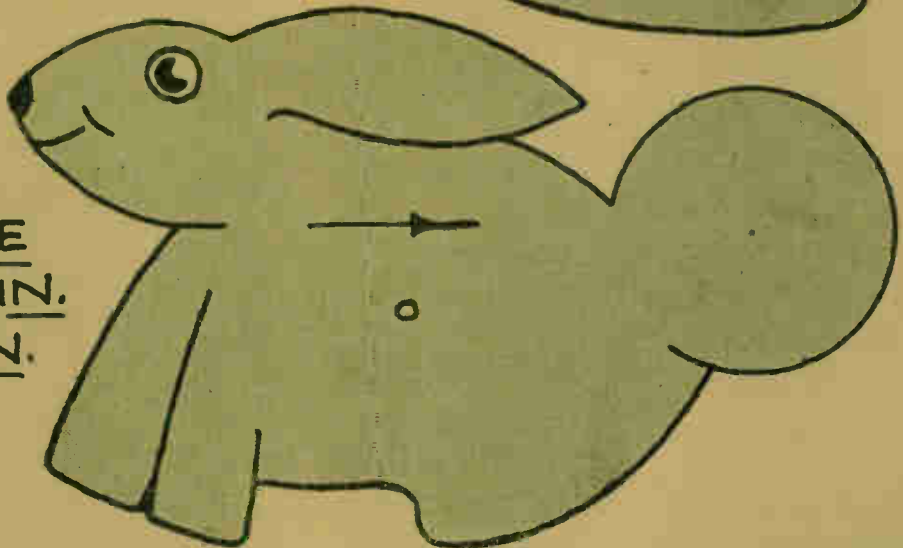



# FRETWORK OUTFITS

*There is nothing like a Hobbies Outfit to keep you happy. Making and doing. Dad and the boys .....all pals together. Hobbies Branches, Stores and Ironmongers everywhere.*



## The CROWN OUTFIT

A useful beginner's set. Contains the tools you need to start fretwork, including a design on wood and instructions. In attractive box. Price 17/6; postage 9d. Free lists from Hobbies Ltd., Dereham, Norfolk and Branches.

## H2 OUTFIT

A low-price Set with a big reputation. Each tool is of sound quality. With design and instructions. Price 9/6; postage 9d.



## The NELSON

The handframe on this set has a natural grip handle. The "Nelson" is really outstanding value. It includes a coloured design on wood. Price 18/6; postage 9d.

## The Popular A1 OUTFIT

Sheer good value has made the A1 popular. It contains a wide range of tools including the famous "lever" hand-frame, six designs and planed wood, and 64-page book of instructions. In handsome box.

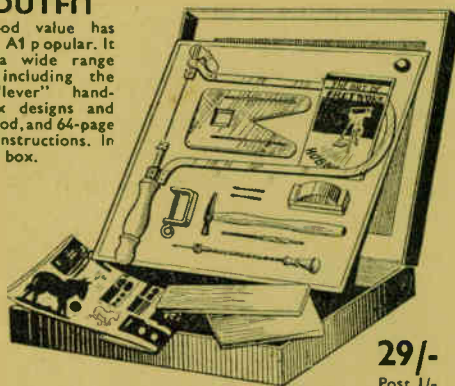

29/-  
Post 1/-

# Treat Yourself to a Fretmachine!

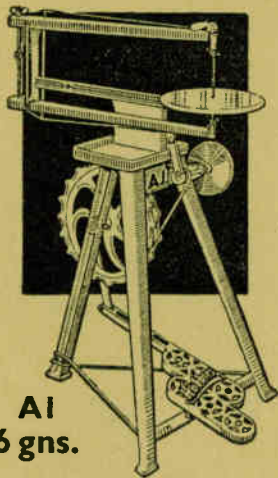

**A1**  
6 gns.

The trusted friend of woodworkers everywhere. A sturdy, sweet-running fretmachine, with tilting table for bevel cutting. It has a clearance of 19ins. behind the saw. Quick, positive tensioning to the sawblade by means of lever on top arm. Cuts wood up to  $\frac{3}{4}$  in. thick.

## THE MARVEL

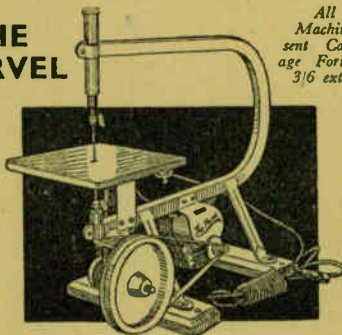

All Machines sent Carriage Forward 3/6 extra

The "Marvel" Bench Machine. Welded steel frame, vertical stroke adjustable saw tension, working parts made from hardened steel. 17ins. clear behind sawblade. With motor £10. Without motor 70/-. Details on request.

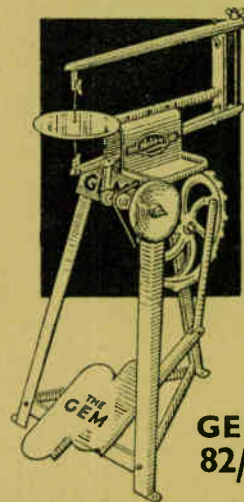

**GEM**  
82/6

Made almost entirely of steel. Non-tilting table. 18ins. clear behind sawblade. Not a toy.....but a sound workmanlike machine built to last. Cuts wood up to  $\frac{3}{4}$  in. thick.



# Hobbies

## WEEKLY

### CONTENTS

	Page
Tame Mice Cage - -	117
The Editor's Notes -	118
A Small Rocking See-saw -	119
Radio Coil Winder -	120
Books to Read - -	121
Things from Tins -	122
Small Folding Workbox	123
Toy-making Notes - -	124
Replies of Interest -	125
Air Matters on Stamps	126

December 8th, 1948

Price Threepence

Vol. 107 No. 2771

**R**EADERS who find an interest in breeding fancy mice will find the cage (illustrated) a useful one. It is reasonably commodious in size, and easy to keep clean, also it is provided with a treadmill for the mice to exercise in, most amusing to watch. Some necessary measurements are included, mostly for use if the cage is made up from boards, but quite a good one can be constructed from a deal box approximating to the sizes given. The wood used need not be heavy, a thickness of  $\frac{1}{2}$  in. would be just about right.

#### Simple Construction

Fig. 1 shows a front view of the cage, and Fig. 2 a side section. Construction is simple enough, as no difficult joints are involved anywhere. Make up the sides, top, and bottom, first, then nail them strongly together.

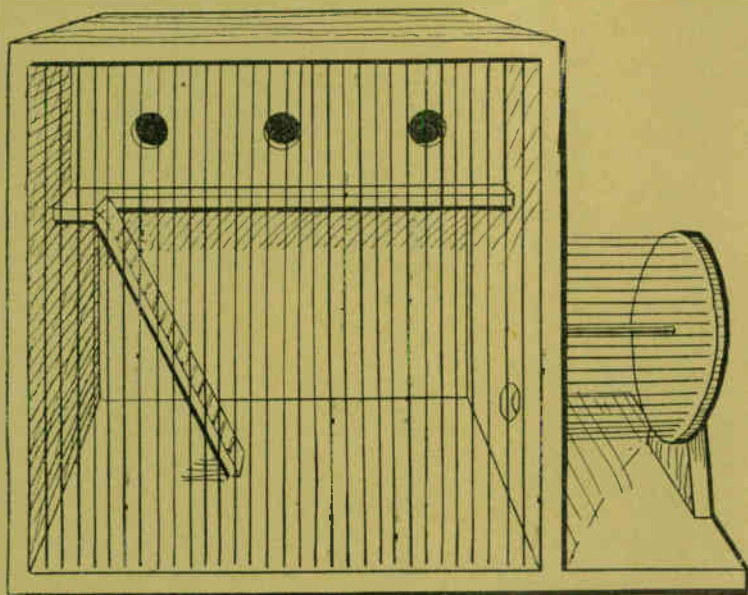

## A CAGE FOR TAME MICE

It will be noticed that the bottom extends over one side just  $4\frac{1}{2}$  ins. to provide a base for the support of the treadmill.

Cut the shelf, A, from wood 6 ins. wide, and reduce it to 5 ins. in width for the major portion of its length, so leaving a space at one end to provide a short landing at the top of the ladder, as shown in the general view.

To this shelf the front board of the

nest boxes is nailed. This board is divided into three equal parts and in the centre of each part, at 2 ins. up, a  $\frac{1}{2}$  in. hole is bored through to admit the mice into their sleeping chambers. Divisional pieces of wood are then cut to size and nailed to the front and shelf to separate the boxes.

#### Fitting the Unit

The whole arrangement is now nailed in the box, allowing enough space at the rear for the back of the cage to enter. Cut the back into three pieces, lengthwise, one 4 ins. wide, to cover the nest boxes; one 2 ins. wide, for a hinge strip; and the remaining part 6 ins. wide, to cover the bottom part. The hinge strip is nailed across both to the shelf and sides, and is stiffened at each end with a triangular piece, as at B, glued in.

The top and bottom parts of the back of the cage are now hinged to open, as in the sectional view, Fig. 2, and small wood or metal buttons fixed to keep them shut up securely, as in detail sketch, Fig. 3.

The treadmill can be constructed and fitted up. This is seen in the front view of the cage, Fig. 1. A support for the mill is made from a piece of the wood, C, Fig. 4. Cut it to size and shape shown, with a 2 in. wide tenon at the bottom. A small hole is bored through, near the top, for the spindle on which the treadmill turns. It should be a tight fit for the spindle—a short length of stiff steel, such as a piece of knitting needle.

All correspondence should be addressed to The Editor, Hobbies Weekly, Dereham, Norfolk.

At the extending end of the bottom of the cage cut a strip of wood out to admit the tenon of the support, and glue and screw the latter in place. In the end of the cage facing it, bore a similar hole for the spindle and below this a lin. hole for the mice to enter the treadmill, as in Fig. 2. These holes, by the way, are more con-

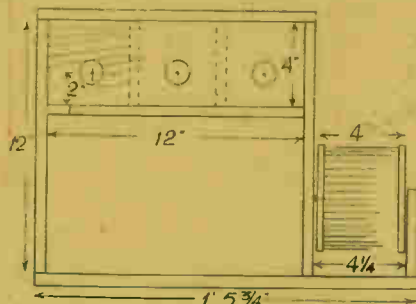

Fig. 1—Front view with dimensions

fit for the wires.

Cut the wires 4ins. long and push them through the holes. Do this carefully and avoid bending the wires in the process. Given tight holes, the completed treadmill should be firm enough.

It is necessary to ensure that the treadmill should always come to rest

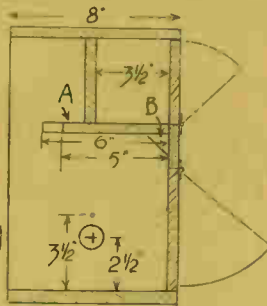

Fig. 2—A side section

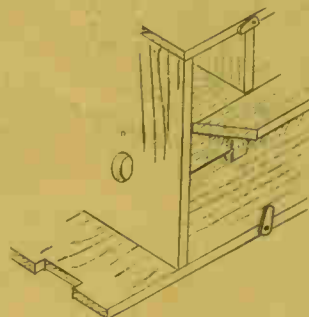

Fig. 3—Constructional details

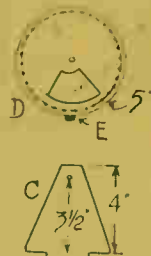

Fig. 4—Wheel and support

veniently bored in the end piece before the parts of the box are nailed together.

The ends of the treadmill, D, Fig. 4, are best cut out from a piece of three-ply, if at all possible, otherwise ordinary fretwood must suffice. Cut them to the diameter given, bore them centrally for the spindle, an easy fit, and in one only cut out an opening, as shown, for the mice to enter. On a pencilled circle 3/16in. from the edges, drill a ring of fine holes for the wire sides of the mill. Ordinary birdcage wire will suit for these, and the holes should be a tight

with the opening opposite the entry opening in the side of the cage, and for this reason a small piece of lead should be fastened to the treadmill at the spot marked E. Now fit the treadmill in place with the spindle. It should turn quite easily, and will not tend to scrape the side of the cage if a thin metal washer is placed each side, over the spindle.

The ladder, by which the mice climb to their nesting boxes, is just a lin. wide strip of wood. A few narrow strips are glued across it to help the mice climb up, then the ladder is fixed in place with glue and a small nail or

two. No separate drawing of this part is provided, as it is quite simple and can be clearly seen in the general view of the cage.

### Front Wiring

The front of the cage should now be wired in. The sizes given will admit a stock size of wire front such as bird

shops generally sell. If this is not available, then get a supply of bird cage wire in straight lengths, and bore a row of holes 1/4in. from the front edges of both top and bottom of the cage, then push the wires through. Space these wires, both in the cage and treadmill, at 5/16in. apart.

This completes the cage. It is best to paint it outside and to distemper the inside, unless you can buy a non-poisonous paint for the interior, such as can be bought for birdcages, and use that. Leave it a little for the smell to fade away, before using.

## From the Editor's Notebook—

THE children of Public Homes and Hospitals at Portsmouth have cause to be grateful to Mr. C. Goodall, of Church Path for his efforts with his Gem fretmachine. He made over 1,200 toys during the war, as well as 3,000 animal splints for the Peoples Dispensary for Sick Animals. Indeed his machine had become worn out, but as a result of a note in a local newspaper, a great-hearted gentleman brought along another, with the hope that the good work might continue. We add our best wishes, too, to this keen worker, 71 years of age, but young and enthusiastic in spirit.

AN enthusiastic reader in Argentina, South America, is anxious to obtain some inlay designs which were published before the war. He is in the fortunate position of having the various colours in natural wood—lucky fellow—and has already completed several. He wants Nos. 1446,

1742, 1941, 2000, 2041, and 2042, as well as the designs of the Coronation Coach (203 Special), The Taj Mahal (No. 202 Special), and St. Paul's Cathedral (No. 187 Special). Readers who have these designs should write direct to Stuart G. Sly, Plaza 2814, 2 Piso "K", Buenos Aires, Argentina, South America. He says he will pay 1/- each for the inlay designs and 2/- each for the others if in good condition.

I AM glad to find how extensive is becoming the practise of hobbies in hospitals and orthopaedic institutions—particularly where T.B. and other long-term treatment is necessary. Hospital life can become very boring without some interest, and most patients delight to find a pastime to enjoy during their illness. I know of several go-ahead places where men, women and children are given a chance to take up a hobby—and indeed where it has sometimes

led to starting business on those lines when they have come out. Among the most popular of the practical hobbies are Perspex work, and general plastic work, toy making, leatherwork, embroidery, knitting, rug making, clay modelling, all of which can be undertaken whilst still in bed, and continued with even more interest as an "up-patient".

WILL readers who seek advice always put their address in the letter, please? Some omit it and suggest publishing the reply in Hobbies Weekly. That is all very well, but I have not room to put all these replies in our pages, and the question may not even be of sufficient general interest to warrant insertion. It may be a long while, in any case, before such reply could appear, so for your own sake, as well as mine, do put your name and address on any correspondence.

The Editor

# A weighted pendulum makes this toy a continuous ROCKING SEE-SAW

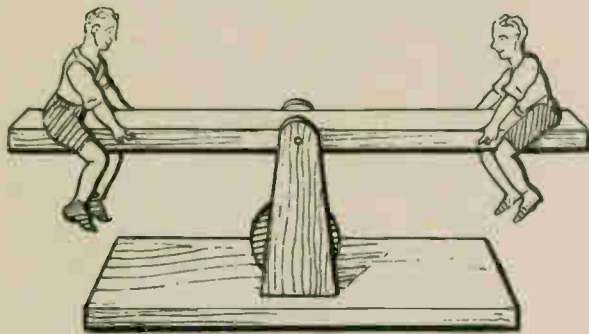

**A**N interesting though simple toy this, just the thing to make for a young child. It can be made up from any small pieces of wood available, and will amuse a kiddie. There is nothing in it to get out of order, the motive power being a lead weight which will cause the seesaw to work for a short while on the same principle as the common pendulum.

The parts of the seesaw, minus the figures and weight, are shown grouped together in Fig. 1, the base, seesaw itself, and the supports between which the seesaw rocks.

The base can be cut from a piece of deal or just common box wood about  $\frac{1}{2}$  in. thick.

Across the centre saw out the two mortise slots shown in the diagram, to suit the thickness of wood used for making the supports.

Give the base a good rub over with glass-paper and leave it smooth. Take care no splintery edges are left. This specially applies when the soft loose-grained wood, often used for boxes, is employed.

## Supports

The supports can be cut from thinner wood, if available,  $\frac{3}{8}$  in. for example, or from scraps of fretwood if any are about. Cut them to length given, plus enough for the tenons at the bottom. They are  $\frac{1}{2}$  in. long and as deep as the wood is thick from which the base is cut.

Taper them a little towards the top, and at  $\frac{1}{4}$  in. down bore a hole through for the nail to go through, which acts as a pivot for the seesaw to rock on. Glue these supports in the base and when the glue is hard, give the whole a coat of paint, some bright pleasing colour, to make it look smart and attractive to a child's eye.

It will be as well to bore this hole from both edges, going half-way through each side. This will better ensure the hole being at true right-angles to the length. Make it an easy fit for the pivot nail. This, by the way, can be a  $1\frac{1}{2}$  in. round wire nail, with the head filed off.

## Pendulum

On either side of this hole, and at right angles to it, bore a small hole through the seesaw. The distance between these holes can be  $\frac{1}{2}$  in. and they should be a tight fit for the gauge of wire used for the weighted pendulum, now to be described.

The seesaw, shown above the base in the diagram, is cut to the length and width given from a piece of wood  $\frac{3}{8}$  in. thick. Having smoothed it with glasspaper, mark the centre of its length on its edges, and there bore a hole right through for the pivot nail to enter.

It will set in a minute or two and can then be removed from the mould. Let it cool, then file it smooth, if necessary, of course.

The wires sticking out of the cast are twisted for 1 in. in length, no more, then the remainder bent to make a fork, as shown at A, the prongs of which should suit the distance between the holes bored in the seesaw. Press well in, and bend over inwards at the top of the seesaw, to make a secure joint.

Now test the seesaw in position. If the nail is a good fit in the supports and a loose easy fit in the seesaw, the latter should rock for quite a while. The figures can now be made to finish the whole work.

## The Figures

The parts for these are drawn over  $\frac{1}{2}$  in. squares in Fig. 3. Note that arms and legs for each figure are similarly lettered to prevent mistakes. The body parts are traced through carbon paper on to soft wood  $\frac{1}{2}$  in. thick, and should be cut carefully out with a fretsaw.

These parts should be shaped up a little, and finished to the best of the reader's ability in that matter. A lot can be done with judicious

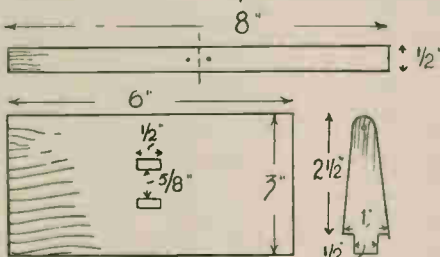

Fig. 1—Main parts of the article

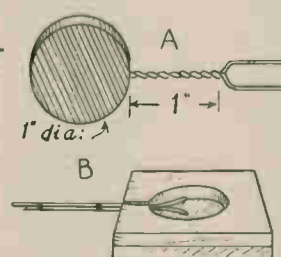

Fig. 2—The pendulum

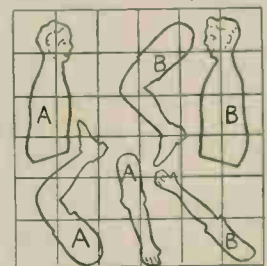

Fig. 3—Figure parts

The complete pendulum is shown at A in Fig. 2. For the wire cut two lengths of stout wire about 4 ins. long each and bind together, temporarily, with a strong thread or thin wire. A mould in which to cast the weight must now be made.

This is the simplest of jobs, the mould simply consisting of two scraps of  $\frac{1}{2}$  in. wood (one with a 1 in. diameter hole bored through it), nailed together. In one side make a saw kerf to half the depth of the mould, as at B, for the wires to lie in. About  $\frac{1}{2}$  in. of the ends of the wire are bent outwards, as in the diagram, and then the wires are pressed in the saw kerf, and any remaining space in the kerf filled up by pressing a match-stick in the space.

Now, in an empty tin, place a few scraps of lead and melt over the fire or on a gas stove. When molten, grip the tin firmly with pliers and pour the lead carefully in the mould.

whittling with a penknife. Be careful to leave those parts of the figures to which the arms and legs are to be glued, quite flat.

Cut two of each of the arms and legs, from thin fretwood,  $\frac{1}{8}$  in. stuff if at all possible. Fix the body parts to the seesaw with glue, and a single thin screw, driven through the seesaw from underneath.

The arms and legs are now trimmed up with a file, the edges being rounded off on their outsides, not the sides facing the figures. Fix them to the body parts with glue and a small fretwork nail, which should make a secure fixing enough.

The figures can now be painted, and the details of features and clothes carefully defined with a small brush. The seesaw itself can be painted or left plain as preferred. Give the pendulum wire a coat of paint to complete and you will then have a novel and attractive toy.

# It will pay the keen amateur to make for himself a RADIO COIL WINDER

**B**ECAUSE efficient coils can be made quite easily, the constructor of the simpler types of radio receiver usually winds his own. About eighty to one hundred turns are used for Medium Waves, and two hundred or so for Long Waves (depending upon the diameter of the former, etc.). Such winding can be done by hand, but if a simple machine is used the turns can be placed more evenly. The job can also be done in less time; it is less trouble and there is no danger of getting the wire into loops, or otherwise tangling it.

Such a winder is, therefore, worth making. With transformers and similar parts requiring a large number of turns, it will save a lot of time and trouble, and the results will be much more even.

## Cutting the Parts

A piece of wood about 6ins. by 10ins. and  $\frac{3}{8}$ in. thick forms the base. Two strips  $2\frac{1}{2}$ ins. by  $\frac{1}{2}$ in. by  $\frac{3}{8}$ in. support the axle on which the spool of wire is placed, and two pieces about  $2\frac{1}{2}$ ins. by  $2\frac{1}{2}$ ins. by  $\frac{3}{8}$ in. hold the winding axle. Pieces are sawn out of the base so that these four pieces fit flush. They are screwed on in the positions shown in the illustrations.

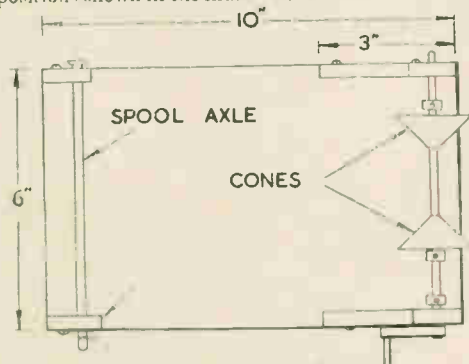

Fig. 1 Plan diagram with dimensions

Two axles are now required. The one which runs through the smaller uprights only serves as a convenient mounting upon which the reel of wire can be placed to unwind. Wood or any metal spindle can be used. One end has a washer glued or soldered on, as the case may be. The other end is notched so that a clip can be slipped on. The axle can, therefore, be withdrawn and replaced to hold the various reels of wire used.

## Cones and Winder

For the second axle, metal is best, and three collars with screws are needed to fit on it. However, these parts can be bought for a few pence. It is also possible to make collars from small blocks of hard wood. One hole

should be drilled for the axle, and another smaller hole at right-angles for a moderately large wood-screw. The screw can be tightened up against the axle, undue force being unnecessary.

## Making Cones

The former or tube being wound is placed between two cones. These assure the tube will be held centrally and level, and any size tube up to the full diameter of the cones can be held in the correct position without trouble.

Failing a lathe, the cones can be made as follows. Take a piece of wood about 2ins. in diameter and 2ins. long and drill it down the centre so that it is a push fit on the axle. Fix it on the axle and hold the axle in the chuck of an ordinary geared drill. The drill can then be gripped in a vice, and if someone turns the handle the cones can be cut with a sharp chisel. As a result they will be quite true and even. If the degree of taper is

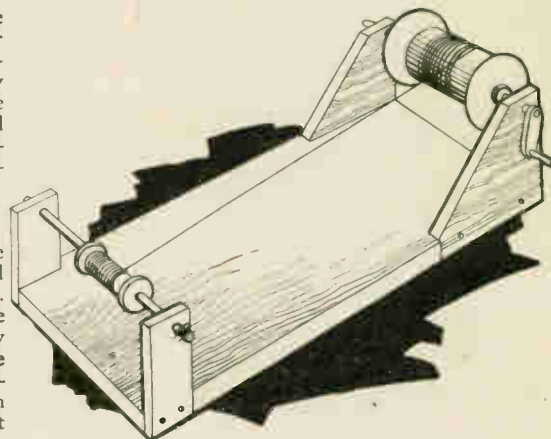

the handle to prevent undue side play.

The cones are then pressed together against the former, which will make it lie centrally, and the two remaining collars tightened up to hold them in place. Friction between collars, cones and former will rotate the latter as the handle is turned. The wire is guided by the left hand. It will be found that it is easy to count the turns correctly and to get them even and tight.

## High Speed Winder

For transformers, etc., the winder shown in Fig. 3 is recommended. The handle is replaced by a small wheel and a large wheel is pivoted on one side member. A strong elastic band will do for the belt, because with such components very fine wire is used and the tension will be slight.

Wheels can be made from wood if no metal ones are available. Washers under the pivot screw will make the action smooth.

If one wheel is  $2\frac{1}{2}$ ins. in diameter and the other  $\frac{1}{2}$ in., this will give a ratio of five to one. If a component requires one thousand turns, it will, therefore, only be necessary to count two hundred turns on the handle, which will only take two or three minutes. With thin wires, take care the spool can rotate freely, and only apply a slight tension to the wire as it is guided through the fingers of the left hand.



Fig. 2 Side view of winder

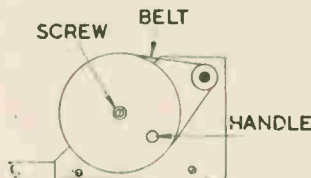

Fig. 3 A simple high-speed job

different that does not matter. An angle of about 45 degrees is convenient.

After finishing, the cones are removed from the axle and parted by sawing. The winding handle is about  $1\frac{1}{2}$ ins. long, and is cut from wood or metal. It is fixed permanently to the axle.

## Using the Winder

When winding a coil, etc., the spool of wire is placed on the spool axle, where it will turn freely. The end of the wire is then anchored to the former by passing it through a pair of small holes. Now loosen the three collars and place the former between the cones. Tighten up the collar near

**Have you got your  
Hobbies Handbook?  
68 Pages and free  
Design. Price 1/- or  
1/2 post free**

# Books to Read!

Here is a review of some recent books published, of particular interest to our readers. Obtainable from usual booksellers or from the publishers mentioned.

## Be Clever with Plastics

by C. W. Read

THE increasing popularity of plastics as a pastime is shown by the interest of our readers in the articles we have in these pages from time to time. Those who followed our series for the beginner—as well as those who have already commenced will find this new handy pocket-size manual most useful. It is compact, written in simple language and profusely illustrated. Apart from a short interesting chapter on the industrial processes the book is divided into two sections—how to undertake the work, and examples of work which can be undertaken. There are literally dozens of practical and ornamental articles to make, including many suggestions for everyday gadgets such as handles for handleless cups, clothes pegs, picture hooks, match holders etc. When you become experienced you can pass to the wide range of attractively useful articles, table lights, jewellery, chessmen, lamp holders, desk accessories, cigarette holders, etc. Altogether a very satisfactory book for the worker in this new and fascinating art. (Published by Bear Hudson Ltd., 63 Goldhawk Road, London, W.12—Price 2/6.

## Introduction to Television

by A. Folwell

THIS concise and practical book covers technical explanations suitable for any reader with a fairly comprehensive knowledge of broadcasting who wishes to know more about the equipment and science of television. The pages deal with the system in use by the B.B.C. and cover not only the receiver itself, but the all important question of aerial. The book is clearly written and well illustrated, and should be of much use to technical staffs and radio engineers who want to be *au fait* with latest developments. (Published by Messrs. Chapman & Hall, 37 Essex Street, London, W.C.2.—Price 9/6.

## How and Why it Works

DO you ever wonder about how a cinema organ really works, or what would happen if and when you pulled a train communication cord, what causes the automatic operation of the traffic lights? There are over one hundred such subjects in this amazingly interesting book. Its 320

pages deal in picture, diagram and letterpress with those things we meet every day, and explains the intricate processes and the cause and effect in simple everyday language. We are so apt to take for granted apparatus and operations which are really a marvel of scientific ingenuity, that such a book as this is a revelation of what goes on behind the scenes. In keeping with the high standards of Odhams Press publications the book is well printed and bound, with large type, clear illustrations and pictorial diagrams which explain, almost without thought, all kinds of operations and processes. It would be impossible, we imagine, to find a reader of Hobbies—or any of his family, or friends—who would not be fascinated by the interest every page contains. (Published by Book Dept., Odhams Press Ltd., 67/8 Long Acre, London, W.C.2—Price 9/6.

## Figures in Action

by Charles Wood

IF you have an aptitude for drawing, and already some knowledge, this little pocket-sized book will undoubtedly carry you several steps further. There is little letterpress matter to weary you, but the line illustrations are a joy and an incentive which few will be able to resist. All sorts of actions or part actions are shown with minimum strokes of the pencil, and accompanying letterpress mentions the points to stress, to soften and so on. Apart from the actual figure work there is an interesting portion and examples dealing with composition and how much improvement can be obtained from a dramatic sense as a background. This second book by Mr. Wood should certainly be as popular as was his first which we reviewed in these pages some time ago.

(Published by The Studio Ltd., 66 Chandos Place, London, W.C.2—Price 3/-

## GLASS DRILLING

I have made several table lamps from odd shaped bottles as mentioned in Hobbies Weekly recently and found the best way of boring a hole is to drill with a broken drill. After drilling a short time, this becomes blunt, but sand can be sprinkled into the hole while drilling.

(A.W.H.—Bexley Heath)

## World of Living Things

by Kenneth Sparrow

HOW little do we realize what goes on in the world of the undergrowth, as we enjoy a walk in the country or a stroll in the park! The little animals and insects under tree and bush, the tiny inhabitants of the pond or river all going about their lawful occasions with that quiet endless bustle of instinct and heredity found in nature. What an interesting study of biology there is to be found if one knows how to understand it. This book, written by a regular "Nature" broadcaster, and illustrated by fine pictures by Harold Bastin, the nature photographer describes the world of living things—feeding, growth, habits, characteristics, etc. of animals and plants we all know—or could know if we cared. The book should appeal to young and old, for its interest is in everyday things, about which we lamentably know so little.

(Published by Vawser and Wiles Ltd., 555 Lea Bridge Road, London, E.10—Price 7/6.

## Writing and Photography

by F.R.U.

THE author of this little paper-covered book, is a frequent contributor to these pages, so his knowledge of free lance journalism is practical and experienced. Readers who have an urge to "write" should certainly read it, because it prevents the submission of articles to editors which they can immediately tell to be amateur and untrained. Being able to do something correctly and to be able to write an explanation of it lucidly are two different matters. There is as much to learn in the art of writing as in anything else. This book gives a well-arranged series of information on both writing and illustration, covering those practical points so helpful in compiling, arranging, offering and selling plain literary work or that with the added virtue of photographic illustration. (Published by L. Warner, Middlefield Lane, Hinckley, Leics.—Price 2/6.

## Weaving for Amateurs

by Helen Coates

FROM the number of letters we receive on the subject there are apparently a large number of readers interested in home weaving—who

(Continued foot of page 122)

# Some more suggestions for making useful THINGS FROM TINS

SOME of the tins now made to hold food stuffs are finished off with neat roll edges, and lend themselves quite well to making useful articles for workshop and home. Two such ideas are illustrated, one a nail box, and the other a fancy vase-like holder, suitable as a container for spills, pipe cleaners or tapers, or for displaying dried grasses or artificial flowers.

## Suitable Container

About the best tin for the latter article is a coffee tin, 1½ lb. size, though other tins of similar shape could, doubtlessly, be used as well. The tin needs to be cleaned out, of course, then provided with a metal base as a stand. For this, cut two strips of metal ¾ in. wide and 9 ins. long. If you can use brass or copper, all the better, but tinplate strips can be employed if nothing stronger is to be found.

Punch a hole in the centre of each strip to admit a ½ in. brass screw bolt, complete with a nut and washer. The holes should have the burrs made by the punching filed away. Bend the strips as at A, in Fig. 1,

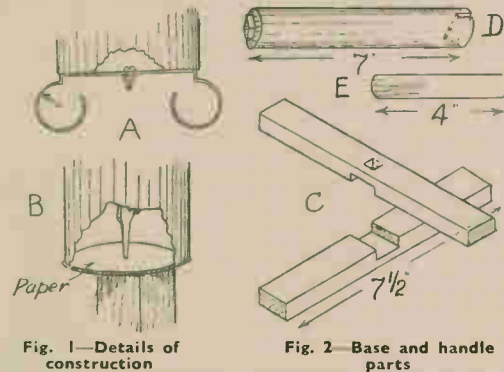

Fig. 1—Details of construction

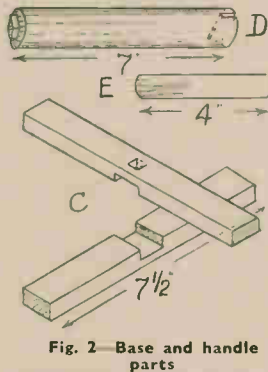

Fig. 2—Base and handle parts

making the circular or near circular ends rather than just 1 in. diameter. The two strips are then to be laid at right angles to each other and fixed together and to the tin at the bottom with the bolt and nut, as shown.

Before this can be done, however, a hole for the bolt must also be punched through the centre of the bottom of the tin. This hole should be punched through from the inside, with the tin resting on the top end of a piece of wood, held between the knees. For better fitting of the stand strips, it is as well to ensure the hole being as truly in the centre of the tin as possible.

This can be more easily done if a circle, a shade less than the diameter of the tin, be struck with compasses on a piece of thin card, cut out and pressed down the tin to lie flat on the bottom, as at B. The point made by the compasses will show the centre and allow the hole to be punched with reasonable accuracy.

## Painting

The vase can be finished with a coat of any of the art enamels, and if a simple border and flower ornament can be added, a pleasing article will result.

For the nail box, choose four of the 1½ lb. tins used for jams, the kind which are closed with cardboard or metal covers, as the edges are then finished nicely with a roll edge. From any pieces of deal at hand cut two strips as at C, in Fig. 2, say, 1 in. wide, and groove them at their centres so that they notch together

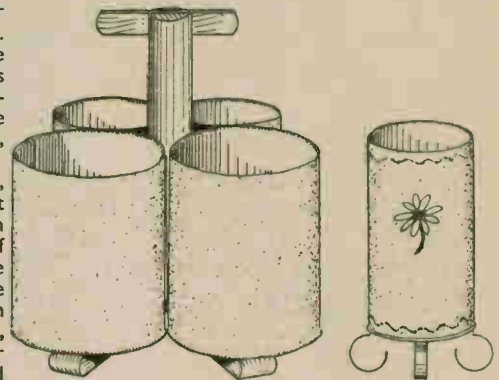

with a halved joint. In one only, the top one, cut out a small mortise slot ¾ in. or ½ in. square.

## The Handle

For the handle, D, a piece of broomstick can be employed or a length of wood 1 in. square instead. At one end cut a stub tenon to fit the mortise in the stand strips, and at the top end, cut a slot out to just admit the wood grip, E, a piece of ½ in. fretwood, ¾ in. wide, or other thinner piece of wood available.

Glue this in the slot in the handle, and drive a nail through the joint to strengthen. Now fix the handle to the stand strips with glue and a single screw driven in from underneath the stand.

The tins have a hole punched in the centres of their bottoms, as done in diagram B, and are fixed to the stand with a single round-headed screw each. The ends of the stand can be nicely rounded off and all be painted or enamelled. This will hold quite a quantity of nails and be invaluable in the home or workshop. You can make it more attractive and prevent rust by painting if desired.

## Books to Read—(Continued from page 121)

would like to construct their own loom or spinning wheel and undertake the creation of useful and beautiful fabric. Although probably one of the oldest of mankind's occupations weaving has still a fascination for people who feel the need to be practical with their hands and create for themselves—and their friends—something beyond the multiple article produced by mass production. Miss Coates whets the appetite with photographs of beautiful articles made by expert amateurs, but at the same time gives opportunity to the beginner by providing instructions for various home-made looms. Progress is shown from simple hand-looms to large pedal looms able to undertake an amazing variety of work. The contents also deals with

fabrics, dyeing, spinning, varieties of weaving, etc., so the reader who follows its pages may easily become expert in his (or her) ability and the possessor of a pleasing and practical pastime.

Published by The Studio Ltd., 66 Chandos Place, London, W.C.1.—Price 10/6.

\* \* \*

## Colour-Paper Decoration

by Frederick T. Day

THE use of nimble fingers with coloured paper, scissors, gum and card can provide a pleasing quiet occupation for those who seek to combine artistic ability with practical results. Mr. Day has produced a worth-while book on the subject, and the illustrated results of his own

ability should entice many more to take up the art. It is a creative hobby particularly suitable for youth groups and clubs of a similar character where co-operative suggestion and help can go hand in hand with creative ideas and practical knowledge. Really beautiful and colourful results can be attained by the judicious use of coloured paper. Chapters deal with the tools and materials needed, how to build up designs, the question of colours, parchment work, table and wall decorations, home and office decoration etc., and a complete index gives ready reference to any particular point needed.

Published by Book Dept., C. Arthur Pearson Ltd., Southampton Street, London, W.C.2—Price 7/6.

# A delightful gift for a lady is this novelty FOLDING WORKBOX

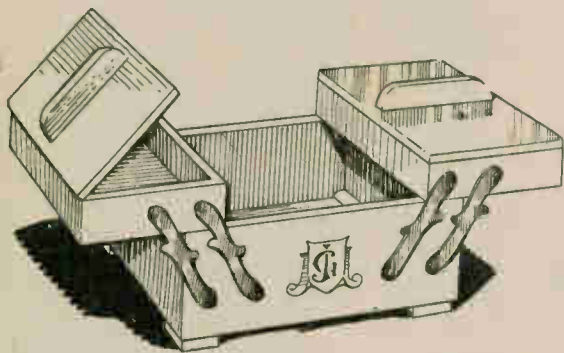

**H**ERE is a type of needlework box both interesting, useful and compact. There is a handy size box, hinged to the top, of which are two trays for cottons, silks, threads and the many little gadgets which make up the kit of the busy housewife. Such an article as this would make a splendid Christmas or Birthday gift.

The front view of the box is given in Fig. 1, and shows one of the top compartments or trays closed over the left half of the box, while the right hand tray is thrown open or folded back, giving access to the large compartment below. The system of hinging the trays to the lower box is interesting and works on the old principle of the parallel rules used in the drawing of a number of straight and parallel lines on paper.

## Box Sizes

The box measures 12 1/2 ins. long, 8 1/2 ins. wide and 5 ins. high. It consists of a floor, A, Fig. 2, two sides, B, and two ends, C, all of 1/2 in. stuff. To make a really satisfactory and strong job, the corners of the box should be pin-jointed together as shown, and glued, with angle fillets, such as D, put along on the floor and ends to hold the floor firmly in place.

The floor fits between the sides and ends as seen in the sectional diagram, Fig. 2. Where a floor fits into a frame such as in this case, it is always

better to mark out the outline of the floor direct from the frame, which ensures a perfect fit.

It would not do, therefore, to cut the floor first and, having knocked the pin-jointed frame together, expect anything of a perfect fit. It will, however, be very necessary to check the inside angles of the frame for

squareness with the tri square or a set square after gluing the parts together.

If the worker should not use the pin-joint method for the angles of the box, but simply butt and glue them together, then the joints and angles must be strengthened by the addition of angle fillets wherever possible.

## Tray Construction

The construction of the trays is shown again in Fig. 2, and the sizes of the rails, F and G, which are all 1 1/2 ins. wide, are given in this diagram, the rails, F, going in between the rails, G, will be 8 ins. long, as all the wood for the trays is 1/2 in. thick. Here again the floor, H, goes in between the rails, F and G, and is held by the angle fillets, H.

The lids for the trays are cut to the exact outline of the frame and cleaned down evenly all round. They consist of a single piece of wood, and the plain handles running across the top, help to stiffen them materially when glued and screwed on from beneath.

The handles measure 5 1/2 ins. by 1/2 in. by 1/2 in. thick. Shallow recesses are cut to receive the hinges as seen in the detail. These may be cut down with the fretsaw to the depth of the two flaps of the hinges and then cleaned out with a sharp pocket knife or chisel. Two pairs of stout 1/2 in. brass hinges should be obtained for the job.

The trays are attached to the box by four pairs of bars made from stout brass and put on with roundhead screws. The outline of one of the bars is given in Fig. 3, and from this the enlargement can be made on to paper, following carefully the

squares which measure 1/2 in. longways by 1/2 in. across the width. Set out these divisions, then follow the outline through each. One half, lengthways only of the design may be done if desired, traced off and transferred to the other side of the centre line, making the complete outline.

## Hinging Pieces

Stout brass large enough to take the eight outlines must be obtained and the paper patterns gummed down to it and cut round with a metal-cutting fretsaw. It should be borne in mind to drill the holes before cutting the strips to outline so they remain perfectly flat and even throughout their length. Some little care must be exercised in the placing of the strips on the box and the trays.

First, taking in hand the trays, run a line in pencil centrally—that is 1/2 in. up from the bottom line along the sides, see dotted line in Fig. 1. Then set out 1 in. and 2 ins. from the inner upright edges of the tray as shown and prick in holes in the wood at these points.

Next, taking in hand the box, set down 3 ins. from the top edge and draw a line extending to the edge, then from the latter set in again the 1 in. and 2 ins. distances on this line and prick in again on the line. Thus the positions for all the screws should have been accurately detailed.

## Trial Fitting

It would be advisable to make a trial with, say, a pair of the strips at first before actually driving home the screws to make quite certain that the trays meet evenly and correctly centred with the box top edge. When all is well, run in the round head screws, putting thin brass washers between the strips and the sides of the box and trays.

Four feet cut from the 1/2 in. or 1/2 in. waste wood glued and nailed on make for a good finish to the box and these may be stained black to give contrast to the other colouring.

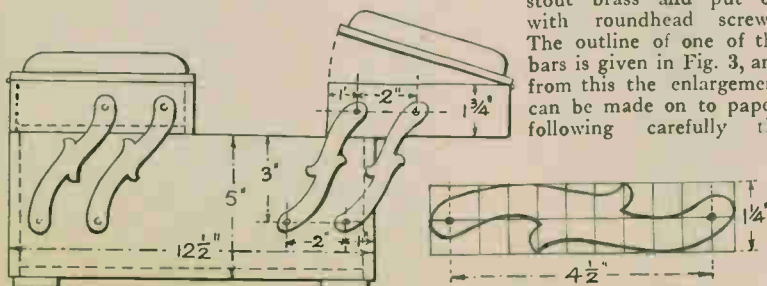

Fig. 3—Shape of brass hinges

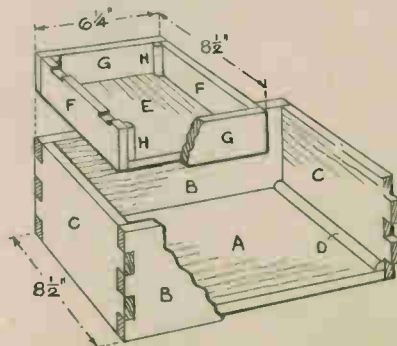

Fig. 2—Constructional detail of boxes

Fig. 1—Side elevation

# General Notes on making some popular large TOYS FOR XMAS

**X**MAS toys, which are normal toys, are generally easy to construct, but some are really impossible, especially pedal motor cars and pedal tricycles. We show, for example, a small car which, in appearance, looks very simple to make. The construction is simple, but only to the man with the materials, tools, and the experience.

The specification of this model is: an all steel body, touring type; drive by crank and pedals; large 8in. rubber tyred disc wheels; nickel-plated radiator; rubber pedals; complete with

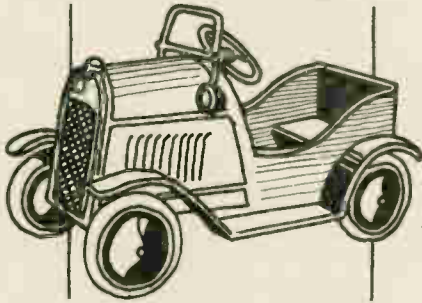

windscreen, side lamps, mudguards and step. Enamelled in smart colours. Overall size: 32ins. by 17ins.

It is always the same story. The best of toys are manufactured almost entirely from metal. The most the home worker can do is to try and copy such toys by using wood and a few odds and ends of metal.

This is usually easy enough where non-mechanical toys are concerned. A pedal car, or tricycle, is different. You simply must have the correct metal parts. Wood, in any shape or form, is no substitute. There is not the same strength, nor the endurance. Things have to be bulky and unwork-

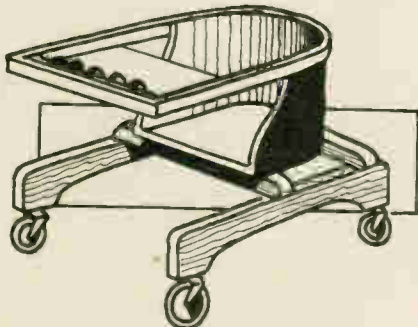

manlike, with many screws and bolts. Consequently, it would be better to purchase a toy car or tricycle rather than attempt to make one of the other.

## Pedal Car Chassis

In pre-war times, of course, it was possible to buy a pedal car chassis,

complete with wheels, steering, and all working parts. All one had to do was to build a suitable wooden body for the chassis. The latter simply bolted to the body. In this case, the construction was greatly simplified, and the car could be built much cheaper than the all-steel models displayed in shop windows.

The chassis was the main item required. It remains the main part of a toy car. It can, however, be omitted. Build the usual body from  $\frac{1}{2}$ in. wood; for example, with card, lino, as a substitute for plywood. The latter is needed for bending the radiator top

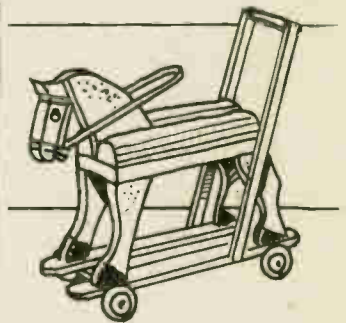
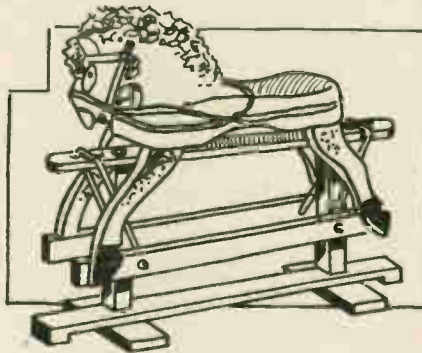
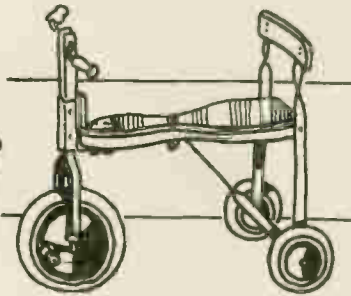

shape. Provide axle supports, which are bent from flat bar and screwed beneath the car body. Fit 8in. disc wheels.

There is no steering. The wheels are a fixture, but free to turn round. You are building, in fact, a large model of an ordinary tin toy car. It will give as

much pleasure as the more realistic type. There is nothing you can do, unless you can undertake the construction of a proper pedal car chassis, which means that you will have to be a mechanic, and know exactly what is required.

## A Pedal Tricycle

The usual toy tricycles, as illustrated, also seem easy to make. The real trouble is the "fixed" front wheel. It must be strongly attached to a cranked axle. Then you must not forget to include two fork pieces for connection to the steering column.

If the bends in the axle are not too sharp, the fork pieces (made from flat bar) can be slipped on once the axle has been brazed to the wheel hub. The cranked axle could be made from  $\frac{3}{8}$ in. mild steel rod (solid stuff). Having slipped on the fork pieces, the pedals, shaped from a hardwood and bored, are fitted and held by means of washers and cotter pins. Holes for the latter will need to be drilled through the rod.

The seat, which is usually 11ins. high, should be shaped from  $1\frac{1}{2}$ in. wood. It is about 16ins. long by 6ins.

wide at the rear end. The steering column could be made from wood (to which the fork pieces are bolted). The column is pivoted to the front end of the seat with a metal bracket which could engage with a second bracket on the seat.

The back rest is a piece of  $\frac{1}{2}$ in. wood screwed to flat bar legs. An axle (solid metal rod) is fitted to the legs. The latter are supported by an under stay, made from flat bar. Note that the flat bar needs to be twisted. The large front wheel is 8ins. to 10ins. in diameter, and the rear wheels 6ins. to 4ins. in diameter. Disc wheels are advised.

## Safety Rocking Horse

A safety rocking horse is one, of course, that cannot rock over. These rocking horses have a height of 24ins. and a length of 33ins. overall. The horse may consist of a flat, thick body



piece to which  $\frac{3}{4}$ in. thick legs are glued and screwed. The "hoofs" of the legs, at the inside, are half-checked for lapping to the rocker rails.

### The Head

The head of the horse should be cut from  $1\frac{1}{2}$ in. or  $1\frac{1}{4}$ in. wood, with the edges scalloped at the eye and nostril positions, using a chisel, or a rasp and glasspaper. The head is fixed to the body, at the centre, by driving in screws via the underside. The body back requires to be upholstered in a simple way, then fluffy material glued to the head to act as a mane. Leatherette strapping and a few covered tacks are needed for the reins, etc.

Painting is, as usual, in bright colours. A flat coat of grey can be laid on first, and allowed to harden in thoroughly before the second coat is applied.

A wooden support is built on the lines shown, after which two rocking cranks, bent from  $\frac{3}{4}$ in. solid metal rod, are made and fitted. The cranks fit on the support, held in place by covering lugs bent from stout sheet

metal, drilled for the suitable screws.

Another simple and popular toy is a horse on wheels, with a push handle. These usually have a padded leatherette seat. The common size is 20ins. long by 20ins. high. The construction of the horse is on similar lines as the rocking horse. In some cases it is usual to make a shallow box which, inverted, has a head attached to its bottom, with the legs attached at each corner, at the inside.

The base consists of two narrow bars of wood connected by two axle pieces. The horse is screwed to the bars, then the handle made and fitted. Small wheels, about 4ins. in diameter, are then attached, using roundhead screws and washers. Wooden wheels, turned from a hardwood, could be used, but the disc wheels are recommended.

### Kiddies' Runabout

A kiddie's runabout is another popular sort of gift. A usual design is shown, and it will be seen that the seat backing is bent to the shape of the seat. For this purpose, you will

need a strip of short-grained plywood.

However, it is possible to have the seat made square. A runabout made this way only requires some pieces of  $\frac{3}{4}$ in. wood. The cross pieces and foot blocks, however, should be made from  $\frac{3}{4}$ in. wood. A small tray is provided, with a wire rod on which is arranged a few wooden balls. The latter need not be round. Squares of wood, with the corners removed, are just as good. The runabout is fitted with 2in. rubber-tyred wagon castors, of the push-in type.

### Blackboard and Easel

The easel is made from  $1\frac{1}{2}$ in. by  $\frac{3}{4}$ in. wood. It should have a height of 28ins. The board, made from  $\frac{3}{4}$ in. wood, measures 16ins. by 12ins. Easel should be varnished. Board needs to be coated with dead black. No need for white lines which require to be painted on, using a white flat paint. Dead black is a special preparation for blackboards. It dries out flat, without shine. Blackboard black, as it is usually called, can be obtained at most leading paint shops.

## Some Replies of General Interest—

### Horn Work

*CAN you tell me the treatment of Horn in turning and finishing as small ornaments, etc.? (D.G.—W.C.I.)*

**H**ORN can be worked and drilled by ordinary tools without particular difficulty. It can also be turned in the lathe, and moulded and flattened by heat. It can be cleaned by scrubbing with strong soda water and fastened together, either with small rivets or a powerful adhesive, like Chatterton's compound.

Polishing is brought about by first scraping with a steel scraper, then rubbing with brick dust and oil, and a final application of rouge or putty powder.

### Miniature Photographs

*I AM interested in the process of reducing photographs by the camera-copying method, so that the result can be used in rings, lockets, etc. Could you advise me on the process necessary to obtain these results, with regard to type of camera, lens, and method of illumination, etc.? (G.W.—Arlington).*

**N**O special apparatus is essential for the photographic work you wish to undertake. All you require is any type of camera with a focussing screen—the older type of plate camera, such as the "Ruby" or "Thornton-Pickard".

The print or object to be copied is set up on an easel or other vertical support, and should be uniformly lighted.

The camera is set up in line with the object and the latter focussed on to the ground glass focussing screen of the camera. The camera is then moved away from, or towards, the object until the focussed image on the screen is the exact size required. A mask with a hole in it of the exact size of the ring, etc., is a convenience and can be placed over the focussing screen.

Having adjusted the camera and got the image as required, a photograph is taken in the usual way. This produces a negative from which a contact print is made.

### De-Magnetizing a Screwdriver

*COULD you inform me of a method, simple or otherwise, to de-magnetize a screwdriver? (T.P.H.—Walworth, S.E.).*

**A**SCREWDRIVER which has become impregnated with magnetism by contact with a powerful permanent magnet, such as a loud-speaker magnet, can be robbed of its magnetic force very easily, but the method is somewhat drastic.

Assuming the shank of an ordinary screwdriver is magnetic to some degree—the degree of being capable of holding small iron screws, etc., to its tip (which is often a nuisance rather than a benefit, at times), the remedy is to light a gas-ring and hold the shank of the screwdriver in the hot flame for a few seconds. When the metal is about to turn red, it is taken away and allowed to cool a moment

before plunging in cold water. The best time to remove the metal is when it is turning a dark blue colour. By quenching, the temperature of the metal will not be rendered soft. The heat drives out the magnetism.

### Wood Worm

*I HAVE noticed signs of wood-worm appearing in the beading of a sideboard. Apart from removing the affected wood, is there anything I can apply to it to kill the worm, or prevent its spreading? (J.F.K.—Totenham).*

**Y**OU will be well advised to watch for further signs of the wood-worm that you suggest is appearing in your sideboard. June and July are the months when they are most visibly active, and unfortunately there is no certain cure or preventive.

### Cassava

*BE good enough to let me know how to proceed to ferment cassava root. (F.C.—Ismalia).*

**A**S you do not state the purpose of fermenting cassava roots, we would point out that it might be possible to ferment the liquid in the root, but not the root itself. Possibly you refer to the sap of the bitter cassava roots, which contain the highly poisonous hydrocyanic acid. Exposing the roots to sustained heat, dissipates the poisonous principle, and when that has been achieved the concentrated juice is used for cassareep and other sauces.



## AIR MATTERS ON STAMPS

ONE section of stamp collecting that has become very popular during the last few years is that dealing with the air mail. This week we propose to talk about the early days of the air mail and describe some of the lesser-known points.

In Great Britain, the first Aerial Post was in 1911 when special post-cards and envelopes were prepared and flown from London to Windsor and also some from Windsor to London. This was done with the sanction of the Postmaster General.

London on December 9th was delivered in Cape Town on the 21st. A specimen of the official envelope is illustrated here.

Other similar flights and extensions of flights have had their special envelopes. For example the London to Rangoon flight had an envelope showing a map of the route Karachi—Delhi—Calcutta—Akyab—Rangoon. The joint operation of the Imperial Airways and Qantas Empire Airways for the England to Australia service has a map of Australia with a kangaroo and speed bird.

men is shown as the second illustration.

In 1934 a scheme for sending letters by rocket was tried out on the Sussex Downs. Letters which were sent had to have the ordinary postage stamps affixed as well as the Rocket-Post stamp which cost 2/6. The next illustration is one of these flown or rocketed covers. The reason for the 1½d stamp is that the letter after going in the rocket was sent on to the addressee by the ordinary overland mail.

### Rocket Troubles

The trouble with this form of very rapid mail transport is the difficulty of making sure that the charge in the rocket is sufficient to carry the projectile so far and no further. And as the temperature of the air, the barometric pressure and so on all affect the rocket each day the charge would differ for a given distance.

Lastly, we record one of the private airmail services, that to Lundy Island.



An official envelope on the South African Christmas flight



For British Stamps



Specimen of an envelope sent by experimental rocket post

A special postmark was made which consisted of two circles, and between the two were the words "First United Kingdom". Inside the circle was "Aerial Post", the date and either the word "London" or "Windsor". Unfortunately there is not one available for illustration.

After that air mail service there was quite a gap before any regular service began. Many experimental flights were made on which a few letters were carried. A number of routes were surveyed with a view to opening them up, and on these also letters were sometimes taken. But as the particular service was generally suspended shortly after, they cannot be called an air mail service.

### High Value

Some of these experimental letters now command quite high prices, and they are very interesting examples for an historical collection. However, one might say that for general purposes the Air Mail did not start until the Imperial Airways flights such as the London to Karachi service which started in 1929.

Then there was the special Christmas flight from London to Cape Town in 1931 and on that a letter posted in

Quite a large number of countries have special stamps for air mail purposes and no doubt you have specimens of some to which you can refer.

Great Britain has never issued such stamps, although an attempt was made to introduce them. At least at the International Stamp Exhibition held in London in May 1923 an essay (that is a suggested design) for an airmail stamp was printed and sold to the visitors to this Exhibition. A speci-

This was started in 1935 by the Atlantic Coast Air Services. They issued special stamps showing a map of the area served, but later the company changed its name and issued a fresh series of stamps. This time showing a picture of a lighthouse with the words "Lundy and Atlantic Coasts Air Lines Ltd.", around the edge of the stamp. This service had to stop when the war broke out in 1939.

That gives a very short idea of the difficulty of making a complete Air postal history collection, because there are so many items which have to be found. This, however, should in no way discourage any one from trying to make such a collection. Just the reverse in fact, because you may always find an item which would interest those who think they have a practically complete collection.



A private air service stamp

**PLYWOOD** offcuts 3/16in. three-ply parcels from 10/- Send stamped addressed envelope for bargain list.—Naylor, 204 Wolverhampton Street, Bilston.

**LATHES**—Have a proper one this time. Edwards & Drage (Tools) Ltd. can supply from stock 5in. "Little John", "Atlas", "Halifax", "Rollo Elf", "Grindturn", "Willimott" and "Myford". Hire purchase arranged. Also "Coronet", "Centrix", "Gala" and "Hobbies". Send us your enquiries.—131 Magdalen Road, Exeter. 56134 and 67745.

**STAMPS**—Grand approval advertising packet. One only to each client. Containing Roosevelt Mourning Issue, Italian Jet Bomber Pictorial, Hitler, Mussolini and General Franco portrait stamps. War and Victory, Unused Kenya, Dominica and Cayman Isles, together with 50 other different foreign and Colonial stamps. Catalogue value over 5/-. All guaranteed genuine. Send 6d. and request approvals, free gift list etc.—W. O. Took, 2 Cowper Street, Hove, Sussex.

**STAMPS** unlimited. Special agent offers 25 free with super approvals. Postage 2½d.—Jones, Messines Park, Londonderry.

**PLASTICS**. Catalin sheets, rods, cylinders and profiles. Perspex sheets and offcuts, clear and coloured, glues, polishes and transfers. Send stamped addressed envelope for details.—Eastern Plastics, Church St., Westbury, Wilts.

**NEON** lamps for assembling "Fairy Glowlight" Christmas tree decoration sets. Sample 3 lamps for 4/6, 15/- doz. Holders free.—Lucas, 22 Hengrove Road, Bristol 4.

**PERSONS** required to make ladies' belts and fancy goods in spare time.—Dept. 3, Somat Plastic Co., Ltd., 8 Middlemarsh, Nottingham.

**NEW** Magic tricks for Christmas. Crazy cut-ups 6d., grand party trick. Bumper lists of America's latest 3d.—De Hempsey, 363 Sandycombe, Kew Gardens, Surrey.

**A** SERVICE for Hobbies readers. Chisels, plane irons, etc., re-ground (any condition) and sharpened to correct angle; small charge.—S.A.E. to T. Beckett, 101, Dalefield Road, Normanton, Yorks.

**L**ONELY? Join Friendship Circle. Details 6d.—Secretary, 34 Honeywell Road, London, S.W.11.

**THE MOST** enjoyable hobby of all. Piano playing. George Ashburnham's postal course is easily followed to its final stages.—APM (53), 3 Airway, Romford.

**MAKE** money from making models. See our new instructive book on this subject. Post 2/9d.—Sutton Models, Billericay.

**H**OME Movies, Projectors, films, 9.5, in great variety. Sale, hire, lists, stamp.—Wayland, 223 Longley Road, Tooting Junction.

**BE** Taller. Quickly! Safely! Privately! No appliances—no tablets—no dieting. Details 6d. stamp.—Malcolm Ross, Height specialist, BCM/HYTE, London, W.C.1.

**L**ONELY? Then write Secretary, U.C.C., 5B.B. Hay St., Braughing, Herts. Genuine. Est. 1905.

**M**ODELS: you can make lasting stone-hard models with Sankey's Pyrama Plastic Cement. Supplied in tins by Ironmongers, Hardwaremen and Builders' Merchants. Ask for instruction leaflet.

**P**ERSONS required to make fancy goods at home. Write for details—Melton Manufacturing Co., Southgate Street, Leicester.

**T**RANSFERS for decorating toys, trays, furniture, fancy goods. List and samples free. Flowers, pixies, dogs, nursery rhymes.—H. Axon Harrison, Jersey.

**F**OR your Hobbies Exposure Meter light cells 6/6. Meter movements 7/10. Moulded cases 8/10. All post free.—Surpluses, 8 Shanklin Drive, Filton, Bristol.

**W**ATCHMAKERS material famine. 10 assorted Geneva watch movements, take 2/7d. the ten. Ten English lever movements 50/- the ten. All from gold and silver cases.—Merkels, The Old Jewellers, Pilgrim Street, Newcastle-on-Tyne.

**H**ENLEY'S Book of Formulas. 10,000 Formulas, processes, trade secrets and new ideas. 900 pages. New cheap edition 16/- post free.—Herga Ltd., 291 Waverley House, Havelock Road, Hastings.

**B**LUSHING, shyness, nerves, self-consciousness, fears, ended. Details under plain cover 1d.—Stebbing Treatment, 28 (HB) Dean Road, London, N.W.2.

**P**RESSED Metal Wheels, per dozen ¾in.—9d. 1in.—1/-. 1½ins.—1/3, 2ins.—1/6. 2fns. (special quality) 1/9. Per gross, ¾in.—6/6. 1in.—7/6. 1½ins.—9/-. 2ins.—12/-. 2fns. (special quality) 15/-. All prices inclusive of purchase tax, postage and packing. Immediate despatch. Doll's House windows, doors, fireplaces. Illustrated catalogue 3d. (Trade supplied.)—Jasons, 135 Nags Head Road, Ponders End, Middlesex.

**A**BSOLUTELY free—two tricks. A Magic Magazine, lists of easy-to-do conjuring tricks, details of Magic Club. Enclose 6d. P.O. to cover postage.—Sid Sonalli, Birmingham, 13.

**£5** to £20 weekly earned at home, running your own Mail Order business. Details 1d.—Stebbing Publications Ltd., (HB) Naphill, High Wycombe.

**BE** Taller in 14 days or money back. Details 1d.—Stebbing System, 28 (HB) Dean Road, London, N.W.2.

**C**ANADIAN Silver Jubilee set, free to all requesting approvals. (Without approvals 9d.). Postage please.—H. A. Smith, 13 New Road, Scole, Diss, Norfolk.

**D**OLL'S House fittings and papers, send S.A.E. for list. Doll's house plan special, send 2/6. Trade supplied.—Zimplan, 88 Ware Rd., Hoddesdon.

**S**POKE Wheels, treaded tyres, 8ins. 9ins. and 12ins. overall diameter. Also Rubber tyred metal disc Wheels ranging from 2ins. to 9ins. Small or large quantities supplied. Write requirements.—Joyden Toy Co., 193 Chase Side, London, N.14.

**"POWER** Tools You Can Make." Famous "Popular Mechanics" plans and constructional details for building drilling machine, jig-saw, band-saw, lathe, etc. All from readily available materials. 12/6d. only, post 7d. Illustrated lists 3,000 American Homecraft books, plans, magazines 6d.—BCM/PUBLICATIONS (H) London, W.C.1.

**T**HE interest in car numbers never ceases. "Where's That Car From?" containing all the car index marks, alphabetically arranged. 54 pages 6d. Now in its sixth edition. From all Newsagents or Raleigh Press, Exmouth.

**J.** MCGARRIGLE & SONS for Jaeroplane and ship kits. All accessories, stamps, lists 3d., wholesale lists 4d.—43 Purbeck Road, Romford.

**W**HEELS for Toys in metal, wood and plastic. Numerous sizes and types. Write for list stating requirements to The Joyden Toy Co., 193 Chase Side, London, N.14.

**T**OY casting moulds, farm animals, soldiers, wallplaques, ornaments, dogs, etc. The largest selection of metal and plaster moulds available. 6d. Illustrated catalogue, S.A.E. for list.—Nuthall, 69 St. Mark's Road, Hanwell, W.7.

**F**REE! Extra special Br. Col. packet scarce Jubilee, Coronation, Victory, Zoological new issue stamps. Request approvals (2½d.)—Thompson, 2 Western Gardens, London, W.5.

**S**HORTHAND in one week. Test Lesson 3d.—Dutton's (H.B.) 92 Gt. Russell Street, London W.C.1.

**100,000** Government surplus bargains. Oil and Radiators complete, 9/6 post 9d. Single, two, three, five and sixteen bank switches from 11d. 12v relays, 1/- each, post 3d. (100 for £2, post 2/-). Magnifying glasses (4½ins.) chrome rim, ebonite handle, in plush lined case, 35/-. (Useful Xmas gifts). Also Fairy Lights from 25/-. Order now in time for Xmas. Send 3d. stamp and S.A.E. for lists of other bargains. Prompt attention to Mail Orders.—J. Milligan, 24 Harford St., Liverpool, 3.

**T**HE ideal drive for home workshop tools and models, Brook ¼ H.P. "CUB" electric motor—single phase split phase. May be obtained from your local electrical contractor.—Brook Motors Ltd., Empress Works, Huddersfield.

# EXTRA CASH IN SPARE TIME



A fascinating way of earning extra cash in spare time from odd pieces of lead. Small Outlay—Large Profits. Sample mould 3/6d. Casting moulds, deep-cut and ordinary type Aeroplanes, Soldiers, Farm and Wild Animals, Cars, etc. Stamped envelope for full list. Illustrated Catalogue 9d.



MASTERCRAFT MOULDS  
69, ST. MARKS ROAD, HANWELL, LONDON, W.7

## Introducing **ADDWOOD**

the NEW Plastic Wood in Powder Form

Mixed as needed, using only a few drops of water IT REMAINS PLIABLE FOR SOME TIME, thus giving ample time to work up as desired. WHEN SET IT CAN BE TREATED EXACTLY AS WOOD—IT IS WOOD. The remainder keeps perfectly in the tin until needed—an important economical factor.

Mixed to the consistency of putty ADDWOOD can be moulded to any shape and when set is exactly like carved wood (the kiddies can use it for modelling). It is NON-INFLAMMABLE and (when set) WATER RESISTING and can be used for Sculptures, and Yachts etc.

ADDWOOD STICKS TO BALSA and is therefore invaluable to the Model Maker.

A half-crown tin will do hundreds of small jobs over a long period. If not already in stock locally send direct for a sample tin—2/6 only—we will send *Post Free*.

STENTOR PRODUCTIONS LTD.,  
40 Broadway, Westminster, S.W.1.

*Trade enquiries invited.*

## Multicraft CATALIN Material

THE most versatile of all handicraft materials, beautiful colours, easily worked with hand tools. Sample Box 10/-. Assortments 25/- and 50/-. Kits for Bookends, Tablelamps, Photo-holders, etc. Sheets, Rods, Cylinders, Sections.

Dept. HM. COULDEN & SMITH  
17, The Mead, West Wickham, Kent

## MODERN WOOD TOYMAKING

A new book giving working details of all types of wood Toymaking with 126 illustrations now ready. Send 2/6 to

MAYFAIR STATIONERY CO.,  
22 Avenue Chambers, Southampton Row, London, W.C.1

## Plans for a model of AN OLD ENGLISH POST WINDMILL

In 4mm. scale with adaptations  
for fixing as a garden model

The plans are prepared with all Modelcrafts care for authenticity. They are also extremely clear for stage-by-stage construction and the instructions are absolutely lucid. This is a delightful model.

**3/6**

POST 3D.

## And the NEW (DECEMBER) MODEL CRAFT MAGAZINE AND LIST No. 8 is just out

Articles on every aspect of modelmaking from making human figures in card to the use of transfers. Over 500 items are included in the list of plans, kits and accessories covering every branch of the craft. Direct or from your modelshop.

**1/-**  
POST FREE

## MODEL CRAFT LTD.

77 (F) Grosvenor Rd., LONDON, S.W.1

## SUPER TOY PLANS

- 10044 Engine and Tender
- 20044 Mechanical Shovel
- 30044 Tippling Lorry
- 40044 Paddle Steamer
- 60044 Toy Fortress



9d each from **HOBBIES** branches and principal stores or 1/- post free, from

**ZIMPLAN** 88 Ware Road  
Hoddesdon, Herts

Something New

## "BINNACLE" MARQUETRY SETS

INTRODUCE A NEW FASCINATING & COLOURFUL HOBBY  
PICTURES

IN CHOICE SELECTED VENEERS

EACH KIT CONTAINS SIMPLE CONCISE INSTRUCTIONS—  
COMPLETE SET OF DRAWINGS, CEMENT, AND SUFFICIENT  
FINE VENEERS FOR

TWO AUTHENTIC PICTURES

ONLY SCISSORS AND RAZOR BLADE FOR TOOLS

PRICE PLUS 4d. POSTAGE FROM DEPT. H.

**5/6** BINNACLE PRODUCTS LTD.  
93 Walkers Heath Road, BIRMINGHAM 30

# Hobbies

## WEEKLY

### CONTENTS

	Page
Toy Engine and Tender	129
Hints and Tips	- - 130
A Jack-in-the-Box	- 131
Toys from Scrap	- - 132
A Standard Lamp	- 133
Model Railway Station	134
Photographic Enlarging	135
What, How and Why	- 136
Care of Accumulators	137
Model Station Layout	138

December 15th, 1948

Price Threepence

Vol. 107 No. 2772

## A SIMPLE SMALL TOY ENGINE & TENDER

**W**E give here working details and instructions for making the attractive little pull-along toy engine and tender shown in the illustration on this page. The total length of engine and tender combined is  $12\frac{3}{4}$  ins., while its height and width are  $3\frac{3}{4}$  ins. and  $2\frac{1}{2}$  ins. respectively.

The toy is very strongly constructed to withstand plenty of rough usage and hard "wear and tear". Wood  $\frac{1}{4}$  in. thick is used throughout except for the three boiler sections which are  $\frac{1}{2}$  in., and glue and fine wire nails will hold all the parts together.

### Tools and Materials

The fretsaw is used for the cutting to outline of all parts of engine and tender, and the shaping of the boiler and the roof of the cab will be carried out with knife, rasp, wood file and finally coarse and fine glasspaper.

Any soft wood can be used as the finished toy will be painted in bright colours on completion.

Commencing work upon the engine we first look at the detail Fig. 1 which gives the general dimensions. Then, from Fig. 2, we get an idea as to how the boiler is made, and this part will be the first to undertake. Three pieces of wood are cut to shape, the outside pieces A (see Fig. 2) being 7 ins. long and the middle piece B,  $4\frac{3}{4}$  ins. long. All three pieces are  $2\frac{1}{2}$  ins. wide.

From Fig. 3 it will be seen how the cab end of pieces A will be shaped, the other ends being cut square across as seen in Fig. 2. When the three parts are cut to shape and glued together the rounded top forming the boiler is carried out as previously described.

The next two pieces to make are the cab sides C, and full measurements are given for one of these in

Fig. 5. The position they will take on the boiler sides A is shown in Fig. 4. The side view Fig. 1 also gives their positions.

### Completing the Cab

Next we make the two side projections D, and these are each  $4\frac{1}{4}$  ins. long by  $1\frac{1}{4}$  ins. wide. The centre for describing the semicircle for the recessed wheel is shown by the measurements. Cut the two pieces carefully and smooth and true up the surfaces before gluing them to the sides of the boiler.

The roof to the cab, E, will be made next, and it consists of a plain  $2\frac{1}{2}$  in. square of wood. It may be roughly shaped at first before it is glued in place on the cab, then afterwards rasped and filed and finally glasspapered and made smooth for the painting.

To make the floor of the cab it will be found that a small block of wood

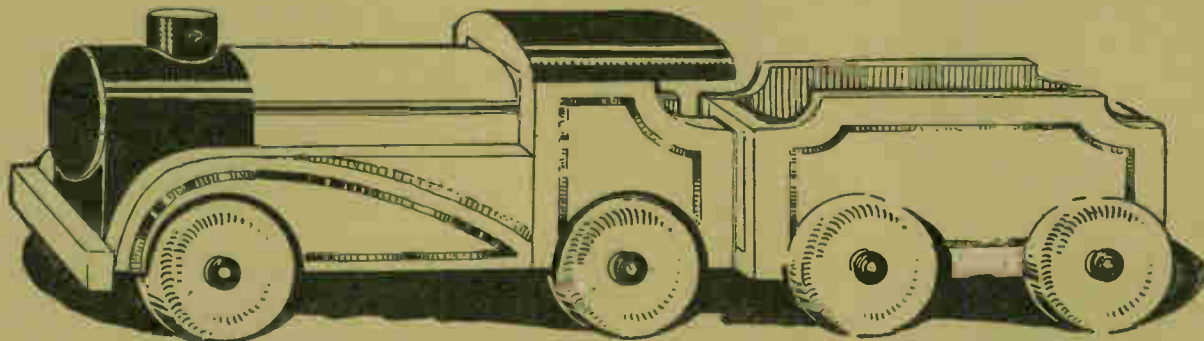

All correspondence should be addressed to The Editor, Hobbies Weekly, Dereham, Norfolk.

measuring  $1\frac{1}{2}$  ins. by  $\frac{1}{2}$  in. square will be wanted. It will be glued to and between the two sides A of the cab. The buffer plates F are pieces  $2\frac{1}{2}$  ins. long by  $\frac{1}{2}$  in. wide, and are made from the  $\frac{3}{8}$  in. wood.

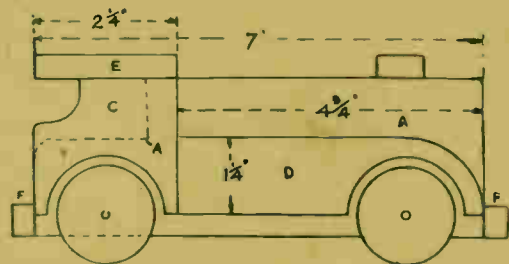

Fig. 1—Side view and dimensions of engine

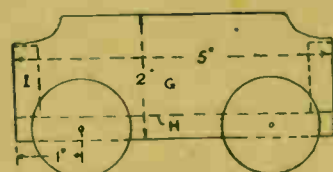

Fig. 6—Side view of Tender

The positions for screwing on the eight  $1\frac{1}{2}$  in. diameter wheels of the engine are easily ascertained from the general make-up of the parts or from Fig. 1. A set of the eight wheels for engine and tender can be bought from Hobbies Ltd. at 2/- for the set.

They should be attached by round-head screws not less than 1 in. in length. Thin metal washers should be put under the screw heads, but this is not absolutely essential.

The funnel is a plain disc of  $\frac{1}{2}$  in. wood shaped and nailed in place. The best way to get the correct shaping to fit the curvature of the boiler,

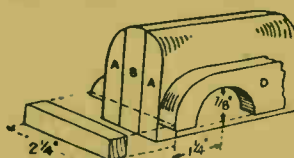

Fig. 2—Building the boiler

is first to bend a piece of glasspaper round the boiler itself, then rub the funnel disc on this until sufficient wood is removed. This allows the disc to saddle-down properly.

The tender is another simple item, the outline of which is given in Fig. 6.

First, the floor H is made, and this is a plain rectangular piece measuring 5 ins. by  $\frac{3}{4}$  in. To the side edges of this piece the two sides G are glued and nailed. The simple top shaping to the sides is easily drawn in and cut with

the fretsaw to a clean smooth curve.

To form the ends of the tender two plain pieces J are put between the sides, these pieces measuring  $1\frac{1}{2}$  ins. by  $\frac{1}{2}$  in. by  $\frac{3}{4}$  in. Finally, the wheels are screwed on, the centres for these being 1 in. distant from the ends, as seen in Fig. 6.

The engine and tender are eventually linked together by a hook and

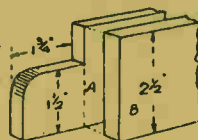

Fig. 3—Cab end



Fig. 5—Cab side

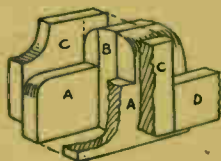

Fig. 4—Cab details

eye. At least two coats of paint should be applied to all the wood-work, or perhaps one coat of good enamel would be found sufficient. Red or green are suitable as a body colour, with black for the front part of the boiler, the chimney and the roof of the cab. If it is desired to carry out the panelled effect shown in the illustration, then this could be done in some contrasting colour.

A useful addition to the boiler front of the engine would be a circular disc of either stout card or thin wood. This, when glued on and painted black, would hide the end grain of the three pieces of wood forming the boiler.

## Hints and Tips for Handymen—

**PERSPEX**, such as the clear stuff, makes a useful cement for repairing chinaware, pottery, fountain pens, etc. It can be dissolved in trichloroethylene and chloroform, or equal parts of acetone and amyl-acetate. Owing to the hard nature of Perspex, however, the chemicals work slowly, and it may take several days or a week for the solvents to produce a thick, clear solution which can be used as a cement.

**THE** brown, rusty spots on old pictures, or the surround of white card, is usually due to dampness and traces of iron, and the trouble is known as "foxing". The spots, if on a water-coloured picture, may be touched with a solution of hydrogen peroxide, or even Milton. Use a pencil brush, and repeat the treatment, if necessary. This will leave small white spots requiring to be expertly touched up with water colour.

**WHITE** glue, which is generally used in violin making, consists of good hide glue (10 parts), zinc oxide (5 parts) and water (10 parts). Prepare the glue in the normal way by steeping and boiling. When prepared, stir in the zinc oxide. This makes a glue which sets dead hard and is very strong. A casein glue is an alternative adhesive to use. This is obtainable in tins as a white powder, requiring the addition of water.

**D**UPLICATING ink, for use with rubber stamps, is made from aniline dye (3 parts), water (15 parts), alcohol (15 parts) and glycerine (50 parts). The water and glycerine are mixed, then the dye dissolved in the spirit, and the dissolved dye added to the water-glycerine mixture.

**WOOD** can be made waterproof with mineral salts. Mix together 6 parts boric acid, 5 parts sal ammoniac and 3 parts of borax. Put into a bath containing 100 parts of water. Items to be waterproofed are immersed in the solution for a few days, or if too large, may be brushed with the solution, applying several applications. In the latter case, the method gives mainly an exterior waterproofing to the wood. The application of wet-wax, or wax floor polish, is an alternative.

**H**OT plate marks on a polished surface may be treated by rubbing with camphorated oil, or equal parts of turps and linseed oil. Wipe afterwards with a cloth dipped in vinegar to remove traces of the oil. The method does not guarantee that marks will be completely removed. It may be effective—or have no effect at all. It is a remedy worth trying, however. Perfume marks may also be treated with the oil preparations.

**B**EFORE glazing window panes in new frameworks, always make a

point of applying a coat of thin paint to the rebates. When this dries, the putty will have a more effective grip than it would on the bare wood.

**G**LAZED tiles, for fireplaces, scullery walls, etc., can be cut with a hacksaw, if soaked in water. However, the cutting is slow, and the blade is soon ruined. The best way to cut glazed tiles is by means of an ordinary glass-cutter, such as the wheel or diamond type. The glazed side is scored, rather like glass, then broken at the score. Generally the break is neat and clean. A bad score, however, may mean the tile breaking roughly so that "chipping" with nippers may be necessary to have the broken edge straight.

**W**HEN fitting a new bar to a back door, etc., make a point of having the metal catch slightly higher than the sliding bar. Reason: The door may sag, as most doors do, so the catch may be troublesome until shifted. A new back door, without braces, will swell and sag.

**T**HE best way to cut glass tubing, or test tubes, is with a diamond-tipped glass-cutter. The tubing should be supported on V-shaped blocks. As the glass is turned, the cutter is pressed against it to make a complete score. By tapping the glass at the score lightly, the waste portion should break off easily and neatly.

# There is nothing really difficult in making A JACK-IN-THE-BOX

**R**EADING an interesting article lately, the writer noted a comment on the absence of that old-fashioned and once popular toy, the Jack-in-the-Box. The comment was true, but one wonders how it comes about that this particular toy has quite disappeared. At any rate here is a description of its construction, which may help to resurrect it for the coming generation. It is an amusing little article, just the thing to make for a kiddy especially for Christmas.

The box itself is shown in Fig. 1 and can be made from fretwood  $\frac{1}{4}$  in. thick, the dimensions allowing for a Jack of the size given. The box could well be made from any common wood available, but the interior dimensions should not be less than  $3\frac{3}{4}$  ins. square for the Jack illustrated. The box can be afterwards covered with fancy paper to look attractive.

## Loose Bottom

The bottom of the box should be left loose, for convenience in fixing the spring and coat of the figure; it should, of course, be nailed on later. A plain lid is provided, hinged to

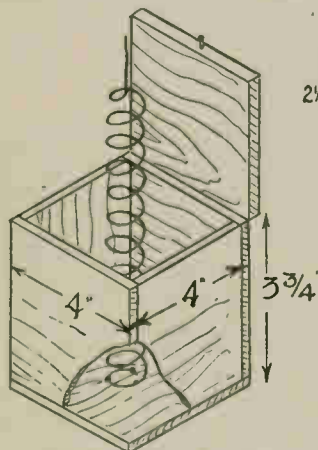

Fig. 1—The box and spring

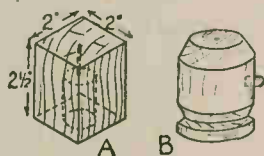

Fig. 2—The jack block

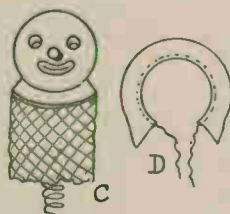

Fig. 3—Forming the head

open easily. Any cheap metal hinge will do, or even a strip of tape glued over the joint will suffice. The box sides are nailed and glued together. The interior of the box sides is covered with paper, also the lid. The outside is also covered, but is better left to the last.

The motive power of the Jack is a strong helical spring. For this a few feet of medium steel spring wire will be required, and if none is available the small length required could probably be bought at a music shop. That used to string the treble notes of a piano might serve. About 2 ins. of the wire should be pushed through

a slot cut in one end of piece of  $\frac{1}{2}$  in. or more round rod, then the remainder should be tightly wound round the rod, slid off and pulled out to about 7 ins. long.

Bend the straight piece to stand vertical in the centre of the spring, then fasten the bottom of the spring to the bottom of the box, letting it stand up the centre, as shown at Fig. 1.

A good way to fasten the spring down is to use small wire staples—three in number. These are pushed through holes in the bottom of the box, from outside, and the ends twisted round the lowest coil of the spring at equal distances apart. By driving these staples from the outside, no sharp ends will be left to scratch little fingers.

The Jack is easily made, the method not requiring any carving worth troubling about. First a block of deal will be required, cut to the dimensions given in Fig. 2 A. If this cannot be cut from one piece of deal, two or more thicknesses can be glued together, but they should be cramped tightly after gluing for a strong joint.

From the centre of the bottom, upwards, bore a 1 in. diameter hole about two-thirds of the distance, and from there bore a fine hole through the remainder to the top of the block, as shown by the dotted outline in the diagram.

The next stage is shown at B. Here the block is chiselled cylindrical shape and bevelled off at the top. At  $\frac{1}{2}$  in. upwards from the bottom saw a line round,  $\frac{1}{4}$  in. deep, and bevel each side of it to the line to make a V-shaped incision round. In the centre bore a  $\frac{1}{4}$  in. hole and glue therein a round piece of wood, letting it project just  $\frac{1}{2}$  in. This will serve as the nose of the figure.

From the V-shaped incision upwards, the wood should now be rounded off to make a ball shape. A little work with file and glasspaper will do this part. Take the block and push it over the spring, until the straight upward piece of the latter emerges through the hole in the top of the block. There it is twisted to a small ring to fix it securely. The features can then be clearly defined, as in the drawing with a lead pencil.

Colour the face, back and front, with black paint, leaving only the eyes

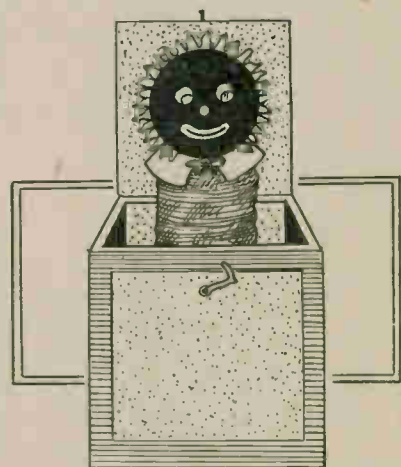

and lips. Put in the pupils of the eyes, as shown, in a green colour, and the lips, red. The dress of the figure, if the covering can be dignified with such a name, is a length of any soft fancy material at hand, wide enough to reach round the base of the figure with an overlap of 1 in., and long enough to reach from the head to the bottom of the box, when the Jack is fully "sprung".

## Dressing

Fix the dress round with glue and a few small nails, and then nail it to the bottom of the box. The general appearance of the Jack will then be as shown in Fig. 3, C. The bottom of the box can now be glued and nailed on.

Round the neck of the figure a paper or linen collar should be tied. Cut it to the shape shown at D, hem the inner edge, and in the hem thread a short length of coloured wool or similar material, by means of which the collar is tied at the neck, and a neat bow to finish it off. Complete the figure to give it a "golliwog" appearance, with a narrow strip of fur, glued over the head across the centre.

The outside of the box should be covered with a fancy, or coloured paper, to make it look pretty. Finish off the job with a hook fastener to keep the lid down. It will be necessary, of course, to test the Jack-in-the-Box, to see it springs upwards when the lid is released, and does not catch anywhere.

## HOBBIES HANDBOOK

1949 Edition — 68 pages — Large design sheet for Model Stage Coach. Colour Air Picture Sheet. Cf Newsagents, Price 1/-. Post Free 1/2 from Hobbies Ltd., Dereham, Norfolk.

# A few odds and ends can be used in these two TOYS FROM SCRAP

THE toy-maker should never despise ready-made items which will just do for this or that, say, a tin which if painted will act nicely as a boiler, or a card box which, without alteration, can form the major part of a model house.

The model crane shown in the first drawing follows this idea closely and is particularly easy to make. It is also quite realistic. The part (B) is a scouring-powder container and forms

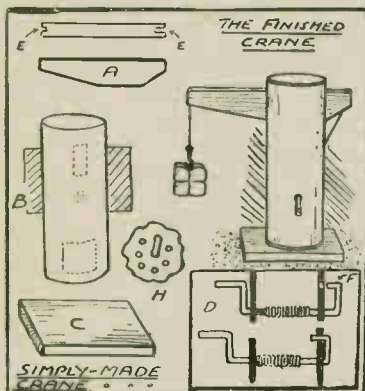

the main tower, while other items needed are a square piece of wood for the base (C), a long piece (A), shaped as shown, for the horizontal jib which this sort of crane has, some pliable wire and a length of twine.

## Cylindrical Pillar

Having obtained the container, which it will be found is made up of a cylindrical card body, with metal ends, cut in it four openings with a sharp blade as shown—the container being inverted. Two, measuring 1 in. by 1 1/2 ins. and located 1/2 in. from the top (one being on either side), are made for the jib to go through, the fitting being as tight as possible without warping the card.

The third hole comes about half-way down and is in the nature of a vertical slot, being eventually to take the cord from the spindle to the jib, whilst the fourth hole is about 1/2 in. from the base and is to allow of bolting the carton to the under piece of wood. If carefully taken out none of these openings will in any way weaken the general make-up of the carton.

The holes made, the "tower" can now be secured to the rectangle (C) by a small bolt going through the centre of the wood and one of the sprinkler holes of the carton which, of course, are now at the bottom. Cut a recess on the under side of the wood to take the head of the bolt, which is tightened up by holding the nut with the fingers

inserted in the opening, a screwdriver doing the turning. The joint, it will be found, is very firm.

## Winding Gear

Next make and fit the spindle, handle and locking-gear, all of which are made from the one piece of wire as (D). First bend one end of the wire to the shape indicated on the right-hand side.

Pass the length through two level holes pierced in the carton sides and finish by bending the further end to the handle shape as per the left-hand side. Care should be taken while doing this not to tear the card "bearings".

Now put in the jib. This is shaped as (A) and as stated should fit tightly through the holes in the top of the carton but glue can also be used to make the job firmer still.

Finally thread a length of the string from the spindle where it must be wound round several times tightly and glued up through the vertical slot in the back, over and along the top of the jib, making use of the notches (E) which keep it in position, and so on to the hanging hook.

The string should be very pliable (of the kite cotton variety) and the notches (E) smoothed to make sure of easy running. It will help matters if as well as the hook at the further end there is a small leaden weight, as this will keep the string taut.

If trouble is experienced in getting the string to grip on the smooth spindle, this may be overcome by removing the length and filing two flat sides about the centre, the end of the string is then laid horizontally along one of these "flats" and bound tightly with glued cotton. A turn or two of the string glued completes the connection.

## Colouring

The model should be finished in bright colours. The load is lifted by rotating the handle and locked in any desired position by pulling the spindle sideways so that the projection (F) engages in one of a series of holes punched in the carton as (H) around the spindle at the correct radius. Six or seven holes are quite sufficient.

## A Mortar

The second model shown here made from 'things that are' is a cotton reel mortar which is capable of firing match sticks for quite a long distance and at a really high velocity.

Required are one of those longish

cotton reels sometimes used for holding thread, a length of strong wide elastic and a few pieces of wood. Trim the two lips off the ends of the reel and smooth well down with glasspaper. This will give a thick barrel as (A). Now take the elastic and fasten it across the one end of the reel with two springs at either side so that it will withstand a good pull.

Next make the simple frame as shown in the bottom left-hand sketch. This must be sturdy. It is built up of three pieces only, a base 3 ins. by 2 ins. and two sturdy side-pieces, just high enough to allow of small nails or screws going through into the middle of the reel. To give strength the base is recessed at the middle of each edge and the uprights are fitted in, being secured by glue and a single screw. The bottom right-hand sketch makes the fitting quite clear.

The height of the reel should be such that it can be tilted up and down a little to aim at various things.

The mortar is now complete. To fire, a matchstick is pushed into the front opening and then elastic and

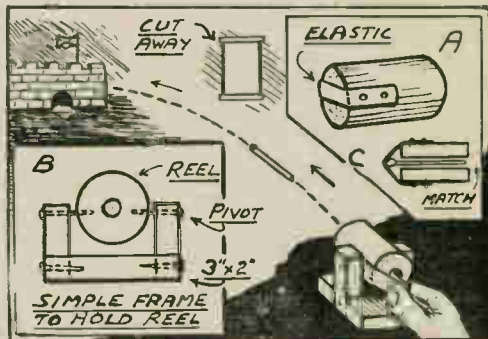

match are gripped together at the back and pulled away from the reel. Let go suddenly, the match now flies out at really a high speed, and if the pull on the elastic has been good and strong, for an amazing distance.

Unless fastened down to something firm, of course, one hand must be pressed on the "mortar" while the other pulls on the elastic and match.

## BOOT POLISH POLISH

BOOT or shoe polish can be used for "waxing" various items. For example, an attache-case made from wood, stained with black spirit stain, then rubbed with black shoe polish, takes on a dull, black sheen which, by constant brushing, can be brightened.



# A hollow pipe, rope and odds and ends can be turned into A STANDARD LAMP

**A**S handicraft workers will know, some articles turn out about the same as you expect them, some are disappointing, while others are definitely better than the conception held in the mind.

The writer can testify that the standard lamp described here falls into the latter class.

To make the lamp—a pole, 5ft. long was first obtained. Various staves and rods were examined and an ideal type was at length found in the handles that are sold for garden tools, i.e. hoes, etc. These are longer than even the longest broom handles and are nicely turned, straight and true. Their diameter is about 1½ ins., which gives a strong and well-proportioned "standard" for the lamp. Indeed, it was found that when covered with the rope a diameter little short of ideal was obtained.

## The Pillar

The "pole" obtained, the next thing is to take out a channel down its entire length of sufficient depth to accommodate a usual electric flex, but as narrow as possible. This can be done with a chisel or gouge or any one of the several other tools found in a woodworker's room. The channel should be as straight as possible, but absolute accuracy is not essential.

The pole is now wrapped from end to end in ordinary plaited clothes line. It was found that a 27-yard line exactly completed the length, the cost of this being about 5/-.

To make a neat start at the top, the covering of the line is stripped back from the core for a few inches. The core is then cut away and the covering pulled straight again. This it will be found gives a tapering end which can be secured for about half a circumference with small sprigs.

The next coil (now of full rope)

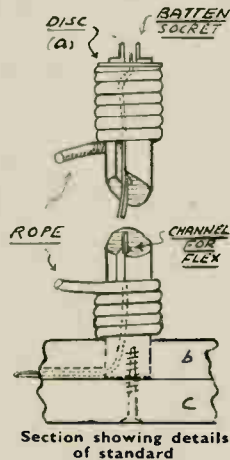

Section showing details of standard

comes close round under this, eliminating any obvious beginning. From here on the rope is wrapped steadily round and down the pole, keeping the tension the same all the time. The wrapping is best done by turning the pole with one hand while the other guides the rope. A second person to help is an advantage.

If the channel for the flex is deep, the wire may be fed in afterwards, but if not the flex must be in position as the winding proceeds.

On reaching the bottom the rope is finished as begun by taking out a length of core and fastening down with sprigs.

At the top end of the pole a disc of thick linoleum (a) carefully cut to the same diameter as the coil of rope, is secured in position. This prevents any danger of the rope riding up and also finishes the top of the standard neatly.

## Top Fittings

The fittings at the top are a standard batten socket, and a holder and switch combined, with externally threaded neck to fit in the socket. A shade frame and the shade completes this section. Shades can be got in many prices and sizes, but a round one of about 2ft. diameter should be chosen and, if possible, in cream. Anyone clever at the work could make their own shade—instructions often being given.

For final appearance the "balance" of the top end is rather important, as nothing looks worse than a too-small shade on the end of a fairly long shank. A 2-foot shade and 5-foot standard of 1½ in. diameter, which is over the rope, gives a very pleasing effect.

Now for the foot. This is made up of two rectangles of wood (b) and (c), the top one being 8 ins. square and the lower 12 ins.

## Get Rigidity

The top rectangle is bored carefully in the centre to take the end of the pole, and for final rigidity it is worth going to some trouble to get the fit perfect and also to see to it that the pole and rectangle are at a 90 degrees angle. On the underside of this piece a channel is also cut from one side to the middle hole. This obviously is to take the flex and lead it out.

The smaller rectangle is now attached to the larger by four screws, the end of the flex lying along the channel.

Now glue the end of the pole—which must be cut dead square and inserting in the hole in (b)—with the flex looking towards the channel, press right home. If slightly tight so that some little pressure has to be used, so much the better.

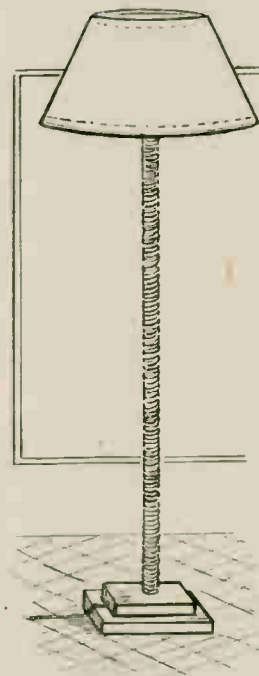

When right home, turn the lamp on its side and insert the screw as shown through the bottom rectangle and into the bottom of the pole on the further side from the flex channel. Take care not to pierce the covering of the cable. With the screw and glue it will be found that a very firm joint is secured.

For the base pieces the writer used two rectangles of mahogany, but of course any suitable rectangles might be employed. Too lightweight wood should be avoided.

## Colouring

Finally comes colouring. Some suggest painting the top and base of a lamp of this kind in one colour, but if clean, the rope looks quite well without any colouring whatsoever. If reasonable care has been taken in the making and the rope kept unmarked, there is no reason why it should not keep in a clean state for quite a long time.

The base, however, needs treatment, and with the rope left white this is best finished in the same colour as the shade, cream if it is cream, green if it is green, etc.

Finally, it is good if the flex can be obtained in the same colour as the general motif of the lamp. Flex can now be bought in most places in several colours—a yellow-covered flex being quite popular. Consequently if this is the tone you have adopted there should be no trouble in getting a match.

# How to construct the Station when building your MODEL RAILWAY

**N**EARLY every owner of a model railway wants to make stations to enhance the realism of the track, but is generally deterred from trying his hand because he does not know the proportions of the various buildings comprising the station. It is probably for this reason that really good models of stations are comparatively rare.

Now the first thing to be done is to consider the plan of the station it is proposed to build, bearing in mind the space available on the model railway layout. Naturally the size of the station increases with its importance, and as on the majority of model railways it would be well-nigh impossible to reproduce a really big station, the appended photograph of a typical small through station shows a type eminently suitable for modelling.

## "O" or "OO" Gauge

In reduced model form the length of the platform is 42ins. in "O" gauge, which is equivalent to 21ins. in "OO" scale; which will accommodate a four-coach train and locomotive. The platforms can, of course, be extended as desired either side of the station buildings, which, incidentally are on the "down" side only. Communication with the other platform is by means of either a subway or a footbridge.

Reverting to the main buildings, the most important is the station-

master's house, the upper story of which is residential and the lower housing the booking hall and office. To comply with Board of Trade requirements there must be the usual lavatory accommodation (C on all diagrams) and a clock.

Now for methods of construction.

In "OO" gauge, cardboard cut to sizes shown will be found very effective, particularly if reinforced with square wood blocks inside each corner. In "O" gauge it may be found more satisfactory to construct the buildings of fretwood or plywood, using normal fretwork methods for cutting out the doors and windows.

## Suitable Material

The writer has, however, seen many scores of beautiful "O" gauge model buildings constructed from hot-pressed board or Bristol board (as used in a drawing office), the joints being made with "Seccotine" and the structures being made finally damp-proof by painting them with shellac varnish before the application of the final colour-coat or "brick" papers.

There are many methods of constructing buildings from Bristol board,



Typical small station suitable for a model

but the simplest is that used for the making of architects' models. This consists of drawing out on stiff card or drawing paper the buildings under construction—as shown in the diagrams (which are to scale)—and painting them with shellac varnish after they have been bent into shape and glued to a base-board.

## Side Panels

All four sides of each building should be drawn in a line as shown, and a "vee" groove cut in the back of the card at the corners (if the card is very thick) so the corners may be formed with sharpness without breaking the card. This method makes quite effective buildings, particularly if the windows and doors are carefully cut out before bending into shape.

It is possible to cut out and paste on small pieces of thin (visiting or post) card to indicate in relief, window-frames and sash-bars; even painting "curtains" or "blinds" on to the celluloid or Perspex used for "glazing" the windows. This method is excellent where casement windows are set in outside reveals, but in cases where double-hung sashes in frames are set in the usual manner behind 4 1/2 in. reveals, it is best—in "O" gauge—to use material about 1/8 in. thick or in "OO" gauge 1 1/2 mm.

## Support Pieces

When planning the reinforcing corners of wood for such buildings be sure to arrange them so they will be so placed as to provide support for the rain-water pipes and gutters. Such pipes are made from 1/8 in. copper wire for "O" gauge and from 1/16 in. wire for "OO" scale.

The walls may be stuccoed with sand sprinkled on to the "tacky" shellac varnish, or they may be painted to represent cement. The brick-papers which are now obtainable quite easily make a very effective finish in "O" gauge, but if the bricks are carefully scribed in by hand with

(Continued foot of page 136)

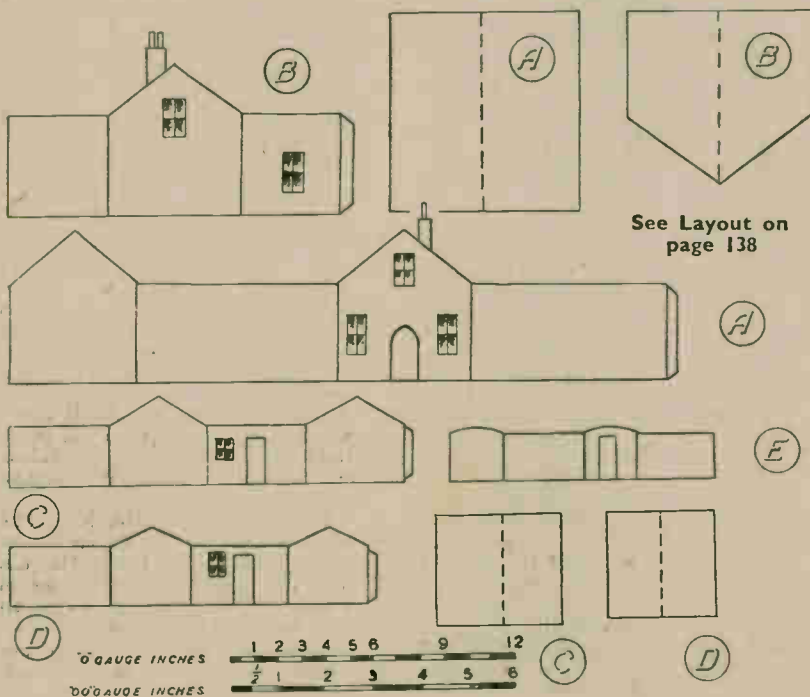

See Layout on page 138

SUPPLEMENT TO HOBBIES No. 2772.

# TOY SALOON CAR

SIZE—10 1/2 ins. LONG, 4 1/4 ins. HIGH,  
4 1/2 ins. WIDE.



PANELS OF WOOD REQUIRED FOR THIS DESIGN  
**FOUR GD6 ONE ND8**  
The price is shown in Hobbies Weekly, December 15th, 1948, but is subject to revision. See the current edition of Hobbies Handbook, or write for price to Hobbies Limited, Bergham, Norfolk.

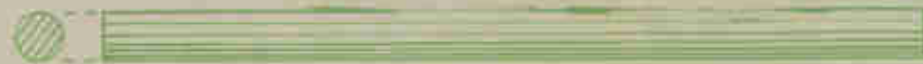
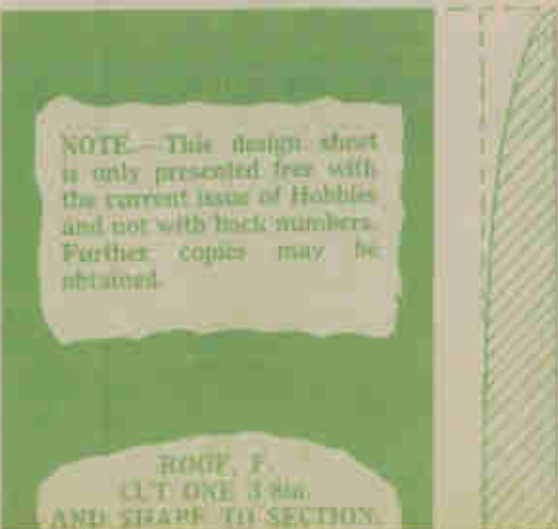
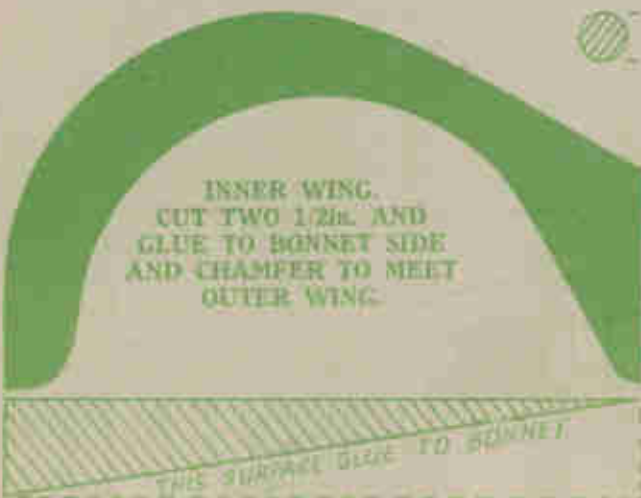

THE ARROWS INDICATE THE DIRECTION OF GRAIN OF WOOD.



SEAT. CUT TWO OF EACH PART 3/8 in. AND SHAPE TO SECTIONS

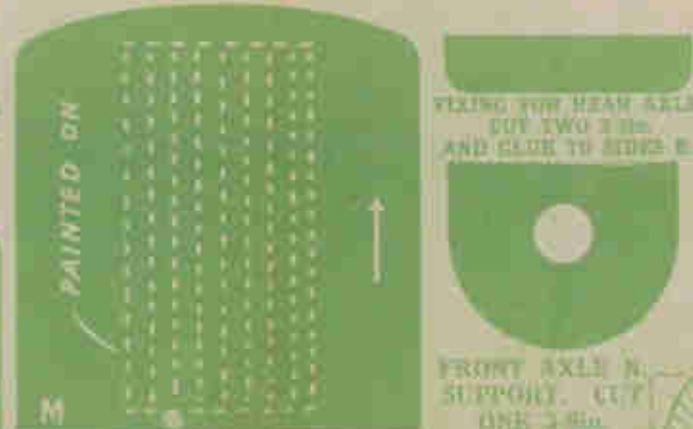

## Instructions how to make this TOY SALOON CAR

**T**HE patterns provide for the making of a sturdy toy, 10½ ins. long, intended to pull along on its four wheels. The parts are cut with the fretsaw, glued together and then the whole thing finally painted. Apart from the cutting, there is the shaping which can be done reasonably easy. In the construction there are three main points to remember.

The first is to glue the whole thing together rigidly so it does not fall apart in the rough and tumble of handling. The second point is to get the shaping nicely done. When the rough block outline is glued together, pare off as much as possible with a sharp penknife. Then with a rasp or coarse file, bring the shape down almost to the final lines. Finally use coarse and fine grade glasspaper to leave a perfectly smooth curved surface as required.

### Care in Painting

The third point is in the painting, and this is the one which will make the whole thing most attractive. The actual colour is a matter of choice, but you can easily follow out that of real cars. Give the whole thing a coat of grey paint, and let it harden right in. Rub it down smooth with very fine glasspaper, and then add the second coat of the main colour. This can be in enamel, blue—black—grey. The various lines and additions are then added when that enamel is perfectly hard. Do it with a fine brush or with a coarse pen-nib.

### Marking Lines

should be silver or aluminium, and the hubs of the wheels can be treated in the same colour. The tyres will be painted on in a dark brown or even black, with the tread painted over.

The wood in most parts is ¾ in. thick with one or two pieces ½ in. which provides a good gluing surface. Do not paste the patterns down, but redraw them on to the wood either through carbon paper or by tracing and transferring. This will leave you both instructions and patterns to which to refer. The various curves forming the shapes are shown by shaded sections adjoining each part, whilst dotted lines indicate the position of adjoining pieces. Cut the parts with the fretsaw to the outlines etc., and clean off any burred edges with glasspaper.

### Order of Construction

Construction is in the alphabetical order of the lettered parts, but the method stated should be followed. Note the floor (A) does not come central on the sides of the body. It projects 3 ins. beyond the front—where it starts to taper. Note, too, it is also glued ⅝ in. upwards from the bottom edge (see dotted line). Glue one side in place, and then add the various cross pieces C, D, F and G. Test these pieces to be all the same width, and note the position and angle at which they are glued. D, you will note, is also shaped to form the top of the luggage grid, and the back edge has to be chamfered to lie flat against E.

The roof F is glued with its top edge

not yet been added. This is to allow placing in position the two seats, etc. These are formed of the two pieces H glued to the side (see Fig. 1) and the seat and back (J and I); one end of the two last-mentioned is rounded. Each seat can be made as a complete unit, and painted now to represent the upholstery.

An odd piece of transparent material, celluloid or Cellophane, can be glued inside the side windows and the back. The front window, however, can be left until later. Paint the inside of the car now, because you will not be able to get at it when the second side is added. Note, too, the hole in G (the front) for the steering column. This is a 1½ in. length of ⅜ in. dowelling with a card or very thin wood steering wheel tacked or glued to its top. The whole thing is glued into the hole made at an angle in the front. Having completed the inside, the second side is glued on.

### Bonnet Portion

Now add the bonnet and radiator, construction of which is shown in Fig. 2. The back end of the bonnet side has to be chamfered lightly so it can lie over the front C. This is the

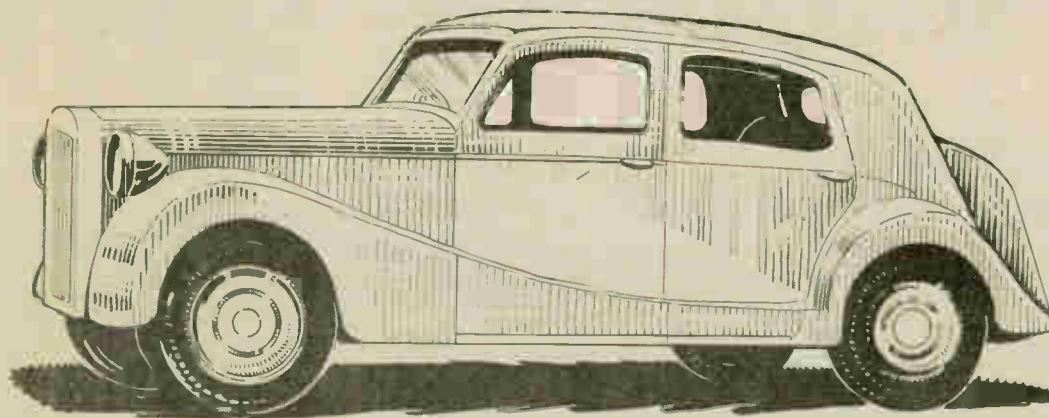

When you lay them on the side—the position is shown dotted on that pattern—you will notice a gap between the bonnet and the mud-guard. This is filled by the inner wing piece. It is cut from ½ in. wood to the outline shown, and then tapered towards its back edge, as seen by the dotted section. This piece must be tested with the outer ring to see it fills the gap nicely, and is glued to the side of the bonnet before the outer wing is put on. The detail at Fig. 3 shows this part in place.

Finally, the outer wing can be glued on the side of the car, and of this spacing piece.

### Wheels

The wheels are 2½ in. diameter (supplied in the parcel), and should be painted and finished before finally fixing. The axles are ¼ in. rods 4 ins. long. The back one is slipped into the open slot of the sides with a rubbing of soap or graphite given to make easy running. It is held there by two little fixing strips which you see illustrated in Fig. 4. The hole in the wheel must be enlarged to take the end of the axle which is glued in firmly. It is also chamfered to

to the underside of the floor in the position shown on the pattern of that part.

Slide the axle through one of them, and then fit on the washer (P). Glue it centrally on the rod, and see the whole thing revolves easily without binding. The ends of the axle are pushed through the projecting pieces N, and then the wheels fitted on as before. See these wheels are glued firmly, if necessary driving a small headless nail through the axle into the wheel itself to make inore secure.

### Additional Parts

The general construction is now complete, but you may like to add additional parts such as the lamps, front screen, number plate, etc. These should, however, be done after painting. The front screen is a piece of celluloid glued to match-stick fillets which have been glued to the body. They are fixed on the underside of the roof and to the sloping edge of the front, as shown in the detail at Fig. 1. The celluloid is laid across, and glued in place.

Lamps can be cut from odd pieces of waste wood, fitted to the front



soak a piece of string in paint, and then lay it in position thus transferring the paint to the article. These lines indicate the doors, window panels, radiator front, luggage opening, etc. The radiator itself, of course,

allow for shaping down later. The top edge of G is also chamfered down. All these positions are shown dotted on the pattern of the side, and can be seen in the diagram at Fig. 1.

**Inside Work**

The second side, remember, has

end does not matter. The two sides are put behind the front, and then the top added.

You can now undertake the shaping by the method mentioned, taking care to get all curves nicely rounded, balanced to each other and with a smooth surface.

**Wings**

The long wings are next prepared.

thin washer between the wheel and the sides to allow for easy running. This can be cut from thin wood or composition, or any little piece of metal.

An under-view of the front axle is shown at Fig. 5. The centre washer P is a thick disc which revolves in the opening cut in the floor and prevents the side play which would otherwise occur. The axle supports N are glued

driven into each part. Tiny metal handles made of a piece of tin can be fitted to the doors, and a similar disc of metal put on the wheels to indicate the central hub.

*Details of cost of wood are shown in Hobbies Weekly, dated Dec. 15th, 1948, or obtainable on request from Hobbies Limited, Dereham, Norfolk.*

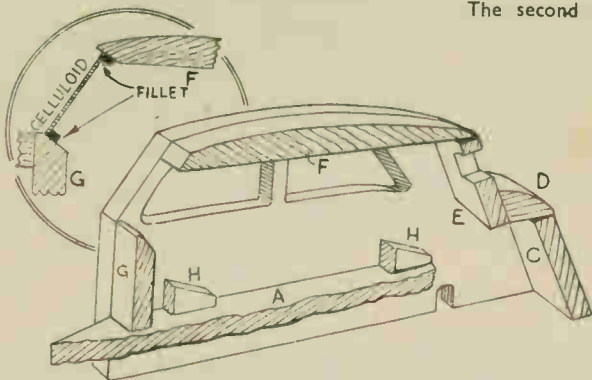

Fig. 1—Cutaway view showing construction of body

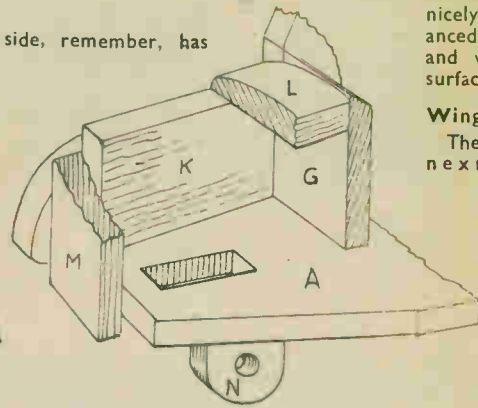

Fig. 2—Building the bonnet portion

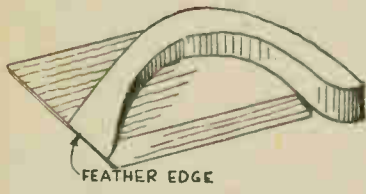

Fig. 3—The tapered wing wedge

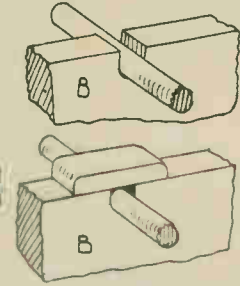

Fig. 4—Upside down view of near axle fitting

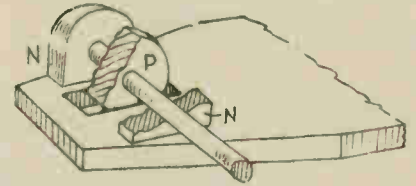

Fig. 5—Underview of front axle

# Those who do photography should read these further ENLARGEMENT HINTS

In the last article on Enlarging the hints given were expressly of a nature to avoid undue waste or extravagance, and to eradicate from the mind of our readers that the practice of this section of the hobby made amateur photography expensive. With this idea in the background it is the intention now to give advice which will undoubtedly prevent wastage and, at the same time, encourage the thought that "Enlarging is Picture Making". It is by carefully studying the results and genuinely criticising each that successful work of a progressive character can be achieved.

## From Perfect Negatives

To begin with, it must be realised that only a perfect negative can give a perfect print. This maxim becomes much more definite when that print is an enlargement. For the very obvious reason that any blemish, no matter how small, whether it is a fog mark, pin hole or black spot on the negative, becomes enlarged also on the print. Therefore a negative should be examined for such and, if possible, the blemishes removed before attempting any further work with it.

In the same way a very flat or over-dense negative, or one that is very contrasty and lacking half-tones must not be expected to give a "pictorial" result. Then again if a negative does not give "sharp" detail in a contact print, due to movement when exposing or a slight mistake in setting the focussing scale correctly, then that lack of sharpness will be accentuated considerably in the enlargement.

This preliminary examination will unquestionably save a lot of paper, developer time and disappointment.

## Portions Only

One very great advantage which will be very quickly recognised by everyone starting to use an enlarger is that it is never necessary to enlarge all the image. It is quite a simple matter to cut out any object on the side of the negative that spoils the composition of the picture and also to cut out some of the foreground or sky.

This would perhaps be better understood by a simple illustration. Let us imagine that you have a good negative of a landscape. Unfortunately in taking it you could not avoid a broken tree which had to be included on one side and an awkward piece of the roadway in the immediate foreground.

When the image is thrown on to the easel these will, of course, be

included. Well, cut them out of the picture simply by racking or placing the enlarger farther away from the easel and refocussing. You will then find a larger image on the easel and the broken tree and piece of roadway is outside the area where your piece of bromide paper is to be pinned. You now have just that section of the negative which gives the picture you desire.

## Masking Cards

To help in this cutting out certain details it will be found that two pieces of black card cut to the shape of a letter "L" (see illustration) will prove most useful. When the full image is seen on the easel there may



Two cards for masking

be some uncertainty as to the advisability of cutting out any section, but, if the black "Ls" are placed in position over the section a very good idea is at once gained as to what the print will look like without it.

## Exposure Aids

A well-equipped dark room will always have these pieces of black card handy and also one or two rectangular pieces. One must have a small hole in the centre and the other a larger hole. The purpose of these is to permit rather more exposure to be given on the print for any particular object or detail of the negative which you consider should appear a little darker and thus brought nearer to the foreground.

These will also prove useful for shading any portion that is included to overprint. When using these pieces it is advisable to hold them between the lens and the easel—not flat against the paper—and to give slight movement to the card. Otherwise you will find a very definite line where the light has acted and increased or, in the case of the shading decreased the exposure. It is certainly worth while making a few trials with these cards in order to become familiar.

Those who read the article about making an enlarger will remember that in the lamp chamber there was sufficient room for the lamp to be shifted either nearer to or farther from the condenser.

Before placing any negative in the enlarger first try your light on the easel to see if an even illuminated disc appears. If there happens to be any dark patch or a colour fringe on the edges it indicates that the lamp is either too near or too far from the condenser. This must be adjusted and you will, by a slight movement of the lamp, get a perfectly illuminated easel, and so avoid a "patchy" print.

## Preventing Waste

Having taken a sheet of paper from its packet do be sure to close the packet and place it in a drawer or where it cannot be exposed to the light from the enlarger. Make this a hard and fast rule. Many sheets of good bromide paper can be quickly spoiled by stray light.

If the resulting prints after drying show irregular brown stains it is a sure indication that you are using (1) an exhausted fixing bath, (2) allowing the prints to overlap in the fixing bath, or (3) allowing too much time for examining the print after taking it from the developer and before plunging it completely into the fixing bath.

## Rinse Before Examination

The last mentioned is quite a common fault. If it is necessary to examine a print while it is undergoing development it must be well rinsed under running water to remove whatever developing solution is on its surface. All developers tend to oxidise on exposure to air and this causes a brown stain which cannot be removed.

The quickest way to destroy surface developer solution remaining on the print is to immerse it in a Stop Bath consisting of ½ oz. Potass. Metabisulphite dissolved in 20 ounces of water. Use this bath for about 3 minutes' soaking, before placing the print in the fixing bath.

## MODEL MOTOR CAR

### This week's Design

**T**HIS week's gift pattern sheet is for making a strong model toy motor car 11 ins. long. The planed wood, set of turned wheels and axle rod are supplied by Hobbies from their branches or agencies for 3/9 or by post from Dereham, Norfolk, for 4/6

# Some helpful replies of subjects dealing with WHAT, HOW AND WHY

**I** RECENTLY purchased a new electrical gramophone motor, of the rim-drive type, with a 9in. turntable. I am rather curious to know how the latter has been covered so neatly with a thin, brown material.

**G**RAMOPHONE turntables are generally covered with thin velvet-reen or something similar, affixed with a special adhesive and a tight-fitting, plated rim. However, in the case of new, up-to-date motors, complete with turntable, etc., a fabric finish is usually applied. In this case, the bare metal is sprayed with an adhesive and, within 10 minutes, covered with a rayon powder, applied with a special gun, known as a fibre-gun, to which is attached a container filled with the powder. Spraytex is the trade-name of the process and anyone can soon learn to use the adhesives and spraying powders. It is just as easy as using a spray-paint outfit.

**W**HY does the mains transformer, which I built, seem to hum and rattle so much?

**O**NE reason is a loose "core" or winding limb. This is the central part of the stalloy stampings, formed by the "leg" of the T-shaped pieces. You must have these packed tightly into the bobbin carrying the windings of wire. Inspection might show that the upper, or lower, T-shaped piece has a "loose" leg which vibrates within the bobbin, due to the alternating nature of the current. Extra stampings should be fitted, or stiff cardboard or paxolin strips. The latter is best, particularly if the windings are planned to suit 6 dozen pairs of stalloy stampings, at say, 8 turns per volt. One or two extra core pieces will not, of course, make much difference.

## Model Railway—(Continued from page 134)

a straight-edge and a blunt knitting-needle, a much more convincing job will result. This work is well worth the extra trouble, and is a work of art instead of a machine-made copy of meticulous, unerring accuracy.

### Construction

Dealing with the construction of the buildings for the small station illustrated, it will be seen from the plan that there are four main buildings flanking the down platform, whilst the front elevation shows that each building is of four-square plan with simple roofing. The shape of the card strips which on folding produce the four walls of each building are shown (flat) at A, B, C, and D; these same letters keying in with the plan.

It will be found easiest to re-draw

**W**HAT is a ball-pen, please, and how does it work?

**A** BALL-POINTED pen is, like almost simple things, an ingenious form of writing device, a tiny metal ball taking the place of a nib. In use, the ball "rolls" over the paper, and being in contact with a sticky ink, it carries traces of the ink which is thus applied to the paper. A refill of ink lasts for six months, and an advantage of the special ink is that it writes "dry" on any kind of paper—even blotting paper. Such a pen is handy for filling forms, coupons, etc., printed on a cheap paper, such as newsprint paper. Ordinary writing ink rather "spreads" on such paper, of course.

**A**RE electric or mechanical shavers any good? It seems to me that a close shave is impossible.

**A** REALLY close shave is impossible, due to the thin guard which is a necessity on all mechanical shaving devices. After all, an electric, or clockwork, shaver operates much in the same way as hair clippers. The principle is similar, if the action is different. With care, a reasonably close shave is obtained—close enough to last for a day, at least. As the shaving is dry, the shavers can be used at any time, once in the morning, and again in the late evening, if necessary.

**H**OW can I obtain a silvery effect on some display stands I have made for a window. I do not want to use aluminium paint or anything like that. I want something that glitters.

**I**N other words, a crystalline effect is desired. This is possible with a modern finishing powder, known as

Dewspray, it being a silvery, crystalline powder which is sprayed upon surfaces treated with a slow air-drying adhesive. While an ordinary spray-gun outfit, having an output of 2 c.f.m. at 30 lb. per sq. in., can be used for applying the adhesive, a special gun, with air and powder control, may be needed for the silver powder, such as the type used for spraying textile powders.

**I**N making a metal chassis for a small receiver, I broke all my metal-cutting fretsaw blades trying to cut holes for the valve bases. Are these holes, in sheet iron, drilled? If so, where can I get drills for boring lin. holes?

**I**F you used sheet iron for making the chassis, it is no wonder that the metal-cutting blades did not stand up to the cutting. Aluminium is just as good as sheet iron or mild steel. It is much easier cut with the blades. In the case of sheet iron, mild steel, etc., any size of hole, from 1in. to 3ins., can be cut with a device known as a tank-cutter. It consists of a shank, fitted with a short 1/4in. drill and an adjustable cutter. When fixed in a brace, it is used just like a centre bit, the drill boring an 1/4in. hole first and serving to keep the cutter working truly. Special cutters, for radio chassis work, are obtainable at most radio stores, or any local hardware-tool shops. If using a soft aluminium of 16 s.w.g., an old 1in. centre bit could be used, boring an 1/4in. hole for the point, then scribing the radius of the hole at both sides of the sheet metal. Only the scriber, and not the cutter, is used of course. If necessary, the cutter could be ground away, leaving the scriber to do the necessary cutting.

these "wall" strips to your own scale, using the scale of inches and feet shown below the diagrams; which are all to the same scale, but reduced to fit the size of these pages. As has been mentioned, this re-drawing can take place directly on to the sheet of card or three-ply being used for the construction.

If Bristol board is being used, then the small tags must be left where shown for sticking the walls into square form, but if fretwood or three-ply is chosen for the larger scale, then care must be taken to deduct from the length of each end (gabled) twice the thickness of the material being used; otherwise your finished buildings will be just that amount bigger in area.

If your railway is a portable or

semi-portable one, it will be advisable to mount each building on its own foundation, or alternatively, the whole run of buildings could be mounted on a sub-base, upon which the platforms could also be fixed at their correct (clearance) distance from the track or tracks.

A view of the station and lay-out of lines etc., is given on page 138.

The siding shown on the plan is optional, and is arranged so that standard points may be used. The siding may be extended as desired to the right to house the longest goods train likely to use the siding.

Finally. Take great care to cut and stick everything dead square, for this is the secret of good modelling.

(To be Continued)



# Ensure long service by a little attention to ACCUMULATOR CARE

**T**HE accumulators used for operating motors and models, for lighting and starting in motors and other vehicles, and for driving radio receivers and other apparatus, can give many long years of almost trouble-free service. If not treated properly they can also be a nuisance, which is a pity because a little practical knowledge is all that is required to keep them in proper order and obtain the longest period of useful life from them.

## What an Accumulator Does

An accumulator is called a secondary cell because it does not generate current (as with a dry cell) but only stores the current put into it. The ordinary accumulator plates are made from red lead pressed into a lead framework.

The plates are immersed in sulphuric acid; during charge sulphate

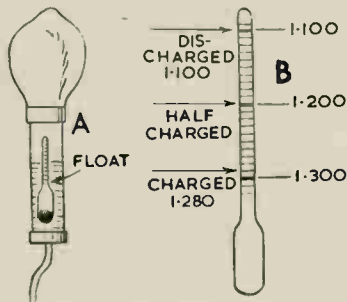

Fig. 1—How specific gravity is measured

is driven off, thereby causing an increase in the specific gravity of the acid. The reverse takes place during discharge.

## Measuring Specific Gravity

This means the state of the cell can be found by measuring the specific gravity of the acid. To do this, a tester such as that shown at "A" in Fig. 1 is used. By means of the rubber bulb acid is drawn up into the glass tube, this causing the float (shown in detail at "B") to rise.

The depth to which the float sinks depends upon the specific gravity of the acid, and the figure on the scale which comes level with the surface of the acid is that giving the gravity.

The usual gravity for various states of charge are shown. As the cell is discharged the float will gradually sink, until a specific gravity of about 1.110 indicates that it is fully discharged.

For preference a cell should not be allowed to discharge completely. It should never be allowed to stand any length of time in a discharged

condition, or its capacity will be reduced.

## Adding Distilled Water

Areas of the plates above the acid cannot function, so distilled water is added to make up for that lost by evaporation. The specific gravity of water is 1.000. Being less dense it will therefore float on the surface of the acid and if the hydrometer (shown in Fig. 1) is used to draw liquid from near the top of the cell after adding water a wrong reading may result. To avoid this, insert the tube well down in the battery and press the bulb several times to mix the acid.

If acid is lost from the cell by spilling, make up the level with dilute sulphuric acid (specific gravity about 1.200). The specific gravity of stronger acid can be reduced by adding distilled water.

## Troubles to Avoid

Fig. 2 shows the more serious

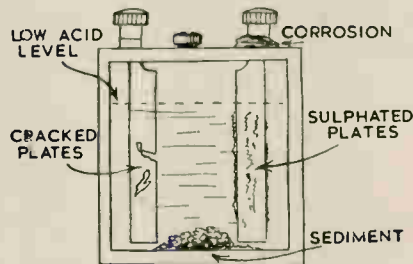

Fig. 2—Some troubles to avoid

troubles to avoid. Rough handling and short-circuiting will make flakes of material fall from the plates. These form a sediment at the bottom, and short circuit the plates internally because the fragments contain lead. If there is much sediment the cell should be charged up, then cleaned out, washing with distilled water. Afterwards fill up with clean acid.

If a cell remains discharged for a

long period sulphate forms on the plates. If severe, this makes the cell almost useless as the crystals act as an insulator between acid and plate. A long period of charge at about one quarter the usual rate will get the cell back into proper condition.

Low acid level reduces the capacity and may result in hard crystals forming on the exposed parts of the plates. So each cell in an accumulator should be filled up so that the plates are covered.

Corrosion, which may eat away terminals and leads, can be reduced considerably by careful scraping and drying. Afterwards the terminals should be smeared with petroleum jelly (Vaseline) because this stops corrosion.

Cracked plates are due to rough handling or standing in a discharged condition. If the accumulator has several cells and the others are in good condition, new plates can be fitted in the defective section. This is sometimes worthwhile in large accumulators.

## Non-Spillable Cells

From time to time a few drops of distilled water should be added to the vent of non-spillable cells, excess being poured off afterwards. The acid in accumulators may be jellified by mixing one part of pure sodium silicate (1.200 specific gravity) to three parts of sulphuric acid (1.400 specific gravity), making sufficient to fill the cell.

The old free acid should then be poured out immediately and the mixture poured in until the accumulator is nearly full. The cell should then be left undisturbed for five to ten minutes, when jellification will be complete.

Such treatment is only worth while where a non-spillable battery is required, that is, for portable wireless sets and, in some cases, for accumulators used to drive models.

## Handyman's Self-Grip Wrench

**S**O many of our readers are Shandymen mechanics in the home and workshop that we know they will be interested in the Mole Self-Grip Wrench which has just been put on the market. The wrench is of the ordinary pliers type, but with one lever adjustable and a special snap-spring action which locks the jaws on the job with enormous grip. The action of fitting to any size work is simple and instantaneous. Once fixed, the hands can be removed whilst the wrench remains locked. It

can be used as ordinary pliers, as a clamp, or with ratchet action or as a small vice for holding tiny parts. The jaws are alloy steel forgings, with machined teeth serrated for grip. There are literally hundreds of jobs for which such a tool is useful and it should certainly be in every reader's tool kit. It can be bought from most ironmongers, in two sizes—7in. at 10/6 and 10in. at 12/6. The smaller one is suitable for jobs likely to be undertaken by our readers. Makers address will be given on request.

# Making a Station for a Model Railway

See page 134

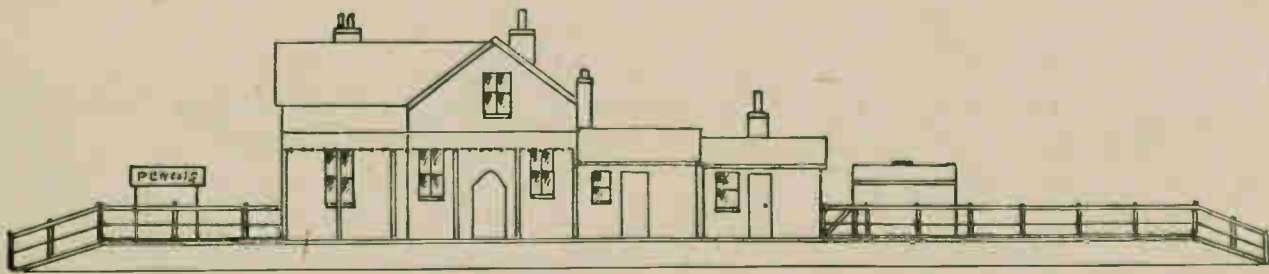
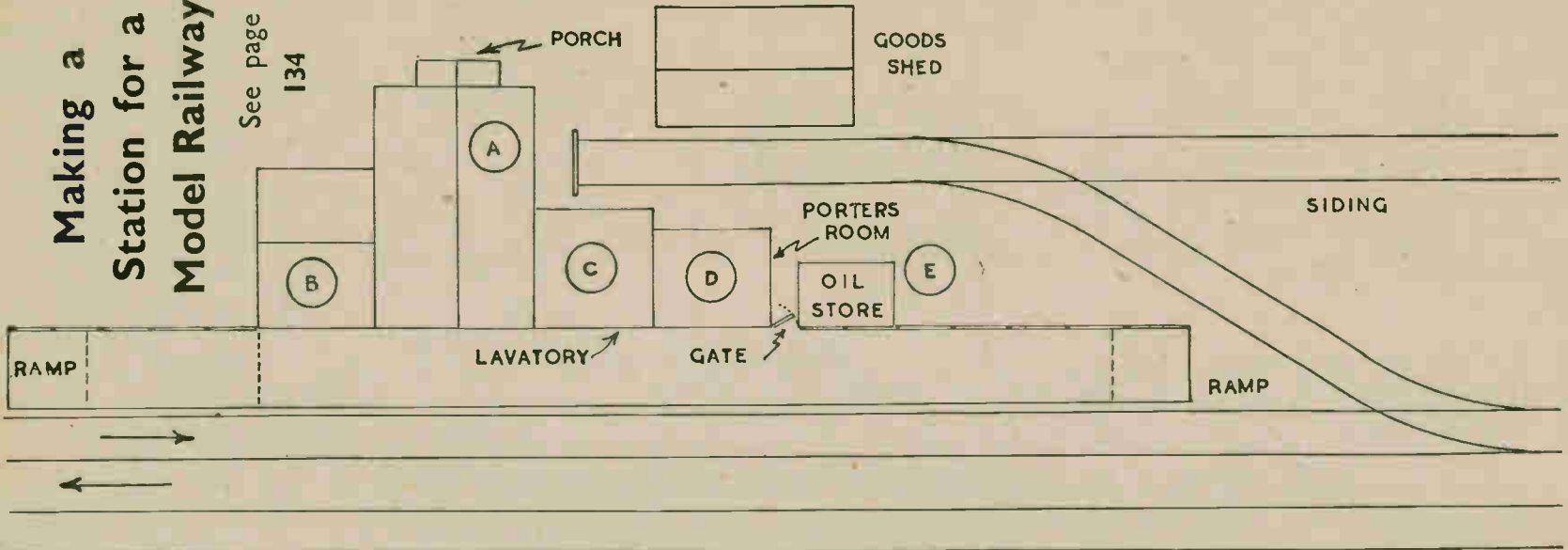

FRONT VIEW



## EX GOVERNMENT BARGAINS

for the Hobbyist and Handyman  
**ELECTRIC MOTORS** from 7/6 24v powerful motors 7/6 Post 1/6  
 Small motors, work off dry cells or 6 or 12v. car battery.  
 Mains motors. 200—250v. AC/DC. Ideal for models, bench grinders, etc.  
 9/6 and 12/6 Post 1/6  
 25/- Post 1/6

### SWITCHES.

Single toggle type ... 1/11 each. Double throw, double pole 2/- each.  
 Twin, magneto ... 11d. each. Three bank ... 4/6 each.  
 Five bank ... 5/11 each.  
 Sixteen bank. (8" x 4" panel with 16 individual snap action switches, plated  
 —ideal for model train operation, etc.) ... 7/11 each.  
 2 way, 15/20 amp. ... 1/11 each.  
 Transparent plastic sheet, 1/2" thick, approx. 100 square inches. 1/9 per piece.  
 Aluminium rivets, assorted boxes, approx. 6 gross ... 2/6 Post 6d.  
 Nuts, bolts, washers, clevis pins, 1 gross assorted. Very handy box. 10/-  
 Small ball bearings, 1/2" bore, drilled attachment flange to outer race. 2/6 each.  
 Warning lights. (Small half coloured glasses, red, green, blue, amber).  
 Suit model railway signals, etc. ... 1/9 each. 3 for 4/6  
 Variable and fixed resistances, junction boxes, fuse boxes, etc.  
**100.000 MORE BARGAINS.** Send 3d. and S.A.E. for illustrated list.  
 to J. MILLIGAN, 24 HARFORD STREET, LIVERPOOL, 3.

## "40 POWER TOOLS YOU CAN MAKE"

Now, You Too, Can Have a  
**MOTORIZED WORKSHOP**



Don't limit your workshop fun and skill to hand tools. Do jobs you never dreamed of before. You can make all the tools listed below, and many others too, simply and easily from the detailed plans and instructions.

**GET THIS AMAZING AMERICAN BOOK NOW!**

Model-makers and Wood Lathes, Jig Saws, Drilling Machines, Saw Benches, Band Saws, Metal Bending Brakes, Planers, Sanders Circle Cutters, Tapping Attachment, Power Hack-Saw, etc., etc.

**ONLY 12/6 POST 8d.**

Turn Scrap and Discarded Materials into Useful **POWER TOOLS** of Small Cost!

40 Power Tools in all  
 Sent on 7 days approval against payment  
 BCM/PUBLICATIONS (HW), LONDON, W.C.1

**POPULAR MECHANICS MAGAZINE**  
 1 year **17/6**  
 Lists U.S.A. Magazines, Homecraft Books and Plans **6d.**

## TOYS you can make of Wood

by **LAWRY TURPIN**  
 An attractive book containing original, easy-to-follow designs for making a variety of toys from odd scraps of wood. Many photographs illustrate the finished toys. 7/6 net.

Parker St., Kingsway, W.C.2  
**PITMAN**

## CHINA POSTAL SERVICE



**1947 SET FREE!!!**  
 The complete, mint, 1947 set of 4 Beautiful, Attractive, Large Pictorial, issued in honour of China's POSTAL SERVICE, will be sent **ABSOLUTELY FREE** to every collector who asks to see a selection of our World Famous Approvals. These interesting and very scarce stamps, of which we have been fortunate enough to obtain a limited supply from Shanghai, are in red, purple, green and blue; their total face value is **4.500**

dollars, and they are **UNUSED**. Designs depict Mail Vans, Post Offices, etc., all inscribed in Chinese characters. Obtain this wonderful set **NOW, FREE!!!** (Enclose 2jd. postage.)

**D. J. HANSON (Dept. H.34), Eastington Goole, Yorks.**

## PLAXIT

Make your own Plastics at home with this new Outfit.

The **PLAXIT** Home Plastics Outfit comprises:—**PLAX** (Syrup) **FORMEX** (Liquid) and **HARDEX** (Powder); when mixed according to instructions (with **HUTIT**), the mixture is poured into moulds and hardens without heat. A **CRAFTMASTER** Flexible Mould (Brooch and Earclip Set) is included with Outfit (Capacity—approx. 45 sets.)

**PLAXIT** is suitable for the home manufacture of Brooches, Buckles, Buttons, Cameos, Earclips, Models, Figures, small parts and fittings, and all types of Art Jewellery.

**THE ONLY PRACTICAL COLD-SETTING HOME PLASTICS OUTFIT!**

Send Stamp (3d.) for full information to:—  
**HOMECRAFTS, (Dept. 17.P)**  
**ALBION STREET, BROADSTAIRS, KENT**

## BOYS! ELECTRIC-MOTOR OUTFIT

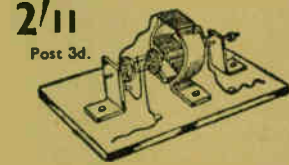

**2/11**  
 Post 3d.  
**WORKS FROM ORDINARY TORCH BATTERY**  
**6,000 REVS. PER MINUTE**  
**EASILY ASSEMBLED**

This outfit comprises **ALL** necessary parts and base ready for simple assembly by any boy to make this working Electric Motor exactly as illustrated.

Apart from its novelty, this has very considerable technical and constructive value. More can be learnt from it regarding Electric Motors than by reading volumes. A most instructive and entertaining toy for boys. Complete with diagrams and very easy instructions. Send 3/2 P.O. or stamps. **IDEAL FOR CHRISTMAS GIFTS.**

Direct only from:— **Wm. PENN LTD. (Dept. EMD),**  
**585, HIGH ROAD, FINCHLEY, LONDON, N.12**



document and you can enlarge to Goliath proportions, projecting actual colourings. Simply plug in to your electric light circuit. Will produce enlargements when focussed direct on to sensitised paper in a dark room 7/9/6. Post and Pack 2/6



ground or we can supply white plastic screen at extra cost of 7/6. No home should be without this Film Projector which will entertain both young and old. Each machine guaranteed 5 years. Send today before stocks are exhausted.  
**HEADQUARTERS & GENERAL SUPPLIES LTD.**  
 Dept. HOB. 196-200 Coldharbour Lane, Loughborough Junct., London, S.E.5.

**PHOTOGRAPHS** any size: thrown on to screen larger than life size if desired, at a few feet distant from screen. Merely insert snap, photograph, drawing, stamps, ordinary picture cards or any proportions, projecting actual colourings. Simply plug in to your electric light circuit. Will produce enlargements when focussed direct on to sensitised paper in a dark room 7/9/6. Post and Pack 2/6

An absolute first-rate machine. Weighs approx. 2 lbs. Complete with bulbs and 2 films at the sensational price of 55/- Post, etc., 2/6. Spare films at 1/3 consist of Comedy Cartoons, Quizzes, Nature Study, etc. Up to 24 varieties. Shows on any white background or we can supply white plastic screen at extra cost of 7/6. No home should be without this Film Projector which will entertain both young and old. Each machine guaranteed 5 years. Send today before stocks are exhausted.

## WEBLEY AIR PISTOLS

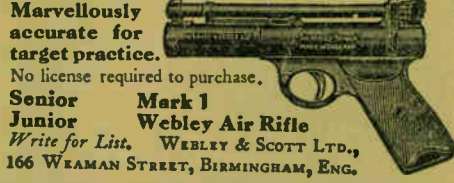

Marvellously accurate for target practice.  
 No license required to purchase.  
**Senior Mark 1**  
**Junior Webley Air Rifle**  
 Write for List. **WEBLEY & SCOTT LTD.,**  
 166 WEAMAN STREET, BIRMINGHAM, ENG.

## BUILD YOUR OWN PRINTING PRESS!

Full working drawings, complete instructions and photographs for 3/6 post free from  
**PRESSPLAN**  
 1189 Pershore Rd., BIRMINGHAM 30



# NEW WALL PLUG

with  
**REMARKABLE HOLDING POWER**

- Plastic expansion gives tremendous holding power;
- High tensile and impact strength; shock and vibration proof;
- Resists water, weather, heat and acids;
- For use in any material, indoors or outside;
- Can be cut without collapsing; easily fixed.

In seven diameter sizes and four lengths. Made in Great Britain and patented in all countries throughout the world.

*Screw it — with*  
**HEWIT**

**HEWIT WALL PLUGS LTD.**  
60, Fenchurch Street, London, E.C.3

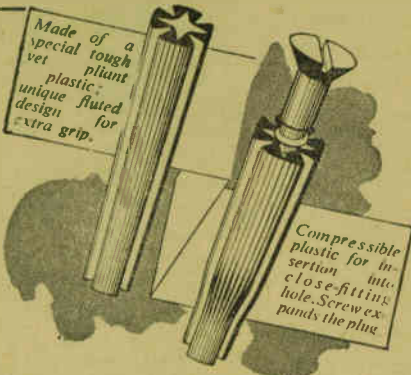

## 1948 JOHNSON PHOTOGRAPHIC COMPETITION FOR AMATEURS

JOHNSONS hold a print competition twice a year. The current one closes on 31st December, 1948. All amateur photographers may enter. Any camera may be used. Contact prints or enlargements may be sent. No entrance fees to be paid and no entry forms have to be filled in. All you have to do is stick a label or title panel from a JOHNSON photographic chemical bottle or package on the back of each print you send in. No limit to the number of entries which may be submitted.

### 60 PRIZES

including  
35 in cash as follows :

- 2 of £5
- 3 „ £2
- 10 „ £1
- 20 „ 10/-

and  
twenty-five  
Consolation  
Prizes of  
Photographic  
Chemicals.

Every type of subject is eligible. Children, animal, home and holiday snapshots. Landscape, seascape, river or street scenes. Garden, flower or tree studies. Architectural, interior or table-top subjects. Prints need not be mounted. Enlargements need not exceed whole-plate size. Name of camera, size of film or plate, developer used and exposure given should be recorded where possible. Write your name and address clearly in block capital letters on the back of each print. Do not send the negative, although we may wish to buy or borrow it if you are a prize winner.

**CLOSING DATE  
DECEMBER 31**

Prize winning prints, not the negatives, will become the property of JOHNSONS. All others will be returned if sufficient postage stamps are enclosed with the entry. All entries must be marked COMPETITION DEPT. and be addressed to

**JOHNSONS OF HENDON**  
335 HENDON WAY, LONDON,  
N.W.4

## She might be **YOUR** ship

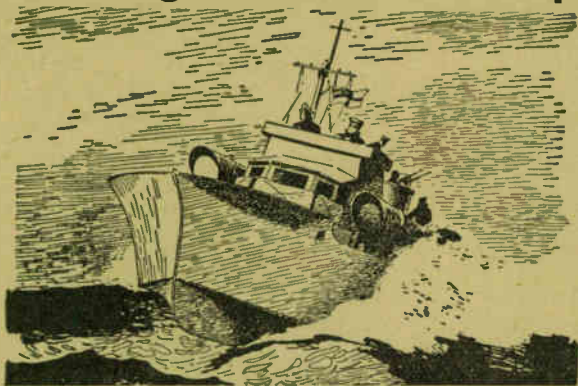

### MOTOR TORPEDO BOAT

Travelling at over 40 knots, armed with two torpedoes, these 'little ships' pack a punch to K.O. an opponent many times their size. If you're in M.T.B.'s you're in for high speed, excitement and thrills aplenty.

Yes, you'll get excitement in the Royal Navy, you'll get interest too, and a worthwhile job with good pay and fine prospects.

If you are between the ages of 15 and 28, call at any Combined Recruiting Centre or write to Director of Naval Recruiting Dept. AX/148, Admiralty, London, S.W.1.

Make the

**ROYAL NAVY**

*your career*

## FOR THE HOME WORKSHOP

You will really be amazed by the Vibro-Tool—the new power hand-tool that is as easy to handle as a pencil. With it you can write on steel, engrave jewellery, glass and plastics, tool leather, carve wood and cut stencils—and a host of other handicraft and workshop jobs . . . with speed and facility you never dreamed possible.

Operating on the vibratory principle, the Vibro-Tool works off 220/250 volt, 50 cycle, AC supply. Just connect to any electric light socket or plug point.

**BURGESS  
virbo-tool**



V.250 VIBRO-TOOL  
complete with stand-  
ard engraving point

**52/6**

BURGESS PRODUCTS CO. LTD., VIBRO-TOOL DEPT. HINCKLEY, LEICS.

# Hobbies

## WEEKLY

### CONTENTS

	Page
One-Runner Sleigh	- 141
Finger Puppets	- - 143
Party Magic	- - - 144
2-Band Crystal Set	- 145
General Notes	- - - 146
Novel Shooting Alley	147
Winter Hiking	- - - 148
Simple Epidiascope	- 149
Shooting Gallery Patterns	- 151

December 22nd, 1948

Price Threepence

Vol. 107 No. 2773

## Be ready for the snow with a ONE-RUNNER SLEIGH

"JUMPER" sleighing is a new winter sport that has originated in America. It means plenty of thrills, spills, and fun, for the novel "sleigh" consists of a runner and a seat, as shown. The user, sitting astride the low seat, has to guide the

device, and maintain balance by the dexterous use of the feet.

Since the runner is only 24ins. long, and the seat 10ins. to 12ins. high, one does not fall far should one over-balance, due to the jumping of the runner over bumps and hollows in a snow's incline. If the incline is fairly

steep, and the snow fairly hard, the sleigh skims over the surface at a great rate.

Legs and feet are apt to swing in all directions in an effort to keep a good balance. Coming to hollows, the sleigh seems to drop into them quicker than the rider, then comes up just as the rider is beginning to drop on the seat. This jumping about, slithering, skidding, sprawling the legs, kicking up furrows of snow with the feet, etc., is part and parcel of the sport.

### Runner and Column

The runner and its column is generally cut complete from a plank 24ins. long by 10ins. wide by 2ins. thick, but you cannot afford to use wood in this manner. The alternative is to use 1in. thick and ½in. thick wood.

The main part is cut from 1in. stuff. This is shown at Fig. 1, and consists of a runner and column piece, the latter being affixed to the runner with dowelling. Approximate sizes are provided.

Having cut out the parts and assembled them, build up a 2in. wide runner and strengthen the column joint with upright stiffener pieces, as in the elevation. To do so, you require two runners cut from ½in. wood to the dotted line. The upright pieces are also cut from ½in. wood.

Glue and nail (or screw) the extra runner pieces to the main runner, one at each side, then add the upright pieces. Before going further, proceed to level the runner with a plane and a spokeshave.

The next thing to add is the metal cover, or shod, to the runner. This

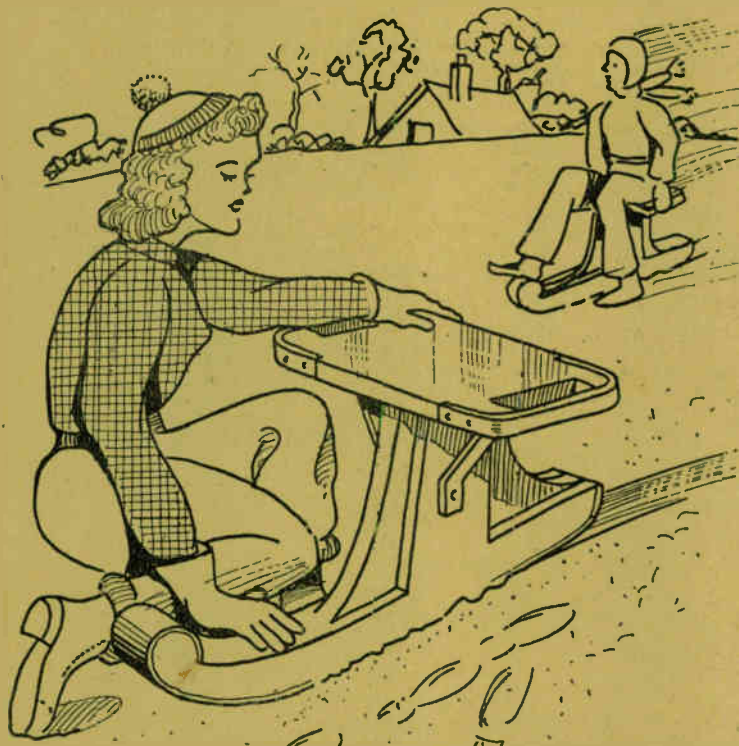

All correspondence should be addressed to The Editor, Hobbies Weekly, Dereham, Norfolk.

metal shod is 2ins. wide or thereabouts, by about 3ft. long. It should be  $\frac{1}{4}$ in. thick, but any sheet metal, preferably mild steel, may be used. Holes are bored here and there where thought essential, then countersunk for suitable flathead iron screws. The strip of metal is then bent into shape so it fits on the runner, following

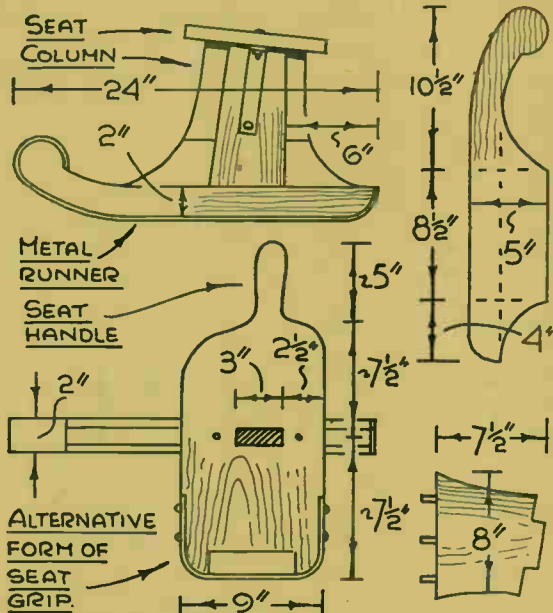

Fig. 1—Side elevation with top plan and runner details

which the screws are inserted.

### The Seat

There are two ways of cutting the seat. You can, for instance, make a plain seat, 15ins. by 9ins. by  $\frac{1}{4}$ in., then

shape the ends, as shown in the top plan, and fit metal grips—flat bars of metal affixed with screws. The other way is to cut the seat so handles are provided at the ends. These handles are rounded over slightly, including the remaining edges of the seat shape.

The handles, however, rather stick out in the way, and you have less control over the jumping sleigh. There is really no actual need to have handles or grips. A bead of wood, firmly attached to the underside of the seat near the ends, will give a good grip for the hands.

The seat, of course, has a mortise which fits tightly into the tenon provided on the top of the main column. Glue the seat well to this, then drive in a flathead screw to increase the strength, as indicated. By the way, note the direction of the grain of the wood of all parts to be cut out.

The seat is further strengthened by means of metal brackets which can be obtained at a hardware store. These are merely flat, right-angle brackets which screw on. You could make a pair easily from flat bar, but as they only cost a few pence per pair, it is better to buy them. They should be 4ins. or 5ins. long. The home-made variety are indicated in the sketch. These, however, could be the right-angle type,

as used for supporting shelves, etc.

### Finishing the Sleigh

All that remains is to file all runner screw heads flush with the metal shod, then give the novelty a coat of enamel paint, or two coats. Bright green is a good colour. As usual, allow the first application to dry before applying the other coat on top.

Do not have any sharp edges on the sleigh. You will, of course, be wearing thick gloves or mittens, while using the sleigh, but a shiver of wood can easily penetrate gloves and mittens. If you have used deal throughout the construction, and do not bother to apply the finishing coats of enamel or remove all sharp corners, it should be remembered that every time the unfinished wood comes into contact with snow or slush, it swells, and in doing so, small shivers of wood, at the sharp edges, may be raised.

A bare or gloved hand, sliding along the edge, could be badly torn or punctured with pieces of the roughened, swollen wood. Therefore, use glasspaper—and apply at least one coat of enamel paint.

### Early Practice

Practice using the sleigh on inclines which are not too steep. Take everything easy, and use your feet mainly to retain your balance. For turning, brake with one foot, meanwhile giving a twisting action to the seat. The sleigh, possessing only a single runner, is not unlike a ski. It can, in the same way as a ski, be turned by leaning over to one side—the side you wish to turn. If you remember that you are riding on a big form of ice-skate, you will soon get the hang of using the sleigh properly.

### Lead Moulds

*PLEASE give me any information as to the making of the hollow type of toy tin soldiers. (A.W.A.—Sheerness).*

THE method of making hollow lead toy soldiers and the like, is quite simple. You need a closed mould, made in two halves and held together with any simple form of clamp. Air-holes are made through the mould at all strategic points to allow egress of air. The molten lead is then poured into the top of the mould (which may conveniently be the base of the soldier or other object), and the lead is then at once poured out again.

This is possible because the lead adjacent to the mould chills and sets very quickly, but that in the middle remains molten. The result is, on opening the mould, a hollow casting. The mould must be cooled from time to time, and in some cases must be made thick in some places (to

absorb heat) and thin in others—for example, where the quantity of metal poured in is small; because the thin walls of the mould heat more quickly and keep the metal fluid enough to enable the centre metal to flow out again.

### Block Plane Mouth

*I HAVE a Block Plane but when I start planing wood, it gets clogged. Could you please tell the way to stop it? (W.F.—Guernsey).*

THE cause of the shavings getting choked is due either to the plane iron not bedding down correctly, or a too narrow mouth. There must be no obstruction to the passage of the shavings. Clean out the mouth of the plane and also clean the iron and wedges. Then try again.

If the fault still occurs, examine the mouth of the plane. There should be a clearance space of  $\frac{1}{16}$ in.—not more—between the edge of the iron and the mouth, to allow passage of the

shavings, and if necessary, the mouth should be widened to permit this.

You do not state if the iron is a double or single one, but if the former, see the top iron lies flat on the under one, and is so fixed as to be level across, and come to  $\frac{1}{16}$ in. from the extreme cutting edge. If you push the plane firmly but slowly along a piece of soft wood, you will be able to see exactly where the shaving gets obstructed.

### Model Yacht Varnish

*BUILDING a model yacht, I am unable to get a good boat varnish. Can you tell me a substitute I can use for the deck, mast, spars, etc.? (F.B.—Liverpool).*

IN the absence of a yacht varnish, you cannot do better than use any good outdoor grade of pale copal varnish. There are many makes of this class of varnish, but the brand known as "Orlik" has proved satisfactory.

# How to amuse your friends by making FINGER PUPPETS

**P**UPPET-MAKING is a hobby which gives hours of pleasure to those who once try it. For the price of a pound of Plasticine you can purchase the main material required. A modelling stand can be made from an odd piece of wood, with a 6in. nail hammered up through it, as shown in Fig. 1. The only other equipment needed to commence is a paste brush, a piece of tissue paper, two pages of newspaper, and a small quantity of Vaseline.

The amount of clay to be used will vary with the size of head required, and this in turn is really decided by the size of your hands. If you have small hands, use half-a-pound, or for



Fig. 1—Rough outline on a simple base

large hands, use the full pound. Three-quarters of the amount used is placed on the nail in rough shape, similar to that shown in Fig. 1. The neck piece should be just over finger thickness.

The remaining quarter is needed to build up the prominent features of the face. A beginner must not be afraid to exaggerate the eyebrows, nose, cheekbones, mouth, ears and chin (see Fig. 1). If you are in doubt as to the position of these extremities, glance casually at whoever happens to be around. This practice usually gives excellent results.

## Simple Tools

Modelling tools may be used, but a penknife or an odd knitting needle, together with your fingers, will soon achieve the desired results.

The next process is to smear the head with Vaseline, and cover it with a layer of torn tissue paper. Use pieces approximately the size of a postage stamp. No paste is needed

with this layer, as the grease will act as a mild adhesive. Use smaller pieces for covering the eyes, nose, lips and ears. Repeat the process, but this time using printed newspaper, pasting each piece edge to edge.

## Paper Layers

The next layer may be plain newspaper torn from the edge of the page. By this means of alternating plain and printed newspaper it is easy to see just where more paper is required to make a completed layer. Five or six layers should be applied in a similar fashion, and then the whole should be left for twenty-four hours to dry out. This will give a firm hard surface.

The Plasticine must now be removed. One sound method is to cut the head from the top down behind the ear, through the side of the neck, and similarly on the other side, using a sharp penknife.

With careful easing, the back 'shell' will come away (Fig. 2), and the clay remaining in the front

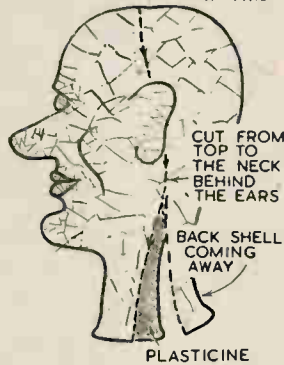

Fig. 2—Shaping the head

wise to cover the joint. Give the whole two more layers of newspaper, one print and one plain. A slightly better finish can be obtained with a final layer of tissue paper. Allow the head to dry out once again.

While the head is drying you can make the two tubes to take the hands. Decide on which of your hands you wish to work the puppet and make one tube to fit the thumb, and the other to fit the little finger.

Hands can be cut out of cardboard, curved inwards, and the wrists bound round with pasted paper until they form a plug to fit into the end of the tubes. Remember, the thumbs must be uppermost when fixing.

## Painting

If the head has been placed in a warm place it should now be ready for painting. Water, poster, or powder colour may be used. A coat of light flesh colour should be applied, and while still wet, slightly darker patches of red or burnt sienna can be worked into the cheeks, nose, and other prominent parts. Avoid 'wooden soldier blobs'.

The eyes have a white base and the iris is coloured as desired, the pupils are painted black. Paint in the eyelashes for female characters. The lips should be brightly painted, the top slightly darker than the lower lip. High-lights may be painted in white where necessary (i.e., eyes, cheeks). Hair and eyebrows can be very effective if wool or fur is used, but, of course, they also may be painted in.

The head completed, it only remains for the clothes to be made.

(Continued foot of page 148)

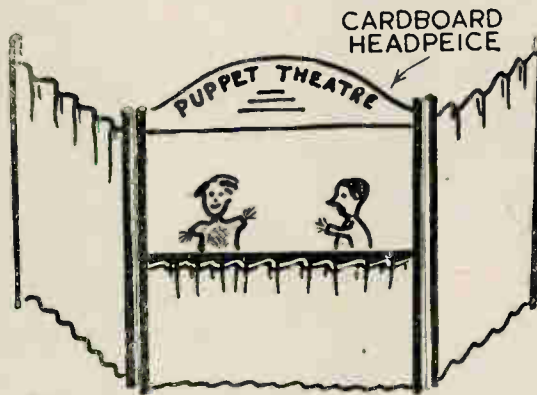

Fig. 4—The puppets operated behind a clothes horse

half can be scraped out with the penknife. Hold this front shell up to the light; if any weak places can be seen, reinforce with small pads of paste-soaked paper.

At this stage it is necessary to prepare a finger size tube of thin cardboard. Paste the tube inside the front half of the neck, securing it with a strip or two of pasted newspaper. Now you must join the front and back with pasted strips, length-

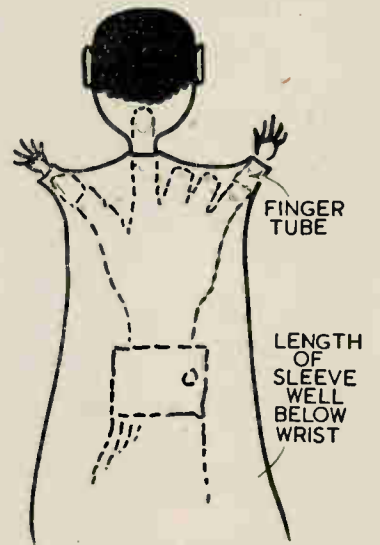

Fig. 3—How the puppet fits over the hand and wrist

# Prove yourself popular by learning how to do SOME PARTY MAGIC

**D**URING the party season, the fellow who can do some conjuring tricks is always popular. Here are some simple but effective tricks you can make up.

## The Vanishing Pictures

Here is an up-to-date version of a grand old "classic" effect. To make it, you must first gather a number of pocket-size magazines of the *Lilliput*, *Men Only*, *Town & Country*, etc. type . . . i.e. well illustrated and, also a copy of an unillustrated magazine of the same size, say, *The Reader's Digest*.

Take the wire staples out of the magazines, and make up a new, composite magazine which has pages alternately plain print and full-page photos. Put a cover on and re-insert the staples.

By means of a Star type razor blade and a metal rule, trim the edges of the new magazine. When this is done, go through the magazine again and trim about 1/16in. off the long sides of the picture pages only.

The book is held in one hand, by the back, and the pages flipped over with the thumb, either downwards (from first to last pages) or upwards (from last to first pages). According to how the pages are flipped, the book can be shown either completely illustrated or completely unillustrated. It is as well to paste a plain brown paper cover over the illustrated cover.

For "patter" you can spin a yarn about an illustrated magazine where the photographers all went on strike, and consequently the magazine appeared without photos. However, there was a happy ending. The dispute was ended and the magazine appeared full of pictures again.

## The Perambulating Pencils

The amateur wizard shows a fold-over type of pencil case (as illustrated) From this he extracts a couple of pencils, and closes the case. The pencils are placed in a long envelope.

At a word of command, the magician orders the pencils to fly home. The envelope is crushed flat: the pencils have gone. On opening the case, the pencils are found there, secure in their loops.

Actually there are two pencil cases sewn back to back. One side has a couple of genuine pencils inserted in the loops, but the other has two dummy paper tubes.

Take a pencil and roll a piece of paper round it so that there are about three or four thicknesses of paper. The paper is glued permanently to the pencil, and when dry is well waxed, by rubbing a candle on

it, and polished. This is the former.

Now obtain some flint paper (glossy coloured paper) and cut it into suitable lengths so they can be rolled round the former, pasted neatly, and then slid off. (Do not get any paste on the former itself). The tubes should be reasonably stiff. You can make two or three dozen at a time. Obtain some pencil stumps, and insert a pointed piece in the top of the tube and a plain piece in the other.

From a short distance these fake pencils look the real thing, but when in the envelope they can be crushed flat to show that they have "gone". The pencil stumps can afterwards be retrieved and used again.

The pencil case is, of course, reversed when re-opened. In order to make the pencils match, paste some of the flint paper over the genuine pencils, too.

## The Circle of Magic

This is a very baffling trick but, like most good tricks, the secret is absurdly easy.

The magician takes a piece of paper about 3ins. square. He folds it in half, and then in half again, so that, when opened, it shows folds at right angles to each other. Using the intersecting lines as a centre, a circle of about 1in. diameter is drawn (freehand). Around this circle, the performer draws other symbols, as shown, explaining (with his tongue in his cheek) that this is an ancient symbol of mystery and magic.

The paper is given to any spectator who is asked to write, in the "circle of magic", the name of anyone. The paper is again to be folded and handed to the performer who does not, of course, see what has been written. He can turn his back.

He now takes the paper and tears it into small pieces, and places them on an ash-tray. The pieces are set on fire (so stiff, tough paper should not be used). Using the pencil as magic wand, the performer "sorts out" (?) the ashes into little pieces. This business is actually a fake but it is necessary to work up the right atmosphere

"Here I see an E", says the magician, "And here's another just like it. This looks like an R. This one is something like it but it hasn't a tail. It's a P. This is a T. T. P. and two E's". He sorts out the heaps a bit more. "I have it. It's PETER."

## Simple Solution

The spectators are quite impressed, and would kick themselves to find how easily they have been tricked. The creases first made in the paper are sharp ones, so that when the paper is refolded, the helper folds it in its original creases. The performer takes the paper between his left first finger and thumb which just cover the circle in the centre.

The paper is torn up, but the centre part is retained . . . a very easy matter. Whilst the paper is burning, the conjurer says that he does not want to catch a glance so he will turn his back. This gives an opportunity of opening and reading what was on the centre of the paper.

Simple as this is, it should be practised well in advance, and should not be repeated. When people urge you to repeat a trick they really mean "You caught me that time but I bet you don't do it twice. I'll be on the look-out this time". You should not give them the chance; get on with another trick.

The diagrams below illustrate these tricks quite clearly, and with a little quiet practice you should be able to carry them out perfectly. Do not, of course, leave it until the last minute to do this, and endeavour to pass them off with casual and witty patter which will definitely help the effect.

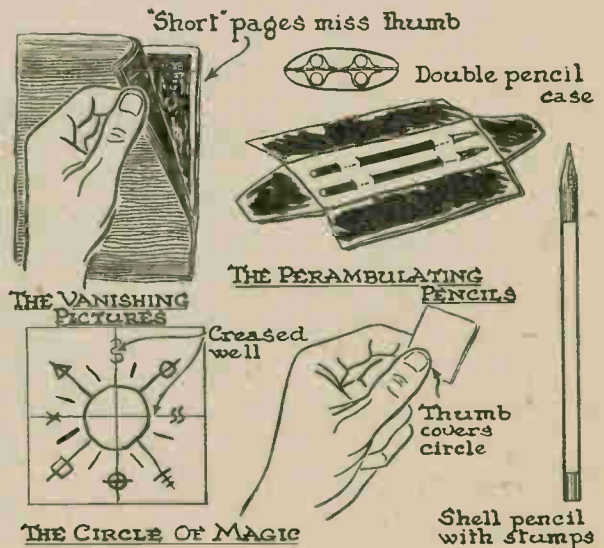



# Earphone reception up to 100 miles on this straightforward TWO-BAND CRYSTAL SET

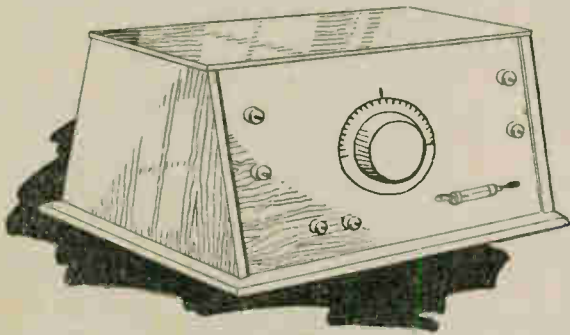

**T**HIS crystal receiver tunes the usual Long and Medium wave-bands and the circuit is intended to give the maximum volume. Good earphone reception is possible at a distance of up to 100 miles or so from one of the more powerful B.B.C. stations, and even at greater distances volume may be satisfactory. During the hours of darkness some foreign stations may be heard, but long-distance reception should never be expected from a crystal set.

## Obtaining Maximum Volume

The aerial and earth should be good. A long, high outside aerial is best, well clear of all surrounding buildings and trees. If a short indoor aerial is used volume will be reduced somewhat, though it may still be sufficient, especially if the aerial is in an upstairs room.

The earth lead should be connected to a metal object buried in damp soil, or to a water-pipe or other object in

contact with the ground. If no earth is used, volume will be severely reduced.

Outside the receiver itself, the remaining point to attend to is the headphones. Some headphones work more loudly than others so a reasonably good pair should be used. They should have a resistance of about 500 to 4,000 ohms (this is usually marked on the phones), and the special low-resistance pairs made for other purposes should be avoided.

## Making the Case

The detail at Fig. 4 shows the sizes to which the pieces of wood should be cut to make a small cabinet with a sloping front. Sides and bottom are made from  $\frac{1}{2}$  in. thick wood and the bottom is bevelled along the sides and front.

For panel and top three ply is suitable, with the panel set back slightly on strips fixed to the sides. Further strips fixed to the top enable this to be lifted off. Alternatively, hinges may be fitted so the top can be opened.

The whole cabinet should be varnished, and the panel may be a different shade. Sheet ebonite and Paxolin are obtainable for panels, and this would give a better finish, if used.

The position of the various parts will be seen from Fig. 2, which also

shows outside connections. Any type of permanent, semi-permanent, or adjustable detector can be used. Small bolts secure it to the panel.

Opposite will be seen two terminals which can be bridged with a wire link. When this link is in position Medium Waves are tuned; when contact is broken, Long Waves are received. An on-off switch can be used instead of this arrangement.

In the centre is the .0005 mfd. tuning condenser, with knob or dial. An air-spaced condenser is best here, though a solid dielectric one will function quite well. With the latter, however, volume is very slightly reduced because the insulation is not so good.

For Aerial, Earth, and Phone connections, fairly large terminals are usually most convenient.

## The Coil

The coil is clearly shown at Fig. 3, and when finished, it is mounted on small wooden blocks.

The diameter of the former and gauge of wire used can be varied within quite large limits. A tube can be made from thin glued cardboard wound several times round some object of convenient size (about  $1\frac{1}{2}$  ins. to  $1\frac{3}{4}$  ins. in diameter). When the glue has set, the tube should be varnished to exclude moisture.

The Medium Wave section is wound between points 1 and 2. It consists of about 70 turns of 32 to 28 S.W.G. wire. The turns are closely side by side and the ends can be secured by passing them through pairs of small holes in the former.

For the Long Wave section, between points 2 and 3, about 200 turns are used, divided into two piles of 100 turns each. Leave about  $\frac{1}{4}$  in. between the piles. All turns must be in the same direction, and a thinner wire (about 36 S.W.G.) is most suitable.

(Continued foot of page 149)

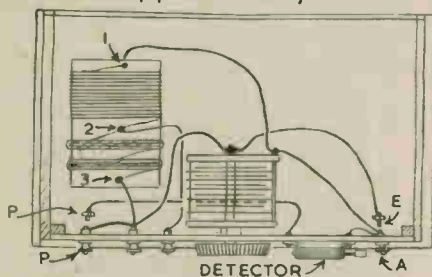

Fig. 1—Wiring diagram of the set

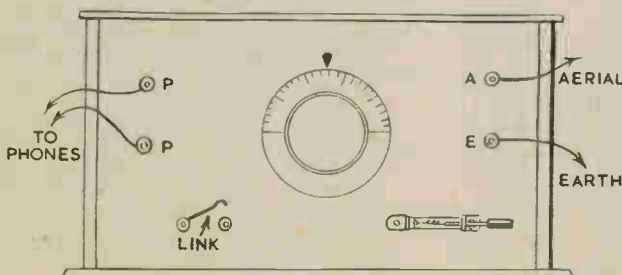

Fig. 2—Panel layout showing connections

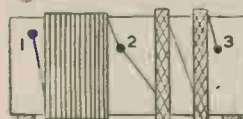

Fig. 3—The tuning coil

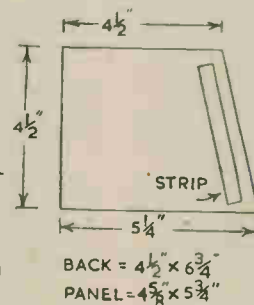
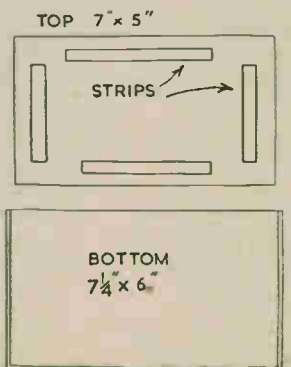

Fig. 4—The pieces required for the case



# Hints on how to keep and use your tools in these GENERAL NOTES

**T**HE aim of the handyman at home should naturally be to have as wide a range of tools as possible, and you may frequently envy the man with the complete cabinet of everything he needs for whatever job comes along. Such a position is more likely to have happened to those who had the idea in mind before the war, because now many of the pre-war tools are unobtainable and the average amateur will at least find them beyond the range of his own pocket.

It is, of course, impossible to acquire this ideal complete range in five minutes, or even five years, and the reader should always have his eye open for adding whatever he can at every opportunity. To have a complete kit of tools, means virtually that you have to have a wide range of every single one.

## Varieties

For instance, there are at least half a dozen different types of hammer which must be in your collection if you are really going to cover everything, but then, of course, few amateurs are likely to do this. Not many, for instance, will have sufficient need of a slate-maker's hammer to make it worth while purchasing such a tool. Or, of course, you can say the same about pliers and nippers.

There are various sizes with various types. There are the plain ones for small work, or the larger handyman variety with wire cutters and grips incorporated. Then, of course, we all know the variety of screwdrivers which are to be found. The point is that you should know which are the best to use, and have them in your tool kit, gradually adding as you can from time to time.

## Use the Right One

How often, for instance, do you find a fellow using the right size of screwdriver for the particular screw he is putting in? The driver is either too large or too small, and in any case, is causing a lot of unnecessary labour and waste of time. Two or three sizes of screwdriver are normally sufficient for the average tool box although one is wise to add from time to time.

A screwdriver, remember, should fit exactly into the slot of the screw so that the mere turning of it will allow the screw to cut its way through the fibres into the wood and make a secure fixing. It is always wrong to endeavour to force a screw home with a lot of unnecessary pressure.

The same applies to saws, both regarding variety and use. There is no point in using a large hand saw to cut a small piece of wood. Or the

other way round. If you can only commence with one tenon saw, a 10in. is quite a handy size. The next time you have the opportunity, get a smaller one, and then a larger, thus you will have three for normal work. In addition, a handsaw will be necessary for the larger bench work, and here about a 24in. blade will be serviceable.

## Question of Quality

The quality of the saw depends on the actual steel used. In a good handsaw you should be able to bend the toe right round to the handle and when it springs back it will become quite straight again.

The quality of the steel, too, affects the cutting, because the teeth will remain sharp and set at the right angle. If you get inferior quality, then the teeth cannot be sharpened so well, and will only tear the wood instead of cutting through it clean and smooth.

It is a common fault in connection with this tool, to use it on damp wood and then hang it up without wiping, for the atmosphere of the shed in which it is kept may not be dry. In consequence, the blade of the saw becomes damp and in turn rusts badly. This should be prevented, not only because the rust itself eats into the metal, but also because the rust forms a surface creating a great amount of friction when cutting.

## Cleanliness

Do keep your sawblades clean, therefore. A rubbing of thin oil before they are hung away will save any trouble arising. If you are doing any fancy work, remember, however, to wipe the oil off before you commence to cut, otherwise it will mark on the wood and leave a blemish which is difficult to remove.

The handyman who is keen on increasing his tool kit will be well advised to keep his eye on local auctions or sales or even second-hand shops. Most of the articles which come forward in such places as this are pre-war manufacture, and therefore likely to be of superior quality and more lasting value than recent ones. Again, whilst you may not be able to afford the actual article yourself, it would serve as an ideal birthday or Christmas present if you can only let suitable people know that it is the thing which would please you most for such an occasion.

## A Source of Supply

Then again, most men at some time or other, have had tools of their own, but possibly have given up using them as they did in their younger days. In consequence, here is another source

of obtaining what you need, merely by mentioning it to fellows who would be only too glad to help you. If you lead the conversation round to the need for, say, a special chisel or mallet, or something of that sort, it is surprising how many people come with the answer "Oh yes, I have one of those".

If this is judiciously followed up you will probably find that the tool in question is not being used, and would be released to you for a small sum or even as a mark of friendship for a gift. Whilst these tools—the second-hand ones, anyhow—are sometimes worn and rusty, they are certainly worth giving a little care and attention to bring them back to a useful life.

## Use of Emery

Emery cloth will clean most rust and grease away from a cutting blade or turning tool, and a rubbing with linseed oil on wooden handles or tool bodies, will clean away old markings and bring the former polish back to a certain extent. Of course, you should not have the actual handle of any tool marked with oil or grease, because if you do, the hand is apt to slip in use, with some danger to the user.

We cannot too strongly stress the need for keeping tools neatly and in a clean condition. Too frequently they are shot into a drawer after use, or put away in a pile in a shed which may be damp and certainly is not dust-proof. For your own sake, it is as well to clean every tool after you have used it, and put it away, not only to be ready for the next occasion, but also handy when you need it. Flat hanging cabinets on the wall can be made to hold quite a lot of small-handled tools such as chisels, drivers, bradawls, etc. Metal racks are obtainable into which these handled tools can be fitted, or you can cut a simple rack yourself from a piece of wood, and fit it in place in the appropriate position.

## A Tool Chest

Larger tools can be kept in a proper tool chest, particulars of which have already been given in these pages. A large box with hinged lid is ideal, but it must be properly fitted inside. Do not just open the lid and throw all the tools in haphazard. If you do, the chisel blade will probably blunt itself against some metal, the teeth of the saw will become damaged in a similar way, and even apart from that, there is the likelihood of tearing your hand the next time you attempt to get some of the tools out.

This last point, of course, brings up another essential which should be

(Continued foot of page 147)

# Patterns for a novel but simple game to make — A SHOOTING ALLEY

**H**ERE is a game that will give hours of fun and amusement. It consists, as our sketch shows, of a castle wall or gateway guarded by men in uniform and equipment of the 15th century. All four men are cut from card or thin wood and mounted on a cardboard disc so they stand firmly each within an archway of the wall.

At an agreed distance from the wall is the contrivance for bowling over these sturdy warriors. Now, various suggestions will occur to our workers for doing this, and two are given here as simple and easy to make.

## Back Wall

Before, however, we tell how to make them we are going to deal with the making of the archways and wall. On cover iii of this issue we give full size patterns of the wall. All that is necessary therefore, is to cut this page from the book, paste down the pattern on to thin wood or stout card and cut round it with a fretsaw. A really substantial job could be made by using wood, as card, whatever its thickness, would in time be liable to get bent and broken.

Use wood  $3/16$  in. or  $1/2$  in. thick and paste the pattern to it, getting it nicely flat by pressing out the air bubbles. When the paste is dry cut round the outline and the arches with the fretsaw and lightly glasspaper the

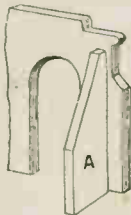

Fig. 1—Back view showing wall support

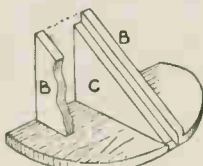

Fig. 2—A simple rolling chute

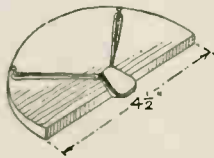

Fig. 3—Catapult and pellet type

back edges to take away the burr left by the saw.

There are two ways of finishing the face of the wall where the stonework shows up realistically. Either the pattern can be left on the wood and varnished to make a good surface for handling, or a tracing can be made of

it and the whole surface then painted grey, or stone-colour, and the stone courses put in with a fine brush.

To make the wall stand upright, two shaped pieces, as A on the pattern sheet, are cut out and glued on the back (see Fig. 1) for the correct position for fixing these. The back of the wall should also be painted or varnished.

## Firing

Continuing with the gadgets for knocking over the men, we show in the sketch how the simple method of trundling a coin down a slope can be made. The coin is held with finger and thumb in a groove, and on its release it runs some distance before toppling over.

The idea is to hold the coin in such a position that it faces one of the men, and if it works out, the coin should enter the archway and do its job. The construction of the running board is easily explained in Fig. 2.

First a baseboard is cut from, say,  $1/2$  in. wood, semi-circular in form and measuring  $4\frac{1}{2}$  ins. long. Upon this is glued three triangular pieces, two as B on the pattern sheet and one as C. The three pieces will be glued firmly together as in Fig. 2, the near piece B in this diagram being drawn away and cut so as to display how the groove is formed.

There are, indeed, a hundred and one things which may happen, and the wise handyman will see that some small first-aid remedies are handy. Some lint, bandage, healing ointment, Dettol, scissors and safety pins are all that is necessary, and these should be kept handy in a box—an old cigar box will do.

Such a box should always be kept



Roll the coin down the chute to knock over the sentry figures

Full size Patterns on page 151

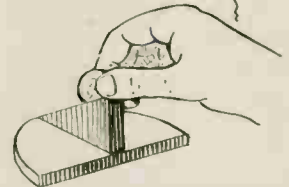

The edge of the base between the two pieces B must be filed to a slope to correspond with piece C so the coin when running will clear the base smoothly. The finished thing can be either painted or varnished.

The second method for knocking over the men is even more simple than that just dealt with. Into the same semi-circular base two wire nails are driven and spaced out somewhat as shown in Fig. 3. Round these nails an ordinary elastic band is looped which, when pulled forward, forms a propelling force for a strip of paper so folded that it is held round the elastic by finger and thumb. Fig. 3 shows this idea—minus the fingers of course.

## The Figures

On the pattern sheet given we show the four figures which should roughly be cut round with scissors and then stuck down to thin wood or stout card. The patterns should, in this case, be left on the wood, and the whole then painted in water colour. The discs on which the soldiers are to be glued should be stout card, size as shown at D on the sheet, and they, too, should be painted.

The game is played by knocking down a soldier and scoring according to the number on the bottom of the disc. It must first be decided how many shots are to be fired by each player. The player who first makes, say, one hundred, proves the winner. Of course there will be many ways of arranging the scoring and the number of players.

## General Notes—(Continued from page 146)

found handy in a workshop, but seldom is. No matter how careful the worker endeavours to be, an occasion is sure to arise when he does some injury to himself which demands immediate attention. A chisel or screwdriver which slips can make a nasty cut or an ugly gash. A screw or nail may tear the skin in a painful manner.

in one place, and can be made more appropriate by painting a Red Cross on the lid or door. Keep it in the same place, because otherwise you will have trouble to find it and waste valuable time searching for the very thing which should be helpful to you at a minute's notice. See too, it is always replenished after you have used any of the contents.

# How to get real enjoyment when you undertake WINTER HIKING

It is good fun hiking in winter, but choose your day. Frequently, we enjoy an interlude of clear skies, when all things are silvered with frost, and the sun blinks crimson through the mists beyond the valley. The air, crisp and fresh, is wonderfully exhilarating, and as you swing along the firm footpath between the fields, you feel that it is grand to be alive.

And when you return homeward, the stars are switching on their silver lamps in the blue dome overhead and you will admit that it has been much better to seek the open air than to stay indoors "croodling" over the fire.

Though days are short and weather often uncertain and maybe inclement, there are many week-ends in winter when the days are sunny and mild or clear and frosty. Then we can go afield and enjoy hiking as much as in summer.

Many Youth Hostels remain open all through the winter, and there is plenty of good company gathered round the fire in the common room at evening, when all the boys, and the girls, have come in from their tramping over field and fell. Accommodation elsewhere than at the Youth Hostel is also generally more easily obtainable at this season, with the summer holidaymakers absent from the countryside.

## Sensible Dress

In winter do not sally forth in the same flimsy rig-out you wore in the summertime. You often see girls and youths—and maybe older ones—hiking in bitter cold weather in the shortest of shorts, with blue knees showing. Do not imitate them. Go forth sensibly clad in warm woollen clothing, and you will be all the happier.

Have good stout stockings or socks, with thick-soled boots fitted with "tackets". Give your boots a good dressing of dubbin before setting out. Keep your feet warm and as dry as possible, and you cannot take much harm.

In very cold and wet weather it is a good plan to line your boots with pieces of newspaper. Newspapers stuffed into boots at the end of the day will absorb any moisture. Wear warm woollen stockings or socks on winter outings; wool next the feet when tramping in cold weather means more comfort. Those who intend to spend the night away from home should carry a dry pair in the haversack, in case of need.

It is advisable to carry a good waterproof "mac" with you, or a cape that comes well down over your knees, in case of a rainy spell. It is as well, too, to carry a cap or sou'-wester, against a possible snow squall. A scarf also may prove useful. As to nether garments, possibly breeches are best for winter tramping. One's jacket will be no worse if fitted with a zipp fastener.

## Avoid the Wilds

Unless you are an experienced hiker or mountain climber avoid the wilder hills and fells in winter. If you must travel over moors and remote ridges of hills at this time of year, do not go alone. Take a companion, for it is both companionable and helpful to have someone to share the "ups and downs" of the road.

It is in winter that unfortunate incidents may occur to hikers right away in remote and wild places. They may be trapped by sudden blizzards, cut off by dense fog, or incapacitated by some accident, such as slipping on icy rock and damaging a limb.

If you cannot have a companion then carry a good whistle, with which to send forth an appeal for aid if necessary, or to attract attention to your whereabouts. In crossing moors and fells keep to the tracks and paths. Do not cross unknown moors without aid of map and compass. And do not allow yourself to get belated in the midst of a moor at winter's nightfall. Carry an electric torch in your haversack—just in case!

Even if you feel indisposed to undertake a week-end tramp in wintertime, you may select a route

near home that will occupy you for a Sunday's walk, choosing a sort of circular route that will take you out by one path and in by another. But do not plan too long a distance; keep your mileage well within limits, so that you can arrive home by dark.

## Week End Refreshments

Take refreshments with you, for it is not so easy to obtain food and drinks in the countryside on Sundays. Of course, if you are working a five-day week, Saturday is the better day for such an outing.

The countryside is ever attractive to the out-doors lover, even in winter. Choose a day when the pale sun shines along the hedgerows and slants across fields gleaming with moisture. Winter is not a "dead" season, and there are many attractive features about it that are as appealing as the soft young green of springtime.

Have you walked through a silent beech wood on a still winter's day when the wind is hushed, with the tall naked trees, so lovely of form, upstanding like the columns of some great cathedral, and not been impressed by the scene?

It is impossible not to feel dwarfed by the spaciousness of the natural aisles, so noticeable now that summer's drapery has been stripped from the wood. Only in winter, on a windless day, can you realize how wonderful is a beech wood.

## Beauties to Enjoy

The countryside teems with interesting things in winter. There are migrant birds to be seen, and some are almost "tame", allowing you a near approach. Though lacking the bright colours of summer and autumn, the hedgerows are beautiful in their nakedness, and you now get better views of the countryside, with the curtains of summer's foliage withdrawn.

So, never mind the mud underfoot; your boots will clean. Get out of doors on every likely occasion. But choose your day if you can.

## Puppets—(Continued from page 143)

This is where a bundle of odd scraps of cloth will come into its own. It is best to make a main undergarment, although this is not essential. A glance at Fig. 3 will give you an idea of the shape. The hands and forearms, already prepared, are sewn into the openings as shown.

When sorting out pieces required, choose colourful patterns, except, of course, for characters whose habitual dress is black or any particularly

sober colour. Ideas for dressing your character can be found in any illustrated book. Small ornaments and jewellery can also be used to good effect—if in keeping with character.

Plays and monologues can be used in presenting puppets to your family and friends. An improvised stage can be made, using a three-sided clothes-horse and curtaining. A provision box can be adapted for use as a

stage, size approximately 2ft. by 1ft. by 1ft. Even curtains and lighting can be fixed as needed.

Once tried, you will find puppetry an absorbing hobby, and when proficient, perhaps a profitable one. But do remember, when glancing round to gain inspiration for the features of your character, be careful not to be too accurate, or, who knows, you may find somebody suing you for libel!

# Home entertainment can be provided with this SIMPLE EPIDIASCOPE

HERE is just the thing to make for a little quiet diversion for the dark evenings. It is an epidiascope and will show snaps, etc. greatly enlarged on a screen. All you need is a few odds and ends, a few electric fittings, and a camera with a fairly big lens.

Obtain a stiff card box roughly of the proportions shown and placing your camera at one side mark how high the lens comes. Here cut a round hole and on the inside fit a card cone (a), which is held over the hole by glued angle-pieces and by the two sheets of white card (b) glued to the sides of the box and curved round to the edge of the cone. They are secured there with pronged paper-fasteners.

## Lamps Needed

Two electric lamps are now hung in the curve formed by the cards. These are suspended from the top of the box by their own flex, the height being such that the brightest part of the

WHITE  
CARD

CAMERA

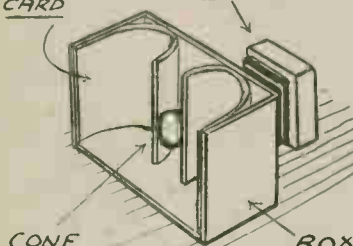

CONE BOX  
A back view of the box and shades

bulbs is level with the centre of the lens. The lamps are wired together in parallel and plugged in to a light socket. They are kept at the right

height by a little insulation tape wrapped round the flex where it enters the card.

At the back of the box, right opposite the cone an opening about 2ins. by 3ins. is cut and fitted along the base and one side with lipped strip of wood fastened by pins.

This back can be a separate sheet of card pushed into the open end of the box and held by its turned-down edge, as (c), or it can be an existing side.

## How to Use

All is now ready. Set the box on a table with your camera in front of the hole with the back off and shutter open. A picture now placed against the opening in the back will appear on a screen rigged up in front of the camera. Sharp focus is obtained by moving the camera as a whole in and out.

If the picture goes straight to the screen it will be the wrong way round but this doesn't matter for many subjects. Reversal can be secured, however, by placing a mirror at 45 degrees in the path of the rays. The

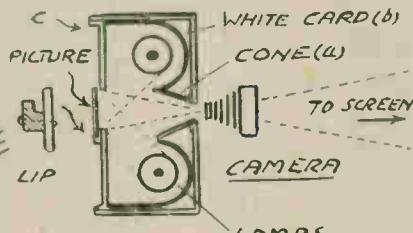

Top sectional view of apparatus

light now shoots off at right-angles and the picture projected on a screen in the new path will be right way round.

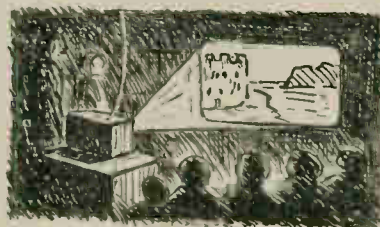

Running a home "show"

It is important to bear in mind continually that the picture on the screen is entirely built up of reflected rays not direct rays as with the magic lantern. This means that every care must be taken not to lose light. To this end a screen which sends back a lot of light to the eye should be used. Screens differ in this respect.

A white-washed board is good, but some apparently white cloths absorb a lot of the rays and give a dull picture. Aluminium-coated plywood also yields a bright result as do the official home cine screens, if you can get one.

## Points to Note

In the epidiascope itself, see to it that the lens is at full aperture and that the glass surfaces are perfectly clean. The reflector cards must be a good white and the lamps adjusted so the fullest brilliance is obtained.

Remember too that bright, clean pictures give better results than dark heavy ones. It is no good blaming the epidiascope if it will not give a satisfactory projection from a snap you can hardly see even through a microscope.

Finally remember that people generally would rather see a smaller bright picture than a bigger one that is dull and a strain to look at.

## Crystal Set—(Continued from page 145)

If smaller diameter formers, or thicker wire, are used, then rather more turns will be required or high wavelength stations may not be reached. However, the actual number, or gauge of wire, is in no way critical.

Fig. 1 shows all the connections, and they can be checked as follows:

Aerial terminal to Detector, to fixed plates of tuning condenser, and to 1 on coil. Earth terminal to moving plates of tuning condenser, to one "switch" terminal, to 3 on coil, and to one Phone terminal. Second Phone terminal to Detector. 2 on coil to second "switch" terminal.

Connections will be easier if the ends of the windings on the coil are left long enough to reach to the various terminals.

With Aerial, Earth, and Phones connected, signals should be heard when the tuning control is turned. The detector, if of the adjustable type, should then be set so that volume is as great as possible.

Droitwich, broadcasting the Light Programme on the Long Waves, is particularly well received throughout the Midlands. Listeners farther away will naturally suffer some reduction in signal strength.

The Medium Wave transmitters are arranged to serve certain parts of the country, and the stations received will depend upon the locality. If it is desired to alter the wavelength to which the coil tunes, then turns can be added to increase the wavelength, and vice versa.

Because of the circuit which must

be used, crystal sets cannot tune very sharply. Furthermore, modifications which sharpen tuning also cause a reduction in volume. But in some localities it may be felt some volume can be sacrificed, and a condenser of about .0001 mfd. to .0003 mfd. can then be connected in series with the aerial lead-in. A pre-set condenser is best, as it can be adjusted to the most suitable value.

A similar effect can be obtained by reducing the length of the aerial, or by taking the aerial to a tapping on the coil. The more turns this tapping is from point 1 on the coil, the sharper will tuning become.

For all general purposes however where maximum volume is required connections should be made just as illustrated

**£5** to £20 weekly earned at home, running your own Mail Order business. Details 1d.—Stebbing Publications Ltd., (HB) Naphill, High Wycombe.

**MAKE** money from making models. See our new instructive book on this subject. Post 2/9.—Sutton Models, Billericay.

**NEW** Magic Tricks for Christmas. Crazy cut-ups 6d., grand party trick. Bumper lists of America's latest—3d.—De Hempsey, 363 Sandycroft, Kew Gardens, Surrey.

**B**LUSHING, shyness, nerves, self-consciousness, fears ended. Details under plain cover 1d.—Stebbing Treatment, 28 (HB) Dean Road, London, N.W.2.

**PRESSED** Metal wheels. Per dozen, 2in.—9d. 1in.—1/-. 1½ins.—1/3. 2ins.—1/6. 2ins. (special quality) 1/9. Per gross, 2in.—6/6. 1in.—7/6. 1½ins.—9/-. 2ins.—12/-. 2ins. (special quality) 15/-. All prices inclusive of purchase tax, postage and packing. Immediate despatch. Doll's house windows, doors, fireplaces. Illustrated catalogue 3d. (Trade supplied).—Jasons, 135 Nags Head Road, Ponders End, Middlesex.

**A**BSOLUTELY free—two tricks, Magic Magazine, lists of easy-to-do conjuring tricks, details of Magic Club. Enclose 6d. P.O. to cover postage.—Sid Sonall, Birmingham, 13

**H**OME Movies, Projectors, Films, 9.5, in great variety. Sale, hire, lists, stamp.—Wayland, 223 Longley Road, Tooting Junction, S.W.17.

**B**E Taller in 14 days or money back. Details, 1d.—Stebbing System, 28 (HB) Dean Road, London, N.W.2.

**T**HE MOST enjoyable hobby of all. Piano playing. George Ashburnham's postal course is easily followed to its final stages.—APM (53), 3 Ayrway, Romford.

**P**ERSONS required to make ladies' belts and fancy goods in spare time.—Dept. 3, Somat Plastic Co., Ltd., 8 Middlemarsh, Nottingham.

**P**ERSONS required immediately to make leather goods in spare time. Write—Dept. 11, Empire Co., 117 Nottingham Road, Loughborough.

**S**TAMPS unlimited. Special agent offers 25 free with super approvals. Postage 2½d.—Jones, Messines Park, Londonderry.

**P**LASTICS. Catalin sheets, rods, cylinders and profiles. Perspex sheets and offcuts, clear and coloured, glues, polishes and transfers. Send stamped addressed envelope for details.—Eastern Plastics, Church St., Westbury, —Wilts.

**C**IGARETTE card collecting. Fascinating hobby for young and old. Catalogue of sets and odds, 3d.—O'Neill, 68 Lavender Vale, Wallington

**S**TAMPS FREE!! Twenty unused (2½d.).—G. H. Barnett, Limington, Somerset.

**P**ERSPEX products pay, so model in the latest medium. Kit comprising brooch pins, delicate coloured bases, handcraft wax (gold, ivory and pastel shades), stiletto, plans, etc. for six superb brooches, price 7/6d.—Also Cigarette/Trinket Box kit 6/11d., and artistic pink and clear Toast Rack set 7/11d. Postage and packing 7d. Polish and cement available. Perspex cut to requirements.—Plastics Home Products, 18 St. Mary's Road, London, N.9.

**P**ETS, by Harper Cory. 48pp of practical tips on how to look after pets of all kinds. 61 illustrations. 1/6d from booksellers, or post free 1/8d. from—Mayflower Publishing Co. Ltd., 17 Farringdon Street, E.C.4.

**M**ODELS: you can make lasting stone-hard models with Sankey's Pyrama Plastic Cement. Supplied in tins by Ironmongers, Hardwaremen and Builders' Merchants. Ask for instruction leaflet.

**C**ASTING moulds for lead soldiers, Indians and Cowboys, animals and novelties. Sample mould 4/-. Catalogue 6d.—Industries, 2 Waldegrave Park, Twickenham.

**"MODERN Wood Toymaker"**, a new handbook with 192 effective designs and illustrations, 2/6 posted.—Industries, 2 Waldegrave Park, Twickenham.

**S**ET of Liberia Triangulars free to approval applicants, 2½d. postage.—Kirby, (T), 96 Taunton Way, Stanmore, Middlesex.

**J.** McGARRIGLE & Sons for aero-plane and ship kits. All accessories new illustrated price list 6d., wholesale lists 9d. Retail stamps list 4d.—43 Purbeck Road, Romford.

**N**EW designs painted on plywood, ready in the new year. Watch our announcement.—Cleaver, 50 Windsor Road, London, N.W.2.

**S**URPLUS bargains for the model maker. Battery electric motors 9/6, 15/- and 17/6. All post extra. Twin magneto switches 11d. (post 7d). Switches: single, tumbler, 1/11 (post 7d). Triple 4/6 (post 9d). Five bank 5/11 (post 1/-). Sixteen bank 7/11 (post 1/4). Dark room lamps with 230v. bulb and flex, 9/6 (post 1/6). Mains F.H.P. motors 200-250v. 25/- (post 1/6). 5 stage epicyclic gear 600-1 reduction (approx. 3ins. by 2ins. overall) 15/- (post 1/-). Send 3d. stamp and S.A.E. for lists—Milligans, 24 Harford Street, Liverpool 3.

**D**OLL'S House fittings and papers, send S.A.E. for list. Doll's house plan special, send 2/6. Trade supplied.—Zimplan, 88 Ware Rd., Hoddesdon.

**W**HEELS for Toys in metal, wood and plastic. Numerous sizes and types. Write for list, stating requirements to The Joyden Toy Co., 193 Chase Side, London, N.14.

**J**ET plane stamp free and free gift for all genuine applicants for my approvals. S.A.E. please—M. Terry, 46 Church St., Middlesbrough.

**L**ONELY? Join Friendship Circle—Details 6d.—Secretary, 34 Honeywell Road, London, S.W.11.

**"POWER Tools You Can Make."** Famous "Popular Mechanics" plans and constructional details for building drilling machine, jig-saw, band saw, lathe etc. All from readily available materials, 12/6d. only, post 7d. Illustrated lists 3000 American Homecraft books, plans, magazines 6d.—BCM/PUBLICATIONS (H) London, W.C.1.

**T**HE interest in car numbers never ceases. "Where's That Car From?" containing all the car index marks alphabetically arranged. 54 pages 6d. Now in its sixth edition. From all newsagents.—Raleigh Press, Exmouth.

**B**IRD & animals collection! Attractive used set five Australian stamps (Cat. 1/-) Free! Request approvals (2½d.).—Williams, "Dunromyn", Castle Lane, Carisbrooke, I.O.W.

**A**LL-METAL Chassis designed for mounting Animal etc., cut-outs. Green platform (6ins. by 2ins.) fitted with 1½ins. red or yellow wheels. Stove enamel finish. 1/9d. each post paid. Reduction for quantities.—Joyden Toy Co., 193 Chase Side, London, N.14.

**F**REE—North Borneo pictorial packet of new issues overprinted with the Royal Cypher. Request approvals (2½d.).—Thompson, 2 Western Gardens, London, W.5.

**B**E Taller. Quickly! Safely! Privately! No appliances—no tablets—no dieting. Details 6d. stamp.—Malcolm Ross, Height Specialist, BCM/HYTE, London, W.C.1.

**L**ONELY? Then write Secretary L.U.C.C., 5B.B. Hay St., Braughing, Herts. Genuine. Est. 1905.

**P**ROFITABLE hobby—make leather goods and help production. Write for details etc.—Dept. 39, Wearwell Products Co., Saxone Buildings, 2 Tarleton Street, Liverpool.

**T**RANSFERS for decorating toys, trays, furniture, fancy goods. List and samples free. Flowers, pixies, dogs, nursery rhymes.—H. Axon Harrison, Jersey.

**F**OR your Hobbies Exposure Meter light cells 6/6d. Meter movements 7/10d. Moulded cases 8/10d. All post free.—Surpluses, 8 Shanklin Drive, Filton, Bristol.

**E**LECTRIC Train Kits. Exact OO scale, finest line ever produced. Illustrated catalogue 6d.—Sutton Models, Billericay.

**U**SE a Brook "CUB" motor in your workshop. Single phase split phase motor ½ H.P. Obtainable from your local electrical contractor or small tools dealer.—Brook Motors Ltd., Empress Works, Huddersfield.

**C**ANADIAN Silver Jubilee set free to all requesting approvals. Without approvals 9d. Postage please.—H. A. Smith, 13 New Road, Scole, Diss, Norfolk.

# Patterns for the SHOOTING ALLEY

For details see page 147

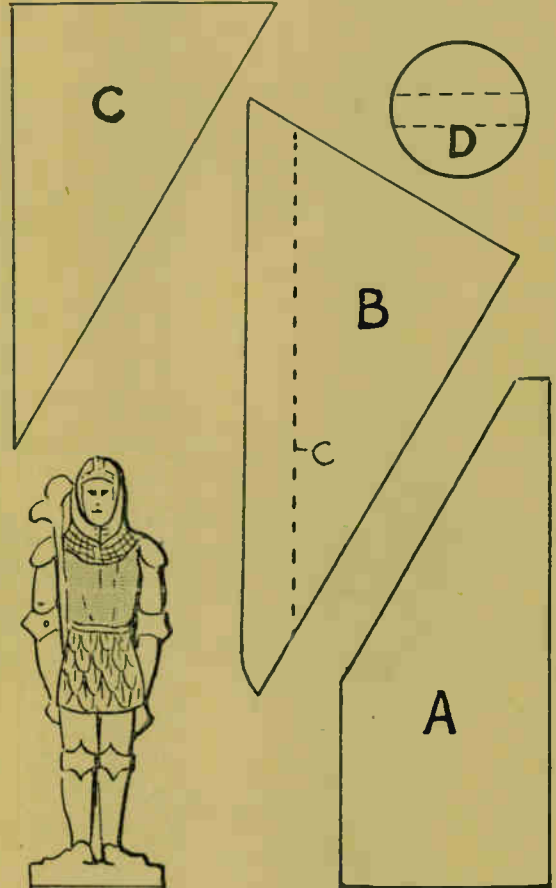
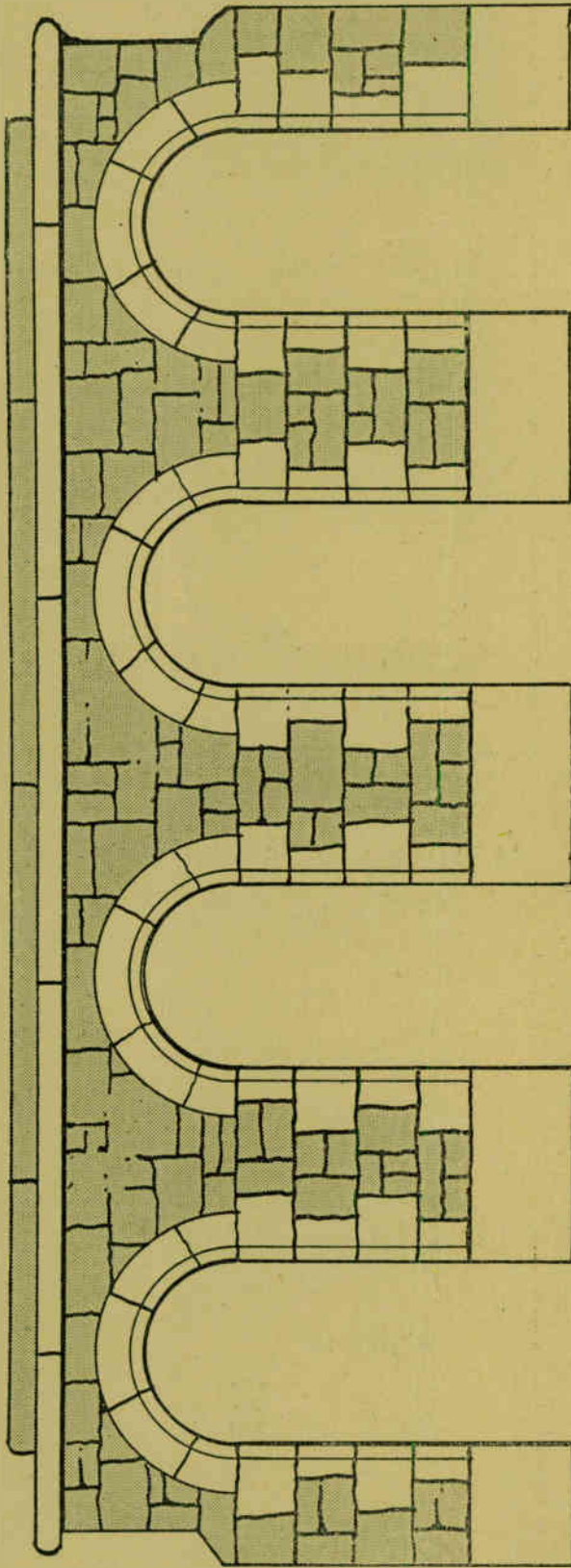



Brilliant England centre-forward,  
the 'wisest head in Soccer' . . .

# Tommy Lawton

SAYS

*"Here's how I cross roads . . ."*

"Fancy foot-work scores on the football-field, where you want to confuse the other side's halves and backs. But on the road, confusion is the last thing you want — it's much too dangerous. Head-work is the thing, when you're crossing a street. Here's how I do it:

- 1 At the kerb — HALT
- 2 Eyes — RIGHT
- 3 Eyes — LEFT
- 4 Glance again — RIGHT
- 5 If all clear — QUICK MARCH

"I take it calmly — no running and dodging — because I wait for a proper gap in the traffic first.

"If you misjudge things in Soccer — well, you're very seldom hurt, anyway. But if you take chances in traffic, and a car or lorry charges you, you may be killed. And the same accident may kill other people. So watch your step, be a good Road Navigator, and cross all streets the Kerb Drill way." *T. Lawton*

Issued by the Ministry of Transport



*Get this book - make these MODELS*

HOUSES · SHIPS · ASHTRAYS · BOOKENDS  
SIGNAL CABINS · RAILWAY STATIONS  
AIRPORTS · DOCKS · RELIEF MAPS · PLAQUES  
MODEL FURNITURE · INKSTANDS · PAPER  
WEIGHTS · MODEL FIGURES & ANIMALS etc.

**SIMPLE TO HANDLE · INEXPENSIVE**

The Instruction Book illustrated tells you how to make such models as above, without special tools or skill, in Sankey's "Pyrum" Plastic Cement. This material, modelled while plastic, dries or bakes to stone-hardness, ready for painting according to instructions. Obtainable at local ironmongers, hobby-shops and art material dealers.

Get Instruction Book by sending 4d. in stamps to the address below



Dept. 3

**J.H. SANKEY & SON, L.P.**

ILFORD

Est. 1857

ESSEX



# QUALIFY FOR A BETTER POST

—by Post!

Let the most progressive, most successful College in the world coach you by correspondence. Choose your career or be advised by us. We take a personal interest in all our students and provide the friendly individual training that quickly leads to success. Make the first move NOW—write for free particulars.

## ★ CHOOSE YOUR CAREER NOW

Blue Prints.  
Book-keeping, Accountancy & Modern Business Methods.  
Building, Architecture and Clerk of Works.  
Cambridge Senior School Certificate.  
Carpentry and Joinery.  
Civil Engineering.  
All Commercial subjects.  
Sanitation.  
Shorthand (Pitman's).  
Concrete and Structural Engineering.

Draughtsmanship.  
Heating and Ventilating.  
Institute of Housing.  
Languages.  
Mathematics.  
Matriculation.  
Municipal & County Engineers.  
Plumbing.  
Quantity Surveying—Inst. of Quantity Surveyors Exams.  
Structural Engineering.  
Surveying.  
Teachers of Handicrafts.

If you do not see your own requirements above, write to us on any subject. Full particulars free.

Direct Mail to **DEPT. 62**

The **Bennett College**  
SHEFFIELD

## You Can Become a HANDICRAFTS INSTRUCTOR

Experience not essential

Men who enjoy making things in wood or metal can turn their hobby into a well-paid, permanent and interesting Career. Short hours, long holidays, and security in a job you would really enjoy, can be yours if you become a Handicrafts Instructor. Let us send details of the easiest and quickest way to get the necessary qualification.

We definitely guarantee  
**"NO PASS — NO FEE"**

If you would like to know about our unique method of preparing you for one of these excellent appointments, write today, and we will send you our informative 108-page Handbook-free and without obligation. Mark your letters "Handicrafts Instructor."

**BRITISH INSTITUTE OF ENGINEERING TECHNOLOGY**

595 Shakespeare Ho., Stratford Place, London, W.1

## Hobbies Handbook for 1949

1/-

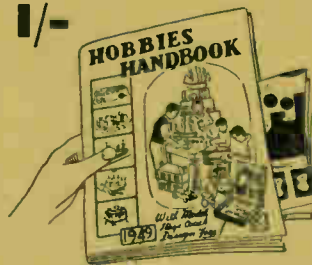

The new edition is now on sale. Revised and brought up to date. 68 pages. Large free design for Model Stage Coach. Coloured sheet of Air Transport. Interesting articles and instructions. Hundreds of things to make.

From Hobbies Branches, newsagents, bookstalls, etc., or sent post free for 1/2 from Hobbies Ltd., Dereham, Norfolk.



# Hobbies

## WEEKLY

### CONTENTS

	Page
Lightship Electric Table Lamp	153
Novel Trump Indicators	- - 155
Radio Hints	- - 156
How to Stain and Polish	157
A Fabric Finish	- - 159
Making Miniature Vehicles	- 160
Craftsman's Notes	- 161
Trump Indicator Patterns	- 163
SUPPLEMENT DESIGN SHEET FOR NOVEL PERPETUAL CALENDAR	

December 29th, 1948

Price Threepence

Vol. 107 No. 2774

## ELECTRIC TABLE MODEL OF THE "NORE" LIGHTSHIP

**A**T the mouth of the Thames lies the submerged "Nore" sand-bank, and, since 1732, there has been a special lightship always stationed there to warn the mariner. This old ship forms the feature of

our design for an electric table lamp, and the novelty should appeal to many who take an interest in ships and shipping. It is a side table electric lamp. The lamp is not in the true sense a model, but it certainly has the almost correct outline and rigging of

the real ship which many holiday-makers know.

The total length from bow to stern is 10 ins., mounted upon a base  $\frac{1}{2}$  in. longer than the hull. Part of the hull, towards the stern, is made hollow to contain a dry battery, and from this, wires lead to the lantern. Within the lantern is an electric flash-lamp bulb held by a bakelite holder to which the connecting wires are most easily fixed.

To the upper mast there is fixed the warning ball, a feature always looked for in buoys and lightships. There is a raised deck abaft the mast, and this is really the cover to the "well" in the hull holding the battery. The cover is screwed to the deck and is therefore easily removable when a new battery is to be installed within.

The only deck fittings shown are a dinghy or lifeboat, and a hatchway cover near the bow.

### Commencing Construction

In the construction of the lamp, commence with the base, a piece of  $\frac{1}{4}$  in. thick wood 10  $\frac{1}{2}$  ins. long by 3  $\frac{1}{2}$  ins. wide. The actual shaping of the two ends of the piece cannot be undertaken until the hull is made, because the outline of the base follows closely that of the hull itself.

To make the hull we require three pieces of  $\frac{3}{8}$  in. thick wood 10 ins. long by 3  $\frac{1}{2}$  ins. wide. Each must be shaped as shown at A in Fig. 1. The pointed bow and the bluff stern shaping is quite simple in outline. Before, however, cutting the three pieces to outline, it will be well to make the deck B, Fig. 1. Set out as shown on  $\frac{1}{4}$  in. wood and cut with the fretsaw.

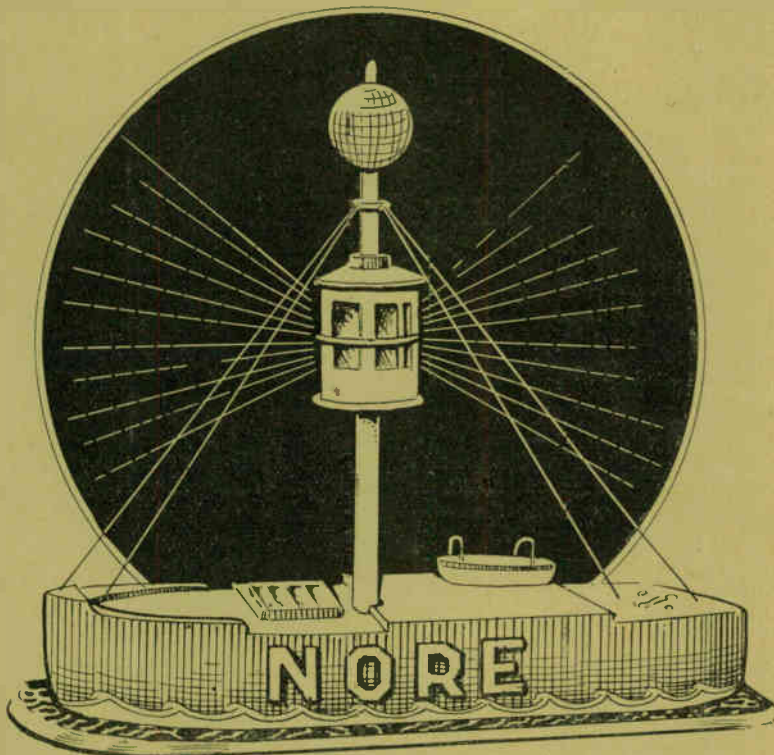

All correspondence should be addressed to The Editor, Hobbies Weekly, Dereham, Norfolk.

Lay the piece on each of the plain pieces A and mark round the outline and the inside opening at the stern. The opening at the bow will not be repeated in the hull pieces A. The  $\frac{1}{4}$  in. diameter hole for the mast is cut in deck B and in one only of the pieces A. Glue the four pieces together and while the glue is hardening, piece D, forming the raised bow, can be outlined on to  $\frac{1}{4}$  in. wood and shaped up.

### Shaping the Hull

At this point the job of smoothing and cleaning up the hull must be done. In Fig. 2 we see how the bow shaping is carried back on the water line. This can be done with the rasp and file.

After the actual shaping at the bow and the gradual levelling down of the three glued joints, both surfaces will need a thorough rubbing with coarse glasspaper and a final finishing and polishing with a very fine grade

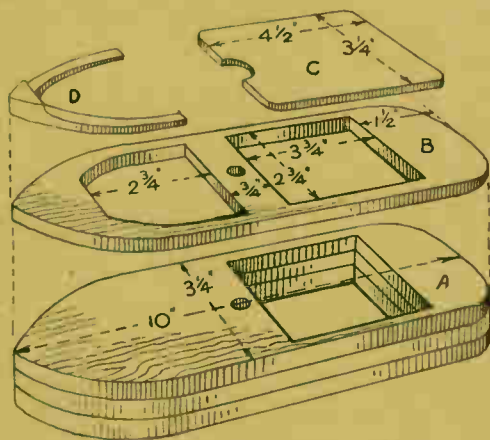

Fig. 1—Parts forming the hull and deck

eventually be fixed to the deck by four round-head brass screws.

The mast is in two distinct parts, the first part extending up from the deck to the lower section of the lantern, the upper part going up from the roof of the lantern to the extreme top. There are two methods of making it. It may be simply a length of  $\frac{3}{8}$  in. round rod measuring  $3\frac{1}{2}$  ins. long and run into the deck for a depth of  $\frac{1}{2}$  in. Or it may be hollow, so the wires connecting the lamp and the switch and battery below may be carried through it, and therefore out of sight.

In the latter case the mast will still be  $3\frac{1}{2}$  ins. long, but made from stout paper pasted over on one side and rolled on to a piece of rod about  $5/16$  in. diameter. Sufficient paper must be rolled so that when perfectly dry it is stiff and firm enough to support the lantern etc.

below. Now it is over the two discs B and C that the lantern fits tightly, and in the diagram (Fig. 3) the upper part of the lantern is shown drawn upwards and away from its fixing.

The top of the lantern consists of the three discs D, E and F, and it is into these that the upper mast will be glued. Disc D is similar to C only it has a  $\frac{1}{4}$  in. hole made in it. Disc E is  $1\frac{1}{2}$  ins. diameter and has the sloping surface shown to represent the roof to the lantern. Disc F is plain and  $\frac{3}{4}$  in. diameter and  $\frac{1}{4}$  in. thick.

### Fixing the Bulb Holder

All three are glued together and the top mast glued into them. This top is of  $\frac{1}{4}$  in. rod  $3\frac{1}{2}$  ins. long. From just above the disc F the mast is tapered slightly and rounded off evenly and neatly at the top. The ball at the extreme top of the mast can be made from cork or from modelling clay.



Fig. 4—Bulb holder parts



Fig. 5—Lantern card

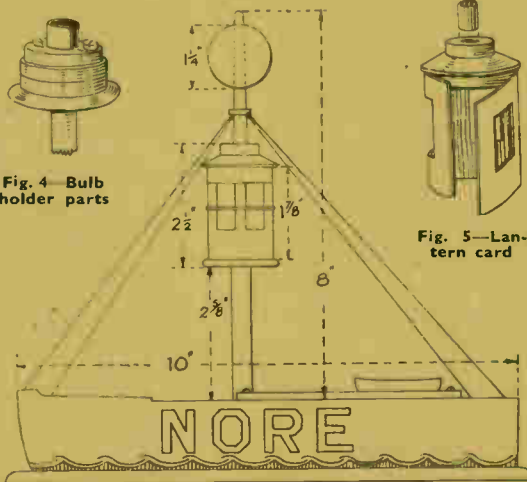

Fig. 2—Side view with helpful dimensions

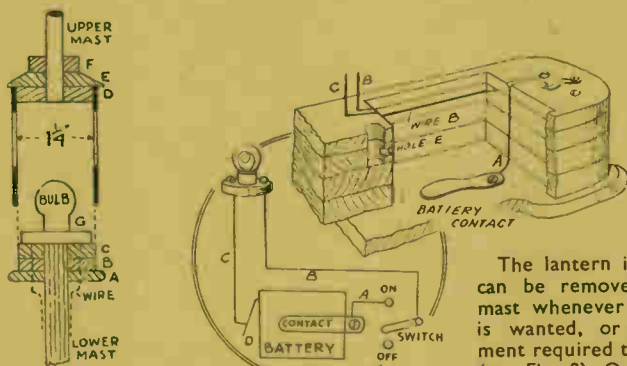

Fig. 3—Lantern sections

Fig. 7—The wiring details

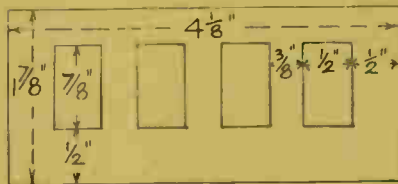

Fig. 6—Shape of lantern case card

The lantern is made so it can be removed from the mast whenever a new bulb is wanted, or any adjustment required to the wiring (see Fig. 3). On top of the lower masts are glued the three members A, B and C. Each is a disc of wood—A  $1\frac{1}{2}$  ins. in diameter and  $\frac{1}{4}$  in. thick, B and C  $1\frac{1}{2}$  ins. in diameter and  $\frac{1}{4}$  in. thick. They each have holes to take the mast. Glue all together and afterwards glue to the mast.

To the topmost disc is screwed the bakelite holder G. The wires from this pass down through holes bored in the discs to the battery and switch

Fig. 4 is a helpful diagram showing the lower members of the lantern and the method of placing and fixing the bulb holder. In Fig. 4 also we see the top section of the lantern with the side of it being bent round.

This side consists of stout card cut to the pattern given in Fig. 6. Draw the outline and then cut with a sharp pocket knife or a safety razor-blade. Slightly moisten the card in order to bend evenly round the disc D and the lower discs B and C. The top of the card only is glued to its disc, and one or two brass pins run in to make a firm fixing. Get a neat butt joint

paper. The base, with edges rounded, can be fixed on to the hull with glue and screws (Fig. 2).

For the upper structure of the lamp, leading dimensions are given in Fig. 2. The deck cover piece C can be of  $\frac{1}{4}$  in. or  $3/16$  in. wood cut to the shape given in Fig. 1. Note how one edge is hollowed out where it fits round the mast. The piece will

(Continued foot of page 160)

# Any card players would appreciate having these novelty TRUMP INDICATORS

**H**ERE are three subjects for our novelty seekers. Trump indicators are one of the many articles that can be made up quickly, and lend themselves to simple cut-outs in wood, with added decoration in colour. Two of our suggestions given here take the form of moving pointers to the particular trump chosen, the third is somewhat different, being first a box container for a pack of playing cards, while on the lid a shaped pivoted clock-hand tells the particular trump suit. Both figures are fixed to movable bases which are pivoted to turn as required.

## Patterns Provided

We devote a whole page to the outlines of the different pieces, thus simplifying the work of the cutter. All he has to do is to stick the patterns down to the wood and cut out. Should two or more indicators of the same design be wanted, then he can mark round each separate piece with a sharpened pencil direct on to the wood.

First then, taking the dog design, use piece, A, on pattern sheet as a

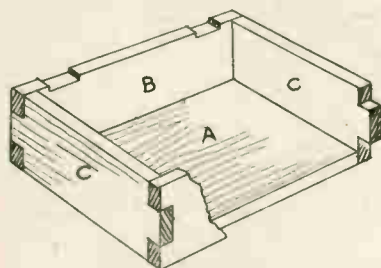

Fig. 1.—How the box is made

base and cut this from either  $\frac{3}{16}$ in. or  $\frac{1}{4}$ in. wood. After cleaning and rounding off the four upper edges of the wood, cut and glue the pieces, B, to the underside which will give the necessary tilt to the indicator to expose it conveniently to view. If these pieces, B, require further strengthening, then some strips of, say,  $\frac{1}{4}$ in. by  $\frac{1}{2}$ in. wood could be glued in the square angles underneath, where they will not ordinarily be seen.

## Bird Marker

The trump markings should be drawn in over carbon paper to get their exact positions before being painted on. Now cut the round disc, C, from  $\frac{3}{16}$ in. or  $\frac{1}{4}$ in. wood, and bore a small hole centrally to take the pivot screw.

The three parts forming the bird, parts D and E, will be cut from  $\frac{3}{16}$ in. wood. The feet of the bird are afterwards glued to the disc, C,

according to the dotted lines shown on C. Glue the legs to the body parts of the bird before the former are finally glued to the disc. Take care that the legs are accurately placed.

When the painting has been done and the feet glued to the disc, the whole is pivoted to the base by running through the piece, A, a round-head screw into the disc.

Allow sufficient clearance for this to turn freely.

## The Dog Indicator

Our second design needs little instruction for the making up. First make the base, F, from  $\frac{3}{16}$ in. or  $\frac{1}{4}$ in. wood, and at the round end of this glue on the disc or toe, G, which tilts it slightly. The front edge of piece, F, could be rounded off with coarse and fine glasspaper. The disc, H, is cut from  $\frac{3}{16}$ in. or  $\frac{1}{4}$ in. wood with small hole in centre.

The three parts, I and J, forming the dog are next cut, painted and glued to the disc. The latter is then pivoted similarly to our previous design.

The dog should be painted white with black spots, so the tail will show up well against the base which, doubtless, will be the plain wood varnished over. The trumps are put on in brilliant colours of red and black.

## A Simple Box

Our third design takes the form of a box to contain a pack of playing cards. On the lid is a pointer or hand which moves around to point at any one of the five trump indicators.

The size of our box inside will measure  $3\frac{1}{2}$ ins. by 3ins. by 1in. deep. The top of the box forms the lid for opening, and a pair of small brass hinges will be recessed into one of the long sides of the box as shown in the detail, Fig. 1. It will be noted in this diagram that a portion of the near long side has been cut away to clearly show how the pin-joint comes in relation to the floor, etc.

The box is strongly put together with the pin-joint or lock method at the corners. We require one piece for the floor, A, measuring  $3\frac{1}{2}$ ins. by 3ins.; two pieces, B,  $4\frac{1}{2}$ ins. by  $1\frac{1}{2}$ ins. for the long sides, and two pieces, C,  $3\frac{1}{2}$ ins. by  $1\frac{1}{2}$ ins. for the ends. Wood is  $\frac{3}{16}$ in. or  $\frac{1}{4}$ in. thick. The lock joints

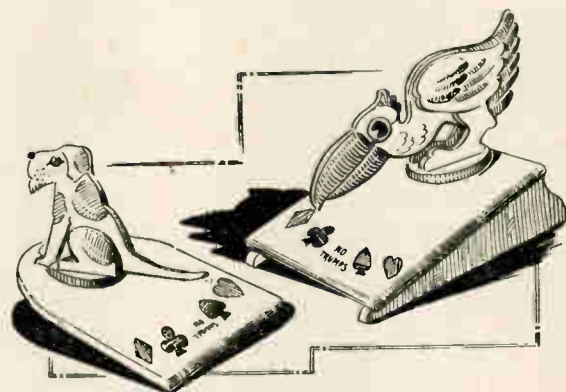

Patterns for main parts are on page 163

at the angles of the box make a very strong joint.

The pin cut on each end of pieces, C, should be  $\frac{1}{4}$ in. wide, the corresponding open mortise being cut to admit it stiffly. Do not, however, have too tight a fit or the top and lower pins on the long sides will tend to split away.

## The Lid

The lid will be of such size that it will lie flush with the sides and ends all round. The hinges, after being screwed into their recesses, should be screwed on flat on the underside.

The five trumps again will be painted on the lid after the whole box has received a thorough glass-papering. Then the pointer or hand shown as K on the pattern sheet, will be cut from  $\frac{1}{4}$ in. or  $\frac{3}{16}$ in. wood and attached to the lid by a round-head screw, a thin card or composition washer being added beneath the head.

## Perpetual Calendar Design

Here's a novel calendar, to last for years, made to the patterns on this week's gift design sheet. A kit of wood (No. 2774) is supplied by any Hobbies Branch for  $\frac{2}{8}$ , or sent post free from Hobbies Ltd., Dereham, Norfolk, for  $\frac{3}{5}$ .

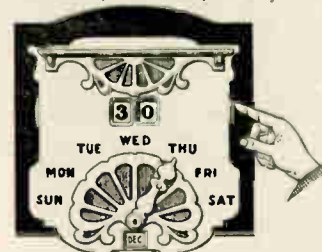

# You will be sure to find something of interest in these RADIO ODDS AND ENDS

SOMETIMES, for the sake of convenience and the neat appearance of the front panel of a home-made, battery-operated, radio set, a rotary switch is required—not the usual type of toggle switch. A simple rotary switch can be made from an old wire-wound variable resistance. This, being old, will be fitted with three terminals. It is only a matter of removing the resistance wire and fitting ordinary enamelled wire of similar gauge.

The enamelled wire is connected in the same way as the resistance wire, but there should be a "break" half-way between the ends. Having removed the enamel from the edge of the copper wire for contact with the slider, the component is mounted on the front panel in the desired position. The L.T. wire from the battery is taken to slider terminal. A second wire is connected to one of the other terminals and taken to the L.T. line of the circuit.

In other words, fit the rotary type switch where the normal toggle switch would be fitted, or rather, where it would be connected. A turn of the knob should switch on the current, or switch it off, either to the right or left, according to which two terminals are used. The central terminal must have the L.T. wire connected to it.

IT'S a great pity that the manufacturers of radio valves, resistances, condensers, etc., do not mark the values of these components more permanently. After a time, the stampings wear off, due to handling, and the amateur radio enthusiast is often confused, particularly in the case of a second-hand item.

In the old days, of course, most radio parts were properly marked or stamped and, where possible, connection terminals were provided. At the present time, to save space, components are given soldering tags, which are rather an inconvenience to the experimenter. In the case of small condensers and fixed resistors, many of these have their values indicated by means of the colour-code system. At present, one has to look for the body, tip and spot colour.

If the body of the resistor is red, the value is 2. If the tip is green, the value is 5. If the spot is orange, the value is 3, meaning three noughts, thus: 000. To find the total value in ohms, one writes down the figures in a line, in the order mentioned, which gives us 25,000 ohms.

Admittedly, some manufacturers take the trouble of attaching a label on small, fixed condensers or resistors, which means that the amateur is more

inclined to buy goods which are neatly labelled, or permanently marked.

Regarding the mains-operated valves, most of these bear a reference mark and the name of the manufacturer. The same can be said of battery valves. The beginner, however, often wants to know what kind of a valve it is, the filament current, anode current, amperage and so forth.

In the case of a mains valve, the heaters could be 4 volt, at 3 amp., or 6 volt, at 3 amp. The base pins, too, could have letters imprinted nearby to show the filaments, the anode, grid, screen-grid, etc. This, perhaps, is asking for too much attention, but a base label, showing the normal valve data, would be greatly appreciated.

FOR the benefit of readers who have colour-coded resistors in hand, here are ten colours, and their respective value figures, as used in the colour-code system:—

0 — Black	5 — Green
1 — Brown	6 — Blue
2 — Red	7 — Violet
3 — Orange	8 — Grey
4 — Yellow	9 — White

By the way, two extra colours are used in the system. These are added to the end opposite to the tip to indicate the tolerance, such as metallic gold (a 5 per cent tolerance) and metallic silver (a 20 per cent tolerance).

Moreover, when there is no spot or top colour on a resistor, one has to take the body colour as indicating these colours. Thus, a resistor which is entirely red in colour would, according to the system, have a value of 2-2-00 ohms, i.e. 2,200 ohms.

BRIMAR base valves, which have six pins, seem rather hard to obtain. Seven-pin and eight-pin valves are more popular, and the use of the six-pin type mentioned should be avoided, as you may have some difficulty in replacing them—or even getting a suitable holder for them. These six-pin valves are indirectly-heated mains types, the most popular being the 6CB triode, the 43 pentode and the 25Y5 rectifier.

There is nothing seriously wrong with these particular valves; they are

*WILL readers note that additional paper which is being allowed to newspapers next month, does not extend to weekly and monthly periodicals such as ours? We regret therefore, being unable to supply copies to those patient would-be readers who are still waiting a return to better times.*

quite efficient, but rather scarce at present. One good thing about them, from the beginner's point of view, is that the heater pins are much thicker than the other four pins, and thus easily distinguished.

THE amount of "hum" present in a detector-pentode valve set, operated by D.C. mains, is usually quite low, even with using a plywood chassis. Much of the humming, however, can be reduced by using screened wire for connection purposes, the wire braiding being connected to earth.

In the case of a 2-valve amplifier, the input leads and anode wires should be screened. This special wire can be obtained at most radio supply shops. As a special note, the metal, braided sleeving must not touch any component to which the insulated wire may be connected. Bare the rubber suitably for connection purposes, and have the metallic sleeving cut so it does not touch the bared wire.

THE normal power pack, for D.C.-A.C. mains operation, generally consists of a smoothing choke, two smoothing condensers, a ballast resistance and a rectifier valve. For A.C. use only, a mains transformer is needed, this serving to supply a suitable high tension current, and low tension currents for the valves. No ballast resistance is required, but the unit will only work off A.C. supplies.

An all-mains unit should have a choke of 300 ohms, 20 henries, at about 40 m/a. The smoothing condensers should be electrolytic, with a peak voltage of 250, and a capacity of 8 mfd. The ballast resistance (mains-dropper) should be of 800 ohms., and 3 amps. This is suitable for a mains of 110 to 250 volts.

Greater smoothing will result if twin chokes and three condensers are used. Two twin 10 henry chokes and three 8 mfd. condensers connected together give fair smoothing. The chokes are first connected together, with the condensers (now called capacitors) connected to the outside of the chokes, with one in the centre, and all the negative (black) ends of the condensers earthed; if desired, the central condenser—sorry!—capacitor, could be a 4 mfd. type, or 6 mfd. type. Twin 20 henry chokes should ensure absolute freedom from hum.

Incidentally, no "raw" A.C. should be applied to the electrolytic capacitors, particularly with the polarity reversed. The earth ends must always be connected to earth wires, or the earth line of the circuit.

# Amateurs should know how to complete woodwork with STAIN AND POLISH

**M**ANY of our readers write us in a state of indecision as to how to finish off the woodwork which they have undertaken. The general request is for staining and polishing, for completing the article by polishing, and the application is for how to go to work. These few notes will therefore be of general interest, and those who have not previously attempted to finish their job in this way may be persuaded to do so.

## Before you Commence

When you realise the amount of time and patience which is expended in the actual making of the article concerned, it does seem a pity to leave it in an unfinished or amateur



state. Another point arises particularly now when wood is so scarce. The only possibility of making an article sometimes, is to use a variety of wood which happens to be at hand. The finished result, therefore, is a range of different coloured timber which certainly does not add to the appearance no matter how good the actual workmanship may be.

## The Final Result

There is often the trouble of wanting to see the completed article really finished. The greatest amount of enthusiasm is shown at the beginning, and the worker starts out taking pains to ensure an excellent piece of work in every way. He selects his wood carefully, cuts it accurately, constructs it as it should be, and finally cleans the whole piece with laborious enthusiasm. Then possibly he feels that the work having been done so far, he sees the result, and has not the effort or aptitude, perhaps, to complete it into what will finally make it a really first-class piece of work.

That is where the art of staining and polishing comes in, and the result so obtained will certainly add very considerably to what is otherwise an unfinished job. Of course, we do not

suggest that every piece of work undertaken is suitable for staining and polishing.

For instance, toys which are to be handled every day by kiddies, are obviously better painted, and this subject has been dealt with at various times for the amateur.

The polished effect is more for the attractive piece of work which will be in use and possibly for decorating the home. Any piece of furniture should obviously be polished. Most of the fretwork designs published should be finished in this way, whilst a number of models lend themselves to this type of finish.

## For the Amateur

Every worker has admired at some time or other, the beautifully polished piece of furniture in his own home, and had a secret longing to be able to do the same thing. There is really no reason why, with a little ability and experience, the average worker should not be able to do the same. He cannot, of course, hope to equal the craftsmanship of the professional french polisher who has probably spent a lifetime at the art.

Nowadays, however, there are very few of these real craftsmen remaining, and few coming along. The utility mass production work which is flooding all spheres does not allow the great attention and time which are really involved by the expert professional. At the same time, an amateur can obtain a really good finish and one of which he can be proud, and which will be quite satisfactory to attract the attention and admiration of all who see the results.

## First Experiments

It must be borne in mind, however, that you cannot get that beautiful glossy surface in five minutes. It is not exactly a matter of the time you put in in producing the polish, but rather of "getting the knack" of it. The point is that the first covering will, in a matter of a few days, sink into the wood and you will have to do the job again. But you will find that this second polish will produce a brilliant surface which is more likely to "stay put" and will last.

The processes involved are not long, and there is something fascinating in each one as it comes along. The stages generally are as follows—apart, of course, from the actual construction of the work.

There is the preparation in cleaning and smoothing. Then there is the staining to get all parts the same



colour. Next, if the wood is of a soft texture, the grain has to be filled and finally you can commence the actual work of polishing. Normally speaking, the work is best carried out on large surfaces so that one can get a sweeping movement. At the same time, the smaller jobs can be equally well undertaken.

## The First Process

First of all there is the question of suitable material, and the amateur now has the opportunity of purchasing complete outfits in which all the necessary requirements are provided. Apart from this, you can buy the filler and the polish and the various stains individually. Above these are needed some glasspaper and the necessary rags for polishing. The actual process of polishing does, of course, provide a very thin film of glazed surface to the wood itself, but unlike varnish, this is almost a part of the grain and not above it.

Varnish is apt to become streaky and glassy unless very carefully applied. It is much more simple to add this because it can be brushed on and allowed to harden. At the same time, there is not the delightfully



Long sweeping motions on large surfaces

smooth surface to the finished work that you can see in nicely french polished wood.

You will have to decide the process before you actually complete the work of construction on whatever you are doing. Some pieces of work are better stained and polished in pieces, before the parts are finally glued together. There are others

which can be quite easily dealt with when the whole work is finished. This, however, is a matter of experience to know which process to undertake.

### A Trial Piece

In any case, you will be well advised to undertake the whole process first on an experimental piece of wood. There is a great deal to be learned in the "feel" of the rubber, or knowing how thickly to apply the stain or how to rub off the superfluous woodfiller.

As is only natural, you will very badly want to make your first attempt at polishing on the actual job you have so admirably completed. Do, however, overcome this urge and make your first attempt at the work on an odd piece of wood. It may mean a little delay in completion of the actual article you want to see done, but the experiment will prove well worth while.

### Clean the Work

Now let us take the whole process stage by stage. First of all, make sure that the wood is thoroughly clean and smooth. Rub it over with fine glass-paper, and then with a clean rag dust away any powdered grain which remains. If there are any holes or bad joints which have to be filled, plug them with plastic wood and smooth down again so the whole surface is flat.

Be sure, in any case, to remove any trace of glue, otherwise your stain will not take effect on the wood itself. All grease, too, must be removed, and you should handle the wood as little as possible once it is finished, otherwise the grease from the hands or fingers will spoil the work.

By the way, the plastic wood which is a more or less modern type of stop, is now available in various forms. Sometimes it is a powder and sometimes a creamy plastic. Some sets very quickly and some takes a fairly long period. Most of it has a habit of shrinking so that in use you have to leave a little bulging and then smooth it down to the actual surface when hard. This plastic woodfiller has the advantage that it can be polished or stained much as ordinary timber, and is certainly very helpful to use on various occasions.

### Staining

Having prepared the wood thoroughly, we can next proceed to the stage of staining. Here there is a variety of opportunity when you remember there is water staining, oil staining, varnish staining, chemical staining and spirit staining.

Most of these, however, need not worry the amateur. He can confine himself entirely to either water or spirit stain. The object of staining, of course, is to colour the wood to a desired shade, and for these, various pigments are used. The clever cabinetmaker can use colouring

matter very often to make an ordinary wood apparently one of the more valuable varieties.

The colour, of course, largely tends to do this, but you must always bear in mind that the actual grain or fibre of the wood cannot be altered. For that reason, do not attempt to stain, say, beech with an oak stain; or try to make a piece of oak timber a smooth open type of walnut.

Then, too, it is wrong to stain the wood so darkly that the beauty of its grain is obliterated altogether. Doing this, you will suggest to the examiner that some cheap wood has been incorporated, which you are anxious to hide with the dark colouring matter. At one time, furniture itself was very dark, but more recently lighter shades have become popular, and in consequence the actual grain of the wood is more visible—as it should be.

### Water Stain

We have mentioned water stain and spirit stain as the two processes which are most apt to appeal to the amateur. Their names suggest exactly what they are. Water stain is made by mixing that liquid with very fine crystals which when dissolved turn the water the colour desired.

For these, there are several dyes available such as gamboge, indigo or even the juice of berries from trees.

## A Happy New Year to all our Readers!

The crystals can be purchased in small quantities quite cheaply and there is the advantage in the mixing that you can get the shade you require by adding more or less crystals to the water.

One point in this connection is that you must have enough stain to do the whole job at one mixing. The stain goes a long way, but it is fatal to half finish a job and not have enough to carry on. The trouble is that in the second mixing it will probably be impossible definitely to get exactly the same shade. Water stain is applied to the wood with a brush or a rag, and must be allowed to dry naturally. This is a slow process, and there is the added disadvantage that the liquid raises the grain of the wood slightly when dry.

### Spirit Stain

The spirit stains or colour dyes cover a number of different colours, and some of the ingredients used are vandyke brown, the umbers, sienna, mahogany lake, and other similar pigments. They are normally purchased in liquid form and being

combined with spirit there is naturally the tendency for quick drying. This means that a surface has to be covered with more speed than is necessary in using the water stain. A brush or clean rag can be used for the purpose.

### Quick Drying

The spirit dye soaks into the wood quickly and evenly, and the board can be used for the next stage very soon after application. These colour dyes are obtainable from most ironmongers in various colours, and in purchasing, you should remember our previous remarks on the question of keeping an oak stain for oak, mahogany for mahogany, etc. It is possible for homemade spirit stain to be undertaken by dissolving any of the anilines in methylated spirits and adding an ounce of thick polish to bind. The trouble involved, not only in mixing, but in obtaining the ingredients, however, is not really worth while.

When ready to commence work, pour the stain into a saucer or have it in a wide-necked jar in which the brush can be dipped without possibility of overturning. If you are undertaking fairly wide surfaces, then use a flat brush to cover as much as possible at one sweep. Apply in the direction of the grain, and remember that end grain always makes the stain darker.

If, therefore, this comes on the same level as a surface grain, you must have a lighter shade to take the end if you want to keep it all the same. A small fine-hair brush is used for edges or to get the stain into awkward corners and quirks. For fretted work it is always advisable to stain the parts individually.

### Fretted Work

This can be done by placing it in a shallow tin tray—such as a biscuit tin lid. Pour the stain into the receptacle and then lay the piece of work into it so it is covered entirely. You can use a sharp-pointed knitting needle to put it in, and to move it about sufficiently for the stain to affect every part.

Do not leave it in too long, but take out and hang up to dry. Do not let in hang in one position too long, however, or the stain will get into the curved or corner pieces of the frets and make that portion darker as it dries. If you are having a large panel, then as far as possible start where any join will be least noticeable. For instance, if you are going round a door, commence at one of the stiles along the crack of the joint. Do these parts first and finish off with the cross stiles keeping the same shade and preventing the stain overlapping to make a double thickness. The staining should be completed as far as possible in one operation, and then the whole of the work left to dry before the next stage is commenced.

(To be continued)

ARROWS INDICATE DIRECTION OF GRAIN OF WOOD.



DESIGN

No. 2774  
29-12-48

SIZE  
6 1/2 ins. WIDE,  
7 ins. HIGH.

SUPPLEMENT TO HOBBIES No. 2774.

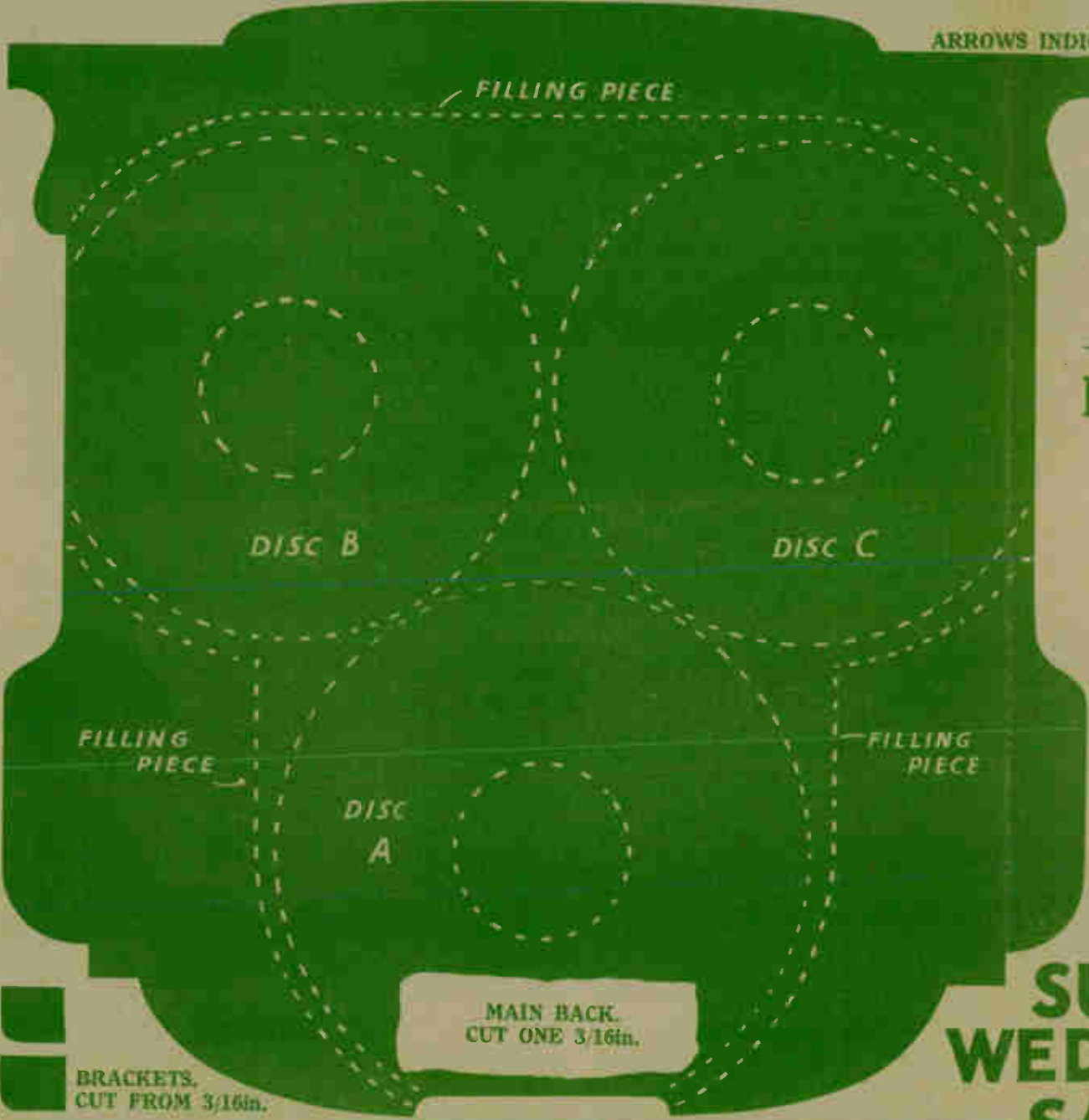

MAIN BACK.  
CUT ONE 3/16 in.



TOP OVERLAY.  
CUT ONE 1/8 in.

# NOVELTY PERPETUAL CALENDAR



CUT OUT THIS DISC AND GLUE TO MAIN BACK.

DISC B.



CUT OUT THIS DISC AND GLUE TO MAIN BACK.

DISC C.

SUN MON TUE  
WED THU FRI  
SAT

CUT THE LETTERS FROM...

BRACKETS.  
CUT FROM 3/16 in.

TOP RAIL.  
CUT ONE 1/8 in.

## A PERPETUAL CALENDAR

**T**HIS novelty calendar can be cut out in wood  $\frac{1}{4}$  in. and  $\frac{3}{16}$  in. thick, with the fretsaw and a few tools. The patterns themselves can be drawn on to the fretwood through carbon paper, or by tracing off. The only parts which need to be stuck down are the three discs containing the figures and numbers and the two ornamental fretted portions.

When complete, the month is indicated by turning the bottom disc so that the name appears at the window. The day of the month is altered by turning a disc each side so that the figures appear centrally whilst the actual day of the week is indicated by moving the pointer to the appropriate name.

### General Construction

There is nothing difficult in the making, but certain points have to be borne in mind. Back and front are both alike in outline shape, and between them come the three discs bearing the figures and wording. The paper circles containing the numbers are pasted down. The centre of each of these discs has to be cut out.

This central circle is glued to the back, and then the outer rim is replaced and so revolves on it. For this reason, you must be particularly careful to cut the centre circle true or the disc will not revolve smoothly. In any case, you should rub the edge of the disc with lead pencil so the graphite reduces the friction. Remember, too, that the disc has the paper left on it, which makes it thicker than the rest of the parts. It will therefore be necessary to glass-paper down this thickness of the rim piece so it will move round without binding on the back and front.

Mark the position of the discs on the back carefully, and note their position A, B and C. Do not mix them up because the left-hand disc is different in rotation from the right-

filling pieces to the back, then glue on the centre discs and then ensure that the surrounding rims are moving smoothly. Lay the front in place and ensure easy movement of the discs without binding before gluing that part in place. The front, of course, has the three window openings, and it will be a good plan to chamfer the edges of these so the figures etc. can be seen more plainly.

### A Milled Edge

If you wish to provide a milled edge to the discs so the fingers grip better, you can do this by rubbing a file across. Put the disc in a vice and just draw the edge of the file across the wood, making marks about  $\frac{1}{16}$  in. apart. All this should be done before the front is actually glued on because once that is in place, you will not be able to alter the mechanism.

The names of the week can be cut from  $\frac{1}{4}$  in. wood, but would look better if they were cut from quite thin metal, aluminium or brass, or even plastic material. Note their position on the front as shown on the pattern, and get them in this semi-circle so the pointer does not hit them in going round.

The fan-shaped overlay is next glued on, and the pointer itself screwed in the position indicated. A thin circular washer of metal or thin leather is put under the head of the screw for ease in rotation. A little raised pin is also made of a piece of waste wood and glued on to or into the pointer near the arrow head. If you have a small fancy knob to screw in, it will serve the same purpose.

### Fancy Shelf

There is a small bracket piece, two supports and a fancy drop ornament along the top, but if you wish, these can of course be omitted. The shelf has its front edge and two ends rounded on the underside. It is glued to the back with the fancy overlay beneath it, and then the two tiny bracket pieces glued in the right angle



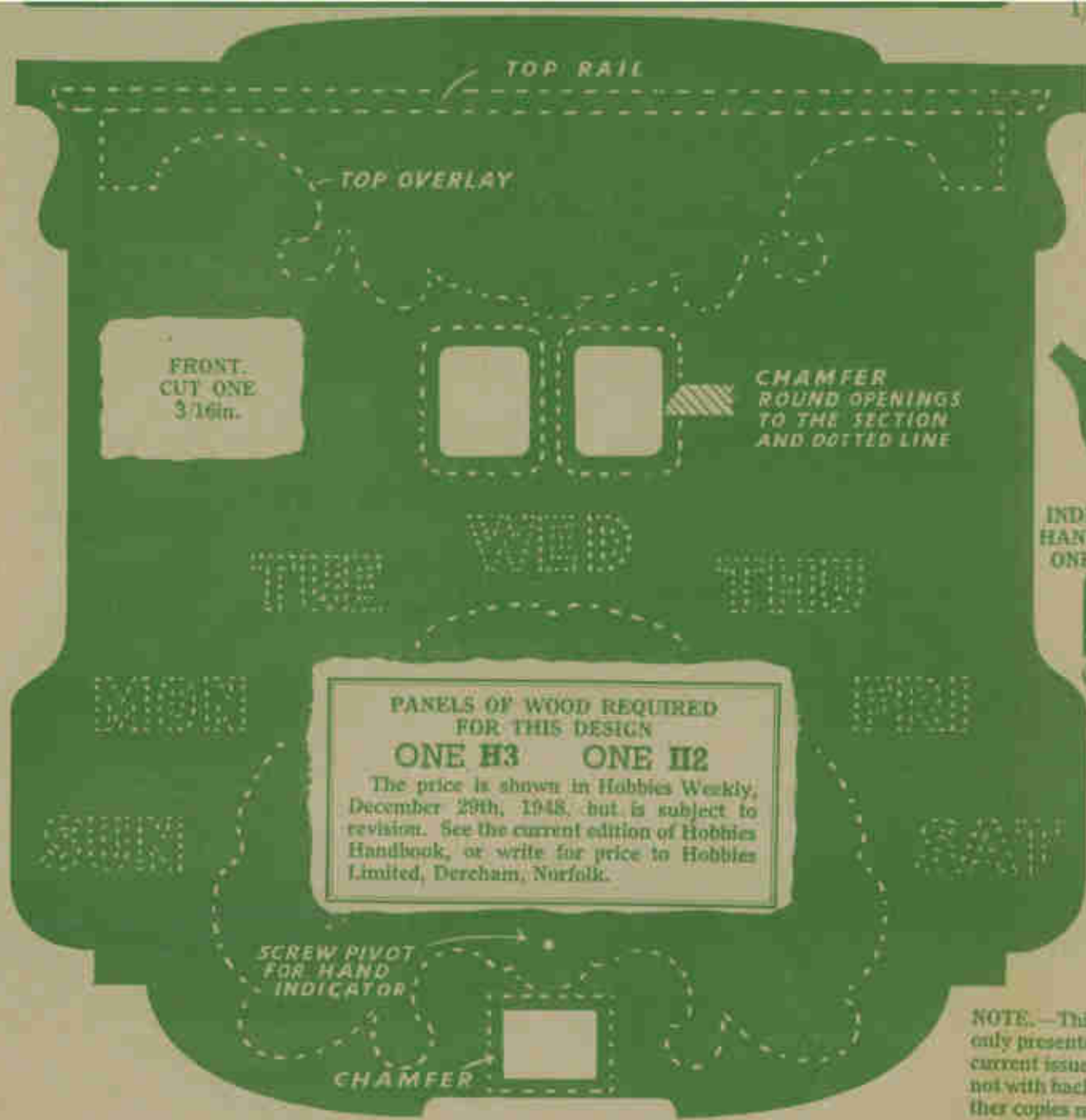

PANELS OF WOOD REQUIRED FOR THIS DESIGN  
**ONE H3 ONE H2**  
 The price is shown in Hobbies Weekly, December 29th, 1948, but is subject to revision. See the current edition of Hobbies Handbook, or write for price to Hobbies Limited, Dereham, Norfolk.



STICK THE LETTERED AND FIGURED PATTERNS TO 1/8in. WOOD, AND CUT ROUND. CUT OUT CENTRE DISCS. THE CIRCLES OF 1/8in. WOOD WILL TURN ON THESE.



NOTE.—This design sheet is only presented free with the current issue of Hobbies and not with back numbers. Further copies may be obtained.

PRINTED IN ENGLAND.

lining pieces are glued between the back and front each side, and above the discs.

In construction you could glue the

pieces. The calendar can be hung by making a suitable hole at the centre near the top, or you can fix the usual brass wall hangers at the back.

# The uses and application in handwork of THE FABRIC FINISH

**P**ERHAPS you have seen the new modern fabric finish? It is usually applied to wood, card, tin, plaster, etc. In fact, any surface can be treated with it. Two examples of its use are gramophone turntables and the interior of the cutlery drawers in sideboards. These are said to be "flock sprayed."

In the majority of cases, however, the word "flock" is a misnomer. Fabric is a better word, because it includes rayon, and the spraying powder is made from this material. Spraytex is the name of the powder prepared from pure rayon hairs, cut fine, or medium, to give a normal or lustre finish.

These powders are packed in special canisters which fit to a special spraying gun known as a fibre-gun. An ordinary paint spraying gun is unsuitable. Such a gun, however, can be used for applying the adhesive for the fabric powders to surfaces.

There are several types of adhesive, the most common being a slow, air-drying type. This begins to dry in ten minutes, becoming hard in a few hours, which gives sufficient time to have the fabric powder applied. The powder is sprayed on rather like paint, it issuing from the gun in a fine cloud. The jet of powder can be controlled at will, including the pressure.

The whole process is just as simple as paint spraying. The only difference is that one must treat the surfaces with the adhesive, and within ten minutes spray the tacky surface with the finishing powder. This produces a lovely textile finish which looks, and feels like expensive baize material.

## Various Bright Colours

As the rayon powders are made in various bright colours, the uses of the new finish are unlimited. Brown is excellent for steel gramophone turntables. Green is ideal for cutlery drawers, card tables, and so on. Black can be used for lining a jewellery case, violin case, optical instrument cases, drawing instruments cases, etc., with grey for suit-cases, as considered fit or necessary.

There are sixteen popular colours in all, which include rose, red, white, cream, leaf green, fawn, gold, yellow, pale blue, royal blue, rust, and pink, with coloured adhesives to match.

Coloured adhesives to match? Yes, it is necessary that the adhesive is of a similar colour to the finishing powder, as the latter, consisting of fine silken hairs, has some transparency. A coloured adhesive, consequently, provides a more suitable base or foundation for the powder, its colour accentuating the colour of the finish.

To be more precise, the adhesives are made in eight colours, such as red, white, cream, brown, green, fawn, black and blue. These are for use in conjunction with powders of a similar colour. Cream, for example, serves for white, yellow or gold powders. In some cases, it is necessary to mix two adhesives, of different colour, to match a particular finishing powder.

Thus, a mixture of red and brown adhesive will match a gold powder. A mixture of red and white adhesive suits a pink powder, whereas black and white adhesives, mixed, produces a grey colour, which suits grey powder.

## Toys and Soft Goods

All kinds of toys and soft goods can be treated with the new fabric finish. Thus, wooden bears and similar animals, can be cut out, fabric finished and mounted on a wheel base. No need for shiny enamel finish. If necessary, certain parts can be "masked" so several colours can be applied. Toy horses, on steel disc wheels, can be fabric sprayed, or the saddles—if provided—may be treated only. Nursery runabouts, furniture, etc., can be similarly treated.

The adhesives and powders are extensively used for interior decoration in cars, caravans, and the cabins of aircraft. It can be applied to aluminium sheeting, asbestos sheeting, thick cardboard, paper, plastic materials, glass—almost everything.

Not only does it serve to give a modern finish to surfaces, but it is waterproof, moth-proof, does not fade, helps to retain heat, and prevents vibration. In the latter case, loud-speaker cabinet interiors need it.

Hitherto it has been the custom to use baize for lining a cutlery drawer, or covering a card table. It is tedious work cutting out the cloth into suitable strips, then affixing it down neatly with glue. No need for all that trouble now.

## Standard Spraying Equipment

Almost any spraying outfit can be used for applying the adhesives and powders. The only addition is the special fibre gun mentioned. Most small spraying outfits have a standard output of 20 to 30 lbs. per square inch. There is sufficient pressure here to operate the fibre-gun successfully.

As in paint spraying, the gun must be held a short distance from the work, and be moved on a level with the surface. Unlike paint, the powder cannot "pile up" if the gun is held in one position for longer than necessary. The adhesive can only absorb so much powder—its limit, after which further applications of powder will merely drop away having nothing to stick

upon. If a double thickness of the finish is wanted, it is possible to apply a coat of adhesive over the first finish, then spray on the powder. A single coat, however, generally suffices for most purposes.

## Large Work

Where much spraying is done, and large work undertaken, the articles to be treated need to be put into some sort of a booth. This booth is merely an enclosure, serving mainly to prevent the powder flying about. The booth is handy in collecting "loose" powder, which can be gathered up and used over again. As the powder is light and apt to float in the air, like dust, the operator of the fibre-gun usually wears a small breathing mask to protect his lungs. The mask is supplied by the firm preparing the gun, adhesives and spraying powders.

The wearing of a breathing mask is nothing unusual, by the way. A mask is usually worn by all users of spraying apparatus, it being absolutely essential when spraying paint, particularly lead paint, as the fine particles are liable to get into the nose and mouth, including the lungs.

## A Mask Needed

Although there are no dangerous or sickening fumes, or anything poisonous connected with fabric adhesives and powders, a mask should be worn, more especially if much spraying is done in an enclosed area. Small articles can usually be put into a box with an open end, and the gun pointed at the work for a few minutes. If desired, a handkerchief could be held over the nose and mouth to serve as a temporary mask. A proper mask, however, enables both hands to be free to manipulate the work and the gun.

## Display Work

Apart from coloured spraying powders, there are crystallising powders which, sprayed on a prepared surface, results in a silvery, glittering finish. Such a finish is ideal for display work in windows, stage settings, etc. To save inquiries, the name of the powder is Dewspray. It is just as easy to apply as the coloured powders.

It will be of further interest to readers to know that the weight of the fabric finish is approximately 4oz. per square foot. Moreover, if the finish becomes soiled, it may be brushed, and with the exception of those applications requiring the use of special adhesives produced for coating rubber, fabric and P.V.C. plastic sheeting, it may be washed or dry cleaned. Surface spots can be removed with a cloth moistened with petrol.

# General instructions by an expert on making MINIATURE VEHICLES

**M**INIATURE vehicle building is a very fascinating branch of model-making and does not need to be expensive. It is a good plan to work to a series of vehicles suitable for the model lay-out or a railway set-piece. Follow the measurements given, but you must also check up the sizes as you go along. Comparison with the miniature buildings and figures will soon show if there is any great difference in scale.

## The Chassis

In all types of vehicles the chassis is simple and made from  $\frac{1}{4}$  in. by  $\frac{3}{16}$  in. or similar. Cross pieces can be in  $\frac{1}{4}$  in.

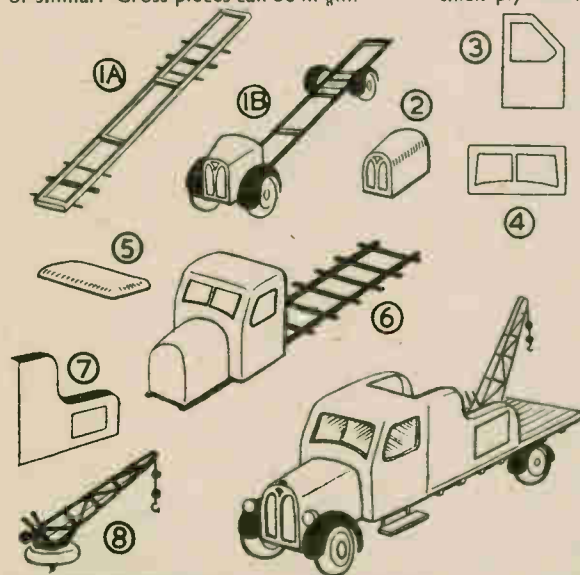

by  $\frac{1}{4}$  in., axles are in  $\frac{1}{4}$  in. dowell rod. The length of the chassis is 1 in. by  $4\frac{1}{2}$  ins. long (see Fig. 1A), with cross-pieces to hold the mudguards as shown. The drawing at Fig. 1B shows the completed chassis. Mudguards can be  $3\frac{1}{16}$  in. wide cut from oddments of tin with tin shears, and  $\frac{1}{4}$  in. model aeroplane wheels are suitable.

Next comes the bonnet (see Fig. 2), which is 1 in. wide at front sloping outwards and backwards to  $1\frac{1}{2}$  ins. and  $\frac{3}{4}$  in. high again sloping up to 1 in. Some vehicles have different shapes and are deeper or slope more, but you can easily adjust the model to the type you are making.

Next make the floor, from  $\frac{1}{4}$  in. thick plywood, if possible, 1 in. deep and  $1\frac{1}{2}$  ins. wide. Now fit on the driving seat,  $1\frac{1}{2}$  ins. wide by  $\frac{1}{4}$  in. by  $\frac{1}{4}$  in., rounded at the edge. The driving seat is useful to form on the sides and back, with the back  $1\frac{1}{2}$  ins. high by  $1\frac{1}{2}$  ins. wide.

Cut out the sides next. These are 1 in. wide by  $1\frac{1}{2}$  ins. high, with a slight slope back as shown in Fig. 3. Note also the window design. The top of the side should be  $\frac{3}{4}$  in. and all the parts so far made fit down on to the sides of the floor. The base of the front of cab is  $1\frac{1}{4}$  ins. by 1 in. and will fit inside the

sides. You can now make the front sloping part complete with the window, shown in Fig. 4.

Make the roof (Fig. 5) from some  $\frac{1}{4}$  in. soft wood so you can round this off to a flat dome shape. When it is cut fit inside the back, front and two sides. The window should be lined with thin transparent sheet and the inside painted in a light shade. A small steering wheel can be added.

## A Breakdown Lorry

This particular model is suggested as a breakdown lorry for the small garage or service station shown in Fig. 6 with the completed bonnet, chassis and cab. Note the realistic cross bearers, made from  $\frac{1}{4}$  in. by  $\frac{1}{4}$  in. stripwood, which you can bring out a little further than the width of cab. A thin bare platform of  $\frac{1}{8}$  in. wood can now be added.

As a breakdown van curved sides are suggested (as Fig. 7) and should be the height of the cab and come to about  $\frac{3}{4}$  in. from rear of chassis. Small lockers can be marked in as shown in the completed model. A cross seat inside and small tool boxes from square  $\frac{1}{4}$  in. wood can be added, whilst a small step can be fitted underneath the cab with bent pins. Petrol tank can be added and made from  $\frac{3}{16}$  in. dowel.

The small crane shown (Fig. 8) could be made from thin card strengthened with small square wood. Levers and other gadgets can be made with pins and thin wire. Two small beads and a hook complete the model which can finally be painted in bright colours.

The suggestions made here can equally well be also carried out on other types of vehicles.

## Note Lightship (Continued from page 154)

where the two vertical edges meet. Varnish the card inside the lantern to retain the necessary stiffness.

A ring of fairly stout wire is next bent round a pole of rather smaller diameter than the lantern and cut off to make the ends butt neatly when it is afterwards sprung round or clipped up on to the lantern. A touch of glue holds the ring in place half-way up the lantern (Fig. 1). The four ropes leading from the deck to the mast consist of fine twine. They may be tied to a simple ring, glued to the mast.

On the deck the ropes are fastened by small wire staples which can be easily removed when it is necessary to renew a bulb in the lantern.

The little boat can be shaped first with the fretsaw from a piece of  $\frac{1}{4}$  in. wood  $1\frac{1}{2}$  ins. by  $\frac{1}{2}$  in. wide. Curve simply to form shape and then glue to the upper deck. Little wire davits may be added if desired.

The simple wiring diagram (Fig. 7)

shows A as leading from the battery contact to the "on" point of the switch. Then B leads from the second point on the switch—the turn-over handle, to the bulb holder up in the lantern. From this holder again a second wire C passes down and connects with the second contact on the battery.

In preparing the contact A, a piece of thin brass about  $1\frac{1}{2}$  ins. by  $\frac{1}{4}$  in. is cut and drilled and screwed to the base of the hull as seen in Fig. 7. The brass is bent up to form contact with the strip on the battery when this latter is dropped into place. The contact strip D of the battery will be made to connect up to the wire C by a simple brass plate fixed inside the "well" of the boat hull, and just abaft the mast.

Here again as the battery is slipped into place it will form contact with the metal plate. A wire will be carried up from the screw of this plate to the

mast as C in both diagrams in Fig. 7.

If the mast is hollow the wires can pass through it into the "well" of the boat through the hole shown at E in Fig. 7.

The lamp is now finished with the exception of painting, and great care must be taken in this important final operation. Lay on a preliminary coat of white paint. It does not follow that drab colouring need be adopted as is the case with the actual lightship. Tints of blue or green in two shades would be most appropriate, with white perhaps for the lettering on the side of the ship.

It must, however, be borne in mind that a really good finish must be made of the two undercoats of paint which precede the final coat.

The lantern would look well picked out in two colours, while the inside should be lined with thin green or red paper which would look most attractive when the light is switched on.

# A Craftsman's Notebook

## Distempered Walls Made More Attractive

SO many people now do their own decorating that ideas on this subject are always welcome. Originality has been introduced into a distempered wall I did recently.

After the first covering of distemper the wall was marked out with rectangles and stippled inside these areas only, the resulting panels showing up pleasingly against the plain background surrounding them.

An even more attractive finish can often be obtained by stippling twice—say, a cream or yellow background stippled first with pink and then again with brown.

A convenient way to mark out the panels, by the way, is to chalk a piece of string, get someone to hold the other end, then spring it against the wall.

A finishing touch can be given the walls with strips of paper bordering costing a few pence per yard, placed 18 ins. or so from the ceiling.

This need not go round the entire wall. Let it come, say, to within about 2 ft. of each corner, and finish off the strip at each end with a few inches of the bordering running downwards at right angles.

## Beeswax Polish

RECIPIES always being appreciated, here is one for making polish to impart the finishing touch of brilliance to wood. Beeswax dissolved in turpentine makes good polish that will also be found excellent for linoleum and giving a shine to the surface of floors that have been stained.

About 2 oz. of beeswax in a gill of turpentine will be about right. When dissolved it will be a fairly thick paste which can be applied with a piece of soft rag and given a brisk but light finishing rub with a soft dry duster.

To make it dissolve more easily the beeswax should be shredded finely. The tin containing the mixture may also be warmed by standing in a pan of hot water, keeping it away from the fire or any naked flame, of course.

## Where Rubber Originates

WITHOUT rubber, travel by road would be far less pleasant than it is. Even wheelbarrows and sack-carts are easier to handle when fitted with tyres. Other everyday uses are so numerous that to satisfy world demands something like 1,000,000 tons a year are needed.

This country alone can use more than a fifth of that, yet a hundred or so years ago our annual imports were not much more than 20 tons.

In its original form rubber is a kind of milky fluid—not the actual sap, however—produced just beneath the bark of certain trees. The trees have to be skilfully tapped by making cuts from which the latex, as it is called, flows out into receptacles. During a year anything from half-a-dozen to a hundred or more tappings are made, according to the type of tree.

Cleansing and chemical action follow at the factories, where the rubber is solidified ready for cutting up and rolling out. Further treatment is then necessary to make it suitable for the particular purpose for which it is to be used.

There are various species of rubber-producing trees in the tropical countries, one of the most important being the Brazilian Hevea, which was introduced into other tropical lands. In India, Ceylon, and elsewhere extensive plantations covering millions of acres have been developed.

## Way with Packing Cases

PACKING cases no longer required for their proper purpose can be put to good use by the home woodworker, particularly in these days when timber is so hard to come by. But to break them up haphazardly, tearing a bit off now and again as required, is hardly the most

satisfactory method of dealing with the empty cases.

The best way is to dismantle any such boxes before starting on the actual woodworking job for which pieces may be needed.

Take them entirely apart, remove all nails carefully, sort the good from the scrap, and finally getting together a neat handy stack of usable material all ready for smoothing up and cutting to shape.

## Setting Up an Aquarium

JUST a hint or two on setting up the aquarium for those of you about to keep a few goldfish for the first time. A roomy rectangular tank is best, allowing a gallon or more of water to each fish.

Besides making the aquarium more attractive, rocks, shells, and underwater plants provide the most natural surroundings for the occupants, the plants also being beneficial in helping to keep the water pure. Sand, pebbles, etc. should be washed before putting into a fish tank.

The first thing is to cover the floor of the tank with about two inches of aquarium compost, or sand and small gravel. Press firm, cover with three or four inches of water, and leave to settle. Then arrange the ornaments and make the plants firm in the sand, finally filling to within a few inches of the top with water.

Leave for a few hours to settle again and for the water to "season", after which it will be ready for the reception of the fish.

The best position for the aquarium is where it will be evenly lighted, but away from direct sunlight. If it must stand close to a sunny window it is advisable to paste a sheet of translucent paper on the side nearer the window.

The Craftsman

## A Reader's Complete Doll's House

ANOTHER example of how a little thought and ingenuity can make even a good model look better. And our readers are very good at it! This Doll's House (from a Hobbies Kit) was made by J. G. Davies of Balgore Square, Gidea Park, Romford, and is worth noting. Additions include flower garden (or plastic wire) built-in garage with room above, rosette ornaments to walls etc. Inside are electric lights and fires run by an old transformer kept in the "coalhouse" you see adjoining the back of the garage. Some little lady is certainly lucky!



# MISCELLANEOUS ADVERTISEMENTS

The advertisements are inserted at the rate of 3d. per word prepaid. Name and address are counted, but initials or groups, such as E.P.S. or £1/11/6 are accepted as one word. Postal Order and Stamps must accompany the order and advertisements will be inserted in the earliest issue. Announcements of fretwork goods or those shown in Hobbies Handbook are not accepted. Orders can be sent either to Hobbies Weekly, Advert. Dept., Dereham, Norfolk, or Temple House, Temple Avenue, London, E.C.4

**L**EATHER, Perspex, Wood, Lampshades, can now be easily embossed with names and decorations in gold, silver, colours, with "Monogold". Complete outfit including tools, materials, instructions 7/6. Details free. Agents wanted.—Dawson, Dept. M.1, 130 Park Street, Oldham. Also from Hobbies Branches.

**P**ROFITABLE hobby—make leather goods and help production. Write for details, etc.—Dept. 39, Wearwell Products Co., Saxone Buildings, 2 Tarleton St., Liverpool.

**S**UPERIOR gift to approval applicants enclosing 3d. stamp.—Greenwood (Dept. H.), 95 Palmerston Road, Boscombe, Hants.

**P**OST FREE—fascinating steel tracing machine for copying and enlarging magazine drawings, maps, etc. Price 5/—Clayton, 16 Westminster Road, Bradford.

**100** SHEETS notepaper and 50 envelopes with your address tastefully printed on former for 10/6; makes useful present.—Windmill Press, 49 Longbrook St., Exeter.

**T**HE MOST enjoyable hobby of all. Piano playing. George Ashburnham's postal course is easily followed to its final stages.—APM (53), 3 Ayrway, Romford.

**P**ERSONS required to make ladies' belts and fancy goods in spare time.—Dept. 3, Somat Plastic Co., Ltd., 8 Middlemarsh, Nottingham.

**P**LASTICS. Catalin sheets, rods, cylinders and profiles. Perspex sheets and offcuts, clear and coloured, glues, polishes and transfers. Send stamped addressed envelope for details.—Eastern Plastics, Church Street, Westbury, Wilts.

**C**IGARETTE card collecting. Fascinating hobby for young and old. Catalogue of sets and odds. 3d.—O'Neill, 68 Lavender Vale, Wallington.

**P**ERSONS required immediately to make leather goods in spare time. Write—Dept. 11, Empire Co. 117 Nottingham Road, Loughborough

**P**ETS, by Harper Cory. 48 pp. of practical tips on how to look after pets of all kinds. 61 illustrations. 1/6 from booksellers, or post free 1/8 from—Mayflower Publishing Co., Ltd., 17 Farrington St., E.C.4.

**G**ALLEON Designs. Range of well-known historical models. Plans, materials and instructions. Write for list.—Hobbies Ltd., Dereham, Norfolk.

**N**EW designs painted on plywood, ready in the new year. Watch our announcement.—Cleaver, 50 Windsor Rd., London, N.W.2.

**P**ERSPEX products pay, so model in the latest medium. Kit comprising brooch pins, delicate coloured bases, handicraft wax (gold, ivory and pastel shades), stiletto, plans, etc., for six superb brooches, price 7/6—also Cigarette/Trinket Box kit 6/11, and artistic pink and clear Toast Rack set 7/11. Postage and packing 7d. Polish and cement available. "Perspex" cut to requirements.—Plastics Home Products, 18 St. Mary's Rd., London, N.9.

**L**ONELY? Join Friendship Circle. Details 6d.—Secretary, 34 Honeywell Road, London, S.W.11.

**C**ELULOSE Acetate. 4 mm. Green, 55ins. by 24ins. 20 sheets; 4 mm. Red, 55ins. by 24ins. 28 sheets; .080 Black, 55ins. by 24ins. 48 sheets; .060 Black, 56ins. by 25ins. 27 sheets; .080 Black, 36ins. by 20ins. 22 sheets; .010 Clear, 49ins. by 21ins. 6 sheets; .120 Clear, 49ins. by 21ins. 7 sheets. Available immediate delivery at reduced prices. Write—Box 3368, Williams's Advertisement Offices, Bradford, Yorks.

**W**ARERITE Panels available for immediate delivery, 48ins. by 48ins. by ½in. Cream, Blue and Black, matt one side. Write—Box 3331, Williams's Advertisement Offices, Bradford.

**C**ATALIN ½in. Rose Quartz, 18ins. by 12ins. 28 sheets available reduced price.—Box 3334, Williams's Advertisement Offices, Bradford.

**L**ONELY? The Social World is Britain's premier pen-pals magazine. Specimen 6d.—Social World, 91 Brandon Street, Motherwell, Scotland.

**C**ARPENTER'S Bench wanted urgently. Must be in good condition. Write—Box 321, Hobbies Weekly, Dereham, Norfolk.

**O**LD photograph film lettering, new idea, practical, profitable. Full instructions 3/6 from—Gray, 61 St. Albans Avenue, Bournemouth.

**40** DIFFERENT stamps free to all applicants for my ½d.—1/- approvals. Includes mint Victory, used Coronation, Silver Jubilee, Ship, Pictorial, etc., etc.—J. F. Smith (Dept. H.), 60 Edison Road, Welling, Kent.

**D**DOUBLE Deck bus model 7½ins. long. Made from pattern sheets, 2638—price 6d. Parcel of wood 3/2 postage 9d.)—Hobbies Ltd., Branches and Dereham, Norfolk.

**1840** PENNY BLACK, first stamp ever issued, absolutely free. Postage 3d.—Martin, 426 Dewsbury Road, Leeds.

**F**REE, Liberia Triangular, to approval applicants enclosing postage.—96 Taunton Way, Stanmore, Middlesex.

**S**TAMPS FREE. Bumper packet. Request discount approvals.—Owen, 237 Hartford Road, Davenham, Northwich.

**M**AKE your own child's pedal motor car. Particulars stamp—"K" Toys, Brookfield Rd., Bristol 6

**'K'** TOYS, Brookfield Rd., Bristol 6, offer glazed pictures for children's puzzles. Sample set 1/- post free.

**S**TAMPS FREE!! Twenty unused (2½d.).—G. H. Barnett, Limington, Somerset.

**C**ASTING MOULDS for lead, Soldiers, Indians and Cowboys, Animals and Novelties. Sample mould 4/-. Catalogue 6d.—Industries, 2 Waldegrave Park, Twickenham.

**"M**ODERN WOOD TOYMAKER" A new handbook with 192 effective designs and illustrations. 2/6 posted.—Industries, 2 Waldegrave Park, Twickenham.

**E**ASY TO MAKE and weave on the Meopham Hand Loom, rugs or silk scarves.—C.W.O. drawings, etc.—Hodgkinson Bros., Meopham Green, Kent.

**F**REE! 10 Japan. Request approvals, postage 2½d.—Fantozzi (HW), Whitegate, Northwich, Cheshire.

**E**ASY TO MAKE, use and sell; the Aluminium Meopham Cultivator, drawings, etc., 3/6 C.W.O.—Hodgkinson Bros., Meopham Green, Kent. Pat. applied for 26377.

**F**REE Two Golden Jubilee, George VI. Approvals from ½d. Discount.—Bishop, 40 Marine Parade, Hythe, Kent.

**S**TAMPS on approval, 3 a penny.—Jeffreys, 2 Bay View, Craigavon, Port Talbot, Glam.

**S**TAMPS, special offer. Bargain packets 5/-, 10/- and £1. British Colonials or whole world. Satisfaction guaranteed. Sent on three day's approval against cash. Write for list of packets. Approvals on request.—W. E. G. Smith, Clarendon, Brettell Lane Stourbridge.

**I**NDIX for Vol. 106—Hobbies Weekly April to Sept.—Useful for binding or reference. Price 1/- post free.—Hobbies Weekly, Dereham, Norfolk.

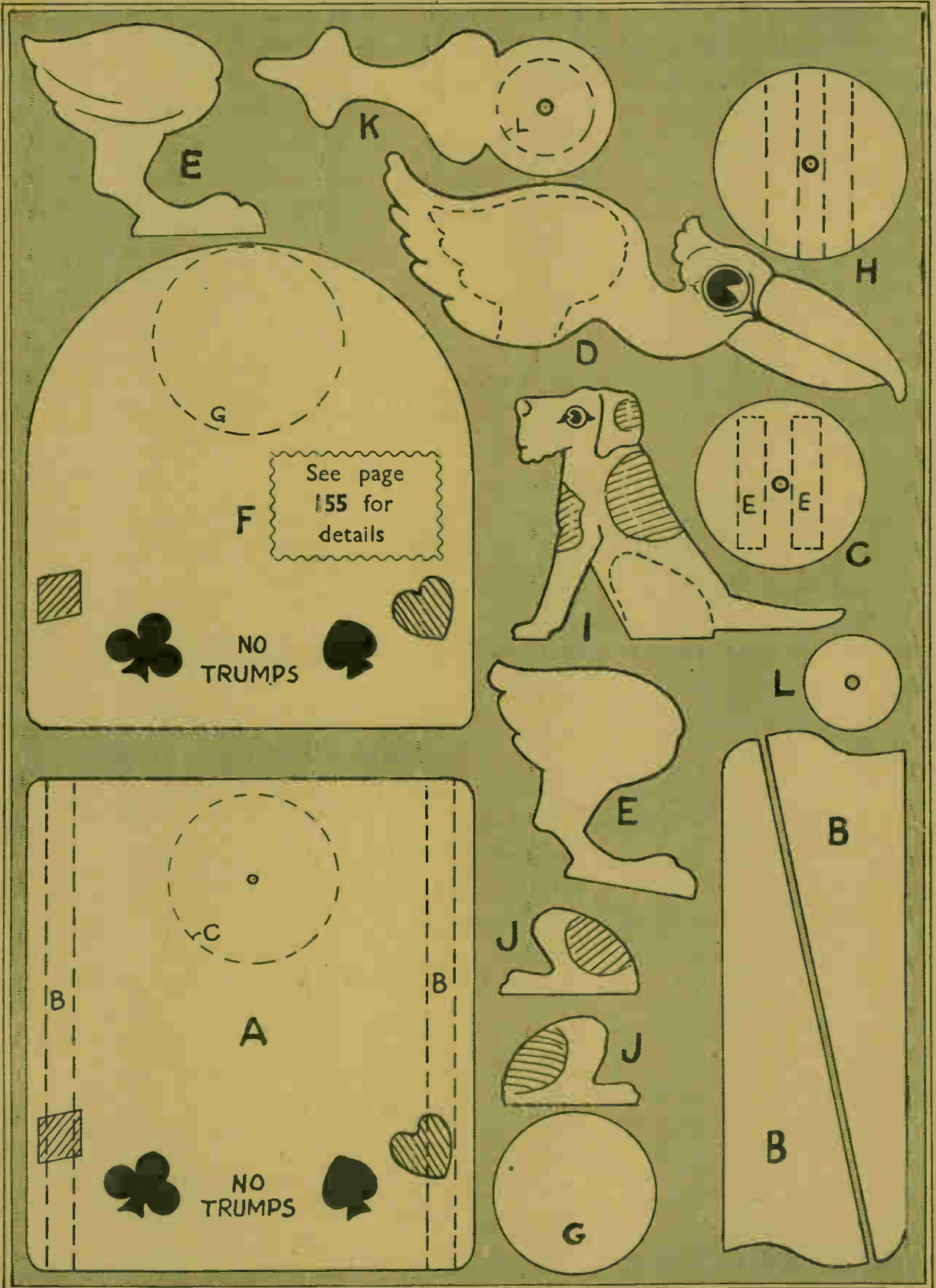

See page  
155 for  
details

NO  
TRUMPS

C

A

NO  
TRUMPS

D

H

I

C

E

L

B

J

J

B

G

K

L

The latest 'V' & W book :

# LINO-CUTTING FOR PLEASURE & PROFIT

by Eric Watson

A first-class book on this most fascinating craft, equally suitable to the general craft-worker and the experienced lino-cut artist.

146 pages, with a coloured frontispiece and 79 diagrams.

Cloth bound, 6/- net.

**VAWSER & WILES (London) LTD.**

555, Lea Bridge Road, London, E.10

## BAR CRAMPS

A strong well-made tool for the carpenter and handyman. Takes work up to 1 ft. 6 ins. long. Easily adjusted to varying lengths as a sash cramp or for wide boards. Strong steel bar with square edges for rigidity

**10/11**

Postage 9d.

At Hobbies Branches  
or from Hobbies Ltd.,  
Dereham, Norfolk.

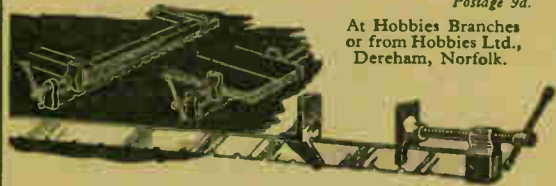

## For all kinds of woodwork **HOBBIES FRETSAWS**

Not only in fretwork and model making but in a hundred and one woodwork, composition plastic, leather or metal sheet jobs you'll find a fretframe handy. And the best blade for any is the saw which is made here by Hobbies from good steel and the experience of forty years of manufacture. Every dozen is distinctly labelled.

**IN 3 GRADES**

Blue Label ... 1/3 per doz.

Yellow Label ... 1/5 "

Metal Cutting ... 1/7½ "

Obtainable from Ironmongers' Stores and Hobbies Branches, or by post (2½d. extra) from **HOBBIES LTD., DEREHAM, NORFOLK**



## AMAZING Ex. Govt BARGAIN SIGNAL LAMP

In stout double-compartment water-proof steel case.

3½-inch lamp with colour discs, for day or night use. Swivel base with metal screw-in stand. Viewfinder and reflector.

Morse key-board. Fully wired, fitted to folding lid.

Lamp can be adapted for car spot light, cycle lamp, numerous other uses.

**7/6**  
Complete  
POST 1/6

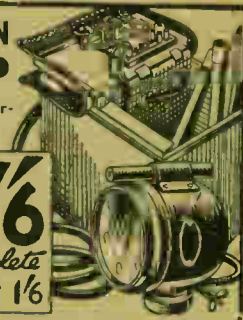

Also small FHP Electric Motors, & 1,000 other Bargains.

Write for illustrated lists.

**PRIDE & CLARKE LTD.**

Dept. H.W., 158, STOCKWELL RD., S.W.9. Phone: BR1xton 6251

## — STAMPS —

**AFTER — CHRISTMAS OFFERS!**

**BEST QUALITY PACKETS—ALL DIFFERENT**

50 SWITZERLAND 2/3 ;	25 BOHEMIA 1/6 ;	50 CHINA 2/9
100 DENMARK 2/9 ;	25 CHINA 1/3 ;	50 HOLLAND 2/- ;
50 NORWAY 2/3 ;	25 GREECE 1/9 ;	50 DENMARK 1/3 ;
	25 CZECHOSLOVAKIA 1/9 ;	50 CANADA 2/-

(ADD 2½d. POSTAGE ON ORDER FOR SINGLE PACKET)

**APPROVALS SENT ON RECEIPT OF 2½d. STAMP**

**R. CURTIN**

10, Broadway Parade, Billet Lane, HORNCHURCH, ESSEX

## GENUINE EX-RAILWAY AND SHIP WATERPROOF TARPULINS

70 sq. ft., £1 ; 140 sq. ft., £2 10s. ; 280 sq. ft., £5 ; approx. 360 sq. ft., £6 ; 720 sq. ft., £12, all inc. carr.



Reduced to **55/-** POST ETC 2/6  
Incl. Films  
The Famous **SOUND-CRAFT**  
**FILM PROJECTOR**

Half price offer from BIF. An absolute first-rate machine, weighs approx. 2lb., complete with bulbs and 2 films, at the sensational price of 55/- post, etc., 2/6. Spare films at 1/3, consist of Comedy, Cartoons Quizzes, Nature Study etc.

Up to 24 varieties ; shows on any white background, or we can supply white plastic screen at extra cost of 5/-. No home should be without this Film Projector, which will entertain both young and old. Each machine guaranteed 5 years. Send today before stocks are exhausted.

**HEADQUARTERS & GENERAL SUPPLIES LTD.**

(Dept. HOB), 196-200 Coldharbour Lane, London, S.E.5.  
1 MIN. LOUGHBOROUGH JUNCTION STATION.

A companion to "WHERE'S THAT CAR FROM?"

**"POPULAR CARS ILLUSTRATED"**

40 pictures and data of modern cars.

Published January 1st. by **RALEIGH PRESS, Exmouth**

From all Stationers and Bookshops. 6d

## A Handy Glasspaper Block

A wooden block with special handle which holds glasspaper taut and always in place. In two sizes, 3in. price 1/3 (postage 2½d.) ; 5in. price 2/3 (post 4d.)

**HOBBIES Ltd. DEREHAM**  
Norfolk, and all Branches

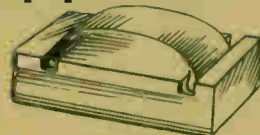

Printed by **BALDING & MANSELL, LTD.**, London and Wisbech, and Published for the Proprietors, **HOBBIES LTD.**, by **HORACE MARSHALL & SON, LTD.**, Temple House, Tallis Street, E.C.4. Sole Agents for Australia and New Zealand : **Gordon & Gotch (A'sia) Ltd.** For South Africa : **Central News Agency Ltd.** Registered for transmission by Canadian Magazine Post.