

# Hobbies

## WEEKLY

### CONTENTS

	Page
A Small Bench - -	141
Electric Pin Game -	143
Useful Lap Desk - -	144
How to use Planes -	145
Cyclist's First Aid Kit -	146
Attache Case Repairs	147
Craftsman's Notes -	148
Wastewood Novelties -	149
Pin Table Patterns -	151

January 7th, 1948

Price Threepence

Vol. 105 No. 2723

## How the home carpenter can make A SMALL BENCH

**D**EAL post material 3ins. by 2ins. is usually used to make a workshop bench, forming, in particular, the legs. But, such material is rather scarce and it might be of interest to know that quite a

good strong bench can be made entirely from 7/8in. thick boards.

Such a bench is illustrated and it can be easily constructed. Essentially, it consists of a front, back and end frames which are ultimately glued and screwed together. The parts of

each frame (leg and cross-rail pieces) are dowelled together in the formations shown at Fig. 1. Thus, the bench is quite inexpensive and simple to build.

In the ordinary way, you would have a lot of work cutting out mortises and tenons and applying half-checking in places. Now, all you have to do is to make four frames and attach them together.

The main part of the bench is the bed plank. This must be 2ins. thick. Anything lighter will not be suitable for hammering articles together, using the plank as a support. A heavy bed plank is always necessary and while it may be as difficult to obtain as the post material, you have, at least, only one piece to buy.

### Deciding on Size

Workshop benches usually stand 4ft. by 2ft. by 3ft. high or 28ins. high. The latter height suits most small workers, the former suiting tall workers. Length depends on the space you have available. The amateur woodworker or handyman will find that the sizes stated in the drawings are of fair proportion and would suit his requirements.

If, so far, you have been making use of an old kitchen table, the bench illustrated could be made, it being much more rigid and more suited for tools, etc. A fairly deep trough for tools is provided, with a large bottom shelf on which various planes, saws, etc., can be kept, ready for instant use.

There is a slight difference in the construction of the front and back frames. The back frame has a 5in.

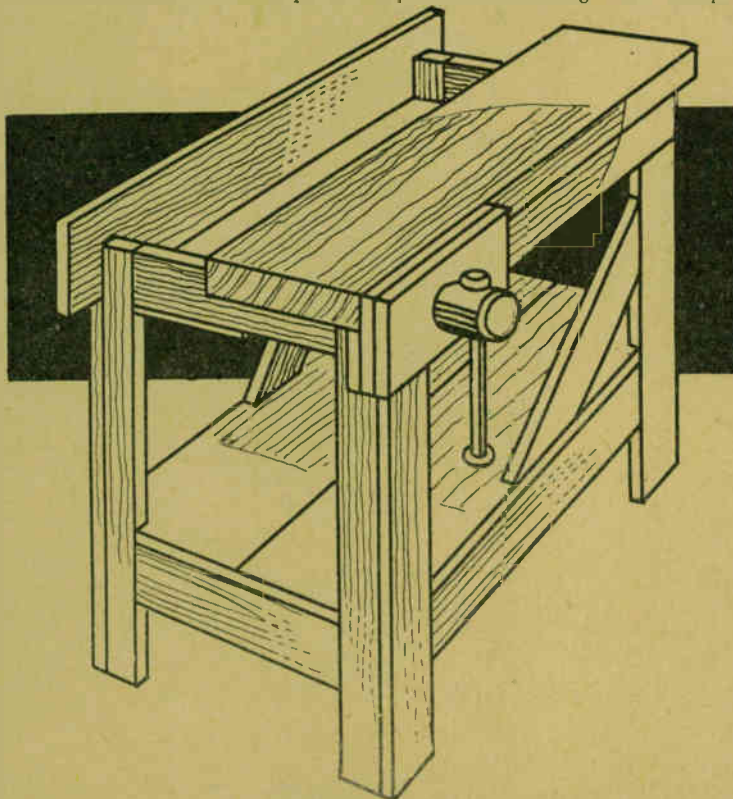

Correspondence should be addressed to The Editor, Hobbies Weekly, Dereham, Norfolk.

141

wide top cross-rail, the front cross-rail being 3ins. wide. The legs are 3ins. wide in both cases.

All leg pieces are 23ins. by 3ins. by 3/4in. To assemble, after preparing for dowelling (three dowels to each joint), attach the bottom cross-rail between the legs, then add the top

bored and countersunk. Suitable screws to use are iron flat-head 2ins. by 8, or 2ins. by 10.

The frames should be put temporary together with the screws (an odd one here and there) to see that everything is in order. The parts are finally assembled by using glue. A strong corner joint, almost as good as a solid leg, will result, and if desired, corner blocks could be added. But it is advisable to have the shelf fitting and the bed plank affixed,

3in. by 8 (or 10) flathead iron screws. A better plan is to make screw pockets in the cross-rails with a gouge, so the screws can be driven into the bed plank at the underside.

It should be explained, by the way, that a cross bar must be fitted centrally between the top end cross-rails, as shown in the top plan and indicated in the end elevation at Fig. 2. The bar acts as a support to the bed plank and divides off the tool trough. It is also necessary to make and fit a bottom to the tool trough, using 3/4in. wood.

### The Vice

An ordinary wood vice may be fitted to the bench, but an all-metal vice is recommended. Another plan, to save expense, is to fit a wedge vice (see inset detail at Fig. 2). In use, a wedge is driven inwards to hold the wood in place which is to be planed, bored, etc.

It is not a vice one can depend upon, however. And like a proper vice, if fitted, the wood must be supported at the opposite end on a heavy dowel peg which, at will, can be inserted into holes bored down the front leg, i.e., the leg to the right of the bench.

It is now possible to buy small all-metal vices costing about 15/- or 12/6. These are easily fitted and quite smooth in action. All-wood vices give a lot of trouble and seldom provide a good grip.

By the way, if you cannot obtain a 2in. thick bed plank, use two 3/4in. deal

### The Shelf and Bed

The bottom shelf consists of two deal boards 32ins. by 10ins. by 3/4in., the corners being checked as shown at Fig. 1. These pieces are set in unglued, being merely screwed to the bottom cross-rails of each frame.

Diagonal-running support slats are added, using glue and fairly long screws, as shown in the illustration in Fig. 2. Be sure to have these supports at the particular end indicated. Pressure and strain always

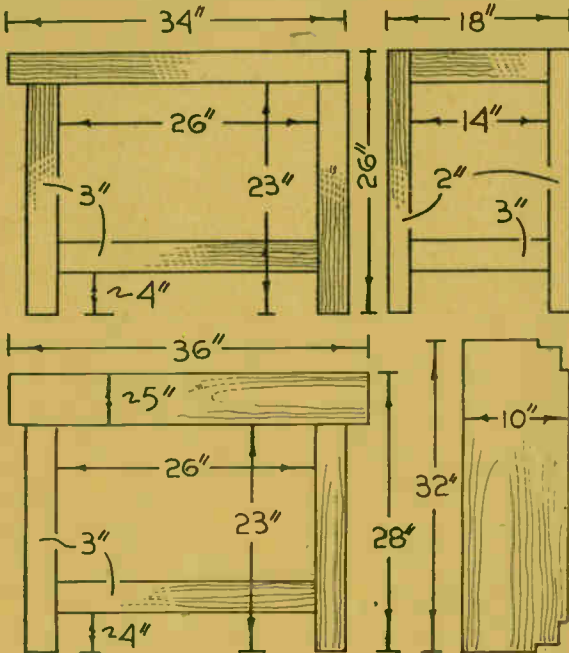

Fig. 1—Front, back and end framework with shelf board

cross-rail. Use sash cramps to press the parts together, or alternatively, a mallet could be used. See that the frames are quite square and identical in size (with exception of the back frame which sits up 2ins. higher). The bed plank will be on a level with this when attached.

### The End Frames

The end frames are both built the same, as shown, using 2in. wide stuff for the legs and 3in. wide stuff for the cross-rails. Note that the legs are 26ins. long—not 23ins. long, like the front and back frame legs. Have three dowel stumps to each cross-rail joint. Holes should be bored 1 1/2ins. to take 3ins. of 3/4in. dowel rod.

There is no need to clean up the joints with a smoothing plane in order to level them, unless desired. After all, it is only a work bench—not a piece of furniture. Just try to be as accurate as possible during the marking out, cutting and boring. Use a boiled glue and allow it to set before going ahead with the assembling of the frames.

### Assembling the Frames

Now, the front and back frames, it will be noted, go against the end frames to be flush. While nails (oval nails) could be used, screws are stronger. A 3/4in. margin should be pencilled down each leg of the front and back frames, then screw holes

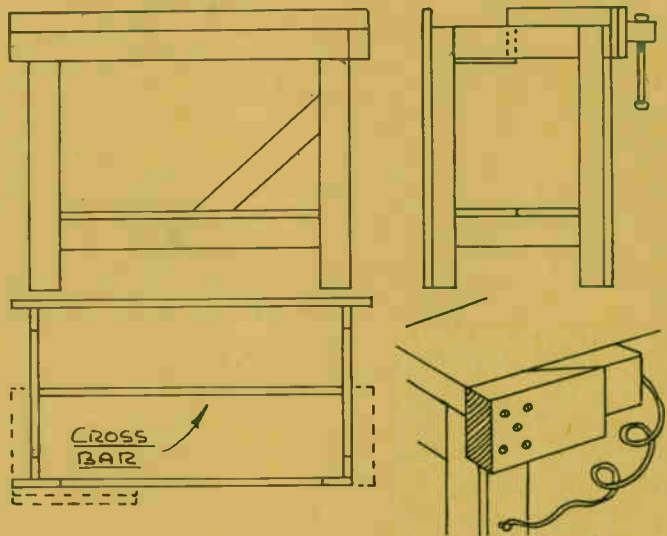

Fig. 2—Side and end view with top plan and wedge vice.

goes towards the bench vice; if the supports are fitted at the left-hand end, they will give little support to the whole bench.

The bed plank is set into position and the bottom side marked for screws. Holes are bored right through the plank and countersunk to suit

shelving boards glued and screwed together, with the screw heads at the underside. To save making pockets for the fixing screws, one piece of shelving could be attached to the bench rails first, then the other added. Screws 1 1/2ins. long are used in both cases.

# Patterns on page 151 for this novel and easily made ELECTRIC PIN GAME

HERE is a small novel table game you might care to make for yourself, it being a form of electric pin game. Actually, no pins are used. Instead, a series of contact studs are wanted, and to provide suitable studs, small brass roundhead screws are used. These are screwed close to the runway of the board in order that the steel ball runs through certain pairs of screw heads, thereby causing an electrical connection to one of the four M.E.S. bulbs.

The screws are staggered so there is a change in the scoring from a single shot. It is really a game of chance. You cannot tell what your luck will be—good or bad. But, there is one thing each player must do, and that is to keep watching the bulbs, not the movement of the ball.

## Running Lights

The steel ball, once fired by the elastic catapult provided, begins to run through the various screws down towards the sloping bottom end. When reached, the ball automatically returns to the catapult. The ball runs by gravity, the board being tilted, by setting its top end on a matchbox or anything similar.

The ball runs through the screws fairly quickly, which is why you must watch the flashing bulbs, for these flicker only for a fraction of a second.

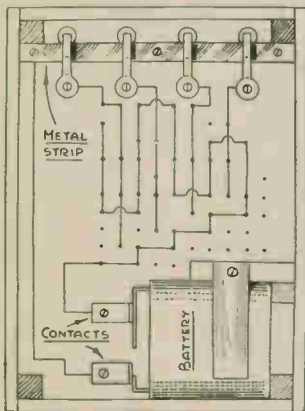

Fig. 1—Back view showing wiring, etc.

As each flicker indicates a score, one must be quick and add up the total of a single run.

To play the game, each player could be allowed three shots. For a penalty, any player who, with his first shot, scores 0, forfeits his other two shots. So as not to have the game too long, players could have five "innings" each, taken alternately. Should, incidentally, the ball become fixed between two screw heads, the board can be tapped to dislodge it.

To ensure accuracy and provide ornamentation, a pattern of the game parts is given full size on page 151. The page gives the size of the baseboard and the screw head positions and holes for the bulbs.

This is cut from a piece of  $\frac{3}{8}$  in. wood. The overlay parts are cut from  $\frac{1}{4}$  in. wood. The overlay parts are pasted down on the wood to be a permanent fixture. These parts can be more plainly seen in the illustration of the finished game.

The catapult is cut from  $\frac{1}{4}$  in. wood, with a small "cup" piece (semi-circular in shape) glued on top. The steel ball is cupped in the catapult by the shape, the ball bounding forwards as soon as the catapult is released. Very little force is necessary to send the ball forward.

Before proceeding with the construction of the game, try and obtain a  $4\frac{1}{2}$  volt flashlight battery, four 3.5 volt bulbs, a  $\frac{5}{16}$  in. diameter steel ball and 60  $\frac{3}{8}$  in. by 6 roundhead brass screws. The latter can be purchased at most hardware stores, the former being obtainable at a bicycle shop.

## The Case Work

Assuming you have cut out the baseboard (8 ins. by  $5\frac{1}{2}$  ins.) and glued the overlay parts to it, a case is made for same, consisting of two side pieces  $8\frac{1}{2}$  ins. by  $1\frac{1}{2}$  ins. by  $\frac{1}{4}$  in. and two end pieces  $5\frac{1}{2}$  ins. by  $1\frac{1}{2}$  ins. by  $\frac{1}{4}$  in. One of the side pieces needs to be slotted to provide an aperture for the tip of the catapult (see illustration).

As the overlay is kept within the case pieces  $\frac{1}{4}$  in. from the top edge, you will now have slot cut  $\frac{1}{4}$  in. lower, i.e.,  $\frac{1}{4}$  in. from the top edge. When done, glue and nail the ends between the sides, then fit corner blocks  $1\frac{1}{2}$  in. long by  $\frac{1}{4}$  in. square; the baseboard screws upon these blocks, so that the ends of the blocks flush at the bottom edge of the case parts.

## Fitting the Screws

With a bradawl or suitable drill, make holes for the screws exactly on the various dots, then drive in the screws. Points will project at the underside and wire is connected to these in the manner shown at Fig. 1.

Any thin plain copper wire may be used. It should not be enamelled or covered with cotton. If you have some cotton-covered coil wire, the covering can be easily removed to expose a plain copper wire. If enamelled, the enamel can be removed by drawing the wire through a piece of folded glasspaper.

Lengths of the wire are connected to the screw points by looping the wire around each point once, then

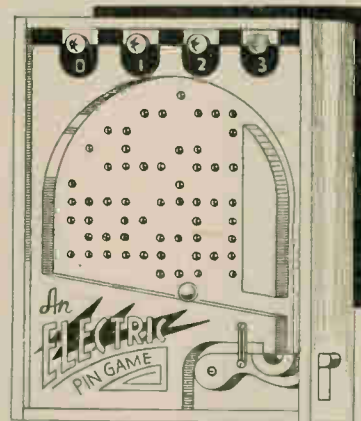

continuing in a similar manner with the rest to be connected by the one piece of wire. Commence wiring from the topmost screws.

These wires are all comparatively short. When attached, be sure to have sufficient length at the top for connecting to the bulb contact pieces. Having the topmost screws wired, get an extra long piece of the wire and, commencing from the lefthand side screw near the top, connect the various screws shown.

The wire at the cross-overs must be raised so it does not touch the wire it crosses, otherwise there will be a short circuit. The longer wire is brought down for connection to one of the battery contacts, as you can see.

## Bulb and Battery Contacts

Bulb and battery contacts are cut from thin sheet brass. A metal strip  $5\frac{1}{2}$  ins. by  $\frac{1}{4}$  in. is affixed, with screws, to the top end so its edge projects slightly over the bulb holes. The threads on the bulbs engage with this edge. A wire runs from the strip down to the second battery contact. These contacts are cut from thin metal sheeting; stout tin would serve. This also applies to the bulb contacts. The latter are bent slightly to touch the lead "tips" of the bulbs.

The battery can be housed as shown, being held in place with a strip of wood working on a screw pivot.

Having fixed a small elastic band to the catapult screws, the work is complete. When the battery arms are bent as shown and fitted in place, the game can be tested right away.

Now, should the ball run between a pair of screw heads and fail to cause a flash, this may be due to a few isolated screw heads. The majority of screw heads are "alive" and if any of these should fail to be connected by the ball, the trouble can be remedied by raising the screw heads slightly, using a screwdriver.



# For fireside comfort in writing make yourself this USEFUL LAP DESK

**R**EADERS will find this desk a most handy appliance, not only for correspondence but also for drawing, painting and doing crossword puzzles on. It can be held on the lap and so makes the user quite independent of the table. Especially is this welcome in the winter, when any drawing or writing can, by its aid, be done by the fireside.

The desk is of simple construction, no other joints being required than plain butt ones, glued and nailed. A view of the desk, minus its top, is shown in Fig. 1, from which the simple construction will be made plain.

## Material Needed

Deal, or other wood available,—it does not matter which,—can be used, some  $\frac{1}{2}$  in. thick for all parts except the top, which can be of thinner stuff,  $\frac{3}{8}$  in. but not less, unless three-ply is available, when it can be  $\frac{1}{4}$  in.

The sides are shown in Fig. 2. These, being of a simple shape, can be marked out on the wood in pencil. The long slot shown is cut in the left side only, its purpose being to allow entry of the fingers of the left hand to steady the desk on the lap while the thumb holds the paper down, during writing or painting.

The easiest way to cut this slot out is to bore a  $\frac{1}{2}$  in. hole at each end with a centre bit, and to saw out the intervening wood with a keyhole saw or fretsaw, the latter tool requiring a coarse blade for the purpose.

## Sides and Rails

Referring to Fig. 1 again, it will be seen that the sides are fixed together with four crossbars, all lettered. The overall width of the desk is shown as  $8\frac{1}{2}$  ins., so if  $\frac{1}{2}$  in. wood is used for the sides, then obviously the crossbars must be  $7\frac{1}{2}$  ins. long. They must, of course, be proportionately less if thicker wood for the sides is used, to keep the overall width the same. Bars, A and B, are  $1\frac{1}{2}$  ins. wide and are fixed across at the front and back.

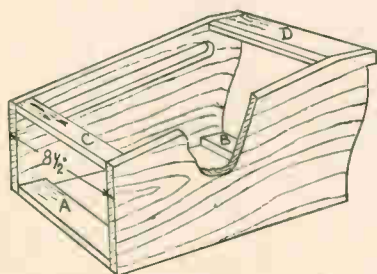

Fig. 1—General view of framework

Bar, C, is  $\frac{1}{2}$  in. wide, and is fixed across with its upper face level with the slope of the sides. Bar, D, is  $2\frac{1}{2}$  ins. wide. This bar, having  $\frac{1}{4}$  in. of its width extending over where the slope commences, should have its extension part bevelled off to suit the slope, as the desk top will rest upon it, and also on C.

The desk top is shown in Fig. 3, and is in two parts, F and G. If a piece of plywood is available for these, all the better, but if not, as  $\frac{3}{8}$  in. wood is not easily got of the necessary width, two pieces of matchboarding, glued together, would serve quite well, the beaded edges being underneath.

A straight piece,  $2\frac{1}{2}$  ins. wide, is required for F, and it has a  $\frac{1}{2}$  in. wide slot cut out in the same way as the side. The cut edges of this slot should be filed and glasspapered to a slight upward bevel.

## The Top

The main top piece, G, is cut to the size given, its outer and bottom edges slightly rounded off and is then fixed to the sloping part of the desk with glue and oval nails. It should project, both sides and front,  $\frac{1}{4}$  in. The back piece, F, is now bevelled off on its front edge, so as to butt flat against the rear edge of part, G, and is then glued and nailed on. The extending edges over sides and back are rounded off to correspond with G.

Give the wood a good rubbing over with a medium glasspaper and make all smooth. Rub smooth the cut edges of the long slot in the left-hand side piece, to make this part comfortable to the fingers. While it

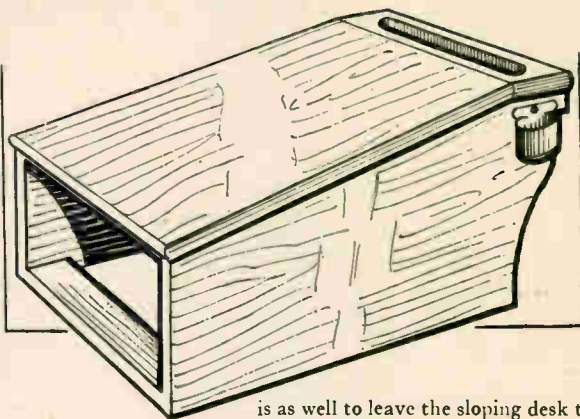

is as well to leave the sloping desk top in the white, the remainder might well be stained oak or mahogany colour, sized, and varnished.

If available, it improves the appearance of the desk if the receptacle on top for pens and pencils is stained a black colour. It is not imperative, and it is scarcely worth trouble to buy the stain for the purpose specially.

## Ink Bottle Holder

For readers who intend to use the desk for correspondence and do not use a fountain pen, a holder to contain the ink bottle is necessary. A simple but quite efficient one can be made by cutting down a tin can of suitable diameter to  $1\frac{1}{2}$  ins. deep, plus a strip  $\frac{1}{2}$  in. by  $1\frac{1}{2}$  ins. one side.

This strip is bent flat, and a hole is punched for a fixing screw, as in detail, E, Fig. 2. This can be given a coat of any available enamel, or be just varnished, and is fixed to the side of the desk where shown in the general view, with a round-headed brass screw.

It should be added that any nail heads in the top should be punched down slightly below the surface, and the holes stopped level. Provided the surface is rendered smooth, the wood top is quite all right for writing upon, and can be easily wiped clean as it becomes soiled in use.

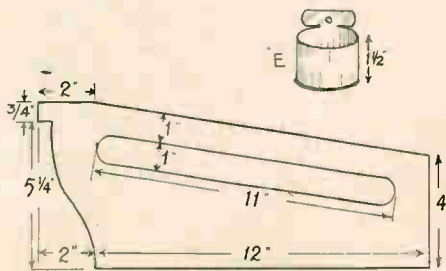

Fig. 2—Detail of side shape with ink bottle holder

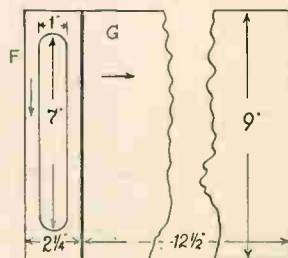

Fig. 2—The lid and top rail

# The home handyman will be interested in these PLANE HINTS

**M**OST amateurs have a plane of one sort or another. Perhaps the commonest is the small metal plane, which certainly has the advantage of cheapness. There is a variety of sizes, each suitable.

As a general rule, however, we recommend the larger sizes as they can be used for many purposes. It must be remembered, however, that a small plane has its limitations, with but a single iron, and must not be expected to do work for which it is not suited.

## How to Sharpen

For trimming up small pieces of wood, for use on the shooting board, and so on, it is just the thing, but one can hardly expect to plane a long joint with it or to smooth up the

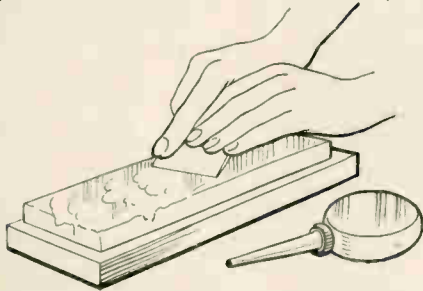

Fig. 1—Sharpening on an oilstone

surface of a piece of cross-grained mahogany.

The first thing to be learned about a plane is the proper way to sharpen it. As bought, the cutter is ground, but it requires to be given a keen edge on an oil stone. Slacken the holding down screw and withdraw the cutter.

Put a few drops of oil on the oil stone, and holding the cutter on it with the bevelled edge lying flat, work it back and forth with a circular motion. Should the edge be at all gashed, it will be necessary to rub it until the gash has been worked out completely. Fig. 1 shows the cutter being sharpened.

After a little practice it is easy to tell from sight when the edge is keen,



Fig. 4—The wooden Smoothing plane

but in the meantime, the thumb should be drawn across it at right-angles as shown in Fig. 2. If sharp, a burr will be apparent. This burr proves that the edge is sharp, but it does not show whether there are any gashes.

## Sighting the Set

An experienced man generally runs his thumb along the edge, but this is not to be recommended to the amateur. His better plan is to examine it by sight, when a gash will be noticeable from its not turning up a burr.

Once the latter has been turned up, the cutter should be reversed, held flat on the stone, and moved to and fro. This removes the burr. Note that it is of the utmost importance that it is held flat when reversed. To finish off with an extra keen edge, the edge should be stropped on a piece of leather. Wipe off the dirty oil from the stone and cover the stone.



Fig. 2—Testing the edge

The cutter of the block plane is replaced with the bevelled side uppermost. To adjust it the plane is held with the sole in a line with the eye (Fig. 3). The cutter should appear as a black line, thin or thick according to the thickness of shaving it is to remove. All single cutter planes are sharpened similarly.

## Wood Smoothing Plane

We now come to the planes fitted with a cutter, and what is known as a back iron. The wooden smoothing plane in Fig. 4 is an example. The first thing that strikes one about it is that the cutter is the other way up, the bevelled side downwards. The



Fig. 5—Tapping out the Iron

back iron is securely fixed to it with a nut and bolt.

Its purpose is to break the shaving as it is removed, and so prevent it from tearing out the grain. The closer the back iron is to the edge, the less likely it is that the grain will be torn out.

Anyone examining a shaving taken off by a plane with a back iron, will notice that across it is a series of marks where the breaks take place. The distance between them equals that of the back iron from the edge of the cutter. By being broken in this way, the strength of the shaving is destroyed.

If the reader took an ordinary knife and cut down a piece of wood,

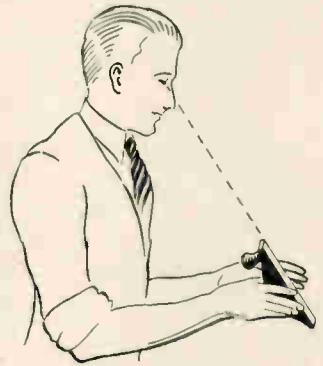

Fig. 3—Sighting the edge

he would find that the shaving he took off would tend to follow the grain of the wood, and would tear out. If the shaving he took off could be broken in the same way as a plane shaving, it would be far less likely to cause damage.

## Removing the Iron

To remove the iron, the plane is struck smartly at the back with the hammer (see Fig. 5). It should be held in the left hand with the thumb in the upper opening pressing on the iron, thus preventing the latter from falling out.

Unscrew the bolt and remove the back iron by passing it along the slot in the cutter. It is then sharpened in the same way as the block plane cutter. In shape, the edge should be

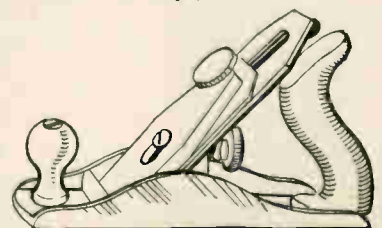

Fig. 6—A general utility metal plane

slightly round so that the shaving removed tapers off to nothing at the edges.

When re-setting, do not hammer the wedge in hard. A comparatively gentle tap is sufficient to hold the iron. A tap with the hammer will send the iron out a little more. To set the plane more finely, the back of the plane should be tapped. The distance the back iron is set from the cutter edge depends upon the class of work being done.

For fine work and for wood which is liable to tear out, it should be set very fine. The plane is used for smoothing up large surfaces which have previously been trued up with the jack plane or by machine.

### Iron Smoothing Plane

Another extremely useful plane is the modern adjustable iron smoothing plane (see Fig. 6). It is handy for all-round work. Not only can it be used for the same purposes as the wood smoothing plane, but it is possible to plane short joints with it,

whilst for end grain it is ideal.

The adjusting lever and screw at the back make it simplicity itself to use. It is sharpened and set in the way already described, except that the hammer is never used on it. To use the plane successfully it is essential that the face is kept lubri-

is a real carpenter's tool. Nowadays it is both expensive and scarce. It is made of beech for toughness, and requires proper handling to get results. The irons are the same as in a smoothing plane and sharpened in a similar way.

The body, being from 14 to 16ins. long will lie flat on large work, and its wide blade can take off good sweeping shavings in the hands of a craftsman. It reduces thick boards, or used on their edges for butt joints.

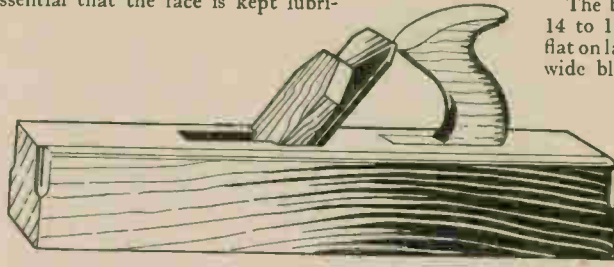

Fig. 7—The large carpentry jack plane of beech

cated. A good plan is to keep a piece of candle at hand and rub this on the sole occasionally.

The jack plane (Fig. 7) is used by the professional for quickly reducing the thickness of a piece of wood, and

The plane is not really necessary to the amateur worker, unless he is going to undertake real carpentry jobs about the house, when it is ideal for planing shelves, truing surfaces, etc.

## A handy accessory to fit to your frame is this CYCLE FIRST-AID KIT

THE increase in road traffic during the past twelve months has resulted in a serious rise in the number of road accidents. It is more important than ever before that cyclists should carry a small first-aid kit at all times—not only for their own sakes, but in order that they may render assistance to others. Prompt first-aid measures have often saved lives.

### A Useful Tip

It is very humiliating to arrive on the scene of an accident and have no materials with which to tend the injured. It was a country policeman

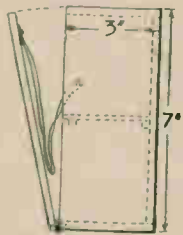

Fig. 2—Side view showing hinged front

who gave the tip on how to construct a useful cabinet which can be fitted into the frame of a cycle without causing inconvenience to the rider.

As you see from Fig. 1, the cabinet is so designed that it may be fitted at the junction of the cross-bar and saddle pillar.

Dimensions are not critical and to a certain extent will be governed by the clearance on your particular machine.

A convenient size, however, for the cabinet would be 7ins. at the top and 6ins. at the base. The difference of 1in. in these two dimensions makes allowance for the angle at which the upright pillar of the frame is set and so permits the cabinet to hang squarely and fit

snugly within the frame. The depth of the cabinet should be 3ins. I found  $\frac{1}{4}$ in. plywood quite satisfactory for constructing the box and  $\frac{1}{8}$ in. for the shelf.

### A Small Shelf

The dimensions of the shelf, which is fitted within the cabinet, should be  $6\frac{1}{4}$ ins. by  $2\frac{3}{4}$ ins. It is held in position by four small blocks of wood as seen in Fig. 2.

The straps for securing the cabinet to the frame are made from odd strips of leather. Tack the strips to the top and side of the cabinet and fasten them around the frame by means of press studs. These can be obtained from any draper's store, though you can use press studs from discarded leather gloves. It will be appreciated that the cabinet may easily be removed from the frame of the cycle when desired.

The side of the cabinet should be hinged so it will open downwards, thus forming a convenient table for preparing the dressings, etc. At no time should a first-aid-er place his materials on the ground.

### The Best Fastener

Experiments for securing the flap of the cabinet found that ordinary fasteners had a nasty habit of working loose as a result of vibrations from the cycle over rough surfaces. The best thing is to fit the cabinet with a small leather strap complete with buckle.

The cabinet should contain as many of the following items as space will allow: iodine or other antiseptic dressing; bandages (1in. to 3in. widths); burn dressings; boracic lint; sal volatile

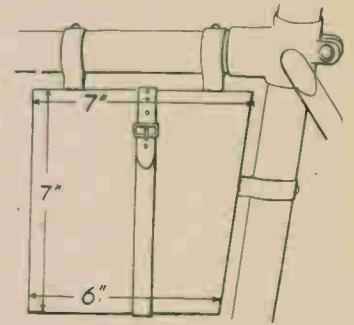

Fig. 1—Showing position and size

adhesive plaster (or adhesive dressings); a tourniquet (ready for instant use); small pair of scissors; safety pins and tweezers.

### First-aid Material

A triangular bandage is often most useful, but if you have not sufficient room in your cabinet, carry it on your person. The tourniquet, though extremely handy at times, can be a dangerous item of first-aid kit in the hands of the inexperienced. It is vital that the pressure on the artery be relaxed at least every fifteen minutes, otherwise serious consequences may result.

Should you be called upon to deal with a broken limb, your cycle pump could form one of the splints. Braces, belts, ties, etc. could also be brought into service for strapping a limb. A small first-aid manual in your pocket is also to be recommended. "Be prepared" is a grand motto for road users these days.



# The odds and ends you can do in undertaking ATTACHÉ CASE REPAIR

**A**T TACHÉ cases are at present in short supply, whilst those that can be obtained, are very expensive. It is quite worth while, therefore, to keep any case you may have, going as long as possible and here are some hints as to how these very handy pieces of personal equipment can be renovated and repaired.

Although these small cases can be made from a large variety of materials, they generally fall under one of three types: (1) real cowhide, (2) cardboard base with leather covering and (3) compressed and glazed cardboard or fibre.

## Clean First

Before doing any repairs, give the case to be overhauled a good cleaning—indeed, this may be all it requires to bring it back to a presentable state. Real leather should first be scrubbed with warm water and soap. The surface is then sponged with clear water only and finally wiped over with a solution made by dissolving about two pennyworth of oxalic acid in a quarter of a pint of warm water.

The leather must be thoroughly dampened before the oxalic acid solution is applied; indeed, the whole success of the cleansing treatment depends on this.

Now let the leather dry out naturally (which may take some time) and then give it a good application of any wax polish. Standard floor or brown-boot preparation will do quite well. Finally, polish well until a nicely glossed surface is obtained. Care must be taken, of course, to see that the washing, acid application and polishing is perfectly even over the various surfaces. Patchy cleaning is almost as bad as no cleaning.

## Removing Stains

If desired, in place of the final polishing, a liberal coat of leather varnish may be applied.

Suppose there is a stubborn ink stain on the leather, this may be removed by steady rubbing with a strong solution of oxalic acid, care being taken not to rub out on to the unaffected leather, or a light patch may ensue.

Should the leather have become dry and hard through many years of use, give several applications of olive oil and then polish as above, putting

*Best Wishes for 1948  
from The Editor to all*

on a very generous coat of whatever preparation you are using, and rubbing it right into the surface.

Card base and leather covered cases allow of the same cleansing treatment, but it must not be so vigorous. Do not polish, however, but apply a coat of leather varnish.

## Initialling

With cardboard and fibre constructions, the wiping over should be of the lightest, the cloth being kept fairly "dry" all the time. When perfectly clean with any unsightly marks there may have been removed, varnish carefully.

Initials look nice on the side of an attache case. If there are no letters, or the original ones have worn away, they may be readily put on or renovated, before polishing, with black enamel, using a fine camel-hair brush for the purpose. It is best first to line in the letter carefully with a very fine pencil. Letters of the "square" variety may be used, which helps a lot, as a ruler can be employed. If there are definite repairs to be made, these should be done after the first general clean—a second wipe over being given when the repair is complete.

## Corners

Corners often need attention. Generally a new "corner cap" should be fitted. These caps can sometimes be obtained ready made from a saddler's and they are put on by running a copper rivet through each of their three faces. Caps can be made from a piece of suitable leather, but they then have to be cut from a section of material as shown and only give strength along two faces.

Before fixing a cap, any gaping seams leading to the corner in question should be stitched. Waxed thread must be used for this and the original stitch-holes again brought into service. If the holes are not too easily found, clean them out with a fine awl, a few at a time as the work proceeds. Handles often need restitching as do the leather tabs that hold the handle rings on some makes.

These handle rings, too, often give trouble by opening. It is best to make the repair very definite here. First

press the opened ring with a pair of pliers so the ends of the metal are again in contact. Then apply a touch of solder over the joint and you will have no more trouble.

The handle "plate" or tab is that piece of leather which holds the ring to the top of the case. This is sometimes stitched and sometimes riveted. The plate has a knack of pulling away in time.

Stitched tabs can be replaced as suggested above, but riveted plates should have an extra layer of material placed on the inside before putting in new rivets, as the trouble probably is that the hole in the case has become too large. In some makes the tab is both stitched and riveted.

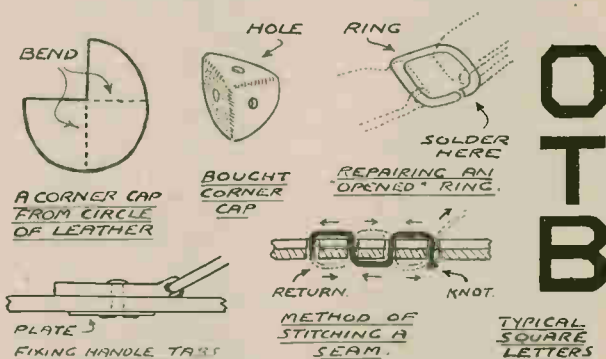

Details of the various parts, etc., mentioned in the article herewith

The piece of material inside can be a circle of tin as found in "pan menders", with a hole in the centre large enough to take the rivet. After making a repair of this nature, it is good to reline the inside top, thus covering the metal.

When the handle itself "goes to pieces" restitching along the side will effect a repair, but often handles can be picked up at a saddler's and if possible in bad cases it is good to replace entirely.

## Locks

Locks often eventually give trouble. They may merely be full of dirt, rusty, or actually broken. Four pins are usually used to hold the lock itself to the case and two for the other part. These come away if a screw-driver is inserted under the metal.

Once free, the mechanism of the lock can be examined and whatever repairs required effected. Replacing is carried out by refitting the pins through the original holes again and re-riveting. As with the handle plates, should the holes in the case walls be too large, a thin strip of tin can be placed on the inside and the pin ends slightly riveted over this.

# A Craftsman's Notebook

## Replacing Tap Washers

**D**RIPPING taps that cannot be turned off securely are untidy as well as wasteful. Even a small drip soon runs away with a large quantity of water and spoils the appearance of the bowl or bath underneath. The usual cause—a worn washer—should receive attention straightaway.

New washers can be bought for a copper at the ironmongers or probably obtained from the local water department. If necessary they may be cut at home from scraps of leather or rubber, but to be efficient they must be perfectly round and of the same size and thickness as the one being renewed.

First of all turn off the water at the

B	R	I	G	H	T	E	N	W
I	D	A	O	A	L	A		
R	N	T	R	I	S	E	R	
O	G	L	E	R	T	O	E	
S		B	E	V	E	S		
E	N	G	L	A	N	D	G	
S		R	A	N	T	A	S	
S		L	E	N	D	S	I	L
I		A	R	E	P	E	O	
F	I	T	P	A	Y	S	P	

**Solution to last Weeks X-Word Puzzle**

main tap in the house, drain off any that remains in the pipes, then unscrew the handle and stem from the faulty tap. A small metal washer will be revealed, and on top of it a similar disc of rubber or leather, this being the washer that needs replacing.

## Lino Blocks

**N**O doubt many readers help to organize exhibitions by making out admission tickets, small posters, and so on. Sometimes they may feel that they would like to ornament their efforts with a striking design, but where large numbers have to be produced it is seldom a practical proposition to draw every one by hand. The use of lino blocks is worth considering.

These are made by cutting the picture into a piece of thick good-quality linoleum from which impressions are taken off on to the paper or card. Where much work of this sort is to be done special cutting and gouging tools may be bought, but for an occasional job the small blade of a penknife will serve. It should be kept sharp.

Make the preliminary drawing on paper, going in for broad masses of black and white after the style of a silhouette. Greater detail can be included after a little experience. Then trace on to the lino, remembering that it must be in reverse so that when pulls are made it will come the right way round again. The areas that are

to be white must be cut away to a good depth with clean edges.

Printing ink is applied with a roller on which it is first evenly distributed by putting a small blob of ink on a sheet of glass and rolling it out. Alternatively, the kind of ink used for duplicators could be applied, or even Indian ink put on with a brush. New cuts will require a fairly liberal application to fill up any small pores in the lino, but excess must be avoided later when re-inking or the results will be smudgy.

The impression may be taken by placing the paper or card in position on top of the block and rubbing into contact with the back of a spoon or a roller, or for greater speed the lino cut can be brought down on top of the paper and plenty of pressure applied. Great care must be taken not to move the paper while printing, as slight movement would result in blurred outlines.

## A Tawny in Town

**I**HAVE seen owls occasionally and I heard them often, but not in quite so unusual a place as recently when I was on a visit to a friend's house.

Going upstairs rather late I paused to examine a roundish shadow reflected on the landing window and was surprised to see an owl on the sill outside. Its mottled brown colouring suggested a Tawny, a surmise that proved correct when my unwary movement caused it to fly off with the hoot peculiar to this species.

Its attention was obviously concentrated on a nearby wall thickly clad with creeper wherein were numerous small birds. But its presence in the district seemed unusual because the house is situated on a busy main road in a populated area close to the town, and the home of the owl must surely have been a good distance away.

## When Using Glue

**T**O prevent the pieces from scattering when breaking glue, wrap the cake in a piece of sacking or cloth. Just cover the small pieces with cold water and allow to stand overnight, then, if a proper glue-pot is not being used, put the pot or tin (not glass) container in a saucepan of water which must be brought to the boil.

Continue to boil the water gently until the glue reaches the right consistency—that is, rather on the thin side yet not watery, and certainly not too thick; it should run off the brush. If too thin further simmering or the addition of more bits of glue is required, if too thick a little more hot water in the glue and further heating. Remember to keep an eye on the outer pan to see that it does not boil dry, adding boiling water when necessary.

Glue should always be used hot. Clean off any previous glue from the surfaces to be joined, and put a fairly thin application of the hot glue on each. Some will probably ooze out and as much as possible of this should be wiped off straightaway, giving the joint a final and more thorough clean up later with a rag wrung out in hot water.

By clamping the two pieces together till firmly set close contact will be assured, and if string is bound around maximum tightness will be secured by inserting a stick and giving a twist.

The Craftsman

One of the most brilliant forwards that ever came from Scotland . . .

## Billy Steel

SAYS

“Here’s MY way to cross a road”



“It’s a forward’s job to break through—on the football field. He must be able to dodge the defence—and have plenty of dash. But dodging and dashing is just asking for trouble when you’re crossing a road. Here’s my way:

- 1 At the kerb—Halt.
  - 2 Eyes—Right.
  - 3 Eyes—Left.
  - 4 Glance again—Right.
  - 5 If all clear—Quick March.
- No need to run, because I wait until there is a real gap in the traffic.

“In Soccer, you go all out to win; so of course you take risks—it would be pretty dull otherwise! But traffic’s not a game. By taking a chance, you may get killed, or kill someone else. So just use your head, remember you’re part of the traffic, learn to be a good Road Navigator, and cross every road the Kerb Drill way.”

Billy Steel

**GET HOME SAFE AND SOUND**

Issued by the Ministry of Transport



# How odds and ends can be converted into WASTEWOOD NOVELTIES

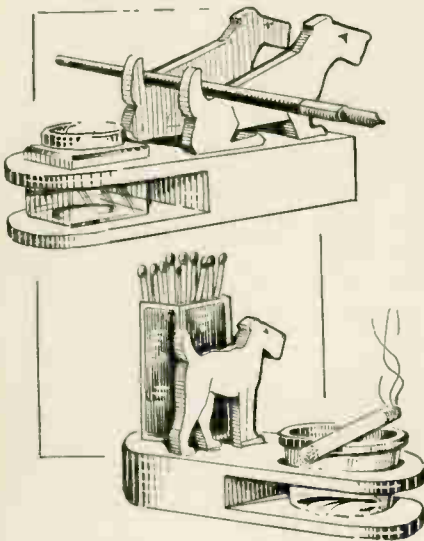

WE include from time to time in these pages, suggestions for using odd pieces of wood which accumulate after working upon some of the larger wood. Here are two simple ideas which could be worked up quite well and which would be suitable as gifts for birthdays or other anniversaries.

If the worker intends making up a number of these articles, it would be advisable, for sake of simplicity and speed of working, to cut a thin wood template of each part.

Then all he need do is to mark round each of these patterns, spacing them out on the wood to the best advantage so as to avoid wastage. The direction of grain of wood must, however, be borne in mind while so doing for sake of strength of the article when it is glued up.

The construction of the articles is extremely simple, as the diagrams in Fig. 1 show. The inkstand is made up of five pieces, two pieces as A, and three pieces as B. Pieces B, measure  $2\frac{1}{4}$  ins. by  $2\frac{1}{4}$  ins. The opening for the ink bottle will be cut away on one of the pieces, A, to the square given in the detail, Fig. 2. Glue the pieces together when cut and put them under

weight until the glue has hardened.

Care must be taken in levelling off the sides and end of the finished "block". The best way to do this is to have a stout piece of board with, say, a half sheet of coarse and fine glass-paper glued on the surfaces. Take care in the rubbing down to keep the block in an upright position, so perfect right angles are maintained.

## Dog Patterns

The two dogs (shown full size), forming the pen rack, may be cut from  $\frac{1}{4}$  in. or  $3/16$  in. wood and glued on to the dotted lines shown on the patterns. Two pieces of some hard variety of wood would be preferable for the dogs to avoid splitting and breakages.

Certain markings on the dogs may be added if desired and put in with indian ink. This is done, of course, before the finish of polish or varnish is applied.

The matchholder with ash tray is similar to our first article. It has only three pieces to complete the base, with an added block on the top, over which the matchbox will slide, allowing the matches to protrude for ease in handling.

## Containers

Two pieces of  $\frac{1}{4}$  in. thick stuff should be chosen for the top and bottom, D, with a  $\frac{1}{4}$  in. piece between them for piece E. Patterns for these pieces are given in Fig. 2. The terrier (F) may be cut from a close-grain hardwood and glued about  $1/16$  in. away from block, E, to allow the lid of the matchbox to slide down behind it as shown in the sketch of the finished article. Block, E, should be  $1\frac{1}{4}$  ins. high by  $1\frac{1}{8}$  ins. wide and  $\frac{5}{8}$  in. thick.

There are a number of finishes which might be adapted for such articles as these, and, of course, the kind of wood used will influence the actual finish and appearance. If hardwood has been used, a wood, perhaps, bearing a pronounced grain effect, then

just a rubbing with linseed oil should bring out the grain and be sufficient.

On the other hand, if a softer wood be used, the grain would be best filled and the surfaces varnished over or even painted in art shades.

## Suitable Finish

The wood, again, might be coated with ebonizing solution and then brush-finished with french polish, two coats being carefully given in a fairly hot temperature so that the shellac mixture flows evenly.

It should be remarked that the kind of jar suggested for the ash tray or pot are those containing meat or fish pastes. These, it has been found make admirable fittings for such articles. When using these containers, however, see they fit loosely the aperture intended for them.

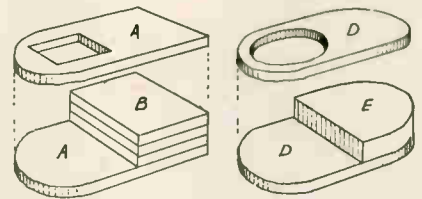

Fig. 1—The wooden base portion

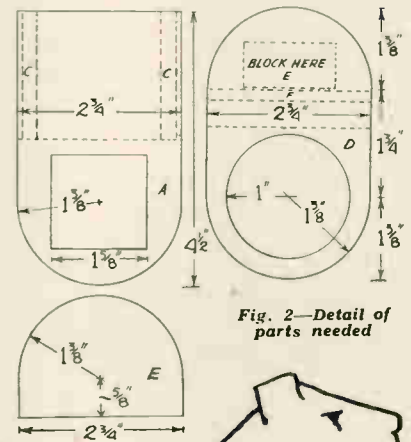

Fig. 2—Detail of parts needed

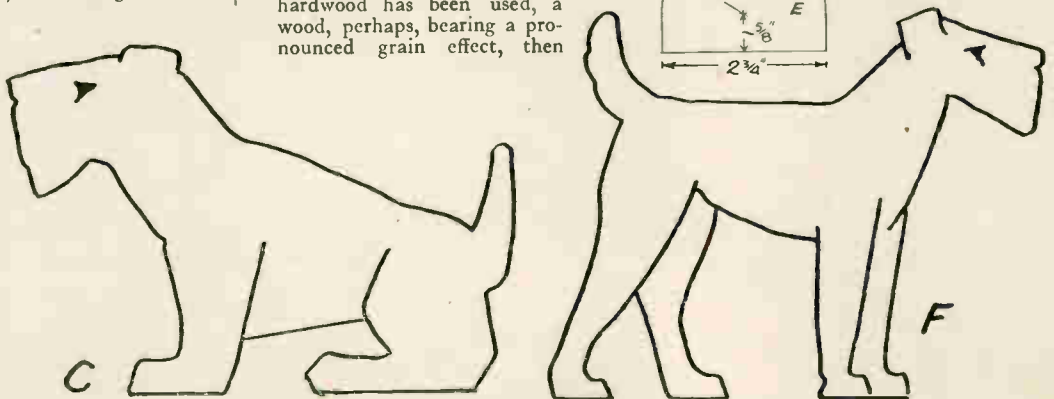

Fig. 3—Full size outline patterns of the two dog shapes to cut out

**B**ARGAIN!  $\frac{1}{2}$  oz. unsorted mixture (about 175 stamps) 2/6.—James, 67 Coledale Drive, Stanmore, Middlesex.

**P**ERSONS required immediately to make leather shopping bags in spare time.—Write (Dept. 11), Empire Co., 117 Nottingham Road, Loughborough.

**L**ONELY? Join Friendship Circle.—Details 6d.—Secretary, 34 Honeywell Road, London, S.W.11.

**50** EARLY stamps 6d. Ask for approvals, from  $\frac{1}{2}$ d.—Cogman, Potter Heigham, Gt. Yarmouth.

**H**ARDWOOD wheels, recessed, ranging from  $\frac{1}{2}$ in. to 4ins. diameter, from 1/3 per dozen, post free. Gross lots supplied. Wood turning of all description.—Dawson & Teakle, 63a Westcote Rd., Streatham, S.W.16.

**M**YSTIFY your friends with magic. Stamp brings you our list.—Bindings, 25 Aberdeen Place, London, N.W.8.

**E**NVELOPES are in great demand. Now is your chance to double your income. Send 5/- for complete instructions and templates. Write—Chas & Co., 3 Southfield Road, Western Boulevard, Nottingham.

**S**PARE-TIME workers required to manufacture plastic fancy goods.—Dept. S.3, Somat Plastic, 8 Middle Marsh, Nottingham.

**W**ALNUT, beech, etc., off-cuts. Send S.A.E. for particulars and price list to—Watterson & Co., Carrs Crescent West, Formby, Lancs.

**A**STOUNDING value. 4 each, Cowboys and Indians on horseback, coloured, 4/3 post free. Ironing Boards, children's, 4/6.—Dickinson, 23 Clutton St., Batley, Yorks.

**T**OYS! All types. See our list.—2d.—Holgate, 7 Hawthorn Terrace, Halifax.

**F**REE! 25 Stamps. Request discount approvals.—Bradbury, 5 Goulden Road, Manchester 20.

**W**OOD-TURNING lathes, Centrix, Radford, Nuttall and Coronet combination all in stock. Send us your enquiries.—Edwards & Drage (Tools), Ltd., 131 Magdalen Rd., Exeter. 56134.

**P**EN-FRIENDS! Stamp Collectors—Hobbyists—join "Cosmopolitan G. & E. Club," Malaya. No membership fees. Enclose postage for particulars to—Robert B. Chua, Gersek via Panchor, Johore, Malaya.

**M**ORSE Practice Sets. Tapper and buzzer on board ready wired, with battery, absolutely complete, 5/9 each, postage 6d. Headphones ex R.A.F. 5/- pair, postage 6d.—Barker, 14 Mardale Ave., M/c. 20.

**S**TAMPS FREE!! Twenty unused (2 $\frac{1}{2}$ d.).—G. H. Barnett, Limington, Somerset.

**N**EW Zealand 2/- and 3/- Pictorials free to purchasers of N.Z. packet containing 100 different Empire stamps (No G.B.) including Commemoratives, Pictorials, New and Peace Issues, 3/- post free.—Bisson, 46 Sumatra Road, London, N.W.6.

**E**LECTRIC Repeater Motors, new, ideal experimenters adaptable for D.C., A.C. synchronous or remote control. 5/- each, post 6d.—F. Lucas, 22 Hengrove Rd., Bristol 4.

**A**LREADY readers in four countries are using my complete details and drawings for building a high quality electric Hawaiian guitar, 7/6 post free.—C. W. Cragg (C), 48 High St., Oakham.

**S**TAMPS, send for my approval sheets, for small and medium collectors, enclose 2 $\frac{1}{2}$ d. stamp for postage. Free gift of eight stamps.—D. Mellenfield, S.D.A. (H.W.), 14 Kings Road, Barnet, Herts.

**40** Power Tools you can make, 12/6, post 8d. Popular Mechanics Press, Chicago. The famous "What to Make", 1947, 7/6. Shop Notes, 1947, 7/6. Following "How to Make" Books, 3/- each: 5 Power Driven Saws; Spray Painting; Caravan and Utility Trailers; Plastics Projects: Wood and Metal Lathes. 21 Action Toys. "Science and Mechanics", the leading American work-shop magazine, one year 15/-, post paid. S.A.E. for lists, books, plans, magazines.—BCM/PUBLICATIONS (H), London, W.C.1.

**B**OYS! Look at this, the most smashing free gift of all. The attractive and lovely Roosevelt Set from San Marino. Absolutely free to all genuine applicants for repeat approvals. Enclosing 3d. stamp, 1/- without approvals.—H. A. Smith, 13 New Road, Scole, Diss, Norfolk.

**C**OPPER Wire, enamelled, tinned, cotton, silk-covered. Screws, nuts, washers, soldering tags, eyelets, rivets. Ebonite and laminated bakelite panels. Coil formers; covered wires. Crystals, permanent detectors, earphones, etc. List S.A.E.—Post Radio Supplies, 33 Bourne Gardens, London, E.4.

**A**GAIN leading the market in competitive trading. Finest quality balloon tyre metal wheels. Per gross,  $\frac{1}{2}$ in.—6/-,  $\frac{1}{2}$ in.—7/-, 1 $\frac{1}{2}$ ins.—8/-, 2ins.—10/- Carriage paid. On orders less than one gross 6d. extra.—Jas. A. Woodbridge & Sons, 135 Nags Head Road, Ponders End, Middlesex.

**L**ONELY? Then write Secretary L.U.C.C., 5B.B. Hay St., Braughing, Herts. Genuine. Est. 1905.

**S**PECIAL Offer. Attractive stamp album, 50 stamps, packet of mounts. Post free 3/.—Gamut (Dept. C), Supplies Co., 24 Gunnersbury Avenue, London, W.5.

**S**TAMPS Free, send 2 $\frac{1}{2}$ d. for free gift and fine selection of approvals.—G. H. Brewer, 9 Wrington Crescent, Bristol, 3.

**W.** McGARRIGLE for aeroplane and ship kits. All accessories. Stamps lists 3d.; wholesale lists 4d.—64 Hillcrest Road, Romford.

**T**OY Wheels, pressed metal, improved balloon tyre design, per dozen  $\frac{1}{2}$ in.—1/6. 1 $\frac{1}{2}$ ins.—1/9. 2ins.—2/6, post paid. We also supply 1 $\frac{1}{2}$ ins. and 2ins. in colour (red, green or orange) at 1/- per dozen extra.—Joyden Toy Co., 193 Chase Side, London, N.14.

**M**ASTERCRAFT Toy Casting Moulds. Soldiers in battledress, planes, tanks, ships, airmen, farm animals and farm hands, wild animals and keepers. Deep cut moulds from 5/- each. Plastercraft wall plaques, ornaments, toys and brooches. Sample brooch mould, two figures 5/-. Buy Mastercraft, avoid copies. Illustrated catalogue 6d. S.A.E. for list. Also flat type German moulds from 2/6.—69 St. Marks Road, Hanwell, London, W.7.

**F**REE! Extra special British Colonial variety packet includes scarce Jubilee, Coronation, Victory, Zoological and latest new issue stamps. Request approvals (2 $\frac{1}{2}$ d.).—Thompson, 70 Cavendish Avenue, London, W.13.

**B**E Taller. Quickly! Safely! Privately! No Appliances—No Tablets—No Dieting. Details 6d. stamp.—Malcolm Ross, Height Specialist, BCM/HYTE, London, W.C.1.

**M**ODELS: you can make lasting stone-hard models with Sankey's Pyruma Plastic Cement. Supplied in tins by Ironmongers, Hardwaremen, and Builders' Merchants. Ask for instruction leaflet.

**T**RANSFERS for decorating toys, trays, furniture, fancy goods. Selection 10/-. 20/- Flowers, pixies, dogs, nursery rhymes.—H. Axon Harrison, Jersey.

**M**ONOMARKS. Permanent London address. Letters redirected. 5/- p.a.—Write Monomark BCM/MON082, W.C.1.

**P**ERSONS required to make plastic or leather fancy goods in spare time.—Dept. G.P.3, Newton Products, Ltd., 93 Goldsmith St., Nottingham.

**Y**OU can look up in "Where's That Car From?" 10,000 car index numbers alphabetically arranged. 56 pages 6d. From all newsagents.—Raleigh Press, Exmouth, Devon. (Post Id.).

**P**ERSONS required make fancy goods at home. Write for details.—Meltan Manufacturing Co. (Area 544), Southgate Street, Leicester.



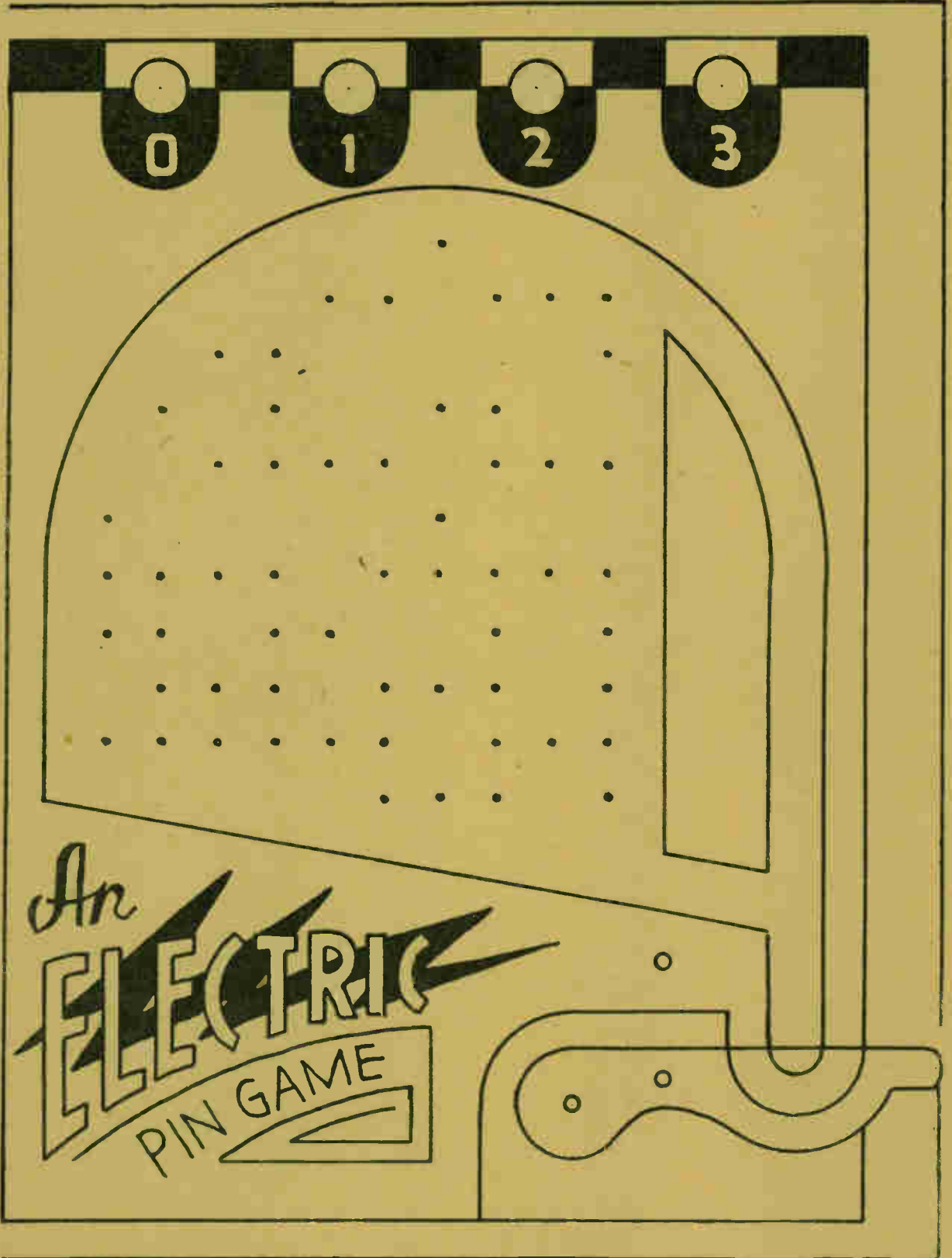

— BOOKS —

- How To Make an Electric Clock** by R. Barnard Way 3s. 3d.  
Notes and sketches for making an electric clock—to operate from dry battery or mains—from the simplest materials and ordinary tools.
- How To Make a Telescope** by E. F. Carter 3s. 3d.  
Principles of refraction and reflection, and the build up of a suitably powerful telescope from purchased lenses; and a cheaper version made from camera lenses.
- Modelling the "Archibald Russell"** by E. Bowness 5s. 3d.  
All the details necessary to construct what must always remain one of the finest sailing ships.
- Tools for Woodwork** by C. H. Hayward 8s. 0d.  
The full range of woodworking tools, their use and sharpening explained and illustrated by over 250 detail drawings and action photographs.
- Modern Woodwork and Furniture Making**  
by G. H. Barker 11s. 0d.  
The making of practical pieces for the home, with fully detailed drawings, photographs, descriptive notes and cutting instructions for making 58 pieces.
- Toys from Scrap** by W. Lee 3s. 9d.  
One of the best-selling books on making toys for private use or profitable sales; 20 designs and working drawings for toys, toy-furniture, etc.
- Staining and Polishing** 8s. 0d.  
Initial preparation and staining; wax, french and cellulose polishing; special finishes to suit particular woods; faults and blemishes and how to avoid them in finishing new work or repolishing old.

**"POPULAR MECHANICS"**

An American magazine of interest and instruction on working principles of everyday things. Recent issues have each contained 300 pages, 200 illus.

By annual subscription, 17s. 6d.

**"MODEL RAILROADER"**

The American model-maker's magazine, profusely illustrated by photographs and drawings of things to make

By annual subscription only, 22s. 6d

**STOBART & SON LTD.**

9 Victoria Street, London, S.W.1

*Manufacturers*  
**SPECIFY IT BECAUSE IT IS  
THE FINEST CORED SOLDER  
IN THE WORLD**

*You*  
**WILL PREFER TO USE  
IT BECAUSE IT MAKES  
PRECISION SOLDERING  
SO SIMPLE**

MULTICORE SOLDERS LTD., MELLER HOUSE, ALBEMARLE STREET, LONDON, W.1

" Why I support the  
**SILVER LINING**  
Savings Campaign "

by J. Arthur Rank

" Many of you will remember the film made for Two Cities by Sir Laurence Olivier—Henry V. It was the story of a small and very tired British army, led by a courageous and determined king, in battle with a much larger enemy.

To-day it is not an army that is in action: it is the whole nation. Like the soldiers in Henry V, and for the same honourable reasons, we are tired. And, like those soldiers, we need all our courage and determination to win this new battle.

We cannot all play as spectacular a part as our archers

at Agincourt. But we all can make a tremendous contribution by supporting the Silver Lining Savings Campaign with all our resources and all our strength.

In this present crisis increased Savings will tell the world that we are determined to win."



*Nation in Savings*  
**for National Prosperity**

*Issued by the National Savings Committee*

**BALLOON STAMP FREE**



YOU can get from us **ABSOLUTELY FREE** this valuable stamp of BELGIUM which shows Prof. Piccard's Balloon. This handsome and large stamp was issued in 1932 to commemorate Prof. Piccard's two ascents into the stratosphere for scientific research.

These stamps are slightly cheaper now than in 1945 when catalogued 2/- each, and we will send one **ABSOLUTELY FREE** to each approval applicant. Just ask for Balloon stamp (free) and selection of our stamps on approval, and enclose 3d. stamps for our postages.

**WINDSOR STAMP CO.**  
(Dept. 12), UCKFIELD, SUSSEX.

*The latest addition to the V & W list :*

**FUN WITH PHYSICS**

by Fredk. Jeffs

A book of novel experiments in heat, light, sound and magnetism that can be performed with safety and simplicity at home. Educational and entertaining at the same time. Well illustrated.

126 pp. cloth bound, **4/6** net.

*Obtainable from all booksellers or from*

**VAWSER & WILES LTD.,**  
555, Lea Bridge Road, London, E.10

A COMPLETE LIST OF PUBLICATIONS WILL BE GLADLY SENT ON REQUEST

Printed by BALDING & MANSELL, LTD., London and Wisbech, and Published for the Proprietors, HOBBIES LTD., by HORACE MARSHALL & SON, LTD., Temple House, Tallis Street, E.C.4. Sole Agents for Australia and New Zealand: Gordon & Gotch (A'sia) Ltd. For South Africa: Central News Agency Ltd. Registered for transmission by Canadian Magazine Post.



# Hobbies

## WEEKLY

### CONTENTS

	Page
Home-made Dog Kennel	153
The Editors's Notebook	154
Glass Jar Vases	155
Making Lantern Slides	156
Novel Match Holder	157
Photo Stand in Perspex	158
Replies of Interest	158
Small Vase Patterns	159

January 14th, 1948

Price Threepence

Vol. 105 No. 2724

## A HOME-MADE DOG KENNEL

THE illustration given here shows a practical type of dog kennel, a little unusual in design because it has a projecting roof at the front which affords good shelter from rain and wind.

A removable floor has also been included, to which the kennel itself may be hinged, making for ease in cleaning.

The whole thing is made up from seven distinct sections, consisting of two gable ends, two sides, two roof slopes and a base.

The length of the kennel is 2ft. 6ins. and its width 20ins., while the height measurement overall is 2ft. 2ins. Matchboarding  $\frac{3}{4}$ in. thick is used for all the outside walls and base, with  $1\frac{1}{2}$ in. by  $\frac{1}{2}$ in. stuff for the various rails.

### The End Gables

The end gables should be made first, and Fig. 1 shows their construction. Cut off four pieces of the  $\frac{3}{4}$ in. matchboarding which is generally about 5 $\frac{1}{2}$ ins. wide and grooved and tongued ready for knocking together. When doing this, see the tongues go right into the grooves to make perfect right angles when completed.

Next cut two rails 20ins. long from the  $1\frac{1}{2}$ in. by  $\frac{1}{2}$ in. stuff and nail them across the boarding as shown. Note that one rail is nailed flush with the lower edge of the boarding, while the one above is 13 $\frac{1}{2}$ ins. from this. The projecting tongue of one vertical edge of the completed board will be planed away, while the groove in the corresponding edge must be planed

away to make square edges, and to finish 20ins. full width.

A centre line should now be drawn on the boards and a distance of 24ins. marked upon this with a height of 18ins. at each side edge as given in Fig. 1. Connect these points to form the slope and saw through.

Next mark out the recesses in the sloping edges which are to take the roof battens. Each recess is 1 $\frac{1}{2}$ ins. wide and  $\frac{3}{4}$ in. or  $\frac{1}{2}$ in. deep and is cut down at right angles to the slope. Each end of the kennel will be identical. In fact, after having made the four boards with their cross rails, the finished one may be laid on this and marked round and cut and planed down.

One end must now have an opening cut in it to the size shown, the wood being sawn away either with a coarse fretsaw or a key-hole saw. The opening so made should be thoroughly glasspapered and all sharp edges or splinters of wood taken off.

### Sides

The two sides of the kennel are made up of six pieces of matchboard knocked together and held by two rails as shown in Fig. 2. If  $\frac{1}{2}$ in. wood

for the rails cannot be obtained, then they may be got out by cutting down some matchboarding and planing away the tongue and groove.

The rails for the holding together of the side uprights are to be 28ins. long, which allows the end sections of the kennel to fit between the sides as Fig. 3 denotes. The enlarged diagram in Fig. 3 shows the end section of the kennel drawn away from the sides which laps on to the ends.

All sections should be screwed together with round-head screws. The top edge of each side must be planed to a chamfer to allow the roof to lie flat, the lines of the chamfer corresponding to the slope of the gable.

### The Base

The next section to make up will be the base, the two sections of the roof being more conveniently and more easily fitted and fixed when this has been made up and lying flat and the kennel stood upon it. The construction of the base is clearly shown in Fig. 5. It is made up of eight

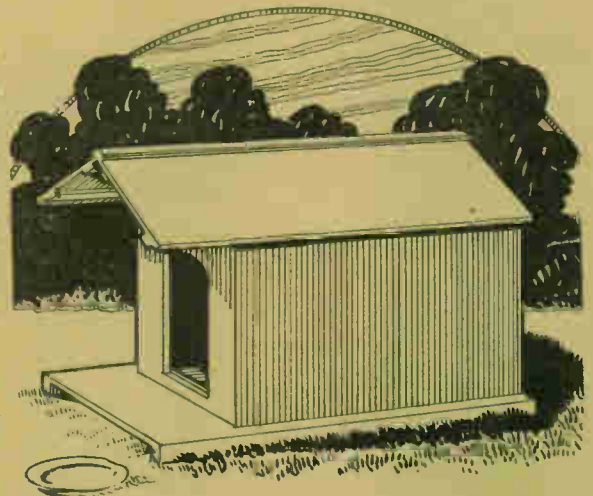

pieces of matchboarding nailed to two stout under rails.

These rails will lie on edge as shown and will be trimmed off at their ends after the matching has been fixed. The tongue and the groove at either end of the base will again be planed

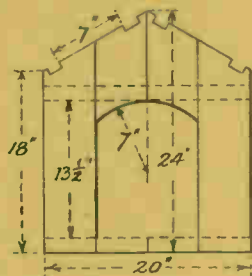

Fig. 1—End details

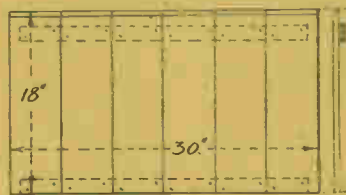

Fig. 2—One of the sides

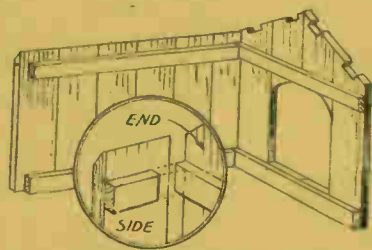

Fig. 3—Helpful constructional details

away, and all edges made smooth. The edging rails should be of stouter wood than the rails of the kennel. If thicker wood is difficult to get, then two thicknesses of stuff can be nailed together, the matching being either screwed or nailed to it.

The construction of one of the roof

slopes with all necessary measurements given is shown in Fig. 4. Here again eight pieces are cut off to length and nailed to rails 1 1/2 ins. by 1/2 in. in section running the whole length as shown. The spacing of the rails should be checked with the recesses made in the gable ends, as it is in these recesses that they must

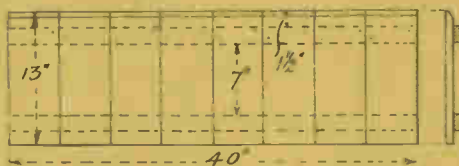

Fig. 4—One of the complete roof slopes

ultimately rest.

The top edge of each roof section must be chamfered to meet at a point, the chamfer, therefore, being planed to an angle marked on the wood. After a final testing to see the rails fit in the recesses properly, the slopes are screwed to the sides and gables.

Some workers may like to finish the ridge of the roof with a suitable capping such as is shown in Fig. 6. If this is done, then the slopes must be planed away slightly along the point to give the ridge a good fixing. The capping should not be less than 1/4 in. thick. A pair or three stout hinges will fix the kennel to the base, the kennel being then cleaned out when required by tipping it to one side.

Regarding the finish to be adopted for the outside, either a priming coat

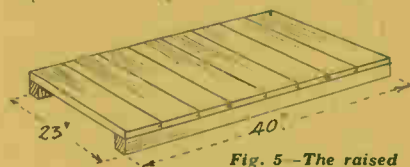

Fig. 5—The raised floor portion



Fig. 6—The ridge strip showing fixing

and two coats of paint should be given, or the whole may be gone over with creosote. The underside of the base should receive a coat of creosote fairly frequently to preserve the wood. The roof slopes would look well and effectively weatherproofed by the addition of either roofing felt or Ruberoid.

## From The Editor's Notebook—

BEFORE the war, as many readers remember, we had a large number of members in the Hobbies League, many of whom corresponded with each other in various parts of the world. Of course, during and since the war, the activities of the League have had to be discontinued owing to paper and staff shortage, although I hope to be able one day to renew the work. Anyhow, I have just heard from two pre-war members in Germany, who are anxious again to have pen-pals through our pages. I do not know all circumstances and it merely says that the writers have a good knowledge of English, and are students interested in general things, our ways of life, etc. I would, however, remind you that letters from Germany are subject to close scrutiny, and for the time being, our ex-enemies are still suspect. Correspondence could naturally be very interesting, providing no political matter was introduced. If any reader wants to write, he can send me his letter, sealed down in a plain, stamped envelope. I will then forward it to Kiel (where the writer is

29 years of age) or to Bremen (a student interested in art and history), whichever is requested.

I AM frequently being asked by readers, particularly campers in summer, how they can make materials waterproof—tents, capes, etc. They, and others will probably be glad to hear of a war-time development which can be successfully adopted to peace time needs. It is called "New" and any material whatever, dipped or brushed with a solution, dried in the ordinary manner, ironed if necessary, becomes as waterproof as a duck's back. And the material stays porous to air, looks and feels exactly the same. This is useful to know for waterproofing canvas hoods, deck chair canvas, and even cycling shirts or shorts! You can even make blotting paper waterproof if you want! This useful solution can, I believe be obtained from big stores, or direct from the makers, Peel and Campden Ltd., 183/189 Queensway, Bayswater, London, W.2.

A MODERN and fascinating type of moulding plastics at home is provided by the new Plexene Outfits. With them you can mould your own shapes for brooches, miniature planes, belt buckles, ash trays, cameos, etc. The method is quite simple. The liquid Plexene, in several bright colours, is mixed with a setting fluid and poured into moulds to set hard. When turned out, you have a practical and ornamental article of pleasing appearance and finish. The Plexene Outfits contain all necessary accessories, including tubes of plastic, setting and cleaning liquid, with mixing bowl, metal moulds, stirring rods, and complete instructions how to go to work. There seems no reason why a large variety of things cannot be made, once you have made the initial trial. Readers of Hobbies are naturally craftsmen and this very modern application of plastics will undoubtedly appeal. Particulars can be obtained from Promotion Features, Ltd., 123 New Bond St., London, W.1

The Editor



# Paste jars and the patterns on page 159 serve for useful GLASS JAR VASES

THE ornamental little jars which are sold filled with potted meats or fish pastes, make splendid little vases when washed and encased in a wooden stand. There are one or two sizes of jars, and, while the smaller size is suitable for the work under review here, the larger ones are, perhaps, more convenient. The latter measures 3½ ins. high and 2 ins. in diameter in the widest part.

The designs here are for two styles of vases to suit the jar mentioned, one having plain square sides and the other tapered sides as seen in the illustration. As there is some amount of fretwork in each design, we have given patterns for these full size on page 159.

## Bases

The bases for the vases are the same for each design. They are made up in two thicknesses of ¼ in. wood and cut to the outlines shown at A and B on the pattern sheet. The circle of wood will be cut from the two pieces so the glass jar inside the vase can be

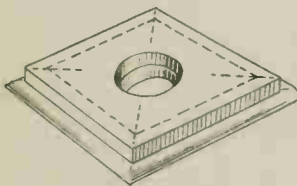

Fig. 1 - The base



Fig. 2 - Taper sides

lifted out by being pushed up with the finger from beneath.

The shaping to the four edges of piece A can be done, first by planing

away a chamfer and then finishing with coarse and fine glasspaper.

The top member of the square vase is shown at C. This is cut from ¼ in. wood and the outer edges shaped to the thumb moulding shown in the section. Clean off the sharp corners and edges of the opening after the top has been glued to its sides. Work the thumb moulding on the outer edges of the top also, after the latter has been fixed on.

## The Sides

In cutting the sides of the square vase, there will be two wide ones (D on the pattern sheet), and two narrower ones to go in between them. The width of the narrow sides is 2 ins. The dotted lines on D show where the narrow sides will be glued.

Cut the fretted panels carefully. After the four sides are glued together, each surface should be thoroughly glasspapered and the join made almost invisible.

It is advantageous when cleaning flat surfaces such as these to have a sheet of coarse and a sheet of fine glasspaper glued down to a stout flat board. The rubbing down can then be more evenly and quickly done. If a piece or two of ¾ in. or ¼ in. triangular

corner fillet can be obtained, it would be a great help in giving added strength to glue this down the inside angles of the finished vase.

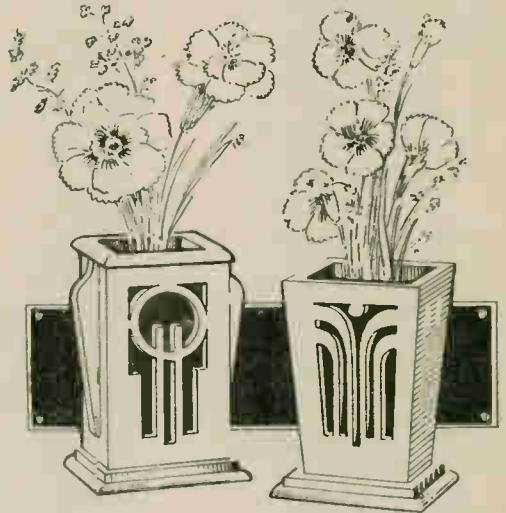

In gluing the sides to the base, draw light pencil lines across the diagonals of the latter, as shown in Fig. 1. This ensures getting even margins all round, when the corners of the vase meet the diagonals evenly at all four points.

## Handles

Simple handle decorations could be added to two of the sides as shown and the outline for one of these handles is given on the pattern sheet at F.

The tapered vase is made in an almost identical manner to the other except that this has no shaped top. Two sides are cut to pattern E, and two narrow ones measuring ¼ in. less in width at top and bottom to go between them.

As the sides taper, two of them (the unfretted let-in sides), must be a little longer, so when the top and bottom edges are cleaned off, they will be in the same plane as the fretted sides.

## Flat Tops

Fig. 2 gives the idea, and shows the two triangular pieces top and bottom which will be rubbed down. At A in the detail the side is again shown glued up, while at B the whole surface has been rubbed down. Our flat glasspaper-board will here come in again most useful for this process.

The finish depends upon the kind of wood used. Mahogany, or any of the darker woods, calls for french polish or varnish or even just a rubbing up with linseed oil. On the other hand, if white or a creamy coloured wood has been used, then this would be best left clean or, perhaps, lightly rubbed with the oil.

## Electro Plating

*I WOULD like to take up dipping or electro-plating of metals as a hobby. Can you help me? (H.L.H.—Grays).*

A SIMPLE electro-plating plant consists of a glass or other container in which the object to be plated may be placed. For copper plating, a solution of 28ozs. copper sulphate, and 4ozs. concentrated sulphuric acid to 1 gallon (or in proportion for smaller quantities) is used. The solution should be kept at about 70°—75°F. A voltage of about 1 or 1½ should be used, the objects forming the negative and a copper sheet the positive electrodes (immersed in the solution).

The objects must be perfectly clean, and as the plating speed will depend on their surface area, this is a

matter for trial. Too rapid plating will result in flaky deposit; the objects should be plated until observation shows sufficient copper has been deposited. To aid control, a variable resistance and voltmeter may be connected so that the voltage used may be adjusted, and an accumulator is the best source of supply.

For silver plating, a silver cyanide bath or silver nitrate 11 parts; sodium hyposulphite 20 parts; sal ammoniac 12 parts, whitening 20 parts and distilled water 200 parts (note this mixture is poisonous to an extreme degree) may be used.

The dynamo may be used for plating, provided the model used gives direct current, and it is operated so uniform output is obtained. Otherwise even plating will not be obtained.

# How the home photographer can make his own pictorial LANTERN SLIDES

AT this season of the year when parties are common amongst friends and neighbours with children, it is a good thing to provide an item in the evenings' entertainment that is a break-away from the usual run of games and competitions.

The suggestion, which is the subject of this month's photographic contribution, is one which will undoubtedly appeal to every amateur who has become expert enough to process his or her own work and has acquired something of a collection of interesting pictures or records.

## For Lectures and Talks

At the outset it is as well to advise readers that there is a very encouraging demand for lantern lectures. Those who are members of any type of Youth club or Scout group should keep this in mind for giving such a lecture to fellow members. It might be a very popular feature, even if it only consisted of the showing of thirty or forty.

It will, without any question, be a start in a department of a hobby which, with a little effort, should prove very helpful in more ways than one. For instance, it will encourage a keener outlook for the pictorial subjects in camera rambles; it will develop greater self-confidence by having to speak before an audience and it will help to earn a little more pocket money, for usually a small fee is readily granted to the lecturer by the association or club to whom the talk is given.

## Straightforward Work

Assuming that you have not, so far, made a slide. It must be understood that there is nothing difficult or intricate in the process. If you have carefully followed out the instructions given in the last two chapters for the making of contact and bromide prints, then there is no reason whatever why you should not be able to produce some excellent results on lantern plates at your first attempt.

If among your collection of nega-

tives there are several capable of yielding good contact prints because of their clear detail, sharp definition, a good range of gradation or tone values and the absence of fog, then those same negatives should certainly be used to make that first collection of slides.

## Lantern Slides

The present day price of lantern plates, 3½ins. by 3¼ins., is 3/3 per dozen; rather on the high side, but it must be remembered that a good slide will last a great number of years in the ordinary way. It is most strongly urged that only those of a well known and reputable firm should be obtained. The author invariably uses those made by Ilford, Ltd.

It is necessary to exclude all white light from the workroom when the actual exposing and developing is proceeding. An orange light is quite good and permits easy manipulation. For those who wish to experiment without going to too much trouble or expense, a Johnson's Metol-Quinol packet developer will be found very efficient indeed. If, however, there are some who like to add a spot of chemistry to their photography, then the following formula is recommended:—

A	Hydroquinone	80 grains
	Soda sulphite cryst.	1 oz.
	Water up to ...	10 ozs.
B	Soda caustic ...	45 grains
	Pot. bromide	18 grains
	Water up to ...	10 ozs.

For use take equal parts of each A and B solutions.

Having selected the desired negative, one of average density, which you would have included in the middle group when making prints, be sure that it is quite clean, free from finger marks or dust particles. The same applies to the glass in the printing frame.

Lay the negative, film side upwards on the glass and in the exact centre. Then place the lantern plate, emulsion side down to the film. Try to arrange it so the negative is centred. Now

clasp the back of the frame into position and see it is well pressed down and is firmly gripped by the springs.

Exposure is, of course, the tricky part of the process and as a guide only approximate times can be given. If the plates in use are of a fast type, place the frame at 4ft. from a 15 watt gas-filled lamp and allow 2 seconds. If you are using the grade of plates known as Gaslight or slow, then put the frame at 18ins. and give 30 seconds exposure.



Winter Sunshine can make a lovely picture

## Developing

Place the exposed plate in the developing dish and pour the solution fairly rapidly over it, being very careful to avoid all air-bells—even the smallest. If the exposure has been correct, the image will start to show itself in about 30 seconds and development be completed in roughly 2½ to 3 minutes. This, however, depends on the temperature of the solution and also, the emulsion.

It is a good plan to inspect the slide, and if the outline of the image can be clearly seen on the back of the plate by reflected light from the orange lamp, then it is safe to assume that development is complete. But until one has had some experience, it is always advisable to allow the developer to complete its work. If the result then happens to be too dark—dense—then it rather suggests that over exposure has occurred.

If too thin, then it is a case of under-exposure. Such a procedure with a first attempt is very strongly

(Continued foot of page 157)

## TOY MOTOR LORRY & TRAILER

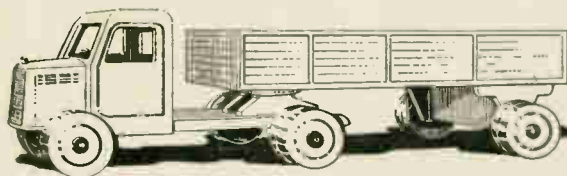

This week's supplement sheet gives patterns for the splendid toy shown. The necessary wood (Kit No. 2724) is supplied, with wheels, for 5/- from Hobbies Branches or sent post free for 5/8 from Hobbies Ltd., Dereham, Norfolk.

NOTE—THIS DESIGN SHEET IS ONLY PRESENTED FREE WITH THE CURRENT ISSUE OF HOBBIES AND NOT WITH BACK NUMBERS. FURTHER COPIES MAY BE OBTAINED.



DESIGN

No. 2724  
14-1-43

THE ARROWS INDICATE THE DIRECTION OF GRAIN OF WOOD.

SUPPLEMENT TO HOBBIES No. 2724.

— TOY —  
**MOTOR LORRY WITH TRAILER**

— SIZE —  
LENGTH 10 1/2 ins.  
HEIGHT 4 1/2 ins.  
WIDTH 4 1/2 ins.



DETAIL OF TURNTABLE

SIDE OF TRAILER, R.  
CUT TWO 1/2 ins.

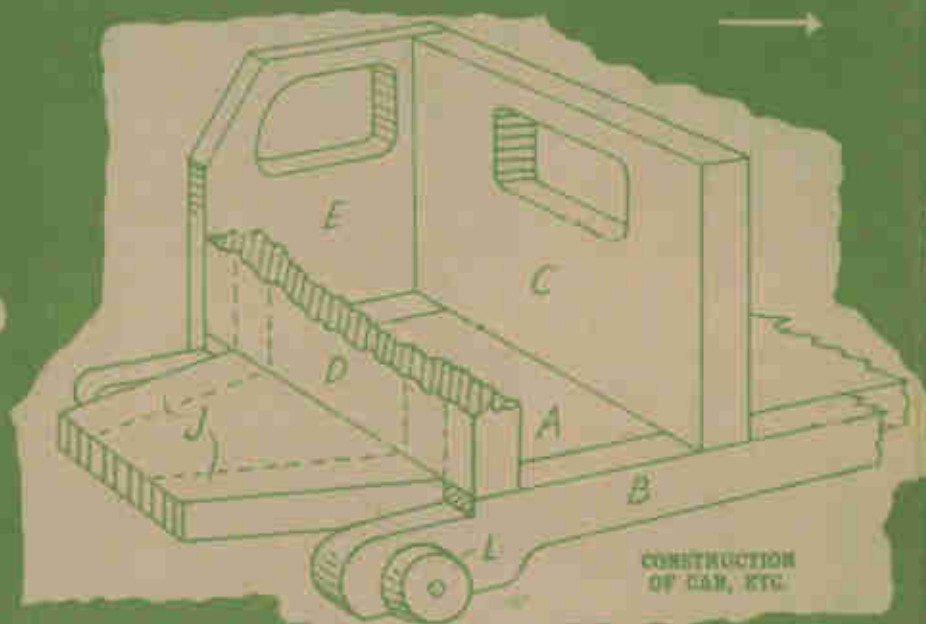

CONSTRUCTION OF CAN, ETC.

WHEEL SUPPORT

FLOOR OF TRAILER, R.  
CUT ONE 2 3/8 ins.

BACK AXLE

PARTS OF WOOD REQUIRED FOR THIS DESIGN

FIVE GD6 ONE H4

The price is shown in *Hobbies Weekly*, January 1943, 1946, but is subject to revision. See the current edition of *Hobbies Handbook*, or write for price to *Hobbies Limited*, Dereham, Norfolk.



FRONT AXLE

TURNTABLE SUPPORT.  
CUT TWO 3/8 ins.

WHEELS—IN ADDITION TO THE TURNED WHEELS SUPPLIED, THERE IS SUFFICIENT WOOD IN THE KIT FOR CUTTING THE FOUR (WHEN WHEELS OF THE TRAILER). THIS IS OPTIONAL, HOWEVER. THESE WOODEN WHEELS SHOULD BE GLUED TO THE PLAIN BACK FACE OF THE TURNED WHEELS SUPPLIED. ROUND-HEAD SCREWS 1/16 ins.

TRAILER, BACK AND FRONT, T.  
CUT TWO 1/2 ins.



## How to make a sturdy pull along toy 6-WHEEL TRAILER

**P**ATTERNS for the trailer lorry illustrated are shown full size on the other side, and when completed, a solid and attractive toy is made. Most of the wood is  $\frac{3}{8}$  in. thick, with some  $\frac{1}{2}$  in. for the trailer. The design parts shown should not be pasted down, but traced off direct to the wood through carbon paper or by tracing paper.

The parts are cut the sizes shown, with the fretsaw, cleaned up and easily fitted together. The sequence of construction follows the lettering of the various parts, but reading these details should be undertaken first to know certain points which have to be noted.

### Forward Chassis

The floor (A) has the two long wheel supports fitted to its edge. The back end projects slightly beyond the floor so the front angle comes where the floor starts to taper. You can see this in the detail. The front and back of the cabin stand on the floor where shown by the dotted lines on the pattern, and then the sides are fitted on the outside of all.

Notice the top edge of the front of the cabin is rounded off. The roof is also rounded nicely to the section shown, before being glued on. Fit all these parts to the cabin first temporarily, and do not glue one side or the roof on until you have added the seat and the steering wheel inside.

The seat is a plain rectangle, one edge of which is slightly chamfered to provide the tilt when glued in place.

The position of the seat is shown by the dotted lines on the pattern of the side. The steering wheel is glued to a short pillar which in turn is glued to the whole side at an angle in the front of the cab.

### Bonnet and Radiator

The engine cover and radiator front are simply three pieces built together. The two sides are (J), the top is (H), and the radiator front (I). This radiator front must be rounded, and would look much better if it also slightly tapers towards the top in thickness. You can see this in the picture of the finished model. Glue all parts together, and round off nicely with glasspaper.

Under the floor two axle pieces are added, one beneath the bonnet and the other (P) towards the back end of the floor. On the top of the floor at the back, are the two turntable support pieces (Q). Their position is shown on the floor pattern. On the top of them as you see in the detailed drawing, the turntable disc, K, is glued. Drill the central hole in this with a  $\frac{1}{8}$  in. bit and keep it clean and true.

### Trailer Portion

The trailer portion can be built as an independent unit. The lorry part itself is merely in box form. The two sides are glued to the side of the floor, and the end pieces put over the ends of all. Glue strongly together. At the back end, glue the wheel supports, O, with the back axle coming between them. See all these parts are glued strongly.

At the front end of the floor a hole

is made to take the short length of dowel which forms the pivot pin on the front portion. This dowel must be securely fixed and should then be rounded at the bottom end and smoothed down so it turns reasonably easily in the hole of the turntable.

In the parcel of wood provided by Hobbies are the six  $1\frac{1}{2}$  in. diameter wheels, turned and rounded ready for fixing with screws. If you want to make the trailer wheels double, as shown in the picture, you can easily cut four circular discs  $1\frac{1}{2}$  ins. diameter and glue one each on the inside of the wheel supplied.

### For Easy Running

Before fitting the wheels, you will have to add the little washer discs shown as L. These are glued immediately over the end of the axle—one is shown in the detail—to allow room for the wheels to turn. The  $\frac{3}{8}$  in. thickness of wood should be rubbed down on glasspaper to about  $\frac{5}{16}$  in. before gluing.

It will also add to the smooth running and turning of the toy if a thin metal or composite disc is added to the turntable where the trailer pivots through.

The completed toy after finally cleaning, is painted in bright colours with panels marked on the truck as shown, radiator and bonnet markings added and possibly transparent material fitted into the cabin for windows and windscreen. No lamps or registration plates are provided for, as the article is intended for a run-about toy rather than a correct model.



TRAILER WHEELS SUPPORT O. CUT TWO 3/8in.

BACK AXLE P FOR TRAILER. CUT ONE 3/8in.

LONG SHOULD BE USED FOR ALL WHEELS

PIVOT PIN. ONE 1/8in. ROD.

AXLE M. CUT TWO 3/8in.

SHAY P. CUT ONE 3/8in.

SIDE OF CAB E. CUT TWO 1/8in.

ROOF G. CUT ONE 3/8in. AND SHAPE TO SECTIONS.

STEERING WHEEL K. CUT ONE FROM STOUT CARD.

TURNABLE N. CUT ONE 1/8in.

STEERING PILLAR. MAKE ONE 1/8in. ROUND ROD.

SIDE OF BONNET J. CUT TWO 3/8in. AND SHAPE TO SECTIONS.

WASHER L. CUT SIX 3/8in. AND RUB DOWN TO 5/16in.

WHEELS SUPPORT B. CUT TWO 3/8in.

FLOOR A. CUT ONE 3/8in.

BONNET TOP H. CUT ONE 3/8in.

RADIATOR FRONT I. CUT ONE 3/8in. AND SHAPE TO SECTIONS.

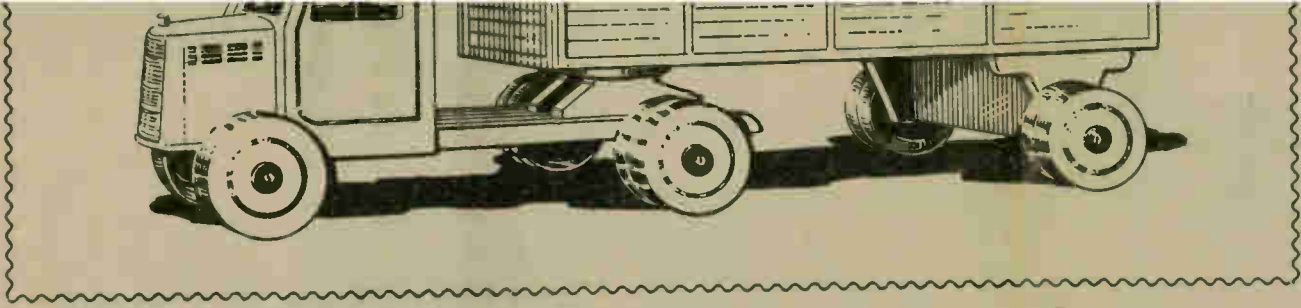



# A few odd pieces of wood will make this attractive NOVEL MATCH-HOLDER

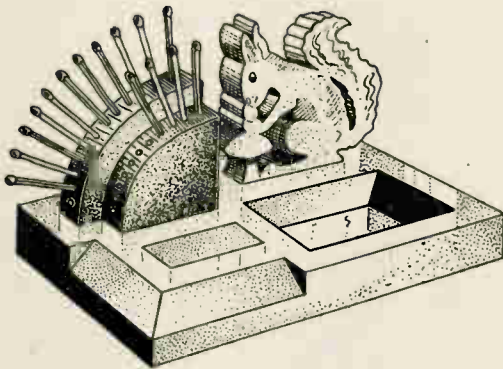

Fig. 1—The novel holder complete

**M**ATCHSTICK holders are usually plain and without much interest. That can hardly apply to the novel holder illustrated at Fig. 1, because there is a simple squirrel statuette, matches are displayed fanwise, making them easily lifted, there is a striker, and a tray is provided for used matches. All of which makes it a suitable item for a useful gift.

All parts are cut from  $\frac{3}{8}$  in. thick wood with a coarse fretsaw. As the item is enamelled, any class of wood serves, but for preference, whitewood is the best.

## Base and Holder

The base is built up from two separate pieces of  $\frac{3}{8}$  in. wood. One piece is a plain oblong, whilst the other—the upper—piece must be cut to the shape shown at Fig. 2.

Cut-outs are the holder and statuette mortises and tray aperture. Glue and panel pin the base parts evenly together, then trim and glasspaper.

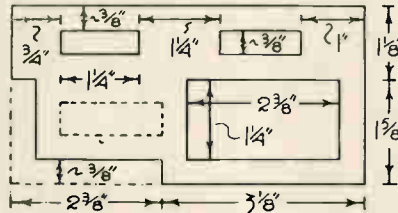

Fig. 2—Size and shape of base

In view of the  $\frac{3}{8}$  in. wide corner fillets which are mitred to length and affixed in the corner ledge provided, the rebate should have been carefully trimmed straight and square.

This also applies to the inside of the tray aperture, the corners being lined with angle fillet. Even if the base pieces are adhered together, trimming can be easily done with a sharp wood chisel.

The holder piece detailed at Fig. 3 gives the size and shape of the second holder piece. Cut both pieces with the grain running upwards as indicated, then pencil a line over the centre of the arc shape of each, dividing the largest piece to give twelve match holes, the smaller piece being divided to give ten holes.

## Match Holes

With an  $\frac{1}{8}$  in. drill, bore the holes so they point towards the corner of the holder the whole way around. This ensures that the inserted matchsticks spread fanwise evenly. The depth of the holes is about  $\frac{1}{4}$  in., and while all kinds of matches will suit,

excepting the waxed, cardboard type, the short round smoker's match is more suitable.

Glue the holders to the base. To make the statuette of the squirrel more realistic, try carving it in relief here and there with a penknife. When all parts have been assembled and touched up with glasspaper, give the whole work one coat of bright red enamel.

When quite dry, rub down this foundation coat with fine glasspaper, leaning lightly. A further coat of the same paint is given to the base only.

The holders and statuette should be coloured bright green, including the ends, sides and bottom of the tray aperture. When enamelled, glue green baize to the underside of the base or else use four wooden or half-round rubber toes. The striker is a strip of No. 1  $\frac{1}{2}$  glasspaper glued on, same being  $\frac{1}{2}$  in. wide.

## CUTTING LIST

- 2 base pieces— $5\frac{1}{2}$  ins. by  $2\frac{1}{2}$  ins. by  $\frac{3}{8}$  in.
- 1 holder piece— $2\frac{1}{2}$  ins. by  $2\frac{1}{2}$  ins. by  $\frac{3}{8}$  in.
- 1 holder piece— $2\frac{1}{2}$  ins. by  $1\frac{1}{2}$  ins. by  $\frac{3}{8}$  in.
- 1 statuette piece— $4\frac{1}{2}$  ins. by  $3\frac{1}{2}$  ins. by  $\frac{3}{8}$  in.
- 6 pieces corner fillet— $3\frac{1}{2}$  ins. by  $\frac{1}{2}$  in. by  $\frac{3}{8}$  in.

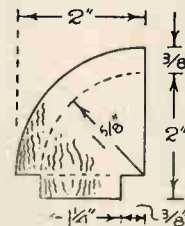

Fig. 3—Holder pieces

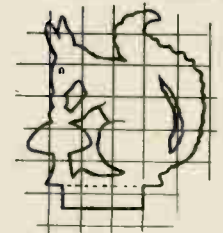

Fig. 4—Squirrel in  $\frac{1}{2}$  in. squares

## Photography (Continued from page 156)

recommended, for it will teach you a lot which will prove very valuable to you subsequently.

The lantern plate should be placed in the acid-fixing bath and allowed to remain there till the whole of the grey cloudiness has disappeared from the back. It is then washed for  $\frac{1}{2}$  hour in running water or given several changes. Place it in a position where it will be free from dust while drying.

## Mounting a Slide

Having pronounced your first attempt as satisfactory, the next operation is that of masking and mounting. Those parts which are not part of the picture have got to be prevented from showing on the screen

when the slide is put through the projector.

The only way to do this effectively, is to cover them with black opaque paper which can be bought in strips or as cut-out masks. The author uses the strips which serve also for binding the slide and the cover glass together. Cover glasses are obtainable for a few pence per dozen, and these want cleaning and freeing from dust before placing in contact with the plate.

When the slide is complete with binding, it is usual to place two indicator spots of white gummed paper on them and always in the same position, so the person putting the slides through the lantern knows

exactly how to handle them. The most usual position is on the top edge and on the back, or glass side, of the actual lantern plate, not the cover glass.

If a collection for regular use is being made, it will be found advantageous to add a white strip to the top of each slide on which can be written its title and also its number in the set. As an alternative, white ink can be used on the black binding strip.

When the slide is placed in the projector the lanternist will turn it so the white spots are at the base and facing the projector lens or screen, thus making sure that the picture on the screen is right way round.



F

# Holders for Glass Jars

(See details page 155)

SECTION

C

E

SECTION

B  
A

D



*You just  
make it and  
bake it—*

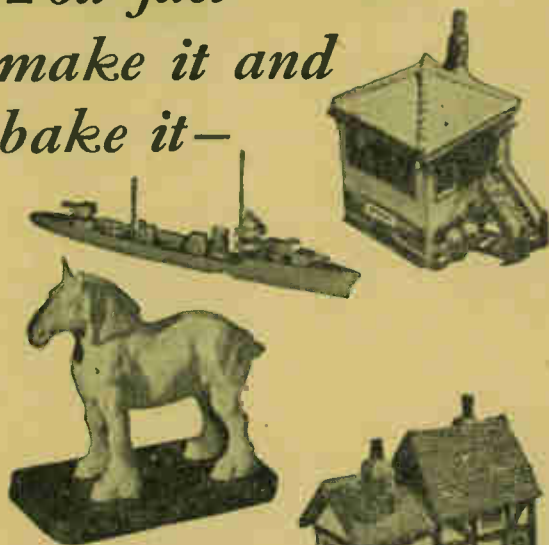

*with the  
**NEW***

## MODELLING MATERIAL

**M**ODEL railway buildings and platform forms, model ships and houses, animals and many useful and permanent objects can be made with Pyroma Plastic Cement. You just "make it and bake it" to stone-hardness, and afterwards, according to our instructions, paint in natural colours, i.e., with enamels, poster-paints, etc. Pyroma is comparatively inexpensive, and is obtainable in tins from Ironmongers, Art Material Dealers and Hobbies Shops. Send Id. stamp for illustrated instruction sheet on Pyroma modelling to the address below.



Write to Dept. 3

**J.H. SANKEY & SON, L.P.**

ILFORD

EST. 1857

ESSEX

NOTE THE LARGE LIP  
FOR EASY POURING



## JOHNSON PLASTIC DEVELOPING DISHES

Easy to empty without splashing or dribbling. Embossed ridges raise prints and prevent accumulation of sediment. Light, strong and not liable to get chipped or broken. Hard, black plastic can be kept clean, bright and free from stains. Impervious to ordinary chemicals.

4½ x 3½ (9 x 12 cm.) 1½-in. deep PRICE 3/-  
4½ x 6½ (13 x 18 cm.) 1½-in. deep .. 4/6  
6½ x 8½ (18 x 24 cm.) 2-in. deep .. 6/9

## JOHNSONS OF HENDON

PHOTOGRAPHIC CHEMICALS & APPARATUS

## GENUINE EX-RAILWAY AND SHIP TARPULINS

Guaranteed good condition and Waterproof. 70 sq. ft., 20/-; 140 sq. ft., £2 10/-; 280 sq. ft., £5; approx. 360 sq. ft., £6; approx. 720 sq. ft., £12. All include carriage.

GENUINE W.D. PIONEER FELLING AXES. Original handles, complete, hardened steel razor edge. Brand new. 18/6 each, carr. 1/6



GENUINE **Stove** 35/-  
Carr. etc. 2/6  
**ADMIRALTY Cooker**  
**COMBINED Lantern**

Economic Oil Burner, impossible to blow out. This Stove lasts a lifetime. Sheer steel, cost £7 7/- to make, clearance 35/-, post 2/6.

**Keep Food Hot! New Ex-Army Steel Food Containers.** Ideal to solve the fuel problem. Keep your cooked meal hot in this container. Ideal for picnics. Size 32" circ., 3½" deep. Bargain 5/9, carr. 1/-  
**'Paratroop' Binoculars** 45/-, post 1/- . Weigh only 7ozs. Telescopes and Prisms available.

**Electric Alarm Clocks** A.C. 200 250, 59/6, post 1/3

HEADQUARTER & GENERAL SUPPLIES LTD. (Dist. HOB, AS/1)  
196-200 Coldharbour Lane, London. S.E.5 1 minute Loughborough Junc.

## KEEP TRACK OF THE MODELS!



Although the production of our famous models is increasing, a large quota is reserved for export, and supplies for the home market are therefore limited.

Send now for our Gauge 'O' Model Railway Catalogue (G/55) price 1/-, giving prices of models available and delivery dates of forthcoming models.

"PECO-WAY", the most realistic Gauge

"OO' Permanent Way. Send for booklet Price 6d.

"Model Railway Handbook", Standard Edition ... 6/6

"How to Build a Working Model Road Tractor, 3" scale" ... 1/-

"How to Build a 1/2" scale 'Flying Scotsman' ... 1/-

"Laying Permanent Way" ... 6d.

"Model Supplies" (L/55) ... 6d.



## BASSETT-LOWKE LTD. NORTHAMPTON

LONDON SHOWROOMS: 112, High Holborn, W.C.1.  
MANCHESTER: 28, Corporation Street.

# Hobbies

## WEEKLY

### CONTENTS

	Page
Table Bookstand - -	161
Mouth Blowlamp - -	162
Electrical Experiments	163
Small Bookcase - -	164
Design Sheet Tips - -	165
Do's and Don'ts - -	166
Acrobat Toy - -	167
A Painting Aid - -	168
Stamp Collecting - -	169
Bookstand Patterns -	171

January 21st, 1948

Price Threepence

Vol. 105 No. 2725

## Patterns are provided for this useful TABLE BOOKSTAND

**T**HIS design is for a very useful type of bookstand with a drawer beneath for pens, pencils, etc. A rather unusual decoration is also suggested in the way of a painted crest or arms of certain counties or countries. The badge or shield of Scotland is shown in this particular case to illustrate the idea, but the maker of the bookstand may, of

course, add whatever decoration he wishes.

### Book Size

The bookstand here is not designed to take large or heavy books, those measuring about 7ins. by 5ins. being most suitable. For the stand itself, wood  $\frac{1}{2}$ in. thick is suggested, while for the floor, sides and back and inner front of the drawer  $\frac{3}{16}$ in. wood

would answer quite well.

We have included on page 171 of this issue full size patterns for the most important parts, parts which are shaped and would otherwise need to be enlarged from a smaller diagram. The two ends of the rack should be made first, and the full size pattern given can be stuck down to the wood and cut out with the fretsaw. When the edges of the piece have been cleaned up and made smooth, it is laid upon the second square of wood and a line drawn round it closely, making when cut round, two exact ends.

These are screwed to a floor measuring  $8\frac{1}{2}$ ins. long and  $5\frac{1}{2}$ ins. wide. Choose a good flat piece for this floor and in erecting the ends upon it, note that the front edge of the uprights come flush with the front edge of the floor, see the picture here.

Also note that the ends are to be set in  $\frac{1}{4}$ in. from the ends of the base so as to ensure a firm fixing for the screws, see enlarged detail in Fig. 1. Counter-sink the screws into the floor and fill the heads either with putty or with glue and saw-dust mixed.

### Back Rails

There are two back rails now to be added, and each is  $8\frac{1}{2}$ ins. long and 2ins. wide, as shown at A and B on the pattern sheet. The position for boring the screw holes through these rails is also shown and must be  $\frac{1}{4}$ in. from the ends. Round off the top corners of the lower rail and all four corners of the rail which comes above it.

When both rails are glued and screwed on, the stand should be rigid,

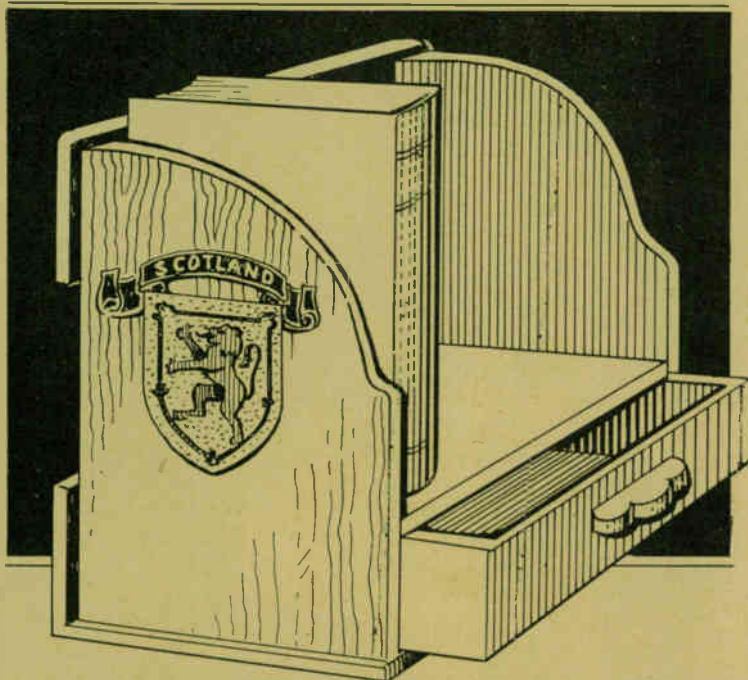

Correspondence should be addressed to The Editor, Hobbies Weekly Dereham, Norfolk.

and with the addition of the floor, the position of which is shown on the pattern of the end, the whole rack will be again strengthened to take the books.

The piece forming the floor measures 7½ ins. long by 5 ins. wide and ¼ in. thick. Get the floor a clear 1½ ins. above the base, the screws, therefore, through the back rail must be 1½ ins. up from its lower edge. Round off the front edge of the floor with coarse and fine glasspaper.

### The Drawer

The drawer is shown in Fig. 1. A full size outline of one of the sides is given, to which are pinned the inner

front and the back. The front rail of the drawer is also shown on the sheet.

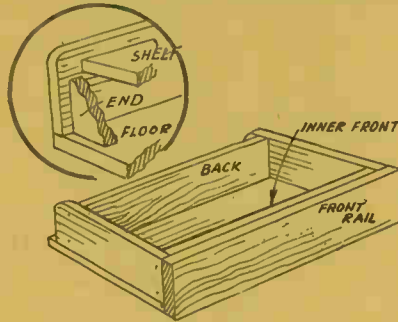

Fig. 1—Details of drawer construction

Check its length and that of the floor direct from the opening between the sides of the completed rack.

The inner front of the drawer is the same depth as the sides. The floor is glued and pinned to these parts. A simple shaped handle is shown on the pattern sheet. The mortise to take the tenon shown must, of course, be cut before the drawer parts are glued up.

The decoration on the ends might be carried out in oil paint or water-colour poster paint with a coating of varnish over to preserve it.

Another method which will appeal to many is to get a carved effect on the shield which they add as decoration.

## A handyman will find it useful to have A MOUTH BLOWLAMP

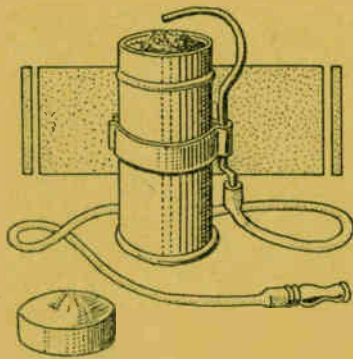

**H**ERE is a real practical piece of work which you can make very easily. Such a device as a blowlamp of the type shown is extremely useful for soldering and general repairs on a small scale. The strong pin-point flame melts solder instantly and allows it to be manipulated about with the iron in the most troublesome corners and places.

All you need is a tin shaving soap container, complete with its lid, odd pieces of tin, a piece of fine brass piping, a piece of laboratory rubber tubing ¼ in. in diameter and the nipple from an old pear push—or you can make a suitable nipple (as a mouthpiece) from ⅜ in. dowelling.

### Flame Material

Of course, to use the blowlamp, you will require some cotton waste and methylated spirit. Failing a small supply of cotton waste, a piece of old towel will serve, twisted and pushed into the container. Indeed, rags could be used, providing they are not woolly.

Begin work by cleaning out all traces of soap from the container. The seam at the side and at the base of the tin must be lined with solder.

A good idea is to melt a piece of

### False Bottom

When prepared, make a false bottom from a piece of tin. This is cut to the shape shown at Fig. 4 and holes drilled or punched in it. The bottom must fit inside the tin container easily, after the "legs" have been bent at right angles (see sectional view at Fig. 2). You can now pour a little spirits into the tin and push in the cotton waste.

The pipe nozzle is bent to shape from the small bore brass pipe. The pipe is soldered to a band of tin cut and made to the shape shown at Fig. 5. Note that the band is split. This is to enable you to adjust the position of the pipe jet by sliding the band up and down the body of the container.

### Fitting the Piping

The rest of the work involved is plain sailing. Insert the length of rubber tubing to the pipe nozzle, at the bottom, the other end being fixed over the pear-push nipple, this serving as a mouthpiece. As we suggested, however, you can make a suitable mouthpiece from dowelling (see Fig. 6).

First of all, drill an ¼ in. hole right through a piece of ⅜ in. dowel rod about 1½ ins. long. Work from both ends to get the hole truly central. With the penknife and a file, cut a shoulder on the dowel as shown, then shape it at the other end as shown and attach to the rubber tubing.

It is advisable to cement the tubing to the mouthpiece with, preferably, rubber solution. The blowlamp is complete, and to use it, apply a lighted match to the fuel and

bring the nozzle pipe down to a position which gives the most heat and a fine pin-point of flame.

Don't blow too lustily into the mouthpiece. Just keep up an even pressure of air. The mouthpiece is held between the teeth, by the way.

### Prevent Evaporation

When the flames from the fuel show signs of dying down, tilt the container downwards so a further supply of the methylated spirits soaks into the waste. Keep the lid on the container when the lamp is not in use to prevent evaporation.

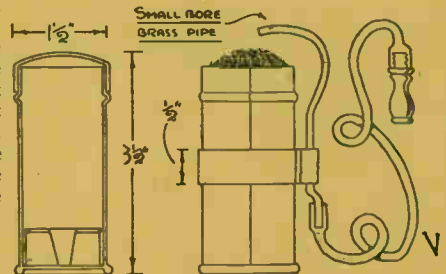

Fig. 2—Section of container

Fig. 3—Tube piece fixed to tin

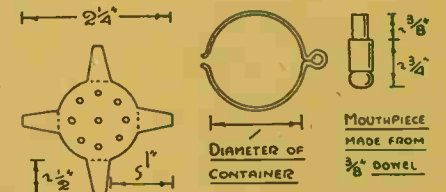

Fig. 4—The holed bottom

Fig. 5—Shape of clip

Fig. 6—mouth-piece parts

Paraffin oil could be tried in the blowlamp, if you have any difficulty in obtaining methylated spirits. The latter gives a warm clean flame, however, while the former gives off a dull sooty flame.



# How the amateur can perform interesting experiments in ELECTRICITY

**V**ARIOUS electrical experiments are possible with the very simplest of apparatus. They illustrate the principles upon which all electrical machinery works, increasing interest and making things which might otherwise be mysteries quite clear. They explain the effects upon which so many things in our daily lives depend and this knowledge may eventually be of use.

Several such experiments, which may be tried by anyone, are described here, with explanations of what actually happens.

## The Galvanometer

As tests will be on a small scale it is best to make up a sensitive meter.

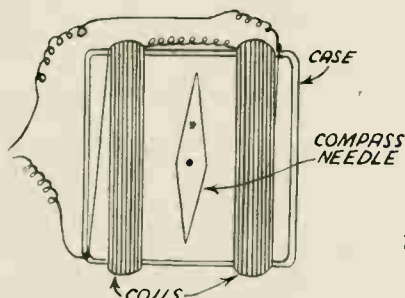

Fig. 1—Compass as galvanometer

This may be done by winding insulated wire round a compass (see Fig. 1). If the compass is in a square case, the wire may be wound round as shown. The more turns, the more sensitive will the galvanometer be, and about 200 or so are necessary. Any fine insulated wire (24 to 36 S.W.G.) is suitable.

The wire is in two sections, all turns in the same direction, so the compass needle is visible between. If a bare needle is used, or the case is circular, a former for the winding may be made from cardboard, copper, brass or zinc.

The case is placed so the needle rests as shown. When a current passes through the wire the winding becomes a magnet, turning the needle, and the meter is sensitive to extremely small currents.

## Generating Currents

The diagram at Fig. 2 shows three methods of generating currents. "A" is the Thermo-Couple, where dissimilar metals in close contact are heated. This system is used in a unit commercially manufactured to operate electrical apparatus from a gas supply, where numerous small jets heat thermo-couples.

To demonstrate this, two different

wires (nickel and copper are best, but iron and copper—or almost any different kinds of wire, will do) are twisted together for about  $\frac{1}{2}$  in. The meter is connected to the wires.

When a flame is held under the twist, the needle of the meter is deflected by the current. It will be found that as the twist is cooling, the needle will turn the other way.

The current produced is very small, and the principle is not much used because of this.

## Batteries

The drawing at B shows a demonstration battery which will turn the needle almost right round. Two coins (silver and copper) or dissimilar metals (brass and zinc, or copper and

iron core) is connected to the meter, and a permanent magnet moved by the pole, current is generated. When the permanent magnet approaches the core a surge is made in one direction; when it is withdrawn an opposite surge arises. It will be found when the magnet is still, no current is made.

Dynamos operate on this system. Sometimes the electro-magnets rotate, and sometimes (as in many cycle dynamos) the permanent magnet. A whole series of impulses arise, lighting bulbs, etc. For large power, this is the most-used method, the giant generators being driven by steam, water-power, etc.

## Transformers

When a current passes through a

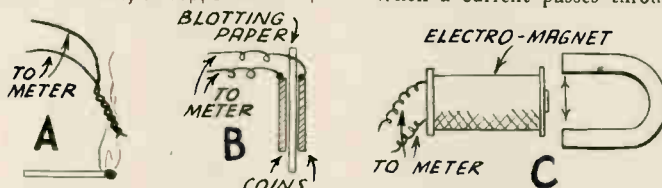

Fig. 2—Generating electric current by (A) heat thermo-couple, (B) voltaic cell and (C) magnetic induction



Fig. 3—How a transformer works

zinc, etc.) are separated by blotting paper. The blotting paper is soaked in acid—fruit juice, etc., is strong enough, although a spot of sulphuric acid is much more powerful.

When the wires from the meter are touched on the coins the needle will turn. If the wires are reversed, the needle will move in the opposite direction. This is because the miniature battery, has a definite polarity, zinc, if used, being negative.

This is the way all dry batteries are made, although sal-ammoniac is generally used instead of acid (because it is less corrosive) and carbon is used for one electrode (because it is not eaten away). If a spent dry-cell is broken open, this will be seen.

If an electro-magnet (a hundred or more turns of wire on an

wire, it induces a weak current in wires near it. If there are many loops of wire, with a metal core, the effect is strengthened. This is how transformers work, and by adjusting the number of turns, voltages may be stepped up or down. (E.g., if the primary has 1,000 turns, and the secondary 2,000 turns, the voltage is approximately doubled).

If two electro-magnets are put together as in Fig. 3, a type of transformer is made. When the battery is connected, the meter pointer will move, then return to rest. As the battery is disconnected, the needle will move again, then come to rest.

(Continued foot of page 164)

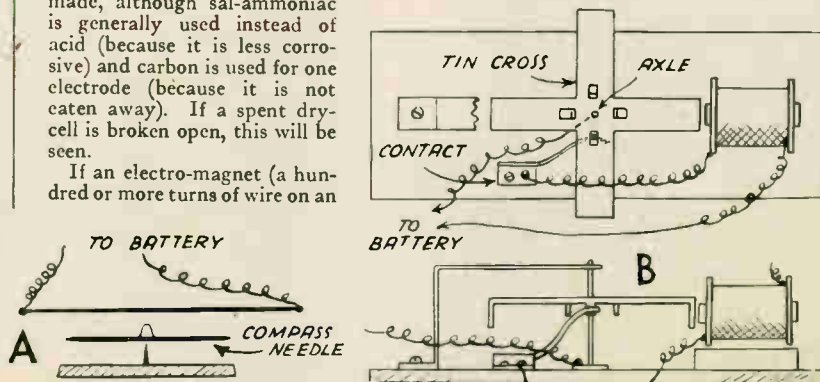

Fig. 4—Shows how an electric motor works, with top and side view

# How to make a plain but attractive SMALL BOOKCASE

THOSE requiring a small simple type of bookcase will find the one detailed herewith ideal in every way. The illustration does not do the finished work justice, but suffices to give anyone some idea of its shape and design.

It is a unique sort of bookcase, one feature being that wavy glass, instead of plain glass, is used in the door frame. This glass has the effect of almost concealing the contents, yet showing the literature in a pleasing manner, but see note at cutting list.

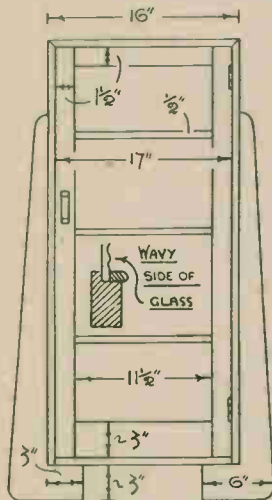

Fig. 1—Elevation and helpful dimensions

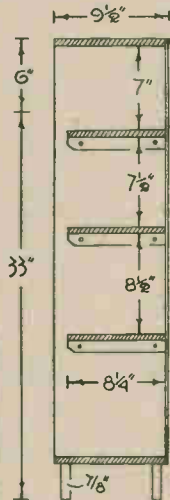

Fig. 2—A sectional elevation

Indeed, such a bookcase could be used as a small china cabinet. It would also be a handy cabinet in a bathroom for soaps, towels, etc., particularly if wavy glass is adopted, and if the woodwork is enamel-

finished to fit in with the colour scheme of the bathroom. If desired thin wood could be used instead of glass.

Any sort of 3/4 in. and 1/2 in. thick wood is used. The carcass is made up of two 3/4 in. gables and a 1/2 in. top and bottom, the former being mitred-dovetailed and the latter lap-dovetailed to the gable ends. The back edges of these parts are, of course, rebated to take a backing of card, lino, etc.

When assembled and squared up, with the backing attached, cut out the four leg pieces and attach them with flathead iron screws to the gables (from the interior side) about 1 in. from the edges. Cross pieces of wood could be fitted between the legs at the bottom as shown by Fig. 1.

When the door has been made, fitted and hinged to show a small break at the front, finish off the work with polish or enamel paint. When fitting in the wavy glass, if obtained, note that the wavy surface goes to the inside of the door.

Slips of wood, as sectioned in the inset detail, are used in holding the glass in place, same being mitred at the corners. A small fret overlay could be affixed to the centre of the bottom door rail.

Shelf fillets are screwed on, at suitable distances, as shown at Fig. 2. If necessary, it is always a simple job to adjust the fillets; it would be a good idea to have the fillets covering the heads of the screws holding the legs to the gables, but it would not matter if the heads show.

This cabinet would look very neat and attractive if the body was finished light oak, with the legs

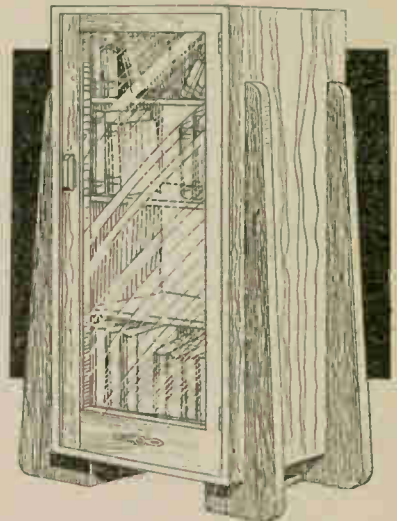

A useful cabinet bookcase 3ft. 3ins. high and 1ft. 9ins. wide

stained a darker shade to contrast. An erinoid handle or knob could be obtained to match the finish.

## CUTTING LIST

- 2 gables—36ins. by 9 1/2 ins. by 1/2 in.
  - 1 top piece—16ins. by 9 1/2 ins. by 1/2 in.
  - 1 bottom—15 1/2 ins. by 9 1/2 ins. by 1/2 in.
  - 4 leg pieces—30ins. by 6ins. by 1/2 in.
  - 2 door stiles—29ins. by 1 1/2 ins. by 1/2 in.
  - 1 door rail (top)—11 1/2 ins. by 1 1/2 ins. by 1/2 in.
  - 1 door rail (bottom)—11 1/2 ins. by 3ins. by 1/2 in.
  - 1 plywood back—36ins. by 16ins. by 1/2 in.
  - 6 shelf fillets—8 1/2 ins. by 1in. by 1/2 in.
  - 3 shelves—17ins. by 8 1/2 ins. by 1/2 in.
  - 2 door slips—30ins. by 1/2 in. by 1/2 in.
  - 2 door slips—14ins. by 1/2 in. by 1/2 in.
- Note:—As glass, in any form, is difficult to obtain, the bookcase could be made and used without a door, as in local libraries.

## Electricity—(Continued from page 163)

As this shows, a steady current cannot work a transformer—the current must be just beginning, or just ceasing. Therefore, a transformer will not work on ordinary direct current, which is why all modern mains supplies are alternating current (where the polarity is changed with each cycle—50 times per second, usually).

By means of transformers, all voltages desired may conveniently be obtained from our A.C. mains.

### A Simple Electric Motor

If one straight wire, a foot or so long, is held closely above a compass needle, the needle will be turned to a certain position if a battery is connected (A in Fig. 4). We found a moving magnet would make a

current, so, in reverse, a current will make a magnet (the needle) move.

At B is shown how a simple electric motor may be arranged. If the circuit is examined, it will be seen current only flows through the magnet when one of the small projecting pieces near the centre of the cross touches the contact.

Contact should be made when each of the arms is approaching the magnet. The magnet then draws it. As the arm comes opposite the magnet, contact is broken. The magnetic effect ceases, and momentum carries the cross (called the "armature") on. This is repeated four times for each revolution, the cross spinning rapidly.

All electric motors work on one of these systems, or a combination of

them. Sometimes the electro-magnets rotate, and sometimes other electro-magnets are fixed, to increase the power. Contact to the appropriate magnets is made by a commutator, which enables the motor to run as required.

With alternating current, the supply is interrupted at a certain speed. Motors with no commutator may be made to run from this, their speed depending upon the number of poles on the armature.

One well-known form of this is the synchronous motor used in clocks, and as each change of current (or cycle) rotates the motor one pole, the motor always runs at exactly the same speed. Such clocks only lose time when the frequency is reduced by the generating stations.

# Your work will be easier and better after reading these DESIGN SHEET TIPS

FROM time to time we receive letters from readers containing questions which obviously reveal that they do not quite understand all the definitions of the markings which are printed for their benefit on the design sheets presented every other week with Hobbies.

It does save such a lot of trouble if you can "read" the drawings correctly, and realise before you actually begin anything, how all the parts are cut, shaped and put together. These notes, therefore, will probably be of interest to a number of our readers and possibly more so to the beginners.

## Design Details

The common trouble is that a design sheet is just given a cursory glance, then the patterns are cut out and pasted down before an immediate commencement is made on the actual cutting. This is all wrong.

If you are going to build a house

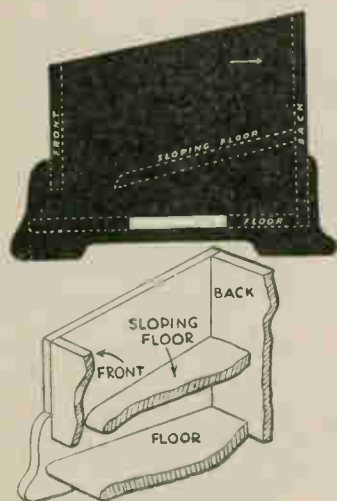

Fig. 2—Dotted lines indicate position of adjoining parts

you obviously must know all the details of the plan and specifications, so that you can have in your mind's eye some idea of not only how the thing will look when it is finished, but also the materials needed in the construction, and where they go together.

Just the same with the design sheet. It is essential to study it carefully to notice the various patterns thereon. In addition to the actual patterns, however, there are frequently a number of symbols or instructions which to those who understand them, will make the whole work much easier. Shaded portions all indicate shaping; broken parts are

to be extended; dotted lines indicate position, etc. Further details of these indications will undoubtedly help the beginner.

Take, for instance, the shaded portions which are shown on some

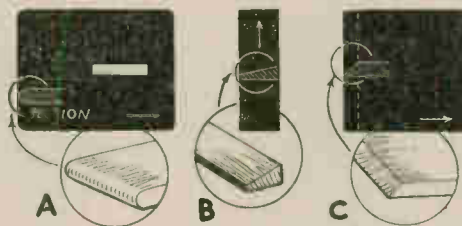

Fig. 1—Three forms of edging to wood

parts. You may see on the sheet a piece printed in solid colour, but at the edge of which is a shaded portion as indicated at Fig. 1. This shaded piece really indicates a side view of the wood, showing how it would appear if viewed from the edge. If you realise this, you will know that the section indicates a rounded curve or a chamfer of some style.

## Shaded Indicators

The two examples shown in Fig. 1 indicate the matter clearly. Always, therefore, note any shaded portion which appears on the design. The rounded section or the chamfered edge must be carried along the whole length of the part shown. If a wide chamfer is shown, it may occupy the whole of the piece as in the detail B, but if it is a narrow chamfer as in C, there is usually a dotted line running right across.

This means that the whole edge has to be chamfered to the angle indicated. This line should be drawn on with pencil parallel to the edge before the actual chamfering or shaping is undertaken.

On some of the patterns, too, you will find indications of adjoining

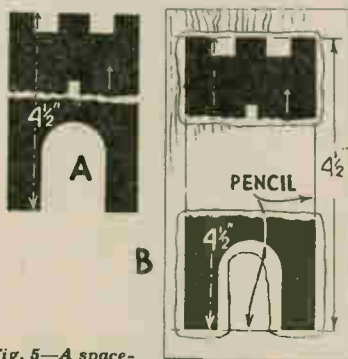

Fig. 5—A space-saving pattern extended to required dimensions

parts made by the dotted lines. These lines also show you very often the actual construction. In a box base, for instance, the sides have to stand upon it and the dotted lines show you quite clearly which two are put inside, the other two to form the rectangle.

Or again, overlays and additional pieces have to be put on in a certain position, and these are indicated by the dotted lines. At Fig. 2 is a drawing of the actual pattern, and then of the piece where the other parts have been added as indicated. Notice in this how the dotted lines show the position of the front, with the gap between the floor, and also

where the overlay is coming on the outside.

## Direction of Grain

In all designs you have an arrow on the pattern, and a note on the sheet to say that this indicates the direction of the grain. Do not forget this point when you are putting the patterns on to the wood. The grain should run generally the longest way of the wood because if it is running across in a

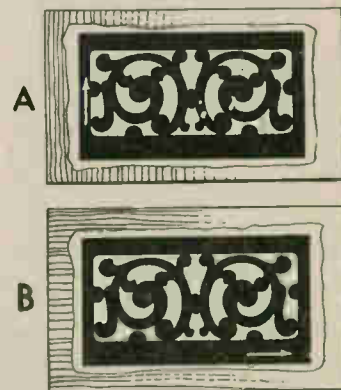

Fig. 3—Keep wood grain longest direction

narrow piece, there is considerable weakness.

You can see this in Fig. 3 where the piece, A, is much more likely to break than piece, B, because the grain runs in the wrong direction. In thin wood, this direction of grain makes all the difference, and this point should be borne in mind.

## Scale Drawings

You also sometimes have a drawing like the one shown at Fig. 4, where several dimensions are given on a small diagram. This is a scale drawing and usually relates to a larger piece of work for which there was not room on the sheet full size. Normally



these scale drawings are all plain rectangular pieces, and as such they can be easily redrawn direct on to a board.

The principal point in marking them out apart from getting the dimensions correct, is to see that the corner angles are rightangles. You may, indeed, have the dimensions what they should be, but the resulting figure need not necessarily be true if the angles are not squared up. This can be done with a setsquare or a tee-square on the first two lines, and then if other measurements are added correctly, the result must be as required.

#### Marking Instrument

Use a sharp pointed pencil in marking dimensions, and keep a very small dot. If you make a thick blob at two or three points, the total difference when you join up the line between them, may be as much as 1/16in. You may, of course, prefer to use a scriber or an awl—a very sharp pointed instrument which will make a little hole indicating the position required.

Now that the paper shortage has decreased the size of the design

sheet, it is often difficult to get the whole of the patterns required in the area provided. At the same time, the work has ornamental edges and is not the plain geometrical pattern which allows a scale drawing. For that purpose, the following expedient is frequently used, and you must be able to recognise it in "reading" the

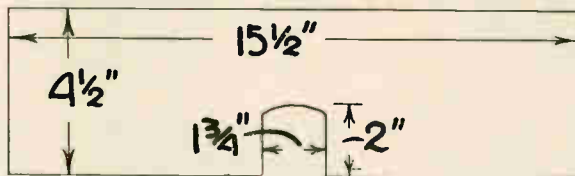

Fig. 4—How dimensions are marked to indicate full size patterns

design sheet published in Hobbies.

The part concerned may have a shaped edge at its two ends, as you will see in the part, A, at Fig. 5. The pattern is not the complete length required, but in order to reduce space on the sheet, has had the middle portion cut out. This is indicated by the wavy white space between the two broken parts and the arrow which is invariably shown upon it indicating the complete length.

Therefore you have to extend the two pieces of the pattern to whatever is needed, as you will see in the diagram at B in Fig. 5.

The pattern is cut in the two parts and pasted down at one end of the wood. From the point indicated by the arrow head you mark off the dimensions shown and run a line completely across the wood.

You must also extend by pencil lines on the wood, the outer edge of the pattern pasted down. Now take the other piece of the pattern and

paste it at the opposite end of the wood so that the dimension required comes on the cross line and the side lines fit squarely on to the pencil marks.

If the patterns have no shaped edge but merely have to be extended to the distance shown, then there is no need to paste them on to the wood. You can measure up the pattern itself and mark it out on to the board again, using the square and ruler.

## Some Do's and Don'ts!

**DON'T** mix hard tap water with drawing ink to thin it or use the residue which may be at the bottom of the bottle. You will spoil your small quantity of ink. Drawing ink is usually waterproof; but, if it has to be diluted, use rain water, which is, of course, distilled water. It is also wrong to put blue-black writing ink into black drawing ink in the hope that such ink will dilute it better. These inks do not mix well, though they may appear to do so in the bottle. In practice, the blue-black writing ink only will flow from the pen, the drawing ink clotting on the nib.

**DO** make a point of using thin, clear machine oil on oilstone slips and oilstones. Thick oils such as motor oils creates a scum on the surface of oilstones which is hard to remove. A good substitute for lubricating oil is ordinary hair oil.

**DON'T** use fish oil for lubricating oilstones. An awful reek results which seems to contaminate everything. Castor oil is just as bad. Paraffin oil is to be preferred, assuming nothing else (see above) is available.

**DO** be sure to remove the wire-edge (burr) from the cutting edges of tools after sharpening them. If this is not done by careful "strapping" on the palm of the hand or a

leather bench strap, the wire-edge breaks off and leaves a blunted edge. The burr must be removed and is done so by correct honing.

**DON'T** use a boiled glue for jointing kitchen table top boards together, especially if the finished top is to be used in the bare state. Constant washing affects the wood and glue so the joints open up after a period. A waterproof glue is best, such as casein glue.

**DO** have deal kitchen table top boards doweled together or tongued and grooved together. Not only is the joining stronger, but the tonguing and grooving prevents water seeping into drawers should the joints open.

**DON'T** be content with what radio junk dealers tell you. See for yourself, while components are being tested, and thoroughly inspect the components in your hand before buying. A defect is often covered by remarks intended to mislead you.

**DO** buy new radio components whenever possible. Some second-hand parts are in quite good condition, but most are far from being efficient, particularly valves, which, outwardly, at least, seem new. Inwardly, excess current may have been applied to the anode—a slightly

higher potential than the valve was intended to take—with a subsequent loss in rectification or amplification. There may also be defects which are caused by allowing the valve to fall. Although such a valve may still be in working order, it might be a "singling" type which spoils reception.

**DON'T** lean heavily on a diamond glass cutter. The deeper score does not ensure that the glass will break neatly. A fine even cut is desirable, done quickly, without heavy pressure and with the diamond rip held at the correct angle. It is also wrong to lend your cutter to another person; he is likely to spoil your special cutting angle.

**DO** use a suitable bradawl when making screw or nail holes at the edge or end of a board. Gimlets, such as the half-twist type, are inclined to split the wood; if holes must be bored, use drills.

**DON'T** handle amplifier or radio chassis units or components which, under certain conditions, may be "live" to earth, i.e., such as A.C. or D.C. mains-operated articles. Always switch off and withdraw the plug.

**DO**, if earthing is essential, have the earthing lead earthed through a condenser of not less than .1 mfd. 400 volt working capacity.

# Much fun is obtained by making this performing ACROBAT TOY

**T**HIS is an improved arrangement of an old but popular toy, giving more control of the movements than before. Formerly the action was decidedly jerky, and unlike the smooth graceful evolutions expected. With this toy the acrobatic movements can be well controlled and gives far more pleasing results.

It is of simple construction. Fig. 1 shows a side and rear view of the arrangement, minus the figure. The few wood parts required for this are cut from  $\frac{3}{4}$  in. deal, such as can be got from a short end of  $\frac{3}{4}$  in. thick matchboard. Any other thicker piece of wood can be used if the width of the base is increased in proportion.

## Box Frame

Cut the base to size given, then the two vertical posts. These are cut at their lower ends to leave  $\frac{3}{4}$  in. wide tenons for fitting to the base. The front post, which is spaced some  $1\frac{1}{2}$  ins. from the edge, will need a mortise cut in the base to house it; the rear post fits into an open slot cut in the rear edge of the base.

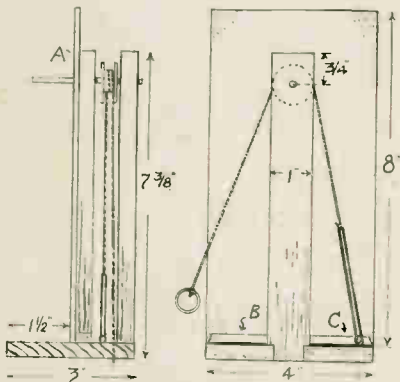

Fig. 1—Side and back view of toy

At the tops where shown, bore  $\frac{1}{4}$  in. holes for the spindle. This spindle can be a 3 in. length of  $\frac{1}{4}$  in. round wood rod. Glue the front post in position, but fix the rear post in with two screws so that it can be removed for slipping the spindle in afterwards.

A suitable wire nail, with head and point filed off, could be substituted for wood as a spindle, but a piece of paper may have to be glued round it at those points where the acrobat and pulley are to be fitted, so that they can be glued in place. The metal should also be roughened up with a file at those places to enable the glue to get a better grip.

Cut the spindle to length. On this is to be fixed a small pulley made from a  $\frac{1}{4}$  in. disc of  $\frac{1}{4}$  in. fretwood with 1 in.

diameter discs of cardboard glued each side. Bore a hole through a tight fit on the spindle, and glue it in place about  $\frac{1}{4}$  in. from the rear end.

## Fitting the Spindle

When the glue is hard the spindle can be fitted in the holes in the post. It should be able to rotate easily, and if inclined to be a bit stiff in action, the bearing holes should be lubricated with a little blacklead, rubbed in with a matchstick.

Cut a stiff piece of cardboard, A, to size given, and where the front end of the spindle will emerge, punch out a  $\frac{1}{4}$  in. hole. This cardboard is then glued to the front post. Two short pieces of wood, B—C, are glued to the base, either side of the front post, to which the cardboard can also be glued.

This cardboard backing might be suitably coloured and decorated, to

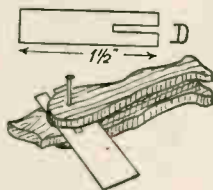

Fig. 3—Figure parts

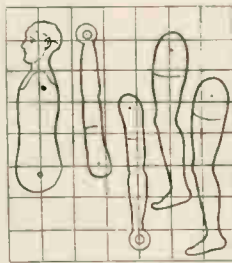

Fig. 2—Marking out figure

add to the attractiveness of the model and provide a pleasing background to the evolutions of the acrobat. Just as a suggestion it might be decorated with red and white stripes, as in the general view, to simulate the interior of a circus tent. Readers will, doubtless, have their own ideas on this matter.

## Pulley and Cord

On the base, where shown in Fig. 1, drive in a screw hook, and attach to this a strong elastic band. Tie a length of thin cord to the band, pass the cord once or twice round the pulley and at the free end tie a small brass curtain ring.

Slip the fingers in this and pull the cord, the pulley should turn easily

and the band be strong enough to pull the pulley back again as the cord is loosened. A to and from movement is then assured, as the cord is manipulated, and the actions



of the acrobat controlled accordingly.

The parts of the acrobat are marked over  $\frac{1}{4}$  in. squares, in Fig. 2. Draw the squares full size on to a piece of  $\frac{1}{4}$  in. fretwood and copy the parts as accurately as possible, then saw out with a fretsaw. Smooth the edges of each part.

In the body part drill the two holes for jointing the arms and legs, the holes being an easy fit for a  $\frac{1}{4}$  in. or  $\frac{3}{8}$  in. round nail. The corresponding jointing holes in the limbs shown by dots, should be fine ones, so that the nails have to be driven through them with a hammer, but not too fine or the wood may split. The holes in the hand portions of the arms should be a tight fit on the spindle.

## Painting Parts

The parts of the acrobat should now be painted or otherwise coloured. As only one side of the figure is viewed, this face side of the parts could be covered with paper, and colouring and details done with crayons. To joint, first cut from a piece of tin, the part, D, in Fig. 3.

Then drive a nail through one arm and leg, far enough for the nails to go through the body part as well. Take the remaining arm and leg, see the point of the nails just enters the jointing holes accurately, then, interpose the tin piece, D, between the limbs and body, as in Fig. 3, and drive the nails right through.

You can lay the figure on a cotton reel while driving the nails home, so the protruding points underneath go into the hole in the reel and not into the bench or table. File off the surplus underneath, then remove the part, D, the purpose of which is obviously to keep enough freedom between body and limbs to allow of unretarded movement. The limbs of the figure should be quite free to move. Then, all being satisfactory, glue the figure to the spindle.



# The home handyman will find this gadget A PAINTING AID

As builders put corners and fancy wood mouldings in our homes, as picture rails, skirting boards, etc., we are faced with rather a trying task when repainting. Especially so when other portions of woodwork or the surrounding wall must not be dabbed. To overcome this task, the painting guides as shown in this article were developed.

Their object is to make painting both quicker and easier. For example, the job of painting the under edge of the picture rail without touching the wall is known to all. With the guide, however, this job no longer holds any terrors. Another frequent use of the guide is that of windows—painting without the trouble of shaving 'runs' off the glass when the paint is dry by the use of a razor blade.

The holder and a guide are seen in Fig. 1. The guide is retained in its holder by a bolt and wing nut tightening up on a sawcut. The holder is shown in greater detail in Fig. 2, and can be made from any odd length of wood, although a piece of

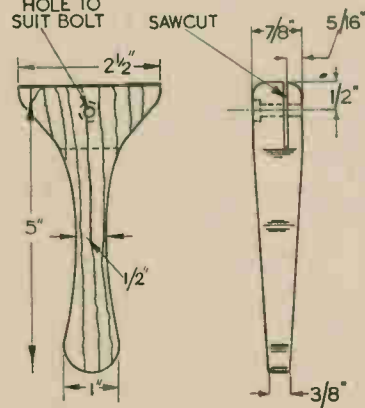

Fig. 2—Outline and side view of holder

hardwood is best. The hole for the bolt must be drilled before any cutting out is done, and preferably with another  $\frac{1}{2}$  in. or so on the length, to avoid any possibility of splitting.

A suitable size bolt is  $\frac{3}{16}$  in. diameter, although a little variation either way is not important. This bolt should have a hexagon head, to prevent the bolt turning when

tightening on the wing nut. The head of the bolt will be carefully pressed into the wood. This is easy to do, but care must be taken.

After drilling the hole to suit the shank of the bolt, the underside of the holder is counter-bored to a depth equal to the thickness of the head of the bolt. The diameter of this counter-boring drill is seen in Fig. 3. The purpose of doing this is to sink the head of the bolt into the wood with the minimum of stress being set up. It will be noticed that only the corners of the head are biting—the portion preventing the bolt turning

After pressing the head into the holder, carefully tap it out again and shape the handle as given in Fig. 2, taking care that the slot is cut on the correct side. When this is done, the bolt can be re-assembled. Slightly roughen the surface of the shank where it fits the holder and the underside of the head, and on these surfaces put a smear of glue when finally assembling.

Some suggestions for the shape of the guides are given in Fig. 4. The best material for these is mild steel sheet, although some of the light alloy

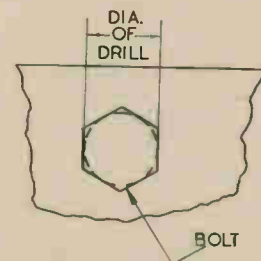

Fig. 3—Underside view, with head of bolt into holder

sheeting now on the market will suffice if it does not bend too easily. If steel is used, a thickness of a  $\frac{1}{32}$  in. is sufficient; if a light alloy is used a thickness of a  $\frac{1}{16}$  in. can be regarded as suitable.

The lip seen at the ends should be bent up for about  $\frac{1}{4}$  in. back, to an angle of, say, 20 degrees or so. This will ensure the hand being kept well

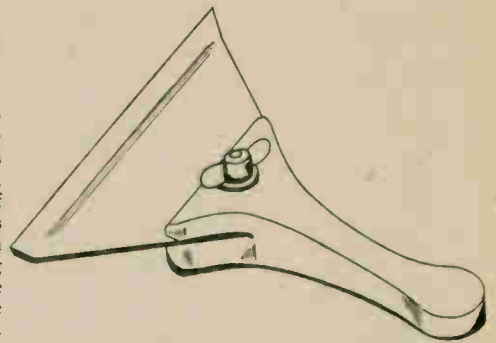

Fig. 1—The complete article ready to use

away from other painted surfaces. In type 'A', the longest side can be about 10 ins., and in 'B', the radius, say, 4 ins. (which will mean the lip being deeper in order that a full radius is lipped).

As pattern 'C' is most used for windows, a length of 4 to 6 ins. is ample. Type 'D' is extremely useful for sharp and awkward corners, and sides of about 6 ins. are best.

The slot cut into these holders must be an easy fit around the bolt, for it can be very annoying having to struggle with the removal of a guide when holding a couple of brushes in the other hand. Another point is, make

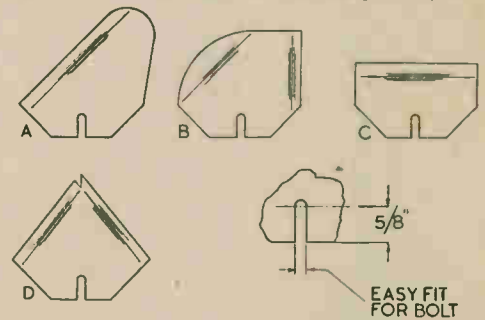

Fig. 4—Suggested guide shapes and slot details

certain that the  $\frac{5}{8}$  in. dimension allows the back edge of the guide to touch the bottom of the sawcut in the holder.

For then, when it is clamped up it cannot move. If this is not done, a slight movement of the guide in the holder might result in a piece of disastrous painting in an awkward corner, for one invariably leans heavily on the guide as a support.

## Stamp Collecting (Continued from page 169)

commemorate something genuine. Generally these stamps are only used for a short period or else the number printed is small, and when they have been used, no more are printed.

Some of the commemorative stamps which have been illustrated and which have gone up in value are mentioned. The Egyptian Royal Wedding stamp of 1938 at that time

cost 1/6; now you would have to give 17/6. The 1936 Polish stamps issued for the Gordon Bennett Race cost 15 pence the two; now they cost as many shillings. The stamps from Papua commemorating the 50th anniversary of the Declaration of Papua as a British Protectorate cost only 11d. in 1934, but now they have gone up to 32/6.

Many more examples could be quoted, but the list would be just like a catalogue. One can only suggest that readers who want their collections to increase in value (and who does not?) should look for quality rather than quantity. And the quality of the British Colonials is generally of the highest. So now you know what to do!



# STAMP COLLECTOR'S CORNER

## ADVICE ABOUT STAMP VALUES

WHENEVER one speaks of the value of stamps, most people immediately think of such stamps as the Post Office Mauritius, the famous British Guiana stamps and so on, but these stamps are scarcely likely to fall into the hands of readers of *Hobbies Weekly*. We must be content with much smaller fish, which to us will taste just as sweet as those mentioned above taste to their owners.

We cannot afford to pay thousands of pounds on our stamps and we must not, therefore, expect our collections to appreciate in value at a very rapid rate.

### Sensible Buying

We certainly can, however, take a little trouble and apply a little thought as to how we spend our modest pennies or shillings so they bring us the best possible return for our money.

If anyone has kept the pages of *Hobbies Weekly* dealing with stamp collecting over the past ten years and compares the cost of the stamps illustrated during that period with the values of these stamps as given in the latest catalogue, then they will most certainly see that in nearly every case there has been a very considerable rise in value.

It is quite impossible for anyone to say definitely that such and such a stamp is bound to increase in value. If there were people who could prophesy this, then obviously those people could very soon become quite rich. They would only need a certain amount of capital and buy the stamps they knew would go up and wait a little while for the rise to take place.

It is possible, however, to make certain suggestions which in the past have proved correct. One such suggestion is to buy British Colonial stamps as soon as they are issued, and another is to buy the highest value stamp you can afford.

### Increased Values

Take as an illustration of the second piece of advice the 1933 Wilberforce issue of Sierra Leone. If, in 1933, one had purchased the ½d., 1d., 1½d., 2d., 3d. and 4d.—six stamps costing altogether 1/-—those six are now catalogued at 25/-.

But if one had bought the one shilling stamp, then they would now have a specimen which is catalogued

at 30/-; the one stamp being worth 5/- more than the total value of the six. The 2/- value of this set is now at £5 10s. 0d.—so you see how the high values appreciate at a much greater rate than the low.

### Jubilee Values

The 1935 Silver Jubilee stamps of King George V have gone up very much and their rise was almost immediate. When issued, the Dominion set cost just 18/-, and now the catalogue value is as many pounds.

Their immediate rise induced many people to buy the Coronation set of King George VI in the hope that they would rise as fast. The result of this was that most people had the Coronation stamps and consequently they were not in great demand. So they did not rise in value to anything like the same extent.

### Two Examples

After all, the price of stamps depends upon the law of supply and demand. It is because the demand for British Colonial stamps is greater than the demand for Foreign, that the first piece of advice is given.

Now let us take one or two examples of stamps that have been illustrated and described in *Hobbies Weekly* and try to find out why they have had such a considerable rise in value.



Fig. 1—Worth 2½ with blue centre—7d. if green

One stamp that was illustrated in an article on "Sugar on stamps" in 1938, was a 5d. stamp from Fiji, showing a picture of sugar cane growing. The frame was in scarlet and the centre in blue. But this annoyed the inhabitants who, as soon as they saw the stamp, asked why sugar cane should be coloured blue instead of its proper green?

The result was that this stamp was withdrawn and re-issued with the centre green. As a result the first issue is now priced at 25/- used and 22/6 unused—quite a good price for a

stamp that only a few years ago cost 5d.

Another illustration from Fiji, but this time the 1½d. value. This shows a picture of a native canoe with the sail up, but there is no one in the canoe to look after it! This caused amusement, so the stamp was re-drawn with a man in the canoe. Now one has to pay 7/6 for the former, but the present issue is only 3d.

### Slight Difference

Now look at the two stamps illustrated, you have to look quite carefully before you notice that under the words "Fiji Islands" one stamp has 180 degrees and the other has nothing. The last mentioned is worth 22/6, but with the 180 degrees, the cost is only 8d.

Another map which has gone up very much indeed in price is the 1 rupee of British Somaliland. This one was issued in 1938 just before the Italians took the Protectorate. When it came back to us another set of stamps was issued; the same design, except that the portrait of H.M. the King was a full face portrait. The difference between these two is a matter of 28/-; the first is 30/- unused and the second is only 2/-.

### Marine Insurance

There are, of course, more or less obvious reasons why the above



Fig. 2—Note the 180° below the Fiji Islands

mentioned stamps have increased in price, but a rather different reason is illustrated by the Dutch Marine Insurance stamp. This was introduced to pay the cost of placing the letter in a special unsinkable safe whilst crossing the water. Not many people paid the rather heavy premium for this privilege, and so the stamps were not much used, and have increased in value at least four times.

Commemorative stamps frequently go up in value more than normal postal issues—that is if they really

(Continued foot of page 168)

**L**EKTRON assists collectors get greatest pleasure from their hobby! Write now for Free Stamps and Approvals, enclosing 2½d. postage. — Lektron Philatelist Service, 15 Earl St., Barnoldswick.

**L**ONELY? Join Friendship Circle. Details 6d.—Secretary, 34 Honeywell Road, London, S.W.11.

**S**PARE-TIME workers required to manufacture plastic fancy goods.—Dept. S.3, Somat Plastic, 8 Middle Marsh, Nottingham.

**S**TAMPS Free—Send 2½d. for free gift and fine selection of approvals.—G. H. Brewer, 9 Wrington Crescent, Bristol 3.

**S**TAMP Collectors! Pen Friends! Hobbyists! Join "Cosmopolitan C. & E. Club", Malaya. Free membership. Enclose postage for particulars to—Robert B. Chua, Gersek via Panchor, Johore (Malaya).

**S**TAMPS for sale, suitable for beginners.—Apply Box No. 678, Hobbies Weekly, Dereham, Norfolk.

**S**TAMPS Free!! Twenty unused (2½d.).—G. H. Barnett, Limington, Somerset.

**I**2 FREE Stamps, cheap approvals. S.A.E.—Bleach, 43 Queen's Road, Blandford, Dorset.

**L**EAD toys! Make your own. Moulds 3/6, Lists 4d.—7 Hawthorn Terrace, Halifax.

**P**ERSONS required immediately to make leather shopping bags in spare time.—Write (Dept. 11), Empire Co., 117 Nottingham Road, Loughborough.

**B**ARGAIN! ½ oz. unsorted mixture (about 175 stamps) 2/6.—James, 67 Coledale Drive, Stanmore, Middlesex.

**50** EARLY stamps 6d.; ask for approvals, from ½d.—Cogman, Potter Heigham, Gt. Yarmouth.

**M**YSTIFY your friends with magic. Stamp brings you our list.—Bindings, 25 Aberdeen Place, London, N.W.8.

**E**NVELOPES are in great demand. Now is your chance to double your income. Send 5/- for complete instructions and templates. Write—Chas. & Co., 3 Southfield Road, Western Boulevard, Nottingham.

**E**LECTRIC Repeater Motors, new, ideal experimenters adaptable for D.C., A.C. synchronous, or remote control. 5/- each, post 6d.—F. Lucas, 22 Hengrove Rd., Bristol 4.

**A**LREADY readers in four countries are using my complete details and drawings for building a high quality electric Hawaiian guitar, 7/6 post free.—C. W. Cragg (C), 48 High St., Oakham.

**S**TAMPS; send for my approval sheets, for small and medium collectors; enclose 2½d. stamp for postage. Free gift of eight stamps.—D. Mellenfield, S.D.A. (H.W.), 14 Kings Road, Barnet, Herts.

**B**E Taller. Quickly! Safely! Privately! No appliances—no tablets—no dieting. Details 6d. stamp.—Malcolm Ross, Height Specialist, BCM/HYTE, London, W.C.1.

**L**ONELY? Then write Secretary U.C.C., 5B.B. Hay St., Braughing, Herts. Genuine. Est. 1905.

**M**ODELS; you can make lasting stone-hard models with Sankey's Pyrama Plastic Cement. Supplied in tins by Ironmongers, Hardwaremen and Builders' Merchants. Ask for instruction leaflet.

**T**RANSFERS for decorating toys, trays, furniture, fancy goods. Selection 10/- 20/-. Flowers, pixies, dogs, nursery rhymes.—H. Axon Harrison, Jersey.

**M**ONOMARKS. Permanent London address. Letters re-directed. 5/- p.a.—Write Monomark BCM/MONOS2, W.C.1.

**Y**OU can look up in "Where's That Car From?" 10,000 car index numbers alphabetically arranged. 56 pages 6d. From all newsagents.—Ralcigh Press, Exmouth, Devon. (Post 1d.).

**F**REE! 25 Stamps. Request discount approvals.—Bradbury, 5 Goulden Road, Manchester 20.

**B**OYS! Look at this, the most smashing free gift of all. The attractive and lovely Roosevelt Set from San Marino. Absolutely free to all genuine applicants for repeat approvals. Enclosing 3d. stamp, 1/- without approvals.—H. A. Smith, 13 New Road, Scole, Diss, Norfolk.

**C**OPPER wire, enamelled, tinned, cotton, silk-covered. Screws, nuts, washers, soldering tags, eyelets, rivets. Ebonite and laminated bakelite panels. Coil formers. Covered wires; crystals, permanent detectors, ear-phones, etc. List S.A.E.—Post Radio Supplies, 33 Bourne Gardens, London, E.4.

**A**GAIN leading the market in competitive trading. Finest quality Balloon Tyre Metal Wheels. Per gross, 3in.—6/6, 4in.—7/6, 5ins.—8/6, 6ins.—10/6. Carriage paid. On orders less than one gross 6d. extra.—Jas. A. Woodbridge & Sons, 135 Nags Head Road, Ponders End, Middx.

**W**. McGARRIGLE for aeroplane and ship kits. All accessories, stamps, lists 3d. Wholesale lists 4d.—64 Hillcrest Road, Romford.

**P**ERSONS required to make fancy goods at home. Write for details.—Melton Manufacturing Co. (Area 544), Southgate Street, Leicester.

**P**ERSONS required to make plastic or leather fancy goods in spare time.—Dept. G.P.3, Newton Products, Ltd., 93 Goldsmith St., Nottingham.

**S**PECIAL Offer. Attractive stamp album 50 stamps, packet of mounts. Post free 3/6.—Gamut (Dept. C), Supplies Co., 24 Gunnersbury Avenue, London, W.5.

**M**ETAL Disc Wheels with rubber tyres, ranging from 2ins. to 9ins. diameter. Also Aluminium (steel bushed) Cast Spoke Wheels, rubber tyred, 6½ins. and 9ins. diameter. Supplied in pairs, fours, dozens or gross lots.—Joyden Toy Co., 193 Chase Side, London, N.14.

**F**REE! Extra special British Colonial variety packet. Includes scarce Jubilee, Coronation, Victory, Zoological and latest new issue stamps. Request approvals (2½d.).—Thompson, 70 Cavendish Avenue, London, W.13.

**D**UTTON 1 week Shorthand. Learnt in 12 2-hour lessons. Accepted by all examining bodies. Test lesson 3d.—Dutton's (H.B.), 92-3 Gt. Russell St., London, W.C.1.

**P**ERSPEX Polish. Genuine "Sinec". As used by R.A.F. Set of three grades: coarse, medium and smooth. 2/6 set, post 8d. Send for free surplus bargain list.—Marble Arch Motor Supplies, Ltd., 286 Camberwell Road, S.E.5.

**P**OST Xmas clearance. A parcel containing ten toy designs and our latest publication "The Art of Wood Finishing". Yours for 9/- only. Usual price 12/6, postage 3d. extra.—M.M.D.A., 51 Wellington Hill West, W.O.T., Bristol.

**40** Power Tools you can make, 12/6 post 8d. Popular Mechanics Press, Chicago. The famous "What to Make" 1947-7/6. Shop Notes, 1947-7/6. Following "How to Make" Books, 3/- each; 5 Power Driven Saws; Spray Painting; Caravan and Utility Trailers; Plastics Projects; Wood and Metal Lathes; 21 Action Toys. "Science and Mechanics", the leading American work-shop magazine. One year 15/-, post paid. S.A.E. for lists, books, plans, magazines.—BCM/PUBLICATIONS(H), London, W.C.1.

**N**OVELTY Packet of unusual stamps free to approval applicants sending 3d. postage.—M. Edwards (N.3), Westcroft, Northchurch Common, Berkhamsted, Herts.

THE WORLD'S GREATEST BOOKSHOP

**FOYLES**  
★ ★ FOR BOOKS ★ ★

Famed for its excellent technical department

New and secondhand Books on every subject

119-125 CHARING CROSS RD., LONDON, W.C.2.  
GERrard 5660 (16 lines) ★ Open 9-6 (including Sat.)



SIDE OF DRAWER

TABLE  
BOOKSTAND  
PATTERNS

see page 161

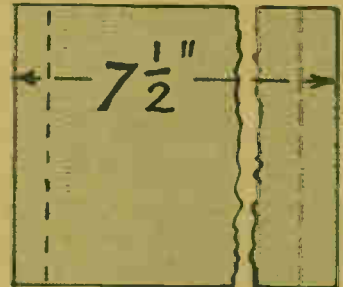

FRONT RAIL  
OF DRAWER

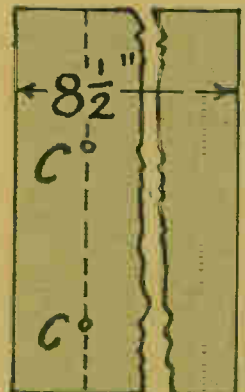

RAILS  
A & B



HANDLE

FLOOR

SUGGESTED COLOURING  
FOR ABOVE

- YELLOW 
- BLUE 
- RED 



and NOW!

**'FABRIKITS'**

Prices from  
**10/6 to 3 Gns.**

**PLASTIC CONSTRUCTIONAL KITS**

We are proud to announce that the first model of the 'FABRIKIT' range is now available.

Embracing as it does a selection of full-scale working diagrams and a generous supply of the very attractive plastic material, 'PERSPEX' (extensively used in modern aircraft), it is not difficult to envisage the many happy hours in store for the fortunate possessor of a 'FABRIKIT'.

Bottles of cement and polishing medium, instructional literature and a small supply of scrap and off-cuts complete the kit. The scrap is intended to acquaint the modeller with the material before proceeding to use the coloured 'PERSPEX'. Price 10.6. Larger kits in course of preparation.

Official I.C.I. 'PERSPEX' and 'CRINOTHENE' Stockists

**PLASTICS (MCR) LTD.**  
11 WHITWORTH ST., MANCHESTER 1

TURN USED **RAZOR-BLADES**  
into **PENKNIFE**



Smart enamelled handle with new blade firmly held by screw. Strong. Send stamped addressed envelope with 1/3 stamps or P.O.

Wm. PENN Ltd., (Dept. KHB)  
585 High Road,  
LONDON, N.12

**PENN'S RUG MAKER**

Recommended in 'Hobbies Weekly' 30-7-47

Makes full-size Rug on ANY machine in a few hours. Enables

wool to be stitched on canvas without waste.



2/9  
Post 3d.

Uses Coupon Free rug wool. No adjustment to machine. Profitable hobby. With simple directions. Send 3/- P.O., cheque or stamps. Direct only from: Wm. PENN LTD. (Dept. HBR) 585 High Road, LONDON, N.12

**BOYS! ELECTRIC-MOTOR OUTFIT**

**3/6**  
Post 3d.



WORKS FROM ORDINARY TORCH BATTERY

**6,000 REVS. PER MINUTE**

**EASILY ASSEMBLED**

This outfit comprises ALL necessary parts and base ready for simple assembly by any boy to make this working Electric Motor exactly as illustrated.

Apart from its novelty, this has very considerable technical and constructive value. More can be learnt from it regarding Electric Motors than by reading volumes. Can also be used for mechanical purposes in operating light constructional models. A most instructive and entertaining toy for boys. Complete with diagrams and very easy instructions. Send P.O. 3/9. Direct only from:—

Wm. PENN LTD. (Dept. EMD),  
585 HIGH ROAD, FINCHLEY, LONDON, N.12



**FOR A REAL Professional FINISH**

'FINISH' is the true test of craftsmanship. It's easy to impart a real professional 'finish' to woodwork and furniture you make at home with "COLRON" WOOD DYE—the finest stain for all practical purposes.

One coat of "COLRON" is all that is required to emphasise the natural beauty of the wood grain. No smears—no 'overlaps'—no trouble. Leave from two to three hours, burnish with rough dry cloth and you have a perfect base for french polishing or for waxing with "RONUK" FLOOR POLISH.

**COLRON WOOD DYES**

8 SHADES—ALL SIZES

Write for colour guide and full details to:

**RONUK LTD. (Dept. 62) Portslade, Sussex**

For the decoration and embellishment of Craft-work, Toys, Figures and for Picture Frames, use

**Acralac**

**SILVER FINISH ALUMINIUM and GOLD PAINT**

GOLD, 2oz. Jars 2/3, ALUMINIUM, 2oz.

Jars 1/9, Half pt. Tins 5/-, Pint 9/6

Both are Pure Metal Lacquers of great covering capacity

From Hobbies Shops, Stationers, Ironmongers

**ACRA PRODUCTS LTD., Shepley, nr. Huddersfield**

# Hobbies

## WEEKLY

### CONTENTS

	Page
Electric Table Lamp -	173
Money Box - - - -	175
Pantograph - - - -	176
Wiring a Pick-up - -	177
Weather Reading - -	179

January 28th, 1948

Price Threepence

Vol. 105 No. 2726

## ELECTRIC TABLE LAMP AND CIGARETTE BOX

A PLACE can always be found in the home for an electric table lamp, whether it be in the bedroom as a bed-side lamp or in downstairs rooms as a side table reading lamp. The usefulness of the

lamp shown here will be fully appreciated in either place, for not only does it give light but it will give a supply of cigarettes, too, from the little drawer in one of the sides of the pedestal.

The full height of base and pedestal

from table top to underside of bulb holder is 8½ ins., while the size of that member immediately standing on the table is 6½ ins. by 4½ ins.

There are five distinct sections to make up the lamp. They are, base, made up from pieces, A and B; the plinth, in which the drawer slides, and which consists of pieces, C, D, E, F and G, and the plinth top, being made up of the two pieces, H and I. Then, above piece, I, comes the pedestal of pieces of larger size, and consisting of parts, J, K, L and M, the two latter pieces constituting the top to the pedestal through which the threaded stem of the bulb-holder will pass.

Commencing work upon the base, prepare piece, B, from the sizes given in Fig. 1. Mark off the sizes carefully to ensure getting the angles perfect right-angles. Next, set out the pieces, C, D and E. Measurements for, C, are given and the back panel, D, will be 4½ ins. long by 2½ ins. wide and will go in between the two ends, C. Note here that all the wood used throughout is ½ in. thick.

The front rail, E, which comes above the drawer when it is slid into place, measures 5 ins. long and is ½ in. wide and must be glued flush with the front edges of, C, as shown in the detail. When all these five parts have been glued up, they must be fastened to the base piece, B, with glue, care being taken to get an equal margin on all three sides. It will be found very necessary to put some screws up through the base, B, into the pieces, C and D, to make a really strong fixture.

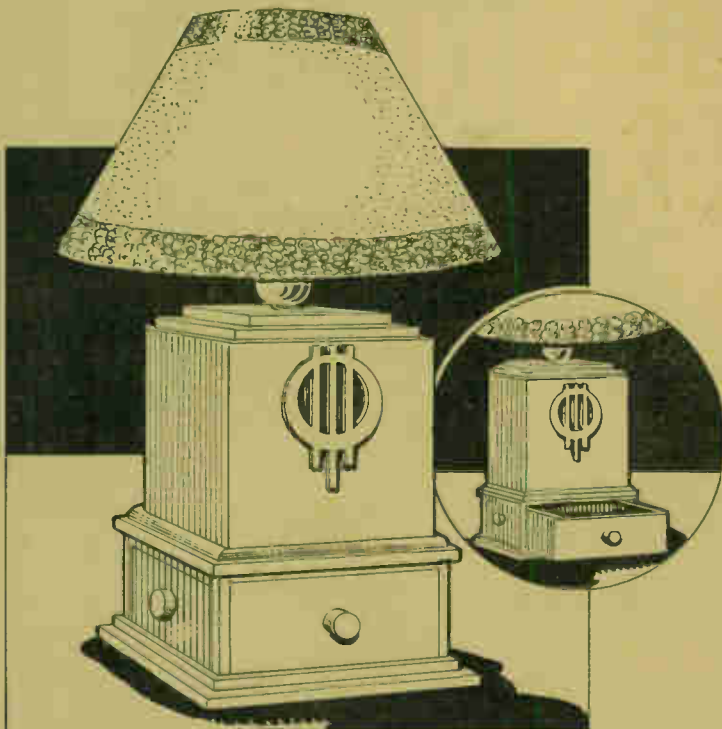

Correspondence should be addressed to The Editor, Hobbies Weekly, Dereham, Norfolk.

The lower base, A, can now be made and glued to, B. Cut off two strips measuring  $6\frac{1}{2}$  ins. long and two  $4\frac{1}{2}$  ins. long, and all  $1\frac{1}{2}$  in. wide, and cut the ends to mitre at 45 degrees as shown in the cut-away corner of the base in Fig. 1. Test the mitres for accuracy of fit before gluing the strips under base, B.

Pieces, G, going round the top edges of pieces, C and D, form the upper guides to the drawer as well as fixing fillets for the panels, H, which go above. Piece, H, is to be  $5\frac{1}{2}$  ins. by

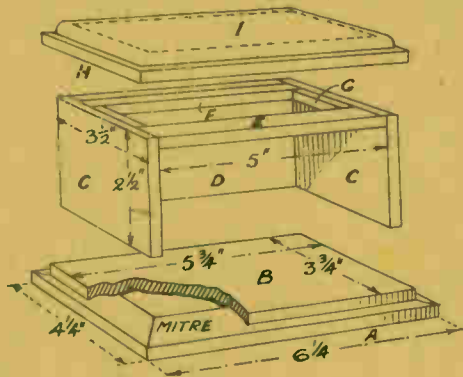

Fig. 1—Base and drawer compartment

$3\frac{1}{2}$  ins., and piece, I, above,  $5\frac{1}{2}$  ins. by  $3\frac{1}{2}$  ins. Glue the two sections together after rounding off the upper edges of piece, I, as seen in the detail, Fig. 1. The dotted lines on this upper piece indicate where the upper pedestal will be glued on.

### The Upper Pedestal

The upper pedestal is shown made up in Fig. 2, the portion cut away allowing a view of the angle fillets glued inside to hold the pedestal firmly to the piece, I. After marking out and cutting the four pieces, J and K, note in the gluing up their position, K going between the front and back pieces, J. When the glue has hardened, rub the top and bottom surfaces on coarse and fine glasspaper so as to bring them perfectly level before they are fixed to, I, and before the main top, L and M, is put on.

As will be noted, there are two pieces of angle fillet glued inside the

top edges of the pedestal to give a firm fixing for the main top.

Pieces, L and M, measure  $4\frac{1}{2}$  ins. by  $2\frac{1}{2}$  ins., and  $4\frac{1}{2}$  ins. by  $2\frac{1}{2}$  ins. respectively.

When gluing the two pieces together, make sure that the margins all round are equal, then bore or cut a hole in the two thicknesses about  $\frac{3}{8}$  in. or so in diameter to take the screw sleeve of the bulb holder. Make a good glued joint where, L, meets the top of the pedestal and see that an even margin of  $\frac{1}{16}$  in. is allowed all round. Additional pieces of triangular or square fillet can be added inside between the sides

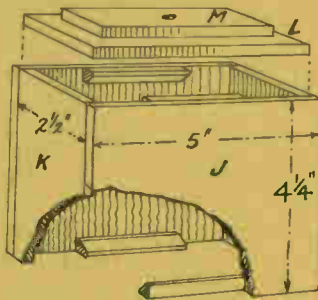

Fig. 2—Main body and top

of the pedestal and pieces, L.

### Cleaning

It only remains now to well clean off each of the four sides of the pedestal, and to do this effectively, it is best to glue a piece of coarse and a piece of fine glasspaper to a piece of stout board and to use this for rubbing the flat surfaces. If the glued joints have been carefully made and cramped up closely, they should hardly show at all after the glasspapering process has been carried out. The drawer portion of the base will, of course, have its sides and ends cleaned off in a similar manner to the pedestal mentioned above, before it is glued to the piece, B.

The drawer is shown made up complete in Fig. 4, and although all necessary measurements are included in the diagram, it would, nevertheless, be a good plan to check off the actual opening in the front of the base into which it will slide, before marking out

the several pieces of wood.

### Assembling the Drawer

The method of assembling the pieces of the drawer should be carefully followed from the diagram, and the glued joints firmly made. Fret-pins driven through the floor into the sides, O, and the back, Q, will greatly help to strengthen the joints. To get a really good fit, all the pieces of wood constituting the drawer should be cut on the large side, so that when the sides are rubbed down on the glasspaper board, a neat and accurate fit is obtained.

The finish to be put upon the whole article will more or less depend upon the kind of wood used. If oak is obtainable, then this may be stained to any desired depth of tone and then brush polished, using the usual french polish. Or again the wood may, after being stained, be oiled and

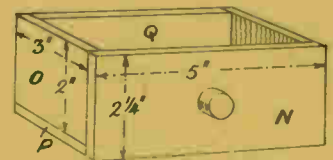

Fig. 4—Construction of Drawer

rubbed up with a wax polish.

### The Overlay

The simple overlay shown in Fig. 3 would be very suitable for the front of the pedestal or, of course, one could be glued on each front and back face if desired. One half of the diagram of the overlay is shown squared over with  $\frac{1}{16}$  in. squares, making for ease in the enlarging process. Twelve full size  $\frac{1}{16}$  in. squares are set out on paper as shown, and the interior work then drawn in and followed in each individual square, traced off on to thin transparent paper and redrawn on the opposite side to complete the symmetrical outline.

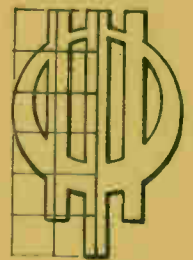

Fig. 3—The ornamental overlay

A small round peg handle would

look well for the drawer, while three more such pegs glued on the other three faces of the base will complete the illusion of there not being a drawer at all on any one face.

The flex to lead up to the bulb and shade holder should pass through a hole made centrally in the back panel, J, and just above the junction of this with the piece, I. The flex is threaded through the central hole in the top of the pedestal and there connected to the holder, which is afterwards screwed on to the sleeve in the top, the flex being then gently pulled taut lower down.



## Design for a LETTER RACK

This week's supplement design is for the striking letter holder illustrated. It is an attractive piece of work for the fretsaw with "Seagull" picture introduced. A complete bit of wood (No. 2726) is supplied by Hobbies Ltd. Dereham, Norfolk for 4/6 post free or is obtainable at any Hobbies Branch for 3/9



# Save for various causes separately in this THREE-PART MONEY BOX



OUR illustration on this page shows at a glance the nature of the novelty box about to be described. Novelties are always much sought after, and we think the one shown should certainly make a strong appeal to those thrifty persons whose idea is to "save".

The box shown is intended wholly for threepenny-pieces, having three distinct compartments, each intended for a definite object in saving. They take the form of, say, "Books", "Holidays" and "Dress", or, again, might be for some household purposes, perhaps, such as "Electricity", "Gas" and "Coal". However, we leave the choice of the three "deserving objects" to the individual who is making the box.

## Box Size

The box suggested here is 4ins. wide and front to back, 4½ins., with height 5½ins. These measurements need not, of course, be strictly adhered to, and a larger box could easily be arranged for, bearing in mind, however, the principal internal construction.

The slots for the insertion of the coins are all cut in the top of the box and slightly to one side of the centre, to give space for the name of the special object of saving. The internal arrangement of the partitions is such that the greatest area for coins is allowed for in two compartments with "doors" for the removal of coins in the floor of the box.

The coins, however, from the rear compartment are taken from a "door" made in the back of the box. A sectional view of the box, that is, a view giving the arrangement of the partitions, but with one side and the back and top removed, is given in Fig. 1. With this diagram as a guide, it should be an easy matter to construct

the whole article.

All six pieces which make the box are identical in size, that is, 4½ins. by 4ins. All wood for these pieces and the interior partitions is ¼in. thick. Mark out the six pieces, getting all the angles square. Having the parts thus cut, mark out the two circles required in the floor as shown in Fig. 2. Also the circle in the back of the box as in Fig. 3.

## Slotted Top

Then, for the top of the box, mark out the slots as in Fig. 4 and cut them neatly. Note that they are not to be more or less than ¼in. in width. The front of the box and the two sides are plain pieces, and these can be decorated with a simple border pattern, perhaps, when the whole thing is put together.

All the parts can now be glued, with the exception of the top, care being taken to see the two sides go between the front and back of the box and the floor and top lay over these as seen in Fig. 1.

Test the box for squareness before the glue has hardened and leave it for a day or so before driving in any

fretpins to strengthen the glued joints. It should, however, not be necessary to add the pins if a sound job has been made of the glued joints.

## Partitions

Now take in hand the making of the partitions. Looking again at Fig. 1, we note that the two uprights, A and B, are 3½ins. by 3½ins. and 3½ins. and 2½ins. in size respectively. One edge of each of these two pieces is chamfered with plane or file to an angle to meet the two pieces, C and D. The angle for piece A, will be 30 degrees and that for B, 60 degrees. Thus one edge of piece C, where it meets piece A, will be also at an angle of 30 degrees, while that for piece D, where it meets B, will be 60 degrees.

The width of piece C, is 2½ins., that of piece D, 1½ins. and both are, of course, 3½ins. long. The lowest edge of piece C, where it meets the floor, will be chamfered to 60 degrees, as also will the lowest edge of piece, D, where it meets the back of the box. Glue the four partition pieces in

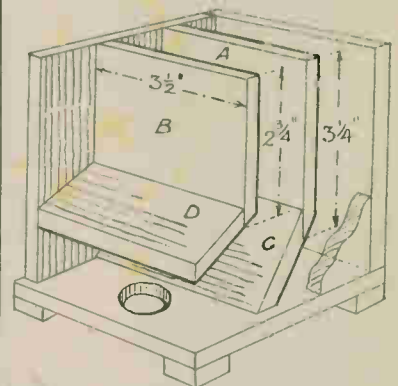

Fig. 1—Cut-away view showing interior pairs as shown in Fig. 1, and then glue them in the box, the space between each upright being 1in. When all parts are secure, the top of the box is glued on.

Four feet are required to raise the floor of the box, these being ¼in. square. To cover the "doors", the circles cut in floor and back, stout brown paper is glued over, the paper being cut 1½ins. in diameter. When it is required to remove the coins, the tip of a pocket knife is passed round the edge of the opening, severing the paper, which can later be renewed.

A more satisfactory "door" could be made in all three cases if the circles of wood were cut on the bevel, the larger circle, of course, being allowed on the outside, so the disc of wood will fall outwards when the paper is cut round. The finished box may be either painted or stained and varnished or french polished.

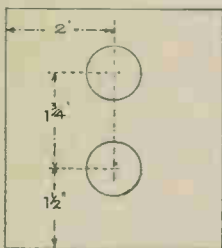

Fig. 2—The Floor



Fig. 3—The Back

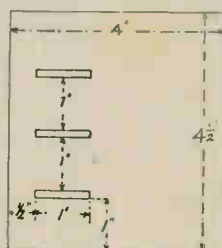

Fig. 4—The Top

# For enlarging or reducing drawings make yourself A PANTOGRAPH

**T**HE Pantograph is a simple drawing instrument, capable of reducing or enlarging any given sketch or diagram. Invented in 1631 by the Jesuit, Christoph Scheiner, and further improved upon, two centuries later, by Professor W. Wallace of Edinburgh, the pantograph's practical application to present-day industry has been so greatly superseded by modern photographic processes as to render it obsolete.

However, for those many home craftworkers who experience difficulty in drawing—delving for carbon and tracing papers whenever it becomes necessary for them to copy a diagram or sketch, and finding themselves completely at a loss when it is imperative that a pattern should be considerably reduced or enlarged by frechand—the Pantograph will be found an invaluable aid.

## Materials Needed

This useful copying device will be found simple to construct and to operate. It will produce enlargements of any given sketch or pattern, from two to five times the original size, and with a slight adjustment, will also reduce a diagram to the same scale—i.e., from one-half to one-fifth of the original size.

The list of materials required is as follows: Four thin strips of plywood (or similar material) measuring 15ins. long by  $\frac{1}{8}$ in. wide; a 2in. square block of wood 1in. in thickness; two small screw-eyes; and a  $1\frac{1}{2}$ in. nail and a 1in. woodscrew; one veneer-pin or small brad; and a 3in. stub of pencil. As will be seen by the foregoing list, most, if not all of the materials needed to make a simple Pantograph can be found in the scrap box of the average household.

Neither need the necessary tools afford you much concern. Your total requirements in this direction will probably amount to a saw, a bradawl, a light hammer, a sharp penknife, and a half-sheet of glass-paper.

## The Arms

With tools and materials ready to hand, your first task will be to make the four arms of your Pantograph Machine (15ins. by  $\frac{1}{8}$ in.) and the small wooden anchor block, 2ins. by 2ins. by 1in. When completed, give the arms and the block a good glasspapering, neatly rounding off each end of the four arms in the manner shown.

The next operation consists of boring a graded series of four small holes in each arm of the Pantograph.

First bore a hole in the centre of the arm (No. 2 in Fig. 1), then,  $2\frac{3}{8}$ ins. further along, bore a second hole. The third hole must be 1in. distant, and the fourth hole another inch beyond the third and  $3\frac{1}{8}$ ins. from the end of the arm, as shown in Fig. 1.

## Correct Hole Position

If you wish any subsequent reduction or enlargement of diagrams that you may make with the Pantograph to approximate to a fair scale, it is important that the four holes be placed in their correct positions, as set out. This accomplished, the holes should then be clearly numbered from two to five, using ink or indelible pencil.

Now take two of the arms and join them together with a veneer pin or

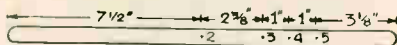

Fig. 1—Detail of holes and arms

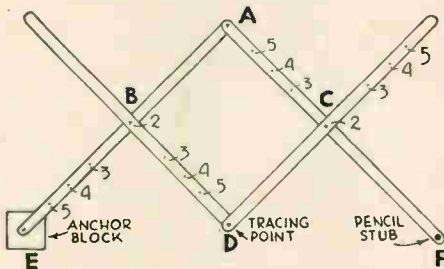

Fig. 2—The completed pantograph

small nail. (See "A" of Fig. 2). Turn the pointed end of the nail over to 'lock' the joint. This should be a reasonably loose one to ensure that the arms can be freely moved, independently of each other. Note the corresponding positions of the numbered holes on each of the arms.

## Joining Arms

The remaining pair of arms should be joined together in a similar manner, except that in place of the veneer pin, a  $1\frac{1}{2}$ in. nail must be used. The point of the nail is not turned under in this instance, but allowed to project below the lower arm to form a tracing point for subsequent use when the Pantograph is fully assembled (see "D" of Fig. 2).

Now place one pair of arms over the other and join the two sets together by inserting small screw-eyes through the holes marked No. 2, as shown in Fig. 2. The lower left-hand corner of the Pantograph should now be screwed down to the small wooden anchor block at "E". The lower right-hand corner being drilled to

receive the three-inch stub of pencil as illustrated at "F" of Fig. 2.

The Pantograph is now ready to operate. Screw the wooden anchor block down into a suitable position on your drawing-board or desk to allow the arms full freedom of movement. Pin the design which you wish to copy, on to the drawing-board so it is immediately beneath the tracing-point at "D" of Fig. 2. Then pin a sheet of drawing paper into position beneath your stub of pencil.

## Tracing the Outline

Now, with your hand on the stub of pencil to hold it to the drawing paper, carefully move the Pantograph so it causes the point of the nail, at "D" of Fig. 2, to trace the outline of the design which you wish to copy.

With a little careful manipulation you will find it a comparatively simple job to reproduce the design on the drawing paper. With practice you will be enabled to copy an ordinary line-drawing in a matter of a few minutes.

It will be found that when the Pantograph is connected at the holes marked No. 2, the completed reproduction will approximate to twice the size of the original.

## Reductions

Similarly, if the Pantograph is connected at the holes marked No. 3, the reproductions will approximate to three times the size of the original design, whilst if the machine is joined at the holes marked No. 4, it will produce a copy four times as large as the original, and so on.

To obtain reductions it is only necessary to transpose the positions of the stub of pencil and the nail which acts as a tracing point. In actual practice, perhaps, you will find it more satisfactory to construct two Pantographs, keeping one for enlargements and the other for reductions.

**D**ON'T forget to "kill" knots in new wood which is to be covered with a finish. Knots should be daubed with thin french polish or patent knotting, which is similar. Knots, being endgrained, absorb paint, thereby creating dull spots.

**D**O allow the full length of a handsaw blade to cut into the wood. By using the centre of the blade only, these particular teeth are blunted; moreover, cutting is slowed up by using part of the blade only.

SUPPLEMENT TO HOBBIES No. 2726

**LETTER RACK**  
THE SEA GULL

PANELS OF WOOD REQUIRED FOR THIS DESIGN

**ONE J3 ONE H3**

The price is shown in Hobbies Weekly, January 20th, 1948, but is subject to revision. See the current edition of Hobbies Handbook, or write for price to Hobbies Limited, Devonham, Norfolk.



—SIZE—  
WIDTH 12 1/2 in.  
HEIGHT 12 1/2 in.

The arrows indicate the direction of grain of wood.

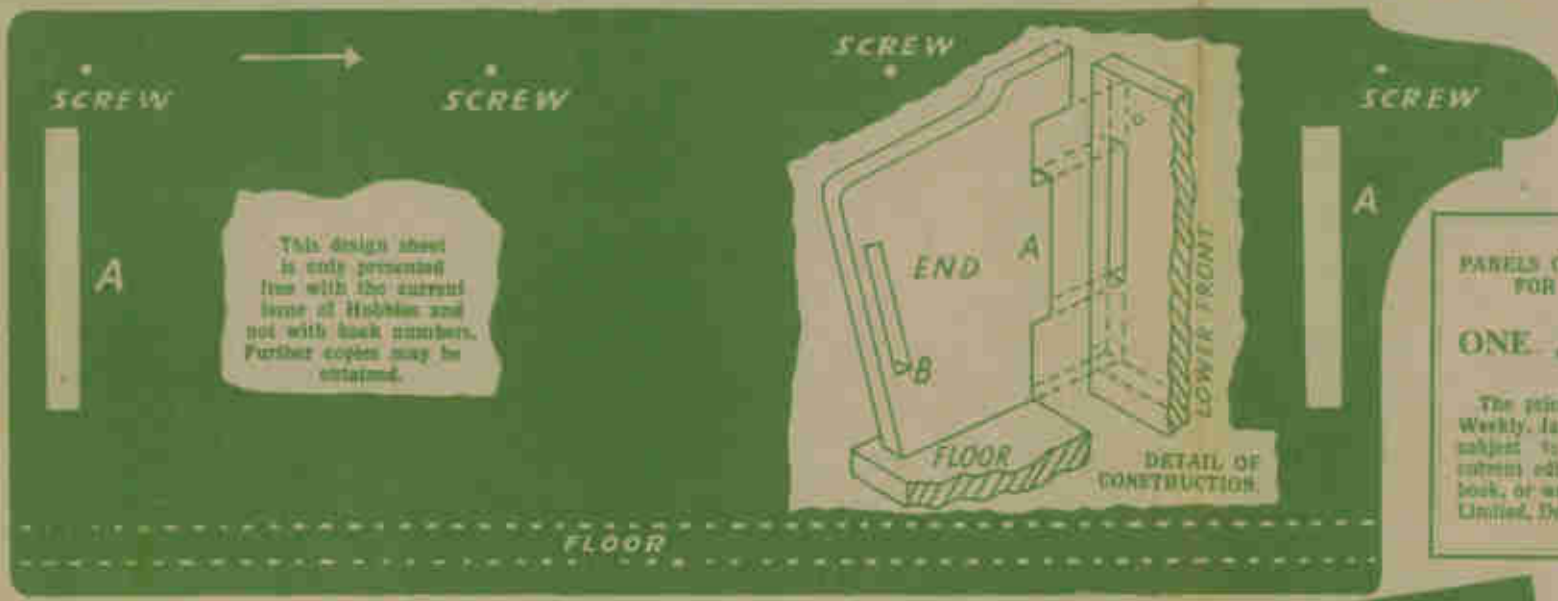

This design sheet is only presented free with the current issue of Hobbies and not with back numbers. Further copies may be obtained.

LOWER FRONT. CUT ONE 3 1/4 in.



FLOOR. CUT ONE 3 1/4 in. TO SIZE SHOWN

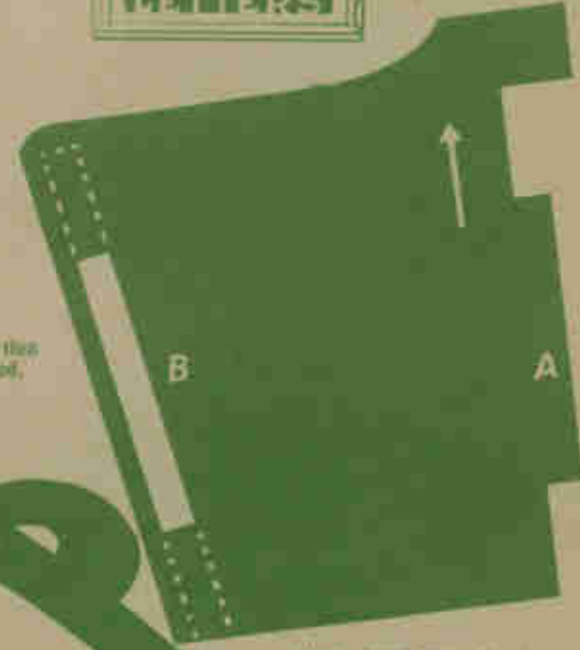



## “SEAGULL” LETTER RACK

ALL parts are cut from 3/16in. boards and the patterns printed on the other side pasted down to them. If the panels suggested are used, the main back will go on the J3 size and the remaining pieces can be cut from the H3—the smaller one.

Take care in laying down the large pattern of the back, to see it does not get wrinkled or have air bubbles under. Apply the paste to the wood and lay the pattern down carefully from one edge to the other. The grain will, of course, go the long way to provide strength.

Cut the fine work of the feathers of the birds first, using a small drill so that the hole does not show in the width of the sawcut. If you cannot manipulate these narrow openings satisfactorily, it is better not to fretsaw them through but merely to sink them into the wood with a V-tool, a carving knife or even a penknife.

### Large spaces last

Leave the largest spaces of the frets until last, to give more strength to the wood to the last moment. Get the leaves nicely balanced and the curved branches in shapely lines. Do not cut the outer edge until last.

Further to enhance the back picture, some coloured paper or fancy material should be glued over the whole lot. Apply the glue evenly, stretch the material out tightly and leave to dry. Do all this before cutting the outer edge of the pattern because you will then have the

backing and the actual back the same shape, and save a lot of trouble of cutting the backing piece by itself.

The actual letter holder is a separate unit. Five pieces form the pocket, and a drawing of the joint construction is shown in the detail. First cut the front with its wording of letters, and back this up if you desire with some fancy paper or material.

### Forming the Pocket

Fix the piece between the ends by the mortise and tenon B, and then fit the whole thing into the lower front (or back of the pocket) by the mortise and tenon A. The little piece at the top of the ends overlaps the top edge of the back, and projects beyond so that when fixed it will rest and bind on the main back.

The floor—a piece 7ins. by 2ins.—is glued under the ends and front up to the front of the main back. It can be glued to the ends and front and screwed through from behind the back of the pocket. The whole of this unit can be stained or finished as desired.

It is then fixed to the back with glue and four screws in the holes indicated. Its position on the back is shown by the dotted line on the pattern of that part. This is 1/4in. inwards from the lefthand edge overlapping the back to 1/2in. A spot of glue on the ends of the projecting pieces of the pocket will give added strength.

Two small brass wall hangers should be added behind the back to allow it to be hung for use.

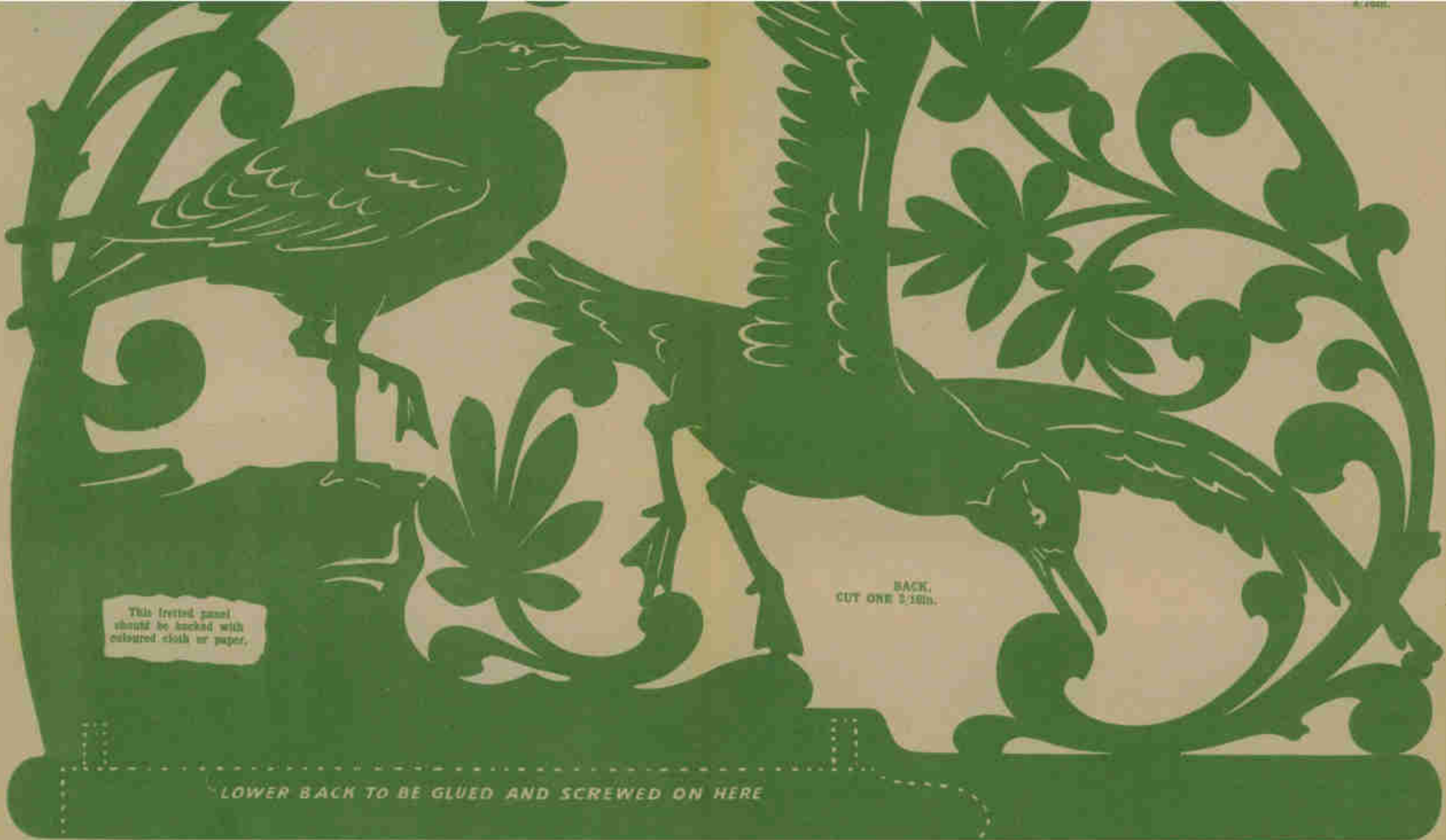

This fretted panel  
should be backed with  
coloured cloth or paper.

BACK,  
CUT ONE 3/16in.

LOWER BACK TO BE GLUED AND SCREWED ON HERE





# How to add the connections to a set when WIRING A PICK-UP

**S**OME receivers have sockets so a gramophone pick-up or microphone can be connected, the amplification obtained making loud-speaker reproduction possible. But other receivers—especially home-built ones—may not have this addition. As numerous queries on this point have been received, instructions for adding such connections are given here.

With a pick-up gramophone, records may be reproduced through a radio set, far greater volume being possible than with ordinary mechani-

In order not to interfere with radio reception, the lead from the valve grid to the switch should be short. For radio reception the switch is set in the "off" position. In some cases reproduction will be improved slightly if the second socket is returned to grid bias about 1.5 volts, instead of to high tension minus. This can easily be tried.

## Connecting to L.F. Stage

With 3- or 4-valve sets (particularly if mains operated) too much amplification will be obtained if the pick-up is connected to the detector.

pick-ups or microphones this gives slightly better results.

## With Mains Receivers

As shown in Fig. 3, connections for a mains valve are the same as with the battery valves. However, where no pick-up is intended to be used, no bias resistor or condenser will be used in the circuit. They may, therefore, be added as shown, and will not influence radio reception.

As an alternative, battery bias may be used. To do this the one pick-up socket is connected to grid bias minus (instead of to H.T. minus as

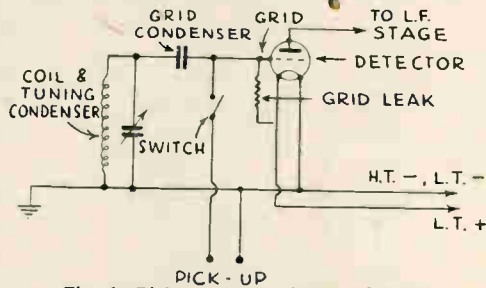

Fig. 1—Pick-up connections to detector

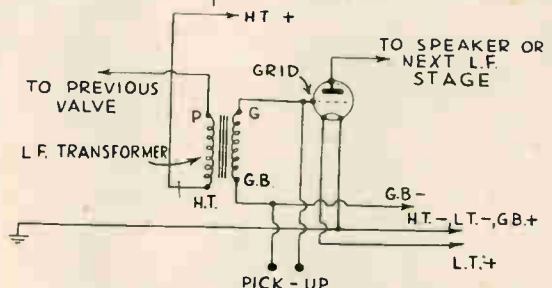

Fig. 2—Pick-up connections to L.F. stage

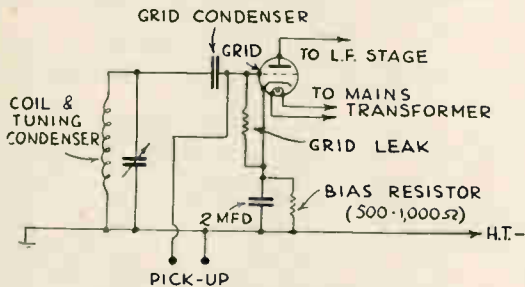

Fig. 3—For a mains operated detector

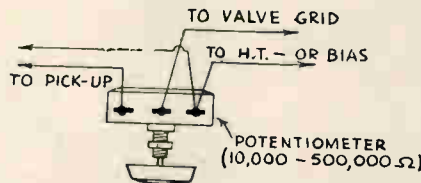

Fig. 4—Adding a volume control

Overloading may arise, giving very loud, distorted reproduction.

In this case the sockets should be connected to the grid of the output valve, or the valve before the output valve, the latter giving most amplification. Fig. 2 shows typical connections.

If resistance capacity coupling is used, the pick-up will be wired across the grid leak, instead of across the transformer secondary, since the grid leak replaces the latter. Connections may be tried on each valve to see which is most suitable.

It is also possible to connect to the primary of the transformer (points "P" and "H.T.") and with some

shown). Grid bias plus is connected to H.T. minus. About 1.5 to 4.5 volts bias (best voltage can be found by trial) should be used.

With low frequency and output valves, the circuit is the same as in Fig. 2, except that the grid component in the receiver (either a leak or transformer) will be returned to H.T. minus.

## Terminals

Two sockets (or terminals) should be mounted on a small insulated strip, which may be screwed or bolted at some convenient place at the back of the receiver. The leads to it should not be longer than necessary, and should not stray near speaker leads, or any other wires in the receiver. If they do, feed-back may cause a hooting noise.

Connections to these sockets may be with twin flex, which is run as convenient to the microphone or pick-up.

## Volume Control

If it so happens that the type of

cal reproduction. A microphone can be used in the same way for amusement with vocal items, etc.

However, it is the electrical details which have to be considered, not the possibilities in home or party entertainment, which will become apparent.

## For Small Receivers

In all cases the pick-up sockets have to be connected so the signal reaches the grid of one of the valves. Fig. 1 shows how this is done with the detector stage. The signal is then amplified by the detector and the valve or valves following it.

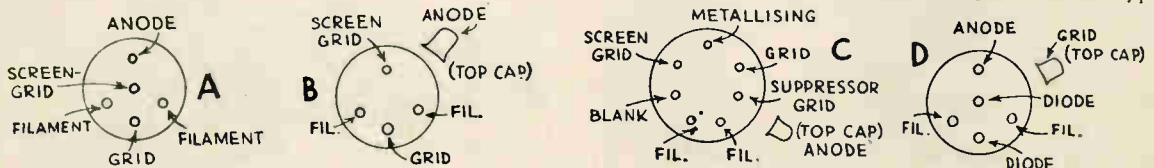

Fig. 5—Details of the various valve bases

volume control in the receiver acts on the radio-frequency stages, then it will not control the volume of gramophone reproduction.

Fig. 4 shows how a volume control may be added. It may be mounted near the pick-up, or somewhere at the back of the set. A component of about .25 megohm (250,000 ohms) is most usual. If a gramophone is being changed to a radio-gram by replacing the tone-arm by a pick-up arm, this volume control can be mounted with its knob on the motor-board.

#### Needle Scratch

This can be cut out or reduced by connecting a condenser of about .005 mfd. or .01 mfd. across the pick-up. As this tends to mellow reproduction, a smaller condenser (about .001 mfd. or .0005 mfd.) may be used if brilliance is required, but will not suppress the scratch so efficiently.

Different types of pick-up are rather differently effected by adding such a condenser, so the best value may need to be found by trial. Cheap, low voltage condensers at about 6d. each are suitable.

#### Grid Connection

As an aid to locating the grid socket, an underneath view of the

most-used valve types is given in Fig. 5 and 6. Looking for the grid condenser and grid leak, or transformer, will also help to show which is the grid socket.

Base "A" is that of all usual battery triodes, pentodes and tetrodes. (The triodes have no centre pin, however). Usual valves of this type are the H1.2, H1.210, L21, LP2, P215, 210LF, 210HL, 215P, 220PT, 220HPT, PM1HL, PM1LF, and all their equivalents.

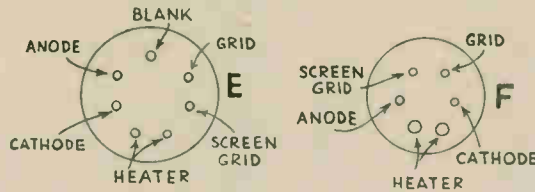

Fig. 6—Two more valve bases

"B" is a screen-grid or pentode base. Such a valve is sometimes used as a detector. Popular types are: VP21, 210VPT, VP215, 220SG, and equivalents.

"C" shows the bases of the same types of valves, but with 7-pin bases. The metallising, suppressor grid, and one filament are generally connected together.

At "D" a battery double-diode-

triode is shown, and this valve is used in superhets. Usual types are: HD22, H2D, HL21DD, and TDD2. Note the top cap is the grid.

"E" shows a mains pentode base. Types are: MPT4, MP/PEN, AC/PEN, 7A2, PEN4VA. "F" shows the Brimar base of similar output pentodes, the type 43 being the most usual.

#### Important

Take care to connect the pick-up properly. The valve numbers given, together with an examination, as mentioned, to find the grid coupling components, will enable the grid socket to be found. If any doubt arises, a radio shop should be consulted, or the valve type (stamped on the bulb) ascertained and the valve looked up in a manual of valve-types.

When using microphones, these should be so placed that the sounds from the speaker cannot reach them, or howling will result. It should not be overlooked some microphones require a transformer for use with them, and will not function without such a transformer.

## GENUINE EX-RAILWAY AND SHIP TARPULINS

Guaranteed good condition and Waterproof. 70 sq. ft., 20/-; 140 sq. ft., £2/10/-; 280 sq. ft., £5; approx. 360 sq. ft., £6; approx. 720 sq. ft., £12. All include carriage.

GENUINE W.D. PIONEER FELLING AXES. Original handles, complete, hardened steel razor edge. Brand new. 18 6 each, carr. 1/6



**Stove Cooker Lantern**  
35/- Carr. etc. 2/6

Economic Oil Burner, impossible to blow out. This Stove lasts a lifetime. Sheer steel, cost £7/7/- to make, clearance 35/-, post 2/6.

**Keep Food Hot! New Ex-Army Steel Food Containers.** Ideal to solve the fuel problem. Keep your cooked meat hot in this container. Ideal for picnics. Size 32" circ., 34" deep. Bargain 5/9, carr. 1/- 'Paratroop' Binoculars 45/-, post 1/- Weigh only 7ozs. Telescopes and Prisms available.

**Electric Alarm Clocks** A.C. 200 250, 59/6, post 1/3

HEADQUARTER & GENERAL SUPPLIES LTD. (Dept. HOB, AS/1) 196-200 Coldharbour Lane, London. S.E.5 1 minute Loughborough Junc.

## A GRAND NEW IDEA FOR MODEL MAKERS MAKE MODEL COACHES



Surpasses Model Ships, Trains, Planes — for interest and profit.

Homecrafts Instruction Leaflet No. 11/21 gives complete instructions for making a realistic model of the "Brighton Mall". A triple plan-sheet fully illustrates step-by-step construction. Price 1/6. Post 1d. Leaflet No. 25. Complete instructions and triple plan-sheet for making a model of the "Overland Stage". Price 1/6. Post 1d. Leaflet No. 28. Complete instructions and triple plan-sheet for making a model of a "State Coach". Price 1/6. Post 1d.

Order from this advertisement or send 1/- for a copy of the illustrated Magazine *Craftworker*, and full details of Instructions Materials, Tools and Fittings for Crafts that are different.

**Homecrafts (Dept. 17), ALBION STREET, BROADSTAIRS, KENT**

## MODEL-MAKER'S KIT

This set of tools has been specially selected for model makers in wood. There is a complete range of reliable necessary tools, a full size pattern sheet from which to make a small model galleon, and a 24-page book of instructions for the beginner, and hints for the experienced.

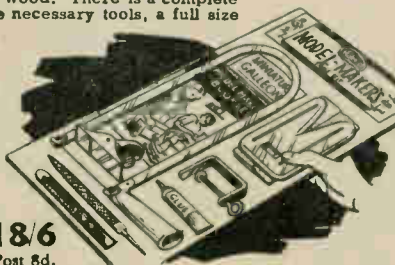

HOBBIES Ltd.

Branches 18/6 Post 8d.  
or Dereham, Norfolk.

## BAR CRAMPS

A strong well-made tool for the carpenter and handyman. Takes work up to 1 ft. 6 ins. long. Easily adjusted to varying lengths as a sash cramp or for wide boards. Strong steel bar with square edges for rigidity

10/11

Postage 9d.



At Hobbies Branches or from Hobbies Ltd., Dereham, Norfolk.

# Apparatus to make and natural signs to know for WEATHER READING

**T**HERE are three main ways that the amateur can tell what sort of weather is likely in the near future. They form an interesting study which can be turned to useful effect when you go out.

The first is to have some means of measuring the air (or barometric) pressure at short intervals and then making deductions from the readings so obtained. The second is to be able to measure the amount of water vapour present, or humidity as it is called, and the third is to be able to interpret the weather signs that Mother Nature herself provides.

Instruments used to measure variations in pressure are spoken of as barometers. On the whole they are expensive to buy—mercurial “glasses” certainly can cost quite a lot.

## Simple Apparatus

Here, however, is a simple measuring apparatus you yourself can make very readily, which forms a good substitute for the commercial article.

A clear glass bottle with a long thin neck is required, this being supported on a simple frame (as shown) in an inverted position over an empty jam jar, also of clear glass. The end of the bottle neck must not reach the bottom of the jar, and the wide part of the neck must not come in contact all round with the outer glass, as this prevents good working.

Now prepare a quantity of water mixed with red ink so as to make a fairly deep-coloured solution, and pour it into the jar. It will be found that the liquid rises to a higher level in the bottle neck than elsewhere.

Next make a simple scale—a piece of wood marked clearly in  $\frac{1}{4}$  in. divisions will do—and fix this behind the neck as shown.

## A Weather Chart

As the air pressure varies it will be found that the level in the neck rises and falls; the change can be as much as 2  $\frac{1}{2}$  ins. In general, the higher the reading, the better the weather that may be expected. When the level gets very low, there will be rain.

If you divide the distance between the highest point to which your liquid goes and the lowest into six divisions (that is eight points) starting from the bottom, they could be marked as: (1) stormy with rain, (2) much rain, (3) rain, (4) change, (5) fair, (6) set fair, (7) very dry.

Sudden changes of level show equally sudden changes in weather, while slow changes indicate a slow approach of a wet or fine spell, according to the way of the movement. Constant level means the

continuation of the sort of weather you are then having.

The “humidity”, or moisture in the air, will also indicate the conditions to be expected. Human hair is very sensitive to degrees of dampness, the more moisture there is in the atmosphere, the shorter it becomes. Remember how taut guy-lines become in rain. It's the same idea.

## A Hair Measure

This fact can be used to make a simple measuring apparatus. Obtain a human hair as long as possible and suspend it with a weight such as a penny on the end, fastened by a touch of sealing wax or plasticine.

The weighted hair should hang freely, and a short graduated card be set behind the coin. It need not have any special markings on it, but is there so you can readily see the variations in height.

When the coin is high up the chart, there is much dampness about and rain may be expected. If hanging low, a dry spell has arrived. As with the coloured water in the barometer, when steady, the weather being experienced will continue, and when moving in one direction or the other, the weather is moving over to the type indicated by the height.

This simple instrument, together

shining, if the seaweed is soft and clammy, take your mac, for rain is on the way.

## Natural Omens

And now about the third method of predicting coming weather—Nature's signs. These are legion, but here are a few:

Very clear air means rain or wind.  
Gossamer floating about—a dry spell.

Swept-looking clouds—wind.  
Morning mist in the summer—a hot day to follow.

A bright sunny early morning—rain later.

Red sunrise—bad weather later.  
Red sunset if not wild-looking, a good day on the morrow.

Other reliable signs are that if cats run about there is wind to come; if cows lie down rain will soon follow; while if spiders build webs with short anchoring fibres gales may be expected. Long fibres mean a spell of fine weather.

Dust blowing in spirals shows rain, while heavy evening and morning dew in summer is a sure sign of a very hot

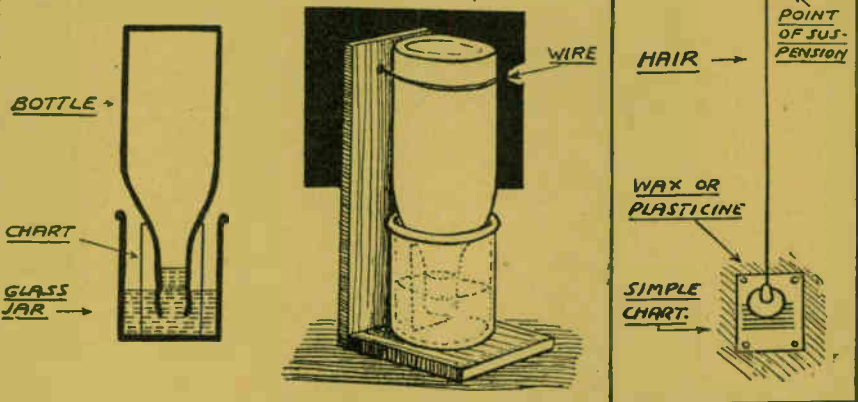

with all others which measure the humidity of the air, is spoken of as a hygrometer.

A substance which contains hygroscopic properties in itself is seaweed, and a bunch may be used as a hygrometer. As the air becomes more humid so the seaweed becomes wet, and dryness of the air is shown by its dryness. Thus, even if there is a shower on but the seaweed (hanging, say, in a porch) is quite dry, then you may know that the shower will soon pass and a nice dry day be coming along. But even should the sun be

day to follow. If the grass is dry in the evening, no matter how warm the night—there is danger of cooler weather on the morrow, or rain.

So they go on. There are simply scores of these signs, and very true they all are.

So you will see that weather forecasting is not really outside the realm of the interested amateur, but like other things proficiency is only obtained with practice and still more practice. So keep at it and in time you will have no need to listen to the B.B.C. predictions.



## How to make Ice-cream with a flame!

It sounds like a first-class conjuring trick. Take a box. Put water in it. Light a gas jet under the box. Take lumps of ice out! That's what a gas refrigerator does. How does it do it? A liquid can't evaporate without getting heat from somewhere. When you put a kettle on a gas-ring, the "somewhere" is the gas flame, and so the water evaporates into steam. When you put a drop of petrol or methylated spirits on your hand, the "somewhere" is your skin, which you can feel getting cold as the spirit evaporates. In a gas refrigerator, there is a boiler, half full of ammonia and water, under pressure. The heat of the gas flame under the boiler makes the ammonia boil off in vapour—still under pressure—into a coil of pipe which cools the ammonia back into a liquid. This liquid ammonia passes into another chamber where there is less pressure. It evaporates. Where does it get the necessary heat from? From the ice-cream mixture that you put into the refrigerator! Finally the ammonia joins up again with the water, goes back into the boiler and the whole thing goes on over and over again—the ice-cream mixture giving up more and more heat, and so getting cold enough to freeze. That's how a flame can freeze—without noise, and with nothing to wear out or give trouble.



Issued by  
THE BRITISH GAS COUNCIL · 1 GROSVENOR PLACE · LONDON · SW1

# NOW is the time to EXCHANGE BOOK TOKENS

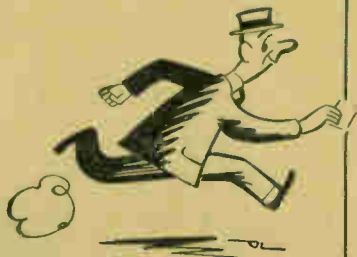

AT ANY GOOD BOOKSHOP

## She might be YOUR ship



### DESTROYER

She's one of the finest fighting ships in the Royal Navy. She's fast and powerful, and 40,000 horse-power turns her screws as she whips through the water at 32 knots. Her crew are proud of her and who wouldn't be? There's a fine career awaiting YOU in the Royal Navy. Good pay, good prospects, plenty of sport and a chance to see the world in a ship you'll be really proud of.

If you are between the ages of 15½-16 or 17-23 call at any Combined Recruiting Centre or write to D.N.R. Dept. AC/148, Admiralty, London, S.W.1.

Make the  
**ROYAL NAVY**  
your career

## Plans for a 36" M.Y.A. RACING YACHT

These plans, for the 'Merlin' drawn up with all the clarity and attention to detail for which Modelcraft is renowned, will build a real classic racer—a creature of grace, beauty and efficiency. The plans include two alternative methods of hull construction. For the less ambitious other model yacht plans for the 'GULL', 'KESTREL' and 'PIXIE' are listed in our magazine and list.

**8/6**  
POST 4d.

## Modelcraft's NUMBER FOUR MAGAZINE & LIST

The magazine section is rich in the garnered wisdom of leaders of every branch of modelmaking. Yet it is as much for the fascinating opportunities opened up by the list of plans, plan-books, kits and accessories that modelmakers buy it. Nearly 450 items are listed including—

GALLEONS, CLIPPERS, OLD-TIME SHIPS AND STRANGE RIGS	GLIDERS AND FLYING MODELS
MINIATURE GALLEONS AND CLIPPERS	SOLID SCALE AIRCRAFT
WARSHIPS	RAILWAY FEATURES
MERCHANT SHIPS	LORRIES, BUSES etc.
WEAPONS OF WAR	CARS
	PERIOD HOUSES

PRICE 1/- Post free SUBSCRIPTION 4/6 Four issues Post free

**MODEL-CRAFT Ltd.**  
77 (F) Grosvenor Road, LONDON, S.W.1