

Hobbies

WEEKLY

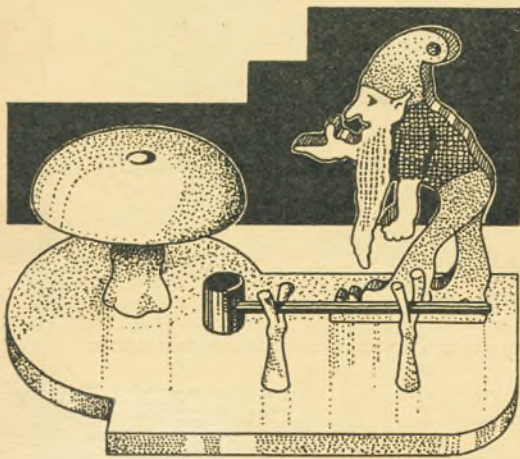

NOVELTY
BELL GONG

FREE DESIGN SHEET
FOR THIS HANDSOME
VASE STAND



August 7th. 1937

2^D

Vol. 84. No. 2181

THE FRETWORKER'S AND
HOME CRAFTSMAN'S JOURNAL

BOYS! Have the Real Thing this Summer...

Steam always fascinates. It is such a live, potent force. A model Steam Launch provides endless joy for the modern boy. Racing across the pond.....the realistic "puff" of the exhaust.....tuning up to get that extra ounce of power. Have the real thing this summer—a Hobbies Steam Launch.

THE "Peggy" STEAM LAUNCH

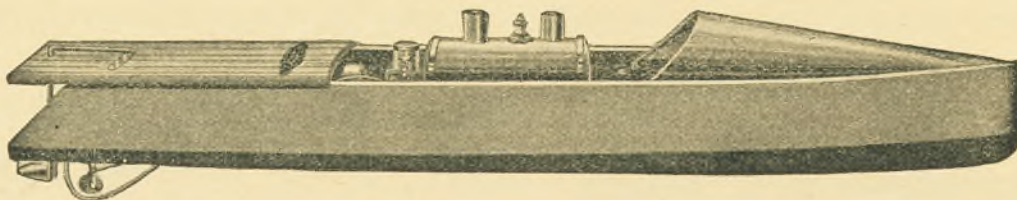

21/-

Postage 1/-

31ins. long, 5 $\frac{3}{4}$ ins. beam. The hull is built by a special process and is finished with bright enamel. The engine is of super-heated pattern to produce a big head of dry steam quickly, exactly as large engines do. A drip lubricator adds to the free running and as all parts are accurately machined and carefully tested, the engine runs smoothly and sweetly for a considerable period at one filling. Two rakish funnels, are fixed to add realism to the boat as she steams steadily across the pond or lake. Packed in strong wooden box.

Steam is the Real Thing!

THE "Swallow" STEAM LAUNCH

20in. long, 3 $\frac{1}{2}$ ins. beam. This model Launch incorporates many new features. The hull is particularly light, whilst the engine is powerful enough to drive the boat 20 minutes at one filling. It is perfectly safe as the boiler is fitted with a safety valve. The engine is of polished brass, and the hull is beautifully finished in two colours of enamel. Packed in strong wood box.

17/6

Postage 7d.

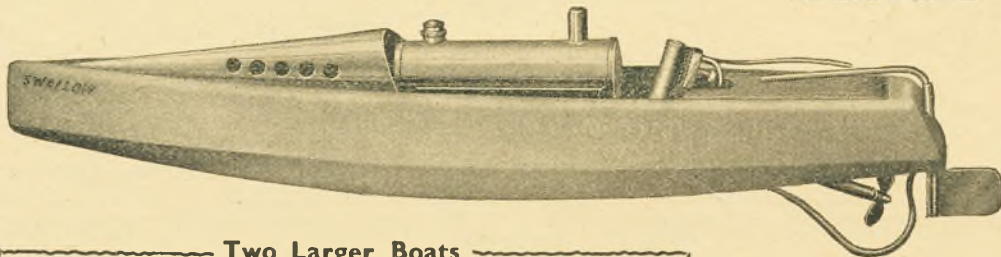

Two Larger Boats

"EAGLE"

27 ins. long, 4 $\frac{1}{2}$ ins. beam.
Single cylinder engine.
32/- Postage 10d.

"SEAHAWK"

28 ins. long, 5 ins. beam.
Twin cylinder engine.
42/- Postage 10d.

Buy from any Hobbies Branch or Agent, or direct from Hobbies Ltd., Dereham, Norfolk.



Hobbies

WEEKLY



August 7th. 1937

Vol. 84. No. 2181

A NUMBER of readers have written from time to time about the Stamps issued in connection with the Coronation. There is, of course, a wide range appearing in the Dominions and the Crown Colonies (the distinction in name was explained in a recent issue) and there are many points of interest even to non-collectors of stamps. Why even George, the tame office boy, is really beginning to learn history and geography in an interesting way from the notes given by my stamp expert. If you have not read any, I can really recommend them as good matter.

SOME time ago I mentioned in these Notes Mr. T. G. Chambers of Otago, in New Zealand because he had charge of children who very badly wanted to know English fellows by writing to them. I asked readers to write to Mr. Chambers accordingly. Now I hear from him that you have all been splendid in this, so it will take him a long time to answer all of them. He asks me to thank all those who did write from the many different countries, and hopes to answer them all gradually. But, for the present, no more please!

IMENTIONED on this page a little time ago the complaint of a fellow who wrote to somebody in our Correspondence Club and had no reply. Now I can give the other side of the case, because if, like the gentleman above, he received a large pile of letters the cost of stamps in answering them is no small amount. It is kinder then, when you write to a pal to enclose a stamp for him to use when replying. Unless, of course, you are writing overseas, for then the stamp cannot be used on an answering letter.

THERE were not so many entries in the Medal Stand Competition as I expected, but the standard of work was higher than any I have seen for a long while. It was pleasing to note,

too, the originality displayed by many competitors to make their entry different from the rest. One worker had backed his wording with mirror glass which made it very effective. Almost all had made beautiful sloping stands to hold the medal, and in one case a complete hinged lid with glass front fitted over a brilliant red velvet cushion for the medal. One of the medal slopes, too, had a piece of ivory lined with bright headed brass nails on to which the velvet was glued. This again gave an excellent and striking effect.

THE actual winner of the Coronation Silver Medal was Miss Winifred Webber of Cannington, Somerset, and you will probably remember seeing her picture recently as the winner of the big National Fretwork Competition last year. Congratulations again to a lady. She only just managed to secure first place, however, because an entry by W. F. Wiggins of Aylesford Street, London, S.W.1, was really a very fine piece of work. So good, indeed, that I have given a special prize to that worker. All the entries where postage was included have been returned to their owners, and will, I know, have a place of pride in the home.

ONE of the League Clubs has a special Form of Application for Membership which may be of interest to other secretaries. It contains a note of the activities of the Club, of the subscription payable, a promise to pay the necessary fees, etc. Then there is a space for the signature, age, address, and (in the case of younger members) the signature of the parent approving. This Form is certainly quite useful for secretaries to have as a record of date of joining, etc., and any who would like a few specimens should write to the Registrar of the Hobbies League stating how many would be required.

CONTENTS

GIFT DESIGN—Vase Pedestal

Fun and Puzzle	434
Fretwork Vase Stand	435
Novel Bell Gong	437
Decorations with Seaweed	438
Match and Spill Holder	439
Car Seat Table	440
Replies of Interest	441
Scout Notes	442
Photographic Competition Pictures	443
Competition Winners	444
Inlaid Wood Blotter Cover	445
Log or Newspaper Container	446
A Model Silk Winder	447
Movable Tool Cabinet	449
Coronation Stamps	453
Blotter Cover Patterns	455

Next Week's Design—Small Clock

Correspondence should be addressed to: The Editor, Hobbies Weekly, Dereham, Norfolk, and a stamp enclosed with the Reply Coupon from Cover is if a reply is required. Particulars of Subscription rates, Publishing, Advertising, etc. are on cover iss.



FUN

AND

PUZZLE

PAGE



When is a policeman like a good musician?

When he keeps to his beat.

What's the way to make a thin boy fat?

Make him look round.

Why is it hard to catch the 12.50 train?

Because it's ten to one if you catch it.

DON'T BELIEVE YOUR EYES

Which is the larger, the centre circle on the left, or the centre circle on the right? The one on the right? No, you're wrong. They're both exactly the same size!

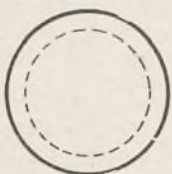

Here's another eye trickster. The broken circle on the left appears to be much larger than the broken circle on the right, but just measure them! You'll find there's no difference!

Why is a nearly-bald man like a greyhound?

(Hare) go a long way. Because he makes a little hair.

Why should males avoid the letter A?

Because it makes men me(a)n.

Why is a knock at the front door like an overcoat?

Because it's an outside wrap (rap).

LION TAMING!

A circus manager was interviewing an applicant for the job of lion tamer. "When would you be able to start?"

"Straight away, sir," replied the man eagerly.

"That's fine, my boy," said the manager. "Go along to the cage and clear up the remains of your predecessor."

CRACKED!

Diner—"Hey, waiter, is this the steak I ordered?"

Waiter—"Yes, sir, that's it."

Diner—"Well, I'm blessed. I thought it was a crack in the plate."

NATURALLY

Talkative Barber—"And what would you like on your head, sir?"

Customer—"My hat as soon as you can manage it."

CHANGING PLACES

Here is a novel but laughable match trick anyone can undertake. The performer places two matchsticks or coins in the right hand and one matchstick in the left hand. He holds the two hands straight out in front of himself, one above the other and a little apart, and asks the audience to assure themselves as to the positions of the matchsticks, i.e., two being in the right hand and one in the left hand. He then closes both hands and states that he will cause the matchsticks to change positions without opening his hands again until the change has been made.

This seemingly impossible trick is easy in the working. By reason of the great care taken by the performer in emphasizing the position of the respective matchsticks, the spectators naturally expect to witness a conjuring sleight. They are, however, somewhat nonplussed when the performer merely crosses his hands and announces that the matchsticks have now completely changed their former positions.

CROSSWORD PUZZLE SOLUTION

This is the solution to the Competition Crossword which appeared in our Coronation Number of March last.

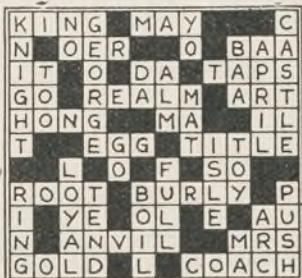

SPELLING TRICK

There is a word containing six letters. Take away one letter and twelve will remain. What is the word?

Take the "s" from dozens and a dozen will remain.

NONSENSE!

Asked by her teacher what she thought the word "nonsense" meant, a little girl replied "Nonsense is when an elephant is hanging over a cliff with its tail tied to a daisy."

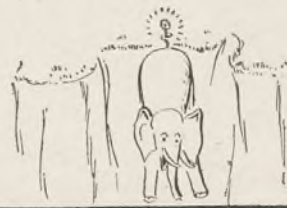

Why are deaf people like Swiss clocks?

Because we cannot make them hear (here).

Why is a selfish person like the letter P?

Because he's first in pry and last in help.

In what way is a hare a brave animal?

When it dies, it dies "game."

Where do sea-horses drink?

In the trough of the waves.

EASY!

Teacher—"How do we get electricity?"

Tommy—"Press the button."

TOO BAD!

"I shan't be marrying Miss Hooker after all. She's refused me."

"Why didn't you tell her about your rich uncle? Didn't she even offer to be a sister to you?"

"I told her about my rich uncle and now she's going to be an aunt to me."

WORSE STILL!

Owing to an unfortunate misprint, which we very much regret, we referred in the last issue of our paper to General — as a battle-scared veteran. We meant, of course, a bottle-scarred veteran.

FRETWORK PEDESTAL VASE STAND

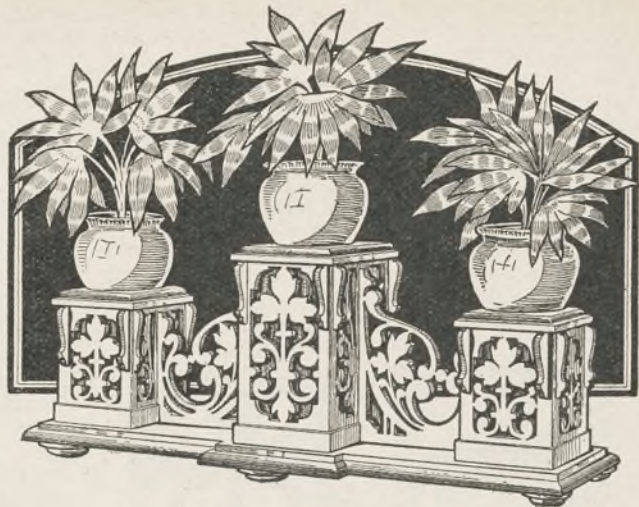

THIS week's large gift design sheet provides the patterns for making a handsome and unusual type of vase stand. As can be seen, it is a nicely fretted holder with three pedestals for a pot type of vase. We have, indeed, had a special vase made for it in brilliant green ware, which exactly fits the receptacle.

Moreover, as usual there is a complete parcel of wood in which all boards are supplied planed and cut the sizes required by each of the parts. In some cases several patterns can be put on the one board, but sufficient timber is provided for all the necessary work. Particulars of this are set out in the material list herewith, as well as the cost of the vases mentioned.

Pair Off the Parts

There is a fair amount of work involved, and the usual points must be remembered in getting out the work. It is advisable, for instance, where two small parts are being cut, to do them immediately after each other.

In this way, when you have completed one you can lay it by your side and watch out the points in cutting the second pattern. You may have gone slightly off the line or made the curve a little broader in one instance. It is, therefore, essential if this cannot be rectified, to have the second portion exactly like it, and to follow out the same lines in that one.

Again, in making the drill holes in the first piece of work, you may come across a position in practice which would have been better for the drill hole. Therefore, if you have the second piece of work at hand, you can make the drill hole immediately in the better place.

The fretted design consists of floral scrollwork, and each panel contains curves which sweep out from a central stem. Follow these out very carefully in each case. Another point, too, is to see that the connecting links where they finish are all the same.

If you glance at the detail at Fig. 1, you will see what a difference can be made. This is the point where good judges of fretwork can soon tell the ability of the worker.

MATERIALS SUPPLIED

Fretwood—For making this Vase Stand we supply a parcel of whitewood (including 6 No. 20 toes) 2/6 or sent post free 3/-.

Fittings—3 (green ware vases (No. 6029) 2/3; a piece of linen cloth, 4d. (postage 6d.))

Complete parcel of wood, vases and cloth for 5/6 post paid.

Remember also when cutting across the grain down the narrow angle, that the saw is apt to jump across the gash into the opposite line if not kept under proper control. Fretwork, it must always be noted, demands as much care and attention in the finishing points as in the actual cutting.

Hints on Finishing

Spend a considerable time even after the cutting has been completed, in looking over the part, studying it carefully, and rectifying any little errors which may have crept in. For this purpose, the tiny fretwork files are essential, then finally the whole thing is cleaned up thoroughly with glasspaper.

Complete each piece as you come to it, both on the back and front, but at the same time notice any little lines on the pattern or points for screws where adjacent parts are to come.

For instance, the bracket pieces under the top are shown on the sides and some slight indication should be made with a pricker before the paper is cleaned off. Thus the position will still be seen when the other part comes to be joined up to it.

Another big point in the construction of this article, is the number of long plain joints where two parts butt up to each other. In only two cases is there a mortise and tenon joint. This butt joint must be true and each line of the edge straight. If not, the glue will not hold the two parts together satisfactorily.

The work of cutting straight lines is not one of the easiest and beginners may prefer to do this with a tenon saw rather than a fretsaw.

On the other hand, after a little practice you should be able to keep to the cutting line with the small blade. Be sure, too, to keep the saw upright. This is nowhere more important than in the cutting of an edge of wood which is to provide a joint butting up to another piece. You can see what a difference will be made if one edge of a piece is close to the adjoining part, but the other edge stands away. The glue cannot grip properly and the part will not make a good joint.

With these little points in mind, we can go ahead with the cutting of the various parts in the thicknesses shown, and clean them all up. Notice where sectional drawings—such as in the base, top, etc.—are given, showing how the edge is to be rounded. This is done first by taking off strips with a plane, then finishing up with glasspaper to get a nicely curved surface.

In the case, too, where large central circles have to be taken out, as in the case of the tops of the vases, cut the outer edge first then shape it round according to the section, before cutting out the large circle inside. If the circle is cut first, then the work is liable to be broken with the turning and twisting during the shaping operations.

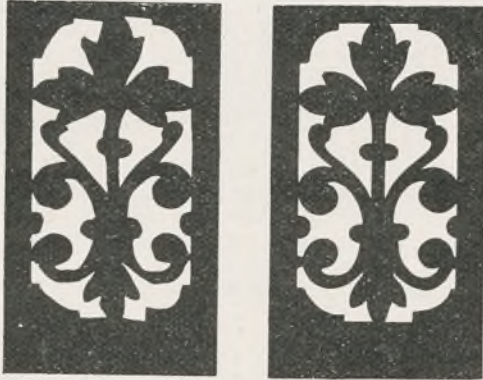

Fig. 1—Note the difference of bad and good cutting

Wherever possible, by the way, test the pattern down with a straight edge along the straight edge of the wood, as this saves you cutting that particular line. Notice, too, that the patterns in some cases on the sheet are shown together.

The Top Portion

This is the case of the top portions of the pedestal. Each top is formed of two pieces, the lower one being solid and the upper one only having a circle to take the vase. A note of this is shown against the proper pattern.

Now a few words about the construction. The first work is the base. This is made up in two layers and a detail at Fig. 2 is helpful. Get out the four narrow strips and glue them together under the upper base which is of thinner material. Then put in the two between pieces which fit into the mortise at A and B. This is essential because it rules the placing of the upright pedestals.

The Central Pedestal

Next put in the central pedestal consisting of its four long upright sides. Two of these sides are narrower than the others, and these are the ones which fit against the uprights already placed in, as well as between the front and back. Of course, all four will have been previously tested out before being glued up, and workers may also like to back up the fretted portions with linen,

paper, leatherette, or some similar fancy material. Even silver paper flattened out looks well to make the fretwork stand up strongly.

Round the base of this central pedestal is $\frac{1}{8}$ in. plinth, and this is glued to the bottom board as well as to the sides of the pedestal itself.

The top, as has been previously mentioned, consists of two pieces. Glue them together, then glue the whole thing very firmly down to the upright sides.

Another plan is to glue down the larger piece first, and if necessary drive in one or two fine fretnails very carefully. Then the upper piece can be glued on.

In order to make a good job of fitting, the vase should press tightly into the circle of the top. To ensure this, stand the vase on the part, pencil round the bottom then cut out with the fretsaw. Afterwards use the half-round file and chamfer the hole larger on one side of the wood to accommodate the sloping tapered sides of the vase.

The Outer Pedestals

We next come to the two outer pedestals which are erected in a very similar way to the central one. Notice they do not extend to the full width of the base, but leave a space of about $\frac{1}{4}$ in. all round.

These end pedestals can also be lined behind the fretwork in a similar manner to the central one, or if preferred some distinctive contrasting material can be used to make it distinctive from the central higher pedestal.

Glue all parts thoroughly, but do not put on the adhesive so thickly that it squeezes out through the joints. If it does happen to do so, wipe it away immediately before it sets.

Little fancy brackets are added to each of these pedestals to hang down below the top. These are dainty shaped parts of which 24 are required. To relieve the monotony of cutting, they should not be undertaken all at once, but got out between

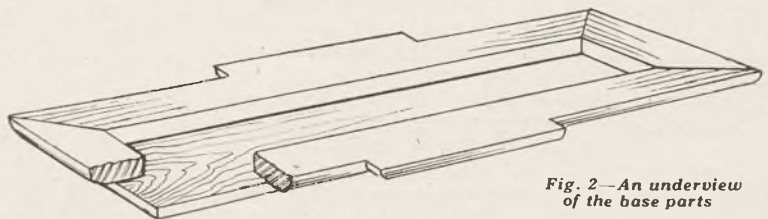

Fig. 2—An underview of the base parts

some of the other pieces. Each is glued below the top near the corner of the pedestal. Notice, however, that they are not actually close to the corner, but set inwards about $\frac{1}{16}$ in. This position is shown clearly on the pattern of the sides.

The whole of the article is raised on six feet, two at each end and one under the projecting portion in the middle. These feet in turn are composed of two pieces. There is the $\frac{1}{4}$ in. diam. circle of $\frac{3}{16}$ in. wood below which is glued the little round shaped toe supplied.

A NOVEL BELL GONG

READERS constantly write asking for more and more money-making ideas—in other words, for useful little articles they can “manufacture” on mass production lines and subsequently turn into hard cash.

This week we give detailed instructions for making a simple, but useful necessity specially suitable for cafés, restaurants and similar places. The design and general arrangement of the gong is quaint and original, the whole being finished in bright enamel colours. Proprietors would want one for every table, and when you realize there are usually twenty or more tables in these establishments, there's going to be big business done somewhere!

The Construction

To save time and to also ensure that the novelties will be identical, thin plywood templates should be made of the base (Fig. 5) and statuette (Fig. 2). The latter is plotted in $\frac{1}{2}$ in. squares which are, as usual, first ruled with pencil and set-square from the squared edges of the wood and the outlines followed faithfully.

The thinner the templates are the easier it is to mark out the shapes and see what you are doing. Stuff about $\frac{1}{16}$ in. thick is ideal, and don't forget that by reversing the templates, you get the opposite effect. You can, then, by way of a change, make some look to the right.

In marking out the base template, note the alternative style of holder that can be used, same being outlined in $\frac{1}{2}$ in. squares at Fig. 6. This takes the form of a water-lily and if painted white, with a green base, would be more fitting than the twig forks. These, however, only require suitable holes in the base (in the approximate position shown) whereas the other necessitates mortises which would be made in the template for marking purposes.

The Bell Gong

Having cut the templates neatly, use a hard, sharp-pointed pencil for marking out; the point should be long and tapering for obvious reasons. If you use the twig forks (taken from any kind of tree or shrubbery), cut a tenon at the base (as seen at Fig. 4) to fit the baseboard holes, a penknife being the best implement. The bark should



Fig. 1—The Completed Novelty

not be peeled off as the twigs look better in the natural state and save extra painting. Twig?

This also applies to the pieces of branch acting as very adequate standards for the bell gong. A 2 in. piece of same is screwed to the base, the gong being held on top with a bifurcated rivet such as used in affixing attaché-case fittings.

To assure the full resonance of tone of the bell, a $\frac{1}{2}$ in. diam. washer of thick inner tube is set between the underside of the bell and its standard as shown by the sectional view at Fig. 3. These rubber washers (felt can be used, too) are quickly cut with a punch made from a piece of $\frac{1}{2}$ in. or $\frac{3}{4}$ in. brass-covered curtain rod. The punch is thus hollow, the outer circumference being filed to give the inner bore a cutting edge.

Use Old Bells

Your greatest drawback will, perhaps, be in obtaining sufficient bell gongs. These, however, do not need to be new, as they will be enamelled a mushroom shade. Old door bells, bicycle bells, alarm-clock bells (there are sometimes two to be found on these clocks) can thus be used, the rusty state helping to lend a rustic, mushroomy effect, so to speak. On the other hand, you could approach a manufacturer of bell gongs (for bicycles, etc.) and ask for a price per dozen.

By stating your business, you should be able to procure a supply comparatively cheap, and before actually ordering a quantity, of course, it would be advisable to make a sample novelty (a really well-made and finished article) and show it to prospective buyers and learn the number required. In the matter of price, be fair and not too astute.



Fig. 2—The figure in $\frac{1}{2}$ in. squares

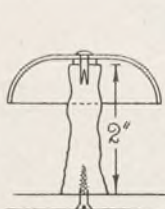

Fig. 3—Section of the bell and holder

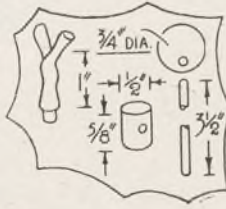

Fig. 4—Detail of beater and holders

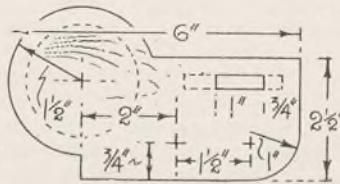

Fig. 5—Size and shape of base



Fig. 6—Alternative type of holder

If you find it difficult to obtain the bells, what about a house-to-house collection, buying up the same at a penny each? Indeed, it is quite probable you will get some for nothing—if you do your “canvassing” nicely. Where there’s a will, there’s a way, you know!

In respect to the beater, the head may consist of (1) a $\frac{3}{4}$ in. diam. ball toe or (2) a $\frac{5}{8}$ in. piece of $\frac{1}{2}$ in. dowelling, the last-mentioned being a cheaper method. The handle is a $3\frac{1}{2}$ in. length of $\frac{1}{4}$ in. dowelling, so drill $\frac{1}{8}$ in. holes for same about $\frac{3}{8}$ in. deep (see Fig. 4).

As a finish, the beater could be enamelled black or in some bright colour contrasting with the rest of the work. The base will be coloured light green, with the base of the statuette and water-lily holders a darker shade.

The gnome’s hat and legs could be enamelled red, and this being so, the whole could be coated this one colour, then, when quite dry, the shirt,

features, etc., could be painted in with other bright colours, i.e., orange for the face and hands, white for the beard, black for the boots, with the shirt brown. A good colour for the “mushroom” would be grey stippled with specks of brown on the top and at the base of the standard.

The underside of the bell will be enamelled also or painted with gold paint, this giving a rich effect. A piece of green baize glued to the base completes the novelty.

MATERIAL REQUIRED

- 1 piece plywood (base), 6 ins. by $3\frac{1}{2}$ ins. by $\frac{1}{4}$ in. thick.
- 1 piece plywood (statuette), 4 ins. by $2\frac{1}{2}$ ins. by $\frac{1}{4}$ in. thick
- 1 ball toe (No. 15), $\frac{3}{8}$ in. diameter.
- 1 piece dowelling, $3\frac{1}{2}$ ins. by $\frac{1}{4}$ in. diameter.
- 1 bell gong (not supplied).
- 1 bifurcated rivet (not supplied).
- 1 tin. by 6 flathead iron screw.
- Some twigs and branching and piece of baize.

DECORATIONS WITH SEAWEED

THERE are so many kinds of seaweed of different shapes, sizes and colours, to be found at the seaside, and these when mounted can be used for decorating all sorts of things.

Make a collection of suitable small pieces of seaweed, wash them thoroughly in fresh water so as to clean them free from all sand and salt.

Now drop a piece in a bowl or sink full of clear water, and let it spread out nicely and float.

Lay a piece of stiff white paper in the water, under the floating weed, and draw it up so that it settles in a good formation on the paper—a penknife can be used to adjust any unruly branches.

Prepare each piece like this, and it will dry out flat and be easy to arrange and stick down.

Some Suggestions

A few of the many uses for seaweed decoration are shown in the illustration, these are just a few ideas.

Use a small piece of coral pink, or delicate green to ornament the corner of an invitation card, or sheet of notepaper; it is, too, a good idea when mounting seaside photographs to stick a tiny spray of seaweed on the corner of the mount to give the picture atmosphere.

Pasten the small pieces down with gum or secotone brushed lightly here and there on the back, not too much, or it will spread outside the weed and show on the paper, press the seaweed down carefully and firmly.

It can either be left matt, or brushed all over with gum to give it a glossy appearance.

A round glass mat may be made beautiful by cutting a circle of gold paper the same size and arranging a nicely shaped branch of fine seaweed in the centre, and fixing it to the paper with gum.

Lightly glue the extreme edge of the paper circle, and lay the glass mat on it so that it is smooth and flat, and keep under pressure.

Cut a thin circle of card for the back, and stick it on. Finish with a strip of gold galon glued neatly round the edge.

Book-ends look well ornamented with seaweed too, either stuck on to plain white, or enamelled wood.

Leave the seaweed as the sole decoration, or else paint a fish or cut one out from a paper plate, and stick it on—an air bubble suggested here and there makes the scheme more realistic—use enamel and a fine brush, and paint them blue or green with a touch of white.

A seaweed branch stuck upon a mirror looks good—this, by the way, is a good notion for camouflaging a crack across the corner.

Seaweed, too, can be used to ornament all kinds of parchment goods, photograph frames, engagement pads, post card blocks and so on, and makes them look something rather out of the ordinary.



NOVEL MATCH AND SPILL HOLDER AND PIPE CLEANERS



HERE is a novel match holder and receptacle for spills and pipe cleaners in the form

of an elephant. It should be made up in some dark wood, ebony, of course, being the ideal, but failing this, a close grained wood such as beech or sycamore should be used. Either of these can be stained black with ebonizing solution, and then varnished or brush polished over.

The base (Fig. 1) is cut square to the measurements given with the top edges planed down to a small chamfer all round as the section shows.

When the shape is marked out, set out the position of the $\frac{1}{2}$ in. mortise to allow for the tenon of the elephant. The outline of the latter is given in $\frac{1}{2}$ in. squares in Fig. 2. Get a piece of wood $\frac{1}{2}$ in. square and divide this up into squares as shown and then fill in the outline.

The Holder

Note the slots in the back of the animal. These need to be cleanly cut $\frac{1}{8}$ in. wide to take the sides C of the box as figured in the diagram Fig. 3. Mark out the outline of one of these sides on to $\frac{1}{8}$ in. wood, then pin another piece to it of equal size and cut through the two together.

Smooth up all edges with glasspaper and test in the slots of the elephant. When a true fit has been made, glue the parts C in the slots and then connect the upper ends with pieces E (Fig. 4). These pieces E measure $1\frac{3}{8}$ ins. by $\frac{1}{8}$ in., and they are glued and pinned with $\frac{1}{4}$ in. fret pins.

Before putting them on, however, they need to be glasspapered down to allow a matchbox to fit fairly stiffly over the whole top. This can only be got by trial, and the pieces should be put on after a sure fit is obtained. As the matchbox is pushed over the block, the tray part is automatically raised so giving free access to the matches inside.

To form the receptacles for the spills, each side of the elephant, the two fronts (D) are put on, these pieces being $1\frac{3}{8}$ ins. by $1\frac{3}{8}$ ins. by $\frac{1}{8}$ in. thick.

Shaping the Animal

The floors are plain pieces $1\frac{3}{8}$ ins. by $\frac{1}{2}$ in. by $\frac{1}{8}$ in. pushed up between the pieces D and the sides of the elephant and glued in. Additional hand work might well be put upon the elephant. The ears may be outlined with the V tool, or again carefully cut in with a sharp pointed penknife.

The eyes, too, could be formed by sinking slightly two tiny glass beads, while the legs could be separated nicely by carving away and undercutting with a carving tool or knife. Any work like this will give an added attractiveness to the article and will well repay the time and trouble spent upon it.

On the front of the spill boxes a square of crimson or blue silk should be pinned, having a fringe formed from the silk itself or from a number of tiny beads carefully threaded and tacked on.

As a final suggestion, the tusks of the elephant would look very nice if made and shaped up from bone. An old bone or ivory penholder would answer well, and it could be cut and filed down and let into small hollows cut in the cheeks each side.

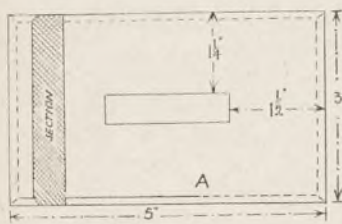

Fig. 1—Outline, with dimensions and section, of the base

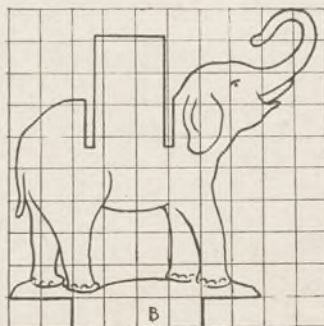

Fig. 2—How to draw the animal

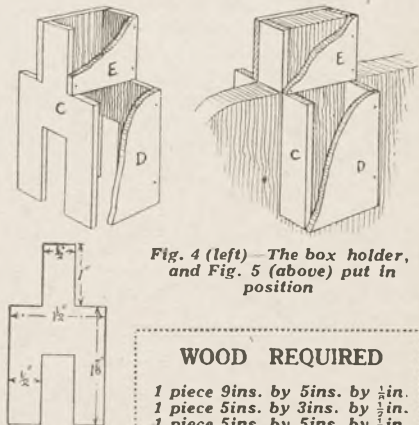
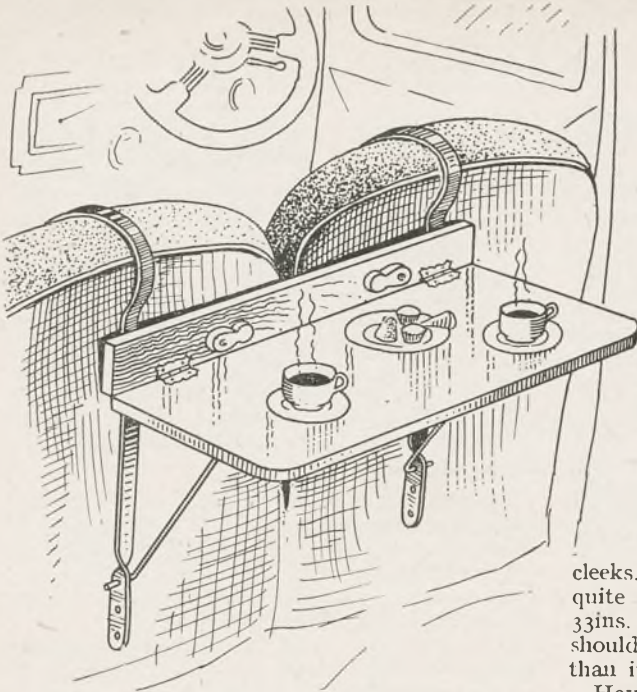

Fig. 4 (left)—The box holder, and Fig. 5 (above) put in position

WOOD REQUIRED

- 1 piece 9 ins. by 5 ins. by $\frac{1}{8}$ in.
- 1 piece 5 ins. by 3 ins. by $\frac{1}{8}$ in.
- 1 piece 5 ins. by 5 ins. by $\frac{1}{8}$ in.

A New Photographic Competition for August will be announced in next week's issue



A CAR SEAT TABLE

tend to mark the upholstery, but if desired, you could prevent any likelihood of this happening by inserting rubber tubing over the prongs—or again, by adhering strips of inner tubing around the underside of them with rubber solution.

Shaping the Cleeks

The most difficult part about this novel table is, perhaps, the making of the cleeks. Once started, however, you will find it quite straightforward, for the bars only measure 33ins. by $\frac{3}{4}$ in. by $\frac{1}{4}$ in. thick, and mild steel, it should be remembered, is softer and more pliable than iron.

Having procured the bars from a local ironmonger or hardware store, bend them to the dimensions provided at Fig. 1 with (1) two iron sash cramps or (2) one sash cramp and an iron vice or (3) a vice and a wrench.

Commence operations by inserting 2ins. of the bar into the jaws of the cramp or vice, and use the rest of the bar as a leverage to obtain the slight curve necessary. Insert the bar 3ins. in the jaws of the implement used, bend as before, then insert a further inch and so on until the curve is completed.

The curve, naturally, will not have a smooth roundness, but this cannot be helped, though the "planes" would be reduced considerably by resorting to $\frac{1}{2}$ in. insertions. If you use a sash cramp for the bending, it is to be assumed that you will have it clamped firmly in a bench vice, i.e., the ordinary wooden kind.

When the crook has been shaped satisfactorily, insert $3\frac{1}{2}$ ins. of the other end of the bar into the cramp or vice. Another cramp (or large monkey wrench) should be tightened about 1in. above it and the bar twisted as shown.

The three holes at this end are 1in. apart and should be drilled with a $\frac{3}{16}$ in. twist bit. The

CAR picnics are ripping—sometimes! It's awful, starting out on a bright, early morn with fleecy clouds and clear blue skies overhead—skies that lure us out into the open, as it were, and then sprinkle those "pennies from heaven" just when we're miles from anywhere. Br-r-r-r! We can't very well have that much-needed snack sitting—or standing up like cows—in a damp field, and to sit huddled in the car eating foodstuffs from the seats is enough to make us "fed up" before we've even had a mouthful!

Really Useful

The idea you see sketched on this page is thus really indispensable on these occasions. These trays grip on the side of cars much in the way illustrated, but as they are used principally for holding coffee and hamburgers, they are very small.

The article shown measures 23ins. long by 9ins. wide, is light, collapsible, easily erected and suitable for seats up to $3\frac{1}{2}$ ins. thick. The cleeks or grips, though bent from mild steel bar, do not

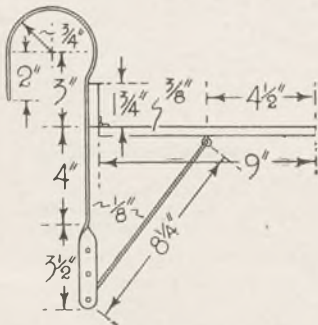

Fig. 1—Side view with dimensions

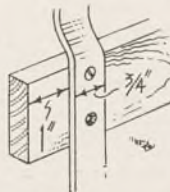

Fig. 2—Attaching the cleek

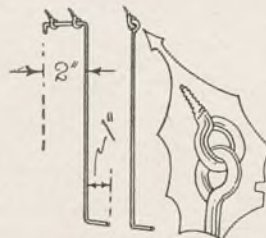

Fig. 3—The wire supports



Fig. 4—A detail of one of the stops

holes required at the top end of the bar (see Fig. 2) are drilled and countersunk to suit $\frac{1}{2}$ in. by 6 flathead iron screws.

The Table Board

At this juncture, obtain a piece of plywood (preferably birch) measuring 24 ins. long by 12 ins. wide by $\frac{3}{8}$ in. thick. This size, besides fitting in with the exemplar per square foot plan favoured by all woodwork supply stores, allows—if desired—an extra inch in the length and width of the table. The measurement suggested, you see, is a usual one suitable for most car seats.

Having planed all edges of the plywood straight, cut off a strip 1 $\frac{3}{4}$ ins. wide. The ragged edges of both pieces are trimmed up to make a neat join, after which two ornamental brass hinges (No. 5379) are screwed over same about 2 ins. from the ends. The foremost corners of the table should be rounded, a penny making a template.

Attach the strip to the bars as seen at Fig. 3. The wire supports are bent to shape, there being two methods. One is to just hook a support to a screw-eye (see inset at Fig. 3) and the other is hooking it to two screw-eyes, this having the advantage of keeping the supports steady.

If you prefer the latter method, the screw-eyes must be inserted to the table before slipping in the shaped rod and turning up the end as shown. The material used in making the supports should be $\frac{1}{2}$ in. solid mild steel rod. It is advisable to slightly round the free ends with a file. It wouldn't be a bad idea to file the edges of the cleeks if they are square and sharp.

Perhaps you are wondering at *three* holes being made in the cleeks? Extra holes have been provided owing to the tilt of some car seats and enable necessary adjustment.

To prevent the table rattling against the cleeks, two plywood stops (see Fig. 4) are screwed to the cross strip. As a finish, the cleeks and supports should be enamelled black, using a good stove or bicycle enamel. The woodwork looks well if french polished a dark mahogany or walnut colour.

MATERIALS REQUIRED

1 piece birch plywood, 24 ins. by 12 ins. by $\frac{3}{8}$ in. thick.
2 pieces mild bar, 33 ins. by $\frac{1}{2}$ in. by $\frac{3}{8}$ in. thick.
2 wire rods, 12 ins. by $\frac{1}{8}$ in. diameter.
2 ornamental hinges (No. 5379).
Several brass screw-eyes, (Mild steel bar and rod obtainable locally).



Brass Book Ends

SOME time ago, in one of your issues, I saw an article on how to make decorative brass plates for book ends. I am unable, however, to find this article among my copies. Could you send me the date?—(E.H.)

THE article on making book-ends which I think you have in mind, appeared in our issue, dated August 31st, 1935.

Plant Frame Heating

COULD you suggest a small heating apparatus for a plant frame size 3 ft. square?—(D.P.)

RAISE the frame on a brick foundation, leaving space for the lamp. Make the frame of wood but line bottom with zinc. A grooved wooden bar is in the centre to allow of sliding panes of glass being fixed. Have wooden knobs at front to keep glass from slipping and raise the back of frame a few inches so that moisture will run off. Have frame facing the sun. When frame is completed, fill bottom of it to the depth of 9 ins., with cocoa-nut fibre, and keep this moist. Into this plunge the pots or boxes with seedlings,

so they may have a genial moist heat. If the pots, pans or boxes are plunged in the fibre up to their rims, little watering will be necessary.

Gunpowder

I WOULD like to know what "F" Gunpowder means. I would also like to know the best kind of glue to use when making fireworks.—(W.R.F.)

THE name "F" gunpowder is given to a particular grade, namely that of a medium grain. Any kind of glue at 2d. or 3d., is suitable for sticking the cases, etc. when making fireworks. Say ordinary fish glue.

A Spot Light

COULD you tell me how to make a spotlight from a car head lamp?—(G.M.)

THE headlamp referred to can be converted to a spot light for mains operation (if A.C.) by means of a small mains transformer, the primary being wound for the supply voltage (probably 230 to 250 volts). The secondary should be either 6 or 12 volts according to choice of lamp bulb. If the head lamp is of American

make, the bulb is probably 6 volt, but 12 volt bulbs can be had from most motor agents and garages. You will find by trial that the current supplied to one filament gives a bright light and a straight beam. This is the contact to use (the return is via the metal part of the lamp). The second filament throws the light sideways and is generally not so bright. You could use a change-over switch and leave a straight beam for spot lighting, and a spread beam for soft floodlighting if desired. The transformer must be able to deliver sufficient amperes at the required voltage—usually 6 amps. at 6 volts or 3 amps. at 12 volts. Secondhand transformers as used in wireless mains units for charging purposes might do, if of the requisite power output, or you could get a Ferranti or a Heybeard model railway transformer, which gives an output of about 12 volts at 2 $\frac{1}{2}$ to 3 amps. In any case, a regulating resistance capable of continuously carrying the required current should be used in the circuit to ensure a correct voltage, otherwise the lamps will quickly burn out. A valve of 0 to 12 ohms with a 6 amp. carrying capacity will be about right.



Scout Notes and News!



More Camping Hints

ONCE more I intend to give you a page of camping hints in the hope they will be of use to you and help to improve your general standard of camping. For you must remember that Scouts are supposed to be trained in the art of camping, and are looked up to as models in this romantic life.

Never pack your billy can or dixie in a dirty condition, when a few fine ashes and a damp rag, together with a little elbow grease, will make them shine as new. A little grease inside, also, will preserve them for another time.

Tent pole joints often swell with the wet and are a trouble to loosen. A little blacklead enables you to polish the joints so they will easily undo under any conditions.

Fat used for frying should be smoking hot before the article to be cooked is placed in it. This ensures that the pores are immediately sealed and grease cannot penetrate the food and make it unpalatable or too rich.

Care of Tents

SO many tents are of the patrol type nowadays that it is an easy matter to dry them after camp if necessary. It is imperative, however, not to pack them away for the winter while they are wet or they will rot. Make sure, too, that the guy ropes are thoroughly dry.

Never pack your tent and pegs loosely together or tearing will result. Pack the tent first and then put the pegs in another bag or wrap them up in a piece of sacking before putting them with the tent.

Adjust the guy ropes last thing at night in case of rain which will tighten them and the least damage will be to drag the pegs from the ground and possibly will split the tent. Keep the tent door wide open day and night, weather permitting. I have seen many a good tent ruined by Tommy Tenderfoot falling over the door into the tent.

Braillings should be rolled up all day and the tent should be empty. Remember a sleeping tent is not a dining room.

The Hay Box

I OFTEN think that not enough use is made of a hay box cooking, especially where wood is scarce. It is simple to make and will cook or keep food hot for a very long time. Here is how to do it.

Get a large box somewhat deeper than your dixie and pad it well with newspapers. Then fill it with hay and afterwards scoop out a nest the same shape as the dixie.

It is very useful for cooking stews and porridge. The latter may be made overnight and will be ready for breakfast next morning. Bring the contents of your dixie to the boil over a brisk fire and then cover with a tight fitting lid. Remove quickly to the hay box and cover with several thicknesses of newspaper and hay and put the lid on the box again.

A meal may be prepared at breakfast time and after a morning's Scouting it will be ready for dinner immediately you return to camp. Try one or two this year, I can recommend them.

Your Patrol Tent

EVERY patrol tent should be the pride of its owners and bear some distinctive marking to show to whom it belongs and perhaps the best way to do this is to stencil the patrol emblem on while a real Scouty border will add to the attractiveness of your tent. All "Hobbies" scouts can do this by cutting plywood stencils of their patrol animal or bird and painting it on the tent.

Take the tent down and lay a flat piece of wood under the canvas which is to be painted, being

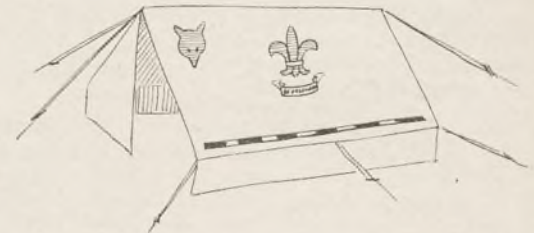

careful to see you have only one thickness. Then place the stencil over it and paint the required colour. Do not use much paint at the edges or it will not give a clean line and if the canvas is already coloured give it a coat of white first.

Here is a suggested design which you can alter to suit your purpose.

Camp Good Turn

NOTHING enhances our reputation as good campers as our tidyness in camping and a good turn to the landowner. Be sure you set aside some part of the camp week to do a good turn to the farmer on whose land you are camping. You will be surprised at the many interesting little jobs he can find you and any act of kindness in repayment for his allowing you to camp will be amply repaid.

One good turn you can do without asking his permission is to clean up your camp site.

The Skipper



HOW TO TAKE COMPETITION PICTURES

THE amateur photographer who makes a habit of preparing good prints and entering them for various competitions is bound to become a really first-class worker. It may take him a long time to reach the stage when he can walk away with a first prize, but if he will persevere without becoming disheartened he will certainly improve his work and be more and more satisfied with his pictures.

Some of you might ask why should entering a competition be the means of improving one's work? Well to start with, you would naturally pick out what you consider to be your best negative and from this you will proceed to make the best possible print, choosing the paper that will in your judgment give the most pictorial result and it is possible you will make three or four prints before you get to a final decision.

One of our most famous photographic artists made no less than 46 prints of an architectural subject before he succeeded in obtaining the effect he was anxious to get. But what a gem that was!

Select a Suitable Print

This is one of the reasons why a person who does not do his or her own developing and printing can never produce such good work as the individual who does. It is only by doing things that we can get practical knowledge.

If you wish to succeed in competitions you must not leave the job to the chemist to do for you. In nineteen times out of every twenty he is not the least bit interested in your snaps and does not care whether you enter or not.

Having tried to explain why you should enter, let us try to reason out what type of work stands a chance and how to proceed to get such results.

Let us start with an open class; that is one where subject is not specified and competitors are allowed to send in anything they like. There are, at this time of the year, quite a number of this type. Frequently they are termed Holiday Competitions or some title meaning the same.

Three Main Points

There are three principal features which the judge will have in his mind when looking through such. These are Composition, Originality and Technique and if you just consider these three points for a few minutes you will realise what a tremendous lot can be crowded under those headings.

A picture can be a snap, but all snaps are not pictures. This is because the majority of snaps are merely the outcome of pressing a trigger and chancing the rest. If the result should happen

to turn out right well then you have been lucky.

But a picture is the result usually of some careful thought and consideration of the subject before attempting to touch the trigger. You have noted the light and what is in the background. You have moved this way and that to secure a better balance in the important features. Calculated the exposure required to give you the correct rendering of the light and tone values and perhaps you have waited until a figure has appeared at a certain point in the scene. All this thought is noted by the judge in the results before him.

Introduce Originality

If you can introduce originality into your entry you are sure to be awarded quite a number of marks. It is a feature which every judge looks for and is very ready to acknowledge. If you can spare the time to look round a photographic exhibition you will see how much striving there is for original ideas and how few get there.

It is not easy to give any actual lines to adopt in order to encourage originality in your work possibly the only advice that can be offered is to avoid following the 'stereotype' and develop as much as possible individuality in all your work.

OUR PHOTOGRAPHIC PICTURE PANEL

A FINDER SCALE.
IT IS AT TIMES VERY HANDY TO BE ABLE TO GAUGE WHAT SIZE SOME OBJECT WILL ACTUALLY APPEAR ON THE NEGATIVE AS IT WOULD OFTEN SETTLE WHETHER A SUBJECT IS WORTH TAKING OR NOT. THIS INFORMATION CAN BE SEEN WHEN TAKING BY FITTING SCALES TO THE SIDE & TOP OF THE FINDER MARKED OUT IN PROPORTIONATE INCHES. EG IF THE

FILM IS $3\frac{1}{2}$ " IN LENGTH THE SCALE SIDE IS 6" INSCRIBED WITH 3 $\frac{1}{2}$ MAIN DIVISIONS A BIG DIVISION OF THE SCALE REPRESENTING 1" ON THE FILM. THUS FINAL SIZES OF OBJECTS CAN BE READILY ESTIMATED. THE EASIEST WAY TO MAKE THE SCALE IS BY THE EUCLID METHOD OF DIVIDING A LINE. FIG. 1.

Now just exactly what is meant by Technique? Well it is a word that is quite often seen and heard in photographic circles and it is largely to do with the quality of the work put into the picture rather than the picture itself. It has to do with the exposure, developing, printing and, yes, even the mounting and the finishing of the picture.

This may not be quite the true meaning of the word but it is near enough and it is the meaning which many amateurs have for it and there is quite a lot of thought given by the judge to this side of the work.

Some folks are surprisingly careless with their prints when they have to mount them and many

a good entry otherwise has lost marks because it has not been trimmed accurately. It may have had quite a lot of paste on its face, or some finger-marks have attracted too much attention. Again it is surprising how often the wrong surface or grade of paper is used.

This then will give the intending competitor a little idea what a judge is going to look for in his print and it also shows to a certain extent what the judge must not find. If you have these few points in mind and enter some of the many competitions which are being run this year you will find that the assertion made in the opening paragraph of this article is perfectly true and that your work will certainly be improved.

JUNE COMPETITION WINNERS

FOR such a 'big' subject as "In the Country" there should have been more entries but the general quality of those received was very good. Each of the competitors kept very well to the subject, with the result that most phases of country life were represented.

There was one fault which showed itself in many



1st Prize "Out on the Open Road"

of the entries and it should be noted by all who intend to compete in the future. Figures can make or mar a picture, and it more often mars than makes if the figure is posing for his or her portrait.

In the entries we have portraits of a person on horse back, a lady on a footbridge, friends in the field, etc. If you are taking landscapes then ask your friend not to look at the camera.

In the senior section the first prize goes to Mr. D. Wilson's "Out on the Open Road." It is a very nice piece, full of the spirit of the country and the only adverse criticism that one can make is that there is perhaps a little too much white cloud. It is somewhat overpowering.

The second prize Mr. J. Dempster's "Proud Motherhood." This would have had first place if the print was better technically but the subject and composition are good.

The prize winners were not the only good prints. "The Peewit's Nest" by Mr. Evernden, was very good, as also was Miss Whitcombe's "Lumber Team" which the latter was spoilt by the man in the background. He is in white and so caught the eye too much.

In the Junior Section there was some first class work and the seniors will have to look to their laurels when these folks turn 16!

First Prize, Miss Hammer, who is too modest to name her entry so we will call it "A Pastoral." The composition is excellent, the light patch on which the cattle are standing gives balance and in fact it is difficult to find anything wrong. Second Prize was a farmyard scene entered by L. Morley.



1st Junior—"A Pastoral"

This was full of interest but it looked as though a much better print could be obtained from the negative.

Others in this class which were quite good were "The Harvesters" by E. G. Tosturn, "The Coast View" by S. G. Antill and "The Shoeing Forge" by P. Newton. This latter would have secured a prize if the horses' hind legs had not been hidden by the smith.

A BLOTTER COVER IN INLAID WOOD

Full size patterns
on page 455

HAVE you ever thought of the possibility of making a little blotter cover with a simple inlay picture in the various kinds of fretwood? It sounds rather complicated, but it is really quite simple, and we have devised a suitable panel which is shown full size on page 455.

The cutting can be done by anyone with a fretsaw and a few small pieces of fancy fretwood. It is not advisable to cut out this work in plywood because the surface and edging does not lend itself to a pictorial panel of this kind.

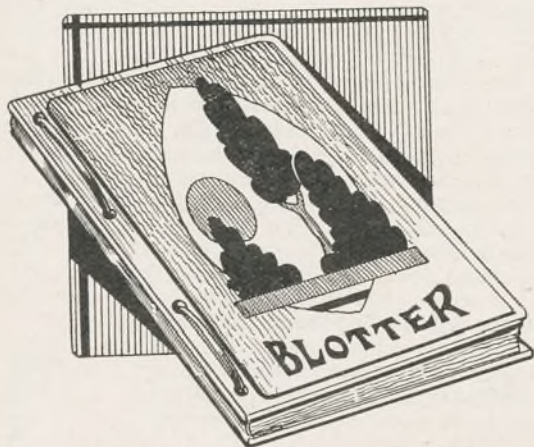

Actually the work forms a useful little piece of experiment for the beginner who has not previously tried inlay. Once having done it, we are sure he will be delighted, and want to go on with some of the larger subjects which appear from time to time in these pages.

All the necessary patterns are shown full size on the page mentioned, and the wood suggested for the inlay is given on the key at the top.

The Main Cover

The actual cover for the blotter is also in wood, being two complete pieces cut only to outline with four holes on the left-hand side. These holes are for binding when the blotting paper is put between the two pieces of board. On the uppermost board is the pictorial panel of the overlay, and this is cut to the outline shown at B.

Two pieces of A are required, $\frac{1}{8}$ in. or $\frac{3}{16}$ in. thick and for this plywood is useful in one piece as forming a back which will not warp.

Now let us see how the inlaid piece is cut out to form a bright picture in three different kinds of wood. You first of all want four pieces of wood

$\frac{5}{8}$ ins. wide and 9 ins. long. Satinwood, mahogany and padouk will do for the actual inlay pieces, and whitewood or satin walnut is suitable for the main portion forming the surround.

All of them, of course, must be in $\frac{1}{16}$ in. wood because they have to be cut together.

Paste the pattern down to any one piece, up to the line marked B, and, of course, include the centre design and the word "Blotter." Then put the four pieces together and drive a nail through all four outside the edge of the design line. Let the nail go right through so it can be turned up underneath and there hammered flat.

Forming the Picture

Now we are ready for sawing. Drill a hole on the cutting line of the fancy design, and use a fine fretsaw. Cut along any of the shapes shown, keeping to the line and returning to the starting point.

Thus, you have four pieces exactly the same, but of these only one is required according to the key. For instance, if you start at the bottom point you want a piece of satin wood, and the others can be discarded.

Next cut out the solid black portion and keep a piece of padouk which comes out. After that you go to the dotted piece keeping the satin wood, then the long narrow strip for which the mahogany is required. So you gradually cut round each piece and build up the picture in the various wood.

The Framework

When the last of this interior work has been cut, go round the outer rectangle to cut away the nails which hold the boards together. Then, in the piece which forms the background—the whitewood or the satin walnut—cut out the long blotter. Thus you have a complete picture in thin wood.

The whitewood or satin walnut forms the main frame, and into this is fitted the various jigsaw-like pieces of the inlaid work.

Glue the main frame to one of the backing pieces of thicker material already cut, then glue in the various inlaid parts. Cramp all of them quite flat until the glue has set, then clean up thoroughly and carefully with glasspaper.

The outer edges of the board should be lightly rounded off with glasspaper, and finally the blotting paper put between and strung in with thick fancy cord or ribbon.

Such a piece of work, of course, lends itself to polish and after you have filled and stained the wood, use Hobbies Lightning Polish to bring up a bright glossy effect.

A LOG OR NEWSPAPER CONTAINER

IN spite of the trend of modern times, the old-fashioned log on the fire still holds its charm. Here is a fireside box in which a supply can be kept handy when fires are necessary. Whether the evenings be warm or cold, the ladies are just as fussy about odd newspapers and magazines lying around. The box shown here would serve equally well as a newspaper container. In short, you have a double chance of pleasing the lady of the house by making it.

The panels are all cut from one 30ins. by 24ins. sheet of 3/16in. thick plywood. The reader has the choice of three types of material. For a first class job either oak faced or gaboony mahogany plywood will be selected. First quality birch plywood, however, may be stained to any desired shade equally well. It also has the advantage of being cheaper.

Fig. 2 gives an idea of the economic setting out of the panels on the sheet. Having cut out the four pieces, the edges are trimmed square and true with a plane. The details of the shaped top of each large panel can be seen in the dimensioned elevations at Fig. 3. A fretsaw will be found to be the handiest tool for cutting them out.

Moulded Legs

The legs are cabinet corner moulding No. 304. Four pieces are cut off 13½ins. long. This length allows a space of 2½ins. between the bottom of the box and the floor. Before fixing the panels, a notch is cut in the inner corner of each leg to take the corner of the bottom as shown at Fig. 4.

The side panels are glued and nailed in position now. The size of the bottom (which is ½in. thick deal) is determined by holding the end panels in position on the completed sides. The required amount is cut off the corners of the bottom, where it fits into the legs. The end panels are held in position again with the bottom in place to make sure that it fits.

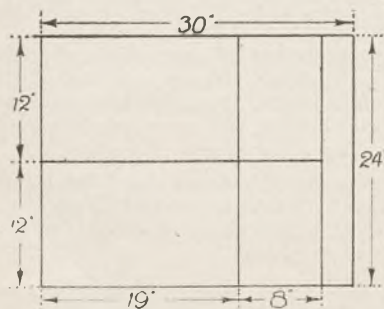

Fig. 2—Cutting the panels

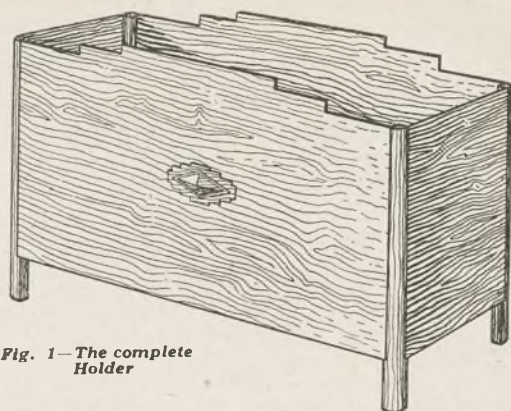

Fig. 1—The complete Holder

It is advisable to make the bottom a shade larger in the first place so that it may be trimmed down to an exact fit after the trial. The whole box may be assembled with glue and nails now. The rebates in the lower ends of the legs are filled in with slips of wood planed to the correct size.

Details of the frets on which the plain raised oak diamonds are mounted are given at Fig. 5. They are cut from 1/16in. or ¼in. plywood. Glue and fine pins are used to fix them about ½in. above the centre line of each side panel.

Numerous finishes are available according to the material used. For birch, a choice can be made from the wide range of shades in which Hobbies Spirits Stain or Powder Dyes are made.

If gaboony mahogany plywood has been used, then Hobbies Lightning Polish in mahogany colour will enrich the wood. In fact, in all cases, Hobbies Lightning Polish either natural or coloured may be used with success.

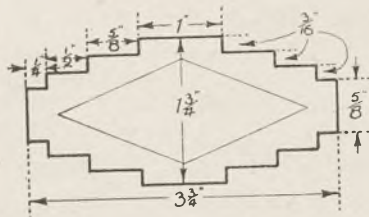

Fig. 5—Details of the fret overl ay



Fig. 4—Fitting the bottom in the leg

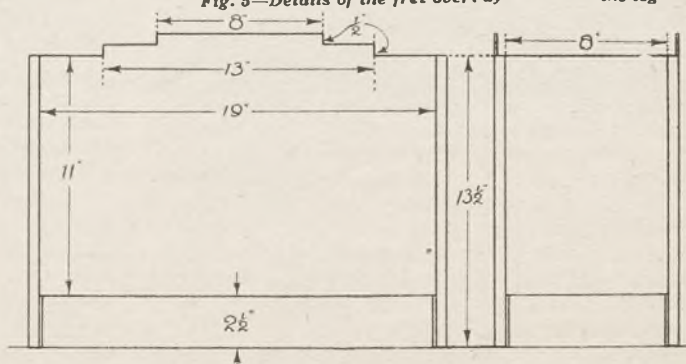

Fig. 3—Dimensions and shapes of various parts

HOW TO MAKE A MODEL SILK WINDER

THE model silk winder shown in the drawings is a replica of one made by the writer, which enabled a lady whose hobby was breeding silkworms, to carry this hobby further than usual, by winding the silk off the cocoons instead of as is usual, stopping at the cocoon stage, the result being a bunch of shimmering silk instead of merely waste cocoons.

In the drawings we show the two side elevations (Figs. 1 and 2) the two end elevations (Figs. 3 and 4), and the plan (Fig. 5).

The whole is built up on the baseboard, which is 18ins. long by 9ins. wide, by 1½ins. thick, and as the drawings are made to scale, all other measurements can be taken from this.

The Main Wheel

The main wheel on which the silk is actually wound off, is mounted in the two standards, A, and is formed by the centre piece B (the shape of which is shown plainly in Figs. 3 and 5), which runs in the standards. The circular piece C, is screwed to the recessed part of B, and to this circular disc are screwed the eight strips D. These

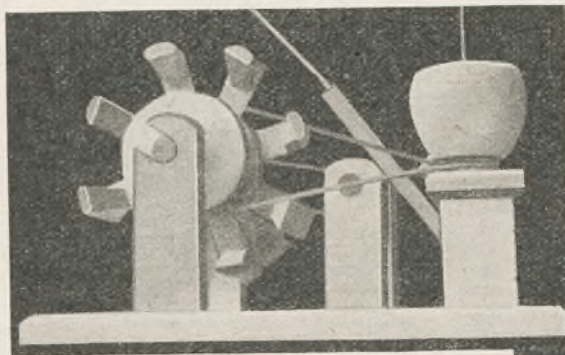

Two views of the completed machine

carry the cross pieces which form the periphery of the wheel.

The centre piece of the wheel is continued through the one standard to carry the small wheel F, so forming the means of driving other parts of the machine. At the same side the centre piece is carried yet another step further to take the driving handle, G, this latter being fitted with a small knob H for convenience in turning the wheel.

Near the other end of the baseboard are fixed another pair of standards (I), these carry the cross-piece (J), which is pierced near one side to take the upright spindle (K). The baseboard is pierced to correspond. This spindle is turned in one piece with the container (L), and immediately below the latter should be formed the small

grooved wheel (M). This is the driving power for this part of the model.

In forming the upright spindle part of the model, the end which enters the baseboard should rest on the bottom of the hole made for it, thus preventing friction on the shoulder and the wheel M.

So far, we have not dealt with the driving power for the container, which consists of the wheel (N), mounted on the spindle (B). On fixing this, a fine gut band can be passed round it, twisting it and then passing it round the wheel (M). So on turning the handle (G), the container and the main wheel will revolve, the former some three times as fast as the latter.

To Prevent Sticking

The machine would wind off the silk as it is, but it would stick together on the large wheel, so it is necessary to prevent this happening. The arrangement in the middle of the baseboard is designed to do this.

The two standards (O), are fixed in the baseboard, and are pierced near the upper ends to take the cylinder (P). One end of the cylinder is carried through the standard to carry the small grooved wheel (R), this wheel being parallel with

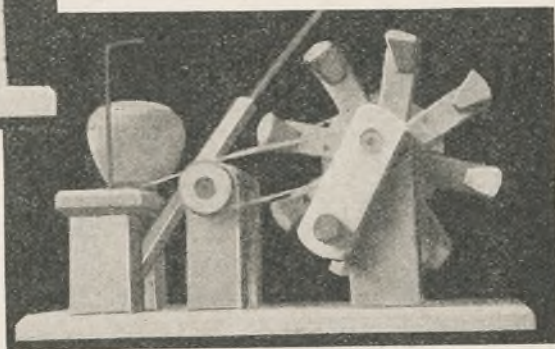

the corresponding wheel (F). On a band being passed round these two wheels, the cylinder (P) revolves with the rest.

The last-mentioned cylinder (P) is grooved with a spiral trench as shown in Fig. 3, and this trench must be made very truly and carefully, finishing it with a square section as shown.

The strip of wood (S) is fitted to the baseboard, and is pivoted with a single screw, so it will move

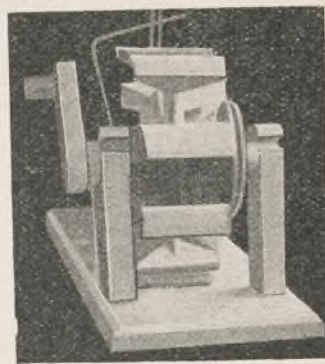

freely from side to side. It must be so that the upper end rests just firmly on the cylinder (P). A hardwood pin is inserted in the strip and fits in the spiral trench closely but not tightly, as in Figs. 1 and 2.

The last-mentioned strip must reach well above the cylinder, and in the end two bright steel wires are inserted, as in Fig. 7. Steel knitting needles do well for these wires, or bone needles are a good substitute, and will not rust.

The Container

The container must be turned so the upper part overhangs by about $\frac{1}{4}$ in., or if preferred, it may be turned so that a lid can be fitted. In the latter case a small smooth hole will be needed in the exact centre. A bent wire must also be fixed to the platform (J), as at (T), and this wire is bent so the upper end finishes over the centre of the container, and slightly above it.

The end of the wire should be flattened and drilled with $\frac{1}{8}$ in. diameter hole, this being made very smooth and even, so the extremely fine threads of silk will slide over it without catching up.

The wheel (U) is fixed to guide the driving band to the driving wheel, the correct place being found by experiment. A block is screwed to the standard to take it.

Now to use the machine. The three driving bands being in position on the respective wheels, the container can be filled half full of warm water, and the cocoons placed in it. Put as many as are well covered, and having preferably been soaked for a short time before. The ends of the silk on six of the cocoons are found, twisted together slightly, passed through the hole in the bent wire (T), passed on between the wires in end of (S), and then on to the large wheel, to which they are fixed.

Starting to Operate

On starting the machine by turning the handle (G), the wheel revolves, taking up the twisted silk. At the same time the container spins round at a good pace, twisting the strands of silk into one, and the cylinder (P) revolves, causing the rod with the wires to oscillate to and fro. This causes the threads to cross and recross each other on the wheel, and prevents them from sticking together.

A sharp look-out must be kept for broken threads, which must at once be twisted together, and the same applies to exhausted cocoons. As soon as one gives out another must be connected up.

The greater part of the machine can be made on the lathe, the various standards can be attached to the base by mortise and tenon, by dowelling, or
(Continued on page 450)

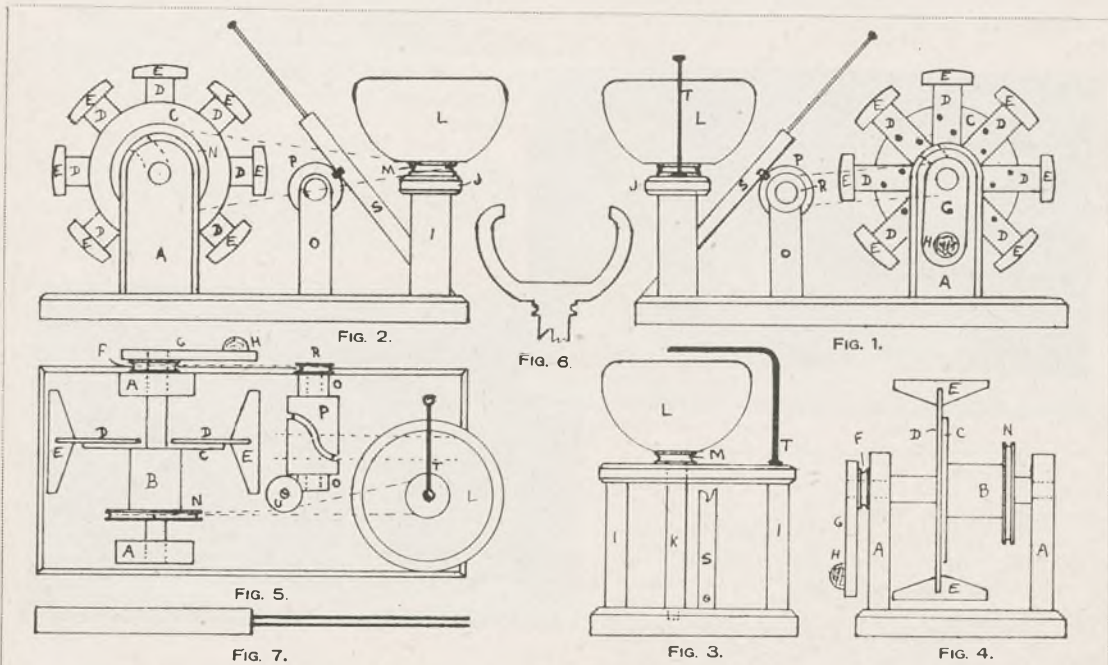

EXPLANATION OF DRAWINGS

Fig. 1. Side elevation of silk winder (right).
Fig. 2. Side elevation of silk winder (left).
Fig. 3. End elevation of silk winder (back).
Fig. 4. End elevation of silk winder (front).
Fig. 5. Plan of silk winder.
Fig. 6. Section of container.
Fig. 7. Vibrator showing guide wires.

LETTER REFERENCES

A. Standards carrying main wheel.
B. Centre shaft of wheel.
C. Disc to carry arms.
D. Arms screwed to C.
E. Shaped pieces forming periphery of wheel.
F. Small driving pulley.
G. Driving handle.
H. Knob on driving handle.
I. Standards carrying platform J.

J. Platform forming bearing for container shaft.
K. Container shaft.
L. Container.
M. Driving pulley on container shaft.
N. Driving wheel for vibrator.
O. Standards to carry vibrator.
P. Vibrator.
R. Pulley driving vibrator.
S. Oscillating part of vibrator.
T. Guide wire for silk strands.
U. Guide pulley for twisted band.

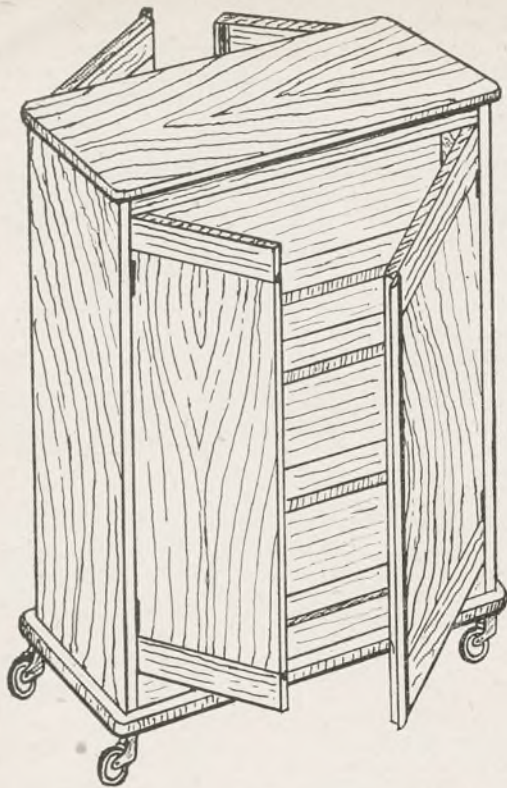

A MOVABLE TOOL CABINET

Fig. 1 shows a suggested layout for the tools on one side, but as every kit of tools varies considerably, this must again be left to personal ideas. A good suggestion would be to have woodworking tools on one side, and metalworking tools on the other.

Begin by making the sides, which are $\frac{3}{4}$ in. thick. As these are a foot wide, it will be necessary to make these in two pieces each 6 ins. wide and joined together by means of an ordinary butt joint. The edges should be planed true, and then glued together, and held in a clamp until the glue sets.

Top and Bottom

The top and bottom of the cabinet can now be made in the same way, but since there is an overlap all round of 1 in the finished measures will be 2 ft. 2 ins. by 1 ft. 2 ins. The edges are rounded off both of these and finished off with glasspaper.

The glue of the sides having set, the surplus can be removed and the mortises for the bearer rails, cut in the corners. Next, the supports for the shelves can be made and fixed. For these we shall require twenty four pieces of wood, 3 ins. long and $\frac{3}{4}$ in. square.

There are also twenty four small pieces of plywood $1\frac{1}{2}$ ins. by $\frac{3}{4}$ in. as each shelf support has one screwed to the end, to keep the removable shelves in position. These details are shown in Fig. 2 which is the end elevation. It will be seen that there are six alternative positions for the shelves on each half of the cabinet, and they can therefore be placed in the most convenient positions.

Rails

The bearer rails can now be made and glued and fixed in place, both at the top and the bottom. In Fig. 3 the plan, or Fig. 4, the perspective view, it will be seen that small right angled pieces of

THIS novel cabinet, is an attempt to overcome the difficulty of quickly finding the tool required, often experienced with the more usual tool box, where everything seems to be on top of the tool you need. The cabinet takes up very little space, and as it is fitted with rubber tyred wheels, it can easily be moved into the light, or even into another room if necessary, where everything will be to hand.

While it was originally intended to be made of ordinary deal, it would of course last for years if made of oak, so this can be left to individual taste.

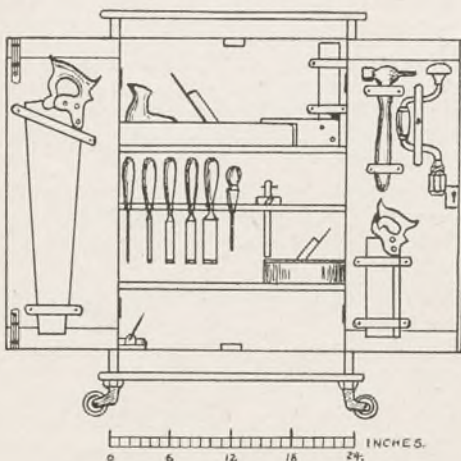

Fig. 1—Suggested layout of tools, with dimension scale

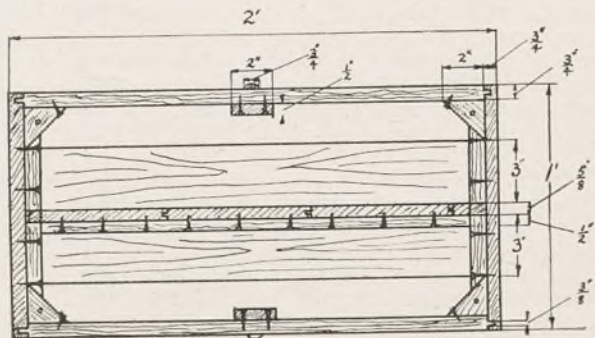

Fig. 3—Looking down on the parts

wood are either screwed or nailed and glued, into the corners at the top.

It is not necessary to add these corner pieces to the lower rails, as the bottom of the cabinet is screwed direct on to the bearer rails from below. These corner pieces can be added to the top now.

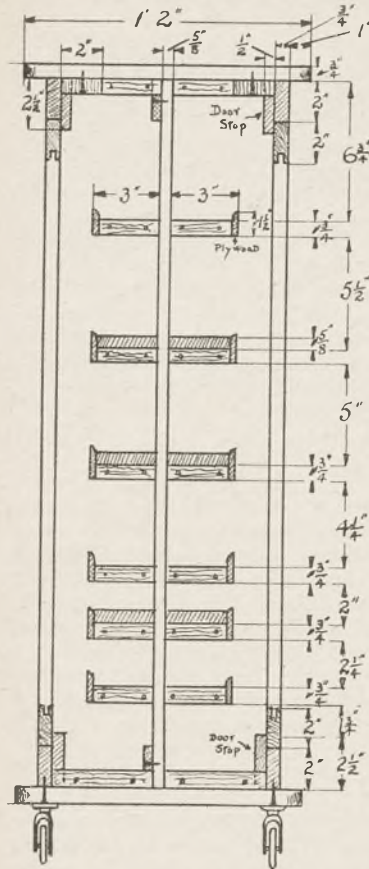

Fig. 2—A sectional view of parts with dimensions

the shelf supports, but in the meantime, the holes can be made and the screws inserted ready to attach.

The centre division (Fig. 5) is built up of tongued and grooved boards, $\frac{5}{8}$ in. thick, and held together by means of battens 2 ins. wide and $\frac{1}{2}$ in. thick screwed along the top and bottom, with the corners cut away as shown in Fig. 5. It will be necessary to add the bottom batten, after this panel is placed into position between the

The remaining four pieces of wood at the top, and the four at the bottom, can now be cut to shape and screwed on as shown in Figs. 2 and 3.

The top of the cabinet can be fixed next, by means of $1\frac{1}{4}$ in. screws, passed through the angle pieces from the inside.

With the addition of the door stops, the main framework is completed. These stops consist of wood $2\frac{1}{2}$ ins. by 2 ins. by $\frac{1}{2}$ in. screwed on to the bearer rail in the centre.

The Doors

The doors are $\frac{3}{4}$ in. thick and have pieces 2 ins. wide tongued and grooved along the top and bottom. The panels can be joined down the centres with a butt joint. The right hand doors have a strip of $\frac{3}{4}$ in. half round moulding nailed and glued down the centre edges. In fixing the bolts, clearance should be allowed for the door stops, that is to say, they should be 1 in. full from the centre edge of the door.

The wheels can be obtained for 6d. each. In some patterns, there is a cage which fits over the spindle. It therefore only requires a hole bored in the corner of the cabinet, and the cage is forced in and held in place by the teeth provided.

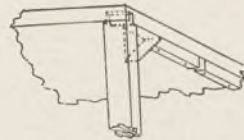

Fig. 4—How the top corners are strengthened

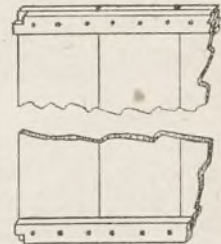

Fig. 5—The centre division

The cabinet can finally be given a coat of varnish stain, or better still stained first and varnished afterwards.

The tools can be held in position with clips which can be bought or strips of wood $\frac{3}{4}$ in. wide with distance pieces underneath screwed to the cabinet.

Model Silk Winder—(Continued from page 448)

by screwing from underneath. If the latter method is adopted it is best to make a small, or stub, tenon.

The holes in which the various cylinders run must be made true, and both the hole and the part to run in it should be well coated with black lead (plumbago) as a lubricant, before putting together. This also applies to the pin and the spiral trench in the cylinder (P), and all other working parts.

Driving Bands and Container

We mentioned gut for driving bands, but strong rubber will answer the purpose equally well, if more conveniently obtained.

The container may also be an aluminium basin, or even earthenware if preferred, provided that it is fixed firmly to the stem with which it revolves, and arrangements are made to prevent the water from splashing as it spins round.

If required as a model only for demonstrating purposes, instead of for actual work on a small scale, there is no reason why it cannot be made on half, or even one quarter the scale shown. In the latter case it would be a good test as to the worker's skill with the lathe.

We may mention in closing that hardwood should be used. Oak is as good as anything, and will stand well, while comparatively easy to work, and not expensive.

One important matter we have left till the finish. That is, the standards (A) must be opened out at the top ends as shown by the curved dotted lines in Figs. 1 and 2, to allow the large wheel to be lifted out for the removal of the silk. By making the openings as shown they do not interfere with the running of the machine, and it is best to leave the making of the slots till the other parts are finished.

A Complete ENGINE UNIT for Model Boats

A powerful steam engine complete with propeller and shaft. Suitable for boats up to 30ins. long.

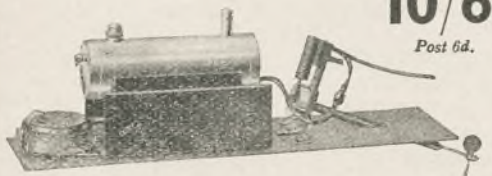

10/6

Post 6d.

Drives a 30in. boat for about 20 minutes on one filling. It has a polished brass boiler with a safety valve that really "works"—new safety type lamp fastening. An engine which is a real glutton for work, direct coupled to propeller. Mounted on metal base.

HOBBIES LTD. DEREHAM

Branches and Agents in principal towns.



*Finding wifey in tears 'midst a flood,
Thomas turned not a hair (he's no
dud),*

*But remarked with a smile,
"You stop YOUR leak, and I'll
With FLUXITE nip the PIPE'S in
the bud!"*

See that FLUXITE is always by you—in the house—garage—workshop—wherever speedy soldering is needed. Used for 30 years in Government Works and by leading Engineers and Manufacturers.

OF ALL IRONMONGERS—IN TINS
4d., 8d., 1/4 and 2/8

Ask to see the FLUXITE SMALL SPACE SOLDERING SET—compact but substantial—complete with full instructions—7/6
Write for Free Book on the Art of "SOFT" SOLDERING and ask for Leaflet on CASE HARDENING STEEL and TEMPERING TOOLS with FLUXITE.

TO CYCLISTS! Your wheels will NOT keep round and true unless the spokes are tied with fine wire at the crossings AND SOLDERED. This makes a much stronger wheel. It's simple with FLUXITE—but IMPORTANT.

THE FLUXITE GUN

is always ready to put "Fluxite" on the soldering job instantly. A little pressure places the right quantity on the right spot and one charging lasts for ages.

Price 1/8



ALL MECHANICS WILL HAVE

FLUXITE

IT SIMPLIFIES ALL SOLDERING

FLUXITE LIMITED, Dept. H., Dragon Works, Bermondsey St., S.E.



284 PAGES!

Page after page of things to make . . . and how to make them. Galleons—Doll's Houses — Electrically - driven Toys—Models of all kinds—Furniture—Toys, etc., etc. A complete price guide for the handyman. Hobbies 1938 Handbook is the book without a substitute. Make sure of your copy NOW!

6^{D.}

*From Bookstalls,
Newsagents,
Hobbies
Branches,
Ironmongers,
or 9d. post free
from Hobbies,
Ltd., Dereham,
Norfolk.*

HOBBIES 1938 HANDBOOK

Bigger and Better . . . !

All previous values eclipsed! No other book gives the handyman so much for his money. Entirely revised. More pages! New editorial features . . . new designs . . . new tools . . . new machines. How to make over 500 things in wood. You'll simply marvel how such a book can be produced and sold for only 6d.!

Gifts Value 2/-

With every copy you get absolutely free, a large design chart measuring 35 by 22½ins. for making a magnificent model Country Inn. You'll say this is the best model you ever saw! There is also a design for a mystery cigarette box . . . a new calendar picture . . . and a design for a fine Clock is yours free, for the asking!

Get Yours Now!

Doll's House Fittings

Made in Polished Aluminium



Door Set. Knocker, Letter Box and Mat. 1/6; post 1½d. Shown two-thirds actual size.

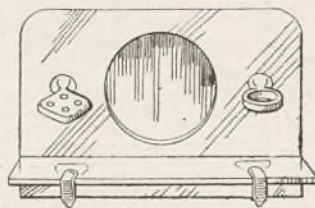

Splashback with Mirror, Shelf, and Brackets for Tumbler and Tooth Brushes. 2/-; post 2d. Shown two-thirds actual size.

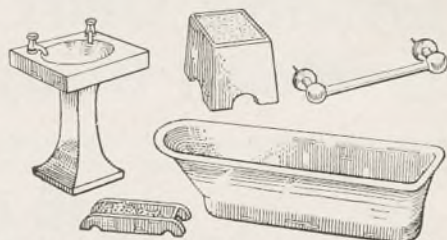

Bathroom Set, 4/6; post 5d. Also sold separately. Bath 1/3. Washbasin 1/6. Stool 9d. Towel Rail 6d. Sponge Rack 6d. Post extra. Shown one-third actual size.

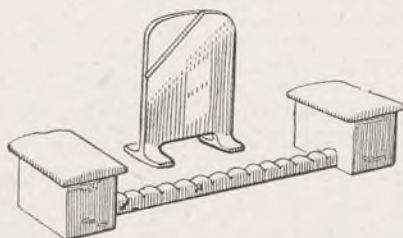

Fireside Set, 1/6; post 2d.

Illustrations are one-half actual size unless otherwise stated.

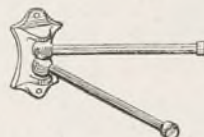

Airer, 1/- post 1½d.



Mat, 6d.; post 1½d.

Buy from any Hobbies Branch or direct from Hobbies Ltd. Dereham.



W.C. 1/-; post 2d.



Linen Bin 9d.; post 1½d.

NEW! Electrical Sets

.. by Hobbies

Learn the "why" and "how" of electricity. Learn while doing, in a practical way..... with a Hobbies Electrical Outfit. Fascinating home pastime which opens the door to hours of absorbing interest—and fun—for the modern boy. But be sure you get a Hobbies Outfit. See the name on the label.

3/- 5/- 7/6 12/6

Postage 6d.

The set shown is 12/6. It's a beauty! Contains an electric motor and induction coil as well as a host of other apparatus. Each Hobbies Electrical Outfit has a step-by-step instruction book. Hobbies Limited, Dereham and Branches.

**Fun - Fascination
Thrills Galore**



STAMP COLLECTOR'S CORNER

CORONATION ISSUES

Now we must expect to have quite a number of new stamps to illustrate, and the first of the Dominion stamps we can show are on an Official First Day Cover which was very kindly sent by Mr. W. Lubach of Queensland. Actually he sent us two, the one illustrated here, and a second one on which there is a printed portrait of H.M. King George VI. The one shown has a clearer postmark than the other.

Notice the way in which the two stamps have been placed on the envelope; just sufficiently far enough apart to allow most of the postmark to appear on the envelope. Consequently it is an easy matter for anyone to

They have the date of the Coronation on them—May 12th, 1937 appears immediately above the King's head—but quite what the duration of the issue will be is uncertain.

By the way, notice in connection with dates that the Australian Cover illustrated here is May 10th, 1937, or two days before the quoted date. The same thing happened in the case of the Jubilee 'First Day Covers.' Covers franked with Silver Jubilee stamps in most cases bear May 6th, yet certain of the Dominions and the British Colonies had other days for authentic 'First Day' covers.

For instance, South West Africa

is the King's head to the left hand side of the stamp.

As mentioned already, the one cent stamp is not a copy, and is illustrated here. On it we see the codfish, and below the fish we read "Codfish, Newfoundland Currency." Such an expression is not to be wondered at when one realises that no fewer than 10,000 people are engaged in the fishing industry. Or that the total value of the fishery products for 1934-1935 was over eight and a quarter million dollars.

The next stamp of the same set is the three cents. This has a map of Newfoundland, including the dependency of Labrador. There is one point about this stamp which seems to raise it above the low level of the others. That is that this particular map marks very clearly the position of the majority of the places which are illustrated on the higher values of the set. It thus serves as an excellent introduction.

For instance, we see Corner Brook marked on the map, yet this is not found on all maps of Newfoundland. But it is the place named on the eight cent stamp—Corner Brook Paper Mills.

The design is not clear, but the inscription at the bottom helps the imagination in this case. The value of newsprint produced in 1933 was over ten and a quarter million dollars, weighing over a quarter of a million tons (the

(Continued on page 454)



Three Newfoundland Coronation Stamps

read the date and any other particulars which may be embodied. Consequently the stamps in each case only receive a very small disfigurement, a matter which makes considerable difference to their value.

So far as the design of these two stamps is concerned, both values are very subdued, and possibly on this account they will appeal to a very great number. While others, perhaps, will think that Coronation time is a time when something a little more ornate might have appeared. Well, it is impossible to please everybody.

Now we come to eleven stamps which have been issued by Newfoundland. At first these were not quoted as Coronation stamps, and dealers when giving the price for complete sets did not include them. Consequently unless collectors have ordered them separately they are liable to be disappointed. If you have ordered the set of Coronation stamps, make sure that you have included this set as well.

That they must rank as Coronation stamps seems definite now.

and South Africa both had May 1st, Australia May 2nd, Bechuana-land May 4th, various regions had May 6th, Cook Islands May 7th, Morocco May 8th and so on. So we must not be surprised if certain covers bearing first day notices should appear before or after the recognised date.

Now a few notes about the Newfoundland set and the designs which appear on them. In a great number of cases we notice the designs are simple copies of the designs of the 1932 set; in fact only the first few are different. All the stamps bear a small portrait of H.M. King George VI., but one cannot say that it is a good one. The opinion of many is that the stamps look cheap. They are of the long shape—like those illustrated—and only in the eight cents



A First Day Coronation Envelope from Australia

newsprint not the dollars), and in 1934 the three hundred thousand tons was valued at over twelve million dollars.

So we can understand why this should appear as well as the cod-fish.

Although the rest of the designs are the same as previous issues, a little has had to be added because of the change in the shape of the stamp. The seven cents is the same as the five cents of the 1932 issue "The Caribou."

The ten cents of this issue has the same design as the ten cents of the old, and is entitled "Salmon, King of the River." The two 14 cents are the same—Newfoundland dog—and the 15c both show "Baby seals" whilst the two 20c. stamps show the Transatlantic Beacon. The picture of loading iron ore at Bell Island serves for the two 24c. stamps, and the scaling fleet is shown on both of the 25 cents.

In the new set the next stamp

is the 48c., while in the old the stamp was the 30c. so these two are the same—the Fishing fleet setting out for the Grand Banks. The set starts with a fishing stamp and finishes with the same theme.

It does seem a pity that the production is not up to the usual high standard, because this is a set which is very well worth having. The designs are truly interesting ones, but naturally a lot of the charm must go if the printing is not suitable.

MISCELLANEOUS ADVERTISEMENTS

"MENDINE."

MENDS Everything. A liquid glue cement in tubes, 2d., 4½d., 8d., from all Stores. If unobtainable, write Mendine, 123 Borough, S.E.1.

MAKE YOUR OWN UKULELE, Mandolin, Guitar, etc. from Hobbies designs and materials. You'll be surprised how easy and cheap it is!—Hobbies Ltd., Dereham.

LONELY? Then write Secy., U.C.C., 16BB. Cambridge St., London, S.W.1. Genuine. Estab'd. 1905.

IVORINE (white) about 1/32in. thick. Just the stuff for fretwork overlays. In sheets 12 by 6ins. 1/6; post 2d. Also Xylonite (black) 1/3.—Hobbies Ltd., Dereham.

EXCELLENT Money-making Opportunities constantly occurring. Strongly recommended. Send stamped addressed envelope for free particulars.—Messrs. Green, 17 Church-lane, Hull, England.

DOLLS' HOUSE Papers, Fittings. Bathroom set, fireside set, door knocker, etc. Write for list.—Hobbies Ltd., Dereham.

INVENTIONS PROTECTED. Booklets gratis.—Reginald W. Barker & Co., Patent Agents, 56 Ludgate Hill, E.C.4.

The advertisements are inserted at the rate of 2d. per word prepaid. Name and address are counted, but initials or groups, such as E.P.S. or £1/11/6 are accepted as one word. Postal Order and Stamps must accompany the order. They will be inserted in the earliest issue. To sell anything except fretwork goods or those shown in Hobbies Handbook. Orders can be sent either to Hobbies Weekly, Advertisement Dept. 30/32 Ludgate Hill, London, E.C.4, or Dereham, Norfolk.

STAMPS. Approvals from ¼d. each. Good discount. Send postcard.—Jones, Bimport, Shaftesbury.

LOW-WING MONOPLANE. Kit of parts for building a 3ft. 10in. wing span model with 14in. airscrew. It's a beauty! 19/6; post 6d.—Hobbies Ltd., Dereham.

MICE. Exhibition breeding stock. Any colour. 5/- trio with cage.—E. D. Blowers (Mrs.), The Mouse Farm, Hemel Hempstead, Herts.

YOU DO BETTER WORK WITH A BENCH. We have them from 21/-. Write for particulars.—Hobbies Ltd., Dereham.

FILE PAD FOR FRETWORK, complete with six files, only 1/9; post 2d.—Hobbies Ltd., Dereham.

MAKING A COT? Here's what you need. Drop side fittings 3/6. Castors 9d. set. Mattress with frame 12/- carriage forward.—Hobbies Ltd., Dereham.

THE WORLD'S MOST POPULAR FRETWORK SET—Hobbies A1, price 10/6; post 9d. Other set. from 1/6 to 20/-. Send for list.—Hobbies Ltd., Dereham.

WHY NOT TREAT YOURSELF to a fretmachine? It will double your output in half the time. Prices from 30/- cash or easy payments.—Hobbies Ltd., Dereham.

CABINET MOULDINGS IN HAZEL PINE



No. 306 This section has a rebate to take ¼ in. wood and may be used as a base or lid moulding. Size 1½ in. by ½ in. Price 2½d. per ft.; 2/- per dozen ft.; 16/3 per 100 ft.



No. 307. Can be used for fillets or as a decorative moulding. Size ½ in. by ½ in. Price 1d. per ft.; 9d. per dozen ft.; 5/9 per 100 ft.



No. 308. Useful on almost any woodwork job. Size ¾ in. by ¾ in. Price 1d. per ft.; 10d. per dozen ft.; 6/3 per 100 ft.

Postage is extra. Buy from any Hobbies Branch or Agent or direct from Hobbies Limited, Dereham Norfolk.



No. 309. Fit this moulding to cabinet doors to exclude dust. Size ¾ in. by ¾ in. overall. Price 1½d. per ft.; 1/3 per doz. ft.; 9/- per 100 ft.

KEY TO INLAY

-  SATIN WOOD
-  MAHOGANY
-  PADOUK

See details
on page
445

← A
← B

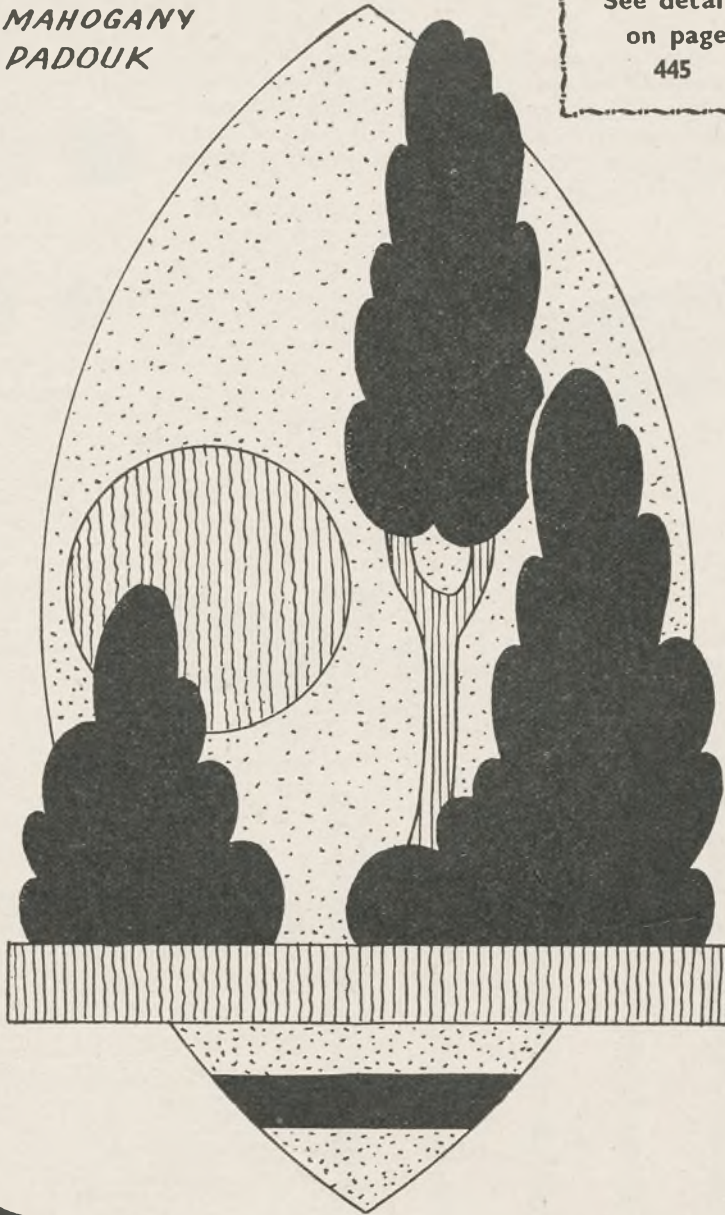

BLOTTER

WOODWORKERS

Not only does the amateur carpenter and fretworker need plain wood, but many accessories in moulding, ornaments, turned legs, and so on. Hobbies Ltd. can supply their needs in reliable goods, well finished and reasonable in price. These are a few lines; a fully illustrated list is free on request.

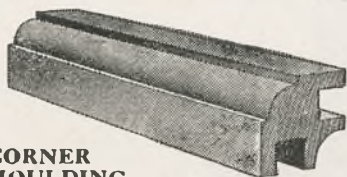

CORNER MOULDING

Makes the construction of boxes, cabinets and tables simple. A groove cut for the side boards. All you have to do is glue the parts in place. No joints to worry about. In oak and hazel pine. Three sizes of groove. Make a trial box now.

	Hazel Pine.	Oak.
No. 45, with 3/16in. GROOVE	1d.	1 1/2d. per foot.
No. 46, " 1/4in. "	1 1/2d.	" "
No. 47, " 3/8in. "	2d.	2 1/2d. " "

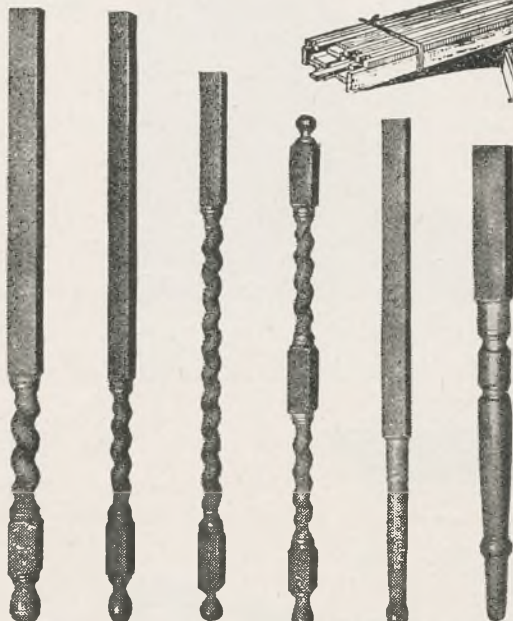

No. 502 No. 501 No. 503 No. 504 No. 508 No. 510

WOOD ORNAMENTS

These handsome wooden ornaments are plain but dignified and, if added judiciously to cabinets, furniture, boxes, wireless sets, etc., will add a big touch of distinction. They are supplied in just the sizes most likely to be required by the amateur craftsman and can easily be put on with a touch of glue. All are made in oak.



No. 217 No. 215 No. 220
No. 218
No. 219 No. 216 No. 221

PLAIN OAK BUTTONS

- No. 217. 1 1/2ins. 9d. per dozen.
- No. 218. 1in. 5d. per dozen.
- No. 219. 5/8in. 3d. per dozen.

ROSETTE CIRCLE

- No. 220. 2ins. 3d. each.
- No. 221. 1 1/2ins. 2d. each.

BUTTON, with Raised Rim

- No. 215. 2ins. Price 1 1/2d. each.
- No. 216. 1 1/2ins. Price 1d. each.



Square Rosette

- No. 222. 1 1/2ins. 2d. each.

STRIPWOOD

For model making, stopping fillets, blocking pieces or a hundred and one odd jobs, these planed strips are ideal. Planed on all sides. In satin walnut.

50 Ft.	100 Ft.
ASSORTED STRIPS	ASSORTED STRIPS
2/6	4/9
Post 4 1/2d.	Post 6d.
18in. Lengths.	2ft. Lengths.

BEADING AND MOULDING OF ALL KINDS

TURNT LEGS FOR THE AMATEUR

The introduction of these legs will be very popular amongst many woodworkers. By their use the handyman can build really large and useful pieces of furniture such as sideboards, bureaux, gramophones, tea wagons, etc. The legs are beautifully turned and cut from good quality wood. They only need a rubbing of glasspaper before being ready for use. We have carefully studied the needs of the amateur worker and here offer a range of legs which should meet every requirement. Moreover, by careful buying, we have been able to keep the price down, and even if you are able to buy cheaper, you can be sure that neither the quality nor the finish is so good as in those we offer.

- No. 501. 1 1/2ins. x 36ins. Twist Gramophone Cabinet Legs in Oak, 5/- for 4. Post 10d.
- No. 502. 2ins. x 36ins. Sideboard Legs in Oak, 1/9 each, 6/6 for 4. Post 1/-.
- No. 503. 1 1/2ins. x 30ins. Twist Pillar in Oak, 6/- for 4. Post 8d.
- No. 504. 1 1/2ins. x 30ins. Tea Wagon Legs in Oak, 1/9 each, 6/6 for 4. Post 8d.
- No. 508. 1 1/2ins. x 30ins. Stand Legs in Oak, 3/- for 4. Post 9d.
- No. 510. 2ins. Deal Table Legs 2ft. 4ins. long, 3/6 for 4. Post 10d.

Orders for Goods by Post should be addressed to Hobbies Limited, Dereham, Norfolk.

HOBBIES

Branches in London, Glasgow, Manchester, Birmingham, Sheffield, Leeds, Southampton and Hull.

HOBBIES

BRANCHES AND AGENCIES. LTD.

Below are the addresses where Hobbies goods can be purchased. In addition, all leading stores and ironmongers stock or can obtain your requirements in fretwork and woodwork, designs, wood, turned legs, moulding, polish, etc.

HOBBIES OWN BRANCHES—

LONDON - - - 16 NEW OXFORD STREET, W.C.1.
 LONDON - - - 147 BISHOPSGATE, E.C.
 LONDON - - - 83 NEWINGTON BUTTS, S.E.11.
 GLASGOW - - - 326 ARGYLE STREET.
 MANCHESTER - - - 10 PICCADILLY.
 BIRMINGHAM - - - 9a HIGH STREET.
 SHEFFIELD - - - 4 ST. PAUL'S PARADE.
 LEEDS - - - 10 QUEEN VICTORIA STREET.
 SOUTHAMPTON - - - 25 BERNARD STREET.
 HULL - - - 13 PROSPECT STREET.
 CANADA
 54 WELLINGTON STREET WEST, TORONTO.

HOBBIES AGENCIES—

Aberdeen.—Jas. Mutch, Ltd., 47 Broad Street; Blackburn.—Mr. H. Mercer, 68 Darwin Street; Bradford.—Messrs. T. Underwood & Co., 13 and 15 Manchester Road; Cambridge.—Mr. H. S. Driver, 28 Hills Road; Canterbury.—Mr. T. D. Goodman, 33 Burgate Street and 16 St. George's Street; Cardiff.—John Hall (Tools) Ltd., 22 and 24 Morgan Arcade; Croydon.—L. H. Turtle, Ltd., 6 Crown Hill; Dover.—Mr. E. F. Bockham, Queen's Gardens; Dublin.—Mr. J. J. McQuillan, 36 Capel Street; Dundee.—Phins Ltd., 20 Nethergate; Folkestone.—Mr. W. Allsworth, 16 and 18 Guildhall Street; Hastings.—Mr. W. H. Mozley, 4 York Buildings; Leicester.—Mr. Frank Berry, 8 Loseby Lane; Liverpool.—Mr. C. Lucas, 17 Houghton Street; London.—Messrs. H. Osman, 166 Aldersgate Street, E.C.; Newport, Mon.—John Hall (Tools) Ltd., 81 High Street; Reading.—Mr. W. J. Sargent, 44 West Street; Swansea.—John Hall (Tools) Ltd., 8 Gower Street; York.—Messrs. J. H. Shouksmith & Sons, 182 Micklegate.

HEAD OFFICE AND WORKS:

DEREHAM, NORFOLK

GENERAL NOTICES.

EDITORIAL.

All Editorial matter should be sent to The Editor, Hobbies Weekly Dereham, Norfolk. If enclosed with orders or other matter for Hobbies Ltd., it should be written on a separate sheet of paper. Any matter requiring an answer must have a stamped addressed envelope enclosed.

DESIGN SHEETS.

The presentation Design Sheet is given only with current copies of Hobbies Weekly, and not with back numbers. The designs, however, can be obtained separately, from Hobbies Ltd., price 4½d., post free, or 10d. in the case of double size sheets.

ADVERTISEMENTS.

All orders and letters respecting advertisements should be addressed either to the Advertisement Manager, Hobbies Weekly, Dereham Norfolk, or to 30/32, Ludgate Hill, London, E.C.4.

INDEXES AND BINDING CASES.

An Index for any volume is obtainable for 4½d. post free, and Binding Cases to take a complete set of 26 issues (making the volume) are supplied for 1/6, or sent post free for 1/8. The Cases are in red linen with gold blocked name on the front. The Azabook Binder, to hold 24 copies which you can fix in yourself is 3/3 (3/6 post free) including two dozen fastening staples.

BACK COPIES.

Back copies are obtainable from the Editorial address given above or from the Publisher, price 2d. a copy, plus postage.

CONTRIBUTIONS.

The Editor is always pleased to consider suitable articles for these pages, which, if accepted, will be paid for at the usual rates. While every effort will be made to return unsuitable contributions (if stamps for that purpose are sent with them), the Editor does not accept any responsibility for their loss.

SUBSCRIPTION.

Hobbies will be forwarded by post to any part of the world at the following prepaid rates. Twelve months 13/-, six months 6/6, three months, 3/3. Registered for transmission by Canadian Magazine Post

Get this HOME Painting Outfit

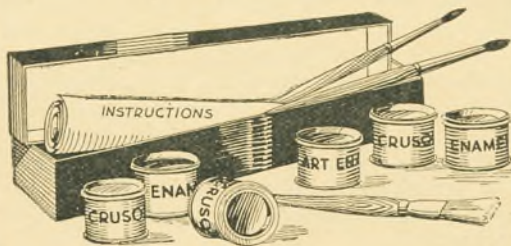

Every handyman needs this Outfit. With it you can paint on wood, glass, leather, pottery, etc.—a delightful and profitable hobby. Complete with 6 tins of enamel, 3 brushes, and instructions as shown.

1/9

Post 3d.

HOBBIES LIMITED, DEREHAM

SPECIAL NAILS for FRETWORK

Those who are constantly using fret nails should snatch at this special bargain. This packet contains nearly ½-lb. of useful 3/16 in. iron nails with sharp points and well cut heads. Worth double.

A big box
6D. ONLY

Postage 3d.



REPLY COUPON

One of these small Coupons and a stamp for 1½d. must be attached to your letter to the Editor, if you are enquiring about anything which demands an answer. Cut the Coupon out and put it in with your letter which should be addressed to The Editor, Hobbies Weekly, Dereham, Norfolk

Thousands Sold . . .

*. . . they Must
be Good!*

Model boats may look alike, but there is a difference. The "Norfolk" Yacht is different! It is better finished, better value.....and it sails better! It is making history in the model yacht world because of its all round superiority and value.

For as little as 5/- you can buy a model with hollow hull and first quality fittings. The large boat has a cabin top with imitation lights.

The Best Value in Model Yachts

14in. Solid ..	2/3	16in. Hollow	7/-
16in. " ..	3/-	18in. " ..	10/6
18in. " ..	3/9	21in. " ..	13/-
12in. Hollow	5/-	24in. " ..	19/-
14in. " ..	5/6	28in. " ..	25/-

Postage extra

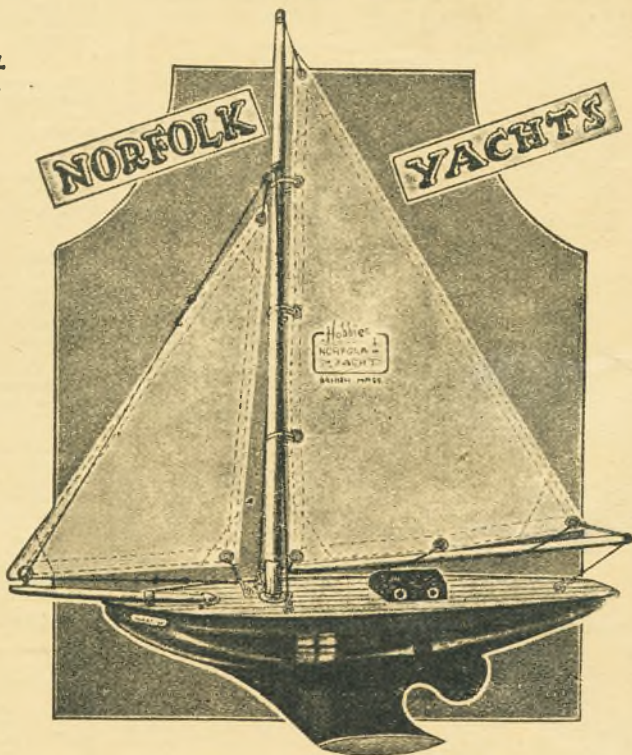

Hobbies 'NORFOLK' Yachts



Holidays are here! For most boys this means fun on the model yacht pond. But what about the Yacht? Don't leave it until the last minute. Thousands of boys up and down the country are sailing Hobbies "Norfolk" Yachts. And how they sail! Go to your nearest Hobbies Branch or Agent and ask to see the "Norfolk" Yacht, and judge it for yourself. If you write to Hobbies Limited, Dereham, Norfolk, an illustrated list will be sent you.

*The Choice of
Boys Everywhere*