

Hobbies

WEEKLY

Making a fullsize
**GRANDMOTHER
CLOCK**

FREE CHART
WITH THIS
WEEK'S ISSUE



January 27th, 1934

Vol. 77 No. 1997

2^D

THE **FRETWORKER'S** AND
HOME CRAFTSMAN'S JOURNAL

MOULDING for the woodworker

These are just the mouldings which the amateur carpenter needs. The base moulding and corner moulding are used in building up gramophone and wireless speakers and cabinets. The angle moulding No. 300, etc., is to cover bad corners, whilst No. 303 is as a cover moulding or drop ornament under an overhang. All are well cut, but quite cheap in price and suitable for any class of work.



BASE MOULDING...2ins. wide, 3/8in. thick...No. 41.
OAK, 3½d. per foot. HAZEL PINE, 3d. per foot.



BASE MOULDING...1½ins. wide, 3/8in. thick No. 42.
HAZEL PINE, Price 1½d. per foot.



MOULDING No. 303 Hazel Pine
1/2in. .. 1½d. per ft. 1/3 per doz.
1in. .. 2d. " " 1/9 " "
1½in. .. 2½d. " " 2/3 " "
Postage Extra.



CORNICE MOULDING
2ins. wide, 3/8in. thick No. 43.
HAZEL PINE, Price 3d. per ft.



GROOVED MOULDING

For cut-out calendars and statuettes. In light wood with 1/8ins. or 3/8ins. groove.
1d. per ft. 10d. for 12ft.

No. 300. — 1/2in. Sides. Price 3d. ft. 2/6 doz. ft.
No. 301. — 1/2in. Sides. Price 2d. ft. 1/9 doz. ft.
No. 302. — 1/2in. Sides. Price 1½d. ft. 1/3 doz. ft.

Give Reference Number when you order and include return postage.



No. 230.—1½d.



No. 231.—2d.



No. 229.—2d.



No. 228.—1½d.

All these rosettes are in beech and measure 1½in. square. Suitable for ornaments on any work.

Obtainable from Hobbies branches or agents everywhere. Or by post from Hobbies Ltd., Dereham, Norfolk

NOW—You can have a BENCH for 5/- down!

Why deny yourself the pleasure of owning a good bench when for as little as 5/- down and a few small weekly payments you can buy one from Hobbies?

One thing is certain, you do better work with a bench. Hobbies' benches have solid 1½in. tops, hardwood vice and stop, a proper receptacle for tools and, what is more, the legs fold under to save space in storage. Yet the bench is perfectly rigid in use.

Don't delay another minute. Decide right now to get the bench you have always wanted.

The Easy Payment Plan does not apply to Ireland or anywhere abroad.

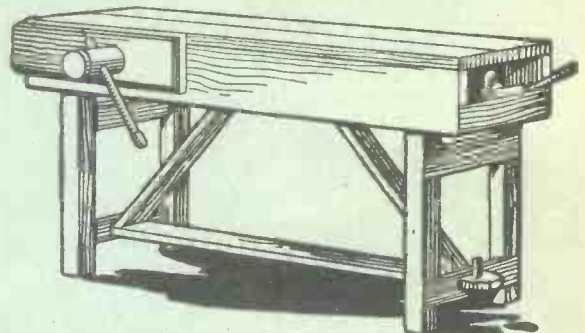

In two sizes:—

4ft. 35/-

5ft. 42/-

Carriage forward

HOBBIES LTD.
DEREHAM, NORFOLK.

Branches in London, Glasgow, Manchester, Birmingham, Sheffield, Leeds, Southampton and Brighton.

Send to-day to Hobbies Limited, Dereham, Norfolk, or call at any Hobbies Branch, for an illustrated list showing how easy it is to buy a good bench under this easy payment plan.



Hobbies

WEEKLY

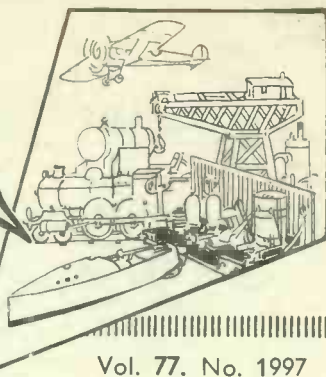

January 27th. 1934

Vol. 77. No. 1997

I CAME across a heading recently in a newspaper which arrested my attention. It was "New Hobbies." Aha, thought I—it is something of interest here. But no, alas, I was disappointed. Some writer had merely found what he took to be a new hobby, but one which was probably done by our readers many, many years. I really should like to hear of some *new* hobbies!

THIS week sees the end of a special Hobbies show being held at Manchester and which probably most readers living in that City have attended. It was held in the City Hall, Deansgate and included a vast array of amazing models and pieces of work undertaken by people of all ages and interests. No doubt many readers were able to send along their own exhibition pieces.

BY the way, when readers and workers receive an award in any of these local exhibitions I hope they will let me know, because Hobbies like to give a further special prize. And, of course, I always like to hear of exhibitions which are going to be held. So often, unfortunately, readers let me know too late, because these pages have to be printed some time before you actually receive them. Let me know as soon as you can and

the matter can be mentioned for the interest of other readers.



THE picture on the left is a realistic piece of work, isn't it? It's not a real plane, as you might think, but simply a model of the Prince of Wales' Fox Moth made from design sheet 1957 which appeared in Hobbies Weekly last April. This piece of work was executed by Master

J. Hulme of Cheadle Hulme, Cheshire, and the model was cleverly arranged for the photograph to give the appearance of it being in flight. Actually, of course, the aeroplane is built in wood, and if any other readers want to try their hand at it, the design and materials are still obtainable.

HERE is a note which is specially for Warrington readers. A letter arrived recently written by Eric to

NOTES of the WEEK

Any new Hobbies?—A Manchester Exhibition—An Award for Winners—The Prince of Wales's Moth Model—Did you write to "Teddy"?

Teddy, but without a home address on. The writer Eric mentioned a birthday he had had, and a school concert with balloons and things. The point is, of course, that Teddy never received the letter because it was put in an envelope addressed to me. I have it now, and if this note should catch the eye of either "Eric" or "Teddy" will they let me know, and the letter concerned can be forwarded to clear up a mystery which has probably been worrying both of them for some time.

I MUST remember, too, to have those chemistry articles in frequently. Somebody has threatened George with a particularly thick ear if he does not persuade me to do so. And I should be frightfully upset to see our young guy arrive with a puffy ear through me.

IF any reader happens to have a design of No. 1144 would he send it along to Wallace H. Maxwell of Main Street, Drummore, Stranraer who is badly in need of it. The sheet is not in stock at Hobbies, but probably several readers can spare their copy. Thank you, very much!

The Editor

THE FUN AND PUZZLE PAGE

TRY IT

TELL any male that he cannot button up his coat in the time you take to count thirty. Unless he has heard this trick before, you win. He may button his coat in thirty seconds, but he'll most likely start with the top button and button it down and not up.

WHAT TIME WAS IT ?

GEORGE asked somebody the time the other day, and the answer he received was "If you ask me in an hour's time it will be as many minutes past 12 o'clock as it now is short of 11 o'clock." Poor George had a hectic time working it out, but having done so he immediately put it across us. Now what was the time ?

For answer see below.

WHAT is there peculiar about the Isle of Wight ? All you people who have stayed there should know—'s'easy ! Why, it has Cows you cannot milk, Fresh water you cannot drink, Needles you cannot thread, and Newport you cannot bottle ! How's that ?

THE soldier was showing his friends the knocker on the front door. "Yes," he said, "I got this knocker when I was in the war in France. I was knocking at a house in a French village when a shell came and blew the house

clean away, leaving me with the knocker in my hand !"

RUDE BOY !

A MAN advertised a donkey for sale, and a fellow called. The door was opened by a small boy, and the enquirer said "I have come about the donkey you have for sale—" "Father, you're wanted," called the lad !

HERE is a simple one which should prove a teaser to some of your friends. A mile of wire fencing is required to go round a field of 40 acres. What size field will be enclosed by two miles of wire. Generally the answer will be given as 80. No ! The answer is 160 acres. Draw a plan of the field and you will see that two miles of fencing will enclose four times as much space as one mile !

THE CORRECT TIME

The answer to the question about the time is 11 o'clock.

THE IMPIES BUILD A GRAMOPHONE !

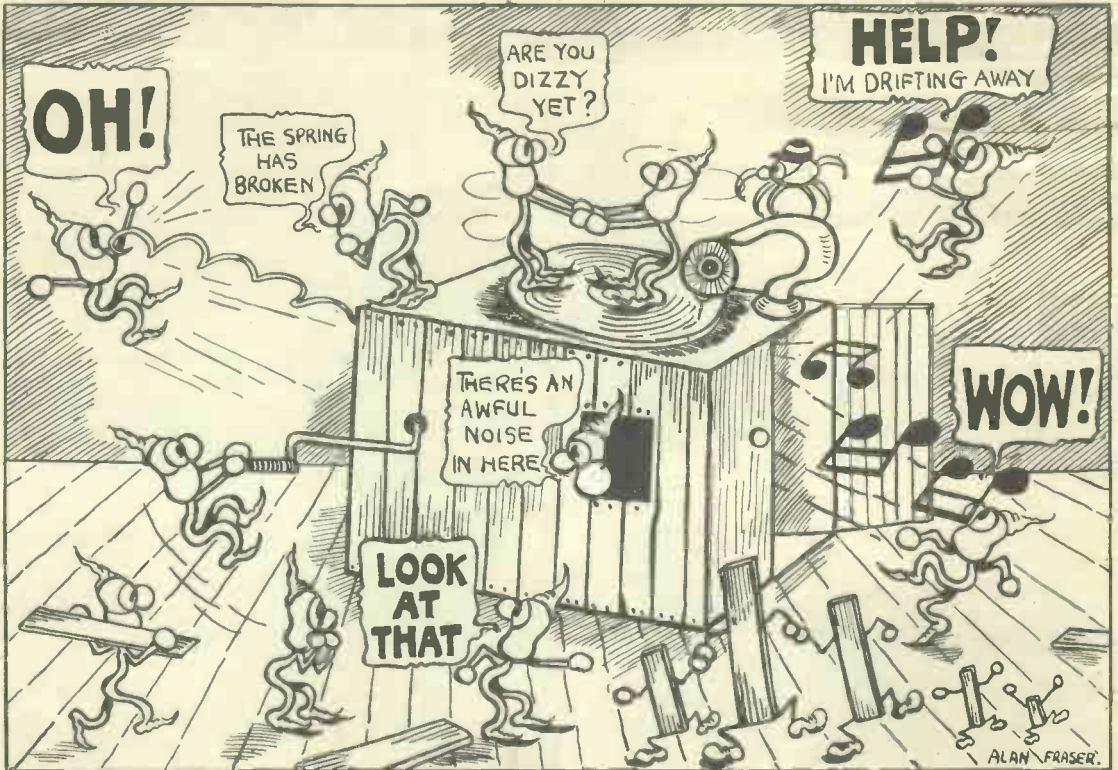

ALAN FRASER.

A CONVERTIBLE RUNABOUT

for use in Winter or Summer

HERE is a topping little run-about for the youngsters—well, more than a runabout for it combines steel runners which make it just the thing for tobogganing down snow-clad hills when the winter is here.

There is nothing difficult in the make-up, and the only tools necessary are just the ordinary kit of the home carpenter or handy man. Briefly explained, the toy (built in hardwood, such as beech),

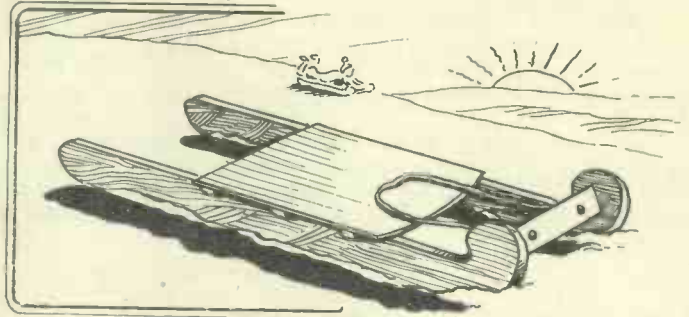

The two runners are cut from $\frac{7}{8}$ in. wood, 36 ins. long by 3 ins. wide by $\frac{7}{8}$ in. thick, and to form the curved fronts two separate pieces are spliced on as shown at Figs. 1 and 2. These two fronts are made from wood 7 ins. by 6 ins. by $\frac{7}{8}$ in., cut round with a coarse

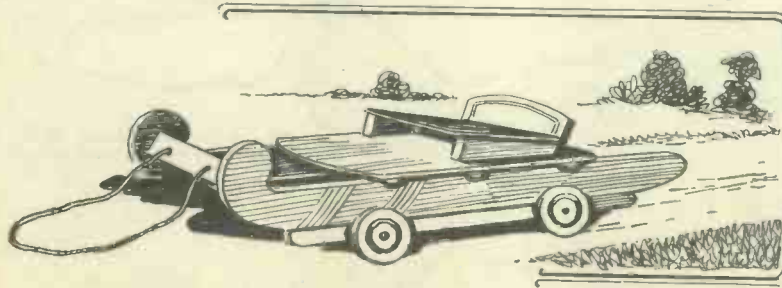

consists of two sides, which are connected together, with cross rails upon which is fixed a flat board. This is all that is necessary for winter use.

Take it out on a snow-clad slope for a run. Lie flat on the board and hang on to the rope connected to the front rail and push off. The runners and curved fronts of the "sleigh" have hoop-iron attached to them so they glide smoothly over the snow. Hours of fun can be got out of one of these little toys.

To turn it to ordinary use where it may be run on the pavement or asphalt path, all that is required is to fix on a pair of wooden rails to which are attached four sturdy hard-wood wheels and it is again in "running order."

The simplest method has been devised for fixing on the wheels. Just put each

pair in place, drop bolts through the runners and through the rails and screw on the wing nuts. Then, upon the board on top of the runners fix on the low seat by means of another bolt and wing nut and it is again ready.

The Construction

A glance at the two illustrations makes the construction clear, and no difficulty should be encountered in the making.

fretsaw. They are then laid in their positions on the rails and marked round, the shape being afterwards cut in.

The joints between the pieces should be made with glue and screws. Mortises an inch long by $\frac{1}{2}$ in. wide must next be made in each curved head to receive the ends of the front cross rail, measuring 2 ins. wide and $\frac{1}{2}$ in. thick as shown in the detail. The length of the cross rail is 12 ins., the two tenons $\frac{7}{8}$ in. wide being cut down from this length. The three main cross rails are 13 ins. long and 1 $\frac{1}{2}$ ins. square, the ends being notched (see Fig. 1) to fit the rails.

The Seat

The plain board to fit on top of these rails should measure 18 ins. by 13 ins. by $\frac{3}{4}$ in. thick, with screws run in from the top. The detail Fig. 3 shows the board fitted in place.

The seat (Fig. 4) is made with two wedge-shape supports cut out of $\frac{3}{4}$ in. stuff 8 ins. by 2 ins. and connected by a cross bar 2 ins. by $\frac{1}{2}$ in. thick. In

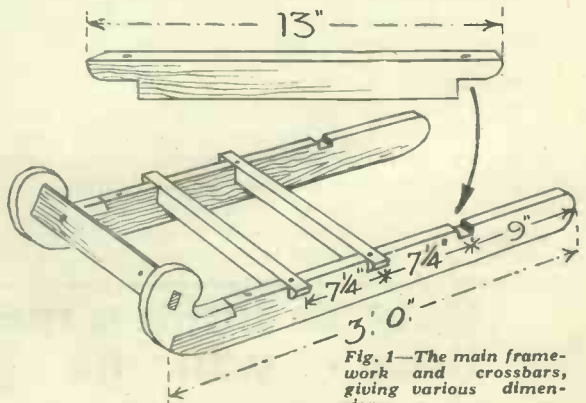

Fig. 1—The main framework and crossbars, giving various dimensions.

A SPECIAL PARCEL

Hobbies have made up a special parcel (No. 224) of beech for all parts with the turned and painted wheels complete for 10/- or sent post free for 11/-

A Convertible Runabout—(continued)

the middle of the latter is bored a hole for the bolt that holds the seat in place. The seat is fixed by screws this piece measuring 13ins. by 8ins. and $\frac{3}{4}$ in. thick. A shallow back to the seat is made from $\frac{7}{8}$ in. stuff to the measurements shown, the top being nicely cut to a curve with the fretsaw.

Minor Points

A hole must be bored in the centre of the seat to allow of the removal of the bolt which holds the seat down. The corners of the seat should all be rounded off and the edges sandpapered down quite smooth.

The running edges of the sides are protected against wear by nailing or screwing round strips of hoop iron bought at any ironmongers or builders' merchant. It should extend the whole length of the

they are to be flush sided with the runners. A glance at the detail will make this clear. The front bolt hole in the runners is 8ins. from the curved front, while the back hole will be 6ins. from the end of this rail.

The bolts should be inserted and tested for length, a washer being placed over the end of each before the wing nuts are run on. It will be found that $\frac{5}{16}$ in. bolts should answer the purpose.

The Wheels

The wheels may be bought from Hobbies at $\frac{1}{3}$ a set if $\frac{5}{16}$ in. diam. wheels are adopted, and $\frac{1}{4}$ - the set if $\frac{1}{4}$ in. are used. Strong 2in. screws are provided with the wheels and they will be found to run into the bearing rails nearly $1\frac{1}{4}$ in. Iron washers should, if possible, be put on the screws



Fig. 2—How the ends of the main runners are cut and jointed up to the crossbars.

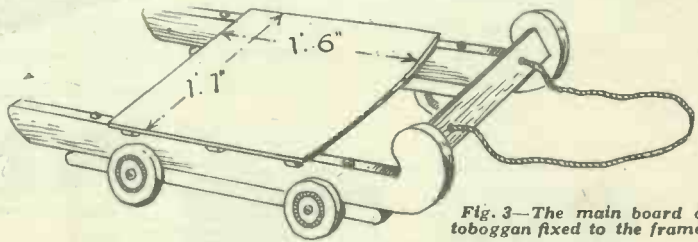

Fig. 3—The main board of the toboggan fixed to the framework.

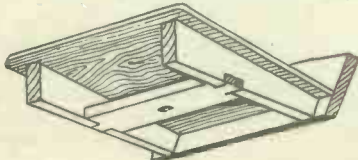

Fig. 4—Three details of the seat giving sizes and a view from beneath.

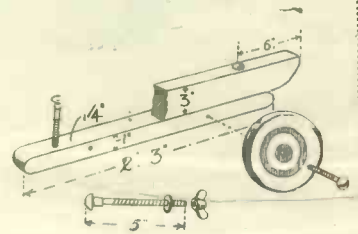
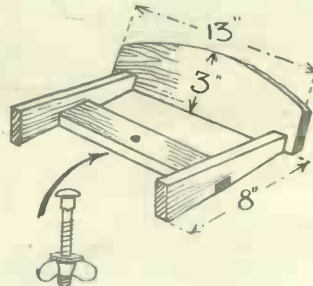
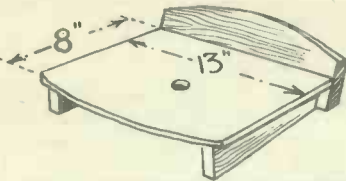

Fig. 5—The running bars on to which the wheels are fixed.

runners or sides and be screwed at short intervals.

The detachable bars with the wheels are next made, see Fig. 5. Two pieces of deal 27ins. long by $1\frac{1}{4}$ ins. wide by $\frac{1}{2}$ in. deep are planed up and prepared and the ends rounded as shown,

Correct Boring

Two $\frac{1}{4}$ in. diam. holes are next made in each piece, one 3ins. from one end and the other $1\frac{1}{2}$ in. from the other end for the bolts and wing-nuts which hold the pieces to the sides. It must be noted that the holes are bored in the $1\frac{1}{4}$ in. width of the pieces and must not therefore be quite central with this width because when in position

each side of the wheels. The positions of the centres of wheels should be marked off 7ins. distant from the ends of the bearer rails.

Paint the article with two coats. Bright colours should be given to some parts, such as green for the runners and dark red for the seat and floor.

How to Finish

Varnish should form a final coat to brighten the paintwork and keep out the damp. Two holes should be drilled in the front rail for a piece of stout rope, used for pulling the trolley when the wheels are in action and as hand-hold when using it as a toboggan.

How to build a model of "The Golden Hind" will be given Next Week!

HOW TO MEND



Read how simple it is!

YOUR OWN SHOES

A Money-saving job for the handyman

THE tools required for this interesting and money-saving hobby are: A sharp knife, a bradawl, a finishing-iron, and a shoe-maker's hammer; not forgetting an iron "foot" (three-in-one). Leather must be chosen according to the type of shoe you wish to repair. It is best to buy this in one piece; ready-cut soles are often odd in quality.

Points to Note

See there is no flaw in the leather, and do not choose an end piece; it will not wear. If you are "repairing" for the family it is essential to study the construction of the worn shoes, because the correct thickness of the new sole varies considerably.

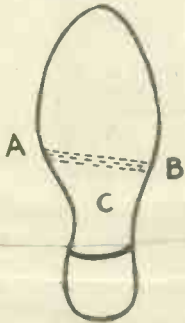

Fig. 1—Stripping.

For instance, heavy boots sometimes have a 'middle' sole; and a thick piece of leather on this type, apart from straining the uppers, will make them altogether too clumsy.

Most cheap shoes, especially ladies', have only a single machine-sewn sole; a light clump must be nailed on top of this, for any attempt to remove the original sole will prove disastrous. The same applies to dancing-pumps and children's footwear up to size 7.

Only if the shoe is welted, can you remove the worn sole with any degree of safety. A welted sole is easily recognised by its projecting edge.

If the shoes have not been repaired before, and you do not wish to 'clump' them, you must strip off the sole from the toe downwards but not too far (see Fig. 1). Never put a heavy sole on old uppers—they will not stand the strain.

Cutting Carefully

Having obtained a suitable piece of leather, place it smooth side downwards, and mark round each shoe (see Fig. 2), keeping the thickest edge to the toes. Avoid waste when cutting; the shade pieces (Fig. 2), will come in handy for building up heels, etc. If the leather is too tough to cut through direct, 'score' the marks with the point of your knife; let the leather overlap the edge of a table, and place a flat-iron on it. Then bend the free end of leather downwards as you 'score' deeper.

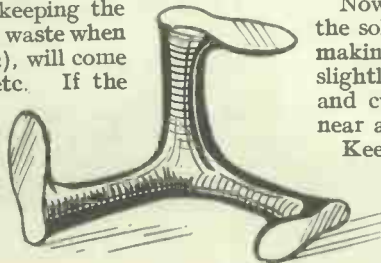

An essential to every shoemaker—the last.

Always keep the knife sharp, especially at the point, and hold your forefinger along the back of the blade. Many serious accidents have occurred through holding the knife 'stab-fashion.' Medium and heavy soles should be soaked in a bowl of cold water; but do not let them become 'pappy.'

Soak and Hammer

When soaked, stand the soles toe-up to drain. This soaking process enables the leather to shrink tightly on to the shoe, and the moisture rusts the iron rivets, making them hold firm. Hammer the rough side thoroughly to compress the fibres, and therefore improve the wearing quality considerably.

Now cut the 'waist' ends obliquely, (like the dotted line in Fig. 1), making the outside edge of the sole longest. 'Skiver' the oblique end, so that the sole held edge ways appears as in Fig. 3. This avoids an uncomfortable bump under the instep.

THICKEST EDGE

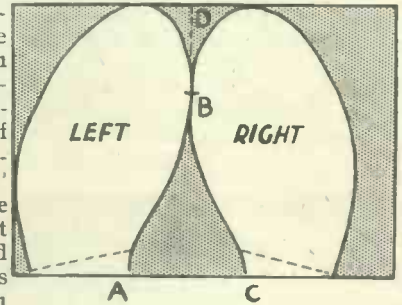

Fig. 2—Marking out the leather.

Carefully strip off the worn sole from the toe downwards with a pair of pincers; note where it is worn most, and insert a small piece of leather between the inner sole, and new sole when fixing.

Fixing the Sole

Always 'skiver' the inner edge of these small pieces to a wafer, to ensure maximum comfort. Sometimes the inner sole itself has a hole in the centre. In this case cut a piece of felt to cover the whole inner sole except the extreme edges.

Now, with the shoe on a 'foot,' secure the sole in position with one or two rivets, making sure that the toe part projects slightly; then hold the shoe upside down and cut carefully round the edge, to as near a perfect shape as possible.

Keep the knife tilted, so as not to cut the uppers. With the aid of your bradawl, mark an even line round the sole where the nails are to be driven. This line

(Continued on next page)

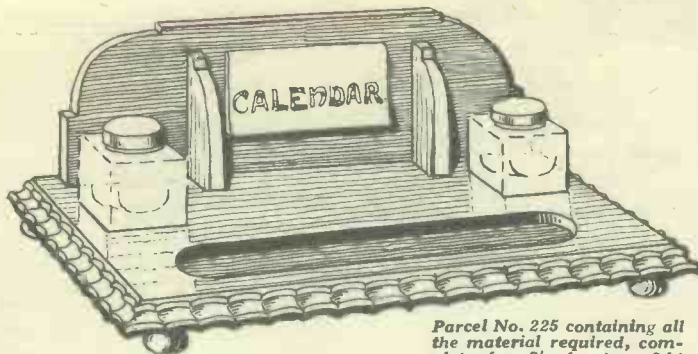

Parcel No. 225 containing all the material required, complete for 3/- (postage 6d.)

A PEN AND INK STAND

MATERIAL REQUIRED.

- Two pieces of 3/16in. fretwood, 10 1/2ins. long by 5ins. wide for the bottom.
- One piece 9 1/2ins. long by 3 1/2ins. wide for the back.
- Two pieces 3ins. long by 3/4in. wide for the supports.
- 3ft. of waved and embossed moulding No. 100 size 1/4in.
- Four ball feet, No. 15 size, 1/4in.
- Two glass inkwells (No. 5661), size 1 1/2ins.
- Calendar pad (No. 6145), size 3 1/2ins. by 2ins.

THE pen and ink stand shown here will impart quite a nice finish to the writing table, but one object to bear in mind when making it is to match the wood in the table. This should not be at all difficult as ordinary 3/16in. fretwood is used, which is available in nearly every kind of wood.

There is no chance of failure in making this article, because it is only necessary to fret out the various parts as shown, and fit them together without having to bother about special joints.

The bottom is in two pieces each measuring 10 1/2ins. long by 5ins. wide, and while the lower piece is quite plain, the upper piece is pierced for two glass inkwells No. 5661 (which should be obtained and measured before the holes for them are cut to make sure of good fits), and also to form the recess for pens, the hole for which is 8ins. long by 1in. wide with rounded ends. The two portions

of the bottom are glued together, the edges are planed square and level

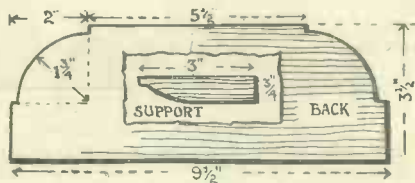

and finished with waved and embossed moulding No. 100, size 1/4in. mitred at the corners.

The back is 9 1/2ins. long by 3 1/2ins. wide, shaped at the top corners, the outlines for shaping being set out with a pair of compasses. Glue and fine pins are used to fix the back 1/4in. in from the edge of the bottom, and the two shaped supports are fixed by similar means. Ball feet fitted under the corners.

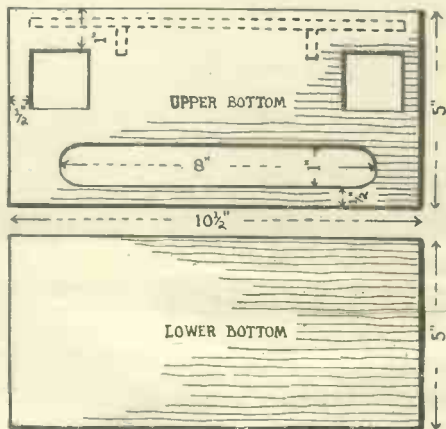

Mending Shoes—(continued from previous page)

should be rather less than 1/4-in. in, and can be gauged by running your thumb-nail round the edge while marking. (see Fig. 4).

Make holes for the nails with your bradawl. Nails at the 'waist' should be closer than the others, for there is a much greater strain there while walking.

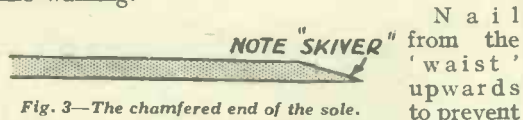

Fig. 3—The chamfered end of the sole.

All that remains now is to finish the edges with a small file or a piece of sandpaper; and then 'heel-ball.' A penny stick of 'heel-ball' (black or

brown) will last a long time. Drop it round the edges like sealing-wax, and smooth with a warm finishing-iron. If the iron is too hot it will burn the leather very quickly.

Heels are quite straightforward, but if they are worn down badly, take off the lifts separately until level, then build up to the original height with odd pieces of leather, but use a good heavy top-piece.

Do not attempt to alter the original height of ladies' heels; you will throw the whole shoe out of gear. In any case, it is best not to tamper with ladies' heels which are badly worn down. Much skill is needed to rebuild them to the correct shape.



Fig. 4—Mark for nails.

DECORATED SHADES



Fig. 5—
A fine
design.

MAKING paper candleshades is a form of craftwork that possesses almost unlimited possibilities for anyone of an artistic turn of mind. They are easy and, what is more in these days of economy, there are no expensive tools and materials to buy. Ordinary strong drawing paper is quite suitable and the decoration can be executed in water colour paint.

First of all the shape to be made should be decided and then the development of the shape worked out. The development being the outline that, when cut out of a sheet of paper and folded up, would give the required shape. For example: Fig. 1 shows a simple circular shade and also the development of it.

On the right hand side a strip of paper about $\frac{1}{4}$ -inch wide, called a "flange," should be left. When the shade is finish-



Fig. 2—
A six-
sided
shade.

ed this is stuck on the underneath side of the opposite end and thus completes the shade. The shades may also be made with any number of sides and the method of getting the correct shape of the development of a six-sided, or hexagonal, shade is shown in Fig. 2.

The two arcs are drawn with a compass, as in Fig. 1, the distance between the two being the depth of the shade C (see Fig. 3), while the length A is marked off on the top arc and the length B on the bottom arc. The dotted lines indicate where the paper would be folded.

Once the development has been drawn out the paper is ready for the painted design. The design may be original, while those who do not possess the

necessary skill for original designing may use a stencil to overcome this obstacle.

Fig. 4 shows two very simple stencils that the veriest amateur could make for himself and which, if executed in two colours or shaded, can be made to look very attractive indeed.

A stencil for one of the faces of the shade only should be cut out of a piece of thin card or stout paper. It can be cut with an ordinary penknife and if the stencil is placed on a piece of glass, while it is being cut, the edges of the design will come out nice and sharp.

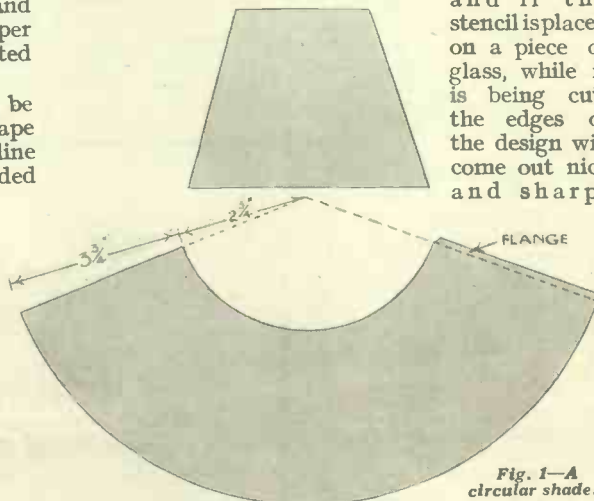

Fig. 1—A
circular shade.

Before using the stencil it should be brushed over with french polish, or linseed oil, and left to dry.

Fig. 5 shows a shade brilliantly decorated with yellow, orange, and red nasturtiums on a black background. This design should be drawn out on a sheet of paper and transferred on to the shades by means of carbon paper. The black background should be painted in with Indian ink.

When the shades are dry they should be wiped over on both sides with linseed oil. This stiffens the paper, renders the shade opaque, and also makes the water colour decoration waterproof.

Shade holders, with spring clips for clipping on to the candles, can be bought almost anywhere for a few pence.

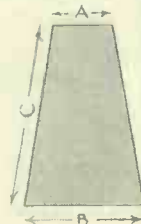

Fig. 3
One section.

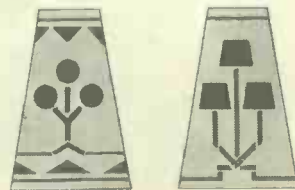

Fig. 4—Two simple
stencil designs.

MONARCH of THE GLEN

"The stag at eve had drunk his fill,
Where danced the moon on Monan's hill
And deep his midnight lair had made
In lone Glenartney's hazel shade."
—SCOTT

ONE of our most fascinating wild animals is the red deer, which is in its natural wild state on the awe-inspiring mountains of the Lake District and the Scottish Highlands. Naturalists of Scotland like to claim it as their own, rarely acknowledging that the herds that browse on the lonely heights of Martindale and Glencoin are as wild as any.

In autumn the red deer "turn to thoughts of love," and it is then stags are of dangerous temper, challenging and attacking intruders on their domains. The rival young bucks roar out their challenges through the night—a weird echoing, rumbling over the black mountains. It is a never-forgotten sight to see a stag silhouetted against an opal sky, in which hangs a moon of old gold, "belling" his defiance.

The clanging of antlers adds to the awe-inspiring sounds as the rivals fight fiercely, often into the morning hours, while the hinds watch with interest for the conqueror will be their lord and master until he should at last meet his defeat.

A strong old champion of many battles may gather round him as many as fifty or sixty hinds, and as many as a hundred have been



Belling his Defiance.

seen to follow one gallant in the Highlands.

These battles will sometimes go on till death or till one admits defeat and retreats.

Sometimes the antlers become interlocked and the stags die of exhaustion. In this, the rutting season, the long hair on a stag's neck stands out to make it appear much thicker, the eyes become blood-shot and his loins become thinner. He rolls in black, peaty pools, to emerge black and slimy,



with the mud dripping off him.

This is probably done to give him a more fearsome appearance. A defeated stag on which old age has told its inevitable tale becomes a tragic soul. With its flame of passion quenched, it will seek solitude or companionship of one in similar plight, or that has had a narrow escape from the rifle. Thus will a life of real romance end in peace and solitude.

The Ruling Monarch

In the case of a young stag, however, that has dared to challenge his elders for the rights of his harem, the love flame will kindle again, after the recuperation of a summer's good feeding: a new pair of antlers grow, and when autumn comes round again



A Royal Stag.

he will be more prepared and experienced to challenge the "Monarchs of the Glen."

This handsome rover of the mountains and glens sheds his horns each year, when he loses all fighting spirit for a time. At the setting of a springtime sun one may see a stag shaking his head—a sign that he is about to shed his horns.

It is seldom that both horns are found together—usually a difference of many yards will separate them, though in Scrope's "Days of Deer Stalking" it is narrated that a forester watched the process. One of the horns was seen to lean on one side and then fall to the ground. The stag tossed up his head and began to shake it, when the other antler dropped off. The stag then bounded high in the air as if in sport, and then tossing his head, dashed quickly away. Where the antlers have parted from the skull is a white base.

Shortly the new antlers begin to grow, consisting of a pair with two points. These are covered with a mouse-coloured "velvet." This covering remains till the antlers have spread to six points each. About August this "velvet" begins to shed, and the stag, by rubbing its antlers on boulders, makes it hang down in shreds, giving it quite a dishevelled appearance. The horns soon become as hard as iron, and white and sharp at the ends (tines).

The Outcasts

Lonesome stags have been seen wandering in such a pastoral county as Cheshire. These have broken away from the ornamental



"We've Fluxite and Solder—
the reliable pair;
Famous for Soldering—
known everywhere!

'Jack Frost' is handy—
that's plain to see!
BUT—not quite so 'handy'
as FLUXITE and ME!"

See that Fluxite and Solder are always by you in the house—garage—workshop—anywhere where simple speedy soldering is needed. All Ironmongers sell Fluxite in tins, 4d., 8d., 1/4 and 2/8

ALL MECHANICS WILL HAVE
FLUXITE
IT SIMPLIFIES ALL SOLDERING

Ask to see the FLUXITE POCKET SOLDERING SET—complete with full instructions—7/6 Ask also for our leaflet on HARDENING STEEL with Fluxite.
FLUXITE LTD. (Dept. H) ROTHERHITHE, S.E.16

FOR ALL REPAIRS!



BUILDING AN ENGINE

is most fascinating work. We realise that many have only a few simple tools: for them the Stuart machined sets are specially provided. An engine like this and many other Stuart engines can be built and completely finished with a very few hand tools.



Send 1d. stamp for 24-page little book No. 15H which describes the simpler Stuart engines. Alternatively for 6d. we send post free our 80-page "Catalogue H," which contains particulars of the full range of Stuart products.

STUART TURNER LTD.
HENLEY-on-THAMES

VENESTA PLYWOOD

at NEW low Prices!

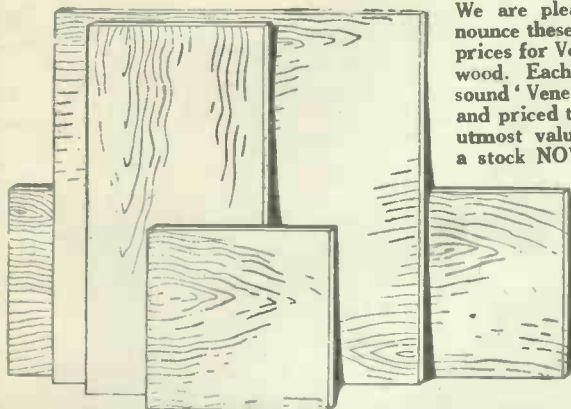

We are pleased to announce these NEW low prices for Venesta Plywood. Each panel is of sound 'Venesta' quality and priced to offer the utmost value. Get in a stock NOW.

From all the usual branches, stores and agencies of Hobbies Ltd. Or by post from Hobbies Ltd., Derebam, Norfolk.

OAK PANELS.
3/16in. THICK.

10in. x 9in. .. Price 6d. Post 5d.
20in. x 14in. .. " 1/4 " 9d.

MAHOGANY.
3/16in. THICK.

10in. x 9in. .. Price 6d. Post 5d.
20in. x 14in. .. " 1/6 " 9d.

BIRCH.
3/16in. THICK.

24in. x 12in. (2 sq. ft.) Price 8d.
36in. x 12in. (3 sq. ft.) .. 1/1
24in. x 24in. (4 sq. ft.) .. 1/5
48in. x 18in. (6 sq. ft.) .. 2/4

BIRCH.
1/4in. THICK.

24in. x 12in. (2 sq. ft.) Price 11d.
36in. x 12in. (3 sq. ft.) .. 1/5
24in. x 24in. (4 sq. ft.) .. 1/11
48in. x 18in. (6 sq. ft.) .. 2/11

Add return postage to these prices.

HOBBIES

For details of construction see page 431

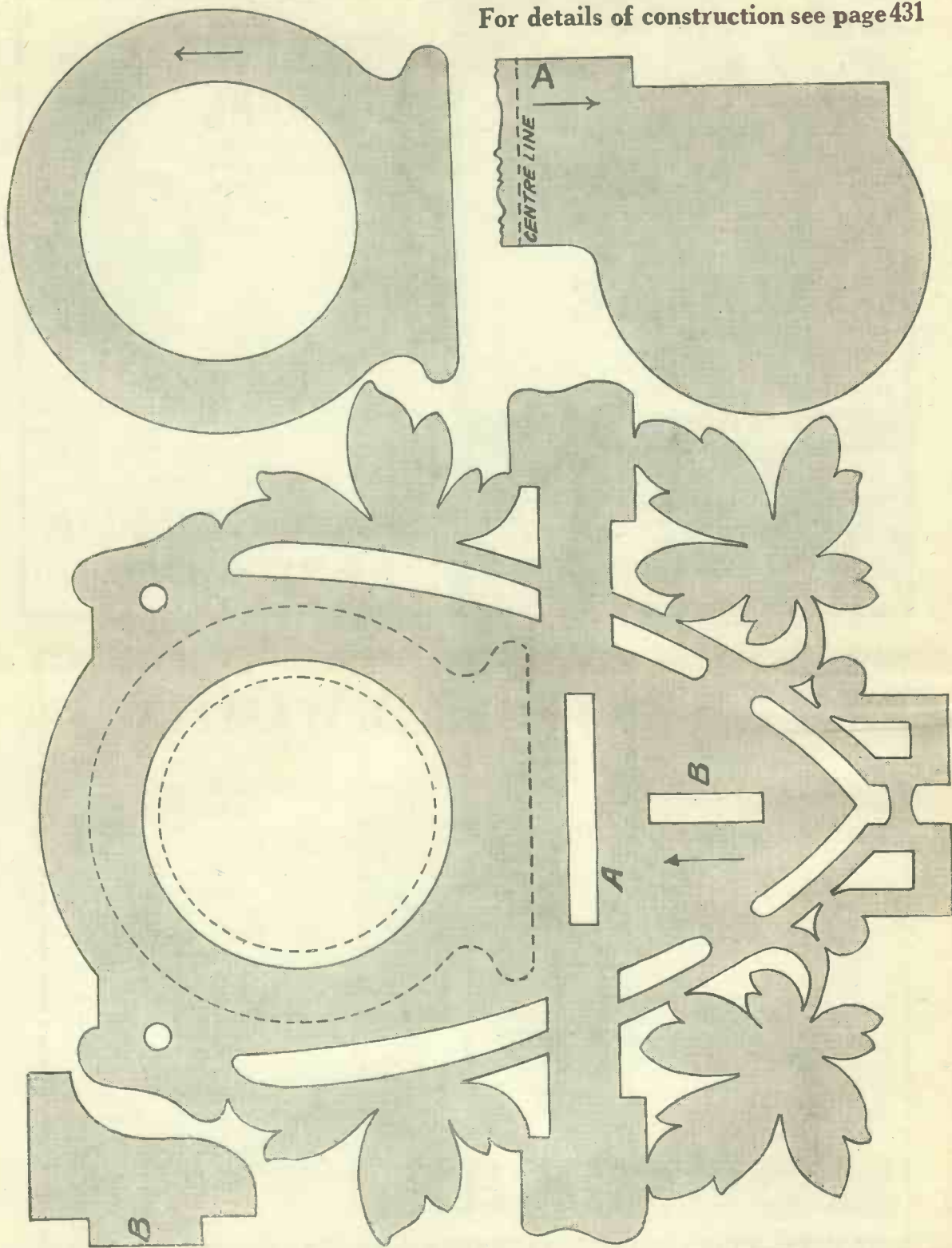

herds in the rich parklands—probably driven off after conquest. The herds refuse to have them back, and they become a source of destruction to the crops.

Still, it's a fine sight to see them eluding their pursuers, by leaping elegantly over the high hedges. They eventually fall to the gamekeeper's gun. One jumped in front of the headlights of a car, over one hedge on to the road, and over the other in two leaps.

Red Deer of the North

One can encounter herds of red deer on the Cumberland and Westmorland mountains—Glen-coign and the noble spurs of the mighty Helvellyn and Martindale Forest, the wild open moor between Ullswater and Haweswater. The latter is the deer park of Lord Lonsdale, and his seat, Lowther Castle, is nearby. His gamekeeper came from the Duke of Athol's estate in the Highlands, so naturally is most interesting when telling anecdotes on deer-stalking.

It is a weird experience to come across shedded antlers lying on the ground looking like fossils of dis-

torted and stunted trees. These wild deer have miles upon miles of open and lonely altitudes over which to rove, going into Naddle Forest on Haweswater banks.

They often swim the lake to feed on the more cultivated lands on the opposite shores, even in rough weather when this stormy lake nestled in the mountains, is tossed into an angry rage.

The deer calves are born in July, and the hind (mother) hides the calf during the day, visiting it early in the morning and late at night. The calf is under mother's care for more than a year, so it often happens that a hind may have two young ones following, with a difference in age of twelve months. Some deer are believed to live a hundred years, while it is stated that a Scottish stag, known as Damk Mor, The Great Stag of Inverness-shire lived over two hundred years.

The Stately Antlers

The male red deer, along with the fox, is the finest ornament to our wild country side, although the latter is too elusive really to play a

conspicuous and picturesque part. The antlers of a stag give it a noble and defiant appearance, and these have been known to have grown to 39 inches in length and to have 20 points.

In the case of a full-grown stag a pair of antlers is grown in ten weeks, which is rapid going for such horny and strong material. A point or tine grows on the antler each year, and when the full growth of six times on each antler is reached it becomes a "royal" stag, seven years old.

Full Growth

Growth stops at fourteen years and the additional points, if any, come from the cup-like top of the antler. The sketch of a royal shown here is the handsome head of a stag from Lord Lonsdale's Martindale Forest in Westmorland, which is in the dining room of the Crown Hotel, Penrith.

Undoubtedly the life of the wild red deer is most romantic, proudly adored by his hinds through all his conquests, until the fateful day, when he should meet his conqueror and lose his retinue.

SIMPLE FRETWORK BRACKET

Full-size patterns are given on page 430

A SIMPLE piece of work which will form excellent practice for the beginner and at the same time prove a useful article for the more expert, is provided in the patterns on the opposite page. It is in the form of a small bracket with a little circular mirror to give it a touch of brightness.

Only three pieces of fretwork are required, and all patterns can be cut from a single board of 3/16in. wood measuring 9ins. long and 8½ins. wide. Or, of course, the pattern for

the back can be cut from a single piece, and the other three pieces taken from odd boards.

Three of the patterns are full size, but the one of the shelf itself is only shown in half. It will be necessary, therefore, to trace out a similar pattern to that given, and transfer it to the opposite side of the centre line, taking care to see that the straight edge of the back is in alignment, otherwise it will throw the shelf out of true.

Cut out all four parts carefully with the fretsaw, and then clean them up with sandpaper in the usual way. Fit the tenon A of the shelf into the mortise in the back, then put in the little support bracket below it at B.

In cleaning it up be careful not to thin down the thickness of the tenons so the parts will be loose in their respective

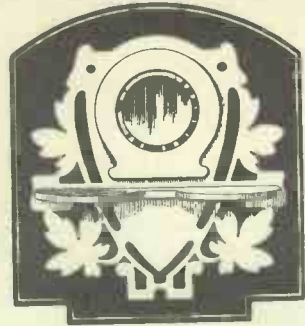

mortises. It is a sign of good workmanship to get a good joint in a job like this.

The mirror is a little round one, obtainable from Hobbies Ltd., its reference number being 5704. Lay it in the circle cut out from the back, and then glue the overlay above it to hold it in place. It is kept in from behind by paper clips, headless pins or a piece of brown paper. If the work is being polished or stained, undertake this before fixing the mirror in place.

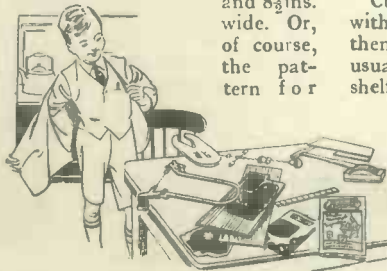

A GRANDMOTHER

If you saw the clock as photographed here, in a shop, you would think it an excellent piece of furniture, and not be above paying anything up to 25/- or 30/- for it, but when you think it can be made by the handyman for 12/- you will see how worth while it is to improve your ability

It is, of course, no use making up the clockcase unless one has a movement to fit it, and we have arranged for a special delivery of suitable clock movements at a reasonable price. These have a quaint coloured face with the numbers printed clearly, and round them are nursery figures of Cinderella, Dick Whittington, Man Friday, and other features of well-known rhymes.

MATERIALS

For making the clock, a par- chestnut with oak faced plywood moulding for the corners and blocking pieces and decorative f is supplied for 9/-. A special dial, chain, weight and all fitting wood is 1/6, and postage on the of wood, movement, etc. is sup-

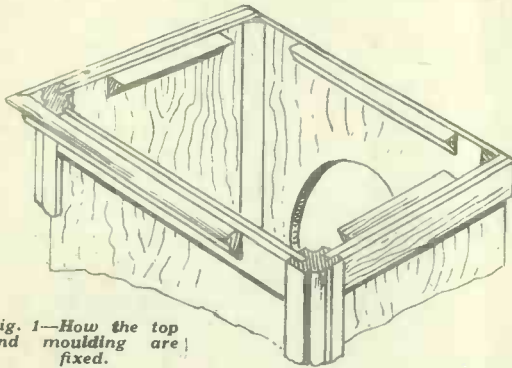

Fig. 1—How the top and moulding are fixed.

with a fretsaw and the carpentry tools. Week by week really useful and practical articles are provided in these pages, and the design chart presented with each contains complete patterns for the construction and building of the various articles.

By the way, although these design sheets are not given free with back numbers, they can be obtained price 4d. by quoting the number which is given next to the volume number on the front cover.

Easy of Construction

To return to the clock—it is built in wood, and as most of the panels can be ply, the cost is quite reasonable. Moreover, it has been planned so the corner posts are the grooved moulding which hold the actual sides of the case, thus rendering the construction quite easy. All one has to do is to fit and glue the side panels into the corner pillars, and the whole thing is provided as a box frame without any further trouble.

Beyond the case itself, there are decorations and additions of moulding, but as these, too, are also supplied by Hobbies, the cost is quite reasonable. Indeed, a complete parcel of all the necessary wood is supplied for 9/-.

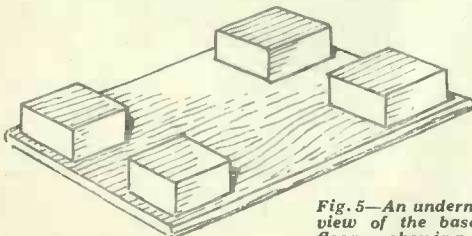

Fig. 5—An underneath view of the base or floor, showing the solid feet blocks.

A Plain Dial

This pendulum clock with chain and weight is supplied complete for 2/11. If one desires, of course, the nursery figures round the outside of the numerals can be cut away and a plain dial left. In any case, the worker is advised to buy the complete parcel of wood and the clock at the same time, in order they may be built up complete.

As can be seen, the clockcase is a tall one with an open front. The movement is fitted above and a pendulum swings just in the opening of the main front. Here, too, are the chain and weight with which the movement is wound.

The special parcel of wood supplied is in spanish chestnut, so it can

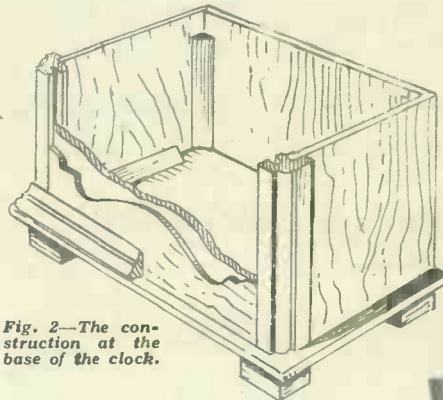

Fig. 2—The construction at the base of the clock.

be left either in its natural state or stained down quite easily to represent oak. The finished clock stands 4ft. 7½ ins. high, is 11 ins. wide and 7 ins. deep from back to front.

The construction has been kept quite simple, and anyone with a fretsaw, tenon saw and a few odd carpentry tools can complete it in one or two spare evenings. Most of the parts required are shown to scale on the design chart, but where there are definite curves and shapes to be cut these are shown full size. This saves the trouble of drawing out for the pieces of paper can be pasted direct to the wood, and cut out with a fretsaw.

All of them are quite thin material—only 3/16 in. thick in most cases.

CLOCK

from Design
Chart No. 1997

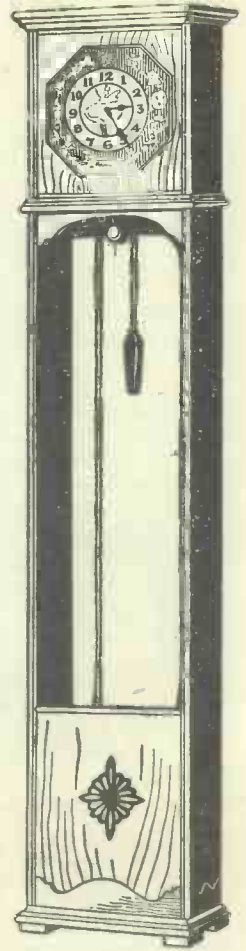

REQUIRED

cel of good quality spanish
d for sides, sufficient grooved
d ornamentation, as well as
ret ready cut for the front,
clock movement with fancy
ys costs 2/11. Carriage on the
clock 6d. A complete parcel
plied for 13/6 carriage paid.

The largest parts are the two sides which are 54ins. long and 6ins. wide cut from 3/16in. plywood. Cut off two pieces of moulding the same length, and test that the sides fit into it satisfactorily. These two pieces of corner moulding form the front edging. The back is made up of a piece of

exactly 28½ins., but it can be easily tested on the work itself. To make the carcass rigid the top and bottom can be added, and in order to strengthen, fillet pieces can be glued flush with the edges as shown by the detail at Figs. 1 and 2.

3/16in. ply 54ins. long and 9½ins. wide.

In the design of this part shown to scale on the chart, a circular opening 6ins. in diameter let down from a centre 6ins. from the top is shown. This provides access to the back of the clock, but if the movement is put on the front before that part is put in, the circular opening can be omitted. Or, of course, if the circle is cut out it can be kept and returned in place as a door if thought fit. The front has only two main parts shown as the top front and the lower front.

The Framework

The latter is a piece of 3/16in. plywood 12×9 which also fits in the moulding of the corners. The top front is given full size because it has not only a shaped bottom edge, but also an opening through which the clock movement itself passes. Thus we have two pieces for the front, two sides and a back, and they can be tested into their respective positions before being finally glued together. Get the back cut dead square with straight edges and glue it be-

Ornamental

The floor and the top are both the same size, and cut from ½in. wood measuring 11ins. long and 7ins. wide. Glue them flush with the back of the clock-case, but with an equal projection on each side and at the front. They are glued, of course, not only to the edges of the carcass, but also to the various blocking pieces put round inside (see Figs. 1 and 2.)

Under the top and above the floor are strips of ornamental moulding passed round. In order, however, that this may lie flat, a filling piece ½in. thick must be glued on first so the moulding itself may come flat over the corner moulding (see Fig. 3.) These filling pieces are 1in. wide at the top, glued immediately beneath that part and close up to the corner moulding. On to this surface is glued three pieces of the fancy moulding shown (No. 303). It is mitred at the

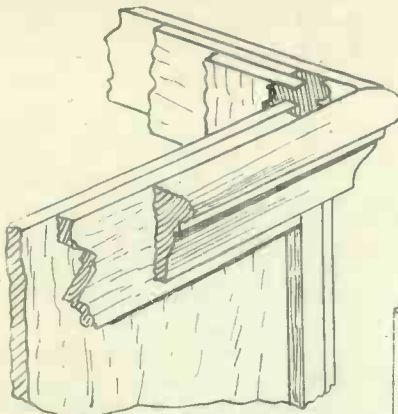

Fig. 3—A detail of the filling pieces with the fancy moulding over it.

tween the two sides, strengthening the corner with a long strip of triangular fillet.

The two pieces forming the front are glued flush with the top edge of the moulding. Between them a filling piece 28½ins. long and ½in. wide is glued into the groove of the moulding. The actual measurement may not be

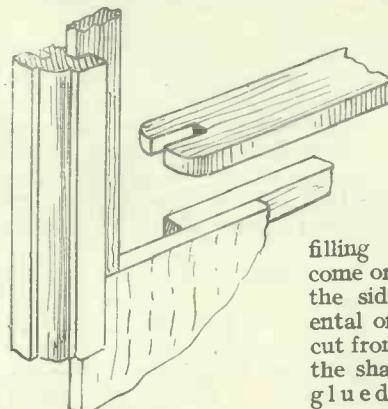

Fig. 4—How the flat rail is fixed across.

two front corners, but left flat and flush with the back edge.

On the floor at the extreme bottom the filling pieces which come on the front and the sides are ornamental ones. They are cut from ½in. wood to the shape shown, and glued on to the respective parts mentioned. Again, some



Many League Clubs, Schools and Literary Societies get good fun from a Debate. Here is how one should be conducted.



THE rules of each debating society vary in different particulars, but the fundamental foundations of a debate are in every case the same.

First, a definite substantive motion is set down for debate. The motion should commence with the word "That" and continue with the ultimate opinion of the meeting if the proposition of the mover of the motion should be unconditionally accepted.

Begin with "That"

For instance, suppose that the question to be debated is:—"Should the police be armed?" the motion should be worded either: "That the police should be armed" or "That the police should remain unarmed."

The speaker to open the debate must be the one who asks the meeting to accept the proposition framed in the motion. He should first outline the motion generally before making any points in the presentment of his argument. The first speaker, i.e., the proposer of the motion, is called the Opener.

Two First Speakers

The Opener is usually followed by the Opposer, who is followed, in turn, by the Seconder for the motion and the Seconder for the opposition. In some societies the Opener is followed by his Seconder, and the Opposer, by his. Sometimes there are no Seconders at all, the main work being done by the Opener and the Opposer.

All Can Speak

After the chief speakers have concluded, the Chairman declares the debate open to those other persons who are present.

Once the debate has been declared open, anyone present may speak. Usually the rules provide that each person shall speak only once; even if they do provide thus, a past speaker is always allowed to say a few words on a point of personal explanation. This arises when a later speaker answers a suggestion made by the earlier speaker, and in doing so, varies what the earlier speaker actually said.

Summing Up

When all those persons who desire to speak have done so, the Chairman invites the two leaders, (one for each side) to sum up generally. In some societies (and in the House of Commons) only the opener is permitted to speak after the debate has been closed to the public. In any event, the first speaker is always entitled to the last word.

When a speaker sums up generally, he is not allowed to introduce new matter. He is merely

permitted to consider those points which have been raised against him, and to deal with them finally. He is also permitted to sum up the points in his favour (which have been mentioned before) and to compare them with the points raised against him.

The Chairman's Chance

After this, the Chairman should commence his summing up. This summary should include all the main points of each side. According to the rules of some societies, the Chairman is permitted to include in his summary his own personal views. He is, however, always obliged to remind the assembly of the points against these views.

And Help

He is permitted to direct the members that certain of the propositions which have been advanced have been inadequately supported (if he does this he should give his reasons). But he cannot compel the audience not to accept the propositions. He may, however, declare that certain points are entirely irrelevant, and direct the voters not to consider these points in determining the question before them. The voters should abide by this direction.

The Voting

The Chairman should point out that each voter, if voting for the motion, should be satisfied beyond all reasonable doubt that the suggestion of the proposition are correct. If there is any doubt at all the vote should be given to the side resisting the motion.

In some societies the Chairman is allowed to vote, in others he has not the privilege. In still others, he has only a casting vote, and in some others he has a second or casting vote.

"Aye" or "Noe"

The Chairman should take the vote by asking those in favour to shout 'aye' and those against to shout 'noe': when these two sounds are uttered simultaneously, one of them become predominant, the Chairman should then say: "I think the 'ayes' (noes) have it." If there is no opposition received he should continue with "The 'ayes' (noes) have it."

The Closure

If there is opposition, or a request for a division before he has declared the final result, after declaring the provisional result, the Chairman should take the individual votes of each member.

When the Chairman has announced the result, he has only one more duty and that is to declare the meeting closed.

A NOVEL CLOTHES AIRER

THE illustration shows the clothes airer fixed on a kitchen wall. The design of this airer is unique as it will accommodate the greatest number of clothes with the least possible inconvenience. It eradicates the encumbrances of a clothes horse and the trouble of raising and lowering a ceiling airer. When not in use, it rests flat against the wall and is inconspicuous.

The size of the airer to be described is large enough to air two dozen clothes at once and by reason of the moving arms no one piece of material touches another, thereby allowing the warm air to pass freely between the clothes. It is made almost entirely of dowelling, i.e. lengths of specially prepared wood, and can be obtained by consulting *Hobbies 1934 Handbook*, page 132.

To Make the Arms

Twenty-four arms are required for the airer illustrated in Fig. 1, but the individual can vary the number as he wishes providing he makes the frame and axis on which they swing long or short enough to receive the number of arms decided upon.

Obtain one dozen 3ft. lengths of dowelling of diameter half an inch and saw each one through the centre to make two pieces exactly 1ft. 6ins. long. Then file one end of each piece round, as shown in Fig.

3, and glasspaper them smooth. Next obtain a piece of any kind of wood, preferably beech, about 3ft. 6ins. long by 1in. square (the last two measurements must be exact). Now mark this off into twenty-four 1½in. lengths allowing ¼-in. between each length for sawing.

You should then be able to see twenty-four oblongs 1½ins. by 1in. marked out on your wood. Draw the diagonals across these oblongs

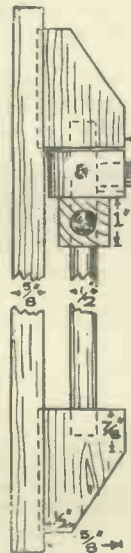
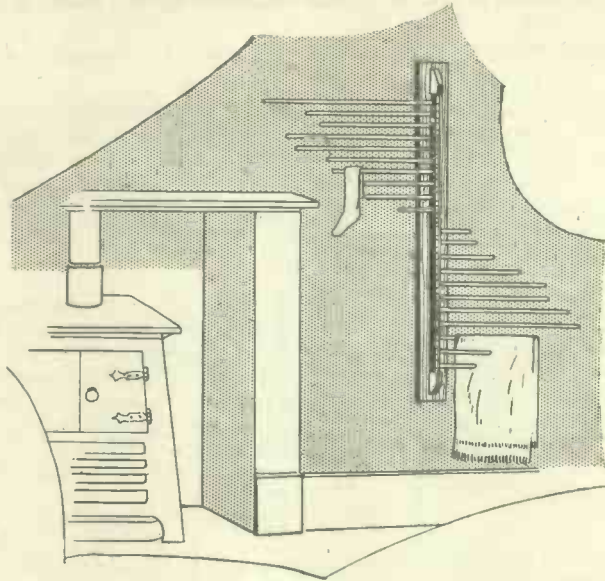

Fig. 1—Dimensions of various parts.



Fig. 3—One of the arms and cleat.



The pieces of dowel rod which have already been prepared, as explained above, can be glued very carefully into these holes. The arms are then finished.

The Back Board and Axis

Prepare a piece of ¾-in. wood 2ft. 6ins. by 2ins. for the back board which is to be fixed to the wall and on it mark out two slots exactly 2½ins. by 1in. at a distance of ½-in. from each end to receive the cleats (see Figs. 2 and 3). Cut these slots to a depth of ¼-in.

Next obtain two pieces of wood each 2½ins. by 1¼ins. by 1in. for the cleats. Test them to make sure that they will fit into the slots which have been cut in the back board. Mark out and cut the bevels 1¼ins. long by 1¼ins. wide. Use a tenon saw and a smoothing plane to do this. The holes in the cleats which hold the axis must now be bored. It is important to do these very accurately or the arms will not swing freely. The centre of each should be ¾-in. from the front edge of the cleat and in the centre of the wood when measuring across it. Bore these holes ½-in. diameter and ½-in. deep.

(Continued on page 436).

and where they cross each other bore ½-in. holes right through the wood. You must be very careful to get the holes perfectly upright. Next saw off the oblong pieces and shape the end of each piece to a semi-circular pattern.

Use a chisel for this purpose and finish it off with a spokeshave. If you do not possess a spokeshave a file and glasspaper are quite useful. The next job is to bore ½-in. diameter holes in the centre of the square end of each piece to a depth of ½-in.

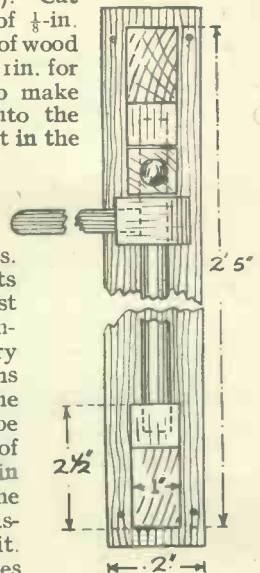

Fig. 2—A front view with one arm in place.

OUR GREAT COMPETITION

ONLY about a fortnight now before the closing of our monster fretwork competition. Don't be too late, because you stand a chance to win a motor bike or one of the 100 prizes offered.

Think of it—a New Imperial Motor Bicycle value 27 guineas going to somebody for a few hours work. Imagine it coming to your house! Isn't it worth a shot?

And even if the motor bike isn't yours, there are plenty of other prizes worth trying for. There is the Billiard Table shown below—one of Riley's famous Home Tables—a Hercules and a Royal Enfield cycle, a gramophone, Adana printing presses, volumes of "The Amateur Mechanic," as well as fret-machines, outfits, tools and a number of fountain pens and consolation prizes.

ALL you have to do is cut out the simple Calendar from Design No. 1983. This was given with Hobbies Weekly of October 21st last year, but copies are still obtainable for 4½d. post free. The prizes will be awarded for the best cutting and finish. The work can be left in its natural wood or given a polished surface as desired.

A special parcel of wood is also obtainable for the parts required. It contains planed mahogany and whitewood and costs only 2/2 (with 6d. extra if you order by post). This parcel is sold at all Hobbies Branches or ironmongers, or is, of course, to be had direct from Dereham, Norfolk. The little calendar pad for use with the design in a set

of bright celluloid cards with numbers and days and months in bright blue. These can be altered for any date, so the calendar will last for years before they are worn up. The complete set is 9d. only, and you should ask for Cards No. 6161 when ordering.

HAVING cut and completed the piece of fretwork, fill in the Entry Form in this or another issue of Hobbies Weekly. Put it with your competition entry, and pack both carefully so they are not damaged. Send them in before February 17th, addressed to The Competition Dept., Hobbies Dereham, Norfolk.

Judging will be undertaken as quickly as possible, the results announced in these pages and prizes despatched immediately.

CLOSING
DATE

FEB. 17th

OVERSEAS JUNE 30th.

FOR overseas readers there is a special list of prizes and in order to give them time to get the entries in, the closing date has been extended to June 30th, 1934. This section has 50 prizes in it, the first being an H.M.V. Portable Gramophone, value £6.

Everyone stands an equal chance. Do not be afraid that your work is not good enough—somebody has to win the prizes, so why not you?

Send along for your design and wood now, or if you want further particulars, write to Dereham or call at a Hobbies Branch for an illustrated leaflet.

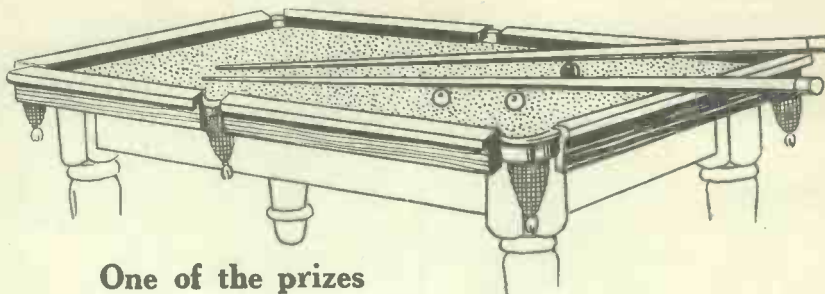

One of the prizes

A Clothes Aired—(continued from previous page)

Fixing the various parts together is a very simple job. Obtain a piece of dowel rod 2ft. in. long for the axis and glasspaper it so that it will pass through the holes in the arms easily. Then string the twenty-four arms on to it by passing it through the holes in them. Next glue each end of the axis for a distance of ½-in. and fix into the holes which have been previously made in the cleats. Then glue the cleats into the slots on the

back board and drive four screws through the back of the board, two into each cleat, to prevent the cleats pulling away from the board.

The aired is then finished and all that is needed is to fix it to the wall with four strong screws passed through the back board into plugs placed in the wall. Good strong screws are needed for this purpose on account of the weight of the clothes to be hung on the aired.

A NOVEL MONEY BOX

The model is made in any fretwood, and the little terrier stands out in front of his kennel in realistic fashion.

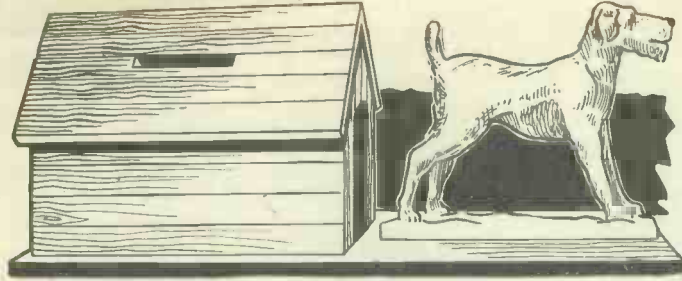

HERE is an article that all our thrifty fretworkers should make up—a doggy money box. It is of ample dimensions and will therefore hold quite a lot of savings and when full may be unlocked from the back, a nice little business-like padlock holding the door secure.

The Kennel Box

In making up the money box the base will first be set out and cut round with the fretsaw. A piece of 3/16in. wood will have an oblong drawn upon it 8 1/4 ins. by 3 1/8 ins., care being taken to get the angles square by means of a set square and rule.

Clean the edges up with sandpaper and then lay

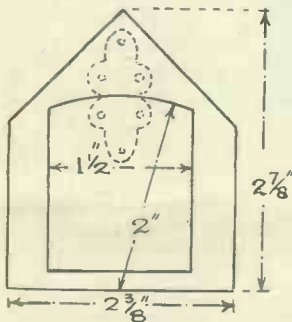

Fig. 3—The ends of the kennel, as described in the article

It is not like the idea of cutting the pages of their Hobbies, thus the idea of giving the pattern of the dog full size so that it may be traced easily.

Take care to get the pattern well covered with the paste so that it sticks down evenly all over—that is, of course, if the paper is to be left on the wood. If it is decided to remove the paper, however, after cutting out, it may be found possible to gently peel it off and then finally to clean up the surface with fine sandpaper.

Colour over the Paper

By allowing the paper to remain on the wood a better surface is presented for colouring up with water colours.

It will be noticed that a tenon is worked on the stand of the dog 1 1/4 ins. long, and when this has been cut the piece may be laid on the base of the box and marked off, a distance of about 1/4 in. being allowed from the front of the stand on the dog's feet to the front edge of the

base. This is seen in the sketch at the head of this page.

Do not glue the tenon in the slot yet until the kennel has been made.

The kennel consists, as the sketch Fig. 2 shows, of two sides, two ends and two roof slopes. The sides are alike and are cut from 3/16in. stuff 4 ins. long by 1 3/8 ins. wide, the ends, in the form of gables, are cut to the sizes given in Fig. 3.

Set one of the ends out first either on paper or direct on to the wood. If on paper, the various points may be afterwards pricked off and then lined up on the wood, or again, the paper may be stuck down to the wood and cut round with the fretsaw.

A parcel of all material, in planed fretwood, ready to mark and cut out is supplied by Hobbies Ltd. Parcel No. 228 price 6d., or sent post free 9d.

The two roof slopes where they meet at a point form a right angle thus making it simple to get the true slopes by means of a set square after measuring up 2 7/8 ins. up the middle of the piece. In one of the ends there will be formed a door as shown; cut round the outline of this door and then fix it again in its original position by means of a pair of small brass hinges screwed on the face of the wood as in the detail Fig. 4.

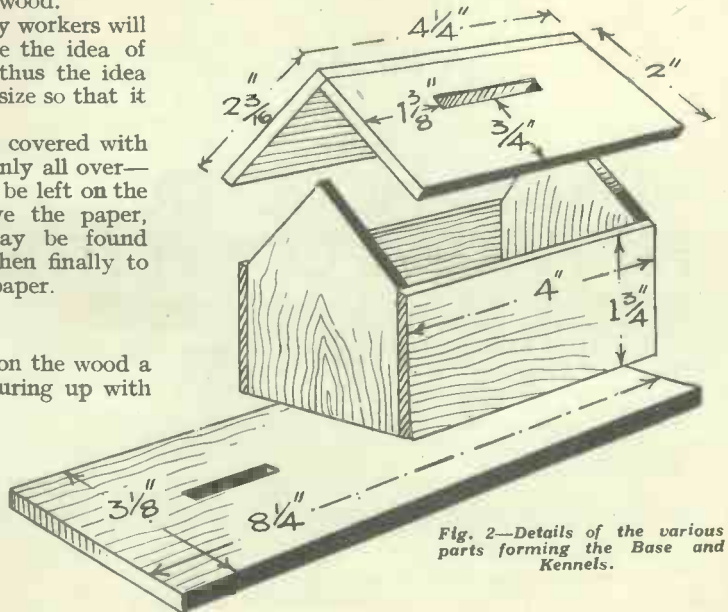

Fig. 2—Details of the various parts forming the Base and Kennels.

Novel Money Box—(continued)

The ends of the kennel may now be glued in between the sides, care being taken to get all angles square and the bottom edges level so that they stand evenly upon the base. Now glue the kennel to the base, leaving a space of about $\frac{1}{4}$ in. clear from front to edge as in the detail Fig. 4.

One or two screws run through the base into the sides and ends will help to make all secure. Two roofs will next be made and these are again from $\frac{3}{16}$ in. wood, one being $\frac{3}{16}$ in. wider than the other and both being $4\frac{1}{2}$ ins. long.

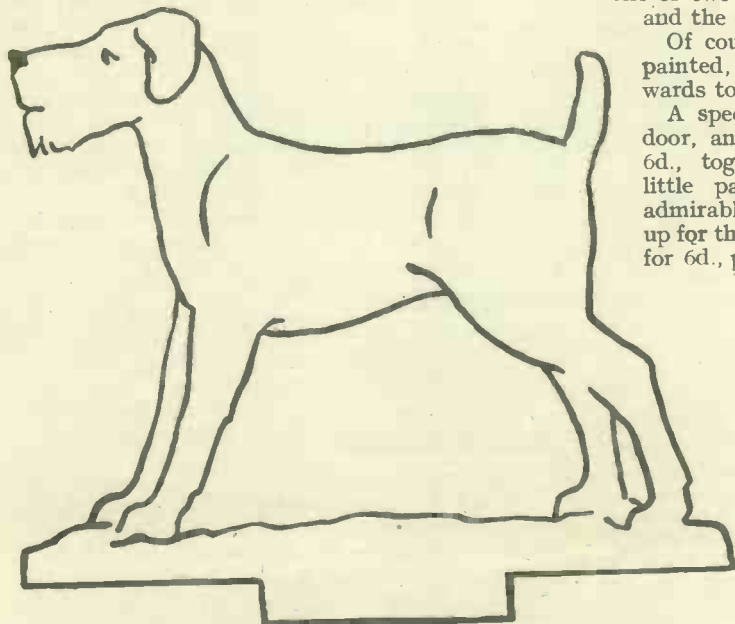

Fig. 1—A full size drawing of the dog, which can be traced off to the wood.

They will be glued together as shown in Fig. 2, and one of the pieces will have a slot cut in it for the coins to drop through. Glue them to the ends and the sides, the extreme top edges of the latter being chamfered off with a small plane or a file so as to make them fit the roofs.

As a finish to the article it is suggested that two coats of clear varnish be given, the first coat to be gently rubbed down with fine sandpaper before the second one is applied.

The dog might also be varnished after lining up in one or two places such as the mouth and eye and the ears with Indian ink.

Of course, the dog would look well if painted, and a coat of varnish given afterwards to preserve the surface.

A special catch will be required for the door, and that sold by Hobbies, No. 5478 at 6d., together with the beautifully made little padlock No. 20 price 1/-, will suit admirably. A parcel of wood has been made up for the money box, and this may be had for 6d., post free 9d.

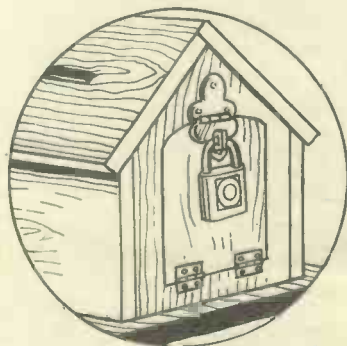

Fig. 4—A detail of how the door is hinged and locked.

HOBBIES MONSTER FRETWORK COMPETITION

Entry Form

Herewith is my entry for the Monster Competition, and I agree to abide by the judge's decision and the rules set out in Hobbies Weekly. *I enclose postal order value..... for return of the entry as soon as possible.

Name

Address

.....

.....

*Strike out this sentence if you do not want the entry back.

Please fill in these particulars, although not essential.

Age..... League No.....

Chief Hobby

A **Grandmother Clock**—(continued from page 433) of the fancy moulding No. 303 is mitred and glued round, so forming the complete ornamental base and top.

It will be noted that there is a slight gap at the corners where this fancy moulding projects beyond the actual corner moulding itself. This little hole can be easily filled with plastic wood, and then filed or chiselled level with the top edge of the moulding. A further ornamental rim is added to the carcass of the clock below the face. As before, it consists of a filling piece and the piece of moulding—this time with the moulding inverted in the same form as before at the base.

Ornamental Edging

Draw a line across the top front $\frac{3}{16}$ in. above the centre of the shaped bottom edge. Complete this line round the sides of the clock with a light pencil mark. This forms the position of the filling piece which can be glued on—taking care to see it is horizontal all round.

To make a neat finish to the lower front, a flat strip rail is added. This is a piece of $\frac{1}{2}$ in. wood $8\frac{1}{2}$ ins. long and $\frac{1}{4}$ in. wide. Its front edge should be rounded slightly to take off the sharpness. A slot is cut at both ends in order to allow the part to slip over the filling piece in the groove. It is glued

to the upper edge of the lower front, and is strengthened underneath behind by small blocking pieces shown. A detail of its position is given at Fig. 4, and it can be clearly seen in place in the picture of the finished clock.

In the parcel supplied is an ornamental fret cut from very thin wood ready to glue on. This is the Hobbies No. 803 and those who are making up the clock from their own material can easily obtain one of these, or another shape independently. They are illustrated in the Hobbies Handbook where also are given particulars of the moulding required for the work. Four deal blocks form the feet, and they are cut $\frac{1}{2}$ ins. square from $\frac{1}{4}$ in. thick wood. All four are glued under the floor of the clockcase, set back from the corners $\frac{1}{4}$ in. as shown by the underneath view at Fig. 5.

Fixing the Works

The clock movement is fixed in from the front, the face being held with four small round headed screws. When the movement is fixed, hang on the pendulum by slipping it over the flat metal strip on the movement. One end of the chain holds the weight, whilst the other hangs down to wind up the clock. To make a nicer pendulum the worker can fix on one of the small round wooden toes, or feet of Hobbies, and stain it.

RAILWAY NOTES AND NEWS

OIL ENGINES VERSUS STEAM

THE fight for efficiency between the oil engine of the Diesel type and the steam engine still continues. It is by no means settled in complete favour of the internal combustion engine, and for very large powers the steam engine reigns supreme.

Certainly the Diesel engine has ousted out the old-fashioned slide-valve cylinder steam driven machine and even larger engines using poppet valves, superheating and condensing, unless they are very carefully designed can be very easily displaced by a Diesel.

One of the latest Power plants made in about nine sizes from 40 to 430 B.H.P. by Marshalls of Gainsboro' are known under the name of the "Locomobile" steam engine. The units are built with the cylinders fixed on top of the boiler, like in a traction engine. The idea is not only to save space but the cylinder or cylinders, in the case of a compound engine, being mounted on the warm boiler can be maintained at its proper working temperature. All parts are also very readily accessible, and with a reasonably good grade of Welsh Steam Coal one brake horsepower can be

obtained from an expenditure of only one and one-tenth lbs. of fuel per hour.

This up-to-date super-economy steam plant is fitted with a superheater to both heat and dry the steam before it enters the cylinders, a feedwater heater to raise the temperature of the supply nearly to that of the boiler, and a jet condenser for the purpose of creating a vacuum on the exhaust side of the engine, to get the utmost value from every pound of steam.

LIGHTNESS IN POWER ENGINES

THE oil or petrol engine, of course, scores where the total weight has to be studied. The idea in the war time was to get an engine which should only scale 1 lb. in dead weight per Brake horse power developed. It was not quite achieved—at least the essential degree of reliability could not be guaranteed—when this figure was approached.

Therefore, there is no doubt about the continued success and use of the Diesel or the petrol engine for cars, aeroplanes and small power units where reduction in weight is important.

It is in rail traction where the fight between steam and oil is most acute at the present moment.

THE NEW GREAT WESTERN RAIL CAR

THIS Streamlined rail motor is now on its service trials on the main line of the Great Western Railway. The chassis tests were made near the Southall works of the AEC, the establishment which builds the London omnibuses.

The new motor is driven by an ordinary Diesel 'bus engine.

These engines with all essential equipment, flywheel, electric starter, motor and generator, weigh round about 15 lbs. per horse power.

The car is carried on two bogies, one of which is the driving one. The 130 H.P. engine is placed on the left-hand side, and is connected through a fluid flywheel and Wilson gear box to the outside of the axle boxes.

The car can be driven from either end, and carrying 69 passengers and luggage at 60 miles per hour weighs in working order only $13\frac{1}{2}$ tons. The "Castle" locomotive in the picture alongside the AEC. car totals 120 tons.

MISCELLANEOUS ADVERTISEMENTS

are accepted for this column at the rate of 2d. per word, Name and address are counted, but initials or groups, such as E.P.S. or £1/11/6 are accepted as one word. Postal Orders or Stamps must accompany the order.

CINEMATOGRAPH Films and machines—Standard size—Lists free—Sample 1/-.—Filmeries, 57 Lancaster Road, Leytonstone, E.11.

VENTRILLOQUISM TAUGHT by post. Wonderful System. Failure impossible. Send stamp for First Lesson Free.—“Valmonde Institute,” 17 Balmoral Road, London, N.W.2.

BUMPER PACKET FREE. 150 different Stamps, includes scarce Pictorials, South West Africa, Rare Stamp Cat. 1/-. Ask to see Approvals.—Smith Bros., 90 Penrose Street, S.E.17.

DRUM Heads 5/- or 7/- post hoop, lapped free.—“Potters,” 36 West Street, London, W.C.2.

GRAMOPHONES, Radiograms, 64 pages How to Make Them, 3d. Motors 6/6. Arms, Speakers, Horns, Springs, Repairs, Pickups, Wireless, Accordians, Violins.—Regent Hob, 120 Old Street, London.

PATENTING INVENTIONS. Handbook free.—King's Patent Agency Ltd., 146H Queen Victoria St., E.C.4.

STAMPS! Halfpenny approvals. 500 sent.—Wyk, 3 Seymour Grove, Manchester.

MORSE TRANSMITTING AND RECEIVING SET. Complete. Post free 2/6.—Parker & Cannell, 216 Bethnal Green Road, E.2.

CIGARETTE CARDS. Lists free.—Gooding, 354 Norwich Road, Ipswich.

POCKET STAMP WALLET FREE.

Size 5½ × 3½ (with strip pockets), Packet of Mounts, Perf. Gauge and a FINE EMBARGO Collection of 25 Soviet Russia Pictorials. Many fine sets. All free to genuine Approval applicants sending 2d. postage (with-out Approvals 1/6).

North Wales Stamp Co. (Dept. H.) 25, Lawson Rd., Colwyn Bay



Boys! Look!

Famous “XLCR” Stamp Outfit is unbeatable value. Contains: Pair Tweezers, Water-mark Detector, Pocket Wallet (Strip pockets) Perforation Gauge, Approval Book (120 spaces), 125 stamp hinges, 5 transparent envelopes. Price list and a free set Pictorial Stamps. All for 6½d. A British-made marvel. Ask your shop. If any difficulty in obtaining, write to

THOMAS CLIFFE, Colwyn Bay.

STAMPS FREE!

100 different, and 2 Air Mail stamps, FREE for 1½d. postage. Mention Gift 29. Approvals, any country, 50% to 75% discount.

A Collection of Stamps makes an Ideal Present

500 stamps from many countries, all different	1/6
2,000 „ from all over the World	13/6
300 „ of the British Colonies	5/-
1,000 „ ditto. (A grand Collection)	4s/-

New list of over 1,000 long sets, free on application.

BRIGHT & SON, 167, Strand, London, W.C.2.

A Mitre Block with Metal Guides

Better than the all-wood block. The saw cuts a clean mitre. 12in. block has extra guide for cutting at right angles.



10in. 2/6

HOBBIES LTD., DEREHAM 12in. 3/6 post 6d.



No. 700b.

12 ins. square, 9 ins. opening. 9d. Post, 6d.

SPEAKER FRETS

Frets for your Radio cabinet cut in good quality Birch Plywood 3/16in. thick. Not just ordinary frets but good enough to use on first class jobs. We have others of equally interesting design. Write for list or call at any Hobbies Branch.



No. 700c.

12 ins. square, 9 ins. opening. 9d. Post, 6d.



No. 701a.

16 ins. square, 10 ins. opening. 1/1. Post, 6d.

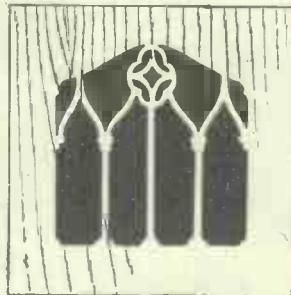

No. 702a.

18 ins. square. 12 ins. opening. 1/3. Post, 9d.

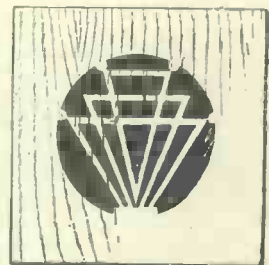

No. 701b.

16 ins. square, 10 ins. opening. 1/1. Post, 6d.

**HOBBIES LIMITED
DEREHAM, NORFOLK**

Branches in London, Glasgow, Manchester, Leeds, Birmingham, Sheffield, Southampton and Brighton.

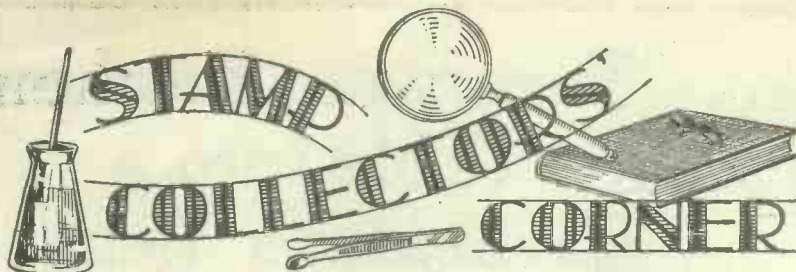

STAMP COLLECTOR'S CORNER

A further article in our series of interesting particulars specially written for the beginner. Back numbers of the earlier articles are still obtainable.

EVEN the beginner is aware that all stamps are not postage stamps. Stamps of one kind or another are used for many purposes, chiefly for collecting fis-



A French Air-mail Stamp.

cal or revenue duties. There are people who collect fiscal stamps (which can no doubt be very interesting) but they are in a small minority. The great mass of collectors representative of the almost universal hobby of Philately are only interested in stamps which serve some definite purpose in connection with the postal service.

Even among postage stamps there are many different classes or kinds serving a variety of postal purposes. The postage stamp you purchase at a post office for affixing to a letter or card to prepay the message to its destination may be regarded as the ordinary kind of postage stamp. We sometimes speak of it as an "adhesive," to distinguish it from envelopes, cards or wrappers bought with the stamps already printed upon them and which we call "stamped stationery." It must be admitted that



Commemorating Queen Wilhelmina's 25 years Reign.

adhesives are the favourites with collectors, stamped stationery being bulkier and not so convenient to collect and arrange.

OUR ordinary stamps are inscribed "Postage and Revenue" and so are those of most of the British Colonials. That implies that they serve to some extent either for postal or fiscal purposes. We collect them either unused, or postally used; we have little or no use for them fiscally used, which is generally denoted by a pen-cancellation or a rubber-stamp obliteration.

In addition to ordinary stamps there are stamps issued for some special service or purpose, and



A Vienna Exhibition Stamp.

which may be grouped in about a score of distinct classes. The chief of these I shall explain briefly in this article.

A FEW countries have used stamps to prepay the fee for the acknowledgment of receipt which the post office transmits to the original sender of a letter or packet. The Republic of Colombia issues such stamps, several other American countries also; and the former stamp-issuing country of Montenegro had them. They are called "Acknowledgment of Receipt" stamps and generally bear the initials A.R. prominently in the design.

Air Stamps are those issued to be used in connection with mail carried by the various air mail services. In England we just use



A Receipt Acknowledgment.

ordinary stamps on air-mail letters but many countries issue special stamps, and these form a large and very popular group of stamps with collectors.

Carriers' stamps were used in early days in America to pay fees on letters carried to addressees' houses at a period when the government post only delivered letters to the post office and people normally had to call and collect them. They form rather a rare class of stamp.



A Luxemburg Charity Stamp.

POSTAL administrations frequently lend a hand in collecting small sums for charitable, philanthropic or propaganda purpose. This is often done by issuing special stamps which may be used for postage, but are sold for a charge higher than the postage. The Post Office collects the extra charge on behalf of the charity, but keeps the postage charge for its own revenue.

New Zealand each year issues a 1d. "health" stamp which is sold at 2d., the extra 1d. being the charity contribution. The Swiss children's stamps issued each year are pretty and popular examples



Commemorating the Huguenots in U.S.A.

of charity stamps. Note: If the stamps were never of any use for postage they cannot be regarded as postage stamps at all, and would not figure in the stamp catalogues.

(to be continued)

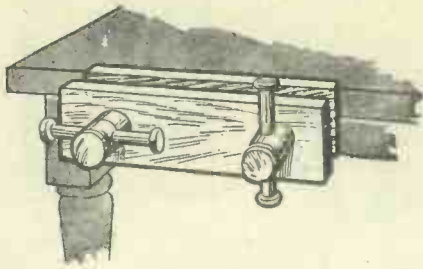

Turn your Kitchen Table into a Carpenter's Bench

A NECESSITY FOR THE HANDYMAN

Every woodworker knows the need of a vice to hold his work, and even if he does not own a carpenter's bench he can now make an excellent substitute on the kitchen table. The strong vice illustrated is fixed to any table with two screws (the holes can be just seen in the picture) through the backboard. Made throughout of strong hardwood—an absolute bargain at the price.

The vices made throughout of hardwood, and the double action screw will hold the wood absolutely tight. The whole thing can be easily fixed to a table and serves for a hundred and one jobs for the handyman.



Ask for Hobbies at any ironmongers or hardware stores.

HOBBIES BENCH VICE

12ins. Long - 2/3

15ins. Long - 3/3

Postage 9d. extra on each.

From Hobbies own branches in London, Glasgow, Manchester, Birmingham, Sheffield, Leeds, Southampton, Brighton.

HOBBIES LTD.—DEREHAM—NORFOLK

For all kinds of Woodwork, use

HOBBIES BRITISH FRETSAW BLADES

THEY LAST!

Mr. J. J. Broughton of Athlone, Ireland, wrote on July 14th, "I have completed one of the Model Altars, and a Wireless Cabinet with overlays, with one blade (No. 4) obtained from you some time ago. The blade is still good."

Used all over the world because they are the best

Look for the Coloured Label

BLUE LABEL	YELLOW LABEL	SILVER LABEL
4 1/2^{D.}	6^{D.}	9^{D.}
Per Doz.	Per Doz.	Per Doz.
4/- Gross	5/6 Gross	8/6 Gross

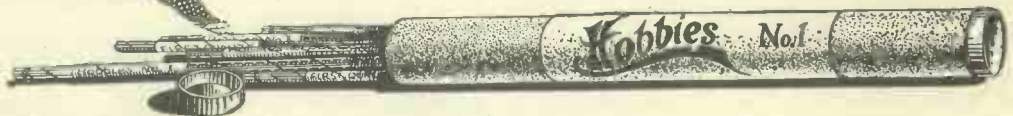

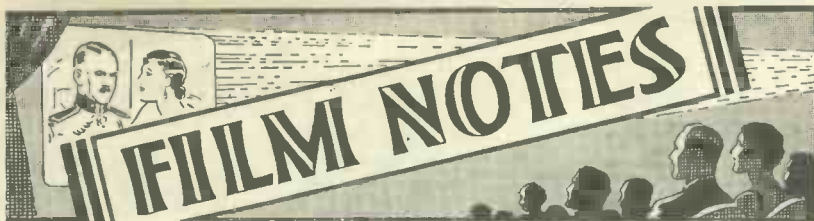

FILM NOTICES

Intimate chat of
people and pictures
which will interest
any film goer.

—BY CINEFAN—

A Home-made Town

"I WAS A SPY" is a film that should be seen by everybody; it has received unstinted praise from critics all over the country, and has, in fact, been described as the best picture to be produced in this country. Herbert Marshall, Madeleine Carroll, Conrad Veidt, Gerald du Maurier, and Edmund Gwenn are the stars, and the picture was directed by our "ace," Victor Saville. The work of making a picture of this class is tremendous. Mr. Saville and his colleagues first went to Belgium where they spent some weeks gathering authentic material.

On their return, the Art experts got busy and built, in all, twenty-five magnificent scenes. The most elaborate of these was the reproduction of the market square at Roulers, and for this set alone, which was finally set up in the fields at Welwyn Garden City, 12,500 plaster bricks, 1,400 imitation slates, 3½ tons of nails and bolts, 1,600 feet of railway lines, and nearly 8,000 squares of glass were used.

Submarine Work

AND while we're speaking of British pictures, the same company (Gaumont-British) has



Jack Hulbert below, in a submarine's "works"

recently produced another film of particular interest to mechanically-minded fellows, since a good deal of the action takes place in and

around a submarine that was built at the Shepherds Bush studios. This had to be something more than just a "set," as it was taken down to Weymouth and had to stand a week's immersion in a particularly rough sea. Naval experts supervised the construction of this vessel, and to prove its accuracy in every detail a number of photographs were taken and mixed with others taken on board one of the real boats. These photographs were shown to men with accurate knowledge of submarines, and they were unable to pick out those of the studio set. "Jack Ahoy" is the title of this production, in which Jack Hulbert stars.

Drawing Mickey Mouse

WHAT a lot we're hearing about the Mickey Mouse cartoons lately! They seem to be the outstanding success of the film world. Four years ago Walt Disney, the creator of Mickey, employed only 20 individuals in his small studio at Hollywood; today there are over 200 on the payroll. As a great many of the chaps who enjoy a weekly visit to the cinema are often asking how these remarkable films are made, a few details here may be of interest.

How it is Done

FIRST of all, a "gag" meeting is held at the studios, ideas talked over, and roughly outlined. Scenario

writers compose a regulation script, adaptors break it down into sequences, scenes, and shots, and the scenic department designs the background. Then three kinds of artists begin to work. These are, firstly, the "animators," who sit at two long

Clark Gable had this model of one of his picture planes presented by an enthusiast.



rows of specially made desks and work by light that streams through a central glass. They develop the gags, draw only the beginning and the end of an action. Their sketches are passed to the "in-betweeners," who draw the small delicately graded changes. Then, thirdly, the "inkers" place a transparent square of celluloid on the drawing and outline boldly in ink on the celluloid. Action is photographed by superimposing these transparent drawings over the painted backgrounds which have been placed under a camera.

15,000 to a Picture!

IT takes about 15,000 separate drawings to make one reel of about 700 feet of Mickey Mouse film, and Walt Disney produces 31 films a year. Like Charlie Chaplin, Mickey is understood all over the world because he does not speak. The Germans call him Michael Maus, the French Michel Souris, the Spaniards Miguel Ratonocito, and the Japanese Miki Kuchi. So the next time you are rocking with laughter at a "Symphony" think of the marvellous work put into its making.

Notice the new method of tension on the back end of the top arm. Quite easy, and yet bringing the saw blade taut with a single throw of the eccentric lever.

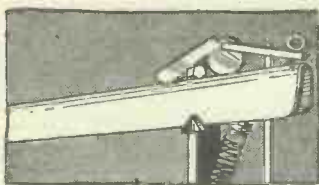

The circular table is polished, and has rounded edges to prevent damaging the work. It can be tilted to either side if required for autofret or ordinary bevel cutting.

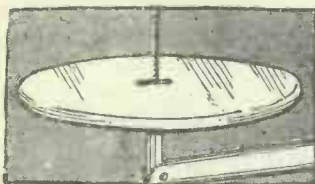

The arms are of steel bent to U shape for strength combined with lightness. A new pattern clamp prevents the saw-blade being put in too short or too far.

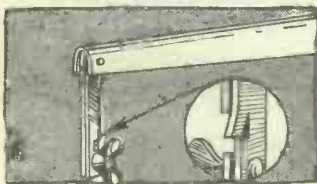

The belt drives in a grooved wheel, and has a firm grip. The balance wheel is heavy, but runs freely on a steel driving spindle.

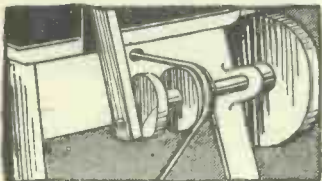

Notice how the treadle is shaped to the feet and properly balanced for easy work. This provides for comfort and reduces weariness.



You don't get tired with a HOBBIES GEM FRET MACHINE

Whatever woodwork you undertake, this latest machine will do it for you easily and speedily. The treadling is so light that the saw travels through wood or sheet metal at an amazing rate, doing the work in about half the time of a handframe. The long arms allow of quite large work, and the strong well-made steel frame makes a machine which will last a lifetime and prove a factory in your own home. Whether for fretwork or ordinary woodwork, the machine will stand up to hard and care-free wear, although any parts can be replaced from stock should it become necessary.

**Complete and
ready to use
for only 40/-**

The machine is in black steel with polished table and arms. All moving parts are easily accessible for oiling. Try one for yourself at any Hobbies Branch. Also obtainable under easy payment terms, supplied on request.



Obtainable through any ironmonger, stores or illustrated leaflets of this and other machines Hobbies Ltd., Dereham, Norfolk.

Hobbies branch. Or free on request to

HOBBIES

LTD.

BRANCHES AND AGENCIES.
Below are the addresses where Hobbies goods can be purchased. In addition, all leading stores and ironmongers stock or can obtain your requirements in fretwork and woodwork, designs, wood, turned legs, moulding, polish, wireless accessories, etc., etc.

HOBBIES OWN BRANCHES—

LONDON - - - - 16 NEW OXFORD STREET, W.C.1.
LONDON - - - - 147 BISHOPSGATE, E.C.
LONDON - - - - 83 NEWINGTON BUTTS, S.E.11.
GLASGOW - - - - 326 ARGYLE STREET.
MANCHESTER - - - - 8 PICCADILLY.
BIRMINGHAM - - - - 9a HIGH STREET.
SHEFFIELD - - - - 4 ST. PAUL'S PARADE.
LEEDS - - - - 10 QUEEN VICTORIA STREET.
SOUTHAMPTON - - - - 25 BERNARD STREET.
BRIGHTON - - - - 68 LONDON ROAD.
CANADA
54 WELLINGTON STREET WEST, TORONTO.

HOBBIES AGENCIES—

Aberdeen.—Jas. Mutch, Ltd., 47 Broad Street; Blackburn.—Mr. H. Mercer, 68 Darwen Street; Bradford.—Messrs. T. Underwood & Co., 13 and 15 Manchester Road; Cambridge.—Mr. H. S. Driver, 28 Hills Road; Canterbury.—Mr. T. D. Goodman, 33 Burgate Street and 16 St. George's Street; Cardiff.—J. Halls (Tools) Ltd., 31 Morgan Arcade; Croydon.—L. H. Turtle, Ltd., 6 Crown Hill; Dover.—Mr. E. F. Rockham, Queen's Gardens; Dublin.—Mr. J. J. McQuillan, 36 Chapel Street; Dundee.—Phins Ltd., 45 Murray Gate; Folkestone.—Mr. W. Allsworth, 16 & 18 Guildhall Street; Hastings.—Mr. W. H. Mozley, 4 York Buildings; Leicester.—Mr. Frank Berry, 3 Loseby Lane; Liverpool.—Mr. C. Lucas, 17 Houghton Street; London.—Messrs. H. Osman, 160 Aldersgate Street, E.C.; Newport, Mon.—J. Halls (Tools) Ltd., 81 High Street; Reading.—Mr. W. J. Sargent, 44 West Street; Swansea.—J. Halls (Tools) Ltd., 8 Gower Street; Wigan.—Mr. Thos. J. S. Clephan, 22 Standishgate; York.—Messrs. J. H. Shouksmith & Sons, 132 Micklegate.

HEAD OFFICE AND WORKS :

DEREHAM, NORFOLK

To really enjoy Woodwork

you must use good Tools

The name of Hobbies is a guarantee that they are good, and any carpenter would be proud to use them. Cheap tools never do good work—here are some you can use for a lifetime—at prices to suit all purses, and every tool British made. Be sure of the best by insisting on Hobbies.

Every Tool is British

RELIABLE TOOL SETS

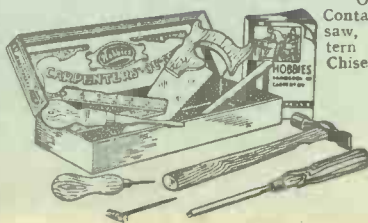

OUTFIT No. 1.

Contains a 10in. Hand-saw, a Warrington pattern Hammer, 3/4-in. Chisel, Screwdriver, 2ft. Folding Rule, Bradawl, Gimlet, a Carpenter's Pencil and a 64-page Handbook.

7/6

Post 9d.

OUTFIT No. 2

Contains a 16in. Handsaw, a Warrington pattern Hammer, Screwdriver, 1/2-in. Chisel, Mallet, Bradawl, Gimlet, Pincers, File, a 2ft. Boxwood Folding Rule, Carpenter's Pencil, and a 64-page Handbook of things to make.



11/6

Post 9d.

OUTFIT No. 3

Contains an 18in. Handsaw, a Mallet, smoothing Plane, a Warrington pattern Hammer, 1/2-in. Chisel, 1/2-in. Gouge, a Screwdriver, Pincers, a File, a Square, 2ft. Boxwood Folding Rule, Gimlet, Bradawl, Carpenter's Pencil, and a 64-page Handbook of things to make.

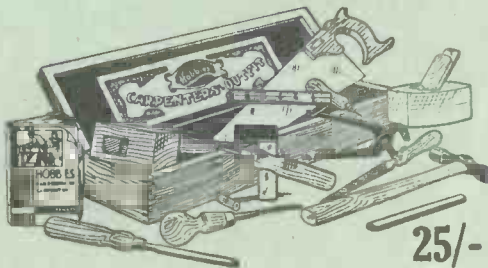

25/-

Post 1/-

Ask for Hobbies at any ironmongers or stores. Hobbies own branches in London, Glasgow, Manchester, Birmingham, Sheffield, Leeds, Southampton, Brighton. Direct by post from Hobbies Ltd., Dereham, Norfolk.

Have you tried TRAYMAKING?

Why not make some trays as Birthday presents for your mother and aunts! A complete parcel of wood, moulding for the edges, handles, and a decorative transfer are supplied cheap and reliable by Hobbies Ltd. All you want is glue and some screws to complete the job. Four sizes of tray are supplied each parcel complete.

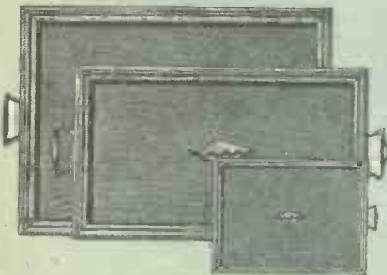

HOBBIES PARCELS

Easy to
make

Complete
parcels
supplied

No. 1 Parcel.

Mahogany faced plywood, 14in. x 11 1/2in. moulding, handles and transfer.

Price 2/6

No. 2 Parcel.

Mahogany faced plywood, 19in. x 11 1/2in. moulding, handles and transfer.

Price 2/9

No. 3 Parcel.

Oak faced plywood, 19in. x 11 1/2in. moulding, handles and transfer.

Price 2/9

No. 4 Parcel.

Oak faced plywood, 20in. x 15in. moulding, handles and transfer.

Price 3/-

Postage 6d. extra on each parcel.

Obtainable from any Hobbies Branch. Or direct from Hobbies Ltd., Dereham, Norfolk. Send for a sample parcel to-day and try one.

MODERN FRETWORK

will interest
Dad and you

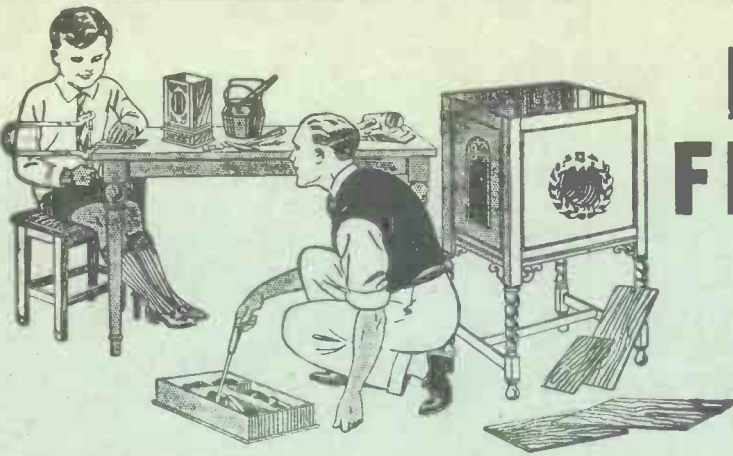

Any handyman can make them

The articles shown below are made from full-size patterns on large design charts. Except where shown, these charts are 4d. each (postage 1d.), and the wood and fittings are supplied complete for the making. The legs are ready turned.

A SMALL STAND

Stands 2ft. 6ins. high—Design No. 1806. Built in Oak, turned legs supplied—Complete parcel 12/6. (Postage 1s.)

A BOOK REST

Length 14ins. Design No. 1715. Built in Mahogany. Complete parcel of planed boards 3/-. (Postage 9d.)

A SLIPPER BOX

Height 15ins. Design No. 1781. In Oak. Grooved legs and corner posts supplied. Price 15/-. (Car. For.)

A MANTEL CLOCK

An 8-day clock in Mahogany. Design No. 1013. Wood complete 2/6. Clock movement 17/6 (Postage 6d.)

AN UMBRELLA STAND

Stands 2ft. 5ins. high. Design 178 Special. (Price 9d.) In Oak. Parcel of wood 13/11 complete. (Car. For.)

A DRAUGHTS BOARD

Draughts board which shuts as a box. In Mahogany and Padouk. Parcel of wood, etc., 4/8. (Postage 9d.) Design No. 664.

A DOLL'S HOUSE

Stands 16ins. high, 10ins. wide. Design 157 Special (9d.) Wood, pillars, windows, etc. Complete 9/4. (Post 1/-).

Hundreds of other similar designs and free charts worth 1/6 are given with the Hobbies Handbook. 268 pages. 20 different pastimes. Price 6d. of any newsagent.

All Hobbies goods are obtainable from leading ironmongers and stores, or Hobbies Branches in London, Glasgow, Manchester, Birmingham, Sheffield, Leeds, Southampton, Brighton.

