

HI-FI WORLD

AUGUST 2014

UK £4.10

www.hi-fiworld.co.uk

FREE READER CLASSIFIED ADS IN THIS ISSUE!



NAIM SUPER NAIT 2
amplifier



QUAD 9AS ACTIVE
loudspeakers



SONY NWZ-ZX1
hi-res Walkman

EXCLUSIVE!

ABBEEY ROAD INTERVIEW

The new Beatles In Mono LPs

COMPETITION



WIN A ROKSAN K2 BT AMPLIFIER WORTH £950! (UK ONLY)

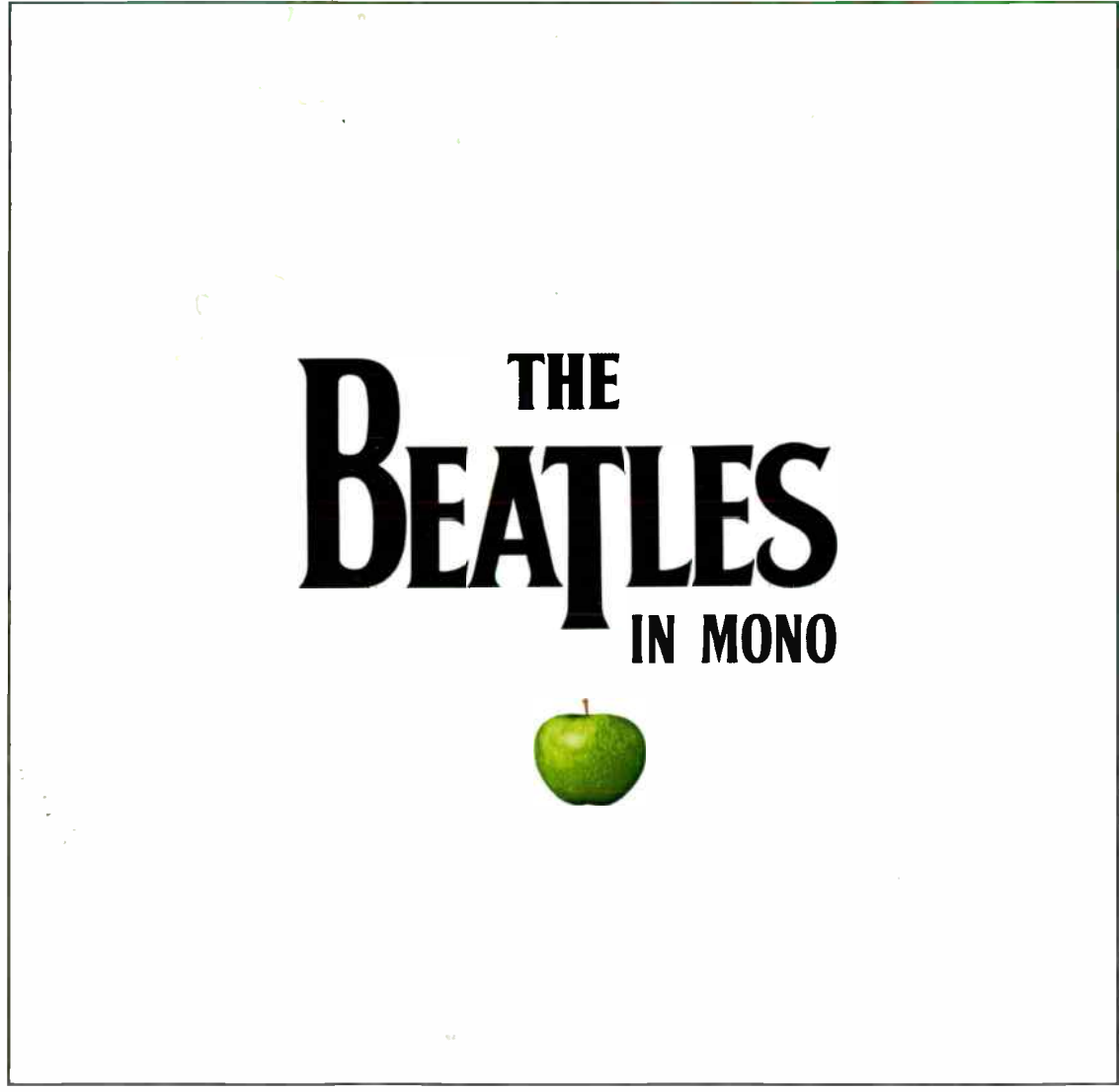

THE BEATLES
IN MONO

08 >
AUGUST 2014
770961 766185

ROHDE & SCHWARZ
MEASUREMENT



JADIS I-35 AMPLIFIER - MUNICH 2014 SHOW REPORT - MCRU NO.127
LOUDPEAKERS - ORTOFON QUINTET BRONZE CARTRIDGE

8 PAGES OF LETTERS - THE BEST WINS A PAIR OF KEF Q100 LOUDSPEAKERS! (UK ONLY)

World Radio History





Paint It Black

New Chord Signature Reference speaker cable.

Now featuring silver-plated signal conductors, PTFE insulation, higher density shielding, greater flexibility and new, improved performance.

Our very first shielded speaker cable has just got a whole lot better - and is also available in black!

Demonstration sets available from all good Chord retailers. Find your nearest at www.chord.co.uk

Hand built in England by music lovers.
Enjoyed by music lovers all over the world.
Now listen.....



THE
CHORD[™]
COMPANY

welcome

EDITOR

Noel Keywood
e-mail: editorial@hi-fiworld.co.uk

DESIGN EDITOR

Faiza Chunara
tel: +44 (0) 20 8206 6018
mob: +44 (0) 7917 047 546
e-mail: adproduction@hi-fiworld.co.uk

PRODUCTION EDITOR

David Noble
tel: +44 (0) 20 8206 6019
e-mail: classifieds@hi-fiworld.co.uk

SALES MANAGER

Louise Palfrey
tel: +44 (0) 203 005 4927
mob: +44 (0) 7917 047 548
e-mail: louise@hi-fiworld.co.uk

ADVERTISING EXECUTIVE

Brad Francis
tel: +44 (0) 1923 677 256
mob: +44 (0) 771 542 1569
e-mail: advertising@hi-fiworld.co.uk

PUBLISHER

Noel Keywood
e-mail: publisher@hi-fiworld.co.uk

FREE READERS CLASSIFIEDS

tel: +44 (0) 20 8 206 6019
e-mail: classifieds@hi-fiworld.co.uk

SUBSCRIPTIONS

tel: +44 (0) 1442 820 580
fax: +44 (0) 1442 827 912
e-mail: hifiworld@webscribe.co.uk

PHOTOGRAPHY

David Noble
tel: +44 (0) 20 8206 6019

WRITERS

Paul Rigby, Rafael Todes, Tony Bolton,
Jon Myles, Martin Pipe



This month you won't help but notice our interest and involvement in The Beatles mono LPs release. The new albums are a technological update to improve sound quality and the historical record. My interview with Abbey Road cutting engineer Sean Magee on p83 teases out the fine details of the thinking behind this ultimate release. Next month we review the new LPs.

Our unique access to this album release comes indirectly through the fact that I've lived close to Abbey Road studios for most of my life, have known people there and have visited many times, welcomed in the past by Brian Southall, EMI director and himself a profuse journo. If you want to know more, get his book *Abbey Road*, available on-line at Amazon – and sitting on the desk in front of me as I type. I use it in conjunction with Mark Lewisohn's *The Complete Beatles Recording Sessions* as a reference. It doesn't pay to get your facts wrong on this topic!

I installed a Quad 33/303 and pair of ESL57s into Paul McCartney's house around the corner from Abbey Road studios many moons ago. Linda McCartney showed me into an upstairs room, the children ran around noisily with the dogs and Paul arrived in his Lambo in suitably impressive style. They were charming and all went well I'm glad to say - nothing blew up – thank heavens for Quad.

Which brings me onto our lead review this month. Quad are alive and well, and their small 9AS powered active loudspeakers – see p10 – suitably impressed us. Connect them to the computer via USB and you're away. Why have the terms Apple and Quad just come into my head?

Also impressive this month were MCRU's No127 loudspeakers. As they played away in our listening room we all came to like them. They were both accurate and exciting – a rare combo. See our review on p36.

The past has come back to haunt us – but that's fine. Turning over a few ghosts for this issue was fun for us – I hope you enjoy it too. The story continues next month...

Noel Keywood, editor.



hi-fi world

Audio Web Publishing
Studio 204,
Buspace Studio,
Conlan Street,
London W10 5AP
www.hi-fiworld.co.uk

verdicts

●●●●● OUTSTANDING
●●●● EXCELLENT
●●● GOOD
●● MIOCROE
● POOR
£ VALUE

amongst the best
extremely capable
worth auditioning
unremarkable
flawed
keenly priced

testing (see www.hi-fiworld.co.uk for full explanations of all our tests)

To ensure the upmost accuracy in our product reviews, *Hi-Fi World* has extremely comprehensive in-house test facilities, and our test equipment - from big names like Rohde & Schwarz and Hewlett Packard - is amongst the most advanced in the world.

Loudspeakers are measured using a calibrated Bruel & Kjaer microphone feeding a Clio-based computer

analyser, using pulsed and gated sinewaves, in a large room to eliminate the room's influence. Pickup arm vibration is measured with a Bruel & Kjaer accelerometer.

No other UK hi-fi magazine has in-house testing, and none has access to such advanced tests across all types of equipment. That's why you can depend on *Hi-Fi World* reviews.



ELECTRONIC MAGAZINE

Go to our website www.hi-fiworld.co.uk to buy an electronic version of this magazine, individual issues, back issues or a subscription.

Distributed by Seymour Distribution Ltd 86 Newman Street London, W1T 3EX Tel: +44 (0) 20 7396 8000 Printed by Artisan Press Limited Tel: +44 (0) 116 235 5221
Our Agents in Malaysia Millennium Hi-Fi & AV Simon Chang Showroom & office, 500-1-3 First Floor Wisma Indah (Shen Court), Jalan Tun Razak 50400 Kuala Lumpur, Malaysia
Tel: 603 9283 8171 Fax: 603 9281 3762 e-mail: info@millennium-audio.com

All unsolicited submissions and goods are at the owner's risk. We accept no responsibility for such submissions, nor do we undertake to return them.
No material may be reproduced from this magazine without the publisher's written permission. © Audio Web Publishing Ltd

contents



LOUDSPEAKERS

QUAD 9AS ACTIVE LOUDSPEAKERS 10

Jon Myles reviews new 'computer desktops' from Quad

MCRU NO.127 LOUDSPEAKERS 36

Noel Keywood is impressed by these floorstanders

SONY WALKMAN NWZ-ZX1 55

Sony's top hi-resolution Walkman, reviewed by Noel Keywood

SYSTEMS

CENTRANCE MASTERCLASS 2504

DACMINI PX DESKTOP SYSTEM 44

Jon Myles looks at a Class D desktop system

DIGITAL

MCRU LDA LINEAR POWER SUPPLY 53

Tony Bolton listens to a power supply upgrade for Audiolab's M-DAC

AMPLIFICATION

JADIS I-35 AMPLIFIER 15

Rafael Todes takes to the glitzy Jadis I-35 valve amplifier.

NAIM SUPERNAIT 2 INTEGRATED AMPLIFIER 40

Naim-owner Jon Myles loves the new Supernait

CAMBRIDGE AUDIO AZUR 851D PRE AMP 48

Martin Pipe is impressed by the technology in Cambridge Audio's new Azur preamplifier



AUGUST 2014

VOLUME 24 : NO. 6

CABLES

95 CHORD CABLES

Tony Bolton finds Chord's 'Tuned Array' cables impress

FEATURES

22 SCIENCE MUSEUM EXHIBITION

Jon Myles visits the Science Museum's audio exhibition

64 MUNICH SHOW REPORT

Tony Bolton takes a trip to Munich's fabulous Hi-End Show

OLDE WORLDE

59 SONY WMD6C WALKMAN

Martin Pipe looks back at Sony's famous top Walkman

VINYL

80 NEWS

All the latest and greatest vinyl releases for you, from the pen of Paul Rigby

83 BEATLES IN MONO LP FEATURE

Noel Keywood explains what lies behind this latest LP release

89 ORTOFON QUINTET BRONZE CARTRIDGE

Tony Bolton spins his vinyl with the new budget moving coil from Ortofon



REGULARS

7 NEWS

Words from the world...

27 MAIL

Eight pages of your views, wonderful as always...

25 COMPETITION

Your chance to win a Roksan K2 BT amplifier worth £950

42 SUBSCRIPTIONS

Ensure your copy every month and save money too!

62 AUDIOPHILE CD

Paul Rigby rounds up the latest audiophile CD releases

69,71,73 OPINION

The team get to grips with matters music, hi-fi and life!

78 DIAL-A-DEALER

A comprehensive guide to UK hi-fi retailers

98 CLASSIC CUTS

Paul Rigby on the Shirelles

93 CLASSIFIEDS

Second-hand bargains

96 NEXT MONTH

What we hope to bring you in the next sizzling issue...

97 ADVERTISERS' INDEX





QAT AUDIO TECHNOLOGY



a worthy partner

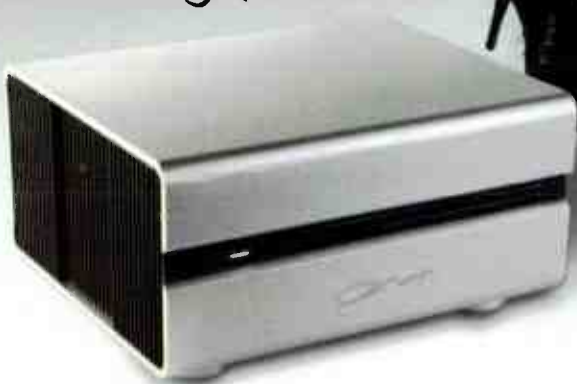

email:news@hi-fiworld.co.uk

news

BEATLES MONO LPs

Beatles fans should make a date in their diary for Monday 8th September 2014.

For that's the day the long-rumoured The Beatles In Mono box set and individual albums will finally be released – comprising the group's nine UK albums, the American-compiled 'Magical Mystery Tour' and a three-disc 'Mono Masters' collection of non-album tracks.

All come on 180-gram vinyl with artwork faithfully replicated from the original pressings. The albums have been newly-mastered for vinyl from the quarter-inch master tapes at London's famous Abbey Road Studios by Grammy award-winning engineer Sean Magee and mastering supervisor Steve Berkowitz.

While the 'The Beatles In Mono' CD box set released in 2009 was created from digital remasters, the new vinyl collection was cut without using any digital technology. Instead Magee and Berkowitz employed the same techniques used in the 1960s – guided by the original albums and detailed transfer notes compiled by the cutting engineers at the time.

Working in the same room at Abbey Road where most of The Beatles albums were cut, the pair used a Studer A80 machine to play back the historic master tapes while the new vinyl was cut on a 1980s-era VMS80 lathe.

The albums were then pressed at the renowned Optimal Media plant in Germany. They are available individually or in a limited-edition 14 LP box set which includes an exclusive 108-page book featuring new essays and a detailed history of the mastering process by award-winning radio producer and author Kevin Howlett.

The book also contains many rare studio photos of The Beatles, fascinating archive documents and articles and advertisements sourced from 1960s publications.

The Beatles In Mono vinyl box set costs £288, while individual albums are £21.99 each apart from The Beatles (White Album) which is £31.99 and the Mono Masters set which is £32.99. All can be pre-ordered now at www.thebeatlesonline.co.uk/thebeatles/Mono-Vinyl.

* See page 83 for our exclusive Abbey Road behind-the-scenes feature on the production of the Beatles In Mono LPs.



ORTOFON MONO SE

In conjunction with the new and definitive The Beatles In Mono LPs release, taken from the master tapes, Ortofon of Denmark have announced a special cartridge to play the discs. Called the 2M Mono SE, it is a tuned mono version of their top-of-the-range 2M Black moving magnet cartridge, fitted with silver wiring and top-quality Shibata profile stylus. Tracking force is 1.4-1.7gms and body weight 7.2gms, so it will fit all arms. Price is €500, available September 2014.



MCINTOSH AMPS AND 'PHONES

Just announced by McIntosh are the MC152 and MC301 amplifiers as well as a new set of headphones.

Each amplifier features McIntosh's blue power meters and black chassis, at a slim 130mm height. Operating at 150W watts per channel, the MC152 is McIntosh's smallest solid-state stereo amplifier to date. Similarly, the MC301 amplifier is McIntosh's smallest monoblock solid-state amplifier, operating at 300 watts. McIntosh has also released a set of new headphones. Known as MHP1000s, there is little hard information on the new design but we will bring more information when we get it.

For more information, call 01202 911886 or click on www.jordanacoustics.co.uk.

ROKSAN SYSTEM PACK

Roksan's K2 Series is the subject of a series of newly created system packages that will allow customers to save £500 when purchasing two items together in a 'pack': available with black or silver faceplates (speakers are available in gloss black only)

For example, the K2 integrated amplifier can be bought with the CD player for £1,250 instead of £1,750 while the K2 BT and TR-5 loudspeakers are available as a pair for £1,320 instead of £1,820.

Click on www.roksan.co.uk or call 020 8900 6801 for more details.



CABASSE LA SPHÈRE

Cabasse has unveiled the new 96kHz version of its reference loudspeaker system, La Sphère, which is supplied with a brand new processor designed for use with high-definition 96kHz files. La Sphère 96kHz also boasts a new amplifier, the Cabasse BC REF500, that has been developed to increase the dynamic capacities of the mid and treble sections of the co-axial four-way speaker system. The company also offers a bespoke solution for each La Sphère customer, presenting the option to select and match amplifiers, the four pairs of speaker cables and the interconnect cables between the processor and the eight amplifiers. The final tuning of the system at the owner's home is performed in conjunction with the authorised dealer and a Cabasse team member who specialises in La Sphère set-ups. Each system optimisation takes a full day and takes into account the characteristics of each component, the acoustics of the room and the musical preferences of the new La Sphère owners.

Click on www.cabasse.com/en for more information.



GAMUT REVISED SUPERIOR

Gamut's Revised Superior loudspeakers are available in four models. The curved enclosures in the RS-Series are based on an inner structure of birch plywood with an outer skin of real wood ash veneers. The RS3 is a full-range speaker designed for a smaller listening room. The RS5's floorstanding design increases bass output compared with the RS3. The bass driver for the low frequencies is an entirely new construction with the cone made from woodfibre and dynamically optimised with a wood dust cap. The bass/midrange driver is a sliced paper cone woofer treated with a selected blend of oils. The RS7 marries the same tweeter used throughout the series with a DC-coupled midrange. Gamut's own M250i mono amplifiers drive the RS9, the largest and most expensive model in the range. Prices are: RS3, £11,850; RS3 column (bolt-on stand), £3,550; RS5, £23,100; RS7, £29,050 & RS9, £74,000.

Click on www.gamutaudio.com or call 01202 630 066 for more information.



SLIC DIGITAL

New British hi-fi cable manufacturer SLIC Innovations has launched its first audiophile interconnect cable – the Eclipse C.

SLIC is an acronym for Super Low Interference Cable which is the philosophy that informs the design of Eclipse C. Focusing on the susceptibility of conventional audio cables to the ingress of electrical noise, Eclipse was designed to eliminate this.

The company says the new cable drastically reduces signal disturbances created when current flows through conductors and has been optimised to work across an ultra-wide frequency range.

The Eclipse C costs £492 for a 1m stereo cable terminated in premium-quality RCA phono plugs. Other terminations and lengths are available. For further details see www.slicinnovations.co.uk.

HEED'S THESIS

Heed has announced a new range of components under the 'thesis' branding. The range is centred on the thesis alpha preamplifier, which features two analogue and four digital inputs. The external thesis π power supply unit powers the analogue stage of the thesis.

Also in the range is the phi phono pre-amplifier which caters for both MM and MC cartridges, and the thesis omega monoblocks. Prices are alpha pre £2850, thesis power supply £1600, thesis phono £2300 and omega monoblock £1750. More information at www.heedaudio.co.uk or phone 01242 511133.



AUDIO SUSPENSION MODULAR REFERENCE RACK

Audio Suspension's new hi-fi shelving system sees platforms made from 20mm acrylic, hand-flame polished to give a mirror surface. Every shelf has a built-in spirit level as well as a cut-out on the back for cable management. All the legs are individually hand-turned and polished from the highest quality stainless steel and feature silicone seals at the top to further isolate the shelves. The spikes are Track Audio sourced.

The Modular Reference Rack starts at £1,200 for a two-tier rack and £2,400 for a four-tier rack.

Click on www.audiosuspension.com or call 01273 270613 for more information..

TEAC REFERENCE 301 & HEADPHONE AMP

TEAC has announced the Reference 301 series which includes the AI-301DA amplifier fitted with aptX Bluetooth, compatible with 2.8MHz/5.6MHz DSD native playback and 32bit/192kHz high-resolution sound sources. It arrives with a Burr Brown PCM1795 DAC and is fitted with two 40W Class D amplifier modules.

Next is the UD-301, DSD-capable 32bit/192kHz DAC with USB input, asynchronous transmission mode capability and 192kHz up-conversion option. It's compatible with 2.8MHz/5.6MHz DSD native playback and 32bit/192kHz high-resolution sound sources. The USB DAC can be directly connected to

a power amplifier or active speaker and the output level (XLR balanced, RCA) can be set to fixed, adjustable or off.

Finally, the LS-301 is a two-way coaxial loudspeaker system utilising a 10cm woofer and 2cm silk-coated tweeter with a rear bass reflex port.

The TEAC AI-301DA and UD-301 are priced at £399, while the TEAC LS-301 is £299.



TEAC has also introduced a new £299 portable headphone amplifier, the HA-P50 with built-in 24bit/96kHz USB DAC. It can also be used with the free TEAC HR Audio Player app for iPhones and other iOS-based devices.

Equipped with a Burr Brown PCM5102 DAC, the HA-P50 processes signals up to 24bit/96kHz resolution. A high/low gain selector enables the output gain to be matched to the impedance of the headphone being used. Click on www.teac-audio.eu for more information.

DYNAUDIO XEO

Danish outfit Dynaudio has announced the updated wireless Xeo loudspeaker. Now with the ability to accept high-resolution audio files up to 24bit/96kHz, the styling has also been updated with discrete screws, smooth satin lacquer finishes and magnetically attached grilles.

The new Dynaudio Xeo models include the compact Xeo 4 and floorstanding Xeo 6 wireless loudspeakers, the Xeo Hub wireless transmitter, the Xeo Extender and the Xeo Link – a device that receives the wireless audio signal and allows the Xeo system to add a subwoofer, headphone amplifier or any other analogue or digital component to a wireless Xeo system.

Virtually any component that can output audio can be connected to the Xeo Hub, which digitally transmits the wireless signal, without compression to the loudspeakers. The Hub includes optical, coaxial and USB digital inputs that each supports up to 24bit/96kHz resolution as well as RCA and mini analogue inputs.

Prices: Xeo 4, £1,550; Xeo 6, £2,700; Xeo Hub, £225; Xeo Link, £135 and Xeo Extender, £135. Click on www.dynaudio.com for more information.



PURE JONGO UPDATE

Pure has announced that its Jongo wireless multiroom speakers can now be used with any music streaming service including Pandora, Rdio, Deezer and Spotify. This new update has been enabled through the integration of Bluetooth Caskeid, an enhancement to the synchronisation technology used in Jongo speakers. Globally, there are 500 different music services available across 100 territories, as well as thousands of radio apps, and this new approach allows users to stream their preferred music or radio service to multiple Jongo speakers throughout their homes.

USB BOX S+

The USB Box S+ DAC uses a XMOS chipset to handle asynchronous USB streaming up to 32bit/384kHz. The sample-rate of a playing file is displayed on the front panel but, in the device, all digital streams are up-sampled (i.e. 44.1, 88.2 & 176.4 sample rates are up-sampled to 352.8kHz; 48, 96 and 192kHz sample rates are up-sampled to 384kHz).

The compact device utilises a single PCM5102A chip from Burr Brown. The benefit of the 2.1V RMS output means the audio signal path after the chip is clear of unnecessary extra capacitors while two filter settings allow users to tailor the sound.

Set-up is as simple as connecting the device up and tweaking a few audio settings in the computer settings (a 24bit driver is provided on a disc with the USB Box S+ for Windows computers, Apple and Linux systems do not need any additional drivers). Price is £169.

Get Active

Jon Myles gives Quad's new active loudspeakers a thorough work-out – and comes away mightily impressed.

Active 'speakers have a lot going for them – and it's not hard to see why. For a start, it allows the designer to approach the critical amplifier/crossover/loudspeaker interface as a unified whole. No passive crossover

resistors, capacitors or inductors between the signal and drive units to filter the frequency range. Instead that's done prior to amplification – meaning everything put out by the amp goes direct to the drive units of the speaker.

And then there's the price.

Building the amplifier and loudspeaker into a single enclosure is much more cost-effective than housing them separately – and also saves you the price of loudspeaker cables.

Just choose a front-end, pre-amplifier option and fire them up.



In the case of Quad's 9AS actives, even a pre-amp is unnecessary. They have a 24/96-capable DAC and an array of inputs to handle just about any source you could think of, plus remote control of volume.

When taken out of the box the 9AS's heritage is immediately obvious. Think the company's 9L mini-monitor – except on steroids.

The 9L heritage comes from the use of a 25mm dome tweeter housed in a proprietary waveguide allied to a 100mm mid/bass Kevlar driver.

It also means the same superb lacquer cabinet finish. Few, if any, loudspeakers at or around the price come close to matching the Quad L series in this respect.

As for the steroids – well, finned heatsinks at the base of each cabinet let you know these are active 'speakers.

Beneath lies the amplifier section which outputs 65 Watts to the mid/bass and 35 Watts to the tweeter in pure Class A/B operation. Hence the heatsinks – there are no Class D modules here.

Together the loudspeakers operate in master/slave configuration – with the latter fed audio signals via a line-level output (of which more later).

The range of inputs at the rear of the main master unit is impressive. Alongside line level RCAs sit S/PDIF optical and coaxial as well as a USB – all capable of accepting file sizes up to 192kHz/24-bit.

Digital duties are handled by a Crystal CS4398 24-bit DAC similar to the ones utilised by Quad's high-end CD players.

There's also a small switch which provides bass EQ suitable for free-standing, desk mount or wall mounting.

Round the front of the master speaker a slim strip allows control of volume and input – while the basic, but functional, remote facilitates sofa-based adjustments.

Set-up is easy enough. Simply plug the two 'speakers into the mains and connect the pair via the supplied line-level lead. Except, unfortunately, the lead doesn't give you much leeway in terms of positioning. In short it's, er, too short – meaning trying to get the 'speakers anything more than four foot apart is nigh on impossible.

You can obviously use your own replacement – but Quad should seriously look at including a longer

"there's no doubt about it, at just £600 the Quad 9AS are outstanding value for money"

lead as part of the package.

That apart, everything else about the Quads exudes quality – even down to the pair of white gloves included in the box to save you getting dirty finger marks all over the high-gloss finish!

SOUND QUALITY

Quad's L Classic line of passive loudspeakers – on which the 9AS is based – have a distinctive house sound. They're smooth, civilised with a hint of warmth but an overall even balance and masses of detail.

added degree of punch and vibrancy apparent.

The immediate impression is of a dry, tight and essentially uncoloured sound.

Those relatively powerful on-board amplifiers tightly-coupled to the drive units gives the loudspeakers a good measure of grip and control of the music.

Playing Massive Attack's remastered 'Blue Lines' – a disc, incidentally, that shows how good CD can still be when done properly – via our resident Cyrus transport



The comprehensive range of inputs on the Quads include line-level analogue, S/PDIF optical and coaxial as well as USB. A supplied lead connects the master unit (left) to the slave loudspeaker.

Indeed, I happily used a pair of Classic 12Ls for a number of years – the only caveat being they needed an amplifier with plenty of grunt and verve to really give of their best.

The 9AS active combination doesn't vary too much from that house sound – except there's an

and the opening bass lines of 'Safe From Harm' were firm, taut and propulsive.

Shara Nelson's vocals also had presence and atmosphere while the Quads missed none of the little details that make the song sound so edgy.

Audio products
designed to combat
phase distortion

Tellurium Q[®]

"In short, I can honestly say the Tellurium Q Black Diamond interconnects and speaker cable are the very best leads that I have ever had in my system."

Tony Bolton, Hi Fi World 2014

HI-FI WORLD
VERDICT ●●●●●

HI-FI WORLD
VERDICT ●●●●●

"I've talked a lot about Tellurium Q of late. I've also sung its praises constantly. To be honest, I wish I had something to grump about, it would make a change but when a company gets a series of products "this right" it is difficult to say anything negative."

Paul Rigby, HiFi World 2012

"A certain magic when it comes to absolute sound quality"

Jimmy Hughes, Hi Fi Choice 2012



The return of the Claymore!

Power amp Product of the Year 2012
Mains cable Product of the Year 2012

hi-fi+ Products of the Year 2010

Hi Fi World
Cable of the Year 2010

Hi Fi Choice
2012 ★★★★★

Jan 2011
Jan 2013

RECOMMENDED

HI-FI WORLD
VERDICT ●●●●●

For more information or to audition one contact TQ directly
www.telluriumq.com +44 (0)1458 251997



The simple remote controls volume and input. Volume level is shown by yellow LEDs on the Master loud-speaker.

True, there's no real low-end to speak of, due to the 'speakers small size, but the overall performance is such that you don't really miss it. Instead they set the toes tapping with the brio in which they punch out the tune.

Moving the EQ switch to give some bass boost helps a little here but you'll still never be shaking the walls with subsonics.

That small size does, however, pay dividends in the soundstaging – with voices and instruments floating free of the 'speaker boundaries and drive units.

Switching to hi-res material in the shape of Rimsky Korsakov's 'Dance Of The Tumblers' (24/96) the Quads' in-built DAC proved itself resolving enough to let me hear the extra definition on offer.

Here violins were well separated and defined, yet eminently smooth. There's perhaps a slight lack of the rich tonality and lifelike bow on string experience you'll get from more expensive 'speakers – but the Quads never sounded artificial or coarse in their delivery.

Indeed, they stayed admirably smooth and even throughout, never attempting to emphasise one part of the sonic spectrum above another but simply playing the music in an even-handed manner.

Replaying the Rimsky Korsakov number – this time in a 320kbps file via an iPod – and the Quads soon let me know I was taking a step backward. Their innate smoothness

meant the sound was never unpleasant – but edging towards bland as opposed to exciting.

Going back to better quality files from standard Red Book CD to above the 'speakers started to shine again.

One consequence of the active configuration is also the ability to go louder than you would expect from a box this size. Tight coupling between amplifier and drivers seemed to allow the volume level to be pushed up higher before the sound began to become obviously stressed.

I'd have a guess that the metallic amplifier housing at the base of each loudspeaker plays a part here – helping to strengthen the cabinet for better rigidity.

Whatever the reason, the little Quads can play at significantly loud levels that seem to elude other similar-sized 'speakers.

On the opening bars of Eleanor McEvoy's 'I've Got You To See Me Through', for example, I was pushing the remote's volume control ever higher until, yes, the strain began to show and it was time to back off – but this was trying to take everything to the limits.

And the 9AS system does have

limits. By its very nature it won't fill big rooms, nor will it give you the whole sonic spectrum.

But at just £600 I'd be struggling to find anything that comes close to matching the all-round capabilities of the 9AS active loudspeakers.

Try putting together a separates system consisting of a pre-amp, amplifier, DAC and loudspeaker that can match it in terms of sonic ability and you'll quickly find yourself having to spend a great deal more.

Instead you could just buy the Quads, add your own front-end and have a superb little system for less than £1200. Put like that, it's hard to find a downside.

CONCLUSION

There's no doubt about it, at just £600 the Quad 9AS are outstanding value for money.

Give them good source material – ideally CD quality and beyond – and they truly shine in terms of punch, tonal quality and all-round musicality.

Overall they have the even-handed quality of Quad's Classic loudspeaker line except with added verve courtesy of the well-implemented active drive system.

MEASURED PERFORMANCE

The Quad 9AS active 'speaker has an even on-axis response and worked well off axis too, largely due to the shallow horn around the tweeter. This can be

FREQUENCY RESPONSE

Green - driver output
Red - port output

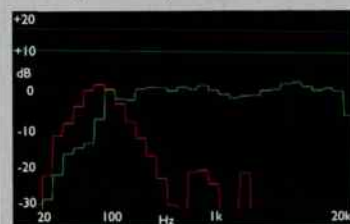

DECAY OVER 200ms

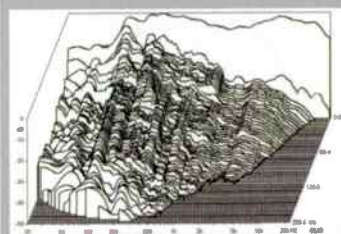

important when listening close, at acute angles to the loudspeaker when it is part of a computer music system on a desk. The small main bass driver

cuts off at 90Hz, the two small rear ports peaking at 80Hz to offer a bit of downward extension, but the 9AS does not go low. A bass boost switch on the rear introduces +5dB of lift at 100Hz and a few dB more lower down, but the box and bass unit are not capable of delivering low frequency power so Quad haven't tried to over-drive the system, to keep the 9AS fast and clean. A shelf setting cuts bass a little.

A 200ms decay analysis showed the 9AS was very clean across the midband and treble. There's a long decay at 100Hz, but that is all.

Sensitivity was high, 96mV rms being needed to deliver 90dB sound pressure level, which is loud. Since most portable players and mobile phones deliver 300mV they will drive the Quads very loud, to nearly 100dB. A 0dB digital input produced 100dB.

The 9AS is a neat active loudspeaker that proved accurate and smooth under measurement.

It is also uncoloured, so should produce a tidy high-fidelity sound from iPad, iPhone or desktop computer, or portable player, or any other source, including an external phono stage of limited gain. **NK**

QUAD 9AS



OUTSTANDING - amongst the best

VALUE - keenly priced

VERDICT

Not just a great active loudspeaker – but a DAC and pre-amp into the bargain as well. Destined to become a bit of a classic.

FOR

- active loudspeakers
- smooth, even tonal balance
- 24/192 capable DAC
- remote control

AGAINST

- small size means limited bass
- interconnect should be longer

Quad
+44 (0)1480 452561
www.quad-hifi.co.uk



HEAR LIKE A PRO

'These are supremely musical mini-monitors with astounding bass punch and rhythmic ability allied to class-leading resolution.'

Hi-Fi World, July 2013



@KEF Audio

KEF Audio UK

LS50

To celebrate 50 years of groundbreaking innovation, our LS50 mini monitor applies KEF's latest acoustic technologies from Blade and beyond to deliver the uncompromised sonic purity, accuracy and transparency we originally pioneered with the legendary LS3/5a professional studio monitor for the BBC. The good news is that you no longer have to be a sound engineer to enjoy the startling illusion of presence it creates.

www.kef.com/LS50

KEF
INNOVATORS IN SOUND

GP Acoustics (UK) Limited, Eccleston Road, Tovil, Maidstone, Kent, ME15 6QP, UK T. +44 (0)1622 672261

Golden lights

Rafael Todes goes all Gallic as he is bewitched by a new valve integrated amplifier from across the Channel.

As we all know, looks aren't everything – especially in the world of hi-fi components.

There's no end of revered products down the years that have looked – on the outside at least – a touch, well, utilitarian would be the word (think the likes of the NAD 3020 or original Naim Nait, for example).

So when something comes along that makes you go 'Wow!' as soon as you lift it out of the box and then continues to beguile once it's pressed into service, it deserves to be welcomed.

So, say a big hello to the Jadis I-35 integrated amplifier because it fulfills both those criteria.

Firstly, it looks superb. The family-owned Jadis company has been hand-building valve amplifiers in the Languedoc-Roussillon region

of southern France since 1983 and it's fair to say their products have a distinctive, luxurious look that sets them apart from the crowd.

The main chassis is a combination of chromed steel with gold knobs and faceplate adorned with the scripted Jadis logo and weighing in at a hefty 31kgs.

It's a look that exudes quality without being overstated – just what you'd want from a £5500 amplifier.

Controls consist of volume, balance and input selector, along with an on/off rocker switch. A remote control is optional.

The valve complement includes five small-signal tubes – the central one being a 12AU7 dual triode that provides line-level gain for both channels of the active pre-amp stage. Two other 12AU7s serve as left and right channel phase splitters for the push-pull power section with a pair

of 12AX7s driving the power tubes.

In our review sample the output section was fitted with KT88 tubes, but customers can also specify the more powerful and relatively new KT120 valves if they wish – see our box-out at the end of the article for more on this topic.

The push-pull output stage is biased to Class A and uses auto-bias, giving a claimed 30 Watts-per-channel of power. The output transformers are of Jadis's own design and hand-wound in house.

Round the back are five line-level RCA inputs (there's no phono stage) as well as two sets of speaker binding posts – which is where things get slightly unusual.

Despite a circuit diagram on the top of the output transformers indicating 4 and 8 Ohm speaker taps are available, as is customary on valve amplifiers, this is, in fact not the case.



SERIES V-12 MAGNESIUM TONE ARM

Based on the multi-award winning Series V pick-up arm, the Series V-12 incorporates the same design and engineering that have made SME a byword for excellence. Coherent musical control is held over the entire frequency range in terms of tonal quality, stability and stereo imaging. Startling dynamic range, neutrality, structurally inert, the Series V-12 embodies every worthwhile feature in a pick-up arm. The 12 inch tone-arm is pressure die-cast in magnesium complete with an integrated headshell to eliminate tone-arm resonances in the audio spectrum and offers a 27% reduction in maximum angular error distortion over 9 inch models. Listening; the benefits of minimal tracking error and harmonic distortion are clearly revealed.

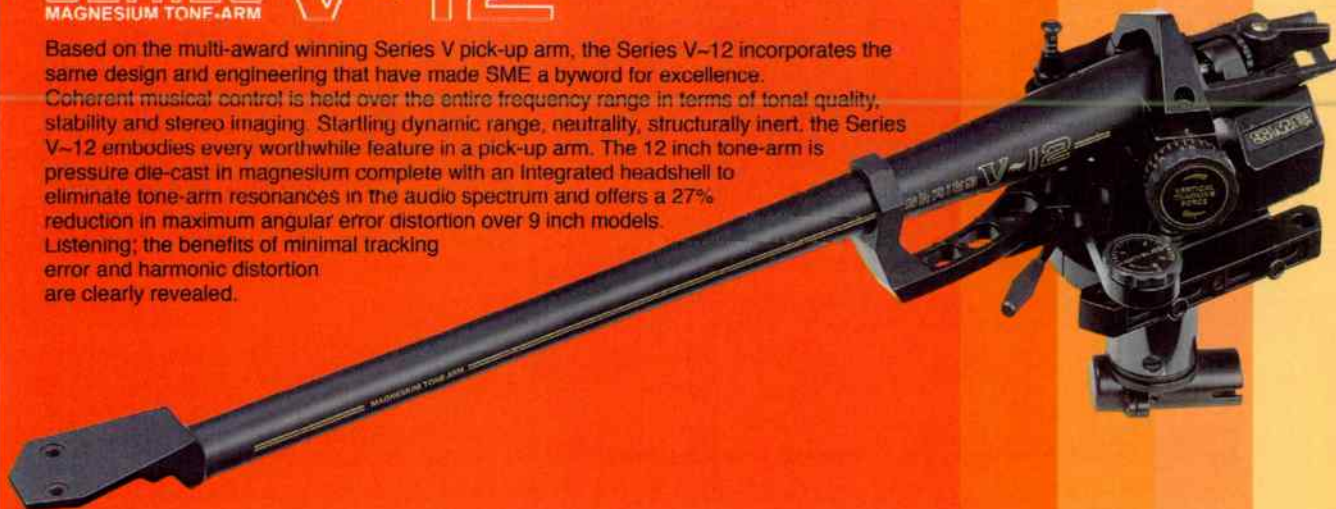

SME

"The best pick-up arm in the world"

SME LIMITED • STEYNING • SUSSEX • BN44 3GY • ENGLAND • TEL +44 (0)1903 814321 • FAX +44 (0)1903 814269 • www.sme.ltd.uk • sales@sme.ltd.uk

Black Rhodium

Twist

Stereo Interconnect Cable

"Offering amazing value for money, every new hi-fi user should demo these interconnects"

HI-FI WORLD
February 2013



Why Choose the Black Rhodium Twist Stereo Interconnect?

- Based upon the multi-award winning Twist Speaker Cable
- Reduced "Transient Phase Distortion" to produce a more natural, open sound
- Improved RFI/EMI rejection from dual twisting of cable
- High quality gold plated RCA terminations
- Ultra low budget price, high class, 5 star performance



Scan this QR code on your smartphone or tablet to download the full Hi-Fi World review and find out more about "Transient Phase Distortion"



(visit www.blackrhodium.co.uk/twisthfw on your PC)

www.blackrhodium.co.uk sales@blackrhodium.co.uk +44 (0)1332 342233



The left and right loudspeaker output sockets are paralleled, so give the same output.

Instead the two sets of loudspeaker outputs in fact run in parallel – with Jadis saying the I-35s “load impedance is pre-adjusted in the factory for loudspeakers from 4 to 16 ohms”.

Our Measured Performance revealed the amplifier’s output transformers are most likely power matched for 10 Ohm loads. In fact power output dipped appreciably into 4 Ohms.

As most ‘speakers these days use bass drivers of around 4 Ohms careful matching is going to be critical to getting the best out of the Jadis.

Also worth noting is that the I-35 inverts signal polarity – so for optimum sound quality the speaker connections should be swapped black for red and red for black on each channel (but you may not hear any difference – see our Letters this month for more about ‘absolute phase’).

A steel mesh valve cover screws to the chassis to protect those

glowing tubes from inquisitive little hands or wandering pets – but, as with most tube amplifiers, the Jadis really does look better without it in situ.

Slide the unit into your rack and fire up those KT88 tubes and the Jadis conveys an undeniable pride of ownership – one which is only heightened as you begin to listen to the performance.

SOUND QUALITY

Slotted into my system and warmed up nicely, the Jadis immediately gives a good impression of itself.

Playing the Decca Solti recording of Mahler’s 9th Symphony, Scherzo. I am impressed with what the Jadis integrated is doing to the sound.

It has good control over the orchestral textures – the violins are sweet with good weight to them and there is a beautifully classic valve twinge to the proceedings.

Where my reference VAC PHI200 monoblocks have more of a matt finish, this is veering towards gloss. It’s an attractive sound, engaging and intensely coloured like a saturated colour photograph.

As a listener I’m sitting halfway back in the concert hall with the Jadis. It means I’m not getting the intense detail the VACs provide which makes me feel I’m on stage with the performers.

But the Jadis sound is one I suspect will make for an easier listen for many.

Two top panel adjusters alter ‘filament tension’ – heater volts – to aid valve matching.

It is simpler to get a perspective of the whole performance from this slightly more distant vantage point and the I-35 has the ability to bring the performance together into one seamless whole.

Yes, some amplifiers will give you more detail and a brighter spotlight on individual performers – but the Jadis has an easy, graceful sound that concentrates on the musical whole.

The Jadis also had more than enough power to easily drive my resident B&W 802Ds. It may not be the most powerful valve amplifier about but it coped well here.

However, although big, the B&Ws are relatively benign with a 90dB sensitivity and 8 Ohm nominal impedance. Switching to a pair of the impressive MCRU No127s (see review this issue) and the Jadis struggled a little more. Yes, it could go loud with ease (the MCRUs are even more sensitive than the B&Ws) but the No127s 4 Ohm impedance saw the sound start to harden as the volume knob was turned towards the 12 noon position. The sound never became offensive – but there was the sense that the Jadis was starting to run out of breath.

Back on the 802Ds and things returned to normal. Sound staging was impressive – with good right to left separation, although the Jadis didn’t have quite the front to back resolution of my VACs.

The bass is also fairly tight by the standards of most valve amplifiers I have heard. It isn’t gut-wrenching in the manner of a megawatt transistor amplifier but is present and correct with good definition. I wonder if perhaps they are putting beauty above truth?

Turning to a favourite Mozart piano concerto – No 18 in B flat major by Barenboim with the Berlin Philharmonic – and the orchestra has a rich tone which is both fulsome



Connect. With the Future...



K2 BT

- aptX Bluetooth streaming input
- Increased output for greater power and clarity
- Improved circuitry for greater efficiency
- Even better sound performance

ROKSAN

The award-winning Roksan K2 series has now been expanded to include a new integrated amplifier. The K2 BT improves on the original K2 Integrated with brand new circuitry and a higher output than ever before. The inclusion of aptX® technology also adds a whole new source input to the amplifier. Now you can stream your favourite music from a Bluetooth-enabled device in original 16-bit CD quality.*

Available Nationwide Now



Distributed by Henley Designs Ltd.

T: +44 (0)1235 511 166 | E: sales@henleydesigns.co.uk | W: www.henleydesigns.co.uk

* On compliant devices.

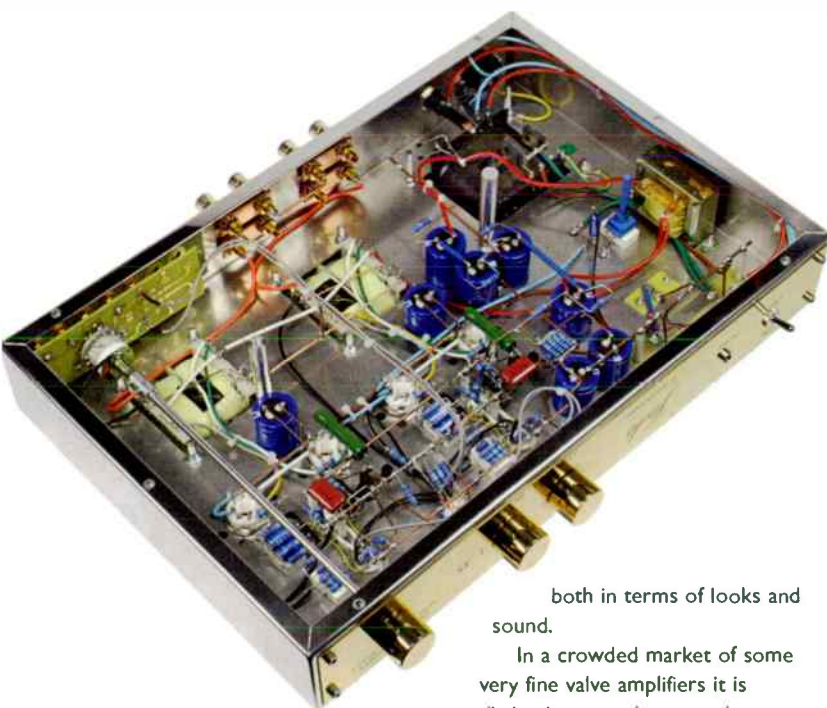

and very appealing.

There's just a hint of the amplifier straining in the loud orchestral tutti and I miss a little of the subtlety of orchestral interplay as the sense of the platform on which the musicians are performing is a bit more crowded than usual.

There is undoubtedly more jumble than I hear through my VAC amps with the dialogues between soloist and orchestra seeming to have less sense to them. This music is testing the amplifier's command, and revealing holes in its defences.

Having said that, the Jadis costs a quarter of the price of the VACs – and its level of detail is exactly what you would expect from an amplifier in its price range.

On a more mundane level, there is slight sonic leakage between inputs, which could cause a problem if you use several on at any given time.

I would have also appreciated a remote control as standard – not optional – at this price point, at least for volume if not for input.

And while the Jadis certainly looks the part with its distinctive blend of polished steel and gold detailing, why oh why make the decision to place three utilitarian capacitors and a heatsink to the left of the valves – spoiling what is, after all, any tube amplifier's shop window?

I like the sight of glowing valves as much as the next man. I can see the reasoning behind the looks, appreciate the bling factor of the silver and gold – but why the capacitors?

But those gripes aside – and, yes, I am being a little picky here – Jadis have produced a very attractive amplifier in the shape of the I-35,

both in terms of looks and sound.

In a crowded market of some very fine valve amplifiers it is distinctive enough to stand out and offer real value for money.

CONCLUSION

The Jadis I-35 is a beautiful-looking amplifier that produces a rich, resonant sound. Detail is good for the price and orchestral textures well realised and

fulsome.

Indeed the Jadis goes about its job with aplomb giving a rich, velvety sound that is typically valve-like and never less than musical.

The main drawback is its lack of 4 and 8 Ohm 'speaker taps which sees a dip in power into lower impedances and means potential buyers will need to take special care in loudspeaker matching.

REFERENCE SYSTEM

VAC PHI200s
B&W 802Ds
Townshend Audio Isolda speaker cables
Esoteric K-05 CD player
PS Audio P10 mains rebuilder

KT88, KT120 OR KT150 POWER TUBES?

KT88s are robust, sound good and cost little - around £40 each. KT120s are a modern upgrade of the KT88 (bigger anode) needing more heater current: they are a plug-in replacement if this is available, as it is on the I-35. KT120s are robust, inexpensive but can sound clanky. KT150s are a new upgrade of the KT120 designed to sound good – but they cost £200 apiece! Because the I-35 can run KT120s it can run KT150s too – at a price. However, the amplifier's power output will not change by using these higher power valves; more HT is needed.

MEASURED PERFORMANCE

Power measured 29 Watts into 8 Ohms (2% distortion). This is the sort of power auto-bias provides when running KT88s conservatively (low-ish anode volts) to conserve their life. So valve life should be long, but power is not high.

Jadis say the I-35 is factory set to suit 4-8 Ohm loudspeakers (internally it can be wired for 4-8, 8-10 or 16 Ohm loads) but it best matches 8 Ohms; with 4 Ohms power dropped to just 12 Watts

(2% distortion). The secondary needs a dedicated 4 Ohm output so it better suits modern 4 Ohm loudspeakers, which most are (i.e. their bass drivers are 4 Ohms).

Distortion levels were a little high, measuring around 0.7% at low signal levels, rising to 1% near full output and 4% at 10kHz near full output. Third harmonic dominated but other higher components were obvious. Bass stayed clean and relatively distortion free, however, so bass quality is likely to be good. Damping factor of 5.6 suggests reasonable speaker control.

Sensitivity was high at 150mV, so the I-35 will go loud quickly as volume is increased. Frequency response covered the audio band, treble rolling off smoothly above 20kHz, as is common with valve amplifiers.

The I-35's output transformers are not ideal for 4 Ohm loudspeakers. This under-utilises the KT88s that in the right environment can produce 40 Watts. Otherwise, measured performance was good, rather than exceptional. **NK**

FREQUENCY RESPONSE

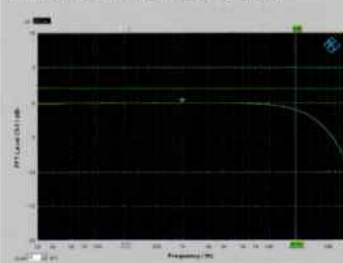

DISTORTION

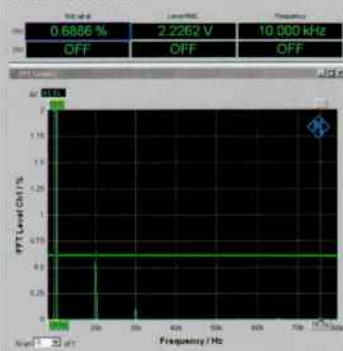

| | |
|---------------------------|------------------|
| Power | 28watts |
| CD/tuner/aux. | |
| Frequency response | 8Hz-20kHz |
| Separation | 65dB |
| Noise | -85dB |
| Distortion | 0.7% |
| Sensitivity | 150mV |
| Damping factor | 5.6 |

JADIS I-35 AMPLIFIER £5500



EXCELLENT - extremely capable

VERDICT

Lovely classic valve sound, but a bit short of power

FOR

- seductive valve sound
- chrome and gold finish
- can use KT120s or 150s

AGAINST

- no remote control
- poor 4 Ohm matching

Absolute Sounds.
+44 (0) 20 8971 3909
www.absolutesounds.com



muso

Muso is Naim's first wireless music system, designed to transform your music into incredible sonic experiences. Through its advanced connectivity, Muso will unleash your digital music, wherever it's stored.

And it's so easy to set up and use that you'll find yourself listening to and enjoying your favourite artists more than ever before.

Combining Naim's expertise in streaming, amplification and loudspeaker technology, Muso is the stage your music deserves, bringing you closer to the songs that inspire your life.

FEATURES INCLUDE:

AirPlay | UPnP™ (Universal Plug 'n' Play) | Bluetooth | Internet Radio | Streaming Services | USB | Digital Input (Optical) | 3.5mm Analogue Input | Multiroom | Six Naim Speaker Drivers | 450W of Amplification | Muso Control App | Touch Panel Volume Control | Remote Control | Room Settings | Loudness Control

To find out more and to pre-order your Muso, call or email Jordan Acoustics today.

Muso will be available in September at an RRP of £895.



World Class | Audio Systems



ESTABLISHED 1973

McIntosh®

LEGENDARY PERFORMANCE™



McIntosh McAire

Built in Apple AirPlay® | Wirelessly stream your itunes
integrated audio system | £3,195.00
20% deposit, then £213.00 x 12 months* **



McIntosh MHA100 [NEW]

2-channel headphone amplifier | £4,995.00
20% deposit, then £133.20 x 30 months* **



McIntosh MT5 [NEW]

2-channel precision turntable | £7,495.00
20% deposit, then £199.87 x 30 months* **

0% finance

Jordan Acoustics offer up to 36 months 0% Finance* ** on most brands. Please call, e-mail or visit instore for further details.

t | 01202 911 886 e | bournemouth@jordanacoustics.co.uk



t | 01592 744 779 e | glenrothes@jordanacoustics.co.uk W | www.jordanacoustics.co.uk

World Radio History

*subject to status **subject to conditions



Horn loaded

London's Science Museum has delved into audiophile history for its latest exhibition – which features a 27-foot long horn that first entranced listeners back in the 1930s. Jon Myles pays a visit to get the background.

It's perhaps even more astonishing to discover the horn is actually a reconstruction of one of the Science Museum's most popular attractions from the 1930s.

The original was commissioned by the museum's then curator of telecommunications Richard Denman and was designed to reproduce the widest possible sound frequency range.

Once a week it would relay programmes from the BBC's London Regional Service to crowds of visitors at a time when the search for high-fidelity replay was in its very infancy.

Indeed, writing in the Audio Engineering Society Journal the audio experts Percy and Geoffrey L. Wilson were of the opinion that "no superior loudspeaker has to date been demonstrated in Britain".

Now its majesty can be heard again after the Science Museum's Workshops team spent months painstakingly recreating the giant loudspeaker for an installation by sound artist Aleksander Kolkowski entitled 'The Exponential Horn: In Search Of Perfect Sound'.

Aleksander – who served as the Science Museum's first ever Sound Artist in Residence during 2012 – is a composer and researcher who uses historical sound recording and reproduction apparatus as well as obsolete media to make new music.

His work invites people to listen to the present through the audio technologies of the past - via performances, installations, recordings and

live historical re-enactments.

To demonstrate the capabilities of the Exponential Horn sound art and archive footage comes from a variety of contributors – including BBC History, Resonance 104.4FM, BBC Radio 3, Archive of the Now, the London College of Communication, the Royal College of Music and the Royal College of Art.

The genesis of the project dates back some six years, when the Science Museum's Curator of Communications John Liffen guided Aleksander through the institution's extensive collection of historical audio artefacts housed in its Blythe House storage facility in West Kensington.

There, lying on a row of filing cabinets, was a nine-foot long, tapered, black metal tube – all that remained of the original horn after it was almost totally destroyed in a demolition accident in 1949.

"The story of the horn and John's extensive research on it sparked my interest" recalls Aleksander enthusiastically.

"I've always been interested in the potential of horn loudspeakers and the Denman really takes that to the limit. Luckily, when I became the museum's Sound Artist in Residence it gave me the chance to initiate the horn's reconstruction".

Not that that was any easy task. But working from Denman's own archived specifications the missing 18-foot section of the horn was painstakingly reconstructed – this time using fibreglass in place of the

Anyone with more than a passing interest in the history of hi-fi will no doubt be well acquainted with a decent smattering of some of the weird and wonderful designs loudspeaker engineers have dreamt up over the years.

From mini-marvels to giant horns needing just a few Watts of power to go deafeningly loud, the search for more accurate sound from transducers has ranged far and wide.

But take a trip to London's Science Museum at the moment and you cannot help but be awe-struck by one design that dwarfs almost any other.

For the Denman Exponential Horn which dominates the establishment's Virgin Media Studio is truly outstanding. As its name suggests the horn loudspeaker is truly massive – measuring some 27-foot long and spreading from 27mm at its source to more than seven feet at the mouth.

Stand in front of it and it's hard not to be astonished at the sheer power, presence and sonic fidelity this monster can produce.



Aleksander Kolkowski with the Denman Exponential Horn in situ at London's Science Museum

original lead and tin alloy.

Over an eight-month period the giant assembly gradually took shape, the Science Museum's expert craftsmen painstakingly smoothing the insides of the horn to ensure a smooth airflow with no unnatural resonances.

Then came the delicate task of choosing the right driver. The original employed a Western Electric 555W device – used extensively at the time for cinema sound systems and, according to John Liffen, still considered one of the greatest transducers ever produced.

The example used in the reconstructed exponential horn is from the Science Museum's own collection – and dates from 1925!

"They really were exceptional drivers" says John. "It's amazing to think something produced so long ago can still sound so good today".

Not surprisingly, though, despite all the work and research, the first full test of the newly-constructed horn outside Blythe House was a nerve-racking experience.

"It was terrifying really" admits Aleksander. "There was no knowing exactly what it would sound like".

"The main concern was whether there would be any resonances in the structure, which we couldn't know properly until we tested it".

And true to the whole project, that first test also delved back into the annals of British audio history.

"The first piece we used was the Henry Hall Orchestra's 'Teddy Bear's Picnic', because it has a great range of high and low frequencies" reveals Aleksander. "In fact it was used by the BBC as a reference for many years".

Indeed the piece – recorded in

1932 – was used by BBC engineers for more than 30 years until the early 1960s to test and calibrate the frequency response of audio equipment such as its recording quality and large tonal range.

Not surprisingly, the reconstruction of Richard Denman's ground breaking horn passed with flying colours.

Stand in front of its seven-foot mouth now hung imposingly in the Science Museum's Media Space and you can hear why.

"It's a totally immersive sound" says Aleksander. "Very natural and true".

The tested frequency range runs from 32Hz up to 6kHz but it's the lifelike, totally organic sound that impresses most – and not just for hi-fi buffs.

On a number of my visits groups of youngsters were gathered around the horn listening rapt to the sounds

THE GOLDEN AGE OF RADIO: THE EXPONENTIAL HORN SYMPOSIUM SATURDAY JULY 12, 2PM-5PM

An afternoon of talks and live demonstrations exploring the history of the Exponential Horn and 1930s radio culture - from the 'Don't Oscillate' campaign against radio interference, to the clash between commercial interest and public service broadcasting.

Speakers include:

John Liffen

The Science Museum's Curator of Communications talks on Roderick Denman, the creator of the exponential horn.

Geoffrey L. Wilson

Professor of Acoustics at Pennsylvania State University, talks about his father Percy Wilson's pioneering work in the development of exponential horns and association with Roderick Denman.

Aleksander Kolkowski

The curator of The Exponential Horn: In Search of Perfect Sound talks on the horn's reconstruction.

Bjørn Kolbrek

Audio researcher and electrical engineer Bjorn Kolbrek explains how horn loudspeakers work and examines the Western Electric driver and horn systems that inspired Denman.

Dan Wilson

Dan Wilson, musician, instrument-builder and researcher, talks on The "Don't Oscillate" campaign, radio and interference during the 1930s.

Seán Street

Radio historian, broadcaster, writer and poet Seán Street explains the struggle between public service (BBC) broadcasting and commercial interests during the 1930s.

of BBC presenters from a long-gone radio age.

And though it might not be practical for everyday domestic use, both Aleksander and John hope the Exponential Horn not only serves as an historical piece but also reveals just what can be achieved in the field of audio reproduction.

"It's setting a benchmark" they say. "It's saying this is what can be done.

"Hopefully people will take things from that and see what can be achieved".

VISITING

The Exponential Horn:

In Search Of Perfect Sound, runs at London's Science Museum in Kensington until July 27. Admission is free.

In addition the museum is running a series of related events, talks and live demonstrations. Log-on to www.sciencemuseum.org.uk/exponentialhorn for full details.



The Science Museum's Workshop team inside the mouth of the horn as they work on it's reconstruction.

icon Audio

2 of our "OUTSTANDING" amplifiers!



"It knows few equals and in these value conscious days makes it a pearl almost beyond price" Roy Gregory



ICON AUDIO
STEREO 60 MKIII
KT150 £2599.95

OUTSTANDING - amongst the best.

VERDICT
A lovely sound with plenty of power and adjustability. A well developed design.



designed by David Shaw

New Stereo 60 III KT150 our finest "modern" integrated amplifier with the new KT150 valves

ICON AUDIO
STEREO 845 PP
£5,999



OUTSTANDING - amongst the best

VERDICT
Gorgeous, liquid valve sound with decent power and a holographic soundstage. Demands to be heard.

FOR
- flowing musical sound
- superb stereo imaging
- easy biasing
- looks superb



New Stereo 845pp Our finest retro integrated amplifier
(Probably the world's first)

Ask for our New Brochure & Price List

Ring or email for sales and service. We sell and fit a wide range of valves and upgrades. Dealers throughout the UK and the World.





WIN **ROKSAN'S SUPERB K2 B2 AMPLIFIER WORTH £950 IN THIS MONTH'S GREAT GIVEAWAY!**

Here's your chance to win the superb Roksan K2 BT amplifier we reviewed in our April 2014 issue. Read the review excerpt below and answer the questions.

"Welcome to an integrated amplifier with built-in Bluetooth, no less. The new Roksan Kandy K2 BT loses its Tape input, but gains the ability to stream music from Bluetooth devices like a smartphone, iPad or similar. And it retains its MM phono stage.

Also rather different from the mainstream is the use of

MOSFETs (specifically 2SK1529s and 2SJ200s) in the analogue output stage. Most other solid-state amps either stick with conventional bipolar transistors, or foray into Class D territory.

The K2 BT can be operated via the supplied 'RMX III' handset, programmable with codes from a computer/website via USB.

Roksan's specs claim that with both channels driven the K2 BT delivers 125W into eight ohms, or 200W into four.

It's not possible to upgrade an original K2 into a K2 BT, because they are rather different, insofar that

the original K2 made provision for a recorder (tape, MD, etc.) but the K2 BT has no such tape loop. Sign of the times? In addition to dedicated CD and phono inputs are three line-level auxiliaries.

Two pairs of chunky binding-post speaker terminals carry the K2 BT's output to loudspeakers, while a screw terminal is provided for grounding a turntable. The final connection is for the stubby Bluetooth aerial, supplied in the package."

For a chance to win this great prize, just answer the four easy questions at right. Send your entries on a postcard only, by August 5th, to:

**August 2014 Competition,
Hi-Fi World magazine,
Studio 204,
Buspace Studio,
Conlan Street,
Notting Hill,
London W10 5AP**

RULES AND CONDITIONS OF ENTRY

- ONLY ONE ENTRY PER HOUSEHOLD
- MULTIPLE ENTRIES WILL BE AUTOMATICALLY DISQUALIFIED
- PURCHASE OF THE MAGAZINE IS NOT A PRE-CONDITION OF ENTRY
- NO CORRESPONDENCE WILL BE ENTERED INTO
- THE EDITOR'S DECISION IS FINAL
- NO EMPLOYEES OF AUDIO PUBLISHING LIMITED, OR OF ANY COMPANIES ASSOCIATED WITH THE PRODUCTION OR DISTRIBUTION OF THE PRIZES, MAY ENTER

QUESTIONS

[1] The Roksan streams via -

- (a) a tap
- (b) a straw
- (c) Bluetooth
- (d) a brick

[2] In its output stage are -

- (a) mice
- (b) MOSFETs
- (c) tubes
- (d) Nakamichi

[3] It retains -

- (a) a MM phono stage
- (b) tape-loop
- (c) track controls
- (d) mono switch

[4] Turntable ground is a -

- (a) copper rod
- (b) brass socket
- (c) brass clip
- (d) screw terminal

entries will be accepted on a postcard only

**MAY 2014 WINNER: CREEK EVOLUTION 50A AMPLIFIER
Lesley Rowell, of Cumbria**



Inspire Hi-Fi

MONARCH TURNTABLE



Quite Simply the Best.

CLINICAL IN ITS USE.
PERFECT IN ITS
EXECUTION.

"A startlingly musical performer with blistering speed and dynamics allied with smoothness, sophistication and purity of tone." *Hi Fi News*

Now part of the Hi Fi World Magazine - World Standards



Verdict:
Startlingly musical performer with blistering speed and dynamics, yet smoothness, sophistication and purity of tone too. Superb.

For:

- Superb transient speed
- Excellent dynamics
- Tonal purity
- Overall musicality

Against:

- nothing



WINNER!
HI-FI NEWS
Ultimate Hi Fi Finest
Product Award 2012

WINNER!
HI-FI WORLD
AWARDS 2012
Best Turntable



Home Demo's of the Award Winning Monarch now available. Contact us for details.

The Monarch turntable takes both 9 and 12 inch arms. Available with SME, Audio Origami, Origin Live and other tonearms. Pictured Monarch shows an SME 12 Inch tonearm.

**Superb Part Exchange Deals given against your current turntable.
Call us for an instant quote...**

**Information & Sales Hotline
01246 472222**

www.inspirehifi.co.uk

Units 2 & 3 / Prospect House / Colliery Close / Staveley / Chesterfield S43 3QE
T: 01246 472222 M: 07932 367555 E: robert@inspirehifi.co.uk



mail



Visit our website at www.hi-fiworld.co.uk or send your emails to letters@hi-fiworld.co.uk. Letter of the month wins a pair of KEF Q100 loudspeakers.

Answers by: **NK** - Noel Keywood; **PR** - Paul Rigby; **TB** - Tony Bolton; **MP** - Martin Pipe; **HB** - Haden Boardman; **RT** - Rafael Todes; **RA** - Rod Alexander; **JM** - Jon Myles.

LETTER OF THE MONTH PRIZE



KEF Q100 LOUDSPEAKERS

For more advice see Letters from earlier issues at www.hi-fiworld.co.uk/letters

A pair of KEF Q100 loudspeakers are on their way to **MARTIN BURGESS**, Letter of the Month winner in our July 2014 issue.

Letter of the Month

BOY FROM THE BLACK STUFF

I tend to listen to vinyl but decided the time had come to throw off my Luddite tendencies and dip my aural toe into the murky world of digital audio. To get digital audio on my laptop, I've been ripping and burning (I've picked up the lingo) CDs to Windows Media Player for a while and transferring the files to MP3 players and mobiles with some success, so the road to hi-res beckoned. With the help of Google and Hi-Fi World I decided that FLAC was the one for me, so how to go about doing it?

I settled on Media Monkey and downloaded their free software without any problems and proceeded to rip my CDs. My euphoria was short-lived as – silly me – additional software is needed to play FLAC files, so at the moment I'm deciding between JRiver or Foobar.

In the meantime I downloaded the free version of Spotify and have found this to be a fantastic way of listening to music reviewed or recommended in Hi-Fi World and other publications to see if I like it. You can also download any old albums or songs you want, although the search sometimes needs either the artist or song/album title. The adverts are a bit of a pain but it's a small inconvenience considering it's free.

I was now getting carried away and decided I needed (wanted, really) a DAC to improve the sound and settled



Here's an inexpensive high-resolution system you can understand and afford: an Audiolab Q-DAC with ESS Sabre32 DAC chip fed by a cheap FiiO X3 digital player, connected through its digital audio output. Fantastic quality and easy – sort of – to use.

on the AudioQuest Dragonfly. This is where I crashed and burned. I excitedly unboxed the sexy looking USB stick and, contrary to what males usually do, decided to read the instructions as they were very short. To my horror I read that it was incompatible with Windows Vista and as, you've probably guessed, I run windows Vista. However there was a way round it and that was to upgrade to a later version of Windows or step back to good old unsupported XP. Ho Hum again.

There now seems to be a third Ho

Hum in the offing as DSD is galloping over the digital horizon and even after reading Noel Keywood's explanation and the feature on page 36 and 37 of the April 2013 issue of Hi-Fi World (I must get a life) I haven't got the vaguest idea what it is or does. But then again, why should I?

I think I'm going to withdraw my toe for the time being and continue being a Boy From The Black Stuff until there is some commonality in all things digital, be it ALAC, FLAC, WAV, MP3 et al. but I'll carry on using WMP and

Spotify (for their convenience) and put up with the poor quality and use vinyl for serious listening sessions.

Best regards,

Dave Arnold.

Thanks for the warnings – and it's interesting that yet again Spotify comes as a top recommendation. Use .WAV files with 24bit resolution if you can, sample rate 48k upward. These will play through anything (data rate limitations excluded) and give you a smooth sound, if the original was true 24bit of course. I use popular and free XLD to sample rate convert.

The only class of digital device I have found truly easy to use and that would eliminate your difficulties is the portable digital player. They cost from £150 for a FiiO X3 up to £2200 or so for the Astell&Kern AK240 but they handle all files (if not necessarily DSD) and play at the press of a button. You can hook them up to the hi-fi too through their headphone output or digital output via a DAC. If you want to KISS (keep it simple stupid) then this is the way to do it!

I use an AK120 with optical digital output, the only small drawback being not all optical digital DAC inputs will play 192k digital; an electrical digital connection as used on the FiiO X3 would be better, because electrical does always handle 192k.

You could consider using a FiiO X3 working into an Audiolab Q-DAC: this is a devastating hi-res digital combo at a great price. The only drawback is the FiiO's small screen and fiddly operation. And then again, I run these systems alongside LP – and guess which is most enjoyable? Ho Hum. **NK**

IS TECHNOLOGY KILLING HI-FI?

I agree with your editorial in the July 2014 issue: there is a real danger of too many technical terms and hard-to-use devices frightening off potential buyers/users of modern hi-fi.

As a computer person I understand the terminology used (most of the time), but (for the Astell&Kern AK240) having to manually solder up a 2.5mm plug for a pair of balanced headphones (I'm glad I didn't have to do that – and nor should anyone else have to) is either a welcome return to the more DIY side of hi-fi or a complete pain in the rear for everyone else. Oh, and then there is the small matter of having to sort out

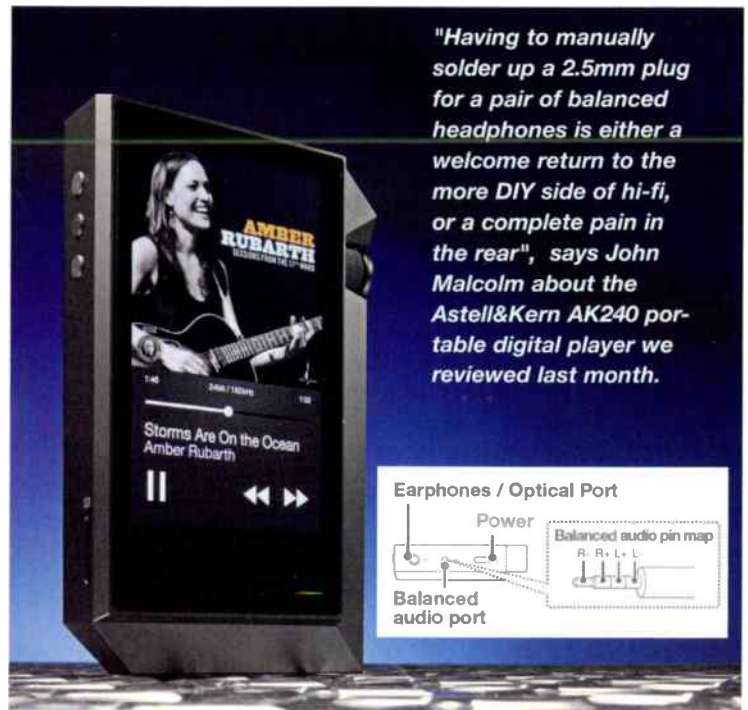

"Having to manually solder up a 2.5mm plug for a pair of balanced headphones is either a welcome return to the more DIY side of hi-fi, or a complete pain in the rear", says John Malcolm about the Astell&Kern AK240 portable digital player we reviewed last month.

the earthing as well – this is complete madness! Not The Nine O'clock News satirised the jargon of hi-fi over thirty years ago; imagine how much fun they could have with today's kit – assuming people would understand the jokes!

Computers – well, to be more precise, the Operating System/Graphic User Interface – have had to get easier to use (...no Microsoft, Windows 8 having big tiles like an oversized mobile phone does not make it easier to use!), and Apple have led the way here, but even so there is still much which can be improved.

And as to what Chord were thinking with their Hugo, well I shudder to think.

People like things that are easy to use, simply laid out, and don't require a dictionary of TLAs (three letter acronyms) to understand. When I got my Marantz amp I just wired up the speakers, connected the inputs and off I went – controls such as Bass and Treble may be redundant on modern

amps but they are easier to understand than DSD-to-PCM and all the various sampling rates etc. Yes, digital needs urgently to standardise on a single rate – 96/24 would suffice for most people? – and do away with all the jargon. What happened to Plug And Go?

So, after a period of simplification – from all the technical things you needed to know about playing an LP, to just popping a CD in the player – hi-fi is in danger of vanishing up its own backside in a mass of confusion, here-today-gone-tomorrow standards and stupid format wars, more numbers than an accountants' convention, and even the merging of devices with computers, creating even more jargon and confusion.

All this is the intellectual equivalent of the rear of a top-of-the-range 11.2 home cinema amp, with all its connectors/sockets. People just switch off and walk away shaking their heads – is it any wonder hi-fi is not mainstream, even if people (when



"The rear of a top-of-the-range 11.2 home cinema amp, with all its connectors/sockets. People just switch off and walk away", says John Malcolm.



Our Please Please Me stereo Factory Sample LP, new from Abbey Road and virtually unplayed to preserve its grooves. It is being used to run in a special Ortofon 2M Mono SE cartridge designed specifically for the new The Beatles in Mono LPs.

demonstrated to properly) have the high-quality equipment (their ears) to appreciate it? It's a real shame.

John Malcolm

Hi John. I understand Astell&Kern can now supply adaptor leads for the AK240 but as I have broken a few 2.5mm jack plugs in the past, they are so small and weak, I suspect this is only half of a good idea. There are other connectors that could better be used. One is a mini-XLR that may just fit the case.

The curious issue of the AK240 is that it was optimised for balanced output in design but then ill equipped to deliver it in any practicable form through the physical connectors in practice.

An easy-to-use output arrangement would make both balanced headphones and balanced-input hi-fi amplifiers easy to use and have obvious appeal to buyers who would see it as a clear benefit (USP) of the product.

Astell&Kern could also consider re-packaging this portable into a dynamite stand-alone high-resolution digital player, a bit like the Aune S1.

I agree that 24/96 should be a recognised hi-res standard although it has become a 'de facto' standard in any case: nearly all devices can play 24/96 PCM. **NK**

THE BEATLES CD REVIEW

Tony Bolton insists in giving me good advice and this time I have to thank him for the information on the Art du Son cleaning fluid which shall prevent me from using aggressive fluids to wash my LPs and 78s with the advantage of not having to replace the fluid on my record

cleaning machine whenever I decide its 78s washing day. Thank you Tony, again and again, for your sound advice.

I was born in 1954 therefore I'm proud to announce that I belong right inside the Beatles generation. Yeah, the one that grew up listening to their records night and day, grew their hair to shocking lengths, wore leather boots with elasticized gusset, knew all Beatles lyrics by heart and whistled along to every guitar solo George Harrison ever played, had all their records and saw religiously their cartoons at noon on TV and their movies at the neighbourhood theater twelve to twenty times in a row.

The loft was our kingdom. My brothers and I kept our model railroad there along with a Dansette, our records, Enid Blyton's books and the bicycles which were hoisted up and down by means of a hand-winch (my youngest

Brother, the Irish Setter Derry and my grandmother's cat Spitfire were regular passengers too).

I was ten when I got my first Beatles record. In fact, not one but three American LPs (two of them are mono records but 'Something New' is a High-Fidelity one already), an EP and two singles. All these goodies were provided by my aunt T who was obtaining her PhD in New York, specialising in the rehabilitation of blind people. A year later she would be at the London University Hospital still completing her studies and then I got in the mail The Beatles first – an LP featuring Tony Sheridan and the very suspicious Beat Brothers. As a bonus the Rolling Stones single 'I Wanna Be Your Man' came along and was soon discarded by my brothers and I after having decided it was a fake. Well, The Beatles first was



What Mario Kopke Tulio in Portugal – and many others around the world – are waiting for: The Beatles mono studio albums, re-mastered from the original mix-down master tapes. They were launched 16th June 2014. A 14 LP boxed edition as well as individual albums will be available.

almost never played because it oddly didn't sound like them at all.

In 1966 my Aunt T, who was 18 years older than I, was back in Portugal launching in Lisbon a rehabilitation centre for the blind and she gave me 'Rubber Soul' in the summer and my grandmother gave me 'The Beatles for Sale' that very same year for Christmas.

Three years latter aunt T died tragically in a car crash driving from Lisbon to Porto where she was to attend the opening of her Oporto Home for the Blind. She was 31 years old.

The first three Beatles American LPs and the European versions of all the remaining Beatles records have traveled along with me during the last fifty years. Their music has been my soul's skin in happy times and painful times as well. Whenever I listen to their music all my old feelings surface once again. Good and bad memories merge in a bittersweet state of mind allowing my dead to resume their places among the living in my heart and mind. There really are people, places, states of mind, smells, sounds, the afternoon sunlight through the windowpanes in the loft that, in my life, can only be revisited to the sound of the Beatles American records.

I was therefore delighted to read Paul Rigby's article on the reissue of the Beatles USA records and was thrilled to know that this CD box resulted in a true audiophile uncompressed rendition of their music. I can't but thank him for a professionally-done job with this review which I appreciated to a deeper extent than the one of a well-written review on any other subject.

Though, feeling an urge to order the USA CDs now, due to the heavy investment I recently made in my vinyl and 78s reproduction separates (restoring and upgrading turntables, buying cartridges, tone arms a phono pre-amp and a Graham Slee Elevator) I will probably wait for the vinyl versions that, I assume, must be on their way.

However there's a remark made 'en passant' by Paul about the impression left by George Martin's 1987 re-masterings on some audiophiles that consider these re-masterings as a tad bright. Of course they are. I believe (that's my humble opinion) that this subtle tendency to 'polish the silver' in the higher frequencies has to do with the will to smartly recreate the way my generation remembers the sound of those early mono records. Most of us played all our records on Dansettes. At the time I was ten my father wouldn't allow us to play our records on the living room's radiogram and, even less, to play them using his music room equipment



Abbey Road today. We managed to get an early morning shot to avoid being run down whilst standing in the middle of the road. The zebra crossing is looking worn out - you can see why by going to the live Abbey Road crossing cam at <http://www.abbey-road.com/crossing>. Crowds still gather, swarm across the crossing and cover the beacons and walls with graffiti.

(the Garrard 301, the KEF Concertos and the Leak amps).

For me, the original way to listen to the Beatles really accentuated the higher frequencies as our reproduction equipment didn't promote bass at all. For many years that was the way the Beatles sound lived in our hearts and souls – almost bass-less. In fact I still have my Garrard beige-and-red Dansette in perfect working order and I am at this precise moment meeting the Beatles again as if it was my first time. Best regards and thanks to all of you guys.

Mario Kopke Tulio, Portugal.

Thank-you for your informative and touchingly personal letters too, Mario. I'm sure all of us relate songs to people and events in our past – and they bring back moving memories.

You'll like to know, I imagine,

that we have been talking to Abbey Road and Universal for some time about the new Mono Master LP box set and individual albums, and we should be reviewing them in our next issue. You will find my introductory interview on p83, explaining the situation.

I live close to the studios, have known people there for many decades and have a Factory Sample set of stereo LPs as a result (won't say how, but it was legit!).

We're playing 'Please Please Me', their first LP, in the office right now with an Ortofon 2M Black stereo cartridge and a new 2M Mono pre-production sample, made specially for these forthcoming The Beatles Mono LPs, that uses the Black's Shibata stylus and silver wiring. This is preparatory to receiving the new Mono LP box set in a week or so.

Our 'Please Please Me' LP sounds



A Dansette Major Deluxe 21 record player. If it evokes memories, then go to <http://www.dansetterevolver.co.uk> where you can get plenty more pics and even videos showing the things playing - with sound! You can buy players and spare parts here too.

Letters On-Line!

You can now read our Letters on-line, from the last issue back to March 2010. That's a treasure trove of information and advice to our readers, as well as a fascinating catalogue of reader's systems and views. There's mountains of buying information, all just a click away on your computer or i-Pad. Have fun!

You can reply to Letters using the e-mail link at the top of the page -

World Mail June 2011 issue

Write to us! E-mail → letters@hi-fiworld.co.uk

Letters are published first in the magazine, then here in our web archive. We cannot guarantee to answer all mail, but we do manage most!

Or comment in the Comment section at the bottom of each page.

Your experts are -
DP David Price, editor; NK Noel Keywood, publisher; PR Paul Rigby, reviewer; TB Tony Bolton, reviewer; RT Rafael Todes, reviewer (Alegri String Quartet); AS Adam Smith, reviewer; DC Dave Cawley, Sound Hi-Fi, World Design, etc.

...or the reply pane at the bottom of the page.
Replies will go on-line and in the magazine if suitable.

Add your comment

Your name:

Subject:

Comment:

Word verification: 



The screenshot shows the HI-FI WORLD website interface. At the top, the 'HI-FI WORLD' logo is prominent. Below it, there's a navigation menu with 'LATEST' and 'Magazine issue date' highlighted. A 'Title Filter' dropdown is set to 'All'. A list of magazine issues is displayed, including the current issue (September 2011) and previous ones from August 2011 back to March 2010. On the right side, there are several advertisements, including one for 'SEVENOAKS' and another for 'audio-T'. A search bar is located at the top right of the page.

Just go to www.hi-fiworld.co.uk and click on Letters in the left hand menu list, under the FEATURES category. This will take you to the individual months of issue. To see the full list set the 'Display' drop-down list to 'All'.

clanky and bright. There's no body in the sound, even with a system strong in this area, comprising Icon Audio PS3 valve phono stage, Quad QMP monoblock power amplifiers and MCRU No142 and Quadral Aurum Wotan VIII loudspeakers. But as you'll likely know, the first album was recorded in a rush, Mark Lewisohn's bible on the subject tells us. So perhaps we must expect 'Please Please Me' to sound bad. But then perhaps not: perhaps the new mono LPs will have more body and life to them at least when compared with our Factory stereos. This is difficult to predict. And what do we make of Tony's comments below? I suspect not all 'Please Please Mes' are the same!

To play these new LPs at their best requires a suitable system. We will use both the forthcoming Ortofon cartridge made for the purpose, known as the 2M Mono SE, through an Icon Audio PS3 phono stage with Mono switch. We will also use a Cadenza Bronze stereo moving coil I expect.

Because Beatle's LPs were monitored on Tannoys, a pair of new Tannoy Kensington Gold Reference loudspeakers are on their way to Hi-Fi World towers (we hope – they keep selling the things to the Japanese!).

I hope you'll find all this interesting. There's so much going on with LP these days that I think you'll find your amazing system will only become ever more valuable to you as time goes on. **NK**

Hi Mario. It is good to hear from you again and to find that my suggestions



Tannoy 15in Lancaster Gold studio monitors at Abbey Road studios, 1971. For the first 'Please Please Me' session Paul McCartney used a bass amp hastily built for him by Abbey Road engineers, employing a Tannoy loudspeaker taken from Echo Chamber No1 – his own amp was unusable!

have given you satisfactory and pleasing results.

I am also awaiting the release of the Beatles LPs with interest. I am lucky enough to have found copies of first pressings of the first six LPs over the years. Some are in very good condition, the copy of 'Please Please Me' looks frighteningly bad but plays surprisingly well, with some inevitable pops and bangs. However, the sound is so fresh and vivid that I refuse to part with this disc and enjoy every minute of listening to it.

I have compared it with more modern mono and stereo pressings, in far better condition, and none of them come close to the sheer presence and drive to the sound of the music on my original. I shall be most curious to compare it to the

new edition.

I can reassure both you and Noel that it is not lacking in bass performance in any way, with a full-bodied and very lucid sound right across the frequency range. **TB**

A CLASSIER OPTION

I find myself approaching fifty years of age and never having bothered before with anything hi-fi, I find myself wanting a classier sound without going silly with money. I simply have a large number of songs on my phone, my family loading them on for me and Queen being my favourites, and I'm fed up with it sounding tinny all the time.

I'm not clued up about what to do here. I know I don't want cables and wires and I must be able to move around with it. I am thinking about



"I was considering using the 8 Ohm taps for the treble section and the 4 Ohm taps for the lower section", says Martin Mason about his Icon Audio Stereo 60 MkII amplifier.



Our in-house turntable and arm, alongside an Astell&Kern AK120 portable, hi-resolution digital audio player. Technically, the AK120 is way ahead, but LP remains a beguiling listening experience.

Spotify but not through my 'phone speakers, no way.

Hopefully I don't sound like a thickie, compared to all you clued up people and hope that you can make a suggestion or two.

Mick Broadbent.

I presume you are listening exclusively through your 'phone's 'speakers and are finding them "tinny". Most 'phones these days have a Bluetooth transmitter. You can send your music to a hi-fi with this using a Bluetooth hi-fi receiver such as the BT 100 from Cambridge Audio. Just connect this into an amplifier. Or you can buy Bluetooth equipped loudspeakers and transmit directly to these. The Frankenspiel FS-X loudspeakers with BMR technology impressed us and they would do fine.

With Bluetooth you can walk around but it is deliberately a short-range transmission system, usually – but not always – confined to the room you are in.

If you want to walk around whilst playing music stored on your 'phone then you need headphones for better sound quality. Big, over-the-ear phones give strongest bass; on-ear phones have less bass but are light, portable and easy to wear, whilst in-ear phones are usually cheap and uncomfortable, but not always – Sennheiser make some very good, if expensive, in-ears. If you want to be free of headphone wires then Bluetooth headphones are a solution; just be aware they need re-charging, as do Bluetooth speakers. **NK**

BI-WIRING

Would you be kind enough as to give me some advice about bi-wiring. I have just bought some Tannoy Definition DC8Ts and am driving them with an Icon Audio ST60 Mk2 valve amp with QED XT400 cabling (17 metres total, left and right channels) and silver-plated

OFC jumper leads and a fifth wire earth cable connected.

Still wanting to improve the sound, I am contemplating bi-wiring with QED Silver Anniversary XT rather than use the same wire that I currently use i.e. the XT400 on the logic that a 1.5 mm² cross sectional area should be O.K. for the treble section with a 4mm² cross sectional area for the lower regions. Is this sensible?

I was considering using the 8 Ohm taps for the treble section and the 4

Ohm taps for the lower section, which from your review was a 2.7 DCR and a 4 Ohm rating in this lower part of the frequency range (on your review of the DC8T you suggested a 4 Ohm loudspeaker rating rather than the 8 Ohm rating given by Tannoy. However your graph suggests that the higher section of the frequency range is the 8 Ohm rating, as claimed by Tannoy).

Will the use of the two taps be beneficial by using different windings for the two sections of the loudspeaker

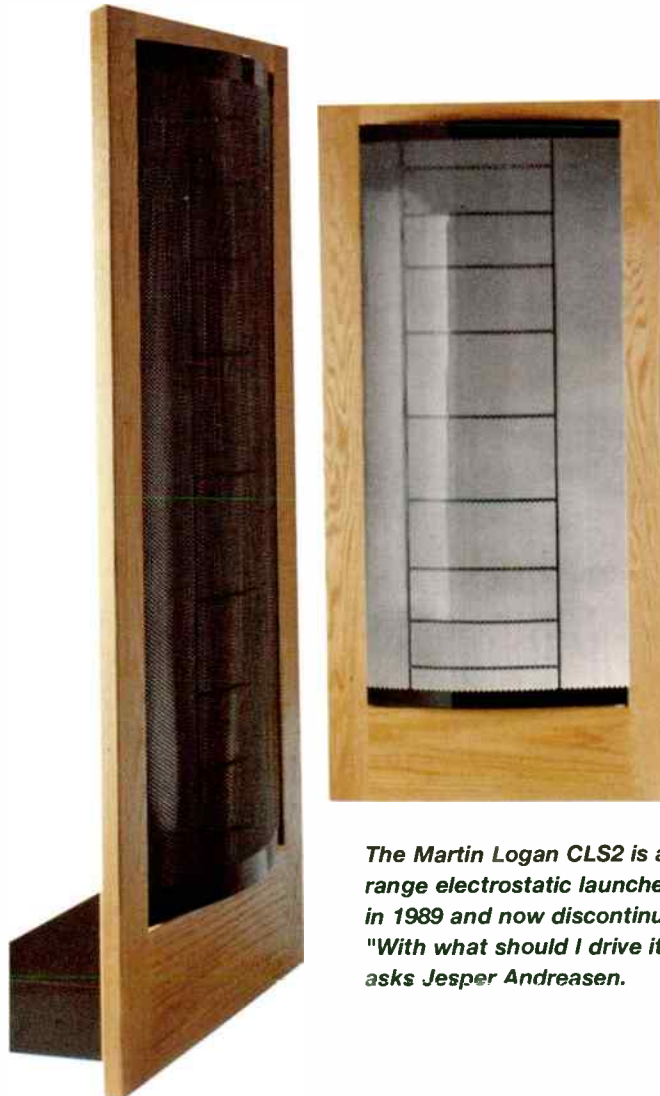

The Martin Logan CLS2 is a full-range electrostatic launched in 1989 and now discontinued. "With what should I drive it?", asks Jesper Andreasen.



To hear Odin in the room, drive your electrostatics with Icon Audio MB845 monoblock power amplifiers, we say.

circuit and therefore reducing the loading and improving the matching and so further dissociate the two sections of the amplifier and loudspeaker?

Thank you in anticipation of your reply and help.

Yours,

**Martin Mason,
Coventry.**

Hi Martin. The answer to your question is 'No'. The 4 Ohm tap swings less voltage than the 8 Ohm full winding so you will make the loudspeaker sound brighter than it is meant to sound. Nice idea all the same – and you can try it if you wish, as no damage will be caused. Otherwise, stick with standard bi-wiring.

If you want to tune the DC8Ts, the foam port bungs will alter bass level usefully and are worth experimenting with. If fully-in gives too little bass and out too much bass, then try introducing an 'air leak', meaning a small resistive venturi. A good start is a drinking straw.

And don't forget the fascinating art of tube rolling. Icon Audio know a lot about the sound of different valves and are worth consulting on this. **NK**

LOW LIFE

I've been living a low-res audio lifestyle lately, using YouTube and an ASUS laptop as a source, feeding shielded solid-core cables into a rebuilt (by my father) Leak Stereo 20 amp with high-quality plastic capacitors in the power supply and Black Gate capacitors throughout the circuit.

This powers a pair of Fostex speakers, the full-range drivers that are made from pulped Banana skins. The sound? More than satisfying. It

pays testament to John Bamford's Rear-End theory, where the most important components are the speakers and amplifier. Though it is not entirely valid, it's a good theory.

Ivor's Garbage-in/Garbage-out analogy was apt for the analogue age, where high-quality engineering was required to elicit a high-quality sound. In the digital age the burden of performance shifts more to the speakers.

I'm old enough to remember taping my favourite songs off the radio with mouldy old tapes and a crappy tape recorder, so YouTube is like the stuff of science fiction. I'd be interested to know what percentage of people use it as their main source.

On to another subject ... walking down the street, I passed a pile of garbage and sensing audio booty (Ed – I think you mean 'bounty' here; 'booty' is something not quite the same!) I dived in head first, Adam Smith-style. While it failed to yield any audio equipment, I found 20 years worth of Audio Journal Yearbooks, featuring all of the components released that year. Further digging only revealed, tragically, a hearing aid.

Upon reading the Journals it seemed their

previous owner had grand plans for his system. Mega-dollar components were circled, big money, hideously complex solid-state preamps which would sell for little money today. It's interesting to see how components age. Their asking price when new often has little to do with their ultimate value.

For the first time in years I feel satisfied with my system. While in the past I dreamt of infinite upgrades, now I just listen to music. Crazy right? I would never have guessed that a laptop and grainy low-res files would lead me to audio nirvana.

My turntables sit dormant. In the new millennium they are just too



"Having recently purchased a lovely pair of Naim SBL loudspeakers in a fetching walnut finish for a modest sum, I am mightily impressed with them", says Tony Hodgkinson.

laborious, expensive and cumbersome. My Elite Townshend Rock Turntable is a great example of that. While playing records I found they would skip at a certain point. I couldn't figure out why. Ultimately extensive investigation revealed that an insect had drowned in the silicon trough and turned translucent, fouling the paddle.

Can you imagine the kids today tolerating that kind of faffing? They want infinite access to music on the go. It's that kind of Blue Sky dreaming that fuels audio developments – and why not?

Ben North

Damping paddles on an arm always were messy and inconvenient. I was never sure they made so much difference either, in spite of their theoretical benefits. I use an SME312S 12in arm at home and we all use an SME309 9in arm in the office listening room, mounted on a Sound Hi-Fi modified Technics SL-1210 – and no one finds this a difficult combo to use. No matter how good hi-res gets it never eclipses the sound of LP, which emerges from the loudspeakers with a sense of power and depth that's a delight. LP is easy and hassle-free in its own way, unlike some modern digital 'music systems' that border on daft.

I freely admit to loving YouTube for music. The old music videos in particular can be fascinating, especially the grainy black-and-white TV appearances of bands long gone, like Peter Green's Fleetwood Mac and other now completely forgotten UK Blues bands like Ten Years After. YouTube seems to have it all, except quality of course. Most of the sound is compressed MP3 or AAC and this bit of it is mediocre. Love it late at night on headphones all the same.

NK

DRIVING STATICS

I've had a pair of Martin Logan CLS 2 electrostatic loudspeakers since my first bonus. They still sound fantastic. But I've heard that with the right valve amp you would be able to see Odin in the room. In your opinion what would that valve amp be? Short answers appreciated. thanks

Jesper Andreasen

Simple – get a pair of Icon Audio MB845 power amplifiers. They have enough power to drive the CLS2s and massive grunt from massive graphite-anode 845 triodes. They can also handle the 1 Ohm load at

20kHz, which will cause transistor amps to expire with obscene haste. **NK**

NAIM SBLs

May I suggest a slot for a future Olde Worlde feature – Naim's SBL loudspeaker.

Having recently purchased a lovely pair of Naim SBL loudspeakers in a fetching walnut finish for a modest sum, I am mightily impressed with them. While they may not be everyone's cup of tea they have sorted out many issues I have had with most 'speakers I have owned over the years.

I recognised that the only speakers I have ever really got along with were all infinite baffle, closed designs and took a hunch I may just like the SBL. My hunch was correct and I am now enjoying music like I haven't for a long time.

What's also interesting is the design of the SBL – and with parts still readily available and modest asking prices for a pair, it makes them a steal.

I purchased a new pair of tweeters from Scanspeak and new crossovers from Naim, again for modest sums just so I can keep these speakers running indefinitely. They are easy to site, respond well to what comes at the beginning of the chain and have the chance to take them active, so what's not to like?

But most of all, gone is the bass boom I often heard from ported bloaters – wonderful. So in your infinite wisdom, I hope you give the SBLs a chance in Olde Worlde. I use Naim amplification and source but feel sure they can work with other brands. Regards,

Tony Hodgkinson.

ABSOLUTE PHASE

I have a couple of queries re: apparent phase. For the last few years I have been aware of some recordings sounding 'trebly' with inferior timing. If I reverse the loudspeaker connections on both loudspeakers – hey presto! Better harmonic/musical timing, no fatiguing treble and better bass/tonal colour. So would I benefit from a pre amp which has a 'phase/polarity reverse' facility?

I use an excellent Woodside (nee Radford) valve preamp (SC 26) which I have had for some years and do not really wish to change it. However, this apparent phase sensitivity is at times highly irritating.

I did enquire with a couple of engineers about modifying the Woodside but the advice was to leave well alone (I was also politely informed by one

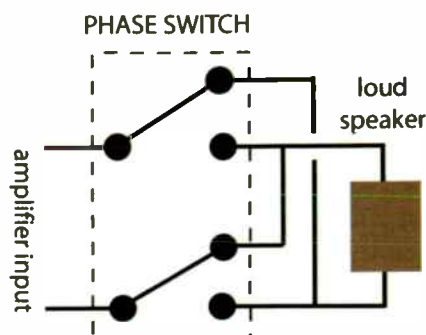

To change absolute phase use a two-pole changeover switch between amplifier and loudspeakers. It should have a current rating of around 5A. Wire it as in our diagram.

engineer that, in theory, I really should not be able to hear phase changes).

Would it be possible for a phase/polarity reverse facility to be built as a separate box for connection between a pre and power amp or source and pre-amp when required?

The system I use is: old 1 bit Phillips CD, Linn/Zeta/Radikal/Koetsu, Woodside pre and power valve amp (also an excellent SET modified Lowther power amp) and Tannoy Silver 12in monitors. I am not an engineer or competent with electronics.

Yours sincerely,

Bruce Williams.

Hmmm... that's an interesting one. As the engineers say, absolute phase is generally regarded as undetectable, although some say otherwise. I've never been convinced I have heard any useful difference but perhaps, as you say, only some recordings seem to benefit. It isn't easy to swop ordinary unbalanced phono lines around, as one line is a ground. Balanced lines can be changed around without difficulty but your system does not have them.

Technically, the cartridge can be swapped, providing one line is not grounded or the loudspeakers. As you have a valve amp with probably at least 1 Ohm output impedance, you could put a changeover switch in the speaker lines. Purists may shudder but it is simple, cheap and should work.

You likely won't get a heavy duty (a few amps) four pole changeover, so may need to use two two-pole changeovers. Buy the switches from Maplins, mount them in a plastic or alloy box then get someone to wire them up. Just ensure there is no wiring error as it would be possible to short a channel, although a valve amp will withstand this for a short time at least. **NK**

MWA-RC Magnetic Wave Absorbers



"Dynamics in the music seem to be more refined with the Magnetic Wave Absorbers fitted and the music flows more smoothly. This is an excellent value accessory for your hi-fi system"

HI-FI Choice, October 2013



These simple yet effective products from Oyaide in Japan have been designed to add further improvements to the equipment and cabling in your system.

MWA-RC caps are manufactured from high quality polypropylene which act reduce the vibrations found on unused RCA contacts on your system.

The inclusion of a 1mm thick piece Oyaide's very own Magnetic Wave Absorption material also acts as a barrier from the noise generated from the unused RCA contacts on your equipment.

Additionally the caps act as a barrier to dust build up in your equipment, which combined with the above can taint the quality of the music you have come to love and enjoy!

TRY THEM FOR YOURSELF... WE GUARANTEE YOU WILL NOT BE DISAPPOINTED

Tel: 01332 342233

sales@blackrhodium.co.uk

www.blackrhodium.co.uk/oyaide

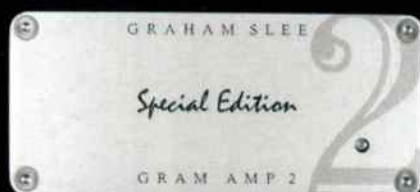

Gram Amp 2 SE phono preamp (top):
Hi-Fi Choice recommended
plus 8 other recommendations



NEW: Majestic DAC/preamp (middle):
top score in 4 out of 4 user reviews

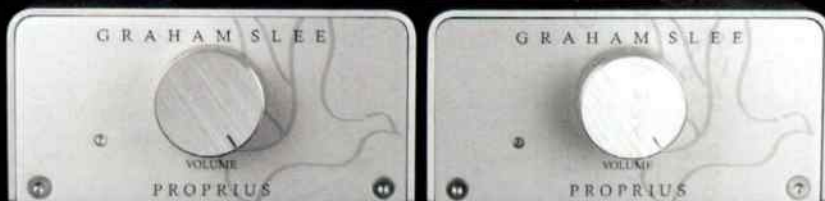

Pair of Proprius monoblock power
amps (bottom): Hi Fi Stars (Germany)
– the reviewer bought them!

Just add turntable, digital sources,
interconnects, speaker cables
and loudspeakers for a jaw
dropping musical treat

...find out more at www.gspaudio.co.uk



Graham Slee Projects Limited,
6 Buttercross Drive, Little Houghton,
Barnsley, S72 0HS
Tel: 01909-568739

Superior Performance Hi-Fi Products

from my Astell&Kern AK120 portable digital player through our Audiolab M-DAC, the No127s imparted a suitable sense of scale, deep organ notes coming across as solid and well defined; these 'speakers really do have quality bass.

The choir stretched broadly across the end of our listening room, in an image that moved beyond the outer edges of the loudspeakers. This gave an expansive quality to the performance, which suited it well, yet at the same time there was enough focus to pick out the choral sections. With no upper treble in the recording, the No127s sounded generally large, powerful yet smooth.

With standard rock having plenty of not-so-sweet upper treble, meaning Tom Petty's 'Refugee' (24/96), drums had punch and upper treble was obvious but not overpowering, tweeters up full. Petty sung from a stage that had a good sense of depth to it and the Hammond organ swirled around clearly. It was a gutsy, smooth, fast-paced and impressive performance.

Harmonica in Marta Gomez's Lucia (24/96) also had a nice



free quality to it, floating in space seemingly unanchored to the physical loudspeaker cabinet, yet as an instrument it was rich and full bodied: it was a very attractive presentation. The No127s also time very well, making explicit the Latin tempo of this song.

CONCLUSION

The longer I listened to the No127s the more I liked them. They've been

honed to produce a beautifully balanced, tightly-controlled sound with the bass depth and dynamic punch so many of us crave. There's no flabbiness, no excess and no overhang; they're temporally tight, relaxingly clean in the time domain and yet viscerally strong too. They have a masterful balance here and there was a lot of freely-offered praise from other listeners at Hi-Fi World towers – always a good sign! This is how you want and hope a loudspeaker might sound.

Weaknesses? Treble from the forward-firing planar magnetic tweeter could be smoother perhaps, but I suspect most listeners will like their 'bite' as it is. This was no big issue.

On balance, I felt the No127s had a great sound and were exciting with both rock and classical. Big sounding, with clean, deep bass and a wide open soundstage, going very loud with ease from a few Watts they have a raft of strengths rivals at double the price struggle to match. I thoroughly enjoyed them, coming away impressed. These are speakers definitely worth hearing.

MEASURED PERFORMANCE

Close up, at or within the usual 1 metre limit of the measuring microphone, the MCRU No127 did not look so good, due to a large dip in its frequency response between its treble unit and top bass/midrange unit, around 1.5kHz.

This looked like a phase dip, suggesting the tweeter was connected out-of-phase. Reversing tweeter phase lessened the problem, producing a flatter midrange, but did not eliminate it. Turning up the rear tweeter output to maximum helped fill in to a useful degree also, but again it did not eliminate the dip completely. It is an amplitude dip – meaning the bass/midrange unit is unable to reach the lower limit of the magnetic planar treble unit.

The measuring microphone had to be moved relatively far (1.5 metres) from the No127 before it started to look integrated, meaning it integrates best in the far field. That's not a problem in real life because most people sit 3 metres away or more but it is worth noting. The dip means that, subjectively, there is no midrange harshness, softening out the sound a little. The fill-in from the rear tweeter is ambient energy that contributes to midrange in particular, and this was audible in use; turn the tweeter down and the dip gets larger.

Our published frequency response

curve otherwise shows strong upper treble output from the planar tweeter, a slightly lumpy lower midrange due to internal cabinet resonances seen in the red port trace, and both strong and extended bass that reaches down to 30Hz with ease. The bass peak at 80Hz will ensure bass is both obvious and 'fast'.

The port is well damped and works around 40Hz, having reasonably strong output. It will add to deep bass left.

The four bass/midrange units

FREQUENCY RESPONSE

Green - driver output

Red - port output

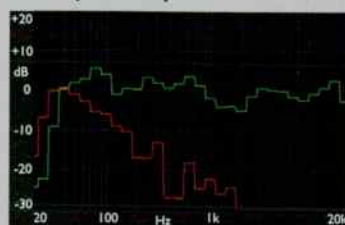

IMPEDANCE



present a lot of cone area and move air well, helping the No127 produce a very loud 91dB from one nominal Watt (2.8V) of input, although a low measured impedance of 4 Ohms helped toward the figure. The No127 will go very loud at low volume settings of transistor amplifiers as a result; valve amps must have a 4 Ohm tap. High powers are not needed, 40 Watts being more than enough for high volume.

As a load the No127 is impressively resistive; it has none of the reactive elements of most loudspeakers, so is a good load. Whilst low impedance suggests high current draw, high sensitivity means the opposite; the speaker is efficient and will be easy to drive.

A 200mS decay spectrum showed quite a lot of bass overhang from what appears a lively cabinet, but overhang is always greater when a loudspeaker produces strong bass from a compact cabinet.

The MCRU No127 is very distinctive when measured. It is wideband, has strong upper treble, powerful bass, is extremely sensitive so needs little power.

It will well match any amplifier able to drive 4 Ohms. Sound quality will be 'impressive' with this combination of properties. **NK**

MCRU NO.127
£2495.



OUTSTANDING - amongst the best

VERDICT

Powerful, wide-band sound, with firm deep bass and precise treble, the No127s are exciting to hear. Temporally clean and well-defined, they have pace, as well as bass.

FOR

- punchy sound
- need little power
- go loud cleanly

AGAINST

- unprotected rear tweeter
- strong high treble
- some midband warmth

MCRU
www.mains-cables-r-us.co.uk



Naim's revised Supernait integrated amplifier has lost its digital inputs – but gained a whole new level of musical insight, says Jon Myles

Analogue art

Whatever you think about Naim, you can never accuse the Salisbury-based outfit of simply following the crowd.

This was, after all, the company that held out for ages before producing its first CD spinner – arguing that it didn't want to rush to market until it could produce something significantly better than what was then on offer.

In contrast, it embraced computer-based and music streaming with an almost evangelical zeal while some other companies were content to watch from the sidelines.

Now that market is expanding exponentially with new amplifiers sporting all sorts of digital inputs what has Naim decided to do? Yep, remove any semblance of them from its flagship integrated.

But for those shaking their heads in bewilderment, it has to be said that there's plenty of clear-headed thinking behind Naim's decision.

For a start, they already produce a comprehensive range of award-winning DACs and streamers at a variety of prices – from the small UnitiQute to the state-of-the-art wallet-busting NDS.

So, they argued, why duplicate

those functions in an amplifier? Instead they decided to re-engineer their Nait range of integrations (the Nait, Nait XS and Supernait) to simply make them the best amplifiers Naim could produce at their respective price points.

As such the Supernait 2 loses its predecessor's digital inputs but gains a whole raft of interior revisions all aimed at helping it do its primary job of driving loudspeakers just that little bit better.

Chief among these is a new power supply section. The 80 Watts per channel output is the same as the previous model but a larger toroidal transformer has been employed to improve the amplifier's dynamic abilities.

The power supply for the preamplifier section also makes use of Naim's discrete regulator technology – which is said to improve impulse response and lower noise.

Other changes include hand-wired inputs which are all individually decoupled for better microphonic isolation, upgraded components in critical areas such as the power amp stage and new PCB and wiring loom layouts.

On the outside the new amplifier retains the familiar Naim black

aluminium triptych-fronted casing of the original Supernait with volume and balance controls to the left – but the 3.5mm headphone socket has been (thankfully!) replaced by a full-size 6.35mm version driven from a new Class A headphone amplifier circuit.

Round the back the comprehensive range of connection options include both RCA as well as Naim's preferred DIN inputs as well as a USB socket – although this is reserved for software updates only.

And true to the company's ethos there's also the facility to add a power supply upgrade in the future – ranging from the £775 Flatcap XS to the luxury Supercap at £3800.

Slide the unit into your equipment and in typical Naim fashion it looks understated yet purposeful – and its 13.4kg weight testifies to the solidity of the casing and size of the new transformer.

SOUND QUALITY

It's fair to say the original Supernait was always something of a special performer at its price point. I've had one in my main system for a number of years and it's a muscular, beefy performer that doesn't lack for detail or subtlety when the music demands it.



The Supernait 2 builds on those attributes but is a much more musical performer all round with an added degree of sophistication that befits its position as Naim's top-of-the-line integrated.

Play some bass-heavy big beat tracks such as The Propellorheads' appropriately-titled 'Decksanddrum sandrockandroll' and the Supernait pounds out the rhythms with an authority and conviction that few rival amplifiers can match.

Driving our reference Quadral Aurum Wotan Vllls, the Naim displayed prodigious low-end power but did so with a calm authority that never once threatened to collapse into an unpleasant blur of bass bloom when the volume was turned up.

Instead what you get is a firm foundation on which the rest of the music can build with the all-important midband taking on a greater solidity and realism as a consequence.

And it's here that the Supernait really shines. The Quadral's ribbon tweeter and metal-coned midrange driver can be rather unforgiving at times – but with the Naim they sounded clean, clear and precise without ever straying into the harshness or unnecessary zing that some other amplifiers can induce.

Instead, on the likes of Sinead O'Connor's 'Sean Nos Nua' there's simply a delicious air and delicacy to the Irish singer's vocals and sparse backing band that brings a live feeling to the proceedings. There's also plenty of detail – O'Connor's intakes of breath between verses and subtle changes in key all beautifully captured.

Those who still (mistakenly) believe Naim amplifiers are more suited to hard-charging music will be amazed at the subtlety on display here.

It's clear the removal of the digital sections and improved power supply has given the new Supernait a more open, spacious sound – as though an extra level of insight has been added.

Yes, it will drive your speakers to wall-shaking levels without strain if so desired – but it will also bring out the subtlety and micro-dynamic details in gentler pieces of music.

And it does so while hanging the elements together in a beautifully-realised soundstage.

Take Jan Garbarek's 'In Praise Of Dreams' collection. Here synthesisers, drums and viola provide an atmospheric, echoing grounding

for Garbarek's soprano and tenor saxophone explorations and through the Naim/Quadral combination it takes on a magical, almost ethereal quality.

Instruments are hung precisely in front of you – the sax parts soaring high above the 'speakers while the sweeping electronica backing spreads right and left to envelop the room.

When Kim Kashkashian's sonorous viola cuts in as a counterpoint to the main sax lines the interplay between the instruments is deeply etched and portrayed with tremendous finesse.

It's clear that the Naim engineering team's decision to strip back the Supernait to its basic analogue amplifier function and concentrate on getting the best from this configuration has paid dividends.

Visionary coach Dave Brailsford famously introduced the concept of marginal gains into British cycling – that is making small improvements

in every area of an athlete's ability to bring huge leaps in overall results.

It seems Naim have taken that philosophy to heart and translated it to electronics with the Supernait 2. The digital inputs may have gone but the attention to detail, improved component specification and revised circuit design that have gone into the Supernait 2 have wrought real benefits in terms of overall ability.

CONCLUSION

To say this is the best integrated amplifier Naim has ever produced is something of an understatement. It's actually among a select group of amplifiers that can take on rivals costing twice the price – combining taut, powerful low frequencies with a lightness and delicacy of touch that lends itself to any genre of music you care to play.



MEASURED PERFORMANCE

Power measured 100 Watts into 8 Ohms and 156 Watts into 4 Ohms, plenty enough power for most loudspeakers in most rooms.

Like all Naims though, the Supernait 2 has a low damping factor that will tend to inflate bass a little; very high damping factors subjectively don't work so well with loudspeakers that are acoustically well damped, so low damping factor suits many loudspeakers, if not all.

FREQUENCY RESPONSE

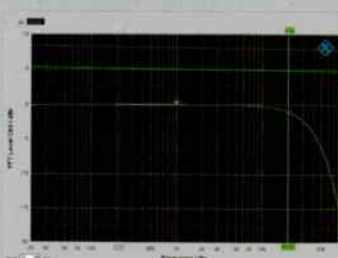

DISTORTION

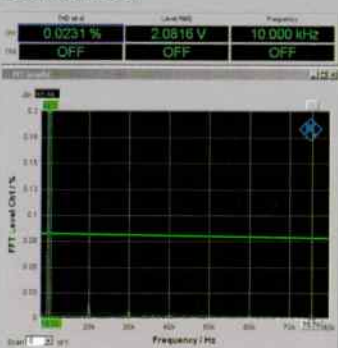

Distortion levels were low at all frequencies and outputs, measuring a low 0.02% maximum at 1 Watt output at 10kHz, where amplifiers produce most distortion.

Another feature Naim have retained in the Supernait 2 is curtailed high frequency response, at all volume level settings output was -1dB down at 20kHz – much like a valve amplifier. The Supernait 2 will definitely avoid any semblance of brightness in its sound.

Sensitivity was high too, measuring 180mV for full output, from the CD input, so the Supernait 2 will reach full output at fairly low settings of its volume control. It also means it will work with low gain external phono stages and because there is no phono input this will be important to anyone wanting to play LP.

The Supernait 2 is powerful and follows Naim design rules, so will give a classic Naim sound our measurements suggest, smooth with solid bass and an easy-going gait. **NK**

| | |
|--------------------|-----------|
| Power | 100watts |
| CD/tuner/aux. | |
| Frequency response | 6Hz-20kHz |
| Separation | 85dB |
| Noise | -93dB |
| Distortion | 0.02% |
| Sensitivity | 180mV |
| Damping factor | 14 |

NAIM SUPERNAIT 2 £2850



OUTSTANDING - amongst the best

VALUE - keenly priced

VERDICT

Naim's traditional pace, rhythm and timing strengths allied to a deliciously open mid-band make for a winning combination

FOR

- dynamic presentation
- taut, tuneful bass
- rhythmic integrity
- build quality

AGAINST

- no digital inputs (!)

Naim Audio
+44 (0) 1722 426 600
www.naimaudio.com

SPRING INTO SUMMER

VISIT OUR WEBSITE: www.hi-fiworld.co.uk

UK SUBSCRIPTION SAVE UP TO

16.5%

SAVE UP TO 16.5% off the cover price when you subscribe to Hi-Fi World. That's an amazing £3.42 per issue, including postage.

FOR BACK ISSUES ENQUIRIES PLEASE CALL

01442 820580

OVERSEAS SUBSCRIPTIONS IF YOU LIVE OUTSIDE THE UK,
PLEASE CALL FOR OUR LATEST PRICES

+44 (0) 1442 820580



**SO WHAT ARE YOU WAITING FOR? CALL NOW!!!
SUBSCRIPTION HOTLINE 01442 820 580**

Lines open Mon-Fri 9.00-5.00 or (weekend answering service available)

FOR OUR
ON-LINE MAGAZINE
GO TO WWW.HI-FIWORLD.CO.UK

email:
hifiworld@webscribe.co.uk

Fax No:
01442 817167

World Radio History

WITH HI-FI WORLD

WHY SUBSCRIBE TO HI-FI WORLD?

- 12 issues a year delivered straight to your door.
- Be first to grab a bargain in our "Free Reader Classified Ads" section.
- Run by dedicated hi-fi engineers and enthusiasts.
- Subscribers receive a minimum 10% Discount annually.
- Hi-Fi World has become famous for its informative reviews and radical kit designs.
- **PLUS!** Subscribe by Direct Debit and receive a 16.5% discount on a yearly subscription (UK only).

Instruction to your Bank or Building Society to pay by Direct Debit



Please fill in this form and send to:

Originator's Identification Number

Hi-Fi World, Subscriptions Department Unit 8, The Old Silk Mill, Brook Street, Tring, Hertfordshire, HP23 5EF

| | | | | | |
|---|---|---|---|---|---|
| 4 | 2 | 7 | 0 | 4 | 9 |
|---|---|---|---|---|---|

Name and full Postal Address of your Bank/Building Society

| | |
|-----------------|-----------------------|
| To: The Manager | Bank/Building Society |
| Address | |
| Postcode | |

Name(s) of Account Holder(s)

| |
|--|
| |
|--|

Branch Sort Code

| | | | | | |
|--|--|--|--|--|--|
| | | | | | |
|--|--|--|--|--|--|

Bank/Building Society Account Number

| | | | | | | | | | | |
|--|--|--|--|--|--|--|--|--|--|--|
| | | | | | | | | | | |
|--|--|--|--|--|--|--|--|--|--|--|

Reference

HF

Instruction to your Bank or Building Society

Please pay Webscribe Ltd Direct Debits from the account in this instruction subject to the safeguards assured by the Direct Debit Guarantee. I understand that this instruction may remain with Webscribe Ltd and, if so, details will be passed electronically to my Bank/Building Society.

| |
|--------------|
| Signature(s) |
| |
| Date |

Bank and Building Societies may not accept Direct Debits Instructions for some types of accounts
The guarantee should be detached and retained by the Payer

The Direct Debit Guarantee

- This Guarantee is offered by all banks and building societies that accept instructions to pay Direct Debits
- If there are any changes to the amount, date or frequency of your Direct Debit Webscribe Ltd will notify you 10 working days in advance of your account being debited or as otherwise agreed. If you request Webscribe Ltd to collect a payment, confirmation of the amount and date will be given to you at the time of the request
- If an error is made in the payment of your Direct Debit by Webscribe Ltd or your bank or building society you are entitled to a full and immediate refund of the amount paid from your bank or building society
- If you receive a refund you are not entitled to, you must pay it back when Webscribe Ltd asks you to
- You can cancel a Direct Debit at any time by simply contacting your bank or building society. Written confirmation may be required. Please also notify us.



I would like a years subscription to Hi-Fi World and receive a discount off the cover price (I have read and accept the terms and conditions).

I would like to pay for my 12 issues by:

6 monthly Direct Debit: Pay £20.91 every 6 months saving 15% off the yearly subscription rate of £49.20

Annual Direct Debit: Pay £41.08 every 12 months saving 16.5% off the yearly subscription rate of £49.20

Annual cheque/credit card: Pay £42.31 saving 14% off the yearly subscription rate of £49.20

Cheques made payable to Audio Web Publishing Ltd.

Your Details

Title _____ Forename _____

Surname _____

Address _____

Post Code _____

Daytime Tel: _____

Email: _____

Please debit my VISA MASTER MAESTRO AMEX (SWITCH)

Security No: (last three digits printed on the signature strip)

| | | | | | | | | | | | | | | | | | | | |
|--|--|--|--|--|--|--|--|--|--|--|--|--|--|--|--|--|--|--|--|
| | | | | | | | | | | | | | | | | | | | |
|--|--|--|--|--|--|--|--|--|--|--|--|--|--|--|--|--|--|--|--|

Valid from Date: ____/____/____ Expiry Date: ____/____/____

Switch card issue No:

Cardholder Signature: _____

Outside UK:-

EUROPE Airmail **£50.00**

OVERSEAS Airmail **£70.00**



Send this form to:

Hi-Fi World, Subscriptions Department Unit 8, The Old Silk Mill, Brook Street, Tring, Hertfordshire, HP23 5EF

MCRU

FROM MAINS TO MUSIC

LDA

LONGDOG AUDIO

NEW LINEAR POWER SUPPLY FOR NAIM UNITISERVE

£995.00



GET IN TOUCH WITH US
WWW.MCRU.CO.UK
DAVID@MCRU.CO.UK

07908 056978
f /mcrultd
t @mcrultd

futureshop

connecting you with AV excellence .co.uk

Hi-Fi Cable, Home Cinema Cable & AV Connectivity Specialists

Expert Advice & Sales

0208 905 1555

+44 20 8905 1555



Wireworld Platinum Starlight USB

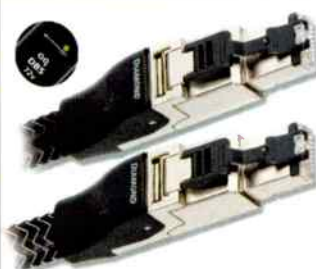

AudioQuest Diamond Ethernet



Atlas EOS 4sq Rhodium Power



Nordost Heimdall 2 Audio Cable



Chord Signature Reference Cable



Monster ISF 2000 HDMI Cable



Van Den Hul The Rock 3T Cable



Tellurium Q Black Speaker Cable

Hi-Fi Cable & Home Cinema Cable Specialists

Bring your hi-fi to life with our high performance award winning cables

www.futureshop.co.uk - call 0208 905 1555

FutureShop.co.uk, Unit 5 MODA Centre, Stirling Way, Borehamwood, Herts, WD6 2BW, England, UK



Centrance supply a nice set of high quality loudspeaker leads with the system.

clear with the atmospheric of the recording venue well captured.

In absolute terms, however, there's a slight graininess to the midband and treble from the unit's Class D amplification modules. While not so much as to smear the overall sound, there isn't quite the same clarity and smooth delivery you get from a good Class A/B design.

In practice this translates to a slight warmth to the system's overall sonic signature. It's not unpleasant but is certainly noticeable.

For their size the Masterclass speakers do an admirable job.

Obviously there's not masses of bass on offer – their small size and the laws of physics prevent this – but they sound lively with a good degree of sonic punch on offer.

Push the volume control on the DACmini PX too far and the 'speakers will start to complain and become distinctly 'boxy' sounding. But as the system is specifically designed for near-field listening this really shouldn't be necessary – unless your desk happens to be the size of a tennis court!

What low end there is, is never less than taut and tuneful. You'll miss the last octave of Peter Hook's bass on New Order's 'Bizarre Love Triangle' but the system does resolve the propulsive thrust of his fret-work pretty well considering its size.

Playing the same New Order track through the headphone output via a pair of Grado SR80i headphones and the lower end became more prominent – showing the DACmini PX's Class A 'phones output is no mere afterthought.

Indeed, headphone replay is extremely good – making the most of the DAC's resolving abilities with a well-judged balance of rhythmic thrust and midband detail.

Overall, almost everything in the

Audiophile Desktop System seems pretty well-judged.

Importantly, the DACmini PX hooked up to a MacBook Pro, iPhone and iPad 4 (via camera connection kit) without fuss, as well as serving CD-playing duties from a Cyrus transport – so whatever source you choose there should be no connectivity problems.

The star of the show is the DAC which combines high-resolution playback with a clean, clear and open sound. Give it some hi-res files to feed on and it really starts to shine.

And while the Class D amplification module employed shows some of the traditional drawbacks of all but the very best of the breed, the overall sound is never less than pleasing and eminently musical. The partnering loudspeakers are lively and entertaining with a good level of detail despite their relatively small size.

CONCLUSION

The CEntrance Audiophile Desktop System is a well-engineered product that while small in size is capable of a big musical performance.

It doesn't have the resolution or all-round sonic ability of a full-size separates set-up – but that's not the point. Instead it's a discrete, user-friendly package designed for those seeking high-quality sound in relatively small spaces.

And to that end, it succeeds admirably well with a nicely-judged sound which errs towards the warm side but still retains a good degree of detail.

Anyone looking to add a decent-sounding system to their desktop should take a listen.

MEASURED PERFORMANCE

The little Centrance DACmini Class D amplifier produced 18 Watts into 8 Ohms and 32 Watts into 4 Ohms. Because the 'speakers measured around 5 Ohms, we've rated it as a 30 Watt amplifier.

Distortion was high at low signal levels, as is common with Class D. It was also on the high side into a 4 Ohm

load, especially at high frequencies where 1.6% was measured into 4 Ohms at 1 Watt output - see below. Frequency response varied with load, again a Class D problem due to its output network, and into 4 Ohms the upper limit was 8kHz - see our analysis - output measuring -4dB down at 20kHz, enough to produce a warm sound balance. As the loudspeakers were 5 Ohms at 20kHz, this will occur in practice.

The DAC was very good, delivering just 0.04% distortion at -60dB and managing a decent 113dB EIAJ Dynamic Range. The S/PDIF electrical input worked up to 192kHz sample rate, but the optical receiver managed 176.4kHz maximum, failing with 192kHz.

The speakers were neat enough, with a bit of bass and treble lift to add life, but nothing excessive. There was obvious boxiness under test.

The CEntrance system turned in a decent performance in most areas, only the Class D amplifier showing weaknesses of the breed. **NK**

FREQUENCY RESPONSE

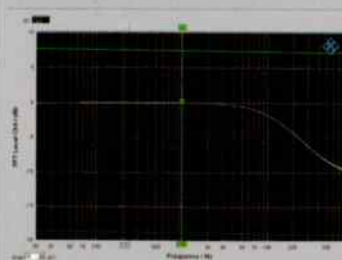

DISTORTION

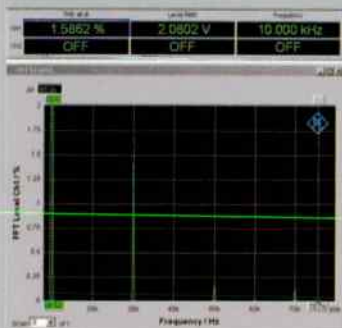

| | |
|--------------------|-----------|
| Power | 30watts |
| Frequency response | 10Hz-8kHz |
| Separation | 78dB |
| Noise | -88dB |
| Distortion | 1.6% |
| Sensitivity | 400mV |

CENTRANCE AUDIOPHILE DESKTOP SYSTEM £1134



EXCELLENT - extremely capable

VERDICT

A desktop system that sounds bigger than it looks and never fails to satisfy.

FOR

- clean, clear sound
- small footprint
- excellent dynamics

AGAINST

- no deep bass
- not the cheapest solution

SCV London
+44 (0)3301 222500
www.scvdistribution.co.uk

Belt, braces and Bluetooth



There's not an awful lot that Cambridge Audio's Azur 851D DAC/preamp cannot do, Martin Pipe discovers

Those whose audiophile aspirations are fettered by modest incomes can thank Cambridge Audio for supplying them with hi-fi equipment that is well-constructed, generously-specified and sounds good – yet is affordable.

The Azur 851 Series takes pride of place at the top of Cambridge's current line-up. Despite employing some cutting-edge technology, none of these sell for more than £1500 each; not an awful lot in the world of audiophile gear.

In terms of sophistication, the £1,200 Azur 851D is a different kettle of fish to Cambridge's popular budget DACMagic models. It takes as its basis the 851C that was introduced a couple of years ago. But out goes the disc transport and in comes a

clutch of audio enhancements and tech-driven conveniences. Among the latter are a pukka headphone amplifier, extra digital inputs and Bluetooth streaming.

In place of the disc-tray is a large screen with dimmable backlight. This is flanked on either side by tiny buttons designed to access functions indicated on the adjacent areas of screen space. Beneath, the sampling rate (but alas not resolution) of the selected audio source is shown. The screen's central real-estate, meanwhile, is given over to a dB-calibrated volume-level indicator. It works in conjunction with a massive control knob that's coupled to a shaft-encoder rather than a high-quality pot; that shouldn't shock you, given the 851D's emphasis on all things digital.

Cambridge hasn't opted for digital control of volume in the analogue domain, as exemplified. Instead, confirms product manager Sam Ellenby, the volume control is implemented in the digital domain. According to Ellenby, "the signal is upsampled to 32-bit floating point and then rescaled". This use of DSP (common in pro gear and software) should help to minimise non-linearities and loss of resolution at low volume levels – although ultimately you're going to be restricted by the 24-bit resolution of the DACs, a pair of Analog Devices AD1955As; one for each channel, working in differential mode.

If you're connecting the Azur 851D to a preamp or integrated with its own volume control, as opposed to a power-amp or active speakers,

then you can bypass the volume control. An independent volume-adjustment is sensibly-available for the headphone amplifier, which goes far beyond the type of circuitry you'll find in the average DAC or CD player.

Built onto a dedicated circuit board, the 851D's headphone amp has its own 'belt-and-braces' power supply circuitry and complementary-pairs of medium-power transistors that drive the transducers of your choice. As much attention has been lavished on just one aspect of the 851D's functionality as you'll find in a good budget solid-state offboarder.

There's plenty of audiophile design evident elsewhere in the 851D. Its internal power arrangements start with an over-specified toroidal mains transformer that, after rectification, supplies current to multiple regulators. Components are high-grade (e.g., metallised polypropylene signal caps, audio-grade electrolytics, high-grade Burr-Brown op-amps and low-noise metal-film resistors) while board layout is neat.

Much of the digital signal processing takes place in an Analog Devices ADSP-BF32 ('Blackfin') 32-bit DSP running proprietary 24-bit/384kHz upsampling algorithms developed by the Swiss company Anagram. However, the DAC only supports sampling rates of up to 192kHz. The post-DAC analogue filters are linear-phase Bessel designs.

The 851D also gives you a choice of digital-filter characteristics – 'linear-phase' (time-coherent, but with some 'pre-ringing'), 'minimum-

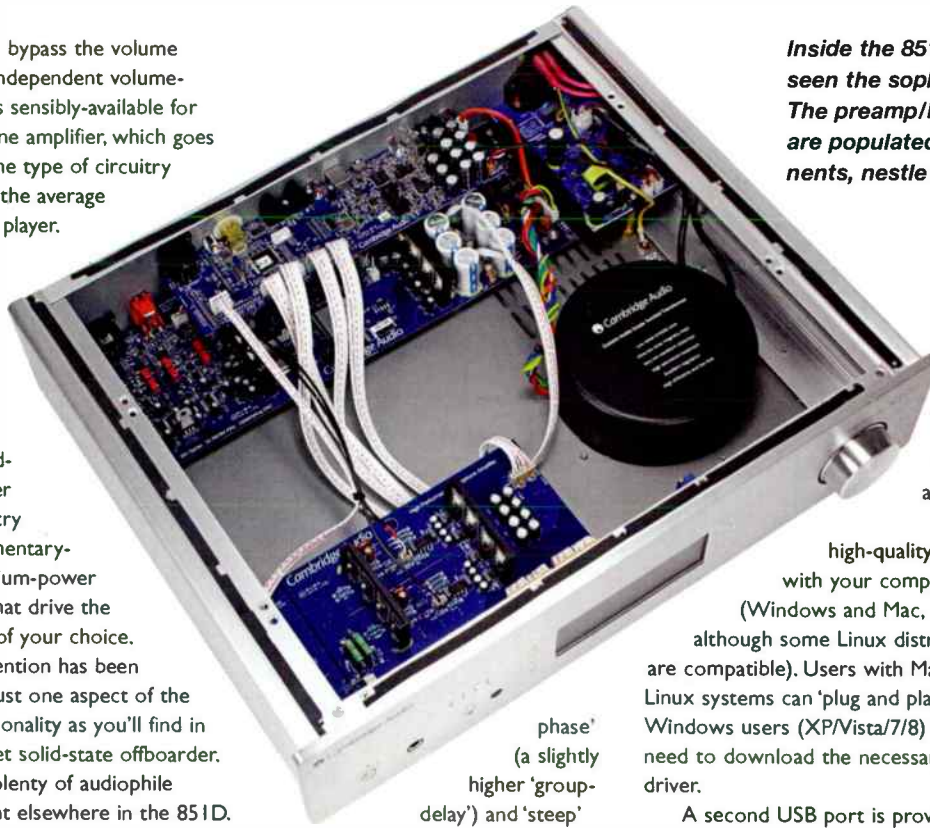

the Azur 851D as a

Inside the 851D. At the bottom left can be seen the sophisticated headphone amplifier. The preamp/DAC and terminal boards, which are populated with decent-quality components, nestle around the rear panel.

phase' (a slightly higher 'group-delay') and 'steep' (a little ringing, but a linear-phase, and courtesy of a slight high-frequency roll-off, a strong rejection of 22.05kHz aliasing artifacts). Cambridge's advice is pragmatic; it suggests 'experimenting with the filters to determine which sounds best to your ears' with each programme source.

The company has also been pragmatic as far as the rear-panel is concerned. You get two inputs with coaxial (phono) and optical (TOSlink) connectivity, two optical-only inputs, a BNC coaxial-only input and a professional AES/EBU terminal. Coaxial and optical outputs convey the selected input unaltered (i.e. with no upsampling, volume adjustment or filtering performed). Useful for those with digital recorders or separate AV systems, I guess.

A Class-1/2 USB port with ground-lift switch enables you to use

high-quality DAC with your computer (Windows and Mac, although some Linux distros are compatible). Users with Mac and Linux systems can 'plug and play'; Windows users (XP/Vista/7/8) may need to download the necessary driver.

A second USB port is provided for the supplied Bluetooth dongle needed to play audio files held on your phone or tablet – you can't, alas, use it to play music files on USB storage devices. A pity; I suspect it would have cost Cambridge little if anything to support playback of uncompressed (e.g., WAV/AIFF) files or for that matter FLAC (lossless) ones.

The rear panel analogue outputs take the form of balanced (XLR) and phono (unbalanced) sockets. It's a shame, considering the 851D's preamp possibilities, that no provision for analogue sources has been made. But that would have meant building in an analogue-to-digital converter and thus upping the price. Interestingly, the unit's AD1955A DAC can accept DSD - a feature that's not harnessed here.

The supplied remote handset is distinctly Cambridge – solidly-built



Practically any digital source can be fed into the 851D. There are no fewer than six digital audio inputs plus a pair of USB ports for computer DAC and Bluetooth use. The analogue output is available in unbalanced (phono) and balanced (XLR) form. The 851D also makes provision for custom installation (RS232, remote in, 12V DC trigger out and Cambridge's control bus).

SUGDEN AUDIO

SAPPHIRE Series

An open window on musical performance



SUGDEN AUDIO launched the first 'Solid State Pure Class A' integrated amplifier to the Hi Fi market in 1967

Today The Heritage Continues with Dedication and Enthusiasm. High Quality Audio Products for the Discerning. Designed and Hand Built in England.

SUGDEN AUDIO

www.sugdenaudio.com

01924 404088 Old Radio History

Rescuing music from technology

with a pleasant feel. It provides access to all of the 851D's functions and will operate some other Cambridge gear.

PERFORMANCE

I tried the 851D with a number of digital sources that included a Cambridge Azur 751BD disc player and Squeezebox Touch streaming/SD/USB player, both fed via the coaxial inputs. A Samsung Galaxy S4 Mini was used to test the unit's Bluetooth capabilities. A Linn LK280 amplified the DAC's output, driving my trusty Acoustic Energy AE109 floorstanders. I also tried the headphone output, alternating between Sony MDR-IRs and Onkyo ES-HF300s. First, playback from disc. Initially, I tried a Blu-ray audio disc (Supertramp's 'Breakfast in America') but sadly couldn't get anything more than 48kHz PCM audio – a clear case of 'downsampling' being imposed to prevent the disc being used as a high-res medium for pirates to work with!

However, even the enforced 48kHz output yielded a fair degree of musical insight – albeit with the overly-incisive treble traditionally associated with this classic slice of late-70s art-rock. I guess that if you have something close to the master tape to downsample, then the results are going to be good. A self-made DVD-A disc containing careful 24/96 transfers of various LP material was more revealing and showed that the full potential of such material can be conveyed via the digital inputs.

All well and good, but as for most of us, CDs make up the bulk of listening, I gave these a spin – the original 44.1kHz/16-bit format being upscaled to the 192kHz/24-bit supported by the DAC.

First, then, to a copy of Can's sprawling but hypnotic Krautrock epic 'Togo Mago'. Overall impressions were ones of neutrality and transparency; you're given an uncoloured musical insight. The otherworldly 'Mushroom' was defined by a fulsome and coherent bass performance – nothing lightweight or overblown here – coupled with a taut handling of percussive matters. With 'Togo Mago' and 'Halleluwah' you're given an insight into the track's makeup and painstaking editing. Yet despite such analytics, you can still enjoy the music for the total freakout it is!

With a 1987 digital Naxos recording of Mussorgsky's 'Pictures At An Exhibition', the rich orchestral textures and hues are identifiable and

contribute to a gloriously-detailed fuller picture.

Throughout the review process, I experimented with the various digital filters. Their effects are subtle, to say the least. With electronic music, the 'minimum-phase' setting had a slight (and I mean slight!) edge. Rather more beneficial in practical terms is the headphone amplifier, which is capable of plenty of oomph and drive. Headphones also show off the Azur 851D's imaging properties to full effect.

The Bluetooth feature is easy enough to use; scan for devices and pair with the newest one found. It sounded more than acceptable – especially with losslessly-compressed tracks – although absolute sound quality is being traded for the convenience of accessing music held on a mobile device. The musical balance was even, although some of the finer detail of complex tracks was masked.



Supplied with every 851D is this BT100 'dongle', which plugs into a dedicated USB socket on the rear panel. With it, you can play music stored on your tablet, smartphone or other portable device.

CONCLUSION

You get an awful lot of DAC for your money, and better still the numerous features (among them, a worthy headphone amp and wide connectivity) are backed up with a convincing sound quality.

That's not to say the Azur 851D is perfect; at very low listening levels, there's a slight veiling of dynamics caused by the digital control. This isn't an issue, of course, if you are driving amplification that makes its own provisions.

MEASURED PERFORMANCE

Frequency response was flat to 60kHz with a 192kHz sample rate digital input, the filters making little difference either at this sample rate or at 44.1kHz sample rate (where 'slow' filters can roll off high treble). The optical S/PDIF input receiver accepted 192kHz, where many still do not – a good point since many digital devices use optical only.

Audio output from the phono sockets (unbalanced) and the headphone output measured a standard 2.2V, and from the XLR sockets (balanced) 4.4V. Higher output from the latter bestowed the 851D with 116dB EIAJ Dynamic Range, a good if unexceptional figure, whilst from the phono sockets this dropped 1.5dB to 114.5dB.

Top DACs now manage 122dB, to get this into context, but CD (i.e. 16bit) manages 100dB, so the 851BD exploits high-resolution digital well, offering clear benefit over CD, but it isn't quite up with the best, notably Audiolab's M-DAC (and Q-DAC) with its ESS Sabre32 chip. Distortion levels were very low all round.

The Cambridge Audio Azur 851D digital preamp measured well in all areas, giving very similar results to earlier Cambridge DACs based on the Wolfson DAC chip, but rivals march ahead. NK

FREQUENCY RESPONSE

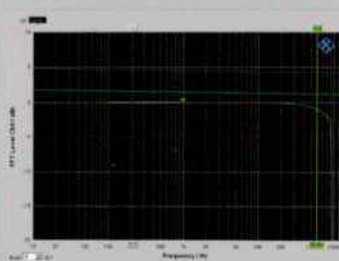

DISTORTION

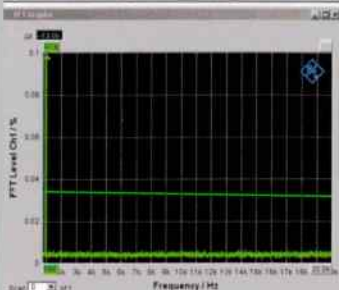

Frequency response (-1dB)
CD 4Hz - 60kHz

Distortion (24bit) %
0dB 0.0002
-60dB 0.035

Separation (1kHz) 112dB
Noise (IEC A) -115dB
Dynamic range 116dB
Output 2.2/4.4V

AZUR 851D DAC/PREAMP, £1,200

EXCELLENT - extremely capable

VERDICT
It sounds good, looks good and continues the Cambridge Audio philosophy of offering the best possible value for money. There are criticisms, but in the great scheme of things they're fairly minor.

FOR
- a sensible design, well-built
- a hint of the high-end at a mid-range price
- capable headphone amplifier

AGAINST
- volume control (defeatable) implemented digitally
- no provision for analogue inputs

Cambridge Audio
www.cambridge-audio.com



High End – Made in Germany



Master Innovation

The Clearaudio catalogue of high quality pressings inc. Deutsche Grammophon re-issues available now



For orders and information contact;

0118 9814238 info@soundfoundations.co.uk

sound foundations
www.soundfoundations.co.uk

Power up!



Tony Bolton is impressed with the new MCRU external power supply for Audiolab's M-DAC.

The Audiolab M-DAC has received some excellent reviews and offers very good performance for the £600 asking price – but as with anything, there is always room for improvement.

So Huddersfield-based MCRU has stepped in to offer a free-standing outboard power supply unit for it.

Designed by engineer Nick Gorham of Longdog Audio, the unit features a split-rail, fully regulated, linear power supply. It boasts a Furutech rhodium-plated IEC inlet socket and a Furutech Audiophile Fuse. It connects to the M-DAC via a 1m long captive lead that transmits the 13.8V 0.5A power required by the DAC.

The metal casework sits on a set of Acoustifeet, which are claimed to absorb resonances and improve the isolation properties of the PSU. The case is available in either black or the silver of this example.

Before I started listening to the effect of the PSU I spent an evening getting acquainted with the Audiolab M-DAC running on its own transformer-based power supply.

I was impressed by the performance for the price, partic-

ularly the way it managed to extract a respectable sound from discs burnt from MP3s.

Fed with pre-recorded Red Book standard CDs I found the sound offered me a well laid-out analysis of the music with a satisfying amount of bass weight without it being at the expense of midrange or treble clarity.

Having got thoroughly tuned into the sound of the M-DAC, I then plugged in the LongDog Audio/MCRU power supply. The lead was long enough that I was able to site the PSU away from the DAC thus avoiding any risk of stray electromagnetic fields from the power supply unit upsetting the signal processing in the DAC.

This was one of those occasions when the term 'night and day difference' really had meaning. The sound adopted a totally different character with vastly improved sonic textures being displayed.

I felt more able to place the various sections of the Philharmonia Orchestra as they played through a selection of Rossini Overtures with Giulini at the helm (HMV 7 67804 2). String tones, in particular, gained a more realistic timbre,

while the potential for trumpet blare was reduced.

At the other end of the musical spectrum, Morcheeba's 'Big Calm' (Indochina ZENO17CD) – with its mix of smoothly luxuriant vocals, samples, real instruments and electronic sounds – seemed to spread out in front of me, awaiting my perusal across a bigger and better defined staging area.

As I discovered last month with the Meridian Prime Headphone Amp, an external PSU has the capability to transform an already good sound into an excellent one and this MCRU device is a particularly good example of the benefits of a properly designed external power supply unit.

It lifts already good performance into the thoroughly excellent league.

Although it might not seem logical to spend another 72% of the cost of the product on enhancing it, the perceived improvement in performance makes it a worthwhile investment.

Audiolab's M-DAC



MCRU AUDIOLAB M-DAC REGULATED POWER SUPPLY UNIT £495.00



OUTSTANDING - amongst the best

VERDICT

An after-market power supply unit that enhances an already good performance from the Audiolab M-DAC

FOR

- improved clarity
- more open and dynamic sound
- better perceived frequency extension

AGAINST

- price

MCRU
+44 (0) 1484 480086
www.mains-cables-r-us.co.uk

ortofon

accuracy in sound



Q uintet

Since 1948 Ortofon have introduced nearly 100 different moving coil pick-up cartridges to the hi-fi market. Their latest models in this long and proud heritage are the Quintet Series.

All Quintet cartridges use the same ABS thermoplastic bodies and neodymium magnets, but each model in the range has its own sonic expression that reflects its status. From the well-rounded **Quintet Red**, through the smooth **Quintet Blue** and spacious yet dynamic **Quintet Bronze** up to the pure audio excellence of the **Quintet Black**, this series offers something for every discerning listener at a very attractive price.

The Quintet Series also includes a true-mono cartridge, for accurate reproduction of older mono recordings.



Distributed by Henley Designs Ltd.

T: +44 (0)1235 511 166 | E: sales@henleydesigns.co.uk | W: www.henleydesigns.co.uk

World Radio History

Sony says...

Sony's NWZ-ZX1 portable digital player promises high-resolution playback in an attractive package. But Sony deliver their own view of hi-res, Noel Keywood finds.

The NWZ-ZX1 is Sony's top portable, high-resolution audio player. For this player they've even milled out an aluminium alloy chassis.

Does it feel good? You bet!

This is a very sexy player to hold and use: it is slim, as rigid as an iPhone and it has a gorgeous high-resolution screen. It should have high-resolution sound too, but this was a bit more contentious. It plays high-resolution files alright, but like the considerably less expensive NWZ-F886

reviewed in our May 2014 issue it does not provide high-resolution sound quality I found.

Since the NWZ-ZX1 costs a hefty £550 it eyeballs the Astell&Kern AK100 MkII so I can make direct comparisons to illustrate the issues – and they are very different players. Like the NWZ-F886 the ZX1 appears to be based on Sony's Experia mobile phones

It lacks their phone functionality of course but it otherwise shares their lovely screen, internet access, web browser and all else. This is far beyond the AK100 MkII: it has no internet access nor all that comes with it. But whilst the Astell&Kern lacks all this, audio wise it is in another league.

The headphone output delivers massive output of 1.8V, six times more than the Sony. This gives it an impressive dynamic range of 116dB, far higher than CD, against the ZX1's miserable 91dB = far lower than CD.

There's a 25dB difference in dynamic range between these players – and they cost the same. This is so gross it is almost implausible. But there are reasons that I think it is useful to explain. They are technical but I'll keep it simple.

Portable MP3 players, mobile phones and such like use headphone drive chips whose design rationale is to drain the battery as little as possible.

Quality is not a priority; it just needs to be adequate to feed cheap ear-bud headphones or lightweight portables.

Also, I learnt recently but have yet to confirm, a British Standard suggests headphone output is limited to 0.3V to avoid hearing damage and this standard has been rolled into a global IEC standard.

This would explain why large global companies like Sony feel it prudent to stay within the Standard, whilst the predominantly Chinese manufacturers of high-resolution players, such as FiiO, iBasso etc ignore this limitation. Instead they use headphone drive chips of far higher quality and far higher output. In their £150 X3 player FiiO use an Analogue Devices AD 8397 to drive headphones and it delivers no less than ten times more output than the ZX1, our tests showed.

So the ZX1 is a high-resolution player in that it plays high-resolution digital files of all common types, up to 192kHz sample rate, except Sony's own DSD. But it has a low-resolution headphone drive chip that strangles performance. Its DAC doesn't look so good either.

Now onto its basic functionality. Connected to the Internet via wi-fi the ZX-1 is more like a phone or tablet than an audio player. It has a web browser, a full suite of web services including location, YouTube, music download, an array of Google sites (because it uses Android OS), even airplane mode. Like the NWZ-F886 it plays mpeg4, WMV9 and AVC(H.264) video and shows photos (jpeg, png). Sony's music store is not loaded, nor is iTunes. Ours had a vinyl carrying case but not the noise cancelling earbuds of the NWZ-F886.

Measuring 60mm wide, 122mm high and just 15mm deep the NWZ-ZX1 is pocketable. Weight on our scales was 136gms – quite light.



Vinyl is black!



The Evo ! What an evocative name and rightly so too! The SL-1200 evolved from a Hi Fi turntable into a DJ deck and now we turn it back into a Hi Fi turntable again! Fitted with the legendary SME 309 tonearm and the Audio Technica AT33EV your emotions will run wild. The AT33EV is itself an evolutionary cartridge hence its EV suffix and matches the SME 309 so well. We have worked with direct drive turntables and moving coil cartridges for 33 years and the EVO has evolved into a mature product that is quite simply a world beater. We can supply completely new units with 6 year guarantees, used ones with 5 year guarantees, or we can convert your own..



The T-01MC moving coil phono stage has been designed to work with every moving coil cartridge from a DL-103 to a Clearaudio Goldfinger Statement. Two reviewers use the T-01MC for their reference system and another compared it favorably to a £9.5K stage noting it was almost as good and with a lower noise floor ! The design comes from Dave Cawley who designed and built his first MC phono stage in 1981. Building on his experience Dave has now produced a dual-mono phono stage with not a single integrated circuit or pnp/npn transistor in sight! No less than 16 FET's are used including a FET discrete power supply. The input FET's are laboriously hand tested and categorised before being inserted in blocks of 8 into the PCB. In stock now at £995.00

TIMESTEP T-01MC PHONOSTAGE £995



VERDICT

New minimalist phono stage, that sonically, punches well above its weight

FOR

- open and precise
- plenty of emotion
- plays old mono records well

AGAINST

- only available in black

**Clearaudio Goldfinger - Transfiguration Proteus - Benz LPS - Denon DL103 - Audio Technica AT33
SME Turntables & Tonearms - Oyaide - Furutech - Klipsch - Whest Audio - 78rpm - SL1200 Mods**

All demonstrated in a relaxing setting with river views! Very high part exchanges & World wide mail order.

Sound Hi Fi Dartmouth Devon 01803 833366 web www.SoundHiFi.com



hear the music . . . not the equipment

• WDKT88 32 watts per channel ultralinear push pull stereo amplifier. Single input power amp or integrated with multi-input relay switching

• WDKEL84 15 watts per channel ultralinear push pull stereo amplifier. Single input power amp or integrated with multi-input relay switching

• WDPHono3 All triode passive equalization valve phono-stage. Dual input option. MC step-up transformers available.
Requires WDPSU3 power supply

• WDPRe3 Transformer coupled single ended valve pre-amplifier. Low output impedance. Multi-inputs utilizing relay switching.
Requires WDPSU3 power supply

• WDPSU3 High performance choke power supply

• WDH35 Transformer coupled single ended valve headphone amplifier. Multiple settings for headphone impedance matching.



Kits and Components for the Audiophile Community

07972 055492 sales@world-designs.co.uk

www.world-designs.co.uk



There's an on-board loudspeaker, a Bluetooth short-range radio connection and NFC (Near Field Communication), for short-range (1 cm) file transfer or music streaming to NFC equipped devices the player is placed against. 128GB of on-board memory is fitted plus a non-user-replaceable lithium-ion battery charged over USB; no charger is supplied. It can play computer music files using DLNA. Music must be loaded using an Android loader.

The NWZ-ZX1 will play FLAC, WAV, ALAC and AIFF. We checked this and 24/192s in the formats stated all played.

There are no external memory card slots and there is no S/PDIF digital output for an external DAC nor a line output for a hi-fi and no input allowing the player to be used as a DAC. High-resolution players usually have a digital output at least so they can drive an external mains powered DAC, acting as a digital transport in effect, but the Sony cannot do this, a serious omission.

SOUND QUALITY

In a nutshell the ZX1 (all sound processing off) was dynamically gentle in its delivery, if revealing across the midband. It had little dynamic push with the Pink Floyd's 'Wish You Were Here' into my Philips Fidelio X1 headphones or Oppo PM-1 magnetic planar headphones when compared to the Astell&Kern AK120 I use. Even with the Philips, which are a tad lively up top, the Sony verged on sounding warm with this track. This is fine by me, when digital gets good it does become smoother than expected but in this case dynamic contrasts were not reproduced by the Sony; it lacked life, pace and punch. Switching in Clear Sound just added some midrange glare that wasn't very nice.

The Eagles 'Busy Being Fabulous' (CD) was clean and smooth – it slid along with a firm bass line and clean time domain contrasts; it was well timed. Again the ZX1 sounded a little laconic; it lacked rhythmic snap, speed or pace. The Astell&Kern AK120 made this track sounded ballsy, stretching its contrasts to introduce some rock'n'roll punch.

The ZX1 sounded refined in many areas; with Lucia Gomez singing 'Lucia' (24/96) it was more revealing across the midband than the AK120 but it again it lacked dynamic contrasts and punch as a result. I moved through a host of review tracks I know well and got this result

consistently: the ZX1 was smooth, well-timed and insightful but lacked punch.

Imaging was superb, sudden centre-stage drum strikes in 'Misery' from Dave's True Story stabbing into my head with laser-located precision. The player is strong here and I suspected the strong upper treble, as revealed by measurement, sharpened image precision. The effect was sonically striking.

The Minnesota Orchestra's 'Dance of the Tumblers' from Rimsky-Korsakov's 'Snow Maiden' (24/96), was beautifully manicured, absolutely concise in its progress and free of blemish it seemed. Unfortunately, with this recording and classical generally, where level is lower than rock, volume levels reached 'modest' with volume up at maximum, with my Philips Fidelio X1s. So I never got the full blast of the orchestra's power that I enjoy on the AK120.



CONCLUSION

The NWZ-ZX1 is a nice player to use, and a nice player to listen to. Nice being the operative word. As with the NWZ-F886, it is a low-res audio player equipped to play high-resolution audio files.

The ZX1 has 10dB less dynamic range than CD when other hi-res players have at least 10dB more. That leaves it hopelessly behind and out of touch with the competition.

It sounded smooth and easy and also very insightful, if dynamically constrained. It has the same internet connectivity as a mobile phone, however, so if this is what you want from a music player, then it will satisfy.

MEASURED PERFORMANCE

Output from the headphone socket was a low 0.3V, much like that of the less expensive NWZ-F886 tested in our April 2014 issue. This is typical of portable players but ten times less than the 3V or so from high-resolution portables. There was no digital output or line output for a hi-fi amplifier so the headphone output must be used, or Bluetooth.

Dynamic Range (EIAJ) from a 24bit file measured a low 91dB, even lower than the NWZ-F886 that measured 96dB. This is almost certainly due to performance variation in the headphone output chip used on these players that is not up to the task of delivering a high-resolution signal. Output is too low and noise too high, limiting dynamic range.

FREQUENCY RESPONSE

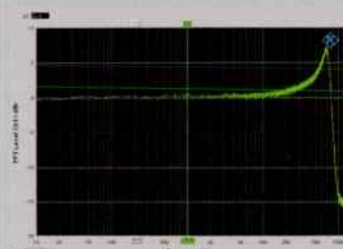

This clearly shows the NWZ-ZX1, like the NWZ-F886, is a low-res portable in its basic electrical topology but able to play high-res files. It does not, however, have the low noise or high linearity needed to exploit the quality of 24bit audio, falling short of CD by 10dB.

Frequency response with 192kHz sample rate files extended to a very high value of 80kHz, strong peaking above 20kHz revealing this is the same circuitry as used on the NWZ-F886.

DISTORTION

| | | | |
|-----|----------|-----------|-----------|
| THD | 0.4191 % | 300.97 µW | 995.86 Hz |
| THD | OFF | OFF | OFF |

The NWZ-ZX1 conveys none of the benefits of high-resolution audio files except wide bandwidth. **NK**

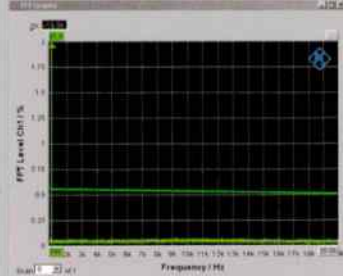

| | |
|---------------------------|-------------|
| Frequency response (-1dB) | 4Hz - 80kHz |
| Distortion, 24bit | (%) |
| 0dB | 0.004 |
| -60dB | 0.4 |
| Separation (1kHz) | 92dB |
| Noise (IEC A) | -90dB |
| Dynamic range | 91dB |
| Output | 0.3V |

SONY NWZ-ZX1 £550



GOOD - worth auditioning

VERDICT

A gentle and insightful delivery makes the ZX1 enjoyable, but it lacks both volume and dynamic power. Good for general entertainment though.

FOR

- hi-res touch screen
- wi-fi and web
- portable and light
- plays YouTube and video

AGAINST

- insufficient volume
- no S/PDIF digital audio output
- low dynamic range
- no DSD

Sony
+44 (0)844 8466 555
www.sony.co.uk

T+A

High Voltage series = superiority thanks to revolutionary technology!

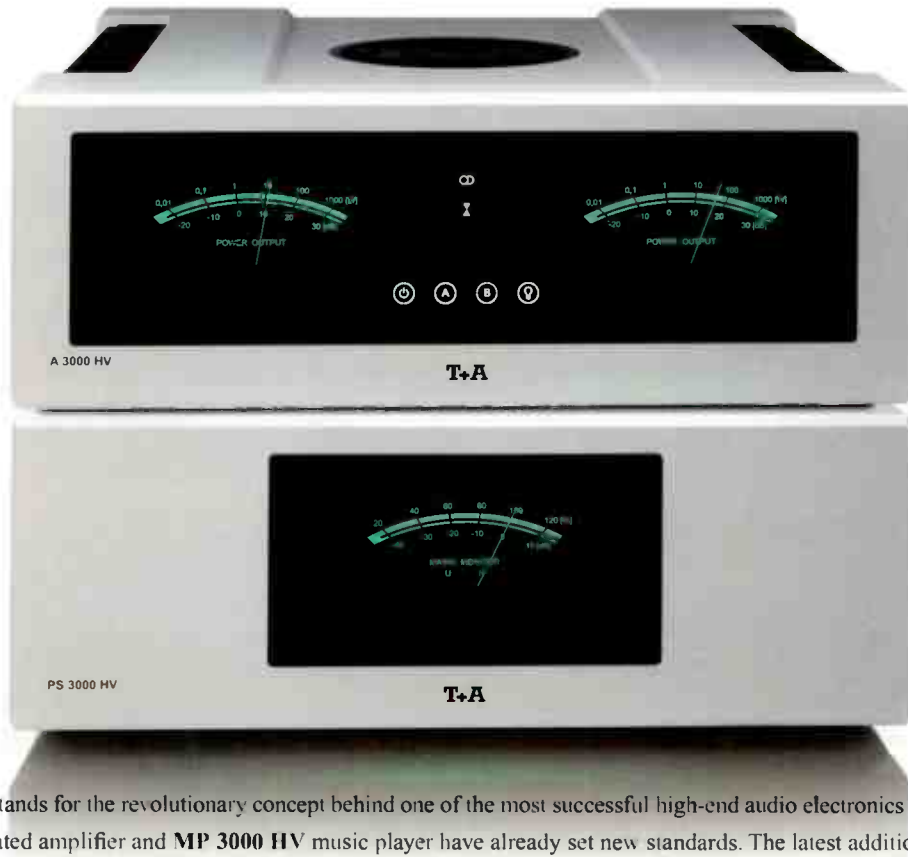

HV = high voltage and stands for the revolutionary concept behind one of the most successful high-end audio electronics series of the past few years! The **PA 3000 HV** integrated amplifier and **MP 3000 HV** music player have already set new standards. The latest additions to the HV Series raise the bar yet again and continue our aim to create a world-beating range of high-end audio products.

The new **A 3000 HV** power amplifier creates more than 500 Watts of continuous power per channel and can be operated either as a stereo or mono amplifier. The optional **PS 3000 HV** power supply adds additional 1200 Watts to the output stages of the A 3000 HV to give a huge current capability.



When combined with the state-of-the-art **P 3000 HV** preamplifier, with its uncompromising design and variety of high quality balanced and RCA inputs, these latest HV Series products create the ultimate High End two channel system which will satisfy even the most discerning music lovers the world over.

Hand built in Germany, the P 3000 HV, A 3000 HV and PS 3000 HV from T+A are available in the UK now.

For more information or to arrange a demonstration, please contact:

AVOKE

Avoke Limited

Tel - +44 (0)7876 246956

Email - info@avoke.co.uk

Web - www.avoke.co.uk

Sony's Walkman goes Pro

The greatest cassette portable of all time? Martin Pipe certainly thinks so!

In the late 1970s, Sony chief and co-founder Akio Morita had a brainwave. A keen music fan, Morita had always wanted listening on the move. Portable radios were an everyday mainstay and, indeed, Sony had played a pivotal role in developing and popularising the pocketable 'tranny'. But they played someone else's choice of music.

Sony produced stereo radio/cassette recorders too and also large and heavy battery-powered stereo cassette decks, but although transportable, none of these options were convenient enough to fulfil Morita's vision of something he could listen to on his frequent plane journeys.

At that time, Sony also marketed pocketable cassette recorders. These mono units were intended for the (non-broadcast) press who would tape interviews with them for later transcription. They were sturdy and reliable but hardly hi-fi. Morita suggested adapting one of these units to his chief audio engineer Nobutoshi Kihara. Out went the microphone



and recording electronics and in went a stereo playback head, preamp and headphone amplifier.

The first model, the snappily-

named TPS-L2, was launched in 1979 with a matching pair of lightweight open headphones. It looked tellingly similar to the journalistic tool that spawned it, but generated enough interest to spur development of new models. These successors – starting with 1981's WM2 – would be smaller and built from the foundations for portable playback. And thus was born the phenomenal Sony Walkman, the iPod of the 1980s.

We should not forget that the Walkman was not the result of focus-grouping, market research or similar corporate methodology. It was instead the realisation of one man's personal vision - and one that paid off handsomely.

Nearly 400 million Sony Walkmen of various types were sold between 1979 and 2009, changing forever how we listened to music. Some of these machines were very



Inside the original version of the WM-D6C. The cylindrical motor can clearly be seen as can the surface-mounted chips that provide the Dolby B and C noise reduction systems. Later revisions tidy things up thanks in no small part to the greater use of surface-mount technology.

sophisticated. Across a decade of Walkman ranges we were treated to models with in-built radio tuners, advanced mechanisms with quartz-locked motors, Dolby noise reduction, form-factors little bigger than the cassettes being played, weather-resistance, fashion-led design and even solar power.

Oh, and there was also recording. You could buy a Walkman with basic recording capability as far back as 1982. The WM-R2 in question had built-in electret microphones (which also captured handling and motor noise!) and a tape counter but no manual control of recording level, ability to cope with quality non-ferric tapes or any form of noise reduction. It was not a hi-fi model – just a decent player with a serviceable stereo recording function good enough for occasional and non-critical use. Doubtless, a handful

out jack enabled the machine to feed hi-fi amps or other audio equipment.

The 600 gram WM-D6's mechanism rejected conventional belt-drive in favour of a 'disc drive' system not dissimilar to the one that underpinned Uher's 4000-series portable reel-to-reel machine. In the WM-D6, the AA battery-shaped motor – here, quartz-locked with a $\pm 4\%$ varispeed alternative – was equipped with a bevelled pulley that came into contact with a rubberised surface (the 'disc') under the weighty brass flywheel that lay beneath the tape-driving capstan shaft. Sony's design was capable of excellent pitch stability, and freedom from wow and flutter. With a latter spec of 0.04% WRMS (NAB-weighted), the WM-D6 bettered many conventional mains-powered decks.

The beefed up bias/erase oscillator allowed the WM-D6

it had conventional moving-coil VU meters, an absence of metal-tape compatibility and long-lasting ferrite heads, the TCD-D5 was similar to the WM-D6 insofar that both machines only offered Dolby B noise reduction.

That might have been acceptable in the late 1970s but tape and cassette-deck technology was advancing rapidly; no longer was Philips' compact-cassette a lo-fi joke. The newer Dolby C could yield an extra 10dB of noise reduction relative to its worthy predecessor.

Sony's answer to this key development, the WM-D6C, came in 1984. Although bearing a close resemblance to the WM-D6, it was different internally. Users could now choose between Dolby B and Dolby C, the latter system rendering tape hiss effectively inaudible.

Connectivity had been bolstered too. In addition to one of the WM-D6's headphone sockets and its -20dB attenuable microphone input, we now had a dedicated line-in jack – located along with the corresponding output, on the rear panel. Yup, with a set of 3.5mm-to-phono leads you could hook up a WM-D6C to your home hi-fi.

And many did – even those with esoteric systems based around Linn, Pink Triangle or Oracle turntables.

At the very least, the WM-D6C made an excellent 'dubbing deck' for use with an existing machine; such an arrangement could trounce many of the 'double decks' that were fashionable by the mid-80s.

You could even connect an external 6 Volt DC power supply when at home; helpful as the WM-D6C ate batteries. Care and attention was needed here, though; the socket's centre-pin is negative rather than the more usual positive. Over the years, many WM-D6Cs have been damaged by accidental reverse-polarity DC connections; the motor speed-control chip is particularly vulnerable (and replacements are difficult to obtain nowadays).

In other respects, the WM-D6C is – like so much Japanese equipment of the 70s and 80s – very reliable. The grease used in various parts of the mechanism can harden, necessitating a strip-down (if your machine won't take up or wind/rewind properly, this is a common cause).

My own machine, bought for around £20 on eBay some years back, was in this condition. The record-playback head is very

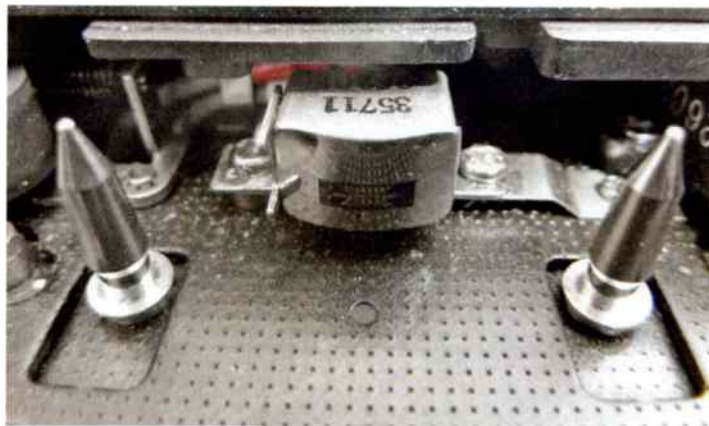

The record-playback head specified for the original WM-D6 and earlier versions of the WM-D6C was a specially-developed amorphous type. Sony switched to a cheaper permalloy type during the 20-year production run of the machine.

were smuggled into various concerts for the clandestine practice of bootlegging...

A machine further up the 1982 range would have been of more interest if you had deeper pockets – in more senses than one. With dimensions of 181x40x95mm, the expensive (£230) WM-D6 outsize by some margin the WM-R2 and WM-2 models but it was far closer to hi-fi. Out went the in-built mics (a 3.5mm jack allowed your own transducers to be connected, and doubled as a line input) and in went Dolby B – which was effective on record as well as playback. Like all Walkmen of the time, a pair of headphone jacks were provided so that two people could enjoy the better-than-usual sound quality of this 'Walkman Professional'. A line-

to record onto decent high-bias chrome/pseudochrome tapes, such as TDK SA and Maxell UDXLII, or even one of the new metal-particle tape formulations that widened still further dynamic range and frequency response.

A superb amorphous record/playback head, developed and made in-house, also enabled the potential of such tapes to be realised. Recording level was set manually with a peak-reading five-LED bar graph that also indicated battery condition.

It may have been bigger than the typical 'play-only' Walkman, but the WM-D6C was dwarfed by a ghetto-blaster or portable cassette deck – including Sony's own 1978-vintage TCD-D5 machine, which was smaller than most and adopted for field use by the BBC among others. Although



What you'll see if you strip down a WM-D6(C) mechanism. Here we see the motor, which couples the brass flywheel via Sony's 'disc drive'. The belt drives the cassette's takeup or feed reels.

resilient although you shouldn't use the admittedly handy cue/review facilities unless necessary. Mechanical bits like nylon gears can fail as can board-mounted sockets and potentiometers. If you have the protective leather case use it to keep dust at bay. As with most portable equipment always remove batteries when it's not in use. Leakage can cause catastrophic corrosion.

The WM-D6C was produced until 2002. A lifespan of eighteen years for a product from a large multinational corporation is almost unheard of! But then again, there was nothing to touch the WM-D6C (for a while Sony did however produce the WM-D3, a more compact Walkman Professional; this could come close to the performance of the more substantial unit although this 'baby' model was Dolby B-only and would only work with ferric or chrome tape).

The newer WM-D6Cs replaced the amorphous head with a cheaper type and made more use of machine assembly-friendly surface-mount electronics. This simplification did make the machine easier to service; most of the wiring looms you can see in the photo of my first-gen unit disappeared! It also meant that Sony could keep the retail price remarkably constant (around £250) for nearly two decades.

Hardly surprisingly, many were sold and put to all manner of tasks. Until Minidisc and solid-state recorders gained ground in the 1990s they were the bootlegger's tool of choice; many an 'audience recording' of an 1980s or 1990s concert started its furtive journey on one of these and a compact stereo electret microphone (often also Sony, not least because it was compatible with the recorder's 'plug in power' system).

Print journalists used WM-D6Cs for interviews and conferences while local radio recorded vox-pops with them. Some commercial recordings (notably a spoken-word album by American cultural icon Henry Rollins) were made with one of these machines.

Yes, the sound quality really was that good; with a decent pair of headphones, you'll marvel how Sony managed to push the boundaries of mobile cassette playback so far. A broad and even frequency response does justice to the throb of the double-bass and the crispness of electronic percussion alike, while the Dolby noise reduction systems all but kill hiss. Even sustained organ notes or complex piano passages are played without any wavering of pitch.

A decent microphone is necessary for live recordings, in keeping with the 'garbage in, garbage

out' philosophy. Unfortunately, the mic preamp is rather on the noisy side; some modified their units with lower-noise components or fed an external mic preamp into the line input.

Which brings us to one of the most famous bootlegs of the '80s, allegedly-taped with a Walkman Professional. In 1986, US alt-folker Michelle Shocked gave an impromptu campfire-side performance at the Kerrville Folk Festival. Shocked had given permission for her performance to be taped by English music enthusiast Pete Lawrence. She thought no more of it until being congratulated on her chart success in England; the recording had been released here without her permission as 'The Texas Campfire Tapes'. The resulting exposure helped Shocked to secure the recording contract that brought us 1988's 'Short Sharp Shocked' LP.

Although the music on 'The Texas Campfire Tapes' is beyond reproach, the recording quality is ropery. It sounds too fast because the batteries in Lawrence's Walkman were dying, causing the mechanism to run slow and no pitch correction was carried out during the transfer to LP. But the lack of dynamics, harsh edge and tape hiss lead me to believe that Lawrence wasn't using a Walkman Professional but a cheaper model.

A WM-D6/D6C or WM-D3, with decent offboard mics, is capable of so much better in terms of sound quality.



Sony's top portable stereo cassette decks grouped together. To the left of the WM-D6C is the WM-D3. This less expensive Walkman Professional option is about the same size as a play-only Sony unit of that time and uses a very similar mechanism. Like the bottom machine that dwarfs both - a compact (but non-Walkman) TC-D5 Pro portable used by BBC TV in the early 1980s - the WM-D3 is capable of making decent recordings.

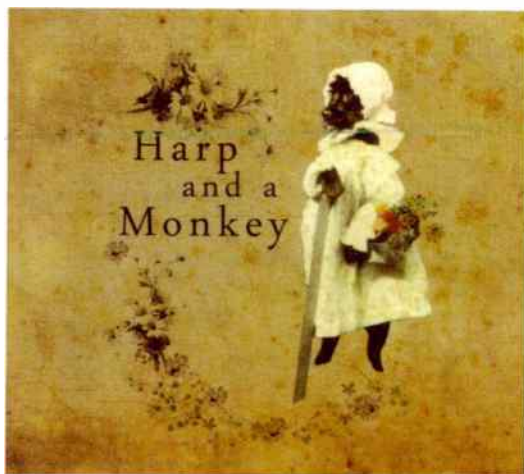

HARP & A MONKEY

All Life Is Here
MoonrakerUK

A brazen celebration of the working class – now where did they go to, eh? Re-branded as the ‘Shameless’ CHAVs, to be mocked and derided? Stripped of pride and history?

Lancashire-based Harp & A Monkey are an English folk outfit for the 21st Century that have no problems contemplating the past while retaining a steady eye on current events and life in general. Take the blended ‘Walkin in the Footsteps of Giants’ which celebrates a ‘right to roam’ victory in Derbyshire but also blends archival interview footage of a chap who volunteered to fight Franco during the Spanish Civil War.

His words on struggling up the Pyrenees was a different sort of ‘right to roam’. The delightfully monikered ‘Tupperware and Tinfoil’ tells of family trips to the seaside. My own childhood was covered in blasted tinfoil. My mother would

surround my own packed lunch sandwiches – featuring rolls the size of bowling balls – with enough metal to span the Mersey. The song predicts the memories that will stem from such outings. My dad had more fun looking for crabs in isolated rock pools than my sister and I ever did.

‘Pay Day’ talks about working in a mill and the host town now suffering from unemployment once the mill closes down. They suffered working in the mill, they suffered without a job. Life, eh?

Imaginative and innovative, this is folk for now and then.

Also look out for Sam Brookes’ ‘Kairos’ (Sam Brookes) a folk singer sporting complex, layered arrangements and a rhythmic flair; Geraint Watkins’ ‘Moustique’ (Jungle) has a reflective yet observant Randy Newman flavour while Sam Semple’s debut, ‘Mystery Songs’, features arresting lyrics investigating self-awareness and our place in the world.



T. REX

Tanx
Edsel

R eleased in 1973, this album acted as a window onto cracks in the T. Rex empire. The album was farsighted and adventurous in its use of soulful backing singers along with horns, providing a blend of genres that added a new dimension to the sound. That said, the hits were not quite as big and the performances not as exciting as those seen within 1971’s ‘Electric Warrior’.

The rock’n’roll extravaganzas were also starting to catch up with the band in terms of work (i.e. touring) and excesses (i.e. drugs).

You can hear the core of the classic T. Rex oeuvre in this album. Tracks such as ‘The Street & Babe Shadow’ and ‘Born to Boogie’ are from the Bolan song chest. There are a few surprises, though, such as the first track off the album ‘Tenement Lady’ which could almost be Fab Four-like in its structure, plus the beautiful ballad ‘Broken Hearted

Blues’.

The LP is in the news because Edsel has re-released the album alongside ‘Zinc Alloy and the Hidden Riders of Tomorrow’ (1974) as part of a five-disc deluxe box set that combines new Visconti-remasters of both albums. Each album is offered across two CDs and comes with a wealth of bonus material including A-sides, B-sides, demos and out-takes. The DVD offers ‘Top Of The Pops’ performances, promo films and other TV appearances. The 12" x 12" hardback book comes with new notes by Mark Paytress and Tony Visconti.

Also look out for other deluxe editions of T. Rex work, including T. Rex (1970) which features ‘Beltane Walk’ and ‘Is It Love’ with Bolan in not-quite-swaggering mood taking a pastoral air, while ‘A Beard of Stars’ (1970) includes ‘Pavilions of Sun’ and ‘Elemental Child’ and sees Bolan beginning to transform from hippie to rock star.

It didn't last long but the group went through a whirlwind of changes. Eventually a UK prog band, Heavy Jelly didn't even exist when a jokey, fictitious review appeared in the magazine Time Out. Fiction begat fact when heightened interest resulted in, bizarrely, two record labels, Island and Head, creating two versions of the band after the event, with singles to match.

The Island version of the group was actually the established outfit Skip Bifferty. The Head release was arguably more interesting. In a rather smirking reference to the original advert the single 'Time Out (The Long Wait)', was released in 1969. The Head incarnation were not entirely inexperienced: John Morshead (guitar/vocals) and Alex Dmochowski (bass) were known from their time with the Aynsley Dunbar Retaliation. A drummer, Carlo Little, and someone called Rocky completed the line-up.

As a result of the single, which

did decent business, the label's managing director, John Curd, registered the Heavy Jelly name and Morshead and Dmochowski looked again at the line-up.

The early album sessions featured Chris Wood and Jim Capaldi from Traffic but they soon left to be replaced by ex-Animals drummer Barry Jenkins and vocalist Jackie Lomax, who joined after a stint at the Beatle's Apple Records label. The Heavy Jelly album was doomed never to be released, however, and Lomax left to start a solo career.

Featuring Badfinger members Pete Ham and Tom Evans along with the Rolling Stones wind section of Bobby Keys and Jim Price the album has a blues-infused prog presentation but there is a lightness of spirit in the delivery. Exhibiting admirable songwriting, it has an almost Beatle-esque edge to the music. No doubt aided by the band members and their own musical philosophies. A fine album with Lomax stamped all over it.

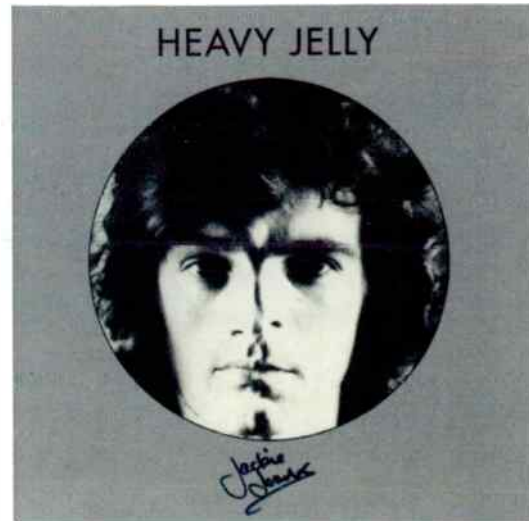

HEAVY JELLY

Heavy Jelly
Angel Air

AUDIOPHILE CD

The new Up Country label is the home of a range of country genre re-issues that provides a value for money, two albums pack on a single CD.

Diffie may not be known to many general music fans but in country circles he is regarded as a quality vocalist sometimes singing novelty songs with a rock edge or plaintive ballads.

He signed with Epic and released his debut album 'A Thousand Winding Roads' in 1990. Taken from that album his first single 'Home' struck immediate success, shooting to No 1 in the country charts, as did his second single 'If the Devil Danced (In Empty Pockets)'. Two further singles, 'If You Want Me To' and 'New Way (To Light Up an Old Flame)' hit the No 2 spot.

The second album on this CD was also Diffie's second album release. 'Regular Joe' packed in all

of the familiar aspects of a nineties country album but there are plenty of high-quality songs and also great performances that lift those songs to another level.

Take the title track which approaches Haggard-like levels of energy while 'Ain't That Bad Enough' is roughed up by Diffie and transformed in the process. A superb pair of albums.

Other albums in this duo series include Brooks & Dunn's 'Brand New Man' (1991), a superb debut with top-quality songs that broaches into pop and rock, alongside 'Hard Workin' Man' (1993), a worthy successor. Clint Black's 'The Hard Way' (1992) feature a host of great singles while 'No Time To Kill' (1993) features a Wynona Judd duet. Finally, Linda Davis' 'Shoot For The Moon' is her steamy blues 1994 release while 'Some Things Are Meant To Be' sees her finally live up to her promise.

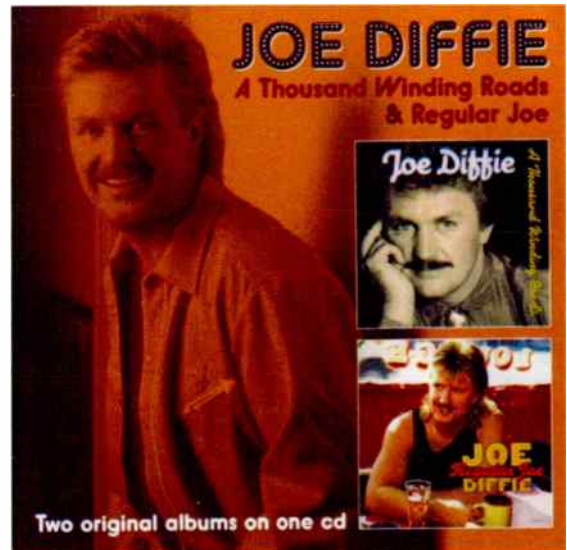

JOE DIFFIE

A Thousand Winding Roads/
Regular Joe
Up Country

Munich '14

Tony Bolton travels to Germany to take in the audio delights of the 2014 Munich High-End Show



This year's High-End Show at the MOC show venue in Munich, the 33rd, was particularly successful. Visitor numbers were up by 10% (17,855 visitors, excluding trade and press) and the exhibitor numbers also increased by 25% with 452 from 40 countries. British audio products were well represented and I am pleased to report that the variety of equipment on display from all corners of the globe reflected the hugely diverse ways that we have found for carrying out that seemingly simple task of reproducing music in our home environment.

All tastes were catered for, whether it was horn loudspeakers or state-of-the-art digital reproduction. I was also interested to note that a number of companies were displaying open-reel tape decks as sources while others were offering pre-recorded tapes for sale.

So without more ado, here are some photographs of the more interesting items on display.



British mains purification and accessory specialists, IsoTek/Blue Horizon, were displaying their Vortex prototype record cleaning machine. www.bluehorizonideas.com



Lutz Precision were showing a Studer B62 tape deck demonstrating their direct copy mastertapes. Available music includes Oscar Peterson. www.analog-audio.eu



This is the Primary Control Reference arm available in either 9", 10.5" or 12" sizes. www.primarycontrol.de



German valve and amplifier manufacturer Elrog displayed these unusually shaped 1m tall ER211 amplifiers. www.elrog.com



These beautifully styled Uniwersum horn loudspeakers are made by Auto-Tech, based in Lublin, Poland. www.horns.pl



Arthur Khoubesserian of the Funk Firm showing a Funk Vector 5 turntable. www.thefunkfirm.co.uk



German Physiks had a range of loudspeakers on display including these PQS-302 Omnidirectional models. www.german-physiks.com



Silbertone were demonstrating a pair of 1926 Western Electric 12A horn loudspeakers originally installed in cinemas for the release of the world's first talking picture "The Jazz Singer".



The horns are driven by this 555 Receiver driver by G.I.P. Laboratories. www.giplaboratory.com



This is the impressive Air Force Two turntable from TECHDAS of Japan. www.techdas.jp



The 170,000 Extreme loudspeakers from Estonian company Estelon. The height of the angled top unit can be adjusted between 1.77-2.07m tall by remote control for optimised listening. www.estelon.com

Xpression Carbon

Xpress your sound,
Xpress your look...



March 2014



February 2014



**NEW UKX VERSION
AVAILABLE NOW!**

Includes free acrylic
platter with Bordeaux
and Midnight Blue
finishes.

A Classic Made New...

The Xpression Carbon is the latest version of Pro-Ject Audio Systems' original turntable, the Pro-Ject 1. This new model employs a brand new carbon fibre tonearm with an Evolution-inspired support structure. The superior motor, with isolation blobs designed by Ortofon, drives a high-quality platter that can be fitted with either a Cork or Felt mat. The plinth is available in three stunning finishes*, and the arm is rounded off with an Ortofon 2M Silver cartridge to create a comprehensive package that would suit any system.

Available in the UK through Henley Designs Ltd.

T: 01235 511 166

E: sales@henleydesigns.co.uk

W: www.henleydesigns.co.uk

 /HenleyDesignsLtd

 /HenleyDesigns!



Pro-Ject
AUDIO SYSTEMS

World Radio History

* Bordeaux finish shown



Switzerland's Boenlicke Audio were showing their W5 and W8 (Anna) loudspeakers to great effect. www.boenlicke-audio.ch



Corum Audio from Italy displayed their impressive loudspeakers which stand over 1.5m tall. www.corumaudio.com



These are the soon to be announced H128 headphones made by ADL of Japan. They will be available in three finishes. Estimated price will be around £300. www.adl-av.com



Serbian company Auris Audio were showing their gorgeously-finished Forte 6550 monoblocks. www.aurisaudio.rs



The Angelo loudspeaker from The Varios of Italy. This is the largest unit of a range that includes desk-top sized speakers. www.thevarios.com



Swedish company Engstrom and Engstrom showed their Lars Type 2 300B monoblock amplifiers costing 55,000. www.thelars.se



This is the Bergmann Sindre Airbearing turntable fitted with their linear tracking airbearing tonearm. www.bergamnaudio.com



Corum Audio also showed their matching Bass Unit and processor/amplifier.

SPECIAL INTRODUCTORY OFFER!!!!

HI-FI WORLD ELECTRONIC EDITION

VISIT OUR WEBSITE: www.hi-fiworld.co.uk

Queries to - esubs@hi-fiworld.co.uk

**Subscribe to our
eco-friendly e-edition of
Hi-Fi World and receive a
50% discount!!!**

- **Receive your issue a week before on-sale dates.**
- **Be the first to grab a bargain in our Free Reader Classified Ads.**
- **In-house lab. tests to AES and IEC standards**
- **Run by dedicated hi-fi engineers & enthusiasts.**
- **No missed issues, or postal delays.**
- **Access your issues from anywhere in the World.**
- **PC and Mac friendly.**
- **Eco-friendly.**

**Subscribe today and receive 12 issues for
£20 – that's an amazing £1.90 per issue!**

check out our free trial issue

**VISIT OUR WEBSITE:
www.hi-fiworld.co.uk and select
"ELECTRONIC EDITION"**

To purchase your e-edition click here

Pay in Sterling, US Dollars or Euros. Non-sterling prices vary according to exchange rate.
Cards accepted: Visa, Maestro (Switch), Mastercard, Solo and Delta.



"Holly was an even greater influence on rock than Elvis Presley"



Paul Rigby

Don't you find it interesting how one person can influence another? If you look over the history of music, for example, you will see a complex spider's web of links and connections where bands form and split, people enter and leave the business, join and leave bands, come together to write a few songs and then move elsewhere to band together with different people to write more songs and so on.

Music history has this on-going flow and change. Yet, in the middle of the seeming chaos of creativity there are nodes. Big, big points that beam out from the spider's web as significant times in music's development. These nodes are very important. They connect many elements of the web together.

In fact, they are responsible for much of the web itself. Elvis Presley is one such node, Bing Crosby is another, The Beatles are a third. From these acts, a mountain of new artists arise, 'influenced' by these dominant figures.

I was flicking through the catalogue of a neat little UK record label, Rollercoaster (www.rollercoasterrecords.com) of late and three of these nodes screamed at me all at once.

The first is Buddy Holly. I would argue that Holly was an even greater influence to rock than Elvis Presley because he was a revolutionary and pioneer, a professional among amateurs. Considering that his work was recorded on such primitive equipment in the most basic of circumstances, Holly had no right to be producing the quality of 'That'll Be The Day', 'Peggy Sue', 'Oh Boy' and 'Not Fade Away' – songs that sound just as fresh and vital today. Talk about influences, Holly was a major influence of the core of current

rock history. How about this for a list? The Beatles, Rolling Stones, Bob Dylan, the Byrds, The Who, Bruce Springsteen...need I go on?

Each one of these artists are themselves seen as significant influences, so what does that make Holly? He is seen as being the Father Of Rock.

But how can anyone hold such a title and die at twenty-two? Just let that sink it for a minute. Twenty-two! This is a man, a very young man, who is responsible for a multi-billion pound industry, in effect, and for the production of some of the most sublime music. Twenty-two? The 'what if' questions that you have to ask yourself almost beggar belief.

Is it any wonder that Rollercoaster spent time digging up a whole host of rarities on CD ('Ohh! Annie!' featuring previously unreleased material from 1956 sessions over two CD discs) and a 10" vinyl disc called 'That Makes It Sound So Much Better' that improves a selection of rarities to audiophile standard.

Another 'node' is Link Wray, an American rock'n'roll guitarist who was a star in the late 1950s. Wray had the knack of over-driving his guitar, creating one of the first distorted electric guitar sounds. The power chord was his invention, for example. Wray is seen as the 'father' (there's that word again) not only of heavy rock but also punk rock. Of course, he was also one of the world's best guitarists out there so you can imagine who might have been influenced by the man. Both Iggy Pop and Jimmy Page admired Wray's rebel attitude and Pete Townshend 'blames' Wray for making him pick up a guitar in the first place,

"I remember being made very uneasy the first time I heard it and yet excited by the savage guitar sounds" says Townshend.

Listen to Wray, then spin a Hendrix record and easily find the links.

Rollercoaster has a great CD on the man called 'The Swan Records Singles Collection' featuring twenty-six nasty guitar songs. Budding Pete Townshends out there should brace themselves.

Speaking of guitar heroes there's also Davey Graham – one of the most important figures in the British folk revival during the sixties. Despite his introverted nature and wish not to pursue fame he, nevertheless, struck a chord (literally) in the hearts of many future folk stars such as Pentangle, Fairport Convention, John Martyn, Martin Carthy, Bert Jansch, Wizz Jones, John Renbourn but also the likes of Paul Simon and Jimmy Page.

The problem with Graham was that he had a life. A life outside of music, that is. He was a truly rounded individual, despite struggling with drugs. Hence, his extensive work for charity (he was on the executive council of MIND, the mental health charity, for example) and his study of languages.

He was also interested in social history, loving to collect old folk songs and poems. His cultural knowledge often spilt into his work as his albums featured an eclectic mixture of musical styles.

Rollercoaster's official bootleg, 'After Hours at Hull University, 4th February 1967' is a perfect insight into Graham the relaxed musical intellectual.

The ability of the artist to break the template, to make unexpected connections and ignore the pattern produces shockwaves within any genre.

The exciting thing about them all is that each had to start somewhere. Look around, one budding genius might be lurking at the bottom of a pub gig bill near you. ●

WELCOME TO THE NORTH EAST

ANATEK RESEARCH
 APOLLO
 ATACAMA
 AUDIOLAB
 ANATEK RESEARCH
 CHORD COMPANY
 CHORD ELECTRONICS
 CLEARAUDIO
 DYNAVECTOR
 EAR YOSHINO
 FOCAL JM LAB
 FUNK FIRM
 GOLDRING
 GRAHAM ENGINEERING
 GRAHAM SLEE
 ISOTEK
 KOETSU
 KUDOS AUDIO
 MARTIN LOGAN
 LYRA
 MAGNEPLANAR
 MICHELL ENGINEERING
 MONITOR AUDIO



NAD
 NAIM AUDIO
 NORDOST
 NOTTINGHAM ANALOGUE
 OPERA
 ORTOFON
 PATHOS ACOUSTICS
 PROJECT
 PS AUDIO
 PURESOUND
 REGA
 REVOLVER
 ROKSAN
 SME
 STAX
 SUGDEN AUDIO
 TEAC ESOTERIC
 TRANSFIGURATION
 TRICHORD RESEARCH
 UNISON RESEARCH
 USHER AUDIO

HIFISOUND Castlegate mill, Quayside, Stockton on Tees. 01642 267012

2NDHANDHIFI.CO.UK

Guaranteed used and ex-demo audio equipment from HiFiSound - the UK's premier source

Call: 0845 6019390 Email: World@2ndhandhifi.co.uk

| | | | | | | | |
|-----------------------------------|------|---------------------------------------------------|------|---------------------------------------------|------|--------------------------------------------------|------|
| Roksan Radius S, ex demo | 799 | Audiolab 8200A, mint boxed ex demo | 499 | AMR 777 Amp and CD ex demo | Call | Focal XS Back Active Mini Monitors, ex demo mint | 199 |
| Rega RP40, ex display, mint boxed | 649 | Audiolab 8200D and 8200P, Pre Power, mint ex demo | 798 | NAIM NDX, ex dem, boxed complete, near mint | 2499 | Martin Logan Summit X, ex demo | Call |
| EAR 834P Deluxe ex demo | 1299 | NAIM NAC252, ex demo, mint boxed | 4499 | NAIM HiCap DR, ex demo, near mint boxed | 949 | Monitor Audio RX6, sealed box | 799 |

| Analogue | Amplifiers | Digital | Loudspeakers |
|------------------------------------------------------------|------------|------------------------------------------------------|--------------|
| Alphason HR100S, vgc | 499 | Arcam Alpha 8, excellent | 149 |
| Audio Research PH3, excellent 120volt | Call | Arcam Alpha 7, remote, excellent | 119 |
| Audio Synthesis ADEQ phono stage excellent | 479 | Arcam Alpha 5+ just serviced | 149 |
| Clearaudio Concept package, nr mint boxed | 699 | Arcam CD23, excellent | 399 |
| Clearaudio Innovation Compact, good condition, | 1999 | Arcam CD73, excellent boxed | 199 |
| Clearaudio Unity Tonearm excellent boxed | 699 | Arcam CD37, excellent | 799 |
| Clearaudio Satisfy Tonearm excellent boxed | 349 | Arcam Alpha 9 DCS ring dac chipset, lovely! | 279 |
| Conrad Johnson TEA 1b Phono stage | 1999 | Beresford TC7510DAC, boxed vgc+ | 99 |
| Garrard 401, Slate Audio plinth | 799 | Cambridge Audio Magic 6, mint boxed | 599 |
| Hadcock 242 Export, ex demo as new | 599 | Cyrus dAD30, 24 bit chip, excellent | 329 |
| Hadcock 242 Integra, ex demo as new | 799 | Cyrus DACX+, excellent boxed | 1099 |
| Kuzmo Slabi Reference, excellent boxed | 3249 | Cyrus daD7, excellent, boxed | 199 |
| Linn Sodek, Ekos, Lingo, boxed | 2249 | Cyrus CDXiSe, excellent, boxed | 449 |
| Linn Sodek, Itak, Valhalla, vgc+ | 899 | Cyrus CD6SE2, excellent, boxed | 399 |
| Linn Sodek, Girkus, Valhalla, Trant mount motor | 599 | Cyrus Streamline, excellent, boxed | 549 |
| Linn Sodek, Lingo, Naim Aro, superb | 2499 | Denon DNP720AE, near mint boxed | 199 |
| Linn Sodek, Akito, Valhalla, excellent | 749 | Goldenote Koala, near mint boxed | 759 |
| Linn Sodek, Bosik plus+, Valhalla, G1042, VGC+ | 699 | Linn Classic | 549 |
| Lyra Erodon Step up | 1499 | Linn Karik 3, excellent boxed remote | 499 |
| MicHELL Gyrodec Export, Origin Live Silver, boxed | 1199 | Moraniz C063K1, vgc | 199 |
| MicHELL GC Power supply, excellent | 299 | Moraniz CD10, excellent boxed new belt kit | 449 |
| MicHELL ISO, vgc renowned phono stage | 199 | Moraniz CD600A, nr mint boxed | 199 |
| MicHELL Technoarm A in black as new mint boxed | 449 | Meridian 506/720 with MSR | 399 |
| MicHELL Orbe, DC motor superb! | 1749 | Meridian G06 | 549 |
| Monitor Audio ET500, c/w PSU, SME3s & Grado Black | 349 | Musical Fidelity ASCD, excellent | 299 |
| Musical Fidelity VLP5/2, excellent | 99 | Musical Fidelity A3CD, excellent | 329 |
| Project Phonobox 2, ex boxed | 179 | Musical Fidelity M1 DAC, excellent boxed | 1199 |
| Rega TFSU, excellent | 119 | Musical Fidelity CD1008 Pro, near mint boxed, remote | 2499 |
| Rega Planar 3, R2700, excellent | 179 | NAIM NDX, ex dem, boxed complete, near mint | 649 |
| Rega Planar 2, R8250, excellent boxed | 179 | NAIM CDX, excellent, boxed remote, REDUCED | 1199 |
| Rega RP8, Apheta Cartridge, excellent boxed | 1249 | NAIM CD57/2, excellent boxed, remote | 499 |
| Roksan Xerxes, XPS2, Linn Fii | 349 | NAIM CD53, excellent boxed, remote | 1999 |
| Roksan Xerxes, Tobrix Zi, XPS, in light wood, ex condition | 699 | NAIM CDX, excellent, boxed remote, late model | 699 |
| Rotel RP3000 Direct Drive TT with matching arm, vgc+ | 1499 | NAIM DVDS, remote | 499 |
| SME V, 1989 model, excellent tons, manual etc | 249 | NAIM CD5ii just serviced, XPS Burndy, boxed | 1999 |
| SME 3009, excellent boxed | 249 | Quod 99CDP, excellent REDUCED | 399 |
| SME 3009/3, excellent boxed | 249 | Rega Planet 2000, excellent | 199 |
| SME 3012, excellent | 399 | Rega Apollo R, excellent | 449 |
| Technics SL120, SME3009 excellent | 799 | Roksan Kandy KAI, reasonable condition | 79 |
| Thorens TD170, Fully Automatic, excellent | 249 | Rotel RCD02, vgc | 99 |
| Tom Evans Groove, 0.85mv/100 ohm, excellent | 849 | Rotel RCD1072, excellent, remote | 249 |
| Townshend Elite Rock, Merlin, Excolibur | 999 | Sony XA9000ES, excellent boxed | 699 |
| Wilson Benesch Act 1 Tonearm, nr mint superb | 799 | TEAC P700, excellent remote | 299 |
| | | YBA GC-10, ex boxed, £1600 new, BARGAIN | 399 |

Telephone 01642 267012, Tue to Sat 10 til 5, or email choice@2ndhandhifi.co.uk

TURNTABLEWORLD

The UKs best selection of vinyl replay products

www.turntableworld.co.uk - the analogue specialists - 01642 267012

World Radio History

"I was grinning with pleasure at the sounds flowing out of my loudspeakers"



Tony Bolton

Over the years I have introduced various components into both of my hi-fi systems until I have got to the point where the sound from them gives me both immense listening pleasure and satisfaction. I run a core set up that regular readers will be familiar with from the 'Equipment used' section that is included in most of my reviews.

Periodically a piece of equipment comes along that has such a dramatic effect upon the sound that reverting to my normal set-up after the review leaves me with a sense of dissatisfaction with what I previously considered to be an enjoyable and involving presentation of the music.

This happened a little while ago when I reviewed the IsoTek Sigmus EVO3 mains purifier. I ran the upstairs system with the new Sigmus in place for a couple of weeks before it had to go back to the manufacturer and I reinstalled the G2 version which has fed power into this system for the last eight years.

Unfortunately there are some changes that are made to a system that are not reversible – and so I found it to be with the Sigmus EVO3. In the review (HFW April 2014) I commented on how dramatic an improvement the performance of the EVO3 version was over the G2 unit and that owners of the older unit would find such substantial benefits in upgrading to the new model that the expense was more than justified.

I should have taken more notice of my own words, because over the ensuing four months since I wrote that review I have found that although I have still enjoyed playing music on the system, my level of enjoyment was somewhat reduced and the overall feeling of satisfaction with the system's performance has

been negated.

Having said that, it will come as no surprise to you to learn that I have just taken delivery of the new EVO3 Sigmus. I just found that I could not live without it.

I plugged it in last night and for the first time since the review sample left this house I was sitting grinning with pleasure at the sounds that were flowing out of my Kelly KT3 loudspeakers.

In the same issue I also reviewed the Vinyl Passion Unity 2 sub-chassis and armboard for the Linn Sondek. Again, the improvement in sound quality was so profound that I found reverting to the standard Linn steel subchassis and MDF armboard proved impossible to live with. I also found none of the other aftermarket options that I have tried could match the performance improvement offered by the Unity 2 so my Sondek now sports the Vinyl Passion set-up as a permanent fixture.

The other change that has happened to the upstairs system was the installation of the SME M2-9R arm for a review. It took the place of my Hadcock 242 Cryo which has given good service for over 10 years. Again, the sonic improvements that the SME brought to the sound of my turntable made it impossible to live without, so that has replaced the Hadcock to become the reference arm on that turntable.

As a tool for this job it is first-class, having detachable headshells that make comparing cartridges very easy. It is also able to accommodate cartridges weighing up to 38g using the SME headshell, or 46g using other plug-in heads such as Ortofon SPUs so I cannot think of any cartridge that this arm will not allow me to use with ease.

Having said that, eagle-eyed readers may have noticed that in this and the previous issue of this

magazine I have been using the Linn Ittok LVII that was the original fitment on the LPI2 when I bought it second-hand some 14 years ago. This has occurred since I wanted to refresh my memory of how the arm sounded and at the same time try out the SME on the Clearaudio Master Solution turntable on the downstairs system. This has brought some interesting aspects of the sound to my attention.

The Ittok is still mounted on the original Linn MDF armboard. I am finding that although I am enjoying the grip to the sound, particularly in the bass area, that the Ittok produces, I am also very aware of a background graininess to the sound that is entirely due to the material that the armboard is made of. I have a feeling that I will be investing in the Unity 2 alloy armboard for this type of arm mounting very soon.

As I have mentioned, I am trying out the SME on the Clearaudio deck. I have borrowed two armboards for this purpose. One is made from clear acrylic and the other machined from a solid billet of aluminium. I am quite curious to see which material's sonic signature works best with this arm. Having tried it on the Sondek with both MDF and the alloy Unity 2 armboards, I found the latter to be far preferable sonically, so I have a feeling that the aluminium Clearaudio mounting may well win my affections.

Now that I have the Sigmus EVO3 powering the system, the Vinyl Passion Unity 2 installed in the Sondek and an arm that gives me excellent sound and makes this job easier, I am currently a man who has regained my previous level of contentment with the sound of my hi-fi. I have no doubt that at some point in the future my equanimity will again be disturbed but until then I am happy with things as they are. ●

Sometimes you just can't see the wood for the trees when you're buying hi-fi.

Clarity is here to help.

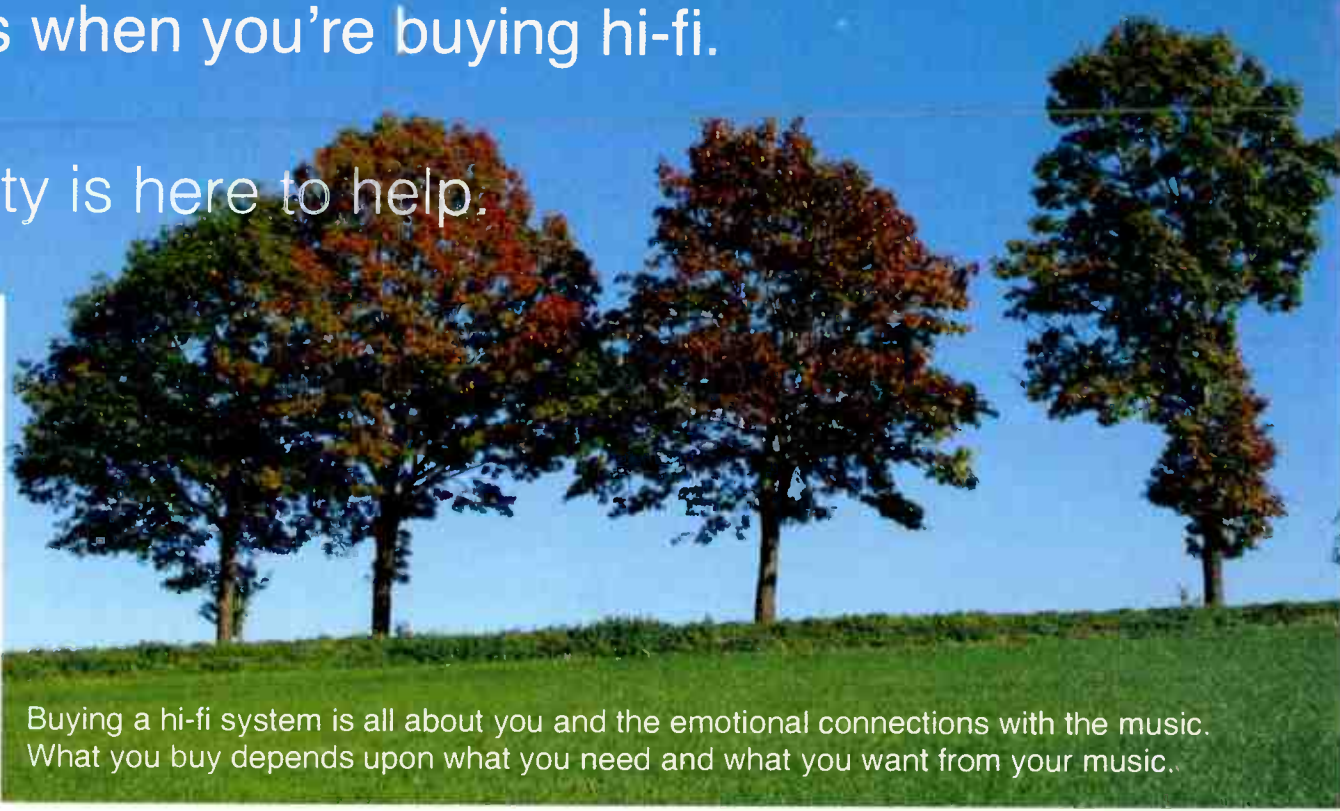

Buying a hi-fi system is all about you and the emotional connections with the music. What you buy depends upon what you need and what you want from your music.

And you can only find the answer at your local expert retailer. You can't audition hi-fi or make comparisons online or by mail order.

Members of **The Clarity Alliance** are the only independent retailers who are trained to industry agreed standards to give you unparalleled levels of product advice and service. Take your time and relax in dedicated listening rooms, try a variety of equipment and music, audition and study each item, get to know it and see how it makes you feel.

www.clarityalliance.co.uk

- ✓ **Free geek time** impartial and honest advice
- ✓ **Transferrable warranty** the freedom to move
- ✓ **Listen great demo facilities**
- ✓ **Knowledgeable staff** a refreshing change
- ✓ **Awful coffee** but we'll always make a cuppa

Let our expert retailers guide you through the myriad of choices and show you some clarity

EAST

Basically Sound
Norwich
www.basicallysound.co.uk
01362 820800

Martins Hi-Fi
Norwich
www.martinshifi.co.uk
01603 627010

LONDON

Adair Acoustic Design
Clerkenwell
www.adairacousticdesign.co.uk
0207 253 2326

Bartletts Hi Fi
Islington
www.bartlettshifi.com
020 7607 2148

Billy Vee Sound Systems
Lewisham
www.billyvee.co.uk
020 8318 5755

Grahams Hi-Fi
City of London
www.grahams.co.uk
020 7226 5500

Oranges & Lemons
Clapham
www.oandlhifi.co.uk
020 7924 2040

Unilet Sound & Vision
New Malden
www.unilet.net
020 8942 9567

MIDLANDS
Nottingham Hi Fi Centre
Nottingham
www.nottinghamhificentre.co.uk
0115 9786919

NORTH EAST
Sound Organisation
York
www.soundorg.co.uk
01904 627108

NORTH WEST
Acoustica
Chester
www.acoustica.co.uk
01244 344227

Chris Brooks Audio
Warrington
www.chrisbrooksaudio.com
01925 261212

SOUTH EAST
Home Media
Maidstone
www.thehomeofhifi.com
01622 676703

Infidelity
Kingston-on-Thames
www.infidelity.co.uk
020 8943 3530

P J Hi-Fi
Guildford
www.pjhifi.co.uk
01483 504801

Soundcraft Hi-Fi
Ashford
www.soundcrafthifi.com
01233 624441

SCOTLAND
Glasgow Audio
Glasgow
www.glasgowaudio.com
0141 332 4707

Holburn Hi-Fi
Aberdeen
www.holburnhifi.co.uk
01224 585713

SOUTH CENTRAL

Overture
Banbury
www.overture.co.uk
01295 272158

Oxford Audio Consultants
Oxford
www.oxfordaudio.co.uk
01865 790879

Phase 3
Worthing
www.phase3.co
01903 245577

The Sound Gallery
High Wycombe
www.soundgallery.co.uk
01494 531682

SOUTH WEST
Gulliford Audio
Exeter
www.gullifordhifi.co.uk
01392 491194

with support from

anthem **av** solutions

ARCAM



audio-technica
Bowers & Wilkins

BRISTON

CLASSE

heed

forget hi-fi - remember music



hi-fi+

JVC

KEF

ONKYO

ortofon

Pioneer

sound.vision.soul

PLINIUS

THE HEART OF MUSIC

PMC

Project

ROTEL

Roth

SENNHEISER

SIM

TEAC

THE CHORD COMPANY

The Multi-Room Company

WHAT HI-FI? SOUND AND VISION



/ClarityAlliance



@clarityalliance

www.clarityalliance.co.uk

clarity

"Beatles mono LPs are definitive renditions of the Beatles music"



Noel Keywood

Many months ago I saw the need for a dedicated mono cartridge to play the forthcoming Beatles mono LPs. The forums were getting into a twist about this issue because Beatles mono LPs are notionally definitive renditions of the Beatles music, in original format, meaning LP of course. Was a mono cartridge necessary for these LPs?

Ideally, you do need a mono cartridge to play them – but there's a problem. Many modern mono cartridges are available to play mono LPs – they ignore stereo groove noise – but their styli are clunkers proportioned for early mono grooves. They were wider than later stereo grooves used on these LPs, necessary to suit modern stereo cartridges.

I realised this when testing an Ortofon 2M Mono a while back. Its 18µm spherical stylus has a relatively large side-radius contact face, when compared to Ortofon's top Shibata stylus with a side-radius one-third the size, just 6µm.

An 18µm radius is too large to read the short-wavelength modulations in a groove at high frequencies, especially on inner grooves where mechanical wavelengths are shortest. On a microgroove test LP the 2M Mono reached 8kHz or so, where conventional stereo Ortofons easily reach 20kHz, like most modern cartridges. Not good.

Worse, the 2M Mono did not track stereo well either, and mistracking causes groove damage. That's hardly what Beatles collectors want to suffer with their brand new, definitive mono box set that will cost £288.

A fully worked-out solution was needed and the answer was obvious: take an Ortofon 2M Mono cartridge, remove its mono stylus, and

replace it with the 2M Black's Shibata profile stylus. Voila! A Beatles mono cartridge, more than able for the job.

Abbey Road liked the idea, because they genuinely wanted to avoid all of the criticism aimed at them over the stereo LPs. And Ortofon liked the idea – it was a goer.

At this point we need to take a rain check. The Beatles remain one of the world's most famous bands. It isn't easy to resurrect anything from them without running into fierce criticism and global controversy if it isn't done properly. Which is to explain the attention to detail I'm talking about here.

There's good justification for carefully re-creating original circumstances and conditions when what is being done now is likely to become a future historical record. The original recording tapes – especially 'Please Please Me' – are shedding their oxide coating; they are not going to last forever.

Replaying these tapes threatens their survival and digital copies become poor replicas as digital improves – high-resolution MP3s you could say. Abbey Road, stung by criticism, have now created a set of new analogue tape masters as a result, just to avoid this issue. Oh the grief!

With this level of attention and care paid to the analogue source, it seemed foolish to me to fall at the last hurdle – the playback cartridge. Nowadays the forums crucify such mistakes – rightly I feel.

What's wrong with playing the new mono LPs with a stereo cartridge, like an Ortofon 2M Black? Basically, nothing. You will get full bandwidth, great tracking and no groove damage.

The same comment applies to Ortofon's moving coils, including the Cadenza Mono with its 8µm side-radius stylus.

But stereo cartridges read vertical information in the groove – and that means groove noise.

The new LPs are unlikely to be very noisy because they are made with virgin vinyl and the lacquers, masters and stampers are all new and will probably see little use; they won't be stamping thousands. So there's no big problem here, but still a mono cartridge will sound better than a stereo and that's enough for Beatles purists – mono it has to be!

Why not get a pre-amplifier with a mono switch and use that? The Icon Audio PS3 valve phono stage we use has just such a switch. This is a simple and effective solution – but most phono stages lack such a switch.

Rather than trade in the hi-fi, the purest solution is to use a mono cartridge – and this I realised raises the horrible possibility of Beatles enthusiasts playing their new, definitive mono LPs with the wrong sort of mono cartridge and damaging them.

I could see a hot potato. Wise advice: don't play your new Beatles mono LPs with a mono cartridge. This would set the forums alight.

You can play these new LPs on your current hi-fi, using a stereo cartridge. But for best results Ortofon will be releasing a 2M Mono SE (Special Edition) moving magnet cartridge with silver wiring and Shibata stylus.

I thought it should be called the Hi-Fi World Beatles cartridge of course, but didn't bother to suggest this to Abbey Road, as I didn't want to engage in discussion with Apple Corps legal department.

Hopefully we will be reviewing this unique new cartridge, carefully labelled the 2M Mono SE, in our next issue.

The Beatles are a difficult subject to cover, but it's well worth the effort. ●



(((AE)))

ACOUSTIC ENERGY

1SERIES

Acoustic Energy have always been associated with audio excellence. Since the original AE-1 monitor speaker was launched in 1988, their products have represented the best audio performance and product reliability available for the price. These principles continue with the new **1-Series**. Consisting of a floor-standing speaker with angled front, compact book-shelf speakers, a centre speaker and a powered subwoofer. The **1-Series** from Acoustic Energy offers unrivalled performance at a price you would not believe.

Stunning Hi-Fi speakers from £199.00



Distributed by Henley Designs Ltd.

T: +44 (0)1235 511 166 | E: sales@henleydesigns.co.uk | W: www.henleydesigns.co.uk

BLUESOUND

A sound experience like no other.
Because it's engineered like no other.

NEW



BLUESOUND IS STREAMING, WIRELESS, MULTI-ROOM, 24-BIT TRUE HIGH-DEFINITION SOUND.

FOR THE LATEST PRICES AND OFFERS VISIT WWW.SSAV.COM OR CONTACT YOUR LOCAL STORE

NEW

£169
OR LESS

Includes Four Interchangeable Grille Cloth Covers



BLACK OR WHITE

DENON • ENVAYA DSB-200 • BLUETOOTH SPEAKER
For sensational sound on-the-go, Denon's DSB-200 features the latest performance advances for listening to music, watching movies, TV or gaming on Bluetooth mobile devices.

£119
OR LESS

LAST CHANCE



BLACK OR WHITE

PIONEER • XW-SMA3 • WIRELESS MUSIC SYSTEM
Delivers stunning sound streamed to wherever you are, from your mobile device, PC or Mac. The built-in, rechargeable battery and splash-resistant exterior make it ideal for indoor or outdoor play.

£179
OR LESS

LAST CHANCE



BLACK OR WHITE

NAD • VISO 1 • WIRELESS MUSIC SYSTEM WITH DOCK
Ideal for wirelessly playing music from your iPod, iPhone, iPad or any Bluetooth device enabled smartphone, tablet or laptop with renowned NAD performance, simplicity and value.

£799
OR LESS

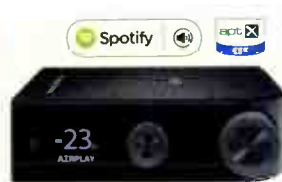

NAD • D 7050 • NETWORK AMPLIFIER / DAC
Combining NAD's most advanced digital platform, Direct Digital technology with Apple AirPlay™, Wi-Fi streaming to create the ultimate plug-in play solution for wireless music.

£2895



NAIM • UNITI 2 ALL-IN-ONE NETWORK SYSTEM
Combines an integrated amplifier, CD player, DAB/FM tuner, internet radio, iPod dock, digital-to-analogue converter and high-resolution 24bit/192kHz capable network stream player.

£1195



NAIM • UNITIQUETE 2 ALL-IN-ONE STREAMING SYSTEM
All-in-one system featuring a 30W amplifier, FM/DAB/Internet radio and wired and wireless connections to play network digital audio. UnitiQuete 2 can play USB-stored music files of up to 32bit/192kHz resolution.

SSAV.COM



PIONEER • N-50 • MUSIC STREAMER
Award-winning audiophile Network player supporting AirPlay™ and DLNA wireless technologies, allowing you to stream music wirelessly from your iTunes libraries or iOS devices. When connected to your home network, you can also enjoy a wide variety of online music services remotely.

NEW

£90
OR LESS



ARCAM • miniBlink • BLUETOOTH DAC
Arcam miniBlink Hi-Resolution Bluetooth Streaming DAC in new micro format. Incredible value and peerless sound quality from Bluetooth. The full suite of Arcam Analogue and Digital Hi-Fi technologies in one tiny new wave product.

NEW

£799
OR LESS



SONY • HAP-S1 HI-RES AUDIO PLAYER SYSTEM
Take your music enjoyment to new heights with Sony's new HAP-S1 50GB Hi-Res audio system with 240W analogue amplifier, easy music file transfer and smartphone browsing.

PLEASE NOTE: SOME BRANDS/PRODUCTS ARE NOT AVAILABLE AT ALL STORES. SPECIAL/ADDED VALUE OFFERS ARE NOT IN CONJUNCTION WITH ANY OTHER OFFER (INC.WAQQ). ADVERT VALID UNTIL 30/07/2014. E&OE

www.SSAV.com

SEVENoaks
SOUND & VISION

World Radio History



£209
OR LESS

PRO-JECT • ESSENTIAL II • TURNTABLE

Entry-level "plug n' play" two speed turntable with single piece aluminium tonearm and pre-fitted Ortofon OM5e cartridge



£299
OR LESS

NAD • C 556 • TURNTABLE

Time to enjoy vinyl collections with extraordinary quality! With a minimalist design, the C 556 turntable offers accurate reproduction by using performance-focused parts and components that put music first



NEW

£575
OR LESS

PRO-JECT • 1 XPRESSION CARBON • TURNTABLE

With its Carbon arm tube and supplied Ortofon 2m Silver cartridge, the 1 Xpression Carbon sets new standards in its price range



£649
OR LESS

ARCAM • FMJ A19 • AMPLIFIER

Arcam's award-winning A19 integrated amplifier delivers 50W per channel and includes seven analogue inputs along with a MM phono input



£399
OR LESS

aptX Bluetooth

**NAD • D 3020
AMPLIFIER / DAC**

Features digital and analogue inputs plus the convenience of wireless streaming with its Bluetooth capability



£399
OR LESS

ARCAM • irDAC • DAC

Designed to be the heart of a digital system. Includes asynchronous USB and a direct iPod input to optimise sound quality. All inputs can be controlled through an IR remote that will also control iPods, iPhones, PC and Mac computers



£799
OR LESS

£749
OR LESS

AUDIOLAB • 8200CD / 8200A • CD / AMPLIFIER

The award-winning 8200CD features a wealth of digital inputs that will keep it playing all your music regardless of how it may be stored



NEW

£975
OR LESS

£1499
OR LESS

CYRUS • CD i / 8 DAC • CD PLAYER / AMPLIFIER / DAC

With its 2 x 70 w power output and extended range of digital inputs, the 8 DAC amplifier is a great partner for the new CD i CD player



£599
OR LESS

AUDIOLAB • M-DAC • DAC / PREAMP

Award-winning DAC featuring a USB input with asynchronous data processing along with two coaxial and optical digital inputs. High-res 24-bit/192kHz music files can be played via its coaxial input



ESSAV
COM

ESSAV
COM

MARANTZ • CD6005 / PM6005 • CD / AMPLIFIER

Replacing the 6004 models, the 6005 amp gains digital inputs using the same 24-bit/192kHz DAC as the CD player which now features enhanced USB playback and improved performance



£499
OR LESS

£699
OR LESS

NAD • C 546BEE / C 356BEE DAC • CD / AMP / DAC

Enjoy music from your computer without musical compromise via the DAC or listen to music from CD with the MP3 / WMA compatible CD player



**AUDIOQUEST • DRAGONFLY v1.2
DAC / HEADPHONE AMP**

An affordable and easy-to-use device that delivers far superior sound by bypassing the poor quality sound card that is built into your computer. DragonFly is a sleek, flash drive sized Digital-Audio Converter that connects to a USB jack on a Mac or Windows PC, turning any computer into a true high-fidelity music source

NEW

£129
OR LESS



£399
OR LESS

**NAD • D 1050
DAC / HEADPHONE AMP**

The best way to add Computer Audio and HD Digital to your hi-fi system. In fact, all digital sources will get a boost when the D 1050 takes over for the inferior digital circuitry found in everything from Blu-ray, DVD and CD players, to music streamers and set top boxes



£1899
OR LESS

£1899
OR LESS

ROKSAN • CASPIAN M2 • CD / AMPLIFIER

The M2 amp boasts 8wpc and five line inputs while the matching CD features a 24-bit DAC plus dedicated power supplies for the output



£599
OR LESS

£499
OR LESS

ROTEL • RA-12 / RCD-12 • AMPLIFIER / DAC / CD

Amplifier with DAC that supports iPod/USB and Bluetooth audio streaming. Includes four analogue line level inputs and a phono input. The RCD-12 CD player is an ideal partner



£1499
OR LESS

NAD • M51 • DAC

This award-winning DAC / pre-amp features optical, coaxial, USB and HDMI inputs, all of which can handle files up to 24-bit/192kHz. The M51 will truly transform any system



£499
OR LESS

SAVE
£300

ARCAM • SOLO MINI • CD / DAB SYSTEM

This award-winning system provides the perfect answer for those craving high quality music reproduction but without the traditional 'pile of boxes' high performance Hi-Fi system



ESSAV
COM

AirPlay

MARANTZ • M-CR610 • CD / DAB / NETWORK SYSTEM

Enjoy great sounding music from diverse sources, including Internet radio, music-streaming services, mobile devices, TV and other digital audio sources



£349
OR LESS

AirPlay

YAMAHA • CRX-N560D • CD / DAB / NETWORK SYSTEM

This Hi-Fi system, with a CD player, DAB/DAB+ tuner for digital broadcasts and Network compatibility with AirPlay, combines elegant design with high quality sound



BOWERS & WILKINS • CM10
Introducing the CM10, a new flagship for the CM series that combines technologies from the Reference ranges with innovative new construction techniques. The result is simply spectacular.

£2999
OR LESS



TANNOY • REVOLUTION DC6T SE
Award-winning compact, floorstanding speakers featuring Tannoy's unique Dual Concentric™ drive unit along with trapezoidal cabinets. Exclusively finished in luxury Espresso colour real wood veneer.

£999
OR LESS



Q ACOUSTICS • CONCEPT 40
The Q Acoustic Concept 40 floorstanding speakers are the latest addition to the award-winning Concept range and deliver unparalleled sonic performance at its price.

NEW **£999.95**
OR LESS

BOWERS & WILKINS • 685 S2
At home on a stand, wall or bookshelf, the versatile 685 S2 is ideal for stereo and home theatre uses in most rooms. And performance is enhanced with the addition of a Decoupled Double Dome tweeter.

NEW **£499**
OR LESS

PRICE INCLUDES STANDS



MONITOR AUDIO SILVER 6
7.5 way speaker system combining excellent dynamics with a naturally rhythmic sonic character and tight, controlled bass. The Silver 6 is an outstanding communicator of music and film audio.

£999
OR LESS



KEF • R500
The smallest of the floorstanders in the R Series. Uses the latest generation Uni-Q driver array and two 5.25-inch aluminium bass drivers. Its slim proportions and sleek contemporary looks make it perfectly suited for any interior.

£1499
OR LESS



PMC TWENTY-22
An astonishingly natural balance and high dynamic capability are the hallmarks of this speaker. It creates a precise sound stage and profound bass performance from its compact cabinet.

£1970
OR LESS



PSB IMAGINE MINI
Meet the newest and smallest member of the ultra-stylish Imagine Series. The deceptively small Imagine Mini makes a big impact on an already impressive range of award-winning speakers.

£599
OR LESS



KEF • LS50
An innovative concept derived from the legendary LS3/5a. Rarely the case in such a compact design, the LS50 monitor delivers a rich, multi-dimensional 'soundstage experience' that is out of all proportion to its size.

£799
OR LESS

SONOS THE WIRELESS Hi-Fi SYSTEM

The Sonos Wireless Hi-Fi System delivers all the music on earth, in every room, with deep, richly textured sound. Sonos is the only system that combines Hi-Fi sound with high-performance wireless. Plus, it's simple to set-up, control and expand so you can easily fill your home with music.

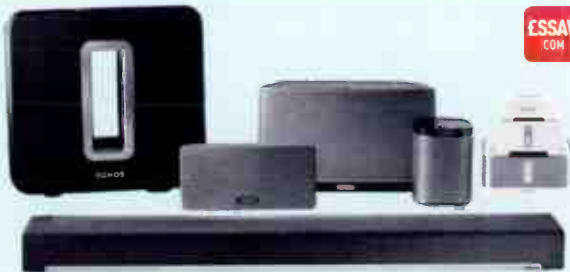

ESSAV
COM

BOWERS & WILKINS P7 HEADPHONES

With P7, everything is designed to allow you to lose yourself in music. Bass is tight, vocals are precisely defined, and there's a wonderful sense of space, balance and clarity across the whole frequency range. P7's cable comes with a remote/microphone attachment, so it works seamlessly with your iPhone.



£329
OR LESS



RUARK AUDIO • MR1 • BLUETOOTH SPEAKER SYSTEM
Standing just 17cm tall, the MR1 speakers feature 20W of Class A/B amplification, a 75mm mid/bass unit and 20mm tweeter in each enclosure. The handcrafted cabinets are finished in a choice of rich walnut veneer, soft white or soft black lacquer.

£299
OR LESS

Q ACOUSTICS BT3 WIRELESS SPEAKERS

The Q Media BT3 consists of just two bookshelf speakers, no separate amplifier is required. You stream your music wirelessly to the BT3 via Bluetooth and high quality aptX.

aptX **Bluetooth**



£349
OR LESS

NAD VISO HP50 HEADPHONES

Designed for long-wearing comfort and listening with ultra-soft noise-isolating earpads, the convenient three-button Apple remote offers full control of all Apple music and call functionality right at your fingertips, plus voice control with Siri-compatible devices.



£249
OR LESS

FOR THE LATEST PRICES AND OFFERS VISIT WWW.SSAV.COM OR CONTACT YOUR LOCAL STORE



Best Independent Retailer (Large) Consumer Electronics
Award Winner 2014

Stores Nationwide

We have a national network of stores and a hard-won reputation for outstanding customer service.

Website

Visit our website for a streamlined on-line experience with an outstanding product selection plus the latest product news and store information.

Aberdeen • 01224 252797
Bishop's Stortford • 01279 506576
Bristol • 0117 974 3727
Brighton **NEW** OPENING JULY
Bromley 020 8290 1988
Cambridge • 01223 304770
Chelsea • 020 7352 9466
Cheltenham • 01242 241171
Charlerywood • 0845 5046364

Epsom • 01372 720720
Exeter • 01392 218895
Guildford 01483 536666
Holborn • 020 7837 7540
Kingston • 020 8547 0717
Leeds (Wetherby) 01937 586886
Loughton • 020 8532 0770
Maidstone 01622 686366
Norwich • 01603 767605

Oxford 01865 241773
Reading • 0118 959 7768
Sevenoaks 01732 459555
Sheffield • 0114 255 5861
Southampton • 023 8033 7770
Tunbridge Wells 01892 531543
Weybridge 01932 840859
Witham (Essex) 01376 501733
Yeovil • 01935 700078

Please Note: Some brands/products are not available at all stores. Special/added value offers are not in conjunction with any other offer (NICWAOO).

* THESE STORES ARE FRANCHISED AND OPERATE UNDER A LICENCE AGREEMENT TO SEVENOAKS SOUND & VISION.

ADVERT VALID UNTIL 30/07/2014. E&OE

SEVENOAKS
SOUND & VISION

World Radio History

This is a comprehensive directory of Hi-Fi Dealers throughout the UK and Ireland.

BERKSHIRE

LORICRAFT AUDIO

Loricraft Audio is now open for visitors but please call to arrange for a visit. You can buy all our products directly from us or through your local dealer. Our internet shop site can take direct orders for our turntables and accessories! Loricraft Audio, The Piggery, Mile End Farm, Wantage Road Lambourn, Berkshire, RG17 8UE Office Phone/Fax : +44 (0)1488-72267
Email: terry@garrard501.com
website: <http://garrard501.com>

STUDIOAV LTD

44 High Street, Eton, Berkshire SL4 6BL
Tel: 01753 631000
Email: sales@studioav.co.uk
www.studioav.co.uk
We are Berkshire's premier Linn dealer (complete range) and LP12 specialists. Naim, Focal, Totem, The Chord Company, Lyra, Dynavector, Benz Micro, with more to follow.

BRISTOL & BATH

THE RIGHT NOTE

Tel: 01225 874728
www.rightnote.co.uk
Happy with your system? Wonder why there's so much for sale secondhand? Avoid the expense of upgrades that never quite "deliver". With infinite patience we'll help you plan longer-term. Brands: Aesthetix, Aurender, Avalon, Bel Canto, Clearaudio, dCS, Gamut, Graham, Kawero, LeadingEdge, Magnum Dynalab, Spiral Groove, VertexAQ, Vitus, VTL.

V AUDIO HI FI CONSULTANTS

36 Druid Hill, Stoke Bishop, Bristol. BS9 1EJ.
Tel: 0117 968 6005.
Website: www.v-audio.co.uk
Email: icvhifi@yahoo.co.uk
ATC, AVI, Nola, ALR Jordan, Audio Analogue, Avid, Black Rhodium,

Electrocompaniet, Edge amps/cd, Harman Kardon, Infinity, Jamo, Lyra, Origin Live, Opera, Ortofon, PS Audio, Michelle, REL, SME, Sugden, Townshend. Specialist in Video Projects by SIM2, Infocus, Sanyo, Power Plan. Screens by Stewart, smx and da-lite. Demos by appointment only. Home trial facilities.

CHESHIRE

ACOUSTICA

17 Hoole Rd, Chester CH2 3NH.
www.acoustica.co.uk
Tel: 01244 344227.
B&W 800 Diamond series dealer
Naim Audio specialist & 500 Series stockist. Other brands carried include Arcam, Audiovector, Audio Analogue, B&W, Classe, Piega, Rega & Spendor. Full demonstration facilities.
Open Tuesday to Saturday 10.00 to 5.30

ACTON GATE AUDIO

www.acton-gate-audio.co.uk
4 Ruabon Road, Wrexham, LL13 7PB,
Tel: (01978) 364500
Arcam, Atlas, Audiolab, Denon, Grado, Michell, Monitor Audio, Dali, Leema, Loewe, Musical Fidelity, Ortofon, Onkyo, Pro-ject, Sonos, QED, Quad, Rel, Roksan, van-den-Hul, Wharfedale, Yamaha.
Tuesday - Saturday 9.00 - 17.00
email: info@acton-gate.com

DOUG BRADY HI FI KINGSWAY

Studios, Kingsway North, Warrington, WA1 3NU
Tel: 01925 828009 Fax: 01925 825773.
Visa Mastercard, Specialist High-End Turntable, Loudspeaker, Streaming and Amplifier retailer. Extensive range online to buy and will ship worldwide Luxurious demonstration facilities. Dedicated work shop for service and repairs. Custom cables made Installations and home delivery available. Car park directly outside Lowest price guaranteed.

CORNWALL

BIGEARS AUDIO

To find a system that will allow you to hear the music instead of the equipment phone Bigears Audio, here you will find an interesting array of new and good quality used equipment! my intention is to have satisfied customers whatever their audio preferences. Naim dealer for the South West.
Email: chrisburchley@btinternet.com.
Tel: 01736-740421

ESSEX

ROCOCO SYSTEMS & DESIGN

Essex/London Linn Specialist
Tel: 01371 856 407 – 0207 454 1234
www.rococosystems.com
We have over 30 years in entertainment solutions, We can give you expert advice on your Linn Hi-Fi, Multi-room AV and Home Cinema systems. P/EX, ex-demo and used Linn available, Demos by appointment . Home Demos welcome. Authorised dealers for Arcam, Artcoustic, Chord, Denon, Linn, Lutron, Kaleidescape, Marantz, Opus, Runko, Systemline, Sonos, Sim2. Linn Service & Repairs

RADLETT AUDIO

Saffron Walden, NW Essex
Tel: 01799 599080
E-mail: radlettaudio@hotmail.co.uk
Website: www.radlettaudio.co.uk
Selling sensible Hi-Fi systems since 1973 Albarry, ATC, Chord Co, Creek, Croft, Devialet, EAR, Funk, Harbeth, Icon Audio, Kudos, LFD, London/Decca, Lyra, Martin Logan, Michell, Neat, Nottingham Analogue, Ortofon, Puresound, PMC, Quad, Rega, SME, Something Solid, Sumiko, Sonneteer, Spendor, Tellurium Q. Turntable specialist - repair and set up.

LANCASHIRE

HOUSE OF LINN MANCHESTER

Telephone: 0161 766 4837
Email: Info@houseoffinn.com
www.houseoffinn.com

The Linn specialists. Independently owned by former Linn staff. Straightforward, professional expertise with demonstration, sales, installation and support for the Linn range of components and systems. The listening experience is so good that demonstrations can last for hours. Discover how we make music sound real in your home! Appointments only.

LONDON

THE CARTRIDGE MAN LTD

88 Southbridge road, Croydon
CRO 1AF Telephone: 020 8688 6565
www.thecartridgeman.com
Email: thecartridgeman@talktalk.net.
UK Distributor: Hiaudio Distribution
Makers of the prize-winning range of MusicMaker cartridges and other desirable audio accessories. We also have a cartridge refurbishing service and rebuild classic valve equipment to the highest standards. "It doesn't have to cost an arm and a leg - but there is no such thing a free lunch, either."

MY AUDIO DESIGN

35 Whitehall, London, SW1A 2BX
Tel: 020 7839 8880 / 07782 137 868
E-mail: sales@madengland.com
Website: www.madengland.com
E-Shop: www.shop.madengland.com
We offer MAD, Benchmark Media, SONOS, WBT, Trichord Research, ATC, FatmanTube, Project, Lehmann, Ortofon, Vandenhul, QED, NAD, Goldring, Grado, Focal, Musical Fidelity, Ex-demo & second hand gears. Custom Installation, Servicing, Custom Design. Appointment Only. Short walk from Embankment, Charing-X & Westminster Tube.

KJ WEST ONE

26 New Cavendish Street, London
W1G 8TY
Tel 020 7486 8262
www.kjwestone.co.uk
The world's finest audio on demonstration in Central London: Audio Research-Devialet-Focal-Harbeth-Jadis- Krell-Linn-Magico-Martin Logan-Naim-Quad-SME-Sonus Faber-Wilson Audio.

MANCHESTER

AUDIO COUNSEL

Audio Counsel, 29 Sam Road, Diggle, Manchester, OL3 5PU
01457 875555
www.audiocounsel.co.uk
dave@audiocounsel.co.uk
Hi Fi from, B&W Densen, Dynavector Cartridges, Dynavector Amplifiers, Isoblu, Naim, Neat Acoustics, Piega, Quadraspire, Rega, Revolver, Shahinian, Totem, Well Tempered Turntables, Zu Loudspeakers. Quality Hi Fi is not plug and play. We deliver and install all systems. Tuesday to Saturday 10.00am to 5.30pm Thursday till 8pm

MIDLANDS (WEST)

SOUND CINERGY

37 high street, Aldridge, WS9 8NL
Tel: 01922 457926
www.soundcinergy.co.uk
clive@soundcinergy.co.uk
Black Rhodium, Chord Co, Exposure, Heed, Kudos, Lehmann, Linn, Marantz, Michell, Monitor Audio, Neat, Nordost, Okki Nokki, Ortofon, Project, REL, Roksan. Check our website for ex dem and secondhand bargains. Ample car parking. Tuesday-Saturday 10-5.30

SUSSEX

15 AUDIO

Churchward Court, 15 Western Road
Lewes, BN7 1RL
Tel: 08448 22 11 15
Email:sales@15audio.co.uk
www.15audio.co.uk
Formerly Sounds of Music, new ownership - demonstration facilities in centre of Lewes. Friendly staff. Free parking. Ayon, Bladelius, Boulder, Coda, Hansen, LSA, SoundLab, SME, WBT and more. Quad centre - 'Digital Clinic' - service centre. Home demo's, delivery and installation. Mon - Frid 10:00am - 6:00pm. Sat 10:00 - 2:00pm. Closed Wednesday.

YORKSHIRE

THE AUDIO ROOM

Savile Street, Hull, HU1 3EF
01482 891375
www.theaudiroom.co.uk
Authorised agents for Audiolab, Bowers and Wilkins including 800 series, Classe,

Denon, Dynavector, Focal, Linn, Naim, ProAc, Quad, Rega, Rotel, Tellurium Q and more. Large open plan showroom with 2 dedicated demonstration rooms, part exchange welcome, friendly & knowledgeable staff. Yorkshire's streaming specialist.

AUDIO REPUBLIC

78 Otley Road, Leeds
Tel: 0113 2177294
www.audio-republic.co.uk
For the best in quality hifi in West Yorkshire, representing Naim Audio, Rega, Sugden, Audio Research, VPI, Krell, Copland, Sonus Faber, Arcam, Nottingham Analogue, Roksan, Hutter, Martin Logan, Proac, PMC, M&K, Finite Elements, SME, Cardas, Kudos Loudspeakers and others. Open Tuesday-Saturday 9.30am to 5.30pm

FANTHORPES HI-FI, TV & CUSTOM INSTALLATION SPECIALISTS

HEPWORTH ARCADE, SILVER STREET,
HULL, HU1 1JU
Established over 60 years
Tel: 01482 223096
Web: www.fanthorpes.co.uk
Email: shop@fanthorpes.co.uk
Part exchange welcome. High-end Second Hand Equipment. Multi-room installations. Demonstration by appointment. Home trials welcome. Interest free credit available. Experienced staff. We stock Arcam, Cyrus, Dali, Denon, Dynaudio, Exposure, Kef, Loewe, Onkyo, Primare, Roksan, Spondor, Sugden and much more.

IRELAND

ARDHOWEN HIFI

10 Menapien Way
Enniskillen, Fermanagh, BT74 4GS
Abbingdon Music Research, Acoustic Masterpiece, Airtight, Benz Micro, Croft, Acoustics, Custom Design, Deltec Precision Audio, Firestone Audio, Graham Slee, Hanns Acoustics, Harmonix, Luxman, My Audio Design, Opera Audio/Consonance, Origin Live, Project, Reference 3A, Reimo, Sugden Audio, True Colours Industries, Trafomatic, Usher, Verity Audio, WLM
www.Ardhowenhifi.com
07581 119913 Tom

vinyl section

contents

AUGUST 2014

www.hi-fiworld.co.uk**THE BEATLES MONO LPS 83**

In a Hi-Fi World Exclusive, Noel Keywood gets the full story behind the latest Beatles mono LP re-masters box set

ORTOFON QUINTET BRONZE 89

Classical music fans will find plenty to enjoy in Ortofon's latest Quintet cartridge, says Tony Bolton

news



WAYLON
RIGHT FOR THE TIME
REMEMBERED

JONATHAN RICHMAN
No Me Quejo De Mi Estrella

GEEZERS
BCR Nashville also release Waylon Jennings's 'Right For The Time (Remembered)', a straight reissue of 'Right For The Time' (1996), a laidback outing in which Jennings tries to make some sense of life. A little known joy.

Also look out for Squeeze vocalist Glenn Tilbrook's self-penned, acoustic 'Happy Ending' (Quixotic; www.quixoticrecords.com), a patchy yet pleasantly eccentric outing.

Cult artist Jonathan Richman's 'No Me Quejo De Mi Estrella' (Munster; www.munster-records.com) features live favourites showing some sophisticated music forms written during this century.

ROCK WITHOUT THE ROLL

From the wild, punk, thrash outfit White Fang comes their self-styled mutant-bubblegum-low-fi-stoner-indie-garage-rock LP 'Full Time Freaks' (Metal Postcard; metalpostcard.com): more substance than style.

Over to the death metal musings of Vampire (Century Media; www.vampireofficial.com) a growling, frenetic old school fest. A respectful nod to the past.

New from Watain is 'Wild Hunt' (www.templeofwatain.com), offering atmospheric black metal, providing a more epic sound giving symphonic touches.

Indie supergroup Divine Fits (ex-Spoon, New Bomb Turks and Wolf Parade/Handsome Furs members) have a new live outing. I have misgivings of the band – they don't really 'fit'. Jamming as friends? Fine. But they don't move forwards. Yet it's beautifully recorded at Third Man Records (thirdmanrecords.com), in 2013.

Two new releases from SPV (www.spv.de) are Freedom Call's 'Beyond' a concept piece with admirably varied and versatile tracklisting, and Hiram's 'Immortal Legacy', a band whose reputation has grown since their 1984 creation. A kill-all, death fest and a jolly good time to be had by all.

Finally look out for the Siichi Sugiyama Band's 'The Smokehouse Sessions'. A Toyko-born, British blues rock fan, this album is too short but he still shows Joe Bonamassa a thing or two.

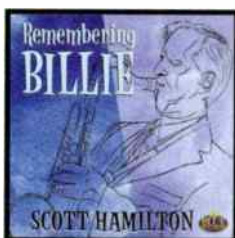
**JUST JAZZ**

Via Blue Duchess and Shining Stone (www.shiningstonerecords.com) is Scott Hamilton's 'Remembering Billie', focusing on her pre-WW2 works. A rare treat for jazz fans to soak in his languid tenor tones.

From Pure Pleasure (www.purepleasurerecords.com) is a quality selection beginning with 'Tubby Hayes New Groove' (2011), a 'lost' hard bop 1959 session. The band are loose with Hayes' soloing on top form. Also look out for Charlie Byrd's 'Brazilian Byrd' (1965) focusing on Antonio Carlos Jobim's works. A highly-agreeable LP with rather short tracks. An ideal introduction to Roland Kirk, 'Third Dimension' combines standards and originals. Playing the tenor sax – Manzello and Stritch simultaneously – it features jaw-dropping solo work.

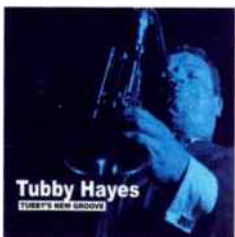

THE HEAT OF THE SUN

A series of real gems for you from Sundazed (www.sundazed.com) including Lula Reed's 'Blue And Moody'. Her sultry blues ballads with Sonny Thompson feature additional sides from 1952 ad 1956.

Two little-seen, early LPs from Nilsson now: 'Pandemonium Shadow Show' (1967) was adored by The Beatles, with its 'Sgt. Pepper' feel. Highly inventive, it is an addictive listen. 'Aerial Ballet' mixes psychedelia, cabaret and pop. This is where you will find the beautiful version of 'Everybody's Talkin'"



MORE MO-FI

Heavyweight in all senses from Mobile Fidelity (www.mofi.com), the star attraction is arguably Ryan Adams' 3LP version of 'Love Is Hell' featuring top-notch mastering and seven extra songs previously only found on the Japanese-issued bonus disc.

Next, the 45rpm edition of Bob Dylan's 'The Times They Are A-Changin'' (1964) where we saw Dylan's first collection of original tracks, featuring protest songs of great energy, passion and quality.

Dean Martin's superb 'This Time I'm Swingin'' (1960) benefitted from the Nelson Riddle touch. Martin exhibited great confidence, finally coming to grips with the album format.

Also look out for Jerry Garcia & David Grisman (1991; with Jim Kerwin and Joe Craven) on an acoustic double album of standards, folk and bluegrass. Emmy-award nominated, this album sparked the progressive bluegrass movement.



BIRDS

The best female singer/songwriter from country's outlaw movement and wife of Waylon Jennings, Jessi Colter's 'Live From Cain's Ballroom' (BCR Nashville; bcrmedia.com) is her first live outing. Recorded in September 2013, Colter's sensuous and feisty songs illuminate her under-rated work.

Also look out for singer-songwriter Judith Owen's 'Ebb & Flow' (Twanky; judithowen.net). There's no edge here but plenty of smooth, easily approachable pseudo-soul.



SPEAK NOW

A staggering selection from the German audiophile outfit Speakers Corner (www.speakerscorner.de) starts with Paul Desmond & Gerry Mulligan's 'Two Of A Mind' (1962) featuring wonderful, piano-free, interplay and common chord changes.

'The Sound Of Wilson Pickett' (1967) features a slew of singles from the great man. His finest album, watch out for the impressive 'Love Is A Beautiful Thing'.

Aretha Franklin's 'Live At Filmore West' (1971) is a sparkling performance, dramatic in tone and wholly satisfying with a brilliant backing. Even Ray Charles pops up!

Finally, via the French-based Sam Records, check out the Barney Wilen Quintet featuring the tenor sax swing player in lyrical mood.



...AND FINALLY

'If Music 2.0' (Ninja Tune; www.ninjatune.net), features rarities and unreleased mixes and is an exclusive for Record Store Day.

Davidge's 'Slo Light' (7Hz Recordings; www.7hzrecordings.com) features electro-pop fronted by a range of guest vocalists including Sandi Shaw. Excellent beats – but I could have done without the voices.

Hans Chew's 'Life & Love' (At The Helm; atthehelmrecords.bigcartel.com) features blues rock-infused boogie with Chew's piano leading the way. Arm flingingly energetic.

Also check out The Ministry Of Wolves' 'Music From Republik Der Wölfe' – a collective retelling of the Brothers Grimm fairy tales via poet Anne Sexton. An intoxicating cloak of adult gothic.

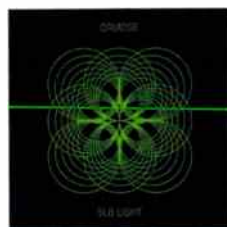
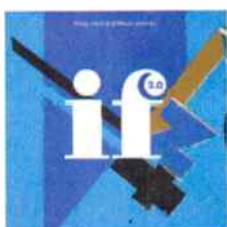



Heatherdale audio limited

Tel. 01903 261213 or (after hours) 07860 660001
e-mail: heatherdale@hifi-stereo.com Web: www.hifi-stereo.com

Main dealer for Wavac amplification

SPEAKERS

Tannoy Glenair 15's, superb/boxed £1995
Tannoy Stirling GR speakers, as new (£3950) only £2995

AMPLIFIERS

Cello Encore monoblocks with Cello Encore pre amp inc' dedicated PSU & Audio Tekne cables £7500
Mark Levinson ML 27.5 power amp, a true classic, boxed with book £1995
Airtight ATM300 amplifier £3995

PRE-AMPS

Musical Fidelity 3A pre amp, boxed, ex' cond. £150

Audio Note Zero R (NOS) pre amp £350
Toft pre amp, balanced and s/e on every input/output £295

CD PLAYERS & TRANSPORTS

Sony SCD-1 CD/SACD player in superb cond' with original box, book and remote control £1995
Accuphase DP55V CD player, superb/boxed £1250
Ancient Audio Lektor CD player £1850
Rega DAC with USB input, MINT/BOXED £325
Musical Fidelity M6 CD player MINT/BOXED £995
CEC TL-0X CD transport (£15k) ex demo £7995
Mark Levinson 31.5/30.6 Reference CD

transport and DAC. superb/boxed (cost new £27,490.00) Offered for £6995

TURNTABLES, CARTRIDGES & TONEARMS

Rega Elys 2 Cartridge, MINT £65

MISCELLANEOUS

1 Metre Madrigal CZ Gel balanced interconnect £295
Studer A-807 pro' stereo tape recorder £2495
Yamaha TX-761 DAB/FM Tuner £195
Okutsu Denko 1.5 metre mains cable (US plugs) £1195

ALL USED CARTRIDGES ARE CHECKED UNDER A MICROSCOPE BEFORE BEING OFFERED FOR SALE. WE TAKE PART EXCHANGE ON NEW & USED STOCK and buy in for cash VISA - SWITCH - MASTER CARD - AMEX - DINERS CLUB WELCOME

Billy Vee

SOUND • SYSTEMS

London Linn & naim Specialist

CALL SALES: (020) 8318 5755 or 8852 1321 - 248 Lee High Road, London, SE13 5PL
Web: - www.billyvee.co.uk email: sales@billyvee.co.uk Full delivery and installation services.



Full Naim Uniti & Classic series available



Full Linn DS range on demonstration

Trade in your CD Player & claim up to £1000 against a new digital Streaming player - offering you easier access to your music and better sound quality
Please call in or visit billyvee.co.uk for full details of this and other great new performance enhancing promotions

All About the Music

BASICALLY SOUND

Digital & Analogue Audio Specialists

01362 820800

enquiries@basicallysound.co.uk
www.basicallysound.co.uk

Epiphany Acoustics

Headphone Amplifiers . DACs . Interconnects



Atratus RCA Interconnects



"Great realism... Tight and punchy bass...
Amazing value for money."

- Hi-Fi Choice

Find out what all the fuss is about at our online shop and use discount code MAG10 for your exclusive 10% discount.

Prices start at under £40/pair

www.epiphany-acoustics.co.uk

THE BEATLES IN MONO



Mono Masters

A new Beatles In Mono LP box set and album set is due. It's an all-analogue release for enthusiasts – derived from the original master tapes. Noel Keywood explains all.

We are about to be treated to yet another set of Beatles album releases. I'm not going to catalogue the many that have gone before, so much as describe in fine detail for Beatles aficionados – and the rest of us! – the thinking behind this new release of a box set, as well as individual albums.

This release is just about the

ultimate in authenticity, insofar as any re-master can be. I visited Abbey Road Studios and spoke to mastering engineer Sean Magee to find out more.

The Beatles music was first released on LP, so this LP box set is the original music delivery format – unlike recent CD re-releases for example, including a 2009 mono CD box set.

Mono was the dominant

recording method at the time of 'Please Please Me', their first LP, a 1963 UK release. At that time and for some time after, Beatles songs were mixed for mono: the final master tape was mono. To produce new-fangled stereo required a different mix down and this was done hastily after the mono mix because at that time stereo was a small market commercially.

So the mono mix was the

RETRO

REPRODUCTION

QUALITY HIGH FIDELITY & VINTAGE

WE CAN NOW PROVIDE IN HOUSE REPAIR SERVICE FOR ALL VINTAGE AND CLASSIC HI-FI EQUIPMENT CALL FOR MORE DETAILS

| AMPLIFIERS | |
|---------------------------------------------------------------------------------------------------------------------------------------------------------------------|-------|
| Ayre V-5XE power amp 18 mths old boxed immaculate | £2750 |
| Audiolab 8000A integrated amp mint condition | £345 |
| Audio Innovations classic 25 integrated amp just serviced | £795 |
| Arcam A32 integrated amp | £495 |
| Audio Research remote valve pre amp with phono stage SP16 | £1795 |
| Bel Canto SEP 2 upgraded to 1 valve remote control | £795 |
| Cyrus original PSX great condition | £175 |
| Cyrus 2 | £225 |
| EAR 834L | £695 |
| EAR V20 valve amplifier | £2495 |
| EAR 802 classic valve with pre amp phono stage (just serviced) | £1195 |
| Eastern Electric M size 20 integrated amp with remote | £895 |
| Harmon Kardon HK990 top of the line heavy weight integrated amp 12mths old | £595 |
| Harmon Kardon 930 twin powered receiver | £195 |
| Harmon Kardon HK770 power amp | £195 |
| Mark Levinson 335 power amplifier | £2995 |
| Mendian 518 digital audio processor | £445 |
| Meridian 201 MKIII pre amp remote | £195 |
| Menimore M200 valve mono bloc 200wpc designed by Tim de Paravicini awesome driving power Mission 776/777 pre and power amplifier 100w cast case work a real classic | EPOA |
| Naim 112 remote control pre with box | £795 |
| Naim NAP120 | £395 |
| Naim NAC12S | £225 |
| Naim 90 power amp boxed | £150 |
| Naim Flatcap 2 boxed | £225 |
| Naim Flatcap boxed | £325 |
| Pioneer A9 integrated amp top of the range | £225 |
| Phase Linear 700 power amp | £395 |
| Quad II Valve amp re-built and re-valved | £495 |
| Quad 34 pre amp phono version | £995 |
| Quad 306 power amp with phono input | £225 |
| Quad 405 | £245 |
| Quad Forty monoblocs | £195 |
| Red Rose 5 integrated valve amp Mark Levinson design new £7000 | £1995 |
| Roksan Kandy MKIII integrated amp | £2995 |
| Rotel PB971 power amp | £395 |
| Rotel RC972 remote pre amp | £195 |
| Rotel RA840BX integrated amp | £125 |
| Rotel RA350 70s vintage amp | £125 |
| Sansui AU517 heavy weight integrated amp | £95 |
| Sony F540E heavyweight integrated | £395 |
| Tanberg TR20 receiver | £245 |
| Wadia 151 DAC and amplifier | £145 |

| SPEAKERS | |
|----------------------------------------------------------------------------------------------------------------|-------|
| Beaumont Virtuoso reference Lowther horn loaded spks with brand new DX4 drive units | £2995 |
| Boston VRM 50s Lynnfield series monitor speakers Cabinet for 12" Tannoy with amplification built in model M508 | £345 |
| Goodmans Axion 201 12" full range 15ohm speaker 1 pair | £195 |
| Goodmans Magnum K's | £295 |
| Impulse H6 valve friendly floorstanding speakers | £295 |
| KEF RDM Two monitor speakers | £245 |
| Linn Index | £125 |
| Linn Sara active speakers | £125 |
| Lockwood Minor cabinet for Tannoy 10" | £195 |
| Lowther PM6 in Horn loaded cabinet | £595 |
| Mendian M30 active speakers | £495 |
| Mission 752 black finish | £295 |
| Mission 773 beech finish | £245 |
| Mono Pulse 32A 8 months old ex dem. | £495 |
| Mono Pulse 32S ex dem. | £245 |
| Monitor Audio 2 bookshelf speaker with rosenut finish | £645 |
| Monitor Audio reference 700 | £245 |
| Quad ESL-989 Electrostatics black finish boxed | £395 |
| Red Rose R3 Ribbon bookshelf speaker new £3000 | £1995 |
| Roksan K2 rosewood finish | £995 |
| Sentorian early 60s corner speaker pair | £295 |
| Snell K classic valve friendly speaker | £495 |
| Sonus Faber Chromena Auditor with stands | £495 |
| Sterling Broadcas LS35A monitor xdem | £1495 |
| TDL RTL3 black finish boxed | EPOA |

| TURNTABLES/TONEARMS | |
|---------------------------------------------------------------------------------------|-------|
| Clearaudio Master Reference with parallel tracking tonearm | £4500 |
| EAR 834P mm with volume | £745 |
| Einstein phono stage beautifully made german crafted new price £3300 | £1995 |
| Garrard 401 | £695 |
| Garrard 301 with SME 3009 arm and beautiful maple plinth | £1495 |
| Linn LP12 with litok with lingo PSU all boxed superb condition | £1495 |
| Linn LP12 black finish with Origin Live motor & PSU | £595 |
| Linn LP12 affromosia finish (lingo PSU missing) | £395 |
| Michell Focus 1 | £295 |
| Michell Gyrodec SE boxed mint | £995 |
| Michell Gyro SE special order black finish brand new in a box, sealed box | EPOA |
| Optonica RM7100 direct drive top of the range turntable | £245 |
| Pioneer Tangential tracking PL L800 | £295 |
| Project Xpression 2 boxed mint | £175 |
| SME 10 with tonearm with V | £3295 |
| SME series 3 tonearms various | EPOA |
| SME 309 boxed | £695 |
| SME 309 series II rebuilt & rewired by Audio | £325 |
| Ongami detachable headshell | £345 |
| Sony PS6750 turntable | £345 |
| Synnx LE1 tonearm recently wired with cardas cable fitted and checked by Audio Ongami | £275 |
| Synnx PU2 tonearm | £295 |
| Thorens TD125 MKII in plinth | £275 |
| Thorens TD160 | £195 |

| RECORDS | |
|------------------------------------------------------------------------------------------|------|
| (downsizing my collection excellent as new condition) | |
| Pink Floyd Pulse Box Set | £295 |
| Led Zeppelin BBC Session 200g | £295 |
| Jimi Hendrix Experience Box Set | £195 |
| Blue Note Freddie Hubbard - Hula Tones 100g | £15 |
| Blue Note Horace Parlan Moving & Grooving Toshiba EM1 | £20 |
| Blue Note Amazing Bud Powell Time Weight Toshiba EM1 | £20 |
| Blue Note Art Blakey and the Jazz Messengers At the Jazz corner of the world Toshiba EM1 | £20 |
| Various others: | |
| Annette Coleman, Don Cherry, Lou Donaldson, Joe Henderson, Bobby Hutcherson | |
| Various other artists available please phone | |

GENEROUS PART EX. ON ALL EQUIPMENT NEW OR USED. WILL BUY GOOD QUALITY EQUIPMENT AS ABOVE. NEXT DAY MAIL ORDER & SPLIT FACILITIES

Opening times: 11.30 - 5.30 Tues. to Sat.
28a Haddington Place, Edinburgh EH7 4AF
Tel/Fax: 0131 558 9989
Email: retro.reproduction@virgin.net
Website: www.retroreproduction.co.uk

Music First Audio

"I've not heard a better preamp..."

- Sam Tellig, Stereophile - Oct '12



IAN HARRISON HI-FI TEL: 01283 702875

HIFI AT DISCOUNT PRICES. FREE NATIONWIDE DELIVERY

SALE! UP TO 40% OFF!

Email: ian.harrison@mercian.myzen.co.uk

SPEND £2000 OR MORE ON ANY TURNTABLE, TONEARM OR TURNTABLE AND ARM AND GET A £500 CARTRIDGE FREE!

| TONEARMS | CARTRIDGES | PHONO STAGES | TURNTABLES |
|---------------|---------------|----------------------|----------------|
| CARTRIDGE MAN | ORTOFON | WHEAT AUDIO | MICHELL |
| MICHELL | AIR TIGHT | MUSICAL SURROUNDINGS | AMAZON AUDIO |
| REGA | DECCA LONDON | TRICHORD | PRO-JECT |
| SME* | DENON | TOM EVANS | THORENS |
| GRAHAM | KOETSU | GRAHAM SLEE | SRM TECH |
| MOTH | GRADO | LEHMANN | EAR |
| ORTOFON | GOLDRING | QUAD | AUDIO TECHNICA |
| PRO-JECT | BENZ MICRO | PURE SOUND | DENON |
| ROKSAN | ROKSAN | PRO-JECT | INSPIRE |
| HELIUS | ZYX | EAR YOSHINO | MUSIC HALL |
| REED | CARTRIDGE MAN | ROTHWELL | |

| HEADPHONES | AMPLIFIERS | CABLES | HIFI FURNITURE |
|----------------|-------------|---------------|----------------|
| SENNHEISER | CREEK | KUBALA-SOSNA | ALPHASON |
| BEYER | SUGDEN | PRO-JECT | QUADRASPIRE |
| DENON | ICON AUDIO | BLACK RHODIUM | SOUNDSTYLE |
| AUDIO TECHNICA | EAR/YOSHINO | QED | CUSTOM DESIGN |
| GRADO | DENON | TRANSPARENT | ATACAMA |
| ERGO | QUAD | WIREWORLD | TRACK AUDIO |
| GOLDRING | TOM EVANS | IXOS | APOLLO |
| | | SUPRA | |

| SPEAKERS | HEADPHONE AMPS | CD PLAYERS | TUNERS |
|--------------|----------------|-------------|--------|
| HARBETH | LEHMANN | CREEK | CREEK |
| OPERA | PRO-JECT | EAR/YOSHINO | DENON |
| QUAD | GRAHAM SLEE | QUAD | QUAD |
| EPOS | CREEK | | |
| Q. ACOUSTICS | FIDELITY AUDIO | | |
| AUROASAL | SUGDEN | | |

ACCESSORIES

DIGITAL STYLUS GAUGES, RECORD CLEANING MACHINES, CLEANERS, AUDIO CASSETTES

* PHONE FOR TERMS PLEASE PHONE TO CONFIRM PRICE & AVAILABILITY PRIOR TO ORDERING. ALL GOODS ARE BRAND NEW & BOXED WITH FULL U.K. GUARANTEES NO EX DEM OR EX DISPLAY GOODS. NO GREY IMPORTS. GOODS ARE NOT SUPPLIED ON APPROVAL. SORRY, NO GENERAL CATALOGUES. PLEASE PHONE OR WRITE FOR SPECIFIC REVIEWS, BROCHURES OR PRICES. SUPPLIER OF HIFI PRODUCTS & ACCESSORIES SINCE 1986 MAIL ORDER ONLY FROM: IAN HARRISON, 7 MILL HILL, REPTON, DERBY, DE65 6QQ. TEL: 01283 702875. 9am - 9pm INCLUDING SUNDAYS.



primary source into which most artistic effort had been put on early LPs; stereo was secondary. This new LP set is mono, referring back to notes made by Harry Moss for the original mono mix-down. The music on these LPs is therefore as the original artists and engineers intended. Re-mastered mono LPs have not been released before.

A set of re-mastered stereo LPs were released in 2011. There were concerns from Beatles enthusiasts – especially the USA where re-mastering historical back catalogue is an art form bordering on religion – that these stereos were derived from a 24/192 digital archive master recording made back in 2005. The taint of digital was smelt and rejected.

To be authentically valuable re-masters, the new, definitive mono LPs had to be derived from the original analogue master tapes – and that's what this new box set does. Yes, they got out the master tapes and re-ran them for these LPs – a heady thought. Also a dangerous one – what if an old tape breaks, sheds its oxide or whatever? Items like this are national treasures; Abbey Road is a listed building by the way (but the zebra crossing is not yet listed!).

The new LPs are,



Abbey Road Studios and Studio 2 where The Beatles recorded their music.



LP production at Optimal Media, Robel, Germany. Clean conditions are used to avoid dirt and fingermarks.

therefore, about as close to the originals, or even closer, than any LPs before.

How can they be closer than before? Because the replay signal chain is technically better and the final LPs are stamped into better vinyl from new stampers. What you get now, then, is of higher basic quality than was available in 1963.

Intriguingly, because the music on these LPs has not been digitally processed it also has not been cleaned up: buyers get a 'warts-and-all' version as close to the masters as possible. This is not to say the LPs are unequalised from the master tapes; they have been equalised following the original studio notes and against copies of the digital masters, so the sound balance has not been altered.

How Abbey Road and Universal got to decide upon such an audiophile release is fascinating. In response to enthusiasts' insistence that digital could not come into it, Sean Magee re-cut 'Please Please Me' from the original analogue master tape to a lacquer acetate (not a metal master) just before Christmas 2012, using the Studer A80 tape recorder and Neumann VMS80 lathe with SX-74 cutter head seen in our pictures. The audio was not passed down a

digital delay line to allow the lathe to adjust groove spacing; instead a 900mS pre-read head on the Studer was used to derive this control signal. What was cut into the acetate was pure analogue.

After Christmas 2012 Jeff Jones

album in 2009, and Mono Masters was also created in 2009 for the mono CD box set; neither has been on vinyl before in this format.

From these tapes and the originals, audio from the A80 was run through the mixing desk you can see

Sean Magee told me this cut "had a life to it" that impressed all those who heard it

from Apple Corp listened and was impressed by the improvement in dynamics the new cut gave compared to earlier LPs.

Sean Magee told me this cut "had a life to it" that impressed all those who heard it. So the decision was made to go ahead with a new set of mono LPs, the ones I am talking about here.

In most cases the original tapes were used but 'Please Please Me' was starting to shed oxide so a new analogue 'transfer master' had to be made for safety's sake. A new tape was also made to compile the two 'Magical Mystery Tour' EPs and Mono Masters, because no LP masters for these titles existed. Magical Mystery Tour has only appeared on CD as an

in our studio shots. Equalisation was applied in real-time as the tapes ran, as done in the past. The signal was then cut to an acetate; Sean said they had not heard a metal master that sounded as natural as an acetate and, in any case, a DMM would destroy the authenticity of this release.

And the LPs themselves? They are made by Optimal Media, based in Robel, in what was once East Germany (<http://www.optimal-media.com/en/press/vinyl>). Sean told me they produced a consistently high quality product – difficult with the LP where stampers become damaged as they wear out and vinyl quality can vary.

The vinyl used is virgin, not recycled, and the LPs are 180gms, with



At left of cutting engineer Sean Magee is the Neumann VMS80 lathe with SX-74 cutter head, used to cut the latest mono LPs. In front is the mixing desk and behind him a B&W 800D studio monitor.



The Studer A80 tape recorder with mono replay head used to re-run the mix-down master tapes. Sean Magee fingers a specially fitted manual azimuth adjustment control to ensure the replay head aligns with the tape's recorded azimuth.

a lip, similar to the originals. Sean assured me the centre hole is always well aligned – so no 'swingers' – and the LP is flat, not dished, a problem caused by differential cooling when the LP is taken prematurely from the press. The sleeves and covers are identical to the originals; Optimal Media even used original folding machines!

At the time of writing (April 2014) the LPs were being pressed. A release date

SWITCH TO MONO

Some preamps, such as those from Icon Audio, have a mono switch that parallels the channels of a stereo cartridge, cancelling out-of-phase noise. Why not use this instead of a mono cartridge?

Differences between the stereo generator coils make cancellation incomplete. And most preamps lack such a switch. A mono cartridge is a better choice, if less convenient.

has been set as September 2014. A box set costing £288 and individual LPs will be made available.

We hope to be bringing you a review in the next issue.

The information in this article comes directly from Universal Music and Abbey Road studios. All facts have been checked by them for accuracy, so the article is an accurate and reliable record.

A SPECIAL BEATLES MONO CARTRIDGE

Reading internet forum discussions about how best to play The Beatles mono LPs and holding in my hand a new Ortofon 2M Mono cartridge that we reviewed in our August 2013 issue, I realised that there was potentially a problem here. It's best to play these LPs with a true mono cartridge, because it produces no vertical information, meaning groove noise. However, these new mono LPs are cut for a stereo microgroove stylus so as to be playable with a modern stereo cartridge of the sort we all have.

An Ortofon 2M Mono and other modern mono cartridges have large spherical styli to suit old mono LPs. On new microgroove LPs they will sound dull, especially on inner grooves, distorted and may jump out of the groove because they ride too high in a microgroove and track poorly as a result. This would damage the new The Beatles mono LPs – not a great idea when they need to be preserved!

The simple solution to this I realised was, in outline, to fit an Ortofon 2M Black Shibata microgroove stylus to a 2M Mono body producing, in effect, a dedicated, high-quality mono cartridge for these LPs, one enthusiasts could buy secure in the knowledge it was perfectly tailored for the task.

I contacted Ortofon who said they could do it and Abbey Road who thought they would like it. As a result a special Ortofon cartridge will become available for the new The Beatles mono LPs. You can of course play them with a normal stereo cartridge but a mono produces less groove noise and gives better sound quality – authentic Beatles mono sound quality! This is a top-quality moving magnet cartridge, perfectly suited to such high-quality LPs.

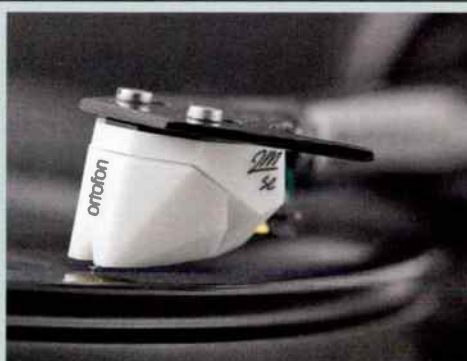

"The Truth, nothing more, nothing less..."



"This level of performance, convenience and style makes for an award winning product."

Jeff Dorgay, Tone Audio Magazine, January 2013



"Oozes quality in both construction and sound"

Paul Rigby, Hi Fi World, March 2013



Ingenium offers the same obsessive design philosophy of our more expensive designs, a ground-up construction engineered for pure audiophile performance.

The unique skeletal design offers unparalleled versatility with a huge choice of single or double arm options. Our prized sapphire bearing and platter system has been retained from the DIVA II, as has the option of using our unique clamping system, which efficiently channels unwanted vibrations away from both the record and platter.

Call today to arrange your private audition.

Analogue Seduction, 6 Manor View, Whittlesey, Peterborough Tel: 01733 350 878

Fanthorpes, Hepworth Arcade, SilverSt, Hull, East Riding of Yorkshire HU1 1JU Tel: 01482 223096

O'Brien Hi-fi, 60 Durham Road, West Wimbledon, London Tel: 020 8946 1528

The Audioworks, 14 Stockport Road, Cheadle, Cheshire, SK8 2AA Tel: 0161 428 7887

www.avidhifi.co.uk

AVID HIFI LIMITED, Bicton Industrial Park, Kimbolton, Huntingdon, Cambs, PE28 0LW
Tel: +44(0)1480 869 900 Fax: +44(0)1480 869 909 E-mail info@avidhifi.co.uk

Classic bronze

Tony Bolton finds himself charmed by Ortofon's new Quintet Bronze moving coil cartridge.

Following on from my review of the new £649 Ortofon Quintet Black cartridge (*Hi-Fi World*, May 2014) I have managed to get hold of its £499 sibling,

the Quintet Bronze. It is housed within a similar ABS (Acrylonitrile/Butadiene/ Styrene) thermoplastic body as the Black model, but in a colour that looked more orange than bronze to my eyes. Internal specification includes neodymium magnets and coils of 99.99% pure copper.

Apart from the colour, the main difference between the cartridges is the stylus profile, the Bronze using a nude Fine Line profile while the black is graced with a nude Shibata diamond.

The straight lines of the body and the good visibility around the stylus and cantilever made setting up the cartridge on my Linn Ittok LVII very easy. Tracking force is a not insubstantial 2.3g – but since this is spread over a large contact area between the stylus and groove wall record wear should be minimal.

As with all cartridges the first few hours of playing allowed the sound to loosen up and expand so that the rather tight and bassless presentation of music was replaced after about 25 hours of use with a more open and lucid sound.

I soon realised that this cartridge had a very different take on the presentation of music to its more expensive counterpart. Whereas the Quintet Black had quite an assertive way of displaying instruments the Bronze seemed to have a more laidback and relaxed approach. This showed through when playing Sidney Bechet's version of the W. C. Handy jazz classic 'St. Louis Blues'.



Bechet's saxophone is played with a slightly rasping edge to the sound, which, with this cartridge, wasn't smoothed out but was presented with a slightly softer leading edge to the notes than the Black would have produced.

Rhythmically, it was very tight, with an ability to get into the swing of the beat that I found very engaging

truly realistic. The opening chords of 'All Along The Watchtower' sounded a little too 'nice', lacking the raw energy that the Black would have produced when playing this track.

"I found the sound very focussed and felt almost as though I was present at a private performance...."

although there were a couple of points where I felt that the attack of the snare drum sound was a little softer in definition than I would ideally like for this sort of music.

I wandered on through my collection, finishing the evening's listening with 'Electric Ladyland' by The Jimi Hendrix Experience. The music sounded pleasant but it lacked a certain edge that enthusiastically played electric guitars need to sound

Stereo placement was good and I was able to pinpoint a performer accurately on a quite wide and reasonably deep soundstage.

The next day I explored classical sounds and found the Bronze gave a far better account of itself. The 1954 mono recording of Wagner's 'Die Meistersingers' sounded far fresher than the age and condition of the record should have allowed. Any surface noise



LEADERS IN THE WORLD'S FINEST HIGH-FIDELITY

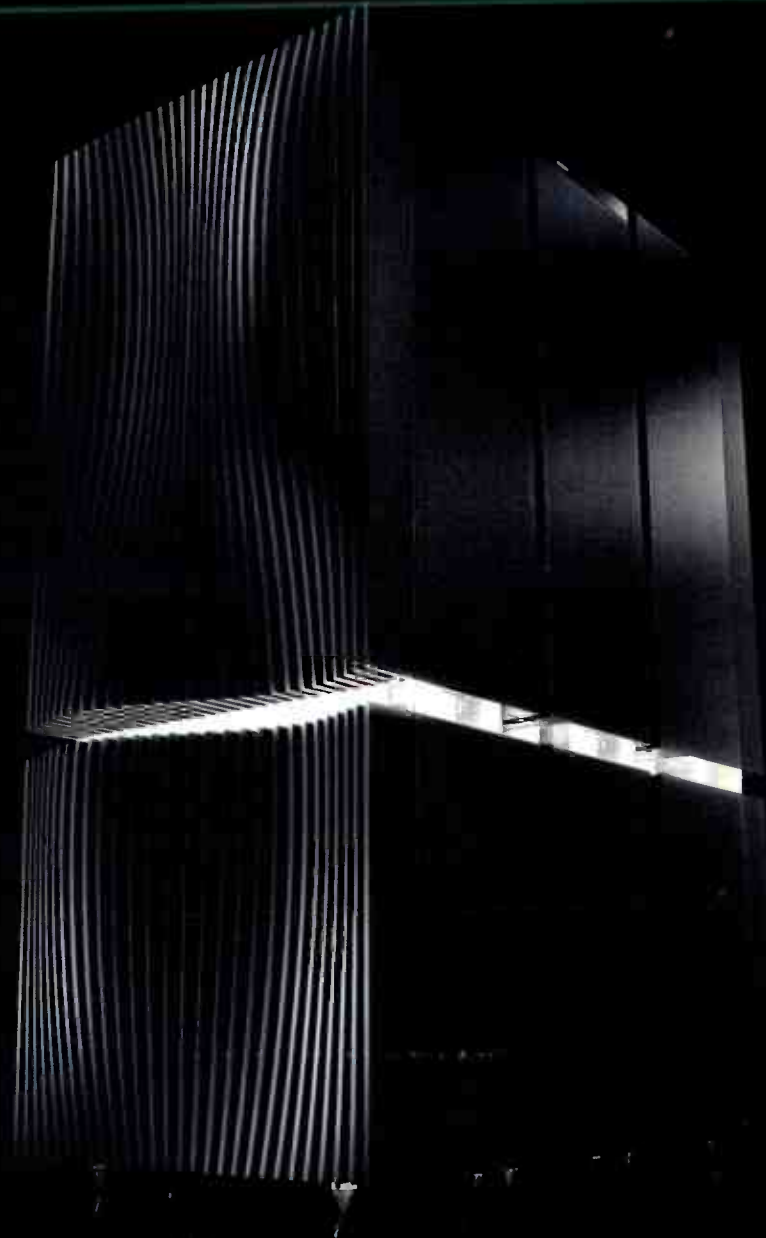

Statement. The London Debut.

28 - 29 May 2014

Naim's flagship amplification system arrives in London for the first time, exclusively at KJ West One.

This is your chance to hear the pinnacle of performance in hi-fi through the Statement NAC S1 preamplifier and NAP S1 mono power amplifiers driving Focal Grande Utopia loudspeakers.

There will also be a range of accessible systems from both Naim and Focal on demonstration for you to enjoy.

Places are limited so make sure you book early by email or telephone to avoid disappointment.



KJ West One | 26 New Cavendish Street | London | UK W1G 8TY

T: 020 7486 8262 | info@kjwestone.co.uk | www.kjwestone.co.uk

was presented as a minor intrusion that was barely noticeable and the focus of the sound was very much on the music contained within the grooves, rather than their physical condition. Tonal colours were well displayed as the orchestra moved from solo instruments to the full ensemble, with a certain correctness about the pacing of the music that left me feeling that I had a better understanding of Knappertbusch's direction of the orchestra, and therefore of the music itself.

Curious to find where else the Bronze's musical strengths lay I explored the folk section of my record collection and found a real synergy between the sound of this cartridge and the style of music played by the likes of Bob Dylan



The Nude Fine Line stylus has dimensions of 8 / 40µm. Recommended tracking force is 2.3g

before he went electric.

I found the sound very focussed and felt almost as though I was present at a private performance of him singing 'All I Really Want To Do'. Dylan's voice is anything but smooth and I was pleased to find myself being presented with a realistic take on how he sounded, with the characteristic rawness of his vocals displayed intact. The accompanying guitar also sounded both right and quite real.

Some cartridges are all-round performers offering a satisfactory presentation of all musical genres. This one was rather more choosy, and most definitely at its best when replaying classical and operatic sounds.

I would go so far as to say that it was noticeably better in this area than the Quintet Black. It also did a good job when playing folk music.

With music that had more 'attitude', such as jazz, I felt that the presentation altered the impact of

The ABS thermoplastic used for the body is a lightweight, impact and scratch resistant material. The cartridge weighs 9g in total

SYSTEM USED

Linn LP12/ Ittok LVII arm.
Luxman E200 phono stage
Townshend Audio Allegri pre-amp
2 x Quad 303 power amps
Kelly KT3 loudspeakers.

the music, taking away a little of the bite that helps make such music sound alive, although I will say that it did an excellent job in showing off quite complex rhythms.

If your tastes are mostly in the classical spectrum then this is a cartridge that you will love and cherish, folk fans will also be well served here. It plays other types of music adequately, but lovers of rock, punk and electronica would be better served looking elsewhere in the Quintet range.

Provided the musical choice is within this cartridge's comfort zone though, it gives an excellent account of itself and will prove a satisfying listen.



MUSIC USED

Wagner. 'Die Meistersinger Von Nurnberg'.
Knappertbusch conducting Vienna Philharmonic Orchestra, Chorus of Vienna State Opera, with Schoeffler, Gueden, Edelmann. Decca Records. LXT 2659 - 64. 1954.

Sidney Bechet and Teddy Buckner. Festival De Jazz 1958. Vogue Records Ltd. LAE 12168. 1958

The Jimi Hendrix Experience. 'Electric Ladyland'. Polydor Records. SPDLP 3. 1968.

Bob Dylan. 'Another Side Of Bob Dylan.' CBS Records. 62429. 1964.

MEASURED PERFORMANCE

Our frequency response graph, using a JVC TRS-1007 test disc, shows an almost ruler flat result from 20Hz to 20kHz, meaning the Quintet Bronze will give very even tonal balance, without either top end brightness due to tip mass resonance or – more likely with higher up the range models from Ortofon – some slight high end loss and warmth. Only on inner grooves (red trace) does output roll away a little but as this is above 10kHz it will hardly be noticeable.

The cartridge rides reasonably high on an LP and vertical tracking angle was high as a result, measuring 32 degrees. This adds quite a lot of second harmonic distortion to left and right signals,

measuring 5%, but it isn't easy to detect subjectively. Channel balance was a bit out too, according to our Shure TTR-109 test disc, at -17dB and -29dB, but an average figure of 23dB is fair enough.

Tracking was good at low frequencies and fair in the mid-band (1kHz), if not up to that of more expensive moving coils, including the Cadenzas from Ortofon. Output was healthy at 0.7mV at 5cms/sec rms.

The Quintet measured well enough to give good practical results, even if it does have some imperfections. NK

FREQUENCY RESPONSE

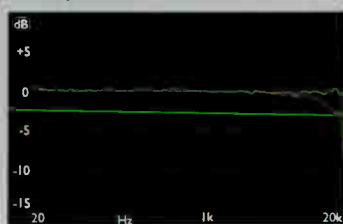

| | |
|--------------------------|--------------|
| Tracking force | 2.3gms |
| Weight | 9gms |
| Vertical tracking angle | 32degrees |
| Frequency response | 20Hz - 20kHz |
| Channel separation | 23dB |
| Tracking ability (300Hz) | |
| lateral | 63µm |
| vertical | 45µm |
| lateral (1kHz) | 16 cms/sec. |
| Distortion (45µm) | |
| lateral | 0.8% |
| vertical | 5% |
| Output (5cms/sec rms) | 0.7mV |

ORTOFON QUINTET BRONZE £499.00



EXCELLENT - extremely capable

VERDICT

Relaxed and easy-going sound from Danish built cartridge. At its best with classical and acoustic folk.

FOR

- smooth, well-mannered sound
- very forgiving of record condition
- at its best with classical/
- excellent grasp of rhythms

AGAINST

- less good with rock, punk or electronica

Henley Designs
+44 (0) 1235 511166
www.henleydesigns.co.uk

Enjoy the Music.com

Audiophile Equipment & Music Reviews
Your resource for high-end audio news & information!

Over 5,700 Web Pages
The most extensive high-end audio knowledge and news online!

Over 150 Audiophile Show Reports
No one has more worldwide show coverage on the Internet!

The Best Contests
Over \$150,000 in prizes offered to our readers!

Internet Partners With Leading Magazines

hifi+ the absolute sound HIFICRITIC HI-FI WORLD hifimedia

Media Partners With Major American Shows

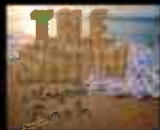

www.EnjoyTheMusic.com

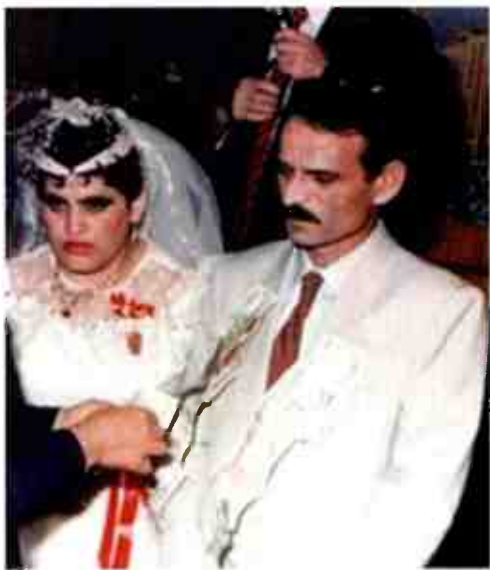

Now, you tell me
I'm not getting
a Funk?

...ever closer

www.thefunkfirm.co.uk 07846 7978367 / 01273 585042



Voltaire
The new name
in
audio excellence



Robson Acoustics
Precision loudspeakers and audio products
Tel: 0845 6433 787
www.robsonacoustics.co.uk
e. sales@robsonacoustics.co.uk

free reader Classifieds

TERMS AND CONDITIONS: Only one advert per reader. No Trade adverts. This section is strictly for readers selling secondhand hi-fi equipment only. Maximum length per advert is 30 words, Adverts over 30 words will not be accepted. Telephone numbers and E-mail addresses are treated as one word. Model numbers are treated as one word i.e. Quad 303 = two words. Email your advert to; classifieds@hi-fiworld.co.uk or fill in the form on page 97 and post it to Hi-Fi World Free Readers Ads, Studio 204, Buspace Studio, Conlan Street, Notting Hill, London W10 5AP. Sorry, we cannot accept adverts over the telephone. The Publisher reserves the right to judge submissions.

WANTED: LATE SME Series IV-D with detachable head-shell. Mint condition. Perfect working order essential. Complete with all tools and accessories. Tel: 01505 346 791 (Renfrewshire)

QUAD 66 CD player, £195. Yamaha CR400 amplifier, exceptional condition, £65. Denon PMA520 amplifier, 70wpc, £70. Ruark Epilogue speakers, £55. Monster HTS 800 power block, sealed package, £60. Tel: 01708 457 691

TARGET HI-FI rack. Two shelves, top isolated. H-49cm, W-51cm, D-41cm. £15. Collection Sheffield. Details Tel: 0114 236 9620 or 07748 846 316

LOTH X Ion BSI stand-mount loudspeakers. 94dB sensitivity. Ideal with valve amps. Excellent condition, £295 ono. Rogers Cadet Mk3 stereo integrated valve amplifier, working order. Offers. Tel: 07946 522 644

HI-FI NEWS magazines. First 4 1/2 years from issue one June 1956 to January 1961. In excellent condition, £100. Tel: 0114 237 8731

HARBETH P3ESR finished in beautiful eucalyptus. They come with Something Solid stands, the ultimate setup for P3's. Sonically perfect and aesthetically stunning. £1000 ono Contact Mike 01597823624

WANTED FAULTY or non working Quad 34 and 44 preamps, Denon mc transformers AU310 or AU320. Contact Mike 01758 613790.

MUSICAL FIDELITY
A308CR Pre-amplifier £695: as new except the price! (RRP was £1500) Great reviews! Musical Fidelity A3.2 RDS Tuner £295: As new Musical Fidelity A308CR CD Player £695: As new (RRP was £2000) Great reviews! All owned by me from new and have less than 100 hours use, still pristine, unmarked (kept covered with a dust sheet), with original boxes, remotes and instructions. They have been protected in an audio rack in my smoke and pet free home. All have the attractive all-silver appearance. Mike (Cheshire) 07500 804700 michael.yates7@ntlworld.com

REGA APOLLO 35th Anniversary Limited Edition in black (vgc, light use), (£750), £375. Rega Mira 3 integrated amplifier in silver (Best Buy, Hifi Choice, Class B, Stereophile, immaculate with a great phono stage - less than a week's use, bought in 2012), (£598), £300. Both boxed with remotes. Tel/text Richard on (07772) 711432/01494 521359 (Bucks) or email richard.schofield@kcl.ac.uk.

POWER SUPPLY for CLASS A amplifiers, self contained, suits John Linsley Hood's or any low power class A amplifier, £279. Pair of used SEAS 10 inch drivers, £99. Tel: 0207 499 8729.

CUSTOM DESIGN wall mounted turntable support Black steel frame Toughened glass shelf Complete with all fixings In as new condition Offers please 01293 524587 West Sussex

RUSS ANDREWS
Ultrapurifier block with mains Zapperator plus 8 Clarity mains modules installed. This is a special one off model. mint condition, RRP £1850 - £1000 or £985 collected. Tel: 01902 884694 email: jukey39@yahoo.co.uk

EAR 834P. Volume control, MM/MC. Version with ECC83 valves, very little use. £750 Audio research PH3 £800, LS15 pre-amp £1500 with top matched valves. Kyri 07712588991

QUAD ELS-57 Speakers Pair (Copper) Quad 33/405 Pre/Power Amps Quad FM3 Tuner plus cables & boxes £350 ono Ring John 07759 654339 (Woking Surrey)

MORROW AUDIO MA1 one metre pair stereo interconnect cable Rave internet reviews £35. West Sussex 01243 528010

MICHELL TECHNOARM
A all packaging, £275 delivered in UK Koetsu Black Goldline, mis-tracking, need rebuild probably, £225 delivered in UK kjholland2@gmail.com. 0141 5520360

SONUS FABER Concertino speakers with Sonus Faber Piano Black fluted stands in excellent condition, with original boxes, £695.00 Musical Fidelity X-Dac V3 £250, Pr 3mtr bespoke Silver High Breed Quintessence speaker cabled, banana termination, £95 Tel Coventry 02476 679165 or davidhirst244@o2.co.uk

SHANLING CDT-100C. 3-D Audio UK tuned. Mint, boxed, remote. Upgraded valves. 24/96 switchable upsampling. Tube or SS output. £1700 new. £700 o.n.o. contact jefftees@live.co.uk for pics, info.

MUSICAL FIDELITY M1-HPA headphone pre amp, mint boxed £225. Project Phono SE MM/MC, VGC £50. QED anniversary XT 2x 3M lengths, QED air-loc plugs unused £40. Tel: 01371-850665 garyrobinson20@btinternet.com

NAKAMICHI CR2E cassette deck £110 ono. Everything works as it should. Lovely sound. Phone John on 07788174437 after 7pm. Kettering, Northants. Buyer collects. Can be demonstrated before sale.

TRICHORD DINO Phono Stage/Power Supply +. Little used, in excellent condition. All original packaging and instructions. £275 ono Phone: 01323 832043 or e-mail: john.harris61@btopenworld.com

WANTED: TOP quality Hi-Fi separates and complete systems, Naim, Linn, Cyrus, Meridian, Audio Research etc, fast, friendly response and willing to travel/pay cash Please call me on 0781 5892458

WANTED: LATE SME Series IV-D with detachable head-shell. Mint condition. Perfect working order essential. Complete with all tools and accessories. Tel: 01505 346 791 (Renfrewshire)

Emporiumhifi

www.emporiumhifi.com

we now have 3 branches
 Head Office based on Suffolk/Norfolk border 01508 518542 01508 518468
 Kent and south East 01304 239419 - Wales and West 01554 750262
 emporiumhifi@yahoo.co.uk

LATEST USED EQUIPMENT

SPEAKERS

ACAPPELLA FIDELIO LOUDSPEAKERS Suffolk £1,000
 ACOUSTIC ENERGY AE1 REFERENCE MK3 PIANO BLACK, BOXED Suffolk £1,080
 ART EXPRESSION V6 FLOORSTANDING SPEAKERS Suffolk £950
 AUDIOPLAN KONTRAST II SPEAKERS Suffolk £575
 CASTLE CHESTER SPEAKERS Suffolk £220
 CHARIO ACADEMY MILLENIUM 2 SPEAKERS, BOXED WITH HNE GRANITE STANDS Suffolk £1,500
 CHARIO CONSTELLATION DELPHINUS SPEAKERS, BOXED, WITH STANDS Suffolk £1,000
 EPOS ELS 303 BLACK SPEAKERS Suffolk £200
 EPOS ELS8 LOUDSPEAKERS, EX DEMO STICK, BOXED Suffolk £160
 EPOS M16I SPEAKERS, CHERRY, EX-DEMO, BOXED Suffolk £350
 IMF PROFESSIONAL MONITORS MK1'S TRANSMISSION LINE LOUDSPEAKERS Suffolk £550
 INFINITY RS2b RIBBON HYBRID SPEAKERS Suffolk £2,000
 JAS ORSA LOUDSPEAKERS BOXED Suffolk £750
 KEF PSW 3000 ACTIVE SUBWOOFER, BOXED Suffolk £300
 KEF PSW 4000 ACTIVE SUBWOOFER Suffolk £960
 KEF REFERENCE 201 SPEAKERS, BOXED WITH STANDS Suffolk £1,150
 KEF XQ5 SPEAKERS, COSMETICALLY DAMAGED CABINETS Suffolk £995
 KINGSOUND HUMMINGBIRD ELECTROSTATIC SUPER TWEETERS Suffolk £400
 LAKE AUDIO MODEL 2POINT 2, WITH RIBBON TWEETERS Suffolk £350
 LOVINGTON HORN SPEAKERS WITH FOSTEX DRIVERS Suffolk £500
 MERIDIAN M20 SPEAKERS, PAIR Suffolk £350
 MILLER & KREISEL SS150 MK2 TRIPOLE THX SPEAKERS Suffolk £900
 NIGHTINGALE CONCENTUS CTR II LOUDSPEAKERS Suffolk £3000
 QUAD 12L2 AVILABLE IN CHERRY, MAPLE OR BLACK Suffolk £920
 QUAD 22L2 LOUDSPEAKERS Suffolk £920
 QUAD 2805 ELECTROSTATIC LOUDSPEAKERS Kent £2,250
 QUAD 988 ELECTROSTATIC SPEAKERS, BOXED Suffolk £2,000
 QUAD 9L ACTIVE SPEAKERS IN PURPLE, NEW, UNUSED Suffolk £300
 QUAD ESL 63 ELECTROSTATIC LOUDSPEAKERS - SERVICED Suffolk £900
 REL STENTOR III SUB Suffolk £1,250
 ROGERS STUDIO 7 LOUDSPEAKERS, MODIFIED Suffolk £300
 ROKSAN OJAN 3X SPEAKERS & 3S SUB Kent £1,000
 RUARK TALISMAN LOUDSPEAKERS Suffolk £200
 SONUS FABER GRAVIS B1 ACTIVE SUBWOOFER Suffolk £500
 2 SCANSPEAK MID/BASS SPEAKER/DRIVERS - 8 OHM 15W/8531K01 Suffolk £175
 SPENDOR A6 SPEAKERS, PAIR WITH BOXES Suffolk £1,000
 SPENDOR SA1 SPEAKERS WITH STANDS Suffolk £950
 SUNFIRE CRM-2 LOUDSPEAKERS CHERRY Suffolk £700
 TAG McLAREN CALLIOPE CENTRE SPEAKER Wales £750
 WHARFEDALE DIAMOND 8.3 LOUDSPEAKERS Suffolk £120
 WILSON CUB SPEAKERS - COME WITH CRATES Suffolk £1,850
 WLM DUO 15 PASSIVE SUBWOOFER Suffolk £200

TURNTABLES, TONEARMS, CARTRIDGES

ACOUSTIC SOLID WOOD MPX TURNTABLE 3 WEEKS OLD Wales £1,500
 CODA 06X FET MM/MC PHONOSTAGE - BOXED Suffolk £1,100
 DECCA LONDON - GARROTT BROTHER MICROSCANNER CARTRIDGE Suffolk £400
 FUNK FXR-II (SME SILVER WIRED) TONEARM Kent £1,150
 FUNK FIRM VECTOR III TURNTABLE Suffolk £850
 GARRARD 301 OIL BEARING GOOD WORKING ORDER Suffolk £900
 GARRARD 401 - GOOD WORKING ORDER Suffolk £500
 GOLDRING Lenco G88 TURNTABLE Suffolk £400
 INSPIRE APOLLID TURNTABLE WITH CUSTOM MADE LID AND UPGRADE EXTERNAL PSU Suffolk £700
 INSPIRE HIFI LINN LP12 VIVID UPGRADE Wales £899
 LINN BASIK TURNTABLE WITH AKITO AND K9 MOVING MAGNET CARTRIDGE Suffolk £350
 LINN LP12 WITH MISSION 774 ARM WITH NEW LINN PACKAGING Suffolk £750
 LINN LP12 ITTOK , CIRKUS, TURNTABLE, ALL BOXED Suffolk £1,750
 MICHELL GYRODEC CALL KENT
 ORACLE DELPHI III WITH SME M2 AND PICKERING MM CARTRIDGE Suffolk £1,200
 RENAISSANCE MOVING COIL PHONOSTAGE, RA-P01 Suffolk £1,080
 RESON ROTA TURNTABLE WITH YOTA ARM Suffolk £2,300
 ROKSAN TMS 3 TURNTABLE WITH REFERENCE PSU Suffolk £4,000
 SME IV TONEARM Suffolk £1,800
 SME V TONEARM - BOXED, GOLD PRINT INTERNAL SILVER WIRED Suffolk £1,800
 SME 3012 TONEARM Suffolk £760
 SUGDEN MASTERCLASS PHONOSTAGE MM/MC Suffolk £700
 SYSTEMEK IIX WITH REGA ARM Suffolk £300
 THORENS TD166 BC MK2 TURNTABLE WITH MAYWARE FORMULA 4 ARM Suffolk £250
 THORENS TD224 TURNTABLE IN PLINTH WITH LID Suffolk £500
 TRAFOMATIC EXPERIENCE PHONO ONE VALVE MC PHONOSTAGE Suffolk £1,200
 VAN DEN HUL COLIBRI XGP MC CARTRIDGE Suffolk £1,750
 VAN DEN HUL GRASSHOPPER IV GLA, BOXED Suffolk £955

AMPLIFIERS, PHONO STAGES

AFFORDABLE VALVE COMPANY KTT88 HIGH END INTEGRATED VALVE AMP Suffolk £700
 ALMARRO 5012A VALVE INTEGRATED AMP Suffolk £1,500
 ANATEK CM0.5 PASSIVE PREAMP WITH REMOTE CONTROL Suffolk £400
 ARIAND PRO845 MK 1V SINGLE-ENDED INTEGRATED VALVE AMPLIFIER Kent £999
 AUDIO INNOVATIONS 2ND AUDIO VALVE MONOBLOCKS Suffolk £950
 AUDIO NOTE M2 PHONO VALVE PREAMPLIFIER Kent £1,650
 CONRAD JOHNSON MV55 POWER AMP Suffolk £900
 COPLAND CSA 29 INTEGRATED AMPLIFIER Suffolk £950
 COUNTERPOINT SA20 HYBRID 220 WATT MOSFET VALVE POWER AMP - UPGRADED Suffolk £1000
 CYRUS XPD AMPLIFIER IN QUARTZ Suffolk £700
 GAMMA AEON REFERENCE - ANNIVERSARY EDITION SINGLE-ENDED VALVE AMPS Suffolk £1,950
 GAMMA ERA REFERENCE VALVE PREAMP Suffolk £850
 GAMMA SPACE REFERENCE VALVE AMP 300B Suffolk £1,400
 GRAAF GM 13.5B MK1 - LINE VALVE PREAMPLIFIER Wales £1,400
 HEART BEAT 300B SINGLE ENDED VALVE MONOBLOCKS Suffolk £900
 HEART LINSTAGE VALVE PREAMP Suffolk £400
 KRELL KRC2 PRE-AMPLIFIER WITH KPE PHONOSTAGE, ALL RECAPPED AND BOXED Suffolk £1,500
 KRELL KSL 2PREAMP, BOXED Suffolk £995
 PAIR OF LEAK TL12+ POWER AMPLIFIERS, SERVICED AND WORKING Suffolk £1,000
 LEAK STEREO 20 VALVE AMPLIFIER WITH MAJOR UPGRADES Suffolk £800
 LEAK TL12 1 MONOBLOCKS, SERVICED Suffolk £5,000
 LFD MISTRAL LE INTEGRATED AMPLIFIER Suffolk £325
 MARK LEVINSON ML 380 PREAMP Suffolk £1,850
 MICREX M1 VALVE/MOSFET HYBRID MONOBLOCK AMPS Suffolk £1,200
 MINSTRAL PARTRIDGE LE VALVE HYBRID INEGRATED AMPLIFIER Kent £900
 MUSICAL FIDELITY M6I INTEGRATED AMP - NEW, UNUSED Suffolk £1,650
 NAIM NAC 62 PRE AMPLIFIER Suffolk £300
 NVO SPA ONE PHONOSTAGE Suffolk £2,222
 OPERA CONSONANCE CYBER 10 SIGNATURE VALVE INTEGRATED AMP - 2A3 TRIODES Suffolk £950
 PARASOUND MC275 POWER AMP Suffolk £375
 PATHOS LOGOS HYBRID VALVE INTEGRATED AMPLIFIER Kent £1,850
 PERRAUX SM3 PREAMP WITH BUILT-IN PHONOSTAGE Suffolk £500
 QUAD II POWER AMPLIFIERS, EXCELLENT SERVICED PAIR Suffolk £1,100
 RED ROSE (MARK LEVINSON) MODEL 5 VALVE INTEGRATED AMPLIFIER Kent £2,000
 ROGUE 99 VALVE PREAMPLIFIER WITH REMOTE CONTROL Suffolk £995
 ROKSAN KANDY KMA 2/3 MKIII POWER AMPLIFIER Kent £450
 TECHNICS SU-C800UM2 PRE AMP & SE-A900SM2 POWER AMPLIFIER Suffolk £450
 TRAFOMATIC EXPERIENCE ELEGANCE 6550 VALVE AMP Suffolk £2,000
 TRAFOMATIC EXPERIENCE LINE ONE VALVE PRE-AMP Suffolk £1,400
 TRILOGY 948 POWER AMP - VALVE AMPLIFIER Suffolk £750
 VERITAS P400 240WATT POWER AMP Suffolk £550
 YAQUIN MS 300B SINGLE ENDED INTEGRATED VALVE AMP Suffolk £500
 WLM PASSIVE CONTROL Suffolk £500

CD PLAYERS

AUDIO NOTE CD ZERO VALVE CD PLAYER Suffolk £900
 CALYX AUDIO 24192 DAC Wales £1,200
 CARY DAC 100T Wales £1,900
 CLASSE 5 CD PLAYER Suffolk £500
 COPLAND CDA823 CDPLAYER Suffolk £1,000
 EASTERN ELECTRIC MINIMAX VALVE CD PLAYER Suffolk £800
 KRELL KAV300CD CD PLAYER WITH REMOTE Suffolk £855
 LECTOR CDPO-6T VALVE CD PLAYER Kent £650
 LECTOR DIGITUBE 2496 VALVE DAC Suffolk £785
 MERIDIAN 500 CD TRANSPORT MKII Suffolk £500
 MICRO SEIKI CD PLAYER Suffolk £900
 OPERA CONSONANCE DROPLET CDP5 0 CD PLAYER Suffolk £1,200
 PINK TRIANGLE ORDINAL DAC Suffolk £800
 PRIMARE CD30 2 CD PLAYER Suffolk £340
 SIM MOON EQUINOX CD PLAYER Suffolk £800
 STELLO DA220 DAC NEW OLD STOCK - 1 YEAR GUARANTEE Suffolk £1,800
 WADIA DIGIMASTER X32 DAC Suffolk £400

MISCELLANEOUS

100 ASSORTED JAZZ RECORDS - RANDOM JOBLLOT, OUR SELECTION Suffolk £100
 100 ASSORTED CLASSICAL RECORDS, RANDOM JOBLDT, DUR SELECTION Suffolk £100
 100 OPERA LPS IN LP AND BOX SETS, RANDOM JOBLLOT, DUR SELECTION Suffolk £100
 NAGRA IV-S STEREO REEL TO REEL Suffolk £1,400
 FANFARE FT1 TUNER WITH REMOTE CONTROL Suffolk £300
 REVOX A77 REEL TO REEL, SERVICED, Suffolk £250
 REVOX B77 REEL TO REEL, SERVICED Suffolk £500
 STAX LAMBDA SIGNATURE HEADPHONES WITH SRM-T1 VALVE ENERGISER/AMP Suffolk £850
 TRY TRV 84HD VALVE HEADPHONE AMP Suffolk £750

WE WANT TO BUY YOUR OLD HIFI

We pay cash and can pick up from anywhere in the UK.
 We can even send you packing materials,

WE WANT TO BUY YOUR RECORD COLLECTION

CALL NOW FOR A QUOTE

Digital Chord

Resident analogue head Tony Bolton finds some digital interconnects that tickle his musical tastebuds.

From their base on Salisbury Plain, near Stonehenge, the Chord Company have been busy creating a new range of digital interconnects using their 'Tuned ARAY' technology.

They are tight-lipped about the details of this new configuration so I can only give you basic details about the construction of these cables.

But, suffice to say, anyone who believes digital interconnects don't make a difference should take a listen to these.

After running the cables in for 150 hours I listened to a range of music and settled on a CD of Janis Joplin performing at Woodstock Festival in 1969 (Columbia/Legacy 88697 48243 2) for the comparative listening. This was played via my Njoe Tjoeb 4000 Reference CD player with the interconnect sending the signal to my Teddy DAC (which upsamples to 24/192).

The most affordable of these three leads is the Anthem. This cable is made with solid core silver-plated conductors, insulated with PTFE and shielded with foil and a high-density braid. This is covered with a PTFE outer jacket. The plugs are Chord's own VEE 3 RCA plugs with an ABS outer shell and silver-plated connectors.

Compared to the cables supplied by most manufacturers with their equipment this cable is light years ahead in every aspect of the sound. I found Joplin's vocals projected forward of the musicians and disentangled from the morass of sound that had previously surrounded it.

The bass sound gained definition and allowed me to follow the rhythm more accurately, while treble sounds were far smoother and more palatable.

After such a good performance I was interested to see

how much it could be improved and was not disappointed by the results when I plugged in the Signature interconnect.

This is a bulky lead that uses high-purity, single crystal solid core conductors, insulated with gas-foamed polyethylene.

There is a dual layer composite shield, a high-density braided shield offering 95% coverage in conjunction with a semi-conductive shield layer. Chord's own ultra-low mass RCA plugs are used.

Although it costs nearly twice as much as the Anthem, I felt the Signature offered excellent value for money with a performance that was, to my ears, twice as good.

The soundstage seemed to become a lot bigger, with space and a little depth visible between the performers.

The bass sound gained a little in weight but a lot in descriptiveness, letting the boozing nature of the bass line on 'Try (Just a Little Bit Harder)' really getting going.

The vocals gained in clarity and I was aware of the background hums and noises from the equipment for the first time.

The Indigo interconnect uses a polished silver-plated copper conductor, insulated by PTFE and surrounded by a combination shield of high-density silver-plated copper braid and heavy gauge silver-plated foil. Precision machined

acrylic plugs with PTFE insulation are fitted.

Now I found the sound had a depth and vibrancy that I have not heard through this part of my system before.

Micro details of Janis Joplin's gravelly voice and her relationship with the microphone were obvious - as was the speed of the attack of the guitar notes. Drums had real punch behind their sound and I felt the timing had much more cohesiveness.

I felt that the Signature offered the best combination of sound-per-pound, the Anthem giving a dramatic improvement over stock cables.

But the real delight was the Indigo. It offered insight and musicality and made listening to digital sources a far more involving experience.



CHORD CO ANTHEM DIGITAL TUNED ARAY £230.00 1M



OUTSTANDING - amongst the best

VERDICT

good sounding cable that offers a detailed take on sound with well projected vocals and good timing

FOR

- timing
- strong central image
- good bass presence

AGAINST

- nothing at the price

CHORD CO SIGNATURE DIGITAL TUNED ARAY £410.00 1M



OUTSTANDING - amongst the best

VALUE - keenly priced

VERDICT

excellent performance for the price with open and dynamic sound

FOR

- good boozing rhythm
- wide soundstage
- well-textured sound

AGAINST

- nothing

CHORD CO INDIGO DIGITAL TUNED ARAY £910.00 1M



OUTSTANDING - amongst the best

VERDICT

superbly open and detailed sounding cable with beautifully timed and solid bass sound

FOR

- fast powerful bass
- open and spacious sound
- obvious background info in recording
- good timbre

AGAINST

- price

Chord Company
+44 (0) 1980 625700
www.chord.co.uk

NEXT MONTH SEPTEMBER 2014 ISSUE

YAMAHA NS-F901 SOAVO LOUDSPEAKERS

Yamaha have updated their sumptuous piano-finish Soavo loudspeakers to new F901 status. They're sitting in our office right now looking glorious. Find out how they sound by reading our comprehensive review in the next issue.

...and we will also be running an in-depth review of the Beatles In Mono LP box set, complete with a review of the matching Ortofon 2m Mono Special Edition cartridge purposed to play them.

Also, we hope to bring you –

Parasound CD1

Audeze LXR Headphones

Thorens TD206 Turntable

Bayan Audio X3 soundbook

Invicta Mirus DXD DSD DAC

The Beatles in Mono LPs review

Arcam FMJ AVR 750 AV Amplifier

Sony SRS-X9 hi-res loudspeaker

World Design HDS3 headphone amplifier

Ortofon 2M Special Edition 'Beatles' mono cartridge

Graham Audio BBC License LS5/9 monitor speakers

...and much more.

This is a selection of what we hope to bring you, not a complete list. We regret that due to a wide range of issues, such as failure under review, we cannot guarantee that all products listed above will appear.

PICK UP THE SEPTEMBER 2014 ISSUE OF *HI-FI WORLD* ON SALE JULY 31ST 2014
OR SUBSCRIBE AND GET IT DELIVERED TO YOUR DOOR: SEE PAGE 42

FREE READER CLASSIFIED ADS ORDER FORM

STOP PRESS

ADVERTISERS INDEX

| | |
|---------------------|-------------|
| 2nd Hand HiFi | 70 |
| Absolute Sounds | OBC |
| Avid HiFi | 88 |
| Bascially Sound | 82 |
| Billy Vee | 82 |
| Black Rhodium | 16,38 |
| Clarity | 72 |
| Emporium HiFi | 94 |
| Enjoy The Music.Com | 92 |
| Epiphany Acoustics | 82 |
| Future Shop | 46 |
| Graham Slee | 38 |
| Heatherdale Audio | 82 |
| Henley Designs | 18,54,66,74 |
| HiFi Sound | 70 |
| Ian Harrison | 84 |
| Icon Audio | 24 |
| Inspire HiFi | 26 |
| Jordan Acoustics | 20,21 |
| KEF | 14 |
| KJ West One | 90 |
| MCRU | 46 |
| Music First | 84 |
| QAT | 6 |
| Retro Reproduction | 84 |
| Robson Acoustics | 92 |
| Sevenoaks | 75,76,77 |
| SME | 16 |
| Sound HiFi | 56 |
| Sounds Fowndations | 52 |
| Sugden | 50 |
| T+A | 58 |
| Tellurium Q | 12 |
| The Chord Company | IFC |
| The Funk Firm | 92 |
| Turntable World | 70 |
| Usher | IBC |
| World Design | 56 |

TERMS AND CONDITIONS: Only one advert per reader. Maximum length per advert is 30 words, Adverts over 30 words will not be accepted. No Trade Adverts. This section is strictly for readers selling secondhand hi-fi equipment only. Telephone numbers and E-mail addresses are treated as one word. Model numbers are treated as one word i.e. Quad 303 = two words. Sorry, we cannot accept adverts over the telephone. The Publisher reserves the right to judge submissions.

You can email your advert to us at: classifieds@hi-fiworld.co.uk or write or type your advertisement copy in block capitals with one word per box and post it to us at:

Hi-Fi World Free Readers Ads,
Studio 204,
Buspace Studio,
Conlan Street,
London W10 5AP

We cannot accept adverts over the telephone

| | |
|----|----|
| 1 | 2 |
| 3 | 4 |
| 5 | 6 |
| 7 | 8 |
| 9 | 10 |
| 11 | 12 |
| 13 | 14 |
| 15 | 16 |
| 17 | 18 |
| 19 | 20 |
| 21 | 22 |
| 23 | 24 |
| 25 | 26 |
| 27 | 28 |
| 29 | 30 |

Name: _____

Address: _____

Post Code: _____

Daytime Tel: _____

FREE READER CLASSIFIED ADVERTS COPY DEADLINES
 SEPTEMBER 2014 - 8TH JULY 2014
 OCTOBER 2014 - 5TH AUGUST 2014

THE SHIRELLES

TONIGHT'S THE NIGHT
1961



"The group never fail to send shivers down the spine with an often raw, stripped vocal delivery that speaks of cutting emotion"

A pioneering girl group, the Shirelles were the first major successful female vocal outfit of the rock era. Spouting a mixture of doo wop and pop with added R&B for good measure, the group also broke new ground because they appealed to white audiences in addition to their core black fans. They also provided a focal point for that phenomenon in songwriting prowess the Brill Building – a centre of excellence that featured such legendary names as Gerry Goffin & Carol King, Burt Bacharach & Hal David, Van McCoy, Neil Diamond, Jerry Leiber & Mike Stoller, Phil Spector, Laura Nyro, Paul Simon, Barry Mann & Cynthia Weil, Sonny Bono, Marvin Hamlisch and more.

The Shirelles were a four-piece consisting of Doris Coley, Addie Harris, Shirley Owens and Beverly Lee.

"We were all friends and baby sitters" said Owens. "We originally considered forming a duet Beverly and myself. Then we thought we could put a group together because what we really wanted was that beautiful harmony and it's difficult for two people to do that".

"So we decided to get two more friends, Doris Coley, whose dad was a preacher and Addie Harris. We were fooling around in the school gym one day, singing and our gym teacher said 'Either you sing in the upcoming talent show or you are staying in after school.' So we picked the talent show".

It was Sceptor Records owner Florence Greenberg (the first lady to run a record label and who included the likes of Dionne Warwick, The Isley Brothers and the Kingmen – remember 'Louie Louie'? - on her roster) who changed the group's name from the Poquellos to The Shirelles. The name was a combination of Shirley Owens first name with top vocal outfit of the time the Chantels.

"Greenberg had one tiny little office in New York, she had just started out" said Owens. "We sang for her. In fact, we sang our own composition 'I Met Him On A Sunday' at a party for her son, who was blind. She subsequently signed us up".

The band always maintained a sense of grace and charm when they performed, a fact that band member Beverly Lee alluded to,

"We were proud of what we did" she says. "We always carried ourselves in a very ladylike manner, very professional. We dressed in a certain way – didn't want to be cleavage and all that".

In-house producer, Luther Dixon was assigned to the group after two initial single flops to give the outfit their signature sound. The Shirelles' first album was a glorious dedication to young love and their teenager-generated, small-minded approach to life: complete with sweet harmonies. Those small aspects of life that hover around desire, potential relationships, girlfriends, boyfriends, dates and more were all consuming with a gay insouciance for the rest of the world's problems. You won't find a Bob Dylan/Pete Seeger-like tale of woe on this platter.

The album, which was released in 1961, was unusual for its time in one respect. That is, it was totally ruled by the quality of the singles. This balance – or lack of balance – in the content of the album would be emulated by much of what came later via the likes of Motown and other imitators of the group.

So with this significant album, you hear the dominant title track but also 'Will You Love Me Tomorrow' and 'Dedicated to the One I Love'. '...Tomorrow' was initially released in 1960 and became the first female vocal group No 1 of the rock era. But that wasn't all, on this album you will also find the track 'Boys'. Ring a bell? It was included on the B-side of 'Will You Love Me Tomorrow' but was also a song that The Beatles turned almost into a pop standard on their own debut album, 'Please Please Me'.

The album is by no means a shallow bucket of singles. There are tracks such as the smoking 'You Don't Want My Love' while Dionne Warwick would later sing another album cut, 'Unlucky'.

Often under-appreciated, the group never fail to send shivers down the spine with an often raw, stripped vocal delivery that speaks of cutting emotion. Now you can revisit the album (along with another excellent album cut 'The Shirelles Sing To Trumpets and Strings' (1963)) via Ace Records (acerecords.co.uk) on a value for money two-fer called, simply, 'Tonights The Night/Sing to Trumpets And Strings'.

PR

USHER

The USHER Dancer Diamond Series features the world's first amorphous DLC (diamond-like carbon) diaphragm tweeter. This is a tweeter which is second to none in the current market. To find out more, visit www.usheraudio.com or your nearest USHER dealer...



"2012 Editor's Choice" Awards --- AUDIO ART

Mini X Diamond

2-way system: 1.25" Diamond DMD dome tweeter, 7" midrange

Sensitivity: 87 dB @ 1 watt / 1m

Nominal impedance: 8 ohms

Frequency response (-3 dB): 41 Hz - 40 kHz

Power handling: 100 watts

Crossover frequencies: 2.3 kHz

Weight: 15.5 kgs/34.2 lbs. per piece

Dimensions (w x d x h): 26 cm x 37 cm x 43.5 cm;



Behind the scenes

Dr. Joseph D'Appolito a world renowned authority in audio and acoustics designs the crossover and performs prototype testing/final fine tuning for Usher Audio. Consulting to a couple of famous audio companies, Joe always finds the tremendous value Usher Audio products represent a delightful surprise in today's high end audio world.

Rueyma Electric Technology Co., Ltd.

No.29-2 Jhonghua Rd., Taipei City 100, Taiwan
Tel: 886 2 2314 3868, Fax: 886 2 2371 7253

Distributed in the UK by Decent Audio

T: 0560 2054669
W: www.decentaudio.co.uk E: info@decentaudio.co.uk

PRIMALUNA.

'NOTHING SHORT OF AMAZING'

HI-FI WORLD

PERFORMANCE THAT LIFTS THEM
ABOVE THE COMPETITION'

HI-FI NEWS

'INVITING AND BEGUILING,
SMOOTH AND REFINED'

HI-FI+

'A SIGNIFICANT BREAKTHROUGH
IN HIGH-PERFORMANCE AUDIO'

THE ABSOLUTE SOUND

'ILLUMINATES MUSIC LIKE VERY
FEW OTHERS'

HI-FI WORLD

'NO EQUALS AT ITS RETAIL PRICE'

HI-FI NEWS

'BOY OH BOY, CAN I EVER
RECOMMEND THIS AMP!'

STEREOPHILE

hi-finews
HIGHLY
COMMENDED

TEST TEST
hvt
Prologue
Premium
1999

2007
DIO

GOLDEN EAR
AWARDS 2010

STEREOPHILE
RECOMMENDED
COMPONENT

The living heart of your sound system.

When Herman van de Dungen founded PrimaLuna, his mission was to create affordable valve amplifiers and CD players that not only harnessed the sheer, sensual musicality of valve technology, but also defied the issues of reliability that sometimes accompany it.

PrimaLuna's Prologue and Dialogue ranges continue to expand, featuring ground-breaking advances such as the unique Adaptive AutoBias™ circuit that allows easy switching between valve types and the jitter-reducing SuperTubeClock™, exclusively incorporated into PrimaLuna's CD players. These innovations help create a benchmark-setting suite of products that builds on the marque's past triumphs, combining excellent sonic definition with a beautifully balanced tonality.

Aesthetically stunning to look at, with a hand-polished black or silver faceplate, PrimaLuna consistently fulfils Herman's original promise of creating the best you can get for the least you can pay.

 PrimaLuna®

 pistol

Pistol Music – a division of Absolute Sounds Ltd.

58 Durham Road, London SW20 0TW T: +44 (0)20 89 71 39 09 F: +44 (0)20 88 79 79 62 www.pistolmusic.co.uk info@absolutesounds.com