

HI-FI WORLD

JULY 2011

UK £4.10

www.hi-fiworld.co.uk

FREE READER CLASSIFIED ADS IN THIS ISSUE!



QAT MS5 *EXCLUSIVE!*
HDD music server



QUAD 11L CLASSIC *EXCLUSIVE!*
loudspeakers



EXCLUSIVE!
TIMESTEP EVO SL1210
turntable



COMPETITION



WIN A NUFORCE ICON 2/
AMPHION ION SYSTEM
WORTH £900
(UK ONLY)

EXCLUSIVE!

ECLIPSE TD712Z/2

loudspeaker



> LEEMA PYXIS/HYDRA II PRE-POWER AMPLIFIERS
> OLDE WORLDE: SONAB OA5-II LOUDSPEAKERS
> TRIANGLE COMETE LOUDSPEAKERS
> ARTISAN SILVER MC PHONO STAGE

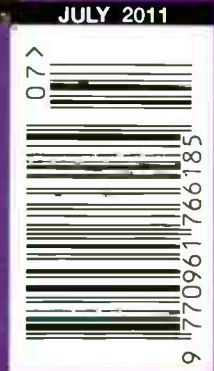

10 PAGES OF LETTERS - THE BEST WINS A PAIR OF KEF iQ30 LOUDSPEAKERS! (UK ONLY)

PRIMALUNA.

"NOTHING SHORT OF AMAZING"
HI-FI WORLD

"PERFORMANCE THAT LIFTS THEM
ABOVE THE COMPETITION"
HI-FI NEWS

"INVITING AND BEGUILING,
SMOOTH AND REFINED"
HI-FI+

"A SIGNIFICANT BREAKTHROUGH
IN HIGH-PERFORMANCE AUDIO"
THE ABSOLUTE SOUND

"ILLUMINATES MUSIC LIKE VERY
FEW OTHERS"
HI-FI WORLD

"NO EQUALS AT ITS RETAIL PRICE"
HI-FI NEWS

"BOY OH BOY, CAN I EVER
RECOMMEND THIS AMP!"
STEREOPHILE

hi-fi news
HIGHLY
COMMENTED

TESTED BY
hvt
PROLOGUE
Premium
TESTED

2007
BEST OF
2007

the absolute sound
GOLDEN EAR
AWARDS 2010

STEREOPHILE
RECOMMENDED
COMPONENT

The living heart of your sound system.

When Herman van de Dungen founded PrimaLuna, his mission was to create affordable valve amplifiers and CD players that not only harnessed the sheer, sensual musicality of valve technology, but also defied the issues of reliability that sometimes accompany it.

PrimaLuna's Prologue and Dialogue ranges continue to expand, featuring ground-breaking advances such as the unique Adaptive AutoBias™ circuit that allows easy switching between valve types and the jitter-reducing SuperTubeClock™, exclusively incorporated into PrimaLuna's CD players. These innovations help create a benchmark-setting suite of products that builds on the marque's past triumphs, combining excellent sonic definition with a beautifully balanced tonality.

Aesthetically stunning to look at, with a hand-polished black or silver faceplate, PrimaLuna consistently fulfils Herman's original promise of creating the best you can get for the least you can pay.

 PrimaLuna®

pistol 

Pistol Music – a division of Absolute Sounds Ltd.

58 Durham Road, London SW20 0TW T: +44 (0)20 89 71 39 09, F: +44 (0)20 89 79 79 62 www.pistolmusic.co.uk Info@absolutesounds.com

WE ARE THE UK'S FASTEST GROWING AUDIO TITLE!!!

welcome

EDITOR

David Price
tel/fax +44 (0) 01672 569090
e-mail: editorial@hi-fiworld.co.uk

DESIGN EDITOR

Faiza Chunara
tel: +44 (0) 20 7625 3129
e-mail: adproduction@hi-fiworld.co.uk

PRODUCTION EDITOR

David Noble
tel: +44 (0) 20 7625 3134
e-mail: classifieds@hi-fiworld.co.uk

ADVERTISING EXECUTIVE

Debi Silver
tel: +44 (0) 1723 500 435
mob: +44 (0) 7966 84 35 36
e-mail: debisilver@hi-fiworld.co.uk

ADVERTISING EXECUTIVE

Brad Francis
tel: 01923 677 256
mob: 07715 421 569
email: brad.francis@sky.com
skype: brad.francis.media

ACCOUNTS

e-mail: accounts@hi-fiworld.co.uk

PUBLISHER

Noel Keywood
e-mail: publisher@hi-fiworld.co.uk

FREE READERS CLASSIFIEDS

tel: +44 (0) 20 7625 3134
e-mail: classifieds@hi-fiworld.co.uk

SUBSCRIPTIONS

tel: +44 (0) 1442 820580
fax: +44 (0) 1442 827912
e-mail: hifiworld@websubscribe.co.uk

PHOTOGRAPHY

David Noble
tel: +44 (0) 20 7625 3134

WRITERS

Haden Boardman, Tony Bolton, Alvin Gold, Steven Green, Paul Rigby, Neville Roberts, Adam Smith, Rafael Todes.

hi-fi world

SUITE G4, ARGO HOUSE
KILBURN PARK ROAD
LONDON NW6 5LF
www.hi-fiworld.co.uk

verdicts

- ● ● ● ● OUTSTANDING
- ● ● ● EXCELLENT
- ● ● GOOD
- ● ● ● MEDIOCRE
- ● POOR
- £ VALUE



Had I been writing this twenty years ago when *Hi-Fi World* was born, the audio landscape would look so different to now. These were the glory days of mid-price separates hi-fi, when every major Japanese manufacturer had a CD player, integrated amplifier and speakers for you, from £399 upwards. Bucketloads of kit was sold – providing it was a mainstream Compact Disc player, integrated solid-state amplifier and bookshelf speakers, invariably housed in a black painted box!

But an awful lot of kit that's common now was unavailable then. Phono stages were practically non-existent, whereas these days they're everywhere. The selection of turntables and tonearms on the market has mushroomed too. Digital convertors, obscure then, are fashionable now and many come with USB inputs and/or network music functionality which was science fiction in 1991.

Back then, valve amplifiers were the stuff of dreams for a few deranged, heretical individuals, or the lived reality of ageing audiophiles who'd never got round to upgrading their nineteen fifties or sixties systems. Now they're everywhere, at every price point – from iPod dock money upwards.

As portables went, Compact Cassette was still king. MiniDisc and DCC were still a few months away, and iPods a full decade or more. Nowadays, for millions of people in this country and beyond, these are normal everyday possessions. Cassette, back then the mightiest music carrier ever in terms of sales, is now a faint shadow of its former self...

Loudspeakers have changed enormously too; twenty years ago it was still variations on a theme of nineteen eighties-style boxes, big bangers with lots of drivers and/or small two way bookshelf designs, most using plastic drive units. These days there's so much more choice; driver technology has improved vastly and there's a movement away from conventional drivers with the use of ribbons and/or electrostatic panels all the more affordable.

It's been a fun twenty years watching things unfold; meanwhile inside this issue you'll find everything that epitomises the best of hi-fi 2011-style, from wild single driver egg shaped speakers to slick digital streamers. Enjoy!

David Price, editor

testing (see www.hi-fiworld.co.uk for full explanations of all our tests)

To ensure the upmost accuracy in our product reviews, *Hi-Fi World* has extremely comprehensive in-house test facilities, and our test equipment - from big names like Rohde & Schwarz and Hewlett Packard - is amongst the most advanced in the world.

Loudspeakers are measured using a calibrated Bruel & Kjaer microphone feeding a Clio-based computer

analyser, using pulsed and gated sinewaves, in a large room to eliminate the room's influence. Pickup arm vibration is measured with a Bruel & Kjaer accelerometer.

No other UK hi-fi magazine has in-house testing, and none has access to such advanced tests across all types of equipment. That's why you can depend on *Hi-Fi World* reviews.



ELECTRONIC MAGAZINE

Go to our website www.hi-fiworld.co.uk to buy an electronic version of this magazine, individual issues, back issues or a subscription.

Distributed by Seymour Distribution Ltd 86 Newman Street London, W1T 3EX Tel: +44 (0) 20 7396 8000 Printed by St.Ives, Plymouth Tel: +44 (0) 1752 345 411
Our Agents in Malaysia Millennium Hi-Fi & AV Simon Chang Showroom & office, 500-1-3 First Floor Wisma Indah (Shen Court), Jalan Tun Razak 50400 Kuala Lumpur, Malaysia
Tel: 603 9283 8171 Fax: 603 9281 3762 e-mail: info@millennium-audio.com

All unsolicited submissions and goods are at the owner's risk. We accept no responsibility for such submissions, nor do we undertake to return them.
No material may be reproduced from this magazine without the publisher's written permission. © Audio Publishing Ltd

71

Quad ILL Classic loudspeakers.



16

Magnum Dynalab MD-105 tuner.



24

Leema Pyxis/Hydra II pre-power amplifier.



52

Triangle Comete LE loudspeakers.



20

Eclipse TD712z/2 loudspeakers.



100

Timestep SL1200 EVO turntable package.

DIGITAL

QAT MS-5 12

Paul Rigby tries out this high end HDD player.

MUSICAL FIDELITY MI CDT/MI CLIC 46

David Price is most impressed by this £1,800 CD transport/network music player combination.

TUNER

MAGNUM DYNALAB MD-105 16

David Price and Rafael Todes enjoy this flagship American FM-only tuner.

LOUDSPEAKERS

ECLIPSE TD712Z/2 20

David Price enjoys these expensive and exotic eggs!

TRIANGLE COMETE LE 52

Adam Smith auditions these limited edition French standmounters.

QUAD IIL CLASSIC 71

David Price tries a fine pair of compact standmounters.

AMPLIFICATION

LEEMA PYXIS/HYRDA II 24

Tony Bolton tries a new British high end pre-power combo...

ONKYO TX-NR609 30

Noel Keywood auditions an affordable network-equipped AV receiver.

ACCESSORIES

ISOTEK SUPERTITAN 51

A superb new high end mains power conditioner is reviewed by Paul Rigby.

TDK SOUNDCUBE 57

Paul Rigby tries this new US designed retro ghetto blaster.

ELAC MICROMAGIC II 119

Paul Rigby reviews this premium priced sub/satellite speaker system.

FEATURES

MEASURED RESPONSE 34

Noel Keywood explains the ins and outs of our comprehensive equipment measurement regime.

UNKNOWN PLEASURES 66

Neville Roberts broaches the controversial subject of cable sound!

OLDE WORLDE 86

Haden Boardman remembers Sonab's classic nineteen seventies OA5-11 omnidirectional loudspeaker.

VINYL

VINYL NEWS 98

Paul Rigby with all the latest black plastic releases.

TIMESTEP SL1200 EVO 100

David Price tries a new, plug and play Technics SL1200 turntable package with an SME 309 tonearm.

CLEARAUDIO CONCEPT MC 109

Tony Bolton cues up this fine mid-price moving coil cartridge.

ARTISAN SILVER MC PHONO 106

Tony Bolton dems a new budget battery powered phono stage.

INSPIRE X100 111

Adam Smith auditions a newly reworked Rega tonearm.



7 NEWS

words from the front...

15 NEW WORLD

Take a look at our new website...

36 MAIL

Ten pages of your views; no small amount of controversy here...

58 WORLD STANDARDS

Brand new, updated guide to the latest and greatest hi-fi hardware on sale.

74 WORLD CLASSICS

Brilliant designs that have stood the test of time...

81 COMPETITION

Your chance to win a great little NuForce Icon 2/Amphion Ion amplifier/speaker combination, worth £900!

82 SUBSCRIPTIONS

Ensure your copy every month and save money too!

84 AUDIOPHILE VINYL

Paul Rigby rounds up the latest audiophile releases.

89, 91, 93, 95, 97 OPINION

The team get to grips with matters music, hi-fi and life!

SOUNDBITES

29 FURUTECH LINEFLUX/ FIDELITY AUDIO HPA200

105 PRO-JECT LEATHER IT/ AVID LEVEL 45

120 DIAL-A-DEALER

A comprehensive guide to UK hi-fi retailers.

123 CLASSIFIEDS

Two pages of second-hand bargains.

128 NEXT MONTH

What we hope to bring you in the next issue...

129 ADVERTISERS' INDEX

130 CLASSIC CUTS

Paul Rigby looks at 'German Punk and Wave: 1978-84 Vol. 1'.



Swedish JAYS' headphones receive top critique and awards in reviews all over the world. Review the range and read what is being said at www.jays.se

NO PHONY

Innovative product development and first class sound.

JAYS®

EST 2007

email:news@hi-fiworld.co.uk

news

ONE FOR ALL

Meridian's new Media Core 600 is described as "a complete Meridian Sooloos multi-zone solution in a single, rack-mountable case". It's said to be "the most powerful and comprehensive product in this category, providing system core, storage, and multi-zone rendering – essentially a complete Meridian Sooloos multi-zone solution – in a single, rack-mountable case". At its heart is the most powerful Sooloos system core to date, incorporating a pair of 2TB hard disk drives configured as a RAID 1 array. This provides enough primary storage for around 5,000 CD albums, and always maintains an automatic mirrored copy of the music collection. There are six audio 'end-points', each with a host of high quality audio outputs enabling easy connection across an entire house or project.

Housed in a brand new case design, Media Core 600 incorporates an "advanced switch-mode power supply and highly efficient cooling system" which make rack-mounting and operation easier and more reliable. It not only stores and manages your entire digital music collection but, when connected to the internet, it also provides easy access to thousands of internet radio stations, plus streamed music services from Rhapsody. It is said to connect easily to a range of control options including wirelessly to the free Sooloos App for iPad, iPhone and iPod Touch. It will work with any of Meridian's DSP Loudspeakers – from the in-wall DSP420 to the Reference DSP8000 – to create an all Meridian, fully digital, distributed audio system. For more details, click on www.meridian-audio.com.



OBITUARY: NORIO OHGA (1930-2011)

Norio Ohga, former President and Chairman, Sony Corporation, passed away on April 23, 2011. He played a huge part in evolving Sony beyond its early days in audio and video, into a global entertainment leader. A student of Tokyo National University of Fine Arts and Music, he first met Sony founders Masaru Ibuka and Akio Morita there and was appointed a consultant and advisor to Tokyo Telecommunications Engineering Corporation (now Sony Corporation) before fully entering the Company in 1959. He paved the way for the launch of a succession of innovative and game-changing products, and along with Morita nurtured the Sony brand to great heights. One of Ohga's favourite expressions was said to be, "The four letters of the 'SONY' brand are our greatest asset."

He personally drove Sony's initiatives to explore CD, his instincts as a musician leading him to push for a 12cm format, providing sufficient recording capacity at 75 minutes to enable listeners to enjoy all of Beethoven's Ninth Symphony without interruption. He led Sony's negotiations with CBS Corp, resulting in the establishment of CBS/Sony Records Inc. (now Sony Music Entertainment Inc.) in 1968. In 1989 Sony purchased Columbia Pictures, turning the company into a global entertainment giant. He then presided over the launch of Sony's game business, with the birth of Sony Computer Entertainment in 1993 and subsequent worldwide success of "PlayStation". In 1988 he was presented with the Japanese Medal of Honor with Blue Ribbon, and in 2001 the Grand Cordon of the Order of the Sacred Treasure. His legacy to the global consumer electronics industry lives on.



FOURTH DIMENSION

Acoustic Energy has launched the Neo 4, a range-topping addition to the affordable Neo range of loudspeakers. This big banger marries a substantially built triple-ported 70-litre cabinet with AE's 38mm wide-bandwidth dual ring radiator tweeter and AE's signature 5.25in aluminium alloy mid-range driver. Bass duties of this true three-way design are handled by a pair of 6.5in bass drivers featuring AE's lightweight aluminium alloy cones. High-mass panel construction and a 32mm thick MDF baffle are used, claimed to be "significantly chunkier than on many manufacturers' designs costing twice the price". This imposing floorstander measures 1,200x300x200mm and boasts 200Watt power handling, 91dB/watt efficiency and a highly linear frequency response from 28Hz to 40kHz, so it should be a good tool for tube amplifier users. It sports Polypropylene capacitors in the crossover, air-core inductors on the HF drivers, while revised long-throw suspension and higher magnetic field strength on the LF drivers produces tighter, more accurate bass it is claimed. Finished in Vermont (Walnut) or Black, it costs £699 per pair. For more details, click on www.acoustic-energy.co.uk or call +44 (0)1285 654 432.



HOLA!

Reader Charles Hillard recommends a special vinyl resource from Spain; Madrid-based Flamenco World. Click on the 'LP Vinilo' tab and you'll find a small but unique selection of flamenco and flamenco/jazz fusion LPs. "I can vouch for the quality of the Cigala Music LPs - my copy of 'Orate' is one of the best-sounding new records I've bought in the last year and that includes a fair few supposedly audiophile pressings", he tells us. Click on www.flamenco-world.com.

FIRST DIRECT

Like nineteen seventies summers on Radio One, Music First Audio are going on the road! Their roadshow starts in Edinburgh on the 9th and 10th July, from 10am to 5pm at the Raddison Blu, the only hotel on the Royal Mile. They will be showing their range of passive transformer preamps, their MC Step up and a brand new valve phono stage together with amplification from Bel Canto Design and loudspeakers from Stirling Broadcast. If visitors would like to try the products with any of their own equipment, MF Audio would be "very happy to accommodate them" and of course, visitors are very welcome to bring their own music. For more details, call +44 (0)1424 858260 or click on www.mfaudio.co.uk.

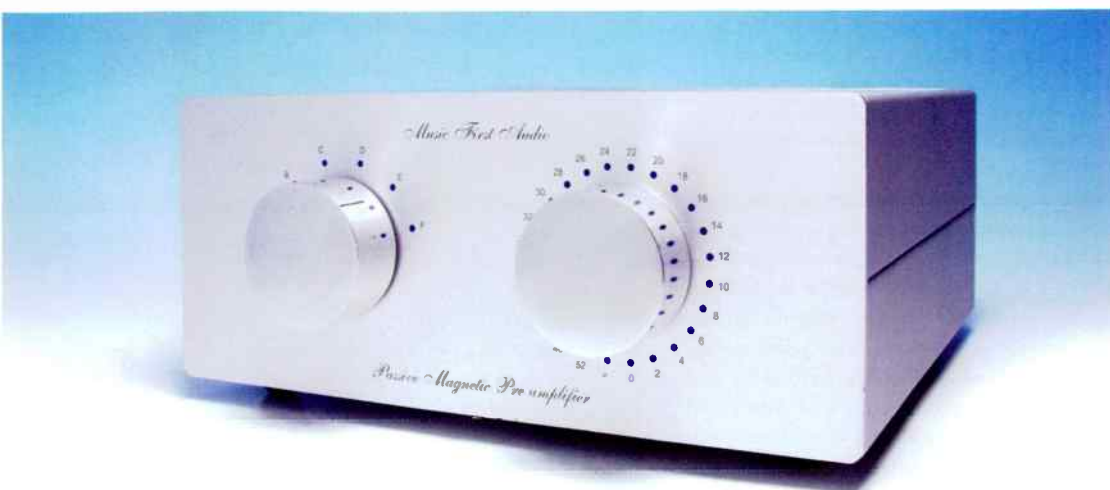

THREE WAY

Sony's new £200 MDR-DS6500 digital surround headphone system is claimed to "reproduce the soundstage of multichannel speakers to create an immersive acoustic space". Its VPT DSP system builds a virtual 7.1 channel soundstage that stretches 'behind and beyond' the screen, they say. The wireless design has an operating range of up to 100m, and automatic tuning switches seamlessly between RF channels to optimise signal reception at all times, with no glitches or drop-outs. The design of the charging cradle houses the phones when not being used; three hours charging time provides power for around twenty hours of listening time. For details, click on www.sony.co.uk.



THIRTY SOMETHING

German speaker manufacturer Quadral are celebrating thirty years of continuous production of their flagship Titan loudspeaker by launching an all-new version. Described as a "mightily impressive, laboratory class, high-end speaker", the Titan VIII comes with a ten year warranty and is available in over 190 colours. It retails at £5,650 per speaker, a slight reduction in price from the previous model. The new loudspeaker will make its world debut at the High-End Society show, Munich, Germany from the 20th – 22nd May, and will be available in the UK and Ireland June onwards from authorised Quadral dealers. For further information, go to www.quodralgb-ie.co.uk.

NEW FRONTIERS

Pioneer has five new AV receivers in both 5.1 and 7.1-channel guises; the VSX-1021 [pictured], VSX-921, VSX-821, VSX-521 and VSX-421. Improved features and functions across the entire range make it easy for consumers to connect their iPhones, iPads and iPods on selected models, the company says. This will for example enable them to access their music and video content as well as share them with others in one room or throughout the home. With AirPlay, music lovers can easily listen to their music library through their home cinema systems using their home network. This works on both the VSX-1021 and VSX-921 and requires iTunes 10.1 or later running on a Mac or PC. Streaming content to the new Pioneer receivers can be done with ease via Bluetooth and/or DLNA. Both the VSX-1021 and VSX-921 offer DLNA v1.5 support, allowing connection to devices with the same feature. Via Ethernet or optional AS-WL300 wireless LAN converter (sold separately), the receivers can access and play high-resolution music (up to 192kHz/24bit for the VSX-1021 and up to 96kHz/24bit for the VSX-921) from a compatible networked device. Audio can also be streamed and controlled through the Pioneer receiver with a smartphone that supports UPnP / DLNA media servers and renderers, giving users an entirely new way to share and play their music collection. With the optional Bluetooth adapter, the whole range of receivers, except the VSX-421, feature wireless Bluetooth transfer of audio content from any A2DP Bluetooth-enabled mobile device or personal computer.

Pioneer has added the vTuner Internet Radio to the VSX-1021 and VSX-921 for access to thousands of Internet radio stations from around the world. From the on-screen display, users can choose from different music formats, station locations or simply search for specific stations and receive the broadcasts with great reception every time. Each model features HDMI (v1.4a with 3D and ARC) connectivity to pass 3D content from a 3D Blu-ray player or 3D cable or satellite broadcast to any compatible display. Pioneer's Auto Multi-Channel Acoustic Calibration is fitted to all models, as is Dolby ProLogic IIz decoding for HD audio formats, including Dolby TrueHD and DTS-HD Master Audio. With the exception of the VSX-421, the new Dolby Pro Logic IIz height channel is also decoded. Advanced Sound Retriever is said to enhance compressed audio files by restoring critical data from portable media players as well as internet radio, "delivering a robust music experience that is near-CD quality". For details see www.pioneer.co.uk.



ULTRA BLACK

Black Rhodium's First DCT Ultra Interconnect is said to be "the first ever to be supplied to customers with two separate cryogenic processes during manufacture". It uses 99.99% pure silver wire, 0.9mm diameter (18 gauge), treated with an advanced Deep Cryogenic Treatment DCT++ process that adds improvements to depth, clarity and timing of audio and video, the company says. The additional processes before and after the DCT in the DCT++ process take these improvements to a much higher level, it's claimed. The Ultra uses high quality PTFE insulation with air gap to minimise dielectric absorption distortion effects and deliver clean pure music, shielded by a double braided silver plated copper screen. Precision manufactured connectors by Oyaide of Japan are fitted; the RCA variant uses Oyaide SLSC precision connectors that feature a 4N pure silver inner connector and rhodium over silver plated brass outer connector, and the XLR uses Oyaide Focus-1 precision connectors with Rhodium over silver plated phosphor bronze connectors with Svarovski rhinestones in blue and red encased in its shell for channel identification! Prices range from £1,250 per 1m pair for the RCA to £1,600/m for the XLR. For further information call +44 (0)1332 342233 or click on www.blackrhodium.co.uk.



IsoTek®

The power to deliver 'clean' power



Aquarius replaced the companies GII Mini Sub and is the latest product in IsoTek's unique range of multi-award winning power conditioners that are designed and hand made in England using the finest materials and built to the highest of standards.

Formed in July 2001 IsoTek's vision has been to create high-quality mains power conditioners that stretch beyond current conventions. Through careful market analysis and extensive research, IsoTek has been able to launch products that dramatically improve the performance of all components used within an audio or visual environment, a fact that has been proved by countless international reviews and over 25 audio awards.

"IsoTek is the leader in mains conditioning products"

HI-FI NEWS

"IsoTek is the UK's biggest name in mains filtration"

HI-FI CHOICE

"Not all mains conditioners are created equal... IsoTek has built itself a reputation as a purveyor of mains conditioners that actually improve (as opposed to just alter) the sound"

HI-FI WORLD

For more information and to obtain your free IsoTek brochure please call:

01276 501 392

info@soundfoundations.co.uk
www.soundfoundations.co.uk www.isoteksystems.com

"The whole auditioning process took about 30 seconds. Play a piece of music on GII Mini Sub. Play it again on Aquarius and wonder why you were so attached to the GII Mini Sub." "Very highly recommended"

HI-FI PLUS. ISSUE 68,



SIRIUS



ACCESSORIES



ORION



VISION



SIGMAS



TITAN



ROCK YOUR REGA!

Following on from their impressive Linn LP12 Vivid modification package, Inspire Hi-Fi have now produced a kit for Rega turntables. The company says that their comprehensive upgrade package takes any Rega turntable, be it an old damaged Planar 2 or 3, right up to the later P5s and above, "to an exceptional level of sound and looks, for a low price". The package starts at £189 for a beautiful, professionally hand crafted solid 50mm Birch Ply plinth with acrylic and Sorbothane coned feet. Everything is manufactured to the highest quality, with attention to detail, enabling the Rega parts to be rebuilt into the new plinth, the company says. Inspire point out that parts of the Rega turntable such as the RB250 and RB300 tonearms, bearing housing and motor etc are of very high quality, and as such form the basis of a sound investment in the Quest upgrade package. Other options include practically any veneer such as Santos Rosewood, Cherry, Maple and Light American Oak. The cost of the full luxurious veneer finish is £89.

Inspire say that the Rega parts such as the bearing and tonearm, when fitted to the new solid Birch ply plinth, give a large improvement in sound and "elevate the Rega turntable up to some currently marketed turntables costing up to £2,000". This is even more so when you add the £89 Inspire 23mm machined acrylic platter, Inspire PUKA record weight, ACRI mat and offboard PSU, they say. Practically any Rega turntable in almost any condition, working or not, can be brought up to an extremely high standard. If spare Rega parts are needed, Inspire are able to provide them and also have new tonearms and cartridges available if required. The package is available for DIY, or Inspire will also offer to carry out the complete rebuild in their factory (which is located 1 minute off J29A of the M1 in Derbyshire) for a special introductory price of £40. If a customer wishes to send the Rega turntable to Inspire, a box and packaging can be provided and Inspire will also collect the turntable from any where in the UK for a small charge. Inspire also offer to do a 'while you wait' rebuild of your Rega turntable (by appointment). For details, call +44 (0)1246 827272 or click on www.inspirehifi.co.uk.



ARM'S LENGTH

Audio Note have three new "exquisitely made tonearms" just out. They use a single piece of machined aluminium for the armtube/headshell, which is internally tapered to keep the arm both stiff and light, it is claimed. Another solid block of aluminium is machined to make the bearing housing which contains 'captured unipivot' bearings. The arm uses the same geometry and fixings as Rega arms, so can be fitted to almost any deck, and thanks to a simple and effective collar, VTA can easily and repeatedly be adjusted in tiny increments. The arms are available in silver or black finishes, the three models being distinguished by the differing grades of Audio Note wiring used internally and externally; Audio Note Arm 1 has copper internal wiring and external wiring (external wire is Audio Note AN-A) for £654, Audio Note Arm 2 has Silver internal wiring and silver Audio Note AN-V external wire at £935, and Audio Note Arm 3 sports Silver internal wiring and silver Audio Note AN-Vx external wire for £1,265. For details see www.audionote.co.uk.

ULTRA VIVID

In the May edition of Hi Fi World we reviewed Inspire Hi-Fi's Vivid upgrade package for the LP12. In the review we stated that the Hercules Power Supply was 'Inspire's Hercules power supply'; we'd like to make it clear that this is Stamford Audio's excellent Hercules power supply, as supplied to us by Inspire. The remainder of the Vivid package is of course manufactured by Inspire Hi-Fi.

Ripping Yarns

A serious music server offering ease of use and proper sound quality is a long-held wish for Paul Rigby. Can the QAT MS5 make his dreams come true...?

Music servers have traditionally been focused on convenience and ease of use, with sound quality very much as an afterthought. For this reason they've acquired something of a poor reputation amongst discerning audiophiles, with only products from Naim and Meridian managing to escape this.

Understandable perhaps, as there's a lot that makes life difficult inside them; hard disk drives, computer CPUs and switched mode power supplies create a lot of sound-degrading electrical noise. But the QAT MS5 promises an audiophile approach, with hi-fi best practice applied where possible within. In the market, it sits right between the Olive 4HD (£2,250) reviewed in the June 2011 issue and the Naim HDX (£4,500) that editor DP rates.

It's certainly well made; its 425x370x265mm, 12.7 kg box initially appears deficient in some facilities but further investigation provides an underlying audiophile determination! For example, there is no wireless internet facility on the QAT (although wired connection is possible), you cannot play a CD directly from the drive, only rip from it and there is no fan built in to cool the Seagate ITB hard disk.

Talking to QAT's general manager, Hongfu Mei, in China, he addressed the fan question, "we chose a fan-less CPU and a passive cooling system for the hard drive in order to reduce mechanical noise." The CD drive, "we picked the TEAC DV-W28SS R93, pull-and-grab mechanism, it

takes less space and has a greater lifespan than a tray mechanism." Less of the budget then had to be applied to the sonic qualities of the playback transport. As it is, the transport is simple, noisy but it does the job and falls silent after the ripping process. As for the lack of Wi-Fi? "We found that it interfered with the music signal."

Add to that lot the inclusion of two AD1955 DACs feeding a fully balanced analogue output stage, and support for a host of file formats such as FLAC (the standard ripping format), WAV, APE, AIFF, WMA, M4A, MP3, AAC, Ogg Vorbis plus others via future software upgrades, and it's been properly thought through. There's also Internet Radio, two USB connections, a digital out for an external DAC, an external monitor socket and the option to upgrade the internal HDD.

Yet QAT haven't forgotten its identity; every good music server should come with a swish control interface and the RP5 remote pad is precisely that. It's a wireless graphics tablet sporting a colour 7" WVGA screen that acts as the QAT's only interface, talking to the server via a screw-in chassis aerial. Supplied with a resistive screen (a capacitive screen is being worked upon for a future upgrade), the tablet, which can be charged up via the mains, is operated with a stylus but will work, at a pinch, with your finger. Running under Windows CE operating system, it will be upgraded to Android 2.2 in the future.

In operation, the QAT worked well with no slip-ups. Ripping was completed, along with the odd

prompt, almost automatically while, if you are connected to the Internet, track names and the cover art are automatically applied. The lack of a Wi-Fi option does limit the QAT's placement, though, because, if your hi-fi is situated away from an Internet point, you will lose that applied CD track/image information. Missing CD text information can be applied

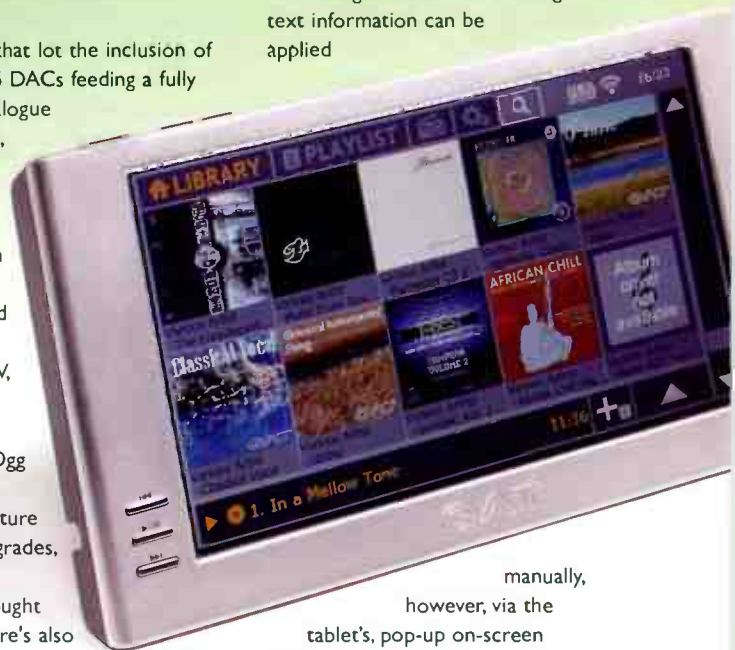

manually, however, via the tablet's, pop-up on-screen keyboard.

This large mobile screen, which incorporates a pull out stand, works well and is a big advantage over the frustratingly small and fixed Naim HDX screen and the poor, out-of-date, interface found on the Olive. Using a standard CD album art icon approach to trigger song access, the QAT interface is not up to Apple standards, certainly, but it remains straightforward to use, responsive and largely fool-proof.

SOUND QUALITY

Plugging the QAT into my reference, valve-based hi-fi via the phono sockets and playing Skunk Anansie's classic LP, 'Stoosh', the MS5 was compared to my superb reference Icon CD-X1 CD player. Of course, the Icon was superior, but what I did hear was a *damn* good attempt by the QAT to give it a run for its money. The sound was powerful, dynamic and had an unexpectedly



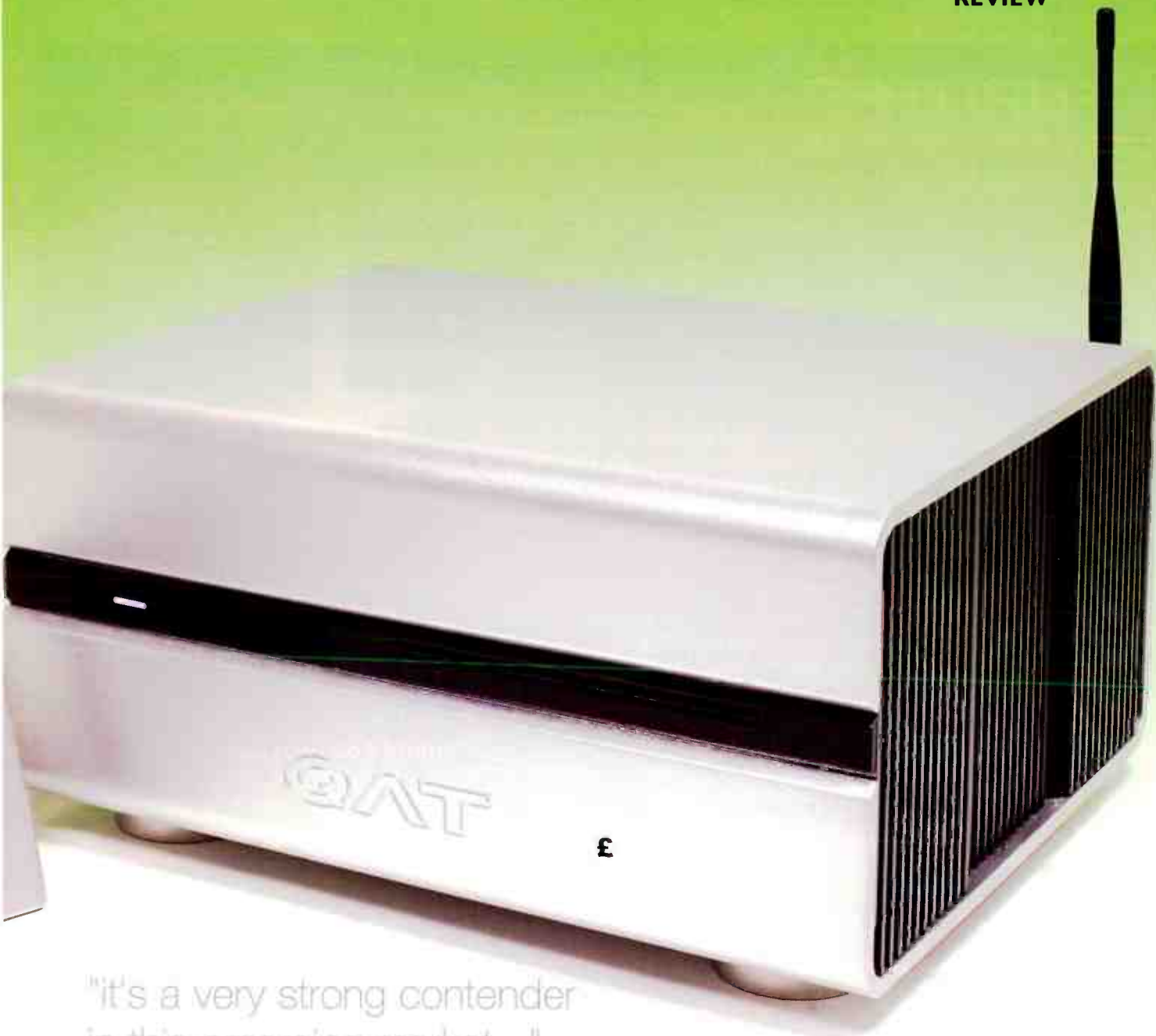

"it's a very strong contender in this emerging market..."

deep and firm bass, lending it both form and mass with a satisfying drum thump and a rhythmic bass guitar line. As a lowly music server, I also expected the QAT to lose control of the upper midrange and treble, but it remained smooth and all of a piece, with fine filigree detailing. It offered a delicate acoustic guitar strum, some glistening tambourine strikes and cymbal work plus sharp rim shots, plus a passionate and emotional accompanying vocal delivery.

The QAT really came into its own via the balanced outputs; indeed it transformed from being a capable music server with sonic aspirations to a genuinely viable audiophile source alternative. It seemed to dig deeper into the mix, offering a smooth yet punchy bass, a surprisingly incisive and nuanced vocal performance plus a stomach punching rhythm guitar. Acoustic guitar and cymbal work exhibited

admirable clarity. While listening to jazz vocalist Carol Kidd's 'Do You Believe', the balanced mode QAT delivered a more propulsive output with more subtle inflections than the unbalanced phono socket output could muster, with a more rhythmically precise approach to lower frequencies.

Does it match the standalone Icon Audio CD player outright? Well no not quite, but then again you wouldn't expect it to. Dynamically, it's a little softer and there isn't quite the same degree of upper mid sparkle. But I'm in no doubt that most sub £2,000 CD spinners would feel distinctly uneasy in the company of the QAT MSS. So is this music server a serious digital alternative to a good hi-fi CD separate? You bet! As such, it's one of the very few hard disk music machines that doesn't need to be plugged into an external digital convertor to give a half decent

sound; it's a testament to the MSS's sound that I didn't feel the need to go running to dCS!

CONCLUSION

After a large amount of listening, I'm confident in saying that when working via its balanced outputs, the MSS offers the best sound reproduction of any recently released music server that I've heard. It knocks the Olive 4HD for six, being superior along the frequency spectrum, while it's at least competitive with Naim's HDX, offering a richer and more contemplative sound even if it lacks the latter's punch and insight. Via the RCA phono outputs however, the sound is obviously less convincing, so I'd suggest you used the XLRs if you possibly can. Factor in a fine, fluid tablet interface and decent build quality, plus a wide feature set and it's a very strong contender in this emerging market.

VERDICT

Taking an audiophile route to music server design, the QAT MSS excels as a music source in its balanced configuration and sports a fine tablet control system.

QAT MSS £3,600
Angelsound Audio
 ☎ +44 (0)1923 352479
 www.angelsoundaudio.co.uk

FOR

- sound via balanced output
- easy, tablet interface
- styling

AGAINST

- no Wi-Fi might vex some



Magnum Opus

The MD 105 is Magnum Dynalab's top solid-state FM tuner, in an already highly accomplished range. David Price and Rafael Todes give it an airing...

It is not easy to review a Magnum Dynalab tuner. Rather like assessing a Bristol motor-car I suspect, frankly there isn't really much in the way of competition; there are other super-cars for sure, but none purposed to do precisely what the Bristol does. And so it is with the MD105, king of an already exalted court. I've reviewed lesser Magnum Dynalabs, and swooned at their sound and lovely another-era ergonomics, so what to expect from this, the £2,695 flagship?

Well, take the previous range topper, the MD 102, upgrade the components with higher tolerated ones, upgrade the capacitors and provide a more stable power supply, and you have the 105. It is said to have "an unrelenting focus" on a complete grounding circuit to eliminate any unwanted stray signals, and a zero negative feedback audio

output stage. The front end of the tuner has five stages of RF filtration with multiple bandwidth settings (normal, ultra wide and narrow), a dual automatic gain control stage to eliminate the need for a local and distant switch, altering the amount of relative gain that's added to the incoming signal. There's the usual auto blend RF circuit, often seen on classic Japanese tuners as 'hi blend', which automatically monitors and adjusts stereo separation to maximise stereo quieting.

Precision tunable matched IF (intermediate frequency) amplifiers are said to ensure consistency in adjacent channel separation, alternate channel separation and low distortion. The RF section is fully shielded and the power supply sports precision voltage stabilisers for precise tuning. A shielded custom designed toroidal transformer is fitted, coupled with a high grade

aluminium chassis. The circuitry is all laid out on thick PCBs to minimise vibration in the chassis, and all contact points are "generously gold plated" for long life. Special AudioCap polypropylene dielectric capacitors with gold plated OFC copper leads are used. Kimber Hyper-Pure copper wiring runs along the signal paths of the analogue output stage, which sports Burr Brown op-amps with Black Gate capacitors. Balanced outputs are provided via gold plated Neutrik XLRs.

As with all Magnum Dynalabs, using it is a joy. Two, easy to read, backlit analogue meters show signal strength (rather optimistically) and tuning accuracy, whilst set in between this is the central blue LED frequency display. Switches beneath provide power (on/off) interstation muting, stereo-mono, bandwidth and a toggle for the signal meter to display multipath. That's pretty much your



"if you're a radio head, then this is surely your goal..."

lot; no presets, no RDS, no MW, no biorhythm counter or cuddly toy! The result is an ergonomic triumph, one that reminds me of the good old days of analogue where tuning stations was actually fun! As with all Magnum Dynalabs however, the real enjoyment started when the music came on...

SOUND QUALITY

Here's one of the cleanest, purest and most musically believable tuners I've heard. Despite the retro looks, there's little that's old school about the Magnum Dynalab in its performance; don't expect a Leak Troughline! But on the other hand, you don't hear the usual greyness, grain or mush of most other modern FM tuners, which seemingly conspire to sully the signal into something resembling that of a £100 CD portable. Instead, this solid-state output stage equipped Magnum Dynalab (there's always the 105T if you want tubes) gives a consummately focused, incisive and detailed rendition of whatever's coming off air.

Bruce Springsteen's 'Born to Run' on BBC Radio 2's Jeremy Vine show sounded very similar to my LP pressing; a little thin tonally but sparkling with detail and punch. As

the song built up to a crescendo, I was struck by the clarity; there was I able to hear into every strand of the mix, instead of a morass of sound that's normally the staple of FM radio listening. Interestingly, this tuner makes you very aware of the BBC's broadcast CD players; it's as if you're listening direct to them. When the music stopped and Jeremy started talking, there was a dramatic difference in the sound; suddenly things filled out and acquired more space; I could hear his voice bouncing off the studio walls.

Moving to Fearne Cotton's Radio One show and I was struck by the difference in sound between The Boss and a modern electro track; 'Mr Saxobeat' by Alexandra Stan is a piece of puerile pop *par excellence* and not one I'd normally endure, but its heavily EQ'd and compressed mix showed the

105's shimmering treble, expansive midband and punchy, insistent bass. It also timed beautifully, those hi hats stopping and starting with great alacrity; I couldn't comment on the dynamics of course, as I suspect there wasn't a decibel's difference between the loudest and quietest moments of the track!

Winifred Robinson's calming strains on Radio Four's 'You and Yours' were beautifully carried, presenting a very strongly resolved central image between my



AMPLIFICATION

ATC SIA2 150 integrated amp.
Mint, ex-demo. (£2838) EPOA

Aaron No.1a reference integrated amp.
Stunning performance, hand crafted in Germany.
(£3450) ex-demo bargain, mint. £2450

Parasound Halo C2 Processor and A52 5 Channel Power Amp. One of the finest HT combos for under £10,000. Original boxes, remote and all accessories. (£5000) only £1595.

Cayin 860 Valve Monoblock Pair (70w).
16mths old, perfect condition, original boxes & manuals. 4, 8 & 16 ohm taps, built-in bias meter for easy calibration. (£4200) Bargain at only £1995.

Mark Levinson 380 pre & 334 power amp.
Excellent, boxed, original packing, factory metal remote. (£12000) £5998

Naim NAC 62. Excellent condition, only £179
Naim NAP 150. Boxed, excellent, bargain £475.

Icon Audio MB25. Stunning 30w valve mono blocks, great reviews, one owner. (£1995) £1095

Pioneer A6 mk2 integrated. Black, ex-display, mint, boxed, full warranty. (£499) £299

Luxman L-507u. New model, mint, boxed, 6 wks old, 4hrs use, supplied by us, genuine reason for sale, please contact us for details. (£4795) EPOA

Raysonic C200 all valve pre-amp. Boxed, unmarked, stunning performance. Cost new £2595 so a complete bargain at £1195.

ATC CA2 pre with P1 power. Mint, amazing reviews, originally supplied by us. Balance of 6yr warranty. (£3096) EPOA

Eastern Electric M520 mkII Integrated Amp.
Our demonstrator, 6mths old, perfect condition, original packing & remote, won Hi-Fi News group test, awarded Editor's Choice. (£1995) only £1295

Restek MPRE+ with MAMP monos. Ex-demo, mint, boxed, 5yr warranty. Scored 85% in recent HiFi Choice review. (£3000) £1595

ASTIntrew AT2000 plus integrated. Black, stunning performance, originally supplied by us. Mint condition. (£1739) £1195

ATC SCA2 pre amp. One owner, supplied by us, only 8mths old. Boxed, mint. (£5261) EPOA

Chord SPM-1200B Power Amp. 250 wpc, black with wooden side accents, excellent condition, recent service from Chord. Original box & packing. Rare as used (£3950). Opportunity at only £1395.

ECA Technologies Vista Pre and Lectern Power Amps. Black with gold logos, immaculate. Very musical combination. (£1700) only £599.

Deltec DPA505 power amp. With Deltech 5005 Slink speaker cable, boxed, manual. (£990) £495.

Eastern Electric MiniMax Pre/power combo.
One owner, supplied by us, unmarked as new, 2 mths old, 5yr warranty. Stunning performance, amazing reviews. (£2195) £1295.

DIGITAL

Antelop Audio Zodia DAC +. Mint condition, ex-demo unit, 5yr warranty. (£1895) EPOA

Naim CD2. Excellent condition, remote, boxed, din interconnect, 12mths warranty. £595.

Cambridge Audio DAC Magic 1. Boxed, excellent condition, perfect for computer audio. £79.

Densen B-420. Black, ex-demo, mint condition. (£1800) £1195

Benchmark DAC1 USB. One owner, silver, excellent condition, boxed, packing (£1295) £795.

NAD M5 SACD/CD player. Part of the NAD Masters Series programme, great reviews. One owner, originally supplied by us. (£1600) £895

TEAC VRDS 25 CD player. Stunning condition and amazing player in black. £695

TEAC VRDS 10 SE. One owner, as new, original packing, 12mth warranty. VERY rare. £595

Densen B-410 CD player. Mint, Gizmo remote (costs £175), one owner, black, great reviews. (£1295) £795

MBL 1621 CD Transport & 1611F D/A Converter. Original cases, manuals & SFG B remote. Arguably best combo in the world today. Piano black & gold, some brassing, minor marks. (£35560) be quick at £12995

audioemotion

Music is our Passion

www.audioemotion.co.uk

t 01333 425 999

QUALITY PRE-OWNED.

LOUDSPEAKERS

Quad ESL 2905. Higher cost Classique finish, one owner, supplied by us, mint, boxed, original shipping cartons. (£7500) EPOA

B&W 802D. Rosenut. Months old (Nov 2010), mint. (£9500) A huge saving on new price £6990.

Wilson Benesch Curve Loudspeakers. Excellent condition, packing, one owner. Boxed. (£5950) £2995

Quad ESL 2805. Brown, one owner, boxed - a rare opportunity. (£5000) £2695 with full warranty.

Verity Sarastro mk1 Speakers. Ex-demo, high gloss Makore (premium finish). Mint with flight cases. (£37995) £13895.

ATC SCM 50 ASL Classic Actives.
Walnut, ex-demo, mint condition. (£10252) EPOA

Klipsch Heresy III Speakers. Walnut, one owner, supplied by us, mint, boxed, 99db efficient and a 5-globe HiFi World review! (£1998) £1495

MBL 121 Speakers. Satin black, one owner, supplied by us, months old. Mint, original factory crates. (£10600 with stands) EPOA

Klipsch P 38f Palladium series. Ex-demo, one of the best speakers you will ever hear. (£9870) EPOA

ADAM Audio A.R.T. Pencil speakers. Cherry/dark silver, astonishing articulation, excellent condition, all original box and packing. (£3600) only £1695.

Audio Physic Virgo V. One owner, supplied by us, excellent, original packing, maple (£5500) £3395

Audio Physic Scorpio II. Latest model, cherry, ex-demo, unmarked. (£3773) £2750

Quad ESL 2905 speakers One owner, mint, boxed very low hours. Amazing reviews (£7000) only £4990 with a 5yr warranty

Audio Physic Tempo VI Loudspeaker Maple, one owner, 6mths old, unmarked, original packing. (£2612) bargain at £1895.

ANALOGUE

Michell Gyro SE with Jeff Spall Audiomods Arm.
Micrometer edition (£800 for arm alone) excellent condition, record clamp, one owner. (£2200) £1295

Creek OBH-18 MM Phono Stage with OBH 1 PSU.
Immaculate, cracking phono stage. (£205) only £115.

Restek MR1A+ Phono Stage Ex-demo, mint. (£1195) £695.

Tom Evans Groove Phono Stage. Boxed, excellent condition, (£1900) £1095

Whest Two Phono Stage. Boxed, as new, ex-display, unused (£795) only £595

Dr Feickert DFA-105 10.5" Tonearm. Stunning, boxed, excellent condition, one owner. (£650) £395

Jelco SA 750E 10" Tonearm. Boxed, new, unused, fantastic reviews (£550) £295

Trichord Dino MM/MC phono stage.

Great reviews, amazing value at only £219

Whest P520 two box phono stage.
Boxed, as new. (£1200) only £595

Roksan Xerxes Turntable with Artimez Tone arm. Black, brand new XPS7 power supply, excellent condition, minor crack to perspex lid at rear. (£3800) £895

Michell Iso MC Phono Stage with Hera PSU.
Original box and packing, excellent condition. (£900) and now only £295

Linn LP12 Arm Board. Original and as new. £25.

Eastern Electric Minimax Phono Stage. Months old, one owner. Sensational (£1495) £1095.

MAINS CONDITIONING

Pure Power 3000i mains regeneration (2011).
Ex-demo, silver, mint. (£3898) EPOA

Van Den Hull BS Hybrid Mainstream mains power cord. 2m, 2 available, both one owner, excellent condition (£350) £199 each.

Vertex AQ Taga (2011). 6-way distribution mains filter, great reviews, one owner, mint. (£906) £685

Naim Hi-Cap (Olive). Excellent, one owner. £359

CABLES

Vertex AQ Mini Monaco Speaker Links.
Set of 4, 80x65x30mm acoustic absorption module - simply sensational. (£570) EPOA

Eichman Express Six 1m interconnect.
Boxed, excellent condition. (£195) £99

Chord Optichord Optical Cable. Toslink to Toslink

· 3m, 50 MHz bandwidth specification. Only £49.

Vertex Hi Resolution Solfonn (rca rca) Interconnect. 1m, ex-demo, simply sensational (£2047) only £1120.

Vertex Silver Solfonn (rca-rca) Interconnect. 1m, ex-demo. (£1092) only £660.

Chord Signature speaker cable. One owner, boxed, as new. 2.5m great reviews. (£775) £445

ACCESSORIES

QUAD ESL 63 GFD MKIIS Speaker Stands.
A 'must have' for any owner of the 63, perfect 'on axis' adjustment regardless of distance. Complete with the original GFD set-up guide (£210) only £95.

Stax SR5-4040 Signature System II with SRM-006t II. Kimik upgrade (£200). Mint, boxed, as new. (£1449). Bargain at £895!

Sennheiser HD600 headphones.
Excellent condition, one owner. (£395) £195

MISC

Mission m7ds Surround Speakers.
Black, original packing and manual, perfect condition, with incredible dispersion. Only £40

RAFAEL TODES SAYS:

Listening to Shostakovich's epic '5th Symphony' on a live Radio 3 broadcast from the Bridgewater hall conducted by Vasily Sinaisky, immediately yielded a rich string texture, woody and complex, bursting with body, yet delicate in its accuracy. The atmosphere of the Bridgewater Hall was captured beautifully, a large deep soundstage, which I could see in front of me, particularly during the tumultuous applause that followed the final notes. Compared to my trusted Naim NAT-02 tuner, bass was far more present and real; the Naim sounded a bit murky in the lower frequencies by comparison. The favourite rhythm that Shostakovich likes to use in so many of his pieces, sometimes used to poke fun at the military, was so much more engaging on the Magnum Dynalab. I particularly like the quality of the plucked notes produced in the second movement on the tuner, they are nail-bitingly fast with quite some punch behind them.

The difference between the two tuners reminds me of upgrading from a good moving magnet cartridge to a classic moving coil, suddenly there is presence, body and real nuance to the sound like those which emanate from the live stage. The quality of individual woodwind instruments through the MD150 ooze with personality. The Naim makes a paler imitation by comparison. The chiselled soundstage of the MD just isn't there with the Naim - it is a pleasant wash, with altogether less information. I also notice where the broadcast

engineer is 'over-controlling', taking the levels down when the music gets too loud. I don't think I have ever been so aware of this annoying tweakery before, but as FM has around 48dB of dynamic range, as compared with 110dB of CD this is an inevitable occurrence, but the MD with its transparency certainly lets you know when it's happening.

Listening to the Vienna Piano Trio playing Mozart live from the Newbury Festival, the MD sounds like there is far less reverb than the Naim. The MD makes much better sense of the performance space, it sounds as if you are a few rows nearer to the performers, and the instruments look and sound bigger. Listening to 'In Tune', Radio 3's live drive time show, produced in a woefully inadequate compromise of a studio which uses both live speech and music, requiring both a dry acoustic for speech, and a wetter acoustic for music, the BBC's solution is to add reverb to the music, in a crude unnatural way. The MD rips this fudge to shreds, unmasking the inorganic nature of the audio processing going on.

This tuner is very quiet, and facilitates the textures of the instruments to come out beautifully. I am aware of the rich complexities of the sound - it is as if the string players have a bit more rosin on their bows, the sound has more edge, bite and body, blood and guts to it. You feel physically closer to the performers. However give it some poor quality material, and it really lets you know! RT



REFERENCE SYSTEM

- MF Audio Passive Preamplifier
- World Audio K5881 valve power amplifier
- Yamaha NS1000M loudspeakers
- Black Rhodium Tango speaker cable

loudspeakers; she has a deep and smooth voice with a rich timbre and the MD-105 rendered this with great skill; I found myself listening to her resonating around the studio walls, with that typical BBC studio low end warmth and top end dullness (having done some radio for the Beeb in my time I know what their studios sound like when you're in one). I also found myself listening to a room mode in my own listening room, the crystal clear feed from the Magnum Dynalab kindly reminding me that my NS1000Ms aren't quite as happy against the rear wall of this new room as they have been in others. Oh dear, moving swiftly on...

CONCLUSION

It's hard to fault the Magnum Dynalab MD-105, simply because its ability far exceeds the quality of about ninety nine percent of British radio broadcasts! It's extremely detailed, almost forensically so, yet can sound beguilingly musical given the chance. The MD-105T tube option I've yet to hear, but I'd imagine that sweetens the pill that is today's largely compressed and digitised FM radio output. This all solid-state version proved to be the

best modern FM tuner I've heard to date, along with being one of the

nicest to use. If you're a radio head, this is surely your goal.

MEASURED PERFORMANCE

Our frequency response analysis shows the MD105 measures flat from 40Hz up to 10kHz within 1dB limits. Slightly unusual is the low frequency roll off, which may lighten bass a tad in direct comparison with other tuners, most of which are flat down to 10Hz. A smooth roll off above 10kHz exists and this will soften the top end slightly, reducing sparkle. There is no mpx filter at 19kHz to notch out pilot tone and the absence of phase rotation it creates will give more 'solid' treble. However, pilot tone was strong, measuring -51dB and this can cause whistles in tape recorders.

Distortion was as expected, measuring 0.4% at 100% modulation and 0.18% at 50% modulation via BW1, mostly second and third harmonic. Levels rose a little via BW2. Although separation was a high 56dB with a 1kHz test tone, distortion in the quiet channel brought this up to a not-so-good -36dB, a common problem in VHF/FM tuners.

The signal strength meter was of little use, reading maximum (8) with a very weak 14µV from the aerial when the tuner needed 34µV for hissy stereo (-50dB noise) and 950µV to reach full quieting. So the meter reads maximum of 8 all the time irrespective of signal strength and it would not reach 10 no matter how strong the signal. Once into full quieting noise measured -69dB on stereo, a normal result.

Frequency response	40Hz-12kHz
Stereo separation	36dB
Distortion (50% mod.)	0.18%
Hiss (CCIR)	-69dB
Signal for minimum hiss	0.95mV
Output	1V
Sensitivity	
mono	3µV
stereo	34µV

FREQUENCY RESPONSE



DISTORTION AT 50% MOD.



VERDICT ●●●●●

Brilliantly capable FM tuner; minimalist in facilities but superlative in sound.

MAGNUM DYNA LAB
MD-105T £2,695
 Audiofreaks
 +44(0)208 9484153
 www.audiofreaks.co.uk

- FOR**
- sublime sonics
 - wonderful ergonomics
 - charm, character, style
- AGAINST**
- sounds too revealing for most UK stations!
 - signal strength meter

Dark Side Of The Tune

David Price says Eclipse's TD712z/2 takes the listener to places other loudspeakers cannot reach...

There are two ways to make a high end loudspeaker. One is to take a conventional box, standard drive units and a well worn cabinet design, then tweak it, finesse it, embellish it, add a bit of stardust and spend longer on the final voicing than you normally would – then punt it out to the trade and hope that fans of your brand, plus well healed sorts willing to try something new, will bite.

The other is to start with a – not to put too fine a point on it – bonkers idea that few are likely to love, and then hone it to perfection, on its own terms so that the designer has achieved exactly what he wanted. Oh, and then work out how much it costs to make and hope it's saleable after all the usual mark ups, dealer margins and VAT have been added!

I'll leave you to guess which of the two approaches the Eclipse TD712z/2 is. It can only afford to be so as part of Fujitsu Ten, which is a huge and long lived manufacturer of automotive audio (credited for producing the world's first car CD player for Toyota, in 1983, for example). Eclipse's parent company has over four thousand employees and

a vast wealth of electronic and mechanical engineering resources. And so whilst Fujitsu Ten goes off and does the donkey work, so to speak, its Eclipse progeny can run round thinking the unthinkable and doing the hitherto undone...

It's ten years since the launch of Eclipse's first product, the TD 'eggs'. These were premium priced, beautifully built active multimedia speakers, cost-no-object high end exotica that had mysteriously shrunk in the wash and selling for a trifling £400! Warp forward a decade and here we have the TD712z, now in their new second incarnation (the originals were launched in 2004); they're £5,100 per pair in silver, £5,400 in black. The 'TD' nomenclature stands for 'Time Domain', which is more than just a clue to the designer's priority; it is the beginning and the end – oh, and the middle bit too. Whereas most loudspeakers are designed above all else, to cover a wide bandwidth (say, from 60Hz to 20,000Hz, roughly), and to be reasonably efficient and go loud, to have a flat(ish) frequency response, with the Eclipse speakers all of this was very much second fiddle. Instead,

the absolute priority was blistering transient speed. This can only come through ultra light drive units (which are exercised by the tiniest dynamic peak) with no crossovers to introduce phase distortion, and cabinets that have absolutely no overhang. And when I say overhang, I don't mean the sort you'd find on your sitting room sideboard; I mean in the sense that they don't store mechanical energy, like a capacitor would electricity, that they then release when they're ready. From this, all else follows...

Indeed, if transient speed is your design priority, the speaker practically designs itself. It's got to be full range (to remove the need for a crossover), it's got to be smallish (to remove the need for an energy storing cabinet), and it's got to have a very light and stiff cone (you can't use a single ribbon or electrostatic panel because there's

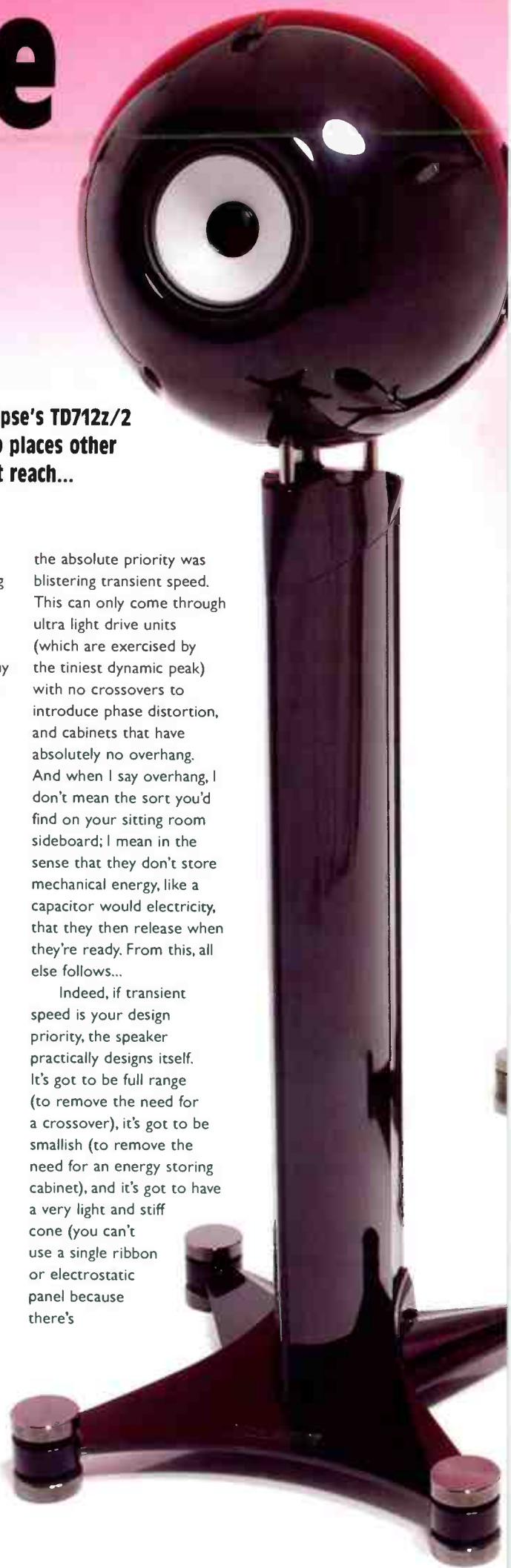



not enough bass). Meet the TD712z/2, ladies and gentlemen! Okay, you could go for a large cabinet or frame and use electrostatic panels or ribbons, but then you've got other issues to deal with, and life becomes a lot more complex, and then suddenly you're diluting your original design brief. That's why Eclipse have kept it simple; like a Caterham Super Seven sports car without a hood or heater, it's purposed to do a very precise job and everything else is for someone

else to worry about!

So the TD712z/2 has a 120mm full range driver with a fibreglass cone mated to a special, ultra flexible rubber surround, and a "huge" magnet behind. It sits in a 989x347x431mm egg shaped cabinet made from steel, zinc, aluminium and composites; the egg is the most rigid form known to nature, say Eclipse, and maximum rigidity means minimum cabinet flex (and associated blurring of the sound). With no two radial surfaces in the same plane, it's not a happy place for standing waves, and the internal zinc-alloy structure makes for a massively strong shell which is bolted to its matching stands which are said to "earth all unnecessary energy" to the floor. An elaborate 'diffusion stay', a five-armed, cast zinc structure on the rear of the drive unit sends any residual energy down into the stand. A special 'poron' material is used to give an ultra strong seal between the driver and cabinet.

The 'damped Wing Stand' allows adjustment of up to 12 degrees upward, and is said to echo the design of an aircraft wing in the way it slices through the air, so as not to diffract the sound emanating from the speaker all around the room, it is claimed. It's made from a combination of extruded and diecast aluminium, offering rigidity and internal damping via irregular sized, kiln dried sand. It has an unusual integrated spike and insulator foot arrangement, which further helps ground stray energy; the speakers can be moved without scratching the floor and adjustments can easily be made, and there's a recess for cables built in. Total weight of one speaker and stand is 25kg.

This new version of the 712 is said to have a more powerful motor system for the drive unit with a more efficient magnet structure, a redesigned damping system for the driver surround, new high-density zinc internal components, a new design of coupling to the integrated stand and a cabinet that's fifty percent larger in volume. The result is a speaker with a claimed "useable" frequency response of 35–26,000Hz; it's notable that this is taken at -10dB points, our measured performance uses a much more realistic -3dB cut off point and tells a different story! We found this loudspeaker to be drivable by our Icon Audio MB845 valve monoblocks, which fortuitously were the best things for it. Transistor amps proved too sterile, whereas most other tube amps were too weak kneed.

SOUND QUALITY

A number of recording studios use the Eclipse TD712z/2s as a sort of semi-near field monitor, pointing right at the sound engineers from behind the mixing desk. They'll go loud, but still won't drive really large rooms, so buyers would be running them in small to medium sized environments, and even here, as our listening shows, they'll not be expecting huge swathes of low frequencies. Frankly, there's *not* an awful lot going on below 100Hz, whereas it's the opposite state of affairs as far as the midband is concerned. However, this doesn't mean shrill, as it's of super quality and that's precisely what makes it the special thing that it is. Whilst there's definitely the sense of these speakers being 'well lit', there's no sense of them (via the right source and amplification) being shrill. Instead, they use their withering intensity to shine a searching light on the mix, putting you right in the centre of the action. The effect is almost like wearing a pair of ultra high end headphones, but without the sensation of having your head in a vice.

There's another point to be addressed; they're not famously extended in the treble either, and this will disappoint some. Whilst not muffled, you're never going to find them airy, spacious and atmospheric. As you get older and your high end hearing falls off, this will become less of an issue, but still for me I could hear obviously less 'air' to recordings than via my reference Yamaha NS1000Ms, for example. The happy caveat to this is that what treble they do have is really rather nice; cymbals have a grace to them that's just not expected from single-celled speakers; it's obvious that a lot of honing has been going on.

So what we have is a deliberately compromised loudspeaker, that forsakes ability at both frequency extremes for prowess in the midband. And what prowess! Sade's 'Hang on to Your Love' can sound like bland 'cafe jazz' – all gentle, lazy Fender Rhodes chords and a sultry crooning – but via the Eclipses it had an unexpected urgency. The walking bass line, closely miked, was fizzing with energy (if not weight), lending the song a tremendously propulsive feel that could have come from a late seventies Stranglers song. This was hardly the stuff of brillecreamed eighties boys in black polo necks languidly smoking Silk Cut; instead the track was utterly gripping and compelling, pure edge of the seat stuff. It wasn't just the bass that did





a class above

With the same innovations as KEF's revolutionary Concept Blade technology showcase, the all-new Q Series from KEF performs like speakers from a higher price class in terms of realism, musicality and off-axis dispersion.

'...you really are given a live performance in your listening room, full of sensation and energy.'

Q100, Hi-Fi World - April 2011.

Q Series

All new Uni-Q array.

Sweet, spacious and true, wherever you sit

A large vented tweeter in the centre of the bass/midrange driver, with a 'tangerine' waveguide and unique Z-flex surround to combine unrivalled dispersion with generous travel for the aluminium MF/LF cone.

Advanced bass technologies.

Deeper, tighter and more accurate bass

Inside the fashionably rectilinear cabinets, the new bass driver combines a rigid superlight cone with a massive vented magnet assembly and an oversized voice coil for exceptional sensitivity and distortion-free power handling.

Total system design.

A holistic approach, with no compromises.

These advanced new drivers only need first order crossovers, maximising fluency and transparency, and KEF's legendary attention to detail extends from innovations for easier bi-wiring to environment-friendly finishes.

this though, as the rhythm guitar playing suddenly became a percussive instrument rather than something to fill the mix out; it was super crisp, ultra fast and infectious. I could hear every 'lick' and how it fitted so precisely in with the backing toms. At the same time Sade's vocals acquired a wonderful grace to their timing, syncopating perfectly with her backing band.

I was also tantalised by the way I heard her various layers of backing vocals; indeed there was one very low level vocal line where she almost speaks the vocal behind her main sung one, and the Eclipse carried this more clearly than I've heard on any other speaker, save perhaps a top Martin Logan. Such was the 'butter slicing' ability of the TD712s that they signposted dynamic accents brilliantly; again whilst not possessing great scale and power, they can show where individual instruments such as snare drums are struck particularly hard, where so many other loudspeakers at the price (such as the big Spendor STs) simply sit on this sort of nuance.

For sure, rhythmic skill is the key to the Eclipses; Next on, Michael Jackson's 'Billy Jean' was hovering in space imperiously in front of my very ears, floating on a wonderful rhythm laid down in the studio so artfully by producer Quincy Jones. Even on flabby boxes it's hard not to tap your feet, but the Eclipses were sublime in this respect, giving a heightened, almost otherworldly sense of the flow of the song, via the ultra percussive playing of the bass guitar, drums, guitar and of course Jackson's vocals. The way the drummer hit the snare then went straight on to the hi hat was a joy, showing just how immense tiny rhythmic details can be in a song. At the same time, there was no sense of these loudspeakers excavating detail for its own sake; whilst they through out vast tracts of information it was all strung together in a wonderfully cohesive way.

Joan Armatrading's 'Love and Affection' had the Eclipses in their element; her voice hung from heavens with utter impunity; you got the sense you could get up and walk about the room and wherever you went it would still be hanging up there majestically. Steel stringed acoustic guitars chimed out, and that saxophone solo soared; strings resounded around as if played from some ethereal orchestra, and backing vocals hung gently behind it all. All the time, the instruments came over with shimmering clarity, and yet slotted so well together temporally. Again and again I kept finding myself

listening intently to the 'inner rhythm' of the song, the subtle interplay between musicians and the way it all timed. This is such a rewarding aspect of music, yet save a few £10,000 electrostatic designs, I don't think I've heard something convey this so well.

Throw some modern jazz at the TD712s and it's quite an unusual experience. Much of why I like listening to music such as Lonnie Smith's 'Think' is the wonderfully opulent textures of the instruments, caught and preserved for generations. With little in the way of low bass (and not much mid bass either, for that matter), the Eclipses gave a distinctive rendition that certainly lacked physical heft, or 'bottom' as one might say. But almost immediately this faded from my mind, and I found myself enthralled by the playing of the instrumentalists, and the fierce syncopations of the music. Once again, these loudspeakers cast an exotic spell over me, pulling me in and heightening the effect of every sinuous twist and turn of the snare drum and double bass playing. Cymbals seemed to glide above everything, gilding a magical musical moment. In superficial terms (i.e. what one might call the 'tone') things were disappointing, but once you heard beyond that there was seriously special things going on.

Indeed, that's my major criticism of the big Fujitsu Tens; they're tonally uninviting. It's that glass fibre cone, methinks, which sounds distinctively dry and lends a certain sort of tonal patina to the proceedings which doesn't quite ring true to me. Ironically, the lack of low bass and high treble were less intrusive for this listener than that dryness. Still, familiarity soon helps you 'tune' this out of the equation, and when you've got used to these loudspeakers' distinctive personality traits, suddenly you're into a world where the timing of the music is unlocked in a way hitherto almost never heard before. I ran the gamut of programme material and the Eclipses never failed to go for the rhythmic jugular within

nanoseconds of the music starting; it's quite a trick!

CONCLUSION

This is what I call 'a character speaker', which is to say that within seconds of hearing it, you know precisely what it's been designed to do – whether you like it or not. If ever there was a transducer that purposefully pursues one kind of greatness, at the expense of all others, then this is it. The Eclipse TD712z/2 singularly excels at making music magic; entrhralling, gripping, compelling. It's not much cop at many of the other things expected of an expensive loudspeaker; you can forget about deep bass and sparkingly atmospheric treble. Instead this loudspeaker makes you a slave to the rhythm, and – as the song says – never stops the action. Whether you think this is worth the asking price is not for me to say, as it appeals to personal taste so it's for an individual listener to decide. That makes it very tricky to rate; in some ways in scrapes three globes, in others it pretty much deserves six. So the answer is to go and listen for yourself.



VERDICT ●●●●●
 Flawed genius, and wilfully so. These loudspeakers don't do everything terribly well, but what they can do is profound and entrhralling; rhythms, dynamics and soundstaging.

ECLIPSE TD712z/2 £5,100
 Eclipse TD Ltd.
 ☎ +44(0) 20 7328 4499
 www.eclipse-td.net

- FOR**
- superb rhythms & dynamics
 - excellent soundstaging
 - forensically detailed
 - superlative build & finish
- AGAINST**
- poor frequency extremes
 - dry tonality
 - needs compact rooms
 - demands smooth source

MEASURED PERFORMANCE

Using a small drive unit in a chamber of limited volume, certain parameters such as bass extension and power handling will be limited. The Eclipse does not escape such limitations, by trading sensitivity for example, and our frequency response analysis clearly shows bass rolls away slowly below 200Hz then faster below 100Hz, so bass will be light and a subwoofer useful. The port provides some output around 40Hz which helps matters, but measuring just +1dB above drive unit output at 80Hz its contribution is limited.

The single drive unit has a smooth response and will lack colouration. It does, however, peak at around 1.5kHz and this effect will add emphasis and presence, boosting vocal intelligibility for example. Upper treble falls away so although the Eclipse will sound forward, it will not sound sharp. As there is no crossover, it will also sound solid in imaging and lack phasiness.

Sensitivity was good at 87dB so high power amplifiers are not obligatory and around 60 Watts will do. Impedance measured 8 Ohms, using pink noise and our impedance graph shows that the load is resistive except at low frequencies where the usual 'side peaks' around port damping are strongly reactive, which some amplifiers do not like.

A 200mS decay spectrum 'waterfall analysis' and colour mapping confirms what the response analysis suggests, that colouration is very low.

The Eclipse will have a light, fast, forward but clean and pure sound. It will also sound solid and stable in its imaging, more so than most loudspeakers. It may well benefit from use with a subwoofer though. NK

FREQUENCY RESPONSE

Green - driver output
 Red - port output

IMPEDANCE



Two's Company

When Leema Acoustics Pyxis preamplifier met its Hydra II power amplifier, it was love at first listen, says Tony Bolton...

Wales based Leema Acoustics have, over the last thirteen years grown from manufacturing respected studio monitor loudspeakers to making a wide range of loudspeakers and electronics encompassing amplifiers,

CD players and phono stages across three distinct series and price points. Although each series is divided by nomenclature, there is nothing to stop the prospective purchaser mixing and matching as we have done here. So, from the Constellation range we have the Hydra II power amplifier, and from the premium

Reference selection, the Pyxis pre-amplifier.

Both units are housed in the customary Leema casework, available in either black or silver. Although they look the same, the sizes do vary slightly, the Hydra II measuring 440x110x320mm (h x w x d) and the Pyxis being 10mm deeper. The

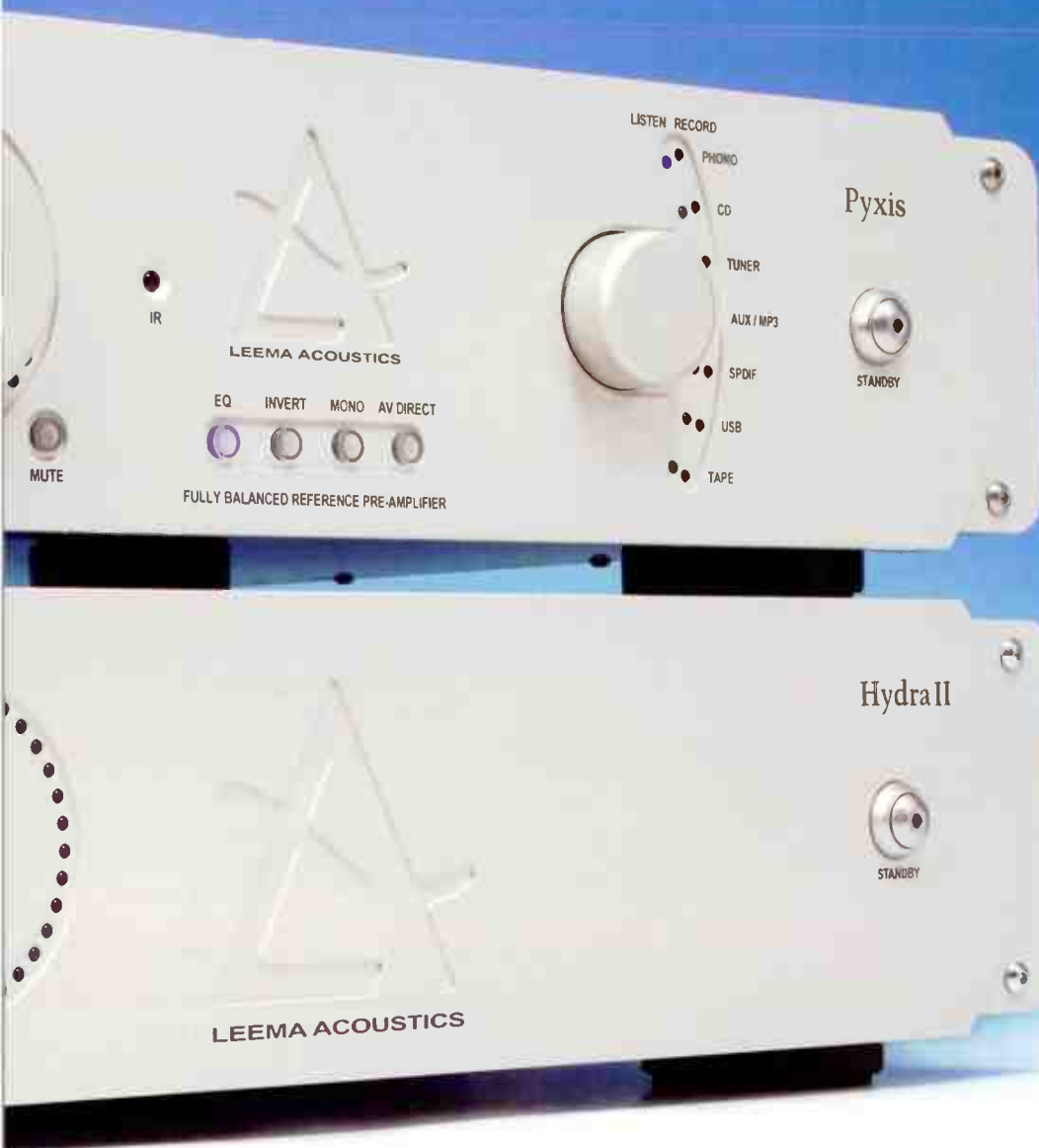

latter weighs 11kg and the former a fairly substantial 18kg.

Sorry to disappoint a certain subsection of our readership here, but reading the instructions is essential with these units [doh! Ed.], since there are various ways to connect them up, and some controls have dual functions. For example, the volume control becomes a bass, treble or balance control when these settings are accessed. After brief experimentation I settled for using the LIPS connection between them, along with the interconnects, which allows the Hydra II's volume to be controlled internally, so that the signal is delivered from the Tucana II or Pyxis at full power. The lower noise floor was noticeable, with both the shape and perceived agility of

the music improving – so care spent setting up is rewarded.

This Pyxis came fitted with the optional moving magnet and moving coil phono stage which costs an extra £404. If both preamp and power amp are purchased together then a special price is available of £6,050, providing a saving of £495. A

Pyxis and two Hydra IIs are available for £9,950, saving £1,035.

SOUND QUALITY

I was able to borrow a Hydra II a little while ago, so have been using it to bi-amp the Chario Ursa Majors on the downstairs system, alongside the resident Tucana II. Although this



Leema Acoustics Hydra II



Leema Acoustics Hydra II

integrated amp does a good job on its own, I periodically wish for a little more control over the twin 170mm subwoofers housed in the lower parts of each cabinet. Adding the Hydra II not only provided this but had the effect of opening up the sound far more than I could have wished for. The combination gave a vast soundstage into which the Philharmonia Orchestra launched itself into Beethoven's 'Choral' Symphony.

It seemed as though the space between the speakers had grown in all dimensions - a similar change in perspective to moving about fifteen rows closer to the action in an auditorium. Detail such as the interaction between the differing groups of singers and instrumentalists became more obvious and the whole experience became considerably more satisfying.

It was also present for the recent preamplifier group test (HFW March 2011) rubbing shoulders with a pair of Icon Audio 845 valve monoblocks and being fed by solid state, valve and passive preamps. It showed itself to have a very well behaved nature, sweet and beguiling, or somewhat feisty, as the music required. Timing was both tight and sprightly, providing beat driven sounds with an infectious zest that was irresistible.

More recently the Pyxis joined the team, and after a good few hours of running in, I played the same Beethoven track, running from the Benz Micro Wood SL into the Leema Agena and then the Pyxis via its XLR input. Although there was a noticeable difference in the grip upon the lower frequencies with this single amped combination, there was an improvement in the detailing and colour of the sound. Wooden instruments had more shape and, it felt, better detail to the graining of the polished wood. Brass instruments

had enough edge to be impactful without vulgarity, and the vocals separated just a little bit more. I felt the Pyxis to be a more open and sharply focused preamp, compared to the already very good one included in the Tucana II.

Since a second Hydra II had been delivered, I was able to try the same track, but with the power amps running as monoblocks. These can deliver a claimed 785W as bridged mono units into the 4 Ohm load of the Ursa Majors so I didn't bother

"individually these are excellent pieces of equipment, but combined they are superb..."



Leema Acoustics Pyxis

exploring the full volume potential, but found that, at the same volume as before, the degree of presence and my interaction with the music had increased to the point that I really felt that I was listening to a performance, rather than having any sensation or awareness that I was listening to a recording. It was majestic.

By way of contrast a few days later I was playing Dusty Springfield's 'Son of a Preacher Man' from the LP 'Dusty in Memphis'. By this point I was using the onboard phono stage and finding it to be a very competent device. Her close miked voice was almost physically there in front of me, with a neat and precise placement of the accompanists

around and behind her. It certainly sounded more coherent and cohesive than I would have expected for the extra cost and proved a worthwhile addition to the preamp. A move to the upstairs system and the Moving Iron MusicMaker III cartridge proved that the MM input was every bit as capable as its MC counterpart.

Over the next few days the digital inputs were explored using both the Njoe Tjoeb CD player as a transport, and my MacBook via the USB input. In both cases the Pyxis's onboard digital converters did an excellent job. The combination of Middle Eastern instruments and melody, mixed with Western influenced electronica on 'Arabica III' on CD was opened up and analysed, then laid out before me for my perusal. Some of the samples are so well done that it isn't always obvious which is a 'real' sound and which is an electronically manipulated one. Listening through this pre-power combination, and the onboard converters clarified that in some cases. It managed to reveal the detail in sound without thrusting it in my face, in the way that some overly revealing players can do. The shape of sounds seemed honestly depicted without a feeling that they were

being spotlit.

I normally regard computers as something of a poor relation as a music source, tending to burn WAV files to disc for replay, but the USB input lived up to the standard set by the other sources. The driving beats of 'Cymatic Frequencies' pounded around the room, the bass, despite its mass, stopping and starting with the alacrity of a Bugatti Veyron. The level of three dimensionality in the staging was impressive, and provided the free space for the noises that populate Progressive Trance to bounce around uninhibited.

CONCLUSION

Overall a truly impressive performance. It can be bettered, but

only by spending a lot more. The Pyxis proved both user friendly, once the instructions were thoroughly read, and to be one of the most capable preamps that I have had in my house. The sound can be bettered by the ModWright LS 36.5 (with matching PSU) (HFW May 2010) but this costs more than twice the price for a line level only unit. The £1,700 Onkyo P-3000R, reviewed last month, offers upsampling on its digital inputs, but only Windows compatibility and not as good a sound.

It is a similar situation with the power amp. Musical Fidelity offer equipment that is at least as powerful as the Leema products, but none of the ones that I have heard have the Hydra II's fleetness of foot, or deftness of touch.

Individually these are excellent pieces of equipment, but combined they are superb. Owners of Tucanas and bi-wirable speakers should start saving now for a Hydra II, but if you can afford it, get the pre/power, Pyxis/ Hydra II combination. They leave Bolton Towers tomorrow, and I will be sad to see them go.



Leema Acoustics Pyxis

REFERENCE SYSTEM

Clearaudio Master Solution turntable
 Clearaudio Carbon Satisfy tonearm
 Benz Micro Ace cartridge.
 Ortofon Vivo Blue cartridge
 Audio Technica AT-F7 cartridge.
 Leema Acoustics Tucana II integrated amp
 Chario Ursa Major loudspeakers

MUSIC USED

Beethoven, Symphony 9 D Minor. Op. 125 ('The Choral'), HMW SLS 5053
 Dusty Springfield, 'Dusty In Memphis', 4 Men With Beards 4M112.
 Various Artists, 'Arabica III', Bar De Lune LUNECD 19
 Various Artists, 'Cymatic Frequencies', Wildthing Records WIL 1 CD 010

VERDICT

LEEMA ACOUSTICS PYXIS

Well specified British designed and built stereo preamplifier with a highly musical sound.

FOR

- open and detailed sound
- fine phono stage
- excellent connectivity
- USB DAC for Windows/OSX

AGAINST

- nothing at the price

VERDICT

LEEMA ACOUSTICS HYDRA II

Consummately smooth, powerful amplifier with good connectivity.

FOR

- expansive soundstaging
- highly detailed
- fine tonal rendering

AGAINST

- nothing

LEEMA ACOUSTICS

PYXIS £3,995

LEEMA ACOUSTICS

HYDRA II £3,495

Leema Acoustics Ltd.

(+44 (0) 1938 811900

www.leema-acoustics.com

MEASURED PERFORMANCE

The Hydra II power amplifier produced 144 Watts into 8 Ohms under measurement, increasing to 240 Watts into 4 Ohms, so it has plenty of muscle. With a high damping factor of 56 control over bass will be tight and the bottom end potentially 'dry' sounding.

Bandwidth was wide, frequency response measuring flat from 4Hz up to 90kHz (-1dB). Sensitivity was unusually high at 310mV in for full output and distortion very low at all frequencies. Our spectrum analysis at 10kHz into a 4 Ohm load clearly shows distortion harmonics hardly exist, so this is a very linear amplifier.

The Pyxis preamplifier has a gain of x5 (14dB) from Auxiliary and CD inputs to output, a normal enough figure. In combination with the sensitive Hydra II this does however make for a very high input sensitivity of 62mV input for full output, perhaps to accommodate low gain external phono stages. The MM phono stage adds an extra x62 gain (x310 in all), which is adequate, and MC adds x1200, again adequate for most MC cartridges. There is no warp filtering and full gain down to 7.5Hz. Equalisation was accurate as our analysis shows, with just 0.3dB variation across the audio band and noise low at 0.4µV/ 0.08V e.i.n. for MM and MC respectively. So both MM and MC phono stage measured well in all respects.

With a full scale 0dB input to S/PDIF from our digital generator the Pyxis gave 6.45V at full volume, so it has plenty of gain and

available drive for power amplifiers. Frequency response was perfectly flat to 21kHz (44.1kHz CD sample rate) but distortion was a little higher than expected, measuring 0.28% at -60dB where 0.22% is common. As a result Dynamic Range was a little on the low side at 96.6dB against a common value of 98dB and a maximum of 100dB.

The Pyxis and Hydra II are a well engineered combination that measure well in all areas, although the digital input was the most linear. NK

Power	144 Watts
HYDRA II	
Frequency response	4Hz-90kHz
Separation	76dB
Noise	-91dB
Distortion	0.02%
Sensitivity	310mV
PYXIS	
Aux	
Frequency response	1Hz-100kHz
Separation	85dB
Noise	-111dB
Distortion	0.002%
Gain	x5 (14dB)
Overload	10.8V out
Disc	
Frequency response	7.5Hz-40kHz

Separation	65dB
Noise	dB
Distortion	0.002%
Gain	x310
Overload	150mV

FREQUENCY RESPONSE

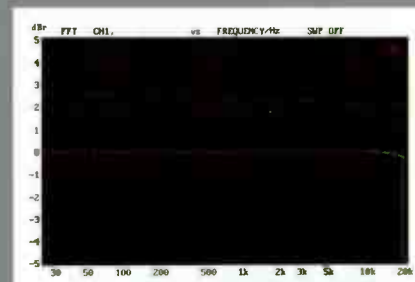

DISTORTION

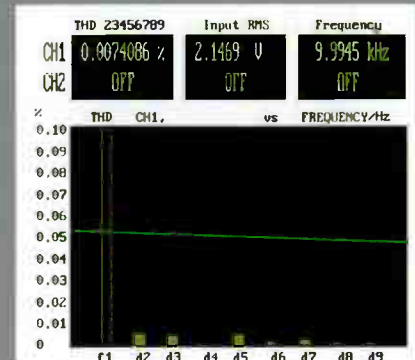



Net Gain

Welcome to the brave new world of network music streaming AV receivers! Noel Keywood samples Onkyo's latest feature-laden TX-NR609...

Home Cinema and the lure of high definition digital surround-sound seems to be waning; Blu-ray isn't on everyone's lips. Yet Onkyo seem not to have noticed and continue to produce superb AV receivers, subtly repurposed to do more than replay movies. Plug in an iPod or iPhone using Apple's supplied USB lead and the new TX-NR609 will play your music in surround sound via a squeaky clean digital connection. But there's more, for just £500...

Measuring 435mm wide and 328mm deep, and weighing a liftable 11.3kgs, the TX-NR609 is relatively compact as AV receivers go and is amazingly compact considering it produced 120 Watts per channel under test [see MEASURED PERFORMANCE]. In use, when not pushed hard, it runs warm but I fancy it stays a little cooler than earlier models; a silent fan kicks in to help cooling if need be, but since 10 Watts or so per channel gives high volume through a modern loudspeaker it will rarely need this.

FACILITIES

Like any modern receiver the TX-NR609 handles DTS HD Master Audio, Dolby TrueHD and all associated digital processing formats. It can convert stereo to surround-sound with Dolby Pro Logic IIz, the 'z' suffix meaning a signal can be derived to feed frontal height loudspeakers and it has DTS Neo6.

Most people will want to use fewer loudspeakers, not more I suspect, and for them the receiver can be set to bi-amp front loudspeakers that have bi-wire terminals, to improve sound quality. I switch the Centre channel off and use quality Left and Right stereo loudspeakers (WAD KLS9s for this review) to produce a phantom centre image, as in normal stereo; a Centre channel suits movie dialogue but not quality music reproduction. My Surround loudspeakers are full range too (Usher S520s) and backs are used on a wall shelf (Usher S520s), but these are unimportant.

Onboard are 24/192 Digital-to-Analogue convertors on each channel, and those with SACD

collections will be pleased to hear that the '609 recognises and decodes DSD fed in through an HDMI cable. You'll need the right Blu-ray player to do this, however, from Cambridge or Oppo for example. The bad news is that although you'll get surround-sound from SACD, it reaches CD quality standards our tests showed, limited by internal DSD-to-PCM conversion. Pricier Onkyos manage better.

There are six HDMI inputs no less, but no multichannel analogue inputs and no multichannel preamp outputs either. You get Composite Video inputs and an output, Component Video inputs and an output, and an HDMI output of course. There are two S/PDIF optical digital inputs and two electrical digital audio inputs, useful for connecting a CD player digitally.

Another room can be fed music, identified as Zone 2. And, finally, there is a VHF/FM coaxial male connector and an AM aerial wire connector, just below an Ethernet socket, all of which supply radio since a vTuner is fitted for internet radio reception.



The '609 will also read music files from a server or from a computer running Windows Media player 11 or 12 (but definitely not iTunes from an iTunes player!). Onkyo's owners manual lists this (see www.eu.onkyo.com).

The front panel carries grey lettering on a black background that was illegible in all except bright lighting, making setup difficult at times. The remote control will normally be used and this was clearly marked, if a little cramped and fussy. The front also carries a USB input to read music files on a memory stick, and an HDMI input too.

SET UP

Before being reviewed the receiver's firmware needed to be checked and updated if necessary. The '609 did a DHCP handshake with my Netgear router over a wired ethernet connection, without difficulty. Firmware update was needed (1031-0200 etc to 1031-0400 etc) and took three minutes on a fast internet connection in central London; Onkyo say this can take up to one hour. I had to reset the receiver's internal DSP three times afterward though before normal operation was resumed, and the remote control had to have its batteries removed before it would reset and work, Onkyo's owner's manual procedure doing nothing. After this kerfuffle – not unexpected – the TX-NR609 was fine for the remaining review period.

Onkyo have changed the operating logic a little to put preferred playback mode into default memories related to the

input used. I found Pure Audio (unavailable in U.S. models), which switches displays off and bypasses signal processing for best sound quality, buried in amongst a myriad of processing schemes; it is unavailable as a selectable override option on the remote control. An alternative Direct mode leaves displays on.

Connected to a big roof mounted multi-element VHF aerial pointed at the Wrotham transmitter that beams BBC stations thirty miles to London, the VHF tuner was set to a station frequency listing to avoid auto-tuning to distant off-set transmitters. I manually tuned then noticed all stations were in mono; the receiver must be auto-tuned for stereo. Station frequency can be punched in on the fly, station preset numbers can be entered into the keypad or the band stepped up and down with a rocker button next to the volume control to choose between forty memory presets – very handy. Onkyo receivers are well thought through in this respect and relatively easy to set up, as AV receivers go that is. Radio Data Service is fitted to receive VHF data. If you appreciate high quality radio Onkyo consistently make a good job of it, I have found.

Onkyo provide a setup microphone and the Audyssey 2EQ loudspeaker and room tuning system, which I choose not to use. Its EQ settings make little sense of my acoustically treated lounge that is 'flat' at the listening position, and room low frequency modes are not equalised, at least in the main channel. I was fascinated to see that Onkyo have now fitted comprehensive low frequency equalisation in

the subwoofer channel, comprising 25/40/63/100/160Hz bands to lessen boomy subwoofer bass. As I use full range loudspeakers I don't use a subwoofer and the main channel has no such LF EQ, which is a pity.

There are a myriad of signal processing schemes, mostly from Audyssey, promising to correct everything you could ever think of and even things you never thought about, but most of the processing is far too technologically simplistic to do anything other than change the sound rather than truly improve it – and there's no end of ways to furtwangle a signal in a DSP! I dialled in Pure Audio to bypass all this.

With radio and older CDs I sometimes listen via Dolby Pro Logic II Music as it clears the front stage of out-of-phase information, adds a little depth and tidies things up generally, benefits outweighing the potential hit to sound quality inherent in conversion to digital and back again.

SOUND QUALITY

I kicked off listening to VHF/FM, and there was an even basic tonal balance with Onkyo's usual strong bass. The soundstage was wide and deep with Adele singing 'Rolling in Deep' on Heart FM, her strong soul delivery coming over forcefully in my lounge. The Onkyo doesn't lack power or punch, but as expected there was a slight lack of high end sparkle from VHF.

Unexpected was some harshness and glare in the upper midband that seemed to affect all stations, bringing insight but an etched quality laced with a smidgen of coarseness. I say this is unexpected because I know Onkyo receivers well and they are usually more benign in their sound than our TX-NR609. Even on Radio 3 with Ingrid Fliter playing Beethoven's Piano Sonata No. 17, I noticed some glare. The tuner did have a slightly hard, mechanical quality.

I thought little of this, attributing it to a budget tuner module, until I span the Trondheim Soloists on 2L's



WORLD STANDARD TESTS



How we perform all the tests, and what they mean, is detailed on our website: www.hi-fiworld.co.uk. Go to the [product category](#) (e.g. Loudspeakers), then [Tests](#).

Hi-Fi World tests all products before they are reviewed. Many fail this first hurdle, rejected for a variety of faults. Pre-testing is crucial but only Hi-Fi World does it. For those products that pass, our measurements give our reviewers invaluable information about behaviour. Hi-Fi World is the only magazine, worldwide, sufficiently well equipped to be able to apply comprehensive tests in all product categories. Here's how we do it...



LOUDSPEAKERS

Loudspeakers are tested with the industry standard Clio measurement system from Audiomatica of Italy, giving results understood and accepted by manufacturers worldwide. Measuring microphones are a Bruel & Kjaer mic. capsule on a B&K SPL meter and an Audiomatica microphone. Our tests include decay plots and coloured contour maps, as well as unique distortion measurement that provides valuable insight into bass behaviour. See our website www.hi-fiworld/loudspeakers/tests for more detail.

PICKUP ARMS

Our unique arm vibration tests are made using a special miniature Bruel & Kjaer accelerometer attached to the arm's headshell, at the cartridge mounting position, as our picture shows. This reveals arm tube bending modes and high frequency vibrations in the headshell, that degrade sound.



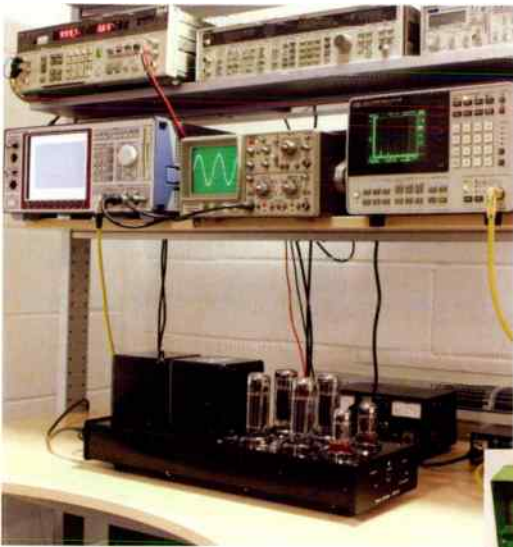

AMPLIFIERS

Amplifiers are connected to large resistive loads, 8 ohms and 4 ohms, and all parameters including power and distortion are measured by a Rohde & Schwarz UPL, the world's most advanced audio analyser. The loads are custom built to our specification, able to absorb 200 Watts without generating high frequency distortion due to magnetic hysteresis caused by iron content in the wire. This allows us to measure crossover distortion at 10kHz accurately and understand its influence upon sound.



DIGITAL CONVERTORS

DACs are connected to the digital signal generator of our Rohde & Schwarz UPL analyser and their analogue output sent to the analyser for analysis. We can measure all parameters and even pre-jitter the signal to test effectiveness of reclocking, allowing us to uniquely determine impact on sound quality.

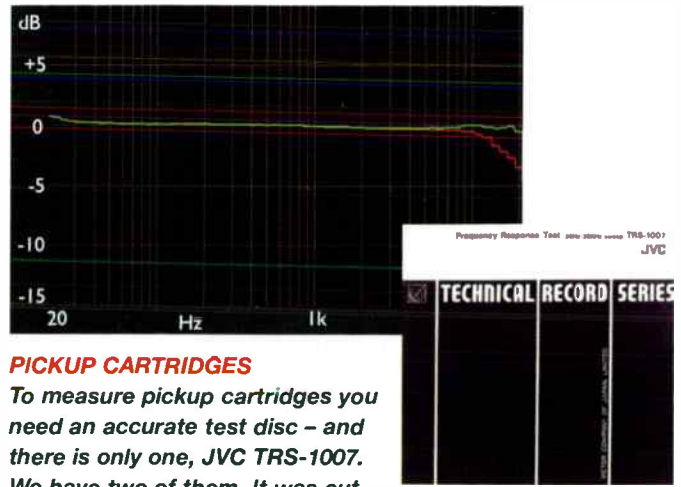
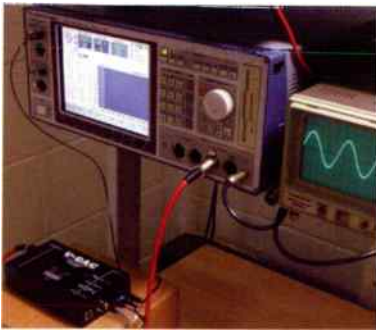

PICKUP CARTRIDGES

To measure pickup cartridges you need an accurate test disc – and there is only one, JVC TRS-1007. We have two of them. It was cut at half speed and needs special equalisation, but is super accurate. That is why our cartridge measurements are of unparalleled accuracy, matching those of Ortofon for example, who also use TRS-1007.



VHF/FM TUNERS

Top quality VHF/FM tuners demand the use of a reference standard RF signal generator and for this we use a Leader 3412 Standard Signal Generator. An external MPX filter and post-equalisation network complete the picture, giving super accurate data for analysis in our Rohde & Schwarz UPL analyser.



TURNTABLES

Analysing turntable speed stability is thorny. We have just bought a Kenwood 180FL Wow & Flutter meter to get a high resolution analysis from its frequency demodulated speed stability output, important to see what Direct Drives are really doing.



CD, DVD AND BLU-RAY PLAYERS

To test CD and SACD players you need top quality test discs – and they come from Philips, inventors of the medium. We use Philips discs, as well as Sony and Denon for CD. We use the expensive but comprehensive Burosch DVD test disc set, with top resolution 24/192 PCM data, for DVD and Blu-ray players.

mail



Visit our website at www.hi-fiworld.co.uk or send your emails to letters@hi-fiworld.co.uk. Letter of the month wins a pair of KEF iQ30 loudspeakers.

LETTER OF THE MONTH PRIZE



KEF iQ30 LOUDSPEAKERS

For more advice see Letters from earlier issues at www.hi-fiworld.co.uk/letters

A pair of KEF iQ30 loudspeakers are on their way to **LAURENCE ROBERTSON**, Letter of the Month winner in our June 2011 issue.

Letter of the Month



A Musical Fidelity V-Link will prise out better sound from Alex Cohen's Mac Mini.

FILE COUNSEL

A couple of years ago I decided (with some persuasion) that my hi-fi took up too much of the living room space and started to look for a solution. I found a small box called a Benchmark DAC1 Pre and hooked it up to a Mac Mini. To my surprise I was blown away by the sound quality and decided to sell my large, room dominating separates. My setup now consists of the above and a pair of ATC SCM20SL Active towers. I have always ripped my CD collection using the Apple Lossless encoder, believing it to be the best way of doing so with the Mac Mini. I have tried other ways e.g. WAV, AIFF and cannot hear any differences between them. Hence I was surprised to read in your recent review of the Electrocompaniet PD-1 that ALAC sounded mediocre when compared to uncompressed WAV! I

am still a long way from needing a hearing aid but as much as I try I cannot hear a difference between ALAC and uncompressed WAV, despite trying just after reading your article. Please help me, as if I am losing quality when ripping my CDs I want to know before I go too far down the wrong path. I believe this is a large area of confusion and with so many manufacturers and customers now using PCs, Macs and other wotsits as music servers I feel it should be addressed. To confirm, I connect the Mac to my Benchmark using USB and the Benchmark to the ATCs with Chord balanced interconnects. I find the sound very musical, detailed and balanced. I own a Cambridge Audio Azur 650BD player that I occasionally use as a CD player and find that the Mac, even though not considered a true audio product, sounds

far better. I also set the Mac for 24bit 96kHz irrespective of the file being played as Benchmark recommend. I find it sounds better than 16 bit 44.1 even though that is the original format. I eagerly await a response.

Alex Cohen

Hi Alex. If you can't hear a difference then don't let it worry you – but there is one. Through my system it's clearly audible, and manifests itself as a slightly opaque, cloudy haze and a touch less rhythmic flow, plus a slight flattening of stage depth.

How can this be? Well, given that ALAC (Apple Lossless Audio Codec) files are identical bit for bit to WAV, the cause must lie not in the files but the way they're delivered. I can only speculate that the extra processing load, allied to possible jitter issues,

causes this. Personally I would always run WAV if I possibly can; why not? These days storage space is not an issue, and surely the best computer file is the original.

There's also the issue that you may at some future date wish to move to a different platform, which may not play ALAC, in which case you'll have to transcode the ALAC files to WAV anyway.

If I were you, I'd invest in a Musical Fidelity V-Link (£99); plug this in to your Mac Mini's USB socket, and feed the V-Link's optical digital out into your Benchmark; you should find a noticeable improvement in sound. This is because the V-Link clocks the Mac Mini asynchronously and its optical out will remove the transmission path of electrical noise into the DAC. Hope this helps! **DP**

Our measurements have shown substantial jitter on the output of a Mac Mini and little on a Cambridge 650BD. Your findings are at odds with this Alex, so other factors may be involved. **NK**

B&W BREAK DOWN

I have a pair of B&W Silver Signature 25 loudspeakers (the model with the slate stands). It came supplied with solid silver cables that have become rather fragile. The PTFE insulation has become so brittle by now that the slightest twist could break the cables. I'd like to be prepared when disaster strikes, so I'd very much appreciate if you could suggest a suitable replacement.

Jan Grinaert,
Tervuren,
Belgium

Hi Jan. One obvious answer is another B&W and the B&W 804D I reviewed in our February 2011 issue comes to mind. It was very impressive in its sound, if not so impressive under measurement. The Diamond tweeter is a little weird: fantastic sound, but one-note with a sparkling diamond quality, so everything sounded great, but without any internal variation! I have never come across anything quite like it. The midband was luminously clear too, and very projective, if not with the levity of a true monitor. The bass was satisfactory but no better and a trifle disappointing; I'm sure B&W could do better. I suspect in a showroom the 804D will blow most else out of the window it is so obviously spectacular, so give it a listen. After the shiny sound of the Silver Signature it may well appeal.

Also, B&W are very good on service so you probably do not

have to say goodbye to the Silver Signatures if you do not want to. **NK**

Why not keep the Silver Signatures. It may not be the most dynamic performer, but it is subtle, detailed and musically expressive and I suspect it will still hold its own even after all these years **AG**

The Bowers & Wilkins Signature Silver 25 dates from around 1991, and did come supplied with a three-metre cable that ran from the crossover to the cabinet. Unfortunately, Bowers & Wilkins is no longer able to supply these cables as spares, as some of the elements of the cable are no longer in production. However, Bowers & Wilkins does offer a repair service, which would be of use here. Due to it being a prestigious model, Bowers & Wilkins would prefer that the speaker be returned to their service centre for refurbishment. Also, due to the age of the Silver Signature 25, Bowers & Wilkins would also conduct a full check and test on the speakers to ensure they are functioning to specification. You should call Bowers & Wilkins on 01903 221700 to arrange for this service.

SHAWN MARIN
(B&W'S P.R.)

NEEDLE TALK

I read with great interest Rafael Todes article on the Garrard 401/Hadcock GH242 partnership as I have a 301/242 combo. It always puzzled me that the Hadcock GH228 is in your World Classics feature yet Noel Keywood admits he was never a fan. I am at the point of trying to decide which cartridge to choose to improve upon the detail of my Goldring 1042 (I also have a Shure V15 Mk4 in hiding). I know that the Cartridgeman's Music Maker III is usually matched with the GH242 but I thought that perhaps there are more choices in the moving coil category so in anticipation I have recently bought a Graham Slee Elevator to pair with my Era Gold V.

Recent answers in the letters column have made me wonder whether the Ortofon Rondo Bronze or the Audio Technica AT 33EV may be suitable candidates as they do not emphasize the treble and are easy on surface noise. Bearing this in mind, should I push the boat out and go for a Kontrapunkt or the Benz Micro SL?

The rest of my kit consists of: Cyrus CDBSE +PSXR, Cyrus DAB 8.0, Cyrus Pre VS2+PSXR, Cyrus Mono Xs and Spondor S5e speakers. Interconnects are a mixture of Atlas Cables Voyager, Explorer and Equator whilst the speakers are bi-wired cables with QED

Silver Anniversary, each cable being 10m long.

What moving coils would suit the GH242, bearing in mind that some of my singles (and odd LP for that matter) are not mint condition. My taste in music is mainly sixties soul, Tamla Motown and R&B. Having been impressed by the bass of the Totem Hawks at the Bristol Hi-Fi show a few years ago, I wonder if these would be a suitable upgrade to the Spondors? An over-riding factor in speaker choice from my advisor is they must be available in maple and not significantly taller than the Spondors. The room is approximately 13 feet square (photos attached).

Thanks,
John Watson



I have a similar ambivalence towards many BMW and Mercedes cars, so I see no contradiction in NK's admission that he is not a fan of the Hadcock. Indeed our industry is full products that are worthy yet which in some respects amount to less than the sum of their parts.

Well set up in an appropriate player, I would always opt for a good moving coil over an MM cartridge. You should find that in most cases this choice will deliver a more even, detailed and firmer sound, with superior dynamic resolution, and a more solid sounding, better integrated bass. The relatively low compliance of most MCs is generally beneficial too, integrating well with most high quality arms, on the whole without detriment to tracking ability.

AG

Hi John. Assuming you have an 8ft high ceiling Cara, a room acoustics programme, shows that at the listening position you have a strong



John Watson's impressive Cyrus system, topped out by a Garrard 301 turntable and Hadcock GH242 arm.

modal peak around 50Hz in your 13ft square room and we publish the wave pattern at this frequency where, as expected, there is a pressure peak along each wall at 50Hz. So, in simple non-technical terms your room honks!

A small loudspeaker is best in this situation and you need high quality too. Audiosmile Kensais come to mind as they are a small loudspeaker that won't over drive your room's low frequency modes but will reveal the quality of your system. The Audiosmiles have a fabulous sound that appeals to everyone, even if the price does not at £2300. However, this is in line with other quality miniatures like Monitor Audio's Platinum PL100, another model you might like to consider. Consider also loudspeakers from Usher and KEF.

I found the Hadcock GH228 arm mild mannered and less than easy to use. I can understand its appeal, but it isn't quite to my taste. It is to that of Rafael Todes though, who feels it complements a Garrard 401 perfectly. I will stick to my SME312S 12in

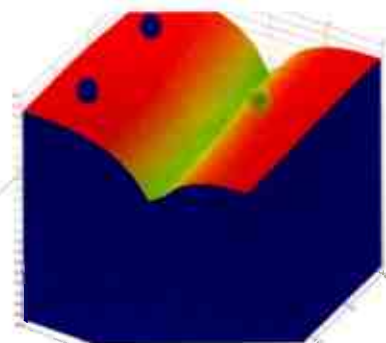

High pressure against the walls at 50Hz in a 13ft square room, Cara says.

magnesium arm on a Garrard 401, which has generally better dynamic resolution. So this is a matter of taste. The Hadcock is a good arm all the same, much respected.

Much as there are numerous well designed and built arms available nowadays, so there are an increasing number of good budget moving coil

(MC) cartridges – and by good I mean without screaming treble. The new Benz Micro Ace is one of them and so is the Audio Technica AT33 EV I am told, although I have not measured or listened to it. The AT OC9 MkII does have peaky treble and although quality is fine, I am not personally in love with its lack of balance. **NK**

THE TRACKING ANGLE

My experience of the Empire 598 Troubador turntable fully agrees with your evaluation. Indeed, a superb turntable, with clever convenience touches and a beautifully engineered bearing system micro-honed Oilite bearings and lapped chrome steel shafts machined as individually matched. Apart from the rubber mat, the on/off switch and a tiny plastic collar to turn the LP illumination on and off around the arm-rest, there is more metal in this thing than most turntable engineering departments today are allowed to dream of. Makes you want to cry about the MDF jobs that try to pass for engineering today. And yes, pity about the iffy removable cartridge mounting platform system.

But I am confused about your description of its 990 tonearm as a "high mass" arm. The fact your Denon 103 worked well with it would appear to bear you out. However, considering the turntable ruled during the early '70s how could such a tonearm cope with the predominantly extremely high-compliance cartridges of the time? Setting aside advertising hyperbole, Empire's own literature suggests the arm is suitable "for stereo cartridges that can track as low as .01 gram". Were there any such things? This suggests ultra-high compliance cartridges. How would they work in a "high mass arm"? Is this then

the ultimate universal tonearm for both high and low compliance cartridges? We must know. I applaud your efforts to champion vinyl replay and to showcase superb products from the past. The reason I buy Hi-Fi World. More please! Thanks,

**Demetri
Victoria,
Canada.**

Cartridges are never designed to track at 0.01 grams, even the ultra-compliant early ADCs like the classic Model 25, with a compliance value of around 50, needed 1.0 grams tracking force minimum, but modern (and even many older designs) generally have correspondingly lower compliance cartridge suspensions and favour higher tracking forces.

No arm is equally suitable for low and high compliance cartridges. SME Series III 9 inch arms work well with high compliance cartridges with tracking forces around 1 – 1.5 gm and any arm claiming to be compatible with MC cartridges will be of high-ish mass, to ensure that L.F. resonance is centred around 8Hz or so, avoiding warp frequencies and the extremely bottom of the audio frequency band. **AG.**

To your question how could such a tonearm cope with the predominantly extremely high-compliance cartridges of the day, the answer is: badly. But you generalise, as not all cartridges were high compliance; most moving coils were relatively low compliance. The Empire may well have suited them. I did once own a top of the range Empire 1000 ZE/X MM cartridge, with a maximum tracking force specified at 1.25gms, but quite frankly it was barely useable at such a low downforce. Sound quality from Empires was always good. I must say; I rather liked them at the time, although a Stanton 681EEE was my choice for many years during that period. **NK**

NEWS OF MY WORLD

It is 10 years since I was first introduced to your magazine (at the time I was hunting up valves for my aunt's 1960s-era radiogram), and within a few issues I was hooked by Hi-Fi World. In doing this I gave up what had been almost three decades of Hi-Fi News and almost every issue now of HFW gives me ideas! I particularly enjoy your Letters pages, hearing the stories of how your readers have put their systems together and their ideas/queries for improving them. Consequently, let me first briefly outline where I am and how I got there.

I was inspired by audio as a 12 year-old when my (Totton, Hampshire)



Empire Troubador turntable, able to track cartridges at 0.01gm asks Demetri from Canada?

school's music teacher acquired a brand-new Goldring Lenco GL75 deck, played through a Heathkit amp (assembled by the physics master) and our class listened to *Sinfonia Antarctica* (a wonderful piece – AG). This was 1963 and the sound was a revelation. I knew then that the production of truly high-quality sound would always be important to me. Of course, I wasn't able to do anything about it until I went to university and in the early 1970s as a graduate student I acquired a Goldring Lenco GL69-Mark II (with Goldring G800 cartridge), a Leak Stereo 70 (from Laskys on Tottenham Court Rd of course) and Tannoy III LZ Monitor Golds. In terms of construction quality, I'd like to point out that the amp and speakers are still going strong, as I passed them on to one of my sons a few years ago!

The late 70s found me in the U.S. where the turntable was upgraded to a Connoisseur BD I fitted with a Grace G707 (unipivot) arm and F9E cartridge, plus a Nakamichi 500 cassette deck. I was still using the Leak amp but now powering the Tannoy drive units fitted in boxes that I had built myself using the Lea-Lampton prescription (Lea & Lampton 1972 IEEE Trans AU-20, 200) for optimal tuning of a reflex port.

Bass was now stunning, but the boxes were rather big (approx 3x2x1.5 ft)! My reference recording here is the stunning Virgil Fox direct-to-disc rendition of the Bach Toccata and Fugue on Crystal Clear Records the white vinyl pressing! This contains 20Hz pedal notes that most people don't even realise are there. My modified Tannoys were set to be flat down to 20Hz and the house literally vibrated. With the construction "bug" now firmly established, I was inspired by my friend and office-mate, Mike Lampton, to build his LZ-1 preamp. The design was written up by him in *Audio Amateur* (1979/1) and was said at the time to be as good as a Hafler DH101. The LZ-1 was based on the Signetics NE5534

op-amp, introduced in the late 70s, the first chip to combine low noise with high slew rate. To complete the chain I constructed a power amp based on OMP-300 MOSFET boards. Headroom was staggering, but I had to watch the volume control very carefully!

Living in the San Francisco Bay Area at the time, I had the opportunity to replace the Tannoy drivers with a 3-way system using JBL 2213s (massive, 12-inch bass units), the Jordan 50mm

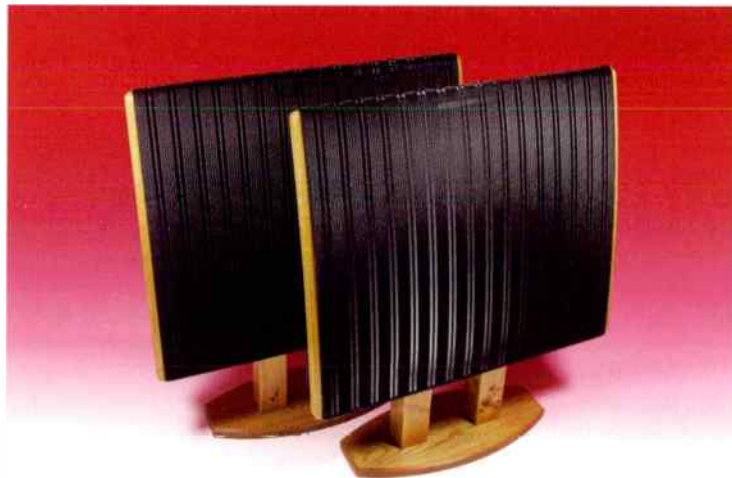

One Thing Audio improved Quad ESL-57 loudspeakers – "your review was spot on" says Phil Charles.

module (mid-range) and JVC ribbon super-tweeters. I shoe-horned these into the boxes I'd built for the Tannoys (but with modified reflex ports) and the effect was very impressive, particularly for the bass. Sadly, the Jordans couldn't handle the power and I abandoned these boxes after I'd managed to accidentally burn out two sets of Jordans!

As an aside, the Nakimichi is still going strong today. In 36 years it has been serviced just twice, with the heads and motor each replaced once. B&W in Sussex are the agents and returned it to mint specification. Just a few months ago I played some cassettes I had recorded from vinyl 20 years ago to my current

graduate students, and I was absolutely stunned that they sounded so much better than MP3! Or CD for that matter!

Fast forward to today and my current system. It's an LP12/Akito/Adikt brought up to 2004 spec, but still retaining the old Valhalla power supply (Lingo was just too expensive) and it plays into a WAD Pre3 system which, with judicious use of the tape monitor output, allows me to feed it into two power amps. Why so? Well, I have two separate sets of speakers, a pair of Rega ELAs in the living room and a pair of Quad ESL57s (OTA-modded to 2004 spec) in the dining room. The latter I had acquired a decade ago when an elderly couple living nearby sold up and were disposing of everything. They had a complete Quad system bought in 1962! I used the Quads for a few years in original form until I read the HFV article about the OTA mods (Oct 2003). I (almost) instantly popped them in the car and drove them up to Leicester to have them operated on by OTA.

All I can say is that your review then was spot on, and visitors here never ceased to be amazed by the sound the modded Quads produce. You might be interested in a small, but very

effective additional mod I have made to the Quads. Since I still possessed my California-era JVC ribbons, I found that they sit beautifully on the wooden base provided by OTA. Wiring them in parallel with the Quads provided a delightful extra "fizz" to the top end of guitar, violin and flute that takes it that bit closer to the sound of the original instrument.

Ah yes, the two power amps. The Regas are right now being driven by a Primaluna Prologue II, which gives a much smoother and more balanced sound than my home-made OMP-300 power amp. And the Quads are driven by a Leak Stereo 20, fully rebuilt to top spec by Classique Sounds. The latter is

a delicious combo, but of course not for headbangers (my own tastes are classical, especially early music and polyphony, plus rock, folk, electronica).

A quick aside about the Regas too. In the mid-90s my boisterous 11-yr old twin boys succeeded in knocking over both speakers which, given the lack of flexibility of the

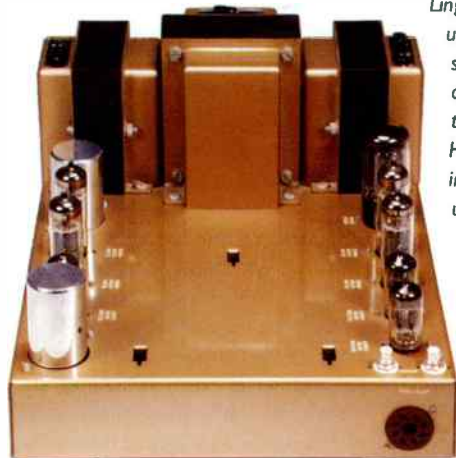

A Leak Stereo 20 from Classique Sounds sounds "delicious" with Quads.

heavily moulded speaker cable, managed to break both speaker terminal units. I found Rega's contact details, e-mailed them about what had happened, asking whether replacement units were available and what the cost would be. Two days later I received by post a pair of replacement terminal units, gratis. Now that's what I call service!

So, why am I telling you all this? There are two components in the turntable that are ageing. The Adikt is now 7 years old, has been well used, and I think it's coming up for replacement. I have been very pleased with it, especially when given top quality pressings (as with some of your reviewers, I love the recent Knopfler work, especially "Kill To Get Crimson" and his duo with Emmylou Harris, "All The Road Running", both of which are quite superb). The cartridge I had been thinking of was the Ortofon 2M Black, which you have raved about. However, having been subjected to almost a decade of Hi-Fi World cartridge reviews, I'm starting to feel that I should at least consider the MC route (I have the Pre3 with the option to connect the transformers inside for MC). The cartridges that I am thinking about (and which gives you an idea of price range) are the Ortofon Rondo Bronze, Dynavector DV20X, and the recently released AT-OC9MLIII. What are your thoughts on these in my system as compared with the MM route? And would their performance be limited by the Akito? I hadn't really been thinking about replacing the arm, but could be persuaded to do so if absolutely necessary.

The second component is the power supply. My Valhalla unit is probably

almost 25 years old! That's because my Linn was acquired in the early 90s from The Sound Gallery in High Wycombe when it was run by the quite outstanding Colin Welford. You will have guessed by now that I'm an academic, with salaries which make it tricky to enter true audiophile territory (upgrades being done then). While I still think the Lingo is expensive (and the SE upgrade absurdly so), I would still like to consider taking this opportunity to "go DC". Perhaps the obvious solution is the Hercules II that you reviewed in HFW (Oct 2007), but I can't understand why you haven't reviewed (or even mentioned as far as I can tell) the Origin Live d.c. motor kits. Given that it appears to be very well-known (and has been adopted by some of your reviewers!), is there a reason for this? The OL includes a number of options ("standard", "advanced" and "ultra") which span

a factor of two in price range. How do they compare with the Hercules? It would seem to me that the OL range ought to be of interest to people with a wide variety of systems, not just LPI2s, so why not review the whole range? And which of them would you recommend in my case?

Phil Charles

Hi Phil. Your Akito would be bettered by an arm like the Rega RB301, or one of the Rega modified jobbies such as the Inspire X100 in this issue, or perhaps better like an SME. We now have Benz Micro making some impressive budget MCs and you should well add them to your list. **NK**

Hi Phil. We will be reviewing the Origin Live power supply in due course, but meanwhile I think you should seriously think about the Inspire Hi-Fi Vivid LPI2 mods

package; I tried this recently and was immensely impressed by the difference it made for under £1,000. The cartridge is the first priority though; I personally would plump for the Audio Technica AT-33EV (£475) which is a brilliant mid-price moving coil; it's streets ahead of the Linn Adikt, offering a smoother, sweeter, more detailed and expansive sound; it will be like moving from AM to FM radio! The OC9 is also very good, but apart from a fraction more dynamic punch it's wholly inferior to the AT33EV, sounding slightly colder, harder, more mechanical and less musically engaging.

The Dynavector is fine too, but lacks the EV's detail and sophistication, especially in the treble, even if it's a tad more rhythmically bouncy. The Ortofon Rondo Bronze is also a fine design, but again I'd take the EV over it, the Rondo not having the latter's subtlety and intricacy. Hope this makes my love for the AT33EV clear! The Akito will track a good moving coil like this well, but you would be rewarded by going up to the likes of an SME 309 or, better still, an Origin Live Silver Mk3a. **DP**

DIANA GIGG

I have just spent the last 70 minutes or so in the company of the gorgeous Diana Krall and a rather decent bottle of red wine (Merlot) listening to her double album "The Very Best of Diana Krall" on two 180 gms circular pieces of vinyl. My research was carried out on the following equipment: a Michell Gyro SE turntable in beautiful black and gold (purpose-built for me at the factory itself) with a Rega RB250 arm, Lutz silver-wired, and Ortofon Rondo Red moving coil cartridge; an elderly Musical Fidelity X-LP phono amp (the barrel-shaped cylindrical version); a Roksan Caspian Mk 1 pre-amp and two Roksan Caspian power amps bi-amping a pair of Living Voice Avatar speakers.

It all sounded rather wonderful,



Inspire Hi-Fi Vivid LP12 – I tried this recently and was most impressed, says David...

with Ms Krall's voice and brilliant jazz piano out there right in front of me, and I drifted off into a sort-of magical dreamland

- 1) How would you suggest I could improve my system?
- 2) Is there a wine other than Merlot that would aid my concentration on the music? [Blue Nun, obviously AG]
- 3) What the heck has Diana Krall's husband, Elvis Costello, got that I haven't?

If you could answer these questions I would be extremely grateful.

**Roy Stockdill
Watford,
Herts, UK**

- [1] An Icon Audio PSI.2 phono stage.
- [2] I find a nice Chateaufeuf-du-Pape slides down rather well...
- [3] A proven record of writing pop songs of the highest quality. **DP**

FOR RICHER, FOR POORER

As someone who has purchased every issue since its inception and also your predecessor, *Hi-Fi Review*, as well as *The Flat Response*, I think you can comfortably call me a fan!



Elvis Costello has talent Roy!

In my earlier exposure to all things hi-fi I can recall many trips to the only two shops in London with prices I could afford. One was Richer Sounds in London Bridge when I could barely see over the high counter, and also Cavendish Sales in Whitechapel. I bought a cheap Tensai amp, some Solavox speakers, borrowed an old Garrard turntable with auto changer and I was away! The sound wasn't brilliant but was certainly better than the transistor radio I was using previously.

A paper round and a couple of years later and I had progressed, bit by bit, to a Mission Cyrus 1 amp, an Akai HX-3 tape deck (not the one I was wanted but as the GX model above was out of stock, and being desperate to spend some money, I settled on this one!), AR Legend turntable with Nagaoka MP11 Boron cartridge from Laskys and a pair of Monitor Audio R352 speakers. Thank god for 0% interest free credit deals, and a very understanding older sister! My 'lightbulb' moment came in 1986 when I visited KJ Leisuresound and they had around



Hitachi FT-5500 MkII VHF/FM tuner owned by Ifield, a real classic with outstanding technical performance.

ten different Linn LP12s with various arms and cartridges on display. I listened to a few of them although I only had around 2 in my pocket! I was hooked. Alas, they didn't offer 0% interest and I knew on my wages I'd have to forgo any food or drink for around 4 months if I were to be able to afford them, so I looked elsewhere! That was in 1986 and since then till now I'm still trying to reach the feeling I felt when I had that 1st audition. To this end, although I read your publication regularly, because of a shortage of funds, I know realistically that I cannot afford to purchase new equipment. To this end I find I am purchasing items from that era and, more importantly more records! My System now is as follows; Linn LP12 with Ittok and Dynavector 10X5 and Original Live Advanced Dc motor, Naim 32.5 and 140, Ruark Talisman Mk1, Nakamichi CR7, Hitachi FT5500 Mk2, Revox B77 Mk2, Alesis Masterlink, Marantz CDR-630 (given to me for nothing!), Sony PCM-R300 DAT machine, Sennheiser HD580 and a Okki Nokki record cleaning machine. I also use a Sony TC-WE835S double tape deck for making copies; An excellent machine with an amazing feature list that I acquired for the princely sum of 25, practically brand new! I also have a few standby items I use when any equipment is being serviced. Rega Planar 3 with RB300 and Goldring 1042, Revox B710 and Nakamichi BX300, Mission Cyrus 2 and a Musical Fidelity tuner (the one to match the A1 amp). To summarise, my system gives me many hours of enjoyment and sometimes not. I may not be typical of many of your readers but I feel that the most important thing is playing and enjoying the music, rather than upsetting yourself when sometimes the sound is not as good as you otherwise expect. I still record only to tape whether DAT or Compact Cassette and reserve special 'challenging' recordings such 70's dub to reel-to-reel primarily. The CD recorders are used to archive tapes only I still record only to tape whether DAT or Compact Cassette and reserve special 'challenging' recordings such 70's dub to reel-to-reel primarily. The CD recorders are used to archive tapes only.

**Ifield Jones
Surrey**

Hi Ifield. You have some fine hi-fi products there, some real classics. It struck me the other day, whilst updating our World Favourites listing on-line, that there are so many really good products around that have just become obsolete and can probably be picked up for a song one way or another, either at end of range knock down prices of the sort Richer Sounds specialise in, or of the same status but from e-bay. It looks like this is the way you do it and being able to resist the temptation of the latest is the best allows a lot of enjoyment to be had at very reasonable prices. **NK**

Fantastic! You have a great collection of kit there and I think your attitude is spot on. I think the only obvious weak point in your system is the Dynavector 10X5 which is a great little entry level MC but hardly taxes the Ittok. Having used (yes, you've guessed it!) an Audio Technica AT33EV moving coil in a tik-tok with brilliant results, I'd counsel splashing some cash on the latest EV version, which will suit your Naim amplification down to a tee! **DP**

M.A.D. FOR IT!

As a recent visitor to the Hi-Fi Wigwam Show at Salford Hall I was particularly taken with a system being displayed in Syndicate 12 Room "Valvebloke". The gentleman in question had a Rega Planar 2, Ortofon 2M Black, Quad 99 CDP-2, Radford STA15, Dynaco ST-70, Audio Innovations 800, Rogers JR149s and IPL M3TLs. My point here is that the items that gave me the most pleasure were the Rogers JR149s and the Radford STA15, I just fell in love and have to say for me this was the highlight of my visit. Now I realise that this is termed, "Olde World" equipment but its communicative sound and lovely balance made me wish for the system myself. Can you recommend a modern equivalent to the Rogers? I currently have a pair of B&W DM60253s driven by an Icon Audio Stereo 40i (one of the originals) which uses KT88s. I love classical music but listen to most genres. Cabling is Atlas Equator and something that surprised me when I inserted



A MyAudioDesign MY1920 comes close to a Rogers JR149 says David.

it into the system is a Tannoy ST50 Supertweeter which has firmed up the bass and opened out the treble. My CD source is a Rega Planet (old style) with a modified Tom Beresford DAC and a Musical Fidelity X-10D Line Buffer. The black stuff is played on a much loved Technics SL-1210Mk2 and an Audio Technica AT12S cartridge - Shibata stylus. Interconnects are Klotz AC110 throughout. I am quite prepared to keep wishing for the Rogers but they are of course a rarity and their prices are now becoming expensive. Budget is up to £1,000. Less of course is preferable and second hand speakers are always worth a listen. I just wish I could find that Rogers sound, which ticks most of my boxes.

Regards,

Nigel Masters

One loudspeaker that really comes close to that sound, but is (if anything) better, is the new My Audio Design My1920. It has an LS3/5a-in-a-modern-setting sort of character; clean and dry and tidy and smooth, but there's a good deal more depth and space and a slightly richer tonality too. You should try them with your Icon Audio Stereo 40, which I suspect will work very well with them. **DP**

SPEAKER ADVICE

I've just returned to the hi-fi hobby after many years away. I replaced an ageing Marantz CD63 and NAD amp with the Naim Uniti. I must admit, the Naim has me playing music every day now, when before it could sound flat and lifeless. The old cliché of records I'd not bothered about before are now sounding fresh and new rings true with me. However, I think I need to change speakers to get the best out of it. Currently, I'm using Quad 12Ls (old model, not the new ones) on solid stands. Due to the requirements of

the room they are just 19cm from the wall and 5ft apart with my listening position being 6ft away. They are wired with Naim NACA 5. I'd also tried Chord Carnival Silverscreen previously but found it not as explicit as the NACA 5.ial due to their placing but nothing that ruins the enjoyment. However, I do find them a little lifeless. Not in terms of treble sparkle but more in terms of projection into the room and rhythm. I've got upwards of £400 to spend on replacements but am loath to do so if I'm purely going sideways. I'd wait and go to £900 if it was a dramatic improvement.

Possibles that have come to mind (purely from reviews with Naim equipment) are Rega and Neat but then I've wondered if the new KEF range might be the ticket at a good price, which would give me more money to spend on music and maybe a NAS for the Uniti. Listening tastes are diverse rock, jazz, punk, occasional classical (well, very occasional!). I'm aware I'm asking the impossible to get the perfect speaker for my situation. But I'd appreciate any feedback you could give. Many thanks - and keep up the good work.

**Jon Myles
Isleworth
London**

I suspect you might be smitten by the Monitor Audio sound, which is fast, projective and on the beat.

Try auditioning Bronze range loudspeakers, which are a real bargain. **NK**

Hmmm – tricky even at £900. For £400 then you're talking the Usher S-520; this is an excellent small loudspeaker that's definitely a little more musical than the Quad 12L but it's hardly night and day. At £900 you've got a wider choice; I'd be tempted to investigate the Eminent Technology LFT-16b for just a few dollars more. We're reviewing this next month and it has a wonderfully fresh and fluid sound; not everyone's cup of tea style-wise, though! **DP**

TAPE END?

I bought a Pioneer CT95 a few months back. Played a few tapes, and it sounds okay. Can you tell me the best tapes to use? Is this a good deck? And where can I get it serviced?

**Mike Kelly
Northampton.**

Best try phoning around your local specialist hi-fi dealers; I am sure at least one of them will know an engineer who they've used in the past who can do the job for you. The best tapes to use are the ones you can get! These days, TDK SAs are still easy to come by, and dirt cheap at around £1 a pop. **DP**



We will be reviewing the Eminent Technology LFT-16 loudspeaker next month, but a preview is on our website now...

Hi Mike. The CT-95 is, to my knowledge, the last (and some say, the best) hi-end cassette deck ever produced by Pioneer. In this respect the answer to your second question is a definitive "yes" – it is a very good deck. And the presence of an auto calibration feature called "Super Auto BLE" makes the answer to your first



Pioneer's CT95 had automatic record equalisation to get the very best from cassette, says Alex Nitikin of ANT Audio.

question easier, as the CT-95 can align its electronics to get the most out of any decent quality cassette. Even plain TDK FE and TDK D Type I cassettes could sound surprisingly good when recorded on this Pioneer. However if you are serious about the sound quality and long life of your recorded tapes I would advise you to get some Type II cassettes as these have lower noise and also would preserve the quality of the sound for many years to come. I have cassettes recorded 20, 25 and even 30 years ago and many of these are still sound great!

Brand new Type II TDK SA tapes are available for under a pound on the Internet and in Richer Sounds shops – that is probably a good starting point. Another source of good quality “new old stock” cassettes is the eBay – you may even find some top quality Type IV “Metal” tapes there though the prices for these cassettes are on the rise. Metal tapes are no longer manufactured and as a result command premium prices.

Type IV cassettes also vary in quality and may disappoint if they were not stored properly. For that reason I mostly use premium Type II cassettes - at 2-4 times the price of the TDK SA these NOS tapes provide the level of performance that would surprise many people who'd never listened to a properly made cassette recording. My favourites are SONY UX-S, UX-Pro, Maxell XL-IIS and TDK SA-X tapes.

Now to your last – and the most difficult question. Servicing a tape deck presents a challenge. The only exception is probably the Nakamichi cassette deck brand as there are still a couple of companies that can do a professional service on these. Owners of other makes are generally out of luck and have to either learn how to do it at home or search for a fellow tape enthusiast with the right tools and experience who would agree to do the job. This is somewhat unfortunate situation as cassette decks (like cars, really!) do require a reasonably regular service to perform

properly and that service can only be done using the right tools and equipment. Just imagine that you own a car and there were no more service stations around! There are several Internet forums that can help a cassette deck owner in this respect and I would recommend TapeHeads.net (<http://www.tapeheads.net>) for friendly advice and technical help.

**ALEX NITIKIN,
ANT AUDIO.**

WALKMAN GO

I'm sorry to trouble you but I need your help! I want to buy a Sony Pro Walkman but obviously they are all secondhand. Do you know of a company that can service/refurbish them?

Many thanks

Malcolm Davey



Sony Pro Walkman – contact Sony about service.

There is no simple answer here. Whether or not your Pro Walkman is serviceable depends on which model you have. Ring Sony on 0844 846655 and plough through the customer service menu to find someone to talk to. Whether anyone outside Sony can service them may depend on the availability of parts. Best of luck anyway. I suspect you'll need it - **AG**.

TANNOY WIRE

Mr. Haden Boardman. I enjoyed your article on Tannoy dual concentric drivers. I own a pair of Golds in like-new condition and yes, I have rebuilt the crossover which may be tinned

copper, but I have doubts about that. If they are aluminium, replacing them with good copper or silver might be the single best upgrade to these amazing drivers. Any light you can shine on this would be appreciated.

**Bob Matz
New York
USA**

The original wiring is tinned copper rather than aluminium. For an upgrade I would suggest replacing this with PCOCC (Pure Copper made by Ohno Continuous Casting process), such as Oyaide 34/0.18 stranding or similar Furutech. Solid core (0.7mm), PTFE insulated high purity silver could be used for the HF, but will sound brighter.

Hope that helps

**DR PAUL MILLS,
CHIEF DESIGNER,
TANNOY.**

HARD SELL

Although I now live in Melbourne and have done so since 1972, I shall always be the product of my English upbringing, in the 1950s. Every Christmas or birthday my mother would make us write a thank you note for every present we received, whether it was to our liking or not. Such was the way good manners and, if you like, protocol ruled her

approach to life. I have, of course over time, come to agree with her. A phrase I like to sum it up “good manners are a social lubricant” So what is all this about? Here is a thank you letter written without mater standing over me! I very much enjoy my system, of Project Perspective turntable, Transcriptor turntable with Shure V15III, Cambridge 640p phono stage, Musical Fidelity XA-1 amp and my home built omni directional speakers. Not quite high end but very musical. Up until recently I had a Micro mc in the Perspective's arm. It finally wore out and so a replacement was sought. I had an old but still in good condition Supex sd700-a mc. and set it up. At first it sounded lovely but I soon found it was sending me to sleep. So

rich and warm was the sound (initially beguiling) that all the excitement in the music was gone. As a listener mostly to jazz, I quickly realised I was missing all the percussion in the music. The top end was so tame it had no zing at all. Great for extended bass of course but I am not a bass freak. I like it real, not just deep. The real bass had gone to be replaced by a warm, comfortable blanket. What to do?

We all know how hard it is to audition different cartridges at a dealers, let alone in our own systems. So I had to do the hi-fi crime and buy with only a review to go by. I purchased my monthly copy of Hi-Fi World, the September 2010 issue to be exact, and there on page 109 was a review of the Audio Technica ATF3/III. At only 189 GBP it grabbed my attention. By the way, we read so many letters of people bleating about the balance of high end to the more affordable in hi-fi journals that I have to say I believe you get it about right. Who among us buys a car magazine only for a review of a Hyundai Getz and ignores the article on the latest Ferrari? Not!!

I purchased the cartridge at a far better discounted price than you quoted, so far so good, and installed it in the Project. Now this is the point of the letter. All the points made in the review, whether positive or negative, were reproduced on my system in exactly the way you describe. The treble is a little bright compared to some and the bass, while not as deep as some, is very quick and full of lots of different notes, very satisfying. Do cartridges need to break in as is the case with other equipment because, now that I have been listening to it over the past week there is no doubt that the sound, in general, has sweetened, especially in the top end or maybe it's just me ears becoming attuned to the sound. As it has bedded in it even has classical recordings sounding better than expected. A true high performance bargain, it has shown itself to be a fine match for my system and a great improvement over the Micro. The point is, your review told me what to expect honestly and so I could not, and was not, disappointed. Keep producing honest reviews, not just ones so glowing it is obvious they are designed only to sell, sell, sell and that I suspect many journals do just that. What a wonderful mix of reviews, articles, vintage and the best letters section anywhere.

Cheers.

**Martin Bray
Melbourne
Australia**

Thanks Martin - kind of you to say so. As I am constantly explaining to manufacturers, some of whom

complain that we've "spoiled" their reviews by saying "negative" things (even if they get the coveted five globes), we are not a marketing wing of the hi-fi industry. We have to put the equipment we review into perspective. Everything ever made has weak points (in absolute terms, if not at its price point), and us pointing them out isn't us spoiling the review, it's giving a sense of perspective and balance. I know our readers won't stay with us if everything's just "this is great and that's great and so is that";

CD player also sits on a Mission Isoplat. Listening is shared equally by vinyl and CD and consists mainly of Blues, Jazz, Rock, Mozart and Tchaikovsky. I now wish to tweak this set up and would welcome your suggestions regarding improving mains.

Many thanks in anticipation,

Mike Thompson

Hi Mike - your system sounds superb on paper, although probably the weakest point is the Trichord Dino phono stage, and so it's this I'd replace first. Either go for the ANT



Icon Audio's PS3 phono stage is ideal for Mike Thompson's system thanks DP, adding much needed valve euphony.

they want some meat on the bone, so to speak. Even products we covet have downsides; nothing yet invented is absolutely flawless; if it was we'd all be out of a job! The AT-F3/II is a great little budget MC, and should gain some much needed sweetness with age have fun with it. **DP**

TWEAK PEAK

At present I am enjoying the following set up:

My sources are a Linn LP12 (serial number 77000 plus), Ekos, Lyra Dorian, Lingo 2, Trampolin, bought second hand two years ago and serviced I reset I year ago when Trampolin and cartridge (new) were fitted, Trichord Dino and Dino+ 2 years old. I also have a Leema Acoustics Antilla CD that is two years old and a Leema Acoustics Tucana (with balanced option) that is two years old. My loudspeakers are Monitor Audio PL100 on MA stands and interconnects are Chord Chameleon Silver Plus. Loudspeaker cables are Chord Rumour 4 bi-wire and mains conditioning an Isotek Mini Sub G 11 with Isotek Mains cables throughout. All of this is on good quality shelving on wall supports. The

Audio Kora 3T or the Icon Audio PS3, depending on whether you want a little valve euphony injecting (via the PS3), or a wonderfully open straight-down-the-line sound from the ANT Audio. Your supports look pretty good to me, as is your cable. The Antilla upgrade would be worthwhile, but don't expect a night and day change, just a subtle improvement. **DP**

No, the weakest point is Tchaikovsky. I recall a Simon Rattle interview in which he said that in all his years leading the Birmingham Symphony Orchestra, he had managed to avoid programming Tchaikovsky altogether. I understand how he must have felt - **AG**

VINYL DEMAND

I write seeking your help regarding an upgrade path for my existing vinyl set-up which consists of a Michell Gyro SE Deck, SME Series IV arm and Ortofon Kontrapunkt b cartridge. The arm is fitted with the standard SME wiring/cable. The above equipment is connected to an EAR 864PL pre-amp,



Michell Orbe is a good replacement for the Gyro SE.

which has an internal phono Stage, an EAR 869, which is used as a power amp and a pair of Spondor S8es.

My main music taste is rock/pop although I do occasionally venture into the realms of classical! I look forward to your response to this request and would just add that I enjoy reading the mail section of your magazine each month as it offers such an interesting variety of content.

Jeff Keilty
West Dorset

Hi Jeff – the weak point here is your deck. The Gyro is superb, but the Michell Orbe is better still, and the obvious next upgrade; it will add bass power and extension, plus a cleaner, more transparent midband and treble, with a more natural rhythmic flow that makes the Gyro sound a little mechanical by comparison. The rest of your system is well placed to signpost the differences, I feel. **DP**

LANDSCAPE

I've been listening to the second Landscape album, From The Tea Rooms Of Mars...(etc) and suggest that (a) it's one of the great unsung synth albums, and (b) the opening track European Man would make a great hi-fi test track, ranging from its quiet and thoughtful opening (dig those not-very-accurate synth piano sounds, or are they meant to sound that way? Who knows with Landscape...) to the (very loud) peak, and finally the song just bounces along from there. It would give your NS-1000s a good workout! Forget Einstein A Go-Go, this track (and the title track) are the classics! Oh, and while I'm on the line, you haven't published a review of Kraftwerk's The Catalogue on vinyl yet. Either (a) there's no real difference compared to the original LPs (I have The Catalogue on CD) [but this wouldn't apply to Electric Cafe/Techno Pop], or (b) there wasn't enough space in the

magazine, or (c) you'd just be having too much time enjoying yourself to write the review!

All the best,
John Malcolm

Thanks for the tip-off, John. I actually have that album and do like it, but whenever I feel the need to hear 'Einstein a Go' I then feel myself reaching for the album that sits next to it in my rack (if it's in the right place, that is), which is New Musik's 'From A to B'; I adore 'Sanctuary' and think Tony Mansfield's songs and arrangements are amazing for that era. I try not to write about Kraftwerk as I become a fawning fool and feel myself drifting into my sixth form dream world where I was going to be the world's greatest ever music writer. Not going to happen, got to let it go! I'll be putting 'The Catalogue' on to my Christmas list though, even if I suspect the reissues won't hold a candle to the original vinyl. **DP**

SITE AND SOUND

You have a new website but have no links to the buying guides and recommended components of the old site. I use the recommended components page quite often, although it was seemingly very out of date, with no components from the last few years. Is it coming back and are you updating it with newer 5(worlds) items?

Also, I have a pair of Cabasse Jonque 302 speakers I bought some 10 years or so ago. What is your opinion of them and how can I get the best bass response from them?

Also, I have an original Roksan Xerxes that I have just got back out of its box after some years in storage, and the motor seems very rough now, and audible. What might be the problem? I have heard that the power supply fails. How do I check that, as the motor still turns albeit with a hand start, which it did not need before?

Many thanks,
Raz Shankar

Hi Raz. An updated World Favourites section has been added and we will be making further updates and adding more information soon. You will also find the 2010 Awards products on the site. I do not know your Cabasse loudspeakers so cannot comment on them. **NK**

There have been several iterations of the basic Xerxes, but the general feeling at Roksan Towers is that something like the main spindle or the motor alignment, for example, may have become misaligned in storage. They suggest that you give them a call at their London HQ on 020 8900 6801, with the player available for visual inspection. **AG**



To cure your Xerxes, 'phone Roksan's London HQ they told us.

FURUTECH

PURE TRANSMISSION

Ultimate Performance Ultimate Refinement Ultimate Luxury



Furutech makes a wide variety of OEM parts known the world over for their quality construction and superb sound. Our engineers examine every part of the signal and power path no matter how small and optimize each and every connection.



Torque Guard Binding Posts

Never over-tighten your speaker cables again with Furutech Torque Guard Binding Posts. It's the most overlooked but weakest link in the quest for tight, low-distortion signal transfer. Change your cables a few times and binding posts quickly loosen up. It's bad enough in modestly-priced speakers where the simple remedy is to unscrew the back plate and tighten the nut behind the post. But with expensive, stand-mounted monitors or larger, more costly speaker systems why take the risk? The Torque Guard's secret is a ratcheting mechanism that prevents them from being over-tightened so you achieve a totally noise-free and undistorted Pure Transmission signal path.



CF-201 CF-202 CF-102 CF-DIN CF-602F CF-601M

FI-E50

FURUTECH Co., Ltd.
Tokyo Japan
e-mail: service@furutech.com
URL: www.furutech.com

Sound Foundations
25 New Road, Blackwater
Camberley, Surrey, GU17 9AY
Great Britain
Tel: +44(0)1276 501 392
info@soundfoundations.co.uk

ELAC

FINEST GERMAN ENGINEERING

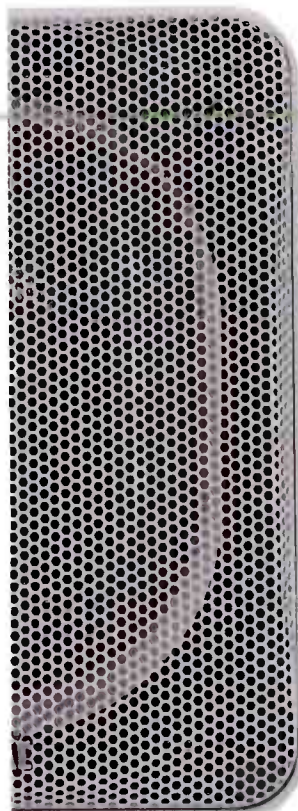

Masterpiece in Miniature

ELAC 301.2
Compact Loudspeaker

UK Office: Atacama Audio • Phone 01455-283251
post@atacama-audio.co.uk • www.elac-audio.co.uk

ELAC Electroacoustic GmbH
www.elac.com

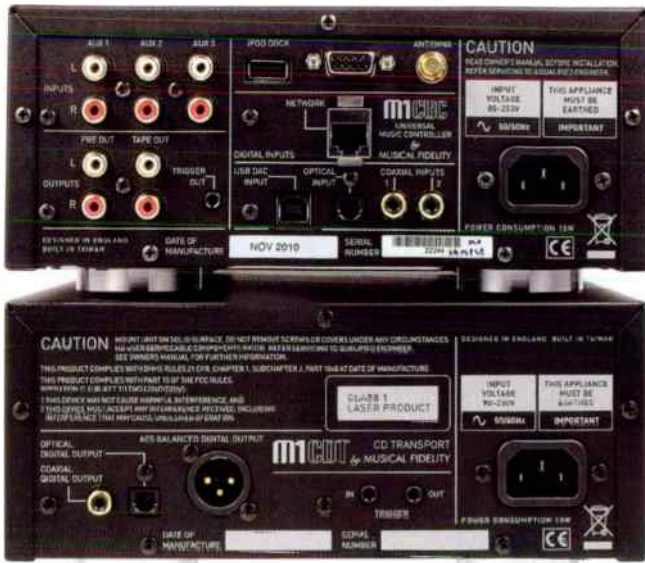

CONCLUSION

Taken apart, both the M1 CDT and the M1 Clic are excellent products; taken together they make an amazing 'do-it-all' CD player for around £1,800, the like of which there is nowhere else. Musical Fidelity seem to be

on a run right now; the past eighteen months have seen one cracking product after another. The Clic of course is the star of the show; it's hard to think of another product that's as versatile at the

price aside from Naim's excellent UnitiQute, which is a slightly different kettle of fish with an amplifier built in. I have no hesitation recommending either of these new M1 series Musical Fidelities, and can only wonder what the competition has in store...



REFERENCE SYSTEM

- Marantz TT1000/Origin Live Illustrious/Ortofon MC Winfeld turntable
- Whest Audio PS.30RDT phono stage
- Musical Fidelity AMS35i integrated amplifier
- Yamaha NS1000M loudspeakers

The Clic doesn't just work off CD however, and so the next test was some music files wirelessly from my Mac. As there's no media server software built in, I first needed to download some. The Clic played out in a stable, fuss-free manner. Fun Lovin' Criminals' 'Up on the Hill' sounded much as it does via CD; a fine soundstage was set up, again with oodles of detail and atmosphere, which pulled me in and held my attention determinedly. Bass was tuneful and articulate, showing the counterpoint with the snare and hi-hats in a most fulfilling way; as per the M1 DAC I wouldn't say it offers the last word in dynamics, but it's certainly good in this respect and excellent at conveying rhythmic and dynamic nuances in a song. Overall, it sounded extremely refined and polished, yet musically satisfying too.

The picture continued for other sources; via the direct digital connection my iPod provided a decently smooth and mature sound rather than the tippy screech you normally get via its analogue output. It played music files off iPod nicely too, whilst internet radio was a real revelation, sounding far more polished than expected. Julia Hartley-Brewer's dulcet tones on LBC were delivered with amazing vibrancy considering the low bitrate and unlovely codec carrying it; the Clic's DAC section's innate refinement was obviously helping here no end. As navigating the internet radio section was so easy via the Clic with its clear screen and easy 'favorites' menu, it rather makes DAB radio redundant.

As a preamplifier, it's surprisingly good too. Feeding it with vinyl via a Marantz TT 1000 and Whest PS.30 RDT phono stage, there was a slight thinning and lightening of the sound compared to running it straight into the integrated amplifier, so don't expect it to compete with serious passive or transformer preamps, but it still sounded commendably unobtrusive and tidy. The powerful crescendo towards the end of Genesis's 'Mad Man Moon' from 'Trick of the Tail' showed the Clic to have great composure; it didn't fall apart when the going got tough.

MEASURED PERFORMANCE

Used as a preamp the Clic offers x4 gain (12dB) via the Preamp output and at full volume 0dB from CD gives 8V out, so there's plenty of drive for power amplifiers, which typically need 1V for full output, a few needing 2V. Frequency response was wide, stretching from 1Hz up to 115kHz. The Tape / Fixed output offers no gain (i.e. x1) but still passes through active stages as it exhibits the same 9.5V output limit as the amplified preamp output. Distortion via the S/PDIF digital input was low, measuring 0.23% at -60dB with a 16bit signal and 0.05% with a 24bit signal.

Random jitter from the CD transport hovered at a low 6pS, there was minimal low rate clock drift and no signal related jitter induced by a -60dB, 1kHz test tone. The transport is especially clean in its output.

The Clic measures well through both its analogue and digital stages. It should have good sound quality. NK

AUX INPUT	
Frequency response	1Hz-115kHz
Separation	98dB
Noise	-110dB
Distortion	0.002%
Gain (Tape/Pre)	x1 / x4
Overload	9.5V

DIGITAL OPTICAL INPUT

Frequency response (CD)	2Hz-21kHz
Separation	97dB
Noise	-101dB
Distortion (-60dB, 16/24bit)	0.23 / 0.05%
Output (0dB, Pre out)	8V

FREQUENCY RESPONSE

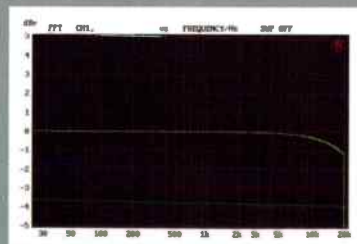

DISTORTION, -60dB, 24 BIT.

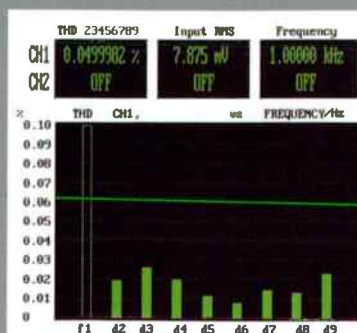

VERDICT ●●●●●
MUSICAL FIDELITY M1 CDT
 Slickly built, attractively styled compact digital transport with strong sound.

FOR
 - clean, open sound
 - slot loading design
 - build, finish, value
 - small size

AGAINST
 - nothing

VERDICT ●●●●●
MUSICAL FIDELITY M1 CLIC CDT
 Highly versatile, easy to use network player/DAC/preamp with excellent sound. Superb value for money.

FOR
 - spacious, airy treble
 - superb midband insight
 - network implementation
 - build, finish, value
 - overall flexibility

AGAINST
 - nothing

MUSICAL FIDELITY M1 CDT £599
MUSICAL FIDELITY M1 CLIC £1,250
 Musical Fidelity
 +44 (0)20 8900 2866
 www.musicalfidelity.com

HP8 MkII



All Triode Headphone Amplifier

Stereo 60 MkIII



KT88/KT120 65W Integrated Amplifier

Stereo 25 MkII



Entry level 25W Integrated Amplifier

MB90 MkII Mono Amplifier



115W KT88/KT90/KT120

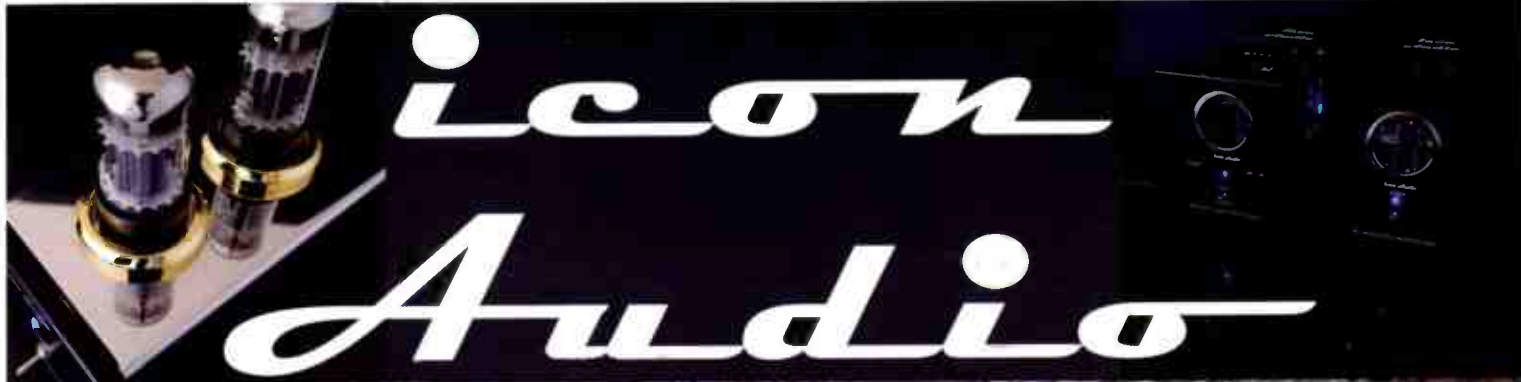

MB845 MkII 110W Triode Mono Amplifiers
Power Amplifier of the year 2010 - HiFi World

MFV2



Bookshelf Loudspeaker

P S 1



All valve phono stage

Stereo 40MkIII



40W EL84/KT88 Intergrated Amplifier

C D X 1



All Valve CD-Player & DAC



Classic Valve Amplifiers

351 Aylestone Road
Leicester
LE2 8TA
Leicestershire
England
Phone: +44 (0) 116 2440593 (E & O E)

Amplifiers from £400 to £6000
Award winning Designs by David Shaw
Also phono stages, CD Players and loudspeakers
See our website for full information
www.iconaudio.com

Clean-up Campaign

There are mains conditioners and then there's the Isotek Super Titan, says Paul Rigby...

There are mains conditioners and mains conditioners; for everyone who's had a good experience there'll be someone claiming a bad one. So you've got to take each product on its own terms, in your system, and not arrive at any preconceptions. This said, Isotek's name precedes them; if there's one company that's made its (fine) reputation from mains-related products, this is it. They do a lot of live demonstrations at hi-fi shows, where time after time, they demonstrate the efficacy of their products. This prompted me to review this, the Super Titan, a flagship of their range.

At £5,995 it's right on the edges of what even high end audiophiles would regard as acceptable, so for me it wouldn't be a case of it doing a bit of good here and there; to justify its price it would have to work wonders! Happily, I have a high end system (although even in this context £6,000 quid is pushing it), so I duly installed it and listened with interest...

It certainly looks the part; it's a beautiful thing in its own right, and massive weighing a beast-like 30kg and spanning 500x500x300mm, in no small part due to the fact that it has to deliver 32A. It builds upon the current Titan model but offers twice as much power and doubles the filtering capability: offering a group of four, seven stage, filters to help remove differential noise (the noise from your fridge, for example) and common mode noise which is a more insidious distortion that you only often notice once it's gone.

Designed to work as a sort of pre-power conditioning combo with the current Aquarius conditioner, the reported ideal configuration for sound quality is to plug your power amp (or monoblocks) directly into the Super Titan, the rest of your

front-end into the Aquarius and the Aquarius itself into the Super Titan. The point of the Super Titan? To deliver clean and consistent power. So what does it sound like?

SOUND QUALITY

Initially utilising Skunk Anansie's 'Stoosh' as a test CD on an Icon CD-XI CD player within a valve system, the listening tests began with the basic reference system presenting a tight, thumping bass with a dynamic rhythm guitar, smoky vocals with discernible acoustic guitar and cymbal elements on the periphery of the soundstage.

Next, the Aquarius mains conditioner presented a more focused soundstage with now, centrally placed, rhythm guitar and bass. The downside was a slight upper midrange lift but the reduction in distortion, improved bass grip and more acoustic guitar and cymbal effects held promise.

My monoblock power amps were then plugged directly into the Super Titan chassis. My reference system has never displayed such a wide and deep soundstage; bass power was immense, almost visceral, while Skin's sometimes subtle vocalisations proved that the upper midrange and treble were particularly nuanced and delicate.

Finally, the monoblocks remained while the front-end loaded Aquarius was connected to the Super Titan. What I heard surprised and shocked me because, up until this point I was presented with more and better

fireworks. The Super Titan removed that. For the first time, I was listening to the music and not the hi-fi. That focused soundstage of the Aquarius-only rig sounded false, in retrospect, and the basic reference sounded relatively veiled and lacking in bass power. Now, the soundstage had a more organic arrangement while each instrument could be heard clearly. In fact, I could have easily written the bass guitar part on a piece of paper; it was that lucid.

Via my Avid Acutus turntable, Ella Fitzgerald's performance on Speakers Corner's 'Cole Porter Songbook' was simply arresting. In standard reference mode, her performance was relatively stodgy, slow and tired. Post Super Titan, Fitzgerald revealed sparkle, a crisp enunciation and elegance. Also, a tremendous instrumental separation was drained of distortion by the Super Titan and, within the resultant gaps, new detail was revealed.

CONCLUSION

Power conditioning has always been of value, but with the Super Titan, it has finally come of age. Here is a system that never imposed itself upon the music. Here, in fact, the music was king, not the hardware. Yes, the Super Titan might cost a pretty penny but this is one of those high-end components which is actually worth every penny – providing you've got them in the first place!



VERDICT ●●●●●
Beautifully built and presented, this is an extremely effective mains conditioning device – but so it should be at the price!

ISOTEK SUPER TITAN £5,995
Isotek
☎ +44 (0)1276 581392
www.soundfoundations.co.uk

FOR
- tonal accuracy
- incisive detail and clarity
- bass interpretation
- 3D soundstaging

AGAINST
- price!

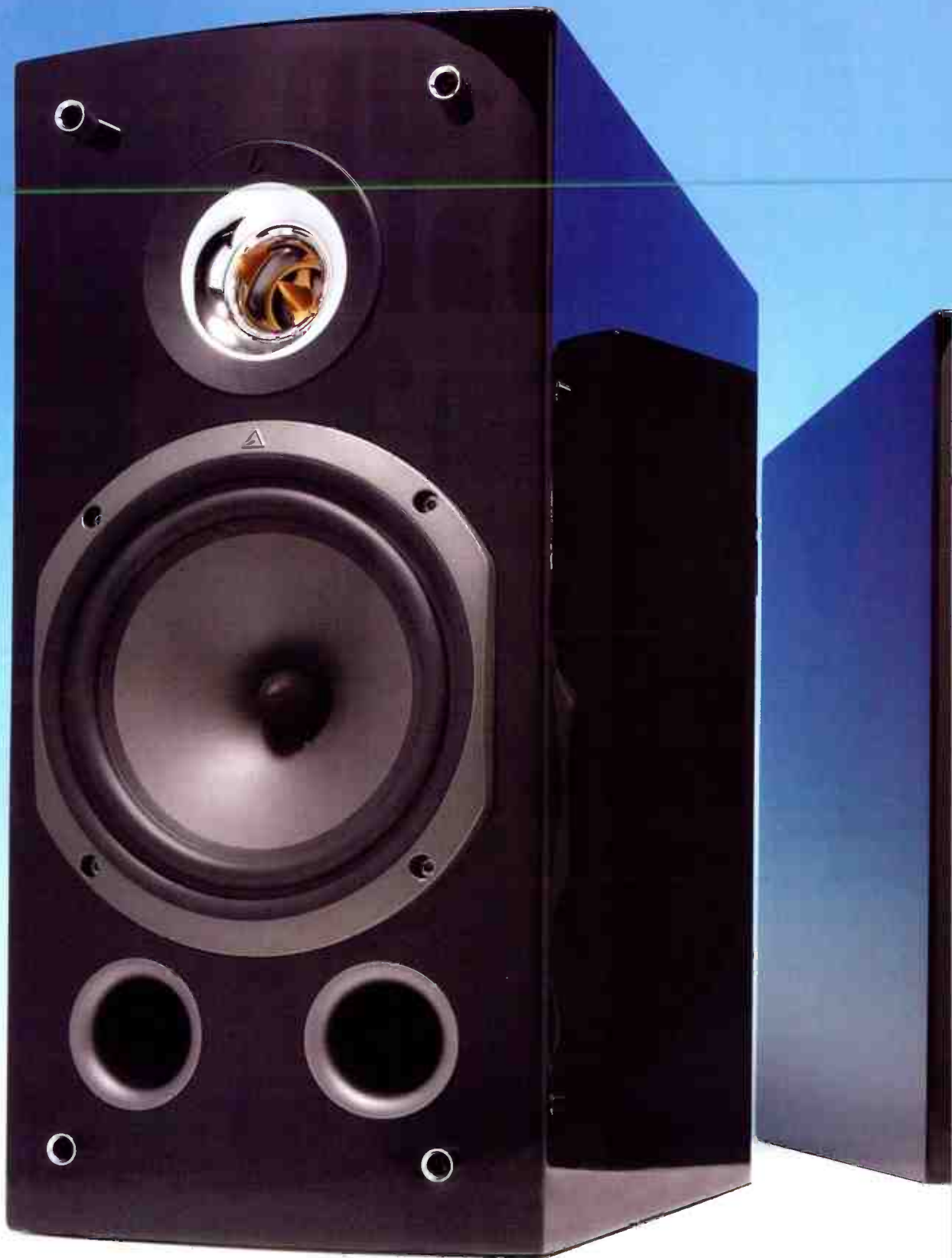

Flying Comete

Adam Smith listens to the 30th Anniversary version of Triangle's Comete loudspeaker...

As yours truly recently celebrated his own birthday and spun out the celebrations for as long as possible, it appears competition is in the offing over the channel in France, as Triangle are continuing their own birthday celebrations with the release of a second special edition pair of loudspeakers, the Comete Limited Edition. Along with the Antal Limited Editions



reviewed by Noel in the February 2011 edition of *Hi-Fi World*, these designs herald the thirtieth birthday of Triangle as a company, marking them out as a well established loudspeaker manufacturer; but also, sadly, a few years younger than me.

All too often such 'special' designs can be nothing more than a quick makeover in order to shift a few more boxes, but Triangle have not fallen prey to this temptation and have ensured enough of a reworking that the resulting units can be considered special, without sacrificing the original design beyond all recognition; after all the standard Cometes are highly capable

loudspeakers in their own right.

The most obvious sign of difference comes when you unpack them and find yourself delicately manoeuvring them out of their rather stylish cloth bags at fingertips in order not to blemish the exceptional gloss black finish – one hand in the recess under the top of the terminal panel and one hand using the front ports would be my recommendation. Around the back is a shiny plate confirming that you are indeed the owner of a Limited Edition pair of loudspeakers and this includes the number of the pair you own, plus an etching of the signature of the company chairman, Marc Le Bihan.

Around the business end, the Comete Limited Editions share the same 130mm bass/midrange driver as their standard counterparts, featuring a cellulose pulp cone with rubber surround on the outside and a hard rubber phase plug in the centre. Above this, though, the differences continue, as the tweeter of the Limited Edition units is slightly different. Still based around a 25mm titanium dome with a front loading horn, the unit is designated the TZ2500 and its horn is now made from solid aluminium; Triangle promising that "its polished surface improves wave flow and delicate sounds are reproduced with ease". Finally, internal wiring is improved over the standard model.

The Comete LEs are compact units, measuring 420x200x335mm

rather hard and shut-in sounding, but a weekend of abuse from a pink noise test CD interspersed with the odd blast of DevilDriver [I'd rather listen to the pink noise – Ed.] had them loosened up very nicely, and when I sat down to listen, a very much more couth and ordered loudspeaker awaited me.

On occasions I have heard listeners at hi-fi shows dismiss Triangle loudspeakers as "too bright" but I feel sure that a few hours in front of the Comete Limited Editions would put this theory to bed once and for all. Yes, they are most certainly not dull or woolly sounding, but the detail that they dig out of the music and serve up is astonishing at times. The tweeter is a thing of great beauty as far as I am concerned, both in visual and auditory terms, as I have seldom heard a unit that can offer such precision, focus and speed but yet never once show even the merest hint of edginess or lack of control. All too often, highly detailed loudspeakers draw you in with their top end insight and then slap you firmly round the ears when it comes to less than perfect recordings. I hesitantly dug one or two out to see if I could trip the Cometes up in this way – four or five hours and a whole pile of CDs later, I concluded that it wasn't going to happen!

The Triangles lay out the innermost complexities of a performance without any sense of strain or difficulty at all. Mozart's violins from 'Eine Kleine Nachtmusik'

"the Triangles lay out the innermost complexities of a performance without any sense of strain..."

(HxWxD) and weighing in at 8.5kg. Their finish and fit are very impressive indeed, with even the plastic surrounds of the drive unit and the connection terminal plate having a high quality feel and appearance. For auditioning, the Cometes were perched onto my Atacama SL600 stands and driven by my Naim Supernait, using both CD and vinyl sources.

SOUND QUALITY

Remembering Noel's comments regarding the running-in period of the Antals, I took care to make sure I applied the same process to the Cometes and this definitely paid off. Straight from the box they were

soared around my room with breathtaking speed and verve, whilst the piano from Tori Amos's 'Pretty Good Year' shimmered gloriously in the centre of the soundstage. The piano is not an easy instrument to get right but the Comete LEs almost seemed to offer a Gallic shrug as if to suggest that this was no challenge at all – the hammers hitting strings were vivid and the decay of each note was glorious, providing a perfect backdrop to Tori's vocals. These vocals were delicate and well ordered, although a little further back in the soundstage than I am used to. The midrange dip [see MEASURED PERFORMANCE] does not adversely affect the performance of voices *per se*; it

mx

S E R I E S

WHAT HI-FI?
SOUND AND VISION



October 2010 - MX1

WHAT HI-FI?
SOUND AND VISION
AWARDS 2010

STEREO SPEAKERS & SUBWOOFERS

BEST STEREO SPEAKERS UP TO £150

MISSION MX1



RECOMMENDED

January 2011 - MX5

WHAT HI-FI?
SOUND AND VISION



May 2011 - MX5

HI-FI WORLD



June 2011 - MX2

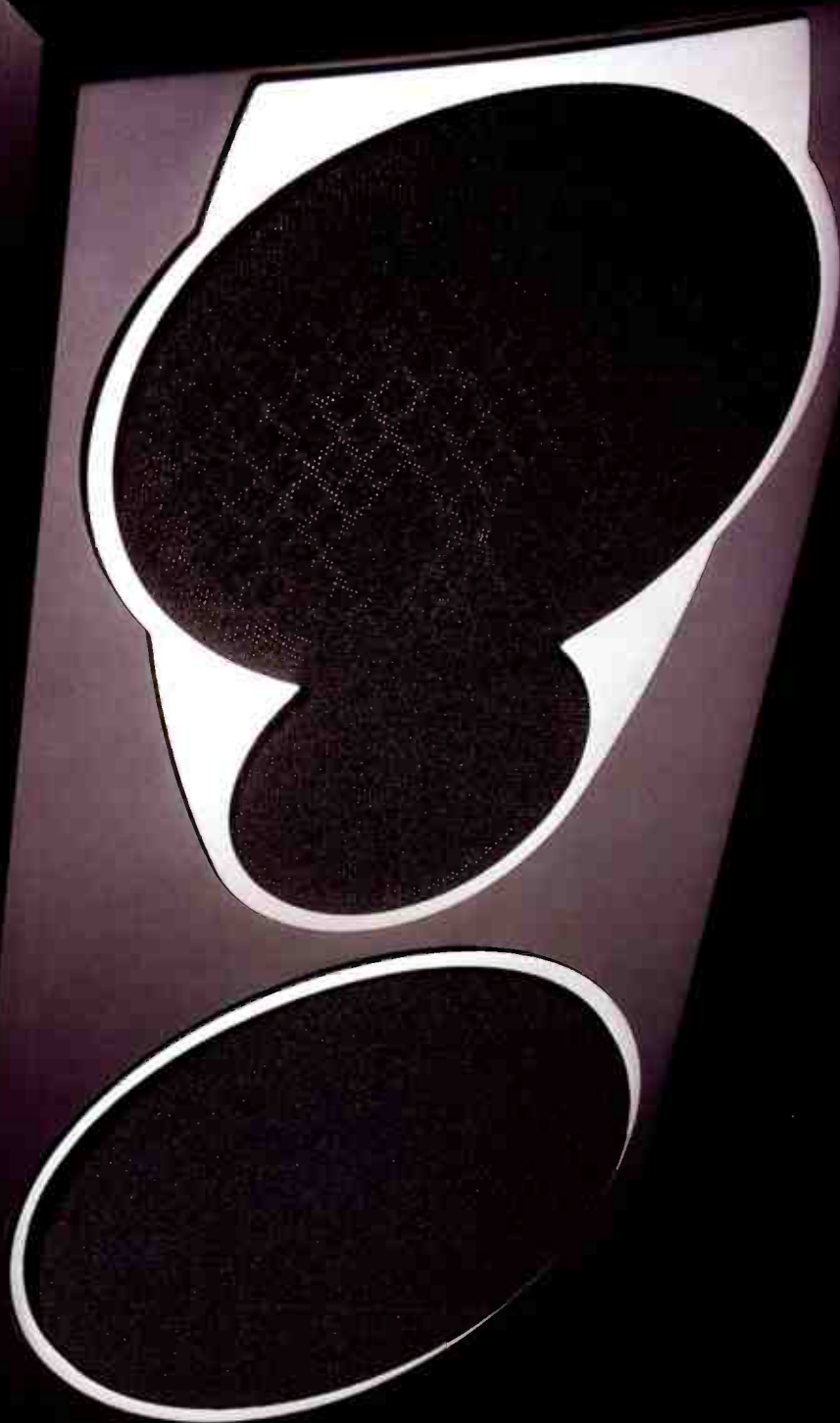

MISSION

IAG House, Sovereign Court, Ermine Business Park, Huntingdon, Cambs, PE29 6XU, UK
Tel: +44(0)1480 447700 Fax: +44(0)1480 431767 <http://www.mission.co.uk>

World Radio History

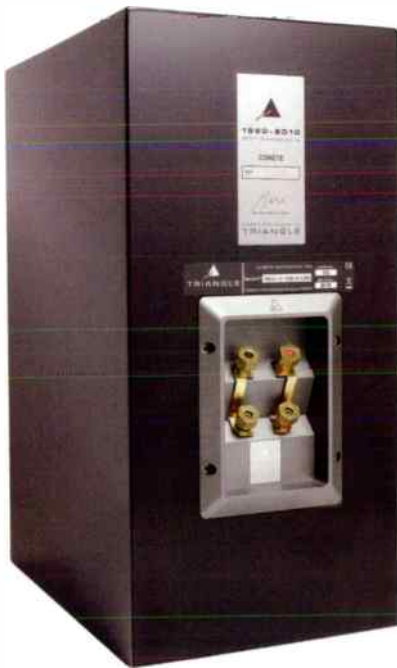

just sometimes fails to draw them right out of the soundstage as some other loudspeakers can. Instruments showed no such problems however, and the Cometes were more than able to distinguish between the cold, stark sound of a modern digital synthesiser and the much more rounded and warm tone of a traditional analogue type.

Aiding the Triangles' detail retrieval in knitting their performance into a cohesive whole was their fine low end performance. All too often designers can attempt to force too much low bass from a small enclosure with the result that the finished loudspeaker has instant 'showroom appeal' but lacks both detail and agility at the bottom end, as the driver and cabinet pairing struggle against the laws of physics. Once again, Triangle have done a fine job here. The Comete LE's go decently low and have impeccable timing, although I did detect an occasional thickening of bass guitar notes that seemed to be exacerbated by the ports at certain frequencies. Despite this though, the Comete LE's bass performance was generally well judged and neatly balanced.

Winding the pace down again once more left me enjoying the fine sense of space from the Cometes. The soundstage they set up is focused towards the centre and they do not stretch the image quite as wide as some of their competitors, but they still perform a superb sonic disappearing act to leave a swathe of music hovering mystically in mid-air at the end of the room. They romped

through my current favourite spatial demonstration track; The Eagles 'Long Road out of Eden', plus some more favourites and the only real disappointment of the session came when I cued up The Pierces' recent CD single 'You'll Be Mine'. Whilst this may be a superb song, the production on it is truly dreadful, being a compressed mess, and the Cometes made no attempt to disguise this. The song was still superb and they separated each instrument and voice very well, but the soundstage all but vanished, to leave me listening to two loudspeakers again. These loudspeakers do not flatter poor recordings, but tell it like it is. This is a good thing, obviously, but might occasionally come as a bit of a shock if you are used to somewhat rose-tinted designs.

CONCLUSION

The Triangle Comete Limited Editions are a very fine pair of loudspeakers and, as a fully paid up member of the 'bigger is better' school of loudspeaker appreciation, this is not something I say lightly. The soundstage that they generate is better than many floorstanders I have heard, and the

detail which they effortlessly pull out of the source material makes the very best of good recordings, no matter what genre of music is involved. Partner them with an amplifier that has a suitable level of midband presence to balance out their slightly recessed midrange, and they're sure to please.

REFERENCE SYSTEM

Garrard 301 turntable
 Alphason HR-100S arm (Cardas wired)
 Audio Technica AT-OC9MLII cartridge
 Marantz CD94/CDA94 CD player
 Anatek MC1 phono stage
 Naim Supernait amplifier



MEASURED PERFORMANCE

The Comete has an unusual frequency response characteristic where both extremes of the audio spectrum are raised, in true loudness contour fashion, whilst the midband has a distinctive dip. Most modern loudspeakers possess the opposite – a midband lift to increase vocal intelligibility and bring the sound stage forward of the loudspeakers. The Comete will sound different to the norm, at least in terms of tonal balance, and it has quite strong treble

our analysis shows. The bass peak means it will sound lively at low levels and, being lightly damped, is probably best partnered with transistor amps and valve amps able to exert some electrical damping, meaning a Damping Factor of 10 or more. The ports peak at 60Hz but are broad tuned and produce strong output down to 40Hz, but not subsonics. Bass will be strong then, and reasonably even, with some emphasis on lower bass likely to add heft. All this comes with high sensitivity, the Comete producing no less than 89dB SPL from one nominal Watt (2.8V) of pink noise input – very loud for a speaker of its size. Amplifiers of 20-60W will run very loud with these speakers.

The decay spectrum is fairly clean although the bass looks a bit hot around

65Hz, due to light damping imposing some overhang.

The Comete will have 'obvious' bass and treble, and a recessed midband that may make for some warmth and recessed vocals. They need little power to go loud and will likely be lively. NK

FREQUENCY RESPONSE

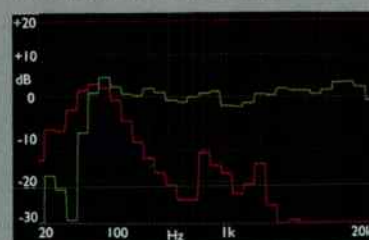

Green - driver output
 Red - port output

IMPEDANCE

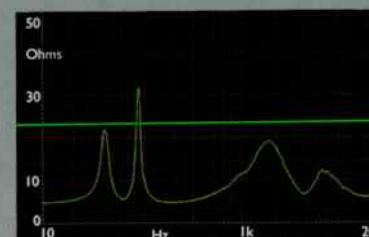

VERDICT ●●●●●

Detail, depth, dynamics and style all add up to compact loudspeakers that are highly impressive performers.

TRIANGLE COMETE LE £950

Triangle Electroacoustique

(+33(0)3 23 75 38 20

www.triangle-fr.com

FOR

- superb dynamics
- fine detailing
- well judged bass
- build and finish

AGAINST

- won't flatter bad recordings
- vocals slightly recessed



Distributed in the UK by Black Rhodium

The mat for the new turntable generation that not only improves sound but looks stunning too!

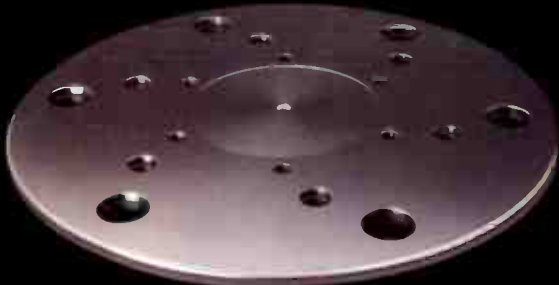

Oyaide MJ-12 Turntable Mat

"gave a sense of ease to the musical proceedings in general and invested the high treble notes with a pleasing shimmer." HiFi World.

For more information on this truly exciting new product and many other high end audio upgrading accessories, including rhodium plated connectors and high purity silver and copper cables, please visit www.oyaide.com or contact your nearest Oyaide dealer on:

www.blackrhodium.co.uk/oyaideukdealers.htm
01332 342233 sales@blackrhodium.co.uk



FIDELITY AUDIO
ACCURATE SOUND REPRODUCTION

**INTRODUCING THE CLASS LEADING
HPA-100 & HPA-200 HEADPHONE AMPS**

"This is a well rounded and balanced piece of kit that provides welcome transparency and clarity, allowing any pair of headphones to sing."

HI-FI WORLD

01302 739998

sales@fidelityaudio.co.uk
www.fidelityaudio.co.uk

Fidelity Audio, Unit 18E Ogden Road, Shaw Lane Industrial Estate
Doncaster, South Yorkshire, DN2 4SQ



TRIANGLE
MANUFACTURE ELECTROACOUSTIQUE



GENÈSE
Nothing but the absolute



GENÈSE RANGE

CRÉATION & DESIGN TRIANGLE FRANCE

www.triangle-fr.com

Master Blaster

TDK enter the digital world with the introduction of the feature-rich Sound Cube iPod dock that, says Paul Rigby, promises to rock the house and wake up the neighbours...



I am not alone, I suspect, of thinking of cassette tapes when the three letters 'TDK' are mentioned in that order. But recently the brand all but disappeared, that great name falling by the wayside. Until now that is, as it's back under different management with a range of portable audio products...

The Sound Cube is an affecting piece of kit. In fact, just taking the thing out of the box, the smell of the leather carry strap brings a satisfying response. The emerging chassis transfers the olfactory to the visual, as the cube-shaped chassis reveals mid/bass drivers on every vertical wall backed by two 5.25in coaxial drivers plus a 20W amp. The sense of the playful is typified by the volume button (which acts as an on/off switch, complete with a heavy retro click) which runs up to '11'. That's right, Spinal Tap fans! Other frontal controls include a bank of touch-sensitive controls for source, EQ, play, skip and presets. There's a large select control with integral Back and OK buttons for individual source commands too.

Spanning 255x255x255mm and weighing in at a tad over 8kg, the Sound Cube's rear sports RCA and Line In ports, a USB port (for an iPod or USB drive), an instrument port (for basic mixing) plus an 18V power jack for the external power supply. The top of the chassis features a

pull-out aerial for the built-in FM/AM radio while the bottom includes a door for 12 'D' batteries. This gives the Sound Cube its portable option and is outrageous in this day and age! Even of the rechargeable type, this portable requirement is extravagant.

SOUND QUALITY

Arguably, the primary use for the Sound Cube will be as an iPod dock (it's a shame that there is no 'tidy' pocket on the chassis). An ill-fitting cable connected my Classic model, being a little wobbly when connected and, on occasion, losing data contact. WAV files via both iPod and a USB memory stick saw a deep, rich bass that, at high volumes, proved too hot for the rather creaky chassis, initiating distortion. This is frustrating because the Sound Cube is a potentially room-filling music source. But still, it does go pretty loud before the madness sets in...

Musically, the TDK handles jazz sympathetically. Bass charm encourages an emotional performance via brass and vocals and, while clarity is lacking and the sound can hardly be described as transparent, the TDK proved to be a pleasant warbling source for background entertainment. Rock was happy to utilise the generous and dominant low frequencies that were available. Its warm, almost sweet presentation provided an effortless

yet rhythmic output that was easy on the ears.

For UK radio users, it's a pity that DAB was not included. Yes, I know that audiophiles deride the format but it does provide unique radio programming which was missed via analogue. FM/AM output was surprisingly good, although a lack of external aerial meant that I couldn't find out just how good it could get. Oh, and be careful with the aerial – it might demand constant tweaking to find the best reception but it's fragile. Mine broke off in my hand... ho hum! Aurally, BBC Radio 4 chatter was rich in timbre with a comforting bass lift, providing a warm, analogue presentation while BBC Radio 2 music offered a full bass wallop with slightly rolled off upper mids that provided a sweet portrait to music that was both flattering and very listenable.

CONCLUSION

The TDK Sound Cube's personality is hardly subtle, especially when compared to a more refined product like the Klipsch iGroove HG, a dock that takes ownership of midrange and treble in the same way that the Sound Cube dictates the bass. The Klipsch offers culture, breeding and a new Tux. The TDK offers lager, a Kiss-Me-Quick hat and a Hawaiian t-shirt! Still, there's a market for this simple, unreconstructed master blaster, I am sure.



VERDICT

All guts and glory, this wins no prizes for musical subtlety but gets the job done in its own big booted way.

TDK SOUND CUBE £299
www.tdkperformance.eu

FOR

- sweet presentation
- low frequencies
- funky looks

AGAINST

- no DAB
- build issues

WORLD STANDARDS

Your guide to the best products we've heard that are currently on sale in the UK...

TURNTABLES

REGA RPI 2010 £225

Pleasing sound, fine build and ease of set-up and use make this a great first 'real' hi-fi turntable.

REGA P2 2008 £300

Excellent value for money engineering, easy set up and fine sound.

REGA P3-24 2008 £405

Seminal affordable audiophile deck with fine bundled tonearm. Tweakable, and really sings with optional £150 outboard power supply.

MICHELL TECNODEC 2003 £579

Superb introduction to Michell turntables - on a budget. Top quality build and elegant design mean it's still the class of the mid-price field.

FUNK FIRM VECTOR II 2009 £860

Innovative engineering gives a nimble, pacy and musical sound that's one of the best at the price.



MICHELL GYRODEC SE 2005 £1,138

Design icon with superlative build and finish. Sound is beautifully smooth, effortless and exceptionally expansive. No longer peerless at the price, but still a brilliant platform.

MARANTZ TT-15S1 2005 £1,299

Cracking all in one deck/arm/cartridge combination, this must surely be the best sounding 'plug and play' package at this price point.

ROKSAN RADIUS 5.2 2011 £1,450

Although getting expensive, the latest Radius is a highly grown up package with a flowing yet engaging nature; a fine package.



AVID DIVA II SP 2010 £2,000

New twin belt drive and power supply make this a more commanding performer, although there's a substantial price hike. Speed, dynamics and detail are hard to beat anywhere near the price.

INSPIRE ECLIPSE SEv2 12

2010 £2,349

Finely engineered, smooth and detailed sounding deck offering valuable twelve inch tonearm compatibility.

NOTTINGHAM ANALOGUE

HYPERSPACE 2010 £2,390

Deliciously spacious, lyrical and beguiling sounding turntable, but lacks ultimate grip.

MICHELL ORBE 1995 £2,500

The top Michell disc spinner remains a superbly capable all rounder with powerful, spacious sound that's delicate and beguiling.

DR FEICKERT WOODPECKER 2010

£3,445

Elegant deck with great low frequency solidity, coherent soundstaging and a precise midband.



LINN LP12SE 2010 £3,510

Surely hi-fi's most iconic turntable, the legendary Sondek goes from strength to strength. New Keel subchassis and Radical DC motor add precision and grip to one of the world's most musical disc spinners. Expensive, though.

ACOUSTIC SIGNATURE

STORM 2011 £3,612

An excellent high end design with a smooth, solid, open and lyrical sound and razor sharp styling and build.

FLETCHER AUDIO OMEGA .5

2010 £3,699

Charming high end turntable that's a fitting testament to the late Tom Fletcher.

PALMER 3 2010 £3,750

Eccentric hand built high end turntable with a pleasingly smooth, sweet and lucid sound.



E.A.T. FORTE S EVO 12 2010 £4,750

Excellent premium price turntable with power, precision and passion aplenty, but relaxed and easy going by nature too. Great value package with the Pro-ject Evo 12" arm option.

ACOUSTIC SOLID

ONE 2007 £4,050

Huge turntable, both in terms of sheer mass and sonic dynamics. Fit up to three arms and enjoy, just don't damage your back moving it...

SME MODEL 10A 1995 £4,556

Exquisitely engineered deck and SMEV tonearm combo that's an extremely accomplished performer with classical music.

AVID VOLVERE

SEQUEL 2007 £4,600

Stylish high end vinyl spinner with industrial strength build quality and a sound to match. Exceedingly neutral yet powerful sound is edge-of-the-seat stuff.

BRINKMANN

BARDO 2010 £5,845

Unique high end direct drive turntable with amazing grip and focus, albeit not the most romantic of natures.



McINTOSH MT10 2008 £8,995

Big, expensive, controversially styled and glows more than some might consider necessary, but an astonishingly good performer.

EAT FORTE 2009 £12,500

Lavishly finished two box, two motor turntable with gorgeous Ikeda 407 tonearm bundled. Exceptionally stable and unfussy performer with a relaxed but highly enjoyable gait.

TONEARMS

REGA RB25I 2009 £136

Capable way past its price point, the new 3-point mount version of the classic RB250 serves up a taut and detailed sound. A little lean for some tastes, but responds well to rewiring and counterweight modification.

MICHELL TECNOARM A 2003 £442

The late John Michell's clever reworking of the Rega theme, using blasting, drilling and rewiring! Surely the best overall performer under £500.

ORIGIN LIVE SILVER 3C 2010 £599
Excellent mid-price tonearm with a clean and open yet lyrical sound.



HADCOCK GH-242 EXPORT 2010 £770
Consummately musical, lyrical sounding tonearm, but needs the right turntable. Excellent value.

SME 309 1989 £767
Mid-price SME comes complete with cost-cut aluminium armtube and detachable headshell. Tight, neutral sound with good tonality, but lacks the IV's pace and precision.

FUNK FIRM FXR II 2010 £1,175
Clever reworking of the ubiquitous Rega platform, the FXR II gives a wonderfully musical, almost unipivot like performance.



AUDIO ORIGAMI PU7 2007 £1,300
The classic Syrinx PU3 updated to spectacular effect. Hand made to order, with any mass, length and colour you care for. Fit, finish and sound truly impressive.

NAIM ARO 1987 £1,425
Charismatic unipivot is poor at frequency extremes but sublime in the midband; truly emotive and insightful.

HELIUS OMEGA 2008 £1,595
Stylish and solid lump of arm with fabulous build quality, that turns in a dynamic and weighty performance.

SME SERIES IV 1988 £1,620
Offers nine tenths of the SME V's magic at just over half price. Exquisitely built and finished, and a design classic. Faces stiff competition these days, but lovely nevertheless.

SME 312S 2010 £1,750
Twelve inch magnesium alloy armtube plus SME V bearings makes an impressive transcription tool with an insightful yet composed sound. Superlative build completes the package.



GRAHAM PHANTOM 2006 £3,160
Sonically stunning arm with magnificent bass dexterity and soundstaging. Build quality up to SME standards, which is really saying something!

TRI-PLANAR PRECISION 2006 £3,600
Immaculate build, exquisite design and one of the most naturally musical and lucid sounds around.

SME SERIES V 1987 £2,389
Vice-like bass with incredible weight, ultra clear midband and treble astound, although some don't like its matter of factness!

LINN EKOS SE 2010 £3,700
Subtle mods over the years, including revised bearings and the recent new wiring has kept it a serious contender in the superarm stakes. Has a commanding musicality all of its own.

OL ENTERPRISE 3C 2010 £4,500
Few if any pivoted arms come close to this arm's combination of liquid musicality and forensic grip.

CARTRIDGES
AUDIO TECHNICA AT-95E 1984 £25

Great starter cartridge that's detailed and musical beyond its price. Superglue the stylus in for better sound!

AUDIO TECHNICA AT-F3/III 2010 £189

Great value entry level moving coil with detail and grip you just can't get from similarly priced moving magnets.

ORTOFON 2M RED/BLUE 2007 £60/£120
Modern, high resolution budget moving magnets that are always an engaging listen.



GOLDRING G1042 1994 £239
One of the best MMs going, with sweet and extended treble and punchy, muscular bass.

ORTOFON VIVO BLUE2011 £275
Super new budget moving coil cartridge from respected Danish manufacturer; a real step up from previous efforts.

DENON DL103R 2006 £295
Awkward to get working properly with a poor mounting arrangement, yet it rewards with a musical performance that makes similar priced cartridges sound cold.

DYNAVECTOR DV10X52003 £295
Distant descendent of the classic Ultimo 10X, this has warmth and sweetness in spades, allied to a punchy bass. Beats G1042 comfortably.

ORTOFON 2M BLACK 2007 £350
Staggeringly good high-end MM that uses a stylus from the MC Jubilee and easily rivals similarly-priced MMs

DYNAVECTOR DV20X-H2003 £395
Deliciously sweet sound with fantastic get-up-and-go makes this a great value budget MC. High output version works a treat with valve phono stages too.



AUDIO TECHNICA AT-OC9MLIII 2010 £399
New stylus and cantilever breathe life into this feisty, punchy and detailed performer.

ORTOFON RONDO BRONZE 2005 £500
Excellent mid-price moving coil with real rhythmic alacrity and a decent deal of finesse.

LYRA DORIAN 2007 £649
Incisive and musical, this baby Lyra is one of the most powerful and revealing MMs at its price point. Beware the sharp treble, though!



BENZ MICRO GLIDER L2 2008 £650
Crisp, clean and detailed MC; particularly impressive at both ends of the frequency spectrum

ZYX R-100H 2005 £799
Exceptionally tight sounding and detailed cartridge with the musical skills to match, this is up with the best at the price, with a presentation all of its own.

TRANSFIGURATION AXIA 2007 £890
Musically adept and highly resolute cartridge with impressive tracking abilities. Top end lift means careful matching required, however.

BENZ MICRO WOOD SL 2010 £945
Highly finished Swiss moving coil that plays music with riflebolt precision.



ORTOFON CADENZA BLUE 2009 £1,000
Musical, out of the box sound, allied to real finesse, makes this a great do-it-all high end moving coil.

ORTOFON CADENZA BRONZE 2010 £1,350
Smooth and engaging high end MC with a slightly warmer and more relaxed presentation than its superb bigger brother.

ORTOFON CADENZA BLACK 2010 £1,650
Ultra incisive, transparent and dimensional moving coil with grip and punch aplenty.

ORTOFON MC WINDFELD 2008 £2,250
Ortofon's new flagship MC is a sophisticated and alluring performer that takes the vinyl experience to a new level.

KOETSU RED K SIGNATURE 2007 £2,399
The new K Signature adds a hefty dose of insight and finesse to the already impressive Red and the results are fabulous.



DIGITAL SOURCES

MUSICAL FIDELITY V-DAC 2010 £170
Clear, concise, low distortion sound belies giveaway price. Supelative value for money.

CAMBRIDGE AUDIO DACMAGIC 2010 £230
A flexible new DAC, this is an impressively rhythmic and detailed performer.

ARCAM rDAC 2010 £300
Cracking budget DAC sporting a fulsome and musical sound with gorgeous build and styling.

MUSICAL FIDELITY MI DAC 2010 £400
Surprisingly sophisticated upsampling DAC with oodles of detail and air, but bass isn't quite as powerful as it could be.

STELLO DA100 SIGNATURE £750
Superbly finessed sounding DAC at the price, with strong driving bass and plenty of air and space.



CAMBRIDGE AZUR 840C 2006 £800
Well built CD player with a silky, yet detailed sound and a whole host of useful facilities. Excellent value for money.

NAIM CDSi 2008 £895
Naim's new italic 'i' variant improves even further on the original mid-price classic, offering super tight, grippy and musical sound.

ROKSAN KANDY K2 CD 2010 £900
A charmingly musical performer at the price, this is a surprisingly sophisticated CD player for the money.

BENCHMARK DAC-1S 2009 £930
Power, precision and poise - allied to real seat-of-the-pants musicality, this DAC justifies its premium price.

MUSICAL FIDELITY M3 CD 2011 £995
Excellent mid-price machine with slick slot loading and an open and inviting sound.

ELECTROCOMPANIET PD-1 2011 £1,250
Quirky but highly capable digital convertor with an effective wireless radio option (£250) and balanced outputs.

SIMAUDIO MOON 300D 2010 £1,290
Lovely fluid sounding DAC with a deep, dark, velvety tonality.



CYRUS CD8 SE 2008 £1,350
Bespoke Servo Evolution mech makes this the most musically engaging machine at the price, with super smooth tonality to boot. Optional PSX-R adds bass and dimensionality.

DENON DCD2010AE 2010 £1,700
Powerful, open sound allied to a rich tonality and satisfying subtlety make this an excellent mid-price buy.

NAIM DAC 2010 £1,995
Superb high end digital convertor with a probing, punchy and forensically detailed sound.

MERIDIAN GO8.2 2011 £2,400
Everyman's modern high end CD player, the stylish, well made Meridian has an extremely enjoyable yet refined and accurate sound.

MARANTZ SA-KI PEARL CD 2010 £2,500
Finely honed affordable high end silver disc spinner, this has a musical lucidity that's unexpected at this price.



LEEMA ANTILLA IIS ECO 2011 £2,995
Stable and smooth yet superbly detailed and musically engaging, this is class of the £3,000 CD player field.

CHORD QBD64 2008 £3,000
Bespoke architecture gives a uniquely musical sound that's beguiling yet proffers dizzying incision and grip.

ELECTROCOMPANIET EMC-IUP 2009 £3,450
Quirky yet extremely capable high end upsampling CD spinner, with a musical fluency that beguiles more than it impresses.



ACCUSTIC ARTS CDPI MK2 2007 £3,985
Styling not to everyone's taste but build quality is impeccable and the performance is stunningly musical.

ESOTERIC X-05 2010 £4,495
Superlative 'affordable high end' CD/SACD spinner with excellent build, massive detail and great poise.

WEISS DAC202 2010 £4,600
Brilliantly open and insightful sounding DAC with a range of useful features.

ELECTROCOMPANIET EMP-1/S 2011 £4,650
Epic in scale, lavish in tone and exuberant in its musicality, this is a memorable SACD spinner. Quirky in operation and modest in finish, though.

NAIM CDX2-XPS2 2003 £4,950
A fine high end machine, but add an XPS2 and it becomes one of the most charismatically engaging 16bit machines we've ever heard. Plays music with such passion!

NAIM CDS3 2003 £7,050
The most polished Naim CD to date; tremendously capable and musical, but lacks the Rottweiler quality of the cheaper CDX2-XPS2.

DCS DEBUSSY 2011 £7,500
Compact, stylish DAC bringing the gloriously smooth, svelte, spacious sound of dCS to a wider audience.

ACCUSTIC ARTS DRIVE 1 MK2/TUBE DAC 2 2007 £7,980
Superbly built high end CD transport and DAC combo that shows just what the format can be capable of. Very tangible, musical sound with wonderful dynamics and glistening harmonics. Only curious styling and clunky build detract from its brilliance!

DCS PAGANINI DAC £9,599
Digital rarely sounds better; dCS's bespoke Ring DAC makes for power, punch and insight on an epic scale. Add clock and upsampler for an even more profound experience.



NAIM CD555/555PS 2006 £14,000
Very probably the best CD player yet made - certainly the most expensive; a digital tour de force.

**NETWORK**

NAIM HDX 2009 £4,405
Interesting one-box network enabled hard disk music system gives superb sonics together with impressive ease of use.

LINN KLIMAX DS 2007 £9,600
Landmark network music player, offering brilliant sonics at up to 24/96 resolution from hard disk/NAS. Expensive, but you can hear why...

PHONO STAGES

CAMBRIDGE AUDIO 640P 2009 £99
Excellent entry level design that raises the bar for budget phono stages. Crisp, smooth yet brightly lit sound on both MM and MC that's a vast improvement on most budget inboard designs.

GRAHAM SLEE ERA GOLD V 2004 £370
Warm, open and musical nature makes this a great budget phono stage.

ICON AUDIO PSI.2 2007 £599
Excellent valve phono stage with good range of facilities and fine imaging abilities.



CHORD CHORDETTE DUAL 2010 £799

Well presented mid price designed with detailed sound and USB input for archiving.

ASTIN TREW AT8000 2010 £880

Expansive, detailed, powerful sound makes this a leading sub-£1,000 contender.

A.N.T. AUDIO KORA 3T LTD 2010 £995

Exceptionally musical and natural sounding all discrete transistor phono stage, with highly lucid, valve-like presentation.

AVID PULSUS 2010 £1,100

Powerful, propulsive, expansive sound puts this right at the top of the £1,000 phono stage tree.

QUAD QC24P 2007 £1,200

Dynamic performer that can be used on its own as a complete phono-level preamp.

ICON AUDIO PS3 2008 £1,500

Super sounding valve phono preamplifier, with an expansive, engaging and organic nature that makes vinyl sheer joy!

SUTHERLAND 20/20 2010 £1,999

Well engineered, smooth sounding solid-state phono stage with a charm of its own.

EMILLE ALLURE 2010 £2,495

Just as the name suggests, this is a lovely way to play LP with an exceptionally open and lucid sound.

**AVID PULSARE** 2010 £3,800

This superbly built, well specified phono stage has a powerful and authoritative sound that bristles with detail and energy.

WHEST PS.30 RDT SE2011 £4,500

The least solid-state sounding Whest we've heard, this builds on the family strengths of precision and grip but adds a welcome poise and fluidity.

NAT AUDIO SIGNATURE 2011 £5,633

Sophisticated sounding, unusually engineered MM and MC phono stage, but faces stiff competition at this lofty price.

AMPLIFIERS**ICON AUDIO STEREO 40/III** 2010 £1,200

Excellent starter tube integrated, with plenty of detail and an expansively musical sound.

**AUDIOLAB 8000S** 2006 £400

In another life, this sold for three times the price, making it a stand-out bargain now. Very clean, powerful and tidy sound but not the world's most beguiling.

NAIM NAIT 5: 2007 £725

The italic 'i' version remains one of the most musically competent and dynamically engaging integrateds at the price.

CAMBRIDGE 840A V2 2007 £750

Version 2 addresses version 1's weaknesses to turn in a mightily accomplished performance, offering power, finesse and detail.

SUGDEN MYSTRO 2010 £1,225

Sugden's first Class AB integrated in a long time surprises; rollickingly good fun, it loses surprisingly little in smoothness to its Class AB siblings.

NAIM NAIT XS 2009 £1,250

With much of the sound of the Supernait at half the price, this is powerful, articulate and smooth beyond class expectations.

CREEK DESTINY 2 2010 £1,445

Beautifully voiced integrated amplifier with a distinctly seductive, tube like sound. A solid-state superstar!

SUGDEN A21A S2 2008 £1,469

Crystalline clarity, dizzying speed and forensic detailing makes this seminal design the most musical at the price, but power limited so needs sensitive speakers.

**CYRUS 8XPD** 2010 £1,500

A quality integrated that suits all genres of music providing insight and clarity in a compact but flexible package.

ANATEK A50R 2007 £1,600

Simple integrated amplifier with super bass grip and effortless dynamics.

VINCENT SA-236MK 2010 £1,749

Big, powerful and expansive sounding hybrid transistor amplifier, with a lively, musical nature.

NAIM SUPERNAIT 2007 £2,475

Integrated *tour de force* from Naim that combines impressive functionality and connectivity with super sound.

AUDIO RESEARCH VS160 2009 £3,298

Load of tube power allied to a strong bass and smooth open midband makes this a grin-inducing listen.

LEEMA TUCANA II 2010 £3,495

Polished high end integrated amp that combines power, detail and genuine musicality with a good range of facilities.

**SUGDEN IA4** 2007 £3,650

Goodly amount of Class A power, icy clarity and a breathtakingly fast, musical sound make this one of the very best super-integrateds.

QUAD II CLASSIC 2010 £4,500

Beautiful retro styled integrated amplifier with a subtle, supple sound - although needs matching to speakers that are easy loads.

QUAD II CLASSIC INTEGRATED 2010 £4,500

Thoroughly modern music maker with classic style and great pedigree, this amp sings with gentle music but is no headbanger!

SIM AUDIO**MOON 600i** 2010 £5,750

Sturdy build, useful facilities and a wonderfully relaxed, seamless and even-handed sound will win this many friends.

MUSICAL FIDELITY**AMS35i** 2010 £6,000

One of the best high end integrateds we've come across, this combines hear-through transparency with musical get-up-and-go.

DARTZEEL**CTH-8550** 2010 £16,500

Charismatic and quirky high end solid-state integrated amplifier with superb sound and a charming visage.

HEADPHONE AMPLIFIERS**FIDELITY AUDIO HPA 100** 2011 £350

Great little headphone amplifier with a lively yet refined and open sound.

MUSICAL FIDELITY**X-CAN V8** 2008 £350

Open and explicitly detailed sound plus serious bass wallop and the ability to drive anything to very high levels makes this a great partner for most mid-to-high end headphones.

PREAMPLIFIERS**CREEK OBH-22** 2008 £350

Brilliant value budget passive, with remote control, mute and input switching, plus an easy, a neutral sound.

ICON AUDIO LA-4 2011 £800

Uses early 6SN7 triodes for liquid sound, has plenty of gain and remote control.

NUFORCE P-9 2007 £2,200

Impressive two box preamp with superb resolution and an engaging sound.

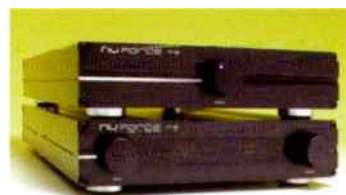
**DPA CA-1** 2010 £2,650

Excellent solid-state preamp with a meticulously detailed and propulsive sound, but a deep velvety tonality.

MELODY PURE BLACK 101D 2007 £3,295

The clarity and openness of valves plus firm grip and fine detail make this a preamplifier masterclass.

MF AUDIO CLASSIC CII SILVER

2010 £4,500

One of the best preamplifiers we've heard at any price, this transformer coupled marvel does very little wrong; its powerful, clean, open yet delicate sound is unmatched at or near the price.



MODWRIGHT 36.5 PRE/PSU
2010 £5,995

Exceptionally open and expansive, yet musically expressive sounding high end preamplifier.

MUSICAL FIDELITY PRIMO
2009 £7,900

Seriously expensive, but one listen explains why. Wonderfully exuberant sound that can only come from a top quality tube design.

POWER AMPLIFIERS
XTZ AP-100 2010 £520

Decently smooth yet usefully muscular, this power amp punches way beyond its price point in sonic and value terms.

QUAD 909 2001 £900

The latest current-dumper has a smooth and expansive character with enough wallop to drive most loads. Not the most musical, but superb value all the same. Lovely build, finish and Quad's legendary service are nice.

NUFORCE REFERENCE 9SE V2
2006 £1,750

Brilliant value for money monoblocks with massive power and super-clean, three dimensional sound.

**DPA SA-1** 2010 £2,850

Pacey, engaging and rhythmic almost to a fault, this solid-state power amplifier isn't the world's most powerful but is none the worse for it.

QUAD II-40 2005 £3,230

Modern tube monoblock power amplifiers with plenty of power, liquid and open mid-band and spacious, airy treble. Explicit, engaging sound, but not as euphonic as some.

ELECTROCOMPANIET NEMO
2009 £4,450 (EACH)

The Norwegian power station is as cool as a glacier tonally, yet impresses with its sheer physicality and fleetness of foot. 600W per channel makes for a massive bang per buck.

ICON AUDIO MB845 MkII 2010
£5,500

With 120W from big 845 valves right down to low frequencies, this power amplifier has massive dynamics and bass swing, yet is easy on the ear.

**QUAD II-80** 2005 £6,000

Quad's best ever power amplifier, this is a dramatic performer with a silky but dark tonality, blistering dynamics, serious power and a compellingly musical sound. They don't come much better.

MUSICAL FIDELITY AMS50
2010 £7,000

Mighty, assured high end full Class A integrated proffering icy clarity allied to real musicality. Lacks the lucidity of the best tube amps but redeems with power and punch.

LOUDSPEAKERS
Q ACOUSTICS 2020 2010 £140

Great little standmounters with a friendly, fun yet surprisingly refined gait. Excellent value starter speakers.

ACOUSTIC ENERGY NEO I
2007 £199

Tidy and well balanced standmounters with pleasing clarity and detail.

MISSION MX2 2011 £200

Sophisticated sound allied with real musical insight makes these small standmounters super value for money.

ACOUSTIC ENERGY NEO I v2
2010 £225

Civilised sounding speaker with fast and tuneful bass.

B&W 686 2007 £279

B&W's new baby standmounters offer a sophisticated and mature performance that belies both their dimensions and price tag.

WHARFEDALE DIAMOND 10.3
2010 £290

Great small standmounters for audiophiles on a budget; dry punchy sound with impressive soundstaging at the price.

MORDAUNT SHORT AVIANO 2 2010 £300

Classy sounding standmounter at a still affordable price.

KEF IQ30 2009 £330

Beautifully built, classily styled standmounters with exceptional image projection and a very clean, detailed sound.

**USHER S-520** 2006 £350

Astonishingly capable budget standmounters that offer detail and dynamics well beyond their price and dimensions.

XTZ 99.25 2010 £640

Disarmingly open and refined at the price, these standmounters bring unexpected civility, refinement and insight to the price point. Exceptional value for money.

**ACOUSTIC ENERGY AE1 CLASSIC**
2006 £845

Brilliantly successful remake of an iconic design; not flawless, but surely one of the most musical loudspeakers ever made.

SPENDOR S3/5E 2004 £950

A natural successor to the BBC LS3/5a, whose impressive neutrality, imaging and evenhandedness makes this a superior, if less charismatic, loudspeaker.

MY AUDIO DESIGN MY1920 2011 £995

Exceptionally smooth, spacious and refined mini monitors that beguile and excite in equal measure.

ELAC BS243 2010 £1,000

More transparent and spacious than they've a right to be at this price, these refined mid-price standmounters represent top value.

RRR FS100 2007 £1,055

Mind-boggling amount of loudspeaker for the money. Big and sturdily built with serious bass and awesome soundstage scale. A real bargain.

**ONE THING AUDIO ESL57**
2007 £1,450

One Thing Audio's modifications keep the good old ESL57 at the very top of the game.

GURU QM-10P 2007 £1,595

Quirky but adorable standmounters that are way off the pace in respect of detail and power, but well capable at playing a tune and pulling you in to the music.

USHER BE-718 2007 £1,600

Beryllium tweeters work superbly, allied to a fast and punchy bass driver. The result is subtle, smooth and emotive.

MARTIN LOGAN SOURCE
2008 £1,600

Brilliant entry level electrostatics, giving a taste of loudspeaker esoterica for the price of most moving coil boxes. Tremendous clarity, evenness and delicacy, although not the world's most powerful sound.

SPENDOR S8E 2008 £1,895

Generously large, silky smooth delivery, this dynamic sounding floorstander is an excellent all rounder.

**ISOPHON GALILEO** 2007 £2,100

Big standmounters that really grip the music and offer quite startling dynamics and grip.

MONITOR AUDIO PL100 2008 £2,300

The flagship 'Platinum' series standmounter has a lovely warm and delicate sound with superlative treble.

EMMINENT TECHNOLOGY LFT8B 2010 £2,300

Brilliant ribbon/moving coil hybrid with seamless, delicate and expansive yet tremendously musical nature.

PMC OB11 2008 £2,950

Cleverly updated floorstanders give scale and solidity in slim and well finished package.

MY AUDIO DESIGN MYCLAPTON
2010 £2,990

Powerful, dynamic, musical yet refined, this unconventional point-source design yields dramatic sonic benefits.

MAD MY CLAPTON GRAND MM
2010 £3,400

Distinctive coaxial standmounters with wonderful soundstaging, bright lucid midband and true musical insight.

YAMAHA SOAVO I.1 2009 £3,000

Musical, transparent large floorstanders with impressive dynamics and cohesion. Excellent build and finish.

**MOWGAN AUDIO MABON**
2007 £3,995

Massively capable loudspeakers that offer dynamics, scale and clarity in an elegantly simple package. Wide range of finishes, too.

B&O BEOLAB 9 2007 £5,000

Technically impressive and visually striking loudspeakers with sound quality that more than matches their looks.

TANNOY DEFINITION DC10T
2010 £5,000

Wonderfully wide and open, super fast and amazingly engaging to listen to.

ECLIPSE
TD712z/2 2011 £5,100

Flawed genius, and wilfully so. These loudspeakers don't do everything well, but what they can do is profound and enthralling; rhythms, dynamics and soundstaging.

ARS AURES MI 2006 £5,995

Sublime build and finish allied to an insightful, assured and even-handed musical performance makes these an essential high end audition.

**QUAD ESL-2905** 2006 £5,995

The old 989 with all the bugs taken out, this gives a brilliantly neutral and open sound like only a top electrostatic can; still not a natural rock loudspeaker, though.

SPENDOR ST 2010 £5,995

This classy sounding, superbly presented big floorstander will appeal to those seeking high end sonics with subtle looks.

REVOLVER CYGNIS 2006 £5,999

Revolver pull out all the stops and show what they can do with this magnificent flagship loudspeaker. A superb monitor that is like a mini B&W 801D in many ways.

VIVID VI.5 2010 £6,000

Breathtaking transparency, superlative coherence and dizzying speed make these one of the best standmounters ever made - providing you like their 'studio sound'.

**GERMAN PHYSIKS LIMITED II**
2011 £7,800

Don't be fooled by the austere looks; this is a superbly enjoyable omnidirectional speaker with a wonderfully fast, expansive sound.

USHER BE-10 2009 £10,500

Clever high end moving coil design with immense speed and dizzying clarity allied to epic punch. Needs the best ancillaries to fly, though...

B&W 801D 2006 £10,500

In many respects, the ultimate studio monitor; dazzling clarity and speed with commanding scale and dynamics.

**ISOPHON**
CASSIANO 2007 £12,900

Drive units featuring exotic materials allied to superlative build quality result in an immensely capable loudspeaker. Not an easy load to drive, however.

REVOLVER CYGNIS GOLD
2010 £15,000

Vast in scale with effortless dynamics and an easy, barrel chested bass, these big bangers are great for loush power tube amps. Large room needed!

MARTIN LOGAN CLX LINEAR
2010 £15,990

Meticulously crafted electrostatic that's free from traditional limitations, this is one of the very best loudspeakers money can buy.

ACCESSORIES**WADIA I701** 2010 £349

The first iPod dock to extract the music digitally, letting you hook your little Apple direct to a DAC for superior sound.

ISOTEK AQUARIUS 2010 £795

Highly accomplished premium priced mains conditioner that delivers the sonic goods, unlike so many others.

TOWNSHEND MAXIMUM
2003 £800

Classy ribbon supertweeter with flexible level settings and cool styling - you'll be amazed at the difference it makes, especially with Quad electrostatics.

HEADPHONES**JAYS V-JAYS** 2010 £49

Wonderful little budget over-ear portable phones with a clean, smooth sound to beat the best of the rest at the price.

**SENNHEISER MX-550** 2005 £19

Our unqualified recommendation for those seeking a serious sounding pair of in-ear phones. Smooth, detailed and musical.

SENNHEISER PX-100 2002 £29

Cracking pair of lightweight open back cans ideal for personals, but good enough for real hi-fi use. Superb build allied to a smooth and engaging performance make them the spiritual successor to the HD400s.

**GOLDRING DR150** 2006 £70

Excellent build and fine sound makes these budget cans superlative value for money.

SENNHEISER HD-590 1998 £199

The company's best real-world cans to date. Open and smooth with plenty of detail. Brightly lit midband makes them an ideal partner for a valve headphone amp.

SENNHEISER HD-650 2004 £250

A super all round reference design with crisp, detailed and even sound allied to superlative build and comfort. Cable upgrade yields great results.

SENNHEISER HD800 2010 £1,000

The ultimate expression of the Sennheiser philosophy offers massive speed, clarity and insight, although lacks some of the charm of the softer, more beguiling rival Staxes.

**STAX SR-007T OMEGA II/SRM-007T** 2006 £2,890

Simply the best headphones we've ever heard at any price, these sweetly translucent electrostatic earspeakers are like no other headphone, or loudspeaker for that matter...

THE SOURCE OF ALL MUSIC



Reference 600
5 STAR AWARD
SEPT 09



Reference 600
5 GLOBES AWARD
SEPT 09



TEAC Reference 600 REDISCOVER YOUR MUSICAL EMOTIONS



TEAC Reference CRH-500DNT THE ULTIMATE SINGLE PERFORMER FROM TEAC

Experience for yourself the new TEAC range. Call 0845 1302511. Visit www.teac.co.uk

iPod dock compatible
with all iPods.
*additional extra

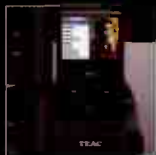

Reference 600

DAB, Internet and FM
radio - listen to hundreds
of new radio stations

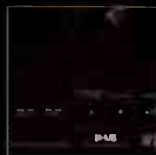

Reference 500/600

USB port - compatible
with MP3 players and
flash memory



Reference 500

Supports
CD, CD-R/RW,
MP3, WMA disc

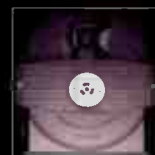

Reference 600

Reference 600:
80+80W
CRH-500: 40W+40W



Reference 500/600



iPod not included

www.teac.co.uk

The leaders in digital music
TEAC

INTERCONNECTS

**TELLURIUM Q
BLACK** 2010 £276/3m

A deep, dark, velvety performer that's nevertheless highly musical, it represents excellent value as mid-price cables go.

**TECHLINK WIRES
XS** 2007 £20

Highly accomplished interconnects at an absurdly low price. Stunning value for money.

**WIREWORLD
OASIS 5** 2003 £99/M

Excellent mid-price design with a very neutral, silky and self-effacing sound. Superb value for money.

**CHORD COMPANY
CHAMELEON 2** £90/M

One of our favourites, these are musical performers with a smooth yet open sound.

**DNM RESON** 2002 £40/M

Neutral and transparent - a steal!

**VDH ULTIMATE
THE FIRST** 2004 £260/0.6M

Carbon interconnects that help you forget the electronics and concentrate on the music. Miraculous transparency. Tight and tuneful bass mixed with air and space results in a cracking cable for the money.

**TCI CONSTRICTOR
13A-6 BLOCK** 2003 £120

Top quality 'affordable' mains outlet block, with fine build and good sonics. Well worth the extra over standard high street specials, which sound coarse and two-dimensional by comparison.

MISSING LINK CRYO REFERENCE 2008 £375

Currently our favourite 'affordable high end' interconnects, with a deliciously smooth, open and subtle sound without a hint of edge or grain. Superb value, inasuch as it's as good as some designs at three times the price.

TUNERS

DENON TU-1500AE 2006 £120

Excellent entry level analogue tuner; slick sonics and fine feature count make it a bargain.

**CAMBRIDGE
AUDIO 640T** 2005 £250

Sweet sounding digital/analogue hybrid with fine build and finish at the price.

ARCAM FMJ T32 2009 £550

Excellent hybrid FM/DAB+ tuner with a smooth, engaging sound. Factor in its fine build and it's a super value package.

**CREEK CLASSIC
TUNER** 2006 £550

No tuner offers better sound per pound; wonderfully three dimensional and smooth from bottom to top.

MICROMEGA FM-10 2010 £750

Don't let the modest proportions fool you, this is a state-of-the-art modern analogue tuner with bespoke internals giving a warm, expansive sound.

MYRYAD MXT-2000 2005 £800

Sumptuous sound and excellent build is all most will ever need in a tuner; superb.

MAGNUM DYNALAB MD-90T 2010 £1,295

Exceptionally able, but commensurately priced, audiophile tuner that cannot fail to charm.

**MAGNUM DYNALAB
MD-100T** 2006 £1,895

One of the best ways to hear FM that we know; superbly open and musical sound in a quirky but characterful package.



SYSTEMS

YAMAHA CRX-M170 2007 £200

One heck of a lot of quality performance on DAB, CD and FM for £200! Optional matching £120 NX-E300 loudspeakers aren't too shabby either.

TEAC DR-H300DAB 2008 £329

Nicely built and styled mini with fine performance on all sources that even plays DVDs!

**NAD C-715DAB** 2008 £429

Small, neat looks cover a truly capable system that shows just what a compact design can achieve.

ARCAM SOLO MINI 2008 £650

Half the size and two-thirds the price of a full-sized Solo, the Mini gives very little away in terms of performance to its bigger brother.

SHANLING MC-30 2007 £650

Quite possibly the cutest all-in-one around with fine performance from the CD player, tuner and MP3 player input. Very low power, though.

**PEACHTREE AUDIO
IDECCO** £1,000

Excellent sounding iPod dock, impressive DAC and fine amplifier section make this an excellent one box style system.

ARCAM SOLO 2005 £1,249

Excellent all-in-one system, with a warm, smooth and balanced sound to match the features and style.

LINN CLASSIK MUSIC 2008 £1,250

Neat update of the original and best one-box stereo system; superbly musical sound beats equivalently priced separates.

NAIM UNITIQUE 2010 £1,350

Great little half width one-box system with truly impressive sound allied to a wealth of source options.

**MERIDIAN F80** 2007 £1,500

Fantastically built and versatile DVD/CD/DAB/FM/AM unit, designed in conjunction with Ferrari. Ignore nay-sayers who sneer that it isn't a 'proper' hi-fi product; most see sense when they listen to it...

**AURA NOTE MUSIC CENTRE** 2007 £1,500

Lovely shiny CD/tuner/amplifier with fine sound quality and dynamic abilities.

NAIM UNITI 2009 £1,995

Uniquely versatile one box music system with excellent ergonomics and sonics to match. A landmark product for Naim.

**LINN CLASSIK
MOVIE** 2007 £2,250

Superbly built all-in-one that offers excellent sound across all formats and is surprisingly easy to use.

**MERIDIAN SOOLOOS 2.1** 2010 £6,990

Thanks to its crisp styling and bright, colourful touchscreen, plus excellent search facilities this is one hard disk music system with a difference. Best partnered to Meridian active loudspeakers.

MARANTZ 'LEGEND' 2007 £22,000

The combination of SA-751 disc player, SC-752 preamp and MA-952 monoblocks delivers jaw-dropping performance.



Unknown Pleasures

Some say cables make a huge difference to sound, others that they're a marketing driven rip-off and proof of the seedy side of the hi-fi industry. Neville Roberts bravely attempts to shed some light on the enigmatic issues in the great cable sound debate...

"A philosopher, a physicist, and a mathematician are travelling through Scotland in a train when they see a black sheep through the window. "That's interesting," says the philosopher, "I see that Scottish sheep are black." "Hmm," says the physicist, "you mean that some Scottish sheep are black." "You are both incorrect," says the mathematician. "All we know is that there is at least one sheep in Scotland and that it is black on at least one side!"

Welcome to the weird and wonderful world of cables, where knowing what's currently knowable isn't quite enough, and indeed can be quite misleading! This is why, when hi-fi journalists assert that wires have 'a sound' of their very own, magazines get a barrage of letters complaining. There's no such thing, they say, as cable sound, and to assert there is, is surely proof of some nefarious agenda, doubtless tied in to advertising, marketing, payola and suchlike...

Whilst there may be or may not be human motives at play in the great cable conundrum, the fact that they apparently measure near identically yet can sound so different doesn't prove the existence of these one iota. What we do know is that we don't know how to comprehensively describe cable sound through technical measurements yet; this is absolutely no proof that cables sound the same, or that you should conclude it's all about marketing!

Personally, I started from the position of a sceptic many years ago. But as a physicist by training, I am used to making judgements on the basis of observable, repeatable experiments, and this had me using

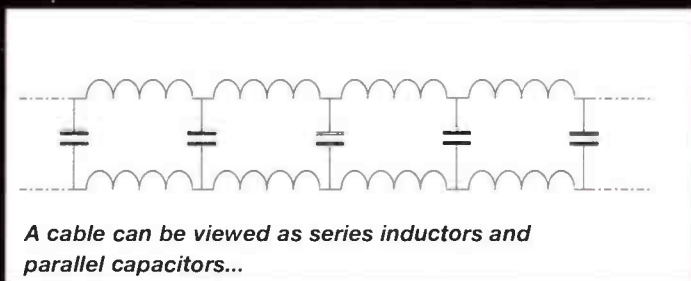

A cable can be viewed as series inductors and parallel capacitors...

my ears and not just calculations, to conclude that cables can and do sound different. There are plenty of excellent articles on the basic theory of cables written by electronics engineers who can explain far better than me the importance of capacitance, inductance, characteristic impedance and so-on. And these things that we can measure are very important, but they don't explain the whole picture...

THE ISSUES

With direct current (DC), a cable is simply two conductors of electricity which are insulated from each other to prevent shorting. The electric and magnetic fields resulting from the

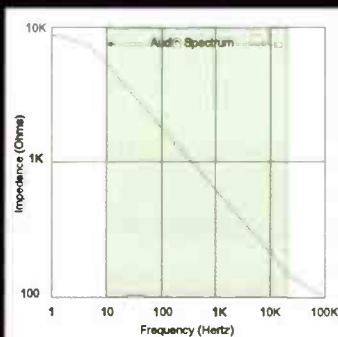

How the characteristic impedance of a typical 75 ohm coaxial cable varies with frequency, with the greatest changes occurring within the audio spectrum!

current flow soon stabilise into a fixed pattern around the conductor. The conductors need to offer negligible resistance to the current flowing within them in order to avoid wasting power through heat generation. Oxygen-free copper has splendid properties, but alas, when it comes into contact with the air or is subjected to high temperatures during the process of applying the insulation, it doesn't stay oxygen-free for long! Silver or silver and gold wire is really excellent, but rather expensive as would be expected. The metal can be cryogenically treated to modify its crystalline structure which, if done correctly, can produce noticeable audible improvements. More on this later...

However, as soon as we start to send alternating current (AC) through cables we need to consider other issues. Apart from the DC electrical resistance of the wires, whether they are audio interconnects, mains cables or loudspeaker cables, the reactive elements of the cables come into play and these in turn will affect the impedance of the cable and the phase characteristics of the signal. The electric and magnetic fields around the conductors will be constantly changing, and that in itself will have the potential to induce undesirable signals in the cable. As frequencies increase, current tends

to flow through the surface of the conductors due to what is known as Skin Effect.

Furthermore, the dielectric properties of the insulator play an important part in modifying the electric and magnetic fields around the conductors. The best dielectric is air, with a Dielectric Constant close to 1.0 (that of a vacuum). However, air would not be a good choice for several reasons, not the least of which is the lack of support for the conductor! Teflon with a Dielectric Constant of 2.1 and Polyethylene at 2.3 would be better choices, but even these will start to have an influence on the fields around the conductor.

Not only are the choices of material important in the design of cables, but also in their construction. Coaxial cables have the benefit of containing the electric and magnetic fields within the cable and help to screen out interference from outside sources and are therefore the design of choice for audio interconnects. Mains and loudspeaker cable construction ranges from simple parallel wires to complex weaves of individually insulated wires.

Then of course, one must not forget the two ends! Plugs and sockets will all play an important part in maintaining the physical layout (such as the use of RCA phono plugs to maintain the coaxial structure). Low contact resistance is extremely important in order to avoid such issues as a connector becoming a point-contact diode, changing its resistance depending on the direction of current flow!

Another complication is interference from outside sources. This can be in the form of electrical interference from the mains transformers or radio frequency signals, such as those generated by mobile phones. It can also be physical interference caused by external vibrations or even internal vibrations from the cables themselves, all of which will induce unwanted signals in the cables. So, I think it is fair to say that the issues affecting cable performance are complex, to say the very least!

THE KNOWLEDGE

Let's start by examining what we can explain – capacitance, inductance, dielectric properties, interference suppression, conductivity and so on. A cable of any length and configuration can be viewed as a network of series inductors and parallel capacitors, as shown in the accompanying diagram. Each of these elements is a little inductance-capacitance (LC) filter, which has

an impedance which varies with frequency. This is insignificant at low frequencies, but starts to become important as the frequency increases. The actual values of inductance and capacitance will give a particular cable its own unique character. As inductance causes the current to lag the voltage (and capacitance has the inverse effect), cables will cause minute phase errors between current and voltage which are frequency-dependent.

At higher frequencies, a cable can also be considered as a transmission line with a defined characteristic impedance, and therefore we must

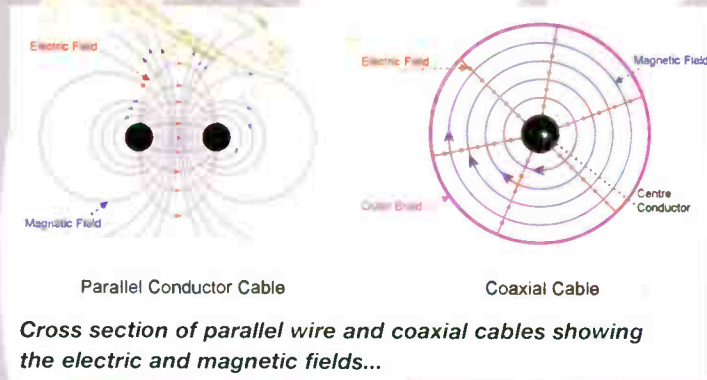

Cross section of parallel wire and coaxial cables showing the electric and magnetic fields...

also consider the wave propagation properties of the cable. Many would argue that even with frequencies of 100kHz or higher, the transmission line effects are not relevant. A frequently quoted rule of thumb is that this only becomes relevant in cables longer than a tenth of the wavelength of the signal – that's about 300m long at 100kHz! However, it's not that signals suddenly change from being the movement of matter to the movement of energy as the frequencies increase, it's just that we need different ways to explain the relevant factors. Let me explain...

It is often thought that it is the movement of electrons that constitutes the signal, when in fact the velocity of the signal is much faster than the speed at which the electrons move. It is actually close to 3×10^8 m/sec, the speed of light. The signal travels through the conductor by displacing electrons in much the same way as a wave moves across the surface of a pond, or more accurately as sound travels through the air (as the air molecules vibrate in the direction of propagation, rather than perpendicular to it as with water). This speed is modified by the properties of the cable, such as the Dielectric Constant of the insulator and the physical configuration of the cable itself. However, even this is an over simplification of the issues as there is still no universally agreed explanation for the phenomenon of

signal propagation. As with light, the true behaviour of signal propagation through a cable is likely to be best explained by a combination of both particle (the propagation of matter, such as electrons) and wave (the propagation of energy) properties and how they interact.

So, why are the transmission line properties of a cable important for audio? As I mentioned earlier, a cable has a defined characteristic impedance. This is the impedance of an infinitely long length of the cable (at a particular frequency). For the sake of argument, let's consider a standard 75 ohm coax cable, although

the same discussion will apply to any cable design. Being infinitely long, there is nothing to reflect the signal back along the cable. If one then removes a finite section from the cable (say, a 1m length), the two pieces left are also infinitely long, by definition, and each has a characteristic impedance of 75 ohms. Therefore, our 1m length of coax would have seen 75 ohms at both its ends and, as I said before, there is nothing to cause reflections of the signal within the cable. So, if this cable is terminated at each end with a 75 ohm load, then the cable is said to be perfectly matched with no reflections to attenuate or distort the signal. This is great for radio frequencies and, in any case, has no relevance at audio frequencies – right? Well, actually, no!

I mentioned that the characteristic impedance of a cable varies with frequency. If we look at a graph of the variation of this for a standard 75 ohm coax cable, the greatest variation occurs between 5Hz and 50kHz – right across the audio spectrum! This is going to give rise to unwanted reflections within the cable which vary with frequency. Granted, these reflections will be tiny, but my argument is that any unwanted signals, however small, are going to add to interference and other unwanted affects that, cumulatively, may well affect the sound that we hear.

The point of mentioning all this is

Vinyl is black!



The award winning A.N.T. phonostage is the preferred choice of many professionals. Featuring breathtaking realism and stunning dynamics, vinyl has never sounded so good! This no-compromise design is available in moving coil or moving magnet versions and features, Class A, no overall feedback, passive equalisation and no transistors or op-amps. Hi Fi World said "Cue up your favourite LP and sit back in awe as the music issues from the groove. It's an exceptionally musical device, bristling with energy" Now available for 35% less directly from the factory on the phone number below!

The Evo! What an evocative name and rightly so too! The SL-1200 evolved from a Hi Fi turntable into a DJ deck and now we turn it back into a Hi Fi turntable again! Fitted with the legendary SME 309 tonearm and the Audio Technica AT33EV your emotions will run wild. The AT33EV is itself an evolutionary cartridge hence its EV suffix and matches the SME 309 so well. We have worked with direct drive turntables and moving coil cartridges for over 30 years now and the EVO has evolved into a mature product that is quite simply a world beater. We can supply completely new units with 5 year guarantees or we can convert your own, even if you bought it used.

SME - AT/OC9 - Benz & Denon cartridges - Clearaudio - Hadcock - SL-1200 mods

Oyaide - Cassette & reel to reel tape - Marantz - Focal - Whest Audio - A.N.T. - Puresound - 78rpm - Iso pods - Audiolab - Onkyo

All demonstrated in a relaxing setting with river views! Very high part exchanges & World wide mail order.

Sound Hi Fi Dartmouth Devon 01803 833366 web www.SoundHiFi.com

Black Rhodium

Enjoy the musical detail, speed and airiness of Black Rhodium's first ever DCT++ interconnect cable



By applying our more advanced DCT++ process to the cable before assembly instead of our standard DCT process after, we have further improved the sound quality of our award winning 'Polar Illusion' cable. At the same time we have added a very effective double braided screen and given the cable a new high end appearance.

Phantom is made from two tightly twisted silver plated copper solid cores insulated in low loss PTFE, responsible for its fast detailed sound quality. DCT++ processing adds depth to the sound and enhances the timing of the music's rhythms. Termination using the highly acclaimed Eichmann Bullet plugs ensures the ultimate in musical detail shines through.

The Phantom is a very special interconnect for Black Rhodium and we have written a short account of its progressive development from cables that have won 5 stars in What HiFi? and 'Best Buy' in HiFi Choice to our new Phantom that we offer today. Hear this cable at you nearest Black Rhodium dealer and you will want to buy it!

www.blackrhodium.co.uk
01332 342233 sales@blackrhodium.co.uk

O'BRIEN HI-FI

AUDIO HOME CINEMA MULTIRoom

Used & Ex-Demonstration Clearance!

	Was	Now!
Amplifiers		
Krell S300i integrated	£2695	£POA
Moon i.5 integrated	£1195	£POA
Moon i1 integrated	£1600	£999
Moon LP3 Phono stage	£499	£299
Moon P3 Pre-amp(s/h)	£2850	£1495
CD Players		
Exposure 3010s CD (New)	£1199	£899
Unison Research Unico CDP	£1295	£649
Music Servers and DACs		
Naim HDX Hard disc player/server	£4500	£SOLD
Sonneteer Morpheus	£2500	£1899
Musical Fidelity V-DAC	£190	£159
Arcam iR ipod Dock	£149	£99
Pioneer NAS 5 ipod Station	£449	£169
Loud Speakers		
Martin Logan Summit X	£12998	£9999
Totem Model 1 Signature	£2300	£1749
Quad ESL57 (s/h)	-	£1250
Rogers LS6 (s/h)	-	£75

Audio Research, Krell, Moon, Ayre, Avid, Naim, Sonus Faber, Martin Logan, Totem, Anthem

**60 Durham Road, West Wimbledon
London SW20 0TW
0208 946 1528 www.obrienhifi.com**

to highlight that the performance of cables is hugely complex and all we can do is surmise what things could be affecting what we hear. The issue is that we can't explain the whole picture at the moment. When we seem to have a nice flat frequency response, why do some interconnect cables sound clearer and cleaner and have better bass control as well as improved imaging? Why do we get similar effects with mains cables, especially mains cables driving turntable electric motors? The fact is that many people, including myself (and I started out as a sceptic many years ago), can hear a difference.

COLD COMFORT

I previously mentioned cryogenic treatment of audio cables. This is a fairly common process applied to metallic alloys to improve their mechanical properties through stress relief and the formation of micro-precipitates, a technique that can also be applied to cables and valves. The physical changes to the metals are clearly evident, which is why, for example, some musical instruments are subjected to cryogenic treatment. There are claims that these instruments experience improved tonal performance due to the altered physical and mechanical characteristics after cryogenic treatment. It is even claimed that tympanic instruments will resist cracking and sliding parts will resist wear and last longer as a consequence of this treatment. In addition to modifications to the physical properties, some people speculate that cryogenic treatment causes the crystal boundaries and the impurities in the metals to be changed and the properties of the dielectric insulators to be modified. The truth here is that no one really knows why this all works – it just does!

As with cryogenic treatment, opinions differ about the value of burning-in cables. Some say it is a complete waste of time. However, many people have experienced permanent changes in sound quality once a cable has been used for a period of time. The weight, body and smoothness can improve and the overall tonal quality is better. Incidentally, should you want to try burning-in your own cables, you can download from the internet a modified pink noise file created for this very purpose by searching for "frybaby.mp3" on Google.

CONCLUSIONS

When I started out with my budget system comprising mainly home-made bits of equipment, I had the

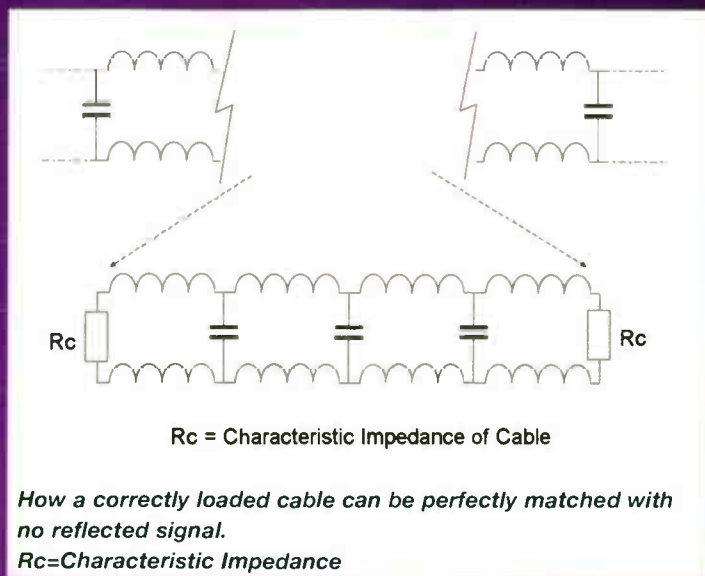

opportunity to try out different cables, but to be honest, I could discern little difference between them and my trusty home brewed concoctions. This was just as well as these elite products were way out of

affected by different cables such as imaging, sound stage depth, clarity and ambience can be completely explained by simple frequency attenuation. Whilst it is easy to define the "first order" effects of LC

"the performance of cables is hugely complex and all we can do is surmise what things could be affecting what we hear..."

my price range as a student. It was only in recent years, as my system has grown in quality, that I started to perceive the improvements offered by one cable above another. Over time, I started to hear the subtle benefits that higher quality cables offered – better clarity and realism, a greater involvement with the performances and lower noise floor. So as we improve our systems, more subtle changes become apparent. Crudely put, if you spend £20,000 on a high-end audio system, you are very likely to hear the improvements that good quality interconnect cables make. Conversely, a cheap system purchased from your local supermarket is unlikely to show any benefit from a Russ Andrews cable upgrade.

Cable-sceptics will point out the apparent irrelevance of typical steady state measurements and are pleased to point out that the calculated frequency effects of the inductive and capacitive values of any normal audio cable at normal lengths are much higher than any audible frequency, including the all-important harmonics. This simplistic argument implies that such delicate, complex and highly variable sonic qualities

filters and how they affect frequency attenuation, their indirect effects of phase errors and time delay of the audio signal on our perception of the more subtle aspects of sound reproduction cannot be so easily defined.

Many people are sceptical about claims of sonic benefits, which they consider to be unsubstantiated since they can't be backed up with scientific proof. With all due respect to the sceptics, that's rather like saying that bumble bees couldn't fly until around 2005 when scientists finally managed to put this perplexing mystery to rest! We constantly live in a world where new, unexplained issues arise.

Physics is the study of how and why things work. We are taught to keep an open mind in all that we do and update our theories based on the input of new information. The theories should then converge on what is actually correct, but we can never be one hundred percent sure. Like bees in flight, maybe one day we will be able to explain most, if not all, of the ways in which cables affect sound, but if that's not in my lifetime, I'll be content to enjoy the unexplained!



Pro-ject

A U D I O S Y S T E M S

Xperience, gained...



V Pack, now including:
Ortofon Vivo Blue cartridge
Pro-ject Evolution tone arm
Pro-ject Xperience turntable
Price tag - £1,000

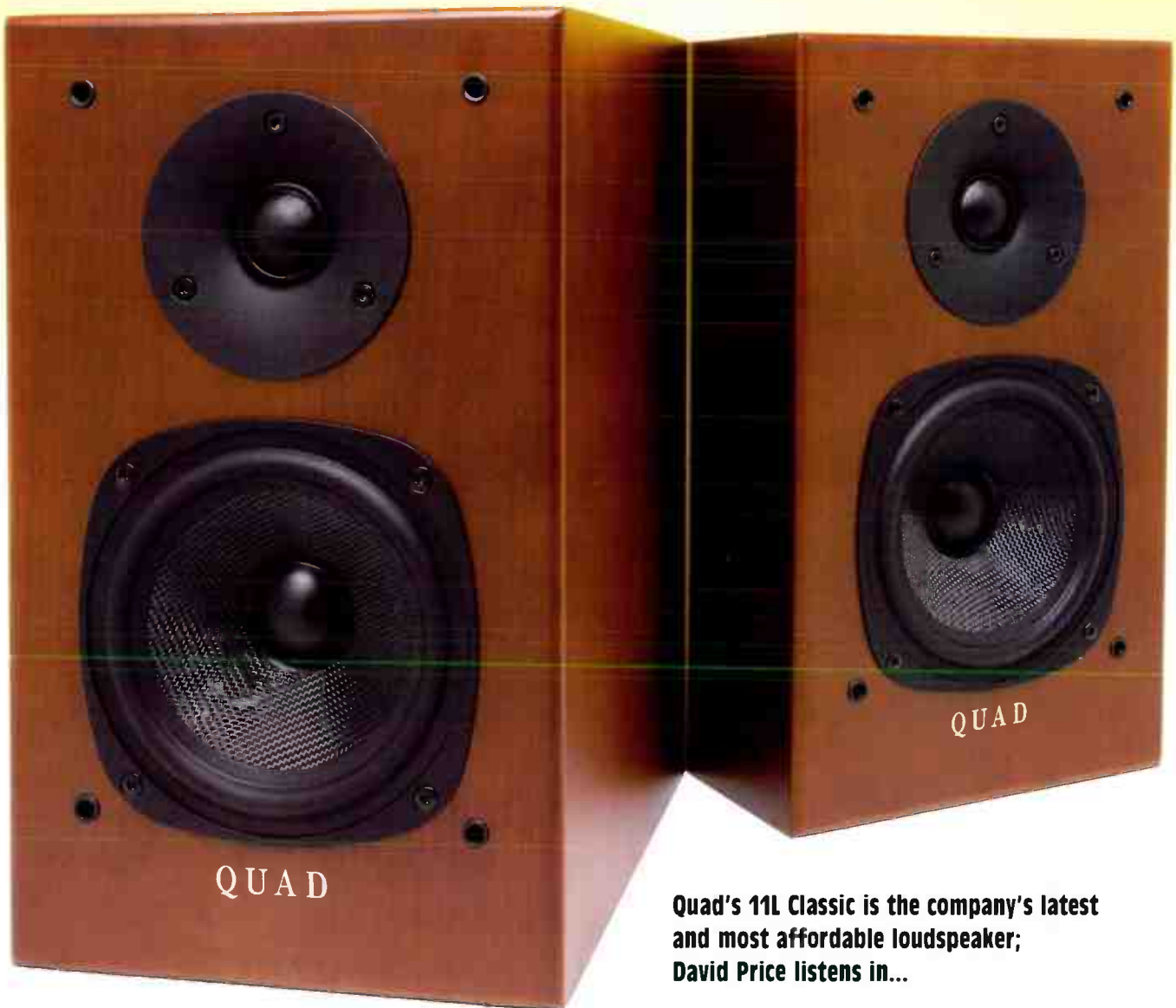

Quad's 11L Classic is the company's latest and most affordable loudspeaker; David Price listens in...

Four Real

The original Quad 11L loudspeaker was radical; not in itself, but as a concept for the company. At the time of its launch in 2002, the phrase 'Quads' was virtually synonymous with electrostatic loudspeakers (the ESL-57, 63 or 988/989). If you had Quad speakers, well you had large panel shaped objects that plugged into the mains! For the company to put its name to an utterly conventional box that owed absolutely nothing to previous loudspeakers was a bold gambit, and I'm sure a few diehard Quad traditionalists privately did not wish it to succeed...

Well, the rest as they say is

history; the speaker made its very own niche as a quality pair of £350 standmounters, being distinctive for both its clean, open and largely viceless sound and, unexpectedly, its superlative finish. Here was a budget speaker that was finished to a standard you'd expect of a product at least ten times its price; its piano lacquer black was sublime.

Reviewed here is the newest, third generation of the 11L. It follows the 11L2 which in turn was a tweaked version of the original, and has identical cabinet dimensions of 310x190x243mm (giving a volume of 11 litres, geddit?) but brings a wider variety of finishes including a cheaper

non-lacquered cherry or rosewood veneer (tested here) for £330, making it £50 less than the cherry or piano black lacquered veneer. The company says it's been extensively revised on the inside, too...

The mid/bass unit gets an upgraded motor system for its 125mm Kevlar cone; this material is a favourite of many modern manufacturers for its relative lightness and stiffness. Partnering this is the upgraded 25mm fabric dome tweeter, with a shallow horn or 'waveguide' housing to control dispersion. The crossover, which does the business at 2.2kHz, has also been upgraded with superior component mounting. Quad

say, with each section placed on its own printed circuit board within the speaker cabinet. Top-quality components are used throughout, including precision-wound inductors, laminated silicon-iron cores for the bass coils and polypropylene capacitors in the signal path.

The cabinet uses a combination of two different wood materials to reduce resonance; high density chipboard and fibre board are laminated together. Inside, specially chosen long-hair acoustic absorbent lining goes on the interior cabinet walls. Twin reflex ports round the back are used, giving more benevolent load characteristics ideal for the sort of system (and room) these are likely to be used in; sensitivity is quoted at 87dB/m [see MEASURED PERFORMANCE]. The wood veneers outside are said to be specially chosen for their grain structure, then laid and polished by hand, and then lacquered as applicable.

SOUND QUALITY

Having spent far more time than is healthy with high end speakers of late, it was fascinating to hear the Quads. I remember the originals, and their successors, and the active versions too, very well – and can report that relatively little is different. It's not as if the company has radically reworked their entry level mini-monitor, but there is certainly a subtle smoothing out of the ILL, and on the whole it comes over as being more polished; impressive given that it was famous for its polish all along. Saint Etienne's 'Hug My Soul' is a bouncy slice of nineties electropop, but it can sound quite poorly recorded on lesser loudspeakers. I was impressed that the Quads gave it a serious airing; they came over as more animated than I remember their predecessors, although they're not exactly party blasters. But allied to this was a refinement simply not expected from a £300 speaker, which is in so very many instances a symphony of booms and squawks and crashes.



I found the bass to be surprisingly tuneful; there's little sense of plodding or one-noting; it's not the world's most extended as you'd expect but it's not been engineered to boom or boof around 90Hz, as per so many classic small Mission designs for example, to add weight and give the illusion of being something bigger than it really is. As such, it follows bass notes going up and down the scale faithfully, letting you concentrate on the tune just as much as the rhythm. It's good at the latter too; stopping and starting as well as can be expected from a budget open box design. The result is a firm and faithful underpinning of what goes on further up the scale.

Although in absolute terms

of omission rather than addition; you get a soft, feathery hi hat sound that doesn't stand out or ever descend into spikiness, yet it's fairly open and atmospheric too. It's nicely balanced into the smoothish midband, and whilst it doesn't quite extend up to where the angels live, the ILL gives the sense that it's 'all of a piece'; you're not listening to the sound of two drive units fighting it out for the right to call the cabinet their own. Again, in ultimate terms the treble lacks low level detail and atmosphere, but it's plenty good enough to signpost difference between the silky cymbal work on 'Reaper' and the harder, more metallic strains of 'New Gold Dream' by Simple Minds.

Classical music is of course the great leveller of any loudspeaker and the Quad took Pamela Thorby's soprano recorder on Linn Records' 'Venice Collection' (The Palladian Ensemble) surprisingly easily in its stride. Recorders are naturally bright and thus sometimes unlistenable even on some fairly pricey loudspeakers, but the ILL sounded composed. It managed to convey the instrument's natural resonances, without exacerbating them. Ditto its reproduction of cello, which was most satisfying

"there was a refinement simply not expected from a £300 loudspeaker..."

a little nasal and opaque, by the standards of the price point the Quad ILL has an excellent midband. Again, it's clean and open, with more resolution of lower level detail than you'd expect; that means the timbre of instruments comes out more than it otherwise might. 808 State's 'Azura' is a powerful techno track with a massive thumping analogue bass synth; as well as giving a deep and powerful rendition it also carried its characteristic sound, dripping with harmonics, in a way I hadn't expected. Ditto its rendering of singer Louise Rhodes' voice, which was icily clear and subtle in its inflection; there was no hint of peakiness or rough edges to spoil my enjoyment of the track. The speaker images well too; I wouldn't quite put it in Eclipse TD712 territory I grant you, but it projected images confidently and managed to give a great 'out of the box' experience.

Blue Oyster Cult's 'Don't Fear the Reaper' showed the Quad's rather lovely (for a budget design) treble. Its tweeter commits the sins

tonally, sounding vibrant and full bodied. The track flowed gracefully, the Quads being capable carriers of rhythm, if not necessarily born to rock! Overall this loudspeaker came across with only very few weaknesses, and certainly there were no flaws at the price which isn't something that can be said of every sub £400 speaker.



DP: Who were you designing the Quad 11L Classics for?

PC: The customer will be after a realistic sound that reveals the exact portrayal of instruments and vocals and allows them to dig deep into the performance. For this Classic edition we felt we could go further by re-evaluating the 11L design to tweak the sound and make this a classic mini-monitor in the LS3/5A tradition. Accordingly the bass performance and presence of the midrange were balanced to enable great insight into the music. This speaker draws you in to the musical performance rather than throwing it at you.

DP: What sort of drivers were used, and why?

PC: As per the last generation, a self-damping impregnated Kevlar lattice weave is used for the bass-midrange unit and a fine polyester woven fabric dome for the treble. However the motor system of the bass driver was redesigned to lower distortion whilst the dust cap and surround were modified to improve clarity in the midband and smooth the response through the crossover region. For the treble unit we designed a new waveguide which improves the upper midrange output and optimises its dispersion to marry with the bass unit through the crossover region.

DP: What type of crossover was employed?

PC: Linkwitz-Riley electrical filters were chosen for the crossover which was extensively evaluated through iteration between measurement, crossover simulation and listening tests. We went through thirty two variations before we were satisfied! In terms of construction we use high performance Polypropylene capacitors in the signal path and low loss laminated silicon-iron core inductors for the bass section. The crossover itself is split into two PCBs to remove interaction between the bass and treble components

and to allow an optimal component layout. Bi-wiring really benefits this speaker. We design and make our own internal cables for the 11L from high purity copper.

DP: How did you arrive at the cabinet design?

PC: Box construction was evaluated carefully to reduce panel resonance. The final choice was a combination of MDF and particle board, the relative thicknesses chosen to lower the audibility of panel resonance as well as block the transmission of the sound from the inside of the cabinet. The walls were optimally braced to control flexure at low frequencies. It is always difficult to get a quart out of a pint pot. Thankfully, these days we can simulate the speaker and crossover performance using advanced software and this allows us to optimise the physical and electrical characteristics to achieve a desired result in a way that would normally take years. Similarly we constructed a virtual crossover which allowed us to balance the requirements of minimum phase and a smooth transition between the drive units as well as ensure a good off-axis response. This gave us a good starting point from which we only needed to fine tune using extensive listening tests.

DP: Is there any one aspect of the design you're particularly pleased with?

PC: The design of the speaker should be viewed as a whole; the components work together to produce a sum greater than the performance of any one part. But I am particularly pleased that the 11L Classic sounds much bigger than its size would lead you to believe. It fits the Quad tradition of an accurate, natural and realistic sounding transducer. In addition it is musically dynamic and revealing, seducing the listener with its performance and creating that all important emotional connection with the music and the performers. It's a speaker to admire the longer you listen to it.



Quad's Peter Comeau

REFERENCE SYSTEM:

Marantz TT-1000 turntable
Whest PS.30 RDT SE phono stage
Musical Fidelity AMS35i integrated amplifier
Yamaha NS1000M loudspeakers
Q Acoustics 2010 loudspeakers

CONCLUSION

It's a strange conundrum; on one hand the Quad brand was often derided as 'pipe and slippers hi-fi', purveyors of reassuringly well made, solid and dependable quality audio equipment for the middle classes; on the other the electrostatics were – and still are – some of the most radical loudspeakers ever made. In the 11L we see more of the former than the latter; if you want left-field from Quad then it's the high end speakers you have to buy. These small boxes are meticulously well engineered to give a neutral, smooth sound via utterly conventional means.

They sound excellent, albeit in a way that might not actually chime so well with their intended market. At this price, people often want a bit of character, a speaker with 'attitude', but the 11Ls are all about getting the job done without drawing attention to themselves. For me, that's precisely what a good budget speaker should do, so it can be kept as people upgrade the rest of their ancillaries, showing each step up without getting in the way. But that won't be everyone's idea of a good time at £300 which is a shame because it's not for loudspeakers to have character, it's the musicians that play through them. A great, grown up loudspeaker at a very teenage price!

VERDICT ●●●●●

Refinement and poise beyond their price allied to superb finish, and there's nothing more you could reasonably ask of these speakers.

QUAD 11L CLASSIC £329.95

Quad Electroacoustics

☎ +44(0)1480 447700

www.quad-hifi.co.uk

FOR

- gentle, sophisticated sound
- pleasingly musical
- compact size
- superb finish

AGAINST

- headbangers don't apply!

MEASURED PERFORMANCE

Our frequency response analysis clearly shows the Quad 11L Classic is unusually smooth and flat in frequency response. This means it will sound both tonally balanced and free from colour. Such loudspeakers are also low on 'character' though; a neutral performer as this will disappear acoustically and not make itself known. The sharp treble peak diminishes off axis and with the Quads facing straight down a room they measure flat in the listening position, around 30 degrees off axis.

Bass rolls down below 150Hz then descends sharply at 70Hz. However, the ports provide strong output around 55Hz and our impedance trace show they provide good bass unit damping too, so the little Quad is likely to have quite obvious and well controlled bass.

Sensitivity was high at 87.5dB, considering the small cabinet size. Impedance measured 6 Ohms with pink noise – a music like signal – but the bass unit is 4 Ohms and minima are 4 Ohms as a result. The load is fairly resistive, a good sign as amplifier matching goes.

The small Quad 11L Classics

are supremely accurate and well engineered. This is a loudspeaker for those who want the unembellished truth, a classic Quad quality. NK

FREQUENCY RESPONSE



Green - driver output
Red - port output

IMPEDANCE

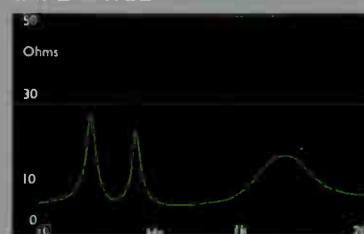

WORLD CLASSICS

Here is our list of the great and good from audio's glorious past, products that have earned their place in hi-fi history. You'll also see some oddities which aren't classic as such, but are great used buys. The year of introduction is given, alongside the original UK launch price.

We do not sell these products. It is for your information only.

DIGITAL

CAMBRIDGE AUDIO CD1 1986 £1500
Inspired Stan Curtis redesign of Philips CD104, complete with switchable digital filter. Lean but tight and musical performer.

CAMBRIDGE AUDIO CD4SE 1998 £200
A touch soft in the treble and tonally light, but outstanding in every other respect.

LINN KARIK III 1995 £1775
The final Karik was a gem. Superb transport gives a brilliantly tight, grippy dynamic sound, albeit tonally dry.

MARANTZ CD73 1983 £700
A riot of gold brushed aluminium and LEDs, this distinctive machine squeezed every last ounce from its 14x4 DAC -super musical



MARANTZ SA-1 2000 £5,000
The greatest argument for SACD. This sublime Ken Ishiwata design is utterly musically convincing with both CD and SACD, beating most audiophile CD spinners hands down.



MERIDIAN 207 1988 £995
Beautifully-built two-box with pre-amp stage. Very musical although not as refined as modern Bitstream gear. No digital output.

MUSICAL FIDELITY TRIVISTA 2002 £4000
When playing SACDs, the sweetest, most lucid and lyrical digital disc spinner we've heard. Old school stereo, pure DSD design. CD sound is up in the £1000 class, too! Future classic.

MERIDIAN MCD 1984 £600
The first British 'audiophile' machine was a sweeter, more detailed Philips CD100. 14x4 never sounded so good, until the MCD Pro arrived a year later.



NAIM CDS 1990 £ N/A
Classic Philips 16x4 chipset with serious attention to power supplies equals grin-inducing sonics.



SONY CDP-101 1982 £800
The first Japanese CD spinner was powerful and involving. Brilliant transport more than compensated for 16x2 DAC, and you even got remote control!

SONY CDP-R1/DAS-R1 1987 £3,000
Sony's first two boxer was right first time. Tonally lean, but probably the most detailed and architectural sounding machine of the eighties.



SONY CDP-701ES 1984 £890
Sony's first ever bespoke high end audiophile machine used a 16x2 DAC to provide a clinically incisive sound; supreme build quality allied to the pure unadulterated luxury of a paperback-sized remote control.

TECHNICS SL-P1200 1987 £800
CD version of the Technics SL-1200 turntable. Massively built to withstand the rigours of 'pro' use and laden with facilities - a great eighties icon. Sonically, it's pure fun, with hefty bass that can still show weedy modern players a thing or two!

YAMAHA CD-X1 1983 £340
Nicely built 16x2 machine with a very sharp and detailed sound; sometimes too much so. Excellent ergonomics, unlike almost every other rival of the time.

COMPACT DISC TRANSPORTS

TEAC VRDS-T1 1994 £600
Warm and expansive sound made this a mid price hit. Well built, with a slick mech.



ESOTERIC P0 1997 £8,000
The best CD drive bar none; TEAC's Tokyo boys pushed the boat out in style. Brilliantly incisive, ridiculously over engineered.

KENWOOD 9010 1986 £600
The first discrete Jap transport was beautifully done and responds well to re-clocking even today.

DACS

CAMBRIDGE AUDIO DACMAGIC 1995 £99
Good value upgrade for budget CD players with extensive facilities and detailed sonics.



DCS ELGAR 1997 £8500
Extremely open and natural performer, albeit extremely pricey - superb.



DPA LITTLE BIT 3 1996 £299
Rich, clean, rhythmic and punchy sound transforms budget CD players.



PINK TRIANGLE DACAPO 1993 £ N/A
Exquisite; the warmest and most lyrical 16bit digital audio we have ever heard. Clever plug-in digital filter modules really worked!



QED DIGIT 1991 £90
Budget bitstream performer with tweaks aplenty. Positron PSU upgrade makes it smooth, but now past it.

TURNTABLES

ARISTON RDI1S 1972 £94

Modern evolution of Thorens' original belt drive paradigm, Scotland's original super-deck was warm and musical, albeit soft. Still capable of fine results today.

ADC ACCUTRAC 4000 1976 £300

Bonkers 1970s direct drive that uses an infra red beam to allow track selection and programming. More of a visual and operational delight than a sonic stunner.

PIONEER PL12D 1973 £36

The beginning of the end for the British turntable industry. When vinyl was the leading source, this bought new standards of noise performance and stability to the class, plus a low friction S-shaped tonearm. Later PL112D was off the pace compared to rivals



PIONEER PLC-590 1976 £600

Sturdy and competent motor unit that performs well with a wide range of tonearms. Check very thoroughly before buying due to electronic complexity and use of some now-obsolete ICs.

DUAL CS505 1982 £75

Simple high quality engineering and a respectable low mass tonearm made for a brilliant budget buy. Polished, smooth and slightly bland sound.

GOLDRING Lenco GL75 1970 £15.65

Simple, well engineered motor unit with soft, sweet sound and reasonable tonearm. Good spares and servicing support even today from specialists. Eminently tweakable. Similar 88 and 99 motor units are budget 301/TD124 rivals.

LINN AXIS 1987 £253

Simplified cut-price version of the Sondek complete with LVX arm. Elegant and decently performing mid-price package. Later version with Akito tonearm better.

LINN SONDEK LP12 1973 £86

For many, the Brit superdeck; constant mods meant that early ones sound warmer and more lyrical than modern versions. Recent 'SE' mods have brought it into the 21st century, albeit at a price.



MARANTZ TT1000 1978 £ N/A

Beautiful seventies high end belt drive with sweet and clean sound. Rare in Europe, but big in Japan.



MICHELL GYRODEC 1981 £599

Thanks to its stunning visuals, this bold design wasn't accorded the respect it deserved until recently. Early examples sound cold and mechanical, but now right on the pace. Clean, solid and architectural sound.

TECHNICS SP10 1973 £400

Seminal Japanese engineering. Sonics depend on plinths, but a well mounted SP10/II will give any modern a hard time, especially in respect of bass power and midband accuracy.

REGA PLANAR 3 1978 £79

Brilliantly simple but clean and musical performer, complete with Acos-derived S-shaped tonearm. 1983 saw the arrival of the RB300, which added detail at the expense of warmth. Superb budget buy.

GARRARD 301/401 1953 £19

Heavy metal - tremendously strong and articulate with only a veiled treble to let it down. In many respects, better than the seventies 'superdecks' that succeeded it.



ROKSAN XERXES 1984 £550

Supposedly the first to 'better' the LP12. Super tight and clean sound, with excellent transients. Less musical than the Sondek, but more neutral. Sagging plinth top-plates make them a dubious used buy.

SONY PS-B80 1978 £800

First outing for Sony's impressive 'Biotracer' electronic tonearm. Built like a tank with a clean and tidy sound, albeit lacking involvement. Scarily complicated and with no spares support - buy with caution!

THORENS TD124 1959 £ N/A

The template for virtually every 1970s 'superdeck', this iconic design was the only real competition for Garrard's 301. It was sweeter and more lyrical, yet lighter and less impactful in the bass.



TOWNSHEND ROCK 1979 £ N/A

The product of academic research by the Cranfield Institute, this novel machine has an extremely clean and fluid sound. Substantially modified through the years, and capable of superb results even today.

TRIO LO-7D 1978 £600

The best 'all-in-one' turntable package ever made, Trio/Kenwood threw their 'engineering best practice' book at this one with startling results. Clean, powerful and three-dimensional sound, ultimately limited by the tonearm.

TO NEARMS

ACOS LUSTRE GST-1 1975 £46

The archetypal S-shaped seventies arm; good, propulsive and involving sound in its day, but ragged and undynamic now.

AUDIO TECHNICA AT 1120 1978 £75

Fine finish can't compensate for this ultra low mass arm's limited sonics - a good starter arm if you've only got a few quid to spend.

ALPHASON HR100S 1981 £150

First class arm, practically up to present-day standards. Buy carefully, though, as there is no service available now. Totally under priced when new, exceptional.



SME 3009 1959 £18

Once state of the art, but long since bettered. Musical enough, but weak at frequency extremes and veiled in the midband. Legendary serviceability and stunning build has made it a cult, used prices unjustifiably high.

GRACE G707 1974 £58

This early Japanese example of the tonearm art has a smooth, lyrical sound. Imported by Linn, fitted to early LP12s. Sonically way off the pace now, though.

REGA RB300 1983 £88

Inspired budget esoterica. Detailed, tight, neutral sound but tonally grey sounding in absolute terms. Responds well to tweaking, and its cheaper RB250 brother better still.



SME SERIES III 1979 £113

Clever variable mass design complete with Titanium Nitride tube tried to be all things to all men, and failed. Charming nonetheless, with a warm and inoffensive sound.

HADCOCK GH228 1976 £46

Evergreen unipivot with lovely sweet, fluid sound. Excellent service backup.



LINN ITTOK LVII 1978 £253

Arguably the first 'superarm'; Japanese design to Linn specs made for a muscular, rhythmic sound with real dynamics. Now off the pace, but the final LVIII version worth seeking out.

NAIM ARO 1986 £875

Truly endearing and charismatic performer - wonderfully engaging mid-band makes up for softened frequency extremes.



CLASSICS

TECHNICS EPA-501 1979 £ N/A
Popular partner for late seventies Technics motor units. Nice build and Titanium Nitride tube can't compensate for middling sound.

INTEGRATED AMPLIFIERS/COMBOS

DELTEC 1987 £1900
Fast, dry and with excellent transients, this first DPA integrated is the real deal for eighties obsessives. Ridiculously punchy 80V per channel from a tiny, half-size box. Radical, cool and more than a little strange.

ROGERS A75 1978 £220
The prototypical Audiolab 8000a – lots of sensible facilities, a goodly power output and nice sound in one box. The later A75II and A100 versions offered improved sonics and were seriously sweet and open to listen to.

EXPOSURE VII/VIII 1985 £625
Seminal mid-eighties Exposure pre-power, offering most of what rival Naim amps did with just that little bit extra smoothness and sweetness. Still, it's by no means 'sweet' by today's standards, being lean, punchy, musical. It's also possessed of that quintessentially eighties look – frumpy black steel boxes with rough silk screened logos!



SUGDEN C51/P51 1976 £130
Soft sounding early Sugden combo with a plethora of facilities and filters, complete with seventies-tastic DIN socketry. A sweet and endearing performer as you'd expect, but lacking in power and poor load driving ability, so partner carefully.

VTL MINIMAL/50W MONOBLOCK 1985 £1,300
Vacuum Tube Logic was one of the Europe's biggest tube names in the eighties, and it shows. Rugged, professional build and finish allied to a lively and punchy sound (albeit with limited power) make them an excellent used buy.

A&R A60 1977 £115
Sweet and musical feature-packed integrated; the Audiolab 8000A used its blueprint to great effect.



CREEK CAS4040 1983 £150
More musical than any budget amp before it; CAS4140 loses tone controls, gains grip.

AUDIOLAB 8000A 1985 £495
Smooth integrated with clean MM/MC phono stage and huge feature count. Extremely reliable, too. Post '93 versions a top used buy.



MCINTOSH MA6800 1995 £3735
Effortlessly sweet, strong and powerful with seminal styling to match.

SUGDEN A21 1969 £ N/A
Class A transistor integrated with an eminently likeable smoothness and musicality. Limited inputs via DIN sockets.

MISSION CYRUS 2 1984 £299
Classic eighties minimalism combines arresting styling with clean, open, lively sound. Further upgradeable with PSX power supply.



MUSICAL FIDELITY A1 1985 £350
Beguiling Class A integrated with exquisite styling. Questionable reliability.



NAIM NAIT 1984 £350
Superb rhythms and dynamics make it truly musical, but tonally monochromatic. Fine phono stage, very low power.

NAD 3020 1979 £69
Brilliantly smooth, sweet and punchy at the price and even has a better phono stage than you'd expect. The archetypal budget super-amp.



MYST TMA3 1983 £300
Madcap eighties minimalism, but a strong and tight performer all the same.

ROGERS CADET III 1965 £34
Sweet sounding valve integrated, uses ECL86 output valves, even has a half useable phono stage, sweet, warm a good introduction to valves



ROTEL RA-820BX 1983 £139
Lively and clean budget integrated that arguably started the move to minimalism.

CHAPMAN 305 1960 £40
Smooth pre/power combo with a sweet and open sound. Not quite up to Leak/Quad standards but considerably cheaper second-hand.

PREAMPLIFIERS

AUDIOLAB 8000C 1991 £499
Tonally grey but fine phono input and great facilities make it an excellent general purpose tool.

CROFT MICRO 1986 £150
Budget valve pre-amp with exceptionally transparent performance.

AUDIO RESEARCH

SP-8 1982 £1,400
Beautifully designed and built high end tube preamplifier with deliciously sweet and smooth sound. Not the last word in incision or grip, but that didn't matter to those who aspired to it.

CONRAD JOHNSON MOTIV MC-8 1986 £2,500
Minimalist FET-based preamplifier from the Yank valve specialists is brilliantly neutral and smooth with a spry, light balance in the mould of Sugden high end stuff. Something of a curio, but worthwhile nonetheless.

LEAK POINT ONE STEREO 1958 £ N/A

Good for their time, but way off the pace these days. Use of EF86 pentode valve for high gain rules out ultra performance. Not the highest-fi!

LINN LK-1 1986 £499
A brave attempt by the Glasgow boys to bring remote controlled user-friendliness to hair-shirt audiophile hi-fi. Didn't quite work, but not half bad for under £100.

LECSON AC-1 1973 £ N/A
Amazing styling courtesy of Allan Boothroyd can't disguise its rather cloudy sound, but a design classic nonetheless.



QUAD 22 1958 £25
The partner to the much vaunted Quad II monoblocks - cloudy and vague sound means it's for anacrophiles only.

QUAD 33 1968 £43
Better than the 22, but Quad's first tranny pre isn't outstanding. Responds well to tweaking/ rebuilding though...

NAIM NAC32.5 1978 £ N/A
The Salisbury company came of age with this, their classic high end pre. Brilliantly fast and incisive sound that's a joy with vinyl but a tad forward for digital.

POWER AMPLIFIERS

HH ELECTRONICS TPA-50D AMPLIFIERS 1973 £110
Simple design with easily available components, solid build quality and fine sound make for a surprisingly overlooked bargain. Not exactly stylish, however.

LEAK STEREO 20 1958 £31
Excellent workaday classic valve amplifier with decent power and drive. Surprisingly modern sounding if rebuilt sympathetically. Irrepressibly musical and fluid.



LEAK STEREO 60 1958 £N/A

Leak's biggest valve power amp offers 35 Watts per channel and more low end welly than the smaller Stereo 20. Despite concerns over reliability their rarity means high prices are the order of the day.

LECSON API 1973 £ N/A

Madcap cylindrical styling alluded to its 'tower of power' pretensions, but it wasn't. Poor build, but decently clean sounding when working.

MARANTZ MODEL 9 1997 £8000

Authentic reproduction monoblocks still more than cut the sonic mustard. Highly expensive and highly sought after.

MICHELL ALECTO 1997 £1989

Crisp, clean and beautifully controlled with gorgeous styling. Partnered with the £1650 Orca this sounds delicious!

LEAK POINT ONE, TL10, TL12.1 1949 £28

Early classics that are getting expensive. Overhauling is de rigueur before use, using original parts if possible. Surprisingly crisp and musical sound, that's far more modern than Quad IIs. Deeply impressive when in fine fettle.



MUSICAL FIDELITY XA200 1996 £1000PR

200W of sweet smooth transistor stomp in a grooved tube! Under-rated oddity.



QUAD II 1952 £22

The all-time classic valve amplifier, with a deliciously fluid and lyrical voice. In other respects though, it sounds hopelessly dated. Low power and hard to partner properly



QUAD 405 1978 £115

The first of the current dumpers is a capable design with smooth, effortless power and a decently musical sound. 606 and 707 continue the theme with greater detail and incision.

QUAD 303 1968 £55

Bullet proof build, but woolly sound. Off the pace, but endearing nonetheless. Some pipe smoking slipper wearers swear by them!

KRELL KMA100 II 1987 £5,750

Ludicrous monoblock version of the giant KSA-100 is one of the seminal eighties transistor power amplifiers. Massive wallop allied to a very clean and open Class A sound makes this one of the best amplifiers of its type, ever.

RADFORD STA25 RENAISSANCE 1986 £977

At the time, very possibly the least cool amplifier on the planet – and we're not talking heat dissipation here. This reworking of Radford's original late sixties design was possessed of a wonderfully rich, old school valve sound with enough power (25W) and lots of subtlety.



PIONEER M-73 1988 £1,200

Monster stomp from this seminal Japanese power amplifier, complete with switchable Class A and Class B operation. Clean, open and assured sounding, albeit a tad behind the pace on high speed dance music. Rosewood side cheeks and black brushed aluminium completes the eighties-tastic experience.



PHONO STAGES CREEK OBH-8 SE 1996 £180

Punchy, rhythmic character with oodles of detail makes this a great budget audiophile classic. Partner with a Goldring G1042 for an unbeatable budget combination.



LINN LINNK 1984 £149

Naim-designed MC phono stage built to partner the original Naim NAIT - yes, really! Fine sound, although off the pace these days.

MICHELL ISO 1988 £ N/A

This Tom Evans-designed black box started the trend for high performance offboard phono stages. Charismatic, musical and punchy - if lacking in finesse.

TUNERS MARANTZ ST-8 1978 £353

Marantz's finest radio moment. Warm, organic sound plus an oscilloscope for checking the signal strength and multipath.



CREEK CAS3140 1985 £199

Excellent detail, separation and dynamics - brilliantly musical at the price. T40 continued the theme...

NAD 4040 1979 £79

Tremendously smooth and natural sound allied to low prices and good availability make this budget analogue esoterica. Needs a good antenna to work properly, however.

NAIM NAT03 1993 £595

The warm, atmospheric sound is further proof of Naim's proficiency with tuners.

PIONEER TX-9500 1976 £295

Another of the serious classic solid-staters. Boasts the usual high end Jap package of fine sound, brilliant sensitivity and superb build.

LEAK TROUGHLINE 1956 £25

Series I an interesting ornament but limited to 88-100MHz only. II and III are arguably the best-sounding tuners ever. Adaptation for stereo easy via phono multiplex socket. Fed by a modern outboard decoder they're deliciously lucid with true dimensionality.



YAMAHA CT7000 1977 £444

Reputedly the best of the classic Jap analogues, this combines sleek ergonomics, high sensitivity and an explicit, detailed sound.

QUAD FM4 1983 £240

Supreme ergonomics and styling allied to a pleasingly lyrical sound with plenty of sweetness and detail made this one of the best tuners around upon its launch.



REVOX B760 1975 £520

More of a semi-pro machine than a domestic bit of kit, the Revox offers superlative measured performance although the sound isn't quite as staggering as the numbers. Fine nonetheless, and surely the most durable tuner here?

NAD 4140 1995 £199

Brilliant affordable digital tuner has a smooth, detailed musical sound plus sensible real-world facilities.

ROGERS T75 1977 £125

Superb mid-price British audiophile design, complete with understated black fascia. Fine sound in the true Rogers mould – smooth and sweet with fine dimensionality.

SANSUI TU-9900 1976 £300

A flagship Japanese tuner designed to steal sales from the likes of Accuphase and Revox, it boasts superlative RF performance and an extremely smooth and lucid sound, along with very fine build and finish.

SONY ST-5950 1977 £222

One of the first Dolby FM-equipped tuners, a format that came to nought. Still, it was Sony's most expensive tuner to date, and boasted a very good sound quality allied to brilliant ergonomics.

SEQUERRA MODEL I 1973 £1300

Possibly the ultimate FM tuner. Massive in terms of technology, size and features dedicated to extracting every ounce of performance from radio, including impressive multi-purpose oscilloscope display.



CLASSICS

TECHNICS ST-8080 1976 £180

National Panasonic's specialist hi-fi brand was a big hitter back then, and this is no exception. Superb FM stage makes for a very clean and smooth listen with lots of detail and depth.



ANALOGUE RECORDERS

YAMAHA TC-800GL 1977 £179

Early classic with ski-slope styling courtesy of Mario Bellini. Middling sonics by modern standards, but cool nonetheless!



AIWA XD-009 1989 £600

Aiwa's Nak beater didn't, but it wasn't half bad nonetheless. Massive spec even included a 16x4 DAC!



PIONEER CTF-950 1978 £400

Not up to modern standards sonically, but a great symbol of the cassette deck art nonetheless.



REVOX A77 1968 £145

The first domestic open reel that the pros used at home. Superbly made, but sonically off the pace these days. B77 better, but couldn't match the Japanese.



SONY WM-D6C 1985 £290

Single capstan transport on a par with a Swiss watch, single rec/replay head better than most Naks. Result: sublime.



SONY TC-377 1972 £N/A

A competitor to the Akai 4000D open reel machine, the Sony offered better sound quality and is still no slouch by modern standards

DIGITAL RECORDERS

SONY MDS-JE55ES 2000 £900

The best sounding MD deck ever, thanks to awesome build and heroic ATRAC-DSP Type R coding.



PIONEER PDR-555RW 1999 £480

For a moment, this was the CD recorder to have. Clean and detailed.

MARANTZ DR-17 1999 £1100

Probably the best sounding CD recorder made; built like a brick outhouse with a true audiophile sound and HDCD compatibility.



KENWOOD DM-9090 1997 £500

Serious and sophisticated sound thanks to well implemented ATRAC 4.5; surprisingly musical MD recorder.

SONY TCD-8 DATMAN 1996 £599

Super clean sound makes this an amazing portable, but fragile.

LOUDSPEAKERS

ACOUSTIC RESEARCH

ARI85 1978 £125

Yank designed, British built loudspeaker became a budget staple for many rock fans, thanks to the great speed from the paper drivers, although finesse was most definitely not their forte...

BBC LS3/5A 1972 £88

Extremely low colouration design is amazing in some respects – articulation, stage depth, clarity – and useless in others (both frequency extremes). Came in wide variety of guises from various manufacturers building it under licence. Partner with Rogers AB1 subwoofers for an extra two octaves of bass!

LOWTHER PM6A 1957 £18 EACH

This seminal full-range driver is still manufactured. High sensitivity, as fitted to many classic horn designs.

HH ELECTRONICS TPA-50D AMPLIFIERS 1973 £110

Simple design with easily available components, solid build quality and fine sound make for a surprisingly overlooked bargain. Not exactly stylish, however.

TANNOY WESTMINSTER 1985 £4500

Folded horn monsters which certainly sound good if you have the space. Not the last word in tautness but can drive large rooms and image like few others.

JR 149 1977 £120

Infamous cylindrical speaker that was ignored for decades but now back in fashion! Based on classic KEF T27 / B110 combo as seen in the BBC LS3/5a. Doesn't play loud, needs a powerful transistor amplifier, but rewards with fine clarity and imaging.



SPENDOR BCI 1976 £240

Celestion HF1300 tweeter meets bespoke Spendor Bextrene mid-bass unit – and the result is a beautifully warm yet well focussed sound. A little bass bloom necessitates careful low-stand mounting, but these prove that the seventies did have some fine designs after all!

QUAD ESL57 1956 £45 EACH

Wonderfully open and neutral sound puts box loudspeakers to shame. Properly serviced they give superb midband performance, although frequency extremes less impressive. Ideally, use in stacked pairs or with subwoofers and supertweeters.



KEF R105 1977 £785

Three way Bextrene-based floorstander (complete with castors!) gave a truly wide-band listen and massive (500W) power handling. A very neutral, spacious and polite sounding design, but rhythmically well off the pace. The quintessential nineteen seventies loudspeaker.

IMF TLS80 1976 £550

Warm and powerful nineteen seventies behemoth with transmission loading and a mixture of KEF and Celestion drive units. Impressively physical wideband sound but rhythms aren't its forte.

MAGNEPLANAR SMGA 198X £800

Technological loudspeaker with genuinely musical abilities; fast, smooth, open, dry.



MISSION 770 1980 £375

Back in its day, it was an innovative product and one of the first of the polypropylene designs. Warm, smooth, clean and powerful sound.



MISSION 752 1995 £495

Cracking Henry Azima-designed floorstanders combined HDA drive units and metal dome tweeters with surprisingly warm results. Benign load characteristics makes them great for valves.

HEYBROOK HBI 1982 £130

Peter Comeau-designed standmounters with an amazingly lyrical yet decently refined sound. Good enough to partner with very high end ancillaries, yet great with budget kit too. A classic.

CELESTION SL6 1984 £350

Smallish two way design complete with aluminium dome tweeter and plastic mid-bass unit set the blueprint for nineteen eighties loudspeakers. Very open and clean sounding, albeit course at high frequencies and limp in the bass. Speakers would never be the same again...

LEAK SANDWICH 1961 £39 EACH

Warm sounding infinite baffle that, with a reasonably powerful amplifier can sound quite satisfying.



QUAD ESL63 1980 £1200

An update of the ESL57, with stiffer cabinets. Until the 989, the best of the Quad electrostatics

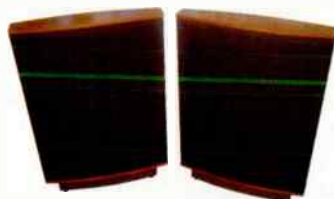

YAMAHA NS1000 1977 £532

High tech Beryllium midband and tweeter domes and brutish 12" woofers in massive sealed mirror image cabs equals stunning transients, speed and wallop allied to superb transparency and ultra low distortion. Partner carefully!



MISSION X-SPACE 1999 £499

The first mass production sub and sat system using NXT panels is a sure-fire future classic - not flawless, but a tantalisingly unboxy sound nevertheless!



CLASSIC CONTACTS

When a classic goes 'poof' your troubles have just started, but there may be a good ending. Replacing failing parts can improve the sound, so here is a short listing of all these companies who specialise in getting a classic up and running again after its deposited a small ring of soot on your ceiling!

GT AUDIO

(Graham Tricker, Bucks) Leak Troughline specialists. Also Quad and most classic tuners, radios and amplifiers restored, repaired.
Tel: 01895 833099
Mob: 07960 962579
www.gtaudio.com

TECHNICAL AND GENERAL

(East Sussex) Turntable parts - wide range of spares and accessories, plus arms and cartridges.
Tel: 01892 654534

CARTRIDGE MAN

(Len Gregory, London) Specialist cartridge re-tipping service and repairs. High quality special cartridges.
Tel: 020 8688 6565
Email: thecartridgeman@talktalk.net
www.thecartridgeman.com

QUAD ELECTROACOUSTICS

(Cambs) Quad's service department, able to repair almost all Quad products, from the very first. (Also Audiolab, Mission & Wharfedale).
Tel: 0845 4580011
www.quad-hifi.co.uk

Dr MARTIN BASTIN

(Shropshire) Garrard 301/401 restoration, renovation and service. Special plinths; rumble cures, etc.
Tel: 01584 823446

ARKLESS ELECTRONICS

(Northumberland) Specialist in repairs, restoration and modifications to all amplifiers, valve or solid state, ancient and modern.
Tel: 01670 530674
Email: info@arklesselectronics.com
www.arklesselectronics.com

SOWTER TRANSFORMERS

(Brian Sowter, Ipswich) Large range of audio transformers for valve amps, cartridges, line drive, interstage plus all associated services.
Tel: 01473 252794
www.sowter.co.uk

WEMBLEY LOUDSPEAKER

(Paul MacCallam, London) Comprehensive loudspeaker servicing.
Tel: 020 8 743 4567
Email: paul@wembleyloudspeaker.co.uk
www.wembleyloudspeaker.com

EXPERT STYLUS COMPANY

(Wyndham Hodgson, Surrey) Stylus replacement service for all types of cartridge. Including precise profiling for 78s. Tel: 01372 276604
Email: w.hodgson@btclick.com

ONE THING

(Coventry) Specialist in electrostatic panel manufacture and repair. Can refurbish ESL 57s and 63s as well as Leak Troughlines and Quad lls.
Email: one.thing@ntlworld.com
www.onethingaudio.com

LORICRAFT AUDIO

(Terry O'Sullivan, Bucks) Garrard 301/401 and their own 501 repair, spares and service.:
Tel: 01488 72267
www.garrard501.com

LOCKWOOD AUDIO

(London) Tannoy loudspeaker parts, restoration and repair. Also Epos and TDL loudspeakers.
Tel: 020 8 864 8008
www.lockwoodaudio.co.uk

CLASSIC NAKAMICHI

(Paul Wilkins, Worthing, West Sussex). Restore, Repair & Service Nakamichi Cassette Decks.
Tel: 01903 695695
Email: paul@bowersandwilkins.co.uk
www.bowersandwilkins.co.uk

OCTAVE AUDIO WOODWORKING

(Bristol) Unit 2, 16 Midland Street, St Phillips, Bristol.
Tel: 0117 925 6015
www.octave-aw.co.uk

REVOX

(Brian Reeves, Cheshire) Revox tape recorder spares, service and repair. Accessories also available.
Tel: 0161 499 2349
Email: brian@revoxservice.co.uk
www.revox.freeuk.com

CLASSIQUE SOUNDS

(Paul Greenfield, Leicester) ESL-57s restored, rebuilt, fully renovated or improved. Leak, Quad valves amps etc.
Tel: 0845 123 5137/
Mob: 0116 2835821
Email: classique_sounds@yahoo.co.uk
www.flashbacksales.co.uk/classique

Definition

Stereo Sound
Grand Prix
Award 2009

Definition DC10T

EDITOR'S CHOICE
HI-FI
magazine

Definition DC10T

Image Hi-Fi
Award 2010
Best Loudspeaker

Definition DC8

MEDIA
TOTAAL
AWARD
2009
BESTE VAN

Definition DC9T



Definition is an outstanding new range of audiophile loudspeakers from Tannoy. Designed to get the very best from stereo music in the home, Definition distills and refines Tannoy's eight decades of loudspeaker expertise into a design of unrivalled performance value and stunning aesthetics.

Defining the art of sound

The three strong range features the very latest Tannoy Dual Concentric™ drivers with WideBand™ tweeter technology, innovative ply-wood cabinets and revolutionary Deep Cryogenically Treated crossovers. Capturing the fundamental dynamics of music yet majoring on the finest instrumental detail, Definition defines the art of sound.

tannoy.com

TANNOY



WIN A NUFORCE ICON 2 AMPLIFIER AND AMPHION ION LOUDSPEAKERS WORTH £900 IN THIS MONTH'S GREAT COMPETITION!

Here's your chance to win the desktop amplifier and speaker combination that Paul Rigby liked so much in the May 2011 issue of *Hi-Fi World*. This is what he said...

"The average size of a new house is reducing with room sizes shrinking, so we now see hi-fi manufacturers seeking ways of not only dropping the size of their kit but they are having to become more innovative in the design of that hardware. This represents a structured partnership between two established brands; NuForce and Amphon, offering an integrated amplifier and a pair of bookshelf speakers as a stylishly presented system. Taking the dinky NuForce Icon 2 first, this amp's small form factor will be ideal for a cluttered living room, study or bedsit as it can be placed in numerous pigeon holes,

hidden away under shelves or can be blended in amongst other personal items. Measuring just 150x90x30mm, the amp weighs in at only 0.45kg, offers 24 Watts into 4 Ohms and 18 Watts into 8 Ohms and is packed full of features. The Amphon speakers are designed in a minimal yet modish fashion as two-way affairs with a rear facing bass port, a 1" titanium treble unit plus a 5.25" paper-based mid/bass cone producing 86dB sensitivity. Relatively compact in size, the speakers span 268x134x220mm and weigh 5kg. The driver grilles can be ordered in a wide variety of colours.

Taking a batch of rock CDs, the system was able to successfully convey the music's energy and excitement. The Amphions, due to their small size, offered restricted lower bass but, aided by the NuForce's inherent accuracy, the available bass was presented with

an illuminating clarity and character. There was never the sense that the lower registers were out of control, which gave a music a real bounce and fluency. Midrange was dominated by the Amphon's superbly insightful drivers which did reach deep into a mix and pulled out previously lost harmonic voices and more subtly placed instruments. Playing a mix of jazz CDs featuring a higher class of mastering, a wealth of detail was always on offer. Acoustic guitars were plucked with a metallic precision while chord changes were tracked as fingers changed position while piano notes were well formed. As a near-field solution, this system really comes into its own, at ease and able to present the listener with a convincing, effortless. All in all, the NuForce/Amphon combination is a good looking, compact system that will improve the sound quality of any computer immeasurably."

For your chance to win this great digital source, just answer the following four easy questions. Send your entries on a postcard only by 30th June 2011 to:

**July 2011 Competition,
Hi-Fi World magazine,
Unit G4, Argo House,
The Park Business Centre,
Kilburn Park Road,
London NW6 5LF.**

RULES AND CONDITIONS OF ENTRY

- ONLY ONE ENTRY PER HOUSEHOLD
- MULTIPLE ENTRIES WILL BE AUTOMATICALLY DISQUALIFIED
- PURCHASE OF THE MAGAZINE IS NOT A PRE-CONDITION OF ENTRY
- NO CORRESPONDENCE WILL BE ENTERED INTO
- THE EDITOR'S DECISION IS FINAL
- NO EMPLOYEES OF AUDIO PUBLISHING LIMITED, OR OF ANY COMPANIES ASSOCIATED WITH THE PRODUCTION OR DISTRIBUTION OF THE PRIZES, MAY ENTER

QUESTIONS

[1] Which two brands are pairing up with this system?

- [a] NuForce and Amphon
- [b] Quad and Audiolab
- [c] Linn and Naim
- [d] Marantz and Tannoy

[2] How powerful is the icon 2 into 8 Ohms?

- [a] 18W
- [b] 180W
- [c] 1.8W
- [d] 0.18W

[3] What is the Ion's bass driver made from?

- [a] paper
- [b] polypropylene
- [c] Kevlar
- [d] carbon fibre

[4] What's special about the ion's grilles?

- [a] they come in a variety of colours
- [b] they're made from Clingfilm
- [c] there aren't any
- [d] they're held on by magnets

July Competition
Hi-Fi World Magazine
Unit G4 Argo House
The Park Business Centre
Kilburn Park Rd.
London NW6 5LF

entries will be accepted on a postcard only

**APRIL 2011 TRIANGLE ANTAL LOUDSPEAKERS WINNER:
Miss Elizabeth Boughton of Burnham**

PUT A SPRING IN YOUR

VISIT OUR WEBSITE: www.hi-fiworld.co.uk

UK SUBSCRIPTION SAVE UP TO



12.5%

SAVE UP TO 12.5% off the cover price when you subscribe to Hi-Fi World. That's an amazing £3.41 per issue, including postage.



FOR BACK ISSUES ENQUIRIES PLEASE CALL

01442 820580

OVERSEAS SUBSCRIPTIONS IF YOU LIVE OUTSIDE THE UK,
PLEASE CALL FOR OUR LATEST PRICES

+44 (0) 1442 820580

SO WHAT ARE YOU WAITING FOR? CALL NOW!!!

SUBSCRIPTION HOTLINE 01442 879097

Lines open Mon-Fri 9.00-5.00 or (weekend answering service available)

FOR OUR
ON-LINE MAGAZINE
GO TO WWW.HI-FIWORLD.CO.UK

email:
hifiworld@webscribe.co.uk

Fax No:
01442 827912

World Radio History

STEP WITH THIS GREAT OFFER

WHY SUBSCRIBE TO HI-FI WORLD?

- 12 issues a year delivered straight to your door.
- Be first to grab a bargain in our "Free Reader Classified Ads" section.
- Run by dedicated hi-fi engineers and enthusiasts.
- Subscribers receive a minimum 10% Discount annually.
- Hi-Fi World has become famous for its informative reviews and radical kit designs.
- **PLUS!** Subscribe by Direct Debit and receive a 12.5% discount (UK only).

I would like a years subscription to Hi-Fi World and receive a discount off the cover price (I have read and accept the terms and conditions).

I would like to pay for my 12 issues by:

6 monthly Direct Debit: Pay £20.47 every 6 months saving 12.5% off the yearly subscription rate of £46.80

Annual Direct Debit: Pay £40.95 every 12 months saving 12.5% off the yearly subscription rate of £46.80

Annual cheque/credit card: Pay £42.12 saving 10% off the yearly subscription rate of £46.80

Instruction to your Bank or Building Society to pay by Direct Debit



Please fill in this form and send to:
Hi-Fi World, Webscribe Ltd, PO Box 464, Berkhamsted, Herts., HP4 2UR

Originator's Identification Number

4	2	7	0	4	9
---	---	---	---	---	---

Name and full Postal Address of your Bank/Building Society

To: The Manager	Bank/Building Society
Address	
Postcode	

Name(s) of Account Holder(s)

--

Branch Sort Code

--	--	--	--	--	--

Bank/Building Society Account Number

--	--	--	--	--	--	--	--	--	--

Reference

HF

Instruction to your Bank or Building Society

Please pay Webscribe Ltd Direct Debits from the account in this Instruction subject to the safeguards assured by the Direct Debit Guarantee. I understand that this instruction may remain with Webscribe Ltd and, if so, details will be passed electronically to my Bank/Building Society.

Signature(s)
Date

Bank and Building Societies may not accept Direct Debits Instructions for some types of accounts
The guarantee should be detached and retained by the Payer

The Direct Debit Guarantee

- This Guarantee is offered by all banks and building societies that accept instructions to pay Direct Debits
- If there are any changes to the amount, date or frequency of your Direct Debit Webscribe Ltd will notify you 10 working days in advance of your account being debited or as otherwise agreed. If you request Webscribe Ltd to collect a payment, confirmation of the amount and date will be given to you at the time of the request
- If an error is made in the payment of your Direct Debit by Webscribe Ltd or your bank or building society you are entitled to a full and immediate refund of the amount paid from your bank or building society
- If you receive a refund you are not entitled to, you must pay it back when Webscribe Ltd asks you to
- You can cancel a Direct Debit at any time by simply contacting your bank or building society. Written confirmation may be required. Please also notify us.



Cheques made payable to Audio Publishing Ltd.

Your Details

Title _____ Forename _____

Surname _____

Address _____

Post Code _____

Daytime Tel: _____

Email: _____

Please debit my VISA MASTER MAESTRO AMEX (SWITCH)

Security No: (last three digits printed on the signature strip)

--	--	--	--	--	--	--	--	--	--	--	--	--	--	--	--	--	--	--	--

Valid from Date: ____/____/____ Expiry Date: ____/____/____

Switch card issue No:

Cardholder Signature: _____

Outside UK:-

EUROPE Airmail **£50.00**

OVERSEAS Airmail **£70.00**



Send this form to:

Hi-Fi World, Subscriptions Department Unit 8, The Old Silk Mill, Brook Street, Tring, Hertfordshire, HP23 5EF

World Radio History

Round About

Haden Boardman tells the story of the long, lost Sonab OA5-II omnidirectional loudspeaker...

Omnidirectional loudspeakers have never really hit the mark in the UK market. Back in the mono radiogram days, lots of systems were fitted with multiple drive unit combinations to help widen the single channel sound, such as Decca Decola, 3x 12" Tannoy or Goodmans units, or Grundig with their switchable seven speaker arrays, for example. But there was no specific thought or design to these; the early days of stereo saw assorted drive units pointing up to the gods with small diffusers on the tops (such as those beautiful Wharfedale columns, or Goodmans 'bowl' speakers to name but two omnis from the late fifties).

It was the early nineteen seventies that really showed a marked technical challenge to the omnidirectional market, with such gems as American Acoustic Research's top LST model, top of the range Goodmans, and the famous Dr Amar Bose's 901 direct-reflect technology. But I feel the most influential speaker from this period was this, the Swedish designed and built Sonab OA5-II.

Sonabs are based on the work of one Stig Carlsson, with what the

designer called 'Ortho Acoustics' (hence the OA in the name; the 5 corresponding to the amount of drive units utilised in the design). Ortho Acoustic theory relies on room boundaries in your front room for the loudspeakers performance. The cabinet must be located quite close to a rear wall, and ideally near a corner (if space permits). Locating the speaker this close to the wall will boost bass output below 300Hz, and the close proximity to the wall allows the tweeters to radiate their extra energy back to the listener's seat.

The whole point is to add an acoustic depth to the presented sound field. To make the back wall of your listening room disappear, and the instruments of the orchestra to float out of thin air (or your back wall). Carlsson argues that without the four little tweeters providing the extra treble energy, this cannot be accomplished. He also seems to advocate that the use of tone controls is not such a bad thing in acoustic room correction.

Manufactured from 1966 to 1973 (in mark II form from 1970), the OA5 followed on from a family of much more expensive units, using active valve power amplifiers based on various output transformer less designs. The earlier OA6 featured OTL amplifiers, active electronics and an extra bass unit. I doubt any of these earlier active designs exist much outside of Sweden, I have never seen any, but are fascinating and sophisticated all the same. The

OA5 was the first standalone passive speaker marketed from Sonab. Box volume is a reasonable 47 litres, its size 240x610x430mm, and the boxes weigh 10kg each. The main drive unit is the superb Alnico magnet equipped Philips 9710M full range speaker (an odd 220mm sized twin cone chassis, something Stig Carlsson had used in even his earliest nineteen fifties prototype designs) pointing up to the ceiling complete with four small Peerless MT20HC 50mm cone tweeters, firing at a central wooden post, and off your walls.

The design is a bass reflex, using a similar acoustic loading technique to that which Goodmans Industries used with the Acoustic Resistance Units on its nineteen sixties designs. The ports are located on the loudspeaker's base. The crossover is decent enough quality, the speaker has a reasonably high efficiency (around 92dB/W) but the power handling capacity of the Philips unit is not outrageously high. Frequency response is claimed as 45Hz-18,000Hz. There are a couple of factory adjustments fitted to the crossover, the Philips full range unit is actually much more sensitive at 97dB/Watt on its own! So it must be attenuated to match the four small tweeters, which are less sensitive, which will not help damping factor.

Input connections are via those once popular two pin speaker DIN 'dot and dash' plugs. Horrid things, I made some adapters up out of a short bit of Chord Rumour speaker



cable, but I should really have fitted better terminals...

Cabinetry is quite nice; a teak veneered 'sleeve' has its black metal grill standing some 50mm proud out of the top, and a black base to the bottom corresponding to the inner 'match tray'.

Service wise, Philips stopped making drive units some twenty years ago, so a blown 9710M means a dead speaker in all truth. Damage can occur to the surround, which is thankfully a cambric paper type and not foam, but due to the horizontal nature of the Sonab, any exposed to cigarette smoke, or used in dusty and damp environments may have problems. The set for review needed a good vacuum cleaning; the inner whizzer cone was almost bonded to the bass cone with fluff, despite a tight grill cloth being fitted (albeit some forty years ago). The 9710M is a great unit, but power handling without the Sonab crossover is only around 10W RMS.

Simple tweaks would be to remove the grill cloth. The units are mounted via proper machine screws, but Sonab chose to use a couple of rubber grommets on each screw to almost decouple the Philips unit from the cabinet. Weird! Internal wire is rubbish, but gaining access to the crossover is a day of a job, and do leave the presets factory fixed, unless you have suitable equipment to calibrate. And the aforementioned two pin speaker DIN connection. Load wise the 9710M dates from the age of the valve amplifier, and these speakers are pretty easy to drive, a valve amp being perfect, something like a Leak Stereo 20 ideal.

SOUND QUALITY

Despite some of Carlsson's claims, the Sonab OA5 proved very room-dependant in its performance. Used with my own little EL84 pentode valve based push-pull Class A integrated design, the Marantz Project D1 DAC and a myriad of digital sources, (cables all from Chord Co Sarum) the results were more than a bit mixed! A modern constructed house with dry lined walls, a very solid floor and very generous proportions (25 by 14 foot) saw the speaker acoustically at quite a loss. The dry lined walls absorbed far too much of the speakers carefully designed treble energy, and actually sounded quite mushy and dull, with a warm balance. Placed as recommended, one had to get quite close to the OA5s to enjoy a decent sound. Lively, but at the same time quite soggy. At the back end of the room, it really was

not very impressive at all, with the sound stage appearing to be almost monophonic in its presentation. Only on some of the more outrageous 1960's Decca Phase Four 'ping pong stereo' recordings did the set come somewhat alive.

It was decided to switch venues,

"these devices loved the more minimal crossed pair XY recording techniques rather than multi track studio constructions..."

back to a large Victorian front room with fourteen foot high ceilings and hard plastered brick walls. With minimum furniture and a solid wood floor and just a few rugs about the place, the Sonabs performed much better, despite the use of an inferior D/A convertor. They really did gain a sense of air and atmosphere. Playing familiar recordings still provided something of a mild disappointment. ABBA, you would of thought being very much at home on these, but not so. My favourite track, 'The Day Before You Came', sounded like it was being played yesterday! Countering this, the classic 'Jazz at the Pawn Shop' actually sounded pretty darn impressive, managing to do what Carlsson intended, with the back wall of the room appearing to disappear to a certain extent.

Changing from record to record, it became clear these devices loved the more minimal crossed pair XY recording techniques rather than multi track studio constructions of fake stereo imagery. On more weighty classical (Stravinsky Firebird) I remained a tad underwhelmed. Jimmy Smith's 'Organ Grinder's Swing' communicated, but for both of the latter, I felt more acoustic power was required in the room. Despite this, I feel that overall the OA5 has quite a lively open sound that, is no doubt quite unique. Bass wise, there is a certain lack of punch and weight, although bass sounds remain quite fulsome. The Philips 9710M drive unit frankly needs a bigger cabinet to perform as a reflex enclosure, a much bigger cabinet. Let's just describe the bass as a tad soft.

The midrange, by using the room boundary, was placed acoustically much higher physically from the speaker, a good thing, but strong vocals, and upfront instruments lost their bite, energy and vitality. Let's just describe the midrange as a tad soft. Treble from a full range unit pointing up to your ceiling is never going to have the full on effect of a drive unit pointing straight at you.

And despite the four little Peerless tweeters bouncing the sounds all around, and the Sonab's reputation for being bright; well let's just describe the treble as a tad soft! I cannot imagine what this speaker would sound like removed from the wall boundary and used with a more

modern transistorised Class AB amplifier; this might explain some of the bright reputation the design has earned over the past forty years...?

CONCLUSION

I have to admit I was a little disappointed by the Sonab OA5. On certain recordings, the speaker did as its designer Stig Carlsson intended, literally making the back wall of the room disappear. But sadly on the vast majority of the music I played, the speaker drew far too much attention to itself, sounding quite coloured and veiled. On the plus side it is very easy to drive to quite loud levels, and as long as it is physically located close to a wall, performed with some consistency. In fact for those not allowed 'proper' loudspeaker set ups because of the domestic acceptance factor, they may be very well worth considering.

I paid £80 for this set off a well-known auction website, the condition is perfect electrically but not immaculate cosmetically. Good pairs have been seen to trade for three times that; which in truth is the value of a pair of the Philips 9710M drive units (in fact I have seen these sell for more on their own; which tells its own story - for the curious a four cubic foot sealed enclosure works best with the alnico version on the '9710M). I cannot help feeling the Ortho Acoustic approach was more relevant in the old mono days.

Carlsson carried on his research and development, and despite the Sonab name falling through different owners (the company went bust in 1989 - in recent times some Chinese made budget speakers aimed at the multimedia market appeared with the Sonab name), he managed to relaunch the designs under a different moniker in the nineties. Stig Carlsson himself sadly suffered a sudden and fatal heart attack in March 1997, and the newer designs, not that dissimilar to the OA5, remain in limbo.





Introducing the new Olive 4HD. Choice without compromise.

The new ultra quiet 2TB Music server



Store up to 20,000 high-resolution HD tracks in 24 bit. With more than 250 times the resolution of CD's, you'll hear the difference immediately.

Find the music you want - fast.



Use the high-resolution touchscreen to select by genre, artist or album; flip through album covers; do a quick search; or save internet radio stations as favorites.



To control your Olive 4 from anywhere in your home, get our iPhone remote app.



Connect multi-room Olive 2 Hi-Fi Players to a wired or wireless home network and you can access your music library and enjoy it in high fidelity in every room of your home. Easily integrates with your current system.

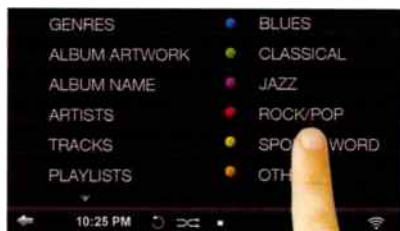

Just insert a CD, tap import on the touchscreen and a few minutes later your music is appropriately tagged and neatly categorized in your music library. Your Olive 4 Hi-Fi Server holds up to 6,000 CDs in original quality.



Unlike listening to your music on a computer, iPod or MP3 music players, the Olive 4 Hi-Fi Server combines a high-resolution DAC, optimized circuit design, CD quality digital sound, ultra-quiet hard drives and passive cooling to eliminate fan noise to deliver the best possible hi-fi audio experience

olive

Olive Music Servers, from under £1000 at great Hi-Fi stores nationwide

Distributed in the UK by:

Henley Designs

01235 511166

www.henleydesigns.co.uk

"please indulge us just this once,
as it's our twentieth birthday year!"



david price

Okay, I admit it. *Hi-Fi World* is not without its *causes célèbres*. We do rather like to have 'great debates' here on this magazine, and they rage on and on in the letters pages sometimes for years, or even decades! Since the first issue arrived on newsagents shelves in 1991, we've created all sorts of journalistic mayhem...

When I joined the team back in 1994, we were in the middle of the fallout from Noel's outrageous contention that valve amplifiers sounded better than solid-state. One of my first tasks as a wet-behind-the-ears editorial assistant was to sift the *Hi-Fi World* postbag for interesting letters (and it was literally a Royal Mail sack back then), and there were hundreds every month telling us that we were just plain bonkers to even give space to the damn things. Noel was declaimed as certifiable, a Luddite, deaf and so on and so forth...

Our next moment of reckoning came when Linn arrived to install the very latest, top of the range Linn Sondek LP12/Ekos/Archiv. It sounded lovely, but then one day Terry O'Sullivan appeared clutching a big old clunker in the shape of a Garrard 401. I did a direct A-B dem and was staggered. I couldn't believe what I'd just heard; the 401 blew it out of the water, especially in the bass department. I can still remember hearing Bob Marley's 'Exodus' sounding so much punchier and more visceral via this old Garrard...

Daring to suggest in print that there was a better turntable (or even as I did a turntable that sounds better *in some respects*) than an LP12 was heresy, so next month, we got two sacks of mail. It was an outrage and a disgrace and *what planet* were we on! First valve amps and now this! Whatever next? Ermm... the Leak Troughline, that's what!

Noel had pulled his old tube

Troughline tuner out of the loft, and Graham Tricker duly fettled it, fitted a new FM decoder and some new passive components, evicted some spiders and blew out their cobwebs. Result? It was the best tuner *any* of us had ever heard. I remember listening to Jazz FM on the office system thinking, "I don't quite know why, but this is nicer than anything else I've ever set ears on". Vast in scale, capacious in stage depth, sugary sweet in tone, it was coloured as hell but what the hell! We simply had to tell everyone, and yes, you've guessed it, the postbag swelled yet more. By that time, I was going on press trips, and meeting some of the journalists at rival magazines. More often than not, someone would very politely sidle over to me at a hotel bar and earnestly enquire, "were you guys being serious about that valve amp/ the Garrard 401...?"

By the mid nineties then, *Hi-Fi World* was getting the reputation as a lunatic fringe magazine. Many manufacturers simply didn't want to be associated with us at all, because they felt their products were too serious to be seen in such a publication; in their minds we were a cross between *Viz* and *Private Eye*, whereas what they aspired to be in was *The Daily Mail*! So my championing of the vinyl format in it didn't help matters, then...

Having recently been living in Japan, I'd noticed that the country that was first to adopt CD had now started selling new vinyl again; BlueNote Japan, EMI Japan and a number of other labels were re-pressing brand new vinyl records and selling them for 3,000 Yen apiece (about £30), considerably more than a new CD. This led me to scratch around and look for any signs of a vinyl revival here, and the BPI duly confirmed that '12" sales were booming. In 1995 I penned a feature entitled 'Black Art', suggested

vinyl sounded better than CD and predicted a UK vinyl revival. Three sacks of mail arrived the next month, mostly addressed to me...

I had calls for my sacking, accusations of deafness, doubts expressed about my sanity and all number of arguments against me, my favourite of which was, "it is clear that CD is superior to vinyl, after all, *What Hi-Fi* says so..." Oh well, there you go. For several years after that, friendly chats with fellow hacks in hotel bars on press trips ended with, "do you *really* think vinyl sounds better than CD?"

Despite some angry letters, we did get a lot of support too – it certainly wasn't all 'outraged of Kidderminster'. And then in 1997, just when I thought it was safe to come out of the cupboard, I bought an old Pioneer PL600 turntable for £17 from Loot. A high end, fully automatic direct drive turntable – after some fettling of its collapsed rubber suspension and general cleaning inside and out – it sounded superb. Its bass was tighter and punchier even than my beloved Michell Orbe, and it had a clearer, more animated sound. Thus began the direct drive debate, which ten years later resulted in us modifying a humble 'DJ deck', the (then) £300 Technics SL1200...

From computer audio to One Thing modded Quad electrostatics and transformer preamps, *Hi-Fi World* has had no shortage of 'discoveries', and generally we haven't been too wide of the mark. The fact that in 2011 you can buy a Brinkmann Bardo direct drive turntable, an MF Audio Passive Pre and a pair of Icon Audio 845 tube monoblock power amplifiers now with total ease now shows how the mainstream has come to us, rather than the other way round. If all this sounds a little self-congratulatory, please indulge us just this once, as it's our twentieth birthday year! ●



Inspire Hi-Fi

Presenting high class, award winning
UK built analogue equipment...

AND WITH DIRECT SALES FROM THE MANUFACTURER THERE'S NO RETAIL MARKUP..

CALL US FOR SPECIAL
HI-FI WORLD READER OFFERS



eclipse^{SE}
TURNTABLE

eclipse^{SE V2} 12
TURNTABLE

Apollo^A i2
TURNTABLE

vivid kit
for Linn LP12 Turntables

Quest
for Rega turntables

Eclipse SEv2 £1,999
Eclipse SEv2 12 £2,499
Apollo with 700 arm £949
i2 Turntable £359
Off board PSU for Eclipse and Apollo £350
LP12 full vivid upgrade package £799 + £50 rebuild

Rega turntable Quest upgrades from £189
Inspire Black Majik MM phono stage £150
Inspire i stage MM phono stage £699
Inspire X100 tonearm £630
Inspire X200 tonearm (12 inch) £699
Other tonearms and cartridges available at special prices

Unit 11 / Markham Vale Environment Centre / Markham Vale / Chesterfield S44 5HY T: 01246 827272 M: 07032 367555 E: robert@inspirehifi.co.uk

www.inspirehifi.co.uk



COME & LISTEN
Our NEW dedicated
listening room is now open.
Call to make an appointment.

Cayin Divine Acoustics



so much for so little

HI-FI World
VERDICT

HI-FI World
VERDICT

HI-FI CHOICE

BEST BUY
HI-FI CHOICE



Cayin
9088-D

XTZ
100.49



Cayin
500MK

XTZ
CD-100



XTZ
99.36



Cayin
HA-1A

XTZ
CD-100 D3



XTZ
Room Analyzer



Divine Acoustics
Proxima2

audiosanctum
PERFORMANCE AND QUALITY

t. 01623 857707 ▶ m. 07517 889 738 ▶ www.audiosanctum.co.uk ▶ info@audiosanctum.co.uk

"Genesis P. Orridge – a strange name from a stranger you should really get to know..."



paul rigby

Genesis P. Orridge – a strange name from a stranger you should really get to know. Genesis is a singer-songwriter, artist and visionary who has, since 1969, spent his career addressing society's 'difficult subjects' and forcing us to look at them. Whether that be pornography, occultism, gender issues, prostitution, the serial killer or just the invisible strictures placed upon us by society. As a result, he and his wide array of musical colleagues have been at the centre of controversy, often under attack from the government or the 'moral majority'. The other side of Genesis however, includes the pursuit of art for art's sake (with a genuine rejection of the profit motive), the improvement of the human condition, education, support for science and for creativity.

In musical terms he is famous for his involvement in underground groups Throbbing Gristle, COUM and Psychic TV. Covering genres such as industrial, rock, pop, noise, world, acid house and more. As he said, "how boring would it be to come up with apparently new formula like industrial music and then do the same thing for the next forty years and then die? That would be hellish. Some do. That's because it's easy, its comfortable or it makes them money. We've never had, as an objective, being famous or to have a hit record or to have more fans or do bigger concerts. If it happens, then that's an accidental by-product – like 'Godstar'."

This was a reference to his hit record as part of Psychic TV, a 1986 tribute to Rolling Stones guitarist Brian Jones, which serves as a touchstone to how Genesis views his art. "It was exciting, something new, something we didn't know we could

do. We were playing at the Hacienda and, afterwards, the then manager said, 'What was that new song you wrote? It was really good, it could be a big hit.' And we didn't know what he was on about, 'The one about Brian Jones,' he replied. We didn't even remember singing about him. So we managed to find someone who had taped the show, transcribed the idea of this song and took the song and similar music to our then label, CBS."

Genesis talked to Muff Winwood, legendary producer and then head of A&R and presented their new 'found' style to him, "He listened to it and said, 'But we signed you to do the weird stuff. No, no, no, you've got to continue what you're doing, it's getting loads of press.' We disagreed, 'No, this is the next record,' we said."

Winwood rejected it, leading Genesis to exclaim, "if you cannot understand the act of creativity, we don't want to be on your label.' And walked out. And then, to prove a point, we released it ourselves and it ended up No. 1 in the indie charts for sixteen weeks and got into the bottom of the national charts. It was just a fluke. The point was, we gave up our record contract with CBS because they wouldn't agree with our idea of aesthetics. We've never rejected money but money has never been the motivation because it comes with strings attached. We've turned down so much, it's almost sickening. It's a principle. As long as you're paying the bills, you're okay."

Which is why the music of Psychic TV has always existed on the edge of society, where it can have the most effect and hold most influence. Now, it is the centre of a mini-celebration as two attractive box sets have been released to celebrate the band's work.

The first Psychic TV collection, from Vinyl On Demand (www.vinyl-on-demand.com), is a 4LP box set of two double albums in velvet-covered gatefolds. They include: 'At Stockholm', produced in cooperation with White Stains in 1990; two Jarman Themes called 'Pirates' and 'Demons'; live performances at the Danceteria, New York (17 & 19 November 1983) featuring future members of Coil plus six rare and/or unreleased tunes including three versions of 'Unclean' and a fifteen minute selection of 'Fondation Raelinne Tape'.

The second collection, from Cold Spring (www.coldspring.co.uk), is a four CD box set featuring spot varnish, matt laminate decoration and including the four 'Themes' albums as a collection for the first time, originally released in 1982, 1985 and 1986 and including the new 'Lady Jaye' album – the LP recorded by Genesis P. Orridge's late partner, Lady Jaye. If you order the box via the internet, you receive a free live CD, 'Live In Basildon', featuring the accidental hit single, 'Godstar'. It also includes a thirty two page booklet of rare photos and essays.

"We are obsessed with messages and information and content," added Genesis. "That's what fascinates us. The messages don't change for us but the strategies do because culture changes. It absorbs and commodifies everything, if it can. We find it uncomfortable to be swallowed up by the amoeba of commercial culture. At the moment, we want to talk about pandrogony and the evolution of the species."

Which is where you come in, dear reader. Because, if you want to know more, buy the music. It's worth the effort. Exactly the same way that next X Factor vomitorium isn't. ●

iDecco *from Peachtree Audio*

“The Peachtree Audio iDecco is a great purchase for those heavily into Digital Audio”

“A serious grown up DAC and integrated amplifier that’s been magically shrunk into a lifestyle box”

David Price, HiFi World, October 2010



peachtree audio

Karat Series

Slim and perfectly formed

An elegant loudspeaker that offers outstanding performance from its slim profile. The Karat Series answers the question of style or function with a resounding “both”.

Our patented “wave” surround allows twice the driver excursion of a Standard half wave design without Cone distortion.

CANTON
pure music



Distributed in the UK Exclusively by Computers Unlimited.

For more information and availability call our Sales Team on **020 8358 9593**

"anyone making important public broadcast technology decisions should be an engineer..."



steven green

One of the most frequently raised objections to the proposal for DAB to be replaced by a more modern digital radio technology is that once a system has been launched "a line has to be drawn in the sand". Everyone should simply get behind the technology, because it's too late to make any changes to it, that is. This is invariably followed by a comment about the technology replacing DAB being out-of-date as soon as it's been launched, and that people would only start complaining when the next technology that improves performance has been invented...

There is of course some merit to these objections, not least because this is the normal way that new broadcast technologies progress. However, such a blanket objection to replacing existing technologies is, in my opinion, a licence to accept incompetence, and that is precisely what has happened with the UK's adoption of DAB.

To briefly recap on some of the features offered by the 1980s version of DAB that we've adopted in the UK: 98% of stereo stations use a bitrate of 128kbps (or lower), which is a one that was judged to deliver "annoying" sound quality in blind listening tests; and a large number of music radio stations now broadcast in mono on DAB due to cost or capacity issues. The reason the broadcasters decided to use such low bit rates in the first place was to squeeze as many stations onto the DAB multiplexes as possible, yet it's estimated that around 100 commercial radio stations (approximately one third of all commercial stations on FM) will never be able to broadcast on DAB because there's either insufficient capacity on the local

multiplex in their area, or because the stations can't afford the incredibly high transmission costs associated with broadcasting on DAB. And this doesn't even take into account the large number of "community" FM stations that have popped up around the country over the last decade that wouldn't be able to broadcast on DAB either. The current proposal is that those stations that can't broadcast on DAB will continue broadcasting on FM after the notional digital radio switchover takes place.

It beggars belief that the BBC and the Radio Authority (who regulated commercial radio before Ofcom took over that role) either completely overlooked the above issues, or knew about them but decided to relaunch DAB in 2002 anyway. Furthermore, DAB could have been upgraded in the late 1990s so that it performed almost as efficiently as DAB+ does today, because most of the technologies that were adopted for DAB+ were available at the time!

Although the AAC+ audio codec that has been adopted for DAB+ wasn't available until 2003, the AAC codec was standardised in 1997, so it could have been incorporated into DAB from that moment onwards. The BBC R&D department took part in two different blind listening tests to compare the performance of AAC with MP2 (which is the codec that is used on the old version of DAB we use in the UK), and both tests confirmed that AAC was twice as efficient as MP2. The BBC R&D department also made reference to this fact in a document published for one of their open days at the time, and warned against reducing the bitrate levels too low with MP2. The other main technology that was adopted in the design of DAB+ was

Reed-Solomon (RS) error correction coding, which was adopted to make transmissions more robust. RS coding was invented in the 1960s, and it had become commonly used by wireless digital communication systems that were designed from the early 1990s onwards.

The process that takes place when technology decisions are made at the BBC is that the experts from the R&D department give presentations about the technologies to the executives, and the executives then decide what to do. So I'm sure that the BBC executives will have been told about the availability of these more modern technologies, but they must simply have decided against adopting them, and opted to relaunch DAB in 2002 without first upgrading it.

I personally think that anyone making important public broadcast technology decisions such as these should be an engineer, or should at the very least have a basic understanding of the technologies. Unfortunately however, the BBC executives making the decisions about DAB were Simon Nelson, whose background was in marketing, and the BBC's Director of Radio Jenny Abramsky, whose background was in journalism. In my opinion, it's not at all surprising that these two people failed to grasp the significance or the ramifications of making the choice that they did, faced with complex technologies...

No one would argue that if DAB were up to the task of being a modern digital radio system then we should stick with it, but the reality is simply that we're being asked to accept a second rate system due to the insufficient understanding of its complexities. As a licence payer, I feel that this is simply unacceptable. ●

Winner of the Most Wanted Product in the USA
 Designed and handbuilt in the UK
 Used all around the world!
 Specialising in high-end vinyl playback
 Tel: +44 20 3176 0376



“ THE ULTIMATE REAL WORLD TONEARM ”

HI FI WORLD MAY 2009

“A new benchmark for musical communication” **STEREOTIMES**

“One of the truly special products I've reviewed in the past 18 years” **STEREOPHILE**

“The best tonearm I've heard” **HI FI WORLD**

“So far ahead of the pack looks about to lap them” **STEREOTIMES**

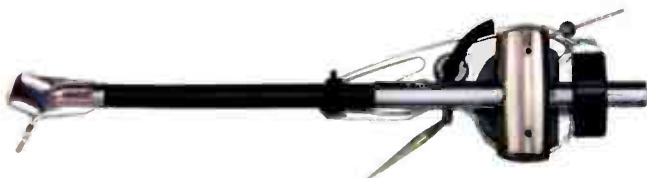

Multi-award winning ORIGIN LIVE TONEARMS make an enormous difference over other arms due to their market leading performance. Delighted owners report that the level of improvement is many times that of a cartridge upgrade - and lasts a lot longer.

These arms simply give an entirely new level of musical satisfaction according to many independent sources - Please see Origin Live web site for full reviews and information.

To eliminate any risk on your part, all arms are offered with a full money back refund should you not be anything other than delighted.

Tonearm Models

- Enterprise
- Conqueror
- Illustrious
- Encounter
- Silver
- OL1

World Awards

Reproducing the original sound



UNIVERSAL MOTOR UPGRADE
 Upgrades & replaces
 motors & power supplies for ALL
 belt drive turntables

“The single most important upgrade you can ever make to any record deck

concerns the motor drive...nothing can prepare you for the shock of going DC. In a word, gobsmacking.” **COMMON GROUND MAGAZINE**

“It's value is nothing short of tremendous.” **LISTENER MAGAZINE**

“The LP12 remains a classic ...but ..upgrade kits by Origin Live can bring a vast improvement to it's performance” **HI FI NEWS**

UNIVERSAL TURNTABLE MOTOR KIT - No one would blame you for being sceptical of an easy to fit, inexpensive dc motor upgrade. Especially one that improves on the best of other power supplies costing over 4 times as much or your money back. It is simply impossible to imagine the level of improvement attained by eliminating the motor vibration that your stylus amplifies over 8,000 times! Our DC motor kit offers massive improvements to all versions of Linn Lingo / Valhalla, Rega, Systemdeck, Roksan, Rock etc. The kits consist of a drop in replacement high grade DC motor and off-board 2 speed control box. Why not order now? - see web site or phone.

- Standard dc Motor Kit - £250
- Advanced dc Motor Kit - £339
- Ultra dc Motor Kit - £570
- Upgrade Transformer - £195
- Upgrade DC 200 motor - £129 with kit

ORIGIN LIVE
 Tel/Fax: +44 02380 578877
 E-mail: originlive@originlive.com
www.originlive.com

"our improved turntable measurement method is already yielding interesting results..."



noel keywood

These days a lot of discussion revolves around the dear old LP and I'm relieved to have the responsibility of arguing this is a valid medium taken from me. As turntables, arms and cartridges develop so we hear more and more about what is on an LP and few listeners seem to have a keener ear for all this than Rafael Todes. That's because he is a music scholar, violinist and the only reviewer to be a professional musician first and hi-fi reviewer second. So when Rafael declares, as he did, the Garrard 401 to be good but far from perfect I feel vindicated. It isn't perfect; I use it because I enjoy it and because it does a great job, meaning it is practical and exciting to listen to. Mine is also so vast and heavy it is immovable and that is just how I like it, because I hand cue and need a turntable that sits still. Mine is mountain-like in its anchoredness to mother earth. Suspended chassis belt drives were a wobbly breed in many senses that could never match up.

Two things the Garrard has; pace and bass. Pace is so great I sometimes get up and look at the strobe and back speed off a bit. Does the turntable run too fast when the strobe says it is running at the right speed? It sounds like it and I really should test this, because I saw a comment the other day, from an American listener, who thought the same as me; it is running fast. But it is equally likely this is the subjective perception linked to the Garrard's transient reproduction, which is peerless. It seems to plough along at vast pace unaffected by the outside world, where belt drives get wobbly and equivocal. The Garrard seemingly shrugs everything off with the power and speed of an express train.

Then there's the bass. How a turntable exhibits stronger bass than

most others I cannot begin to explain, although the need for a high mass plinth may well come into it. This is another widely acknowledged feature of the Garrard 401.

Criticisms are a greyish sounding midband, which I believe is caused by ringing in the platter. Platter damping and a heavy platter mat reduce this.

That turntables are passive and therefore cannot influence the music was the view some time ago, but the mechanisms by which they can influence sound quality are now understood. And this has helped Direct Drives get the exposure they deserve, warts and all. By this I mean they are not perfect, but they do have great strengths and it was never fair or useful to dam them so comprehensively and enthusiastically as UK journalists once did.

Being a 'Garrard man' I empathise with the Technics sound. It is very tightly timed, like a Garrard, but it can seem mechanically metronomic. The last (standard) one I heard, bass was on the vague side of the fence in terms of slam, and air and space were restricted. But the Technics always was squeaky clean in its temporal grip, sanitarily so.

Good minds have come along to address its weaknesses, from a resonant platter to a motor drive supply that is, in some ways, electronically crude. This was explained to me by Dave Cawley of Sound Hi-Fi who is a proper engineer (not a tinkerer) and has delved into the servo system of the SL1200.

As I have been using and testing turntables for a long time and remember the debates about Direct Drives 'cogging' rather than turning smoothly, I was a bit taken aback to be told by Dave that he could see these effects under test. I am not aware that the cogging effects were ever measured; it was scientific

speculation I thought. But Dave Cawley said otherwise. Suddenly my imagination was fired...

The measurement system he used to see this was identical to one I used long ago – and it worked brilliantly. Unfortunately, a crucial element was a Rank Kalee Wow and Flutter meter that died on me. And Wow and Flutter meters went the way of dinosaurs. These days we measure jitter instead!

So I hit eBay in a search and found one in the USA and one in Germany. The one in the USA isn't there any more! It's here, having found a very appreciative UK owner. To be precise it is a Kenwood FL180A and you can see it in our feature on testing, on page 34-35. A W&F meter like this has an FM demodulator onboard and an output from it that, when sent to a spectrum analyser, gives a clear picture of turntable speed variations, from disc eccentricity, through low rate wow and up to higher rate flutter, which is where Direct Drives appear to sin.

So far, analysis from the Kenwood's output has confirmed that the Technics SL1200 has no drift or wow (i.e. variations below a 5Hz rate). Our current W&F meters from Rohde and Schwarz and Clio have already made this clear. Tantalisingly though, a spray of harmonics from 5Hz-10Hz has appeared with one turntable. Are these the mysterious cogging components for which Direct Drive was originally dammed? It certainly looks like it. A belt drive Rega P3/24 doesn't suffer them (but it has typical belt drive wow). I will need to test many more samples before a pattern emerges but our improved turntable measurement method is already yielding interesting results and looks to be very revealing. It will give us a clearer insight into turntable behaviour under test and demystify the subject a little bit more. ●

High End Cable
www.highendcable.co.uk
Call Dave Jackson on 01775 761880



Raidho Acoustics

C2.0

from £14,565.00

"come on designers, how about a few more brand spanking new tonearm designs...?"



adam smith

Whilst I continue to be thrilled at the resurgence in the interest in vinyl which continues to show no signs of abating, I can't help being slightly bemused at the way in which this has manifested itself in terms of the necessary hardware; one piece in particular.

Consider for a moment the turntable – new ones are popping up left right and centre and although these are mainly belt drive, true ingenuity is being shown from quite a few companies in terms of the ways in which to achieve the best from this type of drive system. There are high mass types, low mass types, decks with fixed suspension, bouncy suspension or semi-bouncy suspension and platters that range in size from 'barely bigger than an LP' to 'looks like a Formula One tyre'. Heck, there are even some new idler drive and direct drive units lurking on the fringes of the market, although sadly most bearing price tags that keep them well and truly out of the reach of us mere mortals!

Cartridges are also holding their own. Some classic designs such as the Shure M97xE, Goldring 1000 Series and the dreaded Denon DL-103 never went away, but the likes of Nagaoka, Ortofon, Goldring, Kiseki and Audio Technica are bringing out new designs at a far faster rate than we had ever expected. But what of the arm that is essential to mate the two items, then?

Well, naturally the likes of SME, Graham, Clearaudio and Roksan have been quietly churning out worthy designs for years and we have recently welcomed Jelco back into the fold. Known best as a maker of OEM arms for many manufacturers back in the 1970s and 1980s, this underrated and under-promoted company

brought us the SA-750D and showed just what they were capable of. Add in Helius and Hadcock as smaller names still very much relevant and the inescapable conclusion is this – Rega have the rest of it pretty much sewn up!

Of course this is, in many ways, a very good thing. The RB251 is a storming budget design, and for me, the RB301 betters it quite notably and yet still comes in at a mere £230 or so – one of the all-time audio bargains. Move up to the finely honed RB1000 and this is a design that really can fight with the big boys without sustaining so much as a bloody nose – Rega really hit on a winning formula back in the early 1980s and every vinylist out there owes the company a big debt of gratitude. I strongly suspect that without them the vinyl resurgence would be much less successful, and at the very least a heck of a lot slower.

The concern I have, then, is the same one that Editor DP alluded to in the Letters pages last month regarding his Yamaha NS-1000 loudspeakers – namely why do so many people think that they can do so much better than a company with serious engineering knowledge and a healthy R&D budget? Everywhere you turn these days there appears to be a so-called 'new' arm coming along, about which I get unduly excited, and then I find it's yet another Rega, modified in the manner of whatever the current flavour of the month is and sometimes carrying an absurd price tag. I can't help likening one or two I have encountered to those Vauxhall Novas you see around any Halfords car park on a Saturday night – all the turbos, spoilers, 15" subwoofers and baked bean can sized exhausts cannot possibly turn one into something that it is not. The Nova is a good little car and although

it may well go faster and handle a bit better once modified (well, if it's been done properly, anyway...), underneath it's still a Vauxhall Nova! It's not so different with some of those arms.

To be fair though, there are a few modified Rega-esque gems out there. I don't know the full details of what John Nilsen does to them in his secret Glasgow lair but an Audio Origami'd RB250 is quite a special beast and Michell Engineering have certainly shown that they can take the performance up a notch or five with their Tecnoarm. The new Inspire X100 that I review in this issue also goes straight in at the top of my list of well thought-out modified designs and there are indeed one or two others out there, all of which have been designed by engineers who know what they are doing. Trouble is, it appears that for every competently carried out modification, there is another that at best doesn't cut the mustard, and at worst damages the arm in the process. Word has it that Rega's own service department spends more time than they would like de-modifying some of their arms, and not all the patients come from garden shed bodgers either...

Frankly, the recent announcement from Audio Note of their new range of three arms gladdened my heart, as they are all new designs made from scratch but yet prices start at around £650, proving that a clean-sheet design need not cost purchasers the earth [watch this space for a forthcoming review -Ed.]. The basic Rega arms are brilliant designs, and there are more than a handful of truly worthy modified versions of them out there too but, come on designers, how about a few more brand spanking new arm designs? The hi-fi industry contains some of the finest engineering minds around, so I'm sure it's not too much to ask. ●

vinyl section

contents

JULY 2011

www.hi-fiworld.co.uk

TIMESTEP 1200 EVO 100

Rafael Todes tries a new, plug and play Technics SL1200 turntable package with an SME 309 tonearm.

CLEARAUDIO CONCEPT MC 104

Tony Bolton cues up this fine mid-price moving coil cartridge.

SOUNDBITES 105

Adam Smith tries Pro-ject's Leather It turntable mat and Avid's Level 45 turntable level and 45RPM adaptor.

ARTISAN SILVER MC PHONO 107

Tony Bolton dems a new budget battery powered phono stage.

INSPIRE X100 111

Adam Smith auditions this newly reworked Rega tonearm.



THE MOV LOT

New on Music On Vinyl is Nina Simone's 'And Piano! (1970), an LP that took Simone into the experimental which made this LP a slightly more difficult listen but worth the perseverance. Soft Machine's 'Third' is, unlike the first two of the band's albums, not often seen as a reissue but, presenting a mixture of jazz fusion and electronica, is arguably the band's best LP release. Another candidate for such an accolade is the Screaming Tree's 'Dust' (1996), a tight, hook-laden, worthy piece of lyric writing from the post-grunge, hard rocking outfit.

news

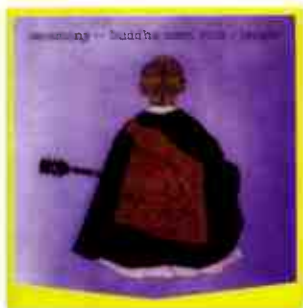

PHOENIX RECORDS

This UK label celebrates Japanese rarities. We start with a Buddhist ceremony featuring the usual finger cymbals *et al.* but with some superb fuzz/psyche guitar playing and female orgasmic moaning! 'Ceremony - Buddha Meet Rock/People' is from 1971. Next, some Japanese prog from the Far East Family Band and their second album, 'The Cave Down To The Earth' (1975); a spacey, Pink Floyd-influenced LP with Gilmouresque guitars, essential for prog heads. Magical Power Mako recorded over twenty LPs, 'Super Record' (1975) mixes folk and psychedelia with extra Asian influences and experimental rock. A sonic experience for those krautrock fans looking for the next stage.

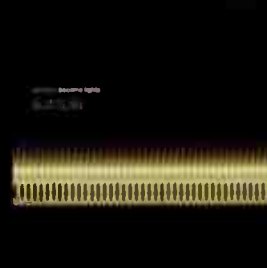

ROQUETING THROUGH SPACE

Krautrock has seeped into and from many of this month's releases. Well, *après moi le deluge* guys, because 'Roqueting Through Space' (Fruits De Mer; www.fruitsdemerrecords.com) is awash with the stuff. Presented as a 500 copy limited edition LP with a free 7" single, it takes tracks from the likes of Neu!, Can and Brainticket and reimagines them via contemporary groups such as Vibravoid and Alpha Omega.



LILLITH DUOS

Reissuing a vinyl album and packing a CD version of the album alongside, Lillith has two Gary Moore albums on offer: '1995 Gary Moore Live At Montreux' plus '1990 Gary Moore Live At Montreux' in which the guitarist returns to his blues roots examining fare from US and British-based blues greats.



BACK ON BLACK

...is back! In the Vinyl

News at any rate with two releases from Witchfinder General, complete with 'Carry On Wench'-type artwork! A New Wave Of British Heavy Metal

movement-era band, influenced by Black Sabbath that later proved to be an influence on the doom metal scene. The excellent 'Death Penalty' (1982) is a Sabbath-a-thon while 'Friends Of Hell' (1983) is a less successful foray yet still of interest to Sabbath fans. Also look out for Motorhead's 'Overkill' (1979) – arguably their best ever – a fierce, in-your-face LP showing the band at the height of their powers. Contact www.backonblack.com.



PJ'S HERE

PJ Harvey's new album, 'Let England Shake' (Island) has hit the beloved wax. A fascinating examination of her country, 'England' takes war, the people and its mores as a central theme. A fascinating conceptual piece.

...AND FINALLY

It's a packed section, this month, so let's get to it... Parzival were a German prog-folk group, majoring on an acoustic sound. This 'Legend' reissue (Sireena; 1970) has an early ELO, Beatle-esque feel with medieval overtones (www.sireena.de). Dutch garage punks The Outsiders, released 'CQ' (Jackpot) in 1968. Complete with R&B, folky tracks plus some post-punk-like songs, this limited edition reissue includes the silver foil cover and a recent band interview (www.jackpotrecords.com). New out on Headspin is The Graviators' self-titled album. Influenced by Black Sabbath with grinding guitar and heavy, syrupy riffs that hang on to your leg like a the teeth of a rabid Doberman.

The Kuhn Brothers & The Mad Rockers (Wah Wah) mix free jazz with psychedelic to form this self-titled LP from 1969. This LP would help to pave the way for the later krautrock classics and so is essential for fans of the genre (www.wah-wahsupersonic.com). The Sound Of Siam: Leftfield Luk Thung, Jazz & Molam In Thailand 1964-1975 (Soundway) is a 2LP compilation. A right mix of themes here: Luk Thung (Thailand's country music) and Molam (roots) combine funk, psyche, soul and the exotic to provide a cornucopia of vibes. A Thai curry of hot and spicy musical tastes (www.soundwayrecords.com).

The Magic Bullets (www.myspace.com/magicbullets), a US-based pop band, has just released its self-titled album via Mon Amie, that immediately reminds me of some of the outfits I used to listen to the eighties such as Orange Juice, complete with jangly guitars. Ah, memories! 'Violet Cries' is the new album from Esben And The Witch (Matador), complete with a download voucher. An indie-rock band from Brighton, they have a punk/gothie/Siouxsie and the Banshees for film soundtracks' edge. See www.matadorrecords.com.

Newly released by NLF3, this math rock LP, 'Beautiful Is The Way To The World Beyond' (Clapping Music; www.clappingmusic.com) will appeal to fans of thoughtful art rock with jazz elements like Tortoise. Finally is Eat Lights Become Lights' new album, 'Autopia' (Enrapture; www.enrapture-records.com). Sounds? Imagine Jamie Oliver starting with an electro/krautrock base and dabbling with other sonic ingredients to see what happens!



Step Change

Sound Hi Fi are offering a brand new Technics SL1200 deck, heavily modified with bearing, feet, mat and power supply tweaks, plus a fitted SME 309 tonearm and Audio Technica MC cartridge. Rafael Todes tries this 'turnkey' turntable package'...

Regular readers will know the story – a once universally derided 'disco deck' is found to have hidden depths. Not very well hidden, actually, as the Technics SL1200 is a superb turntable made a bit less so by its tonearm, turntable mat and feet. Replace these with aftermarket items, and even tweak the power supply (worthwhile but not essential) and you're cooking on gas; the humble '1200 will slay giants...

Trouble is, you can get far too into this. There are umpteen different tweaks, and just as many alternatives using different products which may or may not work better; a thesis could be written on the aftermarket platter mats alone! So what to do if you're one of those naive innocents who just actually wants to, ermm, to listen to music? Contrary to the writings of some people on internet forums, it's actually even more fun to listen to music via the Technics than it is to align every screw in the deck (and that's a lot) so it faces west, or to twiddle with the power supply wiring until the next millennium.

Timestep have the answer; it's an off-the-shelf package of mods which effectively give you a 'plug and play' SL1200, no questions asked. This is the brainchild of Dave Cawley, who runs Sound Hi-Fi; he comes from high end electrical engineering background, having previously worked for Philips in a senior engineering capacity. The Evo, as it's called, is a brand new deck for £3,695, said to provide a 'turnkey' solution for those who don't want to spend the rest of their natural lives twiddling with the innards of an SL1200! There's the option of an Audio Technica

AT33EV moving coil cartridge for an additional £449, and a STB-MS clamp/weight for £225. If you want your own deck modded to full Evo spec (including SME 309), then it's £2,895 plus the aforementioned options. Of course, the Technics SL1200 has now been discontinued, but Dave bought a good quantity of the very last box-fresh ones, so if you do go for the whole package, rest assured you're getting a brand new deck.

The major turntable mod is to bypass the stock power supply and rectifier circuit; Dave removes the transformer and redundant PCB and fits his own power supply. There's also a motor modification to reduce the phase comparator loop filter gain and move the turnover point, thereby eliminating the low frequency instability. Next, he fits a bespoke bearing to replace the standard one, with twice the diameter and twice the surface area of the standard bearing. It runs on a silicon nitride ball on a replaceable PTFE thrust pad. The bearing feels physically more solid than the standard one, and it feels substantial to spin around with the fingers as if surrounded by a more viscous type of oil.

The feet chosen to replace the standard Technics fare are Sorbothane; they're like sticky black logs and are jammed in to the

sockets tightly.

They are squiddy when grabbed; when the turntable was located on my sideboard, these feet seemed amongst the best at insulating exogenous vibrations. This of course may mean little in terms of how the feet help to absorb the energy from the arm and cartridge, but nevertheless it is a good start. The arm selected is an SME 309, a chip off the old V block. Looking physically like its older brother, it performs a fair percentage of its tricks for a lot less money. Currently the list price of the arm is £995. The cartridge supplied on this deck is an Audio Technica AT33EV, a moving coil which costs £449; this cartridge is a particular favourite of editor DP.

SOUND QUALITY

I fired up the deck and listened first to 'Also Sprach Zarathustra', the Richard Strauss' Tone Poem used in the film '2001: A Space Odyssey'. It starts with a very low, earth shaking note on the organ, lasting around twenty seconds – 16Hz according to my iPhone app, which on the this Technics, is rock steady, and provides the platform for the famous brass triad that builds up. There follows a rhythmic figure on the Kettle drums, which the Timestep Technics does to the point where you can feel the instrument in the room. It's a striking sound, only possible from a turntable of superlative speed stability; it gives the music an incredible 'hewn from granite' sense of utter unflappability





and poise. I honestly can't think of another sub-£4,000 deck (including arm) that even comes close.

Listening to 'Loose Tubes' on the Technics, as compared to my Fletcher Audio Omega 0.5 reference, and there seemed to be more impact from the sticks hitting the drums than with the belt drive deck, the percussion sounded more immediate and faster. I felt almost bruised listening to it! The soundstage was large now, and I wasn't aware of the bass problems that were present with the unmodified deck; indeed the mods seem to let the original stock deck out of its cage, so it can run around and make mayhem!

A favourite piece of music of mine is the Mozart 'Concertante for winds', and here the deck showed an ideal blend of grippy detail and warmth of tone which conveyed

the effortless charm of the performance. The pulsating double basses had real clarity, and the tone of the woodwind soloists was really beautiful. There was both body to the sound and finesse to boot; it felt like listening to a reel-to-reel with the master tape.

The first movement of Kurt Weill's second symphony contains a combination of angry and swashbuckling moments. What the deck does so well is communicate

the orchestra was less pronounced compared to my reference Fletcher Audio deck; although this package

better it in so many ways, it does lack a little stage depth across the midband. The section seemed a bit depleted; this is a minor whinge for what is otherwise is a very sweet and smooth sounding cartridge, I found.

On Mozart's 'Symphony No.39', using the same combination I got a huge sounding orchestra, full

"powerful yet stable, commanding and invigorating, scintillating yet subtle, this is a brilliant sounding turntable package..."

the snappy interchanges between instruments, handing over to each other – the timing of the deck really makes this sound exciting. One thing I noticed with this combination (including the optional Audio Technica AT33EV moving coil cartridge), is that the violin section's relative weight in

bodied and lush. I have seldom heard better on this recording. The bass was the tightest I've heard between either deck, and there was a decent soundstage. The tone of the upper strings was warm and well rounded. It let the music breathe in rhythmic terms, something that only top





"...so good I swear it is surrounded by magic"

- Noel Key wood ~ Hi Fi World

Hi fi news

2004 Awards - Editor's Choice
2005 Awards - Best Pre amplifier
2006 Awards - Best Pre amplifier

HI-FI WORLD

2006 Awards - Best Pre amplifier
2010 Awards - Best Pre amplifier
2011 Top product - Group Test



www.mfaudio.co.uk ; info@mfaudio.co.uk :: +44 (0) 1424 858260

Tellurium Qtm

HI-FI WORLD
August 2010

hi-fi+
Cables of
the year 2010



www.TelluriumQ.com



Hi Fi World
product of
the year 2010

The first cables designed primarily to combat phase distortion

"something that I've never heard from any cable at this price point."
Paul Rigby HiFi World August 2010

"Cavernous acoustic space.....palpable sense of reality...good sense of timing and pitch...the sound was controlled and didn't harden as the volume increased...even tonal balance."

Hi Fi News (Feb 2010 edition)

"Whatever you do, don't audition the Ultra Black. As I said before, once you do, there's no going back."

Steve Dickenson, Hi Fi Plus, Awards Issue 2010

Find out why these new cables have won four awards in their first year including two separate product of the year

+44 (0) 1458 251997

Classic Hi-Fi

Aristocratic sound for aristocratic music lovers

For true analogue sound. Classic Hi-Fi... bringing you closer to the musical truth

T.A.C. V-60 valve amplifier
T.A.C. C-60 valve CD player
Usher X-719 hi-end speakers



USHER **T.A.C.**

Above and beyond anything you have heard in the past...
hearing is believing
elegant, precise, outstanding...

For more information of this products please visit our website:

www.classichifiuk.com

For a demonstration please call us on **020 8374 3958**

VALVE AMPLIFIER SERVICING AND REPAIRS

We have over 40 years' experience in the design, construction, repair and servicing of all types of valve (tube) amplifiers. These include: stereo, hi-fi, guitar, cine projector, pre and power amps.

Prices start from:

£25 – initial investigation, testing and diagnosis
£35 – first hour's work, including PAT electrical safety testing
£33 – per hour thereafter, excluding cost of parts required
We will always advise the total cost before proceeding.

Valve testing is offered as a separate service at **£2 to £5** per valve.

We also offer a standard service package for **£75** which includes:

- PAT electrical safety testing
- Cleaning valve bases
- Cleaning potentiometers
- Cleaning all connectors
- Re-soldering dry joints
- Testing all valves

We provide a fully detailed report on the repair carried out.

All test equipment is regularly calibrated and traceable to National Standards.

Please note: We do not undertake work on any solid state equipment.

All prices are subject to VAT.

T: 01444 881968

Bolney, West Sussex

Pannell & Partners
Power Systems Services

david@pannellandpartners.co.uk
www.pannellandpartners.co.uk

Member of the
British Standards Institute

Member of the
Institute of
Electrical & Electronics Engineers

Member of the
Institute of Physics



PRO-JECT LEATHER-IT £50

New to Pro-ject's lineup of handy widgets and accessories are two new turntable mats, one rather simpler and made of cork, but the other made of a quality grade of leather.

Interestingly, leather has not been widely used before as a mat, with only Acoustic Solid and Jean Hiraga being the other exponents that come to mind.

As a softer material, leather has the distinct advantage of not adding undue weight to the platter or suspension of the turntable and its more malleable surface ensures that larger dust particles cannot

cause scratches; something that is not unknown with hard mats.

The mat itself is smart, available in both black and grey, and offers a good level of damping, although not quite enough to fully silence my

Garrard 301's bell-like platter, so the Leather-It went onto the acrylic platter of a top secret turntable DIY project that I currently have in progress [que? Ed.], and the results were most intriguing, yet impressive. Whereas many mat upgrades make things brighter and shinier, the Leather-It instead focuses far more on the midband and seems to lower the noise floor to allow the music to be better heard. Spatiality was improved over the bare platter and it became easier to follow instruments as they played. Equally, bass lines were more vivid, augmenting the turntable's general tunefulness and the top end seemed generally more polished and insightful, but without any hint of undue glare or fizziness. All in all, not only does the Leather-It smell fabulous, it adds a surprising sense of sophistication and poise to vinyl replay and is well worth checking out.

AS

[Contact: +44 (0)1235 511166.
www.henleydesigns.co.uk]

soundbites

AVID LEVEL 45 £40

One of the disadvantages in vinyl's rise from the ashes is that some of the accessories that we took for granted in the past have failed to keep pace with the increase in reproduction equipment. A perfect example is the 45rpm adaptor that allows seven inch singles with large jukebox-style centre holes to be played on a conventionally-spindled platter. Back in the vinyl heyday, you would find these in all shapes, sizes and colours but, today, black plastic seems to be the rather staid norm. Thank goodness for Avid...

The Level 45 is a set comprising a beautifully machined stainless steel 45rpm adaptor along with an equally lovely spirit level. The adaptor and level can be used on their own, of course, but are also designed so that the level fits directly onto the adaptor with the sort of mechanical precision that makes one sigh with pleasure! The result is that correct levelling of the turntable can be achieved with measurements taken directly over the spindle and then you can remove the level and get on with the important business of spinning those old rock 'n' roll 45s. For a mere £40, the pairing won't break the bank of even the most impecunious vinylista and the result is both a handy gadget, and a tantalising taste of the Avid engineering high life. Great value and very useful! **AS**



[Contact: +44 (0)1480 869900.
www.avidhifi.co.uk]



Ever Steady

Artisan Silver Cables' new Silver Moving Coil Phono Stage is unique in its class for using battery operation. Tony Bolton finds it a most competent performer...

Over the last twenty years or so, various pundits have confidently predicted the demise of vinyl, yet over the past few there's been a multitude of new products dedicated to the better reproduction of an allegedly moribund format. It is therefore safe to assume that now, at the start of the second decade of the twenty first century, that the format is very much alive and kicking – and products such as this are testament.

The Artisan Silver Cables' Silver Moving Coil phono stage comes, as their name suggests, from a company that has previously specialised in making interconnects and speaker cables. Artisan Silver Cables is based in Newport, on the Isle of Wight, and is the brainchild of Alister Staniland. He has a background in electronics and an interest in hi-fi that has grown from a life-long passion for music, he says. The company started making solid silver interconnects a couple of years ago, then introduced speaker cable, and now, with the company's trademark Teflon-coated, solid silver internal wiring, they have launched this MC phono stage.

The electronic design has been done by Dr. Chris Gittins, who hand makes and tests each one. Along with the silver wiring, the internals boast Panasonic FK series power smoothing capacitors and the same

company's audio coupling capacitors. This phono stage is unusual, especially at this price point, in that it uses battery power. This is provided by a Vapex 280mAH Nimh battery which is charged by what is described as "a high capacity current source" which "provides a very low noise Virtual Battery Internal DC power supply". This decouples the audio circuitry from the mains, thus providing a quieter background.

reference needs to be made to the instructions to establish which connections are which. The front has a switch and two LEDs. With the switch in the up position the unit is charging and the green light is displayed, flicking it down made the red light glow, and activated the audio circuit. The instructions claim it will run for seven hours before the batteries become discharged; I think that is fairly accurate. I only

"high levels of resolution gave a close tactile quality to the sound that was quite engrossing..."

The casework is made of aluminium and I measured it as being 106mm wide, 127mm long and 35mm high including the feet. My scales showed that it weighed 150 grams. Care may be needed when choosing interconnects since a stiff cable is likely to move the phono stage around the shelf. The supplied mains transformer/plug is fairly bulky and proved a bit of a snug fit in between other plugs on one of my gang sockets.

The rear deck contains the mains connection, a substantial earthing post and four phono sockets for the input and output. These are not labelled or colour coded so

lost power once, and that was at about three o'clock in the morning after a very long listening session. For normal use I would regard the power reserve as more than adequate...

I have found that silver wiring requires a lot more running in than copper, otherwise it can sound somewhat bright and over-exposed in the higher frequencies. For the first few hours of listening this held true with this phono stage. After about fifteen hours things started to tone down a bit and the midrange began to expand to fill the void beneath the treble. Another twenty hours on and the sound began to get a lot more balanced. Purchasers of this

unit would be well advised to allow at least one hundred and fifty hours of use before its full potential is achieved.

SOUND QUALITY

Once the phono stage was settled I started listening to Mozart's 'Eine Kleine Nachtmusik'. This is an unusual recording being on a 12inch 45rpm disc. Although originally made in 1962, and released at the normal 33rpm, this recording was remastered in the nineteen seventies to take advantage of the greater dynamics and detail available when playing at a greater groove velocity. (The 'HMV Classics 45rpm dynamic sound series' also included works by Ravel, Tchaikovsky and Strauss amongst others, and are well worth seeking out.) I was immediately impressed with the levels of detail and texture that flowed out of the speakers. It was certainly more than I expected to hear from a phono stage costing just under £300. I found myself focusing on the sound and style of bowing on the violins, being able to almost picture the arm movements of the players. There was precision aplenty in the stopping and starting of sounds and the whole effect was quite involving.

Moving my focus down to the midrange and again I felt that I was getting almost a closeup of the shape of the sounds and the way that performers were generating them. Here there seemed a lot of shape and texture, although there were a couple of occasions where I felt that a little more depth would have added an extra layer of solidity to the sound. Bass was fast and detailed, although again I was left with a little feeling that, in this system, at least, there could have been a bit more substance to the shape of the lower registers.

A little later I had dug out an old favourite of mine, an LP called 'Ella and Her Fellas'. This 1958 Brunswick release made use of masters that she had made between 1938 and '52 with a selection of the jazz greats of the time, for Decca Records (the American label was a separate company to the British one at the time). The tracks vary from the easy flow of 'Sentimental Journey', with Eddie Hayward and His Orchestra to the uptempo boisterousness of 'Stone Cold Dead In The Market' accompanied by Louis Jourdan and His Tympany Five. Despite the fourteen year age range of the recordings, the quality is excellent and the pressing itself has survived the years very well.

When played through this

phono stage, again the high levels of resolution applied to the detailing in the mid and higher frequencies gave a close tactile quality to the sound that was quite engrossing. There is no stereo/mono switch fitted so the vertical modulation of the stylus over any wear or damage in a laterally cut groove resulted in the usual pops and crackles at the extreme left and right of the soundstage. Since the record was in pretty good condition it wasn't too much of a problem, but I refrained from playing some of the more used records in my collection. The rich velvety textures of Ella's voice were well displayed and the swing to the beat was tightly timed and precise.

Staying with rhythmic sounds I played Bentley Rhythm Ace's eponymously named first LP from 1997. This Birmingham based group was founded by Richard March from Pop Will Eat Itself and Mike Stokes. Live drums were played by Keith York and Fuzz Townsend, who came from the same group as Richard March. The music is an eclectic mixture of live instruments and both instrumental and vocal samples, mixed in with some very odd synth generated sounds and held together by a big driving bass that earned the style the name of 'Big Beat'. Reproduced through this phono stage I was again immersed in the detail and projection of the mid and treble, but would have preferred more bass weight. My Chario/Leema combination is not normally shy in this department, but in this instance it didn't seem quite as powerful as it has done with other equipment combinations.

As such, I think that the Artisan Silver would be a great foil for the dark and rich tonality of amps such as Prima Lunas, where it would complement their lower registers and enhance the higher ones. In most aspects of its performance it seems to punch well above its price, offering an openness and detail that rarely appears unless one spends quite a lot more. I would put a lot of this down to the battery power supply, which by removing the risk of any mains borne interference, allows for the smaller details to stand out. The converse of this is the problem that I have encountered

MUSIC USED

Mozart, 'Eine Kleine Nachtmusik', RPO, HMV 3.
Ella Fitzgerald, 'Ella and Her Fellas', Brunswick LAT 8223
Bentley Rhythm Ace, 'Bentley Rhythm Ace', Skint PCS 7391

REFERENCE SYSTEM

Clearaudio Master Solution turntable
Clearaudio Carbon Satisfy tonearm
Benz Micro Ace cartridge
Ortofon Vivo Blue cartridge
Audio Technica AT-F7 cartridge
Leema Acoustics Tucana II integrated amp
Chario Ursa Major loudspeakers

with a lot of battery powered phono stages - with the exception of the Holfi BattZriaa and the Sutherland Hubble (both far more expensive) - which is a lack of bass weight. The shape and detail are there but the sheer mass isn't.

CONCLUSION

A great new product from Artisan Silver Cables, their new MC Phono Stage offers excellent detailing and insight at the price, with a refreshing lack of general mush considering its very modest price. Its lithe but light low end means it's important to match it to the right cartridge and/or speakers; I'd suggest Audio Technicas and Lyras wouldn't be ideal, whereas the more balanced sounding Ortofons would work well and deep, dark Dynavectors better still. With this caveat in mind, I'd advise prospective purchasers to take advantage of the thirty day money-back guarantee that's offered and have a listen. With the right ancillaries, it offers sparkling performance at the price.



VERDICT

Impressive new battery powered MC phono stage offering super value for money.

ARTISAN SILVER
MC PHONO STAGE £299
Artisan Silver Cables
www.artisansilvercables.com

- FOR**
- smooth, clean sound
 - good high frequency detail
 - battery operation
- AGAINST**
- slightly bass light
 - no mono/stereo switching

MEASURED PERFORMANCE

Our frequency response analysis showing RIAA equalisation accuracy reveals an overall lift of 1dB at high frequencies relative to output at 200Hz so the Artisan phono stage will have a bright balance and emphasise detail perhaps, but it might well make many modern MCs with strong midband output a little hard and bright. Full gain is maintained right down to 1Hz so there is no warp filtering and cone flap may be obvious at times with warped LPs.

Gain measured x1140 so 0.4mV input gives 400mV output, enough to drive most amplifiers even when using a low-ish output moving coil cartridge. However, x1000 does not match the lowest output types; x3000 is needed. In a similar vein input noise was high at 0.7µV; 0.08µV is common for a quiet MC stage, 8dB quieter than the Artisan so this preamp is best used with high output MC cartridges like Ortofons. Distortion was very low at 0.003%,

as is common with chip based phono stages.

The Artisan is a simple enough MC stage with the interesting addition of a battery power supply. It measured performance is satisfactory for good results, if not up with the best. NK

Frequency response	1Hz-44kHz
Separation	73dB
Noise (e.i.n.)	0.2µV
Distortion	0.003%
Gain	x1140 / 61dB
Overload	3.3mVin/3.35V out

FREQUENCY RESPONSE

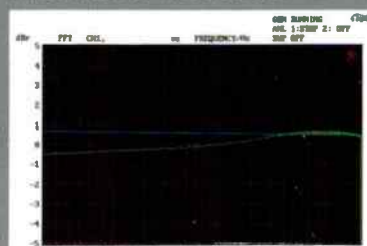

Web classiquesounds.co.uk

Classique Sounds

Specialist Supplier of Vintage Audio

61 Aylestone Drive
Aylestone,
Leicester, Le2 8qe



Tel 0116 2835821
Local rate 0845 1235137
Mobil 07815 188040

Leak Stereo 20 full rebuild using Paper in oil caps £299.00
Conversion of Leak valve pre to passive including Silver wire/solder/rhodium plugs £299.00

wanted classic and modern hifi eqpt.

FOR SALE PRE/POWER AMPLIFIERS

Quad 306 amplifier.	£175	Quad 405-2 power amplifier. Excellent condition.	£325
Insa Design Talon integrated amplifier. 80W channel class A/B	£149	One of only 50 in the UK. Boxed rem instr. Rare	£699
Beam Echo (Avalanche) DL7-35 monoblocks X 2	£POA	Leak Point one mono pre amplifier. Excellent cond.	£99
Sugden Audition P power amplifier. Titanium front.	£349	Quad 66 pre amplifier	£249
Naim Nic-12. Bowed. Naims First.	£99	Croft OTL series 3 valve power amplifier. Ex cond	£999
Beautiful pair Quad II amplifiers with Quad 22 and FM1 tuner and manuals. All boxed and super condition.	£1399	BEZ-Q4B 681C valve pre amplifier.	£229
Audion Sterling Stereo + SE amplifier. 2 X 18W	£749	Arcam Alpha 10 int amp. Bvd. remote & mint.	£799
Kora Explorer 90S1 hybrid valve 60W int amplifier.	£375	Marantz PM-32 integrated amplifier.	£29
Arcam Alpha amplifier. The original.	£49	Quad 303 power amp. Nice condition.	£159
Pair Mullard 520 valve amplifiers. Gorgeous sound	£599	Quad QCC22 pre amplifier Mono	£49
Audion Symphonies V2 valve pre amp. Mint boxed	£299	Krell PAM-1 Pre amplifier. Dual mono design with twin off-board PSU. Silver finish. MM & MC input. G cond.	£899
Krell PAM-1 Pre amplifier. Dual mono design with twin off-board PSU. Silver finish. MM & MC input. G cond.	£899	Rogers Cadet 2 power amplifier. Good condition	£275
Rogers Cadet 2 power amplifier. Good condition	£275	Leak Variotone pre amplifier Ex condition	£199
Chapman valve power amplifier. valve pre amplifier and FM valve tuner. Very unusual and rare	£599	Leak Variotone pre amplifier Ex condition	£199
Quad 34 pre amplifier. Early brown model. 5 pin din	£189	Rotel RC-970BX pre amplifier. Good condition.	£99
Quad II's. Various condition.	£POA	Leak pre amplifier for Leak TL 10.1 Ex condition.	£99
Rogers stereo valve pre amplifier. Very rare.	£149	Leak Stereo 20. Original box. Beautiful condition.	£999
Mission Cyrus 2. Nice condition. Grey finish.	£149	Leak Stereo 20 rebuilt with quality paper in oils.	£799
Rotel RC-840 BK int amplifier with MM & MC	£99	Croft series V1 valve power amplifier. Good cond	£699
Rotel RC850 pre amplifier. Good condition.	£99	Quad 405 power amplifier. Good condition.	£199
Quad 33 pre amplifier. Boxed. Ex condition.	£129	Musical Fidelity A3.2Cr pre amplifier. Silver finish	£499
Pioneer A300X integrated amplifier. Nice condition	£129	Pair Musical Fidelity MA65 class A monoblocks.	£595
Akai AM-U33 int amplifier. Silver. Mint & boxed.	£69	Quad 33 pre amplifiers. From...	£75
Musical Fidelity A100 pure class A integrated 50W	£299	CR Developments Romulus int valve amp. Superb.	£999
Van der Heem. single ended int valve amp. C1964	£199	Leak TL 12- Amplifier. Bronze Mullard tubes.	£349
Beautiful condition 100% original Quad 22 pre amp	£299	Sugden A48 & 148 tuner in wooden sleeve	£299
Scott stereomaster 260 American integrated amp.	£169	Leak Point One stereo pre amplifier. Ex Cond	£199
Leak Variotone point 1 pre amp. Converted to Passive. Pure silver wire/solder/silver plate phonos alps pot.	£425		

TURNTABLES/CD PLAYERS

Thorens TD125 in SME plinth. SME cut out	£295	Thorens TD125 in Thorens plinth with Thorens arm	£249
Quad CD 66 CD player.	£299	Goldring Lenco GL75 with arm.	£149
Ortofon MCA-76 pre amplifier. Boxed/mint	£179	Sony CDP-911E. CD player remote/book. Cost £200	£119
Sony SCD-NB770S SACD CD player. M channel	£79	Rotel RB-965BX (Discrete) CD player.	£149
Sony SACD CD player model SCD-XP730 & rem.	£79	Linn LP12 armboard for Linn arm. Ex condition.	£20
Creek OBH 15 MC/MC/mono pre amp. Boxed/mint	£49	Cambridge Audio CD5 CD player with remote.	£49
Thorens TD126 MK2 electronic & SME series 3 arm.	£449	Ortofon MCA-76 phono pre amplifier. Rare	£149
Michell Focus 1 & Michell arm. Excellent	£399	Ortofon MCA-10 battery MC phono pre amp	£149
SME series 3 tonearm. Nice condition	£249	SME 3009 series II improved non improved from...	£199
Garrard 4HF headshell. Boxed.	£39	Cambridge Audio CD5. Black finish. Boxed/remote	£159
Mint sqaud passive pre amplifier.	£199	Mission 774 tone arm. Mint & boxed.	£249
Marantz CD63 CD player and remote.	£30	Arcam DV78 DVD player. Manual remote. Silver.	£999
Mission 775S turntable Cut out for 774/SME Bowed	£349	Rotel RCD-970BX CD Exc condition/remote	£249
Denon DCD-620 CD player. Good condition.	£29	Arcam Alpha 75E CD player. Award winner.	£159
STD 305S with SME mount. Black finish	£129	Thorens TD150. Teak finish. No lid. Nice condition	£99
Nad 504 CD player. Ex condition. No display	£49	SME 3009 Series II arm. Early split weight version.	£349
Rotel RCD 965 BX. CD player. 7weakers dream.	£149	Rotel RCD 865 BX. CD player. Superb condition.	£99

SPEAKERS

Dynaudio Audience 42 speakers. Stand mount.	£199	Tannoy 605's. Black ash finish.	£50
Rogers F8000 monitors. Slight cabinet damage.	£249	Quad ESL57 mains transformer. New, boxed	£349
Spendor LS23e loudspeakers. Mint. Bvd. Black ash	£649	Celestion 5400f using ribbon tweeters & stands.	£249
Castle system. Dark oak. Bivertable. Nice condition	£199	Klipsch Tangent 300 speakers. Bk. 96sub efficient.	£175
Heco 330S speakers. A classic. New unused boxed	£199	Target 84 speaker stands. Bowed	£175
Kewick Audio Fignay speakers. Solid mahogany	£229	Apogee Centaurus. Tall ribbon speakers. Awesome	£699
Kef Coda 7. Black finish. Bowed & mint.	£69	Miller & Kneisel MKK VX4 active subwoofer. Bk	£220
Swallow RM200 loudspeakers. Rare, similar to BCI	£199	Wharfedale Diamond 9.1 Ex condition & boxed	£120
Kef 101.2 Mini Monitors. Loudspeakers. Walnut.	£129	Pioneer Audio Studio 5% Bookshelf. Cost £599.	£260
Celestion DL12 floor standing speakers	£129	Pioneer 3 piece speaker set. Brand new. Cost £200	£99
Aeon Acoustics Linear speakers. Ribbon tweeters	£399	Meridian remote for 206 series. Rare & gold cond	£199
Pair Quad ESL 67 loudspeakers. Fully reconditioned with all new panels/leads etc. 12 months warranty. Awesome	£1699	Aka AT-K331.1 M-AM stereo tuner. Mint & boxed	£39
Pair Quad ESL 57 speakers. Fully reconditioned including 2 new Otoc treble panels. Awesome sound & dynamics	£1799	Quad FM3 tuner in excellent condition. From...	£99
Quad ESL57 speakers. All fully serviced with full 3 months warranty. Hear what ESL57 should sound like from Celestion Little one speakers in white. Bowed 199	£1200	Marshall ECC83/12AX7 specially selected valves.	£99
	£49	Quad FM1 valve tuner. Bowed. Rare cond.	£899
		Georgie stands for EL563 speakers	£279

OTHER ITEMS

Pioneer CT-5670D cassette deck. 3 hd Digital input	£79	Rotel RB-950BX tuner. Bowed.	£49
Denon TU 2601. II Stereo tuner with RDS	£29	Rotel 850 stereo tuner.	£29
Quad 66 FM tuner	£199	Nakamichi 600 cassette deck. Very rare. Nice cond	£299
Transparent powerline/Schuko plug. 1.9M	£149	1000P1 paper in oil capacitors. Used in Leak amps.	£349
Hitachi FT-5500 FM tuner. A real classic.	£99	Stunning rotel Stylus balance weights in jewel box	£79
Quad FM valve tuner to go with Quad 22.2. From...	£40	Tuning Quad FM1 valve tuner. Bowed. Rare cond.	£125
Quad FM2 valve tuner. Sound amazing	£149	Mullard ECC83 valves. Used and tested. Fine	£29
Mission Cyrus AM FM tuner. Grey finish	£79	Meridian remote for 206 series. Rare & gold cond	£99
HiQ balanced phono pre amplifier. Awesome.	£249	Aka AT-K331.1 M-AM stereo tuner. Mint & boxed	£39
Yamaha TSP 900.5.1 speakers with digital amps	£294	Quad FM3 tuner in excellent condition. From...	£99
Top quality PIO capacitors 0.1 and 0.22uf	£5.99	Marshall ECC83/12AX7 specially selected valves.	£99
Paper in oil capacitors. Metal bodies. I use these on all Quad II rebuilds and they sound amazing. 0.1 and 0.22uf	£8.99	Georgie stands for EL563 speakers	£279
Rupert stands for Quad FM57	£239		

QUAD ESL57 & ELS63 PANELS/SERVICING ETC

New 'The Telling Audio' Widget. All round improvement for 57's & a 'bolder low' for amp 57's
Full rebuild of 75 including latest Otoc treble panels for only £1190.00
We sell serviced Quad ESL57 speakers from only £12... J. pr. Why spend £4000?
ESL57 SPEAKERS STANDARD SERVICE £690. PR
Price includes 2 completely rebuilt treble panels etc. Ring for further info.
"Classique Sounds servicing restores the Quads to a position where they can hold their head high". Jon Marks, HIFI WORLD, April 1999. Full servicing facilities available.



Specialist Suppliers of Audio Accessories
www.mantra-audio.co.uk
ORDER SECURELY @ <https://shop.mantra-audio.co.uk>
SEE WEBSITE FOR CURRENT PRICES & FULL PRODUCT RANGE

CARTRIDGE SELECTION	STYLUS	HEADPHONE SELECTION		
Authorised Dealer for every cartridge full range including:		Grado Prestige SR-60i	£92	
		Prestige SR-80i	£110	
		Prestige SR-325i	£321	
HI FI ACCESSORIES				
		Musical Fidelity V-CAN Headphone Amp	£100	
		Musical Fidelity V-DAC 24 bit DAC	£190	
		Musical Fidelity V-LINK USB Adaptor	£100	
		Musical Fidelity V-LPS Phono Amp MM/MC	£100	
		ARTcessories USB Phono Plus PreAmp	£87	
		analogue-digital computer interface		
		Milty Pro Super Exstatic Brush	£17	
		Shure SFG2 Stylus Force Gauge	£38	
REPLACEMENT STYLI				
Swiss Quality Diamond Styli				
ORFONO full range including:				
DL 103	£POA	N/A	ADC XLM Mk III	£19
DL 103R	£POA	N/A	Akai AN 5, AN 60	£15
DL 110	£POA	N/A	AN2, AN 70	£17
DL 304	£POA	N/A	Aiwa AN11	£15
GRADO full range including:				
Prestige Black 1	£53	£43	Dual DN 145 E, DN 165 E	£19
Prestige Gold 1	£POA	£95	JVC DT 55, DT 60	£15
LYRA full range including:				
Delos	£POA	£POA	National EPS 24 CS, P 30 D, P 33 D	£19
SHURE full range including:				
M92E	£POA	£19	Ortofon FF15/VMS20 EII, OM5/10/20	£15
M 97 XE	£POA	£60	Pioneer PN 210/220/240	£15
M78S	£POA	£44	Shure N75C, N75-6, SC35C	£15
SHURE full range including:				
Blue Point Special	£POA	£POA	N75ED/EJ T2 N75-3, N95ED/EJ	£19
		N/A	N 97 HE, VN 35 HE	£29
			Sony ND 142/155 G, CN234	£15
			ND 143/150/200 G	£17
			Stanton D 681 EEE	£23

EX STOCK DELIVERY BY RETURN OTHERWISE 3-10 DAYS

Order direct online or Tel/Fax (01757) 288652
MANTRA AUDIO (HFW), Town End House, Skipwith, Selby, North Yorkshire YO8 5SQ

IAN HARRISON HI-FI TEL: 01283 702875

HIFI AT DISCOUNT PRICES. FREE NATIONWIDE DELIVERY

SALE! UPTO 25% OFF ANALOGUE EQUIPMENT

TRADE IN YOUR OLD MOVING COIL CARTRIDGE & SAVE UP TO 60% OFF THE RRP.			
TRICHORD DIABLO	£650	MOTH GROUP	£POA
TRICHORD DINO MK2	£300	ROBSON ACOUSTICS	£POA
AUDIO TECHNICA AT33EV	£425	MICHELL ORBE & ORBE SE	£POA
AUDIO TECHNICA AT-OC9 ML3	£390	MICHELL GYRO & GYRO SE	£POA
AUDIO TECHNICA ATF7	£240	MICHELL TECHNO ARM A	£POA
AUDIO TECHNICA ATF3 III	£165	ICON AUDIO	£POA
AUDIO TECHNICA AT2000T	£900	PALMER AUDIO	£POA
SUMIKO BPS EVO III	£205	PROJECT	£POA
TRANSFIGURATION AXIA	£900	LEHMANN AUDIO	£POA
TRANSFIGURATION PHOENIX	£1350	BENZ MICRO	£POA
TRANSFIGURATION ORPHEUS	£2400	TOM EVANS	£POA
CLEARAUDIO SYMPHONY	£675	DENON CARTRIDGES	£POA
CLEARAUDIO CONCERTO	£1150	ROKSAN CARTRIDGES	£POA
CLEAR AUDIO	£POA	GRADO CARTRIDGES	£POA
WHEST AUDIO	£POA	SUMIKO CARTRIDGES	£POA
EAR/YOSHINO	£POA	ORTOFON CARTRIDGES	£POA
HARBETH MONITOR 40	£POA	GOLDRING CARTRIDGES	£POA
HARBETH SUPER HL5	£POA	ROKSAN TONEARMS	£POA
HARBETH COMPACT 7ESS	£POA	DENON HEADPHONES	£POA
CREEK/EPOS	£POA	STAX HEADPHONES	£POA
THORENS	£POA	AUDIO TECHNICA HEADPHONES	£POA

I ALSO SUPPLY:
ACOUSTIC ARTS, ACOUSTIC SOLID, AESTHETIX, AKG, ALPHASON, APOLLO, ASH DESIGN, AUROUSAL, B.C.D.I., BLACK RHODIUM, C.A.T. CARTRIDGE MAN, CUSTOM DESIGN, DIAPASON, EARLYOSHINO, ELEKTRONICS, ERGO, GAMUT, GRAHAM SLEE, GRAHAM, HADCOCK, HALCRO, HEED, HI DIAMOND, IXOS, JUAL, KOETSU, LONDON (DECCA), MONRIO, NAD, NU FORCE, OPERA, OPTIMUM, PATHOS ACOUSTICS, PRO-JECT, PSB, PURE SOUND, QED, REGA, SME, SONY, SUGDEN, SUMIKO, SUPRA, TIVOLI AUDIO, TRANSPARENT, UNISON RESEARCH, USHER AUDIO, VAN DEN HUL, WIREWORLD, KEMP ZYX,

PLEASE PHONE TO CONFIRM PRICE & AVAILABILITY PRIOR TO ORDERING. ALL GOODS ARE BRAND NEW & BOXED WITH FULL U.K. GUARANTEES. NO EX. DEM OR EX DISPLAY GOODS. NO GREY IMPORTS. GOODS ARE NOT SUPPLIED ON APPROVAL. SORRY, NO GENERAL CATALOGUES. PLEASE PHONE OR WRITE FOR SPECIFIC REVIEWS, BROCHURES OR PRICES. SUPPLIER OF HIFI PRODUCTS & ACCESSORIES SINCE 1986 MAIL ORDER ONLY FROM: IAN HARRISON, 7 MILL HILL, REPTON, DERBY, DE65 6GQ.
TEL: 01283 702875. 9am - 9pm INCLUDING SUNDAYS.

Conceptual Part

Tony Bolton listens in to Clearaudio's latest Concept moving coil cartridge...

The Concept is priced at a relatively modest £560, plonking it straight into the most hotly contested part of the MC market. Brands such as Ortofon, Dynavector and Van Den Hul are already well established here, and there also reside some really heavy hitters such as the Benz Micro Ace (£595) which I reviewed in the May 2011 edition of this magazine.

Weighing in at 8 grams, the aluminium and magnesium body is coated with a ceramic surface layer and houses a micro-line stylus attached to a Boron cantilever. The rectangular body shape made alignment fairly easy, although the cantilever is hidden under the body so I found a small torch made the job a little easier. Tracking weight is suggested as 2 grams (+/- 0.2g) and I found that it sounded at its best exactly at this weight.

SOUND QUALITY

After a few days usage the sound settled down. In a classical mood, the first record up was a late nineteen fifties pressing of Heifetz playing the Bruch Violin Concerto. Although very well recorded, this particular pressing is not in the first flush of youth, but the Concept gave a very good account of itself, bypassing most of the wear and tear and seeming to find relatively unplayed parts of the groove wall to reproduce...

The tonal balance of a symphony orchestra and lead violin was very good; the sound was open enough that I could pay attention to different parts of the music, without anything seeming to be over or under emphasised. Bass instruments were well shaped with a depth to them that showed the high level

of competence that mono recording had achieved nearly sixty years ago.

A little later on found me playing a near mint 1956 copy of 'Hoagy Sings Carmichael'. Although at his most popular between the nineteen twenties and forties, his very laid back style was successfully updated for this LP and merged with more contemporary jazz instrumentation. The evergreen 'Georgia On My Mind' had a flow that was as engrossing as it was effortless.

The following evening I returned to more modern fare, and explored some of my electronica collection. Air's classic late nineties album 'Moon Safari', with its combination of synth pop, acoustic guitars and strings, as well as processed vocals, was opened up for inspection in a very musical manner. I enjoyed the precision of the sonic images of the performers and the mesmerising flow to rhythms.

CONCLUSION

The Clearaudio Concept MC is an excellent performer that will give the Benz Micro Ace a run for its money. Both were equally at home with any genre of music that I could find and seemed undisturbed by aged vinyl. I felt that the Ace had a slightly more laid back presentation whereas the

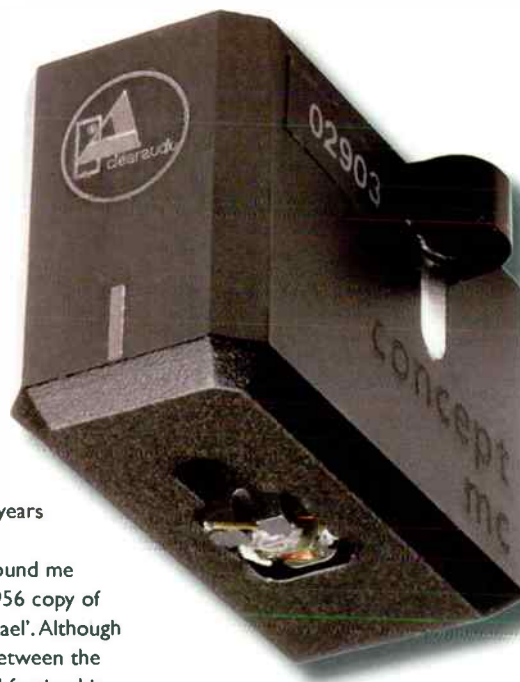

Concept was a little more upfront in its description of sound. I would unhesitatingly put the Concept very high on the audition list; it maintains the Clearaudio pedigree. Recommended.

VERDICT

High quality, affordable new moving coil cartridge with a detailed and open sound.

CLEARAUDIO
CONCEPT MC £560
Audio Reference
 +44 (0)1252 702705
www.audioreference.co.uk

FOR

- midband detail
- expansive soundstage
- good with surface noise
- snappy timing

AGAINST

- nothing at the price

MEASURED PERFORMANCE

The Clearaudio Concept has ruler flat frequency response our analysis shows, all the way up to 8kHz – quite an extraordinary performance. It is as flat as CD in fact. The lift in treble above 8kHz measures +3dB, just enough to be audible as a slight top end sheen. Inner groove tracing loss (red trace) reduces this a little, but not so much as to make the cartridge sound dull on inner grooves; the stylus reads short wavelengths well. The Concept will sound balanced and even, with just a little top end sheen, but it is unlikely to sound overtly bright like many budget MCs.

Tracking was superb at 2gms downforce. The highest level torture tracks at 300Hz and 1kHz were cleared with comparative ease, an unusual result few cartridges manage.

Distortion was very low both on lateral and vertical modulation, the latter being due to an accurate vertical tracking angle value of 22 degrees our tests showed. This is a low distortion cartridge, always a good sign.

Output is on the low side at 0.62mV at 5cms/sec rms, but not so low as to be difficult to work with. Most MC preamps have x1000 gain, enough to

give 620mV output to an amplifier from the Concept and all amps will reach full output with this.

The Concept measured superbly for a budget moving coil cartridge, bettering even the Benz Micro Ace. This market is hotting up. NK

Tracking force	2gms
Weight	8gms
Vertical tracking angle	22degrees
Frequency response	20Hz - kHz
Channel separation	30dB
Tracking ability (300Hz)	
lateral	90µm
vertical	45µm
lateral (1kHz)	25cms/sec.
Distortion (45µm)	
lateral	0.35%
vertical	1.2%
Output (5cms/sec rms)	0.62mV

FREQUENCY RESPONSE

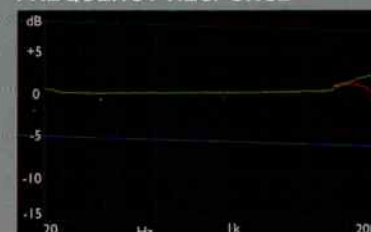

RETRO

REPRODUCTION
QUALITY HIGH FIDELITY & VINTAGE

AMPLIFIERS

Audiolab 8000D british built mint boxed	£395
ANIR 77 integrated amp titanium finish lightcased x dem	£995
Anatek mono blocks £2400 new	£995
Ayre K-1 XE pre amplifier	£2995
Ayre K-5 XE Evolution pre amplifier with remote control and balanced facilities	£2095
Croft integrated valve amp 4x EL34 with valve phono stage	£495
Crown power amp as used in Abbey Road Studio	£450
Cyrus 7 integrated amp	£345
Cyrus PSX silver/black available boxed	£275
Cyrus PSK	£445
EAR 834L dulux chrome finish	£1175
EAR 834L black finish	£595
Eastern Electric mm max	£445
Golden Tube SE2P valve pre amplifier	£495
Hoveland pre amp with phono stage & EL34 power amp	£100
Leak TL 12+ rare hammered paint finish 1961	£95
Linn Aktive amp module	£395
Linn Klassik all in one CD radio, amp boxed mint	£395
Luxman L100 integrated amp 1970 vintage £1000 new	£100
100wpc rosewood case one owner pristine condition	£295
Marantz PH800 integrated amp. £395 new boxed mint	£275
Mendian 100 series pre amp	£95
Mission 776/777 pre and power amplifier 100w case work a real classic	£795
Musical Fidelity A1 MKII excellent condition	£245
Musical Fidelity A100 50watt Class A amp with superb phono stage	£175
NAD model 60 integrated with VU power meters classic	£225
Naim 90.3 power amp boxed	£275
Naim Flatcap mint boxed	£195
Naim 62 pre amp	£495
Naim 250 bott together case mint condition fitted with Russ Andrews electronics	£495
Naim Snaps PSU	£145
Naim NAC 145	£295
Naim 72 pre olive case work with k boards	£395
Naim 140 olive case work	£395
Naim HiCap olive case work	£395
Pioneer AS heavy weight classic 80's integrated amp superb phono stage with variable cartridge loading	£295
Quad 2 mono blocks with original valves	£795
Quad 30.3 power amp last version with IEC sockets	£225
Quad 50E mono bloc excellent condition (pair)	£295
Quad valve tuners and pre amps various	from £45
Rega Mira integrated amp remote boxed mint	£350
Rogue Audio Aides EL34 power amplifier 40w per channel	£795
Rogers Cadet 3 stereo valve amp pristine condition	£395
Roksan Kandy 3 integrated amp black boxed as new	£175
Rotel RB850 power amp	£395
Rotel RC350 pre amp	£195
Rotel RA 920AX	£195
T&A K1 amp and cd player with matching speakers mp over £3000	£1295
TEAC H500 integrated amp	£250
Sugden HeadMaster headphone/line level remote control pre amp	£495
Sugden Audition - P power amp	£295
Sugden Optima 140 integrated amp	£245
VT46 single ended valve amp sowlter output transformers phone for more details	£175
Yamaha natural sound stereo receiver model GR420 mint condition	£175

SPEAKERS

Alumun Cantus black orchid speakers piano black	£495
Acoustic Energy original black Aluminium pillar style AE1 stands	£195
ATC SCM19	£295
QUAM Active 10 bookshelf speaker with stands	£1195
ATC SCM 10 single active speaker was used as a centre speaker	£275
Art Silkeito cherry finish	£245
AVI Active Pro 9 speakers Rosewood finish x dem	£795
Beaumont Virtuoso reference Lowther horn loaded spks	£2495
Castle Howard 2 Oak finish	£495
Cyrus CL350	£495
Olwell Planet omni directional speakers	£295
Dynaudio Audience 40s	£295
JM Lab Electra SR30 wallmounted speakers	£225
JM Lab Chorus speakers	£195
Kenwood KL-888X speakers 15" drive unit	£95
KEF Celest 3	£245
KEF Q55 floorstanding speakers	£695
Leema Kone small floorstanding speakers two pairs available	£195
Linn Sara active speakers	£945
Martin Logan Aenus Electrostatic speakers	£2295
Martin Logan Vantage latest speck with active bass unit mint boxed mp £5195	£1195
Martin Logan Aeon Electrostatic speakers	£195
Mission 741s Freedom ight finish	£195
Mission 753 black	£295
Mission 775s boxed large floorstander with Aerogel drive units	£495
Mono Pulse 324 8 months old ex dem	£645
Mono Pulse 325 ex dem	£495
Musical Stones Italian Solid Marble floorstanding speaker with Dynaudio drive units	£495
Musical Fidelity Reference 2 excellent condition	£895
Neat Petite SX x dem cherry finish	£275
ProAc Tablett 2	£1295
Quad ESL 989 Electrostatic speakers Nouveau version	£2225
Q Acoustics 1030i floorstanding speakers maple finish	£195
Reference 3A DiCapo fantastic spks with low pwr valve ampst	£195
Rogers LS7T large bookshelf speakers	£195
Rogers Studio 1A large bookshelf speakers	£295
Seftonian early 60s corner speaker pair	£795
Spendor SSE maple finish boxed as new condition new £300	£595
SP-1 FF1 open baffle speaker with Fuji mid range unit	£495
Tannoy York reproduction cabinet	£495
Tannoy 12" HPD drive unit with crossover	£495

TURNABLES/TONEARMS

Audio Synthesis moving coil phono stage with 2 box PSU	£495
Clearaudio Victory cartridge £1000 new	£445
Clearaudio Mofon turntable with unipivot tonearm boxed mint	£645
CJ Walker 55 dark cherry finish SME mount	£195
Creek OBH 9 moving coil pre amp	£395
Cyrus E 07 phono stage	£345
B&O Beogram 1000	£65
EAR 834P mm/mc with volume	£795
EAR 324 phono stage ex dem boxed	£295
Garrard 201 with custom aluminium and state plinth	£1195
Garrard 401 in birch ply custom plinth with lid	£195
Graham Slee Fanfare Gram amp 3	£195
Graham Slee PSU11 power supply upgrade as new	£130
Infinity Black Widow tonearm SME mount great with high compliance cartridges	£195
Linn Linn 2 power supply	£495
Linn LP42 Vanous	£445
Linn Littok tonearm mint condition	£395
Linn Sondeck vanous	£495
Linn Licos tonearm	£95
Linn Basik turntable no arm or lid	£85
Leema Agena Hi-End phono stage with USB & DAC various cartridge setup option as new £3000 Smiths old	£2250
Leak early 60's tonearm	£95
Mantecore Magician piano black Linn mount	£295
Michell Gyrodec latest spec	£295
Michell Myro	£295
Michell Hydraulic Transcriber	£495
Michell Focus 1	£295
Moan LP3 phono stage	£195
Project Tube Box 2	£195
Rega turntables various	£245
Revox B790 direct drive turntable with linear tracking tonearm excellent condition various from	£195
Roksan Xerxes with Rega arm and golding cartridge	£495
SME 10 with tonearm with V	£3295
SME 3009 tonearm series II improved with phonolaps various	£225
SME series 3 tonearms various	from £175
Sony Esprit PS SL5 hi-end draw type turntable	£295
System Deck electronic	£245
System deck II biscuit tin model (SME mount)	£245
Technics SL7 direct drive turntable with parallel tracking tonearm	£275
Technics SL1200 MKII	£245
Thorens 10166 MKII	£195
Thorens 125 MKII Turntable	£295
Trichord Dino phono stage 6mths old	£295

CD PLAYERS, DACS

AKAI 93 Hi-End old school 16bit CD player	£395
Arcam CD92 DCS mgdac model silver finish HQCD compatibility	£395
CEC 3300R CD player	£375
Cyrus DAC Master	£195
Cyrus 8 CD player	£295
Enhancement CD120	£375
Marantz 63 MKII KI Signature	£195
MicroMega Drive transport	£195
MicroMega CD132 cd player silver finish	£395
MicroMega stage 4 cd player	£395
Nakamichi CD player 2	£175
Nakamichi MB10 5 disc music bank cd player	£175
Phillips CD510 16bit cd player	£245
Quad 77 CD player startadone grey/blue finish	£245
Rotei RA965 BX classic old school cd player boxed mint condition	£195
Roksan Kandy 3 CD player boxed as new	£345
Rega Planet CD player new style	£195
Shanling CD1 1500 valve award winning cd player 18mths old boxed mint condition £2000 new	£995
Sony CDP X-B200E	£125
Sony XE680 SACD player	£225
Sony SCD XE680 SACD player	£195

MISCELLANEOUS

Abbey Road 1 5mtr power cord	£195
Abbey Road reference interconnect 1mtr	£295
P5 Audio statement biwire speaker cable boxed as new	£695
MAD My sweetie silver interconnect	£345
Pioneer SG9 Graphic Equaliser	£95
Pioneer MXA3 valve multiplex FM decoder ultra rare superb sound	£295
Audio Technica QC9 original	£225
Leak Troughline with GTA inboard decoder	£295
Nakamichi receiver 2	£195
Nakamichi BX150E cassette deck	£175
Nordost cable various phone for details	£295
Sony TCD5M portable professional cassette deck superb quality mint condition	£295

TUNER

Cyrus AM/FM tuner (original version)	£95
Magnum Dymalab Etude tuner black finish boxed mint	£745
Magnum Dymalab 205 FM signal sleuth boxed mint	£745
NAD C440 tuner	£75
NAD 4155 tuner	£50
NAD 4225 tuner	£50
Rotel RT1082 DAB tuner	£225
Rogers SIFM tuner MKIII pristine condition	£95
Sony ST5100 FM/AM classic 70's tuner	£125
Sony 7095 tuner	£75
Toshiba ST230 FM/AM analogue tuner	£95

DUPLICATE

Magneplannar entry level panel speaker	£295
Leak Vanslope/point 1 stereo pre amp various	£295
Quad 2 pre valve & radio various	£295

WE NOW HAVE ON DEMONSTRATION THE SUPERB LEEMA PUI SF + STREAM WITH ZERO SPEAKER! AGENA HI-END PHONO STAGE WITH USB

GENEROUS PART-EX ON ALL EQUIPMENT NEW OR USED WILL BUY GOOD QUALITY EQUIPMENT AS ABOVE NEXT DAY MAIL ORDER & UPLIFT FACILITIES



Opening times: 10.30 - 5.30 Tues to Sat
28a Haddington Place Edinburgh EH7 4AF
Tel/Fax: 0131 558 9989
Email: retro.reproduction@virgin.net
Website: www.retroreproduction.co.uk

ISOKINETIK



ISOkinetik Audio Enhancement

Take your Rega turntable to a higher level of perfection transform your standard Rega to a deck which will compete with others priced over £2,000.

Rega upgrades as reviewed in **HI-FI WORLD**
"There is no doubt that each item make a positive contribution to the overall sound produced"

"Best bang for buck? The ISOweight at under £50 is the best thing to have on your shopping list - it's great value and a surprising improvement"
Neville Roberts HI Fi World Feb 2010

ISOsub Rega sub platter and Ruby bearing
Improved kit from £99.99
ISOdrive Rega, Linn, Systemdek, Thorens PSU £329.99
ISOtone Cordas Rega arm rewire kit £99.99
ISOplatter 2.5mm Rega acrylic platter £119.99
ISOweight Rega tonearm counterbalance £49.99
available in 106q 130q 144q versions



Dealer and distributor enquiries welcome. For a full range of upgrades and accessories, interconnects or speaker cables please email info@isokinetik.co.uk or call 0208 241 8890 www.isokinetik.co.uk

Outstanding in our Field

Audio Home Cinema Multi-Room Installation

Brands offered include:

- Arcam
- Bryston
- Chord Co.
- Dynavector
- HiFi Racks
- Isobue
- Linn
- Naim
- PMC
- Rega
- REL
- Totem
- Wilson Benesch
- Wireworld

Located in the midst of rural Norfolk, Basically Sound offers a relaxing, out of town location for you to visit and experience the best performing audio systems available.

From turntables to the latest in network audio solutions, we ensure that you hear music as it should be heard - and the parking and coffee are free.

Calveley Court, Reymersston, Norfolk. NR9 4QD

01362 820800

enquiries@basicallysound.co.uk
www.basicallysound.co.uk

BASICALLY SOUND



Fireball X100

Adam Smith cues up the sizzling new X100 tonearm from Inspire Hi-Fi...

Vinyl fans amongst you who attended the Heathrow Hi-Fi Show back in March may have paid a visit to the Inspire Hi-Fi room, to check out their range of turntables. As well as the Eclipse, Apollo and range of LPI2 Vivid upgrades, Inspire were showing their new range of Rega turntable modifications in the form of the Quest package. As the room was quite crowded each time I visited however, I wondered exactly how many visitors spotted Inspire's new arms, and if so, how many dismissed them as merely rebadged Regas? I must confess that this was the first thought that crossed my mind until I examined more closely, realised that there were quite a few differences to a vanilla Rega, and then saw a certain arm guru's name mentioned on one of the information banners. Then I became very intrigued indeed...

Robert Isherwood has most certainly made a popular and wise choice for the basis of his new X100 and X200 arms in the form of the OEM Rega RB251, but eighteen months of development work have led to quite a comprehensive range of modifications to the basic structure. Most notably, the arm tube is amputated and a brand new tapered carbon fibre tube is fitted instead, to result in a nine inch arm for the X100, or a twelve inch item

for the X200. To the end of this, a new headshell is fitted, which is actually more of a simple cartridge support platform and offers the potential to remove troublesome resonances suffered by the conventional item. Under the accelerometer at least, it would appear that this has indeed been a successful venture [see MEASURED PERFORMANCE]. At the other end of the arm, the counterweight stub is replaced by a machined stainless steel item and weight, and with these modifications in place, stage two begins.

the best items are sent. Another modification made at this point is the inclusion of a small brass pin into the headshell assembly which is then earthed through the arm wiring. This, Inspire state, "ensures that static build up from record to cartridge and tonearm is nullified, giving better tracking and increased performance of the stylus in the groove".

Fit and finish of the arm is very good indeed, as one would expect, and the new tube is neatly grafted on with just a small silver band giving away the join. The X100 retails for

"one of the best arms you can buy for under £1,000, and for me a new standard by which other Rega-based designs should be judged..."

The name I alluded to earlier appears at this point, as the arms are shipped off to a certain Audio Origami in Scotland where they are fully rewired with Cardas OFC cable and the bearing alignment is checked, set and configured with the levels of precision that we have come to expect from John Nilsen. Robert also states that the bearings are handpicked at Inspire before the arms are sent off, ensuring that only

£699 and the 12" X200 at £769, although Inspire are offering special introductory launch prices of £630 and £700 respectively, and there is the option of a version of either arm with built-in downforce gauge for an extra £80, presumably based on the RB301 instead. Alternatively, you can supply your own Rega arm for modification to X100 status for £550 and to X200 for £600.

Finally, and most encouragingly,



Inspire specify that they are not making any wild claims for their new baby. In particular, Robert says that he has no wish to compare either to the SMEV, which seems a common policy these days, instead stating that the "performance is quite breathtaking". Once battle was done with the new three point Rega mounting, which is structurally effective but a right pain to interface to my Garrard 301's SME style mount, I was ready to be beguiled!

SOUND QUALITY

Firstly, a brief recap; a standard RB251 is a very impressive performer for the money. It is tight, focused and well balanced across the frequency range, but for me belies its budget origins by struggling to involve on an emotional level. Its rather grey tonality is quite a dominant gene within its DNA and few modification packages have ever really eradicated this. As I cued up the Ortofon Kontrapunkt b fitted into the X100 on my 301, I wondered if Inspire would manage to pull this off.

And the verdict is... yes! From the first bars of Caro Emerald's 'Back it Up', the X100 had me in the palm of its hand (or should that be headshell?). This is a track with a funky salsa vibe and as it blasted out into my room, the dreaded ankle twitch began straightaway and I knew if I wasn't careful, I would be up and dancing, which is not a pretty sight. With a bounding, fulsome bass line and the sort of soundstaging that really hammers home the joys of vinyl, the Inspire instantly made me aware that it had most definitely taken the humble RB251's performance up to a much higher level.

Across the upper midrange and treble, the X100 has a delicacy and softness to its nature, with a very genuine sense of tonality. Treble artefacts that lurk hidden in the back of recordings seemed to shimmy forward into the spotlight and drummers seemed to have moved their kits from the distant background and polished up their cymbals. Even more bizarrely, on well known tracks the drummers

in question seemed to be achieving the same level of sound but with less application of effort – an extraordinary phenomenon that I have not encountered before on an arm and can only attribute to the vibrationally very quiet headshell?

It was not just drums that benefitted from this ability either. Slipping the 'Queen of the Night' aria from Mozart's 'Magic Flute' under the stylus left the whole performance emanating from an inky background with incredible dynamic alacrity. The dynamics of the X100 are effortless and very wide and this means that everything from the merest whisper to a rousing crescendo is reproduced with ease; Lucia Popp's superb soprano soared across the soundstage in front of me magnificently. The X100 has a sense of ease in the way in which it sets up a fulsome soundstage that is perfectly balanced in both width and depth terms; indeed it seems to stretch both backwards and forwards by just the right amount.

Rega arms are traditionally competent at the low end, thanks to their impressive rigidity and the modifications that create the X100 have not affected this one iota. In fact, spinning Bob Marley's 'Waiting in Vain' led me to conclude that the X100 is rather more tuneful in the upper bass, resulting in the timing of the track being one of the tightest renditions I have heard and yet losing none of its sheer low end impact. Equally, a spot of dance music from Robert Miles had the fifteen inch bass drivers in my Leak loudspeakers kept firmly in check but, at the same time, pounding enthusiastically. Whether it was a jazz double bass being frantically plucked, a bass guitar being languidly caressed or the metronomic beat of a synthesiser, the X100 rose to the challenge superbly.

All in all, the X100 bounds

REFERENCE SYSTEM

Garrard 301 turntable
Alphason HR-100S tonearm (Cardas wired)
Ortofon Kontrapunkt b cartridge
Audio Technica AT-OC9MLII cartridge
Anatek MC1 phono stage
Naim Supernait amplifier
Leak 2075 loudspeakers

onto the market as a marvelously capable new tonearm. In absolute terms I would say that the unipivot Consonance T988 has just a *fraction* more air and space around its top end and the SME M2-9 has just a touch more fluidity throughout the midband, but the X100 comes very close to them in these areas, which is no mean feat, and pulls firmly ahead of both in the bass department.

CONCLUSION

I couldn't help being slightly concerned that, by following the Rega modification route, there was a risk that Inspire Hi-Fi could have come up with another 'me too' product that merely offered a different way to skin the sonic cat, so to speak. However, the well thought out design, the superb engineering and the icing on the cake in the form of an Audio Origami fettle mean that the X100 is not only one of the best arms you can buy for under £1,000 but, for me is also the new standard by which other similar Rega-based designs should be judged.



MEASURED PERFORMANCE

The Inspire Rega RB251 arm has a first bending mode at 230Hz, a fairly low value suggesting it is less stiff than many modern tubes. However, it is very well damped, so the main mode is strongly suppressed and the usual rotated third order mode hardly exists. The usual Rega tube signature around 1kHz has been all but eradicated. Also banished is the high frequency ringing of the headshell that Regas suffer (and that modern SMEs do not). So the new headshell works very well and should provide the sort of silky smoothness of SMEs, eliminating the small degree of edginess in Regas. Of course, Rega arms are very stiff and give great stereo and dynamics; this

upgrade successfully capitalises on those properties our vibrational analysis suggests. NK

ARM VIBRATION

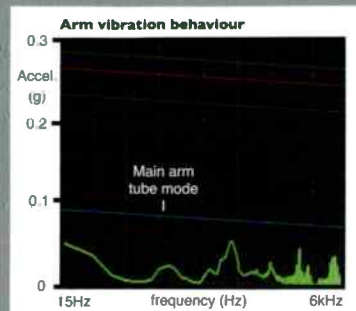

VERDICT

Cleverly engineered, beautifully built and sonically superb, the X100 sets the bar for Rega modifications even higher.

INSPIRE X100 £699
Inspire Hi-Fi
☎ +44(0)1246 827272
www.inspirehifi.co.uk

FOR

- intelligent engineering
- treble purity
- midrange accuracy
- rhythmic coherence

AGAINST

- nothing at the price

THE Missing Link



British Hand Built Audio Cables for People Who Enjoy Music



We also have an Excellent Range of DIY Products & Kits

For Details of Our Full Range of Audio Cables

Please See Our Website or Phone
01623 844478 or 07967 859333

www.the-missing-link.net



SOUNDS SIMPLY SENSATIONAL

This is the best turntable mat I've yet heard. At well under £100, it's a bargain.

Over Price HiFi World.

For superior sound quality, you should try the Isoplatmat. Made from SDS Aluminium, the Isoplatmat isolates your vinyl and needle from vibrations and feedback giving an exceptionally high quality audio. Just place the Isoplatmat on your turntable and to further enhance your music, you can also use Isofeet placed under the components, subwoofers and speakers. You will be amazed at the sonic improvement to your system.

Isoplatmat £87.50 + p&p
Isofeet x 4 £30.00 + p&p

order by phone on
0191 250 0900
order online
www.sounddeadsteel.com

SDS

SOUNDDEADSTEEL.COM

Audio Components

The No.1 choice for Speaker Building & speaker upgrade / refurbishment projects



See our NEW Website www.audio-components.co.uk

Save money by building your own dream loudspeakers - you will obtain better performance for a fraction of the cost compared to buying commercial off-the-shelf speakers.

- Loudspeaker Repair, Upgrade or complete Restoration
- Loudspeaker Design to fit your requirements
- Loudspeaker Drivers and Components
- Loudspeaker Measurement service
- Crossover design and build

- Scanspeak, Peerless, Vifa,
- SEAS, Morel, Jantzen Audio, Volt,
- Aurum Cantus, B&C, Monacor,
- QED, WBT, HYPEX

Leading brands,
Help & advice,
Wide product range,
Phone or buy on-line
FREE DELIVERY!

Tel: 0118 989 0151

Email: enquiries@audio-components.co.uk

Summer Sale Preview!

Preview online now at
www.russandrews.com/sale
or call us to place your order



20% OFF
TORLYTE
RACKS

20% OFF
POWERBLOCKS

40% OFF
ULTRA PURIFIERBLOCKS

10% OFF
CLASSIC POWERKORD™
plus
FREE DCT & Wattgate 320i IEC

10% OFF

Russ Andrews
& KIMBER cables
& accessories

25% OFF
D-60
INTERCONNECTS

Lots more Sale items at
www.russandrews.com/sale
or call UK Local Rate 0845 345 1550

Request a SALE CATALOGUE...

KIMBER KABLE
Exclusive UK distributor

Russ Andrews®

• Mail Order Direct • 60 Day Home Trial • Cable Upgrade Scheme • FREE Delivery
(on orders over £100 within UK Mainland)

REAL STORES • REAL PEOPLE • REAL PRODUCTS • REAL VALUE



NEW

- Cyrus launches its new streaming-compatible products. The range includes the Stream XP (the perfect basis for a new high performance system), Stream X (ideal for adding to a Cyrus system that already includes a DAC) and Streamline (a complete all-in-one music system).
- Monitor Audio introduces the Gold GX speaker range comprising both standmount and floorstanding models along with centre and rear effect speakers and an active subwoofer. GX uses technology from Monitor Audio's flagship Platinum series.
- Denon has added the DBP-2012UD to its range of Blu-ray players. This universal player will play SACD and DVD-Audio discs, as well as 3D Blu-ray discs, and is DLNA-certified for accessing content over your home network.



STORES NATIONWIDE

Aberdeen* 01224 252797
 Basingstoke* 01256 324311
 Blackpool* 01253 300599
 Bolton* 01204 395789
 Brentwood* 01277 264730
 Brighton (Hove)* 01273 733338
 Bristol* 0117 974 3727
 Bromley 020 8290 1988
 Camberley* 01276 685597
 Cambridge* 01223 304770
 Cardiff* 029 2022 8565
 Chelsea* 020 7352 9466
 Cheltenham* 01242 241171

Chorleywood (Watford)* 0845 5046364
 Enfield* 020 8367 3132
 Epsom* 01372 720720
 Exeter* 01392 218895
 Glasgow* 0141 332 9655
 Guildford 01483 536666
 Holborn* 020 7837 7540
 Kingston* 020 8547 0717
 Lancaster* 01524 39657
 Leeds (Vetherby)* 01937 586886
 Lincoln* 01522 527397
 Loughton* 020 8532 0770
 Maidstone* 01622 686366
 Manchester* 0161 839 8869
 Norwich* 01603 767605
 Nottingham* 0115 911 2121

Oxford* 01865 241773
 Poole* 01202 671677
 Portsmouth* 023 9266 3604
 Preston* 01772 883958
 Reading* 0118 959 7768
 Sevenoaks 01732 459555
 Sheffield* 0114 255 5861
 Southampton* 023 8033 7770
 Swansea* 01792 474608
 Swindon* 01793 538222
 Tunbridge Wells 01892 531543
 Warrington* 01925 632179
 Weybridge 01932 840859
 Witham (Essex) 01376 501733
 Worcester* 01905 619059
 Yeovil* 01935 700078

VISIT OUR WEBSITE

for the latest offers and news, as well as the convenient option to order many products on-line or click to reserve before you travel.



NEW 2011 GUIDE

Visit our website and request the new 56 page Sevenoaks and AudioT guide FREE. L.R. Martins Only.

PLEASE NOTE: SOME BRANDS/PRODUCTS ARE NOT AVAILABLE AT ALL STORES. SPECIAL/ADDED VALUE OFFERS ARE NOT IN CONJUNCTION WITH ANY OTHER OFFER (NICWAOO). ADVERT VALID UNTIL 04/07/2011. E&OE
 *THESE STORES ARE EITHER LICENSED OR FRANCHISED AND OPERATE UNDER A LICENCE AGREEMENT TO SEVENOAKS SOUND & VISION.

www.SSAV.com

SEVENOAKS
 SOUND & VISION

World Radio History



REAL PEOPLE

Our staff are friendly, knowledgeable and passionate about music and film and the equipment needed to get the most out of your collection. They will be delighted to assist you in making the right selection to ensure you enjoy your system for years to come.

REAL STORES

Sevenoaks Sound & Vision have Stores Nationwide - Each carries the very best in Home Cinema and Hi-Fi equipment on display, ready for you to watch, listen to and compare in our dedicated demonstration rooms.



REAL PRODUCTS

A wide selection of products from the world's leading manufacturers, both traditional and contemporary is in stock and available for you to take home. We also offer a delivery and installation service as well as a convenient on-line option to click and reserve many of our products before you travel. www.SSAV.com



VIENNA ACOUSTICS CONCERT GRAND

Featuring the Beethoven 'Concert' and 'Baby' Grand. The composer name is selected based on the scale, complexity and power of performance for which they are best known.



SPENDOR A-LINE A3 • A5 • A6 • A9

These high performance, floorstanding speakers combine smart styling with natural veneer finishes. Each model benefits from important advances in Spendor's drive unit technology, cabinet design and crossover engineering.



REGA

Excellent build quality, reliability and ease of use combine to make the RPI a product that will offer a lifetime of musical enjoyment.

RPI TURNTABLE

BOWERS & WILKINS CM SERIES

The CM series offers a combination of high performance and exquisite styling at a very affordable price.



KEFAUDIO Q SERIES

Experiencing the Q Series is like hearing a system costing many times more. Key features include an all new Uni-Q array with advanced bass technologies.



LEEMA ANTILA IIS / TUCANA II CD / AMPLIFIER

This high-end CD player and integrated amplifier combines power, detail and musicality with a comprehensive range of facilities.



AUDIOLAB 8200CD • 8200A CD / AMPLIFIER

The 8200 range includes the award-winning 8200CD which features a wealth of digital inputs that will keep it playing all your music regardless of how it may be stored.



ROKSAN CASPIAN M2 CD / AMPLIFIER

The award-winning M2 amp boasts 85wpc, ultra low noise transformers and five line inputs while the matching CD features a 24-bit DAC along with dedicated power supplies for the outputs.

www.SSAV.com

World Radio History

Please Note: Some brands/products are not available at all stores. Special/added value offers are not in conjunction with any other offer (NICWAOO).

ADVERTVALID UNTIL 04/07/2011 E.&OE.

REAL VALUE

Fantastic value for money is our aim. Although we remain independent, you'll be pleasantly surprised just how competitive we can be - with the added benefit of seeing, hearing and touching the product before you buy, and someone to help if things go wrong.

FOR OUR LATEST PRICES AND OFFERS VISIT

www.SSAV.com



MONITOR AUDIO BRONZE BX2 SPEAKERS
These compact, award-winning, speakers reproduce sound of immense stature and detail. [£ SSAV.COM](http://www.SSAV.com)



DYNAUDIO DM 2/6 SPEAKERS
Compact and versatile, these award-winning speakers deliver authentic Dynaudio sound quality. [£ SSAV.COM](http://www.SSAV.com)



DENON 3D / UNIVERSAL DISC PLAYER
Enjoy Super Audio CD, DVD-Audio and network content in exceptional sound and picture quality with the Denon DBP-1611UD 3D Blu-ray disc player. [£ SSAV.COM](http://www.SSAV.com)



MARANTZ M-CR502DAB CD RECEIVER
Searching for a compact all-in-one music player that looks as great as it sounds? The hunt ends here with the Marantz M-CR502. [£ SSAV.COM](http://www.SSAV.com)



ARCAM SOLO MUSIC CD / FM SYSTEM
Enjoy true hi-end performance with this integrated CD, amplifier and FM tuner system. (FM only version, no DAB tuner). [£ SSAV.COM](http://www.SSAV.com)



CYRUS CD8 SE • 8 XPD CD / AMPLIFIER
Some of the finest hi-fi in the world has just become more affordable. A great opportunity to buy this award-winning CD and amplifier. [£ SSAV.COM](http://www.SSAV.com)



ARCAM rCUBE DOCK SYSTEM
The award-winning rCube is a listening revolution, delivering high-fidelity sound from a portable iPod speaker system. It uses cutting-edge technology and manufacturing excellence, as you'd expect from Arcam. [£ SSAV.COM](http://www.SSAV.com)



KEF KHT 7005 • KHT 8005 AV SPEAKERS
Stunning 5.1 surround sound from only four slim speakers for your flat screen TV. [KHT 7005 £ SSAV.COM](http://www.SSAV.com) [KHT 8005 £ SSAV.COM](http://www.SSAV.com)



YAMAHA CD-S300 • A-S500 CD / AMPLIFIER
With its high quality sound and features such as iPod and MP3/WMA compatibility, the CD-S300 is an ideal partner for the award-winning A-S500 integrated amplifier.



SONOS MULTIROOM PRODUCTS
Play your digital music all over your house without a PC in every room. Just add a ZonePlayer, speakers in the rooms of your choice and a Sonos Controller in hand to access all your digital music.



NAIM UNITI CD / AMP MUSIC STREAMER
Combines an integrated amplifier, CD player, DAB/FM tuner, internet radio, iPod dock, DAC, music file player and network stream player. Please Note: Naim products are not available at all stores.



ARCAM rDAC KW DAC
Featuring all of the benefits of the standard rDAC but with the addition of wireless streaming from your PC, Mac or iPhone. Simply add an Arcam rWave or rWave dongle.



MARANTZ NA7004 NETWORK AUDIO PLAYER
Connect to your favourite music whether it's from your PC, external hard disc, radio broadcast or via Internet Radio or music service.



OLIVE MUSIC SERVERS
Access your digitized music from one centralized library. Everything from 16-bit converted CDs to 24-bit HD files will be at your fingertips along with the ability to play it all in any room of your home.



SOLO NEO NETWORK MUSIC SYSTEM
Combines superb music performance and network audio capabilities allowing it to play stored music in a multitude of formats, along with its internal CD player and radio tuner.

CYRUS MUSIC STREAMERS
The new streaming platform from Cyrus provides the perfect solution for all music lovers. These new streaming music players provide you with immediate access to your entire network music library. Plus you can listen to literally thousands of different internet radio stations from across the

world; all in true hi-fi quality. With the n-remote you can quickly find specific albums, artists or tracks and it makes browsing your network music library a real pleasure. With its sleek body, full colour screen and two-way control, the n-remote is just one of the features that make the new Cyrus streaming music players very special.



CYRUS STREAMLINE • STREAM X • STREAM XP

SEVENOAKS

World Radio History

SOUND & VISION

HEATHCOTE AUDIO

QUALITY HI FI ITEMS REQUIRED NOW!! 07860 511111

TEL: 07860 511111 WEB SITE www.heathcoteaudio.co.uk

PRE AMPS

DPA ENLIGHTENMENT (NEW OLD STOCK-ULTRA RARE)
 ROGUE AUDIO 98 REMOTE VALVE PRE AMP (LATE MODEL)
 NAIM 102 REMOTE PRE (OLIVE CASE)
 SONY TAE-1000ES CONTROL AMP ONE OWNER
 MATISSE REFERENCE 2 BOX PREAMP 64 STEP ATTENUATORS ORDERED AT EXTRA
 COST MIMASIC PHONO STAGE (ONE OWNER FROM NEW)
 MUSIC FIRST SILVER PRE SPECIAL ORDER TWIN VOL. JOTS
 1 RCA/2 BAI AMED INC. 1 RCA + BALANCED OUTS (ONE OWNER FROM NEW)
 H-CAT P-12A PRE AMP (E25007)
 PASS LABS ALEPH P PRE AMP
 JEFF ROWLAND COHERENCE-1 2 BOX PRE C/W PHONO STAGE AND
 ROGUE AUDIO 86 MAGNUM REMOTE PREAMP (ONE OWNER FROM NEW)
 DPA THREE BOX PRE AMP EXCLT
 ALCHEMIST FORSETTI 2 BOX PRE RCA/XLR (ONE OWNER)
 DPA 50S PRE AMP C/W PHONO STAGE
 MUSICAL FIDELITY A3cr REMOTE PRE AMP
 ANTIQUE SOUND LABS L01 PRE AMP/HEADPHONE AMP
 ANTIQUE SOUND/LABS MINI PHONO (2 BOX WITH NOS MULLARD VALVES)
 ROKSAN LS-2 PRE AMP

POWER AMPS

KRELL EVOLUTION 402 STEREO POWER AMP
 PATHOS INPOWER CLASS A HYBRID MONOBLOCKS (SUPERB E9K?)
 PAFWORTH 200M SPECIAL ORDER KT-90 AMPS WITH VOL CONTROL
 SPECIAL ORDER BUILD (ONE OWNER FEW MONTHS USE ONLY)
 LINIQUE OPPORTUNITY! QUAD II DIAMOND JUBILEE 50.0 MONOS UNLISHED
 REMOVED FROM BOXES FOR TESTING ONLY (6K NEW IN 1996)
 ART AUDIO JOTA CHROME/GOLD CHASSIS-VOL POT LITTLE USED SINGLE
 ENDED 32B VALVE AMP (ONE OWNER FROM NEW \$12000 NOW?)
 BALANCED AUDIO TECH. BAT VK-80 P/POWER AMP (88K? ONE OWNER FROM NEW)
 JEFF ROWLAND MODEL3 MONOBLOCKS
 MCCORMACK DNA-12S POWER AMP (ONE OWNER FEW MONTHS USE ONLY)
 DPA 50S POWER AMP 80ABLES (ONE OWNER FROM NEW)
 ROKSAN S1 S POWER AMPS 2 OFF EXCLT CONDITION RARE
 DPA 50S POWER AMP & CABLES
 NAKAMICHI 620 WEDGE POWER AMP
 SONY TAN-55ES POWER AMP ONE OWNER

INTEGRATED AMPS

MUSICAL FIDELITY TR-VISTA-300 2 BOX INTEGRATED
 ART AUDIO INTEGR 30W INTEGRATED IJC/P1 STAGE (ONE OWNER FROM NEW)
 KRELL KAV 300R ULTRA RARE 300I + TUNER (E3950 ONE OWNER FROM NEW)
 MAGNUM DYNALAB MD-20B TUNER AMP (E4K)
 ADVANTAGE 1200 INTEGRATED AMP (2K)
 DENON AIC A1 SR AV AMP (GLD EX2 ONE OWNER)
 WORLD AUDIO DESIGN KT-88 INTEGRATED VALVE AMP (WAD BUILT)
 ALCHEMIST APD-15 MKII INTEGRATED
 REVOX H-5 INTEGRATED & OPTIONAL REMOTE (ONE OWNER)
 DENON PMA 800V SIZEABLE INTEGRATED MM/MC PHONO
 YAMAHA AX-620 AV AMP
 NAKAMICHI AMPLIFIER-2 REMOTE INTEGRATED

COMBO'S

JEFF ROWLAND COHERENCE-1 2 BOX PRE C/W PHONO STAGE AND
 JEFF ROWLAND MODEL3 MONOBLOCKS VGC E2405
 ROKSAN LS-2 PRE AMP AND TWO S1.5 STEREO POWER AMPS EXCLT E1450
 UNISON RESEARCH FEATHER PRE/2S POWER (ONE OWNER FROM NEW) EXCLT/BOXED E1295
 DPA THREE BOX PRE AMP 50S POWER AMP & CABLES VGC E1995
 LYNX STRATOS PRE AND 2 MONOBLOCKS (ONE OWNER TIMEWARP STUFF) MINT/BOXED E995
 DPA 50S PRE AMP C/W PHONO STAGE/ 50S POWER AMP & CABLES VGC E895
 SONY TAE-1000ES PRE/TAN-55ES POWER AMP ONE OWNER MINT/BOXED E799

VINYL

SOUNDSWITH THE VOICE CARTRIDGE FEW HOURS USE
 LINN LP-12 ITTOK CARTRIDGE CIRKUS/TRAMPOLINE/VALHALLA
 SME 20/2 TURNTABLE (ONE OWNER FROM NEW)
 SME 20/2A/SME V TONE ARM (ONE OWNER)
 LINN LP12 ITTOK/CARTRIDGE VALHALLA/CIRKUS/TRAMPOLINE
 ORACLE DELPHI MK WAVE V TONEARM LITTLE USE AS NEW
 REGA P3/R1800/REGA CARTRIDGE
 REGA RB-300 TONEARM
 NOTTS ANALOGUE MENTOR
 EMINENT TECH MODEL 2 AIR BEARING LINEAR TONEARM
 MISSION 774 TONE ARM UPGRADED LEAD
 NOTTS ANALOGUE MENTOR TONE ARM (ONE OWNER LITTLE USE)
 ANTIQUE SOUND/LABS MINI PHONO (2 BOX WITH NOS MULLARD VALVES)
 AUDIO NEMESIS PHONO STAGE (E1000 +)
 PROJECT PHONO BOX (ONE OWNER)
 FIDELITY RESEARCH FR-1 MK3 CARTRIDGE
 REGA FONO MM PHONO STAGE

DIGITAL

SONY SCD 777ES SACD/CD PLAYER
 AUDIOMECA KRATIRA CD PLAYER (CLOCKED)
 WADIA 170 IPOD DOCK (E400+)
 LECTOR 2 BOX CD PLAYER
 BARCLAY DIGITAL F-1 SUPER TRANSPORT (22KI NEW)
 ENSEMBLE DIORINDO TRANSPORT DI-CHRONO DAC/PRE AMP
 CHORD 1500E DAC/DIGITAL PRE AMP (E8800 ONE OWNER FROM NEW)
 SHANLING OMEGA CDT-300 CRYDQAL VALVES
 CHORD 1500E DAC/DIGITAL PRE AMP (E8800 ONE OWNER FROM NEW)
 ACCUPHASE DP-80 TRANSPORT (E8000?)
 MUSICAL FIDELITY TR-VISTA SACD/CD PLAYER (4K NEW?)
 THETA CARMEN CD/DVD TRANSPORT
 MERGE S-2000 160 GB MUSIC SERVER
 MICROMEGA STAGE 2
 CAMBRIDGE AUDIO DACMAGIC (CURRENT MODEL)
 ONKYO NDS-1 MEDIA TRANSPORT
 MERIDIAN 203 DAC
 DENON DFF-3050 200 DISC MULTIPLAYER
 MARANTZ CD-17 40 SIGNATURE (ONE OWNER FROM NEW)
 PERPETUAL TECH P3A 24/96 DAC MIDWRIGHT SIGNATURE-2 (LAST 1)
 PERPETUAL TECH P3A 24/96 DAC MIDWRIGHT SIGNATURE-2 (LAST ONE)
 PERPETUAL TECHNOLOGY P1A DIGITAL ENGINE (LAST ONE)
 PIONEER CD 825 LASER DISC PLAYER (ONE OWNER FROM NEW)
 DENON 3910 UNIVERSAL PLAYER (ONE OWNER)
 VACUUM TUBE LOGIC JLT SACD/CD PLAYER (LAST 1 E1300)
 THETA DATA UNIVERSAL COULD PLAYER (ONE OWNER) RARE
 THETA PRO GEN II DAC GLASS & BALANCED OPTIONS (ONE OWNER)
 THETA DATA II TRANSPORT (SILVER) AES/RCA ETC
 MERIDIAN 602 TRANSPORT 606 DAC
 MICROMEGA CLASSIC SOLO XLR/RCA
 SONY CDP-433ES CLASSIC HEAVYWEIGHT ONE OWNER
 SONY HAR LH-500 80GB HARD DISC/RECDORDER

LOUDSPEAKER

REVEL SALON ULTIMA 1
 FAB AUDIO MODEL 1 ONLY PAIR IN UK (E7.5K)
 ENSEMBLE FIGURA SOLID ALUMINIUM (E5800?)
 MARTEN MILES II CHERRY (8K+ NEW) (ONE OWNER FROM NEW)
 VIVID AHDIO V-1.5 GONG/CLUST
 BOLZANO VLETTTRI BV3003 & BV SUBWOOFER FANTASTIC!
 HYPERION HPS 930W GORGEOUS BIRDS EYE MAPLE (ONE OWNER)
 AURUM CANTUS VILLA (E2500)
 HARPER QUARTETT FABULOUS FLOORSTANDERS (E4000)
 MIRAGE M181 BIPOLAR GIANTS (E6500) (ONE OWNER FROM NEW)
 AURUM CANTUS MUSIC GODDESS (E2500)
 AURUM CANTUS VILLA (E2500)
 AURUM CANTUS VILLA (E2500)
 THEIL CS 1.5 (ONE OWNER FROM NEW)
 AURUM CANTUS V3M GLOSS BLACK (E1700)
 CELESTION A-2 SANTOS ROSEWOOD
 CURIA CA-30 FLOORSTANDERS (E3000 ONE OWNER FROM NEW)
 AURUM CANTUS LEISURE 3 SE (LAST PAIR E1350)
 AURUM CANTUS BLACK ORCHID (LAST PAIR E1300)
 SNEEL TYPE-C MKIV AMERICAN W/NET
 CADEENCE ELECTROSTATIC HYBRID
 AURUM CANTUS LEISURE 3SE
 PROAC CLASSIC 150
 T&A TMR-110 SIZEABLE TRANSMISSION LINE FLOORSTANDERS
 T.L.C.STUDIO ONE LARGE FLOORSTANDERS
 TANNY DC-2000 ONE OWNER
 RIARX TALISMAN-II OFFBOARD X-OVERS
 TANNY 61 L FLOORSTANDERS
 MORDANT SHORT MS-815 (E4K)
 TANNY R-3 FLOORSTANDERS
 KEF REFERENCE SERIES MODEL 70S AV SATELITES 2 PAIRS

TUNERS

MUSICAL FIDELITY AS FM/DAB TUNER (ONE OWNER FEW HOURS USE ONLY)
 SONY ST-5730ES AM/FM TUNER ONE OWNER
 TECHNICS GT-550 RDS TUNER (ONE OWNER)
 AV REF.7 BAND TUNER (ONE OWNER)
 KRELL KAV 300R RARE TUNER AMP (E3950 ONE OWNER FROM NEW)
 MAGNUM DYNALAB MD-20B TUNER AMP (E4K)

TAPE/DAT/MINIDISC

REVOX A-77 HIGH SPEED TWO TRACK ONE OWNER FROM NEW
 SONY TC-153SD PORTABLE TAPE RECORDER 1 OWNER
 SONY 6500S TAPE DECK ONE OWNER
 SONY DTC-1000ES DAT RECORDER
 PIONEER ELITE SERIES MINIDISC RECORDER (URUSHI CHEEKS 110V)
 SONY MDS J840 GS MINIDISC (UK SPECIAL EDITION)
 PIONEER PD-609 CD RECORDER
 TECHNICS BX R5501 TAPE DECK (ONE OWNER)

MISC.

NAIM HI-CAP (SILVER BORDS)
 BLACK RHODIUM 8 WAY MAINS BLOCK
 RUSS ANDREWS YELLO POWER CORD
 RUSS ANDREWS POWER CORD
 AUDIOPLAN CLEAN POWER CORD
 LAT POWER CORDS 2 OFF (BLUE ONES)
 LAT AC-2 LEAD AND REWIND 4 PLUS DISTRIBUTION BLOCK
 PS-AUDIO QUINTESSENCE POWER CENTRE (ONE OWNER FEW HOURS USE ONLY)
 PS-AUDIO QUINTESSENCE POWER CENTRE (E1100)

INTERCONNECT CABLE

TOWNSEND ISOLDA INTERCONNECT 1METRE NEUTRIK
 AUDIOQUEST/ALDIOTRUTH EMERALD 1 METRE PAIR
 AUDIOQUEST RUBY 0.8 METRE PAIR
 AUDIOQUEST DIGITAL 2 AES/FB/DIGITAL CABLE 0.8
 AUDIOQUEST AES/FB/DIGITAL CABLE 1FT
 TRANSPARENT LINK-100 COAX DIGITAL CABLE
 CHORD CD/PRODAC DIGITAL CABLE RCA TO BNC
 QED DUNEX REFERENCE 1 METRE PAIR
 CHORD CHORDING 1.2 METRE PAIR
 TULSA HURRICANE JUNIOR 6 METRE XLR BALANCED
 CABLE TALK ADVANCED-2 1 METRE PAIR RCA
 STRATOS RCA 1 METRE PAIR
 BEYER MICROPHONE CABLE 1 METRE PAIR RCA
 ACOUSTIC ZEN SILVER REF-2 2 METRE XLR PAIR
 NORDOST QUATRO-FIL 1METRE XLR PAIR
 HARMONIX HARMONIX-STRINGS HS-101 1METRE RCA
 HARMONIX HARMONIX-STRINGS HS-101 1METRE XLR
 VERTEX AD SILVER SOLFON BALANCED PAIR
 TARA LABS RSC 1 METRE XLR BALANCED
 LFD SPIROLINK 4 FOOT PAIR

LOUDSPEAKER CABLE

TOWNSEND ISOLDA DCT 2METRE PAIR 2 OFF
 ECOSSE MS2.3 REFERENCE 5 METRE PAIR
 KIMBER APR 2.5 METRE TERMINATED PAIR
 NIRVANA SL-1.3 3METRE PAIR
 MIT MH-750 2.5 METRE PAIR BI-WIRE
 RAPPORT (USHER) 5 METRE PAIR FACTORY TERMINATED
 DPA 5 METRE PAIR TERMINATED FOR 50S AMP
 XLO SIGNATURE 2 TYPE 5-2 4FT PAIR
 QED GENESIS SILVER SPIRAL 3METRE PAIR
 XLO REF-2.5 METRE PAIR
 MIT MH-750 BI WIRE 3 METRE PAIR
 PS AUDIO X-STREAM 3 METRE PAIR (VERY HEAVY)
 DIAMOND HI SILVER 3 METRE PAIR (LOCKING WBT S)
 BLACK RHODIUM S-300 BI WIRE 7 METRE BI WIRE PAIR(E560)
 BLACK RHODIUM S-300 BI WIRE 5 METRE BI WIRE PAIR(E400)
 BLACK RHODIUM S-300 BI WIRE 4 METRE PAIR (E240)
 VAN DEN HUL M.C.CS 122 3METRE PAIR

STANDS

TARGET BLACK GLOSS 5 SHELF STAND
 TARGET B SHELF STAND ON CASTERS
 SOLUS/TARGET R2 SPEAKER STANDS
 SOUNDSTYLE XS106 LAST ONE
 SOUNDSTYLE XS 100 LAST ONE
 PIRATE STANDS FOR SNEEL K ETC
 HUGENS STANDS FOR SNEEL K ETC
 PARTINGTON A-4 ROUND STAND

MINT/BOXED E8750
 EX/DEM/BOXED E4460
 DEM/BOXED E3650
 EXCLT E3740
 MINT/CRAFTED E3450
 MINT/BOXED E2450
 MINT/BOXED E2995
 EXCLT E2795
 DEM E1995
 EXCLT E1995
 NEW E1795
 EXCLT E1795
 DEM/BOXED E1450
 MINT BOXED E1450
 EX DIS E1050
 DEM/BOXED E995
 EXCLT E995
 NEW/BOXED E895
 NEW/BOXED E795
 EXCLT E795
 GC E795
 DEM/BOXED E695
 EXCELLENT E595
 MINT E595
 MINT E275
 EXCELLENT E275
 EXCELLENT E375
 EXCELLENT E375
 EXCELLENT E195
 EACH PAIR E75

MINT/BOXED E3945
 MINT/BOXED E2995
 EXCLT E990
 EXCLT E375
 MINT/BOXED E1395
 EXCLT/BOXED E1395

MINT/PACK TBA
 MINT T34A
 MINT/BOXED E175
 GC E395
 MINT/BOXED E175
 VGC E149
 EXCLT E149

ONE IN E299
 VGC E125
 EXCLT E49
 EXCLT E49
 VGC E49
 EACH E65
 EXCLT E149
 MINT/BOXED E795
 EXCLT E695

EXCLT E149
 EXCLT E195
 GC E49
 EXCLT E85
 EXCLT E99
 EXCLT E89
 EXCLT E775
 EXCLT E650
 EXCLT E175
 EXCLT E20
 EXCLT E25
 VGC E25
 EXCLT E695
 AS NEW/BOXED E325
 AS NEW/BOXED E375
 MINT E895
 MINT/BOXED E199
 AS NEW E149

EACH PAIR E295
 EXCLT E199
 EXCLT E149
 DEM/BOXED E450
 VGC E595
 EX DEM E295
 EXCLT E295
 DEM E495
 MINT/BOXED E199
 EXCLT E325
 EXCLT E695
 EXCLT E395
 EXCLT E895
 EX DEM E300
 NEW E300
 NEW E170
 VGC E375

VGC E149
 VGC E189
 VGC E175
 N.O.S. E199
 N.O.S. E199
 EXCLT E199
 EXCLT E199
 EXCLT E75

ALL MAJOR CREDIT DEBIT CARDS ACCEPTED

The old Sounds of Music is out....
 The new 15audio is in Sussex
 digital suite ~ service centre ~ free parking

Axon AR Biadelius Boulder Coda Clearaudio Gamut Hansen Pearl Quad Soundlab SME WBT

15audio
 Churchward Court
 15 Western Road
 Lewes BN7 1RL
 08448 22 11 15
www.15audio.co.uk



Paul Rigby plays with Elac's Micromagic II active loudspeaker system...

Micro Mates

Having been so enamoured with the World Award winning B5243 standmounted speakers, I was intrigued to see how Elac's little active system would shape up. What you get is a MiCROSUB 2010 BT subwoofer complete with four amps (two for the two bass drivers and two for the two connected satellites) pushing 40W, featuring a control panel on the rear, spanning 218x150x178mm and weighing 4.8 kg while the two 301 passive satellites span 121x91x106mm and weigh just 1.2 kg each.

The controls on the sub include a volume and subwoofer bass level, micro-aerial for Bluetooth operation, sturdy, push button speaker binding posts, a pair of phono inputs, power socket for an external supply, power switch which incorporates a Bluetooth trigger and a subwoofer frequency switch to match your satellite speakers.

SOUND QUALITY

The initial test was as a largish room system, with the satellites perched upon a pair of Atacama HMS I stands, the crossover frequency set at 120Hz to suit the 301.2 satellites and the sub set to 0dB (reflecting the size of my listening room).

Playing a selection of rock CDs via my Icon CD-X1 silver disc spinner, I was immediately impressed with the lower frequency range. Bass was grippy and informative for its associated woofer size. The upper midrange and treble did suffer a little from restricted frequency extension at high volumes with delicate transients never fully explored, yet there was certainly enough information to please all but the most particular of audiophiles.

Varied jazz CDs experienced similar restrictions in the upper frequency areas but, that said, the Elac handled complex guitar picking with aplomb, bass was tuneful and vocals tracked the emotion of the songs easily over a relaxed and ordered soundstage.

Bluetooth output was easily set-up via my Apple iPhone 4, where .wav files extracted via Exact Audio Copy software were punted to the Elac. Requiring more gain to achieve similar volumes, the Bluetooth output was sonically limited, making the uncompressed files sound more like 128kbps MP3s. Still, despite the restricted amount of information on offer, the Elac handled it with admirable clarity..

The system really came into its own when it was hooked up to my PC as a near-field system.

Running rock .wavs, the Elac produced new-found upper midrange sparkle and a beautifully constructed three dimensional soundstage that appeared to range over to the back of my desk and beyond. Plucked rock guitar strings were resonant, while piano was vibrant and animated. Jazz-based vocals were almost playful with a direct, emotional feel. The Elacs proved to like music in a cosy, intimate atmosphere.

CONCLUSION

A fine package, overall. Via Bluetooth it sounds fairly anaemic but does offer the user a flexible, mobile music playback route with a responsive interface deserving of a three globe rating. Feed it decent uncompressed sound sources though and you get an easy, expansive sound that's admirable for its price and size, being both musical and easy on the ear. As you might expect, it works best as a near-field system; for PC or small room use, the Elac Micromagic II is good-natured, melodious and with plenty of detail to delight the ear.



VERDICT ●●●●●

Ideal as a near-field system but also good as a full room set-up, the Elac offers flexibility for anyone looking for a small room or PC-based rig.

ELAC MICROMAGIC II £1,599

Atacama Audio

+44 (0) 1455 283251

www.elac-audio.co.uk

FOR

- overall musicality
- great for near-field use
- versatile design

AGAINST

- dynamic extension
- Bluetooth performance

DIAL A DEALER

This is a comprehensive directory of Hi-Fi Dealers throughout the UK and Ireland.

BERKSHIRE

LORICRAFT AUDIO

Loricraft Audio is now open for visitors but please call to arrange for a visit. You can buy all our products directly from us or through your local dealer. Our internet shop site can take direct orders for our turntables and accessories! Loricraft Audio, The Piggery, Mile End Farm, Wantage Road Lambourn, Berkshire, RG17 8UE Office Phone/Fax : +44 (0)1488-72267 Email: terry@garrard501.com website: <http://garrard501.com>

STUDIOAV LTD

44 High Street, Eton, Berkshire SL4 6BL
Tel: 01753 631000
Email: sales@studioav.co.uk
www.studioav.co.uk
We are Berkshire's premier Linn dealer (complete range) and LP12 specialists. Naim, Focal, Totem, The Chord Company, Lyra, Dynavector, Benz Micro, with more to follow.

BRISTOL & BATH

THE RIGHT NOTE

Tel: 01225 874728
www.rightnote.co.uk
Happy with your system? Wonder why there's so much for sale secondhand? Avoid the frustration and expense of "upgrade-itis", never quite "there". With infinite patience we'll help you plan longer-term. Brands selection: Accustic Arts, Audio Physic, Aesthetix, Bel Canto, CAT, Clearaudio, dCS, Focal, Gamut, Graham, Halcro, Kawero, Magnum Dynalab, VertexAQ, VTL, Wadia.

V AUDIO HI FI CONSULTANTS

36 Druid Hill, Stoke Bishop, Bristol. BS9 1EJ.
Tel: 0117 968 6005.
Website: www.v-audio.co.uk
Email: icvhifi@yahoo.co.uk
ATC, AVI, Nola, ALR Jordan, Audio Analogue, Avid, Black Rhodium, Electrocompaniet, Edge amps/cd, Harman Kardon, Infinity, Jamo, Lyra, Origin Live, Opera, Ortofon, PS Audio, Michelle, REL, SME, Sugden, Townshend. Specialist in Video

Projects by SIM2, Infocus, Sanyo, Power Plan. Screens by Stewart, smx and da-lite. Demos by appointment only. Home trial facilities.

CHESHIRE

ACOUSTICA

17 Hoole Rd, Chester CH2 3NH.
www.acoustica.co.uk
Tel: 01244 344227.
B&W 800 Diamond series dealer
Naim Audio specialist & 500 Series stockist.
Other brands carried include Arcam, Audiovector, Audio Analogue, B&W, Classe, Piega, Rega & Spendor.
Full demonstration facilities.
Open Tuesday to Saturday 10.00 to 5.30

ACTON GATE AUDIO

www.acton-gate-audio.co.uk
4 Ruabon Road, Wrexham, LL13 7PB,
Tel: (01978) 364500
Arcam, Atlas, Audiolab, Denon, Grado, Michell, Monitor Audio, Dali, Leema, Loewe, Musical Fidelity, Ortofon, Onkyo, Project, Sonos, QED, Quad, Rel, Roksan, van-den-Hul, Wharfedale, Yamaha.
Tuesday - Saturday 9.00 - 17.00
email: info@acton-gate.com

DOUG BRADY HI FI KINGSWAY

Studios, Kingsway North, Warrington, WA1 3NU
Tel: 01925 828009 Fax: 01925 825773.
Visa Mastercard, 2 dem rooms, home trial, Agencies include: Arcam, AV1, Chord, Copland, Exposure, Krell, Lyra, Michell, Meridian, Musical Fidelity, Monitor Audio, Naim, ProAc, Roksan, SME, Stax, Isotek, Kudos, Sonos Faber, Spendor, Ortofon, Prima Luna, Quad, Avid, Moon, Nordost, Wilson Benesch, and many more.

CORNWALL

BIGEARS AUDIO

To find a system that will allow you to hear the music instead of the equipment phone Bigears Audio, here you will find an interesting array of new and good quality used equipment! my intention is to have

satisfied customers whatever their audio preferences. Naim dealer for the South West.

Email: chrisburchley@btinternet.com.
Tel: 01736-740421

ESSEX

ROCOCO SYSTEMS & DESIGN

Essex/London Linn Specialist
Tel: 01371 856 407 – 0207 454 1234
www.rococosystems.com
We have over 30 years in entertainment solutions, We can give you expert advice on your Linn Hi-Fi, Multi-room AV and Home Cinema systems. P/EX, ex-demo and used Linn available, Demos by appointment. Home Demos welcome. Authorised dealers for Arcam, Artcoustic, Chord, Denon, Linn, Lutron, Kaleidescape, Marantz, Opus, Runko, Systemline, Sonos, Sim2. Linn Service & Repairs

LANCASHIRE

HOUSE OF LINN MANCHESTER

Telephone: 0161 766 4837
Email: info@houseoflinn.com
www.houseoflinn.com
The Linn specialists. Independently owned by former Linn staff. Straightforward, professional expertise with demonstration, sales, installation and support for the Linn range of components and systems. The listening experience is so good that demonstrations can last for hours. Discover how we make music sound real in your home! Appointments only.

LONDON

THE CARTRIDGE MAN LTD

88 Southbridge road, Croydon
CRO 1AF Telephone: 020 8688 6565
www.thecartridgeman.com
Email: thecartridgeman@talktalk.net
UK Distributor: Hiaudio Distribution
Makers of the prize-winning range of MusicMaker cartridges and other desirable audio accessories. We also have a cartridge refurbishing service and rebuild classic valve equipment to the highest standards. "It doesn't have to cost an arm and a leg - but there is no such thing as a free lunch, either."

DIAL A DEALER

This is a comprehensive directory of Hi-Fi Dealers throughout the UK and Ireland.

MY AUDIO DESIGN

35 Whitehall, London, SW1A 2BX
Tel: 020 7839 8880 / 07782 137 868
E-mail: sales@madengland.com
Website: www.madengland.com
E-Shop: www.shop.madengland.com
We offer MAD, Benchmark Media, SONOS, WBT, Trichord Research, ATC, FatmanTube, Project, Lehmann, Ortofon, VandenHul, QED, NAD, Goldring, Grado, Focal, Musical Fidelity, Ex-demo & second hand gears. Custom Installation, Servicing, Custom Design. Appointment Only. Short walk from Embankment, Charing-X & Westminster Tube.

MANCHESTER

AUDIO COUNSEL

26 High St Cheadle SK8 1AL
www.audio-counsel.co.uk
Tel: 0161-491-6090
Email: dave@audiocounsel.co.uk
Hi Fi from, B&W Densen, Dynavector Cartridges, Dynavector Amplifiers, Isoblu, Naim, Neat Acoustics, Piega, Quadraspire, Rega, Revolver,, Shahinian, Totem, Well Tempered Turntables, Zu Loudspeakers. Quality Hi Fi is not plug and play. We deliver and install all systems. Tuesday to Saturday 10.00am to 5.30pm Thursday till 8pm

MIDLANDS (WEST)

SOUND CINERGY

37 high street, Aldridge, WS9 8NL
Tel: 01922 457926
www.soundcinergy.co.uk
clive@soundcinergy.co.uk
Quality hifi and home cinema from black rhodium, chord co, exposure, focal, linn, marantz, michell, monitor audio, mordaunt short, nad, okki nokki, ortofon, project, rel, roksan, themescene, trichord, vdh. Check our website for ex dem and secondhand bargains. free car parking. tues - sat 10 - 5.30

SOMERSET

ALTERNATIVE AUDIO,

Taunton, Somerset,
Tel: 01984 624242
Email: peter@alternativeaudio.co.uk
www.alternativeaudio.co.uk
We specialise in valve amplification and vinyl replay with the accent on high quality

musical enjoyment, demonstration by appointment. Ex-Dem and used equipment for sale. Analysis Audio, Brinkman, EAR/ Yoshino, Graham Engineering, Experience Filtration, Lector, LFD Audio, Lyra, Music First Audio, NAT Audio, Nottingham Analogue Studio, Quadraspire, Shun Mook, SME, Transfiguration, Vandersteen Audio, Wave Mechanic.

SUSSEX

15 AUDIO

Churchward Court, 15 Western Road Lewes, BN7 1RL
Tel: 08448 22 11 15
Email: sales@15audio.co.uk
www.15audio.co.uk
Formerly Sounds of Music, new ownership - demonstration facilities in centre of Lewes. Friendly staff. Free parking. Ayon, Bladelius, Boulder, Coda, Hansen, LSA, SoundLab, SME, WBT and more. Quad centre - 'Digital Clinic' - service centre. Home demo's, delivery and installation. Mon - Frid 10:00am - 6:00pm. Sat 10:00 - 02:00pm. Closed Wednesday.

YORKSHIRE

THE AUDIO ROOM

2 George Street, Hedon, Hull, HU12 8JH
01482 891375.
www.theaudiroom.co.uk
Authorised agents for Audio Research, Bowers & Wilkins inc 800 series, Bryston, Classe, Denon, Dynavector, Koetsu, Krell, Linn inc Klimax Range, Micromega, Naim, Prima Luna, PMC, ProAc, Quad, Rega, Rotel, Sonus Faber, Stax, Wilson Audio and others. Free & easy car parking, 4 demonstration suites, part exchange welcome, quality & friendly staff, mail order available. The North's most complete hifi dealer!

AUDIO REPUBLIC

78 Otley Road, Leeds
Tel: 0113 2177294
www.audio-republic.co.uk
For the best in quality hifi in West Yorkshire, representing Naim Audio, Rega, Sugden, Audio Research, VPI, Krell, Copland, Sonus Faber, Arcam, Nottingham Analogue,

Roksan, Hutter, Martin Logan, Proac, PMC, M&K, Finite Elements, SME, Cardas, Kudos Loudspeakers and others. Open Tuesday-Saturday 9.30am to 5.30pm

FANTHORPES HI-FI, TV & CUSTOM INSTALLATION SPECIALISTS

HEPWORTH ARCADE, SILVER STREET, HULL, HU1 1JU
Established over 60 years
Tel: 01482 223096
Web: www.fanthorpes.co.uk
Email: shop@fanthorpes.co.uk
Part exchange welcome. High-end Second Hand Equipment. Multi-room installations. Demonstration by appointment. Home trials welcome. Interest free credit available. Experienced staff. We stock Arcam, Cyrus, Dali, Denon, Dynaudio, Exposure, Kef, Loewe, Onkyo, Primare, Roksan, Spondor, Sugden and much more.

IRELAND

TONE-PEARLS RECORDS "REVOLUTIONARY OLD"

Tel: 353-87-942-7618
Email: info@tonepearls.com
www.tonepearls.com
New audiophile LP/vinyl records using the revolutionary new Tone-Pearls and pure analogue techniques. Live recording, unedited, unprocessed, pure analogue recording and cutting, 180g virgin vinyl pressing. New LP released: Piano Music in a Church of West Ireland, Classics of Chopin and Debussy and more...

ARDHOWEN HIFI

10 Menapien Way
Enniskillen, Fermanagh, BT74 4GS
Abbingdon Music Research, Acoustic Masterpiece, Airtight, Benz Micro, Croft, Acoustics, Custom Design, Deitec Precision Audio, Firestone Audio, Graham Slee, Hanns Acoustics, Harmonix, Luxman, My Audio Design, Opera Audio/Consonance, Origin Live, Project, Reference 3A, Reiyomo, Sugden Audio, True Colours Industries, Trafomatic, Usher, Verity Audio, WLM
www.Ardhowenhifi.com
07800 575070 Tom

MIDLAND AUDIO XCHANGE

The Old Chapel
Forge Lane
Belbroughton
Worcestershire
DY9 9TD

t. 01562 731100
f. 01562 730228

e-mail. sales@midlandaudiox-change.co.uk
web . www.midlandaudiox-change.co.uk



Ex-demo and second hand items

	Was	Now		Was	Now
Digital					
Arcam Alpha 8SE CD player S/H	600	199	PenAudio Serenade x-demo	7250	4999
Heed Audio DACtilus DAC BNIB	370	269	ProAc D18 Cherry Xdemo	2195	1850
living Control Music Box 3 BNIB	2887	1499	Sonus faber Cremona Elipsa Maple x-demo	12980	7999
living Control Room Box4 BNIB	1712	999	Shahinian Obelisk Cherry S/H	4500	1950
Primare CD30.2 CD player S/H	1500	699	Von Schweikert Unifield One Monitor 8 months old S/H	4995	1999
Analogue					
Heed Audio Quasar MM/MC 2 box Phono stage x-demo	740	499	Cables and Accessories		
Heed Audio Questar MM Phono stage BNIB	300	219	Apollo 80cm single column Stands S/H	149	99
Kuzma Stabi S/ Stogi S double arm version Xdemo	2795	1750	Cardas Cables Golden Cross 3m speaker cables	1999	999
Kuzma Stogi Tonearm x-demo	1390	799	Electrocompaniet ECS1 M6 feet x4 BNIB	189	49
Mark Levinson No320s Phono Module x-demo	995	649	Jadis KT90 Valves x 4 BNIB	600	300
Pink Triangle LPT/New Heed Orbit PSU/Roksan Tabriz S/H	N/A	599	JPS Ultra Dual bi wire 2x8 Spades to banana S/H	549	279
Rega Planar 3/Super Bias S/H	N/A	199	MIT Terminator II Biwire 2x10ft S/H	599	249
Roksan TMS/Atremiz/DS5 Turntable S/H	N/A	2250	Nordost Heimdall 2x3.5m Speaker cable S/H	1500	799
Well Tempered lab Amadeus BNIB	2195	1899	Spectral MI-350 20ft interconnect S/H	2100	899
Preamplifiers					
Audolici AP01 preamplifier S/H	2100	999	Stereovox 2x2.5m HDXV speaker cable S/H	350	169
Conrad Johnson Classic Phono x-demo	2400	1750	Stereovox HDVX 0.5M digital S/H	199	75
ECS Finestra Preamplifier Phono S/H	N/A	379	Synergistic Research AC master Coupler 5ft IEC-UK S/H	499	149
Krell KAV250p preamplifier S/H	2398	995	Transparent Balanced Reference 2x30ft x-demo	6345	3299
Spectral DMC15SS new in box full warranty	6995	4995	Transparent Reference SC 2x10ft x-demo	6192	3199
Amplifiers					
47 lab 50 Humpty PSU x-demo	1999	1199	Tuners & Tape decks, power supplies		
47 lab 50 w Gain card x-demo	1999	1199	Cyrus DAB 8.0 Tuner Silver S/H	600	379
Audio Technica AT-MA50 Mixing Amplifier S/H	399	149	Magnum Dynalab FTR remote/Tuner for Etude S/H	395	179
Bel Canto eVo4 Poweramplifier S/H	3400	1649	<i>Midland Audio X-change are looking for All high end audio separates best prices paid for good examples.</i>		
Chord Electronics SPM1400 B mono S/H	12000	4299	<ul style="list-style-type: none"> • Suppliers and installers of High Quality Audio Systems • Audio Research • Analysis Plus • Bergmann Audio • Bel Canto • Copland • Crystal Cables • DPA • Devialet • dCS • Dynavector • Electrocompaniet • Emm labs • Finite Elemente • Heed Audio • Jadis • Koetsu • Krell • Lavardin • Lecontoure • Martin Logan • Magneplanar • Neat Acoustics • Olive • Primaluna • Primare • Rega • Shahinian • SME • Sonus Faber • Transparent Audio • Wadia • Well tempered lab • Wilson Audio 		
Electrocompaniet AW250R S/H	4999	2499			
Graaf GM100 Power amplifier re-valved S/H	5999	2299			
McCormack DNA125 power amplifier S/H	1999	995			
Rouge Audio Corus Integrated valve S/H	1850	1199			
Loudspeakers					
Leema acoustics Xero Black Ash S/H	750	499			
Martin Logan Fresco pair inc stands S/H	1500	699			
Martin Logan Quest Light Oak (new panels) S/H	N/A	1299			
Martin Logan Vantage dark cherry x-demo	5149	3499			
PenAudio Charisma x-demo	2715	1899			
PenAudio Charm Sub modules x-demo	2175	1499			

Midland Audio X-change are looking for Audio Research, Krell, Mark Levinson, Naim Audio, SME, Wadia.

FREE READER CLASSIFIEDS

TERMS AND CONDITIONS: Only one advert per reader. No Trade adverts, This section is strictly for readers selling secondhand hi-fi equipment only. Maximum length per advert is 30 words, Adverts over 30 words will not be accepted. Telephone numbers and E-mail addresses are treated as one word. Model numbers are treated as one word i.e. Quad 303 = two words. Email your advert to; classifieds@hi-fiworld.co.uk or fill in the form on page 129 and post it to Hi-Fi World Free Readers Ads, Suite G4, Argo House, Kilburn Park Road, London NW6 5LF. Sorry, we cannot accept adverts over the telephone. The Publisher reserves the right to judge submissions.

CODA CSX Stereo power amp (330watts @ 8 ohms). New NEVER played, balance of 5 yrs warranty, purchased in error. Genuine private sale, highly recommended in HI FI+ 2009 awards £2999 (RRP£5275) For more information. 02392-376247 jameshankin@btinternet.com

NAIM 5i latest excellent condition, £430. Wanted: Bicolor 200 cabinets or constructor of same. Tel: 07716 139 026

ELECTROSTATIC SPEAKERS, very good condition. Inner sound. Buyer to collect. £800. Tel: 0116 291 0415

NAKAMICHI TX1000 self centering computing turntable, 2 arms has separate power supply. Ultra rare make sensible offers. Tel: 01727 825 599 or Email: michael@gypsytower.com

BANG & OLUFSEN Beocord 2400 cassette £50. Technics SL5 turntable £60. Sansui AU701X tuner £60. AR A60 amp, Sony 3140F power amp, spares or repair, £15 each. Tel: 01708 457 691

KIMBER 0.5m PBj 14dB attenuated Naim CD interconnect £40. Kimber 0.5m 11dB attenuated CD phono interconnect £20. Tel: Stuart 07846 675 141 (Northants)

KOETSU BLUE Lace. Brand new. Mounted but unused. Finest ever platinum coiled cartridge 0.2mV output. Very few in existence, boxed. Inspection welcome. 4,995.00 For more details contact Neil on 01925 656990 or npage@tadmur.com

TECHNICS SL1210 Mk2 good working order £160. McIntosh MCD201 SACD/CDP rem. vol., brilliant £1500. Approx 20 wpc single ended valve integrated, modded, good working order, £400. Wanted: B.A.T. integrated, anything B.A.T., Graaf GM20 O.T.L. Tel: Shalom 07951 553 091

LINN BASIK tonearm mounted on Linn LP12 armboard. Very good condition. Offers. Graham Slee Gram Amp 2 S.E. phono stage, mint, boxed, £75. Goldring 1006 cartridge, Little use £25. Tel: 07941 174 804 after 6pm (Gloucestershire)

CASTLE HOWARDS SE2 rosewood, superb condition £495. Rega RB300, modded, £175. Counterpoint SA12 poweramp, v.g.c. £425. Audiolab P&C, grey, pair, £275. Audiolab poweramp, black, UK built, £230. Tel: 01255 421 589

ARCAM SOLO Amp/CD/FM/DAB All-In-One unit, £650. Also Naim Uniti Amp/CD/FM/DAB All-In-One unit (to current specification) £1550. Both in immaculate condition, complete with boxes. Tel: 023 8073 8935

MISSION ELEGANTE E82 floorstanding speakers (pair), anthracite grey, £600. Roksan Kandy K2 integrated amplifier, £500. All excellent condition and boxed, or £1000 for everything. Tel: 0161 437 2898 or Email: steve1bowers-mail.freeserve.co.uk (Stockport)

EBAY MY **** wad kt88 int amp [£1350] £425. Meridian 206 CD player [£1000] £125 open to offers T. 07976 621529 leeds up north

KIMBER D-60 digital coaxial cable, phono, 1m, only 5 hours use (RRP £350) - £190. Yellow mains cables, Russ Andrews filters, other items. Call Mike 01902 884694

ICON AUDIO MB845, Hi-Fi World review 2009, LA4 MkII pre amp. £3500. Tel: 0116 291 0415

WANTED: ROGUE valve power amplifiers. Any condition. Tel: 07765 217 280

WORLD AUDIO 2A3SE single ended triode amp. Well made. Very good condition. PIV capacitors. Spare valves. £550. Tel: Steve 07530 291 920 or Email: stillet@tiscalli.co.uk (Isle of Wight)

AUDIONOTE E SPE HE speakers. These are the later blue cone hemp version in high efficiency guise with silver wiring. Apple Veneer and in fine condition. Includes original stands. Less than a third of new price at £1950. I've finally bought horns! 01424 203192 (East Sussex.)

SONY SA-EX100 active hybrid stand mount loudspeakers 15cm motion feedback bass unit and 2.5x10cm electrostatic top 50watt built in power amps needs 500mv for full output. £495. jlc2me@aol.com 01202575503

LARGE COLLECTION of Hi-Fi World and What Hi-Fi magazines for sale. Approx 15 years worth of copies available. Offers for the lot considered. Contact Mario on 07815926875 (evenings only) or for more details please Email mar@mcapaldi.freeserve.co.uk

AUDIO TECHNICA AT33EV moving coil cartridge as new £375 LUMLEY Heliosphere dual motor high mass turntable 2 years old, lovely with original box etc £1700, £2500 new David 07554016461

ROYD MINSTRELS Special Edition for sale very good condition, cherry wood finish veneer £300 ono; also Arcam CD 82 in black any offers considered. Ring Andrew on 07791529128 or 0207 252 8122

AUDIO RESEARCH Reference 210 mono-amps. 200 Hours use from new, perfect, boxed, manuals, accessories. Stunning sound. Overseas works forces sale of system. 10,995.00 ovno. For more details contact Neil on 01925 656990 or npage@tadmur.com

JMLAB MEZZO Utopia Loudspeakers. Cherry and black piano finish. As new, boxed, manuals. Light use, (£8700), accept £3500. Currently in Naim system, can demonstrate - see review <http://www.stereophile.com/floorloudspeakers/953/index.html> Tel: 07747620856 (London)

TANNOY MONITOR Gold 3LZ speakers, little used, in original oak finish enclosures. £400 Tel: 01227 263568

SONY CDP-X7ESD/DAS703ES £750, CDP-552ESD II £300 TA-F700ES £250 STS-770ES £250 STS-730ES £200 TA-N86B £300. Wadia 2000 transport serviced £1200 Wadia 2000 DAC Sledhammer Interface £1000. noddfa@hotmail.com 07500702061

Enjoy the Music.com



Out Of This World...



Must See Equipment Reviews

Help You Find The Best Gear

Over 100 Show Reports

See The Latest And Greatest Gear

Over 1000 Music Reviews

Show Off Your System With Awesome Tunes



www.EnjoyTheMusic.com

www.EnjoyTheMusic.com

- THE AUDIO BARN FROM ROCK SOLID SOUNDS -



VIVID AUDIO
ELECTROCOMPANET
AUDIO PHYSIC
BLADELIUS
AYON
CODA
MUSIC TOOLS
BOULDER

ASTINTREW
BLACK RHODIUM
BELLES
ORACLE
AURA
STELLO
HI FI RACKS
VITUS



Rock Solid Sound
Systems

The Old Barn, Rosier Business Park, Candyhurst Road, Billingshurst
West Sussex, RH14 9DE. **tel. 01403 782221 or 07950 274224**
info@rocksolidsounds.co.uk - www.rocksolidsounds.co.uk

- Please telephone for an appointment -

Billy Vee
SOUND SYSTEMS

MULTI SOURCE STREAMING SPECIALIST

CALL SALES: (020) 8318 5755 or 8852 1321 - 248 Lee High Road, London, SE13 5PL

0% APR Credit options are available for purchases of new products exceeding £900, please call for details. E&OE

New Naim - UnitiQute DAC & HDX HD Player



UnitiQute Compact streamer
now available



The Naim DAC - NaimUniti series and the HDX marked a turning point in Naim history and delivered a stunning product line-up for the future of quality music. You now have multi source delivery options of up to 24bit studio quality even with the new baby UnitiQute. Splendid! Visit billyvee.co.uk for more info or come and listen.

A selection of Pre-owned & Ex-Dem available at www.billyvee.co.uk

Linn Unidisk SC Universal CD Player E/D (1Yr G/tee)(3145.00)	£995.00
Linn Unidisk 1.1 Universal Player E/D (1Yr G/tee)(8470.00)	£1895.00
Linn Majik-1 Integrated amplifier E/D (2Yr G/tee)(1595.00)	£945.00
Creek Destiny CD Player E/D (2Yr G/tee)(1430.00)	£695.00
Linn Linto Phono preamp Silver S/H (1Yr G/tee)(1180.00)	£549.00
Linn Akurate 2200 Power Amp Sil. E/D (2Yr G/tee)(3000.00)	£1550.00
Linn C5100 5 Ch Chakra Power Amp S/H (1Yr G/tee)(2200.00)	£995.00
Linn Artikulat 320 Speakers Dk Cherry E/D (2Yr G/tee)(8250.00)	£2950.00
Quad 99 Preamplifier E/D (2Yr G/tee)(799.00)	£475.00
Quad 99 Power Amplifier E/D (2Yr G/tee)(599.00)	£349.00

EDISON TWELVE (HFA12)
£325 Kelvin Labs Class A integrated £295 Snell K's £225 Well Tempered Classic Turntable £1395 Wanted Eikos FRI or similar single drive unit speaker Tel: 0113 2559475

MUSICAL FIDELITY A370
power amp looks good sounds good wife hates it she says it looks like a microwave oven, it was taken in as a swap did not realize how big it was so it has to go. collect only (too big to post) £450.00 phone 0191 4171669 after 6pm.

NAIM AUDIO hilene interconnect. As new condition c/w tin box etc. Excellent upgrade. £375. Tel 07970078653 Andy. (Notts).

QED GENESIS speaker cable x3.5m pair £150 ono, kimber kcag 0.5m interconnect £100 ono, missing link cryo 0.6m interconnect £125 ono phone neil on 01652618420 evening n. lincs

QUAD SYSTEM, 67 CD Player, 66 Preamp with controller, 66 FM tuner, 606 power amp. Good condition and all boxed apart from the 606. Will split. £1,150 Tel: 01625 430130

PIONEER CS301 speakers, black, good condition £95. Bang & Olufsen P30 speakers, wood finish, good condition £75. All good working order. Telephone Adrian (01302) 772495

C.J. WALKER CJ58 turntable with Mission arm and A+R C77 cartridge (damaged stylus) for sale. Not used for some years. Serial No. 1070. Tel: 02476 592 585 or Email: martin_mason@talk21.com

QUAD SYSTEM 99 pre, cd, 909 amp .various ages plus 2905 speakers all very good condition. must be collected no boxes. will demo. £3750 ono. tel 01773856828. derbyshire.

WANTED: TOP quality Hi Fi seperates and complete systems, Naim, Linn, Cyrus, Meridian, Arcam etc, fast, friendly response and willing to travel/ pay cash Please call me on 0781 5892458

WANTED FAULTY or non working Quad 34 and 44 pre-amps, fm3 tuners, Quad 405 amplifiers. Contact Mike 01758 613790.

OFFERS INVITED for a Thorens TD160 MK2 turntable in mint condition. Telephone: 01922 644775

NAKAMICHI CR4 Near Mint/Full History from 1986 (B&W) All@£300 Mr Griffiths Mobile 0787 571 9136 (S Wales)

LINN LP12/Beautiful Fluted Afrosomia Fully upgraded with Akito/Grado Platinum cartridge Cikus Bearing/Trampoline2 All@£1500 Mr Griffiths Mobile 0787 571 9136 (S Wales)

FOR SALE Michel Iso Hera phono stage in good con. great sound £175. Zeta tone arm with orig. wood box exc. cond. £350. call richard. 01706841861. Man.

ATACAMA UROPA 8SE 4 shelf hifi/av rack, 5 star Whathifi, cost £520.00p, sale £225.00p o.n.o. Tel: Medway 01634 842874 or e-mail p.evans11@live.co.uk

SONY PS-X600 Turntable fitted with Shure M91ED cartridge. £75. Tel: Steve 01986798524

MARTIN LOGAN Clarity Electrostatic Speakers in excellent condition, finish in black and silver, wonderful open sound £1,250 Telephone 02380 224003 Southampton

TANNOY CHEVIOT HPD 315A twelve inch DC drive units. Good condition. Can be heard. £600 ono. Tel: 01843 835 734 (Kent)

BOWERS & WILKINS CM8 speakers black £895. B & W. PV-1 sub-woofer black £575 all mint as brand new, buyer collects Tel: 020 8951 3178

PROAC D15 two-way floor standing loudspeakers, satin cherry finish. Real wood veneer. Bi-wiring or bi-amping compatible. Smooth and dynamic sound. Good condition. Boxed. £850. Tel: Shaun 07798 838 110 (Bracknell, Berkshire)

KIMBER SELECT 3038 speaker cables 1.00m silver next gen spades, Siltech FTM4SG3 1.00m, Kimber Select KSI136 XLR-XLR 1.00m, KSI1036 Phono-Phono 0.75m. All approximately 50% of retail, all perfect boxed with little use. For more details contact Neil on 01925 656990 or npage@tadmur.com

BANG & OLUFSEN Beogram 6500 record deck, very good condition, £195. Nakamichi BX2 cassette deck, very good condition, £90. Thorens TD166 Mk2 record deck, £95. Marantz PM7001 amplifier, boxed, unused, £175. Tel: 01708 457 691

APOGEE CENTAURUS Ribbon speakers, excellent, £400. Bohlender Radia hybrid ribbon speakers, mint, £850. Tel: 07979 300 421

ROKSAN RADIUS 5 turntable for sale., with Origin Live RB600 arm with Goldring 1022 cartridge. £800 ono. Also Exposure 2010S CD player for sale. Excellent condition. £280 ono. Tel: Andy 01484 427 426

QUAD ESL63s (late serial nos 32,000), black with unused George stands, fully serviced 2009, £1,350. Leak Stereo 60, some Mullard valves, serviced 09 £1,450 Superb sound, can demonstrate Cheltenham area. Inquiries to aasm_1@yahoo.co.uk

LARGE COLLECTION of Hi-Fi World and What Hi-Fi magazines for sale. Approx 15 years worth of copies available. Offers for the lot considered. Contact Mario on 07815926875 (evenings only) or for more details please Email mar@mcapaldi.freemove.co.uk

FLUTTERBUSTER turntable power supply £25. Isokinetic MTB-D motor thrust bearing for Philips/ Impex/ Premotec motors, new, unused, £10. Original instruction manual for Wharfedale Isodynamic headphones. Tel. Alasdair 0113 262 3865

CODA CSX Stereo power amp (330watts @ 8 ohms). New NEVER played, balance of 5 yrs warranty, purchased in error. Genuine private sale, highly recommended in HI FI+ 2009 awards £2999 (RRP£5275) For more information. 02392-376247 jameshankin@btinternet.com

EBAY MY ** wad kt88** int amp [£1350] £425. Meridian 206 CD player [£1000] £125 open to offers T. 07976 621529 leeds up north

Tel. 01903 261213 or (after hours) 07860 660001
e-mail: heatherdale@hifi-stereo.com Web: www.hifi-stereo.com

<p>SPEAKERS Tannoy Stirling SE speakers Boxed/mint (£3000) only £2495</p> <p>PRE-AMPS Trilogy 909 pre amp, ex demo, mint, full man' warranty, (£4495) only £3495 Audio Note Zero Remote controlled pre amp, MINT £350 Audio Note Zero pre amp, Ex cond'. £250 Audio Note M1 pre amp with phono £495 Audio Note M1 Line pre amp £350</p> <p>AMPLIFIERS Pure Sound 18 integrated valve amp, superb cond' boxed Wavac MD-805 monoblocks, as new/ex display, full man' warranty (£12,295) ONLY £8660 Almaro 205 Mk11, NEW, (£1250) special offer £995 TRI TRV-88SE amplifier, NEW, (£1895) special offer £1499 Trilogy 968 power amp, ex demo, full man' warranty, (£4695) only £3750 Audionote P1 power amplifier £795 Lindley Tyson (Quad 11's) KT88 valve monoblocks £3250</p>	<p>Audio Note SORO SE integrated amp. 6 weeks old, very low hours, as NEW, full warranty (£3480) only £2695 Almaro 318B (new) £2550</p> <p>TURNABLES, CARTRIDGES & TONEARMS Maplenoll turntable, air bearing platter and arm, us voltage. £2995 Simon York "ZARATHUSTRA" turntable and PSU with Graham arm, Black/Gold on slate base with glass hinged cover £2995 Callas record clamp (£500) only £225</p> <p>CD PLAYERS & TRANSPORTS Esoteric P-03 transport with D-03 DAC, superb condition, boxed with instructions and remote. (£24,000 new) offered for £12,995 Esoteric G-0RB master clock generator, mint/boxed, (£12,000 new) offered for only £6,995 Unison Research "Simply 845" integrated amplifier, excellent condition. £1795 CEC TL-51XR CD player, MINT £1495 TRI CD player, NEW, (£1895) special offer £1499 Audio Note DAC 2 £795</p>	<p>Audio Note Zero CDT CD Transport £395 CEC TL-1N CD transport, as new, £5795 Esoteric P-05 transport with D-05 DAC, ex demo, full man' warranty, rrp £9590 offered for £7595 Mark Levinson ML 31.5 Reference CD transport £3495 Audio Note Zero DAC, new £399</p> <p>MISCELLANEOUS Nakamichi Dragon cassette deck, boxed/book/ recent service receipt, superb. £695 Kharma KIC-GR. 8 mtr balanced interconnect (£2000) only £795 MIT Profile EX 11 1.5 mtr. balanced interconnect £150 Madrigal (Mark Levinson) 1 mtr. balanced interconnect (£450) only £249 PS Audio Lab 11 power cord, 1.5 mtr. (£450) only £299 Selecion OYAIDE plugs and power strips POA Winds ALLM-01 Stylus Gage new £426</p>
--	--	--

Main dealer for Esoteric

VISA - SWITCH - MASTER CARD - AMEX - DINERS CLUB WELCOME.
WE TAKE PART EXCHANGE ON NEW & USED STOCK and buy in for cash

NEXT MONTH

August's Hi-Fi World will put you in a holiday mood with its wide range of great new kit! Digital fans will be dazzled by Audiolab's superb new affordable 8200CDQ CD player/digital preamplifier, with its ground breaking John Westlake design, while we put the high end Bricasti M1 DAC against the best of the rest. Vinyl fans will enjoy the Inspire Quest turntable upgrade package, claimed to dramatically improve the venerable Rega Planar 3. We've the Tube Amp Company's sizzling value V60 valve integrated, and Storm Audio's excellent V35 solid-stater. Speaker fans look out for one of the weirdest boxes around in the shape of Eminent Technology's LFT-16 ribbon hybrid [pictured]! Here's just some of what we hope to bring you...

STORM AUDIO V35 VERTIGO INTEGRATED AMPLIFIER	INSPIRE QUEST TURNTABLE UPGRADE
MUSICAL FIDELITY V-DAC II DIGITAL CONVERTOR	AMR AM777 INTEGRATED AMPLIFIER
AUDIOLAB 8200CDQ CD PLAYER/PREAMPLIFIER	BRICASTI M1 DIGITAL CONVERTOR
EMINENT TECHNOLOGY LFT-16 LOUDSPEAKERS	PIONEER VSX-1021 AV RECEIVER
TANNOY REVOLUTION DC6 LOUDSPEAKERS	ICON AUDIO PS2 PHONO STAGE
MOWGAN AUDIO ETAIN LOUDSPEAKERS	ORIGIN LIVE ONYX TONEARM
TAC V60 VALVE INTEGRATED AMPLIFIER	ROTH OLI50 LOUDSPEAKERS



**PICK UP THE AUGUST 2011 ISSUE OF HI-FI WORLD ON SALE JUNE 30TH, OR
SUBSCRIBE AND GET IT DELIVERED TO YOUR DOOR: p82**

ADVERTISERS INDEX

2nd Hand Hi-Fi	112
Absolute Sounds	IFC
Air Audio	32
Amphion	IBC
Angel Sound	126
Audio Components	114
Audio Emotions	18
Audio Sanctum	90
Avid Hi-Fi	102
Basically Sound	110
Billy Vee	124
Black Rhodium	56,68
Classi Hi-Fi	104
Classic Sounds	108
Coley	48
Computers Unlimited	92
ELAC	48
Electrocompaniet	OBC
EnjoyTheMusic.Com	124
Fidelity Audio	56
Heathcote Audio	118
Heatherdale Audio	125
Henley Designs	70, 88
Hi-Fi Sound	112
High End Cable	96
I5 Audio	118
IAG	54
Ian Harrison	108
Icon Audio	50
Inspire	28, 90
Isokinetik	110
Jays Headphones	6
KEF	22
Mantra Audio	108
Mei Xing Electronic Factory	32
Midland Audio Exchange	122
Music First	104
O'Brien Hi-Fi	68
Origin Live	94
Pannell & Partners	104
Retro Reproduction	110
Rock Solid Sounds	124
Russ Andrews	114
Sevenoaks	115,116,117
Sound Dead Steel	114
Sound Fowndations	10,14
Sound Hi-Fi	68
Tannoy	80
TEAC	64
TelluriumQ	104
The Missing Link	114
Triangle	56
Turntable World	112
Whest Audio	94

FREE READER CLASSIFIED ADS ORDER FORM

STOP PRESS

TERMS AND CONDITIONS: Only one advert per reader. Maximum length per advert is 30 words, Adverts over 30 words will not be accepted. No Trade Adverts. This section is strictly for readers selling secondhand hi-fi equipment only. Telephone numbers and E-mail addresses are treated as one word. Model numbers are treated as one word i.e. Quad 303 = two words. Sorry, we cannot accept adverts over the telephone. The Publisher reserves the right to judge submissions.

You can email your advert to us at: classifieds@hi-fiworld.co.uk
or write or type your advertisement copy in block capitals with one word per box and post it to us at:

Hi-Fi World Free Readers Ads,
Unit G4, Argo House, Kilburn Park Road,
London, NW6 5LF.

WE WILL ACCEPT PHOTOCOPIES OF THIS FORM

1	2
3	4
5	6
7	8
9	10
11	12
13	14
15	16
17	18
19	20
21	22
23	24
25	26
27	28
29	30

Name: _____
Address: _____
Post Code: _____
Daytime Tel: _____

FREE READER CLASSIFIED ADVERTS COPY DEADLINES

AUGUST 2011 - 6TH JUNE 2011

SEPTEMBER 2011 - 5TH JULY 2011

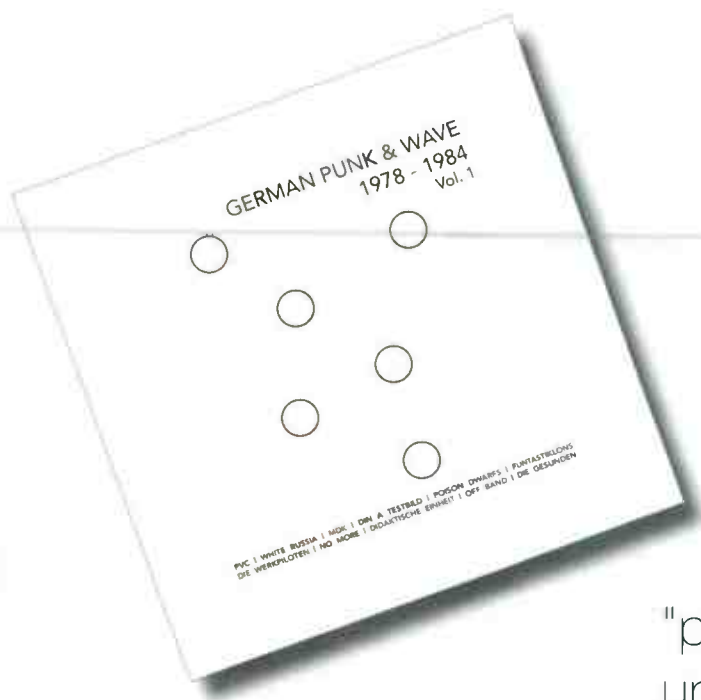

GERMAN PUNK & WAVE: 1978-1984 VOL.1

VARIOUS VINYL ON DEMAND

"pioneering stuff, classics of the underground in fact, which this box set captures perfectly..."

Classic art is often 'classic' because, yes, it's good and from the soul of a true talent, but also because it has been given patronage; backing for materials, a stage for display or funds for distribution. For, if no-one knows about it, it cannot become popular and will not receive national or worldwide acclaim. Music, especially, gains and suffers from these factors and the sub-genres of punk and wave more than most. Because the DIY ethic provided artistic freedoms, those same freedoms meant that most artists of that ilk were left working without a net... or two pennies to rub together. So we have to thank German record label Vinyl On Demand therefore, for bringing together the eleven bands in this boxset that provides, at least to many UK ears, the first chance to hear a selection of classic German punk and wave music.

They include PVC, inspired by UK punk band The Adverts who, despite being formed in 1977, didn't release anything until 1982; White Russia included ex-members of PVC, releasing two LPs during their lifetime. This set includes an album's worth of tracks from each (eleven and twelve respectively); MDK, purveyors of post-punk with a distinct Clash flavour; Din A Testbild were a new wave, punk-electro outfit who moved into synth experiments as did another band in the box set. Poison Dwarfs, with their brief techno stabs. The Didaktische Einheit will be of interest to cold wave fans with their stripped, raw approach while the Off Band and No More explored the darker areas

of post-punk. Other bands include the wonderful Funtastiklons which provided a unique instrumental electronica providing pastoral electro with elements of Kraftwerk and flavours of early UK outfits like early Human League, Die Werkpiloten (check out the hypnotic minimalism of 'New Arrangements' in this boxset) and Die Gesunden who played unrefined melodies that were no less attractive for it.

Utilising a number of Kenwood, Yamaha, Aiwa and Sony decks as sources, label boss Frank Maier had a gamut of sources for this boxset including, "well preserved DATs and original tapes provided by artists and transferred digitally as WAV/AIF. Some artists provided CDs which they recorded from their original cassettes, tapes or quarter inch reels."

Trying to get the best sound from this hotchpotch of sources proved challenging, as the mastering engineer for this box set, Anders Peterson from GS Mastering & Post, explained. "For any compilation, especially one as big as this, it's often tricky to get a homogenic sound. In this case, with recordings dating back twenty-five to thirty years, the recordings were quite different from each other; varying levels, varying instrumentation and overall sound, varying amounts of hiss and other elements of noise and audio artefacts. But that's what's so interesting, challenging and also inspiring about doing audio post on a project like this, being able to present these recordings in a new light, so to speak."

The music on this box set is often basic and primitive, partly by design but also partly because cash was scarce. Peterson recognised the care he had to take with the sources, therefore. "Making the remastering just clean and polished would not do the music justice. So balance is a keyword to pretty much all aspects of the remastering process."

In practical terms, Peterson had to deal with the fact that these groups did not have audiophile concerns in mind before they started recording. The idea was to get the band together in a space, any space, where they could do their thing and hit the record button. Yet that meant that, "on several tracks, there were several layers of various forms of noise and hiss that had to be removed or greatly reduced. I often use analysis software from the French IRCAM studio to locate the troublesome frequency sections and I have an EQ I programmed myself in Csound, where I can basically alter the amplitude of every single frequency in the spectrum. Such a detailed processing is not always required but it gives fantastic possibilities."

The result has been worthwhile though, because the box set preserves the raw nature of the music and conveys the essence of what the bands were trying to achieve. This was both the beginning and end of music as they knew it at that time. Everything was old, this was new, it was pioneering stuff, classics of the underground in fact, which this box set captures perfectly.

PR

“The new bookshelf
to beat at the price.”

Alan Sircom, Hifi+

“If you value hearing exactly what’s on your CDs and LPs, then you’ll want speakers that just get out of the way and let the music speak for itself, and you’ll need to hear Amphion’s Argon3.”

“Argon3 is a right choice for those who like to hear the truth, the whole truth, and nothing but the truth.”

Philip Beaudette, www.Soundstage.com

More information on Amphion products on
www.amphion.fi



Distribution

Amphion Audio Europe | info@amphion-audio-europe.com

www.amphion.fi | info@amphion.fi



ELECTROCOMPANIET

If music *really* matters™



Hjemmekino 6

LYD & BILDE
Best i test
Nr. 02/11 *****
Electrocompaniet PD 1

"One DAC to rule them all"

Bring your digital music collection to life with the new PD 1 DAC from Electrocompaniet.

The new PD 1 is our answer to the growing need for a user friendly DAC with USB interface. With our new DAC you can listen to the music from your CD-player, TV/Satellite tuner, iPod and computer the way it was meant to be. The sound from all your digital sources is improved and listening experience is enhanced.

The PD 1 is easy to install and with the remote control you can change between the sources and adjust the volume – perfect if you connect the PD 1 to a pair of active speakers.

When you connect your computer to the PD 1 all music coming from your computer is upsampled to the best possible quality. The dynamics and the details in the music is restored. With the remote control you can put your play-list on hold or move to the next / previous track without touching your computer.

For wireless streaming from your PC/Mac you can choose to add our USB Music Streamer. With the EMS 1 the music from your computer is streamed wirelessly to the PD 1 and you can put your computer further away from your music system.

Electrocompaniet is Made in Norway

Since the beginning in 1973 Electrocompaniet has always focused on listening pleasure and our main goal is to reproduce music as it was meant to be. Now wonder a lot of studios around the world is using our equipment for editing and mastering – maybe your favourite music is made with Electrocompaniet equipment.

Our main ambition is to give you listening pleasure in your own home and your investment in Electrocompaniet will last for many years.

The vision that drove us in the early days has stayed: If music really matters ...

Made in Norway

www.electrocompaniet.no

World Radio History