

HI-FI WORLD

APRIL 2007

UK £3.80

www.hi-fiworld.co.uk

FREE READER CLASSIFIEDS IN NEXT MONTH'S ISSUE!

YAMAHA SOAVO 1

Stunning new
loudspeaker...



ESOTERIC
X-03SE SACD



SCOOP

DUEVEL'S
Invasion
Force

MID-PRICE
TURNTABLE
SUPERTEST:

- > Acoustic Signature Manfred
- > Michell Tecodec
- > Project Xperience Comfort
- > Roksan Radius 5

SCOOP



COMPETITION
WIN A SET OF
BRILLIANCE HI-FI
CABLES WORTH
£1,000!

APRIL 2007



9 PAGES OF YOUR HI-FI QUESTIONS ANSWERED

Pioneer *sound.vision.soul*

professional sound

STEREO ENJOYMENT **JOIN THE AUDIO EVOLUTION** PURE STEREO ENJOYMENT

rigorously designed
pure sound

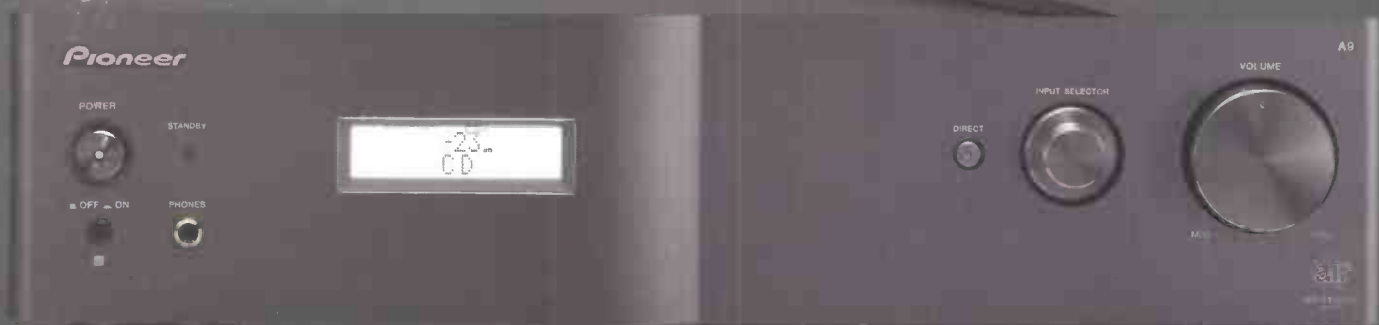

Meet the new breed of 2-channel amplifiers and Super Audio CD player

Based on the acclaimed A-400 amplifier, these new models have been redesigned for the 21st Century. Uncomplicated features and simple linear circuit design are encased in a stylish but rigid construction, giving pure unadulterated sound for your enjoyment.



40 Space oddity - Duevel's out-of-this-world Planets loudspeakers.



45 Black magic - four mid-price turntables face off.

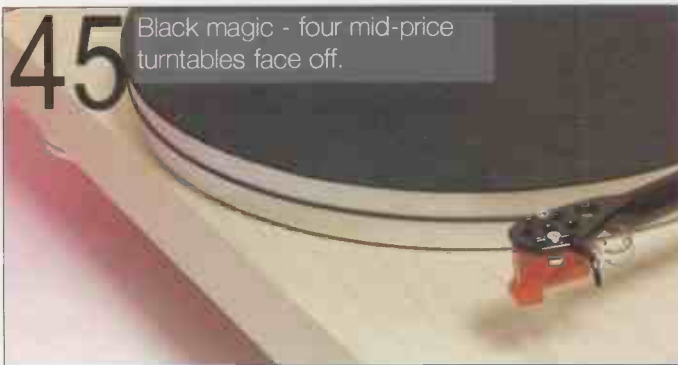

70 Spooky scoop - Graham Phantom B44 tonearm exclusively reviewed.



86 Old school - Technics' SL-P1200 is a DJ CD player the 1980s way.



10 Right cracker - Yamaha Bavo 1 loudspeaker delights us.



14 Japanese battleship - Esoteric's heavy metal X-03SE is a big hitter.

DIGITAL

ESOTERIC X-03SE 14

Channa Vithana auditions this 'Japanese battleship' SACD spinner.

SLIM DEVICES TRANSPORTER 36

This high end network music player is reviewed by Patrick Cleasby.

TECHNICS SL-PI200 86

David Price remembers the world's first ever 'DJ' CD player.

VINYL

VESTAX GUBER CUBE-T CM-01 43

Adam Smith is intrigued by this curious twenty first century turntable...

TURNTABLE SUPERTEST 45

Turntables from Acoustic Signature, Michell, Roksan and Pro-ject go for a spin with Adam Smith.

JOLIDA JD9 51

Noel Keywood listens in to an interesting hybrid phonostage.

ORTOFON SALSA & SAMBA MC 55

Affordable moving coils don't come better than this, thinks Noel Keywood.

WORLD DESIGN SLATEDECK PLINTH 62

World Designs' Slatdeck Garrard 401 plinth is auditioned by Adam Smith.

GRAHAM PHANTOM B44 70

This American unipivot tonearm gets its UK scoop from David Allcock.

AMPLIFICATION

ROTEL RB-1092 26

David Price puts this punchy power amplifier through its paces.

SYSTEMS

DENON DCD-700AE/PMA-700AE 32

David Price tries a new £500 CD player/integrated amplifier from Denon.

FEATURES

ON THE RUN 39

This month it's Neville Roberts' turn to tell all about his system...

REWired FOR SOUND 59

The tortuous tale of rewiring one's tonearm, by Neville Roberts.

INTUNE 68

Forget Digital Radio - the real radio revolution is online, writes Steven Green...

MUSIC NON-STOP 73

Channa Vithana puts together a bespoke high end vinyl system.

MANCHESTER SHOW REPORT 92

Last month's Manchester hi-fi show reported by Adam Smith.

HEATHROW SHOW PREVIEW 94

Adam Smith previews the forthcoming Heathrow hi-fi show.

LOUDSPEAKERS

YAMAHA SOAVO I 10

David Price falls in love with this Japanese floorstander.

AURACOUSTIC AURA 3T 20

Adam Smith auditions these innovative floorstanding loudspeakers.

DUEVEL PLANETS 40

These madcap omnidirectional boxes get the treatment from Adam Smith.

MONITOR AUDIO BR2 52

Adam Smith hears the latest evolution of MA's baby boxes.

DIY SECTION

DIY FEATURE PART 4 96

Peter Comeau explains the circuit development of the WDFhono3



7 NEWS

News of the hi-fi world...

19 SOUNDBITES

David Price auditions Yamaha's NX-UW10 and Supra's Sword interconnect.

25 COMPETITION

Your chance to win a set of Brilliance Hi-Fi interconnects to the value of £1,000!

76 SUBSCRIPTIONS

Ensure your copy every month and save money too!

79, 81, 83, 85, 89 OPINION

The team get to grips with matters music, hi-fi and life.

90 AUDIOPHILE CD

Paul Rigby rounds up the latest music software.

98 KIT & COMPONENTS

Suppliers of kit and components.

99 MAIL

Nine pages of your thoughts, views and queries.

118 DIAL-A-DEALER

A comprehensive guide to UK hi-fi retailers.

120 SPECIALIST HI-FI DEALERS

Purveyors of specialist hi-fi services.

122 MEET YOUR MAKER

Who makes what and how to get in touch.

125 CLASSIFIEDS

Find your second-hand bargains here.

128 NEXT MONTH

What we hope to bring you in the next sizzling issue.

129 ADVERTISERS' INDEX

130 CLASSIC CUTS

Paul Rigby looks at Little Richard's eponymous debut album.

angelsound audio

specialists in two-channel hi-fi

See us at the High Fidelity show (Garros Suite) March 31 to April 1st 2007



Cain & Cain

What's special:
Beautiful furniture
that reproduces
music as well as
the finest speakers
available.



Modwright

What's special:

ModWright 9.0SE

"Excellent full-bodied and involving sound."

Steve Harris, Hi-Fi News, Awarded 18/20

Acoustic Zen

What's special:

"Such is the acoustical and aesthetic splendor of Acoustic Zen audio designer Robert Lee's finest achievement - a loudspeaker design for the rest of us. His Acoustic Zen Adagios, by any measuring stick you care to reference, rank among the finest price/performance offerings in contemporary high end audio. Period." Chip Stern, 6 moons August 2006



Channel Islands

What's special:
Small footprint -
huge performance.
Ingenious design
and performance to
match!



Audio Logic

What's special:
It's a Magnetic Interstage
Vacuum Tube Audio
Processor.



Redpoint (NEW)

What's special:

Every turntable model in the Redpoint product line comes ready to re-connect you to your records. The type and placement of internal damping distinguishes the models and their performance. The Model A utilizes lead shot and oil damping only in the platter. The Model B features 100% more Teflon in the platter, larger damping cavities with silicone and oil and a fully damped base. The Model D further refines the Model B to employ full silicone damping to the arm and motor pods, as well as a distinctive black Teflon platter.

Pure Power

What's special:
Reference Grade AC
Regeneration with
Battery Backup.
Exceptionally good!



Almarro

What's special:

Affordable valve amplifiers
and speakers that are simply
breathtaking!

For more information contact these Specialist Dealers:

Audio Atmosphere
www.audioatmosphere.com
Tel: Stuart on
01785 711232

Heatherdale Audio
www.hifi-stereo.com
Tel: Dave on
01903 872288

Grassdance Audio
www.grassdanceaudio.co.uk
Tel: 01764 650 573

Sounds of Music
www.sounds-of-music.co.uk
Tel: John on
01435 867 438

01923 352 479

info@angelsoundaudio.co.uk

www.angelsoundaudio.co.uk

email: news@hi-fiworld.co.uk

news

G FORCE

Meridian's new G95 surround DVD receiver system is the most powerful member of the company's G Series so far. It boasts full 5.1 surround and stereo modes, a robust slot-loading DVD drive and five built-in 100W digital power amplifiers, plus an active subwoofer output. It plays audio CDs, MP3 CDs, video CDs and DVD-video discs including the DVD side of DualDisc hybrids, and offers on-board decoding of Dolby Digital, DTS, MPEG, and MP3 datastreams for stereo and multichannel playback. Stereo and multichannel digital audio outputs are also available via HDMI at up to 192kHz. The G95 also includes comprehensive preamplifier functionality with multiple analogue and digital inputs including two coaxial digital inputs, two optical digital inputs and three analogue input pairs. Digital signal processing is included to upsample stereo decoded streams, or decode surround bitstreams from external sources. An FM/AM tuner with RDS (G95 model), or a DAB/FM tuner (G95-DAB) is also included. The G95 includes upsampling in stereo mode, and up to 88.2/96kHz multichannel or 192kHz in stereo is delivered as the digital audio component of the HDMI output, at 24bit word length or a bitstream output. On the video side, the HDMI port supports a wide range of high quality digital video options including 480p, 576p, 720p, 1080i and 1080p, the highest video resolution available in the consumer industry. Analogue component out is available at 480p and 576p (plus 1080i pass-through). Prices are £4,150 with the FM/DAB version at around £4,250. For more information, call +44(0)1480 445678 or click on www.meridian-audio.com.



TOP CLASS

Monitor Audio's new flagship Platinum range is described as, "the culmination of many years' research and development by Dean Hartley and his team". The innovatively shaped and braced cabinets are finished in exotic Santos Rosewood and Ebony natural wood veneers which are hand-selected, matched and coated with eleven layers of clear gloss piano lacquer. The front baffles are hand-upholstered in Strathspey leather and loaded with new

custom-developed drive units including, in a departure from tradition, a Ceramic Coated aluminium/ magnesium (C-CAM) ribbon high frequency transducer. The initial three model line-up comprises a compact two-way speaker, the £2,300 PL100, featuring one 6.5" Rigid Diaphragm Technology bass-mid driver and C-CAM high frequency ribbon transducer; a three-way floor standing loudspeaker, the £5,000 PL300, comprising two 8" RDT bass drivers, one 4" RDT mid-range driver and a C-CAM ribbon transducer; and the £2,300 PL350C, a large three-way, four driver centre channel speaker with the same driver complement as the PL300. Custom-designed floor stands are available for the PL100 and PL350C. For more information, call +44(0)1268 740580 or click on www.monitoraudio.co.uk.



COLTRANE REIGNS SUPREME

New from Sweden's Marten Design are the superb flagship Coltrane Supreme loudspeakers. Each channel consists of two enclosures; number one is passive and has four seven inch woofers, a seven inch lower midrange, a two inch diamond midrange (which is currently the only unit like this in the world) and a one inch diamond tweeter. Cabinet number two contains no less than six ten inch long throw bass drivers and these are actively driven by a supplied 500W amplifier that offers comprehensive room-correction facilities. On paper, these sound superbly impressive, and at March's Heathrow High Fidelity Show April/March 2007 you will be able to judge for yourself as they will be on demonstration for the first time in the UK.

No less impressive is the price, which will lighten your bank account to the tune of £125,000. Best to start saving now! More information can be obtained from Kevin Walker at Audiocraft on www.audio-craft.co.uk or +44 (0)1895 253340

2Ms = MAGNIFICENT AND MARVELLOUS?

Big...no, huge news on the vinyl front comes to us from Denmark, where Ortofon have unveiled the first completely new range of MM cartridges designed completely from scratch that has been seen for many years.

Designated the '2M' range, the models are the Red, Blue, Bronze and Black, anticipated to retail for £60, £120, £200 and £300 respectively. The Red, Blue and Bronze offer interchangeable stylus assemblies but the Black model is a standalone flagship. Hi-Fi World will be securing some of the first samples of these to be seen anywhere in the world for an upcoming review but, in the meantime more information can be obtained from Henley Designs on www.henleydesigns.co.uk or +44 (0)1235 511166



MOVING PICTURES

The princely sum of £599.95 buys you Marantz's latest do-it-all digital disc player. Taking its engineering lead from the flagship DV9600 [reviewed next month], the DV7001



employs the same rigid metal chassis with double layer bottom plate and thick metal front panel. Not only does it play ye olde Compact Discs and DVD-videos, but also DVD-Audio and Super Audio CD multichannel music discs, with DVD-R/RW, DivX, MP3, WMA and JPEG compatibility. It's capable of producing a 1080p video signal via "state-of-the-art video scaling circuitry", which also allows upsampling to 720p and 1080i – and there's an HDMI 1.2 interface too. The DV7001 implements the same Cirrus 192kHz/24bit audio DAC across all six channels as the top of the range DV9600, and Marantz's bespoke HDAM modules are used, while the audio board takes in symmetrical signal paths with customised components and a dedicated high-grade audio power supply. There's also an 'Audio Exclusive' mode that bypasses the video circuits and turns the display off, for audiophile sound quality without EMI interference. There's full bass management for DVD-Video, DVD-Audio and SACD discs as well as built-in Dolby Digital and DTS surround sound decoding. For more information, click on www.marantz.co.uk

FLOORED GENIUS

Leema's Xen mini-monitor impressed us greatly a few months back, so it's interesting to see the new floorstanding version hit the market. With a footprint similar to that of the diminutive Xen, but in a miniature floorstanding cabinet, the £2,250 Xone sports careful damping with anti-resonance bitumastic panels, acoustic foam liners and natural wool. The low-mach port provides "optimum reflex alignment of the drive units", and Leema-designed Seas bass and mid-bass drivers with massive, magnetically screened magnet assemblies are used in this two-and-a-half-way design. Nordost Micro-Mono-Filament wiring is used internally and the Xone's crossover features Leema's 'Multi-track PCB'. The Linkwitz-Riley second order crossovers use 'Clarity Cap' capacitors and air and iron dust cored inductors. The design is fully RoHS compliant and features lead-free 2% silver-loaded solder to prevent precious-metal migration between gold and silver plated parts and the solder joints. Two pairs of gold plated binding posts allow individual access to the split crossover, specifically designed to gain the maximum benefit from bi-wiring. Vital statistics are 142x850x207mm and 15kg. For more information, contact Activ Distribution on +44(0)1635 29137 or click on www.leema-acoustics.com.



DREAM ACADEMY

Cambridge Audio's brand new 740 series comprises the £500 740A amplifier and £500 740C CD player, both of which use technology from the company's flagship 840-series. The 740A puts out 100W RMS into 8 Ohms and with two pairs of output transistors per channel has enough peak current capability to get the best from even 'difficult' speakers, says Cambridge Audio. A large front panel allows for assignable inputs and a plethora of features.

Using the upsampling technology married to dual Wolfson WM8740 24bit DACs, the 740C incorporates the same 32bit DSP as the 840C and upsamples to full 24bit 384 kHz. There's also a new £600 640R AV receiver, with HDMI switching, 7x 100 W RMS, HDTV capable via component video or HDMI/DVI, Dolby Digital/EX and DTS/ES/Matrix/discrete formats in all 5.1, 6.1 and 7.1 variants. For more information, click on www.cambridgeaudio.com.



BRISTOL FASHION

The UK's largest exhibition of hi-fi and Home Cinema is taking place in Bristol, at the Marriott Hotel from Friday 23rd to Sunday 25th 2007, from 10am to 5pm each day. There are over 150 brands already booked, from multinationals to one man enthusiast bands – and Hi-Fi World will be there in full effect too! For more information, click on www.bristolhifi.co.uk.

CORRECTION

Our apologies to Select Audio for printing the wrong telephone number in the Melody Pure Black 101d preamplifier review last month. You will have much more success contacting them on 01900 813064!

END OF AN ERA

Last month saw the sad news that Castle Acoustics has gone in to administration. The company had been trading at Park Mill since 1973, but September 2006 saw the company losing its second bid to move out of its premises to sell the land for property development. Skipton-based Castle had wanted to relocate to a more efficient, smaller, single-storey premises, but failed to do so in time. Corporate rescue and recovery specialists Begbies Traynor have said there will be no further production or manufacturing on the site, and the Castle name has now been sold to an unspecified buyer. The machinery, speaker components, truck and vehicles have all now been auctioned off. Hi-Fi World wishes all the company's ex-employees the very best, and laments the loss of another great British specialist hi-fi manufacturer.

RADLETT RELOCATE

Now in its 30th year, Radlett Audio has relocated to the Essex countryside, in the Saffron Waldron area. It is easy to get to and has ample parking outside, and is conveniently located for customers in Essex, Hertfordshire and Cambridge. The product range is virtually unchanged and includes Rega, ZYX, Naim, Nottingham Analogue, ATC, EAR/Yoshino, Tron, Spendor, Chord, Michell, TW Acoustic and other select agencies. Not operating as a conventional High Street shop, the service and demonstrations are on a personal, one to one basis, so booking is essential via +44(0)1799 599080 or email radlettaudio@hotmail.co.uk.



NEW REFERENCE

The ever-popular KEF Reference Series range of loudspeakers has just received its latest update. New finishes and a new Uni-Q driver are the headlines, and it comprises nine models, each available in a selection of "striking furniture-quality finishes", including High-Gloss American Walnut, Piano Black, Satin Sycamore and High-Gloss Cherry. Based around KEF's Austin concept loudspeaker, the line-up includes the classic bookshelf Model 201/2, the floorstanding Models 203/2 and 205/2 and the top-of-the-range Model 207/2. There are also two newly developed centre-channel speakers, Models 202/2c and 204/2c, and a "unique 3-way dipole" surround speaker, Model 206/2DS. Two subwoofers, Model 208 and Model 209 complete the range. Prices start at around £3,300 for Model 201/2 to around £12,000 for the Model 207/2. For more details, contact KEF on +44 (0)1622 672261 or click on www.kef.com.

THIRTYSOMETHING

British loudspeaker specialist Harbeth is about to celebrate its thirtieth anniversary, so is searching for its oldest customer. "There are going to be people still using the HL Monitor, Harbeth's first model," says MD Alan Shaw, "and we are keen to track them down in what is a very special year for us". The company was founded in 1977, and Harbeth promises a host of new developments throughout its anniversary year and wants customers old and new to be included. "Our online user group is a ready-made forum for our customers (www.harbeth.co.uk/usergroup)," adds Alan. "Anyone who thinks they might have the oldest working pair of Harbeth speakers should contact us at once... they are sitting on a piece of audio heritage." Harbeth may be reached by email at sound@harbeth.co.uk or click on www.harbeth.co.uk.



WIRELESS WORLD

Acoustic Energy has launched a dedicated 'AE' version of the hi-fi stereo Bluetooth loudspeakers that it originally designed and manufactured for leading mobile phone operator Orange. Building on the strengths and success of the original model, the enhanced AE version opens up the technology to MP3 phone users on other networks and is compatible with any advanced Bluetooth enabled device. No searching for dedicated cables or connectors – just pair and play. At just £99, the AE 20W active stereo Bluetooth loudspeakers also sport enhancements like Kevlar speaker drivers. They use Advanced Audio Distribution Profile (A2DP) technology to achieve wireless wide bandwidth stereo over distances of up to 10m, automatically pairing with paired Bluetooth devices in range, so mobile phones, PDAs, PCs or MP3 players with a stereo Bluetooth output will give instant playback on demand. Smartphones using Windows Mobile 5.0 or later also function as a remote control for volume. A line-level stereo input on the rear panel means even non-Bluetooth devices, such as an iPod or portable CD player, can be used as a source. For more details, click on www.acoustic-energy.co.uk or call 01285 654 432.

NEW METAL

Mordaunt-Short's new £599.95 Alumni is "the little home cinema speaker that thinks big". Designed to provide an "accessible way into high quality hi-fi and home cinema sound reproduction at a more than affordable price", it boasts the latest generation 3.5" CPC (Continuous Profile Cone) mid/bass drivers, 25mm aluminium dome tweeters, curved cabinets to reduce standing waves, audiophile grade components throughout and a 120W subwoofer featuring a new 8" ultra long throw woofer. There are piano black and white high gloss finishes for satellites, complemented by a subtle satin-finish subwoofer. For details, click on www.mordaunt-short.com.



NEW YORKE

New from Simon Yorke Design is the stunning S9 turntable, complete with matching arm – because of the synergy between the arm and motor, the two components will be offered only as an entity for £4,995. Each unit is hand-crafted, and currently production is restricted to one unit per week, so best to get your order in soon! Watch this space for an exclusive review.

For further information, please contact The Audio Salon on 0845 4000 400, or email Jack Lawson at jack@audiosalon.co.uk



Grand Design

From the company whose name sits on some of the world's best concert grand pianos, studio monitoring equipment, speedboats and motorcycles, comes the brand new Soavo 1 floorstanding loudspeaker. David Price listens in...



Small specialist manufacturers have a great deal to offer. Their products are often more creative, more focused and more appropriate to the needs of a rapidly changing market. But big companies can do just as well, if not better, in other ways. Think of the vast engineering resources available to the giant multinational Yamaha brand, a name behind everything from the wood veneer on Lexus automobiles and luxury swimming pools to powerboats and high performance motorbikes.

A Yamaha design team can call upon engineering resources

unimaginable to the small specialists, but this alone doesn't guarantee a great product. At worst it could end up as a terribly fudged, designed-by-committee, lowest-common-denominator compromise, while at best it may turn out to be an engineering *tour de force* and a breathtaking, epoch-making design in its own right.

To be frank, Yamaha have done both over the years, so to gauge the Soavo 1 loudspeakers you see here, I thought it best to compare them to one of the company's highest ever watermarks – the classic nineteen seventies NS1000M monitor loudspeakers. In some

respects they're still peerless even today; £14,000 Apogee Synergy 1.5s notwithstanding, there are no modern loudspeakers than can hold a candle to them in transient speed, in my opinion. So the £2,000 Soavo 1s, costing about one third of the classic NS1000M in real terms, have a serious scrap on their hands...

Just as Yamaha did with the 1974 TC-800GL, arguably the first ever high end cassette deck, the company has employed the services of an esteemed industrial designer to style the Soavos. This time, it's not Mario Bellini but Toshiyuki Kita, who has designed many successful products for German, Italian and Japanese manufacturers. You can see his work everywhere from the New York Museum of Modern Art to the Centre Georges Pompidou in Paris – plus my own front room, as he shaped the recent range of Sharp Aquos LCD TVs!

The Soavo 1s are beautifully presented, and the woodwork exemplary. The birch veneer cabinet (with Open-Pore finish) uses the same material as Yamaha's finest wood-grain pianos, and comes in a choice of dark brown birch, brown birch, natural birch and black birch finishes. To give you an idea, we're talking the sort of woodwork you used to get from Castle Acoustics.

The cabinets have non-parallel

sides to reduce standing waves, and internally the woofer and midrange sections are divided by a slanted partition, and strengthened with large, vertical ladder-type bracing. The three-way mitered construction of the cabinet joints is said to ensure extremely tight joints so the entire cabinet behaves as a single unit, and diecast aluminium stands are fitted that provide the necessary solid floor contact.

The drive unit array doesn't look anything special, but looks can be deceptive. The 'Advanced Polymer

"these loudspeakers are just plain great at everything..."

injected Mica Diaphragm' midrange cones are said to be extremely light, rigid and sturdy, while the 'Poly-Methyl-Pentene' woofers are claimed to be lighter than either paper or polypropylene. The tweeter is a 3cm aluminium dome with a fully integrated diaphragm/voice coil structure that Yamaha calls the 'DC-Diaphragm'. Diecast aluminium baskets are claimed to ensure solid support for high stiffness, and the hand-carved wooden port aperture is shaped for optimum airflow. At the top of the front baffle, a diecast aluminium tweeter plate is used to isolate the tweeter from cabinet vibration. Edgewise-wound ribbon wire voice coils are used, and the spider is a high performance model from Kurt Müller.

The crossover is said to use the highest quality parts, including Solen metallised polypropylene capacitors and large hollow centre coils with carefully selected wire. No printed circuit boards are used, instead each connection is individually soldered on a thick wooden board, providing larger, shorter signal paths. The speakers are biwireable, but interestingly Yamaha optimised them to be monowired, and this is how they were used for this review. Vital statistics are 349x1,051x487mm, and 27kg apiece.

SOUND QUALITY

Having started the listening with the aforementioned NS1000Ms, which really do sound best when powered with a gutsy tube amplifier (as opposed to solid-state), I switched directly over to the Soavo 1s with my World Audio K5881 tube amplifier still glowing away in the corner. With a quoted sensitivity of 89dB [see MEASURED PERFORMANCE], I wasn't sure if its 20 watts would be enough, but I need not have worried

as they seemed louder than the NS1000Ms' 91dB quoted sensitivity!

First impressions were wholly positive. This is not a tale of how they magically came good after hours of fettling and warming up (so that's the first difference to the NS1000Ms, then!) – they sounded wonderfully alive from the word go. My 1979 pressing of The Crusaders 'Street Life' was cued up and I was instantly struck by their superb tonality. No quacky or honky midband drivers for the Soavos – Randy Crawford's vocals were deliciously carried

without a trace of nasal colouration. They were transparent in the best 'monitor' sense of the word – they just sounded natural.

Moving up to the treble region and the hi-hats were superb, almost as crystalline and pure as the NS1000Ms' Beryllium domes. There was a delightful metallic sheen, but they could almost have been ribbon tweeters, so smooth and clean were they. Down at the other end, there was a strong, fluid bass that didn't sound in the least bit 'out of puff' compared to the NS1000Ms' big twelve inch woofers. Most marked of all – and this thought stayed with me throughout my listening period – was the way the bass melted invisibly into the midband, which dissolved invisibly in to the treble. In other words, the Soavo 1s were brilliantly integrated.

This is the key to these new Yamahas – they have a lovely tone from top to toe. All the drivers present a highly united front, and it's not like listening to three speakers in one. The result is that you can switch recordings and hear dramatically different sounds. For example, UB40's 'King' was obviously recorded in a far rougher environment than the Crusaders' 'Street Life'. The Soavos were completely able to signpost the difference between the studio that a low budget Birmingham reggae album was born in, and the one a highly polished Los Angeles jazz-rock trio chose to record at – along with some of the best session men in the business. Amazingly though, the Soavos proved as enjoyable with the bad recording as the good one.

With tonality and integration already major plus points, the next feather in the Soavo 1s' cap was imaging – here they trounced the NS1000Ms fair and square. The new Yamahas threw out a wonderfully expansive stereo image, so much

so that when toed in slightly in my listening room, they pretty much disappeared into thin air. Again switching from one recording to another simply moved the walls of the recording studio around in the room, the newbies being so skilled at conveying the studio's recorded acoustic. So accomplished were they that I really didn't start hankering after my normal review reference, the Quad ESL-989s, which sure know a thing or two about recreating any given recording's room boundaries, as any electrostatic user will attest...

Anyone who knows LFO's

'Low Frequency Oscillation', a classic slice of early nineties electronica if ever there was one, will be aware of the bass frequencies contained therein. With swathes of 35Hz sub-bass supplied by the now classic Roland TB-303 Bassline bass synthesiser dominating the song, it's a veritable torture track for any loudspeaker (or power amplifier for that matter). Yet it's not just the occasional boom-boom either – the US edition of the CD had a disclaimer printed on the 'longbox' with words to the effect of "this recording could seriously damage your equipment"! Here was something to see what the Soavos could do deep down...

For this little adventure, it was necessary to move to the 500W per channel of the Rotel RB-1092 – my poor old tube amp just wasn't going to supply the motive force. The NS1000Ms went on first, and their twelve inch bass units in massive sealed cabs shrugged off the challenge. Things started rattling in the kitchen and cracks appeared in the walls as the Rotel dutifully served up the grunt, and yours truly began to worry about a visit from the Environmental Health Officer. On went the Soavo 1s, and instead



The Future Sounds Fantastic

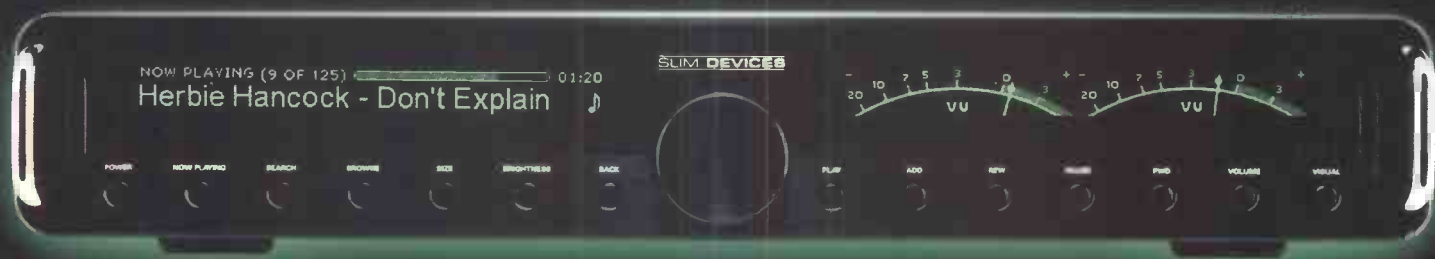

transporter™

The first audiophile network music player

Distributed by:

PROGRESSIVE
CONSUMER ELECTRONICS LTD.

www.progressiveAV.com

SLIM DEVICES

www.slimdevices.com

Experience at:

audio-T

www.audio-t.co.uk

0871 871 9747

of a weak-kneed, pale imitation of what I'd just heard, the new Yamahas duly did the business too. In truth, they were fraction less taut than the NS1000Ms' sealed boxes (but any reflex port loaded box will be, in my opinion), but seemed less constrained and even more relaxed about the vast amount of air they were being asked to move. Even at seriously high levels, there was not one jot of compression or strain, and the midband and treble remained totally unflustered by what the bass drivers were doing.

As I ran through my music collection, I was struck by how 'music independent' the Soavos were. Many say the NS1000Ms are 'the ultimate rock loudspeaker', whereas Quad's 989 really excel with classical, but the new Yamahas sang their hearts out

superb at microdynamics, capturing every last nuance of expression from the orchestra. The lack of compression, previously demonstrated by the LFO track, meant they caught the poignancy of the music's crescendos brilliantly. They were such a successful match for the Rotel RB-1092 that at times they sounded breathtaking.

Before the audition period, I hadn't expected to be writing a long paean of praise to a £2,000 loudspeaker design from a company that's been out of the serious hi-fi market (in the UK at least) for longer than I care to remember, but it's hard not to love them. Still, they are not perfect – no loudspeaker is – and their long-lost cousins were able to pinpoint a few foibles. First, although these speakers are very

a tad more bouncy and feel less constrained – I'm not sure if this is down to the NS1000M bass driver or the sound of the poor amplifier driving it huffing and puffing!

CONCLUSION

A tremendously capable loudspeaker then, and one I could happily live with even after serious exposure to the likes of Quad ESL-989s electrostatics

REFERENCE SYSTEM

- Michell GyroDec/TecnoArm/vdH The Frog turntable
- Noteworthy Audio PhoNote phonostage
- Marantz CD63 KI DP CD player
- MF Audio Passive Magnetic Preamp (silver)
- World Audio Design K5881 power amp (modified)
- Rotel RB-1092 power amplifier
- Yamaha NS1000M loudspeakers
- Black Rhodium interconnects/cables

"transparent in the best 'monitor' sense, they just sound natural..."

whatever I threw at them. One of the high points of the listening period was my Deutsche Grammophon vinyl pressing of Beethoven's 'Pastoral Symphony' (Karajan, Berlin Philharmonic), and the first side was a joy. Again, that wonderful seamless integration, super image articulation and sheer musical brio was very much in evidence, but the Soavo 1s' excellent midband really shone out as well. There was an awful lot of detail coming through; in some ways more so than the NS1000M, particularly in terms of low level atmospheric cues and a sense of spaciousness.

The Soavos are fun to listen to, and this certainly didn't change with classical programme material. Dynamics were excellent, these speakers having a rare ability to go from soft to loud at the drop of a hat, and they were also

fast by conventional moving coil standards, the NS1000Ms showed that they could be even faster still. The latter's Beryllium midrange domes transmit the very beginning of notes with disarming speed, and the big cones of the Soavos (very light though they are) just can't quite compete. Likewise, compared to the NS1000Ms, the midband has an only-just-noticeable dryness to it – it's the inevitable sound of a big cone moving air. Still, it is barely perceptible, being less conspicuous even than the Kevlar mid driver in the mighty £10,000 B&W 801Ds, for example.

At the frequency extremes, those aluminium domes are exceptionally accomplished performers, but lack that final few percent of silky transparency the NS1000Ms possess. Interestingly though, while the Soavos don't have that supernatural smoothness (when presented with an appropriate signal of course), they do have more air and space. Down below, the Soavos boast a very taut yet musically fluid bass, but lack that last few percentage points of grip that the NS1000Ms have (again, given the right amplifier to drive them). The flipside is that the new Yamahas sound

or Yamaha NS1000Ms (both work out about three times as expensive in real terms). The Soavos are just plain great at everything - they're as musical as they come at the price, yet impressively neutral and transparent in the best monitor tradition. They're remarkably insensitive to the genre of music you choose, seeming to excel with almost everything you throw at them. They seem excellent in all conventional hi-fi senses (imaging, dynamics, detailing, etc.) yet don't sound like they were born in the laboratory – quite the reverse, as they love to boogie. Finally, there's the sort of woodworking that wouldn't look out of place in the interior of the latest Range Rover, with a similarly high level of contemporary style. Fine all round musical instruments, I can think of no other £2,000 floorstander I would currently choose over them.

VERDICT ●●●●●
Surely the most capable all round floorstander at its price, the Soavo is musical, dynamic and transparent in equal high measures. Superlative build and finish complete the pretty picture.

YAMAHA SOAVO 1 £2,000
Yamaha Electronics UK Ltd.
☎ +44(0)1923 233166
www.yamaha-uk.com

- FOR**
- musicality
 - finesse
 - seamless integration
 - design, build, finish

- AGAINST**
- nothing



MEASURED PERFORMANCE

The Yamaha Soavo 1s have a very good and flat frequency response across their full bandwidth and all drive units integrate well with each other. The slight lift in treble response around the 8-10kHz region will add detail and will combine well with the small dip towards 3kHz to ensure no harshness in the midband.

Bass from the two main drivers starts to roll off below around 60Hz and is augmented by the port, which has a broad response that reinforces down to 30Hz. The Soavo 1s should have a good, clean and detailed sound with good bass weight.

Average measured impedance was 6 Ohms, dipping to a minimum of around 4 Ohms at 150Hz. Sensitivity is high at a measured value of 89dB and so, provided the Soavo 1s are used with an amplifier that is happy with a

genuine 4 Ohm load, then they should work well with 40-50W. AS

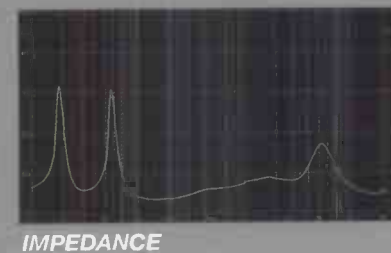
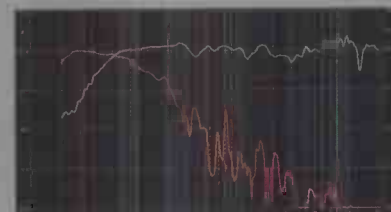



Sun Rising

Esoteric's X-01 is one of the best digital disc spinners this magazine has heard, so it was great to discover that it had spawned a more affordable variant, the X-03SE. Channa Vithana finds it full of eastern promise...

When I reviewed the £8,995 Esoteric X-01 SACD/CD player last August, I was astonished by the quality of mechanical engineering detail that went into it. With its flawless construction and VRDS Neo transport, it put similarly priced high end players to shame. This peerless engineering was handsomely repaid in the resultant sound quality, making X-01 one of my all time hi-fi high watermarks.

Then followed the lower cost X-03, using another iteration of the new VRDS Neo transport. Subsequently, SE versions of the X-03 (and UX-03), with similarly flawless casework to the more expensive X-01, have become available. So here for review we have the £4,995 X-03SE, replete

with beautiful aluminium casework, flush mounted via countersunk fixings and three heavyweight, semi-floating tooled steel feet, all similar to the X-01. Apart from looking a million dollars, Esoteric says this is all in the cause of vibration reduction for better sound.

Other upgrades involved new 6N (99.9999%) purity copper wire for "improved audio resolution characteristics and acoustic texturing". Capacitors and resistors like those from the £34,000 (approx.) Esoteric P-01/D-01 ultra high-end model are used, while the DAC and analogue stages are also enhanced. The X-03SE also uses WBT Nextgen phono sockets for the analogue and coaxial digital outputs, better compared to the previous X-03.

The (Vibration-free Rigid

Disc-clamping System) VRDS Neo transport is the latest of a long line of bespoke mechanisms from Teac, the parent company of Esoteric. The VRDS Neo used within the X-03SE is, understandably for the lower price, a less substantial version than the one from the X-01. Consequently it uses a slightly less sophisticated floating laser pick-up mechanism, albeit one that is still superior to the typically feeble plastic types found in other designs, while the sidewalls of the transport, although of similar thickness, are now two-part instead of single piece machined plates. Instead of the 20mm thick SS400 steel bridge holding the disc clamping 'turntable', the X-03SE uses a bridge section which is 'only' 10mm thick.

The disc clamping 'turntable' fitted to the underside of the bridge



is made of duralumin, and designed to handle the higher rotating speed of SACDs and DVDs (for the UX-03SE) which Esoteric say is about 4.5 times that of standard CDs. By preventing disc vibration using the 'turntable', Esoteric states that this enables "smooth turntable response and stable data acquisition properties". The 'turntable' also has a black finish to its underside, says Esoteric, to "absorb any diffused reflection of the laser from the pickup". The disc loading drawer of the X-03SE is a beautiful piece of engineering, as it glides in and out with precision compared to the cheap and nasty drawers found on many ROM driven CD spinners. Esoteric says that this 'cut-aluminium' tray actually has an effect on sound quality too.

The X-03SE uses two Burr-Brown 24bit DACs per channel for improved linearity and common noise rejection. The DAC board has a DAC transformer to remove all noise generated from the transport mechanism and digital circuitry, and the +/-3ppm claimed clock accuracy is the same as the X-01. At the rear, there are stereo outputs in balanced XLR sockets to complement the phono sockets, optical and coaxial digital outputs, and an iLink (IEEE1394) jack for stereo and multichannel digital output. In addition to the heatsink and IEC power socket is a "Word Sync In"

"this is an old school Japanese battleship machine in all its glory..."

BNC socket to connect to a separate Esoteric Master Clock Generator like the G-05 for "elimination of jitter". The X-03SE measures 442x153x353mm and weighs 23.6kg.

SOUND QUALITY

The defining characteristic of the Esoteric X-03SE is its lucidity. It is wonderfully free flowing, whatever it is asked to play. Furthermore, it boasts outstanding instrumental and vocal separation - amongst the best

rhythmically astute, finely phrased and entirely cohesive music, whatever the genre.

For example, the 'Bartok Concerto For Orchestra' CD sounded crisp, clear and bold, with individual elements like violins, horns and cello having a dramatic presentation with masses of low level detail. Instrumental separation was outstanding, the disc sounding as if it could have been recorded yesterday using the finest new old stock

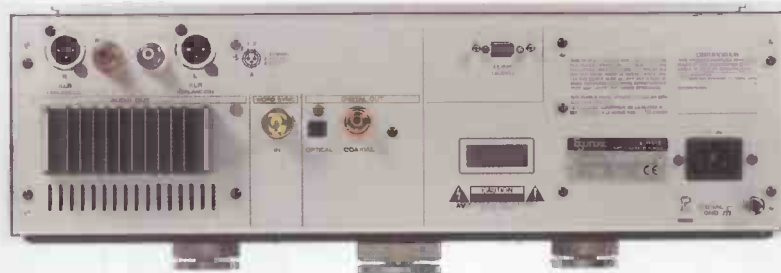

I have heard. This means it can incise deep into recordings such as the murky sounding 'Brainwashed' by George Harrison, to unveil beautifully clear and convincing vocals. Such brilliant instrumental and vocal separation does not predispose it to cliché however - it is not just another super detailed but clinical Japanese player. Rather, it produces

analogue equipment. Big orchestral crescendos were superb, without a hint of exaggeration, strain or fuss.

On 'Borg Sex' by Joe Satriani from the 'Engines of Creation' SACD, the powerful bass lines had outstanding impact, imbuing a deeply involving feel to the mixture of electronica and purist rock guitar playing. Instrumental separation



The new Artikulat Loudspeaker System. Gorgeous.

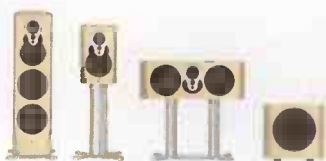

Linn Products Limited.
For more information or a demonstration call 0500 888 909 www.linn.co.uk



NAIM THAT TUNE...

During the audition period, I was able to compare the £4,995 Esoteric X-03SE with the redoubtable £6,920 Naim CDX2 & NAPS555 combination, into a £7,450 Naim 252/Supercap preamplifier and £5,300 Naim NAP 300 power amplifier via Spendor S9e loudspeakers (£2,700). The Naim CD player was more full-bodied in the deeper parts of the Ligeti 'Edition 7, Chamber Music' CD, where for example, the horns had a richer tonal character. But the Esoteric was clearer overall and more spatially precise, with a superb combination of instrumental separation and wide open clarity that the Naim, though excellent, couldn't quite match. On George Harrison's 'Any Road' from the 'Brainwashed' CD the Esoteric sounded clearer and wider than the more expensive Naim combination. Also Harrison's vocals sounded better animated and nuanced with less of a lower-mid chesty quality. Where the Naim was superior though was with instrumental timbre, where it delivered the sound of electric and acoustic guitars with more convincingly natural weight, impact and texture. The Esoteric was emphatically no slouch in this area, but its ability was to first deal with the overall picture of the music and then into the details, whereas the Naim, though excellent with the main thrust of the music, was better into the critical details of compositions. The Naim also had superior bass extension (a Naim speciality) if not more bass tunefulness, which was equal between the two. So by comparison, the Esoteric at £4,995 held its own within a Naim system, against the £2,000 more expensive combination of CDX2 & NAP555. Understandably, the more costly Naim bettered it on instrumental details like timbre and resolution, but in areas like bass tunefulness and rhythm they were equal, while in spatial terms and clarity, the Esoteric was superior overall – a superb result.

was again brilliant; exacting but never clinical.

Timbre was also superb, the wildly

different guitar textures and melodies being beautifully revealed. The music from Joe Satriani flowed freely and was propulsive. It was a delight to hear Tony Bennett's rendition of 'I Left My Heart In San Francisco' on 'The Ultimate Tony Bennett' SACD. His sublime vocal phrasing was stirring - the clarity and spatiality meant the singing was immaculately reproduced yet emotionally soulful.

MUSIC:

- Bartok, Reiner/Chicago Symphony Orchestra, 'Concerto For Orchestra' (1954/2004)
- Joe Satriani, 'Engines Of Creation' (2000)
- Tony Bennett, 'The Ultimate...' (2000)
- Bryan Ferry, 'Boys And Girls' (1985/2005)
- György Ligeti 'Edition 7, Chamber Music' (1998)

'Don't Stop The Dance' by Bryan Ferry from the 'Boys And Girls' hybrid SACD had deep, propulsive bass lines and no discernible flabbiness to the low frequencies. Rhythmically strong yet incisive and sophisticated, the Esoteric provided an expansive and enveloping sound full of rich timbre to the vocals, backing vocals and instruments. The guitar parts on 'Slave To Love' had a three-dimensional depth which was convincingly natural. Important percussion parts of this song were also revealed with precision, and entirely in time with the guitar, bass lines and vocals. What I heard was effortless musicality, with none of the lazy, dislocated and ponderous euphony that some premium priced players deliver.

CONCLUSION

The machined Esoteric logo on the top panel, flawlessly crafted thick aluminium casework and sleekly gliding disc loader drawer of the X-03SE speak volumes about the quality of the mechanical engineering contained inside. Unlike some rivals, resonant folded-steel casework and noisy ROM drives are nowhere to be found - this is an old school Japanese battleship machine in all its glory. In this case, that impeccable engineering pays sonic dividends too – it isn't just for showroom appeal. The result is a beautifully neutral, open

and detailed sound that's as musical as it is transparent. Although not the very best CD player ever made, it's not so far away from that accolade, yet costs a fraction of the 'uber machines' like Naim's CD555/555PS or Esoteric's own P-01/D-01.



With this in mind, it actually represents decent

value – especially when you remember that the X-03SE handled itself so ably against the £2,000 more expensive Naim CDX2/NA PS555 combination [see NAIM THAT TUNE]. One of the most 'complete' CD players we've heard, with beautiful build, elegant styling and super sonics, the Esoteric X-03SE has it all.

REFERENCE SYSTEM:

- Densen B-250 & B-330 amplifiers (£6,000)
- Waterfall Victoria loudspeakers (£2,000)
- Naim CDX2/NA PS 555 CD player (£6,920)
- Naim 252/SuperCap preamplifier (£7,450)
- Naim NAP 300 power amplifier (£5,300)
- Spendor S9e loudspeakers (£2,700)

VERDICT ●●●●●

Surely the most complete silver disc player at the price, the brilliantly built Esoteric is musical and detailed in equally generous measures.

ESOTERIC X-03SE £4,995
Teac Esoteric Company
☎ +44(0)1727 865 488
www.symmetry-systems.co.uk

FOR

- superlative transport
- ultra revealing yet musical
- outstanding build

AGAINST

- measured performance

MEASURED PERFORMANCE

Our convolved impulse analysis shows an absolutely flat frequency response to 21.3kHz with CD, normal enough, and to 26kHz with SACD - a relatively disappointing result as SACD usually reaches 60kHz (-1dB) and ultimately 100kHz -12dB. This is significantly less than the quoted specification, which is wrong, Teac tell me.

Distortion levels on CD were higher than expected nowadays, the -60dB result of 0.42% being around double that now commonly achieved, balanced output providing no improvement. SACD gave an improvement, but at 0.18% the -60dB figure was still higher than expected, Marantz's 7001 managing 0.02% for example.

Noise was low and output very high at 3.56V, the standard being 2V. Balanced output was double this at a whopping 7V.

The EIAJ dynamic range result of 104dB was lower than the usual 112dB, primarily due to distortion at -60dB.

The X-03 was a little disappointing in that it fell short of current standards with both CD and SACD. It has some fine internal technologies though and so how it will sound is an open question. NK

Frequency response (-1dB)

CD	2Hz - 21.3kHz
SACD	2Hz - 26kHz

	CD	SACD
Distortion		
0dB	0.0004%	0.0003%
-6dB	0.001%	0.0013%
-60dB	0.42%	0.18%
-80dB	3.6%	0.55%
-100dB	-	1.9%
Separation (1kHz)		110dB
Noise (CD, IEC A)		-107dB
Dynamic range (EIAJ, CD)		104dB
Output (unbal. / bal.)		3.56 / 7V

FREQUENCY RESPONSE

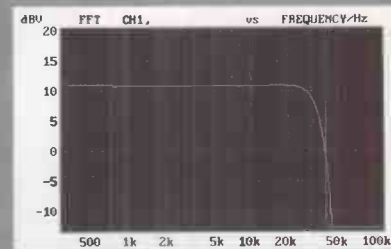

DISTORTION

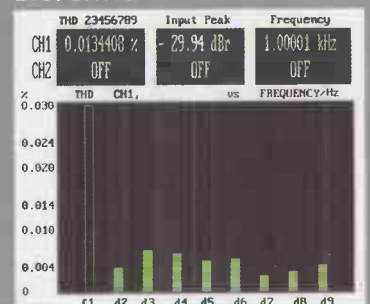

selectaudio
exquisite audio products

t. +44 (0)1900 813064

www.selectaudio.co.uk

e. select.audio@tiscali.co.uk



Melody Pure Black 101d Preamplifier

Melody



Pure Black 101d (rear)



Astro Black 50



Pure Black 88



Astro Black 40

- AirTight
- Emillé
- Luxman
- **Melody**
- Reimiyo
- Acoustic Signature
- Basis
- EMT
- Feastrex
- Gershman
- King Sound
- Basis PSTT Cables
- Boston Audio
- Harmonix

Melody Pure Black 101d Valve Preamplifier

In a very short time Australian designed Melody amplifiers have achieved world-wide acclaim. The company's **Pure Black 101d** valve pre-amplifier, for example, has already won recognition amongst Japan's hi-fi cognoscenti where it is now considered to be one of the three finest pre-amps in the world - regardless of price. Not surprisingly, this highly specified pre-amp features superior components throughout its state-of-the-art circuitry by specialists like Aerovox and Jensen. What is surprising is the price, at just £3,295.

Now Melody amplifiers are available here in Europe and already the French specialist magazine "Revue du Son et Home Cinema" has awarded the **Melody Pure Black 101d** its highest accolade, commenting "...this pre-amplifier is worthy of association with the best in the world..." Please call for further information.

SUPRA SWORD INTERCONNECT £349/0.8M

Supra is one of the only European cable brands that actually manufactures its own cables, to its own specifications, in its own factory (in Sweden). For a long time now, it has been producing very worthy, fine sounding interconnects and speaker cables, in any colour you like as long as it's pale blue. Successful as this has been, most buyers apparently still want luminous hues of purple or yellow for their aftermarket audio interconnects. So the new Sword is – shock, horror – semi-translucent, ermm, pale blue. Those crazy Swedes!

The cable itself is altogether more impressive – it boasts a number of Supra patents, the key one being the bifilar wound Litz conductors, each comprising 24 individually insulated wires. This bifilar winding is built with twelve of these wires helically wound in one direction and twelve in the opposite direction. This divides the magnetic field into opposing directions resulting in self-cancellation, says Supra. Because Sword's conductors comprise a number of insulated wires, dynamic

skin effect is cancelled, so therefore Sword behaves as a non-inductive and phase-stable cable, the theory goes.

In a high end cable market dominated by the likes of Chord Company, Black Rhodium and Nordost, it's a difficult call for a less well known name such as Supra, but the Sword is good enough to take on anything. Of course, each different variety of cable has its own character, but the Supra's will win many friends. It is exceptionally neutral, with just a touch of dryness noticeable against the likes of the (much more expensive) Chord Indigo. Bass is seriously strong and clean, but there's no artificial bloom. Midband is translucent, with a light, airy, spacious, widescreen presentation, and treble gloriously crisp and delicate. Rhythmically, the Sword lacks the exuberance of Black Rhodium rivals, but instead chooses to remain very controlled and detailed, even in exceptionally complex musical

passages. Dynamically it's also bold and powerful, whilst never losing it – if ever there was a cable that suited the phrase 'grace under pressure', this is it. An essential audition at the price then, an ideal for taming a splashy, loose or wayward high end system. For more information, click on www.supracables.co.uk or call +44(0)1223 441 299.



YAMAHA NX-U10 £149

As ever more people rip their entire CD collections to their computer hard drives, to play through network music players such as the Slim Devices Transporter, or via the now ubiquitous iPod digital music portable, it makes more sense to provide computers with decent sound systems for those moments when you want to access your music but can't play it any other way than by the built in speaker system. Unfortunately, the hardware manufacturers haven't quite twigged this yet, and even savvy brands like Apple still provide little in the way of audiophile satisfaction from even their high end notebooks. Enter Yamaha, whose NX-U10 is a one-box audio upgrade package for such applications. Plug it into any PC or Mac USB socket, and your music's digital datastream is pulled off the motherboard and into the built-in DAC of the Yamaha. It's converted to analogue, then amplified by a high quality 20W Class D amp and



piped out of the two small speakers at either end. The beautiful aluminium cabinet is designed to get the most out of these tiny transducers, and the result is a surprisingly civilised big sound that's far superior to any laptop sound system.

Basically then, the NX-U10 is a portable active digital speaker system designed to work hand-in-glove with a USB equipped notebook computer, but it does also accept a single analogue input (via 3.5mm minijack) should you want to plug in your iPod or MD portable too. It really is portable too, making it

ideal for those who use their notebooks for music in hotel rooms, and is powered either via the USB link or 4 AAA batteries, whereupon it gives four hours of playback. The result is music you'd never imagined possible from something this size. Of course, it's not a full range hi-fi device but all the basics are there – it's clean controlled and couth, with a surprisingly room filling sound and real detail and insight – especially via USB. It's far preferable to listening via your notebook PC, and you can slip it easily into your hand luggage. An excellent product for musos on the move. For more information, click on www.yamaha-uk.co.uk.

Hidden Aura

Adam Smith listens to the new Auracoustic Aura 3T loudspeakers



According to my dictionary, an aura is defined as 'a feeling or character that a person, place or thing seems to have'. Marxist cultural theorist Walter Benjamin also used the term to describe the feeling of awe created by unique or remarkable objects such as works of art or relics of the past. The Aura 3Ts are definitely far too young to be considered relics of the past, and whether you think them works of art is a personal matter, but they definitely generate a feeling of awe in most people who look at them! From this I would say that they have a definite aura, and are thus well named.

Auracoustic may be a new name to many, but the company has roots stretching back to the early 1970s. Originally they restricted themselves to the design and manufacture of professional loudspeakers under the name of Acoustic Sound Systems. However things moved along another step when A.S.S. were approached to design and construct a bespoke domestic hi-fi loudspeaker and the rest, as they say, is history. The Auracoustic range currently comprises five models, from the entry level £3,448 Aura 1 right up to the four way active model Aura 4T, which will relieve your wallet to the not inconsiderable tune of £14,654.

The 3Ts come in one down from the top and our review samples were impressively large and certainly very white indeed! Interestingly enough the Aura

3Ts fitted surprisingly well into the *Hi-Fi World* listening room as they were in front of a white wall and did a reasonable impression of disappearing. Fortunately Auracoustic will make your 3Ts in virtually any colour you desire, so whitewashing the walls of your house for minimal aesthetic upheaval is not necessary. A certain amount of upheaval is however required to position them, as they measure a healthy 985x540x630mm (max. HxWxD) and tip the scales at a not inconsiderable 65kg per 'speaker.

Auracoustic have very sensibly made use of top quality drive units including a twelve inch (300mm) Volt bass driver and three inch (75mm) midrange dome, and a one inch (25mm) Scanspeak Revelator tweeter. Designer Tony Rossell has taken good advantage of these high quality drivers and used this to make the crossover relatively simple. As an example, there is no electrical rolloff of the midrange dome at the upper end - the natural rolloff of the driver itself is utilised, with a suitable slope on the lower end of the tweeter spectrum to ensure good integration.

The paint finish on the cabinet is a rough textured type, which may not confer the ultimate in domestic harmony but the quality of the paintwork is beyond reproach. A powder coated metal grille, finished in the same colour as the cabinets is provided, but this is best removed, using the allen key supplied, for best results. Although the 3Ts have no provision for spikes, Auracoustic do supply cork domes to protect wooden floors, should your room have them. Three sets of terminals are provided on the rear panel to allow for bi- or tri-wiring or -amping

SOUND QUALITY

It is easy to detect the professional loudspeaker influence behind the Aura 3Ts, as they have a big, bold and dynamic character. From the first moment of the stylus hitting the groove, the music leaps out from the 'speakers and places performers right into your lap. Their overall balance is a very forward one, and they will definitely hit the spot for anyone whose system needs some livening up.

One of the most noticeable aspects of the 3T's performance is the astonishing amount of midrange and treble detail that they retrieve from music. Virtually all instruments really came alive, but my over-riding memory of the listening evaluation concerned percussive instruments. Drum skins had real form, and you could almost hear the drum sticks

swiping through the air to make contact with them. Cymbals were large and solid, with a superb metallic 'ting' to them - I suspect those really in the know could probably identify the cymbal manufacturer from a really good recording! Even a gently shaken set of maracas had real body and atmosphere.

A good part of the reason for this level of detail is the aforementioned overall balance of the loudspeaker. As can be seen from

"they sure hit the spot for anyone whose system needs livening up..."

the frequency response graph [see MEASURED PERFORMANCE] the 3T's output has an upward trend with increasing frequency and they have a bright overall balance. Fortunately, as they make use of a well designed tweeter which has been carefully integrated to the midrange, this only occasionally made things hard, with one or two singers becoming rather 'spitty' on poor recordings.

As we have said before, we do like the idea of a midrange dome, as it has definite benefits in terms of good midrange projection and detail, thanks to a wide dispersion pattern. Unfortunately, their implementation is not always wholly successful and integration with other drive units can be something of a challenge. Auracoustic have done very well in this respect, however, and there are no nasties present in the midrange/tweeter crossover region. The fact that they have achieved this, as mentioned previously, without the use of a low pass filter on the upper end of the midrange dome's range speaks very highly of the design.

Spinning a classical CD showed that the Aura 3Ts can lay out an orchestra just as well as a rock band and once again, instrument separation and atmosphere was impeccable. Making use of pieces that alternated between soft and loud, the manner in which the orchestra quietened to leave a single instrument playing was almost uncanny - it was easy to pick out where that soloist was sitting and if the 'action' moved to one of his colleagues, you knew it instantly.

Taking a softer, jazzier recording courtesy of Diana Krall, her vocals almost caressed the microphone, and the sound of fingers running up and down the fretboard of the backing double bass was quite eerie. The main bass

notes were excellently weighted and had real body without any sense of 'bloom' - one of the chief benefits of a large drive unit in a sturdy enclosure.

Moving to rock music, the Aura 3Ts proved they can more than carry a tune. They have lightning-fast reactions and stop and start on the proverbial sixpence. Once again, all instruments were rock-solid within a track, and located firmly between the loudspeakers. Throughout the

listening session, I was aware of subtle effects that I had never really been aware of before, such as the movement of a hand on a keyboard or on a guitar fret. If you want to hear absolutely everything that is going on in your recordings, then you really ought to check out the Aura 3Ts.

Bass performance of the Auracoustics was intriguing. As a result of the



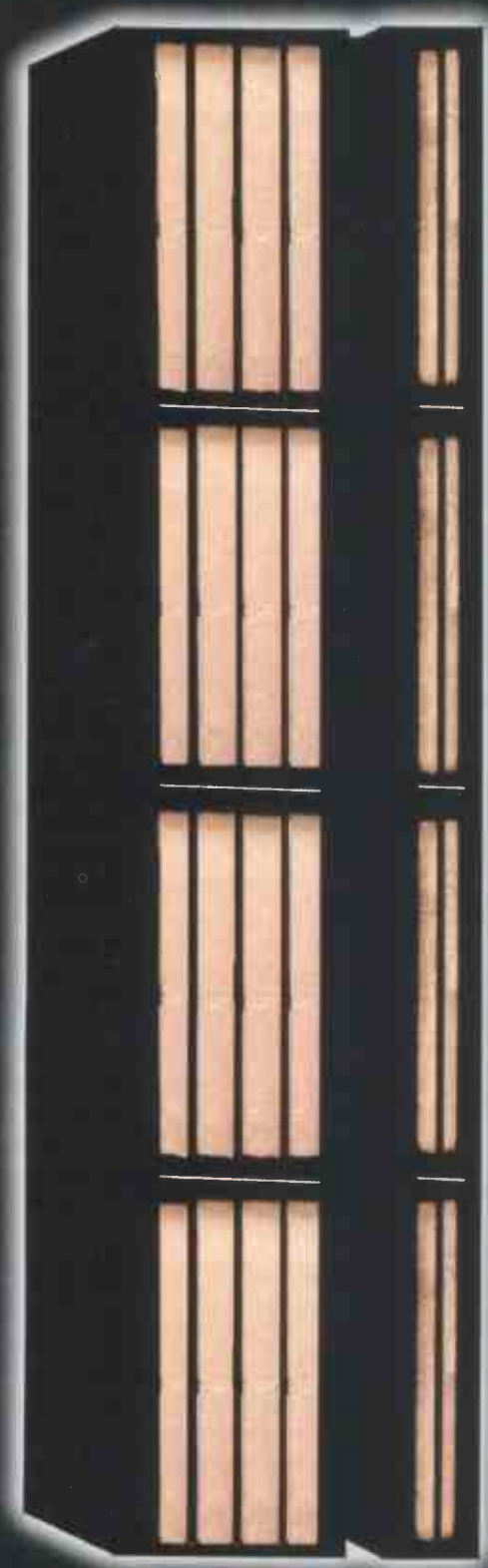

PINSHTM 9.0

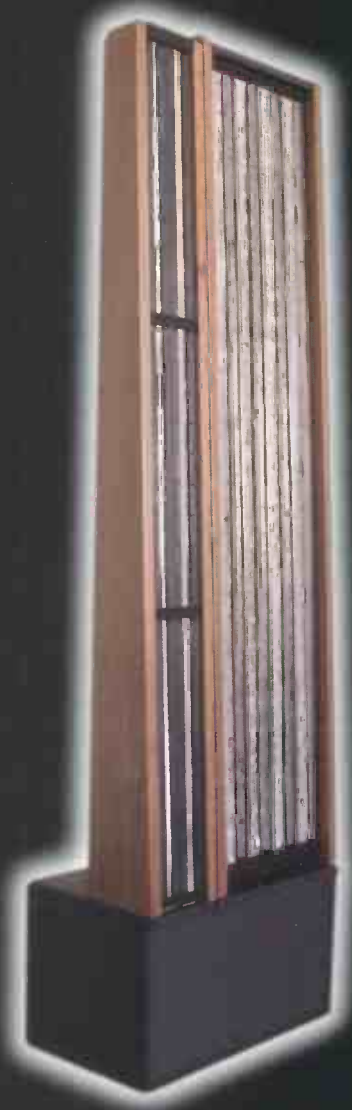

PINSHTM 6.0

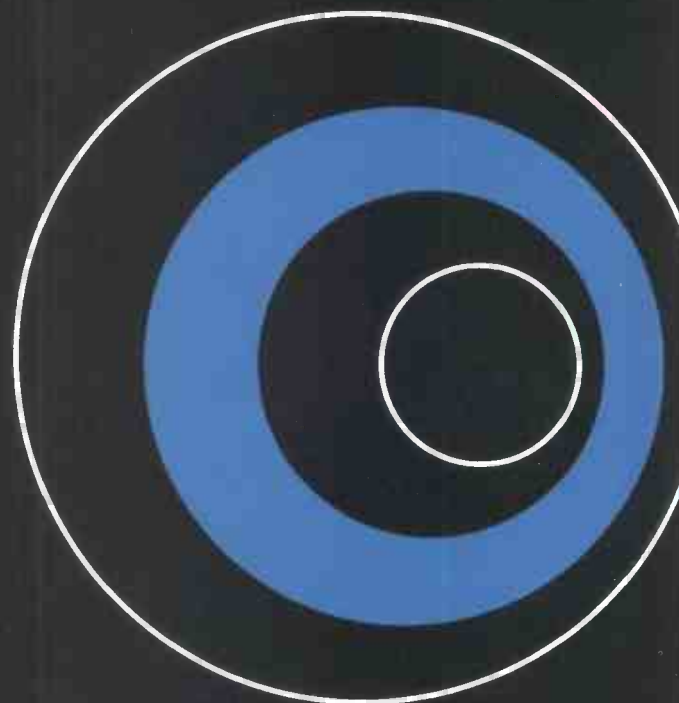

world leaders in ribbon technology

Tel: +44 (0) 208 683 6700 . www.pinsh.com



with superb detail. However, because of their bright nature, they will ruthlessly reveal a harsh or poor recording - there is no sugar-coating here. If your chosen album is poorly produced with a thin and screechy sound, you will certainly hear it. One or two discs in the office lasted no more than ten seconds or so in the CD player before we had to turn them off to avoid potential ear torture.

One final interesting aspect of the Aura 3Ts was that their overall character is quite strong, and they do not seem

dynamic and forward treble I was expecting the bass to be big and bold, but it is actually surprisingly subtle. Part of the reason for this is that they exhibit no boom or wallow in the low end, showing that the choice of bass driver and its integration with the cabinet and port system is a judicious one. The

overly fussy about partnering equipment. To illustrate this, most of the listening session was carried out using our Quad QC-twentyfour and Quad II-forty pre and power amps and even with these, high frequencies were bright and forward - we have

harsh - something that can be an issue with digital amplifiers like this. What I found was that the treble character barely changed - the Aura 3Ts clearly have their own dominant nature, and are not particularly fussy about what powers them.

CONCLUSION

The Auracoustic 3Ts are a very interesting loudspeaker. Clearly a great deal of thought by an experienced designer has gone into them and most aspects of their performance are very good. When it comes to accurate reproduction of instruments' finer details, I have heard very few loudspeakers at any price point that can resolve like the Aura 3Ts.

The Auracoustics are forward and dynamic with real treble and midrange energy and a bass that, whilst a little 'shy' at times, has good depth and pace, without any hint of boom. In many ways they have the characteristics of a true monitor loudspeaker, in that they are ruthlessly revealing. This is a good thing most of the time, but the downside is that bad recordings really do sound bad.

If you are used to an aural diet of soft, mellow loudspeakers such as low-powered full range units driven by valve amplifiers, the performance of the Auracoustic Aura 3Ts could well come as something of a shock. However, if you really want to hear right into your recordings and are not afraid of what they might tell you, then they are definitely worth auditioning. They have their own unique 'aura' that could well be what you have been waiting for.

VERDICT ●●●●●
Lively and dynamic loudspeakers with excellent detail retrieval and exciting sound, but their forward balance may prove too relentless for some.

AURACOUSTIC
AURA 3T £12,348
Universal Audio Limited
☎ +44 (0) 1702 613321
www.auracoustic.co.uk

FOR
- superb mid and treble detail
- taut, fast bass
- unfussy load

AGAINST
- bass impact a little lacking
- forward balance

"...the Auracoustic Aura 3Ts are dynamic, forward and exciting with superb detail!"

Aura 3Ts are not bass-light by any means, and they not only go deep, but have superb upper bass detail and pace. I just felt on occasions that they seemed to be holding back a little and I do wonder if the dip in the response at 200Hz found during measurement [see MEASURED PERFORMANCE] is aiding this. Consequently anyone who is hoping for a big loudspeaker to pummel their chest and rearrange their internal organs might find them to be a little restrained in this respect.

So, the Auracoustic Aura 3Ts are dynamic, forward and exciting

certainly never heard treble like it from them before! However, the Quads do have quite a soft bass and, for this reason, I hooked up a pair of NuForce Reference 9 power amplifiers. I had a feeling that they would tighten up and improve the Aura 3Ts bass further (which they did) but I was also concerned as to whether the treble would become too

MEASURED PERFORMANCE

The Auracoustic Aura 3Ts have a gently rising output trend in their response, which means they will sound bright and lively. The midrange and treble region is smooth, with only a small undulation around the area where the mid and treble units cross over - the two units are mated together well and this lift will serve to increase midrange detail.

Bass output from the twelve inch driver is good down to 60Hz and usefully enhanced by the port, which fires out of the sloped bottom of the loudspeaker and is tuned to around 35Hz. The 'dip' in the response at 200Hz seems to be a cancellation issue between the drive units, but further investigation would be required to confirm the source of this.

The Aura 3Ts have a high average measured impedance of 10.8 Ohms, dipping to a minimum of around 5 Ohms and this, combined with their high measured sensitivity of 90dB, means

that they go loud with as little as 20W, and are not a difficult load to drive. AS

FREQUENCY RESPONSE

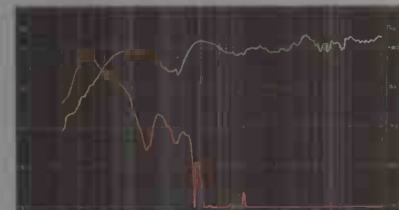

Green - driver output
Red - port output

IMPEDANCE

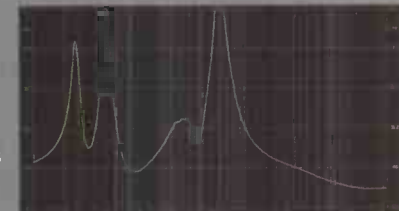

In a world where so much looks the same,
we take pride in being different !

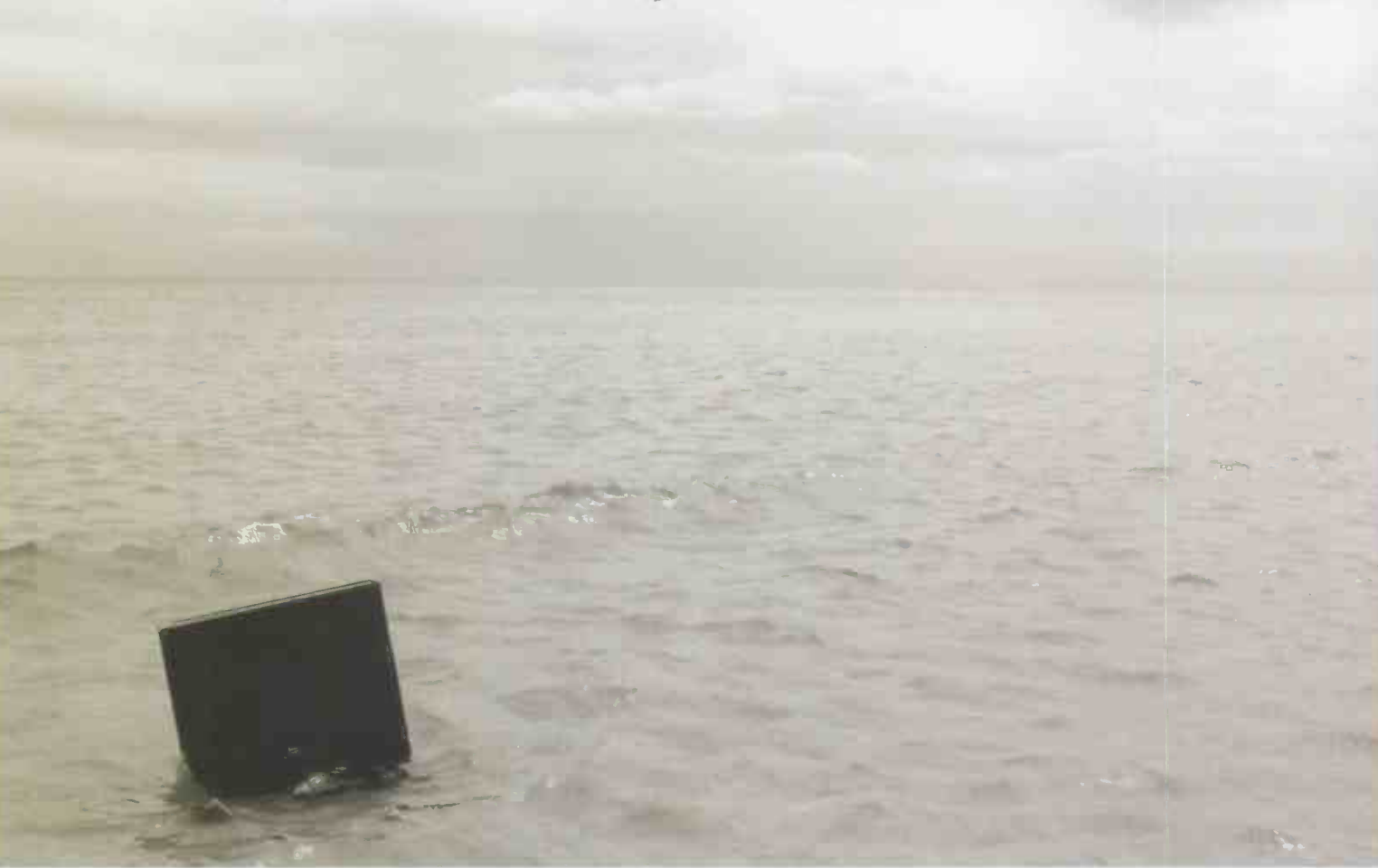

Lifetime warranty is a natural part of our philosophy

Densen products are built for life and for long-lasting state-of-the-art performance. That's why all Densen products come with an exclusive lifetime warranty. The warranty is a global carry-in warranty that lasts as long as you own the product. At this time in history, Densen is the only manufacturer to offer lifetime warranty on high-end Hi-Fi. However, the warranty is no longer valid if you want to find out if the products float on water. Believe us, they don't...

It is our intention to make complete products. Not just products that are sonically superior, but complete like a perfect circle. As you learn about Densen, you'll discover that we go the extra mile in every aspect: design, user-friendliness, quality, warranty, upgradeability, production methods and of course sound quality. But you really won't have a clue about it all until you get to hear and see what we're talking about in real life. Then you will know what we mean when we say Air-Guitar factor (say what? check our website). There is one Air-Guitar / Air-Baton included with every Densen product. LIFE IS TOO SHORT FOR BORING HI-FI

This is some of the awards our products have received from the most respected magazines in the world:



Authorised dealers:

Acoustic Arts, Bedfordshire, Tel. 01923 245250 - Adventures In Hi-Fi Ltd., Chester, Tel. 01942 234202 - The Audio Room, Hedon, Tel. 01482 891375 - Adams & Jarrett, East Sussex, Tel. 01424 437165 - Divine Audio, Leicestershire, Tel. 01858 432999 - Glasgow Audio, Glasgow, Tel. 01413 324707 - Hi-Fi Studios, Doncaster, Tel. 01302 725550 - Holburn Hi-Fi, Aberdeen, Tel. 01224 585713 - New Audio Frontiers, Loughborough, Tel. 01509 264002 - Phonography, Ringwood, Tel. 01425 461230 - Practical Hi-Fi, Lancaster, Tel. 01524 39657 - Practical Hi-Fi, Manchester, Tel. 01618 398869 - Practical Hi-Fi, Preston, Tel. 01772 883958 - Practical Hi-Fi, Warrington, Tel. 01925 632179 - R.J.F, Cornwall, Tel. 01209 710777 - Sound Seduction, Sevenoaks, Tel. 01732 456573 - VideoTech, Huddersfield, Tel. 01484 516670

Densen Audio Technologies - Phone: (+45) 75 18 12 14 - E-mail: mail@densen.dk

w w w . d e n s e n . c o m

WIN A SET OF BRILLIANCE HI-FI CABLES WORTH £1,000 IN THIS MONTH'S GREAT COMPETITION!



April's *Hi-Fi World* competition is a competition with a twist! Instead of us choosing which bit of kit you have the chance to win, this month you do! You can literally choose any combination of cables from Brilliance Hi-Fi, up to but not exceeding the value of £1,000!

Brilliance is an excellent new cable brand. We've traced their evolution over the past few years, from makers of basic, 'affordable audiophile' budget interconnects to purveyors of extremely impressive high end cables of the interconnect and loudspeaker variety. Nowadays, the company offers everything any stereo or multichannel audiophile would want, including digital and AV interconnects and single or biwired loudspeaker cables. Whatever the cable, we've found that Brilliance has not lost touch with its 'value for money' ethos, meaning that £1,000 spent with them buys you a lot of high quality cabling. David Price had this to say about the Brilliance Hi-Fi Euphony:

"This mid-to-high end interconnect is equally no-nonsense in presentation – no lurid 'day-glo' shell suit colours here. The braided sleeve is of excellent quality, and the soldering to the WBT-0144 locking RCA plugs is excellent too. These are a pain for reviewers constantly plugging and unplugging cables, but once you've locked them into position, they stay! Euphony uses a twisted pair configuration, but beyond this Brilliance doesn't specify technical details. The performance speaks volumes, the Euphony proving more than price competitive - in sub-£300 terms this is utterly on the pace with an expansive, detailed and engaging sound. Whilst it never sounds explicitly detailed it is no less informative and more engaging to listen to than almost all rivals under £300. Bass is full but controlled, midband is mellifluous and beguiling, and treble silky smooth and spacious. Overall, an excellent interconnect that just plays music. Many will be reassured that much of the purchase price has been spent on the cable, rather than fancy packaging."

Here's what DP wrote about the Brilliance Purity AES/EBU DCT digital interconnect, costing £170/m: "Brilliance Hi-Fi's new Purity DCT Balanced Digital AES/EBU interconnect is designed for high end domestic and professional digital applications. The Purity has a true 110 Ohm impedance-matched design using the latest shielded twisted pair (STP) cable and Neutrik XLR plugs with gold plated contacts. Low capacitance of 39 pF/m ensures minimal signal degradation on this, the most critical of applications from the digital source of your audio system. Performance is further enhanced by advanced screening and termination topology, and the cable parts have been cryogenically treated in order to maximise the listening experience. Price is a very affordable £140 for the first half metre with an additional £30 for each additional half metre, (or part thereof). *Hi-Fi World's* audition of this cable has been encouraging; as we've found with the company's other products, it gives results way beyond those expected at the price".

If you'd like the chance to win Brilliance Hi-Fi interconnects to the value of £1,000, then all you have to do is answer the following four easy questions. Send your entries on a postcard by 31st March 2007: **April 2007 Competition, Hi-Fi World magazine, Unit G4, Argo House, The Park Business Centre, Kilburn Park Road, London NW6 5LF.**

RULES AND CONDITIONS OF ENTRY

- ONLY ONE ENTRY PER HOUSEHOLD
- MULTIPLE ENTRIES WILL BE AUTOMATICALLY DISQUALIFIED
- PURCHASE OF THE MAGAZINE IS NOT A PRE-CONDITION OF ENTRY
- NO CORRESPONDENCE WILL BE ENTERED INTO
- THE EDITOR'S DECISION IS FINAL
- NO EMPLOYEES OF AUDIO PUBLISHING LIMITED, OR OF ANY COMPANIES ASSOCIATED WITH THE PRODUCTION OR DISTRIBUTION OF THE PRIZES, MAY ENTER

QUESTIONS

[1] How did DP describe The Euphony's presentation?

- [a] "no-nonsense"
- [b] "full on"
- [c] "loud and proud"
- [d] "gauche"

[2] What configuration does the Euphony use?

- [a] twisted pair
- [b] double or quits
- [c] uptown top-ranking
- [d] naughty but nice

[3] What impedance does the Purity have?

- [a] 110 Ohm
- [b] 1 Ohm
- [c] 11 Ohm
- [d] 1,010 Ohm

[4] How have the Purity's cable parts been treated?

- [a] cryogenically
- [b] spiritually
- [c] abysmally
- [d] sympathetically

April Competition
Hi-Fi World Magazine
Unit G4 Argo House
The Park Business Centre
Kilburn Park Rd.
London NW6 5LF

entries will be accepted on a postcard only

**JANUARY 2007 ACOUSTIC SIGNATURE CHALLENGER WINNER:
Mrs. Penny Bell of Bagshot, Surrey**



Don't let the heatsinks fool you, Rotel's new RB-1092 Class D stereo power amplifier is a super cool customer, says David Price.

Ice Cool

The past few years have seen a quiet revolution in stereo amplifier design, as we've witnessed a migration from one way of designing power amplifiers to another. The move from Class AB to Class D operation is significant for a number of reasons – arguably almost on a par with the move from tube to transistor in the great scheme of amplifier things.

For many years, the natural choice for a do-it-all amplifier design was Class B, where the output transistors are switched on (and then off) if and when power is demanded from them. This was a sensible way of putting electrical energy into your speakers, being a lot more efficient than Class A which kept the output transistors permanently powered up. Thanks to the lack of 'switching distortion', the latter class sounded cleaner, but drank power like it was going out of fashion and generated massive heat which caused its own set of problems.

Then came Class D operation, using a completely new type of switching circuitry. The technology has been around for a while now, but early examples were certainly not very successful for audiophile applications, possessing an unpleasantly sterile sound. In the past two years though, we've seen

some very impressive designs from the likes of Lyngdorf, Onkyo, Flying Mole and NuForce. Large reserves of clean power and the conspicuous lack of that metallic upper-midband mush that most Class AB designs possess has made them a qualified sonic success. However, Class D's detractors point to what is still a slightly matter-of-fact character and lack of tonal breadth.

Now, Class D operation is finding itself in more and more audiophile arenas, and Japanese manufacturers have been particularly swift to adopt the technology. Efficiency is the main advantage – power is only dissipated by the output transistors during the very short interval between their on and off states. Also, because this instantaneous power dissipated is so low, smaller heatsinks and less robust power supplies are needed, meaning lower weight (and lower build and shipping costs too). Love or loathe the Class D sound, there's no denying that it's cheap and efficient.

Rotel is the latest big name to go the Class D way, the RB-1092 using the ICE power technology first seen on its RMB-1077 amplifier. At £1,595 it's not cheap, but promises a massive 500W per channel into 8 Ohms [see MEASURED PERFORMANCE]. There's also the RB-1091 monoblock design, retailing for just £995. Both are available in

either silver/black, or black finishes. Measuring 432x92x407mm, the RB-1092 is sizeable device and at 10kg is fairly heavy too, but much of the Rotel's bulk and weight is taken by the visually impressive matt black heatsinking.

SOUND QUALITY

The RB-1092 found itself driving both my Quad ESL989 and Yamaha NS1000M loudspeakers, and turned in an extremely pleasant performance with both. Kicking off with Supertramp's 'Breakfast in America' CD, the Rotel showed itself as a quintessentially Class D sounding device. The phrase 'massive reserves of clean power' springs to mind – the RB-1092 goes very loud, just as its spec suggests. Furthermore, it sounds smooth and even right across the frequency band. Bass is dry and strong and well articulated, midband expansive, detailed and dimensional and treble was crisp and clean. This is quite similar to the NuForce Reference 9SEs in this respect – the sound proving so agreeable that on a superficial level that it's hard to criticise.

Bass was truly promising. It isn't overtly imposing – the amplifier doesn't keep reminding you of its bulk – but was never less than strong and insistent. As 'The Logical Song' builds to a crescendo the track

becomes louder and louder, and ever more complex, but the Rotel resolutely refused to go light in the bass. Instead it remained firmly in control, shrugging off the increased demand on it with disdain. Bass lines were always firm and full of body. However, compared to the admittedly pricier pair of NuForces, the bass was a tad less tuneful, suggesting that the move to two RB-1091 monoblocks might yield returns in this area.

The midband was superb, in a Class D kind of way. I fear that valve aficionados - and I am one - shall never be convinced that digital amplifiers will achieve the same vocal presence as a good tube design. Kate Bush's 'The Sensual World' was a joy, with oodles of detail, fantastic control and composure, impressive dynamics

"the Rotel keeps its cool when other power amplifiers are losing theirs..."

and a strong stereo soundstage, but her icy voice sounded chilly - not 'cold' as such, just dispassionate, the Rotel lacking the intimacy you get from the similarly priced Unison Research S6 tube amplifier for example. Moving back to Supertramp, and Rodger Hodgson's voice (a tad shrill through the wrong equipment) was very clearly depicted, lacking little in detail and sounding only slightly thin compared to my reference World Audio Design K5881 valve amplifier - but then again, so it does through every other transistor amplifier I've heard!

Still, with its lovely taut and gutsy bass and smooth and expansive midband, the Rotel proved extremely satisfying to listen to. Even Dave Brubeck's 'Take Five' on vinyl was warm and engrossing experience, the fractionally dry character of the RB-1092 compensating for the euphonic tonal bloom of my vdH Frog cartridge here. It is a genuinely musically communicative bit of kit - forget those early tales of Class D amplifiers sounding like the aural equivalent of watching the grass grow.

I was very impressed by its upper mid band, which compared to ye olde Class AB was most smooth - REM's 'Perfect Circle' showed none of the clang of my old Musical Fidelity XA-200s, for example. Its tonality isn't exactly dark and velvety, but is very neutral and most certainly not brightly lit across the midband. Same goes for the treble too, which was

a wonderfully clean and spacious experience. True, tube treble is nicer, but whether it's more accurate is another story...

The Rotel was actually best suited to classical music. It is a taut, composed, tidy sounding design with massive reserves of power, and this shows itself at lower levels by a lack of strain on crescendos. Debussy's 'Submerged Cathedral' was a perfect

example of this - the Rotel hanging on Trojan-like as the brooding piano cadences got ever louder. This is its forte - it keeps its cool when most other power amplifiers around are losing theirs. Again, that expansive midband, bristling with detail, was a pleasure to listen to - the RB-1092 being subtle enough to capture every nuance and inflection of the playing.

CONCLUSION

A couple of years back, a power amplifier as competent as this across so many areas would have been a revelation, but we're now in an age where Lyngdorf's superb SDA2175 can do a good deal of what the Rotel does at half the price. However, it isn't anywhere near as powerful or transparent. On the other hand, less than twice the outlay buys you a pair of NuForce Reference 9SE monoblocks, which have greater transparency and musical lucidity, plus dizzying speed too.

These rivals show the Rotel RB-1092 to be a brilliant bridge between the two. For many, the Lyngdorf might not be quite



REFERENCE SYSTEM

- Micell GyroDec/TecnoArm/vdH The Frog turntable
- Whest Audio PS20/MSU20 phonostage
- Marantz CD63 KI DP CD player
- MF Audio Passive Magnetic Preamplifier (silver)
- World Audio Design K5881 power amp (modified)
- NuForce Reference 9SE monoblock power amps
- Quad 989 loudspeakers
- Yamaha NS1000M loudspeakers
- Black Rhodium interconnects/cables

enough, whereas the NuForces may prove too pricey. Here the Rotel is a great buy - it has an extremely accomplished sound and massive reserves of power. I suspect the half a kilowatt is too much for any normal mortal, but it's the grace that the Rotel displays at lower levels that makes having this extra 'cubic capacity' under the hood worth having. It's a genuinely svelte sounding bit of kit, capable of making very nice noises with even the most demanding of loudspeakers. To do so much for £1,595 means it represents excellent value and is an essential audition - but I'm still not so sure about those heatsinks...

VERDICT

Excellent sonic performance and vast power reserves make this a superb premium power amplifier.

ROTEL RB-1092 £1,595

Rotel
+44 (0) 1903 221 600
www.rotel.co.uk

FOR

- tonal accuracy
- control
- power

AGAINST

- nothing at the price

MEASURED PERFORMANCE

The Rotel's power output is so high that pulsed sine wave tests had to be applied. These revealed an rms output of no less than 576 watts into 8 Ohms and 1,076 watts into 4 Ohms - vast amounts of power. Rotel current limit at 40A no less. So the RB-1092 can deliver very high volume from an insensitive loudspeaker in a very large room. Loudspeaker power handling capacity needs to be high if all this power is used. As nearly 70V appears across the output sockets, fully shrouded. Speaker loudspeaker outputs are fitted for safety.

Distortion levels were low at around 0.01%, except when delivering high frequencies into a 4 Ohm load when level rose to 0.2%, mainly third harmonic. This should not be of much consequence subjectively. As digital amplifiers go, the RB-1092 produces very little distortion.

The amplifier is bandwidth limited to exactly 20kHz (-1dB), but there is still a switching frequency signal of around 1.5V at 364kHz. Both loudspeaker terminals are 61V d.c. above ground too, as expected from a high power digital amplifier.

The RB-1092 is a digital design,

offering super high power output with no heat, from a small package. It is bandwidth limited to eliminate high frequency distortion and spuria. The result should be a smooth, muscular sound, likely with good transients and clear low levels due to absence of crossover hash. NK

Power	576 watts
CD/tuner/aux.	
Frequency response (-1dB)	5Hz-20kHz
Separation	101dB
Noise	-122dB
Distortion	0.01%
Sensitivity	3V

DISTORTION

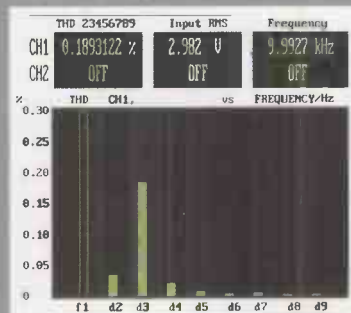

UPGRADE YOUR HI-FI SYSTEM

Call your local
SEVENOAKS store for
a free demonstration

Experience the best hi-fi at
SEVENOAKS



WHAT HI-FI?
SOUND AND VISION
AWARDS 2006
BEST-SELLING SYSTEM
BEST-SELLING COMP
ARCAM SOLO

*"The Solo sticks its neck out,
and goes it alone – and it's an
unmitigated success. Looks, style
and ability, for now, this is the
one-box system to rule them all"*

ARCAM SOLO MUSIC SYSTEM

- Amazing sound from an integrated system
- Exceptional quality CD, FM and DAB digital radio
- Integrated iPod connection - hear how good your iPod can sound
- From Arcam, a great British company

Try it with...

MONITOR AUDIO RS1 SPEAKERS

- Compact Design
- Metal Cone Technology
- Available in a Choice of Finishes

WHAT HI-FI?
SOUND AND VISION
★★★★★
DECEMBER 2005



WHAT HI-FI?
SOUND AND VISION
AWARDS 2006
BEST-SELLING SYSTEM
BEST-SELLING COMP
PROJECT DEBUT III



Revive your record collection

with Project turntables. The range includes the award-winning Debut (pictured above).

PROJECT DEBUT III

- Two Speed, Belt Drive
- Supplied Complete with Cartridge
- What Hi-Fi? Award Winner



WHAT HI-FI?
SOUND AND VISION
★★★★★
APRIL 2006

YAMAHA CRX-M170

- Comprises CD Player, Amplifier and DAB/FM Tuner
- Compact System
- What Hi-Fi? Recommended

ONKYO CS-515DAB

This award-winning micro delivers exceptional performance and is superb value for money.

"A truly musical micro system"



WHAT HI-FI?
SOUND AND VISION
AWARDS 2006
PRODUCT OF THE YEAR
ALUMINUM FINISH
ONKYO CS-515DAB

MARANTZ

Marantz products range from high-end hi-fi to HD-ready DVD players and AV receivers. Its hi-fi range includes the CD5000 and CD50010SE CD players, the SA7001 SACD player and the PM4001 amplifier, offering a taste of high-end audio at an incredibly competitive price.



WHAT HI-FI?
SOUND AND VISION
★★★★★
JANUARY 2006



NEW

CYRUS

If you've enjoyed listening to music before, try listening to it through a Cyrus system. With every product tuned by ear, Cyrus represents a quality of sound, which is rare at any price. **NEW DAB 8.0 Tuner.**

PRIMARE

With class-leading build quality, and a unique blend of sophisticated Scandinavian design, Primare build elegant, reliable, easy-to-use systems that promise years of high quality performance.



WHAT HI-FI?
SOUND AND VISION
AWARDS 2006
BEST CD PLAYER
BEST STEREO AMPLIFIER
BEST STEREO AMPLIFIER
BEST STEREO AMPLIFIER
BEST STEREO AMPLIFIER

Getting the most from your hi-fi system

Sevenoaks has 34 years' experience in the hi-fi market - and nobody knows more about getting the most from music. With the major brands in stock, Sevenoaks can help you choose individual components or design a complete system from scratch. Just tell our in-store experts what you listen to, when and where.

- OUTSTANDING VALUE
- TOP QUALITY BRANDS
- LATEST TECHNOLOGY
- EXPERT IMPARTIAL ADVICE

SEVENOAKS

SOUND & VISION

The Experts in Home Entertainment

MONITOR AUDIO BRONZE BR5 SPEAKERS

The new BR5 is an astonishing mix of clarity, exuberance and power from a deceptively slender loudspeaker.

- 2.5-Way Design
- Finish Options Available

"Unmatchable musical sound from a floorstander under £500 coupled with Monitor Audio's excellent build quality"

WHAT HI-FI?
SOUND AND VISION
★★★★★
MARCH 2006

SONOS DIGITAL MUSIC SYSTEM

Sonos is the first and only digital music system that lets you play all your digital music, all over your house - and control it from the palm of your hand.

"Simple to set-up, great to use... Sound-quality is first-rate"



WHAT HI-FI?
SOUND AND VISION
AWARDS 2006
BEST DIGITAL MUSIC SYSTEM

ARCAM DIVA SERIES

Arcam believes that superb sound quality is vital to the real enjoyment of music. The DIVA range reproduces music at a level that is remarkably true to life.



WHAT HI-FI?
SOUND AND VISION
AWARDS 2004
BEST CD PLAYER
£250-£500
Arcam CD731

Don't Forget! Accessories make the difference

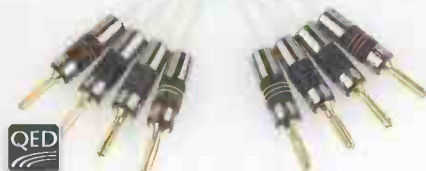

QED

The quality of sound and vision a system produces is determined as much by its accessories as its main components. At Sevenoaks, accessories are not an afterthought - our staff can demonstrate the difference the right accessories can make to your home entertainment experience.

SPENDOR S5e SPEAKERS

- Hand-made 'e' generation bass-midrange drive units reward with a uniquely clear and musical sound.
- Natural wood cabinets incorporating Dynamic Damping engineered to eliminate booming.

WHAT HI-FI?
SOUND AND VISION
★★★★★
OCTOBER 2004



KEF iQ5 SPEAKERS

- Uni-Q Design
- Finish Options
- Floorstanding
- What Hi-Fi? Award-Winner

"The iQ5s are little stars, providing stunning scale and authority from discreetly sized towers... The iQ5s are fully deserving Products of the Year."

WHAT HI-FI?
SOUND AND VISION
AWARDS 2006
PRODUCT OF THE YEAR
VIDEO PRODUCT
KEF IQ5



ROTEL 06 SERIES

Rotel's 06 Series will give you years of enjoyment and offers excellent value for money. This range of separates creates a sound that, the more you hear it, the better it gets.

"RA05 - Best stereo amplifier under £500 in Awards 2006"

WHAT HI-FI?
SOUND AND VISION
AWARDS 2006
STEREO AMPLIFIER
BEST STEREO AMPLIFIER UNDER £500
ROTEL RA05



NEW



Design & Custom Install at SEVENOAKS



A vision for every home

Create your dreams with the latest home entertainment technology. Whether it be home cinema, quality hi-fi or multi-room, Sevenoaks will transform your home and increase your viewing and listening pleasure.

Sevenoaks Design and Custom Install provides a solution that meets your exact needs and budget.

At Sevenoaks, we create bespoke home entertainment systems of the highest quality that complement your home and lifestyle.

With 49 stores and over 30 years of experience, Sevenoaks creates systems that will transform your life.



Multi-room systems

A multi-room system puts all your home cinema and/or hi-fi equipment in one place and gives you control at the touch of a button. Put screens and speakers in as many rooms as you want and control what you listen to or watch from one central hub. With hard-disk technology, you can store your entire DVD and CD collections in one place and play different films or music tracks in different rooms at the same time.

Sevenoaks staff are experienced at installing both simple and complex multi-room systems, ensuring they integrate with look and feel of your home as well as being fully functional and easy to operate.



How it works

The Sevenoaks custom install service takes in everything from initial site visits to designing and planing your system, through to project management and installation to ensure you get the most from your home entertainment system.

Sevenoaks consults with you at every stage and, if required will liaise with builders and architects.



Call your local SEVENOAKS store to book a site survey or a free in-store demonstration

SEVENOAKS GUIDE

Pick-up our 2007 Hi-Fi & Home Cinema Guide at your local store. Alternatively, it can be ordered via our Website and posted to you (UK mainland addresses only) FREE OF CHARGE.



SIM2 DOMINO D35 DLP PROJECTOR

SIM2 is synonymous with the finest quality home cinema projectors and the new D35 model adds to that enviable reputation.

INFOCUS IN76 DLP PROJECTOR

Fill your screen with bright, vivid, crisp and detailed images with this award-winning, 720p resolution, DLP projector.



Choose the best in the business

Sevenoaks Sound & Vision is the UK's largest specialist retailer of high-quality home entertainment solutions. With 49 stores nationwide and a proud history of satisfying customers, Sevenoaks has a hard-earned reputation as the most comprehensive provider of home cinema, hi-fi and multi-room audio systems, offering excellence in customer service and a unique design and custom install option.

Ahead of the field

- **LEADER for quality brands.** Sevenoaks' 100 per cent independent status means it can bring together the finest components and systems under one roof.
- **LEADER for quality staff.** Sevenoaks employees are home cinema and hi-fi enthusiasts with a passion for the products and satisfying customers.
- **LEADER for quality service.** At Sevenoaks, customers are treated as individuals and solutions are designed for individual needs.
- **LEADER for custom install.** Few retailers have more experience of designing, installing and optimising bespoke systems in homes.

- OUTSTANDING VALUE
- TOP QUALITY BRANDS
- LATEST TECHNOLOGY
- EXPERT IMPARTIAL ADVICE

SEVENOAKS

SOUND & VISION

The Experts in Home Entertainment



Your nearest store
www.ssav.com

All SEVENOAKS stores:

- are staffed by experts in home cinema and hi-fi
- stock leading brands to offer a range of quality products
- offer impartial and personal service
- have home cinema and hi-fi demonstration rooms

Come and visit us

ABERDEEN

57 CROWN STREET
01224 252797

BEDFORD

29-31 ST PETERS STREET
01234 272779

BRIGHTON

57 WESTERN ROAD, HOVE
01273 733338

BRISTOL

92B WHITELADIES ROAD, CLIFTON
0117 974 3727

BROMLEY

39A EAST STREET
020 8290 1988

CAMBRIDGE

17 BURLEIGH STREET
01223 304770

CARDIFF

104-106 ALBANY ROAD
029 2047 2899

CHELSEA

403 KINGS ROAD
020 7352 9466

CHELTENHAM

14 PITVILLE STREET
01242 241171

CRAWLEY

32 THE BOULEVARD
01293 510777

CROYDON

369-373 LONDON ROAD
020 8665 1203

EALING OPEN SUNDAY

24 THE GREEN
020 8579 8777

EDINBURGH

5 THE GRASSMARKET
0131 229 7267

EPSOM OPEN SUNDAY

12 UPPER HIGH STREET
01372 720720

EXETER

28 COWICK STREET
01392 218895

GLASGOW OPEN SUNDAY

88 GREAT WESTERN ROAD
0141 332 9655

GUILDFORD

73B NORTH STREET
01483 536666

HOLBORN

144-148 GRAYS INN ROAD
020 7837 7540

HULL

1 SAVILE ROW, SAVILE STREET
01482 587171

KINGSTON OPEN SUNDAY

43 FIFE ROAD
020 8547 0717

LEEDS

62 NORTH STREET
0113 245 2775

LEICESTER

10 LOSEBY LANE
0116 253 6567

LINCOLN

20-22 CORPORATION STREET (OFF HIGH ST)
01522 527397

LOUGHTON

7-9 GOLDINGS HILL
020 8532 0770

MAIDSTONE OPEN SUNDAY

96 WEEK STREET
01622 686366

MANCHESTER

69 HIGH STREET, CITY CENTRE
0161 831 7969

NEWCASTLE

19 NEWGATE STREET
0191 221 2320

NORWICH

29-29A ST GILES STREET
01603 767605

NOTTINGHAM

597-599 MANSFIELD ROAD, SHERWOOD
0115 911 2121

OXFORD

41 ST CLEMENTS STREET
01865 241773

PETERBOROUGH OPEN SUNDAY

36-38 PARK ROAD
01733 897697

PLYMOUTH

107 CORNWALL STREET
01752 226011

POOLE

LATIMER HOUSE, 44-46 HIGH STREET
01202 671677

PRESTON OPEN SUNDAY

40-41 LUNE STREET
01772 825777

READING

3-4 THE WALK, KING STREET
0118 959 7768

SEVENOAKS

109-113 LONDON ROAD
01732 459555

SHEFFIELD OPEN SUNDAY

635 QUEENS ROAD, HEELEY
0114 255 5861

SOLIHULL

149-151 STRATFORD ROAD
0121 733 3727

SOUTHAMPTON

33 LONDON ROAD
023 8033 7770

SOUTHGATE

77 CHASE SIDE
020 8886 2777

STAINES OPEN SUNDAY

4 THAMES STREET
01784 460777

SWINDON

8-9 COMMERCIAL ROAD
01793 610992

SWISS COTTAGE OPEN SUNDAY

21 NORTHWAYS PARADE, FINCHLEY RD
020 7722 9777

TUNBRIDGE WELLS

28-30 ST JOHNS ROAD
01892 531543

WATFORD

478 ST ALBANS ROAD
01923 213533

WEYBRIDGE

43 CHURCH STREET, THE QUADRANT
01932 828525

WITHAM (ESSEX)

1 THE GROVE CENTRE
01376 501733

WOLVERHAMPTON

29-30 CLEVELAND STREET
01902 312225

YEOVIL

14 SILVER STREET
01935 700078

FOR OPENING HOURS, PLEASE CALL YOUR LOCAL STORE OR VISIT OUR WEBSITE

PRICING POLICY

We always try to ensure our prices are highly competitive. In the event you can find the same products and excellent service at a lower price, please bring it to our store managers' attention.

FLEXIBLE FINANCE OPTIONS*

Spread the cost of buying. Flexible finance options* are available on the majority of products we stock.

*Written details on request. Licensed credit brokers. Minimum balance £400. Subject to status.

PLEASE NOTE

Some products/brands are not available at all stores. Please call to confirm or visit our website before travelling. Special Offers and Sale Offers - Not in conjunction with any other offer.

ADVERT VALID UNTIL AT LEAST 05/04/2007, E&OE.

Sound Value

After a protracted period of absence, Denon is back in the affordable stereo separates markets. David Price finds the £500 DCD-700AE/PMA-700AE CD player/integrated amplifier combo gives plenty of sound per pound...

I've always been a big fan of Denon. I've owned a 1978 DP-2500 turntable, 1979 PM-850 integrated amplifier and 1988 DCD-3520 CD player and in the past, marvelled at the beautiful way they were put together, and enjoyed the exquisite noises they made. So it was with great sadness that I noticed a few years ago that they were more or less abandoning stereo for multichannel AV. I know they've had real success with their DVD players, but frankly that is not where my heart lies...

Amazingly though, on a trip to Japan a year and a half ago I spied a high end integrated amplifier and a silver disc player that did not play umpteen combinations of Digital Versatile Disc. Sure enough, it was a top notch two channel stereo CD player – Denon, it seemed, were back on the block.

The next surprise was hearing of this pair. Both the DCD-700AE CD player and PMA-700AE amplifier cost

£249.95, and as such are gunning for Cambridge Audio's 640C and 640A respectively – a tough act to follow, let alone beat. Good for Denon, because as recently as the early nineties they virtually owned this segment of the market. Trouble is, the UK designed and Chinese made Cambridges are really rather good. Better still, they have an eminently 'UK friendly' sound, which is smooth and warm and sumptuous (as cheap-as-chips hi-fi goes, that is), so it's all the more hard for Denon to gain a foothold, then...

SECONDS OUT

Round One – perception. Let no one ever say that the Japanese don't know how to present a product. The Chinese-made Cambridge Audios are nicely finished in a chunky kind of way, but the Denons by contrast look and feel silkier than the sheets you'd find in a Hollywood movie star's bed. The brushed aluminium is truly classy, the action of the volume

control lovely, and the disc drawer moves more slickly than many UK silver disc spinners at ten times the price (not saying much, I grant you). Even at this bargain-basement price, the Denons are made in Japan at the company's massive Shirakawa factory, and as soon as you pull them out of their boxes you're reminded what this means.

Still, the DCD-700AE feels dull to use. Ergonomically straight out of the 1987 edition of Denon's corporate CD player styling manual, there's nothing new to write home about except an alphanumeric display. The buttons are slick, but the steel wrap case is a tad resonant and worse still is the back panel, which has a cheap captive power lead. Denon take note: Cambridge Audio fit an IEC socket to the 640C and so should you. This is the biggest disappointment for me.

The velveteen finish of the PMA-700AE's front panel again makes its Cambridge Audio rival's fascia feel like it's been grit-blasted in a





Rear views of the Denon DCD 700AE (Top) and PMA 700AE (Bottom).

Shenzhen shed, so much sleeker is it. The knobs all move nicely and the machine is less resonant because its large casing is obviously full of over-specified mains transformers. It has a welter of facilities, including loudspeaker switching, tape dubbing and tone controls, although in practice I went straight for the Source Direct button. Again, the captive power lead was a major disappointment - I'd recommend any long term user to have an IEC socket fitted the day the warranty expires...

In terms of what's inside, here Denon wheel in their big guns. No off-the-rack technology for the DCD-700AE - it uses Denon's own in-house interpolative AL24 Processing and 24bit 'Advanced Segment' DAC seen (and heard) on their top models. The mech has been carefully mounted and braced, and the power transformer mounted in a position that keeps leakage flux away from the audio circuit. Curiously, there's a pitch control which can be adjusted $\pm 12\%$ in 0.1% increments through control from the master clock. Vital statistics are 434x107x279mm and 4.2 kg.

The PMA-700AE, Denon says, inherits the UHC Single Push-Pull Circuit used in Denon's high-end integrated amplifiers, with high current power transistors. The same Schottky barrier diode used in high-end models is used for the PMA-700AE's rectifier circuit. It employs Denon's Signal Level Divided Construction (SLDC) in which the circuits for small and large signals, the microprocessor and other circuits are separated, "in an ideal manner to minimize interference among the circuits". In addition, a CD/phono input relay switch injected with an inert gas is used to form a straight signal path and maintain signal purity. The Microprocessor Stop Mode

automatically halts all operations of the microprocessor when it is not needed during playback. It's a well specified affair with preamplifier output, record out and a passable MM phono in. The magic numbers are 434x121x337mm and 7kg.

SOUND QUALITY

Although this is a system review, I thought it only fair to listen to both CD player and amplifier in isolation

first, before hearing the dynamic duo (or gruesome twosome, as the case may be) in action. So, kicking off with the DCD-700AE, I began with Isaac Hayes' 'Theme From Shaft'. Being an avid Paul Rigby reader, I've been noting with interest what he's written about the superb quality of recent CD remasters. Well, this is an old, full fat, high caffeine AAD (analogue recording, analogue mastered) transfer and it still sounds superb. Before digiphiles get too excited, I have to say the original Stax (AAA) first vinyl pressing is totally transcendental (one of the best I've ever heard), but the plain-Jane CD transfer hasn't lost too much in translation. The question is, was the Denon up to doing it justice?

The answer is yes - it sounded quite special for a £250 CD spinner. It is very couth, and what it does wrong isn't terribly offensive. Like the Cambridge 640C v2, it is impressively bouncy yet still quite detailed too, and decently smooth with it. With modest loudspeakers such as Wharfedale Diamond 9.1s on the end of my MF Audio Silver Passive Pre and Rotel RB-1092 power amp, things were a little hard, but as soon as I

plugged in six grand's worth of Quad ESL-989 loudspeakers the DCD-700AE showed itself to be a civilised performer that throws out oodles of detail. Better still, it doesn't make things sound mechanical like Japanese CD spinners of yore - here I heard a full, three dimensional soundstage with real emotional expression. This was frankly more than I'd bargained for.

Another classic seventies vinyl

"together, they fly - it's a great way to start out on the separates hi-fi ladder..."

pressing is Supertramp's 'Breakfast in America', and here the remastered CD sings. Again, it doesn't hold a candle to the vinyl, but it still makes very nice noises. 'Oh Darling' showed why 'Breakfast' was every hi-fi dealer's favourite dem disc back in 1979 - beautiful hi-hats, a powerful bass line and smooth harmonies. The Denon sounded svelte indeed, positively bristling with detail and real musical *joie de vivre*. Switching to Cambridge Audio's 640C, and I heard a slightly fuller bass but it was slower too, and with a cloudier midband and less finessed treble. Considering this is (was) the best at the price, the Denon surely delivered.

Hooking up the PMA-700AE to Wharfedale's £100 Diamond 9.1s mini monitors wasn't bad - it gave a big, full bodied and energetic sound with little harshness - but I couldn't help wondering what it would be like in absolute terms, and sure enough the electrostatics were wheeled in with fantastic results. The £249 PMA-700AE is not, as you might imagine, a natural partner for Quad ESL-989s, but it did a surprisingly good job of driving them all the same. What the tediously neutral

MEGALINE
EUPHONIA
HELICON
MENTOR - 6
PIANO
IKON
CONCEPT
SUBWOOFER



MEET OUR MENTOR

FEATURES

- Wide Dispersion
- 3D Audio
- Low Resonance Cabinets
- Time Coherence
- Hand Crafted
- Amplifier Optimised



IN ADMIRATION OF MUSIC

and revealing Quads told me was that here is an integrated that's been cunningly 'voiced' to work in screechy, bass-light systems. To wit, there's a definite bloom in the low frequencies, but this doesn't come from untrammelled reserves of power, but a slight warmth that's akin to a gentle loudness curve. The trouble is - if anything - it's a little soft and fizzy in absolute terms, but this shouldn't offend.

Interestingly, put against its integrated amplifier nemesis, the Cambridge Audio 640A, the Denon proved slightly thinner yet more fleet

their new stuff, and it normally comes from their own factory stock. This Denon duo is a perfect example of this.

In absolute terms, the DCD-700AE is the stronger of the two here. It is superb at the price - surprisingly couth yet bristling with energy too. The PMA-700AE is obviously a 'less than neutral' design, with generous lows and a big, fat, punchy sound that is exposed as being hazy and coloured when you move up to

REFERENCE SYSTEM

Marantz CD63KI DP CD player
Cambridge Audio 640C CD player
MF Audio Silver Passive Preamplifier
Rotel RB-1092 power amplifier
Cambridge Audio 640A integrated amplifier
Wharfedale Diamond 9.1 loudspeakers
Quad ESL-989 loudspeakers
Black Rhodium interconnects/speaker cables

such as my beloved DG recording of Beethoven's Sixth Symphony (Karajan), the Denon system is satisfying, but less than neutral, and a tad hazy across the midband thanks to the PMA-700AE. The Cambridge Audio combo has a more insightful mid, but is obviously fluffier at the frequency extremes. I found the Denon least convincing on classical, but again this is down to the way the amplifier is voiced - the DCD-700AE is very clean and neutral even with this.

CONCLUSION

Thumbs aloft then for such an impressive pairing. The DCD-700AE is the better of the two, turning in a truly open, neutral yet musically engaging sound, the only criticism being a slight lack of focus compared to the best £600 machines around. The PMA-700AE is musical, with a warm and human heart, and really sings when given anything with a propulsive bassline. It wins no prizes for neutrality, but like the old NAD3020 of yore, that doesn't mean it's any less fun to listen to. Together, they fly - it's a great way to start out on the separates hi-fi ladder. Partner with a pair of Usher S-520 or ALR Jordan Entry S loudspeakers and you've a brilliant £700 system. Still, this Denon duo is impressive through any pair of loudspeakers, so welcome back to the future Denon - stereo is here to stay.

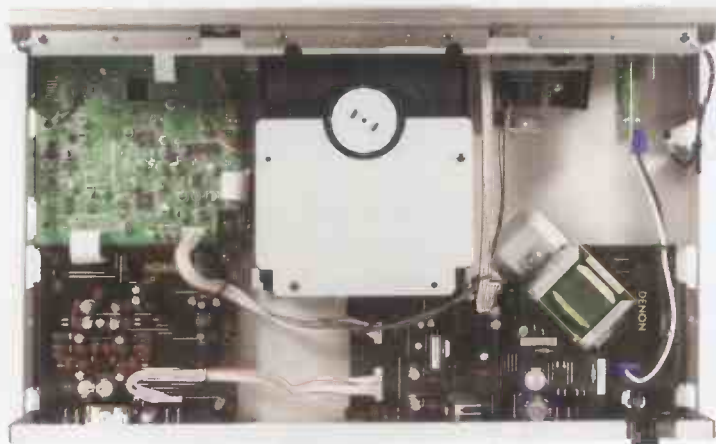

Denon DCD 700AE internal view.

of foot. It's not quite so soupy as the Cambridge in the upper bass, and really does push songs along in a way that its UK designed rival cannot. Still, the other side of this is that the 640A is a tad more spacious and has better depth perspective. Either way, both are worthy at the price, and the only real advance in my book is the £499 Onkyo A-933 integrated. Slightly coloured in the bass and hazy in the treble, the Denon nevertheless makes a very nice noise at the price, and when you put it together with the DCD-700AE, the magic starts...

more expensive, accurate amplifiers. Together though, the two Denons work famously, and it really is a case of them being greater than the sum of the parts. System against system, the Denon sounds more powerful, bigger hearted and better animated than the Cambridge, which is a tad more relaxed and reserved. The Denon paints in big, broad brush strokes, making the processed pop of ABC's 'Show Me' a joy. Still, shift to acoustic jazz like Herbie Mann's 'Summertime' and it's again big and sumptuous. With classical music,

COME TOGETHER

Just before I began writing up this review, a reader from Australia called and said he'd just read a review of the Cambridge Audio 640C v2 in a local hi-fi rag, and wondered if he should change his Rotel RCD-02 in the light of such a glowing review. I replied that worthy as the Cambridge Audio was, I doubted that it was worth the expense, particularly as he had an all Rotel system already. My point was that - just as car and motorcycle manufacturers set up their suspension systems around particular tyre packages, so hi-fi manufacturers voice their CD players to work with their own amplifiers, and so on. Acoustic engineers always use specific equipment when voicing

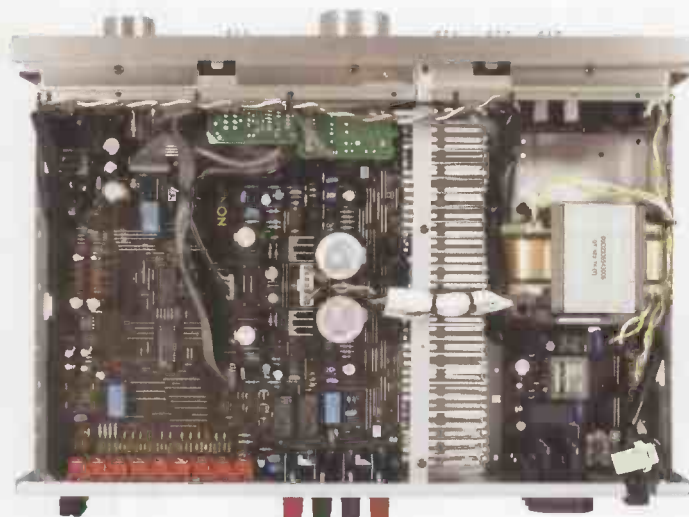

Denon PMA 700AE internal view.

VERDICT

Svelte sounding budget barnstormer offering fine finish and superb sound per pound.

DENON DCD-700AE £249.95

Denon UK

+44 (0)1234 741 200

www.denon.co.uk

FOR

- rhythmic ability, insight
- fascia finish
- value

AGAINST

- captive mains lead

VERDICT

Big hearted integrated with powerful bass and real musicality - performance belies price.

DENON PMA-700AE £249.95

Denon UK

+44 (0)1234 741 200

www.denon.co.uk

FOR

- bold, big hearted sound
- fascia finish
- facilities

AGAINST

- captive mains lead



On the Move

Slim Devices Squeezebox has proved one of the most successful of a new breed of wireless network music players, and now it has a big brother in the shape of the high end Transporter - with full 24/96 playback capability and a hefty price tag to match. Patrick Cleasby listens in...

I was surprised when Slim Devices gave us advance warning of the Transporter's imminent arrival – a machine which was to cost more than six times the price of its already very capable little brother. Was there really a market for a wireless network music player bearing all kinds of professional interfaces and claiming audiophile electronics? After all, computer music is all compressed rubbish isn't it?

Well the market was obviously keen, as we reviewers quite sensibly had to wait for the first production models to be snapped up by eager punters, particularly in America. When I met up with Slim Devices' Jez Hildred at the recent Hammersmith show he revealed that the ethos behind the machine's design was the old 'let's just throw everything at it' principle, and tellingly, that this was the first time that a Slim device had true end-to-end routing for 24/96 material – important for those of us who fillet such files out of DVDs or create vinyl transfers at such high resolutions. So I assured Jez that I would be throwing the full weight of my 24/96 rips at the Transporter...

Before we get to its myriad capabilities however, let's take a look at the design enhancements and those surprising connectivity specifications that make this the high end machine that it is. The physical design is attractive, and in common

with the Squeezebox is available in two colours - either black all over or black display windows offset by a brushed aluminium look, finished with pro rack mount-type chrome tube 'handles'. The LED displays are the same muted grey-green as before, only the Transporter adds an extra panel to the right of the big knob which dominates the front panel. The extra panel can be configured to display quite attractive VU meter and spectrum analyser emulations, or additional track information.

The most obvious improvement over the Squeezebox is the option of control from the front of the device itself, with the big knob allowing more serious library scrolling, and optionally volume control. This is

"a dreamboat for a select band of wireless music junkies..."

activated by one of the fourteen buttons that range under the display panels, which generally just duplicate existing remote control options.

With the price bump, one would expect a more sophisticated remote than the somewhat flimsy effort which came with the Squeezebox, and you do get a more substantial feel, more satisfying button transport and backlighting, but disappointingly there are no ergonomic or operational enhancements, save the

addition of a Sleep button – gee whiz!

The pro interface options are most likely to appeal to the ultra high end US installer market, and they encompass a raft of XLR connections both balanced analogue out, balanced digital (AES-EBU) in and out, and even a studio-type external word clock BNC input! Why AES-EBU in? Well Slim rate their convertors so highly that they suggest the box can be used as an outboard DAC for all digital source connections (coaxial BNC and RCA S/PDIF and Toslink in and out are obviously also catered for). DAC inputs are selected through the Transporter's menu system.

For those familiar with the Squeezebox's operation,

the Transporter's interface is fundamentally the same. For those who aren't, a useful and straightforward manual is provided, and exhaustive support information is available online. Almost any Slim setup issue can be resolved with a brief search on the internet forums. The Transporter requires version 6.5 of the Slimserver software, which is still the current release.

My previous Squeezebox experience reassured me that PC



installation is every bit as easy as Mac, so this time I restricted myself to Mac – installing on a 12" G4 PowerBook with 512MB of RAM. The software seemed to run alright (minimum RAM specs are 256MB, but I feel it may be sluggish at that), with the server starting from System Preferences panel easily. Most straightforward setups should be a doddle to install into.

SOUND QUALITY

Are the Transporter's converters worthy of its maker's claims of suitability as a standalone DAC? The answer is an emphatic yes. Eager to test the veracity of those 'hi res' claims I prepared 24/96 files of Queen's 'The Game'. Armed with a Squeezebox for comparison I was able to ascertain that, as expected, the Slimserver would not handle 24bit Apple Lossless files (much digital nastiness resulted from the attempt), so I was restricted to the full fat 4.5 Mbps stream that 24/96 stereo PCM represents. While the Squeezebox would attempt to play it, it stuttered when tracks were initially selected, and the sound did have the hallmarks of some digital truncation somewhere – a more than usually harsh and brittle sound.

Moving to the Transporter, with 'PCM 96K' flagged up on the Arcam AV receiver's display, the sound was rich in bass with a gloriously real reverb tail. Indeed, the sound was even marginally superior to the original DVD-A stereo track playing digitally into the AVR-350 from the Arcam DVI 37! Maybe this is as you should expect, given that the digital file method should result in less jitter than a disc spinning transport. However, even with Transporter, Router and laptop all in the same room that heavy stream did occasionally lead to break up after track skipping. If your situation permits, use the Ethernet connection to either the player, the computer or both - it should help if you must challenge your system with massive 24/96 data rates!

The real revelation of the Transporter was the AK4396 DAC. While the 24/96 digital output was extremely clean and precise, it did lack some warmth, and the DAC of the Transporter rendered the digital stream more smoothly than that of the Arcam amp. Some bass detail and precision was lost, but the overall result was more listenable and less fatiguing. Indeed, it made me want to go through my collection to see how good it could all sound. With many thousands of tracks to choose from, the Transporter kept me busy for a long while. The highlights of my 16/44-based Apple Lossless files revealed that what works for high resolution also holds true for mere 'CD quality' music. Even the relatively dynamically compressed remaster of Ted Nugent's 'Stranglehold' was made to sound exciting, without being a strain. I don't have much truck with MP3, but even the odd dubious artefact like the massively compressed new Bloc Party album (escaped early once again) sounded surprisingly listenable.

This time round I even briefly dabbled with some internet radio (and got a surprisingly chunky sounding Axel F from an eighties station), and Slim's clever 'taste-learning' Pandora service. (See www.pandora.com for details of this new internet radio sensation.)

CONCLUSION

Slim Devices have pulled a rabbit out of the hat with the Transporter – if you're convinced that you want to hold your library on hard disk in the best quality possible, you should want one of these. Due to the death of DVD-Audio far too few people have heard how good 24/96 PCM

WELL CONNECTED

Slim Devices' new Transporter is the most expensive network music player on sale today in the UK. Network music players are an increasingly popular way of listening to music, and one that could become the norm, putting an end to traditional optical disc-based sources such as CD or DVD players, one day. The principle is simple - you store your music on your computer or music server's hard drive in any one of a number of formats including MP3, AAC, lossless or WAV, at any resolution up to 24/96. Your computer sends the music to your wireless router via 802.11g wireless or an Ethernet cable, and this beams it to a network music player such as the Transporter (it can also be sent via an Ethernet cable, but then you lose the convenience of a wireless connection). The network music player then decodes the data and converts it from digital to analogue, offering a line level output that goes straight into the 'aux' input of your amplifier. It also acts as a 'front end' for your music, with play, pause and skip controls and a display giving track information. Providing you keep a music library on your computer, and so many do these days because of the iPod explosion, it's a very convenient and fuss-free way to access a huge amount of music, with surprisingly good sound too. DP

can sound, but those who have gone to the bother of archiving their vinyl at the superior resolution should welcome the opportunity to play their material at this quality so conveniently.

The only fly in the ointment is the imminent arrival of the super fast 802.11n wireless standard, which will more easily accommodate the high bandwidths high resolution wireless music playback requires. Once the standard is established, it's a reasonable guess that devices like the Transporter will step up to it, and that is perhaps an obstacle to laying out a not inconsiderable amount of money right now. But if your ambitions don't extend to pushing the bandwidth envelope, the Slim Devices Transporter is a dreamboat for that select band of wireless music junkies.

VERDICT

Exemplary standards across the board make this ideal for high end wireless music fans, but whether there's a market for it remains to be seen.

SLIM DEVICES
TRANSPORTER £1,295
 Slim Devices
 ☎ +1 (650) 210 9400
www.slimdevices.com

FOR

- compelling sound
- onboard DAC facility
- connectivity

AGAINST

- wireless 24/96 issues
- underwhelming remote
- whither 802.11n?



// the singularly most addicting piece of gear I have ever heard"

10 AUDIO REVIEW

"A new benchmark for musical communication" **STEREO TIMES**

"One of the truly special products I've reviewed in the past 18 years" **STEREOPHILE**

Winner of Stereo Times magazine Most wanted component of 2005 award 

"The best tonearm I've heard" **HI F1 WORLD**



Your cartridge can deliver vastly improved results if coupled with a high grade arm. Great tonearms of the past were recognised for what they contributed but we would suggest it's time to upgrade. Massive performance improvements are now possible, so why not advance your system to a new level? After all, a significant tonearm upgrade offers many times the improvements of those given by cartridge upgrades, and last a lot longer. Our multi-award winning arms are offered with a no risk, money back guarantee should you be anything other than delighted.

Tonearm Models

Enterprise
Conqueror
Illustrious
Encounter
Silver
OL1

 2005 World Awards

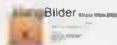

Closest to the original sound



Ultimate performance

"The best musical results of any turntable I've ever heard, regardless of price."

Since I've been listening to turntables professionally for 32 years and am aware of the pitfalls of ultimate proclamations, I hesitate somewhat to make this statement. Nevertheless, it is true. The level of musical communication available from the Illustrious/Aurora Gold is in a class by itself. It sets a new reference."

STEREO TIMES on the Aurora gold turntable & illustrious tonearm

ORIGIN LIVE
Tel/Fax: +44 02380 578877
E-mail: info@originlive.com

Full information on web site

www.originlive.com

Signature Audio Systems

- Capturing the emotion in music -

focus

brands

Indulge your senses

Occasionally, a loudspeaker is created which distinguishes itself from the rest. The new F1 monitor from Ars Aures does exactly that – due to its sublime sound and stylish Italian design.

Developed over two years by Ars Aures' Head of Acoustics, Maurizio Salvo, the F1 monitor is a reference speaker. Never before has a monitor loudspeaker of this size produced such soundstage and imaging, the base response is comparable with a floorstanding loudspeaker.

The F1 monitor:

- uses bespoke drive units.
- tweeter is capable of a lower crossover frequency allowing the application of 6db/octave phase coherent slope.
- crossover network features premium audio capacitors and super litz inductors.
- is created from 25mm MDF to reduce cabinet resonance, with a front baffle of 30mm.

These are handmade by Italian craftsmen and luxuriously finished in one of 14 standard colours. Or why not specify the colour of your choice? At £1,999 (including matching stand and VAT) this represents incredible value for money.

If you would like to realise the true potential of your existing audio components we highly recommend the new F1 monitor from Ars Aures. For more information contact Signature Audio Systems.

*Additional fee for non standard colours

Ars Aures Loudspeakers
Art Audio Amplifiers
David Gill Audio
Eggleston Works Speakers
Ensemble Audio
Mapieshade Audio
Silver Audio Cables

contact

Signature Audio Systems
Biggin Hill, Kent

Tel: 0208 480 3333
Mob: 07918 022870
07738 007776

E-mail: info@signaturesystems.co.uk

Web: www.signaturesystems.co.uk



"The F1 Bookshelf is exceptional value... and provides amazing bass reproduction for such a small speaker." Phil Gold, enjoythemusic.com

Hi-Fi World
VERDICT 

On The Run

From humble beginnings with an old BSR radiogram, Neville Roberts describes the evolution of his system to the present day...

My first venture into the delights of audio started with a BSR mono valve radiogram, courtesy of my parents. It had a BSR autochanger, complete with a crystal cartridge of unknown origin. Early experiments included the connection of a Collaro Studio mono valve tape recorder, the construction of an infinite baffle external loudspeaker (fitted with an old Wharfedale drive unit), and the installation of a Stanton magnetic cartridge. Fitting the cartridge necessitated building a two-transistor RIAA magnetic pre-amp (powered from the valve heater supply) and (I now cringe at the thought) fitting a heavy duty counter-balance spring to the BSR tonearm to get the tracking weight down into single figures! Well, my pocket money wouldn't stretch to anything better, but I had now been bitten by the hi-fi bug...

Years passed and when I finally started earning money, the top priority was saving for a proper system. Having experimented with a home made Haffler box, I ventured into the realms of quadraphonic sound with the purchase of a Marantz 4230 integrated tuner-amp and the ubiquitous Garrard SP25 fitted with a Shure M95ED cartridge. I could now enjoy my friend's recording of Mussorgsky: Pictures at an Exhibition - the Tomita synthesiser version with the 'Ballet of the Unhatched Chicks' running around the room!

The Shure M95 became a V15; the quadraphonic era passed and 4x12 watts per channel wasn't enough to drive my LNB Paralab 20 transmission line speakers, even bridged to 2x30 watts, so the Marantz was relegated to being a tuner and preamp, driving a home made stereo power amplifier. The SP25 was replaced with a Technics direct drive turntable fitted with a Mayware Formula 4 unipivot arm, a Fidelity Research FR1 Mk 2 moving coil cartridge and matching

transformer.

Elements of my current system started to appear here with the Mayware arm, shortly to be followed by the construction of a pair of the Chris Rogers' PRO9-TL transmission line loudspeakers, as per the article published in the October 1976 issue of *Practical Hi-Fi and Audio*. I still think the KEF B139 is the best bass driver ever made...

The system remained fairly static for many years until I started the move back to valves with the building of a WAD K5881 in the late nineties. A sequence of upgrades ensued, both to the components within the various items and to the items themselves, in order to arrive at the system as it is today.

On the left of the photo, the WAD 300B PSE monoblocks can be seen, resplendent on their own purpose-built MDF support unit. They drive the PRO9-TLs beautifully, one of which has sneaked into the photograph from the sitting room. Apart from the speakers, the whole system resides in the adjacent study affording excellent acoustic insulation for the record deck from the speakers. I also have a pair of home-made eighth-wave transmission line speakers for use in the study - for details of these, see the *Hi-Fi World* October 2005 issue.

Above the eighth-wave speaker are a pair of Sennheiser HD580 headphones that are driven from the WAD Headphone II unit. Above the headphone amp sits the three units of the WAD Series II modular preamp, and below is a Yamaha T-700 tuner which, although bought in the eighties, still sounds great. Below the tuner is my old friend, the Njoe Tjoeb 4000 CD player with valve output and all the upgrades, which gives my record deck a run for its money. Nevertheless, the deck (an



Origin Live motor and Ultra power supply partnering the Mayware Formula 4 unipivot arm fitted with a Lyra Clavis DC moving coil cartridge) is still on top - both physically and as my premier source! Also going strong after over twenty years are a Pioneer CT-F850 cassette deck and Sony TC-377 reel-to-reel tape deck for my legacy tape format recordings.

It might appear a bit of a hotchpotch, but the whole system hangs together surprisingly well. Thanks to significant investment in the 'innards' of many of the items, such as paper-in-oil capacitors, Mullard and Siemens valves, as well as the set of four 300B TJ Premium Mesh plate triodes glowing away on the monoblocks, I have a system that really does bring my recordings to life and transport me to the concert hall in the comfort of my sitting room. So I seem to have come full circle - once again, nothing but valves between stylus and speaker with not a single transistor in the way!

Beyond the Planets

Adam Smith revs up to Warp Factor nine to catch the Duevel Planet loudspeakers...

For many years now, loudspeaker designers have come up with many different methods of addressing the age-old problem of obtaining good realism and atmosphere from two boxes. As has been discussed many times

in the pages of magazines, the sound we hear when we are perched in our listening seat with a long, cool G&T is made up of more than just sound waves from the drive units, but reflections from all the boundaries of the room as well.

This also holds true at the other

end of the chain, in that the music that is recorded, be it in a recording studio or concert hall, comprises both direct and reflected sound. Hence it seems reasonable to follow the assumption that the best way to reproduce this phenomenon most accurately is by using a loudspeaker



that radiates in all directions.

Whilst never really catching the buying public's imagination in a big way, there are many companies over the years who have made good inroads into omnidirectional designs, and Duevel are a German company who are very keen on the idea, with all four of their current model range making use of this approach.

The Planets are the new babies of the range and retail for £800. Your money buys you a small and neat pair of compact floorstanders that measure 830x260x156mm (HxWxD) and will not break your back with their weight of 10kg. Driver lineup consists of a one inch (25mm) tweeter and a bass driver that is quoted as being six inches (150mm). However this is measured across the complete chassis, and from a point of view of the area of active operation, the driver is closer to being a five inch (125mm) type. Oh, the joys of differing driver specification methods...

Clearly, however, the most striking aspect of the Planets is their diffuser 'orbs'. For the bass driver, a sphere of approximately 95mm diameter is used, with its lower face around 60mm from the centre of the driver, along with a 50mm diameter sphere around 40mm away from the tweeter. Both drivers fire at the undersides of these orbs, with the resultant effect that the sound is spread out in a 360 degree radius around the loudspeakers.

Duevel provide a usefully concise instruction sheet for the Planets, that covers all the necessary basics of positioning, along with warnings not to, "celebrate and throw the hottest music parties" with your new loudspeakers too soon after purchase - wise words! Following Duevel's instructions, with the wider sides of the loudspeakers facing towards me and the woofers innermost, I was ready to blast off and establish orbit around the Planets...

SOUND QUALITY

The first thing to note with loudspeakers like this is that they offer a completely different perspective to music when compared to conventional units. Your brain is telling you something is amiss as there is no apparent sound coming from the front, but instead the soundstage is cast upwards and generally behind the loudspeakers, which takes a little while to adjust to especially if, like me, you have never really spent any time listening to omnidirectional loudspeakers before.

However, once my hearing had adjusted, I was intrigued to hear

really vivid soundstaging - the Planets painted a superb aural picture and it was possible to shut my eyes and hear my favourite bands laid out before me. Midrange performance from the Planets made the best of their soundstaging abilities: vocals in particular were very lucid and singers had real body and depth. The full emotion of performances was conveyed by the Planets, from the husky purr of Diana Krall to the raspy snarl of Metallica's James Hetfield.

Bass lines were generally confident and pacy through these 'speakers, and they have good weight and punch for their size. The bass guitar and fretless bass that Jennifer Warnes makes use of on her album 'The Hunter' were presented with great tunefulness and clarity, although I did find that some pounding dance music could catch them out somewhat, and leave them a little struggling to keep up. Upper bass detail was good however, and the Planets certainly had the ability to resolve this aspect of all types of music.

At higher frequencies, treble was sweet and clean, but the overall presentation was quite soft, and not as incisive as other conventional loudspeakers with metal dome tweeters. This is of course not necessarily a bad thing, as some can veer towards hardness. There was nothing missing from any recordings at the treble end of things, but the Planets did have a generally smoother presentation. This also resulted in a tendency to move some high frequency aspects of recordings into the background, rather than bringing them right to the front of the soundstage where they should be.

Intriguingly however, one resultant effect of this was not to make things hard to follow, but to add even further to the sense of space and atmosphere offered by the Planets, assisting in the widening of the soundstage that they achieved.

Interestingly, the Planets really shone with classical music and added vast space and ambience to orchestral material. The impression of the concert hall that they

"they offer a completely different perspective compared to conventional units..."

generated was very convincing, and all instruments had a vivid placement to them. Their impressive bass added good weight to crescendos but they also whispered sweetly when required.

CONCLUSION

A fellow acoustic engineer and former colleague of mine once commented that he felt that there were basically two types of listeners - the 'frequency people' who listen for deep bass, clear treble and dynamics; and the 'time people' who value stage depth, timing, atmosphere and instrument placement above all else.

I certainly think he had a point and for those of you out there who identify yourselves with the latter description, you will probably find that the Duevel Planets are right up your street.

As something of a novice when it comes to listening to omnidirectional loudspeakers, I found the Planets eminently enjoyable to audition and, returning back to 'normal' loudspeakers afterwards was a bit of a comedown. They have superb abilities in terms of imaging and lifelike presentation, cast a much bigger soundscape than their size suggests and offer a unique and enjoyable perspective on all types of music, particularly classical.

VERDICT ●●●●£

Unusual looking and thoroughly enjoyable loudspeakers with superb imagery.

DUEVEL PLANETS £800

Distributed by REAL HI-FI

+44(0) 870 9096777

www.realhi-fi.com

FOR

- soundstaging and scale
- bass pace and depth
- 'talking point' styling!

AGAINST

- treble lacks incision

MEASURED PERFORMANCE

The output trend of the Duevel Planets is downwards with increasing frequency, but this is a typical characteristic of a loudspeaker with upward-facing drive units, owing to the fact that it is being measured off-axis. The general response of the Planets is smooth and both drive units integrate well with each other and the diffusing globes.

Bass output is good for a compact enclosure, reaching down to 60Hz before being reinforced by the port at 50Hz. This is a downward-firing item and so will achieve further bass enhancement from its proximity to the floor.

Measured sensitivity of the Planets is 80dB, but this is again affected by the attitude of the drivers when measuring, and is equivalent to around 84dB for a 'conventional' loudspeaker. Average impedance of the Planets is 8.3 Ohms, dropping to a minimum of 4.5 Ohms. The response is generally quite level but there is a large inductive component at higher frequencies,

meaning that an amplifier with at least 50W output would be a sensible match. AS

FREQUENCY RESPONSE

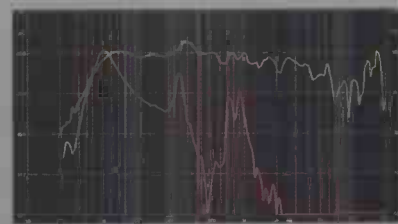

Green - driver output
Red - port output

IMPEDANCE

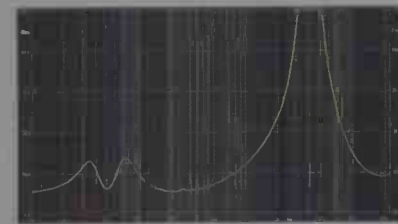



Hi-definition audio

Explore your senses with the ultimate in world class Hi-Fi

Visit www.naim-audio.com for details of your nearest retailer
or email info@naim-uk.com



world class sound...

NAIM AUDIO LIMITED Southampton Road, Salisbury, England SP1 2LN



VESTAX GUBER CUBE-T CM-01 £549

Firstly, let me reassure you of two things. One, that we have not turned into a DJ magazine and, two, that the above photo has not been transposed - the arm really is on the wrong side! Now, clearly this is not the usual sort of thing covered by a serious hi-fi magazine, but when I contacted the thoroughly nice people at Leisuretec to obtain the Vestax PDX2300-MkII Pro that we reviewed in our February issue, they asked if we would like to cover the Guber Cube-T CM-01 as well. After one look at it, how could *Hi-Fi World's* resident turntable nut possibly refuse?

The CM-01 is a limited edition deck that marks the first unit from Vestax's Guber range. According to Leisuretec, Guber is a, "new brand produced by Vestax for people with fashion and design at the heart of their sensibility. The Guber Cube-T CM-01 was originally conceived by Vestax to allow working DJs the opportunity to play vinyl at home on a turntable that was not only familiar to them but in addition sounded and looked great too." To aid in this endeavour, other models are apparently in the pipeline, including a belt drive turntable, loudspeakers and even a valve amplifier.

The Guber Cube-T CM-01 uses Vestax's proven direct drive motor technology and although lacking the finger-shredding torque of the

PDX2300-MkII Pro, still has pleasingly swift start and stop times. Both 33 and 45rpm are available at the touch of a button and speeds can be quartz locked, or varied by up to plus or minus 10%. The CM-01 even has a built-in MM phono preamplifier and so will work straight into a line level input of an amplifier or mixer.

So far, reasonably conventional, but what about that arm? Well, the short, straight arm was reinvented by Vestax a few years back for scratch DJs under the 'ASTS' or 'Anti-Skipping Tonearm System' moniker. Briefly, the bias applied to a 'normal' arm counteracts its natural inward pull due to the record's rotation but, when spun backwards, the bias then works in the same direction as the natural force, which can cause the arm to leap out of the groove. The short straight arm has an area in the centre of the record where there is no overall force on it and so this is more stable for 'scratching'. As to the arm being positioned on the left, well... it certainly looks unusual, but the second arm rest at the back of the unit clearly shows you that the arm needs to be swung over here to start play at the back of the unit.

Resisting the mischievous urge to install an Ortofon Rondo Bronze cartridge into the Vestax, I instead chose the more sensible option of a Goldring 1012GX and was pleasantly surprised by the quality of the CM-01. Obviously there are hi-fi units at

less
than
half its
£549

retail price that will show it a sonic thing or two, but it really is quite enjoyable.

The direct drive motor confers the traditional strengths of decent bass weight and pace to the sound, and the midrange was quite detailed with good levels of emotion. The only real area where the CM-01 fell behind was its rather soft and veiled treble. This was not helped by the higher than usual levels of tracking error from the short arm (up to 17 degrees), but there was no hint of distortion and I can see no reason why the Guber should start chiselling the sides of your grooves when used with a decent cartridge within its recommended tracking force range. I have been using an ASTS type deck, amongst others, for a number of years for gentle DJ duties myself and have not destroyed grooves on my twelve inch singles so far.

So there we have it. It is not a hi-fi turntable, nor is it a feature-packed ultimate DJ tool, but the Vestax Guber Cube-T CM-01 is a superbly built, stylish and unusual curio that even manages to sound quite decent. I for one am glad it is around.

Contact: Leisuretec Distribution
+44 (0) 1525 850085
www.leisuretec.co.uk

tangent



TANGENT HIFI 100 SYSTEM

Traditional stereo system with up to date functions and sound quality. The Tangent HiFi 100 system is our top of the range product for stereo.

We have carefully chosen all of the best parts and the combination gives a performance hard to beat.

DESIGN | ENGINEERING | PERFECTION

For more information please visit
www.tangent-audio.com

strong stackable vinyl storage for 12"/lp/ep

iCubeTM **orderline**
0161
881
8112

intelligent vinyl storage

stylish cubes ready made in natural 18mm mdf



i-cubes.co.uk buy 4 get free 48hr delivery



Podium prefer to leave it to others to talk on their behalf.

Hi-Fi World wrote ...

'..... demonstrated a new range of "flat horn" loudspeakers called Podium-1, whose manufacturers say it does not use ribbons, subwoofers or electrostatics. The Podium-1s look vanishingly thin in profile. Approximate retail price is in the £3,000 to £4,000 range and their sound was outstanding – they had a deep and wide presentation to worry Quads at twice the price...'

An owner wrote:

'The Podiums really do rewrite the rule book of loudspeakers! An ultra-low colouration, full frequency range panel with massive bass extension, which images over most of the listening room and is insensitive to position. Oh - and looks stunning.'

Stereophile wrote:

"..... with a money-back-if-not-satisfied guarantee; and it delivers a sound with a very generous and convincing sense of scale." & " its ability to generate impressive dynamics was both intriguing and very persuasive indeed."

<http://www.podiumsound.co.uk>

Telephone 0845 2297922

Playing the Field

Want a new, high quality record deck? Adam Smith takes four affordable turntable/arm combos for a test drive.

More and more people are being bitten by the 'black disc bug' and gaining a step forward in sound quality by taking what effectively amounts to a step backwards in technology.

Our vinyl versus CD demonstrations at Manchester's Northern Sound and Vision Show in January this year provoked some interesting results. All we did was play the same piece of music on vinyl and CD through good quality front ends and let listeners decide for themselves which they preferred, requesting a show of hands at the end of each demonstration for the result. On the Saturday the result was 60% in favour of vinyl and 40% CD, but on the Sunday the response was closer to 90% for vinyl.

Exploring the racks of high street music stores shows ever increasing selection of new releases on vinyl, including a few more wacky ones. Picture discs and coloured singles seem more and more common, and I also have two recent purchases, one of which is on eight inch vinyl and the other on five inch vinyl! Naturally, these are hardly the last word in top sound quality, but the ever increasing numbers of 45rpm double LPs and 180 or 200 gram reissues of classic albums mean there has not been a better time to invest in a turntable for quite a while.

Of course, modern turntables vary greatly in price. From the very fine £130 Project Debut III up to...well the sky's the limit, there is a surprisingly wide range of models to tempt you and your wallet, but for many people, the attraction of a unit with an integrated tonearm is high, in order to remove another complex variable from the vinyl equation!

With this in mind, we decided to see what could be bought for around the £700 - £1000 mark and duly present our four contenders.

First up, at the lower end of the price bracket is the £650 Project Xperience Comfort which comes complete with integrated Pro-ject 9c carbon fibre arm. Second is the Roksan Radius 5 which weighs in at £750 complete with Nima tonearm.

Moving towards the upper end of our price scale we have the £995 Acoustic Signature Manfred, which is complete with AS250 arm, and at £1000 another familiar face in the form of the Michell TecnoDec, complete with TecnoArm.

All of these units represent excellent value for money from well established manufacturers. We evaluated them using various cartridges, including the Goldring 1012GX and Ortofon Salsa and also compared them to our office reference unit, the Pioneer PLC-590 fitted with SME M2-10 arm. Playing through an Eastern Electric Minimax phono stage, into Quad QC-twentyfour/II-40 amplifiers and Spendor S8e loudspeakers. This is, in truth, used as a benchmark system, the SME being their 'budget', entry level model, albeit costing as much as these complete packages. We wondered if any of them would significantly turn the tables on our benchmark or its rivals in the group. Read on to find out...





PRO-JECT XPERIENCE COMFORT £650

Our first contender is the Pro-ject Xperience Comfort, which is available in a choice of gloss finishes. Our review sample came with a good quality Olivewood finish, but Cherry, Apple, Black and Wenge (which is like a dark walnut) are also offered.

The Xperience Comfort has a 2kg platter driven by the belt around its periphery, and the motor is decoupled from the plinth by a simple rubber mounting system, initially reminiscent of that used on the dreadful Connoisseur BDI. Unlike the BDI, however, the Pro-ject's motor is smooth, vibration-free, not prone to turning backwards and the mounting feels good and sturdy.

The Pro-ject 9c arm makes use of a carbon fibre armtube that is tapered and terminates in an aluminium headshell securely glued to the tube. A good range of adjustment is provided on it, including armtube rotation to facilitate accurate azimuth setting.

The 'Comfort' title refers to the fact that this deck has an integrated auto stop and lift system. I realise that many of you may have dropped the magazine in horror at this point, but rest assured that this is an opto-

electronic device that does not interfere with tracking, unlike the hundredweight or so of metalwork that used to hang off the underside of a Garrard SP25's arm.

Rumours that a six record autochange version will be next, however, are unconfirmed as yet...

SOUND QUALITY

The Xperience Comfort is a fine, smooth performer that is a perfect antidote to anyone suffering from a case of CD harshness. Bass is weighty and solid but lacks some definition and pace at the very low end. The opening notes from the bass guitar on Primal Scream's 'Loaded' had a tendency to blur into each other and this robbed the track of its rhythm somewhat, although the impact of the drum beats were positive and firm.

In the midrange, vocalists were clean and well formed and instruments had good body and depth, Michael Hedges' acoustic guitar on 'Aerial Boundaries' had a lovely body and resonance to it, but the Xperience did tend to blunt the leading edges of the plucked strings, meaning that they lost their initial impact to a certain extent.

At the top of the tree, treble was

sweet and detailed but not the most insightful. Cathy Dennis's acapella version of 'Too Many Walls' was beautifully presented and had good emotion, without veering towards sharpness.

Moving to classical, 'Jupiter' from Holst's 'Planets Suite' had excellent scale and instrument detail. On slower sections each instrument was well defined but when everything shifted up a gear, the Xperience Comfort did become a little muddled and gave a rather blurred overall result.

CONCLUSION

The Pro-ject Xperience Comfort can be a little lacking in real emotion at times, and was not too happy when the music, either classical or rock, became too complicated, as it tended to become rather muddled.

That said, the deck has an enjoyably laid-back and smooth nature to its overall presentation and never becomes harsh or fatiguing. As a fit-and-forget package that offers fine sound quality and convenience for a good price, the Xperience Comfort makes an excellent case for itself, but doesn't quite dig right to the emotional depths at the bottom of those precious grooves.

VERDICT ●●●●£

A smooth performer with an easy-going nature that is a doddle to set up and use

PRO-JECT XPERIENCE COMFORT

£650

Henley Designs

+44(0) 1235 511166

www.project-audio.com

FOR

- Smooth and beguiling nature
- End of side lift-off
- Ease of use and set-up

AGAINST

- Lower bass rather muddled
- Not too happy with complex material



ROKSAN RADIUS 5 £750

Roksan muscled their way into the affordable turntable arena very successfully a few years back with the extremely stylish Radius 5. Following on from the seminal Xerxes and TMS models, Roksan proved that it was not necessary to spend a fortune in order to obtain a well designed and good-looking unit.

As well as eye-catching Perspex, the Radius 5 is also available in maple and walnut wood finishes. These tend to be a little overlooked because of the considerable visual appeal of the Perspex, and so we are attempting to redress the balance here by reviewing a model finished in maple.

As with all of the other models in the test the platter is driven around its periphery by a long rubber belt. With the Radius 5, the platter is a custom-machined acrylic type, but I was rather disappointed that it is not a particularly securely located once on the spindle and can be easily 'wobbled' by hand when in place. The motor itself is a synchronous type that has a machined pulley with four grooves. Initially I wondered if these were for 16, 33, 45 and 78rpm but it turns out they are for 33 and 45rpm on either a 50 or 60Hz mains supply! The motor on our review

sample also had a regular 'wobble' that affected speed stability and took a while to settle down when running.

Pre-fitted to the Radius 5 was the Roksan Nima arm. This is a unipivot design that is very nicely made. Featuring an aluminium alloy arm tube with an acrylic headshell, the Nima comes with comprehensive and well illustrated instructions which help to ease the more involved setup required by an arm of this type.

SOUND QUALITY

The Radius 5 immediately announces itself as a dynamic performer. Whilst still having good bass depth and punch, detail was much improved and the Primal Scream's bass guitar had real impact and rhythm; the whole track benefitting from an injection of pace from the Roksan.

Where the Radius 5/Nima combo really came into its own, however, was in the midrange and treble. The whole presentation had a superb sense of scale to it, and instruments and singers had depth and an accomplished sense of 'air' around them. Michael Hedges seemed to have moved his guitar stool closer to the microphone and every nuance of his playing came through loud and clear, with every plucked string having real

body.

'Jupiter' sounded much more happy played on the Roksan. This time, when things moved up a gear or two, the Radius 5 blasted everything out with great gusto but without ever becoming confused. All instruments were rock solid in their location and the aforementioned sense of scale gave fabulous dynamism and grandeur to the recording.

Treble was no less impressive from the Roksan combo. High frequencies were sweet and clear and the gently tapped cymbals on Simply Red's 'Sad old Red' had an excellent metallic ring to them.

CONCLUSION

The Roksan Radius 5 and Nima arm are a thoroughly excellent combination, performing happily and consistently with a good range of music. Detail retrieval was flawless and the Roksan combination really does justice to vinyl of all kinds.

Certainly the Nima arm is an 'interesting' and rather wobbly experience if you have never used a unipivot before but this, and the more complicated setup procedure, are well worth making the effort for, as the results are magnificent.

VERDICT

A musically engaging and thoroughly satisfying turntable that sounds even better than it looks

ROKSAN RADIUS 5 £750

Henley Designs

+44(0) 1235 511166

www.roksan.co.uk

FOR

- Superbly detailed sound
- Sense of space and atmosphere
- Styling

AGAINST

- Platter does not feel secure on spindle



ACOUSTIC SIGNATURE MANFRED £995

Acoustic Signature are perhaps most well known for their stylish and heavy-weight high-end models like the 43kg Analog One. The Manfred is their budget offering, incorporating similar technology and the same attention to detail as the expensive models.

One feature of their technology is the bearing used on the Manfred, the bottom of which consists of a material called Tidorfolon - an alloy of vanadium, ferrite, Teflon and titanium - and Acoustic Signature say this is noiseless, wear-free and self-lubricating. In addition, the Manfred's bearing uses sintered bronze bushings in the shaft, which are heated and soaked in oil during manufacture, whereupon the oil soaks in like a sponge and means no additional lubricant is required - very neat!

The Manfred's base is a 38mm wooden item available in Maple, Piano Black and Cherry and the 24mm thick platter is belt driven from the motor, which stands on its own in a cutout in the plinth. This is powered by the 'SmallAlpha' power supply, which offers front-panel switching for 33 and 45rpm.

The tonearm fitted to the Manfred goes under the name of the Acoustic Signature AS250, but there are no prizes for guessing from the model number that this marks the latest disguise under which lurks the tried and trusted Rega RB250.

SOUND QUALITY

The first aspect of the Manfred's sound that becomes apparent on listening is its bass. For a belt drive deck, this is impressively weighty and deep, and has excellent timing without ever becoming boomy. Low frequency detail retrieval was also very good, although still not quite up to the standard of the Roksan. Primal Scream again came across very well, but the tactile feel of the bass guitar's strings on "Sad old Red" were a little muted.

The Manfred has a pleasingly open midrange with good definition, but one that can be a little 'safe' mainly, I feel, due to the Rega-derived arm which has a midband that tends to be rather lacking in emotion. That said, the soundstage offered by the Manfred has excellent breadth and depth, but just misses out slightly on the sense of space offered by the Roksan.

At the high frequency end, the Acoustic Signature deck is very tidy. Treble is well defined and has good insight, but some percussive effects could tend to be a little further back in the soundstage than is normal. This never left the Manfred sounding 'soft', however, and meant that it never became harsh or steely, even with less than sympathetic recordings.

Overall, the Manfred tends to fall between the Pro-ject and Roksan in its character, being more dynamic and detailed than the former, but lacking the ultimate atmosphere of the latter. One final note I made during listening is that Acoustic Signature's bearing technology clearly works well, as the deck is very quiet and silences in music were very vivid.

CONCLUSION

The Acoustic Signature Manfred is a fine turntable that offers excellent sound together with fine styling and build quality at a competitive price.

As a package complete with the AS250 arm the Manfred offers good convenience and ease of setup. Also to its credit is the fact that it would be capable of handling an even better arm at some point in the future, should the upgrade bug bite.

VERDICT

A sturdy and well-built turntable that offers excellent sound quality in an easily set-up package

ACOUSTIC SIGNATURE

MANFRED £995

Distributed by Select Audio

+44(0)1900 813064

www.acoustic-signature.com

FOR

- Deep and taut bass
- Composed and well defined midrange
- Ease of setup

AGAINST

- Can be a little emotionally sterile



MICHELL TECNODEC £1000

Since the company's inception around forty years ago, J.A. Michell Engineering has been synonymous with high quality vinyl replay components.

The TecnoDec is the baby of Michell's current range, but still incorporates many features found in its bigger brethren, such as a low noise DC motor and acrylic/vinyl platter that approximates the mechanical and acoustic properties of the record itself, for optimum coupling between the two items. Michell claim that this results in a neutral and precise sound, with reduced susceptibility to clicks and pops.

Once again, a belt drive system is used, and the motor has a two stage pulley to facilitate 33 and 45rpm - as with the Roksan, clean fingers are required for speed changing in order to avoid contaminating the belt.

Available as a package for £1000, the TecnoDec can be supplied with the Michell TecnoArm - a good quality re-working of the tried and trusted Rega RB250 which has the arm tube perforated and damped, and the internal wiring replaced with litz type cable in a single run

from cartridge tags to phono plugs. The TecnoWeight counterbalance upgrade and VTA adjuster are also part of the package, optimising compatibility with virtually any cartridge.

SOUND QUALITY

Once again, the Michell has very good bass, a testament to the quality of the drive system. Low frequencies were deep and detailed, with excellent rhythmical abilities. This is aided in no small part by the TecnoArm, which we have found in the past to have excellent bass resolution abilities. Both the Simply Red and Primal Scream tracks held no fears for the Michell, and it was up there with the Roksan in reproducing these tracks superbly.

Stereo imaging and midrange detail were also beyond reproach. 'Jupiter' was presented by the Michell combo with great enthusiasm and soundstage depth and all instruments were clearly defined. The upgrades that Michell make to the basic Rega arm to turn it into the TecnoArm work well in terms of adding excitement and improving detail, but their downside, which I have experienced in the past with our

own TecnoArm in the office is in the upper registers.

Whilst treble does indeed become more extended, the TecnoArm tends to emphasise higher frequencies. Although this did have the handy side effect of adding extra definition to Michael Hedges' acoustic guitar strings, the downside was that cymbals tended to be a little fizzy, and sibilants on vocals occasionally became a little spitty, as was the case once or twice during the Cathy Dennis track.

CONCLUSION

The Michell TecnoDec is a bold and dynamic character that carries rhythms with aplomb, but can be quiet and composed when required. It offers excellent levels of insight into music and has good bass delivery

Its only downside is treble that can be a little forward. This is the character of the partnering TecnoArm. It enhances warm sounding cartridges, typically moving magnet types, but is less successful with today's bright sounding moving coils, so judicious cartridge selection and choice of matching equipment is necessary.

VERDICT

Dynamic and exciting, the TecnoDec offers plenty of rhythmical insight and low end detail.

MICHELL TECNODEC £1000

J.A. Michell Engineering Ltd.

☎ +44(0) 208 953 0771

www.michell-engineering.co.uk

FOR

- Bass depth and detail
- Styling and build quality
- Dynamic character

AGAINST

- Treble can be unruly



For someone who has a strong interest (or obsession, according to my wife!) in turntables, a group test like this is an enjoyable experience. Although here at Hi-Fi World we have the opportunity to play with some more exotic vinyl spinners that have correspondingly exotic price tags, it is reassuring to discover that excellent results can indeed be obtained for the comparatively modest sums required to purchase any of our contenders in this group.

In all cases, your money buys you a well designed and neatly styled turntable and arm package to which you only need to add the cartridge of your choice, plug into a suitable phono input and you're away. Naturally there are differing levels of setup required by each unit but none require a degree in physics and all have concise instructions to help you on your way. Equally, however, there is a very good chance that if you find yourself a friendly dealer, he or she will do the chore for you and deliver the unit ready to rock 'n' roll.

None of the contenders will disappoint, and all are more than capable of proving why we are such big fans of vinyl, but I am sure you would like to know which one we would recommend that you spend your money on so, without further ado, let the verdict commence!

First to consider would be the Pro-ject Xperience Comfort. This is a fine deck, very well built and with the addition of a well designed end of side auto stop and lift system. I am sure we have all been in a situation where we have either left the room and forgotten that the record has

ended, thus leaving the stylus grinding along in the runout groove, or even nodded off during the record and woken up to that familiar "click, click" a few hours later! In a case like this, the Xperience Comfort is invaluable. Add to this the fact that it is the most 'ready to go' out of the box and it makes a strong case for itself.

Sound quality is good, and the Pro-ject has a very fluid and relaxed nature. Where it stumbles is when it comes to faster-paced music, or material with complex and pacy bass lines. In these situations it struggles to keep up and for this reason it is somewhat outclassed by the other competitors here.

Moving upwards, we have the Acoustic Signature Manfred and the Michell TecnoDec. Both are quite similar in nature and offer weighty and detailed bass with excellent low frequency definition and soundstaging. Where they differ is in the midrange and treble, with the Manfred having a rather smoother and more subtle nature compared to the ebullience and dynamism of the TecnoDec.

It is not the case that the Manfred is something of a dull beast though, far from it. It is more than happy to rock or boogie when required, but just does not quite have the sheer gusto of the Michell. Conversely, however, the Michell can occasionally tip over into being a little ragged, thanks to the somewhat sharp nature of its TecnoArm, compared to the rather smoother AS250 fitted to the Manfred.

Assembly for the two items is similar as they both use standalone motors that sit beside the main plinth. The arm is supplied separately in the box with the Michell, but it can be simply dropped into the pre-cut

armboard and so neither are unduly complicated to set up. If pushed to choose between the two, then the smoothness and composure of the Manfred would win for me, but both units are thoroughly competent and enjoyable, and highly capable £1000 vinyl players.

So, that leaves number four, the Roksan Radius 5. It has superbly fast and solid bass which, although not digging quite as deep as the Michell or Acoustic Signature, has bags of detail and great timing. The treble and midrange are where the Radius and Nima combo really score, however, as they offer a truly exquisite sense of space and atmosphere around music. Vocals and acoustic instruments really shone through the Roksan and it successfully combines the pace and verve of the Michell with the smoothness and sophistication of the Acoustic Signature.

The Nima arm is a very distinctive item that takes a little getting used to if you are not familiar with a unipivot design. It also requires a more involved setup procedure than any of the other units on test but this is made much easier thanks to the comprehensive and easy to understand instructions that are also well illustrated. The effort is well worth it, though, and the Roksan more than repays the time and effort spent on setting it up every time you play a record. For this reason, the Radius 5 gets my vote as a worthy winner.

We would like to extend our grateful thanks to Simon Griffin at Turntable World (+44(0)1325 241888) for supplying the Michell and Roksan review units.



Tube Talk

Jolida's JD9 Tube hybrid phono stage is super value for money, says Noel Keywood...

An unusual product arrived recently from the USA, in the shape of the Jolida JD 9 Tube Phono Stage. Priced at just £400, it offers all the adjustments necessary for both moving magnet and moving coil cartridges, as well as the promise of valves (sorry, *tubes*), to add that extra something to the sound.

Jolida proportion the casework so a turntable can be placed on top, but as record players are usually sited on a dedicated shelf, I'm not sure many will take up their suggestion! Still, it explains the sizeable imperial dimensions: 17in wide, 13in deep and 2in high.

The rear panel carries one set of RCA phono input sockets, but two sets of outputs, High level and Low level. Unusually, High is the direct output taken from a pair of 12AX7 valves, with Low being a resistively attenuated version of this signal. It's therefore best to use High, unless input overload distortion or muddle is heard, when Low should be used.

Behind a small screw-on panel lie two sets of DIP switches, three to set gain and a bank of nine to adjust input conditions: 47k Ohms with 47, 100, 150, 220pF capacitive loading for moving magnet cartridges, and 100, 300, 1,000 Ohms for moving coils. These are common values, sufficient to match any modern cartridge.

The gain available is huge, as the JD 9 uses three OP37 solid-state op. amps and a 12AX7 valve configured to give x3.8 gain, so providing an enormous output swing of 27V. A maximum gain of x11,650 is possible, five times more than the x2,000 or so that is common.

SOUND QUALITY

The Jolida JD 9 is fairly distinctive, especially against a good solid-state alternative like the Lehmann Black Cube which, at a similar price (£495), is representative of the herd. The Lehmann is smooth, well-ordered, and very polished in its sound, but the Jolida has real zest, due much to the extra high frequency energy present as a result of its equalisation characteristic. In a bright system this may well tip the balance to sharpness, but in a softer system it could be just what is required.

Also to be taken into account is the cartridge used. With a 'warm' Shure moving magnet like the M97Xe, the Jolida will be a firm choice, no argument. But if your cartridge is, say, a bright sounding Ortofon Samba as reviewed in this issue then the Jolida makes matters worse. It isn't as accurate as rivals and this will swing preferences one way or another.

I used an Ortofon Salsa with it, and found the two worked well together, giving a forward and quite forceful sound. Across the midrange, vocals were well fleshed out, seemingly with good body and better lit than the well damped Lehmann. Here I felt the valves were introducing their magic, even though they lie at the end of the signal chain. Down at low frequencies bass quality was firm and defined, if not as well resolved as is possible.

With a Goldring 1012GX moving magnet cartridge, the qualities of the JD 9 became more apparent. Eleanor McEvoy's voice was again better lit, a little more forceful and with a convincing dynamic. The Black Cube was again very tidy, but pulled the whole sound stage back into a smooth, well ordered picture lacking the Jolida's *joie de vivre*. This is a phono stage with good projection and plenty of life to it.

CONCLUSION

At the price, you get a lot of ability from Jolida's JD 9 Tube Phono Stage. It is an unusual design but one that works well at every level. The nearest convincing improvement you will get above a stage like this will require an outlay of £1,100 on an Eastern Electric Minimax, which puts the JD 9 into context as something of a bargain.

VERDICT

Fine sound from an inexpensive but complex phono stage that does it all.

JOLIDA JD 9 £400

Distributed by RPM Audio

+44 (0) 7790 907737

www.jolida.com

FOR

- vigorous sound
- strong detailing
- fine vocals

AGAINST

- bright balance

MEASURED PERFORMANCE

The JD 9 has steadily climbing treble, up by 1dB overall at 20kHz relative to output at 300Hz, our analysis shows. This will give a bright sound. It has no warp filter, being -1dB down at 13Hz, so bass will not be attenuated.

Gain measured x100, x600 and x1,800 for MM and MC cartridges respectively from Low output, multiplied by x6.8 from High output.

Input noise was low at 0.2uV, if not as low as other solid-state designs that get down to 0.04uV. All the same, hiss will be barely noticeable and hum was negligible. Overload occurs at 4.8V/27V Low/High out, which translates back to 43mV, 8mV and 2.7mV input overload values - all perfectly adequate. NK

Frequency response	13Hz-56kHz
Separation	68dB
Noise (e.i.n., A wtd.)	0.2uV
Distortion	0.01%
Gain (Low out)	x100, x 600, x1,800
Overload (MM/MC)	43mV/ 8mV, 2.7mV

FREQUENCY RESPONSE

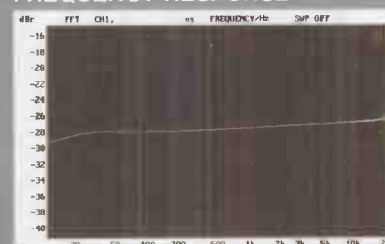

Bronze Age

Adam Smith Listens to Monitor Audio's new Bronze BR2 standmounting loudspeakers...

Never ones to rest on their laurels, Monitor Audio have not been content to sit back and bask in the praise garnered for their highly competent Bronze range and, in October 2006, announced the introduction of a completely reworked lineup, the Bronze Reference series.

As before, the model range consists of two standmounters, two floorstanders, dedicated rear channel and centre channel units, and a 150W powered subwoofer, so Monitor Audio have all bases covered from budget two channel right up to a good value complete surround sound system. All loudspeakers in the range benefit from redesigned drive units, and the BR2 makes use of improved versions of the C-CAM tweeter and the MMPiI bass driver.

C-CAM stands for Ceramic-Coated Aluminium/ Magnesium, and the new tweeter uses a dome formed from this material that is only 30um thick. Allied to this is a new type of injection-moulded neoprene for the surround which Monitor Audio claim, "exhibits ideal damping, allowing extended high frequencies, but permitting the dome to move freely at low frequencies". One of the arts of tweeter design is to strike a balance between allowing the dome to move freely, which often works best by having a very light surround, and having enough surround damping to ensure that when the dome breakup occurs, it does so in a controlled fashion so as not to be audibly objectionable. Monitor Audio's tweeters have always tended to be a strong point of their loudspeakers and if the new technology improves on them further, results should be good.

The bass driver goes under the moniker of MMPiI, which stands for 'Metal Matrix Polymer' and refers to the cone material, which is injection-moulded by a special process to achieve different thicknesses at different points on the cone. Chief improvements are in the magnetic

motor structure and chassis, which is better ventilated to improve airflow and reduce rearward reflections from the cone.

As if this wasn't enough to have you reaching for the cheque book, the cabinets have new improved finishes and come in Black Oak, Cherry and Walnut colour options, the latter of which was supplied for review. Personally, I think they look much smarter and more expensive than the old Bronze range, despite no increase in price for several of the models. Of course, this is all academic if they sound like a rusty biscuit tin full of nails, and so to make sure this was not the case, the Bronze BR2s sat atop some Sound Organisation Z1 stands and connected up to our reference Naim Nait 5i integrated. Auditioning was carried out using a Cambridge Azur 840C CD player and Pioneer PLC-590/SME M2-10/Ortofon Salsa turntable playing through an Eastern Electric Minimax phono stage.

SOUND QUALITY

It never ceases to surprise me how modern, budget loudspeakers can sound much 'bigger' than their compact proportions would suggest. The Bronze BR2s are another design that pull this trick off quite neatly, with their ability to fill a decent-sized room with a convincingly capacious soundstage, fed with an average number of watts.

The midrange of the BR2s is well-projected and detailed, giving vocalists and acoustic instruments





and taut strike that would normally be expected. Monitor Audio have clearly worked hard to achieve good bass extension from the cabinets and have succeeded in this respect but, personally I would willingly trade a few low end Hertz for a little more tautness and realism.

Moving through various styles of music showed the Bronze BR2s are quite happy with a wide variety of source material. They were equally content with Mozart's 'Eine Kleine Nachtmusik' as they were rocking along to the likes of Pink Floyd, or wafting out the gentle and atmospheric vocals of Madeleine Peyroux.

CONCLUSION

The Monitor Audio Bronze BR2s are a worthy addition to the £200 loudspeaker market and I was pleased to find that they are not just a quick makeover of their predecessors, but mark a genuine step forward.

Monitor Audio's incorporation of improved technologies in both drive units and a subtle but pleasing restyle to the cabinets has given the BR2s a big step forward in terms of their overall style and character, and they have a 'grown up' and capable sound quality.

Bearing in mind the caveat regarding their low bass performance, I can see the BR2s winning many fans and finding themselves in demand on the end of good quality budget setups.

extension for the cabinet size. They are able to deal with complicated and

excellent body and weight. The soundstage that they generate is sizeable and stable and projects well beyond the loudspeakers. The Monitor Audios were particularly impressive with live recordings, such as Eric Clapton's 'Unplugged' and placed you nicely in the audience.

Treble performance was, as expected, very good. Monitor Audio always seem to have had a knack of assembling a good tweeter and the latest version of their C-CAM design used on the BR2s is no exception. The lift in output from around 16kHz upwards that can be seen in the frequency response trace [see MEASURED PERFORMANCE] does indeed add sparkle and detail, but is at a sufficiently high frequency not to cause any harshness. High frequencies were airy and open, adding real form to high notes without becoming splashy.

Bass from the Bronze BR2s is pleasingly fast and detailed with good

fast bass lines without falling over themselves, and have good upper bass resolution. The output from the front-mounted port is spread over a surprisingly wide frequency range, rather than the usual situation where it would peak at one frequency. This does indeed help to extend the bass down further than might be expected but the downside is that this does result in some boxiness at the very bottom end.

Whilst much better than their predecessors in this respect, I was still aware that bass drums in rock music, and enthusiastically struck tympani in classical, tended to come across with a rather plasticky thud as opposed to a realistic

VERDICT ●●●●● £
Usefully improved and likeable loudspeakers that offer fine performance across a wide range of music.

MONITOR AUDIO
BRONZE BR2 £200
Monitor Audio Ltd.
+44 (0)1268 740580
www.monitoraudio.co.uk

FOR
- scale and soundstaging
- sweet and detailed treble
- improved styling

AGAINST
- boxy and somewhat artificial low bass

MEASURED PERFORMANCE

The Monitor Audio Bronze BR2s have a commendably flat response across the output spectrum. The only deviation is at higher frequencies where output dips slightly before rising by around 7dB at 20kHz. This is something of a Monitor Audio trait and usefully increases sparkle and detail. Fortunately there should be no consequent risk of harshness owing to the high quality design of the tweeter.

Bass output starts to drop from the main driver at around 100Hz and is then augmented by the port, which has an unusually broad output from 80 down to around 30Hz. This will confer good bass weight for the enclosure's size, but may potentially give the low bass a 'boxy' nature.

The impedance curve shows no areas for concern, being commendably smooth. Average measured impedance is 5.3 Ohms, dipping to a minimum of 3.3 Ohms. Measured sensitivity is high at 88dB and the Monitor Audios should work well with around 30-40W

minimum, but will require an amplifier that can drive a genuine 4 Ohm load. AS

FREQUENCY RESPONSE

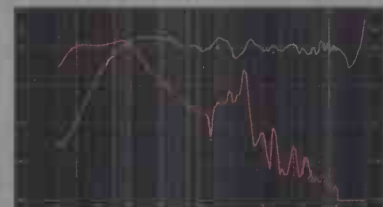

Green - driver output
Red - port output

IMPEDANCE

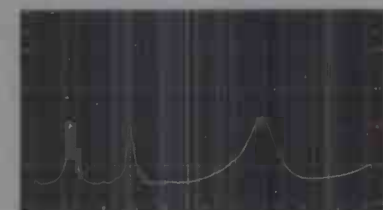



Lucy just couldn't understand Tom's sudden lack of interest in an early night



Pro-ject
AUDIO SYSTEMS

WHAT HI-FI?
SOUND AND VISION
AWARDS 2006
PRODUCT OF THE YEAR
TURNTABLES
PRO-JECT RPM 5

WHAT HI-FI?
SOUND AND VISION
AWARDS 2006
TURNTABLES
BEST TURNTABLE UNDER £300
PRO-JECT DEBUT III

Superb Hi-Fi

Just a little more desirable than the norm

Let's Dance

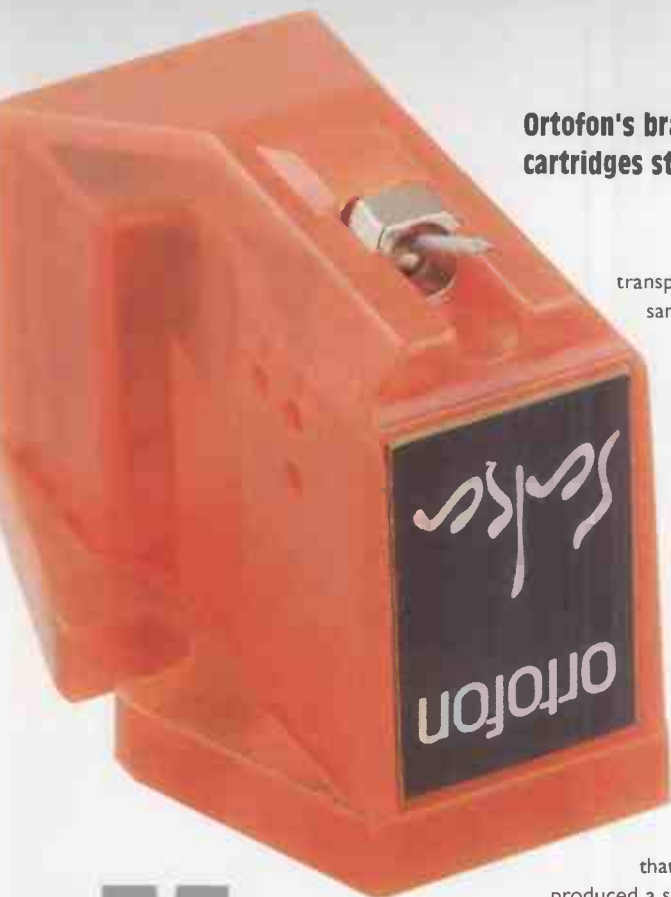

Ortofon's brand new Salsa and Samba moving coil cartridges strut their stuff for Noel Keywood...

Moving coil cartridges have always been the ones to beat when it comes to sound quality. Even Ortofon's early SPU, still available, developed a durable reputation for sound that hangs on to this day. I owned one for a short while and it joined a Decca London Blue on my 'interesting' shelf, due mainly to its mass and mediocre tracking. All the same, back in a time when tracking forces commonly ran to two figures and sound quality was ropey, it had qualities other cartridges lacked. Since then the moving coil has maintained its supremacy, being known generally for sweet treble, an open midband and often tight bass.

Many attempts have been made to move these qualities downmarket into cheaper designs, but with limited success. To date budget designs from Ortofon and Dynavector, to name but two, have been good, but not quite good enough to challenge the best moving magnets, such as those from Goldring.

Above £200 or so the advantage starts to swing toward the moving coil though, whose sound becomes more refined, cohesive and

transparent. All the same, some swear by Denon's £90 DL103, even if here at *Hi-Fi World* towers we have reservations. I found the DL103R at twice the price more acceptable, if over-bright. It is against cartridges like this, as well as the Goldring's perhaps, that Ortofon has produced a slew of new, low cost MCs. Last month I reviewed the least costly, blue-bodied £100 Tango; this month I am looking at the next two up, the yellow Samba (£150) and the red bodied Salsa (£199).

You might expect these to offer graded improvements over the Tango - a better stylus, improved tracking and those other little things that are done to cartridges to wring more performance from them. Against my expectations, in this respect the yellow Samba struck me as a little unusual, whilst the red Salsa turned out to meet these expectations precisely. Of these two cartridges it represents the next step up from the Tango in what an Ortofon MC can typically offer, notably good all round performance coupled with basic accuracy.

Tracking force for the Salsa is 2.2gms, in the centre of a 2-2.4gms range, just like most moving coils, but unlike the unusual Samba which tracks at just 1.5gms. Both cartridges weigh a normal 7gms, so unlike the lightweight Tango they will balance out in any arm without a problem. The main difference is that the £199 Salsa retains Ortofon's legendary accuracy of frequency response, albeit with some slight lift to keep

things concise even on inner grooves where, otherwise, tracing loss causes some dulling of the sound.

This is the sort of performance I have come to expect from Ortofon's over the years, and it is one reason why they are, model to model, basically very accurate in what they render from LP. Not everyone values this, admittedly, nor is it necessarily enough in itself to ensure a really good sound. But for me it is a prerequisite; I do not much like to hear either the edginess and spit that comes from a peaky cartridge, nor the warmth and - sometimes - blandness that comes from a rolled off response, usually from older moving magnet designs.

So the orange £199 Salsa fits slickly into the scheme of things within the company's broad moving coil range, that in the UK now stretches from the £100 Tango up to the £1,100 MC Jubilee. It tracks well, has a Fine Line stylus like the old FLs of yore and needs a preamp with an input impedance of 20ohms or more, Ortofon suggest. As most come with a 100ohm input nowadays there is no potential matching problem here. The Salsa also has quite healthy output at 410uV at 5cms/sec peak (580uV rms) so whilst it needs a proper moving coil preamp, hiss should not be a problem. The Samba weighs in at 420uV rms and so is not vastly different.

Both cartridges come in a simple plastic case, along with fixing screws. Their body size and shape raises no mounting or headshell fit issues. Unlike the more expensive Rondo series the bodies do not have tapped, blind fixing holes, but simple lugs. Unlike Tango, Samba and Salsa have swing-down stylus guards that can be removed. There is a small sound quality benefit from doing so, once the cartridge has been safely installed in an arm.

SOUND QUALITY

I recognised the intrinsic rightness of the Salsa's sound straight away.

20 - 22 Cadham Centre
Glenrothes KY7 6RU, Scotland

email: info@shadowaudio.co.uk
web: www.shadowaudio.co.uk

sales line : 0844 800 0073
sales line : 0844 800 0074
after sales : 0844 800 0075

The finest selection of Hi-Fi Products in the UK - all under one roof:

ART Audio, ART Loudspeakers, Audio Analogue, Aurum Cantus, Audio Zone, Audio Physic, Audionet, ATC, AVI, Bel Canto, Black Rhodium, Blue Note, Bryston, CEC, Custom Design, Croft, Dali, DK Design, EAR/ Yoshino, Eastern Electric, GamuT, Goldring, Graaf, Hovland, Hyperion, IsoTek, JAS Audio, JungSon, Lumley, Manley Labs, Marantz, McIntosh, Musical Fidelity, Musical First, Nordost, Opera, Origin Live, Ortofon, Pass Labs, Pathos, PMC, Project, QED, Qinput, Ref 3a, Resolution, Roksan, Shanling, Soundstyle, Stello, TacT Audio, Triangle, Trichord, Townshend Audio, Unison Research, Wadia, Whest, Wilson Benesch, Vertex AQ, VPI and many more.

*subject to conditions

Used Product Listing

Remember !! List is updated on our web site daily!

DIGITAL	
Micromega Aria, black, ex HiFi Choice review model (£2150)	£1395
Shanling CDT100, exc cond, gold legs, fully boxed (£1650)	£995
Micromega CD132, ex-dem, black finish, as new condition, boxed (£849)	£595
Arcam Diva 93i, silver, exc cond, boxed, manual, r/c, 1 yr old, (£1000)	£595
Musical Fidelity DM25 DAC + Transport, only a few months old (£4900)	£2995
Krell KPS25s, upgraded to SC spec only 1 year ago!, exc cond, boxed, manual, remote, sublime presentation/detail as you would expect from a £25k player!!	£4995
AVI Lab Series CD, current spec, boxed, unmarked condition (£1499)	£1195
Shanling CDT300 Omega Drive, ex-dem, immaculate cond (£4000)	£2995
Resolution Audio Opus 21, 2 box cd player, boxed, black/silver (£2950)	£2295
AVI S2000 CD player, exc cond, 1 owner from new!, original box (£995)	£249
AVI S2000 DAC, exc cond, only 1 owner from new!, fully boxed, great (£995)	£249
Marantz SA15-S1, silver finish, unmarked condition, high end SACD! (£1100)	£795
Unison Research Unico Valve output CD, only 3mths old, latest ver (£1250)	£895

AMPLIFIERS	
Exposure 23 Pre Amp, mint, boxed, remote (£1400)	£795
Exposure 28 Power Amp, mint, boxed (£1400)	£795
Bryston 4B-SST Power Amp, 2 months old!, like new, 300wpc (£2750)	£2249
EAR Yoshino 834T Hybrid Int, mint, boxed, 8 months old! Bargain! (£2800)	£1995
Qinput A1.0x, ex What HiFi review model, boxed in immac cond (£300)	£230
Qinput A-8000 MK II, ex HiFi World review model, boxed as new (£1295)	£795
Parasound A21 Power Amp, immac condition, silver, only 1yr old (£1500)	£895
Musical Fidelity A5 Int, 250wpc, 6 months old, boxed, as new (£1499)	£995
Musical Fidelity A5 Power Amp, 6 months old, boxed, immac (£1499)	£995
Bryston B-100 SST Int amp (inc dac module), unmarked condition, boxed (£3750)	£2995
McIntosh C220 Pre, only 2 months old!, boxed, mint, Simply stunning! (£3300)	£2795
Chord CPA2800 pre-amp+phono stage, £2800 new, in black, immac	£1295
Jadis DA30 valve integrated, mint, 2yrs old, fully boxed, 30wpc (£4000)	£1995
Bel Canto Evo 2i Integrated, boxed, mint cond (£2800)	£1695
Arcam FMJ Pre, good cond, boxed, manual, remote, only 1 year old! (£1200)	£795
Arcam FMJ P35 Power Amp, good cond, boxed, manual (£850)	£595
AVI Lab Series integrated, immac, boxed, remote, 200wpc into Bohms! (£1599)	£995
AVI Lab Series Power Amp, Immac, less than 1yr old, boxed (£1650)	£995
Pathos Logos, brand new sealed box, cane order, great opportunity (£2700)	£2295
Eastern Electric M520 Int, What Hi-Fi 5 star review, 4 months old (£1539)	£1095
Eastern Electric Minimax Pre, ex-dem, mint condition, boxed (£769)	£649
Manley Labs Neo Classic 300b Monoblocks, 25wpc, mint! Sensational! (£5895)	£3995
Krell PAM 5 pre amp with phono stage, exc cond, boxed (£2000)	£549
Cyrus Pre X VS, immac cond, only 5 months old!, one prev owner (£1000)	£749
Nagra PSA Power Amp, very rare, only 6 months old!, immac, stunning	£3395
Quad QC 24 Pre / II Forty Monos, exc cond, boxed, manuals, 4 yrs old (£3995)	£1895
AVI S2000 Pre Amp, exc cond, 1 owner from new, fully boxed, superb (£995)	£249
Audionet Sam V2 Integrated, silver, boxed, exc cond (£2400)	£1195
ATC S/A2-150 Integrated, black, mint, as good as new, boxed (£2400)	£1895
ATC S/A2-150 Int amp, black, mint cond, as good as brand new (£2400)	£1395
Shanling SP-80C Monoblocks, excellent, gold legs, fully boxed (£2000)	£1295
Lyngdorf (TacT) TDA2200, digital int, full room correction, excellent (£2395)	£1495
Unison Research Unico Line, only 3 months old!, boxed, manual (£950)	£749
Bow Walrus Power Amp, boxed, exc cond, 150wpc (£3995)	£1795
Bow Warlock Pre, boxed, exc cond, fully balanced, r/c (£3495)	£1495
Pass Labs X1 Pre Amp, mint, less than 1yr old!, sep power supply (£4700)	£3495

LOUDSPEAKERS	
Hyperion 938, gloss black finish, Immac cond, very low hours (£3750)	£2895
Quad 989, Vintage finish, only 6 months old, boxed, mint cond (£5000)	£3795
Acoustic Energy AE1 Classic, ex-display, never been played, fully boxed (£845)	£650
Wilson Benesch Arc, silver stands and side cheeks, immac cond (£2600)	£1795
B&W CM4 speakers, in Rosenut, 5 years old, boxed	£449
Sonus Faber Cremona, natural maple finish, 5 mths old, boxed, Superb (£5k)	£3795
Thiel CS 1.6, black finish, absolutely unmarked, like new, 6 months old! (£1700)	£1249
Ref 3a De Capo-1, redwood finish, superb cond, boxed (£2500)	£1695
JM Lab Diva Utopia BE, exc cond, boxed, tweeter covers and spikes (£7500)	£4250
Art Emotion Signature, maple, 1yr old, boxed with grills, mint (£9000)	£5995
Quad ESL-63 Electrostatics, mint condition!, vintage finish (brown grills)	£1149
PMC FB1+, cherry, boxed, immac cond, few mths old! (£1695)	£1295
Monitor Audio GR20, 2yrs old, black, boxed, exc cond (£1500)	£795
Monitor Audio GR20, cherry, good cond, orig boxes, great upgrade! (£1500)	£795
PMC OB1, in oak, boxed as new, 6 mths old, simply stunning! (£2700)	£1995
JAS Orior, birds eye maple finish, mint, 10 months old!, fully boxed (£2300)	£1795
JAS Audio Orsa, ex HiFi Plus review model, poplar tumor (£1399)	£1149
Zingali Overture 3S, cherry, exc cond, orig packaging, 1 year old (£4250)	£2250
ART Siletto 6, maple, ex-dem, as new condition, boxed, wonderful (£2000)	£1395
ProAc Studio 140, mahogany finish, brand new - never used but box opened, recent 5 stars What Hi-Fi, evenly balanced sound with high quality finish!	£1195
JAS Audio Supertweeters, Review pair, sound awesome! (£649)	£595

ANALOGUE	
Trichord Diablo phono stage, exc cond, only 9mths old, boxed (£750)	£495
Trichord Dino+ PSU, silver, exc cond, 1yr old, boxed, manual, superb (£249)	£175
Wilson Benesch Full Circle, boxed as new, exc cond (£2100)	£1495
Audio Research PH5 PhonoStage, MM/MC, mint, 6 months old!, fully boxed with manual and remote, incredible phono stage at this price! (£1795)	£1395
VPI Scout inc JMW-9 tonearm, immac cond, boxed, very little usage (£1650)	£1195

MISC	
Nordost Blue Heaven Speaker Cable, ex-dem, 4m pair, bi-wire (£489)	£349
Isotek Gil Minisub, silver front, current spec, immac cond (£545)	£395
Naim Hi Cap power supply, good condition, serial no. 304xx, superb upgrade	£349
Hovland Reference Speaker Cable, exdem, boxed, 8ft pair, single wired (£1200)	£795
Townshend Supertweeters, titanium finish, boxed as new, exc (£800)	£649
Nordost Thor, ex-dem, immaculate condition, boxed, Valhalla wired (£1600)	£1195
Isotek Titan mains conditioner, few months old, boxed (£1500)	£1095
Nordost Valhalla Speaker Cable, 3m per side, bi wire with z-plugs (£5700)	£3995

First Showing

(Shanling MC-3)



The speaker with big balls

Am Omni-directional speaker bargain...

Duevel Planets: £800/pair

On a completely different planet.

Duevel's newest model called the 'Planets' brings omni-directional magic to a completely new audience. Visually the 'Planets' will shock and the price will definitely surprise! Retailing at just £800, the beautiful 'Planets' look like no other loudspeaker and sonically they deliver a first rate performance that is nothing short of astonishing.

Hi-tech engineering, unique design, excellent frequency and phase response ensure the 'Planets' deliver a natural sound that can be described as addictive!

Battleship Shanling

Shanling launch the visually striking CD-T150...



Shanling CD-T150: £2000

Available: March 2007

The elegant 4-cylinder-supports isolate the chassis, sensitive electronics and advanced Philips CD-PRO 2 linear tracking mechanism, delivering a stunning performance from CD. Call or email Shadow Audio for more details on this affordable, visually striking - digital wonder.

MC-3 Valve Music Centre

Shanling launch the beautiful MC-3...

Shanling MC-3: £500
Available: March 2007

MC-3 cleverly combines a high quality CD player, tuner, dedicated i-POD input and tube power amplifier in one chassis. Just add speakers! A brilliant one box solution.

Demand is going to be very high for the MC-3, so place your order early!!

For every MC-3 you purchase, we will give you:

- Free UK Delivery*
- 30-day money-back guarantee*
- High-quality power cord*

The Transporter

Wireless music streaming of the highest quality...



Slim Devices' Transporter™ was designed to appeal to the most discerning audiophiles and music lovers. It streams digital music with sound quality that surpasses even the most exotic compact disc players.

At the heart of Transporter is a "no compromise" attitude to component selection and electronic design.

At £1299 it is a true audiophile bargain!

List updated daily.
Subscribe to the Shadow Audio Newsletter to receive this list once a week automatically by email.



From the comfort of your own chair, you can now order select products from the Shadow Audio Web Site, 24-hours a day. Visit our web site to place your orders today.

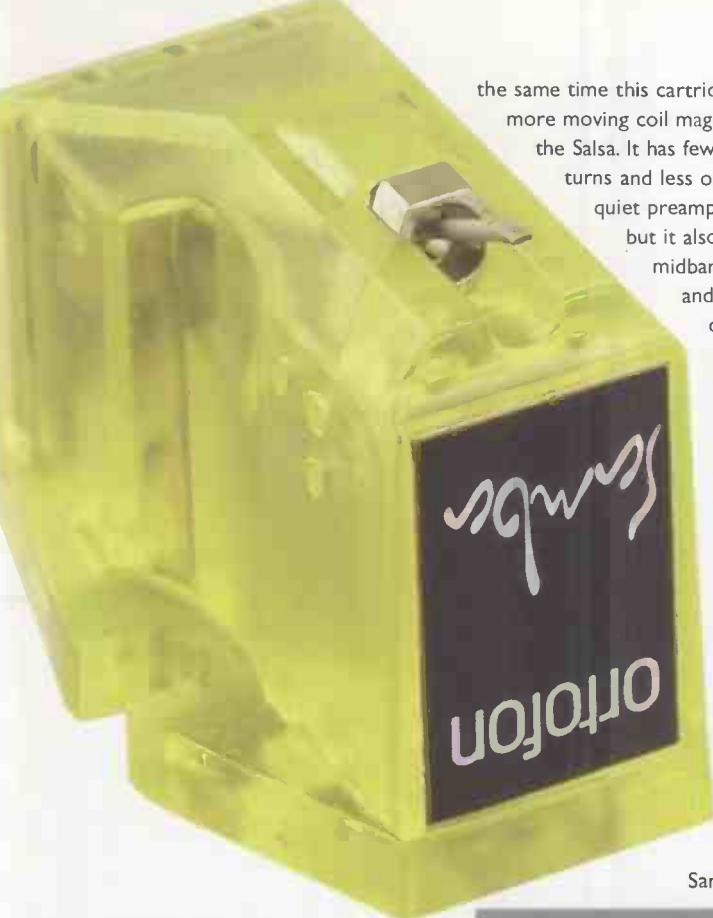

the same time this cartridge had more moving coil magic than the Salsa. It has fewer coil turns and less output, so a quiet preamp is needed, but it also has real midband clarity and delicious dynamics; drums on Phil Collins' 'Hello, I Must be Going' album had the impact I expect from a good MC costing much more. In this respect the Samba was

quite a fright, but an impressive one. It is definitely a DL103R competitor, having much the same tonal balance, but with more controlled bass and a less coloured midband. I fancy the Denon sounds smoother and more relaxed however; due to superior tracking, but feel the Ortofon shades it in all other respects. The Samba is a breathtaking moving coil to listen to, providing you can tolerate its treble, or perhaps have a system that needs a little extra vim here.

Here are a pair of inexpensive cartridges that both have real talent, and offer a goodly amount of moving coil magic. For those who want both clarity and accuracy, the orange Salsa is the one to choose. But the less expensive yellow Samba, although bright sounding, has generally better clarity and more gripping dynamics. So there's no clear-cut choice here; they are different, but each is talented in its own way and good value by moving coil standards, where a top model can cost thousands.

VERDICT ●●●●● £

SALSA
Dynamics and clarity give real moving coil magic, but too bright for some.

- FOR**
- fast, punchy sound
 - midband clarity
 - strong imaging

AGAINST
- brightness

VERDICT ●●●●● £

SAMBA
Couth, balanced and correct sounding, this is one sophisticated budget MC.

- FOR**
- accuracy
 - treble smoothness
 - composure

AGAINST
- lack of verve

ORTOFON SALSA £200
ORTOFON SAMBA £150
☎ +44 (0)1235 511166
www.henleydesigns.co.uk

It comes across as composed in every area, with an even tonal balance that laid out instruments in a democratic manner, each with the same influence as its neighbour. Cymbals didn't dominate, nor did they draw attention to themselves especially. Bass from drums and double bass was firm, in seemingly perfect balance and reasonably forceful. As has happened in the past, I got the best overall performance from a Rega RB250 arm, and this model or the RB300 are a suitable match I feel, in price and in the way they resist the higher vibrational forces from a moving coil.

The Salsa was clear, balanced and completely competent in this arm. It didn't have the verve of a Goldring 1012GX - a fun listen I really like - but it was more balanced and more couth. It lacks the clear-cut image outlines, dynamics and composure of Ortofon's Rondo range above it price-wise, and has none of the openness and finesse of the Kontrapunkt b I use. These are all far more expensive though. At £200 the Salsa is probably one of the most balanced sounding cartridges on the market today, giving a clear and accurate rendition of what is on an LP, but it's a sober sounding, 'sensible shoes' performer where balance is everything.

The less expensive, yellow bodied Samba tracks at a light 1.5gms and, as measurement suggests, has quite a sharp edge to its sound, due to raised treble. Sibilance often took on a hiss that was lacerative, yet at

MEASURED PERFORMANCE

SALSA

The Salsa tracks at 2.2gms and tracking was good, almost up with the best. In terms of frequency response, our graphs clearly show this is a fairly accurate cartridge, veering toward just a tad of emphasis on outer grooves and a flat result on inner grooves, so expect good detailing without obvious brightness. Vertical tracking angle was high at 30 degrees, giving distortion on vertical modulation of 5%. Luckily, this is mainly innocuous second harmonic. Output was fair at 0.58mV at 5cms/sec rms, not as high as more expensive Ortofon's, so a quiet preamp is needed. The Salsa offers an even sound with good tracking ability at a low price; this is Ortofon's least expensive, accurate moving coil cartridge. NK

Tracking force	2.2gms
Weight	7gms
Vertical tracking angle	30degrees
Frequency response	22Hz - 20kHz
Channel separation	24dB
Tracking ability (300Hz) lateral	90µm
vertical	45µm
lateral (1kHz)	23cms/sec.
Distortion (45µm) lateral	1%
vertical	5%
Output (5cms/sec rms)	0.58mV

FREQUENCY RESPONSE

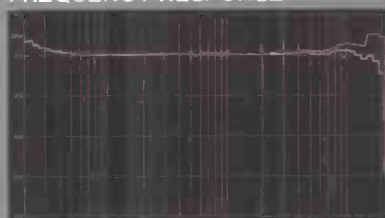

Red - outer grooves
White - inner grooves

SAMBA

The Samba is unusual in being an MC that tracks at low force; just 1.5gms is recommended, whereas MCs usually track at 2gms or more. Tracking was good, if not comparable to the £50 more expensive Salsa. Unlike Tango below it or Salsa above it, the Samba has strongly emphasised treble and will sound bright, possibly spitty, even on inner grooves where tracing loss was minimal. It may be aimed at the Denon DL103R, which is also bright, or at those who want lots of detail. Vertical tracking angle was reasonably accurate at 26 degrees, keeping distortion down. Output was low at 0.42mV at 5cms/sec rms, so a good preamp is needed. Basically the Samba offers a forward sound, with low tracking force. Tango below and Salsa above in price are more accurate. NK

Tracking force	1.5gms
Weight	7gms
Vertical tracking angle	26degrees
Frequency response	22Hz - 20kHz
Channel separation	26dB
Tracking ability (300Hz) lateral	60µm
vertical	45µm
lateral (1kHz)	22cms/sec.
Distortion (45µm) lateral	1%
vertical	3.4%
Output (5cms/sec rms)	0.42mV

FREQUENCY RESPONSE

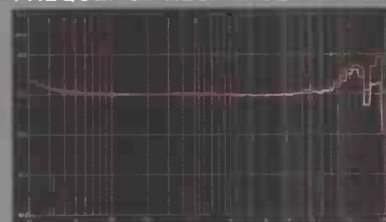

Red - outer grooves
White - inner grooves

whestTWO *west-tōō*, *n* musical, detailed; radical



www.whestaudio.co.uk

t: 020 8965 4535

Hear every detail. Feel every nuance.



NEW

Digital Integrated Amplifier

CA-S10

Dual Monaural Construction 100W x 2 / 8Ω



Digital Integrated Amplifier

CA-S3

CD case size, 20w x 2/8Ω



Contact: ICG Consultancy TEL:01442 399548 E-Mail: ian@icgconsultancy.co.uk

Come and see us at the Bristol Show

Totally Wired

One of the most dramatic upgrades to modern and classic tonearms alike is to replace old or cheap internal wiring with fancy new stuff. The good news is that it's cheaper and easier than you think, says Neville Roberts...

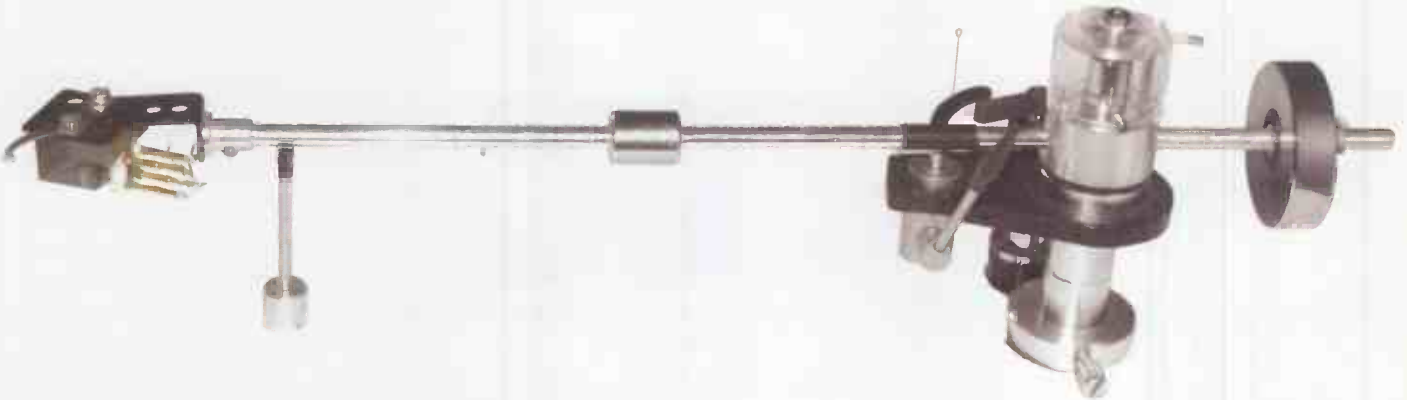

It has never ceased to amaze me how seemingly minor changes to a hi-fi system, such as upgrading your interconnects, can have such a significant effect on the overall sound. This realisation has led me to go right through my system, substituting my loudspeaker cables, preamplifier to power amplifier inter-

attack the wires within. Changing the wires in a tonearm is not simply a case of unplugging the old ones and plugging in the new set – the whole shebang needs to be carefully disassembled and put back together. Still, the good news is that although no ten minute pre-supper job, it's still perfectly do-able by any nimble fingered DIY'er.

GETTING GOING

After doing some homework on the internet, I decided on Audio Note 99.99% pure silver tonearm wire. Of course, there are countless alternatives, and you'll have to take your own view on what suits you and your system best. In the case of the Audio Note, it is made from three individually insulated strands, each 0.05mm in diameter, coated with six coats of polyurethane varnish. Not only should this sound good, it will also be extremely flexible - an essential requirement for tonearms. It is supplied in lengths of 0.5m and is available in clear, blue, red and green colours. The whole project should cost around £60, including a set of four new gold-plated cartridge pins.

The most important thing you need to know about this is that it is very thin - each strand is about the size of a human hair. Obviously then, you can't treat it as you would 13A mains cable. Quite apart from threading the wire into the arm,



The old wires (left) are an awful lot thicker than the new ones...

connecting the wire at both ends is challenging to say the least, so you need to work on your technique...

Before commencing the rewiring process, I found it essential to find a way to solder the wires to the cartridge connecting pins and the arm socket while there was still half a metre to play with. Obviously, stripping the wire was out of the



These are the new wires, so soldering is going to be tricky!

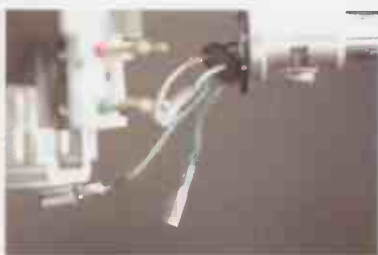

Here are the old wires, long overdue for the chop...

connects and phono amp to preamplifier interconnects, and even fitting a replacement tonearm cable. So it got to the point when the only things left to upgrade were the very wires in my tonearm themselves...

My pickup arm, a Mayware Formula 4 unipivot, is over twenty five years old and definitely in need of some TLC. The Lyra Clavis DC cartridge that I have recently fitted sounds superb, but still I couldn't help feeling that the internal signal paths were past their sell-by date. This prompted me to take the plunge, and



The new wires soldered to the old ones, ready for pulling through.

question, and it was far too thin to use emery paper to remove the varnish from the strands. The third option was to simply use the heat from a soldering iron to melt the varnish and, at the same time, apply the solder to tin the wire. This was not as easy as it sounds, as my initial attempts resulted in the wire 'disappearing' as I heated it! It simply



The dismantled socket in the dismantled armbase.

vaporised away due to its thinness, so the use of a temperature controlled soldering iron is vital.

I eventually managed to achieve a balance between the temperature of the iron and the length of time to apply heat in order to melt the varnish and tin the wire. To say it takes a bit of trial and error is something of an understatement, so be prepared for a steep learning curve. Before starting to dismantle your arm then, it's best to practice tinning the wire until you're confident you can do this repeatedly. Remember, you have eight connections to make and a limited



Close-up of the unipivot assembly.

length of wire to deal with, once you have threaded it through the tonearm.

DISMANTLING

Before removing the tonearm from your turntable, it's a good idea to record some measurements, such as the height adjustment. After all, you did spend a considerable amount of time adjusting the vertical tracking angle (VTA) of your cartridge, didn't you? This will greatly help the process of reassembly. Once the tonearm is removed from the turntable, disconnect the pins from



Inside the unipivot showing the dashpot...

the cartridge and desolder the pins from the wire. Similarly, remove the socket from the arm base and desolder the wires from the socket, having first noted which colours go to which pins.

The next stage is to replace the wire in the arm. The new wire is quite strong, but it is delicate and the tricky part is to thread it from the arm at the pivot end, down the support to the socket. This requires the wire to make a 90 degree bend at the pivot. The easiest way is to attach the new wire to the old wire



The top of the unipivot, close-up.

at the headshell end and gently pull it through. Twist the four old wires together and solder these to the four new wires that have also been twisted together. Try to do this as smoothly as possible to minimise the risk of snagging. When you've done this, you're ready to start the nerve-racking job of pulling the old wire out, which will also thread the new wire in.

Start by clamping the arm in a support to allow both hands free to guide the wires. Gently start to pull the old wire from the bottom of the arm support and at the same time, feed the new wire in at the headshell end. Keep feeding the wire in until the join reaches the pivot. Be especially careful as you guide the wire around the 90 degree bend at the pivot. Fortunately, the new wire will be more flexible than the old, but the last thing you want is for the wire to break halfway though the process! Keep going until you see the join emerging from the base of the arm.

At this point, treat yourself to a stiff drink to steady your nerves - you've earned it! You are now ready to connect up the new wire. |



Believe it or not, the new wires will have to negotiate this 90 degree bend around the dashpot!



Home at last: the Lyra Clavis now affixed to the arm's new gold plated pins...

recommend fitting the cartridge pins to the new wire next. Tin the new pins and the wire, then reheat the pin and while the solder is molten, insert the tinned wire into the solder and allow to cool and the solder to solidify. It helps to have the pin clamped so you can use one hand for the soldering iron and the other to hold the wire.

When you have completed all four, pull the surplus wire through the arm to leave sufficient at the headshell end to connect to the cartridge. Now you can cut off the surplus wire at the arm base end, allowing some surplus to facilitate wiring up the socket. Finally, tin the new wires and connect them to the appropriate pins on the socket using the same process that you used to solder the cartridge pins.

It is a good idea at this point to test for continuity between each pin and the socket with a multimeter. Also check that there are no shorts between pins and also between each pin and the tonearm earth. You can then feed the surplus length into the arm support tube and refit the socket in the arm base. Go and have another drink!

BACK TOGETHER

You are now ready to reassemble the arm and refit it in your turntable. With my unipivot design I thought it would be a good opportunity to replace the silicone damping fluid in the dashpot while I had the arm in pieces. Over the years, the damping fluid had degraded to a treacle-like substance, so I contacted Len Gregory, AKA 'The Cartridge Man', who supplied me with a syringe of a modern replacement gel that does not degrade like the silicone fluid previously used.

"be methodical, and have the odd snifter of Jack Daniels to steady your nerves..."



Optimum working of the Mayware depends on getting the right amount of damping fluid.

Firstly, the old fluid had to be removed from the dashpot and from around the steel needle in the unipivot head. It is a bit of a messy process, as the silicone is rather sticky and does tend to get everywhere. Use plenty of disposable paper towels and lots of cotton buds to thoroughly clean out the dashpot. When finished, the dashpot can be easily filled with the new gel from the syringe. Remember not to fill the dashpot up completely to allow for the volume of the steel needle. Complete the reassembly and set the arm using the measurements you took prior to disassembly. Finally, connect up the cartridge, plug in the tonearm cable and make sure it is all working.

Before settling down to listen, you should completely recalibrate the arm, as you are unlikely to have aligned the arm precisely using your measurements alone. Of course, tracking weight, cartridge alignment, and VTA should all be rechecked.

IN THE END

Was it all worth it? Well, from my experience, it certainly was. As always seems to be the case, just when you think your system is sounding the best it can, there is always room for improvement. I was hoping for better clarity and precision of instruments within the stereo image, and was not disappointed. However, what I was not expecting was the huge improvement at the lower end of the frequency spectrum.

Yes, the stereo imaging had improved, and there was a greater

sense of space, coupled with a sharpening of instrument placement between the loudspeakers. Yet the most noticeable improvement was in the tightness of bass notes - kettle drums in particular had greater punch. An old favourite test record of mine is Stravinsky's 'The Firebird Suite' performed by the Atlanta Symphony Orchestra on Telarc digital recording DG-10039. The deep and extended drum roll during the opening sequence was noticeably cleaner and more controlled. Further into the recording, the strings were clearer and crisper, and you could almost identify individual violins within the orchestra.

Overall, it was a heck of an upgrade for just £60, and less difficult than I'd feared. Get some soldering practice in first, be methodical and meticulous - and have the odd snifter of Jack Daniels to steady your nerves - and you shouldn't go far wrong.

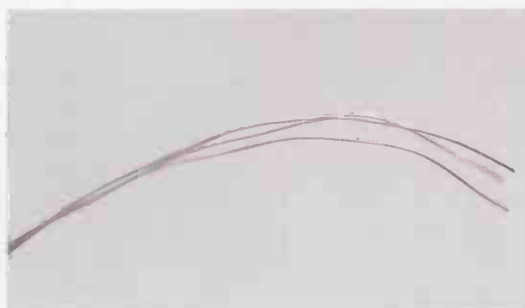

It's amazing the difference a few little bits of wire can make!

Stoned Again



Once upon a time, resonant wooden plinths were the order of the day for Garrard's classic transcription turntable, and they sure did a great job - of hiding the turntable's true potential. Now though there are plenty of options to house your 301 or 401, such as this new Slatdeck product from World Designs. Adam Smith turns on and tunes in...

Around fourteen years ago, a certain magazine called *Hi-Fi World* caused no small amount of surprise when it dusted the cobwebs off a (then) thirty year old relic, spent some money on it and declared it more than capable of showing modern machinery a thing or two. The relic in question was the Garrard 401 and it now seems almost universally accepted that the 401 and its elder brother the 301, are magnificent units that, once properly set up and running, can exceed the high standards in vinyl replay set by modern turntables.

Of course, the key phrase here is, "once properly set up and running". Back when the 401 was

new it would invariably find itself situated in a teak sideboard type unit, or a big wooden plinth (SME's 'Baby's bathtub' anyone?) which did the deck no favours. As it contains a motor roughly the size of that found in a modern washing machine, which produces a heck of a lot of mechanical energy, a resonant cabinet of this type was the last thing it needed and it was no wonder that many owners, including our very own Noel Keywood, were plagued with rumble problems. However, a good industry has now arisen around the old Garrard units and if you want new bearings, idler wheels, dedicated power supplies, remanufactured switch plates or even a complete rebuild, then there are people out

there who can supply them.

Now this is superb news, especially for a committed 301 owner like myself, but the issue still remains of what to do with your 301 or 401 once it arrives in your home in the sort of operational condition that the Swindon factory would have been proud of, likely after renovation.

Many different types of exotic and not-so-exotic materials have found themselves with a Garrard fitted to them, but the multi-layered marine ply wood bases seem to have flourished the most in recent times. Whilst these are undoubtedly good units, the problem is that the more layers of wood you apply, the more damping is achieved and the quieter and better your Garrard sounds.

While this is all well and good, the issue arises that there is the remote possibility that, by the time it sounds spot on, your plinth has so many a layers that a step ladder is required to cue a record!

Consequently it would seem to make more sense to use a material that is composed of layers within itself, but that is far more dense and stable than wood, meaning that a much thinner slice of it will confer the same amount of damping and isolation as half an oak tree - like slate, for example...

Slate is a naturally occurring material that has unique properties as it is formed from multiple sedimentary layers. As I remember seeing on a visit to a Lake District slate mine, this makes it easy to cut very thin slices in order to form roof tiles, for example.

There are many forms of slate, however, and not all are as brittle or easy to split as roofing slate. The 'daddy' of the slate world is Welsh Blue Slate and this is considerably harder than roofing slate, making it eminently suitable for carving. Carrying this out and making a turntable plinth from it should, in theory, work superbly and offer excellent damping, in addition to high mass and rigidity.

The word 'slate' has been associated with Garrard plinths in the past, courtesy of the long defunct Slate Audio, but rumour has it that this was more of a granite type material than true slate. However, the range of Slatedeck plinths now offered by World Designs are made from the aforementioned Welsh Blue slate and available in a wide variety of shapes and sizes to suit a number of turntables.

Currently, there are single layer and dual layer plinths available in thicknesses of 20mm and 30mm. These are presently available to suit the Garrard 301 and 401, the Thorens TD124 or Goldring Lenco GL75/78 types. Next on the list will be the Goldring G88 and G99 types, whereupon all of the most popular idler drives will be covered. Equally impressive is the extensive range of matching armboards that allow virtually any arm from nine to twelve inches to be accommodated. Even more intriguing is the new Slatedeck 'Universal Arm Mount' which fits arms with a Linn type arm pillar onto an SME type mounting pattern - genius!

Naturally, looking for the very best, we decided to test the top of the tree model, and World Designs provided us with the dual layer 30mm plinth, supporting a Garrard

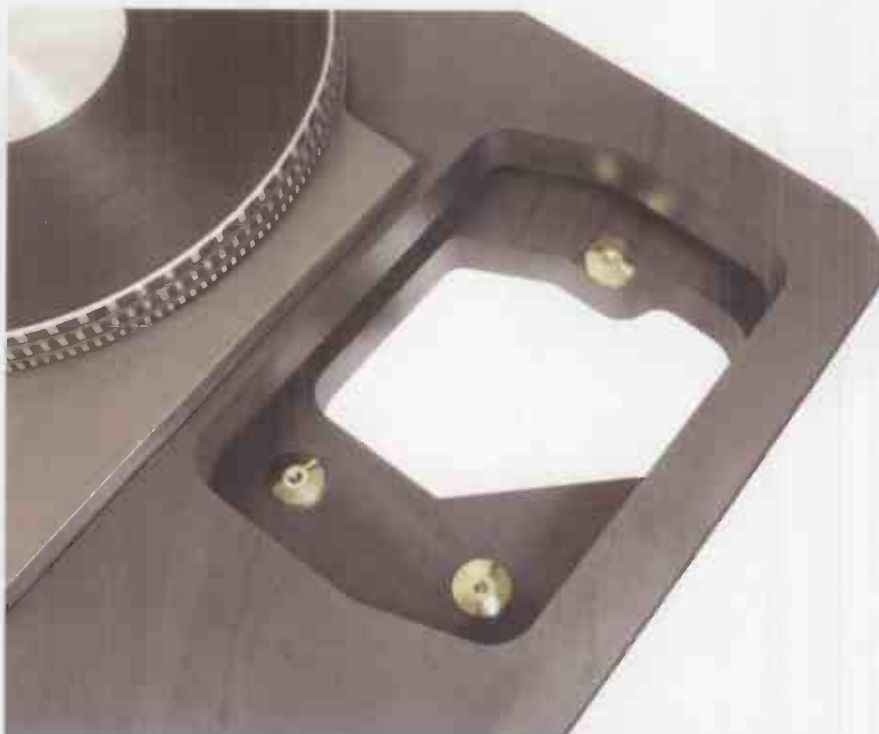

The Slatedeck's armboard sits within a cutout in the top layer, resting on spikes sat upon the lower layer. This insulates the tonearm from the motor board very effectively.

401. SME were kind enough to supply a shiny new 312 twelve inch arm to go with this and I bolted into this an Ortofon Rondo Bronze MC cartridge.

them from moving when trying to position it.

World Designs' Peter Comeau advised that the assembly process is really a two-person job but, being

"the Slatedeck setup added a whole new dimension to the music..."

GETTING GOING

Setup instructions for the Slatedeck items are very comprehensive and easy to follow. After using some of the supplied Linseed oil to buff up the finish of each item to a lustrous shine, the first step is to position the lower layer of the plinth onto its three spikes, for which one uses the stiff packing foam that the unit is supplied in. In a similar vein, the second layer sits on a further three spikes on top of this. Incidentally, all spikes are supplied with cups to sit in so that neither your turntable stand, nor the top of the lower layer are marked by the spikes which sit upon them. The 401 was then fitted to the upper tier and its motor transit springs released.

The arm is fitted to a completely separate slate base which sits within a cutout in the upper tier of the plinth, resting on a further three spikes on the top of the lower tier. Positioning this is more of a chore than the plinth layers themselves and it helps immensely if you follow Slatedeck's advice and stick the spikes for this item onto the underside of the arm base to stop

an obstinate sort I had a go at it on my own and found that it was not an unduly difficult task, with the exception of the weight of each piece of slate and the slightly fiddly arm positioning. However, with the plinth built, turntable warmed up and emitting that fabulous smell of warm grease that only older equipment gives, and the arm duly positioned and set up, we were ready to go.

SOUND QUALITY

We have long held the belief here at *Hi-Fi World* that, when done properly, the aural experience that vinyl offers really cannot be beaten. The small turntable group test elsewhere in this issue proved to me that, for around £1,000, superb results can be obtained and I can imagine one or two people wondering whether the extra expenditure on a setup like this would be worth it. Well, I can tell you that the Slatedeck/401/SME/Ortofon combination moves the experience up to a whole new level.

As a 301 owner, I am well used to the good old Garrard bass which, if you haven't experienced it, is solid and seriously deep. Other turntables



DIY Speaker Parts - Drive Units, Crossover Components, Floor Spikes



We have selected SEAS Drive Units for their natural sounding performance and smooth response allowing simple crossovers to be used. Below is a selection of drive units from the complete SEAS range that we hold in stock. Ring us to enquire about drive units not shown here.

SEAS A26RE4 £71.98
25cm (10") Paper Cone Bass unit as used in the WD25 Speaker kits

SEAS CA22RNX £83.79
22cm (8") Paper Cone Bass unit 89dB for TL or Aperiodic designs

SEAS CA18RLY £51.11
18cm (7") Paper Cone Bass unit 88dB for TL or Aperiodic designs

SEAS CA15RLY £53.52
15cm (5.75") Paper Cone Bass unit 87dB for Bass Reflex designs

SEAS 29TFF/W £38.34
29mm soft dome treble unit used in the WD25 STD speaker kits

SEAS T29CF001 £137.82
29mm Excel soft dome treble unit used in WD25 XL speaker kits

SEAS T25CF002 £161.09
25mm Excel 'Millenium' treble unit lowest distortion, smooth response



SONIQS M8 spike set £4.70
Set of four speaker floor spikes with matching M8 cabinet inserts

SONIQS M4x16mm £0.08

SONIQS M4x25mm £0.09

Hex Hd Nickel Plated wood screws

SONIQS PDC per metre £2.61
Heavy 6mm Bitumen Panel Dampening Compound 50mm wide strip

SONIQS CDF per metre £1.49
Long fibre enclosure damping mat 30mm thick by 250mm wide

Aperiodic reticulated foam £1.25
80ppi reticulated foam strip for Aperiodic port airflow resistance



SONIQS Polypropylene Caps

SONIQS capacitors are formed from high voltage polypropylene film and hand soldered using silver solder to copper leads. Construction and resin encapsulation has been formulated for optimum acoustic and electrical performance.

PXX 1.0uF 250V £1.13

PXX 1.5uF 250V £1.28

PXX 2.2uF 250V £1.41

PXX 3.3uF 250V £1.70

PXX 4.7uF 250V £2.06

PXX 5.6uF 250V £2.35

PXX 6.8uF 250V £2.66

PXX 8.2uF 250V £2.90

PXX 10uF 250V £3.18

PXX 12uF 250V £3.74

PXX 15uF 250V £5.03

PXX 18uF 250V £6.03

SAX 1.0uF 630V £2.40

SAX 1.5uF 630V £2.81

SAX 2.2uF 630V £3.17

SAX 3.3uF 630V £4.19

SAX 4.7uF 630V £4.49

SAX 5.6uF 630V £5.28

SAX 6.8uF 630V £6.16

SAX 8.2uF 630V £6.93



SONIQS Ferrite Inductors

SONIQS coils are wound on high density 12.5mm dia. ferrite cores for high power handling and dynamic range. High purity copper 0.71mm wire heat bonded to reduce vibrational effects. Tolerance 5%. State value required when ordering.

25mm core 0.33 - 0.6mH £2.47

50mm core 0.6 - 1.0mH £3.49

50mm core 1.1 - 2.5mH £3.98

SONIQS Air-Core Inductors

SONIQS air core coils utilise 0.56mm dia high purity copper wire on a rectangular bobbin that allows vertical and horizontal orientation to minimise coupling effects. Tolerance 5%. State value required when ordering.

Air-core coil 0.18 - 0.5mH £1.99



Vitreous Enamel Power Resistors

High Power resistors encapsulated in Vitreous Enamel to minimise vibrational effects. Tolerance 5%. State value when ordering.

3W 0.68 - 100 Ohms £0.99

7W 1.0 - 100 Ohms £1.47



SONIQS TP1 panel £3.60

Bi-wireable terminal panel with gold plated connections allowing spade, bare wire and 4mm plugs. Plain Tufnol CCB circuit board also available to fit PCB slot at rear to allow component hard wiring.

SONIQS CCB board £1.49

tend to sound a bit lightweight and slow by comparison, even when the 301 or 401 is in a basic plinth. Fortunately the Slatedeck plinth makes the best of this and augments it by adding an even further degree of tunefulness into the mix. There is equipment that can shake the room and rearrange your internal organs with its bass power, and there is other equipment that has the low frequency rhythmical ability to start and stop instantly, but it is a stunning experience to hear a turntable that can do both - the Slatedeck/401 is one of the best.

Moving through some of the records I also used in the group test, the Slatedeck setup added a whole new dimension to most of them. With Simply Red's 'Picture Book' bass guitar had astonishing levels of detail and grip, punching forth from the loudspeakers with real authority. The soundstage set up by the

midrange detail from music and locked everything in an absolutely vice-like soundstage. The phrase 'grip

of iron' was suggesting itself to me at this point, but perhaps 'grip of slate' would be more appropriate.

The sublime and sweet midrange of the SME, combined with lower levels of tracking distortion thanks to its twelve inch length meant that vocals and backing instruments were detailed and revealing, with stunning levels of richness and scale.

The traditional area where the Garrard is said to be lacking is the



The Slatedeck's substantial armboard, showing the spikes on which it sits - an ideal home for an SME 312 arm.

"...the Slatedeck setup brought forth even more midrange detail from music and locked everything in an absolutely vice-like soundstage."

Slatedeck and Garrard is positively vast, extending well beyond, behind and around the loudspeakers.

I have long been of the opinion that the bass reproduction is fundamental to a musical performance, no matter what genre of music is being played, and that if the bass is lacking in some way, it is difficult to rescue the rest of the frequency spectrum. This certainly seemed to hold true as the Slatedeck setup brought forth even more

treble but I cannot help wondering if this is something of a misnomer. True, it does not have the sharp insight of some units, but everything is there and presented in a beautifully natural way. The Slatedeck combination does not attempt to add any artificial sheen to material, but the likes of flutes and cymbals have real presence and a truly lifelike form.

Finally, I know that many of you will still have the word 'rumble' lurking at the back of your minds,



The finish of the Slatedeck is impeccable, as are the spikes and spike cups supplied with it.

but let me reassure you, the Slatedeck/401 setup was silent, with nary a murmur from the loudspeakers as the stylus met the groove! In fact, I was pleased (yet rather dismayed) to hear that it was quieter than my own (non slate-plinthed) 301...

CONCLUSION

It has been fascinating for me to watch the resurgence in interest in classic idler drive turntables over the years. I was telling anyone who would listen that the Garrard 301 was a fabulous old thing even before *Hi-Fi World* rediscovered it and it has surprised even me how people are extracting previously unheard-of levels of performance from units like the Goldring Lenco GL75, which was considered a good, if not exceptional unit, even in its day.

I would say that the key step in achieving this level of performance from an old unit is in the plinth in which it is fitted. Even the original 301 and 401 manuals specified that the decks should be fitted to a "substantial" motor board, yet this was largely ignored.

World Designs and Slatedeck have come up with a worthy product that forms a perfect starting point with which to build a truly worthy record playing system and the design and finish of the Slatedeck units is beyond reproach.

The Slatedeck/Garrard 401/SME 312/Ortofon Rondo Bronze combination here is an absolutely superb record player and one of the best I have ever heard, regardless of price or age and I will be truly sorry to see it leave the office.

VERDICT ●●●●●

A brilliant way to release the full potential of a classic turntable motor unit, this comes unreservedly recommended.

**SLATEDECK DUAL LAYER
PLINTH SYSTEM** £1200
(as tested)

World Designs
☎ +44(0) 1832 293320
www.world-designs.co.uk

FOR

- confers phenomenal bass
- excellent detailing
- superb vibration control
- looks

AGAINST

- time-consuming assembly

Self indulgence can be a wonderful thing...

What is High-end?

High-end Home Entertainment is the very best Hi-Fi & Home Cinema products available for your home, your living space. These are Home entertainment products, designed by the finest Manufacturers and minds across the world. Each has the same goal - to give you the listener, you the viewer - a whole new experience in sound and vision.

Each Exhibitor has its own dedicated demonstration suite

It is your chance to discover, see and hear the finest products all in one show. Exhibitors will be on hand to tell you more about the products and answer any questions you may have.

For just £7* (per person), you eyes and ears will experience Home Entertainment on a scale that you just cannot experience anywhere else.

Rob Bird, Show Organiser

Save money...

Don't forget to download your privileged ticket from www.chestergroup.org/heathrowshow07.

How do i get there?

Show Location/Show Opening Times:

Park Inn Hotel, Heathrow
Sat (31st): 10.00am – 5.00pm
Sun (1st): 10.00am – 4.00pm

Show Directions:

There is a regular shuttle bus to and from the airport (H2 Hopper) and uniquely for people travelling by car to our show there will be a dedicated carpark within the Hotel. More importantly you can park all day for just £5.

Adjacent to London's major motorway networks M4 / M25, just 0.3 miles from London's Heathrow 1, 2 and 3 terminals, 15 miles from London city centre and Central London only 15 minutes train ride away on the "Heathrow Express"

DIRECTIONS - BY CAR

From London A4:
Follow signposts for terminals 1,2 & 3. At traffic lights where you would turn left for the Airport, turn right and then take the first left into the Hotel entrance.

From M25:

Follow signs for M4 Terminals 1,2 & 3. Take exit 4 off the M4 for terminals 1,2 & 3. Avoid entering the tunnel into the Airport and take the spur road to your left and turn left at the first set of lights. You are now in front of the Hotel.

From the M4:

Take exit 4 off the M4 for terminals 1,2&3. Avoid entering the tunnel into the Airport and take the spur road to your left and then turn left at the first set of lights. You are now at the Hotel.

Getting there by Train/Bus?

Take the Piccadilly Line tube or the Heathrow Express and alight at Terminals 1,2&3. The Hotel Hoppa picks up at intervals outside each Terminals 1,2&3. Catch the Hotel Hopper H2 to PARK INN HEATHROW.

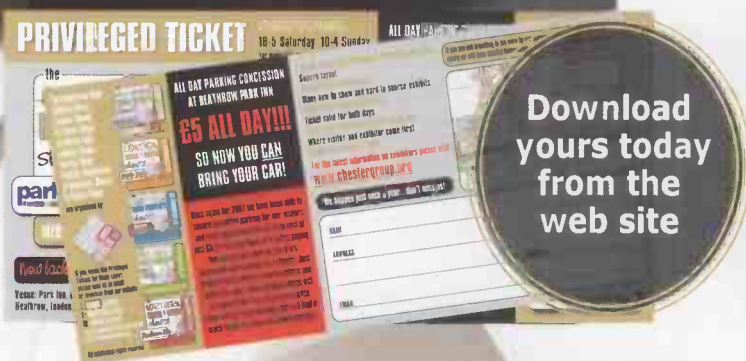

Chesterfield Communications

Stone Cottage, Guy Lane, Foulk Stapleford, Hargrave, Chester, CH3 7RZ

Organisers of the above show. All intellectual rights reserved.

PRIVILEGED TICKET

SHOW OPEN
10-5 Saturday 10-4 Sunday
For more info see our website

ALL DAY PARKING CONCESSION
AT HEATHROW PARK INN

PRIVILEGED TICKET



Download
yours today
from the
web site

THE
HEATHROW
HIGH FIDELITY
show '07

park inn



31 March - 1 April 07

MEDIA SPONSORS: HI-FI WORLD

Exhibitors include:

A'Audio
 Absolute Analogue
 Acoustat
 Aeon Acoustics
 Alium Audio
 Amadeus
 Angelsound Audio
 Anatek Acoustics
 Aspara Acoustics
 Audio Acoustics
 Audiocraft
 Audionote
 Diverse Vinyl
 English Valve Amps
 Ensemble Audio
 Phasonics
 GT Audio
 Hi-Fi World
 Hi-Fi Critic
 Horn Audio
 Integrated Engineering Services
 Lovington Horn Loudspeakers
 Metropolis Music
 Music Martters
 MySpace
 Noteworthy Audio
 Pinsh
 Podium
 Progressive Consumer Matters
 Signature Audio Systems
 Stamford Audio
 Tannoy
 The Acoustic Partnership / Audion
 Sound Gallery
 Townshend Audio
 True Colours
 Trichord Research
 UKD
 Vertex AQ
 Whest Audio ...

Brands include:

Acoustat, Acoustic Zen, Aeon Acoustics,
 Allaerts, Almarro Products, Amphion
 Loudspeakers, Anatek, Antique Sound
 Lab, Ars Aures Loudspeakers, Art Audio
 Amplifiers, Ashbourne Loudspeakers,
 Aspara Loudspeakers, Audio Acoustics,
 Audio Analogue, Audio Logic, Audio Note,
 Audio Tekne, Audioengine, Audion, Aurum
 Cantus, Avantgarde Acoustic, Bcd, Bolzano
 Villettri, Bright Star, Cain & Cain, Channel
 Islands Audio, Consonance, Custom Design,
 Cut Loose Audio, David Gill Audio, Dh
 Labs Cables, Diapason, Diverse Vinyl, Diy,
 Eera, Eggleston Works, Ensemble, Fab
 Audio, Final, Finite Elemente, Furutech,
 Golden Sound, Graaf, H-Cat, Hidiamond,
 Hi-Fi Critic, Hi-Fi Tuning, Hi-Fi World,
 Horn Audio, Isoclean, Isolation, Isophon
 Loudspeakers, J.C. Verdier, Jorma Design,
 Kemp Electronics, Lavardin Technologies,
 Lfd Audio, Lindemann, Locus Design,
 Lovington Horn Loudspeakers, Lutron, Lyra
 Cartridges, Lys, Mapleshade Audio, Marten
 Design, McIntosh, Modwright Instruments,
 Monrio, Music Matters, My Sonic Cartridge,
 MySpace, Nordic Concept, Noteworthy
 Audio, Oehlbach, Omega Speakers, Opera,
 Ortofon Spus, Pathos, Phy- Hp, Pinsh,
 Plinius, Podium, Pure Power, Red Wine
 Audio, Redpoint, Reference 3a, Revolver
 Loudspeakers, Rockport, Rogue Audio,
 Royal Blue, Schrider, Silver Audio, Slim
 Devices, Sme, Sophia Electric And Western
 Electric, Sound Good Room Panels, Sound
 Practice, Spirelux, Stamford Audio,
 Stellavox, Tannoy, Tonewinner, Townshend
 Audio, Triangle, Trichord Research, Tron,
 True Colours, Tusk Audio, Tw Acoustic And
 Zyx, Unison Research, Viablue, Vyger
 Turntables, Wavac, Weiss Digital Audio,
 Ypsilon

The sign of good shows...

t : +44 (0)1829 740 650 f : +44 (0)845 280 0065 w : www.chestergroup.org

Organisers of the above show. All intellectual rights reserved.

In Tune



Forget Digital Radio - the real radio revolution is online. Gone are the days of absurdly low bit rates – Internet radio sound is now as good as DAB, and can only get better, writes Steven Green...

Another huge leap in quality will happen this summer when the BBC launches its iPlayer. Along with carrying live streams of BBC television channels and allowing people to download programmes they missed, iPlayer will carry live streams of all the national BBC radio stations at 128kbps in both AAC and RealAudio formats. The high bit rate TV and radio streams will use an Internet distribution technology called 'multicasting', which vastly reduces the cost of distributing broadcast content over the 'net, and this allows the broadcasters to provide their TV channels and radio stations at far higher quality [see p83 – Ed.].

Following work the BBC has done with multicasting, ITV and three out of four of the largest commercial radio broadcasters – GCap Media, Emap and Virgin Radio – have also been testing the technology, so it is expected that most or all of their stations will be available via multicasting once the BBC iPlayer is launched this summer.

Taking all of the above improvements into account, this would mean that the large majority of all of the big UK radio stations will have 128kbps or higher bit rate streams available online by the summer.

Although I have strongly criticised the use of 128kbps for DAB

comes close to matching FM.

This doesn't mean that all 128kbps Internet streams will sound good however, because if poor quality audio is fed into the encoders then poor quality will come out, but at least with these broadband Internet streams it won't be the audio compression that's most at fault like it is on DAB.

The increases in bit rates of the UK-based stations described above are really just bringing the British stations up to the level that thousands of Internet radio stations have been using for a few years now, which is why I've felt for some time that Internet radio has acquired an undeserved reputation for poor quality. For example, on the Shoutcast Internet radio portal alone there are approximately 4,350 stations using bit rates of 128kbps MP3 or higher, including 400 stations using bit rates between 192kbps and 320kbps. Considering that 128kbps MP3 provides approximately the same level of audio quality as 192kbps MP2, which only Radio 3 uses on DAB in the UK, then clearly the quality of Internet radio is much underrated.

A WORLD OF CHOICE

The most striking feature of Internet radio is not the audio quality though, but the huge number of stations available from the UK and around the world. There are around 18,000

The audio quality of the UK radio station Internet streams is currently undergoing a radical transformation. Gone are the days when every British radio station provided their online streams at bit rates so low it made AM sound good; now many UK commercial radio stations are available at true broadband bit rates, with more to follow soon.

The first commercial radio broadcaster to use broadband bit rates for its online streams was Virgin Radio, which provides its four radio stations in numerous audio formats, with the best quality streams using 160kbps Ogg Vorbis.

More importantly however, GCap Media, which is the UK's largest commercial radio group, has recently launched broadband streams using 128kbps WMA for all, or at least the vast majority of the large number of local and national radio stations it owns, including Classic FM and all of its digital stations. So for instance, if you're disappointed that the new national digital jazz station, theJazz, is only available in mono on DAB, you can listen to it online in stereo and at better quality.

"the Internet will become the source of the highest quality radio available.."

in these pages on previous occasions, the problem besetting DAB is the use of the outdated and inefficient MP2 audio codec. In contrast, the Internet streams described above are all using modern and efficient codecs that perform very well at 128kbps. For example, both AAC and WMA at 128kbps are capable of providing audio quality that either matches or

streams on Shoutcast alone, and that is just one of the portals, albeit probably the biggest. So if you're disappointed with the choice available on DAB and FM as I am, then Internet radio should be a godsend. However, the vast majority of stations available on the big portals like Shoutcast are of the presenter-less 'jukebox' variety, so if you insist

on a radio station having a DJ or a presenter then it may not be your cup of tea. On the other hand, neither do the vast majority of stations have adverts...

The large number of stations available means that it takes time to sort the wheat from the chaff, though. But since most people listen to very few radio stations, investing time in finding new ones can pay dividends. So the first stage in discovering what it has to offer is to visit one of these Internet radio portals. They let you list stations by genre, and some such as Shoutcast and Icecast, give additional information, such as the bit rate of the stream and what's currently playing, which helps to eliminate many of the stations at a stroke. Internet radio portals are aimed at PC users, but there is now a small but growing range of Wi-Fi Internet radios available, such as the MagicBox Imp or the Acoustic Energy Wi-Fi Radio (pictured), and media adaptors that allow you to play Internet radio on your hi-fi system (as well as playing audio from your PC), such as the Squeezebox.

Recent news is that Reciva (which produces the receiver modules that power all Wi-Fi Internet radios currently available in the UK) and Frontier-Silicon (which produces the receiver modules that power around 75% of all UK DAB radios) have each designed receiver modules that combine Wi-Fi Internet radio with DAB and FM reception, and portable radios using these modules are expected to be released in the coming months, with Pure Digital being one receiver manufacturer that has expressed its interest in bringing out such a product.

Audience measurement body RAJAR estimates that only 22% of UK adults have ever listened to Internet radio, although their figures may exclude non-UK stations. Although listening is still only a minority pastime, I think the launch of the BBC iPlayer along with the improvement in quality on the commercial radio streams will provide the spark for the rapid growth of Internet radio over the next few years. And, for the reasons outlined in my opinion column, I think the use of Internet multicasting will lead to the 'net becoming the source of the highest quality radio available in years to come. Internet radio's future is very rosy indeed.

INTERNET RADIO: HOW IT WORKS

When a user clicks a link on a web page to listen to an Internet radio station, the user's computer and the Internet server go through a process of exchanging messages back and forth in order to set up a (virtual) connection between the computers. Once this connection has been made the server will begin transmitting the Internet radio stream to the user's computer.

However, although the term 'stream' conjures up images of there being a steady and continuous transmission from the server to the user's PC, all data that is sent over the Internet is combined into relatively small chunks of data, called IP (Internet Protocol) packets. This means that a radio station's audio datastream must first be split up into discrete chunks, and these chunks are placed into IP packets before being sent over the Internet. So rather than there being a continuous data transmission, it will actually consist of the transmission of one IP packet containing audio data, followed by a relatively long gap, then transmission of another packet, and so on...

Each IP packet has a small amount of information at the beginning of the packet called the header, which contains the IP addresses of the source (the server in this case) and destination (the user's PC) computers, along with information such as how much data is contained in the packet. Following the header is the body of the packet, which contains the actual useful data that is being sent to the destination – in this case the compressed audio of the radio station.

In between the server and the user's PC, the IP packets are directed across the Internet by routers, which examine the destination IP address in the header of the packets, compare that with tables of addresses they have stored in their memory, and then send the packets out along the most appropriate route so that each IP packet gets closer to its destination. After a few of these 'hops' between Internet routers, the IP packet arrives as if by magic at the destination PC.

If we ignore how packets get from A to B and assume that they just get there, it is easiest to visualise the connection between the server and the user's PC as being a water pipe that drains into a bucket with a hole in the bottom at the user's end. The bucket with a hole in the bottom will let the water run out at a continuous rate, and the job of the server is to try and ensure that the bucket never empties by pouring more water into the pipe when required.

What this amounts to in real-life is that the bucket at the user's PC is a data buffer (data memory), which is large enough to store a few seconds' worth of audio. The hole in the bucket is analogous to the audio decoder on the user's PC removing data from the buffer at a constant rate, and the user's PC monitors how much data is in the data buffer and sends messages back to the server requesting it to send a certain number of bytes in order to try and keep the buffer relatively full.

The reason the data buffer is needed is to allow for delays in receiving packets from the server, which could either be due to the server being too busy to send the packets fast enough or due to packets being delayed due to being kept waiting in queues at the Internet routers. If the delays are too great the buffer will empty altogether and the audio stops until more data arrives – when this happens the media player or Internet radio will display the dreaded "Rebuffering" message...

My experience of listening to Internet radio is that rebuffering problems are caused by problems at the servers and not at the Internet routers, and as the bigger radio stations use professionally managed servers they tend to be reliable, whereas the smaller stations are less so. Rebuffering should become less of an issue over time as Internet bandwidth continues to get cheaper and more plentiful and the processing power of server computers increase.

The screenshot shows the SHOUTcast website interface. At the top, there's a navigation bar with links like 'Home', 'New!', 'Download', 'Winamp', 'Documentation', 'Stats', and 'Support/forums'. Below that is a search bar and a list of radio stations. The list has columns for 'Name', 'Action', and 'Bitrate'. The first few entries are:

Name	Action	Bitrate
Acoustic Romance - www.tastin.ro - Hi Music Station	5671-8312	32
977 The 90s Channel	43201322	128
POLSKAS FOLIA PL (L - Muzyka na TOPE (Polskie Radio) Jajopus	35114272	48
977 The 90s Channel	32554252	128
French Vibes Radio	26495833	192
Techno France Dance (House)	26416000	128
Republic of Korea Top Radio: MUKULCAST.COM * KPOP	25284152	128

CLICK ON THESE:

www.reciva.com
www.tuner2.com
www.icecast.com
www.radiotime.com
www.octoshape.com
www.radiofeeds.co.uk
www.publicradiofan.com
www.music.aol.com/radioguide/bb
www.shoutcast.com [pictured left]

Shadow Dancing



Graham Engineering tonearms have acquired an enviable reputation over the years for engineering and musicality alike, and the 'clean sheet' Phantom B44 promises more of the same. David Allcock auditions the new spook on the block...

Back in the late eighties, when the future of analogue looked bleak and the high end tonearm market was dominated by the SME Series V, a radical new American design surfaced. The Graham 1.0 was a unipivot, a type that had fallen out of favour due to instability and difficulty of setup. It was a US market sensation, winning many friends overnight.

Over the next decade, the Graham got better with every new incarnation, from the 1.5, 1.5t and 1.5 t/c series to the 2.0 and ultimately the 2.2 incarnations. By the time the latter had been released, Bob Graham, owner and designer of Graham Engineering, felt he had taken the original design as far as it could go, and realised that to make a significant improvement to the sound would require a complete redesign. This took over two years, and resulted in the B44 Phantom you see here.

Even to the casual observer, it's obvious the B44 is very different to the 2.2, as there is not a single component shared between the two arms. Even the base, whilst using an SME cut-out like the 2.0, is an entirely new. Compared with the 2.0, the B44

SETUP

Unboxing and setting up this arm proved a delight, as you cannot fail to be impressed by the attention to detail in both packaging and accessories. The latter include a jig to precisely align the cartridge on the mounting plate, a pair of precision tweezers for attaching the cartridge pins, a magnifying glass, two allen keys for adjusting both the body and the cue level to account for deep platters, and the damping oil in a syringe. I had this arm mounted on my Basis Gold Debut Standard turntable in under twenty minutes, and the supplied instructions were clear and easy to follow. It should be noted that this arm is supplied without a tonearm cable, instead the base is terminated in a SME type DIN connector, as a result you will need to budget for a high quality phono cable for this arm, the B44 was supplied with Graham's own IC-70, which is a silver cable, but I found in my system the IC-70 was a shade forward and I preferred the balance of my XLO Signature cable.

ceramic section manufactured to precisely varying diameters to prevent resonance. Indeed, everywhere you look, attention has been paid to minimising vibration - even the finger lift is a tapered piece manufactured from stainless steel to cut resonance. Most closely related to the 2.0 is the Phantom's counterweight, which has a much larger diameter but is thinner, and again a knurled control precisely adjusts this counterweight on a thread mechanism, allowing very precise control of downforce.

The most radical design innovation is 'Magnaglide', which uses a pair of neodymium magnets, one on the main bearing body and a second on an independently pivoted beam. This both provides lateral stabilisation of the tonearm and precise azimuth adjustment, as the

system like every other tonearm, but closer examination shows it's a non-contact system, applied purely via the magnet assembly.

SOUND QUALITY

I was fortunate to have with me for comparison, not only the new arm's Graham 2.0 Deluxe and 2.2 predecessors, but an SME Series V tonearm too. My Benz Glider moving coil hadn't been in the groove more than a few seconds before I realised this tonearm was very special indeed...

Most obvious was that the new Phantom B44 has a much more powerful bottom end than either of its predecessors, as the bass guitar in the opening bars of Brian Ferry 'Limbo' carried more weight and drive than with either of the older Grahams, and also showed more dexterity and precision than the SME V. Whilst the SME initially sounded like it had more bass, it lacked the ability of the B44 to describe what the musician was really doing with the bass guitar, whereas the B44

gave a more natural portrayal.

Likewise the bass

"the new Phantom B44 looks set to give its rivals a nasty fright!"

has no outriggers, used in unipivot designs to stabilise the tonearm in the lateral plane, the VTA adjuster is easier to use with a larger diameter knurled control with a vernier gauge for precise adjustments, and the stub end where the removable arm wand mates with the body is much longer, now manufactured from stainless steel with a larger diameter.

The arm tube uses a single

magnet on the beam is adjusted via a knurled control with the magnet once again mounted on a thread drive mechanism, again allowing the azimuth to be very precisely adjusted. The arm is fluid damped to prevent both bearing chatter and damp the operation of the bearing. Mention must also be made of the unique anti-skate mechanism. At first glance it appears to use a thread and weight

line of Mark Shreeve's 'Icon' exploded out of my speakers in a manner I've not heard from my 2.0 or the 2.2, and sadly the SME V was left trailing with a bass which sounded like the arm was wading through treacle.

The midband was up to Graham's usual high standard, with outstanding transparency regardless of the cartridge used, given a suitable



recording such as the aforementioned 'Bette Noir' or Jennifer Warnes' 'Famous Blue Raincoat'. On lesser recordings this did become a rather 'warts and all' exercise, allowing you to hear some of the less desirable aspects of the recording process, but given the right record the B44 was capable of conveying the musical event in a realistic manner matched by very few arms, in my experience.

Indeed, the mighty SME V proved outclassed in the midband also, offering a slight hazy opaqueness not heard from the B44. Jennifer Warnes' voice on 'Bird on a Wire' was superbly

"..the B44 was capable of conveying the musical event in a realistic manner matched by very few arms..."

proportioned, whilst the slightest shift in weight and emphasis could be easily heard connecting the listener with the performer. The saxophone was wonderfully carried with no undue upper midrange forwardness and just a hint of warmth.

The B44 also impressed with excellent treble focus - cymbals, tambourines and keyboards all sounded superb, with particular cymbals having that slightest hint of metallic sheen without undue emphasis or forwardness. Whilst I have always enjoyed the performance of the older 2.0 in this area, the B44 subtly improved on this with improvements in control and focus. Once again I found the SMEV slightly outclassed in this field, lacking the open sound of either the 2.0 or the B44. Whilst providing very good focus I felt the overall high frequency performance of SMEV relative to the B44 to be muted and slightly reticent compared with other aspects of its performance.

It was immediately obvious in a back-to-back comparison with the 2.0 that the soundstaging of the B44 was substantially larger, both in

horizontal and depth planes. Vocalists and musicians were very well proportioned, whilst focus was outstanding with performers tightly defined in space. Brian Ferry's 'Bette Noir' was capable of coaxing remarkable imaging out of the B44, with not only Ferry, but also each of his backing vocalists clearly spatially defined.

The depth plane was also excellent. Whilst the SMEV was capable of delivering a substantial image, it lacked focus and space, resulting in less defined sound that made it hard to tell whether the backing vocalists were in front of the keyboard on the right of the stage, or behind. With the B44 however, it was immediately obvious the vocalists were behind the keyboards but in front of the drum kit.

CONCLUSION

Whilst £2,495 is undeniably costly, the

arm wands make this the natural choice for enthusiasts with more than one cartridge. Sonically accomplished, in my system it proved in another class entirely to the already excellent SME Series V, delivering superior imaging, sound balance, speed and dynamics. Admittedly the SME is rather cheaper, but I still feel the Graham justifies the price premium. Self evidently the best Graham pickup arm to date, the new Phantom B44 looks set to give all its rivals a nasty fright!

Graham Phantom B44 offers every last penny's worth of performance. The engineering is superb, the installation easy, calibration a joy and the removable

THE GRAHAM STORY

Graham Engineering is the product of Robert Graham, a life-long audiophile whose love of hi-fi began in his teenage years with the classic names such as McIntosh, Garrard and Electro-Voice. Robert's first tonearm design dates back to 1975 when he was working at Lincoln Laboratory, the research and development wing of M.I.T., and he built around fifteen of these early arms, which shared very little with his current designs other than the fact that the main bearing was a unipivot. The first true production arm came in 1979 and was called the Excalibur, and this was refined and modified throughout the early to mid eighties to eventually become known as the Model 1.0. At this time there was interest in this design from McIntosh, who were planning to move into the area of analogue replay, having already procured the designs for some MC cartridges, but at this time McIntosh was not in the best of financial health and were forced to abandon this, along with many other projects.

The Model 1.0 continued in production throughout the eighties on a part-time basis, with the arm being built outside of Bob Graham's normal work at Lincoln Labs, and in 1991 the Model 1.5 was released. This was updated twice during its lifetime, once to the 't' variant, which added tungsten balance weights and a tungsten counterweight, and then again to the 'c' variant which changed the arm tube to a ceramic model. In 1997 the Graham 2.0 was released, and by this time word about the Graham unipivot tonearm had got out amongst analogue connoisseurs, and such were the demands of manufacturing it that Bob Graham decided to retire from Lincoln Laboratories and Graham Engineering Inc. was formally born.

The 2.0 continued to attract critical acclaim from all corners of the audiophile world until Bob Graham decided to once again evolve this model into the 2.2, an upgrade which centered primarily on the bearing which was released in 2001. This model continued to sell strongly and along with manufacturing this new arm, Bob Graham endeavoured to improve 2.2 but found himself continually up against the limitations of the original design. In 2004 he resigned himself to the fact that nothing short of a complete redesign would give him the performance improvement he was looking for, so began a 'clean sheet' design which three years later became the B44 Phantom reviewed here.

VERDICT

Superlative sound, outstanding build and easy setup makes this the newest member of the world's elite tonearm club.

GRAHAM PHANTOM B44 £2,495
Audio Reference Ltd.
☎ +44(0)1252 702705
www.audioreference.co.uk

FOR
- sound balance
- imaging
- ease of installation
- outstanding build quality

AGAINST
- price

REVIEW SYSTEM

Basis Gold Debut Standard turntable
Graham 2.0 Deluxe tonearm
SME Series V tonearm
Benz Glider L2 MC / Music Maker III MM Cartridge
Klyne System 7 PX 3.5 phonostage
Mark Levinson 326S preamplifier
Bryston 3B-SST power amplifier
Martin Logan Vantage speakers
Hyperion Sound Design HPS-938 speakers
Isotek Titan and Nova mains filters
Atlas Elektra interconnects
Atlas Ichor Bi wire speaker cable
Isotek Elite mains cable

Going for Gold

Channa Vithana pushes the humble Michell TecnoDec turntable to its very limits in this bespoke high end vinyl system...



Michell TecnoDec - suitably tweaked, it really is good enough to feed a £7,000 system!

Back in March 2006, Michell's humble £575 TecnoDec won our turntable group test, thanks to its sophisticated sound. Properly fettled and set-up with a £124 Rega RB250, it is an engaging, rhythmically astute and musical LP source. But better still, it responds more to clever tweaking than many of its rivals - you can really 'supersize' this turntable's sound by adding vinyl go-faster goodies. I opted for the £67.99 Michell TecnoWeight and £18.50 VTA arm adjuster, and a £53.95 Funk Firm Achromat turntable platter mat (made from lightweight aerated vinyl), and the results were great, so in this month's system feature I decided to wring the very last ounce of performance out of it, matching it up to a range of excellent ancillaries.

First of all, a serious cartridge is needed, and here I can thoroughly recommend the £300 Ortofon Rondo Red MC cartridge. All of us here at *Hi-Fi World* love the Rondo series, and the Red proves a neutrally unflappable ally for the TecnoDec/

RB250 (and completes the system that won the turntable group test back in the March 2006 issue, p18). But as this month's system is for those feeling a little flush, I decided to push the Michell 'to the max' with the £995 Transfiguration Spirit III MC cartridge, made in Japan by Immutable Music Inc.

I found the Transfiguration exceptionally musical. Comparing it to the formidable Linn Akiva (using a £995 Linn Linto phonostage), almost twice the price at £1,800, the Spirit proved superior to my ears. For example, using a £10,000 high-end Origin Live/Densen/Spendor reference system, the Transfiguration had a comparatively cleaner, more revealing sound with higher resolution and more spatiality. Instrumental and vocal phrasing was where the Transfiguration pulled ahead. While the Linn Akiva had slightly deeper bass, the Transfiguration revealed a more naturally tuneful bass delivery. In the finest Japanese tradition, the Transfiguration is exquisitely built, where the cartridge body

is 'resonance controlled' by its aluminium-formed design. A boron cantilever with Ogura PA (3x30µm) diamond stylus is used, while a Permalloy square core and pure silver coils are also employed. The Transfiguration weighs 7.8gms and the recommended tracking force is 2gms.

With a tuned up mid-price turntable loaded to the gunwales with goodies and a very posh pickup, some serious amplification was needed. Enter Renaissance Amplification, by Integrated Engineering



Funk Firm Achromat platter mat can work wonders...



...and the Transfiguration Spirit III is a superb £995 moving coil.



Renaissance Amplification RAP-02/RA-02 pre-power amplifier and RP-01 phonostage is a compelling combination, thinks Channa Vithana...

Solutions Ltd (IES). Based in Southampton, Hampshire, the company started out initially with valve designs and have latterly branched-out into solid-state. The four-input £649 RAP-02 preamplifier

MC phonostage complete with an external 24v DC power supply. Due to the use of transformers (with mu-metal shields), the RP-01 is claimed to have a large overload capability. The active stages are said to be fully

'Polyglass' midrange driver. The 836V has three port-tubes, two at the front, and a cast-aluminium plinth enabling 360-degree venting from the third internally downward-firing port. A finely crafted aluminium and magnesium alloy 25mm inverted dome tweeter employs a new surround suspension, better magnet and the omission of Ferro-fluid, which Focal says is "extremely damaging to detail and dynamics". The 20mm MDF cabinets are internally braced between the drivers, while 25mm CNC cut MDF side panels feature internally machined surfaces to minimise standing waves. The central section is completed in gloss black acrylic and is nicely counterbalanced with smooth, satin 'Moka' or 'Ebony' finishes for the side panels. Claimed measurements are 40Hz-28kHz frequency response and 92dB sensitivity, dimensions are 1,148x282x375mm.

"a pure and very musical system that exceeds the sum of its parts..."

is a single voltage gain stage discrete MOSFET class-A line amplifier complete with a 24-position Elma switched attenuator volume control, said to be "significantly more transparent than the Alps Blue Velvet potentiometer". At £1,499 the matching RA-02 power amplifiers are class AB monoblocks that each use two complementary pairs of high current lateral MOSFETS and have a claimed power output of 50W into 8 Ohms.

The £1,495 Renaissance RP-01 phonostage isn't as ordinary as it looks, thanks to its use of input and output transformers. It is described as a low-noise, high-gain

balanced Class A throughout, so the RP-01 is consequently available with balanced outputs as an option. The Renaissance casework incorporates laminated aluminium, polymer and steel layers to prevent ringing. The front panels (except PSU) feature 12.5mm anodised aluminium plates, available in silver or black. The RAP-02 preamplifier and two RA-02 monoblocks are £1,999 as a combination, saving £149 individually.

For the loudspeakers, I chose the new single-wired £1,549 Chorus 836V by Focal-JMLab, a three-way design featuring three 165mm 'Polyglass' (cellulose and silica micro-balls) bass drivers and one 165mm

SOUND QUALITY

Conventional wisdom has it that with vinyl systems you should spend the lion's share of the system's total

value on the source. Well, considering that the Michell TecnoDec is but half the price of the cartridge, we've obviously gone against it! So it's a real testament to the quality of the TecnoDec that this system sounds so pure and musical – we've got genuinely impressive high end results without spending silly money.

The music was engaging, exhilarating and yet highly resolved timbrally on 'Mozart Piano Concertos, Nos. 11 & 16' (1974) by Daniel Barenboim. Here, individual instruments from the orchestra were entirely identifiable, the phrasing of the violins was outstanding, and the layered sequence of notes

did not sound artificial in any way. Barenboim's piano playing was just as rewarding – I could hear its wonderful phrasing and tonal beauty, and there was a cohesive combination of tempos, rhythm and timbre.

With the duet 'Overtime' By Willie Nelson and Lucinda Williams from 'It Will Always Be' (2004), the music overall was deep, immersive and superbly rendered. Vocals were striking in their extension, convincing in their timbre and resolution, and the instruments were clear, expressive and balanced without dominating or becoming lost in their compositional relationship to the

vocals.

'She Sells Sanctuary' from 'Love' (1985) by The Cult was clear, rhythmically articulated and excellent in tempo. 'Love' is a somewhat bright album – the guitars can be strident and Ian Astbury's vocals can have uncomfortable ringing distortions. However, with this system there was no such nastiness. Instead, it reproduced the propulsive rock music of The Cult at their best, with super-clear detail and very good instrumental separation.

On 'Behaviour' (1990) by the Pet Shop Boys, I was greeted with outstanding resolution to the deep, lavish synthesiser harmonies, making for a compellingly immersive sound. Neil Tennant's vocals on 'Being Boring' are particularly tricky to reproduce, being semi-whispered, but here I could easily discern the fine nuances of his hushed vocal expressions. Rhythms and tempos were tunefully reproduced, and the electronic beats pulsed with precision.

CONCLUSION

I'll grant you that this is rather an odd assemblage of components, but it works, and furthermore shows what a great bit of kit the Michell TecnoDec source is. By opting for this lowly turntable, I was able to splash out on the pricey Transfiguration cartridge, and the combination proved a compelling one – to the rhythmically engaging quality of the TecnoDec was added the polish and panache from the Spirit moving coil. Then there was the dynamite combination of Renaissance RAP-02/RA-02 pre and power amplifiers and RP-01 phono stage, which provided a spatially wide yet musically engaging power station for the vinyl source. Finally, the Focal 836V loudspeakers proved entirely up to the task of transducing all this, making for a seamlessly well-balanced sound that has power and finesse. Indeed, the Focals belied their £1,549 price by offering resolution almost at the level of the outstanding £4,750 Bosendorfer VC-2 (see *HFW* August 2006, p46). As a whole then, this is a pure and very musical system that exceeds the sum of its parts – a rare example of that much talked about thing called synergy.

Vivid sounding Focal-JMLab Chorus 836V floorstanders complete the picture...



RENAISSANCE
RAP-02/2XRA-02 £1,999
RENAISSANCE RP-01 £1,495
Renaissance Amplification
☎ +44 (0) 238 090 5020
www.highendaudio.co.uk

FUNK FIRM ACHROMAT £53.95
The Funk Firm
☎ +44 (0) 208 697 2705
www.thefunkfirm.co.uk

TRANSFIGURATION
SPIRIT III £995
Transfiguration
☎ +44 (0) 125 270 2705
www.audioreference.co.uk

FOCAL-JMLAB CHORUS
836V £1,549
Focal-JMLab
☎ +44 (0) 845 660 2680
www.focal-uk.com

MICHELL TECNODEC £575
REGA RB250 £124
MICHELL TECNOWEIGHT £67.99
MICHELL VTA ADJUSTER £18.50
MICHELL ENGINEERING
☎ +44 (0) 208 953 0771
www.michell-engineering.co.uk

MUSIC

Daniel Barenboim, 'Mozart Piano Concertos, Nos. 11 & 16' (1974)
Willie Nelson, 'It Will Always Be' (2004)
The Cult, 'Love' (1985)
Pet Shop Boys, 'Behaviour' (1990)
New Order, 'Waiting For The Sirens' Call' (2005)

SUBSCRIBE TODAY SPECIAL

VISIT OUR WEBSITE: www.hi-fiworld.co.uk

UK SUBSCRIPTION ONLY £40

£40.00 FOR 12 MONTHS PLUS 1 FREE ISSUE UK ONLY

FREE postage & packaging.



SO WHAT ARE YOU WAITING FOR? CALL NOW!!!

SUBSCRIPTION HOTLINE 01442 879097

Lines open Mon-Fri 9.00-5.00 or (weekend answering service available)

TEXT SUBS.HIFI TO 07797 800 800 and we'll call you back

email:
hifiworld@webscribe.co.uk

Fax No:
01442 872279

INTRODUCTORY OFFER!!!!

- Get your issue of hi-fi world straight to your door!
- Get to our amazing classified ads first and grab a bargain!!
- Run by dedicated hi-fi engineers and enthusiasts.
- Hi-Fi World has become famous for its informative reviews and radical kit designs.

FOR BACK ISSUES ENQUIRIES PLEASE CALL
01442 879097
OVERSEAS
+44 (0) 1442 879097



YES! I want to subscribe to Hi-Fi World for:-
 £40.00 for 12 months plus 1 free issue (UK only)

Your Details

Title _____ Initial _____ Surname _____

Address _____

Post Code _____

Daytime Tel: _____

Start Issue _____

Delivery Address (if different) _____

I would like to pay by cheque made payable to Audio Publishing Ltd.

Please debit my VISA MASTER SWITCH AMEX

Security No: (last three digits printed on the signature strip)

Valid from Date: _____ / _____ / _____ Expiry Date: _____ / _____ / _____

Switch card issue No:

Cardholder Signature: _____

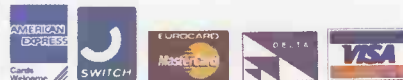

Please choose service:-

EUROPE Airmail **£50.00**

OVERSEAS Airmail **£70.00**

Send this form to:
 Hi-Fi World, Subscriptions Department
 PO Box 464, Berkhamsted,
 Hertfordshire, HP4 2UR

Some decisions are just so simple

WHAT HI*FI?
SOUND AND VISION

AWARDS 2006

PRODUCT OF THE YEAR

STEREO AMPLIFIERS

ROKSAN KANDY L.III



"If you like vintage kit, then you owe it to yourself to visit an event like this..."



adam smith

Sunday 11th February saw my yearly pilgrimage down to Tonbridge in Kent for John Howes' annual Audiojumble - the biggest and best of all the vintage audio gatherings. Now in its fifteenth year, this was the largest event ever, with stalls spilling over into a second hall. I have been attending this event for about thirteen of those years, initially as a 'punter' but more recently, using it to dispose of those unwanted items from my collection (invariably to make room for more new ones!) and it is interesting to see how it has undergone something of a renaissance in the past couple of years...

Looking back maybe six or seven years, it looked like the whole event might have been faltering, as attendances dipped a little and less money could be seen to be changing hands, thanks to our good old friend eBay. There seemed no longer any need to drag yourself out of a nice warm bed in the depths of February for a trek to Kent in order to see if there was something that might possibly tickle your fancy, when you could peruse a much greater selection of equipment from the comfort of your own home and have it delivered to your door.

Naturally the course of things did not run as smoothly as might have been expected and, as David Price's article on eBay in our January 2007 issue showed, the pitfalls of such an endeavour are many. I know that many people are becoming disillusioned with eBay, the prices charged for some equipment on there and the seemingly ever-increasing multitude of 'scammers' who ruin it for everybody else. This is where an event like the Audiojumble comes into its own.

The advantages of being able to look at and have a good poke round the item in which you are interested

can never be underestimated. Equally, the sellers invariably have an excellent knowledge of the items that they are offering for sale, either because the item has been owned by them for a considerable time, or they are dealers with a working knowledge of the products they are offering.

Regarding the sellers, I am pleased to report that the vast majority of people who attend such an event are a fine bunch. Naturally, with stall holders like John Howes himself, our very own Haden Boardman and, of course me, you would not expect it to be otherwise! Generally, stall holders are regulars, enthusiasts and dealers who are thus well known and extremely unlikely to knowingly sell you a 'pup'. I cannot recall ever having witnessed an altercation of the likes of, "Oi! That turntable/amplifier/valve you sold me last year was a duffer - what are you going to do about it?" This suggests that most buyers go home extremely happy with their purchases.

The wonderful thing about the Audiojumble is the bewildering array of equipment that can be found perched proudly on, or tucked under, each table. Naturally, the likes of Quad amplifiers, Leak tuners and Garrard 401s are plentiful but it is the rarities that always excite me.

For instance, this time I spotted an original Nakamichi 1000 series cassette deck, a huge Audio Note Meishu amplifier and a magnificently restored Leak Stereo 50. These rubbed shoulders with a whole host of more regular items such as AR, Thorens and Ariston turntables; loudspeakers from the likes of B&W, Tannoy and Goodmans; and a veritable cornucopia of Japanese electronics. In the past I have seen items the likes of which I have never come across before or since, and it is always a fantastic experience to see something rare and expensive in the flesh.

In my opinion however, the biggest advantage the Audiojumble has over eBay is in terms of pricing. Generally the sellers price their equipment pretty competitively and there is always room to haggle, especially if the item you have set your heart on is still left near the end of the day. I speak from experience that what can seem to be a rather silly offer early on in the day becomes much more tempting near closing time, when it looks like the equipment is going to end up coming back home with you!

The only downside is with respect to those who have been influenced by the aforementioned optimistic prices reached [supposedly - Ed.] on eBay, and are pricing their wares accordingly. These are easily spotted at the end of the day as they are loading up nearly as much equipment as they brought with them. As an example from this recent event, the good old Technics SL-1600Mk2 turntable is a lovely thing and the one I saw was in immaculate condition, but I'm afraid it is still not worth the £200 that was being asked for it. Needless to say, it did not sell...

If you like vintage equipment, then you owe it to yourself to visit an event like this. The thrill of finding something you have always fancied is very addictive and the skill of knowing when to grab something or keep looking to see if there is another, cheaper, one there is one that is quickly learnt! And for the record, I had a good sale thank you, and didn't buy too much - just a couple of arms and a budget cartridge. Oh, and that huge DJ mixer for £5 seemed too good to pass up...

As a footnote, there is a second event this year due to popular demand, on Sunday, September 2nd. Full details can be found at www.audiojumble.co.uk ●

Walrus

Exciting New Products
From Around The World.
Available Now At Walrus.

Phone: +44(0)20 7724 7224
Fax : +44(0)20 7724 4347
Shop : 11 New Quebec Street
London W1H 7RW
Web : www.walrus.co.uk
Email : contact@walrus.co.uk

MBL 111 RC



'Dieses ist nicht ein Dalek aus Deutschland?!' Of course not! This is the MBL 111RC loud-speaker. Here at the shop, we have the even more amazing looking full-range model, the MBL 111E Radialstrahler-Hybrid System 1 loud-speakers available for audition. Also available for demo too is MBL's top of the range CD Player, the MBL 1531. 'Wirklich wundervoll, yah...!'

Basis Audio 2500 Signature



We've just taken delivery of the latest Basis Audio 2500 Signature Turntable, as if there are not enough turntables at Walrus already! No doubt some of you might think it looks and sounds just like another brand of fashionable turntable in acrylic these days! Well, you'll be wrong. For an example, what look like 4 ordinary aluminium legs turn out to be very sophisticated, user adjustable, oil-damped suspension towers...



Hørning Agathon Ultimate



Remember when you were taught never to judge a person or an object by its look? The Hørning Agathon Ultimate is a classic example. The technology involved with these loudspeakers is so complex that we decided its best for you to read about them on the web. No doubt you'll also come across the excellent reviews too. Wait till you see the back of the loudspeaker; looks nothing like the back of your fridge...



The Music First Audio Passive Magnetic Preamp has been winning awards and accolades for the last year or so. Walrus was one of the first dealers in the UK to demonstrate its virtues.



Brinkmann La Grange Turntable

Emille is a new brand from Korea. As it turns out the Emille KI-240 is one of the best sounding valve-powered integrated amplifiers available in the UK today. We are sure you'll agree with us...



Emille KI-240

Musically satisfying... modern yet romantic is what comes to mind when describing the sound of this new valve driven line stage pre-amplifier, the Melody Pure Black 101D.



The real Simon Yorke with his S7 Turntable and Tonearm system.

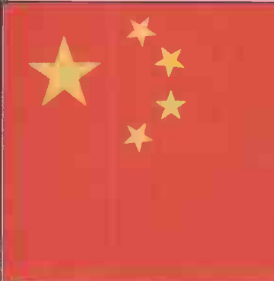

The new Shanling CD Player, CDT-500, is visually so striking that we thought it best for you to come and see it in the flesh. Meanwhile we can show you what the national flag of China looks like!



Walrus' New Mascot

"five years from now, hi res won't arrive in SACD packaging, but naked via broadband..."



paul rigby

The future of audiophile music has never been in such a state of flux and uncertainty as it is now. The market is currently awash with music formats which, as I have already argued in previous issues, is a 'good thing'. I'm a worrier, however. My current concerns centre around high resolution music. Where is it going to come from in, say, five years' time?

Presently, we are lumbered with CD as the only mass market physical format. We've all griped about it at some time or another. However, there is evidence that it has received a bad press mainly because of the initially poor quality tools mastering engineers had at their disposal during the early years of CD's existence. Recent changes have meant that, for those record labels who care a damn, CD sound quality has actually risen. However, it suffers from a glass ceiling - it can only sound as good as its own sonic limitations allow. For better sound, digital audiophiles must look elsewhere.

We can also discard Blu-Ray and HD-DVD. They may be great for storage on PCs, useful for future computer games (all those hi-res images and sound), perfect to replace DVD to show hi-res pictures on your HDTV, but they're not for audio. Sure, no real decisions have been made regarding a dedicated audio spin-off for either format, but it's more than likely that any audio-only stream will be packaged as part of the extras in a high definition music DVD.

We can also quickly discard the other popular mass medium, the lossy sound file download, such as the MP3, that so many iPodders are listening

to right now. These bastardised audio formats are, to some, an actual threat to our audio future. The argument running along the lines of - 'if youngsters see lossy audio as the norm, where will the impetus be to market hi-res audio at all?' Well, the impetus will be from the older generations who value quality over convenience...

As such, let us turn to the niche audio formats: DVD-A, SACD and vinyl. DVD-A is suffering the most. Lack of industry support, no High Street retail support, little internet retail support and next-to no studio support. This is a dead format. Vinyl, on the other hand, is like Uncle Albert from BBC TV's 'Only Fools And Horses' - it came to stay for a day, ended up moving in and no-one could shift him after that. Vinyl just doesn't want to go away.

The older generations have a major say in vinyl's continued success. Why? Call it nostalgia, call it searching for value for money, they have the disposable income to keep audiophile record labels in business. With the introduction of expensive 45rpm editions and high specification box sets, vinyl has now become aspirational. The deluxe format. The format with style and panache, the one to be seen with. For youngsters, basic vinyl editions of contemporary groups are popularly retro and affordable, hip hop DJs still use 12" singles and 7" singles sales are still rising. Vinyl is here to stay - albeit in its niche.

This leaves us with SACD. The only reason it has any presence in the market is because of the CD layer stuck to it. Many music fans don't even realise they have a hi-res SACD source available. They think they're

just buying a run-of-the-mill CD. This fact is unimportant right now - it is important for the future though, because SACD's hi-res beating heart, DSD, is being kept on life-support because of that CD layer. If a future hi-res digital format is to create a vinyl-like niche in five years' time it will be via DSD - and it will not be within its SACD packaging, it will arrive naked, without any SACD label, via broadband. Whether that's via iTunes or some other carrier I can't say, but I'm sure that in three years' time, broadband speeds will increase from up to 8mb/s to up to 56mb/s via the ADSL3 broadband standard. In five years, that broadband speed will be in widespread use. That will be the time when any record label who has already invested in SACD facilities will be able to give us a flat DSD file direct from the studio or via a music carrier like iTunes.

DSD is the best digital format out there right now. It is being improved too. Michael Bishop, Senior Recording Engineer for Telarc declared that, "DSD will soon double its sampling rate. That affects the analogue conversion to DSD. At the current 2.8MHz, high frequency noise can affect playback. By doubling the sampling rate you would lose that noise into the upper frequency layers. This would mean that the entire musical bandwidth up to 50kHz would be devoted to music only."

It's by no means a done deal. Everything can go wrong between here and there. However, audiophile digital music fans five years from now may no longer be utilising physical formats at all but regularly buying their albums as DSD downloads. Now that's what I call music! ●

More and more firms are introducing top-performing amplifiers as integrateds – preamp and power in one box.

All

Together now

Bel Canto and Gamut both offer remarkable integrated amplifiers but with radically different designs.

While Bel Canto use **ANALOGUE SWITCHING** for their power supplies, Gamut's special feature is their output stage that uses only **ONE PAIR** of very high power transistors per channel.

Comment on Bel Canto's highly technical solid state amps often mentions the "**ANALOGUE**" qualities, understandable with designer Stronczer's SET valve background.

Hi-Fi Choice's view on the Gamut Di 150: "This is clearly a gorgeous amplifier" and made it the Editor's Choice that month.

Bel Canto's own implementation of the ICEPower module technology produces a simple, very compact circuit. A huge bonus is the **AMAZING VALUE**: only £1799 for the S300i stereo. Just don't make the mistake of relating performance to cost! This amp is stunning.

Gamut have merged their highly-regarded D3 preamp with the well-established D200 power amplifier (an earlier Editor's Choice) to produce an impressively **CAPABLE AND TRANSPARENT** component.

"The Gamut delivers a level of insight that can transform a decent recording into a gripping musical journey." Hi-Fi Choice.

Come and listen to them both.

Customers say we make some of the **BEST SOUNDS** they have ever heard, so you know we can do the same in your home. Our advice will take account of your best components and guide you where change is needed, in stages you can afford.

You **AVOID EXPENSIVE MISTAKES**, enjoy music along the way and save money in the long run.

JUST LISTEN AND YOU'LL KNOW

CD: ACCUSTIC ARTS, BEL CANTO, dCS (ELGAR, DELIUS, PURCELL, VERDI, VERONA, P8i), GAMUT, RESOLUTION AUDIO, STELLO, WADIA. **VINYL:** AESTHETICS, AVID, CLEARAUDIO, DNM, GRAHAM, THE GROOVE, LEHMANN, MICHELL, ORIGIN LIVE, SUMIKO BLUE POINT SPECIAL, TRANSGURATION. **AMPLIFIERS:** BEL CANTO, CAT, DK DESIGN, DNM, GAMUT, HALCRO, HOVLAND, SONNETEER, STELLO. **LOUDSPEAKERS:** AUDIO PHYSIC, DALI, ETHOS, GAMUT, NEAT, TOTEM. **CABLES:** CHORD Co., DNM, NORDOST, SILTECH, VERTEX AQ. **MAINS:** Vertex AQ. **SUPPORTS:** ARCICI, STANDS UNIQUE, VERTEX AQ

The
Right
Note

Music in the home

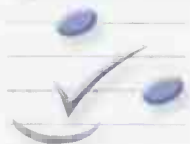

BATH

01225 874728

or lo-call

0845 230 7570



BRITISH DESIGN AND
ENGINEERING AT ITS BEST

After 35 years, Michell is still a family run business with a team of dedicated and proud craftsmen, producing quality turntables and accessories

Orbe SE



The Michell flagship for music lovers who are not prepared to compromise

Gyro SE

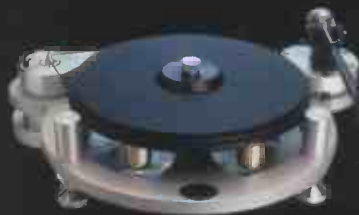

The classic Michell turntable, refined over many years of development to its current level of performance.

TecnoDec



Entry level turntable incorporating features from the classic Gyro

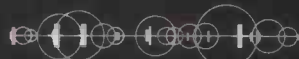

MICHELL ENGINEERING

J A Michell Engineering Ltd
2 Theobald Street, Borehamwood,
Hertfordshire, England, WD6 4SE

Telephone: 020-8953 0771
Fax: 020-8207 4688
michell-engineering.co.uk

See us at the Sound & Vision
Bristol Show Marriott Hotel on
23rd - 25th February 2007

"DAB will never be able to compete with multicasting in audio quality, so long as the BBC plays ball..."



steven green

The BBC's plans to launch on-demand and streaming Internet services have moved a step closer to reality after the BBC Trust, which replaced the BBC Board of Governors, gave its blessing to the BBC's iPlayer.

The BBC iPlayer is similar in concept to the BBC Radio Player in that it allows users to access both live streams and recordings of programmes broadcast over the previous seven days. But the iPlayer is far broader in scope than the Radio Player, supporting both TV and radio; streaming at broadband bit rates; the ability to download TV programmes and store them on your computer for up to thirty days; and audio downloads without DRM (Digital Rights Management) protection.

The technology that enables the BBC to offer its TV programmes for download is peer-to-peer (P2P), as used by the infamous music file-sharing networks. But this article will look at the technology behind the live 'net streams for the BBC's TV channels and radio stations, called multicasting, which in years to come will make the Internet a serious competitor to conventional TV and radio broadcasting.

The current method of distributing broadcast streams over the 'net, called unicasting, consists of sending one stream to each person wanting to view or listen to a channel. Multicasting replaces this by just sending one stream of each channel to each ISP (Internet Service Provider) that supports multicasting, and the ISP forwards the streams to any of its customers requesting them. So for a high number of users, multicasting saves almost 100% of the Internet bandwidth for

the broadcaster and thus reduces the distribution costs to almost 0% of what they would have been if unicasting were used. This allows the broadcasters to provide far higher bit rate levels and thus higher audio and picture quality levels for their channels.

When the iPlayer actually launches however, which should be some time this summer, the bit rate levels won't be anywhere near as high as they should eventually be (for reasons I'll return to below), and the bit rates used for the BBC TV channels and radio stations will probably be the same as they were on a trial of the technology last year. Then, the BBC TV channels were available in two video formats: in the new MPEG-4 H.264 format at 1Mbps, which should provide a similar level of picture quality to a typical commercial TV channel on digital TV, and in the Real format at 350kbps, which provides lower quality.

The radio stations in the multicasting trial were provided in both the AAC and RealAudio formats at 128kbps, and as AAC is a modern audio codec, at 128kbps it is capable of matching – or at least approaching – good FM audio quality, and should sound far better than DAB.

However, considering how low the costs are, I don't see any reason why the BBC can't provide AAC streams at a bit rate of 192kbps or even higher and finally offer what they originally promised us for DAB: near CD-quality and better quality than on FM. What's more, Virgin Radio used 192kbps for its four stations on the BBC multicasting trial, so I fail to see why the BBC cannot match that bit rate!

There is one large caveat, however, which is that audio encoders

obey the computing adage "garbage in, garbage out". That is, if the BBC doesn't provide high quality going into the encoders then high quality will not come out. So the quality of the AAC multicast streams will show the BBC's true colours with regards to whether it does or does not care about the audio quality of its radio stations.

Short term issues aside, the true potential of multicasting will only come about once most people have ADSL2+ "up to 24 meg" broadband connections and the ISPs' networks have the capacity to handle large numbers of high bandwidth streams.

The Holy Grail once these things are in place is for HDTV to be multicast. The BBC has already successfully tested this, and as HDTV is not expected to be transmitted on Freeview until after analogue switch-off in 2012 it's likely that the ISPs will gleefully support HDTV well before then as a means of attracting new customers. With bit rate levels for HDTV streams being in the region of 10 to 24Mbps (that's around 80 to 160 times higher than the 128kbps AAC radio station streams!), high quality radio would be a piece of cake in comparison. I would hope that the BBC will provide its stereo radio stations at a minimum of 256kbps AAC within the next couple of years. Going forward, I'd like to see the music stations' streams being fed by 24bit/192kHz sources, streams with surround sound, and lossless audio streams as well.

It's good that DAB has finally adopted the AAC+ codec, because it'll improve the quality when listening in the car, but for home listening DAB will never be able to compete with multicasting in terms of audio quality – as long as the BBC plays ball, that is... ●

"this system is something of a musical genius"

– What Hi-Fi? Sound and Vision

WHAT HI-FI?
SOUND AND VISION



January 2007

Performance series

L2 Series Loudspeakers
99 Series Electronics



A new breed

Quad L2 series Loudspeakers

The Quad 99 series electronics and L2 series loudspeakers are a match made in heaven. Detail, accuracy and refinement all combine to present one of the most musical and insightful systems available – and with our new 99CDP-2, will integrate seamlessly into your digital world allowing up to 6* digital sources to benefit from our state-of-the-art DACs

* CDP-2 includes 3 x Optical and 2 x Co-axial digital inputs.

QUAD

the closest approach to the original sound.

Quad Electroacoustics Ltd,
IAG House, Sovereign Court, Ermine
Business Park, Huntingdon, Cambs, PE29
6XU

Tel :- 01480 447700, Fax :- 01480 431767
www.quad-hifi.co.uk

"although there was a cull a decade or so ago, the best hi-fi retailers have survived..."



dominic todd

Reading from EMI's press releases at the beginning of the year, anyone would have thought it was 1999 and MP3 was just starting to get a hold. Despite iTunes generating record profits for Apple last year, the fall in sales of CDs and the general presumption that music software is rapidly moving away from 'solid formats' to downloads, it seems that EMI have only just noticed...

In a statement peppered with some of the finest management speak I've ever read, they talk of "de-layering" management and "strengthening EMI's digital and consumer capabilities". I think that translates to job loses and investment in downloads, but I could be wrong. Either way, the fact that such a global music giant could be apparently so easily caught out by changing trends is surprising, especially since the large music retailers are some of the most flexible within the retail industry.

Had large music stores relied solely upon traditional methods for selling music, then they'd have long since disappeared. The combined forces of DVD and games consoles, with a few fringe items such as MP3 players, have kept the Virgin Megastores and HMVs of this world going of late. Furthermore, the retailers were quick to compete with the Internet by both having a strong presence there and by sharpening prices in store.

We hear much about the rising rate of inflation these days, but you can be certain that none of it comes from music software. CD prices haven't just gone down in real terms over the past fifteen years, they've gone down period. So as music lovers I'm sure that whilst we all regret the

diminishing amount of music available at large record shops, we can equally understand the reason for it, and that at least with popular recordings, we've all benefited via lower prices. Of course as music downloads take an ever larger share of the pie, the big music stores are going to have to adapt, perhaps via a move towards selling more hardware, or maybe even having to face withdrawing from the High Street altogether and becoming internet-only companies.

Ten years ago, the idea of a traditional retailer operating exclusively online seemed unlikely, at least by the year we're at now. With hi-fi, it was argued, potential customers would always want to be able to listen to and look at a product. In some respects this has turned out to be the case, but in the wider world of electronics it's far from it. Recently I've noticed a number of deceased electrical retailers' brand names being exhumed to front web-based retail companies. Of course, with some of the brands, it is merely that - just a brand with little relationship to what the name originally stood for.

One such company is Laskys. This erstwhile hi-fi chain majored on separates in the seventies and was probably where many of us, myself included, first glimpsed the delights of CD, or stood in awe at the highly damped cassette doors that took an age to eject. With such a great history of budget separates, what a shame it is to find the current Laskys eschewing the format altogether. Sure enough, instead of real hi-fi there are one-box systems and, needless to say, dozens of flat screen televisions.

Laskys aren't alone. Dixons and Miller Brothers are two other major High Street brands to have been

resurrected for the internet and, as with Laskys, the hi-fi separates buyer is going to be disappointed. Dixons' idea of a separates range is a range of Tangent bits and a couple of pairs of speakers. Millers are slightly more comprehensive, but offer little to get excited about. In fairness, neither were ever major hi-fi retailers; Dixons did cameras and Miller Bros has always been a brown and white goods mixed retailer. They don't disappoint quite so much as Laskys, then, but I can't help but think they could all offer something more inviting - even if it is just a single range of separates...

Buyers of real hi-fi left these multinational chains years ago, switching to the smaller independents. Like the music retailers, even the smaller chains have had to adapt and you'll now find plenty of TVs and AV equipment at your local Richer Sounds, Sevenoaks or Superfi. Yet, you will also still find plenty of decent hi-fi there too. After the sad demise of many of these medium sized hi-fi retailers in the nineties, we have now had a decent period of stability, with the retailers left more focused and offering better service than ever before. Better still, the independents have been stable in numbers these past few years, again showing that there may have been quite a cull in hi-fi retailers a decade or so ago but in general the best have survived.

Hi-fi retailers of all sizes have had to adapt, and it is a shame that we're never likely to see large multinational retailers offering a comprehensive selection of hi-fi separates again. Yet, what can't be denied is that those retailers which have survived and adapted, haven't forgotten about real hi-fi. They may have changed, but hi-fi is still core, and that's to the advantage of all of us. ●



David Price gets into the groove with the world's first 'disco' CD player, Technics' 1987 SL-P1200...

Club Classic

Nineteen eighty seven was a transitional year for the world's first mass digital music carrier. In Europe, we were all running variants of first generation machines, the Marantz CD54 and Meridian MCD being big sellers in the audiophile community. Philips' TDA1541 sixteen bit, four times oversampling DAC was just beginning its strong but short-lived bid for global fame, appearing in the newest high end Arcam, Missions and Sonys. Cambridge Audio's CD1 remained arguably the best sounding silver disc spinner on the planet, despite being a heavily reworked first

generation Philips CD104, and lacking the build quality of the ever-better sounding Japanese 'battleships' coming from across the sea.

At the time, Technics was an extremely strong hi-fi brand, and nowhere was it more impressive than in CD players. They were very 'eighties looking' machines – big, fussy fascias festooned with facilities and vast, needlessly complex fluorescent displays. The first generation SL-P10 had recently made way for the SL-P1000 which was a redoubtable design, just about able to hold its own with monstrously priced (and sized) behemoths like Sony's CD-P557ESD.

Still the most interesting thing in the new 1987 Technics catalogue was the SL-P1200, a (then) unfashionable top loading CD spinner with a pitch control and 'jog dial' offering precise and accurate control of cueing. Like the turntable with which it shared a model number (and indeed feet!), the 1200 was a 'pro' design made for nightclub use, and like the turntable of the same name it was very robustly made - more so than the SL-1200, as it happens.

The idea was brilliant - bundle all the front-loading SL-P1000's internal componentry inside a large, robust, top loading casing with a vast angled display, making it ideal for 'pro'

nightclub use. Matsushita, Technics' parent company, had already found that adapting its old 1973 SL120 turntable for pro use had proved a nice little earner, and so why not follow the formula for the digital generation?

Like the SL-PI1000, the major sales point for the 'PI200 was the large search dial, this time on the top right of the case instead of the front left of the fascia. This gave easy access to all its elaborate cueing facilities, such as A-B Repeat for example. The pitch control was virtually unique at the time, and must have seemed amazing to those who get excited about such things. The display is also big fun, being large and full of flashing legends and numbers – there's a 'music calendar', track time display and even a tenths and hundredths of seconds display for when you do your split second cueing!

Although the button-festooned

silver disc spinner, and all the more so when you have to conclude that it actually fares rather well. My recollection of Japanese machines of this age was that they were shrill and mechanical sounding, and certainly in the first respect the Technics isn't the smoothest around. For example a £250 Cambridge Audio 640C has a softer upper mid band, making the Technics sound a tad 'chrome-plated' on female vocals and strings. Still, however 'robust' the Technics' upper mid may be, it's not bright like the Sonys of that era, and careful interconnect matching and/or use of a valve amplifier would certainly ameliorate it. It's certainly nowhere near as hard as I remember late eighties machines being demmed in hi-fi shops at the time.

Move downwards and you're in for a shock, as the Technics has a truly powerful yet relaxed bass. In fact, it reminds me of a Meridian

SL1200, its treble isn't going to win prizes for finesse and decorum. Likewise, stereo imaging is very strong left to right, but don't wait up for a deep capacious recorded acoustic.

CONCLUSION

This is special because no other modern machine either looks or sounds like it - such chest-pounding bass, real 'up and at 'em' musicality and a sense of utter unflappability isn't common these days. The downsides – poor depth perspective and a brightly lit midband almost go unnoticed amidst the fun it has. Then there's the weird styling, garish display and tenths and hundreds of a second readout – well, your friends won't have one, that's for sure! Factor in the brilliant build and it's a truly appealing purchasing proposition.

The SL-PI200 didn't reach these shores until 1988, and then only in relatively small numbers, so don't expect to snap one up for nothing. Particularly with a machine that could have been carted around every wedding and sixth form disco in town for the first half of the nineteen nineties, it's essential to get one in excellent cosmetic condition (as proof of light domestic use only). Two versions were made – the SL-PI200 and the SL-PI200B. The latter adds balanced XLR outputs in addition to RCA phonos, and a rear panel IEC power socket as opposed to a captive flying power lead – and it is very much the one to go for. I have seen mint, boxed Bs now going for as much as £750 to eager buyers, and this isn't so silly considering its superb build, rarity and the fact that replacement lasers are still available from Technics Europe. Find a tatty non-B though, and you can look at as little as £250 – as with so many classics of the hi-fi and non-hi-fi variety, condition is everything. Either way, there are few better ways to play your classic collection of early Beatmasters, Bomb the Bass and Coldcut CD singles.

"it makes modern machines sound like they need to start pumping iron and give up smoking..."

top panel must have delighted spiky haired eighties button pushers, the real surprises were under the hood. By any standards, including those of today, the SL-PI200 is a beautifully built machine. Inside, it is separated into four main sections, power, CD transport, control/ servo and digital to analogue conversion. Two separate power transformers - one for digital electronics and the other for analogue sections - are used, and there are independent power supplies everywhere. Two Burr Brown PCM54HP DACs are used, there's a headphone amp with its own volume control, and very high quality internal wiring is in evidence.

SOUND QUALITY

It's fascinating to put a 'blast from the past' like this against a modern

MCD Pro in the way it can pile-drive large amounts of barrel-chested low frequencies into the listening room. As it delivers that capacious bass, the SL-PI200 never for a second sounds out of breath – quite the reverse in fact. Indeed the old Technics made a modern £600 Audiolab 8000CD sound like it was the one that needed to start pumping iron and give up smoking...

The midband also shares the energy and commitment of the bass. As I've said, it's brightly lit, but displays great enthusiasm for playing music – it really pumps out songs with all its (big) heart. In this respect, and in so many others, it is spookily similar its SL1200 vinyl cousin. It's a tad rough and ready, but has massive energy and real resolve to make music sound magical. Also like the





Who loves music as much as you? We Do

WINTER SALE EXTENDED FOR A FURTHER MONTH

Exhibiting at Tonbridge and Bristol Hi-Fi Shows !!

Committed to bringing YOU the very best and latest of Audiophile releases!!

OKKI NOKKI CADENCE RECORD CLEANING MACHINE



£285.00

HERCULES POWER SUPPLY



£169.99

New to UK!!!

**BRAHMS: VIOLIN CONCERTO/JASCHA HEIFETZ, VIOLIN 200GRM 9 X 45RPM BOX SET
SPECIAL INTRODUCTORY PRICE!!**



£429.99

The ultimate Heifetz/RCA collector's edition. All nine titles are now, for the first time, available as single-sided 12-inch 45-RPM releases on Classic's proprietary 200-gram Super Vinyl Profile, in addition, the 33 discs that comprise this deluxe edition are housed in the Classic Records Road Case. This limited edition set will surely become a highly sought after collector's item almost instantly.

February New releases/Pre orders - LP's

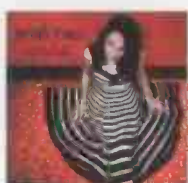

FOR DETAILS ON ANY OF THE ABOVE PLEASE PHONE US OR VISIT OUR WEBSITE

Stamford Audio Ltd, Unit H3, The Mount, Cardinals Green, Cambridge CB21 4QX
Tel: 01223 894999 Email: www.stamfordaudio.com

"the days of big advances in high fidelity have seemingly passed..."



noel keyword

It's ironic that as the amount of hi-fi products coming to market gets ever larger, so many long term listeners feel that there are ever fewer reasons to buy.

The days of big advances and shiny new technologies in high fidelity that make an overwhelming case for themselves have seemingly passed. Now, it is large, flat TV screens that say "buy me", not hi-fi.

Stagnation of technology doesn't affect hi-fi alone. In spite of a whole range of promising new propulsion systems we are still struggling with the internal combustion engine. Every time I walk past the Science Museum's lovely Rover JET1 gas turbine coupe, an odd mixture of the old and new, I am reminded of how we once believed that something as exotic - the engine that is! - was surely our future, but it hasn't turned out that way.

All the 'easy' inventions have been invented, from antibiotics to nuclear fission. Medical advances have become a hard slog, and power from nuclear fusion remains a long way off in spite of the effort being put into it. Even space exploration has receded for humans, unable to easily survive zero gravity, or solar radiation. It's a bit bleak, after all those wonderful coloured cutaway diagrams in Eagle of spaceships of the future. Kids don't enjoy such science fiction fantasies anymore, instead they come home talking about CO2 emissions!

Hi-fi is suffering this dilemma too. There are improvements, but for many they are not so large as to make an overwhelming case to upgrade from what we already have. The biggest improvement we have been presented with, the move from analogue to digital via the Compact Disc, turned out to be not quite what was expected. The optical disc has been a fantastic success, of that

there is no doubt, but the music code on it has been a mixed blessing. Because digital comes as a fixed code, it is fundamentally non-upgradeable. Whereas old analogue systems could be continuously improved, digital systems cannot. Once a system becomes outdated, it must be scrapped completely and replaced. This applies very much to CD, one of the world's first digital technologies. SACD was an ingenious way of improving it without too much upheaval, but it got overlooked somewhere in the rush to A/V. 'Tis a pity, because SACD gets approval from audiophiles: its sound is a perceptible improvement on CD.

With insufficient room on DVD for video, cramming on audio as well has demanded the use of Dolby and DTS compression (data reduction) and, no matter how good a compression scheme may be, it doesn't advance audio quality. Few are willing to populate their lounge with loudspeakers too, so all those extra channels simply go unused, folded down into two channels. DVD is no way ahead for audio, where it is just an adjunct to video.

Will BluRay or HD-DVD offer anything better? Few are confident they will. Both increase the amount of storage available on optical discs, mainly to lengthen movie playing time, as well as accommodate high definition pictures. BluRay can pack in up to six channels of high definition PCM audio, but whether anyone will put audio onto it is another matter. The music business has to see a market for it, and at present it hardly exists, although declining CD sales might persuade it to think again. I recently asked Sony whether we will ever see DSD on BluRay, turning it into SACD's successor, but no reply as yet. Perhaps they are scratching their heads over this one, but somehow I suspect not and we may have an

answer soon.

Talking to people in the broadcast business about DAB has alerted me to the view that the internet is seen as the way ahead for radio, not terrestrial transmission. They have a point. As internet speeds increase, it could offer quality as well as quantity, leaving DAB for cheap portables. Sadly, that means no more shiny super tuners, studded with meters and buttons.

Loudspeakers are an area where not just the easy inventions, but even difficult ones, were invented long ago. Today's drive unit comes from the 1920s, and ribbon and electrostatic drivers predate it. The oldest of all, taken from singing Victorian street arc lights, is the ionophone - and how obscure is that? NXT is a promising way of exciting panels, but it suffers the problem of any panel when asked to produce bass. Work continues on tuning loudspeakers to rooms using a microprocessor, but it introduces the need for sensing microphones, which complicates the issue and there's little agreement over how to equalise rooms in any case!

Then there's the theoretically complex digital loudspeaker, a panel loudspeaker whose surface is populated with mini drive units fed from an extraordinarily complex digital signal processing system. This idea is being worked on around the world right now, and is likely the next big thing in high fidelity. Such a loudspeaker would be supremely adjustable, able to fire low distortion sound in specific directions. I suspect bass would be limited by panel size as usual, so whether these loudspeakers will be quite all we hoped for as the next big technology remains to be seen. If I am wrong - and they are - then we might finally all be lusting after a hi-fi product in the near future instead of a bigger TV screen. Here's hoping. ●

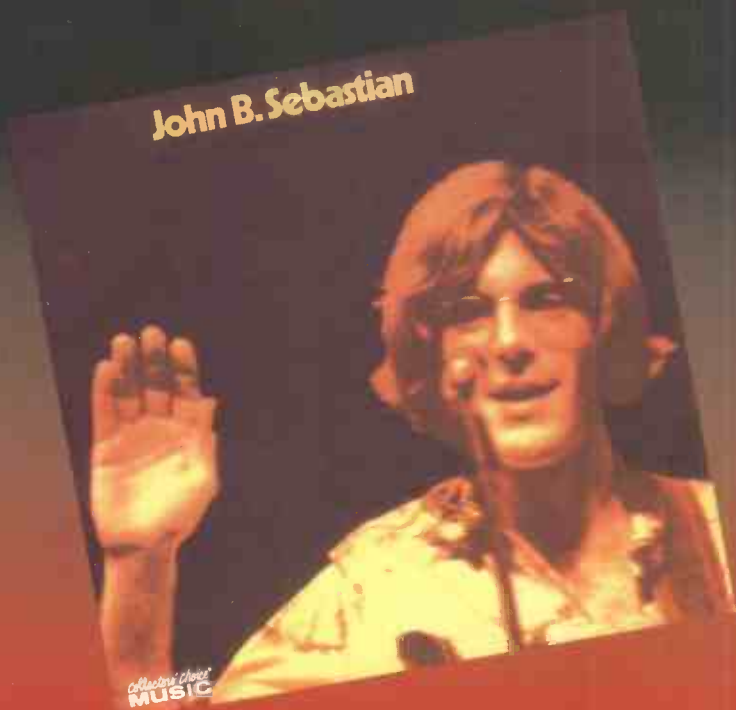

JOHN SEBASTIAN
John B. Sebastian
Collector's Choice

Sebastian achieved fame as the lead singer for The Lovin' Spoonful. The band had an array of hits during the mid-1960s, including 'Daydream' and 'Summer in the City'. Sebastian even had a solo No.1 in 1976 with 'Welcome Back' – a staple on BBC Radio 2 over here for many years. An active chap, he wrote or co-wrote hits for others, wrote Broadway and film music and worked with a string of legendary figures such as Crosby, Stills and Nash, the Doors, Bob Dylan, the Everly Brothers and more. Anyone who saw the '60s Woodstock documentary will have seen Sebastian too.

This, his first solo outing, proved to be a form of stretching his creative limbs from the confines of a band environment. So we see everything from country music on 'Rainbows All Over Your Blues' to the R&B of 'Baby, Don't Ya Get Crazy' and 'Magical Connection' which even introduces some samba into the mix. The album proved an eclectic collection that showed those old Lovin' Spoonful fans the more personal side of Sebastian and his restless spirit. Also featured on this album are Stephen Stills, David Crosby and Graham Nash among others.

The sound is admirable and is derived from the original, first generation, Reprise masters as opposed to second generation tapes owned by MGM which also issued the album on original vinyl. Also look out for other Sebastian releases via Collector's Choice: 'Cheapo-Cheapo Productions Presents Real Live', 'Tarzana Kid', 'The Four of Us' and 'Welcome Back'. This is a significant body of work and one that has been lost to us for many years. In fact, despite this music being principally recorded for Reprise, there have been no CD versions available in recent memory. Collector's Choice should be congratulated, therefore.

JOE MEEK
The EP Collection
Castle Music

The world of Joe Meek is weird, wonderful, sometimes tragic but always fascinating. Meek was an eccentric '60s genius, a music producer and innovator. His studio had a unique sound, as the twelve EPs in this excellent box set can testify. Pete Reynolds did the mastering on the set and declared that the raw material came in many forms but hardly ever from mastertape, which lies within the hen's teeth category. Often, avid collectors would send flat transfers from their own priceless collections

of original EPs on cassette...

Reynolds likes a challenge, though, "We've got a Studer cassette deck which the BBC used to use – they're superb machines. The problem with most cassettes is the playback chain, the heads. It's relatively easy to put a signal onto tape so, especially with older cassettes that I handle, it's often the case that a better signal was put onto tape than was possible to pick up during playback. However, with my kit, the whole signal can be accessed. I also use an Azimuth Corrector from Cedar, necessary because it's difficult to align someone else's tape that was played and aligned on an unknown machine. The Corrector analyses the left/right signals then it works out the time differences between the two. We can then nudge the timing to correct it." The sound is vastly improved in this manner.

Set within colour card sleeves, featured artists include: John Leyton, The Tornadoes, Mike Berry, the Blue Men and Don Charles – there are four tracks on each EP and the lot is highly recommended. Also look out for the complementary releases: 'Just Like Eddie: The Heinz Anthology'; 'They Were Wrong!: Joe's Boys Volume 1' and 'Vampires, Cowboys, Spacemen & Spooks: the Very Best of Joe Meek's Instrumentals'.

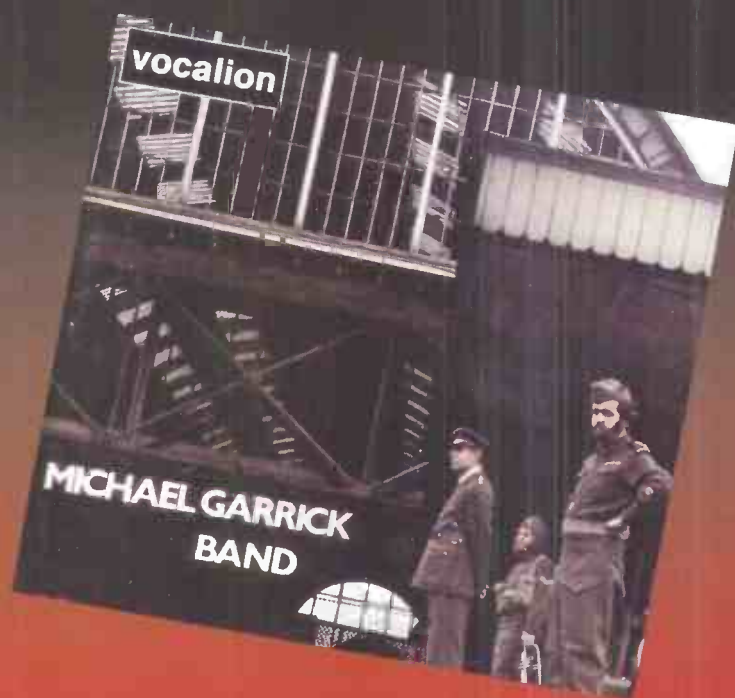

MAGAZINE **Real Life** **Virgin**

Howard Devoto left The Buzzcocks in 1977 to form his new band, Magazine. They modified the punk sound, adding art rock and keyboards whilst still retaining that edgy Krautrock feel. 'Real Life', a superb release, was the band's album debut which effectively displayed Devoto's cryptic lyric writing. Highlights include 'Shot By Both Sides' and the 'Light Pours Out Of Me'.

The Magazine masters, "were recorded on Ampex tape which was suspect at the time," said Sean Magee, mastering engineer at Abbey Road. "The glue compound had been changed and over time it actually relaxes and you start to lose the oxide. You get shedding, a sticky gunge, like someone's poured syrup all over your tape machine. So we baked the tapes at 50 degrees centigrade for three days which makes the glue solidify enough to play. The whole lot were put into baking – I didn't even see if they needed it. The rule was - Ampex tapes? Stick 'em in the oven." Once baked they were all fine and played back on an original Studer A820, half-inch machine. There were no recording notes with the tapes, the whole project was started from

scratch. "I had the original masters, the unprocessed music that came out of the studio as opposed to the tweaked music that went into production."

Sean also had the original CD versions which were, luckily, flat transfers from the later production master tapes. From there on in Sean had a good A-B reference comparison. He then tried to improve on the original CDs by curing excess hiss and dropouts. The result is excellent - a definite improvement on the original release. Also look out for other new Magazine reissues: 'The Correct Use of Soap', 'Magic, Murder and the Weather', 'Jerky Versions of the Dream' and 'Secondhand Daylight'.

MICHAEL GARRICK BAND **Home Stretch Blues** **Vocalion**

If not a 'lost' genius, then at least a sadly neglected one, Garrick was an avant garde jazz pioneer that helped give British jazz a voice. He blended literature with music, featured choral arrangements within jazz and experimented with jazz groupings. 'Home Stretch Blues', originally on Argo, was released in 1972 and featured the legendary Norma Winstone. Garrick's music is tight; there's nothing wasted. That's not to say that it's dry either, as Garrick

creates his music with both wit and richness.

This CD release was derived from a good quality master, licensed from Decca and mastered by Mike Dutton, whose experience stems back through a period with Pye and back to Morgan Studios with Mickie Most. The recording included EQ and other processing notes but these were immediately discarded, "I started from scratch," said Dutton. "Everything then was cut for LP," so the accompanying notes were written with vinyl in mind, "When you do that, the bass is cut, for example, because you can't cut low bass on an LP and bits of the stereo had to be brought in. An elliptical cutter was used to centre the bass. I know people love vinyl but it's not true stereo because of this filtering."

In fact, Dutton is not a big fan of vinyl per se, "it plays perfectly for three or four times and then it's crap. I've been listening to masters all my life and I've always been so upset that people haven't been able to listen to it properly. I just can't stand all the crackle or vinyl's inherent distortion – the LPs wear." Which is partly why Garrick is on CD, a format which, due to the immense improvement in signal processing over the past eighteen months, seems to be experiencing its second wind.

CONTACTS:

Diverse Vinyl
+44(0)1633 256261
www.diversevinyl.com

Stamford Audio
+44(0)1223 894999
www.stamfordaudio.com

Show Time

Adam Smith reports from the Manchester Northern Sound and Vision show

The weekend of the 27th and 28th January saw the SAS Radisson Hotel at Manchester Airport playing host to Chesterfield's annual Northern Sound and Vision show. A good turnout of both exhibitors and attendees ensured that the show had a superbly lively atmosphere all weekend. Attendance was up 50% on the Saturday according to the show organisers, proving that the home entertainment industry, and two-channel equipment in particular, is alive and kicking.

Hi-Fi World were pleased to be sponsoring the show and attending along with World Designs, and were very sad that Peter Comeau was unable to attend due to a badly broken wrist the morning before the show. Fortunately we are happy to report he is on the mend.

Demonstrations of vinyl versus CD and a valve amplifier versus a transistor one were the order of the day in the Hi-Fi World/World Designs room, and we were delighted that these were so well attended. It also seems that part of the success of this room was down to the two heavyweights of loudspeaker technology that we chose to use, as the Tannoy Westminster Royals and B&W 801Ds are seldom seen outside the pages of magazines. Our use of a 21 year old Pioneer Direct Drive turntable also provoked some intrigue, but the general consensus was that it sounded very fine once loaded up with an SME M2-10 arm and Ortofon Salsa cartridge, and driving the loudspeakers through a World Designs WD88VA amplifier.

Equally well supported were our daily clinics for attendees to come along and ask us and audio related questions; mains treatments and valves seemed to be the 'hot' topics of the weekend!

Signature Audio were playing the 'black and shiny' card, which attracted yours truly very quickly. Fortunately their range of equipment, which included Ars Aures and Egglestone Works loudspeakers, and Art Audio amplifiers, proved that beauty was more than skin deep and sounded superb.

Following on from their twin-armed turntable at the Edinburgh Show in October, Hi Audio went one better by fitting three onto their Acoustic Solid turntable this time - a Cartridge Man Conductor, SME V and a Hadcock GH242. Fitted with Cartridge Man cartridges, and connected to separate phono preamplifiers, this allowed instant switching between each item for comparison. Played through Nu-Force amplifiers and Usher loudspeakers, all three sounded very impressive. We look forward to seeing if they can fit four on at the next show!



Not only did Select Audio have the most impressive room, being on the ninth floor with panoramic picture windows overlooking the airport, they also had one of the largest ranges of equipment on show. As well as the Basis turntable, Melody amplifiers and Kingsound loudspeakers being demonstrated, there were static displays of Luxman amplifiers, Acoustic Signature turntables, Feastrex loudspeakers and the huge Emille valve amplifiers. We thought the sound was excellent, and we heard quite a few comments to this effect from visitors exiting the room.



Scotland's Mowgan Audio made their first appearance at a show south of the border, demonstrating their Artio, Mellt and Mabon loudspeakers. Technical Director Bill Bridge reported 99% positive feedback from listeners over the weekend and was wondering if this was just people being courteous. Judging by the high quality of sound coming from all three loudspeakers, I suspect that he need not worry.



New faces at the show, Robson Acoustics hail from Cumbria and were showing a range of loudspeakers finished in a very impressive range of real woods, hides and granite. These were playing with the help of their own loudspeaker cables, monoblock power amps and the best looking passive preamp I have seen for a long time, made from a solid block of wood! Sound from the Mk2 versions of their Greystoke Opulus 'speakers was dynamic and detailed, with very impressive bass for their size.



Henley Designs were showing their fine and stylish lineup of Project, Ortofon and Roksan equipment, making some very fine sounds. Also on show were their new Fatman ipod docking station and matching valve amplifier.



Attracted to the Metropolis Music room by reports of loudspeakers that looked like "two nuns hunched over" according to a visitor, I was intrigued to see the Hansen Audio loudspeakers that were responsible for this description! Fortunately they sounded superb, driven by Boulder amplifiers and the stunning Lumley Stratosphere turntable.





Heathrow Takes Off

Adam Smith previews the upcoming delights of the Heathrow High Fidelity Show

The world of home entertainment and audio equipment has seen some interesting happenings over the last ten years or so, mainly since the advent of surround sound. It is very true that the home cinema market has grown spectacularly, and the range of equipment available is huge. From the likes of a £100 all-in-one unit to the highest of high end with price tags that look more like a telephone number, there is a staggering array of multi-channel items out there with which to fill your 'viewing' room.

Interestingly, however, there has not been the sudden death of two channel equipment that many predicted would follow. In fact, quite the opposite. Stereo equipment has enjoyed an even bigger resurgence than many people anticipated. There are many of us out there, myself included, who run dedicated surround sound systems as well as a more 'serious' two channel setup and the majority of Hi-Fi shows cater for both technologies and allow prospective purchasers to check out the latest technology from all fronts under one roof.

I think that even the most hardened two-channel fans out there would admit that even they cannot help but raise a grin at the experience of a good explosion through a capable subwoofer but, when you are at a show and trying to have a listen to a pair of loudspeakers playing some gentle classical, it can be a little frustrating to have said explosion pounding at you from the

room next door! With this in mind it is often a relief to find a show that is purely dedicated to two channel reproduction; the Heathrow High Fidelity Show is just such an event.

Taking place at the Park Inn Hotel, Heathrow, on Saturday March 31st and Sunday April 1st the show is an excellent opportunity for smaller and more specialist manufacturers and dealers to showcase their wares and we at Hi-Fi World are delighted to be sponsoring the event..

Obviously our trade stand will be present, but we will also be manning a room, along with World Designs, where their range of amplifiers, loudspeakers and Slatedeck turntable plinths will be on display and also playing. As has proved to be so popular at other recent events, we will be running demonstrations and hosting clinics for you to come along and ask your hi-fi questions, and members of the Hi-Fi World team will be on hand all weekend to discuss anything audio-related that you care to ponder.

As to other exhibitors, we have received word that Audiocraft will be demonstrating the rather jaw-dropping £125,000 Marten Designs Coltrane Supreme flagship loudspeakers from Sweden. As these make use of two enclosures per channel, one of which is a dedicated bass cabinet with no less than six drivers, actively driven by a 500 Watt amplifier and featuring comprehensive room correction facilities, this should be very impressive. We just hope, for their neighbours' sake, that they resist the temptation to play anything

featuring loud explosions...

In other rooms, Signature Audio will be repeating their very successful and popular demonstrations from January's Manchester Sound and Vision show with the help of their range of impressive equipment, including Ars Aures and Egglestone Works loudspeakers, and Art Audio Amplifiers.

Lovington Horn will be demonstrating their affordable take on horn loudspeakers, the SH1s. These aim to provide superb sound quality from a domestically acceptable package at a reasonable price and do so by using a single four inch Fostex driver in each enclosure to provide a true full range performance.

Of course, one of the chief delights I find at any of the shows like this, is the opportunity to leaf through the latest vinyl releases, and judging by the crowds I invariably have to make my way through in order to do this, I am not alone! With this in mind, both Diverse Vinyl and Stamford Audio will undoubtedly be drawing many people with their excellent selection of new releases and classic re-issues and I shall have to remember to leave my credit card at home, in case the temptation should prove too much.

So there you have it, a brief overview of the delights awaiting you in March. Accessibility to the hotel is excellent, with good rail, underground and motorway links, and I have even heard a rumour that there is a small airport nearby...

We look forward to seeing you there!



How to get there?

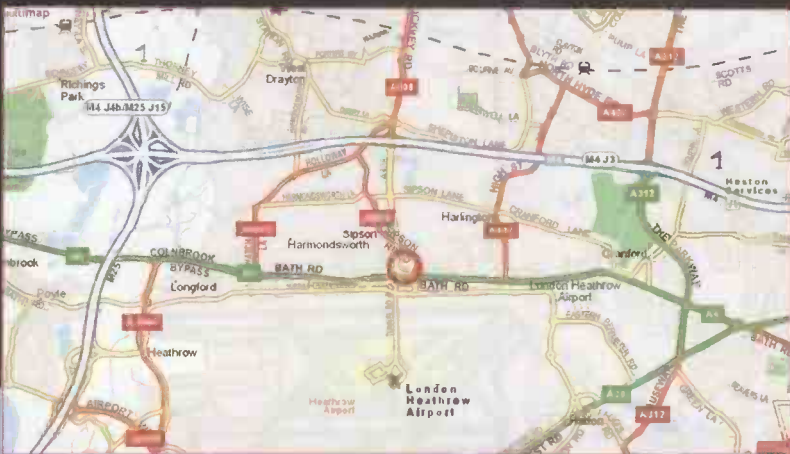

Exhibitors

A'Audio	GT Audio	Consumer Matters
Absolute Analogue	Hi-Fi World	Signature Audio
Acoustat	Hi-Fi Critic	Systems
Aeon Acoustics	Horn Audio	Stamford Audio
Alium Audio	Integrated	Tannoy
Amadeus	Engineering	The Acoustic
Angelsound Audio	Services	Partnership /
Anatek Acoustics	Lovington Horn	Audion
Aspara Acoustics	Loudspeakers	Sound Gallery
Audio Acoustics	Metropolis Music	Townshend Audio
Audiocraft	Music Martters	True Colours
Audionote	MySpace	Trichord Research
Diverse Vinyl	Noteworthy Audio	UKD
English Valve Amps	Pinsh	Vertex AQ
Ensemble Audio	Podium	Whest Audio ...
Phonatics	Progressive	

DIRECTIONS - BY CAR

From London, along A4
Follow signposts to Terminals 1, 2, & 3. At traffic lights where you would turn left for Airport, turn right and then take first left into Park Inn Hotel entrance.

From M25

Follow signs for M4 Terminals 1, 2 & 3. Take exit 4 off the M4 for Terminals 1, 2 & 3. Avoid entering the tunnel into the airport and take the spur road to your left and turn left at the first set of lights. You are now in front of the hotel.

From the M4

Take exit 4 off the M4 for terminals 1, 2 & 3. Avoid entering the tunnel into the airport and take the spur road to your left and turn left at the first set of lights. You are now at the hotel.

BY TRAIN OR BUS

Take the Piccadilly Line tube, or the Heathrow Express from Paddington, and alight at Terminals 1, 2 or 3. The Hotel Hoppa picks up at intervals outside each of Terminals 1, 2 & 3. Catch the Hotel Hoppa H2 to PARK INN HEATHROW.

BY PLANE

If you are flying in either take a taxi (£6-£8 approximately) or use a Hotel Hoppa bus that picks up at intervals outside each of Terminals 1, 2 & 3. Catch the Hotel Hoppa H2 to PARK INN HEATHROW.

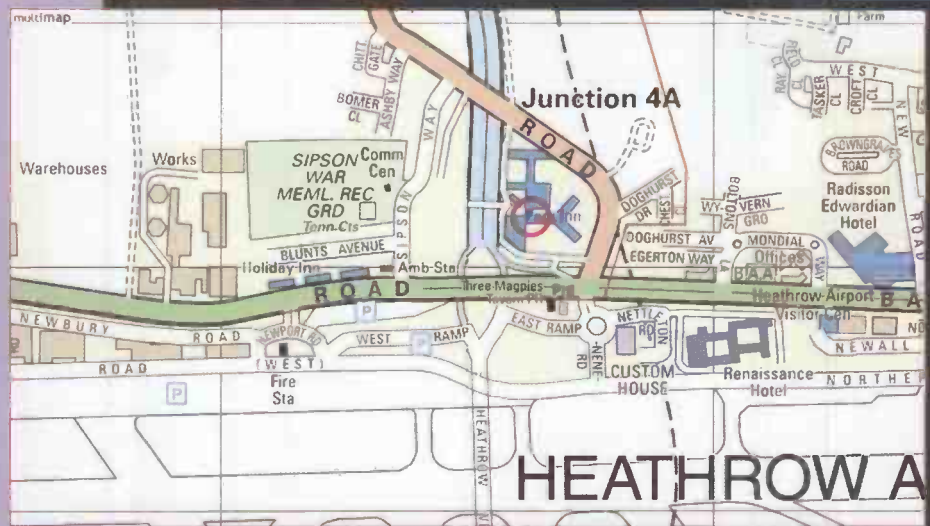

LOCATION

PARK INN HEATHROW

www.heathrow.parkinn.co.uk

for directions
and hotel details

Address:

Park Inn Hotel,
Bath Road,
Heathrow,
Middlesex, UB7 0DU.

Or go to:

www.multimap.co.uk
and type in postcode
UB7 0DU.



WD Series 3 Mod

Part 4



This month Peter Comeau shows how the latest in the World Designs modular preamplifier range, WDPHono3, has been developed.

There are many ways of configuring a phono stage but only a few designs meet the requirements of tonal accuracy and maximum retrieval of musical detail. In essence a phono stage is simply a preamplifier capable of boosting the very low signal levels from turntable cartridges and applying the necessary equalisation to correct the RIAA response.

However, as is often the case with hi-fi design, the highest performance levels are more difficult to achieve than simple theory would dictate. To correct for RIAA equalisation, applied during the record mastering process to help maximise bass power and reduce noise levels, the preamplifier stage has to have a minimum of three filter slopes.

The easiest way to achieve this equalisation without introducing excess noise and distortion is to use some form of frequency selective feedback. However, as we take the view that high levels of feedback give poor subjective performance, it would help our cause if we used passive filtering to apply the required equalisation.

CIRCUIT DESCRIPTION

If you look at the circuit diagram for WDPHono3 you will see that it

has three ECC83 stages separated by two passive filter circuits. VIa is an input gain section which is AC coupled to the low frequency EQ section formed by R11/C7/R13. Note that these components are selected to better than 1% tolerance – you'll need this to ensure accurate tracking of the RIAA curve in all the EQ components.

This EQ circuit takes into account the impedance of the preceding and following stages and also includes the coupling capacitor C1 which provides the subsonic filter at 20Hz. This is necessary to avoid the preamplifier (and power amp and speakers) from being overloaded by subsonic signals from the turntable.

Because of the level of bass boost from the RIAA EQ, this filter is not to be derided lightly. It is all very well providing a spec busting response flat to 5Hz but this doesn't, in our experience, always result in a good subjective performance. Remember that any phono amplifier is boosting bass frequencies heavily to compensate for the RIAA curve and is therefore prone to overload and clipping if subsonic frequencies are let through.

Turntables are, themselves, prone to subsonic signal pickup, whether it is from record warps in the

5-7 Hz range, pickup arm/cartridge resonance in the 12-16Hz range or even building resonance in the 3-9Hz range. Yes, you read it right, "building resonance". If your turntable is sitting, for example, on a table resting on floorboards then it could well be picking up infra-sonic signals generated by traffic outside, footfalls, doors closing, toilets flushing etc! You may not know that your whole building shakes at these frequencies, but your turntable can act as an unwitting seismograph in picking them up.

You will see that C1 has bypass capacitors C3/C5 which are switched in and out from the front panel Subsonic filter switch. This provides a simple method of adjusting the subsonic filtering from the IEC recommended 20Hz to a slightly wider bandwidth at 12Hz or to a band limiting 30Hz. Which you prefer may well depend on how your turntable is set up - we offer the switch so that each listener can decide for themselves - there are no right and wrong with this one!

A second gain stage provided by VIb is implemented to restore the signal level that has been attenuated by the passive LF RIAA EQ section before it. The output from this is DC coupled to the next section of the RIAA EQ network R19/R21/C9 which provides the 75uS compensation and 3.18uS time constant. The latter is a relatively new development which found favour as a 'tweak' to the original Phono2 design. The standard RIAA curve does not limit the high frequency boost applied during record mastering and, if allowed to go on to 100kHz, would run the risk of burning out cutter heads. The 3.18uS time constant was introduced to protect the cutters in the '70s and its 'correction' circuit in

lar Preamplifier

our preamp provides a reduced HF phase shift too which goes towards explaining its popularity amongst those who have adopted this 'tweak'.

FINE TUNING

For those with measurement capability we have introduced the option of 'fine tuning' the 75uS section with a trimmer capacitor across C9. Using an inverse RIAA network, a signal generator and an oscilloscope you can trim C9 to give a 'perfect' square wave and help compensate accurately for the Miller capacitance of the output stage valve. This is, perhaps, just icing on an already rich cake, but if you've got the capability to fine tune the EQ this way then why not use it?

The final stage is a cathode follower 'buffer' to provide the correct load to the 75uS EQ section and interface, via a lower output impedance, to the outside world, namely our WDPre3 or an integrated power amplifier. Don't make the mistake, though, of thinking that this buffer stage is a line output capable of driving long leads. It isn't suited to that, but keep the connecting leads under 0.5m to your integrated amplifier and you'll get excellent results. If you want to use long leads to your power amp then interface to the WDPre3, as that is what it is designed to do!

A final word, now, on the power supply. The original Phono2 used simple decoupling for the HT stage inside its case which worked fine if you assume a fairly close physical coupling between PSU and Phono unit. However those users of MC cartridges often feel that a bit of space between the magnetic fields produced by the PSU and the delicate signals running through the MC step-up transformers doesn't do any harm.

So for WDPHono3 we have pushed the boat out and decoupled each stage from the HT line so that there is now no dependency on the PSU for HT stability. There are, of course, added benefits in inter-stage isolation too. Suffice it to say that WDPHono3 takes an already successful design and improves on it.

Next month: MC Step Up and Performance

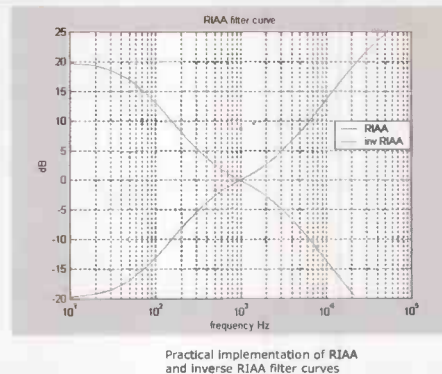
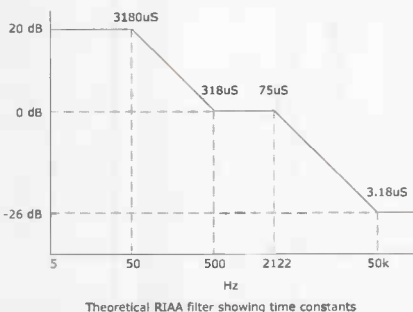

RIAA EQ COMPONENT TOLERANCE

This question of component tolerance in RIAA EQ circuits is something that is often overlooked, especially in commercial designs. We have found in the past that the slightest error in tracking the RIAA curve gives big tonal balance changes. For example a 0.5dB loss at 20kHz can make the overall stage sound 'warm' and lacking in treble detail, whilst a similar boost in output at 20kHz can make the overall balance sound 'bright'.

You might be surprised, as we initially were, that such a small difference can have such a big effect. After all loudspeakers get away with response variations of 3dB or more!

The answer lies in the way the RIAA EQ is configured. If you look at the RIAA graph above you will see that there are two EQ steps, the LF range and the HF range. If we just consider the HF range you can see that it occupies a substantial part of the overall spectrum from 2122Hz upwards and is over three octaves wide. So a 0.5dB error can reduce or increase the level of treble energy in the music over a wide frequency bandwidth. The ear picks this up as a drift in the tonal balance quite easily because it is over such a wide frequency range. By comparison the 3dB peaks and dips in a speaker response usually only affect a narrow frequency band and are more difficult to 'hear'.

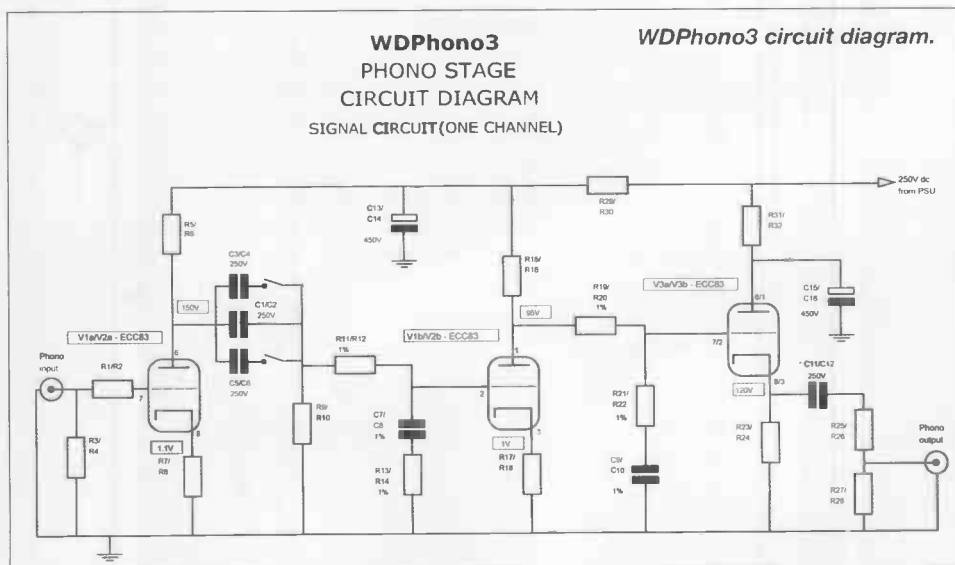

kit & component suppliers

COMPONENT SUPPLIERS

Audio Synthesis

PO Box 50 Nottingham, NG9 1DX.
Tel. 01159 224138 Fax. 01159 229701.
Email salesinfo@audiosynthesis.co.uk.

Website www.audiosynthesis.co.uk
VISHAY BULK FOIL RESISTORS - unquestionably the world's finest resistor for audio applications. Thousands of VSRJ 0.3W 300V 5ppm 1% values in stock at the lowest possible prices eg. values up to 20K at £3.50+vat.
HIGH PURITY SILVERWIRE - Teflon insulated >99.99% purity, 0.6mm and 1.0mm diameter. Ideal for internal wiring, interconnects or speaker cables.

Noteworthy Audio Limited,
36 Buckingham Street, Aylesbury,
Buckinghamshire, HP20 2LH
Tel: 01296 422224

email: info@noteworthyaudio.co.uk
web: www.noteworthyaudio.co.uk
Suppliers of a selected range of audiophile valve kits and components. Including the Stoetkit range of valve amplifiers, Audio Note one times oversampling Dac Kit 1.1 and Lowther drive units. Plus a range of components and accessories from Eichmann, Furutech, Wonder Solder, Caig and many more. For a list of the extensive range of manufactured products and the special offers we stock please see our website or call for details. We are open from 9.30 to 5.30 Tuesday to Saturday, with demonstration stock of our kits available - please call in advance to book an audition.

Audiocom Int. Ltd

Unit 14 Pier Road, Pembroke Dock,
Pembrokeshire, SA72 6TR
Tel: 01646 685601 Fax: 01646 685602
Web: www.audiocominternational.com
E-mail: info@audiocominternational.com
Extensive range of audio passives and active components including DACT, Black Gate, Sanyo, Elna & Vishay. We are the manufacturer and sole distributor for Superclock 3 master clock & Invisus discrete regulators. Visit our online store for pricing and information. Secure online ordering available.

LOUDSPEAKER KIT SUPPLIERS

Arena Electronics Ltd

59 Main Street, Great Gidding
Huntingdon, Cambridgeshire PE28 5NU
Tel: 01832 293320 Fax: 01832 293372
e-mail: sales@seas.co.uk
Website: www.seas.co.uk
Arena Electronics was appointed official UK distributor for SEAS high performance drive units in January 2006. We offer the full range of SEAS drive units, designed and built in Norway, together with speaker kits and advice for DIY speaker builders. These include the World Designs WD25A project, complete parts for which can be purchased on our website including the cabinet kit.

IPL Acoustics,

Chelsea Villa, Torrs Park,
Ilfracombe, North Devon, EX34 8AY
Tel/Fax: 01271 867439

Please visit website for full catalogue of products: www.iplacoustics.co.uk
IPL supply a range of 9 high quality transmission line speaker kits and a full range of Hi Fi and AV speaker kits including 2 powerful active subwoofers. Drive units are available from Hi Vi research, Seas, Morel, Fountech (Ribbon tweeters) and IPL custom built drivers.
IPL also supply quality crossover components, cabinet accessories, including Silver plated PTFE insulated cables, and the very highly rated Aher-Hamblin Digital amplifier.

Impact Audio

Unit 102, The Courtyard
Radway Green Business Centre
Radway Green, Crewe,
Cheshire, CW2 5PR.
Tel: 01270 883243 Fax: 01270 882241
email: info@impactaudio.co.uk
Website: www.impactaudio.co.uk

Main UK distributors of VISATON loudspeaker kits, drive units and accessories. We offer over 35 professionally designed kits from one of Europe's leading manufacturers. Drive units include the MHT 12 ribbon tweeter, TI 100 titanium cone midrange and the new TIW range of high power woofers. Contact us for a free catalogue or visit our website for full details.

Wilmslow Audio

50 Main Street, Broughton
Astley, Leicester, LE9 6RD
Tel: 01455 286603 Fax: 01455 286605
Email: sales@wilmslowaudio.com
Website: www.wilmslowaudio.com

Contact us for a copy of our FREE Full Colour Catalogue or visit our Website with secure online ordering.
The UK's largest supplier of loudspeaker kits, drive units and components. We also have a range of subwoofer kits and amplifier modules available. Official UK distributor for ATC, Morel, Peerless, Scan-speak, Seas, Vifa and Volt. Beware of imitations, we only stock drive units made by the genuine manufacturers. We offer a full repair and upgrade service on most makes of loudspeakers.

VALVE AND OUTPUT TRANSFORMER SUPPLIERS

Chelmer Valve Company Ltd

The Stables, Baddow Park
Great Baddow, Chelmsford, Essex,
CM2 7SY
Tel: 01245 241300 Fax. 01245 241309.
Email: sales@chelmervalue.com

Web Site: www.chelmervalue.com
Premium range of audio valves, tested/selected for low noise, hum, microphony; power valves burnt-in. Huge stock of valves/tubes of all type, audio valves (inc. NOS types), industrial etc. Also large stocks of semiconductor. Many obsolete types.

Billington Export Ltd

1E Gillmans Trading Estate
Billingshurst, West Sussex RH14 9EZ
Visitors by appointment only
Fax: 01403 783519
E-mail: sales@bel-tubes.co.uk
Web: www.bel-tubes.co.uk

Guaranteed new/old stock valves for audio & industrial use Vintage types including Mullard, GEC, Telefunken & RCA. Large stocks of Chinese & Tesla. Major stockists of the Billington Gold brand. Free catalogue on request. Attractive prices on large orders. Minimum order £100.00

MODIFICATION SERVICES

Audiocom Int. Ltd

Unit 14 Pier Road, Pembroke Dock,
Pembrokeshire, SA72 6TR
Tel: 01646 685601 Fax: 01646 685602
Web: www.audiocominternational.com
E-mail: info@audiocominternational.com
Upgrade services available for all CD, SACD & DVD players. With our latest products we are able to advance CD playback way beyond what 'stock' players are capable of resolving. Our extensive knowledge base and upgrade techniques make us world leaders in digital upgrades. Various upgrade solutions are available to suit your budget and desired performance.

REPAIRS & RESTORATION

The UK's Leading Service & Restoration Specialists. Repairs/Restorations to Modern/Classic/Vintage valve hi-fi, musical and cinema amplifiers, control units etc. We will even build that kit for you or design something special. Please visit our Website at: www.audiolabs.co.uk for complete details of our comprehensive services. Alternatively, contact us at:-

Audio Laboratories (Leeds)
3 Kildare Terrace Industrial Estate Leeds
LS12 1DB UK
Tel/Fax +44 (0)113 2440378

Arkless Electronics.

Tel. 01670 829891
E-mail: arkless.electronics@btinternet.com
Specialist in repairs, restoration and modifications to all amplifiers, valve or solid state, ancient and modern. Design service for companies and hobbyists. Amps, preamps, phonostages, active crossovers, psu's etc custom built to order. Kits built/debugged. Please enquire for any other services. Ex design engineer for well known hi-fi companies.

**To advertise in this space
please call
020 7372 6018
or email:
advertising@hi-fiworld.co.uk**

mail

Visit our website at www.hi-fiworld.co.uk or send your emails to letters@hi-fiworld.co.uk. Letter of the month wins a pair of Precious Metals interconnects and one years FREE subscription to Hi-Fi World.



Letter of the Month

CASH CONVERSION

As a hi-fi reader and listener since 1973, it has been fascinating to see how the technologies and markets have developed over the years. I have never been in the vanguard of new product buyers but usually wait until the units are established and the price reduced before investing. Occasionally I have also pounced on second-hand bargains, and as a result I have a system that probably cost me a small fraction of what it would have been when new to the market.

I have a Pickering FA104 Gyroise turntable with XVI5/1200 cartridge and (new) 625E stylus, bought second-hand as a student in 1978 (anyone familiar with this?), a JVC cassette deck of slightly later vintage and a Rotel RT940AX tuner that I bought second-hand before Christmas for £35 – aren't good second-hand FM tuners cheap at the moment? I have a Rega Brio 3 amplifier, again second-hand but super condition, and most recently a Pioneer PDR 609 CD recorder. My speakers are home-made KEF Chorales bought from Wilmslow Audio in 1973 and still going very strong, through QED 79 strand cable.

I have a NAD 521i (with Chord Chrysalis) CD player that always impressed me but never threatened the Pickering turntable for clarity and musicality. Then I found another bargain - Cash Converters had a Harman Kardon HD710 CD player for a song! When installed I found that the start and eject buttons were the only ones that worked, but eBay came up trumps with a remote for a tenner and I was in business. The sound was tremendous; a league or two higher than the NAD and comparable to the Pickering with a good pressing.

Sadly, six months later, the HK has started to jump or refuse to play all but



Marantz CD52SE – brilliant budget CD sound for peanuts.

the latest CDs. These are kept clean and I have a lens cleaning disc but the problem is still there. Having paid just £24 plus £10 for the remote, I would be happy to have it fully serviced, but is it worth it and where should I go? I cannot justify at present what may be £300 to replace it. Is the 710 worth reviving, or should I go hunting for another bargain?

While I'm here, what would you suggest should be my next tweak? I have had some fun with Flat-Foot Sorbothane Isolators (off the internet) and some success with the Tacima 6 way mains conditioner from Maplin. My Alphason ADS147 rests on its spikes on a large slab of marble. My Chorales now have computer sound deadening material surrounding the speakers on the front baffle, again from Maplin. This proved to be one of my most successful tweaks!

So, I've been hooked since the great days when Hi-Fi Answers was my monthly read and I look forward to many more years of a hi-fi-bre diet (sorry!). Thanks to you for providing the continuity and longevity I was missing with other new-only mags and for providing the missing link with my hi-fi youth.

Andy Entwistle

Harman tell me that Select TV (tel: 0117 9775287) act as main service agents in the UK for their products. If you need any more help contact Harman Consumer products at 01707 278100 and Technical Help. I hope this helps.

Budget CD players are something of a muchness nowadays, often using identical chipsets and sounding alike as a result. The Cambridge 540C is a good value new player you may want to audition, but I suspect you'll find something interesting on eBay. **NK**

Hi Andy – nice to know you've got a fine sound without lavishing large sums of money, that's what this magazine is all about! To answer your CD quandary, well you've just got to go for a Marantz CD52SE or CD63SE, or if you can really pull the stops out, a CD63KI Signature. Your Harman Kardon CD spinner isn't half bad, but either Marantz will show you how good cheap classic silver disc spinners can sound – they're very musical, more so than almost any Japanese players of the same vintage. Invest another £10 or so on a bottle of Kontak (or £3 for a bottle of Isopropyl alcohol from your local dispensing chemist) to clean all your contacts, and Bob's your funny uncle! **DP**

TECHNICS TWEAKED

I notice in the current issue of your magazine that the topic of high end direct drive turntables has once again reared its head. In December 2005 I decided to throw caution to the wind and address this issue head on. I already had in my possession a brand new Technics SL1210 Mk2 (don't ask!) and a Linn LVX arm.

Mating these two components



Watch this space for the ultimate Technics SL1200.

together proved to be a lot easier than I had envisaged. The fashioning of an MDF armboard to accommodate the LVX proved the most exacting task, care being needed to ensure correct arm geometry and to give it a professional-looking finish. The right-angled plug at the base of the arm had to be removed, modifying it to hang straight down and substituting the cable for a superior type on the way - I used Van Damme balanced patch from Maplin to which a DIN plug was fitted at the other end. I could see no other mods that could usefully be carried out apart from changing the mains cable. I cannot see how one can change the bearing oil - surely the main bearing on a direct drive mechanism is the motor armature; or am I missing something?

How does it sound? Well, I sold my full spec LP12/1ttok after around seven weeks of living with this turntable and I have never regretted it!

John Taylor

Many thanks for your letter and the picture, John. The SL1210 is indeed a soundly designed unit, and both David and I are fellow owners. Mine has only had a few basic tweaks as it still carries out DJ duties, but David has embarked on an upgrade odyssey on his own unit. Perhaps we should start up a Technics modders club? **AS**

Well, I'm not quite there yet with my 'ultimate Technics', but first impressions of my partially tweaked twelve hundred are that it's doing something my GyroDec doesn't do - which is to serve up stunning bass transients - but it's also lacking much of the magic of the GyroDec too - it's positively coarse across the upper midband. Apologies, readers, for not

getting my tweaked SL-1200 feature into the April issue; I am afraid we have had 'logistical' difficulties, but we're nearly there. Watch this space, as they say... **DP**

UK RULES?

I enjoyed your comments about units of force and downward pressure on pickup heads in the February 2007 Issue. However, as an old mechanical guy who long ago packed away his water-cooled slide rule and log tables, may I ask you sparkies a question that has long bothered me?

I frequently read in audio publications that amplifiers or loudspeakers are made to UK specification, thus justifying large price differences between UK, US and mainland Europe for the same equipment. However, in my opinion, after the Primary transformer, all circuits are the same. For example, the KT88 requires the same H.T. and heater voltage from Timbuktu to Tunbridge Wells, while transistors require the same positive and negative voltage rails no matter where they are in the world.

Whilst I agree that the primary side of the mains transformer will vary from country to country as some markets will require switchable options or different fusing, but this is nothing that a simple modification will not cover. The mains transformer input to output ratio will vary due to different supply voltages but the overall copper and lamination count will be similar.

Chassis are invariably made using a CNC machine, so there is no great difference between twenty holes in its base and twenty-two; I could go on forever! So please, what is UK specification?

Pat Rickwood

As you say, UK electrical specification basically means working at 230V (nominal) and 50Hz mains, there being little difference after the transformer primary. Primary side fuses are a lower current rating and the mains side have to conform to UK safety regs, which these days are based on IEC regs. The thing actually has to work up to 245V or so without expiring, but that is fairly easy to cope with nowadays.

There are, however, other sides to all this. If the product is manufactured in a country, notably the USA, where everything is completely different, a UK version is in effect a 'special', made in lower quantity. Both casework and mains transformer will differ, and as these are the most expensive

items in the bill of parts, making them in shorter runs increases costs.

If a product comes in through an importer then both carriage and the importers margin get added in to the retail price. Where this is the case, price is quite likely to be above that of the product in its home market. So although it's a UK spec. product, it isn't the actual electrical bits that solely determine price. A whole host of factors are at play. **NK**

RADIO GAGA

I agree with every word in the letter (January 2007) from Ms J. L. Wilson and I think that the response from both NK and DP was inadequate. In each case, your replies amounted to a Gallic shrug and a "que faire...?" If we cannot rely on you hi-fi scribes to demand quality in sound, what is the point of your existence? The truth is that Radio Three listeners are being badly let down by the BBC. We pay a big tax (aka the licence fee) to this unelected organisation and yet they choose to prioritise Jonathan Ross's salary and TV content which is garbage, full of repeats apart from the occasional 'Bleak House' and 'Planet Earth'. The least we can ask for our licence fee is a decent Radio Three even if all the other radio channels are compromised.

I have the advantage of living in France for many months a year and I wish UK listeners could hear the FM signal of Radio France Musique. Having spent Christmas and New Year in the UK, I was depressed by the pedestrian content and the poor sound of Radio 3 over the holiday period. Not worth coming home for, really. On my return to France, I chanced to turn on RFM with a live broadcast from St Petersburg of

the Orthodox Christmas Mass - I had other things to do but just sat there spellbound. The variety in the ultra deep bass voices of the priests, the depth of sound stage and ambience - you could almost hear the incense censors swinging. This is the level of broadcasting you guys should be demanding on our behalf: instead you accept the status quo in your sophisticated world-weary way. Not good enough. We don't pay the BBC for crap and we don't pay HFW to

Wells has now upped sticks and moved across La Manche! Meanwhile, back in Tunbridge Wells things have changed; the BBC is not the least bit concerned with what they now see as narrow interest groups such as ourselves. I can assure you I have tried to speak to the Press Office at the Beeb about such matters but the last time (in every sense) I did this I was shouted at and had the phone slammed down on me. The BBC is,

in both quantity and quality, the two not being mutually exclusive as the BBC seem to think. At present there isn't the will to improve quality and it isn't even a matter of debate.

These days the BBC has become something much more than just a broadcaster: it has a huge property portfolio, print publishing supported by TV, internet publishing and heaven knows what else. Small matters such as radio sound quality barely feature - hence the Gallic shrug from me. So keep a seat at the bar warm for me Rob. Salut! **NK**



Radio France Musique - shows British stations a thing or two in terms of sound quality, apparently.

accept low audio standards.

My views are based on Meridian 504 and 104 radios in the UK with a Ron Smith aerial (104 better than the 504 in many ways...) and in France I listen to the superb AVI S 2000 MT II employing just a plastic wire aerial. The story of the last five years has been an ill-informed public accepting reduced quality in the name of technical innovation. iPods are light years inferior to the Sony Walkman, DAB inferior to good FM, Plasma TV inferior to CRT. Okay, they should include Hans C. Andersen's "The Emperor's Clothes" in the National Curriculum, and wasn't it Sam Goldwyn who said, "you never go bankrupt by underestimating public taste"? But journalists have a lot to answer for and need to up their game in telling the public and the BBC the difference between quality and the unacceptable.

I will now drop down to the local bar for a calming Pastis and game of boules (never, never say "betanque"...!) before ripping up some cobble stones to barricade the dreadful local radio station. French pop music is a subject for another day.

Rob Cochran

Hello Rob. So Disgusted of Tunbridge

these days, an organisation out of public control in my view. It receives a huge income from its license fee (and wants much more). Its early adoption of DAB was a classic example of poor decision-making and its much discussed profligacy. The BBC will only be brought under control when the whole business of a compulsory license fee to watch TV in the UK is tackled. There are many ways of doing this, but I suspect no political party is prepared to risk it, for fear of coming under sustained attack on television.

We have mounted a campaign, if you wish to call it that, pointing out that DAB in the UK is substandard by any measure, by what is technically possible with compressed audio and by VHF/FM standards. We are not liked for it, I can assure you, by broadcasters or by set (hi-fi) manufacturers, both of which feel their interests are being undermined. All the same, DAB is now recognised as a mediocre quality channel suitable for portable radios, rather than CD quality digital as they so laughably tried to label it. But I am not sure this amounts to much. The UK deserves a rounded broadcast network, one that can deliver stations

As contraire, Rob. I'm not quite sure how you've managed to get to the position where you think we're apologists for what's happening in broadcasting in this country. I really can't remember reading or writing a single page of this magazine that has celebrated the wonder and greatness of DAB - quite the reverse. This isn't just a hunch, as a number of DAB radio/tuner manufacturers have told me in no uncertain terms that they don't like our magazine 'ranting' against their lovely new Digital Radio technology. As for our radio expert Steven Green, well if you've bothered to read his missives over the past year then I seriously doubt you'd be putting pen to paper. So I can only assume you've posted your letter to the wrong magazine, or maybe it's just confusion on your part, caused by one Pastis too many? PS - by the way, apart from the ill-informed attack on our lovely magazine, I couldn't agree more! **DP**

Rob, I completely agree with your view that the BBC should provide Radio 3 at the highest standard - I think they should provide all of their services at the highest quality within the financial constraints they're under, which they're most certainly not doing at present.

I agree with Noel when he says that the BBC doesn't care about the audio quality of its stations any more, because if they did care then they wouldn't have chosen to use such low audio quality on DAB. But I think there's another element to this, as well, which is that, in my opinion, the BBC bases its audio quality decisions on the predicament they're in with the quality on DAB, as they're desperate for DAB to be a success. So I think their use of dynamic range compression on FM is more of a ploy to get the audiophiles on-board DAB rather than anything else. Whether Radio 3 sounds better on FM or DAB becomes debatable when dynamic range compression is applied on FM, whereas if they didn't use it

on FM there would be no contest and the audiophiles would flock back to FM. Then they would end up being criticised more about DAB's quality than they already are. And with R3 listeners being a vociferous and influential bunch, that's about the last thing they'd want to happen.

And although this may all sound like a bit of a conspiracy theory, they've got form for not providing the highest quality possible on other platforms as well: they could easily increase the bit rates of their stations on digital satellite but they chose not to, and the audio quality of the stations on Freeview aren't as good as they should be for the bit rate levels they use.

And as Noel says, I think we've tried our best to highlight the deficiencies with DAB, which has included criticising the BBC's audio quality on several occasions. So we certainly haven't stayed silent about the BBC's low quality standards. But you also have to bear in mind that the BBC is self-regulating with regards to technical quality matters, and they show no sign of changing their ways, so the occasional Gallic shrug is inevitable, although I think it's more through exasperation than anything else. **SG**

THE ROAD TO REDEMPTION

Is it just me? It all started in 1973 when I went to Tottenham Court Road which, at that time, was infested with shops which sold what was considered to be hi-fi equipment and in one of these I bought the first system of separates which, at last, I could afford - the ubiquitous Pioneer PL12D with a Shure M75ED2, a Goodmans Module 80 tuner-amp and Celestion Ditton 25 speakers. For a long time I thought it was great.

I then made a major mistake by going to a modest hi-fi exhibition and unfortunately heard something a little bit better. Mistake number two was probably a lot worse because I bought a hi-fi magazine which gave information about some incredible, mind-blowing pieces of equipment. From then onwards life was never the same because the quest had been triggered, namely an attempt to achieve great sound on a limited budget. Since then I have learnt many lessons, of which perhaps the most important is always try before you buy and that really requires the help of a friendly, honest dealer and, strange to say, there are a few around.

It may be a mistake to read magazines because the damned things have so many wonderful reviews that they really make you want to buy, certainly to listen or to try. I have tried a number of times but usually have been



Pioneer PL12D - many people's ticket to the wonderful world of hi-fi...

disappointed, which leads me to another major problem. We all hear things differently, just as we have variations in taste, touch, sight, etc. I go to as many exhibitions as I can just to see and hear all this wonderful equipment. I wander into one of those little hotel bedrooms and see a few people really enjoying what they hear. Others walk in and walk straight out, as I often do, because they just don't like it, so what is wrong? Is it the room acoustics, is it an equipment mismatch, is it some distortion which is unacceptable to many people or is it an inexplicable dislike of what we are hearing? In other words, is it me? I often lust after a Zanden or MBL system but what is the use? I do not have the money and my listening room is not a concert hall.

This brings me to the domestic problem. My listening room is our lounge and my wife is not quite sympathetic. Unfortunately, a hi-fi system may not be a pretty sight and to many women all equipment should be matchbox size and the speakers should be like OXO cubes, everything to be hidden in a drawer. Everything we have is over-priced and just try explaining to your wife that interconnects, which are just bits of wire to her, are worth hundreds of pounds for a metre pair. She would want to take you to the doctor to have you certified as insane. Blessed are the ones who cannot hear differences between cables!

Thirty four years on I am still searching, still on a budget. Occasionally I put on a well recorded disc and am rewarded by a sound which is almost magical. However, the next day it just isn't the same. Maybe it is the electrical supply or maybe because it is raining. Perhaps it is global warming or an earthquake on the other side of the planet. It might have been what I had for breakfast or maybe, again, it is just me?

Now the race is almost run but the winning post will be forever out of reach. The hearing equipment is beginning to age and fade and soon I suppose I will be too old to care anyway. Was the quest fun or was it frustrating agony? Perhaps a bit of both. I suppose I should have listened to my wife in the very

beginning.

Just a last thought. Most of today's young people seem to be quite happy with the noise/sound which comes out of their mobile phones or iPods and I am beginning to fear that the true audiophile is becoming an endangered species.

Tudor Williams

*Ah yes, the sound at Shows! That's a subject in itself - and having recently returned from the Northern Sound & Vision Show at Manchester where our room didn't match our expectations I am well aware of how variable and sometimes disappointing things can be. In our case the room was large and, according to our Cara pre-show acoustic analysis, likely to sound good. But what we didn't know until we got there was that every wall, plus the ceiling, was false. They were built from light panelling that resonated like crazy when rapped with the knuckles. This sucks out bass energy degrading the sound. In this instance it robbed our Tannoy's and B&Ws of bottom end slam. We were disappointed, as were many listeners, who were expecting more. With hotel rooms you get what you are given - and often it isn't what it seems! **NK***

*Oh come, come, Tudor - yours has not been a fruitless search. There's nothing wrong with seeking out the best for you and yours, even if your wife is - amazingly - unable to understand why some hi-fi wires are sold in lurid colours at one hundred times cost price! Don't be so cynical - yours was not a wasted journey - you'll get there in the end. Music can be magic - you know that. Just close your eyes and forget the cost. Finally, don't be a drudge - leave the youngsters alone, there's nothing wrong with iPods, and all the kids want to do is have a good time! **DP***

POWER RANGER

Can you please advise on a 200 watt-plus mono amplifier to power my home-made sub filter and speakers? This

must have very low impedance handling capability (i.e. - below 4 Ohms) and no fan cooling. I am using two 16.5in Scanspeak drivers and one passive 18in in a 6.5 cube. Also, how about a no-compromise subwoofer design in Hi-Fi World - one with no boom? Like.

You do not specify your budget, but the first amp that springs to mind is the Behringer A500 reviewed in our December issue. Although not the last word in terms of treble and midrange, David Allcock found that it had bass that was an exceptional result at the price. Add in the lack of fan cooling that you prefer, along with a measured output of 203W into 4 Ohms in stereo mode (this will increase when used in bridged mono mode) and you have a bargain for £139. Of course, if your pocket is a little deeper there's always the Krell Evolution One with 450W of Class A output for somewhere around £13,000... **AS**.

You may be interested in amplifier modules from Prism Audio (www.prismaudio.co.uk) which are also available from RS Components, if you have an account (trade only). **NK**

I have been most impressed with the Rotel £1,595 RB-1092 reviewed this issue - half a kilowatt and it doesn't even get hot. Unlike many Class D designs, this one really sings too. Krell should be worried. **DP**

PH NEUTRAL?

Thank you for your review of the Artemis labs PH-1 Phono Stage, and for the glowing comments about our product, sic: a super high quality phono stage with translucent midrange, superb imaging and intricately detailed treble.

Unfortunately the attributes awarded to the unit in the editor's comments and in the contents pages are not reflected in the article itself, which is particularly chimerical in nature, meaning that the Audiophile Club are unlikely to gain any new converts to this excellent product.

I am very surprised at the lack of contact between the magazine and ourselves, and even astounded that you have described the PH-1 as purely a MM phono stage in various places within

the review. My main concern is that you chose to review it yourself, without reference to me, about which equipment you were proposing to use, when it was originally intended for David Price and his Grasshopper GLA IV, a high quality MC cartridge of medium output, which is what I use personally, with great success and little valve noise.

Anyone knows that you cannot get a dead quiet all-valve phono-stage, so it is just a question about the degree of noise, and with my Audio Aero Prestige monoblocks, 40 watts of SE output, the match is one that is made in heaven, without undue noise. If you were proposing to use very low power amps or low output MCs, you should have been aware of our PL-1 phono stage, complete with a step-up transformer together with the same array of valves as in the PH-1. In my system, this was the first combination that I tried, but I felt that the PL-1 had too much gain, and the PH-1 was a near perfect match at the volume levels that I employ.

So why is it that your magazine

To start at the end first, you were asked for the price of the phono stage which was being reviewed, not the preamplifier, so how the latter was quoted and got into print is an open question. Whilst the PH-1 is a good preamp for the reasons quoted, it is not especially competitive at this price. As the PL-1 is more complex, with transformers, I presume it is more expensive; you don't mention price. Magazines act independently and don't ask manufacturers or distributors for their views on a review prior to publication. We are happy to print your views though. **NK**

Hi Ron - I am sorry that you think your product didn't get a positive enough review. To respond to some of the points you raise, it is not normal for magazines to have extensive contact and/or consultation with manufacturers during reviews - assuming we have all the



Behringer A500 - not the last word in sophistication, but it's a lot of power per pound!

prefers to shoot itself in the foot, getting the wrong emphasis on products or fielding blatant typos, which could be corrected by a simple phone call? HFW did in fact phone me for the retail price, so you could have run the other issues by me, to arrive at a better article. Incidentally, you did in fact get the price wrong as well, which is £1,995, which is closely matched to the USA price, and has a build quality typical of much higher priced equipment. It is the matching pre-amplifier which sells for £2,195.

In the USA, magazines give a right of reply, which ends up in the same issue, and is therefore a sensible conclusion for the reader. I trust that you will feature my unabridged response, so that readers can be made fully aware of the potential of the PH-1 and of the alternative high-gain PL-1.

Ron Tabor

facts we need - as the general idea is that we go away and take an independent view of the product. You yourself told me that the PH-1 works very well in your system, and that you think it has adequate gain with most MC cartridges, but that "you don't listen at high volumes". I would suggest that many readers wanting the PH-1 with its lower cost and lack of additional, sound-degrading gain stages, do listen at high volumes. I certainly do (when my neighbour's out) and I know many other audiophiles who do too. In this situation, the PH-1 may prove a little noisy.

Whilst the unit was originally specified for me, Noel is a more knowledgeable and experienced judge of tube amplifiers than I, and it is for this reason that I envisaged

no problem in handing the review over to him. Indeed, I would venture to suggest that he has had more experience of tube products than any other UK hi-fi journalist around, so this makes his comments all the more apposite (both the many positive ones, and the negative ones too!). The point stands that, although it was a very fine sounding bit of kit, in faces extremely stiff competition from the likes of the Eastern Electric Minimax at £1,100 and £1,750 Note Products PhoNote, to name but two.

DP

DIGITAL DILEMMA

I would be grateful for your advice, primarily on choosing a CD player that will work in synergy with my system. This currently comprises a Garrard 401 in a ply and sand plinth on Foculpods; Origin Live modified Rega RB250 with SME fluid damper and a Goldring 1042. I have also fitted two Ringo platter damping rings to the 401 along with a glass platter mat, cut and drilled by a local glass merchant for me. My current CD player is a Technics SL-P477A.

Electronics comprise a Naim NAC72 preamp, HI-CAP power supply, two NAPI40 power amps and a NAXO active crossover. These are all sat on inflated rubber inner tubes and located on a homemade marble six tier stand. Loudspeakers are Wilmslow Audios V2 Home Studio Monitors using Volt 8 in bass drivers and Scanspeak D2905 tweeters on home made marble stands spiked to the floor, and connected to the amplifiers via Naim cable. These are aided by a REL Stadium 2, spiked to the floor. I also use Chord Chameleon cable for the CD player, and QED cable to the other units.

My listening room measures 27ft by 10 to 13ft and the speakers are at the wider end, firing down lengthways. This has a suspended wooden floor with brick supports every 18in and I have installed a dedicated mains spur to four, two-way switchless sockets. I also use Russ Andrews Yello cables and Martin Bastin's Wave Mechanic Power supply.

Sadly the CD player is d-d-doing an Arkwright and j-j-jittering about! At the moment I am listening through a £25 Alba DVD player hooked up to the television and plugged into the Naims through a long phono lead. I use this cheap slimline unit as my other Roadstar DVD player was too high to fit when my Freeview box malfunctioned and I decided to replace it with a new recording unit. I was appalled at the monotone bass which emanated from the dearer (£40!) Roadstar unit. I assumed that, as it was dearer, it would sound better, but the Alba is much more tuneful in the bass. In fact, it does not sound totally unpleasant; certainly not

as detailed as the CD player, but clearly the law of diminishing returns starts at basement level.

Which CD player do you think would suit best? One of the Naim CDs would be a first choice, just to get all those nice green lights the same, but which one? My brother has a Meridian and I like its natural, organic sound, but would this be too warm for my system? Do I need a more incisive sound? I would probably buy second-hand unless you think there is a new flavour of the month/year that would gel particularly well?

Now that my Cambridge Audio digital tuner has gone belly-up (that's two digital deaths- is this common?) I use the Freeview for radio and it is definitely more detailed in the bass and more articulate than DAB. The Freeview sound does generally seem quite bass-light, however, and I wonder if this is a generic sound? I wish I had auditioned it beforehand, but I wonder how many High Street stores would be prepared to hook it up to an audio unit. One

In fact, the most important improvement I made to my system was to the speakers, and it was also the cheapest mod, too! I took out all the internal wadding and replaced it with Deflex panels, that wobbly stuff like Sorbothane, all over the rear face. I also coated all the insides with Copydex to further reduce internal reflections. As a result, the speakers appeared to disappear more from the room and sounded more like electrostatics. The treble appears more focused and I could hear the reduction in distortion and time smear as the treble energy was absorbed by the Deflex panels and not reflected back. Bass had more articulation; with acoustic bass I could imagine the room around each of the strings as they vibrated. I have also fitted felt around my tweeters. This has again focused the treble a little - what are your thoughts on the benefits of this mod?

I do also keep looking at my 401 and wondering if there is much to improve there? It has been serviced by



Naim CD5i - a seriously musical sounding silver disc spinner]

problem I do have, however is that an annoying hum occurs when I switch the Freeview to the Naims - do you have any advice on how to get rid of this, please? The system is on a dedicated spur but the TV, REL, etc., are on the normal ring main.

I have spent years developing the system and am very pleased with the sound. When I listened to a £20,000 Naim system I wondered why people pay so much more. Now that I have visited the excellent London hi-fi shows, I am even more convinced that I have met my own law of diminishing returns. I can certainly agree with your assertions to some readers that they should buy a certain bit of kit to re-balance the sound and then sit back and enjoy! I found it immensely interesting to listen to the different sounds coming from the demo rooms at the shows. I felt that a major difference in sound was always down to different loudspeakers. A digital source is a digital source; vinyl always seemed to sound better, as one would expect at those prices!

Doctor Martin Bastin, with his Super Magnum bearing mod and oil. I was wondering if better quality oil would help? Also, would the Origin Live Silver be a good cost-effective upgrade? I already have an OL modified Rega RB250 with my own addition of an SME fluid damper, the addition of which has made for a very neutral and unflappable sound. What are your thoughts on arm damping? Finally, as mentioned, I use a glass platter on my 401 and I have not heard any other material get close to it for transparency and control. Does anyone still make a high quality glass platter mats any more - I know Slate Audio used to but I cannot source one. Does Noel use a glass platter on his 401?

Anyway, time to put the boots on and enjoy the fresh New Year air. Thanks for such an informative magazine. The articles on specific subjects such as speaker design and placement and the advances (sic) in digital radio are helping me to make informed decisions about how I listen to my music.

Ray Spink

Hi Ray. Your choice of which Naim CD player depends on you. I can recommend all of them, but it's all down to how much you want to spend. My personal fave, aside from the £14,000 CD555, is the CDX2, which does an awful lot at £2,650. Still, it's a very charismatic, overtly musical device which got even this vinyl junkie starting to look lovingly at the old silver Frisbees! The CD5i is a good start as any though – Naim stuff has superb resale values so it won't cost you much to own before you upgrade to something really serious. I also really rate it as a highly accomplished all rounder – nothing at the price betters it in the musicality stakes.

The Origin Live Silver tonearm is indeed a step or three up the ladder. Right now, the latest version is a total honey, and you'll really need to get a brilliant cartridge before you push it beyond its limits. You'll find additional resolution, musicality and tonal detailing (and colour) to your existing tweaked Rega. Spectra Dynamics Deflex panels are great aren't they? They really do kill resonance. I have a noisy diff bearing in my 1987 Jag XJ6, and there are some judiciously attached to my inner rear wheel arches to cut the noise down! I'm assured they work brilliantly in speakers too.

I've found the £80 SoundDeadSteel Isoplatmat (www.sounddeadsteel.com/ISOPLATMAT.html) works brilliantly on any Mazak type platter, and I can see no reason why the Garrard's would be any different. It really removes a layer of 'zing' and 'clang' from the sound, even with very good platter systems such as the Michell GyroDec's – it's a great upgrade, and better I think than glass, which is far less inert. As for oil, I always recommend Redline 5W30 as the best affordable bearing oil (£12 per quart, and you get to put most of it in your car's sump), or vdH TLF if you want a bespoke £35 formulation. Either way, you're getting something using the very best polyol ester base stocks available, and it should last forever, unless you're Adam Smith and have 94 turntables to keep revolving!
DP

Thanks for that Ray. I use my 401 au naturel, that is without a glass platter or anything else, but it is on a Martin Bastin plinth and was impressively restored by him originally.

Felt rings around tweeters absorb surface waves and minimise diffraction at cabinet edges. They usually produce a measurable and audible improvement. Similarly, arm damping invariably adds a little to the sound of an arm, but these

are complex systems that respond to most tweaks. I really couldn't comment upon any improvement different oil might make: this is too specialised even for me! Peter Comeau's loudspeaker articles benefit from both his technical knowledge and Peter's long industry experience. I am glad you enjoy them. **NK**

DIGITAL DILEMMA 2

I read your review on the Marantz CD5001 and Cambridge Audio 640C V2. I am replacing my ageing Marantz CD63SE which has a wonderful musical, full-bodied midrange. I have B&W floorstanding speakers, Rotel power amps and a valve preamp. I compared the Marantz CD63SE to various CD players. The Rotel 1072 sounded bland and had a rolled off top end, the Marantz CD6000SE was a bit bright and hard sounding, the Marantz CD7300 was too mellow and slow sounding. The NAD C542 had a very musical midband, solid bass, but rolled off top end and not as open and detailed as the Cambridge.

I ended up getting the Cambridge, but on my system the midrange is a bit thin-sounding, lacking a bit of body and warmth and the various harmonics on the guitar or piano, sounding exciting but at times cold, dry and clinical. I could not believe how good the old Marantz CD63SE sounded. For example, the tone of the piano or trumpet on the Miles Davis 'Kind of Blue' CD or the echo of the guitar on a Ry Cooder CD.

My question is: is the Arcam CD73T a better sounding CD player than the Cambridge, as it is nearly the same price in Australia at the moment? What is the character of its sound? I like warmth,

*Hi Steve – the Marantz CD63SE just happened to be a particularly musical performer. I don't know why (I'm sure Ken Ishiwata knows, and I'll ask him next time I speak with him), but it was. Indeed, we all noticed this at the time. I remember Noel using one to drive a pair of WAD K5881 monoblocks direct, back in the mid nineties, with truly impressive results. So the short answer to your question is no – there's nothing really comprehensively better than the CD63 until you start splashing out around £1,125 on the likes of Naim's CD5i. The Marantz isn't the best at everything at the price, but the overall package was great. I'm sure your 640C is better in some ways, but not every way. Likewise, it would be foolish to go for an Arcam CD73T, which will be better than the 640C in some ways, but not all. Truthfully, you're not 'upgrading' here, you're 'side-grading', basically rearranging the chairs on the lawn – and it's not going to make your garden any bigger. Save your money, then go for something serious at the £1,000 mark next. **DP***

ICONIC ASSUMPTION

I must take issue with some comments made by Adam Smith in his review of the Icon Audio Stereo 300 (Jan 2007). Adam describes this amp as having inconsistent treble and poorly defined bass. He cites a lack of impact in the opening drums on 'Copperhead Road', amongst other things, and suggests that the amps timing is not all it could be (just



Marantz CD63SE - requires a big upgrade step to significantly improve upon.

detail and excitement. What other CD players do you recommend? Is the old Marantz CD63SE still that good that you have to pay a lot more to beat it significantly? Any thoughts would be appreciated.

Steve Nicholas

about kept up with the pace). He then concludes that this amp is more suitable for classical material.

Ermm, why? When I read the review I happened to be listening to Elgar's 'Enigma Variations', which contain several percussion passages which

have as much impact as the opening of 'Copperhead Road', and also have numerous shifts in tempo requiring a fleet-footed amp. An inconsistent, if sweet, treble would make such a mess of pieces like Biber's 'Rosary Sonatas'. Poorly defined bass is poorly defined and undesirable on classical material just as much as it would be on rock or jazz or anything. These sonic flaws do not make an amp suitable for classical material in

technical issues, such as the lack of a 4 Ohm tap, which surely contribute to the sonic problems. If a piece of kit is faulty, say so, don't try to pass it off as suitable for a type of music which the reviewer seems not to have listened to.

Dave Dallard

A well rounded argument, and I have to say you raise a valid point. The fact is that, whilst we try to audition

and natural with these. Combined with its excellent soundstage, this is my reasoning behind why I stated that it was good for classical and vocal music. However I perhaps did generalise a little too much and I hold my hand up to not listening to the more enthusiastic and explosive type of classical that you mention. I have to agree that the Stereo 300 may have similar problems with music of this type as it did with Steve Earle, and this is something that potential purchasers should be aware of.

With this in mind, let me re-word part of my conclusion to the effect that I can see its archetypal valve sound finding favour with many listeners and if you like your music presented in this way and have plenty of MELLOW classical or vocal material in your record or CD library, then you should certainly put the Stereo 300 high on your audition list.

I am afraid I would, however, still assert that the innate character of some equipment does often suit one type of music more than another. Sometimes a hard transistor amplifier that makes violins sound like a tortured cat is just what is required for a bit of hard rocking, in just that same way that the likes of Diana Krall, Norah Jones, etc., sounded divine through the Icon amplifier, despite its relative shortcomings in other areas. **AS**

In extremis (well, it sounds good!) I agree with you: classical and rock can be demanding and a good amp should handle them both. Unfortunately, human nature and perceptions being what they are, those that worship fast rock often like a certain sharpness and hardness of delivery that acts against classical



Icon Audio Stereo 300 amplifier: classically mellow.

any way, quite the opposite I would say, as little, if any, classical music is about wallowing in lush, syrupy strings. Indeed, I would question how Adam reached such a conclusion when he does not mention any classical music in the review.

This sort of clichéd idea that there is such a thing as classical kit or rock kit is mistaken. The properties needed to make music, as opposed to unrelated noises, are the same regardless of genre. Adam and Noel in fact highlight

each piece of equipment with as many different styles of music as possible, if we were to use every single genre on every test item, there would probably be one review per month in the magazine! The fact is, that I did indeed use some classical material when auditioning the Stereo 300, including Holst's Planets Suite, Pachelbel's Canon and Vivaldi's Four Seasons and it sounded remarkably composed

Billy Vee
SOUND SYSTEMS

SPECIAL OFFERS & EX-DISPLAY BARGAINS

SOME AS NEW (MARKED*) 24HR DEL ONLY £8. CHECK STOCK BEFORE ORDER. S/H = Pre-Owned. E6OE

CALL SALES: (020) 8318 5755 or 8852 1321 - 248 Lee High Road, London, SE13 5PL

❖ Creek - Destiny CD/Amp + PMC DB1 System



£2735
Save £340

Creek have a winner here. Tuneful, vibrant, a great partner for PMC - Come and listen. Could this be *your* Destiny? For this month we include PMC DB1+ for half price!

B&W 704 Speakers Maple E/D (2Yr G/tee)	(1400.00)	£975.00
B&W 703 Speakers Rosenut E/D (2Yr G/tee)	(2000.00)	£1395.00
Linn Mimik CD Player S/H - (6Mth G/tee)	(1100.00)	£375.00
Linn AV5103 DTS Processor - Black (1Yr G/tee)	(4500.00)	£895.00
Linn Klout Power amplifier S/H (1Yr G/tee)	(2400.00)	£895.00
Linn Chakra 2200 Power Amp Silver E/D (2Yr G/tee)	(2530.00)	£1795.00
Naim NAC82 Preamp S/H - (1Yr G/tee)	(2500.00)	£995.00
Naim CDS3 CD Head Unit Ex/Dem (2Yr G/tee)	(5325.00)	£3895.00
Naim XPS2 Power Supply S/H (2Yr G/tee)	(2550.00)	£1675.00
Naim Allae Speakers Cherry S/H (1Yr G/tee)	(2250.00)	£1495.00
ProAc Studio 130 Speakers E/D (2Yr G/tee)	(1099.00)	£769.00
Spendor S6e Speakers Maple E/D (2Yr G/tee)	(1495.00)	£995.00

For latest News, Products, Offers, additions to our pre-owned and ex-display bargains in Marketplace section please visit www.billyvee.co.uk.



Michell GyroDec – with decent oil and nicely bouncing springs, it sings its little heart out!

strings in particular. Truly accurate products that handle both musical genres equally well, as they should, fall between camps, those with hardened attitudes feel. It's all a little disappointing really. **NK**

GYRO MOTION

A long time ago in a Hi-Fi World column far, far away, do I remember correctly that David mentioned an exotic high tech motor oil that he used on his Gyro spindle? (I think I remember Mobil-1 from one column, but another column mentioned something obscure, maybe from an aerospace use?). I was on the verge of buying a vastly overpriced thimble sized vial from a dealer for my Orbe, but vaguely remembered the article. I have a friend in the oil retail trade, so I might as well look into it first. I did start to trawl my shelves of back issues over the weekend to find David's words of wisdom, but they've been there far too long and the size of the task defeated me. So I thought I'd be cheeky and mail you direct to see if you could remember what issue that was in, or had a better indexing system than me!

I think you also did an article on setting up a Gyro suspension, the endless task of swivelling springs to get the perfect bounce? Can you remember what issue that was in or offer any tips? I've got a slight wobble in the middle of my bounce since changing the arm over Christmas, maybe it's time to double check my technique!

Paul Cook

"I refer the honourable gentleman to the answer I gave some moments ago" – Redline 5W30 or van den Hul TLF. The stock Michell oil is actually Mobil-1, which is already very good indeed, but not quite up to the aforementioned in my humble opinion. As for setting up your Gyro, I think that deserves another article

in its own right (watch this space) – the basic message is get it on a 100% level surface, don't touch the level adjusters at all and get the springs turned in such a way that the deck bounces like a jelly! **DP**

GARRARD GUIDANCE

I have a Garrard GT35P turntable, which uses an electronically governed DC motor with +/- 3% speed adjustment, an S-shaped alloy arm with magnesium headshell, and it will track down to 0.75gms with the right cartridge. I use an Audio Technica AT130E cartridge at present and I am pleased with the sound, but I would like to know a few things, please.

Firstly, is it worth rewiring the arm with good quality wire? Secondly, would I get a better sound with a different cartridge, such as a Goldring 1042? Finally, how would it compare with modern budget decks, as it is difficult to demo record decks in my area? I have already renewed the deck motor as I was lucky enough to obtain two spare items from Garrard/Plessey before they packed up at Swindon.

Incidentally, my system comprises Marantz PM14 Mk2KI amplifier, Marantz CD17 Mk2 KI Compact Disc player and Marantz LD300 loudspeakers, reconed with Peerless drivers. This is completed by a Sony RCDW3 for CD copies and an old Akai CS-M3 for making tapes for the car.

Mike Smith

Let me first just say that I am a big fan of Garrard turntables, and have been for a long time. It was the act of pulling apart my father's old SP25Mk3 to see how it worked that started me on the road to turntable obsession and, in my late twenties, my collection of Garrard decks numbered around seventy different models! Consequently I am

very familiar with the GT35p and, much as I always hate to say this to anyone about anything they are fond of, it really wasn't one of Garrard's crowning glories.

The GT35p and its stablemates, the GT15 and GT25 dated from the late 1970s and were one of Garrard's last ditch attempts at regaining the budget turntable crown that had been stolen from them by the likes of the Pioneer PL12D. Sadly, they did not succeed as the decks were cheaply made, lightweight and resonant. The arms were not actually too bad by budget deck standards, but quality control problems led to great variability, and it was pot luck whether you happened to find a good one as opposed to one with wobbly, floppy bearings. Strangest of all, on the GT25 and GT35p units, which were automatic decks, Garrard placed the mechanical gubbins directly under the arm, moving it away from the spindle. All very well, but they then chose to drive it using a toothed rubber belt which was running the whole time, unlike the earlier units, in which the mechanism was driven directly from the spindle, but fully disengaged whilst playing. This continually-running rubber belt tends to add a quite noticeable low frequency growl to the deck, both through the loudspeakers as well as through the air and if you don't mind manual operation, it is worth removing it.

As to your questions, I really don't think the unit is worth spending too much money on. If yours is sounding respectable then you must have one of the better-made samples but, if you are considering a Goldring 1042 then I assume that you have £150 or so burning a hole in your pocket. If this is the case, putting £130 of it towards a Project Debut 3 will absolutely wipe the floor with the GT35p, and even £40-60 spent on a good example of the aforementioned Pioneer PL12D from eBay will give you a big improvement in sound quality, even if you stick with your current cartridge.

AS

Spot on Adam - I remember the GT35P as one the last stands of the Garrard brand, when they'd just been bought by Gradiante circa 1979. Reviews at the time put the '35 as sounding worse than the GT15, which was a fully manual design at £60 or so. Basically, a (£40 on eBay) Dual CS505 would wipe the floor with it. Don't confuse the '35 with the majesty of something like the 401 – this was not, in effect, the same company. **DP**

History has a way of repeating itself...



1. TRANSCRIPTORS REFERENCE TURNTABLE 2. FLUID ARM 3. STYLUS SCALES
[RANGE OF SPARE PARTS AVAILABLE / FULL TURNTABLE RESTORATION SERVICE]

TRANSCRIPTORS TURNTABLES

UK Distributor: English Valve Amplifiers

67 Springfield Road · St Leonards-on-Sea · East Sussex · TN38 0TU

Tel: 01424 445107 · Mob: 07842 126218 · Email: paul@valve-amps.co.uk · Web: www.valve-amps.co.uk

LANGREX SUPPLIES LTD

DISTRIBUTORS OF ELECTRONIC VALVES, TUBES AND SEMI-CONDUCTORS AND I.C.S.

UNIT 4, DAUX ROAD, BILLINGSHURST, WEST SUSSEX, RH14 9SJ

24 HOURS EXPRESS MAIL ORDER SERVICE ON STOCK ITEMS

E-MAIL LANGREX@AOL.COM

PHONE

01403 785 600

FAX

01403 785 656

A selection of our stocks of **New Original Valves/Tubes.**
Many other brands available

STANDARD TYPES		SPECIAL QUALITY TYPES				OTHER TYPES		
ECC83	E.I	4.00	A2900/CV6091	GEC	17.50	12BY7A	GE	7.00
ECC85	RFT	12.00	E82CC	SIEMENS	10.00	5687WB	ECG	6.00
ECC88	BRIMAR	6.00	E88CC	MULLARD	20.00	5814A	GE	5.00
ECC88	MULLARD	10.00	E88CC/CV2492	BRIMAR	15.00	6072A	GE	10.00
ECH81	MULLARD	4.00	E88CC GOLD PIN	TESLA	8.50	6146B	GE	20.00
ECL82	MULLARD	6.00	ECC81/CV4024	MULLARD	7.50	6201	GE	6.00
EF86	PHILLIPS	20.00	ECC81/M8162	MULLARD	10.00	6336A	RCA	35.00
EL84	MULLARD	40.00	ECC81/6201	MULLARD	12.50	6550C	SVET	20.00
EZ81	MULLARD	12.00	ECC82/CV4003	MULLARD	20.00	6922	ECG	6.00
EZ80	MULLARD	5.00	ECC82/M8136	MULLARD	22.50	7027A	GE	25.00
GZ33/37	MULLARD	25.00	ECC83/CV4004	MULLARD	40.00	7308	SYL	5.00
GZ32	MULLARD	25.00						
GZ34	JAPAN	15.00	AMERICAN TYPES					
5Z4G	BRIMAR	7.50	5R4GY	RCA	7.50	E88CC	TESLA	4.00
6V6GT	BRIMAR	7.50	5U4GB	SYLVANIA	15.00	ECC81	RFT	4.00
12BH7	BRIMAR	12.00	5Y3WGT	SYLVANIA	5.00	ECC82	RFT	8.00
12E1	STC	10.00	6BX7GT	GE	10.00	EF86	USSR	8.00
13E1	STC	85.00	6B4G	SYLVANIA	22.00	EL84	USSR	4.00
807	HYTRON	7.50	6BQ5	GE	20.00	EL34	SVETLANA	10.00
811A	USSR	10.00	6FQ7	SYLVANIA	7.50	EL34	E.I	6.00
6080	MULLARD	10.00	6L6GC	SVETLANA	12.50	EL34	SVETLANA	30.00
						6CA7	EI	8.00
						6SL7GT	USA	7.50
						6SN7GT	USA	10.00

Please visit our **NEW website www.langrex.co.uk**

THESE ARE A SELECTION FROM OUR STOCK OF OVER 6000 TYPES. PLEASE CALL OR FAX FOR AN IMMEDIATE QUOTATION ON ANY TYPES NOT LISTED. WE ARE ONE OF THE LARGEST DISTRIBUTORS OF VALVES IN THE UK. SAME DAY DESPATCH VISA/ACCESS ACCEPTABLE. OBSOLETE TYPES A SPECIALITY. CREDIT CARD MIN ORDER £10.00.

OPEN TO CALLERS MON.- FRI. 9AM - 4PM. CLOSED SATURDAY

ADD 17.5% VAT TO TOTAL INC UK P&P SMALL ORDERS £5.00, LARGE/HIGH VALUE /O'SEAS PLEASE ENQUIRE





Quality That Speaks For Itself

The Missing Link



Finest Quality Audio Cables Hand Built in Britain by
The Missing Link for Your Individual Needs

Very Reasonable Prices & *Better By Design...*

We also have
an Excellent Range
of DIY Products
& Kits

For More Information and for Personal Attention
Contact Mark or Jan

01623 844478 or 07967 859333

info@the-missing-link.net

www.the-missing-link.net



Made by enthusiasts for enthusiasts



MB50 Monoblocks



CM05 Preamp

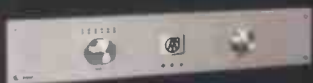

A50R Integrated amplifier

Anatek's famous fully patented output stage helps to produce a remarkably natural sound. It has all the benefits of Class A (non-switching) with no crossover distortion but does not generate the heat and consequent stresses on components.

For more information please visit:
www.anatekacoustics.co.uk
or call +44 (0)1903 524602

Anatek Acoustics

RETRO

REPRODUCTION

QUALITY HIGH FIDELITY & VINTAGE

AMPLIFIERS

Arcam FMJ C30 top end pre-amp	£1100new	£595	ProAc Tablette 2000 signature	£595
Arcam Alpha 9 remote pre		£295	ProAc Tablette MKII Boxed	£295
Audio Innovations Series 500 Integrated		£495	Quad 10L spondor design	£395
Audio Innovations Series 200 MKII PWR		£295	Spondor SP3-1P cherry ideal for valve amps	£695
Audio Research SP11 pristine boxed		£1795		
Audio Research VT60 valve power re-valved		£995	TURNTABLES	
Audio Research M300 mono blocks		£3995	EAR 324 phono stage ex-dem	£1495
Boulder 500AE power amp boxed	£6500new	£1995	Luxman Vacuum Platter Turntable	£595
Crimson 630D mono blocks 100W		£495	Linn Ittock tone arm	£275
Cary 301SE Western electric valves		£1495	Linn cirrus	EPOA
Cat SL1 Ultimate phono pre		£3395	Linn Lingo PSU	£495
DNM pre power		£795	Manticore Mantra Turntable with rega	£295
EAR B34L Valve Line Stage		£495	Musical Fidelity XLP	£95
GAMUT D200 Boxed, Mint		£1750	Michell focus 1 turntable, linn arm	£295
one of the worlds finest, new	£6500	£3395	Michell Gyrodec with QC power supply	£895
Krell KSA100		£995	Nottingham Analogue horizon	£395
Krell KAV 400XI		£1995	Rotel RQ370BX phono stage	£95
Linn LK280 Boxed		£350	Roksan Radius 5 no arm	£395
McIntosh MA2275 Int. Amp New	£6000	£3495	Sansul SR222 MKIV	£125
McIntosh MA6850 Int. Amp New	£4500	£2250	System deck 2X2 with RB300 acrylic platter	£350
Naim Hi-Cap Olive Green		£425	System deck Various from.....	£150
Naim 250 Bolt Case mint just serv. by naim		£695		
Naim 82 Pre amp		£995	CD PLAYRS, DACs	
Naim 42.5		£145	Arcam Alpha 9	£450
Perreux 3150 power amp		£595	Audionote CDT2, top loading Transport	£795
Perreux pro sm3 pre amp		£195	DCS P8I	EPOA
Quad 34 Pre		£195	DCS Purcel upsampler factory serviced	£995
Quad 44 Pre		£195	Linn Ikemi CD player	£995
Quad 99 Pre		£395	Marantz CD6000 OSE	£195
Quad 99 CD player with digital pre amp,		£650	Meridian 518 processor	£395
as new, boxed			Meridian 506 20 bit CD player	£495
Quad 303 Power Amp		£175	Meridian 208 CD player	£295
Quad 405 Power Amp boxed		£195	Meridian 205 Original Multi bit player	£295
Quad 405 MKII Power Amp boxed		£225	Musical Fidelity NewVista 3D CD player	£1795
Quad 606 Power Amp		£375	Pioneer Precision PDS505 CD player	£195
Rotel RB970 BX Power Amp		£150	Philips CD850 Hi-Fi World fave	£125
Sugden Transimpedance Amp 6months old		£445	Primare CD20	£395

SPEAKERS

ATC Active SCM10 with cable X Dem	£1395	Rega Planet Transport and DAC	£595
Audionote ANJ silver speaker boxed	£495	Theta DS Pro Progeny	£350
Fuji SF1 open baffle speaker rare	£595	Teac H500 champagne finish	£125
Horning One Lowther birch ply	£1295	Teac VRDS8 cd player	£395
JBL TI-6K floor standing speakers as new	£795		
JM Labs Micro Utopia, Black finish	£995	MISCELLANEOUS	
Kef Q5 cherry finish	£350	Audiolab 8000T tuner mint boxed	£395
Linn Kellidh, black finish ku-stone base	£345	Magnum Dynolab Etude tuner boxed	EPOA
Linn Ninka 6 months old	£795	Magnum Dynolab 205 FM signal Steuth	EPOA
Living Voice Auditorium MKI cherry	£795		
Living Voice Auditorium MKII cherry	£1295	DUE IN...	
Martin Logan SL3 new price £3500	£1995	Michel Gyrodec	
Tannoy Super tweeter new with STL cable	£495	LP12 original 1974	
Tannoy Dimension 10 £5000 new 1year old	£2495	Gale 401 speakers with chrome stands	
Neat Petite3 6months old	£495	Musical fidelity P270	
Neat Vito floorstanding speakers with	£1495	Mission logo style pre power	
ultimatum upgrade, beech finish, work		Yamaha CT7000 Boxed	
well with Naim		Kerr Mcosh 25W mono blocs with pre	
Naim SBL speakers	£595	Shunyata Hydra Mains blocs and cables	
Naim Intro floorstanding speakers	£395	Lecson pre amp power amp & tuner RARE	

GENEROUS PART-EX. ON ALL EQUIPMENT, NEW OR USED. WILL BUY GOOD QUALITY EQUIPMENT AS ABOVE. NEXT DAY MAIL ORDER & UPLIFT FACILITIES

Opening times: 10.30 - 5.30 Tues. to Sat.
28a Haddington Place, Edinburgh EH7 4AF
Tel/Fax: 0131 558 9989
Email: retro.reproduction@virgin.net
www.retroreproduction.com

High End Cable

visit www.highendcable.co.uk
 For the best prices telephone Dave Jackson on
 01775 761880
 Free P&P worldwide on all interconnects

Abbey Road Cable
 Analysis Plus
 Audience
 Chord Company
 Ecosse
 Hovland
 Nordost
 Oehlbach
 Stereovox
 Purist Audio Design
 Tannoy
 Townshend
 van den Hul
 Wyrewizard
 IsoTek - Power Conditioning
 Cable Tower

Clearlight Audio Cones
 Oehlbach Accessories
 Accessories
 STAX headphones
 Echo Busters
 Arye CD - IsoTek CD
 Oehlbach Phono PreAmp
 Lyra Moving Coil
 Ortofon Moving Coil
 Sumiko Moving Coil

Second hand

Sub woofer cables
 Media cables
 iPod cables
 XLR cables
 Pulsar Points
 Component cables
 Digital cables
 DIN cables
 HDMI cables
 DVI cables
 Jumpers
 Optical cables
 Mains & Power cables
 SCART
 S video
 ONLINE SHOP

Reference cables include free Burn In.

Nola Viper Reference



At the 2007 CES Show in Las Vegas, the speaker that appeared in more rooms than any other must have been various models from the Nola Viper range, looking particularly beautiful in their new piano finishes (see photo). As you go up the range more of the drivers employ alnico magnets, which are very expensive, hence the price increase from around £3.5K to £13K . The fact that other manufactures use Nola to demonstrate their equipment, speaks volumes about their quality. These are unique speakers, so please do view their website (www.nolaspeakers.com), for more details and reviews from the Show, and then give us a call for a demo!

V'audio HIFI Consultants

36 Druid Hill, Stoke Bishop, Bristol BS9 1EJ

Tel/Fax: 0117 968 6005

email: icvhifi@yahoo.co.uk

Rochester Hi-Fi

30 HIGH STREET, ROCHESTER, KENT, ME1 1LD - 01634 880037



ARCAM, ATACAMA, AUDION, AUDIOPHILE BASE, AVI, **CHORD CABLES**, CHORD ELECTRONICS, CLEARAUDIO, CREEK, DALI, **DK DESIGN**, EPOS, EUPEN, **EXPOSURE**, **FOCAL JMLAB**, GAMUT, GRAVES AUDIO, GRAHAM SLEE, LAT INTERNATIONAL, METRONOME TECHNOLOGIES, NORTHSTAR, NOTTINGHAM ANALOGUE, **NU FORCE**, OPTIMUM, ORIGIN LIVE, PARTINGTON, PROJECT, QUADRASPIRE, **RESOLUTION AUDIO**, RENAISSANCE, STIRLING LS35/a, **TANNOY PRESTIGE**, USHER.

www.rochesterhi-fi.co.uk

PRICES INCLUDE P & P FOR UK DELIVERY 1 TO 10 DAYS -
SEE WEBSITE FOR FULL PRODUCT RANGE AND SHIPPING
CHARGES TO EU & WORLDWIDE

CARTRIDGE SELECTION	STYLUS	HEADPHONE SELECTION
Goldring		GRADO Award winning Headphones
Elektra £33 £28 GEX £24		Prestige Series SR-60 £75
1006 £76 £62 GEX £54		SR-80 £90
1012 GX £95 £76 GEX £67		SR-125 £140
1022 GX £126 £104 GEX £86		SR-225 £175
1042 £144 £117 GEX £108		SR-325i £260
Eroica LX/H £135 £113 GEX N/A		Reference Series RS-1 £635
Elite £238 £194 GEX N/A		RS-2 £450
Audio Technica		REPLACEMENT STYLI
AT 95 E £25	£16	Swiss Quality Diamond Styli
AT 110 E £30	£18	ADC XLM MK III £17
AT OC9 ML II £330	£295 EX	Akai AN 5, AN 60 £13
Denon		AN2, AN 70 £15
DL 103 £105 £95 EX N/A		Aiwa AN11 £13
DL 103R £190 £170 EX N/A		Dual DN 145 E, DN 165 E £17
DL 110 £79 £69 EX N/A		JVC DT 55, DT 60 £13
DL 160 £95 £83 EX N/A		National EPS 24 CS, P 30 D, P 33 D £13
DL 304 £210 £190 EX N/A		Ortofon FF15/VMS20 EII, OM5/10/10/20 £17
Grado		Pioneer PN 210/220/240 £13
Prestige Black £40	£29	Shure N 75 C, SC 35 C £13
Prestige Gold £110	£77	N 75 ED T2, N 75 EJ T2 £17
Lyra		N 95 ED/EJ, N 75 3 (78) £17
Dorian £495 £395 EX N/A		VN 35 E £20
Argo £795 £635 EX N/A		N 97 HE, VN 35 HE £27
Shure		Sony ND 142/155 G, CN234 £13
M 97 XE £98	£58	ND 143/150/200 G £15
Sumiko		Stanton D 681 EEE £21
Blue Point Special £235 £200 EX		***Over 500 Styli Types Stocked***
Blackbird £585 £500 EX		

GEX - Goldring new for old exchange price for any make/type of cartridge
EX - Exchange price same make moving coil cartridge

Order direct online or Tel/Fax (01757) 288652
MANTRA AUDIO (HFW), Town End House, Skipwith, Selby, North Yorkshire YO8 5SQ

Web classiquesounds.co.uk
Classique Sounds
Specialist Supplier of Vintage Audio
61 Aylestone Drive
Aylestone, Leicester, Le28 8qe
Tel 0116 2835821
Local rate 0845 1285137
Mobil 07815 188040

Leak Stereo 20 full rebuild using Jensen Paper in oil caps £299.00
Conversion of Leak valve pre to passive including Silver wired/soldered/rhodium plugs £299
Rothwell Indus SE passive pre amplifier. Now in stock. Awesome. Just £799.00

wanted classic and modern hifi eqpt.

FOR SALE. PRE/POWER AMPLIFIERS

Pair Musical Fidelity MA65 class A monoblocks. £595	DNM pre amp with PSU, Audakone enhanced. £395
Arcam Alpha 10 amplifier. Super condition. Remote. £449	Ming Da MC7R valve pre amplifier. Mint & boxed. £250
Pioneer A300 integrated amplifier. £99	Musical Fidelity X can tube headphone amp. Boxed. £125
Quad 33 pre amplifiers. From..... £75	Rothwell Indus SE passive pre amp. Awesome. New. £799
Pair Leak TL12+ amplifiers. Stunning. Bronze finish. £799	Pr Leak TL10.1 amplifiers. 100% original. Beautiful. £149
Luxman LV-103 int hybrid amplifier. Boxed. Rare. £349	Meridian Linear MC phono stage/pre-amp. Boxed. £799
Quad 405/2 power amplifier. Mint condition. Boxed. £249	Quad 303 power amp. Down on 1 channel. £65
Exposure Super V111 power amplifier. Cost £849. £249	Quad 34 pre amp. Excellent cond & bxd. 5 pin din. £249
Heybrook C2 pre amplifier. Includes MM & MC. £199	John Shearme 2.5 int amplifier. Ex condition. Boxed. £295
Musical Fidelity A1 Classic class A amp. Bxd. Mint. £225	Arcam Alpha 9 integrated with remote & MM/MC. £249
Shearme 3.5 power amp. Ex condition. Boxed. £295	Mod Squad passive pre amp. Absolutely stunning. £299
Musical Fidelity A100 pure class A integrated. 50W. £299	Sugden A21A in wooden case. Beautiful condition. £249
Musical Fidelity Pre 8 pre amplifier. Chrome front. £149	Leak Varioslope pre amp. converted to passive. Silver. £395
Rogers Cadet 3 pre-power with tuner. Superb. £349	Nakamichi PA5 100W/CH power amp. Cost £1300. £650
Nakamichi CA5 pre-amplifier. Ex cond. Cost £750. £375	Nad monitor series 1300 pre-amp with MM/MC. £149
Wilmslow Audio Mercury B power amp. Ltd edition. £295	Unison Research Mystery One line level pre amplifier. Stunning condition with box/book. Serviced. Cost £1700. £995
Leak Varioslope pre amp. Converted to Passive. Pure silver wire/silver solder/rhodium plate phono/alps pot. £350	Galactron MK-2121 amplifier. 60 watts of pure class A. Beautiful Italian styling. Wood cheeks. Cost new £1400. £699
Marantz PM17 int amplifier & rem. Mint. Boxed. £549	Leak Stereo 30 integrated amplifier. £50
Musical Fidelity B1 integrated amplifier. Good cond. £125	Leak Varioslope pre amp. Ex condition. £95
Rogers Cadet 3 valve integrated amplifier. Ex cond. £175	Quad 33 pre amplifier. Mint/boxed/instructions. £125
Quad 405/1. Excellent condition. £195	Quad 405/1. Boxed and in good condition. £225
Affordable valve Co tube amplifier. Mint & boxed. £550	Naim NAC92 pre amp. S/NO 161840. Mint. Boxed. £299
Musical fidelity Typhoon pre and power amplifier. With balanced cables. MM/MC input. Boxed & instructions. £695	Leak TL12+ valve amplifiers. Bronze finish & rebuilt with expensive paper in oil caps & Rhodium plate phono. £695
Quad 303 power amplifiers from..... £125	Leak Stereo 20 rebuilt with Jensen paper in oils. £695
Marantz PM66SE KI signature integrated amplifier. £199	Tube Technology Unisis valve power amp. Mint bxd. £299
Linn LK1 pre-amp and remote. Good condition. £249	Linn LK2 power amplifier. Good condition. £299
Quad 11s in various condition and prices. £POA	Leak Stereo 20 valve power amplifiers from..... £Various
Naim Nap 180 power amplifier. Mint. Boxed. £799	Harmon Kardon integrated valve amp 110V. V rare. £299

TURNTABLES

Garrard 301. Stunning condition. Strobe platter. £599	Project I.2 with cartridge. Ex condition & boxed. £119
Linn Axiis with Akito tone-arm. £295	SME 3009 series II improved. Excellent condition. £150
Manitcore Mantra with Linn Basic+ tone arm. Excon. £249	Transcriptors Hydraulic Reference turntable. Nice. £799

SPEAKERS

Kef IQ1 dual concentric speakers. Boxed as new. £139	Roksan ROK-ONE speakers. Black. Mint. Boxed. £295
Pair EL563 electrostatic speakers. Brown cloths. £799	Celestion Ditton 44's. Super condition. £175
Pair Celestion Ditton 66 Studio monitor loudspeakers in fabulous condition. These speakers are amazing. £199	Pair ESL57 in black. Excellent condition. £450
Pair Quad ESL57 speakers. Bronze. Super condition. £699	Celestion Lite one-speakers in white. Boxed. £99
Celestion Lite one-speakers in white. Boxed. £99	Dynaudio Audience 62's. Ex cond/boxed. Cherry. £450
Pair Quad ESL63 speakers in black. All new panels and full service. 1 year guarantee. Beautiful condition. £799	Pair Quad ESL57 spkrs. Fully rebuilt by One Thing Audio. Black cloth fronts. 5 star review in HiFi World. Mint. £1899
Pair Quad ESL57 and EL563 speakers. £209	Mordant Short MS201 pearl. Brand new. Black. £169
Quad 11s in various condition and prices. £POA	Quad ESL57 speakers. All fully serviced with full 3 months warranty. Hear what ESL57s should sound like. From. £1200 pr

OTHER ITEMS

Cambridge Audio CD5 CD player with remote. £49	Arcam Alpha 9 CD player with remote. Cost £800. £399
Yamaha MDX 595 full size mini disc player. £69	Grado prestige series SR-125 headphones. Boxed. £89
Trichord Research Pulsar one Dac with book. £1399	Mission Cyrus FMT tuner in ex condition. £400. £175
SME M2-9 tone-arm. Boxed. Superb. £599	Nobs Analogue ace-space tone-arm. Unused/boxed. £499
Synrix PU2 one-arm. Boxed. £149	Manantz CD63 in champagne. 1983 vintage. V nice. £199
Quad FV4. Late charcoal grey finish. Superb. £225	Yamaha YST SW-300 subwoofer. Cost £350. Sell. £149
Sony JE-S10 Mini disc player. Full size. Black. £59	Marantz CD73 in champagne. 1983 model. Superb. £299
Sony CDP-N1303 CD player. Boxed. Remote. Cheap. £25	Trichord Research/PDS707 transport. Clock 3. Exe. £495
Roksan ROK-DS4 PSU for ROK-DA1 DAC. Mint. £295	Roksan ROK-DA1 DAC. Stand alone. DAC. Mint. £275
Nad CS41j Cd player. Mint & boxed. £199	Sony IAR-LH500 CD with built in 80G hard drive. £249
Musical Fidelity TL FM tuner. Award winner. £300. £95	Pioneer PD-S505 Cd + PSU & Mod by Tom Evans. £299
Audionote DAC 3 Valve output. Stunning. £1750. £POA	Teak sleeve for Quad 33/FM3 Excellent condition. £39
Quad FM1 Valve tuners. Various prices from only. £POA	Trichord Research Pulsar 1 Dac with Michell PSU. £799
Linn Tuner. Mint. Boxed. Very unusual. Cost £549. £199	Quad FM3 tuner in excellent condition. £99

QUAD ESL57 & EL563 PANELS/SERVICING ETC
Full rebuild of 57s including latest Ottec treble panels for only £1399.00
We sell serviced Quad ESL57 speakers from only £1200.00pr. Why spend £4000+?
ESL57 SPEAKERS STANDARD SERVICE £649. PR
Price includes 2 completely rebuilt treble panels etc. Ring for further info.
"Classique Sounds servicing restores the Quads to a position where they can hold their head high", Jon Marks. *HIFI WORLD*. April 1999. Full servicing facilities available.

TRANSLUCENT. (somewhat of a bargain) Hifi World. Jan 1999
PURE SILVER INTERCONNECT CABLE
99.99% pure silver conductors. Quality gold plated RCA phono plugs.
Half Metre terminated £70.00 One metre terminated £90.00. Available with Eichmann plugs + £30
New Translucent **ULTRA + Heavy duty. 99.99% pure silver (4N).**
Eichmann 24 Kt gold plate plugs £199.00 per metre. Or £149 per half metre.
7 day money back guarantee if not better than existing cable

WANT TO HEAR MORE MUSIC?
Then get rid of the noise!

NC - the total solution to mains noise and interference



Fit a Trichord Clock 4 and 'Never Connected' power supply to improve the performance of your CD or DVD player. Let us undertake the work for you in our Modification Workshop.



Contact us now to see how we can help you to reduce the noise in your system:

Trichord Research
Tel: +44 (0)1684 311600 Fax: +44 (0)1684 311928
sales@trichordresearch.com
www.trichordresearch.com

HEATHCOTE AUDIO

TEL: 07860 511111

**EQUIPMENT REQUIRED FOR IMMEDIATE CASH PURCHASE.
PLEASE PHONE GEORGE 10-6PM**

NEW/EX.DISPLAY

DCSVERDI ENCORE TRANSPORT (£9500) & ELGAR + DAC (£9500)
DCS PBI SACD/CD PLAYER WITH VOLUME CONTROL (£7500)
VACUUM STATE JLT SACD PLAYER
PERPETUAL TECH/MDWRIGHT P1-A/P3-A/PSU
NORTH AMERICAN PRODUCTS H-CAT PRE AMP (2850)
PERIGEE FK-1 LATEST RIBBONS
MUSIC FIRST PASSIVE MAGNETIC (SILVER WIRED £2750)
MUSIC FIRST PASSIVE MAGNETIC (COPPER WIRED £1600)
PLINIUS SB-300 (RETAIL £4650)
PLINIUS SA-201 (RETAIL £3600)
PLINIUS 9100 INTEGRATED (RETAIL £1700)
FAB AUDIO MODEL-ONE 97db (RETAIL £7500)
FAB AUDIO BRAT
AURUM CANTUS VOLA (RETAIL £2500)
AURUM CANTUS MELODY M-102 PIANO BLACK (RETAIL £2400)
AURUM CANTUS MUSIC GODDESS PIANO BLACK (RETAIL £2500)
AURUM CANTUS MOON GODDESS II (RETAIL £2500)
AURUM CANTUS LEISURE 3SE (RETAIL £1200)
AURUM CANTUS LEISURE 2SE (RETAIL £900)
AURUM CANTUS LEISURE 2SV (RETAIL £700)
AURUM CANTUS BLACK ORCHID (RETAIL £1200)
HARPUR QUARTETO (£4000)
AMPHION KRYPTONS (£8500)
EGGLESTONWORKS ANDRA II (\$19K+)
EGGLESTONWORKS ROSA
EGGLESTONWORKS FONTAINE II
CELESTION A-2 (SANTOS ROSEWOOD) LAST PAIR (£1500+)
ELECTROCOMPANET EC 4.7 REMOTE PRE AMP
PERPETUAL TECH P-1A 24/96 UPSAMPLING DIGITAL ENGINE (LAST ONE)
PERPETUAL TECH/MDWRIGHT SIG.2 MODULAR PSU (LAST ONE)
AUDIO ALCHEMY DDS III CD PLAYER/TRANSPORT (NEW OLD STOCK)
AUDIO ALCHEMY DDE VIII HDCD DAC TOS/COAX/I2S (NEW OLD STOCK)
AUDIO ALCHEMY DDE V1.2 HDCD DAC TOS/COAX/AES/EBU/I2S (NEW OLD STOCK)
AUDIO ALCHEMY DDE V1.1 HDCD DAC TOS/COAX (NEW OLD STOCK)
WALKER PROCEMIUM PROLOGUE/ULTIMATE SPEED CONTROL ETC (\$35000+)

TRANSPORTS/DACS/CD/

SONY SCD-777ES SACD/CD
MUSICAL FIDELITY TRI VISTA 21 96/192 UPSAMPLING DAC
VACUUM STATE JLT SACD PLAYER (RAVE REVIEWS)
PERPETUAL TECH/MDWRIGHT P1A/P3A/PSU
PIONEER PD-95 ULTRA RARE FLAGSHIP PLAYER (SUPERB)
DX-71X DAC & VOL. CONTROL RCA/BAL. OUT
TRICHORD DIGITAL TURNTABLE
MERIDIAN 563 BALANCED DAC
THETA CARMEN CD/DVD TRANSPORT RARELY ON THE MARKET
THETA DATA TRANSPORT
AUDIO ALCHEMY ACC CD PLAYER/TRANSPORT
CHORD 1500E 2 DACS + EXTRA 96/192 KHZ MODULE & VOLUME CONTROL (£6600 NEW)
MSB LINK DAC 24/96KHZ MODULE (FANTASTIC FOR THE MONEY!)
Z SYSTEMS Z-3src UPSAMPLER (£1450 NEW)
DENON DPF-13030 200 CD MULTIPLAYER
DENON DVD 2800 (GOLD)
PRIMARE V-25 CD/DVD PLAYER (PROGRESSIVE SCAN (£1000 NEW)
CAMBRIDGE AUDIO D-505E
PERPETUAL TECHNOLOGIES MODULAR PSU (RUNS P1A AND P3A)

SOLID STATE

NORTH AMERICAN PRODUCTS H-CAT PRE AMP SUPERB (£2850)
ALCHEMIST FORSETTI PRE & POWER AMPS
MAGNUM DYNALAB MD-208 RECEIVER (SUPERB)
PLINIUS SB-300 (RETAIL £4650)
PLINIUS SA-201 (RETAIL £3600)
PLINIUS 9100 INTEGRATED (RETAIL £1700)
SONY TAE-1 PRE & TAN-1 POWER AMPS (AWESOME)
SONY TAE9000-ES PRE & TAN9-ES POWER AMPS
AUDIO SYNTHESIS DESIRE DECADE POWER AMP (ALMOST UNUSED)
McCORMACK RLD-1 REMOTE PRE & DNA-12S POWER AMPS
LUXMAN M-105 DUAL MONO CLASS A POWER AMP
GRYPHON ALLEGRO SONATA FLAGSHIP DUAL MONO PRE AMP (6 MONTHS USE)
CONRAD JOHNSON PFR REMOTE CONTROL PRE AMP (£3000 NEW)
CONRAD JOHNSON PF-1 PRE & PHONO STAGE
BEL CANTO PRE-1 PREAMP & EVO 200.2 POWER AMP
PERREAX SA-3/PMF-150 PRE (MM,MC,IP)POWER AMPS (300 WATTS X 2)
MARANTZ MA-700 200 WATT MONOS THX 4 OFF 3 MONTHS USE
MARANTZ PM-6010 OSE 2 HOURS USE
NAD C372 FEW HOURS USE ONLY
SONY TAB-940R FEW HOURS USE ONLY
PIONEER A-400
TOCA SECA-SE (COLIN WONFOR £3600 NEW) 20 WATTS X 2 CLASS A POWER AMP

LOUDSPEAKERS

PERIGEE FK-1 LATEST RIBBONS
B&W NAUTILUS 802
CELESTION A-3 HUGE FLOORSTANDERS
AMPHION KRYPTONS (£8500)
BKS 128 RIBBON HYBRID (STAR GALAXY GRANITE)
FAB AUDIO MODEL-ONE 97db (RETAIL £7500)
FAB AUDIO BRAT
KLIPSCH LEGENDARY CORNER HORNS BIRDS EYE MAPLE
SNELL TYPE C IV AMERICAN OAK

NEW £12995
DISPLAY £4995
NEW £995
EX.DEM £1595
EX.DEM £1475
EX.DEM £2850
EX.DISPLAY £2250
EX.DISPLAY £1295
EX.DEM/OISPLAY £3450
EX.DEM/OISPLAY £2460
EX.DEM/OISPLAY £1250
EXDEM/AS NEW £4750
EX.OISPLAY £395
EX.OISPLAY £1750
EX.DISPLAY £1750
EX.OISPLAY £1850
EX OISPLAY £1850
EX OISPLAY £995
EX OISPLAY £695
EX OISPLAY £450
EX.OISPLAY £995
EX DISPLAY £2450
BRAND NEW £5750
BRAND NEW £9995
BRAND NEW £5750
BRAND NEW £2750
BRAND NEW £995
NEW/BOXED £695
BRAND NEW £495
NEW/BOXED £395
NEW/BOXED £350
NEW/BOXED £275
NEW/BOXED £250
EX DEM £12500

MINT/BOXED £1150
MINT/BOXED £795
BRAND NEW £995
EX.DEM £1595
MINT/BOXED £1250
MINT/BOXED £995
EXCLT £450
EXCLT £395
MINT/BOXED £1495
VGC £495
GC £325
MINT/BOXED £2795
MINT/BOXED £375
MINT/BOXED £450
BOXED £195
MINT/BOXED £395
EX.DEM £450
VGC £95
BOXED £295

EX DEM/BOXED £1475
MINT/BOXED £1595
MINT/BOXED £1995
EX.DEM/OISPLAY £3450
NEW/OISPLAY £1250
EXCLT/BOXED £6500
EXCLT/BOXED £1250
AS NEW/BOXED £1295
MINT/BOXED £2250
MINT/BOXED £1995
MINT/BOXED £4995
MINT/BOXED £1495
EXCLT £895
EX.DEM/BOXED £2895
GC £325
MINT/BOXED £995
MINT/BOXED £195
EXCLT £995

EX.DEM/BOXED £2850
MINT/BOXED £3850
MINT/BOXED £1350
NEW/BOXED £5750
MINT/BOXED £1550
EXDEM/AS NEW £4750
EX.OISPLAY £395
EXCLT RING £995

ALL AURUM CANTUS LOUDSPEAKERS BELOW HAVE RIBBON TWEETERS

AURUM CANTUS SUPREME (RETAIL £10,000)
AURUM CANTUS VOLA (RETAIL £2500)
AURUM CANTUS MELODY M-102 PIANO BLACK (RETAIL £2400)
AURUM CANTUS MUSIC GODDESS PIANO BLACK (RETAIL £2500)
AURUM CANTUS MOON GODDESS II (RETAIL £2500)
AURUM CANTUS LEISURE 3SE (RETAIL £1200)
AURUM CANTUS LEISURE 2SE (RETAIL £900)
AURUM CANTUS LEISURE 2SV (RETAIL £700)
AURUM CANTUS BLACK ORCHID (RETAIL £1200)
HARPUR QUARTETO (£4000)
MARTEN MILES II CHERRY (8K+ NEW)
AUDID PHYSIC CALDERA II (10K NEW?)
JM LABS MEZZO UTOPIA (£8300? NEW)
EGGLESTONWORKS ANDRA II (\$19000 ++)
MIRAGE M151 BI POLAR LOUDSPEAKERS
ALR JORDAN NOTE-5 SPECIAL BUBINGA WOOD FINISH (£27.5K NEW)
LURA 0A-30 BIRDS EYE MAPLE (£2700+? NEW)
TRINITY AUDIO TRIDENT FLOORSTANDERS TRI-WIRE
PROAC STUDIO 150 CHERRYWOOD
AUDIDNOTE ANE-D ROSEWOOD
TLC CLASSIC-1 FLOORSTANDERS CHERRYWOOD
KEF IQ-3
KEF IQ-7
KEF IQ-5
KEF Q1
ACOUSTIC ENERGY AE-109
TANNOY SENSYS DR2 ROSEWOOD
T+A TMR-100 TRANSMISSION LINE FLOORSTANDERS

VALVE AMPS

TRILOGY 918 PRE AMP (CHROME)
TUBE TECHNOLOGY SYNERGY REMOTE INTEGRATED
AUDIO INNOVATIONS FIRST AUDIO POWER AMP
ROGUE AUDIO 66 MAGNETIC REMOTE PREAMP
MICHAELSON AUDIO CHRONOS 2 BOX PRE/PHONO STAGE & 2 X 116 WATT MONOS
SERVICED RE-VALVED AND IN SUPERB CONDITION RARE OPPORTUNITY!
CONRAD JOHNSON PF-5 C/W PHONO STAGE (£2000?)

VINYL

TOM EVANS MICRO GROOVE
AQ-VOX PHONO STAGE RCA & BALANCED
NVA TWO BOX MC PHONO STAGE
ANTIQUE SOUNLABS MINI PHONO STAGE 2-BOX
TRANSCRIPTORS & SKELETAL ARM (COLLECTORS ITEM)
WALKER PROCEMIUM PROLOGUE SIG/ULTIMATE SPEED CONTROL ETC (\$35000+)
QUASAR LE SKELETAL BRASS/ACRYLIC TURNTABLE SUPERB
FORSSELL AIR FORCE-1 REF./ARM/FLYWHEEL
ROGUE AUDIO STEALTH PHONO STAGE MM/MC (£800)

TUNERS /TAPE/DAT/MINIDISC/MISC.

LEAK TROUGHLINE STEREO
LEAK TROUGHLINE MONO
QUAD FM-4 RCA
SONY 700E 3 HEAD TAPE MACHINE
SONY DTC-1000 DAT RECORDER
SONY MDS-JB920 QS MINIDISC
HITACHI FT-5500 MKII CLASSIC TUNER

MAINS CABLES/BLOCKS/CONDITIONERS ETC

TARA LABS RSC AIR POWER CORD 6FT SHUKO AND IEC
SILTECH OCTOPUS 8-WAY MAINS BLOCK (SHUKO)
MISSING LINK CRYO REF POWER CORD
ISOTEK POWER CORD

LOUDSPEAKER CABLE

DPA BLACK SILNK 2 X 4 METRE PAIRS LOCKING WBTS
SONORAN PLATEAU HI END USA CABLE 4.2 METRE PAIR
MIT TERMINATOR-6 3.5 METRE PAIR
RENAISSANCE SIGNATURE 3 METRE PAIR (£1300)
RENAISSANCE SILVER 4 METRE PAIR
RAPPORT USA 5 METRE PAIR PACKAGED X 2
TARA LABS PRIME 1800 18 FEET PAIR BI-WIRE AS NEW BOXED
PS AUDIO X-STREAM 3 METRE BI-WIRE BOXED (HUGE!)
DIAMOND- HI SILVER CABLE 3 METRE PAIR U.S.
NIRVANA AUDIO SL-SERIES 2.3 METRE PAIR EX DEM,(FACTORY TERMINATED)
TRANSPARENT WAVE 200 2 METRE PAIR
AUDIONOTE AN-L 3 METRE PAIR (FACTORY TERMINATED SILVER SPADES)
QED XT-350 4.5 METRE PAIR AIRLOC TERMINATED
PRICE

SPECIAL OFFER

BLACK RHODIUM S-130X2 BI-WIRE CABLE BRAND NEW LTD QUANTITY (£18.00)
BLACK RHODIUM S-300 BI WIRE CABLE BRAND NEW LTD QUANTITY (£40.00)

INTERCONNECT

MISSING LINK CRYO REF GOLD XLR 1 METRE
MISSING LINK CRYO REFERENCE. 1 METRE BULLET PLUGS
HOVLAND G-3 1 METRE BALANCED XLR CABLE
ACOUSTIC ZEN SILVER REFERENCE BALANCED XLR 3.5 METRE PAIR
ACOUSTIC ZEN SILVER REFERENCE 1.5 METRE
NEOTECH PROFESSIONAL CABLE 0.5 METRE AS NEW BOXED
BLACK RHODIUM ORATORIO BALANCED XLR 1METRE/2 METRES
BLACK RHODIUM CONCERTO 0.5/1 METRE
BLACK RHODIUM SYMPHONY 1 METRE (SEVERAL) CANCELLED ORDER
BLACK RHODIUM SYMPHONY 0.5 METRE

EX.DEM/AS NEW £6750
EX.DISPLAY £1750
EX.DISPLAY £1750
EX.DISPLAY £1850
EX DISPLAY £1850
EX DISPLAY £995
EX.DISPLAY £695
EX.DISPLAY £450
EX.DISPLAY £995
EX.DISPLAY £2450
EXCLT/BOXED £3750
EXCLT £3250
MINT/BOXED £4250
EX.DEM £7995
EXCELLENT £2250
EX.DEM/BOXED £1250
MINT/BOXED £895
EXCLT £895
EXCLT £795
AS NEW £595
AS NEW £375
AS NEW £250
EXCLT/BOXED £175
EXCLT £195
EXCLT £450
VGC £750

EXCLT £995
FANTASTIC £3450
EXCLT £795
MINT/BOXED £995
ULTRA RARE £3995
GC £595

MINT/BOXED £450
NEW £395
EXCLT TBA
EX.DEM £299
LOVELY £795
EXCELLENT £2500
EXCLT £1275
EXCLT/BOXED £750
EX.DEM £395

DUE IN TBA
DUE IN TBA
BOXED £225
MINT £250
GC TBA
VGC TBA
GC £110

NEW/BOXED £295
EXCLT/BOXED £375
EXCLT £95
EXCLT £75

EACH PAIR £395
£750
£195
£795
£995
EACH PAIR £295
£750
£795
£795
£495
£175
£195
HALF

£10 PER METRE
£25 PER METRE

AS NEW/BOXED £275
EXCLT/BOXED £225
MINT/BOXED £275
£1250
£595
£175
BRAND NEW RING
BRAND NEW £80/100
BRAND NEW £65
BRAND NEW £55

WEB SITE www.heathcoteaudio.co.uk UPDATED DAILY!

www.Pressblog.net

Contact us to find out more about publishing your latest news online instantly.

+ : +44 (0)5600 759 412 : +44 (0)1273 677773
e: publish@pressblog.net : w: www.pressblog.net

"PB is waiting for you to email him
your hi-fi related news/press
releases..."

Sign-up today for your free account and
PB will publish all your press releases
on pressblog for you, for the first month
- for free.



there is only one turntableworld!

Aesthetix, Avid, Clearaudio, Decent Audio, Dynavector, Goldring, Grado, Graham, Hadcock, Lyra, Michell, Moth, Nottingham Analogue, Origin Live, Ortofon, Project, Roksan, Rothwell, Graham Slee, Shure, SME, Sumiko, Transfiguration, Trichord, Whest Audio, Wilson Benesch and VPI

probably the largest analogue
dem selection in the UK

30b Larchfield St, Darlington, DL3 7TE.

Tel: 01325 241888 or email: world@turntableworld.co.uk

they used to say, it's grim up north...

Acoustic Energy, Apollo, Atacama, Audio Analogue, AVI, Ayre Acoustics, Chord Cable, Chord Electronics, Consonance, Creativ, Custom Design, Esoteric, Grado, Isotek, Kudos, Monitor Audio, Nbien, Neat, Opera, Pathos, Primare, Pure, Resolution Audio, Revolver, Roksan, Shanling, Stadesign, Sugden, System Audio, TEAC, Triangle, ... not any more

hifisound

30b Larchfield St, Darlington, County Durham, DL3 7TE.

Tel: 01325 241888

Email: world@hifisound.co.uk

Qualify hifi equipment always required for cash... Call us before you trade in... Commission Sales too

0845 6019390 or call, or email world@2ndhandhifi.co.uk or visit our shop in County Durham

Accessories	Speakers	Digital	Analogue
249 Accustic Arts Amp 1 ex, boxed	599 Accustic Energy A2Z, ex black	AVI 2000 Reference CD player	Alphason Kenon, excellent
3999 Arcam A32, ex silver / w remote	699 Accustic Energy A2Z, ex black	AVI 2000 Reference CD player	Alphason Kenon, excellent
149 Arcam A32, ex silver / w remote	699 Accustic Energy A2Z, ex black	AVI 2000 Reference CD player	Alphason Kenon, excellent
3999 Arcam A32, ex silver / w remote	699 Accustic Energy A2Z, ex black	AVI 2000 Reference CD player	Alphason Kenon, excellent
3999 Arcam A32, ex silver / w remote	699 Accustic Energy A2Z, ex black	AVI 2000 Reference CD player	Alphason Kenon, excellent
3999 Arcam A32, ex silver / w remote	699 Accustic Energy A2Z, ex black	AVI 2000 Reference CD player	Alphason Kenon, excellent
3999 Arcam A32, ex silver / w remote	699 Accustic Energy A2Z, ex black	AVI 2000 Reference CD player	Alphason Kenon, excellent
3999 Arcam A32, ex silver / w remote	699 Accustic Energy A2Z, ex black	AVI 2000 Reference CD player	Alphason Kenon, excellent
3999 Arcam A32, ex silver / w remote	699 Accustic Energy A2Z, ex black	AVI 2000 Reference CD player	Alphason Kenon, excellent
3999 Arcam A32, ex silver / w remote	699 Accustic Energy A2Z, ex black	AVI 2000 Reference CD player	Alphason Kenon, excellent

0845 6019390

www.2ndhandhifi.co.uk ... what are you up for?



TURBOCHARGING YOUR REGA ARM

"Nothing less than total dynamite" HI-FI WORLD

If you are the proud owner of any Rega tonearm, you are now in the enviable position to transform its performance into the league of super arms with our modifications. The OL structural modification at £75 will enable your Rega to perform at a level exceeding that of some arms costing over £1000!! High performance rewiring with high grade litz wire is also offered at an additional £70 and external rewiring is also £70 further increasing the performance.

"I have to say the Rega modifications turn this humble arm into a real giant killer. Gone is the rather grey, sterile sound of the cooking Rega. Instead, tonal colour is fresh, dynamics have great speed and impact, and the sound stage is huge."

HI-FI WORLD ON STRUCTURAL MODIFICATION

Structural modification awarded 5 star rating by



Structural Modification - £75

Internal Rewiring - £70

External Rewiring - £70

High conductivity phono plugs £20

Slotted arm tube - £85

If you do not have an arm we can supply the OL1 arm (manufactured by Rega) £124

Arm modifications normally returned within 1 - 3 days

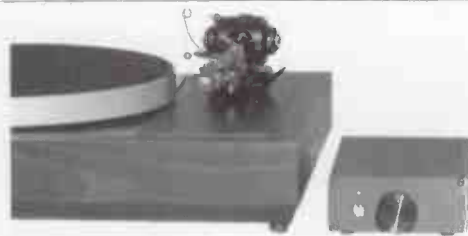

"The single most important upgrade you can ever make to any record deck concerns the motor drive...nothing can prepare you for the shock of going DC. In a word, gobsmacking." COMMON GROUND MAGAZINE

"It's value is nothing short of tremendous." LISTENER MAGAZINE

"The LP12 remains a classic ...but ..upgrade kits by Origin Live can bring a vast improvement to its performance" HI FI NEWS

UNIVERSAL TURNTABLE MOTOR KIT - No one would blame you for being sceptical of an easy to fit, inexpensive dc motor upgrade. Especially one that improves on the best of other power supplies costing over 4 times as much or your money back. It is simply impossible to imagine the level of improvement attained by eliminating the motor vibration that your stylus amplifies over 8,000 times! Our DC motor kit offers massive improvements to all versions of Linn Lingo / Valhalla, Rega, Systemdeck, Roksan, Rock etc. The kits consist of a drop in replacement high grade DC motor and off-board 2 speed control box. Why not order now? - see web site or phone.

Standard dc Motor Kit - £199

Advanced dc Motor Kit - £339

Ultra dc Motor Kit - £570

Upgrade Transformer - £175

Upgrade DC 200 motor - £129 with kit

ORIGIN LIVE

Tel/Fax: +44 02380 578877

E-mail: info@originlive.com

www.originlive.com

IAN HARRISON HI-FI TEL: 01283 702875

HI-FI AT DISCOUNT PRICES. FREE NATIONWIDE DELIVERY

SALE!

TRADE IN YOUR OLD MOVING COIL CARTRIDGE & SAVE UP TO 60% OFF THE RRP.

CARTRIDGES & STYLJ	HIFI FURNITURE	HEADPHONES	DVD
VAN DEN HUL	B.C.D.	ERGO	SONY
ZYX	CUSTOM DESIGN	SHURE	MINI DISC
JAN ALLAERTS	OPTIMUM	BEYER	SONY
DENON	ASH DESIGN	STAX	LOUDSPEAKERS
CARTRIDGE MAN	APOLLO	SENNHEISER	OPERA
AUDIO TECHNICA	SOUND STYLE	SONY	TRIANGLE
GOLDRING	SOUND	AKG	FINAL
SUMIKO	ORGANISATION	GRADO	ELAC
TRANS-	ALPHASON	AUDIO-	HARBETH
FIGURATION		TECHNICA	EPOS
GRADO		CASSETTE DECKS	USHER AUDIO
ORTOFON	CABLES	PIONEER	DIAPASON
RESON	VIRTUAL -	SONY	TANNAY
CLEAR AUDIO	DYNAMICS	TUNERS	AMPLIFIERS
KOETSU	BLACK RHODIUM	PURE DIGITAL	CREEK
SHURE	TRANSPARENT	DENON	HALCRO
TONEARMS	QED	SONY	MOTH
SME	ORTOFON	CREEK	C.A.T.
GRAHAM	NORDOST	PHONO STAGES	GAMUT
MOTH	SUPRA	HEED	ALOIA
CARTRIDGE MAN	WIREWORLD	GRAHAM SLEE	EAR
CLEARAUDIO	CD PLAYERS	WHEST AUDIO	AUDIO VALVE
HADCOCK	AUDIO ANALOGUE	TRICHORD	ACCUSTIC ARTS
MICHELL	MONRIO	MOTH	GRAAF
TURNTABLES	GAMUT	CREEK	MONRIO
MICHELL	SONY	NAD	AUDIO ANALOGUE
CLEAR AUDIO	CREEK	EAR	PATHOS -
EAR		TOM EVANS	ACOUSTICS
ACOUSTIC SOLID		CLEAR AUDIO	UNISON -
			RESEARCH

PLEASE PHONE TO CONFIRM PRICE & AVAILABILITY PRIOR TO ORDERING. ALL GOODS ARE BRAND NEW & BOXED WITH FULL U.K. GUARANTEES. NO EX. DEM OR EX DISPLAY GOODS. NO GREY IMPORTS. GOODS ARE NOT SUPPLIED ON APPROVAL. SORRY, NO GENERAL CATALOGUES. PLEASE PHONE OR WRITE FOR SPECIFIC REVIEWS, BROCHURES OR PRICES. SUPPLIER OF HI-FI PRODUCTS & ACCESSORIES SINCE 1986. MAIL ORDER ONLY FROM: IAN HARRISON, 7 MILL HILL, REPTON, DERBY, DE65 6GQ. TEL: 01283 702875. 9am - 9pm INCLUDING SUNDAYS.

audioXpress... It Just Sounds Better

Your Favorite Audio - One New Magazine!

- PROJECTS
- REVIEWS
- THE NEWEST TECHNOLOGIES
- AUDIO CLASSROOM
- and Much More!



Subscribe To This Great Monthly Publication Today!

Only \$59.95 us for 12 Issues!

audioXpress • PO Box 876 • Peterborough, NH
03458-0876 USA • Phone: 603-924-9464

Fax: 603-924-9467 • E-mail: custserv@audioXpress.com

ORDER ONLINE AT: www.audioXpress.com



Heatherdale
audio limited



202 Findon Road, Worthing, WEST Sussex. BN14 0EJ
Tel. 01903-872288 or (after hours) 07860 660001 Fax. 01903-872234
e-mail: heatherdale@hifi-stereo.com /www.hifi-stereo.com

**0% FINANCE AVAILABLE FOR UP TO 3 YEARS ON
SELECTED ITEMS.
SUBJECT TO STATUS. CONDITIONS APPLY.**

SPEAKERS

JM LABS Mezzo Utopia speakers
B&W 801 MK 1 speakers
B&W 802 MK 1 speakers
Morduant Short MS902 speakers
Tannoy Westminster Royal HE speakers
Hales Trancendence 5 speakers
Dynaudio Audience 7 speakers with stands
Origin Live OL-2 speakers
KEF Concorde speakers

£1995
£695
£650
£99
£9995
£2895
£395
£250
£150

AMPLIFIERS

Mark Levinson ML336 Power Amp
Meridian 605 Monoblocs
Audionote Keron Mono Amps (£28000)
Perraux 200IP Intergrated Amp
Exposure 15 Integrated Amp
Mark Levinson ML432 Power Amp
Kora Triode 100 SB Monoblocs
Classe A CA201 Power Amp
Audionote Neiro mono-blocks

CD PLAYERS & TRANSPORTS

Mark Levinson ML31.5 CD Transport
Esoteric XO3SE CD/SACD Player (our demo model)
Sony CDPMA1 CD Player

£1995
£2495
£9995
£3495

MISCELLANEOUS

1 meter pair Mandrake Balanced Interconnect
JPS "The Power AC Plus" 2 meter Power Cord
Sony AM/FM ST-SE370 Tuner
Technics ST-610L Tuner (FM/MW/LW)
Transparent Music Wave+ 10-ft pair
Hitachi FT5500 MK II Tuner
Technics ST-GT550 Tuner
Winds ALM-01 Stylus Gage (New)
Sony ST-SE570 Tuner
15 Foot Transparent Music Wave Super single mono run.

£295
£195
£75
£65
£425
£125
£65
£525
£60
£795

TURNTABLES, CARTRIDGES & TONEARMS

Mark Levinson 25S Phonostage with power supply
Thorens TD160 with Thorens Tonearm
Blue Pearl Turntable with Graham Phantom arm
My Sonic Eminent cartridge (new)

£1995
£195
£POA
£2750

VISA - SWITCH - MASTER CARD - AMEX - DINERS CLUB WELCOME.
WE TAKE PART EXCHANGE ON NEW & USED STOCK and buy in for cash

IAN EDWARDS
MAKERS OF FINE HAND MADE FURNITURE

Tel: 01423 500442 Fax: 01423 705200 www.iansbespokefurniture.co.uk

The Old Chapel, 282 Skipton Road, Harrogate, N. Yorks, HG1 3HE

*Elegant Storage Solutions
for
Hi-Fi, Books,
LPs, CDs,
DVDs*
Special orders welcome



Super 14 Wizard Rotary Unit. 2296 CDs, etc



74" V-Max can hold 660 CDs etc



JT Hi-Fi CD/Cassette Unit



Charlotte Drawer unit for 480 CDs & 75 Cassettes 32" x 21" x 21"



plug 'n' play 'n' smile



kudos
www.kudosaudio.com

0845 4586698 for details...



One Decent Wallshelf

Thoroughly Recommended - David Price, Hi-Fi World Jan 06

featuring:
steel frame with multipoint fixing
upto 25mm thick 1/2 metre acrylic isolation platform
tuning pack for system matching
available:
hdw - £129
odw (pictured) - £249
odwt (2 shelf) - £349
all in either silver or black



The Decentscale

featuring:
non metallic construction suitable for all types of cartridge
record height measuring platform (patent applied for)
upto 20% more accurate than any other sub £100 scale
available:
now! - £35



Wallshelves, Isolation Platforms, Digital Tracking Force Scales, Cables

Decent Audio 0845 6019390



We are proud to announce that we are dealers for VPI RECORD DECKS, ROKSAN, ORTOFON, GOLDRING, PROJECT, E.A.R. INCA DESIGN, ISOTEK, WE HAVE VARIOUS CARTRIDGES IN STOCK - MORE EQUIPMENT ARRIVING DAILY - please ring, or see web. EMAIL: mailto:info@matrixhi-fi.co.uk WEB: www.matrixhi-fi.co.uk

matrix hi-fi

NEW AND GOOD QUALITY VINTAGE/USED HI FI

65-67 DARENTH ROAD, DARTFORD KENT DA1 1LU - UK

TEL: 01322 281787/281700/292391/227668 FAX: 01322 229908

RECORD DECKS/HEAD AMPS/TONE ARMS	Quad FM3	£ 99.00
ACOUSTIC SOLUTIONS NEW (IDEAL FOR MIDI SYSTEMS)	YAMAHA CT710 TUNER	£ 45.00
GOLDRING GR1.2 WITH RB250 ARM		
AND GOLDRING ELECTRA CART BRILLIANT		
GOLDRING GR2	CD/HDDCD/SACD/DVD/MD PLAYERS	£499.00
NEW PROJECT PHONO STAGE MM MC	CARY CAD955 TUBE CD PLAYER	£1,399.00
NEW - PROJECT VALVE PHONO STAGE	MUSICAL FIDELITY XVM	£ 349.00
MM/MC WITH OUTBOARD PSU	NEW INCA KATANA CD PLAYER - BARGAIN	£ 600.00
NEW - ROKSAN RADIUS DECK WITH UNI-PIVOT ARM	NEW INCA KATANA SE	£ 395.00
- wood/acrylic	KATANA SE X DEMO	£ 260.00
NEW MICHELLE LINI COVER	ARICAM DELTA BLACK BOX	£ 189.00
NOTTINGHAM ANALOG MENTOR TONE ARM	TRICORD RESEARCH PULSER DAC WITH EXTERNAL	
LINN LP12 BASIC PLUS ARM IN MPLINTH	TRI POWER SUPPLY UPGRADED TO HDDC	£ 699.00
NAD 5120 - NEW GOLDRING ELAN CART	MERIDIAN 505 20BIT REMOTE	£ 499.00
REGA FLAHERZ/LINING	MERIDIAN 200 CD	£ 299.00
THORNS TD170	MERIDIAN 200 CD WITH 203 DAC	£ 399.00
QED DISCOVER MM PHONO STAGE	MICROMEGA DRIVE 2 & DAC - MINT BOXED	£ 499.00
VPI SCOUT WITH UNIPIVOT ARM	MARRANT/HEART VALVED CD PLAYER	£ 599.00
TARGET 7/TABLE WALL SHELF	NEWBOXED BLACK OR GOLD	£ 199.00
	NAD DVD/CD T550 MINT	£ 399.00
PRE-AMPS	THETA DSPRO BASIC II DAC	£ 399.00
ALBANY PASSIVE PRE	AUDIO NOTE DAC3 AND BORDER PATROL PSU	£ 999.00
MUSICAL FIDELITY A3CR BOXED MINT	MICRO SEKI CD PLAYER CDM2 - SUPERB	£ 800.00
SYMPHONIC AUDIO VALVE LINE WITH REMOTE	MYRYAD MC100 CD PLAYER	£ 299.00
NEW ROTHWELL PASSIVE PRE	AUDIOJLAB 6030 SERIES DAC - BOXED	£ 199.00
MARSH P2020T HYBRID	ASSEMBLAGE DAC3 HDDC	£ 199.00
QUAD 44 - GREAT	CAMBRIDGE ALDO DAC MAGIC	£ 150.00
QUAD 34	EXPOSURE 2010 CD PLAYER	£ 299.00
POWER AMPLIFIERS - VALVE	SHANLING CDT80	£ 849.00
AUDIO INNOVATIONS SERIES 300	SHANLING CT200 SACD EX DEMO	£ 1,650.00
AUDIO NOTE ZERO MONO BLOCKS	NEW SHANLING CT200 SACD SEE WEB SITE	£ 2,150.00
KLYSTRON 243 MONO BLOCKS 15WATT	SHANLING CDT 300 OMEGA LIMITED EDITION	£ 3,899.00
NEW - SHANLING STEREO INTEGRATED AMP		
(SEE WEB SITE - ORDERS TAKEN NOW)	SPEAKERS	
VAR E 34 INTEGRATED 25 WATT	MONITOR AUDIO MA2 DOMESTIC REFERENCE	£ 199.00
RADFORD STA 25 WOODS/DOE EXCELLENT	KEF MODEL ONE-TWO CHERRY FLOORSTANDERS	£ 499.00
RADFORD STA 35 MODIFIED BLK/GOLD	KEF CSS BLK STAND MOUNT, STANDS NOT INC	£ 150.00
AUDIO RESEARCH CLASSIC 60 - vvc	SPENDOR SP1 VCC WITH STANDS	£ 299.00
SHANLING POWER AMPS (SEE WEB SITE)	GRADANT REVOLUTION (€3700 NEW)	£ 1,899.00
SHANLING MONO BLOCKS EX DEMO	NEW MISSION MQ1 SERIES BEECH	£ 129.00
HIFILANG 845/8038 STEREO SINGLE	OPTIMUS LINUM TWEETERS	£ 150.00
ENDED MKII AWESOME	AUDIO NOTE ANJ TEAK	£ 499.00
POWER AMPLIFIERS - SOLID STATE	SILVERADO PIANO BLACK INC. STANDS	£ 1,499.00
SUGDEN A213 - GREAT	SHIELL 'E' TEAK WITH TARGET STANDS	£ 649.00
NEW ACOUSTIC SOLUTIONS SP101	ACOUSTIC SOLUTIONS SMALL	
CYRUS 2	BOOKSHELF BEECH/CHERRY	£ 299.95
ZETA ECLIPSE MONO BLOCKS		
QUAD 303	POWER CONDITIONERS	
QUAD 405 II	ISOTEK POWER CLEAN	£ 299.00
QUAD 656	ISOTEK ORION 2416V OR 8 WAY	£ 70.00
CRIMSON 630C MONO BLOCKS & PRE AMP	ISOTEK MINI SUB	£ 495.00
TUNERS, CASSETTE DECKS ETC.	MISC	
NEW Acoustic Solutions DAB Tuner	CABLES - Silver Arrow - Van De Hull - QED	
NEW PURE EVOKES - 1KT RADIO CHERRY/MAPLE	SOUND STYLE EQUIPMENT RACKS & VARIOUS	
NEW - PURE DIGITAL 701ES DAB TUNER	BEYER HEADPHONES - PLEASE PHONE	

THE LARGEST SELECTION OF QUALITY TUBES ONLINE

TUBE SHOP.COM

WHAT'S HOT AT THE TUBESHOP

GUITAR TUBES

HI-FI TUBES

NOS TUBES

Tube Rings
by Duende Criatura



BRIMAR
Mullard
SYLVANIA



WWW.TUBE-SHOP.COM
OR CALL US 0170 9220404

AWARD WINNING PRODUCTS FROM AUDIOCRAFT



web: www.audio-craft.co.uk
email: kevin.walker@audio-craft.co.uk
tel: 01895 253340

OEHLBACH PURE

CONNECTIONS THAT WORK...SUPERBLY

No. 1 in Germany

Oehlbach Phono Pre-Amplifier (MM/MC)
'Excellent' - StereoPlay Magazine - (11/06)
RRP £145, Offer to Hi-Fi World Readers
£125 (with this ad only), P&P £5.

Oehlbach Fusion Two Speaker Cable
Mono-crystalline, all HPOCC(r) Copper cable
World first core and foil geometry
for high surface area and low volume.

2 x 2m - £375

2 x 3m - £425

P&P - £9

(Please specify terminators)

www.oehlbach.co.uk

AWARD WINNING CABLES



Distributed by Acoustat (UK) Ltd.

Tel: +44 (0)20 8863 8979 Email: sales@acoustat.co.uk

MIDLAND AUDIO XCHANGE

The Old Chapel
Forge Lane
Belbroughton
Worcestershire
DY9 9TD

t. 01562 731100
f. 01562 730228

e-mail. sales@midlandaudiox-change.co.uk
web . www.midlandaudiox-change.co.uk



Ex - demo and second hand items

	Was	Now			
Digital			Loudspeakers		
Audio Synthesis DAX Decade 22 Bit Balanced S/H	3500	1799	Audio Physic Spark 3 maple X-demo	1699	1099
Audio Synthesis DAX Decade 22 Bit Single ended S/H	2999	1499	BKS 107MKII Supreme hybrid Ribbons S/H	1750	799
Arcam Diva CD92 Silver dCS Ring Player S/h	799	449	Diapason Adamantes III with stands S/H	2150	1299
dCS P8i SACD/CD Player factory re sealed full warranty	7500	3999	JM Lab Micro Utopia Classic x-demo	4700	3750
dCS Verdi laScala SACD/CD Transport/upsampler S/H	9000	4250	JM lab Electra 927 be Anniversary S/H	2800	1699
dCS Verdi Encore Transport BNIB	9500	6449	Martin Logan Aeon I Oak x-demo	3189	2300
dCS Elgar Plus DAC BNIB	9500	6449	Monitor Audio Radius 360 Subwoofer Cherry S/H	350	249
Densen Beat400 XS x demo	2600	1499	Pen Audio Rebel 2 x-demo	995	699
Linn Karik Numerik DAC S/H	1500	499	Pen Audio Charm Active Subwoofer x-demo	1995	999
Linn Karik CD Player S/H	1999	499	ProAc Response D25 Maple x-demo	2800	2199
Marantz CD65 KI Sig MKII S/H	N/A	329	Rega ELA 2000 S/H	850	449
Nagra DAC x-demo	7250	3999	Sonus Faber Concerto Walnut S/H	998	599
Orpheus labs Zero CD player x demo	4600	2999	Sonus faber Ironwood Stands S/H	449	229
Theta Generation V Balanced S/H	6290	1299	Spendor S3 Cherry S/H	599	379
Theta Pro Basic II DAC with Oscom/Balanced S/H	2990	695	Wilson Audio Witts S/H	11000	2999
			Cables and Accessories		
Analogue			BCD Engineering 1000 Table 4 tier S/H	1650	899
Heed Audio Orbit 1 TT PSU New & Boxed	225	179	Cogan Hall Intermezzo EMD 0.75m RCA S/H	N/A	99
Kuzma Stabl/Stogi S Turntable New & Boxed	N/A	1399	Madrigal MDC2 1m RCA/RCA 75ohm Digital Cable new boxed	420	249
Mc Cormack Micro Drive Phono Stage S/H	650	399	Nordost Shiva 2m mains cable x-demo	220	175
Phonomena Phono stage MM/MC BINB	650	399	Shun Mook 1pr Spatial Controller x-demo	450	229
Phonomena BPS Battery supply for phono BINB	650	399	Shun Mook Ultra Diamond Resonators set of 3 x-demo	710	399
Rega P2 /Bias Turntable S/H	270	179	Siltech LS188 Classic 2x3m Silver & Gold Speaker cable BNIB	3950	2995
Vdh Grasshopper GLAIII MC Cartridge x-demo	2500	1699	Sound Organisation Record Rack with CD insert S/H	N/A	40
VPI HR-X Turntable x-demo	9250	6999	Stands Unique Sound Tower Cabinet 10 S/H	499	279
			Stands Unique Isolation Slab 10 S/H	179	99
Preamplifiers			Spectral MI-350 20ft Interconnect RCA-RCA x-demo	1400	799
Audio Analogue Bellini Remote Preamplifier X-demo	625	399	Transparent The Link 1.5m RCA-RCA S/H	190	99
Audio Research SP16 with Phono Stage x-demo	2249	1749	Transparent Music Link Plus 10ft RCA-RCA S/H	459	229
Audio research LS1 Hybrid Preamplifier S/H	1798	649	Western Electric 300b Valves 1Pair NEW	650	549
Conrad Johnson PV14L Remote controlled valve x-demo	2399	1750	Vdh CD102 MkIII 2m S/H	199	99
Conrad Johnson Premier 18LS x-demo	4000	1999			
Convergent Audio CAT SL1 Signature Black S/H	6000	2299	Tuners & Tape decks, power supplies		
Densen B200 Preamplifier S/H	1100	799	Densen Beat 800 AM/FM Tuner x demo	850	599
Electrocompaniet EC4R Preamplifier S/H	1799	599	Magnum Dynalab FTR remote/Tuner for Etude S/H	395	199
Musical Fidelity X P100 Preamplifier S/h	899	499	Naim Audio NAT05 FM/AM Tuner S/H	855	699
Nagra PLL with remote x-demo	5450	2999	Isotek Substation special version S/H	1600	795
Nagra PLP battery Phono stage x-demo	7250	4999			
Orpheus Two Preamplifier x-demo	3200	1999			
Roksan L1 Preamp (requires PSU) S/H	2299	995			
Roksan L1.5 Preamplifier (requires PSU) S/H	2699	1299			
Sugden masterclass Preamplifier x-demo	2300	1599			
Spectral DMC 30s Reference Preamplifier x-demo	7600	4499			
Amplifiers					
Audio Research VM220 Valve mono Amplifiers x-demo	9000	7499			
Audio Research VT60 Stereo Power Amplifier S/H	1995	795			
Audio Research VS55 Stereo Power Amplifier S/H	2499	1699			
Audio research VT100MKIII Valve Power Amplifier S/H	6400	3999			
Conrad Johnson MV60 SE Valve Amplifier S/H	2500	1895			
Conrad Johnson Premier 350SA x demo	8000	5999			
Densen Beat 340 x-demo	1800	999			
Densen Beat 320 S/H	1800	999			
Densen Beat 300xs x-demo	1800	999			
Krell KAV400xi Black x-demo	2498	2199			
Nagra MPARCMi X -demo	10450	7999			
Musical Fidelity XA200 mono Power Amplifiers S/H	999	599			
Orpheus Three power amplifier x-demo	2995	1799			
Roksan S1.5 stereo power amplifier silver S/H	1495	599			
Sugden masterclass monos x demo	6600	4999			
			<i>Suppliers and installers of High Quality Audio Systems</i>		
			47 Laboratory	• Living Voice	
			ATC	• Lyra	
			Audio Research	• Magnum Dynlab	
			Cardas	• Mark Levinson	
			Clearaudio	• Martin Logan	
			Conrad Johnson	• Mimetlsm	
			Copland	• Nordost	
			Crystal Cables	• Primaluna	
			Dartzeel	• Primare	
			dCS	• ProAc	
			Densen	• Rega	
			DNM/Reson	• Siltech	
			Electrocompaniet	• Sonus Faber	
			Finite Elemente	• Sugden	
			Jadls	• Transparent Audio	
			Koetsu	• VPI	
			Krell	• Wadia	
			Kuzma	• Wegg 3	
			Lavardin	• Wilson Audio	

Midland Audio X-change are looking for Audio Research, Krell , Mark Levinson , Naim Audio, SME, Wadia.

dial a dealer

This is a comprehensive directory of Hi-Fi Dealers throughout the UK and Ireland.

BRISTOL & BATH

THE RIGHT NOTE

Tel: (01225) 874728. Are you happy with your system? We find that most audiophiles listen for most of the time to systems that are 'not quite right'. Forget the 'Best Buy' reviews and putting a system together like a patchwork quilt. Let us assess the vast range available, you judge the results. We'll help you to plan a system for the future, even if you spread the purchases. Leave 'up-grade-itis' behind, save money and enjoy music all the time. Just listen, and you'll know.

CD: Accuphase, Audio Synthesis, Bel Canto, dCS, Resolution Audio, Wadia. Vinyl: Basis, Clearaudio, DNM, Graham, Michell, Sumiko, Transfiguration.

Amps: Advantage, CAT, DNM, Gamut, Spectral.

Speakers: Audio Physic, NEAT, Verity Audio. Tuners: Magnum Dynalab. (Credit Cards Accepted).

V AUDIO

HiFi Consultants: 36 Druid Hill, Stoke Bishop, Bristol. BS9 1EJ. Tel: 0117 968 6005. ATC, AVI, Alon, ALR Jordan, Audio Analogue, Avid, Black Rhodium, Electrocompaniet, Eslab Digital Amps, Harman Kardon, Infinity, Jamo, Lyra, Origin Live, Opera, Ortofon, PS Audio, Ruark, Michell, REL, SME, Sugden, Townshend, Triangle, Unison Research Valve Amps, VPI. Specialists in Video Projectors by SIM2, Infocus, Sanyo; screens by Stewart, Draper, Da-Lite, Owl, and Amps/DVD's by Harman Kardon etc. Demos by appointment only. Home trial facilities. We are not a shop.

CHESHIRE

ACOUSTICA

17 Hoole Rd, Chester CH2 3NH. www.acoustica.co.uk. Tel 01244 344227. All the best in HiFi & Home Cinema from Amphion, Arcam, ART, Audiolab, Ayre, B&W Nautilus, Classe, Focal, JM Lab, Monitor Audio, Naim Audio, Primare, Rega, REL, Rotel, Spondor, Sugden, Thiel, Wadia. We offer full demonstration facilities, interest free credit and delivery & install systems throughout Cheshire, Merseyside & North Wales. Opening hours are Tuesday to Saturday 10.00 to 5.30.

ACTON GATE AUDIO

4 Ruabon Road, Wrexham, North Wales, Tel. 01978 364500. www.acton-gate-audio.co.uk Audio Visual Specialists. Arcam, Audio Analogue, AVID, Bose, Celestion, Castle, Denon, Harman Kardon, Jamo, JM Lab, KEF, Marantz, Michell, Mission, Onkyo, Opera, Pro-Ject, Musical Fidelity, NAD, QUAD, Roksan, Ruark, Tannoy, Teac, Tivoli, Unico, Unison Research, Wharfedale, Yamaha, DSP Club Member, Demo Room, installation service. Easy Parking and Motorway access. All major credit cards accepted. 9.30 - 5.30 daily. Closed Sunday & Monday.

"OBJECTS OF DESIRE"

available at:-

ORPHEUS AUDIO

Tel: 0161 428 1539

e-mail: anything@orpheusaudio.co.uk www.orpheusaudio.co.uk 3D Acoustics Acoustic Zen, Brilliance, Consonance, Custom Design, DK Design Group, EAR/Yoshino, Hyperion, JAS Loudspeakers, Lyra, Monopulse, Music First, Shanling, Sumiko, VPI, Whest Audio, Wireworld. Home demonstrations available 5 mins off Junction 3 M60.

CORNWALL

BIGEARS AUDIO

To find a system that will allow you to hear the music instead of the equipment phone Bigears Audio, here you will find an interesting array of new and good quality used equipment! my intention is to have satisfied customers whatever their audio preferences. Naim dealer for the South West. chrisbirchley@btinternet.com Tel: 01736-740421

DEVON

USHER & NAD IN DEVON

Come round for a coffee and hear the Usher Dancers and the fabulously over engineered Usher P-307 preamplifier partnered with the Usher R.1.5 Class A amplifier. Or maybe the Usher 520's on a NAD amplifier. Sound sources are the Usher CD-1 player with 'the' Burr-Brown DAC and op-amps, the amazing Goldring turntables and NAD CD players. Cables from QED or studio quality Van Damme. Sound Hi Fi, Viewpoint House, Dartmouth, Devon, TQ6 9HN. Free parking. 01803 833366 www.SoundHiFi.com

LEICESTERSHIRE

DIVINE AUDIO

The Courtyard, Bennett's Place, High Street, Market Harborough, LE16 7NL. 01858 432999

Leicestershire's freshest hi-fi and home cinema retailer, offering a service that you expect in an environment that will excite you. Stunning cinema and two channel demonstration facilities, comfy chairs and coffee!

We get outstanding results from Arcam FMJ, Art Loudspeakers, Chord Company, Focal JMLab, Infocus, Isoblu, Kube Design, Loewe televisions, NAD, Nottingham Analogue, Opera, Partington, Pathos, ProAc, Pro-Ject, PMC, Quadraspire, Sugden, Unison Research and a few other surprises.

Open Tuesday - Saturday 9.30 - 5.30 or by arrangement. Free parking 01858 432999, www.divineaudio.co.uk, info@divineaudio.co.uk

MIDDLESEX

RIVERSIDE HI-FI

422 Richmond Road, East Twickenham, Middlesex, TW1 2EB. Tel: 020 8892 7613 Fax: 020 8892 7749. www.riversidehifi.co.uk

Audio Research, Blueroom, Bose, B&O, Copland, Denon, Elac, Infocus, Krell, Linn, Living control, Martin Logan, Michell, Monitor Audio, Musical Fidelity, NAD, Project, QED, Rel, Sennheiser, Sonus Faber, Teac, Theta, Wilson. Finance available. Subject to status. Written details available on request. Export orders welcome. UK mail order available. 3 demonstration rooms. All major credit cards. Open 10am-5.30pm Mon-Sat.

STAFFORDSHIRE

ACOUSTICA

114 Wolverhampton Rd, Stafford ST17 4AH. www.acoustica.co.uk. Tel 01785 258216. All the best in Hi-Fi & Home Cinema from Arcam, ART, Audiolab, Ayre, B&W, Focal, JM Lab, MJ Acoustics, Monitor Audio, Naim Audio, Primare, Rega, REL, Rotel, Spondor, Sugden, Thiel, Wadia, Yamaha Pre Eminent. We offer full demonstration facilities, interest free credit and delivery & install systems throughout Staffordshire & the Midlands. Opening hours are Tuesday to Friday 10.00 to 5.30, Saturday 10.00 until 5.00.

SUFFOLK

AUDIO IMAGES

128 London Road North, Lowestoft, Suffolk, NR32 1HB Tel: 01502 582853. info@audioimages-hifi.com. www.audioimages-hifi.com Castle, Denon, Harmon Kardon, Jamo, Mirage, Rothwell, Roksan, Sugden, Screen Play, Synthesis, Triangle, Tom Evans Audio Design, Vienna, Vincent, Volta Cables. Refreshingly different selection. Dem Room, Professional AV installer's from budget to high end. Full credit facilities. 9.30 to 5.30 Mon & Sat

GIG BRIGHTON

(01273) 700759 info@gig-hifi.co.uk. Open by appointment only. Brighton's newest, freshest and most independently minded specialists in two-channel hi-fi. Tube amps, high sensitivity speakers, Class A transistor amps, electrostatic speakers and more. In-house servicing, repair and upgrades to tube amps a speciality. Michell, Shanling, Eastern Electric, Atma-sphere, Zu, Audiostatic, Coincident Speaker Technology, Pass Labs, Sugden, Symposium, Ferguson-Hill.

SOMERSET

ALTERNATIVE AUDIO,

Brompton Ralph, Taunton, Somerset, Tel: 01984 624242 www.alternativeaudio.co.uk. Email: peter@alternativeaudio.co.uk We specialise in valve amplification and vinyl replay with the accent on high quality musical enjoyment. Ex-Dem and used equipment for sale.

Home evaluation scheme. Border Patrol, Clearaudio, Diapason, EAR/Yoshino, Experience Filtration, Lector, LFD Audio, Lyra, Music First Audio, Nottingham Analogue, Opera, Quadraspire, Shun Mook, SME, Transfiguration, Unison Research, Vandersteen Audio.

YORKSHIRE

HIFI HUT - REAL HIFIDELITY

01943 880010 or 07736 392852 Rural setting A59 Yorkshire. **NO THANKS:** TVs, PCs 0% Finance, Ebay horrors, Naim, Denon etc.... **YES PLEASE:** JBL K2s9800 SE and JBL Project Array. LFD amps, cables and supports. McIntosh amps and CDs. Esoteric X-OSE and P70/D70. AKG Headphones and Creek amps. Audion Golden Nights 300Bs. Neat Ultimatum Series. etc.. Phone Paul, but not if you are boring!! Window shopping or never buying don't bother. www.hifihut.co.uk

YORKSHIRE (WEST)

AUDIO REPUBLIC,

78 Otley Road, Leeds 0113 2177294, www.audio-republic.co.uk for the very best in quality hifi in West Yorkshire and beyond, representing Naim Audio, Rega, Totem, Sugden, Shahinian, JM Lab, Filtech, TEAC, Nottingham Analogue, Spectral, Living Voice, Hutter Furniture, Accuphase, Quadraspire, Chord Cables, Dynaudio. Choice of shop or home demonstrations, open Tues - Sat 9.30am to 5.30 pm. Please phone for a chat and directions.

PREMIER AUDIO

- now demonstrating - Room 1: DCS Elgar, Purcell & Verdi Transport, Plinius CD Lad & 250 Power, Verity Fidelo & Sonus Faber Speakers, Siltech Cables, Isotek Sub Station, BDA Equipment Stands Room 2: Audio Aero, Audio Synthesis, Kora Pre & Power, Pink Triangle CD/Amp, Martin Logan / Audio Physics Speakers, Arcici Equipment Stand, Isotek Sub Station P/S Audio Synthesis, Audio Physics, Audio Aero, Absolute Sounds, DCS, Kora, Plinius, Siltech, Arcici, BDA, Pink Triangle, Avid Turntables, Project, Ortofon, Van den Hul, Mirage. P/X welcome Home demonstration good selection of S/hand. We are 10mins J39 - M1 10mins J30 M62 Tel: Wakefield 01924 255045 - Colin Grundy.

WALES

ACTON GATE AUDIO

4 Ruabon Road, Wrexham, North Wales, Tel. 01978 364500. www.acton-gate-audio.co.uk See our main ad under Cheshire.

VINYL/RECORD MAIL ORDER

DIVERSE VINYL

10 Charles Street, Newport, NP20 1JU. Tel/Fax: 01633 259661/256261. Email: sales@diverse-music.co.uk Probably the most varied and impressive selection of brand new LPs you'll find anywhere: international new releases, reissues and audiophile products. Also UK distributor of the Disco Anti Stat LP Cleaning Device. Call for a free catalogue, or visit www.diversevinyl.com

PRODUCT TESTING IN HI-FI WORLD

To ensure the upmost accuracy in our product reviews, *Hi-Fi World* has extremely comprehensive in-house test facilities, and our test equipment - from big names like Rohde & Schwarz and Hewlett Packard - is amongst the most advanced in the world.

Loudspeakers are measured using a calibrated Bruel&Kjaer microphone feeding a Clio-based computer analyser, using pulsed and gated sinewaves, in a large room to eliminate the room's influence. Pickup arm vibration is measured with a Bruel&Kjaer accelerometer.

No other UK hi-fi magazine has in-house testing, and none has access to such advanced tests across all types of equipment. That's why you can depend on *Hi-Fi World* reviews.



specialist hi-fi dealers

London

Oranges & Lemons



020 7924 2040

www.oandlhi.co.uk

61 Webbs Road, Battersea, SW11 6RX
email: oranges.lemons@virgin.net



O'Brien Hi-Fi

60 Durham Road - London - SW20 0TW

020 8946 1528 or shop@obrienhifi.com

www.obrienhifi.com

Martin Logan Clarity
Moon IS
Sonus Faber Concerto
Krell KAV300CD
Copland CDA B23
Audio Analogue Enigma
Sonus Faber Cremona
Unison Research CDP

Speakers - Ex Demonstration - Cherry
Amplifier - Ex Demonstration - Black
Speakers - Part Exchange - Walnut
CD Player - Part Exchange
CD Player - Ex Demonstration
System - New, Boxed with Warranty
Speakers - New, Slight damage
CD-Player - Ex Demonstration

£1895 (€2200)
£2100 (€2695)
£550 (€970)
£795 (€3000)
£1595 (€2100)
£695 (€899)
£4200 (€5000)
£699 (€895)

Sonus faber. WILSON AUDIO



Velodyne

Mail Order

NEW catalogue out now
packed with **award winning** products



"We defy anyone not to notice the improvement in performance when you switch... to a PowerKord."
What Hi-Fi, May 2004.

- exclusive mains leads
- exclusive Hi-Fi equipment
- exclusive speaker cable
- exclusive CD accessories
- exclusive supports



WHAT HI-FI?
SOUND AND VISION
AWARDS 2004
BEST MAINS LEAD
UNDER £100
Russ Andrews
Classic PowerKord

Russ Andrews
Classic PowerKord™
from £55

order online at www.russandrews.com
or call UK Local Rate 0845 3451550 quote AWORLD

Exclusive UK Retailer for

KIMBER KABLE

Russ Andrews Accessories Ltd, 2B Moreland Court,
Westmorland Business Park, Shap Road, Kendal, LA9 6NS, UK.
Tel: +44 (0)1539 797300 Fax: +44 1539 797325

Russ Andrews
Solutions for better music & movies

Services & Consultants

HIFI RECLAMATION WANTED

Classic British Hi-Fi Components and Systems!
Top prices paid for vintage or classic audio
separates, accessories or literature.

0845 644 3340

Front End Problem? *contact*

The Cartridge Man

It doesn't have to cost an arm and a
leg to get the best - listen to my
Koetsu - and Decca -eater.

Also agents for Croft, Hadcock,
E.A.R., Michell &
Moth.

plus cartridge re-tipping service
020 8688 6565

Website: www.thecartridgeman.com

Valves & Tubes



Buy CVC. PREMIUM HI - FI valves direct from us.
All valves processed for improved performance.
We also have stock of MAJOR BRAND types inc.
MULLARD, GEC, BRIMAR, RCA, GE, PHILIPS, etc.

The Stables, Baddow Park, Great Baddow, Chelmsford,
Essex, CM2 7SY. Tel: 01245 241301 Fax: 01245 241309
Email: sales@chelmervalve.com

Loudspeaker Repairs

D.C. Boultons

Loudspeaker Repairs & Manufacture

All types including P.A. Disco, Hi-Fi. Juke Box etc.

Agents for B&C, Celestion, Eminence,
Fane, Precision Devices etc.

From re-foams to complete re-builds, even with
slipped magnets.

Trade and retail supplied.
Custom units our speciality.

Over 35 years experience of loudspeaker design

Unit 12, Damgate Lane Ind. Est, Acle, Norwich,
NR13 3DJ

Tel 01493 750075 Fax 01493 751155

To advertise in this
space please call
020 7372 6018
or email:
advertising@hi-fiworld.co.uk

specialist hi-fi dealers

Yorkshire

Aeon Acoustics

ISO-PLATFORMS & FEET LOUDSPEAKERS
MADE FROM NEW GYRO-PNEUMATIC
AUDIO MATERIAL www.spiralex.com



PCT Patents & Design Copyrights pending

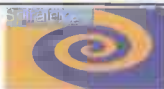

Audio Isolation Materials

Aeon Acoustics
Newlands, Littlethorpe Lane,
Ripon, North Yorkshire. HG4 1UB
SPC@spiralex.com
01765 604288

Smart Audio Materials with
extended bass response & clarity

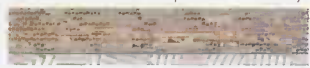

To advertise in this
space please call
020 7372 6018
or email:

advertising@hi-fiworld.co.uk

Two-channel
Home Cinema
Custom Install
Full System Design
Installation
Free Consultation

Audiostone
Electrocompaniet
True Colours

Vivid Audio

Hi-Fi Consultant
Rowles Music Limited
Lancing, Sussex

Tel 01903 530005
Mob 07950 274224
ray@rowlesmusic.co.uk
www.rowlesmusic.co.uk



Rowles Music Limited

Analogue Seduction

where music is our passion

Specialists in turntables and high precision hi-fi related essentials

Tel: +44
(0) 1733
344768



GRAHAM SLEE



ISOTEK

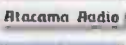

MERLIN

AUTHORISED DEALERS FOR

Avid, Ayre, Cartridge-Man, Creek Audio,
Chapter Audio, Clearaudio, Clearlight
Audio, Chord Electronics, Chord Company,
Dynavector, Ecosse Reference, Epos,
Graham, Graham Slee, Hadcock, Isotek,
Lyra, Michell Engineering, Merlin Cables,
Roksan, Rothwell Audio, Nordost, Origin
Live, Oracle, Ortofon, Project, SME, Stax,
Sumiko, Sugden, Trichord Research,
Usher Audio, VPI, Whetst Audio,
Wilson Benesch

Analogue Seduction are dedicated towards two channel
Hi-Fi, specialising in vinyl replay. We have dedicated
demonstration facilities and are based in Peterborough, Cambs

Please visit our website to browse or purchase some of our
turntable setup tools and essentials, that are not easily
available elsewhere.

01733 344768

www.analogueseduction.net

We'd like to make it
perfectly clear for you.....

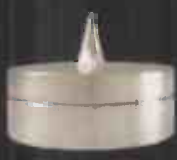

Perfectly clear music quality.
Perfectly clear video & DVD quality.

The Sonic Freedom Spike® System can be
used with any Hi-Fi separate, video and DVD
systems to improve sound and picture quality.

SONIC FREEDOM LTD

TEL: 01726 66650 MOBILE: 07910 231774

info@sonicfreedom.co.uk

www.sonicfreedom.co.uk

diverse vinyl

THE UK'S ONE STOP SHOP FOR NEW LPs

Now stocking NEW Classical audiophile LPs from:
Deutsche Grammophon, Decca, Westminster, Tacet,
Mercury Living Presence, London, Harmonia Mundi
and more



Call 01633 259661

for a catalogue

or browse online

www.diversevinyl.com

Cambridgeshire

Sussex

Cornwall

Vinyl Mail Order Specialists

meet your maker

A reference guide to Britain's manufacturers and distributors

CREEK AUDIO LTD

12 Avebury Court, Mark Road,
Hemel Hempstead, Herts, HP2 7TA.
Tel. 01442 260146
E-mail: info@creekaudio.com
Internet: www.creekaudio.com

The beginning of 2006 saw Creek Audio launch two exciting new ranges, EVO at entry level and its high end - Destiny. At the same time, Creek's most popular products in the past 5 years, the 5350SE amp, CD50mk2 CD player and T50 tuner are now badged as Creek Classics. The OBH miniature range completes this new Creek line-up.

EPOS ACOUSTICS

2 Avebury Court, Mark Road,
Hemel Hempstead,
Herts, HP2 7TA
Tel. 01442 260146.
Email: info@epos-acoustics.com
Website: www.epos-acoustics.com

Innovative design and superior sound distinguish EPOS speakers from other brands in similar price categories. Nine models in total including a 5.1 surround system. All available in 3 finishes. Supporting stands and plinths complement the speakers. In addition to its two channel appeal, Epos is now equally sought after in the fast expanding world of home cinema. -

MONITOR AUDIO LIMITED

24 Brook Road, Rayleigh,
Essex SS6 7XL
Tel 01268 740 580.
Fax 01268 740 589
e-mail: info@monitoraudio.co.uk
website: www.monitoraudio.co.uk
Monitor Audio designs and manufactures British loudspeakers of the highest quality. Since 1972 Monitor Audio has been developing and perfecting the implementation of metal drivers, innovative crossovers, and exemplary speaker cabinet construction and finish to further the ideal of achieving sound which to the original is "as close as it gets".

PMC/BRYSTON

PMC & Bryston are Emmy award winning Loudspeaker & Amplifier manufacturers - Used throughout the professional world as reference. Our clients record for Deutsche Grammophon, Decca and countless blockbuster Movies. The identical, award winning ATL (Advanced Transmission Line) technology is used in all HiFi designs from the DB1+, TLE1 Sub through to the Active BB5 XBD.
PMC Ltd
43-45 Crawley Green Road.
Luton, LU2 OAA.
Tel: 08704 441044 Fax: 08704 441045
Email: sales@promonitor.co.uk
website: www.pmc-speakers.com
website: www.bryston.ca

SUGDEN AUDIO PRODUCTS

Designed and manufactured in the UK each Sugden product is hand-built by one highly skilled technician. A full range of pure class A amplifiers are available including integrated, stereo power and the incredible Masterclass balanced monoblocks. The class A HeadMaster offers a pre-amp with three inputs a fixed and variable output with remote control. The HeadMaster can be used as a control unit in a high quality audio system and excels with headphones. Please contact us for product information, dealer list and brochures.
Tel: 01924 404088
email info@jesugden.co.uk.

**To advertise in this space
please call 020 7372 6018
or email:
advertising@hi-fiworld.co.uk**



website: www.bigearsaudio.org.uk updated daily

Quality used vintage & modern equipment bought, sold-part-exchange most welcome! audio cables & accessories - bigears speaker cable and interconnects-mail order specialists worldwide.

The Most Definitive Dealer In the South West of England.

WE ACCEPT PAYPAL PAYMENTS and ALL CREDIT CARDS!!

NAIM dealer for the South West:
TANNOY, KEF, LECTOR, VIVA, AUDION, AUDIO NOTE, MICHELL

<p>VALVE AMPS</p> <p>EAR 861 POWER AMP, MINT, £2500 EAR 864 MINT, PRE-AMP £1750 CANARY AUDIO 806 [£2500] £1000 CONRAD JOHNSON P910AL £450 CROFT VITA FULL PRE-AMP £990 CROFT EL84 POWER-AMP £350 AUDION SILVER NOTE ONE £2500 AUDIO NOTE OTO SE £1499 RGD PX4 VALVE AMPS FROM THE 1950'S BEST EVER?? £2500 YAOIN HS-12B VALVE PRE-AMP WITH PHONO STAGE MC/MM £225 CR DEVELOPMENTS ROMULUS 5881 [25WATTS] [£2995] £1250 AUDIO RESEARCH VT60 POWER AMP £1050 LECTOR VALVE HYBRID, INTEGRATED, 50 WATTS, NEW £1050 ARIA MUSIC ANGLE KT88 VALVE AMP £625 AUDIO NOTE OTO SE INTEGRATED £1899 EASTERN ELECTRIC M520 INTEGRATED AMPLIFIER £1539 MEIXING MC67-HA VALVE TUBE PRE AMPLIFIER £575 CROFT OTL 3'S M/BLOCKS PERFECT FOR ELECTROSTATICS £1250 AUDION EL34 INTEGRATED STEREO AMP £999 AUDION STERLING MK1 EL34 £650 AUDION STERLING MKII EL34 £750 BLACK CAT ELECTRONICS PX4 VALVE, STEREO £2750 POWER AMP [LOWTHERS/TANNOY] CASTLE 7'S AUDIO NOTE KIT 4, 61.65, 25WATTS £850 ANTHEM X1 EL34 SINGLE ENDED VALVE INT. AMPLIFIER £425 ARIA 300B, EXCELLENT VALUE-NEW £875 AFFORDABLE VALVE AMP KT88 TMODE £825 BAT 3KI, HYBRID, PHONO STAGE, BOXED £1400 SONIC FRONTIERS ANTHEM 1 EL84S INTERGRATED £625 QUAD IIS, PLUS 22, SERVICED, EXCELLENT £850-1000 LEAK STEREO 60 £875 LEAK STEREO 20, MINT £550</p> <p>TRANSISTOR AMPS</p> <p>NAIM NAIT 5I £715 AUDIO SYNTHESIS -DESIRE POWER AMP £625 CONRAD JOHNSON SONOGRAPHE SC-1 £225 Z AMP TAMP DESIGN, STUNNING PERFORMANCED £1500</p>	<p>NAIM NAIT 5I £2500 MAGNUM REFERENCE MF125 MONO POWER AMPS £1750 MVL A1 INTEGRATED, CLASS A, 100 WATTS £1000 NAIM SNAPS, JUST SERVICED. TAG MCLAREN CLASSY PRE-AMP, MM, MC, [£850] £450 MISTRAL INTEGRATED, BLACK, WARM BUT DYNAMIC £990 LINX STRATOS VDH WIRED PRE-AMP DUAL-MONO £350 QUAD 66 PRE-AMP WITH LARGE CONSOLE CONTROL £2500 QUAD 33/44 PRE-AMPS, 303/306/405 POWER AMPS ALWAYS £1499 AVAILABLE £2500 EXPOSURE SUPER 8 POWER AMP £225</p> <p>SPEAKERS</p> <p>TOWNSHEND GLASTONBURY 11'S, RE-CONDITIONED £1050 BEAUHORN ACCELERARDO'S HUGE HORN SPEAKERS DX2'S £625 SONUS FABER ELECTA AMATOR'S, BEAUTIFUL, BOXED £1899 LINN ISOBARIK'S, MINT £1539 LINN KANS PLUS STANDS, £575 AUDIO NOTE E'S WITH STANDS £1250 QUAD ESL 57'S BRONZE, SERVICED, BOXED, £999 GALE 401'S RE-BUILT £650 ROGER BBC LS3/5AS, 110HMS, WALNUT, MINT £750 TANNOY 3L2'S 10 GOLDS MINT £2750 CASTLE 7'S £850 LOWTHER DELPHICS, MINT, DX2'S, DX3'S £425 LOWTHER BIGOR 2000'S USES 2 PAIRS OF DX2'S £875 HORNING AGATHONS DX2'S, DX3'S £825 TOTEEM MITES [£499] AS NEW, BOXED £1400 QUAD ESL57'S 'BLACK', REBUILT & SERVICED BY BIGEARS BOXED, £625 JORDAN WATTS EX-BBC £850-1000 DYNABOND CONTOURS £875 SPENDOR BC1'S MINT £550 MONITOR AUDIO MONITOR 3'S £550 EPOS ES 11 BRILLIANT SMALL STAND MOUNTER, £715 RUARK SABRES, CHERRY CELESTION SL6'S EXCELLENT COND. £425 HEYBROOK QUINTETS, GOLD PIETZO TWEETER (£1450) £425 NAIM ARIVAS EX-DEM [£1300] £950 JRI50 AS JRI49 BUT BIGGER, NEW FOAM COVERS, MINT £450</p>	<p>£715 RUARK ICON'S [£350] MINT, £285 £475 USHER S-520 PIANO 'BLACK' £850 £450 LOWTHER ACOUSTA'S PM7AS £550 £225 EPOS M14'S BOXED £225 £450 TANNOY CANTERBURY'S 12" SILVERS £4000 £225 TANNOY LANCASTERS 15 GOLDS £1400 £275 TANNOY CORNER YORKS 15 REDS £4500 £425 NAIM CREDO'S IN CHERRY BEAUTIFUL, BOXED £775 KEF CORELLIS, MINT, £150</p> <p>EPOA £715</p> <p>CD PLAYERS</p> <p>LECTOR CDP-7T, TOP LOADER £2150 MHZS CD88 TOP LOADING 24BIT 196K XLR TUBE CD PLAYER £875 SONIC FRONTIERS ANTHEM, MULTI-CHANGER, VALVE £850 £2500 ROKSAN KASPIAN CD, BOXED, £375 £1275 ROKSAN CANDY CD AS NEW, BOXED £550 £425 USHER CD-1 [ASTONISHING!!] £455 £325 AUDIONOTE CD 1 DAC AS NEW, BOXED [£950] £650 £1250 LECTOR DCP-06T VALVE CD PLAYER £875 £850 NAIM CDS1 £825 £425 MARANTZ CD17 MKII [£850] £595 £750 AUDIO INNOVATIONS FISH-EYE CD-TUNER BOXED AS NEW £225 £750 CYRUS DAD7 & PSX AS NEW AND BOXED £725 £325 CYRUS CDB7 & PSX AS NEW, BOXED £675</p> <p>TURNTABLES/ACCESSORIES</p> <p>£1250 TRICHORD DIABLO WITH NEVER CONNECTED POWER SUPPLY £1050 AND HIGH PERFORMANCE PSU INTERCONNECT [£1524] £675 £850 GARRARD 401, SME 3009, DYNAVECTOR 10XS, £85 THE ISOLATOR-UNBELIEVABLE RESULTS!! £575 ORIGIN LIVE SILVER ARM £350 ALL GRAHAM SLEE PHONO STAGES £275 CARTRIDGE-MAN MUSIC MAKER 3 AS NEW, £425 £185 ORTOFON RONDN BRONZE, AS NEW, £375 £175 OKKI NOKKI RECORD CLEANING MACHINE £255</p>
---	--	---

chrisbirchley@btinternet.com ☎ 01736 740421
mobile: 07947 678256

Tel: 01435 865 212

Fax: 01435 865 213

www.sounds-of-music.co.uk

Firgrove Business Park, Firgrove Road
Cross in hand, Nr Heathfield,
East Sussex, TN21 0QL.
By appointment only please.

• 8 Demonstration Suites

- One of the best product selections in the UK
- Free all-day parking to the door
- Over 50 years of experience
- 75% upgrading buy back scheme, if upgrading within 2 years*
- One-month home trial scheme*
- Extended Guarantees for free
- *subject to conditions

sounds of music

Visit the NEW web site: www.sounds-of-music.co.uk

Vinyl has never sounded better...

“ The huge sense of presence confirmed this was vinyl, but one which was extracting an unbelievable level of information from every record I played. ”

Ian Harris, Hi-Fi News Review, March 2007

With a Lifetime guarantee included with every 'Stratosphere' - the only thing you have to worry about is how many hours in a day you can find to sit down and listen!



FURUTECH deMag LP, DISC and Cable Demagnetizer

First UK debut

Improves Compact Disc!



The Furutech deMag completely demagnetizes LPs and optical disc media such as CD, CD-R, DVD, MD, Game CD, Photo CD, SACD, and DVD Audio. Plus it's an indispensable accessory for keeping interconnect cables, connectors and power cords demagnetized to prevent magnetic signal distortion.

magnetic distortion. Just loop your cables and power cords with their connectors on the deMag and begin treatment.

Improves Vinyl!



Disc Magnetization Is No Mystery

The silk-screened label on an optical disc contains chemical compounds such as iron, nickel, and cobalt. These materials are all strongly magnetic and easily remagnetized. The reflective information-bearing surface of optical media contains 99% aluminum, but 1% of these same highly magnetic materials! Even aluminum is considered a weak magnetic conductor.

The Sound

Demagnetizing both sides of optical media before play results in a greater sense of power, dynamics, and resolution, with cleaner, blacker backgrounds and a larger, more stable soundstage, vivid tonal colors and deeper extension at both ends of the frequency range. Demagnetization also allows the delicacy, refinement and nuance of a performance to shine through, along with micro- and macro-dynamics you need to realize the full potential of music and movies.

Improves Cables!



How can an LP be magnetized? It's plastic!

The fact is that pigment added to the plastic during the manufacturing process is the culprit. The minute amount of ferrous material in the pigment causes LPs to become magnetized.

The Image

Since the deMag Demagnetization Process eliminates all magnetic distortion noise, video displays of all types benefit from less ghosting, color shift, "snow", vertical and horizontal interference lines. After treatment you'll notice a higher resolution picture with more finely graded contrast, clean and precise, with bright, beautifully saturated colors and a more sophisticated color pallet.

Demagnetizing Cables

Electric current generates a magnetic field as it flows through a power cord or conductor. However, magnetic impurities within the materials themselves become magnetized and introduce further

You will never play CD or Vinyl again without the deMag.



WDKEL84 Valve Amplifier Kit

"The quality that can be gleaned from this amp is a fine introduction to the joys of the valve sound"

The WDKEL84 features a pair of EL84 valves in Push Pull configuration per channel, providing two channels each 18 Watts into an 8 Ohm load. Available as a 5 input integrated amplifier with ALPS volume control.

WDKEL84 kit £369

WDKEL84 built and tested £544



WD88VA Valve Amplifier Kit

"It proved itself to be an engaging valve amplifier that measured well and sounded superb. Quite simply it plays music, and plays it extremely well."

Adam Smith, Hi-Fi World Dec 06

Often described as a 'sweet sounding' valve, our particular implementation of the KT88 makes sure that it is driven to its ultimate performance. Available as a 35W stereo power amplifier with single input volume control, or as a relay switched integrated with five inputs.

WD88VA Integrated Amp kit £849

WD88VA built and tested £1099



Headphone II Valve Amplifier Kit

"Headphone II is a single-ended design with the power pentode wired up in triode configuration for added purity and is as quiet as a mouse"

A beautifully simple stereo headphone amplifier design using Mullard ECL83 valves. It works directly from any source. The circuit uses twin high specification E/I output transformers that can be wired to drive any headphones between 16 to 300 Ohms.

Headphone II kit £275

Headphone II built and tested £404



WD25A Standmount Speaker Kit

"The one aspect that stands out is the easy ability to resolve instruments and voices ... bass quality and definition is a revelation"

Cabinet kit (pair) £179

The aperiodic enclosure offers the bass clarity and definition of a larger closed box, together with the efficiency and easy amplifier load necessary for users of valve amplifiers. Available with SEAS STD soft dome treble unit, or high performance SEAS Excel treble unit.

WD25A STD kit (pair) £215

WD25A XL kit (pair) £398



WD25T Floorstanding Speaker Kit

"The WD25T always sounds crisp and taut, but can 'rumble' menacingly giving impressive physicality reminiscent of far larger boxes. Imaging is superb, the midband is also special; it's very open with masses of detail about the condition of the recording"

Cabinet kit (pair) £398

Cunningly arranged as an aperiodic enclosure leading to a lower sealed compartment, the WD25T combines the optimum damping of aperiodic loading with the bass extension of a large closed box. Available with STD soft dome or high performance Excel treble units.

Both the WD25 kits are based around a SEAS 26cm (10") paper cone bass unit with an efficiency of 89dB for 1W. The crossover has been developed for an easy drive 6 - 8 Ohm load making the system ideal for all types of amplifiers.

WD25T STD kit (pair) £279

WD25T XL kit (pair) £459



All our kits are complete with pictorial easy-to-follow instructions.
All parts are included - all you need is a screwdriver and soldering iron.

www.world-designs.co.uk
Tel: 01832 293320

private ads

PLEASE NOTE:

PRIVATE ADS WILL APPEAR AS FREE READERS CLASSIFIEDS FROM NEXT MONTHS ISSUE. PLEASE SEE PAGE 129 FOR DETAILS.

TECHNICS SL-PI200 Classic Pro DJ CD player, mint condition, perfect working order. offers. Tel: 07983 619671 (Apr)

LEGENDARY CROWN DC300A power amplifier in superb condition, recently serviced AB+B output configuration. Freq Response DC - 20kHz. T.H.D. 0.0005% at full power. Will drive into any load. 2 x 150 watts into 8 ohms. 2 x 300 watts into 4 ohms. £350. Tel 07932 664480. (Apr)

RARE KOETSU rebuild by Sugano JR. To Platinum standard with diamond cantilever. Offers. Also Urushi Gold with diamond cantilever rebuild unused, £2700 ono. Silver cables better than Siltech. Best leave a message. Phone 07802 843 769 6pm to 7pm (Apr)

TDL STUDIO 3 speakers. Immaculate. Original packaging. Non-smoking household. £275. Tel: 01902 336 260. Email: djreynolds@v21.me.uk (Wolverhampton) (Apr)

TEAC VRDS 10 £320. Tri-angle Celius 202 £570. Myryad MA120 MPI100 Pre/Power £620. Micromega Microdac £95. Tannoy R2 floorstanders £150. Audiolab 8000A £110. Pioneer A300R Precision £170. Tel: 01260 295 804 (Apr)

PRIMARE T21 tuner £150 ono. AVI Bigga-Tron Red Spot speakers (cherry) £200 ono. Rega CD player £150 ono. All excellent condition. Tel: Shaun 01226 244 341 (evenings) (Apr)

GRADO RS1 headphones. superb sound. Untiring and comfortable. Fine condition. Bought Grado GS1000. £195. Tel: 01752 773 369 (Apr)

NAKAMICHI CR7, mint condition, instructions, remote, boxed. £650. Rogers LS3/5A 15ohm, good condition. £550. Audio Research SP9, superb phono stage, boxed, immaculate. £450. Rega Planar 3. £120. Tel: 0771 297 6103 (Apr)

ROGERS LS3/5A (Ser. 012621 A+B) with matching Rogers ABI bass units (Ser. 002703 A+B) on stands. The classic. Beautiful sound. £650. Tel: 01460 78759 (Somerset) (Apr)

RUARK SABRE III speakers, rich walnut. HFC and WHF best buy. One year old. Boxed, superb condition. £600. Tel: 01970 615 386 (Wales) (Apr)

HI-FI REVIEWERS buy these! Tom Evans Linear A. amplifier. £2150. Vibe preamp. £1100. Living Voice OBX-R speakers, maple with Electrofluidics crossover cable. £2050. All immaculate. Tel: Mike 01224 572 370 or Email: dif.af@btinternet (Apr)

AUDION SILVER Night 300B parallel single ended monoblocks. Two years old, in perfect condition with boxes, manuals & receipts £2450. Telephone John 0797 110 6514 for details/photos Aylesbury area (Apr)

SHANLING CDT100 HDCD Valve CD Player. Two years old from Noteworthy Audio, in perfect condition with boxes manuals etc £1050. Telephone John 0797 110 6514 for details/photos Aylesbury area (Apr)

E.A.R. 859 Quality British valve integrated £950 (£2740) Superb sound. Serviced at E.A.R. factory. Owners manual and receipts. Tel: Adrian 0113 252 1016 (or leave message) (Apr)

TRILOGY 902 preamp and matching Trilogy 958 mono blocks power amps £5000. New, boxed, manuals. £1900. Tel: 01772 315 723 (Apr)

GRADO SR60 headphone August 2004 £35 ono. Naim NAC5 cable 7 metres £35 ono. 2x Russ Andrews Powercords £25 ono each. Tel: Andy 07949 383 571 (Apr)

SPENDOR S8E cherry finish speakers. Cost £2000. 5 months old. Can demo. Accept £1000 for quick sale. Clacton on Sea area. Tel: 01255 421 954 or Mobile 07984 851313 (Apr)

TECHNICS SL-PI200 Classic Pro DJ CD player, mint condition, perfect working order. offers. Tel: 07983 619671 (Apr)

LEGENDARY CROWN DC300A power amplifier in superb condition, recently serviced AB+B output configuration. Freq Response DC - 20kHz. T.H.D. 0.0005% at full power. Will drive into any load. 2 x 150 watts into 8 ohms. 2 x 300 watts into 4 ohms. £350. Tel 07932 664480. (Apr)

RARE KOETSU rebuild by Sugano JR. To Platinum standard with diamond cantilever. Offers. Also Urushi Gold with diamond cantilever rebuild unused, £2700 ono. Silver cables better than Siltech. Best leave a message. Phone 07802 843 769 6pm to 7pm (Apr)

NAKAMICHI CR7, mint condition, instructions, remote, boxed. £650. Rogers LS3/5A 15ohm, good condition. £550. Audio Research SP9, superb phono stage, boxed, immaculate. £450. Rega Planar 3. £120. Tel: 0771 297 6103 (Apr)

GUIDELINES FOR BUYING AND SELLING SECOND-HAND EQUIPMENT

FORTHE BUYER

1. Not everyone is honest - Buyer Beware!
2. Don't send cash!
3. Accept no verbal guarantees.
4. Have you heard the item or something similar? If not, why do you want it?
5. Don't pretend to have knowledge - it's your fingers that will get burnt!
6. Is it working? If not, why not?
7. Has it been modified and, if so, have notes been kept?
8. Was it any good in the first place?
9. Don't send cash!
10. If you are in the slightest doubt, arrange an audition (see point 5) If it's too far, wait for another time.
11. Either buy it or don't: vendors are excusably impatient with 'consultation' exercises.
12. Don't send cash!

FORTHE SELLER

1. Not everyone is honest - Seller Beware!
2. Make no verbal guarantees.
3. Even 'nearly new' is still second-hand. If the manufacturer's guarantee is no longer in force, your price should reflect this.
4. There is very little intrinsic value in second-hand hi-fi; it's only worth what someone will pay for it.
5. The best guide to pricing is last month's Classifieds: that a 'classic' was worth £xxx a year or two ago is no guide. Values fall as well as rise.
6. Amateur second-hand dealing is not a big money game: you win some, you lose some.
7. Be prompt with despatch. If in doubt about buyer's bona-fides, either wash out the deal or send C.O.D.
8. There will always be time-wasters; be tolerant within reason!







BUY / SELL HOME CINEMA MULTIROOM INSTALL HI - FI

www.choice-hifi.com

tel: 020 8392 1959 mob: 07768 720456

info@choice-hifi.com



DIY Valve Amplifier Parts - Valves, PCBs, Connectors, Hardware



We stock a full range of valves (tubes) from famous manufacturers. The list below is a selection of favourites. If you don't see what you want - please ring or e-mail. We are happy to match valves on request.

EL84M Russian (Sovtek)	£11.49
EL84 JJ (to Tesla Specification)	£9.75
JJ 300B (popular and reliable)	£83.50
EH300B Gold Grid	£69.00
Svetlana KT88 (outstanding)	£36.50
Sovtek 6550 WE	£19.49
Sovtek 5881	£12.49
EL34 ElectroHarmonix	£11.85
EL34 JJ (balanced and precise)	£15.49
5U4G Sovtek	£9.94
GZ34 JJ	£16.99
5687 WB Philips NOS (gutsy)	£12.49
Svetlana 6N1P	£6.50
6SN7GT EH (to RCA spec)	£10.25
ECF80 EI	£7.30



VALVE BASES

B7A Chassis Mount	£4.70
B9A Chassis Mount	£4.70
B9A PCB Mount	£4.70
Octal Chassis Mount	£4.70
UX4 Chassis Mount	£16.98

BOOKS

Valve & Transistor Audio Amps by John Linsley Hood	£24.50
Self on Audio by Douglas Self	£26.50
Valve Radio & Audio Repair Handbook by Chas E. Miller	£22.50

Valve Amplifiers by Morgan Jones	£29.50
Building Valve Amplifiers by Morgan Jones	£19.50
Life & Works of A.D. Blumlein by R.C. Alexander	£18.00
Understand Amplifiers by Owen Bishop	£19.50
Audio & Hi-Fi Handbook edited by Ian Sinclair	£34.50



Eichmann Bullet Plug phono plugs - pack of 4	£25.00
Neutrik Professional Gold Plated phono plugs - pack of 2 - Red/W	£1.69
Gold plated, teflon insulated phono sockets - pack of 2	£4.75
Silver plated speaker terminals pack of 2	£9.40
Twin speaker Terminal Set chassis insulated - Red/Bk	£2.94
Chassis mount earth post nickel plated	£1.23



ALPS Blue Beauty 50k dual log pot.	£13.69
ALPS Blue Beauty 100k dual log pot.	£23.00
Stereo carbon track 100k dual log pot.	£2.95
Cermet 'Humbucker' 2W at 70 C 22R or 100R linear pot.	£8.99
6 way Selector Switch 2 pole 6 way rotary wafer	£1.88
AC 'mains' chassis switch DPST 4A silver contacts	£1.99



Hardwire Tag Board twin rows of 18 tags	£2.33
Switched IEC AC 'mains' inlet chassis mount with fuse	£2.88
Unswitched IEC AC 'mains' inlet chassis mount with fuse	£2.34
UK IEC AC 'mains' cable fitted with fused plug, 2m length	£5.36

PRINTED CIRCUIT BOARDS

HD83 Headphone II	£16.25
Phono II phono stage	£16.25
PSU II power supply	£16.25
Pre II preamplifier	£16.25
KEL84 Power amp	£24.98



POWER SUPPLY PARTS

UF5408 700V 3A rectifier diode ultra-fast recovery	£1.25
Cree CSD4060A rectifier diode Schottky 600V 4A	£6.75
Jensen 4700uF 16v DC 4 terminal electrolytic	£25.85
RIFA 47uF 100V DC PEG Axial Al Electrolytic	£2.99
RIFA 100uF 100V DC PEG Axial Al Electrolytic	£4.25
Polyester 0.1uF 630v DC WIMA Metalised film	£0.55
Polyester 0.47uF 630v DC WIMA Metalised film	£1.29
Panasonic FC 220uF 500V DC Low ESR Al electrolytic	£8.95
Bridge Rectifier 25A 700V 28.5mm x 7.5mm	£3.25

We stock a wide range of parts to facilitate the build of valve amplifiers. Please ring or e-mail for details. See our on-line catalogue at World Designs, 59 Main Street, Great Gidding, Huntingdon, Cambs, PE28 5NU

trade ads

PLEASE NOTE:
**ALL TRADE ADS WILL
 APPEAR IN THE
 DIAL-A-DEALER SECTION
 BEGINNING IN NEXT
 MONTHS ISSUE!**

SLIM DEVICES Squeezebox ultimate power supply upgrade. Replace the Squeezebox switching power supply with a wide bandwidth, low noise, fast transient response linear regulated power supply. 01931 712822, paulhynes@freezone.co.uk, paulhynesdesign.com (Jun)

VINYL LP's Wanted. Folk, Rock, Jazz, Blues, Reggae, Soul, Classical. Must be in excellent condition. See website for more information. Phone:- 0845 094 1997 Lists:- tantrel@bigfoot.com Website:- http://www.tantrel.com/ (Apr07)

AMAZING CABLES! DIY or ready made solid silver interconnects, speaker cables and powercords, with world-class connectors. True high end performance at real-world prices. Sole UK agent for Voodoo Cable of Germany - www.voodoo-cable.com Tel. 0115 982 5772 after 7pm. Email: bob@skydivers.co.uk (Aug)

FOR SERVICE, Repairs, Upgrades and Re-Manufacturing of all valve audio equipment. Leak Troughline specialists, realigned etc. For more information contact E.F.G. (London) Ltd inc. E. Gane and Son Est 1948 on 020 8743 2727 (Apr)

RARE, DELETED and new vinyl records for sale. Free monthly 20 page catalogue. 1000s of vinyl LPs, EPs & 45s. 99% ex to mint condition - all at fair prices with many bargains! 60's & 70's Rock, Pop, Jazz, Folk, Soundtracks, Blues, Psychedelic & Progressive. Selling vinyl since 1989. Do not miss out. Write or phone: Sugarbush Records (HFW), 8 Hawkenbury Road, Tunbridge Wells, Kent, TN2 5BJ, UK. 01892 541 746. Or browse website: www.sugarbushrecords.com (Apr)

REVOX SALES Service Tape Supplies. PR99 MkIII £1200. MkII £950. B710 £500. B760 £450. B67 £450. A810 £750. A80VU £1200. A807VU £1200. A710 £500. A807 £500. Tel: 01246 275 479 (Apr)

AUDIO VALVES. Over 100 types. Stock list available. Wilson Valves, 28 Banks Avenue, Golcar, Huddersfield, HD7 4LZ. Tel: 01484 654 650. Fax: 01484 655 699. Email: wilson@zoo.co.uk (Apr)

AUDIOPHILE OBJECTIVE for New, X-Display and Preowned Hi-Fi. Regular brands and some not so known. We're 5 miles south of Stansted airport in Sawbridgeworth. Free Parking. Tel: 01279 724 024. Hi-Fi Purchased. (Jul)

AUDIO SHED. Top quality hi-fi for sale. Beauhorn, Croft, Voodoo, Headlund Horns, Experience Filtration, H-Cap, Cut Loose Audio, Canary Audio, Omega speakers etc. Blackgates and Audio Valves also available. Please call 01923 828 765 or 07900 918 882 (Apr)

AUDIOPUBLIC, 78 Otley Road, Headingley, Leeds, 0113 217 7294. Yorkshire's newest Hi-Fi retailer, stockists of Naim Audio, Rega Research, Conrad Johnson, Sugden, Dynavector, (cartridges and amplifiers) and many more. Please call for advice. (Apr)

EX DEMONSTRATION Klipsch loudspeakers. Klipschorns Oak £3000. La Scalas black £1500. Heresys walnut £750. KG5.5 black £550. KG4.5 black £450. KG3.5 black £350. Midland Radio Supplies. 0121 706 0313 (Jun)

BRILLIANCE SYNERGY - 2006 What Hi-Fi best stereo interconnect award. Praised by HFW and included in HFC Buyer's Bible. Demonstration cables available. Contact Mike on 07963 117 341 or see www.brilliancehifi.co.uk for dealerships. (Apr)

**- WANTED -
 EARLY HI-FI
 CLEAR CRYSTAL SYSTEMS**
 John Petrie-Baker
 Tel: 020 7328 9275

BUILD YOUR own single ended Class A amp. Better sounding than most £2k+ models. Simple build. Kit available. Download this design and other articles free from:- www.inline-electronics.co.uk (Apr)

STUDER 807 Reel to Reel two track professional tape recorder, balanced connections, in good condition. Heads replaced, re-calibrated, minor scratches on back of metal casework, otherwise clean. Controls function perfectly. Due to weight - very heavy - buyer advised to collect when purchasing. £650.00 ovno. M & J Design Ltd (Music) Tel: 01628 622115 or Email: John501hifiman@aol.com (Apr)

SUPERB balanced or phono interconnects made to your required lengths. As Hi-Fi enthusiasts, we started making cables several years ago, listening tests over the last three years guided us in our direction and choice of materials. We use only silver plated pure copper wire, from the outset these were configured to reject interference and present the cleanest and clearest sound possible for the signal, the end result being sublime listening pleasure. Each stereo pair of cables are serial numbered, with their own instructions and are guaranteed. M&J Design Ltd (Music) Tel: 01628 622115 or Email: John501hifiman@aol.com



Visit the web site today to apply for our **NEW Hi-Fi Show Loyalty Card.** Your exclusive pass to all our uk hi-fi shows.



01219 740 650
 www.chestergroup.org



BUY/SELL



HOME CINEMA



MULTIROOM INSTALL



HI - FI

www.choice-hifi.com

tel: 020 8392 1959 mob: 07768 720456

info@choice-hifi.com

NEXT MONTH

May 2007's Hi-Fi World springs into action with a host of weird and wonderful products for your pleasure, from affordable to exotic! Here's just some of what we hope to bring you...

SIMON YORKE S9 TURNTABLE **EXCLUSIVE!**

AESTHETIX RHEA PHONO STAGE

SHANLING SCD-T2000 CD/SACD PLAYER **(PICTURED)**

ORIGIN LIVE ENTERPRISE TONEARM **EXCLUSIVE!**

ECS AUDIOPHILE LINE PREAMPLIFIER

AUDIOFLIGHT 2 INTEGRATED AMPLIFIER

ORTOFON 2M MOVING MAGNET CARTRIDGES **EXCLUSIVE!**

HARBETH HL COMPACT 7ES-3 LOUDSPEAKERS

CAMBRIDGE AUDIO 740A INTEGRATED AMPLIFIER

OLDE WORLDE: MORDAUNT SHORT 442 LOUDSPEAKERS

LEHMANN BLACK CUBE LINEAR USB HEADPHONE AMPLIFIER

MID-PRICE CD PLAYER SUPERTTEST:

CAMBRIDGE AUDIO 840C

ROKSAN CASPIAN M1

LECTOR CDP0.6T **EXCLUSIVE!**

VINCENT CD-S6



**PICK UP THE MAY 2007 ISSUE OF HI-FI WORLD ON SALE MARCH 30TH, OR
SUBSCRIBE AND GET IT DELIVERED TO YOUR DOOR: p76**

ADVERTISERS INDEX

2ndhand hifi	113
Anatek Acoustics	109
Angel Sound	6
Audio Xpress	114
AudioCraft	110
B&W	BC
Big Ears	122
Billy Vee	106
Chesterfield	66,67
Choice Hi-Fi	125,127
Classique Sounds	111
Dali	34
Decent Audio	115
Densen	24
English Valve Amplifiers	108
Flying Mole	58
Heathcote	112
Heatherdale Audio	115
Henley Designs	54,78
Hi-Fi Sounds	113
High End Cable	116
Ian Edwards	115
Ian Harrison	114
iCube	44
Kudos	115
Langrex	108
Linn	16
Mantra Audio	111
Matrix	110
Michell Engineering	22
Midland Audio Exchange	117
Naim	42
Oehlbach	110
Origin Live	38,114
Pinsh	16
Pinsh	22
Pioneer	IFC
Podium	44
Pressblog	112
Quad	84
Retro Reproduction	109
Rochester HiFi	116
RPM	123
Select	IBC,18
Select Audio	BC
Sevenoaks	28,29,30,31
Shadow Audio Cons.	56
Signature Audio	38
Slim Devices	12
Sounds of Music	123
Stamford Audio	88
Tangent	44
The Missing Link	109
The Right Note	82
Trichord Research	111
Tube Shop	110
Turntable World	113
V'Audio	116
Walrus	80
Whest Audio	58
World Design	64,124,126

FREE READER CLASSIFIED ADS ORDER FORM

STOP PRESS

PLEASE NOTE:
FROM NEXT MONTH THE TRADE
CLASSIFIED ADVERTS WILL MOVE
TO THE DIAL-A-DEALER SECTION.
PLEASE PHONE 020 7372 6018
FOR BOOKING DETAILS.

TERMS AND CONDITIONS: Maximum length per advert is 30 words, Adverts over 30 words will not be accepted. Telephone numbers and E-mail addresses are treated as one word. Model numbers are treated as one word i.e. Quad 303 = two words. Only one advert per reader. Sorry, we cannot accept adverts over the telephone. The Publisher reserves the right to judge submissions

You can email your advert to us at: classifieds@hi-fiworld.co.uk
or write or type your advertisement copy in block capitals with one word per box and post it to us at: Hi-Fi World Free Readers Ads,
Unit G4, Argo House, Kilburn Park Road,
London, NW6 5LF.

WE WILL ACCEPT PHOTOCOPIES OF THIS FORM

1	2
3	4
5	6
7	8
9	10
11	12
13	14
15	16
17	18
19	20
21	22
23	24
25	26
27	28
29	30

Name _____

Address _____

Post Code _____

Daytime Tel: _____

FREE READER CLASSIFIED ADVERTS COPY DEADLINES

MAY 2007 - 9TH MARCH 2007

JUNE 2007 - 5TH APRIL 2007

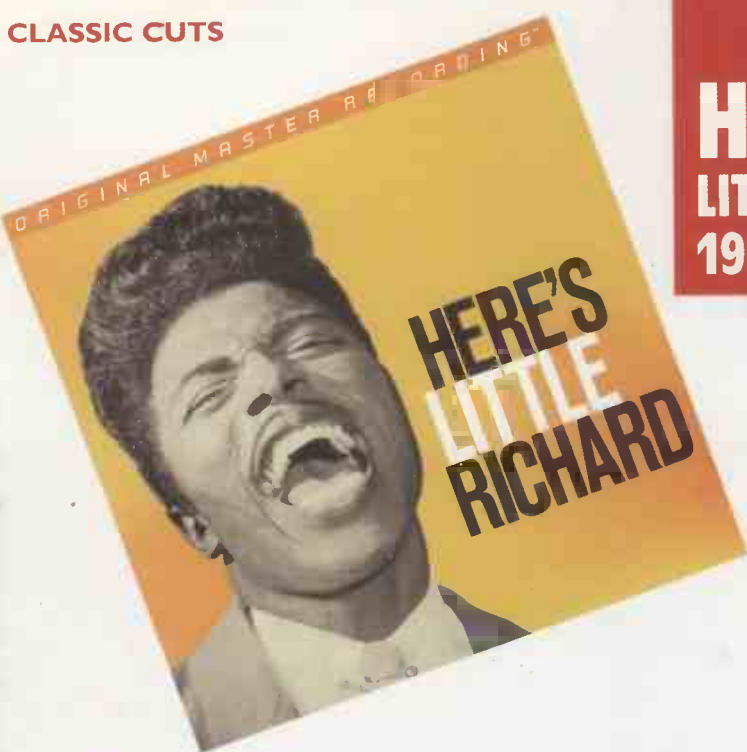

HERE'S LITTLE RICHARD

LITTLE RICHARD

1957/1958

From one of the greatest entertainers of modern times, a true legend and an influence on all modern musicians to an extent, this release includes two Little

Richard albums and features genre classics such as 'Tutti Frutti', 'Ready Teddy', 'Long Tall Sally', 'Good Golly, Miss Molly' and 'Lucille'.

Mobile Fidelity's A&R man Michael Grantham, the in-house musicologist, helped source the mastertapes which were originally recorded on the Speciality label, owned by Fantasy but, as all masters have done over the years, they moved from pillar to post. In this case, the Concord label now own them.

The masters were well preserved, however. They even include work invoices. You can see where a tape has had added echo or EQ. Remember too that these songs were singles, and never meant to reside on an LP, originally. Hence, they were recorded all over the place, and they sound like it too. Some were recorded in Los Angeles, some in Louisiana and some in various radio stations.

This new release has been mastered from original mastertapes of EP and single sessions, by Shawn Britton, Chief Mastering Engineer at Mobile Fidelity. He explained that, "We got lucky in finding the Little Richard tapes. I have eight different reels here. I listened to each and every take of each song. One of the songs, for example, included four different demos. You have to listen to each, note for note, to find the original version."

"for anyone interested in Little Richard on vinyl, Mobile Fidelity is the only way to go..."

Of course, the first problem was the tape condition, "Every splice came apart, the adhesive dried out on all the splicing tape. Also, this is old acetate-based tape which is very brittle - not like the modern polyester-based tape." Which resulted in some careful tape recorder work by Britton. For example, when the take-up reel on the right of the tape machine is accumulating tape, if a splice then breaks, the take-up reel accelerates at a great rate of speed with the tape flapping at the end of the reel.

"With acetate tape," said Britton, "you really don't want that to happen because this particular tape type can actually shatter. So when that happened, I'd have to jump in and grab the reel as quickly as possible and splice the tape back together. You can judge when a splice is coming off the supply reel, though. You can see it moving across."

This was helped by a heavily modified Studer A80 tape machine, a precise transport that's very gentle on tape. In fact, you can adjust the torque on the wind-off motors and also adjust how much tension is being applied as you wind the tape.

This is only part of the job, however. "When I look at the sonic characteristics of a tape I'll play it at half speed so I can check the tape azimuth before and after a splice." This is because the original artist will have often mixed the same music on different days. It doesn't mean,

however, that on day one they will record the same tape on the same machine with the same alignment as they might on day two, "It's a good idea, therefore," added Britton, "to check the azimuth on both sides of a splice. You can gauge that on an oscilloscope - especially at half speed."

For the final release, this Little Richard release needed sensitive EQ help to make the album sound consistent because of the different recording times and locations. Sensitive because there is a problem using EQ, as Britton explains, "Let's say you feel that you need to process a vocal around 4,500-5,000 cycles per second. When you smooth that out, that EQ will also affect the sax solo and the guitar, the snare drum and everything else that falls within that band. It's a trade-off. Too much processing results in 'riding' EQ throughout a record. You only really do that to awful recordings. It actually causes smearing. You can hear the EQ coming in and out. For some titles, though, it can't be helped. It's damage control - like how I cook dinner." After a thoughtful pause, Britton added that, "I could set fire to a salad".

It goes without saying that, for anyone interested in Little Richard or the historical music of this period, Mobile Fidelity on either audiophile, half speed vinyl (which should be out as you read this) or SACD, is the way to go. **PR**



feastrex
a journey into space-time

BASIS
B

Reimyo Harmonix

EMT

luxman

Acoustic
Signature

AIR
TIGHT

AirTight
Emillé
Luxman
Melody
Reimyo
Acoustic Signature
Basis
EMT
Feastrex
Gershman
King Sound
Basis PSTT Cables
Boston Audio
Harmonix



Emillé
300BSE

A. Gershman Black Swan
B. Reimyo DAP-777
C. Reimyo PAT-777
D. Basis Vector Tonearm
E. EMT JSD Cartridge
F. Luxman 509F
G. Basis PSTT Cables

H. Basis 2800 & Vector Arm
I. Feastrex Coaxial Drive Unit
J. AirTight ATM300B
K. Feastrex D6
L. Harmonix TU-220MT
M. Harmonix HS-101 SLC
N. Emillé 300BSE

AudiLincs T. 01476 591090
Brighton Hifi Ex. T. 01580 878101
Retrò Reproduction T. 0131 558 9989

Grass Dance T. 01764 650573
Hazelmere T. 01494 865398
Walrus T. 0207 7247224

The Sound Surgery T. 01392 662920

B&W Bowers & Wilkins

The new B&W 800 Series
Incorporating B&W crossover technology



> **CLEANSSED**

Audio signals are like spring water. The further they flow from their source, the greater the risk to their natural purity and vitality. Like a glass of cool, clear water, fresh from the stream, nothing compares to hearing music with the cleansing clarity it was created with.

At B&W, we like to get listeners as close to the source as possible. The signal path in an 800 Series speaker couldn't be any shorter, simpler or sweeter. By optimising, in every detail, the mechanical design of the drive units, we minimise the need for extra electrical components in the crossover. Less quantity, more quality. Every component we do use is handpicked after painstaking listening tests. Together in the 800 Series crossover, they deliver sound with every original nuance and texture intact.

Not all water tastes the same. No other speakers sound like the 800 Series.

www.bw800.com

Visit our website and order your free DVD
Call +44 (0)1903 221 500



Only 800 Series models with this symbol use
B&W diamond tweeter technology