

P. Jones

SUBSCRIPTION OFFER
FREE BEYERDYNAMIC DT 231
GALACTIC HEADPHONES
see p126

hi-fi

MARCH 2006

UK £3.60

WORLD

INTO THE GROOVE

Funk Firm Vector turntable tested **NEW!**

COMPETITION

win a ZYX R-100H MC cartridge!

TURNTABLE GROUP TEST

PRO-JECT X-PACK, MICHELL TECNODEC,
ROKSAN RADIUS 5 & MARANTZ TT-15S1

VINYL SPECIAL ISSUE:

- AQVOX 2CI PHONOSTAGE
- ULTIMATE VINYL ACCESSORIES
- MOTH INCOGNITO ARM REWIRE
- TRICHORD DIABLO PHONOSTAGE **SCOOP**
- RECORD TIME: HISTORY OF THE LP
- ESSENTIAL TURNTABLE SET-UP GUIDE
- ZYX R-100H MOVING COIL CARTRIDGE
- GOLDRING Lenco GL99 REDISCOVERED
- REVOX B795: CLASSIC PARALLEL TRACKER
- JULIAN VEREKER'S PHONOSOPHIE NO.3 TURNTABLE

10 PAGES OF HI-FI Q&A * CLASSIFIED ADS

World Radio History

MARCH 2006



9 770961 766154

INTENSE

The RA-03 integrated Amplifier



Individually, Rotel's O2 Series products will make a striking difference to the way you hear music.

The RA-03 integrated amplifier, for example, is the latest in a long line of Rotel products that have benefited from meticulous component selection, painstaking refinement and balanced design. When partnered with the RCD-02, though, it's a match made in HiFi heaven. The chemistry is instant, and a powerful listening experience.

Get them connected.

To find out how the Rotel O2 Series can take you to the world's greatest musical menus, visit www.rotel.com.



B&W Group Ltd., Dale Road, Worthing, West Sussex BN11 2BH, United Kingdom, 01903 221 500

World Radio History



welcome

EDITOR

David Price
tel/fax: +44 (0) 1275 371 386
e-mail: editorial@hi-fiworld.co.uk

DESIGN EDITOR

Faiza Chunara
tel: +44 (0) 20 7625 3129
fax: +44 (0) 20 7328 1844
e-mail: adproduction@hi-fiworld.co.uk

PRODUCTION EDITOR

David Noble
tel: +44 (0) 20 7625 3134
fax: +44 (0) 20 7328 1844
e-mail: classifieds@hi-fiworld.co.uk

ADVERTISING

Debi Silver
tel: +44 (0) 20 7372 6018
fax: +44 (0) 20 7328 1844
e-mail: advertising@hi-fiworld.co.uk

ACCOUNTS

Sharon Mehlhom
tel: +44 (0) 20 8841 8892
fax: +44 (0) 20 8841 9144
e-mail: accounts@hi-fiworld.co.uk

WORLD AUDIO DESIGN

www.worldaudiodesign.com
tel: +44 (0) 845 257 5600
e-mail: sales@worldaudiodesign.com

PUBLISHER

Noel Keywood
e-mail: publisher@hi-fiworld.co.uk

PRIVATE & TRADE CLASSIFIEDS

tel: +44 (0) 20 7625 3134
fax: +44 (0) 20 7328 1844
e-mail: classifieds@hi-fiworld.co.uk

SUBSCRIPTIONS

tel: +44 (0) 1442 879097
fax: +44 (0) 1442 872279
e-mail: hifiworld@webscribe.co.uk

WRITERS

Dominic Todd
Channa Vithana
Paul Rigby
Steve Green
John May
Neal Gibbons
Neville Roberts

hi-fi world

SUITE G4, ARGO HOUSE
KILBURN PARK ROAD
LONDON NW6 5LF
www.hi-fiworld.co.uk

testing

Hi-Fi World has its own advanced test laboratory and acoustically treated listening room, and a dedicated team of experienced listeners. We review thoroughly by extensive auditioning, rather than by quick-fire group listening tests. Our engineering team designs a wide range of products in-house. No other hi-fi magazine is so expert and dedicated.



The future, it seems, is digital. These days, it's hard to pick up a newspaper or magazine and not read about how downloading is transforming the music business...

But there's one format that, according to the Recording Industry Association of America (RIAA), has doubled in percentage of music sales since 2000 to become a multi million dollar industry - vinyl.

Funny, isn't it, how the media's bastions of customer taste seem obsessed over the success of iPods, digital downloads, et al., whilst largely ignoring a fast growing (but admittedly niche) format?

Of course, it would be mischievous to suggest that because the turntable was (essentially) invented in 1887 by Emile Berliner, it is no longer newsworthy... The iPod, on the other hand, is driven by a massive media and public relations machine with megabucks spent on TV, magazine and poster advertising.

So obvious is vinyl's resurgence that even in the area of singles, one where downloads have decimated CD single sales (down 24%), seven inch black plastic sales have grown by 87% in the UK from April 2004 to 2005 [source: BPI]!

Whilst digital downloads now seem to cater for average music buyers, vinyl singles are thriving with rock acts like Franz Ferdinand, Kaiser Chiefs and Iron Maiden. This suggests that vinyl buyers are mad about music (and vice versa), and so is this magazine - which is why this issue is devoted to the 'black stuff'.

Reports of vinyl's demise, as they say, have been greatly exaggerated. Certainly, the hi-fi industry is doing cracking business from black plastic, and there's never been a better time get into analogue.

Indeed, there's a wealth of stunningly styled, innovatively designed affordable audiophile kit available now, not least Funk Firm's Vector turntable (p10) which we put against some redoubtable rivals from Pro-ject, Roksan, Michell and Marantz (p15).

Elsewhere we have the story of vinyl (p34), a comprehensive guide to getting the best from it (p50) and a round up of the best accessories (p63). There's a range of kit on test, from Trichord's superb Diablo phonostage (p26) to Zyx's great new R-100H moving coil cartridge (p45).

I suspect that analogue addicts will love this issue, but I hope it also helps digiphiles unlock the possibilities of this quirky, loveable and superb sounding format, so they too can cross the vinyl frontier!

David Price, editor

verdicts



OUTSTANDING
EXCELLENT
GOOD
MEDIOCRE
POOR
VALUE

simply the best
extremely capable
worth auditioning
unremarkable
seriously flawed
keenly priced



Distributed by Seymour Distribution Ltd 86 Newman Street London, W1T 3EX Tel: +44 (0) 20 7396 8000 Printed by St.Ives, Plymouth Tel: +44 (0) 1752 349 413
Our Agents in Malaysia Millennium Hi-Fi & AV Simon Chang Showroom & office, 500-1-3 First Floor Wisma Indah (Shen Court), Jalan Tun Razak 50400 Kuala Lumpur, Malaysia
Tel: 603 9283 8171 Fax: 603 9281 3762 e-mail: info@millennium-audio.com

All unsolicited submissions and goods are at the owner's risk. We accept no responsibility for such submissions, nor do we undertake to return them.
No material may be reproduced from this magazine without the publisher's written permission. © Audio Publishing Ltd

10

Funk Firm Vector - an important new affordable audiophile turntable



57

Phonosophie N°3 - Naim Audio's Julian Vereker swore by his...



72

The mighty Revox B795 - classic seventies parallel tracker

6

Trichord's new Diablo - one of the best phono stages around



41

AQVOX 2C1 - interesting mid-price phono stage with balanced operation



15

Michell TecnoDec - still groovy after all these years (well, two)...

VINYL SPECIAL ISSUE

P-FUNK 10

Channa Vithana auditions the important new Funk Firm Vector turntable...

FEELING GROOVY 15

... and then puts it against four turntable/ tonearm packages from Pro-Ject, Michell Engineering, Roksan and Marantz.

TWO'S COMPANY 26

David Price auditions Trichord Research's brand new Diablo phonostage.

BIRTH OF THE COOL 34

Neville Roberts tells the vinyl story, from its historic beginnings to the present day.

VOX POP 41

Noel Keywood thinks the AQVOX 2C1 balanced phonostage should win friends...

ZYX APPEAL 45

The esoteric Zyx R-100H moving coil cartridge gets an audition from Noel Keywood.

ARMED FORCE 49

David Price looks at the Moth Group tonearm rewiring service.

GETTING INTO THE GROOVE 50

Noel Keywood has this comprehensive guide to buying, matching, setting up and tuning a turntable.

JULIAN'S TURNTABLE 57

Channa Vithana hears the Phonosophie N°3 - turntable of choice for Naim boss Julian Vereker.

WAX FACTORS 63

David Price runs through some of the best specialist vinyl accessories...

VITAL IDLE 67

Goldring's classic GL75/GL99 turntable is well worth pursuing, thinks Neal Gibbons...

PARALLEL UNIVERSE 72

David Price tells the story of Revox's legendary turntable, the B795.

DIY FEATURE PART 2 83

In the second in a series of articles, Peter Comeau details a stunning new loudspeaker from World Designs.

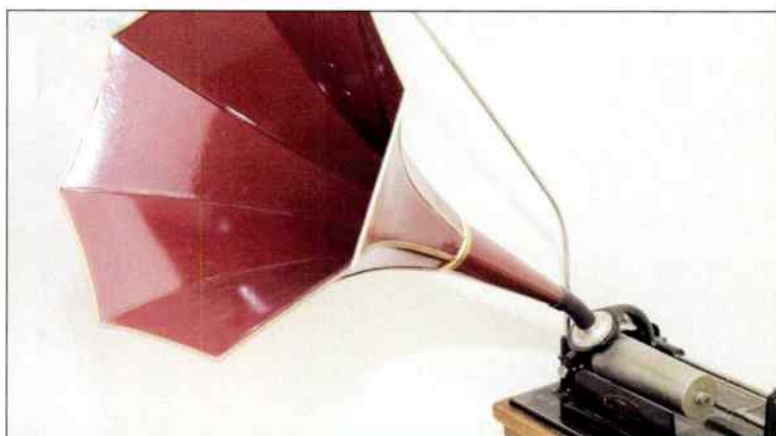

34

7 NEWS

Words from the front...

71 COMPETITION

Your chance to win the superb ZYX R-100H moving coil cartridge!

74 AUDIOPHILE VINYL

Paul Rigby rounds up four of the best new audiophile vinyl releases.

77,79,81 OPINION

The team get to grips with matters music, hi-fi and life!

91 WORLD STANDARDS

Our fave raves - the latest and greatest from the world of hi-fi.

98 KIT & COMPONENTS

Purveyors of specialist hi-fi services.

99 MAIL

Ten pages of your views and comments.

118 DIAL-A-DEALER

A comprehensive guide to UK hi-fi retailers.

120 SPECIALIST HI-FI DEALERS

Purveyors of specialist hi-fi services.

121 MEET YOUR MAKER

Who makes what and how to get in touch.

125 CLASSIFIEDS

Five pages of second-hand bargains.

126 SUBSCRIPTIONS

Ensure your copy every month and save money too.

128 NEXT MONTH

But a small selection of what we hope to bring you in the next sizzling issue.

129 ADVERTISERS' INDEX

130 CLASSIC CUTS

Paul Rigby pens a paean of praise to Leftfield's 1995 club classic 'Leftism'.

SUPER NATURAL BALANCE



TAKE A STAND: HELICON 300

"They ooze finesse, and deliver generous doses of authority and scale. If that sonic character appeals, take a listen to them. You will be impressed."

What Hi-Fi | Sound & Vision







"This is a delicious loudspeaker that's very easy to like, because of the way it projects and communicates the music with a fine combination of delicacy and enthusiasm."

Paul Messenger | Hi-Fi Choice

"There are very few loudspeakers - even at considerably higher prices - that can reproduce triangles, cymbals or acoustic guitar so breathtakingly..."

Holger Biermann | Stereoplay

FEATURES

-  Wide Dispersion
-  3D Audio
-  Low Resonance Cabinets
-  Time Coherence
-  Hand Crafted
-  Amplifier Optimised

[HELICON300 STAND AVAILABLE]

IN ADMIRATION OF MUSIC

DALI UK +44 (0)845 644 3537 ■ DALI USA +1 360 733 4446 ■ DALI Deutschland +49 6028 4390 ■ DALI Denmark +45 96 72 11 55



www.dali.dk

World Radio History

news@hi-fiworld.co.uk

news

CLASS ACT

At CES Marantz announced the £350 PM7001, the successor to the PM7200. Their declared aim is to get the very best out of Class B performance in a slimline enclosure. The oversized transformer supplies 70W per channel leading to claimed low-end improvements. Discrete channel circuitry is said to give great imaging. Component-wise the latest versions of Marantz's High Definition Amplifier Modules, HDAM-SA2 are employed. Excitingly the £550 PM7001KI amplifier is the first component to be fine-tuned by Ken Ishiwata in over in two years. Ken's improvements include reshaped power handling characteristics through the use of a high-grade power supply, and the anticipated copper-plated and reinforced chassis. For more information, click on www.marantz.co.uk

MOVIE STAR

Three years after launch, the Linn Klassik Movie System is becoming an enduring favourite in the arena of all-in-one home theatre solutions. It has now received its first major facelift and quite swish it looks too! Functionality covers the usual DVD player, CD player and AM/FM tuner bases, but there is no space for high-resolution formats. Available in black or white, or even in silver and graphite to go with their ideal loudspeaker complement, Linn's KOMPLEMENT speakers, it sports two RJ45 connectors for multiroom, which also allow the CMS to be integrated into an installed setup using Linn's Knekt technology. UK pricing is set at £2,750, and further details can be obtained from your local Linn stockist or www.linn.co.uk, or phone 0161 7661021.



HEADY STUFF

Pathos Acoustics have named their new CD player Endorphin, as they think it can reproduce that natural Dopamine high by spinning your favourite music better than ever before! Along with the stunning styling, it includes dual 24/192 DACs, a tube analogue stage and balanced analogue outputs in addition to single-ended analogue and both coaxial and optical digital. Dimensions are 480x400x100mm. The Endorphin is not expected until April, and there is no UK pricing as yet, but indicative dollar pricing is \$7,950. For more information, click on www.pathosacoustics.com.



RECEIVING LOUD & CLEAR

Denon's AVR-170S has received several upgrades to constitute the new AVR-1706, a 7.1 110W channel A/V receiver of considerable ability at a great value point. A new high-performance 32bit DSP has been supplied and all surround processing is carried out at 96kHz, including Dolby PLIIx and DTS Neo:6. All audio DACs run at 24/192, and it is possible to bi-amp the front speakers if required. The power supply as also been upgraded too, plus HD-ready component video inputs and a 7.1 pre-out. All in all a substantial bargain at £249.99. Phone 01234 741 200 for more details or click on www.denon.co.uk.

CABLE IXOTICA

IXOS have spent ten years at the forefront of cable design, patenting their cable geometry, winning many awards, with expanding business a around the globe. Their new IXOTICA line of interconnects is said to be the pinnacle of those developments, and they do look very tasty indeed. Hand-terminated, they are available in both balanced and single-ended RCA versions, and there is also a matching TOSLINK cable. Prices range from around £150 for the IX1 level to around £500 for IX3. Have a look at their website www.ixos.co.uk, which will also help you locate a local dealer.



SOLO ACCOMPANIMENT

The stakes are constantly being raised in making the best use of the iPod's potential for integration, and Arcam will lift the bar with their £60 rLead, which is to be launched at the Bristol Hi-Fi show, but is already available in stores. RLead ticks all the right boxes, feeding the audio at line level, charging the iPod (from a USB socket or iPod USB power adaptor), displaying track information and allowing Solo remote control of the iPod. This will work with all Solos and any iPod which has the standard thirty pin connection (only generations one and two, and iPod Shuffles can't join the party). For more information, click on

www.arcam.co.uk

INSTALLERS IPOUT IPODS!

iPort have been around for a couple of years now, but their latest IW (In Wall) series products add infrared remote control, two-way RS232 control (allowing iPod metadata display) and the ability to send balanced video over distance, keeping them up to speed with the latest developments in the iPod's capabilities. Upgradeable mother boards also ensure that they should continue to do so for all but the entry level IW-1 (£195), which is unbalanced and intended for local room usage. IW-2 (£345) gives you the IR remote iPort and makes the upgrade options accessible. iPort is distributed by www.armourhe.co.uk, contactable on 01279 501111, but perhaps a good first port (groan!) of call for you installation-type people would be your local, friendly CEDIA installer.

LINN-DEPENDENCE DAY

To mark twenty five years of Linn at Peter Tyson Hi-Fi (Tullie House, Castle Street, Carlisle CA3 8TP), there will be a two day event featuring a speech by Ivor Tiefenbrun MBE - Linn's founder and Managing Director - on March 3rd and 4th. On show will be products from Linn throughout the ages, musical presentations and Linn Records. All enquiries to Mathew Tyson on 01228 546756.

HI DEF

Dolby Laboratories used January's CES show to display their latest range of surround technologies, which are about to descend on us when those fabled new High Definition disc formats finally arrive. The big real-life step-up with Dolby TrueHD is the ability to supply 7.1 channels of surround sound losslessly from disc, although the format can theoretically support up to 14 channels. It's not all about the disc formats either, as versions of Dolby's new codec will also soon be found in PCs, Xbox360, HD Broadcasts and even cars. Benefits of the new codec are even available to those with older A/V receivers, as Dolby Digital can be supplied from the new disc formats at 640kbps, which is nearly 200kbps over the current DVD-Video spec maximum. Of course legacy analogue inputs will also allow for lossless surround as they did back in the days of good old DVD-Audio, and for the high end, there's always 7.1 lossless through HDMI!





SHOWTIME!

Hi-Fi World will be attending the forthcoming *Bristol Sound & Vision 2006 Show* (Friday 24th – Sunday 26th February 2006) with another fantastic Subscription offer. This year we have joined forces with Beyerdynamic and are offering our readers a pair of the ever-popular DT231 Galactic Stereo Headphones with a retail value of £39.95! So for all new subscribers, why not take advantage of this offer and receive not only 12 issues of *Hi-Fi World* but a pair of Beyerdynamic Galactic headphones as well, and all for £40.00! This offer is only available at the Bristol Show so don't forget to come and see our team on the Mezzanine Level outside 'The Conservatory'. World Designs will be demonstrating the WD25A Loudspeaker Kit as featured in *Hi-Fi World's* DIY Supplement so pop in, have a chat and a listen! World Designs will be in Room 215. The venue is the Bristol Marriott City Centre Hotel, Lower Castle Street, Bristol, from 10am – 5pm every day, and prices are £7 for adults, £3.50 for Students/Senior Citizens; accompanied children under 16 get in free.

Also, grab the chance to enter our Showtime competition to win a pair of Beyerdynamic DT880s worth £199.95.



DARED TO BE DIFFERENT

Dared are a Chinese company making a wide range of distinctive, affordable valve amplifiers, and their wares are now available in the UK via Northern Ireland-based Kronos Hi-Fi. The range of products includes seven integrated amplifiers (SE and PP), a valve headphone amplifier, three preamplifiers and six power amplifiers (SE and PP). Prices start at £450 for the integrated amps and a pair of 300B mono blocks is under £1000. Have a look at www.kronoshi-fi.co.uk for more details, including a 30 day trial for Dared amplifiers, and they are also contactable by e-mail at David@kronoshi-fi.co.uk.



ISONGBOOK FOR IPOD

The new Tivoli iSongBook looks like the ultimate solution for quality mobile iPod music when out and about. Based on Tivoli's songbook clock AM/FM radio alarm, it boasts many innovations such as a retractable dock, a detachable second speaker and the ability to wake up the iPod for alarm purposes. There is also a credit card-sized remote that can control iPod Album and Playlist features. The unit takes six AA batteries and even includes an integrated charger for rechargeables. The iSongBook is available now for £299 from John Lewis and other department stores as well as specialist retailers. Click on www.ruark.co.uk for more details, or contact Alan O'Rourke, alan@ruark.co.uk, tel: 01702 601410.

QONDUIT MAINS BUSINESS

QED have a new Performance Mains Cable called the Qonduit. Its three cores are each constructed from eighty-four strands of 99.999% Oxygen Free Copper and three separate, independent layers of PVC insulation are interspaced with OFC copper braid and an Aluminium Mylar Foil to produce a highly effective, dual anti-interference screen. The IEC connector incorporates twenty-four carat gold plated contacts for decreased connection impedance. Qonduit is available in 1.5m and 3.0m lengths. The UK prices are £40 and £60 respectively. QED's distributor Armour Home Electronics claim this cable can outperform competitors at four times the price. QED's website is www.qed.co.uk.

OBITUARY: DAVID GAMMON



Transcriptors Limited founder/designer David Gammon passed away after a long illness on the third of December 2005, aged 72. Born in Coventry in 1933, David grew up in the city. In the 1960s he designed the Sweep Arm and Stylus Brush and was eventually to start production them at his own premises, expanding from Holloway Road to Borehamwood and finally

Carlow, Ireland. His most famous and thought provoking turntable is the Hydraulic Reference which was used in the late Stanley Kubrick's 1971 classic, 'A Clockwork Orange' and which was later produced under license by JA Michell Engineering Ltd. His company is still in business and is now run by his eldest son Michael. David will be sadly missed by his family and all those who knew and came into contact with him.

MINI MARANTZ MARVEL

Marantz have introduced a compact £350 CD player, amplifier, and DAB/FM/AM radio which looks like it would make a very stylish kitchen receiver, the addition of AM/FM to DAB being a bet-hedging masterstroke. There are plenty of analogue and digital inputs and outputs, as well as a subwoofer out. The CR601 has a low resonance, acoustically damped, ultra-rigid chassis, giving solid CD playback and solid weight at 6Kg! This one should be worth a look...

ERRATUM

Apologies to Vivid Audio, as incorrect contact details were listed in February's issue. The correct details are: www.vividaudio.co.uk (tel) 01903 530005 (mob) 07950 274224.

P-Funk

In September 2005, Arthur Khoubessarian, nuclear physicist and Pink Triangle founder, launched The Funk Firm. Utilising metallurgists and thermoplastic engineers, The Funk Firm updated the innovative spirit and lateral-thinking technological know-how of Pink Triangle at a lower-cost with the new Funk Vector turntable. Channa Vithana listens in.

In my humble opinion at least, Pink Triangle is easily one of the most memorable turntable manufacturers from the past twenty years, because they popularised the use of acrylic platters, DC motors, inverted sapphire bearings and battery power supplies years before many better established rivals. Now, these are all commonplace...

This however is not a Pink Triangle, yet still shares the same

spirit, the same DNA, the same lateral thinking and the same desire to do things differently. Could one again say that someday all belt drive turntables could be made this way?

There are currently two Funk Firm turntables. The £760 Funk Vector differs from its lower-cost £450 Funk sibling with the inclusion of the bespoke Vector Drive system. The Vector Drive consists of three asymmetrically aligned pulleys for the belt; one is actively connected to the

DC motor, and two are passive.

Vector Drive is due to the Funk Firm's dissatisfaction with conventional one pulley systems. The one-pulley problems, according to Funk, start when, "the motor drives the platter (in its gap) in one direction. No longer gyroscopic now, the unstable platter teeter-totters constantly, (struggling) to stay upright".

Their solution is as follows;



where the, "Vector's triple pulley support arrangement frees the platter from the need to self-correct and it now rotates uniformly, reducing demands on the motor. So current varies less. We can return to the idea of gyroscopic motion and...pitch resolution is noticeably enhanced. Three pulleys are the minimum to achieve stability, for by contrast, a motor and one passive pulley only balances along a straight-line direction leaving the platter free to "rattle" side to side. Vector's asymmetric geometry is the result of having one motor driving with two passive anchors. The alternative of three motors acting to the centre is entirely out of the question – (where, in practice) the motors will always be fighting each other – and that's a really bad idea!"

The three pulleys drive the belt around an acrylic sub-platter. The two passive pulleys are affixed to a curved metal plate which is screwed into the plinth. The sub-platter locates the surgical stainless-steel spindle that is situated within a "sapphire slug (which is) precision ground and shaped to accept the hardened steel ball bearing fixed into the main sleeve". The bearing mechanism is sited within an oil bath to keep it continuously lubricated and to also apply damping.

The intricately curved plinth evokes abstract artistic sensibilities from the fifties and sixties and is flawlessly finished with a deep, mauve-like metallic gloss. Funk says that "the plinth is made from 25mm MDF; sculpted on CNC routers with a very large diameter bull nose edge which exposes a very feathery surface which then has to be sealed and hand sanded prior to sealing and finishing. A visually fully exposed compound shape, it's a finisher's nightmare!"

The plinth underside is machined to attractively accommodate the wire from the plug-in transformer without clutter. However, I would have preferred the socket from the transformer wire to have been right-angled as that would be even more unobtrusive.

The power supply feeds the DC motor and its incorporated speed control, which is operated by a finely machined and artistically fashioned metal knob, delineated by a red collar.

The speed control calibration for both 33 and 45 rpm can be accessed either side of the metal knob. Funk says that "the electronics use a DC servo; (where) errors detected are corrected by actual 'brakes' in the electronic circuits. These brakes act more quickly, speedily returning the

platter to its correct operation. (Its action is analogous to the traction control fitted to Formula 1 cars."

Funk Firm turntables use a proprietary Acroplat platter made from an aerated cored vinyl in preference of the usual Acrylic, vinyl and/or MDF. They say a "vinyl (platter) on its own would mean that resonances within the record are merely repeated in the record support structure (the platter or mat). The introduction of the bubbles means that while the interface is perfectly matched to the record, the bulk mechanical property of the platter/mat is gradually altered by the damping afforded by the aerations. Result: We have a more stable support than with a simple, hard vinyl".

The design is finished off with three suitably funky spherical feet which use a compliant Sorbothane sandwich construction and an attractive screw-in black acetyl clamp "to effect good contact between record and platters".

The Funk Vector is a deceptively simple, yet technologically interesting turntable comprising clever lateral-thinking, grounded in science. Though I would have preferred a few minor detail enhancements, such as a more attractive fixing to the front passive pulley, I think the Vector, taken as

"coalesce artistic exposition and technological intelligence with stunning sound, and you have one of the best £1,000 turntables in production"

a whole, is an aesthetic success where it manages to be fluidly modern yet work harmoniously in either traditional or contemporary milieu – and it does so by being utterly distinctive. For 2006, a £49 dust cover called the Eyelid, higher-performance power supply for the DC motor/speed control and a new Funk Firm Tonearm are planned releases.

SOUND QUALITY

Designed like no other 'affordable audiophile' turntable in its price category, it came as no surprise to find that the Funk Vector sounded quite special. With the excellent £429 Michell TecnoArm 'a' tonearm fitted, it produced a beautifully elegant harpsichord from the 1975 release 'Scarlatti Harpsichord Sonatas' by Blandine Verlet. Here the already excellent performance of the Vector

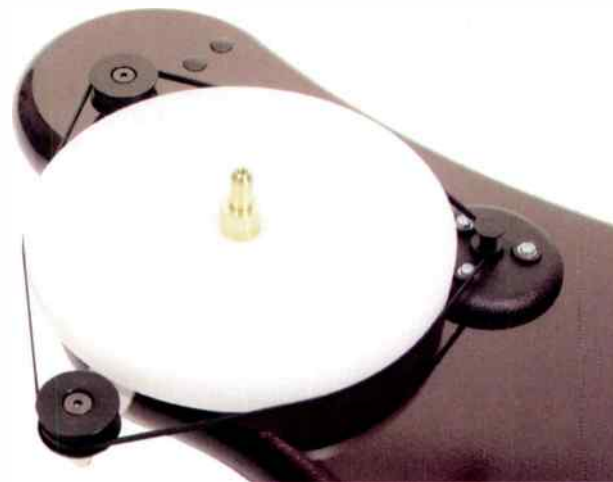

with a cooking Rega RB250/ Michell Tecnoweight combination gave way to new much finer levels of resolution and delicacy. The Vector really benefited from the inclusion of the TecnoArm 'a', where the speed, deftness and timbre were superb and much improved. The Funk Vector proved its mettle, and I could really appreciate the lower-frequencies of the harpsichord, which were stunningly realised, with depth and dynamics. Indeed, the harpsichord had a finely crafted three-dimensional quality that made it beautifully lifelike. It boasted a gloriously wide dynamic range, and it was this aspect that really convinced me of the qualities of the Funk Vector, as the Michell

arm did not reveal any weaknesses, rather it enhanced the intrinsic music making ability of the turntable.

The title track of 'Welcome To The Pleasuredome' by Frankie Goes To Hollywood had a huge, epic feel. There was simply more musical information on offer throughout the complex production, than its price rivals. Details like timbre were excellent, with real sophistication and finesse. In particular, the inherently good bass reproduction of the Funk Vector was really special with the TecnoArm 'a', thus bass dexterity and extension had massive amounts of control, texture and definition which meant more power and dynamics into and out of the musical structure.

The sound opened out really wide, with excellent spatiality, and the music on 'Welcome...' simply sounded effortless yet engaging, where finessed details like the

CYRUS



CDEX

CYRUS

hand-crafted award-winning hi-fi systems

cyrusaudio.com

World Radio History

powerful drum crescendos were authoritative.

Aphex Twin's track '4' from the 1996 'Richard D. James Album' was powerful, propulsive and solid via the Funk Vector's superb bass dexterity and extension. Here the driving rhythms were heightened as the musical structure they underpinned gained in excitement and sophistication. The details such as the multiple melodies within the composition were handled brilliantly as their resolution was most impressive in quality as well as feel – they were always part of the bigger musical picture, rather than nice sounding but glaringly isolated elements.

The piano and bass from the 1997 recording 'None But The

Lonely Heart' by Charlie Haden and Chris Anderson were of a piece and together. The sound was graceful in its confidence, where the stability and control of the Funk Vector enabled the layering of struck notes on the piano to be seamless through the composition, as there was real symbiotic energy with the piano and bass playing (which is very important as both of these instruments have proved to be awkward to reproduce cohesively). Bass lines were powerful yet musically animated, where they had wonderful definition and articulation to convey a well-rounded and three-dimensional feel.

CONCLUSION

A fascinating bit of kit for sure, the Funk Firm Vector brings extremely high levels musicality to an already excellent class. Containing the Achroplat platter, Vector Drive, DC speed-control and attractively peculiar yet intentionally wobbling feet, the Funk Vector is technologically distinct to the majority of similarly-priced turntables currently available. Packaging these sound-quality enhancing engineering applications within a quirky yet stunningly distinctive plinth (which is conversely formed from just MDF) is a rare feat. Coalesce the

qualities of artistic exposition and technological intelligence with stunning sound-quality and you have one of the best sub £1,000 turntables now in production. The only blemishes on an otherwise perfect copybook are the question marks over some aspects of its finish, and the fact that its pricing is tantalisingly close to the next class of 'budget superdecks', where the Michell GyroDec remains a redoubtable performer, and one that's better finished to boot.

Since Pink Triangle changed the scenery twenty years ago others have stepped in with their own views of how LP should be played. All the same, the new Funk Vector is an innovative and intriguing design that should be heard if you are looking for a quality turntable at an affordable price.

MUSIC:

Blandine Verlet 'Scarlatti Harpsichord Sonatas' (1975)
Frankie Goes To Hollywood 'Welcome...' (1984)
Aphex Twin 'Richard D. James Album' (1996)
Charlie Haden & Chris Anderson 'None But The Lonely Heart' (1997)

REFERENCE SYSTEM:

Ortofon Rondo Red cartridge (£300)
Linn Linto phonostage (£995)
Densen B-250/B-330 amplification (£6,000)
Waterfall Victoria loudspeakers (£2,000)

THE RIVALS

Turn to p15 and you'll find four more 'affordable audiophile' turntables tested; so how does the Funk Vector compare? The £760 Funk fitted with an upgraded £210.49 RB250 (as used with the Michell TecnoDec) was able to provide an even more effortless delivery with the Aphex Twin track '4' than the best group test contenders, as it had a freer-flowing sense of naturalness and a very quiet background to reveal the finer details like timbre. The Funk produced an exceptionally stable structure for the 'Scarlatti Harpsichord Sonatas' recording and was deliciously vibrant with extension, timbre and phrasing. The acoustic decay and space around notes were superb in their veracity. The sound was spatially convincing from 'Welcome...' by Frankie Goes To Hollywood, where the multilayered production was ably revealed.

With the bass and piano from 'None But The Lonely Heart' by Charlie Haden & Chris Anderson, I could appreciate the way the bass was being played as a musical instrument, rather than a set (or partial set) of low-frequencies, where the fingers slid across the bass strings with greater authenticity as the notes were being played.

Overall, the Funk Vector expanded the already superb high-resolution ability of the £850 Roksan Radius 5/Nima and £999 Marantz TT-15S1. Yet, the Funk did not have the same incision as the £785.49 Michell TecnoDec/upgraded RB250, yet nevertheless still revealed all facets of the music with its own engaging, musical approach. This was down to its subjectively very silent background and low surface noise where music seemed at first to be less engaging but actually it was all there in a wider, deeper spatiality than the Michell.

At £970.49 including the upgraded RB250 tonearm combination, the Funk Vector was more expensive than the Michell, Roksan and (assuming it was bought without its MM cartridge) probably the Marantz also – thus its musical superiority is logical and no surprise. However, where the Funk Vector could have been better was in the overall material finish. Whilst its plinth was beautifully crafted and flawlessly finished, some of the other details like fixings could have been even better, and as such the Michell and Marantz especially were better finished with superior perceived value, at least.

DESIGN MATTERS

Funk Firm designer Arthur Khoubesserian talks to Channa Vithana

WAS THERE AN AESTHETIC DESIGN PHILOSOPHY FOR THE PLINTH OR WAS IT ALL FOR ENGINEERING?

Unashamedly aesthetic! I am fed up with the universal preponderance of the pseudo "techno engineered look" with no thought for sympathetic harmonisation in the home. Even worse of course is the straightforward box construction so beloved because it is the cheapest to manufacture – and looks it! Certainly we all want something to stand out but it is a sad indictment that hi-fi has become tram lined and considered nerdy because of the alienation brought about by the very need to be different. Surely we are more creative than that?



VERDICT ●●●●●

A genuinely intelligent and innovative attempt to produce the best sounding turntable at the price, the Funk Vector should be right at the top of your sub-£1,000 vinyl shopping list.

FUNK FIRM VECTOR £760

The Funk Firm
☎ +44 (0)208 697 2705
www.thefunkfirm.co.uk

FOR

- effortlessly musical sonics
- attractive, scientific design
- usefully upgradeable

AGAINST

- detail finishes could be better

early hours | eleanor mcevoy

Early Hours on vinyl is the high point of our audio endeavours so far. It is rapidly selling out.

The vinyl edition of **YOLA** has already sold out. **MOSCODESIGN** will be commissioning a new **YOLA** 1/2 speed master with new "special run" 180 gram vinyl pressing available this season.

Radio concert, **Eleanor McEvoy - Her Songs and Music**, performed by the **RTE Concert Orchestra** with Eleanor McEvoy which was recorded live in Dublin's NCH is available on the RTE website <http://www.rte.ie/radio1/inconcert/>

LATE NEWS: NEW Eleanor McEvoy SACD/CD available later this year.

Enquiries: moscodesign@attglobal.net



MSM51SACD128

STEREO CD - SA-CD - 5.1 SURROUND SA-CD

Early Hours the LP half-speed mastered at Metropolis released by MOSCOVINYL on 180 gram vinyl (catalogue no. MOSV101)

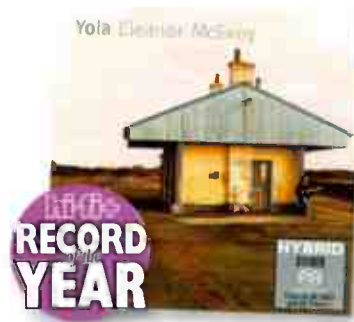

Yola

Released 2001

EMCD 1 / EM SACD 1

Released on Market Square Records (2002)

MSM SACD 113

For tour dates, see www.eleanormcevoy.net

The soundsurgery is a new company with a difference.

We offer distinctive products, personally evaluated, that we know will make a difference to your system.

> Are you dissatisfied?

> Do you keep changing your kit but never seem to get what you're looking for?

> Are you bored with sterile, clinical sound?

Accessories can, and do make profound differences. (And you don't have to re-mortgage the house!)

If you treat cables and supports as essentials, you will be surprised at how beautiful your system can sound!

The future of retail is on the Internet... The soundsurgery offer a shop, articles, reviews and consultation through this media. However, we offer the same quality of demonstration and consultation that you would expect from a shop.

If you're not internet savvy, don't worry we are only a phone call away!

At The soundsurgery we have confidence in all the companies we represent. We recognise their products to be the best in their price ranges, and often beyond.

We provide home visits by arrangement. Alternatively, individual appointments can be made with us.

We offer friendly, non-pushy advice. All products come with free UK delivery and a two year warranty.

The soundsurgery are happy to post items to European destinations.

Individually selected accessories and components, which offer genuine musicality and outstanding performance. Local and mail-order demonstrations available on request.

ask@soundsurgery.co.uk

01392 662920

07989022492

Audio Desk Systeme
Black Rhodium Polar cables
Ebony Iso-Cones
Exactpower
Graham Slee
Pearcable
Monopulse
Rothwell
Stereovox
Stillpoints
Supra Sword
Timber Matrix Formation
Whest Audio
Van den Hul
Vertax AQ



PORTFOLIO

the soundsurgery
www.soundsurgery.co.uk

RELEASING
THE
MUSIC
FROM THE
SYSTEM

feeling groovy

In this increasingly dislocated, remote-controlled, distant and electronically dilate world, one of the finest escape routes available is to sit back, relax and feel something musically real, emotive and tactile – something only a properly crafted turntable and an LP record can provide. With this in mind, Channa Vithana lined up four turntable/ tonearm packages from Pro-Ject, Michell Engineering, Roksan and Marantz...

Vinyl was once a lowly mass music carrier, offering often poor sound, user-unfriendliness and the constant threat of damage to hardware and software alike due to ham-fisted handling. Then came CD, and instead of black plastic disappearing off the map (as the music industry, it seemed, had rather hoped), it became the preserve of the well heeled, who loved it for the touch, feel, sight and sound – not to mention its price-induced exclusivity.

Now though, analogue disc is making a move back to the mass market, thanks to the availability of a new generation of 'affordable audiophile' decks. A modern, high-performance, turntable/ tonearm combination need not cost stratospheric prices and these four specimens are at an attainable (budget to mid-level) cost, and all satisfy tangibility and tactile delight through well-crafted engineering, design and sound-quality.

Although the Roksan and Pro-Ject feature a level of suspension in their motor housings (and additionally in the sub-plinth of the Roksan), none of these turntables can be described as isolated through full spring suspension. For that reason (like all turntables, sprung or not) they need to be supported on an isolated, stable and level surface, as far away as possible from loudspeaker or other induced vibrations for the best sound-quality. All the models also have screw-in feet which will help to provide a degree of adjustability to further level the platter.

Cleaning cartridge pins and phono sockets can also benefit sound quality but be careful not to let the cleaning fluid travel into the cartridge body - it is best to check with the cartridge and tonearm manufacturer first. Once the turntable and tonearm has been correctly set-up according to instructions and levelled, it is important to consider proper running-in of bearings, cartridge and tonearm cable.

The set up is actually straightforward for each of these turntables, as they don't contain the complexities of spring-suspension adjustment. A dealer set-up is the easiest method, but if you intimately study the workings of the turntable, this will make it unproblematic to maintain its best sound-quality and upgrade various parts later, if desired.

These turntable/ tonearm combinations were all reviewed using a £300 Ortofon Rondo Red MC cartridge (the Pro-Ject X Pack actually includes one in its price). The Rondo Red is the lowest model in the Rondo series behind the £400 Rondo Blue and £500 Rondo Bronze and it has an intrinsically neutral and unflappable sound that's plainly effective as a reviewing tool, to reveal the musical abilities (or lack thereof) of the turntables under the scrutiny of this comparative evaluation. So here we go...



PRO-JECT X PACK £650



For a high-value turntable system - look no further than an X Pack. It features a Pro-Ject 2 Xperience turntable (including Pro-Ject 9c tonearm and record clamp) and Pro-Ject Speed Box both from the Czech Republic, and a Danish Ortofon Rondo Red MC cartridge. They cost £600, £75 and £300 respectively, yet are inclusive within the X Pack for only £50 more than the £600 standard price of the 2 Xperience turntable, at only £650.

The 2 Xperience turntable itself is attractively made and finished overall. The high quality acrylic plinth is similar to the more expensive Perspective turntable in Pro-Ject's extensive range and has minutely smoothed off corners preventing sharp edges.

The plinth sits on three screw-in feet which are nicely made. Each foot features an aluminium and (Sorbothane) sandwich construction which gives a small but controlled amount of compliance, with felt-like pad at the plinth interface and a finely machined silver aluminium cone facing point down onto the turntable support.

At the front, on top of the plinth, are two satin finished end caps to cover the threaded holes for the feet below; the third foot is not visible from above when the platter is in place. I would have preferred a neater switch arrangement as its cabling trough (on the plinth underside) is visible and takes a little away from the clean lines afforded by the finish of the plinth.

The bearing assembly consists of inverted and hardened stainless steel

points with sapphire 'thrust-pads' and is located inside a sintered bronze bearing housing.

The platter is nicely finished and machined from MDF, measuring approximately 35mm in thickness and weighing 2kg. The platter incorporates a 4mm thick 'flat-ground layer of vinyl' to match the LP playing surface.

The 2 Xperience comes with Pro-Ject's 9c tonearm with carbon-fibre armtube. It is fully tuneable, with pillar height adjustment to optimise VTA (Vertical Tracking Angle), anti-skating via thread and weight and cartridge down force through an adjustable counterweight.

The arm utilises an inverted bearing design with four ABEC7 ball races. The 9c counterweight is suitable for cartridge weights between 6-10g as standard and an optional counterweight can handle 9-14g weights. The counterweight didn't have quite the precision feel of the Roksan, Michell or Marantz arms; however, I was still able to get an accurate 2.3g recommended loading for the Rondo Red cartridge.

The arm base is terminated within a screened box and separated arm wire terminates at gold-plated phono sockets at the rear. It requires separate interconnects (standard-looking cable incorporating earth-lead is supplied). The arm lift mechanism of the 9c did not glide down with the gentle, 'semi-automatic' silken movement of the Michell, Rega or Marantz arms and

required a touch more action to move the stylus firmly onto the LP.

The Pro-Ject Speed Box is a small device which can alternate speed between 33 and 45rpm without the need to flip the belt onto a different pulley. The Speed Box is connected firstly to the AC supply from the plug-in transformer and then connects to the power supply input at the rear of the plinth. It is a good, convenient device to use and having tried the 2 Xperience without it (using manual belt change) I found there was no discernible difference to the sound quality.

The Danish-made Ortofon Rondo Red is a relatively low-cost MC cartridge which normally goes for £300. It has an inherently unflappable, neutral yet musical nature and features a body made of a ground wood in resin composite and a nude elliptical diamond on an aluminium cantilever. Tracking force range is between 2-2.5g with a recommended setting of 2.3g. Load impedance range is between 10-200ohms and it weighs 10.5g. The X Pack was reviewed without the included acrylic lid and head-shell lift-lever for better sound quality, as recommended in the instructions, to lessen unwanted vibrations into the tonearm and turntable.

SOUND QUALITY

The music from 1975 recording 'Scarlatti Harpsichord Sonatas' played by Blandine Verlet was presented with a very good level of speed and precision to the phrasing of



the harpsichord, surprising for a £650 turntable package like the X Pack. There was excellent delicacy and combined with the phrasing, this proved to be very enjoyable. The more expensive £785.49 Michell TecnoDec combination proved to have the edge on timbre and a discernible superiority with a more engaging stance though. The sound of the Pro-Ject however was tight, focussed and well controlled overall, with a slight leaning towards smoothness and a small yet discernible level of warmth.

The Pro-Ject was a little less illuminated than the Michell when playing the title track from 'Welcome To The Pleasuredome' by Frankie Goes To Hollywood from 1984. Consequently, the Pro-Ject had a slightly warmer and smoother musical stance and while it had good speed stability and, interestingly, a more relaxed sound as well; compared to the Michell, the Pro-Ject was not as extended with Holly Johnson's vocals, nor did it have quite the power-slam of the drum crescendos either. However, the Pro-Ject's enjoyably expansive nature – the ability to convey spatiality in the music – was just about superior to the Michell.

The music from '4' by the Aphex Twin on his 1996 'Richard D. James Album' was reproduced with a full-bodied and slightly warmer hue than the vibrant and engaging Michell TecnoDec. The second melody was revealed with delicacy though, and

was very pleasant, as was the sub-melody to the main rhythmical thrust. Interestingly, where the Pro-Ject was more expansive than the Michell

with Frankie Goes To Hollywood, here it was slightly more inward-looking. Consequently, there was a richer midrange, which helped bring out some of the differing timbre and texture in the composition rather nicely, but this seemed dislocated concerning musical cohesiveness and vibrancy.

On Charlie Haden & Chris Anderson's 'None But The Lonely Heart' LP from 1997, the Pro-Ject portrayed the piano playing with a warm and smooth timbre. The midrange once again was rich and flavoursome, which rather suited the piano playing in a late-night, smoke-filled jazz-club vibe. The bass lines however, in the opening piano and bass only track 'The Night We Called It A Day' – though deeply extended, were somewhat lacking in cohesion and dexterity. This produced slightly loose low-frequencies and a little dislocation to the piano playing, where they did not flow so easily

together. The Pro-Ject did show good speed stability though and with the piano especially, provided atmospheric enticement through its attractively mid-orientated timbre and with more pronounced inhaled breaths from the two players.

"a very good all round package which is unbeatable value for money"

CONCLUSION

The £650 X Pack is a very good all round package which is unbeatable value for money. I liked the Pro-Ject 2 Xperience turntable which normally costs £600 (with 9c arm) as it is nicely made, finished and has a simple yet clever motor suspension for better sound. The Pro-Ject Speed Box is also good, as it provides the easy convenience of a switched speed control between 33 or 45rpm and subjectively it made little or no difference to the overall sound quality.

The 9c tonearm is also good but could have been even better if it was able to accommodate a superior end-stub and counterweight like those offered by Michell or Origin Live for instance. The X Pack would not, I feel, fare so well in a high-end system. However, as a package with the included Ortofon Rondo Red MC it will delight in many budget to mid-price systems.

VERDICT ●●●● £

Decently musical sound, fine build and blistering value for money.

PRO-JECT X PACK £650

Pro-Ject Audio Systems

☎ +44 (0)1235 511 166

www.henleydesigns.co.uk

FOR

- outstanding value package
- well built, attractive turntable
- speed and midrange

AGAINST

- tonearm could be better
- musically uncohesive
- needs better interconnect

MICHELL TECNODEC/RB250/TECNOWEIGHT/VTA

£785.49

The Michell TecnoDec costs £575 and was supplied with a standard £124 (Michell badged) Rega RB250 tonearm with their excellent £67.99 Tecnoweight and £18.50 VTA Arm Adjuster. Michell preferred this option of arm, counterweight and VTA adjuster over their more expensive £429 TecnoArm 'a', as that was designed primarily to match their higher priced £987/£1,239 Gyro SE/GyroDec turntables.

The TecnoDec plinth is a single piece of black acrylic which is partially shaped to the turntable above, smoothly resolved into an arm platform. A rectangle area is cut into a curve at the left to accept the motor unit. The turntable is beautifully crafted, though I would have preferred matching coloured/machined hex-head fixings into the acrylic plinth instead of the three black ones used.

The plinth sits on three attractively peculiar feet (!) using long aluminium cylinders culminating into inverted machined cones which are screwed up into them. The inverted cones have funky rubber-like pads which feature six further mini pads. In practical terms they do offer a minute amount of compliance and due to their rubber-like pads, also some stability, material isolation and grip. The underside of the plinth also has a useful arm cable tie to help further isolate the arm from vibrations and harmful cable twisting.

The TecnoDec uses an inverted bearing, which Michell says uses 'a case-hardened steel shaft that is secured upright in an oil well, threaded into the subchassis from below. A massive bronze housing, precision-machined as a pair with the shaft, is attached to the platter via the integral record spindle. A thrust ball sits on the flat top of the shaft centralized by an inverted cone in the



top of the housing.

This housing has a spiral machined into its inner bore to draw a high quality synthetic oil from the bath to the top of the bearing shaft as the housing rotates with the platter. A hole is drilled from the top of the shaft down to the oil well to allow the trapped oil to return to the bottom. This unique oil pumping mechanism results in low friction and wear, and in low rumble and noise'.

The inverted bearing is located in the centre of the round section of the platter and connected to the arm mounting via a ground wire on the plinth undercarriage. The DC motor favoured by Michell is detached within a finely crafted aluminium housing and is very quiet and slick in operation. Like the arm mounting on the plinth I would have preferred a matching coloured hex head fixing and metal switch cover to add the final detail-polish to the motor housing. The pulley drives a 'precision-ground soft round-section neoprene belt' which is guided around the outside edge of the Acrylic platter (similar to GyroDec but without hanging brass weights).

The RB250 tonearm, Tecnoweight and VTA Arm Adjuster make for a high-quality yet affordable package that can be completed in stages if funds are limited. I would recommend getting the low-cost £18.50 VTA Arm Adjuster first to add to the £124 RB250 as this provides excellent arm height adjustability, for parallel alignment of the arm tube to the LP surface, negating the use of shims. The Michell VTA Arm Adjuster is

essentially a nicely finished aluminium collar/sleeve that screws in between the arm base and locking nut. It also gives an attractive finish to the top arm/plinth interface.

The Tecnoweight is an upgrade counterweight designed to replace the more crudely finished standard Rega RB250 type. The Michell Tecnoweight consists of five pieces: stub shaft, two scallop weights (one for cartridge weights between 3-6g and the other for 6-13g), slide tube and finger adjuster. The stub shaft screws into the rear of the RB250 arm tube, then slide and secure the chosen scallop into the slide tube with a small grub screw and finally adjust the cartridge down force to suit by screwing in the finger adjuster behind the affixed scallop weight and secure it with a grub screw visible at the top. The completed Tecnoweight is a beautiful and elegant engineering solution, though it would look even better with a matching visible grub screw at the top.

SOUND QUALITY

Speed, delicacy and vibrancy from a 1975 solo harpsichord release, the 'Scarlatti Harpsichord Sonatas' by Blandine Verlet, was simply excellent via the Michell TecnoDec. The harpsichord reproduction was a delight, where the phrasing was first rate as one could follow each consecutive note layer for layer without any dislocation of frequencies that can cause a forced sound. The timbre to the harpsichord



was very good as the Michell combined gracefulness with good dimensionality to procure a more realistic in-room sound.

The music was enjoyably ferocious and thrillingly dynamic, with the drum crescendos in particular resonating deep into the listening room with huge effortless power from the 1984 release 'Welcome To The Pleasuredome' by Frankie Goes To Hollywood. The speed, attack and dynamics of the instruments to the title track from 'Welcome...' were fantastic, imbuing the music with grip, scale and effortlessness as a whole.

On '4' from 1996 release 'Richard D. James Album' by Aphex Twin, bass energy was superb with the Michell, where it resonated with precision yet revealed the emotively welcoming feel of the composition also. Thus the low-frequencies were taut and composed and because of this they were allowed to go deep when deemed by the music - and not (by the turntable) into a flabby one-note bass - whilst remaining faithful to the qualities intrinsic within the musical structure. The beautiful and asymmetrically balm-like melodies were nicely reproduced without added warmth, liquidity or sweetness, rather they were superbly revealed and at ease within the driving rhythms and percussive elements without being

expressed in dislocation to the rest of the compositional parts.

With the 2004 release of Charlie Haden & Chris Anderson's 'None But The Lonely Heart' the piano was nicely portrayed with excellent phrasing and timbre. The bass lines were voluminous yet musically expressive and textured. The music as a whole was played with conviction as it was engaging and the Michell was also good at excavating the details of the struck piano keys and subtle low-level shifts in the bass playing - all of which accumulated within a well-crafted and expressed music making ability.

CONCLUSION

The £785.49 Michell TecnoDec and tonearm combination of RB250/Tecnoweight and VTA Arm Adjuster is a really superb music making source. The £575 TecnoDec turntable is beautifully crafted and finished. It was a delight to set-up, being very simple and logical, while the 'oil-pumping' bearing system was excellent. I enjoyed its quirky feet, which were also well made and finished. The £124 Michell-badged RB250 tonearm was a glove-fit with the attractively machined and usefully practical £67.99 Tecnoweight and £18.50 VTA Arm Adjuster where both devices could be relied upon to minutely calibrate the cartridge to the LP playing surface.

Both of these devices transformed the humble yet famous RB250 not only sonically, but also enhanced it materially, with a more high-end, elegant attire.

The TecnoDec, in this guise using the Ortofon Rondo Red MC, was almost the opposite (in sound-quality terms only) of a higher-cost Michell Gyro SE/TecnoArm combination I heard recently; where the Gyro SE had a deeper and wider spatiality to music, the TecnoDec, subjectively had better musical timing and a

"music was enjoyably ferocious and thrillingly dynamic..."

more engagingly cohesive ability with timbre and low-frequencies. Conspiratorially, I think this is down to the lack of springs in the TecnoDec and when properly set-up and planted on a suitable surface, it really produces the musical goods.

The TecnoDec had an illuminating ability with music and in the high-end Densen/Waterfall reference system used to review it, there was a real synergy which bodes well for upgrades from a budget/mid price system to a more revealing combination. Conversely, due to this inherent illuminating ability, the Michell should be steered clear of bright and/or really low-cost systems. One could go even further with an upgraded £325 Michell HR Power Supply for the DC motor and a £429 Michell TecnoArm 'a', but the reviewed TecnoDec system is deservedly outstanding.

VERDICT ●●●●●

Superbly focused and dynamic sound with great pace and space, this remains the state-of-the-art mid-price turntable - and the superlative finish hardly detracts.

**MICHELL TECNODEC/RB250/
TECNOWEIGHT/VTA £785.49**

J A Michell Engineering Ltd.

☎ +44 (0)208 953 0771

www.michell-engineering.co.uk

FOR

- excellent engaging music
- dynamics and grip
- fantastic build and finish

AGAINST

- colour-matching of fixings

ROKSAN RADIUS 5 (ACRYLIC) & NIMA ARM £850



The £850 Roksan Radius 5 turntable in Acrylic comes complete with the beautifully named and styled

Nima unipivot tonearm, which separately would cost £350. The Radius 5 is also available in lacquered walnut and maple veneer finishes; the maple veneer is priced at £750.

The main plinth has "three chromed adjustable spiked feet (to assist levelling and optimum coupling to the surface upon which the Radius 5 rests". At the underside of the main plinth is a cable tie for the Nima tonearm cable to be secured and isolated from potential vibrations coming back into the arm itself.

The motor block cleverly contains not only the motor but all the electronics as well. For neatness the top of the motor block is finished with a raised plate which has the Roksan Radius moniker as well as the switch and along with the platter, it keeps the electronics hidden from normal viewing conditions. The motor is a custom made synchronous motor fitted with a machined solid aluminium alloy pulley. The motor block features a, 'motor assembly, (that is) also mounted to the main plinth, (it) is further decoupled to avoid motor noise and vibration break through'. This decoupling seems to be a form of suspension where the motor and its spindle move in one plane from side to side and features a minute spring-like action to the pulley.

The main bearing spindle is fitted to the sub-plinth and isolated from the vibrations of the main plinth which carries the motor block.

The Nima tonearm uses a stainless steel unipivot bearing and is a

wonderfully intricate design as it is hand made from 'ten individual precision machined components'. The armtube is a very finely finished, satin, aluminium alloy and carries the same signal cable entitled 'Special Roksan Flexible PCB' which was developed for Roksan's £1,000 Artemiz tonearm. The arm cable is then terminated at the arm base with a gold-plated five-pin to gold-plated RCA phono plug interconnect lead.

The Nima is locked-down in transit and requires three simple operations to free it; the first is a reusable blue plastic tie around the armtube, second is a black plastic-sleeved transit lock screwed into the back of the Nima which needs to be removed and then utilised to fix the metal counterweight peg and thirdly the acrylic bearing yoke needs to be gently pushed down to free it from the o-ring around the arm bearing housing. Once done, the VTA (vertical tracking angle) can be adjusted via a small grub screw to the right of the Nima at its platter surface edge (arm pillar holder) so that the arm tube is parallel to the platter and LP.

Cartridge downforce is adjusted by the beautifully finished counterweight which firmly attaches itself to its peg. The counterweight can be also be gently rotated clockwise/

anti-clockwise (when the anti-skate thread and weight is attached) to adjust the cartridge azimuth to align it correctly to the record surface.

The Acrylic head-shell is an attractively angular design which provides plenty of room for cartridge adjustment and wires to be accommodated without too much bending. However, on the review sample the opening of the armtube at the headshell end had some blue foam-like substance which looked like it was employed to minimise vibrations into the arm cable, but it was not attractive and detracted a little from the Nima's otherwise beautiful design and finish.

I would also have preferred a more attractive arm locking nut and shake proof washer to the standard Rega RB250 style, as this can be seen above, through the clear acrylic.

SOUND QUALITY

The Roksan Radius 5/Nima tonearm combination had a superb high-resolution sound with the harpsichord playing by Blandine Verlet on her 1975 release of 'Scarlati Harpsichord Sonatas'. Phrasing was also excellent and the timbre was first-rate, as I



could appreciate the tonality of the harpsichord with finesse and yet even more expression and extension over the lower-cost Pro-Ject and Michell combinations. Only the Marantz TT-15S1 was the equal of the Roksan with this recording in terms of resolution. However, where the Roksan was divergent with the Marantz was in a small but discernible sweetness to its music making abilities. The upper-mid frequencies of the harpsichord though, were sublime in dexterity and thus reproduced with aplomb.

The music from the Roksan on 'Welcome To The Pleasuredome' was generally effortless from the 1984 Frankie Goes To Hollywood release. Every element was finely balanced when conveying the instruments and vocals. The resolution of the instruments and vocals was just wonderful and the Roksan offered superb spatiality for the price, providing a free-breathing, yet also tightly cohesive and an under-control quality. The one area where the Roksan didn't excel was in bass dexterity and extension with 'Welcome...' as it was not quite as able as the Michell in conveying the thunderous drum crescendos, which subjectively are the most engaging, demanding and active low-frequencies

on this recording. The drum crescendos are not a mere window-dressing detail; rather they form an important and dynamic part of the composition and relate a lot of power and emotion into the rest of the music.

The Aphex Twin track '4' from the 1996 release 'Richard D. James Album' sounded tightly focused, yet expansive also as the Roksan took the wildly asymmetrical rhythms and melodies in its stride. The music was well-balanced with good reproduction of melodies within the composition. Compared to the Michell, the Roksan – while very good with stunning resolution – wasn't quite as engaging or powerful with '4'. However, this aspect is not noticeable in isolation.

The Roksan was able to reproduce an amazing piano timbre; the frequencies from treble to lower-mid were beautifully expressed on 'None But The Lonely Heart' by Charlie Haden & Chris Anderson from 1997. Once again the Roksan was a delight, with an excellent high-resolution ability.

Bass lines were reproduced well with very good dexterity and extension. However, the Michell and Marantz both bettered the Roksan in the low-frequencies as they had a finer grasp of the subtleties which make up the greater whole so that

the bass lines sounded more real and animated, while the Roksan couldn't quite pull it off in the same manner on this recording. The Roksan did have a slight but discernible sweetness to the music contained in 'None But The Lonely Heart', and this will appeal to some hi-fi devotees.

"the Roksan's strength resides in its superb resolution and a slight yet discernible sweetness"

CONCLUSION

The £850 (Acrylic) Roksan Radius 5 turntable including Nima tonearm is a very accomplished source indeed. It is obvious when looking at its design and construction philosophy that a lot of clever thought has gone into crafting an authentic music-making device. The Roksan offers spatiality to music and presents details like the timbre, delicacy and phrasing of a harpsichord and piano exceptionally well. I felt subjectively it fared less well with bass extension and dexterity, where, while being of a very high standard, the low-frequencies were better reproduced via the Marantz and Michell turntables.

The Roksan's strength though resides in its superb resolution and, for some, a slight yet discernible sweetness. I personally think the Nima tonearm is outstanding and it would make a wonderful choice on its own. The Radius 5 and Nima are attractively designed, well made and meticulously crafted.

VERDICT ●●●● £

Truly beguiling sound from an charismatic package that bestows the joys of an unconventional unipivot tonearm.

ROKSAN RADIUS 5 (ACRYLIC) & NIMA TONEARM £850
Roksan Audio Ltd.
☎ +44 (0)208 900 6801/6802
www.roksan.co.uk

FOR

- appealing design
- high-resolution, cohesive music
- excellent Nima tonearm

AGAINST

- bass could be better

MARANTZ TT-15S1 (INC. ARM & MM CARTRIDGE) £999



To me it is unsurprising that Marantz based their latest turntable on one of Clearaudio's designs. Having used as a reference and then reviewed, the beautifully crafted £1,350 Clearaudio Champion Level 1 turntable, I can see exactly why Marantz has developed the Clearaudio Emotion model as the basis for the new TT-15S1 turntable. This is because both companies employ a similar build-quality obsessed philosophy where almost all of their products have been flawlessly finished, even at budget prices. This surely makes for an agreeable manufacturing synergy between the two.

The Marantz is thus stunningly crafted and beautiful to look at with its opaque acrylic platter and plinth, plus elegantly designed arm. It is part of the current Marantz Premium range and has differences to the Clearaudio Emotion, starting with the supports, where it employs three large and solid aluminium feet (unlike the Clearaudio which uses three acrylic, screw-in cones).

The plinth itself is a tactile delight with a finely finished surface and nicely machined, gently rounded edges, it reeks of understated distinction. Gently curved details to either side of the plinth fascia differentiate the Marantz to the Emotion where on plan view; it is styled with a similar profile to match the Marantz Premium series £1,100 PM-15S1 amplifier and matching SACD player or the higher end 11 series. In the centre of the fascia rests the Marantz logo.

The motor unit slots into an opening at the rear left of the plinth. It is encased in a high-quality, heavy, alloy cylinder. The acrylic belt pulley is then

fitted to the motor spindle with three internal acrylic-like screws.

Speed change is manual with selection of small pulley groove for 33/3 and large groove for 45rpm. The motor base features six clear synthetic feet to prevent movement and minimise vibration. Further decoupling is possible by removing the o-ring around the motor cylinder shaft if it is in contact with the inner surfaces of the plinth opening.

The Marantz uses the "hard and smooth surface of the maintenance free ceramic bearing (which) offers nearly resistance free movement of the axle (spindle)". The spindle itself is mirror-polished in surface and is located within a satin-finished machined component that forms the connection to the platter on its top cylindrical aspect. Then there is a small cylindrical extrusion above which is similar in diameter to the spindle and accepts the (included) plastic Clever Clamp which though lightweight, manages to securely affix an LP to the platter.

The Marantz tonearm is similar to the Satisfy unit supplied with the Emotion. However, unlike some iterations, the tonearm features a complete Clearaudio Direct Wire cable regime from headshell to Neutrik phono sockets instead of terminating at a box for phono interconnects. Additionally, Marantz states, "the horizontal bearing of this two-axis tone-arm uses a shaft made out of wolfram; their polished ends are running in sapphire watch bearings. The

vertical tonearm bearing is made of extremely precise and long life ceramic.

The headshell allows very accurate placement of any cartridge type... (while) the contact-less magnetic anti-skating allows free movement of the arm and ensures (an) accurate stereo image. For the TT-15S1 the aluminium arm is anodised to shift the resonance frequency, reducing the influence of the arm to the sound". The counterweight was an absolute delight in use and the easiest to set-up in comparison to the Pro-Ject, and Roksan in particular, as it moved with an assured and stable precision.

The Marantz at £999 comes complete with a Clearaudio Virtuoso Wood MM cartridge, for more information on which, please refer to our review of the TT-15S1 in the February 2005 issue. For this assessment however, the Marantz was used (like the Roksan, Michell and Pro-Ject) with a £300 Ortofon Rondo Red MC cartridge. Marantz UK says a customer may be able to buy the TT-15S1 for less than the £999 price, sans the Virtuoso Wood MM cartridge, though "they would need to sort this out with their local (Marantz) dealer".

SOUND QUALITY

The Marantz produced a superb rendition of the 1975 'Scarlati Harpsichord Sonatas' by Blandine Verlet, where it was the equal of the superbly high-resolution Roksan Radius 5/Nima with this recording in almost every musical aspect. Therefore resolution was very high while the



phrasing of the playing was also consummately expressed, with deftness and layering to die for. The Marantz just edged the Roksan on overall musical cohesion with an utterly stable control of frequencies.

Wonderfully capable, expressive yet completely in control, the Marantz was really enjoyable when it played the 1984 release of 'Welcome To The Pleasuredome' by Frankie Goes To Hollywood. It was expansive in its widescreen spatiality which created a broad musical canvas for the complexities of the production to inhabit. The Marantz had great control of all the frequencies and in particular with the bass where it had excellent definition and articulation; thus producing radiant low-frequencies, beautifully executed with authority, power and finesse even with the drum crescendos.

The Marantz was also excellent with details like the timbre and texture to Holly Johnson's vocals and instruments which was the final polish to a high-quality yet musical account of the title track 'Welcome To The Pleasuredome'.

Subjectively, so quiet was the background of the Marantz that even a comparatively rougher but melodically thrilling recording like the 'Richard D. James Album' from 1996 by Aphex Twin was authoritative and musically



literate. The whole structure of the music was so cohesively reproduced that I could

Marantz was better in the bass as it was able to deliver extension and dexterity with very fine expressiveness. The Marantz provided a very silent yet open background or musical canvas for this ostensibly simple but ultimately complex and difficult to reproduce jazz recording.

CONCLUSION

Well-executed, beautifully designed yet simple engineering really appeals to me and the Marantz had heaps of it. It manages to look even more stunningly

"a high-resolution source component in almost every tangible acoustic aspect..."

enjoy all the different melodies hidden within and extruded from the main rhythmic thrust and not fear for dislocated aspects that might bring on a forced or strained relationship with the divergent forms and elements of the track '4'.

The inherent togetherness of the Marantz was revealed on the most difficult recording used with all the turntables in the comparative review. Here the piano and bass from 1997 recording 'None But The Lonely Heart' by Charlie Haden & Chris Anderson were in unison as they were symbiotically coupled, where one instrument was allowed to lead while the other underpinned it with its own melodic and structured forms without dominating or being recessive, thereby avoiding a forced presentation.

Piano playing was reproduced very well, if not quite as stunningly high-resolution as the Roksan, however the

crafted than the (peerlessly finished) Clearaudio DNA it is based on, with clever touches like the finely machined solid aluminium feet which are proportionally just right for the opaque acrylic plinth that matches the fascia profile of the other Marantz Premium series components.

The sound is similarly elegant, refined and yet powerful and dynamic also. The Marantz was capable and authoritative with all the music used in more than just a competent manner; it was a high-resolution source component in almost every tangible acoustic aspect. Only the Michell TecnoDec could also claim to be as musically cohesive with all the music used. For me, this is a fantastic product and combined with the excellent £2000 Marantz SA-11S1 SACD player that I reviewed earlier, the TT-15S1 is easily one of Marantz's best source products.

VERDICT

Surely the most musical sub-£1,000 turntable, the addition of a fine MM cartridge makes this the best value package at the price.

MARANTZ TT-15S1 (INC. ARM & MM CARTRIDGE) £999.00

Marantz UK Ltd.

☎ +44 (0)1753 680 868

www.marantz.com

FOR

- elegant, simple engineering
- beautifully understated style
- high-resolution, cohesive and stable music

AGAINST

- TecnoDec even more engaging

Let others speak for us:

"Hi-fi nirvana is the only way to describe the new range of products by mbl, which made its debut with sleek components. These appealing products from Germany managed to cause quite a stir not only in the way they looked but more in the way they sounded. People were mesmerised, eyes glued to the strange looking contraptions as music flowed seamlessly without a trace of harshness. The 101E speaker was an achievement in itself, with an actual revolving tweeter for uniform dispersion. Encore!"
(AUDIOPHILE)

"... it is very difficult to put in words how truly magnificent the 6010 D is!! ... I can end the search for the best components now, and focus on what is most important. The Music! ..."
(Eric H., Glendale, USA)

Flight to infinity



Proudly distributed by



MBL Distributor for the UK and Ireland
T: +44- (0)1932 - 86 45 48
www.soundventure.co.uk
email: sales@soundventure.co.uk

Demonstrations available by appointment
Retailers welcome!

conclusion

For this comparative review, it was illuminating when two of the ostensibly simplest recordings ('Scarlatti Harpsichord Sonatas' and 'None But The Lonely Heart') provided the most interesting and varying differences in sound between the Pro-Ject X Pack, Michell TecnoDec combination, Roksan Radius 5/Nima and Marantz TT-15S1.

Of the four, it was the £785.49 Michell TecnoDec/ RB250/ Tecnoweight and VTA Arm Adjuster combination that was fully able to exploit the intrinsic musical structure of all the recordings used to convey an effortlessly dynamic, powerful and engaging quality that was shockingly good for its asking price. The Michell combination was simply excellent at creating convincing musical compositions and had the ability to dig very deep into them to bring out wonderfully affecting timbre from a harpsichord and piano, or drum crescendo from 'Welcome To The Pleasuredome' by Frankie Goes To Hollywood and electronic samples folded together in a rhythmically melodic stew as on the Aphex Twin 'Richard D. James Album'.

Beyond the sound quality, the TecnoDec is also a beautifully crafted piece of audio engineering in almost every aspect of its construction and I like its simplicity, logical set-up and quirkily designed feet. It also has excellent build-quality and upgradeability with a superior £325 HR power supply for its DC motor and £429 TecnoArm 'a' tonearm if so desired. The Michell combination, as reviewed, worked brilliantly in the high-end reference set-up used in the review, and would thus be comfortable within an upgrade system strategy from a budget/mid-price level and then towards the high-end.

Combining sleek design and excellent performance, the £999.00 Marantz TT-15S1 package is more than the sum of its (peerlessly crafted) Clearaudio DNA. It had an unflappably musical sound quality with all the recordings used, and encompassed subjectively very low surface noise with LPs that created

an especially stable and quiet canvas for music to be presented on. The Marantz expanded on the superb Michell combination with better resolution on all the recordings used, with a wonderfully expansive and elegant expression. However, it wasn't quite as engaging as the Michell. The Marantz TT-15S1 is, in my estimation, the most (through long-term appreciation) satisfyingly designed turntable in the group with its elegantly sleek-by-design lines and - economical use of and yet luxuriously appointed - material construction.

The Roksan Radius 5 and Nima tonearm combination at £850, in acrylic form, will win many admirers towards its dynamically designed styling. It is, outwardly, the most complicated design of the four turntables as it features an isolated sub-plinth. Subjectively, I found the Roksan had a small but discernible sweetness towards the music used which will appeal to some but personally I felt it detracted a little from the individuality of the music. The Roksan also had a variable bass quality, where the upper-mid regions on the harpsichord recording were fantastic but the upper, mid and lower bass was less able than either the Michell or Marantz. However, these criticisms are only on a comparative basis and were never abhorrent or noticeable in isolation.

Generally though, the Roksan is one of the best at the price with a stunningly good high-resolution music making ability that provides extended and beautifully crafted frequencies from the treble to lower midrange regions. And as such it ably revealed musical emotion with a deft touch and an emotive expressiveness which was superior to the lower-cost Michell, and just a fraction better



than the Marantz with these particular frequencies.

Of course, the best value turntable combination here easily went to the £650 X Pack containing Pro-Ject 2 Xpression turntable, 9c tonearm, 33/45rpm Speed Box and Ortofon Rondo Red MC cartridge which would sell separately for £975! The 2 Xperience turntable is well-made, nicely styled in acrylic and features, like the Roksan, a suspended motor assembly for better sound. As standard, the X Pack was a good combination as it produced a stable and yet fast presentation with a superb midrange.

It was a little dislocated in certain frequencies though, which made for a slightly forced quality with the rock/pop of 'Welcome To The Pleasuredome' and jazz style of 'None But The Lonely Heart' but the X Pack did better on the 'Scarlatti Harpsichord Sonatas' and the electronic realm of the 'Richard D. James Album'. Fitted with a suitably good upgrade interconnect into the phono terminated box at the base of the 9c tonearm and using the earth lead from its standard cable, the superb value X Pack would suit many a budget to mid price set-up in favour of a more revealing high-end one. If there's ever conclusive

REFERENCE SYSTEM

Linn Linto phonostage (£995)
Densen B-250/B-330 amplification (£6,000)
Waterfall Victoria loudspeakers (£2,000)

MUSIC

Blandine Verlet 'Scarlatti Harpsichord Sonatas' (1975)
Frankie Goes To Hollywood 'Welcome...' (1984)
Aphex Twin 'Richard D. James Album' (1996)
Charlie Haden & Chris Anderson - 'None But The Lonely Heart' (1997/2004)

David Price auditions Trichord Research's new Diablo phonostage against its latest and greatest rival...

Life is never simple. When I first heard Whest Audio's PS.20/ MsU.20, I was convinced it was a step-change in the sound quality available to analogue addicts with around £1,000 in their pocket. Trichord, I'm sure, won't thank me for saying this, but the Delphini that I knew and loved suddenly sounded rather ragged compared to this mysterious, midi-sized, twin box combo...

And so to the new. The Diablo is the Delphini's replacement, and it is – in the top NC PSU aspirated guise (£1,198) – a natural rival. In fact, it is the closest thing to it on the market. Both are high performance, take-no-prisoners, transistor phono stages. Both offer a range of cartridge matching options, and attempt to be all things to all men (you'd expect that, at this price). Both claim to offer superb sound, and indeed (without wishing to pre-empt the verdict) both do.

But there the similarity ends - I'm a little disconcerted that two superb phono stages can sound so different.

SOUND QUALITY

High end vinyl is strange, inasmuch as the distinctions it throws up are often quite subtle in absolute terms, yet when you've spent an entire LP side listening they suddenly sound profound. With phono stages, the Trichord Diablo - Whest Audio divergence is a case in point.

Living with the Trichord Diablo for a week has had me at sixes and sevens. My current cartridge is a Koetsu Red Signature (more of which in a subsequent issue – but suffice to say I love it, despite its rosy, rich and coloured sound), and my current phonostage is the Whest. Well, the Trichord suits the Koetsu much, much better. But last month I was using an Ortofon Rondo Bronze and the Whest would have been so much better for this. It's all about the dreaded 'synergy', I'm afraid...

The Trichord is upfront and engaging. Its designer, Graham Fowler, describes it unashamedly as such. He doesn't pretend it's the best 'f-ing phonostage in the world', unlike

others, which is good of him because it's not. But it's still one of the best value in the world and it's extremely capable in absolute terms. I've heard phonostages at five times the price which don't connect with music like this does.

My listening consisted of a track on the Trichord, then the same on the Whest, then the next on the Trichord, and the same on the Whest, and so on. I can honestly say that I heard two great phono stages, but with quite different presentations. They weren't that different, because you could tune out much of the changes by swapping speaker cables (I use Townshend's Isolda DCT generally, which is a little 'dark' and 'laid back', but switch to the Supra Sword speaker cables, 'upfront' and 'engaging', and it had much the same effect as switching as moving from Whest to Trichord).

Not to put too fine a point on it, the Trichord is like standing in the stalls at a live concert, whereas the Whest is like being at the back of the circle. The former is bracing, challenging and engaging like few others, the latter is widescreen, panoramic, dimensional and far more svelte and sophisticated. Neither is better, though. I'm sorry to say – but the obverse of this is that both are – in their own right - superb.

For example, Freeez's 'Caribbean Winter' is deliciously svelte and silky through my reference Whest. It is so sophisticated, so smooth, so 'proper' sounding. The noise is amazingly low, and everything from the instrumental soundstaging to the location of the vocals seems so right. Switch to the Trichord and suddenly things are far more upfront; the whole recorded

acoustic is narrower (less expansive between the speakers, but obviously more upfront and closer to the listener. The treble is a tad brighter and more splashy (although still far more couth than CD), and the bass is more energetic, more 'punk' sounding. The Whest is like an ECM jazz fusion album, the Trichord is The Damned's 'New Rose' at 45rpm.

Interestingly though, despite its 'upfrontness', don't think the Trichord is harsh, because it isn't. It's just a difference in accent, in style, in presentation. There is nothing wrong with the Diablo (quite the reverse), it's just that it goes straight for the musical jugular, whereas some might prefer more 'coffee and cream' and less straight Vodka.

Fleetwood Mac's 'Don't Stop' was a great example of how the Trichord can pull a recording out of itself. On DVD-A it's quite forward, but on ye olde vinyl LP this is a quintessentially



Company

MMMC PHONO AMPLIFIER

Diablo

DC POWER SUPPLY

NCPSU

THE DIABLO IN DETAIL

Trichord says the circuitry is signal non-inverting and constructed using high performance, audio grade bipolar and JFET operational amplifiers from Analog Devices and Linear Technology. Metal oxide resistors and ultra low impedance capacitors throughout for lowest possible noise. The RIAA equalisation network is part passive and part active. The capacitors and resistors used in this stage are very close tolerance audiophile types. Four ultra low impedance, low noise wide-band voltage regulator circuits are employed to power both channels. The non-ferrous cabinet is made of aluminium, a design that reduces Eddy current propagation that can affect sound reproduction dramatically. The Diablo is user adjustable with a set of four DIP switches on the underside of the unit. These switches allow for adjustment of cartridge loading and gain setting. Three versions of power supply are available for the Diablo including a 'Never Connected' version.

massive soundstage (left to right, front to back) conjured up, whereas the Diablo pushed it all right up to the plane of the speakers. Again, hi hats and ride cymbals were far less subtly resolved through the Diablo, which pushed the Koetsu Red Signature's treble performance down a notch to mere Koetsu Red! Yet this didn't seem to matter though, such was the way it sang.

CONCLUSION

The verdict is simple; you've got to hear both of these in your system to come to any sort of serious conclusion about which is better. I could have waxed lyrical about how either of them eek out massive amounts of information from the groove, provide exceptionally high fidelity vinyl replay and will (with a good source) have you beguiled by your black plastic, but rather like 'Bridget Joneses Diary', both suitors (Clever and D'Arcy) are a class act, it's just different strokes for different folks. My verdict, which is that both are superb, isn't a cop-out; it's pure pragmatism; now you decide..

warm sounding analogue recording. The combination of the rich and rosy Koetsu plus the svelte Whest gave a rather 'Radio Two' presentation, whereas the Diablo went straight for the jugular vein, and really got into the groove. Bass is a little lighter, tighter and tauter than the Whest (not much, though), and the midband is more forward and less well proportioned, and the treble a little rougher and more raucous.

Moving to 4hero's 'Escape That', and the Trichord was again more musically engaging with my Koetsu reference, but that didn't stop the Whest signposting everything that the Trichord wasn't doing quite right. The wonderful sense of scale from the Whest was arresting; it's something that digiphiles don't realise they're missing; the song sounded so three dimensional, with a

MEASURED PERFORMANCE

Trichord have run equalisation flat from 10Hz up to 32kHz, meaning there is no warp filtering in this phono stage. However, 3150uS gain is a little down, just -0.5dB or so, as our spectrum analysis shows. As a result this stage will have dry sounding deep bass, but it will have kick, when it's there on disc at least. A smidgen of emphasis above 1kHz in the 75uS time constant should ensure there's plenty of shine and detail, without groove distortions becoming too obvious.

Equivalent input noise measured 0.04uV, IEC A weighted. This is as low as it gets, so the Diablo is unusually quiet and fine for low output MCs.

Overload occurred at 13.2V out, translating to 41mV in with MM High output to 1.5mV in with MC Very Low output.

Gain was high at all settings, with MM High measuring x326, Low x560, MC Normal x2113 and MC Low x4680. For MCs with less output than asphyxiated gnat, there's a

desperation setting that gives x 8474, an unusually high gain.

The Diablo measures very well in all respects and will work well in practice with all amplifiers, even insensitive models. NK

Frequency response	10Hz-32kHz
Separation	78dB
Equivalent input noise (IEC A)	0.04uV
Distortion	0.001%
Gain	MM x326, x560; MC x2113, x4800, x8474
Overload	MM 41mV, 23mV; MC 6mV, 2.8mV, 1.5mV

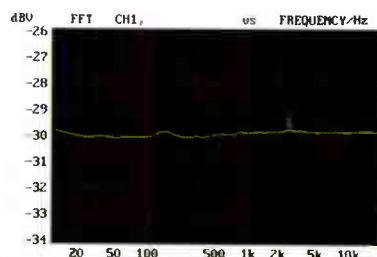

VERDICT

A superbly musical performer, this is one of the very best phonostages at or near the price, but – as ever – an audition in your own system is essential.

TRICHORD DIABLO

+ NCPSU £1,198

Trichord Research Ltd.

+44 (0)1684 292792

www.trichordresearch.co.uk

SEVENOAKS

SOUND & VISION

Winter Sale Now On!

Save £s in our fabulous Winter Sale. For information on all the latest offers, visit www.ssav.com or call your nearest store on Freephone 0800 587 9909

NEW STORES

LOUGHTON & YEOVIL

We are pleased to announce that these new stores are now open: -

LOUGHTON

7-9 GOLDINGS HILL • 020 8532 0770

YEOVIL

14 SILVER STREET • 01935 700078



Specialist hi-fi & home cinema

Contemporary hi-fi is constantly setting new standards in sound reproduction and design. Whatever you listen to, Sevenoaks can recommend separate components that will bring your music collection to life and complement your home. We're enthusiasts and experts, passionate about helping you build (or upgrade) a system that will delight for years to come.

The recent growth of DVD has led to a huge rise in demand for home cinema equipment - DVD players, AV receivers, projectors and plasma screens but, with so many options, it's not easy to know which ones will suit your needs. Indeed, in the face of this quickly evolving and often bemusing array of products, we aim to assist you in assembling a home cinema system to be proud of - one that achieves outstanding picture and sound quality.



WHAT IS IT? RCD-02 CD PLAYER
AWARDS 2005
PRODUCT OF THE YEAR
THE COMPANY
BEST BUY

Rotel

The 02 Series is Rotel's entry-level range. The RCD-02 CD player combined with either an RA-01, RA-02 or RA-03 integrated amplifier represents true audiophile performance at an affordable price. For increased high-end performance, the RC-03/RB-3 pre/power amplifiers are available. The RT-02 tuner completes the range.

Audiolab NEW 8000 Series

Audiolab's new 8000 series offers a definitive and genuine hi-fidelity performance from a no-nonsense approach to engineering. These famous products have all been re-engineered to create a complete two channel range, including the 8000S, 8000Q, 8000M and 8000P models plus a all new CD player. A 7.1 channel pre and power amplifier completes the range.



Project

Project is currently one of the world's leading suppliers of turntables, with a range of models designed to satisfy all levels of expectation and budget. The range is simple to use, maintenance free and will function for a lifetime.



WHAT IS IT? PROJECT TUNER
AWARDS 2005
BEST BUY

Roksan

Roksan designs and manufactures some of the most acclaimed hi-fi equipment currently available. All Roksan products are carefully evaluated by experienced engineers at every stage of the design process with the emphasis on performance and build quality.



B&W

The focus of Bowers and Wilkins Loudspeakers has always been to offer the best possible musical experience. With a combination of the latest R&D techniques and a passion for music, B&W produces a diverse range of products befitting the largest audio manufacturer in the UK.



B&W MINI THEATRE MT-30

"Talented, covetable and worth every penny, the MT-30 (and PV1 especially) could well be heading for iconic status."

WHAT IS IT? MINI THEATRE
AWARDS 2005
BEST BUY

WHAT IS IT? MINI THEATRE
AWARDS 2005
BEST BUY

Cyrus

If you've enjoyed listening to music before, try listening to it through a Cyrus system. With every product tuned by ear, Cyrus represents a quality of sound, which is rare at any price. Invest in a Cyrus system and you'll be rewarded with a wealth of sound you wouldn't have thought possible.



WHAT IS IT? CYRUS SYSTEM
AWARDS 2005
BEST BUY

Winter Sale



Quad

founded in 1938, Quad's history is one of audio excellence. Today's range includes both electronics and speaker systems.



i-Deck



Silver RS1

Monitor Audio

Since 1972 Monitor Audio has been developing and perfecting the implementation of metal drivers, innovative crossovers, and exemplary speaker cabinet construction and finish to further the ideal of achieving sound which is to the original "as close as it gets". The range includes - **GOLD**, **SILVER RS**, **BRONZE** and **RADIUS** speakers, plus the exciting new **i-Deck** docking station, an excellent any-room companion for your iPod.



Silver RS6 AV Package

Digital Radio

With **Digital Audio Broadcasting (DAB)** capability, these **high-quality tuners** deliver **more stations** and offers **pure, distortion-free, CD-like sound**, while providing **useful radio and data services**.



Pure DRX702ES & NEW Denon TU-1800DAB

Wharfedale

Diamond 9.1

"Wharfedale has been updating and tweaking its Diamonds for 20 years - and rough they're not! Tight bass, clear midband, and sparkling treble for not a lot of cash."



Diamond SW150

"Considering the price, the detail and definition to the bass are controlled and cohesive - equally adept with movies and music."

KEF

Replacing the highly successful Q Series, KEF's New iQ line-up comprises eight models from the entry-level iQ1 bookshelf to the impressive iQ9 floorstander. All models incorporate KEF's Uni-Q driver technology and are available in a variety of finishes.



Other KEF ranges include XQ, KHT and the Award-winning KIT100 Home cinema system.

KEF KIT100 "Creating a virtual surround sound experience has never been simpler or more effective, thanks to this two speakers plus subwoofer concoction from KEF."

Acoustic Energy

Established in 1987, Acoustic Energy is one of Britain's premier loudspeaker manufacturers offering one of the most targeted range of hi-fi and home cinema loudspeaker systems on the market today.

"The legendary AE1 lives on in this groundbreaking new version... It sets a new standard for small speakers."



KEF iQ5

"The iQ5s are little stars, providing stunning scale and authority from discreetly sized towers..."

The iQ5s are fully deserving Products of the Year."



KEF KHT1005

"The KHT1005 is an ideal first-time buy, and will suit those looking to 'downsize' to a more living-room friendly style of speaker."



Arcam

Arcam has spent more than a generation building some of the finest high-fidelity products the world has ever seen. Whether you're interested in two-channel or a complete multi-channel AV system, the Arcam DiVA series offers the music and movie lover the most complete range of high-performance home entertainment solutions from any specialist manufacturer.



Arcam Solo Music System

"Excellent all-round sound combined with the convenience of a one-box product."

Marantz

Marantz is introducing a host of new products ranging from high-end hi-fi to HD-ready DVD players and AV receivers. The two main products groups are the 'premium' and 'range' series.

The SR9600THX Ultra2 AV receiver offers seven channels, each 140w, and features HDMI inputs. The groundbreaking DV9600 is one of the first DVD players capable of upscaling images to 1080p and is fully prepared for the high-definition future.



NEW MARANTZ SR9600 AV RECEIVER



ESSENTIAL ACCESSORIES

The right accessories can make or break your system. Our carefully selected range, including **QED**, **SOUNDSTYLE** and **GRADO**, will ensure you get the very best performance from your system.



Arcam Solo Music System

"Excellent all-round sound combined with the convenience of a one-box product."



A3.5 SERIES

Musical Fidelity

Musical Fidelity's A3.5 Series amplifier, using circuitry closely related to A5's, and upsampling CD player combine high end performance, visuals and finish at a competitive price.

PLEASE NOTE Some products/brands are not available at all stores. Please call to confirm or visit our website before travelling. Special Offers and Sale Offers: - Not in conjunction with any other offer. Advert valid until at least 09/02/2006, E&OE.

Winter Sale Now On!

Save £s in our fabulous Winter Sale. Visit www.ssav.com or call your nearest store on Freephone **0800 587 9909** for the latest prices and information.



Denon

Denon, Japan's oldest audio company, has established an enviable reputation for the performance of both its hi-fi and home cinema products, winning numerous awards and accolades over the years. Its stylish systems have succeeded in becoming the benchmark by which all others are judged.

WHAT HI-FI? SOUND AND VISION AWARDS 2005
PRODUCT OF THE YEAR
RECORD 700 1332

WHAT HI-FI? SOUND AND VISION AWARDS 2005
TECHNOLOGY
RECORD 700 1332

WHAT HI-FI? SOUND AND VISION AWARDS 2005
TECHNOLOGY
RECORD 700 1332



Smart Life S-301



DVD-A1XV "The most obvious winner of any category this year has to be Denon's evolutionary step in DVD deck design, the landmark DVD-A1XV... An astonishing piece of kit that has no equals."

AVC-A1XV "It's not often we can't find fault with a product, but as we said in our review, "It not only expands the home cinema envelope, it shreds it and then nukes it for good measure." HOME CINEMA CHOICE • AWARDS 2005



Yamaha

Yamaha is recognised as a world leader in the fields of musical instruments and audio equipment, and in more recent years, home cinema. New models for 2005 include upgraded AV receivers, amplifiers, and DVD players plus the innovative YSP-1 virtual surround speaker.



YAMAHA'S DVD-S2500, DSP-AX7575E & RX-V4600

Harman Kardon

Harman/Kardon's high quality audio, audio/visual and multi-room products are more than just boxes with knobs on, they are declarations of passion for music and movies. Producing pure, realistic sound with ever smarter engineering and simpler design,

Harman/Kardon products delight both the audio purist and the film lover around the world. We invite you to experience the unique combination of artistry and engineering that is Harman/Kardon.



REL

In a market packed with subwoofers claiming to deliver the ultimate bass experience, only one brand of sub-bass system can prove its supremacy. With a record of review success stretching back over a decade, REL is acknowledged as the leading provider of deep, clean bass frequencies.



M&K

Enjoy cinema as the director intended with a speaker system that is genuinely designed for surround sound. Every Miller & Kreisel surround sound system is designed around the highest quality centre speaker available and partnered with two identical main speakers, producing seamless panning across the front soundstage, combined with remarkable clarity and effortless dynamics.

Onkyo

"A Dinky design that offers a vigorous listen, plus reassuringly solid build... Onkyo's CR-505DAB is a fab buy."



Onkyo DS-A1 iPod Connector Dock



Pioneer

Pioneer's AV amplifiers and receivers are sound-tuned by the world-famous Air Studios to perfectly recreate the natural sound and energy of the original performance. The result is powerful, pure and crisp. Coupled with HDMI and iLink digital connectivity, as well as a connection for your iPod and PC, the audio adventure is even more absolute.



DVD Recorders

Although making digital recordings of TV broadcasts isn't new, the choice, versatility and quality of recorders keep getting better. Our product selection includes DVD only, hybrid DVD/hard-disk and multi-format models.



ESSENTIAL ACCESSORIES

The right accessories can make or break your system. Our carefully selected range, including QED, SOUNDSTYLE and GRADO, will ensure you get the very best performance from your system.



£ PRICING POLICY

We always try to ensure our prices are highly competitive. In the event you can find the same products and excellent service at a lower price, please bring it to our store managers' attention.

FLEXIBLE FINANCE OPTIONS*

Spread the cost of buying. Flexible finance options* are available on the majority of products we stock. *Written details on request. Licensed credit brokers. Minimum balance £400. Subject to status.

PLEASE NOTE Some products/brands are not available at all stores. Please call to confirm or visit our website before travelling. Special Offers and Sale Offers - Not in conjunction with any other offer. Advert valid until at least 09/02/2005. E&OE.

Winter Sale



Specialist home cinema

At the heart of any home cinema is its screen: Sevenoaks Sound & Vision can put you in the picture with a selection of flat-panel displays and projection systems. LCD and plasma screens are just a few centimetres thick and come in sizes from a 13inch portable to over 60inches.



Sharp Aquos

Only Sharp Aquos LCD TV offers so much perfection. With supreme styling, the appeal of the Aquos range is obvious. The Titanium Series combines Sharp's sixth-generation LCD panel with stunning, angular-styling, titanium colour-finish and superb build quality to produce a premium class of LCD idTVs

TITANIUM SERIES LC-45GD1E LCD TV with integrated FREEVIEW

"Sharp's mammoth 45in LCD TV is a testament to the growing viability and performance of large-scale LCD. Its 1,920 x 1,080 resolution panel allows high-definition pictures to be viewed without compromise and when exploited to its full potential, the results could see this screen hung in a gallery. Images are so crisp and sharp, it almost makes reality look dull. We think it's inspirational. Go pay homage." HOME CINEMA CHOICE • AWARDS 2005

FREEVIEW channel and service subject to coverage. Aerial upgrade may be required.

Loewe

Concept L32 32" LCD TV

With its minimalist, functional design, slim profile and ease of operation, the Concept L32 exudes all of the classic Loewe virtues.

"This HD Ready set boasts 1366x768 resolution and plenty of inputs, including HDMI, component video and two Scarts. It also packs an integrated digital TV tuner, and - as ever with Loewe sets - its speaker set-up is a cut above most rivals... The Concept L32 is immensely attractive: it deserves to sell very well indeed."



32WLT58 LCD TV

"All in all, this is a great set. The twin HDMI inputs lift it a step above the current competition, while the performance could easily grace something far costlier."

WHAT IS VIDEO • XMAS 2005 #301

Toshiba LCD TV

These super-slim screens will take your breath away. Each model has been moulded from a stunning blend of cutting-edge design and state-of-the-art technology to create the ultimate audio-visual sensation. The collection comprises LCD screen technology, offering unrivalled combinations of image quality and sophistication and a variety of screen sizes and options, including integrated digital tuner.

SEVENOAKS

SOUND & VISION



Pioneer

Following its highly successful '5' series, Pioneer has unveiled its sixth generation of plasma TVs. The 43" PDP-436XDE and 50" PDP-506XDE models include built-in digital tuners plus dual HDMI inputs.

PDP-436XDE PLASMA TV

"Pioneer's latest is also its greatest: this is a truly wonderful HD-Ready TV."



Samsung

Milano LE40M61B 40" LCD TV

Samsung's New 40" LCD TV (LE40M61B) was honored with an EISA award for its premium display technology in terms of contrast ratio (5000:1), color expression (6.44 billion colors, 92% color gamut for NTSC), viewing angle (178°) and response time (8 ms). Also the model's simple body design focuses the viewer's attention on the screen. On the front of the minimalist design, the speakers are hidden from view in the bottom bezel and nothing distracts from the superb image quality



Panasonic Viera

There seems little doubt that the future of television is flat, and the future of flat is the award-winning VIERA range from the world leaders in screen technology, Panasonic. The VIERA range consists of both LCD and Plasma televisions. New additions to the range include 37, 42 & 50in PV500 models with support for both high-definition and MPEG-4 recording.



TH42PV500 PLASMA TV

"All told, Panasonic's new TH42PV500 is a stunning set that's clearly the new class leader."



Winter Sale Now On!

Save £s in our fabulous Winter Sale. Visit www.ssav.com or call your nearest store on Freephone 0800 587 9909 for the latest prices and information.



Projection

If you'd prefer to measure your screen-size in feet, how about one of the new generation of projectors? The latest designs are delivering superb results at increasingly affordable prices, and they're more home friendly than previous projectors, too.



ScreenPlay

From the worldwide leader in digital projection technology and solutions, InFocus® ScreenPlay™ DLP™ projectors are changing the face of home cinema offering market-beating performance, specification and value at every price point.

SP7210

"The new projector's picture is just phenomenal... Looks like ScreenPlay's success story is set to continue."



SP4805

"Another stunning success from ScreenPlay - there's never been a better time to take the big-screen plunge."

Sim2

Sim2 Multimedia is a world-leading manufacturer at the forefront of home cinema technology and a name synonymous with high-end home cinema projection.

HT300E "Spectacular, in a word... Another terrific projector from Italy's finest."
WHAT VIDEO • ISSUE 292



Themescene

Since its launch, the multi-award winning ThemeScene™ brand has rapidly established a five-star reputation for uncompromised image quality.

H30A "There are so many good points it's hard to know where to start... Just how much better can budget DLP projectors get?!"
WHAT VIDEO • ISSUE 292



DVDO iScan™ VP30

The iScan™ VP30 is a high-definition video processor and A/V hub that converts standard or high definition from your DVD player, VCR, PVR, HD set top box, game console, or PC to any output resolution between 480p and 1080p, including popular HDTV resolutions such as 720p and 1080i.

Product Selection

Listed below is a small selection of our extensive product range. **Please note:** Some products/brands are not available at all stores. Please call to confirm or see the brand locator at www.ssav.com before travelling.

TURNABLES

Goldring GR2	£ SALE
Linn RANGE	£ SALE
Michell RANGE	£ SALE
Project RANGE	£ SALE
Roksan Radius 5	£ SALE

TUNERS

Arcam RANGE	£ SALE
Cyrus FM X	£ SALE
Denon TU260L MKII	£ SALE
Harman Kardon RANGE	£ SALE
Linn RANGE	£ SALE
Marantz RANGE	£ SALE
Pure DRX-701ES DAB	£ SALE
Pure DRX-702ES DAB/FM	£ SALE
Rotel RANGE	£ SALE

CD PLAYERS

Arcam RANGE	£ SALE
Audiolab RANGE	£ SALE
Cyrus RANGE	£ SALE
Denon DCD485	£ SALE
Linn RANGE	£ SALE
Marantz RANGE	£ SALE
Meridian RANGE	£ SALE
Musical Fidelity RANGE	£ SALE
NAD RANGE	£ SALE
Quad RANGE	£ SALE
Roksan RANGE	£ SALE
Rotel RANGE	£ SALE

CD RECORDERS

Yamaha CDR-HD1500	£ SALE
-------------------	--------

AMPLIFIERS

Arcam RANGE	£ SALE
Audiolab RANGE	£ SALE
Cyrus RANGE	£ SALE
Denon PMA355	£ SALE
Linn RANGE	£ SALE
Marantz RANGE	£ SALE
Meridian RANGE	£ SALE
Musical Fidelity RANGE	£ SALE
NAD RANGE	£ SALE
Quad RANGE	£ SALE
Roksan RANGE	£ SALE
Rotel RANGE	£ SALE
Yamaha AX396	£ SALE

HI-FI SPEAKERS

Acoustic Energy Aegis Evo One	£ SALE
Acoustic Energy Aegis Evo Three	£ SALE
Acoustic Energy Aelite RANGE	£ SALE
Acoustic Energy AE1 MKIII	£ SALE
AVI Neutron IV	£ SALE
B&W RANGE	£ SALE
KEF RANGE	£ SALE
Linn RANGE	£ SALE
Meridian RANGE	£ SALE
Mission RANGE	£ SALE
Monitor Audio RANGE	£ SALE
Quad RANGE	£ SALE
Ruark RANGE	£ SALE
Wharfedale RANGE	£ SALE

HI-FI SYSTEMS

Arcam Solo Ex Speakers	£ SALE
Denon RANGE	£ SALE
Linn Klassik Music Ex Spks	£ SALE
Monitor Audio i-Deck	£ SALE
Onkyo CR505DAB Ex Spks	£ SALE
Teac RANGE	£ SALE
Yamaha CRX-M170 Ex Spks	£ SALE

DVD SYSTEMS

Denon RANGE	£ SALE
KEF KIT100 Inc Speakers	£ SALE
Teac RANGE	£ SALE

MULTI-ROOM AUDIO

Cyrus Link RANGE	£ SALE
Living Control RANGE	£ SALE
Yamaha MusicCast RANGE	£ SALE

DVD PLAYERS

MAKE & MODEL	REGION 2	MULTI REGION
Arcam RANGE	£ SALE	£ SALE
Cyrus RANGE	£ SALE	£ SALE
Denon RANGE	£ SALE	£ SALE
Denon DVD-ATXV	£ SALE	£ SALE
Harman Kardon RANGE	£ SALE	£ SALE

Marantz RANGE	£ SALE	£ SALE
Meridian RANGE	£ SALE	£ SALE
Panasonic RANGE	£ SALE	£ SALE
Pioneer RANGE	£ SALE	£ SALE
Samsung DVD-HD950	£ SALE	£ SALE
Toshiba SD350	£ SALE	£ SALE
Yamaha RANGE	£ SALE	£ SALE

DVD RECORDERS

MAKE & MODEL	REGION 2	MULTI REGION
Panasonic RANGE	£ SALE	£ SALE
Pioneer RANGE	£ SALE	£ SALE

AV AMPLIFIERS & RECEIVERS

Arcam RANGE	£ SALE
Audiolab RANGE	£ SALE
Cyrus RANGE	£ SALE
Denon AVC-A1XV AV Amplifier	£ SALE
Denon RANGE	£ SALE
Harman Kardon RANGE	£ SALE
Lexicon RANGE	£ SALE
Marantz RANGE	£ SALE
Onkyo RANGE	£ SALE
Pioneer VSX-1014s AV Receiver	£ SALE
Pioneer VSX-2014i AV Receiver	£ SALE
Pioneer VSX-AX5Ai AV Receiver	£ SALE
Pioneer VSA-AX10Ai AV Amplifier	£ SALE
Pioneer NEW RANGE	£ SALE
Rotel RANGE	£ SALE
Yamaha DSP-AX7575E AV Amplifier	£ SALE
Yamaha RX-V357 AV Receiver	£ SALE
Yamaha RX-V557 AV Receiver	£ SALE

AV SPEAKERS & PACKAGES

Acoustic Energy Evo 3B	£ SALE
Artcoustic RANGE	£ SALE
Audica RANGE	£ SALE
B&W RANGE	£ SALE
B&W Mini Theatre RANGE	£ SALE
KEF KHT1005	£ SALE
KEF KHT2005.2	£ SALE
KEF Q7 AV	£ SALE
M&K RANGE	£ SALE
Mission M Cube	£ SALE
Mission Elegant RANGE	£ SALE
Monitor Audio RANGE	£ SALE
Mordaunt Short Genie	£ SALE
Quad L-Series	£ SALE
Wharfedale Diamond 9 HCP	£ SALE
Yamaha YSP RANGE	£ SALE

SUBWOOFERS

B&W RANGE	£ SALE
M&K RANGE	£ SALE
MJ Acoustics RANGE	£ SALE
Monitor Audio RANGE	£ SALE
Quad L Series	£ SALE
REL RANGE	£ SALE
Wharfedale Diamond SW150	£ SALE

PLASMA

Fujitsu RANGE	£ SALE
Hitachi RANGE	£ SALE
LG RANGE	£ SALE
Loewe RANGE	£ SALE
Panasonic RANGE	£ SALE
Pioneer PDP436XDE 43"	£ SALE
Pioneer PDP506XDE 50"	£ SALE
Samsung RANGE	£ SALE

LCD TV

Hitachi RANGE	£ SALE
LG RANGE	£ SALE
Loewe RANGE	£ SALE
Panasonic RANGE	£ SALE
Philips RANGE	£ SALE
Samsung RANGE	£ SALE
Sharp Aquos RANGE	£ SALE
Toshiba RANGE	£ SALE

PROJECTORS

Optoma RANGE	£ SALE
Screenplay RANGE	£ SALE
Screenplay SP5700 (REFURBISHED, LAST FEW)	£ SALE
Sharp RANGE	£ SALE
Sim 2 RANGE	£ SALE
Sim 2 C3X	£ SALE
ThemeScene RANGE	£ SALE

ACCESSORIES

We have a wide range of Accessories from QED, Soundstyle, Grado, Goldring and more...

£ PRICING POLICY

We always try to ensure our prices are highly competitive. In the event you can find the same products and excellent service at a lower price, please bring it to our store managers' attention.

FLEXIBLE FINANCE OPTIONS*

Spread the cost of buying. Flexible finance options are available on the majority of products we stock. *Written details on request. Licensed credit brokers. Minimum finance £400. Subject to status.

PLEASE NOTE

Some products/brands are not available at all stores. Please call to confirm or visit our website before travelling. Special Offers and Sale Offers - Not in conjunction with any other offer. Advert valid until at least 09/02/2006, E&OE.

Who are Sevenoaks?

Established as Sevenoaks Hi-Fi in 1972, we have grown steadily onto one of the leading independent home entertainment specialists in the UK, earning a reputation for outstanding service, choice and value for money. In 1995, reflecting our commitment to the emergent new technologies in home cinema, our name was changed to Sevenoaks Sound & Vision. We now have 49 stores across the land stocking a broad range of exceptional equipment and accessories.

How to shop at Sevenoaks

When it comes to making big decisions about what to buy, there's no substitute for actually road-testing your prospective purchases - seeing, hearing and experiencing the products in action, with the benefit of our expert knowledge and guidance to help you choose.

Hi-Fi & Home Cinema Guide

New 2006 Edition

Pick-up a copy of our new **68 Page Guide** at your nearest Sevenoaks Sound & Vision store or order a copy via our Website. The brochure will be posted to you (UK mainland addresses only) **FREE OF CHARGE**.



New Sevenoaks Website

The fully re-designed Sevenoaks Sound & Vision website has news and information on the Sevenoaks group and detailed pages to help you locate your nearest store. You will find all our fabulous **WINTER SALE** offers and, in addition, hundreds of **STOCK CLEARANCE** items available from our stores nationwide.

To find out more, just click on www.ssav.com

WITH OUR CUSTOM DESIGNED INSTALLATIONS, your home entertainment choices become as convenient as they are clever. We can help transform every room and every home, whatever your requirements and budget.

Our installation experts are trained to the highest standards in all areas and provide a prompt, reliable and totally professional service. Rest assured also that our commitment to service doesn't end once your equipment is in place. Sevenoaks staff will continue to support you and your kit long after your initial visit to one of our stores.



Custom
Installation

SEVENOAKS

SOUND & VISION

NATIONWIDE STORE GUIDE

ABERDEEN 01224 252797

● 57 CROWN STREET *OPEN SUNDAY*

BEDFORD 01234 272779

● 29-31 ST PETERS STREET

BRIGHTON 01273 733338

● 57 WESTERN ROAD, HOVE

BRISTOL 0117 974 3727

● 92B WHITELADIES ROAD, CLIFTON

BROMLEY 020 8290 1988

● 39A EAST STREET

CAMBRIDGE 01223 304770

● 17 BURLEIGH STREET

CARDIFF 029 2047 2899

● 104-106 ALBANY ROAD

CHELSEA 020 7352 9466

● 403 KINGS ROAD

CHELtenham 01242 241171

● 14 PITTVILLE STREET

CRAWLEY 01293 510777

● 32 THE BOULEVARD

CROYDON 020 8665 1203

● 369-373 LONDON ROAD

EALING 020 8579 8777

● 24 THE GREEN *OPEN SUNDAY*

EDINBURGH 0131 229 7267

● 5 THE GRASSMARKET

EPSOM 01372 720720

● 12 UPPER HIGH STREET *OPEN SUNDAY*

EXETER 01392 218895

● 28 COWICK STREET

GLASGOW 0141 332 9655

● 88 GREAT WESTERN ROAD *OPEN SUNDAY*

GUILDFORD 01483 536666

● 73B NORTH STREET

HOLBORN 020 7837 7540

● 144-148 GRAYS INN ROAD

HULL 01482 587171

● 11 SAVILE ROW, SAVILE STREET *OPEN SUNDAY*

KINGSTON 020 8547 0717

● 43 FIFE ROAD *OPEN SUNDAY*

LEEDS 0113 245 2775

● 62 NORTH STREET *OPEN SUNDAY*

LEICESTER 0116 253 6567

● 10 LOSEBY LANE

LINCOLN 01522 527397

● 20-22 CORPORATION STREET (*OFF HIGH STREET*)

LOUGHTON 020 8532 0770 **NEW**

● 7-9 GOLDINGS HILL

MAIDSTONE 01622 686366

● 96 WEEK STREET

MANCHESTER 0161 831 7969

● 69 HIGH ST, CITY CENTRE

NEWCASTLE 0191 221 2320

● 19 NEWGATE STREET

NORWICH 01603 767605

● 29-29A ST GILES STREET

NOTTINGHAM 0115 911 2121

● 597-599 MANSFIELD ROAD, SHERWOOD

OXFORD 01865 241773

● 41 ST CLEMENTS STREET

PETERBOROUGH 01733 897697

● 36-38 PARK ROAD *OPEN SUNDAY*

PLYMOUTH 01752 226011

● 107 CORNWALL STREET

POOLE 01202 671677

● LATIMER HOUSE, 44-46 HIGH STREET

PRESTON 01772 825777

● 40-41 LUNE STREET *OPEN SUNDAY*

READING 0118 959 7768

● 3-4 KINGS WALK SHOPPING CENTRE

SEVENOAKS 01732 459555

● 109-113 LONDON ROAD

SHEFFIELD 0114 255 5861

● 635 QUEENS ROAD, HEELEY *OPEN SUNDAY*

SOLI HULL 0121 733 3727

● 149-151 STRATFORD ROAD

SOUTHAMPTON 023 8033 7770

● 33 LONDON ROAD *OPEN SUNDAY*

SOUTHGATE 020 8886 2777

● 77 CHASE SIDE

STAINES 01784 460777

● 4 THAMES STREET *OPEN SUNDAY*

SWINDON 01793 610992

● 8-9 COMMERCIAL ROAD

SWISS COTTAGE 020 7722 9777

● 21 NORTHWAYS PDE, FINCHLEY RD *OPEN SUNDAY*

TUNBRIDGE WELLS 01892 531543

● 28-30 ST JOHN'S ROAD

WATFORD 01923 213533

● 478 ST ALBANS ROAD

WEYBRIDGE 01932 828525

● 43 CHURCH STREET, THE QUADRANT

WITHAM (ESSEX) 01376 501733

● 1 THE GROVE CENTRE

WOLVERHAMPTON 01902 312225

● 29-30 CLEVELAND STREET

YEovil 01935 700078 **NEW**

● 14 SILVER STREET

OPENING HOURS: PLEASE TELEPHONE OR VISIT OUR WEBSITE

E-MAIL: [insert store location]@ssav.com

Winter Sale Now On!

Save £s in our fabulous **Winter Sale**. Visit www.ssav.com
or call your nearest store on Freephone **0800 587 9909**
for the latest prices and information.

Birth Of

For many, analogue audio is quite literally the beginning and end of recorded music. Neville Roberts tells its story, from its historic, humble beginnings to the latest and greatest high end high fidelity turntables...



The history of recorded sound dates right back to 1796 when Antoine Favre, a Swiss watchmaker, described his idea for what we now call the cylinder musical box. Really an automated musical instrument which does not record an arbitrary sound, it was a means of playing a pre-determined tunes at will. In order to play an acoustic signal, a means to record the sound had to be devised.

Sound is a longitudinal wave that is generated by a source, such as a musical instrument, and travels through a medium (air) to reach the ear, which in turn converts the vibrations of the eardrum into an electrical signal that is interpreted by the brain. The term 'longitudinal' refers to the sound wave being in the same plane as the direction of travel of the wave. This is unlike the ripples on a pond, which are transverse waves as the water moves up and down in the same spot as the wave travels along the surface of the pond. Sound waves are successive compactions and rarefactions of the

air about a mean point as the wave travels at 330m/s through the air. The challenge of sound recording is to record these air vibrations in a permanent form.

This was first done in 1857 on a 'phonoautograph' by a Frenchman called Leon Scott on a cylinder blackened with smoke. However, there was no way to play this recording back and this was, therefore, of little use!

Thomas Alva Edison's early attempts at recording involved recording Morse code on a disc. This was

essentially a disc with binary data recorded as a track on the surface - sound familiar? Edison did not consider this digital system suitable for recording sound at the time as he turned his attention to analogue means...

The wax cylinder was the first commercially produced acoustic recording. This was based on a technique invented by Edison of the USA in 1877. By wrapping tin foil around a cylinder, he famously intoned "Mary had a little lamb" into a diaphragm which caused a stylus to cut a groove of varying depth on the tinfoil, which corresponded to the movement of the diaphragm caused by the air vibrations that impinged on it. Using a separate stylus and diaphragm, he was able to play this recording back.

Edison ignored his invention for a few years while he worked on electric light, but later resumed his interest in sound reproduction and devised a way of mass-producing cylinders by making a one-piece cylindrical mould of a master cylinder by electroplating.

In 1887, Emile Berliner, also in the USA, patented a machine that recorded these vibrations on a zinc disc, rather than a cylinder. This was called the gramophone recorder and it imprinted grooves on the flat side of the disc. Instead of recording the sound by varying the depth of the groove (the 'hill and dale' method of recording) as with the phonograph, the recording was made laterally in a spiral groove of constant depth on a flat disc. Berliner called this audio disc a 'gramophone record'.

Both the above methods were, of course, totally mechanical. In order to transfer enough energy to the cutting stylus to record the



Edison Amberol label.

vibrations, some form of acoustic impedance matching had to be devised that matched the high impedance of the air to the low impedance of the diaphragm. This was achieved by the use of a tapered horn with an exponential flare. This was tremendously important - try listening to a phonograph or acoustic gramophone without the horn attached! Without a horn, the sound is quiet, thin and tinny. With the horn, the volume increases dramatically, and so does the frequency response. These horns became beautifully decorated features of the design of phonographs and gramophones. The larger horns produced the best sound and often required metal support structures to hold them in place.

Early disc recordings and phonograph cylinders had about the same audio fidelity, although the cylinder has theoretical advantages of constant linear groove speed and the greater dynamic range of the hill-and-dale groove geometry. Cylinders were either two or four minutes in duration and recorded at 160rpm. Berliner's discs ran at 30rpm for two minutes duration.

FOR THE RECORD

Edison was still trying to develop a process of mass-production of his cylinders in 1887 and it took until 1900 to solve the problem, when he used a type of wax which, after

Phonograph wax cylinder.



The Cool



being cast into a mould, shrank just sufficiently on cooling to release itself from the grooves enabling it to be withdrawn from the mould. The Columbia Phonograph was formed in 1889 to market a treadle-powered graphophone, although the company had more success selling cylinders of music, especially of military bands and the music of Sousa.

In 1894, the American Graphophone and Columbia Phonograph companies merged to form the ancestor of the Columbia Record Company. Meanwhile, Berliner's Gramophone Company started marketing a 7" 70rpm single-sided disc that played for two minutes at a cost of 50 cents each. Power for both cylinder phonographs and disc gramophones ranges from hand-cranked and treadle-powered motors to spring-driven clockwork and battery-powered electric motors.

Although the cylinder and record coexisted during the first decade of the 20th century, the gramophone record was easier to mass-produce than cylinders. By 1913, the disc record prevailed and cylinder phonographs were no longer made. Dance music was all the rage and orchestras were formed to meet the demand. Edison created thick discs of ballroom music with a vertically

modulated groove rotating at 80rpm. Other manufacturers produced discs recorded at 78rpm and the programme material catered for all tastes, including classical, jazz and dance music, as well as popular performers of the time like Harry Lauder. When World War I ended in 1918, the record industry took off

and in the following year, Victor produced the first pop music record that sold over one million copies ("Dardanella" by the Ben Selvin orchestra). By 1922, recorded music was the most popular form of entertainment in the USA.

The recession hit in 1923 and Columbia and Victor were hit hard. However, Western Electric, together with AT&T and Bell Labs, developed an electrical recording system which revolutionised the recording process. Now, microphones could be used instead of acoustic horns which gave a huge leap in the quality of the recordings.

Records were produced double-sided and played for about five minutes per side.

In 1925, the speed of a record was standardised in the USA at 78.26rpm. This speed was chosen as it was easy to achieve with a 3600rpm electric motor and a 46-1 reduction gear ($3600/46 = 78.26$).

By 1930, the natural material of shellac was replaced with synthetic resins, but they were still noisy, brittle and easily broken.

The Second World War saw many of the performers drafted into the armed forces and the production of gramophones was suspended. However, after the war, the industry took off again and so did developments in technology. RCA had conducted some research into a new form of record material in 1931 using "Vitrolac" vinyl plastic that recorded at a 33 1/3rpm 'professional' speed. This failed to replace the popular 78s at the time, but the lower surface noise and greater resiliency was remembered. Also,



Shellac 78s.

shellac was in short supply so 78s started to be manufactured in vinyl.

In 1948, Columbia Records introduced the 12" microgroove LP recorded at 33 1/3rpm and pressed in vinyl. Not to be outdone, RCA Victor launched the 45rpm vinyl single in 1949. This was a turning point as the 45 held the same

"Shellac is a natural plastic made from the secretion of an Indian lac beetle, mixed with cotton and powdered slate together with wax to provide lubricant"

amount of material as a 12" 78 and was lighter and more rugged. Singles made in the USA had 1" diameter centre holes and required an adaptor to be fitted, either to the record or the turntable, to play on UK standard spindles. Most juke boxes were of USA origin and UK singles had a push-out removable centre to accommodate the USA standard spindle.

The heyday of the 45 came with



Close up of a ceramic cartridge

vivid audio .co.uk

Laurence Dickie, world-renowned designer of the famous Nautilus Loudspeaker system, has developed and patented new advanced drive units which are integral to the striking new Vivid Audio range of Loudspeakers. A true technical tour de force - both visually stunning and unquestionably musically rewarding.

Laurence Dickie

It takes a special combination of characters to achieve successful partnerships. Vivid Audio has come into being because of the coming together of just that sort of team. Much of the innovation is the brainchild of the Brighton-based designer Laurence Dickie. Since a young age, Laurence Dickie has been passionate about music and the sciences but his particular obsession has been with loudspeakers. With his insatiable zest for learning and discovering, he has been developing his passion from school days through University and beyond. Laurence (Dic) has honed his skills in the design of loudspeakers of extraordinary performance. His achievements to date are noteworthy, to say the least, and he commands a deep respect from his peers. But, Dic does not simply design loudspeakers.....

.....he takes the proposed design concept and improves it beyond the point most designers are happy to "sign off".

Joining forces with the South African contingent of Bruce and Deone Gessner and Philip Guttentag (forming Vivid Audio), was the ideal career move since he could now be involved in designing and engineering products in their entirety. It meant his having a say at every stage of development, from the acoustic performance to the aesthetic design of each product. Dic's involvement in the Vivid Audio story is one that started approximately five years ago when he set out to create a range of drivers for professional monitors. He was introduced to the other members of Vivid two years later when it quickly became clear that these same drivers would be eminently suitable for a new range of groundbreaking designs they had been developing.

For a new high-end speaker manufacturer to succeed it was clear from the outset that such a company would have to deliver products featuring more than just innovative engineering. These products would have to deliver an acoustic performance rendering them virtually invisible. They would need to refine acoustic performance to a new level which encourages the listener to want more, rather than tire and need a break.

Vivid Audio wanted to achieve all these things but not just at any price. That's why they made considerable effort to extract the best performance imaginable from each component using customary materials wherever possible. Which is why there are no standard parts to be found in any of their loudspeakers.

Every component is made to their own exacting specification. Most hidden away but quietly delivering a listening experience not to be forgotten.

C1 Centre Channel Loudspeaker
3 way system
£3,750.00

V1/1.5 Full Range Loudspeaker (NEW)
2 way system
£3,950.00 / £4,500.00

" Even a seasoned speaker designer was just transported into the film, effortlessly and instantly. And that after all, is what the filmmakers' art is all about and what we hope our home cinema kit will deliver to us in our homes. Only the best kit does it this well and Vivid is up there. It is big and it is clever. "

Vivid Audio Surround Sound System (B1, K1, C1)
Adam Rayner, Home Cinema Choice, August 2005.
Gold Star Reference Status

" An extremely revealing and genuinely neutral loudspeaker with dynamic range, timing and imaging to die for.

A true world class loudspeaker from a brand that knows how to get results. "

Vivid Audio B1
Jason Kennedy, Hi-Fi Choice
Editors Choice Award

" Seamless is a much-banded term in describing speaker sound, but the K1 gave a definitive reference point for applying the description. What may be termed the aspiration of this speaker was nigh-on perfect. "

Vivid Audio K1
Andrew Harrison, HI-FI News, Dec 2005

" To create ultimate detail in a range of monitor studio loudspeakers for the home. Vivid took a completely new and radical approach to their design...

...this meant surpassing existing speaker technology in order to reach a no compromise solution, giving unparalleled musical insight, resolution, speed, dynamics and tonal accuracy. "

To arrange an audition please contact:
vividaudio.co.uk

Product Discovery
Of The Year
Annual Award 2004

Gold Star
Reference Status
Guarantee

EDITOR'S CHOICE
HI-FI CHOICE
magazine

K1 Full Range Loudspeaker
3 & 1/2 way system
£10,750.00

B1 Full Range Loudspeaker
3 & 1/2 way system
£7,750.00

Both two-channel and home cinema configurations available. Choice of 5 standard colour finishes or custom colour matching.





Parlophone label 'Jumping Bean'.

the rock-and-roll era. The 45rpm single was a low-cost, collectable commodity that teenagers could smuggle home unnoticed to play on their trendy Dansette record players in their bedrooms! For the Mums and Dads, there was the radiogram that were pieces of furniture that graced the sitting room. The improved sound quality of the vinyl LP, coupled with the large wooden cabinets of the radiograms, led to the birth of the hi-fi era and the record industry rose to meet the challenge...

EQUALISATION

The process of changing the frequency response of the recording to reduce noise and make best use of the recording medium, soon became an issue. For acoustically recorded cylinders or records, a constant velocity recording is produced. This provides a flat response as the velocity is measured as the stylus crosses the depth corresponding to an unmodulated groove. For a given loudness, the variation in groove depth (modulation) is proportional to the reciprocal of frequency.

When electronic amplification came along for records, a constant velocity recording was ideally suited to a magnetic cartridge for playing back '78s as these produce an output proportional to velocity. However, this also reproduced the surface noise of the record and this method of recording did not make best use of the groove as the high frequencies produced only a tiny modulation of the groove.

Therefore, in the 1950s, the RIAA (Record Industry Association of America) standard was adopted that boosted high frequencies during the recording process, which would then be attenuated during playback and therefore also attenuate the high frequency noise. In addition, this process made much better use of the groove and resulted in a modulation that was largely constant across the frequency range, which is effectively a 'constant displacement' recording. Furthermore, the discovery of the piezo-electric effect gave rise to lighter and simpler-to-manufacture

crystal and ceramic cartridges. These produce a much higher output and an output signal proportional to displacement, not velocity. RIAA recordings could then be played back on low-cost players with simple circuitry as no playback equalisation was required.

STEREO TYPES

Towards the end of the 1950s, 'high fidelity' versions of the radiogram became available. These were the

"much lighter and with much lower surface noise, vinyl quickly became the standard for all sizes of record..."

first integrated hi-fi systems, albeit mono. However, developments would be influenced by the research of Alan

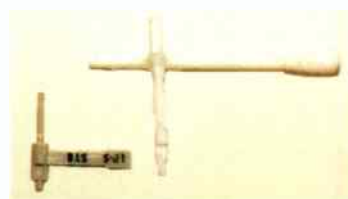

Original stylus.

Blumlein in the 1930s into binaural sound for cinemas.

Blumlein was aware that two audio channels could add a special dimension to recorded sound, but a commercially viable system would have to be developed. Back in 1931, Blumlein patented a system for recording two channels in a single groove of a record recorded at 45 degrees, giving a sum and difference signal. A great advantage of this is that existing mono record players would pick up the sum signal and play both channels through the speaker, hence the system was compatible with mono equipment.

EMI, Blumlein's employer, had not made any use of Blumlein's binaural patents since the mid 1930s. In 1955, Decca tried to patent a two-channel system that they called 'stereophonic sound' and, although this was not successful, it did prompt EMI to begin experimenting with the concept again in April 1955. Sir Malcolm Sargent conducted a series of tests at Abbey Road and this led to the first stereo LPs being produced in 1958.

To play these new stereo LPs, audio equipment manufacturers rose to meet the challenge. For example, the Pye 1207 stereogram, designed by a young furniture designer, Robin Day, whose square edged and matt-

finished modern designs fitted in well with the '60s contemporary tastes in furniture, became a best-seller. Designer names like Denmark's Bang and Olufsen competed with international companies such as Phillips, based in the Netherlands.

The 1960s saw the birth of the 'hi-fi separate' and established names like Quad and Leak had competition from the likes of Trio (the UK-branded version of the Japanese maker Kenwood) and US makers

Fisher and Scott. In 1963, Leak introduced one of the first stereo transistorised amplifiers, the Stereo 30. Leak claimed that the sound quality from their transistorised equipment was every bit as good as that from valves, but such early solid-state models were not always praised (or later ones for that matter!).

FOUR REAL

The development of quadraphonic records was announced in 1971. This process recorded four separate sound signals on an LP. A variety of techniques was used; one method recorded the four channels by electronically matrixing the channels down to two. When the records were played, circuits in the amplifiers were able to decode the signals back into the original four channels. There were two main systems of matrixed quadraphonic records produced, the SQ system from CBS and the Sansui QS system. A different format, CD-4 developed by RCA, encoded rear-channel information on an ultrasonic carrier, which required a special wideband cartridge to pick it up. Typically the high-frequency information wore off after only a few playings, and CD-4 was even less successful than the two matrixed



Pye 10inch 78 vinyl.



“ Desire... ”

WATERFALL

“ The result is an overall crispness and clarity that is rarely matched by conventional wood-bodied speakers. ”
Hi-Fi Choice, Jan 2005

“ I soon came to appreciate the intrinsically musical character here and found myself listening at great length. ”
Hi-Fi News July 2005

“ They succeed by being beautiful both inside and out, combining elegance and superlative engineering rigorously as an aesthetic expression. ”
Hi-Fi World, June 2005



T+A



VERDICT ●●●●●

V10 Integrated Valve Amplifier
Hi-Fi World, November 2005

Brilliantly accomplished, uniquely designed modern valve amp with sonics and style to match.

“ A Certifiable Masterpiece. This is to debut amplifiers what LED Zeppelin 1 was to debut LP'S. ”
Ken Kessler, HiFi News, Feb 2004

Authorised Stockists:

Unique Sound & Vision
London, (t) 020 7272 0922

Guildford Audio
Guildford, (t) 01483 537577

Sounds of Music
Near Heathfield, (t) 01435 865212

TechnoGnosis
Basildon, (t) 07770 851445

The High End
London, (t) 020 8876 3355

Laser Vinyl
Bromsgrove, (t) 07976 544236

Home Networks Sound & Vision
Birmingham, (t) 07785 241478

Videotech
Huddersfield, (t) 01484 516670

Music Unlimited
Leverton, (t) 01205 871699

Audience
Bath, (t) 01225 333310

Alto AV
London, (t) 0845 456 9614

Oxford Audio Consultants
Oxford, (t) 01865 790879

Midland Hi Fi Studio
Wolverhampton, (t) 01902 380083

Hadwins
Cumbria, (t) 01539 722557

Transparent Distribution Ltd
Coxmoor Road, Sutton in Ashfield, NG17 5LA, UK

(tel/fax) 01623 517000
info@transparentdl.co.uk, www.transparentdl.co.uk



Transcriptors Limited



Transcriptors T6 Turntable

69 Broadfields
Calverton
Nottinghamshire
NG14 6JQ

Telephone: +44 (0) 7005 964 349
Fax: +44 (0) 7005 964 347
Website: www.transcriptors.co.uk
Email: transcriptors_limited@yahoo.co.uk



British made subwoofers
at out of this world prices



XLS200 - £279.00

275W Compact Subwoofer
Over 100,000 award winning subwoofers
manufactured to date

Buy online at :-
www.bkelec.com/new

Coming Soon To A Home Cinema Near You

Qube 150 a 150W 12" Sealed enclosure subwoofer at £179.00
The Monolith a 300W 12" Ported enclosure subwoofer at £379.00



BK Electronics, Unit 1, Comet Way, Southend-On-Sea,
Essex. SS26TR
Tel :- 01702-527572 Fax :- 01702-420243 email :-
sales@bkelec.com

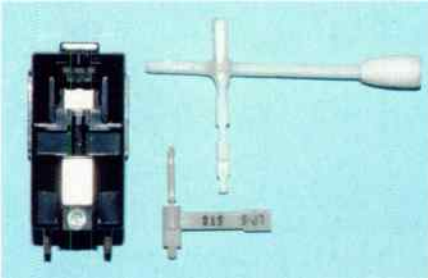

Cartridge with turnover stylus

formats. All these formats proved commercially unsuccessful, but were an important precursor to later 'surround sound' systems, as seen in SACD and home cinema today.

In the late 1970s, 'direct-to-disc' records were produced by the likes of Sheffield Labs for the audiophile niche market, which completely bypassed use of magnetic tape in favour of a high quality transcription directly onto the master lacquer disc. Also during this period, half-speed mastered and 'original master' records were released, such as Mobile Fidelity Sound Lab's recording of 'Dark Side of the Moon', using expensive state-of-the-art technology.

The early 1980s saw the introduction of 'DBX-encoded' records, again for the audiophile market. These were completely incompatible with standard hi-fi systems as they required sophisticated DBX noise reduction encoding and decoding hardware. The purpose of this was to provide a significant reduction in playback noise and increase dynamic range. A similar and very short-lived technique involved using the CBS-developed CX noise reduction system.

Also in the late 1970s and 1980s, a method to improve the dynamic range of mass-produced records was developed, using highly advanced disc cutting equipment. These techniques, marketed as the CBS Discomputer and Teldec Direct Metal Mastering, were used to reduce inner-groove distortion. Their success – or lack thereof – remains the topic of heated debates in high end vinylphile circles to this day!

While all this development was going on, the vinyl record was the primary medium for distributing recorded material, with reel-to-reel

tape coming in as a distant second. The 8-track cartridge was developed primarily as a medium for car stereos, but companies like General Electric tried to market portable 8-track players, but these never caught on.

It was the Phillips Compact Cassette (1963) with its small size and recordability that triumphed in the 1970s over the other rival formats to the LP record. However, the quality could never match that

"despite its drawbacks, so much of what vinyl does is so right that it's the only format which can be truly called 'high resolution'..."

achieved by a well produced vinyl LP. It took the development of domestic digital formats to finally oust vinyl from the mass market and the 1980s saw the introduction of the convenient and rugged Compact Disc, which took over from the LP.

THE DEATH OF VINYL?

Now that the CD has completely replaced vinyl for the distribution of classical music, the music industry is only producing records for the specialist dance, jazz, rock and pop music markets. Further developments with digital formats such as SACD and Blu Ray technology has now led to the CD now being classified as a 'legacy format'!

Much has been written about the innate quality of an analogue recording and how much inaudible high frequencies can contribute to the depth, clarity and spaciousness of the sound. Despite the apparent limitations of susceptibility to scratches, limited dynamic range and wearing ability, a well cared for high quality vinyl recording played on a good system can, in my opinion, still outperform the best that digital has to offer and I for one, will not be discarding my record collection in a hurry! Many others share this view, and in the second half of the twenty first decade, vinyl sales are growing steadily and it is becoming the 'specialist' audio format of choice for young and old alike.

Despite its myriad technical drawbacks, relative fragility and storage problems, so much of what vinyl does is inherently right that it is arguably the only format which can be truly called 'high resolution'.



Capitol label on a 10 inch disc



Brunswick label on a 10 inch disc



Pye label on a rare 10 inch disc



Decca label on a 12 inch disc

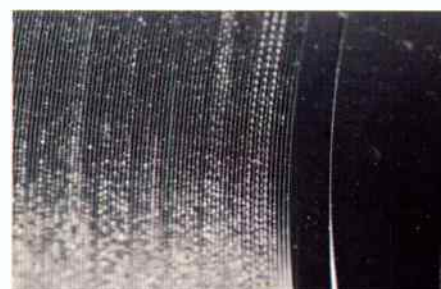

Grooves in a 45rpm vinyl single

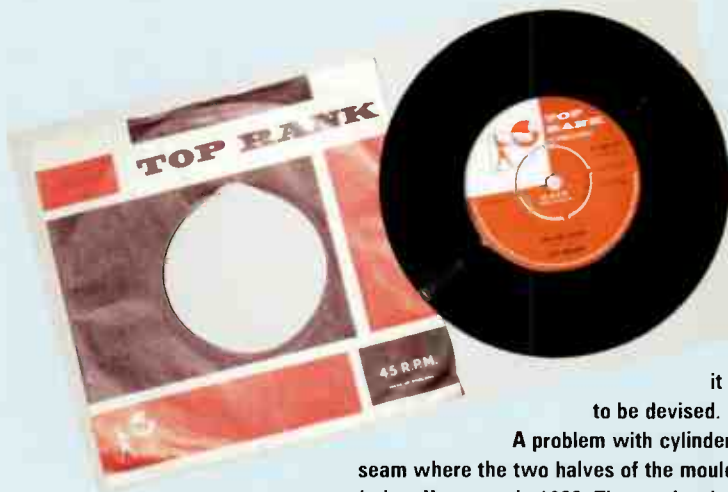

MASTER CLASS

When Edison first started making cylinder recordings for sale to the general public, he realised that he would have to devise some method of mass production. Several master cylinders could be cut at the same time by having a number of cylinder recorders recording the live performance simultaneously. In the early days, all recordings were indeed original recordings but as the volume of sales increased, it was soon realised that a method of mass production would have to be devised.

A problem with cylinder recordings is that a conventional split mould would produce a seam where the two halves of the mould join. This would produce an unacceptable click at every half-revolution. However, in 1900, Thomas Lambert developed a process that created a copper negative of a wax master cylinder using heat and pressure to mould celluloid copies from the copper negative.

Thomas Edison saw the potential of this method and thanks to a team of lawyers (Lambert's company was out of business by 1907!) managed to apply this process using a wax that shrinks slightly on cooling so that it can be withdrawn from a one-piece mould without damage. The master cylinder was electroplated to produce the one-piece negative mould, from which a large number of wax cylinders could be produced. However, as demand increased, many masters were needed and this required the performers to repeat their performance many times over!

A record is much easier to mass-produce using a conventional two-part mould. In the early days, discs were cut directly from the live performance and this was an entirely mechanical process. The invention of the electronic valve enabled microphones to be used that were connected to an amplifier which drove the cutting stylus. With the development of magnetic tape recording, a master recording was made on audio tape and this was then used to cut the master record.

Early master records were made using a disc of zinc that had been coated with a thin wax. The recording stylus cut through the wax to expose the metal underneath. The disc was then etched with acid to form a groove in the metal master positive. This was then copied to make a negative copy which was subsequently used to press the final discs for sale.

Later, discs were mastered by cutting the full groove directly into a hard lacquer. The lacquer is subsequently electroplated with a nickel alloy. The metal is then removed from the lacquer to produce a master that is a negative of the original disc. This is then electroplated again to produce a positive "Mother" copy. From this, a number of negative "Stampers" are created that are used in the hydraulic presses to mould the final records. This system allows a large number of records to be pressed quickly by using multiple stampers and all from one original performance, much to the relief of the artists! Furthermore, as the stampers wore out, new ones could be made from the mother positives.

PRESSING MATERIALS

Early disc records were made from vulcanite by the likes of Emile Berliner in 1893. However, in 1897, a shellac mixture was used as this was much harder wearing. Shellac is a natural plastic made from the secretion of an Indian lac beetle. This was mixed with cotton and powdered slate together with wax to provide some lubricant.

Phonograph cylinders were originally made of wax. In 1912, Edison started using Blue Amberol, a form of celluloid that had a lower surface noise than either wax cylinders or shellac records. But by 1913, Edison realised that the flat disc record had won the format war of the time and he started selling records made of a resin plastic called Condensite. This material was similar to the first artificial plastic, Bakelite. Edison used a reproducer that was similar in design to the one he had developed for his Blue Amberol cylinder players.

Shellac, and the synthetic resins used later, was the medium of choice for records until 1950. In 1948, Columbia had perfected the 12" LP vinyl disc, followed by RCA Victor who launched the 45rpm vinyl single in 1949, which held the same amount of material as the 12" 78rpm shellac disc. Vinyl was much lighter, more rugged and had a much lower level of surface noise than shellac and quickly became the standard for all sizes of record.

Over the years, the commercial pressure to keep manufacturing costs to a minimum resulted in thinner records being produced and an increase in the use of recycled vinyl being added to the mix. This resulted in a decline in the quality of many records produced in the 1970s with poor surface noise and a greater tendency to warp. However, the late 70s and 80s saw the development of audiophile recordings that used 100% virgin 180g vinyl. Now that vinyl has become a specialist pursuit, these days virtually all new vinyl pressings use virgin vinyl – and the result is that, some fifteen years after most people moved to Compact Disc, pressing standards are superb. For many, analogue disc has become the *de facto* audiophile music carrier.

VOX Pop

Here's an interesting and affordable phonostage with the usual option of fully balanced operation. Noel Keywood thinks the AQVOX 2C1 should win friends...

If you want to work your way up, as funds permit, from moving magnet to moving coil, a universal preamplifier like the Aqvox Phono 2 C1 reviewed here may well make sense.

Priced at £498, it isn't from the bargain bin, but then it does have an ace up its sleeve - the ability to work with moving coils in fully balanced mode. That makes it a specialised design then, potentially capable of top flight audiophile results, but also able to accommodate humble budget MM cartridges. Here's a Jack of all Trades then, but is it master of none?

The 2 C1 is nicely built and finished. The casework is classy, with sculpted side extrusions, a thick bevelled front panel, screwed down top and bottom plates, and a busy rear panel full of sockets and switches. Aqvox apply a neat satin silver finish all over that makes it look all-of-a-piece.

Plug in and switch on and you are greeted with intense blue front panel indicators, one LED for power, another for XLR/ phono and the third an illuminated push button for the warp filter. This defaults to 'on', so I promptly turned it off after switch on as warps are not a problem in my

particular set up and bass became lean with it on.

The rear panel has a daunting array of options, in terms of things to select and sockets to use. Basically, you can use the 2 C1 in fully balanced mode, with balanced input and output, through XLR connectors. The cartridge and arm must be wired up fully balanced and the amplifier this preamp feeds must have a fully balanced input, usually through XLR sockets again. What's the benefit? Well, it rejects hum and interference when they exist in common mode form, which broadly speaking means affecting both signal lines, positive and negative. Few hi-fi set ups are fully balanced and there's plenty of argument about the detail, but the principle seems a good one.

Unbalanced outputs, via normal phono sockets, are also fitted and these run in parallel with the balanced outputs; there is no switching between the two, unlike the inputs.

So the 2 C1 is unusual in, offering normal phono socket (unbalanced) inputs or, alternatively, fully balanced XLRs. The latter works into a current injection input amplifier that matches low impedance sources, meaning

moving coil cartridges, and Aqvox recommend it is used as a first preference for moving coils, offering best quality. This input is not suitable for moving magnet cartridges, whereas the conventional phono inputs can work with both MMs and MCs.

As Aqvox state, pickup cartridges are fundamentally balanced sources and many arms can maintain this as their internal wiring is not earthed. To go balanced the output cables should be twin and screen construction, as used with microphones, and I got very good results simply rewiring using an oxygen free copper mic cable from Maplin, with a good screen braid and foil drain. The trouble with this cable is its large diameter!

The conventional phono inputs (RCA) have three basic gain settings marked as 0dB, +6dB and +20dB, although under measurement +20dB turned out to be +15dB. However, there is enough gain here to accommodate both Moving Magnet and Moving Coil cartridges, although the maximum gain of $\times 681$ will barely be adequate with really low output MCs of 0.2mV or so. The front panel volume controls reduce gain indepen-





"it was smooth, pleasantly dimensional, uncoloured and well composed in what it did"

dently on each channel, so plenty of fine tuning is available.

Input impedance is 47k, suitable for MM cartridges, but 1kohms and 100ohms can be switched in to match moving coils. Additionally four extra parallel capacitance values can be selected for MMs, from 47pF to 470pF, independently selected on each channel.

Cartridge buffs will recognise that this is a full house as far as variable input conditions go. I like to see 10ohms for low impedance MCs; 100ohm is high. However, higher gain and better quality is available from the balanced XLR inputs for MCs and those with quality, low output moving coils should use this input, Aqvox suggest. There's a lot of gain available here, no less than x1500 from a 10ohm source.

SOUND QUALITY

I connected up the 2 CI, plugged in my SME's normal unbalanced phono leads and sat back for a quick initial assessment. What I heard sounded suspiciously like mild distortion; there was a slight coarseness I had not heard from stages like the smooth Cyrus Phono X, working with my Ortofon Kontrapunkt b. On the test bench it was apparent that overload margins are poor and that they improved usefully with volume turned down to half, so this is how I subsequently reviewed the preamp.

Returning the unit to my system the Ortofon, which has quite healthy output, then sounded smooth

enough with +20dB gain selected and 100ohms input Z. I felt the sound was a little lean and this balance remained. After many hours running in I settled in to like the Aqvox. Via the unbalanced inputs it may not be quite the greatest stage available but it was smooth, pleasantly dimensional, uncoloured and well composed in what it did. The equalisation used rolls off highs above 1kHz and in use this is heard as an easy air to treble, relaxed and not bright. There is a lift above 10kHz but only on occasion did this add a little top end spit.

Because low frequencies also roll away slowly you end up with a lean sound and a slightly forward midband that pushes vocals out and slightly, but artificially, improves enunciation. Running the gamut from old sixties classics like Green Manalishi, to more recent Joan Armatrading and Skunk Anansie (mid-nineties) the respective vocalists, Peter Green,

Joan Armatrading and Skin all took up a well defined centre stage position and their lyrics were easy to comprehend. The sound stage was especially wide, with strong full left and right images, an area where the Phono 2 CI was skilful. There could usefully have been just a tad more low frequency push, such as you get from Japanese and many UK phono stages which commonly offer more gain down to 20Hz or so. A Chord Symphonic stage delivered seismic lows by comparison. Since Aqvox fit a switchable warp filter I don't see why they don't follow RIAA when it is switched out. Rolling off bass is a German /European approach, not so popular in the UK and almost unheard of in Japan and the USA.

I was unsettled again by feeling there was even less low frequency push via the balanced XLR inputs, after rewiring my turntable. In the end, with volume set to half for best overload performance and the Phono 2 CI well bedded in, it delivered a beguiling sound via the balanced XLR inputs. There was a superb sense of insight that brought life to singers, portraying them smoothly but solidly centre stage with life and often vigour. Gabrielle has a beautifully soft, expressive voice and listening to her singing Rise was delightful. She took a gentle but real presence, with superb expression and timbral richness - that smokiness in her voice was very obvious - and the relaxed ease yet fully fluent delivery was entrancing. Backing vocalists were well separated, one from another, and arrayed believably behind, in a sound stage with a good sense of dimension to it.

Tina Turner's 'Steamy Windows' had artificial bass emphasis, a low end boom if you like, and seemingly had no great power through the Aqvox, whereas this track thunders along through the Chord Symphonic. I again noticed a lack of seismic bass when spinning 45rpm singles, some of which are seemingly able to rearrange the brickwork. A (far more expensive) Chord Symphonic, also

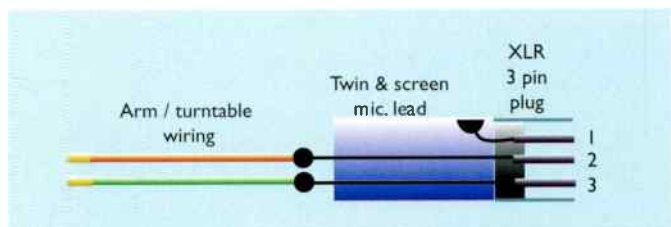

Twin and screen microphone lead caters for low level balanced connection, where heavy screening to resist hum is needed. The screen does not carry the audio signal. Often it is a copper braid, augmented by a foil 'drain'.



working in balanced mode, delivered genuine low end events from Carol Kenyon's entertaining 'Dance With Me', something the Aqvox barely hinted at. Whilst the Aqvox's insight was mostly appreciated, its

light balance was a mixed blessing. Spinning the Undertones gave a performance with all the speed and enthusiasm well portrayed, but not so much bottom end drive from drums. I enjoyed using this phono stage,

but it needs careful matching regarding overload levels. This considered, the Phono 2 CI looks a fine proposition at the price, with a wonderfully civil delivery and plenty of atmosphere.

VERDICT ●●●●● £
Brilliantly versatile yet affordable phono stage with a beguiling sound, but careful matching essential. Balanced operation of real benefit.

AQVOX PHONO 2 CI £498
Aqvox Audio Devices
+49 (0)40-410 068 90
www.aqvox.de

- FOR**
- smooth and dimensional sound
 - expansive soundstage
 - balanced operation
 - flexibility
- AGAINST**
- low overload ceilings
 - gain controls affect sound



A balanced SME arm lead from GT Audio. Just plug in and you are balanced! Note the chunky XLR plugs, with earth, positive and negative signal lines.

SO WHAT IS A BALANCED CONNECTION?

Both positive and negative pins of a cartridge connect directly to an amplifier, neither being grounded. So instead of the green (or blue) ground line from a cartridge connecting to the outside screen braid of a coaxial cable, it has its own conductor. The outside screen of a balanced cable doesn't carry signal and is usually grounded at the amplifier alone.

This arrangement is commonly used in long microphone cables to minimise noise and hum pickup. It is popular in studios, where balanced working is common. XLR plugs are the weapons of choice. They are big and bulky for domestic use, but easily accept large diameter exotic cables.

Balanced working differs most within the input amplifier though. It is known as a differential amplifier, and as such rejects signals that are equal in amplitude and phase in both hot and cold signal lines. The amount of rejection is called common mode rejection. Normal single-ended amplifiers don't do this. These days nearly all high quality audio amplifier chips have differential inputs, so differential working isn't difficult to implement. It is simple to turn a diff amp. into single-ended and in practice many audio inputs are diff. amps. so connected.

So it makes sense to connect differentially, even if an amplifier isn't a true balanced design internally. Hum loops are eliminated and in most cases hum minimised. The reason why it isn't common is due to the bulkiness and cost of XLRs, as well their rarity in hi-fi equipment. Re-cabling can be difficult, true balanced audio cable is rare, and most sources are not balanced in themselves. However, the pickup cartridge is a balanced sourced, so it is a prime candidate for balanced connection.

A balanced source may be centre tapped. It is impractical to centre tap a cartridge bobbin though, nor is it necessary. This ground references the line. Another way of achieving the same result is to connect equal value resistors from each signal line to ground, of low value to minimise noise. Around 500ohms should be right with MCs.

MEASURED PERFORMANCE

The unbalanced inputs (phono sockets) offer a normal x110 gain for moving magnet cartridges, switchable with rear DIP switches up to x681 maximum. The front 'volume' controls can reduce these figures, offering useful manual variation. In total this is enough gain even for high output moving coils, if not for low output ones.

Unfortunately, the overload figures for this input are poor at just 21mV in / 2.3V out. Distortion rises first in the output stages though, ameliorated by turning volume down to half. Then the unit accepts 57mV in / 3V out for 0.1% distortion. That the output overload limit increases suggests output stage working conditions change with volume control position - not impossible - so design could certainly be improved.

At full gain of x681 the overload limits were 3mV / 2.3V out or 9.2mV / 3V out at half volume. Again, the former figures are low, the latter acceptable, so the Aqvox should be used at 'half volume' on the front panel controls.

The balanced input offers x1500 fixed gain, unaffected by the DIP switches - ideal for low output moving coil cartridges. Again, overload is poor at 1.6mV in, but increases to an acceptable 4mV in (at 0.1% thd) at half volume.

RIAA equalisation is fairly accurately applied, both my own network and that in our Rohde & Schwarz UPL analyser showed, highlighting a slight low frequency roll down below 1kHz (i.e. in the 315 / 3150uS sector) toward 30Hz, the lower -1dB limit, and a slight roll down toward 10kHz, and lift thereafter. This would suggest a mildly mid-forward balance to the

sound. The switchable subsonic filter pulls the upper -1dB limit up to 43Hz, in line with IEC requirements.

Noise levels were average. Quieter stages are available nowadays, with less input noise. Hiss is unlikely to be obvious, except with low output MCs fed into the unbalanced input.

The Phono 2CI is satisfactory in measured terms, but no more - even at the price. It could usefully be improved. NK

Frequency response (-1dB) 30Hz - 33kHz

Overload	
Unbalanced x110	21mV in / 2.3V out
full volume	57mV in / 3V out
half volume	
x681	3mV in / 2.3V out
full volume	9.2mV in / 3V out
half volume	
Balanced	
full volume	1.6mV
half volume	4mV

Equivalent input noise, IEC A wtd.	
Unbalanced in / out (x110)	0.65uV
Balanced in / unbal out	0.13uV

Gain	
Unbalanced	x110 to x681
Balanced	x1500

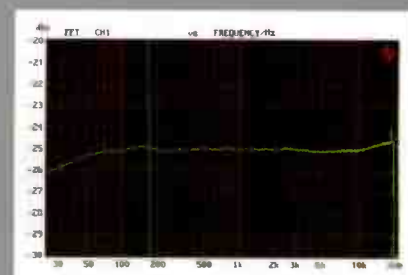



The TORUS
Infra-sonic Generator

It could make the
sub-woofer seem rather
out-of-date.

Wilson benesch
THE FUTURE IS CARBON

You thought legendary
dCS CD replay was out of
reach? Now the world's
best comes in one box at
one quarter the price!

The best

one-box CD?

Most people rate the three- and four-box dCS CD/SACD players as the best in the world – including the US **STEREOPHILE** magazine.

So when dCS re-package all that **REMARKABLE TECHNOLOGY** into one slim box the world takes note.

The new £7k P8i plays SACDs and CDs and **UPSAMPLES CDs** to DSD, the format of SACD, for a fuller, more natural sound. Instruments and voices develop more of their character and there's a greater "ambience" and presence.

A key dCS achievement is their unique **RING DAC** at the heart of the conversion process. Its accuracy, combining the best aspects of both multi-bit and one-bit, brings out the fine detail in the recordings and the **REALISM**.

We like to use the **DIGITAL VOLUME CONTROL** and connect directly to the power amp – **NO PREAMP** – for the greatest realism and dynamics.

Digital inputs allow for superb D/A conversion of other digital sources, eg DVD with optional upsampling to DSD. Integrate the P8i with a home theatre for stunning sound.

Your investment is protected with one of the best **UPGRADE SCHEMES**. Software can be brought up to the latest spec from a CD and hardware upgrade is via part-exchange.

Customers say we make some of the **BEST SOUNDS** they have ever heard, so you know we can do the same in your home. Our advice will take account of your best components and guide you where change is needed, in stages you can afford. You **AVOID EXPENSIVE MISTAKES**, enjoy music along the way and save money in the long run.

JUST LISTEN AND YOU'LL KNOW

CD: ACCUSTIC ARTS, AUDIO SYNTHESIS, BEL CANTO, dCS (ELGAR, DELIUS, PURCELL, STELLO, VERDI, VERONA), WADIA. **VINYL:** AVID, BASIS, CLEARAUDIO, DNM, GRAHAM, THE GROOVE, LEHMANN, MICHELL. **ORIGIN LIVE, SUMIKO BLUE POINT SPECIAL, TRANSGURATION.** **TUNERS:** MAGNUM DYNALAB. **AMPLIFIERS:** BEL CANTO, CAT, DK DESIGN, DNM, GAMUT, HOVLAND, SONNETEER, STELLO. **LOUDSPEAKERS:** AUDIO PHYSIC, DALI, ETHOS, NEAT, TOTEM. **CABLES:** ARGENTO, CHORD Co., DNM, NORDOST, VERTEX AQ ETC. **MAINS** Vertex AQ. **SUPPORTS:** ARCICI, STANDS UNIQUE, VERTEX AQ

The
Right
Note
Music in the home

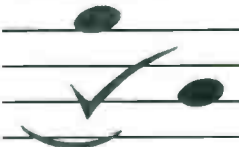

BATH
01225 874728
or NEW lo-call
0845 230 7570

ZYX Appeal

Not a well known name in the UK, but ZYX (pronounced Ziks) are a specialist Japanese high-end cartridge manufacturer. Noel Keywood listens in to the surprisingly good R-100H high output moving coil...

ZYX make moving coil cartridges with attention paid to the finest of details. This is true high-end audio, with all that that means, including a lofty price - but were not talking megabucks for the simply named R-100H cartridge. It comes in at £625, a figure that might have you whistling between your teeth if you thought LPs warrant little effort or expense, but not if you have a treasured collection of them with music that can never be found again. Or, as in my case, with music that also doesn't transit well to digital, like Hendrix, in spite of all the effort put into this task. 'Electric Ladyland' on CD isn't - cough - quite the same as LP - and that's being kind!

I'm sure one day, perhaps soon, we will have a high resolution digital medium that better conveys what was on the master tapes, and music like this will be reissued all over again, but even then a myriad of lesser artists would be ignored. So rather than buying a new digital wonder box and disc, which is going to cost more than £625 in any case, there's a case to be made for spending a similar sum on a cartridge like this. Of course, you will need a turntable, arm and decent phono stage, but interestingly the ZYX R-100H, like many MCs, suits a medium mass arm like the Rega RB300 and could be used in something like the Origin Live OLI or Silver, although it will benefit from being used in an arm a few notches up the quality scale, like an Illustrious or SME IV.

Quality cartridges these days come lavishly packaged and, in spite of their small, size, intriguingly constructed with a high standard of finish - just look at a Van den Hul

Grasshopper. The ZYX doesn't. Doubtless adhering to an ancient Japanese philosophy I've not heard of, this cartridge is the least photogenic I've ever dragged from a box. Luckily, this matters not one iota to me, as the trinket side of hi-fi, often accompanied by extensive claims, doesn't much capture my imagination.

ZYX make a good enough argument for their use of a plastic body. They say it is eddy current free, rigid, well damped and gives improved sound as a result. Goldring have used Pocan for long enough and it has always seemed to work well, whilst others commonly choose aluminium for its strength, light weight and good screening properties. That the ZYX R-100H looks kitchen-sink functional means it isn't going to sell on sight alone - and you won't be inviting friends home to look at your ZYX, that's for sure! But that's not to say you won't be inviting them to listen to it...

The signal coils are wound from high purity copper, the cantilever is (unusually, these days) a boron rod and the stylus a line contact type known as a micro-ridge. The H stands for High, as in high output. Where the standard R-100 delivers 0.24mV from a 4ohm coil, ZYX state in their literature, the H has twice as many turns, a generator impedance of 8ohms and an output of 0.48mV as a result. Sounds good, but putting on more turns also increases effective tip mass, with an expected reduction in tracking ability. You don't get something for nothing by doing this, although you can by increasing pole piece field strength through a more efficient magnetic circuit or by using a stronger field magnet.



I prefer to run a low impedance generator like this into 10ohms or so, as it gives a better damped, cleaner sound with many cartridges, but ZYX recommend 100ohms or more. As the mechanical damping looks reasonably good, perhaps this is justified. All the same, square wave ringing was evident, as with most MCs, and a low load minimises this and is worth trying.

Weighing in at just 5gms the ZYX is very light; 6gms is a typical figure these days. My SME counterweight was screwed in close to the arm pillar, but at least this minimises arm mass. I suspect the R-100H will be at the limit of what many arms can handle. Securing it to the headshell was straightforward enough, as was connecting up. The output pins are colour coded.

A tracking force of 2gms is recommended, within a range of 1.8-2.2gms. I ended up using 2.2gms, as tests showed the R-100H is no great tracker.

SOUND QUALITY

I've had the happy experience of living with an Ortofon Kontrapunkt b moving coil cartridge strapped into my SME312 arm headshell for many months now. High calibre modern pickup cartridges like this are a world apart from their predecessors, no matter how rose tinted your glasses are when looking back. Not only is the Ortofon a precision device

Walrus



11 New Quebec St, London W1

Have we got turntables? Do bears... no, forget that. Of course we have!



We don't have a problem with turntables at all (some shops seem to have - how much choice do you see in your local hi-fi store, that is if they even sell proper hi-fi any more). This venerable way to reproduce music in your home still happens to offer the most realistic sound quality of anything available today. You can spend a fortune on the latest digital components to still only get a fraction of what even a relatively modest cost vinyl front end has to offer. You probably already have the "software" for it tucked away in a corner somewhere, assuming you're not a vinyl user already. And, the best thing is, it's not going to become obsolete - you won't have to worry like the digital aficionados do about the next miracle format and having to repurchase everything again! Provided you look after them, those vinyl discs contain an almost unlimited amount of information, and as you gradually upgrade your front end, you get to hear ever more of it.

Our advice on turntable/arm/cartridge matching is second to none (provided, obviously, you purchase from us!) and our subsequent building of your turntable will ensure you get the full performance from it (we see quite a few turntables purchased elsewhere or second-hand which aren't working properly). We also don't forget about you after you walk out the door, it remains important to us to keep your deck working to your satisfaction over the years. Just thought we'd remind you that vinyl playing is still our priority!

However...

Even we have to face the fact that more and more of (to us) people tell us they visit us for digital for analogue. Er, yes. So, we have to be very making some absolutely superb digital products example. Consonance also make some wonder-(pictured) is the latest wonder from this company. also a complete departure for this price range (the upsampling DAC and a valve output stage, all in a



you want decent digital disc spinners, and ironically players specifically because of our enthusiasm careful what we choose. The Chinese have been lately, you've all seen the success of Shanling, for full products, and the Consonance Droplet 5.0 Not only does it sound excellent, the styling is Droplet costs £1995). You get a 24 bit / 192k unit which weighs just under an astonishing 30 Kg.

But it's not only the Chinese who're making digital waves, as it were. Our own home-grown favourite, Musical Fidelity, have come out with an astonishing two box player, a new model in their acclaimed KW series, the DM 25 transport and DAC. The digital and analogue sections are both effectively "dual mono", and although you can buy the units separately, there are very few other makes you can use them with because they connect using the esoteric dual mono twin cable system, a method only one or two far more expensive units use. The outcome is sound quality well ahead of what you might expect of the price tag - both units together cost £3995. And, in case you were wondering, those things sticking out the top of the transport are levelling adjusters for the unique isolating feet, nothing more sinister!



Even when you hear them playing full orchestral music, or even rock, they are very special. Instruments sound as they were meant to, voices are utterly natural. These are a must hear design if you are a "serious" listener.

And, just a little reminder about the superb Stirling Broadcast LS 3/5a loudspeakers. Now, we know these are about as unfashionable as it gets. Modern speakers are supposed to be big, bold, full of high-tech drivers, and with a multi hundred watt power handling tag. And indeed, most modern designs are just fine for purely electronic music, where tonal accuracy, subtlety, and even soundstaging take second place to sheer grunt. For acoustic music and spoken voice, though, these BBC designed mini monitors are absolutely unparalleled.



Finally, we now have the fantastic Hyperion HPS-938 loudspeakers on demo - sorry, no room for a piccie - book now for a listen.

air tangent amazon amplifon apollo furniture argento audible illusions audio aero audio physic black rhodium breuer dynamic brinkmann cartridge man cawsey clearaudio consonance decca london duevel dynavector ear yoshino final lab goldring graham (tonearms) graham slee hadcock heart heed audio hyperion (loudspeakers) incognito isolda jadis kr electronics klimo koetsu lavardin lyra magneplanar mcintosh michell engineering morch musical fidelity nordost nottingham analogue opus 3 origin live ortofon pro-ject rega (turntables) revolver ringmat roksan shun mook shanling shelter sme something solid sonneteer spendor stax stirring broadcast sugden sumiko tannoy tci cables tom evans townshend audio transfiguration trichord trigon van den hul voodoo wireworld xlo

tel: 020 7724 7224 fax: 020 7724 4347 email: contact@walrus.co.uk web: www.walrus.co.uk



subjectively, bringing devastating insight and analysis to LP, it also manages this within a framework of even-handedness that removes tonal colour. In this it seemingly turns LP to a medium that is every bit as well ordered as CD, but without the coldness and monotonicity. But the Kontrapunkt b is acknowledged as being pretty accomplished - and of course you pay for this, £750 or thereabouts, no less. Against a cartridge like this I didn't hold out too much hope for the ZYX.

Last record off the turntable - a Garrard 401 - was Heaven Seventeen's 'How Men Are', conceived at the same time as Compact Disc, yet sounding fresh as a daisy today, in every way. The ZYX was bolted into place and we were off. Even today I am liable to dive over the back of my settee with much so called hi-fi, but the ZYX held no surprises. Well it did, as no surprise was a big surprise. Measurement had forewarned of a balance and capability similar to that of the Kontrapunkt but cartridges can vary so much in all ways I wasn't expecting a presentation similar to that of the Kontrapunkt - but that is what I got.

Here then is a sense of balance and correctness that just seems right from the off; there were no emphases to cope with and adjust to, no foibles to tolerate. The ZYX delivers a straight card, it sounds smooth and balanced. Like any top-flight moving coil though, it has clarity and dimensionality in spades, together with a tight sense of dynamic that makes music a gripping experience. Individual singers in the female backing chorus repeating 'Sunset Now', in the track of the same name, were slightly better separated from each other than even the Ortofon managed, giving a little extra insight into the performance. The ZYX was a little tighter and more controlled, if a little less relaxed than the Ortofon. It would be hard to choose between

the two, quite frankly. Meaning the ZYX is a flyer.

The cackling and chatter at the start of Jackie Leven's wonderful 'Call Mother a Lonely Field' was clear and brightly presented, the drum roll sounded taut and menacing as it should and when the bass guitar kicked in it was strong and taut, but not overbearing. There was detail to be heard in both drum and bass, more ld wagger than was delivered by the Kontrapunkt, but then again the ZYX didn't have the relaxed confidence

of Ortofon's Kontrapunkt either. Of the two I'd settle for the latter, but only just - and I could understand any argument for the former.

When it comes to tracking, a 12in 45rpm single will be the greatest challenge. The solid clank of the Garrard's industrial-strength speed change system had the platter spinning at fierce rate and on went Lynyrd Skynyrd's 'Free Bird'. Not a top quality recording by any means; I have plenty of 45rpm singles that sound far better. All the same, discs must be playable irrespective of recording quality and who wouldn't want to play an old original of this stature? Highly detailed and concise across the middle frequencies, bringing incision to guitar strings and vivid clarity to vocals, the ZYX was impressive enough in this way. Unfortunately, it also sounded brittle and barely in control, a classic sign of being close to the tracking limit; there was an uncomfortable edginess.

To check this I bolted the Kontrapunkt back in - a top tracker - and spun the disc again. Sure enough it cruised through the difficult parts, where rhythm guitar is accompanied by two leads and the drummer is trying to destroy the cymbals. The Kontrapunkt sounded relatively relaxed about all this going on, keeping rhythm stable at right, leads at middle and left. So I spun a wide range of 45rpm singles, including some with seismic bass, like John Lydon's 'World Destruction' and Carol Kenyon's 'Dance With

Me', but the ZYX never again seemed under pressure. Only this one single, and no LP I played, seemed to cause such upset, and neither did Shure's original Audio Obstacle Course, TTR-101.

I noticed also subtly different treble qualities, the Ortofon revealing a wealth of fine detail, if with a little thinness, the ZYX sounding a trifle more full bodied and sonorous, if not so well elaborated. To put this into perspective then, the R-100H seems well able to tackle heavy bass

cuts with large groove excursions but it may, on occasion, get a little upset about strong midrange and treble levels. The trade off is a sense of tautness and grip that the Kontrapunkt didn't have, together with a fabulously wide sound stage with firm images all the way across it.

CONCLUSION

The ZYX R100-H is nothing other than a very high definition cartridge, taut as a drum and very fast, superbly clear and even handed too. At £625 it's a bit of a snip - you don't get top flight tracking and I suspect the standard version (i.e. not H) would perform better in the midband in this regard, but it was good enough to get through most real life music material. An interesting and welcome new contender.

"here's a sense of balance and correctness that just seems right from the off..."

VERDICT

Exceptionally tight sounding and detailed cartridge with the musical skills to match, this is up with the very best at the price, with a presentation all of its own.

ZYX R-100H £625
 GT Audio
 ☎ +44 (0)1895 833099
 www.gtaudio.com

FOR

- excellent imaging
- dynamic sound
- grip

AGAINST

- mediocre tracking

MEASURED PERFORMANCE

Our frequency response analysis shows the R-100H has a smooth frequency response with little variation across the audio band. The usual midrange dip measures -1dB maximum and stylus tip mass resonance is also a well controlled +1dB. Inner groove tracing loss occurs above 10kHz and will hardly be audible, amounting to a -3dB loss at 20kHz.

Distortion levels were unusually low, suggesting good stylus tip shape and a linear generator. A measured vertical tracking angle of 24 degrees helped here. Unfortunately, tracking at low and middle frequencies was poor by today's standards, and this will introduce distortion if mistracking occurs.

The R-100H measures well, except for tracking. The low output version is likely to manage better in this area. NK

Tracking force 2gms
 Weight 5.3gms

Vertical tracking angle	24degrees
Frequency response	20Hz - 20kHz
Channel separation	35dB
Tracking ability (300Hz)	
lateral	45µm
vertical	45µm
lateral (1kHz)	16cms/sec.
Distortion (45µm)	
lateral	0.4%
vertical	2.5%
Output (5cms/sec rms)	0.7mV

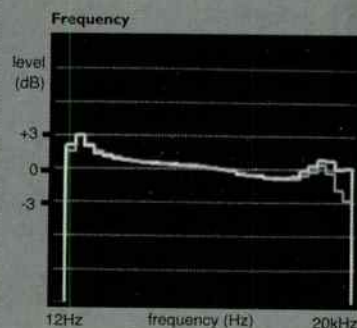

"A little champ of price/quality ratio: available at an affordable price, especially for a tube amplifier of more-than-usual power."

AUDIO REVIEW Italy, July 2004, Claudio Checchi

"PrimaLuna ProLogue One is now my 'affordable reference amplifier'. With apologies to various British and Italian geniuses, this amplifier has to my ears - no equals at its retail price."

HI-FI NEWS and review, July 2004, Ken Kessler

"A refreshing change from the transistor competition with a captivating presentation. Excellent finish and build quality makes for a package strong on value."

HI-FI WORLD, August 2004, Dominic Todd



PrimaLuna

Music is a pleasure not to be denied. So, too, the beauty of music reproduced by valves should be accessible to all. To make available to a wider audience the seductive, silky sound of the vacuum tube, PrimaLuna has developed a range of all-valve amplifiers with the construction, power and sonic performance of high-end electronics, but with one unique, inimitable feature: prices that can only be described as 'entry level'!

Since the arrival of the Prologue One, the audio community has been unable to contain its joy nor reign in its praise because PrimaLuna has revolutionised the concept of 'affordable audio.' With a pair of integrated amplifiers with prices more typical of mundane, solid-state products, PrimaLuna showed other manufacturers that compromises in fit and finish, styling and facilities are unnecessary.

Now PrimaLuna can offer the pride of ownership of true separates to aficionados on a budget. As promised, PrimaLuna has expanded the range upward with three exciting new models for users whose requirements demand separates rather than integrated amplifiers.

To meet these needs, the music lover can now consider the Prologue 3 dual-mono valve preamplifier with four line level inputs, and a choice of two matching stereo power amplifiers. The Prologue 4 provides 35W/channel from EL34 valves, while the Prologue 5 delivers 40W/channel courtesy of the classic KT88 tube.

And there's more good news: PrimaLuna has also announced retro-fittable auto bias boards for the Prologue 1 and 2, and a moving-magnet phono stage for the Prologues 1, 2 and 3. Additionally, there is now a choice of optional gold or silver front panels in place of the standard finish.

Audition the full range of Prologue models at the Pistol Music dealer of your choice. And prepare your wallet for a pleasant surprise.

PISTOL
MUSIC



For your nearest Pistol Music dealer, please contact Pistol Music
58 Durham Road, London SW20 0TW

T: +44 (0)20 89 71 39 09 F: +44 (0)20 88 79 79 62 www.pistolmusic.co.uk

PISTOL MUSIC is a member of **REDFER GROUP LTD**

Armed Force

David Price looks at the Moth Group tonearm rewiring service.

These days, most modern tonearms come with decent wiring, but there's a considerable number of fine classic tonearms which, whilst enjoying fine structural and mechanical design back in their day, were let down by the wiring.

The late nineteen seventies and early eighties was when tonearms got seriously good (from Syrinx and Acos to Zeta and Alphason) but even then, relatively late in the analogue day so to speak, the world was a little less enlightened about the difference cables could make.

Maybe this isn't so surprising, as it wasn't until the mid-to-late eighties that self-respecting audiophiles were buying QED 79 strand or Monster Cable for their loudspeakers, and later still when the stock interconnects made way for serious stuff. Tonearms, it seems, were the last to benefit from truly high quality, bespoke wire; SME's Series V (from 1987) was one of the first to boast top quality leads from cartridge pins to phono plugs.

Moth Marketing is one of the best known aftermarket rewirers, so we decided to try our luck with an old Rega R200 (S-shaped, Acos-made) arm. This actually a good bit of kit; in some ways it's way, way behind the RB300 that replaced it, but it's undeniably more musical if properly fettled. The trouble is that ours wasn't, until it came back from Moth...

OPTIONS

For Rega type arms, Moth recommends its Incognito loom, unique in that it rewires in a single run of cable from the cartridge tag to the phono plug, inner and outer cables replaced by a single sweep of uninterrupted Cardas high quality copper Litz, with no solder joints, plugs or sockets. As it leaves the arm pillar, the cable is run into a 'Faraday Cage' construction, a

flexible screened assembly, star-earthed at the base of the pillar, with a separate earth conductor terminated in a small gold plated crocodile clip. High quality gold connectors are used throughout the loom.



The length of the external section of the loom is 1.2m. The Cardas loom for Rega arms is available in both kit form (£115) and as an in-house service by Moth in Bedford (£129). Moth can also rewire Rega arms with stock Rega cabling complete with the separate inner and outer cable assemblies for as little as £25. Those feeling more adventurous can go for the ultimate van den Hul silver continuous inner and outer cable run for £350.

For Decca arms, Moth offers a variety of cable types, particularly Cardas and VDH, employing one of two methods, either with separate inner and outer cables, or with a form of the Incognito loom, offering a continuous cable run from cartridge tag to phono plug. Where replacement parts are required, new original Decca parts are always used. There's also a universal version of the Incognito loom, suitable for fitting to the vast majority of tonearms, be they unipivot or traditional bearing type, in both kit form (£140) and as an in house installation by Moth (£165).

VERDICT

Our Rega R200 arrived with a very neat looking new loom, nicely terminated with Incognito RCA phono plugs. Compared to the original 1979 Rega wiring and plugs, the audible differences were stark; whereas the old cabling sounded grey, leaden and tonally thin, the Incognito loom – after a few days running in – was far fuller in tone with better differentiated instrument timbre. Bass was deeper, faster, more rhythmic and less 'plastic' sounding. Midband was obviously more three dimensional, with lots more low level detailing and that aforementioned wider tonal palette. Treble was smoother, sweeter and more spacious. In short, whereas the original arm sounded obviously off-the-pace compared to a stock new Rega, now it wasn't so much a case of being 'inferior' as 'different'; indeed in many ways I found myself preferring the reborn S-shaped for its natural, lucid midband. A firm thumbs up then; an Incognito rewire may be just what your ailing classic arm need, and you may be pleasantly surprised by the sound per pound ratio too.

CONTACT
www.britishaudio.co.uk

Getting Into

For many, black plastic is by far the best music carrier around, but it doesn't give of its best easily. So, for vinyl virgins, Noel Keywood has this comprehensive guide to buying, matching, setting up and tuning a turntable, arm and cartridge...



Some of the parts you may need in an LP toolkit. Get a small toolcase to house these items in one easy-to-find place.

TURNTABLE

The best choice of starter turntable is a Goldring GR1.5, Rega P2 or a Project Debut. In packages like this you get a simple belt drive turntable that offers 33rpm or 45rpm if the belt is moved manually - a tedious process if you want to play 45s. I enjoy playing 12inch 45rpm singles, which were cut to have a fantastically dynamic sound. If you want to spin 45s then a fast, convenient speed change mechanism will be important.

Turntables once suffered 'rumble' and 'wow', but both are rare these days. If you buy an old turntable,

especially with idler drive instead of belt, watch out for these problems though.

The pickup arm is a highly specialised item. It must move freely on good bearings. It must also be rigid, if the cartridge is to realise its full potential. Adequate rigidity is difficult to achieve and a primary requirement for good sound quality. The standard here for decades has been Rega's RB250/300 arm. Built from a one-piece casting, it is simple but very effective and can taken as a minimum requirement for high fidelity. Origin Live offer various tune-ups, as do Rega nowadays.

If you want to aim higher than

this, there's no lack of choice in both turntables and arms, but you really need to start to consider other influences, especially turntable location and phono stage quality if the whole set up is to work well. Turntables are sensitive to floor movement and acoustic feedback, whose influence can be minimised with care. The pickup cartridge also becomes a major issue.

CARTRIDGE

Budget pickup cartridges, costing anything from £40 for a Goldring 1006 up to £200 or so for a Goldring 1042, both good choices, are 'moving magnet' types, commonly abbreviated

The Groove

to 'MM'. Goldring, Ortofon, Stanton, Shure, Pickering and Grado still make fine starter models.

The stylus assembly of an MM is removable - it simply pulls out. This has important advantages. The delicate and easily damaged stylus can be removed before the cartridge body is fitted to the arm's headshell. If you use a Rega for example, with non-removable headshell, this can be a boon. Removable headshells make cartridge fitment and alignment easy, but it's still possible to slip whilst tightening up a screw and see the whole lot go skyward. A removable stylus can also be replaced quickly and conveniently when worn out, or damaged.

Moving magnets have other advantages. They deliver a fairly strong signal of a few mVs (millivolts, or thousandths of a volt). This makes hiss and hum less obvious. But they must feed into a relatively high load of 47kohms. Luckily, it is universally accepted that an MM input is 47k.

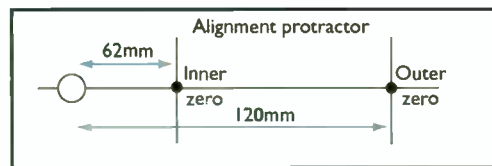
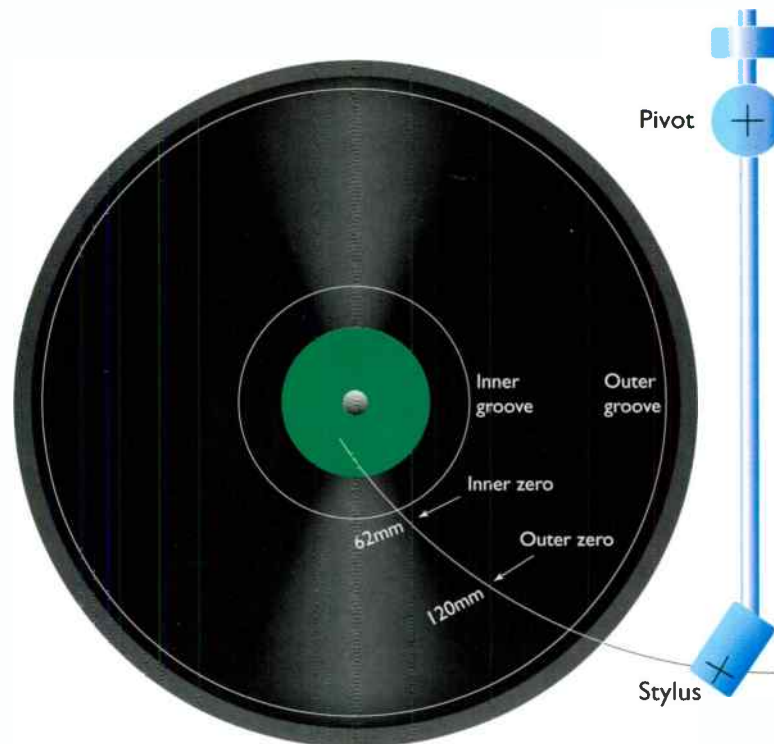

The pickup cartridge tracks across a disc in an arc, but during manufacture it is cut in a straight line. The tracking angle error that results produces distortion. Alignment using a protractor (below) minimises this.

Quite a few modern amplifiers possess MM phono inputs, usually of mediocre quality. There's no shortage of external designs available

nowadays though. Generally, a gain of x100 is provided (at 1kHz), to magnify those few millivolts up to a level high enough for a Tuner or Aux input. However, these days, with insensitive amplifiers that need 500mV for full output, volume will have to be turned right up. To avoid this, either use an amplifier with 200mV input sensitivity or a phono stage with x200 gain minimum, or selectable gain.

Modern MM cartridges do everything right; there are no specific limitations. They track extremely well, meaning the stylus stays in the groove on loud passages, so the groove is not damaged. On this matter, by the way, it is important to understand that low tracking force does not minimise groove wear or damage and is not at all beneficial. Line contact tips distribute down

Output from a modern moving coil cartridge, like the ZYX R-100 shown here, is flat within tight 1dB limits from 40Hz up to 20kHz - an impressive performance. LP is an accurate medium.

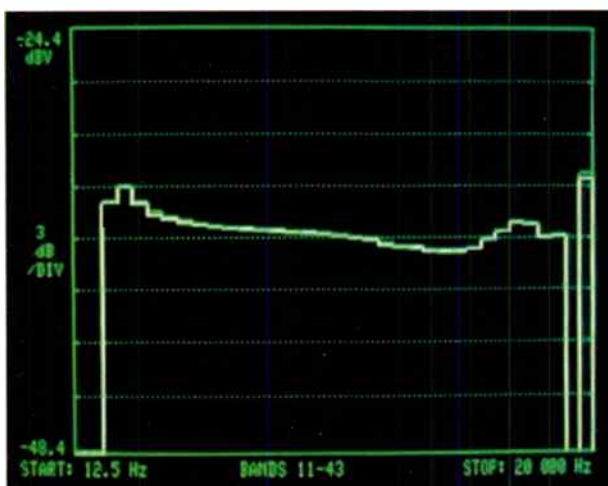

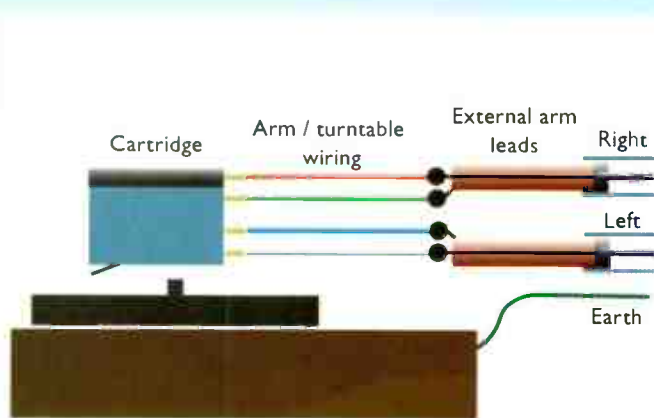

The wiring and earthing arrangement used in many turntables keeps all metalwork earthing, including that of the arm, separate from the cartridge generator wires. The latter usually earth back at the phono plugs only. Hum can arise when electrical earthing is made through mains earth for safety, in which case connecting the green earth lead is likely to cause hum.

There are many earthing schemes. For example the cartridge body will be earthed by a metal arm, but it won't be by an acrylic one. In the latter case the cartridge body / screening case, which acts as a hum screen, must be earthed through a signal ground.

force to avoid stressing a groove wall past its plastic limit and, these days, 1.8gms downforce is common. Don't think 1.5gms is better; it is the lowest limit in truth.

Moving magnet cartridges not only track well, they have good styli and offer a flat frequency response, free from the warmth of old designs, and free from their treble peakiness. A modern MM like the trusty Goldring 1042 is a great choice for quality LP replay, without moving into this subject's esoteric climes.

If you have a steady hand, your pocket can stand it and you want to hear LP image, sound stage and possess a dynamic that can be breathtaking, then a good 'moving coil' cartridge is the way to go. Super delicate and with a fixed stylus, they are easy to destroy and expensive to have repaired, so check costs and procedure here first.

I suggest you do not bother with cheap MCs either; I have never heard one that was convincingly better than a 1042. Many sound cold or sterile, and a little flat or boring. Yet you suffer all the expense of special preamp, etc. Serious MCs start at £400 for the likes of an Ortofon Rondo Blue or so, and that's just for the cartridge. As their output is miniscule so a lot more amplification is needed, up to x2000, or up to twenty times more than an MM. Hiss and hum then become an issue. Luckily, these days, due to stronger magnets, better magnetic circuits and a few more coil turns, output is kept up to 0.3mV or so, ten times less than an MM. So MC preamps with

x1000 gain or so are satisfactory, and both hiss and hum less problematic.

Moving coil cartridges have very few coil turns and this is probably why they sound better. Their generators in theory work well beyond 20kHz, ZYX claiming 100kHz for example. They also need a low load of 100ohms or thereabouts, and not the 47k of a MM. You can, however, feed an MC into a 47k MM stage and get away with it, whereas you cannot feed an MM into a low impedance MC stage, in spite of the gain available. For best quality though, an MC cartridge must be properly loaded; phono preamps that offer 47k only will not provide ideal results, and MC is not worth doing on the cheap like this.

PHONOSTAGES

All pickup cartridges need both preamplification to make their weak signal strong enough for a normal line input (Aux, Tuner, etc), and equalisation to boost lows and cut highs in order to get a flat frequency response. This is because LPs are cut with bass reduced and treble boosted, to lessen groove excursion at low frequencies and minimise surface noise (hiss). If you play an LP unequalised you get a thin, scratchy sound. RIAA (Radio Industries Association of America) equalisation is always used, unless you spin earlier 78s, which require various differing equalisations.

When choosing a preamp for MM cartridges you need low noise, accurate RIAA equalisation, adequate overload headroom and sufficient

gain. Watch out for inadequate gain and poor power supplies. One will have you cranking amplifier volume right up, and the other will compromise sound quality. It is easy to design and build a phono stage around cheap integrated circuits, but this is a good way to ensure LP sounds flat and lifeless. Then you will think talk about the supremacy of LP over CD is delusional.

Finally, valve phono stages release a sound from LP that is unmatched for soundstaging. However, valves are too noisy for moving coil cartridges. Either a simple (x10gain) transistor gain stage must be used, or a step-up transformer. Valves are fine with moving magnets though and a valve stage with a quality MM cartridge is a way to go. Trouble is, good valve preamps are still rare.

TURNTABLE POSITIONING

Suspended wooden floors can bounce so much that movement in a room becomes impossible when playing a record. There are various solutions.

Most obvious is to use a wall shelf. Ideally this should be attached to a solid brick wall, not a weak, resonant partition wall. A shelf between a fireplace chimney breast and a side wall is a good solution, keeping the turntable by the chimney breast and away from the corner if possible, to minimise bass feedback. The shelf should be rigid and non-resonant, either of thick wood or

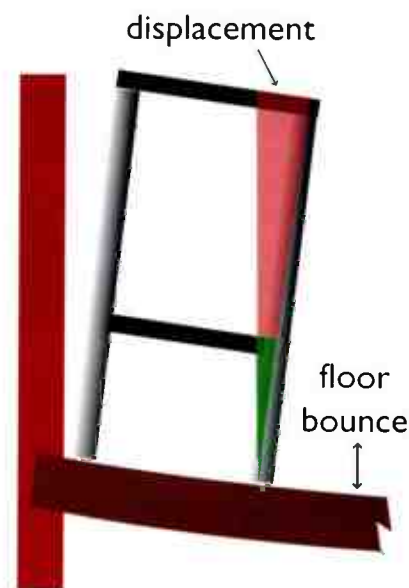

Mounting a turntable atop a high stand greatly increases its displacement (red) compared with that on a low shelf or table (green), when floor bounce exists, so a low position is more stable.

glass. A sand filled shelf is ideal. Turntables do need deep shelves though, 12in or more. If you have a bay window, with window shelf effectively on the wall beneath it, this is a good location.

If a shelf isn't possible, a turntable table is an alternative. To

to a solid, suspensionless, high mass plinth is not certain though. Compact belt drives are easy to accommodate domestically and do a very good job. However, large, stable, high mass plinths are a more convenient platform for esoteric pickup arms, as suspension bounce can be a nuisance.

adjusters of various types too. Small Stanley tool carriers are ideal for this.

Faced with a cartridge in its box, and an arm to put it in, remove the cartridge from box and then extract its stylus assembly (MM only), as per the instructions supplied. Put it safely aside and attach cartridge body to headshell. Michell Engineering make a neat set of stainless steel bolts with Hex heads for this. Otherwise, use the screws supplied. Ensure the cartridge is not skewed in the headshell, as this has a big affect on tracking geometry and increases distortion substantially. A parallel sided cartridge body helps here, being aligned with the headshell's main axis - see our diagram. If you fix into an SME shell, cartridge position is not adjustable; the arm must be moved later. In most other headshells the cartridge moves in slots; fix at centre initially.

Connect up the cartridge, pressing home the tiny cartridge pin connectors. Sometimes they don't fit snugly and may need to be bent in or out a little. This is a very fiddly task, for which it is best to use jewellers' pliers. Check condition afterward with a magnifying glass. The colour convention is -

LEFT CHANNEL

White - hot (+)

Blue - cold (-)

RIGHT CHANNEL

Red - hot (+)

Green - cold (-)

If you see an earth strap from the outer screen case to either green or blue pins (i.e. earth) leave it in place. If you then suffer hum it will have to be removed. This will happen if the cartridge body is metal and it earths the case to ground via the pickup arm, with an earth established via the

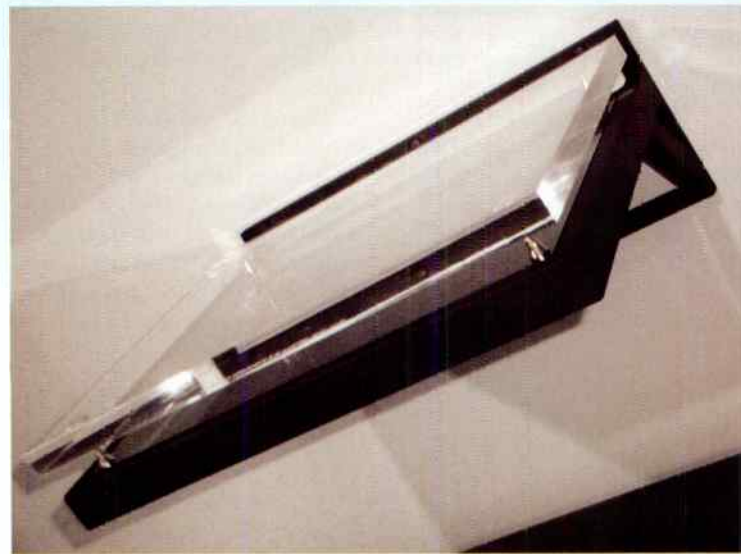

Purpose built turntable wall shelf with thick acrylic top plate by Decent Audio. Tel: 0845 6019390.

minimise upset by floor bounce, keep it against a wall, where joint movement is at a minimum, or in a corner where it is almost zero. Again, joint movement between a chimney breast and side wall is also minimal so this is a good place to avoid floor bounce if it plagues you. Use a low turntable table too, as displacement is much greater atop a tall table, or equipment rack, due to the rocking motion induced by floor bounce.

Those with firm concrete floors and floor area to play with can experiment with choosing a site away from corners and walls, to lessen bass feedback. A thick Perspex dust cover also helps reduce acoustic feedback.

To minimise colouration any support table or shelf should have plenty of mass and a well damped structure. Wood, marble and glass are popular choices. A low wooden table, using three sturdy timber legs and a marble top is simple enough to make and will do a good job.

Belt drive turntables with a suspended sub-chassis, an idea pioneered by Acoustic Research in America and popularised by Thorens in Europe, offer some immunity from external vibration of all sorts. Their suspension systems need to be adjusted to allow a good degree of freedom in all directions. Linn setup being notorious as the most religious but thorough. That belt drive is better isolated and less immune to the outside world in comparison

SETUP

There is quite a lot of religion attached to arm and cartridge setup. It's always best to bear in mind however that the LP is quite an approximate and variable medium. For example, when the original master is cut on a lathe, lacquer spring back makes modulation slant angle imprecise, so the 22degrees 'ideal' vertical tracking angle figure is somewhat nominal. Most cartridges don't have a VTA of 22degrees either, more like 26-32, in order to have satisfactory disc surface clearance. So Vertical Tracking Angle is variable. That's no reason not to optimise it, as I will explain, but absolute precision isn't possible with LP.

It's helpful to have a small kit of tools and parts for LP. In it you need jewellers pliers or small 'snipe nosed' electrical pliers, for attaching tiny cartridge pins. A set of small Hex keys and a few small screwdrivers are usually needed too, to tighten cartridge fixing screws, plus a stylus brush, alignment protractor, tracking force gauge and even an illuminated magnifying glass to check stylus and cantilever for dirt, damage and such like. SME owners will need to stow keys and

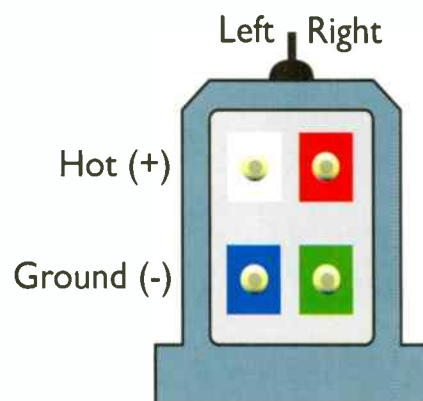

Cartridge colour code and the terms commonly applied to identify the pins. If an earth strap exists, remove it only if hum cannot be eradicated by other means.



The 'Decentscale' has a special weighing platform which enables an accurate measurement to be taken at near record height. This is essential for accurate measurement to 0.01gram accuracy. Just £35.

arm wiring, so forming a hum loop.

With pins connected but stylus assembly missing, the arm can be adjusted into rough balance, usually by moving the rear counterweight forward or backward. Set bias to zero. Push the stylus assembly into place. If it has a removable guard, take it off.

At this point it is usual to balance out the arm so it floats horizontally, before applying tracking force via a dial (spring) arrangement. If tracking force is applied by moving the rear counterweight forward, do this according to instruction to get the tracking force needed by the cartridge. Most cartridge manufacturers stipulate an optimum, which is now commonly 1.8gms-2gms. Use the optimum and only go up to maximum later if you suspect tracking is a problem. Modern cartridges rarely mistrack overtly, but they can sound coarse and edgy at their limit. Increasing tracking force to maximum should cure this. Ideally,

use a tracking force gauge to check your settings.

At this point, with bias still at zero, place the cartridge's stylus point on the position indicated on the arm's tracking alignment gauge and check for error. Loosen cartridge bolts slightly and move cartridge forward or back in headshell until there is no error. With an SME the arm must be moved. It is common to align for zero tracking error, meaning a perfect tangent to the groove, close to the innermost

groove, at 60mm-62mm from the centre of the turntable spindle (i.e. radius). Many protractors have another alignment point further out, at around 120mm radius. The cartridge will be at a tangent here too, if the arm designer has got his sums right. Of the two points the innermost is crucial; the outermost is a check. Tighten up bolts and re-set tracking force, as it will have changed a little.

You may, at this point, need to rotate the cartridge headshell axially to get the cartridge sitting truly vertical (Rega arms don't have this adjustment) and also set arm height at the pillar so that the arm is horizontal. You can experiment here later, by lowering the arm



Weight and thread bias force mechanism of the Roksan arm. It applies an outward force to counteract to natural inward force that arises from an offset headshell. Other methods are springs and magnets. Bias improves tracking. Experiment to get the most stable sound.



Misaligning a cartridge in the headshell by a few degrees significantly increases tracking distortion. At left the cartridge body is in alignment with the headshell axis. At right we show a 5 degree error - small in visual terms but large in its affect upon performance.

pillar below horizontal a little, to lower vertical tracking angle and see whether you prefer the results. They are LP dependent though, so use many LPs before making a decision.

Now set bias force as recommended by the arm manufacturer. You may like to re-adjust finely later, especially if tracking is a problem.

The turntable should be horizontal. Use a spirit level to check this. It's best if the table or shelf it is sitting on is set accurately in the first place.

Cartridges need a running in period, where the cantilever settles a little and the stylus polishes up. Allow ten to twenty hours playing time for this. At around 1,000-2,000 hours though a stylus will be worn out. The sound can become curiously dead and lifeless at this point.



Thorens TD125, an early suspended sub-chassis turntable. The platter and arm float on a spring suspended sub-chassis, for isolation from vibration. Chassis bounce makes arm cueing a little difficult.



Garrard 401 bolted straight into solid plinth. Derived from the 301, it was intended for heavy duty use in studios and the like. Decks like this are very easy to use, as in heavy plinths they are very steady.

Maintenance revolves around keeping the stylus clean as well as the LPs. Use a stylus brush and brush gently from back to front to remove dust and fluff. If inspection with a magnifying glass shows gunge around the stylus it usually comes away with Isopropyl alcohol. These days the chemist will eye you suspiciously when

you ask for it, and question your need too. It's a poison and must be labelled and stored as such. It is a popular and effective cleaning agent though.

Finally, the cantilever of a cartridge is a fine aluminium alloy tube that is very delicate and easily bent. Don't ever let anyone use a duster near it, as destruction is all

but guaranteed. Lock the arm into its holder if possible, when not in use, so it can't be accidentally knocked out. Lower the dust cover for added protection. And if you find using an arm lift on a suspended sub-chassis turntable difficult, consider getting a heavy, stable, solid chassis type. They are much easier to use.

IMPEDANCE

With lots of coil turns to get a high output voltage, Moving Magnet cartridges all have a high generator impedance and therefore must feed a high load impedance - the amplifier's phono input. Luckily, all MM inputs are 47k ohms (forty seven thousand ohms) - as that's a universal convention.

In the past it was not uncommon to tune the high frequency response of MM cartridges by increasing load capacitance. Some phono stages still have this facility for completeness, offering around 50pF-400pF that can be switched in progressively. These days, our measurements with a calibrated test preamplifier show, increasing capacitance rarely improves matters much. Often it will roll off upper treble but peak up the upper midband, around 6kHz. Because cartridge these days are fairly accurate this rarely improves the sound greatly, but it may in some

cases prove useful.

The situation with moving coil cartridges is more complicated. There is no agreed load standard, but most need 100ohms. Very high output types may require more - up to 1kohms. However, very low output types, usually with a generator impedance of 3ohms or less, can work best into 10ohms or so. Capacitive loading is never applied, as big values would be needed, for little benefit, because

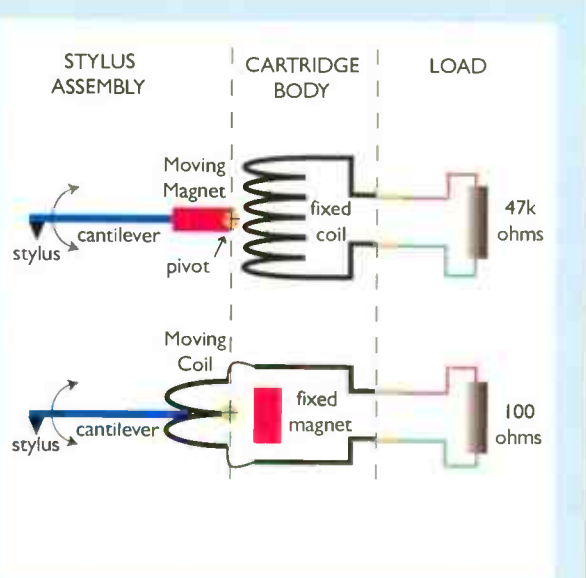

MC generators are fundamentally flat.

All these things considered, you'll find that properly located and set up, a good modern record deck will repay the effort with a stunning sound.

"The best tonearm I've heard"

HI FI WORLD

Winner of Stereo Times magazine Most wanted component of 2004 award



"A new benchmark for musical communication" STEREO TIMES

"One of the truly special products I've reviewed in the past 18 years" STEREOPHILE

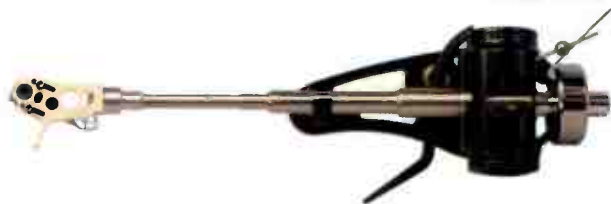

The new generation of tonearms from Origin Live have won admiration and rave reviews across the world for good reason - these arms better the best by a significant margin. Whatever your current arm, you can at last treat yourself to a serious upgrade. Why not arrange for a demonstration now.

Tonearm Models

Conqueror - £2500
 Illustrious - £1570
 Encounter - £970
 Silver - £599
 O.I.1 from - £124



Demonstrably better



NEW SOVEREIGN DECK

Ultimate performance for your system

"The best musical results of any turntable I've ever heard, regardless of price."

Since I've been listening to turntables professionally for 32 years and am aware of the pitfalls of ultimate proclamations, I hesitate somewhat to make this statement. Nevertheless, it is true. The level of musical communication available from the Illustrious/Aurora Gold is in a class by itself. It sets a new reference."

STEREO TIMES on the Aurora gold turntable & illustrious tonearm

ORIGIN LIVE
 Tel/Fax: +44 02380 578877
 E-mail: info@originlive.com

Full information on web site

www.originlive.com



HI-FI & HOME CINEMA

griffin
audio

- Amphion • Arcam • ART • Audiolab • AVID • Ayre • B&W •
- Classé • Focal.JM Lab • Linn Products • MJ Acoustics • Monitor Audio •
- Naim Audio • Nautilus • Primare • Quadraspire • Rega • REL • Rotel •
- Shahinian • Spendor • Sugden • Thiel • Wadia •

The Best of British – Arcam hi-fi and home cinema
 call us for a demonstration



Acoustica
 17 Hoole Road
 CHESTER CH2 3NH
01244 344227
www.acoustica.co.uk

Acoustica
 114 Wolverhampton Road
 STAFFORD ST17 4AH
01785 258216
www.acoustica.co.uk

Griffin Audio
 3 Gibb Terrace, Gibb St
 BIRMINGHAM B9 4AA
0121 224 7300
www.griffinaudio.co.uk

Julian's Turntable



Wanting to try something different to his Linn LP12 turntable, Naim's late, great Julian Vereker fixed his formidable gaze upon German company PhonoSophie and their bespoke N°3 turntable. Channa Vithana tells the story...

Andy Blockley runs Überphon, the UK distributor for PhonoSophie. He has two separate reference systems within his main listening room. The primary one, unsurprisingly, consists of high-end PhonoSophie CD players, power supplies and amplifiers. The second system however, utilises mostly 'olive' Naim Audio electronics and a PhonoSophie N°3 turntable; as used by Naim's legendary founder as his own reference disc spinner.

Based in Hamburg, PhonoSophie was started some twenty years ago by talented audio engineer Ingo Hansen. The company's first two analogue disc spinners were called

– unsurprisingly – the N°1 and N°2.

The N°1 was a modified, 'super-charged' Thorens TD-166 MK VI utilising special PhonoSophie engineered components. These included; chrome springs which were chrome plated four times, using a "conic pressure absorbing spring principle for improved decoupling". There were also high-quality super-finished motor pulleys that minimised "wow and flutter and less low frequency noise, due to higher surface quality and higher mass" and an inner metal platter which had "less wow and flutter, less low frequency noise due to a smoother belt transmission with a higher mass. Using metal, both parts of the plate

also played a role in motor noise shielding".

Subsequently, there were additional improvements to the chassis. A PhonoSophie N°2 turntable was also produced (a modified Thorens TD-146) using new real-wood construction. Thorens TP90/TP90S tonearms were likewise part of the package.

During 1986-1993, PhonoSophie's Ingo Hansen distributed Naim Audio in Germany, and Andy says that – as a result of this – "JV (Julian Vereker) became familiar with the (PhonoSophie) N°3 development at a time when the extent of Naim's involvement with Linn was diminishing. The turntable JV

audiolab

Have you been
missing something?



audiolab
8000 series

The original 8000 series from Audiolab started something of a revolution in value and performance. When they disappeared from the market, the hi-fi world lost a well-loved and reliable friend.

Now, the new 8000 series marks a strong return to the original brand values and philosophy. These famous products have been re-engineered to create a complete two channel range, including the famous 8000S, 8000Q, 8000M and 8000CP models as well as an all new CD player.

7.1 channel pre and power amplifiers have been added to create a series of building blocks capable of meeting your system needs now and for the future.

The new 8000 series offers a definitive and genuine hi-fidelity performance from a no-nonsense approach to engineering

Audition them now and find out just what you've been missing.

audiolab

Sovereign Court, Ermine Business Park,
Huntingdon, Cambs, PE29 6XU
www.audiolab.co.uk

Tel: +44 (0)1480 447700
Fax: +44 (0)1480 431767

(subsequently) used was identical to the 1994 model I own in that it has the Naim ARO tonearm and the Naim P3PS power supply".

The N°3 was a complete clean-sheet design by Phonosophie and it remains their reference today. In an intriguingly cyclical turn of events, Andy says that a "budget version using the P3 (N°3) turntable design was subsequently built by Thorens as the TD2001 (there was also a 3001), fitted with the Thorens TP90 tonearm. Although the turntable looks similar, the only parts in common between the N°3 and the TD2001 are the Perspex dust cover and hinges, the speed change knob and the centre spindle cover".

What Phonosophie did for the N°3 was to look at all the best suspended subchassis turntable designs around, including the Linn LP12, and the brief was to make a superior turntable system. So most intriguingly, the N°3 uses three leaf springs instead of conical springs for the subchassis suspension. (In my subjective opinion, when simply doing a push test on some turntables and watching the return characteristics of their suspension, I consider leaf springs to present a more consistent and linear motion than the standard coiled springs which can tend to bounce with too much vibrational energy going back into the sub-chassis instead of away from it.)

A high quality step motor was also used in combination with the leaf springs "to reduce resonance below 9Hz, thereby avoiding any audible mechanical resonance affecting the tonearm and cartridge". Phonosophie say they achieve this by "using (self-centring/levelling) leaf springs, (where) resonance stays as low as 5Hz, (which is) knowingly set an octave deeper than the arm/pickup resonance, thus removing intermodulations from the spectrum entirely". The leaf springs are adjustable through holes in the chassis without having to open up the N°3. It is no surprise that Naim

Audio also prefer to use leaf springs as they employ three of them for the transport in their high-end CDS3 CD player for instance.

The plinth itself is described as relatively lightweight to ensure that energy is not stored within it. Phonosophie says that, "the sub chassis consists of a special chip board and is veneered on both sides. The resulting case construction is extremely firm, (with) lower resonance characteristics compared to using standard materials". The bearing and spindle assembly like most high-end turntables is first-class in construction. Phonosophie says, "indispensable for the smooth, vibration-free rotation is the playless bearing giving the lowest possible friction tolerances between bush and spindle. Special oil is used for minimum LF rumble and wow and flutter. The three point mounting is secured with turned brass bushes delivering the required decoupling from sub-chassis and bearings".

The N°3 turntable originally came with a Thorens TP90 tonearm as used in the earlier N°1 and N°2 models where Phonosophie went so far as to design the TP90 in collaboration with Thorens. However, Phonosophie preferred the combination of their N°3 turntable and Naim Audio's ARO unipivot tonearm instead as the "ultimate combination". Andy says that "so impressed was JV with the synergy of the turntable with the ARO, that a new Naim power supply was designed and built specifically for the PHONOSOPHIE N°3, called the Naim P3PS. This collaboration

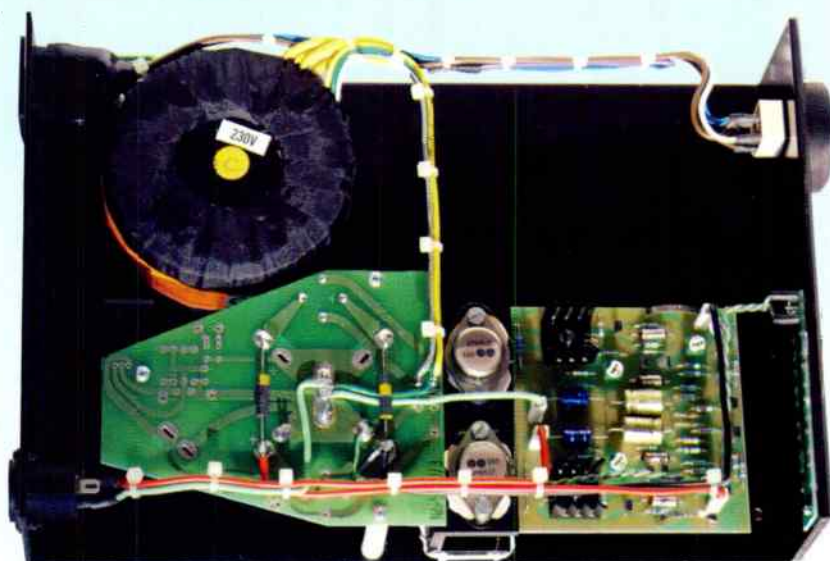

Naim P3ps power supply internal view.

between Phonosophie and Naim is identical in external appearance to the Armageddon supply for the LP12, but the design is completely different. Rather than the AC output of the Armageddon, the P3PS produces an extremely stable 20V DC output required for the P3".

For this collaboration, Phonosophie had sent one of their designer/engineers to Salisbury to help Naim with the design of the P3PS. After this the Naim Prefix phonostage was fitted to the N°3 plinth. Andy uses a £1,600 Phonosophie Power Control 2 power supply into the Prefix on his N°3 and says that, "in performance terms the PC2 is between the Hi-Cap and Supercap".

Andy Blockley's system history has included Thorens turntables. In 1975 his system consisted of Thorens TD160/TPI6/Shure M75EDII, which was £87 new. A Trio TD1600G integrated amplifier and Wharfedale Unit 4 speakers (assembled from kit form) were also used. In 1979 he installed a £33 Grado FI+ cartridge, £136 Technics SU8022K integrated amplifier and £220 RAM 150 speakers. In the same year he replaced the Technics with a new £199 A&R Cambridge A60 amplifier. In 1985 a £545 second-hand Linn LP12/Ittok/Asaka system substituted the Thorens TD160/TPI6/Grado FI+, while the RAM 150s were sited on £57.50 Sound Factory SF3 stands. 1987 saw the £676 Naim 42-5/140 pre-power replacing the A&R Cambridge A60. In 1989 The RAM 150s were replaced with £495 Epos ES14 + stands and in 1991 an Audio Technica OC7 took over from the Asaka cartridge.

It was during the mid-nineties that both Andy and JV made the major change from LP12 to

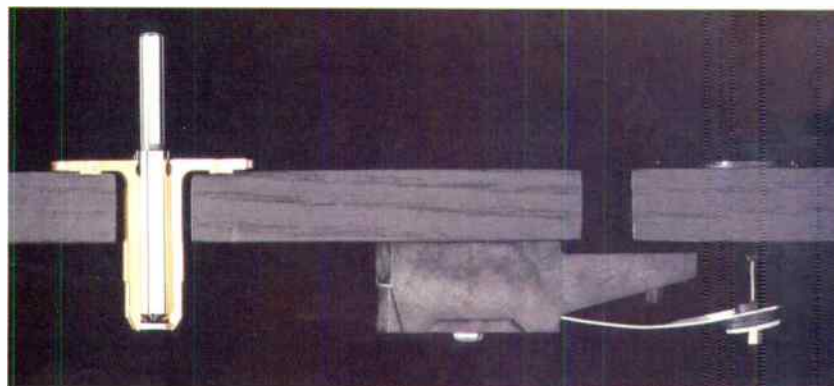

Cross section showing bearing spindle and leaf spring suspension.

Our Motives are clear



www.neat.co.uk

01833 631021

neat acoustics

music sounds better **neat**

mk4 DRUID

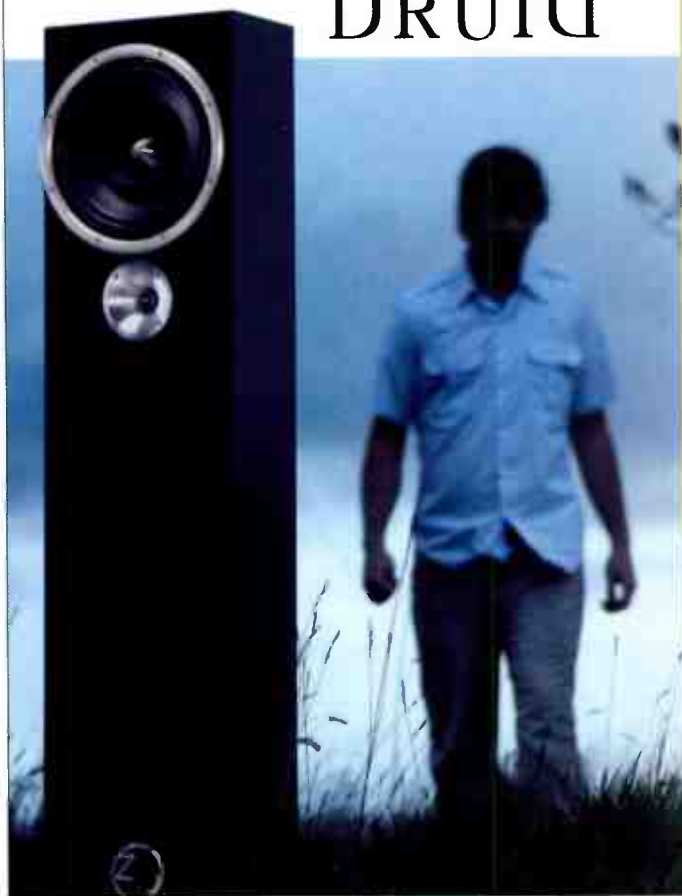

It's time for tubes to rock...

With 101 dB sensitivity and a 12 Ohm load, the Zu Druid is tailor-made for the real world demands of lower-powered tube amplifiers. Using Zu's own 8.5 octave bandwidth full-range driver, allied to a super-tweeter, the Druid lets any amplifier sing its heart out with no crossover to interrupt the proceedings. It's neither demanding of space nor difficult to place in the room and could well be the last loudspeaker you ever need to buy. £2,395 per pair through Musicology dealers.

Musicology is the exclusive UK distributor for Atma-sphere, Audiostatic, Coincident Speaker Technology, Ferguson-Hill, Pass Labs, Rives, Symposium, Zu

Contact us on 01273 700759 or email: sales@musicology.co.uk

www.musicology.co.uk

Musicology

Phonosophie N°3. Andy says, "I was then in the fortunate position of being able to shop around for a new turntable and in 1994 the main flat-earth contenders were the LPI2 and the Roksan Xerxes. I had heard the Michell and Voyd turntables but their musical presentation did not suit me as much as the Linn and the Roksan".

Around this period Andy says that "Colin Welford at Son et Lumiere in London had heard the P3 (N°3) at JV's house and as a result started supplying them as an alternative to the LPI2, as both were available with a Naim power supply (the LPI2 Armageddon or the P3PS) and the ARO". Thus when Andy heard the Phonosophie N°3/Aro/P3PS at Son et Lumiere he immediately wanted to purchase it because "to me it has all the sense of rhythm and pace that I enjoyed from the Linn, but is far more neutral in tone without putting undue emphasis on the upper mid-bass. Correctly supported, it is capable of amazingly deep yet tuneful bass and it is also incredibly good at extracting subtle detail from the mix. To characterise the presentation, I would put it between the "bounce" of the LPI2 and the clinically accurate Roksan TMS. It is much easier to set-up than a Linn and does not drift over time. Only very occasional re-levelling and belt and oil changes are required".

Andy's second system currently consists of the Phonosophie N°3/ Naim P3PS/Naim ARO/Lyra Clavis which cost him £3,750 in 1994. Then he later added a Naim 'four pack'



Cartridge and head shell close up

of 4x135 power amplifiers, NAC 82 preamplifier with two Hi-Cap power supplies which he preferred to a single Super-Cap, then passive Naim SBL speakers for £2250, which he later converted to fully active status with a SNAXO 2-4 active crossover and Super-Cap power supply. He says that the "retail price of the amplification components is around

£20k"! Andy said that he would have gone further by using a high-end Naim NAC 52 preamplifier but then he started his commercial involvement with Phonosophie and naturally being the UK distributor, he is following a different amplification path with his main Phonosophie system.

The Phonosophie N°3 is available as a package from Überphon with different tonearms including: Kuzma Stogi S arm for £3,275, Phonosophie One-Point 1 arm for £3,750, Kuzma Stogi at £3,875, Kuzma Stogi Reference for £4,375 or with Naim ARO at £4,475 (shown in main picture with £1,475 Phonosophie Flair MC Cartridge). And last but not least Andy says "a small number of these Naim spec P3 models are available from Phonosophie in the UK as a limited edition PHONOSOPHIE N°3 at a retail price of £5,475 complete with Naim ARO tonearm and the Naim P3PS".

SOUND QUALITY

Listening to Kate Bush and 'The Hounds Of Love' through the fully active Super-Capped/SNAXO Naim SBL speakers was simply sublime. The control the Phonosophie N°3/ Aro/P3PS/Lyra Clavis source system had over the music and speakers was incredible. There was a seamless, effortless flow, which was beautifully timed, crafted and coherent. The vocals were well-integrated into the acoustic whole with lifelike alacrity. The musical instruments and the wonderful, esoteric arrangements were delivered with high-resolution and definition.

Miles Davis and 'Tutu' had a radiant bass quality with an excellent combination of low-frequency dexterity and extension.

On the 'Colour Of Spring' by Talk Talk the decaying notes to the musical instruments were most enjoyable, as was the layering which helped to focus on some of the more abstruse compositions. The resolution and spatiality to the horn



Phonosophie No.3 turntable with Naim amplification.

melody was brilliant, without a hint of ringing distortion into the higher frequencies. The deceptively powerful melodic basslines were both agile and controlled. Listening to Mahavishnu John McLaughlin and 'Goodbye Pork Pie Hat' there was a deeply resonating in-room deft acoustic with superb guitar phrasing. The sound was engaging. On Mahavishnu Orchestra 'Birds Of Fire' there was the same effortlessness as on the Kate Bush vinyl, with control over all the frequencies and stunning musical timing which provided a free-flowing sound quality with no discernible subjective distortion.

The sound of Andy's system driven by the Phonosophie N°3/ ARO/P3PS/Lyra Clavis combination can be described as simply effortless in power, linearity, control and finesse. The Naim SBLs evidently disappeared sonically providing a complete out of body musical experience that I have rarely encountered, usually only with electrostatics, some active speakers or high-quality headphones.

Additionally, the Phonosophie N°3 system had the agile yet powerful wallop of only the best solid-state hi-fi. Listening to the music at much higher than normal volumes than either of us normally would was possible, simply because there were seemingly unstoppable dynamics and a distinct lack of grain or coarseness to the music.

The Phonosophie N°3 is one of the best high end source systems I have heard, and it is expensive, but (unlike many expensive hi-fi components which are plainly overpriced) the performance is commensurate with price. The build quality is excellent and with the £5,475 Phonosophie N°3/Naim ARO/ Naim P3PS iteration in particular you will have a kinetic slice of hi-fi history.

**PHONOSOPHIE N°3/NAIM
ARO/NAIM P3PS £5,475
Phonosophie
☎ +44 (0)1730 261924
www.uberphon.co.uk**

Masters Series



THERE ARE MASTER MUSICIANS AND MASTER FILM MAKERS.

[Now There's The Masters Series To Bring Out The Best In Both.]

MASTERFUL. PURE AND SIMPLE.

Introducing the Masters Series from NAD. The Masters Series catapults technology and design far ahead and sets an exciting new benchmark of performance. NAD's product philosophy has always been to offer audio and video components of exceptional performance, outstanding value and operational simplicity. As evidence, NAD has earned an impressive string of five-star reviews, over its 30 plus year history.

Several years in the making, the legendary Bjorn Erik Edvardsen, has taken NAD's "Music First" philosophy – a design

discipline that puts your listening pleasure first – to new heights. While others talk about build quality, only NAD offers you something more attuned to your highest expectations. We call it Build-Artistry™.

Think of it as brilliant engineering – but to an exponential level. So while no expense was spared in development, the cost to you is less than with other premium brand offerings. If that sharpens your desire for sound quality the way master musicians and master film makers would want it played, ask for an audition of the Masters Series at your nearest NAD authorized custom retailer today.



Shown above, the M3 Dual Mono Integrated Amplifier. The super clean internal layout plays a major role in reducing noise and distortion far below the audible threshold. A unique synthesis of digital, analog, and software engineering has resulted in an amplifier that excels in every performance category.



M3 Dual Mono integrated Amplifier



M55 Universal Digital Disc Player

www.NADelectronics.com

Lenbrook UK : Unit 2, Old Wolverton Road, Old Wolverton, Milton Keynes MK12 5NP
Tel: 01908 319360

NAD

Wax Factors

There's more to analogue audio than meets the eye; keeping your turntable and records in tip-top condition needs specialist accessories. David Price runs through some of the best...

MICHELL ENGINEERING CARTRIDGE MOUNT KIT £7

To set up a turntable successfully, you have to get down to the nuts and bolts - literally. The interface between your cartridge and your tonearm's headshell has a dramatic effect on the sound. If they are not locked to one another properly, then the bass gets loose, the midband cloudy and undynamic and the treble vague. Clamp the two together properly however, and the music assumes pace and grip, allied to real dynamics and focus. Trouble is, most mounting hardware supplied with cartridges is often woefully inadequate for the job. This excellent quality kit from Michell Engineering contains two 10mm and

two 16mm long stainless steel Allen bolts, washers, nuts and an Allen key. They're easily strong enough to clamp cartridge and arm together like there's no

tomorrow - in fact

you'll be able to crack most cartridge bodies and/or headshells if you're not careful. So the trick is to tighten the nuts hard, but as soon as you sense that you're applying too much torque (i.e. lots of effort, no movement) then ease off just a touch. This done, you can be sure you'll be getting top performance from your cartridge.

Michell Engineering Ltd.
+44.(0)208.953.0771
www.michell-engineering.co.uk

GOLDRING EXSTATIC INNER SLEEVES £12 PER 25

Although most vinyl junkies are desperately worried about the damage their stylus could be doing to their prized LPs, in truth one of the most dangerous moments of the record playing ritual is taking records out - and putting them back in - their sleeves. How so? Well, most UK pressings come with cardboard or paper inners

which are as tough as old boots. All it takes are a few small dirt particles on the record surface and every time

you slip them in and out of 'bed', your playing surface gets a severe scrubbing! It's interesting that in Japan - home of the very best vinyl pressings and an obsessive attention to detail - that every new LP comes with a very soft sleeve such as Goldring's Ecstatic inner. Treated for resistance to static electricity and soft so as to not damage the disc surfaces, these aren't so much an accessory as essential if you're serious about your record collection lasting the distance. They're a tad less easy to manipulate than the nasty bits of paper that come with British pressings - but still every LP should have one.

Goldring +44 (0)1279 501111
www.goldring.co.uk

HIKEA LACK COFFEE TABLE £19.95

For less than twenty drink vouchers, you can buy this 950x550x450mm bit of clear lacquered, birch veneered MDF from your friendly local Ikea store. It looks very neat (far better than the price suggests), has very clean proportions and best of all, sounds much better than nothing. For those who can't afford expensive, bespoke turntable stands, wall shelves, etc., this is much better than just plonking your deck on the dressing table or (Heaven forbid), the floor. If you're really tweaky, you can bang a short nail into each of its four legs (make sure to get the levels right), so your makeshift turntable table



suddenly gains 'spikes'. Okay, most readers will laugh, but those counting every last penny will be amazed by how you can get so much for so little.

Ikea
www.ikea.co.uk

VANTAGE AUDIO RECORD WEIGHT

There have been countless different designs of record clamps and weights over the years, with most people – at least from the Linn Sondek school – doubting the efficacy of all. Well, the truth is that they do work, but they're very context dependent. Clamps are ideal for suspended subchassis belt drives, where they're light enough not to upset the suspension, whereas weights are often better with non-suspended direct drives with massy plinths. This weight is interesting for several reasons, not least because it's an exact replica of that supplied as original equipment with Trio's legendary Lo-7D. Together with Trio's outer stabilising ring, it has an obviously audibly beneficial effect on this superb deck's sonics, and even by itself brings appreciable gains in grip and focus. The Vantage Audio weight, a vast, heavy, superbly machined lump of brass (usually painted in gunmetal grey - although the early sample pictured was not), works in precisely the same way, and brings the exact same benefits. It's brilliant for non-suspended direct drives (or idlers for that matter), but put it on your GyroDec and it will ground out the springs and stop them doing their job isolating!

Vantage Audio
+44 (0)1823 433650
www.vantageaudio.com

RUSS ANDREWS TIPTONIC STYLUS CLEANER £9.95

The point where needle and groove meet is always a messy place; even if your record is superficially clean, there's bound to be some tiny debris resident in the groove which only the stylus can 'plough' out. Of course, this then accumulates on your prized diamond, causing it to mistrack slightly, resulting in subtle but audible degradation of the sound; this manifests itself particularly at high frequencies, which can either coarsen, or dull, or both. The answer is a good stylus cleaner; isopropyl alcohol diluted with distilled water does an excellent job, but if you can't be bothered to mix it yourself, then this is a great and far more user-friendly alternative. This 15ml bottle and cleaning brush is gently removes the hard, baked-on scunge that

encrusts your stylus, with excellent sonic results.

Russ Andrews Accessories
+44 (0)1539 825500
www.russandrews.com

KONTAK CONTACT CLEANER £15

Put simply, the best all round cleaning solution we've tried. This works wonders on all electrical contacts found on (or in) your turntable, from the cartridge pins at one end of your tonearm to the RCA phono plugs at the other, and anything inbetween. Apply a small amount of fluid to one of the supplied 'pipe cleaners' and watch in amazement as the end goes black with dirt straight off what had previously looked like a clean



surface. Whatever you put this stuff on – from arm leads to turntable mains plugs – it brings a subtle but obvious improvement, which is cumulative. This latest incarnation of Kontak comes in just the one bottle, and evaporates less quickly than of yore, which is welcome news to Kontak junkies who would watch in amazement as their supplies disappeared into the ether at an alarming rate (seemingly regardless of whether they put the top back on or not!). A great product that works wonders with all hi-fi contacts, but it's never more profound than with vinyl, where the signal levels are infinitesimally small.

Kontak
+44 (0)1733 327929
www.kontak.co.uk

SHURE SFG-2 STYLUS GAUGE £25

Your tonearm manufacturer has thoughtfully provided a tracking force gauge, which is often accurate to within a quarter of gram (or if it's an SME, within a tenth). Still, independent corroboration



never hurt anyone, so for this reason there are a number of stylus pressure gauges on sale. The best in my opinion is that made by The Cartridge Man, but this is jolly expensive. Second is Technics SH-50PI – an exquisite bit of kit long since discontinued. If you're looking to spend less, then Shure's evergreen SFG-2 is the answer. It's well made – although it lacks the stunning build of the two aforementioned devices – and does the job very accurately (it tallies with my SH-50PI very closely). The only fly in its ointment is Ortofon's own gauge, which costs just one third of this and is just as accurate, although its very plasticky and can easily break. With this in mind, this comes highly recommended. Never underestimate your lugholes though, as they are more accurate still.

Goldring +44 (0)1279 501111
www.goldring.co.uk

VIBRAPODS £4.75 EACH

Designed to absorb vibrations and improve the sound, these support 'feet' are said to work in both horizontal and vertical planes, and are made to fit at or near the heaviest areas of the equipment's casing and at the edges. There are five models



available, all of which have different load capacities, so you should buy the ones suitable for your turntable. You can also combine them, or just use three or four. They can be placed facing either up or down. (Amusingly, if you overload them and squish them into oblivion, the original shape can be restored by placing them on a flat baking tray and cooking them in the oven at 175F for ten minutes.)

They're an excellent, cheap, upgrade for non-suspended subchassis turntables. Placed under something like a Rega

P3, for example, the sound opens out and gains focus, as well as becoming more relaxed (i.e. less edgy) at the same time. You'll find the bass takes on a life of its own, and things cohere better right across the frequency spectrum. Three Vibrapods and a bit of MDF also makes an impressive sounding turntable 'subtable' too, for ridiculously little money. Fantastic value for money.

StoneAudio UK Ltd.
+44 (0)1202 743777
www.stoneaudio.co.uk

GOLDRING SUPER EXSTATIC £12

Once you've managed to find some inner sleeves that don't sandpaper your record surfaces every time you take them in and out, then it's time to keep them clean. Here, Goldring

has another solution – the Super Exstatic. It's a carbon fibre record cleaning brush which works as well as almost any other I've tried, and is well made and presented to boot. The basic idea is – buy a new record, apply this from the inside (i.e. spindle side) slowly moving out to the run-out groove for about 3-5 seconds, gently lifting off the surface dust. That, plus decent inners, is all you'll ever need for record care. Simple as that. Unless of course you're a denizen of second hand shops, or like to have to odd party or three when, in a drunken haze, your sacred disc care routine goes up in smoke. In this case, the Super Ecstatic will help. but it won't remove serious scunge – for this you'll need a proper record cleaning machine – or alternatively ask your local hi-fi dealer if he

has a Keith Monks record cleaner (assuming he knows what vinyl LPs are, of course, as not all of them do these days...) I'll be covering this subject in a later issue – as it's a big one – but if it's everyday record care you need, this and the Exstatic inner sleeves will be all you'll ever need. Heartily recommended.

Goldring
+44 (0)1279 501111
www.goldring.co.uk



TWEAKING - THE BASICS

[1] Cartridges should be properly aligned and securely fixed to the headshell.

Use a good quality alignment protractor such as that from Ortofon/ Henley Designs, or the hard-to-find Mobile Fidelity GeoDisc (try the internet!), and secure the cartridge in place with quality Allen bolts (such as those from SME), tightened hard. Not too hard mind, or you'll crack your cartridge body or headshell! When fitting the cartridge, don't touch the bare cartridge pins as the dirt from your fingers will degrade the electrical connection and dull the sound - if possible, always clean them with liberal amounts of isopropyl alcohol before fitting.

[2] Don't trust your tracking force to your tonearm - unless you have something of the quality of an SME Series V! Ortofon's stylus force gauge is very accurate, cheap at £6 and easy to use – better still, Technics' long-deleted SH-50P1 is a breeze to use and still occasionally available in the classifieds for under £20. Rega RB300 owners – and indeed any users of arms with springs to apply downforce - should try setting the tracking force to zero (effectively disengaging the spring) and balancing the arm via the counterweight and a stylus pressure gauge. The springs in some arms can cause sound degradation.

[3] The condition of the main bearing is paramount, so be careful when moving your deck around. Always remove the outer platter - and avoid heavy turntable mats or record clamps that could overload the bearing. Most main bearing housings can be flushed out with detergent, cleaned with isopropyl alcohol and then refilled to the recommended level with the lightweight fully synthetic motor oil such as Mobil 1 (as used in Michell decks), or better still van den Hul's TLF.

[4] Turntable drive belts should be renewed if excessively loose, or otherwise regularly cleaned with isopropyl alcohol on a lint-free duster. Check the cleanliness of the belt's path (the surfaces it comes into contact with, including the drive pulley and inner platter) and clean it if necessary with isopropyl alcohol, including the pulley, belt and inner platter.

[5] Stylus cleanliness is all-important. Isopropyl alcohol is the stuff to use, applied on a smart fine artist's brush from back to front. Take care not to get fluid onto the upper part of the cantilever, as it can work its way up into the suspension with unfortunate results. An even better answer is vibrating stylus cleaner such as Audio Technica's AT637. Now long deleted, they can still be picked up in the classifieds for under £25. Back in the eighties, obsessive vinyl users used to keep their styluses clean with a special type of sandpaper such as Linn's Green Stuff – it's effective but has disastrous consequences if used any more than occasionally. Another idea is Cardas's Sweep record, which not only cleans the stylus by vibrating it ultrasonically but also offers a Densen DeMagic-style demagnetising track too. Again, look online or in the classifieds.

WANT TO HEAR MORE MUSIC? Then get rid of the noise!

NC - the total solution to mains noise and interference

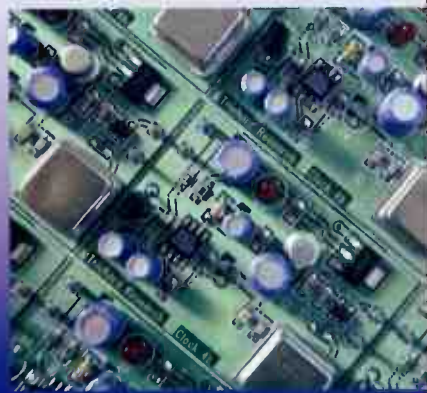

Fit a Trichord Clock 4 and 'Never Connected' power supply to improve the performance of your CD or DVD player. Let us undertake the work for you in our Modification Workshop.



Contact us now to see how we can help you to reduce the noise in your system;

TRICHORD RESEARCH

Tel: +44 (0)1684 311600 Fax: +44 (0)1684 311928
sales@trichordresearch.com
www.trichordresearch.com



Specialist Suppliers of Audio Accessories
www.mantra-audio.co.uk

PRICES INCLUDE P & P FOR UK DELIVERY 1 TO 10 DAYS -
SEE WEBSITE FOR FULL PRODUCT RANGE AND SHIPPING
CHARGES TO EU & WORLDWIDE

CARTRIDGE SELECTION		STYLUS	HEADPHONE SELECTION	
Goldring			GRADO Award winning Headphones	
Elektra	£33 £28	GEX	£24	Prestige Series SR-60 £75
1006	£76 £62	GEX	£52	SR-80 £90
1012 GX	£95 £76	GEX	£67	SR-125 £140
1022 GX	£124 £100	GEX	£86	SR-225 £175
1042	£143 £114	GEX	£100	SR-325i £260
Eroica LX/H	£133 £109	GEX	N/A	Reference Series RS-1 £635
Elite	£232 £190	GEX	N/A	RS-2 £450
REPLACEMENT STYLI				
Swiss Quality Diamond Styli				
Audio Technica				
AT 95 E	£23		£16	ADC XLM Mk III £17
AT 110 E	£28		£17	Akai AN 5, AN 60 £13
AT OC9 ML II	£330 £295	EX		AN2, AN 70 £15
Denon				Aiwa AN11 £13
DL 103	£105 £95	EX	N/A	Dual DN 145 E, DN 165 E £17
DL 110	£79 £69	EX	N/A	JVC DT 55, DT 60 £13
DL 160	£95 £83	EX	N/A	National EPS 24 CS, P 30 D, P 33 D £13
DL 304	£210 £190	EX	N/A	Ortofon FF15/VMS20 EII, OM20 £17
Grado				Pioneer PN 210/220/240 £13
Prestige Black	£40		£27	Shure N 75 C, SC 35 C £13
Prestige Gold	£110		£73	N 75 ED T2, N 75 EJ T2 £17
Lyra				N 95 ED/EJ, N 75 3 (78) £17
Dorian	£495 £395	EX	N/A	VN 35 E £20
Argo	£795 £635	EX	N/A	N 97 HE, VN 35 HE £27
Shure				Sony ND 142/155 G, CN234 £13
M 97 XE	£98		£58	ND 143/150/200 G £15
V 15 V xMR	N/A		£204	Stanton D 681 EEE £21
Sumiko				***Over 500 Styli Types Stocked***
Blue Point Special	£235 £200	EX		
Blackbird	£585 £500	EX		

GEX - Goldring new for old exchange price for any make/type of cartridge
EX - Exchange price same make moving coil cartridge

Order direct online or Tel/Fax (01757) 288652
MANTRA AUDIO (MFW), 22 GARTH AVENUE, NORTH DUFFIELD, SELBY, NORTH YORKS YO8 5RP

....experience the music



www.whestaudio.co.uk
T: 020 8965 4535

Vital Idle

Goldring's venerable idler-driven GL75/GL99 turntable is a secondhand bargain well worth pursuing, thinks Neal Gibbons...

Thirty years ago, there was a heated debate raging in the pages of the UK hi-fi press, over the respective merits of belt and direct drive turntables. In the belt camp was the redoubtable Ivor Tiefenbrun (of Linn Sondek fame), plus a number of other British turntable designers. In the direct drive corner was the whole of the burgeoning Japanese consumer electronics industry, which was rapidly moving away from belts on technical grounds (and, if we're honest, cost too).

Belt drive, it was argued, offered superior subjective speed stability, because the deck wasn't always 'hunting' for the right speed. Direct drive, it was argued, offered superior objective speed stability because the wow & flutter measurements were vastly better than the likes of the Linn. What both camps forgot, of course, was idler drive...

Idler works by driving the platter directly from the inner lip of the turntable platter rim. In



Thanks in no small part to this magazine's re-examination of the effects that turntable drive systems have upon their sound, there's been a lot of talk on internet audio forums of late about idler decks. Some of this is hot air (web forums are prone to sensationalism, and the logical fallacy that one individual's experience is somehow universally applicable and binding), but there's still more than a grain of truth in the idea that they have something special about their sound.

With this in mind, I decided to take the plunge and buy one myself.

over the odds, and no, I'm not going to tell you how much...

The GL99 differs to the GL75 in that the arm is mounted off the main deck chassis. The GL75 has its arm located directly on to the chassis limiting the choice of tonearms that can be fitted unless drastic surgery is used to cut the corner off the chassis. My deck arrived, packaged well and fully functioning, except I could not turn it off. I discovered the 'off' button had been repaired but not well enough to fully engage with the deck's off mechanism.

All the GL decks work on a similar principle. There is a metal chassis to which the main bearing is bolted along with a high torque four pole AC motor. The motor shaft is extended with a conical profile. Above this sits a vertical mounted idler wheel with a rubber drive rim, 'floating' on the end of a positioning arm. The arm can move the idler wheel up and down the conical motor shaft thus varying the speed an infinite amount between 16rpm and 78rpm!

On top of the wheel sits an 8lb cast aluminum platter, the wheel therefore drives the platter in the vertical plane. The idler wheel is moved out of position, disengaging with the platter and motor when the 'off' button is pressed, no electronics here, just good old mechanical linkages.

"given that this deck is nearly forty years old, its performance is nothing short of remarkable!"

truth, it conferred a very strong, punchy sound but was prone to noise transmission problems, which both belt drive and direct drive circumvented by other means. The most famous idler deck is surely the Garrard 301/401, which by 1976 was about as fashionable as drainpipes and 'a short back and sides', but a number of British designs used it – because it was cheap, simple and effective – such as Goldring's long, lost GL75 and derivatives.

I thought it was going to be difficult, but a quick internet search located about half a dozen, most of which where on ebay, alas! I watched prices for a few weeks and was astonished, it seems the word had already got out. Prices were stupidly high; where the GL75 was selling for £15-£35 a month earlier they where now going for £100. I persisted and located a good 1967 example of a GL99, bidding frenzy got the better of me though and I ended up paying way

Make it
a date!

24th – 26th
February 2006
10am – 5pm
every day
at the
Marriott City Centre
Hotel
Lower Castle St.
Bristol

The UK's favourite show -
now in its 19th great year!

SOUND & VISION

THE BRISTOL SHOW

Over 130 brands... with more
booking every week

HI-FI, HOME CINEMA, FLAT SCREENS,
PROJECTORS, HIGH DEFINITION TELEVISION,
CUSTOM INSTALLATION – IT'S ALL AT BRISTOL

Some early sneak previews... (and we know there are lots more
surprises in store!)

- ★ **SKY HIGH DEFINITION TV** – High-Definition will be the biggest revolution in TV picture quality in decades. It's going to be bigger, better and sharper and will transform TV viewing forever. Sky launches its HD service in 2006. Come and talk to us about Sky HD.
- ★ **ARCAM** – the FMJ AV9 THX Ultra2 HDTV processor
- ★ **CYRUS** – new CD8 XT and CyrusLink models
- ★ **NAD** – launching the incredible Masters Series
- ★ **NAIM** – nVi home cinema receiver and CDS555 CD player
- ★ **PIONEER** – a new High Definition Plasma TV
- ★ **REGA** – the first public outing for the new Apollo CD player
- ★ **ECLIPSE** – launching the TD510 Time Domain Monitors
- ★ **MERIDIAN** – see and hear the all new DSP3100 compact loudspeaker
- ★ **PMC** – the wafer series of flat panel loudspeakers
- ★ **PROJECTION DESIGN** – the Model Three 1080p - single chip DLP projector
- ★ **TECHNOLOGY** – check out the latest networking products from Roku, Sonos, Acoustic Energy, Hifidelo and more...
- ★ **TOTEM ACOUSTIC** – welcome in the new Tribe loudspeaker
- ★ **YAMAHA** – YSP800 sound projector, surround sound from one small box.

Fantastic deals and
special offers available

PLUS YOUR CHANCE TO WIN SOME SUPERB
PRIZES IN THE SHOW COMPETITION

Admission: Adults £7.00; Students/OAPs/UB40s £3.50; Accompanied
children under 16 free

www.bristolshow.co.uk

BRANDS ON SHOW INCLUDE:

Acoustat, Acoustic Energy, Aesthetix, AMX, Anthony Gallo, Apart, Apollo, Arca, Arcam, Artison, Audinni, Audiolab, Audionet, AV Forum, B&W, Bandridge, Beamax, Black Rhodium, Blok, Boston, Bryston, Cabasse, Canton, Case Logic, Chord Company, Cinemax, Clearaudio, Clearlight Audio, Cyrus, Cyruslink, Dali, Da-Lite, Denon, Diverse Vinyl, Dynaudio, Eclipse, Einstein, Flying Mole, Focal, Fujitsu, GamuT, Halcro, Hi-Fi Plus, Hi-Fi World, Inca Design, Infocus, Isotek, Ixos, Jamo, J.L. Audio, KEF, Kondo, Kudos, Lexicon, Linn, Living Voice, Lutron, Meridian, Merlin Cables, Michell, M&K, Monitor Audio, Moon, Myryad, NAD, Naim Audio, Nbien, Neat, NHT, Nordost, Onkyo, Philips iPronto, Pioneer, Plasmaticcabinets, PMC, Primare, ProAc, ProfiGold, Projection Design, PSB, PURE, Puresonic, QED, Quad, Quadraspire, Rega, REL, Resolution, Rogers, Rotel, Ruark, Runco, Russound, Sennheiser, Shakti, Sharp, Shun Mook, Sim2, Sky, Sound Organisation, Soundstyle, Spectral, Spondor, Stands Unique, Stello, Stil-stands, Storex, Stuff Magazine, Tact, Talk Electronics, Tannoy, Teac, Techlink, The Funk Firm, Tivoli, Totem Acoustic, Trichord, TCI, Uvem, Velodyne, Vivante, Vivid, Vogels, VPI, Wharfedale, What Hi-Fi? Sound & Vision, Wilson Benesch, Wireworld, World Audio Design, Yamaha and more.



Easy local parking in
Broadmead and
Bond Street NCPs.

GETTING TO THE SHOW

By train: Temple Meads Station is a short distance from the Marriott and is accessible by bus, foot or taxi.

By car: from the M4 take J19 (M32 – Bristol). Follow signs for City Centre and RAC signs to the Show.

For the very latest
information please
check out
our website...

www.bristolshow.co.uk



audio
EXCELLENCE
www.audio-excellence.co.uk

audio T
www.audio-t.co.uk

World Radio History

In association with

WHAT HI-FI?
SOUND AND VISION

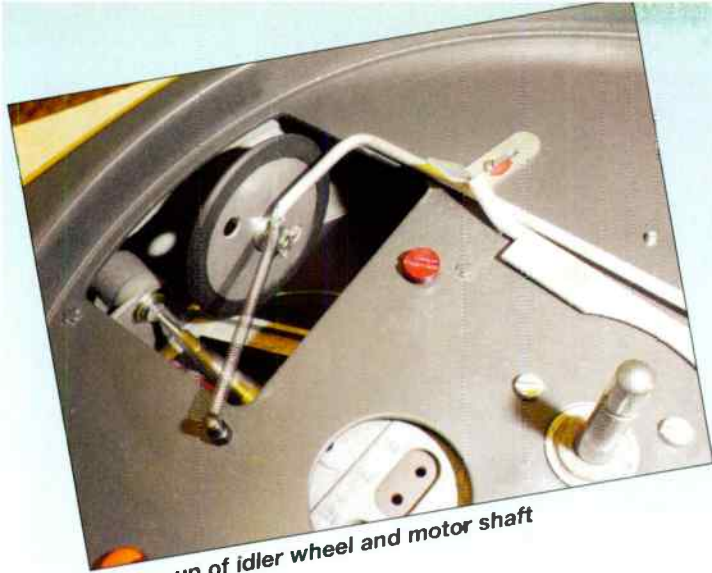

Close up of idler wheel and motor shaft



Motor, Idler and main bearing

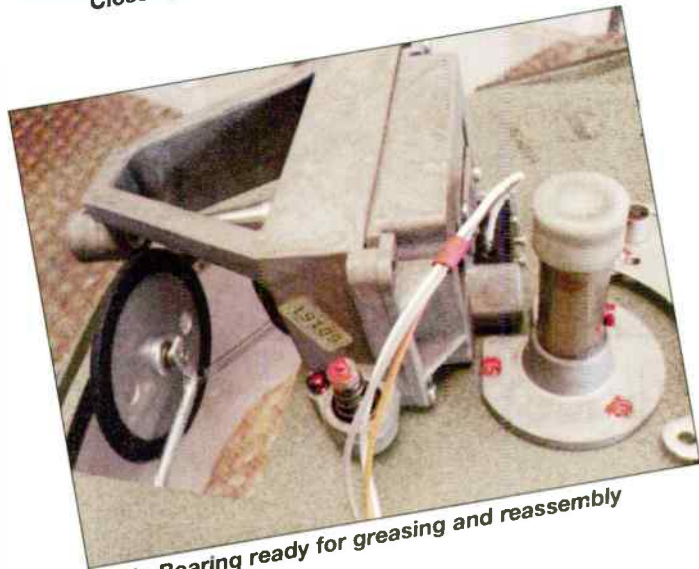

Main Bearing ready for greasing and reassembly



Close up of gasket and VTA adjuster

There are detail differences between models but I won't go into them here, they all work along the same principle using the same main parts.

Following advice gleaned from the Internet, I regreased the main bearing using Castrol 'Moly' car grease and pulled the motor apart to re-grease the motor bearings as well. It's also possible to use a grease available from Halfords called 'Finish Line' with Dupont Teflon.

These decks are simple and easy to work on; you could pull one apart and reassemble it within an hour or so. Unless you are really ham-fisted they will not break.

The motor needs to hang freely by its suspension and must not touch the chassis or plinth. If set up properly these decks should be virtually rumble free. After my re-greasing efforts I could detect no obvious rumble from my deck with my ear was pressed against the plinth or with the cartridge in the run-out groove of an LP and the volume turned up. What was all that fuss about in the seventies regarding

rumble from these decks?

With the deck serviced I needed to modify the box plinth that it came with to accommodate a modern tonearm. The deck shipped with the original Lenco tone arm, which had to go! I decided to use my OL modded RB250 with Tecnoweight. The arm has an effective length of 223mm, which corresponded with the edge of the existing Lenco arm hole! I decided to use a variable OL VTA adjuster taken from an OL 'standard' deck I had. This does away with the Rega nut and washer system, using instead an aluminum tube within a tube to provide variable VTA; a grub screw secures the tube against the arm. As the VTA adjuster had a three point screw down base it neatly straddled the existing arm hole which I had extended with a saw to cover the required 223mm arm length.

As the Rega is taller than the Lenco arm (especially with the OL VTA adjuster) I needed to raise the '99 chassis by the appropriate amount to ensure correct VTA. I made up an MDF gasket to raise it by 12mm using the original plinth cutout

as a template. With the template in position the VTA was close to being correct, at the time I wished I had used 18mm MDF, however, I found the sound improved by using an old, thick Rega felt mat on top of the existing rubber one, lifting the record up by 3mm to get the VTA spot on.

Given that this deck is nearly forty years old its performance is nothing short of remarkable. It has such a natural tone and sense of ease that it beguiles like only a good turntable can. Sure, it does not have that nth degree of detail or clarity and air to the treble such as the GyroDec and its soundstage is not as wide, but it drives bass lines along with great authority and sure footedness. I found piano particularly pleasing, especially Jazz, there was richness, detail and depth that challenged my existing Orbe platter Gyro SE - possibly a touch better.

This is only the start. The deck is said to improve further with a heavy mass plinth and it is crying out for a good MC cartridge. Yes, I paid far too much for it but so far it has been worth every penny.

icon Audio

Valve Amplifiers designed to get the best out of modern power hungry speakers!

Stereo 60

KT88 Integrated 2x 65w rms
Brand new UK design
ALL TRIODE Push-pull driver
Stage. Triode mode 2x 30w
Choke regulated PSU.
Remote control. Four inputs
plus tape loop. Hand built
Huge transformers (weight 33kg)
From £1,299 inc Russian valves
(Upgrades available)



icon Audio Stereo 60

Designed to get the best from the KT88 the Stereo 60 will deliver 65 watts of valve power at very low distortion from 20Hz to 20kHz (+0-0.1db). Enough power to drive almost any speaker with warmth & detail that only valves provide. Beautiful build quality.



icon Audio Stereo 300

Stereo 300

300B Integrated amplifier
Full 2x 35w rms
UK Designed. Hand built
Remote control
ALL TRIODE driver stage
Choke regulated PSU
Four inputs plus tape loop
Huge transformers (weight 35kg)
From £1,599 inc Russian Valves
(Upgrades available)

Now you can afford a superb 300B amp that does not need super efficient speakers! 35watts of 300B power will fill your room with lush sumptuous musical tones whether Classical, Jazz or Rock music.

LA4 Line pre-amp

Valve rectification.
Twin choke smoothing.
All triode design
Remote control
Four inputs plus tape loop
DC heaters
High and low level output
Stunning looks
From £649.95 complete



icon Audio LA4 Line Pre-amplifier

Stereo 40i Classic



Stereo 40i Classic

Upgraded design
Choke regulated power supply
3 Inputs, plus tape loop
Triode switching (20 watts)
45rms watts x 2 (KT88 version)
All Mullard NOS driver option
Still From only £899.95

Also: Stereo 40i £599.95, Stereo 40i Special Edition £699.95

- Other models available, see our website or ask for a leaflet
- Designed in Leicester UK
- Wide choice of valves: Inc, Mullard, JJ, EH, Svetlana, Sovtek
- Each amp carefully commissioned & tested in Leicester
- All supplied with beautiful valve covers
- Part Exchange facility for your old equipment, ask us!

Features: Hand built 'Point to Point' wiring. No printed circuit board. ALPS Volume control. Gold plated terminals. Audiophile components by Solen, Rubicon. Silver audio cable. Steel & alloy plate construction. Soft start. Unique HT delay. Comprehensive manual Inc DIY valve change info.

Coming Soon: Our new "Made for Valve Amps" Loudspeakers!

Buy with confidence. Established UK Company. Proven reliability. Unbeatable advice & back up service. Try for 30 days, refund if not delighted*

For more info visit our website at www.Iconaudio.co.uk

Or ask for an Illustrated Leaflet Auditions by appointment.

Phone 07787 158791 Email sales@iconaudio.co.uk

icon Audio 351 Aylestone Road Leicester LE2 8TA

*Conditions apply

Visa and MasterCard accepted

CE marked

Send for free catalogue

IMPACT AUDIO
For The Best In Audio Components

LOUDSPEAKER KITS - DRIVE UNITS - ACCESSORIES.



APR 2



State of the art drive units
Huge range of accessories

MHT 12 Ribbon tweeter



Transmission line kits

Via 120 TL



High End 816
Ribbon Drivers unit surround system

Visaton make some of the best drive units in the world, and we stock in some of the best systems around. They also offer great value for money and total reliability.



IMPACT AUDIO

www.impactaudio.co.uk

Tel: 01270 883243 Fax: 01270 882241

info@impactaudio.co.uk

Radway Green - Crewe - Cheshire - CW2 5PR

VISATON GERMANY

The Missing Link



Missing Link Cryo Reference Interconnect
5n Pure Solid Core Silver with Silver Eichmann Bullets
Cryogenically Treated - From £225

Cables Based on Science - Not Mythology



ORBIT POWER From £65

With Silver Maringo & Silver EPS-500 Mains Plug

For Details of Our Full Range of Audio Cables

Please See Our Website or Phone

0115 8779089 or 07967 859333

www.the-missing-link.net

**WIN A SUPERB
ZYX R-100H HIGH OUTPUT
MOVING COIL CARTRIDGE
IN THIS MONTH'S GREAT
COMPETITION!**



Here's your chance to win a fantastic moving coil, made by one of Japan's few specialist cartridge marques! Here's a reminder of what Noel Keyword said about this esoteric bit of kit on p45 of this issue:

"The ZYX R-100H suits a medium mass arm like the Rega RB300 and could be used in something like the Origin Live OLI or Silver, although it will benefit from being used in an arm a few notches up the quality scale, like an Illustrious or SME IV. ZYX make a good enough argument for their use of a plastic body. They say it is eddy current free, rigid, well damped and gives improved sound as a result... The signal coils are wound from high purity copper, the cantilever is a boron rod and the stylus a line contact type known as a micro-ridge. The H stands for High, as in high output. Where the standard R-100 delivers 0.24mV from a 4ohm coil, ZYX state in their literature, the H has twice as many turns, a generator impedance of 8ohms and

an output of 0.48mV as a result.

Here then is a sense of balance and correctness that just seems right from the off; there were no emphases to cope with and adjust to, no foibles to tolerate. The ZYX delivers a straight card, it sounds smooth and balanced. Like any top-flight moving coil though, it has clarity and dimensionality in spades, together with a tight sense of dynamic that makes music a gripping experience. Individual singers in the female backing chorus repeating 'Sunset Now', in the track of the same name, were slightly better separated from each other than even the Ortofon managed, giving a little extra insight into the performance... the ZYX is a flyer.

The cackling and chatter at the start of Jackie Leven's wonderful 'Call Mother a Lonely Field' was clear and brightly presented, the drum roll sounded taut and menacing as it should and when the bass guitar kicked in it was strong and taut, but not overbearing... Highly detailed

and concise across the middle frequencies, bringing incision to guitar strings and vivid clarity to vocals, the ZYX was impressive enough in this way... The ZYX R100-H is nothing other than a very high definition cartridge, taut as a drum and very fast, superbly clear and even handed too... Exceptionally tight sounding and detailed cartridge with the musical skills to match, this is up with the very best at the price, with a presentation all of its own".

If you'd like to win one, then all you have to do is answer the following four easy questions. Send your entries by 28th February 2006 on a postcard to:

**March 2006 Competition,
Hi-Fi World magazine, Unit G4,
Argo House, The Park Business
Centre, Kilburn Park Road,
London NW6 5LF.**

QUESTIONS

[1] ZYX's plastic body is free of what?
[a] eddy currents
[b] Nelson raisons
[c] chocolate peanuts
[d] sugar sultanas

[2] What type of stylus is used?
[a] micro-ridge
[b] spherical
[c] parabolic
[d] hyper-elliptical

[3] What does the 'H' in the ZYX's model number mean?
[a] high output
[b] heavenly
[c] high flying
[d] hopeful

[4] NK concluded by saying the ZYX has a presentation that's...?
[a] "all of its own"
[b] "out to lunch"
[c] "all of a piece"
[d] "all over the place"

March Competition
Hi-Fi World magazine
Unit G4 Argo House
The Park Business Centre
Kilburn Park Rd.
London NW6 5LF

RULES AND CONDITIONS OF ENTRY

- ONLY ONE ENTRY PER HOUSEHOLD
- MULTIPLE ENTRIES WILL BE AUTOMATICALLY DISQUALIFIED
- PURCHASE OF THE MAGAZINE IS NOT A PRE-CONDITION OF ENTRY
- NO CORRESPONDENCE WILL BE ENTERED INTO
- THE EDITOR'S DECISION IS FINAL
- NO EMPLOYEES OF AUDIO PUBLISHING LIMITED, OR OF ANY COMPANIES ASSOCIATED WITH THE PRODUCTION OR DISTRIBUTION OF THE PRIZES, MAY ENTER

entries will be accepted on a postcard only

**DECEMBER 2005 EASTERN ELECTRIC MINIMAX M520 WINNER:
Margaret Surrey of Winlaton, Tyne & Wear**

Parallel



David Price tells the story of Revox's legendary parallel tracking turntable, the B790.

Back in the mid nineteen seventies, the Revox name was considered by many to be 'the best of the best'. The company was regarded as being a purveyor of ultra high end kit that was head and shoulders above even the top US brands. Evidence of this, as if it were needed, was the A77 tape recorder, which was used in recording studios and top end hi-fi systems alike. The subsequent B77 consolidated this, and became a badge of pride for any well heeled, self respecting audiophile with a thousand pounds to spend.

The company also made other hi-fi separates too, including some superb amplifiers and tuners, and even a range of turntables. Being Revox, these had to be special, and expensive, and engineered and built like absolutely nothing else. They were also expected to have superlative performance, and reliability second to none. Not to put too fine a point on it, Revox set out to swat the emerging (and

meticulously made) high end Japanese competition like a fly. By the look of their products of this era, you could say that they largely succeeded.

Retailing for £400 in 1978 (when a new Linn LP12 would have set you back £230), the B790 was an extremely expensive device. This was reflected in both the design and build, which was (at the time) utterly state-of-the-art. The 449x142x395mm deck was finished in exactly the same style as the B77 tape recorder, being a mix of grey Nextel finished steel and aluminium (weighing 11kg). It sported the very best Quartz-referenced, direct drive motor (giving 0.05% wow and flutter figure, around half that of a Valhalla Linn LP12), and a parallel tracking 40mm ceramic tonearm that was the subject of no less than three patents, weighing 40g and with an effective mass of just 3g.

In keeping with the company's 'studio' credentials, the B795 does not offer a welter of facilities. This is in marked contrast to the Revox's Japanese rivals of the day, such as the pricier Pioneer PL-L1000

(£450), which had more comprehensive automation. The Revox was, essentially, confined to stop-start and cueing; the three buttons (up/down, arm left, arm right) being a model of ergonomic excellence. You cue up the arm, it returns at the end, and that's your lot! Still, as per Technics' epoch-making SL10, the ergonomic excellence concealed engineering sophistication; the arm has servo-electronics to control its movement and LED optical sensing to detect the end of side, along with automatic muting (a la SL10) for cueing activities.

In use, not even a Technics SL10 compares to the Revox; put a record on, swing the arm across into position and be amazed with the precision with which it 'clicks' into place (think Mercedes S-class doors shutting). Then press the lower button (which itself has the exact feel of something only found in the best laboratory measuring instruments), watch the cueing 'courtesy light' switch off and hear the 'whirr' of the arm electronics-activated lift-lower

Universe

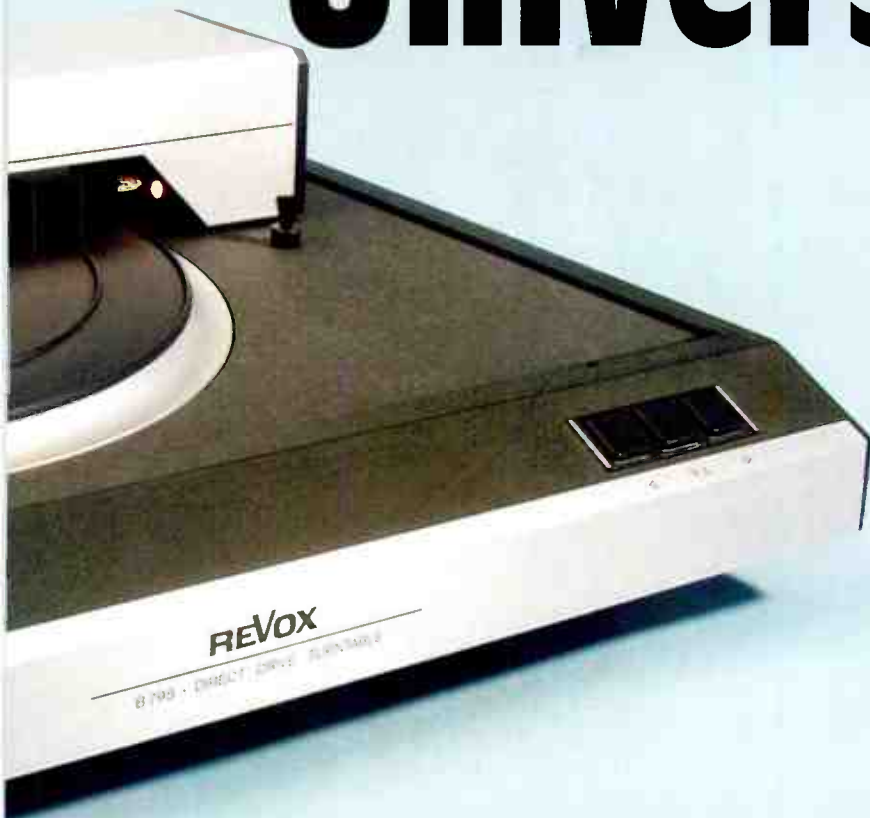

motor. Fascinatingly, the Pioneer PL-L1000's lift-lower motor is ultra quiet (think Lexus), whereas the Revox sounds like a big, gutsy, studio-spec motor (think 1970s Merc SL)!

Like the PL-L1000, the B795 also sports an independently sprung subchassis – a rare feature for any direct drive, and a desirable one too. It betokens the fact that the designer(s) have given serious thought to the sound. The turntable motor is silent, as you'd expect, and gets up to speed within around 0.9 of a second. In use, the general feel of the deck is sublime. It feels like only a Revox can; this is the sort of crazily over-the-top build that the likes of classic EMT and Garrard turntables exude. In the same way that any Range Rover driver knows that their car pummels the road (and not the other way round), so a Revox owner enjoys the feeling of total mechanical imperturbability. As a gauge, Nakamichi Dragon cassette decks feel fragile...

The B795 sounds like it feels, which is like a rock - it has tremendous power. If ever there was a turntable with 'steam roller' like sonic characteristics, this is it. Having the best quartz locked, direct driver motor, a reasonably massy platter and superb isolation, you can imagine that it's tight, and in control. Bass is

prodigious, with a sense of unflapability that you simply don't hear from belt drives. It's dynamic like few others, and blessed with remarkably low rumble or other extraneous noises.

Love them or loathe them, the Revox's parallel tracking arm is brilliantly well implemented. It's smooth, quiet and gives that distinctive sound you get from parallel trackers – which is that of an extremely expansive soundstage,

to 'just play music', rather akin to a high quality open reel tape recorder, indeed...

These days, the Revox B795 is a rare beast on the secondhand market, but the brilliant build means that whilst many Japanese and British superdecks have either failed or gone out of tune badly (respectively), the Revoxes tend to continue to give sterling service. A surprisingly large number of 795s (and 790s, which were basically the same but with

"Revox set out to swat the emerging high end Japanese competition like a fly... and largely succeeded..."

vast from left-to-right, and fine dimensionality. There's also no sense of an arm moving across a groove (with the concomitant changes in treble response as the stylus heads ever closer to the run-out groove), making for a very neutral, even sound right across the frequency range (and indeed across the radius of the disc). It's a clean, incisive and self-effacing sound; it isn't charismatic or romantic (as per Linn LPI2), but is never less than neutral and in control. It seems

variable pitch and a digital speed readout) were sold, but you'll have to look to Germany to find them in decent quantities on the secondhand market. Still, a top example is easily worth £500 of anybody's money; and parts and service manuals are still in reasonable supply. Not every audiophile's cup of tea perhaps, but those wanting a superb semi-auto analogue disc spinner with a legendary name on the front should start searching.

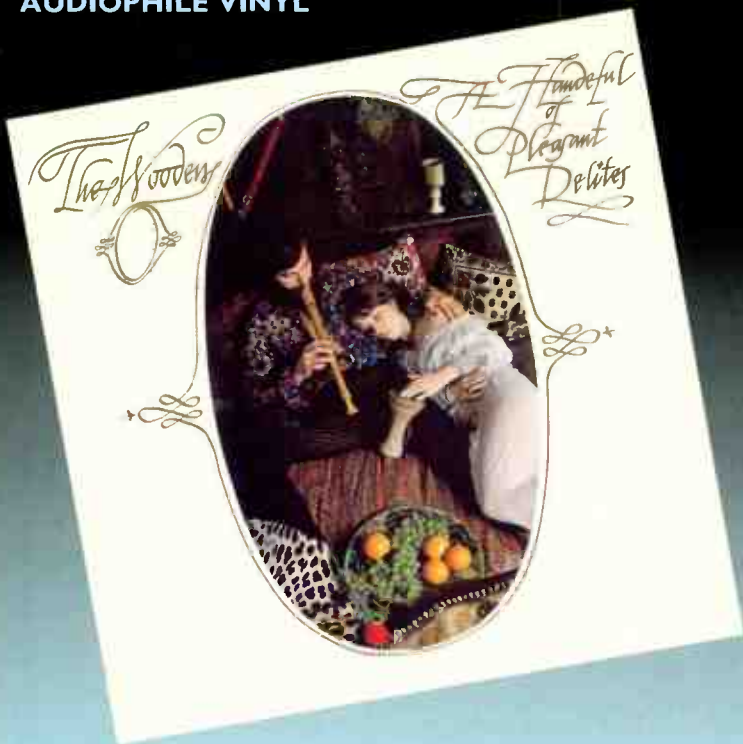

THE WOODEN O
A Handeful Of Pleasant Delites
Akarma

Vinyl really comes into its own when classic or rare albums are reissued. Of course, we often see rarities re-released on CD, but there are two problems with this method. Firstly, as with this release, the original vinyl, whilst garnering a cult following on the Middle Earth label in 1969, was never really seen in its original guise in large numbers. Hence, not too many people have been able to appreciate the original album in all its glory. This folk release has to be enjoyed in its original 12" format to get a sense of its delicate production values. You just can't sense the same atmosphere from a CD, a format that would not look out of place stuck on the top of spear adjacent to a series of shrunken heads – small and lifeless, if not overly hairy.

Next, especially where reissues are concerned, look at the tracklisting for this album and witness a track called 'Maypole'. It would be listed as Track 8 on a CD. However, in real life, this is Track 1, Side 2. That is a very important distinction. When planning an album on vinyl, bands were often meticulous when planning the formal tracklisting. Running down to the end of side one was noted, the physical act of getting up to turn the record over was taken into consideration and so on. Hence, the music was carefully organised, often

like a theatrical production, to have a beginning, middle and end – even for basic, non-concept, albums. The art of pacing was very important for any vinyl album. Dump the lot onto a CD and you rip apart that essential element of pacing. Irrevocably damaged, the album loses its structure. On vinyl, where it belongs, this acoustic folk album is full of pace. Lead by James Harpham, the group feature jazz stylings and baroque moods with plenty of experimental moments to keep you alert. Akarma has done a great job in reissuing the album, improving on the original sound quality (Middle Earth without lacked sufficient reserves of cash, the original pressing quality of the label suffered and was never very high) and reproducing the original artwork in all its glory.

CABARET VOLTAIRE
Live At The Hacienda 11.08.83
Get Back/Cherry Red

On Saturday February 3rd, 1916, the inauguration of the Cabaret or 'artist-tavern' Voltaire, took place, located at Spiegelgasse 1 in Zurich. Hugo Ball (writer and theatre director) made an agreement with the owner of the tavern 'Meierei' to use the backroom for a literary cabaret – as well as to increase the sale of beer, sausages and sandwiches. Finding their name from those first Dadaist gatherings, the eighties band consisted of Richard H. Kirk on guitars, Stephen Mallinder on bass and Chris Watson who messed

about with tape loops and the like, before samplers became popular. "It was all kind of pretty basic stuff and we were using synthesisers and tape recorders and tape loops. We couldn't play instruments as such so we just made a noise," said Kirk.

Although primarily an industrial and electronic band, Cabaret Voltaire were never afraid to explore other genres, stretching their own talents and combining their past experiences, moving from experimental electronics to funk and techno. In fact, it was just after the departure of Chris Watson (in October 1981, on the eve of an international tour, to pursue a career in television sound recording), that this album's session, now re-released by the Italian label, Get Back, was recorded. The venue itself, Manchester's Hacienda, was and is, as famous as the band itself. This live performance, in 1983, was recorded soon after Cabaret Voltaire had signed with the label, Some Bizarre/Virgin. In fact, most of the songs featured that night and on this release were included on the then recently released album, *The Crackdown*, one of their best albums and a release that saw the band moving towards the techno genre, although the style is distinctly menacing and hence retains that core industrial theme that was the band's roots. Excellently mastered, the album consists of nine tracks including: 'In The Shadows', 'Over And Over' and the title track of the new album, 'Crackdown'.

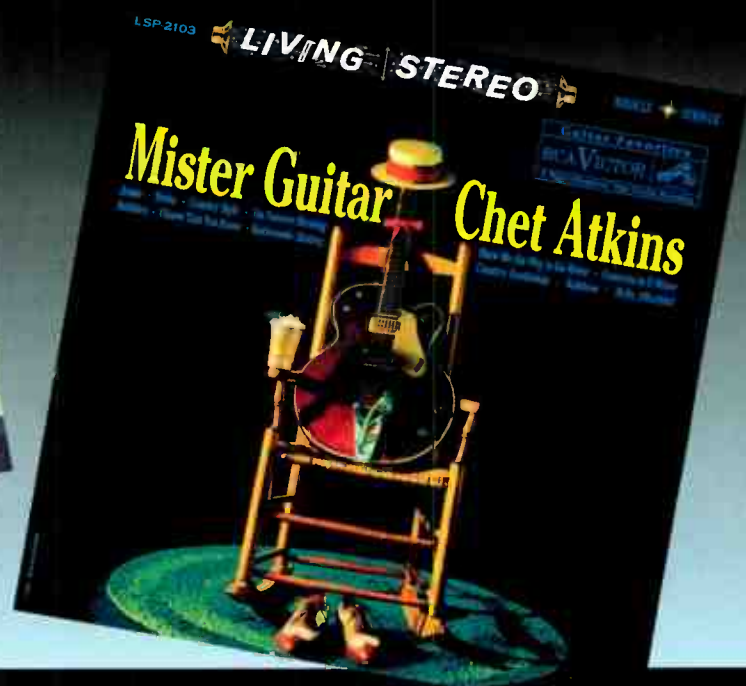

STEVIE RAY VAUGHAN AND DOUBLE TROUBLE *Couldn't Stand The Weather* Pure Pleasure/Epic

Stevie Ray Vaughan was an odd artist. Undoubtedly, the man was a talented guitarist, in fact, many people regard Vaughan as one of the best axemen there has ever been. At the same time, however, many others felt that Vaughan never truly discovered and exploited his true potential. Whether it was the stylistic direction he took, his negligible song writing, his choice of song covers and so on, there was always a sense that there should have been more to come from the man. That is to take nothing away from Vaughan's library of recorded works or his blistering live performances, however, which often reached dizzy heights. Hey, there is a statue of the man standing in his home town of Austin in Texas, USA, which is more than can be said of many artists – even in the USA. Originally released in 1984, this, Stevie Ray Vaughan's second album, has now been reissued by Pure Pleasure, a UK company run by Tony Hickmott, on 180gm vinyl with some very creditable mastering, expanding the sound stage and sharpening up the drum attacks. Midrange also increases in power. The album itself is cocky, almost arrogant in its stance with an excellent rendition of the title-track. Vaughan also displays his jazz-influenced stylings in both 'Scuttle Buttin' and 'Stang's Swang'.

Stevie Ray Vaughan died in a helicopter crash along with four others in the early hours of August 27th, 1990 in East Troy, Wisconsin. He had just played in front of 30,000 on a bill at an outdoor concert in Alpine Valley with Eric Clapton, his brother Jimmie, Buddy Guy, Robert Cray and Jeff Healey. Vaughan was flying off to when the helicopter crashed in fog into the side of a ski slope less than a mile from the venue. Hence, the artists was destined to remain somewhat of an enigma. Original copies of this album, the two disk version, can be bought from the specialist record retailer, Esprit (www.eil.com) for £33. There is also a single disk, 8-track, version available for £20 and a Dutch version can be purchased for around £10. A CD version is also readily available from the High St or via www.amazon.co.uk.

CHET ATKINS *Mister Guitar* Speakers Corner/RCA

Atkins was certainly one of the most influential guitarists of the past century, inspiring musicians from many differing genres of music. However, he was influential in the music industry as a whole too. He oversaw construction of RCA's famous Studio B, for example. By the 1960s he was juggling his own surging career whilst producing other artists like Waylon Jennings and Charlie Pride. He was even made a vice

president at RCA in 1968. However, picking guitars was his first love, either on one of over 100 albums to his credit or acting as sideman for others – such as playing guitar on Elvis Presley's 1956 hit, Heartbreak Hotel. Atkins also became the youngest inductee into Country Music Hall of Fame. The appeal of Atkins' music extended beyond the boundaries of the country music world and he is considered the primary architect of the more lush and uptown 'Nashville Sound' that drew on his country music roots. Some country music purists accused Atkins of selling out but the sound proved popular. Later, some would claim, the 'Nashville Sound' saved country music at a time when the world was shifting to rock and pop.

This album, which first appeared in 1959, is a beautiful production by the German outfit, Speakers Corner, from the RCA original. With excellent mastering and perfect artistic production, this album is undoubtedly the best version of the album there has ever been, and that includes the original. Utilising a small band of musicians, the album provides a welcome, stripped sound that allows Atkins' musicality to show through clearly. Finding an original Chet vinyl album is going to be a problem. The best method of grabbing an original copy would be to scour US-based record dealers. Hence, this release from Speakers Corner is invaluable.

CONTACT:

Vivante
01293 822 186
www.vivante.co.uk

Putting the enjoyment back into Hi-Fi!

Best Part-Exchange Prices anywhere

For full details of our extremely comprehensive range of products, our extensive used listing, links to reviews, technical information and much more, visit www.shadowaudio.co.uk



Digital

Wadia 302 CD player, only 2 months old (£4000)	£2995
Advantage CD15 in black, 12 mnths warranty (£4595)	£1395
Cyrus CD6, latest spec in black (£650)	£449
Meridian 508 20-bit cd player, boxed as new	£749
Musical Fidelity CD Pre 24 (£2000)	£849
TEAC P700 CD transport, boxed as new, rare	£399
Marantz CD94, boxed, 9/10 condition, very rare	£369
Unison Research Unico CD Triode valve CD player	£895
Musical Fidelity Nu-Vista CD player	£1395
Bel Canto PL-1, boxed as new, ex-dem. (£6990)	£POA
Cyrus Discmaster CD Transport, Black, PSX-R available	£295
Bel Canto PL-1 Universal CD/DVD-A/SACD (£9490)	£POA
Shanling CDT-100 (3D acoustics UK model) - £1600	£990
Audio Analogue Paganini (£950)	£695
Musical Fidelity A308CD player	£995
Roksan Kandy MKIII silver/black ex-dem	£450

Amplifiers

Krell 400xi integrated, boxed, unmarked (£2800)	£1895
Rogue Audio 99 Magnum pre-amp, silver (£2495)	£995
EAR V20 integrated amplifier. Stunning looks (£3595)	£1995
McIntosh MA2275 valve integrated (£5773), ex-dem	£POA
McIntosh MA6500 integrated amp, ex-dem (£3361)	£POA
Krell KAV500ii integrated, very very rare (£5000)	£1995
Pathos Classic One mkII, boxed as new (£1400)	£995
Bow ZZ1 integrated amp. Black, unmarked (£3350)	£1495
Musical Fidelity KW500, originally supplied by us new	£3199
McIntosh MHT200 8x140wpc, home cinema heaven	£3950
ATC SPA2 150 power amp, in original wooden crate	£1995
Audio Innovations 2nd Audio Monoblocks (£3000)	£1200
Audionet Amp II monoblocks (£5250)	£1995
Audionet Pre 1 inc EPS, (£3465) - incredible saving!	£995
Musical Fidelity A300cr dual mono power amplifier	£695
Musical Fidelity A308 pre amplifier (£2000)	£795
McIntosh MC252 power amplifier (£3852)	£2995
Classe 47.5 pre amplifier (£3300)	£695

Linn Wakonda pre amplifier, black	£495
ESLab DXS4 digital power amplifier (£2600)	£995
Graaf GM50, award winning valve amp, black	£2795
Chord SPM 1200E in silver one + Integra Legs	£3495
Copland CSA 28 integrated amp, excellent. (£1500)	£695
Audio Valve Eklipse Pre-amplifier, boxed as new (£2395)	£1295
Pathos TT-RR integrated amplifier, one owner (£3595)	£1995
Jeff Rowland Model 8ti power amplifier, mint (£14000)	£5895
Bel Canto Evo4, boxed as new, ex-dem (£3499)	£POA
Bel Canto Pre2, boxed as new, ex-dem (£2999)	£POA
Bel Canto EVO 2i, boxed as new, ex-dem (£2750)	£POA
Meridian 557 Power amplifier, boxed, one owner	£795
McIntosh MCS01 Monoblocks (pair), boxed as new,	£POA
AVI Lab Series Integrated amplifier (£1500)	£949
Croft TS1 with Epoch Pre (£3000)	£1250
Audio Analogue Puccini Settanta (£950)	£795
Musical Fidelity X-150 v3 (£799)	£650
Hovland HP100 pre+built in phstage (£5350)	£3595
Hovland Radia Power amplifier (£7995)	£4995
Hovland HP200 + phono stage (£7325)	£4995
Audio Analogue New Maestro (£1750)	£1255
Audio Analogue Primo Setanta	£325
Roksan Kandy MKIII (silver or black)	£450

Loudspeakers

Zingali Overture 3S, boxed, one owner, as new (£4000)	£1595
Wilson Benesch Actor speakers in Cherry	£1495
PMC GB1 speakers, boxed as new, oak	£745
ATC SCM-35, cherry, boxed as new (£1999)	£1395
Monitor Audio GR10 speakers in cherry, mint (£850)	£390
PMC OB1 speakers in cherry, boxed as new (£2700)	£1595
ART Expression V6, boxed as new, cherry (£3250)	£1995
ATC SCM-50ASL finished in Yew, boxed as new £7947)	£4995
Wilson Benesch Curve speakers (£5000)	£3495
Dali Helicon 400 (£3300)	£1995
Ref 3a Dacapo i, maple (£2700)	£1650
Triangle Heliade, Champagne finish (£595)	£395
Wilson Benesch ARC's with stands (£2500)	£1699

Triangle Australe in cherry (£3300)	£1995
Living Voice Avatar OBX-R in Cherry	£2895
Wilson Benesch Discovery (£5700)	£3895
Quad 989 ESL Vintage, new £5000	£3600
Quad 988 ESL in Nouveau, cost new £3750	£2999
Audio Physic Virgo III, Cherry	£2895

Analogue

SME 10a boxed as new, one owner (£3600)	£2395
Krell KPE Reference Phono Stage, boxed, manual, excellent	£1395
Mark Levinson JC-1 phono stage, very rare, only produced between 1976-1977. Battery power only.	£1495
Pro-ject Tube Box - as new - superb valve phono stage	£195
Linn LP12, Ittok LVII, one owner, very good condition	£495
SME 10, boxed AS NEW (£1500)	£1895
SME 20/2a + SME V tonearm (£5695)	£3695
Wilson Benesch Full Circle+Ply Cart (£2100)	£1495
Michell Orbe SE boxed as new	£1595
SME 10A, boxed	£2495
Nottingham Analogue Spacedec	£695
Trichord Dino - silver front	£199

Miscellaneous

Nordost Brahma 20m Mains cable (£895)	£595
Nordost Solar Wind 1.0m interconnect	£49
Nordost Red Dawn rev11 1.0m interconnect, as new	£150
Isol8 2k Qube, boxed as new, one owner. (£1595)	£795
Vertex AQ Roraima Plus, mains lead with filter (£490)	£395
Grado RS2 reference headphones, unused. (£550)	£350
Isol8 Gil Minisub, boxed as new, ex-display (£495)	£375
PS Audio P600 power plant, just serviced. Multivave model (£2895)	£1395
ISOL8 Mainline2 digital mains lead (£225)	£129
Kimber ATC 2x4.5m (£262)	£145
Atlas Navigator XLR Interconnect, 2.5m (£400)	£225
Nordost Vishnu 2m mains lead, one owner as new (£450)	£349
Townshend Super Tweeters in Titanium matt (£800)	£650

List is updated on a daily basis via website

Want to part-exchange your Hi-Fi? - talk to us!!!

 shadow audio web site updated 'daily'
  web site contains comprehensive product information, reviews and images
  best part exchange prices anywhere in the uk
  finest/largest selection of new hi-fi products in the uk
  exciting new 'never seen before' products
  30-day money back guarantee on many new brands*
  free, friendly and honest advice
  unbeatable long-term customer care and service
  give us a call today!

*(CONDITIONS APPLY)

"different hi-fi components usually perform at their best when separate..."



dominic todd

Just over a year ago there was a common prediction amongst the newspaper and magazine gadget columns. The prediction went that right about now, we'd have the need for just two electronic devices.

The first would be based at home and centre around either the laptop or static home computer. From this device we'd not only compute and surf the web, but also make phone calls, control house functions, watch DVDs and TV and, finally, store and playback music. The second device would be a cross between an iPod and a mobile phone. Its uses would be to make phone calls, take pictures, watch TV, surf the net and listen to music. Now, unless you've let modern technology completely pass you by, you'll know that both these products now, in some form or another, exist.

In actual fact they probably existed, at least in the most part, when the predictions were first made, or even before I remember having a mobile phone with MP3 player (which I never used) over three years ago. Yet, although the products do now exist, the prediction is wrong - because although the hardware is out there we aren't buying them, and we aren't buying them for similar reasons that readers of this magazine don't, as a rule, buy all-in-one hi-fi systems. As any dedicated hi-fi buff will tell you, the more items that are separately encased the better. This begins with the simple CD, amp and speaker trio, which will indeed sound far better than any all-in-one of the same price, and tops out with a system that uses a dozen or so boxes to do exactly the same thing. Separating

pre and power, transport and DAC, power supplies, phone stage, speaker crossovers and so on doesn't always enhance the sound but, if done properly, more often than not will do. It's simply the case that electronic components work at their best when different functions are electrically and mechanically isolated from one another.

Returning to those two wonder devices and taking a closer look reveals many flaws. Although phone calls may now easily and cheaply be made using a PC, the computer usually needs to be left on and you still have to pay for a Broadband connection. The quality of streaming TV is improving, but it is still not ideal. Even the advent of Wi-Fi, wireless, connectivity hasn't brought about the widespread integration of all that is electronic, quite as some may have hoped. Even though the computer can now wirelessly stream music or TV to other parts of the house, it hasn't been widely taken up. The same is true of music. As a nation, although downloading music is growing at a fast rate, it's nothing like as accelerative as the take up of DVD, or even CD, has been. In short, we still appear to be fond of a separate TV, especially if it's Plasma or LCD, and a separate hi-fi system, even if that separate hi-fi system isn't often a separates one.

The second, portable device has yet to really take hold for similar reasons. The nation's love affair with the iPod continues unabated and no mobile phone with MP3 has even come close to challenging its combination of sleek styling, high storage, ease of use and sound quality. Likewise, I know of nobody that is even remotely interested in reasonably serious photography using

a mobile phone as a camera. Perhaps one day they will, and maybe even Apple will add that much talked about iPod phone connection. Yet, even if they ever do they will face huge problems.

Perhaps foremost of these are price and quality. Yet even if these are overcome and it possible to buy, say, a phone with MP3 of iPod quality and a camera of Nikon Coolpix standard with web and TV, for around £200-£300, then there's still the issue of ergonomics. Even now, there are still plenty of MP3 players, alone, that are less than intuitive.

Looking at the wider world, those masters of car interior ergonomics, BMW, have struggled with their integrated, menu-driven function system, iDrive. The reaction to this was, and still is, somewhat hostile and when you have to scroll through several menu settings simply to turn on the heated rear window, it's not hard to understand why. This is exactly the same sort of problem that a phone/MP3/TV/camera/web browser faces in that to accommodate them all the interface is likely to be complicated and most unuser-friendly - in other words the very opposite of the best MP3 players which, in turn, have proved the most popular with the buying public; iPod, Shuffle, Creative Zen etc.

Whilst some forms of integration can make sense, it's easy to go too far. Reliability can suffer, which has always proved to be another good argument for buying hi-fi separates if one part fails then the whole system isn't put out. Ultimately we mustn't get carried away with integration. Different components usually perform at their best when separate. After all, we don't drive around in our houses do we? Now there's a thought...! ●



BRITISH DESIGN AND
ENGINEERING AT ITS BEST

After 35 years, Michell is still a family run business with a team of dedicated and proud craftsmen, producing quality turntables and accessories



Orbe SE

The Michell flagship for music lovers who are not prepared to compromise

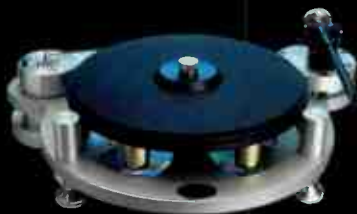

Gyro SE

The classic Michell turntable, refined over many years of development to its current level of performance.



TecnoDec

Entry level turntable incorporating features from the classic Gyro



MICHELL ENGINEERING

J A Michell Engineering Ltd
2 Theobald Street, Borehamwood,
Hertfordshire, England, WD6 4SE

Telephone: 020-8953 0771
Fax: 020-8207 4688
michell-engineering.co.uk

Model Ti48

Audiophile CD/Hard-Disk Transport

*The best digital
audio source ...*



*... is a
hard-disk drive*

- Save CDs / Play CDs -
- Upsample / Oversample -
- Add dither / Change filters -
- **Enjoy music -**

zero one

www.zerooneaudio.com

Available in the UK from AngelSound Audio
Telephone : 44(0)1923 352479
Web : www.angelsoundaudio.co.uk

NOTEWORTHY AUDIO

hi-fi by enthusiasts

BELOW IS A SMALL SELECTION FROM OUR RANGE OF CAREFULLY CHOSEN EQUIPMENT

Denon DL-103 MC cartridge. The 103 has been in production since 1963, and for good reason - its performance is legendary throughout the world. Probably the best value cartridge available today at just £100.



Denon DL-304 This is a wonderfully transparent sounding MC cartridge that is almost unmatched for its midband quality which is especially amazing when its low £210 price is taken into account.

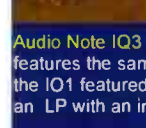

Audio Note IQ3 This is Audio Note's top MM cartridge and it features the same diamond and titanium cantilever also used in the IO1 featured below. It successfully captures the energy on an LP with an involving dynamic and fast sound: £350.



Music Maker 3 The Music Maker is a moving iron cartridge that rightly has become a legend in its own lifetime. Its effortlessly musical presentation makes most other cartridges sound as if they're trying to hard: £625

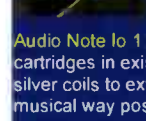

Audio Note Io 1 MC cartridge. Surely one of the finest cartridges in existence, the Io uses Alnico magnets and pure silver coils to extract everything from your LP's in the most musical way possible: £1,595.



We firmly believe that the way to get the best performance from any MC cartridge is to use a high quality step up transformer. It is for this reason that we stock a range of designs, from the new **Note Products Step-Note** at £200 (pictured left), the **Audio Note** range priced between £390 to £4,500 and the **Music First Audio** copper or silver wired designs which start from £1,500 and offer a variety of ratios and impedances via front mounted switches.



Noteworthy Audio

36 Buckingham Street, Aylesbury, Bucks. HP20 2LH. Tel: 01296 422224
www.noteworthyaudio.co.uk



"the change would allow DAB to fulfil its original promise, and become the digital radio system of the 21st Century"



steven green

There's currently a waiting game going on in the world of DAB to see if the WorldDAB Forum, who oversee standards worldwide, decides to incorporate the MPEG-4 AAC (Advanced Audio Coding) and HE AAC (High Efficiency AAC) audio codecs into the Eureka 147 DAB standard in the next few months.

Although WorldDAB will not be drawn officially on the subject, the chairman of the WorldDAB Technical Committee, Frank Herrmann, was quoted last year as saying that technical developments had paved the way to adopt these new audio codecs, and many involved in the technical side of DAB in the UK now think it's a case of when this will happen rather than if.

Unfortunately, the UK cannot currently adopt the new standard – dubbed DAB version 2, or DABv2 – because it would make the 2 – 3 million DAB radios sold to date obsolete overnight. However, the UK communications regulator, Ofcom, surprisingly wrote this comment in a statement following a public consultation on digital radio:

"Ofcom is aware that some other countries, which currently have no DAB services or where set sales have been minimal, are considering adopting the new standard.

These developments mean that receivers may be developed for the international market which can receive both the existing MPEG-2 services and any new AAC MPEG-4 services (together with DRM). Ofcom would welcome this development and encourages the radio industry to work with manufacturers to develop and market such radios as standard.

Such a development could mean that, a number of years from now, when the vast majority of radios

in the market can receive both MPEG-2 and AAC MPEG-4 services, multiplexes in the UK may be able to make use of AAC, thus further enhancing spectrum efficiency, allowing the provision of additional services to increase listener choice."

Although at first sight it might seem a little reckless to make a few million – currently new – DAB receivers obsolete at some point in the future, I think it is an excellent long-term decision.

Firstly, when you include all the portable radios, hi-fi tuners, tuners in micro systems, car stereos, portable stereos etc, it is estimated that there are about 125 – 150 million analogue radio receivers in the market. And all of these receivers need to be replaced if they ever want to switch FM off (which will probably happen in the next 10 – 15 years). Therefore, the current 2 – 3 million DAB receivers will eventually become only a small minority of all those in the UK.

Secondly, by the time such a change is made most current receivers will have been discarded or replaced. As a comparison, the number of ITV Digital terrestrial set-top boxes in the market just after the launch of Freeview in October 2002 was just over 1 million, but there were only 289,000 left by September 2005 – a pretty dramatic reduction in just three years.

DAB version 2 is really a product of the development of the South Korean-designed DMB (Digital Multimedia Broadcasting) system, which was designed for mobile TV use. The designers of DMB took the current DAB system and added modern audio and video codecs and stronger error correction to it, and DAB version 2 is virtually identical to DMB, but without the requirement for video.

Luckily, the two DAB module

design companies, Frontier-Silicon and Radioscape, have already released DMB modules, and as they implement their receivers in software it wouldn't take them long to release modules that can support both new and old DAB standards.

Another motivation behind DAB version 2 is that, just like we currently have combined FM/AM receivers, in future it is very likely we will have combined DAB/DRM receivers, and because DRM uses the AAC/HE AAC codecs as standard, there will be decoders for these audio formats in all such combined receivers anyway, so it makes sense to take advantage of this fact.

You may be wondering whether such a change would be worthwhile? Consider this: the audio quality of the BBC's music stations would be transformed from the current poor quality to near CD-quality; all the BBC's mono stations could become stereo; reception would be significantly more robust than it is today; and there would be space left over for the BBC to launch a couple of multimedia services.

Commercial radio could provide a lot more stations, or improve the audio quality of those they already have, or free up space for multimedia data services, or any combination thereof. And the 90 – 120 existing analogue stations that won't have a home on DAB even after the forthcoming DAB expansion could be carried. In essence, the change would allow DAB to fulfil its original promise, and become the digital radio system of the 21st Century.

However, if such a change is to transpire then it needs the support of both the broadcasters and the manufacturers, who might not play ball. And before DAB version 2 can even happen it requires WorldDAB to make the decision to update the standards. So the wait goes on.. ●

feel the energy of sound...

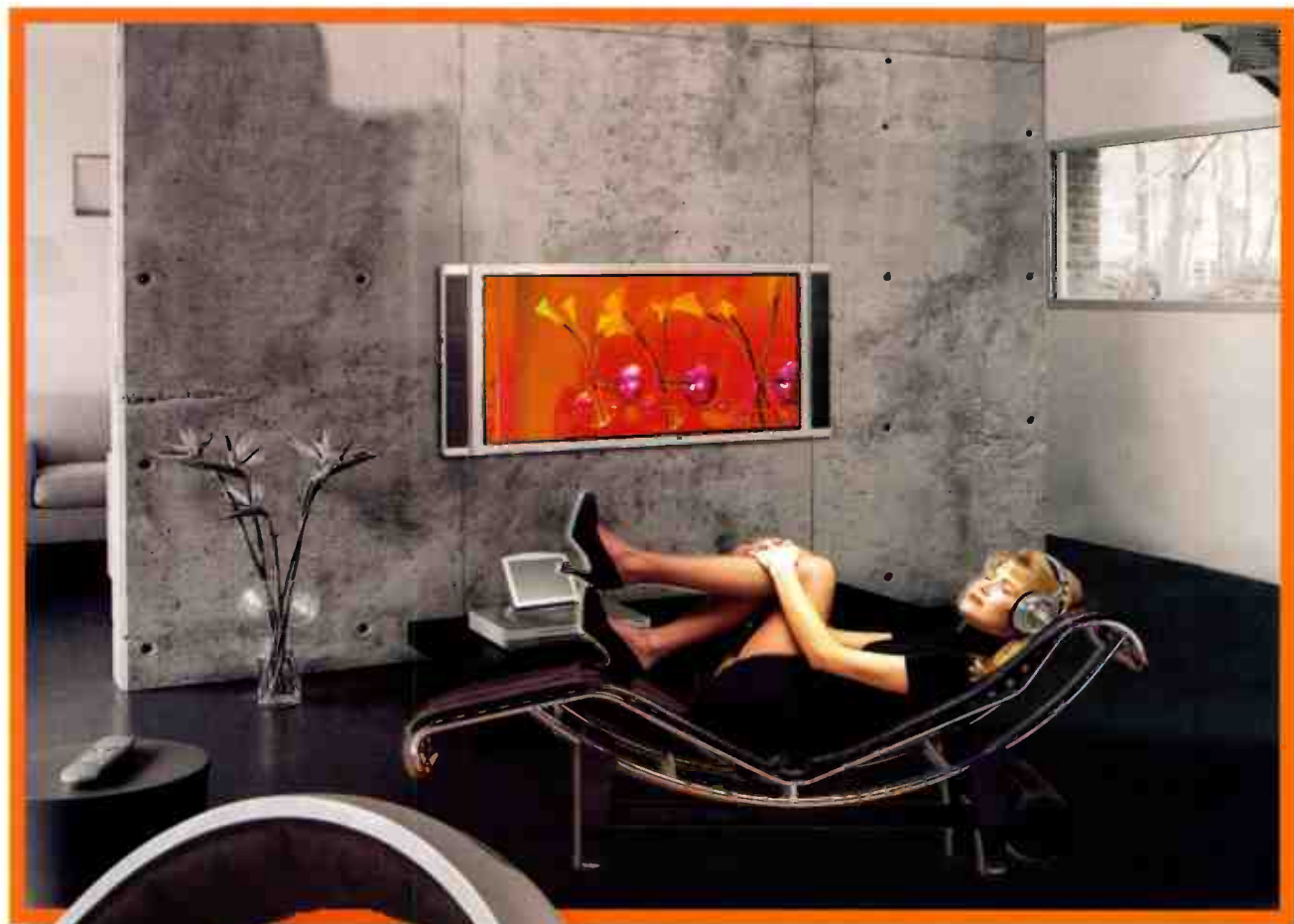

DTX 900

see the new range...



DTX 700

DTX 800

DT 770

DT 880

DT 990

beyerdynamic

www.beyerdynamic.co.uk

"balanced connection sounded more focused and certainly more succinct across the midband..."



noel keyword

Christmas will be a fading memory by the time these words reach daylight, but an idea that won't go away so easily, however, is vinyl.

I spent the quieter moments of the festive season wrestling with my Garrard 401 and a soldering iron, turning my record deck from unbalanced to fully balanced working, in a bid to release massive amounts of previously hidden information, giving me a reinvigorated LP player capable of better results than even forthcoming Blue Ray.

At present the tiny and fragile signal a cartridge generates gets channelled down a connection network that's as tortuous as a Spanish plumbing system. Arm re-wirers spotted potential for improvement here some time ago and in this issue we look at what Moth have to offer in this area. There can be three mechanical connectors in the signal path, for example, cartridge pins, arm output phono sockets and amplifier input phono sockets, all of which tarnish over time and need cleaning, at least. Moth can haul out the lot and replace with replace with modern components, which is very necessary.

I was concerned with something slightly different though, rearranging this connection scheme completely so that the signal doesn't pass down the inner conductor of a screened lead, and back through the screening braid, where it can be joined by other signals that don't come from the cartridge at all and are entirely unwanted. Most audible is hum, often accompanied by harmonics that produce a buzz, caused by a hum loop. The loop is a circuit, where the differing potentials of electrical items drive a current, in this case through the screen braid of the record deck, where it jostles with the delicate signal from the pickup. It isn't a nice

idea at all, and by any standards it is an archaic one, a left over from a time when LP was standard issue in every home and every nut bolt and piece of wire within players had to be cheap as chips.

The microphone is also a fragile analogue device, a transducer engineers say, that also produces a tiny signal from a fully balanced source, or generator. And ever since the thing was brought into life by Bell in 1876, getting the best from it has been a challenge. Not only do microphones produce tiny signals, on a stage or in a studio they may be many metres away from amplification. For that last decade or two it has been common practice to connect up microphones using a fully balanced connection, which eliminates hum loops and automatically cancels induced hum too, as well as any other interference their long leads may pick up, because they act like aerials.

So the problem has been tackled and largely solved, in principle at least. This isn't why my interest has been intensifying though. In electronics a device known as a differential amplifier has been around for a long time. Nowadays, largely because 24bit digital audio in theory demands the ability to push noise and distortion 144dB below 2V, or 0.06uV, there's big demand for super quiet, ultra low distortion chips from the global CE business that is keeping the likes of Texas Instruments and Cirrus Logic busy. This in turn has produced a lot of interesting (to me!) data on differential amplifiers, balanced working and the whole palaver that surrounds the subject, from ground referencing, to screening, to input offsets and impedances, to noise from resistors, and to cables and connectors. Curiously, a moving coil cartridge is the ideal thing to connect up to a diff. amp., pulling its noise floor down to a minimum, which these days may be

close to the Johnson noise produced by the wire in the cartridge itself!

One day, in for review came a Chord Symphonic phono stage with fully balanced inputs, then the Aqvox Phono 2CI. Of course, both were spirited away to NK towers with a haste not normally given to phono stages. But if they were reading the same Application Notes I was reading, then a short session with the soldering iron should, or could, bring forth new wonders from LP I told myself...

SME keep their tonearm wiring balanced up to the phono connectors that mate with the amplifier. No ground connection is made through the braid. However, the cable used is coaxial and this had to be changed to twin and screen microphone cable, terminated by XLR plugs. As RS could only sell me a 100m reel, I bought Maplin's best instead, which uses oxygen free copper conductors sheathed in a copper braided cable with a thick foil drain. Squeezing it into the small, right angled DIN socket that SME use was like getting Dump Truck into a Mini: the two were not made for each other. But with a lot of prodding and grunting and magnifying I did it. At the other end of the cable I suddenly realised why XLR plugs are wonderful things - they accept bloated audio cables like this with alacrity.

I finally connected up and sat back, waiting to be amazed. Er, it didn't really happen! Balanced connection did sound a little more focussed and certainly more succinct across the midband, where vocalists and instruments stood out in firmer relief, but that's it so far. When I pluck up enough courage I shall do more lead swapping in front of a Chord Symphonic fully balanced stage to see if it better resolves differences. Christmas might be a fading memory but this topic is not. ●

brighton hi-fi exchange

email : dave@hifiguy.co.uk
web : www.hifiguy.co.uk

telephone : 01424 201 157
mobile : 07734 436 180



Acoustic Signature

Masterpieces of analog music reproduction developed, produced and made for natural listening. You lose nothing; all the emotions that are on your records can be heard. After all, music is for everybody. Very special products indeed...



Basis

The philosophies underlying Basis designs are sound principles of physics; provable concepts that result in the most accurate replay of records possible. Precise execution of those principles is critical, and you'll find Basis turntables are made with exacting care and precision machining unsurpassed in the industry.



Hyperion

At £3750 (piano black version) the Hyperion 938 Loudspeakers are truly exceptional.

The Hyperion speaker will excite, delight and move you like only the very best products can! One of our favourite speakers!



Luxman

Finally Luxman is back in the UK at long last and its definitely been worth the wait! The L-509F Integrated Amplifier (£3800) is shown above and we have not heard anything below £10k that comes even close... it really is that good. Call for more details.



Music First

David Price says, "The MF Audio pre-amp is extremely open and sophisticated musical performer that betters a number of even more expensive designs."

We definitely agree!

▶ WHO?

- brighton hi-fi exchange is run by people who are very passionate about hi-fi
- we are the South Coasts leading stockists of: new, used, ex-dem specialist Hi-Fi equipment
- every product is thoroughly inspected and tested
- every product is sensibly priced so that you will not find the same product cheaper anywhere.

▶ SERVICES

- we will travel anywhere in the country to pick up your equipment
- we will travel anywhere in the country to deliver your equipment
- expert and friendly advice
- no pressure to buy
- audition products in the comfort of your own home before buying
- world-wide shipping, please call for a quote.

▶ WEB SITE

- visit www.hifiguy.co.uk
- view our complete product list online
- product list updated daily
- description and product images for most products
- visited by hundreds of people on a daily basis
- be quick as products are sold very quickly
- visit regularly to avoid disappointment!

South Coast Main Dealer for:

Acoustic Signature, Basis, Luxman

Also Dealers for:

Acoustic Zen, Airtight, Amphion, Audience, Audio Valve, BAT, Border Patrol, Boulder, Cabbase, C.A.T, CEC, Clearaudio, Gamut, Graham, Halcro, Hovland, Hyperion, Lavardin, Music First, Oracle, Pass Labs, Plinius, PS Audio, Reference 3A, RogueAudio, S.P.J Record Players, Transfiguration, Vincent & Many More...

for the widest selection of used hi-fi and the best prices anywhere: visit www.hifiguy.co.uk

THE LARGEST SELECTION OF QUALITY TUBES ONLINE

TUBE SHOP.COM

WHAT'S HOT AT THE TUBESHOP

GUITAR TUBES
HI-FI TUBES
NOS TUBES

Tube Rings by Duende Cratura

BRIMAR
Mullard
SYLVANIA

WWW.TUBE-SHOP.COM
OR CALL US 0870 9220404

vivante
VINYL RECORDS

The most beautiful music format in the world.
180 gram audiophile vinyl limited edition records.

PURE PLEASURE RECORDS LIMITED

NEW

Mary Black
Babes In The Wood
Dara / Pure Pleasure PAPAN 002

NEW

Taj Mahal
Recycling the Blues & Other Related Stuff
Columbia PAPAN 31605

Stevie Ray Vaughan
Couldn't Stand The Weather
Epic PAPAN 39304 (2LP)

Memphis Slim
Memphis Slim, U.S.A.
Candid CJS 9024

Vivante Productions Ltd
Tel: +44 (0)1737 559 357 Fax: +44 (0)1737 559 503
Email: sales@vivante.co.uk Web: www.vivante.co.uk

bass-ic instinct

Here is the second part of our World Design Aperiodic loudspeaker, with a 10in bass unit. Designer Peter Comeau describes cabinet construction.

Part 2: Cabinet construction



Final cabinet assembly, with strap to hold cabinet whilst glue dries.

As discussed in last month's DIY Supplement describing the aperiodic cabinet design of the WD25A, the cabinet is neither a bass reflex nor an infinite baffle, but operates like a closed box with the advantage of controlling the fundamental bass unit/box resonance through a resistive 'port'.

This 'port' is no more or less than a slot in the cabinet which

is heavily stuffed. The stuffing can be adjusted to maintain a low Q bass unit/box resonance, in other words the typical sharp, closed box resonance is damped to allow easier amplifier control of the bass unit. This is of particular advantage to lower powered amplifiers or amplifiers with restricted output impedance such as valve (tube) amps.

In addition, the 'knee' where the low frequency response begins to fall away is smoothed and the very

low bass extension is raised, both of which have the subjective effect of making the bass sound more extended with superior transient attack. With amplifiers as described above the bass will also sound cleaner and more controlled by comparison with other closed box or reflex box designs of similar size for the diameter of bass unit we are using here.

The best selling aperiodic design was the SEAS designed Dynaco

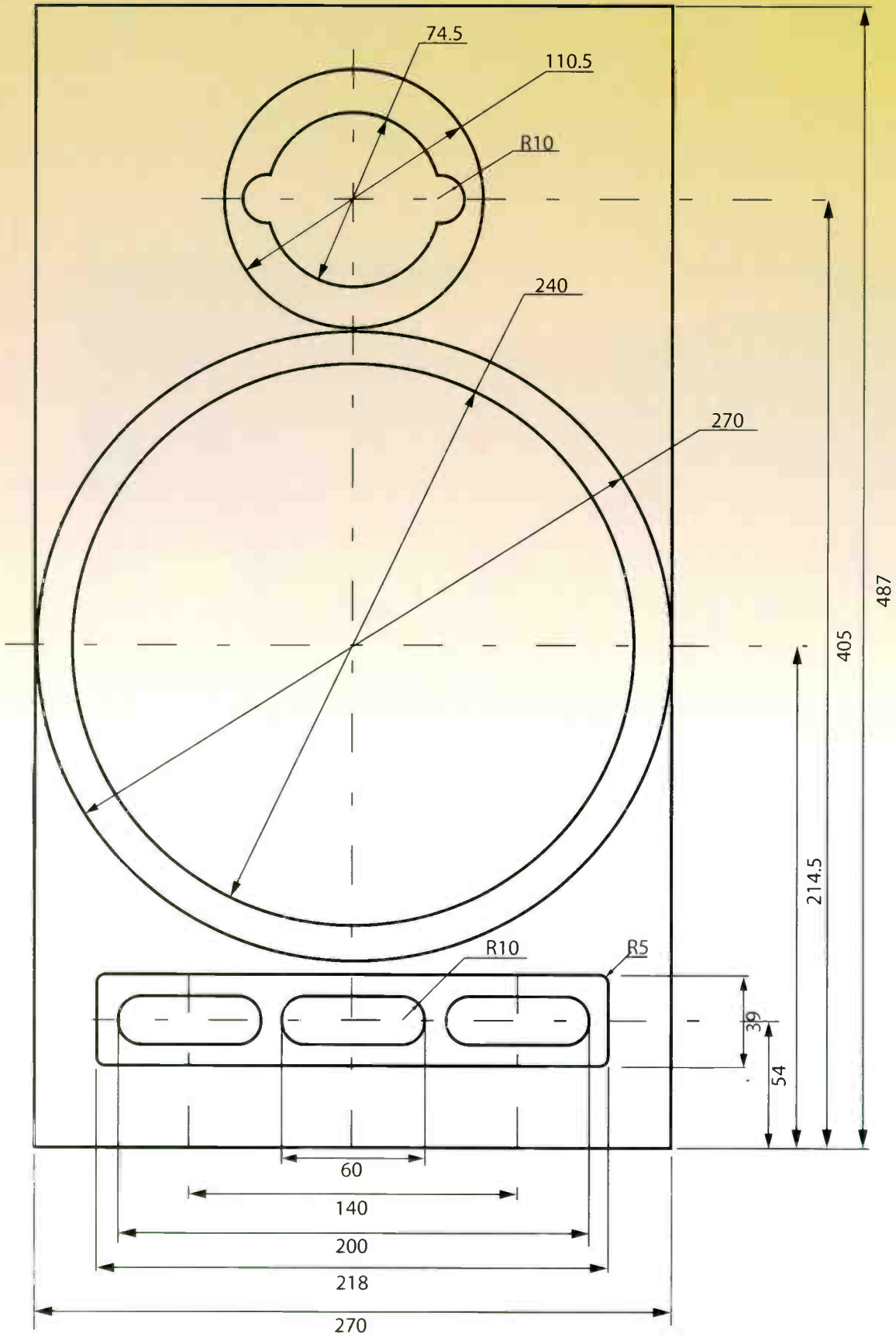

Front baffle dimensions.

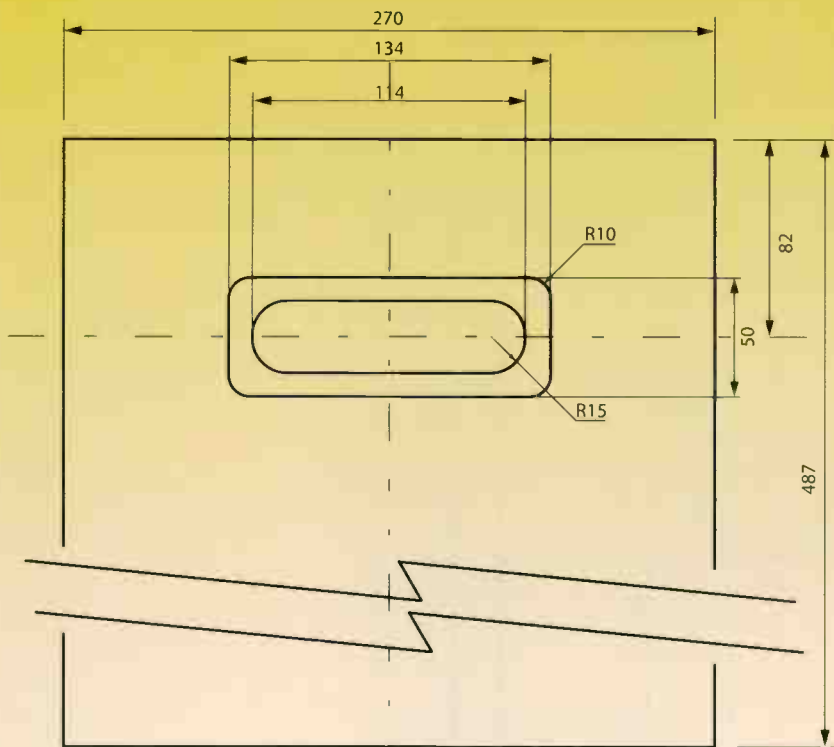

Rear baffle dimensions.

A25 which used matted fibreglass to provide a resistive layer over the 'port'. This was held in place by netting stapled to the front of the cabinet to avoid any movement of the fibreglass due to the significant airflow in and out of the cabinet at very low frequencies. If not held in place the fibreglass mat could 'beat' together with the movement of the cone.

As the Dynaco A25 was developed at a time when most users kept their drive units covered up

with a heavy fabric grille, the looks of the fibreglass and its net did not raise any cosmetic objections. For the WD25A, however, we are leaving the grille option to the constructor and so the speaker has to look good unclothed.

Luckily modern materials can come to our rescue and we found the answer in the form of reticulated foam. This is foam sheet where the 'bubbles' in the foam are connected to form a latticework. Reticulated foam is typically used for water

filtration – foam with larger pore sizes is used for foam loudspeaker grilles too and they are so 'open' that you can literally pour water straight through them.

For our resistive, aperiodic 'port', however, we needed a much smaller pore size with a high resistance to the large air velocity resulting from substantial cone displacements. Reticulated foam of 80 ppi (pores per inch) proved ideal and gave us the cosmetic result we were after.

CABINET DESIGN

For ease of cutting we have kept to the use of 19mm MDF panels throughout the WD25A cabinet. As MDF has an obvious subjective character if allowed to resonate over large, unsupported panel areas we have incorporated internal bracing to quell such resonances. This bracing, in conjunction with a wall lining

of dense fibrous damping material, results in a cabinet which has a resonant character well below the output of the drive units and is therefore subjectively 'quiet'.

The great advantage of MDF, other than its ease of cutting and finishing, is that it makes for a strong and rigid front baffle. Or at least it does until you cut a 25cm hole in it for the bass unit! Again the bracing comes into effect, supporting not only the front baffle between the treble unit and bass unit but also



Front side of front baffle, with routed cutouts for flush fitting of drive units.

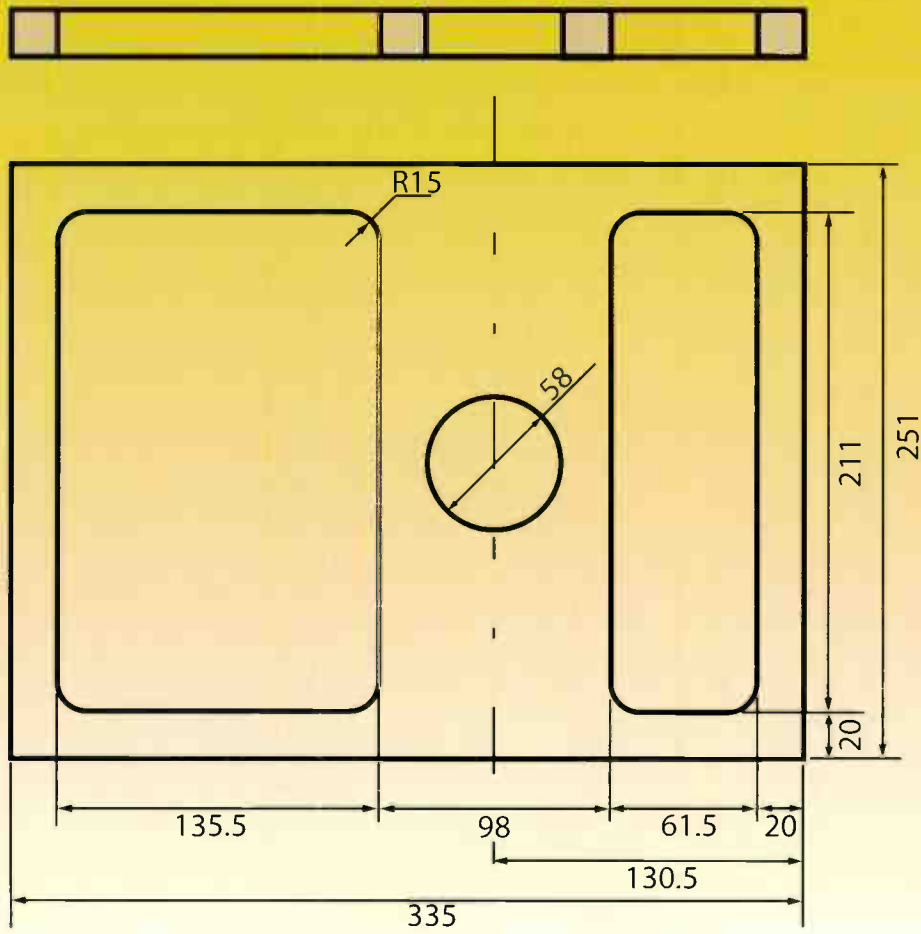

LOWER VERTICAL BRACE (CROSS SECTION ABOVE)

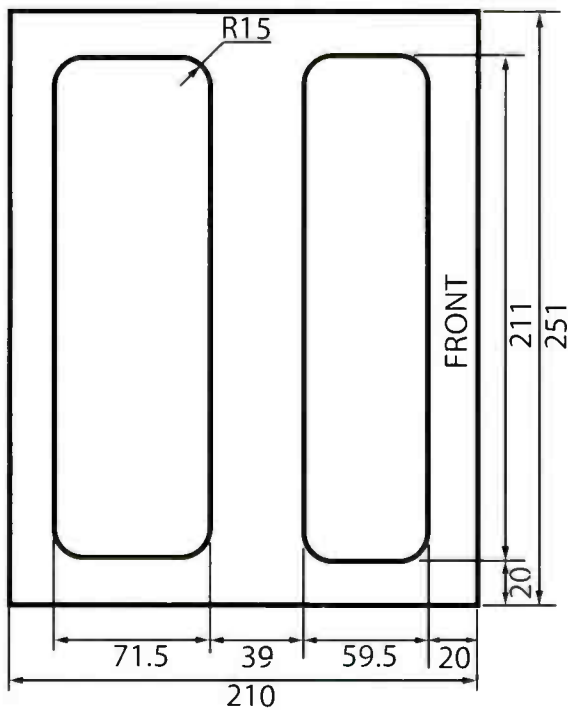

HORIZONTAL BRACE
'FRONT' INDICATES ADJACENT TO FRONT BAFFLE

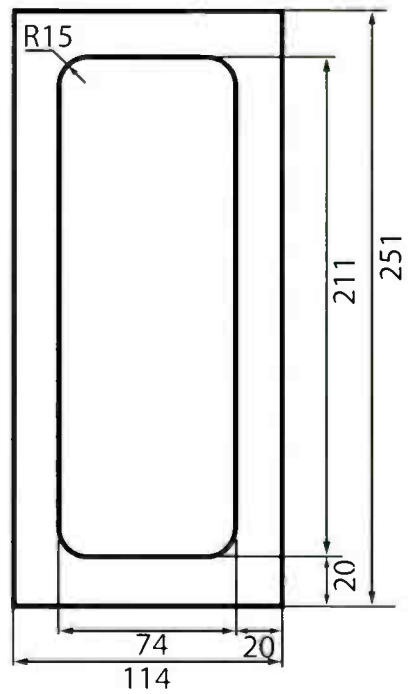

UPPER VERTICAL BRACE



Cut horizontal and vertical braces.

bracing the magnet of the bass unit against the front baffle. This has two effects: it stiffens the whole cabinet carcass and it reduces resonance within the bass unit chassis itself. You would be surprised how much this affects the subjective transient response of the system.

One of the problems of bracing the bass unit like this is that you feed more vibration into the cabinet. Try doing this with a fairly 'lively' cabinet and the cabinet panels

end up making as much noise as the output of the treble unit.

We suggest the WD25A is placed on firm and torsionally rigid stands, ideally using thin wafers of Blu-Tack to stop them sliding on the stand top plate. This should provide a neutral base for the drive units to perform at their best. (If you find the stands 'ring' when you tap them try filling any uprights with vermiculite (available from garden centres).

We have designed the cabinet

so that it can be cut from sheet without mitring and the only 'difficult' part of cutting is the rebating of the drive unit recesses and 'port' recess. This will be fairly easily accomplished with a hand router and these are cheap enough to be regarded as a standard item in the woodworker's tool inventory these days. We suggest that the front and rear baffles are inset by 1 mm or so to allow for woodworking tolerances. The only really critical dimension is

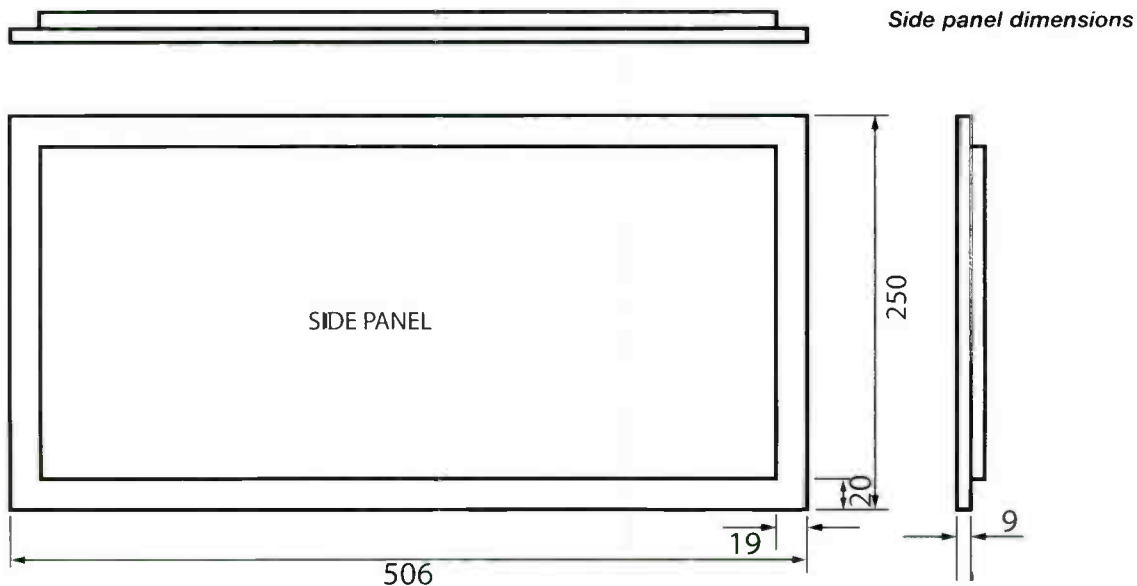

Falcon Electronics

<http://www.falcon-components.co.uk>

Full Price List and Focal details on Web Site

DRIVE UNITS: by FOCAL & seas, and a pick of the best from other manufacturers.

100+ CROSSOVER NETWORKS: - Active & Passive, Components, Accessories,

New LS3/5A type Crossovers & Components

PLUS P.A./Professional Sound Equipment

Speaker Repairs also available - Contact for details.

Dedshete back in stock

COMPONENTS

SOLENE Polypropylene capacitors. 0.1mFd. to 100mFd.

NEW Values:- 3.0mFd 400v 5% & 9.1mFd 250v 2.5%

Polyester and Polycarbonate Film Capacitors. 0.1mFd. to 10mFd.

ALCAP Reversible Electrolytic Capacitors (Non-Polar);

50v, 100v & Low Loss. 2mfd. to 600mFd.

FALCON Custom-wound Inductors.

FERRITE:- Standard, High Power, Super Power, Super-Super Power

AIRCORED 0.56 - 1.25mm wire; IRON DUST. 1mm wire

TAPPED INDUCTORS:- 0-10mH in 1mH steps & 0-1mH in 0.1mH steps

AUDIO AMATEUR PUBLICATIONS

Back year sets of Speaker Builder, Audio Amateur & Glass Audio, plus the Audio Anthology Set.

Altogether 50+ books and Audio Amateur's magazine year sets.

Focal Unit Range

Price List & Unit Specs FREE on Web site - available in .pdf format

A range of Falcon Designed and Manufactured Units coming later this year.

8 inch - 15 inch

12 inch and 15 inch on Die-cast Magnesium Chassis.

SUPPLIERS TO THE TRADE SINCE 1972

Send for our FREE price list PL32: Just send a large S.A.E. (47p stamp) or US\$3

bill overseas, Europe US\$2 bill, 2 or 3 International Reply Coupons (IRC) to:-

(Dept HFW) Unit 12 Damgate Industrial Estate,

Damgate Lane, ACLE, Norwich, Norfolk. NR13 3DJ Tel (0)1493 751100

NOTEWORTHY AUDIO DIY

- Silver plated phono sockets: £2.50 each
- Silver plated phono plugs: £4 each
- Silver plated 4mm plugs: £3.50 each
- Silver plated binding posts/4mm sockets: £4.25 each

- Eichmann Gold Bullet phono plugs: £26 for four
- Eichmann Silver Bullet phono plugs: £65 for four
- Eichmann Cablepod binding posts: £30 per pack
- Eichmann Gold Bayonet banana plugs: £30
- Eichmann Silver Bayonet banana plugs: £90

- Furutech IEC plugs from £19.95
- Furutech IEC chassis sockets from £4.95
- Furutech FI-1363 mains plug, perfect for large cables: £50

- Inca gold plated mains plugs: £20 each
- Wonder Solder £2.25 metre
- uninsulated 0.5mm pure silver wire: £2.25 metre
- Gold plated 13 Amp mains fuses: £2.50 each
- Deoxit contact cleaner/enhancer: £13.95
- B9A ceramic gold plated valve sockets: £2.95 each
- UX4 ceramic valve sockets (for 2A3/300B): £5.95 each

All items are available via mail order or in person from our shop, please call or visit our website for further information.

- Lowther drive units
- PHY-HP drive units
- Wonder Solder
- Oyaide connectors
- Eichmann connectors
- Stoetkit valve amplifier kits
- Furutech IEC sockets and plugs
- Inca Gold plated mains plug
- DeoxIT contact cleaner
- Unsleeved 0.5mm Pure silver wire

Noteworthy Audio

36 Buckingham Street, Aylesbury, Bucks, HP20 2LH

Tel: 01296 422224

www.noteworthyaudio.co.uk



WHITE NOISE

AUDIO KITS, MODULES, COMPONENTS

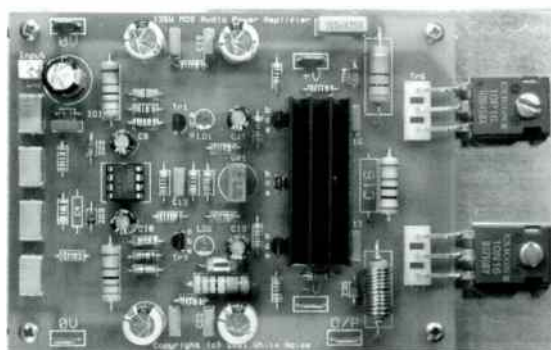

PRODUCTS INCLUDE:- Power Amplifiers 30-250W, Preamplifiers, Phono stages, Active Crossovers, Power Supplies, Buffer Amplifiers, Balanced line drivers / receivers, Stepped attenuators, Gold plated connectors, Cables, Capacitors, Resistors, Semiconductors, Transformers, Subwoofers, Loudspeaker drive units

WHITE NOISE
11 STATION
ROAD
BEARSDEN
GLASGOW
G61-4AW

Web:- <http://www.wnaudio.com>
Email:- david.white38@ntlworld.com
Tel:- 0141-942-2460 (until 9pm)
Fax:- 0141-587-7377

audioXpress... It Just Sounds Better

Your Favorite Audio - One New Magazine!

- PROJECTS
- REVIEWS
- THE NEWEST TECHNOLOGIES
- AUDIO CLASSROOM
- and Much More!



Subscribe To This Great Monthly Publication Today!

Only \$59.95 US for 12 Issues!

audioXpress • PO Box 876 • Peterborough, NH
03458-0876 USA • Phone: 603-924-9464

Fax: 603-924-9467 • E-mail: custserv@audioXpress.com

ORDER ONLINE AT: www.audioXpress.com

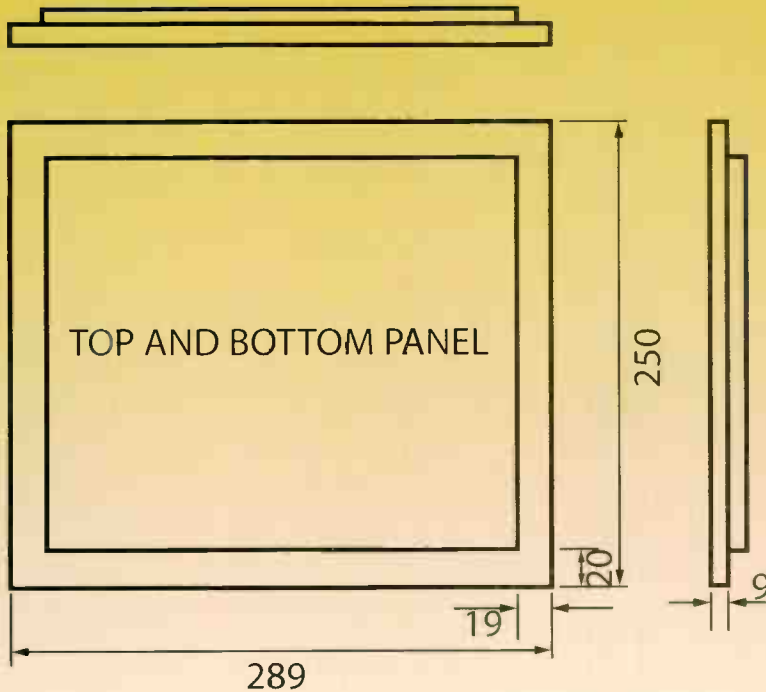

Top and bottom panel dimensions.

the 96.5mm depth from the rebated area around the bass unit hole to the front of the vertical brace. This is because the bass unit magnet butts up to the brace, but even then you can be a half mm out as the gasket will absorb this tolerance. We used oak veneered MDF and finished the cut edges with a matching glue-on veneer strip to give what we feel is a nice looking piece of furniture when the finishing lacquer is applied.

We haven't detailed any plans for a grille, particularly as we think the cabinet and drive units look very nice unclothed, but those who want one, if only for protection of the drive units, can no doubt devise their own wood frame and stretch fabric over it.

CABINET CONSTRUCTION

Cut out the panels and braces according to the plans. The cut-out for the treble unit is to suit the SEAS Excel T29CF001. You can use a smaller diameter hole for the SEAS Prestige 29TFF/W (dimensions given in Technical Information on the SEAS.co.uk website) or use the gasket around it that we supply with the drive unit kit.

Use a good set square to mark out the panel sizes on your MDF sheet, as having perfectly dimensioned edges will help the box construction no end. If you are using a jig saw to cut the panels buy the best, and sharpest, wood cutting blade you can find – MDF is tough on saw blades and you need something that can cut through it like butter if you are going

to keep those edges straight.

You don't have to rout out the holes in the braces – you can drill a starting hole and create the cut-outs with a jigsaw quite easily. Note the hole in the middle of the vertical brace behind the bass unit. This is to take the 'bump back' extension of the magnet. We'll be supporting the main part of the magnet against this brace with a thin gasket, so the 'bump back' has to poke through it.

If you don't fancy cutting the

woodwork a 'flat panel' kit of ready veneered pre-cut MDF panels for you to glue together is available from World Designs.

We found it easiest to glue up the sides, front and rear baffles of the cabinet first, keeping them together whilst the glue was drying with box strapping or cabinet clamps (you could use masking tape at a pinch but it doesn't 'squeeze' the panels together as well). You can check the 'squareness' of this part of the construction by dropping in the horizontal brace – it should fit snugly and you can glue it in at this point to keep the box square. Drop in the top and bottom portions of the vertical brace temporarily as a check to make sure you have positioned the horizontal brace accurately.

When the glue has dried you can then glue in the portions of the vertical brace. It is helpful to place the bass unit the front baffle and then offer up the bottom part of the vertical brace to it. If you like you can use wood cleats to help glue the braces to the side panels but we found a good helping of strong wood glue did the job well. Don't be tempted to use hot melt – it just doesn't provide the same sort of bond as a good PVA woodworking glue.

Finally, glue in the top and bottom panels with generous amounts of glue on the mating surfaces with the braces. Use your box webbing to strap them in place whilst the glue dries. Wipe off any excess glue from the outside of

Watching glue dry! A top view of the internal baffle arrangement, showing vertical brace position.



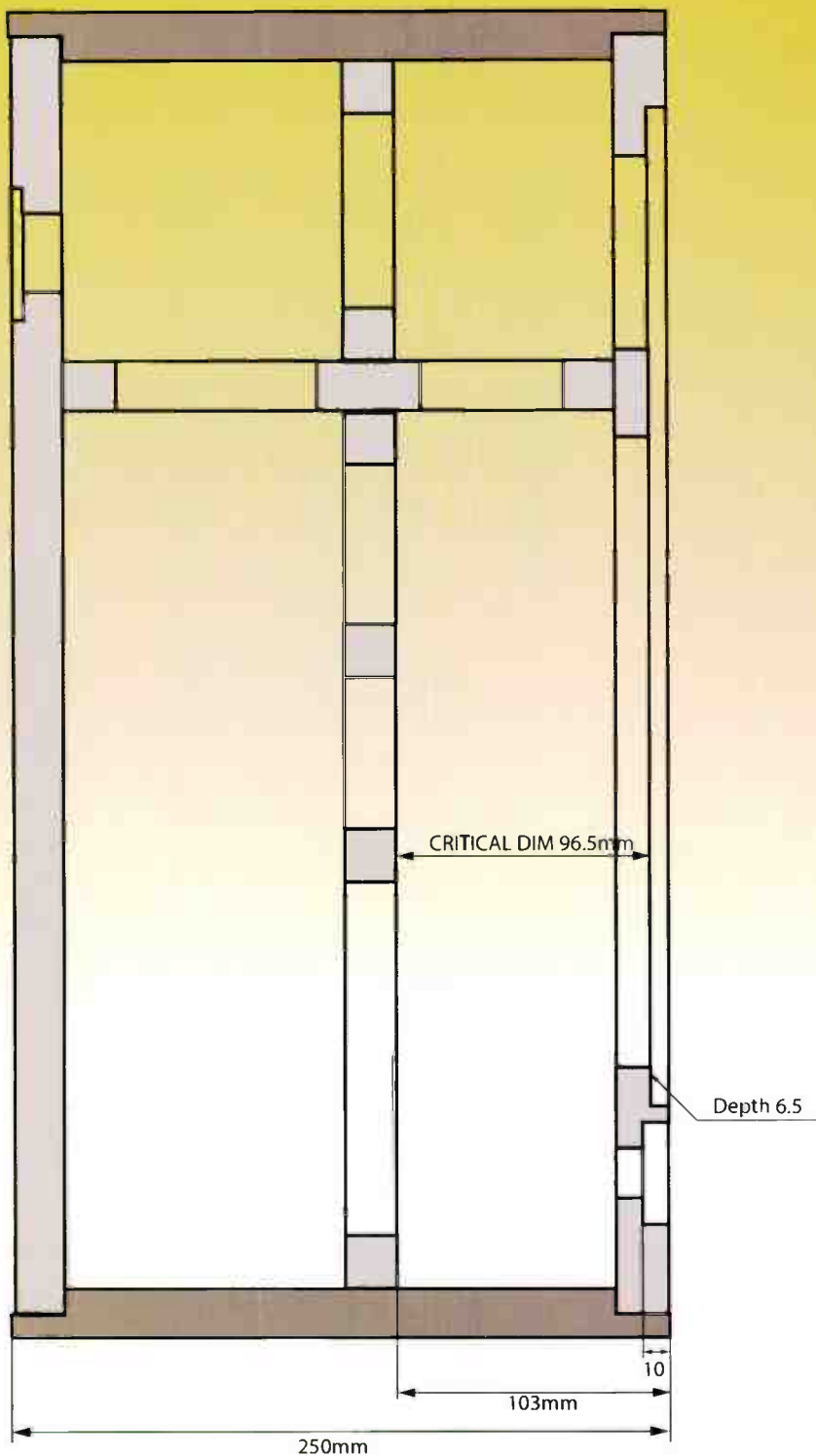

Cross Section through speaker

the cabinet so it doesn't mark the veneered surfaces.

Finally check the drive units and terminal panel fit correctly before a final hand sanding of all edges, sanding off any imperfections or glue marks on the veneer (but don't get so heavy handed you sand through the veneer!). A final polish using fine sandpaper will prepare the veneer surface for lacquering.

Before using a spray lacquer polish off any dust on the veneer surface and spray in a well ventilated area that is as dust free as you can make it. It's much better to apply several light sprays than one heavy

one and several coats will give a nice sheen to the cabinet. We'll leave it up to you whether you use a high gloss or semi-matt lacquer. Semi-matt is easier to work with as it doesn't show up marks. High gloss requires a lot of light coats before it looks really good.

FINISHING TOUCHES

Once everything is fully dry (and it's worth being patient and waiting 24 hours at least), it is time to add the components.

First to go in is the terminal panel with crossover and wiring and lead the wires through to their

respective drive unit holes. Then position the internal damping. All you need is one long sheet measuring 66cm x 24cm that runs down the back of the cabinet and curls over inside of the top and bottom panels, plus four pieces each 25cm x 11cm. These sit either side of the cabinet above and beneath the vertical brace. This damping is in position to reduce internal reflections and cut down the sound transmission through the cabinet walls. There is no need to add more damping internally to help the bass unit as our aperiodic 'port' will do that for us.

Take a 215mm x 38mm x 12mm strip of 80 ppi reticulated foam (strips are available from World Designs) and glue it, using an all purpose solvent glue, to the front of the 'port'. Make sure that you glue all round the rebated area of the recess to hold the foam firmly in place as we don't want the foam to 'flap' at low frequencies.

Stick the bass unit magnet gasket to the vertical brace around the hole for the 'bump back' part of the magnet. Connect the wires to the drive units, checking the polarity as you do. If you prefer to use solder joints rather than the connectors just cut the latter off and strip the wires. Don't do this unless you are good at soldering, though, and make a good mechanical connection before the solder is applied. A connector is better sonically than a poor solder joint!

You can then place the drive units in position, with their sealing gaskets, before screwing them down. We prefer to use wood screws rather than bolts and 'T' nuts or inserts as wood screws into MDF have less tendency to loosen with vibration. On the other hand those listeners who prefer to tighten their drive unit screws on a regular basis may want to use bolts and inserts. Note that the bass unit sitting on its magnet gasket will be slightly proud of the front baffle at first. The gasket will compress and the whole bass unit assembly will bed down after a time and this is the point to do the final tightening of the screws.

**Next month -
Crossover details and
subjective performance.**

**To order loudspeaker kit
see page 124**

World standards

These are the best products we've heard that are currently on sale in the UK, complete with the date they were originally launched and their current retail prices. Watch out for regular updates...!

TURNTABLES

AN TT I/ARM ONE/IQ1 1998 £725
Redesigned Systemdek IIX now off the pace, but the arm and cartridge are both star performers.

LINN LP12/ LINGO 1973 £2100
The quintessential belt drive superdeck offers a beguilingly musical midband at the expense of lumpy bass and nebulous imaging. Latest Lingo brings a new lease of life, with even more punch and polish.

MICHELL TECNODEC 2003 £575
Superb introduction to Michell turntables on a budget. Top quality build and elegant design make it the class of the mid-price field right now.

MICHELL GYRODEC SE 2002 £870
Its beauty is more than skin deep - superbly build and finish allied to clever design equals class leading performance. Latest DC motor with 'Never Connected' PSU make it all the more unassailable.

MICHELL ORBE SE 2002 £1916
Cost-no-object evolution of the Gyro adds massy acrylic platter and two-stage isolation. Fantastically capable all rounder with commanding, powerful, detailed sound that gets the best from almost any arm and cartridge



PRO-JECT DEBUT II PHONO SB 2002 £170
Fuss-free all in one starter turntable, complete with built in phono stage. Not a star performer, but a fine midi system upgrade all the same.

REGA P3 2000 £298
Great entry level audiophile deck with fine bundled tonearm. Tweakable, and responds well to careful siting on a Base platform.

REGA P25 2001 £619
Until the TecnoDec, the best mid-price turntable package. Fine build and elegant styling. Clean, open sound but limited at frequency extremes in absolute terms.

SME MODEL 10A 1995 £3333
Exquisitely engineered deck and arm combo, but dry and clinical sounding compared to rivals. Accomplished performer with classical music, nonetheless.

CLEARAUDIO REFERENCE 1996 £4,070
Fine bass articulation and power allied a stunningly open and atmospheric midband and beautifully etched treble makes this one of the very best sounding turntables at any price. Michell's Orbe offers marginally more impactful bass, but can't touch that amazing mid. Exquisite.

ORIGIN LIVE AURORA GOLD 2004 £1,470
Seminal 'entry level high end' deck showing Mark Baker's characteristically obsessive attention to detail. The result is an extremely wide open and natural sounding machine that lacks the Michell GyroDec's slightly 'mechanical' nature - along with some of its scale and accuracy. Ideal for those seeking that classically beguiling vinyl sound.



GOLDRING GR-1 2004 £140
Essentially a Rega P2 built down to very low price and bundled with a decent Goldring MM, this is cracking value for money. Head and shoulders above its immediate rivals, it offers a surprisingly musical and detailed sound that will stun those new to vinyl - which is precisely what it was designed to do.

THORENS TD190 2003 £290
Ease of set up and use, allied to fully automatic operation mean that, although hardly the last word in performance, this deck is most certainly a model of convenience.

ROKSAN RADIUS 5 2003 £750
Fantastic value allied to intelligent, interesting and 'out of the box' design makes for a wonderful entry-level superdeck. Open and musical sound is more inviting that Michell TecnoDec rival, and the bundled Nima Unipivot arm is a superstar.



MICHELL TECNOARM A2003 £399
John Michell's brilliant reworking of the Rega RB250 theme, using blasting and drilling techniques usually seen in motorsport! The result is the best sounding arm at £400, and as good as most at four times the price. Runs SMEV very close in all except bass, and betters it for musicality. Stunning.

ORIGIN LIVE AURORA 2003 £1600
Cleaner than a Linn LP12 and warmer and more mellifluous than a Michell GyroDec - but lacks the latter's incision and dimensionality. When fitted with an OLI arm, this package is all many will ever want...

CLEARAUDIO REFERENCE 2003 4,000
The company's best value vinyl spinner; good enough to get the best from almost any tonearm and cartridge combination. Brilliantly open and neutral sound; superlative pitch stability; stunning build and styling - Michell Orbe does most of this at half the price, however.

TO NEARMS

TECHNICS SL1200/III 1973 £395
Slick build makes it a respectable performer, although the cheapo arm limits it - fit a Rega RB250 and it's suddenly a serious mid-price machine.



HADCOCK 242 SE 2000 £649
Latest of a long line of unipivots, with added mass, revised geometry and better finish. Musical like few others at or near the price.

LINN EKOS 1987 £1700
Subtle mods over the years, including revised bearings and the recent new wiring has kept it a serious contender in the superarm stakes. Lacks the SME's slam, the OL's clarity or the ARO's emotion, but has a feisty musicality all of its own.

ORIGIN LIVE ILLUSTRIOUS 2002 £1570
A modern superarm with battleship build. Extremely strong, even and open sound in the mould of the late, lamented Zeta, plus fine tonal colouring. Exquisite.



NAIMARO 1987 £1425

Charismatic unipivot is poor at frequency extremes but sublime in the midband; truly emotive and insightful.

ORIGIN LIVE SILVER 2502001 £625

This fully developed and expertly fettled Rega boasts a superbly even, transparent and tuneful sound. Gives away only a small degree of finesse and dimensionality to top arms.

REGA RB250 1984 £112

Sold through Moch Marketing, this is capable far beyond its price point, with a tight, lean and detailed sound. Responds brilliantly to Origin Live counterweight modification, and well to rewiring.

SME 309 1989 £767

Entry level SME complete with cost-cut aluminium armtube and detachable headshell. Tight, neutral sound with good tonality, but lacks the IV's pace and precision.

SME SERIES IV 1988 £1127

Offers nine tenths of the SMEV's magic at just over half price. Exquisitely built and finished, and a design classic. Faces stiff competition these days, but lovely nevertheless.

SME SERIES V 1987 £1614

The so-called Best Pickup Arm in the VWorld isn't, but comes close. Vice-like bass with incredible weight, ultra clear midband and treble. Does everything except beguile the listener.

CARTRIDGES**ORTOFON KONTRA 'B** 1999 £720

Surprisingly articulate performer by Ortofon standards. All the brand's usual polish and detail allied to real vim. Loves making music!

**AUDIO TECHNICA AT-110** 1984 £29

Great starter cartridge that's refined, detailed and musical beyond its price.

DYNAVECTOR DV10X5 2003 £250

A distant descendent of the classic Ultimo 10X, this has warmth and sweetness in spades, allied to a punchy bass. Beats G1042 comfortably.

GOLDRING G1042 1994 £135

One of the best MMs going, with sweet and extended treble and punchy, muscular bass.

LYRIA LYDIAN BETA 1998 £600

An altogether more beguiling listen than the MC30S, although not quite as incisive. Superb all rounder, nonetheless.

SUMIKO BPS 1995 £250

Charismatic performer with rhythm aplenty, but in other respects way off the pace – lacks smoothness and sophistication of the DV10X5.

LYRA PARNASSUS DCT 1997 £1895

Jonathan Carr's masterpiece is a brilliantly lyrical and fluid performer, with a deliciously sweet tone and immense subtlety and polish.

ORTOFON MC25FL 1994 £285

Strong budget MC with a cleaner and more detailed sound than the Dynavector; more sterile and less emotive, however.

ORTOFON MC30 SUPR' 1995 £550

Beautifully clean and detailed device with real finesse, albeit a tad mechanical sounding.

DYNAVECTOR DV20X-H2003 £395

The best modern budget MC combines deliciously sweet sound with fantastic get-up-and-go. High output version works a treat with valve phono stages too.

**MUSIC MAKER** 1999 £575

When mated with a good quality arm, this hand finished high-output pick-up gives an ear-boggling account of itself. Very high compliance ensures maximum information retrieval. An absolute (grain orientated) gem.

SHURE V15XMR 1994 £350

The most musical MM yet made – brilliantly dynamic and punchy in the classic Shure mould, yet refined and tidy too.

KOETSU RED 2004 £1,600

Although the new Koetsus have lost some of their 'romance', you'll not hear a more lyrical and emotive performer. Startlingly 'analogue' nature makes rival Ortofon and Clearaudios sound frigid.

ORTOFON KONTRA PUNKT C 2004 £1,000

The most secure tracking MC we've heard; its super clean, fast, detailed and neutral sonics make it a brilliant partner to warmer sounding turntables.

DIGITAL DISC PLAYERS**CREEK CD5011** 2004 £699

Extensive revisions make this an altogether more beguiling machine, and one of the best at its price. Extremely musical sound that's surprisingly upfront for a Creek design. Excellent mid-price purchase, with only its Marantz rival to challenge it.

CYRUS CD8 2003 £1000

Highly incisive, engaging, grippy and dynamic sound, but needs careful matching to smooth ancillaries. Optional PSX-R adds bass and dimensionality.

LINN GENKI 1999 £995

Undeniably fast, lithe, musical and fun - but some won't take to its dry, wry character. Works best in all-Linn systems, where it really rises to the challenge!

ARCAM FMJ CD33T 2003 £1,300

Superbly detailed midband allied to excellent bass extension makes this a powerfully musical machine in the best traditions of Arcam CD spinners. Nothing to criticise at the price, everything to recommend it!

**LINN IKEMI** 1999 £1950

Has the brilliant focus and clarity of the previous Karik III with a dose more tonal richness and polish. More grip and poise than most at any price - still superb!

MARANTZ CD17 II 2002 £800

Oft-overlooked middleweight boasts a truly beguiling sound with lots of tonal flavour. Sits awkwardly between the £600 and £1000 price points, where some brilliant value buys reside, though.

NAIM CDX2-XPS2 2003 £4950

A fine high end machine, but add an XPS2 and it becomes one of the most charismatically engaging 16bit machines we've ever heard. Plays music with such passion!

NAIM CDS3 2003 £7050

The most polished Naim CD to date; tremendously capable and musical, but lacks the Rotweiler quality of the cheaper CDX2-XPS2.

PHILIPS DVD963SA 2003 £400

Creamy CD sound allied to superb SACD and DVD video playback makes this brilliant value for money.

REGA PLANET 2002 £498

Rhythmic and beguiling performer, although lacks the warmth of tone needed to better its Marantz rival. Superb ergonomics and design, nonetheless.

MARANTZ SA-17S1 2003 £1400

Brilliant CD playback comes close to the best at any price, while SACD performance is almost as convincing - superbly warm and three dimensional nature makes listening a joy. However, the lack of DVD-Audio decoding and poor feature count makes it look middling value compared to some of the universal players here.

**REGA JUPITER** 2002 £1000

A Planet on steroids, this machine adds depth and breadth to its baby brothers already impressive sound. Good, but facing stiff competition.

MUSICAL FIDELITY TRI-VISTA21 DAC 2003 £1,200

Superbly neutral and expansive sound makes this offboard digital-to-analogue convertor an excellent upgrade to any mid-price CD player – fed by a decent transport, few 16bit players at any price come close.

**CAMBRIDGE AUDIO 640C** 2003 £250

Tremendously well-rounded yet engaging sound makes this the best budget silver disc spinner by far. Build quality is excellent at the price, and the styling bang up to the minute. Blistering value for money.

CREEK CD5011 2004 £699

Extensive revisions make this an altogether more beguiling machine, and one of the best at its price. Extremely musical sound that's surprisingly upfront for a Creek design. Excellent mid-price purchase, with only its Marantz rival to challenge it.

DENON DVD-2200 2003 £499

Superb do it all mid-price player; fine DVD-A and SACD sound allied to excellent video performance will be all many could ever want. Ultimately it's a little bright and mechanical sounding, but you have to go into high end territory to truly better it. Stunning value.

PANASONIC DVD-S75 2002 £120

Real ability and fine measured performance for an unbelievably low price. Impressive in its own way, if not truly audiophile. If you just want a cheap DVD spinner with DVD-Audio as a bolt-on goodie, this is the one.

PIONEER DV-868AVI 2003 £799

Pioneer's most accomplished mid-price machine to date, this boasts full DVD-A/SACD playback, a welter of facilities and the all-important HDMI video and I-Link audio digital outputs, making it nigh-on future-proof. Factor in fine – if not outstanding – sound and superb pictures and it's practically impossible to fault.

SONY SCD-XB790 2003 £250

Quite unlike any other budget Sony CD spinner we've heard, here's a very 'analogue' sounding machine that's smooth and warm and even. Factor in fine SACD playback and this machine is a brilliant budget buy – unless you want DVD-Audio that is, which it lacks.

**ORELLE CDI00EVO 2003 £1,200**

Extremely engaging and musical sound, but maybe a tad too bracing for some tastes. Superb aesthetics complete an attractive package.

ARCAM CD73 2004 £400

The best all rounder at the price; unfailingly smooth and couth sound allied to fine build and attractive styling makes this a worthy upgrade to entry-level designs.

ARCAM DV78 2004 £800

We've not found a more capable 'real world' DVD player; peerless picture and CD sound at the price, although lack of universal playback will deter some.

ARCAM FMJ CD33 2004 £1,300

Consummate smoothie with an unusually organic and natural sound, but lacks the command of some rivals. Its all round sonic, aesthetic and ergonomic polish will endear it to many.

CAMBRIDGE AUDIO**AZUR 640C 2004 £250**

The best budget CD spinner we've heard; warm and satisfyingly musical; fine build and aesthetics and that remote control make for an unarguable package at the price.

DENON DVD-A11 2004 £1,600

Classic Japanese 'battleship' DVD universal machine does practically everything superbly, with no obvious weak points except the undistinguished CD sound. Top value.

EXPOSURE 3010 2003 £1,200

One of the most 'analogue' CD players, second only to the Shanling. Wonderfully beguiling balance leaves you looking for the tube output stage.

LINN CLASSIC MOVIE**SYSTEM DI 2002 £2,500**

Superb ergonomics and performance from this one-box beauty. The best 'home theatre in a box' you can buy.

LINN UNIDISK I.1 2004 £6,500

Surely the ultimate universal DVD player; superb in every department, but its CD playback shines brightest considering it's not a bespoke Red Book machine.

MARANTZ CD7300 2003 £350

Superlative build and styling for the money, and the sound is as good as you'll get below £600. Smooth, detailed and engaging beyond its price.

MUSICAL FIDELITY X-**RAY V3 2004 £900**

Striking looking mid-price stunner with very even, accurate and even sonics; perfect for those seeking detail and neutrality over character and/or colour.

NAIM CD51 2004 £825

The most engaging mid-price CD player on the market, but with a surprisingly velvety sound. Delightful build and iconic styling make this one of Salisbury's true classics.

PIONEER DV-8681 2003 £800

The best mid-price universal player right now; CD sound is respectable, SACD and DVD-A impressive and the video truly special. Does everything very well for the price.

SHANLING SCD-T200C 2004 £2,150

Superb SACD player with tube output stage; arresting looks and truly special sound; be sure to go for 3DAcoustics version for best sound and UK aftersales support.

SONY SCD-XA3000ES 2003 £600

Surprising mid-price SACD spinner with multi-channel capability; sweet sound; not the best at the price but certainly the most versatile.

SONY SCD-XA9000ES 2003 £1,600

Slick, beautifully built high end SACD player with very transparent, if rather dry, sound. Unexpectedly sweet CD playback but not the most gripping at the price.

STELLO DP-200 2004 £1,495

Brilliant do-it-all upsampling DAC preamp with headphone output and phono in. One of the best digital to analogue converters around, allied to mind-boggling flexibility.

DIGITAL RECORDERS**APPLE IPOD 40GB £399**

Genre-defining best of breed, thanks to supreme ergonomics and build allied to fine sound.

PIONEER PDR-609 2001 £200

Brilliant value CD recorder that makes excellent recordings from its digital inputs. Half decent digital converters, too.

PHILIPS DVDR880 2003 £370

Poor CD audio playback, but makes great DVD video recordings and boasts fine ergonomics. Top AV value.

SONY RCD-W3 2002 £250

Usual superb Sony ergonomics make for non-nonsense budget buy. Fine direct digital copies, but analogue input poor. Middling sonics, but there's a digital output!

YAMAHA CDR-HDI300E2002 £600

HD means MD-style ease of editing, but compromises recording quality ever-so slightly. Add decent CD replay and it's a fine all rounder nonetheless – top value.

**ONKYO MB-S1 2001 £1100**

An interesting machine complete with MP3 functionality, but high price, fussy ergonomics and over-smooth sound make it mediocre value against the Yamaha.

PHONO STAGES**CREEK OBH-21SE 2003 £250**

Musically enjoyable yet highly refined for the price – a superb buy. Gives the Dino a real hard time.

EAR 834P 1993 £400

Classic tube design with a deliciously warm and expansive sound – shame about the loose bass and veiled treble!

LINN LINTO 2000 £900

A musical and incisive performer, with more speed than the Delphini at the expense of detail and tonal colour.

QED DISCSAVER 1995 £35

Rhythmic, bouncy sound via battery, although it's bright and forward. Great value, but £100 more on the X-LP is well worth it!

TRICHORD DINO 2002 £299

Great all rounder with switchable MM/MC. Fast, fluid and smooth like no others at the price.

TRICHORD DELPHINI 2003 £995

The very latest 'Never Connected' variant is easily the best, bringing velvety smoothness to an already refined and engaging performer. Neutral to a fault – some will mourn the passing of the charismatic ISO.

MUSICAL FIDELITY**XLPSV3 2003 £249**

Fine all rounder at the price, which a satisfyingly full bodied sound that's smoother than the Creek but a tad less engaging. Only Trichord's Dino, with its easy upgradability for just £50, reflects badly on this fine bit of kit.

PROJECT PHONOBOX LE2004 £99

Great little box that improves on most bundled phono stages found in budget integrated amplifiers, adding detail and definition and a measure of smoothness too. If £100 is all you're prepared to spend, then do it happily on this, but you'll get obviously better results from the £250 brigade.

WHEST AUDIO PS.20**/MSU.20 2004 £1,000**

Disarmingly clean, smooth, open sound makes this the very best phono stage we've auditioned to date, but some will still prefer the gutsier feel of the Trichord Delphini.

GRAHAM SLEE ERA**GOLDV 2004 £460**

Wonderfully warm, open and musical nature makes this an essential audition for those wanting a top value mid-price phono stage.

AMPLIFIERS**ARCAM DIVAA65 PLUS 2002 £370**

Classic budget Arcam fare – decently sweet and open with sensible facilities and plenty of power.

**ARCAM FMJ A32 2001 £1150**

For those who value serious power and labyrinthine facilities over outright clarity or grip. A very impressive all rounder with an unusually muscular power amp at this price.

AUDIO NOTE OTO SE 2000 £1199

This baby tuber is beautifully sweet and creamy, but lacks solid-state's clarity, detail and incisiveness. Low, low power means speaker choice critical.

AUDIO NOTE SORO SE 2000 £1699

Wonderfully out-of-the-box sounding tube middleweight is all about sweetness and fluidity. Limited power and loose bass, but little the worse for it.

CYRUS 6 2003 £600

Cracking do-it-all mid price design, bringing svelte sound, good connectivity and upgrade-ability and stunning style and build.

CYRUS 8 2003 £800

Unusually warm and lyrical for a solid-stater, with decent power and punch. PSX-R adds dynamics, detail and dimensionality.

**MERIDIAN 551** 1994 £895

Evergreen middleweight is a serious performer even now. Tonally a tad dry, it's still very smooth and svelte with bags of power, detail and grip. Class act.

SUGDEN A21A 1993 £1020

The most musical amplifier at the price, bar none. Delicious Class A sound is smooth, sweet and wonderfully transparent with true tonal colour. Low power, so match carefully.

AUDIO RESEARCH VSI55 2003 £2,895

The Naim NAP250's tubular alter ego; oodles of power allied to a strong bass and smooth open midband makes this a brilliant all round amplifier. Lacks the subtlety and finesse of the low powered single-ended brigade but makes up for it with sheer brio.

CREEK A501R 2004 £550

Consummately smooth yet engaging sound makes it a serious player at the price, but don't expect Creek's traditional sumptuousness. Fine value nonetheless.

MONRIO MC207 2003 £1,100

Powerful, muscular sound allied to real finesse makes this unusual integrated an essential audition at the price.

MARANTZ PM-17MKII KI MODIFIED 2004 £1,500

Gloriously offbeat do-it-all design with a truly warm, smooth and three dimensional sound. Think of this as a latter-day Audiolab 8000a - with a good deal more colour and finesse - and you'll have its measure. Lowish power output at the price, but fine real world speaker driving ability.

UNISON RESEARCH S6 2002 £1,625

Tremendously musical and lithe sound with real finesse and subtlety too. Very slightly upper mid forward encourages careful partnering with ancillaries (Revolver R45s are ideal), but overall fantastic value for money.

**ORELLE SA100EVO** 2003 £1,200

Fine build, exquisite design and a wonderfully lucid sound make this an essential audition at the price.

MUSICAL FIDELITY X-150 2004 £800

Brilliant shoebox-sized powerhouse is sweeter and more mellifluous than Nait 51, but less taut in the bass. Oodles of power, striking aesthetics, sensible facilities and great build make this a rare bargain.

NAD C352 2004 £300

Classic NAD mix of smooth, punchy sound with plenty of watts and sensible, real-world facilities; a great introduction to real hi-fi.

NAIM NAIT 51 2004 £825

The most musically engaging integrated at or near the price; real sophistication in sound allied to grip and power aplenty. Iconic styling and great build complete a very pretty picture.

NAIM NAC282/NAP200 2004 £4,000

Wonderfully taut bass, lightening midband and incisive treble makes for an enthralling listen; this cracking combination looks great and is superb value too.

PRIMA LUNA PROLOGUE 1 2004 £800

Unlike almost every other budget tube integrated we've tested, it's nicely built, decently powerful and engineered well enough to let the benefits of tubes shine out loud; sweet, open, liquid. Cracking value.

STELLO S200 2004 £1,495

Oodles of smooth, clean power with plenty of pace and pleasing subtlety too. Factor in exquisite build and a low price and this is true audiophile bargain.

AV AMPLIFIERS

DENON AVR-2803 2003 £650

Superb mid-price 7.1 channel extravaganza with nearly all the decoding power you'll ever need. Powerful, open and clean sound (at the price) makes it capable with music, and superb on movies. Fine ergonomics and great build makes this receiver hard to beat as an all-rounder.

**NAIM AV2/NAP 150/NAPV 175** 2002 £4,190

Brilliant audiophile multichannel pre-power amplifier combo; not as good with music as a two-channel Naim set-up at the same price, obviously, but surprisingly close. Elegant control layout plus a strong, clean and brilliantly engaging sound make this a serious crossover product. Ultimately lacks power compared to similarly priced Arcam gear, but is more musically involving.

PIONEER VSA-AX51 2004 £1,000

The ability to hook up to Pioneer's DV-868i via i-Link (nee FireWire) means that this multichannel AV amplifier can do all the digital conversion onboard makes the a very special product, which when used with the aforementioned DVD spinner sounds better even than the sum of its parts.



HEADPHONE AMPLIFIERS

SUGDEN HEADMASTER2003 £600

Unusual combined preamplifier and headphone amplifier, this boasts a surprisingly smooth and open sound which suffers only when compared to preamps, at twice the price.

MUSICAL FIDELITY

X-CANSV3 2003 £249

Mr Michaelson's best headphone amplifier to date, with an extremely open and explicitly detailed sound plus serious bass wallop and the ability to drive any phones to very high levels. Errs towards brightness with some headphones, so match carefully and use smooth cables.

PREAMPLIFIERS

CREEK OBH-12 2000 £220

Brilliant value budget passive, giving little away in sonics to far more expensive designs. Connectivity and build aren't great, but what do you expect at this price?

**MF AUDIO PASSIVE PRE2003** £1500

Novel and effective pre with switchable gain via a transformer, and balanced operation. Open and incisive sound, yet makes most active rivals sound edgy by comparison.

NAIM NAC112 2002 £660

Affordable admission ticket to the Salisbury high end experience. Detailed and dynamic, if tonally rather lacklustre.

LINN LK140 2000 £800

Dry and grey sounding, but decently dynamic and musically engaging all the same. A worthy worker in a budget Linn system.

MUSICAL FIDELITY

A308 CR 2003 £2400

Superb transistor behemoth, worth partnering with any high end CD player or preamp. Oodles of grunt served up with poise and purpose.

MARANTZ SM-17 2001 £700

Useful budget power amp with plenty of clean transistor power. Not the most transparent, but sweet and clean all the same. Fine build completes a great value package.

**NAIM NAP150** 2002 £795

Driven by a decent source and a NAC112, this gives highly enjoyable results - providing you like the Naim sound! Taut, fast and feisty despite its relative lack of power.

QUAD 909 2001 £900

The latest current-dumper has a smooth and expansive character with enough wallop to drive most loads. Not the most musical, but super value all the same. Lovely build, finish and Quad's legendary service are nice.

CROFT TWIN STAR 2003 £1750

With a taste of the best of both tube and transistor, this latest update of the Croft classic is a truly endearing experience.



GRAAF GM20 OTL 2003 £3,300

Awesome output transformer-less valve power amp gives dazzling speed and incision, with an ethereal soundstaging and delicious filigree detail. Tremendous punch belies its humble 20W power rating. Factor in one of the most exquisite finishes this side of an Aston Martin and it's very hard to say no...

SUGDEN MUSICMASTER

2003 £1,300

Quintessential Class A Sugden sound is not warm as many expect, but extremely neutral and open with real tonal colour. By comparison, tubes sound bloated and standard solid-state hazy and brittle. Superb when partnered with efficient loudspeakers like Revolver R45s, but many will find it underpowered.

**LOUDSPEAKERS****B&W CDM1 NT** 2002 £750

Fine clarity and imaging allied to pleasing warmth and great rhythmic cohesion make these standmounters an essential audition.

CASTLE CONWAY 3 2003 £930

Superbly smooth and crisp performers, with a big hearted musical sound. Ultimately coloured though, with a slow, plummy bass.

CYRUS CLS70 2001 £800

Charismatic performer with a fast, tight and open midband, but lacks cohesion and scale..

KEF Q1 2003 £250

Highly polished and articulate standmounters at the price, but demand good ancillaries for best results.

KLIPSCH HERESY II 1997 £1100

An outstanding high sensitivity loudspeaker with midrange and treble horns coupled with infinite baffle 12" bass driver. Effortless, fast and accurate.

LINN NINKA 2001 £995

Major on rhythms and dynamics, making them an involving listen. Reasonably refined, too - but tonally disappointing.

EPOS ELS-3 2003 £200

Plenty of brio and a decent degree of refinement makes this budget baby a fine value contender.

**MISSION 782SE** 2003 £900

Bright and tight design capable of brilliant speed and grip, at the expense of warmth. Demands high quality, high powered ancillaries.

MONITOR AUDIO B4 2003 £350

An unusually smooth and lucid performer at the price, and its 3-way design means it drives rooms well. Fine engineering, but build and finish so-so.

REVOLVER R45 2003 £899

Wonderfully easy to drive floorstanders that are a dreamboat for tube amplifiers, and great for party-minded transistor users too. Great attack transients, fluid and musical bass and midband and couth treble make them fine all-rounders.

W'DALE DIAMOND 8.1 2001 £120

Still the best baby budget standmounters around. Tight and grippy thanks to Kevlar drivers, but invariably limited in the frequency extremes.

**MORDAUNT SHORT 9142002** £300

Warm, detailed and articulate performer, but a touch loose in the bass and veiled up top. Fine partner for budget valve amps.

NAIM ALLAE 2002 £1990

Taut and grippy like few others, this speaker majors on transient speed. Surprisingly smooth for a Naim box, with nicely etched treble. As always, tonally dry.

QUAD ESL-988 2001 £3400

Wonderfully neutral and self-effacing with sublime imaging and projection. Treble lacks extension, bass lacks weight - although the pricier 989 answers the latter resoundingly.

PERIGEE FK-1L 2002 £5000

Charismatic Aussie ribbon design with deliciously open mid and treble, allied to fine bass weight. The right room and ancillaries essential. Engaging, musical and powerful sound. Superb.

TDK S-80 2002 £90

Ingenious NXT multimedia sub/sat system has a wonderfully even and open sound - like baby electrostatics.

**MARTIN LOGAN CLARITY** 2003 £2,895

Supremely transparent and open with brilliant depth perspective and image projection. The midband is up there with the very best at any price, while the bass and treble integrate well but don't especially shine. Dynamically limited, with middling bass punch, but that's not the point - that deliciously fluid and intricate midband wins great respect.

TANNOY EYRIS DC1 2003 £699

The combination of dual concentric treble/midband drivers plus supertweeters make for a very spacious and expansive sounding loudspeaker, albeit one that's a little bright and loose in the bass. An excellent mid-price design well worth auditioning.

MONITOR AUDIO GR60 2002 £2,295

In some ways, these come close to Yamaha's legendary NS1000Ms, thanks to their tremendous clarity, great transients and 'full-fat' wide bandwidth performance. Bright and clean, but never fatiguing or uncouth. A truly accomplished all rounder that gives a real taste of 'super-fi' at a reasonably affordable price.

TOWNSHEND MAXIMUM

2003 £800

Another brilliant niche product from Max, these ribbon aspirated supertweeters add space and atmosphere to any good high end loudspeaker, and more surprisingly perhaps make things more fluid and musical too. Superb affordable esoterica.

KEF Q4 2004 £400

Hard to argue with the value of this small footprint floorstander; very couth, even, dimensional and detailed sound works well in confined spaces and large rooms alike.

ELAC FS207.2 2004 £1,000

Deeply capable mid-price floorstanders, distinguished by superb JET ribbon tweeter which is unmatched by class rivals; engaging, slightly warm nature needs serious transistor power to sing.

EPOS M22 2004 £950

Classic Epos blend of speed, attack, power and punch will delight rock and techno fans alike, but classical and jazz buffs will crave more colour and textuality.

MONITOR AUDIO S8 2003 £800

Very few can rival this floorstander's all round ability; highly smooth, warm and three dimensional sound allied to an easy load and good sensitivity makes this hard to overlook.

REVOLVER RW16 2004 £400

Outstanding standmounter with tonal accuracy and speed that totally belies its price; good sensitivity for a small box makes it great with valve amps too. A budget audiophile classic.

SPENDOR S3/SE 2004 £950

A natural successor to the BBC LS3/5a, whose impressive neutrality, imaging and evenhandedness makes this a superior, if less charismatic, loudspeaker.

TOWNSHEND MAXIMUM

2003 £800

The best affordable supertweeter we've heard - you'd be amazed at the difference it makes! Classy ribbon design, flexible level settings, cool styling...

HEADPHONES**JECKLIN FLOAT TWO** 1998 £99

Wonderful panel-like sound from these esoteric-looking headclamps.

SENNHEISER MX-500 1999 £19

Our unqualified recommendation for those seeking a serious sounding pair of in-ear phones. Smooth, detailed and musical.

SENNHEISER PX-100 2002 £29

Cracking pair of lightweight open back cans ideal for personals, but good enough for real hi-fi use. Superb build allied to a smooth and engaging performance make them the spiritual successor to the HD400s.

**SENNHEISER HD-650** 2004 £250

Not the best headphone in the world, but a superb all round reference all the same. Very crisp, detailed and even sound allied to superlative build and fine comfort makes all most people will ever want. Cable upgrade yields great results.

LANGREX SUPPLIES LTD

DISTRIBUTORS OF ELECTRONIC VALVES, TUBES AND SEMI-CONDUCTORS AND I.C.S.

1 MAYO ROAD • CROYDON • SURREY CRO 2QP

24 HOURS EXPRESS MAIL ORDER SERVICE ON STOCK ITEMS

E-MAIL LANGREX@AOL.COM

PHONE
020 8684 1166

FAX
020 8684 3056

A selection of our stocks of **New Original Valves/Tubes.**
Many other brands available

STANDARD TYPES			SPECIAL QUALITY TYPES			OTHER TYPES		
ECC83	E.I	4.00	A2900/CV6091	GEC	17.50	12BY7A	GE	7.00
ECC85	RFT	12.00	E82CC	SIEMENS	7.50	5687WB	ECG	6.00
ECC88	BRIMAR	6.00	E83CC	TESLA	7.50	5814A	GE	5.00
ECC88	MULLARD	10.00	E88CC	TESLA	7.50	6072A	GE	10.00
ECH81	MULLARD	3.00	E88CC/CV2492	BRIMAR	15.00	6146B	GE	20.00
ECL82	MULLARD	5.00	E88CC GOLD PIN	TESLA	8.50	6201	GE	6.00
ECL86	PHILIPS	10.00	ECC81/CV4024	MULLARD	6.00	6336A	RCA	35.00
EF86	PHILIPS	20.00	ECC81/M8162	MULLARD	7.50	6550C	SVET	20.00
EL37	MULLARD	30.00	ECC81/6201	MULLARD	10.00	6922	ECG	6.00
EZ81	MULLARD	10.00	ECC82/CV4003	MULLARD	15.00	7027A	GE	25.00
EZ80	MULLARD	5.00	ECC82/M8136	MULLARD	17.50	7308	SYL	5.00
GZ33/37	MULLARD	25.00	ECC83/CV4004	MULLARD	40.00			
GZ32	MULLARD	25.00						
5Z4G	BRIMAR	7.50						
6V6GT	BRIMAR	7.50						
12BH7	BRIMAR	12.00						
12E1	STC	10.00						
13E1	STC	85.00						
807	HYTRON	7.50						
811A	USSR	10.00						
6080	MULLARD	10.00						
			AMERICAN TYPES					
			5R4GY	RCA	7.50	E88CC	TESLA	4.00
			5U4GB	SYLVANIA	15.00	ECC81	RFT	3.00
			5Y3WGT	SYLVANIA	5.00	ECC82	RFT	6.00
			6BX7GT	GE	7.50	ECC83	RFT	8.00
			6B4G	SYLVANIA	22.00	EF86	USSR	5.00
			6FQ7	SYLVANIA	7.50	EL84	USSR	3.00
			6L6GC	GE/SYL	20.00	EL34	SVETLANA	7.50
			6L6WGB	SYL	20.00	EL34	E.I	6.00
			12AX7WA	SYLVANIA	6.00	6SL7GT	USA	7.50
						6SN7GT	USA	7.50

THESE ARE A SELECTION FROM OUR STOCK OF OVER 6000 TYPES. PLEASE CALL OR FAX FOR AN IMMEDIATE QUOTATION ON ANY TYPES NOT LISTED. WE ARE ONE OF THE LARGEST DISTRIBUTORS OF VALVES IN THE UK.

SAME DAY DESPATCH VISA/ACCESS ACCEPTABLE. OBSOLETE TYPES A SPECIALITY.

CREDIT CARD MIN ORDER £10.00.

OPEN TO CALLERS MON.- FRI. 9AM - 4PM. CLOSED SATURDAY

U.K. P & P 1-3 VALVES £2.00, 4-6 VALVES £3.00 ADD 17.5% VAT TO TOTAL INC P+P O'SEAS P & P PLEASE ENQUIRE

VISA



Watford Valves

7 DAYS A WEEK 9AM - 9PM The Audiophiles Choice
All output valves multi-tested and digitally matched
Full no quibble guarantee. Expert advice on all valve amps

CRYOGENICALLY TREATED AUDIO VALVES

Cryo treated audio valves offer sonic improvements normally only attainable by using rare and expensive new old stock classics. Deep Cryogenic Treatment reduces the temperature of the valves to -195 degrees Centigrade. This has the effect of realigning the molecules of the metal structures and removing stress from the anode plate caused during manufacture. This process therefore enables complete uniformity of the valves electron flow providing a reduction in the valves noise floor and microphony levels. Following this treatment on preamp/signal valves we have seen massive reductions in hiss, microphonics and noise floor and output valves have shown improvements in bass depth and clarity, providing a smoother more detailed sound.

This is a great option for the audio market and provides NOS quality at an affordable price. **Cryo treated audio valves**

ECC83/7025	Harma	£15.31	EL34 original Svetlana	£19.77
ECC83/5751	GE	£18	E34L STR Harma	£17.01
ECC81/CV4024	Mullard	£18	6L6GC original Svetlana	£19.77
ECC82/CV4003	Mullard	£30	6550C original Svetlana	£28.00
E84L	Harma	£12	6922 SQ Harma	£28.00

NEW OLD STOCK AUDIO TUBES

5687WB	PHILIPS	£7.00
5703WB	RAYTHEON	£8.00
5842WA	RAYTHEON	£16.00
5U4GB	AMPEREX	£16.00
6080WC	G.E.	£9.00
6188/6SL7GT	PHILIPS	£18.00
6550A	G.E.	£65.00
6GK5	G.E.	£14.00
ECC32	MULLARD	£85.00
ECC81	R.F.T.	£8.00
ECC82	R.T.	£12.00
ECC83	PHILIPS	£12.00
ECF80	R.C.A.	£10.00
ECF82	TUNGSRAM	£8.00
ECL86	A.E.G.	£15.00
EF80	TELEFUNKEN	£10.00
EF804S	TELEFUNKEN	£40.00
EF86	PHILIPS	£20.00

MAIL ORDER OR
ORDER ON LINE



01923 893270

Fast mail order/next day delivery/World Wide shipping
1000's more valves stocked. Prices exclude VAT and carriage.

Fax: 01923 679207

www.watfordvalves.com



SENNHEISER HD-590 1998 £199

The company's best real-world cans to date. Open and smooth with plenty of detail. Brightly lit midband makes them an ideal partner for a valve headphone amp.

**INTERCONNECTS****WIREWORLD OASIS 5 2003**

£99/M Excellent mid-price design with a very neutral, silky and self-effacing sound. Superb value for money.

CHORD CO. CHAMELEON 2£90/M

One of our favourites, these are musical performers with a smooth yet open sound.

VDH ULTIMATE THE FIRST £260/0.6M

Carbon interconnects that help you forget the electronics and concentrate on the music. Miraculous transparency. Tight and tuneful bass mixed with air and space results in a cracking cable for the money.

**DNM RESON****£40/M**

Neutral and transparent - a steal!

TCI CONSTRICTOR**13A-6 BLOCK 2003 £120**

Top quality 'affordable' mains outlet block, with fine build and good sonics. Well worth the extra over standard high street specials, which sound coarse and two-dimensional by comparison.

NORDOST BLUE HEAVEN £150/M

Some of the fastest and most transparent cable around.

**TUNERS****ARCAM T61 2002 £250**

This sleek looking and refined sounding FM/AM tuner isn't the last word in musical involvement, but is fine value, nonetheless.

**ARCAM DT81 2003 £650**

A fine radio, hampered only by its seriously compromised DAB medium. Probably the best DAB tuner ever, but one for Digital Radio enthusiasts only...

CAMBRIDGE AUDIO DAB300 2003 £150

Fine ergonomics allied to great ease of use and respectable DAB sound makes this superb value.

**DENON TU-260L MK II 1998 £130**

If you want the best FM sound at the lowest possible price, then this ancient tuner remains peerless after all these years. There are better analogue designs around, but are either near-impossible to find or are now long-deleted.

CYRUS FM X**£500**

Great for Cyrus users, but its dry and precise sound can't match the best of the rest at the price. Worthy, nonetheless.

**MYRYAD MT 100 1999 £600**

One of hi-fi's nice surprises, this is a beautifully designed and built bit of kit with a deliciously sweet and svelte sound which really does justify its high price.

NAD S400 2003 £600

Highly accomplished specialist high end analogue tuner with a deliciously open and lucid sound, but it can't quite match the Myryad all the same.

PRIMARE T21 2002 £600

Seriously accomplished design with mature sonics, great styling and fine build.

**PURE DIGITAL****DRX-702ES 2003 £249**

Great with Digital Radio, but thin a tad sounding on FM at times. It's a top hybrid, nonetheless...

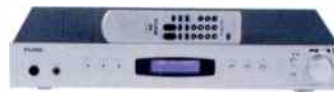
**SYSTEMS****DENON D-M3 I 2003 £250**

Excellent CD receiver package with surprising sonics and a brilliant tuner as a bonus, although its amplifier section doesn't quite match the Onkyo. Optional speakers are mediocre.

ONKYO CS-210 2003 £300

Superb value thanks to excellent sound, great built and ease of use, but the bundled 'speakers' rather let the side down.

LINN CLASSIK 2002 £995

The best one-box stereo system money can buy; superbly musical sound beats equivalently priced separates. £2,500 Classik Movie Di deserves the same accolade, but adds DVD video playback and surround sound.

**PIONEER NS-DV990 2003 £799.95**

Whiz-bang technology fest with DVD universal playback, discrete display and NXT flat panel speakers. Superb for the spare room or study - truly intelligent and elegant design - but don't expect it to match the sonics of AV separates.

**For all your advertising requirements
please call 020 7372 6018**

**or email:
advertising@hi-fiworld.co.uk**

kit & component suppliers

COMPONENT SUPPLIERS

Audio Synthesis

PO Box 50 Nottingham, NG9 1DX.
Tel: 01159 224138 Fax: 01159 229701. Email
salesinfo@audiosynthesis.co.uk. Website
www.audiosynthesis.co.uk
VISHAY BULK FOIL RESISTORS - unquestionably the world's finest resistor for audio applications. Thousands of VSRJ 0.3W 300V 5ppm 1% values in stock at the lowest possible prices eg. values up to 20K at £3.50+vat.
HIGH PURITY SILVERWIRE - Teflon insulated >99.99% purity, 0.6mm and 1.0mm diameter. Ideal for internal wiring, interconnects or speaker cables.

Audio-Links

7 Fairmont Crescent,
Scunthorpe,
North Lincolnshire, DN16 1EL
Tel: 01724 870432
Fax: 01724 875340
Email: audiolinks@ntlworld.com

Extensive stock of specialist audiophile components for valve and solid state enthusiasts. Supplier of the largest range of high-end audio volume controls in Europe. 30 page catalogue - Free via e-mail or £3.00 posted.

Noteworthy Audio Limited,
36 Buckingham Street, Aylesbury,
Buckinghamshire, HP20 2LH
Tel: 01296 422224

email: info@noteworthyaudio.co.uk
web: www.noteworthyaudio.co.uk
Suppliers of a selected range of audiophile valve kits and components. Including the Stoekit range of valve amplifiers, Audio Note one times oversampling Dac Kit 1.1 and Lowther drive units. Plus a range of components and accessories from Eichmann, Furutech, Wonder Solder, Caig and many more. For a list of the extensive range of manufactured products and the special offers we stock please see our website or call for details. We are open from 9.30 to 5.30 Tuesday to Saturday, with demonstration stock of our kits available - please call in advance to book an audition.

White Noise

11 Station Road, Bearsden,
Glasgow, G61 4AW
Tel: 0141 942 2460
Fax: 0141 587 7377
Email: david.white38@ntlworld.com
www.wnaudio.com

Supplier of the widest range of standard and audiophile kits for solid state preamplifiers, power amplifiers, headphone amplifiers, power supplies, MM/MC phono stages, active crossovers, balanced i/o modules, and stepped attenuators; more kits in the pipeline. All kits use the highest quality, glass fibre, solder masked, silkscreened, PCBs. We also supply a wide range of active (esp. Japanese transistors and Exicon mosfets) and passive components, gold plated connectors, and silver plated wires. Write, phone or email for a free catalogue. Mail order only.

Audiocom Int. Ltd

Unit 14 Pier Road, Pembroke Dock,
Pembrokeshire, SA72 6TR
Tel: 01646 685601 Fax: 01646 685602
Web: www.audiocominternational.com
E-mail: info@audiocominternational.com
Extensive range of audio passives and active components including DACT, Black Gate, Sanyo, Elna & Vishay. We are the manufacturer and sole distributor for Superclock 3 master clock & Invisis discrete regulators. Visit our online store for pricing and information. Secure online ordering available.

LOUDSPEAKER KIT SUPPLIERS

Arena Electronics Ltd

59 Main Street
Great Gidding
Huntingdon
Cambridgeshire PE28 5NU
Tel: 01832 293320
Fax: 01832 293372
e-mail: HYPERLINK "mailto:sales@seas.co.uk" sales@seas.co.uk
Website: HYPERLINK "http://www.seas.co.uk" www.seas.co.uk

Arena Electronics was appointed official UK distributor for SEAS high performance drive units in January 2006. We offer the full range of SEAS drive units, designed and built in Norway, together with speaker kits and advice for DIY speaker builders. These include the World Designs WD25A project, complete parts for which can be purchased on our website including the cabinet kit.

IPL Acoustics,

Chelsea Villa, Torrs Park,
Ilfracombe, North Devon, EX34 8AY
Tel/Fax: 01271 867439

Please visit website for full catalogue of products:

www.iplacoustics.co.uk
IPL supply a range of 7 high quality transmission line speaker kits, and a full range of Hi Fi and AV speaker kits, including 2 active subwoofers. Drive units are available from Audax, Seas, Morel, Legend (Ribbon Tweeters), and IPL custom built metal coned drivers. IPL also supply; quality capacitors, inductors and cabinet accessories, including Silver Plated PTFE insulated cables.

Impact Audio

Unit 102, The Courtyard
Radway Green Business Centre
Radway Green, Crewe, Cheshire, CW2 5PR.
Tel : 01270 883243
Fax : 01270 882241
email : info@impactaudio.co.uk
Website : www.impactaudio.co.uk

Main UK distributors of VISATON loudspeaker kits, drive units and accessories. We offer over 35 professionally designed kits from one of Europe's leading manufacturers. Drive units include the MHT 12 ribbon tweeter, T1 100 titanium cone midrange and the new TIW range of high power woofers. Contact us for a free catalogue or visit our website for full details.

WILMSLOW AUDIO

50 Main Street, Broughton
Astley, Leicester, LE9 6RD
Tel: 01455 286603
Fax: 01455 286605

Email: sales@wilmslowaudio.com
Website: www.wilmslowaudio.com
Contact us for a copy of our FREE Full Colour Catalogue or visit our Website with secure online ordering.

The UK's largest supplier of loudspeaker kits, drive units and components. We also have a range of subwoofer kits and amplifier modules available. Official UK distributor for ATC, Morel, Peerless, Scan-speak, Seas, Vifa and Volt. Beware of imitations, we only stock drive units made by the genuine manufacturers. We offer a full repair and upgrade service on most makes of loudspeakers.

VALVE AND OUTPUT TRANSFORMER SUPPLIERS

Watford Valves

3 Ryall Close, Bricket Wood,
St. Albans, Herts, AL2 3TS
Tel: 01923 893270 Fax: 01923 679207

Specialist in new old stock and current production valves. Sole UK distributor of the Harma Diamond range selected for their superior performance. Huge range held, stockists of Mullard, GE, Philips, National, Brimar, Sylvania, Telefunken, RCA, MOV and many more. All valves are new boxed and guaranteed. For free price list and specialist advice call or fax Derek Rocco, Watford Valves.

Chelmer Valve Company Ltd
The Stables, Baddow Park
Great Baddow, Chelmsford, Essex,
CM2 7SY

Tel: 01245 241300
Fax: 01245 241309.

Email: sales@chelmervalue.com
Web Site: www.chelmervalue.com

Premium range of audio valves, tested/selected for low noise, hum, microphony; power valves burnt-in. Huge stock of valves/tubes of all type, audio valves (inc. NOS types), industrial etc. Also large stocks of semiconductor. Many obsolete types.

Billington Export Ltd

1E Gillmans Trading Estate
Billingshurst, West Sussex RH14 9EZ
Visitors by appointment only
Fax: 01403 783519

E-mail: sales@bel-tubes.co.uk
Web: www.bel-tubes.co.uk

Guaranteed new/old stock CRT's for audio & industrial use Vintage types including Mullard, GEC, Telefunken & RCA. Large stocks of Chinese & Tesla. Major stockists of the Billington Gold brand. Free catalogue on request. Attractive prices on large orders. Minimum orders £100.00

MODIFICATION SERVICES

Audiocom Int. Ltd

Unit 14 Pier Road, Pembroke Dock,
Pembrokeshire, SA72 6TR
Tel: 01646 685601 Fax: 01646 685602
Web: www.audiocominternational.com
E-mail: info@audiocominternational.com
Upgrade services available for all CD, SACD & DVD players. With our latest products we are able to advance CD playback way beyond what 'stock' players are capable of resolving. Our extensive knowledge base and upgrade techniques make us world leaders in digital upgrades. Various upgrade solutions are available to suit your budget and desired performance.

REPAIRS & RESTORATION

The UK's Leading Service & Restoration Specialists. Repairs/Restorations to Modern/Classic/Vintage valve hi-fi, musical and cinema amplifiers, control units etc. We will even build that kit for you or design something special. Please visit our Website at:-
www.audiolabs.co.uk for complete details of our comprehensive services. Alternatively, contact us at:-
Audio Laboratories (Leeds)
3 Kildare Terrace Industrial Estate Leeds LS12 1DB UK
Tel/Fax +44 (0)113 2440378

Arkless Electronics.

Tel. 01670 829891

E-mail:

arkless.electronics@btinternet.com

Specialist in repairs, restoration and modifications to all amplifiers, valve or solid state, ancient and modern. Design service for companies and hobbyists. Amps, preamps, phonostages, active crossovers, psu's etc custom built to order. Kits built/debugged. Please enquire for any other services. Ex design engineer for well known hi-fi companies.

mail

Visit our website at www.hi-fiworld.co.uk or send your emails to letters@hi-fiworld.co.uk. Letter of the month wins a pair of Precious Metals interconnects and one years FREE subscription to Hi-Fi World.



Letter of the Month

THE GREAT DEBATE – SLIGHT REFRAIN

Here's my two bob's worth with respect to the eternal 'analogue versus digital' debate.

I have been a reader of your publication for more years than I care to remember (I hark back to the days when your esteemed publisher held the view that the world was flat, and Blighty was the edge of the universe). I find your magazine to be a stimulating and entertaining read, and especially enjoy your balanced and well-researched 'new technology' articles.

Being a child of the (nineteen) fifties I was an aficionado of valves n' vinyl. However, sometime in the nineteen eighties things changed dramatically. There was a world shortage of vinyl, LPs became lightweight and thin, some pressings were eccentric, many were warped, surface noise was increased, and overall quality was down. Obtaining a good sound from vinyl was dependent upon so many variables, it was akin to riding downhill with a tailwind at dusk on a Tuesday in summer. I was not happy!

Imagine my delight when Von Karajan declared 'all else is gaslight', and Philips proudly proclaimed 'perfect sound forever'. I sold my vinyl front end, which consisted of a Rega Planar 3 turntable, Mission arm and Garrott moving coil cartridge, and became an early adopter of Compact Disc. It was not a happy union, the resultant sound being harsh, sterile and thin.

Despite the unacceptable sound of CD I wasn't going to revert to vinyl, thus began my quest for good digital sound. I tried lots of different machines, which utilized many diverse technologies, these included multibit, bitstream, PCM, PEM, and PWM players. I even tried (without success) a valve hybrid player.

Fast forward to 2005 where my search for acceptable sound has led me to a PWM CD player and valve amplification. To my ears I prefer the sound of PWM based machines, especially

the ones utilising Technics Mash technology. These machines do nothing especially brilliantly, but importantly don't do much wrong.

Part of my dissatisfaction with early digital was down to poor recordings. Recording in the digital domain is quite different to recording analogue, and my experience suggests that it is only in recent years that good digital recordings have become available. Digital also improves when it is fed into valves.

I read with interest your recent review of the TACT (PWM based) amplifier and am not surprised that the sound was found to be neutral and lacking in harshness, for this concurs with my experience of PWM done properly. I, like you, believe that PWM is the way of the future for solid-state amplification.

All of the foregoing leads me to what I consider is an important but overlooked issue with respect to your CD versus vinyl reviews. Put simply, I don't believe that your analogue versus digital shootouts are valid because they don't take into account system synergy.

My point is that if a system is optimised for the reproduction of vinyl, then simply inserting a digital front end into the system is not valid. This is because of the seemingly incompatible sonic characteristics of each technology. Vinyl tends to sound sweet warm and



Herbert Von Karajan supported the launch of Compact Disc, declaring all else "gaslight".

expansive, and digital tends to sound detailed and analytical. If a system has been optimised for vinyl and a CD player is inserted, the resultant sound will generally be bright and thin. Conversely if a system is optimised for digital and a turntable is inserted, the resultant sound will generally be thick and coloured.

I believe that digital components should be assessed in systems that have been optimised for digital technology, and that analogue components should be assessed in systems that have been optimised for analogue technology. Only then can any meaningful conclusion be drawn. Many thanks for your excellent publication, keep up the good work and most of all retain an open mind for there is merit in all should you seek it.

Lou Ricci,
Australia

My atlas has Blighty at the centre and Oz at the edge Lou. Don't know which bookshop you got yours from, but I should take it back and ask for a refund!

I well remember Karajan's epic comment about CD, which was as auspicious as Atlee's declaration of "Peace In Our Time". Happily, I was eagerly peering into the screen of a new spectrum analyser at the time and it told another story altogether: 30% distortion or, in bad cases, more than 100% distortion. Never had I encountered a situation where there was more distortion than signal - analogue never got so bad! That's why CD sounded harsh. Otherwise, I can understand anyone being persuaded that digital was 'perfect' at the time, such was the torrent of inaccurate data and persuasive comment from the uninformed.

But as you say things have improved steadily over the years, if slowly, and nowhere more than in recording quality. The best modern recordings, often 24bit, can sound very clean on CD. I regularly update my classical to take account of new recording technologies. Rock albums still vary a lot I find. We have startling sounding demo CDs lying around the office, against which the latest CDs sound relatively drab.

On the technology front I appreciate that it makes sense to try and get the best from CD, but at the same time it is limited in resolution in both amplitude and time domain, and there is only so much that can be achieved. Although it is hard to counter the objection that using valve output stages can by definition do little more than enhance what is a strictly circumscribed digital signal, it does seem to work. CD players like the Shanling CD-T80 and the Eastern Electric 520 give a lovely sound, by CD standards.

I understand your point about a system being optimised for CD being unsuitable for LP and vice-versa. But we do not try and optimise our playback systems in such a fashion at HFW towers, nor do we get much opportunity to quite frankly. A reviewer's life is one of enforced agnosticism, immersed in one faith in the morning and another after noon, sometimes. I have spent Christmas and the New Year with Tannoy Yorkminsters, for example, and they are deadly accurate under measurement. Running LP and CD through a valve amp into these loudspeakers (reviewed next month) gives even results from both, but at present LP remains a nose ahead. As LP is not by any means going to make a comeback, the observation

doesn't amount to much, unless you paid no attention to Karajan and kept your LP collection, in which case you will find modern turntables and cartridges give a dry balance much akin to CD, whilst at the same time offering a larger and better laid out sound stage, more tactile bass and a general feeling of naturalness not easily matched by CD.

I'm more disappointed by DVD-A and SACD, which I hoped would have offered more benefit than they seemingly have been able to, although I know many people who swear by SACD in particular. The new year should bring us Blue Ray however - and new promise perhaps. But as you suggest, I am not sure we will hear one iota of difference until better recordings come out of studios. And at present they are all investing in expensive and complex surround-sound equipment, rather than high resolution stereo. **NK**

Lou, thank you for an unusually sensible and untendentious letter on this still-hot debating topic. I absolutely take your point - which is that whatever your source, you fashion your system around it. This is absolutely correct, and whether it's AM radio, 8-track cartridge or DVD-Audio, you should do so if you're living with it. But Noel is also correct, inasmuch as we don't have the time or the inclination to embark on many months of system-building specifically for one component. That's a perfectly reasonable position for a magazine, which has to try a number of products every month. Essentially, if you put a product on to the market, it has to be able to work in most systems, reasonably well... We give it more than a fighting chance (unlike some other mags which have a quick 'how's your father' listening panel approach to auditioning, we live with the stuff, and tweak our own reference systems appropriately), and that's good enough. If we find we can't get something to work as well as



What NK said about CD in 1985. A new and powerful distortion analyser showed it was candlelight..

expected, we say so, and we always review with the caveat that you - the reader - you make your own mind up in the final instance, and not let a bunch of hi-fi hacks tell you what's best for you. I hope you, and all readers can understand that we regard ourselves as 'contributing to an intelligent debate' on the subject, rather than being all-knowing deities with no space for disagreement. That said, I still reckon LP blows CD out of the water... **doh! DP**

MOREOVER...

I have read your magazine since issue two and as a regular subscriber I look forward to it arriving each month, and even at the age of eighty one I still like to dabble with hi-fi equipment and I am also a lover of classical music which does not appear to feature much in your equipment reviews.

I think that you have got the balance right between vinyl and CD, and I particularly like the constructional articles as being a Mechanical Engineer I have built turntables, pick-up arms, tuners, amplifiers, and speakers, so please keep it up.

With regard to the vinyl versus CD debate, I play both formats and believe they have equal merit given the right recording quality, and I play my CDs in a Marantz CD94 which I bought secondhand and which in its day was top of the range. I wonder if it would be worth having it upgraded and would value your opinion on this?

My main reason for writing is that I have been given an American SAE amplifier and preamplifier which appear to have a good specification and I wondered if you consider them worthy of spending time and money on refurbishment.

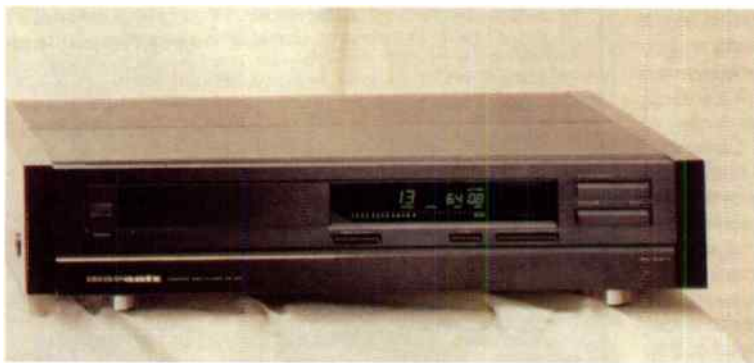

Marantz CD94 – classic sixteen bit silver disc.

They had not been used for about two years and so I powered them up to mains voltage in steps of 50volt over a period of a week to reform the electrolytic capacitors and the power amplifier worked okay when connected to my Musical Fidelity preamp.

The sound was disappointing compared with the upgraded Quad 405 that I normally use, lacking in soundstage and ambience, although it did retrieve fine detail, and the question is: will it improve substantially with a change of capacitors, some of which are very large with screw terminals?

The preamp is not working and without a circuit diagram it is difficult to check where the signal stops and so far I can only verify that the power supply is working but am reluctant to spend more time on it at this stage until I receive your opinion.

This SAE equipment was originally purchased about 1976 and I am hoping that you would have experienced it and be able to give your opinion on its potential. Also, where any replacement components can be sourced, for which I would be most grateful.

Bob Angus

Hi Bob. I have heard an SAE in the past and, like you, was unimpressed. It was a pretty mediocre. I'd venture to suggest that is why you got it free and why it had not seen much use. Because an amplifier is old by no means it is good or worth restoration. The world seems to have gone a bit mad about all this; old kit is not necessarily good kit, as we are saying more and more these days. You have a proper hi-fi amplifier in the 405, and upgraded too (as it needs to be, since original 405s were nothing to write home about). So leave the SAE in peace I say, a peace it deserves! **NK**

HAPPY TALK

I normally always audition upgrades to my hi-fi, but while going through a divorce and getting hammered by legal fees my Verna valve preamp blew up - the transformer went on it and without any specs a new one could not

be made. I was left running Quicksilver power amps into Magnepan SMG III A passive loudspeakers, which was not ideal, to be honest!

In January last year you reviewed the Ming Da MC-7R preamplifier. I could scrape funds for one from ICON Audio, who advertised it in your magazine. They put better valves in and did some mods so it would work with my amplifiers. In fact they were most helpful because I know nothing about what specs mean on inputs of power



Ming Da MC-7R – quite a good preamp, actually...

amps, etc. They took the time to help and got rewarded with a wonderful looking preamp! I must confess I expected to use it has a stopgap until funds allowed me to find a better one. Well, all I can say is that it blows (no pun intended) my other pre away, and I have no intention to replace it at all. It really is a great preamplifier - thanks Guys for reviewing this!

Next, I decided to take a gamble on the Shanling CD-T80 silver disc spinner. Again I could not get to hear one where I live, but my old Teac CD player was ten years old and I suspected it must

be better than that! Well it is, and it's wonderful! I use LP and CD, and over that last year my set up has never sounded so good! A big thank you to every one at Hi Fi World - alas it's the wrong way to upgrade but it worked wonderfully for me!

Andrew Footman

You said it, Andrew! **DP**

A LITTLE BIT OF POLITICS...

Anyone wishing to buy hi fi equipment above the level of the mass produced stuff is likely to look at a hi-fi magazine for impartial advice. Who would trust the advice of a dealer who has to make a profit to survive? The item which will make him the most profit is what he is more than likely hoping to sell.

So we consumers look to the magazines. But are the magazines really as impartial as they may seem to the naive reader? They rely on the good will of the manufacturers as well as magazine sales to stay in business. Their job is to enthuse the reader, to make him covet the next upgrade. Why

else buy a magazine? The magazines are quite obviously acting as a public relations voice for the industry. Could you please answer in your columns the question of the conflict of interest between promoting the sales of hi-fi and protecting the consumer?

Why do we never see the rights of the consumer promoted? For instance, the cartel that obviously exists among manufacturers. Prices are identical all over the country. There is no free market. Any dealer who undercuts a rival is going to have the manufacturer ceasing to supply. I thought there were

laws designed to protect the consumer against price fixing but the magazines are silent on the issue. Could the reason be that they are afraid to raise it because of their reliance on indirect income, through goodwill and advertising, on the manufacturers? They are in effect on the side of the manufacturers rather than the consumers they purport to advise.

Anthony Carroll

Your presumption that a cartel exists because prices are similar around the country borders on bizarre, I would suggest. They settle at a level because of the way open markets operate under the pressure of competition. If one dealer were to slash prices others would usually follow, to a similar, if not lower price. So there is a leveling effect.

Below a certain point, continuing to trade ceases to be profitable and normally a market cannot go into this region for any period of time, so there is a lower threshold. If one business does trade here, under external subsidy say, in order to put rivals out of business in order to destroy free market conditions, then the Office of Fair Trading would get involved in the UK.

So what you see isn't the result of cartel conditions. Don't you think that if it was so obvious a cartel existed then it would be investigated by the Office of Fair Trading? **NK**

I think your views are a tad extreme. May I ask, do you think Princess Diana was assassinated by the government, or do you deny the moon landings ever took place? There are lots of

alien abductions these days, aren't there (but the newspapers collude not to print news of them)? To be brutally frank – much as it would be a convenient opportunity to knock our commercial magazine rivals here – every serious hi-fi journalist I've met is of an independent disposition, regardless of magazine title or company. You might be surprised to know that I wantonly 'fraternise' with 'opposition' journalists from all the other UK hi-fi mags, and am even good friends with some of them (shock, horror!), and I can say with confidence that journos (as a breed) are a tad skeptical about manufacturers (Gawd knows, we have to work with them every day) and aren't naturally predisposed to (if you pardon my vulgar Americanism) 'kiss butt'. In fact, if we could have most of the UK hi-fi industry up against the wall (come the revolution, etc.), then we would.

Okay, I'm exaggerating for dramatic effect here (quite a bit, actually), but my substantive point is that we hacks generally see ourselves as the antidote to public relations people, and not brothers in arms. I certainly feel this, much as I like and

respect lots of hi-fi PR people on a personal level. Your perception, which is obviously to the contrary, suggests to me that you have – in the words of the song – "a suspicious mind". **DP**

CLASSIC SOUNDS

Can I suggest some products that should be on your 'classics' list? If the Audio Technica AT1120 tonearm rates a mention, then surely you must acknowledge the Mayware Formula 4 tonearm? This was that late 1970s rarity: a low mass tonearm that really worked and still sounds respectable - and, to boot, a quirk-free unipivot. They managed to be both low mass and reasonably rigid and their damping and variable effective mass feature allow them to work well with both high compliance moving magnets and low compliance moving coils. I know that the bloke that produced them was a bit difficult to deal with but credit where it is due: a Mayware Mk III in good condition is still a match for many modern arms (I have tested it against a Rega RB250) and a MkIV or MkV is even better. My Mk V managed to sound fine with high compliance cartridges such as the old Goldring G900SE and

The screenshot shows the Office of Fair Trading website. The header includes the OFT logo and navigation links like 'Home', 'Search', 'Contact', and 'Home'. A search bar is present with the text 'Enter Keywords' and a 'GO' button. Below the navigation, there are tabs for 'Consumer information', 'Business information', 'News and publications', 'Adviser resources', 'About the OFT', and 'Approved codes of practice'. The main content area is titled 'Competition Act 1998' and contains text explaining the act's purpose and provisions. A sidebar on the right lists 'more business information' with links to various legal powers and regulations.

If you think there's a massive conspiracy to fix prices across Britain, these are the people to contact. The Office of Fair Trading offer lots of advice on their website. Go to www.of.gov.uk.

SHUNYATA RESEARCH

ESCALANTE DESIGN

HEGEL MUSIC SYSTEM

ONZOW ZERO DUST

WWW.AUDIOATMOSPHERE.COM

Mayware's rather good high output moving coil (MC7V8II) but it also sounds absolutely splendid with my latest acquisition: a Denon DL-103. The best thing about Maywares is that, as jeweled unipivots, there is almost nothing to go wrong with them, so they make an excellent secondhand buy.

The Rogers HG88 is not one of the fashionable valve amplifiers it is a remarkably good real world device, as it is an integrated and has a good quality phono input. In 1985 I rescued one from a friend's snow covered rubbish heap (literally), dried it out and had

the plinth to a non-resonant drum the same diameter as an LP record, (b) made the plinth, subchassis and platter entirely out of non-resonant wood and composite materials and (c) fitted a good quality motor and bearing and a stable three-point suspension.

With a little tweaking, the sound is good and with an outboard power supply it is excellent. Place it amidst any collection of old or new turntables and the classic simplicity and simple 'rightness' of the design of the CJ61 sets it apart from the crowd. Study the details and whereas its competitors



Colin Walker CJ61 turntable - a forgotten gem?

a defect on one channel repaired. I then listened with astonishment as it completely outclassed the sound from the latest Best Buy 'budget superamp' I had just bought. It is quiet, untemperamental and produces a strong, clean, stable sound that gets better the longer you listen to it. Somehow its 8 watts per channel manage to do as much useful work as the 30 watts per channel of the modern amplifier it replaced. I notice that 'classic' valve gear is supposed to be quirky, difficult and strictly for enthusiasts but I think the Rogers deserves a vote for being none of these things - and still sounding good. (It's a better amp than the Cadet that you list.)

The Walker CJ61 turntable is a different sort of classic: a design, which appeared just when CD was knocking the bottom out of the turntable market, so it never sold on the scale it deserved. However it was potentially a very important design, because in it designer Colin Walker produced what is in many ways the definitive low-cost high quality turntable - an effective, reliable, fuss-free suspended subchassis turntable for around 100. He did this by stripping away all the non essential elements that clutter most turntables and then taking a radical but practical approach to the design of what was left: he (a) reduced

have awkward or ineffective suspensions, resonant armboards, clanging metal platters and subchassis etc. etc., the CJ61 has none of these things - there is nothing superfluous and everything is right. I firmly believe that if it had appeared a few years earlier, or if CD had appeared a few years later, the CJ61 would have taken a huge slice of the turntable market and would have been regarded as an obvious 'shoo-in' for your list of 'classic' hi fi designs.

I notice you don't have a section for classic pickups but these are very interesting. I have just bought a Denon DL-103 and once I got it run in and loaded 'just right' (150 ohms) I have been absolutely astonished by the sound - in the Mayware arm and Walker turntable it is amazingly good, far better than CD, better than any other pickup I have owned previously and without any apparent vices. What I am trying now to understand is what on earth all the progress in hi-fi has been about when Denon were making something this good in 1963!

As for other 'classic' pickups, no doubt there will be many views but it could be an interesting section, as the Denon has made me question many of my assumptions about technical progress over the last forty years or so and led me to wonder how some of the

famous names of the past would really compare on a level playing field. It could make an interesting feature: I notice that there is a US website which is still selling some old ADC 10E cartridges (legendary 3/4g tracking devices from the late 1960s) and it would be fascinating to see these rate against some others of the time (Shure VI5s or M75EDs) and also the Denon DL-103, the inevitable Deccas and a couple of present day 'contenders'. (FYI, I once had a loan of a Shure M3D, which I mounted in a Rega RB250 and sounded very good.) My guess is that some of the top names of the past would sound old hat but others could cause a few surprises. (We already know about the Ortofon SPU.)

Alasdair Beal

Thanks for that, Alasdair - and several fair points well made, but I have to say that 'classic cartridges' aren't much cop against the current crop, with the possible exception of some Supexes. As for the Denon DL-103, please don't get me started on this. I'll take your thoughts on board, which only leads me to conclude that there is indeed a parallel universe where the 103 is a great cartridge and I am king of the world, as far as I know... **DP**

REEL ADVICE

I have a reel to reel quarter-track tape recorder on its last legs, largely due to perished belts. I have many hours of precious listening on the tapes which I would like to preserve. What is the best way of doing this?

Nick Walker

Hi Nick - I suggest you get your belts replaced; best place to do this is: Audio Laboratories (tel +44 (0)113 244 0378). Their address is: 3 Kildare Terrace Industrial Estate, Leeds LS12 1DB. **DP**

BRINGING IT ALL BACK HOME

Release Denon's DP1300M deck from Japan! (Nov HFW). I've owned a Denon DP 57L for twenty plus years (recently fitted with a Goldring 1042) and I would be delighted to see the successor to the DP57L and DP62L decks reviewed and made available here.

Why are many quality Japanese items not available in the UK? For example following my fruitless attempts to source new Technics pre and power amps SE3000 (mentioned in August HFW) or SUA 909, which included requests to Panasonic UK, Bracknell and Matsushita in Osaka, both of whom were unhelpful, I had to settle for a used Technics SE1000. Let's not forget to press for the release for Denon's DP 1300M!

Paul Hopper

Hi Paul, the answer is that – in crude terms – the sums don't add up. I find this saddening, as if the various UK importers of these illustrious Japanese products showed some imagination (and were prepared to risk losing a small outlay), they may well change the way their brand as a whole is viewed in this country. I know this, you know this, and they probably suspect this, but they have to make money and it's a gamble – and few people in largish companies follow their hunches; it's much easier to play it safe. Sad as it is, I suppose you can't blame them? **DP**

BANISHING THE BOOMBUG

I kept delaying to buy a new CD player as long as I didn't get the sound right in my listening room. I own a ten years old Kenwood DP 7090 CD player which isn't a bad machine in its own right (4 Burr Browns) and a LFD Integrated amplifier LE Mk II (which replaced a Rotel) and Spendor S6 (which replaced BCI's). Yes, I'm a fan of Spendor, but the BCI's boomed too much. Yet I still have the problem with the S6's with difficult material.

I gained a lot with careful positioning, diffusing panels on the walls and ceramic ball isolation feet from Finite Element for both speakers and units (which are hung on the wall). QED Silver anniversary, LFD interconnect, Van den Hul Mainstream and JenTech mains-block complete the picture. And yes, there's my trustworthy Thorens TD160 Super with a small Linn K5 element and Creek preamp, but I neglect them a little. What I can't say from my brilliant old Sansui TU750...

Everything is splendid when I play Bach or Mozart. Voices are beguiling, strings are silky, my room is a soundstage, I almost hear nothing but music. I think I'm at the limits of my system, but when playing rock (from Dylan to Turin Brakes), in busy fragments there's the old boom-bug again and the idea that something is losing track of each instrument, leaving them to drown in a small pool of mud, vibrations still circling in my room ever so slightly... Is it me who is asking too much, is the CD the culprit or do I finally have to choose a new CD-source?

I have heard better sounding machines in the shops alright, but they didn't seem to solve the problem either - that's why I thought it must be the recording. Still, when I read your review of the Shanling CD-T80 I thought there might still be machines that can keep

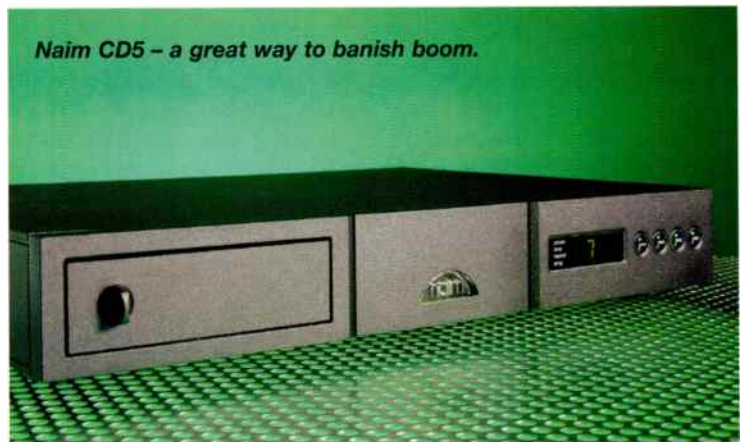

better track. Creek or Marantz seem to have nice players, but I must say that I'm attracted to Naim for the solid simplicity of their drawer and for the fact that on a hi-fi show their stand was the only one I went back to for refuge - so bad the rest seemed to my ears. I have to include here that I have a hearing problem with one fairly deaf ear that can't tolerate unharmonics and bad room acoustics very well and that is plagued by tinnitus. Still, this doesn't stop me from enjoying music.

So - should I really go and listen to a CD5i or a CD5x even and compare them with my Kenwood DP7090? Opening up the Kenwood the power supply seems so miserable compared to new players, or am I overlooking something else? On the other hand, I listen a lot to France Musique who have fantastic live performances in the studio and they never give me the boom bug. Anyhow, thanks for brainstorming with me. Yours is the only magazine I felt would understand the problem...

Carl Stein
Belgium

Well, why not Carl? For a lot of people Naim offer an answer to their prayer for good sound, so you should arrange a demonstration if possible. Naim CD players do measure differently and you can be assured of a presentation different to your Kenwood, which is a standard engineering job. One of our reviewers, John May, is happy that his Naim CD5i withstands comparison with today's quality CD players, and he runs a Shanling CD-T80 alongside it. Obviously, the sound is quite different, with the Naim offering a strongly rhythmic sound, from firm bass underpinnings. Shanling's CD-T80 is clean, very open and has a sound stage with dimensionality - rare with CD.

That remnant of boom is unlikely to come from your CD player. It is most likely a feature of the loudspeaker, as Spendor do allow the cabinet to resonate a little in order to provide fulsome bass. However, I have found that an effective way to reduce room boom is to place

IKEA® UNITED KINGDOM

Bookcase BILLY £35.00

(price reflects selected options)
designer: IKEA of Sweden



- ▶ Strong enough to carry heavy books.
- ▶ Utilise the full height of the room by adding a height extension unit.
- ▶ Protect your books from dust and light by adding panel doors or glass doors.
- ▶ Brighten up your bookcase with TJUGOFEM bookcase lighting.
- ▶ Adjustable shelves; adjust spacing according to your needs.
- ▶ 1 fixed shelf for high stability.
- ▶ Add shelves as your storage needs change.
- ▶ Tempered glass shelf is available.

size

40x202 cm



Put one of these in the corner and fill it with books to suppress room boom. But get the tall one, not the short one.

an Ikea Billy bookcase (or similar) in a corner and fill it with books and LPs. Make sure you get the highest bookcase possible, at least 6ft tall, as you need to fill the corner. If one is not enough, then try and fill a second corner this way. This is an effective way to damp down main room modes and should cure the boom you are experiencing. **NK**

OUT WITH THE OLD?

My system comprises Thorens TD 160 II turntable, Grace G707 arm, Denon DL103 cartridge, NAD S500 Denon TU-580RD, Pioneer Reference Series (1987) Pre C90 preamplifier and Power M90 power amplifier, driving KEF Reference 1.2 loudspeakers.

The above probably represents the best value for money I have ever spent in my fairly long life. I have had, and continue to have, hours of pleasure from this set-up. I have had the amps serviced by a vastly experienced hi-fi engineer (a few internal bits replaced etc, don't ask me what!) and apparently they are as good as new.

My question is: "Is it worth replacing the amps with more modern equipment?" and if so then how far up the current market do I have to go to gain an appreciable improvement, i.e. to take full advantage of improvements in technology?

I do intend replacing the turntable and am inclined towards an Nottingham Analogue Spacedeck, Hadcock set-up. My musical tastes extend to everything but classical and heavy metal.

I realise that trying a few amps out is probably the next step, but I wondered if I could prevail upon you to position the market for me before I start that process. I read the mags and yours gives me the feeling that you live in the real world as opposed to just giving plaudits to the latest products without comparing them with those that have gone before.

David Hutchinson

If you are happy with your amplifiers I tend to suggest you don't rip them out for the sake of it. It seems wasteful and it sometimes seems to me ebay is full of good equipment that has been replaced for no reason other than it is getting on a bit. Still that's every buyer's good fortune, I guess...

Amplifiers have improved little, largely as a result of better components rather than circuitry. If you really want to hear a difference try and listen to a valve amplifier like the Quad QC twenty four preamp and II-forty power amplifier. In my view you should set aside the DL103 cartridge and move up to something a bit more in touch with what is possible today, and here I suggest you look at our review of the Ortofon Rondo Bronze. **NK**

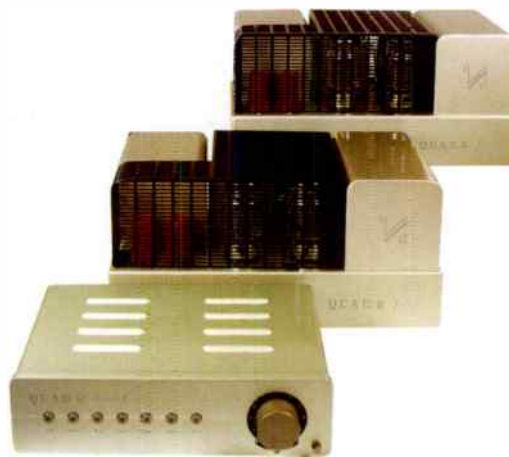

Quad valve amplifiers - for a different sound.

STEP DOWN

Good day to all of you. I have a serious issue to resolve in relation to all my audio system.

I have been living in Taiwan for several years, and during this period I have slowly built two systems, for two separate rooms. In Taiwan, the voltage is 120V 60Hz and all the components work with this voltage/frequency.

I have Audio Research VS155 120V/60Hz and Thorens Turntable TD 2030 (Transformer 120V 50/60 Hz) and Accuphase E212 integrated amplifiers and an Accuphase CD player (both of them 120V 50/60 Hz).

Recently I have been confirmed a transfer to another country where 220V 50Hz voltage is used! I was thinking to use a voltage transformer which I can find of good quality here in Taiwan, but I have the following questions for which I would really appreciate your help.

1 For the units which have 50/60Hz on the tag, I believe there should be no problems using the voltage transformer. Am I correct?

2 For the Audio Research VS155, the cycles are 60Hz only. May it cause any problem to connect the amplifier to a step down voltage transformer?

3 Is there any implication in any way to the sound of the system if a transformer is connected between the units and the AC outlet?

4 I also have a power conditioner (TICE Solo) which is also rated at 120v 60Hz and I would like to use it between the Audio Research VS155 and the Step Down Transformer. Do you think this may improve what it will be eventually lost by using only the transformer?

**Carla De Giorgia
Taiwan**

Hi Carlo. In your situation it is normal to use a Step Down Transformer as you say, and this

usually takes the form of an 'auto-transformer', a device with just one winding on it, tapped down at various points. It can step up or down, according to which way around you connect it. Ideally, you should try and hear it working under load before purchase as transformers can hum and buzz badly if not properly built. Some are designed to run hot too; up to 80degrees C is acceptable to transformer manufacturers, but would be bl**y hot to you or me.

The Audio Research VS155 should work well at 50Hz instead of 60Hz. It will draw a few amps or so, so if you can reset it internally to work at 220V, I'd suggest you do so. It makes less sense for a U.S. manufacturer to provide a 220V option than it does for a European manufacturer to provide a 110V tap on a 220V winding, so you will likely have a U.S. 110V only model.

Stacking transformers isn't the best idea, although there are plenty between any power station and the final consumer. You may notice a slight softening of bass as a result of increased supply impedance caused by the auto-transformer. You can minimise this by buying the biggest transformer possible. Doing this will also minimise production of noise and heat. I do not know how the Tice Solo will respond. I suggest you try it and see. It is likely to offer a similar result in this situation as before. **NK**

AROUND THE CLOCK

I don't wish to turn your letters pages into some kind of hi-fi forum but I want to respond to Fred Straw's query regarding transports and clocking. Following advice that you kindly offered to me a couple of issues ago regarding what transports I should look for to



TEAC VRDS-T1 responds brilliantly to clocking...

match my M.F.Tri-Vista 21, I came across a mint Teac T1 for £120 (one of your recommendations) that was duly purchased. As it stood this sounded pretty damn good through the Tri-Vista (oddly, noticeably better than a Teac VRDS 10 CD that a dealer had loaned to me?)

Following your advice regarding clocking I contacted Trichord Research who put me in touch with a local supplier who said that he could fit a Clock 4 and also do a couple of mods for me. The Teac was delivered and returned within a week. Straight from the off it was in a different league than pretty much anything that I had heard. I really cannot stress how good the Teac/Trichord Clock 4 is, especially now it is run in. The main areas of noticeable improvement are transparency, detail, soundstage (huge!) but most of all musicality - it just sounds so natural and effortless. The total cost of the Teac/Clock 4 is less than £500, which is just a joke considering what it sounds like. My advice to Fred Straw would be to get a Tri-Vista 21 and pair it up with a clocked TEAC T1.

Dave Mayer

All I can say is... yes! **DP**

KIT AND KABOODLE

I have recently acquired two kit build record decks. They were produced by a company called Input Design in England. They are still in their original boxes and contain full build instructions. What appears odd is that neither kit lists a drive motor or arm/cartridge as part of the kit. Presumably the buyer had to source these parts.

Does anyone know anything about this company? I'm wondering if it would be worth assembling the kits - the components appear to be of good quality, but obviously, I've no idea what they would sound like. Any information would be most gratefully received, especially relating to the company; which arm/cartridge to use and which kind of motor. Someone did suggest that I could use a redundant DC motor from a video player, which seems quite an ingenious idea.

Andy

The Input Design KitDek was a mid-to-late nineteen eighties turntable kit, using - basically - Rega bits. It was a platter, switch, plinth and not much more, as I recall. As such, it sounds similar to a Rega Planar 2 (providing you fit a Rega RB250, although it

was sold with a Linn Basik+, if I'm not mistaken). Yes, it's a decent little deck, but nothing to write home about; the new Rega P3 would blow it away, and the likes of a Michell TecnoDec (et al.) would eat it for breakfast, twice. **DP**

CLOCKWISE

I have a Trichord Clock 2 that I initially was going to put into my old but trusty tank the Akai CD93 reference master but I know have a much better sounding Marantz CD63KI Signature, and still the clock. Should I put it into the already great sounding CD63? I ask this because I wonder how Ken himself feels about relocking as in the DP version nothing was stated about relocking.

Cetin

Indeed, the CD63KI DP was not reclocked; this is because it was very carefully tuned around the unlocked mech and so simply changing the clock willy-nilly would - or at least could - alter the balance and screw things up. Obviously, the stock KI wasn't painstakingly tuned for a specific sound, so you're less likely to spoil the supper, so to speak. I'd say go for it - but make sure your mod is reversible just in case. **DP**

GET IT TAPED!

Being a contrary person in some ways, I got a hankering recently to play audio cassettes again a few weeks ago. I duly got a few (very) cheap tapes of some of my fave albums not collected so far on vinyl and had dug out my old Walkman. Then I read the latest issue of my mag and read the review of the new issue of 'Songbird' by Eva Cassidy. I have liked her music but not actually bought any albums, just getting the tracks I had

Billy Vee
SOUND SYSTEMS

SAVE UP TO 50% ON EX-DISPLAY BARGAINS

SOME AS NEW (MARKED*) 24HR DEL ONLY £5. CHECK STOCK BEFORE ORDER. S/H = Pre-Owned Unit

CALL SALES: (020) 8318 5755 or 8852 1321 - 248 Lee High Road, London, SE13 5PL

Arcam AV8 A/V Preamp S/H (2Yr G/tee)	(3150.00)	£1795.00	Linn 5103 AV Processor - Silver (2Yr G/tee)	(4500.00)	£1995.00
Arcam P7 7-Channel Power Amp S/H (2Yr G/tee)	(2995.00)	£1695.00	Linn Majik Amplifier - Blk S/H (1Yr G/tee)	(945.00)	£375.00
Arcam FMJ CD33 CD Player (2Yr G/tee)	(1349.00)	£795.00	Linn LK100 Power amplifier S/H (1Yr G/tee)	(650.00)	£325.00
AVI Amp Lab Series CD Player (2Yr G/tee)	(1400.00)	£849.00	Linn LK140 Power amplifier S/H (1Yr G/tee)	(750.00)	£459.00
AVI Pro 9 Speakers - Cherry (S/H) (2Yr G/tee)	(799.00)	£445.00	Linn 2250 Power Amplifier Silver (2Yr G/tee)	(1995.00)	£1195.00
B&W DM602 Speakers Blk S/H (6 Mth G/tee)	(299.00)	£95.00	Naim 112 Preamplifier S/H (1Yr G/tee)	(660.00)	£445.00
B&W DM604s3 Floor Speakers S/H (1Yr G/tee)	(799.00)	£495.00	Naim NAC52 Preamplifier Olive S/H (1Yr G/tee)	(3685.00)	£2190.00
Denon DV1400 Multi-format DVD Player (1Yr G/tee)	(399.00)	£219.00	Naim SuperCap P/Supply New Style S/H (1Yr G/tee)	(2315.00)	£1795.00
KEF Q Compact Speakers - Silver (2Yr G/tee)	(189.00)	£129.00	PMC OB1 Speakers - Oak E/D (2Yr G/tee)	(2450.00)	£1795.00
KEF Q4 Speakers (Cherry) (2Yr G/tee)	(399.00)	£249.00	Sugden CD21 CD Player Display As New (1Yr G/tee)	(1049.00)	£649.00
Linn Unidisk SC M/format Player Silver (2Yr G/tee)	(2995.00)	£2249.00	Sugden A21a Line Amplifier As New (1Yr G/tee)	(949.00)	£595.00
Linn Kairn Phono Preamplifier S/H (1Yr G/tee)	(2200.00)	£859.00	Yamaha HD1300 H/Disk CD Player (1Yr G/tee)	(599.00)	£429.00

For latest addition to our pre-owned and ex-display bargains please visit the marketplace section of our new website at billyvee.co.uk.

heard individually. Only the next day, I passed a shop and saw a secondhand copy of this very album on tape for the humble sum of £2.49 and bought it without a second thought.

Playing it on the Walkman was a great experience that night. I had inherited my brother's old Aiwa dual tape deck as part of my system. Come to tonight and I thought I would play 'Songbird' on it. It was a revelation. My rather rag tag system (NAD 3020, said tape deck and Celestion Ditton 22 'speakers and budget wire) just showed how much that listening to music is the only reason to get this kit. The tape had a lovely warm full sound, the speakers handling the bass well. Not too much treble because of Dolby, but I heard everything playing, in its place and it was just so nice!

I hope I got my meaning across. Firstly because of my brother's encouragement, the enjoyment of reading your mag and advice of your good selves I got to this point. I will make steps to improve my system as money allows, but will listen to the music more, not just the equipment. Many thanks gents, past and present and I look forward to reading your mag for as long as it goes on.

Paul Clewlow

Thanks Paul – and yes, I'm also amazed at how cheap prerecorded music cassettes are these days; £5 will often buy you ten albums from Oxfam. With a half decent cassette deck (and there were plenty made), they're capable of surprisingly good results considering their cost! **DP**

BITS AND PIECES

I am looking for a supply of idler wheels for early BSR decks - any suggestions very much appreciated!

John Walker

Anyone looking for miscellaneous spares for classic turntables would do well to contact Technical and General Ltd. on 01752 848816. Their full postal address is P.O. Box 53, Crowborough, East Sussex, TN6 2BY. Tel: 01892 654 534. **DP**

TAKE ON ME

I have had pleasure of getting your assistance previously. And I must say that I am delighted with my Goldring 1006. Therefore I turn to you again, with another cartridge/RIAA questions, because it is very difficult to test cartridges on your own system. And how many dealers have got a 125/Hadcock combination in their shop? Since you have tested all the equipment in my vinyl setup, I therefore turn to you.

First the background data. My turntable is a Thorens 125 mkII, with a Hadcock 242SE arm. A nice deck that I am very pleased with. Until now I have

been using the 1006, and fed the signal to a Creek OBH-BSE phono-amp. My amplifier is an Audia Flight II, connected to my Vienna Acoustics Mozart speakers with Chord Odyssey2. It has worked great, but I would like to get an even better sound. Therefore I have bought a second hand Clearaudio Basic Symmetry MC-RIAA, and I am now using a Benz Micro Gold MC-cartridge. However, I want to change the cartridge as I feel that an improvement here will be worthwhile.

I have been considering one of the Ortofon Kontrapunkt cartridges, because these are very nice MC performers, which would probably suit the Basic Symmetry very well. You have tested the Basic Symmetry, so do you have any suggestions for the cartridge that will make a match made in heaven? If you think that the Basic Symmetry is the wrong choice of RIAA, please let me know, and suggest the right one. And one last question - what would be a suitable interconnect between the RIAA and my amp? And when these least issues are being solved, I think I have reached my final setup for many, many years.

**Morten,
Copenhagen**

Okay, well if it's something to last you 'for many years', may I suggest the following? We love the Ortofon

it should still give excellent results with your superb tonearm. As for an interconnect – van den Hul's The First would be just the job, brilliantly neutral with a slightly 'dark' tonality to match the Ortofon's 'brightly lit' upper midband. **DP**

DIRECT DOWN UNDER

A quick note in relation to firstly the excellent review you recently ran on the lovely Spondor S8e and secondly the letter from 'Ben' in the same issue. What an accurate well written account of what Spondor really is about and the alternative it offers in the loudspeaker market place! Thanks for that.

In relation to Ben's letter (page 107) he finishes his note to you by mentioning that Spondor's are hard to audition in Australia as they are sold 'direct'. I would like to counter his suggestion that products that are sold direct are hard to audition and I would also like to offer a few reasons why we made the tough decision to sell direct rather than through a dealer network.

Firstly the reasons. In Australia there is a small population spread over a huge country, but like anywhere else cheap home cinema speakers/equipment and custom installation have become the mainstay of any 'specialist' audio business. In Australia we have nearly as many brands available as anywhere else



Thorens TD125 – a serious turntable needs serious ancillaries.

Kontrapunkt c (at under £1,000 there's little to touch it, period), and it suits Whest Audio's PS.20/ MsU.20 phonostage (£1,600) brilliantly. What this gives you is an exceptionally smooth and clean source, with lovely detailing and sublime tracking - it's a fit and forget solution. I'm not convinced that your Thorens TD125 is quite up to it, but if you like it and it's in tip-top condition,

in the world, but we are now left with very few dealers who are set up or even interested in properly demonstrating decent hi-fi. This wealth of brands available to very few dealers has put companies like ours in a difficult position when it comes time to bring even a famous brand like Spondor back into a marketplace that it left ten years before.

We were frustrated by the high level of interest from the public in

Spendor's new range and the complete lack of interest from quality dealers in a new product when they already had a cupboard full of premium, known quantity, brands. Hence the very difficult decision was made to import the product and sell it direct to the end user (customer). The benefit of this fine product being readily available to the Australian public in my mind outweighing the disadvantage of not being able to walk into a store for quick (and many cases meaningless) audition.

Some of the advantages of our direct sell plan were and still are an obligation

free in-home demo, reduced retail prices, better service as the consumer is dealing direct with the importer and getting first hand information, and we are now adding agents around the country to come out and install the speakers for the in-home demo. This also removes the need for the security up-front payment we normally request for our in-home trial and removes the need for us to charge for return freight as well.

I feel that a demo with your own music in your own room on your own equipment is very much the best way to audition any potential hi-fi purchase

and therefore I suggest that our system has plenty to offer potential Spendor purchasers. This is backed up by plenty of happy customers who have purchased Spendors from us using this system over the last couple of years.

If you could pass this info on to Ben it would be greatly appreciated as from what he says a pair of S8es would suit him perfectly.

Thanks again for a first class magazine and this opportunity to reply.
Andrew Hutchison.
Australia
(www.homecinemaimports.com)

MORE ON THE ATMA-SPHERE S30 POWER AMPLIFIER

Thank you for taking time to evaluate the Atma-sphere MP3 preamp and S30 power amp combination. We're delighted that the amp found favour in subjective terms but would like to correct the facts regarding the tubes used, and also to qualify the power output and the versatility (or not!) of the amplifier. Regarding the power tubes – the S30 does not use expensive 300B triodes as reported, it uses 6AS7G triodes which are one of the cheapest tubes available (\$26 a pop from Atma-sphere). Furthermore, the amp doesn't require matched pairs, and is also very easy on tubes so a good life expectancy can be forecast (10,000 hrs has been reported!). Lastly – the tubes are warranted for 12 months from new.

Regarding power output of the S30 – Atma-sphere quote 30w into 8ohms, rising to 45w into 16ohms (OTL amps like higher impedances), so not quite sure what's happened in the testing!

More importantly, the S30 and indeed any of the Atma-sphere designs can be married successfully to 'normal' 8 ohm and lower impedance loudspeakers by using the Zero autoformers which look like toroidal transformers only they have just one set of windings i.e the signal doesn't have to 'jump' from one set of windings to another – the Zeros' one set of windings carry multiple taps that are used to 'magnify' the loudspeaker's impedance to suit the power curve of whatever amplifier is used to drive them. For example, we have a customer who is successfully driving a pair of Quad 63s with an Atma-sphere S30 using the Zeros on their 3x impedance setting (I guess making the 63s a nominal 20ohm load?). The Zeros sit between the amps and the speakers and are effectively a loudspeaker 'fix' to allow their use with OTL amps. The Zeros are £695 a pair – check out www.zeroimpedance.com for all the info on these marvellous devices.

best regards

Simon Matanle

Musicology,

Website: musicology.co.uk,

Email: info@musicology.co.uk,

Tel: +44 (0) 1273 700759

The amp generated a lot of distortion figures, as its behaviour and distortion pattern was a complex one compared to a solid-state amp., or one with less hum. The wrong figures were put into print. As the manufacturers state, full output for 3% distortion was recorded as 30W with a Rohde & Schwarz UPL spectrum analyser reading only harmonics. However, a balanced distortion meter, a Hewlett Packard 8903B, showed there was some instability as the amp moved into clip and, taking this into account, it gave 18W output for 3% distortion. The 0.3% distortion limited output, which I normally use



as a sensible maximum, was 2W though. Consequently, we reviewed the amplifier using this as a sensible limit. Had we pushed it harder, to the 30W claimed, our conclusions would have been less favourable. So whether it is a 2W, 20W or 30W amplifier rather depends upon how much distortion you are prepared to tolerate as a listener.

From our point of view it isn't fair for us to use 0.3% distortion as a rule of thumb limit for the products we review generally, but 3% for a specialised amplifier simply because its manufacturer chooses to use such a high limit. Sorry to say then, that by our general standards, which are hardly rigorous - Harold Leak used 0.1% after all! - the Atma-Sphere was a 2W amplifier.

Yes, the valves were 6AS7G triodes and not the 300Bs, which look similar. Our apologies for not spotting this. As you say, it makes valve replacement much less expensive.

An auto step down transformer is a neat idea, but not an inexpensive one at £695 a pair. Without it the Atma-Sphere produces 3% for 2W into 4ohms, so it does not like low loads, and it has no 4ohm tap option of course. Direct coupled valve amps generally do not like low loads and triangulate into them, as valves are high impedance devices unable to deliver current, causing them to slew.

All this rather highlights the specialised nature of the Atma-Sphere and direct coupled valve amps in general. Nice idea then, but perhaps output transformers aren't such a bad idea after all. With them, auto-transformers are unnecessary. For those not convinced, listen to this amplifier with sensitive, high impedance loudspeakers to get the best from it. And, like us, keep volume down for a clean, clear sound. **NK**

audio cables & accessories
- bigears speaker cable and
interconnects-mail order
specialists worldwide

BIGEARSAUDIO
website: www.bigearsaudio.com updated daily

quality used vintage
& modern equipment
bought, sold-part-
exchange most welcome!!

If you're looking for exciting, dynamic, full bodied soundmounts then you must audition
this... simply the best... **ANYWHERE!!**

WE ACCEPT PAYPAL PAYMENTS and ALL CREDIT CARDS!!

Cryogenically treated, fitted with "Eichmann Silver Bullet
Plugs", the best cable at any price, hearing is believing-please to audition a pair!! £295 per metre pair

**NAIM: AUDIO NOTE: ROKSAN: ISORILE: ATACAMA: AUDIO ANALOGUE:
AUDION: BLACK CAT ELECTRONICS: CAR-TRIDGE: MAX: CONSOUNANCE: VAAE EQUIPMENT: ETALON
AUDIO: GOLDRING: GRAAF: GRAHAM SLEE: HEAD-DOCK: HEART: MICHELL: MISSION: ORIGIN LIVE:
ORTOFON: PATHOS ACOUSTICS: PROJECT: SHANLING: SME: TRIANGLE: SPEAKERS: MONOPULSE
UNISON RESEARCH: USHER LOUDSPEAKERS: MISSION SPEAKERS & SURROUND SOUND SYSTEMS**

VALVE AMPS	Monitor Audio Monitor 3 Speakers (Top Treeter Model)	£275
AUDIO RESEARCH LS15, boxed as new	Epos ES 11 brilliant small stand mounter,	£245
AUDIO RESEARCH L59, boxed as new	Epos M15's excellent all rounder, floor standers	£350
PATHOS CLASSIC ONE, boxed as new,	RUARK SARRIS, cherry,	£275
BEARD P35 MK1	RUARK Equinox in black, very nice!!	£275
WORLD AUDIO EL34 AMP	Celestion SL5's excellent cond.	£275
AUDION EL34 STEREO POWER AMP	Hybrook Quinets; gold piezo tweeter (£1450)	£425
AUDION 3008 STEREO POWER AMP ex-dem (£2150)	VIENNA ACOUSTICS Mozart speakers, as new, boxed (£1500)	£950
Black Cat Electronics P24 Valve PAIR of PHONO blocks (Lowthers/Tannoy)	QUAD 111's, cherry, beautiful,	£249
Black Cat Electronics stunning Valve line stage/FET PhonoStage/PREAMP	Q149, metal, cylindrical speakers like BBC LS3/5a's mint,	£375
Beautiful ARION Class A Valve Integrated AMP uses 5881 valves	HERNDON M5's, active, as new plus stands and all cables,	£375
Croft Super Micro tube phono/pre-amp		
Audion CD1 Valve pre-amp - classy sound		
ANTHEM X1 EL 34 single ended stereo valve integrated amplifier		
BAT 3K hybrid phono stage, boxed		
MISTRAL 5881 push-pull 20 watt integrated		
TRANSISTOR		
ETALON Suprampli remote, 40watts, simply stunning	SHANLING CDB0	£450
KELVIN LAB5 class A, PH and MC phono stages	SOME FRONTIERS SFCD1	£850
MYL A1 integrated, class A, 100 watts	NAIM CDS	£835
NAIM MAC 42-5, mint	LEITCH TUBE CD PLAYER CDP06T	£950
NAIM MAC 42-5, as new, phono by-pass mod.	PARANZETI CD17 MKII (£850)	£595
NAIM SNAPS, just serviced,	Audio Innovations full-range CD-TUNER boxed as new	£219
NAP 110 very nice,	CYRUS DAD7 & PSX as new and boxed	£725
MISTRAL integrated, black, warm but dynamic	HEART CD6000SE LE	£750-00
CYRUS 1 good classic,	SHANLING SCD-1200C/NEW	£2150
LINX STRATOS/VDH wired pre-amp dual-mono	SHANLING CDT100 MK2 CD player, as new boxed	£1250
QUAD 66 pre-amp with large console control	Marantz CD4000 OSE as new boxed	£175
QUAD 99 two mono blocks, excellent condition,	MTRAD CD10 boxed	£215
QUAD 33/44 pre-amps, 303/306/405 power amps always available	MTRAD CD20 boxed	£295
Exposure 11 and 12 Pre-amp and Power Supply	DPA PDM1 Series 2 DAC	£135
Exposure Super 8 Power Amp	CAIRN FOG 2	£1500
SPEAKERS		
LIVING VOICE - Auditoriums as new-boxed, maple (£1750)		
ETALON Supraton 1		
ETALON Supraton 2 very natural sound		
NAIM Credos in cherry beautiful, boxed		
AUDIO NOTE AN-1 LOUDSPEAKERS with stands, everything you could want		
boxed and new 1 year old		
REF 105/7 REFERENCE LOUDSPEAKERS, darlek type,		
TOTEM MITES (449) AS NEW, boxed		
MONOPULSE 2245 ex-dem, seriously dynamic		
QUAD ESL57's black, known history		
QUAD ESL 63 Speakers complete service by QUAD		
QUAD ESL 63 Speakers complete service by ONE THING		
Jordan Watts Modular speakers rare matched pair ex-BBC		
Small speakers K's fantastic small speaker		
CELESTION VF302's "s" shaped style, (£650)		

chrisbitchley@btinternet.com 01736 740421
07947 678256

Rochester Hi-Fi

30 HIGH STREET, ROCHESTER, KENT, ME1 1LD
- 01634 880037 - www.rochesterhi-fi.co.uk

ADVANTAGE
ARCAM
ATACAMA
AUDICA
AUDION
AUDIOPHILE BASE
AVI
BAT
BOULDER
CAIRN
CLEARAUDIO
CYMBAL
DALI
JMLAB
GAMUT
GOLDRING
GRADIENT
GRADO
GRAHAM SLEE
GRAVES AUDIO
LOEWE
LUMLEY
MERLIN
MUSIC MAKER
MUSIC TOOLS
NAD,
NOTTINGHAM ANALOGUE
OPTIMUM
PARTINGTON
PURE
QUADRASPIRE
STELLO
TIVOLI
TRANSFIGURATION
USHER
VINCENT





CALL NOW TO UPGRADE YOUR SYSTEM

RETRO REPRODUCTION

QUALITY HIGH FIDELITY & VINTAGE

AMPLIFIERS

Arcam Alpha 9 Pre Amp, top of line	£350	ProAc Response 1S Rosewood finish	£650
Arcam Alpha 9 Power Amp	£350	Quad 67 ESL, like new, brown	£995
Audio Research LS1 silver, mint	£595	Quad 988 Electrostatics, 15mths old	£2495
ATC 150 Integrated Amp, 12mths old	£1395	REL Q201E sub woofer maple finish	£495
ATC CA2 Pre Amp Remote, boxed as new	£495	Ruark Prelude MKII cherry finish boxed	£495
Consouance Cybar 10 Integrated Amp,	£495	Ruark Balmoral 12" drive units	£995
6550 tubes, superb headphones stage		Totem Arrow speakers sealed boxed new	£725
Conrad Johnson MV55 power, boxed	£795	Yamaha NSM 1060 black	£995
Cyrus PSXR PSU unit silver, boxed	£275		
Cyrus 7 Integrated Amp Silver, boxed	£495		
EAR 834P Valve Phono Amp	£450		
EAR 834L Valve Line Stage	£495		
Hoveland L200 valve remote pre amp	£POA		
one of the worlds finest, 1 month old			
KR ENT. 18BSI valves 842, 18watt	£1495		
McIntosh 2275 New £5500	£3795		
Marantz PM7200 Class A integrated amp	£235		
Musical Fidelity Nu-Vista 300 Power Amp	£2295		
boxed new Serial No. 002			
Naim NAP90 with 92 Pre Amp	£495		
Naim 140	£295		
Naim 120 with NAC 12N (serviced)	£250		
Nytech CTA252X22 CPA602 ARC101	£195		

CD PLAYERS DACS

Arcam Delta 170.3 transport	£150
Arcam Delta 110 digital pre	£95
Audionote CDT2, top loading Transport	£795
Audio Alchemy DAC in the box	£95
AudioLab 8000 transport & dac, boxed	£895
Cyrus DAD7 top loading CD Player, boxed	£425
Marantz CD17 K1 Signature	£495
Marantz CD6000-05E	£195
Meridian 206 Delta Sigma CD Player	£250
Meridian 206 Original Multi bit player	£395
Meridian 500 series 24 bit	£795
MicroMega Stag+ 5 CD Player	£250
Musical Fidelity E609 CD, Piano black	£250
Musical Fidelity X-Disc HDCD boxed	£175
Naim CDX 1999 boxed	£1295
Naim CDi 16 bit one of Naim's finest	£895
Pioneer Precision PCSS505 CD player	£195
Phillips CD850	£145
Quad 66 CD Player	£350
Quad 67 CD Player	£495
Quad 77 standaline CD player	£395
Roksan DP1 Transport 5	£395
Teac H500 champagne finish	£125

MISCELLANEOUS

A&R Tuner	£45
Cambridge Audio T55 (boxed mint)	£75
Denon TU260L	£65
Sugden Tuner	£85
Quad FM3 Tuner (boxed mint)	£95
Quad FM4 Tuner	£195

CD RLS

DNM pre power amp, plastic case model	
JBL K2 £20,000 new	
Krell FPB200 power amp	
Neat MFS ash finish	
Quad 809 Monoblocks	£POA
Quad 99 CDP2 CD/pre	£125
DNM Redeko Speakers with stands	£695

GENEROUS PART-EX. ON ALL EQUIPMENT, NEW OR USED. WILL BUY GOOD QUALITY EQUIPMENT AS ABOVE. NEXT DAY MAIL ORDER & UPLIFT FACILITIES

cairn EAR N

A SME n

Opening times: 10.30 - 5.30 Tues. to Sat
28a Haddington Place, Edinburgh EH7 4AF
Tel/Fax: 0131 558 9989
Email: retro.reproduction@virgin.net
www.retroreproduction.com

Bosendorfer

Renowned for the skill and craftsmanship in building the finest traditional concert grand pianos, Bosendorfer has now created a line of loudspeakers using a new design radically different from those of the past. Going against the usual conventions of loudspeaker construction, Bosendorfer's cabinet design is a living, resonating body not an inert édead'shell. This creates a sound stage which comes significantly closer to the live experience than is achievable by conventional loudspeaker systems.

Musical sounds are formed by a complex blending of the fundamental tone, formants and overtones. The formants are primarily responsible for voice recognition because they determine the timbre: their frequencies remaining constant even when the overall tone changes. This basic musical principle, along with the consideration of high pulse dynamics, makes music come to life.

In the expert opinion of leading acousticians, the critical parameters for authentic sound reproduction include extremely low levels of modulation distortion in frequency, amplitude, pulse, time-base, phase and inter-modulation- loudspeakers that function **three-dimensionally**, as only **Bosendorfer's do**, satisfy these requirements.



These parameters are especially important for reproduction of tones such as vibratos, violin tones or the human voice, which are themselves a kind of frequency modulation. Additional modulation caused by electronic intervention or use of filters only leads to a distortion and misrepresentation of the original sound.

Since Bosendorfer loudspeakers were designed without losing sight of this **law of tonality**, they are capable of producing live music of every genre with incredible accuracy. In this way, sound quality, recording quality and musical expression can all be heard to their full advantage.

Threshold



AUDUSA

AUDUSA EUPEN The world's only true Ferrite technology cables - a high quality ferrite is extruded over the conductor strands. Power Cords - GNLM 5/2.5 (CSA 2.5) and GNLM 05/04. From £48 for a 1m power cord terminated with an IEC and MK tough plug. Also available are the CMS Analog, Digital and Video Interconnects with RCA, XLR or BNC connectors.

A must for all digital products - CDP, DAC/Transports, DVD, Sat/Cable receivers, Digital power and pre amp etc. Equally effective on TV's CRT/Plasma/TFT

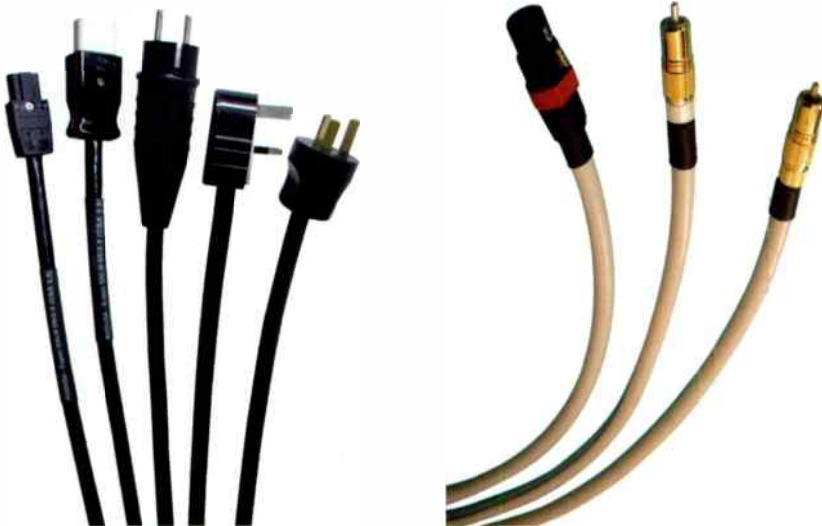

AUDUSA OOM products include ceramic speaker cable isolators from the USA, MK Tough plugs, IEC's, Wattgate 320L IEC and USA Plugs with silver plated contacts. Locking banana and RCA connectors with silver plated pins. New in stock are 13 amp fuses with silver plated end caps.

LAT INTERNATIONAL - USA

Power, Analogue, Tonearm, Digital, Video interconnects and single and biwire speaker cable.

Silverfused wire technology.

NEW FOR 2005

IC 300 Analog and DI-30 Digital Interconnects, AC-2 MKII Power cord, SS800 and SS1000 MKII Speaker cables.



WWW.AUDUSA.COM

T: 020 8241 9826, 020 8264 0249 F: 020 8241 0999 E: sales@audusa.com



SOUND DEAD STEEL ISOPLATMAT £79.95

Placing the mat on any deck's platter is quite amazing; flick the circumference of the platter without the SDS mat and it 'tings' (especially if it's metal, or glass rather than Acrylic) – but then add the SDS mat and repeat the exercise and it's far more akin to a dull 'thunk'.



This shows how the mat takes so much mechanical energy out of the platter, deadening it down more effectively than any rubber, felt, glass, cork or Sorbothane mat I've ever tried. If the 'finger test' proves its mechanical efficacy, then you should hear the difference it makes when records are spun in anger.

This is the best turntable mat I've yet heard. It may not work with every deck equally and may also require some experimentation (rubber mat on or off, arm VTA up or same, etc.), but I've tried it on a wide variety of decks (budget and high end, belt drive and direct) and every time I've wanted to keep it on rather than reverting back to stock. At well under £100, it's a bargain!

David Price - Hi-Fi World January 2006

Sound Dead Steel Ltd

54 Kingsway South
Team Valley
Gilesgate
NE31 0SQ

ISO9001:2000

Tel: 0181 482 1147

Noise Abatement Society and

email: sds-uk@btconnect.com

DEFRA John Connell Technology

www: sounddeadsteel.com

Award Winner 2005

Art Audio

Established by Tom Willis 1988

TUBE SOUND Turntable mat and isolation blocks. made from high density carbon.

CRYOGENIC TREATED Valves and components.

Send for our list of Direct Sale Components

VALVES

Transformers, push pull, single end. All chosen for our High End Amplifiers.

STOCKISTS & INFORMATION

On our range of valve amplifiers.

LONDON

Hear Here, (Kensington) West London.

P: 020 7 937 0856 M. 07768738372

E. hearhear@onetel.com

MIDLANDS

Definitive Audio, Long Eaton, Nott's.

P. 0115 973 3222 F. 0115 973 3666 E. shout@definitiveaudio.co.uk

NORTH

Shadow Audio Consultants, Glenrothes, Fife.

P. 01592 744 779 F. 01592 744 710 E. info@shadowaudio.co.uk

Art Audio (UK) Ltd

62 Vaughan Avenue, Hucknall, Nott's. NG15 8BT.

website: www.artaudio.com Email: t.willis2@ntlworld.com

CLASSIQUE SOUNDS

(LEICESTER)

UK agent for One Thing Audio.

VINTAGE HIFI & VALVE SPECIALIST. TEL 0845 123 5137 (local rate, UK only)

WANTED Vintage and modern hifi eqpt.

Part exchange welcome.

Leak Stereo 20 full rebuild using Jensen Paper in oil caps £299.00
Conversion of Leak valve pre to passive including Silver wired/soldered/rhodium plugs £299.00

FOR SALE. PRE/POWER AMPLIFIERS

Leak Variatone pre amp. Converted to Passive. Pure silver wire/silver solder/rhodium plate phono/valps pot.	£ 350	Quad 99 power amplifier. Mint & boxed.	£ 349
Quad 33 pre amplifiers. From.....	£ 75	Marantz's SR110 receiver. Mint and boxed/remote	£ 120
Affordable valve Co tube amplifier. Mint & boxed.	£ 550	Naim NAC 92 pre amp. SNO 161840. Mint. Boxed	£ 299
John Sheame 2.5 int amplifier. Ex condition. Boxed	£ 295	John Sheame 3.5 power amp. Ex condition. Boxed.	£ 295
Meridian Linear MC phono stage/pre-amp. Boxed.	£ 149	Anatek A50 Class A integrated. Cost £1000. 50W/ch	£ 449
Musical fidelity Typhoon pre and power amplifier. With balanced cables. MM/MC input. Boxed & instructions.	£ 295	Galactron MK-2121 amplifier. 60 watts of pure class A. Beautiful Italian styling. Wood cheeks. Cost new £1400	£ 699
Marantz PM17 int amplifier & rem. Mint. Boxed.	£ 549	Musical Fidelity F16 Class A power amp. Mint/Boxd	£ 1350
Musical Fidelity A1 class A integrated amplifier.	£ 199	Musical Fidelity B1 integrated amplifier. Good cond	£ 125
Nad monitor series 1300 pre-amp with MM/MC.	£ 149	CR Developments Carmenta Line valve pre-amp.	£ 450
Woodside STA-50. BG. SE. Valve power amp. Mint.	£ 999	Woodside SC26 Valve line pre amplifier. Ex cond	£ 690
Leak Stereo 30 integrated amplifier.	£ 50	Leak Stereo 70 integrated amplifier.	£ 60
Leak TL12+ valve amplifiers. Bronze finish & rebuilt with expensive paper in oil caps & Rhodium plate phono.	£ 695	Leak Stereo 20 rebuilt with Jensen paper in oils.	£ 695
Arcam 8P power amplifier. Mint/boxed/instructions	£ 175	Cyrus 111 integrated amplifier. Excellent	£ 299
Quad 303 power amplifiers from.....	£ 125	Quad 405/1. Boxed and in good condition	£ 225
Arcam Zeta 1. Pro logic Cinema amp. Cost £999.00	£ 450	Tube Technology Unisys valve pwr amp. Mint bxd	£ 995
Marantz PM66SE Ki signature integrated amplifier	£ 199	Linn LK2 power amplifier. Good condition	£ 299
Linn LK1 pre-amp and remote. Good condition.	£ 249	Leak Stereo 20 valve power amplifiers from....	£ POA
Quad 11s in various condition and prices	ePOA	Harmon Kardon integrated valve amp. 110V. V rare	£ 299
Naim Nap 180 power amplifier. Mint. Boxed.	£ 379	Nakamichi PA5 100W/CH power amp. Cost £1300	£ 650
Nakamichi CA5 pre-amplifier. Ex cond. Cost £750	£ 795		

TURNTABLES

Linn Basic turntable with Linn LVX tonearm	£ 175	Arison RD80 with Linn tone arm. Ex condition.	£ 149
CJ Walker CJ55 turntable. Cut out for Linn arm	£ 79	Transcriptors Hydraulic Reference turntable. Nice	£ 799
Manicore Mantra with Linn Basic+tone arm. Excon	£ 249	STD 30SS motor unit. No arm. Nice deck.	£ 100

SPEAKERS

Beautiful pair of Quad ESL57 spkrs. Black finish. Very late serial numbers and rarely found in this condition.	£ 795	Pair Quad ESL57's. Great condition. Brown cloth	£ 999
Pair MAF speaker stands for Quad ESL63 speakers	£ 199	Snell E2's with dedicated stands. Just Serviced.	£ 699
Pair Sendor S3 mini speakers (cherry) Boxed. mint	£ 350	Pair Quad ESL63's. Ex cond with RA oak feet.	£ 1199
Quad ESL57's Bronze. Serviced Quad 2003 Superb	£ 750	Acoustic Energy Aesprit AE300. Mint/bxd.	£ 400
Castle inversion 15 & dedicated stands. Cost £700	£ 345	Acoustic Energy Aesprit AE300. Mint/bxd.	£ 400
Pair Quad ESL63 speakers in black. All new panels and full service. 1 year guarantee. Beautiful condition	£ 1799	Quad ESL63 speakers. Upgraded with the Black Gate cap mvd and all new panels 18 months ago. Boxed	£ 1399
Quad ESL63 speakers. Fully rebuilt by One Thing Audio. Black cloth fronts. 5 star review in HiFi World. Mint	£ 1799	Rupert stands for Quad ESL57 and ESL63 speakers	£ 200
Pair Quad ESL57 and ESL63 speakers	£ 295	Morkunt Short MS201 pearl. Brand new. Black	£ 169
B&W 602.5 Series 3 floorstanders. Beech finish.	£ 295	Rolskan ROK-ONE speakers. Black. Mint. Boxed.	£ 295
Quad ESL57 speakers. All fully serviced with full 3 months warranty. Hear what ESL57's should sound like From £999 pr			

OTHER ITEMS

Musical Fidelity T1 FM tuner. Award winner. £300	£ 95	Sony ST-D77ES DAB tuner. DAB/FM/AM. Gold	£ 299
Nad C5411 Cd player. Mint & boxed	£ 199	Stax SR-3 electrostatic headphones with energizer.	£ 125
Musical Fidelity Tubalog Valve DAC. Rare & mint	£ 299	Revox G36 2 track R/Reel. Valve and very rare.	£ 349
Trichord Research powerblock 500. Mint condition	£ 195	Quad MC phono module for Quad 34 pre amplifier	£ 40
EME 309 tone arm. Mint & boxed @ only	£ 475	Acos Lustre tone arm. Boxed.	£ 79
Mod Squad passive pre amp. Absolutely stunning	£ 299	Audionote DAC 1. Valve Dig to analogue converter	£ 399
Trichord Research Pulsar 1 Dac with Michell PSU	£ 999	Trichord Research/PDS707 transport. Clock 3. Exc.	£ 450
Pioneer PD-S05 Cd + PSU & Mod by Tom Evans	£ 499	Pioneer PDR-509 CD recorder/player. Boxed £300	£ 99
Nakamichi DR4 Cassette recorder. Mint.	£ 150	Sony HAR-LH500 CD with built in 80G hard drive	£ 249
Bulgian 3 pin mains plugs for Quad/Leak etc. Each @	£ 10	Bulgian style P29 mains plugs for Quad 11's etc.	£ 25 pr
Quad FM1 Valve tuners. Various prices from only	£ POA	Stax SR5 electrostatic headphones with energizer.	£ 125
Trio KT880L synthesiser tuner. AM/FM. Black.	£ 75	SME 3009 tonearms from.....	£ 150
Decca London international tone arm. New. Boxed.	£ 175	One Thing Audio Stereo Decoder. New.	£ 200
Linn Tuner. Mint. Boxed. Very unusual. Cost £549	£ 249	Quad FM3 tuner in excellent condition.	£ 99

QUAD ESL57 & ELS63 PANELS/SERVICING ETC

Full rebuild including latest Otec panels/ bass panels & cosmetics 57's £1350

Serviced Quad ESL57 speakers from only £999.00. pr Why spend £4000+?

ESL57 SPEAKERS STANDARD SERVICE £599 per pair

Price includes 2 completely rebuilt treble panels etc. Ring for further info.

"Classique Sounds servicing restores the Quads to a position where they can hold their head high", Jon Marks. HIFI WORLD. April 1999. Full servicing facilities available.

TRANSLUCENT. (somewhat of a bargain) Hifi World. Jan 1999

PURE SILVER INTERCONNECT CABLE

99.99% pure silver conductors. Quality gold plated RCA phono plugs.

Half Metre terminated £70.00 One metre terminated £90.00. Available with Eichmann plugs + £30

New Translucent ULTRA + Heavy duty. 99.99% pure silver (4N).

Eichmann 24 Kt gold plate plugs £199.00 per metre. Or £149 per half metre.

7 day money back guarantee if not better than existing cable

New for 2005. Translucent digital cable. 99.99% pure silver conductor. 1M @ £59 .5M @

£39 Translucent Ultra + digital cable & Eichmann plugs. 99.99% silver conductor.

1M @ £99 .5M @ £69

1.0MM 99.99% pure silver wire @ £15m. 0.5mm pure silver wire @ £6.00m

New 24K gold plated Nakamichi locking banana plugs and RCA phonos @ £4.95 each

New Quality Rhodium plated RCA phono sockets. The best @ only £4.99 a L/R pair.

QED SPEAKER CABLES AT 30% OFF.

Silver Anniversary @ £3.85M.....Micro @ £1.20M.....Original @ £1.95M..... Contour flat @ £1.60

Bronze special edition @ £2.10M...Genesis silver spiral bi wire...Awesome cable at only £42.00M

Silver Anniversary bi-wire @ £7.00.....Profile 4X4 @ £7.00M.....Original Bi-wire @ £3.45M

TEL 0845 123 5137 (Calls charged at local rate anywhere in the UK)

Tel 0116 2135821 or 07815188040 (Mobile). Callers by appt only.

Opening times 10.00am-6.00pm Mon-Friday. 10.00am-2.00pm Saturday.

61 Aylestone drive, Aylestone, Leicester. LE2 8QE.

Email classique_sounds@yahoo.co.uk

Heatherdale
audio limited

202 Findon Road, Worthing, WEST Sussex. BN14 0EJ
Tel. 01903-872288 or (after hours) 07860 660001 Fax. 01903-872234
e-mail: heatherdale@hifi-stereo.com //www.hifi-stereo.com

10% FINANCE AVAILABLE FOR UP TO 3 YEARS ON SELECTED ITEMS. SUBJECT TO STATUS. CONDITIONS APPLY.

SPEAKERS			
Mordaunt Short MS815 speakers	£175	Musical Fidelity 3A Pre Amp	£175
BKS Hybrid 107 Supreme speakers	£1495	Audionote M3 phono Pre Amp	£2750
B&W John Bowers Active speakers	£495	Meridian G02 Pre Amp	£1295
Elitax Liberty 5+ speakers	£140	Mark Levinson 25S phono stage with PSU	£2395
KEF Concorde speakers	£150	Exposure 11 & 12 pre with power supply	£595
Celestion A compact speakers	£195	Naim Nac 92 with Nap 90/3 amp	£595
B&W DM602 series 3	£195	Audio Research SP14	1495
Mordaunt-Short MS 3.30 speakers	£95	Proceed PAV pre-amp	£1395
Audio Physics Tempo's	£795		
B&W Silver signature 30's	£2995	AMPLIFIERS	
Spica TC-50 speakers	275	Mark Levinson ML20.5 Amps	£4495
Orchid LWO speakers ex-demo	£1995	Pioneer Reference system C-73 pre amp/M-90A power amp/	
Martin Logan CLS11 speakers (brand new panels)	£1995	PO93 CD player/CT-91A Cassette deck	only £2495
		Accuphase E307 Integrated Amp Mint	£2500
PRE-AMPS:		Accuphase A20V Class A Amp Mint	£2500
Rotel RC995 Pre Amp	£295	Sirius (Gamut 2) Power amp latest spec	£1795
Conrad Johnson MC-10 Pre Amp	£395	Mark Levinson ML 33 Reference mono's	£11995
		Perreux 200ip int amp	£1095
		Audionote Neiro mono-blocks	£5495
		Parasound HCA 1000A amp	£345
		Audionote Kegon mono's (new £28000)	£11995
		Advantage integrated amp	£1495

ALL USED CARTRIDGES ARE CHECKED UNDER A MICROSCOPE BEFORE BEING OFFERED FOR SALE.

VISA - SWITCH - MASTER CARD - AMEX - DINERS CLUB WELCOME. WE TAKE PART EXCHANGE ON NEW & USED STOCK and buy in for cash

KITS.

DESIGNS ENGINEERED FOR EXCELLENCE WITH:-

- POLYPROP CAPS
- AIR CORED COILS
- HI-TEC DRIVERS
- TOP GRADE COMPONENTS



- CABINETS INCLUDED WITH OPTIONS ON FINISH
- NOTES AND SPECIFICATIONS
- COMPREHENSIVE INSTRUCTIONS
- AVAILABLE AS COMPLETED UNITS WITH STANDARD OR EXOTIC VENEERS
- DISCRETE COMPONENTS
- CUSTOM MACHINING SMALL PANELS, JOINTS & CUT-OUTS

FOR FURTHER DETAILS:-

Q.T.A. Systems

2 Wheatsheaf Way
Linton - Cambs CB1 6XB
Tel: 01223 891091

www.qtasystems.co.uk

MUSONIC STYLI

How to get the most out of your record player in 3 easy steps:

- 1. Buy from Musonic**
- 2. Fit your purchase to your player**
- 3. Turn up the volume**

**After 50 years in the business
We know what we're talking about!**

**Manufacturers and suppliers of Styli,
Pickup Cartridges and Audio Accessories.**

Musonic (UK) Limited
Unit 13, Wenta Business Centre, Colne Way,
Watford, Hertfordshire, WD24 7ND
Email: sales@musonic.co.uk
Tel: 01923 213344
Fax: 01923 213355

For info and to buy online visit:
www.musonic.co.uk

**For all your advertising requirements
please call 020 7372 6018**

or email:

advertising@hi-fiworld.co.uk

whether its Michell Gyro SE v Nottingham Analogue Spacedeck
or Trichord Diablo NC v Graham Slee Era Gold/Elevator

whether its Consonance Droplet v Ayre Acoustics Cx7e
or Shanling CD-T80 v Roksan Kandy Mk3

whether its Audio Analogue Reference Pre and Monoblocks v ?!
or AVI Lab Series v Pathos Classic One

whether its Usher Audio Dancer Be v Neat Ultimatum
or Acoustic Energy Aelite 3 v System Audio SA1530

Find your winner with us!

Acoustic Energy, Apollo, Atacama Audio Analogue, AVI, Ayre Acoustics, Chord Cable, Consonance, Creaktiv, Custom Design, Esoteric, Grado, Inotek, Nbien, Neat, Opera, Pathos, Pure, Resolution Audio, Revolver, Roksan, Shanling, Standesign, System Audio, Teac, Triangle, Unison Research, Usher Audio, Van Den Hul and more!

30b Larchfield St, Darlington, County Durham, DL3 7TE Tel: 01325 241688 Email: world@hifisound.co.uk

www.2ndhandhifi.co.uk



...what are you up for?

Digital - CD, DVD etc

AHI Njoe Tjoeb 99 nr mint boxed
Arcam CD82T as new
Arcam CD72T, block
Arcam CD33T, nr mint boxed
Audio Analogue Maestro 192/24 ex dem
Audiomeca Obsession ex, boxed
Cyrus CD8, ex, boxed
Cyrus CD7G, ex, boxed
Cyrus PSR both colours, from
Marantz DV4100SE
Marantz CD63K1 Signature, ex remote
Marantz CD17 K1 nr mint
Marantz CD85 ex boxed
Meridian 208, ex 209 remote ond phono stage
Meridian 200 Transport, ex remote
Meridian 263 DAC
Meridian 507/24, ex, remote
Micromega Stage 1
Micromega Stage 2 ond matching DAC
Micromega T-drive and T-dac nr mint boxed
Micromega Duo CD3/BS2 nr mint boxed
Micromega Optic bargain intro to Micromega
Monarchy DIP vgc
Musical Fidelity XRay original
Musical Fidelity CDT
Musical Fidelity A3CD, nr mint boxed
Musical Fidelity Kw SACD as new
NAD C541i nr mint boxed
NAIM CD5 nr mint boxed
NAIM CD3 ex
NAIM CDS2/XPS2 nr mint boxed
NVA Transparent Statement, ex crated
Proceed PDT2, nr mint boxed
Rotel RCD971 ex, remote
Rotel RCD991
TEAC T1/D1 ex
TEAC DV50S sealed box, full warranty, THE BEST!
Theta DS Pro Progeny
Theta Pearl Transport, nr mint boxed

Radio/Recorders

Arcam T61 nr mint boxed
Morantz ST4000 ex
Myryod T30 nr mint boxed
Nakamichi DR2 ex
Pare 701ES ex boxed
Quad FM2 the great hybrid, Quad serviced 2005
Quad FM4 ex boxed
Siny JA50ES Minidisc

Amplifiers

199 Albarry AP4 Preamp, Active/Passive
399 Arcam A75+ Integrated, black
229 Arcam Alpha 9 Preamp and Power amp, nr mint, boxed
749 Arcam Alpha FMJ C30 Preamp
Coll Audio Analogue Maestro 150w ref, nx crated
399 Audio Analogue Pucari Seltinho, fab integrated ex dem
Call Audio Innovations, 200/500 pre and power, ex, boxed
Call Audiolab 8000A Integrated
229 AudioNote OTO, nr mint a steel at
Call AVI S2000M Integrated fair
199 Audio Research LS25 Preamplifier, as new boxed
2299 AVI S2000M Integrated fair
349 Bryston BP25 and 4BST Pre/Power, mm/mc, remote
1949 Chord SPM 1000b,
1199 Creek 4330Mk2r Integrated, remote as new boxed
249 Crimson 610C/630D Pre/Monos, nr mint boxed
599 Croft Lineage Preamp
499 Cyrus Power, ex boxed
179 Cyrus 3 Integrated, ex boxed
699 Denon POA6600 Monoblocks, ex boxed
649 Denon DM30 Power, ex boxed
Call DNM Twin Preamp
129 Graaf WB72 and 50/50 Pre/Power combo, ex boxed
349 IFL MA80/MA100/MA100 Pre/Power x2 lovely combo
349 Krell KWA100 Monoblocks, ex, boxed
2499 Linn Kairn (late), LK100, BK140 combo, ex boxed
1099 Lumley Reference 120 Monoblocks
1499 Meridian 555 power
449 Meridian 505 Monoblocks, ex boxed
899 Meridian 205 Monoblocks, ex
499 Micromega Tempo 2
3499 Musical Fidelity 3a Preamp/P150 Power, ex
699 Musical Fidelity A1000 Integrated nr mint boxed
299 Musical Fidelity MA-X50 Monoblocks
299 Musical Fidelity Pre/Typhoon
179 NAIM 92/90 pre, power combo, ex boxed
Call Odyssey - quality monster American oamp: from just
499 Pathos Logos, just back from UKD service, ex boxed remote
1599 Primare A20 mk2, nr mint integrated
399 Quad 50 Monoblocks
299 Quad 34 Preamp and 306 Power amp, each from
149 Quad 44 Preamp, 405 and 405/2 Power amps from
179 Quad 77 Integrated ex with 77 system remote
349 Quad 606, 606mk2 and 707 Power, each from
379 Quad 909 SEALED BOX
749 Roksan Cospan M Pre/Manos x/dem
Call Roksan Kandy Mk3 superb integrated
299 Rotel RC995 superb preamp with system remote
299 Unison Research S6 Integrated, nr mint
949 Unison Research Mystery One Preamp - BARGAIN!
699 XTC Pre 1 Pow 1 combo - mint boxed
1549

Speakers

Acoustic Energy AE1 ex, new bass drivers
Acoustic Energy AE1 Mk2 vgc
Acoustic Energy AE1mk3 ex dem
Acoustic Energy AE2, ex black
Acoustic Energy AE20, ex piano black, c/w stands
Acoustic Energy AE505 nr mint boxed
ATC SCM20, Piano black, vgc, boxed stands
AudioNate ANJ-SPE ex, boxed
AVI Positron, burr finish, ex
AVI NuNeutron IV ex, boxed cherry
B&W CDM7NT, ex, boxed
Castle Eden, ex boxed
Dynaudio Audience 10 ex
KEF Q65SE, ex
KEF Reference 1.2 nr mint boxed
KEF RDM1 nr mint boxed, superb bookshelf
Nbien NX6 Standmount ex
Prac Studio 125
QUAD ESL63 Floorstand, Quad serviced 2005 REDUCED!
QUAD ESL63 Floorstand - bargain, for details please Call
QUAD 11L Standmount, boxed - REDUCED
QUAD 22L Floorstand, piano black boxed
QUAD 12L Standmount as new
Revolver R33 ex dem, well reviewed bargain
Ruork Sabre ex black
Ruork Polladin, vgc
Ruork Equinox vgc, bargain
Sonus Faber Concertino c/w stands
Tandberg Studio Monitor Large
Tannay Chatsworth Floorstand
Wharfedale Diamond series, various

Systems/Misc

Cyrus - PSXR, ex boxed from
JPW 204/200/208 - 5.1 Speakers
Isotek CleanLine
NAIM XPS2 nr mint boxed, less than 1 yr old
NAIM Flatcap
Nordost Shiva Mains 2m
Nordost Red Dawn RCA 1m
Nordost Blue Heaven RCA 1m
Nordost Blue Heaven XLR 0.6m
Nordost Solor Wind 1m
Project Headbox
Pure Elan portable DAB, new
QUAD 99CDP/909 ex boxed
QUAD 34/306 Pre/Power, nr mint grey
TEAC A1/D1/T1 - Amp/CD/Tuner

Analogue

399 Alchemist Bragi Phono stage c/w Forsetti p/s
449 Audio Research PH3SE, nr mint boxed
1249 Coll Chord Phono stage, ex boxed
999 Coll Electrocopianet Phono stage, mm/mc, Lynnwood p/s
399 Graham Slee Era Gold/Elevator combo nr mint boxed
599 JBE SlateSeries 3/Mission774 rare as...
349 Linn LP12/Syrinx PU3 ex afrosomia
479 Call Linn LP12/Velhalla/Akito
399 Linn LP12/OL Advanced DC Kit
Call Linn LP12/Velhalla, ItakLVI, K9 ex
399 Linn Itak 12*
749 Linn Itak 12*
299 Linn Ekos, nr mint boxed
249 Linn Ekos, nr mint boxed
199 Michell Gyro-dec Export
349 Michell Reference Hydraulic/Fluid arm
699 Michell Focus One/Mission 774LC arm
249 Michell Gyrodec SE nr mint boxed
498 Michell Tecadec ex dem
Call Michell Mycro RB300 Incognito rewire, ex
499 Michell Iso/Hera
299 Mission 774 original arm
149 MRM Source heavyweight suspended deck
499 Nottingham Analogue The Foot Tonearm
599 Ortofon Dalphi V, full version, turbo ps, SME IV as new
3749 Ortofon Live Aurora Gold ex dem
249 Ortofon Live Silver as new
999 Ortofon Kontrapunkt B
429 Ortofon MC20 Supreme ex dem
300 Ortofon MC30 Supreme
Call Ortofon MC30 Supreme
349 Pink Triangle LPT/RB250, the best I've seen
379 Pink Triangle PT
649 Project Phono box LE boxed certificate
59 Project RPM65B c/w project arm, ex, boxed
299 Project RPM9X NEW, SAVE £300
799 Project Tube Box, ex
199 Project Phono SE
Call Rega Planar 2/RB250, vgc
299 Rega Planar 3/RB300, vgc
149 Rega Planar 3/RB300, vgc
79 Rotel RQ970
139 SME IV nearly new, nr mint boxed etc
899 SME 3009 boxed
179 Thorens TD 150b boxed
Call Thorens TD 125/SME3009
Call Thorens TD 150b/Mayware vgc
249 Townsend Elite Rock Mk2/Mission 774LC
499 Transcriptors Skeleton/Vestigal
39 Transcriptors Hydroallic Reference
649 Transcriptors Saturn, vgc
1149 Transfiguration Spirit 3, 50 hours max- REDUCED
349 Wilson Benesch Act/Act 2 orm ex
2499

tel 0845 6019390 lo-call, or email world@2ndhandhifi.co.uk

Quality hifi equipment always required for cash... Call us before you trade in... Commission Sales too
VISIT OUR WEBSITE, OR CALL TO SPEAK TO A REAL PERSON TUESDAY TO SATURDAY 10 TO 5-ISH

HEATHCOTE AUDIO

TEL: 01992 653999 MOBILE: 07860 511111 WEB SITE www.heathcoteaudio.co.uk

UPDATED DAILY MOST EQUIPMENT IS ONE OWNER AND BOXED

EQUIPMENT URGENTLY REQUIRED FOR IMMEDIATE CASH PURCHASE. PLEASE PHONE GEORGE 10-6PM

VALVE AMPS

ROGUE AUDIO TEMPEST MAGNUM (NEW SPEC FEW HOURS DEM USE £2800)
 ROGUE AUDIO 86 MAGNUM REMOTE PRE AMP
 ROGUE AUDIO 88 MAGNUM POWER AMP
 ROGUE AUDIO 99 MAGNUM REMOTE PRE INC. PHONO STAGE
 ROGUE AUDIO STEREO 90 POWER AMP
 AUDIOM REFERENCE PRE AMP INC. PHONO STAGE (£2500+)
 GRAAF 50/50/POWER AMP
 CROFT SUPER MICRO-III C/W MC. PHONO STAGE (REVALVED)
 BILL BEARD P-100 POWER AMP (REVALVED)
 AUDIO INNOVATIONS 1000 SERIES 111
 LUMLEY M-120 MONOBLOCS TRIODE SWITCHABLE CHROME FINISH
 UNISON RESEARCH 845 INTEGRATED (SUPER AMP)
 UNISON RESEARCH C-5 REMOTE PRE AMP MM/MC PHONO STAGE
 EAR 834P MM/MC/VOLUME CONTROL

VINYL

ALPHASON SONATA/SEPERATE PSU/HR-100 MCS ARM VD.HUL WIRED
 EAR 834P MM/MC/VOLUME
 LINN LP-12/VALHALLA/CIRCUS/AKITO/K-9
 LINN LP-12/VALHALLA/BAKIK PLUS/CARTRIDGE
 LINN LP-12 BASIK LVY CURVED TONEARM/VMS20E LOVELY ORIGINAL SPEC.
 LINN AXIS/BASIK PLUS TONEARM/CARTRIDGE
 LINN AXIS
 ROKSAN XERXES COGNOCENT/PSU/REGA ARM
 NOTTS. ANA. SPACE DECK/ EXTRA GRAPHITE PLATTER
 CLEARAUDIO CHAMPION LEVEL -1 & UNIFY ARM 20 HOURS USE (RETAIL £2200)
 SYSTEMDECK IIX-900
 SYSTEMDECK TRANSCRIPTION 2 SPEED T/TABLE
 ARISTON Q-DECK/ARM BOXED INSTRUCTIONS ETC
 ROGUE AUDIO STEALTH PHONO STAGE MM/MC (£800)
 LEHMAN BLACK CUBE SE (RETAIL £650?) LAST ONE!
 DENSEN DRIVE MC. PHONO STAGE & PSU
 A.D.C. ALT-1 TONEARM
 BILL BEARD BATTERY POWER HEAD AMP
 REGA PLANER-3

CD/DVD

PERPETUAL TECHNOLOGY PA-1/PA-3 MONOLITHIC PSU ALL SIG-2 LAST 1
 CHORD 1500E 2 DACS + EXTRA 96/192 KHZ MODULE & VOLUME CONTROL (£6800 NEW)
 ALCHEMIST FORSETTI APD33A TRANS. & APD34A DAC INC.VOL.CONTROL
 AUDIO ANLOGUE PAGANINI
 SONY SCD-1 FLAGSHIP SACD/CD (£4500)
 SONY CSD-1 AS ABOVE
 PIONEER PD-95 ULTRA RARE FLAGSHIP PLAYER
 WADIA 8 TRANSPORT AES/BNC/AT&T GLASS
 MSB LINK DAC 24/96khz MODULE
 THETA CARMEN CD/DVD TRANSPORT RARELY ON THE MARKET.
 CEC TL-51 BELT DRIVE TOPLOADER (3 MONTHS USE)
 AUDIOMECA DAMNATION TRANSPORT AES/EBU BNC/COAX
 PRIMARE V-25 DVD PROGRESSIVE SCAN ETC (£1000) LAST ONE!
 TECHNICS SLP-2000 REF.PLAYER (APPROX £1000 TRICHORD UPGRADES)
 Z SYSTEMS Z-3src UPSAMPLER (£1450)
 TEAC P-500 TRANSPORT

SOLID STATE

SONUS FABER MUSICA
 JEFF ROWLAND MODEL 5B POWER AMP
 ELECTROCOMPANET EC 4.7 REMOTE PRE AMP
 PASS LABS ALEPH-P PRE AMP LEGENDARY!
 MUSICAL FIDELITY A-300 REMOTE INTEGRATED MM/MC PHONO
 DPA 50S PRE AND POWER C/W LONG SPEAKER LEADS/INTERCONNECT VERY RARE
 AVI 2000 SERIES PRE AMP & SYSTEM REMOTE
 CLASSE CP-60 REMOTE 2 BOX PRE AMP
 CLASSE CA-400 POWER AMP
 GRYPHON S-100 CLASS-A POWER AMP
 PLINIUS SA-102 CLASS A POWER AMP
 SONY TAE-1 PRE & TAN-1 POWER AMPS (AWESOME)
 ALCHEMIST 'THE ALCHEMIST' HUGE 220 WATT POWER AMP (RARE!)
 ALCHEMIST 'THE ALCHEMIST' REMOTE PRE AMP (£5000+)
 ALCHEMIST 'THE ALCHEMIST' MONOBLOCS (£9000)
 CONRAD JOHNSON PFR REMOTE CONTROL PRE AMP (£3000)
 MERIDIAN 565 PROCESSOR
 MERIDIAN 562V
 ROKSAN LS-2 PRE

MINT/BOXED £1895
 EXCLT/BOXED £995
 EXCLT/BOXED £995
 CURRENT SPEC £1495
 MINT/BOXED £1295
 NOS £995
 AS NEW £1395
 MINT/BOXED £395
 GC £895
 MINT/BOXED £1250
 MINT/BOXED £1895
 MINT/BOXED £1595
 EXCLT £695
 MINT £425

EXCLT/BOXED £1150
 MINT £425
 EXCLT £595
 EXCLT £450
 VGC £395
 MINT/BOXED £295
 MINT/BOXED £225
 MINT/BOXED £795
 MINT/BOXED £950
 20 HOURS USE £1595
 GC £150
 EXCLT £175
 £99
 EX.DEM £395
 BRAND NEW/BOXED £450
 VGC £275
 EXCLT £99
 EXCLT £395
 EXCLT £99

BRAND NEW £1895
 MINT/BOXED £2795
 MINT/BOXED £1695
 MINT/BOXED £495
 MINT/BOXED RING
 MINT/BOXED £1895
 MINT/BOXED £1250
 EXCLT £1450
 MINT/BOXED £375
 MINT/BOXED £1695
 MINT/BOXED £895
 EXCLT £575
 NEWBOXED £495
 MINT £795
 MINT/BOXED £450
 EXCLT £350

MINT BOXED 1250
 EXCLT £2495
 BRAND NEW/BOXED £995
 MINT £1150
 MINT/BOXED £895
 MINT/BOXED £1250
 £395
 MINT £1650
 VGC £3250
 MINT £2895
 MINT £2750
 MINT/BOXED £6500
 EXCLT £2795
 EXCLT £3450
 EXCLT £4750
 MINT/BOXED £1895
 TBA
 TBA
 EXCLT £395

LOUDSPEAKERS

SNELL TYPE A-II
 TDL REFERENCE MONITORS (WALNUT)
 LINN KANS
 LINN SARA'S & DEDICATED STANDS
 TRINITY AUDIO TRIDENT FLOORSTANDERS TRI-WIRE
 CURA CA-30 BIRDS EYE MAPLE
 CURA CA-21
 MIRAGE M1si BI POLAR LOUDSPEAKERS (EXCELLENT!)
 MIRAGE BPS-210 SUBWOOFERS (2)
 ART-2 PRECISION MONITOR FLOORSTANDERS PIANO BLACK (£6000)
 DYNAUDIO CRAFT REF. MONITORS & DEDICATED STANDS
 TANNOY BERKLEYS 15 INCH REFURBISHED
 ALR JORDAN NOTE-5
 RED ROSE SPIRIT RIBBON LOUDSPEAKERS
 PROAC STUDIO 150 CHERRYWOOD
 AUDIONOTE ANE-D ROSEWOOD
 CELESTION A-2 (SANTOS ROSEWOOD) LAST PAIR (£1500+)
 KELLY KT-3 HIGH 95 DB SENSITIVITY CHERRY VENEER
 CASTLE HOWARD-2 (PREMIUM BEECH FINISH)
 CASTLE AVON
 ACOUSTIC ENERGY ASW FB-110 SUBWOOFER
 ACOUSTIC ENERGY AE-109
 REL STORM-1 SUBWOOFER
 CELESTION A-6S SUBWOOFER REDUCED

TUNERS/TAPE/ETC

LYNX THETA TUNER (VERY RARE/GOOD)
 SONY 700ES 3 HEAD TAPE DECK

RACKS/STANDS

SONUS ELITE 4 SHELF
 SOUNDSTYLE XS 105
 SOUNDSTYLE XS-100
 SOUNDSTYLE XS 105 S SHELF ONE ONLY
 SOUNDSTYLE STATUS RANGE ST-105
 SOUNDSTYLE STATUS RANGE ST-100
 TARGET R-2 FILLED STANDS SILVER OR BLACK
 ATTACAMA R-274 FILLED 24 INCH STANDS
 ATTACAMA R-274 LEAD FILLED
 ELEMENTAL 20 INCH LOUDSPEAKER STANDS FANTASTIC SEE PIC ON WEB

LOUDSPEAKER

RENAISSANCE 4 METRE PAIR
 TARA LABS PRIME 1800 18 FEET!! PAIR BI-WIRE AS NEW BOXED ETC
 PS.AUDIO X-TREAM BI-WIRE 3 METRE PAIR
 CHORD CO RUMOUR-2 4 METRE PAIR EX.DIS
 NIRVANA AUDIO SL-SERIES 2.3 METRE PAIR EX DEM. FACTORY TERMINATED
 AUDIONOTE AN-L 3 METRE PAIR (FACTORY TERMINATED SILVER SPADES)
 MIT MH-350 3 METRE PAIR
 NORDOST FLATLINE-GOLD BI-WIRE 3 METRE
 QED XT-350 4MM AIRLOC PLUGS

INTERCONNECT

RENAISSANCE 2 METRE XLR & RCA
 RENAISSANCE 1 METRE SIGNATURE RCA
 HOVLAND G-3 1 METRE XLR BALANCED
 MISSING LINK CRYO 0.5 METRE XLR BALANCED
 ACOUSTIC ZEN SILVER REFERENCE 12 FT PAIR BALANCED XLR
 ACOUSTIC ZEN SILVER REFERENCE 1.5 METER RCA
 XLO 3 METRE PAIR (PHONO) EX.DEM
 TULSA HURRICANE JUNIOR BALANCED XLR 6.5 METRE PAIR
 TULSA HURRICANE JUNIOR BALANCED XLR 1 METRE PAIR
 AUDIOQUEST DIAMOND 2 X 2 METRE PAIRS
 AUDIOQUEST LAPIS 4 METRE PAIR
 NEOTECH PROFESSIONAL CABLE 0.5 METRE PAIR EX.DIS BOXED
 CABLE TALK-3 DIGITAL COAX 1 METRE NEW/BOXED
 BLACK RHODIUM SYMPHONY 0.5 METRE OR 1 METRE
 BLACK RHODIUM CONCERTO AWARD WINNING CABLE 0.5 METRE OR 1 METRE
 BLACK RHODIUM ORATORIA
 NORDOST VARIOUS INC.MOONGLOW

MOST EQUIPMENT STOCKED IS ONE OWNER MINT/BOXED, SIMILAR QUALITY VINTAGE AND MODERN
 PLEASE PHONE GEORGE 10-6PM

EXCLT £2750
 EXCLT £1150
 EXCLT £225
 MINT/BOXED £495
 £895
 MINT/BOXED £1095
 MINT £750
 £2750
 TBA
 MINT £2995
 MINT/BOXED £1595
 LOVELY £995
 EX.DEM/BOXED £1195
 MINT £750
 EXCLT £895
 £795
 BRAND NEW/BOXED £1195
 MINT/BOXED £695
 EXCLT £695
 EXCLT £395
 AS NEW £350
 EXCLT £225
 VGC £450
 NEW/BOXED £295

EXCLT £195
 MINT £295

MINT £295
 EX.DEM £149
 BRAND NEW/BOXED £195
 BRAND NEW/BOXED £195
 BRAND NEW/BOXED £275
 BRAND NEW/BOXED £250
 EXCLT £225
 VGC £149
 MINT £195
 MINT/BOXED RING

CABLES PLEASE SEE WEB FOR FULL LIST

RING
 £795
 £750
 £70
 £475
 £225
 £195
 TBA
 TBA

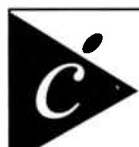

BUY / SELL

HOME CINEMA

MULTIROOM INSTALL

H I - F I

www.choice-hifi.com

tel: 020 8392 1959 / 1963 mob: 07768 720456

info@choice-hifi.com

High End Cable

www.highendcable.co.uk
Call Dave 01775 761880 or order online



Chord Signature Reference interconnects And Speaker cable



Stereovox Digital cables HDXV 75 ohm HDX2 AES EBU 110 ohm



Chord Power cords



IsoTek Multi way



Interconnects, speaker cable & Scart



Nordost Interconnects and tonearm cables



Ortofon Rondo Range

Chord | Acoustic Zen | Stereovox | Nordost UK | van den Hul | IsoTek Black Rhodium DCT | Ayre | STAX | Ortofon | Turbosound | Second hand

Free delivery worldwide on all interconnects

Up to 25% trade allowance on your old cables & equipment

www.highendcable.co.uk or call Dave on 01775 761880

HIFI Classics

Get The Original Experience!

Hificlassics Germany
webmaster@hificlassics.de
www.hificlassics.de



SPENDOR+++QUAD+++ROGERS+++AUDIOMASTER+++AND MORE!

IAN HARRISON HI-FI TEL: 01283 702875

HI-FI AT DISCOUNT PRICES. FREE NATIONWIDE DELIVERY

SALE!

TRADE IN YOUR OLD MOVING COIL CARTRIDGE & SAVE UP TO 60% OFF THE RRP.

CARTRIDGES & STYL	HIFI FURNITURE	HEADPHONES	DVD
VAN DEN HUL	BLOK	SHURE	SONY
ZYX	B.C.D.	BEYER	MINI DISC
JAN ALLAERTS	CUSTOM DESIGN	STAX	SONY
DENON	OPTIMUM	SENNHEISER	LOUDSPEAKERS
CARTRIDGE MAN	ASH DESIGN	SONY	OPERA
AUDIO TECHNICA	APOLLO	AKG	TRIANGLE
GOLDRING	SOUND STYLE	GRADO	FINAL
SUMIKO	SOUND	AUDIO-	ELAC
TRANS-	ORGANISATION	TECHNICA	HARBETH
FIGURATION	ALPHASON		EPOS
GRADO	CABLES	CASSETTE DECKS	MISSION
ORTOFON	VAN DEN HUL	PIONEER	DIAPASON
RESON	VIRTUAL -	SONY	WHARFEDALE
CLEAR AUDIO	DYNAMICS	TUNERS	AMPLIFIERS
KOETSU	BLACK RHODIUM	PURE DIGITAL	CREEK
SHURE	TRANSPARENT	DENON	HALCRO
TONEARMS	QED	SONY	MOTH
SME	ORTOFON	CREEK	C.A.T.
GRAHAM	NORDOST	PHONO STAGES	GAMUT
MOTH	ARGENTO	HEED	ALOIA
CLEAR AUDIO	AUDIO	GRAHAM SLEE	EAR
HADCOCK	SUPRA	WHEST AUDIO	AUDIO VALVE
MICHELL	WIREWORLD	TRICHORD	ACCUSTIC ARTS
TURNTABLES	CD PLAYERS	MOTH	GRAAF
AUDIO TECHNICA	AUDIO ANALOGUE	CREEK	ORELLE
GOLDRING	MONRIO	NAD	MONRIO
MICHELL	GAMUT	EAR	AUDIO ANALOGUE
CLEAR AUDIO	SONY	TOM EVANS	PATHOS -
	CREEK	CLEAR AUDIO	ACOUSTICS
	ORELLE		UNISON -
			RESEARCH

PLEASE PHONE TO CONFIRM PRICE & AVAILABILITY PRIOR TO ORDERING. ALL GOODS ARE BRAND NEW & BOXED WITH FULL U.K. GUARANTEES. NO EX. DEM OR EX DISPLAY GOODS. NO GREY IMPORTS. GOODS ARE NOT SUPPLIED ON APPROVAL. SORRY, NO GENERAL CATALOGUES. PLEASE PHONE OR WRITE FOR SPECIFIC REVIEWS, BROCHURES OR PRICES. SUPPLIER OF HI-FI PRODUCTS & ACCESSORIES SINCE 1986. MAIL ORDER ONLY FROM: IAN HARRISON, 7 MILL HILL, REPTON, DERBY, DE65 6GQ. TEL: 01283 702875. 9am - 9pm INCLUDING SUNDAYS.

hi-fi WORLD

ASSISTANT EDITOR FOR HI-FI WORLD WANTED

Hi-Fi World is looking for a talented Assistant Editor.

Candidates will have an understanding of electronics, a love of music, and an interest in hi-fi. Excellent communication and writing skills are an absolute must. This is a demanding role in every respect. Enthusiasm and dedication are essential, as are organisational skills. I.T. skills are also required.

There is a need to travel to shows, press conferences and manufacturers, not just in the UK but around the world.

The job is based in our main office in Kilburn, London, so applicants must be within reasonable commuting distance.

If you are interested, please send your CV to publisher@hi-fiworld.co.uk

MIDLAND AUDIO XCHANGE

The Old Chapel
Forge Lane
Belbroughton
Worcestershire
DY9 9TD

t. 01562 731100
f. 01562 730228

e-mail. sales@midlandaudiox-change.co.uk
web . www.midlandaudiox-change.co.uk



Ex - demo and second hand items

	Was	Now			
Digital			Pen Audio Chara x-demo	1600	995
Accuphase DP55V CD Player x-demo	2999	1999	Rega ELA Cherry X-demo	749	549
Audio Synthesis DAX Decade 22bit Balanced S/H	3700	1899	Rel Acoustic Stadium III light Oak S/H	1500	795
Audio Synthesis DAX Decade 22 Bit Single ended S/h	2999	1499	Sonus Faber Leather Stands, fixed height, x-demo	310	220
Audio Synthesis Transend Transport S/H	3799	1899			
Electrocompaniet ECD1 24/192 Khz multi-input DAC BNIB	1299	699			
Mark Levinson No360s DAC S/H	7500	2999	Cables and Accessories		
Meridian 206 CD Player S/H	N/A	399	Cardas Neutral Reference 1m RCA-BNC S/H	550	375
Musical Fidelity Nu Vista CR 3D Player S/H	2999	1699	Cogan Hall Intermezzo EMD 0.75m RCA S/H	N/A	199
Orpheus labs One DAC with anagram x-demo	3150	1799	Kudos S50 60cm Stands S/H	199	79
Primare V10 CD/DVD Player x-demo	795	499	Kimber 8TC 3ft IEC-MK S/H	N/A	99
Theta Generation V Balanced S/H	6290	1799	Nordost Valkyrja 1m RCA-RCA interconnect x-demo	1469	795
Theta Pro Basic II DAC with Oscom/Balanced S/H	2990	895	Nordost Valkyrja 1m XLR-XLR interconnect x-demo	1503	829
			Nordost SPM Reference 1m pair RCA-RCA interconnect S/H	649	399
Analogue			Nordost SPM Reference 0.6m pair RCA-RCA interconnect S/H	539	279
Audio Research PH3 Phono Stage x-demo	1699	1099	Nordost BLACK KNIGHT 1m pair RCA-RCA interconnect S/H	70	39
EAR The Head MC Transformer S/H	N/A	299	Nordost SOLAR WIND 1m pair RCA-RCA interconnect S/H	109	59
Koetsu Black 100 hours only S/H	995	599	Nordost SOLAR WIND 0.6m pair RCA-RCA interconnect S/H	92	49
Kuzma Stabi/Stogi S Turntable New& Boxed	N/A	1399	Nordost RED DAWN REVII 2m pair single wired Speaker cables S/H	695	399
Roksan Xerxes XPS3/tabrizi/OC9 S/H	N/A	599	Madrigal MDC1 1m AES/EBU 110ohm Digital Cable new boxed	420	249
Roksan Xerxes XPS1/Rega RB250/K9 S/H	N/A	499	SAP Audio Relaxa MKII Floating Isolation Platform x-demo	399	299
			Siltech SPO18M 4m Mains cable IEC-Shuko x-demo	495	295
Preamplifiers			Siltech FT12 G3 2x0.8m Silver Speaker cable x-demo	540	275
Audio Analogue Bellini Remote Preamplifier X-demo	625	499	Siltech LS38G3 2x2.5m Silver Speaker cable x-demo	800	399
Conrad Johnson PV10bL valve Preamplifier x-demo	1299	799	Siltech LS188 Classic 2x3m Silver & Gold Speaker cable BNIB	3950	2995
Conrad Johnson PV14L Remote controlled valve x-demo	2399	1750	Spectral MI-350 15ft Interconnect RCA-RCA x-demo	1400	799
Densen B250 Preamplifier 2 weeks old S/H	1100	699			
Mark Levinson No380 Preamplifier S/H	4999	2499	GREAT DEALS ON SILTECH AND SPECTRAL CABLES!! CHECK WEB-SITE FOR DETAILS!!		
Roksan L1 Line Preamplifier Silver S/H	2250	799	Transparent Music Wave Bi Wire 2x8ft S/H	499	249
Roksan DS4 Black PSU S/H	449	199	VDH CS-122 HYBRID 2x3m pair Speaker cable ex- demo	172	85
Spectral DMC 30s Reference Preamplifier S/H	7600	4999	VDH Goldwater 2x3m pair Speaker cable ex-demo	48	25
			VDH D-352 HYBRID 2x3m pair Speaker cable ex-demo	205	99
			VDH MAGNUM HYBRID 2x3m pair Speaker cable ex-demo	280	149
Amplifiers					
Audio Analogue Donizetti Mono Power Amplifiers X-demo	1050	729	Tuners & Tape decks, power supplies		
Audio Research VT60 Re Valved S/H	1999	995	Accuphase PS500V Conditioner x-demo	3750	2499
Audio Research CL60 S/H	N/A	1399	Magnum Dynalab FT-R Remote/Preset Switcher S/H	399	199
Conrad Johnson MV60 SE Valve Amplifier S/H	2500	1895	Magnum Dynalab FT101A "Etude" FM Tuner S/H	1250	699
Electrocompaniet ECI 1 Class A integrated S/H	3289	995	Nakamichi DR3 cassette deck S/H	N/A	149
Electrocompaniet AW220 Stereo Power Amplifier S/H	1499	749	PS Audio PS300 multiwave x-demo	1750	999
Electrocompaniet AW120 Dmb Stereo Power Amplifier S/H	2499	1399	Quad FM4 Grey /Phono Tuner S/H	N/A	249
ECS EA1 Mono Amplifiers (pair)	6500	2999	Rega radio 3 Silver X-demo	398	279
OCM 500 Soloist stereo power amp, awesome S/H	2700	899	Rotel RT 950BX Am/FM Tuner S/H	N/A	99
Naim NAP135 1988 S/H	N/A	1199	Tice Solo Powerline Enhancer S/H	N/A	249
Krell KSA 150 S/H	N/A	1299	Tice Solo AV Power Conditioner S/h	N/A	249
Pathos Classic 1 Mk. 1 Hybrid integrated amplifier	1250	749			
Pathos Logos valve Hybrid S/H	2750	1699	<i>Suppliers and installers of High Quality Audio Systems</i>		
Primare A30.2 Power amplifier x-demo	1299	799			
Red Rose Sprit integrated x-demo	1000	649			
Rega Maia Power amplifier Black x-demo	548	399			
Roksan S1.5 Power Amplifier Silver S/H	1499	549			
Roksan S1.5 Power Amplifier Silver S/H	1499	549			
Spectral DMA150 Amplifier x-demo	6850	4750			
Loudspeakers					
Audio Physic Yara Monitor Cherry x-demo	549	399			
Audio Physic Yara Floorstander x-demo	999	749			
Audio Physic Virgo 3 Maple x-demo	4500	2999			
Avalon Acoustics Symbol x-demo	2900	1999			
ATC Active SCM10 SL x-demo	1650	1199			
ATC Active SCM50ASL Maple S/H	7989	3999			
ATC SCM7 Cherry x-demo	499	375			
JM lab Diva Utopia Light wood S/H	7600	4999			
JM Lab Electra 926 Rosenut S/H	2300	1299			
JM lab Electra 927 be Anniversary last pair! New	2800	2400			
JM Lab Micro Utopia Anigre with Stands S/H	3999	1599			
JM Lab Sib XL x5 Grey S/H	1000	650			
Martin Logan Clarity Cherry 4 months old S/H	2498	1999			
Martin Logan Aeon I Oak BNIB	3189	2500			
Pen Audio Rebel 2 x-demo	995	699			
Pen Audio Chanisma x-demo	1995	1199			

Midland Audio X-change are looking for Audio Research, Krell , Mark Levinson , Naim Audio, SME, Wadia.

dial a dealer

This is a comprehensive directory of Hi-Fi Dealers throughout the UK and Ireland.

BRISTOL & BATH

THE RIGHT NOTE

Tel: (01225) 874728. Are you happy with your system? We find that most audiophiles listen for most of the time to systems that are 'not quite right'. Forget the 'Best Buy' reviews and putting a system together like a patchwork quilt. Let us assess the vast range available, you judge the results. We'll help you to plan a system for the future, even if you spread the purchases. Leave 'up-grade-itis' behind, save money and enjoy music all the time. Just listen, and you'll know.

CD: Accuphase, Audio Synthesis, Bel Canto, dCS, Resolution Audio, Wadia.

Vinyl: Basis, Clearaudio, DNM, Graham, Michell, Sumiko, Transfiguration.

Amps: Advantage, CAT, DNM, Gamut, Spectral.

Speakers: Audio Physic, NEAT, Verity Audio. Tuners: Magnum Dynalab. (Credit Cards Accepted).

V'AUDIO

HiFi Consultants: 36 Druid Hill, Stoke Bishop, Bristol. BS9 1EJ. Tel: 0117 968 6005. ATC, AVI, Alon, ALR Jordan, Audio Analogue, Avid, Black Rhodium, Electrocompaniet, EsLab Digital Amps, Harman Kardon, Infinity, Jamo, Lyra, Origin Live, Opera, Ortofon, PS Audio, Ruark, Michell, REL, SME, Sugden, Townshend, Triangle, Unison Research Valve Amps, VPI. Specialists in Video Projectors by SIM2, Infocus, Sanyo; screens by Stewart, Draper, Da-Lite, Owl, and Amps/DVD's by Harman Kardon etc. Demos by appointment only. Home trial facilities. We are not a shop.

CHESHIRE

ACOUSTICA

17 Hoole Rd, Chester CH2 3NH. www.acoustica.co.uk. Tel 01244 344227. All the best in HiFi & Home Cinema from Amphion, Arcam, ART, Audiolab, Ayre, B&W Nautilus, Classe, Focal, JM Lab, Monitor Audio, Naim Audio, Primare, Rega, REL, Rotel, Spondor, Sugden, Thiel, Wadia. We offer full demonstration facilities, interest free credit and delivery & install systems throughout Cheshire, Merseyside & North Wales. Opening hours are Tuesday to Saturday 10.00 to 5.30.

ACTON GATE AUDIO

4 Ruabon Road, Wrexham, North Wales, Tel. 01978 364500. www.acton-gate-audio.co.uk
Audio Visual Specialists. Arcam, Audio Analogue, AVID, Bose, Celestion, Castle, Denon, Harmon Kardon, Jamo, JM Lab, KEF, Marantz, Michell, Mission, Onkyo, Opera, Pro-Ject, Musical Fidelity, NAD, QUAD, Roksan, Ruark, Tannoy, Teac, Tivoli, Unico, Unison Research, Wharfedale, Yamaha, DSP Club Member, Demo Room, installation service. Easy Parking and Motorway access. All major credit cards accepted. 9.30 - 5.30 daily. Closed Sunday & Monday.

CHESHIRE

ORPHEUS AUDIO

Tel: 0161-428 1539
e-mail: anything@orpheusaudio.co.uk
www.orpheusaudio.co.uk
Hi-fi with style and substance. Hyperion loudspeakers and amplifiers, award-winning VPI turntables, Whest Audio, Consonance, EAR/Yoshino, Shanling, Music First pre-amp, 3D Sonics, Monopulse, Lyra, Sumiko, Wire World, Brilliance, Heart, Audiophile APS. Thirty day money-back guarantee (conditions apply).

CORNWALL

BIGEARS AUDIO

To find a system that will allow you to hear the music instead of the equipment phone Bigears Audio, here you will find an interesting array of new and good quality used equipment! my intention is to have satisfied customers whatever their audio preferences. Naim dealer for the South West.
chrisbirchley@btinternet.com
Tel: 01736-740421

LEICESTERSHIRE

DIVINE AUDIO

The Courtyard, Bennett's Place, High Street, Market Harborough, LE16 7NL
01858 432999
Leicestershire's freshest hi-fi and home cinema retailer, offering a service that you expect in an environment that will excite you. Stunning cinema and two channel

demonstration facilities, comfy chairs and coffee!

We get outstanding results from Arcam, Art Loudspeakers, Audio Analogue, Chord Company, Exposure, Focal JMLab, Infocus, Isoblu, Kube Design, Metz televisions, NAD, Opera, Oray Screens, Partington, Pathos, ProAc, Pro-Ject, Quadraspire, Revolver, Sugden, Triangle, Unison Research and a few other surprises.

Open Tuesday – Saturday 9.30 – 5.30 or by arrangement. Free parking 01858 432999, www.divineaudio.co.uk, info@divineaudio.co.uk

MIDDLESEX

RIVERSIDE HI-FI

422 Richmond Road, East Twickenham, Middlesex, TW1 2EB. Tel: 020 8892 7613 Fax: 020 8892 7749. www.riversidehifi.co.uk
Audio Research, Blueroom, Bose, B&O, Copland, Denon, Elac, Infocus, Krell, Linn, Living control, Martin Logan, Michell, Monitor Audio, Musical Fidelity, NAD, Project, QED, Rel, Sennheiser, Sonus Faber, Teac, Theta, Wilson. Finance available. Subject to status. Written details available on request. Export orders welcome. UK mail order available. 3 demonstration rooms. All major credit cards. Open 10am-5.30pm Mon-Sat.

STAFFORDSHIRE

ACOUSTICA

114 Wolverhampton Rd, Stafford ST17 4AH. www.acoustica.co.uk. Tel 01785 258216. All the best in Hi-Fi & Home Cinema from Arcam, ART, Audiolab, Ayre, B&W, Focal, JM Lab, Mj Acoustics, Monitor Audio, Naim Audio, Primare, Rega, REL, Rotel, Spondor, Sugden, Thiel, Wadia, Yamaha Pre Eminent. We offer full demonstration facilities, interest free credit and delivery & install systems throughout Staffordshire & the Midlands. Opening hours are Tuesday to Friday 10.00 to 5.30, Saturday 10.00 until 5.00.

SUFFOLK

AUDIO IMAGES

128 London Road North, Lowestoft, Suffolk, NR32 1HB Tel: 01502 582853. info@audioimages-hifi.com. www.audioimages-hifi.com

Castle, Denon, Harmon Kardon, Jamo, Mirage, Rothwell, Roksan, Sugden, Screen Play, Synthesis, Triangle, Tom Evans Audio Design, Vienna, Vincent, Volta Cables. Refreshingly different selection. Dem Room, Professional AV installer's from budget to high end. Full credit facilities. 9.30 to 5.30 Mon & Sat

SURREY

VIVANTE PRODUCTIONS

LTD, Unit 6, Fontigarry Business Park, Reigate Road, Sidlow, Surrey, RH6 8QH

E Mail: sales@Vivante.co.uk
On Line: www.sales@vivante.co.uk

Tele: 01293-822186
Fax: 01293-820509
Vinyl, SACD, XRCD, HDCD, HDAD, CD etc. – We do the lot! Check our website to see the thousands of interesting titles we have available. Contact us to receive our free monthly newsletter. Ps: we pride ourselves on friendly, fast service and a world beating Musical selection!

SUSSEX

GIG BRIGHTON

(01273) 700759
info@gig-hifi.co.uk
Open by appointment only.
Brighton's newest, freshest and most independently minded

specialists in two-channel hi-fi. Tube amps, high sensitivity speakers, Class A transistor amps, electrostatic speakers and more. In-house servicing, repair and upgrades to tube amps a speciality. Michell, Shanling, Eastern Electric, Atma-sphere, Zu, Audiostatic, Coincident Speaker Technology, Pass Labs, Sugden, Symposium, Ferguson-Hill.

YORKSHIRE (WEST)

AUDIO REPUBLIC,

78 Otley Road, Leeds
0113 2177294,
www.audio-republic.co.uk for the very best in quality hifi in West Yorkshire and beyond, representing Naim Audio, Rega, Totem, Sugden, Shahinian, JM Lab, Filtech, TEAC, Nottingham Analogue, Spectral, Living Voice, Hutter Furniture, Accuphase, Quadraspire, Chord Cables, Dynaudio. Choice of shop or home demonstrations, open Tues - Sat 9.30am to 5.30 pm. Please phone for a chat and directions.

PREMIER AUDIO

- now demonstrating - Room 1: DCS Elgar, Purcell & Verdi Transport, Plinius CD Lad & 250 Power, Verity Fidelo & Sonus Faber Speakers, Siltech Cables, Isotek Sub Station, BDA Equipment Stands Room 2: Audio Aero, Audio Synthesis, Kora Pre

& Power, Pink Triangle CD/Amp, Martin Logan / Audio Physics Speakers, Arcici Equipment Stand, Isotek Sub Station P/S Audio Synthesis, Audio Physics, Audio Aero, Absolute Sounds, DCS, Kora, Plinius, Siltech, Arcici, BDA, Pink Triangle, Avid Turntables, Project, Ortofon, Van den Hul, Mirage. P/X welcome Home demonstration good selection of S/hand. We are 10mins J39 - M1 10mins J30 M62 Tel: Wakefield 01924 255045 - Colin Grundy.

WALES

ACTION GATE AUDIO

4 Ruabon Road, Wrexham, North Wales, Tel. 01978 364500. www.action-gate-audio.co.uk See our main ad under Cheshire.

VINYL/RECORD MAIL ORDER

DIVERSE VINYL

10 Charles Street, Newport, NP20 1JU.
Tel/Fax: 01633 259661/256261.
Email: sales@diverse-music.co.uk
Probably the most varied and impressive selection of brand new LPs you'll find anywhere: international new releases, reissues and audiophile products. Also UK distributor of the Disco Anti Stat LP Cleaning Device. Call for a free catalogue, or visit www.diversevinyl.com

PRODUCT TESTING IN HI-FI WORLD

Hi-Fi World measures all incoming products before sending them out to reviewers and is unique in having such a rigorous vetting system. It reflects our dedicated approach to assessing audio equipment. Nothing gets by before thorough scrutiny.

In-house measurement is costly and time consuming, yet it has always been central to our belief that both readers and manufacturers deserve it, because there is no alternative if complex technologies are to properly assessed.

Measurement achieves many things. It ensures a product is working properly before it is subjectively auditioned. We pick up problems like loudspeaker drive units wired out-of-phase by accident, digital filters that roll-off in a bizarre fashion due to design error, a transmission line loudspeaker with no bass (!), amplifiers with excessive d.c. offsets, excessive jitter and all manner of other funnies.

Manufacturers published data is then checked against our measurements. There is usually little problem here.

The reviewer is then given the results. This gives useful guidance on what to watch out for in listening tests. For example, if three CD players use the same chip set they may well sound much alike in their basic attributes, if not identical. This is useful information for a reviewer.

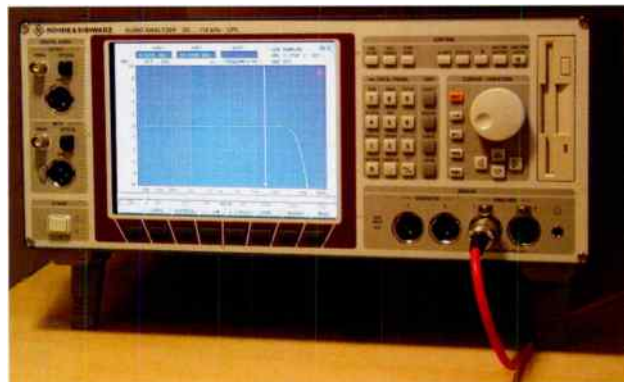

Hi-Fi World uses a range of test equipment from around the world, including a Rohde & Schwarz UPL for testing CD and DVD players. Amplifiers are tested with 8903B Audio Analysers from Hewlett Packard. Loudspeakers are measured with a Bruel & Kjaer measuring microphone and Hewlett Packard 3561A spectrum analysers. We use three of these for basic test work and to ensure our listening room and conditions are balanced. Tuners are measured with a Leader 30125 Lab generator and Marconi 2015 RF generator, plus external MPX filters and equalisation.

We continue to upgrade our testing to keep up with the latest standards, to ensure that both readers and manufacturers receive the most accurate information possible about the items we review. No one does it better than Hi-Fi World.

specialist hi-fi dealers

London

Oranges & Lemons



020 7924 2040

www.oandlhifi.co.uk
61 Webbs Road, Battersea, SW11 6RX
email: oranges.lemons@virgin.net



Cambridgeshire

Analogue Seduction

Authorised dealers for:
AVID, Creek Audio, Chord Electronics, Graham Slee,
Pathos, Trichord Research, Usher Audio, Wilson Benesh

Visit our website to browse or purchase some of our
turntable setup tools and essentials, that are not easily
available elsewhere.

www.analogueseduction.net

Regional

shunyata research

the professionals' reference

AUDIO ATMOSPHERE
tel 01785 71232 stuart@audioatmosphere.com
www.audioatmosphere.com

Naim Specialists

A New Dawn for Naim and Tom Tom Audio...
...the only dealer in the world specialising
purely in these world class products

Extensive selection of current Naim Audio product range
on demonstration and the largest stock of pre-loved
Naim Audio equipment on the planet

New website at www.tomtomaudio.com
Telephone • St Albans 01727 86 86 59

LAI-D-BACK AUDIO LTD

For the secret sound from a single-ended valve
amplifier made by hand.

For more information
mailto:mail@laidbackaudio.co.uk
www.laidbackaudio.co.uk

Phone 01905 640028 Fax 01905 641596

Services & Consultants

**HIFI RECLAMATION
WANTED**

Classic British Hi-Fi Components and Systems!
Top prices paid for vintage or classic audio
separates, accessories or literature.

0845 644 3340

Front End Problem?
contact
The Cartridge Man

It doesn't have to cost an arm and a
leg to get the best - listen to my
Koetsu - and Decca -eater.

Also agents for Croft, Hadcock,
E.A.R. Mitchell &
Moth.

plus cartridge re-tipping service
020 8688 6565
Website: www.thecartridgeman.com

Mail Order

NEW catalogue out now
packed with **award winning** products

WHAT HI-FI? SOUND AND VISION AWARDS 2004
BEST MAINS LEAD UNDER £100
Russ Andrews Classic PowerKord

"We defy anyone not to notice the
improvement in performance when
you switch... to a PowerKord."
What Hi-Fi, May 2004.

- exclusive mains leads
- exclusive Hi-Fi equipment
- exclusive speaker cable
- exclusive CD accessories
- exclusive supports

order online at www.russandrews.com
or call UK Local Rate 0845 345 1550 quote AWORLD

Exclusive UK Retailer for
KIMBER KABLE

Russ Andrews Accessories Ltd, 28 Moreland Court,
Westmorland Business Park, Snap Road, Kendal, LA9 6NS, UK.
Tel: +44 (0)1539 797300 Fax: +44 1539 797325

Russ Andrews
Solutions for better music & movies

Valves & Tubes

CVC Chelmer Valve Company
for audio valves

Buy CVC. PREMIUM HI - FI valves direct from us.
All valves processed for improved performance.
We also have stock of MAJOR BRAND types inc.
MULLARD, GEC, BRIMAR, RCA, GE, PHILIPS, etc.

The Stables, Baddow Park, Great Baddow, Chelmsford,
Essex, CM2 7SY. Tel: 01245 241301 Fax: 01245 241309
Email: sales@chelmervalue.com

To advertise in this space
please call 020 7372 6018
or email:
advertising@hi-fiworld.co.uk

specialist hi-fi dealers

Yorkshire

Aeon Acoustics

ISO-PLATFORMS & FEET LOUDSPEAKERS
MADE FROM NEW GYRO-PNEUMATIC
AUDIO MATERIAL www.spiralex.com



PCT Patents & Design Copyrights pending



Audio Installation Materials

Aeon Acoustics
Newlands, Littlethorpe Lane,
Ripon, North Yorkshire, HG4 1UB
SPC@spiralex.com
01765 604288

Smart Audio Materials with
extended bass response & clarity



Loudspeaker Repairs

D.C. Boultons

Loudspeaker Repairs & Manufacture

All types including P.A. Disco, Hi-Fi, Juke Box etc.

Agents for B&C, Celestion, Eminence,
Fane, Precision Devices etc.

From re-foams to complete re-builds, even with
slipped magnets.

Trade and retail supplied.
Custom units our speciality.

Over 35 years experience of loudspeaker design

Unit 12, Damgate Lane Ind. Est, Acle, Norwich,
NR13 3DJ

Tel 01493 750075 Fax 01493 751155

IAN EDWARDS
MAKERS OF FINE HAND MADE FURNITURE

Elegant Storage Solutions for
Hi-Fi, Books,
LPs, CDs,
DVDs
Special orders welcome



Tel: 01423 500442 Fax: 01423 705200 www.iansbespokefurniture.co.uk

The Old Chapel, 282 Skipton Road, Harrogate, N. Yorks, HG1 3HE

Super 14 Wizard Rotary Unit, 2296
CDs, etc



74" V-Max can hold 660 CDs etc



JT Hi-Fi CD/Cassette Unit



Charlotte Drawer unit for 480 CDs
& 75 Cassettes 32" x 21" x 21"



Vinyl Mail Order Specialists

diversevinyl

LP MAIL ORDER SPECIALISTS

OVER 3000 BRAND NEW LPs IN OUR CATALOGUE

A wide range of musical genres stocked...
including brand new releases, reissues
and audiophile LPs

CALL FOR A CATALOGUE OR BROWSE ONLINE

01633 259661 sales@diversevinyl.com

THE DISCO ANTI STAT
LP CLEANING SYSTEM



leaves your LPs clean and
static free. Simple to use
and easy to store away in
your LP racking.

£43.95 (plus p&p)

www.diversevinyl.com

To advertise in this space
please call 020 7372 6018

or email:

advertising@hi-fiworld.co.uk

MANUFACTURER

meet your maker

A reference guide to Britain's manufacturers and distributors

CREEK AUDIO LTD

12 Avebury Court, Mark Road, Hemel
Hampstead, Herts, HP2 7TA.
Tel. 01442 260146

E-mail: info@creekaudio.com
Internet: www.creekaudio.com

Creek Audio manufactures in the UK.
Current products include A50i, A50iR
and 5350SE integrated amplifiers,
CD50 Mk2 CD player, and T50 tuner.
All products are similarly styled providing
an easy mix and match choice
depending on budget. Our miniature
OBH range includes two phono pre-
amplifiers, two headphone amplifiers
and a passive pre-amplifier.

EPOS ACOUSTICS

2 Avebury Court, Mark Road,
Hemel Hampstead, Herts, HP2 7TA.
Tel. 01442 260146.

Email: info@epos-acoustics.com
Website: www.epos-acoustics.com
Innovative design and superior sound
distinguish EPOS speakers from other
brands in similar price categories.
Nine models in total including a 5.1
surround system. All available in 3
finishes. Supporting stands and plinths
complement the speakers. In addition
to its two channel appeal, Epos is
now equally sought after in the fast
expanding world of home cinema. -

FALCON COMPONENTS LTD

Unit 12 Damgate Industrial Estate,
Damgate Lane, ACLE, Norwich,
Norfolk, NR13 3DJ

Tel. 01493 751100 Fax 01493 751155
E-mail: sales@falcon-acoustics.co.uk
Web: www.falcon-acoustics.co.uk
FOCAL drivers. SOLEN polypropylene
capacitors, TAYDEN high quality
PA loudspeaker units. Largest specialist
Audio-inductor UK manufacturer.
Comprehensive range of DIY speaker
parts, kits and accessories. Sub-bass
and electronic filters. Audio Amateur
Publications. Audio Computer
Software. Pro-Audio equipment and
loudspeaker repairs. Enquiries send
47p sae for full price list or visit our
website.

MONITOR AUDIO LIMITED

24 Brook Road, Rayleigh,
Essex SS6 7XL
Tel 01268 740 580.
Fax 01268 740 589

e-mail: info@monitoraudio.co.uk
website: www.monitoraudio.co.uk
Monitor Audio designs and manufactures
British loudspeakers of the highest
quality. Since 1972 Monitor Audio
has been developing and perfecting
the implementation of metal drivers,
innovative crossovers, and exemplary
speaker cabinet construction and finish
to further the ideal of achieving
sound which to the original is "as
close as it gets".

PMC/BRYSTON

PMC & Bryston
are Emmy award winning Loudspeaker
& Amplifier manufacturers - Used
throughout the professional world
as reference. Our clients record
for Deutsche Grammophon, Decca
and countless blockbuster Movies.
The identical, award winning ATL
(Advanced Transmission Line) technology
is used in all HiFi designs from
the DBI+, TLE1 Sub through to the
Active BB5XBD.

PMC Ltd 43-45 Crawley Green Road,
Luton, LU2 0AA. Tel: 08704 441044
Fax: 08704 441045

Email: sales@promonitor.co.uk
Web: www.pmc-speakers.com

SUGDEN AUDIO PRODUCTS

Designed and manufactured in the
UK each Sugden product is hand-built
by one highly skilled technician. A full
range of pure class A amplifiers are
available including integrated, stereo
power and the incredible Masterclass
balanced monoblocks. The class A
HeadMaster offers a pre-amp with
three inputs a fixed and variable
output with remote control. The
HeadMaster can be used as a control
unit in a high quality audio system
and excels with headphones. Please
contact us for product information,
dealer list and brochures.
01924 404088 email info@jesugden.co.uk

CD PLAYERS AND DACS

ALCANTAR CD92 boxed	400
AVANTAGE 11 cd transport, piano black finish	900
AUDIO ANALOGUE MASTERING mk1 CD, boxed	625
AUDIO ANALOGUE MASTERING mk2 CD, boxed	375
AUDIO NOTE CD2 valve cd player	400
AUDIO NOTE CD3 with Border Patrol psu	1250
AUDIO SYNTHESIS DATA DECADE DAC, boxed	1150
CEC 11001 cd player, boxed	970
LECTOR CD PLAYERS IN STOCK	see next section
MARANTE CD10 big ugly heavyweight	1200
MARANTE CD12 LE transport / dac, boxed	1350
MSB PLATINUM 3 compacting dac, boxed	1500
QUAD 66 CD	520
MUSICAL FIDELITY A3 CD, boxed	400
NAIM CD1 cd player	2000
PASS LABS DIGITAL 1 dac, with volume control	2000
PIRE TRIANGLE CARDINAL transport	425
QUAD 66 CD	350
ROKSAN CASPIAN mk1 CD player	425
SHANLING CD100 new	450
SUGDEN SDAT mk2 cd player	600
TEAC D1 dac	200
TEAC PRO 71 cd player, boxed	250
TEAC PRO 10 CD PLAYER, boxed	325
TECHNICS SP1010 cd player, silver	250
THEIA UNIVERSAL DATA transport, serviced, boxed	700
THEIA PRAGMATIC dac, boxed, good sweet dac recommendations	600
THEIA PRO BASIC 2, dac, boxed	710
THEIA PRO BASIC 2a, dac, balanced outputs, boxed	850

TURNABLES/ARMS/CARTRIDGES

AUDIO TECHNICA ATOC30 mc	200
CAYTON mc setup with 3 impedance choices	200
CLEARAUDIO EVOLUTION acrylic turntable with Clearaudio weighted arm, boxed	1100
CEC AEG 7 PHONO/STAGE, black, boxed	350
DEMON DL103 mc new boxed	120
DEMON DL304 used but clean, boxed	120
GRABBY SLEE PHONO/STAGES	NOW IN STOCK
HADCOCK GATE2 and half shaver wired, new	600
KOETSU RED SIGNATURE rebuilt by expert stylus	1000
KOETSU ORITE... just given the OK by expert stylus co. boxed	1000
LECTOR PHONOAMP SYSTEM 2 box valve mini/cas phono stage awesome at	1350
LHIN ARMY reasonable like built	350
LHIN A55 turntable with built arm	200
LHIN TUNERMAN CABLE UPGRADE, epoxy back if you dont like it!	75
LUXMAN PD 131 nice clean direct drive deck, not for SME mount	150
LYRA HELIXON SL mini boxed, very light use	800
MICHEL GPROTECK upgraded with UK psu, Orbe slatter, clamp arm motor, juncos	300
Rega arm and head	100
MICHELL CTR9 SE new in stock, decent trade in offered	419
MICHELL TERMO 2 arm UK sales only	600
MICHELL HYDRAULIC REFERENCE, late version, 3mc 300p arm	NOW
MICHELL CDSYSET in stock	300
MUSICAL FIDELITY RLPS 3 arm version	200
MUSICAL FIDELITY RLPS 3 phono stage, boxed	230
ORION LIVE but one modern deck with rega arm and 20 dening cartridge	400
ORTOFON MC10 SUPREME 200-300 hrs use only, excellent	275
ORTOFON KONTRAPUNKT A new boxed, 500	350
ORTOFON KONTRAPUNKT B new boxed	SPECIAL OFFER, 500
ORTOFON KONTRAPUNKT A new boxed, 500	600
PIRE TRIANGLE ANNIVERSARY with battery psu, nice custom	350
PROJECT PHONO BOX	135
REGA basic mc stage	125
REGA PLANAR 2 with mc250	150
RE300 INCOGNITO rewired	250
REVOX R790 remarkable with parallel tracking arm	250
ROKSAN COGNOSCENTI (piano black version), tripod stand, SME 319	1050
SMEETER 901 boxed very fine hours	1000
SUMICO BLUEPOINT SPECIAL boxed	150

MICHEL ALECTO MONOBLOCKS	1000
MUSICAL FIDELITY PNE 8 with MA65 class A macablocks	600
MUSICAL FIDELITY A11 amp	280
MUSICAL FIDELITY DA THOMAS, the big one	150
MUSICAL FIDELITY A3 integrated amp	175
MUSICAL FIDELITY A300E 200watt power amp, boxed	400
MUSICAL FIDELITY A370 upgraded to mk2	200
MUSIC FIRST AUDIO PASSIVE MAGNETIC pre (HYC) home demo.	1100
PASS ID preamp 3 box	1600
PASS ALEPH 3 poweramp 30 watts class A	300
PASS ALEPH 0 micoblocks	300
PLINIUS 8100 integrated amp, boxed silver,	1000
QUAD 33 academy vision mk1mk2, gold phono etc, boxed	50
QUAD 34/405 MK1 wooden sleeve only	150
QUAD 66 very nice, with remote	275
REGA MIMA amplifier mini, boxed	120
ROWLAND COHERENCE balanced reference preamp, psu	1000
ROWLAND BALANCED PHONO/STAGE	80
SIM AUDIO CELESTE PW4000 integrated amp	150
SONOGRAPHIE 250 pre/level - made by conrad johnson	150
SONUS FABER MUSICA excellent integrated amp, gold full sized	300
SUGDEN MASTERCLASS power amp, black, boxed	350
SUGDEN CS1851 pre power only model late 1990s class A power amp	550
SUGDEN HX3100 integrated amp	250
TALA ELECTRONICS HURRICANE 2 power amp	200
TECHNICS SU-C3000 preamp, battery powered	250

TUNERS, CASSETTE DECKS, REEL-TO-REEL, HEADPHONES ETC

CANYON TX-10	100
CRYSTAL 7 ST	275
DEMON T11	2000
LEAL THUNDERLINE II STEREO	120
LEAL THUNDERLINE 3 PHONO service	80
MICROMEGA STAGE TUNER	150
MUSICAL FIDELITY F500 tuner	150
QUAD FM3 tuner, boxed	200
QUAD FM4 tuner, boxed	250
REGA RADIOS, boxed	150
REVOX R740 100 watt, 4000 Hz, 1000 Hz	275
REVOX G26 2000 watt, 4000 Hz, 1000 Hz	350
ROTEL STRADAL mini tube tuner	125
SONY D777ES dual and tin tubes, champagne finish	250
SONY TC777 and 7000 with dual cover	75
STAR LARSSEN HORN REFERENCE 4 SERSI enlarger	500
TEAC A035 CASSETTE deck, black, boxed	350
TEAC FM4 tuner, boxed	200
TEAC FM4 grey	250
TEAC R4000, boxed	150
REVOX R740 100 watt, 4000 Hz, 1000 Hz	275
REVOX G26 2000 watt, 4000 Hz, 1000 Hz	350
ROTEL STRADAL mini tube tuner	125
SONY D777ES dual and tin tubes, champagne finish	250
SONY TC777 and 7000 with dual cover	75
STAR LARSSEN HORN REFERENCE 4 SERSI enlarger	500
TEAC A035 CASSETTE deck, black, boxed	350
TEAC FM4 tuner, boxed	200
TEAC FM4 grey	250
TEAC R4000, boxed	150
REVOX R740 100 watt, 4000 Hz, 1000 Hz	275
REVOX G26 2000 watt, 4000 Hz, 1000 Hz	350
ROTEL STRADAL mini tube tuner	125
SONY D777ES dual and tin tubes, champagne finish	250
SONY TC777 and 7000 with dual cover	75
STAR LARSSEN HORN REFERENCE 4 SERSI enlarger	500
TEAC A035 CASSETTE deck, black, boxed	350
TEAC FM4 tuner, boxed	200
TEAC FM4 grey	250
TEAC R4000, boxed	150
REVOX R740 100 watt, 4000 Hz, 1000 Hz	275
REVOX G26 2000 watt, 4000 Hz, 1000 Hz	350
ROTEL STRADAL mini tube tuner	125
SONY D777ES dual and tin tubes, champagne finish	250
SONY TC777 and 7000 with dual cover	75
STAR LARSSEN HORN REFERENCE 4 SERSI enlarger	500
TEAC A035 CASSETTE deck, black, boxed	350
TEAC FM4 tuner, boxed	200
TEAC FM4 grey	250
TEAC R4000, boxed	150
REVOX R740 100 watt, 4000 Hz, 1000 Hz	275
REVOX G26 2000 watt, 4000 Hz, 1000 Hz	350
ROTEL STRADAL mini tube tuner	125
SONY D777ES dual and tin tubes, champagne finish	250
SONY TC777 and 7000 with dual cover	75
STAR LARSSEN HORN REFERENCE 4 SERSI enlarger	500
TEAC A035 CASSETTE deck, black, boxed	350
TEAC FM4 tuner, boxed	200
TEAC FM4 grey	250
TEAC R4000, boxed	150
REVOX R740 100 watt, 4000 Hz, 1000 Hz	275
REVOX G26 2000 watt, 4000 Hz, 1000 Hz	350
ROTEL STRADAL mini tube tuner	125
SONY D777ES dual and tin tubes, champagne finish	250
SONY TC777 and 7000 with dual cover	75
STAR LARSSEN HORN REFERENCE 4 SERSI enlarger	500
TEAC A035 CASSETTE deck, black, boxed	350
TEAC FM4 tuner, boxed	200
TEAC FM4 grey	250
TEAC R4000, boxed	150
REVOX R740 100 watt, 4000 Hz, 1000 Hz	275
REVOX G26 2000 watt, 4000 Hz, 1000 Hz	350
ROTEL STRADAL mini tube tuner	125
SONY D777ES dual and tin tubes, champagne finish	250
SONY TC777 and 7000 with dual cover	75
STAR LARSSEN HORN REFERENCE 4 SERSI enlarger	500
TEAC A035 CASSETTE deck, black, boxed	350
TEAC FM4 tuner, boxed	200
TEAC FM4 grey	250
TEAC R4000, boxed	150
REVOX R740 100 watt, 4000 Hz, 1000 Hz	275
REVOX G26 2000 watt, 4000 Hz, 1000 Hz	350
ROTEL STRADAL mini tube tuner	125
SONY D777ES dual and tin tubes, champagne finish	250
SONY TC777 and 7000 with dual cover	75
STAR LARSSEN HORN REFERENCE 4 SERSI enlarger	500
TEAC A035 CASSETTE deck, black, boxed	350
TEAC FM4 tuner, boxed	200
TEAC FM4 grey	250
TEAC R4000, boxed	150
REVOX R740 100 watt, 4000 Hz, 1000 Hz	275
REVOX G26 2000 watt, 4000 Hz, 1000 Hz	350
ROTEL STRADAL mini tube tuner	125
SONY D777ES dual and tin tubes, champagne finish	250
SONY TC777 and 7000 with dual cover	75
STAR LARSSEN HORN REFERENCE 4 SERSI enlarger	500
TEAC A035 CASSETTE deck, black, boxed	350
TEAC FM4 tuner, boxed	200
TEAC FM4 grey	250
TEAC R4000, boxed	150
REVOX R740 100 watt, 4000 Hz, 1000 Hz	275
REVOX G26 2000 watt, 4000 Hz, 1000 Hz	350
ROTEL STRADAL mini tube tuner	125
SONY D777ES dual and tin tubes, champagne finish	250
SONY TC777 and 7000 with dual cover	75
STAR LARSSEN HORN REFERENCE 4 SERSI enlarger	500
TEAC A035 CASSETTE deck, black, boxed	350
TEAC FM4 tuner, boxed	200
TEAC FM4 grey	250
TEAC R4000, boxed	150
REVOX R740 100 watt, 4000 Hz, 1000 Hz	275
REVOX G26 2000 watt, 4000 Hz, 1000 Hz	350
ROTEL STRADAL mini tube tuner	125
SONY D777ES dual and tin tubes, champagne finish	250
SONY TC777 and 7000 with dual cover	75
STAR LARSSEN HORN REFERENCE 4 SERSI enlarger	500
TEAC A035 CASSETTE deck, black, boxed	350
TEAC FM4 tuner, boxed	200
TEAC FM4 grey	250
TEAC R4000, boxed	150
REVOX R740 100 watt, 4000 Hz, 1000 Hz	275
REVOX G26 2000 watt, 4000 Hz, 1000 Hz	350
ROTEL STRADAL mini tube tuner	125
SONY D777ES dual and tin tubes, champagne finish	250
SONY TC777 and 7000 with dual cover	75
STAR LARSSEN HORN REFERENCE 4 SERSI enlarger	500
TEAC A035 CASSETTE deck, black, boxed	350
TEAC FM4 tuner, boxed	200
TEAC FM4 grey	250
TEAC R4000, boxed	150
REVOX R740 100 watt, 4000 Hz, 1000 Hz	275
REVOX G26 2000 watt, 4000 Hz, 1000 Hz	350
ROTEL STRADAL mini tube tuner	125
SONY D777ES dual and tin tubes, champagne finish	250
SONY TC777 and 7000 with dual cover	75
STAR LARSSEN HORN REFERENCE 4 SERSI enlarger	500
TEAC A035 CASSETTE deck, black, boxed	350
TEAC FM4 tuner, boxed	200
TEAC FM4 grey	250
TEAC R4000, boxed	150
REVOX R740 100 watt, 4000 Hz, 1000 Hz	275
REVOX G26 2000 watt, 4000 Hz, 1000 Hz	350
ROTEL STRADAL mini tube tuner	125
SONY D777ES dual and tin tubes, champagne finish	250
SONY TC777 and 7000 with dual cover	75
STAR LARSSEN HORN REFERENCE 4 SERSI enlarger	500
TEAC A035 CASSETTE deck, black, boxed	350
TEAC FM4 tuner, boxed	200
TEAC FM4 grey	250
TEAC R4000, boxed	150
REVOX R740 100 watt, 4000 Hz, 1000 Hz	275
REVOX G26 2000 watt, 4000 Hz, 1000 Hz	350
ROTEL STRADAL mini tube tuner	125
SONY D777ES dual and tin tubes, champagne finish	250
SONY TC777 and 7000 with dual cover	75
STAR LARSSEN HORN REFERENCE 4 SERSI enlarger	500
TEAC A035 CASSETTE deck, black, boxed	350
TEAC FM4 tuner, boxed	200
TEAC FM4 grey	250
TEAC R4000, boxed	150
REVOX R740 100 watt, 4000 Hz, 1000 Hz	275
REVOX G26 2000 watt, 4000 Hz, 1000 Hz	350
ROTEL STRADAL mini tube tuner	125
SONY D777ES dual and tin tubes, champagne finish	250
SONY TC777 and 7000 with dual cover	75
STAR LARSSEN HORN REFERENCE 4 SERSI enlarger	500
TEAC A035 CASSETTE deck, black, boxed	350
TEAC FM4 tuner, boxed	200
TEAC FM4 grey	250
TEAC R4000, boxed	150
REVOX R740 100 watt, 4000 Hz, 1000 Hz	275
REVOX G26 2000 watt, 4000 Hz, 1000 Hz	350
ROTEL STRADAL mini tube tuner	125
SONY D777ES dual and tin tubes, champagne finish	250
SONY TC777 and 7000 with dual cover	75
STAR LARSSEN HORN REFERENCE 4 SERSI enlarger	500
TEAC A035 CASSETTE deck, black, boxed	350
TEAC FM4 tuner, boxed	200
TEAC FM4 grey	250
TEAC R4000, boxed	150
REVOX R740 100 watt, 4000 Hz, 1000 Hz	275
REVOX G26 2000 watt, 4000 Hz, 1000 Hz	350
ROTEL STRADAL mini tube tuner	125
SONY D777ES dual and tin tubes, champagne finish	250
SONY TC777 and 7000 with dual cover	75
STAR LARSSEN HORN REFERENCE 4 SERSI enlarger	500
TEAC A035 CASSETTE deck, black, boxed	350
TEAC FM4 tuner, boxed	200
TEAC FM4 grey	250
TEAC R4000, boxed	150
REVOX R740 100 watt, 4000 Hz, 1000 Hz	275
REVOX G26 2000 watt, 4000 Hz, 1000 Hz	350
ROTEL STRADAL mini tube tuner	125
SONY D777ES dual and tin tubes, champagne finish	250
SONY TC777 and 7000 with dual cover	75
STAR LARSSEN HORN REFERENCE 4 SERSI enlarger	500
TEAC A035 CASSETTE deck, black, boxed	350
TEAC FM4 tuner, boxed	200
TEAC FM4 grey	250
TEAC R4000, boxed	150
REVOX R740 100 watt, 4000 Hz, 1000 Hz	275
REVOX G26 2000 watt, 4000 Hz, 1000 Hz	350
ROTEL STRADAL mini tube tuner	125
SONY D777ES dual and tin tubes, champagne finish	250
SONY TC777 and 7000 with dual cover	75
STAR LARSSEN HORN REFERENCE 4 SERSI enlarger	500
TEAC A035 CASSETTE deck, black, boxed	350
TEAC FM4 tuner, boxed	200
TEAC FM4 grey	250
TEAC R4000, boxed	150
REVOX R740 100 watt, 4000 Hz, 1000 Hz	275
REVOX G26 2000 watt, 4000 Hz, 1000 Hz	350
ROTEL STRADAL mini tube tuner	125
SONY D777ES dual and tin tubes, champagne finish	250
SONY TC777 and 7000 with dual cover	75
STAR LARSSEN HORN REFERENCE 4 SERSI enlarger	500
TEAC A035 CASSETTE deck, black, boxed	350
TEAC FM4 tuner, boxed	200
TEAC FM4 grey	250
TEAC R4000, boxed	150
REVOX R740 100 watt, 4000 Hz, 1000 Hz	275
REVOX G26 2000 watt, 4000 Hz, 1000 Hz	350
ROTEL STRADAL mini tube tuner	125
SONY D777ES dual and tin tubes, champagne finish	250
SONY TC777 and 7000 with dual cover	75
STAR LARSSEN HORN REFERENCE 4 SERSI enlarger	500
TEAC A035 CASSETTE deck, black, boxed	350
TEAC FM4 tuner, boxed	200
TEAC FM4 grey	250
TEAC R4000, boxed	150
REVOX R740 100 watt, 4000 Hz, 1000 Hz	275
REVOX G26 2000 watt, 4000 Hz, 1000 Hz	350
ROTEL STRADAL mini tube tuner	125
SONY D777ES dual and tin tubes, champagne finish	250
SONY TC777 and 7000 with dual cover	75
STAR LARSSEN HORN REFERENCE 4 SERSI enlarger	500
TEAC A035 CASSETTE deck, black, boxed	350
TEAC FM4 tuner, boxed	200
TEAC FM4 grey	250
TEAC R4000, boxed	150
REVOX R740 100 watt, 4000 Hz, 1000 Hz	275
REVOX G26 2000 watt, 4000 Hz, 1000 Hz	350
ROTEL STRADAL mini tube tuner	125
SONY D777ES dual and tin tubes, champagne finish	250
SONY TC777 and 7000 with dual cover	75
STAR LARSSEN HORN REFERENCE 4 SERSI enlarger	500
TEAC A035 CASSETTE deck, black, boxed	350
TEAC FM4 tuner, boxed	200
TEAC FM4 grey	250
TEAC R4000, boxed	150
REVOX R740 100 watt, 4000 Hz, 1000 Hz	275
REVOX G26 2000 watt, 4000 Hz, 1000 Hz	350
ROTEL STRADAL mini tube tuner	125
SONY D777ES dual and tin tubes, champagne finish	250
SONY TC777 and 7000 with dual cover	75
STAR LARSSEN HORN REFERENCE 4 SERSI enlarger	500
TEAC A035 CASSETTE deck, black, boxed	350
TEAC FM4 tuner, boxed	200
TEAC FM4 grey	250
TEAC R4000, boxed	150
REVOX R740 100 watt, 4000 Hz, 1000 Hz	275
REVOX G26 2000 watt, 4000 Hz, 1000 Hz	350
ROTEL STRADAL mini tube tuner	125
SONY D777ES dual and tin tubes, champagne finish	250
SONY TC777 and 7000 with dual cover	75
STAR LARSSEN HORN REFERENCE 4 SERSI enlarger	500
TEAC A035 CASSETTE deck, black, boxed	350
TEAC FM4 tuner, boxed	200
TEAC FM4 grey	250
TEAC R4000, boxed	150
REVOX R740 100 watt, 4000 Hz, 1000 Hz	275
REVOX G26 2000 watt, 4000 Hz, 1000 Hz	350
ROTEL STRADAL mini tube tuner	125
SONY D777ES dual and tin tubes, champagne finish	250
SONY TC777 and 7000 with dual cover	75
STAR LARSSEN HORN REFERENCE 4 SERSI enlarger	500
TEAC A035 CASSETTE deck, black, boxed	350
TEAC FM4 tuner, boxed	200
TEAC FM4 grey	250
TEAC R4000, boxed	150
REVOX R740 100 watt, 4000 Hz, 1000 Hz	275
REVOX G26 2000 watt, 4000 Hz, 1000 Hz	350
ROTEL STRADAL mini tube tuner	125
SONY D777ES dual and tin tubes, champagne finish	250
SONY TC777 and 7000 with dual cover	75
STAR LARSSEN HORN REFERENCE 4 SERSI enlarger	500
TEAC A035 CASSETTE deck, black, boxed	350
TEAC FM4 tuner, boxed	200
TEAC FM4 grey	250</

marantz® P R E M I U M S E R I E S



Experience the
perfection *of purity*



Marantz introduces the TT-15S1 to enhance its hi-fi series

www.marantz.com | Marantz 01753 680868

WORLD



DESIGNS

A NEW RANGE OF KITS FOR THE AUDIOPHILE from WORLD DESIGNS

WD25A Aperiodic Stand-mount Loudspeaker Kit

Harking back to a 1970s classic loudspeaker, the WD25A is bang up to date, with modern drive units and an aperiodic bass system exclusively designed for World Designs by SEAS of Norway.

The aperiodic enclosure offers the bass clarity and definition of a larger closed box, together with the efficiency and easy amplifier load necessary for users of valve amplifiers. In fact, the easy drive nature of this nominal 8 Ohm loudspeaker gives it a dynamic performance which far outperforms modern stand-mount speakers.

Based around a 10 inch bass unit with soft paper cone and butyl rubber surround, the WD25a is available in two versions. The standard kit incorporates a simple, elegant crossover with one capacitor and a resistive attenuator for the treble unit. This is a soft fabric dome with integrated wide surround and features a low resonant frequency and excellent inherent self damping to suit the first order crossover.

The XL kit utilises an advanced treble unit from the SEAS Excel range featuring a 29mm SONOMEX fabric dome driven by a powerful Neodymium magnet system. A moulded zinc chamber behind the dome provides a very low resonant frequency and incorporates good damping. This allows the use of low viscosity ferrofluid for high power handling. The front plate is machined from 6mm aluminium.

Both kits are complete with bi-wire, gold plated terminals fitted to an oval terminal panel that carries the crossover PCB. Crossover components have been chosen for optimal performance with the drive units and feature high power resistors and inductors and low loss polypropylene capacitors. LC-OFC cabling is used to connect to the drive units.

www.world-designs.co.uk

Tel: 01832 293320



Kits come complete with full constructional drawings and details, drive units, crossovers and recommended internal damping material, in fact everything you need except the cabinets.

Cabinet kits are also available, as are the individual components. For more details, please check our website:

www.world-designs.co.uk

Standard WD25a kit
£215 per pair

WD25a XL kit
£398 per pair

private ads

Dealers must not advertise in the Private Classified section. Monthly consecutive insertions will be considered Trade advertising. The Publisher reserves the right to judge submissions.

T+AV10 INTEGRATED
amp £1800. Advantage S1-100 integrated amp 100wpc £1000. Linn LP12, Ittok LVII arm, Karma cartridge £650. NHT subwoofer system, active crossover, 250w mono amps £600. NHT amplifiers 250w monoblocks £400. Tel: 020 8531 5979 (Mar)

AUDIO RESEARCH LS8
preamp. Black, boxed, new valves. £925 including secure postage. Tel: 01752 291 625, mobile 07969 773 164 (Mar)

CONRAD JOHNSON MV55
power amp, mint. EL34 Triode or Pentode operation (22/55 watts). Offers. Tel: 01590 672451 (evening) or 02392 336312 (Mar)

MERIDIAN 200 CD transport.
Mint, boxed, instructions, £275 ono. Philips 870 CDR recorder c/w remote, instructions, as new, £150. Tel: Mike 01246 209 578, 01246 570 556 (Apr)

VALHALLA INTERNAL PSU
for Linn Sondek. Mint condition. Rare and sought after now. Many users still prefer Valhalla over external units. Much warmer sound. £150. Call Gordon 01292 570 562 or 07941 463 474 (Ayrshire) (Mar)

YAMAHA CT7000 tuner
full service and realignment by Armstrong, London, May, 2004. Written receipt with original service and owners manuals. Outstanding condition. £795. Buyer collects. Tel: 01202 730 449 (Poole, Dorset) (Mar)

FOR SALE. Rose RV23S valve pre-amp, re-valved. Rose RPI90 power amp, 70 watts. Both superb condition. Manual & boxed. £490. Pair VV302 valves £60. The Head MC transformer £200. Tel: 01903 247 779 (Sussex) (Apr)

HI-FI FOR SALE: Myriad HP100 pre-amp, 2 MA 240 power amps, Meridian 588 CD, Kef Reference 2+2 speakers. Ecosse cables, Henley Design cherry rack. All boxed and mint condition. £3000 or nearest offer. Can audition. Tel: 01454 411093 (Mar)

SUGDEN A21a Class A integrated, titanium finish. 5 globe review, 'brilliantly musical and natural'. £550 (£950). Revolver R33 standmounts, good match with above £300 (£500). Both boxed, as new. Tel: 07769 705 214 (Ealing) (Mar)

GRAHAM SLEE ERA Gold
phono stage £200. New style Linn Lingo wiring loom and new motor £420. One Thing FM decoder for Troughline etc. £100. All o.n.o. Tel: 01844 358 104 (Mar)

PAIR OF E.A.R. 509 monoblocks. Also E.A.R. 802 preamp. Facility for 2 tape decks. Copy 1 to 2, 2 to 1. Contact Jim on 00 33 2 33 480 391 or Email: jejim@wanadoo.fr (Mar)

TALK ELECTRONICS Cyclone
integrated 60wpc £150. 4x 5m lengths van den Hul CS122 speaker cable connected for bi-wiring. Cost £240, accept £75. Tel: 0116 284 9087 (Leics area) (Mar)

NAIM NAT01 tuner, silver/black, £350. Roof-mounted aerial if required. Tel: 01754 760 560 (Skegness) (Mar)

B+W NAUTILUS 805 spekaers. Cherrywood finish with dedicated B+W stands. Mint condition. Boxes, cloths etc. £850. Tel: 0121 601 0325 or 077719 18568 (Mar)

QUAD 99 System. Pre-amp, CDP-1 CD, tuner, 909 power amplifier. Ex-Quad demo units, mint condition. Also Ruark Equinox speakers with integral stands. Complete system £2995 ono (£5500 new). May split. Tel: 023 8073 8935 (Mar)

LEAK SANDWICH 600 speakers. Four speakers in Teak. Approximate size 27" x 15" x 13". Offers of £500 negotiable. Tel: 01844 291055. Email: philipandhelen@btinternet.com (Mar)

WANTED: MUSICAL Fidelity
headphone amp V3. Tel: Tom 01395 273 631 (Exmouth, Devon) (Mar)

RUSS ANDREWS Jumbo oak
cone feet. £2 each. Hi-End German banana plugs. Fluted pins. Side cable entry. Offer bi-wire option from single output socket. £3 each. Super bargain. Tel: 01752 773 369 (Mar)

MICROMEGA DUO CD3.1/ Duo Pro 2 CD player. In black. Stirling AES/EBU interconnect cable included. Very good condition, with original packaging £490. Tel: 01271 864 791 or Email: michael.isger@tesco.net (Mar)

SPENDOR BCI/SPI factory
upgrade. Better bass +5dB headroom. Immaculate £450. Nakamichi BX1 cassette, excellent performance £75. Transcriptors Hydraulic Reference turntable, arms, complete, original, £695. Gale 401A £395. Tel: Richard 020 8885 6339 (London) (Mar)

WORLD AUDIO KLS3 gold
speakers, 1" thick mahogany cases complete but not stained. Varnished £350. Shearman Phase 2 reference amp and Phase 3 reference power amp £300 each or £550 pair. Tel: 01202 621213 or 07966 906687 or Email: mikebrookbank@tiscali.co.uk (Poole) (Mar)

BOSE 901 Series VI direct/
reflecting speakers, walnut finish, with 901 active equaliser and 901 speaker pedestals, £800. Tel: 01892 521 561 (Mar)

NAIM CDI CD player. Good condition, remote, interconnect, instructions, boxed, £350 ono. Tel: 01234 852 675 or 07905 476 446 (Mar)

NAKAMICHI 1000ZXL
computing cassette deck with factory supplied Dolby C unit and remote control. One owner and less than 100 hours use since new. In mint condition aided by custom built soft-lined storage/transport container. Performance verified by Bowers & Wilkins. Can be demonstrated. £2000. Tel: 01344 304 612 (Berkshire) (Apr)

WANTED: any BBC LS3/5a
loudspeakers, good Decca Ribbons. Please call 0208 6899187 (Mar)



BUY / SELL
HOME CINEMA
MULTIROOM INSTALL
HI - FI

www.choice-hifi.com

tel: 020 8392 1959 / 1963 mob: 07768 720456
info@choice-hifi.com

trade ads

Dealers must not advertise in the Private Classified section. Monthly consecutive insertions will be considered Trade advertising. The Publisher reserves the right to judge submissions.

VINTAGEWIRELESS COMPANY LONDON
Website: www.vintagewirelesslondon.co.uk
Buy-Sell-Exchange.
Vintage Hi-Fi. Repairs, Spares, Restoration. All valve equipment Wanted for cash: Tannoy, Quads, Garrard and audio valves. Please call us at 17 Bell Street, London, NW1 5BY.
Tel: 020 7258 3448
Fax 020 7258 3449
Email: vwirelesslondon@aol.com
(Jun06)

AUDIOPUBLIC,
78 Otley Road,
Headingley, Leeds,
0113 217 7294.
Yorkshire's newest Hi-Fi retailer, stockists of Naim Audio, Rega Research, Conrad Johnson, Sugden, Dynavector, (cartridges and amplifiers) and many more. Please call for advice. (Mar)

AUDIOPHILE OBJECTIVE For New, X-Display and Pre-Owned Hi-Fi. Roksan, Musical Fidelity, NAD, Epos, Marantz, Project, Castle, Audioquest, Revolver. Other brands pre-owned. 16 Allen House, The Maltings, Sawbridgeworth, Herts. Tel: 01279 724 024. Easy Free Parking (Mar)

MONARCHY AUDIO DIP 48/96 Upsamplers for sale at only £210 including delivery. Brand new UK 240v model supplied. Go to www.media-zone.co.uk or Email: sales@media-zone.co.uk for more details. (Mar)

AUDIO SHED. Top quality hi-fi for sale. Beuhorn, Voodoo, Headlund Horns, Experience Filtration, H-Cap, Cut Loose Audio, Canary Audio, Omega speakers etc. Blackgates and Audio Valves also available. Please call 01923 828 765 or 07900 918 882 (Mar)

AMAZING CABLES Solid silver interconnects from £110, with air / teflon insulation and WBT plugs. Silver speaker and mains cables from £250. Fantastic performance, refund guarantee. 0115.982.5772 after 7pm, Email: bob@skydivers.co.uk (Jul)

BRILLIANCE SYNERGY Teflon interconnects. Hi-Fi Choice said 'We like these cables a lot'. AES/EBU and XLR balanced interconnects for those requiring ultimate performance. Demonstration cables available. Contact Mike on 07963 117 341
www.brilliancehifi.co.uk (Mar)

**-WANTED -
EARLY HI-FI
VALVE AMPLIFIERS
AUDIO VALVES
CLEAR CRYSTAL SYSTEMS
John Petrie-Baker
Tel: 020 7328 9275**

FOR SERVICE, Repairs, Upgrades and Re-Manufacturing of all valve audio equipment. Leak Troughline specialists, re-aligned etc. For more info contact E. Gane and Son (Est 1948) on 020 8743 2727 (Mar)

HORN ACOUSTICS. We manufacture horn enclosures to Lowther designs. Come and listen to Opus 1, Fidelio, Bicolor 200 at Heathrow High-Fidelity Show, 1-2 April. Email: info@hornspeakers.co.uk (Mar)

ULTIMATUM MFS with unused matching Neat stands, was £3,500 now only £2,750 (only six months old - little demonstrated): carriage paid within UK - contact on 01463831658 or highlandaudio@aol.com (Mar)

CLASSIC CONTACTS

When a classic goes 'poof' your troubles have just started, but there may be a good ending. Replacing failing parts can improve the sound, so here is a short listing of all those companies who specialise in getting a classic up and running again after its deposited a small ring of soot on your ceiling!

CLASSIQUE SOUNDS
(Paul Greenfield, Leicester)
ESL-57s restored, rebuilt, fully renovated or improved. Leak, Quad valves amps etc. Tel: 0845 123 5137 / Mob: 0116 2835821
Email: classique_sounds@yahoo.co.uk
www.flashbacksales.co.uk/classique

GT AUDIO
(Graham Tricker, Bucks)
Leak Troughline specialists. Also Quad and most classic tuners, radios and amplifiers restored, repaired.
Tel: 01895 833099 / Mob: 07960 962579
www.gtaudio.com

AUDIOLAB
(Phil Pimblott, Leeds)
Renovation, repair and restoration. Specialist in valve hi-fi, radio transmitters, cinema amps, kit building.
Tel: 0113 244 0378
www.audiolabs.co.uk

QUAD ELECTROACOUSTICS
(Cambs)
Quad's service department, able to repair almost all Quad products, from the very first.
Tel: 0845 4580011
www.quad-hifi.co.uk

Dr MARTIN BASTIN
(Shropshire)
Garrard 301/401 restoration, renovation and service. Special plinths; rumble cures, etc.
Tel: 01584 823446

LORICRAFT AUDIO
(Terry O'Sullivan, Bucks)
Garrard 301/401 and their own 501 repair, spares and service.
Tel: 01488 72267
www.garrard501.com

LOCKWOOD AUDIO
(London)
Tannoy loudspeaker parts, restoration and repair. Also Epos and TDL loudspeakers.
Tel: 020 8 864 8008
www.lockwoodaudio.co.uk

CARTRIDGE MAN
(Len Gregory, London)
Specialist cartridge re-tipping service and repairs. High quality special cartridges.
Tel: 020 8 688 6565
www.listen.to/thecartridgeman

TECHNICAL AND GENERAL
(East Sussex)
Turntable parts - wide range of spares and accessories, plus arms and cartridges.
Tel: 01892 654534

REVOX
(Brian Reeves, Cheshire)
Revox tape recorder spares, service and repair. Accessories also available.
Tel: 0161 499 2349
Email: brian@revoxservice.co.uk
www.revov.freeuk.com

SOWTER TRANSFORMERS
(Brian Sowter, Ipswich)
Large range of audio transformers for valve amps, cartridges, line drive, interstage plus all associated services.
Tel: 01473 252794
www.sowter.co.uk

ONETHING
(Coventry)
Specialist in electrostatic panel manufacture and repair. Can refurbish ESL 57s and 63s as well as Leak Troughlines and Quad IIs.
Email: one.thing@ntworld.com
www.onethingaudio.com

OCTAVE AUDIO WOODWORKING
(Bristol)
Unit 2, 16 Midland Street, St Phillips, Bristol.
Tel: 0117 925 6015
www.octave-aw.co.uk

ARKLESS ELECTRONICS
(Northumberland)
Specialist in repairs, restoration and modifications to all amplifiers, valve or solid state, ancient and modern.
Tel: 01670 829891
Email: arkless.electronics@btinternet.com

WEMBLEY LOUDSPEAKER
(Paul MacCallam, London)
Comprehensive loudspeaker servicing.
Tel: 020 8 743 4567
Email: paul@wembleyloudspeaker.co.uk
www.wembleyloudspeaker.com

EXPERT STYLUS COMPANY
(Wyndham Hodgson, Surrey)
Stylus replacement service for all types of cartridge. Including precise profiling for 78s
Tel: 01372 276604
Email: w.hodgson@btclick.com

CLASSIC NAKAMICHI
(Paul Wilkins, Worthing, West Sussex)
Restore, Repair & Service Nakamichi Cassette Decks.
Tel: 01903 695695
Email: paul@bowersandwilkins.co.uk
www.bowersandwilkins.co.uk

NEXT MONTH

BIG BANGERS!

April 2006's Hi-Fi World takes an in-depth look at one of our most favourite things – big bangers. Yes, it's large loudspeaker time! Be amazed as hardened hi-fi hack Noel Keywood, normally not one to unleash purple prose, waxes lyrical on the mighty Tannoy Yorkminster. See how Quad 989 aficionado David Price gets on with their American alter egos, the big and beautiful Martin Logan Summits. And read with interest how the team reckon these beasts compare with the very best small loudspeakers; is less is more, or simply not enough? Here's just a small selection of the other kit we hope to bring you:



- Supra Sword loudspeaker cable
- Marantz CD5001 OSE CD player
- Custom Design loudspeaker stands
- Luxman L-505f integrated amplifier
- Qinpu A-8000/II integrated amplifier
- Focal 918 floorstanding loudspeakers
- Krell KAV-400Xi integrated amplifier
- Prima Luna Prologue 3/5 pre-power amplifier

**PICK UP THE APRIL 2006 ISSUE OF HI-FI WORLD ON SALE FEBRUARY 28TH,
OR SUBSCRIBE AND GET IT DELIVERED TO YOUR DOOR: p126**

classifieds ads order form

ADVERTISERS INDEX

Absolute Sounds	48
Acoustica	56
Art Audio	111
Audio Atmosphere	102
Audio T	68
Audio Xpress	88
Audiolab	58
Audusa	110
Beyerdynamic	80
Big Ears	109
Billy Vee	106
Brighton Hi-Fi Exchange	82
Choice Hi-Fi	115,125
Classique Sounds	111
Cyrus	12
Dali	6
Decent Audio	122
Emporium (The)	122
Falcon Acoustics	88
Heathcote Audio	115
Heatherdale Audio	112
Hi-End Cable	116
Hi-Fi Classics	116
Hi-Fi Sounds	113
Ian Harrison	116
Icon Audio	70
Impact Audio	70
Langrex Supplies Ltd	96
Linn	BC
Mantra Audio	66
Matrix	114
Michell Engineering	78
Midland Audio Exchange	117
Mikam North	14
Musicology	60
Musonic	112
NAD	62
Naim	IBC
Neat Acoustics	60
Northern Sound & Vision	48
Noteworthy	78,88
Origin Live	56,114
QTA	112
Retro Reproduction	109
Rochester HiFi	109
Rotel	IFC
Sevenoaks	28,29,30,31,32,33
Shadow Audio Cons.	76
Sound Dead	111
Sound Surgery	14
Sound Venture	24
The Missing Link	70
The Right Note	44
Transparent Dist. Ltd	38
Trichord	66
Tube Shop	82
Turntable World	122
Vivid Audio	36
Vivante	82
Walrus	46
Watford Valves	96
Whest Audio	66
White Noise	88
Williams Hart	114
Wilson Benesch	44
World Design	124
Zero One Audio	78

RATES - ALL ADVERTS MUST BE PRE-PAID

Maximum length per advert is 30 words, each additional word is 50p extra. Telephone numbers and E-mail addresses are treated as one word. Model numbers are treated as one word i.e. Quad 303 = two words. Please tick the box for the advert required

Dealers must not advertise in the Private Classified section. Monthly consecutive insertions will be considered Trade advertising. The Publisher reserves the right to judge submissions

Private magazine advert	£10 per month	<input type="checkbox"/>
Private magazine advert display black box	£15 per month	<input type="checkbox"/>
Trade magazine advert	£10 per month	<input type="checkbox"/>
Trade magazine advert display black box	£15 per month	<input type="checkbox"/>

Please write or type your advertisement copy in block capitals with one word per box.

Please continue on a separate sheet if necessary.

WE WILL ACCEPT PHOTOCOPIES OF THIS FORM

1	2
3	4
5	6
7	8
9	10
11	12
13	14
15	16
17	18
19	20
21	22
23	24
25	26
27	28
29	30

Name _____

Address _____

Post Code _____

Daytime Tel: _____

<input type="checkbox"/>	<input type="checkbox"/>	<input type="checkbox"/>	<input type="checkbox"/>	<input type="checkbox"/>	<input type="checkbox"/>	<input type="checkbox"/>	<input type="checkbox"/>	<input type="checkbox"/>	<input type="checkbox"/>	<input type="checkbox"/>	<input type="checkbox"/>	<input type="checkbox"/>	<input type="checkbox"/>	<input type="checkbox"/>	<input type="checkbox"/>	<input type="checkbox"/>	<input type="checkbox"/>	<input type="checkbox"/>	<input type="checkbox"/>
--------------------------	--------------------------	--------------------------	--------------------------	--------------------------	--------------------------	--------------------------	--------------------------	--------------------------	--------------------------	--------------------------	--------------------------	--------------------------	--------------------------	--------------------------	--------------------------	--------------------------	--------------------------	--------------------------	--------------------------

Please debit my VISA/MASTER/SWITCH Card No.(Switch card issue No _____)

Valid Date: _____ Expiry Date: _____ Cardholder Signature: _____

I enclose a cheque/postal order for £ _____ Made payable to: Audio Publishing Ltd.

Send in your private classified ads with our NEW Freepost service. No need for a stamp!

Send this form together with your payment in an envelope marked:

Hi-Fi World, FREEPOST LON3478, LONDON NW6 6YR



PRIVATE & TRADE CLASSIFIED ADVERTS COPY DEADLINES

APRIL 2006 - 7TH FEBRUARY 2006

MAY 2006 - 10TH MARCH 2006

LEFTFIELD

LEFTISM

1995



The best dance album there has ever been, basically. Absolutely seminal in nature and form. Track one, 'Release The Pressure', a blend of ragga and techno technology is foreboding, predicting the album, warning about what is to come, rising out of the swamp with almost ethereal flute effects before Earl Sixteen confesses his search for 'peace and unity'. This first track is a statement of policy but also a reflection of the times. It was a sort of hippy throwback era fuelled by Ecstasy but peace and unity was the clarion call, mixed in with an awful lot of spiritualism and chilled personalities. All you had to do was wander around the Glastonbury and Tribal Gathering festivals for proof of that. The massive, yet easy paced, bass that knocks you sideways is another distinctive feature of both the album and the band. Having seen Leftfield live in the Royal Court, Liverpool, the same place I had witnessed the vision of Kraftwerk (who I was destined to see for a second time at Tribal Gathering, which was an interesting twist of fates) almost ruined my hearing for life. Like the siren's call, the music was sweet yet deadly.

The delicious exoticism of 'Afro-Left', track two, connects to you to World music's potential and asks, no, scratch that, demands, that you dance. 'Djum Djum' might be spouting a foreign language but its lyricism, lying in and around the techno beat pyrotechnics is treacle-like how it

insinuates itself into your brain. 'Song Of Life', which uses the drum loop from the Beastie Boys' 'Looking Down The Barrel Of A Gun' as the backdrop for a haunting female vocal, flows into Tony Halliday, lead singer for the indie band, Curve, who arrives as if pushed on stage reclining on a chaise lounge. With beats of rhythms reminiscent of 'Wish You Were Here'-era Pink Floyd, Halliday's sexy vocal which lies over a ragga vibe is a perfect ying-yang experience and the song pushes a positive Original message to all its listeners.

And so the album goes, brilliant track after brilliant track. And then 'Open Up' appears – which starred (and stared) ex-Sex Pistols and ex-PiL main man, John Lydon as the principle vocalist.

"I really think he [Lydon] is a great singer," Leftfield's Neil Barnes commented. "He's got an original, soulful voice. I knew he would come out with something special because he was really nervous. Put John on the spot – that's the best way. We treated him like we treat anybody else. We weren't star-struck. We made him work and he liked that. He did have everything worked out. He's a professional. He plays that down in himself but he really works at it."

The song was written months before a series of fires in California, USA. When it was coincidentally released during these spate of fires it was banned from many TV and radio stations as being insensitive and provocative, especially with its "Burn

Hollywood Burn" refrain. Top Of The Pops offered it small snippets but MTV withdrew it entirely.

"Who are they to be purveyors of good taste?", railed John Lydon at the time. "There are governing bodies to decide what should and shouldn't be played. They've overstepped their mark. I find that bloody offensive. That's what is offensive in this country. Not a song like this, which in no way bears any relation to the catastrophe in California. It's nothing to do with that. So I see it as a bit of a victimisation thing going on. We worked hard putting this video together. There's not a lot of money about here. We cared about the product. It's damn upsetting to see things like that going on. I don't like to be anyone's victim. Year in, year out, it just gets more and more restrictive and people just seem to put up with it. How dare they dictate what is good or bad taste?"

The controversy didn't do the album any harm, however, quite the opposite, in many ways because it reflected the growing politicisation of the times, the Criminal Justice Bill, the Poll Tax riots and the like. The politics are, in fact, what we are left with on the final track, '21st Century Poem' – a call to take a stand. The album can still be readily purchased in the High St. but vinyl lovers should check out two releases. Firstly, apart from the official double vinyl album, there was a three disk version released, providing a longer version of 'Open Up' plus two tracks not available on the CD version. **PR**



n-Vious ?



bloody right

World class sound with clarity of vision. This powerful new performer boosts the home cinema experience up to a whole new level.

n-Vi An upgradeable high-end, integrated D/D player, DVD-A player, CD player, AV processor, audio pre-amp and 5 channel power amplifier - all together in one neat package. Digital audio inputs for integration with your games console, satellite receiver and mp3 player, plus optional FM/DAB radio module.

Experience full Dolby® Digital, DTS, Dolby® Pro Logic II and Neo:6™ surround sound from the comfort of your own armchair. Brought to you by the people with a passion for sound. So you can enjoy movies like never before.

To find out more right now visit n-Vious.com

Pod is a trademark of Apple Computer, Inc.



world class sound... with vision

World Radio History



The new Artikulat Loudspeaker System. Gorgeous.



Linn Products Limited.
For more information or a demonstration call 0500 888 909 www.linn.co.uk

