

# hi-fi

JANUARY 2006

UK £3.60

WORLD

**COMPETITION**

win a superb  
SHANLING CD-T80  
valve CD player!

## WORLD CLASS

Quad's superb QC-twenty four /II-forty tube amplifier



MERIDIAN 808i - THE ULTIMATE DIGITAL DISC SPINNER?  
COPLAND CSA29 TUBE-TRANSISTOR HYBRID AMPLIFIER  
PHONOSOPHIE CLASSIC I INTEGRATED AMPLIFIER  
UNISON RESEARCH UNICO CDP VALVE CD PLAYER  
ALR JORDAN ENTRY 'S' MINI-MONITORS  
EXPOSURE 35 INTEGRATED AMPLIFIER  
ESSENTIAL AUDIO ACCESSORIES  
PINSH 2.1 LOUDSPEAKERS  
ZU DRUID LOUDSPEAKERS

**HI-FI WORLD AWARDS 2005 SPECIAL p8 I**

10 PAGES OF HI-FI Q&A \* CLASSIFIED ADVERTISEMENTS

JANUARY 2006



9



Best seat in the house

The experiences this chair has had! The amazing performances, concerts and gigs it has witnessed from all around the musical world. From the front row at Carnegie Hall to the stalls at Brixton Academy, from the dress circle of the Sydney Opera House to the bar in Ronnie Scott's – this chair has been there! It has experienced music as it should be heard – alive and vibrant, with every nuance and emotion as clear as the musicians intended.

The Rotel O2 Series is a new range of hi-fi from a company with a reputation for delivering award-winning sounds at realistic prices. The O2 Series' superb sound is the result of Rotel's Balanced Design Concept – an integrated approach that ensures five star performance.

To find out how the Rotel O2 Series can take you to the world's greatest musical venues, visit [www.rotel.com](http://www.rotel.com).

## The Rotel O2 Series

*including the RA-03 amplifier*



**Rotel RA-03**  
May 2005



B&W Loudspeakers, Dale Road, Worthing, West Sussex BN11 2BH, United Kingdom, 01903 221500

World Radio History



**Rotel RA-03**  
April 2005



# welcome

## EDITOR

David Price  
tel/fax: +44 (0) 1275 371 386  
e-mail: [editorial@hi-fiworld.co.uk](mailto:editorial@hi-fiworld.co.uk)

## DESIGN EDITOR

Faiza Chunara  
tel: +44 (0) 20 7625 3129  
fax: +44 (0) 20 7328 1844  
e-mail: [adproduction@hi-fiworld.co.uk](mailto:adproduction@hi-fiworld.co.uk)

## PRODUCTION EDITOR

David Noble  
tel: +44 (0) 20 7625 3134  
fax: +44 (0) 20 7328 1844  
e-mail: [classifieds@hi-fiworld.co.uk](mailto:classifieds@hi-fiworld.co.uk)

## ADVERTISING

Debi Silver  
tel: +44 (0) 20 7372 6018  
fax: +44 (0) 20 7328 1844  
e-mail: [advertising@hi-fiworld.co.uk](mailto:advertising@hi-fiworld.co.uk)

## ACCOUNTS

Sharon Mehlhom  
tel: +44 (0) 20 8841 8892  
fax: +44 (0) 20 8841 9144  
e-mail: [accounts@hi-fiworld.co.uk](mailto:accounts@hi-fiworld.co.uk)

## PUBLISHER

Noel Keywood  
e-mail: [publisher@hi-fiworld.co.uk](mailto:publisher@hi-fiworld.co.uk)

## PRIVATE & TRADE CLASSIFIEDS

tel: +44 (0) 20 7625 3134  
fax: +44 (0) 20 7328 1844  
e-mail: [classifieds@hi-fiworld.co.uk](mailto:classifieds@hi-fiworld.co.uk)

## SUBSCRIPTIONS

tel: +44 (0) 1442 879097  
fax: +44 (0) 1442 872279  
e-mail: [hifiworld@websubscribe.co.uk](mailto:hifiworld@websubscribe.co.uk)

## WRITERS

Dominic Todd  
Channa Viithana  
John May  
Paul Rigby  
Steve Green



For something so subjective, isn't it rather strange that so many hi-fi buyers make their purchases with little or no listening?

The reason it's so surprising is that no two similarly priced products sound the same, and sometimes the differences can be dramatic. Moreover, there's nowhere near as much performance-price parity as people think.

For example, anyone spending £1,000 on a CD player cannot be confident that the model they choose isn't outperformed (either to their ears, or in absolute terms) by something at half or even one third of the price...

To me, this merely goes to show why it's so desperately important to audition what you're thinking of buying against its obvious alternatives. So why don't people do this?

Well, it's all a question of access. There are plenty of decent dealers in the UK, but trying to assemble a wide range of rivals for the product you're looking at buying, at any one of these, is tricky. The reason for this is - of course - politics; the brands that any given dealer chooses to sell.

This is a function of several things, from whether the dealer rates the product, to the magazine reviews, to the margin he's getting. Manufacturers, distributors and dealers never desist from discussing this (usually in complaining and carping terms, I hasten to add), and the upshot is that the choice available to buyers with cash to spend is never as good as it could be.

This is where our hi-fi magazines come in - not just *Hi-Fi World*, but our rivals too. In the absence of a level playing field in the dem. room, punters are forced to magazine reviews whether they like it or not. And 'Awards' issues seem to make the difference to sales.

This month, starting on p81, we feature our 'top ten' hi-fi products of the past year. These are - without doubt - seriously special bits of kit. But on p26, you'll see why *Hi-Fi World's* are awards with a difference. That's because we don't pretend that they're the beginning and end of what's good in the market. The reason for this is that when you're forced to come up with one 'best' CD player (or amplifier, or speaker, etc.), then you exclude several other superb designs which may actually work better than our one 'World Winner'.

So I hope you'll find that we've treated this 'Awards' issue with intelligence; we've recommended our faves, and also detailed why other rival designs could be better for you.

David Price, editor

## verdicts



OUTSTANDING  
EXCELLENT  
GOOD  
MEDIocre  
POOR  
VALUE

simply the best  
extremely capable  
worth auditioning  
unremarkable  
seriously flawed  
keenly priced

## hi-fi world

SUITE G4, ARGO HOUSE  
KILBURN PARK ROAD  
LONDON NW6 5LF  
[www.hi-fiworld.co.uk](http://www.hi-fiworld.co.uk)

## testing

*Hi-Fi World* has its own advanced test laboratory and acoustically treated listening room, and a dedicated team of experienced listeners. We review thoroughly by extensive auditioning, rather than by quick-fire group listening tests. Our engineering team designs a wide range of products in-house. No other hi-fi magazine is so expert and dedicated.



Distributed by Seymour Distribution Ltd 86 Newman Street London, W1T 3EX Tel: +44 (0) 20 7396 8000 Printed by St.Ives, Plymouth Tel: +44 (0) 1752 349 413  
Our Agents in Malaysia Millennium Hi-Fi & AV Simon Chang Showroom & office, 500-1-3 First Floor Wisma Indah (Shen Court), Jalan Tun Razak 50400 Kuala Lumpur, Malaysia  
Tel: 603 9283 8171 Fax: 603 9281 3762 e-mail: [info@millennium-audio.com](mailto:info@millennium-audio.com)

All unsolicited submissions and goods are at the owner's risk. We accept no responsibility for such submissions, nor do we undertake to return them.  
No material may be reproduced from this magazine without the publisher's written permission. © Audio Publishing Ltd

# 10

Quads reborn: Noel Keywood celebrates the new...



# 20

Meridian 808i: the ultimate digital disc spinner?



# 34

Philips DVP9000: DVD/SACD par excellence



# 38

Best of both worlds? Channa Vithana tries Copland's tube-transistor hybrid

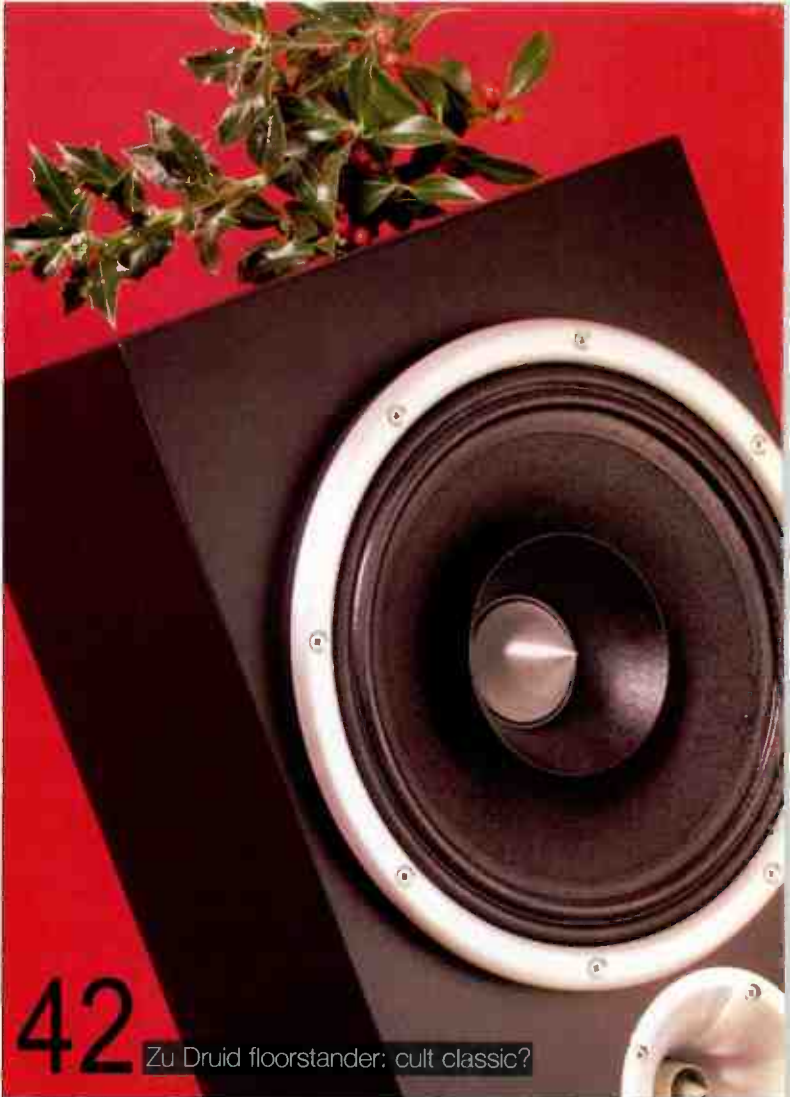

# 42

Zu Druid floorstander: cult classic?



# 60

ALR Jordan Entry S mini monitor; less is more



### **FORTY, SOMETHING 10**

Noel Keywood finds Quad's latest QC-twenty four and II/forty pre-power amplifier something truly special...

### **THE GOOD LIFE 20**

Meridian's premium priced 808i CD player/digital preamplifier gets reviewed by Channa Vithana.

### **WORLD CLASS 26**

David Price puts the *Hi-Fi World Awards* 2006 into perspective...

### **HISTORY, MAN 34**

Dominic Todd tries Philips' new DVP9000, their latest DVD/SACD player.

### **SMOOTH OPERATOR 38**

Channa Vithana auditions Copland's CSA29 hybrid valve/transistor integrated amplifier.

### **CULT APPEAL 42**

Zu's Druid is one of wackiest floorstanders around, thinks Channa Vithana...

### **TOTAL EXPOSURE 46**

The 35 is Exposure's latest top of the range integrated amplifier; John May listens in.

### **CHRISTMAS CRACKERS 50**

David Price finds six great ways for audiophiles to spoil themselves, over the festive season and beyond...

### **ONE LOVE 55**

Channa Vithana auditions the affordable Unico CDP from Italy's Unison Research.

### **SUPER MINI 60**

There's no shortage of miniature loudspeakers, but it's rare to see one up to ALR Jordan's Entry S, says Dominic Todd...

### **PINSH POINT 62**

Masters of the ribbon tweeter Pinsh have the new 2.1 floorstander out; Channa Vithana tried a pair.

### **CLASSIC GOLD? 66**

Channa Vithana reviews German high end specialists Phonosophie's Classic 1 entry level integrated amplifier...

### **WORLD MUSIC 70**

Paul Rigby rounds up his nine favourite audiophile vinyl releases of the year.

### **HI-FI WORLD AWARDS 81**

Editor David Price rounds up his favourite hi-fi separates from the past year.

# WORLD AWARDS

# 81

### **7 NEWS**

words from the front...

### **75,77,79 OPINION**

The team get to grips with matters music, hi-fi and life!

### **80 COMPETITION**

Your chance to win the superb Shanling CD-T80 valve CD player!

### **98 KIT & COMPONENTS**

Purveyors of specialist hi-fi services.

### **99 MAIL**

Ten pages of your views and comments.

### **118 DIAL-A-DEALER**

A comprehensive guide to UK hi-fi retailers.

### **120 SPECIALIST HI-FI DEALERS**

Purveyors of specialist hi-fi services.

### **121 MEET YOUR MAKER**

Who makes what and how to get in touch.

### **123 CLASSIFIEDS**

Three pages of second-hand bargains.

### **126 SUBSCRIPTIONS**

Ensure your copy every month and save money too.

### **128 NEXT MONTH**

What we hope to bring you in the next sizzling issue...

### **129 ADVERTISERS' INDEX**

### **130 CLASSIC CUTS**

Paul Rigby pens a paean of praise to Ennio Morricone's 1966 classic, 'The Good, The Bad And The Ugly'...

# KEF®



*"They produce stunning scale and authority"*



## Q SERIES Acoustic intelligence

You don't have to be a genius to understand why the new Q Series speakers sound so good. The clue's in the name: iQ.

Drawing heavily on research carried out for our legendary Reference Series, each and every component has been completely redesigned.

New fully-shrouded binding posts with oxygen-free copper wiring. And new super-rigid curved cabinets engineered from higher density material, with a choice of stunning new finishes.

New long-throw bass units with more than double the excursion, delivering far greater output and much lower distortion.

New wide dispersion Uni-Q arrays with extended bandwidth tweeter for SACD and DVD audio.

All these performance enhancements make the new Q Series the best ever value speaker range from KEF – and that's exactly what we mean by 'Acoustic Intelligence'.





news@hi-fiworld.co.uk

# news

## DEBUTANT(E)

Pro-Ject's new Debut e budget turntable is based on the Debut III, but is an electronic version featuring electronic platter start/arm lower and arm lift/platter stop. Unlike many past models from other sources, the Pro-Ject Debut e uses an optical sensor to determine stylus position which is not only extremely effective but also has no degrading effect on sound quality, claim Pro-Ject. This new model is available immediately in black or silver and sells for around £210 through approximately three hundred outlets in the UK and Eire. For more information, click on [www.henleydesigns.co.uk](http://www.henleydesigns.co.uk).



## SONGBOOK

Ruark Acoustics Ltd, sole UK distributors of Tivoli Audio electronics, have introduced a stylish portable radio to the range. The Tivoli SongBook portable features FM and AM wavebands, plus an alarm clock, sleep timer and a built-in charger for NiMH/NiCad batteries (sold separately). The unique rubberised coating helps to protect SongBook from the weather and from everyday wear and tear, and there's a rear keyhole cut-out for wall-mounting. Songbook is available in

White, Red, Blue, Yellow, Green, Silver and Black for around £159.99. Tivoli products are available through a wide range

of specialist audio retailers and department stores such as Conran, Harrods, Selfridges, and John Lewis. For more information, click on [www.ruark.co.uk](http://www.ruark.co.uk).

## ONE OF A KIND

Audion's Silver Note One (£2,500) is said to be an extremely high quality power amplifier, employing a feedback free, single ended topology and 2A3 valves. The Silver Note is completely hand made and hard wired with pure silver wire in selected parts of the audio stage. Only high quality components are used to ensure the finest sound and non ferrous (military grade aluminium) casework is used for both sonic and cosmetic reasons. A combination of 5687 and 6922 valves are used to feed the mono plate Sovtek 2A3 output valve, and the design produces 4 watts per channel (6dBV). For details, call Noteworthy Audio on 01296 422 224 or click on: [www.noteworthyaudio.co.uk](http://www.noteworthyaudio.co.uk).



## GREET STATIC

ER Audio of Western Australia has been supplying electrostatic loudspeaker kits and repair kits for commercial ESLs such as Quads and B&W to the audiophile community for the past fifteen years. The company has now announced new American and UK/Europe distributors to coincide with the release of the flagship electrostatic loudspeaker DIY kit, the Acorn. The Acorn is available in two stages of completion: Version 1 is a full DIY version, while Version 2 is partially completed with semi-assembled panels and pre-built, tested and matched electronics. The Acorn has a double-stacked ESL array with three electrically separate sections. Construction is easy and straightforward, says ER Audio. Sonically, it reckons the Acorn is up amongst the very best of commercial ESLs regardless of cost. For more information contact: Colin Topps at [ctaudio@btinternet.com](mailto:ctaudio@btinternet.com) or click on [www.eraudio.com.au](http://www.eraudio.com.au).

## TECHNO-COLOUR

True Colours Industries new Rhodium-plated SCR mains cable is claimed to filter out noise from the mains supply and reduce incoming and outgoing radiated noise. Sonic improvements include more detail, bigger sound stage, better dynamics and a deeper and fuller bass, says TCI. The sonic improvements the TCI Super Constrictor Rhodium (SCR) cable claims to show the careful application of tried and tested construction techniques combined with expensive, high-performance components and materials.

The natural filtering effect on dirty mains is significant and capable of carrying more than 60 amps at 500 volts RMS, making the SCR "virtually transparent to the power supply". The Rhodium plating is said to deliver lower contact resistance than standard plugs, lower maintenance and better long term stability than either silver or gold and a smooth, yet dynamic sonic signature. The cable uses sixteen PTFE insulated Silver-plated Copper conductors, braided construction for excellent RF rejection and filtering, polyolefin outer insulation with external Nylon braid for abrasion resistance. The silver-plated copper conductors are PTFE insulated in a braided configuration and then sleeved in halogen-free polyolefin insulation and finally wrapped with tough, but flexible Nylon braid. Prices start at £200/m. Click on [www.true-colours.com](http://www.true-colours.com).

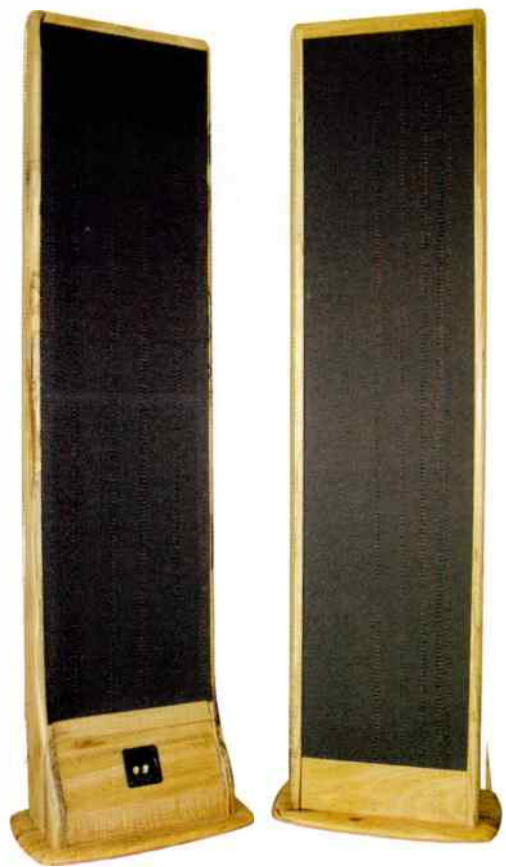

## SHOP TALK

Radlett Audio has moved from St. Albans to Rickmansworth in Hertfordshire. The new telephone/fax is now 01923 772118, e-mail is [radlettaudio@hotmail.co.uk](mailto:radlettaudio@hotmail.co.uk) and the website is [www.radlettaudio.co.uk](http://www.radlettaudio.co.uk). Radlett's mailing address is 9 Holywell Hill, St. Albans, Herts. AL1 1EU.

## NEW PROCESS

Arcam's new high end £3,600 FMJ AV9 multi-channel surround processor builds on the high standards set by the AV8 and adds key technologies and features, such as a 5-way 1080p capable, HDMI switch to ensure its integration with HD devices such as DVD/ BluRay/ HD-DVD players, Sky HD boxes etc. In addition, wide-bandwidth 1080p capable component video connections, will handle all legacy devices and displays. The AV9 features new high-precision calibration options and is built to the strictest Lucas Film THX Ultra2 spec. Both case and chassis feature Arcam's unique Acousteel damping with constrained layer case construction and multiple separated power supplies feeding the critical audio and video circuits. Designed and built in the UK, by a dedicated team of Arcam analogue, digital, software and broadcast video engineers, the AV9 is said to be a true reference quality product and Arcam's view of the ultimate home cinema processor. For more information, call Arcam on 01223 203 200 or click on [www.arcam.co.uk](http://www.arcam.co.uk).







## MAGIC BOX

The new SP150 Audio Jukebox from Acoustic Solutions is priced at around £199, and offers a host of facilities for those looking for an affordable hard disk-based music centre. CDs can be loaded directly onto the SP150's internal 40GB hard drive with a simple touch of a button, so that means music doesn't have to be downloaded via a computer beforehand. In addition, it is equipped with Audio Blend software making it the world's first jukebox system capable of segueing tracks together, thus providing hours of uninterrupted music playback. The SP150 can be used as a normal CD player or you can choose to load your favourite songs onto its internal hard drive. To transfer tunes simply insert a CD of your choice into the SP150 and select copy. Tracks are quickly transferred to the hard drive ready for you to select and play within minutes. Up to 8000 average length tracks can be stored thanks to the internal automatic file management system that formats the hard drive and compresses file sizes producing maximum music space. If you don't want to compress files, around 800 uncompressed tracks can be stored. The SP150 also features an integrated CD track information database that stores artist, album and track data. When a track is played the associated information is displayed on the LCD screen. Its crisp extruded aluminium finish means that the SP150 complements the stylish Acoustic Solutions SP hi-fi range, which includes the SP111 digital (DAB) radio tuner, the SP121 CD player and the SP101 & SP102 amplifiers. For more information, click on [www.acousticsolutions.com](http://www.acousticsolutions.com).



## RECEIVING LOUD AND CLEAR

Denon's new AVR-3806 is the latest £999.99 do-everything multichannel product from the Japanese audio specialist. Owing much of its design to its more advanced big brother XV series, it is claimed to deliver incredible performance from a more compact and affordable package. Key features of the 3806 include the advanced Audyssey MultEQ™ XT room correction and calibration technology that is capable of minimising the effects of room acoustics for up to six listeners. Seven discrete 120/160 watt power amplifiers and multiple-channel output, with independent audio and video processing capabilities allow a 3-room multi-source, multi zone home entertainment system from a single component. Audio performance is maximized through Denon's latest DDSC-D (Dynamic Discrete Surround Decoder-Digital) with AL24 Processing Plus. There's also the latest Denon Link 3 (DL3), claimed to sound better than HDMI or Firewire, for movies or music. Fully SACD capable, DL3 allows the amplifier to receive high resolution, multichannel digital audio data directly from DL3 DVD players for the best sound from all disc formats. SACD is kept as pure DSD all the way to the DACs. For more information, click on [www.denon.co.uk](http://www.denon.co.uk) or call [01234 741 200](tel:01234741200).

## XTRA TECHNOLOGY

QED Silver Anniversary 'XT' is a completely new speaker cable, claimed to "deliver a purity of sonic performance previously not even contemplated at this price point." The new cable introduces QED's high end 'X-Tube' technology into a mid-priced product for the first time. The precise cylindrical construction of the silver-plated, 99.999% pure, oxygen free copper cables reduces the distortion caused by 'skin effect'. The cable is a standard 'figure 8' configuration and is attractively finished, with each silver-plated core visible through a flexible 3.9mm diameter clear polyethylene outer sheath. For ease of assembly and to ensure correct speaker 'phasing' the inner spacers, which maintain the cylindrical configuration, are colour coded red and white as well as being 'crushable' to allow straightforward crimping with 'Airloc' speaker plugs. Cost is £5.50 per metre (including vat), and is available from QED dealers nationwide. For more information, click on [www.qed.co.uk](http://www.qed.co.uk).

## CLASSIQUE QUALITY

We'd like to say a belated thank you to Paul Greenfield at Classique Sounds ([classique\\_sounds@yahoo.co.uk](mailto:classique_sounds@yahoo.co.uk)), who has provided much of the olde worlde kit reviewed in the magazine over the past year or two, including the delicious Marantz MA5 monobloc power amplifiers, the wonderful Meridian MCD Pro CD player, the Marantz CD63 (original top loader) CD player from December 05 and the forthcoming Sony MDS-JA555ES battleship MiniDisc recorder (keep your eyes peeled). All Paul's stock is of an extremely high standard, and his prices surprisingly low too; before classic hi-fi hunters waste time and money on internet auction sites, call him on [0845 123 5137](tel:08451235137)!

## THIRD WORLD

Pure Digital's new EVOKE-3 DAB portable brings together the best features of PURE's DAB digital radio range, including ReVu(tm), SD-card support, MP3 playback, tri-band reception, USB upgradeability, SnoozeHandle and Electronic Programme Guide (EPG). It uses the latest Frontier Chorus FS1010 chip, which incorporates a META multi-threaded processor and DAB technologies developed by Imagination Technologies' Metageance and Enigma divisions. It sports integrated full range hi-fi speakers and a bass reflex port for enhanced bass performance. A dedicated DSP audio processor allows users to adjust the sound to their own preferences. EVOKE-3 is compatible with EPG broadcasts which enable users to browse the programmes on a single station or all programmes at a particular time, see a short description of each programme, and select them for scheduled listening or recording to SD memory card. It is also 'USB Upgradeable' over an Internet connection (PC required). Whether it's enhancements to the DAB standard or new features from PURE, the USB connector enables users to keep their EVOKE-3 up to date. Users can also transfer recordings and MP3 files between a PC and EVOKE-3 over the USB connection. EVOKE-3 will be on sale from November 2005 for £199.99 inc. VAT. See [www.pure.com](http://www.pure.com) for stockists or call [01923 277 488](tel:01923277488).



# Forty, Something

It isn't often that valve aficionado Noel Keywood finds a 'tubular belle' that is so well engineered and voiced that he finds it almost beyond reproach, but Quad's latest QC-twenty four and II/forty pre-power combination is such a thing...

I suspect a good many *Hi-Fi World* readers will know that the Quad QC-twenty four valve preamplifier and II-forty power valve combination I am reviewing here is a modern update of a much venerated classic, the Quad 22/II, first released in 1953.

Looking at it, you might think not a lot has changed, and in some ways it hasn't. Quad have retained both the original style - or the essence of it - as well as the original packaging arrangement of preamp accompanied by two monobloc power amps. So why re-engineer an old classic like this?

There's steadily growing interest in old classics of all sorts, often because they embodied properties lost to the modern world. In this case both the preamp and power amps retain the elegant simplicity of style that proved a timeless feature of the originals. Additionally, they offer





an attractive alternative to the sound of transistors. There's a growing understanding and acceptance worldwide that valves provide an alternative sound. Especially in China, where this amplifier is now built, as the Chinese still manufacture valves and if their domestic market is any guide, still very much believe in the quality valves offer.

This is still a modern amplifier though, not an anachronism designed for wistful old fogeys. And although wistful old fogeys may well like it, as I did, forget steam power; this has quite an engine under the bonnet. It isn't a slow and sedate veteran by any means!

The QC-twenty four preamp is a self-powered, standalone unit, unlike the original. Measuring just 30cms (1ft) long and 18cms deep (7in) its compact, sitting comfortably on a nine inch deep shelf, with room for the rear connectors. By today's standards it is small, yet it is dimensionally similar to the original. It also uses a similar control layout, with a nice simple power switch and large volume control situated conveniently at right.

Inside, there is a miniature, wire-ended Philips 6111WA double triode valve. This is a military device, used in missiles I'm told, with extremely long life and enormous robustness. It provides a gain of x6 via the normal inputs (i.e. CD, Tuner, etc), our measurements showed. That's high, twice as much as usual and, coupled with a useful 3.45V / 20V input/output limit means this preamp will in theory drive any power amplifier from any source.

However, with no cathode follower line driver, output impedance is high. Quad recommend the preamp sees at least 50k load, which excludes most solid-state power amps. In practice there's gain to spare so it might drive many power amps satisfactorily. High output impedance also means the preamp isn't suited to drive long cables to the power amps.

The use of just one triode per channel does have the advantage of simplicity though, introducing very little degradation to the sound. There's no penalty to be paid here if the Quad power amps are used.

Maintaining this purist approach, Quad switch the rear inputs with relays to avoid wiring looms. The front panel push buttons are actuators in effect; they don't carry the audio signal. It's the only proper way to do it and a neat arrangement by any standards. An orange LED at the centre of each button lights when that input is selected. Signal purity is

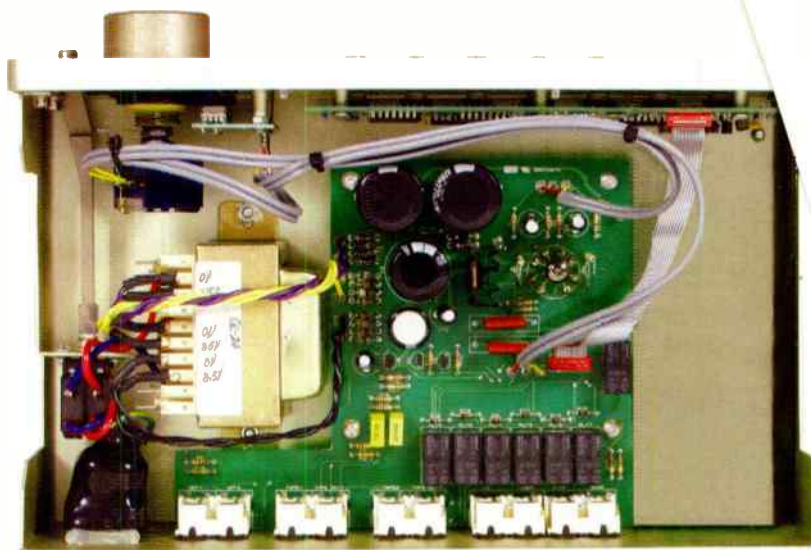

**Inside the QC-twenty four preamplifier. Nice, big Alps Blue volume control (top left), logic board behind input selectors, relays next to rear inputs.**

maintained by the use of an Alps Blue volume control, a recognised high quality audio component.

All this is quite different from the original Quad 22 of course. This new preamp really is a specialised design, quite unlike most rivals of today, or yesterday. With just one amplifying device and quality components the idea is to attain exceptional levels of clarity.

Quad will offer an external valve phono stage soon. The QC twenty four is line only in itself.

The preamp is beautifully built, although the lacquer spray finish is a tad underwhelming, I felt. The basic steel chassis is bent, welded and ground, a series of processes normally avoided because of cost. The front panel looks as if it might be milled from a slab, but in fact is a casting in true Quad tradition. This is how Quad originally achieved the attractive curves and three-dimensional detailing that's such a strong feature of the original. It's not seen nowadays because of high initial cost and inflexibility; once a die has been made it is difficult to modify. The pressure die casting Quad use on this new incarnation is a work of art behind the front panel!

The large volume control - a beauty to use, just like the original - sits on its own plastic moulding. Beneath is the delightful Quad balance control. It moves over a short quadrant and looks fetchingly ingenious perhaps, but gives rise to an expensive tangle of levers and parts behind the fascia. Redesigning and assembling this little lot must have had a few folk whistling through

their teeth, I think. By any standards Quad's early engineering was a bit absolutist and completely free from cost concerns, meaning it was expensive to produce. But that's what it takes to make a classic, and equally to remake it.

Modern day Quad, now a part of China based International Audio Group, or IAG, have taken no shortcuts with this one. What you get is a solidly made preamplifier that

"Quad's early engineering was completely free from cost concerns - but that's what it takes to make a classic, and equally to remake it..."

is delightfully easy and satisfying to use, as well as taking up little space. It is blissfully easy on the eye, too. The finish could look a little more refined, but it is a dedicated audiophile design that uses simplicity to achieve signal purity. Few preamplifiers are so neatly yet thoroughly designed to do their job as well as this.

The II-forty power amplifiers mimic the original IIs in basic layout and design, but they are larger, as Quad point out. The main reason is because the original IIs produced 15W each from a pair of KT66s operating in push-pull, but the II-fortys use a pair of quality KT88s in push-pull to deliver a chunky 40W. Okay, it doesn't sound much by transistor standards, but it is more than enough to drive a reasonably sensitive loudspeaker to very high volume in truth. If you really want to wick it, then a valve amp also overloads more gracefully, moving progressively into muddle, rather than the hard clip and distortion of

# Walrus



11 New Quebec St, London W1

Have we got turntables? Do bears... no, forget that. Of course we have!



We don't have a problem with turntables at all (some shops seem to have - how much choice do you see in your local hi-fi store, that is if they even sell proper hi-fi any more). This venerable way to reproduce music in your home still happens to offer the most realistic sound quality of anything available today. You can spend a fortune on the latest digital components to still only get a fraction of what even a relatively modest cost vinyl front end has to offer. You probably already have the "software" for it tucked away in a corner somewhere, assuming you're not a vinyl user already. And, the best thing is, it's not going to become obsolete - you won't have to worry like the digital aficionados do about the next miracle format and having to repurchase everything again! Provided you look after them, those vinyl discs contain an almost unlimited amount of information, and as you gradually upgrade your front end, you get to hear ever more of it.

Our advice on turntable/arm/cartridge matching is second to none (provided, obviously, you purchase from us!) and our subsequent building of your turntable will ensure you get the full performance from it (we see quite a few turntables purchased elsewhere or second-hand which aren't working properly). We also don't forget about you after you walk out the door, it remains important to us to keep your deck working to your satisfaction over the years. Just thought we'd remind you that vinyl playing is still our priority!

## However...

Even we have to face the fact that more and more of (to us) people tell us they visit us for digital for analogue. Er, yes. So, we have to be very making some absolutely superb digital products example. Consonance also make some wonder-(pictured) is the latest wonder from this company, also a complete departure for this price range (the upsampling DAC and a valve output stage, all in a



you want decent digital disc spinners, and ironically players specifically because of our enthusiasm careful what we choose. The Chinese have been lately, you've all seen the success of Shanling, for ful products, and the Consonance Droplet 5.0 Not only does it sound excellent, the styling is Droplet costs £1995). You get a 24 bit / 192k unit which weighs just under an astonishing 30 Kg.

But it's not only the Chinese who're making digital waves, as it were. Our own home-grown favourite, Musical Fidelity, have come out with an astonishing two box player, a new model in their acclaimed KW series, the DM 25 transport and DAC. The digital and analogue sections are both effectively "dual mono", and although you can buy the units separately, there are very few other makes you can use them with because they connect using the esoteric dual mono twin cable system, a method only one or two far more expensive units use. The outcome is sound quality well ahead of what you might expect of the price tag - both units together cost £3995. And, in case you were wondering, those things sticking out the top of the transport are levelling adjusters for the unique isolating feet, nothing more sinister!



And, just a little reminder about the superb Stirling Broadcast LS 3/5a loudspeakers. Now, we know these are about as unfashionable as it gets. Modern speakers are supposed to be big, bold, full of high-tech drivers, and with a multi hundred watt power handling tag. And indeed, most modern designs are just fine for purely electronic music, where tonal accuracy, subtlety, and even soundstaging take second place to sheer grunt. For acoustic music and spoken voice, though, these BBC designed mini monitors are absolutely unparalleled.



Even when you hear them playing full orchestral music, or even rock, they are very special. Instruments sound as they were meant to, voices are utterly natural. These are a must hear design if you are a "serious" listener.

Finally, we now have the fantastic Hyperion HPS-938 loudspeakers on demo - sorry, no room for a piccie - book now for a listen.

air tangent amazon amplifon apollo furniture argento audible illusions audio aero audio physic black rhodium breuer dynamic brinkmann cartridge man cawsey clearaudio consonance decca london duevel dynavector ear yoshino final lab goldring graham (tonearms) graham slee hadcock heart heed audio hyperion (loudspeakers) incognito isolda jadis kr electronics klimo koetsu lavardin lyra magneplanar mcintosh michell engineering morch musical fidelity nordost nottingham analogue opus 3 origin live ortofon pro-ject rega (turntables) revolver ringmat roksan shun mook shanling shelter sme something solid sonneteer spendor stax stirring broadcast sugden sumiko tannoy tci cables tom evans townshend audio transfiguration trichord trigon van den hul voodoo wireworld xlo

tel: 020 7724 7224 fax: 020 7724 4347 email: [contact@walrus.co.uk](mailto:contact@walrus.co.uk) web: [www.walrus.co.uk](http://www.walrus.co.uk)

World Radio History



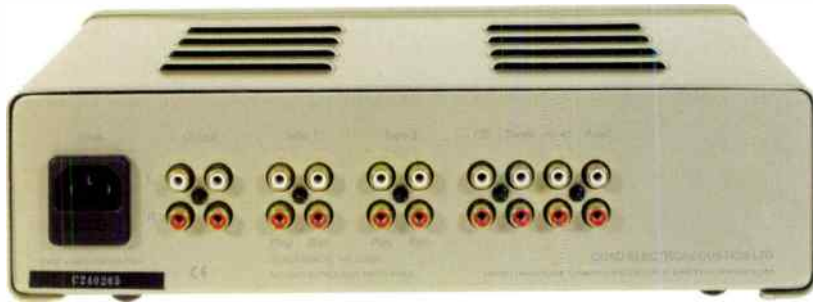

a transistor amplifier. Which is why many people say that valve watts are louder than transistor watts.

Delivering more power means bigger transformers all round, mains and output. So the II-fortys are heavy, but by today's standards where everything has swollen to almost incomprehensible proportions, they are still fairly compact. And, like the preamp, they have pleasing and useful proportions, seemingly able to fit in anywhere.

Another hidden factor that swells size and weight, but also sets the Quad IIs apart from so many rivals, is the use of a 5U4G valve rectifier in place of the more common solid-state diode bridge. This gives slow start up, but also a purer valve sound, free from a slight hardening that bridges usually impose. The circuit is all but identical to Peter Walker's original, using a transformer primary winding to add cathode coupled feedback.

As with the preamp, you encounter no religion with the power amps. Put them on a stand or the floor - but not carpet - connect up using the IEC power lead supplied, and a phono-to-phono to deliver the audio signal from the preamplifier, and you are in business. Press the rocker style power switch on each and the amplifier starts up silently; there's no intimidating thrum as a vast transformer rocks the chassis, just a gently intensifying glow from the valve filaments. Both 4ohm and 8ohm outputs are provided, so all modern loudspeakers are catered for. The output terminals accept 4mm plugs, spade connectors and bare wire.

## SOUND QUALITY

A modern valve amplifier, as I categorise it, is a fascinating beast, as well as an intriguing one. It displays all the strengths of valves, as well as those of transistors, almost without compromise. And this is how the Quad system struck me from the off. Almost magically it combines extreme dynamism with a presentation in which solid-state glare and that peculiarly flat, uninvolved

presentation of transistor amplifiers are absent. You get a sound with a sense of life and an absence of unnaturalness that, to me, is unequivocally more realistic than we have sadly become accustomed to in much

"this is what a really good valve amplifier can do: inject a dynamic that is almost frightening..."

of today's hi-fi.

Indeed, it suits Rock every bit as much as Classical music. In this respect the new Quad valve amplifier differs markedly from the old. The 22/II combo I once used for a short while was a little too mellifluous and polite in its low frequency delivery for Rock to have real impact. It was smooth and easy on the ear, but also a bit vague by modern standards. I wouldn't have expected to get much out of classic heavy rock like Steve Earle's 'Copperhead Road', for example, but the new Quads breathed life and power into the kick drum, and enlivened the cadenced drum strikes. There's all the low end grunt from solid-state, but without the flat and somewhat hard sounding follow through. Earle's rich Southern tones were as clearly presented as I've ever heard them and the chiming steel string guitars sounded lustroously resonant, with no hint of the artificial incision that so often lies behind them.

Yet that's not to say the Quads don't convey what at times is an enormous amount of high frequency energy in modern Rock. The stinging tambourine strikes in 'Esmerelda's Hollywood', from 'The Hard Way', were actually more vivid than I've heard them from solid-state amplifiers, which would surprise most sceptics convinced valve amps somehow do what they do by smothering the sound. In this case the reverse was true; the Quads gave strong high frequency transients ballistic impact. And this is what a really good valve amplifier can

do: inject a dynamic that is almost frightening. Dynamic contrasts seem stretched, but in truth they're just given full rein.

With so little active circuitry in the signal path you can expect an amplifier like this to possess enormous midrange insight - and it did. Billy Idols vocal theatrics were spot lit in 'Soul Standing By', capturing all his expressive devices. And the Quad rocks; you'd want to play 'White Wedding' on it. Carol Decker is another singer not short of vocal expression and I was delighted to hear further into what has always been the muddled sound of TPau's 'China in Your Hand'. The muddle is real and within the recording, so



**The QC-twenty four's wire-ended Philips 6111WA double triode valve. Originally for military use, like sitting atop an ICBM, it is rugged.**

there's only so much an amplifier can do, but I heard more of La Decker's expressive range than I have ever really appreciated before. Here the Quad started to pull way ahead of what I am used to, bar my own 300B perhaps. The Quad paints a more vivid picture than a classic 300B push-pull, but then this is what you can expect from the KT88 when it's enjoying the right support circuitry.

A delight of valves of course is that their intrinsic smoothness and lack of glare or grain suits Classical music as much as Rock. And so it was with the Quads. The orchestra swelled magnificently in the Overture of Wagner's 'Rienzi', horns had a rich, sonorous and throaty rasp, and

# True Digital...

We class our amplifiers that accept analogue inputs and digitize the signal as 'semi-digital.' They offer great performance and value. Our range starts at £775.

True digital amplifiers accept a digital signal and do not require this 'unnecessary' initial conversion. Less distortion, purer music. Superior technology. A little more expensive to create - but worth it.



## TDA2200 - 200w True Digital Amplifier

Our latest formidable product, the TDA2200, further supports Lyngdorf's mission to build the world's highest performing, best-value intelligent digital amplifiers and room correction systems.

Available now, and ready to accept the forthcoming room correction system module.

## The Design

State of the art sound quality achieved with further development and refinement to the clock, power supplies and output stages to reduce jitter and noise. More power, detail and music is delivered with an uncanny smoothness from a pitch-black background.

Powerful room equalization, speaker and subwoofer crossovers extend this amplifier to an incredibly comprehensive and advanced digital system. Room interactions can be minimalised, which results in a breath-taking improvement to musical enjoyment.

Simple, logical and elegant system building. Just connect a CD transport to this amplifier and you have all the necessary electronics to drive your speakers. No need to purchase DACs, preamplifiers, numerous interconnects, power cables and shelves.

As new software becomes available, the performance and functionality of the TDA2200 can be upgraded, protecting your investment.

LYNGDORF

0870 9 100 100  
www.tactaudio.co.uk  
www.lyngdorfaudio.co.uk

This soundsurgery is a new company with a difference.

We offer distinctive products, personally evaluated, that we know will make a difference to your system.

> Are you dissatisfied?

> Do you keep changing your kit but never seem to get what you're looking for?

> Are you bored with sterile, clinical sound?

Accessories can, and do make profound differences. (And you don't have to re-mortgage the house!)

If you treat cables and supports as essentials, you will be surprised at how beautiful your system can sound!

The future of retail is on the internet... This soundsurgery offer a shop, articles, reviews and consultation through this media. However, we offer the same quality of demonstration and consultation that you would expect from a shop.

If you're not internet savvy, don't worry we are only a phone call away!

At This soundsurgery we have confidence in all the companies we represent. We recognise their products to be the best in their price ranges, and often beyond.

We provide home visits by arrangement. Alternatively, individual appointments can be made with us.

We offer friendly, non-pushy advice. All products come with free UK delivery and a two year warranty.

This soundsurgery are happy to post items to European destinations.

Individually selected accessories and components, which offer genuine musicality and outstanding performance.

Local and mail-order demonstrations available on request.

ask@soundsurgery.co.uk

01392 662920

07989022492

Audio Desk Systeme  
Black Rhodium Polar cables  
Ebony Iso-Cones  
Exactpower  
Graham Slee  
Pearcable  
Monopulse  
Rothwell  
Stereovox  
Stillpoints  
Supra Sword  
Timber Matrix Formation  
Whest Audio  
Van den Hul  
Vertax AQ



PORTFOLIO

thesoundsurgery  
www.soundsurgery.co.uk

RELEASING  
THE  
MUSIC  
FROM THE  
SYSTEM



their interjections stabbed out with impressive strength. This comes from both the extreme resolution of the Quad, linked to its unfettered dynamics; instruments are lifted from a mix and given life. It's wonderful to hear, a treat in musical entertainment.

Needless to say, strings have vivacity and even that edginess and wiriness that comes from gut bowed hard, but you're so aware of their natural properties, such is the resolution of timbral signature, that it all seems vividly right. When the orchestra falls silent except for the menace of distant thunder from a kettle drum, the Quad captures

and expresses the mood perfectly. It wasn't an undifferentiated rumble that my brain struggled to resolve and make sense of, so much as a musical instrument being carefully but skillfully manipulated by a musician. In this sense the Quads made music more of a natural and fulfilling experience than I usually enjoy, and of course Wagner is not a composer whose music survives an amplifier lacking dynamics or resolution. So it enhances classical if anything.

What held for Wagner was repeated with violins and brass in 'Scheherazade'. Orchestral sections stood out in clear relief, heightening

the drama of the performance as horns replied to strings in clear point and counter point.

What held so well for Rock vocals applied equally well to Opera. The Quad portrayed Renee Fleming with a sense of full-bodied ease that struck me as completely real. Whether any recorded performance can be so is doubtful of course, but that's how it seemed. Not so much a cleverly contrived simulacrum, representative but not real, as a real person singing. Again, the Quad offers a degree of entertainment with Opera that's hard to find elsewhere in high fidelity. It's a masterful product as such.

The new Quad valve amplifier is a perfect update of the famous original 22/II. It is a masterful design in itself, getting the best out of one of the world's best audio valves to provide a modern, dynamic and exciting sound. In conjunction with lovely styling and superb ergonomics this is one of the best sounding, most elegant and easy to use hi-fi amplifiers you could ever hope to come across.

**THE ORIGINALS**

Quad's first valve amplifier combination comprised the QCII mono preamplifier partnered with one Quad II monobloc power amplifier, introduced in 1953. By 1959 the stereo was catching on so Quad introduced the Quad 22 two channel preamp, for use with two Quad II monoblocs. This combination sold steadily until 1969, when they were replaced by the solid-state 33/303 amplifier, introduced 1967.

As both valves and old classics have become progressively more popular over the last decade or so, the Quad 22/II combination has gained wide recognition as an elegant exemplar of the valve art. The preamplifier, which uses two ECC83 double triodes and two EF86 pentodes, is compact, very well made in most, if not all areas, stylish in a way reminiscent of the 1950s, yet at the same time pure enough of line and in shape to appeal today.

The Quad II monobloc power amplifiers use a circuit unique to Quad, to deliver 15W apiece with little distortion, from GEC KT66 output valves.

Nowadays, Quad 22/II set ups are sought after classics. They come with a host of difficulties though. The preamplifier is all but unusable, as it is festooned with LP equalisation circuits and associated switches. Sound quality is usually veiled - poor by modern standards, largely because the many switches have corroded, weak input sockets have loosened and internal components have deteriorated over time. Comprehensive restoration can remedy this, but the input sockets must be changed, so originality will be lost. See what expert Graham Tricker says though, on p16.

The preamplifier switches mains voltage through to the power amps via a cable harness, and also receives power back from them. It is not self-powered, so cannot be used on its own.

The power amps can be used alone, and often are. Costing less than a modern valve amplifier they have been pressed back into service around Britain and the world as their reputation spread. Put Quad II into Google and see what you get!

Generally, unrestored the Quad IIs deliver an easy, slightly mellifluous sound, with limited bass impact. I was told by Peter Walker that the output transformers, which are small, were designed to saturate at bass frequencies to provide a measure of protection for the ESL-57 electrostatic loudspeakers. Delivering 15W each from a pair of KT66 Kinkless Tetrodes, they are not power houses.

The new QC-twenty four preamplifier has none of the tone control or equalisation circuitry of the 22, nor the mechanical switches. Instead it has a switching logic board and associated miniature relays. This avoids wiring looms and open contacts. The new preamp also has its own power supply.

The new Quad II-forty power amplifiers are larger than the original IIs, using KT88 output valves instead of KT66s. These days the KT88 has been recognised as a great audio amplifying device, and the new II-forty does a fine job in exploiting its potential to the full.



**VERDICT** ●●●●●

Brilliantly open, fast and uncoloured sounding, this ultra modern valve pre-power combination is definitive of the breed

**QUAD QC-TWENTY FOUR £770**  
**QUAD II-FORTY £3,230PR**  
 Quad Electroacoustics Ltd.  
 ☎ +44 (0)845 4580011  
 www.quad-hifi.co.uk

**MEASURED PERFORMANCE**

Twin KT88s in push-pull normally give around 40W maximum output. In the Quad II forty power amplifier a smidgeon more is available - 45W maximum to be precise. This is about right; a unequivocal 40W but no more, so as not to over drive the valves. It's enough to drive any sensitive floorstander to high volume. Similar power was available from both taps: 45W from the 8ohm section and 42W from the 4ohm tap on it. Load matching was good, unlike a majority of valve amps. Full power was delivered at low (40Hz) and high frequencies too (10kHz)

Distortion in the power amplifier was a classic second harmonic at all frequencies. Third harmonic started to appear at high outputs, due to magnetic saturation, but otherwise the transformers showed their quality by not intruding in this fashion. Levels were low too, below 0.1% most of the time, even close to full output. As always, there was more distortion at high frequencies, but as it was second harmonic and still at 0.2% at normal outputs, this is hardly consequential. So the power amplifier put in a great performance, due to good basic circuit design and fine output transformers. In this area it was a classic. Hum output was incredibly low at 0.3mV at 50Hz and the same at 100Hz.

The preamp has a lot of gain: no less than x6 - twice as much as usual. This gave the line inputs (CD, etc) a high sensitivity of 180mV for full output. All the same, with 2V in

from CD and 1V out to the power amp., distortion measured 0.07%, second harmonic only. Maximum input was 3.5V and output 20V.

This is an classic valve amp in measurement terms, one that turns in a great measured performance, free from weaknesses. NK

Power	45watts
CD/tuner/aux.	
Frequency response	2Hz-38kHz
Separation	83dB
Noise	-106dB
Distortion	0.05%
Sensitivity	180mV
Disc	
Frequency response	12Hz-28kHz
Separation	67dB
Noise	-74dB
Distortion	0.08%
Sensitivity	1.6mV
Overload	25mV

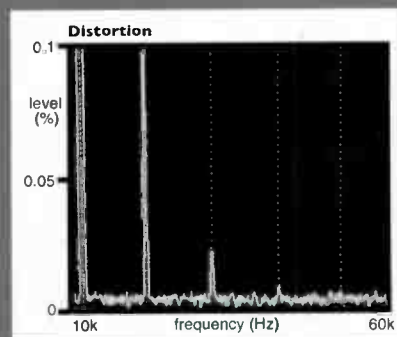

# TRUST YOUR SENSES



[HELICON FAMILY]

IN ADMIRATION OF MUSIC

DALI UK +44 (0)845 644 3537 ■ DALI USA +1 360 733 4446 ■ DALI Deutschland +49 6028 4390 ■ DALI Denmark +45 96 72 11 55

World Radio History





*"This DALI speaker is brimming with talent and seduction."  
"A new candidate in the world of top-of-the-range speakers  
at competitive prices."*

Robert Lacramp & Jean Hiraga | Revue Du Son & Home Cinema | '04



Golden Eye Award - 2004  
The Perfect Vision

*"In stereo configuration, the Helicon 400 ascended to the top  
of a very short list of premium \$4k-per pair floorstanders."*

Neil Gader | The Perfect Vision | Nov/Dec '04

*"Imaging is superbly spacious and "out of the box",  
with precise focus and good depth layering."*

Paul Messenger | Hi-Fi Choice | March '05



Golden Ear Award - 2004  
The Absolute Sound

*"While this speaker's alluring good looks might make even  
a super model green with envy, its sound is better still."*

Neil Gader | The Absolute Sound | Dec '04/Jan '05

## FEATURES



Wide Dispersion



3D Audio



Low Resonance Cabinets



Time Coherence



Hand Crafted



Amplifier Optimized



# original

**Professional hi-fi restorer Graham Tricker tells you what to look out for when buying classic Quad 22/11s...**

**T**he Quad II power amplifiers were originally designed to partner the Quad ESL 57 electrostatic loudspeaker. I often get asked what sort of pre-amplifier to use with them. The answer is: what's wrong with the original Quad 22? It works very well providing it has been carefully serviced/restored. However, if you looking to achieve a higher level of fidelity, then you should consider preamps from EAR and Verdier. I think it amazing that even today many audiophiles still use Quad 11s in very expensive systems and obtain excellent results.

What to look for before you purchase Quad 11s? Firstly, check their general condition, in particular around the base of the transformers. If you see any traces of black bitumen or tar then beware, as this indicates the mains or output transformers have overheated due to component failure. It is not

uncommon for amplifiers with this problem to work for a few weeks or even months, then fail. Replacement transformers are extremely expensive so this would often make them an uneconomical purchase if replacement becomes necessary.

It is a good idea to get secondhand Quads checked out by a competent service engineer before you switch them on, or they may be a bang.

The amplifiers sound best with original GEC KT66s and Mullard GZ32 rectifiers. Any that have had the GZ32 rectifier replaced with a GZ34 or even worse, silicon diodes, should be changed back to original spec.

Avoid ones that are not original, or have been rewired or butchered in any way. The original wiring is very good quality and the original loudspeaker sockets are silver-plated so should be left alone. RCA phonos can be fitted in place of the original 6

pin Jones plug if they are to be used with a modern preamp, along with individual mains switches.

There's no shortage of opinion and help available when it comes to buying and running Quad 22 / 11s. Just be aware of the drawbacks. In original form sound quality will be good, certainly easy and unchallenging, but below modern day standards in bass power at least. The parts will be 40yrs old and deterioration takes an inevitable toll. If you replace all the old parts though, the amplifiers will then be unoriginal and devalued. The output transformers are no match for those in new 11-fortys, and power much lower too. Reliability will be questionable. They are old classics, best restored and treated with respect like an old car or motorbike.

**Graham Tricker**  
**G T Audio** 01895 833099  
 e-mail: [gtaudio@btinternet.com](mailto:gtaudio@btinternet.com)  
[www.gtaudio.com](http://www.gtaudio.com)

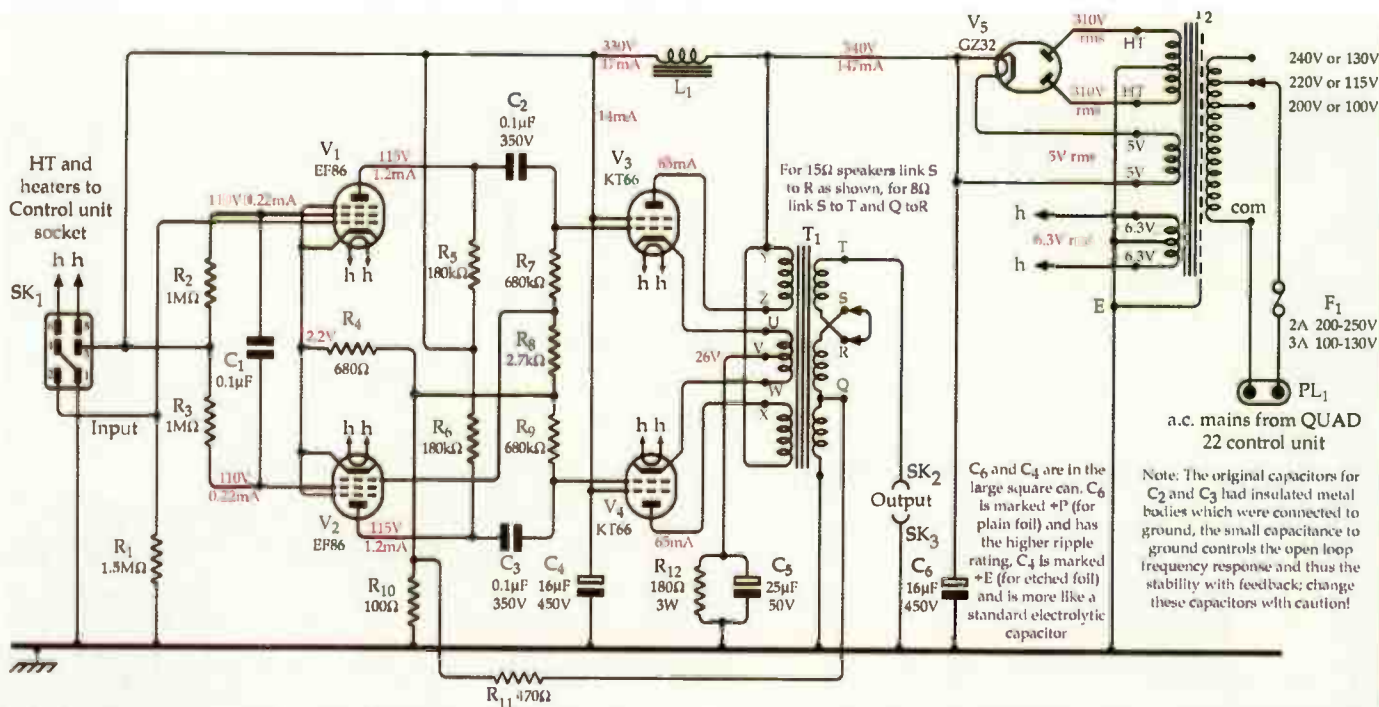

QUAD II Power Amplifier Schematic Drawing

Redrawn in original style by Keith Snook *d.c.~daylight ltd*

*The original Quad II power amplifier circuit, courtesy of Keith Snook. Uniquely, the KT66 cathodes receive feedback from the output transformer, a Quad innovation.*



# equipment

THE  
**QUAD**  
**22**  
CONTROL UNIT

*... a new unit anticipating trends  
in future listening requirements*

*In the changeover from  
mono to stereo Quad adverts  
showed how customers could  
use either one or two power  
amplifiers with the Quad II  
control unit.*

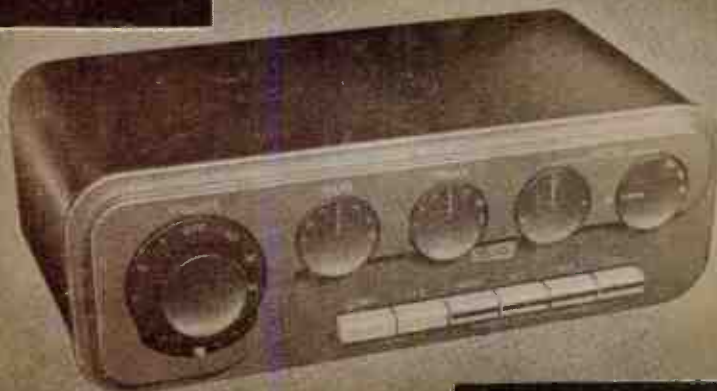

Used with a single QUAD II power amplifier  
the unit provides every facility and  
refinement at present associated with the  
QUAD II control unit.



Used with two QUAD II power amplifiers,  
the unit will in addition accommodate  
all forms of Stereo programmes with all the  
necessary facilities for that medium.  
Whilst providing extreme flexibility—  
the push buttons for example, provide  
eleven different services—straightforward and  
logical control has been maintained.



*A descriptive booklet is now available—free on request.*

ACOUSTICAL MANUFACTURING CO. LTD. HUNTINGDON, HUNTS. Telephone. Huntingdon 361

#### WHAT TO PAY:

Original set, average condition: £275 - £400  
Original set, good to excellent: £400 - £800  
(budget to get them properly serviced)  
basic service       £100 approx.  
full restoration    £350 approx.

#### MORE INFORMATION:

Keith Snook  
[www.dc-daylight.ltd.uk](http://www.dc-daylight.ltd.uk)  
Specialist information on parts and through engineering.

Paul Greenfield, Classique Sounds.  
[www.flashbacksales.co.uk](http://www.flashbacksales.co.uk)  
Specialist parts and restoration.  
tel: 0845 123 5137

# The Good Life

Anyone with £8,000 to spend on a digital disc player finds themselves in a most pleasant predicament, thanks to the wealth of superb hardware on sale. Meridian's 808i is one of the most interesting options; a DVD-Audio compatible CD player complete with sophisticated digital preamplifier built in, it's a natural partner to the DSP series of digital active loudspeakers. But how does it do as a standalone source component? Channa Vithana finds out...

**M**eridian can be proud of its history of illustrious digital disc spinners. The evolutionary MCD and MCD Pro were at the dawn of commercial Compact Disc in 1984. Then in 1985 arrived the superb 200/203 series, which remains my favourite Meridian in pure design idiom. With its confidence-inspiring and gorgeously tactile fully opening transport, Meridian claimed invention to the first separate transport and DAC CD player. The 200 series initialised the distinctive transport in a drawer philosophy for Meridian CD players that continued until the demise of the 506/508 series in the nineties which gave way to the current models that use a DVD-ROM drive hidden behind a flap

Before you is the latest in the line, an anniversary 808 series machine. Actually, it's available in two versions: the £7,195 808 CD player with selectable fixed or variable output and the £8,250 808i CD player preamplifier complete with both analogue and digital inputs. The latter (reviewed here) is described as

encompassing "the highest-quality CD playback available anywhere, at any price"! It features Meridian's favoured DVD-ROM drive as the transport, which for me is a little disappointing considering Meridian's own history in beautifully appointed CD transports.

Its ROM drive, says Meridian, "allows multiple passes to be made, ensuring that the correct data (is) recovered from the disc and improving Compact Disc's error-correction a hundredfold. It also allows complete buffering of the recovered data. To ensure the lowest possible jitter, (the) 808 incorporates three buffers, two of which are used as FIFOs. By the time the data is passed to the DACs or the digital output, the jitter is incredibly low

— in fact (the) 808 has the lowest jitter we have ever measured on a CD player: around 90 picoseconds, with the jitter spectrum held below 0.1Hz".

'Resolution Enhancement' digital signal processing is used, in which the original 44.1kHz, 16-bit audio is upsampled to 176.4kHz, 24bit in one of three 150MIPs (million instructions per second) processors operating with 48bit internal precision. "This is 'true' DSP upsampling, unlike anything else available in the marketplace", says Meridian. The 808 DACs are said to be multibit oversampled delta-sigma D/A converters, combined with a matching proprietary analogue output stage. Internal construction is much like a PC



#### MUSIC USED:

Marie-Claire Alain 'Bach Organ Masterpieces Vol.2' (1994/2003)  
 Ysaÿe/ Zehetmair 'Sonatas Pour Violin Solo' (2004)  
 Depeche Mode 'The Singles 86>98' (1998)  
 A-ha 'Memorial Beach' (1993)  
 Bee Gees 'Number Ones' (2004)  
 AC/DC 'The Razor's Edge' (1990)  
 Nikolaus Harnoncourt 'Bach Mattheus-Passion' (2001) DVD-A  
 Steve Stevens 'Flamenco A Go Go' (2001) DVD-A  
 REM 'In Time, The Best Of 1988-2003' (2005) DVD-A



tower but arranged on its side. The internal components are slotted like cards into a motherboard. These separate cards have their own power supply and buffering, and comprise: computer, decoder, FIFO buffers, DSP upsampling, D/A conversion, digital output, analogue input, analogue output and digital input. Meridian says audiophile-grade capacitors are used throughout, and each component – even each resistor – has been selected for its sonic contribution. The PCBs are all multilayer, many of them using 6-layer technology for the lowest noise and jitter and for optimum grounding.

The Meridian's internal chassis uses finely crafted and extruded bracing plates which form a skeletal frame along with the inner sidewalls and base plate. Within this frame and in-between two bracing plates at the rear are slotted the various cards. To the right of the rear panel is an isolated and sealed compartment for the IEC mains input and power switch. Then the ROM drive is located at the front with the power supply and display. The inner chassis/frame is sealed with a top layer.

Meridian has accomplished an exceptionally difficult task in designing an attractive 480x175x411mm outer packaging as it is, internally, in essence, a substantially constructed and sophisticated PC tower. Unlike almost all PC towers however the

Meridian in pure design language, due to its outer surfaces, is beautifully composed and is a lasting design which gets better the more one looks at it. It consists of two finely crafted L-section extruded metal panels on either side which have a series of ribbed details running along their outer sides; they are attached to the inner chassis via attractive hex head fixings.

The front is a substantial and solid one-piece component, centrally framing the display, upper flap, and disc-loader drawer flap and control buttons. It is finished in similar satin silver to the side panels. The complete casework is very solid overall and appropriately confidence inspiring. The glass top and various panels fit together very well, and a gentle finger-knuckle rap showed a well-damped structure.

The display, buttons and flaps are finished in gloss, which complements the glass top surface expressing sophisticated reflectivity. There is also

a black finish option.

The ergonomics, user interface, display legibility and uplit Meridian MSR+ remote are all first-rate communicative instruments and a delight in use and function. The one area in build quality for the £8,250 Meridian that should have been better is the material and moving parts of the disc-loading drawer flap, top flap and operation buttons. They are acceptable, but not flawless in fit and operational feel – as on the £9,000 Esoteric X-01 SACD/CD or the £6,190 Chord Blu/ Dac64 transport/ DAC – which is mandatory at this price.

For example, firstly, the operation buttons though wonderfully ergonomic, are slightly flimsy in comparison to a sub-£1,000 Marantz universal player's controls, let alone the Esoteric X-01 or Blu/Dac64.

Secondly, the ROM drive disc-loader drawer is noisy when it opens and shuts. It is not the worst sounding ROM drive but even a



*"A little champ of price/quality ratio: available at an affordable price, especially for a tube amplifier of more-than-usual power."*

*AUDIO REVIEW Italy, July 2004, Claudio Cimochi*

*"PrimaLuna ProLogue One is now my 'affordable reference amplifier'. With apologies to various British and Italian geniuses, this amplifier has to my ears - no equals at its retail price."*

*HI-FI NEWS and record review, July 2004, Ken Kessler*

*"A refreshing change from the transistor competition with a captivating presentation. Excellent finish and build quality makes for a package strong on value."*

*HI-FI WORLD, August 2004, Dominic Todd*



# PrimaLuna

Music is a pleasure not to be denied. So, too, the beauty of music reproduced by valves should be accessible to all. To make available to a wider audience the seductive, silky sound of the vacuum tube, PrimaLuna has developed a range of all-valve amplifiers with the construction, power and sonic performance of high-end electronics, but with one unique, inimitable feature: prices that can only be described as 'entry level'!

Since the arrival of the Prologue One, the audio community has been unable to contain its joy nor reign in its praise because PrimaLuna has revolutionised the concept of 'affordable audio.' With a pair of integrated amplifiers with prices more typical of mundane, solid-state products, PrimaLuna showed other manufacturers that compromises in fit and finish, styling and facilities are unnecessary.

Now PrimaLuna can offer the pride of ownership of true separates to aficionados on a budget. As promised, PrimaLuna has expanded the range upward with three exciting new models for users whose requirements demand separates rather than integrated amplifiers.

To meet these needs, the music lover can now consider the Prologue 3 dual-mono valve preamplifier with four line level inputs, and a choice of two matching stereo power amplifiers. The Prologue 4 provides 35W/channel from EL34 valves, while the Prologue 5 delivers 40W/channel courtesy of the classic KT88 tube.

And there's more good news: PrimaLuna has also announced retro-fittable auto bias boards for the Prologue 1 and 2, and a moving-magnet phono stage for the Prologues 1, 2 and 3. Additionally, there is now a choice of optional gold or silver front panels in place of the standard finish.

Audition the full range of Prologue models at the Pistol Music dealer of your choice. And prepare your wallet for a pleasant surprise.

**PISTOL**  
MUSIC



For your nearest Pistol Music dealer, please contact Pistol Music  
58 Durham Road, London SW20 0TW

T: +44 (0)20 89 71 39 09 F: +44 (0)20 88 79 79 62 [www.pistolmusic.co.uk](http://www.pistolmusic.co.uk)

**PISTOL MUSIC** is a division of Abolateral Sounds Ltd



much cheaper £895 Unison Research Unico CDP CD player uses a smoother and silent ROM disc-loader in comparison...

The upshot of having Meridian DAC and ROM components in this player is that it can read and play DVD Audio discs in stereo. The display stated 192k 24Bit MLP DVD-A when I loaded 'In Time, The Best Of 1988-2003' by REM. Additionally the Meridian read 48k and 96k on the other DVD-A discs used. This is a great feature!

On its rear panel, the 808i has a generous six analogue inputs, three coaxial digital inputs, two optical inputs, and both balanced XLR and phono stereo analogue outputs. There are two digital coaxial outputs; one is an auxiliary which can handle 44.1kHz and the other labelled MHR (Meridian High Resolution) can do 44.1kHz or upsampled 88.2kHz and is suitable for connection to Meridian's beautifully designed high-end DSP active speakers. There are a series of communication / software upgrade interfaces such as Meridian comms/RS232/trigger sockets, and IEC mains socket plus switch. There also appears to be some extra empty card slots possibly for future expansion or upgrades.

## SOUND QUALITY

Playing 'Bach Organ Masterpieces Vol.2' brought on a deep presentation with the Meridian; I found the unravelling of phrasing most enjoyable. Beyond immediacy, as the organ pieces were in full flow, I could distinguish a small but discernible stridency on the higher frequencies as they flared out when the organ was in its most powerful stride. The resolution of the organ was good, but the musical timing which can importantly convey the emotional impact of struck keys was a little minimised. Thus notes were generally well placed but slightly awkward which upset the flow of the organ pieces.

On the Ysaÿe/ Zehetmair 'Sonatas Pour Violin Solo', the violin had plenty of attack, with some nicely revealed phrasing. The timbre of the violin was quite delicate, with some good multilayered harmonics that helped to express the emotional feel

of the solo. When the violin went into quieter, darker passages (the recording went into near silent parts also) the Meridian was very good at detail retrieval. An exceptionally quiet background enabled portrayal of low level violin detail with clarity. There was some higher frequency stridency when the more demanding violin notes were rendered though.

The grandly distended 'Never Let Me Down Again' by Depeche Mode from 'The Singles 86>98' sounded very good overall through the Meridian. It was able to express the melodic and rhythmical details rather well – which procured a sophisticated feel. Dave Gahan's vocals were forward in placement to the musical structure but sounded excellent. The backing vocals were conveyed with clarity. The instrumental separation was good, giving a sophisticated feel. The higher frequencies and midrange were the most prominent aspects to the Meridian and although a little brightly lit, 'Never Let Me Down Again' did not go into similar stridency as on the Bach and Ysaÿe/ Zehetmair pieces. The musical timing was good, but could have been better, to bring the overall sound into more of a balanced stance.

The 1993 recording of 'Memorial Beach' by A-ha is a thing of aural and melancholic beauty. So, the instrumental and vocal separation on 'Locust' was good with clear enunciation of the different musical instruments and Morten Harket's vocals. However the atmospheric noir-ish nature of the song was a little minimised because the depth and spatiality required for 'Locust' did not seem to come forth as readily as it should. Bass dexterity and extension, while easily recognisable as musical, was not as expressive in timbral acuity as it could have been. Structurally however everything was held together well by the Meridian and 'Locust' subsequently had good musical timing.

From the mid-seventies, 'Jive Talking' by the Bee Gees is a superb recording and it sounded nicely layered and suitably funky via the Meridian. The main vocals were really good as they are sung in a hushed style which the Meridian ably extracted and revealed. The melodic

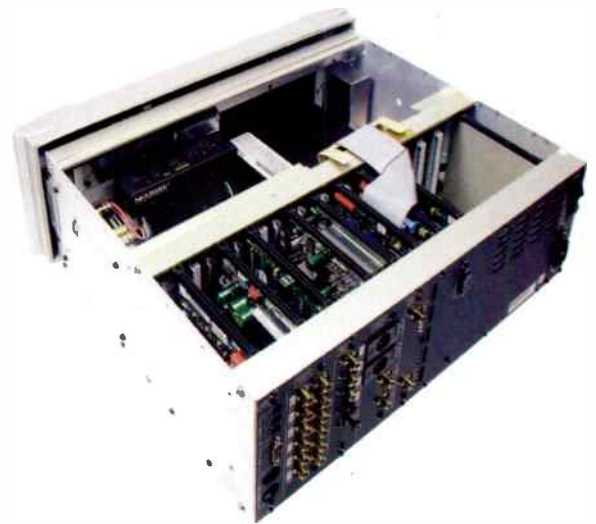

backing vocals were timbrally good but somewhat strident and more prominent within the mix. The bass was appropriately nimble and its dextrous quality was very good.

Playing AC/DC and their 'Thunderstruck', I was pleasantly surprised by the rendering of Brian Johnson's vocals. They were richly hewn, and agreeably growling instead

## THE EDITOR SAYS:

Having lived with the Meridian 808i for the best part of six months now, initially with the DSP-7000 active digital loudspeakers partnering and then latterly as a digital preamp, I can only express my profound admiration for such a well integrated digital source/preamp package. But still I have qualifications.

First, that sense of 'hewn from solid' that you get from Japanese high-end simply isn't there; Channa is spot on when he says that the disc drawer simply doesn't 'feel' right for a product at this price. Although the Meridian is a beautiful visual design, it doesn't work so well on a tactile level; it feels less expensive than, say, Sony's SCD-XA9000ES at £1,600.

Second, although I felt its DAC section to be superb (DVD-Audio has rarely sounded this convincing, and embarrasses any Japanese design I've heard), its CD abilities aren't much above most £2,000 machines. Certainly, a £5,000 Naim CDX2/XPS2 would surpass it. I feel. The reason, I believe, is the transport. It is good, but it's a DVD-ROM, and when you put it against an excellent, bespoke Red Book CD transport, you realise that no matter how cleverly Meridian's engineers have re-clocked the data, it's just not as good.

I can see why Meridian has gone for a DVD-ROM mech – what with the company's avowed enthusiasm for DVD-A and its upgrade potential into a high end DVD video machine – but if it's CD and CD only that you're interested in, than this introduces compromises...

Meridian would argue that this is to miss the point, that it's a 'do-it-all' machine that integrates seamlessly with their DSP series of active digital speakers. I'll happily concede this. It has been designed to work within a Meridian system. DP



CYRUS

**WHAT HI-FI?**  
SOUND AND VISION  
**AWARDS 2005**  
PRODUCT OF THE YEAR  
CD PLAYERS  
CYRUS CD6a

**WHAT HI-FI?**  
SOUND AND VISION  
**AWARDS 2005**  
CD PLAYERS  
BEST CD PLAYER £1000-£1500  
CYRUS CD6a

CYRUS

hand-crafted award-winning hi-fi systems

[cyrusaudio.com](http://cyrusaudio.com)

World Radio History



**COMPARISON**  
**MERIDIAN 808I VS. CHORD BLU/DAC64**

On the 'Bach Organ Masterpieces Vol.2', the organ was of a very high resolution through the Chord Blu/Dac64 in comparison to the Meridian. Additionally the subjective stridency prevalent on the Meridian was almost completely eradicated. Consequently the timbre to the higher frequencies was superb. The Meridian was subjectively superior with detail retrieval though.

The musical timing was superb on the Ysaye/Zehetmair 'Sonatas Pour Violin Solo' through the Blu/Dac64. Violin through the Blu/Dac64 had delicacy and attack within the recording. The subjective stridency of the Meridian was absent.

On 'Never Let Me Down Again' by Depeche Mode, the Blu/Dac64 was preferable I felt, even though the Meridian put in a very good performance. There was superior musical timing, excellent instrumental separation (equal with the Meridian), vocal expressiveness and an effortless flow of driving rhythms.

AC/DC's 'Thunderstruck' was stunning via the Blu/Dac64 with widescreen dynamism and powerful rhythmical propulsion. There was excellent musical timing which led to a beautifully balanced stance that enabled 'Thunderstruck' to sound enjoyably rock and roll. The rhythm and lead guitars were also superior to the Meridian as almost all of the subjective stridency was absent. However the Meridian was still superior with Brain Johnson's vocals.

of harsh or grating. For instance he can turn his vocals quite nicely, from semi-rap to scream and the Meridian revealed this rather well. The driving rhythm was also good, with decent impact. However the main high-frequency lead guitars sounded somewhat strident.

Things got dramatically better when I connected the Meridian directly to the power amplifier and switched it to its excellent, smoothly proficient variable output volume control (through a few simple menu steps). Here the resolution gained immensely with a much more radiant sound, improved spatiality and vocals gaining better definition. The low-frequencies timed well, within the structures of the music. This was a wholesale improvement over the fixed output. There was still a trace of hardness to the higher-frequencies though. However, this improved performance with direct connection to a power amplifier does show the potential of the 808/808i connected to a complete Meridian DSP active speaker system.

I listened to the 808 as a DAC, by connecting it to a classic TEAC P30 transport and the difference was not subtle. The Meridian using its own transport in comparison sounded diffuse in the low frequencies and slightly hard at the upper frequencies. With the P30 transport connected, the sound became more dimensional, and the whole structure of the music was underpinned with an enjoyably tuneful solidity that brought focus to better musical timing, weight and definition in all areas of the Meridian's performance. This showed that while the ROM transport was lacking slightly, in comparison its DAC implementation was much better.

**CONCLUSION**

Subjectively I found the Meridian 808i had a superb DAC and (inclusive of the cheaper 808) an excellent, smoothly graduated variable volume control. Both of these qualities bode well for its analogue and digital preamplifier section which along with the generous set of inputs would make a technologically elegant hub.

The performance of the 808i with its own volume control significantly bettered its fixed output (when directly connected to a power amplifier). This also hints at the potential of an all Meridian system with the 808/808i and a set of Meridian DSP active speakers. So it is understandable if Meridian would prefer that most, if not all 808/808is would be connected this way.

However, at this very high-end price level and considering Meridian's "808 Signature Reference Compact Disc Player" designation, it must perform brilliantly as a standalone player. And as such, the Chord Electronics Blu/Dac64 transport and DAC at a lower £6,190 price outperformed the Meridian (even when directly connected to a power amplifier), I felt.

The key criticism is the ROM drive; this was the weak link on CD. It is very good by any standards, but at this price it should be nigh on peerless even against the best money

can buy. However, the Meridian does play DVD Audio in stereo and without the need for an annoying screen if you simply want to listen to music, and here it was preferable. The Meridian 808i's strengths are its benign tonality and detail retrieval on and with DVD-Audio. Of course, it is also ergonomically superb and its exterior design language is first-rate, procuring an enduringly beautiful piece of industrial design that will appeal to Meridian's discerning and loyal patrons.

**VERDICT** ●●●●

Quite possibly the best integrated disc player/ digital preamplifier money can buy in both style and sonic terms – but less convincing as a standalone Compact Disc spinner at its rarefied price point.

**MERIDIAN 808I** £8,250  
Meridian Audio Ltd.  
☎ +44 (0)1480 445678  
www.meridian-audio.com

**FOR**

- excellent ergonomics
- DVD-a sound-quality
- aesthetics and remote

**AGAINST**

- CD sound quality
- better connected direct
- less than flawless build

**MEASURED PERFORMANCE**

Our frequency response plot of this CD player show it has a high pass filter that removes frequencies below 10Hz. In the unbalanced impulse analysis this adds a slight +0.1dB lift below 200Hz. The effect isn't so obvious via the balanced output, but the filter response is quite clearly shown in our analysis. At high frequencies the 808 is completely flat, reaching up to 20.2kHz before the anti-alias filter takes effect. The effect is small but may just be perceptible as slightly livelier bass than is common.

Distortion levels were similar via both balanced and unbalanced outputs, but the former gave slightly better results, as it should. The 808 was up with the best, providing excellent results at all signal levels. The balanced output managed to yield an EIAJ dynamic range value (113dB) that was better than any player we have tested – an expected benefit of proper balancing.

Jitter hovered at a minuscule 5pS across the audio band.

Output was high at 2.4V, and very high via the balanced output at 4.2V.

This is a player to be used via its balanced outputs, to gain benefit of cancellation of common mode signals. Then it measures slightly better than any other player available. NK

Frequency response (-1dB)	
CD	8Hz - 20.2kHz
Distortion	CD
0dB	0.001%
-6dB	0.001%
-60dB	0.18%
-80dB	4.4%
Separation (1kHz)	102dB
Noise (IEC A)	-106dB
Dynamic range	113dB
Output	2.4 / 4.4V

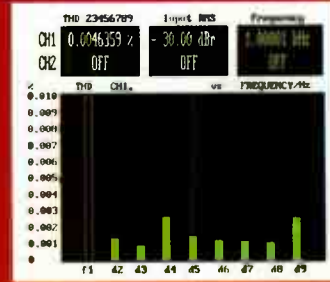
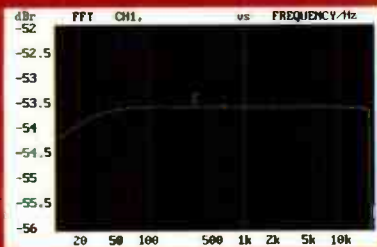

## David Price puts the Hi-Fi World Awards 2005 into perspective...

# World

In this issue, starting on p81, you'll find ten pages devoted to the *Hi-Fi World Awards 2005*. The idea is pretty simple; to list the best product we've reviewed in each of ten categories over the past year.

The ten winners you'll read about are quite superb, and – all things considered – the best new product of their type we've come across this year. Nothing can detract from this, and every last one of them is a class act in the great scheme of things. But there's more to this than meets the eye...

What doesn't fit the format of 'awards' is that very often other, arguably 'lesser' products work better in the real world, or conversely, other far more expensive products perform much better, but simply don't warrant a gong because of the value for money offered by cheaper designs. So what I'd like to do is run through the different categories, talking about the winners and the runners up.

### THE GREAT AND THE GOOD

In the turntable section, the Rega P5 gets the gong. This isn't because it's the best vinyl spinner in the world (it isn't), but we felt that the P5 is a lovely package. Of course, there are some very impressive rivals around.

The Michell TecnoDec is a brilliant all round product; in terms of timbral accuracy and textural insight, it's head and shoulders above the Rega, but still the P5 has a brilliant rhythmic 'zing' that harks back to the eighties in terms of musicality and expression.

The Roksan Radius is also deeply special, and the unipivot arm gives it an effortlessness and liquidity than the Rega lacks, but still I think the P5 brings something to the party in the sub-£1,000 category.

We also tried the £1,979 Origin Live Resolution Modern turntable, and this would be the runner up this year. It's a far more capable deck than the Rega P5 in absolute terms, and truly superb overall, but still the

combination of sound per pound and user friendliness (the Rega is a true 'plug and play design) edges the P5 ahead.

The Origin Live Conqueror is, for me, the arm of the year; it's wonderful, but not everyone will think so. Unipivot arms, especially the latest high-end derivations of the Hadcock, are superb and they have a rhythmic flow that makes the OL sound mechanical; in other respects, the OL beats them. Actually, an arm that's really gone up in my estimation (and it was already very high!) is the Michell Tecnoarm. I've been running one of these in lieu of my SME Series IV, and aside from the obvious gorgeous finish, styling and design of the SME, the Tecnoarm gives little away in terms of sound. Indeed, if anything, it's more musical and less 'constrained' sounding, despite its inferior bass and midband focus. Considering the Michell's absurdly low price – and the fact that the newer ones seem to be better still – it's stunning value.

Lyra's Argo cartridge is another case in point, showing how hard it is to come up with summary judgements. It's a lovely cartridge that's obviously ahead of the legendary Lydian. But suddenly Ortofon is back in the fight with stunning stuff. The Kontrapunkt B, no matter what you play, just makes music and yet is brilliantly open and clean with it, and although it's a couple of years old now isn't off the pace at all. The Lyra is a masterful modern moving coil, but my gosh the Kontrapunkt runs it close (better in some ways), and it just shows you that cartridges now are so accomplished, even in the sub-£1,000 sector.

Whilst digital has gradually got better (and indeed has even deteriorated in some respects – e.g. CD transports), then analogue has raced ahead, with significant new products seemingly every year. I have to say, digital lovers, that if you want serious sound per pound, then a Rega P5 on an Audiophile Furniture Base SP01

tracking an Ortofon Rondo Bronze MC is a fearsome way to part with £1,300 ...

Naim's Stageline is an unlikely winner of the best phonostage gong. I say unlikely because it's basically a bolt-on extra for the company's Nait 5 integrated. It's a very 'Naim sounding' product, as you'd expect, with oodles of bass grip and a very strong and punchy sound, one that makes the Trichord Dino is tad loose and wobbly sounding. But the Dino still has a bigger and more textural sound, and spending just a few pounds more brings you the option of Graham Slee's phonostages which are more liquid and beguiling still.

Tough choices, but Naim's Stageline is helped by the company's vast range of power supplies, some of which take it into superstar territory. Still, spending just under £1,000 brings you the option of the Whest Audio – which to my ears is still the cleanest sounding I've yet heard. Decisions, decisions!

Given that *Hi-Fi World* defines itself as Britain's 'affordable audiophile' magazine, I had to scratch my head long and hard about giving a £9,000 SACD player the best CD spinner gong. But I wanted to underline Teac's (sorry: 'Esoteric') commitment to Red Book digital; the company makes CD transports par excellence, and given that the world and his wife has given up on these (remember: most companies buy in the cheapest and tweak it; i.e. computer DVD-ROM drives), I felt it was important to recognise this.

Going back to the eighties, Linn's Ivor Tiefenbrun quite rightly pointed out that everything begins (and ends) with your source and digital is no different. The ultimate CD player has to start with the ultimate transport, and the Esoteric X-01 has this (the ultimate SACD transport, at least; the ultimate CD transport is very probably Esoteric's 1998 P0). Sublime engineering gives the Esoteric its superb sound. It's a stunner.

I'd say Marantz's SA-1 from several years back comes very, very



# Class

close on SACD, and then there's the fact that the likes of Shanling's CD-T80 at one twentieth of the price almost sounds far better than one twentieth as good on CD...

Onkyo's DV-SP1000E gets the universal player award, and it's a redoubtable digital disc spinner. There's lots of choice out there from Pioneer, Denon, Arcam *et al*, but this machine really floats my boat. It's superb on music (not as good as a similarly priced CD spinner, of course, but better than all similarly priced universal machines to our ears), and has fine pictures too. Then there's its brilliant Japanese 'battleship' build; this sort of thing is increasingly rare these days, but rest assured this is a statement product from a Japanese company that doesn't do things by halves.

The only cloud on Onkyo's horizon is Naim's DVD5; £2,350 buys you a machine that plays movies well and makes nice noises with the soundtracks, but when you slip a CD in, it starts doing things that most sub £1,000 CD spinners can't – which is to 'just play music'. It's a brilliantly musical listen and (unfathomably) better even than Naim's CD5i CD spinner in some respects, and that's not small praise. If SACD doesn't concern you but you want great DVDs and CD sound par excellence, this is the one. If SACD is a serious thing for you, the Onkyo makes total sense.

In the world of integrated amplifiers, our world was rocked by the TacT/Lyngdorf (semi) digital amps – the SDA12175 was a peach. But the Sugden A21SE did it for me. I listened to one after the other, and back, and although I couldn't help being bowled over by the Lyngdorf (its power, its scale, its authority), the Sugden just sang like no others can. It's a truly unique sound; bright and crisp and open like no other integrations, yet it plays music like its life depended on it. There's something about it that makes you want to unplug your TV, pull your phone out of the socket, power down your computer and run

the gamut of your record or CD collections until the early hours. It makes you want to forget yourself and all the grim practicalities of life, and just 'go off on one' and get lost in music.

And so on to the Lyngdorf; the Sugden's nemesis. Everything that's wrong with the A21SE is right with the SDA2175, and (less pointedly) vice versa. This thing costs £775 and has all the power and authority you'd expect from a Krell. It has a lovely, velvety tonality and seems to be able to lock any given strand of a mix perfectly in space between the speakers. It is self assured, svelte and sophisticated – to an extent that totally belies its price tag.

The downside is that it's as romantic as a bag of chips behind the bike sheds; where the Sugden gets you all misty eyed about anything it plays, the Lyngdorf is matter-of-fact about things – to a fault. Nor does it have that Naim-style 'feel the bass guitar' musicality, or the warm sweet euphony of a Prima Luna Prologue tube power amplifier. You pay your money, and takes your choice...

Mission's e82 is an 'uber floorstander'; it's not the most charismatic loudspeaker ever made, but instead gets its award by doing so much so well. At £1,690 it's a brilliant distillation of Mission's classic values of punch and pace, but brings real refinement to the mix, too – and positively sings with medium powered valve amps. Those who liked the 770 will instantly recognise the e82 as a Mission, but be more than a little surprised by its myriad other abilities. Not since the 752 have we found such an impressive design from this company.

Still, there were some seriously capable rivals for the best speaker award, not least the Monitor Audio Radius 90. At around £250, this is a mini monitor par excellence; a honey of a baby box. It sounds like every last millimetre was designed with music in mind, and makes everything you play through it a celebration. It's small, bandwidth limited and

compressed at high levels (just like any other small box), but you just don't notice it, as it's such great fun.

Finally, the other speaker that made a huge impression on me in 2005 was the Pinsh 1; a small box with a superb bespoke ribbon tweeter that is open, sweet and couth way beyond its price. With products like these, it can't be an easy job being a speaker manufacturer...

Last but not least, headphones. Put crudely, Stax is about as close to a 'cottage industry' manufacturer as Japan gets. I don't mean this in a disparaging way; my point is that the company makes very specialised low volume headphones with serious engineering merit. The result is unique; a tube aspirated electrostatic that sounds like nothing else around. It's fast but warm in a way you'd imagine a pair of Quad ESL57s driven by Quad IIs to be; it's a very special sound and a country mile away from the superb Sennheiser HD650s (even driven by a Musical Fidelity X-CANS v3). The latter is superbly clear and dry and architectural, the former is a little loose, but fast and musical to excess. The silly nineteen seventies finish is an obvious drawback for many, but for this writer was yet more proof (as if he needed it) that here is a very unusual, rather wacky and quite lovely pair of headphones.

## AWARDS 2005: THE WINNERS

<b>TURNTABLE:</b>	REGA P5
<b>TO NEARM:</b>	ORIGIN LIVE CONQUEROR
<b>CARTRIDGE:</b>	LYRA ARGO
<b>PHONOSTAGE:</b>	NAIM STAGELINE S
<b>CD PLAYER:</b>	ESOTERIC X-01
<b>UNIVERSAL PLAYER:</b>	ONKYO DV-SP1000E
<b>INTEGRATED:</b>	SUGDEN A21SE
<b>POWER AMPLIFIER:</b>	LYNGDORF AUDIO SDA2175
<b>LOUDSPEAKERS:</b>	MISSION e82
<b>HEADPHONE:</b>	STAX SRS-4040

now turn to p81 for AWARDS 2005

# SEVENOAKS

## SOUND & VISION

With over 30 years experience, **SEVENOAKS SOUND & VISION** is one of the largest and most respected Audio/Visual retailers in the country.

Each Sevenoaks Sound & Vision store stocks a wide range of quality products, covering all categories of specialist home entertainment, from Hi-Fi separates and systems to DVD recorders, widescreen plasma televisions and projection systems.

Our fully trained installation experts can neatly and seamlessly integrate a home cinema or hi-fi system into your home. All electronics can be hidden away, speakers discreetly mounted either in the wall or ceiling and the complete system operated via remote control.

Whatever your requirements, Sevenoaks Sound & Vision has a diverse range of products and the expertise to advise, demonstrate and guide you through the home entertainment jungle.



### Specialist hi-fi & home cinema

Contemporary hi-fi is constantly setting new standards in sound reproduction and design. Whatever you listen to, Sevenoaks can recommend separate components that will bring your music collection to life and complement your home. We're enthusiasts and experts, passionate about helping you build (or upgrade) a system that will delight for years to come.

The recent growth of DVD has led to a huge rise in demand for home cinema equipment - DVD players, AV receivers, projectors and plasma screens but, with so many options, it's not easy to know which ones will suit your needs. Indeed, in the face of this quickly evolving and often bemusing array of products, we aim to assist you in assembling a home cinema system to be proud of - one that achieves outstanding picture and sound quality.

### NEW STORES

#### LOUGHTON & YEovil

We are pleased to announce that these new stores are now open: -

#### LOUGHTON\*

7-9 GOLDINGS HILL • 020 8532 0770

#### YEovil

14 SILVER STREET • 01935 700078



\*QUE TO OPEN 19TH NOVEMBER 2005



WHAT HI-FI? AWARDS 2005  
PROUD OF THE YEAR  
BEST CD PLAYER  
£1000-1500

### Rotel

The 02 Series is Rotel's entry-level range. The RCD-02 CD player combined with either an RA-01, RA-02 or RA-03 integrated amplifier represents true audiophile performance at an affordable price. For increased high-end performance, the RC-03/RB-3 pre/power amplifiers are available. The RT-02 tuner completes the range.



WHAT HI-FI? AWARDS 2005  
PROUD OF THE YEAR  
BEST TURNTABLE  
£1000-1500

### Roksan

Roksan designs and manufactures some of the most acclaimed hi-fi equipment currently available. All Roksan products are carefully evaluated by experienced engineers at every stage of the design process with the emphasis on performance and build quality.

### Audiolab NEW 8000 Series

Audiolab's new 8000 series offers a definitive and genuine hi-fidelity performance from a no-nonsense approach to engineering. These famous products have all been re-engineered to create a complete two channel range, including the 8000S, 8000Q, 8000M and 8000P models plus a all new CD player. A 7.1 channel pre and power amplifier completes the range.



### Project

Project is currently one of the world's leading suppliers of turntables, with a range of models designed to satisfy all levels of expectation and budget. The range includes the Award-winning Debut (pictured left), Xpression II, Perspective and RPM Series.



WHAT HI-FI? AWARDS 2005  
PROUD OF THE YEAR  
BEST CD PLAYER  
£1000-1500

### Cyrus

If you've enjoyed listening to music before, try listening to it through a Cyrus system. With every product tuned by ear, Cyrus represents a quality of sound, which is rare at any price. Invest in a Cyrus system and you'll be rewarded with a wealth of sound you wouldn't have thought possible.



### B&W

The focus of Bowers and Wilkins Loudspeakers has always been to offer the best possible musical experience. With a combination of the latest R&D techniques and a passion for music, B&W produces a diverse range of products befitting the largest audio manufacturer in the UK.

### B&W MINI THEATRE MT-30

"Talented, covetable and worth every penny, the MT-30 (and PV1 especially) could well be heading for iconic status."



WHAT HI-FI? AWARDS 2005  
PROUD OF THE YEAR  
BEST CD PLAYER  
£1000-1500





## Quad

Founded in 1938, Quad's history is one of audio excellence. Today's range includes both electronics and speaker systems.



## Monitor Audio

Since 1972 Monitor Audio has been developing and perfecting the implementation of metal drivers, innovative crossovers, and exemplary speaker cabinet construction and finish to further the ideal of achieving sound which is to the original "as close as it gets". The range includes - **GOLD, SILVER RS, BRONZE** and **RADIUS** speakers, plus the exciting new **i-Deck** docking station, an excellent any-room companion for your iPod.



Silver RS6 AV Package

## Digital Radio

With Digital Audio Broadcasting (DAB) capability, these high-quality tuners deliver more stations and offers pure, distortion-free, CD-like sound, while providing useful radio and data services.



Pure DRX702ES & NEW Denon TU-1800DAB

## Wharfedale

### Diamond 9.1

"Wharfedale has been updating and tweaking its Diamonds for 20 years - and rough they're not! Tight bass, clear midband, and sparkling treble for not a lot of cash."



### Diamond SW150

"Considering the price, the detail and definition to the bass are controlled and cohesive - equally adept with movies and music."



## KEF

Replacing the highly successful Q Series, KEF's New IQ line-up comprises eight models from the entry-level IQ1 bookshelf to the impressive IQ9 floorstander. All models incorporate KEF's Uni-Q driver technology and are available in a variety of finishes.



Other KEF ranges include XQ, KHT and the Award-winning KIT100 Home cinema system.

**KEF KIT100** "Creating a virtual surround sound experience has never been simpler or more effective, thanks to this two speakers plus subwoofer concoction from KEF."



### KEF IQ5

"The IQ5s are little stars, providing stunning scale and authority from discreetly sized towers... The IQ5s are fully deserving Products of the Year."



## Acoustic Energy

Established in 1987, Acoustic Energy is one of Britain's premier loudspeaker manufacturers offering one of the most targeted range of hi-fi and home cinema loudspeaker systems on the market today.

"The legendary AE1 lives on in this groundbreaking new version... it sets a new standard for small speakers."



### KEF KHT1005

"The KHT1005 is an ideal first-time buy, and will suit those looking to 'downsize' to a more living-room friendly style of speaker."



## Arcam

Arcam has spent more than a generation building some of the finest high-fidelity products the world has ever seen. Whether you're interested in two-channel or a complete multi-channel AV system, the Arcam DiVA series offers the music and movie lover the most complete range of high-performance home entertainment solutions from any specialist manufacturer.



## ESSENTIAL ACCESSORIES

The right accessories can make or break your system. Our carefully selected range, including **QED, SOUNDSTYLE** and **GRADO**, will ensure you get the very best performance from your system.

## Marantz

Marantz is introducing a host of new products ranging from high-end hi-fi to HD-ready DVD players and AV receivers. The two main products groups are the "premium" and "range" series.

The SR9600THX Ultra2 AV receiver offers seven channels, each 140w, and features HDMI inputs. The groundbreaking DV9600 is one of the first DVD players capable of upscaling images to 1080p and is fully prepared for the high-definition future.



NEW MARANTZ SR9600 AV RECEIVER



## Teac

TEAC's all-new Reference Series offers innovation in audio-visual technology. The CR-250 DAB CD Receiver is a superb one-box unit which, when linked to a pair of speakers, makes for a cracking music system. While the Reference 300 Series T-H300DAB Mk II DAB/AM/FM tuner, when matched with the new 300 Series Mk II amplifier and CD player, forms another outstanding system.

Also available, the beautifully styled, award-winning Legacy systems, offering DVD with satellite speaker home cinema excellence.



PLEASE NOTE Some products/brands are not available at all stores. Please call to confirm or visit our website before travelling.  
\*Added Value Offers - From range available in-store. Not in conjunction with any other offer. ADVERT VALID UNTIL AT LEAST 15/12/2005, E&OE.





## Denon

Denon, Japan's oldest audio company, has established an enviable reputation for the performance of both its hi-fi and home cinema products, winning numerous awards and accolades over the years. Its stylish systems have succeeded in becoming the benchmark by which all other are judged.



**DVD-A1XV** "The most obvious winner of any category this year has to be Denon's evolutionary step in DVD deck design, the landmark DVD-A1XV... An astonishing piece of kit that has no equals."  
**AVC-A1XV** "It's not often we can't find fault with a product, but as we said in our review, "It not only expands the home cinema envelope, it shreds it and then nukes it for good measure." HOME CINEMA CHOICE • AWARDS 2005



## Yamaha

Yamaha is recognised as a world leader in the fields of musical instruments and audio equipment, and in more recent years, home cinema. New models for 2005 include upgraded AV receivers, amplifiers, and DVD players plus the innovative YSP-1 virtual surround speaker.



YAMAHA'S DVD-S2500, DSP-AX7575E & RX-V4600

## Pioneer

Pioneer has introduced three new DVD players. The super-slim (49.5mm high) DV-2850, DV-380 and DV-585A. All models are DivX compatible and deliver exceptionally high-quality pictures using a 108 MHz/12-bit Video D/A Converter. The **DV-585A** (Below) is a universal player, compatible with both DVD-Audio and SACD music discs.



## REL

In a market packed with subwoofers claiming to deliver the ultimate bass experience, only one brand of sub-bass system can prove its supremacy. With a record of review success stretching back over a decade, REL is acknowledged as the leading provider of deep, clean bass frequencies.



M&K NS "Wonderful surround sound performance, agile and deep subwoofer."

## M&K



Enjoy cinema as the director intended with a speaker system that is genuinely designed for surround sound. Every Miller & Kreisel surround sound system is designed around the highest quality centre speaker available, as this critical speaker will reproduce more than 70% of a film soundtrack. Partnered with two identical main speakers, this produces seamless panning across the front soundstage, combined with the remarkable clarity and effortless dynamics that has made M&K the first choice in recording studios worldwide.



Onkyo DS-A1 iPod Connector Dock



## Onkyo

"A Dinky design that offers a vigorous listen, plus reassuringly solid build... Onkyo's CR-505DAB is a fab buy."

## Harman Kardon

Harman's 7.1-channel DPR 2005 and DPR 1005 digital path receivers take Harman's groundbreaking digital path receiver platform to new levels of performance and functionality utilising a fully digital signal path from input to output, along with advanced features and technologies.



## DVD Recorders

Although making digital recordings of TV broadcasts isn't new, the choice, versatility and quality of recorders keep getting better. Our product selection includes DVD only, hybrid DVD/hard-disk and multi-format models.



## ESSENTIAL ACCESSORIES

The right accessories can make or break your system. Our carefully selected range, including QED, SOUNDSTYLE and GRADO, will ensure you get the very best performance from your system.



## £ PRICING POLICY

We always try to ensure our prices are highly competitive. In the event you can find the same products and excellent service at a lower price, please bring it to our store managers' attention.

## FLEXIBLE FINANCE OPTIONS\*

Spread the cost of buying. Flexible finance options are available on the majority of products we stock. \*Written details on request. Licensed credit brokers. Minimum balance £400. Subject to status.

**PLEASE NOTE** Some products/brands are not available at all stores. Please call to confirm or visit our website before travelling.

\*Added Value Offers - From range available in-store. Not in conjunction with any other offer. ADVERT VALID UNTIL AT LEAST 15/12/2005. E&OE.





## Specialist home cinema

At the heart of any home cinema is its screen: Sevenoaks Sound & Vision can put you in the picture with a selection of flat-panel displays and projection systems. LCD and plasma screens are just a few centimetres thick and come in sizes from a 13inch portable to over 60inches.



## Sharp Aquos

Only Sharp Aquos LCD TV offers so much perfection. With supreme styling, the appeal of the Aquos range is obvious. The Titanium Series combines Sharp's sixth-generation LCD panel with stunning, angular-styling, titanium colour-finish and superb build quality to produce a premium class of LCD idTVs

### TITANIUM SERIES LC-45GD1E LCD TV with integrated FREEVIEW

"Sharp's mammoth 45in LCD TV is a testament to the growing viability and performance of large-scale LCD. Its 1,920 x 1,080 resolution panel allows high-definition pictures to be viewed without compromise and when exploited to its full potential, the results could see this screen hung in a gallery. Images are so crisp and sharp, it almost makes reality look dull. We think it's inspirational. Go pay homage." HOME CINEMA CHOICE • AWARDS 2005

FREEVIEW channel and service subject to coverage. Aerial upgrade may be required.

# SEVENOAKS

SOUND & VISION



## Pioneer

Following its highly successful '5' series, Pioneer has unveiled its sixth generation of plasma TVs. The 43" PDP-436XDE and 50" PDP-506XDE models include built-in digital tuners plus dual HDMI inputs.

### PDP-436XDE PLASMA TV

"Pioneer's latest is also its greatest: this is a truly wonderful HD-Ready TV."



## Panasonic Viera

There seems little doubt that the future of television is flat, and the future of flat is the award-winning VIERA range from the world leaders in screen technology, Panasonic. The VIERA range consists of both LCD and Plasma televisions. New additions to the range include 37, 42 & 50in PV500 models with support for both high-definition and MPEG-4 recording.



### TH42PV500 PLASMA TV

"All told, Panasonic's new TH42PV500 is a stunning set that's clearly the new class leader."



## Loewe

### Concept L32 32" LCD TV

With its minimalist, functional design, slim profile and ease of operation, the Concept L32 exudes all of the classic Loewe virtues.

"This HD Ready set boasts 1366x768 resolution and plenty of inputs, including HDMI, component video and two Scarts. It also packs an integrated digital TV tuner, and - as ever with Loewe sets - its speaker set-up is a cut above most rivals... The Concept L32 is immensely attractive: it deserves to sell very well indeed."



## Samsung

### Milano LE40M61B 40" LCD TV

Samsung's New 40" LCD TV (LE40M61E) was honored with an EISA award for its premium display technology in terms of contrast ratio (5000:1), color expression (6.44 billion colors, 92% color gamut for NTSC), viewing angle (178°) and response time (8 ms). Also the model's simple body design focuses the viewer's attention on the screen. On the front of the minimalist design, the speakers are hidden: from view in the bottom bezel and nothing distracts from the superb image quality



## Hitachi

### PLATARA 42PD7200 42" PLASMA TV

"Alright, we admit it, we rather like this screen. In fact, it's very difficult to find a reason why anyone hankering for a 42in plasma shouldn't go out and buy one. Five stars for Hitachi and a new standard for affordable excellence for everyone else." WHAT VIDEO • ISSUE 294





## Projection

If you'd prefer to measure your screen-size in feet, how about one of the new generation of projectors? The latest designs are delivering superb results at increasingly affordable prices - and they're more home friendly than previous projectors, too.



## ScreenPlay

From the worldwide leader in digital projection technology and solutions, InFocus® ScreenPlay® DLP™ projectors are changing the face of home cinema offering market-beating performance, specification and value at every price point.

"The new projector's picture is just phenomenal... Looks like ScreenPlay's success story is set to continue."

**SP7210**

"Another stunning success from ScreenPlay - there's never been a better time to take the big-screen plunge."

**SP4805**



## Sim2

Sim2 Multimedia is a world-leading manufacturer at the forefront of home cinema technology and a name synonymous with high-end home cinema projection.

**MT300E** "Spectacular, in a word... Another terrific projector from Italy's finest."  
WHAT VIDEO • ISSUE 292



## Themescene

Since its launch, the multi-award winning ThemeScene™ brand has rapidly established a five-star reputation for uncompromised image quality.

**M30A** "There are so many good points it's hard to know where to start... Just how much better can budget DLP projectors get?!"  
WHAT VIDEO • ISSUE 292

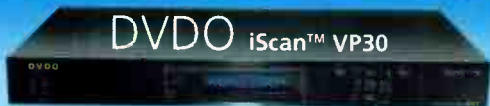

The **iScan™ VP30** is a high-definition video processor and AV hub that converts standard or high definition from your DVD player, VCR, PVR, HD set top box, game console, or PC to any output resolution between 480p and 1080p, including popular HDTV resolutions such as 720p and 1080i.

## £ PRICING POLICY

We always try to ensure our prices are highly competitive. In the event you can find the same products and excellent service at a lower price, please bring it to our store managers' attention.

## FLEXIBLE FINANCE OPTIONS\*

Spread the cost of buying. Flexible finance options are available on the majority of products we stock. \*Written details on request. Licensed credit brokers. Minimum balance £400. Subject to status.

## PLEASE NOTE

Some products/brands are not available at all stores. Please call to confirm or visit our website before travelling.  
\*Added Value Offers - From rings available in-store. Not in conjunction with any other offer.  
ADVERT VALID UNTIL AT LEAST 15/12/2004. £8.05.

## Product Selection

Listed below is a small selection of our extensive product range. **Please note:** Some products/brands are not available at all stores. Please call to confirm or see the brand locator at [www.ssav.com](http://www.ssav.com) before travelling.

### TURNTABLES

Goldring GR2	£ CALL
Linn RANGE	£ CALL
Michell RANGE	£ CALL
Project RANGE	£ CALL
Roksan Radius 5	£ CALL

### TUNERS

Arcam RANGE	£ CALL
Cyrus FM X	£ CALL
Denon TU260L MKII	£99.95
Harman Kardon RANGE	£ CALL
Linn RANGE	£ CALL
Marantz RANGE	£ CALL
Pure DRX-701ES DAB	£179.95
Pure DRX-702ES DAB/FM	£229.95
Rotel RANGE	£ CALL

### CD PLAYERS

Arcam RANGE	£ CALL
Audiolab RANGE	£ CALL
Cyrus RANGE	£ CALL
Denon DCD485	£119.95
Linn RANGE	£ CALL
Marantz RANGE	£ CALL
Meridian RANGE	£ CALL
Musical Fidelity RANGE	£ CALL
NAD RANGE	£ CALL
Quad RANGE	£ CALL
Roksan RANGE	£ CALL
Rotel RANGE	£ CALL

### CD RECORDERS

Yamaha CDR-HD1500	£469.95
-------------------	---------

### AMPLIFIERS

Arcam RANGE	£ CALL
Audiolab RANGE	£ CALL
Cyrus RANGE	£ CALL
Denon PMA355	£159.95
Linn RANGE	£ CALL
Marantz RANGE	£ CALL
Meridian RANGE	£ CALL
Musical Fidelity RANGE	£ CALL
NAD RANGE	£ CALL
Quad RANGE	£ CALL
Roksan RANGE	£ CALL
Rotel RANGE	£ CALL
Yamaha AX396	£169.95

### HI-FI SPEAKERS

Acoustic Energy Aegis Evo One	£119.95
Acoustic Energy Aegis Evo Three	£229.95
Acoustic Energy Aelite RANGE	£ CALL
Acoustic Energy AE1 MKIII	£ CALL
AVI Neutron IV	£ CALL
B&W RANGE	£ CALL
KEF RANGE	£ CALL
Linn RANGE	£ CALL
Meridian RANGE	£ CALL
Mission RANGE	£ CALL
Monitor Audio RANGE	£ CALL
Quad RANGE	£ CALL
Ruark RANGE	£ CALL
Wharfedale RANGE	£ CALL

### HI-FI SYSTEMS

Arcam Solo Ex Speakers	£ CALL
Denon RANGE	£ CALL
Linn Klassik Music Ex Spks	£ CALL
Monitor Audio i-Deck	£249.95
Onkyo CR505DAB Ex Spks	£ CALL
Teac RANGE	£ CALL
Yamaha CRX-M170 Ex Spks	£ CALL

### DVD SYSTEMS

Denon RANGE	£ CALL
KEF KIT100 Inc Speakers	£ CALL
Teac RANGE	£ CALL

### MULTI-ROOM AUDIO

Cyrus Link RANGE	£ CALL
Living Control RANGE	£ CALL
Yamaha MusicCast RANGE	£ CALL

### DVD PLAYERS

MAKE & MODEL	REGION 2	MULTI REGION
Arcam RANGE	£ CALL	£ CALL
Cyrus RANGE	£ CALL	£ CALL
Denon RANGE	£ CALL	£ CALL
Denon DVD-A1XV	£ CALL	£ CALL
Harman Kardon RANGE	£ CALL	£ CALL

Marantz RANGE	£ CALL	£ CALL
Meridian RANGE	£ CALL	£ CALL
Panasonic RANGE	£ CALL	£ CALL
Pioneer RANGE	£ CALL	£ CALL
Samsung DVD-HD950	£ CALL	£ CALL
Toshiba SD350	£79.95	£89.95
Yamaha RANGE	£ CALL	£ CALL

### DVD RECORDERS

MAKE & MODEL	REGION 2	MULTI REGION
Panasonic RANGE	£ CALL	£ CALL
Pioneer RANGE	£ CALL	£ CALL

### A/V AMPLIFIERS & RECEIVERS

Arcam RANGE	£ CALL
Audiolab RANGE	£ CALL
Cyrus RANGE	£ CALL
Denon AVC-A1XV AV Amplifier	£ CALL
Denon RANGE	£ CALL
Harman Kardon RANGE	£ CALL
Lexicon RANGE	£ CALL
Marantz RANGE	£ CALL
Onkyo RANGE	£ CALL
Pioneer VSX-1014s AV Receiver	£399.95
Pioneer VSX-2014i AV Receiver	£499.95
Pioneer VSX-AX5Ai AV Receiver	£749.95
Pioneer VSA-AX10Ai AV Amplifier	£1799.95
Pioneer NEW RANGE	£ CALL
Rotel RANGE	£ CALL
Yamaha DSP-AX757SE AV Amplifier	£399.95
Yamaha RX-V357 AV Receiver	£149.95
Yamaha RX-V557 AV Receiver	£299.95

### A/V SPEAKERS & PACKAGES

Acoustic Energy Evo 3B	£679.95
Artcoustic RANGE	£ CALL
Audica RANGE	£ CALL
B&W RANGE	£ CALL
B&W Mini Theatre RANGE	£ CALL
KEF KHT1005	£299.95
KEF KHT2005.2	£599.95
KEF Q7 AV	£ CALL
M&K RANGE	£ CALL
Mission M Cube	£ CALL
Mission Elegante RANGE	£ CALL
Monitor Audio RANGE	£ CALL
Niordant Short Genie	£649.95
Quad L-Series	£ CALL
Wharfedale Diamond 9 HCP	£ CALL
Yamaha YSP RANGE	£ CALL

### SUBWOOFERS

B&W RANGE	£ CALL
M&K RANGE	£ CALL
MJ Acoustics RANGE	£ CALL
Monitor Audio RANGE	£ CALL
Quad L Series	£ CALL
REL RANGE	£ CALL
Wharfedale Diamond SW150	£ CALL

### PLASMA

Fujitsu RANGE	£ CALL
Hitachi RANGE	£ CALL
LG RANGE	£ CALL
Loewe RANGE	£ CALL
Panasonic RANGE	£ CALL
Pioneer PDP436XDE 43"	£ CALL
Pioneer PDP506XDE 50"	£ CALL
Samsung RANGE	£ CALL

### LCD TV

Hitachi RANGE	£ CALL
LG RANGE	£ CALL
Loewe RANGE	£ CALL
Panasonic RANGE	£ CALL
Philips RANGE	£ CALL
Samsung RANGE	£ CALL
Sharp Aquos RANGE	£ CALL
Toshiba RANGE	£ CALL

### PROJECTORS

Optoma RANGE	£ CALL
Screenplay RANGE	£ CALL
ScreenPlay SP5700 (REFURBISHED, LAST FEW)	£1499.95
Sharp RANGE	£ CALL
Sim 2 RANGE	£ CALL
Sim 2 C3X	£ CALL
ThemeScene RANGE	£ CALL

### ACCESSORIES

We have a wide range of Accessories from QED, Soundstyle, Grado, Goldring and more...



# Who are Sevenoaks?

Established as Sevenoaks Hi-Fi in 1972, we have grown steadily onto one of the leading independent home entertainment specialists in the UK, earning a reputation for outstanding service, choice and value for money. In 1995, reflecting our commitment to the emergent new technologies in home cinema, our name was changed to Sevenoaks Sound & Vision. We now have 49 stores across the land stocking a broad range of exceptional equipment and accessories.

## How to shop at Sevenoaks

When it comes to making big decisions about what to buy, there's no substitute for actually road-testing your prospective purchases - seeing, hearing and experiencing the products in action, with the benefit of our expert knowledge and guidance to help you choose. To get the most from your Sevenoaks Sound & Vision experience, simply follow this checklist:

- **ESTABLISH YOUR AIMS** - Are you tweaking an existing system to improve sound or picture quality, or are you looking for a more fundamental and comprehensive upgrade?
- **BRING YOUR FAVOURITE DISCS WITH YOU** - To ensure you get the most from the music and movies in your collection, it pays to test equipment using those very same discs or records, that way you can readily compare levels of performance. However, if you prefer, we can supply a selection of demo discs - current mainstream entertainment that serves to highlight the capabilities of the equipment.
- **JUST ASK** - If you are unsure of any aspect of the products or technologies available, or would like more information about installation options, simply let us know and our staff will be happy to help you out.
- **TAKE YOUR TIME** - We want you to be as happy as possible with your choices, so please take as much time as you need to determine which products are right for you.

**WITH OUR CUSTOM DESIGNED INSTALLATIONS**, your home entertainment choices become as convenient as they are clever. We can help transform every room and every home, whatever your requirements and budget.

Our installation experts are trained to the highest standards in all areas and provide a prompt, reliable and totally professional service. Rest assured also that our commitment to service doesn't end once your equipment is in place. Sevenoaks staff will continue to support you and your kit long after your initial visit to one of our stores.



## Sevenoaks Website

The Sevenoaks Sound & Vision website has news and information on the Sevenoaks group and detailed pages to help you locate your nearest store. In addition, there are hundreds of **SPECIAL OFFERS** and **STOCK CLEARANCE** items available from our stores nationwide - many with savings of up to 50%. To view our regularly updated product lists, visit [www.ssav.com](http://www.ssav.com) and click on **special offers**



### Hi-Fi & Home Cinema Guide 2005 EDITION

Pick-up a copy of our **72 Page Guide** at your nearest Sevenoaks Sound & Vision store or order a copy via our Website. The brochure will be posted to you (UK mainland addresses only) **FREE OF CHARGE**.

# SEVENOAKS

SOUND & VISION

## NATIONWIDE STORE GUIDE

- ABERDEEN** 01224 252797  
● 57 CROWN STREET *OPEN SUNDAY*
- BEDFORD** 01234 272779  
● 29-31 ST PETERS STREET
- BRIGHTON** 01273 733338  
● 57 WESTERN ROAD, HOVE
- BRISTOL** 0117 974 3727  
● 92E WHITELADIES ROAD, CLIFTON
- BROMLEY** 020 8290 1988  
● 39A EAST STREET
- CAMBRIDGE** 01223 304770  
● 17 BURLINGH STREET
- CARDIFF** 029 2047 2899  
● 104-106 ALBANY ROAD
- CHELSEA** 020 7352 9466  
● 405 KINGS ROAD
- CHELtenham** 01242 241171  
● 14 PITTVILLE STREET
- CRAWLEY** 01293 510777  
● 32 THE BOULEVARD
- CROYDON** 020 8665 1203  
● 369-373 LONDON ROAD
- EALING** 020 8579 8777  
● 24 THE GREEN *OPEN SUNDAY*
- EDINBURGH** 0131 229 7267  
● 5 THE GRASSMARKET
- EPSOM** 01372 720720  
● 12 UPPER HIGH STREET *OPEN SUNDAY*
- EXETER** 01392 218895  
● 28 COWICK STREET
- GLASGOW** 0141 332 9655  
● 88 GREAT WESTERN ROAD *OPEN SUNDAY*
- GUILDFORD** 01483 536666  
● 73B NORTH STREET
- HOLBORN** 020 7837 7540  
● 144-148 GRAYS INN ROAD
- HULL** 01482 587171  
● 1 SAVILE ROW, SAVILE STREET *OPEN SUNDAY*
- KINGSTON** 020 8547 0717  
● 43 FIFE ROAD *OPEN SUNDAY*
- LEEDS** 0113 245 2775  
● 62 NORTH STREET *OPEN SUNDAY*
- LEICESTER** 0116 253 6567  
● 10 LOSEBY LANE
- LINCOLN** 01522 527397  
● 20-22 CORPORATION STREET (*OFF HIGH STREET*)
- LOUGHTON** 020 8532 0770 **NEW**  
● 7-9 GOLDINGS HILL (*DUE TO OPEN 19 NOVEMBER*)
- MAIDSTONE** 01622 686366  
● 96 WEEK STREET
- MANCHESTER** 0161 831 7969  
● 69 HIGH ST, CITY CENTRE
- NEWCASTLE** 0191 221 2320  
● 19 NEWGATE STREET
- NORWICH** 01603 767605  
● 29-29A ST GILES STREET
- NOTTINGHAM** 0115 911 2121  
● 597-599 MANSFIELD ROAD, SHERWOOD
- OXFORD** 01865 241773  
● 41 ST CLEMENTS STREET
- PETERBOROUGH** 01733 897697  
● 36-38 PARK ROAD *OPEN SUNDAY*
- PLYMOUTH** 01752 226011  
● 107 CORNWALL STREET
- POOLE** 01202 671677  
● LATIMER HOUSE, 44-46 HIGH STREET
- PRESTON** 01772 825777  
● 40-41 LUNE STREET *OPEN SUNDAY*
- READING** 0118 959 7768  
● 3-4 KINGS WALK SHOPPING CENTRE
- SEVENOAKS** 01732 459555  
● 109-113 LONDON ROAD
- SHEFFIELD** 0114 255 5861  
● 635 QUEENS ROAD, HEELEY *OPEN SUNDAY*
- SOLI HULL** 0121 733 3727  
● 149-151 STRATFORD ROAD
- SOUTHAMPTON** 023 8033 7770  
● 33 LONDON ROAD *OPEN SUNDAY*
- SOUTHGATE** 020 8886 2777  
● 77 CHASE SIDE
- STAINES** 01784 460777  
● 4 THAMES STREET *OPEN SUNDAY*
- SWINDON** 01793 610992  
● 8-9 COMMERCIAL ROAD
- SWISS COTTAGE** 020 7722 9777  
● 21 NORTHWAYS PDE, FINCHLEY RD *OPEN SUNDAY*
- TUNBRIDGE WELLS** 01892 531543  
● 28-30 ST JOHN'S ROAD
- WATFORD** 01923 213533  
● 478 ST ALBANS ROAD
- WEYBRIDGE** 01932 828525  
● 43 CHURCH STREET, THE QUADRANT
- WITHAM (ESSEX)** 01376 501733  
● 1 THE GROVE CENTRE
- WOLVERHAMPTON** 01902 312225  
● 29-30 CLEVELAND STREET
- YEovil** 01935 700078 **NEW**  
● 14 SILVER STREET

**OPENING HOURS:** PLEASE TELEPHONE OR VISIT OUR WEBSITE  
**E-MAIL:** [insert store location]@ssav.com



# History, Man

No one can bring technology to the masses quite like Philips, a company responsible for a welter of great digital disc spinners over the years. Dominic Todd tries the new DVP9000, their latest DVD/SACD player...

**R**emember the Philips CD840? Launched in the early part of 1990, it was one of the first truly affordable (£350) Bitstream CD players. Now we take the technology for granted, but back then it caused a frisson of excitement and had other manufacturers rewriting their product plans in order to get on the 1bit bandwagon. In more recent years, Philips have been rather reticent in launching quality audio products but now, with the DVP9000, they're back with an exciting product at an affordable price – just like the CD840 sixteen years ago.

It's true to say that there's little ground breaking about the technology packed into the DVP9000, but 'packed' is most certainly the operative word, especially given its £400 price tag. Essentially, it's a reheated, reworked DVD-9635A, a machine that received great critical

acclaim in this magazine over two years ago. Two features stand out on the audio side that will be of particular interest to readers of this magazine. The first is SACD – available in multichannel or stereo format. The second, and potentially most exciting, is the inclusion of a Direct Stream Digital (DSD) processor which upsamples standard CD signals (44.1kHz/16 bit) to the high resolution 192/24 format. Whilst CDs will never give more than 16 bits of information, the upsampling effect makes it far easier for the filters downstream and, as we've seen with other upsampling CD players, should give greater refinement.

Although cheap by upsampling CD player standards, it's good to see that Philips has paid plenty of attention to other electrical components. The Cirrus Logic CS4398 DAC, whilst not top notch, is well respected. The main op-amp is an Analog Devices ultra high

bandwidth model (AD18066), and there's a fair share of Nichicon "fine gold" and Rubycon capacitors used within the audio stage of the player. What you don't get is the same sort of quality power supply that you'll find in similarly priced CD players – there's just a tiny frame transformer. Nevertheless the power supply is at least fully screened from the rest of the player, and the chassis is a solid affair. Also rare for a DVD player of this price is the use of high quality printed circuit boards.

As a CD only player, this alone would be a fairly impressive spec for the price, but there's more still. Although of less interest to audiophiles, the video side of the Philips shows real promise, too. The DVP9000 is simply packed with video enhancement systems that, not so very long ago, would have been the preserve of £1,000+ DVD players. Faroudja's highly impressive DCDi is perhaps the star of this and will





upscale standard 576p DVD images to 720p or 1080i (Progressive or interlaced) high resolution formats. In effect, it's the video equivalent of DSD. Other visual aids include TrueLife technology that is designed to enhance progressive scan material by boosting contrast and colour intensity without adding "noisy" artefacts. Finally, the NSV Precision Video processor utilises a 12-bit video DAC to further reduce image noise.

As you'd now expect from a machine of this price an HDMI, digital, socket is fitted. In addition to this, the component, composite, coaxial and six and two channel audio output RCAs are all gold plated. Rounding up this impressive tally of socketry are SCART, SVHS and optical digital outputs. In this respect, the DVP9000 wants for nothing. The one area where the DVP9000 could be seen as wanting, though, is in not providing DVD-Audio decoding.

Philips machines have not exactly had an enviable reputation for build quality in the past, but this model seeks to change that. The Chinese construction is precise, and the metal front panel and tight panel fit demonstrate an integrity that was lacking with the bygone CD840 and its ilk. Whilst being a subjective point, I rather liked the styling. There are areas where function follows form, not least with the circular display, but the over all impression is cohesive and expensive in appearance – indented badging and all.

## SOUND QUALITY

With sonics being of primary concern, I spent most of the review listening to a selection of CDs and SACDs. By and large, the DVP9000 gave a fine account of itself. With Peter Cinotti's 'Some Kind Of Wonderful', there were elements of the sound that reminded me of more expensive upsampling CD players. With the reproduction of the guitar, for example, the notes were formed in a precise, fluid motion that gave a good impression of realism. Bass wasn't the strongest, but it blended seamlessly with the rest of the mix and had relatively good definition, too, given the price of the player.

Treble was smoothly portrayed, if not quite so finely detailed as some. Whilst no Naim CD5i in this regard, timing proved surprisingly agile – especially against some of the more leaden and stilted opposition. Interestingly, individual instruments came out better than others in the DVP9000's interpretation of the song. Piano tone for example, was

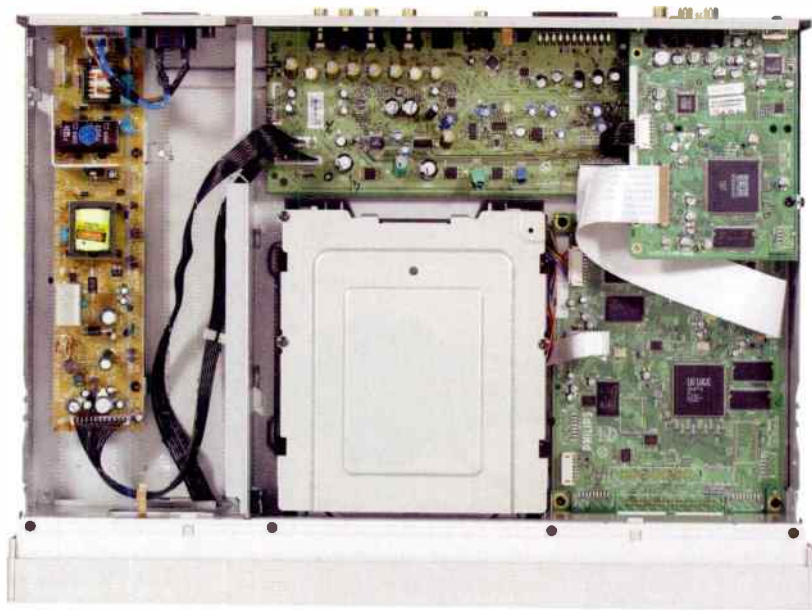

excellent, with a fine, full-bodied resonance and presence. On the other hand, the saxophone lacked a little focus, and wasn't as precisely conveyed as other instruments had been.

Annie Lennox's 'A Thousand Beautiful Things', showed that the DVP9000 could competently handle female vocalists without lapsing into a fatiguing harshness. Vocals were very well defined and intimate. Whilst

detail, and had the further effect of stimulating the listeners' interest, thus making the sound more involving...

Switching back to DSD CD, and I found that when listening to Classical music there was the same variation in instrumental portrayal that I'd noticed earlier. Higher strings were sweetly portrayed, and there was good body to the lower registers, too. Instruments stuck in the middle

"the sound that reminded me of more expensive upsampling CD players..."

the player didn't sound as fluid as some, it was a relief to find that it didn't harden the sound when under pressure. A slight softening characterised the bass response but, again by class standards, this wasn't a flaw. Perhaps most impressive of all was the layering of sound and sparkling percussion detail. Once again, there were moments when I could easily have believed this to be a far more expensive machine.

Moving from the DSD-enhanced CD to SACD brought about the usual improvements. Genuine 24bit reproduction lent an increased air of solidity to the music. The staging had palpably greater depth and superior imaging, too. The control of dynamics, with some notes appearing to source from an inky blackness, reminded me of the very characteristics that made Bitstream popular all those years ago – a wonderful lack of background hash. This obviously enhanced fine

though, in this case the woodwind, sounded curiously recessed and a little shut-in. I suspect that the slightly lifeless midrange wouldn't be so apparent had the treble not shone so brightly. Being fair to the DVP9000, the lack of full range transparency is hardly unusual at this price, even amongst the better sounding CD players.

The sound certainly proved a cut above the DVD norm, and I'm pleased to say the same of the picture. With its many processors and settings, finding the right one for your particular screen and tastes can take some time, but once done the results are well worth it. Initially the picture can appear almost too vivid. The contrast levels are so strong and the colour vivid that, unless you're watching an animation, the results can be a little unnatural. Once I'd tweaked the settings, this did improve, although I still feel that

## "The best tonearm I've heard"

HI FI WORLD

Winner of Stereo Times magazine Most wanted component of 2004 award 

"A new benchmark for musical communication" STEREO TIMES

"One of the truly special products I've reviewed in the past 18 years" STEREOPHILE



The new generation of tonearms from Origin Live have won admiration and rave reviews across the world for good reason - these arms better the best by a significant margin. Whatever your current arm, you can at last treat yourself to a serious upgrade. Why not arrange for a demonstration now.



*Demonstrably better*

### Tonearm Models

Conqueror - £2500  
 Illustrious - £1570  
 Encounter - £970  
 Silver - £599  
 O.L.I from - £124



NEW SOVEREIGN DECK

## Ultimate performance for your system

"The best musical results of any turntable I've ever heard, regardless of price."

Since I've been listening to turntables professionally for 32 years and am aware of the pitfalls of ultimate proclamations, I hesitate somewhat to make this statement. Nevertheless, it is true. The level of musical communication available from the Illustrious/Aurora Gold is in a class by itself. It sets a new reference."

STEREO TIMES on the Aurora gold turntable & illustrious tonearm

ORIGIN LIVE  
 Tel/Fax: +44 02380 578877  
 E-mail: info@originlive.com

Full information on web site

[www.originlive.com](http://www.originlive.com)

# ACOUSTICA

HI-FI & HOME CINEMA

**griffin**  
audio

• Amphion • Arcam • ART • Audiolab • AVID • Ayre • B&W •  
 • Classé • Focal.JM Lab • Linn Products • MJ Acoustics • Monitor Audio •  
 • Naim Audio • Nautilus • Primare • Quadraspire • Rega • REL • Rotel •  
 • Shahinian • Spendor • Sugden • Thiel • Wadia •

**The fabulous Focal.JM Lab Electra Be range**

is now at Griffin Audio in Birmingham, please call to arrange a demonstration



Acoustica  
 17 Hoole Road  
 CHESTER CH2 3NH  
**01244 344227**  
[www.acoustica.co.uk](http://www.acoustica.co.uk)

Acoustica  
 114 Wolverhampton Road  
 STAFFORD ST17 4AH  
**01785 258216**  
[www.acoustica.co.uk](http://www.acoustica.co.uk)

Griffin Audio  
 3 Gibb Terrace, Gibb St  
 BIRMINGHAM B9 4AA  
**0121 224 7300**  
[www.griffinaudio.co.uk](http://www.griffinaudio.co.uk)





**THE RIVALS**

Fitting neatly between two products, the DVP9000 sensibly avoids any price comparison with Denon players. In terms of universal DVD players, its greatest rival has to be the new Marantz DV6600 (£350). Like the Philips,



the DV6600 also features video upscaling and more than a nod towards superior sound quality. What it lacks, however, is the DVP9000's DSD, and this is noticeable. Whilst the sound quality is still a cut above the norm it can't match, at least with CD, the Philips' informative treble or precisely formed notes. With an inferior video DAC, the picture is also a little less vivid, although some may prefer this. On the plus side it does have DVD-A and comes in at £50 less. For those more interested in CD reproduction, then £400 would buy you the still deeply impressive Arcam DiVA CD73T. Although it won't play films, it will offer a consistency through the frequency range that the Philips lacks. Refinement is first class, and whilst not as spirited in the treble as the DVP9000, the detail is there – it's just not so obvious. In short, if you're only ever going to play CDs then the Arcam is still, in my mind, the best £400 player for the task. For multitasking, though, the Philips is top of the heap.

some rivals, particularly from Denon and Panasonic, give a more naturally balanced picture. Other than that, detail was superb and, barring the odd colour error, fast motion scenes remained free from blur.

**CONCLUSION**

Like many of its universal rivals, the Philips DVP9000 isn't fault free. Compared to a decent £400 CD player, there are areas of the sound quality that don't quite measure up – notably in terms of the midrange. Having said that, there were times when the DVP9000 genuinely excelled and, were it to be placed in a CD group test, I should think it would be far from disgraced. Clearly the upsampling DSD is responsible for much of the magic, and Philips should be applauded for making the technology so readily available. As a stand-alone music only machine, the DVP9000 just misses the mark. As a decent DVD player with which to occasionally play music on, though, the Philips DVP9000 is superb. Despite its flaws it's still a class leader – just like the good old CD840 all those years ago...

**MEASURED PERFORMANCE**

The processing within the DVP9000 Cineos player curiously affects frequency response, as our high resolution convolved impulse analysis shows. What looks like severe filter mismatching produces a +1dB lift at 6kHz before output undulates prior to roll off. A steady tone analysis confirmed this result. CD will sound brighter than usual as a result, but likely highly detailed. CD Direct offered no improvement.

SACD gave a flatter result, within fractions of a dB from 2Hz right up to 38kHz, above which output rolled down to -43dB at 100kHz.

Distortion levels were low on both CD and SACD, if not definitive. As always SACD manages much better at -60dB, producing three times less distortion than CD. It also resolves a -100dB tone, with just 3.7% distortion - impressive.

The DVP9000 will predictably sound different with CD. With SACD it looks normal enough under measurement. NK

Frequency response (-1dB)  
CD 2Hz - 18kHz

Distortion (CD)  
0dB 0.0006%

-6dB	0.0004%
-60dB	0.25%
-80dB	4.3%
Separation (1kHz)	-120dB
Noise (IEC A)	-102dB
Dynamic range	108dB
Output	1.7V

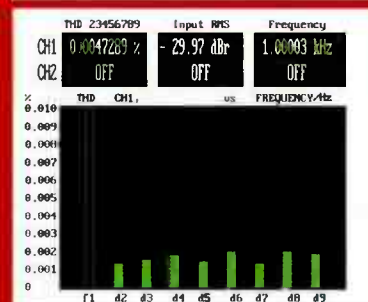
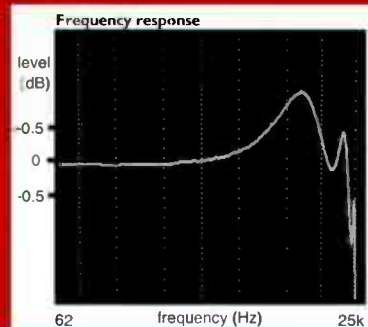

**VERDICT** ●●●●£

Impressive sound from both upsampled CD and SACD, plus an above average picture, finish and feature count, make this an excellent value do-it-all digital disc spinner.

**PHILIPS DVP9000** £395  
Philips  
+44 (0) 906 1010 016  
www.philips.co.uk

**FOR**  
- upsampling CD sound quality  
- picture  
- feature packed

**AGAINST**  
- lack of sonic transparency

# Smooth Operator

One of hi-fi's great imponderables is the undeniable synergy between modern digital audio sources and classic tube amplification. Copland's CSA29 valve/transistor hybrid integrated amplifier is a case in point, says Channa Vithana...

**A**sk any seasoned audio aficionado, and they'll not deny that there are some mystical, magical and invariably inexplicable synergies in hi-fi that reappear time and time again. One is the obvious pairing of tube and transistor amplification (i.e. tube preamp, tranny power), another – and perhaps even more easily demonstrable – is that of digital audio sources and tube amplification. Of course, all tube amps invariably sound 'tubular', so a clever trick is to offer a hybrid which takes down a bit of this warmth and softness but keeps the thermionic valve's characteristic essential sweetness. The £1,998 Copland CSA29 is

one such product, using one preamp valve per side at the input stage, plus a conventional solid-state power amp stage.

Ostensibly it is an austere looking apparatus, but upon closer inspection the Copland actually reveals itself, through its 430x110x390mm dimensions, as an elegantly proportioned piece. For instance, it has a large and thick front panel which has the rare distinction of having the company logo deeply machined into its surface. The logo application looks like an expensive exercise as not many hi-fi companies do this, but it lends the Copland an air of civility before it has been heard.

There are also some beautifully

crafted volume and source control knobs which (especially the volume knob) when gazed at remind me of the superb Mark Levinson era Cello laboratory style from the eighties.

The control and volume knobs move with an assured, well-oiled precision. In the middle of the fascia is a display using red letter font, and either side of it are a tape selector and power standby switch.

On the rear panel there is a connection for Ground/Earth, phono sockets for Phono/RIAA, Tape out, Tape in, Tuner, CDP (CD), AUX 1, AUX 2, then two 12V DC remote jacks, speaker outputs and an IEC mains socket.

Internally, the Copland is as





elegant as it is out.

There's a large mains input board between the IEC socket and sizeable mains toroidal transformer. This feeds into the main board which features notably - four large 10000uF and two smaller 2200uF reservoir capacitors. The board is separated schematically with identical components, inclusive of capacitors and a mini heat sink, each for the left and right channel.

Each channel has one 6992 Russian Sovtek valve which is used for the input differential stage. Copland states that they use these valves to allow "the notably smooth and transparent properties of valves to blend with the power and dynamics of the transistor electronics".

The main board is connected to a large, chunky heat sink above which are top panel perforations for ventilation.

At front right is an Alps Japan motorised volume potentiometer and at the left is the input select encoder which is connected to the display board attached onto the rear of the

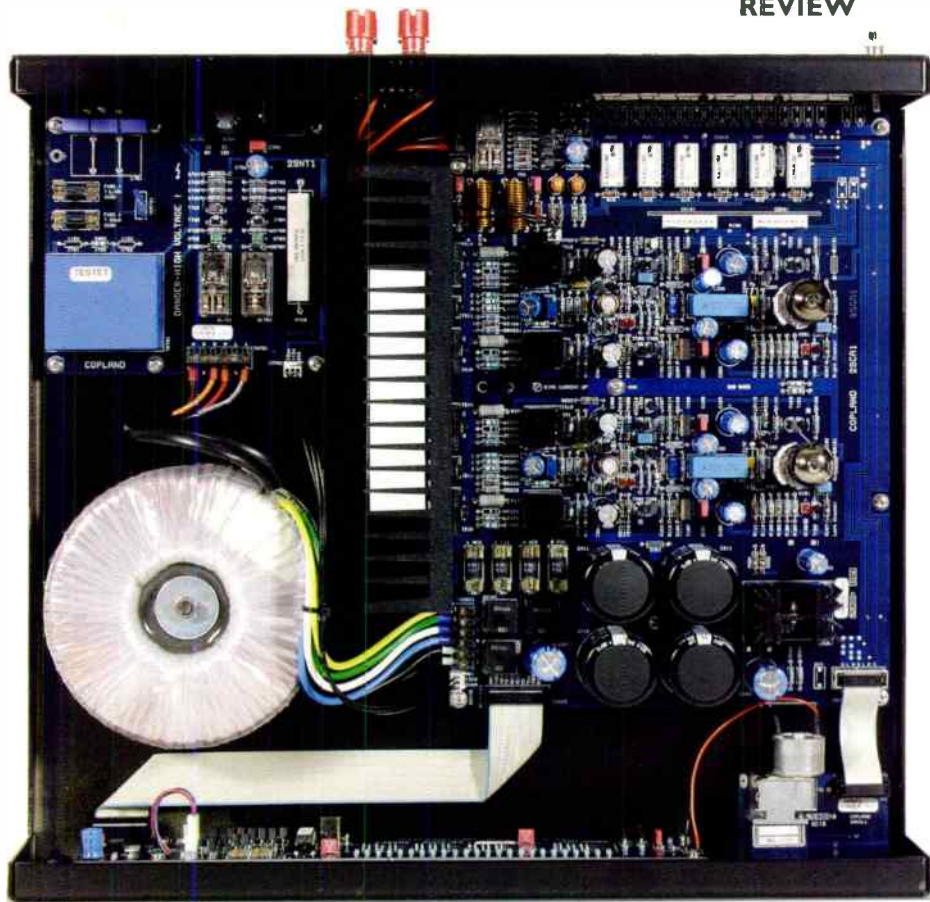

#### COPLAND MEETS MOON

Substituting the £1,998 Copland with a £1,595 Moon Audio i-3 integrated amplifier was an almost night and day difference with the Hilary Hahn SACD. The Moon had a more upfront and ostensibly augmented and engaging presentation. It also had the edge in musical timing and deeper bass extension, though bass dexterity was the same on both amplifiers. So the Moon had more impact and weight on the Hilary Hahn SACD, yet the Copland had better instrumental timbre when considering individual elements in the detail of musical structure. For instance, Hilary Hahn's violins had a more sophisticated enunciation through the Copland and though this may seem a minor consideration, it amounts to a major portion of the emotional content when you consider the impact that the tone of a violin has.

On the Goldfrapp SACD, the Moon projected Alison Goldfrapp's voice further forward than the Copland and also had an even more expansive presentation, her vocals sounding very life-like. However the Copland managed a better overall balance with the musical and vocal timbre, if not quite the same musical timing as the Moon.

With the 'Bach Mattheus Passion' DVD-A, the Moon through its expansive presentation was more widescreen but the Copland had the edge on vocal definition and timbral sophistication. The Moon was better able to express the full weight of the orchestration and choir when crescendos appeared, but the Copland's innate sense of control and tonal sophistication was minimised.

On the REM 'Green' DVD-A there was better musical timing through the Moon and, as with Goldfrapp's SACD, some extra vocal projection leading to a more forward presentation. The chiming guitars used throughout 'Green' were, however, a little ragged compared to the Copland, as they sounded a touch strained through the less costly Moon. The Copland also had a superior midband to the Moon on the REM DVD-A and it excelled with this rather straight-up piece of rock music.

front panel.

The Copland has a claimed 85W per channel and 0.05% THD at all levels [see MEASURED PERFORMANCE]. It weighs 15kg and is supplied with a remote that can additionally control the Copland CDA822 CD player.

There is an optional £140 plug-in phono board. It employs discrete components in active RIAA correction circuitry, with low noise input-FET transistors.

#### SOUND QUALITY

Hearing the nimble viola playing of Hilary Hahn on the 'Lark Ascending' segment of the Elgar/Vaughn Williams SACD was most enjoyable through the Copland. Violin tone was delicate yet very musical. There was good musical timing, the Copland ably expressing the elastic phrasing of Hilary Hahn's performance. The violin was sophisticatedly portrayed with a good balance within the rest of the musical structure. All the musical strands were well balanced with the Copland when it came to providing a convincing musical whole.

The sound of the Copland with the Hilary Hahn SACD was very slightly warm yet no less engaging, as I could follow all the different elements without once highlighting particular ones. When it came to the crescendos, the Copland was always in control, being neither fatiguing nor soporific. Thus my attention was not

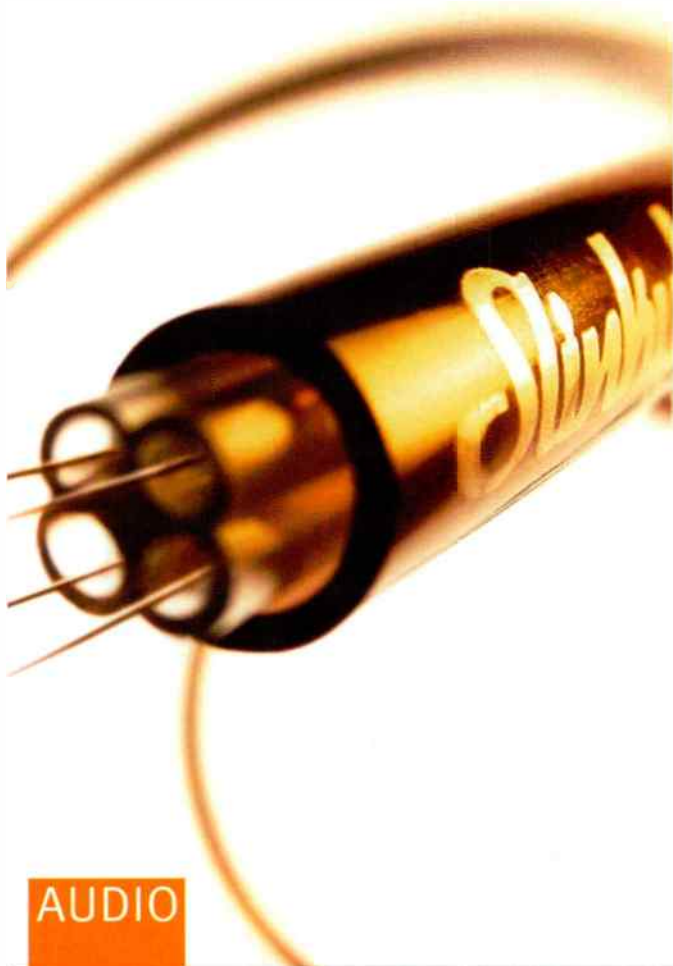

AUDIO

42

## Slinkylinks

"They're very smooth, insightful, silky, couth, and detailed with oodles of atmosphere"

"Slinkylinks perform very strongly indeed even in the very best high end systems at a reasonable price"

*HIFI World July 2005*

Unique air and silver cables starting from only £180

Just a click away at [www.audi542.com](http://www.audi542.com)

**You thought legendary dCS CD replay was out of reach? Now the world's best comes in one box at one quarter the price!**

## The best

## one-box CD?

Most people rate the three- and four-box dCS CD/SACD players as the best in the world – including the US **STEREOPHILE** magazine.

So when dCS re-package all that **REMARKABLE TECHNOLOGY** into one slim box the world takes note.

The new £6.5k P8i plays SACDs and CDs and **UPSAMPLES** CDs to DSD, the format of SACD, for a fuller, more natural sound. Instruments and voices develop more of their character and there's a greater "ambience" and presence.

A key dCS achievement is their unique **RING DAC** at the heart of the conversion process. Its accuracy, combining the best aspects of both multi-bit and one-bit, brings out the fine detail in the recordings and the **REALISM**.

We like to use the **DIGITAL VOLUME CONTROL** and connect directly to the power amp – **NO PREAMP** – for the greatest realism and dynamics.

Digital inputs allow for superb D/A conversion of other digital sources, eg DVD with optional upsampling to DSD. Integrate the P8i with a home theatre for stunning sound.

Your investment is protected with one of the best **UPGRADE SCHEMES**. Software can be brought up to the latest spec from a CD and hardware upgrade is via part-exchange.

Customers say we make some of the **BEST SOUNDS** they have ever heard, so you know we can do the same in your home. Our advice will take account of your best components and guide you where change is needed, in stages you can afford.

You **AVOID EXPENSIVE MISTAKES**, enjoy music along the way and save money in the long run.

**JUST LISTEN AND YOU'LL KNOW**

**CD:** ACCUSTIC ARTS, AUDIO SYNTHESIS, BEL CANTO, dCS (ELGAR, DELIUS, PURCELL, STELLO, VERDI, VERONA), WADIA. **VINYL:** AVID, BASIS, CLEARAUDIO, DNM, GRAHAM, THE GROOVE, LEHMANN, MICHELL, ORIGIN LIVE, SUMIKO BLUE POINT SPECIAL, TRANSGURATION. **TUNERS:** MAGNUM DYNALAB. **AMPLIFIERS:** BEL CANTO, CAT, DK DESIGN, DNM, GAMUT, HOWLAND, SONNETEER, STELLO. **LOUDSPEAKERS:** AUDIO PHYSIC, DALI, ETHOS, NEAT, TOTEM. **CABLES:** ARGENTO, CHORD Co., DNM, NORDOST, VERTEX AQ ETC. **MAINS:** Vertex AQ. **SUPPORTS:** ARCICI, STANDS UNIQUE, VERTEX AQ

## The Right Note

Music in the home

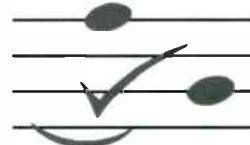

## BATH

01225 874728

or lo-cost

0845 230 7570



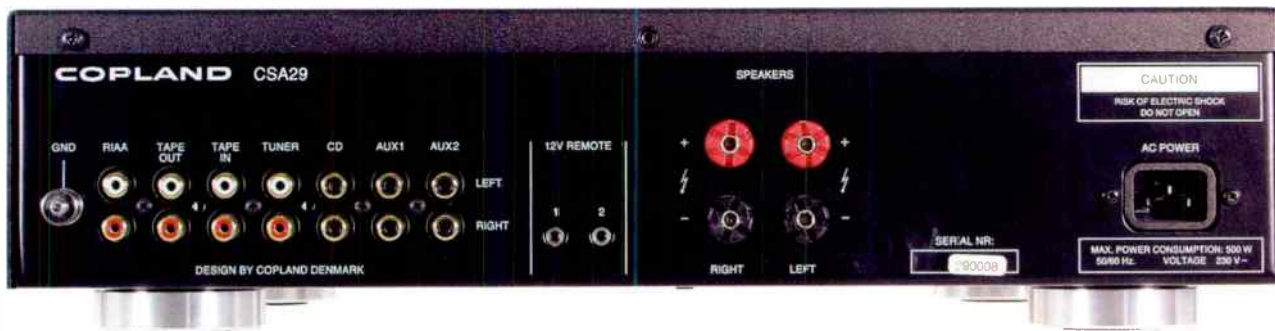

forced to waver or held hostage.

With Goldfrapp's 'Supernature' SACD, the Copland beautifully portrayed Alison Goldfrapp's glacial vocals. She surrounded the listening room with her gorgeous voice where it was portrayed deliciously and emotively in her characteristically longing lyrical expressions. The musical separation was even better than on the Hilary Hahn SACD as I could clearly define every strand and element. The unravelling of complexly layered treated instruments, synthesiser and vocals was excellent with good musical timing. This ability allowed a superbly resonating synthesiser part to come forth and then evaporate, allowing Alison Goldfrapp's vocals to effortlessly slide into the mix. The overall sound was well balanced with good resolution and a focussed presentation. Bass extension and dexterity on the Goldfrapp SACD was tuneful and well integrated into the rest of the musical structure.

Playing the 'Bach Mattheus-Passion' DVD-A was interesting through the Copland, as it can be quite demanding, being unnecessarily warmer on more richly hued systems with its grand orchestration that combines male and female choirs. However, with the Copland, the sound was expansive yet under complete control without an ounce of sugary sweetness or unnecessary flabby warmth. This was most welcome and the choir also excelled, sounding sophisticated and timbrally convincing. Musical separation was also good on this demanding piece as the emphasis shifted from the various vocals to the huge sound of the orchestrations.

REM's 'Pop Song 89' from the 'Green' DVD-A had a wonderful midband thrust to it and the sound was enjoyably controlled and focussed yet as thrilling as I could hope for from this occasionally strident recording. On the

seriously intoned and sarcastically written 'World Leader Pretend', the sound was again well-balanced with a superb midband expressing the upper frequencies of the bass and orchestrated melodies very well. Michael Stipe's vocals had the required forlorn presentation that the song's lyrics command. The musical separation, just as on the Goldfrapp SACD, was excellent with some very good instrumental layering which allowed the musical timing to remain untainted. There is a nice piano melody to 'World Leader Pretend' which comes through in its last quarter and it sounded just right – not ostentatious, tiring or lost. Rather it was beautifully placed and came through the Copland driven Waterfall speakers with verve.

**CONCLUSION**

The Copland CSA 29 is a stylish and elegantly proportioned amplifier. Build quality is excellent and the rarely employed deeply machined logo is a major plus point to its well-dressed physique. Its sound

quality can also be described as such - being controlled, focussed and also timbrally convincing. The Copland was adept with all the music used in this review but I felt it was better with the electro-pop of Goldfrapp in steering their music with a balanced conviction, and the power-pop rock of REM's 'Green' where it excelled in the midband having control and finesse with excellent textural – this latter point is the amplifier's greatest strength. At £1,998 it's costly for an integrated, but still demands an audition to reveal its many abilities.

**MUSIC**  
 Hilary Hahn/LSO/Sir Colin Davis 'Elgar Violin Concerto & Vaughn Williams - The Lark Ascending' SACD (2004)  
 Goldfrapp 'Supernature' 2005 (SACD)  
 Nikolaus Harnoncourt 'Bach Mattheus-Passion' (2001) DVD-A  
 REM 'Green' DVD-A (1989/2005)

**REFERENCE SYSTEM**  
 Moon Audio i-3 integrated amplifier (£1,595)  
 Onkyo DV-SP1000E universal player (£2,800)  
 Waterfall Victoria Speakers (£2,000)

**MEASURED PERFORMANCE**

Although this amplifier reaches down to 2Hz it doesn't pass d.c., which is always useful. At the other end of the spectrum the CSA29 gets right up to 120kHz, so this is a wideband amp, but one that doesn't trip out if presented with d.c. from a source.

Power output was a solid 90W into 8ohms and 156W into four ohms - plenty enough to drive most loudspeakers to very high volume even in a big room. As most loudspeakers are 4ohm these days the larger figure is what you will generally get.

Distortion was low and just second harmonic in the midband, but at 10kHz the figure worsened considerably to 0.02% at 1W, with upper harmonics appearing. This is classic crossover distortion and although low in level is never nice to see. This may not be the most svelte sounding amp as a result, but if low feedback is the reason then it might also sound open and dynamically unfettered. NK

Power	90watts
CD/tuner/aux.	
Frequency response	2Hz- 117kHz
Separation	92dB
Noise	-103dB
Distortion	0.02%
Sensitivity	264mV
dc offset	4mV

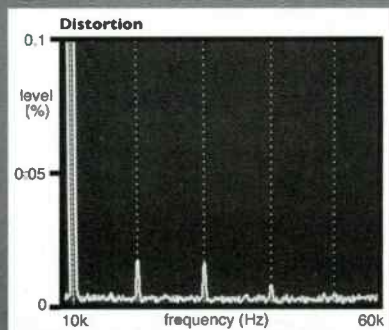

**VERDICT** ●●●●●  
 Unfailingly svelte, sophisticated and smooth - both to listen to and look at - this is a truly desirable high end integrated.

**COPLAND CSA29 INTEGRATED AMPLIFIER** £1,998  
 Copland  
 ☎ +44 (0)208 971 3900  
 www.copland.dk

**FOR**

- luxurious build
- elegant sound
- svelte design

**AGAINST**

- price

# cult status

Based in Ogden, Utah in the US, Zu make some intriguingly designed and specified loudspeakers, of which the Druid floorstander is definitely one, says Channa Vithana...

Supplied by Brighton-based distributor Musicology, the Zu Druid mk4 is an attractively proportioned floorstanding speaker with a slim-line depth elaborating its elegant stance. It is described as a 'one and a half way' type and uses a crossover-free full-range drive unit along with a super tweeter. The claimed specifications are 8ohms minimum impedance (12ohm nominal) and a very high sensitivity of 101dB. It also has an impressive claimed 35Hz-25kHz bandwidth and 300W power handling [see MEASURED PERFORMANCE]. So it should in theory be very amplifier friendly, to even low-powered valve models.

The bespoke Zu260FR-G2 full-range crossover-free driver measures 260mm in diameter and Zu says it has a very linear motor with 25g moving mass, natural fibre cone assembly and cast frame, precision machined motor and pole assembly.

Zu praise their single, full-range driver, saying that standard hi-fi drivers are not capable of playing much over three octaves without having problems in dispersion, imaging, timbre and timing.



The Zu-T1 super tweeter is made from a CNC machined billet of aluminium and uses a "split shelf" (12 kHz/15kHz) high-pass filter.

The Druid isn't a closed box (infinite baffle) speaker and Zu declares that it is not a bass-reflex, horn or transmission-line design either. Instead the Druid uses a proprietary "Griewe" driver loading based on engineer/designer Ron Griewe's research (see [www.zucable.com](http://www.zucable.com) for more information on this). Briefly, Zu claim their loudspeaker enclosure offers maximum wideband cone damping, proper control and coupling of rear acoustic energy and reduces low-frequency time delay.

Additionally Zu prefer the "Griewe" method because they state that "transmission lines and ported designs of all types control cone motion but at the expense of group delay and other forms of distortion; sealed enclosures (infinite baffles) perform with much less group delay distortions but cause cone motion to be excessive; horns damp cone motion well but distort amplitude and phase".

The Druid employs Zu B3 cable internally which is silver alloy terminated using a solderless cold forged method. The "Griewe" driver loading is terminated with a very fine mesh opening at the undercarriage of the Druid plinth with airflow sustained by the recommended 10-20mm gap made by the spikes. Nothing if not unusual!

The cabinet is 20mm MDF wood core inclusive of a laminated "phenolic composite skin". Its dimensions are 1270x280x160mm with a plinth footprint of 300x300mm. There are two sets of screw-in spikes for levelling and placement, one for carpet and the other for wooden flooring.

The Druids weigh 28kg each and come in two standard finishes; Black Satin and Tokyo Frost. Zu state that the Black Satin "has the optical qualities of black glove leather, a slight satin texture over matte black" while Tokyo Frost "is less, heavy metal black and silver, the hue is graphite (grey), the texture is that of fine sandstone and there is a hint of glinting pearl in the finish"! Zu can also accommodate high-gloss customised paint finishes at a price premium.

At the rear of the cabinet finished by an attractive metal plate, is a beautifully fabricated Cardas Patented Binding Post which Zu states uses "pure" unplated copper. It features a single fixing knob at its rear complete with two o-ring grips

around its shaft. It is designed to accept bare wire, spades, pins and banana plugs and is a practical delight, being a model of elegant engineering.

In the flesh and silhouetted, the

abilities of the Druid were also very good with excellent integration between the super tweeter and full range driver. Bass dexterity was suitably multilayered, which allowed

"their inherently good musical timing and timbre enhance low power amplifiers brilliantly..."

Druid is a rather attractive slimline monolith and at 1,270mm high it is taller than average. As a minor, but distinct aesthetic consideration I would have preferred the full range Zu260FR-G2 driver to be flush-mounted like the supertweeter. Additionally, I would have liked to see both the drivers (flush-mounted) within neatly chamfered/ machined circular openings to give the final buff to the aesthetics, though this may affect the depth of the cabinets. Both drive units are attached with square head fixings which are superior to the nasty cheap-looking crosshead screws that are still tiresomely used in some high-end designs.

At the lower part of the front panel / baffle, is a Zu logo. Though it could have been even better (everything can), I am not

the low-frequencies to be expressive and musically communicative as they reached the depths, providing a very focused, yet deep bass extension. This was pleasantly surprising as I had expected a speaker equipped with a high-efficiency full-range driver to be proficient in timbre and musical timing at the expense of low-frequency weight and extension.

From 'The Colour Of Spring' by Talk Talk, 'Happiness Is Easy' was ushered in amid excellent instrumental separation, along with Mark Hollis's vocals being stunningly rendered in a superb three-dimensional quality that was very convincing. The eerie children's choir slithered into the composition with alacrity and was deftly layered within the rest of the instrumentation. This ability to unravel complexly

#### PLACEMENT

I used two listening rooms for the assessment of the Druids. The first measured 4x3M with concrete walls, timber suspended joists and floorboards with laminate wood flooring above. The second room was larger at 6.5x4.5M with concrete walls and concrete floor with laminate wood as the surface. I found that in both listening conditions the Druids worked better at a minimum of 700mm well clear of the rear walls which aided spatiality and procured better control and more agile bass. For the smaller room I preferred a straight ahead position and with the larger one, a slight ten-degree toe-in.

complaining as the overall design is rather pleasing to the eye, especially for a large American speaker, as they can sometimes be ill at ease proportionally and over-fussy in appearance - which the Druid certainly is not in the flesh. The Druid is designed, built and finished to a very good standard.

#### SOUND QUALITY

Listening to the lilting orchestrations of the Balanescu Quartet on 'Maria T' was most rewarding through the Zu Druids. The instrumental timbre of the violins and cello was wonderful, with a lustrous and vividly layered acoustic. The spatiality offered by the Druids was also very good, not only enabling the music to spread out across the room but also allowing the three-dimensional timbre to flood out and around me in the listening room. The musical timing

composed and multilayered music is a real strength of the Druids as they expressed a superb atmospheric feel to 'Happiness Is Easy'. The horn melody was timbrally convincing, resonating with in-room presence. This recording is tricky, using elastic deployment of lower mid to deepest, powerful low-frequencies; however, the Druids authoritatively handled the bass lines - which were focused, deep and expressive.

With the distinctive deep-house dance music approach of 'Blue' by LaTOUR, the Druids ably intimated the long hypnotic snake-like melodies and insistent beats that originally drew me to this piece. Interestingly, they did not reveal the rather hard and brittle treble quality that 'Blue' has due to its less than perfect recording quality. Instead I could listen to 'Blue' at much higher



Meridian's multi-award-winning 800 Reference Series has a new stable-mate: the 808 Signature CD Player, shown right.



## Meridian's 808. Hear how good your CDs really are.

**M**eridian's 800 Reference Series has come to be regarded as the pinnacle of audio and video playback, with a level of quality so high that *Stereophile* had to introduce a new category for the 800 Optical Disc Player and 861 Digital Surround Controller.

Now we've added a new component that will make your Compact Disc collection sound even better: the **808 Signature CD Player**.

Each 808 is individually signed by the designers and co-founders of Meridian, Bob Stuart and Allen Boothroyd. Each is optimized for the ultimate in CD playback. Quite simply, we think the 808 is the best CD player ever made.

Choose between two models: the 808 player-only – to integrate with your existing system – and the 808i with full stereo preamp functionality. Either will flawlessly drive a pair of Meridian DSP Loudspeakers directly –

like the DSP7000 or our flagship DSP8000 – or an amplifier (such as our G57) and conventional speakers if you prefer.

For more, contact your authorised Meridian dealer or installer – and experience, for the first time, the full potential of your CD collection.

Superb audio/video components from Meridian. Are you listening?

BOOTHROYD STUART  
**MERIDIAN**

**Meridian Audio Limited.**  
Latham Road, Huntingdon,  
Cambridgeshire PE29 6YE, UK  
**T:** +44 1480 445678  
**F:** +44 1480 445686  
**info@meridian-audio.com**  
**www.meridian-audio.com**





**REFERENCE SYSTEM**

- Chord Electronics Blu/Dac64 CD player (£6,190)
- Unico CDP CD player (£895)
- Densen B-250/B-330 amplification (£6,000)
- Eclipse A502 single-input amplifier (£875)
- Waterfall Victoria Speakers (£2,000)

**MUSIC**

- Balanesco Quartet 'Maria T' (2005)
- Talk Talk 'The Colour Of Spring' (1986)
- LaTOUR (1991)

volumes than normal, feeling I was enveloped within its dream-like composition and still not missing any details or low-frequency groove oscillations.

I tried the Druids in a lower cost system comprising the £875 Eclipse A502 single-input integrated amplifier and £895 Unison Research Unico CDP CD Player. I found that much of my findings from the high-end £12,190 Densen and Chord

bass extension. On 'Blue' by LaTOUR the Waterfalls had a slight edge to musical timing but the Druids were notably superior on most other aspects to this piece with a deeper bass extension, weight and a finer sense of timbre to convey an even more atmospheric feel. I can confirm the Druids very fine subjective bass extension and dexterity as they were powerful yet focused. This is because the Druids (with a claimed 35Hz for

Minimax M520, bring that final polish to its previously very good but potentially excellent musical timing.

They're positively benign in that they can take some completely different music, not change the identity of the compositions yet be beneficial to their respective qualities. They have a high-resolution sound with excellent timbre, superb driver integration plus bass dexterity and extension. Combined with fine build, finish and distinctive yet attractive design, they proved a great success sonically in either a £12,190 high-end or £1,770 lower cost system. Accordingly, they get a deservedly rapturous recommendation - but they're most emphatically not everyone's cup of tea; so try before you buy!

"they get a deservedly rapturous recommendation - but they're most emphatically not everyone's cup of tea;"

Electronics system also applied to the much lower priced one, albeit with obvious proportionate sound quality. There was great driving ability with the claimed 30W per channel power output of the Eclipse A502. I comfortably reached some very high volumes while never going anywhere near to pushing the Eclipse A502 amplifier to its 30W limit!

Both bass extension and more complex bass dexterity were skillfully enunciated by the Druids, as was some superb timbre with both vocals and violins. The Druids did not treat the lower-cost Eclipse/Unico system with contempt or an upturned nose and proficiently went about their music making business in a well-timed and highly involving manner.

Comparing the £2,395 Druids to my regular reference, the £2,000 Waterfall Victoria floorstanders, I found the Waterfalls had less timbral acuity than the Druid on the Balanesco Quartet's 'Maria T', though the resolution of instruments was equal between the two. On 'Happiness Is Easy' by Talk Talk, both speakers were equally enticing in regard to Mark Hollis's vocals, instrumental timbre, bass dexterity and

low-frequencies) ably matched the excellent subjective bass extension of the (claimed 38Hz) £2,000 Pinsh 2.1s I reviewed recently.

**CONCLUSION**

I was delighted with the £2,395 Zu Druids - they would make brilliant partners to lower powered amplifiers old (and new), like the £1,539 18W/24W Minimax M520 and £949 20W Sugden A21a reviewed in the November issue - or even the ludicrously inexpensive Sonic Impact T-Amp that John May recently fell for, with just 4W to call its own! The Druids with their inherently good musical timing and timbre would enhance these amplifiers brilliantly, by augmenting their excellent timbral qualities and additionally in the case of the

**VERDICT**

Special in appearance, engineering and sonics alike, these are in a gang of one if a serious high efficiency loudspeaker is required - but match carefully!

**ZU DRUID 4** £2,395

Zu  
+44 (0)1273 700 759  
www.musicology.co.uk

**FOR**

- superb driver integration
- bass dexterity
- instrumental timbre

**AGAINST**

- measured performance
- lightweight bass
- charismatic sound will not suit all

**MEASURED PERFORMANCE**

The Zu's output stops fairly suddenly at 100Hz, a limit bettered by even mini loudspeakers these days. It has no deep bass, the price of using a light bass cone to get high sensitivity. Unfortunately, absence of bass also resulted in an unspectacular sensitivity figure of 90dB being recorded, as low frequencies contribute strongly to measured sensitivity. If sensitivity measurement were midband weighted (e.g. IEC A) then doubtless the Zu would reach 93dB or so for one nominal watt (2.8V) of input, but whether this is sufficient benefit considering lack of bass is arguable I feel.

Predictably, in view of the design of the drive units, frequency response varied wildly according to listening / microphone position. Our published response is the best possible, averaged in the far field for best integration, and on the tweeter axis. Even here, where treble is strongest, output falls steadily toward high frequencies, shelving to -5dB down above 3kHz, so the Zu will have a warm balance.

Measuring 11ohms overall, impedance is high. Our analysis shows it is also substantially

resistive, so the Zu is a very light load on any amplifier.

The Zu is idiosyncratic. It's measured performance isn't very impressive even as light cone/ high sensitivity loudspeakers go. NK

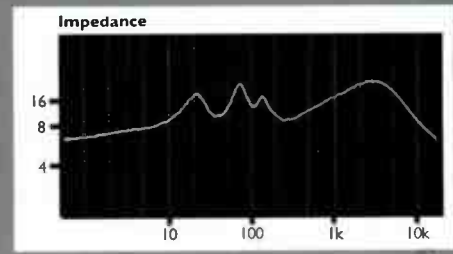
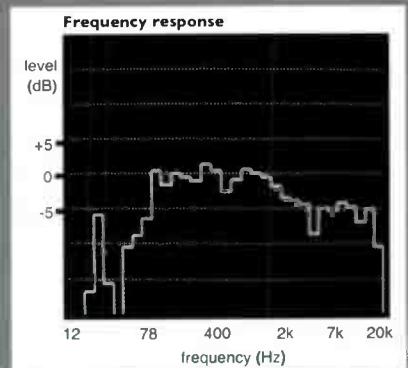

# Total Exposure

The XXXV is Exposure's latest top-of-the-range integrated amplifier, but competition is fierce and it has much to prove. John May wonders if it has what it takes...?

**A**ny audiophile knows that Exposure has over thirty years experience in designing and manufacturing distinctive and highly regarded equipment, starting back in 1974. The company's certainly never been one to follow the pack, or – let's face facts – to win any awards for innovative styling, but has certainly built up an enviable reputation for sound quality. How then does its latest and (it says here) greatest fare?

For sure, the hand-built Class AB Exposure XXXV (35 in Arabic numerals) integrated wears its intentions on its sleeves. Flat-Earthers (are there any still out there?) will love this amplifier, possessing as it does just a volume control, a source select control and the on-off switch. Nothing fancy here, though there's a typical 'parts-bin'

type plastic remote which can also be used with a complete Exposure system.

Like Exposures of the past, styling is best described as understated, with its extruded 6mm thick satin black finish front panel (Titanium finish is also available), and rough textured matt black finish of the aluminium enclosure cover. These materials have been chosen to control chassis resonance and stray magnetic fields. The appearance has been jazzed up a little by red LEDs inserted into both the volume and selector controls. (In fact the Exposure 35 shares the same basic chassis, lid, heatsink, volume and selector switch and other parts as their cheaper 3010 amplifier.)

Quality of fit and finish is fair, but compared with the likes of something like a Marantz PM-15S1 or the Lyngdorf Audio SDA1 1275, leaves

a little to be desired...

Around the back are six pairs of gold-plated phono inputs, plus one pair of record out sockets, and two pairs of pre-outs which allow the 35 to be used as a preamplifier if you wish to upgrade to a power amplifier at a later date, or bi-amp.

Additionally, there's also the option of installing a £200 phonostage card which entails whipping the lid off and merely removing a small jumper-board from the main PCB, and plugging in the phono module in its place and securing it with the supplied bolts. There are also two sets of 4mm speaker terminals allowing bi-wiring to be used, and the usual IEC mains inlet.

Looks are of course just one side of the story – Exposure are renowned for putting all their efforts into getting the best sound possible





from an amp rather than some flavour of the month design. Taking off the cover revealed one of the largest toroidal transformers I've seen in a while, which goes some way to explaining the hefty 11.5kg weight of this unit. It's custom manufactured by SIGA and is some 25% bigger than the unit used in their 3010 amplifier. Cascade circuitry is used for improved immunity for the PSU from the vagaries of the UK mains supply.

There are two linear regulators used per channel. Exposure says that they only act upon the small signal section of the amplifier, not the output stage, so the regulator

has a much easier time of it. The Exposure 35 features a fast

bipolar transistor output stage, while the tidy looking pre and power PCBs used in the 35 are both new, double-sided designs which feature thicker track routing than before, in addition to better positioning of components on the board, and shortest signal paths possible.

High quality capacitors from Elna are used in critical areas, and there are two bulky looking reservoir caps. per channel made especially for Exposure. The volume pot is the ever-popular Alps Blue, and the source selector is also an Alps unit.

### SOUND QUALITY

One of the first things that caught my attention with the Exposure 35 was its punchy bass performance. Regular readers will know I'm particularly partial to products that manage well in this department, and I'm happy to say the 35 excelled here. Listening to Stravinsky's 'The Rite of Spring' on a DDD Naxos recording the vicious, primordial sounding kettle drums during the 'Part II: The Sacrifice' really kicked home. One could really feel the intent behind this piece, as – I'm sure – could my neighbours...

Witnessing the musical equivalent of the creation of the universe is probably not everyone's idea of ideal late-night listening, but it sure showed what the Exposure was capable of.

Thankfully the 35 was also equally at home with the mellower moments in this piece as well, and had a quite delicious way with strings in particular, almost valve-like in fact. The 'Adoration of the Earth' was beautifully relayed through my reference Mission e82 loudspeakers. This

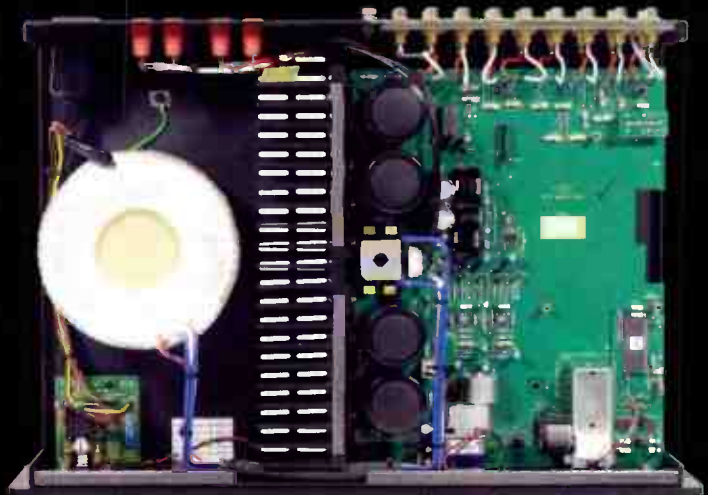

"with its beefy power supply, the Exposure was able to go from quiet to loud and back again with a casual shrug of its output transistors..."

amplifier is particularly good at describing the individual characteristics of particular instruments. The bassoon solo in this section was fascinating to listen to – not just for the realistic way in which it was portrayed, but also the depth it inhabited within the soundstage which really turned this into a 'being there' performance rather than a passable electronic interpretation of a real event. With its beefy power supply, the Exposure was able to go from quiet to loud and back again with a casual shrug of its output transistors!

Moving on to something more modern in the shape of the superbly recorded and produced 'The Diary of Alicia Keys', and grin-inducing sonics were again the order of the day. The piano which opens the track, 'Harlem's Nocturne' was possessed of just the right combination of weight, richness, harmonics and – as each note tailed away – decay. Piano appears to be one of those instruments that is particularly difficult for an amplifier to 'describe', but the Exposure 35 pulled this off with deceptive ease. In fact I'd go as far as saying that this is the best amplifier I've yet heard to do justice to this particular instrument.

Drums then kicked in with a real sense of authority and a satisfying thud, an ability which would go down a storm with fans of Rock and Dance music in particular. Certainly the Exposure really gave a blistering performance with Black Sabbath's 'Paranoid' CD, in my Naim CD11. The temptation was there to just keep raising the volume control up the scale... who needs an amp that goes to '11' when you have a design like this?

# SHANLING

## CD-T80

"Ironically, the star performer of this month for me turned out to be the reference machine tested in our lead review on p12 - the Shanling CD-T80. It offered the best of what each of the other CD players now had to offer in terms of sound quality rolled into one package. It had the sweetness and purity of sound necessary to do justice to Classical and simpler acoustic music. It also possessed the low-down grunt, speed and crispness of sound to do justice to Rock and Dance music. It could also wrestle music out of discs I previously thought undisplayable due to their appalling sound quality. Not only that but build quality is absolutely top notch putting others to shame here. It features well plus it also upgrades and even comes with a superb audio file manager and remote." *Hi-Fi World December 2005*

"Shanling could have asked £1,500 for the CD-T80 and it would still be something of a bargain. With machined-in lettering on the front panel instead of the screen-printed lettering, some fancy blue LEDs and upgraded valves they could ask £2,000. As it stands at £650, it's the new standard bearer at this price point, and a firm five gopher to boot." *Hi-Fi World December 2005*



**VERDICT** ●●●●●

Shanling have set a new standard for CD players at this price point, and it's a five gopher to boot.

**3D acoustics by shanling**



Real hi-fi have worked closely with Shanling to create an improved range of products for the UK without increasing the current prices.

[www.3dacoustics.com](http://www.3dacoustics.com)

**3D sonics**



UK-made "statement" products. CD and SACD player, valve monoblocs, loudspeakers and cables. What we believe to be the best.

[www.3dsonics.com](http://www.3dsonics.com)

**Hyperion**



Exciting new loudspeakers from the States with ultra-competitive price-tags. Featuring patented technological breakthroughs like "spider-less" drivers with fluid-damping and active dust-caps (Synchro-Vibrate Flattop). Rave reviews and Awards galore".

[www.hyperionsound.com](http://www.hyperionsound.com)

**mf audio**



The best pre-amp in the world. Passive or active operation utilising transformers (no resistors whatsoever). Made in the UK.

[www.mfaudio.co.uk](http://www.mfaudio.co.uk)

**hornlit**



Exceptional full-range horn speakers from Denmark employing heavily-modified Lowther drivers in 3-way configurations.

[www.horninghybrid.com](http://www.horninghybrid.com)

**audiophile aps**



The best mains power regenerators money can buy.

Price: competitive too.

[www.audiophileaps.com](http://www.audiophileaps.com)

**bias king**



If your valve amplifier has adjustable bias you definitely need one of these meters with accurate digital read-out.

[www.biasking.com](http://www.biasking.com)

**heart**



£1600 for a pair of hard-wired single-ended 300B gorgeous-looking monoblocs made in Holland. How do they do it?

[www.heartaudio.nl](http://www.heartaudio.nl)

**metaxas**



The only solid-state amps we have come across that can truly rival the tonal richness and resolution of a valve amp.

[www.metaxas.com](http://www.metaxas.com)



**HPS-938 LOUSPEAKER**

editors' choice  
the absolute sound  
2004

BLUE MOON  
AWARD

distributed in the uk exclusively by

**Real hi-fi**

For prices, additional information and Dealer List please visit our web site, email us or call Matthew at Real hi-fi.  
Tel: 0870 909 6777 | [info@realhi-fi.com](mailto:info@realhi-fi.com) | [www.realhi-fi.com](http://www.realhi-fi.com)



**HISTORY**

Exposure Electronics has a history that can be traced back to 1974. Like many of today's well-known British brands (Linn, Naim, Arcam amongst others) Exposure started life as a cottage-industry type of affair fronted by John Farlowe (now chairman of the company). Their products were firmly tailored towards a certain type of sound quality, and looks were something of a secondary importance.

During the 80s their products were extremely popular with the 'flat earthers' of the day, and shared a similar type of idiosyncratic sound quality as the amplifiers manufactured at the time by Naim. With products such as their popular X Integrated Amplifier in the mid 80s it looked as if their continued success was assured. Unlike Naim however which continued expanding and refining their range in both looks and sound quality in the 90s, under the leadership of the late Julian Vereker, the company lost their way and struggled during this period. Thankfully rescue came in the shape of a far-east Malaysian buyer, and Exposure Electronics Ltd was born in March 2000. Their newfound financial stability has resulted in a new and exciting range of Exposure products, still very much in the mould of their old products sound-wise, but with better looks and levels of build quality.

Turning to the midband, I was impressed with the way it was handled. Many solid-state devices can sound a tad course with female vocals in particular, but the Exposure had no such handicaps. Alicia Keys's was delivered with extreme care and delicacy. There was a pleasing sense of sweetness and liquidity to the sound that reminded me immediately of my own restored Quad II valve amps, but without the drawbacks of this classic design, namely speaker driving ability and dexterity in the lower bass regions.

Frank Zappa's superlative 'For Calvin' on his 'The Grand Wazoo' again highlighted the confident speaker driving abilities of this design. Drums in particular were extremely well handled, and sounded pretty close to that feeling of being at a live concert, with that satisfying 'thump' which you can feel as much as hear with the kick drum – great stuff!

Individual musical strands were separated reasonably well, but I found myself wishing for a little more openness and sparkle in the treble. This amplifier reminded me of some of the earlier Naim designs in regards to its sheer clout and edge of the seat listening experience especially with Rock. However, I felt it was a little too rounded off and syrupy sounding at times, and the bass a little too thick to do full justice to all genres of music.

I was impressed with the consistent performance of the Exposure XXXV. A lot of equipment tends to sound better late in the evening when demands on the local



mains supply are lessened. Due to the exceptionally well designed power supply of the Exposure and its cascade circuitry it seems less sensitive than most here. In fact, Exposure point out that the PSU is the backbone of any decent design, and from my time spent with the 35 and also Naim equipment I agree whole-heartedly.

While an attractive listen the Exposure definitely sits on the warm side of neutral, and those seeking forensic levels of information retrieval and an impartial performance would be best advised to look elsewhere. Something I found out also with a bit of late night listening is that the amplifier doesn't give of its best at low levels. You really do need to crank the volume control up to fully appreciate what it is capable of.

Rock and Dance music fans in particular will fall in love with the XXXV. The only real fly in the ointment, as it were, is a slight hiss that could occasionally intrude on quiet passages on classical music, but even then it was only when listening at fairly low levels. To be fair to Exposure they do mention in the instructions that a bit of hiss is normal. Still, I was mildly surprised that a

product of this price would have hiss levels this high in the first place.

**CONCLUSION**

One cannot ignore the fact that times are changing fast in the world of hi-fi, and manufacturers need to keep abreast of changes if they are to compete. There's no denying that the Exposure 35 is one impressive sounding amplifier. However, £1,599 is a princely sum for an integrated amplifier, and the optional phono stage is £200 extra on top of that. Competition at the £1,000-£1,500 price level is fierce - witness the quality of the amps in our November group test as an example.

All the same, at this price level, value for money is in the eye (or the ear) of the beholder. What the Exposure XXXV does, it does exceedingly well, offering a beguiling mix of the best virtues of valve and solid-state sound quality in one neat package. It's one to audition with confidence then, but there are cheaper alternatives which offer a similar level of performance.

**VERDICT** ●●●●

Charmingly musical amplifier with a persuasive combination of delicacy and power. Fatigue free listening, but at a hefty price.

**EXPOSURE XXXV INTEGRATED** £1,599  
 Exposure Electronics Ltd.  
 ☎ +44 (0) 1273 423877  
 www.exposurehifi.com

- FOR**
- fantastic bass performance
  - valve-like midrange
  - fatigue-free performance

- AGAINST**
- slightly curtailed treble
  - price
  - phono card extra

**MEASURED PERFORMANCE**

This is a real Exposure! Unlike others I have tested recently this one does what those of yore were famous for: total insensitivity to load. A measure of this is maintenance of full output volts even into a low load of 4ohms. As a result, power exactly doubles, from 85W to 170W. The real point is, though, that a strong sense of solid bass grip and hefty slam are achieved. The XXXV outperforms all rivals here.

Distortion behaviour was first rate too, as second harmonic always predominated, even at high frequencies. This will ensure the XXXV always sounds easy on the ear, free from stridency, greyness or slight coarseness.

Even frequency response was identical to that of earlier Exposures, band limited to 26kHz at the top end, and a low but not excessively low 5Hz at the other end.

The XXXV is a true Exposure; it

should sound very dynamic, yet easy on the ear at the same time - usually an attractive combination. NK  
 Power 85watts

CD/tuner/aux.  
 Frequency response Hz-kHz  
 Separation 98dB  
 Noise -96dB  
 Distortion 0.013%  
 Sensitivity 240mV

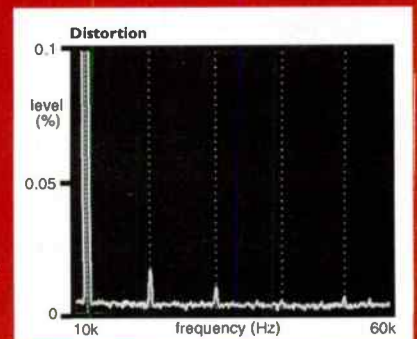



# Christmas

David Price finds six great ways for audiophiles to spoil themselves, over the festive season and beyond!

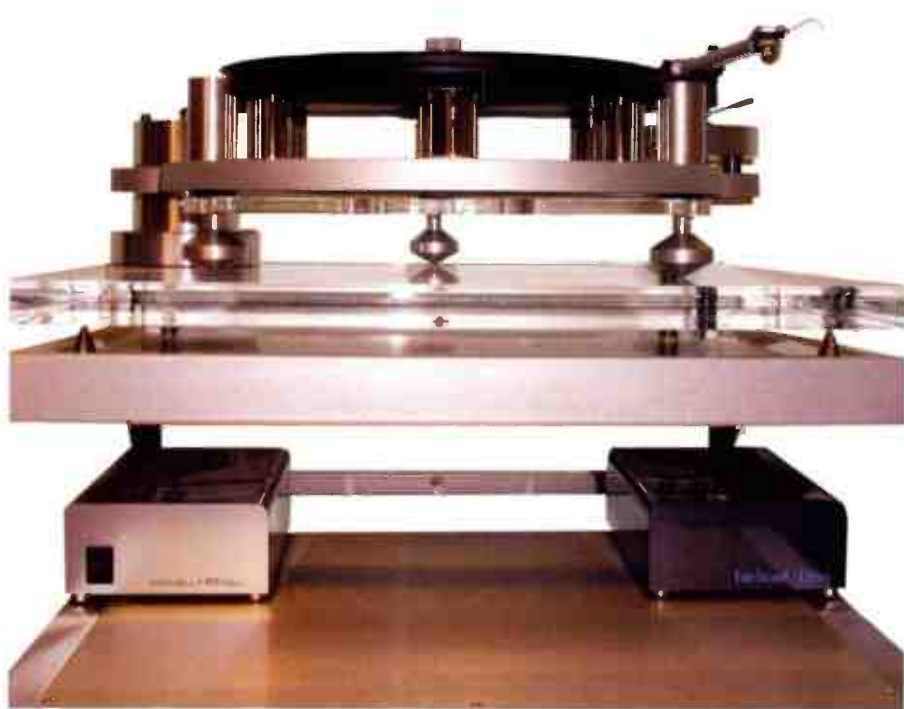

## TURNTABLE WORLD ODW £249.99

Regular readers will know how often we 'bang on' about isolation, positioning and vibration suppression in the pages of this magazine. This isn't because I've got strange proclivities for bits of squashy rubber, spikes and the like, but rather that it never ceases to amaze me how much difference proper isolation, positioning and vibration suppression makes! Having access to a massive range of review kit, some of which is very expensive, I'm constantly struck by how bad it can sound if insufficiently isolated from the mechanical movements of the room (i.e. vibration from the loudspeakers). And I'm also amazed by how good budget kit can be if it is sited and isolated properly; for example, a £200 CD player can better a £2,000 one if it's correctly placed (and the other isn't). This is all the more so with analogue turntables, which are designed to pick up one kind of mechanical vibration through the stylus, but be immune to every other kind. Of course, this is a very

tall order, and not one single design succeeds completely, and the cheaper you get, the worse they all are in this respect. Trouble is, most turntables are sited on tables (of one sort or another), and tables – of course – sit on floors, which are directly coupled to (guess what?) the speakers! An altogether more superior solution is a wall shelf, which at least has the benefit of being partially decoupled from the speakers (the vibrations have to travel through the floor first, before they reach the walls). Enter Turntable World's O.D.W. (One Decent Wallshelf)...

This elegant looking product offers two layers of Acrylic decoupling support, seated in a substantial steel frame. The main platform is a massive half metre wide slab of 25mm Acrylic; it's no coincidence that this material is chosen by no small number of turntable manufacturers for its very 'dead' acoustic properties. The shelf can be mounted on virtually any type of wall and can carry in excess of 30kg making it suitable for all but the

highest mass products. A tuning kit is also supplied for system matching if required. A twin platform version (for power supplies and/or phono stages) is in development, and there's a budget one-piece version with one plane of 12mm Acrylic for £129. Price for price, this is one of the most dramatic upgrades you can make. Those using bog-standard coffee tables or basic hi-fi furniture will be amazed at the improvement in sound brought by the ODW. It gives a far more stable, solid and assured sound, with an almost mastertape-like sense of 'unflappability' and imperturbability, no matter how loud you play music. Music sounds more three dimensional, smoother and fuller - whilst being faster and more insightful too. Rhythmically, the ODW makes a huge difference to basic non-suspended decks such as Rega's P3, but even Michell's GyroDec SE (which is comparatively well isolated) really flies. Best of all though, the effect isn't limited to turntables, as CD players and amplifiers (especially of the thermionic variety) all benefit quite significantly. Thoroughly recommended.

Decent Audio  
☎ +44 (0)845 6019390



# Crackers

## NO-RING RINGS £3 EACH

There's plenty right with the thermionic valve, but its one obvious flaw is the fact that it's made of glass. Aside from breaking if you drop it, the critical problem of this material is that it's microphonic – especially when valve shaped! Microphonic electronic components are precisely what you don't want; the idea is to keep all types of mechanical vibrations away from passive componentry because it has such an adverse effect on the sound.

While the judicious application of Foculpods (et al.) and sheets of Sorbothane damping stuck everywhere the eye can't see can effectively isolate your turntable plinth, CD player case and integrated amplifier insides, it's kind of hard to wrap your tubes up in sticky rubber, as they (and it) will overheat with all sorts of unpleasant results. So how then to isolate your precious valves? Well, No-Ring Rings are bespoke damping rings from New Zealand's Design Build Listen. The idea is that you slip them on over your valve, and all sorts of beneficial effects ensue. The material is rated to 220°C (430°F in old money), so it shouldn't smoke like a pair of Ford Mustang tyres when the 'loud pedal' is pushed. Indeed, Design Build Listen claim they will continue for at least the life of the valve. No Ring Rings are available in three sizes to suit common preamplifier valves (and it is with these, rather than power tubes, where their benefit is claimed to be most obvious); small (for tubes 19-22mm like ECC83 / 12AX7, EL84), medium (for tubes 28-33mm like EL34, 6SN7GT, GZ34) and large (for tubes 36-40mm such as 6L6GC, 6080).

The company says that, although it provides rings for power tubes that need to dissipate significant amounts of heat, the rings could reduce their ability to do so and so it cannot guarantee their longevity. The effect on the ECC83 input valves on my World Audio K588II were subtle, but worthwhile. The overall sound was obviously cleaner and the midband more dimensional, while the bass took on a more tuneful and less 'bloated' character and the treble seemed lighter and more delicate. Indeed, there was a small but genuinely noticeable improvement right across the frequency band, making the amplifier sound lighter, tighter and more sprightly. Considering the extremely modest price, I'd call the No-Ring Ring a brilliant upgrade; you can spend much more on cables and get less improvement. We found that the improvements aren't consistent, inasmuch as the more microphonic valve designs (i.e. some ECC88s) are improved much more than tubes with a 'quieter' mechanical design. Still, they're a great little stocking filler; just a shame that they come supplied in 'surgical appliance pink' – black or grey coloured ones would flatter the look of one's treasured tubes rather more.

fax: +64-3-4773817  
www.designbuildlisten.com

## ARTKUSTIK AUDIO ANIMATOR £375

The association between snake oil and hi-fi wonder cures is undeniable; ever since the eighties we've been regaled by tales of bits of bamboo rolled on the thighs of virgins (or whatever), bits of charged aluminium foil that rearrange the ions around your listening room (or whatever) and no small number of oddly shaped cones and feet, invariably at absurdly high prices, that claim the world and deliver absolutely nothing (whatever). Well, with this in mind, I couldn't help thinking of the Artkustik Audio Animator. Upon close inspection, it seems precisely this; ludicrously expensive, beautifully finished and – as Douglas Adams would have put it – 'mostly harmless'. I have to say that its sizeable retail price further predisposed me to scepticism; one wonders quite how it is justified on cost grounds. The claim is that the Audio Animator is used to "reduce material stress... using the regularities of physics, it transfers the structural order of crystals to each object, in its proximity, regardless of which material it is made of plastic, wood or metal." Oh, so that's how it works! (Now I'm sure we all understand...) How then is it used? Well, the manufacturer says, "all that needs to be done is to pass it just over the surface of both sides of the CD... and the same applies to records, tone arms and system components." Normally, there would not be room for such hocus-pocus in the pages of this magazine, but the reason I agreed to review it is that simply put, I heard its effects – before my very ears – at last year's Munich High End hi-fi show, in a room full of other people, who also seemed to think the same...

Finally trying one at home, again, this curious device had the same subtle but beneficial effect. In both cases, the sound lost a small degree of its brittleness and 'two dimensionality', making things smoother, richer and more open and expansive sounding. This was a very subtle effect, but it was constantly audible. In fact, it was most profound using the Audio Animator as a standalone device placed on equipment. I placed it on my World Audio K588I valve amp and Michell GyroDec, and in both cases it was audibly beneficial. Indeed, it gave more of an improvement the closer you got to the source; standing it on the Gyro's Perspex base made the system sound obviously smoother and more musical, with the spaces between the notes obviously more marked, and thus improving timing. Placing it on the motor housing of the Michell made even more of an effect, the AA seemingly sucking noise out of the system, making it sound more open and rhythmically engaging, with cleaner tonality and darker silences. In all instances, this 'magic wand' did indeed cast a subtle but useful spell on all that it touched, and as such is recommended – although only those with expensive, well sorted systems will find it justifies the premium price.



www.uberphon.co.uk

**GOLDRING PA1 £59.50**

Considering its low price, this MM phono stage is, unpredictably, made in England rather than China. Goldring says it combines "audiophile grade components with an exceptional adherence to RIAA specification". It is a small, solidly constructed black box measuring approximately 116x103x26mm. The PA1 is formed from two metal C-sections; one is smaller (containing the single phono stage circuit board) slotted within and screwed to the flanges of the larger section. The Chinese-made £40 Cambridge Audio 540P phono stage is more attractive utilising profiled sides and a satin silver finish, but due to its smaller size the PA1 can be tucked away from view with ease and Goldring says it fits under their GR1.2 or GR2 turntables. There is a power in socket for the 24V AC plug-in transformer power supply, red LED power indicator, phono socket input + output and earth screw. The PA1 has a quoted 47kohm in parallel with 100pF input loading and 15Hz-100kHz frequency response (50kohm load).

It sounds great at the price; with a £150 Rega Super Elys MM cartridge fronting a high-end Origin Live turntable, the unhurried jazz vibe of 'The Night We Called It A Day' from 'None But The Lonely Heart' (1997/2004) by Charlie Haden and Chris Anderson (piano) was superb on the midrange frequencies of the solo piano with a suitably expressive and adept timbre. The bass playing by Charlie Haden was fluid in its effortlessness with good extension and dexterity. Timing was very good, allowing seamless layering of the bass and piano notes. The acoustic decay around piano and bass notes was also excellent which meant that there was presence and augmentation to the three-dimensional feel to the timbre for both instruments. Being extra critical, there was the slightest of upper frequency variation on the piano where there was an occasional glare to the piano notes but this was minute considering the superb musical coherence. Playing the glossy 'Jetstream' by New Order from 'Waiting For The Sirens' Call' (2005), Bernard Sumner's vocals were beautifully clear and animated into the room. Instrumental and vocal separation was excellent with a complimentary structural feel and well-timed sound. The Goldring is superb for the price; the £40 Cambridge Audio 540P has slightly more subjective surface noise and sounds thinner than the Cambridge. Although it has a slight edge on musical timing, still the Goldring is much better at instrumental and vocal timbre with a more three-dimensional sound and superior resolution. Fine value for money then, and as such this pocket-sized Goldring merits a very strong recommendation.

+44 (0)1279 501111  
www.goldring.co.uk



+44 (0)1235 511166  
www.vandenhul.com





## VAN DEN HUL THE BRIDGE - £6/M

There's no doubting the provenance that this loudspeaker cable comes with. The company's charismatic frontman AJ van den Hul is a man obsessed with the minutiae of materials design, engineering and technology, and has built a reputation for attention to detail that's virtually unsurpassed in Europe. Despite this, he remains a modest man (without much to be modest about), unprepossessing and charming with it – setting him apart from many 'get rich quick' merchants who chose 'cable marketing' as their chosen 'road to revenue'... Although vdH is famous for excellent, hand-built phono cartridges, the company truly made a name for itself in interconnects with its use of pure carbon in

The First, which sounds quite unlike anything else on the market - in a wholly positive way. At just £6/m, The Bridge is dramatically less expensive, although still displays excellent build quality. A dense, silver-coated high-purity matched crystal Oxygen-free Copper cable, it is said to be, "the ideal speaker cable for the demanding, yet budget oriented listener... (that) forms an ideal match and perfect companion for van den Hul's similarly conceived multi-purpose interconnect The NAME." Both flexible signal conductors consist of 98 strands of dense pure Silver coated Matched Crysta. Oxygen Free Copper (MC-OFC), which is said to be exceptionally compatible with different sources and systems, with low loop resistance of 0.018 ohm/m (and low parallel capacitance of 35 pF/m). Although available off the reel, vdH offer termination with high quality connections for £25. Finally, the rugged and hardwearing 'Hulliflex' jacket provides excellent protection against environmental degradation and ensures long life.

Despite its modest retail price (many systems can be wired for less than £50), the Bridge provides a spry and engaging sound that's obviously more finessed than most price rivals. It's light and open by nature, rather like a window onto a crisp winter morning. You'll not find it dazzling, but there's definitely a 'brightly lit' nature to it that's ideal for fuzzy budget Bitstream CD players or murky sounding transistor amplification. Despite this, The Bridge is never forward or offensive; ever with stark sounding sources and amplification, it remains cool and well behaved, making an excellent 'all round' wire. Bass is strong and defined, although it doesn't have the sense of being a 'bottomless pit'

## SOUND DEAD STEEL ISOPLATMAT £79.95

Turntables are literally precision analogue measuring instruments, using the cartridge stylus as the sensor. The needle traces the groove, its relative deflection causing the coils/magnets in the cartridge to transduce this mechanical energy into electrical energy, which is duly amplified and converted back into mechanical energy by your loudspeaker voice coils. This is the theory, at least, but in practice the stylus also picks up vibrations from the loudspeaker sound waves via the turntable itself. Indeed, the turntable acts as a kind of microphone, capturing all manner of ambient energy and feeding it back into the system (thus muddying the sound). This is why isolation is all important, as is suspension design and so the mechanical 'quietness' of the platter (which is the closest point of contact between the turntable and the stylus). Trouble is, a great many decks still use metal platters (usually Mazak, a cheap kind of aluminium alloy) which tend to ring like a bell when struck with a fingernail. Manufacturers attempt to damp this ringing with, variously, felt, rubber or Acrylic mats, but there's always room for improvement. Sound Dead Steel's platter mat consists of two steel discs of differing thicknesses, with a layer of polymer sandwiched between, which is then balanced and then black powder coated. It's simple to use; you just place the disc on your existing platter, and then (where applicable) put the existing mat on top. Because the disc is only several millimetres thick, it shouldn't upset the arm's Vertical Tracking Angle (VTA) too much, but if it does, then obviously you'll have to adjust the arm height slightly. In decks with no mat (such as the Michell GyroDec), then the platter mat can go straight on the top.

Placing the mat on any deck's platter is quite amazing; flick the circumference of the platter without the SDS mat and it 'tings' (especially if it's metal, or glass rather than Acrylic) – but then add the SDS mat and repeat the exercise and it's far more akin to a dull 'thunk'. This shows how the mat takes so much mechanical energy out of the platter, deadening it down more effectively

than any rubber, felt, glass, cork or Sorbothane mat I've ever tried. If the 'finger test' proves its mechanical efficacy, then you should hear the difference it makes when records are spun in anger. There's a dramatic reduction in clang in the midband, causing a real drop in nasal colouration. The whole soundstage opens out (front to back, left to right), the tonality of the instruments is better discernible, the bass appears tighter and more fluid and the treble smoother and cleaner. Even with a turntable with excellent disc support such as a Michell GyroDec, the SDS mat makes an obvious difference, taking it a good way towards Orbe performance – but with a Mazak plattered classic Japanese Direct Drive, it's night and day; the SDS mat making the deck sound obviously less bright yet faster and more incisive too. This is the best turntable mat I've yet heard. It may not work with every deck equally and may also require some experimentation (rubber mat on or off, arm VTA up or same, etc.), but I've tried it on a wide variety of decks (budget and high end, belt drive and direct) and every time I've wanted to keep it on rather than reverting back to stock. At well under £100, it's a bargain

sounddeadsteel@blueyonder.co.uk

☎ +44 (0)773 682 1690

audiolab



WWW.STEREO.CO.UK

As the area's leading Hi-Fi Specialist, we invite you to our superb demonstration suite to audition the fantastic new range of hifi separates from Audiolab.

Free Parking. Finance Available (subject to status)  
Romers Hi-Fi, 11 Lomax Street, Great Harwood,  
Blackburn, Lancs. BB6 7DJ

9am > 5pm Mon - Sat

01254 880220

**ROMERS**

the home entertainment specialists

## Model Ti48

Audiophile CD/Hard-Disk Transport

**The best digital  
audio source ...**



**... is a  
hard-disk drive**

- Save CDs / Play CDs -
- Upsample / Oversample -
- Add dither / Change filters -
- **Enjoy music -**

Available in the UK from AngelSound Audio  
Telephone : 44(0)1923 352479  
Web : [www.angelsoundaudio.co.uk](http://www.angelsoundaudio.co.uk)

zero one

[www.zerooneaudio.com](http://www.zerooneaudio.com)

## mk4 DRUID



*It's time for tubes to rock...*

With 101 dB sensitivity and a 12 Ohm load, the Zu Druid is tailor-made for the real world demands of lower-powered tube amplifiers. Using Zu's own 8.5 octave bandwidth full-range driver, allied to a super-tweeter, the Druid lets any amplifier sing its heart out with no crossover to interrupt the proceedings. It's neither demanding of space nor difficult to place in the room and could well be the last loudspeaker you ever need to buy. £2,395 per pair through Musicology dealers.

Musicology is the exclusive UK distributor for Atma-sphere, Audiostatic, Coincident Speaker Technology, Ferguson-Hill, Pass Labs, Rives, Symposium, Zu

Contact us on 01273 700759 or email: [sales@musicology.co.uk](mailto:sales@musicology.co.uk)

[www.musicology.co.uk](http://www.musicology.co.uk)

Musicology



# One Love

**Suddenly everybody's doing it – fitting tube output stages to their CD players, that is. Channa Withana auditions the affordable Unico CDP from Italy's Unison Research...**

**H**ot on the heels of the Shanling CD-T80 that did so well in last month's digital issue (causing pain to a number of silver disc spinners at nearly twice its price, if you remember last month's group test), comes the £895 Unico CDP from Unison Research. This is essentially a downsized version of the more expensive CD; it does not use cheaper components to its bigger brother, but rather employs simpler circuitry and fewer features.

There are four main differences between the CDP and more expensive CD. The first is the omission of the voltage stabilising circuit (and external heatsink) which gave a degree of mains immunity.

Second is the omission of the digital input, third is that the CDP uses one valve instead of two in its output stage and fourth the CDP has

no balanced output sockets.

The CDP uses the same TEAC CD-ROM transport as the Unico CD. Unison Research says that the motors incorporated in the transport are of the low-vibration, brushless, asynchronous type. The laser has a glass lens, which is superior to the plastic lenses used in most CD players. The guides and supports for the moving parts of the tray are lapped steel (not plastic), and the output signal from this transport is S/PDIF format. As an added bonus this mechanism is mounted on a rubber suspension to reduce the possibility of vibration affecting the reading capability of the laser diode.

That the transport uses steel guides and supports for the moving parts is a welcome feature for a ROM mechanism, but in this case it is not really a surprise as it comes from TEAC. As Japanese brand TEAC is Esoteric's parent company, the £9,000

Esoteric X-01's transport (though obviously far more complex and expensive) also featured the same engineering philosophy with brushless motors, plus well-built and finely crafted guides eschewing cheap and flimsy plastic parts to improve sound quality.

Inspecting the transport revealed that it had its own stiff delineating folded metal sub-chassis, with the same non-flex thickness as the casing and lid. It is fixed to the sturdy fascia at the front. The transport is then supported by a sandwich layer of plastic and rubber washers at four points and then the sub-chassis sits on foam-like disks at the rear with no metal contact to the main chassis base-plate.

DACs and DSP chips are from Crystal and a Philips microprocessor for disc reading and display is also employed. A Crystal chip is used for the digital signal processing



# Angelsound Audio



## Cain&Cain

Most loudspeakers dictate your choice of amplifier so Cain & Cain decided to make loudspeakers that do just the opposite...

Single-ended / push-pull valve or transistor amplification, it makes no difference to Abby. The Abby is a true introduction into high efficiency speaker systems of simple yet refined design. That pays tribute to "classic" forms and re-interpret them with current thinking. The result is that Abby has succeeded and found a soft spot in audiophile's ears, hearts and homes all across the world.

A superb matching subwoofer called the Bailey is also available.

Abby / Bailey Subwoofer from £1,399

## ModWright

What does a World Class Tube Pre-amplifier cost?

ModWright are renowned for improving other people's products but what would happen if they released their own?

Answer: SWL 9.0 and SE Pre-amplifier. Top quality parts are used throughout including FRED and Schottky diodes, metal film Vishay resistors, ceramic tube sockets and high quality film caps in signal path applications insure exceptional performance.

What does a World Class Tube Amplifier cost? SWL 9.0 - £1599 and SE - £1995.



## NuForce

There is a NuForce of Power Amp in the UK...

THIS IS NOT A DIGITAL AMP

NuForce introduce a revolution in switching amplifier design that rivals and surpasses most linear and vacuum tube amplifiers ([www.nuforce.com](http://www.nuforce.com))

Ideal for two-channel or Home Cinema solutions.

Monoblock (each):  
Reference 8 : £549.00  
Reference 8b: £631.00  
Reference 9: £799.00

5 channel system packages:  
HT Ref Pack 1 : £2836.00  
HT Ref Pack 2 : £3393.00



We are exclusive UK Distributors for the following products:

NuForce Amplifiers, The Cain And Cain Co, Channel Islands Audio, IsoClean Power, ModWright, Quantum, QRT, R S Audio Cables, Solitone Cables, Sound Engineering Turntables, Vivid Audio Cables, Xtreme and Quicksilver Paste

01923 352 479 | [www.angelsoundaudio.co.uk](http://www.angelsoundaudio.co.uk)



“ Desire... ”

## WATERFALL

“ The result is an overall crispness and clarity that is rarely matched by conventional wood-bodied speakers. ”  
Hi-Fi Choice, Jan 2005

“ I soon came to appreciate the intrinsically musical character here and found myself listening at great length. ”  
Hi-Fi News July 2005

“ They succeed by being beautiful both inside and out, combining elegance and superlative engineering rigorously as an aesthetic expression. ”  
Hi-Fi World, June 2005

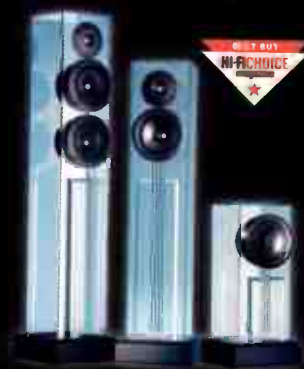

## T+A



## VERDICT

V10 Integrated Valve Amplifier  
Hi-Fi World, November 2005

Brilliantly accomplished, uniquely designed modern valve amp with sonics and style to match.

“ A Certifiable Masterpiece. This is to debut amplifiers what LED Zeppelin 1 was to debut LP'S. ”  
Ken Kessler, HiFi News, Feb 2004

### Authorised Stockists:

**Unique Sound & Vision**  
London, (t) 020 7272 0922

**Guildford Audio**  
Guildford, (t) 01483 537577

**Sounds of Music**  
Near Heathfield, (t) 01892 545688

**TechnoGnosis**  
Basildon, (t) 07770 851445

**The High End**  
London, (t) 020 8876 3355

**Laser Vinyl**  
Bromsgrove, (t) 07976 544236

**Home Networks Sound & Vision**  
Birmingham, (t) 07785 241478

**Videotech**  
Huddersfield, (t) 01484 516670

**Music Unlimited**  
Leverton, (t) 01205 871699

**Audience**  
Bath, (t) 01225 333310

**Alto AV**  
London, (t) 0845 456 9614

**Oxford Audio Consultants**  
Oxford, (t) 01865 790879

**Midland Hi Fi Studio**  
Wolverhampton, (t) 01902 380083

**Hadwins**  
Cumbria, (t) 01539 722557

**Transparent Distribution Ltd**  
Coxmoor Road, Sutton in Ashfield, NG17 5LA, UK

(tel/fax) 01623 517000  
info@transparentdl.co.uk, [www.transparentdl.co.uk](http://www.transparentdl.co.uk)





**CONTEXT**

Compared to the £895 Unico, the much celebrated £650 Shanling CD-T80 was indeed different. The violins on the Balanescu composition were definitely lighter and in particular, with the cello there was less timbral connection and weight afforded by the Shanling. The violins ostensibly appeared more delicate, but were actually a little strident in comparison to the Unico. Instrumental separation of the Shanling was very good though, and it had a generally more forward stance.

The Shanling did have a slight edge on musical timing though, but this was not agonisingly obvious. With Nina Perrson's vocals, here the Shanling was superior to the Unico or 'I Need Some Fine Wine...' with a more animated delivery.

Against a more expensive player like the £1,350 Densen B-400 Plus, the superiority of the Densen showed with a finer overall resolution, generally (but not always) better musical timing and more widescreen spatiality over the lower-cost Unico on all the music, and this is as expected.

Interestingly, the Unico had a slight edge with timbre to the cello – which surprised me as the Densen is no slouch in this area. Secondly, timbre on instruments and vocals was again surprisingly equal between the Unico and Densen on 'You Need Some Fine Wine...' by The Cardigans.

**NOEL KEYWOOD SAYS:**

No doubt - the Unico CDP comes over as more naturally balanced and deeper sound-staged than the Shanling CD-T80. By way of contrast the Shanling seems "silver plated" in its treble, perhaps overly concise as a result. But.

Other effects lurked in the background, complicating comparison. The Shanling was quite obviously sweeter; I detected turgidity in the CDP and differences here became apparent with the LSO playing Rachmaninov. Whilst sheeny with strings, the Shanling was purer, speedier more concise and very forceful when the orchestra suddenly interjected. The CDP sounded almost sloth and turgid against it.

The comparison was made more difficult by the Unico better suiting the balance and qualities of a Sugden A21a amplifier, whilst the Shanling was 'loveliness with tinsel' when paired with the Quad valve amplifiers I review this month.

In a bright system most would choose the Unico CDP I suspect; in a balanced one, listen carefully first. Here, I'd choose the Shanling. NK

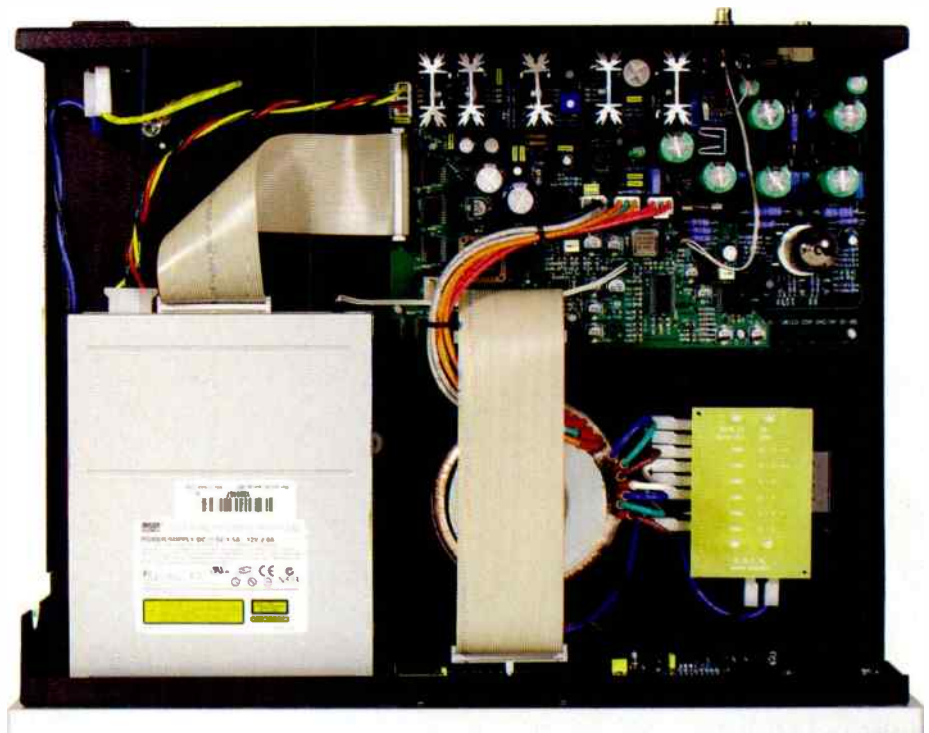

minimising "clock-jitter", then the digital signal is oversampled to 96kHz with a filter using a Crystal CS8420 chip. After this the signal goes to a Crystal CS4392 24/192 DAC. This freshly converted analogue signal is filtered by a passive network and sent to a valve preamp stage which operates in pure Class A. This valve output stage is said to be zero feedback and utilises an Electro Harmonix Russian 12AU7A/ECC82EH variety.

Unison says that, "the electronic circuits are fed from one large, low-flux power transformer designed specially by Unison Research for this project. Five separate stabilized power supply stages are used, of which the one providing anode voltage (to the valve) is a power MOSFET stage".

Externally the Unico CDP is an elegant design, with successful ergonomics, superb light-sensitive display and simple but practical button layout. The front fascia is approximately 14.5mm thick and is finished with attractive extra-fine satin silver. Proportionally the disc loader drawer-front is attractively slimline and works well in compositional terms with the display/sensor openings, buttons and wood bodied logo.

The build quality of this player is excellent and so is the finish and design. However, I would have liked to see the lid in the same colour and texture to the front panel, plus a more discrete model nomenclature – as sophisticated finishing touches.

**SOUND QUALITY**

The orchestrations of 'Maria T' by the Balanescu Quartet were nicely rounded, with a delightful timbre to the violins and cello. Violins in particular were very good for a player in this price range. Cello had excellent timbre with some superbly textural qualities which procured a full-bodied feel to the music. The whole of 'Maria T' had an effortless flow to it through the Unico CDP. Musical timing was also very good as I could not discern any oddities with dislocated frequencies or instrumental separation, which might have robbed the music of a decent surge. The sound of the Unico CDP with the Balanescu piece could be described as enjoyably expressive in its timbre and deeply spatial and atmospheric in its overall execution – which suited the music very well.

Solo piano playing on the Ligeti 'Keyboard Works' was well-rounded in timbre. With deft articulation and placement of rendered piano notes I could really enjoy the method of the occasionally arresting compositions. The Unico was able to show a multilayered acoustic with just the solo piano from the higher frequencies to the lowest ones without any ringing distortions that can sometimes occur when keys are struck with emotional physicality.

On the spiky but melodic 'I Need Some Fine Wine And You, You Need To Be Nicer' by The Cardigans, the Unico produced an interesting mix of potently rendered instruments, with bass and drums being very

# audiolab

Have you been  
missing something?



audiolab  
8000 series

The original 8000 series from Audiolab started something of a revolution in value and performance. When they disappeared from the market, the hi-fi world lost a well-loved and reliable friend.

Now, the new 8000 series marks a strong return to the original brand values and philosophy. These famous products have been re-engineered to create a complete two channel range, including the famous 8000S, 8000Q, 8000M and 8000P models as well as an all new CD player.

7.1 channel pre and power amplifiers have been added to create a series of building blocks capable of meeting your system needs now and for the future.

**Audition them now and find out  
just what you've been missing.**

**The new 8000 series offers a  
definitive and genuine hi-fidelity  
performance from a no-nonsense  
approach to engineering**

audiolab

Sovereign Court, Ermine Business Park,  
Huntingdon, Cambs, PE29 6XU  
[www.audiolab.co.uk](http://www.audiolab.co.uk)  
Tel: +44 (0)1480 447700  
Fax: +44 (0)1480 431767





convincing. Yet it was also able to excavate some very finely textured and engrossing high-frequencies and to Nina Perrson's vocals and the hook-like guitar melodies. It was this combination of the boldly structured buzz and hum of the electric rhythm guitars, bass and drums and then finely rendered fragile yet sweet but slightly evil female vocals plus guitar

Savoy's rhythmic guitar melody was very convincing, being timbrally expressive near the end.

## CONCLUSION

I was very pleased at the performance of the £895 Unico CDP indeed, and can describe it as having a long lasting, delightful aftertaste instead of a nasty sharp bitter one

of the Ligeti CD.

To my ears, the Unico outclassed the £650 Shanling CD-T80 in almost every area, and considering its relatively small price premium can be considered superb value. Indeed, it even had a few successful uppercuts at the more costly £1,350 Densen B-400 Plus player. An interesting and unarguably superb sounding CD spinner, the Unison Research CDP represents brilliant value for money and makes the established sub-£1,000 machines look all the more venerable.

"the whole of 'Maria T' had an effortless flow to it through the Unico CDP"

melodies that really amazed me with the Unico. It takes a little more time to appreciate this but it will inevitably become noticeable in long term ownership. The musical separation enabled me to concentrate on both the intricacies and the overall structure of the song. The sound of The Cardigans as a whole was most enjoyable, beautifully conveying a real sense of intimacy for tightly focussed guitar-pop with a classic rock and roll swagger.

With 'Locust' from 1993 recording 'Memorial Beach' by A-ha, there was a superb atmospheric feel enabled by the noir-ish vocals of Morten Harket. The whole of 'Locust' had a really moody, epic quality through the Unico as it opened out the sound brilliantly. There was a nice counterbalance to the full-bodied brooding keyboards by Magne Furuholmen and bass guitar with the chilling stately drum track. Guitar melodies were also nicely portrayed with appropriate levels of buzzing, crackling feedback which was most enjoyable.

On the driving rerecording of 'Move To Memphis', Morten Harket's vocals spread out across the room, while the bass extension and dexterity was just right, enabling nimble but deep low-frequencies to be present without upsetting the musical timing or the song structure. Paul (Pal) Waaktaar-

that some sub-£1,000 CD players can have. It didn't take long for me to realise that here was a CD player that enjoyed revealing the finer, inner workings of an instrument or voice with aplomb. Additionally it had a powerful and dynamic ability, well-balanced musical timing and real finesse which unravelled the joys of complex multilayered music such as the A-ha and Balanescu Quartet CDs or the simpler rock and roll of The Cardigans and solo piano intricacies

## MUSIC

Balanescu Quartet 'Maria T' (2005)  
György Ligeti Edition 6 'Keyboard Works' (1997)  
The Cardigans 'I Need Some Fine Wine...' (2005)  
A-ha 'Memorial Beach' (1993)

## REFERENCE SYSTEM

Shanling CD-T80 CD Player (£650)  
Densen B-400 Plus CD Player (£1,350)  
Eclipse A502 single-input amplifier (£895)  
Phonosophie Classic 1 integrated amplifier (£2,000)  
Zu Druid Speakers (£2,295)

## MEASURED PERFORMANCE

The Unico has a flat frequency response, free from the top end roll down common to valve CD players. However, there was a +0.2dB plateau lift below 100Hz, reaching down to 10Hz, and this may well affect the subjective balance too, adding a little emphasis to low frequencies.

Distortion levels were higher than is possible, both at high levels due to the valve, and lower down due to the digital convertor used. There may be some slight colour, like greyness, or a little coarseness from this. This wasn't an especially linear player by current standards.

There was a jitter spectrum on the digital output, peaking at a high 8nS, a bad sign.

In keeping with mediocre linearity dynamic range by the EIAJ standard was a poor 101dB. Output was slightly low at 1.7V.

The CDP doesn't produce class leading results and could usefully be improved. NK

Frequency response (-1dB)	CD	2Hz-21.3kHz
Distortion	0dB	0.15%
	-6dB	0.07%
	-60dB	0.6%
	-80dB	32%
Separation (1kHz)		74dB
Noise (IEC A)		-92dB
Dynamic range		101dB
Output		1.7V

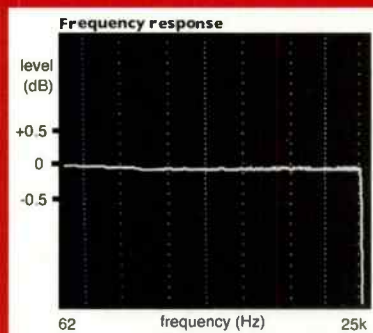

## VERDICT

Superbly engineered yet quirky too, this hybrid CD player gives nothing away to any price rivals and thus represents superb value.

**UNISON RESEARCH UNICO CDP** £895  
Unison Research  
☎ +44 (0)1753 652 669  
www.ukd.co.uk

**FOR**

- timbre, power and finesse
- excellent build and finish
- long-term musical satisfaction

**AGAINST**

- patience to appreciate

# Super Mini

**There's no shortage of miniature loudspeakers on the market, but it's rare to see one as well done as the latest ALR Jordan Entry S, says Dominic Todd...**

**T**here's something about small speakers that sets them apart. Detractors will say it's the almost total lack of low frequencies

and the tendency to compress heavy transients, whereas their advocates say that they're musical and phase coherent in a way that no big box can be.

This, the latest ALR Jordan Entry S, is a case in point. It does some things extremely well and offers fantastic sound per pound. True, there's nothing particularly unique about cabinet construction; it's made of MDF that is of adequate thickness, but at least the tiny size of the cabinet ensures rigidity in itself and there's certainly no need for extra bracing. It's wrapped in a well-finished vinyl, with an unusual front baffle décor; at first glance the entire baffle appears to be made from a composite, but a closer inspection reveals it to be simply a graphite-textured paint. That aside, the baffle is neatly chamfered and this, along with the narrow width, should create 'out of the box' stereo imaging.

Although diminutive, ALR Jordan have always maintained that the Entry S is suitable for use as a full range miniature in its own right – something our measurements concurred with. No doubt the rear mounted bass reflex port will play its part here, but then there's also those drivers to consider. The 8.5cm bass cone stretches across the length of the baffle and is certainly a size or two up from the usual satellite only affair. Given that this is a small speaker that could be used in cramped spaces, the woofer's magnetic shielding is a sensible addition.

The tweeter is of the standard soft dome variety and should complement the metal woofer well – the combination of metal cone and dome in small speakers hasn't always been a great recipe in the past. The crossover is a conventional, non-

biwirable, affair, but one which is at least fitted with chunky, gold-plated, binding posts. The whole impression is one of a well thought through design with good quality engineering playing a greater role than gimmicky innovations.

Finally, if the beech hue of the test 'speakers aren't to your taste, then you've an additional choice of black or silver. For the more colourful types, blue grilles are still an option!

## SOUND QUALITY

From the moment you hear the first note on these baby 'speakers, you know you're going to be in for a rewarding listen. The first shock, and it is a shock, was the sheer volume of sound that's emitted from such tiny cabinets. For a 'speaker that makes

even a Linn Kan look podgy, the big soundstage and vivid vocals from Kate Bush's 'Moment of Pleasure' were highly impressive. By standards of larger designs the orchestra did have a restricted scale, but not by as much as you might think.

At this point I was beginning to fear the Entry S might be a one trick pony, with dynamics and wallop but no subtlety – I needn't have worried. Bush's vocals can be a tough test for even the most accomplished 'speaker, but the tiny Jordans gave them an intimacy free from harshness. Only at the highest volumes did they begin to harden, and even then it was at least a progressive decline.

With the 'speakers being so small

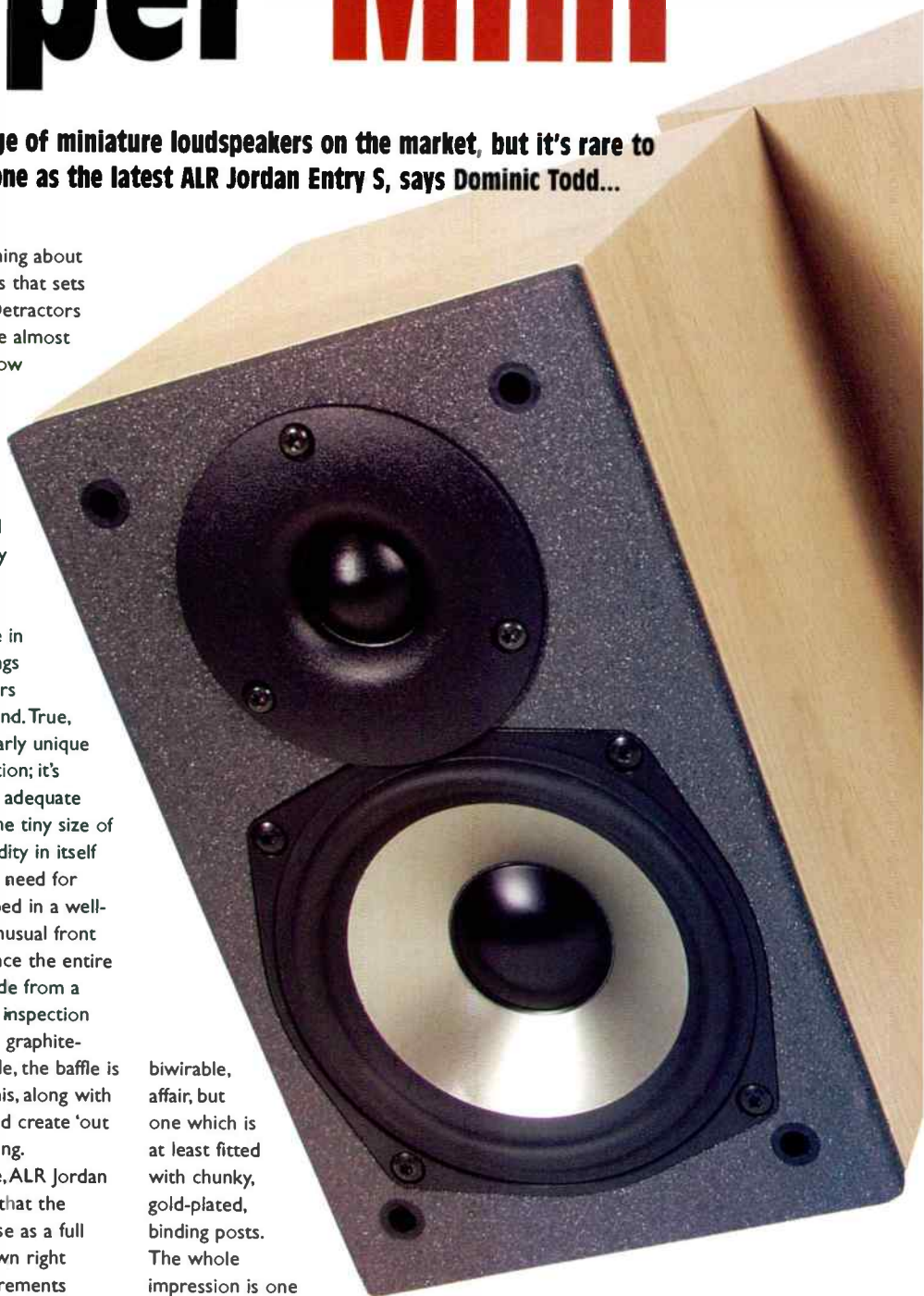



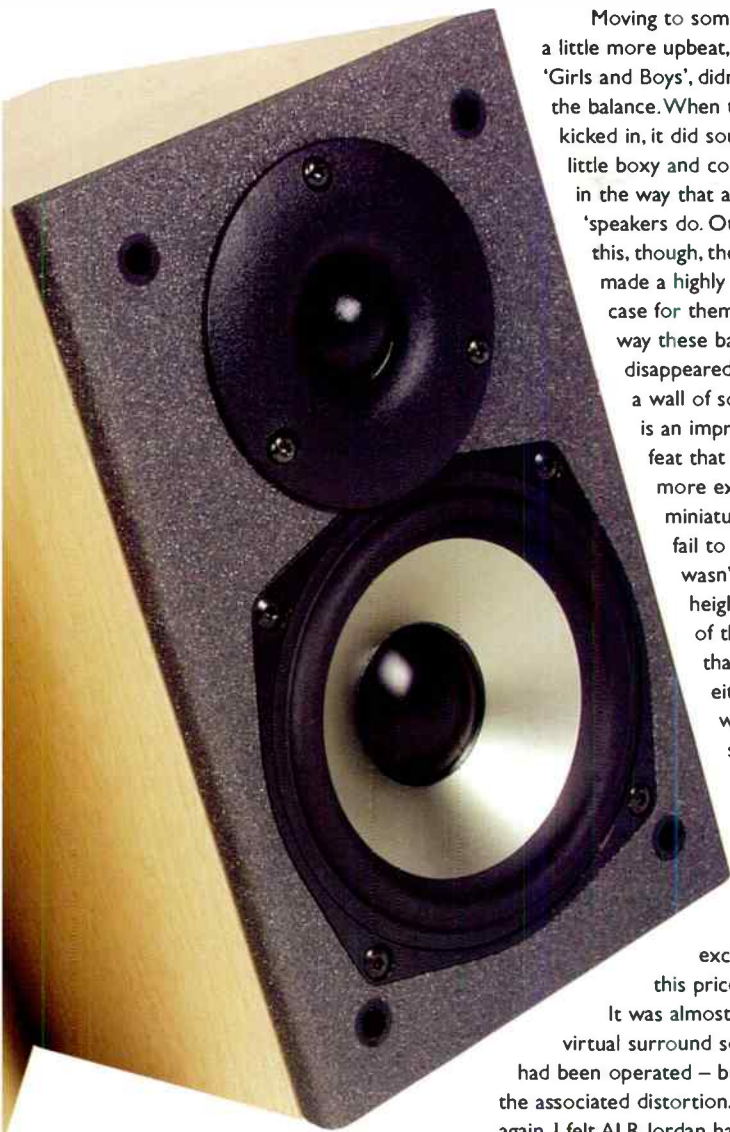

Moving to something a little more upbeat, Blur's 'Girls and Boys', didn't upset the balance. When the bass kicked in, it did sound a little boxy and compressed in the way that all small 'speakers do. Other than this, though, the Entry S' made a highly convincing case for themselves. The way these babies just disappeared within a wall of sound is an impressive feat that even far more expensive miniatures often fail to replicate. It wasn't just the height and width of the staging that impressed, either. The way the sliding electric guitar was projected well into the room was exceptional for this price of 'speaker. It was almost as though a virtual surround sound system had been operated – but without the associated distortion. Once again, I felt ALR Jordan had struck a good balance. Whilst the song had the appropriate harshness, it never became tiring or over-bearing.

I had expected them to be a tough load to drive, and had increased the volume accordingly. In actual fact, when it came to listening to Peter Cincotti's 'He's Watching', I was turning the volume down, not up. Partly this was because the Entry S' are a little forward in balance, although not excessively so. But mainly it was because they proved to be an easier load for the amplifier than I'd expected. They aren't mega efficient, but most amps likely to be partnered with them shouldn't have a problem.

Once adjusted, the vocals proved far bolder than I'd ever have imagined. This was, no doubt in part at least, helped by the rock-solid imaging – courtesy of the particularly narrow baffles. If the treble wasn't as relentless as I'd feared, then the downside to this was a slight lack of focus from the percussion. Given the size of the 'speaker I think ALR Jordan have the balance about right, though. An explicit treble is all very well, but when there isn't a strong bass to balance it, it often becomes overwhelming...

Before the test, I would have thought that a large-scale orchestra would have rather overwhelmed the Entry S', but with my confidence in the 'speaker's abilities growing steadily, I decided to try Chabrier's 'Espana'. My confidence was well placed. With the exception of the horns sounding a little shut-in – as though they'd run out of space to breathe – the rest of the performance gave little indication that it was emanating from such tiny cabinets. Both the complexity and volume of the piece were handled with aplomb, and the dynamics, driving and widespread for one so small. There wasn't the most explicit treble detail, but neither was

**PLACEMENT**

The usual criteria for small speakers apply – tall stands with the tweeter at ear level. Interestingly, ALR Jordan actually recommend inverting the speaker (with tweeter at the bottom) if the cabinets are to be placed higher than 1.5m. If stands aren't possible then the Entry S should prove to be fairly flexible. The wall mounting fixtures on the rear of the 'speakers indicate that this is a possibility, as does the port bung – vital if the 'speaker is to be placed squarely against a rear wall.

it excessively vague. Strings were smoothly conveyed and the brass, with the exception of the horns, had an excellent sense of vibrancy and realism. I found one of the most endearing qualities of the Entry S' to be their intimacy.

**CONCLUSION**

So has the latest ALR Jordan Entry S maintained its status as one of the finest minis under £200? The answer is an emphatic 'yes'. For imaging and staging this is probably the finest sub-£200 'speaker, and will comfortably fend off many of those costing multiples of its amount. Given the tiny size, dynamic scale is also impressive. Of course, it won't match a similarly priced floorstander, but it will probably come closer than you might think. The only slight let down for me, was some boxiness in the midrange. The Entry S proves that real hi-fi can come in small packages and be reasonably priced – long may it continue to do so!

**VERDICT** ●●●●£

Small in size but not in stature, this loudspeaker's imaging and dynamics make it a true 'super mini'.

**ALR JORDAN ENTRY S £199**

ALR Jordan/Überphon

+44 (0) 1730 26 19 24

www.alr-jordan.com

**FOR**

- exceptional staging
- intimacy
- dynamics per square inch

**AGAINST**

- can sound forward
- obvious bass limitations

**MEASURED PERFORMANCE**

Small loudspeakers can measure well, early Wharfedale Diamonds being a classic example. The Entry S also does pretty well in this area, our analysis shows. It is relatively flat in frequency response from 20kHz down to 100Hz, below which output rolls off quickly. In practice this may make the Entry S sound a little lean, and there's no lack of high frequency energy from the tweeter, that's for sure. As its response is fairly smooth though, treble quality may well be better than usual.

The port is tuned to 60Hz, but imposes fairly broad damping on the bass unit, so bass quality should be good. Port output reaches down to 40Hz, but its contribution will likely be small here.

Like all small loudspeakers the Entry S is insensitive, producing just 81dB SPL from one nominal watt of input. This isn't helped by a high overall impedance of 9ohms, largely resistive our analysis shows.

This is a very neatly

engineered small speaker that measures well. It should give a good account of itself. NK

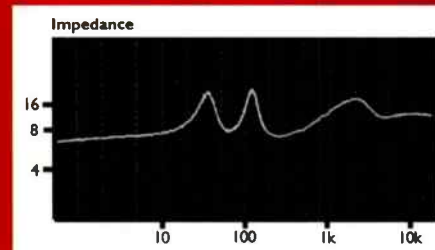
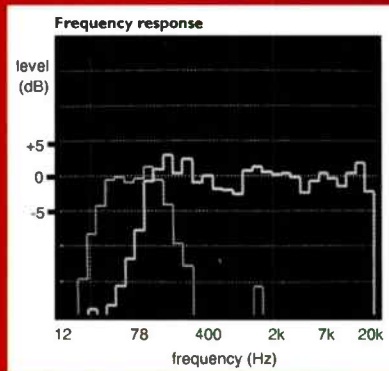



# Pinsh Point

Masters of the ribbon tweeter Pinsh have a new 'point one' range out, with a fresh look and engineering tweaks. Channa Vithana tried the mid-price 2.1 floorstander...





**N**ot a famous name, Pinsh, but don't for one minute think the company does cheap, cynical, marketing-driven designs. The jewel in the Pinsh crown is its own bespoke ribbon tweeter, which is a league better than the already very respectable ribbons coming from China, appearing in speakers such as those from Aurum Cantus.

These new £2,000 Pinsh 2.1 floorstanders are situated in the middle of the current Pinsh hierarchy, ahead of the smaller standmount 1.2 and behind the larger twin-bass driver Pinsh 3s. They sport conventional finishes, which should please more customers, being less esoteric looking than their spray-painted predecessor, the 2.0s (which I personally thought were fantastically finished). There are Black-Ash, Rosenut and Cherry real wood veneer options. The Rosenut of the review pair was excellent, reminiscent of the superlative bespoke finish of Castle speakers. For instance, the veneer has that smooth ultra high-quality feel to the touch and none of the raggedy texture that lesser finishes have. Also the veneer as it wraps and joins around corners and junctions is flawless.

The cabinet is made of a 22mm thick "Hormflex" material and it is constructed by a Danish company to Pinsh specification. Near the bottom of the rear panel are a set of single-wire binding posts. They are neatly framed within a circular opening, which is chamfered and veneered as it turns inward - a much better alternative to the standard black plastic moulding found on most speakers. Pinsh say that biwired terminals can be ordered, but the cost does not warrant the slight improvement in sound. At the underside of the cabinets are four screw-in threaded spikes for isolation and levelling.

The Pinsh 2.1s sport the same dimensions to the 2.0 predecessors at 160x900x186mm, but now feature a gently curved top plus a delineated front baffle. The front loaded port has also moved slightly higher than the old model and is neatly framed within the curve at the base of the baffle.

Of the port, Pinsh say that it is high pressure compressed (formed) with additional compounds for this application, which it claims makes the system sound like a sealed enclosure and not like a ported design.

The baffle is an interesting design, because ostensibly it looks rather flamboyant as it flares out and frames the top quarter of the cabinet but

then as it tapers inwards to the port, it brings on a slimmer profile to the already slender cabinet and as such, silhouetted, makes for a distinguished, more elegant feel than the previous 2.0 model. For sound quality reasons Pinsh state that the front baffle design also gives the least diffraction.

The Pinsh 2.1s, like all the models in their range, feature bespoke ribbon tweeters. However, though similar, they have a superior ribbon tweeter to the lower cost standmount 1.2 model having "tighter tolerance, a slightly stronger magnetic field, slightly improved transient attack and slight(ly) extended frequency range in both directions". The ribbon tweeter has a quoted frequency response of 4000Hz to 40kHz and uses rare earth magnets with a mass of just 7mg.

The five-inch woofer is made by Morel as an OEM unit which is then re-engineered to a secret specification by Pinsh. They say the woofer has a 75 mm aluminium voice coil former, aluminium wire wound, with no air gaps. With impulse response fast enough to follow our PINSH ribbon, says the

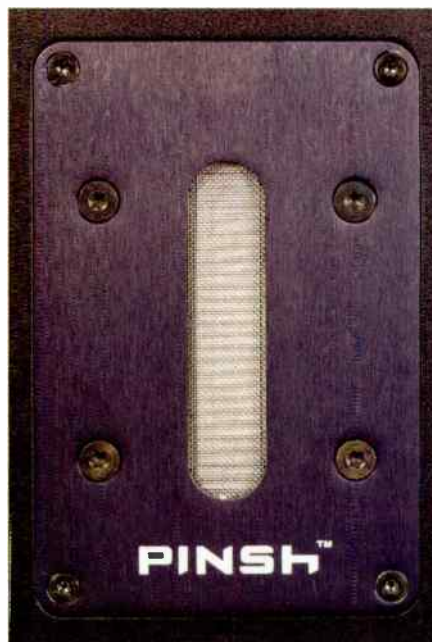

composition. Nevertheless, the Pinsh 2.1s demonstrated their complete yet unashy control of the dynamics from the string quartet. The violins were superbly portrayed

"the bespoke Pinsh 2.1 ribbon tweeter remains musically, beautifully, loquacious..."

manufacturer, DC resistance is 5.2 ohms". The crossover is unspecified but is also bespoke to Pinsh and they state that the absolute minimum of components is used. The Pinsh 2.1s have a quoted sensitivity of 88dB and 8ohm impedance [see MEASURED PERFORMANCE].

In setting up I preferred a closer than usual 2000mm spacing, but well clear of the back walls at 600-700mm away to avoid any time smear which can muddy the integration between midband and bass when a speaker (especially ported) is placed too close to the rear walls. This time smear can make speakers sound unnatural, sluggish and odd in the midband.

### SOUND QUALITY

Listening to 'String Quartet No.1, Metamorphoses Nocturnes' from György Ligeti's 'String Quartets And Duets' (though beautifully recorded) is challenging in pure compositional terms. So much so that there is little to separate its ferocity and speed with an offering by the thrash metal group Slayer! Thus, usual concerns about stridency from violins through speakers are heightened with this

with an excellent full-resolution, full-bodied timbre. This is surely down to the bespoke Pinsh 2.1 ribbon tweeter which is such a benign (in a good way) device that it is adaptable to differing dynamics and styles yet remains musically, beautifully, loquacious.

On the six and a half minute version of 'Barber's Adagio for Strings [Ferry Corsten Remix]' by William Orbit, the Pinsh 2.1s showed their superlative bass dexterity and extension - blasting out the spine-tingling prologue to this remix with an unyielding hunger. As the prologue faded into the familiar melodies of Barber's adagio, bass quality was truly vast in both volume and ability as there was none of the usual low-frequency dislocation that can crop up with some speakers. Rather, the integration of the complete frequency range from upper treble to low deep bass was stunning. Thus notes which go deep actually travel a complete acoustic path, letting you join in the ride as it plumbs the depths instead of suddenly, queasily, dropping you into lower regions. The resolution was also very good considering this is a dance remix!

# Masters Series



THERE ARE MASTER MUSICIANS AND MASTER FILM MAKERS.

[ Now There's The Masters Series To Bring Out The Best In Both. ]

## MASTERFUL. PURE AND SIMPLE.

Introducing the Masters Series from NAD. The Masters Series catapults technology and design far ahead and sets an exciting new benchmark of performance. NAD's product philosophy has always been to offer audio and video components of exceptional performance, outstanding value and operational simplicity. As evidence, NAD has earned an impressive string of five-star reviews, over its 30 plus year history.

Several years in the making, the legendary Bjorn Erik Edvardsen, has taken NAD's "Music First" philosophy – a design

discipline that puts your listening pleasure first – to new heights. While others talk about build quality, only NAD offers you something more attuned to your highest expectations. We call it Build-Artistry™.

Think of it as brilliant engineering – but to an exponential level. So while no expense was spared in development, the cost to you is less than with other premium brand offerings. If that sharpens your desire for sound quality the way master musicians and master film makers would want it played, ask for an audition of the Masters Series at your nearest NAD authorized custom retailer today.



*Shown above, the M3 Dual Mono Integrated Amplifier. The super clean internal layout plays a major role in reducing noise and distortion far below the audible threshold. A unique synthesis of digital, analog, and software engineering has resulted in an amplifier that excels in every performance category.*



M3 Dual Mono integrated Amplifier



M55 Universal Digital Disc Player

[www.NADelectronics.com](http://www.NADelectronics.com)

Lenbrook UK : Unit 2, Old Wolverton Road, Old Wolverton, Milton Keynes MK12 5NP  
Tel: 01908 319360

**NAD**



Propelled from the off with one of the most innovative and funkiest bass lines ever is 'Pull Up To The Bumper' by Grace Jones. It is aspirated by the peerless Sly and Robbie on drums and bass; this is an engagingly rhythmic song that never fails to impress with its sheer musical brio and sophistication. The Pinsh 2.1s eagerly feasted on the drum and bass offerings, not only on the controlled but plentiful low-frequencies but also on the (more

"the beats and rhythms pulsed within the grandly orchestrated synthesiser swathes."

complex than it first appears) vocals of Grace Jones. Here her voice was ably revealed when extra echo/reverb has been applied in places and her uniquely entrancing deeper tenor which goes from semi-rap to more melodic singing.

The sophisticated pure instrumentation and efficient rhythm compositions of 'Pull Up To The Bumper' were augmented by deep, lush and expansive synthesisers when it was substituted by the Trevor Horn produced 'Slave To The Rhythm'. Here, even more of Grace Jones's vocals were revealed with a deliciously enveloping acoustic as the beats and rhythms pulsed within the grandly orchestrated synthesiser swathes.

So how do the Pinsh 2.1s compare to my reference Waterfall Victoria speakers costing the same £2,000? The Waterfalls in comparison do not have the bass extension of the Pinsh 2.1s, as they didn't go as low on either the Grace Jones or William Orbit pieces. The Waterfalls are more hardcore than the Pinsh 2.1s though, and the Pinsh proved more sympathetic and forgiving to all the music used in the review which is down to its superb ribbon tweeter.

In contrast the Waterfalls have such a superlatively revealing integration of the upper bass to treble that they can be a little too revealing at times for most people (but not for me). The Waterfalls did have a slight advantage on musical timing over the Pinsh 2.1s but in isolation this was not an issue for the

Pinsh speakers as they ably handled the classical, dance and reggae-funk compositions in the listening sessions with an unalloyed unflappability.

**CONCLUSION**

The Pinsh 2.1s are a very interesting speaker, as they can do arresting low frequencies with superior bass extension yet combine this with excellent driver integration that dismisses any low-frequency

dislocation that might upset good musical timing. They were a real treat with all the music thrown at them and adept both beyond and below the cost of the £12,000-plus review system that I used. I think the key to understanding the Pinsh 2.1s hinges on their ribbon tweeter, as it is very special, being enjoyably benign. It is this component that gives the Pinsh 2.1s their sympathetic nature to differing musical styles.

I also think that these 2.1 models are even better value than the much cheaper Pinsh 1 standmounters that I reviewed in the October 2005 Issue, as they offer better sound quality with the requisite bigger scale and power of a floorstander without any

glaring compromises in musical timing against the smaller standmounters. Combine that with superb bass extension and dexterity, plus the elegant styling and excellent build quality – and you have an adaptable, sympathetic yet engaging speaker with pedigree.

**REFERENCE SYSTEM:**  
 Chord Electronics Blu CD Transport/ DAC64 (£6,190)  
 Densen B-250 pre & B-330 power amplifiers (£6,000)  
 Waterfall Victoria loudspeakers (£2,000)

**MUSIC**  
 György Ligeti (Edition 1) 'String Quartets And Duets' 1997  
 William Orbit 'Barber's Adagio For Strings' 1999  
 Grace Jones 'Private Life: The Compass Point Sessions' 1998

**VERDICT** ●●●●£  
 Highly accomplished mid-price floorstander with brilliant treble; an essential audition.

**PINSH 2.1** £2,000  
 Pinsh  
 ☎ +44 (0)208 683 6700  
 www.pinsh.com

**FOR**  
 - bass extension and dexterity  
 - high-resolution sound  
 - elegant design and build

**AGAINST**  
 - fussy styling

**MEASURED PERFORMANCE**

Output from the Pinsh 2.1 plummets below 63Hz, although the port makes a contribution down to 30Hz. However, output from 60Hz to 125Hz is emphasised, so the 'speaker will have strong upper bass. The amount of variation suggests a fairly uneven or lumpy sound, likely coloured by the box. There is a suckout at 200Hz, sufficiently wide to affect cohesiveness, then output falls steadily toward high frequencies. With output around 6kHz -5dB down on the midband the Pinsh 2.1 will have a warm balance.

Frequency response varied markedly with vertical position, due to beaming from the ribbon tweeter. Our published result is the best possible, with measurement on the ribbon's forward axis, so seating height will be fairly critical.

Sensitivity was low at 81dB, partly because the Pinsh has a high impedance of 8ohms and it's almost completely resistive, so it is easy to drive but needs power. The 2.1 looks a little ragged

under measurement but it's ribbon tweeter will doubtless have audible strengths. NK

# Classic Gold?

Hand built to very high standards in Hamburg, German high end specialists Phonosophie have developed a range of individualistic and upgradeable hi-fi. The Classic 1 integrated is their entry level amplifier.

In my estimation, the design of the current Phonosophie range, including CD players, is quite stunning. Maintaining a distinct brand identity, the Classic 1 amplifier is attractive, exuding minimalist confidence, having just the two control knobs, one for volume and another for source select. The on/off switch is located at the rear.

The black casework is especially attractive in the flesh and has an ultra-smooth surface with an exceptionally fine lateral grain. Unlike

the similar silhouette of the olive Naim three-series, it is constructed from two U-section panels and attached with hex-head fixings to the sides. Phonosophie says of its casework that, "in contrast to the heavy armour wrapped around common high-end audio components, (it) does not suffer from vibrations caused by retained energy trapped between thick metal sheets". And I can confirm this, as a gentle finger-knuckle rap to a large olive Naim component had very noticeable resonance but on the Classic 1 it

was superbly damped without ringing, especially considering its slender 4mm thick aluminium construction.

Further, Phonosophie states that, "RFI is reduced significantly as this unit is virtually sealed without the need for air vents for cooling etc. Unused sockets can be screened off using DIN shielding plugs (£37.50 each) to further eliminate RFI". The rear panel has DIN sockets for three line inputs, two tape and upgrade connections. A switched IEC mains input, single-wire banana plug speaker sockets and BNC input (with ground





screw) for the optional configurable £250 MM or MC phono boards (or extra line-in) are also included.

The Classic I measures 447x70x340mm and is rated at a claimed 45W/8ohms and 70W/4ohms [see MEASURED PERFORMANCE]. Internally it features a motorised Alps Japan volume control which can accept optional remote-control circuitry and handset for £245.

The Classic I uses a transformer made by Toroid with a 150VA rating. For the power supply, there are three capacitors rated at 10,000uF, one for the preamplifier stage and two for the power amplifier section. These are relatively low value components, used primarily for their speed rather than for sheer power delivery.

Star earthing is employed; Phonosophie says that, "the speed and transient ability of the amplifier is improved and the noise-gate level is higher. A key design objective of all Phonosophie amplifiers is to be able to respond to transient/impulse signals extremely quickly without loss of power".

The Classic I amplifier circuit eschews coils for greater speed and like some Naim amplifiers, is not meant to be used with high-capacitance speaker cables. The Classic I must therefore be used with only low-capacitance speaker cable such as Phonosophie's own and with a minimum of four metre lengths. The Classic I was supplied with a high-quality Phonosophie Powercord CU and an optional £164.98 PK2 BD25 DIN/BNC interconnect (inclusive of two phono adapters). Alternatively other brands also do very high-quality DIN/phono leads such as The Chorc Company

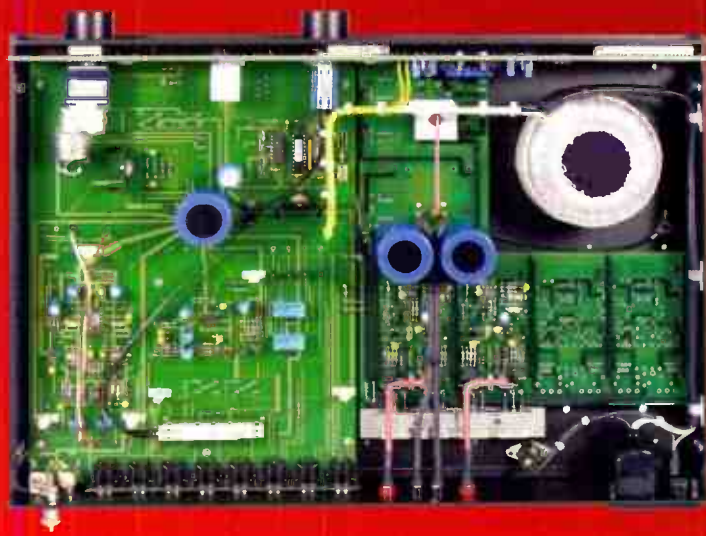

and Russ Andrews Accessories (Kimber Kable).

### SOUND QUALITY

The solo violin from the Ysaye/Zehetmair 'Sonatas Pour Violon Solo' was multilayered in its timbre. There was excellent tonal shading and colour, with no discernible subjective coloration. The violin had a rich and engrossing quality, making the midband highly articulate, without going into a forward emphasis that might disturb the complete musical structure. This is particularly prescient when you can enjoy the acoustic decay to violin notes, because they can fade with longevity and this ability enhances the communication of a believable three-dimensional sound. The violin phrasing was also a delight, as the playing and tonality combined to imbue the music with in-room legitimacy - it was convincing.

As the Kronos Quartet started, there was a deep resonating musical acoustic to 'Summer Overture' from 'Requiem For A Dream'. With just the right balance to appreciate

texture and timbre yet good musical timing and impactful decay to notes, the Phonosophie proved most adept.

On the dark, brooding 'Lux Aeterna', there was a rock-solid foundation to the instrumentation. As the violin stealthily made its way into the composition, the large cello sound flooded out. The music pulsed and throbbed with very high resolution of the low-frequencies. The main violin melody appeared with deft placement as the piece accumulated into the central, plaintive musical thrust. The sound on 'Lux Aeterna' was incredibly well-balanced, hence musical timing was good. Additionally, the Phonosophie was in control of any wayward low or high-frequencies that can occur on distinctive string quartet compositions as by the Kronos Quartet.

I was surprised at the superb high-resolution sound when listening to the driving, hard-rock from sleaze-metal group L.A Guns. Their 1994 'Vicious Circle' bears a stripped-down, but well-played melodic stance with punk-like attitude. Listening







Paul Rigby rounds up his nine favourite audiophile vinyl releases of the year.

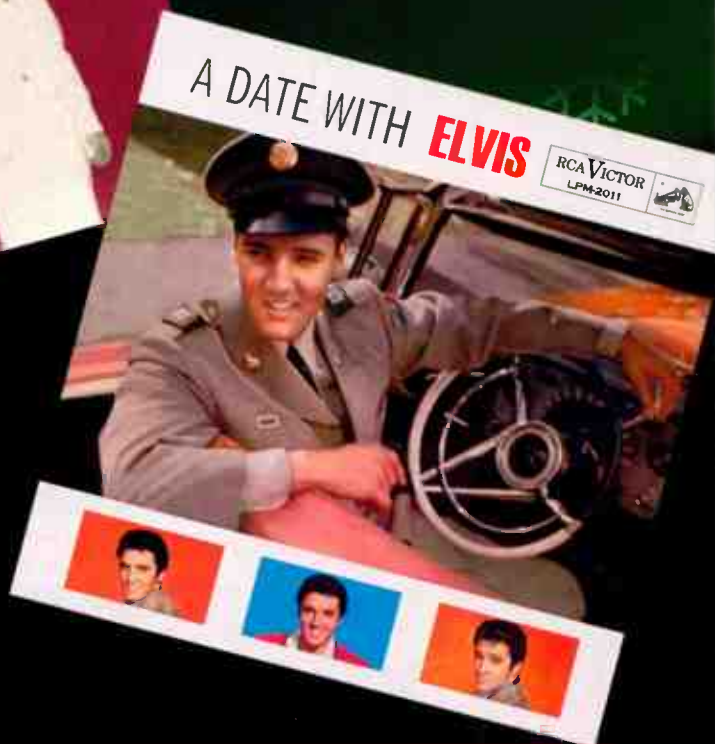
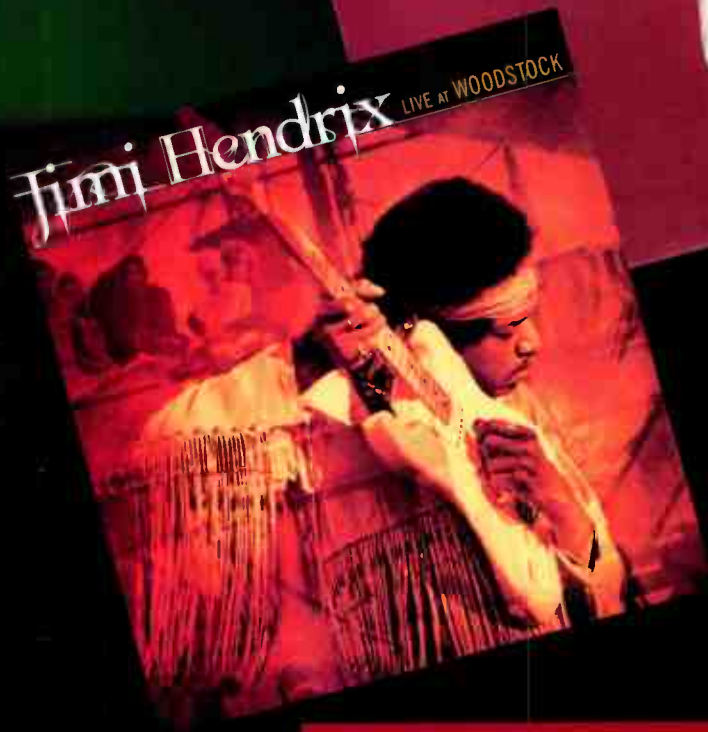

**CHARLIE FEATHERS**  
**GET WITH IT**  
**Revenant**

A beautifully produced set from Revenant, this release has benefited from close attention from the Italian company, Akarma. Previously available as a CD set only, the Italian outfit purchased the rights to produce this unique vinyl box set that features the masters of his singles for Sun, Meteor, King, Kay, Walmay and Holiday Inn. Feathers' raw rockabilly talent fights against the primitive production on these masters but, in some ways, the latter actually enhances the passion in his performance. The package also includes Sun demos, alternative takes, early home recordings with the likes of Jim Kimbrough plus a photo-packed booklet. The three vinyl box set is presented on clear vinyl which arrive in a slip case sleeve. This is a unique historical document for a criminally ignored performer who helped forge rock'n'roll into the popular medium it later became.

**ELVIS PRESLEY**  
**A DATE WITH ELVIS**  
**Speakers Corner / RCA Victor**

With Elvis in the Army, during 1959, RCA was struggling to come to terms with losing its cash cow. The label came up with a brilliant idea for all of Elvis' grieving fans by producing an album with a calendar on the rear so that each fan could mark off each day before their hero would be back on stage where he belonged. The album

contained unreleased, at that time, tracks recorded before Elvis entered the army including a selection of songs recorded by the Sun label that had yet to enjoy a wide American release at that time. Now reissued by the German audiophile specialist label, Speakers Corner, the record and its packaging have been produced in all their glory and on 180gm vinyl. This is a welcome return for a previously neglected Elvis album.

**JIMI HENDRIX**  
**LIVE AT WOODSTOCK**  
**Classic/Experience Hendrix**

A marketing triumph from US-based audiophile specialists, Classic, this Hendrix box set commemorates the 35th Anniversary of Jimi Hendrix's historic performance at the Woodstock Music & Art Fair in August 1969. Despite the music itself being of importance, the packaging is arguably the star featuring three slabs of white vinyl, a 36-page, large format booklet including photographs, essays and interviews with Eddie Kramer, Mitch Mitchell and Billy Cox. Yet that's not all, you also receive a 7" vinyl single featuring studio versions of Izabella and Message To The Universe recorded at New York's Hit Factory studios a week following the Woodstock performance. You also receive a replica Woodstock ticket and a guitar pick. The music itself has been carefully remastered from original master tapes with the assistance of Eddie Kramer, the chap who had a large responsibility in recording the entire Woodstock event.



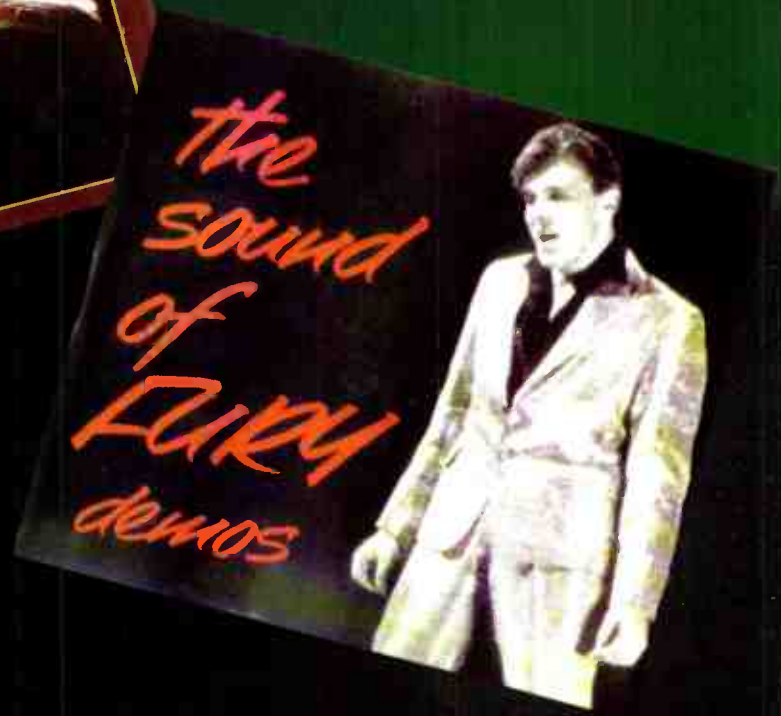

**EVA CASSIDY**  
**SONGBIRD**  
**Hot/Didgeridoo**

Pressed on 180gm vinyl, this special edition of the popular album from Eva Cassidy is a limited affair. Numbered on the rear on the sleeve, there are only 10,000 copies of the record in circulation. Despite the album being, for want of a better word, 'popular' which is often a mixed metaphor for lacking in quality due to mass commercial production, this particular album has been excellently recorded and mastered. Hence, the vinyl version is able to plunder those sonic benefits. For example, Cassidy's instrumental accompaniment is beautifully highlighted on many of the tracks. Acoustic guitars are not just acoustic guitars, they are guitars with metal or nylon strings, for example. Cassidy's vocals are also allowed to soar on this edition. Many will be surprised to hear, especially after her effective, yet largely low-key, rendition of 'Over The Rainbow', that Cassidy possessed some startling 'soul mama' chops – yet the vinyl handed the lot perfectly.

**BILLY FURY**  
**THE SOUND OF FURY DEMOS**  
**Earmark**

Arguably the greatest British rockabilly album of all time, 'The Sound Of Fury' is a firm favourite among rock'n'roll fans which brought a sense of respectability to the British pop scene in 1960. This welcome release of the album's associated demos and off-cuts shows just how a modern vinyl release, which encompasses all the current techno-

logical benefits of the age such as heavy-weight vinyl, careful mastering and high quality packaging can seamlessly merge with history by taking advantage of original master recording tapes, the original 10" release format and the original, period, artwork. Earmark should be congratulated for their thoughtful and considered approach to this vinyl release which could, in so many ways, have been a disaster. It also proves that, with a little thought, care and attention, music can be so much more than a series of binary ones and zeros.

**VARIOUS**  
**JAZZ FOR HI-FI LOVERS**  
**Sundazed/Euphoria**

An album that was produced for audiophiles? You might be forgiven for being suspicious of such a production whilst mentally labelling it in the same league as the numerous test records currently roaming the market. However, whilst technically excellent, this album was created, in 1958, with music as its prime focus with excellent selections from a host of jazz stars including Kenny Clarke, Zoot Sims, Paul Quinichette and Oscar Pettiford. The production of the final album was afforded critical attention. Any elaborate recording set-ups were dispensed with to simplify the final process. The result presents greater dynamic range with a smooth playback bereft of any damaging extraneous frequencies. Sundazed did a great job in sourcing the original Dawn label master tapes in the first place, never mind finding a source to reproduce the original artwork.

# NOTEWORTHY AUDIO

*hi-fi by enthusiasts*

BELOW IS A SMALL SELECTION FROM OUR RANGE OF CAREFULLY CHOSEN EQUIPMENT

**Denon DL-103** MC cartridge. The 103 has been in production since 1963, and for good reason - its performance is legendary throughout the world. Probably the best value cartridge available today at just £100.



**Denon DL-304** This is a wonderfully transparent sounding MC cartridge that is almost unmatched for its midband quality which is especially amazing when its low £210 price is taken into account.

**Audio Note IQ3** This is Audio Note's top MM cartridge and it features the same diamond and titanium cantilever also used in the IO1 featured below. It successfully captures the energy on an LP with an involving dynamic and fast sound. £350.



**Music Maker 3** The Music Maker is a moving iron cartridge that rightly has become a legend in its own lifetime. Its effortlessly musical presentation makes most other cartridges sound as if they're trying to hard. £625

**Audio Note Io 1** MC cartridge. Surely one of the finest cartridges in existence, the Io uses Alnico magnets and pure silver coils to extract everything from your LP's in the most musical way possible. £1,595.



We firmly believe that the way to get the best performance from any MC cartridge is to use a high quality step up transformer. It is for this reason that we stock a range of designs, from the new **Note Products Step-Note** at £200 (pictured left) the **Audio Note** range priced between £390 to £4,500 and the **Music First Audio** copper or silver wired designs which start from £1,500 and offer a variety of ratios and impedances via front mounted switches.



## Noteworthy Audio

36 Buckingham Street, Aylesbury, Bucks. HP20 2LH. Tel: 01296 422224  
www.noteworthyaudio.co.uk



## Townshend

Since 1975 Townshend Audio has been producing world class high fidelity components, the latest being the TA565CD silver disk player. CD sound is simply outstanding: smooth, lively, fast and completely un-fatiguing. Employing Enhanced Deep Cryogenically Treated™ copper wire-wound coupling transformers in the output circuit together with damped spring isolation, the specification and the sound quality exceeds anything currently available.

And by the way, it plays DVD-Video, SACD and DVD-Audio in stereo and multichannel!



Also new is the Versatile Seismic Sink Stand (VSSS). Employing polymer suspension elements, the VSSS isolates ground-borne vibration from 2Hz upwards.

Available in all standard widths and with up to 8 shelves, the stand can take 70kg (total) on infinitely adjustable shelves.

Finally, the Hi Fi World Accessory of the Year 2004, the Maximum Super Tweeter sits on top of your existing speakers or on special brackets for Quad 57 and round sloping topped speakers.

"The difference was staggering" - Hi Fi World, Jan 04.

For a demonstration of the above on the full Townshend Audio stereo or surround sound cinema system in Hampton Court, Surrey, or for your nearest dealer information.



## call Townshend Audio

+44(0)20 8979 2155

or see [www.townshendaudio.com](http://www.townshendaudio.com)

## The Missing Link



**Missing Link Cryo Reference Interconnect**  
5n Pure Solid Core Silver with Silver Eichmann Bullets  
Cryogenically Treated - From £225

Cables Based on Science - Not Mythology



**ORBIT POWER From £65**

With Silver Marincos & Silver EPS-500 Mains Plug

The Perfect Gift For This Christmas  
A Missing Link Gift Token...Now Available

0115 8779089 or 07967 859333

[www.the-missing-link.net](http://www.the-missing-link.net)

## Needles & Spins

**TURNTABLES**  
**CARTRIDGES**  
**TONEARMS**  
**RECORDS**  
CLEANING EQUIPMENT  
**ACCESSORIES**

**VINYL AT ITS BEST**

[www.needles-and-spins.co.uk](http://www.needles-and-spins.co.uk)

0115 877 0781



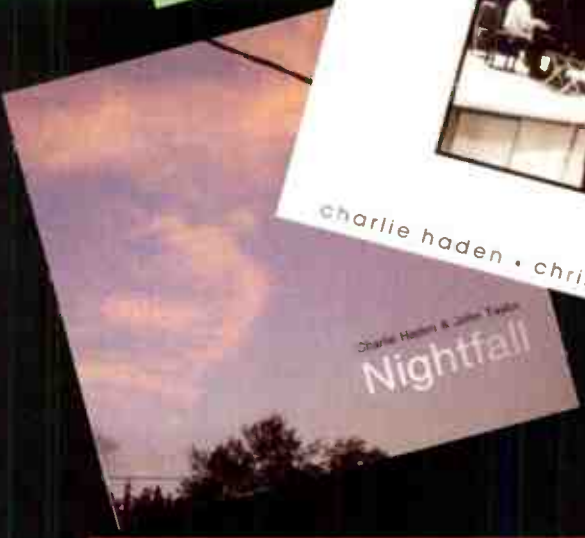

**KRAFTWERK**  
*MINIMUM-MAXIMUM*  
**EMI**

Already released as a CD box set, this live collection really came to life – an apt pun on a band better known for their showroom dummy animatronics – when EMI released the records as a vinyl box set. The latest band line-up of Ralf Hütter, Florian Schneider, Fritz Hilpert and Henning Schmitz toured the world, during 2004, playing a grand total of 69 shows. This collection presents the top highlights from the tour giving you 22 tracks recorded throughout Europe, Japan and the USA. All the hits are present including 'The Robots', 'Tour De France', 'The Man Machine', 'Pocket Calculator' and 'Autobahn'. The set includes four vinyl discs contained in sleeves portraying the band in action at one of the many tour venues. The whole collection is stored in a strong box that features a full track listing on the rear. This is an excellently produced set that all Kraftwerk fans should track down.

**PATRICIA BARBER**  
*NIGHTCLUB*  
**Mobile Fidelity**  
*MODERN COOL*  
**Mobile Fidelity**

Patricia Barber is a pianist and vocalist hailing from Chicago, USA. A jazz vocalist, her sultry style is gaining many fans around the world from all sides of the jazz fraternity as well as people who just like to hear a good song sung well. The production shows influences

from the likes of Miles Davis, Ella Fitzgerald, Count Basie, Nat King Cole and Shirley Horn. Mobile Fidelity has enhanced the quality of the original recording by releasing the albums in 45rpm editions. Because the production of a 45rpm version of a standard album means that a single album then becomes a multi-disc set, the packaging often becomes a bit of a headache for the label. In this case, Mobile Fidelity has solved the problem by containing the disks in stiffened plastic sleeves which have then been encased in a sturdy box.

**CHARLIE HADEN & CHRIS ANDERSON**  
*NONE BUT THE LONLEY HEART*  
**CHARLIE HADEN & JOHN TAYLOR**  
*NIGHTFALL*  
**Naim**

Taking similar care with the production of its vinyl that it does with the production of its excellent hi-fi equipment, Naim has a successful, yet specialist vinyl output – in this case featuring jazz bass man, Charlie Haden, and 'friends'. This instrumental music is both lyrical and smooth whilst maintaining a certain freshness that keeps you transfixed. The benefit is helped by the superb recording methods achieved by Naim engineer, Ken Christianson, recording with a basic set up. Christianson utilised a minimal number of microphones, some ageing analogue recording equipment, drawing on a stash of seven-inch reels of rare 3M 966 tape that is no longer produced. The result is a sublime presentation set on a wide sound stage offering so much 'air' to the performance I had to sit through both sides with my coat on.

**CONTACT:**  
Vivante  
01293 822 186  
[www.vivante.co.uk](http://www.vivante.co.uk)



**Treat yourself this Christmas! Jas Audio has unleashed the ultimate upgrade for any loudspeaker and it costs just £649...**

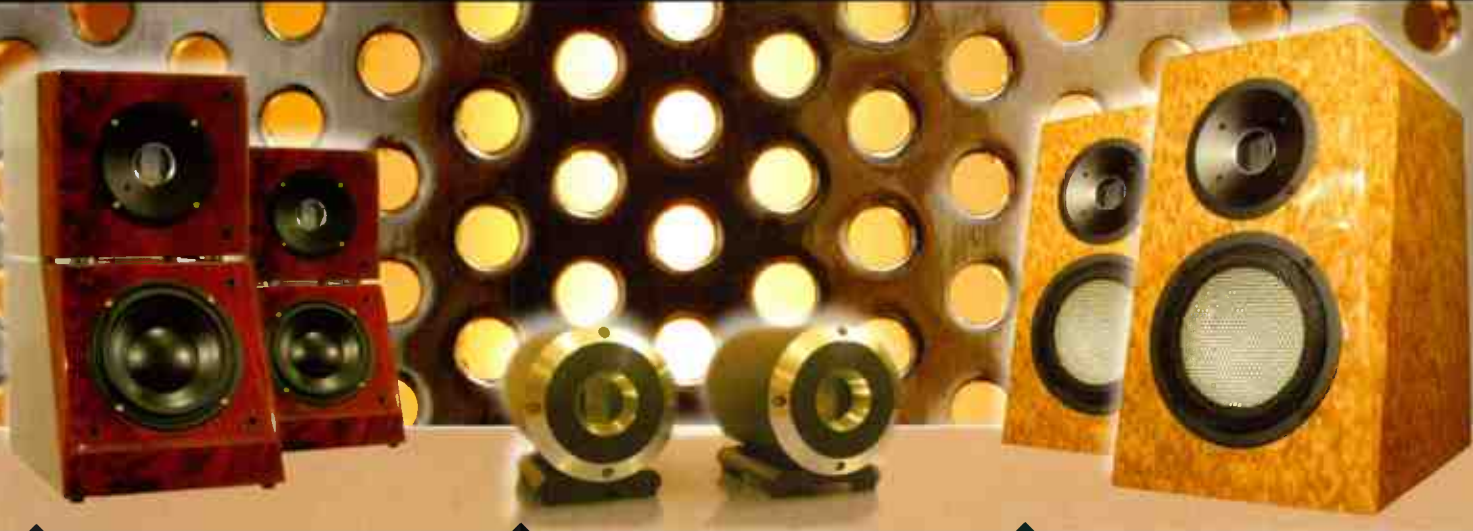

**Orsa (£1,399 pair)**

This 2-way speaker has a distinct twin cabinet design. This vertically vented speaker has venting ports between the upper and lower cabinets, which produces a 360 degree sound field that give rise to excellent 3-D soundstage.

**Super Tweeter (£649 pair)**

This is one of the most cost-effective upgrades for any loudspeaker. A twin-ribbon super tweeter with 100kHz frequency response. Housed in a beautiful aluminium cylindrical shape cabinet, each speaker weighs less than 2lb. Soundstage, clarity, layering, openness, airiness and resolution will improve dramatically!

**Orior (£2,299 pair)**

Smooth, precise and powerful! Never has a 2-way speaker sounded so big and with such details in its sonic reproduction. The quick and agile bass region goes below 30Hz, easily outshining many large floor standing speakers at any price range.

**ALL JAS-AUDIO PRODUCTS COME WITH A NO RISK 30-DAY MONEY BACK OPTION\* (CONDITIONS APPLY)**

**We offer the Best Part-Exchange Prices**

For full details of our extremely comprehensive range of products, our extensive used listing, links to reviews, technical information and much more, visit [www.shadowaudio.co.uk](http://www.shadowaudio.co.uk)



**Digital**

Bel Canto PL-1, boxed as new, ex-dem. (£6990)	<b>EPOA</b>
Primare D80.2 boxed (£1595)	<b>£795</b>
Cyrus Discmaster CD Transport, Black	<b>£349</b>
Naim CD5i, boxed as new	<b>£625</b>
Bel Canto PL-1 Universal CD/DVD-A/SACD boxed as new, Full DCDi (£9490) ex-demo	<b>EPOA</b>
Theta Cobalt 307 DAC, boxed in black as new	<b>£185</b>
Audio Synthesis DAX Discrete in Black (£4000)	<b>£2195</b>
EAD DSP 9000 Pro S3 DAC pre	<b>£995</b>
Wadia 302 CD player (£4000)	<b>£2995</b>
Musical Fidelity Nu-Vista CD Player	<b>£1495</b>
Shanling CDT-100 (3D acoustics UK model) - £1600	<b>£990</b>
Audio Analogue Paganini (£950)	<b>£695</b>
Musical Fidelity A308 CD player	<b>£995</b>
Roksan Kandy MKIII silver/black ex-dem	<b>£450</b>

**Amplifiers**

Conrad Johnson PV-10BL pre amp,	<b>£545</b>
Musical Fidelity X-80 int amp, ex-display, (£499)	<b>£295</b>
Jeff Rowland Model 8 ti power amp (£14000)	<b>£5895</b>
Naim Hi Cap, boxed as new.	<b>£550</b>
Naim 102 Pre amplifier, boxed as new condition	<b>£495</b>
Roksan Caspian M1 pre + 2xM1 Mono blocs (£3500)	<b>£1995</b>
Jeff Rowland Model One power amplifier	<b>£1295</b>
YBA 2 Pre-amp, exceptional value (£3000)	<b>£995</b>
Bel Canto Evo4, boxed as new, ex-dem spec» (£3499)	<b>EPOA</b>
Bel Canto Pre2, boxed as new, ex-dem spec» (£2999)	<b>EPOA</b>
Bel Canto EVO 2i, boxed as new, ex-dem. (£2750)	<b>EPOA</b>
Graaf GM50, 2 months old, boxed (£4000)	<b>£2995</b>
McIntosh MA6500 int amp, ex-dem, as new. (£3361)	<b>EPOA</b>
Meridian 557 Power amplifier, boxed	<b>£795</b>
Nagra VPA mono blocks, 8 months old (£10500)	<b>£6399</b>
Rotel Pre/Mono Combo RCO3 pre, 2x RB03 power amplifiers	<b>£495</b>

McIntosh MHT200 8x140 wpc, home cinema heaven, ex-dem (£6503)	<b>EPOA</b>
McIntosh MCS01 Monoblocks (pair), ex-dem (£7800 - pair)	<b>EPOA</b>
AVI Lab Series Integrated amplifier (£1500)	<b>£949</b>
Conrad Johnson PV14L pre, 2yrs old (£2300)	<b>£1250</b>
Unison Research SR-1 integrated (£1325)	<b>£699</b>
Classe CP 47.5 reference pre amp	<b>£1295</b>
ES Lab DXS4 digital amplifier	<b>£1295</b>
Croft TS1 with Epoch Pre (£3000)	<b>£1795</b>
ART Conductor Pre-amp	<b>£895</b>
Audio Analogue Puccini Settanta (£950)	<b>£795</b>
Sugden Masterclass Mono blocks (£6600)	<b>£3895</b>
Musical Fidelity X-150 v3 (£799)	<b>£650</b>
Hovland HP100 pre+built in phstage (£5350)	<b>£3595</b>
Hovland Radia Power amplifier (£7995)	<b>£4995</b>
Hovland HP200 + phono stage (£7325)	<b>£4995</b>
Audio Analogue New Maestro (£1750)	<b>£1255</b>
Audio Analogue Primo Setanta	<b>£325</b>
Roksan Kandy MKIII (silver or black)	<b>£450</b>

**Loudspeakers**

ATC SCM 50 ASL (Active) Anniversary, boxed as new, one owner, only 3months old. (£13000)	<b>£7995</b>
Usher AC10 loudspeakers. Very rare in Walnut and a bargain. Boxed as new. (£7000)	<b>£2995</b>
Living Voice Auditorium II in cherry, boxed, superb condition	<b>£995</b>
ATC SCM-50ASL finished in Yew (£7947)	<b>£4995</b>
Tannoy Dimension TD10 speakers (£5000)	<b>£2395</b>
Klipsch Klipschorns. Orig boxes/packing, walnut (£8000)	<b>£2495</b>
ART Audio Skibo Speakers+ ART stands (£1100)	<b>£595</b>
Wilson Benesch Curve speakers (£5000)	<b>£3495</b>
Triangle Titus ES stand mount (£370)	<b>£269</b>
Dali Helicon 400 (£3300)	<b>£1995</b>
Audio Note AN-ED speakers	<b>£695</b>
Mission 780 SE, boxed	<b>£185</b>

Living Voice Avatar II, finished in cherry (£2700)	<b>£1595</b>
Nola (Alon) Elite Signature speakers (£8000)	<b>£3595</b>
Ref 3a Dacapo i, maple (£2700)	<b>£1650</b>
JM Lab Cebalt 816s (£999)	<b>£595</b>
Triangle Hellacke, Champagne finish (£595)	<b>£395</b>
Wilson Benesch ARC's with stands (£2500)	<b>£1699</b>
Triangle Australe in cherry (£3300)	<b>£1995</b>
Living Voice Avatar OBX-R in Cherry	<b>£2895</b>
Wilson Benesch Discovery (£5700)	<b>£3895</b>
Quad 989 ESL Vintage, new £5000	<b>£3600</b>
Quad 988 ESL in Nouveau, cost new £3750	<b>£2999</b>
Audio Physic Spark3, Cherry or light maple	<b>£1250</b>
Audio Physic Tempo 3i, Cherry or light maple	<b>£1395</b>
Audio Physic Tempo3i SE, Cherry/light maple	<b>£1799</b>
Audio Physic Virgo III, Cherry	<b>£2895</b>

**Analogue**

Pro-ject RPM4 Turntable, boxed as new (£350)	<b>£195</b>
Rega P25 with Super Elys Cartridge	<b>£450</b>
Audio Synthesis Passion Phono stage, unused, (£1295)	<b>£695</b>
Ortofon Jubilee, very low hours, as new, be quick!	<b>£595</b>
SME 10, boxed AS NEW (£2800)	<b>£1895</b>
SME 20/2a + SME V tonearm (£5695)	<b>£3695</b>
Wilson Benesch Full Circle+Ply Cart (£2100)	<b>£1495</b>
Musical Fidelity M1 turntable, boxed as new	<b>£1990</b>
Mitchell Orbe SE boxed as new	<b>£1595</b>
SME 10A, boxed	<b>£2495</b>
Nottingham Analogue Spacedec	<b>£695</b>
Trichord Dino - silver front	<b>£199</b>

**Miscellaneous**

Naim Hi Cap, boxed as new	<b>£550</b>
Nordost Vishnu 2m mains lead, as new (£450)	<b>£349</b>
PS Audio P600 power plant (£2895)	<b>£1595</b>
Townshend Super Tweeters in Titanium matt	<b>£650</b>

List is updated on a daily basis via website



"the recordings I am talking about have real incision subjectively; they are almost lacerative"



## noel keywood

**A**n anecdote I often resort to, to illustrate a point, runs like this. Once upon a time, when the skies were dark and dinos' roamed the earth, before Man as we know him today lived, there existed a reviewer. At this point I hear a refrain from many manufacturers "yeah, we know him, we know him!". But let me continue.

He reviewed an NAD cassette deck and found it sounded wonderful. Clean, dynamic and great for rocking around the escarpment, whilst chucking boulders at beasts; he grunted that this was great Mesozoic entertainment.

Had this reviewer spent more time in his cave listening to Liberace who, I can assure you, existed in the same period, then he might have noticed that this deck could hold a note with all the steadiness of a Stegosaur after a night out at The Atlantic Bar and Grill. Even NAD were amused by this as they well knew this deck was most suited to replaying sea shanties.

The point of this little anecdote is that if you want to be an effective hi-fi reviewer you may have to get used to Liberace.

The music I choose to listen to often has to do a job - and whether I like it or not isn't necessarily the point. Indeed, if I don't use a broad and carefully chosen 'appropriate' selection then I may never notice characteristics, strengths or failings that exist, such as cassette deck wow.

Worse, as my time with any product will usually be less than that of any potential purchaser relying on my words of wisdom (cough) to make an informed choice, oversights or misunderstandings that arise from using music that doesn't fully and effectively probe a product's boundaries of performance will likely

be picked up by others, whether they listen to Liberace or not.

Personally, I prefer Ashkenazy, but each to his own. Piano can do a great job at times at revealing more than just the sort of unsteadiness that boxes of cogs and wheels once suffered.

It was my mother who played piano and would occasionally watch Liberace, a sort of Elvis of the ivories. I would peer around the door in a mixture of horror and wonder, as the Rolling Stones were up and running by then and these were different worlds. Mind you, according to which generation you are from, I can definitely see arguments about who's Triassic and who's Jurassic here!

So the music I use when reviewing has little connection with my taste in music, and what I like to listen to isn't necessarily suitable as a review tool. All of which has been said to excuse myself from constantly mentioning Toni Braxton as an artist I use when checking out hi-fi equipment!

No, I'm not a great fan of female love songs, even if they come with attitude, like those from Christina Aguilera. They're simply good, modern recordings with the right sort of content to stress system components effectively, often using vocals or instruments that are not too far away from sounding reasonably unprocessed and natural.

In the case of both Toni Braxton and Steve Earle, both of whom I use regularly, I know from measurement, using a fast spectrum analyser that what's on the CD spans the entire audio range, with harmonics from struck chords on steel string guitar sending treble levels off the scale all the way up to 20kHz for example. A subjectively bright recording may peak up, energy wise, at 3kHz-6kHz - not enough to send a poor tweeter into

hysterics. The recordings I am talking about have real incision subjectively; they are almost lacerative, provoking much equipment into less than ideal behaviour. This way I can be fairly assured I'll tease out problems if they are there. These discs give a system a real work over in double quick time and I know what to expect from them.

I re-use these tracks, and others, time and time again because I know how they sound and can quickly and assuredly get a handle on what a product is doing. They are reliable benchmarks in effect, making for consistency over a period of time. That's also why most of them are dated. Their use has nothing to do either with my taste or, in particular, all the other music that gets played on a system under review. A wide variety of material must be chosen, but it is chosen to do a job, not to entertain me!

I also try to use material that's reasonably mainstream and not too esoteric. That way I hope most readers can understand and associate with what's being talked about, instead of encountering strange descriptions that read like a coded message from a Mason's Lodge.

Choice of music will always be one of those emotive subjects, like which computer you use or car you drive, that tends to set some people off. With reviewing though, music choice isn't necessarily as straightforward as it might seem. Some readers may well think my choice of music has all the subtlety needed to knock out a Stegosaur at ten paces - but to some extent that's the point. In my case though it's the hi-fi equipment that takes a proverbial beating to see how it will react. Luckily for me it doesn't have four legs and weigh forty tons, saving me from becoming someone's future anecdote. ●

When detail matters.....



The new MR5 equipment support from Henley Designs, serious about sound!

**H** Henley Designs 01235 511166  
[www.henleydesigns.co.uk](http://www.henleydesigns.co.uk)



*Johann Sebastian would have been very proud.*

The Kontrapunkt series from Ortofon. Named as a sign of respect for possibly the greatest, and the last, of Johan Sebastian Bach's works - The XIXth Contrapunctus. From around £400 and available from most quality Hi-Fi stores.

Distributed by Henley Designs, 01235 511166, [www.henleydesigns.co.uk](http://www.henleydesigns.co.uk)





"vdH's TLF oil isn't cheap, but will transform your sound"



## David Price

**W**hat with me being the editor of a hi-fi magazine, I suppose I should be penning big 'pronouncements' about the state of the industry, or soliloquies on where hi-fi is heading, or suchlike, but instead – if you'll pardon my self-indulgence – I'd like to use this column to talk about something altogether less profound and (yet) more interesting to audiophiles...

Oil is quite an important thing, really. Without it, our car engines would go bang within seconds and – more appositely for this magazine, our turntables wouldn't spin, nor would our CD mechanisms. Personally speaking, I have been fascinated by the subject since my 'gap year', when I went to work for Exxon, designing 'viscometrics' software. On the very first generation of IBM PCs back in 1984-85, I coded programs for boffins in white coats that simulated the behaviour of various oils under load at the Esso Research centre, helping them develop their response to Mobil One, the world's first commercial synthetic oil.

I took a crash course in how oil works; I learned about its viscosity index (crudely put, how slippery it is), its shear resistance (how much load it takes before it chemically breaks down, carbonates and stops protecting), its friction coefficient (how much energy it loses – and turns to heat – between moving parts). In cars, these all determine how much wear your engine suffers at differing temperatures and how much power an engine makes (and how cool it runs).

In hi-fi, it's also critical. Take, for example, your turntable main bearing. If it uses cheapo petroleum oil, the platter spins with more resistance,

putting a higher load on the motor, causing more drain on the power supply, and more electrical noise in the system as a result. Exactly the same happens in CD mechs, although there's obviously less load (no 10kg spinning platters here), but it still adds up to the same. Indeed, anywhere in your hi-fi where there are motors and bearings, oil has an effect.

Now, in the great scheme of things, whenever metal meets metal, oil is better than no oil (car drivers take note!), clean oil is better than dirty oil, good new oil is better than bad new oil, and new synthetic oil is better than new mineral oil. Synthetic oil is a clever exercise in a kind of genetic engineering. Mineral oil is – not to put too fine a point on it – fossil fuel. It's old plants from millions of years ago, turned into a kind of organic slush by mother nature and preserved under the Earth's crust. Organic oil is alright for cooking prawn crackers in a frying pan (unless the heat's too high on the hob, when it starts burning), but not so good at being ultra slippery and low in friction. Synthetic oil is more up to the job; blended by those aforementioned Chemistry PhDs in laboratories, it's far more stable and – in engines – provides much better lubricity and longevity.

The thing is, synthetic oil uses bought-in, specially formulated 'base stocks'. These are far better than dinosaur juice at protecting when metal meets metal, but aren't created equal. The only super-stable base stock is a formulation called polyol ester; to the best of my knowledge this is the only base stock capable of withstanding the massive pressure/load/strain found in jet engines. Again, as far as I'm aware, the only auto oil manufacturer who uses this is Redline ([www.redlineoil.com](http://www.redlineoil.com)). This stuff is amazing in cars; you can feel

your engine run smoother, get less hot, give better fuel consumption and more power. It might be regarded as overkill for non-aero applications, but I'm sufficiently convinced of its properties not to run anything else in my car engines/ power trains.

Now, here's where DP gets howls of derision. It also has an audible benefit in turntable main bearings. Vinyl is a massively high resolution music carrier (the sky's the limit, or your pocketbook), and when you've got a well fettled turntable, if you use Redline you can hear the difference. It's not profound, but it just sounds better...

For this reason, it was fascinating to talk to AJ van den Hul about oils. This arch tweaker of audio, a man who makes even Ken Ishiwata look positively disinterested when it comes to understanding detail points of system set-up, has developed his own bespoke oil for audiophile applications called TLF "The Low Friction" ([www.vandenHul.com](http://www.vandenHul.com)). With my anorak-like oil awareness, I immediately asked AJ which base stock he uses for TLF, and lo and behold it was polyol ester. Only the best is good enough...

I've just flushed out the main bearing of my Pioneer PL-L1000 turntable and replenished it with TLF, and am sitting here listening to the results as I write this. The sound is sublime; there's musicality, fluidity and an 'organic' feel to the sound. The deck is singing like never before. This is because the platter is spinning with less friction than it ever did, taking the load off the quartz-referenced servo, meaning there's less electrical drain on the motor's PSU. Result: faster attack transients, more musical bass, a deeper recorded acoustic and more detail; even the high treble seems more spacious. TLF isn't cheap at £35 a pop; but could transform your analogue sound! ●

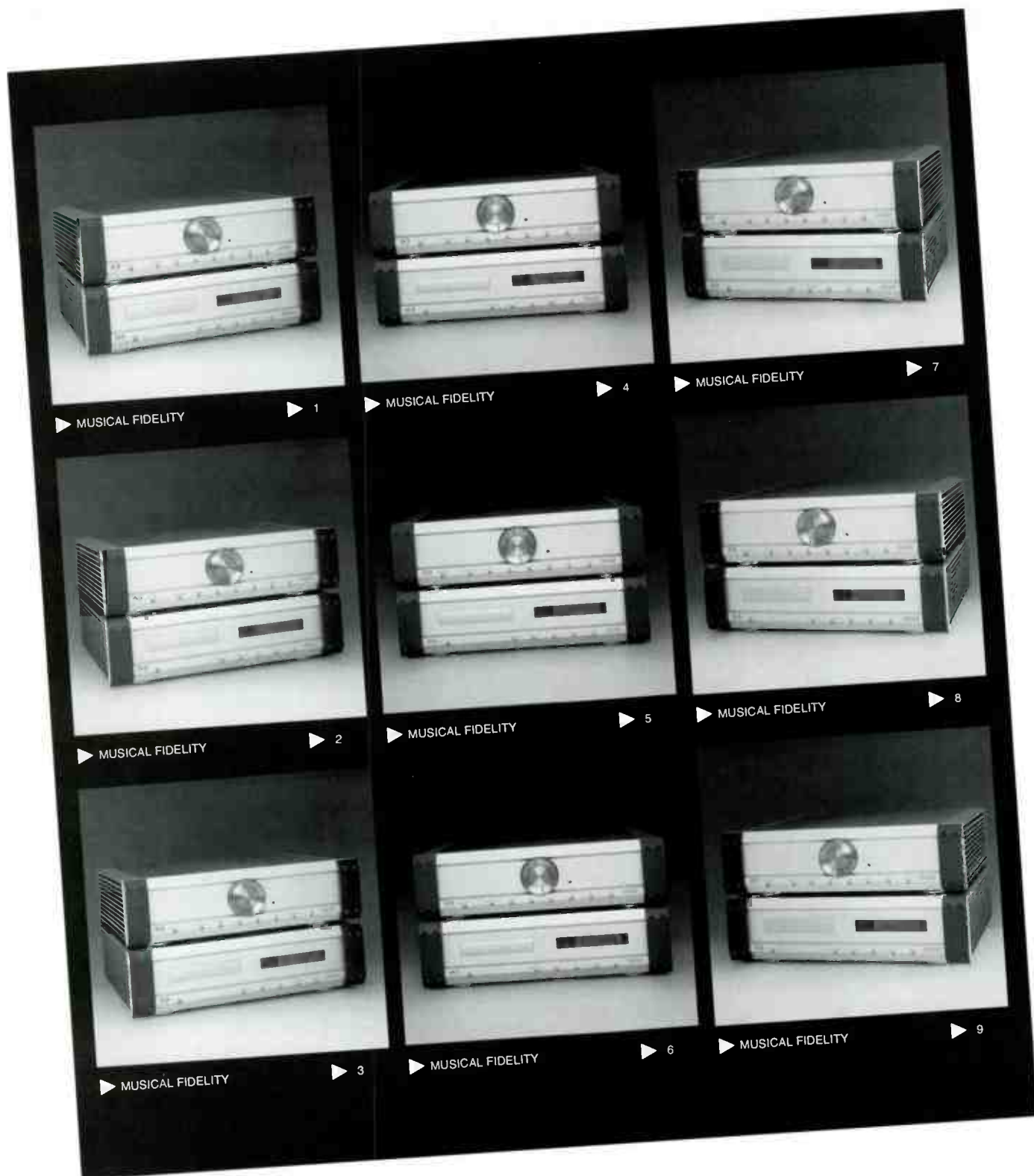

NEW FROM MUSICAL FIDELITY.  
A5 SERIES.  
X SERIES ACCESSORIES. X SERIES COMPONENTS.  
kW INTEGRATED, PREAMP AND POWER AMP.  
M1 TURNTABLE.  
HEARING IS BELIEVING.

FOR DETAILS OF YOUR NEAREST STOCKIST, RING 020 8900 2866 OR VISIT [MUSICALFIDELITY.COM](http://MUSICALFIDELITY.COM)



# "Ofcom's Radio Review Phase 2 is bad news for radio listeners who hoped that DAB would provide good sound"



## steven green

Ofcom recently published Phase 2 of its Radio Review, which outlines its plans for the future of radio following a consultation on its original proposals, which were contained in Phase 1 of the review.

The main points are that Ofcom is going ahead with its proposal to abolish the minimum bit rate levels on digital radio in favour of a "co-regulatory system"; there will be one new national DAB multiplex; all areas that don't currently have a local DAB multiplex will get one, but this will still leave between 70 and 90 of the existing 326 analogue radio stations unable to transmit on DAB, and Ofcom envisage that the new DRM radio system could be used to allow these stations to transmit digitally.

In the Phase 1 consultation document, Ofcom said that there would either be one or two new national DAB multiplexes, but judging by the language used in the Phase 2 document it looks unlikely that the UK will be able to secure international clearance for the spectrum for the second new multiplex. We will not know until the Regional Radio Conference (RRC) has concluded in June next year.

This issue has ramifications for the BBC, who say they have "made known to Ofcom [their] strong interest in acquiring extra transmission capacity". But if only one additional national multiplex is launched I think it is extremely unlikely that the BBC will be able to acquire any additional national DAB capacity. If two new national multiplexes were launched, however, then there would at least be a faint glimmer of hope.

The problem the BBC faces is that Ofcom has a duty to "secure

a wide range of radio services throughout the UK", and it will use the "beauty parade" method to award licences for new multiplexes to the applicant that extends the breadth of choice the most.

Clearly, if the BBC wants extra capacity for its existing stations, this would reduce the number of new stations that could be launched on the new multiplex, so such an application would be deemed to be less desirable than one that intends to use all of the capacity for new stations.

And if this wasn't bad enough, the BBC would have to find commercial radio groups willing to cooperate with it in a bid, but the commercial radio groups have expressed their vehement opposition to the BBC acquiring any additional national capacity. Still, stranger things have happened...

The only piece of promising news was Ofcom's response to the issue of the 70 to 90 stations that will not be able to transmit on DAB. Ofcom concluded that using the DRM system in the MW-band may allow some of these stations to transmit digitally, but added that, "there may be a case for freeing-up some existing spectrum from other radio uses".

There is some spectrum in Band I (47 – 68 MHz) that Ofcom's 'Spectrum Framework Review: Implementation Plan' flagged as being "potentially available for award", and this frequency band is assigned to broadcasting use across Europe, which would obviously make it suitable for broadcasting use in the UK (international clearance permitting), even though the UK currently uses it for mobile services.

Additionally, work is underway on extending the DRM system from its current upper limit of 30MHz to

work at frequencies up to 120MHz, which would mean that the extended system could be employed if any Band I spectrum were freed up.

Members of the DRM Consortium have already said that the extended system (which will be renamed DRM+ once the work is complete) will use 50kHz channel bandwidths, and because it is such an efficient system DRM+ stations using this channel bandwidth will be able to provide very good audio quality – certainly higher quality than Radio 3 on DAB.

And because DRM+ uses such narrow bandwidth channels a lot of channel slots can be fit into a small bandwidth – twenty 50kHz channel slots per MHz. Therefore, if Ofcom allocated even a relatively small amount of spectrum for DRM+ use, it could still potentially significantly increase the number of digital radio stations UK listeners can receive.

I'll return to the issue of abolishing the minimum bit rate levels at a later date. Suffice it to say, though, that Ofcom's plan will inevitably result in a lot of commercial radio stations reducing the bit rates they use, and that's hardly going to be a good thing for the audio quality on DAB.

Overall, Ofcom's Radio Review Phase 2 is very bad news for radio listeners who hoped that DAB would provide good sound quality, especially if the BBC doesn't get any additional national capacity. But as Ofcom's remit is to widen the choice of radio stations listeners can receive, then hopefully they'll free-up a reasonable amount of spectrum for DRM+ to use, which could also provide this elusive good audio quality that we were originally – and still are – promised that digital radio would provide. ●



**WIN A SUPERB SHANLING CD-T80 VALVE CD PLAYER WORTH £650 IN THIS MONTH'S GREAT COMPETITION!**

**H**ere's your chance to win a fantastic Real Hi-Fi by Shanling CD-T80 CD player - the machine that pretty much beat all the group test contenders in December 2005's *Hi-Fi World!* This is what reviewer John May had to say:

"I'm happy to say that straight away the Shanling CD-T80 impressed, weighing 9kg, and measuring a respectable 430x82x370mm... Finish is of a very high standard for the price. The front panel is a very sturdy 11mm thick brushed aluminium slab containing the basic transport controls to the right, a centrally mounted transport tray, and the standby power button to the left... I was immediately taken with the neat layout and quality construction. Of particular note are the impressive potted power transformer on the left of the transport mechanism which accounts for a fair share of the Shanling's 9kg. Also of note is the fact that the Philips CDM12.10 transport mechanism is itself housed in an aluminium enclosure, affording additional electrical shielding and mechanical damping of the delicate transport within. Such attention to detail is rarely found on CD Players with a four figure price tag.

Component quality is equally high with low-ESR Rubycon types taking care of the power supply side of things, with Nichicon 'Gold Tone' and 'Fire Gold' capacitors vying for attention elsewhere. There is also a pair of high quality film capacitors in the output section rather than the more often used but sonically inferior electrolytic types. The output stage is a delight as it features *Hi-Fi World's* favourite amplifying devices - valves!

In this instance there are a pair of 6N3 dual triode valves on output duty.

Even from cold I could tell the CD-T80 was something special. This thing loves music - with a passion! Slipping in a CD of Neil Young's 'Decade' I was floored by the extremely life-like sounds vibrating their way out of my superb reference Mission e82 speakers. It was the effortlessness of the sound that caught my attention from the outset. The sense of acoustic space was holographic - here's a player that has the ability to transport the venue into your listening room, or you to the venue! (Depends what you're drinking or smoking at the time I guess!) The natural decay of crisply plucked guitar notes was also something you rarely hear from your average 16bit spinner. Everything just hung together perfectly and - most importantly - kept the feet tapping throughout this CD. To be honest it sounded more like SACD than ye olde 16bit... The Shanling can also boogie with the best of them, which was evident from 'The Knock (Drums of Death Part 2)', where it managed that rare trick of pulling you into the music as if you'd heard the track for the first time again... Hearing a player

like this reminds you how processed other CD players can sound (more of this in the proceeding group test).

Shanling's CD-T80 is a special sounding player. The way it imbues life and soul into just about every disc you care to play through it is really quite addictive. There wasn't one disc I played which tripped the Shanling up, and believe me I tried. With some brands, one gets the feeling that their 'budget' machines are deliberately stripped down to avoid affecting sales of their pricier products. However with the CD-T80 one gets the impression that Shanling have pulled out all the stops to give you the best value for money possible... The rock solid build quality, plus the fact the op-amps and valves can be upgraded if the user wishes it, is the icing on the cake. Shanling could have asked £1,500 for the CD-T80 and it would still be something of a bargain."

If you'd like to win this superb silver disc spinner, then all you have to do is answer the following four easy questions. Send your entries by 30th December 2005 to:  
**January 2006 Competition, Hi-Fi World magazine, Unit G4, Argo House, The Park Business Centre, Kilburn Park Road, London NW6 5LF.**

## QUESTIONS

[1] How much does the Shanling CD-T80 weigh?

- [a] 9kg
- [b] 100g
- [c] 90kg
- [d] 9g

[2] What is the CD transport housed in?

- [a] an aluminium enclosure
- [b] a chrome enclosure
- [c] a Sorbothane enclosure
- [d] a banstand

[3] What tubes are used in the analogue output stage?

- [a] a pair of 6N3 dual triode valves
- [b] a brick of KT88s
- [c] two Western Electric 300Bs
- [d] a quartet of ECC83s

[4] How did John May describe the sense of acoustic space?

- [a] "holographic"
- [b] "peerless/ferrous"
- [c] "transcendental"
- [d] "bangin"

January Competition  
*Hi-Fi World* Magazine  
Unit G4 Argo House  
The Park Business Centre  
Kilburn Park Rd.  
London NW6 5LF

## RULES AND CONDITIONS OF ENTRY

- ONLY ONE ENTRY PER HOUSEHOLD
- MULTIPLE ENTRIES WILL BE AUTOMATICALLY DISQUALIFIED
- PURCHASE OF THE MAGAZINE IS NOT A PRE-CONDITION OF ENTRY
- NO CORRESPONDENCE WILL BE ENTERED INTO
- THE EDITOR'S DECISION IS FINAL
- NO EMPLOYEES OF AUDIO PUBLISHING LIMITED, OR OF ANY COMPANIES ASSOCIATED WITH THE PRODUCTION OR DISTRIBUTION OF THE PRIZES, MAY ENTER

**entries will be accepted on a postcard only**

**OCTOBER 2005 ROTEL/B&W SYSTEM WINNER:  
Alice Picari of Leicester**



# WORLD AWARDS

David Price rounds up the year's best hi-fi products...

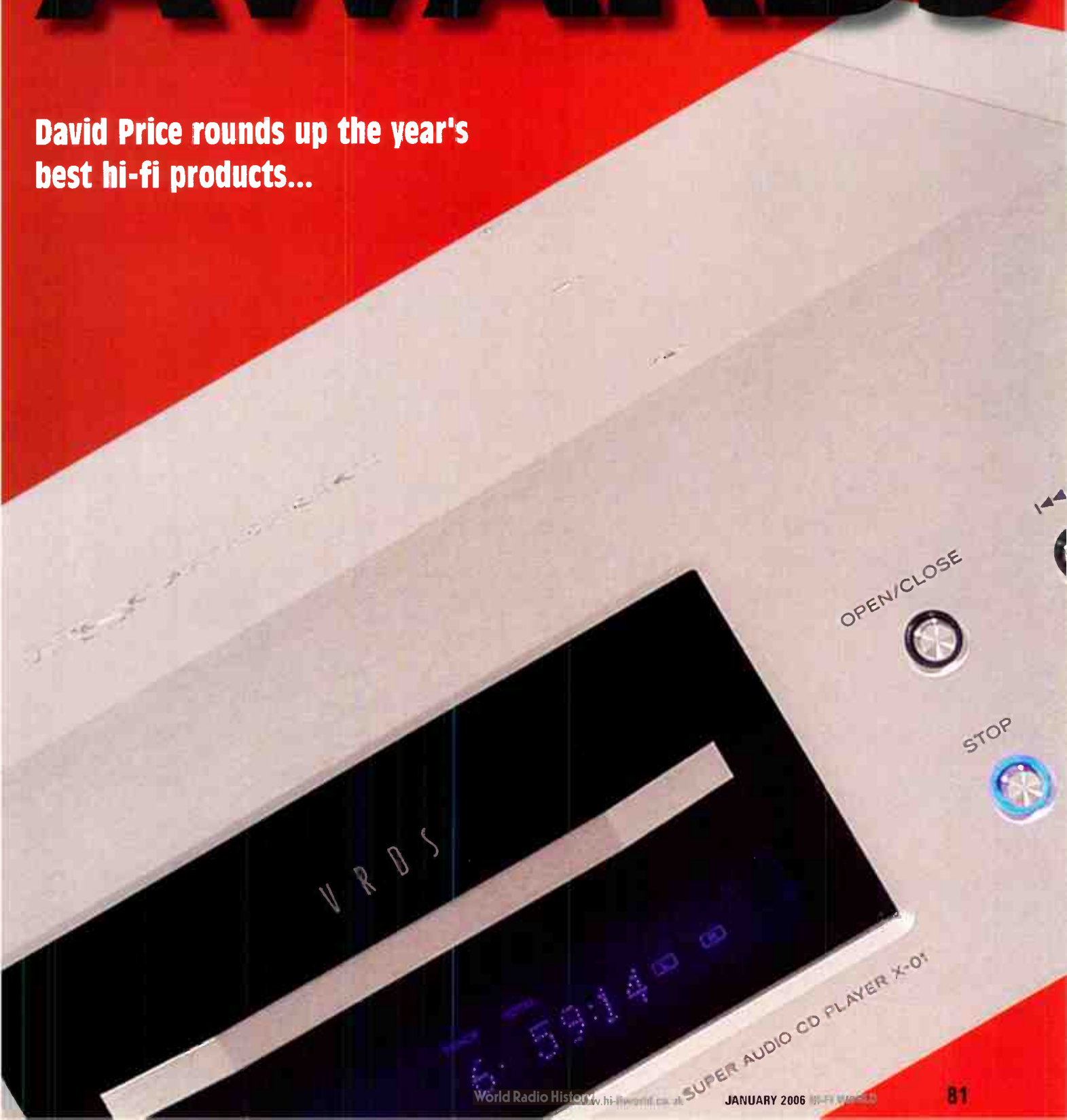

To hear the fine detail you some times need a little *muscle*

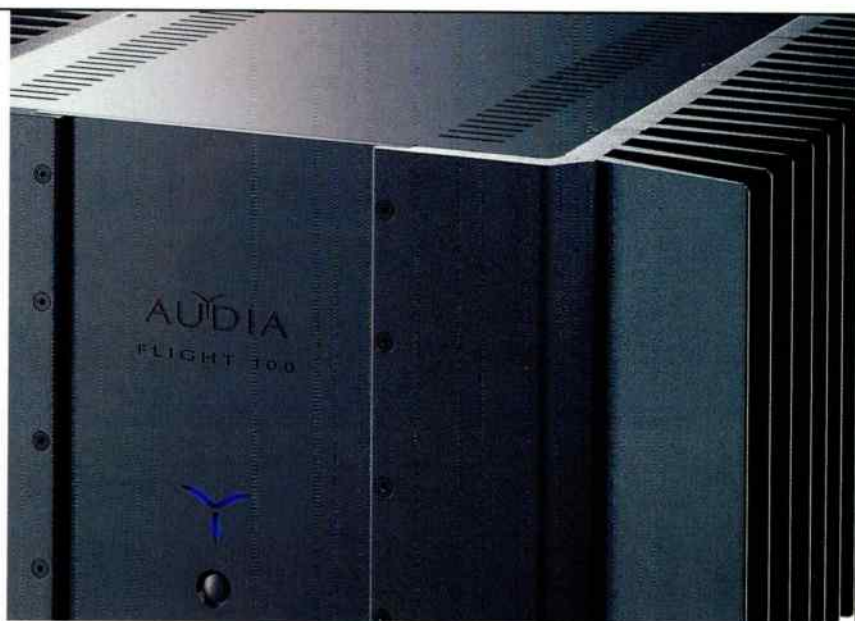

**AUDIA**



Distributed in the UK by: Henley Designs Ltd, 01235 511166, [www.henleydesigns.co.uk](http://www.henleydesigns.co.uk), [info@henleydesigns.co.uk](mailto:info@henleydesigns.co.uk)



HDMI



SOURCE



SCART



ANALOG



VIDEO

Distributed in the UK by:

Henley Designs, 01235 511166  
[www.henleydesigns.co.uk](http://www.henleydesigns.co.uk)





## TURNTABLE: REGA P5

**R**ega wrote the rule book of high performance, low cost turntables. The art of design is that of intelligent use of resources and materials at any given price point. Here, we see Rega's £698 mid-price product, a sector which allows the company to spend a little more money on the bare essentials than it can on the brilliant, class leading P3. Of course, you'll have to factor in a serious quality support table as part of your budget, but what you do get is the RB700 tonearm, which is essentially a better tolerated and specified RB300. The other thing that's upgraded from the P3 is the plinth – or rather, the surround. While the cheaper deck follows the original Rega template of fibreboard plinth sitting on 'vibration absorbing' feet, the P5 is the entry-level model in the range with a form of serious decoupling – the inner 'low mass micro fibre' (i.e. an MDF variant) plinth (450x130x360mm)

sits on a deliciously finished tubular aluminium surround. The surround is offered in silver satin or black satin finishes. The P5 sports a 15mm hand crafted, floated plate glass platter, topped by a thin felt mat, and there's a choice of power supplies – the direct 24v for the supplied 'wall wart' or a DIN socket for the new Rega TT PSU optional upgrade power supply for the P5 turntable. It's a crystal-locked low distortion sine wave generator design which isolates the motor from the vagaries of this country's AC mains supply, and also has the benefit of providing switched 33/45 RPM operation.

It is beautifully built – nothing else looks (and feels) classier at the price – and brilliantly simple to unpack and set-up. Here's one of the most musical analogue disc spinners around – it has real *joie de vivre*, an incredible sense of get-up-and-go that instantly appeals and endears. It's brilliantly fast, detailed, engaging, energetic and

bracing – no matter what music you feed it. The P5 enthral with its speed and directness. Its midband is startlingly well articulated. It's the sense of 'connectedness' you get that impresses most. Left-to-right imaging is stunning, no less. The location of all the elements within the mix is as good as I've heard from practically any turntable at any price; it's just so strong, so positive, so focused. Next most apparent is the pace and timing – the P5 just gets right into the groove and bounces along at a blistering pace. It's also great dynamically too – not the best in absolute terms of course, but it's the 'microdynamics' that are so confidently carried that gives an almost mastertape-like sense of 'being there', of witnessing a musical event first hand, rather than having it described to you some time after the fact. Put pithily, the Rega really rocks. At just £698, this is an audiophile bargain of great proportions.

**CONTACT:**  
Rega Research  
01702 333071  
[www.rega.co.uk](http://www.rega.co.uk)

# marantz® PREMIUM SERIES



*As the EISA jury explained: "The New PM-15SI proves Marantz is still a serious force in audiophile two-channel music equipment. Luxury touches include a shimmering solid-aluminium fascia. Advanced technology includes an accurate electronic volume control. And thanks to a unique four-way stacking option, with central channel steering, the PM-15SI is ready and willing to lend its natural, powerful sound to movies as well as music. It completely justifies its membership of the high class Premium component range."*

The Premium Series is exclusively available through the following authorised dealers:

#### Cambridgeshire

Audiovision, St Neots: 01480 471202

#### Cheshire

Sound of Music, Crewe: 01270 214143

#### Cumbria

Peter Tyson, Carlisle: 01228 546756

#### Derbyshire

Superfi, Derby: 01332 360303

#### East Sussex

Adams & Jarrett, St. Leonards-on-Sea: 01424 437165

#### Guernsey

Teleskill AV Ltd: 01481 722323

#### Hampshire

Sevenoaks Sound & Vision, Southampton: 02380 337770

#### Humberside

Manders Hi-Fi, Grimsby: 01472 351391

Sevenoaks Sound & Vision, Hull: 01482 587171

#### Kent

Canterbury Hi-Fi, Canterbury: 01227 765315

#### Leicestershire

Leicester Hi-Fi, Leicester: 0116 253 9753

#### London

Sevenoaks Sound & Vision, Holborn: 020 7837 7540

#### Manchester

Practical Hi-Fi, Manchester: 0161 839 8869

#### Middlesex

Harrow Audio, Harrow: 020 8930 9933

#### Northamptonshire

AV Land, Wellingborough: 01933 442222

Classic Hi-Fi, Kettering: 01536 310855

#### Scotland

Sevenoaks Sound & Vision, Glasgow: 0141 332 9655

#### Surrey

Sevenoaks Sound & Vision, Epsom: 01372 720720

Unilet Sound & Vision, New Malden: 020 8942 9567

#### Tyne-and-Wear

Global Hi-Fi, Newcastle: 0191 230 3600

#### Yorkshire

Vickers Hi-Fi, York: 01904 629659

[www.marantz.com](http://www.marantz.com) | Marantz 01753 680868

boec  
musi  
matt





# TONEARM: ORIGIN LIVE CONQUEROR

**O** rigin Live's Conqueror is the new pretender to the 'top tonearm in the world' mantle, and a worthy one at that.

Retailing for £2,500, it's a good bit pricier too than OL's previous flagship Illustrious, but the fit and finish is even better, and has a lovely 'camera' quality about it. I still think that, in this respect, nothing compares to an SME V, yet the Conqueror comes oh-so-close. Starting at the bearing housing, it seems similar to the Illustrious, but adds widely spaced, bespoke Origin Live-designed ceramic bearings located in a new high inertia yoke incorporating a newly developed decoupling design. Bias compensation remains the thread and weight system – although it's a tad old hat, there's no sound degrading springs to worry about, unlike the SME Series V. The arm tube is the next most obvious change – it's a new stainless steel finished ultra-

low resonance slotted design, tapering in several times, which looks (put crudely) rather like a telescopic radio aerial! Wiring is a 'high grade', with the addition of Silver Bullet plugs. The new headshell is rigid alloy with torsion webbing, while at the other end is OL's trademark 'structural' counterweight upgrade.

The top Origin Live makes music sound bigger, more natural and less processed. Over the Illustrious, there's a slight widening of that already capacious soundstage, and an obvious deepening too – and the concomitant sense of the speakers being less obviously present. There's a tad more bass control, yet it's not 'technical', but musical, in quality. There's more treble air and space, and a silkier, more natural upper mid. The arm simply seems more planted, less troubled by the physical undulations of the groove. There's more information (than the Illustrious) right across the frequency

range – tiny inflections which you couldn't quite hear on the cheaper arm become significant elements of both the mix and the song itself. You can certainly point to that tauter, tighter and ever-so-slightly stronger bass and superior treble extension, but in truth where the new OL really shines is communicating the texture – the grain – of the voices and instruments. There's an eerie sense of connectedness to the original recording, like you've pressed the focus button on your camera.

The Conqueror is a special performer and it's not unrealistic to suggest that it's one of the best tonearms yet made, benefitting from years of accumulated experience. Of course, arms are also subjective things (unipivot lovers won't care for it so much), but if you're after a truly versatile real-world tool, that's not fussy about arms, cartridges or types of music it's asked to play, then look no further.

**CONTACT**  
Origin Live  
+44 (0)2380 578877  
[www.originlive.com](http://www.originlive.com)



## CARTRIDGE: LYRA ARGO

**A**sk any analogue audiophile to name a great Japanese cartridge maker and the chances are they'll reply with the words 'Koetsu', 'Supex' or even 'Denon'. But of late, another Nipponese name has been very much in the ascendant – Lyra. Now twenty years in business, each Lyra cartridge is designed by Tokyo-based American vinyl junkie Jonathan Carr in conjunction with Yoshinori Mishima, the artisan who hand-builds each piece. The current range is thoroughly modern, using high-tech materials and built to stringent high-precision standards. Each individual cartridge is then voiced, like a musical instrument, by Mishima. Such 'hand-voicing' also allows him to compensate for variations between individual cartridge samples. The £795 Argo is the new entry-level model from Lyra. The light 6.5g body is machined from a single piece of aluminium alloy for superior rigidity, then hard-anodised. Its shape prevents the formation of variable eddy currents that would otherwise

interfere with the primary magnetic field and distort the signal generation process. There are no pole pieces inside, only two symmetrical disc magnets. The Lyra-designed Ogura line contact stylus is at the end of a low-mass diamond block measuring 0.08x0.12x0.5mm. The cantilever is solid boron rod with an extra metal reinforcement jacket. Both cantilever assembly and interior body structure were designed so that the cantilever mounts directly to the cartridge body, obviating the need for intermediate mounting methods like pole pieces or subcarriers. The 4-ohm low-impedance signal coils are wound from high-purity copper over a chemically-refined high-purity iron core.

From rest, the Argo is a little mechanical sounding, but given a few minutes to warm up this is an extremely able performer, not just at this price, but any. Anybody who knows Lyra cartridges know that they're 'thoroughly modern Moving Coils' with unusual and innovative mechanical design. Funnily enough,

this is precisely how the Argo sounds. It lacks the romance of Dynavector or Koetsu cartridges at or near its price, and can be best likened to a 'Japanese Ortofon Kontrapunkt'. By this, I mean the Lyras are extremely balanced, subtle and incisive – in a way that few similarly priced rivals can be. Wonderfully open and expansive, its soundstage is extremely wide and deep yet precisely articulated. Vocals are uncommonly direct. You get real wideband sound, stretching up from a tight and tidy bass all the way to the extended and even treble. There's an effortlessness to the midband, which is wonderfully expressive. Guitars sound raunchy and emotive, with real grain and wonderful patina to the human voice. This superb mid-fi moving coil falls comfortably between our other two favourite sub £1,000 designs (Ortofons Kontrapunkt B and C) in absolute ability, but brings more dynamic and rhythmic expression to the party. A beautifully engineered and built, yet thoroughly modern, machine.

**CONTACT:**  
Symmetry  
+44 (0)1727 865488  
[www.symmetry-systems.co.uk](http://www.symmetry-systems.co.uk)





# PHONO STAGE: NAIM STAGELINE S

**A**lthough designed for Naim amplifiers, this curious little (£205 plus PSU; see text) phono amplifier can be used with other brands providing a suitable 4-pin DIN to phono lead (which can be made up by The Chord Company, for instance) is used. It requires an external power supply (or Naim preamp) for operation. It embodies Naim's meticulous upgrade philosophy, enabling progress from the following 24vDC power supplies: i-Supply (£85), Flatcap2 (£515), Hi-Cap2 (£925) or even a Supercap (£2,775!). It comes in four factory-set options including an MM version, however this designated S type is for low output MC cartridges and is set at 100µV/470ohms. For the MC versions there is a higher specification for the first gain stage which consists of an input stage with five paralleled, low-noise transistors to achieve the required low noise and high gain. The Stageline S is housed in Naim's bluff and solidly constructed aluminium

57x121x187mm casing which has a continuous outer sleeve that the circuit board slides into. The front panel is thick and gently curved, replete with shadow band, which separates it from the main case and is a nice design detail.

At the rear it has two DIN sockets for power-in/ signal-out along with a set of very high-quality braced gold-plated phono signal-in sockets and ground connection. I tested the Stageline S with two power supplies, the new low cost i-Supply and the more expensive Flatcap2. The i-Supply is at Naim's new entry-level PSU, available in three variants designated h, i and s. Externally it is a 57x12x77mm plastic box weighing in at 900g with a captive mains cable on one end and a fixed 240° 5-pin DIN plug suitable for connection to a Stageline (s) on the other.

The £290 i-Supply Stageline S combination has the familiar Naim structural discipline with timing and grip alloyed to superb resolution. It has powerful impact and a sense of

almost complete unflappability. It isn't as immediately emotional or poetic as some rivals but isn't fussy either, handling dynamics very well without ever straining with forceful orchestration swings or a musical break when the tempo changes.

The £715 Flatcap2 Stageline S takes the disciplined, unflappable efforts of the already good i-Supply and additionally embraces the poetic and emotional delivery to even higher standards. And it does so within the famous Naim sound – grip, resolution and timing. It is dynamic without resorting to a monochromatic musical stance. Compared to the i-Supply Stageline S, it initially sounds slower but this is not the case upon further listening, as it proves broader, deeper and quieter, revealing depth, texture and body to instrumentation.

As any user of a Naim preamplifier (classic or modern) knows, the standard phonostages are superb, and the Stageline brings them to a broader audience in an extremely cost-effective way.

**CONTACT:**  
Naim Audio Limited  
+44 (0) 1722 332 266  
[www.naim-audio.com](http://www.naim-audio.com)

# Our Motives are clear



[www.neat.co.uk](http://www.neat.co.uk)

01833 631021

neat acoustics

music sounds better **neat**



MICHELL ENGINEERING

## The Michell Odyssey 2004

Limited Edition Turntable

Based on the classic Gyrodec, the Limited Edition Michell Odyssey 2004 will be produced in a numbered series of just 100 pieces supplied in an all black finish, with a black acrylic base, added clear acrylic spyder to give a second level of isolation. The signature weights are in a nickel silver finish. The turntable comes complete with record clamp, black TecnoArm "A", and matching black HR Power Supply. With its striking finish, attention to detail and outstanding sound quality it will only be a short period of time before the 100 units are snapped up.



MICHELL ENGINEERING

J A Michell Engineering Ltd  
2 Theobald Street, Borehamwood,  
Hertfordshire, England, WD6 4SE

Telephone: 020-8953 0771

Fax: 020-8207 4688

[www.michell-engineering.co.uk](http://www.michell-engineering.co.uk)







# CD PLAYER: ESOTERIC X-01

It is not everyday that we at *Hi-Fi World* review a digital disc spinner retailing for £8,995. but the Esoteric X-01 is not an everyday digital disc spinner. For many years now, unbeknownst to most of us here in the UK, TEAC has been making some dramatic high end designs under the guise of 'Esoteric', mostly for home market consumption. TEAC's Vibration-free Rigid Disc clamping System (VRDS) transport first appeared on 1987's P-10/P-1/X-1 models, and ran through the seminal P-0/P-0s (1997) which was described in its native Japan as probably the best CD drive ever. Now in 2005 we have the VRDS-NEO mech inside the Esoteric X-01 SACD/CD, which – significantly – is the first SACD capable VRDS mechanism, developed as "TEAC's flagship 50th anniversary product". Unsurprisingly perhaps, the Esoteric is a beautifully constructed, well-crafted yet refreshingly simple design which

lends its 442x153x353mm bulk (plus considerable 25kg weight and gorgeous platinum finish) a clean and at-ease confidence in any setting. The engineering is clear and lucid; there are no 'specially modified' delusional claims made about bolt-on plates, tuning or pseudo reinforcement to cheap OEM transports here. It is formed from two very thick, complexly machined sidewalls which house most of the transport components and is stiffened above by a massive bridge unit across them which is made of 20mm thick SS400 steel. Esoteric engineer Kazutaka Tsuda told *Hi-Fi World* that the X-01 uses four (Burr Brown) DAC PCM1704 chips in each left and right channel.

The listener is greeted with an supremely sophisticated treble, which lights up the music with stunning resolution. The sound is subjectively so low in distortion that the Esoteric has complete control of the rhythms, while

bass is deliciously tuneful, eliciting stunning definition and extension. There is incredible control of a multilayered midband. The Esoteric separates divergent elements with ease, procuring excellent timing and thus a better musical appreciation without once bringing attention to the technology or instrument used. The Esoteric's treble is sophisticated without being silky, smooth or sweet – rather it is simply truthful, allowing huge amounts of light into the music (when present) and is complex enough to have many different shades that illuminated the music properly. The sound is huge, powerful and spacious. This is an ultra high-end hi-fi instrument – and looks, feels and sounds it. It boasts a level of engineering and finish to shame any supercar, plus nigh on peerless sound on CD and SACD. This digital *tour de force* belligerently raises two fingers up to its price rivals. Surely one of the best silver disc spinners money can buy?

**CONTACT:**  
Esoteric  
(TEAC Corporation) UK  
+44 (0)1727 865 488  
[www.symmetry-systems.co.uk](http://www.symmetry-systems.co.uk)

# TUBE SHOP.COM

## WHAT'S HOT AT THE TUBESHOP



GOLDEN DRAGON

They're now considered essential as far as I'm concerned, and bring a new meaning to the term "Simply the best!"

Roy Gregory - Hi-Fi+ magazine



Tube Rings  
by Duende Criatura

## WHAT'S COOL AT THE TUBESHOP



Cryogenically treated tubes really make a difference!

Read all about it online:

[www.cryogenictubes.com](http://www.cryogenictubes.com)



WWW.TUBE-SHOP.COM  
OR CALL US 0870 9220404

THE LARGEST SELECTION OF QUALITY TUBES ONLINE

# icon Audio New Models!

## Stereo 60

KT88 Integrated 2x 65w rms  
Brand new UK design  
ALL TRIODE Push-pull driver  
Stage. Triode mode 2x 30w  
Choke regulated PSU.  
Remote control. Four inputs  
plus tape loop.  
Huge transformers (weight 33kg)  
From £1,299 inc valves  
(Upgrades available)



icon Audio Stereo 60

## Stereo 300

300B Integrated amplifier  
Full 2x 35w rms  
UK Designed  
Remote control  
ALL TRIODE driver stage  
Choke regulated PSU  
Four inputs plus tape loop  
Huge transformers (weight 35kg)  
From £1,599 inc valves  
(Upgrades available)



icon Audio Stereo 300

## LA4 Line pre-amp

Valve rectification.  
Twin choke smoothing.  
All triode design  
Remote control  
Four inputs plus tape loop  
DC heaters  
High and low level output  
Stunning looks  
From £649.95 complete



icon Audio LA4 Line Pre-amplifier

## PS 1 Phono Stage

High output, with level control  
Will drive most power amps!  
All valve, all triode, no feedback  
Passive RIAA. Custom British moving  
coil TX option. Choke regulated  
smoothing. Separate power  
supply. 9kg. Upgrades available  
From only £399.95 complete



## Stereo 40i Classic

Upgraded design  
Choke regulated power supply  
3 inputs, plus tape loop  
Triode switching (20 watts)  
45rms watts x 2 (KT88 version)  
All Mullard NOS driver option  
**Still from only £899.95**



Stereo 40i Classic

- Other models available, see our website or ask for a leaflet
- Designed in Leicester UK
- Wide choice of valves: Inc, Mullard, JJ, EH, Svetlana, Sovtek
- Each amp carefully commissioned & tested in Leicester
- All supplied with beautiful valve covers
- Part Exchange facility for your old equipment, ask us!

Features: Hand built 'Point to Point' wiring. No printed circuit board. ALPS Volume control. Gold plated terminals. Audiophile components by Solen, Rubicon, Silver audio cable. Steel & alloy plate construction. Soft start. Unique HT delay. Comprehensive manual Inc DIY valve change info.

Buy with confidence. Established UK Company. Proven reliability. Unbeatable advice & back up service. Try for 30 days, refund if not delighted\*

For more info visit our website at [www.iconaudio.co.uk](http://www.iconaudio.co.uk)

Or ask for an Illustrated Leaflet Auditions by appointment.

Phone 07787 158791 Email [sales@iconaudio.co.uk](mailto:sales@iconaudio.co.uk)

**icon Audio** 351 Aylestone Road Leicester LE2 8TA

\*Conditions apply

Visa and MasterCard accepted

CE marked





# UNIVERSAL PLAYER: ONKYO DV-SP1000E

**G**reat names come and go in hi-fi, and Onkyo's did precisely this. Once one of Japan's audiophile Royal family - up there with the likes of Luxman and Nakamichi - it fell from grace for years, until 2005 when several serious products showed a real return to form. The DV-SP1000E is one such example, a £2,800 behemoth that measures 435x123x374mm and weighs 12.1kg. It is constructed using a four-part anti-resonance heavy-gauge reinforced-steel internal chassis. The central chassis is compartmentalised into separate sections, including beautifully crafted solid brass feet. The chassis is then stiffened by top plate, front plate and nicely extruded and profiled side sections, all made from 'aircraft-grade' aluminium. Internally, the Onkyo's elaborate chassis construction makes sense with Wolfson 192kHz/24-Bit DACs and a set of dual high-purity, heavy-gauge, shielded cables to directly output digital or PCM bit-streams from the disc to the back

panel from the two sets of optical and coaxial digital outputs at the rear. For the power supply, there is a large shielded Onkyo 'High-Power Transformer' and separate board with oversize electrolytic capacitors connecting to the IEC socket at the rear. The Onkyo has an excellent video specification, as PAL (576i) and NTSC (480i) DVDs can be enhanced using 'Opus FlexScale' where you can experience HD level 720p and 1080i, thus eliminating the need for costly external scalars. For multichannel and stereo audio, there's a Video circuit off button, plus Display control button and phono outputs for 5.1 and stereo analogue downmix. In use, it feels one of the slickest machines around; second only to the £9,000 Teac X-01 in our humble opinion.

DVD universal players are, by nature, compromised. They can never deliver ultimate performance with music, so the question is how well the machine works as an all-rounder. This is where the Onkyo betters any price rival we've heard. It sports a superbly three dimensional

musical vista, with both vocals and instruments revealed in an utterly convincing and realistic presentation. There's a solid rightness to the pace and rhythms of the Onkyo with brilliant musical timing and fine instrumental timbre. Tonality is stunning for a universal machine, instruments being allowed to resonate and reverberate in naturally enveloping three-dimensional forms around the listener. Strings have a radiant tonality, nicely expressive and multi-layered, containing delicacy, timing, timbre and excellent instrumental decay. Resolution of the instruments and the musical structure is first-rate. Those unfamiliar with the brand will be delighted to discover the superlative Japanese construction quality too. Considering it is a universal player, it's exceedingly musical with fantastic timing. Factor in the excellent video, slick operation and a 'modest' (for high-end) price, and the Onkyo DV-SP1000E surely represents the state of the art in do-it-all digital disc spinners.

**CONTACT:**  
Onkyo  
+44 (0)1494 681 515  
[www.onkyo.co.uk](http://www.onkyo.co.uk)

# *The colouration's in the finish*



# *Not in the music*







# INTEGRATED AMPLIFIER: SUGDEN A21SE

**S**ugden's evergreen integrated amplifier has always been an extremely focused product that sounds like nothing else on the market. Most people, who've never heard pure Class A operation, believe it to be super-smooth and 'valve-like', but Sugden's superlative implementation is neither. Rather, it resides in a magical 'other world' of glass-clear, incisive and neutral-to-a-fault amplification. Trouble is, the '21a' is an extreme product; care has to be taken when matching it to loudspeakers. It doesn't like anything that's tricky in the load department and nor does it suffer inefficiency gladly. The new £1,995 A21SE addresses these issues at a stroke, making one of the most musical sounding integrated amplifiers ever made. It brings increased output power, wider bandwidth, reduced distortion and greater load tolerance to the party and adds remote volume

control, relay switched input signals and a completely new casing. The completely new line stage amplifier with a cascode input stage, current feedback, with the input and output in phase is said to give all the benefits of high input impedance, high voltage gain in its first stage, low distortion with wide bandwidth, low noise and very low output impedance. The line stages are supplied by their own current shunt power supplies driven by a separate transformer winding. Result: thirty fairly weak kneed watts of sheer sonic bliss.

The clarity and musical ease of the A21SE has to be heard to be believed. It's very, very close to the 'a' in nature, but offers substantially more real-world driving power, meaning it's less at the mercy of unforgiving loudspeakers, which in turn allows the essence of the A21 sound to flood out, untempered and untrammelled. The first thing that strikes you is the tonality – or

lack of it. It makes almost any other transistor amplifier sound fuzzy, mushy, woolly, grey and compressed. It also makes them appear clumsy and unwieldy, with a surfeit of power but no useful way of exploiting it. The A21SE is, by comparison, beautifully balanced, fleet of foot and finessed, yet an extremely potent tool despite its lack of shove. The interesting thing is that, despite a paucity of absolute power, it's able to go from super quiet to very loud with dizzying speed. Dynamics are amazing, breathtaking even. Rhythmically and dynamically then, it's a revelation, and I've never heard an amp at this price that has such breathtaking clarity. However musically brilliant it may be, you'll have to partner it carefully and forgive it its lack of silky precision when you use the volume knob. With nearly all of the strengths of tube amplifiers and few of their vices, this is arguably the ultimate audiophile integrated amplifier.

**CONTACT:**  
J.E.Sugden & Co Ltd.  
01924 404088  
[www.sugdenaudio.com](http://www.sugdenaudio.com)



# POWER AMPLIFIER: TACT SDA2175 (now LYNGDORF AUDIO)

**C**lass D 'digital' amplification had a troubled birth several years back; it sounded acerbic and unpleasant, despite the obvious benefits of high power output and low running temperatures (the output stage turns 95% or so of the power it consumes into audio energy). Tact's early products were the obvious exception to the rule, and now – as Lyngdorf Audio – the company is romping along with a new generation of more affordable products such as this, the 'semi-digital' SDA2175 at a mere £775. Class D digital amplifiers produce so little heat they need little heatsinking. The SDA-2175 is a good example; it has shallow heatsinks down either side just 1cm deep, yet under test this amp swung a massive 220W into 8ohms and 360W into 4ohms - and barely got warm! At 15.5kgs the unit is heavy, but at 450mm wide it's reasonably compact

for such high power. This product measures superbly; there was no sign of crossover distortion right across the audio band and spectrum analysis showed third harmonic always dominated, and not only did the SDA-2175 completely avoid the sins of the standard analogue output stage, it also showed no signs of transfer function skewing with level, load or frequency changes. This means it will not change its dynamic characteristics, imposing a modulation pattern upon the distortion it produces. So this is one incredibly consistent and stable amplifier in terms of its dynamic characteristics.

The SDA2175 is uncannily smooth, amazingly well proportioned (in a sense, 'architectural') and brilliantly insightful. It has tremendous detailing, and an eerie ability to let one strand of the mix not interfere with another. Its treble is silky (like Japanese high end) and spacious, its

midband epitomises the notion of 'glass clear', bass is strong and tuneful. It goes loud effortlessly, shows no sign of strain at any level and is always genteel and finessed, even when the preamp volume knob is wrecklessly wielded. At the price, I have heard nothing that approaches this blend of competencies - it is truly unique in this respect. However, it will still not be everyone's cup of tea, as the sound is so refined, even handed and essentially flawless that you're left wanting a touch more 'raunch' and emotional commitment (that special 'spark of life' that the Sugden A21a has in spades). Ultimately though, it's churlish to complain, because the SDA2175 is so much more capable than any of its price rivals in most respects. Indeed, only those seeking a conspicuously characterful sound should look elsewhere. As such, the splendid Lyngdorf Audio SDA2175 power amplifier gets the gong.

**CONTACT:**  
Lyngdorf Audio UK  
08709 100100  
[www.tactaudio.co.uk](http://www.tactaudio.co.uk)





# LOUDSPEAKERS:

## MISSION e82

**S**peaker sound is so much a matter of personal taste, and invariably heavily room dependent. Mission's e82 floorstanders are a case in point: when Dominic Todd reviewed them several months back, he was unwilling to give them the full five globe rating, much to Mission's chagrin. Investing inordinate amounts of time and effort in coaxing the best from most speakers often returns very little, but 'twas not so with the e82s. They got better and better, so much so that recent re-evaluation – plus a starring role in December's Group Test reference system – has seen them nose past the finishing line just ahead of the best of the rest. Whatever your proclivities, aesthetic and/or sonic, there's no denying that these are mightily impressive loudspeakers when suitably set-up. Look past the superbly applied lacquer and you'll find an equally well-finished cabinet, tapered to break up standing waves and increase rigidity. Speaking

of which, the Mission rates remarkably well here. What Mission call a "Grania", enclosure turns out to be constructed from several layers of MDF and fibreboard, of various grades, all sandwiched together. The differing materials all work to effectively damp the sound at different frequencies, with even the glue used playing its part. In addition to this, a vertical brace strut and several ring braces ensure this has to be one of the most rigid 'speakers in its class. Mission uses a d'Appolito configuration, whereby the treble unit sits between the mid range and bass drivers. The former is from "Viotex" synthetic, the latter being a fibre polymer matrix and lacquer coating ("Paramid") design. Although small in size, Mission claim that the combined surface area of the four bass units equals that of a 10" cone.

Being a tall, slim tower design, it's not like the e82s were ever going to have swingeing, seismic bass. Rather, Mission has done what Mission do

best, which is to make a speaker designed to work in real, boomy rooms with all sorts of domestic imponderables to content with. Properly fettled (on the end of a decent tube amp power amp, for example), they turn in a stunning performance for the price. Missions have a traditionally 'forward' and engaging sound, and the e82s follows the trend, but adds finesse, depth, dimensionality and superlative soundstaging to the vim and vibrancy. Rhythmic insight is excellent at the price; that taut and tuneful bass really pushing rock and jazz music along, yet despite their bracing and upfront character, they're genuinely couth in a way that belies their price tag. Even at high levels, where rivals stumble and fall, the Missions keep their lids on - with panache. Overall, these are an excellent real world loudspeaker. Give them time, love and tenderness, and you'll find them a true affordable audiophile loudspeaker, if there ever was such a thing.

**CONTACT:**  
Mission UK  
+44 (0) 1480 423700  
[www.mission.co.uk](http://www.mission.co.uk)

# GIVE YOUR SENSES A BREAK!

## GET YOUR HANDS ON SOME OF THESE....



### PRIVILEGED TICKET

**YOUR ALL IN ONE SAVER!!**  
Northern Sound & Vision Show  
Now back for it's 7th year.

**SAVE £3 ON YOUR ALL IN ONE SAVER!! (£8 on the day)**

**ALL DAY PARKING CONCESSION**

**YOUR EXCLUSIVE SHOWSHOP PASS**

**FREE MAGAZINE & PROGRAMME**

**SHOW TIMES**  
Sat 28th Jan: 10.00 - 5.00  
Sun 29th Jan: 10.00 - 4.00

**GREAT ACCESS.** Shuttlebus from Show Carpark. 7 minutes walk from Rail & Coach Terminal, all undercover. Direct access from Terminals 1-3.

### PRIVILEGED TICKET

**SAVES YOU £3**

This ticket is valid for both days  
**KEEP THIS STUB SAFE**  
Good access for the disabled  
**MORE TICKETS?**  
Call us, email us, download from our website, call at any participating dealer, avforums or even photocopy.

### ALL DAY PARKING CONCESSION

**JUST £5**

See over for full details

### CAR PARKING TICKET

Not valid unless stamped

### SAVE £100

Building of the show...  
200...  
of ab...  
s...  
the se...  
on t...  
or b...  
in...  
every...  
discount...  
most prod...  
known bra...  
There are e...  
lines, clear...  
demo stock...  
in fact someth...  
everyone. See...

In conjunction with  
**AVForums**  
www.avforums.com the UK's most popular AV website

# Northern Sound & Vision 2006

The Quality Home Entertainments Show  
Radisson SAS, Manchester Airport  
**28 - 29 January 2006**

## The Northern Sound & Vision Show

28-29 January 2006  
**7th YEAR**

The only UK venue with direct undercover access by Plane, Train & Coach.  
**Plus 2 minute shuttle bus service from our reserved carpark.**  
The biggest show outside of the South.  
**Mega Showshop, Best Sounding Hotel, Everything that's high quality Home Ents.**

**The Heathrow High Fidelity Show**  
1-2 April 06  
Park Inn, Heathrow

**Scottish Sound & Vision**  
New Technology  
2 Day ShowShop  
October 7-8 2006  
Radisson SAS, Glasgow

**TRADE ENQUIRIES?**  
At the time of going to press there was a very limited amount of space remaining - ring us immediately for details.



The UK's only High End Show  
**NOW IN ITS 6TH YEAR**

Scotland's own show  
**NOW IN ITS 5TH YEAR**

\* From most sponsoring dealers, our website, email, fax us or the dog & bone.  
As many as you want - bring a friend - tickets valid for both days.

**Chesterfield Communications**

T: 01829 740650 F: 0845 280 0065  
E: roy@chestergrp.fsnet.co.uk www.chestergroup.org





# HEADPHONE: STAX SRS-4040 SIGNATURE II

**W**ho'd be a headphone wearer? Well, DJs like them (for obvious reasons), as do people in small flats or terraced houses, with late night listening habits. But for most, they're a flawed compromise designed to placate problems elsewhere, rather than an uplifting aural experience. Well, even the most ardent loudspeaker lovers may find Stax's SRS-4040 Signature IIs even better than the real thing... Stax only makes headphones – and they are supremely comfortable. They weigh just 295g plus cable, which is a brilliant 'wearability' enhancer... The SRM-606t Driver Unit's champagne gold front panel boasts a dual-gang volume control to the right, with one power On/Off switch and two input switches to the left. Immediately underneath are three five-pin ear-speaker outputs. Round the back,

there are two pairs of RCA ins, a ground, one pair of outs and one pair of XLR ins, plus the usual IEC power input. The SRM-006t now features a Class A tube output stage (6FQ7/6CG7) working with a low noise dual FET input, the amplifier using pure balanced DC configuration – ideal for those high end Japanese CD and DVD players with their balanced XLR outs. It gives 60dB of gain with 300V R.M.S. (1kHz) output voltage for the electrostatic panels of the earspeakers.

The 4040 package doesn't sound like any other headphone. There are obvious reasons for this: electrostatic panels have superb response times (due to the lightness of the diaphragms), and in the 4040s they are very well implemented... Probably the cleanest sounding headphones I've heard, the Staxes are supremely natural. Of course they're precise, but don't confuse precision with dissipation - they play what comes

into them with eerie insight, as if a grimy window has been forced open to reveal the bright, brilliant sunlight outside. It's utterly addictive and compellingly enjoyable; all of a sudden, you've got this magical shortcut to your favourite recordings, and you start attacking your record or CD collection in earnest. The brilliance of the Stax 4040 package is that despite the sharp relief it throws on the deficiencies of your power amp and loudspeakers (rendering them irrelevant), it's never punishingly analytical. You never feel discomfort, or the sense that you're listening to the music because you want to hear all that new detail. Rather, despite that technical insight, you listen because you want to get into the music. Like the record label of the same name, the Staxes have soul. You'd need to spend nigh on £10,000 to buy power amplification and speakers capable of similar musical insight.

**CONTACT:**  
Symmetry  
+44 (0)1727 865488  
[www.symmetry-systems.co.uk](http://www.symmetry-systems.co.uk)

# kit & component suppliers

## COMPONENT SUPPLIERS

### Audio Synthesis

PO Box 50 Nottingham, NG9 1DX.  
Tel. 01159 224138 Fax. 01159 229701. Email  
salesinfo@audiosynthesis.co.uk. Website  
www.audiosynthesis.co.uk

VISHAY BULK FOIL RESISTORS - unquestionably the world's finest resistor for audio applications. Thousands of VSRJ 0.3W 300V 5ppm 1% values in stock at the lowest possible prices eg. values up to 20K at £3.50+vat.

HIGH PURITY SILVERWIRE - Teflon insulated >99.99% purity, 0.6mm and 1.0mm diameter. Ideal for internal wiring, interconnects or speaker cables.

### Audio-Links

7 Fairmont Crescent,  
Scunthorpe,  
North Lincolnshire, DN16 1EL  
Tel: 01724 870432

Fax: 01724 875340

Email: [audiolinks@ntlworld.com](mailto:audiolinks@ntlworld.com)

Extensive stock of specialist audiophile components for valve and solid state enthusiasts. Supplier of the largest range of high-end audio volume controls in Europe. 30 page catalogue - Free via e-mail or £3.00 posted.

**Noteworthy Audio Limited,**  
36 Buckingham Street, Aylesbury,  
Buckinghamshire, HP20 2LH

Tel: 01296 422224

email: [info@noteworthyaudio.co.uk](mailto:info@noteworthyaudio.co.uk)

web: [www.noteworthyaudio.co.uk](http://www.noteworthyaudio.co.uk)

Suppliers of a selected range of audiophile valve kits and components. Including the Stoetkit range of valve amplifiers, Audio Note one times oversampling Dac Kit 1.1 and Lowther drive units. Plus a range of components and accessories from Eichmann, Furutech, Wonder Solder, Caig and many more. For a list of the extensive range of manufactured products and the special offers we stock please see our website or call for details. We are open from 9.30 to 5.30 Tuesday to Saturday, with demonstration stock of our kits available - please call in advance to book an audition.

### White Noise

11 Station Road, Bearsden,  
Glasgow, G61 4AW

Tel: 0141 942 2460

Fax: 0141 587 7377

Email: [david.white38@ntlworld.com](mailto:david.white38@ntlworld.com)

www.wnaudio.com

Supplier of the widest range of standard and audiophile kits for solid state preamplifiers, power amplifiers, headphone amplifiers, power supplies, MM/MC phono stages, active crossovers, balanced i/o modules, and stepped attenuators; more kits in the pipeline. All kits use the highest quality, glass fibre, solder masked, silkscreened, PCBs. We also supply a wide range of active (esp. Japanese transistors and Exicon mosfets) and passive components, gold plated connectors, and silver plated wires. Write, phone or email for a free catalogue. Mail order only.

### Audiocom Int. Ltd

Unit 14 Pier Road, Pembroke Dock,  
Pembrokeshire, SA72 6TR

Tel: 01646 685601 Fax: 01646 685602

Web: [www.audiocominternational.com](http://www.audiocominternational.com)

E-mail: [info@audiocominternational.com](mailto:info@audiocominternational.com)

Extensive range of audio passives and active components including DACT, Black Gate, Sanyo, Elna & Vishay. We are the manufacturer and sole distributor for Superlock 3 master clock & Invisus discrete regulators. Visit our online store for pricing and information. Secure online ordering available.

## LOUDSPEAKER KIT SUPPLIERS

### IPL Acoustics,

Chelsea Villa, Torrs Park,  
Ilfracombe, North Devon, EX34 8AY

Tel/Fax: 01271 867439

Please visit website for full catalogue of products:

[www.iplacoustics.co.uk](http://www.iplacoustics.co.uk)

IPL supply a range of 7 high quality transmission line speaker kits, and a full range of Hi Fi and AV speaker kits, including 2 active subwoofers. Drive units are available from Audax, Seas, Morel, Legend (Ribbon Tweeters), and IPL custom built metal coned drivers. IPL also supply: quality capacitors, inductors and cabinet accessories, including Silver Plated PTFE insulated cables.

### WILMSLOW AUDIO

50 Main Street, Broughton  
Astley, Leicester, LE9 6RD

Tel: 01455 286603

Fax: 01455 286605

Email: [sales@wilmslowaudio.com](mailto:sales@wilmslowaudio.com)

Website: [www.wilmslowaudio.com](http://www.wilmslowaudio.com)

Contact us for a copy of our FREE Full Colour Catalogue or visit our Website with secure online ordering.

The UK's largest supplier of loudspeaker kits, drive units and components.

We also have a range of subwoofer kits and amplifier modules available.

Official UK distributor for ATC, Morel, Peerless, Scan-speak, Seas, Vifa and Volt.

Beware of imitations, we only stock drive units made by the genuine manufacturers. We offer a full repair and upgrade service on most makes of loudspeakers.

## VALVE AND OUTPUT

### TRANSFORMER SUPPLIERS

#### Watford Valves

3 Ryall Close, Bricket Wood,  
St. Albans, Herts, AL2 3TS

Tel: 01923 893270 Fax: 01923 679207

Specialist in new old stock and current production valves. Sole UK distributor of the Harma Diamond range selected for their superior performance. Huge range held, stockists of Mullard, GE, Philips, National, Brimar, Sylvania, Telefunken, RCA, MOV and many more. All valves are new boxed and guaranteed. For free price list and specialist advice call or fax Derek Rocco, Watford Valves.

### Chelmer Valve Company Ltd

The Stables, Baddow Park  
Great Baddow, Chelmsford, Essex,  
CM2 7SY

Tel: 01245 241300

Fax: 01245 241309.

Email: [sales@chelmervalue.com](mailto:sales@chelmervalue.com)

Web Site: [www.chelmervalue.com](http://www.chelmervalue.com)

Premium range of audio valves, tested/selected for low noise, hum, microphony; power valves burnt-in. Huge stock of valves/tubes of all type, audio valves (inc. NOS types), industrial etc. Also large stocks of semiconductor. Many obsolete types.

### Billington Export Ltd

1E Gillmans Trading Estate  
Billingshurst, West Sussex RH14 9EZ

Visitors by appointment only

Fax: 01403 783519

E-mail: [sales@bel-tubes.co.uk](mailto:sales@bel-tubes.co.uk)

Web: [www.bel-tubes.co.uk](http://www.bel-tubes.co.uk)

Guaranteed new/old stock CRT's for audio & industrial use Vintage types including Mullard, GEC, Telefunken & RCA. Large stocks of Chinese & Tesla. Major stockists of the Billington Gold brand. Free catalogue on request. Attractive prices on large orders. Minimum orders £100.00

## MODIFICATION SERVICES

### Audiocom Int. Ltd

Unit 14 Pier Road, Pembroke Dock,  
Pembrokeshire, SA72 6TR

Tel: 01646 685601 Fax: 01646 685602

Web: [www.audiocominternational.com](http://www.audiocominternational.com)

E-mail: [info@audiocominternational.com](mailto:info@audiocominternational.com)

Upgrade services available for all CD, SACD & DVD players. With our latest products we are able to advance CD playback way beyond what 'stock' players are capable of resolving. Our extensive knowledge base and upgrade techniques make us world leaders in digital upgrades. Various upgrade solutions are available to suit your budget and desired performance.

## REPAIRS & RESTORATION

The UK's Leading Service & Restoration Specialists. Repairs/Restorations to Modern/Classic/Vintage valve hi-fi, musical and cinema amplifiers, control units etc. We will even build that kit for you or design something special. Please visit our Website at:

[www.audiolabs.co.uk](http://www.audiolabs.co.uk) for complete details of our comprehensive services. Alternatively, contact us at:

**Audio Laboratories (Leeds)**

3 Kildare Terrace Industrial Estate Leeds

LS12 1DB UK

Tel/Fax +44 (0)113 2440378

### Arkless Electronics.

Tel. 01670 829891

E-mail: [arkless.electronics@btinternet.com](mailto:arkless.electronics@btinternet.com)

Specialist in repairs, restoration and modifications to all amplifiers, valve or solid state, ancient and modern. Design service for companies and hobbyists. Amps, preamps, phonostages, active crossovers, psu's etc custom built to order. Kits built/debugged. Please enquire for any other services. Ex design engineer for well known hi-fi companies.



# mail

Visit our website at [www.hi-fiworld.co.uk](http://www.hi-fiworld.co.uk) or send your emails to [letters@hi-fiworld.co.uk](mailto:letters@hi-fiworld.co.uk). Letter of the month wins a pair of Precious Metals interconnects and one year's FREE subscription to Hi-Fi World.



## Letter of the Month

### BIAS ADJUSTMENT

I am an avid reader of the hi-fi press from Australia, the USA and the UK, and one of the things that I long ago noticed was that the Yanks and Aussies were unbiased and neutral in their reviewing of equipment from all over the world versus their own; but unfortunately the same could not always be said of the Brits. There is an incredible array of terrific hi-fi gear from countries such as Japan, the USA, Australia, the UK, Sweden, Denmark, Italy, Canada, etc, and it deserves to be reviewed on its merits, and not just its location.

My gear now is principally Japanese in the electronics area (Denon and Rotel amps, Denon universal CD players, Yamaha CD player, Denon tuner), the speakers are Australian (ER Audio electrostatics from Perth - the best speakers that I have owned), Swedish and Canadian, but alas alack, nothing British. I have reviewed a lot of very good (and some not so good) British gear over the years and did own a Rega Planar 3 turntable, and have some Brit speaker cable, but that is about it.

I think that the reasons for this hinge on the fact that a lot of the Brit gear was and is expensive, is underpowered amplification-wise for our larger living rooms, and the speakers have not really sounded big enough (or were too directional) for my liking. There are of course exceptions; I would love to own a pair of the top of the range B&W Nautilus loudspeakers, but they are just too expensive for my pockets.

Once again, thanks just not for the editorial, but also the redress through the very interesting reviews!

Jim Nylander

I'd agree with you Jim. American and Australian (etc.) mags - or their writers - were less biased, or nationally neutral we could say, than the Brits. I had to suffer the Dark Age, the 1980s, when valves and anything other than a belt drive could not be mentioned for fear of

not being used again as a reviewer by the established press. It was a very censorious environment, maintained by a small coterie of individuals, carriers of the faith as they saw it. Strange and vaguely ludicrous ideas were prominent, and good basic theory ignored. So, for example, all the problems of early digital got little or no mention, but a green pen applied to a CD made all the difference, whilst the wonder of belt drive and the sprung subchassis pushed all else aside. This excluded everything coming out of Japan of course. I would hope those days are over.

We shouldn't forget, though, that low cost can militate strongly in favour of local product. Distributor and dealer margins, plus local taxes like VAT, all added onto the shipping costs of imported product can be quite a penalty. Then there's the small room factor you mention, which favours small loudspeakers and low powered amplifiers for good technical reasons. These factors justify, to some degree, national bias.

I detect quite a strong change recently though. The internet has had an effect, no doubt, but so has globalisation. Shipping costs are relatively low nowadays and journey times short. This has sucked more overseas product into the UK market, especially whilst consumer spending remains strong here. There's more variety than ever before as a result - and a broader outlook I hope. NK

Without wishing to be too literal, Hi-Fi World is as it says, about the world of hi-fi, and the world does not - as that 'coterie' of reviewers once believed, end at the port of Dover. That's why we've given lots of coverage to brilliant hi-fi designs (from Japan,

etc.), old and new, irrespective of whether there's any dosh in it for us. If we write great things about a 1979 Denon direct drive turntable or a 1988 Kenwood CD transport, the company is hardly likely to [a] notice it from their central Tokyo headquarters [b] write us a big cheque to advertise. Therefore, this isn't necessarily expedient for us in a business context (and, I hate to say, that all magazines are first and foremost commercial concerns; we don't get a grant from the government for our 'services to advancing the audiophile debate', sadly), but we do it for this reason, and this reason alone: Hi-Fi World is the only UK magazine whose publisher is a hi-fi journalist (and indeed, an enthusiast too - don't conflate the two!), and he is willing to accept that we have a duty to readers to actually say what we think about something, even it doesn't buy him a penthouse in Bermuda or a bullet-proof Bentley. I hope that our readers know, appreciate and value this! That said, there is some stunning stuff coming from the UK, and I have to say, it's one of the few industries we have in this country that we can be genuinely proud of. British or Foreign, if it's good then we'll shout about it. DP



Eighties Jap classic largely ignored in UK.



**KEF R107 – an oldie but a goodie**

### IN PRAISE OF...

This is in praise of the fabulous KEF R107 speakers. I think that they deserve a spot in your World Classics listings for their excellent all-round performance. I purchased my mkI version of these large speakers in May this year and am very glad I did. They have a superbly clear, natural mid and treble allied to a weighty and punchy bass, are easy to drive and don't need some huge power amp to get them to sing. They 'time' really well too, all good foot tapping stuff. The new releases from Goldfrapp and Kraftwerk, for example, sound really good; big, full-bodied and dynamic. My musical tastes are quite eclectic, but they have yet to disappoint with any programme material, from all manner of classical to jazz, rock and pop. I would thoroughly recommend them to anybody should they ever be in a position to acquire a pair.

The guy I purchased them from suggested that the mkII versions with their early type metal dome tweeters are not so good in the treble, although they do offer bi-wire terminals, if you think that important. I use mine with

my Naim CDX, Conrad Johnson PV10B and Chord SPM 400 amps. The amps were serviced by Audiofreaks and Chord to be sure all was well - I didn't want any 'ornaments'. I have a second system in my study which includes a Sony CDP-X77ES CD player, which replaced a CDP-557ES, rather like David Price mentioned in response to another letter last month. I must say that I concur with his comments, although I am now tempted to dig the 557 out from store in the garage to give it another go to see how they compare again. I enjoyed the reviews and details about the classic Japanese and other equipment recently, I always think your magazines a good read - please keep it up!

**Russell Varney**

### GOING DIGITAL

I'd like to get access to digital radio. I've an idea to get a relatively cheap Freeview box with digital out and feed the signal to my Chord DSC 1100 DAC. I think this might give better results than a similarly priced DAB receiver, as I understand bitrates are higher with digital TV. Plus I'd get the extra Freeview channels. I'd really appreciate your thoughts on this - are there any potential problems? Also, do you know of any Freeview receivers with digital out? Most budget boxes don't have it.

**Geoff**

Hi Geoff. Freeview does offer higher bit rates and better audio quality, but it does not have the wide selection of stations available on DAB. It does, however, have stations not available on DAB, like the excellent Mojo. So Freeview and DAB aren't identical and therefore not interchangeable. If you like what's on Freeview, then get it! Bear in mind that all digital radio comes strongly compressed (that is, data reduced) and in my experience an external DAC contributes little extra to what is often strongly circumscribed sound quality. **NK**

### NINETY NINER

I read your review of the Quad 99 series components with considerable interest. I have been a Quad user for many years and have been running the 99 series for over two years (including the 99 preamp) and I find it superb. One point that is worth making is that the 99 preamp includes a versatile, good quality phono stage which makes it very good value at £750 for those, who like me, have multiple sources.

I broadly agree with your review but I was not clear whether you used the system with single ended audiophile interconnects as most reviewers recommend, or with the Quadlink cables? The reason for asking is that perversely, I have found that it works at

its best - and by a considerable margin - when used with the fully balanced Quadlink cables. The rider to this is that I purchased the longer Quadlink, which allow the use of good supports, and I have also supercharged it by adding an IsoTek 2k cube power conditioner for the 909 and an IsoTek Substation for the rest of the kit, including my venerable LP12. The loudspeakers are Tannoy Westminster Royal HEs connected by VdH Magnum cable (I agree with NK's view on VdH cables)

The differences in sound quality are significant using the Quadlink. There is more detail across the audio spectrum and a natural unforced quality, which does not seem to me to be present when used with single ended interconnects. There is also incredible low frequency power and definition coupled with awesome dynamics. The Tannoys are capable of truly breathtaking low frequency performance and they can really do the disappearing act with good recordings.

I would appreciate any thoughts you may have why I should be getting results which are apparently so far adrift from perceived wisdom. Oh, and one other question. I currently use the 99 CDP CD player. Do you think the new Mk2 model would be a worthwhile upgrade?

**David King**

Hi David - yes, I've heard the 99 system do great things Quad-linked. But the whole point of the range revamp, and specifically the new 99 CDP-2, is that it's also designed to function properly as a 'stand alone' machine (i.e. not necessarily with any other Quad kit). With this I concur. I thought JM's group test of digital disc players last issue was most illuminating, but let's remember it was only a snapshot, a moment in time, with a particular reference system, and I'm not sure if I'd have put the 99 behind the Shanling as JM did. I keep banging on about synergy (maybe one day someone might write in saying they agree - I live in hope...), and I've found both the 99 CDP-2 and the 909 particularly effective together, and also in several non-Quad systems, although I have to say I'd only buy the 99 pre if it was precisely to complete a Quad system. The new version of the 99 is quite a bit better than the original (15-20%), but if you're going to take a big hit selling the oldie only to buy the new one, I'm not sure if it's cost-effective. Same old problem - price vs. performance gain! The only answer is for you to listen and make your own mind up. It would most likely cost you about 50 CDs-worth of money, which is a useful way of conceptualising things in value for money terms **DP**





**Quad 99 CDP-2 – great within a Quad system and without**

### BOGNOR STANDARD

*I have moved to Bognor Regis from Scotland where my new house is being built. My previous home had a dedicated spur with gold plated, non-switched sockets - but time moves on. I seek advice from this apparent hi-fi desert as I am instructing my house electricians (i.e. testing mains supply for varying voltage, dirty supply, etc.) I have my lounge and bedroom on the ground and first floors to consider. I will have a Magnum Dynalab 208 receiver and the bedroom Meridian 5000 series with CD, SACD and turntable. I need advice on what to do to ensure a good mains supply.*

**Graham Adams**

With house wiring you'll always be faced with the need to do the best possible within current wiring regulations, BS7671, published by the Institute of Electrical Engineers (see [www.iee.org/Publish/WireRegs/index.cfm](http://www.iee.org/Publish/WireRegs/index.cfm)). These are drafted to ensure safety and are sufficiently comprehensive to make special arrangements difficult.

On the supply side you get what you're given. On the consumer side of the meter I would suggest it's best to run heavy duty 32A cabling. This is normally used for high current spurs, feeding a kitchen for example. In twin and earth construction it's a brute to work with so your electricians are likely to object: ("naah, you don't want that mate!). I know the refrain well...! Or you can lay two runs of standard cable side by side around a ring main, as I have done in the

past. The safest arrangement is to use single cables in steel conduit, Victorian style. These days you can get stainless steel conduits, EMI screened conduits and even flexible conduits. I think I am right in saying all this lies well within regs and will pass safety inspection, so you can get a wiring certificate.

If you have a poor (noisy or distorted) mains supply, supply filtering is possible. My supply is reasonably clean but all the same I often use a massive 10A mains transformer to deliver a fully balanced supply, and a brace of 20uF motor start capacitors eliminate all high frequency rubbish. This sort of set up cannot be installed into the house wiring system. It has to be external to it. It will increase the impedance of your supply and may well not suit big power amps., which usually sound grippier with a stiff supply. However, my transformer supplier reports making many high current isolators, onto which are hung motor starts (large capacity, high voltage polypropylene capacitors) in Delta arrangement to clean a dirty incoming supply and apparently this works well. A transformer like this is best installed in an external earthed steel case. Alternatively, Isotek specialise in mains filtering systems and offer various well respected solutions for those who have specific problems (see: [www.isotek.com](http://www.isotek.com)). **NK**

### AND ANOTHER THING!

*If I see one more mention about Yamaha NS1000M speakers, anything by Onkyo,*

*Teac, Denon, Christina Aguilera (give me strength), Origin Live, I'm never gonna buy another issue - and I have every issue since 96/97.*

*Thank God you got rid of that Patrick Apple Mac nut - he was the most boring read ever in hi-fi. And on your Classic Cuts section, why not let people know what pressing is the best to get? In the current issue you recommend the remastered Sinatra because it had Extra tracks - what about the sound quality?*

*Finally, I'd like to know how many of your readers you think actually understand the graphs you put in? I bet the actual figure is 5-10% if that. So why not actually explain what they mean?*

**Tim**

Apple continues to make great product which demands to be written about - constantly innovating, constantly improving, always better than the competition. I don't know if iPod reviews or Apple columns were what you were objecting to, but as I've said before, if it's boring you, just don't read it.

I have to take issue with your complaint over Classic Cuts - if you still have all those back issues, then you clearly haven't read them properly - go back and check my Classic Cuts for Pink Floyd, Stephen Duffy, Kirsty MacColl, The Cure and Lloyd Cole among others, which all show clear information on frequently 'remaster ain't best' comparisons to ten or twenty year old CDs - as well as informed guidelines to any high resolution plans. Hats off to you for recognising that this comparison needs to be made, but in the main we've got that angle covered already. **PC** (the Apple Nut).

Well, it's a toss up between Christina Aguilera and Frank Sinatra, if you ask me Tim. But I take your point: even I am a bit bored by NS1000Ms, which were good, but there is a limit...

Technicalities and theory turn a lot of people off too, hence our reluctance to publish anything other than the shortest resume of what measurement revealed. Having said that, perhaps some readers would like to know more and I am sure we can at least find space to occasionally explain what our graphs are about.

**NK**

Hmmm... well the offer is extended to Noel (as it always has been) to zoom down the M4 to hear my NS1000Ms. We seem to agree about so much, so I'd be very interested in his thoughts on how well I've got my Yams working! As for Teac (don't

you mean Esoteric?), is there anything wrong in signposting their mastery of the CD transports (and the ensuing benefits for the rest of the player)? Ninety nine percent of CD spinners use cheapo, bought-in computer ROM mechs, with lots of reclocking. Strikes me that reclocking is like Elastoplast, it's a good palliative but to damage already done.

Now that I've had my two (and a half, and a bit...) cents on how analogue is obviously superior to digital, my next crusade (if you pardon the 'Dubyah' vernacular) is to get the hi-fi industry, which makes lots of money selling CD players still, to come up with decent CD transports. Why is it that stuff done in 1988, with no reclocking, sounds better than digital disc spinners nearly twenty years later? The answer is that it's cheap as chips to take a dodgy computer mech (optimised for 32x read) and reclock it, run it at super slow speeds its servo was never designed for (i.e. Red Book CD 1x speed!), and then cross their fingers and pray that it will work as well as proper CD mechs of yore! As usual, this is a case of the bean counters engineering CD players, and not engineers. At least Teac still have a couple of blokes in a back room somewhere in Tokyo who remember how to make a proper CD mech. – hence my support of this brand.

Onkyo is another great name with serious engineering clout, hence my happiness that they've finally woken up and started climbing back to where they always used to be (just ask any Japanese audiophile), which is at the top of the pile.

I'd also concur with Patrick's support of Apple's stuff; I know that hardened PC types begrudge this company's success, but it's no accident, I assure you. True, Apple did not invent the digital audio portable, but if they can knock even Sony (another company I revere, albeit not so much of late) off the top sales spot, then they have to be doing something right.

I won't comment on Noel's choice of music software in his

reviews however; each to their own; but I can say (with genuine happiness) that I own not a single disc from the aforementioned chanteuse... DP

### PART EXCHANGING

*Very interesting debate on the merits, or otherwise, of buying second-hand kit on e-bay. Before the Internet existed, there were classified ads in the hi-fi mags, as there are today, but I bet the majority of hardcore punters waited for Thursday morning, and the arrival of the legendary Exchange & Mart! I can trace my interest in hi-fi to this august*

*Some very interesting results emerged. I was naturally taking most of the hi-fi mags, to monitor prices, and read the reviews on the kit we had. One very well known reviewer wrote a rave review on a not-so-cheap Japanese tuner amp that was in our stock. I replaced my reference amp with this item, and sat back to listen. Result? Where's the music gone? Muddled midrange, piercing treble and muddy bass.*

*I had a similar experience with a pair of top of range speakers from a well-known manufacturer: horrible midrange suck out, which sent me*



**Thorens TD125 – how we used to live**

*journal...*

*Back in the early 1970s a friend of mine got an offer he couldn't refuse, but needed (financial) help with. He was offered the current stock from a hi-fi dealer who was closing down and emigrating. So we bought it, split it 50/50 and advertised in Exchange & Mart.*

*As well as making a small profit, this enterprise saved me a fortune in upgrading. We had the full range of kit: amps, tuners, turntables, speakers, cassette decks, full price range, and British, Japanese, and European. Before selling we had to test each item, as not all the stock was new. It was not long before a reference system emerged as all the kit was tested, and items swapped between us, which sold better in one area than the other (I lived in North London, my friend South of London)*

*straight back to my speakers, although to be fair more than one reviewer had picked this up. So I learnt to always listen to any proposed upgrade, preferably at home, or in a set up where I knew the other components, before parting with the readies.*

*My main listening source back then was vinyl and the system I eventually settled on, until mortgage and family commitments forced its sale, was: Thorens 125 turntable with SME II arm and V15 III cartridge, feeding Cambridge 110 amp, driving Rogers Export Monitors. Not state of the art, but for the price and when compared to all else – no contest!*

*Returning to the e-bay debate. My main system amp was bought from a dealer, second-hand (lots of listening), and the other components through your classified section. However, for my home*

SHUNYATA RESEARCH

ESCALANTE DESIGN

HEGEL MUSIC SYSTEM

ONZOW ZERO DUST

WWW.AUDIOATMOSPHERE.COM



office system I bought the amp and CD on e-bay. The price was right, and I collected them. Should a component fail, I can junk it and get a replacement cheaper than a repair. Controversial I know, but I bet my replacement will be less than a lot of people pay for an upgrade. Hi-fi would be a very dull subject without lots of controversy and debate.

**Jim Egan**

Agreed; and 'second-hand' stuff can be a way of getting a dream sound for peanuts. But before we all get too carried away, the secondhand hi-fi market is like the secondhand car market. You can buy a used mid-nineties BMW 750iL car for a thousand quid at auction, representing a massive saving on its £50,000 selling price. This seems like a dream come true, an amazing way of beating the system. After all, why buy a plastic-fantastic 'One series' for seventeen times as much, complete with a four pot banger of an engine? Well, the answer is that – unless you really know what you're looking for, your 750 could be nothing more than an ornament on your drive, days after you bought it, due to serious mechanical neglect by its umpteen former owners. Buying hi-fi presents exactly the same problem; why do people sell stunning high-end gear for peanuts? Answer: because it's jiggered, and they're hoping the buyer won't notice...

Even as editor of this august journal, and one who thinks he's seen every trick in the book, I often get caught out, buying a lemon that goes bang (miraculously) about an hour after I've got it home. Result: expensive rebuild or off to the dump with it. Manufacturer's spares support (or lack thereof) should be the beginning and end of what an item is worth, not what some e-bay equivalent of 'Flash Harry' says on his auction listing (or misquotes this magazine as saying). My message: unless you know a certain secondhand bit of kit is supported for spares, or you have a donor machine, for Heaven's sake, save yourself the heartache and buy new! This isn't just my personal prejudice. I'm merely pointing that without the required lasers, motors and/or bits of rubber to fix it, it's worth diddly when it breaks – and if it's old, then rest assured, it will! So do your homework. **DP**

### LIVING (?) ORNAMENTS

First of all, congratulations for your magazine. Besides the usual new staff reviews, I particularly appreciate the attention you pay to older items,

showing that things are not sounding worse just because they are not the new 64 bits, 2 million times oversampling (or is it upsampling?) and with a purple laser.

It is counting with that spirit, and bearing in mind that this is the only magazine knowledgeable in classic high-end Japanese gear, that I address my question. I have recently purchased secondhand a wonderful Technics SL-Z100 / SH-X1000 CD player. I knew already that the transport unit was showing some problems, stopping play randomly... I guess that the transport is old, in need of new parts (or a full transport unit, who knows). Although the converter was worth the price alone, I would really, really like to have this wonderful combo fully working. The problem is that Technics as a brand is not around anymore, although its mother company, Matsushita, is active.

Do you know if there is any policy of this company for the support of Technics equipment, at least of their old top machines? If not, what should I do? By the way, when the SL-Z100/SH-X1000 happened to play together, it makes me wonder what is really new under the sun nowadays in CD replay?  
**Pedro Gil Uppsala**

Hi Pedro – the answer is that there's nothing really new in CD replay, aside from some stunning high-end stuff from Esoteric, Chord, and the like. I'm afraid that your letter merely illustrates my previous point; if Technics don't support it secondhand (and lo and behold they don't), then all you have is a nice ornament. I have a mint Sony CD-PI01 which I think (in a way) is one of the best CD spinners I've ever heard, but they all seem to fail on one particular IC (the CD drawer controller), and this part is no longer available. Moral of the story: always check whether the part is available BEFORE you buy, not after. I hate to say so, but that's probably why your lovely Technics combo was up for sale in the first place... so maybe it wasn't as much of a bargain as you thought? **DP**

### IMPACT-FUL

At last - a British hi-fi magazine not only acknowledging the existence of the Sonic T-amp, but also publishing an article on how it can be 'modded' to improve its performance. Curiosity having got the better of me, I imported four of these little devils in June (four avoided postage and packaging!) in order to see - or should that be to hear - for myself what all the website interest was about, particularly on [www.diyaudio.com](http://www.diyaudio.com) which you acknowledge in your article.

Stock SIs straight from the box will almost certainly disappoint, although I

heard clarity and staging to die for. Run them in for at least 100 hours - I used a 12 volt wall power unit from Maplins and later switched to a 4A 12 volt sealed lead acid battery. The 'blackness' i.e. lack of any background noise is superb.

Did I do the mods? Well no, not yet. The Surface Mount Devices (SMDs) and small soldering points look a bit scary! I decided instead to buy the Autocostruire kit ([www.autocostruire.com](http://www.autocostruire.com)) which uses quality components from the outset and avoids using SMDs. It also has a little more power, being based on Tripath's TA2020 chip and not the SI's SMD TA2024. Comparing both as stock items, each having been run-in for a minimum of 100 hours, the Autocostruire, wins hands-down.

I intend to upgrade and rehouse my SIs. No matter how good any amplifier is, it still has its own 'sound characteristics' and needs to be matched to the right external equipment. I do not think many hi-fi dealers would be prepared to allow me to connect a modded SI to their sales stock! So, I would be interested to have your views on which input source, tuner, CD player, cables and loudspeakers would be best suited to the SIs.

**Gordon Hargreaves**

The published frequency response for this amplifier on [www.autocostruire.com](http://www.autocostruire.com) is calibrated in dBm into 4ohms. It shows a -1.5dBm or so roll down at 20kHz due to the necessary output filters. Its normal to use dBV and, not unsurprisingly, the result then looks worse, by a factor of two in fact. Few hi-fi amps roll down -2dB



**Why waste time with old cartridges when you can bag a G1042 for just over £100?**

or more at 20kHz, as this degree of high frequency loss will be audible as a warm sound.

To minimise high frequency roll

off you should ideally keep the load seen to Bohms or thereabouts. As precise filter behaviour depends upon the Q of the output inductors its impossible to say from inspection exactly how the T-amp will respond to a higher load, but it is load sensitive, like most digital (PWM) amps, that's for sure. And in my experience, as theory would predict, the filters attenuate less into higher loads. This does mean its tonal balance will vary according to the loudspeaker used. I could easily suggest you simply stick to flat impedance loudspeakers, like the Dali Ikon for example. But whilst a flat impedance loudspeaker might be a good technical match, that doesn't mean you will like its sound, as this depends on a wide range of other variables. As a rule of thumb though, use a higher load for a brighter sound. **NK**

### OLD SKOOL

*My system comprises Cambridge Audio Azure 640a amplifier, Cambridge Audio Azure 640P phono preamp, Dunlop Systemdek II (Biscuit tin) turntable with Linn LVX tone arm. Mordaunt Short 914 speakers (in open space) interconnects are QED Qnect I speaker cable (bi-wire) QED Silver Anniversary. The Dunlop Systemdek is a more recent addition due to me returning to vinyl.*

*I want a good cartridge to complete the package: either MM or MC. Most of the cartridges I remember from years gone by are the Rega Bias, Nagaoka Boron MPI I, Linn K9 and the A&R Cambridge P77. Are these still in existence and are they okay for my system? Or can you advise of any alternatives? Budget between £20-£100. I like good detail from the midrange.*

**Mick**

You are showing your age Mick! The cartridges you mention are not in existence, but the Rega and Cambridge cartridges were rebadged Goldring. Goldring still make the fine budget models in the 1006, 1012GX, 1022GX and 1042. They are all suitable for your arm, so buy according to price. **NK**

### USHERING IN A NEW

*I was intrigued to read your review on the Usher power amp and the remarks as to how similar it looked to an early Krell. In fact, externally at least, both front and back, it is an exact replica of the Threshold S300 American power amp produced in the eighties and early nineties. This amp was a Stasis design with low feedback and the first 15W of 150W were in Class A. Their range of amps included both Class A designs and the more common Class A/B. All*

*performed in an exemplary fashion with a unique sound quality. I had never heard an amplifier expose so much detail whilst at the same time preserving a neutral vocal and midrange with phenomenal bass resolution and a treble speed, extension and delicacy that defies description.*

*As you may have guessed, I own such an animal, the S300 series. It must be some fifteen years old now, still mint and in my view, outperforms any other power amp I have matched it against. I can't start to imagine how their pure Class A designs performed - and nor could I ever afford one!*

*If audiophiles are now able to access the performance of the Threshold at this price point they are in for a very pleasant surprise. Just thought you and your readers may be interested!*

**David Purton**  
**Designer of the Omen Ra**  
**Loudspeaker**  
[www.omen-ra.com](http://www.omen-ra.com)

### PORT PROBLEMS

*Noel Keywood's 'Modern Speaking' in October's issue caught my interest so much I have re-read it several times. His advocacy of ribbon tweeters made a lot of sense, and it was good to have the reviews of the Pinsh I and the Aurum Cantus Leisure in the same issue. However, they both have rear ports which would not be suitable for my 'listening room', and they were both fairly expensive. Are there any other two-way, stand mounted speakers with ribbon tweeters and front ports worth listening to? Does anyone make a kit? Are there any designs with plans?*

*Your DIY Supplement is an excellent way of allowing others to 'practice what you preach' at reasonable cost. Is Noel Keywood able to 'practice what he preaches' and come up with a design for a two-way speaker with a ribbon tweeter for a future DIY Supplement? Have you ever featured any speakers with ribbon tweeters in your DIY supplement?*

**Mark Haine**

Hi Mark. Ports are tuned to work from 60Hz down to 30Hz, the higher frequency being common on small speakers, the lower one on floorstanders. A wavelength at 60Hz is 1.8ft, considerably more than the front-rear dimensions of a loudspeaker. The sound wave propagates evenly around the loudspeaker at this low frequency, much in the way a wave spreads outward from a stone thrown into water, so at the frequency of operation it matters little whether the port is on the front or rear panel.

There are other factors to consider. The most significant are



**Naim Allae; truly, madly, deeply a music maker.**

higher frequency box echoes and colourations. These have a shorter wavelength and are more directional. They can be heard from a port, but a rear port makes them less audible. That's the main reason ports are usually mounted on the rear baffle. Our measurements of port output clearly show a lot of loudspeakers produce quite strong port colourations. So rear ports are generally best. The only circumstance favouring a front port is a loudspeaker designed for wall placement. **NK**

### MOTORCYCLE EMPTINESS

*Thanks for continuing to produce an excellent magazine - my only beef is the decline of Computer Audio World just when things are getting interesting - especially for us PC users who see Macs as over priced, under specified, and inflexible - the Fisher Price of computers. My reason for writing is an urge to upgrade my speakers - I am currently using Tannoy DC3000s that I bought about fifteen years ago. At the time they were a compromise giving great bass and dynamics at the expense of transparency and treble quality. I'm hoping that modern technology and a bit more money may enable me to have it all... or at least most of it.*

*The rest of my system comprises*



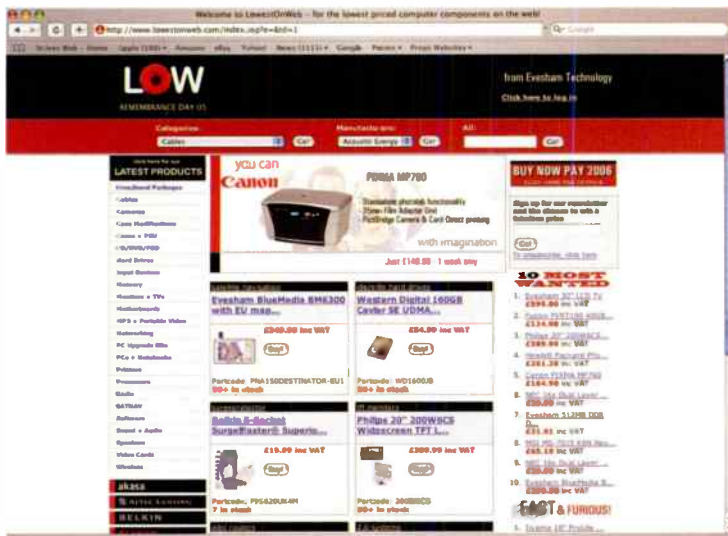

### Magical computer valve thingie – guaranteed to make your PC pitch-perfect!

LP12/new Lingo /Ittok/ Kontrapunkt h; Naim CD5/HiCap; and Naim 52/Supercap/250. My musical tastes include pretty much everything except classical. I am looking at floorstanders in the £1,000-£1,500 range - possibly stretching a little as just about anything seems available as "ex-dem" these days. My shortlist includes B&W 704s, Spendor S5es, PMC GB1s, Naim Allaes, Monitor Audio GR60s; and Dynaudio 72se - the latter 3 being available ex-dem in Bristol within my budget.

Of course I'm going to listen before I buy but as I ride a motorcycle and don't own a car it's problematic hearing speakers on the end of a system similar to mine. The local Naim dealer only stocks a couple on my list and there's no way my Naim set up will fit on my bike! My question (at last!) is - what kinds of set up would be useful for comparative purposes in whittling down my list? Dealers have suggested monobloc Cyrus or Musical Fidelity systems. I will try at home before final purchase but would like it to be a maximum of two contenders. Any comments on my shortlist would also be welcome.

**Brian Petheram**

Why is it that so many people are so disparaging about Macs? Nick Clarke, the esteemed designer of the Quad 99 CDP-2, referred to my PowerBook as an 'Etch-a-Sketch'! What is wrong with you guys; don't you like computers that don't crash, don't spend hours loading up an unstable OS and don't have a clunky user interface that can't seem to talk to its peripherals properly? Not wishing to be a conspiracist or anything, but I can see a parallel here between you PC lot and those who believed, for nigh on twenty years, that the Linn LP12 was the only turntable that played music. It's pure conditioning, prejudice and a lack of objective reason!

Now, moving swiftly on to hi-fi (what with this being Hi-Fi World, and everything...). If you can get Naim Allaes ex-dem for £1,500, you're doing something right, at least. I still remember reviewing these a couple of years back, and they're very, very musical speakers (in the Naim idiom). You'll not find them brilliant in tonality or texturality but my God, on the end of a NAC282/NAP200 with CDX2/XPS-2, they didn't half sing! The Monitor Audio GR60s would be my other bet (simply because you've got a Naim system, so that kind of suggests to me what sort of sound you like), which are

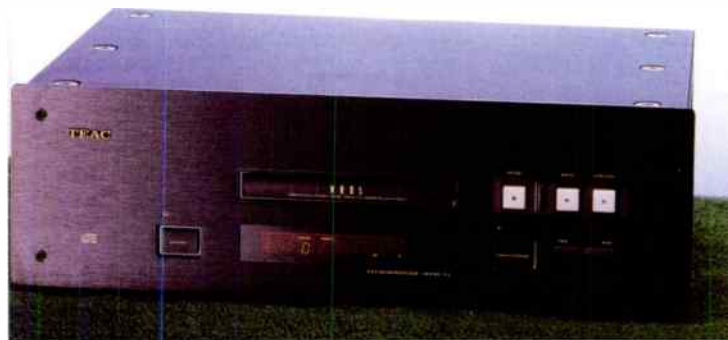

**TEAC VRDS-T1: they don't make 'em like they used to...**

genuinely distinguished wideband loudspeakers. Big, powerful, fast, sharp, punchy, they're a real treat. And they're also visceral in a way that the Naims can only dream of.

Given that you can't get your NAP250 in the top box of your Honda Melody (ouch David - that was below the belt! NK), I'd suggest a full-blown Cyrus system as a decent dealer dem. substitute. This is warmer and texturally more faithful than your Naim, but still has at least some of the grip and grunt (providing you can see a few PSX-Rs in there). Finally, Mission's e82 is a honey at £1,600-

ish; very fast and engaging with real refinement too. DP

### DOOBRIEWHATSI!

Thought someone involved with Computer Audio World might want to have a little squizz at this computer device. Okay, so it's cheap and cheerful but it might provide a welcome and valid improvement to cheap consumer sound cards (without spending a fortune on pro quality sound cards). Might also be a prime candidate for DIY audio-ers, as I could see this device being a great idea but compromised by component quality, etc., and an upgrade to a better valve and components may be the way to go: <http://www.lowestonweb.com/Products/ShopDisplayInfoMain.asp?e=F9E492E4-4524-40D3-A81B-D4F1E8293CBB> "Coolermaster Musketeer 3"

Its own marketing 'bumph' is rubbish, but I can see it taking the pressure off inadequate output stages of motherboards and soundcards, being a little more capable of driving the line level to amps and speakers of your choice, and the analogue volume control makes it easy to leave the internal PC digital volume at max, as anything less than maximum on a PC means bits of data being thrown away.

Lastly, when did a little rose tinted bloom on brittle computer sound do anyone any harm?

Anyway, I just thought it was cool and in the spirit of the magazine so would drop you a heads-up (even if it

doesn't work - it still nails your vacuum tube tendencies to the mast and is very cool, like the vacuum tube clock you once featured - can't be bad having a tube and VU meter on the front of your PC)! Have got one on order!

**John Hogg**

Thanks for that John; write in and tell us if yours is any good, then we'll tee up a review! DP

### TRANSPORT 2006

Last month, I read with interest DP's reply to Dave Mayer's transport quandary and wondered if you



**Quartz locked direct drive DJ deck – a great thing to base a high end hi-fi turntable on!**

could advise which route I should take to upgrade my CD replay and loudspeakers? I have a TEAC VRDS-T1 transport (which very occasionally skips) and an Audio Alchemy VI.1 Digital Decoding Engine (DAC). This is feeding into a Gryphon Callisto 2100 integrated amplifier, driving ProAc Studio 100 loudspeakers on Target R1 stands. Speaker cables are single runs of Ecosse MS 2.3 which on the whole seem to work well in my room, better in fact with this amp than the biwire Blue Heavens that I was using with my previous amps (Sugden A21a and Electrocompaniet ECI-2, which both worked better with the Bi-Wire Blue Heavens)!

As you can see I have spent a not inconsiderable sum of money on hi-fi over the last nine years; sometimes just to move sideways - a more informed approach is required.

Now to my query: should I do as you suggested (Trichord Clock 4 mod

the Teac as well as have a new laser fitted then upgrade the DAC with a PSU-3 (presently a PSU-1). Or should I mod the Teac and purchase a Musical Fidelity Trivista 21 DAC 3? Or should I sell the whole lot and buy a Linn Ikemi? My loudspeakers work quite well in my room (17 feet by 12 feet), although practicalities dictate that I listen across the width of the room, so through experimentation I have found that the best compromise is for the speakers to be toed in at 45 degrees, placed two feet, three inches away from the back wall and six feet, six inches apart. I admit that some music sounds better with the speakers only toed in slightly, but imaging is served well by toeing them in at 45 degrees.

I have tried various floorstanders of different manufacture at around £1,200-£2,000 but in the main bass response is too much and unbalances the sound. Should I look for another

standmounter, or should I try a drier floorstander like Naim's Allae - unfortunately I have as yet been unable to find a dealer who is willing to let me try them at home without purchasing first. I have varied musical taste but mostly listen to the likes of Pink Floyd, Nick Cave, Janice Joplin, etc. I would be grateful for any other suggestions. My budget is £4,000 to £5,000.

**Fred Straw**

Hi Fred, well this is a typical example of a hopelessly complicated and highly interlinked query. My answer is simply to address the first, key point, and then ask you to write in again when you've done this; otherwise, there are too many variables to legislate for.

First, your TEAC VRDS-T1 is a very good mid-price transport, better than any of the modern ROM designs (hey, wow – it was designed for CD playback, not data retrieval at 64x!) and so is well worth saving. A skipping transport tells me that [a] there's dirt on the lens, so take the top off (with power disconnected from the mains) and clean it, very gently, with a cotton bud dipped in isopropyl alcohol (go to Boots' dispensary and ask for a small bottle, it will cost you pennies), or [b] your laser is about to sing 'Goodnight Sweetheart'. I hate to say, but I'd suspect the latter, as it's getting on a bit.

The good news is – and this goes for almost all TEAC mechs. – that it is serviceable, and quite cheaply too. There's a brilliant London based service centre called NSS Limited (38, Waterside Centre, Hanwell, London W7 2QA; tel: +44 (0) 208 8935835; ask for Simon Matharu) who can fit a new laser and tune the whole unit back to new spec for under £200 (approx). This will invariably improve

**Billy Vee**  
SOUND SYSTEMS

**SAVE UP TO 50% ON EX-DISPLAY BARGAINS**

SOME AS NEW (MARKED\*) 24HR DEL ONLY £5. CHECK STOCK BEFORE ORDER. S/H = Pre-Owned Unit

CALL SALES: (020) 8318 5755 or 8852 1321 - 248 Lee High Road, London, SE13 5PL

Arcam DV89 DVD-A Player New (2Yr G/tee) . . . . .	£1299.00	Linn 5103 AV Processor - Silver (2Yr G/tee) . . . . .	(4500.00)	£1995.00
Arcam AVR 200 AV Receiver (2Yr G/tee) . . . . .	£799.00	Linn Majik Amplifier - Blk S/H (1Yr G/tee) . . . . .	(945.00)	£375.00
Arcam FMJ DV27 Player S/H - Silver (6 Mth G/tee) . . . . .	£849.00	Linn LK100 Power amplifier S/H (1Yr G/tee) . . . . .	(650.00)	£325.00
Arcam DT81 DAB Digital Tuner (2 Yr G/tee) . . . . .	£649.00	Linn 2250 Power Amplifier Silver (2Yr G/tee) . . . . .	(1995.00)	£1195.00
Arcam FMJ CD33 CD Player (2Yr G/tee) . . . . .	£1349.00	Linn Trikan Centre Spkr - Maple (2Yr G/tee) . . . . .	(495.00)	£249.00
AVI Amp Lab Series Integrated (2Yr G/tee) . . . . .	£1400.00	Naim 112 Preamplifier S/H (1Yr G/tee) . . . . .	(660.00)	£445.00
AVI Pro 9 Speakers - Cherry (S/H) (2Yr G/tee) . . . . .	£799.00	Naim NAC102 Preamplifier S/H (1Yr G/tee) . . . . .	(1175.00)	£499.00
Denon AVR 3805 AV Amplifier (1Yr G/tee) . . . . .	£999.00	Naim NAP 180 Power Amplifier S/H (1Yr G/tee) . . . . .	(1200.00)	£695.00
KEF KHT 1005 Sub - Sat System (2Yr G/tee) . . . . .	£299.00	Naim Ariva Speakers - Maple (2Yr G/tee) . . . . .	(1250.00)	£595.00
KEF Q4 Speakers (Cherry) (2Yr G/tee) . . . . .	£399.00	Rotel RA-01 Amplifier (2Yr G/tee) . . . . .	(249.00)	£159.00
Linn Unidisk SC M/format Player Silver (2Yr G/tee) . . . . .	£2995.00	Sugden A21p Power Amplifier (1Yr G/tee) . . . . .	(823.00)	£495.00
Linn Kairn Phono Preamplifier S/H (1Yr G/tee) . . . . .	£2200.00	Yamaha HD1300 H/Disk CD Player (1Yr G/tee) . . . . .	(599.00)	£429.00

For latest addition to our pre-owned and ex-display bargains please visit the marketplace section of our new website at [billyvee.co.uk](http://billyvee.co.uk).



the sound dramatically, and then it's time to send it to Trichord to get a Clock 3 mod. This done, you should try to audition DACs; your Audio Alchemy is ancient history, and a very crude device by modern standards; we've been extremely impressed by the NET Audio Sonance (see December 05 issue), which will give you the sort of sound (in conjunction with your tweaked TEAC) equivalent to most £3,000 machines – so it's worth doing. This done, come back to me for speaker advice. **DP**

## DRIVEN

Given how much better direct-drive Nakamichi cassette decks sound than belt or gear-driven ones, and the fact that record decks are even more sensitive to drive quality (high level signals and transients cause much more drag on the stylus than average), one would expect a well-engineered direct-drive turntable to be able to produce a fundamentally better focused and more realistic sound than a belt-driven one. With all the high quality British-made belt-driven turntables around, how great could it be if some enterprising manufacturer bought in a Japanese direct-drive mechanism (for example) and built a turntable to match? Alternatively, the manufacturer could import such a turntable and then tweak it as little or as much as price-points allow?

A common claim is that turntables have higher temporal resolution than CD players, but that CD players have higher temporal accuracy. As a consequence, digital recordings played on a turntable often sound particularly dreadful, because they suffer from the worst of both worlds. However, using a well engineered direct-drive, the temporal accuracy of LP playback can be greatly improved over a belt-drive system, allowing digital recordings to sound much better. Unfortunately for them, however, analogue recordings sound far better again having gained much greater focus and stability and lost what was considered to be a temporal accuracy problem of LPs (when in fact it was a characteristic of the playback device, the turntable).

**James Morrow**

Hi James, the great thing about your letters is that – instead of me having to sit here and make one up that totally concurs with my strongly held opinions – you just send 'em in prewritten for me. Thanks for that! You'll be interested to know that a certain Mr Simon Bennett of Absolute Analogue is, acting on the exact same suggestion from moi several months earlier, about to launch a heavily modded quartz lock

direct drive turntable (of DJ origins) to an unbelieving market. So we'll soon see [a] how well he's modded it and [b] how many of the belt driven hi-fi hack brigade actually take to it. I await this with interest! **DP**

## HARD SPEAKING

I read with interest in the November issue, Andrew Hoyle's letter regarding his problems selecting and buying a turntable. I have had similar experiences in the UK, with UK loudspeaker manufacturers.

I felt it was probably time to upgrade my Tannoy HPD 315 Dual Concentrics in Tannoys Chatsworth enclosures, which I purchased in 1975, apart from a recone and a professional cabinet rebuild they remain pretty much the same. To this end, I contacted Tannoy and asked if they had a Prestige dealer in the West Midlands. They then told me that the nearest Prestige dealers were in Sussex or Devon! Very convenient! I could buy from both dealers using a credit card but if I didn't like the Turnberrys I would have to arrange to have the loudspeakers shipped back to the dealer, the shipping paid for by me of course!

Through sheer frustration, I decided to write to Tannoy, as the only email address on the Tannoy website is customer services, you can't seem to email anyone else, and after about two days, I had a telephone from Bill Lee who was now distributing Tannoy. He told me he had arranged to have a pair of Turnberrys shipped to Acoustica (Griffin Audio), a non Tannoy dealer, who then arranged with me to have a home dem. Grateful thanks to John McAvoy and Paul at Griffin Audio. I didn't buy the Turnberrys but the service from John was first class.

I consider it a must that loudspeakers are heard in the context of the customer's own domestic environment and I would never buy as a result of a dealer demonstration of a loudspeaker.

I have had a similar experience with AVI and their Trio loudspeakers. No AVI dealer seems to carry a demonstration pair because AVI do not have loan pairs of Trios. I could go to AVI at Stroud and listen to them, then buy through my local dealer. I would prefer my local AVI dealer to get the Trios for me to try at home before I part with any money but I don't think this will happen.

After these experiences, I have decided to keep my current loudspeakers. I thought that the idea of a consumer led business was to sell its products to the consumer, after my experiences I am beginning to doubt this.

**Mike Bickley**

Yep! **DP**

The problem Tannoy have with their Prestige range is that of prodigious size and weight, they tell me. Few dealers are able to allocate the space needed to store monsters like this. Also, bear in mind Mike, that transportation is both difficult and expensive. Today's Health & Safety laws suggest two men are needed to lift a 36kg Turnberry. So to give you a demo of the Turnberrys, a lot of effort was expended. **NK**



**Tannoy Turnberry, a Prestige range loudspeaker for those with prestige homes. These babies need room to breathe but can sound remarkable. Difficult to audition though, because few dealers can afford the space.**

## PICKUP ARTIST

Thanks for putting my over enthusiasm politely in its place (Letters, Nov. 2005). However, I think you slightly misunderstood the point of my suggestion of having a look at some old pickup cartridges. I'm not one of the nostalgic 'they don't make them like they used to' brigade and wasn't trying to suggest that all the old gear I listed is actually better than today's best. I had in mind a review more in the spirit of when you pull out some old records to listen to and find that a lot of stuff that you thought was great at the time now sounds dreadfully dated but some things stand out, sounding absolutely great despite the years. (In music, think Frank Sinatra and Count Basie, or Paul Robeson, early Roxy Music according to taste.)

In hi-fi, most of the amplifiers and speakers which magazines raved about

in the 1970s or 1980s have been left far behind, yet designs like the Leak TL12, Radford STA25, Quad ESL57 and BBC LS3/5a somehow seem to defy the years and stand up almost as well now as they did when they first appeared. I have often wondered how some of the 'fave raves' of yesteryear in the pickup cartridge stakes would fare under today's spotlight. We all know that the Deccas won't lie down (no matter how much we want them to) and there's also the awkward old Ortofon SPU and the EMT. However what would we make now of the Shures, Ortofons and ADCs that the magazines raved about in the 1960s and 1970s? I reckon that if you pick carefully from the 'oldies bin' you could put together a fascinating comparison, showing up some of them as over-rated duds but maybe also picking up a surprise or two. (A proper test of an ADC 26 - or, if you can't find one, an ADC 10E, might finally lay to rest the question of how good it was and stop people endlessly trying to find them on the internet.)

As for the Denon DL-103 - I didn't mean to suggest that it is better than today's best - I'm sure it isn't. What I find remarkable is that (at least to my ears and in my system), for such an old design it puts up a surprisingly respectable showing: the response is nearly ruler-flat and well extended at both extremes, stereo separation is excellent and tracking is secure. I reckon it outclasses later designs such as the Shure M75ED, Goldring G820E, Goldring G900SE (elder brother to today's favourite 1000 series) and various others I have tried over the years.

Is the DL-103 really 'a right old stinker'? We might have to agree to differ on this but before we do it would be worth staying with the question just a little longer. A lot of mythology about the DL103 is fairly well off the mark: for example, it isn't as low compliance as people say (or as Denon suggest) and it is actually quite happy in a medium mass arm. (It works perfectly in my Mayware Mark V.) It regularly attracted good reviews in Hi-Fi Choice and elsewhere right through the 1980s, consistently being reported as measuring and sounding well. It still has many distinguished fans today. Trawling the internet I found a lot of favourable comments but also, interestingly, one contributor who shared your view - he criticised it as hopelessly brash and crude.

When some people say that an item sounds good but others say it is terrible, does this just reflect different tastes (or ears), or might their different opinions actually reflect differences in what they were hearing? Interestingly, I can make my DL103 sound as bad as

the critic says, or as good as the others say, just by making a simple adjustment. Electrical loading is the key. The input impedance seen by a moving coil cartridge can vary widely depending on the preamplifier or step up transformer it is fed into. The issue of loading pickup cartridges is well covered on a useful website (<http://www.hagtech.com/loading.html>). Moving coil cartridges often have a large ultrasonic response peak, depending on loading, and, as outlined in Peter J Comeau's fascinating article (November 2005 issue), this can have quite serious effects with some amplifiers. Are the differences between supporters' and critics' experiences with the DL103 actually just a reflection of the amplifiers and input loadings they fed it into?

Once the Denon DL103 is run in, its treble becomes noticeably brighter and using a 10:1 step up transformer into 47kohms (effective input impedance 470ohms), I found that the sound became brash and crude in my system, just as the internet

what did you feed it into? If the answer is 100-125ohms, then we shall just have to agree to differ. However if it was more than that, maybe in the interests of fairness you should get the old thing out again, give it another go with a lower loading and see what you make of it. I wouldn't claim that it will necessarily outclass today's finest (or even the AT33 you swapped it for, which is a fine cartridge) but you might find that it isn't really 'a right stinker' - and maybe agree that what Denon achieved back in 1963 is actually worth a bit of respect?  
**Alasdair Beal**

Thanks again Alasdair, for an erudite and reasoned argument backed by extensive hands on research; as such it is totally out of place in the letters section of a hi-fi magazine and I would ask you to immediately desist from writing such scurrilous propaganda, in the fear that you might give the other readers the wrong idea (Nurse, the screens, etc.)  
**DP**



**Defying the years: a Radford STA25 valve amplifier. You're still looking good baby!**

critic said. At that stage I would have happily endorsed your description of it as 'a right old stinker'. However when I reduced the amplifier input loading to 12.5kohm (125ohm at the pickup) the problem disappeared and the sound became excellent - just like its supporters say. Was the listener who didn't like the DL103 was using it with a 10:1 transformer into 47k ohms on an amplifier that didn't like ultrasonic rubbish, whereas those who like it are using MC preamps (usually 100 ohm input impedance), or 20:1 transformers (120 ohm effective input impedance), or else they are using 10:1 transformers with amplifiers which are ultra stable or bandwidth-limited and aren't troubled by ultrasonic rubbish?

Does any of this ring any bells? When you tested the DL103, David,

Alright, Alasdair, you win! The DL103 was wonderful for a 1963 design. But it's 2005 now and the world moves on.

On Moving Coils, I always use 100ohms, or even 3ohms for a low output type like a top range Ortofon. This helps damp the generator, tightening and cleaning the sound considerably. Using 47k is just sloppy low-end practice.

And finally, modern top end MCs like the Ortofon Kontrapunkt are so breathtakingly good they redefine what a pickup cartridge can get from LP, turning all else into the dust of history. Products like this change perspectives a bit, in my view. I still greatly respect many old designs, but those days are over. Time to let go.  
**NK**



# RETRO REPRODUCTION

## QUALITY HIGH FIDELITY & VINTAGE

### AMPLIFIERS

<b>Audio Research</b> SP9 boxed mint MKII	£895	<b>Quad 67 ESL</b> like new, brown	£995
<b>Audio Research</b> SP9 MKII black, boxed	£795	<b>Quad 12L</b> rosewood finish speakers	£375
<b>ATC</b> 150 Integrated Amp, 12mths old	£1395	<b>Quad 988</b> Electrostatics, 15mths old	£2495
<b>ATC</b> CA2 boxed as new	£1395	<b>REL Q201E</b> sub woofer maple finish	£495
<b>ATC</b> SA2 top of the range ATC amp	£495	<b>Ruark Prelude</b> MKII cherry finish boxed	£495
<b>Consonance</b> Cyber 10 integrated Amp, B550 tubes, superb headphones stage	£495	<b>Tannoy Balmoral 12"</b> drive units	£395
<b>Conrad Johnson</b> MV55 power, boxed	£795	<b>Totem Arrow</b> speakers sealed boxed new	EPOA
<b>Cyrus</b> PSXR PSU units, boxed	£245	<b>Yamaha NSM 1000</b> , black	£995
<b>EAR</b> 834P Valve Phono Amp	£450		
<b>EAR</b> 834L Valve Line Stage	£495		
<b>Hoveland</b> L200 valve remote pre amp one of the worlds finest, 1 month old	EPOA		
<b>KR Ent.</b> 188SI valves 842, 18watt	£1495		
<b>Marantz</b> PM7200 Class A integrated amp	£235		
<b>Musical Fidelity</b> Nu-Vista 300 Power Amp boxed new Serial No. 002	£2295		
<b>Naim</b> NAP90 with 92 Pre Amp	£495		
<b>Naim</b> 140	£295		
<b>Naim</b> 120 with NAC 12N (serviced)	£250		
<b>Nytech</b> CTA252XD2 CPA602 ARC101 full active system	£195		
<b>Pioneer</b> A300R	£36		
<b>Quad 44</b> Pre	£195		
<b>Quad 66</b> Pre with remote	£395		
<b>Quad 77</b> Pre with remote	£395		
<b>Quad 99</b> CD player with digital pre amp, as new, boxed	£850		
<b>Quad 303</b> Power Amp	£175		
<b>Quad 405</b> Power Amp boxed	£195		
<b>Quad 405</b> MKII Power Amp boxed	£225		
<b>Quad 606</b> Power Amp	£450		
<b>Rega</b> Brio silver finish	£250		
<b>Rotel</b> RB970 BX Power Amp	£150		
<b>Roksan</b> Caspian power	£345		
<b>Roksan</b> Candy KA-1 remote amp	£295		
<b>Suggden</b> A21 titanium finish	£645		
<b>Sumo Anthem</b> MKIII balanced Pre Amp	£250		

<b>TURNTABLES</b>			
<b>Delphin</b> phono stage	£395		
<b>Garrard 401</b> SME plinth	£375		
<b>Nottingham</b> TT2 Turntable with Linn arm	£195		
<b>Kuzma</b> turntable with Stogi - S arm	£895		
<b>Linn LP12</b> Valhala mint boxed	£495		
<b>Lehmann</b> black cube phono stage	£295		
<b>Micelli</b> focus 1 turntable, linn arm	£295		
<b>Micelli Gyrodec</b> with QC power supply	£895		
<b>Nottingham</b> Analogue horizon	£425		
<b>Pull Hynes</b> valve phono stage	£350		
<b>Roksan</b> Radius 5 with tabriz-z, as new	£595		
<b>Tom Evans</b> µGroove Phono Stage, PSU	£375		
<b>System deck</b> Various from.....	£150		

<b>CD PLAYERS, DACs</b>			
<b>Arcam</b> Delta 170.3 transport	£150		
<b>Arcam</b> Delta 110 digital pre	£95		
<b>Audionote</b> CDT2, top loading Transport	£795		
<b>Audio Alchemy</b> DAC in the box	£95		
<b>Audiolab</b> 8000 transport & dac, boxed	£895		
<b>Cyrus</b> DAD7 top loading CD Player, boxed	£425		
<b>Linn</b> Numeric DAC	£225		
<b>Marantz</b> CD17 K1 Signature	£495		
<b>Marantz</b> CD6000 OSE	£195		
<b>Meridian</b> 206 Delta Sigma CD Player	£350		
<b>Meridian</b> 500 series 24 bit	£795		
<b>MicroMega</b> Stage 5 CD Player	£250		
<b>Musical Fidelity</b> E900 CD, Piano black	£250		
<b>Musical Fidelity</b> X-Dac HDCD boxed	£175		
<b>Naim</b> CDX 1999 boxed	£1295		
<b>Naim</b> CDI 16 bit one of Naim's finest	£895		
<b>Pioneer</b> Precision PDS505 CD player	£195		
<b>Philips</b> CD850	£145		
<b>Quad</b> 66 CD Player	£350		
<b>Quad</b> 77 standalone CD player	£395		
<b>Roksan</b> DP1 Transport 5	£395		
<b>Teac</b> H500 champagne finish	£145		

**GENEROUS PART-EX. ON ALL EQUIPMENT, NEW OR USED. WILL BUY GOOD QUALITY EQUIPMENT AS ABOVE. NEXT DAY MAIL ORDER & UPLIFT FACILITIES**

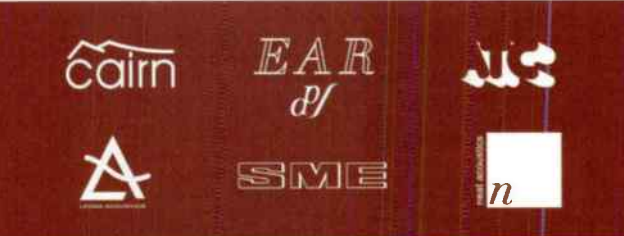

Opening times: 10.30 - 5.30 Tues. to Sat.  
28a Haddington Place, Edinburgh EH7 4AF  
Tel/Fax: 0131 558 9989  
Email: retro.reproduction@virgin.net  
www.retroreproduction.com

# BIG EARS AUDIO

quality used vintage and modern equipment bought, sold-part-exchange most welcome!!

**WE ACCEPT PAYPAL PAYMENTS and ALL CREDIT CARDS!!**  
**NAME: FULL RANGE OF PRODUCTS INCLUDING ALL ACCESSORIES and THEIR SUPERB CD RANGE!!**  
 website: [www.bigearsaudio.org.uk](http://www.bigearsaudio.org.uk) updated daily

**UNIQUE BLACKCAT PANTHER INTERCONNECTS, Cryogenically treated, fixed with \*Eichmann Silver Bullet Plugs\* £185 per metre pair**

**SELECTED PRODUCTS FROM:** AUDIO NOTE: **ROKSAN**; **ISOBUE**; **ATACAMA**; **AUDIO ANALOGUE**; **AUDION**; **BLACA-CAT ELECTRONICS**; **CAR-TRIDGE MAN**; **CONSONANCE**; **VALVE EQUIPMENT**; **ETALON AUDIO**; **GOLDING**; **GRAAF**; **GRAHAM SLEE**; **HAD-COCK**; **HEART**; **MICHELL**; **MISSION**; **ORIGIN**; **ORTOFON**; **PATHOS**; **ACE STYCS**; **PROJECT SHANLING**; **SME**; **TRIANGLE SPEAKERS**; **MONOPULSE LOUDESPEAKERS**; **UNISON RESEARCH**; **USHER LOUDESPEAKERS** AND **SURROUND SOUND SYSTEMS**

<p><b>VALVE AMPS.</b></p> <p>AUDIO RESEARCH 13.5, boxed as new £1195</p> <p>AUDIO NOTE 010, board all new, £1295</p> <p>EAR 834P, £450</p> <p>EAR 834L, £495</p> <p>AUDIONOTE 1314 AMP £1195</p> <p>AUDIONOTE 1314A AMP £1195</p> <p>AUDIONOTE 300B STEREO POWER AMP ex-dem (2150) £1195</p> <p>Conrad Johnson P108, as new-valued £1195</p> <p>Black Cat Electronics P24 Valve, PAIR of MONO bloc's (Lowthers) (2000) £1195</p> <p>Black Cat Electronics stereo valve line stage (1) Phono Stage (PREAMP) £1195</p> <p>Nottingham TT2 turntable with Linn arm £195</p> <p>Vortexton 6.6 valve monoblock power amp, beautiful, very well built (quad 6) valve original 22 pre-amp in very good original condition KT66 £495</p> <p>Leam stereo 20 valve, near mint, ribbon, with stored pre E184 £495</p> <p>Logers Cable 1 pre-power valve near mint ECL84 £495</p> <p>Kobay Hi88 integrated (E184) £495</p> <p>Leam 11.6, re-built, mint, cable, beautifully clean KT61 £495</p> <p>1/2 Mozart two mono blocks, plus mono valve tuner nice single ended E134 £495</p> <p>1/2 Super Micro tube phono pre-amp £495</p> <p>1/2 Super Micro tube phono pre-amp integrated RFP uses 5AR7 valves £495</p> <p>NOTTINGHAM X1 EL 34 single ended stereo valve integrated amplifier £1195</p> <p>NOTTINGHAM X1 EL 34 single ended stereo valve integrated amplifier £1195</p> <p>NOTTINGHAM X1 EL 34 single ended stereo valve integrated amplifier £1195</p> <p>NOTTINGHAM X1 EL 34 single ended stereo valve integrated amplifier £1195</p>	<p>TOLE ELECTRONICS REFERENCE STUDIO 4 HUGE FLOORSTANDING SPEAKERS (seven units per cabin block) (E6500) £795</p> <p>TOLE ELECTRONICS REFERENCE STUDIO 4 HUGE FLOORSTANDING SPEAKERS (seven units per cabin block) (E6500) £795</p> <p>TOLE ELECTRONICS REFERENCE STUDIO 4 HUGE FLOORSTANDING SPEAKERS (seven units per cabin block) (E6500) £795</p> <p>TOLE ELECTRONICS REFERENCE STUDIO 4 HUGE FLOORSTANDING SPEAKERS (seven units per cabin block) (E6500) £795</p> <p>TOLE ELECTRONICS REFERENCE STUDIO 4 HUGE FLOORSTANDING SPEAKERS (seven units per cabin block) (E6500) £795</p> <p>TOLE ELECTRONICS REFERENCE STUDIO 4 HUGE FLOORSTANDING SPEAKERS (seven units per cabin block) (E6500) £795</p> <p>TOLE ELECTRONICS REFERENCE STUDIO 4 HUGE FLOORSTANDING SPEAKERS (seven units per cabin block) (E6500) £795</p> <p>TOLE ELECTRONICS REFERENCE STUDIO 4 HUGE FLOORSTANDING SPEAKERS (seven units per cabin block) (E6500) £795</p> <p>TOLE ELECTRONICS REFERENCE STUDIO 4 HUGE FLOORSTANDING SPEAKERS (seven units per cabin block) (E6500) £795</p> <p>TOLE ELECTRONICS REFERENCE STUDIO 4 HUGE FLOORSTANDING SPEAKERS (seven units per cabin block) (E6500) £795</p>
---	---

**TRANSISTOR**

EAR 834P, £450

EAR 834L, £495

AUDIO NOTE 1314 AMP, £1195

AUDIO NOTE 1314A AMP, £1195

AUDIONOTE 300B STEREO POWER AMP ex-dem (2150), £1195

CONRAD JOHNSON P108, AS NEW-VALUED, £1195

BLACK CAT ELECTRONICS P24 VALVE, PAIR OF MONO BLOC'S (LOWTHERS), (2000), £1195

BLACK CAT ELECTRONICS STEREO VALVE LINE STAGE (1) PHONO STAGE (PREAMP), £1195

NOTTINGHAM TT2 TURNTABLE WITH LINN ARM, £195

KUZMA TURNTABLE WITH STOGI - S ARM, £895

LINN LP12 VALHALA MINT BOXED, £495

LEHMMANN BLACK CUBE PHONO STAGE, £295

MICELLI FOCUS 1 TURNTABLE, LINN ARM, £295

MICELLI GYRODEC WITH QC POWER SUPPLY, £895

NOTTINGHAM ANALOGUE HORIZON, £425

PULL HYNES VALVE PHONO STAGE, £350

ROKSAN RADIUS 5 WITH TABRIZ-Z, AS NEW, £595

TOM EVANS µGROOVE PHONO STAGE, PSU, £375

SYSTEM DECK VARIOUS FROM....., £150

**CD PLAYERS:**

Arcam Delta 170.3 transport, £150

Arcam Delta 110 digital pre, £95

Audionote CDT2, top loading Transport, £795

Audio Alchemy DAC in the box, £95

Audiolab 8000 transport & dac, boxed, £895

Cyrus DAD7 top loading CD Player, boxed, £425

Linn Numeric DAC, £225

Marantz CD17 K1 Signature, £495

Marantz CD6000 OSE, £195

Meridian 206 Delta Sigma CD Player, £350

Meridian 500 series 24 bit, £795

MicroMega Stage 5 CD Player, £250

Musical Fidelity E900 CD, Piano black, £250

Musical Fidelity X-Dac HDCD boxed, £175

Naim CDX 1999 boxed, £1295

Naim CDI 16 bit one of Naim's finest, £895

Pioneer Precision PDS505 CD player, £195

Philips CD850, £145

Quad 66 CD Player, £350

Quad 77 standalone CD player, £395

Roksan DP1 Transport 5, £395

Teac H500 champagne finish, £145

**MISCELLANEOUS**

A&R Tuner, £46

Cambridge Audio T55 (boxed mint), £75

Denon TU260L, £85

Denon Tuner, £85

Quad FM3 Tuner (boxed mint), £95

Quad FM4 Tuner, £195

**DUKE IN...**

DNM pre power amp, £495

JBL K2 £20,000 new....., £2000

Krell FPB200 power amp, £495

Macintosh Valve int. amp. KT88 12months old, £495

Neat MF9 ash finish, £495

Quad 909 Monoblocks, £495

Quad 99 CDP2 CD/pre, £125

## Rochester Hi-Fi

30 HIGH STREET, ROCHESTER, KENT, ME1 1LD  
- 01634 880037 - [www.rochesterhi-fi.co.uk](http://www.rochesterhi-fi.co.uk)

**ADVANTAGE**

**ARCAM**

**ATACAMA**

**AUDICA**

**AUDION**

**AUDIOPHILE BASE**

**AVI**

**BAT**

**BOULDER**

**CAIRN**

**CLEARAUDIO**

**CYMBOL**

**DALI**

**JMLAB**

**GAMUT**

**GOLDGRIND**

**GRADIENT**

**GRADO**

**GRAHAM SLEE**

**GRAVES AUDIO**

**LOEWE**

**LUMLEY**

**MERLIN**

**MUSIC MAKER**

**MUSIC TOOLS**

**NAD**

**NOTTINGHAM ANALOGUE**

**OPTIMUM**

**PARTINGTON**

**PURE**

**QUADRASPIRE**

**STELLO**

**TIVOLI**

**TRANSFIGURATION**

**USHER**

**VINCENT**





**CALL NOW TO UPGRADE YOUR SYSTEM**

# MIDLAND AUDIO XCHANGE

The Old Chapel  
Forge Lane  
Belbroughton  
Worcestershire  
DY9 9TD

t. 01562 731100  
f. 01562 730228

e-mail. sales@midlandaudiox-change.co.uk  
web . www.midlandaudiox-change.co.uk



## Ex-demo and second hand items

	Was	Now		
<b>Digital</b>				
Accuphase DP77V CD/SACD player x-demo	7600	4999	PenAudio Chara x-demo	1600 995
Audio Synthesis DAX Decade 22bit Balanced S/H	3700	1899	REL Acoustics Strata5 Maple BNIB	800 649
dCS Elgar + DSD version latest specification S/H	9499	4499	Revel Studio Blue/Silver Speakers S/H	9995 4999
dCS Purcell DSD version latest specification S/H	4999	2299	Rega ELA Cherry X-demo	749 549
Mark Levinson No360s DAC S/H	7500	2999	Sonus Faber Concerto Home, Walnut x-demo	999 699
Meridian 206 CD Player S/H	N/A	399	Sonus Faber Ironwood Stands, Walnut, adjustable x-demo	480 339
Meridian G08 CD S/H	2250	1899	Sonus Faber Leather Stands, fixed height, x-demo	310 220
Orpheus labs One DAC with anagram x-demo	3150	1799	<b>Cables and Accessories</b>	
Primare V10 CD/DVD Player x-demo	795	499	Cardas Neutral Reference 1m RCA-BNC S/H	550 375
Theta Generation V Balanced S/H	6290	1999	Cogan Hall Intermezzo EMD 0.75m RCA S/H	N/A 199
Theta Pro Basic II DAC with Oscom/Balanced S/H	2990	995	Kudos S50 60cm Stands S/H	199 79
Wadia 830 Black CD Player S/H	3000	1699	Nordost Valkyrja 1m RCA-RCA interconnect x-demo	1469 795
<b>Analogue</b>				
Dynavector XV1s 200hrs S/H	2900	1499	Nordost Valkyrja 1m XLR-XLR interconnect x-demo	1503 829
Audio Research PH3 Phono Stage x-demo	1699	1099	Madrigal MDC1 1m AES/EBU 110ohm Digital Cable new boxed	420 249
EAR The Head MC Transformer S/H	N/A	399	SAP Audio Relaxa MK1 Floating Isolation Platform x-demo	299 199
Michell Delphini 2 box S/H	1125	599	SAP Audio Relaxa MKII Floating Isolation Platform x-demo	399 299
Koetsu Black 100 hours only S/H	995	599	Siltech SPQ18M 4m Mains cable IEC-Shuko x-demo	495 295
Koetsu Rosewood 300 hours S/H	1299	749	Siltech SPX30 Classic 3m Mains cable BNIB	710 369
Kuzma Stabi/Stogi S Turntable New& Boxed	N/A	1399	Siltech SPO18M 2.5m Mains cable IEC-Shuko x-demo	345 169
Roksan Xerxes XPS1/tabrizi/ S/H	N/A	599	Siltech SPO20M 0.5 Mains cable BNIB	175 99
Roksan Xerxes XPS3/Rega RB300 S/H	N/A	499	Siltech FT12 G3 2x0.8m Silver Speaker cable x-demo	540 275
SME 10A Turntable S/H	2775	1995	Siltech LS38G3 2x2.5m Silver Speaker cable x-demo	800 399
Triplanar Series VI Tonearm S/H	3500	1999	Siltech SPX30 Classic 1m Mains cable BNIB	330 229
Transfiguration Temper MC 600Hrs S/H	1950	799	Siltech SPX30 Classic 2m Mains cable BNIB	520 259
<b>Preamplifiers</b>				
Audio Analogue Bellini Remote Preamplifier X-demo	625	499	Siltech LS188 Classic 2x3m Silver & Gold Speaker cable BNIB	3950 2995
Audio research LS25 MKII Valve Preamplifier S/H	4999	2999	Siltech Octopus 3m 8 way distribution box x-demo	955 499
Mark Levinson No380 Preamplifier S/H	4999	2499	Siltech Octopus SPX30 Classic 3m 8 Way Distribution BINB	995 499
Spectral DMC 30s Reference Preamplifier S/H	7600	4999	Siltech SPO18M 4m mains cable x-demo	495 259
Spectral DMC15 Preamplifier S/H	4800	3250	Spectral MH-750 20ft Speaker cable x-demo	2100 1199
TAG McLaren AVR30RSL7.1 T2 processor S/H	2300	995	Spectral MI-330 15ft Interconnect RCA-RCA x-demo	800 499
<b>Amplifiers</b>				
Audio Analogue Donizetti Mono Power Amplifiers X-demo	1050	729	Spectral MI-350 15ft Interconnect RCA-RCA x-demo	1400 799
Audio Research VT60 Re Valved S/H	1999	995	Transparent Music Wave Ultra 2x8ft S/H	2259 999
Electrocompaniet EC1 1 Class A Integrated S/H	3289	995	Wireworld Equinox 3++ 3m pair speaker cables S/H	1199 399
ECS EA1 Mono Amplifiers (pair)	6500	2999	<b>Tuners &amp; Tape decks, power supplies</b>	
OCM 500 Soloist stereo power amp, awesome S/H	2700	899	Cyrus FM7.5 Tuner Black S/H	599 249
Musical fidelity A1000 S/H	1500	849	Exactpower AC regulator 4 outlets S/H	1999 899
Naim NAP135 1988 S/H	N/A	1199	Magnum Dynalab FT101 "Etude" FM Tuner S/H	1250 699
Naim Hi Cap Olive 1998 S/H	N/A	499	Magnum Dynalab FT-R Remote/Presets Switcher S/H	399 199
Krell FPB750mcx Mono Amplifiers S/H	28900	14999	PS Audio Power plant 300 Multiwave x-demo	1600 999
Krell FPB300 Stereo Power Amplifier S/H	9899	3999	Rega radio 3 Silver X-demo	398 279
Krell FPB600 Stereo Power Amplifier S/H	11898	5299	Tice Solo Powerline Enhancer S/H	N/A 299
Krell KAV500 3 channel Amplifier S/H	5498	1999	Tice Solo AV Power Conditioner S/H	N/A 299
Pathos Logos valve Hybrid S/H	2750	1699	<i>Suppliers and installers of High Quality Audio Systems</i>	
Primare A30.2 Power amplifier x-demo	1299	799	47 Laboratory • Living Voice	
Red Rose Sprit Integrated x-demo	1000	649	ATC • Lyra	
Rega Maia Power amplifier Black x-demo	548	399	Audio Research • Magnum Dynlab	
<b>Loudspeakers</b>				
Audio Physic Spark 2 American maple x-demo	1299	799	Cardas • Mark Levinson	
Audio Physic Yara Monitor Cherry x-demo	549	399	Clearaudio • Martin Logan	
Audio Physic Yara Floorstander x-demo	999	749	Conrad Johnson • Mimetism	
Audio Physic Virgo 3 Maple x-demo	4500	2999	Copeland • Nordost	
Avalon Acoustics Symbol x-demo	2900	1999	Cyrstal Cables • Primaluna	
ATC Active SCM10 SL x-demo	1650	1199	Dartzeel • Primare	
ATC Active SCM50ASL Maple S/H	7989	3999	dCS • ProAc	
ATC SCM7 Cherry x-demo	499	375	Densen • Rega	
B&W703 Cherry Floorstanders S/H	1999	1299	DNM/Reson • Siltech	
JM lab Diva Utopia Light wood S/H	7600	4999	Electrocompaniet • Sonus Faber	
JM lab Electra 927 be Anniversary last pair! New	2800	2400	Finite Element • Sugden	
JM Lab Micro Utopia Anigre with Stands S/H	3999	1699	Jadis • Transparent Audio	
JM Lab Sib XL x5 Grey S/H	1000	650	Koetsu • VPI	
Martin Logan Clarity Cherry 4 months old S/H	2498	1999	Krell • Wadia	
Martin Logan Aeriis I Oak S/H	2199	1299	Kuzma • Wegg 3	
Martin Logan Aeon I Oak BNIB	3189	2500	Lavardin • Wilson Audio	
Pen Audio Rebel 2 x-demo	995	699		
Pen Audio Charisma x-demo	1995	1199		

Midland Audio X-change are looking for Audio Research, Krell, Mark Levinson, Naim Audio, SME, Wadia.



**hifisound** by enthusiasts, for enthusiasts

30b Larchfield St, Darlington, County Durham, DL3 7TE. Tel: 01325 241888 Email: world@hifisound.co.uk

The amazing **USHER AUDIO DANCER** Be loudspeakers now on dem...

...the most beautiful loudspeaker you are ever likely to hear!

Acoustic Energy, Apollo, Atacama, Auzio Analogue, Creaktiv, Chord Cable, Custom Design, Grado, Isotek, Nbien, Neat, Opera, Pathos, Pure, Resolution Audio, Revolver, Rcksan, Shanling, Ständesign, Teac, Triang'e, Unison Research, Usher Audio, Van Den Hul and more!

**www.2ndhandhifi.co.uk**



## ...what are you up for?

Digital - CD, DVD etc	Amplifiers	Speakers	Analogue
AHI Njoe Tjoeb 99 nr mint boxed 199	Albary AP4 Preamp, Active/Passive 199	Acoustic Energy AE1 ex 249	Alchemist Bragi Phono stage c/w Forsetti p/s 399
Arcam CD82T as new 399	Arcam A85 Integrated, nr mint boxed 199	Acoustic Energy AE1 Mk2 vgc 419	Audio Research PH3SE, nr mint boxed 1249
Arcam CD72T 199	Arcam Alpha 9 Preamp, remote, nr mint, boxed 249	Acoustic Energy AE2, ex block 249	Chord Phono stage, ex boxed 999
<b>Arcam Alpha 7SE nr mint boxed</b> Call 749	Arcam Alpha FMJ C30 Preamp 699	Acoustic Energy AES05 nr mint boxed 999	Heybrook TT2, boxed 149
Audiolab 8000CDM and DAC 699	Audio Analogue Maestro, 150w Ref., nr mint crated 799	ATC Anniversary 50s limited edition as new SOLD OUT!!! 999	JBE SlateSeries 3/Mission774 rare etc... 349
Audiomeca Obsession ex, boxed 399	Audiolab 8000A Integrated 429	ATC SCM20, Piano black, vgc, boxed stands 249	Kinshw Perception phonostage and p/s 479
Audiolab DV41000SE 129	Audiolab 8000P Power ex boxed 499	AVI Positron, burr finish, ex 199	Linn LP12/Syrinx PU3 ex ofromosia 899
Marantz CD63KI Signature, ex remote 499	Audiolab 8000C Preamp ex boxed 199	AVI Positron, burr finish, ex 199	Linn LP12/Lingo/Ekos ex block 1499
Marantz CD17 KI nr mint 499	AudioNote 8000C Preamp ex boxed 599	B&W CDM7NT, ex, boxed 1699	Linn LP12/Lingo/Ekos, ofromosia, boxed 1599
Marantz CD60000SE LTD Edition version 149	AudioNote OTO, nr mint + steel at 2399	B&W 801S3 Matrix Floorstander REDUCED BARGAIN!!!! 1699	Linn Basik, Basik Plus 399
Marantz SA1 vgc boxed 349	Audio Research VT100 Power 799	B&W CDM1 marked 249	Linn Itok 12 799
Meridion 208, ex 209 remote and phono stage 299	Audio Research LS25 Preamp/Filter 349	Castle Eden, ex boxed 899	Linn Ekos, nr mint boxed 699
Meridion 200 Transport, ex remote 299	AVI S2000M Integrated fair 749	Dynaudio Contour 1.3 Mk2, vgc 899	Michell Gyrodec Export 649
Meridion 263 DAC 179	AVI S2000MP/MM Pre/Manos 1199	EPOS M15, Dork Cherry, vgc boxed 249	Michell Focus One/Mission 774LC arm 249
Micromega Stage 1 399	Carm Mea Monoblocks, as new, Class A yum 499	KEF Reference 1.2 nr mint boxed 279	Michell Gyrodec SE nr mint boxed 599
Micromega Stage 2 and matching DAC 799	Chord SPM 1000B, 249	KEF RDM1 nr mint boxed, superb bookshelf 249	Michell Tecnoarm/Tecnoarm A from 449
Micromega T-drive and Tidac nr mint boxed 899	Creek 4330Mk2r Integrated, remote as new boxed 599	Mission 752 Floorstander ex 499	Michell Mycro RB300 Incognito rewire, ex 299
Micromega Duo CD3/BS2 nr mint boxed 129	Crimson 610C/630D Pre/Manos, nr mint boxed 499	Monitor Audio Silver S8 floorstander new 249	Michell Iso/Hero 299
Micromega Optic bargain intra to Micromega Monarchy DIP vgc 149	Cross Linestage Preamp 279	NEAT Petite 3, Cherry mint boxed 179	Nottingham Analogue Spacedeck/Arm ex 749
Musical Fidelity XPSU v3 as new 179	Cyrus Power, ex boxed 249	Proac Studio 125, ex boxed 699	Oracle Delphi V, full version, as new 2999
Musical Fidelity CDT 199	Cyrus 7 Integrated, nr mint boxed 349	Proac Tablette 50, nr mint boxed 179	Orion Live fully modded OL as new only a few mths old 349
Musical Fidelity A3CD, nr mint boxed 399	Cyrus 3 Integrated, ex boxed 279	Proac Tablette 2000, nr mint boxed 349	Orion Live Silver as new 429
Musical Fidelity Kw SACD as new 2999	Denon POA4600 Monoblocks, ex boxed 449	QUAD ESL63 Floorstander, Quad serviced 05 REDUCED!!!! 1199	Ortofon Kontrapunkt A 299
<b>Myrrad T20 nr mint boxed</b> Call 199	Meridian 555 power 899	QUAD ESL63 Floorstander 279	Ortofon MC20 Supreme ex dem 299
NAD C541i nr mint boxed 999	Meridian 205 Monoblocks, ex 449	QUAD 121 Standmount, boxed 399	Pink Triangle LPT/RB250, the best I've seen 379
NVA Transparent Statement, ex crated 1749	Micromega Tempo 2 449	QUAD 121 Standmount as new 199	Project Phono box LE boxed certificate 149
Pass Labs D1 DAC ex, cost \$5000 new 999	Musical Fidelity 3c Preamp/P150 Power, ex 299	REL Q50 Subwoofer 899	Rego Planor 2/RB250, good 599
Proceed PDT2, nr mint boxed 699	Musical Fidelity A1000 Integrated nr mint boxed 699	Sonus Faber Electa Amator 2, nr mint boxed c/w stands 399	Rego Planar 2/RB250, ex boxed 179
QUAD 99CDP as new 349	Musical Fidelity X80, as new 279	Tanberg Studio Monitor Large 649	Rego Planar 3/RB300 119
Roksan Caspian, nr mint 549	Musical Fidelity A3 Integrated 449	Tanoy DC100 Standmount 199	Roksan Xertes/Tobriz Zi 449
Shanling SCD200 nr mint boxed 9 months old 549	Musical Fidelity Pre/Typhoon 299	TDL Studio 1 ex 799	Roksan Radius 3/Tobriz 429
TEAC T1/D1 ex 179	Odyssey HT3, 3 Channel 180w power amp 699	Triangle Antal ES ex dem 799	Roksan Radius 5/Nimo ex dem 679
Sony XA20ES 599	Odyssey Stratos, nr mint stereo power 499	Wharfedale Diomand series, various 649	Rotel RQ970 79
Theta Data Basic 2 Transport, nr mint boxed 395	Odyssey Khartago, nr mint stereo power 499	Wharfedale Evo 30, nr mint boxed 299	SME 1V nearly new, nr mint boxed etc 999
Theta DS Pro Progeny 499	NAIM 62/140 Pre/Power, nr mint 159	Wilson Benesch Orator, ex 649	Thorens TD124MK2/SME3009, superb condition 499
Theta Pearl Transport, nr mint boxed 449	Pathos Logos, just back frm UKD service, ex boxed remote 149	Wilson Benesch Curve Floorstander, as new 159	Thorens TD160b/Mission 774 vgc 249
<b>Systems, Cables etc</b>	Quad 405 and 405/2 Fewer services from 249	<b>Radios and recorders</b>	Townshend Elite Rock Mk2/Mission 774LC 799
Cyrus - PSXR, ex boxed 399	Quad 44 Preamp ex boxed 299	Arcam T61 nr mint boxed 99	Transcriptors Skeleton/Vasigal 649
JPW 204/200/208 - 5.1 Speakers 299	Quad 77 Integrated ex 349	Creek 4030 Great FM tuner 79	Transcriptors Hydraulic Reference 349
Isotek Cleanline 379	Quad 707 Power, ex 999	Call 299	Transcriptors Saturn, vgc 749
Marantz CD6000LE, PM60100SE, ST4000 999	<b>Quad 909 ex, boxed</b> Call 1149	Call 299	Transfiguration Spirit 3, 50 hours max 379
Musical Fidelity A3 Amp/CD/Tuner 999	Roksan Caspian M Pre/Manos x/dem 349	Call 299	Trichord Research Dino/Dino+ p/s nr mint boxed 399
Musical Fidelity Xcans v3 as new 1149	Roksan Caspian Integrated, original series, remote 299	Call 299	Voyd Valdi/Helius Scarpio, fair 849
QUAD 99CDP/909 ex boxed 349	Roksan Caspian Power original series 649	Call 299	Williams Hort two box phono stage 2499
QUAD 34/306 Pre/Power, nr mint grey 449	Sumo Artemis/Andromeda 3 Pre/Power, ex boxed 149	Call 299	Wilson Benesch Act/Act 2 arm ex 1399
TEAC A1/D1/T1 - Amp/CD/Tuner	Unison Research Mystery One Preamp	Call 299	Wilson Benesch Full Circle ex dem

**Special pre Christmas deals in RED... tel 0845 6019390 lo-call, or email world@2ndhandhifi.co.uk**

Quality hifi equipment always required for cash... **Call us before you trade in... Commission Sales too VISIT OUR WEBSITE, OR CALL TO SPEAK TO A REAL PERSON TUESDAY TO SATURDAY 10 TO 5-ISH**

# turntableworld!

Our Dem facilities offer a wide selection of all types of analogue equipment from all the best brands including...

Clearaudio, Dynavector, Tom Evans, Goldring, Grado, Hadcock, Lyra, Michell, Moth, Nottingham Analogue, Origin Live, Ortofon, Project, Graham Slee, SME, Sumiko, Transfiguration, Trichord, Whest Audio and Wilson Benesch

**...there is no better analogue decision**

turntableworld! is at 30b Larchfield St, Darlington, DL3 7TE. Tel: 01325 241888 or email: world@turntableworld.co.uk

**0% FINANCE AVAILABLE FOR UP TO 3 YEARS ON SELECTED ITEMS. SUBJECT TO STATUS. CONDITIONS APPLY.**

**SPEAKERS**

Ellax Liberty 5+ speakers £140  
 KEF Concorde speakers £150  
 Celestion A compact speakers £195  
 B&W DS6 Diapole surround speakers £175  
 B&W DM602 series 3 £195  
 Boston THX centre speaker £150  
 Mordaunt-Short MS 3.30 speakers £95  
 Audio Physics Tempo's £795  
 B&W Silver signature 30's £3995  
 Spica TC-50 speakers 275  
 Orchid LWO speakers ex-demo £2795  
 Martin Logan CLS11 speakers (brand new panels) £1995

**PRE-AMPS:**

Mendian G02 Pre Amp £1295  
 Mark Levinson 25S phono stage with PSU £2395  
 Mark Levinson 28 with phono stage £1195  
 Exposure 11 & 12 pre with power supply £595  
 Naim Nac 92 with Nap 90/3 amp £595

Toft LBPA pre-amp (balanced) £495  
 Audionole M8 with phono, remote (new) £12500  
 Audio Research SP14 1495  
 Proceed PAV pre-amp £1395  
 Mark Levinson ML32 ref pre-amp with phono £8500

**AMPLIFIERS**

Rega Elax integrated amp £95  
 Pioneer Reference system C-73 pre amp/M-90A power amp/ PD93 CD player/CT-91A Cassette deck only £2495  
 Accuphase E307 Integrated Amp Mint £2500  
 Accuphase A/20V Class A Amp Mint £1795  
 Sirius (Gamut 2) Power amp latest spec £850  
 Rotel RC-995 Remote pre-amp with RB-992 power amp (balanced) £11995  
 Mark Levinson ML 33 Reference mono's £1395  
 Perreux 200ip int amp £5495  
 Audionole Neiro mono-blocks £345  
 Parasound HCA 1000A amp £15000  
 Audionole Kegan mono's (new) £1495  
 Advantage integrated amp

**CD PLAYERS & TRANSPORTS**

Mendian G0R 24 bit CD Player £1795  
 Lab 47 flat fish with Progression dac & PSU £3995

202 Findon Road, Worthing, WEST Sussex, BN14 0EJ  
 Tel. 01903-872288 or (after hours) 07860 660001 Fax. 01903-872234  
 e-mail: heatherdale@hifi-stereo.com //www.hifi-stereo.com

Roksan Atlessa with ROC DA1 dac & PSU £895  
 Gamut CD-1R CD player £1495

**MISCELLANEOUS**

Sony ST-S5570 Tuner £60  
 Denon DCD 590 CD Player £60  
 15 Foot Transparent Music Wave Super single mono run. £795  
 Zerodust Stylus cleaner (new) £25  
 Zerodust CD & lens cleaning cloths (new) £17.50

**TURNABLES, CARTRIDGES & TONEARMS**

Mark Levinson 25S with PSU £2395  
 Michell Gyrodec with OC PSU mint/boxed Ex demo £995  
 Koetsu Urushi boxed/mint please call  
 My Sonic Eminent (EX review) £1995  
 Audio Tekni Cartridge with step up (Ex review) £2250  
 Blue Pearl (the prototype) Turntable with Gold Plated SME-V arm £9995  
 Zyx airey Cryogenic copper cables £425  
 Project 6.9 Turntable (without cartridge) £995  
 Audio Tekne Cartridge with step-up transformer £2995  
 My Sonic Eminent cartridge (new) £2750  
 Dynavector DV-DRT XV1S cartridge £1995  
 Project 9c S carbon fibre silver wired arm £375  
 Project RPN9J turntable without cartridge £550

VISA - SWITCH - MASTER CARD - AMEX - DINERS CLUB WELCOME.  
 WE TAKE PART EXCHANGE ON NEW & USED STOCK and buy in for cash

ALL USED CARTRIDGES ARE CHECKED UNDER A MICROSCOPE BEFORE BEING OFFERED FOR SALE.

**www.AudioAuctionHouse.co.uk**

BUY & SELL YOUR BUY & SELL YOUR  
 PRE OWNED – HIFI PRE OWNED - HIFI

"Serving the U.K and European community"  
 & Sell Your Hifi Where it will be Noticed!

Excellent rates, Convenience, and Security  
 You decide what Ads will work best for you!

"Dedicated to the Audiophile Community"  
 All Hi Resolution Picture quality!

Your items will get sold or We will relist it Free!  
 A Quality Site for dealers and consumers.  
 Special incentives for Dealers and Multiple listings

Please send Inquiries to  
**aaudioman@hotmail.com**

**Q.T.A. SYSTEMS**

DESIGNS ENGINEERED FOR EXCELLENCE WITH:-

- POLYPROP CAPS
- AIR CORED COILS
- HI-TEC DRIVERS
- TOP GRADE COMPONENTS

• CABINETS INCLUDED WITH OPTIONS ON FINISH

• NOTES AND SPECIFICATIONS

• COMPREHENSIVE INSTRUCTIONS

• AVAILABLE AS COMPLETED UNITS WITH STANDARD OR EXOTIC VENEERS

• DISCRETE COMPONENTS

• CUSTOM MACHINING SMALL PANELS, JOINTS & CUT-OUTS

FOR FURTHER DETAILS:-

**Q.T.A. Systems**  
 2 Wheatsheaf Way  
 Linton - Cambs CB1 6XB  
 Tel: 01223 881091

[www.qtasystems.co.uk](http://www.qtasystems.co.uk)

**For all your advertising requirements  
 please call 020 7372 6018**

**or email:  
 advertising@hi-fiworld.co.uk**



# diverse vinyl

10 charles st newport south wales np20 1ju  
01633 259661/256261 sales@diversevinyl.com

## RECOMMENDED NEW RELEASES

Athelete	Tourist	£TBC
Bonnie Prince Billy	Summer In The Southeast (live)	£14.90
Brian Wilson	What I Really Want For Christmas	£TBC
Cream	Live At Royal Albert Hall	£TBC
Deep Purple	Rapture Of The Deep 2LP	£13.90
Espers	The Weed Tree	£TBC
Kate Bush	Aerial	£18.90
Madonna	Confessions On A Dancefloor	£TBC
Rolling Stones	Rarities 1971-2003	£TBC
Steve Reid	Spirit Walk (Soul Jazz)	£13.90
Theivery Corporation	The Cosmic Game (4LP set)	£19.90
My Morning Jacket	Z	£19.90
Robbie Williams	Intensive Care	£13.90

## REISSUES:

Buddy Guy/Jr Wells	Going Back To Acoustic	£19.90
Donovan	Sunshine Superman	£15.90
Jimi Hendrix	The Singles Collection (box set)	£59.95
John Coltrane/Thelonius Monk	Live At Carnegie Hall	£TBC
My Bloody Valentine	Loveless/Isn't Anything each	£15.90
Queen	A Night At The Opera	£TBC
Richard/Linda Thompson	Shoot Out The Lights	£TBC
Stevie Ray Vaughan	Couldn't Stand The Weather	£23.90
Tim Buckley	Goodby And Hello	£TBC

Plus Flaming Lips re-issues back on for Nov - call for details

MERRY CHRISTMAS FROM ALL AT DIVERSE VINYL

THE PERFECT XMAS PRESENT FOR THE VINYL FAN IN YOUR FAMILY:

## DISCO ANTI STAT LP CLEANER

Probably the most economical LP cleaning device on the market Only £43.95

Call for details

Call for a catalogue of over 3500 brand new LPs, or visit

[www.diversevinyl.com](http://www.diversevinyl.com)

## WANT TO HEAR MORE MUSIC? Then get rid of the noise!

NC - the total solution to mains noise and interference

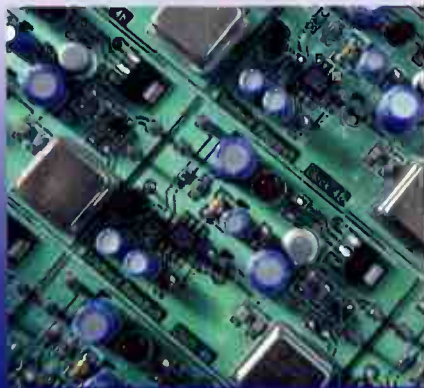

Fit a Trichord Clock 4 and 'Never Connected' power supply to improve the performance of your CD or DVD player. Let us undertake the work for you in our Modification Workshop.



Contact us now to see how we can help you to reduce the noise in your system.

## Trichord Research

Tel: +44 (0)1684 311600 Fax: +44 (0)1684 311928  
sales@trichordresearch.com  
www.trichordresearch.com

## CLASSIQUE SOUNDS

(LEICESTER)

UK agent for One Thing Audio

VINTAGE HIFI & VALVE SPECIALIST. TEL 0845 123 5137 (local rate.UKonly)

## WANTED Vintage and modern hifi eqpt.

Part exchange welcome.

Leak Stereo 20 full rebuild using Jensen Paper in oil caps £299.00  
FOR SALE.PRE/POWER AMPLIFIERS

Galactron MK-2121 amplifier. 60 watts of pure class A. Beautiful Italian styling. Wood cheeks.Cost new £1400	£ 699
Marantz PM17 int amplifier & rem.Mint.Boxed.	£ 449 Musical Fidelity F16 Class A power amp. Mint/Boxd
Musical Fidelity P172 pre-amp. Cost £499 1988	£ 125 Naim NAC 92 pre amp. S/NO 161840. Mint. Boxed
Nad monitor series. 1300 pre-amp with MM/MC.	£ 149 CR Developments Carmenta Line valve pre-amp.
Marantz's Duoeto receiver-CD system to include SR110 receiver and CD110 Cd player. All boxed and mint.	£ 230
Woodside STA-50.BG.SE.Valve power amp.Mint.	£ 999 Woodside SC26 Valve line pre-amp/ifier.Ex cond
Leak Stereo 30 integrated amplifier.	£ 50 Leak Stereo 70 integrated amplifier.
Quad 33 pre-amplifiers. From	£ 75 Musical Fidelity P270 power amp.150W Class A
Leak TL12+ valve amplifiers.Bronze finish & rebuilt with expensive paper in oil caps & Rhodium plate phono	£ 695
Pair Quad 11 valve power amps. Rebuilt by GT Audio and revalued. Sound amazing and in V good condition.	£ 695
Meridian Modular pre/power amplifier. Ex cond.	£ 249 Single Leak TL12+ amplifier in Champagne. Nice
Arcam 8P power amplifier. Mint/boxed/instructions	£ 175 NVA A60 stereo power amplifier. Good condition
Quad 303 power amplifiers from	£ 125 Cyrus 111 integrated amplifier. Excellent.
Arcam Zeta 1.Pro logic Cinema amp. Cost £999.00	£ 450 Quad 405/1. Boxed and in good condition.
Arcam Alpha 3 amplifier. Mint.Boxed/Instructions	£ 100 Musical Fidelity B1 integrated amplifier. Good cond
Marantz PM66SE K1 signature integrated amplifier	£ 199 Tube Technology Unisai valve pwr amp. Mint bxd
Linn LK1 pre-amp and remote. Good condition.	£ 249 Linn LK2 power amplifier. Good condition
Quad 11s in various condition and prices	£POA Leak Stereo 20 valve power amplifiers from. ....
Naim Nap 180 power amplifier. Mint. Boxed.	£ 799 Harmon Kardon integrated valve amp 110V. V rare
Nakamichi CAS pre-amplifier. Ex cond. Cost £750	£ 375 Nakamichi PA5 100W.CH power amp. Cost £1300

## TURNTABLES

Project 1 Expression. TT. Mint and boxed.	£ 120	Transcriptors Hydraulic Reference turntable. Nice	£ 799
Mantecore Maura with Linn Basic+tone arm.Excon	£ 249	STD .305S motor unit. No arm. Nice deck.	£ 100

## SPEAKERS

Genexxa Pro LX5 speakers. Ribbon tweeters.Boxed.£ 129	Pair Quad ESL63's excellent cond. with RA oak feet	£1199
UKD Opera Callas speakers with genuine stands.	£ 795 Roksan ROK-ONE speakers. Black. Mint. Boxed.	£ 295
Castle inversion 15 & dedicated stands. Cost £700	£ 345 Acoustic Energy Aesprit AE300.Mint/bxd.	£ 400
Acoustic Energy Aegis Evo 3 in maple. Exc. boxed	£ 199 Snell E12's with dedicated stands. Just Serviced.	£ 699
Pair Quad ESL63 speakers in black. All new panels and full service. 1 year guarantee. Ready for beginning Aug.	£ 1799	
Pair Quad ELS63s. Black finish and Exc condition	£1000 Phillips Motional feedback speakers. Rare	£ 175
Pair Quad ESL57. New treble panels.Nice cond.	£ 899 Kef Cresta 1. Mint & boxed. Black ash finish	£ 59
Quad EL563 speakers. Upgraded with the Black Gate cap mod and all new panels 18 months ago.Boxed	£1399	
Pair Quad ESL57 spkrs. Fully rebuilt by One Thing Audio. Black cloth fronts.5 star review in Hifi World. Mint.	£1799	
Rupert stands for Quad ESL57 and ELS63 speakers	£ 200 Mordant Short MS201 pearl. Brand new. Black	£ 169
B&W 602.5 Series 3 floorstanders. Beech finish.	£ 295 Cestison F30 floorstanders. Mint. Boxed.Black ash	£ 129
Quad ESL57 speakers.All fully serviced with full 3 months warranty.I hear what ESL57s should sound like From	£900pr	

## OTHER ITEMS

Sony ST-D777ES DAB tuner. DAB/FM/AM. Gold	£ 299	Marantz PM85 Cd player. Rosewood cheeks. Boxed	£ 99
Musical Fidelity Tubalog Valve DAC. Rare & mint	£ 299	Revox G36 2 track R/Reel. Valve and very rare.	£ 249
Musical Fidelity Digilog DAC. Superb build/sound.	£ 149	Quad MC phono module for Quad 34 pre amplifier	£ 40
Phillips CD850 CD player. Cost £400.inc remote.	£ 79	Acos Lustre tone arm. Boxed.	£ 79
Pioneer F-504RDS Precision FM/AM Tuner. Boxed	£ 125	SME 309 tone arm. Mint & boxed @ only	£ 475
Mod Squad passive pre amp.Absolutely stunning	£ 299	Audiomote DAC 1. Valve Dig to analogue converter	£ 399
Trichord Research Pulsar 1 Dac with Michell PSU	£ 999	Trichord Research/PDS707 transport.Clock 3. Exc.	£ 450
Trichord Research powerblock 500. Mint condition	£ 195	Trichord Research Powerblock 1000. Ex condition.	£ 295
Pioneer PD-S505 Cd + PSU & Mod by Tom Evans	£ 499	Pioneer PDR-509 CD recorder/player. Boxed	£ 300
Nakamichi DR4 Cassette recorder. Mint.	£ 150	Sony HAR-LH500 CD with built in 80G hard drive	£ 249
Bulgjin 3 pin mains plugs for Quad/Leak etc.Each	@ £ 10	Bulgjin style P29 mains plugs for Quad 11's etc.	£ 25pr
Quad FM1 Valve tuners. Various prices from only	£ POA	Stax SR5 electrostatic headphones with energizer.	£ 125
Trio KT880L synthesiser tuner. AM/FM. Black.	£ 75	SME 3009 tonearms from.....	£ 150
Decca London international tone arm. New. Boxed.	£ 175	One Thing Audio Stereo Decoder. New.	£ 200
Linn Tuner. Mint.Boxed. Very unusual. Cost £549	£ 249	Quad FM3 tuner in excellent condition.	£ 99

## QUAD ELS57 & ELS63 PANELS/SERVICING ETC

Full rebuild including latest Otec panels/ bass panels & cosmetics 57's £1175

Reconditioned Quad ESL57 speakers from only £999.00.pr.Why spend £4000+?

ESL57 SPEAKERS STANDARD SERVICE £595 per pair

Price includes 2 completely rebuilt treble panels etc. Ring for further info.

"Classique Sounds servicing restores the Quads to a position where they can hold their head high", Jon Marks. HIFI WORLD. April 1999.Full servicing facilities available.

TRANSLUCENT. (somewhat of a bargain) Hifi World. Jan 1999

## PURE SILVER INTERCONNECT CABLE

99.99% pure silver conductors. Quality gold plated RCA phono plugs.

Half Metre terminated £70.00 One metre terminated £90.00. Available with Eichmann plugs + £30

New Translucent ULTRA + Heavy duty. 99.99% pure silver (4N).

Eichmann 24 Kt gold plate plugs £199.00 per metre. Or £149 per half metre.

7 day money back guarantee if not better than existing cable

New for 2005. Translucent digital cable. 99.99% pure silver conductor. 1M @ £59 .5M @ £39

Translucent Ultra + digital cable & Eichmann plugs. 99.99% silver conductor.

1M @ £99 .5M @ £69

1.0MM 99.99% pure silver wire @ £15m.....0.5mm pure silver wire @ £6.00m

New 24K gold plated Nakamichi locking banana plugs and RCA phonos @ £4.95each

New Quality Rhodium plated RCA phono sockets. The best @ only £4.99 a L/R pair.

## QED SPEAKER CABLES AT 30% OFF.

Silver Anniversary @ £3.85M.....Micro @ £1.20M.....Original @ £1.95M..... Contour flat @ £1.60

Bronze special edition @ £2.10M...Genesis silver spiral bi wire...Awesome cable at only £42.00M

Silver Anniversary bi-wire @ £7.00.....Profile 4X4 @ £7.00M.....Original Bi-wire @ £3.45M

TEL. 0845 123 5137 (Calls charged at local rate anywhere in the UK.)

Tel 0116 2835821 or 07815188040 (Mobile). Callers by appt only.

Opening times 10.00am-6.00pm Mon-Friday.10.00am-2.00pm Saturday.

61 Aylestone drive. Aylestone, Leicester, LE2 8QE.

Email [classique\\_sounds@yahoo.co.uk](mailto:classique_sounds@yahoo.co.uk)





## TURBOCHARGING YOUR REGA ARM

"Nothing less than total dynamite" HI-FI WORLD

If you are the proud owner of any Rega tonearm, you are now in the enviable position to transform its performance into the league of super arms with our modifications. The OL structural modification at £75 will enable your Rega to perform at a level exceeding that of some arms costing over £1000!! High performance rewiring with high grade litz wire is also offered at an additional £70 and external rewiring is also £70 further increasing the performance.

"I have to say the Rega modifications turn this humble arm into a real giant killer. Gone is the rather grey, sterile sound of the cooking Rega. Instead, tonal colour is fresh, dynamics have great speed and impact, and the sound stage is huge."

HI-FI WORLD ON STRUCTURAL MODIFICATION

Structural modification awarded 5 star rating by



Structural Modification - £75

Internal Rewiring - £70

External Rewiring - £70

High conductivity phono plugs £20

Slotted arm tube - £85

If you do not have an arm we can supply the OL1 arm (manufactured by Rega) £124

Arm modifications normally returned within 1 - 3 days



"The single most important upgrade you can ever make to any record deck concerns the motor drive...nothing can prepare you for the shock of going DC. In a word, gobsmacking." COMMON GROUND MAGAZINE

"It's value is nothing short of tremendous." LISTENER MAGAZINE

"The LP12 remains a classic ...but ..upgrade kits by Origin Live can bring a vast improvement to its performance" HI FI NEWS

**UNIVERSAL TURNTABLE MOTOR KIT** - No one would blame you for being sceptical of an easy to fit, inexpensive dc motor upgrade. Especially one that improves on the best of other power supplies costing over 4 times as much or your money back. It is simply impossible to imagine the level of improvement attained by eliminating the motor vibration that your stylus amplifies over 8,000 times! Our DC motor kit offers massive improvements to all versions of Linn Lingo / Valhalla, Rega, Systemdeck, Roksan, Rock etc. The kits consist of a drop in replacement high grade DC motor and off-board 2 speed control box. Why not order now? - see web site or phone.

Standard dc Motor Kit - £199

Advanced dc Motor Kit - £339

Ultra dc Motor Kit - £570

Upgrade Transformer - £175

Upgrade DC 200 motor - £129 with kit

ORIGIN LIVE

Tel/Fax: +44 02380 578877

E-mail: info@originlive.com

www.originlive.com

## WILLIAMS HART ELECTRONICS

HART ELECTRONIC KITS TRADED FOR OVER 30 YEARS



Mosfet Monoblock Power Amp Kits  
ONE OF THE BEST AMPLIFIERS YOU WILL HEAR! Regardless of price  
REVIEWED IN HI-FI NEWS AS "...EXCEPTIONAL...  
SELF EVIDENTLY CORRECT"



Single Ended Class A Valve Sound  
15Watt Power Amp modules  
FOR THOSE WHO WANT THAT VALVE  
MIDBAND BUT BASS AND TREBLE TO MATCH



ACTIVE R/Control SUBWOOFER MODULE £177.30



Speakers Designed & Built to Order

Advertise your Hi-Fi on my website (FREE)  
Also: Award Winning Phono Stage Kit, Active Crossover Modules, Speaker Drive Units,  
M Cap Capacitors, Caddock Resistors, Remote Control Volume and much more.

WEB SITE: www.williamshart.com e-mail: sales@williamshart.com  
Tel: 0034649587248

PLEASE SEE WEBSITE FOR NEW CONTACT DETAILS  
PERSONAL VISITORS SHOULD PHONE FIRST TO AVOID DISAPPOINTMENT  
Run by former Technical Director of Wilmislow Audio



## MATRIX HI-FI

INCA KATANA CD PLAYER NOW ON DEMO.  
WE ARE PROUD TO ANNOUNCE THAT WE ARE NOW DEALERS FOR ROKSAN, ORTOFON,  
GOLDRING, PROJECT, E.A.R. WE HAVE CARTRIDGES IN STOCK  
- MORE ARRIVING DAILY - PLEASE RING, OR SEE WEB.

### RECORD DECKS/HEAD AMPS/TONE ARMS

Acoustic Solutions New (Ideal for triol systems)	£ 69.99	NEW - PURE DIGITAL 701ES	£219.00
MING-DA MC767-FD MC/MM VALVE PHONO	£299.00	NEW - PURE DIGITAL 702ES WITH FM & DIG	£329.00
GOLDRING GR1 WITH RB250 ARM AND	£249.00	Quad PM3	£ 99.00
GOLDRING ELECTRA CART. BRILLIANT	£139.00	YAMAHA CT110 TUNER	£ 45.00
GOLDRING GR2	£249.00	Nad 402 TUNER	£ 80.00
NEW PROJECT PHONO STAGE MM MC	£ 45.00		
NEW - PROJECT VALVE PHONO STAGE	£300.00		
MM/MC WITH OUTBOARD PSU			
NEW - ROKSAN RADIUS DECK WITH			
UNI-PIVOT ARM - wood/acrylic	£749/849		
NEW MICHELLE UNI COVER	£ 44.99		
PROJECT PHONO BOX SE - MC MM	£249.00		
COJUNK HEAD AMP MC	£349.00		
NOTTINGHAM ANALOG MENTOR TONE ARM	£600.00		
LINN LP12 BASIC PLUS ARM IN M/PLINTH	£800.00		
LINN LP12 TITOK LVI ARM IN M/PLINTH	£99.00		
NAD 5120 - NEW GOLDRING ELAN CART.	£120.00		
MUSICAL FIDELITY XPHONO BOX MM/MC			

### PRE-AMPS

AUDIO RESEARCH SP11 BLK VGC	£ 1,199.00	NEW P.C.A. KATANA CD PLAYER - BARKWIN	£ 600.00
CROFT INTEGRATED VALVE PRE INC MM	£299.00	NEW INCA KATANA SE	£ 995.00
QUAD 44 PRE WITH MM VGC	£249.00	AUDIO SYNTHESIS DAX DECADE	£1,199.00
RAPPAPORT - Russ Andrews modified	£149.00	MARANTZ CD94 AND CDA94 VGC	£550.00
TAG MC/JARIN F3 PNT0 - MC & MM	£249.00	WADIA WT3200 CD TRANSPORT COAX/OP	£999.00
LINN KAIRN / REMOTE EXCELLENT	£599.00	MERIDIAN 506 20BIT REMOTE	£ 499.00
MARSH P2000T HYBRID PRE	£699.00	TOM EVANS BIGOS PRECISION CW WITH	
CONCORDANT EXHILARANT VALVE	£399.00	SEPARATE POWER SUPPLY - AWESOME	£1,499.00

### POWER AMPLIFIERS - VALVE

PAIR - 11HP25 MONO BLOCKS, RARE IN	£2,300.00	NEW P.C.A. KATANA CD PLAYER - BARKWIN	£ 600.00
PAIR. BLUE EXCELLENT CONDITION	£1,100.00	NEW INCA KATANA SE	£ 995.00
RADFORD STA 25 WOODSIDE EXCELLENT	£1,199.00	AUDIO SYNTHESIS DAX DECADE	£1,199.00
RADFORD STA 35 MODIFIED BLK/GOLD	£ 899.00	MARANTZ CD94 AND CDA94 VGC	£550.00
KLYSTRON 2A3 MONO BLOCS 15WATT	£1,300.00	WADIA WT3200 CD TRANSPORT COAX/OP	£999.00
NEW SHANLING STEREO INTEGRATED AMP	£1,399.00	MERIDIAN 506 20BIT REMOTE	£ 499.00
SEE WEB SITE - ORDERS TAKEN NOW	£1,399.00	TOM EVANS BIGOS PRECISION CW WITH	
AUDIO RESEARCH CLASSIC 60 - vgc	£ 399.00	SEPARATE POWER SUPPLY - AWESOME	£1,499.00
LEAK STEREO 20 GOLD	£2,000.00	DPA ENLIGHTENMENT CX32	£249.00
SHANLING POWER AMPS (SEE WEB SITE)	£1,500.00	PINK TRIANGLE ORIGINAL DAC	£299.00
SHANLING MONO BLOCS EX DEMO		PINK TRIANGLE DA CAPO & CARDINAL CD	

### POWER AMPLIFIERS - SOLID STATE

QUAD 33	£90.00	HEART/MARANTZ VALVED CD PLAYER	£799.00
QUAD 405	£249.00	NEW/BOXED BLACK OR GOLD	
QUAD 606	£399.00	NAD DVD/CD 1550 MINI	£249.00
CRIMSON 630C MONO BLOCS & PRE AMP	£799.00	MICROMEGA DRIVE 2 AND DAC -	
MUSICAL FIDELITY A370 - EXCELLENT	£1,150.00	MINT - BOXED	£599.00

### INTEGRATED VALVE AMPS

AUDIO NOTE OTTO WITH MM PHONO	£ 799.00	SHANLING CD T100 HCCD EX DEMO	£1,250.00
YARLAND EL84 , X2 INPUTS, 8 WATT	£ 199.00	SHANLING CD T100 HCCD (SEE WEB SITE)	£1,650.00
		SHANLING SCD T200 SACD EX DEMO	£1,600.00
		SHANLING SCD T200 SACD (SEE WEB SITE)	£2,150.00
		MUSICAL FIDELITY A3 CD PLAYER	£450.00
		MUSICAL FIDELITY E60 CD PLAYER	£150.00

### TUNERS, CASSETTE DECKS ETC.

MELBY - Acoustic Solutions DAG tuner	£ 99.00		
--------------------------------------	---------	--	--

### MATRIX HI-FI

65-67 DARENTON ROAD  
DARTFORD  
KENT DA1 1LU - UK  
TEL: 01322 281787/ 281700/ 292391/ 227668  
FAX: 01322 229908

EMAIL: mailto:info@matrixhi-fi.co.uk  
WEB: www.matrixhi-fi.co.uk

NEW AND GOOD QUALITY  
VINTAGEUSED HI FI



# HEATHCOTE AUDIO

TEL: 01992 653999 MOBILE: 07860 511111 WEB SITE [www.heathcoteaudio.co.uk](http://www.heathcoteaudio.co.uk)

UPDATED DAILY MOST EQUIPMENT IS ONE OWNER AND BOXED

**EQUIPMENT URGENTLY REQUIRED FOR IMMEDIATE CASH PURCHASE. PLEASE PHONE GEORGE 10-6PM**

## LOUDSPEAKERS

TDL REFERENCE MONITORS (WALNUT)  
B&W 802 NAUTILUS (CHERRYWOOD)  
MIRAGE M1si BI POLAR LOUDSPEAKERS (EXCELLENT!)  
MIRAGE BPS-210 SUBWOOFERS (2)  
ART-2 PRECISION MONITOR FLOORSTANDERS PIANO BLACK (£6000)  
DYNAUDIO CRAFT REF. MONITORS & DEDICATED STANDS  
TRINITY AUDIO TRIDENT FLOORSTANDERS TRI-WIRE  
TANNOY BERKLEYS 15 INCH REFURBISHED  
LINN SARA'S & STANDS  
ALR JORDAN NOTE-5  
SNELL C MKIV AMERICAN OAK  
RED ROSE SPIRIT RIBBON LOUDSPEAKERS  
SOUNDLAB MILLENIUM 3 LATEST SPEC EX DEM (£9300+ NEW)  
KLIPSCH LEGENDARY CORNER HORNS BIRDS EYE MAPLE VENEER  
PROAC STUDIO 150 CHERRYWOOD  
AUDIONOTE ANE-D ROSEWOOD  
CELESTION A-2 (SANTOS ROSEWOOD) LAST PAIR (£1500+)  
KELLY KT-3 HIGH 95 DB SENSITIVITY CHERRY VENEER  
CASTLE HOWARD-2 (PREMIUM BEECH FINISH)  
CASTLE AVON  
ACOUSTIC ENERGY ASW FB-110 SUBWOOFER  
ACOUSTIC ENERGY AE-109  
REL STORM-1 SUBWOOFER  
CELESTION A-6S SUBWOOFER  
TRIANGLE TITUS ES 1 WEEK OLD  
IMF PROFESSIONAL MONITOR VII  
CELESTION DITTON 25 LOVELY WELL CARED FOR PAIR

## CD/DVD

MARK LEVINSON NO.39 CD/PRE BEAUTIFUL EXAMPLE  
UNICO CD 24/96 VALVE OUTPUT CD PLAYER (£1250)  
PINK TRIANGLE DE-CAPO 24 BIT HDCD FILTER FITTED  
SONY SCD-1 FLAGSHIP SACD/CD (£4500)  
PIONEER PD-95 ULTRA RARE FLAGSHIP PLAYER  
MICROMEGA CLASSIC SOLO (NEW MECH)  
WADIA 8 TRANSPORT AES/BNC/AT&T GLASS  
ALCHEMIST FORSETTI APD33A TRANSPORT & APD34A DAC INC.VOLUME CONTROL  
CHORD 1500E 2 DACS + EXTRA 96/192 KHZ MODULE & VOLUME CONTROL (£6800 NEW)  
PERPETUAL TECHNOLOGY PA-1/PA-3 MONOLITHIC PSU ALL SIG-2 LAST 1  
MONRIO 18B DAC SEPERATE PSU  
MSB LINK DAC 24/96kHz MODULE  
THETA CARMEN CD/DVD TRANSPORT RARELY ON THE MARKET.  
CEC TL-51 BELT DRIVE TOPLOADER (3 MONTHS USE)  
AUDIOMECA DAMNATION TRANSPORT AES/EBU BNC/COAX  
PRIMARE V-25 DVD PROGRESSIVE SCAN ETC (£1000) EX DIS.NEW  
TECHNICS SLP-2000 REF.PLAYER (APPROX £1000 TRICHORD UPGRADES)  
Z SYSTEMS Z-3src UPSAMPLER (£1450)  
MERIDIAN 200 TRANSPORT DPA DELTRAN MOD

## VINYL

NOTTS ANN.MENTOR/GRAPHITE PLATTER/EMT AIR TONE ARM  
CLEARAUDIO BASIS/ BASIS REGAARM/LINN K-18  
ROGUE AUDIO STEALTH PHONO STAGE MM/MC (E800)  
ROKSAN XERXES COGNOCENT/PSU/REGA ARM  
NOTTS. ANA. SPACE DECK/ EXTRA GRAPHITE PLATTER  
CLEARAUDIO CHAMPION LEVEL -1 & UNIFY ARM 20 HOURS USE (RETAIL £2200)  
SYSTEMDECK IIX-900  
SYSTEMDECK TRANSCRIPTION 2 SPEED T/TABLE  
ARISTON Q-DECK/ARM BOXED INSTRUCTIONS ETC  
LEHMAN BLACK CUBE SE (RETAIL £650?) LAST ONE!  
DENSEN DRIVE MC. PHONO STAGE & PSU  
A.D.C. ALT-1 TONEARM  
SYRYNX PU-2 TONEARM & INSTRUCTIONS. (ONE OWNER FROM NEW)  
REGA PLANNER-3  
SME SERIES 3

## VALVE AMPS

AUDIO RESEARCH VT-150SE MONOBLOCS (SUPERB)  
TUBE TECHNOLOGY PROPHET 2 BOX PRE (MC,PHONO) & 2 GENESIS MONOBLOCS  
AUDIO INNOVATIONS 1000 SERIES 111  
ROGUE AUDIO TEMPEST MAGNUM (NEW SPEC FEW HOURS DEM USE £2800)  
LUMLEY M-120 MONOBLOCS TRIODE SWITCHABLE CHROME FINISH

EXCELLENT 1175  
MINT/BOXED TBA  
£2895  
TBA  
MINT £2995  
MINT/BOXED £1595  
£895  
LOVELY £995  
MINT/BOXED £495  
EX.DEM/BOXED £1195  
MINT £1250  
MINT £750  
MINT £5495  
EXCLT £3750  
EXCLT £895  
£795  
BRAND NEW/BOXED £1195  
MINT/BOXED £695  
EXCLT £695  
EXCLT £395  
AS NEW £350  
EXCLT £225  
VGC £450  
NEW/BOXED £375  
BOXED £275  
£150

UNISON RESEARCH 845 INTEGRATED (SUPER AMP)  
AUDIONOTE ZERO PRE AMP & MONOBLOCS  
MICHAELSON AUDIO CHRONOS 2 BOX PRE/PHONO & MONO'S (ULTRA RARE £10,000 NEW)  
UNISON RESEARCH C-5 REMOTE PRE AMP MM/MC PHONO STAGE  
JADIS JPS-2 TWO BOX PRE (WAS £8000)  
JADIS DEFY-7 100 WATTS CHANNEL

MINT/BOXED £1595  
MINT/BOXED £850  
EXCLT £3995  
EXCLT £695  
EXCLT £2995  
EXCLT £2995

## SOLID STATE

MARK LEVINSON 335 POWER AMP  
CLASSE CP-60 REMOTE 2 BOX PRE AMP  
CLASSE CA-400 POWER AMP  
ELECTROCOMPANET EC 4.7 REMOTE PRE AMP  
ROKSAN LS-2 PRE & 2 S-1.5 STEREO POWER AMPS  
GRYPHON SONATA ALLEGRO PRE AMP WAS £12000 (6 MONTHS USE ONLY)  
GRYPHON S-100 CLASS-A POWER AMP  
PLINIUS SA-102 CLASS A POWER AMP  
PASS LABS ALEPH-P PRE AMP LEGENDARY!  
SONY TAE-1 PRE & TAN-1 POWER AMPS (AWESOME)  
ALCHEMIST 'THE ALCHEMIST' HUGE 220 WATT POWER AMP (RARE!)  
ALCHEMIST 'THE ALCHEMIST' REMOTE PRE AMP  
MUSICAL FIDELITY A-300 REMOTE INTEGRATED MM/MC PHONO  
MUSICAL FIDELITY A3cr REMOTE PRE/MM PHONO & MATCHING A3cr POWER AMP  
MUSICAL FIDELITY MX 2 BOX PRE AMP  
MUSICAL FIDELITY A-370.2  
THORENS TTC PRE & TTA CLASS A POWER AMP  
DPA 50S PRE AND POWER C/W LONG SPEAKER LEADS/INTERCONNECT VERY RARE  
CONRAD JOHNSON PFR REMOTE CONTROL PRE AMP (£3000)

MINT/BOXED £3450  
MINT £1650  
£3250  
BRAND NEW/BOXED £995  
EXCLT/BOXED £1795  
MINT/BOXED £5995  
MINT £2895  
MINT £2750  
MINT £1150  
MINT/BOXED £6500  
MINT £2795  
MINT £3750  
MINT/BOXED £895  
MINT £1250  
EXCLT £395  
MINT £1250  
MINT/BOXED £695  
MINT/BOXED £1250  
MINT/BOXED £1695

## TUNERS/TAPE/ETC

AVI 2000 TUNER  
LYNX THETA TUNER (VERY RARE/GOOD)  
SONY 700ES 3 HEAD TAPE DECK

MINT/BOXED £275  
EXCLT £195  
MINT £295

## RACKS/STANDS.

SONUS ELITE 4 SHELF  
SOUNDSTYLE XS 105  
SOUNDSTYLE XS-100  
SOUNDSTYLE XS 105 5 SHELF ONE ONLY  
SOUNDSTYLE STATUS RANGE ST-105  
SOUNDSTYLE STATUS RANGE ST-100  
TARGET R-2 FILLED STANDS SILVER OR BLACK  
ATTACAMA R-274 FILLED 24 INCH STANDS  
ATTACAMA R-274 LEAD FILLED  
ELEMENTAL 20 INCH LOUDSPEAKER STANDS FANTASTIC SEE PIC ON WEB

MINT £295  
EX.DEM £149  
BRAND NEW/BOXED £195  
BRAND NEW/BOXED £195  
BRAND NEW/BOXED £275  
BRAND NEW/BOXED £250  
EXCLT £225  
VGC £149  
MINT £195  
MINT/BOXED RING

## CABLES PLEASE SEE WEB FOR FULL LIST

## LOUDSPEAKER CABLES

RENAISSANCE 4 METRE PAIR  
TARA LABS PRIME 1800 18 FEET!! PAIR BI-WIRE AS NEW BOXED ETC  
PS.AUDIO X-TREAM BI-WIRE 3 METRE PAIR  
CHORD CO RUMOUR-2 4 METRE PAIR EX.DIS  
NIRVANA AUDIO SL-SERIES 2.3 METRE PAIR EX DEM. FACTORY TERMINATED  
AUDIONOTE AN-L 3 METRE PAIR (FACTORY TERMINATED SILVER SPADES)

RING  
£795  
£750  
£70  
£475  
£225

## INTERCONNECT

RENAISSANCE 2 METRE XLR & RCA  
RENAISSANCE 1 METRE SIGNATURE RCA  
HOWLAND 1 METRE XLR BALANCED  
MISSING LINK CRYO 0.5 METRE XLR BALANCED  
ACOUSTIC ZEN SILVER REFERENCE 12 FT PAIR BALANCED XLR  
ACOUSTIC ZEN SILVER REFERENCE 1.5 METRE RCA  
SILVER ARROW 1 METRE BALANCED XLR EX.DEM (£1200 NEW)  
XLO 3 METRE PAIR (PHONO) EX.DEM  
TULSA HURRICANE JUNIOR BALANCED XLR 6.5 METRE PAIR  
TULSA HURRICANE JUNIOR BALANCED XLR 1 METRE PAIR  
AUDIOQUEST DIAMOND 2 X 2 METRE PAIRS  
AUDIOQUEST LAPIS 4 METRE PAIR  
NEOTECH PROFESSIONAL CABLE 0.5 METRE PAIR EX.DIS BOXED  
CABLE TALK-3 DIGITAL COAX 1 METRE NEW/BOXED  
BLACK RHODIUM SYMPHONY 0.5 METRE OR 1 METRE  
BLACK RHODIUM CONCERTO AWARD WINNING CABLE 0.5 METRE OR 1 METRE

RING  
RING  
AS NEW/BOXED £275  
AS NEW/BOXED £125  
£1450  
£695  
£595  
£225  
£299  
£55  
£450 EACH  
£450  
£199  
£50  
BRAND NEW £50/65  
BRAND NEW £75/95

**MOST EQUIPMENT STOCKED IS ONE OWNER MINT/BOXED, SIMILAR QUALITY VINTAGE AND MODERN PLEASE PHONE GEORGE 10-6PM**

For all your advertising requirements  
please call 020 7372 6018

or email:  
[advertising@hi-fiworld.co.uk](mailto:advertising@hi-fiworld.co.uk)

**IAN HARRISON HI-FI** TEL: 01283 702875

HIFI AT DISCOUNT PRICES. FREE NATIONWIDE DELIVERY

**SALE!**

**TRADE IN YOUR OLD MOVING COIL CARTRIDGE & SAVE UP TO 60% OFF THE RRP.**

CARTRIDGES & STYLI	HIFI FURNITURE	HEADPHONES	DVD
VAN DEN HUL	BLOK	SHURE	SONY
ZYX	B.C.D.	BEYER	<b>MINI DISC</b>
JAN ALLAERTS	CUSTOM DESIGN	STAX	SONY
DENON	OPTIMUM	SENNHEISER	<b>LOUDSPEAKERS</b>
CARTRIDGE MAN	ASH DESIGN	SONY	OPERA
AUDIO TECHNICA	APOLLO	AKG	TRIANGLE
GOLDRING	SOUND STYLE	GRADO	FINAL
SUMIKO	SOUND	AUDIO-	ELAC
TRANS-	ORGANISATION	TECHNICA	HARBETH
FIGURATION	ALPHASON		EPOS
LONDON (DECCA)	<b>CABLES</b>	<b>CASSETTE DECKS</b>	MISSION
GRADO	VAN DEN HUL	PIONEER	DIAPASON
ORTOFON	VIRTUAL -	SONY	WHARFEDALE
RESON	DYNAMICS	<b>TUNERS</b>	<b>AMPLIFIERS</b>
CLEAR AUDIO	BLACK RHODIUM	PURE DIGITAL	CREEK
KOETSU	TRANSPARENT	DENON	HALCRO
SHURE	QED	SONY	MOTH
<b>TONEARMS</b>	ORTOFON	CREEK	C.A.T.
SME	NORDOST	<b>PHONO STAGES</b>	GAMUT
GRAHAM	ARGENTO	HEED	ALOIA
MOTH	AUDIO	GRAHAM SLEE	EAR
CLEAR AUDIO	SUPRA	WHEST AUDIO	AUDIO VALVE
HADCOCK	WIREWORLD	TRICHORD	ACCUSTIC ARTS
MICHELL	<b>CD PLAYERS</b>	MOTH	GRAAF
<b>TURNTABLES</b>	AUDIO ANALOGUE	CREEK	ORELLE
AUDIO TECHNICA	MONRIO	NAD	MONRIO
GOLDRING	GAMUT	EAR	AUDIO ANALOGUE
MICHELL	SONY	TOM EVANS	PATHOS -
CLEAR AUDIO	CREEK	CLEAR AUDIO	ACOUSTICS
	ORELLE		UNISON -
			RESEARCH

PLEASE PHONE TO CONFIRM PRICE & AVAILABILITY PRIOR TO ORDERING. ALL GOODS ARE BRAND NEW & BOXED WITH FULL U.K. GUARANTEES. NO EX. DEM OR EX. DISPLAY GOODS. NO GREY IMPORTS. GOODS ARE NOT SUPPLIED ON APPROVAL. SORRY, NO GENERAL CATALOGUES. PLEASE PHONE OR WRITE FOR SPECIFIC REVIEWS, BROCHURES OR PRICES. SUPPLIER OF HIFI PRODUCTS & ACCESSORIES SINCE 1986. MAIL ORDER ONLY FROM: IAN HARRISON, 7 MILL HILL, REPTON, DERBY, DE65 6GG. TEL: 01283 702875. 9am - 9pm INCLUDING SUNDAYS.



# Listen Carefully

Good value is alive and well.

Excellent sound at sensible prices can be found.

After much searching I have my first three suppliers. Ayre, Thiel and Esoteric digital. There are others out there no doubt. When I find them, and if the chemistry is right, I'll represent them in my deliberately small specialist showroom in North London.

You'll be surprised I think by the relaxed atmosphere here. That's because I offer just one demonstration slot in the morning, one in the afternoon and occasionally one in the evening. No fuss, no hurry, no interruptions, no other visitors, no parking wardens and no coercion. You'll benefit from my years of experience and you'll receive my undivided attention.

I offer home demonstrations in London, Kent, Essex, Cambridgeshire, Hertfordshire, and Bedfordshire too, and some uncommonly generous upgrade paths from entry level to the pinnacle. Just telephone me on 020 8447 8485.

With me you can listen to the Ayre AX-7e, K-5xe, K-1xe, P-5xe, V-5xe, V-1xe, CX-7e and C-5xe. Also the Thiel CS1.6, CS2.4 and SS1. Finally, the Esoteric, UX-1, P-01, D-01 mono DAC and G-0s master clock generator..

In summary then – calm and intelligent demonstrations for lovers of all types of music.

**www.listencarefully.co.uk**

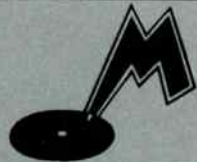

## MUSONIC STYLI

**How to get the most out of your record player in 3 easy steps:**

- 1. Buy from Musonic**
- 2. Fit your purchase to your player**
- 3. Turn up the volume**

**After 50 years in the business We know what we're talking about!**

**Manufacturers and suppliers of Styli, Pickup Cartridges and Audio Accessories.**

Musonic (UK) Limited  
Unit 13, Wenta Business Centre, Colne Way,  
Watford, Hertfordshire, WD24 7ND

Email: sales@musonic.co.uk

Tel: 01923 213344

Fax: 01923 213355

For info and to buy online visit:

**www.musonic.co.uk**



# High End Cable

www.highendcable.co.uk  
Call Dave 01775 761880 or order online



Chord Signature Reference interconnects



Stereovox HDXV Digital interconnect



Nordost TYR Reference interconnects



IsoTek TITAN Power Conditioner



Nordost Valhalla



Nordost Tonearm Cables TYR FREY HEIMDALL

Chord | Acoustic Zen | Stereovox | Nordost UK | van den Hul | ISOL-8  
Black Rhodium DCT | Ayre | STAX | Ortofon | Turbosound | Second hand  
Free delivery worldwide on all interconnects.

For many more money saving offers and information please visit  
www.highendcable.co.uk or call Dave on 01775 761880



Specialist Suppliers of Audio Accessories  
www.mantra-audio.co.uk

PRICES INCLUDE P & P FOR UK DELIVERY 1 TO 10 DAYS -  
SEE WEBSITE FOR FULL PRODUCT RANGE AND SHIPPING  
CHARGES TO EU & WORLDWIDE

CARTRIDGE SELECTION		STYLUS		HEADPHONE SELECTION	
Goldring Elektra	£33	£28	GEX	£24	GRADD Award winning Headphones
1006	£76	£62	GEX	£52	Prestige Series SR-60
1012 GX	£95	£76	GEX	£67	SR-80
1022 GX	£124	£100	GEX	£86	SR-125
1042	£143	£114	GEX	£100	SR-225
Erolca LX/H Elite	£133	£109	GEX	N/A	SR-325i
	£232	£190	GEX	N/A	Reference Series RS-1
					RS-2
					£635
					£450
REPLACEMENT STYLI					
Swiss Quality Diamond Styli					
ADC	XLM Mk III				£17
Akai	AN 5, AN 60				£13
	AN2, AN 70				£15
Aiwa	AN11				£13
Dual	DN 145 E, DN 165 E				£17
JVC	DT 55, DT 60				£13
Grado	National EPS 24 CS, P 30 D, P 33 D				£13
Prestige Black	£40		£27		Ortofon FF15/VMS20 EII, OM20
Prestige Gold	£110		£73		Pioneer PN 210/220/240
Lyra					Shure N 75 C, SC 35 C
Dorian	£495		£395		N 75 ED T2, N 75 EJ T2
Argo	£795		£635		N 95 ED/EJ, N 75 3 (78)
Shure					VN 35 E
M 97 XE	£98		£58		N 97 HE, VN 35 HE
V 15 V xMR	N/A		£204		Sony ND 142/155 G, CN234
Sumiko					ND 143/150/200 G
Blue Point Special	£235		£200		EX
Blackbird	£585		£500		EX
					Stanton D 681 EEE
					£21
***Over 500 Styli Types Stocked***					

GEX - Goldring new for old exchange price for any make/type of cartridge  
EX - Exchange price same make moving coil cartridge

Order direct online or Tel/Fax (01757) 288652  
MANTRA AUDIO (HFW), 22 GARTH AVENUE, NORTH DUFFIELD, SELBY, NORTH YORKS YO8 5RP

The most important and expensive components of a valve amplifier are valves and transformers. £200 or £500 for a pair of huge "push pull" output transformers produces good bass + lots of "inter leaved" windings for better high frequency and "stability". Huge £150 mains transformers gives a less "processed" sound. Selected "matched" set of valves cost £50 or £160. If we could achieve the same quality of sound with £10 volume control, £10 wires, £10 capacitor, we could have saved a lot of money !!!

Money back guarantee (less £30 UK or £100 overseas) that you prefer :-

£850 or £1,000 or £1,250 or £1,450 "KT88 Triode Connection" amplifiers to most transistor amplifiers, most transistor / valve hybrid amplifiers, most Single Ended valve amplifiers, most Ultra Linear valve amplifiers selling for £2,000 to £20,000

£850 "KT88 Triode Connection" + high quality £350 "3 way" speakers to "ultra linear" valve amplifiers + £600 "2 way" and "2.5 way" speakers

£700 EL34 valve amplifiers (40 watts + 40 watts) to most transistor amplifiers and transistor / valve hybrid amplifiers costing £1,000 to £2,000

£500 EL34 valve amplifiers (40 watts + 40 watts) to most £700 amplifiers.

Telephone 01634 268662 anytime or 01634 373410 for Mr Andrew Everard's review in Gramophone Magazine and Summary of 21 testimonials from satisfied customers. www.affordablevalvecompany.co.uk

www.affordablevalvecompany.com

Buy direct & save £££

Shop prices are expensive because of rent, rates, wages  
Free UK delivery  
Subsidised £50 UPS delivery to overseas countries.

4 years of proven reliability.  
2 years guarantee.



Massive expensive "potted" transformers

Unbelievably huge transformers

KT88 valves are more expensive than 6550 valves

Expensive non-magnetic stainless steel chassis

£1,250 Triode Connection

£1,400

Ultra Linear £1,050 £1,150

larger transformer

KT88 valves are more expensive than 6550 valve

huge transformer

American 5670 valves

2, or 6 pieces of silver capacitors

Triode Connection

Ultra Linear £650 £750

£850

£1,000

Properly matched famous Svetana EL34 valves

larger transformer

huge transformer

40 watt + 40 watt

Chinese 6N3 valves

American 5670 valves

Upgradeable to £1,000

KT88 amplifier +£50 carriage +£50 for usedvalves

£500

£600 £700

# dial a dealer

This is a comprehensive directory of Hi-Fi Dealers throughout the UK and Ireland.

## BRISTOL & BATH

### THE RIGHT NOTE

Tel: (01225) 874728. Are you happy with your system? We find that most audiophiles listen for most of the time to systems that are 'not quite right'. Forget the 'Best Buy' reviews and putting a system together like a patchwork quilt. Let us assess the vast range available, you judge the results. We'll help you to plan a system for the future, even if you spread the purchases. Leave 'up-grade-itis' behind, save money and enjoy music all the time. Just listen, and you'll know.

CD: Accuphase, Audio Synthesis, Bel Canto, dCS, Resolution Audio, Wadia.

Vinyl: Basis, Clearaudio, DNM, Graham, Michell, Sumiko, Transfiguration.

Amps: Advantage, CAT, DNM, Gamut, Spectral.

Speakers: Audio Physic, NEAT, Verity Audio. Tuners: Magnum Dynalab. (Credit Cards Accepted).

### V'AUDIO

HiFi Consultants: 36 Druid Hill, Stoke Bishop, Bristol. BS9 1EJ. Tel: 0117 968 6005. ATC, AVI, Alon, ALR Jordan, Audio Analogue, Avid, Black Rhodium, Electrocompaniet, Eslab Digital Amps, Harman Kardon, Infinity, Jamo, Lyra, Origin Live, Opera, Ortofon, PS Audio, Ruark, Michell, REL, SME, Sugden, Townshend, Triangle, Unison Research Valve Amps, VPI. Specialists in Video Projectors by SIM2, Infocus, Sanyo; screens by Stewart, Draper, Da-Lite, Owl, and Amps/DVD's by Harman Kardon etc. Demos by appointment only. Home trial facilities. We are not a shop.

## CHESHIRE

### ACOUSTICA

17 Hoole Rd, Chester CH2 3NH. www.acoustica.co.uk. Tel 01244 344227. All the best in HiFi & Home Cinema from Amphion, Arcam, ART, Audiolab, Ayre, B&W Nautilus, Classe, Focal, JM Lab, Monitor Audio, Naim Audio, Primare, Rega, REL, Rotel, Spendor, Sugden, Thiel, Wadia. We offer full

demonstration facilities, interest free credit and delivery & install systems throughout Cheshire, Merseyside & North Wales. Opening hours are Tuesday to Saturday 10.00 to 5.30.

### ACTON GATE AUDIO

4 Ruabon Road, Wrexham, North Wales, Tel. 01978 364500.

www.acton-gate-audio.co.uk  
Audio Visual Specialists. Arcam, Audio Analogue, AVID, Bose, Celestion, Castle, Denon, Harmon Kardon, Jamo, JM Lab, KEF, Marantz, Michell, Mission, Onkyo, Opera, Pro-Ject, Musical Fidelity, NAD, QUAD, Roksan, Ruark, Tannoy, Teac, Tivoli, Unico, Unison Research, Wharfedale, Yamaha, DSP Club Member, Demo Room, installation service. Easy Parking and Motorway access. All major credit cards accepted. 9.30 - 5.30 daily. Closed Sunday & Monday.

## CORNWALL

### BIGEARS AUDIO

To find a system that will allow you to hear the music instead of the equipment phone Bigears Audio, here you will find an interesting array of new and good quality used equipment! my intention is to have satisfied customers whatever their audio preferences. Naim dealer for the South West. chrisbirchley@btinternet.com Tel: 01736-740421

## LEICESTERSHIRE

### DIVINE AUDIO

The Courtyard, Bennett's Place, High Street, Market Harborough, LE16 7NL  
01858 432999

Leicestershire's freshest hi-fi and home cinema retailer, offering a service that you expect in an environment that will excite you. Stunning cinema and two channel demonstration facilities, comfy chairs and coffee!

We get outstanding results from Arcam, Art Loudspeakers, Audio Analogue, Chord Company, Exposure, Focal JMLab, Infocus, Isoblu, Kube Design, Metz televisions, NAD, Opera, Oray

Screens, Partington, Pathos, ProAc, Pro-Ject, Quadraspire, Revolver, Sugden, Triangle, Unison Research and a few other surprises.

Open Tuesday - Saturday 9.30 - 5.30 or by arrangement. Free parking 01858 432999, www.divineaudio.co.uk, info@divineaudio.co.uk

## MIDDLESEX

### RIVERSIDE HI-FI

422 Richmond Road, East Twickenham, Middlesex, TW1 2EB. Tel: 020 8892 7613 Fax: 020 8892 7749. www.riversidehifi.co.uk  
Audio Research, Blueroom, Bose, B&O, Copland, Denon, Elac, Infocus, Krell, Linn, Living control, Martin Logan, Michell, Monitor Audio, Musical Fidelity, NAD, Project, QED, Rel, Sennheiser, Sonus Faber, Teac, Theta, Wilson. Finance available. Subject to status. Written details available on request. Export orders welcome. UK mail order available. 3 demonstration rooms. All major credit cards. Open 10am-5.30pm Mon-Sat.

## STAFFORDSHIRE

### ACOUSTICA

114 Wolverhampton Rd, Stafford ST17 4AH. www.acoustica.co.uk. Tel 01785 258216. All the best in Hi-Fi & Home Cinema from Arcam, ART, Audiolab, Ayre, B&W, Focal, JM Lab, MJ Acoustics, Monitor Audio, Naim Audio, Primare, Rega, REL, Rotel, Spendor, Sugden, Thiel, Wadia, Yamaha Pre Eminent. We offer full demonstration facilities, interest free credit and delivery & install systems throughout Staffordshire & the Midlands. Opening hours are Tuesday to Friday 10.00 to 5.30, Saturday 10.00 until 5.00.

## SUFFOLK

### AUDIO IMAGES

128 London Road North, Lowestoft, Suffolk, NR32 1HB Tel: 01502 582853. info@audioimages-hifi.com. www.audioimages-hifi.com  
Castle, Denon, Harmon Kardon, Jamo, Mirage, Rothwell, Roksan,



Sugden, Screen Play, Synthesis, Triangle, Tom Evans Audio Design, Vienna, Vincent, Volta Cables. Refreshingly different selection. Dem Room, Professional AV installer's from budget to high end. Full credit facilities. 9.30 to 5.30 Mon & Sat

## SURREY

### VIVANTE PRODUCTIONS

LTD, Unit 6, Fontigarry Business Park, Reigate Road, Sidlow, Surrey, RH6 8QH

E Mail: sales@Vivante.co.uk  
On Line: www.sales@vivante.co.uk  
Tele: 01293-822186

Fax: 01293-820509  
Vinyl, SACD, XRCD, HDCD, HDAD, CD etc. - We do the lot! Check our website to see the thousands of interesting titles we have available. Contact us to receive our free monthly newsletter. Ps: we pride ourselves on friendly, fast service and a world beating Musical selection!

## SUSSEX

### GIG BRIGHTON

(01273) 700759

info@gig-hifi.co.uk.

Open by appointment only. Brighton's newest, freshest and most independently minded specialists in two-channel hi-fi. Tube amps, high sensitivity

speakers, Class A transistor amps, electrostatic speakers and more. In-house servicing, repair and upgrades to tube amps a speciality. Michell, Shanling, Eastern Electric, Atma-sphere, Zu, Audiostatic, Coincident Speaker Technology, Pass Labs, Sugden, Symposium, Ferguson-Hill.

## YORKSHIRE (WEST)

### AUDIO REPUBLIC,

78 Otley Road, Leeds  
0113 2177294,

[www.audio-republic.co.uk](http://www.audio-republic.co.uk) for the very best in quality hifi in West Yorkshire and beyond, representing Naim Audio, Rega, Totem, Sugden, Shahinian, JM Lab, Filtech, TEAC, Nottingham Analogue, Spectral, Living Voice, Hutter Furniture, Accuphase, Quadraspire, Chord Cables, Dynaudio. Choice of shop or home demonstrations, open Tues - Sat 9.30am to 5.30 pm. Please phone for a chat and directions.

### PREMIER AUDIO

- now demonstrating - Room 1: DCS Elgar, Purcell & Verdi Transport, Plinius CD Lad & 250 Power, Verity Fidelo & Sonus Faber Speakers, Siltech Cables, Isotek Sub Station, BDA Equipment Stands Room 2: Audio Aero, Audio Synthesis, Kora Pre & Power, Pink Triangle CD/Amp, Martin Logan

/ Audio Physics Speakers, Arcici Equipment Stand, Isotek Sub Station P/S Audio Synthesis, Audio Physics, Audio Aero, Absolute Sounds, DCS, Kora, Plinius, Siltech, Arcici, BDA, Pink Triangle, Avid Turntables, Project, Ortofon, Van den Hul, Mirage. P/X welcome Home demonstration good selection of S/hand. We are 10mins J39 - M1 10mins J30 M62 Tel: Wakefield 01924 255045 - Colin Grundy.

## WALES

### ACTON GATE AUDIO

4 Ruabon Road, Wrexham, North Wales, Tel. 01978 364500. [www.acton-gate-audio.co.uk](http://www.acton-gate-audio.co.uk) See our main ad under Cheshire.

## VINYL/RECORD MAIL ORDER

### DIVERSE VINYL

10 Charles Street, Newport, NP20 1JU.

Tel/Fax: 01633 259661/256261.

Email: sales@diverse-music.co.uk

Probably the most varied and impressive selection of brand new LPs you'll find anywhere: international new releases, reissues and audiophile products. Also UK distributor of the Disco Anti Stat LP Cleaning Device. Call for a free catalogue, or visit [www.diversevinyl.com](http://www.diversevinyl.com)

## PRODUCT TESTING IN HI-FI WORLD

Hi-Fi World measures all incoming products before sending them out to reviewers and is unique in having such a rigorous vetting system. It reflects our dedicated approach to assessing audio equipment. Nothing gets by before thorough scrutiny.

In-house measurement is costly and time consuming, yet it has always been central to our belief that both readers and manufacturers deserve it, because there is no alternative if complex technologies are to properly assessed.

Measurement achieves many things. It ensures a product is working properly before it is subjectively auditioned. We pick up problems like loudspeaker drive units wired out-of-phase by accident, digital filters that roll-off in a bizarre fashion due to design error, a transmission line loudspeaker with no bass (!), amplifiers with excessive d.c. offsets, excessive jitter and all manner of other funnies.

Manufacturers published data is then checked against our measurements. There is usually little problem here.

The reviewer is then given the results. This gives useful guidance on what to watch out for in listening tests. For example, if three CD players use the same chip set they may well sound much alike in their basic attributes, if not identical. This is useful information for a reviewer.

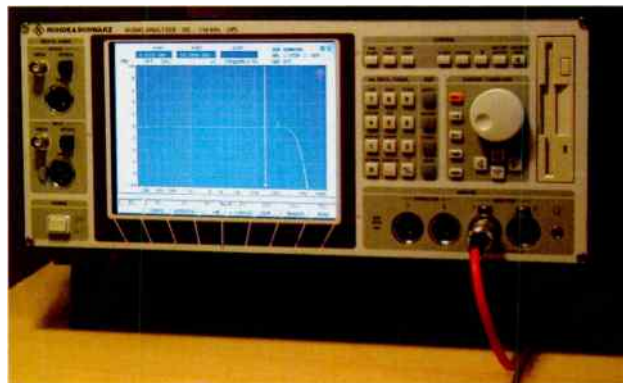

Hi-Fi World uses a range of test equipment from around the world, including a Rohde & Schwarz UPL for testing CD and DVD players. Amplifiers are tested with 8903B Audio Analysers from Hewlett Packard. Loudspeakers are measured with a Bruel & Kjaer measuring microphone and Hewlett Packard 3561A spectrum analysers. We use three of these for basic test work and to ensure our listening room and conditions are balanced. Tuners are measured with a Leader 30125 Lab generator and Marconi 2015 RF generator, plus external MPX filters and equalisation.

We continue to upgrade our testing to keep up with the latest standards, to ensure that both readers and manufacturers receive the most accurate information possible about the items we review. No one does it better than Hi-Fi World.

# specialist hi-fi dealers

London

## Oranges & Lemons



020 7924 2040

www.aandhi.co.uk  
61 Webbs Road, Battersea, SW11 6RX  
email: oranges.lemons@virgin.net



Vinyl Specialists

vivante

Vivante Productions Ltd,  
111 G. F. Road, B. Road, Pa.  
Tel: 01905 222116  
Email: info@vivante.co.uk  
On Line: www.vivante.co.uk

### Vinyl is back?

Truth is, it never really went away. That's why we have been busy keeping vinyl fiends happily supplied all these years. Call us for our free catalogue and newsletter and find out more about the huge range of top quality titles we have available.

Not only that – we give friendly knowledgeable service and the best possible prices. Look forward to hearing from you.

Regional

shunyata research



the professionals' reference

AUDIO ATMOSPHERE

tel 01785 711232 stuart@audioatmosphere.com  
www.audioatmosphere.com

Naim Specialists

tom tom audio

## A New Dawn for Naim and Tom Tom Audio...

...the only dealer in the world specialising purely in these world class products

Extensive selection of current Naim Audio product range on demonstration and the largest stock of pre-loved Naim Audio equipment on the planet

New website at [www.tomtomaudio.com](http://www.tomtomaudio.com)  
Telephone • St Albans 01727 86 86 59



## LAIID-BACK AUDIO LTD

For the sweet sound from a single-ended valve amplifier made by hand.

For more information  
mail@laidbackaudio.co.uk  
www.laidbackaudio.co.uk

Phone 01905 640028 Fax 01905 641596

Services & Consultants

## HIFI RECLAMATION WANTED

Classic British Hi-Fi Components and Systems!  
Top prices paid for vintage or classic audio separates, accessories or literature.

08 45 644 3340

## Front End Problem?

contact

## The Cartridge Man

It doesn't have to cost an arm and a leg to get the best - listen to my Koetsu - and Decca - eater.

Also agents for Croft, Hadcock, E.A.R. Michell & Moth.

plus cartridge re-tipping service  
020 8688 6565

Website: [www.thecartridgeman.com](http://www.thecartridgeman.com)

Mail Order

NEW catalogue out now  
packed with award winning products



"We defy anyone not to notice the improvement in performance when you switch... to a PowerKord."  
What Hi-Fi, May 2004.

- exclusive mains leads
- exclusive Hi-Fi equipment
- exclusive speaker cable
- exclusive CD accessories
- exclusive supports



WHAT HI-FI?  
SOUND AND VISION  
AWARDS 2004  
BEST MAINS LEAD  
UNDER £100  
By: Andrew  
Classic PowerKord

Russ Andrews  
Classic PowerKord™  
from £55

order online at [www.russandrews.com](http://www.russandrews.com)  
or call UK Local Rate 0845 345 1550 quote AWORLD

Exclusive UK Retailer for

KIMBER KABLE

Russ Andrews Accessories Ltd, 28 Moreland Court,  
Westmorland Business Park, Shap Road, Kendal, LA9 6NS, UK.  
Tel: +44 (0)1539 797300 Fax: +44 1539 797325

Russ Andrews  
Solutions for better music & movies

Valves & Tubes

CVC Chelmer Valve Company

Buy CVC PREMIUM HI - FI valves direct from us.  
All valves processed for improved performance.  
We also have stock of MAJOR BRAND types inc.  
MULLARD, GEC, BRIMAR, RCA, GE, PHILIPS, etc.

The Stables, Baddow Park, Great Baddow, Chelmsford,  
Essex CM2 7JY. Tel: 01245 241301 Fax: 01245 241309  
Email: [info@chelmervalue.com](mailto:info@chelmervalue.com)

To advertise in this space  
please call 020 7372 6018  
or email:  
[advertising@hi-fiworld.co.uk](mailto:advertising@hi-fiworld.co.uk)



# specialist hi-fi dealers

Yorkshire

## Aeon Acoustics

ISO-PLATFORMS & FEET LOUSPEAKERS  
MADE FROM NEW GYRO-PNEUMATIC  
AUDIO MATERIAL [www.spiralex.com](http://www.spiralex.com)



PCT Patents & Design Copyrights pending

Smart Audio Materials with  
extended bass response & clarity



Audio Isolation Materials  
Aeon Acoustics  
Newlands, Littlethorpe Lane,  
Ripon, North Yorkshire. HG4 1UB  
SPC@spiralex.com  
01765 604288

Loudspeaker Repairs

## D.C. Boultons

Loudspeaker Repairs & Manufacture

All types including P.A. Disco, Hi-Fi, Juke Box etc.

Agents for B&C, Celestion, Eminence,  
Fane, Precision Devices etc.

From re-foams to complete re-builds, even with  
slipped magnets.

Trade and retail supplied.

Custom units our speciality.

Over 35 years experience of loudspeaker design

Unit 12, Damgate Lane Ind. Est, Acle, Norwich,  
NR13 3DJ

Tel 01493 750075 Fax 01493 751155

IAN EDWARDS  
MAKERS OF FINE HAND MADE FURNITURE

Elegant Storage Solutions for  
Hi-Fi, Books,  
LPs, CDs,  
DVDs



Special orders welcome

Tel: 01423 500442 Fax: 01423 705200 [www.iansbespokefurniture.co.uk](http://www.iansbespokefurniture.co.uk)  
The Old Chapel, 282 Skipton Road, Hamgate, N. Yorks, HG1 3HE

'Super 14 Wizard' Rotary Unit. 2296  
CDs, etc



74" 'V-Max' can hold 660 CDs etc



JT Hi-Fi CD/Cassette Unit



Charlotte Drawer unit for 480 CDs  
& 75 Cassettes 32" x 21" x 21"



# meet your maker

A reference guide to Britain's manufacturers and distributors

MANUFACTURER

### CREEK AUDIO LTD

12 Avebury Court, Mark Road, Hemel Hempstead,  
Herts, HP2 7TA.

Tel. 01442 260146

E-mail: [info@creekaudio.com](mailto:info@creekaudio.com)

Internet: [www.creekaudio.com](http://www.creekaudio.com)

Creek Audio manufactures in the UK. Current products include A50I, A50IR and 5350SE integrated amplifiers, CD50 Mk2 CD player, and T50 tuner. All products are similarly styled providing an easy mix and match choice depending on budget. Our miniature OBH range includes two phono pre-amplifiers, two headphone amplifiers and a passive pre-amplifier.

### EPOS ACOUSTICS

2 Avebury Court, Mark Road, Hemel Hempstead,  
Herts, HP2 7TA

Tel. 01442 260146.

Email: [info@epos-acoustics.com](mailto:info@epos-acoustics.com)

Website: [www.epos-acoustics.com](http://www.epos-acoustics.com)

Innovative design and superior sound distinguish EPOS speakers from other brands in similar price categories. Nine models in total including a 5.1 surround system. All available in 3 finishes. Supporting stands and plinths complement the speakers. In addition to its two channel appeal, Epos is now equally sought after in the fast expanding world of home cinema. -

### FALCON COMPONENTS LTD

Unit 12 Damgate Industrial Estate, Damgate  
Lane, ACLE, Norwich, Norfolk, NR13 3DJ

Tel. 01493 751100 Fax 01493 751155

E-mail: [sales@falcon-acoustics.co.uk](mailto:sales@falcon-acoustics.co.uk)

Web: [www.falcon-acoustics.co.uk](http://www.falcon-acoustics.co.uk)

FOCAL drivers. SOLEN polypropylene capacitors, TAYDEN high quality PA loudspeaker units. Largest specialist Audio-inductor UK manufacturer. Comprehensive range of DIY speaker parts, kits and accessories. Sub-bass and electronic filters. Audio Amateur Publications. Audio Computer Software. Pro-Audio equipment and loudspeaker repairs. Enquiries send 47p sae for full price list or visit our website.

### MONITOR AUDIO LIMITED

24 Brook Road, Rayleigh, Essex SS6 7XL

Tel 01268 740 580. Fax 01268 740 589

e-mail: [info@monitoraudio.co.uk](mailto:info@monitoraudio.co.uk)

website: [www.monitoraudio.co.uk](http://www.monitoraudio.co.uk)

Monitor Audio designs and manufactures British loudspeakers of the highest quality. Since 1972 Monitor Audio has been developing and perfecting the implementation of metal drivers, innovative crossovers, and exemplary speaker cabinet construction and finish to further the ideal of achieving sound which to the original is "as close as it gets". As we enter the 21st Century, Monitor Audio leads the way in offering speakers that suit every pocket and which integrate seamlessly with both Hi-Fi and AV systems.

### PMC/BRYSTON

PMC & Bryston are Emmy award winning Loudspeaker & Amplifier manufacturers - Used throughout the professional world as reference. Our clients record for Deutsche Grammophon, Decca and countless

blockbuster Movies. The identical, award winning ATL (Advanced Transmission Line) technology is used in all HiFi designs from the DBI+, TLEI Sub through to the Active BB5XBD.

PMC Ltd 43-45 Crawley Green Road, Luton, LU2

OAA. Tel: 08704 441044 Fax: 08704 441045

Email: [sales@promonitor.co.uk](mailto:sales@promonitor.co.uk)

Web: [www.pmc-speakers.com](http://www.pmc-speakers.com)

### SUGDEN AUDIO PRODUCTS

Designed and manufactured in the UK each Sugden product is hand-built by one highly skilled technician. A full range of pure class A amplifiers are available including integrated, stereo power and the incredible Masterclass balanced monoblocks. Our stunning Bijou system now comes with a single-ended pure class A power Amplifier with optional integral stand. Two analogue tuners have joined the range matching our A2I and Bijou series, offering a digital user interface with excellent facilities. Each amplifier series has a matching CD player with a class A output stage and heavily modified transport. The class A HeadMaster offers a pre-amp with three inputs a fixed and variable output with remote control. The HeadMaster can be used as a control unit in a high quality audio system and excels with headphones. Please contact us for product information, dealer list and brochures.

01924 404088

email [info@jesugden.co.uk](mailto:info@jesugden.co.uk).

# Oxford Audio Consultants Ltd.

OUR SUPERB SERVICE IS THE SAME REGARDLESS OF PRICE



## Now Demonstrating



Ex-Demonstration & Previously Owned Equipment

### SALE LIST

Audio Aero Capitole MK 1	£3,500.00
Audio Aero Prima	£895.00
Conrad Johnson PF1L preamp	£395.00
Conrad Johnson Premier 18LS	£2,000.00
Conrad Johnson Premier 350	£5,500.00
Copland CSA 8 Integrated amp	£495.00
GM Audio BCD 4 shelf table	£700.00
Hales Concept 5	£2,500.00
Jadis JD3	£1,295.00
Martin Logan Quest	£1,495.00
Michell Gyrodek	£550.00
Musical Fidelity Trivista amplifier	POA
Musical Fidelity Trivista CD	POA
Naim CDS3/XPS2	£4,995.00
Nordost Red Dawn speaker cable	POA
Nordost Valhalla 1m pr interconnect	£1,200.00
Onkyo Integra system	£2,995.00
REL Stadium II	£550.00
Stands Unique Reference table	£395.00
Tannoy Dimension TD10	£2,995.00
Tannoy Dimension TD12	£3,995.00
TEAC D2 D/A Converter	£295.00
Theta Data Basic 2	POA
Theta Probasic 3	£1,495.00
Transparent Reference phono cable/SME plug	£395.00
Transparent Reference s/e 1m	£995.00
Transparent XL 20 amp power cable	£650.00
Triangle Leo Minor	POA
Wadia 64.4 DAC	£995.00
Wadia WT2000 CD Transport	£995.00
Wilson Audio Sophia	£8,995.00

**0% interest free credit**

Licensed Credit Broker

REFER TO OUR WEBSITE FOR THE LATEST UPDATED SALE LIST.

Agencies include: Anthony Gallo, Artcoustic, Atacama, Audio Aero, Audio Analogue, Audio Research, Avid, Beyer, Blok, Bose, Burmester, Canton, Chord Company, Copland, Crestron, darTZeel, Denon, Diapason, Dreamvision, Fujitsu, GM Audio, Graaf, Harman Kardon, Hitachi plasma, i-scan, Isoblu, Isotek, Jadis, Jamo, Kef, Koetsu, Krell, Linn Classic, Living Control, Loewe, Lyra, Marantz, Martin Logan, Michell, Mission, Musical Fidelity, NAD, Naim, Nevo, Nordost, Opera, Opus, Ortofon, Parasound, Pathos, Pioneer, Prima Luna, Project, Pure, Quadraspire, Rako, REL, Sennheiser, Sharp Aquos LCD, SME, Sonus Faber, Speakercraft, Spectral tables, Stands Unique, Stax, Stewart Screens, T & A, Tannoy, Teac, Theta, Tivoli, Transparent, Triangle, Unison Research, Vantage Point, Vogel, Whest Audio, Wilson Audio, Wireworld, Yamaha

Cantay House, Park End Street  
Oxford OX1 1JD

Telephone: Oxford (01865) 790879

Facsimile: Oxford (01865) 791665

E-MAIL: [info@oxfordaudio.co.uk](mailto:info@oxfordaudio.co.uk)

WEBSITE: [www.oxfordaudio.co.uk](http://www.oxfordaudio.co.uk)



# SIMPLY STAX

When you listen through any Stax electrostatic earspeaker, the air becomes sweeter, colours seem brighter and your senses come alive.

Demand for STAX products always exceeds supply. Consequently global representation is deliberately restricted.

STAX  
earspeaker  
systems  
range in price  
from £349 to  
£2,495 including  
vat.

You can enter the STAX family via previously owned systems from as little as £150 from us - complete with parts and labour warranty.

We demonstrate and supply the largest range of STAX products anywhere and we only sell STAX.

[www.simplystax.co.uk](http://www.simplystax.co.uk)  
Telephone 020 8447 8485  
Ask for Howard





# private ads

Dealers must not advertise in the Private Classified section. Monthly consecutive insertions will be considered Trade advertising. The Publisher reserves the right to judge submissions.

CHORD SPM2000B 6 channel amplifier with 4 legs, £4399 (rrp £6502), silver with gold knobs/badges, secondary system, unused, original box / documents and still under warranty. Further information / details / picture, Email: wetstring@wanadoo.fr or Tel: 0033 549652272 (Feb)

CHORD CPA2200 pre-amplifier with 4 legs, £2359 (rrp £3487), silver with gold knobs/badges, secondary system, unused, original box / documents and still under warranty. Further information / details / picture, Email: wetstring@wanadoo.fr or Tel: 0033 549652272 (Feb)

AERIAL ACOUSTICS MODEL 5B loudspeakers finished in maple plus purpose built stands, £1895 (rrp £2800), purchased for a secondary system, but unused, original box / documents. Further information / details / picture, Email: wetstring@wanadoo.fr or Tel: 0033 549652272 (Feb)

FOR SALE. Linn Kolektor pre-amp with remote, 10 inputs with phono. Will drive any power amp. Mint, box and manual. (£600) £285. Tel: 01903 247 779 (Jan)

MONITOR AUDIO Gold Reference 10's with stands, light oak finish, mint, unused, boxed. £450. Tel: 01621 744 580 (Essex) (Jan)

GRADO SR60, excellent £50 ono. Also A&R Cambridge T21 tuner, black, £50 ono. Tel: 01743 363 116 (Shrops) (Jan)

**TANNOY DREAD-NOUGHT** monitors, 3 way active time aligned, including dedicated X06000 Dreadnought active parametric crossovers. 121dB continuous. Tannoys most powerful speakers. One of only two pairs. £27,000 ono. Offers and details please call 020 8577 1912 or 0798 565 8839 (Jan)

SME 10 turntable with SME Mk IV arm (14 months old) hardly used, with Lyra Helikon cartridge (brand new). Immaculate. Original boxes and manuals. £2695 (£4380 new) Could sell separately. Tel: 01285 810 233 (Cirencester) (Jan)

LINN SONDEK black Cirkus, Lingo, Ittok, LVII, £995. Conrad Johnson PV10 £395. Musical Fidelity F22 valve pre £395. Nordost Blue Heaven 3m bi-wire £300. All boxed and excellent condition. Tel: 01270 874 216 (Jan)

ARCAM CD 73T CD player, as new condition. Very little use. Boxed. Bargain. £200. Arcam A85 integrated amplifier. Superb powerful amp in new condition. Boxed. Bargain. £300. Tel: 01473 682 909 (Jan)

MULLARD 5-10 monoblocks. Triode input stage. Superbly constructed using quality components on sturdy 3mm aluminium chassis in smart maroon and black livery. £350 pair. Also Marantz CD63-SE £75. Tel: 0161 456 4649 evenings (Jan)

RECORD DECK, Rega Planar3, Linn K9 cartridge, £95. Subwoofer Audio Pro B2-40 £120. Goodmans LS3/5a BBC speakers, walnut, £220. Audio twin cassette deck, Technics RS-M222 £25. All vgc. Collect. Tel: 01462 712 6044 (Jan)

EXPOSURE PRE-AMP 21 and two power amps 18. Ideal for bi-amping. Excellent condition. Original boxes and remote control. £2700 new, sell £1400 ono. Tel: 07752 039 587 (Leicestershire) (Jan)

WADIA 301 CD player £1875 (£3650) Hegel power amplifier 150 wpc £875 (£2500). Linn LP 12 turntable £340. American Acoustic Developments E48 slim, 3-way, floor-standing speakers £225 (£600). Tel: 01202 767 873 (Dorset) (Jan)

DYNAUDIO CONTOUR 1.8 MkII loudspeakers in cherry veneer, excellent sound and condition, £975 ono (£1895). Welcome to demo here, no boxes hence buyer collects. Tel: 01903 731 970 (West Sussex) (Jan)

MARK LEVINSON Model 36 transport, matching 37 DAC, black, mint condition. £3300. Audio Research SP11 preamp plus power supply with Audio Research Classic 60 power amp £3000, plus other items. Tel: John 01708 662 840 (Jan)

ROTEL RCD-02 CD player. HDCD facility. As new, boxed, superb. Cost £380. Will accept £200. Buyer collects or by arrangement. Tel: 02380 274 494 (Jan)

THE 'HEAD' MC Transformer, £300. SME '3' in box plus manual £80. Bronze CA1 arms £20 each. Black £35 each. Linn Kolektor 10 input pre-amp and remote £270. Tel: 01903 247 779 (Sussex) (Feb)

**FOR SALE.** Unwanted competition prize won in T3 magazine. Top of the range Opus multi room audio system, value £4200. Wanted £2000 ono. Tel: 0121 454 1893 or 07791 749 921. Perfect Xmas present. (Jan)

TRICHORD PULSAR Series 2 DAC, external power supply £770. Audio Synthesis DAX discrete black £1800. Papworth MIA200 integrated amp £750. All mint, boxed. Tel: 01626 333 871 (Jan)

**T+A V10 INTEGRATED amp** £1800. Advantage S1-100 integrated amp 100wpc £1000. Linn LP12, Ittok LVII arm, Karma cartridge £650. NHT subwoofer system, active crossover, 250w mono amps £600. NHT amplifiers 250w monoblocks £400. Tel: 020 8531 5979 (Mar)

STEFAN AUDIOART Equinox upgrade cable for Sennheiser HD 595, HD 600 and HD 650 headphones. 8' length. New and unused £90 ono. Tel: R. Richards 01639 641 043 (Jan)

WANTED - ROGERS, Harbeth, KEF or similar, one pair of BBC LS3/5a Monitor speakers. Private buyer. Tel: 01394 388 399. (Feb)



BUY / SELL
HOME CINEMA
MULTIROOM INSTALL
HI - FI

## www.choice-hifi.com

tel: 020 8392 1959 / 1963 mob: 07768 720456  
info@choice-hifi.com

The best of

# ROKSAN

Technology



**NEW Maths !!!**  
**£650 + £650 = £1000**

**Maths - Illogical**

**Saving - Colossal**

**Experience - Emotional**



CD player  
INTEGRATED amp

### AWARDS

- ★★★★★
- CD player**      **INTEGRATED amp**
- Kandy MkIII integrated amplifier**  
WHAT HI-FI? SOUND AND VISION Winner 2004 Awards
- Kandy MkIII CD**  
HI-FI CHOICE Bronze award 2004 Awards
- Kandy MkIII integrated amplifier**  
WHAT HI-FI? SOUND AND VISION Winner 2003 Awards
- Kandy MkIII integrated amplifier**  
WHAT HI-FI? SOUND AND VISION Winner 2002 Awards
- Kandy MKIII integrated amplifier**  
Five Stars  
WHAT HI-FI? SOUND AND VISION October 2003
- Kandy CD**  
Five Stars  
WHAT HI-FI? SOUND AND VISION First test July 2003
- Kandy MKIII integrated amplifier**  
Five Stars  
2003 SUPERTEST WINNER (5 Star Gold)  
WHAT HI-FI? SOUND AND VISION May 2003
- Kandy Integrated amplifier**  
Five Stars  
2002 SUPERTEST WINNER (5 Star Gold)  
WHAT HI-FI? SOUND AND VISION Feb 2002
- Kandy CD player, Amplifier & Speakers**  
Five Stars  
WHAT HI-FI? SOUND AND VISION January 2001
- Kandy Integrated amplifier**  
Five Stars  
WHAT HI-FI? SOUND AND VISION April 2000
- Kandy CD**  
Five Stars  
WHAT HI-FI? SOUND AND VISION March 2000

TWIN PACK  
TWIN PACK  
TWIN PACK  
TWIN PACK  
TWIN PACK



**HENLEY DESIGNS**  
Tel: 01235 511 166  
[www.henleydesigns.co.uk](http://www.henleydesigns.co.uk)

# KANDY

For everyone



© 2005 Roksan Audio Limited



# private ads

Dealers must not advertise in the Private Classified section. Monthly consecutive insertions will be considered Trade advertising. The Publisher reserves the right to judge submissions.

VAN DEN HUL 'The Name' interconnect £20. Target equipment rack £25. Sanyo D80 cassette deck £30. Chord Chrysalis interconnect £20. Micromega MSI speakers £45. Postage available. Tel: Clive 01483 569 837 (Jan)

MISSION 752 Freedom speakers £200. Marantz PM7200 amplifier £185. TCIViper interconnect £25. DNM Reson speaker cable £4 metre. Tel: 01582 724 414 (Jan)

**SONUS FABER** Minuetto speakers and ironwood stands £725. Excellent condition. Krell KAV300i integrated amplifier. Excellent condition. £1150. Tel: 01782 333 390 (Jan)

HI-FI FOR Sale. Accuphase DP-75V Precision 24/196 Disc Player, email for Stereophile report, 18 months light use, Rolls Royce build quality, £3,950. Accuphase DG28 Digital Voicing Equaliser with leads plug in, remote. mike. Tunes the room/recording in the digital domain 1/6th octave 20hz-20khz, 4presets. £1,950. Serious fun. Accuphase DP 70-V exceptional build 52lbs wt analogue sound £1,250. Accuphase T108 FM Tuner, remote. £550. Conrad Johnson Premier II Valve power amp. 70 w.p.c. Recently revalved £1200 ono. Cardas Golden Ref 1.5m RCA mint, £600. Cardas Gold Ref 0.5m xlr £300. Synergistic Research digital XLR with active shield and power coupler special. £550 ono. Tel: 01706 813 987 or mobile 07780 698 650 (Jan)

SUGDEN CD21 £725. Marantz PM14 MkII K1 £500. PMC DB1+ cherry £285. PMC DB1 cherry £255. Panasonic PTA-E500 projector £500. Tel: 01295 275 983, mobile 07908 850 722 (Banbury) (Jan)

NORDOST BLUE Heaven, 1 metre £80. Shiva 2 metre £165, new, boxed. 'Soundstring' bi-wire jumpers 8" £75 mint. Transparent Link 100 1.5m latest network, mint £110. Link 100 'old' network £70. Email: ckw@btinternet.com (Jan)

WADIA 301 CD player £2500. Krell 300iL amplifier £1500. Ruark Talsiman III speakers £1000. All excellent condition and boxed. Tel: John 020 8418 9437 (Jan)

RUARK EPILOGE speakers £95. QED A240CD amplifier £60. Thorens TD160 turntable £125. Aiwa F640 three head cassette £45. Technics STG 55AL tuner £45. Castle Clifton speakers, cherry, mint £50. Tel: 01708 457 691 (Jan)

PATHOSTT-RR, legendary hybrid integrated (£3600) £1650. Audio Magic ST-1 speakers/stands, like Qin's (£3800) £950. Wanted: Valve amp, eg. Graaf, Jadis, Audio Research, Cary, etc. Exchanges considered. Tel: 01316 610 126, 07811 335 060 (Jan)

PAIR SHANLING SP-80 mono block valve amps. As new condition, superb sound £1150. Prima Luna Prologue Two integrated valve amp, superb sound, mint condition £650. Tel 02380 224 003 (Jan)

NORDOST: VALHALLA power; 2m (£1800) £1100 / 1m £600. Valhalla 1.5m bi-wire (£3750) £2000. Brahma, 0.75m boxed £300. Wanted: Valve amp, eg. Graaf, Jadis, Border Patrol, etc. Exchanges considered. Tel: 01316 610 126, 07811 335 060 (Jan).

CLASSICAL RECORD Collection For Sale. Collection of approximately 210 assorted classical LP's in very good condition. Will not split. More info on request. £175 Buyer collects. Tel: 01604 410726 (Northampton) (Jan)

QUAD 99 CDP CD player and preamplifier. 2 years old. Excellent condition boxed with manual. Can demo. £650. (£1000) Yamaha CR 450 FM/AM receiver 25 wpc, walnut grain finish with manual. Good condition (1975) £30. Tel: 01604 410726 (Northampton) (Jan)

SOUND ORGANISATION spiked turntable stand. (Z040?) Sand filled. Suitable for LP12 or similar. Good condition £30. 5m pair Van den Hul CSI22 speaker cables (terminated with bananas) £65. (£150) Tel: 01604 410726 (Northampton) (Jan)

BANG AND OLUFSEN classic record deck. Beogram 2012 circa 1974 with original box. Going for a song. Tel: Martin 01837 840 438 (Jan)

STEFAN AUDIOART Equinox upgrade cable for Sennheiser HD 595, HD 600 and HD 650 headphones. 8' length. New and unused £90 ono. Tel: R. Richards 01639 641 043 (Jan)

## GUIDELINES FOR BUYING AND SELLING SECOND-HAND EQUIPMENT

### FOR THE BUYER

1. Not everyone is honest - Buyer Beware!
2. **Don't send cash!**
3. Accept no verbal guarantees.
4. Have you heard the item or something similar? If not, why do you want it?
5. Don't pretend to have knowledge - it's your fingers that will get burnt!
6. Is it working? If not, why not?
7. Has it been modified and, if so, have notes been kept?
8. Was it any good in the first place?
9. **Don't send cash!**
10. If you are in the slightest doubt, arrange an audition (see point 5) If it's too far, wait for another time.
11. Either buy it or don't: vendors are excusably impatient with 'consultation' exercises.
12. **Don't send cash!**

### FOR THE SELLER

1. Not everyone is honest - Seller Beware!
2. Make no verbal guarantees.
3. Even 'nearly new' is still second-hand. If the manufacturer's guarantee is no longer in force, your price should reflect this.
4. There is very little intrinsic value in second-hand hi-fi; it's only worth what someone will pay for it.
5. The best guide to pricing is last month's Classifieds: that a 'classic' was worth £xxx a year or two ago is no guide. Values fall as well as rise.
6. Amateur second-hand dealing is not a big money game: you win some, you lose some.
7. Be prompt with despatch. If in doubt about buyer's bonafides, either wash out the deal or send C.O.D.
8. There will always be time-wasters; be tolerant within reason!



Choice  
hifi



BUY / SELL



HOME CINEMA



MULTIROOM INSTALL



HI - FI

**www.choice-hifi.com**

tel: 020 8392 1959 / 1963 mob: 07768 720456

info@choice-hifi.com





# trade ads

Dealers must not advertise in the Private Classified section. Monthly consecutive insertions will be considered Trade advertising. The Publisher reserves the right to judge submissions.

**VINTAGE WIRELESS COMPANY LONDON**  
Website: [www.vintagewirelesslondon.co.uk](http://www.vintagewirelesslondon.co.uk)  
Buy-Sell-Exchange.  
Vintage Hi-Fi. Repairs, Spares, Restoration. All valve equipment Wanted for cash: Tannoy, Quads, Garrard and audio valves. Please call us at 17 Bell Street, London, NW1 5BY.  
Tel: 020 7258 3448  
Fax: 020 7258 3449  
Email: [vwirelesslondon@aol.com](mailto:vwirelesslondon@aol.com)  
(Jun06)

**BRILLIANCE NOW** offers an affordable AES/EBU interconnect for those requiring ultimate performance.  
HFW have said "Sound/£ ratio is superb". "Most neutral, beguiling, excellent".  
Demonstration cables available.  
Contact Mike on 07963 117 341  
[www.brilliancehifi.co.uk](http://www.brilliancehifi.co.uk) (Jan)

**AUDIOPUBLIC**,  
78 Otley Road, Headingley, Leeds, 0113 217 7294.  
Yorkshire's newest Hi-Fi retailer, stockists of Naim Audio, Rega Research, Conrad Johnson, Sugden, Dynavector, (cartridges and amplifiers) and many more. Please call for advice. (Jan)

**AUDIOPHILE OBJECTIVE** For New, X-Display and Pre-Owned Hi-Fi. Roksan, Musical Fidelity, NAD, Epos, Marantz, Project, Castle, Audioquest, Revolver. Other brands pre-owned. 16 Allen House, The Maltings, Sawbridgeworth, Herts. Tel: 01279 724 024. Easy Free Parking (Feb)

**AMAZING CABLES!** Solid silver interconnects from £110, with air/teflon insulation and WBT plugs. Silver speaker and mains cables from £250. Fantastic performance, refund guarantee.. Tel: 0115 982 5772 after 7pm, or Email: [bob@skydivers.co.uk](mailto:bob@skydivers.co.uk) (Jan)

**MONARCHY AUDIO DIP**  
48/96 Upsamplers for sale at only £210 including delivery. Brand new UK 240v model supplied. Go to [www.media-zone.co.uk](http://www.media-zone.co.uk) or Email: [sales@media-zone.co.uk](mailto:sales@media-zone.co.uk) for more details. (Feb)

**AVI LABORATORY** integrated amplifier integrated with MM/MC phono stage, £1,800 now £1,100 : Ecosse Reference Cable - 0.8m Maestro SE A Interconnect Cable RCA, £175 plus stereo pair 6m MS2.3 (mono crystal) Speaker Cable Banana factory terminated, £355 now both combined price of only £295 : recently serviced Sugden SDT-1 CD player - analogue sound for £600 : all carriage paid within UK - contact on 01463831658 or [highlandaudio@aol.com](mailto:highlandaudio@aol.com)

**WANTED - EARLY HI-FI CLEAR CRYSTAL SYSTEMS**  
John Petrie-Baker  
Tel: 020 7328 9275

**STUDER A807 £450. A80 VU £750. B67 VU £750. A710 £600. A810 VU 4-speed £1400. Revox PR99 £750. B710 £550. B760 £450. Uher RM4000 £250. PR99 III £1200. PR99 MkII £950. Tel: 01246 275 479 (Jan)**

**FOR SERVICE**, Repairs, Upgrades and Re-Manufacturing of all valve audio equipment. Leak Troughline specialists, re-aligned etc. For more info contact E. Gane and Son (Est 1948) on 020 8743 2727 (Jan)

**ezCHASSIS'S™ PRE-PUNCHED** cabinets for DIY amplifiers. Three heights, variants for valve and transistor amplifiers. Cosmetic options (supplied with labels, screws and feet. Also (Class A) heatsinks, handles and sockets.  
[www.designbuildlisten.com](http://www.designbuildlisten.com)

## CLASSIC CONTACTS

When a classic goes 'pooof' your troubles have just started, but there may be a good ending. Replacing failing parts can improve the sound, so here is a short listing of all those companies who specialise in getting a classic up and running again after its deposited a small ring of soot on your ceiling!

**CLASSIQUE SOUNDS**  
(Paul Greenfield, Leicester)  
ESL-57s restored, rebuilt, fully renovated or improved. Leak, Quad valves amps etc.  
Tel: 0845 123 5137 / Mob: 0116 2835821  
Email: [classique\\_sounds@yahoo.co.uk](mailto:classique_sounds@yahoo.co.uk)  
[www.flashbacksales.co.uk/classique](http://www.flashbacksales.co.uk/classique)

**GT AUDIO**  
(Graham Tricker, Bucks)  
Leak Troughline specialists. Also Quad and most classic tuners, radios and amplifiers restored, repaired.  
Tel: 01895 833099 / Mob: 07960 962579  
[www.gtaudio.com](http://www.gtaudio.com)

**AUDIOLAB**  
(Phil Pimblott, Leeds)  
Renovation, repair and restoration. Specialist in valve hi-fi, radio transmitters, cinema amps, kit building.  
Tel: 0113 244 0378  
[www.audiolabs.co.uk](http://www.audiolabs.co.uk)

**LOCKWOOD AUDIO**  
(London)  
Tannoy loudspeaker parts, restoration and repair. Also Epos and TDL loudspeakers.  
Tel: 020 8 864 8008  
[www.lockwoodaudio.co.uk](http://www.lockwoodaudio.co.uk)

**Dr MARTIN BASTIN**  
(Shropshire)  
Garrard 301/401 restoration, renovation and service. Special plinths; rumble cures, etc.  
Tel: 01584 823446

**LORICRAFT AUDIO**  
(Terry O'Sullivan, Bucks)  
Garrard 301/401 and their own 501 repair, spares and service.  
Tel: 01488 72267  
[www.garrard501.com](http://www.garrard501.com)

**CARTRIDGE MAN**  
(Len Gregory, London)  
Specialist cartridge re-tipping service and repairs. High quality special cartridges.  
Tel: 020 8 688 6565  
[www.listen.to/thecartridgeman](http://www.listen.to/thecartridgeman)

**REVOX**  
(Brian Reeves, Cheshire)  
Revox tape recorder spares, service and repair. Accessories also available.  
Tel: 0161 499 2349  
Email: [brian@revoxservice.co.uk](mailto:brian@revoxservice.co.uk)  
[www.revovx.freeuk.com](http://www.revovx.freeuk.com)

**SOWTER TRANSFORMERS**  
(Brian Sowter, Ipswich)  
Large range of audio transformers for valve amps, cartridges, line drive, interstage plus all associated services.  
Tel: 01473 252794  
[www.sowter.co.uk](http://www.sowter.co.uk)

**TECHNICAL AND GENERAL**  
(East Sussex)  
Turntable parts - wide range of spares and accessories, plus arms and cartridges.  
Tel: 01892 654534

**QUAD ELECTROACOUSTICS**  
(Cambs)  
Quad's service department, able to repair almost all Quad products, from the very first.  
Tel: 0845 4580011  
[www.listen.to/quad-hifi.co.uk](http://www.listen.to/quad-hifi.co.uk)

**ONE THING**  
(Coventry)  
Specialist in electrostatic panel manufacture and repair. Can refurbish ESL 57s and 63s as well as Leak Troughlines and Quad IIs.  
Email: [one.thing@ntlworld.com](mailto:one.thing@ntlworld.com)  
[www.onethingaudio.com](http://www.onethingaudio.com)

**OCTAVE AUDIO WOODWORKING**  
(Bristol)  
Unit 2, 16 Midland Street, St Phillips, Bristol.  
Tel: 0117 925 6015  
[www.octave-aw.co.uk](http://www.octave-aw.co.uk)

**ARKLESS ELECTRONICS**  
(Northumberland)  
Specialist in repairs, restoration and modifications to all amplifiers, valve or solid state, ancient and modern.  
Tel: 01670 829891  
Email: [arkless.electronics@btinternet.com](mailto:arkless.electronics@btinternet.com)

**WEMBLEY LOUDSPEAKE**  
(Paul MacCallam, London)  
Comprehensive loudspeaker servicing.  
Tel: 020 8 743 4567  
Email: [paul@wembleyloudspeaker.co.uk](mailto:paul@wembleyloudspeaker.co.uk)  
[www.wembleyloudspeaker.com](http://www.wembleyloudspeaker.com)

**EXPERT STYLUS COMPANY**  
(Wyndham Hodgson, Surrey)  
Stylus replacement service for all types of cartridge. Including precise profiling for 78s  
Tel: 01372 276604  
Email: [w.hodgson@btclick.com](mailto:w.hodgson@btclick.com)



# NEXT MONTH

## NEW (R)EVOLUTION

February's Hi-Fi World looks at the past, present and future of high fidelity sound. We explain how speaker design has evolved, review six floorstanders, then pit the winner against a classic. We hear the Cambridge CD1, the ultimate eighties silver disc spinner, then put it against today's digital state-of-the-art. And there are features on getting your classic kit restored, and archiving your analogue and digital music collections, and much much more! Here's just some of the kit we hope to bring you:

- Naim NAC282/NAP200 solid-state pre-power
- Prima Luna Prologue 3/5 valve pre-power
- Atma-sphere S.30 II tube power amplifier
- Audio Research D-150 power amplifier
- Stax SR007 electrostatic earspeakers
- Marantz DV-7600 universal player
- Cain & Cain Abby loudspeaker
- Dali Ikon 5 loudspeaker

**PICK UP THE FEBRUARY 2006 ISSUE OF HI-FI WORLD ON SALE DECEMBER 30TH, OR SUBSCRIBE AND GET IT DELIVERED TO YOUR DOOR: p126**



# classifieds ads order form

## ADVERTISERS INDEX

Absolute Sounds	22
Acoustica	36
Angel Sounds	56
Audio 42	40
Audio Atmosphere	102
Audio Auction House	112
Audiolab	58
Big Ears	109
Billy Vee	106
Choice Hi-Fi	123,125
Clarity Cap	68
Classique Sounds	113
Cyrus	24
Dali	16,17
Diverse Vinyl	113
Heathcote Audio	115
Heatherdale Audio	112
Henley Designs	76,82,92,124
Hi-End Cable	117
Hi-Fi Sounds	111
Hi-Fidelity	68
Ian Harrison	116
Icon Audio	90
Kef	6
Linn	BC
Listen Carefully	116
Mantra Audio	117
Marantz	84
Matrix	114
Meridian	44
Michell Engineering	88
Midland Audio Exchange	110
Missing Link	72
Musical Fidelity	78
Musicology	54
Musonic	116
NAD	64
Naim	IBC
Neat Acoustic	88
Needles & Spins	72
Northern Sound & Vision	96
Noteworthy	72
Origin Live	36,114
Oxford Audio	122
QTA	112
Real Hifi	48
Retro Reproduction	109
Rochester HiFi	109
Romers Hifi	54
Rotel	IFC
Sevenoaks	28,29,30,31,32,33
Shadow Audio Con.	74
Simply Stax	122
Sound Surgery	14
TACT	14
The Right Note	40
Townshend	72
Transparent Dist. Ltd	56
Trichord	113
Tube Shop	90
Walrus	12
Whest Audio	68
Williams Hart	114
Zero One Audio	54

## RATES - ALL ADVERTS MUST BE PRE-PAID

Maximum length per advert is 30 words, each additional word is 50p extra. Telephone numbers and E-mail addresses are treated as one word. Model numbers are treated as one word i.e. Quad 303 = two words.

Please tick the box for the advert required

Dealers must not advertise in the Private Classified section. Monthly consecutive insertions will be considered Trade advertising. The Publisher reserves the right to judge submissions

Private magazine advert	£10 per month	<input type="checkbox"/>
Private magazine advert display black box	£15 per month	<input type="checkbox"/>
Trade magazine advert	£10 per month	<input type="checkbox"/>
Trade magazine advert display black box	£15 per month	<input type="checkbox"/>

Please write or type your advertisement copy in block capitals with one word per box.

Please continue on a separate sheet if necessary.

WE WILL ACCEPT PHOTOCOPIES OF THIS FORM

1	2
3	4
5	6
7	8
9	10
11	12
13	14
15	16
17	18
19	20
21	22
23	24
25	26
27	28
29	30

Name \_\_\_\_\_

Address \_\_\_\_\_

Post Code \_\_\_\_\_

Daytime Tel: \_\_\_\_\_

Please debit my VISA/MASTER/SWITCH Card No.(Switch card issue No \_\_\_\_\_)

Valid Date: \_\_\_\_\_ Expiry Date: \_\_\_\_\_ Cardholder Signature: \_\_\_\_\_

I enclose a cheque/postal order for £ \_\_\_\_\_ Made payable to: Audio Publishing Ltd.

Send in your private classified ads with our NEW Freepost service. No need for a stamp!

Send this form together with your payment in an envelope marked:

**HI-FI World, FREEPOST LON3478, LONDON NW6 6YR**



**PRIVATE & TRADE CLASSIFIED ADVERTS COPY DEADLINES**

FEBRUARY 2006 - 5TH DECEMBER 2005

MARCH 2006 - 6TH JANUARY 2006

ORIGINAL MOTION PICTURE SOUNDTRACK



The Good, The Bad and The Ugly  
MUSIC BY ENNIO MORRICONE

# ENNIO MORRICONE

## THE GOOD, THE BAD AND THE UGLY

### 1966

**H**ow did it happen? Here we have a seemingly obscure foreign cowboy film. It doesn't come from the USA, it's not big budget, it's packed with English and non-English speaking actors and there's some odd dubbing going on for English speaking territories. Okay, Clint Eastwood's in it. But then, plenty of Hollywood stars have featured in obscure films before which have sunk without trace or reputation. Yet the film, the director and the whole genre becomes a massive hit worldwide. Not only that, the soundtrack goes ballistic. The theme of the film creeps into the very fabric of our culture. It's everywhere. It's in the charts, it's on TV adverts, it's in the office, in the playground, it even becomes part of the acts of several TV comedians.

Born in 1928, in Italy, and a school friend of the film's director, Sergio Leone, Ennio Morricone is the major film composer of modern times. His CV is staggering, with around 550 film soundtracks to his credit, then there's the forty or so TV soundtracks and his theatre work, his additional conductorial roles, his musical director responsibilities and so on.

His work on 'The Good, The Bad And The Ugly' was groundbreaking in many subtle, yet important, ways. His unique vocal arrangements, the use of whip cracks, Sicilian folk instruments, trumpets and the 'new' Fender electric guitar – these adventures in sound were widely copied and emulated by other composers. The

magic of the soundtrack is that the music lifted visual moments to incredible crescendos which made the music an integral part of the film action, instead of being subordinate to it.

"I come from a background of experimental music which mingled real sounds together with musical sounds," Morricone said, explaining his decision to integrate his sonic conglomeration, "so I used real sounds partly to give a kind of nostalgia that the film had to convey".

Morricone also used realistic sounds in a psychological way. With 'The Good, The Bad And The Ugly', said Morricone, "I used animal sounds - as you say, the coyote sound - so the sound of the animal became the main theme of the movie. I don't know how I had this idea. It's just according to your experiences and following the musical avant-garde."

His choice of music and sounds were carefully arranged, however. Studying the film itself supplied him with ideas that enabled his music to add to the emotion of the moment. "I have to see a definitive cut of the film before I even start thinking about the music, let alone writing it. After seeing the movie I tell the director what my feelings are and what I would like to do. He accepts what I say or discusses it or destroys it. Eventually we have to find a compromise."

There are many flavours of the soundtrack out now on CD. Broad Morricone compilations feature the principle themes from the film plus many other of Morricone's works. For example, 'Once Upon A Time....

The Essential Ennio Morricone Film Music Collection via [www.amazon.co.uk/exec/obidos/search-handle-url/?size=20&store-name=music&index=usic&field-label=Silva%20Screen/202-0746682-2889429](http://www.amazon.co.uk/exec/obidos/search-handle-url/?size=20&store-name=music&index=usic&field-label=Silva%20Screen/202-0746682-2889429) 'Silva Screen', is a 2CD career retrospective. In addition, 'The Very Best Of Ennio Morricone' soundtrack CD, from Virgin, offers a similar selection, but this time on a single disk. For a complete overview of the film soundtrack itself you will need to look at 'The Good, The Bad And The Ugly', via EMI. A twenty one track CD soundtrack, from EMI, featuring unreleased tracks. An eleven track cut-down version of the CD is also available, notable for still being available on the rapidly disappearing cassette format, as an import via EMI America from Amazon.co.uk.

The very best version of the film soundtrack, an Italian Spaghetti western let us not forget, is from Italy itself. Via the soundtrack specialists, Dagored, 'The Good, The Bad And The Ugly Music By Ennio Morricone – Original Motion Picture Soundtrack' presents a selection of music as grand as its title. Available on 180gm vinyl, this double album is held in a superb gatefold displaying large still image scenes from the film with the title: Il Bruno, Il Brutto, Il Cattivo emblazoned within. This Dagored version packs in the same wealthy twenty one tracks seen on the EMI CD version – ten of those have never been released on record before. The record also includes a full credit list including the soloists. If you like soundtracks and you're a Morricone fan, you need this album. **PR**



ASHFORD  
Soundcraft 01233 624441

BATH  
Audience 01225 333310

BANBURY  
Overture 01295 272158

BRIGHTON  
Audio T 01273 609431

BRISTOL  
Audio Excellence 0117 926 4975

CAMBERLEY  
Audio T 01276 685597

CHEADLE  
Audio Counsel 0161 491 6090

CHELTENHAM  
Audio T 01242 583960

CHESTER  
Acoustica 01244 344227

CROYDON  
Kimberley Audio & Visual 020 8654 1231

EDGESBASTON  
Music Matters 0121 429 2811

EPSOM  
Audio T 01372 748888

EXETER  
Sevenoaks Hi-Fi 01392 218895

GUILDFORD  
PJ Hi-Fi 01483 304756

HAYWARDS HEATH  
Norman Hobbs 01444 413353

HIGH WYCOMBE  
The Sound Gallery 01494 531682

HORSHAM  
Audio Designs 01403 267766

HULL  
Audio Room 01482 891375

KINGSTON-UPON-THAMES  
Infidelity 020 8943 3530

LEICESTER  
Cymbiosis 0116 262 3754

LONDON N1  
Grahams Hi-Fi 020 7226 5500

LONDON N2  
The Studio 020 8348 0990

LONDON SE13  
Billy Vee Sound Systems  
020 8318 5755

LONDON SW11  
Oranges & Lemons 020 7924 2040

NOTTINGHAM  
Castle Sound & Vision  
0115 958 4404

MANCHESTER  
Fortissimo 07740 659086

PORTSMOUTH  
Audio T 023 9266 3604

READING  
Audio T 0118 958 5463

SALISBURY  
Salisbury Hi-Fi 01722 322169

SHEFFIELD  
Audio Images 0114 273 7893

SHEFFIELD  
Creative Audio 01743 241924

ST. ALBANS  
Tom Tom Audio 01727 893928

TAUNTON  
Mike Manning Audio 01823 326688

TAYSIDE  
Robert Ritchie 01674 673765

WORCESTER  
Audio Excellence 01905 619059

WORTHING  
Phase 3 Hi-Fi 01903 245577

YEQVIL  
Mike Manning Audio 01935 47936

YORK  
The Sound Organisation 01904 627108



n-system

"...the performance is in a league of its own..."

Home Cinema, June 2005

The list does not constitute the full naim retailer list but those which carry the full n-series AV System including speaker package.

For more details please telephone  
**+44 1722 332266**  
or visit  
**www.naim-audio.com**





## The new Artikulat Loudspeaker System. Gorgeous.

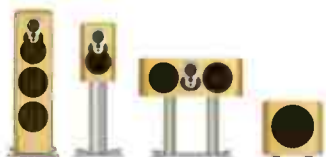

Linn Products Limited.  
For more information or a demonstration call 0500 888 909 [www.linn.co.uk](http://www.linn.co.uk)

